

ETSI TS 138 521-1 V17.5.0 (2022-09)



**5G;
NR;
User Equipment (UE) conformance specification;
Radio transmission and reception;
Part 1: Range 1 standalone
(3GPP TS 38.521-1 version 17.5.0 Release 17)**



Reference

RTS/TSGR-0538521-1vh50

Keywords

5G

ETSI

650 Route des Lucioles
F-06921 Sophia Antipolis Cedex - FRANCE

Tel.: +33 4 92 94 42 00 Fax: +33 4 93 65 47 16

Siret N° 348 623 562 00017 - APE 7112B
Association à but non lucratif enregistrée à la
Sous-Préfecture de Grasse (06) N° w061004871

Important notice

The present document can be downloaded from:

<http://www.etsi.org/standards-search>

The present document may be made available in electronic versions and/or in print. The content of any electronic and/or print versions of the present document shall not be modified without the prior written authorization of ETSI. In case of any existing or perceived difference in contents between such versions and/or in print, the prevailing version of an ETSI deliverable is the one made publicly available in PDF format at www.etsi.org/deliver.

Users of the present document should be aware that the document may be subject to revision or change of status.

Information on the current status of this and other ETSI documents is available at

<https://portal.etsi.org/TB/ETSIDeliverableStatus.aspx>

If you find errors in the present document, please send your comment to one of the following services:

<https://portal.etsi.org/People/CommitteeSupportStaff.aspx>

If you find a security vulnerability in the present document, please report it through our
Coordinated Vulnerability Disclosure Program:

<https://www.etsi.org/standards/coordinated-vulnerability-disclosure>

Notice of disclaimer & limitation of liability

The information provided in the present deliverable is directed solely to professionals who have the appropriate degree of experience to understand and interpret its content in accordance with generally accepted engineering or other professional standard and applicable regulations.

No recommendation as to products and services or vendors is made or should be implied.

No representation or warranty is made that this deliverable is technically accurate or sufficient or conforms to any law and/or governmental rule and/or regulation and further, no representation or warranty is made of merchantability or fitness for any particular purpose or against infringement of intellectual property rights.

In no event shall ETSI be held liable for loss of profits or any other incidental or consequential damages.

Any software contained in this deliverable is provided "AS IS" with no warranties, express or implied, including but not limited to, the warranties of merchantability, fitness for a particular purpose and non-infringement of intellectual property rights and ETSI shall not be held liable in any event for any damages whatsoever (including, without limitation, damages for loss of profits, business interruption, loss of information, or any other pecuniary loss) arising out of or related to the use of or inability to use the software.

Copyright Notification

No part may be reproduced or utilized in any form or by any means, electronic or mechanical, including photocopying and microfilm except as authorized by written permission of ETSI.

The content of the PDF version shall not be modified without the written authorization of ETSI.

The copyright and the foregoing restriction extend to reproduction in all media.

© ETSI 2022.
All rights reserved.

Intellectual Property Rights

Essential patents

IPRs essential or potentially essential to normative deliverables may have been declared to ETSI. The declarations pertaining to these essential IPRs, if any, are publicly available for **ETSI members and non-members**, and can be found in ETSI SR 000 314: "*Intellectual Property Rights (IPRs); Essential, or potentially Essential, IPRs notified to ETSI in respect of ETSI standards*", which is available from the ETSI Secretariat. Latest updates are available on the ETSI Web server (<https://ipr.etsi.org/>).

Pursuant to the ETSI Directives including the ETSI IPR Policy, no investigation regarding the essentiality of IPRs, including IPR searches, has been carried out by ETSI. No guarantee can be given as to the existence of other IPRs not referenced in ETSI SR 000 314 (or the updates on the ETSI Web server) which are, or may be, or may become, essential to the present document.

Trademarks

The present document may include trademarks and/or tradenames which are asserted and/or registered by their owners. ETSI claims no ownership of these except for any which are indicated as being the property of ETSI, and conveys no right to use or reproduce any trademark and/or tradename. Mention of those trademarks in the present document does not constitute an endorsement by ETSI of products, services or organizations associated with those trademarks.

DECT™, **PLUGTESTS™**, **UMTS™** and the ETSI logo are trademarks of ETSI registered for the benefit of its Members. **3GPP™** and **LTE™** are trademarks of ETSI registered for the benefit of its Members and of the 3GPP Organizational Partners. **oneM2M™** logo is a trademark of ETSI registered for the benefit of its Members and of the oneM2M Partners. **GSM®** and the GSM logo are trademarks registered and owned by the GSM Association.

Legal Notice

This Technical Specification (TS) has been produced by the ETSI 3rd Generation Partnership Project (3GPP).

The present document may refer to technical specifications or reports using their 3GPP identities. These shall be interpreted as being references to the corresponding ETSI deliverables.

The cross reference between 3GPP and ETSI identities can be found under <http://webapp.etsi.org/key/queryform.asp>.

Modal verbs terminology

In the present document "**shall**", "**shall not**", "**should**", "**should not**", "**may**", "**need not**", "**will**", "**will not**", "**can**" and "**cannot**" are to be interpreted as described in clause 3.2 of the [ETSI Drafting Rules](#) (Verbal forms for the expression of provisions).

"**must**" and "**must not**" are **NOT** allowed in ETSI deliverables except when used in direct citation.

Contents

Intellectual Property Rights	2
Legal Notice	2
Modal verbs terminology.....	2
Foreword.....	17
1 Scope	18
2 References	18
3 Definitions, symbols and abbreviations	19
3.1 Definitions	19
3.2 Symbols.....	20
3.3 Abbreviations	22
4 General	23
4.1 Relationship between minimum requirements and test requirements	23
4.2 Applicability of minimum requirements	24
4.3 Specification suffix information.....	24
4.4 Test points analysis	25
4.5 Applicability and test coverage rules.....	25
4.6 Pass fail decision rule of test case	25
5 Operating bands and Channel arrangement.....	25
5.1 General	25
5.2 Operating bands.....	26
5.2A Operating bands for CA	29
5.2A.1 Intra-band CA	29
5.2A.2 Inter-band CA	30
5.2A.2.1 Inter-band CA (two bands).....	31
5.2A.2.2 Inter-band CA (three bands).....	33
5.2A.2.3 Inter-band CA (four bands).....	33
5.2B Operating bands for DC	33
5.2C Operating band combination for SUL	33
5.2D Operating bands for UL MIMO	34
5.2E Operating band for V2X.....	35
5.2E.1 V2X operating bands	35
5.2E.2 V2X operating bands for concurrent operation.....	35
5.3 UE channel bandwidth	36
5.3.1 General.....	36
5.3.2 Maximum transmission bandwidth configuration	36
5.3.4 RB alignment	38
5.3.5 UE channel bandwidth per operating band	38
5.3.6 Asymmetric channel bandwidths	41
5.3A UE channel bandwidth for CA	42
5.3A.1 General.....	42
5.3A.2 Maximum transmission bandwidth configuration for CA	42
5.3A.3 Minimum guard band and transmission bandwidth configuration for CA.....	42
5.3A.4 Void	44
5.3A.5 UE channel bandwidth per operating band for CA	44
5.3E Channel bandwidth for V2X	45
5.3E.1 General.....	45
5.3E.2 Channel bandwidth for V2X concurrent operation.....	46
5.3I Channel bandwidth for RedCap	46
5.4 Channel arrangement.....	46
5.4.1 Channel spacing.....	46
5.4.1.1 Channel spacing for adjacent NR carriers	46
5.4.2 Channel raster	46
5.4.2.1 NR-ARFCN and channel raster.....	46

5.4.2.2	Channel raster to resource element mapping.....	47
5.4.2.3	Channel raster entries for each operating band	47
5.4.3	Synchronization raster	49
5.4.3.1	Synchronization raster and numbering.....	49
5.4.3.2	Synchronization raster to synchronization block resource element mapping.....	50
5.4.3.3	Synchronization raster entries for each operating band.....	50
5.4.4	TX–RX frequency separation	52
5.4A	Channel arrangement for CA.....	52
5.4A.1	Channel spacing for CA.....	52
5.4A.2	Channel raster for CA.....	53
5.4A.3	Synchronization raster for CA	53
5.4A.4	Tx-Rx frequency separation for CA.....	53
5.4E	Channel arrangement for V2X	53
5.4E.1	Channel spacing.....	53
5.4E.2	Channel raster	53
5.4E.2.1	NR-ARFCN and channel raster.....	53
5.4E.2.2	Channel raster to resource element mapping.....	53
5.4E.2.3	Channel raster entries for each operating band	53
5.4E.3	Synchronization raster for V2X.....	54
5.5	Void.....	54
5.5A	Configurations for CA.....	54
5.5A.0	General.....	54
5.5A.1	Configurations for intra-band contiguous CA.....	54
5.5A.2	Configurations for intra-band non-contiguous CA	58
5.5A.3	Configurations for inter-band CA.....	58
5.5A.3.1	Configurations for inter-band CA (two bands)	59
5.5A.3.2	Configurations for inter-band CA (three bands)	64
5.5A.3.3	Configurations for inter-band CA (four bands).....	66
5.5B	Configurations for DC.....	66
5.5C	Configurations for SUL.....	67
6	Transmitter characteristics	69
6.1	General	69
6.1A	General	71
6.1E	General	86
6.2	Transmitter power	91
6.2.1	UE maximum output power.....	91
6.2.2	UE maximum output power reduction.....	97
6.2.3	UE additional maximum output power reduction.....	122
6.2.4	Configured transmitted power	272
6.2A	Transmitter power for CA	279
6.2A.1	UE maximum output power for CA.....	279
6.2A.1.0	Minimum conformance requirements	279
6.2A.1.0.1	Void.....	279
6.2A.1.0.2	Void.....	279
6.2A.1.0.3	UE maximum output power for Inter-band CA.....	279
6.2A.1.0.4	UE maximum output power for Intra-band contiguous CA	281
6.2A.1.0.5	UE maximum output power for Intra-band non-contiguous CA	281
6.2A.1.1	UE maximum output power for CA (2UL CA).....	281
6.2A.2	UE maximum output power reduction for CA.....	287
6.2A.2.0	Minimum conformance requirements	287
6.2A.2.0.1	FFS	287
6.2A.2.0.2	FFS	287
6.2A.2.0.3	Maximum Power Reduction for Inter-band CA	287
6.2A.2.0.4	Maximum Power Reduction for Intra-band contiguous CA.....	287
6.2A.2.0.5	Maximum Power Reduction for Intra-band non-contiguous CA.....	289
6.2A.2.1	UE maximum output power reduction for CA (2UL CA).....	291
6.2A.3	UE additional maximum output power reduction for CA.....	311
6.2A.3.0	Minimum conformance requirements	311
6.2A.3.0.1	FFS	311
6.2A.3.0.2	FFS	311
6.2A.3.0.3	UE additional maximum output power reduction for inter-band CA	311

6.2A.3.1	UE additional maximum output power reduction for CA (2UL CA).....	315
6.2A.4	Configured output power for CA.....	320
6.2A.4.0	Minimum conformance requirements	320
6.2A.4.0.1	Configured transmitted power level	320
6.2A.4.0.2	$\Delta T_{IB,c}$ for CA	324
6.2A.4.0.2.1	FFS	325
6.2A.4.0.2.2	FFS	325
6.2A.4.0.2.3	$\Delta T_{IB,c}$ for Inter-band CA.....	325
6.2A.4.1	Configured transmitted power for CA (2UL CA)	327
6.2B	Transmitter power for NR-DC	333
6.2B.0	General.....	333
6.2B.1	UE maximum output power for NR-DC.....	333
6.2B.1.0	Minimum conformance requirements	333
6.2B.1.0.1	FFS	333
6.2B.1.0.2	FFS	333
6.2B.1.0.3	UE maximum output power for inter-band NR-DC	333
6.2B.1.1	UE maximum output power for NR-DC	334
6.2B.2	UE maximum output power reduction for NR-DC.....	336
6.2B.2.0	Minimum conformance requirements	336
6.2B.2.0.1	FFS	336
6.2B.2.0.2	FFS	336
6.2B.2.0.3	UE maximum output power reduction for Inter-band NR-DC	336
6.2B.2.1	UE maximum output power for NR-DC	336
6.2B.3	UE additional maximum output power reduction for NR-DC.....	338
6.2B.3.0	Minimum conformance requirements	338
6.2B.3.0.1	FFS	338
6.2B.3.0.2	FFS	338
6.2B.3.0.3	UE additional maximum output power reduction for inter-band NR-DC	338
6.2B.3.1	UE additional maximum output power reduction for NR-DC	338
6.2B.4	Configured output power for NR-DC	340
6.2B.4.0	Minimum conformance requirements	340
6.2B.4.0.1	Configured transmitted power level for NR-DC	340
6.2B.4.0.2	$\Delta T_{IB,c}$ for NR-DC.....	343
6.2B.4.0.2.1	FFS	343
6.2B.4.0.2.2	FFS	343
6.2B.4.0.2.3	$\Delta T_{IB,c}$ for Inter-band NR-DC	343
6.2B.4.1	Configured transmitted power level for NR-DC	343
6.2C	Transmitter power for SUL	346
6.2C.1	Configured transmitted power for SUL	346
6.2C.2	$\Delta T_{IB,c}$	349
6.2C.3	UE maximum output power for SUL.....	349
6.2C.4	UE maximum output power reduction for SUL.....	352
6.2C.5	UE additional maximum output power reduction for SUL.....	362
6.2D	Transmitter power for UL MIMO	397
6.2D.1	UE maximum output power for UL MIMO.....	397
6.2D.2	UE maximum output power reduction for UL MIMO.....	401
6.2D.3	UE additional maximum output power reduction for UL MIMO.....	415
6.2D.4	Configured transmitted power for UL MIMO	451
6.2E	Transmitter power for V2X	454
6.2E.1	UE maximum output power for V2X	454
6.2E.1.0	Minimum conformance requirements	454
6.2E.1.1	UE maximum output power for V2X / non-concurrent operation	455
6.2E.1.1D	UE maximum output power for V2X / non-concurrent operation / SL-MIMO	456
6.2E.2	UE maximum output power reduction for V2X	458
6.2E.2.0	Minimum conformance requirements	458
6.2E.2.1	UE maximum output power reduction for V2X / non-concurrent operation	459
6.2E.2.1D	UE maximum output power reduction for V2X / non-concurrent operation / SL-MIMO	464
6.2E.2.2	UE maximum output power reduction for V2X / concurrent operation.....	466
6.2F	Transmitter power for shared spectrum channel access	470
6.2F.1	UE maximum output power for shared spectrum channel access.....	470
6.2F.2	UE maximum output power reduction.....	472
6.2F.3	UE additional maximum output power reduction for shared spectrum access	472

6.2G	Transmitter power for Tx Diversity.....	478
6.2G.1	UE maximum output power for Tx Diversity	478
6.2G.2	UE maximum output power reduction for Tx Diversity	482
6.2G.3	UE additional maximum output power reduction for Tx Diversity	493
6.2I	Transmitter power for RedCap.....	497
6.2I.1	UE maximum output power for RedCap	497
6.2I.2	UE maximum output power reduction for RedCap	499
6.2I.3	UE additional maximum output power reduction for RedCap	499
6.2I.4	Configured transmitted power for RedCap.....	539
6.3	Output power dynamics.....	540
6.3.1	Minimum output power	540
6.3.2	Transmit OFF power.....	543
6.3.3	Transmit ON/OFF time mask	544
6.3.3.1	General	544
6.3.3.2	General ON/OFF time mask	544
6.3.3.3	Transmit power time mask for slot and short or subslot boundaries	549
6.3.3.4	PRACH time mask.....	549
6.3.3.5	Void.....	556
6.3.3.6	SRS time mask	556
6.3.3.7	PUSCH-PUCCH and PUSCH-SRS time masks	565
6.3.3.8	Transmit power time mask for consecutive slot or long subslot transmission and short subslot transmission boundaries	565
6.3.3.9	Transmit power time mask for consecutive short subslot transmissions boundaries	565
6.3.4	Power control.....	566
6.3.4.1	General	566
6.3.4.2	Absolute power tolerance.....	566
6.3.4.3	Relative power tolerance	569
6.3.4.4	Aggregate power tolerance.....	586
6.3A	Output power dynamics for CA	590
6.3A.1	Minimum output power for CA	590
6.3A.1.0	Minimum conformance requirements	590
6.3A.1.1	Minimum output power for CA (2UL CA)	590
6.3A.2	Transmit OFF power for CA.....	593
6.3A.2.0	Minimum conformance requirements	593
6.3A.2.1	Transmit OFF power for CA (2UL CA)	593
6.3A.3	Transmit ON/OFF time mask for CA	594
6.3A.3.0	Minimum conformance requirements	594
6.3A.3.0.1	Transmit ON/OFF time mask for intra-band contiguous CA	594
6.3A.3.0.2	Transmit ON/OFF time mask for intra-band non-contiguous CA	594
6.3A.3.0.3	Transmit ON/OFF time mask for inter-band CA.....	594
6.3A.3.1	Transmit ON/OFF time mask for CA (2UL CA)	595
6.3A.3.1_1	Time mask for switching between two uplink carriers.....	601
6.3A.4	Power control for CA.....	606
6.3A.4.1	Absolute power tolerance for CA.....	606
6.3A.4.1.0	Minimum conformance requirements.....	606
6.3A.4.1.1	Absolute power tolerance for CA (2UL CA).....	606
6.3A.4.2	Relative power tolerance for CA.....	609
6.3A.4.2.0	Minimum conformance requirements.....	609
6.3A.4.2.1	Relative power tolerance for CA (2UL CA).....	610
6.3A.4.3	Aggregate power tolerance for CA	618
6.3A.4.3.0	Minimum conformance requirements.....	618
6.3A.4.3.1	Aggregate power tolerance for CA (2UL CA)	618
6.3B	Output power dynamics for NR-DC.....	622
6.3B.1	Minimum output power for NR-DC	622
6.3B.2	Transmit OFF power for NR-DC.....	622
6.3B.3	Transmit ON/OFF time mask for NR-DC	622
6.3C	Output power dynamics for SUL	622
6.3C.1	Minimum output power for SUL	622
6.3C.2	Transmit OFF power for SUL.....	624
6.3C.3	Transmit ON/OFF time mask for SUL	625
6.3C.4	Power control for SUL.....	627
6.3C.4.1	Absolute power tolerance for SUL.....	627

6.3C.4.2	Relative power tolerance for SUL.....	629
6.3C.4.3	Aggregate power tolerance for SUL	637
6.3D	Output power dynamics for UL MIMO	640
6.3D.1	Minimum output power for UL MIMO	640
6.3D.2	Transmit OFF power for UL MIMO.....	642
6.3D.3	Transmit ON/OFF time mask for UL MIMO	644
6.3D.4	Power control for UL MIMO.....	650
6.3D.4.1	Absolute power tolerance for UL MIMO.....	650
6.3D.4.2	Relative power tolerance for UL MIMO.....	653
6.3D.4.3	Aggregate power tolerance for UL MIMO	665
6.3E	Output power dynamics for V2X	668
6.3E.1	Minimum output power for V2X.....	668
6.3E.1.0	Minimum conformance requirements	668
6.3E.1.1	Minimum output power for V2X / non-concurrent operation	668
6.3E.1.1D	Minimum output power for V2X / non-concurrent operation / SL-MIMO.....	670
6.3E.2	Transmit OFF power for V2X	673
6.3E.2.0	Minimum conformance requirements	673
6.3E.2.1	Transmit OFF power for V2X / non-concurrent operation	673
6.3E.2.1D	Transmit OFF power for V2X / non-concurrent operation / SL-MIMO	674
6.3E.2.2	Transmit OFF power for V2X / con-current operation	675
6.3F	Output power dynamics for shared spectrum channel access.....	675
6.3F.1	Minimum output power	675
6.3F.2	Transmit OFF power for shared spectrum channel access.....	676
6.3F.3	Transmit ON/OFF time mask for shared spectrum channel access	677
6.3F.3.1	General	677
6.3F.3.2	General ON/OFF time mask	677
6.4	Transmit signal quality.....	680
6.4.1	Frequency error.....	680
6.4.2	Transmit modulation quality.....	682
6.4.2.1	Error Vector Magnitude	682
6.4.2.1a	Error Vector Magnitude including symbols with transient period	690
6.4.2.2	Carrier leakage	694
6.4.2.3	In-band emissions	697
6.4.2.4	EVM equalizer spectrum flatness	703
6.4.2.5	EVM equalizer spectrum flatness for Pi/2 BPSK.....	707
6.4A	Transmit signal quality for CA.....	711
6.4A.1	Frequency error for CA.....	711
6.4A.1.0	Minimum conformance requirements	711
6.4A.1.1	Frequency error for CA (2UL CA)	711
6.4A.2	Transmit modulation quality for CA.....	713
6.4A.2.1	Error Vector Magnitude for CA.....	713
6.4A.2.1.0	Minimum conformance requirements.....	713
6.4A.2.1.1	Error Vector Magnitude for CA (2UL CA).....	714
6.4A.2.2	Carrier leakage for CA.....	717
6.4A.2.2.0	Minimum conformance requirements.....	717
6.4A.2.2.1	Carrier leakage for CA (2UL CA).....	717
6.4A.2.3	In-band emissions for CA	720
6.4A.2.3.0	Minimum conformance requirements.....	720
6.4A.2.3.1	In-band emissions for CA (2UL CA)	721
6.4B	Transmit signal quality for NR-DC.....	724
6.4B.1	Frequency error for NR-DC.....	725
6.4B.2	Transmit modulation quality for NR-DC.....	725
6.4B.2.1	Error Vector Magnitude for NR-DC	725
6.4B.2.2	Carrier leakage for NR-DC	725
6.4B.2.3	In-band emissions for NR-DC.....	725
6.4C	Transmit signal quality for SUL.....	725
6.4C.1	Frequency error for SUL.....	725
6.4C.2	Transmit modulation quality for SUL.....	726
6.4C.2.1	Error Vector Magnitude for SUL.....	726
6.4C.2.2	Carrier leakage for SUL	729
6.4C.2.3	In-band emissions for SUL	730
6.4C.2.4	EVM equalizer spectrum flatness for SUL	731

6.4C.2.5	EVM equalizer spectrum flatness for Pi/2 BPSK for SUL	732
6.4D	Transmit signal quality for UL MIMO.....	735
6.4D.1	Frequency error for UL MIMO.....	735
6.4D.2	Transmit modulation quality for UL MIMO.....	737
6.4D.2.1	Error Vector Magnitude for UL MIMO	737
6.4D.2.2	Carrier leakage for UL MIMO	740
6.4D.2.3	In-band emissions for UL MIMO	743
6.4D.2.4	EVM equalizer spectrum flatness for UL MIMO	746
6.4D.3	Time alignment error for UL MIMO	749
6.4D.4	Requirements for coherent UL MIMO	750
6.4E	Transmit signal quality for V2X.....	753
6.4E.1	Frequency error for V2X	753
6.4E.2	Transmit modulation quality for V2X	753
6.4E.2.1	General	753
6.4E.2.2	Error Vector Magnitude for V2X.....	753
6.4E.2.2.1	Error Vector Magnitude for V2X / non-concurrent operation.....	753
6.4E.2.2.1D	Error Vector Magnitude for V2X / non-concurrent operation / SL-MIMO.....	755
6.4E.2.4	In-band emissions for V2X	756
6.4E.2.4.1	In-band emissions for V2X / non-concurrent operation	756
6.4E.2.4.1D	In-band emissions for V2X / non-concurrent operation / SL-MIMO	759
6.4E.2.4.2	In-band emissions for V2X / con-current operation	760
6.4E.2.5	EVM equalizer spectrum flatness for V2X.....	762
6.4E.2.5.1	EVM equalizer spectrum flatness for V2X / non-concurrent operation	762
6.4E.2.5.1D	EVM equalizer spectrum flatness for V2X / non-concurrent operation / SL-MIMO	764
6.4E.2.5.2	EVM equalizer spectrum flatness for V2X / con-current operation	766
6.5	Output RF spectrum emissions.....	767
6.5.0	General.....	767
6.5.1	Occupied bandwidth	768
6.5.2	Out of band emission	770
6.5.2.1	General	770
6.5.2.2	Spectrum emission mask	770
6.5.2.3	Additional spectrum emission mask	781
6.5.2.4	Adjacent channel leakage ratio	788
6.5.2.4.1	NR ACLR.....	788
6.5.2.4.2	UTRA ACLR	791
6.5.3	Spurious emissions	793
6.5.3.1	General spurious emissions.....	793
6.5.3.2	Spurious emissions for UE co-existence	796
6.5.3.3	Additional spurious emissions	823
6.5.4	Transmit intermodulation	849
6.5A	Output RF spectrum emissions for CA.....	852
6.5A.1	Occupied bandwidth for CA	852
6.5A.1.0	Minimum conformance requirements	852
6.5A.1.0.1	Void.....	852
6.5A.1.0.1a	Occupied bandwidth for Intra-band contiguous CA.....	852
6.5A.1.0.2	Occupied bandwidth for Intra-band non-contiguous CA.....	852
6.5A.1.0.3	Occupied bandwidth for Inter-band CA	852
6.5A.1.1	Occupied bandwidth for CA (2UL CA).....	852
6.5A.2	Out of band emission for CA.....	856
6.5A.2.1	General	856
6.5A.2.2	Spectrum emission mask	856
6.5A.2.2.0	Minimum conformance requirements.....	856
6.5A.2.2.1	Spectrum emission mask for CA (2UL CA).....	857
6.5A.2.4	Adjacent channel leakage ratio	862
6.5A.2.4.1	NR ACLR.....	862
6.5A.2.4.1.0	Minimum conformance requirements	862
6.5A.2.4.1.0.3	NR ACLR for Inter-band CA.....	863
6.5A.2.4.1.1	NR ACLR for CA (2UL CA).....	863
6.5A.2.4.2	UTRA ACLR	866
6.5A.2.4.2.0	Minimum conformance requirements.....	866
6.5A.2.4.2.1	UTRA ACLR for CA (2UL CA)	866
6.5A.3	Spurious emission for CA.....	868

6.5A.3.1	General spurious emissions for CA.....	868
6.5A.3.1.0	Minimum conformance requirements.....	869
6.5A.3.1.1	General spurious emissions for CA (2UL CA).....	869
6.5A.3.2	Spurious emission for UE co-existence.....	874
6.5A.3.2.0	Minimum conformance requirements.....	874
6.5A.3.2.0.1	Spurious emissions for UE co-existence for intra-band contiguous CA.....	874
6.5A.3.2.0.2	Void	876
6.5A.3.2.0.3	Spurious emissions for UE co-existence for Inter-band CA	876
6.5A.3.2.1	Spurious emissions for UE co-existence for CA (2UL CA).....	886
6.5A.4	Transmit intermodulation for CA	903
6.5A.4.0	Minimum conformance requirements	903
6.5A.4.1	Transmit intermodulation for CA (2UL CA)	903
6.5B	Output RF spectrum emissions for NR-DC.....	906
6.5B.1	Occupied bandwidth for NR-DC	906
6.5B.2	Out of band emission for NR-DC	906
6.5B.2.1	General.....	906
6.5B.2.2	Spectrum emission mask.....	906
6.5B.2.4	Adjacent channel leakage ratio	906
6.5B.3	Spurious emission for NR-DC.....	906
6.5B.4	Transmit intermodulation for NR-DC.....	906
6.5C	Output RF spectrum emissions for SUL.....	906
6.5C.1	Occupied bandwidth for SUL	906
6.5C.2	Out of band emission for SUL.....	908
6.5C.2.1	General.....	908
6.5C.2.2	Spectrum emission mask for SUL.....	908
6.5C.2.3	Additional spectrum emission mask for SUL	912
6.5C.2.4	Adjacent channel leakage ratio for SUL	913
6.5C.2.4.1	NR ACLR for SUL.....	913
6.5C.2.4.2	UTRA ACLR for SUL	914
6.5C.3	Spurious emissions for SUL	915
6.5C.3.1	General spurious emissions for SUL.....	915
6.5C.3.2	Spurious emissions for UE co-existence for SUL.....	917
6.5C.3.3	Additional spurious emissions for SUL	919
6.5C.4	Transmit intermodulation for SUL	936
6.5D	Output RF spectrum emissions for UL MIMO.....	938
6.5D.1	Occupied bandwidth for UL MIMO	938
6.5D.1_1	Void	940
6.5D.2	Out of band emission for UL MIMO	940
6.5D.2.1	General.....	940
6.5D.2.2	Spectrum emission mask for UL MIMO.....	940
6.5D.2.3	Additional spectrum emission mask for UL MIMO	946
6.5D.2.4	Adjacent channel leakage ratio for UL MIMO	950
6.5D.2.4.1	NR ACLR for UL MIMO.....	950
6.5D.2.4.2	UTRA ACLR for UL MIMO	952
6.5D.2_1	Void	956
6.5D.3	Spurious emissions for UL MIMO	956
6.5D.3.1	General spurious emissions for UL MIMO.....	956
6.5D.3.2	Spurious emissions for UE co-existence for UL MIMO	958
6.5D.3.3	Additional spurious emissions for UL MIMO	959
6.5D.3_1	Spurious emissions for UL MIMO (Rel-16 onward).....	966
6.5D.3_1.1	General spurious emissions for UL MIMO (Rel-16 onward)	966
6.5D.3_1.2	Spurious emission for UE co-existence for UL MIMO (Rel-16 onward).....	967
6.5D.3_1.3	Additional spurious emissions for UL MIMO (Rel-16 onward).....	968
6.5D.4	Transmit intermodulation for UL MIMO	970
6.5E	Output RF spectrum emissions for V2X	973
6.5E.1	Occupied bandwidth for V2X.....	973
6.5E.2	Out of band emission for V2X.....	973
6.5E.2.1	General.....	973
6.5E.2.2	Spectrum emission mask for V2X	973
6.5E.2.2.1	Spectrum emission mask for V2X / non-concurrent operation.....	973
6.5E.2.2.1D	Spectrum emission mask for V2X / non-concurrent operation / SL-MIMO	978
6.5E.2.3	Additional Spectrum emission mask for V2X	980

6.5E.2.3.1	Additional Spectrum emission mask for V2X / non-concurrent operation.....	980
6.5E.2.3.1D	Additional Spectrum emission mask for V2X / non-concurrent operation / SL-MIMO	984
6.5E.2.4	Adjacent channel leakage ratio for V2X	986
6.5E.2.4.1	Adjacent channel leakage ratio for V2X / non-concurrent operation	986
6.5E.2.4.1D	Adjacent channel leakage ratio for V2X / non-concurrent operation / SL-MIMO	988
6.5E.3	Spurious emissions for V2X	990
6.5E.3.1	General spurious emissions for V2X	990
6.5E.3.2	Spurious emissions for UE co-existence for V2X.....	990
6.5E.3.2.1	Spurious emissions for UE co-existence for V2X / non-concurrent operation.....	990
6.5E.3.2.1D	Spurious emissions for UE co-existence for V2X / non-concurrent operation / SL-MIMO	991
6.5E.3.3	Additional spurious emissions requirements for V2X	993
6.5E.3.3.1	Additional spurious emissions requirements for V2X / non-concurrent operation	993
6.5F	Output RF spectrum emissions for shared spectrum channel access.....	994
6.5F.1	Occupied bandwidth for shared spectrum channel access	994
6.5F.2	Out of band emission for shared spectrum channel access	995
6.5F.2.1	General	995
6.5F.2.2	Spectrum emission mask for operation with shared spectrum channel access.....	995
6.5F.2.4	Adjacent channel leakage ratio for operation with shared spectrum channel access	998
6.5F.2.4.1	Shared spectrum channel access ACLR	998
6.5F.3	Spurious emissions for shared spectrum channel access	1001
6.5F.3.1	General spurious emissions	1001
6.5F.3.2	Spurious emissions for UE co-existence	1003
6.5G	1003	
6.5G.1	1003	
6.5G.2	1003	
6.5G.2.1	1003	
6.5G.2.2	1003	
6.5G.2.3	Adjacent channel leakage ratio for Tx Diversity.....	1003
6.5G.2.3.1	NR ACLR for Tx Diversity	1003
7	Receiver characteristics	1006
7.1	General	1006
7.1A	General	1006
7.1I	General	1007
7.2	Diversity characteristics	1007
7.3	Reference sensitivity	1007
7.3.1	General.....	1007
7.3.2	Reference sensitivity power level	1007
7.3.3	$\Delta R_{IB,c}$	1033
7.3A	Reference sensitivity for CA	1033
7.3A.0	Minimum conformance requirements	1033
7.3A.0.1	General	1033
7.3A.0.2	Reference sensitivity power level for CA	1033
7.3A.0.2.1	Reference sensitivity power level for Intra-band contiguous CA.....	1033
7.3A.0.2.2	Reference sensitivity power level for Intra-band non-contiguous CA.....	1033
7.3A.0.2.3	Reference sensitivity power level for Inter-band CA	1034
7.3A.0.2.4	Reference sensitivity power level for SDL bands.....	1034
7.3A.0.3	$\Delta R_{IB,c}$ for CA.....	1037
7.3A.0.3.1	General	1037
7.3A.0.3.2	$\Delta R_{IB,c}$ for Inter-band CA.....	1037
7.3A.0.4	Reference sensitivity exceptions due to UL harmonic interference for CA	1039
7.3A.0.5	Reference sensitivity exceptions due to intermodulation interference due to 2UL CA	1043
7.3A.0.6	Reference sensitivity exceptions due to cross band isolation for CA.....	1058
7.3A.1	Reference sensitivity power level for 2DL CA without exception	1060
7.3A.1_1	Reference sensitivity power level for 2DL CA exceptions.....	1066
7.3A.2	Reference sensitivity power level for 3DL CA.....	1081
7.3A.3	Reference sensitivity power level for 4DL CA.....	1086
7.3A.4	Reference sensitivity power level for 5DL CA.....	1091
7.3B	Void.....	1092
7.3C	Reference sensitivity for SUL	1092
7.3C.0	Minimum conformance requirements	1092
7.3C.0.1	General	1092

7.3C.0.2	Minimum conformance requirements for Reference sensitivity power level.....	1092
7.3C.0.3	Δ RIB,c for SUL	1094
7.3C.1	General.....	1095
7.3C.2	Reference sensitivity power level for SUL	1095
7.3C.3	Reference sensitivity power level for SUL (3CC)	1108
7.3D	Reference sensitivity for UL MIMO	1108
7.3D.1	General.....	1108
7.3D.2	Reference sensitivity power level for UL MIMO	1109
7.3E	Reference sensitivity for V2X.....	1110
7.3E.1	General.....	1110
7.3E.2	Reference sensitivity for V2X / non-concurrent operation	1110
7.3F	Reference sensitivity for shared spectrum channel access	1113
7.3F.1	General.....	1113
7.3F.2	Reference sensitivity power level	1113
7.3F.3	Δ RIB,c	1117
7.3I	Reference sensitivity for RedCap	1118
7.3I.1	General.....	1118
7.3I.2	Reference sensitivity power level	1118
7.4	Maximum input level	1143
7.4A	Maximum input level for CA	1145
7.4A.0	Minimum conformance requirements	1145
7.4A.0.1	Maximum input level for Intra-band contiguous CA	1145
7.4A.0.2	Maximum input level for Intra-band non-contiguous CA	1146
7.4A.0.3	Maximum input level for Inter-band CA	1146
7.4A.1	Maximum input level for CA (2DL CA)	1146
7.4A.2	Maximum input level for CA (3DL CA)	1150
7.4A.3	Maximum input level for CA (4DL CA)	1154
7.4D	Maximum input level for UL MIMO	1159
7.5	Adjacent channel selectivity.....	1161
7.5A	Adjacent channel selectivity for CA.....	1167
7.5A.0	Minimum conformance requirements	1167
7.5A.0.1	Adjacent channel selectivity for Intra-band contiguous CA	1167
7.5A.0.2	Adjacent channel selectivity Intra-band non-contiguous CA	1169
7.5A.0.3	Adjacent channel selectivity Inter-band CA	1170
7.5A.1	Adjacent channel selectivity for CA (2DL CA).....	1170
7.5A.2	Adjacent channel selectivity for 3DL CA.....	1185
7.5A.3	Adjacent channel selectivity for 4DL CA.....	1194
7.5D	Adjacent channel selectivity for UL MIMO.....	1203
7.5F	Adjacent channel selectivity.....	1205
7.5F.1	Adjacent channel selectivity for shared spectrum channel access	1205
7.6	Blocking characteristics	1207
7.6.1	General.....	1207
7.6.2	In-band blocking.....	1208
7.6.3	Out-of-band blocking.....	1213
7.6.4	Narrow band blocking	1219
7.6A	Blocking characteristics for CA	1222
7.6A.1	General.....	1222
7.6A.2	Inband blocking for CA	1222
7.6A.2.0	Minimum requirements.....	1222
7.6A.2.0.1	In-band blocking for Intra-band contiguous CA.....	1222
7.6A.2.0.2	In-band blocking for Intra-band non-contiguous CA	1223
7.6A.2.0.3	In-band blocking for Inter-band CA	1224
7.6A.2.1	In-band blocking for CA (2DL CA).....	1224
7.6A.2.2	In-band Blocking for CA (3DL CA)	1232
7.6A.2.3	In-band Blocking for CA (4DL CA)	1241
7.6A.3	Out-of-band blocking for CA.....	1249
7.6A.3.0	Minimum conformance requirements	1249
7.6A.3.0.1	Out-of-band blocking for Intra-band contiguous CA	1249
7.6A.3.0.2	Out-of-band blocking for Intra-band non-contiguous CA	1250
7.6A.3.0.3	Out-of-band blocking for Inter-band CA.....	1250
7.6A.3.1	Out-of-band blocking for CA (2DL CA)	1251
7.6A.3.2	Out-of-band blocking for CA (3DL CA)	1259

7.6A.3.3	Out-of-band blocking for CA (4DL CA)	1266
7.6A.4	Narrow band blocking for CA	1271
7.6A.4.0	Minimum conformance requirements	1271
7.6A.4.0.1	Narrow band blocking for Intra-band contiguous CA	1271
7.6A.4.0.2	Narrow band blocking for Intra-band non-contiguous CA	1271
7.6A.4.0.3	Narrow band blocking for Inter-band CA	1272
7.6A.4.1	Narrow band blocking for CA (2DL CA)	1272
7.6A.4.2	Narrow band blocking for CA (3DL CA)	1277
7.6A.4.3	Narrow band blocking for CA (4DL CA)	1279
7.6C	Blocking characteristics for SUL	1282
7.6C.1	General	1282
7.6C.2	In-band blocking for SUL	1282
7.6C.2_1	Inband Blocking for SUL with DL CA	1283
7.6C.2_1.1	Inband Blocking for SUL with 2 DL CA	1283
7.6C.3	Out-of-band blocking for SUL	1286
7.6C.3_1	Out-of-band blocking for SUL with DL CA	1288
7.6C.3_1.1	Out-of-band Blocking for SUL with 2 DL CA	1288
7.6D	Blocking characteristics for UL MIMO	1292
7.6D.1	General	1292
7.6D.2	In-band blocking for UL MIMO	1292
7.6D.3	Out-of-band blocking for UL MIMO	1294
7.6D.4	Narrow band blocking for UL MIMO	1295
7.6E	Blocking characteristics for V2X	1296
7.6E.1	General	1296
7.6E.2	In-band blocking for V2X	1297
7.6E.2.0	Minimum conformance requirements	1297
7.6E.2.1	In-band blocking for V2X / non-concurrent operation	1297
7.6E.2.2	In-band blocking for V2X / con-current operation	1297
7.6E.3	Out-of-band blocking for V2X	1298
7.6E.3.0	Minimum conformance requirements	1298
7.6E.3.1	Out-of-band blocking for V2X / non-concurrent operation	1298
7.6E.3.2	Out-of-band blocking for V2X / con-current operation	1298
7.6F	Blocking characteristics for shared spectrum channel access	1298
7.6F.1	General	1298
7.6F.2	In-band blocking for shared spectrum channel access	1299
7.7	Spurious response	1302
7.7A	Spurious response for CA	1304
7.7A.0	Minimum conformance requirements	1304
7.7A.0.1	Minimum conformance requirements for intra-band contiguous CA	1304
7.7A.0.2	Void	1304
7.7A.0.3	Minimum conformance requirements for inter-band CA	1304
7.7A.0.4	Minimum conformance requirements for intra-band non-contiguous CA	1305
7.7A.1	Spurious response for CA (2DL CA)	1305
7.7A.2	Spurious response for 3DL CA	1306
7.7A.3	Spurious response for 4DL CA	1307
7.7D	Spurious response for UL MIMO	1308
7.7E	Spurious response for V2X	1309
7.7E.0	Minimum conformance requirements	1309
7.7E.1	Spurious response for V2X / non-concurrent operation	1309
7.7E.2	Spurious response for V2X / con-current operation	1310
7.8	Intermodulation characteristics	1310
7.8.1	General	1310
7.8.2	Wide band Intermodulation	1310
7.8A	Intermodulation characteristics for CA	1315
7.8A.1	General	1315
7.8A.2	Wide band Intermodulation for CA	1315
7.8A.2.0	Minimum conformance requirements	1315
7.8A.2.0.1	Wide band Intermodulation for Intra-band contiguous CA	1315
7.8A.2.0.2	Wide band intermodulation for Intra-band non-contiguous CA	1316
7.8A.2.0.3	Wide band Intermodulation for Inter-band CA	1316
7.8A.2.1	Wide band Intermodulation for CA (2DL CA)	1317
7.8A.2.2	Wide band Intermodulation for CA (3DL CA)	1323

7.8A.2.2.5.2	Wide band intermodulation for Inter-band CA.....	1327
7.8A.2.3	Wide band Intermodulation for CA (4DL CA).....	1328
7.8A.2.3.5.1	Wide band intermodulation for Inter-band CA.....	1330
7.8D	Intermodulation characteristics for UL MIMO	1332
7.8D.1	General.....	1332
7.8D.2	Wide band Intermodulation for UL MIMO	1332
7.8E	Intermodulation characteristics for V2X	1334
7.8E.1	General.....	1334
7.8E.2	Wide band Intermodulation for V2X.....	1334
7.8E.2.0	Minimum conformance requirements	1334
7.8E.2.1	Wide band Intermodulation for V2X / non-concurrent operation.....	1334
7.8E.2.2	Wide band Intermodulation for V2X / con-current operation.....	1334
7.9	Spurious emissions	1334
7.9A	Spurious emissions for CA.....	1336
7.9A.0	Minimum conformance requirements	1336
7.9A.1	Spurious emissions for CA (2DL CA).....	1336
Annex A (normative): Measurement channels.....		1339
A.1	General	1339
A.2	UL reference measurement channels	1339
A.2.1	General	1339
A.2.2	Reference measurement channels for FDD	1340
A.2.2.1	DFT-s-OFDM Pi/2-BPSK	1340
A.2.2.2	DFT-s-OFDM QPSK.....	1341
A.2.2.3	DFT-s-OFDM 16QAM.....	1342
A.2.2.4	DFT-s-OFDM 64QAM.....	1344
A.2.2.5	DFT-s-OFDM 256QAM.....	1345
A.2.2.6	CP-OFDM QPSK	1347
A.2.2.7	CP-OFDM 16QAM	1348
A.2.2.8	CP-OFDM 64QAM	1350
A.2.2.9	CP-OFDM 256QAM	1352
A.2.3	Reference measurement channels for TDD.....	1355
A.2.3.1	DFT-s-OFDM Pi/2-BPSK	1355
A.2.3.2	DFT-s-OFDM QPSK.....	1355
A.2.3.3	DFT-s-OFDM 16QAM.....	1355
A.2.3.4	DFT-s-OFDM 64QAM.....	1355
A.2.3.5	DFT-s-OFDM 256QAM.....	1355
A.2.3.6	CP-OFDM QPSK	1355
A.2.3.7	CP-OFDM 16QAM	1355
A.2.3.8	CP-OFDM 64QAM	1355
A.2.3.9	CP-OFDM 256QAM	1355
A.3	DL reference measurement channels	1355
A.3.1	General	1355
A.3.2	DL reference measurement channels for FDD	1356
A.3.2.1	General.....	1356
A.3.2.2	FRC for receiver requirements for QPSK.....	1357
A.3.2.3	FRC for maximum input level for 64QAM	1360
A.3.2.4	FRC for maximum input level for 256 QAM	1363
A.3.3	DL reference measurement channels for TDD.....	1366
A.3.3.1	General.....	1366
A.3.3.2	FRC for receiver requirements for QPSK.....	1367
A.3.3.3	FRC for maximum input level for 64QAM	1370
A.3.3.4	FRC for maximum input level for 256 QAM	1373
A.4	CSI reference measurement channels.....	1376
A.5	OFDMA Channel Noise Generator (OCNG).....	1376
A.5.1	OCNG Patterns for FDD	1376
A.5.1.1	OCNG FDD pattern 1: Generic OCNG FDD Pattern for all unused REs.....	1376
A.5.2	OCNG Patterns for TDD.....	1376
A.5.2.1	OCNG TDD pattern 1: Generic OCNG TDD Pattern for all unused REs	1376

A.6	1376	
A.7	V2X reference measurement channels	1377
A.7.1	General	1377
A.7.2	FRC for V2X receiver requirements for QPSK.....	1377
A.7.3	FRC for maximum input level for 64QAM.....	1379
A.7.4	FRC for maximum input level for 256QAM.....	1380
A.7.5	FRC for transmitter requirements.....	1382
Annex B (normative):	Propagation Conditions.....	1386
B.0	No interference.....	1386
Annex C (normative):	Downlink physical channels.....	1387
C.0	Downlink signal levels	1387
C.1	General	1387
C.2	Setup.....	1387
C.3	Connection	1389
C.3.0	Measurement of Transmitter Characteristics.....	1389
C.3.1	Measurement of Receiver Characteristics	1389
Annex D (normative):	Characteristics of the Interfering Signal	1391
D.1	General	1391
D.2	Interference signals.....	1391
Annex E (normative):	Global In-Channel TX-Test	1393
E.1	General	1393
E.2	Signals and results.....	1393
E.2.1	Basic principle.....	1393
E.2.2	Output signal of the TX under test	1393
E.2.3	Reference signal	1393
E.2.4	Measurement results.....	1394
E.2.5	Measurement points	1394
E.3	Signal processing.....	1394
E.3.1	Pre FFT minimization process.....	1394
E.3.2	Timing of the FFT window	1395
E.3.3	Post FFT equalisation.....	1396
E.4	Derivation of the results	1397
E.4.1	EVM.....	1397
E.4.2	Averaged EVM	1397
E.4.3	In-band emissions measurement.....	1398
E.4.4	EVM equalizer	1400
E.4.4.1	EVM equalizer spectrum flatness.....	1400
E.4.4.2	EVM equalizer spectral shaping filter	1401
E.4.5	Frequency error and Carrier leakage	1401
E.4.6	EVM of Demodulation reference symbols (EVM _{DMRS})	1401
E.4.6.1	1 st average for EVM _{DMRS}	1402
E.4.6.2	Final average for EVM _{DMRS}	1402
E.4.7	Modified signal under test.....	1402
E.5	EVM and inband emissions for PUCCH.....	1405
E.5.1	Basic principle.....	1405
E.5.2	Output signal of the TX under test	1405
E.5.3	Reference signal	1405
E.5.4	Measurement results.....	1405
E.5.5	Measurement points	1405
E.5.6	Pre FFT minimization process.....	1405

E.5.7	Timing of the FFT window	1406
E.5.8	Post FFT equalisation.....	1406
E.5.9	Derivation of the results	1407
E.5.9.1	EVM _{PUCCH}	1407
E.5.9.2	Averaged EVM _{PUCCH}	1407
E.5.9.3	In-band emissions measurement	1407
E.6	EVM for PRACH	1409
E.6.1	Basic principle.....	1409
E.6.2	Output signal of the TX under test	1409
E.6.3	Reference signal	1409
E.6.4	Measurement results.....	1409
E.6.5	Measurement points	1409
E.6.6	Pre FFT minimization process.....	1410
E.6.7	Timing of the FFT window	1410
E.6.8	Post FFT equalisation.....	1411
E.6.9	Derivation of the results	1411
E.6.9.1	EVM _{PRACH}	1411
E.6.9.2	Averaged EVM _{PRACH}	1412
Annex F (normative): Measurement uncertainties and Test Tolerances		1413
F.1	Acceptable uncertainty of Test System (normative)	1413
F.1.1	Measurement of test environments.....	1413
F.1.2	Measurement of transmitter.....	1414
F.1.3	Measurement of receiver	1424
F.2	Interpretation of measurement results (normative)	1428
F.3	Test Tolerance and Derivation of Test Requirements (informative).....	1429
F.3.1	Measurement of test environments.....	1429
F.3.2	Measurement of transmitter.....	1430
F.3.3	Measurement of receiver	1438
F.4	Uplink power window	1441
F.4.1	Introduction	1441
F.4.2	Setting the power window above a requirement.....	1441
F.4.2.1	NR FR1	1441
F.4.3	Setting the power window below a requirement	1441
F.4.3.1	NR FR1	1441
F.4.4	Setting the power window centred on a target value	1441
F.4.4.1	NR FR1	1441
Annex G (normative): Uplink Physical Channels		1442
G.0	Uplink Signal Levels	1442
G.1	General	1442
G.2	Set-up	1444
G.3	Connection	1444
G.3.0	Measurement of Transmitter Characteristics	1444
G.3.1	Measurement of Receiver Characteristics	1444
G.3.2	Measurement of Performance Requirements.....	1444
Annex H (normative): Statistical Testing.....		1445
H.1	General	1445
H.2	Statistical testing of receiver characteristics.....	1445
H.2.1	General	1445
H.2.2	Mapping throughput to error ratio.....	1445
H.2.3	Design of the test.....	1446
H.2.4	Numerical definition of the pass fail limits	1447
H.2.5	Pass fail decision rules	1448

H.2.6	Theory to derive the pass fail limits (Informative).....	1448
H.2.6.1	Numerical definition of the pass-fail limits	1448
H.2.6.2	Simulation to derive the pass-fail limits for testing 95% throughput.....	1449
H.2A	Statistical testing of receiver characteristics with CA.....	1450
H.2A.1	General	1450
H.2A.2	Mapping throughput to error ratio.....	1450
H.2A.3	Design of the test.....	1450
H.2A.4	Pass fail decision rules	1450
Annex I (informative):	Change history	1451
History		1486

Foreword

This Technical Specification has been produced by the 3rd Generation Partnership Project (3GPP).

The contents of the present document are subject to continuing work within the TSG and may change following formal TSG approval. Should the TSG modify the contents of the present document, it will be re-released by the TSG with an identifying change of release date and an increase in version number as follows:

Version x.y.z

where:

- x the first digit:
 - 1 presented to TSG for information;
 - 2 presented to TSG for approval;
 - 3 or greater indicates TSG approved document under change control.
- y the second digit is incremented for all changes of substance, i.e. technical enhancements, corrections, updates, etc.
- z the third digit is incremented when editorial only changes have been incorporated in the document.

The present document is one part of a multi-part Technical Specification (TS) covering the New Radio (NR) User Equipment (UE) conformance specification, which is divided in the following parts:

- 3GPP TS 38.521-1: " NR; User Equipment (UE) conformance specification; Radio transmission and reception; Part 1: Range 1 Standalone" (the present document).
- 3GPP TS 38.521-2 [13]: " NR; User Equipment (UE) conformance specification; Radio transmission and reception; Part 2: Range 2 Standalone".
- 3GPP TS 38.521-3 [14]: "NR; User Equipment (UE) conformance specification; Radio transmission and reception; Part 3: Range 1 and Range 2 Interworking operation with other radios"
- 3GPP TS 38.521-4 [15]: "NR; User Equipment (UE) conformance specification; Radio transmission and reception; Part 4: Performance".
- 3GPP TS 38.522 [16]: NR; User Equipment (UE) conformance specification; Applicability of RF and RRM test cases;
- 3GPP TS 38.533 [17]: NR; User Equipment (UE) conformance specification; Radio resource management;

1 Scope

The present document specifies the measurement procedures for the conformance test of the user equipment (UE) that contain RF characteristics for frequency Range 1 as part of the 5G-NR.

The requirements are listed in different clauses only if the corresponding parameters deviate. More generally, tests are only applicable to those mobiles that are intended to support the appropriate functionality. To indicate the circumstances in which tests apply, this is noted in the "*definition and applicability*" part of the test.

For example only Release 15 and later UE declared to support 5G-NR shall be tested for this functionality. In the event that for some tests different conditions apply for different releases, this is indicated within the text of the test itself.

2 References

The following documents contain provisions which, through reference in this text, constitute provisions of the present document.

References are either specific (identified by date of publication, edition number, version number, etc.) or non-specific.

For a specific reference, subsequent revisions do not apply.

For a non-specific reference, the latest version applies. In the case of a reference to a 3GPP document (including a GSM document), a non-specific reference implicitly refers to the latest version of that document in the same Release as the present document.

- [1] 3GPP TR 21.905: "Vocabulary for 3GPP Specifications".
- [2] 3GPP TS 38.101-1: "NR; User Equipment (UE) radio transmission and reception; Part 1: Range 1 Standalone".
- [3] 3GPP TS 38.101-2: " NR; User Equipment (UE) radio transmission and reception; Part 2: Range 2 Standalone".
- [4] 3GPP TS 38.101-3: " NR; User Equipment (UE) radio transmission and reception; Part 3: Range 1 and Range 2 Interworking operation with other radios".
- [5] 3GPP TS 38.508-1: "5GS; User Equipment (UE) conformance specification; Part 1: Common test environment".
- [6] 3GPP TS 38.331: "NR; Radio Resource Control (RRC); Protocol specification".
- [7] Recommendation ITU-R M.1545: "Measurement uncertainty as it applies to test limits for the terrestrial component of International Mobile Telecommunications-2000".
- [8] 3GPP TS 38.211: "NR; Physical channels and modulation".
- [9] 3GPP TS 38.213: "NR; Physical layer procedures for control".
- [10] 3GPP TR 38.903: "NR; Derivation of test tolerances and measurement uncertainty for User Equipment (UE) conformance tests".
- [11] 3GPP TR 38.905: "NR; Derivation of test points for radio transmission and reception conformance test cases".
- [12] 3GPP TS 38.214: "NR; Physical layer procedures for data".
- [13] 3GPP TS 38.521-2: "NR; User Equipment (UE) conformance specification; Radio transmission and reception; Part 2: Range 2 Standalone".
- [14] 3GPP TS 38.521-3: "NR; User Equipment (UE) conformance specification; Radio transmission and reception; Part 3: Range 1 and Range 2 Interworking operation with other radios".
- [15] 3GPP TS 38.521-4: "NR; User Equipment (UE) conformance specification; Radio transmission and reception; Part 4: Performance".

- [16] 3GPP TS 38.522: "NR; User Equipment (UE) conformance specification; Applicability of RF and RRM test cases".
- [17] 3GPP TS 38.533: "NR; User Equipment (UE) conformance specification; Applicability of RF and RRM test cases".
- [18] 3GPP TS 38.321: "NR; Medium Access Control (MAC) protocol specification".
- [19] 3GPP TS 38.133: "NR; Requirements for support of radio resource management".
- [20] 3GPP TS 38.215: "NR; Physical layer measurements".
- [21] 3GPP TS 36.521-1: "Evolved Universal Terrestrial Radio Access (E-UTRA); User Equipment (UE) conformance specification; Radio transmission and reception; Part 1: Conformance Testing".
- [22] ITU-R Recommendation SM.329-10, "Unwanted emissions in the spurious domain".
- [23] 3GPP TS 38.307: "NR; Requirements on User Equipments (UEs) supporting a release-independent frequency band".
- [24] 3GPP TS 37.213: "Physical layer procedures for shared spectrum channel access".
- [25] 3GPP TS 36.508: "Common test environments for User Equipment (UE)"

3 Definitions, symbols and abbreviations

3.1 Definitions

For the purposes of the present document, the terms and definitions given in TR 21.905 [1] and the following apply. A term defined in the present document takes precedence over the definition of the same term, if any, in TR 21.905 [1].

Aggregated Channel Bandwidth: The RF bandwidth in which a UE transmits and receives multiple contiguously aggregated carriers.

Carrier aggregation: Aggregation of two or more component carriers in order to support wider transmission bandwidths.

Carrier aggregation band: A set of one or more operating bands across which multiple carriers are aggregated with a specific set of technical requirements.

Carrier aggregation bandwidth class: A class defined by the aggregated transmission bandwidth configuration and maximum number of component carriers supported by a UE.

Carrier aggregation configuration: A combination of CA operating band(s) and CA bandwidth class(es) supported by a UE.

Con-current operation: The simultaneous transmission and reception of sidelink and Uu interfaces while operation is agnostic of the service used on each interface.

Contiguous carriers: A set of two or more carriers configured in a spectrum block where there are no RF requirements based on co-existence for un-coordinated operation within the spectrum block.

Contiguous resource allocation: A resource allocation of consecutive resource blocks within one carrier or across contiguously aggregated carriers. The gap between contiguously aggregated carriers due to the nominal channel spacing is allowed.

Contiguous spectrum: Spectrum consisting of a contiguous block of spectrum with no sub-block gaps.

Inter-band carrier aggregation: Carrier aggregation of component carriers in different operating bands.

NOTE: Carriers aggregated in each band can be contiguous or non-contiguous.

Intra-band contiguous carrier aggregation: Contiguous carriers aggregated in the same operating band.

Intra-band non-contiguous carrier aggregation: Non-contiguous carriers aggregated in the same operating band.

RedCap UE: A UE capable of supporting RedCap [IE].

Sub-band: For a UE that supports shared spectrum channel access in wideband operation, a sub-band is the set of RBs within an approximately 20 MHz segment of the channel where the wideband channel is uniformly divided into an integer number of 20 MHz sub-bands. Sub-bands may be separately allocated in uplink and downlink.

Sub-block: This is one contiguous allocated block of spectrum for transmission and reception by the same UE. There may be multiple instances of sub-blocks within an RF bandwidth.

Sub-block bandwidth: The bandwidth of one sub-block.

Sub-block gap: A frequency gap between two consecutive sub-blocks within an RF bandwidth, where the RF requirements in the gap are based on co-existence for un-coordinated operation.

UE transmission bandwidth configuration: Set of resource blocks located within the UE channel bandwidth which may be used for transmitting or receiving by the UE.

Vehicular UE: A UE embedded in a vehicle, permanently connected to an embedded antenna system that radiates externally for NR operating bands.

NOTE: Vehicular UE does not refer to other UE form factors placed inside the vehicle.

Wideband operation: For a UE that supports shared spectrum channel access, wideband operation refers to operation within a channel larger than 20 MHz in which intra-cell guard bands may be configured to distinguish individual RB-sets

3.2 Symbols

For the purposes of the present document, the following symbols apply:

ΔF_{Global}	Granularity of the global frequency raster
ΔF_{Raster}	Band dependent channel raster granularity
Δf_{OOB}	Δ Frequency of Out Of Band emission
$\Delta F_{\text{TX-RX}}$	Δ Frequency of default TX-RX separation of the FDD operating band
ΔMPR_c	Allowed Maximum Power Reduction relaxation for serving cell c
$\Delta P_{\text{PowerClass}}$	Adjustment to maximum output power for a given power class
ΔR_{1R}	Reference sensitivity adjustment due to support for 1 antenna ports
ΔR_{B}	The starting frequency offset between the allocated RB and the measured non-allocated RB
$\Delta R_{\text{IB},c}$	Allowed reference sensitivity relaxation due to support for inter-band CA operation, for serving cell c
$\Delta R_{\text{IB},4R}$	Reference sensitivity adjustment due to support for 4 antenna ports
ΔShift	Channel raster offset
ΔT_c	Allowed operating band edge transmission power relaxation
$\Delta T_{c,c}$	Allowed operating band edge transmission power relaxation for serving cell c
$\Delta T_{\text{IB},c}$	Allowed maximum configured output power relaxation due to support for inter-band CA operation and due to support for SUL operations, for serving cell c
$\text{BW}_{\text{Channel}}$	Channel bandwidth
$\text{BW}_{\text{Channel,block}}$	Sub-block bandwidth, expressed in MHz. $\text{BW}_{\text{Channel,block}} = F_{\text{edge,block,high}} - F_{\text{edge,block,low}}$
$\text{BW}_{\text{Channel_CA}}$	Aggregated channel bandwidth, expressed in MHz
$\text{BW}_{\text{Channel,max}}$	Maximum channel bandwidth supported among all bands in a release
BW_{GB}	$\max(\text{BW}_{\text{GB,Channel}(k)})$
$\text{BW}_{\text{GB,Channel}(k)}$	Minimum guard band defined in clause 5.3A.1 of carrier k
BW_{DL}	Channel bandwidth for DL
BW_{UL}	Channel bandwidth for UL
$\text{BW}_{\text{interferer}}$	Bandwidth of the interferer
$\text{Ceil}(x)$	Rounding upwards; $\text{ceil}(x)$ is the smallest integer such that $\text{ceil}(x) \geq x$
$\text{Floor}(x)$	Rounding downwards; $\text{floor}(x)$ is the greatest integer such that $\text{floor}(x) \leq x$
F_c	RF reference frequency on the channel raster, given in table 5.4.2.2-1
$F_{c,\text{block,high}}$	F_c of the highest transmitted/received carrier in a sub-block
$F_{c,\text{block,low}}$	F_c of the lowest transmitted/received carrier in a sub-block
$F_{c,\text{low}}$	The F_c of the lowest carrier, expressed in MHz
$F_{c,\text{high}}$	The F_c of the highest carrier, expressed in MHz
$F_{\text{DL_low}}$	The lowest frequency of the downlink operating band

F_{DL_high}	The highest frequency of the downlink operating band
F_{UL_low}	The lowest frequency of the uplink operating band
F_{UL_high}	The highest frequency of the uplink operating band
$F_{edge,block,low}$	The lower sub-block edge, where $F_{edge,block,low} = F_{C,block,low} - F_{offset,low}$
$F_{edge,block,high}$	The upper sub-block edge, where $F_{edge,block,high} = F_{C,block,high} + F_{offset,high}$
$F_{edge,low}$	The <i>lower edge</i> of aggregated channel bandwidth, expressed in MHz. $F_{edge,low} = F_{C,low} - F_{offset,low}$
$F_{edge,high}$	The <i>higher edge</i> of aggregated channel bandwidth, expressed in MHz. $F_{edge,high} = F_{C,high} + F_{offset,high}$
$F_{interferer} (offset)$	Frequency offset of the interferer (between the center frequency of the interferer and the carrier frequency of the carrier measured)
$F_{interferer}$	Frequency of the interferer
F_{offset}	Frequency offset of the interferer (between the center frequency of the interferer and the closest edge of the carrier measured)
$F_{offset,high}$	Frequency offset from $F_{C,high}$ to the <i>higher edge</i> or $F_{C,low}$ to the <i>lower edge</i>
$F_{offset,low}$	Frequency offset from $F_{C,high}$ to the upper <i>UE RF Bandwidth edge</i> , or from $F_{C,block,high}$ to the upper sub-block edge
$F_{offset,low}$	Frequency offset from $F_{C,low}$ to the lower <i>UE RF Bandwidth edge</i> , or from $F_{C,block,low}$ to the lower sub-block edge
F_{OOB}	The boundary between the NR out of band emission and spurious emission domains
F_{REF}	RF reference frequency
$F_{REF-Offs}$	Offset used for calculating F_{REF}
$F_{REF,Shift}$	RF reference frequency for Supplementary Uplink (SUL) bands and for the uplink for all FDD bands
$F_{uw} (offset)$	The frequency separation of the center frequency of the carrier closest to the interferer and the center frequency of the interferer
$GB_{Channel}$	Minimum guard band defined in clause 5.3.3
L_{CRB}	Transmission bandwidth which represents the length of a contiguous resource block allocation expressed in units of resources blocks
$Max()$	The largest of given numbers
$Min()$	The smallest of given numbers
n_{PRB}	Physical resource block number
NR_{ACLR}	NR ACLR
N_{RB}	Transmission bandwidth configuration, expressed in units of resource blocks
N_{RB_agg}	The number of the aggregated RBs within the fully allocated aggregated channel bandwidth
$N_{RB_agg} = \sum_1^j N_{RB_j} * 2^{\mu_j}$	for carrier 1 to j, where μ is defined in TS 38.211 [8]
$N_{RB,c}$	The transmission bandwidth configuration of component carrier c, expressed in units of resource blocks
$N_{RB,c,j} = N_{RB_j} * 2^{\mu_j}$	for carrier j, where μ is defined in TS 38.211 [8]
$N_{RB,largest\ BW}$	The largest transmission bandwidth configuration of the component carriers in the bandwidth combination, expressed in units of resource blocks
$N_{RB,low}$	The transmission bandwidth configurations according to Table 5.3.2-1 for the lowest assigned component carrier in clause 5.3A.1
$N_{RB,high}$	The transmission bandwidth configurations according to Table 5.3.2-1 for the highest assigned component carrier in clause 5.3A.1
N_{REF}	NR Absolute Radio Frequency Channel Number (NR-ARFCN)
$N_{REF-Offs}$	Offset used for calculating N_{REF}
$P_{C_{MAX}}$	The configured maximum UE output power
$P_{C_{MAX},c}$	The configured maximum UE output power for serving cell c
$P_{C_{MAX},f,c}$	The configured maximum UE output power for carrier f of serving cell c in each slot
P_{EMAX}	Maximum allowed UE output power signalled by higher layers
$P_{EMAX,c}$	Maximum allowed UE output power signalled by higher layers for serving cell c
$P_{Interferer}$	Modulated mean power of the interferer
$P_{largest\ BW}$	Power of the largest transmission bandwidth configuration of the component carriers in the bandwidth combination
$P_{PowerClass}$	The nominal UE power (i.e., no tolerance)
$P-MPR_c$	Power Management Maximum Power Reduction for serving cell c
P_{RB}	The transmitted power per allocated RB, measured in dBm
P_{UMAX}	The measured configured maximum UE output power
P_{uw}	Power of an unwanted DL signal
P_w	Power of a wanted DL signal
RB_{Start}	Indicates the lowest RB index of transmitted resource blocks

RB_{start_CA}	Indicates the lowest RB index of transmitted resource blocks for intra-band contiguous CA
SCS_c	SCS for the component carrier c
$SCS_{largest\ BW}$	SCS for the largest transmission bandwidth configuration of the component carriers in the bandwidth combination
SCS_{low}	SCS for the lowest assigned component carrier in section 5.3A.1
SCS_{high}	SCS for the highest assigned component carrier in section 5.3A.1
tp	Transient Period value signalled by the UE
tp_{start}	Start position of transient period relative to the symbol boundary
$T(P_{CMAX, f, c})$	Tolerance for applicable values of $P_{CMAX, f, c}$ for configured maximum UE output power for carrier f of serving cell c
$T_{L,c}$	Absolute value of the lower tolerance for the applicable <i>operating band</i> as specified in section 6.2.1
SS_{REF}	SS block reference frequency position
$UTRA_{ACLR}$	UTRA ACLR

3.3 Abbreviations

For the purposes of the present document, the abbreviations given in 3GPP TR 21.905 [1] and the following apply. An abbreviation defined in the present document takes precedence over the definition of the same abbreviation, if any, in 3GPP TR 21.905 [1].

ACLR	Adjacent Channel Leakage Ratio
ACS	Adjacent Channel Selectivity
A-MPR	Additional Maximum Power Reduction
BS	Base Station
BW	Bandwidth
BWP	Bandwidth Part
CA	Carrier Aggregation
CA_{nX-nY}	Inter-band CA of component carrier(s) in one sub-block within Band nX and component carrier(s) in one sub-block within Band nY where nX and nY are the applicable NR <i>operating bands</i>
CC	Component Carriers
CG	Carrier Groups
CM	Cubic Metric
CORESET	Control Resource Set
CP-OFDM	Cyclic Prefix-OFDM
CW	Continuous Wave
DC	Dual Connectivity
DCI	Downlink Control Information
DFT-s-OFDM	Discrete Fourier Transform-spread-OFDM
DL	Downlink
DM-RS	Demodulation Reference Signal
DTX	Discontinuous Transmission
EIRP	Equivalent Isotropically Radiated Power
E-UTRA	Evolved UTRA
EVM	Error Vector Magnitude
FFT	Fast Fourier Transformation
FR	Frequency Range
FRC	Fixed Reference Channel
GNSS	Global Navigation Satellite System
GSCN	Global Synchronization Channel Number
HARQ	Hybrid Automatic Repeat Request
IBB	In-band Blocking
IDFT	Inverse Discrete Fourier Transformation
IE	Information Element
ITS	Intelligent Transportation System
ITU-R	Radio communication Sector of the International Telecommunication Union
MBW	Measurement bandwidth defined for the protected band
MCG	Master Cell Group
MOP	Maximum Output Power
MPR	Allowed maximum power reduction
MSD	Maximum Sensitivity Degradation
MU	Measurement Uncertainty

NR	New Radio
NR/5GC	NR connected to 5GC
NR-ARFCN	NR Absolute Radio Frequency Channel Number
NS	Network Signalling
NSA	Non-Standalone
OCNG	OFDMA Channel Noise Generator
OOB	Out-of-band
PBCH	Physical Broadcast Channel
PDCCH	Physical Downlink Control Channel
PDSCH	Physical Downlink Shared Channel
P-MPR	Power Management Maximum Power Reduction
PRACH	Physical Random Access Channel
PRB	Physical Resource Block
PSCCH	Physical Sidelink Control CHannel
PSSCH	Physical Sidelink Shared CHannel
QAM	Quadrature Amplitude Modulation
RB	Resource Block
RE	Resource Element
RedCap	Reduced Capability
REFSENS	Reference Sensitivity
RF	Radio Frequency
RMC	Reference Measurement Channel
RMS	Root Mean Square (value)
RNTI	Radio Network Temporary Identity
RoT	Rise Over Thermal
RSRP	Reference Signal Receiving Power
Rx	Receiver
SA	Standalone
SC	Single Carrier
SCG	Secondary Cell Group
SCS	Subcarrier spacing
SDL	Supplementary Downlink
SEM	Spectrum Emission Mask
SL	Sidelink
SL-MIMO	Sidelink-Multiple Antenna transmission
SNR	Signal-to-Noise Ratio
SRS	Sounding Reference Symbol
SUL	Supplementary uplink
SS	Synchronization Symbol
SS	System Simulator
TAE	Time Alignment Error
TAG	Timing Advance Group
TPC	Transmit Power Control
TT	Test Tolerances
Tx	Transmitter
UE	User Equipment
UL	Uplink
UL MIMO	Uplink Multiple Antenna transmission
ULFPTx	Uplink Full Power Transmission
V2X	Vehicle to Everything

4 General

4.1 Relationship between minimum requirements and test requirements

The TS 38.101-1 [2] is a Single-RAT specification for NR UE, covering RF characteristics and minimum performance requirements. Conformance to the TS 38.101-1 [2] is demonstrated by fulfilling the test requirements specified in the present document.

The Minimum Requirements given in TS 38.101-1 [2] make no allowance for measurement uncertainty (MU). The present document defines test tolerances (TT) and measurement uncertainty. These test tolerances are individually defined for each test. The test tolerances are used to relax the minimum requirements in TS 38.101-1 [2] to create test requirements. For some requirements, including regulatory requirements, the test tolerance is set to zero.

The measurement results returned by the test system are compared - without any modification - against the test requirements as defined by various levels of “Shared Risk” principle as described below.

- a) Core specification value is not relaxed by any relaxation value ($TT=0$). For each single measurement, the probability of a borderline good UE being judged as FAIL equals the probability of a borderline bad UE being judged as PASS.
 - Test tolerances equal to 0 ($TT=0$) are considered in this specification.
- b) Core specification value is relaxed by a relaxation value ($TT>0$). For each single measurement, the probability of a borderline bad UE being judged as PASS is greater than the probability of a borderline good UE being judged as FAIL.
 - Test tolerances lower than measurement uncertainty and greater than 0 ($0 < TT < MU$) are considered in this specification.
 - Test tolerances high up to measurement uncertainty ($TT = MU$) are considered in this specification which is also known as “Never fail a good DUT” principle.
- c) Core specification value is tightened by a stringent value ($TT<0$). For each single measurement, the probability of a borderline good UE being judged as FAIL is greater than the probability of a borderline bad UE being judged as PASS.

Test tolerances lower than 0 ($TT<0$) are not considered in this specification. The “Never fail a good DUT” and the “Shared Risk” principles are defined in Recommendation ITU-R M.1545 [7].

4.2 Applicability of minimum requirements

- a) In TS 38.101-1 [2] the Minimum Requirements are specified as general requirements and additional requirements. Where the Requirement is specified as a general requirement, the requirement is mandated to be met in all scenarios
- b) For specific scenarios for which an additional requirement is specified, in addition to meeting the general requirement, the UE is mandated to meet the additional requirements.
- c) The spurious emissions power requirements are for the long-term average of the power. For the purpose of reducing measurement uncertainty it is acceptable to average the measured power over a period of time sufficient to reduce the uncertainty due to the statistical nature of the signal.
- d) All the requirements for intra-band contiguous and non-contiguous CA apply under the assumption of the same slot format indicated by UL-DL-configuration-common in the PCell and SCells for NR/5GC.

4.3 Specification suffix information

Unless stated otherwise the following suffixes are used for indicating at 2nd level subclause, shown in Table 4.3-1.

Table 4.3-1: Definition of suffixes

Clause suffix	Variant
None	Single Carrier
A	Carrier Aggregation (CA)
B	Dual-Connectivity (DC)
C	Supplement Uplink (SUL)
D	UL MIMO
E	V2X
F	Shared spectrum channel access
I	RedCap

A terminal which supports the above features needs to meet both the general requirements and the additional requirement applicable to the additional subclause (suffixes A to F) in clauses 5, 6 and 7. Where there is a difference in requirement between the general requirements and the additional subclause requirements (suffixes A to F) in clauses 5, 6 and 7, the tighter requirements are applicable unless stated otherwise in the additional subclause.

A terminal which supports more than one feature in clauses 5, 6 and 7 shall meet all of the separate corresponding requirements.

For a terminal that supports SUL for the band combination specified in Table 5.2C-1, the current version of the specification assumes the terminal is configured with active transmission either on UL carrier or SUL carrier at any time in one serving cell and the UE requirements for single carrier shall apply for the active UL or SUL carrier accordingly. For a terminal that supports SUL, the current version of the specification assumes the terminal is not configured with UL MIMO on SUL carrier.

For a terminal that supports operation in shared spectrum, the current version of this specification assumes in the uplink sub-bands within a wideband channel shall be contiguously allocated to the UE. The uplink requirements for one or more non-transmitted sub-bands between two transmitted sub-bands does not form a part of the current version of this specification.

4.4 Test points analysis

The information on test point analysis and test point selection including number of test points for each test case is shown in TR 38.905 [11] clause 4.1.

4.5 Applicability and test coverage rules

The applicability and test coverage rules for NR/5GC and EN-DC capable devices shall include the following:

If a test case for a FR1 NR band in a device is tested in EN-DC mode inter-band operation for non-exceptional requirement as per TS 38.521-3 [14], it shall fulfil the coverage requirement for that test case for NR/5GC FR1 test requirements for that NR band and need not be retested.

Editor's Note: The Clause number 4.5 already exists in the specification. so the clause number was changed to 4.6:

4.6 Pass fail decision rule of test case

Unless explicitly specified, a test case is passed only when all the measurements in the test case are passed. A measurement is one execution of the test procedures using a specific combination of various conditions, including test configuration, testing UL/DL power level, frequency location of interference and sweeping frequency location of emission measurement etc. If multiple component carriers are involved in one measurement, the measurement is passed only when all the component carriers are passed.

5 Operating bands and Channel arrangement

5.1 General

The channel arrangements presented in this clause are based on the operating bands and channel bandwidths defined in the present release of specifications.

NOTE: Other operating bands and channel bandwidths may be considered in future releases.

Requirements throughout the RF specifications are in many cases defined separately for different frequency ranges (FR). The frequency ranges in which NR can operate according to this version of the specification are identified as described in Table 5.1-1.

Table 5.1-1: Definition of frequency ranges

Frequency range designation	Corresponding frequency range
FR1	410 MHz – 7125 MHz
FR2	24250 MHz – 52600 MHz

The present specification covers FR1 operating bands.

5.2 Operating bands

NR is designed to operate in the FR1 operating bands defined in Table 5.2-1.

Table 5.2-1: NR operating bands in FR1

NR operating band	Uplink (UL) operating band BS receive / UE transmit $F_{UL_low} - F_{UL_high}$	Downlink (DL) operating band BS transmit / UE receive $F_{DL_low} - F_{DL_high}$	Duplex Mode
n1	1920 MHz – 1980 MHz	2110 MHz – 2170 MHz	FDD
n2	1850 MHz – 1910 MHz	1930 MHz – 1990 MHz	FDD
n3	1710 MHz – 1785 MHz	1805 MHz – 1880 MHz	FDD
n5	824 MHz – 849 MHz	869 MHz – 894 MHz	FDD
n7	2500 MHz – 2570 MHz	2620 MHz – 2690 MHz	FDD
n8	880 MHz – 915 MHz	925 MHz – 960 MHz	FDD
n12	699 MHz – 716 MHz	729 MHz – 746 MHz	FDD
n14	788 MHz – 798 MHz	758 MHz – 768 MHz	FDD
n20	832 MHz – 862 MHz	791 MHz – 821 MHz	FDD
n24 ¹⁶	1626.5 MHz – 1660.5 MHz	1525 MHz – 1559 MHz	FDD
n25	1850 MHz – 1915 MHz	1930 MHz – 1995 MHz	FDD
n26	814 MHz – 849 MHz	859 MHz – 894 MHz	FDD
n28	703 MHz – 748 MHz	758 MHz – 803 MHz	FDD
n29	N/A	717 MHz – 728 MHz	SDL
n30 ³	2305 MHz – 2315 MHz	2350 MHz – 2360 MHz	FDD
n34	2010 MHz – 2025 MHz	2010 MHz – 2025 MHz	TDD
n38 ¹⁰	2570 MHz – 2620 MHz	2570 MHz – 2620 MHz	TDD
n39	1880 MHz – 1920 MHz	1880 MHz – 1920 MHz	TDD
n40	2300 MHz – 2400 MHz	2300 MHz – 2400 MHz	TDD
n41	2496 MHz – 2690 MHz	2496 MHz – 2690 MHz	TDD
n46	5150 MHz – 5925 MHz	5150 MHz – 5925 MHz	TDD ¹³
n47 ¹¹	5855 MHz – 5925 MHz	5855 MHz – 5925 MHz	TDD
n48	3550 MHz – 3700 MHz	3550 MHz – 3700 MHz	TDD
n51	1427 MHz – 1432 MHz	1427 MHz – 1432 MHz	TDD
n53	2483.5 MHz – 2495 MHz	2483.5 MHz – 2495 MHz	TDD
n65	1920 MHz – 2010 MHz	2110 MHz – 2200 MHz	FDD ⁴
n66	1710 MHz – 1780 MHz	2110 MHz – 2200 MHz	FDD
n70	1695 MHz – 1710 MHz	1995 MHz – 2020 MHz	FDD
n71	663 MHz – 698 MHz	617 MHz – 652 MHz	FDD
n74	1427 MHz – 1470 MHz	1475 MHz – 1518 MHz	FDD
n75	N/A	1432 MHz – 1517 MHz	SDL
n76	N/A	1427 MHz – 1432 MHz	SDL
n77 ¹²	3300 MHz – 4200 MHz	3300 MHz – 4200 MHz	TDD
n78	3300 MHz – 3800 MHz	3300 MHz – 3800 MHz	TDD
n79	4400 MHz – 5000 MHz	4400 MHz – 5000 MHz	TDD
n81	880 MHz – 915 MHz	N/A	SUL
n82	832 MHz – 862 MHz	N/A	SUL
n84	1920 MHz – 1980 MHz	N/A	SUL
n95 ⁸	2010 MHz – 2025 MHz	N/A	SUL
n96 ¹⁴	5925 MHz – 7125 MHz	5925 MHz – 7125 MHz	TDD ¹³
n97 ¹⁵	2300 MHz – 2400 MHz	N/A	SUL
n99 ¹⁶	1626.5 MHz – 1660.5 MHz	N/A	SUL

NOTE 1:	UE that complies with the NR Band n50 minimum requirements in this specification. Shall also comply with the NR Band n51 minimum requirements.
NOTE 2:	UE that complies with the NR Band n75 minimum requirements in this specification. Shall also comply with the NR Band n76 minimum requirements.
NOTE 3:	Uplink transmission is not allowed at this band for UE with external vehicle-mounted antennas.
NOTE 4:	A UE that complies with the NR Band n65 minimum requirements in this specification shall also comply with the NR Band n1 minimum requirements.
NOTE 5:	FFS.
NOTE 6:	A UE that supports NR Band n66 shall receive in the entire DL operating band.
NOTE 7:	A UE that supports NR Band n66 and CA operation in any CA band shall also comply with the minimum requirements specified for the DL CA configurations CA_n66B and CA_n66(2A) in the current version of the specification.
NOTE 8:	This band is applicable in China only.
NOTE 9:	FFS.
NOTE 10:	When this band is used for V2X SL service, the band is exclusively used for NR V2X in particular regions.
NOTE 11:	This band is unlicensed band used for V2X service. There is no expected network deployment in this band.
NOTE 12:	In the USA this band is restricted to 3450 – 3550 MHz and 3700 – 3980 MHz.
NOTE 13:	This band is restricted to operation with shared spectrum channel access as defined in 37.213 [24].
NOTE 14:	This band is applicable in the USA only subject to FCC Report and Order FCC 20-51
NOTE 15:	The requirements for this band are applicable only where no other NR or E-UTRA TDD operating band(s) are used within the frequency range of this band in the same geographical area. For scenarios where other NR or E-UTRA TDD operating band(s) are used within the frequency range of this band in the same geographical area, special co-existence requirements may apply that are not covered by the 3GPP specifications.
NOTE 16:	DL operation in this band is restricted to 1526 – 1536 MHz and UL operation is restricted to 1627.5 – 1637.5 MHz and 1646.5 – 1656.5 MHz.

5.2A Operating bands for CA

5.2A.1 Intra-band CA

NR intra-band contiguous carrier aggregation is designed to operate in the operating bands defined in Table 5.2A.1-1 and Table 5.2A.1-2, where all operating bands are within FR1.

Table 5.2A.1-1: Intra-band contiguous CA operating bands in FR1

NR CA Band	NR Band (Table 5.2-1)
CA_n40	n40
CA_n41 ¹	n41
CA_n46 ¹	n46
CA_n48	n48
CA_n66	n66
CA_n77 ¹	n77
CA_n78 ¹	n78
CA_n79 ¹	n79
NOTE 1: The minimum requirements only apply for R15 non-simultaneous Tx/Rx between all carriers for TDD combinations. In R16,R17,this note is not applicable.	

Table 5.2A.1-2: Intra-band non-contiguous CA operating bands in FR1

NR CA Band	NR Band (Table 5.2-1)
CA_n48(*)	n48
CA_n66(*)	n66
CA_n71(*)	n71
CA_n77(*)	n77
CA_n78(*)	n78
NOTE 1: The minimum requirements only apply for non simultaneous Tx/Rx between all carriers. for TDD combinations.	
NOTE 2: The notation CA_nX(*) in this table indicates intra-band non-contiguous CA for band nX. The configurations for each band are in 5.5A.2.	

5.2A.2 Inter-band CA

NR inter-band carrier aggregation is designed to operate in the operating bands defined in Table 5.2A.2.1-1, 5.2A.2.2-1 and Table 5.2A.2.3-1, where all operating bands are within FR1.

If the mandatory simultaneous Rx/Tx capability applies for a band combination, the mandatory simultaneous Rx/Tx capability also applies for the band combination when the applicable band combination is a subset of a higher order band combination.

Table 5.2A.2-1: Void

Table 5.2A.2-2: Void

Table 5.2A.2-3: Void

5.2A.2.1 Inter-band CA (two bands)

Table 5.2A.2.1-1: Inter-band CA operating bands involving FR1 (two bands)

NR CA Band	NR Band (Table 5.2-1)	DL interruption allowed (Note 8)
CA_n1-n3	n1, n3	
CA_n1-n8	n1, n8	
CA_n1-n77	n1, n77	No
CA_n1-n78	n1, n78	No
CA_n1-n79	n1, n79	No
CA_n3-n5	n3, n5	
CA_n3-n41 ¹	n3, n41	No
CA_n3-n77 ¹	n3, n77	No
CA_n3-n78 ¹	n3, n78	No
CA_n3-n79 ¹	n3, n79	No
CA_n5-n7	n5, n7	
CA_n5-n78 ¹	n5, n78	No
CA_n7-n78 ¹	n7, n78	
CA_n8-n75 ¹	n8, n75	
CA_n8-n78 ¹	n8, n78	No
CA_n8-n79 ¹	n8, n79	No
CA_n24-n41	n24, n41	
CA_n24-n48	n24, n48	
CA_n24-n77	n24, n77	
CA_n25-n46 ⁶	n25, n46	
CA_n26-n66	n26, n66	
CA_n26-n70	n26, n70	
CA_n28-n41	n28, n41	
CA_n28-n75 ²	n28, n75	
CA_n28_n78 ¹	n28, n78	No
CA_n28-n79	n28, n79	
CA_n29-n66	n29, n66	
CA_n29-n70	n29, n70	
CA_n29-n71	n29, n71	
CA_n41-n78 ¹	n41, n78	
CA_n41-n79 ³	n41, n79	No
CA_n46-n48 ⁶	n46, n48	
CA_n46-n66 ⁶	n46, n66	
CA_n48-n66	n48, n66	
CA_n48-n70	n48, n70	
CA_n48-n71	n48, n71	
CA_n66-n70	n66, n70	
CA_n66-n71	n66, n71	
CA_n70-n71	n70, n71	
CA_n75-n78 ¹	n75, n78	
CA_n76-n78 ¹	n76, n78	
CA_n77-n79	n77, n79	
CA_n78-n79 ⁵	n78, n79	
<p>NOTE 1: Applicable for UE supporting inter-band carrier aggregation with mandatory simultaneous Rx/Tx capability.</p> <p>NOTE 2: The frequency range in band n28 is restricted for this band combination to 703-733 MHz for the UL and 758-788 MHz for the DL.</p> <p>NOTE 3: The frequency range below 2506MHz for Band n41 is not used in this combination.</p> <p>NOTE 4: Applicable for frequency range above 4800 MHz for Band n79 in this combination.</p> <p>NOTE 5: For UEs supporting band n77, the minimum requirements apply only when there is non-simultaneous Rx/Tx operation between n78-n79 NR carriers. This restriction applies also for these carriers when applicable NR CA configuration is part of a higher order configuration.</p> <p>NOTE 6: The PCell is allocated in the licensed band in this combination.</p> <p>NOTE 7: The minimum requirements apply only when there is non-simultaneous Rx/Tx operation between n77-n79 NR carriers. This restriction applies also for these carriers when applicable NR CA configuration is part of a higher order configuration.</p> <p>NOTE 8: Applicable when dynamic Tx switching is conducted. The DL interruption requirement is specified in clause 8.2.2.2.10 of 38.133 [13].</p>		

5.2A.2.2 Inter-band CA (three bands)

Table 5.2A.2.2-1: Inter-band CA operating bands involving FR1 (three bands)

NR CA Band	NR Band (Table 5.2-1)
CA_n26-n66-n70	n26, n66, n70
CA_n29-n66-n70	n29, n66, n70
CA_n48-n66-n70	n48, n66, n70
CA_n48-n66-n71	n48, n66, n71
CA_n48-n70-n71	n48, n70, n71
CA_n66-n70-n71	n66, n70, n71
CA_n1-n78-n79	n1, n78, n79

5.2A.2.3 Inter-band CA (four bands)

Table 5.2A.2.3-1: Inter-band CA operating bands involving FR1 (four bands)

5.2B Operating bands for DC

The operating bands are specified in clause 5.5B for operation with NR dual connectivity configured, where all operating bands are within FR1.

5.2C Operating band combination for SUL

NR operation is designed to operate in the operating band combination defined in Table 5.2C-1, Table 5.2C-2, Table 5.2C-3 and Table 5.2C-4, where all operating bands are within FR1.

If the mandatory simultaneous Rx/Tx capability applies for a band combination, the mandatory simultaneous Rx/Tx capability also applies for the band combination when the applicable band combination is a subset of a higher order band combination.

Table 5.2C-1: Operating band combination for SUL in FR1

NR Band combination for SUL	NR Band (Table 5.2-1)
SUL_n41-n83 ²	n41, n83
SUL_n78-n80 ²	n78, n80
SUL_n78-n81 ²	n78, n81
SUL_n78-n82 ²	n78, n82
SUL_n78-n83 ²	n78, n83
SUL_n78-n84 ²	n78, n84
SUL_n78-n86 ²	n78, n86
SUL_n79-n80 ²	n79, n80
SUL_n79-n81 ²	n79, n81
SUL_n79-n83 ²	n79, n83
NOTE 1: If a UE is configured with both NR UL and NR SUL carriers in a cell, the switching time between NR UL carrier and NR SUL carrier is 0us.	
NOTE 2: For UE supporting SUL band combination simultaneous Rx/Tx capability is mandatory.	
NOTE 3: For release 15 and release 16 UE supporting SUL band combination, UL MIMO is not configured on SUL carrier.	

Table 5.2C-2: Operating SUL band combination with intra-band non-contiguous CA in FR1

FFS

Table 5.2C-3: Operating SUL band combination with intra-band contiguous CA in FR1

NR Band combination for SUL	NR Band (Table 5.2-1)
SUL_n41-n83	n41, n83
SUL_n78-n80	n78, n80
SUL_n78-n84	n78, n84
SUL_n79-n83	n79, n83
NOTE 1: If a UE is configured with both NR UL and NR SUL carriers in a cell, the switching time between NR UL carrier and NR SUL carrier is 0 us.	
NOTE 2: For UE supporting SUL band combination simultaneous Rx/Tx capability is mandatory.	

Table 5.2C-4: Operating SUL band combination with inter-band CA in FR1

NR Band combination for SUL	NR Band (Table 5.2-1)
CA_n1_SUL_n78-n80	n1, n78, n80
CA_n1_SUL_n78-n84	n1, n78, n84
CA_n3_SUL_n78-n80	n3, n78, n80
CA_n28_SUL_n41-n83	n28, n41, n83
CA_n28_SUL_n79-n83	n28, n79, n83
NOTE 1: If a UE is configured with both NR UL and NR SUL carriers in a cell, the switching time between NR UL carrier and NR SUL carrier is 0 us.	
NOTE 2: For UE supporting SUL band combination simultaneous Rx/Tx capability is mandatory.	

5.2D Operating bands for UL MIMO

NR is designed to support UL MIMO where all of the operating bands are in FR1 defined in Table 5.2D-1.

Table 5.2D-1: NR operating bands for UL MIMO in FR1

NR operating band
n1
n2
n3
n7
n25
n30 ¹
n34
n38
n39
n40
n41
n46
n48
n66
n70
n71 ²
n77
n78
n79
n84
n95
n97
NOTE 1: Uplink transmission is not allowed at this band for UE with external vehicle-mounted antennas.
NOTE 2: UL MIMO is targeted for FWA form factor.

5.2E Operating band for V2X

5.2E.1 V2X operating bands

NR V2X is designed to operate in the operating bands in FR1 defined in Table 5.2E.1-1.

Table 5.2E.1-1: V2X operating bands in FR1

V2X Operating Band	Sidelink (SL) Transmission operating band	Sidelink (SL) Reception operating band	Duplex Mode	Interface
	$F_{UL_low} - F_{UL_high}$	$F_{DL_low} - F_{DL_high}$		
n38 ¹	2570 MHz - 2620 MHz	2570 MHz - 2620 MHz	HD	PC5
n47	5855 MHz - 5925 MHz	5855 MHz - 5925 MHz	HD	PC5
NOTE 1: When this band is used for V2X SL service, the band is exclusively used for NR V2X in particular regions.				

5.2E.2 V2X operating bands for concurrent operation

NR V2X operation is designed to operate concurrent with NR uplink/downlink on the operating bands combinations listed in Table 5.2E.2-1.

Table 5.2E.2-1: Inter-band con-current V2X operating bands

V2X con-current operating Band	NR or V2X Operating Band	Interface
V2X_n71-n47	n71	Uu
	n47	PC5

5.3 UE channel bandwidth

5.3.1 General

The UE channel bandwidth supports a single NR RF carrier in the uplink or downlink at the UE. From a BS perspective, different UE channel bandwidths may be supported within the same spectrum for transmitting to and receiving from UEs connected to the BS. Transmission of multiple carriers to the same UE (CA) or multiple carriers to different UEs within the BS channel bandwidth can be supported.

From a UE perspective, the UE is configured with one or more BWP / carriers, each with its own UE channel bandwidth. The UE does not need to be aware of the BS channel bandwidth or how the BS allocates bandwidth to different UEs.

The placement of the UE channel bandwidth for each UE carrier is flexible but can only be completely within the BS channel bandwidth.

The relationship between the channel bandwidth, the guardband and the maximum transmission bandwidth configuration is shown in Figure 5.3.1-1.

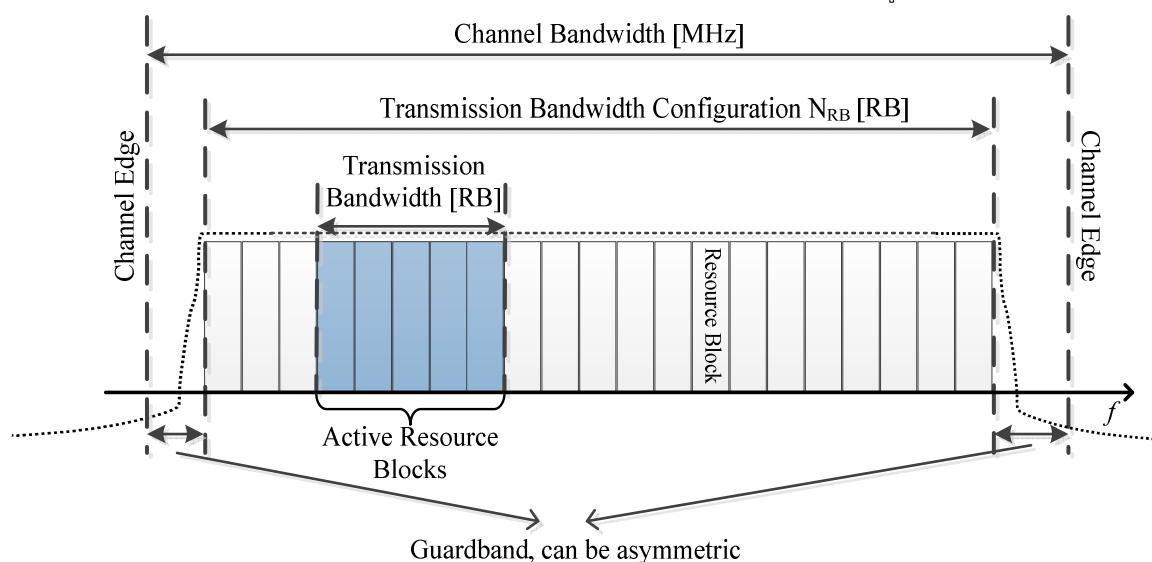

Figure 5.3.1-1: Definition of the channel bandwidth and the maximum transmission bandwidth configuration for one NR channel

5.3.2 Maximum transmission bandwidth configuration

The maximum transmission bandwidth configuration N_{RB} for each UE channel bandwidth and subcarrier spacing is specified in Table 5.3.2-1.

Table 5.3.2-1: Maximum transmission bandwidth configuration N_{RB}

SCS (kHz)	5 MHz	10 MHz	15 MHz	20 MHz	25 MHz	30 MHz	40 MHz	50 MHz	60 MHz	70 MHz	80 MHz	90 MHz	100 MHz
	N_{RB}	N_{RB}	N_{RB}	N_{RB}	N_{RB}	N_{RB}	N_{RB}	N_{RB}	N_{RB}	N_{RB}	N_{RB}	N_{RB}	N_{RB}
15	25	52	79	106	133	160	216	270	N/A	N/A	N/A	N/A	N/A
30	11	24	38	51	65	78	106	133	162	189	217	245	273
60	N/A	11	18	24	31	38	51	65	79	93	107	121	135

5.3.3 Minimum guard band and transmission bandwidth configuration

The minimum guard band for each UE channel bandwidth and SCS is specified in Table 5.3.3-1.

Table 5.3.3-1: Minimum guard band for each UE channel bandwidth and SCS (kHz)

SCS (kHz)	5 MHz	10 MHz	15 MHz	20 MHz	25 MHz	30 MHz	40 MHz	50 MHz	60 MHz	70 MHz	80 MHz	90 MHz	100 MHz
15	242.5	312.5	382.5	452.5	522.5	592.5	552.5	692.5	N/A	N/A	N/A	N/A	N/A
30	505	665	645	805	785	945	905	1045	825	965	925	885	845
60	N/A	1010	990	1330	1310	1290	1610	1570	1530	1490	1450	1410	1370

NOTE: The minimum guard bands have been calculated using the following equation: $(BW_{channel} \times 1000 \text{ (kHz)} - N_{RB} \times SCS \times 12) / 2 - SCS/2$, where N_{RB} are from Table 5.3.2-1.

Figure 5.3.3-1: Void

The number of RBs configured in any channel bandwidth shall ensure that the minimum guard band specified in this clause is met.

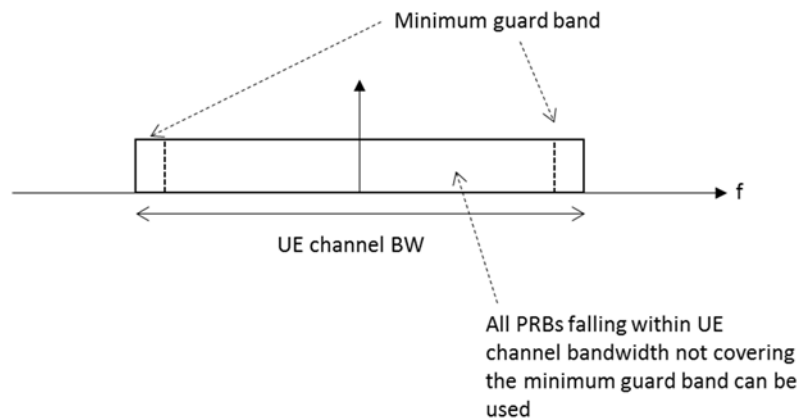

Figure 5.3.3-2: UE PRB utilization

In the case that multiple numerologies are multiplexed in the same symbol due to BS transmission of SSB, the minimum guard band on each side of the carrier is the guard band applied at the configured channel bandwidth for the numerology that is received immediately adjacent to the guard.

If multiple numerologies are multiplexed in the same symbol and the UE channel bandwidth is >50 MHz, the minimum guardband applied adjacent to 15 kHz SCS shall be the same as the minimum guardband defined for 30 kHz SCS for the same UE channel bandwidth.

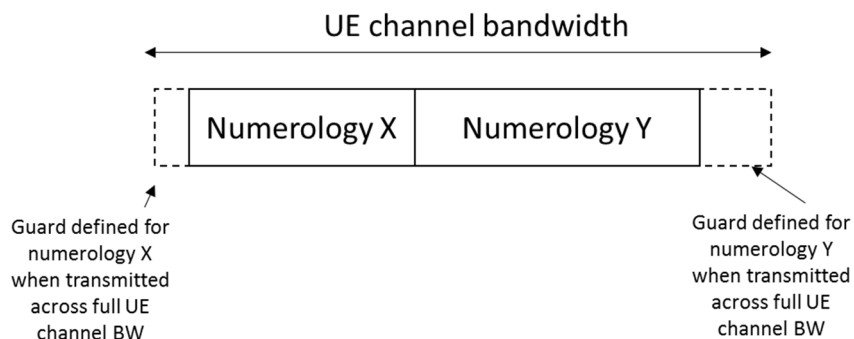

Figure 5.3.3-3: Guard band definition when transmitting multiple numerologies

NOTE: Figure 5.3.3-3 is not intended to imply the size of any guard between the two numerologies. Inter-numerology guard band within the carrier is implementation dependent.

[For a UE supporting wideband operation], the nominal intra-cell guard bands and the corresponding sizes of the RB sets separated by the said guard bands are as specified in Table 5.3.3-2 for each UE channel bandwidth and sub-carrier

spacing for the downlink and uplink. The nominal intra-cell guard bands in Table 5.3.3-2 are applicable when the respective IE *intraCellGuardBandsUL-List* and *intraCellGuardBandsDL-List* [6] for the uplink and downlink are not provided, as specified in [12] clause 7.

Table 5.3.3-2: Nominal intra-cell guard bands for wideband operation

SCS (kHz)	40 MHz	60 MHz	80 MHz
15	105-6-105 (216)	N/A	N/A
30	50-6-50 (106)	50-6-50-6-50 (162)	50-6-50-5-50-6-50 (217)
60	23-5-23 (51)	23-5-23-5-23 (79)	23-5-23-5-23-5-23 (107)
NOTE 1: The intra-cell guard band is denoted $TBW_0-GB_0-\dots-GB_{N_RBset-2}-TBW_{N_RBset-1}$ for $N_RBset > 1$ number of RB-sets with TBW_r the maximum transmission bandwidth (PRB) of RB-set r and GB_r the guard band (PRB) above the upper edge of RB-set r . The RB-set 0 is starting at the first common resource block (CRB) of the carrier as indicated by <i>offsetToCarrier</i> . The total transmission bandwidth configuration (size of resource grid) including guard bands is given in between parentheses.			

For a UE that supports shared spectrum channel access, there are no uplink or downlink intra-cell guard bands for operation with 10 MHz and 20 MHz channel bandwidths; the maximum transmission bandwidth configurations for these channel bandwidths are in accordance with clause 5.3.2.

For each UE channel bandwidth and sub-carrier spacing given by Table 5.3.3-2, the maximum transmission bandwidth configuration of the carrier including intra-cell guard bands, if configured for the uplink and downlink by the respective IE *intraCellGuardBandsUL-List* and *intraCellGuardBandsDL-List* [6], and corresponding RB-set(s) shall be in accordance with clause 5.3.2 with a minimum inter-cell guard band of the UE channel bandwidth as specified in Table 5.3.3-1 for the uplink and downlink. Minimum requirements specified for wideband operation in Clause 6 and Clause 7 also apply for intra-cell guard bands larger than the nominal sizes in Table 5.3.3-2 as listed in Table 5.3.3-3 for each sub-carrier spacing; each guard band in order of CRB index must be larger than or equal to the corresponding nominal guard band specified in Table 5.3.3-2 for each channel bandwidth.

Table 5.3.3-3: Applicable intra-cell guard bands for wideband operation

Parameter	Unit	SCS	
		15 kHz	30 kHz
Intra-cell guard band (size)	PRB	6,7	5,6,7
Transmission bandwidth (size) of RB-set	PRB	104,105	49,50,51

If the UE is configured with zero width intra-cell guard bands for the uplink and downlink by the IE *intraCellGuardBandsUL-List* and *intraCellGuardBandsDL-List* [6] on a carrier greater than 20 MHz, the maximum transmission bandwidth configuration for the uplink and downlink shall be in accordance with clause 5.3.2 with a minimum inter-cell guard band of the UE channel bandwidth as specified in Table 5.3.3-1.

5.3.4 RB alignment

For each numerology, its common resource blocks are specified in Clause 4.4.4.3 in TS 38.211 [8], and the starting point of its transmission bandwidth configuration on the common resource block grid for a given channel bandwidth is indicated by an offset to “Reference point A” in the unit of the numerology. The *UE transmission bandwidth configuration* is indicated by the higher layer parameter *carrierBandwidth* [6] and will fulfil the minimum UE guard band requirement specified in Clause 5.3.3.

5.3.5 UE channel bandwidth per operating band

The requirements in this specification apply to the combination of channel bandwidths, SCS and operating bands shown in Table 5.3.5-1. The transmission bandwidth configuration in Table 5.3.2-1 shall be supported for each of the specified channel bandwidths. The channel bandwidths are specified for both the TX and RX path.

Table 5.3.5-1: Channel Bandwidths for each NR band

NR Band	SCS (kHz)	UE Channel bandwidth (MHz)													
		5	10	15	20	25	30	40	45	50	60	70 ⁶	80	90 ⁶	100
n1	15	5	10	15	20	25 ⁶	30 ⁶	40 ⁶	45 ¹²	50 ⁶					
	30		10	15	20	25 ⁶	30 ⁶	40 ⁶	45 ¹²	50 ⁶					
	60		10	15	20	25 ⁶	30 ⁶	40 ⁶	45 ¹²	50 ⁶					
n2	15	5	10	15	20	25	30	40							
	30		10	15	20	25	30	40							
	60		10	15	20	25	30	40							
n3	15	5	10	15	20	25	30	40		50					
	30		10	15	20	25	30	40		50					
	60		10	15	20	25	30	40		50					
n5	15	5	10	15	20	25 ³									
	30		10	15	20	25 ³									
	60														
n7	15	5	10	15	20	25	30	40		50					
	30		10	15	20	25	30	40		50					
	60		10	15	20	25	30	40		50					
n8	15	5	10	15	20										
	30		10	15	20										
	60														
n12	15	5	10	15											
	30		10	15											
	60														
n14	15	5	10												
	30		10												
	60														
n20	15	5	10	15	20										
	30		10	15	20										
	60														
n24	15	5	10												
	30		10												
	60		10												
n25	15	5	10	15	20	25 ⁶	30 ⁶	40 ⁶							
	30		10	15	20	25 ⁶	30 ⁶	40 ⁶							
	60		10	15	20	25 ⁶	30 ⁶	40 ⁶							
n26	15	5	10	15	20										
	30		10	15	20										
n28	15	5	10	15	20 ⁹		30 ^{6,9}								
	30		10	15	20 ⁹		30 ^{6,9}								
	60														
n29	15	5	10												
	30		10												
	60														
n30	15	5	10												
	30		10												
	60														
n34	15	5	10	15											
	30		10	15											
	60		10	15											
n38	15	5	10 ¹¹	15	20 ¹¹	25	30 ¹¹	40 ¹¹							
	30		10 ¹¹	15	20 ¹¹	25	30 ¹¹	40 ¹¹							
	60		10 ¹¹	15	20 ¹¹	25	30 ¹¹	40 ¹¹							
n39	15	5	10	15	20	25	30	40							
	30		10	15	20	25	30	40							
	60		10	15	20	25	30	40							
n40	15	5 ⁷	10	15	20	25	30	40		50					
	30		10	15	20	25	30	40		50	60		80		
	60		10	15	20	25	30	40		50	60		80		

n41	15		10	15	20		30	40		50					
	30		10	15	20		30	40		50	60	70	80	90	100
	60		10	15	20		30	40		50	60	70	80	90	100
n46	15		10 ⁷		20			40							
	30		10 ⁷		20			40			60		80		
	60		10 ⁷		20			40			60		80		
n47 ¹¹	15		10		20		30	40							
	30		10		20		30	40							
	60		10		20		30	40							
n48	15	5 ⁷	10	15	20		30	40		50 ⁸					
	30		10	15	20		30	40		50 ⁸	60 ⁸	70 ⁸	80 ⁸	90 ^{8,10}	100 ⁸
	60		10	15	20		30	40		50 ⁸	60 ⁸	70 ⁸	80 ⁸	90 ^{8,10}	100 ⁸
n50	15	5 ⁷	10	15	20			40		50					
	30		10	15	20			40		50	60		80 ³		
	60		10	15	20			40		50	60		80 ³		
n51	15	5													
	30														
	60														
n65	15	5	10	15	20										
	30		10	15	20										
	60		10	15	20										
n66	15	5	10	15	20	25 ⁶	30 ⁶	40							
	30		10	15	20	25 ⁶	30 ⁶	40							
	60		10	15	20	25 ⁶	30 ⁶	40							
n70	15	5	10	15	20 ³	25 ³									
	30		10	15	20 ³	25 ³									
	60		10	15	20 ³	25 ³									
n71	15	5	10	15	20										
	30		10	15	20										
	60														
n74	15	5	10	15	20										
	30		10	15	20										
	60		10	15	20										
n75	15	5	10	15	20										
	30		10	15	20										
	60		10	15	20										
n76	15	5													
	30														
	60														
n77	15		10	15	20	25	30	40		50					
	30		10	15	20	25	30	40		50	60	70 ¹⁰	80	90 ¹⁰	100
	60		10	15	20	25	30	40		50	60	70 ¹⁰	80	90 ¹⁰	100
n78	15		10	15	20	25	30	40		50					
	30		10	15	20	25	30	40		50	60	70 ¹⁰	80	90	100
	60		10	15	20	25	30	40		50	60	70 ¹⁰	80	90	100
n79	15							40		50					
	30							40		50	60		80		100
	60							40		50	60		80		100
n53	15	5	10												
	30		10												
	60		10												
n80	15	5	10	15	20	25	30								
	30		10	15	20	25	30								
	60		10	15	20	25	30								
n81	15	5	10	15	20										
	30		10	15	20										
	60														
n82	15	5	10	15	20										
	30		10	15	20										
	60														

n83	15	5	10	15	20		30 ⁹								
	30		10	15	20		30 ⁹								
	60														
n84	15	5	10	15	20	25	30	40		50					
	30		10	15	20	25	30	40		50					
	60		10	15	20	25	30	40		50					
n86	15	5	10	15	20			40							
	30		10	15	20			40							
	60		10	15	20			40							
n95	15	5	10	15											
	30		10	15											
	60		10	15											
n96	15				20			40							
	30				20			40		60		80			
	60				20			40		60		80			
n97	15	5	10	15	20	25	30	40		50					
	30		10	15	20	25	30	40		50	60	70	80	90	100
	60		10	15	20	25	30	40		50	60	70	80	90	100
n99	15	5	10												
	30		10												
	60		10												

NOTE 1: Void.
 NOTE 2: Void.
 NOTE 3: This UE channel bandwidth is applicable only to downlink.
 NOTE 4: For test configuration tables from the transmitter and receiver tests in Section 6 and 7 that refer to this table for test SCS, the Lowest SCS refers to lowest supported SCS per channel bandwidth, Highest SCS refers to highest supported SCS per channel bandwidth.
 NOTE 5: For test configuration tables from the transmitter and receiver tests in Section 6 and 7 that refer to this table and list and list the test SCS as Mid or any other value; if that value is not supported by the UE in UL and/or DL, select the closest SCS supported by the UE in both UL and DL.
 NOTE 6: This UE channel bandwidth is optional in R15.
 NOTE 7: For this bandwidth, the minimum requirements are restricted to operation when carrier is configured as an SCell part of DC or CA configuration.
 NOTE 8: For this bandwidth, the minimum requirements are restricted to operation when carrier is configured as a downlink SCell part of CA configuration.
 NOTE 9: For the 20 MHz bandwidth, the minimum requirements are specified for NR UL carrier frequencies confined to either 713-723 MHz or 728-738 MHz. For the 30MHz bandwidth, the minimum requirements are specified for NR UL transmission bandwidth configuration confined to either 703-733 or 718-748 MHz.
 NOTE 10: This UE channel bandwidth is optional in R16.
 NOTE 11: These UE channel bandwidths are applicable to sidelink operation.
 NOTE 12: This UE channel bandwidth is optional in R17.

5.3.6 Asymmetric channel bandwidths

The UE channel bandwidth can be asymmetric in downlink and uplink. In asymmetric channel bandwidth operation, the narrower carrier shall be confined within the frequency range of the wider channel bandwidth.

In FDD, the confinement is defined as a maximum deviation to the default Tx-Rx carrier centre frequency separation (defined in Table 5.4.4-1) as following:

$$\Delta F_{TX-RX} = | (BW_{DL} - BW_{UL}) / 2 |$$

The operating bands and supported asymmetric channel bandwidth combinations are defined in Table 5.3.6-1.

Table 5.3.6-1: FDD asymmetric UL and DL channel bandwidth combinations

NR Band	Channel bandwidths for UL (MHz)	Channel bandwidths for DL (MHz)	Asymmetric channel bandwidth combination set
n24	10	5	0
n66	5, 10	20, 40	0
	20	40	
	5, 10	20, 25, 30, 40	1
	20, 25, 30	40	
n70	5, 10	15	0
	5, 10, 15	20, 25	
n71	5	10	0
	10	15	
	15	20	
NOTE 1: The assignment of the paired UL and DL channels are subject to a TX-RX separation as specified in clause 5.4.4.			

In TDD, the operating bands and supported asymmetric channel bandwidth combinations are defined in Table 5.3.6-2.

Table 5.3.6-2: TDD asymmetric UL and DL channel bandwidth combinations

NR Band	Channel bandwidths for UL (MHz)	Channel bandwidths for DL (MHz)
n50	60	80
NOTE 1: Both centre frequency and BWP-ID shall match between DL and UL carriers as defined in TS 38.331 [6] cl. 6.3.2 and TS 38.213 [9] clause 12.		
NOTE 2: In a case a UE is configured with a full width of BWP within both UL/ DL channels, the centre frequency of UL/ DL channels shall be same.		
NOTE 3: A position of Point A is common between UL and DL carriers as defined in TS 38.331 [6] cl. 6.3.2.		

5.3A UE channel bandwidth for CA

5.3A.1 General

Figure 5.3A.1-1: Void

Figure 5.3A.1-2: Void

5.3A.2 Maximum transmission bandwidth configuration for CA

For carrier aggregation, the maximum transmission bandwidth configuration is defined per component carrier and the requirement is specified in subclause 5.3.2.

5.3A.3 Minimum guard band and transmission bandwidth configuration for CA

For intra-band contiguous carrier aggregation, *Aggregated Channel Bandwidth* and *Guard Bands* are defined as follows, see Figure 5.3A.3-1.

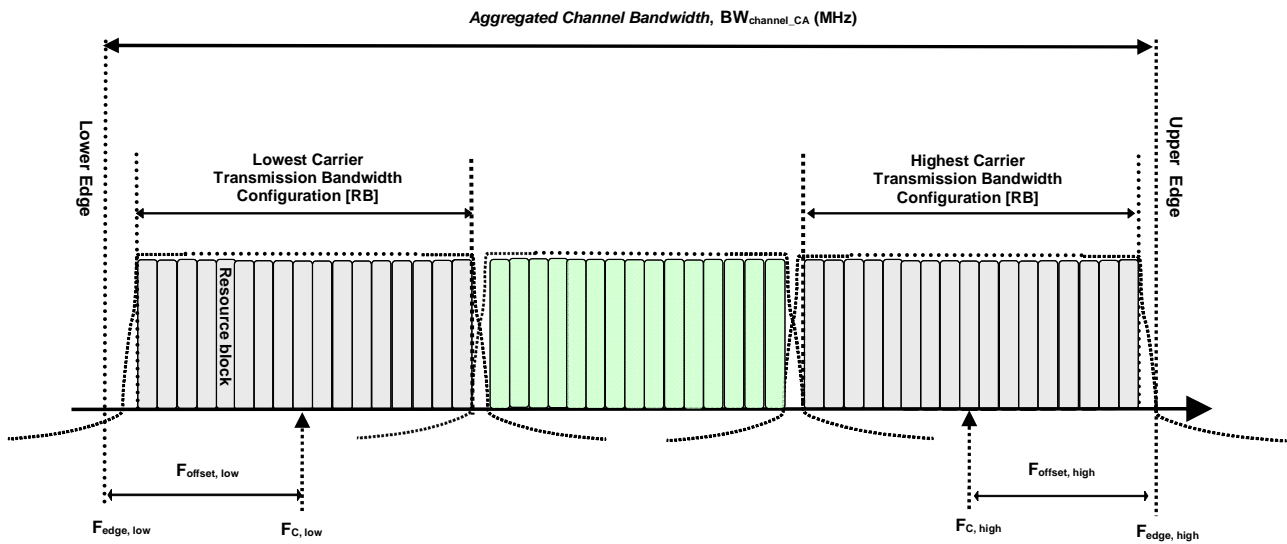

Figure 5.3A.3-1: Definition of *Aggregated Channel Bandwidth* for intra-band carrier aggregation

The *aggregated channel bandwidth*, $BW_{\text{Channel_CA}}$, is defined as

$$BW_{\text{Channel_CA}} = F_{\text{edge,high}} - F_{\text{edge,low}} \text{ (MHz)}.$$

The lower bandwidth edge $F_{\text{edge,low}}$ and the upper bandwidth edge $F_{\text{edge,high}}$ of the aggregated channel bandwidth are used as frequency reference points for transmitter and receiver requirements and are defined by

$$F_{\text{edge,low}} = F_{C,\text{low}} - F_{\text{offset,low}}$$

$$F_{\text{edge,high}} = F_{C,\text{high}} + F_{\text{offset,high}}$$

The lower and upper frequency offsets depend on the transmission bandwidth configurations of the lowest and highest assigned edge component carrier and are defined as

$$F_{\text{offset,low}} = (N_{\text{RB,low}} * 12 + 1) * SCS_{\text{low}} / 2 + BW_{\text{GB}} \text{ (MHz)}$$

$$F_{\text{offset,high}} = (N_{\text{RB,high}} * 12 - 1) * SCS_{\text{high}} / 2 + BW_{\text{GB}} \text{ (MHz)}$$

$$BW_{\text{GB}} = \max(BW_{\text{GB,Channel}(k)})$$

$N_{\text{RB,low}}$ and $N_{\text{RB,high}}$ are the transmission bandwidth configurations according to Table 5.3.2-1 for the lowest and highest assigned component carrier, SCS_{low} and SCS_{high} are the sub-carrier spacing for the lowest and highest assigned component carrier respectively. SCS_{low} , SCS_{high} , $N_{\text{RB,low}}$, $N_{\text{RB,high}}$, and $BW_{\text{GB,Channel}(k)}$ use the largest μ value among the subcarrier spacing configurations supported in the operating band for both of the channel bandwidths according to Table 5.3.5-1 and $BW_{\text{GB,Channel}(k)}$ is the minimum guard band for carrier k according to Table 5.3.3-1 for the said μ value. In case there is no common μ value for both of the channel bandwidths, $\mu=1$ is used for SCS_{low} , SCS_{high} , $N_{\text{RB,low}}$, $N_{\text{RB,high}}$, and $BW_{\text{GB,Channel}(k)}$.

For intra-band non-contiguous carrier aggregation *Sub-block Bandwidth* and *Sub-block edges* are defined as follows, see Figure 5.3A.3-2.

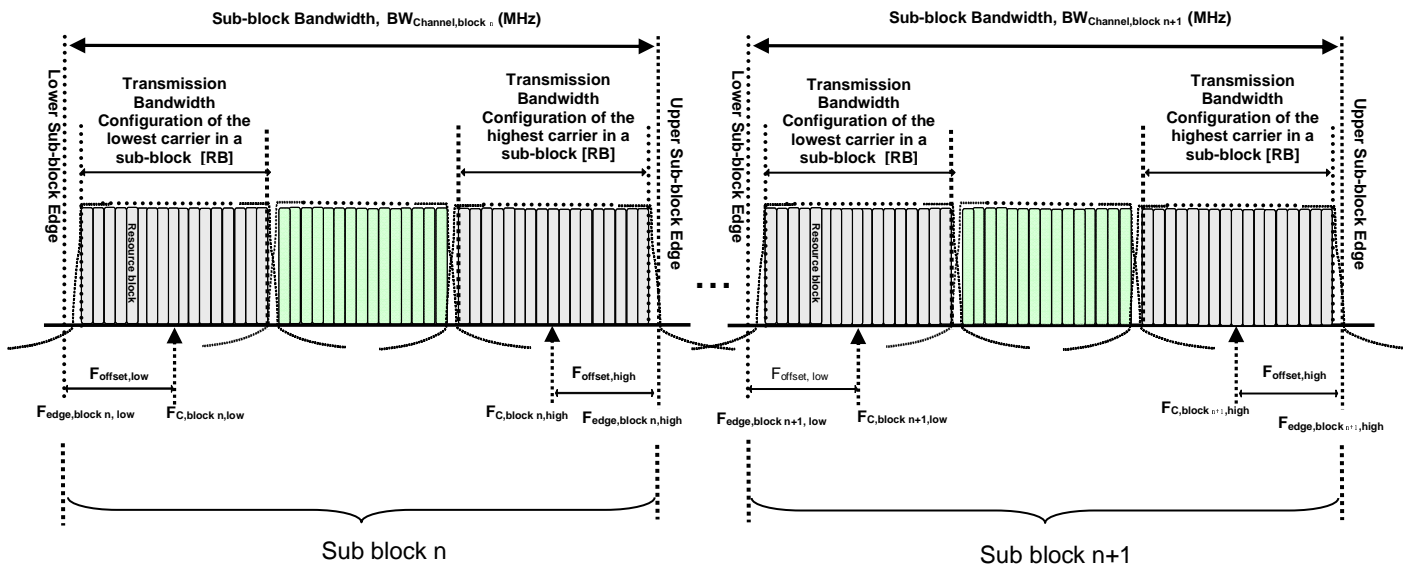

Figure 5.3A.3-2: Definition of sub-block bandwidth for intra-band non-contiguous spectrum

The lower sub-block edge of the Sub-block Bandwidth ($BW_{Channel,block}$) is defined as

$$F_{edge,block,low} = F_{C,block,low} - F_{offset,low}$$

The upper sub-block edge of the Sub-block Bandwidth is defined as

$$F_{edge,block,high} = F_{C,block,high} + F_{offset,high}$$

The Sub-block Bandwidth, $BW_{Channel,block}$, is defined as follows:

$$BW_{Channel,block} = F_{edge,block,high} - F_{edge,block,low} \text{ (MHz)}$$

The lower and upper frequency offsets $F_{offset,block,low}$ and $F_{offset,block,high}$ depend on the transmission bandwidth configurations of the lowest and highest assigned edge component carriers within a sub-block and are defined as

$$F_{offset,block,low} = (N_{RB,low} * 12 + 1) * SCS_{low} / 2 + BW_{GB} \text{ (MHz)}$$

$$F_{offset,block,high} = (N_{RB,high} * 12 - 1) * SCS_{high} / 2 + BW_{GB} \text{ (MHz)}$$

$$BW_{GB} = \max(BW_{GB,Channel(k)})$$

where $N_{RB,low}$ and $N_{RB,high}$ are the transmission bandwidth configurations according to Table 5.3.2-1 for the lowest and highest assigned component carrier within a sub-block, respectively. SCS_{low} and SCS_{high} are the sub-carrier spacing for the lowest and highest assigned component carrier within a sub-block, respectively. SCS_{low} , SCS_{high} , $N_{RB,low}$, $N_{RB,high}$, and $BW_{GB,Channel(k)}$ use the largest μ value among the subcarrier spacing configurations supported in the operating band for both of the channel bandwidths according to Table 5.3.5-1 and $BW_{GB,Channel(k)}$ is the minimum guard band for carrier k according to Table 5.3.3-1 for the said μ value. In case there is no common μ value for both of the channel bandwidths, $\mu=1$ is used for SCS_{low} , SCS_{high} , $N_{RB,low}$, $N_{RB,high}$, and $BW_{GB,Channel(k)}$.

The sub-block gap size between two consecutive sub-blocks W_{gap} is defined as

$$W_{gap} = F_{edge,block n+1,low} - F_{edge,block n,high} \text{ (MHz)}$$

5.3A.4 Void

5.3A.5 UE channel bandwidth per operating band for CA

The requirements for carrier aggregation in this specification are defined for carrier aggregation configurations.

For intra-band contiguous carrier aggregation, a carrier aggregation configuration is a single operating band supporting a carrier aggregation bandwidth class with associated bandwidth combination sets specified in clause 5.5A.1. For each

carrier aggregation configuration, requirements are specified for all aggregated channel bandwidths contained in a bandwidth combination set, a UE can indicate support of several bandwidth combination sets per carrier aggregation configuration. For intra-band non-contiguous carrier aggregation, a carrier aggregation configuration is a single operating band supporting two or more sub-blocks, each supporting a carrier aggregation bandwidth class.

For intra-band non-contiguous uplink carrier aggregation, frequency separation class (Fs) specified in Table 5.3A.5-2 indicates the maximum frequency span between lower edge of lowest component carrier and upper edge of highest component carrier that UE can support per band combination in uplink in non-contiguous intra-band operation when the signalling is absent for dualPA-Architecture IE.

For inter-band carrier aggregation, a carrier aggregation configuration is a combination of operating bands, each supporting a carrier aggregation bandwidth class.

Table 5.3A.5-1: NR CA bandwidth classes

NR CA bandwidth class	Aggregated channel bandwidth	Number of contiguous CC	Fallback group
A	$BW_{\text{Channel}} \leq BW_{\text{Channel,max}}$	1	1, 2, 3 ⁴
B	$20 \text{ MHz} \leq BW_{\text{Channel_CA}} \leq 100 \text{ MHz}$	2	2, 3 ⁴
C	$100 \text{ MHz} < BW_{\text{Channel_CA}} \leq 2 \times BW_{\text{Channel,max}}$	2	1, 3 ⁴
D	$200 \text{ MHz} < BW_{\text{Channel_CA}} \leq 3 \times BW_{\text{Channel,max}}$	3	
E	$300 \text{ MHz} < BW_{\text{Channel_CA}} \leq 4 \times BW_{\text{Channel,max}}$	4	
G	$100 \text{ MHz} < BW_{\text{Channel_CA}} \leq 150 \text{ MHz}$	3	2
H	$150 \text{ MHz} < BW_{\text{Channel_CA}} \leq 200 \text{ MHz}$	4	
I	$200 \text{ MHz} < BW_{\text{Channel_CA}} \leq 250 \text{ MHz}$	5	
J	$250 \text{ MHz} < BW_{\text{Channel_CA}} \leq 300 \text{ MHz}$	6	
K	$300 \text{ MHz} < BW_{\text{Channel_CA}} \leq 350 \text{ MHz}$	7	
L	$350 \text{ MHz} < BW_{\text{Channel_CA}} \leq 400 \text{ MHz}$	8	
M ³	$50 \text{ MHz} \leq BW_{\text{Channel_CA}} \leq 200 \text{ MHz}$	3	3 ⁴
N ³	$80 \text{ MHz} \leq BW_{\text{Channel_CA}} \leq 300 \text{ MHz}$	4	
O ³	$100 \text{ MHz} \leq BW_{\text{Channel_CA}} \leq 400 \text{ MHz}$	5	

NOTE 1: $BW_{\text{Channel,max}}$ is maximum channel bandwidth supported among all bands in a release
NOTE 2: It is mandatory for a UE to be able to fallback to lower order NR CA bandwidth class configuration within a fallback group. It is not mandatory for a UE to be able to fallback to lower order NA CA bandwidth class configuration that belong to a different fallback group.
NOTE 3: This bandwidth class is only applicable to bands identified for use with shared spectrum channel access in Table 5.2-1.
NOTE 4: Fallback group 3 is only applicable to bands identified for use with shared spectrum channel access in Table 5.2-1.

Table 5.3A.5-2: NR intra-band non-contiguous UL CA frequency separation classes

NR NC CA frequency separation class	Maximum allowed frequency separation
I	100 MHz
II	200 MHz
III	[600MHz]

5.3E Channel bandwidth for V2X

5.3E.1 General

NR V2X operation channel bandwidths for each operating band is specified in Table 5.3.5-1 in subclause 5.3.5. The same (symmetrical) channel bandwidth is specified for both the transmission and reception path.

5.3E.2 Channel bandwidth for V2X concurrent operation

For NR V2X inter-band con-current operation in FR1, the NR V2X channel bandwidths for each operating band is specified in Table 5.3E.2-1.

Table 5.3E.2-1: Inter-band con-current V2X configurations

V2X con-current operating band Configuration	NR Bands	SCS kHz	5 MHz	10 MHz	15 MHz	20 MHz	30 MHz	40 MHz	50 MHz	Maximum bandwidth [MHz]	Bandwidth combination set
V2X_n71A-n47A	n71	15	Yes	Yes	Yes	Yes				60	0
		30		Yes	Yes	Yes					
		60									
	n47	15		Yes		Yes	Yes	Yes			
		30		Yes		Yes	Yes	Yes			
		60		Yes		Yes	Yes	Yes			

5.3I Channel bandwidth for RedCap

The requirements in this specification apply to the combination of channel bandwidths, SCS and operating bands shown in Table 5.3.5-1 with maximum channel bandwidth of 20MHz. The transmission bandwidth configuration in Table 5.3.2-1 shall be supported for each of the specified channel bandwidths up to 20 MHz. The channel bandwidths are specified for both the TX and RX path.

5.4 Channel arrangement

5.4.1 Channel spacing

5.4.1.1 Channel spacing for adjacent NR carriers

The spacing between carriers will depend on the deployment scenario, the size of the frequency block available and the channel bandwidths. The nominal channel spacing between two adjacent NR carriers is defined as following:

- For NR operating bands with 100 kHz channel raster,

$$\text{Nominal Channel spacing} = (BW_{\text{Channel}(1)} + BW_{\text{Channel}(2)})/2$$

- For NR operating bands with 15 kHz channel raster,

$$\text{Nominal Channel spacing} = (BW_{\text{Channel}(1)} + BW_{\text{Channel}(2)})/2 + \{-5\text{kHz}, 0\text{kHz}, 5\text{kHz}\} \text{ for } \Delta F_{\text{Raster}} \text{ equals } 15 \text{ kHz}$$

$$\text{Nominal Channel spacing} = (BW_{\text{Channel}(1)} + BW_{\text{Channel}(2)})/2 + \{-10 \text{ kHz}, 0 \text{ kHz}, 10 \text{ kHz}\} \text{ for } \Delta F_{\text{Raster}} \text{ equals } 30 \text{ kHz}$$

where $BW_{\text{Channel}(1)}$ and $BW_{\text{Channel}(2)}$ are the channel bandwidths of the two respective NR carriers. The channel spacing can be adjusted depending on the channel raster to optimize performance in a particular deployment scenario.

5.4.2 Channel raster

5.4.2.1 NR-ARFCN and channel raster

The global frequency channel raster defines a set of RF reference frequencies F_{REF} . The RF reference frequency is used in signalling to identify the position of RF channels, SS blocks and other elements.

The global frequency raster is defined for all frequencies from 0 to 100 GHz. The granularity of the global frequency raster is ΔF_{Global} .

RF reference frequencies are designated by an NR Absolute Radio Frequency Channel Number (NR-ARFCN) in the range (0...2016666) on the global frequency raster. The relation between the NR-ARFCN and the RF reference frequency F_{REF} in MHz is given by the following equation, where $F_{\text{REF-Offs}}$ and $N_{\text{Ref-Offs}}$ are given in Table 5.4.2.1-1 and N_{REF} is the NR-ARFCN.

$$F_{\text{REF}} = F_{\text{REF-Offs}} + \Delta F_{\text{Global}} (N_{\text{REF}} - N_{\text{REF-Offs}})$$

Table 5.4.2.1-1: NR-ARFCN parameters for the global frequency raster

Frequency range (MHz)	ΔF_{Global} (kHz)	$F_{\text{REF-Offs}}$ (MHz)	$N_{\text{REF-Offs}}$	Range of N_{REF}
0 – 3000	5	0	0	0 – 599999
3000 – 24250	15	3000	600000	600000 – 2016666

The channel raster defines a subset of RF reference frequencies that can be used to identify the RF channel position in the uplink and downlink. The RF reference frequency for an RF channel maps to a resource element on the carrier. For each operating band, a subset of frequencies from the global frequency raster are applicable for that band and forms a channel raster with a granularity ΔF_{Raster} , which may be equal to or larger than ΔF_{Global} .

For SUL expect n95, n97 bands and for the uplink of all FDD bands defined in Table 5.2-1, and for TDD bands n34, n39, n48, n90 and n38,.

$$F_{\text{REF, shift}} = F_{\text{REF}} + \Delta_{\text{shift}}, \Delta_{\text{shift}} = 0 \text{ kHz or } 7.5 \text{ kHz.}$$

where Δ_{shift} is signalled by the network in higher layer parameter frequencyShift7p5kHz [6]. For Band n34, n38, n39, n48, $F_{\text{REF, shift}}$ is only applicable to uplink transmissions using a 15 kHz SCS.

The mapping between the channel raster and corresponding resource element is given in Section 5.4.2.2. The applicable entries for each operating band are defined in Section 5.4.2.3

5.4.2.2 Channel raster to resource element mapping

The mapping between the RF reference frequency on the channel raster and the corresponding resource element is given in Table 5.4.2.2-1 and can be used to identify the RF channel position. The mapping depends on the total number of RBs that are allocated in the channel and applies to both UL and DL. The mapping must apply to at least one numerology supported by the UE.

Table 5.4.2.2-1: Channel raster to resource element mapping

	$N_{\text{RB}} \bmod 2 = 0$	$N_{\text{RB}} \bmod 2 = 1$
Resource element index k	0	6
Physical resource block number n_{PRB}	$n_{\text{PRB}} = \left\lfloor \frac{N_{\text{RB}}}{2} \right\rfloor$	$n_{\text{PRB}} = \left\lfloor \frac{N_{\text{RB}}}{2} \right\rfloor$

k , n_{PRB} , N_{RB} are as defined in TS 38.211[8].

5.4.2.3 Channel raster entries for each operating band

The RF channel positions on the channel raster in each NR operating band are given through the applicable NR-ARFCN in Table 5.4.2.3-1, using the channel raster to resource element mapping in subclause 5.4.2.2.

For NR operating bands with 100 kHz channel raster, $\Delta F_{\text{Raster}} = 20 \times \Delta F_{\text{Global}}$. In this case every 20th NR-ARFCN within the operating band are applicable for the channel raster within the operating band and the step size for the channel raster in Table 5.4.2.3-1 is given as $\langle 20 \rangle$.

For NR operating bands with 15 kHz channel raster below 3GHz, $\Delta F_{\text{Raster}} = I \times \Delta F_{\text{Global}}$, where $I \in \{3, 6\}$. Every I^{th} NR-ARFCN within the operating band are applicable for the channel raster within the operating band and the step size for the channel raster in Table 5.4.2.3-1 is given as $\langle I \rangle$.

For NR operating bands with 15 kHz channel raster above 3GHz, $\Delta F_{\text{Raster}} = I \times \Delta F_{\text{Global}}$, where $I \in \{1, 2\}$. Every I^{th} NR-ARFCN within the operating band are applicable for the channel raster within the operating band and the step size for the channel raster in table 5.4.2.3-1 is given as $\langle I \rangle$.

In frequency bands with two or more ΔF_{Raster} : For 15 kHz and 30 kHz channel raster, the higher ΔF_{Raster} applies to channels using only the SCS that is equals to or larger than the higher ΔF_{Raster} and SSB SCS is equal to the higher ΔF_{Raster} .

Table 5.4.2.3-1: Applicable NR-ARFCN per operating band

NR operating band	ΔF_{Raster} (kHz)	Uplink Range of N_{REF} (First – <Step size> – Last)	Downlink Range of N_{REF} (First – <Step size> – Last)
n1	100	384000 – <20> – 396000	422000 – <20> – 434000
n2	100	370000 – <20> – 382000	386000 – <20> – 398000
n3	100	342000 – <20> – 357000	361000 – <20> – 376000
n5	100	164800 – <20> – 169800	173800 – <20> – 178800
n7	100	500000 – <20> – 514000	524000 – <20> – 538000
n8	100	176000 – <20> – 183000	185000 – <20> – 192000
n12	100	139800 – <20> – 143200	145800 – <20> – 149200
n14	100	157600 – <20> – 159600	151600 – <20> – 153600
n20	100	166400 – <20> – 172400	158200 – <20> – 164200
n24	100	325300 – <20> – 332100	305000 – <20> – 311800
n25	100	370000 – <20> – 383000	386000 – <20> – 399000
n26	100	162800 – <20> – 169800	171800 – <20> – 178800
n28	100	140600 – <20> – 149600	151600 – <20> – 160600
n29	100	N/A	143400 – <20> – 145600
n30	100	461000 – <20> – 463000	470000 – <20> – 472000
n34	100	402000 – <20> – 405000	402000 – <20> – 405000
n38	100	514000 – <20> – 524000	514000 – <20> – 524000
n39	100	376000 – <20> – 384000	376000 – <20> – 384000
n40	100	460000 – <20> – 480000	460000 – <20> – 480000
n41	15	499200 – <3> – 537999	499200 – <3> – 537999
	30	499200 – <6> – 537996	499200 – <6> – 537996
n46 ²	15	743334 – <1> – 795000	743334 – <1> – 795000
n47	15	790334 – <1> – 795000	790334 – <1> – 795000
n48	15	636667 – <1> – 646666	636667 – <1> – 646666
	30	636668 – <2> – 646666	636668 – <2> – 646666
n50	100	286400 – <20> – 303400	286400 – <20> – 303400
n51	100	285400 – <20> – 286400	285400 – <20> – 286400
n53	100	496700 – <20> – 499000	496700 – <20> – 499000
n65	100	384000 – <20> – 402000	422000 – <20> – 440000
n66	100	342000 – <20> – 356000	422000 – <20> – 440000
n70	100	339000 – <20> – 342000	399000 – <20> – 404000
n71	100	132600 – <20> – 139600	123400 – <20> – 130400
n75	100	N/A	286400 – <20> – 303400
n76	100	N/A	285400 – <20> – 286400
n77	15	620000 – <1> – 680000	620000 – <1> – 680000
	30	620000 – <2> – 680000	620000 – <2> – 680000
n78	15	620000 – <1> – 653333	620000 – <1> – 653333
	30	620000 – <2> – 653332	620000 – <2> – 653332
n79	15	693334 – <1> – 733333	693334 – <1> – 733333
	30	693334 – <2> – 733332	693334 – <2> – 733332
n80	100	342000 – <20> – 357000	N/A
n81	100	176000 – <20> – 183000	N/A
n82	100	166400 – <20> – 172400	N/A
n83	100	140600 – <20> – 149600	N/A
n84	100	384000 – <20> – 396000	N/A
n86	100	342000 – <20> – 356000	N/A
n95	100	402000 – <20> – 405000	N/A
n96 ³	15	795000 – <1> – 875000	795000 – <1> – 875000
n97	100	460000 – <20> – 480000	N/A
n99	100	325300 – <20> – 332100	N/A

NOTE 1: The channel numbers that designate carrier frequencies so close to the operating band edges that the carrier extends beyond the operating band edge shall not be used.

NOTE 2: The following N_{REF} are allowed for operation in Band n46: see Table 5.4.2.3-2.

NOTE 3: The following N_{REF} are allowed for operation in Band n96: see Table 5.4.2.3-3.

Table 5.4.2.3-2: Allowed N_{REF} (NR-ARFCN) for operation in Band n46

Channel Bandwidth	Allowed N_{REF}
10 MHz	782000, 788668
20 MHz	744000, 745332, 746668, 748000, 749332, 750668, 752000, 753332, 754668, 756000, 765332, 766668, 768000, 769332, 770668, 772000, 773332, 774668, 776000, 777332, 778668, 780000, 781332, 783000, 784332, 785668, 787000, 788332, 789668, 791000, 792332, 793668
40 MHz	744668, 746000, 748668, 751332, 754000, 755332, 766000, 767332, 770000, 772668, 775332, 778000, 780668, 783668, 786332, 787668, 790332, 793000
60 MHz	745332, 746668, 748000, 752000, 753332, 754668, 766668, 768000, 769332, 773332, 774668, 778668, 780000, 784332, 785668, 787000, 791000, 792332
80 MHz	746000, 747332, 752668, 754000, 767332, 768668, 774000, 779332, 785000, 786332, 791668
NOTE:	10 MHz channel bandwidth shall only apply in certain regions where the absence of non 3GPP technologies can be guaranteed on a long-term basis in this version of specification.

Table 5.4.2.3-3: Allowed N_{REF} (NR-ARFCN) for operation in Band n96

Channel Bandwidth	Allowed N_{REF}
20 MHz	797000, 798332, 799668, 801000, 802332, 803668, 805000, 806332, 807668, 809000, 810332, 811668, 813000, 814332, 815668, 817000, 818332, 819668, 821000, 822332, 823668, 825000, 826332, 827668, 829000, 830332, 831668, 833000, 834332, 835668, 837000, 838332, 839668, 841000, 842332, 843668, 845000, 846332, 847668, 849000, 850332, 851668, 853000, 854332, 855668, 857000, 858332, 859668, 861000, 862332, 863668, 865000, 866332, 867668, 869000, 870332, 871668, 873000, 874332
40 MHz	797668, 800332, 803000, 805668, 808332, 811000, 813668, 816332, 819000, 821668, 824332, 827000, 829668, 832332, 835000, 837668, 840332, 843000, 845668, 848332, 851000, 853668, 856332, 859000, 861668, 864332, 867000, 869668, 872332
60 MHz	798332, 799668, 803668, 805000, 809000, 810332, 814332, 815668, 819668, 821000, 825000, 826332, 830332, 831668, 835668, 837000, 841000, 842332, 846332, 847668, 851668, 853000, 857000, 858332, 862332, 863668, 867668, 869000, 873000
80 MHz	799000, 804332, 809668, 815000, 820332, 825668, 831000, 836332, 841668, 847000, 852332, 857668, 863000, 868332

5.4.3 Synchronization raster

5.4.3.1 Synchronization raster and numbering

The synchronization raster indicates the frequency positions of the synchronization block that can be used by the UE for system acquisition when explicit signalling of the synchronization block position is not present.

A global synchronization raster is defined for all frequencies. The frequency position of the SS block is defined as SS_{REF} with corresponding number GSCN. The parameters defining the SS_{REF} and GSCN for all the frequency ranges are in Table 5.4.3.1-1.

The resource element corresponding to the SS block reference frequency SS_{REF} is given in subclause 5.4.3.2. The synchronization raster and the subcarrier spacing of the synchronization block are defined separately for each band.

Table 5.4.3.1-1: GSCN parameters for the global frequency raster

Frequency range	SS Block frequency position SS_{REF}	GSCN	Range of GSCN
0 – 3000 MHz	$N * 1200\text{kHz} + M * 50\text{ kHz}$, $N=1:2499, M \in \{1,3,5\}$ (Note 1)	$3N + (M-3)/2$	2 – 7498
3000 - 24250 MHz	$3000\text{ MHz} + N * 1.44\text{ MHz}$ $N = 0:14756$	$7499 + N$	7499 – 22255

NOTE 1: The default value for operating bands with SCS spaced channel raster is $M=3$.

5.4.3.2 Synchronization raster to synchronization block resource element mapping

The mapping between the synchronization raster and the corresponding resource element of the SS block is given in Table 5.4.3.2-1.

Table 5.4.3.2-1: Synchronization raster to SS block resource element mapping

Resource element index k	120

k is the subcarrier number of SS/PBCH block defined in TS 38.211 clause 7.4.3.1[8].

5.4.3.3 Synchronization raster entries for each operating band

The synchronization raster for each band is given in Table 5.4.3.3-1. The distance between applicable GSCN entries is given by the <Step size> indicated in Table 5.4.3.3-1.

Table 5.4.3.3-1: Applicable SS raster entries per operating band

NR operating band	SS Block SCS	SS Block pattern ¹	Range of GSCN (First – <Step size> – Last)
n1	15kHz	Case A	5279 – <1> – 5419
n2	15kHz	Case A	4829 – <1> – 4969
n3	15kHz	Case A	4517 – <1> – 4693
n5	15kHz	Case A	2177 – <1> – 2230
	30kHz	Case B	2183 – <1> – 2224
n7	15kHz	Case A	6554 – <1> – 6718
n8	15kHz	Case A	2318 – <1> – 2395
n12	15kHz	Case A	1828 – <1> – 1858
n14	15 kHz	Case A	1901 – <1> – 1915
n20	15kHz	Case A	1982 – <1> – 2047
n24	15 kHz	Case A	3818 – <1> – 3892
	30 kHz	Case B	3824 – <1> – 3886
n25	15 kHz	Case A	4829 – <1> – 4981
n26	15 kHz	Case A	2153 – <1> – 2230
n28	15kHz	Case A	1901 – <1> – 2002
n29	15 kHz	Case A	1798 – <1> – 1813
n30	15 kHz	Case A	5879 – <1> – 5893
n34	15kHz	Case A	NOTE 5
	30kHz	Case C	5036 – <1> – 5050
n38	15kHz	Case A	NOTE 2
	30 kHz	Case C	6437 – <1> – 6538
n39	15kHz	Case A	NOTE 6
	30 kHz	Case C	4712 – <1> – 4789
n40	30kHz	Case C	5762 – <1> – 5989
n41	15kHz	Case A	6246 – <3> – 6717
	30 kHz	Case C	6252 – <3> – 6714
n46 ³	30 kHz	Case C	8993 – <1> – 9530
n50	30kHz	Case C	3590 – <1> – 3781
n48	30 kHz	Case C	7884 – <1> – 7982
n51	15kHz	Case A	3572 – <1> – 3574
n53	15 kHz	Case A	6215 – <1> – 6232
n65	15 kHz	Case A	5279 – <1> – 5494
n66	15kHz	Case A	5279 – <1> – 5494
	30kHz	Case B	5285 – <1> – 5488
n70	15kHz	Case A	4993 – <1> – 5044
n71	15kHz	Case A	1547 – <1> – 1624
n74	15kHz	Case A	3692 – <1> – 3790
n75	15kHz	Case A	3584 – <1> – 3787
n76	15kHz	Case A	3572 – <1> – 3574
n77	30kHz	Case C	7711 – <1> – 8329
n78	30kHz	Case C	7711 – <1> – 8051
n79	30kHz	Case C	8480 – <16> – 8880 ⁷
			8475 – <1> – 8884 ⁸
n96 ⁴	30 kHz	Case C	9531 – <1> – 10363

NOTE 1: SS Block pattern is defined in section 4.1 in TS 38.213 [9]
NOTE 2: The applicable SS raster entries are GSCN = {6432, 6443, 6457, 6468, 6479, 6493, 6507, 6518, 6532, 6543}.
NOTE 3: The following GSCN are allowed for operation in band n46:
GSCN = {8996, 9010, 9024, 9038, 9051, 9065, 9079, 9093, 9107, 9121, 9218, 9232, 9246, 9260, 9274, 9288, 9301, 9315, 9329, 9343, 9357, 9371, 9385, 9402, 9416, 9430, 9444, 9458, 9472, 9485, 9499, 9513}.
NOTE 4: The following GSCN are allowed for operation in band n96:
GSCN = {9548, 9562, 9576, 9590, 9603, 9617, 9631, 9645, 9659, 9673, 9687, 9701, 9714, 9728, 9742, 9756, 9770, 9784, 9798, 9812, 9826, 9840, 9853, 9867, 9881, 9895, 9909, 9923, 9937, 9951, 9964, 9978, 9992, 10006, 10020, 10034, 10048, 10062, 10076, 10090, 10103, 10117, 10131, 10145, 10159, 10173, 10187, 10201, 10214, 10228, 10242, 10256, 10270, 10284, 10298, 10312, 10325, 10339, 10353}.
NOTE 5: The applicable SS raster entries are GSCN = {5032, 5043, 5054}
NOTE 6: The applicable SS raster entries are GSCN = {4707, 4715, 4718, 4729, 4732, 4743, 4747, 4754, 4761, 4768, 4772, 4782, 4786, 4793}
NOTE 7: The SS raster entries apply for channel bandwidths larger than or equal to 40 MHz
NOTE 8: The SS raster entries apply for channel bandwidths smaller than 40 MHz

5.4.4 TX–RX frequency separation

The default TX channel (carrier centre frequency) to RX channel (carrier centre frequency) separation for operating bands is specified in Table 5.4.4-1.

Table 5.4.4-1: UE TX-RX frequency separation

NR Operating Band	TX – RX carrier centre frequency separation
n1	190 MHz
n2	80 MHz
n3	95 MHz
n5	45 MHz
n7	120 MHz
n8	45 MHz
n12	30 MHz
n14	-30 MHz
n20	-41 MHz
n24	-101.5, -120.5 MHz
n25	80 MHz
n26	45 MHz
n28	55 MHz
n30	45 MHz
n65	190 MHz
n66	400 MHz
n70	300 MHz
n71	-46 MHz
n74	48 MHz

NOTE 1: Default TX-RX carrier centre frequency separation.

5.4A Channel arrangement for CA

5.4A.1 Channel spacing for CA

For intra-band contiguous carrier aggregation with two or more component carriers, the nominal channel spacing between two adjacent NR component carriers is defined as the following unless stated otherwise:

For NR operating bands with a 100 kHz channel raster:

$$\text{Nominal channel spacing} = \left\lceil \frac{BW_{\text{Channel}(1)} + BW_{\text{Channel}(2)} - 2|GB_{\text{Channel}(1)} - GB_{\text{Channel}(2)}|}{0.6} \right\rceil 0.3 \text{ [MHz]}$$

while for NR operating bands with 15 kHz channel raster:

$$\text{Nominal channel spacing} = \left\lceil \frac{BW_{\text{Channel}(1)} + BW_{\text{Channel}(2)} - 2|GB_{\text{Channel}(1)} - GB_{\text{Channel}(2)}|}{0.015 * 2^{n+1}} \right\rceil 0.015 * 2^n \text{ [MHz]}$$

with

$$n = \mu_0$$

$$n = \mu_0$$

where $BW_{\text{Channel}(1)}$ and $BW_{\text{Channel}(2)}$ are the channel bandwidths of the two respective NR component carriers according to Table 5.3.2-1 with values in MHz, μ_0 is the largest μ value among the subcarrier spacing configurations supported in the operating band for both of the channel bandwidths according to Table 5.3.5-1 and $GB_{\text{Channel}(i)}$ is the minimum guard band for channel bandwidth i according to Table 5.3.3-1 for the said μ value with μ as defined in TS 38.211. In case

there is no common μ value for both of the channel bandwidths, $\mu_0=1$ is selected and $GB_{Channel(i)}$ is the minimum guard band for channel bandwidth i according to Table 5.3.3-1 for $\mu=1$ with μ as defined in TS 38.211.

The channel spacing for intra-band contiguous carrier aggregation can be adjusted to any multiple of least common multiple of channel raster and sub-carrier spacing less than the nominal channel spacing to optimize performance in a particular deployment scenario.

For intra-band non-contiguous carrier aggregation, the channel spacing between two NR component carriers in different sub-blocks shall be larger than the nominal channel spacing defined in this subclause

5.4A.2 Channel raster for CA

For inter-band and intra-band contiguous carrier aggregation, the channel raster requirements in clause 5.4.2 apply for each operating band.

5.4A.3 Synchronization raster for CA

For inter-band and intra-band contiguous carrier aggregation, the synchronization raster requirements in clause 5.4.3 apply for each operating band.

5.4A.4 Tx-Rx frequency separation for CA

For inter-band carrier aggregation, the Tx-Rx frequency separation requirements in subclause 5.4.4 apply for each operating band.

For intra-band contiguous carrier aggregation, the same TX-RX frequency separation as specified in Table 5.4.4-1 is applied to PCC and SCC, respectively.

5.4E Channel arrangement for V2X

5.4E.1 Channel spacing

For NR V2X, the channel spacing requirements in clause 5.4.1 apply for each operating band.

5.4E.2 Channel raster

5.4E.2.1 NR-ARFCN and channel raster

For NR V2X, the NR-ARFCN and channel raster requirements in clause 5.4.2.1 apply for each operating band.

For NR V2X UE, the reference frequency can be shifted by configuration.

$$F_{\text{REF_V2X}} = F_{\text{REF}} + \Delta_{\text{shift}} + N * 5 \text{ kHz}$$

where

$\Delta_{\text{shift}} = 0 \text{ kHz}$ or 7.5 kHz indicated in IE (*frequencyShift7p5khz*), and

N can be set as one of following values $\{-1, 0, 1\}$, which are signalled by the network in higher layer parameters or configured by pre-configuration parameters.

5.4E.2.2 Channel raster to resource element mapping

For NR V2X, the channel raster to resource element mapping requirements in clause 5.4.2.2 apply for each operating band.

5.4E.2.3 Channel raster entries for each operating band

For NR V2X, the channel raster entries, the channel raster entries requirements in clause 5.4.2.3 apply for each operating band.

The RF channel positions on the channel raster in each NR V2X operating band are given through the applicable NR-ARFCN in Table 5.4.2.3-1, using the channel raster to resource element mapping in subclause 5.4E.2.2.

For NR V2X operating band n47, $\Delta F_{\text{Raster}} = I \times \Delta F_{\text{Global}}$, where $I \in \{1\}$. Every I^{th} NR-ARFCN within the operating band are applicable for the channel raster within the operating band and the step size for the channel raster in Table 5.4.2.3-1 is given as $\langle I \rangle$.

5.4E.3 Synchronization raster for V2X

There is no synchronization raster definition for NR V2X for both licensed bands and unlicensed bands.

5.5 Void

5.5A Configurations for CA

5.5A.0 General

The configurations for CA operating band including Band n41 also apply for the corresponding CA operating bands with Band n90 replacing Band n41 but with otherwise identical parameters. For brevity the said configuration for CA operating bands with Band n90 are not listed in the tables below but are covered by this specification.

Non-contiguous resource allocation and almost contiguous allocation are not applicable for each NR carrier of intra-band contiguous and non-contiguous CA configurations.

For a CA configuration with one or more operating band supporting asymmetric channel bandwidths as specified in sub-clause 5.3.6, requirements are defined for an asymmetric UL and DL channel bandwidth combination of a supported asymmetric channel bandwidth combination set for an operating band of the CA configuration when the said UL and DL channel bandwidths are also contained in a supported bandwidth combination set of the CA configuration.

5.5A.1 Configurations for intra-band contiguous CA

Power class 3 is supported for all uplinks. Power classes other than power class 3 are supported as indicated in Table 5.5A.1-1.

Table 5.5A.1-1: NR CA configurations and bandwidth combination sets defined for intra-band contiguous CA

NR CA configuration / Bandwidth combination set								
NR CA configuration	Uplink CA configuration or single uplink carrier ⁶	Channel bandwidths for carrier (MHz)	Channel bandwidths for carrier (MHz)	Channel bandwidths for carrier (MHz)	Channel bandwidths for carrier (MHz)	Channel bandwidths for carrier (MHz)	Maximum aggregated bandwidth (MHz)	Bandwidth combination set
CA_n40B	-	20	80				100	0
		50	50					
CA_n41C	n41 ^{4,5} CA_n41C	40	80, 100				180	0
		50, 60, 80	60, 80, 100					
		10	100				190	1
		15, 20	90, 100					
		40	80, 90, 100					
50, 60, 80, 90	60, 80, 90, 100							
CA_n46B	-	20, 40, 60	20, 40				100	0
CA_n46C	-	60, 80	60, 80				160	0
CA_n46D	-	60, 80	80	80			240	0
CA_n46E	-	80	80	80	80		320	0
CA_n46M	-	20, 40, 60	20, 40	20, 40			140	0
CA_n46N	-	20, 40, 80	20, 40	20, 40	20, 40		200	0
CA_n46O	-	20, 60	20, 40	20, 40	20, 40	20, 40	220	0
CA_n48B	CA_n48B	5	15, 20				40	0
		10, 15, 20	10, 15, 20					
		15, 20	15, 20					
	-	10	50, 60, 80, 90				100	1
		15, 20	40, 50, 60, 80					
		40	40, 50, 60					
-	10, 15, 20, 30, 40	10, 15, 20, 30, 40, 50, 60, 70, 80, 90				100	2	
CA_n66B	-	5 ²	20, 40				50	0
		10	15, 20, 40					
		15	15, 20					
CA_n77C	CA_n77C	50	60, 80, 100				200	0
		60	60, 80, 100					
		80	80, 100					
		100	100					
		10	100				200	1
		15, 20	90, 100					
		25, 30	80, 90, 100					
		40	70, 80, 90, 100					
50, 60, 70, 80, 90, 100	60, 70, 80, 90, 100							

CA_n77D	-	100	100	100			300	0
CA_n78B	-	20	50				70	0
CA_n78C	CA_n78 C	50	60, 80, 100				200	0
		60	60, 80, 100					
		80	80, 100					
		100	100					
		10	100					
		15, 20	90, 100					
		25, 30	80, 90, 100					
		40	70, 80, 90, 100				200	1
		50, 60, 70, 80, 90, 100	60, 70, 80, 90, 100					
CA_n78D	-	100	100	100			300	0
CA_n79C		50	60, 80, 100				200	0
		60	60, 80, 100					
		80	80, 100					
		100	100					
CA_n79D	-	100	100	100			300	0

NOTE 1: Unless otherwise stated, minimum requirements are applicable irrespective of the order of the component carriers.
NOTE 2: 5 MHz is not applicable for 30/60 kHz SCS.
NOTE 3: The aggregated bandwidth must be greater than or equal to the minimum for the bandwidth class defined in Table 5.3A.5-1, and smaller than or equal to the maximum aggregated bandwidth.
NOTE 4: Power Class 2 is allowed for this uplink combination or single uplink carrier in this downlink/uplink combination
NOTE 5: Power Class 1.5 is allowed for this uplink combination or single uplink carrier in this downlink/uplink combination
NOTE 6: Only single uplink carriers with power class other than PC3 are listed.

Table 5.5A.1-2: Void

5.5A.2 Configurations for intra-band non-contiguous CA

Table 5.5A.2-1: NR CA configurations and bandwidth combination sets defined for intra-band non-contiguous CA

NR CA Configuration	Uplink Configurations	Channel bandwidths for carrier (MHz)	Channel bandwidths for carrier (MHz)	Maximum Aggregated bandwidth (MHz)	Bandwidth combination set
CA_n48(2A)		10, 15, 20, 40, 50, 60	10, 15, 20, 40, 50, 60, 80, 90, 100	140 ²	0
		10, 15, 20, 30, 40, 50, 60, 70, 80, 90, 100	10, 15, 20, 30, 40, 50, 60, 70, 80, 90, 100	140 ²	1
CA_n66(2A)	-	5 ^(note) , 10, 15, 20	5 ^(note) , 10, 15, 20, 40	60	0
		5, 10, 15, 20, 25, 30, 40	5, 10, 15, 20, 25, 30, 40	80	1
		5, 10, 15, 20, 40	5, 10, 15, 20, 40	80	2
CA_n71(2A)	-	5,10, 15, 20	5,10,15, 20	30	0
CA_n77(2A)	-	20, 40, 80, 100	20, 40, 80, 100	200	0
CA_n78(2A)		10, 20, 40, 50, 60, 80, 90, 100	10, 20, 40, 50, 60, 80, 90, 100	200	0
		10, 20, 25, 30, 40, 50, 60, 80, 90, 100	10, 20, 25, 30, 40, 50, 60, 80, 90, 100	200	1
		10, 20, 25, 30, 40, 50, 60, 70, 80, 90, 100	10, 20, 25, 30, 40, 50, 60, 70, 80, 90, 100	200	2

NOTE 1: 5 MHz is not applicable for 30/60 kHz SCS.
NOTE 2: Parameter value accounts for both, the maximum frequency range of band n48 (150 MHz), and the minimum frequency gaps in between NR non-contiguous component carriers.

5.5A.3 Configurations for inter-band CA

Table 5.5A.3-1: Void

Table 5.5A.3-2: Void

Table 5.5A.3-3: Void

5.5A.3.1 Configurations for inter-band CA (two bands)

Table 5.5A.3.1-1: NR CA configurations and bandwidth combinations sets defined for inter-band CA (two bands)

NR CA configuration	Uplink CA configuration or single uplink carrier ⁵	NR Band	Channel bandwidth (MHz) (NOTE 3)													Bandwidth combination set	
			5	10	15	20	25	30	40	50	60	70	80	90	100		
CA_n1A-n3A	CA_n1A-n3A	n1	5	10	15	20											0
		n3	5	10	15	20	25	30									
		n1	5	10	15	20	25	30	40	50							1
		n3	5	10	15	20	25	30	40								
CA_n1(2A)-n3A	-	n1	See CA_n1(2A) bandwidth combination set 0 in Table 5.5A.2-1													0	
		n3	5	10	15	20	25	30	40								
CA_n1(2A)-n5A	-	n1	See CA_n1(2A) bandwidth combination set 0 in Table 5.5A.2-1													0	
		n5	5	10	15	20											
CA_n1A-n8A	CA_n1A-n8A	n1	5	10	15	20											
		n8	5	10	15	20											
CA_n1(2A)-n8A	-	n1	See CA_n1(2A) bandwidth combination set 0 in Table 5.5A.2-1													0	
		n8	5	10	15	20											
CA_n1A-n77A	-	n1	5	10	15	20											0
		n77		10	15	20			40	50	60		80	90	100		
CA_n1A-n78A	CA_n1A-n78A	n1	5	10	15	20											0
		n78		10	15	20			40	50	60		80	90	100		
CA_n1A-n78A	CA_n1A-n78A	n1	5	10	15	20	25	30	40	50							1
		n78		10	15	20			40	50	60		80	90	100		
CA_n1A-n78A	CA_n1A-n78A	n1	5	10	15	20	25	30	40								2
		n78		10	15	20			40	50	60		80	90	100		
CA_n1A-n78(2A)	CA_n1A-n78A	n1	5	10	15	20											0
		n78	See CA_n78(2A) Bandwidth Combination Set 0 in Table 5.5A.2-1														
		n1	5	10	15	20	25	30	40	50							1
		n78	See CA_n78(2A) Bandwidth Combination Set 1 in Table 5.5A.2-1														
		n1	5	10	15	20											
CA_n1A-n78C	CA_n1A-n78A	n78	See CA_n78C Bandwidth Combination Set 0 in Table 5.5A.1-1													0	
		n1	5	10	15	20	25	30	40	50							1
		n78	See CA_n78C Bandwidth Combination Set 0 in Table 5.5A.1-1														
		n1	5	10	15	20	25	30	40								2
		n78	See CA_n78C Bandwidth Combination Set 0 in Table 5.5A.1-1														
CA_n1(2A)-n78A	-	n1	See CA_n1(2A) bandwidth combination set 0 in Table 5.5A.2-1													0	
		n78		10	15	20	25	30	40	50	60	70	80	90	100		

CA_n1A-n79A	CA_n1A-n79A	n1	5	10	15	20										0
		n79							40	50	60		80		100	
CA_n3A-n5A	CA_n3A-n5A	n3	5	10	15	20	25	30	40	50						0
		n5	5	10	15	20										
CA_n3(2A)-n5A	-	n3	See CA_n3(2A) Bandwidth Combination Set 0 in Table 5.5A.2-1													0
		n5	5	10	15											
CA_n3(2A)-n8A	-	n3	See CA_n3(2A) Bandwidth Combination Set 0 in Table 5.5A.2-1													0
		n8	5	10	15	20										
CA_n3A-n41A	n41 ⁴ CA_n3A-n41A ⁴	n3	5	10	15	20	25	30								0
		n41		10	15	20			40	50	60		80	90	100	
CA_n3A-n77A	-	n3	5	10	15	20	25	30								0
		n77		10	15	20			40	50	60		80	90	100	
CA_n3A-n78A	CA_n3A-n78A	n3	5	10	15	20	25	30								0
		n78		10	15	20			40	50	60		80	90	100	
		n3	5	10	15	20	25	30	40							1
		n78		10	15	20	25	30	40	50	60	70	80	90	100	
CA_n3A-n78(2A)	CA_n3A-n78A CA_n78(2A)	n3	5	10	15	20	25	30								0
		n78	See CA_n78(2A) Bandwidth Combination Set 0 in Table 5.5A.2-1													
	CA_n3A-n78A	n78	See CA_n78(2A) Bandwidth Combination Set 2 in Table 5.5A.2-1													1
CA_n3(2A)-n78A	-	n3	See CA_n3(2A) bandwidth combination set 0 in Table 5.5A.2-1													0
		n78		10	15	20	25	30	40	50	60	70	80	90	100	
CA_n3A-n79A	-	n3	5	10	15	20	25	30								0
		n79							40	50	60		80		100	
CA_n5A-n7A	-	n5	5	10	15	20										0
		n7	5	10	15	20	25	30	40	50						
CA_n5A-n78A	CA_n5A-n78A	n5	5	10	15	20										0
		n78		10	15	20			40	50	60		80	90	100	
		n5	5	10	15	20										1
		n78		10	15	20	25	30	40	50	60	70	80	90	100	
CA_n5A-n78(2A)	CA_n5A-n78A	n5	5	10	15	20										0
		n78	See CA_n78(2A) Bandwidth Combination Set 2 in Table 5.5A.2-1													
CA_n7A-n78A	CA_n7A-n78A	n7	5	10	15	20										0
		n78		10	15	20			40	50	60		80	90	100	
		n7	5	10	15	20	25	30	40	50						1
		n78		10	15	20	25	30	40	50	60	70	80	90	100	
CA_n8A-n75A	-	n8	5	10	15	20										0
		n75	5	10	15	20										
CA_n8A-n78A	CA_n8A-n78A	n8	5	10	15	20										0
		n78		10	15	20			40	50	60		80	90	100	

		n8	5	10	15	20										1
		n78		10	15	20	25	30	40	50	60		80	90	100	
CA_n8A-n78(2A)	CA_n8A-n78A	n8	5	10	15	20										0
		n78	See CA_n78(2A) Bandwidth Combination Set 1 in Table 5.5A.2-1													
CA_n8A-n79A	-	n8	5	10	15	20										0
		n79		10	15	20			40	50	60		80		100	
CA_n24A-n41A	CA_n24A-41A	n24	5	10												0
		n41		10	15	20		30	40	50	60		80	90	100	
CA_n24A-41(2A)	CA_n24A-41A	n24	5	10												0
		n41	See CA_n41(2A) Bandwidth Combination Set 1 in Table 5.5A.2-1													
CA_n24A-n48A	CA_n24A-48A	n24	5	10												0
		n48	5	10	15	20			40	50	60		80	90	100	
CA_n24A-n48B	CA_n24A-48A	n24	5	10												0
		n48	See CA_n48B Bandwidth Combination Set 1 in Table 5.5A.1-1													
CA_n24A-48(2A)	CA_n24A-48A	n24	5	10												0
		n48	See CA_n48(2A) Bandwidth Combination Set 0 in Table 5.5A.2-1													
CA_n24A-n77A	CA_n24A-77A	n24	5	10												0
		n77		10	15	20	25	30	40	50	60	70	80	90	100	
CA_n24A-n77C	CA_n24A-77A	n24	5	10												0
		n77	See CA_n77C Bandwidth Combination Set 1 in Table 5.5A.1-1													
CA_n25A-n46A	-	n25	5	10	15	20										0
		n46				20			40		60		80			
CA_n26A-n66A	CA_n26A-n66A	n26	5	10	15	20										0
		n66	5	10	15	20	25	30	40							
CA_n26A-n70A	CA_n26A-n70A	n26	5	10	15	20										0
		n70	5	10	15	20 ¹	25 ¹									
CA_n26A-n66(2A)	CA_n26A-n66A	n26	5	10	15	20										0
		n66	See CA_n66(2A) Bandwidth Combination Set 0 in Table 5.5A.2-1													
CA_n28A-n41A	CA_n28A-n41A	n28	5	10	15	20										0
		n41		10	15	20			40	50	60		80	90	100	
CA_n28A-n41A	CA_n28A-n41A	n28	5	10	15	20										1
		n41		10	15	20	25	30	40	50	60		80	90	100	
CA_n28A-n75A	-	n28	5	10	15	20										0
		n75	5	10	15	20										
CA_n28A-n78A	CA_n28A-n78A	n28	5	10	15	20										0
		n78		10	15	20			40	50	60		80	90	100	
CA_n28A-n78(2A)	CA_n28A-n78A	n28	5	10	15	20										0
		n78	See CA_n78(2A) Bandwidth Combination Set 0 in Table 5.5A.2-1													
CA_n28A-n79A		n28	5	10	15	20		30								0

	CA_n28A-n79A	n79							40	50	60		80		100	
CA_n29A-n66A	-	n29	5	10												0
		n66	5	10	15	20			40							
CA_n29A-n66B	-	n29	5	10												0
		n66	See CA_n66B Bandwidth Combination Set 0 in Table 5.5A.1-1													
CA_n29A-n66(2A)	-	n29	5	10												0
		n66	See CA_n66(2A) Bandwidth Combination Set 0 in Table 5.5A.2-1													
CA_n29A-n70A	-	n29	5	10												0
		n70	5	10	15	20 ¹	25 ¹									
CA_n29A-n71A	-	n29	5	10												0
		n71	5	10	15	20										
CA_n41A-n78A	-	n41		10	15	20			40	50	60		80		100	0
		n78		10	15	20			40	50	60		80	90	100	
CA_n41A-n79A	CA_n41A-n79A	n41		10	15	20			40	50	60		80	90	100	0
		n79							40	50	60		80		100	
		n41		10	15	20			40	50	60					1
		n79							40	50	60		80		100	
CA_n41C-n79A	CA_n41A-n79A CA_n41C	n41	See CA_n41C Bandwidth Combination Set 0 in Table 5.5A.1-1													0
		n79							40	50	60		80		100	
CA_n46A-n48A	CA_n46A-n48A	n46				20			40		60		80			0
		n48				20										
CA_n46B-n48A	CA_n46A-n48A	n46	See CA_n46B Bandwidth Combination Set 0 in 38.101-1 Table 5.5A.1-1													0
		n48				20										
CA_n46C-n48A	CA_n46A-n48A	n46	See CA_n46C Bandwidth Combination Set 0 in 38.101-1 Table 5.5A.1-1													0
		n48				20										
CA_n46D-n48A	CA_n46A-n48A	n46	See CA_n46D Bandwidth Combination Set 0 in 38.101-1 Table 5.5A.1-1													0
		n48				20										
CA_n46E-n48A	CA_n46A-n48A	n46	See CA_n46E Bandwidth Combination Set 0 in 38.101-1 Table 5.5A.1-1													0
		n48				20										
CA_n46A-n66A	-	n46				20			40		60		80			0
		n66	5	10	15	20	25	30	40							
CA_n48A-n66A	CA_n48A-n66A	n48	5	10	15	20			40	50 ¹	60 ¹		80 ¹	90 ¹	100 ¹	0
		n66	5	10	15	20			40							
		n48	5	10	15	20			40	50 ¹	60 ¹		80 ¹	90 ¹	100 ¹	1
		n66	5	10	15	20	25	30	40							

		n48	5	10	15	20		30	40	50 ¹	60 ¹	70 ¹	80 ¹	90 ¹	100 ¹	2
		n66	5	10	15	20	25	30	40							
CA_n48A-n66(2A)	CA_n48A-n66A	n48	5	10	15	20		30	40	50 ¹	60 ¹	70 ¹	80 ¹	90 ¹	100 ¹	0
		n66	See CA_n66(2A) Bandwidth Combination Set 0 in Table 5.5A.2-1													
CA_n48A-n70A ⁶	CA_n48A-n70A	n48	5	10	15	20		30	40	50 ¹	60 ¹	70 ¹	80 ¹	90 ¹	100 ¹	0
		n70	5	10	15	20 ¹	25 ¹									
CA_n48A-n71A	CA_n48A-n71A	n48	5	10	15	20		30	40	50 ¹	60 ¹	70 ¹	80 ¹	90 ¹	100 ¹	0
		n71	5	10	15	20										
CA_n48A-n71(2A)	CA_n48A-n71A	n48	5	10	15	20		30	40	50 ¹	60 ¹	70 ¹	80 ¹	90 ¹	100 ¹	0
		n71	See CA_n71(2A) Bandwidth Combination Set 0 in Table 5.5A.2-1													
CA_n48B-n66A	CA_n48A-n66A	n48	See CA_n48B Bandwidth Combination Set 0 in Table 5.5A.1-1													0
		n66	5	10	15	20			40							
		n48	See CA_n48B Bandwidth Combination Set 1 in Table 5.5A.1-1													1
		n66	5	10	15	20	25	30	40							
		n48	See CA_n48B Bandwidth Combination Set 2 in Table 5.5A.1-1													2
		n66	5	10	15	20	25	30	40							
CA_n48B-n70A	CA_n48A-n70A	n48	See CA_n48B Bandwidth Combination Set 2 in Table 5.5A.1-1													0
		n70	5	10	15	20 ¹	25 ¹									
CA_n48B-n71A	CA_n48A-n71A	n48	See CA_n48B Bandwidth Combination Set 2 in Table 5.5A.1-1													0
		n71	5	10	15	20										
CA_n48(2A)-n66A	CA_n48A-n66A	n48	See CA_n48(2A) Bandwidth Combination Set 0 in Table 5.5A.2-1													0
		n66	5	10	15	20	25	30	40							
		n48	See CA_n48(2A) Bandwidth Combination Set 0 in Table 5.5A.2-1													1
		n66	5	10	15	20	25	30	40							
		n48	See CA_n48(2A) Bandwidth Combination Set 0 in Table 5.5A.2-1													2
		n66	5	10	15	20	25	30	40							
CA_n48(2A)-n70A	CA_n48A-n70A	n48	See CA_n48(2A) Bandwidth Combination Set 1 in Table 5.5A.2-1													0
		n70	5	10	15	20 ¹	25 ¹									
CA_n48(2A)-n71A	CA_n48A-n71A	n48	See CA_n48(2A) Bandwidth Combination Set 1 in Table 5.5A.2-1													0
		n71	5	10	15	20										
CA_n66A-n70A	-	n66	5	10	15	20	25									0
		n70	5	10	15	20 ¹	25 ¹									
CA_n66B-n70A	-	n66	See CA_n66B Bandwidth Combination Set 0 in Table 5.5A.1-1													0
		n70	5	10	15	20 ¹	25 ¹									
CA_n66(2A)-n70A	-	n66	See CA_n66(2A) Bandwidth Combination Set 0 in Table 5.5A.2-1													0
		n70	5	10	15	20 ¹	25 ¹									
CA_n66A-n71A	CA_n66A-n71A	n66	5	10	15	20			40							0
		n71	5	10	15	20										
		n66	5	10	15	20	25	30	40							1
		n71	5	10	15	20										
CA_n66A-n71(2A)	-	n66	5	10	15	20			40							0
		n71	See CA_n71(2A) Bandwidth Combination Set 0 in Table 5.5A.2-1													

	CA_n66A-n71A	n66	5	10	15	20	25	30	40								1
		n71	See CA_n71(2A) Bandwidth Combination Set 0 in Table 5.5A.2-1														
CA_n66(2A)-n71A	CA_n66A-n71A	n66	See CA_n66(2A) Bandwidth Combination Set 0 in Table 5.5A.2-1													0	
		n71	5	10	15	20											
CA_n66(2A)-n71(2A)	CA_n66A-n71A	n66	See CA_n66(2A) Bandwidth Combination Set 1 in Table 5.5A.2-1													0	
		n71	See CA_n71(2A) Bandwidth Combination Set 0 in Table 5.5A.2-1														
CA_n66B-n71A	CA_n66A-n71A	n66	See CA_n66B Bandwidth Combination Set 0 in Table 5.5A.1-1													0	
		n71	5	10	15	20											
CA_n70A-n71A	CA_n70A-n71A	n70	5	10	15	20 ¹	25 ¹										0
		n71	5	10	15	20											
CA_n70A-n71A(2A)	CA_n70A-n71A	n70	5	10	15	20 ¹											0
		n71	See CA_n71(2A) Bandwidth Combination Set 0 in Table 5.5A.2-1														
CA_n75A-n78A	-	n75	5	10	15	20											0
		n78		10	15	20			40	50	60		80	90	100		
CA_n76A-n78A	-	n76	5														0
		n78		10	15	20			40	50	60		80	90	100		
CA_n77A-n79A	-	n77		10	15	20			40	50	60		80	90	100		0
		n79							40	50	60		80		100		
CA_n78A-n79A	-	n78		10	15	20			40	50	60		80	90	100		0
		n79							40	50	60		80		100		

NOTE 1: This UE channel bandwidth is applicable only to downlink.

NOTE 2: The minimum requirements for intra-band contiguous or non-contiguous CA apply.

NOTE 3: The SCS of each channel bandwidth for NR band refers to Table 5.3.5-1.

NOTE 4: Power Class 2 is allowed for this uplink combination or single uplink carrier in this downlink/uplink combination

NOTE 5: Only single uplink carriers with power class other than PC3 are listed.

NOTE 6: The same configuration applies to corresponding NR-DC configuration in Table 5.5B.1-1. If UE supporting NR-DC configuration do not support the corresponding CA configuration, NR-DC configuration is used in CA test cases.

5.5A.3.2 Configurations for inter-band CA (three bands)

Table 5.5A.3.2-1: NR CA configurations and bandwidth combinations sets defined for inter-band CA (three bands)

NR CA configuration	Uplink CA configuration	NR Band	Channel bandwidth (MHz) (NOTE 3)											Bandwidth combination set			
			5	10	15	20	25	30	40	50	60	80	90		100		
CA_n1A-n78A-n79A ⁴		n1	5	10	15	20											0
		n78		10	15	20			40	50	60	80	90				
		n79							40	50	60	80					
		n1	5	10	15	20											1

	CA_n1A-n78A CA_n1A-n79A CA_n78A-n79A	n78		10	15	20	25	30	40	50	60	80	90		
		n79							40	50	60	80			
CA_n26A-n66A-n70A	CA_n26A-n66A CA_n26A-n70A	n26	5	10	15	20									0
		n66	5	10	15	20	25	30	40						
		n70	5	10	15	20 ¹	25 ¹								
CA_n29A-n66A-n70A	-	n29	5	10											0
		n66	5	10	15	20			40						
		n70	5	10	15	20 ¹	25 ¹								
CA_n29A-n66B-n70A	-	n29	5	10											0
		n66	See CA_n66B Bandwidth Combination Set 0 in Table 5.5A.1-1 in TS38.101-1												
		n70	5	10	15	20 ¹	25 ¹								
CA_n29A-n66(2A)-n70A	-	n29	5	10											0
		n66	See CA_n66(2A) Bandwidth Combination Set 0 in Table 5.5A.2-1 in TS38.101-1												
		n70	5	10	15	20 ¹	25 ¹								
CA_n48A-n66A-n70A	CA_n48A-n66A CA_n48-n70A	n48	5	10	15	20		30	40	50	60	80	90	100	0
		n66	5	10	15	20	25	30	40						
		n70	5	10	15	20 ¹	25 ¹								
CA_n48A-n66A-n71A	CA_n48A-n71A CA_n66A-n71A CA_n48A-n66A	n48	5	10	15	20		30	40	50	60	80	90	100	0
		n66	5	10	15	20	25	30	40						
		n71	5	10	15	20									
CA_n48A-n70A-n71A	CA_n48A-n71A CA_n70A-n71A CA_n48A-n70A	n48	5	10	15	20		30	40	50	60	80	90	100	0
		n70	5	10	15	20 ¹	25 ¹								
		n71	5	10	15	20									
CA_n66A-n70A-n71A	CA_n66A-n71A CA_n70A-n71A	n66	5	10	15	20			40						0
		n70	5	10	15	20 ¹	25 ¹								
		n71	5	10	15	20									
CA_n66A-n70A-n71(2A)		n66	5	10	15	20	25	30	40						0
		n70	5	10	15	20 ¹	25 ¹								

	CA_n66A-n71A CA_n70A-n71A	n71	See CA_n71(2A) Bandwidth Combination Set 0 in Table 5.5A.2-1											
CA_n66B-n70A-n71A	CA_n66A-n71A CA_n70A-n71A	n66	See CA_n66B Bandwidth Combination Set 0 in Table 5.5A.1-1 in TS 38.101-1											0
		n70	5	10	15	20 ¹	25 ¹							
		n71	5	10	15	20								
CA_n66(2A)-n70A-n71A	CA_n66A-n71A CA_n70A-n71A	n66	See CA_n66(2A) Bandwidth Combination Set 0 in Table 5.5A.2-1 in TS 38.101-1											0
		n70	5	10	15	20 ¹	25 ¹							
		n71	5	10	15	20								
NOTE 1: This UE channel bandwidth is applicable only to downlink														
NOTE 2: For the 20 MHz bandwidth, the minimum requirements are specified for NR UL carrier frequencies confined to either 713-723 MHz or 728-738 MHz.														
NOTE 3: The SCS of each channel bandwidth for NR band refers to Table 5.3.5-1.														
NOTE 4: Simultaneous Rx/Tx capability for TDD combinations does not apply for UEs supporting band n78 with an n77 implementation.														

5.5A.3.3 Configurations for inter-band CA (four bands)

Table 5.5A.3.3-1: NR CA configurations and bandwidth combinations sets defined for inter-band CA (four bands)

Editor's note: table missing??

5.5B Configurations for DC

For an NR-DC configuration specified in Table 5.5B.1-1, the bandwidth combination sets for the corresponding NR CA configuration in 5.5A.3, i.e., dual uplink inter-band carrier aggregation with uplink assigned to two NR bands, are applicable to Dual Connectivity. If UE supporting NR-DC configuration do not support the corresponding CA configuration, NR-DC configuration is used in CA test cases.

Table 5.5B.1-1: Inter-band NR-DC configurations (two bands)

Editor's note: table missing??

5.5C Configurations for SUL

Table 5.5C-1: Supported channel bandwidths per SUL band combination

SUL configuration	NR Band	Channel bandwidth (MHz) (NOTE 1)													Bandwidth combination set
		5	10	15	20	25	30	40	50	60	70 MHz	80	90	100	
SUL_n41A-n83A	n41		10	15	20		30	40	50	60		80	90	100	0
	n83	5	10	15	20		30								
SUL_n78A-n80A	n78		10	15	20			40	50	60		80	90	100	0
	n80	5	10	15	20	25	30							1	
	n78		10	15	20	25	30	40	50	60	70	80	90		100
	n80	5	10	15	20	25	30	40							0
SUL_n78A-n81A	n78		10	15	20			40	50	60		80	90	100	
	n81	5	10	15	20										
SUL_n78A-n82A	n78		10	15	20			40	50	60		80	90	100	0
	n82	5	10	15	20										
SUL_n78A-n83A	n78		10	15	20			40	50	60		80	90	100	0
	n83	5	10	15	20									1	
	n78		10	15	20	25	30	40	50	60	70	80	90		100
	n83	5	10	15	20		30								0
SUL_n78A-n84A	n78		10	15	20			40	50	60		80	90	100	
	n84	5	10	15	20									1	
	n78		10	15	20	25	30	40	50	60	70	80	90		100
	n84	5	10	15	20	25	30	40	50						0
SUL_n78A-n86A	n78		10	15	20			40	50	60	70	80	90	100	
	n86	5	10	15	20										
SUL_n79A-n80A	n79							40	50	60		80		100	0
	n80	5	10	15	20	25	30							1	
	n79							40	50	60		80			100
	n80	5	10	15	20	25	30	40							0
SUL_n79A-n81A	n79							40	50	60		80		100	
	n81	5	10	15	20										
SUL_n79A-n83A	n79							40	50	60		80		100	0
	n83	5	10	15	20		30								

NOTE 1: The SCS of each channel bandwidth for NR band refers to Table 5.3.5-1.

Table 5.5C-2: Supported channel bandwidths per SUL band combination with intra-band non-contiguous CA

FFS

Table 5.5C-3: Supported channel bandwidths per SUL band combination with intra-band contiguous CA

SUL band combination with CA	SUL configuration	NR Band	5 MHz	10 MHz	15 MHz	20 MHz	25 MHz	30 MHz	40 MHz	50 MHz	60 MHz	70 MHz	80 MHz	90 MHz	100 MHz	Bandwidth combination set
SUL_n78C-n80A	SUL_n78A-n80A	n78	See CA_n78C Bandwidth Combination Set 1 in Table 5.5A.1-1													0
		n80	5	10	15	20	25	30	40							
SUL_n41C-n83A	SUL_n41A-n83A	n41	See CA_n41C Bandwidth Combination Set 1 in Table 5.5A.1-1													0
		n83	5	10	15	20		30								
SUL_n78C-n84A	SUL_n78A-n84A	n78	See CA_n78C Bandwidth Combination Set 1 in Table 5.5A.1-1													0
		n84	5	10	15	20	25	30	40	50						
SUL_n79C-n83A	SUL_n79A-n83A	n79	See CA_n79C Bandwidth Combination Set 0 in Table 5.5A.1-1													0
		n83	5	10	15	20		30								

Table 5.5C-4: Supported channel bandwidths per SUL band combination with inter-band CA

SUL band combination with CA	SUL configuration	NR Band	5 MHz	10 MHz	15 MHz	20 MHz	25 MHz	30 MHz	40 MHz	50 MHz	60 MHz	70 MHz	80 MHz	90 MHz	100 MHz	Bandwidth combination set
CA_n1A_SUL_n78A-n80A	SUL_n78A-n80A	n1	5	10	15	20	25	30	40	50						0
		n78		10	15	20	25	30	40	50	60	70	80	90	100	
		n80	5	10	15	20	25	30	40							
CA_n1A_SUL_n78A-n84A	SUL_n78A-n84A	n1	5	10	15	20	25	30	40	50						0
		n78		10	15	20	25	30	40	50	60	70	80	90	100	
		n84	5	10	15	20	25	30	40	50						
CA_n3A_SUL_n78A-n80A	SUL_n78A-n80A	n3	5	10	15	20	25	30	40							0
		n78		10	15	20	25	30	40	50	60	70	80	90	100	
		n80	5	10	15	20	25	30	40							
CA_n28A_SUL_n41A-n83A	SUL_n41A-n83A	n28	5	10	15	20		30								0
		n41		10	15	20		30	40	50	60		80	90	100	
		n83	5	10	15	20		30								
CA_n28A_SUL_n79A-n83A	SUL_n79A-n83A	n28	5	10	15	20		30								0
		n79							40	50	60		80		100	
		n83	5	10	15	20		30								

6 Transmitter characteristics

6.1 General

Unless otherwise stated, the transmitter characteristics are specified at the antenna connector of the UE with a single or multiple transmit antenna(s). For UE with integral antenna only, a reference antenna with a gain of 0 dBi is assumed.

Transmitter requirements for UL MIMO operation apply when the UE transmits on 2 ports on the same CDM group. The UE may use higher MPR values outside this limitation.

Unless otherwise stated, Channel Bandwidth shall be prioritized in the selecting of test points. Subcarrier spacing shall be selected after Test Channel Bandwidth is selected.

Uplink RB allocations given in Table 6.1-1 are used throughout this section, unless otherwise stated by the test case.

Table 6.1-1: Common uplink configuration

Channel Bandwidth	SCS(kHz)	OFDM	RB allocation							
			Edge_Full_Left (Note 2)	Edge_Full_Right (Note 2)	Edge_1RB_Left	Edge_1RB_Right	Outer_Full	Inner_Full	Inner_1RB_Left	Inner_1RB_Right
5MHz	15	DFT-s	2@0	2@23	1@0	1@24	25@0	12@6	1@1	1@23
		CP	2@0	2@23	1@0	1@24	25@0	13@6	1@1	1@23
	30	DFT-s	2@0	2@9	1@0	1@10	10@0	5@2 ¹	1@1	1@9
		CP	2@0	2@9	1@0	1@10	11@0	5@2 ¹	1@1	1@9
	60	DFT-s	N/A	N/A	N/A	N/A	N/A	N/A	N/A	N/A
		CP	N/A	N/A	N/A	N/A	N/A	N/A	N/A	N/A
10MHz	15	DFT-s	2@0	2@50	1@0	1@51	50@0	25@12	1@1	1@50
		CP	2@0	2@50	1@0	1@51	52@0	26@13	1@1	1@50
	30	DFT-s	2@0	2@22	1@0	1@23	24@0	12@6	1@1	1@22
		CP	2@0	2@22	1@0	1@23	24@0	12@6	1@1	1@22
	60	DFT-s	2@0	2@9	1@0	1@10	10@0	5@2 ¹	1@1	1@9
		CP	2@0	2@9	1@0	1@10	11@0	5@2 ¹	1@1	1@9
15MHz	15	DFT-s	2@0	2@77	1@0	1@78	75@0	36@18	1@1	1@77
		CP	2@0	2@77	1@0	1@78	79@0	39@19 ¹	1@1	1@77
	30	DFT-s	2@0	2@36	1@0	1@37	36@0	18@9	1@1	1@36
		CP	2@0	2@36	1@0	1@37	38@0	19@9	1@1	1@36
	60	DFT-s	2@0	2@16	1@0	1@17	18@0	9@4	1@1	1@16
		CP	2@0	2@16	1@0	1@17	18@0	9@4	1@1	1@16
20MHz	15	DFT-s	2@0	2@104	1@0	1@105	100@0	50@25	1@1	1@104
		CP	2@0	2@104	1@0	1@105	106@0	53@26	1@1	1@104
	30	DFT-s	2@0	2@49	1@0	1@50	50@0	25@12	1@1	1@49
		CP	2@0	2@49	1@0	1@50	51@0	25@12 ¹	1@1	1@49
	60	DFT-s	2@0	2@22	1@0	1@23	24@0	12@6	1@1	1@22
		CP	2@0	2@22	1@0	1@23	24@0	12@6	1@1	1@22
25MHz	15	DFT-s	2@0	2@131	1@0	1@132	128@0	64@32	1@1	1@131
		CP	2@0	2@131	1@0	1@132	133@0	67@33	1@1	1@131
	30	DFT-s	2@0	2@63	1@0	1@64	64@0	32@16	1@1	1@63
		CP	2@0	2@63	1@0	1@64	65@0	33@16	1@1	1@63
	60	DFT-s	2@0	2@29	1@0	1@30	30@0	15@7 ¹	1@1	1@29
		CP	2@0	2@29	1@0	1@30	31@0	15@7 ¹	1@1	1@29
30MHz	15	DFT-s	2@0	2@158	1@0	1@159	160@0	80@40	1@1	1@158
		CP	2@0	2@158	1@0	1@159	160@0	80@40	1@1	1@158
	30	DFT-s	2@0	2@76	1@0	1@77	75@0	36@18	1@1	1@76
		CP	2@0	2@76	1@0	1@77	78@0	39@19	1@1	1@76
	60	DFT-s	2@0	2@36	1@0	1@37	36@0	18@9	1@1	1@36
		CP	2@0	2@36	1@0	1@37	38@0	19@9	1@1	1@36
40MHz	15	DFT-s	2@0	2@214	1@0	1@215	216@0	108@54	1@1	1@214
		CP	2@0	2@214	1@0	1@215	216@0	108@54	1@1	1@214
	30	DFT-s	2@0	2@104	1@0	1@105	100@0	50@25	1@1	1@104
		CP	2@0	2@104	1@0	1@105	106@0	53@26	1@1	1@104
	60	DFT-s	2@0	2@49	1@0	1@50	50@0	25@12	1@1	1@49
		CP	2@0	2@49	1@0	1@50	51@0	25@12 ¹	1@1	1@49
45MHz	15	DFT-s	2@0	2@240	1@0	1@241	242@0	120@60	1@1	1@240
		CP	2@0	2@240	1@0	1@241	242@0	121@60	1@1	1@240
	30	DFT-s	2@0	2@117	1@0	1@118	119@0	60@30	1@1	1@117
		CP	2@0	2@117	1@0	1@118	119@0	60@30	1@1	1@117
	60	DFT-s	2@0	2@56	1@0	1@57	58@0	27@13	1@1	1@56
		CP	2@0	2@56	1@0	1@57	58@0	29@14	1@1	1@56

Channel Bandwidth	SCS(kHz)	OFDM	RB allocation							
			Edge_Full_Left (Note 2)	Edge_Full_Right (Note 2)	Edge_1RB_Left	Edge_1RB_Right	Outer_Full	Inner_Full	Inner_1RB_Left	Inner_1RB_Right
50MHz	15	DFT-s	2@0	2@268	1@0	1@269	270@0	135@67	1@1	1@268
		CP	2@0	2@268	1@0	1@269	270@0	135@67	1@1	1@268
	30	DFT-s	2@0	2@131	1@0	1@132	128@0	64@32	1@1	1@131
		CP	2@0	2@131	1@0	1@132	133@0	67@33	1@1	1@131
	60	DFT-s	2@0	2@63	1@0	1@64	64@0	32@16	1@1	1@63
		CP	2@0	2@63	1@0	1@64	65@0	33@16	1@1	1@63
60MHz	15	DFT-s	N/A	N/A	N/A	N/A	N/A	N/A	N/A	N/A
		CP	N/A	N/A	N/A	N/A	N/A	N/A	N/A	N/A
	30	DFT-s	2@0	2@160	1@0	1@161	162@0	81@40	1@1	1@160
		CP	2@0	2@160	1@0	1@161	162@0	81@40	1@1	1@160
	60	DFT-s	2@0	2@77	1@0	1@78	75@0	36@18	1@1	1@77
		CP	2@0	2@77	1@0	1@78	79@0	39@19 ¹	1@1	1@77
70MHz	15	DFT-s	N/A	N/A	N/A	N/A	N/A	N/A	N/A	N/A
		CP	N/A	N/A	N/A	N/A	N/A	N/A	N/A	N/A
	30	DFT-s	2@0	2@187	1@0	1@188	180@0	90@45	1@1	1@187
		CP	2@0	2@187	1@0	1@188	189@0	95@47	1@1	1@187
	60	DFT-s	2@0	2@91	1@0	1@92	90@0	45@22	1@1	1@91
		CP	2@0	2@91	1@0	1@92	93@0	47@23	1@1	1@91
80MHz	15	DFT-s	N/A	N/A	N/A	N/A	N/A	N/A	N/A	N/A
		CP	N/A	N/A	N/A	N/A	N/A	N/A	N/A	N/A
	30	DFT-s	2@0	2@215	1@0	1@216	216@0	108@54	1@1	1@215
		CP	2@0	2@215	1@0	1@216	217@0	109@54	1@1	1@215
	60	DFT-s	2@0	2@105	1@0	1@106	100@0	50@25	1@1	1@105
		CP	2@0	2@105	1@0	1@106	107@0	53@26 ¹	1@1	1@105
90MHz	15	DFT-s	N/A	N/A	N/A	N/A	N/A	N/A	N/A	N/A
		CP	N/A	N/A	N/A	N/A	N/A	N/A	N/A	N/A
	30	DFT-s	2@0	2@243	1@0	1@244	243@0	120@60	1@1	1@243
		CP	2@0	2@243	1@0	1@244	245@0	123@61	1@1	1@243
	60	DFT-s	2@0	2@119	1@0	1@120	120@0	60@30	1@1	1@119
		CP	2@0	2@119	1@0	1@120	121@0	61@30	1@1	1@119
100MHz	15	DFT-s	N/A	N/A	N/A	N/A	N/A	N/A	N/A	N/A
		CP	N/A	N/A	N/A	N/A	N/A	N/A	N/A	N/A
	30	DFT-s	2@0	2@271	1@0	1@272	270@0	135@67	1@1	1@271
		CP	2@0	2@271	1@0	1@272	273@0	137@68	1@1	1@271
	60	DFT-s	2@0	2@133	1@0	1@134	135@0	64@32	1@1	1@133
		CP	2@0	2@133	1@0	1@134	135@0	67@33 ¹	1@1	1@133

Note 1: The allocated RB number L_{CRB} is $\text{ceil}(N_{RB}/2) - 1$ in order to meet Inner RB allocation definition ($RB_{Start,Low} \leq RB_{Start} \leq RB_{Start,High}$) described in subclause 6.2.2 of TS 38.101-1 [2].

Note 2: For power class 1.5, Edge_Full_Left is defined as 4 RBs allocated at the left edge of the transmission bandwidth (4@0), and Edge_Full_Right is defined as 4 RBs allocated at the right edge of the transmission bandwidth (4@ $N_{RB}-4$).

6.1A General

Editor's note:

Uplink RB allocations for intra-band UL CA with mixed numerology is FFS

The minimum requirements for band combinations including Band n41 also apply for the corresponding band combinations with Band n90 replacing Band n41 but with otherwise identical parameters. For brevity the said band combinations with Band n90 are not listed in the tables below but are covered by this specification.

Uplink RB allocations for intra-band CA given in Table 6.1A-1a are used throughout this section, unless otherwise stated by the test case.

Table 6.1A-1a: Common uplink configuration for intra-band contiguous 2UL CA (contiguous RB allocation)

BW _{channel_CA} (MHz)	SCS for all CC (kHz)	Channel bandwidth combination (MHz)	OFDM	RB allocation (Inner Full)			RB allocation (Outer Full)			
				N _{RB_al} _{loc}	CC1 L _{CRB1} @RB _{Start1}	CC2 L _{CRB2} @RB _{Star} _{t2}	N _{RB_al} _{loc}	CC1 L _{CRB1} @RB _{Star} _{t1}	CC2 L _{CRB2} @RB _{Star} _{t2}	
20	15	5+15	CP	52	0@0	52@1	104	25@0	79@0	
			DFT-s	50	0@0	50@0	100	25@0	75@0	
		10+10	CP	52	26@26	26@0	104	52@0	52@0	
			DFT-s	50	25@27	25@0	100	50@2	50@0	
		15+5	CP	52	52@26	0@0	104	79@0	25@0	
			DFT-s	50	50@29	0@0	100	75@4	25@0	
25	15	5+20	CP	65 ⁴	0@0	65@7	131	25@0	106@0	
			DFT-s	64	0@0	64@7	125	25@0	100@0	
		10+15	CP	65 ⁴	20@32	45@0	131	52@0	79@0	
			DFT-s	65	20@32	45@0	125	50@2	75@0	
		15+10	CP	65 ⁴	47@32	18@0	131	79@0	52@0	
			DFT-s	65	45@34	20@0	125	75@4	50@0	
	20+5	CP	65 ⁴	65@32	0@0	131	106@0	25@0		
		DFT-s	64	64@35	0@0	125	100@6	25@0		
	30	10+15	CP	60 ⁴	9@15	21@0	124	24@0	38@0	
			DFT-s	58	9@15	20@0	120	24@0	36@0	
		15+10	CP	60 ⁴	23@15	7@0	124	38@0	24@0	
			DFT-s	58	20@18	9@0	120	36@2	24@0	
		60	10+15	CP	56	4@7	10@0	116	11@0	18@0
				DFT-s	56	4@7	10@0	112	10@1	18@0
	15+10	CP	56	11@7	3@0	116	18@0	11@0		
		DFT-s	56	10@8	4@0	112	18@0	10@0		
	30	15	10+20	CP	79	13@39	66@0	158	52@0	106@0
				DFT-s	76	12@40	64@0	150	50@2	100@0
15+15			CP	79	40@39	39@0	158	79@0	79@0	
			DFT-s	76	40@39	36@0	150	75@4	75@0	
20+10			CP	79	67@39	12@0	158	106@0	52@0	
			DFT-s	76	64@42	12@0	150	100@6	50@0	
30		10+20	CP	74	5@19	32@0	150	24@0	51@0	
			DFT-s	74	5@19	32@0	148	24@0	50@0	
		15+15	CP	76	19@19	19@0	152	38@0	38@0	
			DFT-s	72	20@18	16@0	144	36@2	36@0	
		20+10	CP	74	32@19	5@0	150	51@0	24@0	
			DFT-s	74	32@19	5@0	148	50@1	24@0	
60		10+20	CP	68	2@9	15@0	140	11@0	24@0	
			DFT-s	68	2@9	15@0	136	10@1	24@0	
		15+15	CP	72	9@9	9@0	144	18@0	18@0	
			DFT-s	72	9@9	9@0	144	18@0	18@0	
		20+10	CP	68	15@9	2@0	140	24@0	11@0	
			DFT-s	68	15@9	2@0	136	24@0	10@0	
35	15	15+20	CP	93	33@46	60@0	185	79@0	106@0	
			DFT-s	92	32@47	60@0	175	75@4	100@0	
		20+15	CP	93	60@46	33@0	185	106@0	79@0	
			DFT-s	92	60@46	32@0	175	100@6	75@0	
		30	15+20	CP	88	16@22	28@0	178	38@0	51@0
				DFT-s	86	16@22	27@0	172	36@2	50@0
	20+15	CP	88	29@22	15@0	178	51@0	38@0		
		DFT-s	86	27@24	16@0	172	50@1	36@0		
	60	15+20	CP	80 ⁴	8@10	12@0	168	18@0	24@0	
			DFT-s	80	8@10	12@0	168	18@0	24@0	
		20+15	CP	80 ⁴	14@10	6@0	168	24@0	18@0	
			DFT-s	80	14@10	6@0	168	24@0	18@0	

BW _{channel_CA} (MHz)	SCS for all CC (kHz)	Channel bandwidth combination (MHz)	OFDM	RB allocation (Inner Full)			RB allocation (Outer Full)			
				N _{RB_al} loc	CC1 L _{CRB1} @RB _s tart1	CC2 L _{CRB2} @RB _{Star} t2	N _{RB_al} loc	CC1 L _{CRB1} @RB _{Star} t1	CC2 L _{CRB2} @RB Start2	
40	15	10+30	CP	106	0@0	106@1	212	52@0	160@0	
			DFT-s	100	0@52	100@0	210	50@2	160@0	
		20+20	CP	106	53@53	53@0	212	106@0	106@0	
			DFT-s	104	54@52	50@0	200	100@6	100@0	
		30+10	CP	106	106@53	0@0	212	160@0	52@0	
			DFT-s	100	100@60	0@0	210	160@0	50@0	
	30	10+30	CP	100 ⁴	0@0	50@1	204	24@0	78@0	
			DFT-s	100	0@0	50@1	198	24@0	75@0	
		20+20	CP	100 ⁴	26@25	24@0	204	51@0	51@0	
			DFT-s	100	25@26	25@0	200	50@1	50@0	
		30+10	CP	100 ⁴	50@25	0@0	204	78@0	24@0	
			DFT-s	100	50@27	0@0	198	75@3	24@0	
	60	10+30	CP	96	0@0	24@1	196	11@0	38@0	
			DFT-s	96	0@0	24@1	184	10@1	36@0	
		20+20	CP	96	12@12	12@0	192	24@0	24@0	
			DFT-s	96	12@12	12@0	192	24@0	24@0	
30+10		CP	96	24@12	0@0	196	38@0	11@0		
		DFT-s	96	24@13	0@0	184	36@2	10@0		
45	15	15+30	CP	106 ⁴	26@53	80@0	239	79@0	160@0	
			DFT-s	118	18@61	100@0	235	75@4	160@0	
	30	15+30	CP	116	9@29	49@0	232	38@0	78@0	
			DFT-s	114	9@29	48@0	222	36@2	75@0	
	60	15+30	CP	112	4@14	24@0	224	18@0	38@0	
			DFT-s	112	4@14	24@0	216	18@0	36@0	
50	15	10+40	CP	134	0@0	134@15	268	52@0	216@0	
			DFT-s	128	0@0	128@12	266	50@2	216@0	
		20+30	CP	133	40@66	93@0	266	106@0	160@0	
			DFT-s	130	40@66	90@0	260	100@6	160@0	
		30+20	CP	133	94@66	39@0	266	160@0	106@0	
			DFT-s	130	90@70	40@0	260	160@0	100@0	
		40+10	CP	134	134@67	0@0	268	216@0	52@0	
			DFT-s	128	128@76	0@0	266	216@0	50@0	
		30	10+40	CP	128 ⁴	0@0	64@8	260	24@0	106@0
				DFT-s	128	0@0	64@8	248	24@0	100@0
			20+30	CP	128	19@32	45@0	258	51@0	78@0
				DFT-s	126	18@33	45@0	250	50@1	75@0
	30+20		CP	128	46@32	18@0	258	78@0	51@0	
			DFT-s	126	45@33	18@0	250	75@3	50@0	
	40+10	CP	128 ⁴	64@32	0@0	260	106@0	24@0		
		DFT-s	128	64@34	0@0	248	100@6	24@0		
	60	10+40	CP	120 ⁴	0@0	30@4	248	11@0	51@0	
			DFT-s	120	0@0	30@4	240	10@1	50@0	
		20+30	CP	120 ⁴	9@15	21@0	248	24@0	38@0	
			DFT-s	116	9@15	20@0	240	24@0	36@0	
		30+20	CP	120 ⁴	23@15	7@0	248	38@0	24@0	
			DFT-s	116	20@18	9@0	240	36@2	24@0	
		40+10	CP	120 ⁴	30@15	0@0	248	51@0	11@0	
			DFT-s	120	30@17	0@0	240	50@1	10@0	
55	15	15+40	CP	147 ⁴	6@73	141@0	295	79@0	216@0	
			DFT-s	143	8@71	135@0	291	75@4	216@0	
	30	15+40	CP	144	2@36	70@0	288	38@0	106@0	
			DFT-s	136	4@34	64@0	272	36@2	100@0	
	60	15+40	CP	136	1@17	33@0	276	18@0	51@0	
			DFT-s	132	1@17	32@0	272	18@0	50@0	

BW _{channel_CA} (MHz)	SCS for all CC (kHz)	Channel bandwidth combination (MHz)	OFDM	RB allocation (Inner Full)			RB allocation (Outer Full)		
				N _{RB_al} loc	CC1 L _{CRB1} @RB _s tart1	CC2 L _{CRB2} @RB _{Star} t2	N _{RB_al} loc	CC1 L _{CRB1} @RB _{Star} t1	CC2 L _{CRB2} @RB _{Star} Start2
60	15	10+50	CP	161	0@0	161@28	322	52@0	270@0
			DFT-s	160	0@0	160@28	320	50@2	270@0
		20+40	CP	161	26@80	135@0	322	106@0	216@0
			DFT-s	160	25@81	135@0	316	100@6	216@0
		30+30	CP	160	80@80	80@0	320	160@0	160@0
			DFT-s	160	80@80	80@0	320	160@0	160@0
	40+20	CP	161	136@80	25@0	322	216@0	106@0	
		DFT-s	160	135@81	25@0	316	216@0	100@0	
	50+10	CP	161	161@80	0@0	322	270@0	52@0	
		DFT-s	160	160@82	0@0	320	270@0	50@0	
	30	10+50	CP	156	0@0	78@15	314	24@0	133@0
			DFT-s	150	0@0	75@14	304	24@0	128@0
		20+40	CP	156	12@39	66@0	314	51@0	106@0
			DFT-s	152	12@39	64@0	300	50@1	100@0
		30+30	CP	156	39@39	39@0	312	78@0	78@0
			DFT-s	152	40@38	36@0	300	75@3	75@0
	40+20	CP	156	67@39	11@0	314	106@0	51@0	
		DFT-s	152	64@42	12@0	300	100@6	50@0	
	50+10	CP	156	78@39	0@0	314	133@0	24@0	
		DFT-s	150	75@44	0@0	304	128@5	24@0	
	60	10+50	CP	152	0@0	38@8	304	11@0	65@0
			DFT-s	144	0@0	36@7	296	10@1	64@0
		20+40	CP	148	5@19	32@0	300	24@0	51@0
			DFT-s	148	5@19	32@0	296	24@0	50@0
30+30		CP	152	19@19	19@0	304	38@0	38@0	
		DFT-s	144	20@18	16@0	288	36@2	36@0	
40+20	CP	148	32@19	5@0	300	51@0	24@0		
	DFT-s	148	32@19	5@0	296	50@1	24@0		
50+10	CP	152	38@19	0@0	304	65@0	11@0		
	DFT-s	144	36@22	0@0	296	64@1	10@0		
70	15	20+50	CP	188	12@94	176@0	376	106@0	270@0
			DFT-s	181	1@105	180@0	370	100@6	270@0
		30+40	CP	188	66@94	122@0	376	160@0	216@0
			DFT-s	184	64@96	120@0	376	160@0	216@0
		40+30	CP	188	122@94	66@0	376	216@0	160@0
			DFT-s	184	120@96	64@0	376	216@0	160@0
	50+20	CP	188	176@94	12@0	376	270@0	106@0	
		DFT-s	181	180@90	1@0	370	270@0	100@0	
	30	20+50	CP	184	5@46	87@0	368	51@0	133@0
			DFT-s	174	6@45	81@0	356	50@1	128@0
		30+40	CP	184	32@46	60@0	368	78@0	106@0
			DFT-s	184	32@46	60@0	350	75@3	100@0
		40+30	CP	184	60@46	32@0	368	106@0	78@0
			DFT-s	184	60@46	32@0	350	100@6	75@0
	50+20	CP	184	87@46	5@0	368	133@0	51@0	
		DFT-s	174	81@52	6@0	356	128@5	50@0	
	60	20+50	CP	176	2@22	42@0	356	24@0	65@0
			DFT-s	168	2@22	40@0	352	24@0	64@0
		30+40	CP	176	16@22	28@0	356	38@0	51@0
			DFT-s	172	16@22	27@0	344	36@2	50@0
		40+30	CP	176	29@22	15@0	356	51@0	38@0
			DFT-s	172	27@24	16@0	344	50@1	36@0
	50+20	CP	176	43@22	1@0	356	65@0	24@0	
		DFT-s	168	40@25	2@0	352	64@1	24@0	

BW _{channel_CA} (MHz)	SCS for all CC (kHz)	Channel bandwidth combination (MHz)	OFDM	RB allocation (Inner Full)			RB allocation (Outer Full)		
				N _{RB_al} loc	CC1 L _{CRB1} @RB _s tart1	CC2 L _{CRB2} @RB _{Star} t2	N _{RB_al} loc	CC1 L _{CRB1} @RB _{Star} t1	CC2 L _{CRB2} @RB Start2
80	15	30+50	CP	215	53@107	162@0	430	160@0	270@0
			DFT-s	210	50@110	160@0	430	160@0	270@0
		40+40	CP	216	108@108	108@0	432	216@0	216@0
			DFT-s	216	108@108	108@0	432	216@0	216@0
		50+30	CP	215	163@107	52@0	430	270@0	160@0
			DFT-s	210	162@108	48@0	430	270@0	160@0
	30	30+50	CP	210	25@53	80@0	422	78@0	133@0
			DFT-s	210	25@53	80@0	406	75@3	128@0
		40+40	CP	212	53@53	53@0	424	106@0	106@0
			DFT-s	208	54@52	50@0	400	100@6	100@0
		50+30	CP	210	80@53	25@0	422	133@0	78@0
			DFT-s	210	80@53	25@0	406	128@5	75@0
	60	30+50	CP	204	12@26	39@0	412	38@0	65@0
			DFT-s	192	12@26	36@0	400	36@2	64@0
		40+40	CP	200 ⁴	26@25	24@0	408	51@0	51@0
			DFT-s	200	25@26	25@0	400	50@1	50@0
50+30		CP	204	39@26	12@0	412	65@0	38@0	
		DFT-s	192	40@25	8@0	400	64@1	36@0	
90	15	40+50	CP	243	95@121	148@0	486	216@0	270@0
			DFT-s	240	96@120	144@0	486	216@0	270@0
		50+40	CP	243	149@121	94@0	486	270@0	216@0
			DFT-s	240	150@120	90@0	486	270@0	216@0
	30	40+50	CP	238	46@60	73@0	478	106@0	133@0
			DFT-s	234	45@61	72@0	456	100@6	128@0
		50+40	CP	238	73@60	46@0	478	133@0	106@0
			DFT-s	234	72@61	45@0	456	128@5	100@0
	60	40+50	CP	232	22@29	36@0	464	51@0	65@0
			DFT-s	224	20@31	36@0	456	50@1	64@0
		50+40	CP	232	36@29	22@0	464	65@0	51@0
			DFT-s	224	36@29	20@0	456	64@1	50@0
100	15	50+50	CP	270	135@135	135@0	540	270@0	270@0
			DFT-s	270	135@135	135@0	540	270@0	270@0
	30	50+50	CP	264 ⁴	67@66	65@0	532	133@0	133@0
			DFT-s	256	64@69	64@0	512	128@5	128@0
	60	50+50	CP	256 ⁴	33@32	31@0	520	65@0	65@0
			DFT-s	248	32@33	30@0	512	64@1	64@0
105	15	N/A							
	30	15+90	CP	282	0@0	141@33	566	38@0	245@0
			DFT-s	270	0@0	135@30	558	36@2	243@0
		25+80	CP	280 ⁴	0@0	140@5	564	65@0	217@0
			DFT-s	270	0@0	135@3	560	64@1	216@0
	60	15+90	CP	276	0@0	69@17	556	18@0	121@0
			DFT-s	256	0@0	64@14	552	18@0	120@0
		25+80	CP	272 ⁴	0@0	68@3	552	31@0	107@0
DFT-s			256	0@0	64@1	520	30@1	100@0	

BW _{channel_CA} (MHz)	SCS for all CC (kHz)	Channel bandwidth combination (MHz)	OFDM	RB allocation (Inner Full)			RB allocation (Outer Full)		
				N _{RB_al} loc	CC1 L _{CRB1} @RB _s tart1	CC2 L _{CRB2} @RB _{Star} t2	N _{RB_al} loc	CC1 L _{CRB1} @RB _{Star} t1	CC2 L _{CRB2} @RB Start2
110	15			N/A					
	30	10+100	CP	296	0@0	148@50	594	24@0	273@0
			DFT-s	288	0@0	144@48	588	24@0	270@0
		20+90	CP	296	0@0	148@23	592	51@0	245@0
			DFT-s	288	0@0	144@21	586	50@1	243@0
		30+80	CP	294	4@74	143@0	590	78@0	217@0
			DFT-s	294	3@74	144@0	582	75@3	216@0
		40+70	CP	294	32@74	115@0	590	106@0	189@0
			DFT-s	N/A	N/A	N/A	N/A	N/A	N/A
		50+60	CP	294	59@74	88@0	590	133@0	162@0
			DFT-s	282	60@73	81@0	580	128@5	162@0
		60+50	CP	294	88@74	59@0	590	162@0	133@0
			DFT-s	282	81@81	60@0	580	162@0	128@0
		70+40	CP	294	115@74	32@0	590	189@0	106@0
			DFT-s	N/A	N/A	N/A	N/A	N/A	N/A
		80+30	CP	294	143@74	4@0	590	217@0	78@0
			DFT-s	292	144@73	2@0	582	216@1	75@0
		90+20	CP	296	148@74	0@0	592	245@0	51@0
			DFT-s	288	144@80	0@0	586	243@2	50@0
		100+10	CP	296	148@74	0@0	594	273@0	24@0
			DFT-s	288	144@81	0@0	588	270@3	24@0
	60	10+100	CP	288 ⁴	0@0	72@25	584	11@0	135@0
			DFT-s	288	0@0	72@25	580	10@1	135@0
		20+90	CP	288	0@0	72@12	580	24@0	121@0
			DFT-s	288	0@0	72@12	576	24@0	120@0
		30+80	CP	288	2@36	70@0	580	38@0	107@0
			DFT-s	288	2@36	70@0	544	36@2	100@0
		40+70	CP	288	15@36	57@0	576	51@0	93@0
			DFT-s	N/A	N/A	N/A	N/A	N/A	N/A
		50+60	CP	288	29@36	43@0	576	65@0	79@0
			DFT-s	280	30@35	40@0	556	64@1	75@0
		60+50	CP	288	43@36	29@0	576	79@0	65@0
			DFT-s	280	40@39	30@0	556	75@4	64@0
		70+40	CP	288	57@36	15@0	576	93@0	51@0
			DFT-s	N/A	N/A	N/A	N/A	N/A	N/A
		80+30	CP	288	71@36	1@0	580	107@0	38@0
			DFT-s	272	64@43	4@0	544	100@7	36@0
		90+20	CP	288	72@36	0@0	580	121@0	24@0
			DFT-s	288	72@37	0@0	576	120@1	24@0
		100+10	CP	288 ⁴	72@36	0@0	584	135@0	11@0
DFT-s			288	72@38	0@0	580	135@0	10@0	

BW _{channel_CA} (MHz)	SCS for all CC (kHz)	Channel bandwidth combination (MHz)	OFDM	RB allocation (Inner Full)			RB allocation (Outer Full)		
				N _{RB_al loc}	CC1 L _{CRB1} @RB _{s tart1}	CC2 L _{CRB2} @RB _{Star t2}	N _{RB_al loc}	CC1 L _{CRB1} @RB _{Star t1}	CC2 L _{CRB2} @RB _{Star t2}
115	15	N/A							
	30	15+100	CP	310	0@0	155@40	622	38@0	273@0
			DFT-s	300	0@0	150@37	612	36@2	270@0
		25+90	CP	308 ⁴	0@0	154@12	620	65@0	245@0
			DFT-s	300	0@0	150@10	614	64@1	243@0
		90+25	CP	308 ⁴	154@77	0@0	620	245@0	65@0
			DFT-s	300	150@85	0@0	614	243@2	64@0
	100+15	CP	310	155@78	0@0	622	273@0	38@0	
		DFT-s	300	150@86	0@0	612	270@3	36@0	
	60	15+100	CP	304	0@0	76@20	612	18@0	135@0
			DFT-s	300	0@0	75@20	612	18@0	135@0
		25+90	CP	304	0@0	76@7	608	31@0	121@0
			DFT-s	300	0@0	75@7	600	30@1	120@0
		90+25	CP	304	76@38	0@0	608	121@0	31@0
			DFT-s	300	75@39	0@0	600	120@1	30@0
		100+15	CP	304	76@38	0@0	612	135@0	18@0
			DFT-s	300	75@40	0@0	612	135@0	18@0
		120	15	N/A					
30			20+100	CP	324	0@0	162@30	648	51@0
	DFT-s			324	0@0	162@30	640	50@1	270@0
	30+90		CP	322	0@0	161@3	646	78@0	245@0
			DFT-s	320	0@0	160@2	636	75@3	243@0
	40+80		CP	322	25@81	136@0	646	106@0	217@0
			DFT-s	320	25@81	135@0	632	100@6	216@0
	50+70		CP	320 ⁴	53@80	107@0	644	133@0	189@0
			DFT-s	N/A	N/A	N/A	N/A	N/A	N/A
	60+60		CP	324	81@81	81@0	648	162@0	162@0
			DFT-s	324	81@81	81@0	648	162@0	162@0
	70+50		CP	320 ⁴	109@80	51@0	644	189@0	133@0
			DFT-s	N/A	N/A	N/A	N/A	N/A	N/A
	80+40		CP	322	136@81	25@0	646	217@0	106@0
			DFT-s	318	135@82	24@0	632	216@1	100@0
	90+30		CP	322	161@81	0@0	646	245@0	78@0
			DFT-s	320	160@83	0@0	636	243@2	75@0
	100+20		CP	324	162@81	0@0	648	273@0	51@0
			DFT-s	324	162@81	0@0	640	270@3	50@0
60	20+100		CP	316	0@0	79@16	636	24@0	135@0
			DFT-s	300	0@0	75@14	636	24@0	135@0
	30+90		CP	316	0@0	79@2	636	38@0	121@0
			DFT-s	300	0@0	75@0	624	36@2	120@0
	40+80		CP	312 ⁴	12@39	66@0	632	51@0	107@0
			DFT-s	304	12@39	64@0	600	50@1	100@0
	50+70		CP	312 ⁴	26@39	52@0	632	65@0	93@0
			DFT-s	N/A	N/A	N/A	N/A	N/A	N/A
	60+60		CP	312 ⁴	40@39	38@0	632	79@0	79@0
			DFT-s	304	40@39	36@0	600	75@4	75@0
	70+50		CP	312 ⁴	54@39	24@0	632	93@0	65@0
			DFT-s	N/A	N/A	N/A	N/A	N/A	N/A
	80+40		CP	312 ⁴	68@39	10@0	632	107@0	51@0
			DFT-s	304	64@43	12@0	600	100@7	50@0
	90+30		CP	316	79@40	0@0	636	121@0	38@0
			DFT-s	300	75@46	0@0	624	120@1	36@0
	100+20		CP	316	79@40	0@0	636	135@0	24@0
		DFT-s	300	75@46	0@0	636	135@0	24@0	

BW _{channel_CA} (MHz)	SCS for all CC (kHz)	Channel bandwidth combination (MHz)	OFDM	RB allocation (Inner Full)			RB allocation (Outer Full)		
				N _{RB_al} loc	CC1 L _{CRB1} @RB _s tart1	CC2 L _{CRB2} @RB _{Star} t2	N _{RB_al} loc	CC1 L _{CRB1} @RB _{Star} t1	CC2 L _{CRB2} @RB _{Star} t2
125	15			N/A					
	30	25+100	CP	336 ⁴	0@0	168@19	676	65@0	273@0
			DFT-s	324	0@0	162@16	668	64@1	270@0
	100+25	CP	336 ⁴	168@84	0@0	676	273@0	65@0	
		DFT-s	324	162@95	0@0	668	270@3	64@0	
	60	25+100	CP	328 ⁴	0@0	82@10	664	31@0	135@0
			DFT-s	324	0@0	81@10	660	30@1	135@0
		100+25	CP	328 ⁴	82@41	0@0	664	135@0	31@0
			DFT-s	324	81@44	0@0	660	135@0	30@0
	130	15			N/A				
30		30+100	CP	350	0@0	175@10	702	78@0	273@0
			DFT-s	324	0@0	162@3	690	75@3	270@0
40+90		CP	350	18@88	157@0	702	106@0	245@0	
		DFT-s	340	20@86	150@0	686	100@6	243@0	
50+80		CP	348 ⁴	46@87	128@0	700	133@0	217@0	
		DFT-s	346	45@88	128@0	688	128@5	216@0	
60+70		CP	350	74@88	101@0	702	162@0	189@0	
		DFT-s	N/A	N/A	N/A	N/A	N/A	N/A	
70+60		CP	350	101@88	74@0	702	189@0	162@0	
		DFT-s	N/A	N/A	N/A	N/A	N/A	N/A	
80+50		CP	348 ⁴	130@87	44@0	700	217@0	133@0	
		DFT-s	346	128@89	45@0	688	216@1	128@0	
90+40		CP	350	157@88	18@0	702	245@0	106@0	
		DFT-s	340	160@85	10@0	686	243@2	100@0	
100+30		CP	350	175@88	0@0	702	273@0	78@0	
		DFT-s	324	162@108	0@0	690	270@3	75@0	
60		30+100	CP	344	0@0	86@5	692	38@0	135@0
			DFT-s	324	0@0	81@3	684	36@2	135@0
		40+90	CP	344	8@43	78@0	688	51@0	121@0
			DFT-s	332	8@43	75@0	680	50@1	120@0
		50+80	CP	344	22@43	64@0	688	65@0	107@0
			DFT-s	336	20@45	64@0	656	64@1	100@0
		60+70	CP	344	36@43	50@0	688	79@0	93@0
			DFT-s	N/A	N/A	N/A	N/A	N/A	N/A
		70+60	CP	344	50@43	36@0	688	93@0	79@0
			DFT-s	N/A	N/A	N/A	N/A	N/A	N/A
		80+50	CP	344	64@43	22@0	688	107@0	65@0
			DFT-s	336	64@43	20@0	656	100@7	64@0
		90+40	CP	344	78@43	8@0	688	121@0	51@0
			DFT-s	336	75@46	9@0	680	120@1	50@0
		100+30	CP	344	86@43	0@0	692	135@0	38@0
			DFT-s	324	81@51	0@0	684	135@0	36@0

BW _{channel_CA} (MHz)	SCS for all CC (kHz)	Channel bandwidth combination (MHz)	OFDM	RB allocation (Inner Full)			RB allocation (Outer Full)				
				N _{RB_al} loc	CC1 L _{CRB1} @RB _s tart1	CC2 L _{CRB2} @RB _{Star} t2	N _{RB_al} loc	CC1 L _{CRB1} @RB _{Star} t1	CC2 L _{CRB2} @RB _{Star} Start2		
140	15			N/A							
	30	40+100	CP	378	11@95	178@0	758	106@0	273@0		
			DFT-s	372	6@100	180@0	740	100@6	270@0		
		50+90	CP	376 ⁴	39@94	149@0	756	133@0	245@0		
			DFT-s	372	36@97	150@0	742	128@5	243@0		
		60+80	CP	378	67@95	122@0	758	162@0	217@0		
			DFT-s	368	64@98	120@0	756	162@0	216@0		
		70+70	CP	376 ⁴	95@94	93@0	756	189@0	189@0		
			DFT-s	N/A	N/A	N/A	N/A	N/A	N/A		
		80+60	CP	378	122@95	67@0	758	217@0	162@0		
			DFT-s	368	120@97	64@0	756	216@1	162@0		
		90+50	CP	376 ⁴	151@94	37@0	756	245@0	133@0		
			DFT-s	372	150@95	36@0	742	243@2	128@0		
		100+40	CP	378	178@95	11@0	758	273@0	106@0		
			DFT-s	372	180@93	6@0	740	270@3	100@0		
		60	40+100	CP	368 ⁴	5@46	87@0	744	51@0	135@0	
				DFT-s	348	6@45	81@0	740	50@1	135@0	
	50+90		CP	368 ⁴	19@46	73@0	744	65@0	121@0		
			DFT-s	364	16@49	75@0	736	64@1	120@0		
	60+80		CP	368 ⁴	33@46	59@0	744	79@0	107@0		
			DFT-s	368	32@47	60@0	700	75@4	100@0		
	70+70		CP	368 ⁴	47@46	45@0	744	93@0	93@0		
			DFT-s	N/A	N/A	N/A	N/A	N/A	N/A		
	80+60		CP	348	56@44	31@0	744	107@0	79@0		
			DFT-s	368	60@47	32@0	700	100@7	75@0		
	90+50		CP	368 ⁴	75@46	17@0	744	121@0	65@0		
			DFT-s	364	75@46	16@0	736	120@1	64@0		
	100+40		CP	368 ⁴	89@46	3@0	744	135@0	51@0		
			DFT-s	360	90@45	0@0	740	135@0	50@0		
	150		15			N/A					
			30	50+100	CP	404 ⁴	32@101	170@0	812	133@0	273@0
		DFT-s			388	32@101	162@0	796	128@5	270@0	
60+90		CP		406	60@102	143@0	814	162@0	245@0		
		DFT-s		396	54@108	144@0	810	162@0	243@0		
70+80		CP		404 ⁴	88@101	114@0	812	189@0	217@0		
		DFT-s		N/A	N/A	N/A	N/A	N/A	N/A		
80+70		CP		404 ⁴	116@101	86@0	812	217@0	189@0		
		DFT-s		N/A	N/A	N/A	N/A	N/A	N/A		
90+60		CP		406	143@102	60@0	814	245@0	162@0		
		DFT-s		396	144@101	54@0	810	243@2	162@0		
100+50		CP		404 ⁴	172@101	30@0	812	273@0	133@0		
		DFT-s		388	162@111	32@0	796	270@3	128@0		
60		50+100		CP	400	15@50	85@0	800	65@0	135@0	
				DFT-s	388	16@49	81@0	796	64@1	135@0	
		60+90		CP	400	29@50	71@0	800	79@0	121@0	
				DFT-s	388	25@54	72@0	780	75@4	120@0	
		70+80	CP	400	43@50	57@0	800	93@0	107@0		
			DFT-s	N/A	N/A	N/A	N/A	N/A	N/A		
		80+70	CP	400	57@50	43@0	800	107@0	93@0		
			DFT-s	N/A	N/A	N/A	N/A	N/A	N/A		
		90+60	CP	400	71@50	29@0	800	121@0	79@0		
			DFT-s	388	72@49	25@0	780	120@1	75@0		
		100+50	CP	400	85@50	15@0	800	135@0	65@0		
			DFT-s	388	81@54	16@0	796	135@0	64@0		

BW _{channel_CA} (MHz)	SCS for all CC (kHz)	Channel bandwidth combination (MHz)	OFDM	RB allocation (Inner Full)			RB allocation (Outer Full)					
				N _{RB_al} loc	CC1 L _{CRB1} @RB _s tart1	CC2 L _{CRB2} @RB _{Star} t2	N _{RB_al} loc	CC1 L _{CRB1} @RB _{Star} t1	CC2 L _{CRB2} @RB _{Star} Start2			
160	15	N/A										
		30	60+100	CP	434	53@109	164@0	0	@162	@0		
				DFT-s	432	54@108	162@0	864	162@0	270@0		
		70+90	CP	432 ⁴	81@108	135@0	0	@189	@0			
			DFT-s	N/A	N/A	N/A	N/A	N/A	N/A			
		80+80	CP	432 ⁴	109@108	107@0	864	216@1	216@0			
			DFT-s	432	108@109	108@0	868	217@0	217@0			
		90+70	CP	432 ⁴	137@108	79@0	868	245@0	189@0			
			DFT-s	N/A	N/A	N/A	N/A	N/A	N/A			
		100+60	CP	434	164@109	53@0	870	273@0	162@0			
	DFT-s		432	162@111	54@0	864	270@3	162@0				
	60	60+100	CP	424 ⁴	26@53	80@0	856	79@0	135@0			
			DFT-s	424	25@54	81@0	840	75@4	135@0			
		70+90	CP	424 ⁴	93@0	13@0	856	93@-93	121@0			
			DFT-s	N/A	N/A	N/A	N/A	N/A	N/A			
		80+80	CP	424 ⁴	54@53	52@0	856	107@0	107@0			
			DFT-s	416	54@53	50@0	800	100@7	100@0			
		90+70	CP	424 ⁴	68@53	38@0	856	121@0	93@0			
			DFT-s	N/A	N/A	N/A	N/A	N/A	N/A			
		100+60	CP	424 ⁴	82@53	24@0	856	135@0	79@0			
DFT-s			424	81@54	25@0	840	135@0	75@0				
170	15	N/A										
		30	70+100	CP	460 ⁴	74@115	156@0	924	189@0	273@0		
				DFT-s	N/A	N/A	N/A	N/A	N/A	N/A		
		80+90	CP	460 ⁴	102@115	128@0	924	217@0	245@0			
			DFT-s	456	100@117	128@0	918	216@1	243@0			
		90+80	CP	460 ⁴	130@115	100@0	924	245@0	217@0			
			DFT-s	456	128@117	100@0	918	243@2	216@0			
		100+70	CP	460 ⁴	158@115	72@0	924	273@0	189@0			
			DFT-s	N/A	N/A	N/A	N/A	N/A	N/A			
		60	70+100	CP	456	36@57	78@0	912	93@0	135@0		
	DFT-s			N/A	N/A	N/A	N/A	N/A	N/A			
	80+90		CP	456	50@57	64@0	912	107@0	121@0			
			DFT-s	456	50@57	64@0	880	100@7	120@0			
	90+80		CP	456	64@57	50@0	912	121@0	107@0			
			DFT-s	456	64@57	50@0	880	120@1	100@0			
	100+70		CP	456	78@57	36@0	912	135@0	93@0			
			DFT-s	N/A	N/A	N/A	N/A	N/A	N/A			
	180		15	N/A								
				30	80+100	CP	488 ⁴	95@122	149@0	980	217@0	273@0
		DFT-s				480	96@121	144@0	972	216@1	270@0	
90+90		CP		488 ⁴	123@122	121@0	980	245@0	245@0			
		DFT-s		480	120@125	120@0	972	243@2	243@0			
100+80		CP		488 ⁴	151@122	93@0	980	273@0	217@0			
		DFT-s		480	150@123	90@0	972	270@3	216@0			
60		80+100		CP	480 ⁴	47@60	73@0	968	107@0	135@0		
				DFT-s	480	45@62	75@0	940	100@7	135@0		
		90+90		CP	480 ⁴	61@60	59@0	968	121@0	121@0		
			DFT-s	480	60@61	60@0	960	120@1	120@0			
100+80		CP	480 ⁴	75@60	45@0	968	135@0	107@0				
		DFT-s	480	75@60	45@0	940	135@0	100@0				

BW _{channel_CA} (MHz)	SCS for all CC (kHz)	Channel bandwidth combination (MHz)	OFDM	RB allocation (Inner Full)			RB allocation (Outer Full)		
				N _{RB_alloc}	CC1 L _{CRB1} @RB _s tart1	CC2 L _{CRB2} @RB _{Star} t2	N _{RB_alloc}	CC1 L _{CRB1} @RB _{Star} t1	CC2 L _{CRB2} @RB _{Star} t2
190	15			N/A					
	30	90+100	CP	516	116@129	142@0	1036	245@0	273@0
			DFT-s	504	108@137	144@0	1026	243@2	270@0
	100+90	CP	516 ⁴	144@129	114@0	1036	273@0	245@0	
		DFT-s	504	144@129	108@0	1026	270@3	243@0	
	60	90+100	CP	512	57@64	71@0	1024	121@0	135@0
			DFT-s	504	54@67	72@0	1020	120@1	135@0
		100+90	CP	512	71@64	57@0	1024	135@0	121@0
			DFT-s	504	72@63	54@0	1020	135@0	120@0
	200	15			N/A				
30		100+100	CP	544	137@136	135@0	1092	273@0	273@0
			DFT-s	540	135@138	135@0	1080	270@3	270@0
60		100+100	CP	536 ⁴	68@67	66@0	1080	135@0	135@0
			DFT-s	512	64@71	64@0	1080	135@0	135@0

NOTE 1: BW_{channel_CA} is defined in clause 5.3A.3
 NOTE 2: N_{RB_alloc} for intra-band contiguous UL CA is defined in 6.2A.2.0
 NOTE 3: RB allocation for configurations where at least one CC is DFT-s-OFDM with CBW=70MHz is FFS
 NOTE 4: The allocated RB number N_{RB_alloc} is $\text{ceil}(N_{RB_agg}/2) - 1 \cdot 2^\mu$ in order to meet Inner RB allocation definition (RB_{Start,Low} ≤ RB_{Start} ≤ RB_{Start,High}) described in subclause 6.2A.2.0.

Table 6.1A-1b: Common uplink configuration for intra-band contiguous 2UL CA (non-contiguous RB allocation)

BW _{chan} nel_CA (MHz)	SCS for all CC (kHz)	Channel bandwidth combination (MHz)	RB allocation (Inner)			RB allocation (Outer1)			RB allocation (Outer2)		
			N _{RB} alloc	CC1 LCRB1@ RB _{Start1}	CC2 LCRB2@ RB _{Start2}	N _{RB} alloc	CC1 LCRB1@ RB _{Start1}	CC2 LCRB2@ RB _{Start2}	N _{RB} alloc	CC1 LCRB1@ RB _{Start1}	CC2 LCRB2@ RB _{Start2}
20	15	5+15	26	1@23	1@23	65	1@18	1@57	104	1@0	1@78
		10+10	34	1@31	1@11	63	1@15	1@25	104	1@0	1@51
		15+5	25	1@55	1@0	65	1@19	1@4	104	1@0	1@24
25	15	5+20	27	1@24	1@25	81	1@22	1@77	131	1@0	1@106
		10+15	43	1@39	1@29	80	1@21	1@48	131	1@0	1@78
		15+10	43	1@39	1@2	80	1@21	1@21	131	1@0	1@51
		20+5	24	1@83	1@0	80	1@28	1@1	131	1@0	1@24
	30	10+15	20	1@19	1@14	37	1@9	1@21	62	1@0	1@37
		15+10	20	1@19	1@0	37	1@9	1@7	62	1@0	1@23
60	10+15	9	1@9	1@6	18	1@5	1@11	29	1@0	1@17	
	15+10	8	1@11	1@0	18	1@5	1@4	29	1@0	1@10	
	30	10+20	54	1@48	1@49	98	1@25	1@70	158	1@0	1@105
		15+15	51	1@48	1@19	95	1@27	1@41	158	1@0	1@78
		20+10	49	1@58	1@0	98	1@23	1@14	158	1@0	1@51
	60	10+20	23	1@22	1@20	47	1@13	1@35	75	1@0	1@50
15+15		23	1@23	1@7	45	1@12	1@18	76	1@0	1@37	
20+10		20	1@32	1@0	47	1@12	1@7	75	1@0	1@23	
30	15	10+20	54	1@48	1@49	98	1@25	1@70	158	1@0	1@105
		15+15	51	1@48	1@19	95	1@27	1@41	158	1@0	1@78
		20+10	49	1@58	1@0	98	1@23	1@14	158	1@0	1@51
	60	10+20	8	1@7	1@5	22	1@6	1@16	35	1@0	1@23
		15+15	10	1@11	1@2	21	1@5	1@7	36	1@0	1@17
		20+10	7	1@18	1@0	22	1@6	1@3	35	1@0	1@10
35	15	15+20	62	1@58	1@40	113	1@31	1@64	185	1@0	1@105
		20+15	62	1@56	1@11	114	1@31	1@38	185	1@0	1@78
		30	15+20	28	1@28	1@17	54	1@15	1@30	89	1@0
	60	20+15	28	1@27	1@3	54	1@14	1@16	89	1@0	1@37
		15+20	12	1@13	1@6	25	1@6	1@12	42	1@0	1@23
		20+15	12	1@13	1@0	25	1@6	1@6	42	1@0	1@17
40	15	10+30	55	1@50	1@52	130	1@36	1@113	212	1@0	1@159
		20+20	70	1@65	1@28	129	1@36	1@58	212	1@0	1@105
		30+10	52	1@109	1@0	130	1@39	1@8	212	1@0	1@51
	30	10+30	23	1@22	1@20	62	1@17	1@54	102	1@0	1@77
		20+20	32	1@32	1@12	62	1@17	1@27	102	1@0	1@50
		30+10	21	1@58	1@0	63	1@18	1@2	102	1@0	1@23
	60	10+30	10	1@10	1@8	30	1@9	1@27	49	1@0	1@37
		20+20	14	1@15	1@4	29	1@7	1@11	48	1@0	1@23
		30+10	8	1@31	1@0	30	1@9	1@0	49	1@0	1@10
45	15	15+30	79	1@76	1@75	146	1@44	1@110	239	1@0	1@159
	30	15+30	37	1@37	1@35	70	1@20	1@51	116	1@0	1@77
	60	15+30	16	1@17	1@14	33	1@9	1@23	56	1@0	1@37
50	15	10+40	57	1@51	1@55	165	1@48	1@160	268	1@0	1@215
		20+30	87	1@83	1@63	161	1@47	1@101	266	1@0	1@159
		30+20	87	1@84	1@10	161	1@47	1@47	266	1@0	1@105
		40+10	54	1@163	1@0	165	1@53	1@1	268	1@0	1@51
	30	10+40	24	1@23	1@22	79	1@21	1@75	130	1@0	1@105
		20+30	41	1@41	1@30	78	1@22	1@48	129	1@0	1@77
		30+20	41	1@41	1@3	78	1@22	1@21	129	1@0	1@50
		40+10	21	1@86	1@0	79	1@28	1@0	130	1@0	1@23
	60	10+40	9	1@10	1@7	38	1@10	1@36	62	1@0	1@50
		20+30	18	1@20	1@13	37	1@10	1@22	62	1@0	1@37
		30+20	18	1@21	1@0	37	1@10	1@8	62	1@0	1@23
		40+10	7	1@45	1@0	38	1@14	1@0	62	1@0	1@10
55	15	15+40	84	1@78	1@82	182	1@54	1@156	295	1@0	1@215
	30	15+40	39	1@37	1@37	89	1@27	1@77	144	1@0	1@105
	60	15+40	17	1@17	1@15	43	1@13	1@37	69	1@0	1@50

BW _{chan} ne_CA (MHz)	SC S for all CC (k Hz)	Chann el bandwi dth combin ation (MHz)	RB allocation (Inner)			RB allocation (Outer1)			RB allocation (Outer2)		
			N _{RB} alloc	CC1 LCRB1@ RBStart1	CC2 LCRB2@ RBStart2	N _{RB} alloc	CC1 LCRB1@ RBStart1	CC2 LCRB2@ RBStart2	N _{RB} alloc	CC1 LCRB1@ RBStart1	CC2 LCRB2@ RBStart2
60	15	10+50	56	1@51	1@54	192	1@49	1@188	322	1@0	1@269
		20+40	107	1@102	1@102	195	1@57	1@145	322	1@0	1@215
		30+30	104	1@102	1@45	193	1@58	1@90	320	1@0	1@159
		40+20	98	1@119	1@0	195	1@55	1@33	322	1@0	1@105
		50+10	47	1@224	1@0	189	1@82	1@0	322	1@0	1@51
	30	10+50	23	1@23	1@21	93	1@22	1@90	157	1@0	1@132
		20+40	51	1@50	1@49	96	1@29	1@73	157	1@0	1@105
		30+30	49	1@50	1@20	94	1@28	1@43	156	1@0	1@77
		40+20	46	1@61	1@0	96	1@28	1@17	157	1@0	1@50
		50+10	19	1@115	1@0	92	1@42	1@0	157	1@0	1@23
	60	10+50	9	1@10	1@7	44	1@9	1@41	76	1@0	1@64
		20+40	22	1@23	1@20	46	1@14	1@35	75	1@0	1@50
		30+30	23	1@24	1@8	45	1@13	1@19	76	1@0	1@37
		40+20	20	1@32	1@0	46	1@14	1@8	75	1@0	1@23
		50+10	8	1@58	1@0	44	1@22	1@0	76	1@0	1@10
70	15	20+50	110	1@105	1@108	229	1@69	1@191	376	1@0	1@269
		30+40	126	1@121	1@86	229	1@69	1@137	376	1@0	1@215
		40+30	126	1@119	1@28	229	1@67	1@79	376	1@0	1@159
		50+20	100	1@171	1@0	229	1@67	1@25	376	1@0	1@105
	30	20+50	51	1@50	1@49	112	1@33	1@93	184	1@0	1@132
		30+40	61	1@60	1@42	112	1@33	1@66	184	1@0	1@105
		40+30	61	1@59	1@12	112	1@32	1@37	184	1@0	1@77
		50+20	47	1@87	1@0	112	1@32	1@10	184	1@0	1@50
	60	20+50	22	1@23	1@20	55	1@17	1@47	89	1@0	1@64
		30+40	27	1@26	1@16	55	1@17	1@32	89	1@0	1@50
		40+30	29	1@29	1@6	54	1@15	1@17	89	1@0	1@37
		50+20	21	1@21	1@0	54	1@15	1@3	89	1@0	1@23
80	15	30+50	143	1@139	1@121	261	1@80	1@180	430	1@0	1@269
		40+40	142	1@137	1@62	260	1@77	1@120	432	1@0	1@215
		50+30	143	1@138	1@10	261	1@78	1@68	430	1@0	1@159
	30	30+50	69	1@69	1@59	128	1@39	1@88	211	1@0	1@132
		40+40	68	1@68	1@29	128	1@39	1@60	212	1@0	1@105
		50+30	69	1@68	1@3	128	1@38	1@32	211	1@0	1@77
	60	30+50	32	1@34	1@27	62	1@18	1@41	103	1@0	1@64
		40+40	31	1@33	1@12	62	1@19	1@29	102	1@0	1@50
		50+30	32	1@35	1@1	62	1@18	1@14	103	1@0	1@37
90	15	40+50	161	1@156	1@100	294	1@89	1@166	486	1@0	1@269
		50+40	161	1@156	1@46	294	1@89	1@112	486	1@0	1@215
	30	40+50	78	1@77	1@48	144	1@43	1@80	239	1@0	1@132
		50+40	78	1@77	1@21	144	1@43	1@53	239	1@0	1@105
	60	40+50	36	1@39	1@22	71	1@22	1@41	116	1@0	1@64
50+40	36	1@38	1@8	71	1@22	1@27	116	1@0	1@50		
100	15	50+50	178	1@174	1@81	326	1@101	1@156	540	1@0	1@269
	30	20+80	50	1@50	1@48	160	1@48	1@156	268	1@0	1@216
		50+50	86	1@86	1@38	160	1@49	1@75	266	1@0	1@132
		80+20	45	1@173	1@0	159	1@59	1@0	268	1@0	1@50
	60	20+80	21	1@23	1@19	77	1@22	1@74	131	1@0	1@106
		50+50	41	1@42	1@17	79	1@25	1@38	130	1@0	1@64
80+20	19	1@89	1@0	77	1@31	1@0	131	1@0	1@23		
105	15	N/A									
	30	15+90	38	1@37	1@36	162	1@35	1@158	283	1@0	1@244
		25+80	63	1@63	1@60	171	1@54	1@159	282	1@0	1@216
	60	15+90	16	1@17	1@14	79	1@15	1@75	139	1@0	1@120
25+80		29	1@30	1@27	84	1@27	1@79	138	1@0	1@106	

BW _{chan} ne_CA (MHz)	SC S for all CC (kHz)	Chann el bandwi dth combin ation (MHz)	RB allocation (Inner)			RB allocation (Outer1)			RB allocation (Outer2)		
			N _{RB} alloc	CC1 LCRB1@ RBStart1	CC2 LCRB2@ RBStart2	N _{RB} alloc	CC1 LCRB1@ RBStart1	CC2 LCRB2@ RBStart2	N _{RB} alloc	CC1 LCRB1@ RBStart1	CC2 LCRB2@ RBStart2
110	15		N/A								
	30	10+100	24	1@23	1@22	162	1@22	1@159	297	1@0	1@272
		20+90	50	1@50	1@48	175	1@49	1@172	296	1@0	1@244
		30+80	77	1@77	1@75	178	1@56	1@155	295	1@0	1@216
		40+70	97	1@96	1@86	178	1@55	1@126	295	1@0	1@188
		50+60	96	1@96	1@58	177	1@55	1@98	295	1@0	1@161
		60+50	98	1@96	1@31	180	1@56	1@73	295	1@0	1@132
		70+40	97	1@96	1@3	178	1@55	1@43	295	1@0	1@105
		80+30	74	1@144	1@0	178	1@55	1@15	295	1@0	1@77
		90+20	44	1@202	1@0	173	1@74	1@1	296	1@0	1@50
		100+10	20	1@254	1@0	160	1@115	1@1	297	1@0	1@23
	60	10+100	9	1@10	1@7	79	1@9	1@76	146	1@0	1@134
		20+90	22	1@23	1@20	85	1@22	1@82	145	1@0	1@120
		30+80	35	1@37	1@33	87	1@27	1@75	145	1@0	1@106
		40+70	46	1@47	1@41	87	1@28	1@61	144	1@0	1@92
		50+60	45	1@47	1@26	86	1@26	1@46	144	1@0	1@78
		60+50	45	1@47	1@12	86	1@26	1@32	144	1@0	1@64
		70+40	46	1@49	1@1	87	1@26	1@19	144	1@0	1@50
		80+30	33	1@75	1@0	87	1@26	1@5	145	1@0	1@37
90+20		19	1@103	1@0	85	1@37	1@0	145	1@0	1@23	
100+10		7	1@129	1@0	79	1@57	1@0	146	1@0	1@10	
115	15		N/A								
	30	15+100	38	1@37	1@36	176	1@35	1@172	311	1@0	1@272
		25+90	64	1@64	1@62	186	1@58	1@178	310	1@0	1@244
		90+25	59	1@187	1@0	187	1@59	1@0	310	1@0	1@64
		100+15	34	1@240	1@0	176	1@98	1@0	311	1@0	1@37
	60	15+100	16	1@17	1@14	86	1@16	1@83	153	1@0	1@134
		25+90	28	1@30	1@26	91	1@28	1@87	152	1@0	1@120
		90+25	26	1@96	1@0	91	1@32	1@1	152	1@0	1@30
		100+15	13	1@123	1@0	86	1@50	1@0	153	1@0	1@17
	120	15		N/A							
30		20+100	50	1@50	1@48	189	1@49	1@186	324	1@0	1@272
		30+90	77	1@77	1@75	195	1@61	1@177	323	1@0	1@244
		40+80	106	1@105	1@104	195	1@60	1@148	323	1@0	1@216
		50+70	105	1@105	1@76	194	1@60	1@120	322	1@0	1@188
		60+60	105	1@105	1@47	194	1@60	1@91	324	1@0	1@161
		70+50	105	1@105	1@22	194	1@61	1@65	322	1@0	1@132
		80+40	101	1@117	1@0	195	1@61	1@38	323	1@0	1@105
		90+30	73	1@173	1@0	195	1@61	1@10	323	1@0	1@77
		100+20	45	1@229	1@0	187	1@88	1@1	324	1@0	1@50
		60	20+100	22	1@23	1@20	91	1@21	1@87	159	1@0
30+90			36	1@37	1@34	95	1@29	1@85	159	1@0	1@120
40+80			48	1@50	1@46	95	1@29	1@72	158	1@0	1@106
50+70			50	1@52	1@36	95	1@29	1@58	158	1@0	1@92
60+60			50	1@52	1@22	94	1@29	1@43	158	1@0	1@78
70+50			50	1@52	1@8	95	1@29	1@30	158	1@0	1@64
80+40			46	1@62	1@0	95	1@29	1@16	158	1@0	1@50
90+30			34	1@88	1@0	95	1@29	1@2	159	1@0	1@37
100+20			20	1@116	1@0	91	1@45	1@0	159	1@0	1@23
125	15			N/A							
	30	25+100	64	1@64	1@62	203	1@63	1@200	338	1@0	1@272
		100+25	58	1@216	1@0	201	1@74	1@1	338	1@0	1@64
	60	25+100	29	1@30	1@27	98	1@28	1@94	166	1@0	1@134
100+25		26	1@110	1@0	98	1@38	1@0	166	1@0	1@30	

BW _{chan} ne_CA (MHz)	SCS for all CC (kHz)	Channel bandwidth combination (MHz)	RB allocation (Inner)			RB allocation (Outer1)			RB allocation (Outer2)				
			N _{RB} alloc	CC1 LCRB1@ RBStart1	CC2 LCRB2@ RBStart2	N _{RB} alloc	CC1 LCRB1@ RBStart1	CC2 LCRB2@ RBStart2	N _{RB} alloc	CC1 LCRB1@ RBStart1	CC2 LCRB2@ RBStart2		
130	15		N/A										
	30	30+100	77	1@77	1@75	211	1@67	1@199	351	1@0	1@272		
		40+90	106	1@105	1@104	211	1@66	1@170	351	1@0	1@244		
		50+80	114	1@114	1@94	211	1@66	1@143	350	1@0	1@216		
		60+70	115	1@114	1@66	211	1@66	1@141	351	1@0	1@188		
		70+60	115	1@114	1@39	211	1@66	1@87	351	1@0	1@161		
		80+50	115	1@115	1@12	211	1@66	1@59	350	1@0	1@132		
		90+40	101	1@145	1@0	211	1@66	1@31	351	1@0	1@105		
		100+30	73	1@201	1@0	211	1@67	1@4	351	1@0	1@77		
	60	30+100	35	1@37	1@33	104	1@32	1@97	173	1@0	1@134		
		40+90	49	1@50	1@47	103	1@32	1@83	172	1@0	1@120		
		50+80	55	1@56	1@45	103	1@32	1@69	172	1@0	1@106		
		60+70	55	1@56	1@31	103	1@32	1@55	172	1@0	1@92		
		70+60	55	1@56	1@17	103	1@32	1@41	172	1@0	1@78		
		80+50	56	1@57	1@5	103	1@32	1@27	172	1@0	1@64		
		90+40	47	1@75	1@0	103	1@32	1@13	172	1@0	1@50		
		100+30	33	1@103	1@0	104	1@32	1@0	173	1@0	1@37		
140		15		N/A									
	30	40+100	107	1@105		1@71	1@192	FFS	379	1@0	1@272		
		50+90	124	1@123	228	1@71	1@165	FFS	378	1@0	1@244		
		60+80	125	1@124	228	1@72	1@137	FFS	379	1@0	1@216		
		70+70	123	1@124	227	1@72	1@109	FFS	378	1@0	1@188		
		80+60	124	1@124	228	1@72	1@82	FFS	379	1@0	1@161		
		90+50	124	1@124	229	1@73	1@56	FFS	378	1@0	1@132		
		100+40	102	1@172	229	1@73	1@28	FFS	379	1@0	1@105		
		60	40+100	49	1@50	113	1@36	1@97	FFS	186	1@0	1@134	
	50+90		60	1@61	113	1@36	1@83	FFS	186	1@0	1@120		
	60+80		59	1@61	111	1@35	1@66	FFS	186	1@0	1@106		
	70+70		59	1@61	111	1@35	1@52	FFS	186	1@0	1@92		
	80+60		59	1@61	111	1@35	1@38	FFS	186	1@0	1@78		
	90+50		60	1@63	113	1@36	1@27	FFS	186	1@0	1@64		
	100+40		47	1@89	113	1@36	1@13	FFS	186	1@0	1@50		
	150		15		N/A								
			30	50+100	132	1@132	1@130	245	1@78	1@189	406	1@0	1@272
60+90		134		1@133	1@104	245	1@77	1@159	407	1@0	1@244		
70+80		133		1@133	1@76	244	1@77	1@131	406	1@0	1@216		
80+70		133		1@133	1@48	244	1@77	1@103	406	1@0	1@188		
90+60		134		1@133	1@21	245	1@77	1@76	407	1@0	1@161		
100+50		127		1@147	1@0	245	1@79	1@50	406	1@0	1@132		
60		50+100		62	1@64	1@60	121	1@39	1@94	200	1@0	1@134	
		60+90	64	1@67	1@50	121	1@39	1@80	200	1@0	1@120		
		70+80	64	1@66	1@36	121	1@39	1@66	200	1@0	1@106		
		80+70	64	1@66	1@22	121	1@39	1@52	200	1@0	1@92		
		90+60	64	1@66	1@8	121	1@39	1@38	200	1@0	1@78		

		100+50	60	1@76	1@0	121	1@39	1@24	200	1@0	1@64
160	15	N/A									
	30	60+100	143	1@142	1@122	262	1@84	1@183	435	1@0	1@272
		70+90	142	1@142	1@94	262	1@84	1@156	434	1@0	1@244
		80+80	143	1@143	1@68	262	1@84	1@128	434	1@0	1@216
		90+70	143	1@143	1@40	262	1@84	1@100	434	1@0	1@188
		100+60	144	1@143	1@13	261	1@83	1@70	435	1@0	1@161
	60	60+100	69	1@70	1@59	129	1@42	1@91	214	1@0	1@134
		70+90	69	1@70	1@45	129	1@42	1@77	214	1@0	1@120
		80+80	70	1@71	1@33	129	1@42	1@63	214	1@0	1@106
		90+70	70	1@71	1@19	129	1@42	1@49	214	1@0	1@92
		100+60	70	1@71	1@5	129	1@42	1@35	214	1@0	1@78

BW _{channel_CA} (MHz)	SCS for all CC (kHz)	Channel bandwidth combination (MHz)	RB allocation (Inner)			RB allocation (Outer1)			RB allocation (Outer2)		
			N _{RB_alloc}	CC1 L _{CRB1} @RB _{Start1}	CC2 L _{CRB2} @RB _{Start2}	N _{RB_alloc}	CC1 L _{CRB1} @RB _{Start1}	CC2 L _{CRB2} @RB _{Start2}	N _{RB_alloc}	CC1 L _{CRB1} @RB _{Start1}	CC2 L _{CRB2} @RB _{Start2}
170	15	N/A									
	30	70+100	153	1@152	1@115	278	1@88	1@176	462	1@0	1@272
		80+90	152	1@152	1@86	277	1@88	1@147	462	1@0	1@244
		90+80	152	1@152	1@58	278	1@90	1@122	462	1@0	1@216
		100+70	152	1@152	1@30	278	1@88	1@92	462	1@0	1@188
	60	70+100	74	1@75	1@55	137	1@43	1@86	228	1@0	1@134
		80+90	74	1@75	1@41	136	1@43	1@71	228	1@0	1@120
		90+80	74	1@75	1@27	137	1@45	1@60	228	1@0	1@106
		100+70	74	1@75	1@13	137	1@43	1@44	228	1@0	1@92
	180	15	N/A								
30		80+100	161	1@161	1@104	295	1@94	1@171	490	1@0	1@272
		90+90	161	1@161	1@76	294	1@94	1@142	490	1@0	1@244
		100+80	161	1@161	1@48	295	1@94	1@115	490	1@0	1@216
60		80+100	78	1@80	1@50	145	1@46	1@83	242	1@0	1@134
		90+90	78	1@80	1@36	145	1@46	1@69	242	1@0	1@120
		100+80	78	1@80	1@22	145	1@46	1@55	242	1@0	1@106
190		15	N/A								
	30	90+100	171	1@171	1@95	311	1@99	1@164	518	1@0	1@272
		100+90	171	1@171	1@68	311	1@100	1@137	518	1@0	1@244
	60	90+100	83	1@84	1@45	154	1@50	1@82	256	1@0	1@134
		100+90	83	1@85	1@31	153	1@49	1@66	256	1@0	1@120
200	15	N/A									
	30	100+100	180	1@180	1@86	328	1@105	1@159	546	1@0	1@272
	60	100+100	88	1@89	1@41	163	1@53	1@80	270	1@0	1@134

NOTE 1: BW_{channel_CA} is defined in clause 5.3A.3
 NOTE 2: N_{RB_alloc} for intra-band contiguous UL CA is defined in 6.2A.2.0

6.1E General

Sidelink RB allocations given in Table 6.1E-1 are used for V2X test cases, unless otherwise stated by the test case.

Table 6.1E-1: Sidelink configuration for PSSCH/PSCCH

BW _{channel} (MHz)	SCS (kHz)	Parameters	RB allocation			
			Outer_Full	Outer_10RB_Left	Outer_10RB_Right	Inner_Full
10MHz	15	PSSCH allocation	50@0	10@0	10@42	25@12
		PSCCH allocation	10@0	10@0	10@42	10@12
		sl-StartRB-Subchannel-r16	0	0	42	12
		sl-SubchannelSize-r16	10	10	10	25
		sl-NumSubchannel-r16	5	1	1	1
		sl-FreqResourcePSCCH-r16	10	10	10	10
		sl-TimeResourcePSCCH-r16	3	3	3	3
	30	PSSCH allocation	24@0	10@0	10@14	12@6
		PSCCH allocation	10@0	10@0	10@14	10@6
		sl-StartRB-Subchannel-r16	0	0	14	6
		sl-SubchannelSize-r16	12	10	10	12
		sl-NumSubchannel-r16	2	1	1	1
		sl-FreqResourcePSCCH-r16	10	10	10	10
		sl-TimeResourcePSCCH-r16	3	3	3	3
	60	PSSCH allocation	10@0	10@0	10@1	N/A
		PSCCH allocation	10@0	10@0	10@1	N/A
		sl-StartRB-Subchannel-r16	0	0	1	N/A
		sl-SubchannelSize-r16	10	10	10	N/A
sl-NumSubchannel-r16		1	1	1	N/A	
sl-FreqResourcePSCCH-r16		10	10	10	10	
sl-TimeResourcePSCCH-r16		3	3	3	3	
20MHz	15	PSSCH allocation	105@0	10@0	10@96	50@25
		PSCCH allocation	10@0	10@0	10@96	10@25
		sl-StartRB-Subchannel-r16	0	0	96	25
		sl-SubchannelSize-r16	15	10	10	10
		sl-NumSubchannel-r16	7	1	1	5
		sl-FreqResourcePSCCH-r16	10	10	10	10
		sl-TimeResourcePSCCH-r16	3	3	3	3
	30	PSSCH allocation	50@0	10@0	10@41	25@12
		PSCCH allocation	10@0	10@0	10@41	10@12
		sl-StartRB-Subchannel-r16	0	0	41	12
		sl-SubchannelSize-r16	10	10	10	25
		sl-NumSubchannel-r16	5	1	1	1
		sl-FreqResourcePSCCH-r16	10	10	10	10
		sl-TimeResourcePSCCH-r16	3	3	3	3
	60	PSSCH allocation	24@0	10@0	10@14	12@6
		PSCCH allocation	10@0	10@0	10@14	10@6
		sl-StartRB-Subchannel-r16	0	0	14	6
		sl-SubchannelSize-r16	12	10	10	12
sl-NumSubchannel-r16		2	1	1	1	
sl-FreqResourcePSCCH-r16		10	10	10	10	
sl-TimeResourcePSCCH-r16		3	3	3	3	

BW _{channel} (MHz)	SCS (kHz)	Parameters	RB allocation			
			Outer_Full	Outer_10RB_Left	Outer_10RB_Right	Inner_Full
30MHz	15	PSSCH allocation	160@0	10@0	10@150	80@40
		PSCCH allocation	10@0	10@0	10@150	10@40
		sl-StartRB-Subchannel-r16	0	0	150	40
		sl-SubchannelSize-r16	10	10	10	10
		sl-NumSubchannel-r16	16	1	1	8
		sl-FreqResourcePSCCH-r16	10	10	10	10
		sl-TimeResourcePSCCH-r16	3	3	3	3
	30	PSSCH allocation	75@0	10@0	10@68	36@18
		PSCCH allocation	10@0	10@0	10@68	10@18
		sl-StartRB-Subchannel-r16	0	0	68	18
		sl-SubchannelSize-r16	15	10	10	12
		sl-NumSubchannel-r16	5	1	1	3
		sl-FreqResourcePSCCH-r16	10	10	10	10
	60	PSSCH allocation	36@0	10@0	10@28	15@7
		PSCCH allocation	10@0	10@0	10@28	10@7
		sl-StartRB-Subchannel-r16	0	0	28	7
		sl-SubchannelSize-r16	12	10	10	15
		sl-NumSubchannel-r16	3	1	1	1
sl-FreqResourcePSCCH-r16		10	10	10	10	
40MHz	15	PSSCH allocation	216@0	10@0	10@206	105@52
		PSCCH allocation	10@0	10@0	10@206	10@52
		sl-StartRB-Subchannel-r16	0	0	206	52
		sl-SubchannelSize-r16	12	10	10	15
		sl-NumSubchannel-r16	18	1	1	7
		sl-FreqResourcePSCCH-r16	10	10	10	10
		sl-TimeResourcePSCCH-r16	3	3	3	3
	30	PSSCH allocation	105@0	10@0	10@96	50@25
		PSCCH allocation	10@0	10@0	10@96	10@25
		sl-StartRB-Subchannel-r16	0	0	96	25
		sl-SubchannelSize-r16	15	10	10	10
		sl-NumSubchannel-r16	7	1	1	5
		sl-FreqResourcePSCCH-r16	10	10	10	10
	60	PSSCH allocation	50@0	10@0	10@41	25@12
		PSCCH allocation	10@0	10@0	10@41	10@12
		sl-StartRB-Subchannel-r16	0	0	41	12
		sl-SubchannelSize-r16	10	10	10	25
		sl-NumSubchannel-r16	5	1	1	1
sl-FreqResourcePSCCH-r16		10	10	10	10	
		sl-TimeResourcePSCCH-r16	3	3	3	3

Table 6.1E-2: Sidelink configuration for PSFCH

BW _{channel} (MHz)	SCS (kHz)	Parameters	RB allocation					
			PSFCH_1RB_Left	PSFCH_1RB_Right	PSFCH_2RB_Left	PSFCH_2RB_Right	PSFCH_Max_Gap	
10MHz	15	PSFCH allocation	1@0	1@51	2@0	2@50	1@0	1@49
		sl-StartRB-Subchannel-r16	0	2	0	2	0	
		sl-SubchannelSize-r16	25	25	25	25	25	
		sl-NumSubchannel-r16	2	2	2	2	2	
	sl-PSFCH-RB-Set-r16	Bitstring of length 50, The leftmost 4 bits and rightmost 4 bits are set to "1" and the rest are set to "0"						
	30	PSFCH allocation	1@0	1@23	2@0	2@22	1@0	1@23
		sl-StartRB-Subchannel-r16	0	0	0	0	0	
		sl-SubchannelSize-r16	12	12	12	12	12	
		sl-NumSubchannel-r16	2	2	2	2	2	
	sl-PSFCH-RB-Set-r16	Bitstring of length 24, The leftmost 4 bits and rightmost 4 bits are set to "1" and the rest are set to "0"						
	60	PSFCH allocation	10@0	1@10	2@0	2@9	1@0	1@9
		sl-StartRB-Subchannel-r16	0	1	0	1	0	
sl-SubchannelSize-r16		10	10	10	10	10		
sl-NumSubchannel-r16		1	1	1	1	1		
sl-PSFCH-RB-Set-r16	Bitstring of length 10, The leftmost 2 bits and rightmost 2 bits are set to "1" and the rest are set to "0"							
20MHz	15	PSFCH allocation	1@0	1@105	2@0	2@104	1@0	1@104
		sl-StartRB-Subchannel-r16	0	1	0	1	0	
		sl-SubchannelSize-r16	15	15	15	15	15	
		sl-NumSubchannel-r16	7	7	7	7	7	
	sl-PSFCH-RB-Set-r16	Bitstring of length 105, The leftmost 14 bits and rightmost 14 bits are set to "1" and the rest are set to "0"						
	30	PSFCH allocation	1@0	1@50	2@0	2@49	1@0	1@49
		sl-StartRB-Subchannel-r16	0	1	0	1	0	
		sl-SubchannelSize-r16	25	25	25	25	25	
		sl-NumSubchannel-r16	2	2	2	2	2	
	sl-PSFCH-RB-Set-r16	Bitstring of length 50, The leftmost 4 bits and rightmost 4 bits are set to "1" and the rest are set to "0"						
	60	PSFCH allocation	1@0	1@23	2@0	2@22	1@0	1@23
		sl-StartRB-Subchannel-r16	0	0	0	0	0	
sl-SubchannelSize-r16		12	12	12	12	12		
sl-NumSubchannel-r16		2	2	2	2	2		
sl-PSFCH-RB-Set-r16	Bitstring of length 24, The leftmost 4 bits and rightmost 4 bits are set to "1" and the rest are set to "0"							
30MHz	15	PSFCH allocation	1@0	1@159	2@0	2@158	1@0	1@159
		sl-StartRB-Subchannel-r16	0	0	0	0	0	
		sl-SubchannelSize-r16	20	20	20	20	20	
		sl-NumSubchannel-r16	8	8	8	8	8	
	sl-PSFCH-RB-Set-r16	Bitstring of length 160, The leftmost 16 bits and rightmost 16 bits are set to "1" and the rest are set to "0"						
	30	PSFCH allocation	1@0	1@77	2@0	2@76	1@0	1@74
		sl-StartRB-Subchannel-r16	0	3	0	3	0	
		sl-SubchannelSize-r16	25	25	25	25	25	
		sl-NumSubchannel-r16	3	3	3	3	3	
	sl-PSFCH-RB-Set-r16	Bitstring of length 75, The leftmost 6 bits and rightmost 6 bits are set to "1" and the rest are set to "0"						
	60	PSFCH allocation	1@0	1@37	2@0	2@36	1@0	1@35
		sl-StartRB-Subchannel-r16	0	2	0	2	0	
sl-SubchannelSize-r16		12	12	12	12	12		
sl-NumSubchannel-r16		3	3	3	3	3		
sl-PSFCH-RB-Set-r16	Bitstring of length 36, The leftmost 6 bits and rightmost 6 bits are set to "1" and the rest are set to "0"							

BW _{channel} (MHz)	SCS (kHz)	Parameters	RB allocation					
			PSFCH_1RB_Left	PSFCH_1RB_Right	PSFCH_2RB_Left	PSFCH_2RB_Right	PSFCH_Max_Gap	
40MHz	15	PSFCH allocation	1@0	1@215	2@0	2@214	1@0	1@215
		sl-StartRB-Subchannel-r16	0	0	0	0	0	0
		sl-SubchannelSize-r16	12	12	12	12	12	12
		sl-NumSubchannel-r16	18	18	18	18	18	18
	sl-PSFCH-RB-Set-r16	Bitstring of length 216, The leftmost 36 bits and rightmost 36 bits are set to "1" and the rest are set to "0"						
	30	PSFCH allocation	1@0	1@105	2@0	2@104	1@0	1@104
		sl-StartRB-Subchannel-r16	0	1	0	1	0	0
		sl-SubchannelSize-r16	15	15	15	15	15	15
		sl-NumSubchannel-r16	7	7	7	7	7	7
	sl-PSFCH-RB-Set-r16	Bitstring of length 105, The leftmost 14 bits and rightmost 14 bits are set to "1" and the rest are set to "0"						
	60	PSFCH allocation	1@0	1@50	2@0	2@49	1@0	1@49
		sl-StartRB-Subchannel-r16	0	1	0	1	0	0
sl-SubchannelSize-r16		25	25	25	25	25	25	
sl-NumSubchannel-r16		2	2	2	2	2	2	
sl-PSFCH-RB-Set-r16	Bitstring of length 50, The leftmost 4 bits and rightmost 4 bits are set to "1" and the rest are set to "0"							

Table 6.1E-2: Sidelink configuration for S-SSB (PSBCH)

BW _{channel} (MHz)	SCS (kHz)	RB allocation		
		S-SSB_Low	S-SSB_Mid	S-SSB_High
10MHz	15	11@0	11@21	11@41
	30	11@0	11@7	11@13
	60	11@0	11@0	11@0
20MHz	15	11@0	11@48	11@95
	30	11@0	11@20	11@40
	60	11@0	11@7	11@13
30MHz	15	11@0	11@75	11@149
	30	11@0	11@34	11@67
	60	11@0	11@14	11@27
40MHz	15	11@0	11@103	11@205
	30	11@0	11@48	11@95
	60	11@0	11@20	11@40
NOTE:		sl-AbsoluteFrequencySSB-r16 for each S-SSB allocation is specified in TS 38.508-1 [5] 4.3.1.8.		

6.2 Transmitter power

6.2.1 UE maximum output power

6.2.1.1 Test purpose

To verify that the error of the UE maximum output power does not exceed the range prescribed by the specified nominal maximum output power and tolerance.

An excess maximum output power has the possibility to interfere to other channels or other systems. A small maximum output power decreases the coverage area.

6.2.1.2 Test applicability

This test case applies to all types of NR Power Class 1 and 3 UE release 15 and forward.

This test case applies to all types of NR Power Class 2 UE not supporting txDiversity-r16 release 15 and forward.

6.2.1.3 Minimum conformance requirements

The following UE Power Classes define the maximum output power for any transmission bandwidth within the channel bandwidth of NR carrier unless otherwise stated. The period of measurement shall be at least one sub frame (1ms).

Table 6.2.1.3-1: UE Power Class

NR band	Class 1 (dBm)	Tolerance (dB)	Class 2 (dBm)	Tolerance (dB)	Class 3 (dBm)	Tolerance (dB)
n1					23	± 2
n2					23	$\pm 2^3$
n3					23	$\pm 2^3$
n5					23	± 2
n7					23	$\pm 2^3$
n8					23	$\pm 2^3$
n12					23	$\pm 2^3$
n14	31 ⁶	+2/-3			23	± 2
n20					23	$\pm 2^3$
n24					23	+2/-3 ³
n25					23	$\pm 2^3$
n26					23	$\pm 2^3$
n28					23	+2/-2.5
n30					23	± 2
n34			26	+2/-3	23	± 2
n38					23	± 2
n39			26	+2/-3	23	± 2
n40					23	± 2
n41			26	+2/-3 ³	23	$\pm 2^3$
n48					23	+2/-3
n50					23	± 2
n51					23	± 2
n53					23	± 2
n65					23	± 2
n66					23	± 2
n70					23	± 2
n71					23	+2/-2.5
n74					23	± 2
n77			26	+2/-3	23	+2/-3
n78			26	+2/-3	23	+2/-3
n79			26	+2/-3	23	+2/-3
n80					23	± 2
n81					23	± 2
n82					23	± 2
n83					23	+ 2/-2.5
n84					23	± 2
n86					23	± 2
n95					23	± 2
n97					23	± 2
n99					23	+2/-3 ³

NOTE 1: $P_{PowerClass}$ is the maximum UE power specified without taking into account the tolerance.

NOTE 2: Power class 3 is default power class unless otherwise stated.

NOTE 3: Refers to the transmission bandwidths confined within F_{UL_low} and $F_{UL_low} + 4$ MHz or $F_{UL_high} - 4$ MHz and F_{UL_high} , the maximum output power requirement is relaxed by reducing the lower tolerance limit by 1.5 dB.

NOTE 4: FFS

NOTE 5: FFS

NOTE 6: Generally, PC1 UE for Band n14 is not targeted for smartphone form factor. The UE power class 1. Requirements for Band n14 are applicable for public safety scenario only.

If a UE supports a different power class than the default UE power class for the band and the supported power class enables the higher maximum output power than that of the default power class:

- if the field of UE capability *maxUplinkDutyCycle-PC2-FRI* is absent and the percentage of uplink symbols transmitted in a certain evaluation period is larger than 50% (The exact evaluation period is no less than one radio frame); or

- if the field of UE capability *maxUplinkDutyCycle-PC2-FR1* is not absent and the percentage of uplink symbols transmitted in a certain evaluation period is larger than *maxUplinkDutyCycle-PC2-FR1* as defined in TS 38.331 [6] (The exact evaluation period is no less than one radio frame); or
- if the IE *P-Max* as defined in TS 38.331 [6] is provided and set to the maximum output power of the default power class or lower;
- shall apply all requirements for the default power class to the supported power class and set the configured transmitted power as specified in sub-clause 6.2.4;
- else if the UE does not support a power class with higher maximum output power than PC2; or
- if the IE *P-Max* as defined in TS 38.331 [6] is provided and set to the maximum output power of the power class 2 or lower;
- shall apply all requirements for power class 2 to the supported power class and set the configured transmitted power as specified in clause 6.2.4;
- else shall apply all requirements for the supported power class and set the configured transmitted power class as specified in sub-clause 6.2.4;

The normative reference for this requirement is TS 38.101-1 [2] clause 6.2.1.

6.2.1.4 Test description

6.2.1.4.1 Initial conditions

Initial conditions are a set of test configurations the UE needs to be tested in and the steps for the SS to take with the UE to reach the correct measurement state.

The initial test configurations consist of environmental conditions, test frequencies, test channel bandwidths and sub-carrier spacing based on NR operating bands specified in table 5.3.5-1. All of these configurations shall be tested with applicable test parameters for each combination of test channel bandwidth and sub-carrier spacing, and are shown in table 6.2.1.4.1-1. The details of the uplink reference measurement channels (RMCs) are specified in Annexes A.2. Configurations of PDSCH and PDCCH before measurement are specified in Annex C.2.

Table 6.2.1.4.1-1: Test Configuration Table

Initial Conditions			
Test Environment as specified in TS 38.508-1 [5] subclause 4.1		Normal, TL/VL, TL/VH, TH/VL, TH/VH	
Test Frequencies as specified in TS 38.508-1 [5] subclause 4.3.1		Low range, Mid range, High range	
Test Channel Bandwidths as specified in TS 38.508-1 [5] subclause 4.3.1		Lowest, Mid, Highest (NOTE 3)	
Test SCS as specified in Table 5.3.5-1		Lowest, Highest	
Test Parameters			
Test ID	Downlink Configuration	Uplink Configuration	
	N/A for maximum output power test case	Modulation (NOTE 2)	RB allocation (NOTE 1)
1		DFT-s-OFDM PI/2 BPSK	Inner Full
2		DFT-s-OFDM PI/2 BPSK	Inner 1RB Left
3		DFT-s-OFDM PI/2 BPSK	Inner 1RB Right
4		DFT-s-OFDM QPSK	Inner Full
5		DFT-s-OFDM QPSK	Inner 1RB Left
6		DFT-s-OFDM QPSK	Inner 1RB Right
NOTE 1: The specific configuration of each RB allocation is defined in Table 6.1-1.			
NOTE 2: DFT-s-OFDM PI/2 BPSK test applies only for UEs which supports half Pi BPSK in FR1.			
NOTE 3: For band n28, the Highest test channel bandwidth is replaced by 20MHz due to MPR is always larger than 0dB for 30MHz bandwidth.			

1. Connect the SS to the UE antenna connectors as shown in TS 38.508-1 [5] Annex A, Figure A.3.1.1.1 for TE diagram and section A.3.2 for UE diagram.
2. The parameter settings for the cell are set up according to TS 38.508-1 [5] subclause 4.4.3.

3. Downlink signals are initially set up according to Annex C.0, C.1, C.2, and uplink signals according to Annex G.0, G.1, G.2, G.3.0.
4. The UL Reference Measurement Channel is set according to Table 6.2.1.4.1-1.
5. Propagation conditions are set according to Annex B.0.
6. Ensure the UE is in state RRC_CONNECTED with generic procedure parameters Connectivity *NR*, Connected without release *On*, Test Mode *On* and Test Loop Function *On* according to TS 38.508-1 [5] clause 4.5. Message contents are defined in clause 6.2.1.4.3.

6.2.1.4.2 Test procedure

1. SS sends uplink scheduling information for each UL HARQ process via PDCCH DCI format 0_1 for C_RNTI to schedule the UL RMC according to Table 6.2.1.4.1-1. Since the UE has no payload and no loopback data to send the UE sends uplink MAC padding bits on the UL RMC.
2. Send continuously uplink power control "up" commands in every uplink scheduling information to the UE; allow at least 200ms starting from the first TPC command in this step for the UE to reach P_{UMAX} level.
3. Measure the mean power of the UE in the channel bandwidth of the radio access mode. The period of measurement shall be at least the continuous duration of one active sub-frame (1ms) and in the uplink symbols. For TDD symbols with transient periods are not under test.
4. For UEs supporting Power Class 2 or Power Class 1, repeat steps 1~3 on the applicable bands with message exception of P-Max defined in Table 6.2.1.4.3-2.

6.2.1.4.3 Message contents

Message contents are according to TS 38.508-1 [5] subclause 4.6 and 5.4 with the following exceptions.

Table 6.2.1.4.3-1: PUSCH-Config

Derivation Path: TS 38.508-1 [5], Table 4.6.3-118 with condition TRANSFORM_PRECODER_ENABLED

Table 6.2.1.4.3-2: P-Max (Step 4)

Derivation Path: TS 38.508-1 [5], Table 4.6.3-89			
Information Element	Value/remark	Comment	Condition
P-Max	23		PC2 UE or PC1 UE

Table 6.2.1.4.3-3: Void

6.2.1.5 Test requirement

The maximum output power, derived in step 3 shall be within the range prescribed by the nominal maximum output power and tolerance in Table 6.2.1.5-1 for Power Class 3, Table 6.2.1.5-2 for Power Class 2, Table 6.2.1.5-2a for Power Class 1.

The maximum output power, derived in step 4 shall be within the range prescribed by the nominal maximum output power and tolerance in Table 6.2.1.5-1.

Table 6.2.1.5-1: Maximum Output Power test requirement for Power Class 3

NR band	Class 1 (dBm)	Tolerance (dB)	Class 2 (dBm)	Tolerance (dB)	Class 3 (dBm)	Tolerance (dB)
n1					23	$\pm 2 \pm TT$
n2					23	$\pm 2^3 \pm TT$
n3					23	$\pm 2^3 \pm TT$
n5					23	$\pm 2 \pm TT$
n7					23	$\pm 2^3 \pm TT$
n8					23	$\pm 2^3 \pm TT$
n12					23	$\pm 2^3 \pm TT$
n14					23	$\pm 2 \pm TT$
n20					23	$\pm 2^3 \pm TT$
n24					23	$+2 + TT / -3.0^3 - TT$
n25					23	$\pm 2^3 \pm TT$
n26					23	$\pm 2^3 \pm TT$
n28					23	$+2 + TT / -2.5 - TT$
n30					23	$\pm 2 \pm TT$
n34					23	$\pm 2 \pm TT$
n38					23	$\pm 2 \pm TT$
n39					23	$\pm 2 \pm TT$
n40					23	$\pm 2 \pm TT$
n41					23	$\pm 2^3 \pm TT$
n48					23	$+2 + TT / -3 - TT$
n50					23	$\pm 2 \pm TT$
n51					23	$\pm 2 \pm TT$
n53					23	$\pm 2 \pm TT$
n65					23	$\pm 2 \pm TT$
n66					23	$\pm 2 \pm TT$
n70					23	$\pm 2 \pm TT$
n71					23	$+2 + TT / -2.5 - TT$
n74					23	$\pm 2 \pm TT$
n77					23	$+2 + TT / -3 - TT$
n78					23	$+2 + TT / -3 - TT$
n79					23	$+2 + TT / -3 - TT$
NOTE 1: $P_{PowerClass}$ is the maximum UE power specified without taking into account the tolerance						
NOTE 2: Power class 3 is default power class unless otherwise stated						
NOTE 3: Refers to the transmission bandwidths confined within F_{UL_low} and $F_{UL_low} + 4$ MHz or $F_{UL_high} - 4$ MHz and F_{UL_high} , the maximum output power requirement is relaxed by reducing the lower tolerance limit by 1.5 dB						
NOTE 4: TT for each frequency and channel bandwidth is specified in Table 6.2.1.5-3						

Table 6.2.1.5-2: Maximum Output Power test requirement for Power Class 2

NR band	Class 1 (dBm)	Tolerance (dB)	Class 2 (dBm)	Tolerance (dB)	Class 3 (dBm)	Tolerance (dB)
n34			26	+2+TT/-3-TT		
n39			26	+2+TT/-3-TT		
n41			26	+2+TT/-3 ³ -TT		
n77			26	+2+TT/-3-TT		
n78			26	+2+TT/-3-TT		
n79			26	+2+TT/-3-TT		
NOTE 1: $P_{PowerClass}$ is the maximum UE power specified without taking into account the tolerance						
NOTE 2: Power class 3 is default power class unless otherwise stated						
NOTE 3: Refers to the transmission bandwidths confined within F_{UL_low} and $F_{UL_low} + 4$ MHz or $F_{UL_high} - 4$ MHz and F_{UL_high} , the maximum output power requirement is relaxed by reducing the lower tolerance limit by 1.5 dB						
NOTE 4: TT for each frequency and channel bandwidth is specified in Table 6.2.1.5-3						

Table 6.2.1.5-2a: Maximum Output Power test requirement for Power Class 1

NR band	Class 1 (dBm)	Tolerance (dB)	Class 2 (dBm)	Tolerance (dB)	Class 3 (dBm)	Tolerance (dB)
n14	31	+2+TT/-3-TT				
NOTE 1: $P_{PowerClass}$ is the maximum UE power specified without taking into account the tolerance						
NOTE 2: Power class 3 is default power class unless otherwise stated						
NOTE 3: Refers to the transmission bandwidths confined within F_{UL_low} and $F_{UL_low} + 4$ MHz or $F_{UL_high} - 4$ MHz and F_{UL_high} , the maximum output power requirement is relaxed by reducing the lower tolerance limit by 1.5 dB						
NOTE 4: TT for each frequency and channel bandwidth is specified in Table 6.2.1.5-3						

Table 6.2.1.5-2b: Void**Table 6.2.1.5-3: Test Tolerance (UE maximum output power)**

	$f \leq 3.0\text{GHz}$	$3.0\text{GHz} < f \leq 4.2\text{GHz}$	$4.2\text{GHz} < f \leq 6.0\text{GHz}$
BW \leq 40MHz	0.7 dB	1.0 dB	1.0 dB
40MHz < BW \leq 100MHz	1.0 dB	1.0 dB	1.0 dB

For the UE which supports inter-band NR CA configuration, inter-band NR-DC configuration, SUL configuration or inter-band EN-DC configuration, $\Delta T_{IB,c}$ as specified in 6.2A.4.0.2 for NR CA, 6.2B.4.0.2 for NR-DC, clause 6.2C.2 for SUL, or TS 38.521-3 [14] clause 6.2B.4.2 for EN-DC applies. Unless otherwise stated, $\Delta T_{IB,c}$ is set to zero. In case the UE supports more than one of band combinations for CA, NR-DC, SUL or DC, and an operating band belongs to more than one band combinations then

- When the operating band frequency range is ≤ 1 GHz, the applicable additional $\Delta T_{IB,c}$ shall be the average value for all band combinations defined in clause 6.2A.4.0.2, 6.2B.4.0.2, 6.2C.2 in this specification and 6.2B.4.2 in TS 38.521-3 [14], truncated to one decimal place that apply for that operating band among the supported band combinations. In case there is a harmonic relation between low band UL and high band DL, then the maximum $\Delta T_{IB,c}$ among the different supported band combinations involving such band shall be applied
- When the operating band frequency range is > 1 GHz, the applicable additional $\Delta T_{IB,c}$ shall be the maximum value for all band combinations defined in clause 6.2A.4.0.2, 6.2B.4.0.2, 6.2C.2 in this specification and 6.2B.4.2 in TS 38.521-3 [14] for the applicable operating bands.

6.2.2 UE maximum output power reduction

Editor's Note: The following aspects are either missing or not yet determined:

- The test requirements updates for n77 PC1.5 UE indicating modified MPR-Behavior in Table 6.2.2.3-4a

6.2.2.1 Test purpose

The number of RB identified in Table 6.2.2.3-1 is based on meeting the requirements for adjacent channel leakage ratio and the maximum power reduction (MPR) due to Cubic Metric (CM).

6.2.2.2 Test applicability

The requirements of this test apply to all types of NR Power Class 3 UE release 15 and forward and NR Power Class 1 UE release 15 and forward in NR Band n14.

The requirements of this test apply to all types of NR Power Class 2 UE not supporting txDiversity-r16 release 15 and forward.

NOTE: Test execution is not necessary if TS 38.521-1 6.5.2.4.1 is executed.

6.2.2.3 Minimum conformance requirements

UE is allowed to reduce the maximum output power due to higher order modulations and transmit bandwidth configurations. For UE power class 2 and 3 and UE power class 1 in n14, the allowed maximum power reduction (MPR) is defined in Table 6.2.2.3-2, Table 6.2.2.3-1 and Table 6.2.2.3-5, respectively for channel bandwidths ≤ 100 MHz.

If the relative channel bandwidth $\leq 4\%$ for TDD bands or $\leq 3\%$ for FDD band, the Δ MPR is set to zero.

If the relative channel bandwidth is larger than 4% for TDD bands or 3% for FDD bands, the Δ MPR is defined in Table 6.2.2.3-3.

Where relative channel bandwidth = $2 \cdot BW_{\text{Channel}} / (F_{\text{UL,low}} + F_{\text{UL,high}})$.

The allowed MPR for SRS, PUCCH formats 0, 1, 3 and 4, and PRACH shall be as specified for QPSK modulated DFT-s-OFDM of equivalent RB allocation. The allowed MPR for PUCCH format 2 shall be as specified for QPSK modulated CP-OFDM of equivalent RB allocation.

Table 6.2.2.3-1: Maximum power reduction (MPR) for power class 3

Modulation		MPR (dB)		
		Edge RB allocations	Outer RB allocations	Inner RB allocations
DFT-s-OFDM	Pi/2 BPSK	$\leq 3.5^1$	$\leq 1.2^1$	$\leq 0.2^1$
		$\leq 0.5^2$		0^2
	Pi/2 BPSK w Pi/2 BPSK DMRS	$\leq 0.5^2$	0^2	
	QPSK	≤ 1	0	
	16 QAM	≤ 2	≤ 1	
	64 QAM	≤ 2.5		
	256 QAM	≤ 4.5		
CP-OFDM	QPSK	≤ 3	≤ 1.5	
	16 QAM	≤ 3	≤ 2	
	64 QAM	≤ 3.5		
	256 QAM	≤ 6.5		
NOTE 1: Applicable for UE operating in TDD mode with Pi/2 BPSK modulation and UE indicates support for UE capability <i>powerBoosting-pi2BPSK</i> and if the IE <i>powerBoostPi2BPSK</i> is set to 1 and 40 % or less slots in radio frame are used for UL transmission for bands n40, n41, n77, n78 and n79. The reference power of 0dB MPR is 26dBm.				
NOTE 2: Applicable for UE operating in FDD mode, or in TDD mode in bands other than n40, n41, n77, n78 and n79 with Pi/2 BPSK modulation and if the IE <i>powerBoostPi2BPSK</i> is set to 0 and if more than 40% of slots in radio frame are used for UL transmission for bands n40, n41, n77, n78 and n79.				

Table 6.2.2.3-2: Maximum power reduction (MPR) for power class 2

Modulation		MPR (dB)		
		Edge RB allocations	Outer RB allocations	Inner RB allocations
DFT-s-OFDM	Pi/2 BPSK	≤ 3.5	≤ 0.5	0
	QPSK	≤ 3.5	≤ 1	0
	16 QAM	≤ 3.5	≤ 2	≤ 1
	64 QAM	≤ 3.5	≤ 2.5	
	256 QAM	≤ 4.5		
CP-OFDM	QPSK	≤ 3.5	≤ 3	≤ 1.5
	16 QAM	≤ 3.5	≤ 3	≤ 2
	64 QAM	≤ 3.5		
	256 QAM	≤ 6.5		

Table 6.2.2.3-3: ΔMPR

NR Band	Power class	Channel bandwidth	ΔMPR (dB)
n28 and n83	Power class 3	30 MHz	0.5
n40 and n97	Power class 3 and power class 2	100 MHz	1

Table 6.2.2.3-4: Void**Table 6.2.2.3-4a: Void****Table 6.2.2.3-5: Maximum power reduction (MPR) for power class 1 for Band n14**

Modulation		MPR (dB)		
		Edge RB allocations	Outer RB allocations	Inner RB allocations
DFT-s-OFDM	Pi/2 BPSK	≤ 0.5	≤ 0.5	0
	Pi/2 BPSK w Pi/2 BPSK DMRS	≤ 0.5	0	0
	QPSK	≤ 1		0
	16 QAM	≤ 2		≤ 1
	64 QAM	≤ 2.5		
	256 QAM	≤ 4.5		
CP-OFDM	QPSK	≤ 3	≤ 1.5	
	16 QAM	≤ 3	≤ 2	
	64 QAM	≤ 3.5		
	256 QAM	≤ 6.5		

Where the following parameters are defined to specify valid RB allocation ranges for Outer and Inner RB allocations:

N_{RB} is the maximum number of RBs for a given Channel bandwidth and sub-carrier spacing defined in Table 5.3.2-1.

$$RB_{Start,Low} = \max(1, \text{floor}(L_{CRB}/2))$$

where $\max()$ indicates the largest value of all arguments and $\text{floor}(x)$ is the greatest integer less than or equal to x .

$$RB_{Start,High} = N_{RB} - RB_{Start,Low} - L_{CRB}$$

The RB allocation is an Inner RB allocation if the following conditions are met:

$$RB_{Start,Low} \leq RB_{Start} \leq RB_{Start,High}, \text{ and}$$

$$L_{CRB} \leq \text{ceil}(N_{RB}/2)$$

where $\text{ceil}(x)$ is the smallest integer greater than or equal to x .

An Edge RB allocation is the one for which the RB(s) is (are) allocated at the lowermost or uppermost edge of the channel with $L_{CRB} \leq 2$ RBs.

The RB allocation is an Outer RB allocation for all other allocations which are not an Inner RB allocation or Edge RB allocation.

If CP-OFDM allocation satisfies following conditions, it is considered as almost contiguous allocation

$$N_{\text{RB_gap}} / (N_{\text{RB_alloc}} + N_{\text{RB_gap}}) \leq 0.25$$

and $N_{\text{RB_alloc}} + N_{\text{RB_gap}}$ is larger than 106, 51 or 24 RBs for 15 kHz, 30 kHz or 60 kHz SCS respectively where $N_{\text{RB_gap}}$ is the total number of unallocated RBs between allocated RBs and $N_{\text{RB_alloc}}$ is the total number of allocated RBs. The size and location of allocated and unallocated RBs are restricted by RBG parameters specified in sub-clause 6.1.2.2 of TS 38.214 [12]. For these almost contiguous signals in power class 2 and 3, the allowed maximum power reduction defined in Table 6.2.2.3-2 and Table 6.2.2.3-1 are increased by

$$\text{CEIL}\{ 10 \log_{10}(1 + N_{\text{RB_gap}} / N_{\text{RB_alloc}}), 0.5 \} \text{ dB},$$

where $\text{CEIL}\{x, 0.5\}$ means x rounding upwards to closest 0.5dB. The parameters of $\text{RB}_{\text{Start,Low}}$ and $\text{RB}_{\text{Start,High}}$ to specify valid RB allocation ranges for Outer and Inner RB allocations are defined as following:

$$\text{RB}_{\text{Start,Low}} = \max(1, \text{floor}((N_{\text{RB_alloc}} + N_{\text{RB_gap}})/2))$$

$$\text{RB}_{\text{Start,High}} = N_{\text{RB}} - \text{RB}_{\text{Start,Low}} - N_{\text{RB_alloc}} - N_{\text{RB_gap}}$$

For the UE maximum output power modified by MPR, the power limits specified in subclause 6.2.4 apply.

The normative reference for this requirement is TS 38.101-1 [2] clause 6.2.2.

6.2.2.4 Test description

6.2.2.4.1 Initial conditions

Initial conditions are a set of test configurations the UE needs to be tested in and the steps for the SS to take with the UE to reach the correct measurement state.

The initial test configurations consist of environmental conditions, test frequencies, channel bandwidths and sub-carrier spacing based on NR operating bands specified in table 5.3.5-1. All of these configurations shall be tested with applicable test parameters for each combination of test channel bandwidth and sub-carrier spacing, and are shown in Table 6.2.2.4.1-1, Table 6.2.2.4.1-2, Table 6.2.2.4.1-2a and Table 6.2.2.4.1-3. The details of the uplink reference measurement channels (RMCs) are specified in Annexes A.2. Configurations of PDSCH and PDCCH before measurement are specified in Annex C.2.

Table 6.2.2.4.1-1: Test Configuration Table for power class 3 (contiguous allocation)

Initial Conditions																																																																																			
Test Environment as specified in TS 38.508-1 [5] subclause 4.1		Normal, TL/VL, TL/VH, TH/VL, TH/VH																																																																																	
Test Frequencies as specified in TS 38.508-1 [5] subclause 4.3.1		Low range, High range																																																																																	
Test Channel Bandwidths as specified in TS 38.508-1 [5] subclause 4.3.1		Lowest, Highest																																																																																	
Test SCS as specified in Table 5.3.5-1		Lowest, Highest																																																																																	
Test Parameters for Channel Bandwidths																																																																																			
Test ID	Freq	Downlink Configuration	Uplink Configuration																																																																																
		N/A for Maximum Power Reduction (MPR) test case	<table border="1"> <thead> <tr> <th>Modulation (NOTE 2)</th> <th>RB allocation (NOTE 1)</th> </tr> </thead> <tbody> <tr><td>DFT-s-OFDM Pi/2 BPSK</td><td>Inner Full</td></tr> <tr><td>DFT-s-OFDM Pi/2 BPSK</td><td>Edge_1RB_Left</td></tr> <tr><td>DFT-s-OFDM Pi/2 BPSK</td><td>Edge_1RB_Right</td></tr> <tr><td>DFT-s-OFDM Pi/2 BPSK</td><td>Outer Full</td></tr> <tr><td>DFT-s-OFDM Pi/2 BPSK</td><td>Inner Full</td></tr> <tr><td>DFT-s-OFDM Pi/2 BPSK</td><td>Edge_1RB_Left</td></tr> <tr><td>DFT-s-OFDM Pi/2 BPSK</td><td>Edge_1RB_Right</td></tr> <tr><td>DFT-s-OFDM Pi/2 BPSK</td><td>Outer Full</td></tr> <tr><td>DFT-s-OFDM QPSK</td><td>Inner Full</td></tr> <tr><td>DFT-s-OFDM QPSK</td><td>Edge_1RB_Left</td></tr> <tr><td>DFT-s-OFDM QPSK</td><td>Edge_1RB_Right</td></tr> <tr><td>DFT-s-OFDM QPSK</td><td>Outer Full</td></tr> <tr><td>DFT-s-OFDM 16 QAM</td><td>Inner Full</td></tr> <tr><td>DFT-s-OFDM 16 QAM</td><td>Edge_1RB_Left</td></tr> <tr><td>DFT-s-OFDM 16 QAM</td><td>Edge_1RB_Right</td></tr> <tr><td>DFT-s-OFDM 16 QAM</td><td>Outer Full</td></tr> <tr><td>DFT-s-OFDM 64 QAM</td><td>Edge_1RB_Left</td></tr> <tr><td>DFT-s-OFDM 64 QAM</td><td>Edge_1RB_Right</td></tr> <tr><td>DFT-s-OFDM 64 QAM</td><td>Outer Full</td></tr> <tr><td>DFT-s-OFDM 256 QAM</td><td>Edge_1RB_Left</td></tr> <tr><td>DFT-s-OFDM 256 QAM</td><td>Edge_1RB_Right</td></tr> <tr><td>DFT-s-OFDM 256 QAM</td><td>Outer Full</td></tr> <tr><td>CP-OFDM QPSK</td><td>Inner Full</td></tr> <tr><td>CP-OFDM QPSK</td><td>Edge_1RB_Left</td></tr> <tr><td>CP-OFDM QPSK</td><td>Edge_1RB_Right</td></tr> <tr><td>CP-OFDM QPSK</td><td>Outer Full</td></tr> <tr><td>CP-OFDM 16 QAM</td><td>Inner Full</td></tr> <tr><td>CP-OFDM 16 QAM</td><td>Edge_1RB_Left</td></tr> <tr><td>CP-OFDM 16 QAM</td><td>Edge_1RB_Right</td></tr> <tr><td>CP-OFDM 16 QAM</td><td>Outer Full</td></tr> <tr><td>CP-OFDM 64 QAM</td><td>Edge_1RB_Left</td></tr> <tr><td>CP-OFDM 64 QAM</td><td>Edge_1RB_Right</td></tr> <tr><td>CP-OFDM 64 QAM</td><td>Outer Full</td></tr> <tr><td>CP-OFDM 256 QAM</td><td>Edge_1RB_Left</td></tr> <tr><td>CP-OFDM 256 QAM</td><td>Edge_1RB_Right</td></tr> <tr><td>CP-OFDM 256 QAM</td><td>Outer Full</td></tr> <tr><td>DFT-s-OFDM Pi/2 BPSK w Pi/2 BPSK DMRS</td><td>Edge_1RB_Left</td></tr> <tr><td>DFT-s-OFDM Pi/2 BPSK w Pi/2 BPSK DMRS</td><td>Edge_1RB_Right</td></tr> <tr><td>DFT-s-OFDM Pi/2 BPSK w Pi/2 BPSK DMRS</td><td>Outer Full</td></tr> </tbody> </table>	Modulation (NOTE 2)	RB allocation (NOTE 1)	DFT-s-OFDM Pi/2 BPSK	Inner Full	DFT-s-OFDM Pi/2 BPSK	Edge_1RB_Left	DFT-s-OFDM Pi/2 BPSK	Edge_1RB_Right	DFT-s-OFDM Pi/2 BPSK	Outer Full	DFT-s-OFDM Pi/2 BPSK	Inner Full	DFT-s-OFDM Pi/2 BPSK	Edge_1RB_Left	DFT-s-OFDM Pi/2 BPSK	Edge_1RB_Right	DFT-s-OFDM Pi/2 BPSK	Outer Full	DFT-s-OFDM QPSK	Inner Full	DFT-s-OFDM QPSK	Edge_1RB_Left	DFT-s-OFDM QPSK	Edge_1RB_Right	DFT-s-OFDM QPSK	Outer Full	DFT-s-OFDM 16 QAM	Inner Full	DFT-s-OFDM 16 QAM	Edge_1RB_Left	DFT-s-OFDM 16 QAM	Edge_1RB_Right	DFT-s-OFDM 16 QAM	Outer Full	DFT-s-OFDM 64 QAM	Edge_1RB_Left	DFT-s-OFDM 64 QAM	Edge_1RB_Right	DFT-s-OFDM 64 QAM	Outer Full	DFT-s-OFDM 256 QAM	Edge_1RB_Left	DFT-s-OFDM 256 QAM	Edge_1RB_Right	DFT-s-OFDM 256 QAM	Outer Full	CP-OFDM QPSK	Inner Full	CP-OFDM QPSK	Edge_1RB_Left	CP-OFDM QPSK	Edge_1RB_Right	CP-OFDM QPSK	Outer Full	CP-OFDM 16 QAM	Inner Full	CP-OFDM 16 QAM	Edge_1RB_Left	CP-OFDM 16 QAM	Edge_1RB_Right	CP-OFDM 16 QAM	Outer Full	CP-OFDM 64 QAM	Edge_1RB_Left	CP-OFDM 64 QAM	Edge_1RB_Right	CP-OFDM 64 QAM	Outer Full	CP-OFDM 256 QAM	Edge_1RB_Left	CP-OFDM 256 QAM	Edge_1RB_Right	CP-OFDM 256 QAM	Outer Full	DFT-s-OFDM Pi/2 BPSK w Pi/2 BPSK DMRS	Edge_1RB_Left	DFT-s-OFDM Pi/2 BPSK w Pi/2 BPSK DMRS	Edge_1RB_Right	DFT-s-OFDM Pi/2 BPSK w Pi/2 BPSK DMRS	Outer Full
Modulation (NOTE 2)	RB allocation (NOTE 1)																																																																																		
DFT-s-OFDM Pi/2 BPSK	Inner Full																																																																																		
DFT-s-OFDM Pi/2 BPSK	Edge_1RB_Left																																																																																		
DFT-s-OFDM Pi/2 BPSK	Edge_1RB_Right																																																																																		
DFT-s-OFDM Pi/2 BPSK	Outer Full																																																																																		
DFT-s-OFDM Pi/2 BPSK	Inner Full																																																																																		
DFT-s-OFDM Pi/2 BPSK	Edge_1RB_Left																																																																																		
DFT-s-OFDM Pi/2 BPSK	Edge_1RB_Right																																																																																		
DFT-s-OFDM Pi/2 BPSK	Outer Full																																																																																		
DFT-s-OFDM QPSK	Inner Full																																																																																		
DFT-s-OFDM QPSK	Edge_1RB_Left																																																																																		
DFT-s-OFDM QPSK	Edge_1RB_Right																																																																																		
DFT-s-OFDM QPSK	Outer Full																																																																																		
DFT-s-OFDM 16 QAM	Inner Full																																																																																		
DFT-s-OFDM 16 QAM	Edge_1RB_Left																																																																																		
DFT-s-OFDM 16 QAM	Edge_1RB_Right																																																																																		
DFT-s-OFDM 16 QAM	Outer Full																																																																																		
DFT-s-OFDM 64 QAM	Edge_1RB_Left																																																																																		
DFT-s-OFDM 64 QAM	Edge_1RB_Right																																																																																		
DFT-s-OFDM 64 QAM	Outer Full																																																																																		
DFT-s-OFDM 256 QAM	Edge_1RB_Left																																																																																		
DFT-s-OFDM 256 QAM	Edge_1RB_Right																																																																																		
DFT-s-OFDM 256 QAM	Outer Full																																																																																		
CP-OFDM QPSK	Inner Full																																																																																		
CP-OFDM QPSK	Edge_1RB_Left																																																																																		
CP-OFDM QPSK	Edge_1RB_Right																																																																																		
CP-OFDM QPSK	Outer Full																																																																																		
CP-OFDM 16 QAM	Inner Full																																																																																		
CP-OFDM 16 QAM	Edge_1RB_Left																																																																																		
CP-OFDM 16 QAM	Edge_1RB_Right																																																																																		
CP-OFDM 16 QAM	Outer Full																																																																																		
CP-OFDM 64 QAM	Edge_1RB_Left																																																																																		
CP-OFDM 64 QAM	Edge_1RB_Right																																																																																		
CP-OFDM 64 QAM	Outer Full																																																																																		
CP-OFDM 256 QAM	Edge_1RB_Left																																																																																		
CP-OFDM 256 QAM	Edge_1RB_Right																																																																																		
CP-OFDM 256 QAM	Outer Full																																																																																		
DFT-s-OFDM Pi/2 BPSK w Pi/2 BPSK DMRS	Edge_1RB_Left																																																																																		
DFT-s-OFDM Pi/2 BPSK w Pi/2 BPSK DMRS	Edge_1RB_Right																																																																																		
DFT-s-OFDM Pi/2 BPSK w Pi/2 BPSK DMRS	Outer Full																																																																																		
1 ³	Default																																																																																		
2 ³	Low																																																																																		
3 ³	High																																																																																		
4 ³	Default																																																																																		
5 ⁴	Default																																																																																		
6 ⁴	Low																																																																																		
7 ⁴	High																																																																																		
8 ⁴	Default																																																																																		
9	Default																																																																																		
10	Low																																																																																		
11	High																																																																																		
12	Default																																																																																		
13	Default																																																																																		
14	Low																																																																																		
15	High																																																																																		
16	Default																																																																																		
17	Low																																																																																		
18	High																																																																																		
19	Default																																																																																		
20	Low																																																																																		
21	High																																																																																		
22	Default																																																																																		
23	Default																																																																																		
24	Low																																																																																		
25	High																																																																																		
26	Default																																																																																		
27	Default																																																																																		
28	Low																																																																																		
29	High																																																																																		
30	Default																																																																																		
31	Low																																																																																		
32	High																																																																																		
33	Default																																																																																		
34	Low																																																																																		
35	High																																																																																		
36	Default																																																																																		
37 ^{4,5}	Low																																																																																		
38 ^{4,5}	High																																																																																		
39 ^{4,5}	Default																																																																																		

NOTE 1: The specific configuration of each RB allocation is defined in Table 6.1-1.
NOTE 2: DFT-s-OFDM Pi/2 BPSK test applies only for UEs which supports Pi/2 BPSK in FR1.
NOTE 3: UE operating in TDD mode with Pi/2 BPSK modulation and UE indicates support for UE capability *powerBoosting-pi2BPSK* and the IE *powerBoostPi2BPSK* is set to 1 for bands n40, n41, n77, n78 and n79.
NOTE 4: UE operating in FDD mode, or in TDD mode in bands other than n40, n41, n77, n78 and n79, or in TDD mode the IE *powerBoostPi2BPSK* is set to 0 for bands n40, n41, n77, n78 and n79.
NOTE 5: Applicable to UEs indicating support for UE capability *lowPAPR-DMRS-PUSCHwithPrecoding-r16*.

Table 6.2.2.4.1-1a: Void

Table 6.2.2.4.1-2: Test Configuration Table for power class 2 (contiguous allocation)

Initial Conditions				
Test Environment as specified in TS 38.508-1 [5] subclause 4.1		Normal, TL/VL, TL/VH, TH/VL, TH/VH		
Test Frequencies as specified in TS 38.508-1 [5] subclause 4.3.1		Low range, High range		
Test Channel Bandwidths as specified in TS 38.508-1 [5] subclause 4.3.1		Lowest, Highest		
Test SCS as specified in Table 5.3.5-1		Lowest, Highest		
Test Parameters for Channel Bandwidths				
Test ID	Freq	Downlink Configuration	Uplink Configuration	
		N/A for Maximum Power Reduction (MPR) test case	Modulation (NOTE 2)	RB allocation (NOTE 1)
1	Default		DFT-s-OFDM Pi/2 BPSK	Inner Full
2	Low		DFT-s-OFDM Pi/2 BPSK	Edge_1RB_Left
3	High		DFT-s-OFDM Pi/2 BPSK	Edge_1RB_Right
4	Default		DFT-s-OFDM Pi/2 BPSK	Outer Full
5	Default		DFT-s-OFDM QPSK	Inner Full
6	Low		DFT-s-OFDM QPSK	Edge_1RB_Left
7	High		DFT-s-OFDM QPSK	Edge_1RB_Right
8	Default		DFT-s-OFDM QPSK	Outer Full
9	Default		DFT-s-OFDM 16 QAM	Inner Full
10	Low		DFT-s-OFDM 16 QAM	Edge_1RB_Left
11	High		DFT-s-OFDM 16 QAM	Edge_1RB_Right
12	Default		DFT-s-OFDM 16 QAM	Outer Full
13	Low		DFT-s-OFDM 64 QAM	Edge_1RB_Left
14	High		DFT-s-OFDM 64 QAM	Edge_1RB_Right
15	Default		DFT-s-OFDM 64 QAM	Outer Full
16	Low		DFT-s-OFDM 256 QAM	Edge_1RB_Left
17	High		DFT-s-OFDM 256 QAM	Edge_1RB_Right
18	Default		DFT-s-OFDM 256 QAM	Outer Full
19	Default		CP-OFDM QPSK	Inner Full
20	Low		CP-OFDM QPSK	Edge_1RB_Left
21	High		CP-OFDM QPSK	Edge_1RB_Right
22	Default		CP-OFDM QPSK	Outer Full
23	Default		CP-OFDM 16 QAM	Inner Full
24	Low		CP-OFDM 16 QAM	Edge_1RB_Left
25	High		CP-OFDM 16 QAM	Edge_1RB_Right
26	Default		CP-OFDM 16 QAM	Outer Full
27	Low		CP-OFDM 64 QAM	Edge_1RB_Left
28	High		CP-OFDM 64 QAM	Edge_1RB_Right
29	Default		CP-OFDM 64 QAM	Outer Full
30	Low		CP-OFDM 256 QAM	Edge_1RB_Left
31	High		CP-OFDM 256 QAM	Edge_1RB_Right
32	Default	CP-OFDM 256 QAM	Outer Full	
NOTE 1: The specific configuration of each RB allocation is defined in Table 6.1-1.				
NOTE 2: DFT-s-OFDM Pi/2 BPSK test applies only for UEs which supports Pi/2 BPSK in FR1.				

Table 6.2.2.4.1-2a: Test Configuration Table for power class 1 for Band n14 (contiguous allocation)

Initial Conditions				
Test Environment as specified in TS 38.508-1 [5] subclause 4.1		Normal, TL/VL, TL/VH, TH/VL, TH/VH		
Test Frequencies as specified in TS 38.508-1 [5] subclause 4.3.1		Low range, High range		
Test Channel Bandwidths as specified in TS 38.508-1 [5] subclause 4.3.1		Lowest, Highest		
Test SCS as specified in Table 5.3.5-1		Lowest, Highest		
Test Parameters for Channel Bandwidths				
Test ID	Freq	Downlink Configuration	Uplink Configuration	
			Modulation (NOTE 2)	RB allocation (NOTE 1)
		N/A for Maximum Power	DFT-s-OFDM Pi/2 BPSK	Inner Full
1	Default		DFT-s-OFDM Pi/2 BPSK	Edge_1RB_Left
2	Low		DFT-s-OFDM Pi/2 BPSK	Edge_1RB_Right
3	High		DFT-s-OFDM Pi/2 BPSK	Outer Full
4	Default		DFT-s-OFDM QPSK	Inner Full
5	Default		DFT-s-OFDM QPSK	Edge_1RB_Left
6	Low		DFT-s-OFDM QPSK	Edge_1RB_Right
7	High		DFT-s-OFDM QPSK	Outer Full
8	Default		DFT-s-OFDM 16 QAM	Inner Full
9	Default		DFT-s-OFDM 16 QAM	Edge_1RB_Left
10	Low		DFT-s-OFDM 16 QAM	Edge_1RB_Right
11	High		DFT-s-OFDM 16 QAM	Outer Full
12	Default		DFT-s-OFDM 64 QAM	Edge_1RB_Left
13	Low		DFT-s-OFDM 64 QAM	Edge_1RB_Right
14	High		DFT-s-OFDM 64 QAM	Outer Full
15	Default		DFT-s-OFDM 256 QAM	Edge_1RB_Left
16	Low		DFT-s-OFDM 256 QAM	Edge_1RB_Right
17	High		DFT-s-OFDM 256 QAM	Outer Full
18	Default		CP-OFDM QPSK	Inner Full
19	Default		CP-OFDM QPSK	Edge_1RB_Left
20	Low		CP-OFDM QPSK	Edge_1RB_Right
21	High		CP-OFDM QPSK	Outer Full
22	Default		CP-OFDM 16 QAM	Inner Full
23	Default		CP-OFDM 16 QAM	Edge_1RB_Left
24	Low		CP-OFDM 16 QAM	Edge_1RB_Right
25	High		CP-OFDM 16 QAM	Outer Full
26	Default		CP-OFDM 64 QAM	Edge_1RB_Left
27	Low		CP-OFDM 64 QAM	Edge_1RB_Right
28	High		CP-OFDM 64 QAM	Outer Full
29	Default		CP-OFDM 256 QAM	Edge_1RB_Left
30	Low		CP-OFDM 256 QAM	Edge_1RB_Right
31	High		CP-OFDM 256 QAM	Outer Full
32	Default		DFT-s-OFDM Pi/2 BPSK w Pi/2 BPSK DMRS	Edge_1RB_Left
33 ³	Low		DFT-s-OFDM Pi/2 BPSK w Pi/2 BPSK DMRS	Edge_1RB_Right
34 ³	High		DFT-s-OFDM Pi/2 BPSK w Pi/2 BPSK DMRS	Outer Full
35 ³	Default			

NOTE 1: The specific configuration of each RB allocation is defined in Table 6.1-1.
 NOTE 2: DFT-s-OFDM Pi/2 BPSK test applies only for Ues which supports Pi/2 BPSK in FR1.
 NOTE 3: Applicable to UEs indicating support for UE capability *lowPAPR-DMRS-PUSCHwithPrecoding-r16*.

Table 6.2.2.4.1-2b: Void

Table 6.2.2.4.1-3: Test Configuration Table for power class 2&3 (almost contiguous allocation)

Initial Conditions				
Test Environment as specified in TS 38.508-1 [5] subclause 4.1		Normal, TL/VL, TL/VH, TH/VL, TH/VH		
Test Frequencies as specified in TS 38.508-1 [5] subclause 4.3.1		Low range, High range		
Test Channel Bandwidths as specified in TS 38.508-1 [5] subclause 4.3.1		Highest		
Test SCS as specified in Table 5.3.5-1		Lowest, Highest		
Test Parameters for Channel Bandwidths				
Test ID	Freq	Downlink Configuration	Uplink Configuration	
		N/A for Maximum Power	Modulation	
			RB allocation (NOTE 1)	
1	Default		CP-OFDM QPSK	Inner Full
2	Default		CP-OFDM QPSK	Outer Full
3	Default		CP-OFDM 16 QAM	Inner Full
4	Default		CP-OFDM 16 QAM	Outer Full
5	Default		CP-OFDM 64 QAM	Outer Full
6	Default	CP-OFDM 256 QAM	Outer Full	
NOTE 1: The specific configuration of each RB allocation is defined in Table 6.2.2.4.1-4.				
NOTE 2: Test applies only for UEs which support almost contiguous UL CP-OFDM transmissions. For PC2 UE which support almost contiguous UL CP-OFDM transmissions, test is only applicable for Release 16 and forward.				

Table 6.2.2.4.1-4: Uplink configuration for almost contiguous allocation

Channel Bandwidth(MHz)	SCS(kHz)	OFDM	Outer Full		Inner Full	
			Cluster1 RB allocations (LCRB @ RB _{start})	Cluster2 RB allocations (LCRB @ RB _{start})	Cluster1 RB allocations (LCRB @ RB _{start})	Cluster2 RB allocations (LCRB @ RB _{start})
25	15	CP	48@0	53@80	N/A	N/A
	30	CP	24@0	25@40	N/A	N/A
	60	CP	12@0	13@18	N/A	N/A
30	15	CP	64@0	64@96	N/A	N/A
	30	CP	32@0	30@48	N/A	N/A
	60	CP	16@0	14@24	N/A	N/A
40	15	CP	80@0	88@128	N/A	N/A
	30	CP	40@0	42@64	N/A	N/A
	60	CP	20@0	19@32	12@12	8@28
45	15	CP	80@0	116@126	48@64	55@128
	30	CP	40@0	55@64	24@32	26@64
	60	CP	20@0	26@32	12@16	12@32
50	15	CP	96@0	110@160	48@64	48@144
	30	CP	48@0	53@80	24@32	24@72
	60	CP	24@0	25@40	12@16	12@36
60	15	CP	N/A	N/A	N/A	N/A
	30	CP	64@0	66@96	32@32	16@80
	60	CP	32@0	31@48	16@16	8@40
70	15	CP	N/A	N/A	N/A	N/A
	30	CP	80@0	77@112	32@32	16@80
	60	CP	40@0	37@56	16@16	8@40
80	15	CP	N/A	N/A	N/A	N/A
	30	CP	80@0	89@128	32@32	16@80
	60	CP	40@0	43@64	16@16	8@40
90	15	CP	N/A	N/A	N/A	N/A
	30	CP	96@0	101@144	32@32	16@80
	60	CP	48@0	49@72	16@16	8@40
100	15	CP	N/A	N/A	N/A	N/A
	30	CP	112@0	97@176	48@64	48@144
	60	CP	48@0	55@80	24@32	24@72

1. Connect the SS to the UE antenna connectors as shown in TS 38.508-1 [5] Annex A, Figure A.3.1.2.1 for TE diagram and section A.3.2 for UE diagram.
2. The parameter settings for the cell are set up according to TS 38.508-1 [5] subclause 4.4.3.
3. Downlink signals are initially set up according to Annex C.0, C.1, C.2, and uplink signals according to Annex G.0, G.1, G.2, G.3.0.
4. The UL Reference Measurement Channel is set according to Table 6.2.2.4.1-1, Table 6.2.2.4.1-2, Table 6.2.2.4.1-2a and Table 6.2.2.4.1-3.
5. Propagation conditions are set according to Annex B.0.

6. Ensure the UE is in State RRC_CONNECTED with generic procedure parameters Connectivity NR, Connected without release On, Test Mode On and Test Loop Function On according to TS 38.508-1 [5] clause 4.5. Message contents are defined in clause 6.2.2.4.3.

6.2.2.4.2 Test procedure

1. SS sends uplink scheduling information for each UL HARQ process via PDCCH DCI format 0_1 for C_RNTI to schedule the UL RMC according to Table 6.2.2.4.1-1, Table 6.2.2.4.1-2, Table 6.2.2.4.1-2a and Table 6.2.2.4.1-3. Since the UE has no payload and no loopback data to send the UE sends uplink MAC padding bits on the UL RMC.
2. Send continuously uplink power control "up" commands in every uplink scheduling information to the UE; allow at least 200ms for the UE to reach P_{UMAX} level.
3. Measure the mean power of the UE in the channel bandwidth of the radio access mode. The period of measurement shall be at least the continuous duration of 1ms over consecutive active uplink slots. For TDD, only slots consisting of only UL symbols are under test.
4. For UEs supporting Power Class 1 in Band n14 and Power Class 2, repeat steps 1~3 for Test ID 22 and 36 in Table 6.2.2.4.1-1 on the applicable bands with message exception of P-Max defined in Table 6.2.2.4.3-2.

NOTE 1: When switching to DFT-s-OFDM waveform, as specified in the test configuration Table 6.2.2.4.1-1, Table 6.2.2.4.1-2, send an NR RRCReconfiguration message according to TS 38.508-1 [5] clause 4.6.3 Table 4.6.3-118 PUSCH-Config with TRANSFORM_PRECODER_ENABLED condition.

6.2.2.4.3 Message contents

Message contents are according to TS 38.508-1 [5] subclause 4.6 and 5.4 with the following exceptions:

Table 6.2.2.4.3-1: PUSCH-Config

Derivation Path: TS 38.508-1 [5] subclause 4.6.3 Table 4.6.3-118 PUSCH-Config			
Information Element	Value/remark	Comment	Condition
PUSCH-Config ::= SEQUENCE {			
resourceAllocation	resourceAllocationType0		Almost contiguous allocation
	resourceAllocationType1		Contiguous allocation
}			

Table 6.2.2.4.3-2: P-Max (Step 4)

Derivation Path: TS 38.508-1 [5], Table 4.6.3-89			
Information Element	Value/remark	Comment	Condition
P-Max	23		PC2 UE or PC1 UE

Table 6.2.2.4.3-2a: Void

Table 6.2.2.4.3-3: DMRS-UplinkConfig (Test ID 37 - 39 in Table 6.2.2.4.1-1)

Derivation Path: TS 38.508-1 [5], Table 4.6.3-51			
Information Element	Value/remark	Comment	Condition
DMRS-UplinkConfig ::= SEQUENCE {			
transformPrecodingEnabled SEQUENCE			
{			
dmrs-UplinkTransformPrecoding-r16			
SEQUENCE {			
pi2BPSK-ScramblingID0	Not present		
pi2BPSK-ScramblingID1	Not present		
}			
}			
}			

Table 6.2.2.4.3-4: ServingCellConfig

Derivation Path: TS 38.508-1 [5] Table 4.6.3-167			
Information Element	Value/remark	Comment	Condition
ServingCellConfig ::= SEQUENCE {			
uplinkConfig SEQUENCE {			
powerBoostPi2BPSK	1		Test IDs where NOTE 3 in Table 6.2.2.4.1-1 applies.
	0		Test IDs where NOTE 4 in Table 6.2.2.4.1-1 applies.
}			
}			

6.2.2.5 Test requirement

The maximum output power, derived in step 3 shall be within the range prescribed by the nominal maximum output power and tolerance in Table 6.2.2.5-1 to Table 6.2.2.5-9a.

The maximum output power, derived in step 4 shall be within the range prescribed by the nominal maximum output power and tolerance in Table 6.2.2.5-1 and Table 6.2.2.5-3.

Table 6.2.2.5-1a: UE Power Class test requirements Band 24 for Power Class 3 (contiguous allocation)

Test ID	$P_{\text{PowerClass}}$ (dBm)	$\Delta P_{\text{PowerClass}}$ (dB)	MPR (dB)	$\Delta T_{C,c}$ (dB)	$P_{\text{CMAX_L,f,c}}$ (dBm)	$T(P_{\text{CMAX_L,f,c}})$ (dB)	$T_{L,c}$ (dB)	Upper limit (dBm)	Lower limit (dBm)
5	23	0	0	0 (1.5 ²)	23.0 (21.5 ²)	2.0	3	25.0 + TT	20.0 - TT (18.5 - TT ²)
6	23	0	0.5	0 (1.5 ²)	22.5 (21.0 ²)	2.0	3	25.0 + TT	19.5 - TT (18.0 - TT ²)
7	23	0	0.5	0 (1.5 ²)	22.5 (21.0 ²)	2.0	3	25.0 + TT	19.5 - TT (18.0 - TT ²)
8	23	0	0.5	0 (1.5 ²)	22.5 (21.0 ²)	2.0	3	25.0 + TT	20.5 - TT (18.0 - TT ²)
9	23	0	0	0 (1.5 ²)	23.0 (21.5 ²)	2.0	3	25.0 + TT	20.0 - TT (18.5 - TT ²)
10	23	0	1	0 (1.5 ²)	22.0 (20.5 ²)	2.0 (2.5 ²)	3	25.0 + TT	19.0 - TT (17.5 - TT ²)
11	23	0	1	0 (1.5 ²)	22.0 (20.5 ²)	2.0 (2.5 ²)	3	25.0 + TT	19.0 - TT (17.5 - TT ²)
12	23	0	1	0 (1.5 ²)	22.0 (20.5 ²)	2.0 (2.5 ²)	3	25.0 + TT	19.0 - TT (17.5 - TT ²)
13	23	0	1	0 (1.5 ²)	22.0 (20.5 ²)	2.0 (2.5 ²)	3	25.0 + TT	19.0 - TT (17.5 - TT ²)
14	23	0	2	0 (1.5 ²)	21.0 (19.5 ²)	2.0 (3.5 ²)	3	25.0 + TT	18.0 - TT (16.0 - TT ²)
15	23	0	2	0 (1.5 ²)	21.0 (19.5 ²)	2.0 (3.5 ²)	3	25.0 + TT	18.0 - TT (16.0 - TT ²)
16	23	0	2	0 (1.5 ²)	21.0 (19.5 ²)	2.0 (3.5 ²)	3	25.0 + TT	18.0 - TT (16.0 - TT ²)
17	23	0	2.5	0 (1.5 ²)	20.5 (19.0 ²)	2.5 (3.5 ²)	3	25.0 + TT	17.5 - TT (15.5 - TT ²)
18	23	0	2.5	0 (1.5 ²)	20.5 (19.0 ²)	2.5 (3.5 ²)	3	25.0 + TT	17.5 - TT (15.5 - TT ²)
19	23	0	2.5	0 (1.5 ²)	20.5 (19.0 ²)	2.5 (3.5 ²)	3	25.0 + TT	17.5 - TT (15.5 - TT ²)
20	23	0	4.5	0 (1.5 ²)	18.5 (17.0 ²)	4.0 (5.0 ²)	3	25.0 + TT	14.5 - TT (12.0 - TT ²)
21	23	0	4.5	0 (1.5 ²)	18.5 (17.0 ²)	4.0 (5.0 ²)	3	25.0 + TT	14.5 - TT (12.0 - TT ²)
22	23	0	4.5	0 (1.5 ²)	18.5 (17.0 ²)	4.0 (5.0 ²)	3	25.0 + TT	14.5 - TT (12.0 - TT ²)
23	23	0	1.5	0 (1.5 ²)	21.5 (20.0 ²)	2.0 (2.5 ²)	3	25.0 + TT	18.5 - TT (17.0 - TT ²)

Test ID	$P_{\text{PowerClass}}$ (dBm)	$\Delta P_{\text{PowerClass}}$ (dB)	MPR (dB)	$\Delta T_{C,c}$ (dB)	$P_{\text{CMAX}_{L,f,c}}$ (dBm)	$T(P_{\text{CMAX}_{L,f,c}})$ (dB)	$T_{L,c}$ (dB)	Upper limit (dBm)	Lower limit (dBm)
24	23	0	3	0 (1.5 ²)	20.0 (18.5 ²)	2.5 (4.0 ²)	3	25.0 + TT	17.0 - TT (14.5 - TT ²)
25	23	0	3	0 (1.5 ²)	20.0 (18.5 ²)	2.5 (4.0 ²)	3	25.0 + TT	17.0 - TT (14.5 - TT ²)
26	23	0	3	0 (1.5 ²)	20.0 (18.5 ²)	2.5 (4.0 ²)	3	25.0 + TT	17.0 - TT (14.5 - TT ²)
27	23	0	2	0 (1.5 ²)	21.0 (19.5 ²)	2.0 (3.5 ²)	3	25.0 + TT	18.0 - TT (16.0 - TT ²)
28	23	0	3	0 (1.5 ²)	20.0 (18.5 ²)	2.5 (4.0 ²)	3	25.0 + TT	17.0 - TT (14.5 - TT ²)
29	23	0	3	0 (1.5 ²)	20.0 (18.5 ²)	2.5 (4.0 ²)	3	25.0 + TT	17.0 - TT (14.5 - TT ²)
30	23	0	3	0 (1.5 ²)	20.0 (18.5 ²)	2.5 (4.0 ²)	3	25.0 + TT	17.0 - TT (14.5 - TT ²)
31	23	0	3.5	0 (1.5 ²)	19.5 (18.0 ²)	3.5 (4.0 ²)	3	25.0 + TT	16.0 - TT (14.0 - TT ²)
32	23	0	3.5	0 (1.5 ²)	19.5 (18.0 ²)	3.5 (4.0 ²)	2	25.0 + TT	16.0 - TT (14.0 - TT ²)
33	23	0	3.5	0 (1.5 ²)	19.5 (18.0 ²)	3.5 (4.0 ²)	2	25.0 + TT	16.0 - TT (14.0 - TT ²)
34	23	0	6.5	0 (1.5 ²)	16.5 (15.0 ²)	5.0	2	25.0 + TT	11.5 - TT (10.0 - TT ²)
35	23	0	6.5	0 (1.5 ²)	16.5 (15.0 ²)	5.0	2	25.0 + TT	11.5 - TT (10.0 - TT ²)
36	23	0	6.5	0 (1.5 ²)	16.5 (15.0 ²)	5.0	2	25.0 + TT	11.5 - TT (10.0 - TT ²)
37	23	0	0.5	0 (1.5 ²)	22.5 (21 ²)	2.0	2	25.0 + TT	20.5 - TT (19.0 - TT ²)
38	23	0	0.5	0 (1.5 ²)	22.5 (21 ²)	2.0	2	25.0 + TT	20.5 - TT (19.0 - TT ²)
39	23	0	0	0 (1.5 ²)	23 (21.5 ²)	2.0	2	25.0 + TT	21.0 - TT (19.5 - TT ²)

NOTE 1: $P_{\text{PowerClass}}$ is the maximum UE power specified without taking into account the tolerance.

NOTE 2: Transmission bandwidths confined within $F_{\text{UL}_{\text{low}}}$ and $F_{\text{UL}_{\text{low}}} + 4$ MHz or $F_{\text{UL}_{\text{high}}} - 4$ MHz and $F_{\text{UL}_{\text{high}}}$.

NOTE 3: TT for each frequency and channel bandwidth is specified in Table 6.2.2.5-5.

Table 6.2.2.5-1: UE Power Class test requirements(for Bands n1, n2, n3, n5, n7, n8, n12, n14, n20, n25, n26, n30, n34, n38, n39, n40, n41, n50, n51, n53, n65, n66, n70, n74) for Power Class 3 (contiguous allocation)

Test ID	$P_{\text{PowerClass}}$ (dBm)	$\Delta P_{\text{PowerClass}}$ (dB)	MPR (dB)	$\Delta T_{\text{C,c}}$ (dB)	$P_{\text{CMAX_L,f,c}}$ (dBm)	$T(P_{\text{CMAX_L,f,c}})$ (dB)	$T_{\text{L,c}}$ (dB)	Upper limit (dBm)	Lower limit (dBm)
1	23	-3	0.2	0 (1.5 ²)	25.8 (24.3 ²)	2.0	2	28.0 + TT	23.8 - TT (22.3 - TT ²)
2	23	-3	3.5	0 (1.5 ²)	22.5 (21.0 ²)	2.0	2	28.0 + TT	20.5 - TT (19.0 - TT ²)
3	23	-3	3.5	0 (1.5 ²)	22.5 (21.0 ²)	2.0	2	28.0 + TT	20.5 - TT (19.0 - TT ²)
4	23	-3	1.2	0 (1.5 ²)	24.8 (23.3 ²)	2.0	2	28.0 + TT	22.8 - TT (21.3 - TT ²)
5	23	0	0	0 (1.5 ²)	23.0 (21.5 ²)	2.0	2	25.0 + TT	21.0 - TT (19.5 - TT ²)
6	23	0	0.5	0 (1.5 ²)	22.5 (21.0 ²)	2.0	2	25.0 + TT	20.5 - TT (19.0 - TT ²)
7	23	0	0.5	0 (1.5 ²)	22.5 (21.0 ²)	2.0	2	25.0 + TT	20.5 - TT (19.0 - TT ²)
8	23	0	0.5	0 (1.5 ²)	22.5 (21.0 ²)	2.0	2	25.0 + TT	20.5 - TT (19.0 - TT ²)
9	23	0	0	0 (1.5 ²)	23.0 (21.5 ²)	2.0	2	25.0 + TT	21.0 - TT (19.5 - TT ²)
10	23	0	1	0 (1.5 ²)	22.0 (20.5 ²)	2.0 (2.5 ²)	2	25.0 + TT	20.0 - TT (18.0 - TT ²)
11	23	0	1	0 (1.5 ²)	22.0 (20.5 ²)	2.0 (2.5 ²)	2	25.0 + TT	20.0 - TT (18.0 - TT ²)
12	23	0	1	0 (1.5 ²)	22.0 (20.5 ²)	2.0 (2.5 ²)	2	25.0 + TT	20.0 - TT (18.0 - TT ²)
13	23	0	1	0 (1.5 ²)	22.0 (20.5 ²)	2.0 (2.5 ²)	2	25.0 + TT	20.0 - TT (18.0 - TT ²)
14	23	0	2	0 (1.5 ²)	21.0 (19.5 ²)	2.0 (3.5 ²)	2	25.0 + TT	19.0 - TT (16.0 - TT ²)
15	23	0	2	0 (1.5 ²)	21.0 (19.5 ²)	2.0 (3.5 ²)	2	25.0 + TT	19.0 - TT (16.0 - TT ²)
16	23	0	2	0 (1.5 ²)	21.0 (19.5 ²)	2.0 (3.5 ²)	2	25.0 + TT	19.0 - TT (16.0 - TT ²)
17	23	0	2.5	0 (1.5 ²)	20.5 (19.0 ²)	2.5 (3.5 ²)	2	25.0 + TT	18.0 - TT (15.5 - TT ²)
18	23	0	2.5	0 (1.5 ²)	20.5 (19.0 ²)	2.5 (3.5 ²)	2	25.0 + TT	18.0 - TT (15.5 - TT ²)
19	23	0	2.5	0 (1.5 ²)	20.5 (19.0 ²)	2.5 (3.5 ²)	2	25.0 + TT	18.0 - TT (15.5 - TT ²)

Test ID	P _{PowerClass} (dBm)	ΔP _{PowerClass} (dB)	MPR (dB)	ΔT _{C,c} (dB)	P _{C_{MAX}L,f,c} (dBm)	T(P _{C_{MAX}L,f,c}) (dB)	T _{L,c} (dB)	Upper limit (dBm)	Lower limit (dBm)
20	23	0	4.5	0 (1.5 ²)	18.5 (17.0 ²)	4.0 (5.0 ²)	2	25.0 + TT	14.5 - TT (12.0 - TT ²)
21	23	0	4.5	0 (1.5 ²)	18.5 (17.0 ²)	4.0 (5.0 ²)	2	25.0 + TT	14.5 - TT (12.0 - TT ²)
22	23	0	4.5	0 (1.5 ²)	18.5 (17.0 ²)	4.0 (5.0 ²)	2	25.0 + TT	14.5 - TT (12.0 - TT ²)
23	23	0	1.5	0 (1.5 ²)	21.5 (20.0 ²)	2.0 (2.5 ²)	2	25.0 + TT	19.5 - TT (17.5 - TT ²)
24	23	0	3	0 (1.5 ²)	20.0 (18.5 ²)	2.5 (4.0 ²)	2	25.0 + TT	17.5 - TT (14.5 - TT ²)
25	23	0	3	0 (1.5 ²)	20.0 (18.5 ²)	2.5 (4.0 ²)	2	25.0 + TT	17.5 - TT (14.5 - TT ²)
26	23	0	3	0 (1.5 ²)	20.0 (18.5 ²)	2.5 (4.0 ²)	2	25.0 + TT	17.5 - TT (14.5 - TT ²)
27	23	0	2	0 (1.5 ²)	21.0 (19.5 ²)	2.0 (3.5 ²)	2	25.0 + TT	19.0 - TT (16.0 - TT ²)
28	23	0	3	0 (1.5 ²)	20.0 (18.5 ²)	2.5 (4.0 ²)	2	25.0 + TT	17.5 - TT (14.5 - TT ²)
29	23	0	3	0 (1.5 ²)	20.0 (18.5 ²)	2.5 (4.0 ²)	2	25.0 + TT	17.5 - TT (14.5 - TT ²)
30	23	0	3	0 (1.5 ²)	20.0 (18.5 ²)	2.5 (4.0 ²)	2	25.0 + TT	17.5 - TT (14.5 - TT ²)
31	23	0	3.5	0 (1.5 ²)	19.5 (18.0 ²)	3.5 (4.0 ²)	2	25.0 + TT	16.0 - TT (14.0 - TT ²)
32	23	0	3.5	0 (1.5 ²)	19.5 (18.0 ²)	3.5 (4.0 ²)	2	25.0 + TT	16.0 - TT (14.0 - TT ²)
33	23	0	3.5	0 (1.5 ²)	19.5 (18.0 ²)	3.5 (4.0 ²)	2	25.0 + TT	16.0 - TT (14.0 - TT ²)
34	23	0	6.5	0 (1.5 ²)	16.5 (15.0 ²)	5.0	2	25.0 + TT	11.5 - TT (10.0 - TT ²)
35	23	0	6.5	0 (1.5 ²)	16.5 (15.0 ²)	5.0	2	25.0 + TT	11.5 - TT (10.0 - TT ²)

Test ID	P _{PowerClass} (dBm)	ΔP _{PowerClass} (dB)	MPR (dB)	ΔT _{C,c} (dB)	P _{C_{MAX}L,f,c} (dBm)	T(P _{C_{MAX}L,f,c}) (dB)	T _{L,c} (dB)	Upper limit (dBm)	Lower limit (dBm)
36	23	0	6.5	0 (1.5 ²)	16.5 (15.0 ²)	5.0	2	25.0 + TT	11.5 - TT (10.0 - TT ²)
37	23	0	0.5	0 (1.5 ²)	22.5 (21 ²)	2.0	2	25.0 + TT	20.5 - TT (19.0 - TT ²)
38	23	0	0.5	0 (1.5 ²)	22.5 (21 ²)	2.0	2	25.0 + TT	20.5 - TT (19.0 - TT ²)
39	23	0	0	0 (1.5 ²)	23 (21.5 ²)	2.0	2	25.0 + TT	21.0 - TT (19.5 - TT ²)

NOTE 1: P_{PowerClass} is the maximum UE power specified without taking into account the tolerance.

NOTE 2: For Band n2, n3, n7, n8, n12, n20, n26, n41, transmission bandwidths confined within FUL_{low} and FUL_{low} + 4 MHz or FUL_{high} – 4 MHz and FUL_{high}.

NOTE 3: TT for each frequency and channel bandwidth is specified in Table 6.2.2.5-5.

Table 6.2.2.5-2: UE Power Class test requirements (for Bands n28 with channel bandwidth other than 30MHz, n71) for Power Class 3 (contiguous allocation)

Test ID	$P_{\text{PowerClass}}$ (dBm)	$\Delta P_{\text{PowerClass}}$ (dB)	MPR (dB)	$\Delta T_{C,c}$ (dB)	$P_{\text{CMAX}_{L,f,c}}$ (dBm)	$T(P_{\text{CMAX}_{L,f,c}})$ (dB)	$T_{L,c}$ (dB)	Upper limit (dBm)	Lower limit (dBm)
5	23	0	0	0	23.0	2.0	2.5	25.0 + TT	20.5 - TT
6	23	0	0.5	0	22.5	2.0	2.5	25.0 + TT	20.0 - TT
7	23	0	0.5	0	22.5	2.0	2.5	25.0 + TT	20.0 - TT
8	23	0	0.5	0	22.5	2.0	2.5	25.0 + TT	20.0 - TT
9	23	0	0	0	23.0	2.0	2.5	25.0 + TT	20.5 - TT
10	23	0	1	0	22.0	2.0	2.5	25.0 + TT	19.5 - TT
11	23	0	1	0	22.0	2.0	2.5	25.0 + TT	19.5 - TT
12	23	0	1	0	22.0	2.0	2.5	25.0 + TT	19.5 - TT
13	23	0	1	0	22.0	2.0	2.5	25.0 + TT	19.5 - TT
14	23	0	2	0	21.0	2.0	2.5	25.0 + TT	18.5 - TT
15	23	0	2	0	21.0	2.0	2.5	25.0 + TT	18.5 - TT
16	23	0	2	0	21.0	2.0	2.5	25.0 + TT	18.5 - TT
17	23	0	2.5	0	20.5	2.5	2.5	25.0 + TT	18.0 - TT
18	23	0	2.5	0	20.5	2.5	2.5	25.0 + TT	18.0 - TT
19	23	0	2.5	0	20.5	2.5	2.5	25.0 + TT	18.0 - TT
20	23	0	4.5	0	18.5	4.0	2.5	25.0 + TT	14.5 - TT
21	23	0	4.5	0	18.5	4.0	2.5	25.0 + TT	14.5 - TT
22	23	0	4.5	0	18.5	4.0	2.5	25.0 + TT	14.5 - TT
23	23	0	1.5	0	21.5	2.0	2.5	25.0 + TT	19.0 - TT
24	23	0	3	0	20.0	2.5	2.5	25.0 + TT	17.5 - TT
25	23	0	3	0	20.0	2.5	2.5	25.0 + TT	17.5 - TT
26	23	0	3	0	20.0	2.5	2.5	25.0 + TT	17.5 - TT
27	23	0	2	0	21.0	2.0	2.5	25.0 + TT	18.5 - TT
28	23	0	3	0	20.0	2.5	2.5	25.0 + TT	17.5 - TT
29	23	0	3	0	20.0	2.5	2.5	25.0 + TT	17.5 - TT
30	23	0	3	0	20.0	2.5	2.5	25.0 + TT	17.5 - TT
31	23	0	3.5	0	19.5	3.5	2.5	25.0 + TT	16.0 - TT
32	23	0	3.5	0	19.5	3.5	2.5	25.0 + TT	16.0 - TT
33	23	0	3.5	0	19.5	3.5	2.5	25.0 + TT	16.0 - TT
34	23	0	6.5	0	16.5	5.0	2.5	25.0 + TT	11.5 - TT
35	23	0	6.5	0	16.5	5.0	2.5	25.0 + TT	11.5 - TT
36	23	0	6.5	0	16.5	5.0	2.5	25.0 + TT	11.5 - TT
37	23	0	0.5	0	22.5	2.0	2.5	25.0 + TT	20.0 - TT
38	23	0	0.5	0	22.5	2.0	2.5	25.0 + TT	20.0 - TT
39	23	0	0	0	23	2.0	2.5	25.0 + TT	20.5 - TT

NOTE 1: $P_{\text{PowerClass}}$ is the maximum UE power specified without taking into account the tolerance.
NOTE 2: TT for each frequency and channel bandwidth is specified in Table 6.2.2.5-5.

Table 6.2.2.5-2a: UE Power Class test requirements (for Band n28 with 30MHz channel bandwidth) for Power Class 3 (contiguous allocation)

Test ID	$P_{\text{PowerClass}}$ (dBm)	$\Delta P_{\text{PowerClass}}$ (dB)	MPR (dB)	$\Delta T_{\text{C,c}}$ (dB)	$P_{\text{CMAX_L,f,c}}$ (dBm)	$T(P_{\text{CMAX_L,f,c}})$ (dB)	$T_{\text{L,c}}$ (dB)	Upper limit (dBm)	Lower limit (dBm)
5	23	0	0.5	0	22.5	2	2.5	25.0 + TT	20-TT
6	23	0	1	0	22	2	2.5	25.0 + TT	19.5-TT
7	23	0	1	0	22	2	2.5	25.0 + TT	19.5-TT
8	23	0	1	0	22	2	2.5	25.0 + TT	19.5-TT
9	23	0	0.5	0	22.5	2	2.5	25.0 + TT	20-TT
10	23	0	1.5	0	21.5	2	2.5	25.0 + TT	19-TT
11	23	0	1.5	0	21.5	2	2.5	25.0 + TT	19-TT
12	23	0	1.5	0	21.5	2	2.5	25.0 + TT	19-TT
13	23	0	1.5	0	21.5	2	2.5	25.0 + TT	19-TT
14	23	0	2.5	0	20.5	2.5	2.5	25.0 + TT	18-TT
15	23	0	2.5	0	20.5	2.5	2.5	25.0 + TT	18-TT
16	23	0	2.5	0	20.5	2.5	2.5	25.0 + TT	18-TT
17	23	0	3	0	20	2.5	2.5	25.0 + TT	17.5-TT
18	23	0	3	0	20	2.5	2.5	25.0 + TT	17.5-TT
19	23	0	3	0	20	2.5	2.5	25.0 + TT	17.5-TT
20	23	0	5	0	18	4	2.5	25.0 + TT	14-TT
21	23	0	5	0	18	4	2.5	25.0 + TT	14-TT
22	23	0	5	0	18	4	2.5	25.0 + TT	14-TT
23	23	0	2	0	21	2	2.5	25.0 + TT	18.5-TT
24	23	0	3.5	0	19.5	3.5	2.5	25.0 + TT	16-TT
25	23	0	3.5	0	19.5	3.5	2.5	25.0 + TT	16-TT
26	23	0	3.5	0	19.5	3.5	2.5	25.0 + TT	16-TT
27	23	0	2.5	0	20.5	2.5	2.5	25.0 + TT	18-TT
28	23	0	3.5	0	19.5	3.5	2.5	25.0 + TT	16-TT
29	23	0	3.5	0	19.5	3.5	2.5	25.0 + TT	16-TT
30	23	0	3.5	0	19.5	3.5	2.5	25.0 + TT	16-TT
31	23	0	4	0	19	3.5	2.5	25.0 + TT	15.5-TT
32	23	0	4	0	19	3.5	2.5	25.0 + TT	15.5-TT
33	23	0	4	0	19	3.5	2.5	25.0 + TT	15.5-TT
34	23	0	7	0	16	5	2.5	25.0 + TT	11-TT
35	23	0	7	0	16	5	2.5	25.0 + TT	11-TT
36	23	0	7	0	16	5	2.5	25.0 + TT	11-TT
37	23	0	1	0	22	2.0	2.5	25.0 + TT	19.5 - TT
38	23	0	1	0	22	2.0	2.5	25.0 + TT	19.5 - TT
39	23	0	0.5	0	22.5	2.0	2.5	25.0 + TT	20 - TT

NOTE 1: $P_{\text{PowerClass}}$ is the maximum UE power specified without taking into account the tolerance.

NOTE 2: TT for each frequency and channel bandwidth is specified in Table 6.2.2.5-5.

Table 6.2.2.5-3: UE Power Class test requirements (for Bands n48, n77, n78, n79) for Power Class 3 (contiguous allocation)

Test ID	$P_{\text{PowerClass}}$ (dBm)	$\Delta P_{\text{PowerClass}}$ (dB)	MPR (dB)	$\Delta T_{C,c}$ (dB)	$P_{\text{CMAX}_L,f,c}$ (dBm)	$T(P_{\text{CMAX}_L,f,c})$ (dB)	$T_{L,c}$ (dB)	Upper limit (dBm)	Lower limit (dBm)
1	23	-3	0.2	0	25.8	2.0	3	28.0 + TT	22.8 - TT
2	23	-3	3.5	0	22.5	2.0	3	28.0 + TT	19.5 - TT
3	23	-3	3.5	0	22.5	2.0	3	28.0 + TT	19.5 - TT
4	23	-3	1.2	0	24.8	2.0	3	28.0 + TT	21.8 - TT
5	23	0	0	0	23.0	2.0	3	25.0 + TT	20.0 - TT
6	23	0	0.5	0	22.5	2.0	3	25.0 + TT	19.5 - TT
7	23	0	0.5	0	22.5	2.0	3	25.0 + TT	19.5 - TT
8	23	0	0.5	0	22.5	2.0	3	25.0 + TT	19.5 - TT
9	23	0	0	0	23.0	2.0	3	25.0 + TT	20.0 - TT
10	23	0	1	0	22.0	2.0	3	25.0 + TT	19.0 - TT
11	23	0	1	0	22.0	2.0	3	25.0 + TT	19.0 - TT
12	23	0	1	0	22.0	2.0	3	25.0 + TT	19.0 - TT
13	23	0	1	0	22.0	2.0	3	25.0 + TT	19.0 - TT
14	23	0	2	0	21.0	2.0	3	25.0 + TT	18.0 - TT
15	23	0	2	0	21.0	2.0	3	25.0 + TT	18.0 - TT
16	23	0	2	0	21.0	2.0	3	25.0 + TT	18.0 - TT
17	23	0	2.5	0	20.5	2.5	3	25.0 + TT	17.5 - TT
18	23	0	2.5	0	20.5	2.5	3	25.0 + TT	17.5 - TT
19	23	0	2.5	0	20.5	2.5	3	25.0 + TT	17.5 - TT
20	23	0	4.5	0	18.5	4.0	3	25.0 + TT	14.5 - TT
21	23	0	4.5	0	18.5	4.0	3	25.0 + TT	14.5 - TT
22	23	0	4.5	0	18.5	4.0	3	25.0 + TT	14.5 - TT
23	23	0	1.5	0	21.5	2.0	3	25.0 + TT	18.5 - TT
24	23	0	3	0	20.0	2.5	3	25.0 + TT	17.0 - TT
25	23	0	3	0	20.0	2.5	3	25.0 + TT	17.0 - TT
26	23	0	3	0	20.0	2.5	3	25.0 + TT	17.0 - TT
27	23	0	2	0	21.0	2.0	3	25.0 + TT	18.0 - TT
28	23	0	3	0	20.0	2.5	3	25.0 + TT	17.0 - TT
29	23	0	3	0	20.0	2.5	3	25.0 + TT	17.0 - TT
30	23	0	3	0	20.0	2.5	3	25.0 + TT	17.0 - TT
31	23	0	3.5	0	19.5	3.5	3	25.0 + TT	16.0 - TT
32	23	0	3.5	0	19.5	3.5	3	25.0 + TT	16.0 - TT
33	23	0	3.5	0	19.5	3.5	3	25.0 + TT	16.0 - TT
34	23	0	6.5	0	16.5	5.0	3	25.0 + TT	11.5 - TT
35	23	0	6.5	0	16.5	5.0	3	25.0 + TT	11.5 - TT
36	23	0	6.5	0	16.5	5.0	3	25.0 + TT	11.5 - TT
37	23	0	0.5	0	22.5	2.0	3	25.0 + TT	19.5 - TT
38	23	0	0.5	0	22.5	2.0	3	25.0 + TT	19.5 - TT
39	23	0	0	0	23	2.0	3	25.0 + TT	20.0 - TT

NOTE 1: $P_{\text{PowerClass}}$ is the maximum UE power specified without taking into account the tolerance.

NOTE 2: TT for each frequency and channel bandwidth is specified in Table 6.2.2.5-5.

Table 6.2.2.5-4: UE Power Class test requirements (for Bands n34, n39, n41, n77, n78, n79) for Power Class 2 (contiguous allocation)

Test ID	P _{PowerClass} (dBm)	ΔP _{PowerClass} (dB)	MPR (dB)	ΔT _{c,c} (dB)	P _{C_{MAX}L,f,c} (dBm)	T(P _{C_{MAX}L,f,c}) (dB)	T _{L,c} (dB)	Upper limit (dBm)	Lower limit (dBm)
1	26	0	0	0 (1.5 ²)	26.0 (24.5 ²)	2.0	3	28.0 + TT	23.0 - TT (21.5 - TT ²)
2	26	0	3.5	0 (1.5 ²)	22.5 (21.0 ²)	2.0	3	28.0 + TT	19.5 - TT (18.0 - TT ²)
3	26	0	3.5	0 (1.5 ²)	22.5 (21.0 ²)	2.0	3	28.0 + TT	19.5 - TT (18.0 - TT ²)
4	26	0	0.5	0 (1.5 ²)	25.5 (24.0 ²)	2.0	3	28.0 + TT	22.5 - TT (21.0 - TT ²)
5	26	0	0	0 (1.5 ²)	26.0 (24.5 ²)	2.0	3	28.0 + TT	23.0 - TT (21.5 - TT ²)
6	26	0	3.5	0 (1.5 ²)	22.5 (21.0 ²)	2.0	3	28.0 + TT	19.5 - TT (18.0 - TT ²)
7	26	0	3.5	0 (1.5 ²)	22.5 (21.0 ²)	2.0	3	28.0 + TT	19.5 - TT (18.0 - TT ²)
8	26	0	1	0 (1.5 ²)	25.0 (23.5 ²)	2.0	3	28.0 + TT	22.0 - TT (20.5 - TT ²)
9	26	0	1	0 (1.5 ²)	25.0 (23.5 ²)	2.0	3	28.0 + TT	22.0 - TT (20.5 - TT ²)
10	26	0	3.5	0 (1.5 ²)	22.5 (21.0 ²)	2.0	3	28.0 + TT	19.5 - TT (18.0 - TT ²)
11	26	0	3.5	0 (1.5 ²)	22.5 (21.0 ²)	2.0	3	28.0 + TT	19.5 - TT (18.0 - TT ²)
12	26	0	2	0 (1.5 ²)	24.0 (22.5 ²)	2.0	3	28.0 + TT	21.0 - TT (19.5 - TT ²)
13	26	0	3.5	0 (1.5 ²)	22.5 (21.0 ²)	2.0	3	28.0 + TT	19.5 - TT (18.0 - TT ²)
14	26	0	3.5	0 (1.5 ²)	22.5 (21.0 ²)	2.0	3	28.0 + TT	19.5 - TT (18.0 - TT ²)
15	26	0	2.5	0 (1.5 ²)	23.5 (22.0 ²)	2.0	3	28.0 + TT	20.5 - TT (19.0 - TT ²)
16	26	0	4.5	0 (1.5 ²)	21.5 (20.0 ²)	2.0 (2.5 ²)	3	28.0 + TT	18.5 - TT (17.0 - TT ²)
17	26	0	4.5	0 (1.5 ²)	21.5 (20.0 ²)	2.0 (2.5 ²)	3	28.0 + TT	18.5 - TT (17.0 - TT ²)
18	26	0	4.5	0 (1.5 ²)	21.5 (20.0 ²)	2.0 (2.5 ²)	3	28.0 + TT	18.5 - TT (17.0 - TT ²)
19	26	0	1.5	0 (1.5 ²)	24.5 (23.0 ²)	2.0	3	28.0 + TT	21.5 - TT (20.0 - TT ²)
20	26	0	3.5	0 (1.5 ²)	22.5 (21.0 ²)	2.0	3	28.0 + TT	19.5 - TT (18.0 - TT ²)
21	26	0	3.5	0 (1.5 ²)	22.5 (21.0 ²)	2.0	3	28.0 + TT	19.5 - TT (18.0 - TT ²)
22	26	0	3	0 (1.5 ²)	23.0 (21.5 ²)	2.0	3	28.0 + TT	20.0 - TT (18.5 - TT ²)
23	26	0	2	0 (1.5 ²)	24.0 (22.5 ²)	2.0	3	28.0 + TT	21.0 - TT (19.5 - TT ²)
24	26	0	3.5	0 (1.5 ²)	22.5 (21.0 ²)	2.0	3	28.0 + TT	19.5 - TT (18.0 - TT ²)

Test ID	P _{PowerClass} (dBm)	ΔP _{PowerClass} (dB)	MPR (dB)	ΔT _{C,c} (dB)	P _{C_{MAX}_L,f,c} (dBm)	T(P _{C_{MAX}_L,f,c}) (dB)	T _{L,c} (dB)	Upper limit (dBm)	Lower limit (dBm)
25	26	0	3.5	0 (1.5 ²)	22.5 (21.0 ²)	2.0	3	28.0 + TT	19.5 - TT (18.0 - TT ²)
26	26	0	3	0 (1.5 ²)	23.0 (21.5 ²)	2.0	3	28.0 + TT	20.0 - TT (18.5 - TT ²)
27	26	0	3.5	0 (1.5 ²)	22.5 (21.0 ²)	2.0	3	28.0 + TT	19.5 - TT (18.0 - TT ²)
28	26	0	3.5	0 (1.5 ²)	22.5 (21.0 ²)	2.0	3	28.0 + TT	19.5 - TT (18.0 - TT ²)
29	26	0	3.5	0 (1.5 ²)	22.5 (21.0 ²)	2.0	3	28.0 + TT	19.5 - TT (18.0 - TT ²)
30	26	0	6.5	0 (1.5 ²)	19.5 (18.0 ²)	3.5 (4.0 ²)	3	28.0 + TT	16.0 - TT (14.0 - TT ²)
31	26	0	6.5	0 (1.5 ²)	19.5 (18.0 ²)	3.5 (4.0 ²)	3	28.0 + TT	16.0 - TT (14.0 - TT ²)
32	26	0	6.5	0 (1.5 ²)	19.5 (18.0 ²)	3.5 (4.0 ²)	3	28.0 + TT	16.0 - TT (14.0 - TT ²)

NOTE 1: P_{PowerClass} is the maximum UE power specified without taking into account the tolerance.

NOTE 2: For Band n41, transmission bandwidths confined within F_{UL_low} and F_{UL_low} + 4 MHz or F_{UL_high} – 4 MHz and F_{UL_high}.

NOTE 3: TT for each frequency and channel bandwidth is specified in Table 6.2.2.5-5.

Table 6.2.2.5-4a: UE Power Class test requirements for Band n14 for Power Class 1 (contiguous allocation)

Test ID	$P_{\text{PowerClass}}$ (dBm)	$\Delta P_{\text{PowerClass}}$ (dB)	MPR (dB)	$\Delta T_{C,c}$ (dB)	$P_{\text{CMAX_L,f,c}}$ (dBm)	$T(P_{\text{CMAX_L,f,c}})$ (dB)	$T_{L,c}$ (dB)	Upper limit (dBm)	Lower limit (dBm)
1	31	0	0	0	31.0	2.0	3	33.0 + TT	28.0 — TT
2	31	0	0.5	0	30.5	2.0	3	33.0 + TT	27.5 — TT
3	31	0	0.5	0	30.5	2.0	3	33.0 + TT	27.5 — TT
4	31	0	0.5	0	30.5	2.0	3	33.0 + TT	27.5 — TT
5	31	0	0	0	31.0	2.0	3	33.0 + TT	28.0 — TT
6	31	0	1	0	30.0	2.0	3	33.0 + TT	27.0 — TT
7	31	0	1	0	30.0	2.0	3	33.0 + TT	27.0 — TT
8	31	0	1	0	30.0	2.0	3	33.0 + TT	27.0 — TT
9	31	0	1	0	30.0	2.0	3	33.0 + TT	27.0 — TT
10	31	0	2	0	29.0	2.0	3	33.0 + TT	26.0 — TT
11	31	0	2	0	29.0	2.0	3	33.0 + TT	26.0 — TT
12	31	0	2	0	29.0	2.0	3	33.0 + TT	26.0 — TT
13	31	0	2.5	0	28.5	2.0	3	33.0 + TT	25.5 — TT
14	31	0	2.5	0	28.5	2.0	3	33.0 + TT	25.5 — TT
15	31	0	2.5	0	28.5	2.0	3	33.0 + TT	25.5 — TT
16	31	0	4.5	0	26.5	2.0	3	33.0 + TT	23.5 — TT
17	31	0	4.5	0	26.5	2.0	3	33.0 + TT	23.5 — TT
18	31	0	4.5	0	26.5	2.0	3	33.0 + TT	23.5 — TT
19	31	0	1.5	0	29.5	2.0	3	33.0 + TT	26.5 — TT
20	31	0	3	0	28.0	2.0	3	33.0 + TT	25.0 — TT
21	31	0	3	0	28.0	2.0	3	33.0 + TT	25.0 — TT
22	31	0	3	0	28.0	2.0	3	33.0 + TT	25.0 — TT
23	31	0	2	0	29.0	2.0	3	33.0 + TT	26.0 — TT
24	31	0	3	0	28.0	2.0	3	33.0 + TT	25.0 — TT
25	31	0	3	0	28.0	2.0	3	33.0 + TT	25.0 — TT
26	31	0	3	0	28.0	2.0	3	33.0 + TT	25.0 — TT
27	31	0	3.5	0	27.5	2.0	3	33.0 + TT	24.5 — TT
28	31	0	3.5	0	27.5	2.0	3	33.0 + TT	24.5 — TT
29	31	0	3.5	0	27.5	2.0	3	33.0 + TT	24.5 — TT
30	31	0	6.5	0	24.5	2.0	3	33.0 + TT	21.5 — TT
31	31	0	6.5	0	24.5	2.0	3	33.0 + TT	21.5 — TT
32	31	0	6.5	0	24.5	2.0	3	33.0 + TT	21.5 — TT
33	31	0	0.5	0	30.5	2.0	3	33.0 + TT	27.5 — TT
34	31	0	0.5	0	30.5	2.0	3	33.0 + TT	27.5 — TT
35	31	0	0	0	31.0	2.0	3	33.0 + TT	28.0 — TT

NOTE 1: $P_{\text{PowerClass}}$ is the maximum UE power specified without taking into account the tolerance.
NOTE 2: TT for each frequency and channel bandwidth is specified in Table 6.2.2.5-5.

Table 6.2.2.5-4b: Void

Table 6.2.2.5-5: Test Tolerance (Maximum Power Reduction (MPR))

	$f \leq 3.0\text{GHz}$	$3.0\text{GHz} < f \leq 4.2\text{GHz}$	$4.2\text{GHz} < f \leq 6.0\text{GHz}$
BW \leq 40MHz	0.7 dB	1.0 dB	1.0 dB
40MHz < BW \leq 100MHz	1.0 dB	1.0 dB	1.0 dB

Table 6.2.2.5-6: UE Power Class test requirements (for Bands n1, n2, n3, n5, n7, n8, n12, n14, n20, n25, n26, n30, n34, n38, n39, n40, n41, n50, n51, n53, n65, n66, n70, n74) for Power Class 3 (almost contiguous allocation)

Test ID	$P_{\text{PowerClass}}$ (dBm)	$\Delta P_{\text{PowerClass}}$ (dB)	MPR (dB)	MPR increase (dB)	$\Delta T_{c,c}$ (dB)		$P_{\text{CMAX}_L,f,c}$ (dBm)		$T(P_{\text{CMAX}_L,f,c})$ (dB)		$T_{L,c}$ (dB)	Upper limit (dBm)	Lower limit (dBm)	
					0	1.5^2	20	18.5^2	2.5	4^2			17.5 - TT	$14.5 - TT^2$
1 ⁴	23	0	1.5	1.5	0	1.5^2	20	18.5^2	2.5	4^2	2	25.0 + TT	17.5 - TT	$14.5 - TT^2$
1 ⁵	23	0	1.5	1	0	1.5^2	20.5	19^2	2.5	3.5^2	2	25.0 + TT	18 - TT	$15.5 - TT^2$
2 ⁶	23	0	3	1.5	0	1.5^2	18.5	17^2	4	5^2	2	25.0 + TT	14.5 - TT	$12 - TT^2$
2 ⁷	23	0	3	1	0	1.5^2	19	17.5^2	3.5	5^2	2	25.0 + TT	15.5 - TT	$12.5 - TT^2$
3 ⁴	23	0	2	1.5	0	1.5^2	19.5	18^2	3.5	4^2	2	25.0 + TT	16 - TT	$14 - TT^2$
3 ⁵	23	0	2	1	0	1.5^2	20	18.5^2	2.5	4^2	2	25.0 + TT	17.5 - TT	$14.5 - TT^2$
4 ⁶	23	0	3	1.5	0	1.5^2	18.5	17^2	4	5^2	2	25.0 + TT	14.5 - TT	$12 - TT^2$
4 ⁷	23	0	3	1	0	1.5^2	19	17.5^2	3.5	5^2	2	25.0 + TT	15.5 - TT	$12.5 - TT^2$
5 ⁶	23	0	3.5	1.5	0	1.5^2	18	16.5^2	4	5^2	2	25.0 + TT	14 - TT	$11.5 - TT^2$
5 ⁷	23	0	3.5	1	0	1.5^2	18.5	17^2	4	5^2	2	25.0 + TT	14.5 - TT	$12 - TT^2$
6 ⁶	23	0	6.5	1.5	0	1.5^2	15	13.5^2	5	5^2	2	25.0 + TT	10 - TT	$8.5 - TT^2$
6 ⁷	23	0	6.5	1	0	1.5^2	15.5	14^2	5	5^2	2	25.0 + TT	10.5 - TT	$9 - TT^2$

NOTE 1: $P_{\text{PowerClass}}$ is the maximum UE power specified without taking into account the tolerance.

NOTE 2: For Band n2, n3, n7, n8, n12, n20, n26, n41, transmission bandwidths confined within $F_{\text{UL_low}}$ and $F_{\text{UL_low}} + 4$ MHz or $F_{\text{UL_high}} - 4$ MHz and $F_{\text{UL_high}}$.

NOTE 3: TT for each frequency and channel bandwidth is specified in Table 6.2.2.5-5.

NOTE 4: Applicable for CBW/SCS combinations other than CBW=40MHz when SCS=60kHz.

NOTE 5: Only applicable for CBW 40MHz when SCS is 60kHz.

NOTE 6: Applicable for CBW/SCS combinations other than CBW=30MHz when SCS=15kHz and CBW=30MHz, 60MHz, 90MHz when SCS=30kHz and CBW=25MHz, 60MHz, 90MHz when SCS=60kHz.

NOTE 7: Only applicable for CBW=30MHz when SCS=15kHz and CBW=30MHz, 60MHz, 90MHz when SCS=30kHz and CBW=25MHz, 60MHz, 90MHz when SCS=60kHz.

Table 6.2.2.5-6a: Void

Table 6.2.2.5-7: UE Power Class test requirements (for Bands n28 with channel bandwidth other than 30MHz, n71) for Power Class 3 (almost contiguous allocation)

Test ID	$P_{\text{PowerClass}}$ (dBm)	$\Delta P_{\text{PowerClass}}$ (dB)	MPR (dB)	MPR increase (dB)	$\Delta T_{C,c}$ (dB)	$P_{\text{CMAX_L,f,c}}$ (dBm)	$T(P_{\text{CMAX_L,f,c}})$ (dB)	$T_{L,c}$ (dB)	Upper limit (dBm)	Lower limit (dBm)
1 ³	23	0	1.5	1.5	0	20	2.5	2.5	25.0 + TT	17.5 - TT
1 ⁴	23	0	1.5	1	0	20.5	2.5	2.5	25.0 + TT	18 - TT
2 ⁵	23	0	3	1.5	0	18.5	4	2.5	25.0 + TT	14.5 - TT
2 ⁶	23	0	3	1	0	19	3.5	2.5	25.0 + TT	15.5 - TT
3 ³	23	0	2	1.5	0	19.5	3.5	2.5	25.0 + TT	16 - TT
3 ⁴	23	0	2	1	0	20	2.5	2.5	25.0 + TT	17.5 - TT
4 ⁵	23	0	3	1.5	0	18.5	4	2.5	25.0 + TT	14.5 - TT
4 ⁶	23	0	3	1	0	19	3.5	2.5	25.0 + TT	15.5 - TT
5 ⁵	23	0	3.5	1.5	0	18	4	2.5	25.0 + TT	14 - TT
5 ⁶	23	0	3.5	1	0	18.5	4	2.5	25.0 + TT	14.5 - TT
6 ⁵	23	0	6.5	1.5	0	15	5	2.5	25.0 + TT	10 - TT
6 ⁶	23	0	6.5	1	0	15.5	5	2.5	25.0 + TT	10.5 - TT

NOTE 1: $P_{\text{PowerClass}}$ is the maximum UE power specified without taking into account the tolerance.
NOTE 2: TT for each frequency and channel bandwidth is specified in Table 6.2.2.5-5.
NOTE 3: Applicable for CBW/SCS combinations other than CBW=40MHz when SCS=60kHz.
NOTE 4: Only applicable for CBW 40MHz when SCS is 60kHz.
NOTE 5: Applicable for CBW/SCS combinations other than CBW=30MHz when SCS=15kHz and CBW=30MHz, 60MHz, 90MHz when SCS=30kHz and CBW=25MHz, 60MHz, 90MHz when SCS=60kHz.
NOTE 6: Only applicable for CBW=30MHz when SCS=15kHz and CBW=30MHz, 60MHz, 90MHz when SCS=30kHz and CBW=25MHz, 60MHz, 90MHz when SCS=60kHz.

Table 6.2.2.5-7a: Void

Table 6.2.2.5-7b: UE Power Class test requirements (for Band n28 with 30MHz channel bandwidth) for Power Class 3 (almost contiguous allocation)

Test ID	$P_{\text{PowerClass}}$ (dBm)	$\Delta P_{\text{PowerClass}}$ (dB)	MPR (dB)	MPR increase (dB)	$\Delta T_{C,c}$ (dB)	$P_{\text{CMAX_L,f,c}}$ (dBm)	$T(P_{\text{CMAX_L,f,c}})$ (dB)	$T_{L,c}$ (dB)	Upper limit (dBm)	Lower limit (dBm)
2 ³	23	0	3.5	1.5	0	18	4	2.5	25.0 + TT	14 - TT
2 ⁴	23	0	3.5	1	0	18.5	4	2.5	25.0 + TT	14.5 - TT
4 ³	23	0	3.5	1.5	0	18	4	2.5	25.0 + TT	14 - TT
4 ⁴	23	0	3.5	1	0	17.5	4	2.5	25.0 + TT	14.5 - TT
5 ³	23	0	4	1.5	0	17.5	5	2.5	25.0 + TT	12.5 - TT
5 ⁴	23	0	4	1	0	18	4	2.5	25.0 + TT	14 - TT
6 ³	23	0	7	1.5	0	14.5	5	2.5	25.0 + TT	9.5 - TT
6 ⁴	23	0	7	1	0	15	5	2.5	25.0 + TT	10 - TT

NOTE 1: $P_{\text{PowerClass}}$ is the maximum UE power specified without taking into account the tolerance.
NOTE 2: TT for each frequency and channel bandwidth is specified in Table 6.2.2.5-5.
NOTE 3: Applicable for CBW=30MHz when SCS=60kHz.
NOTE 4: Applicable for CBW=30MHz when SCS=15kHz and CBW=30MHz when SCS=30kHz.

Table 6.2.2.5-8: UE Power Class test requirements (for Bands n48, n77, n78, n79) for Power Class 3 (almost contiguous allocation)

Test ID	$P_{\text{PowerClass}}$ (dBm)	$\Delta P_{\text{PowerClass}}$ (dB)	MPR (dB)	MPR increase (dB)	$\Delta T_{C,c}$ (dB)	$P_{\text{CMAX_L,f,c}}$ (dBm)	$T(P_{\text{CMAX_L,f,c}})$ (dB)	$T_{L,c}$ (dB)	Upper limit (dBm)	Lower limit (dBm)
1 ³	23	0	1.5	1.5	0	20	2.5	3	25.0 + TT	17 - TT
1 ⁴	23	0	1.5	1	0	20.5	2.5	3	25.0 + TT	17.5 - TT
2 ⁵	23	0	3	1.5	0	18.5	4	3	25.0 + TT	14.5 - TT
2 ⁶	23	0	3	1	0	19	3.5	3	25.0 + TT	15.5 - TT
3 ³	23	0	2	1.5	0	19.5	3.5	3	25.0 + TT	16 - TT
3 ⁴	23	0	2	1	0	20	2.5	3	25.0 + TT	17 - TT
4 ⁵	23	0	3	1.5	0	18.5	4	3	25.0 + TT	14.5 - TT
4 ⁶	23	0	3	1	0	19	3.5	3	25.0 + TT	15.5 - TT
5 ⁵	23	0	3.5	1.5	0	18	4	3	25.0 + TT	14 - TT
5 ⁶	23	0	3.5	1	0	18.5	4	3	25.0 + TT	14.5 - TT
6 ⁵	23	0	6.5	1.5	0	15	5	3	25.0 + TT	10 - TT
6 ⁶	23	0	6.5	1	0	15.5	5	3	25.0 + TT	10.5 - TT

NOTE 1: $P_{\text{PowerClass}}$ is the maximum UE power specified without taking into account the tolerance.
NOTE 2: TT for each frequency and channel bandwidth is specified in Table 6.2.2.5-5.
NOTE 3: Applicable for CBW/SCS combinations other than CBW=40MHz when SCS=60kHz.
NOTE 4: Only applicable for CBW 40MHz when SCS is 60kHz.
NOTE 5: Applicable for CBW/SCS combinations other than CBW=30MHz when SCS=15kHz and CBW=30MHz, 60MHz, 90MHz when SCS=30kHz and CBW=25MHz, 60MHz, 90MHz when SCS=60kHz.
NOTE 6: Only applicable for CBW=30MHz when SCS=15kHz and CBW=30MHz, 60MHz, 90MHz when SCS=30kHz and CBW=25MHz, 60MHz, 90MHz when SCS=60kHz.
NOTE 7: Test applies only for UEs which support almost contiguous UL CP-OFDM transmissions. For PC2 UE which support almost contiguous UL CP-OFDM transmissions, test is only applicable for Release 16 and forward.

Table 6.2.2.5-8a: Void

Table 6.2.2.5-9: UE Power Class test requirements (for Bands n34, n39, n41, n77, n78, n79) for Power Class 2 (almost contiguous allocation)

Test ID	P _{PowerClass} (dBm)	ΔP _{PowerClass} (dB)	MPR (dB)	MPR increase (dB)	ΔT _{C,c} (dB)		P _{C_{MAX}L,f,c} (dBm)		T(P _{C_{MAX}L,f,c}) (dB)		T _{L,c} (dB)	Upper limit (dBm)	Lower limit (dBm)	
					0	1.5 ²	23	21.5 ²	2	2 ²			20 - TT	18 - TT ²
1 ⁴	26	0	1.5	1.5	0	1.5 ²	23	21.5 ²	2	2 ²	3	28.0 + TT	20 - TT	18 - TT ²
1 ⁵	26	0	1.5	1	0	1.5 ²	23.5	22 ²	2	2 ²	3	28.0 + TT	20.5 - TT	19.0 - TT ²
2 ⁶	26	0	3	1.5	0	1.5 ²	21.5	20 ²	2	2.5 ²	3	28.0 + TT	18.5 - TT	17.0 - TT ²
2 ⁷	26	0	3	1	0	1.5 ²	22	20.5 ²	2	2.5 ²	3	28.0 + TT	19 - TT	17.5 - TT ²
3 ⁴	26	0	2	1.5	0	1.5 ²	22.5	21 ²	2	2 ²	3	28.0 + TT	19.5 - TT	18.0 - TT ²
3 ⁵	26	0	2	1	0	1.5 ²	23	21.5 ²	2	2 ²	3	28.0 + TT	20 - TT	18.5 - TT ²
4 ⁶	26	0	3	1.5	0	1.5 ²	21.5	20 ²	2	2.5 ²	3	28.0 + TT	18.5 - TT	17.0 - TT ²
4 ⁷	26	0	3	1	0	1.5 ²	22	20.5 ²	2	2.5 ²	3	28.0 + TT	19 - TT	17.5 - TT ²
5 ⁶	26	0	3.5	1.5	0	1.5 ²	21	19.5 ²	2	3.5 ²	3	28.0 + TT	18 - TT	16.0 - TT ²
5 ⁷	26	0	3.5	1	0	1.5 ²	21.5	20 ²	2	2.5 ²	3	28.0 + TT	18.5 - TT	17.0 - TT ²
6 ⁶	26	0	6.5	1.5	0	1.5 ²	18	16.5 ²	4	5 ²	3	28.0 + TT	14 - TT	11.5 - TT ²
6 ⁷	26	0	6.5	1	0	1.5 ²	18.5	17 ²	4	5 ²	3	28.0 + TT	14.5 - TT	12.0 - TT ²

NOTE 1: P_{PowerClass} is the maximum UE power specified without taking into account the tolerance.
NOTE 2: For Band n41, transmission bandwidths confined within F_{UL,low} and F_{UL,low} + 4 MHz or F_{UL,high} – 4 MHz and F_{UL,high}.
NOTE 3: TT for each frequency and channel bandwidth is specified in Table 6.2.2.5-5.
NOTE 4: Applicable for CBW/SCS combinations other than CBW=40MHz when SCS=60kHz.
NOTE 5: Only applicable for CBW 40MHz when SCS is 60kHz.
NOTE 6: Applicable for CBW/SCS combinations other than CBW=30MHz when SCS=15kHz and CBW=30MHz, 60MHz, 90MHz when SCS=30kHz and CBW=25MHz, 60MHz, 90MHz when SCS=60kHz.
NOTE 7: Only applicable for CBW=30MHz when SCS=15kHz and CBW=30MHz, 60MHz, 90MHz when SCS=30kHz and CBW=25MHz, 60MHz, 90MHz when SCS=60kHz.
NOTE 8: Test applies only for UEs which support almost contiguous UL CP-OFDM transmissions. For PC2 UE which support almost contiguous UL CP-OFDM transmissions, test is only applicable for Release 16 and forward.

Table 6.2.2.5-9a: Void

For the UE which supports inter-band NR CA configuration, inter-band NR-DC configuration, SUL configuration or inter-band EN-DC configuration, ΔT_{IB,c} as specified in 6.2A.4.0.2 for NR CA, 6.2B.4.0.2 for NR-DC, clause 6.2C.2 for SUL, or TS 38.521-3 [14] clause 6.2B.4.2 for EN-DC applies. Unless otherwise stated, ΔT_{IB,c} is set to zero. In case the UE supports more than one of band combinations for CA, NR-DC, SUL or DC, and an operating band belongs to more than one band combinations then

- a) When the operating band frequency range is ≤ 1 GHz, the applicable additional ΔT_{IB,c} shall be the average value for all band combinations defined in clause 6.2A.4.0.2, 6.2B.4.0.2, 6.2C.2 in this specification and 6.2B.4.2 in TS 38.521-3 [14], truncated to one decimal place that apply for that operating band among the supported band combinations. In case there is a harmonic relation between low band UL and high band DL, then the maximum ΔT_{IB,c} among the different supported band combinations involving such band shall be applied

- b) When the operating band frequency range is > 1 GHz, the applicable additional $\Delta T_{IB,c}$ shall be the maximum value for all band combinations defined in clause 6.2A.4.0.2, 6.2B.4.0.2, 6.2C.2 in this specification and 6.2B.4.2 in TS 38.521-3 [14] for the applicable operating bands.

6.2.3 UE additional maximum output power reduction

Editor's note: The following aspects are either missing or not yet determined:

- Tests for network signalling values NS_07, NS_40, NS_09 not complete.
- The requirements of this test apply in test case 6.5.3.3 Additional Spurious Emissions for network signalling values NS_44, NS_46, NS_47, NS_48, and NS_49 to all types of NR Power Class 2 and 3 UE release 16 forward, and UE release 15 if the corresponding channel bandwidths are supported.

6.2.3.1 Test purpose

Additional emission requirements can be signalled by the network. Each additional emission requirement is associated with a unique network signalling (NS) value indicated in RRC signalling by an NR frequency band number of the applicable operating band and an associated value in the field *additionalSpectrumEmission*. Throughout this specification, the notion of indication or signalling of an NS value refers to the corresponding indication of an NR frequency band number of the applicable operating band, the IE field *freqBandIndicatorNR* and an associated value of *additionalSpectrumEmission* in the relevant RRC information elements [6].

To meet the additional requirements, additional maximum power reduction (A-MPR) is allowed for the maximum output power as specified in Table 6.2.1.3-1. Unless stated otherwise, the total reduction to UE maximum output power is $\max(\text{MPR}, \text{A-MPR})$ where MPR is defined in clause 6.2.2. Outer and inner allocation notation used in clause 6.2.3 is defined in clause 6.2.2. Unless stated otherwise, Edge RB allocations get the same A-MPR as Outer RB allocations. In absence of modulation and waveform types the A-MPR applies to all modulation and waveform types.

6.2.3.2 Test applicability

The requirements of this test apply in test case 6.5.2.3 Additional Spectrum Emission mask for network signalling values NS_03, NS_03U, NS_04, NS_06, and NS_35 to all types of NR UE release 15 and forward and NR Power Class 1 UE release 15 and forward in NR Band n14.

The requirements of this test apply in test case 6.5.2.4.2 Adjacent channel leakage ratio for network signalling values NS_03U, NS_05U, NS_43U and NS_100 to all types of NR Power Class 3 UE release 15 and forward.

The requirements of this test apply in test case 6.5.2.4.2 Adjacent channel leakage ratio for network signalling values NS_03U, NS_05U, NS_43U and NS_100 to all types of NR Power Class 2 UE not supporting txDiversity-r16 release 15 and forward.

The requirements of this test apply in test case 6.5.3.3 Additional Spurious Emissions for network signalling values NS_04, NS_05, NS_05U, NS_12, NS_13, NS_14, NS_15, NS_17, NS_18, NS_21, NS_37, NS_38, NS_39, NS_40, NS_41, NS_42, NS_43, NS_43U, NS_44, NS_45, NS_48, NS_49, NS_50 and NS_56 to all types of NR Power Class 3 UE release 15 and forward.

The requirements of this test apply in test case 6.5.3.3 Additional Spurious Emissions for network signalling values NS_04, NS_05, NS_05U, NS_12, NS_13, NS_14, NS_15, NS_17, NS_18, NS_21, NS_37, NS_38, NS_39, NS_40, NS_41, NS_42, NS_43, NS_43U, NS_44, NS_45, NS_48, NS_49, NS_50 and NS_56 to all types of NR Power Class 2 UE not supporting txDiversity-r16 release 15 and forward.

NOTE: Test execution is not necessary if 6.5.2.3, 6.5.2.4.2 and 6.5.3.3 are executed.

6.2.3.3 Minimum conformance requirements

6.2.3.3.1 General

Table 6.2.3.3.1-1 specifies the additional requirements with their associated network signalling values and the allowed A-MPR and applicable operating band(s) for each NS value. In case of a power class 3 UE, when IE *powerBoostPi2BPSK* is set to 1, power class 2 A-MPR values apply. The mapping of NR frequency band numbers and values of the *additionalSpectrumEmission* to network signalling labels is specified in Table 6.2.3.3.1-1A.

For almost contiguous allocations in CP-OFDM waveforms in power class 3, the allowed A-MPR defined in clause 6.2.3 is increased by $\text{CEIL}\{10 \log_{10}(1 + N_{\text{RB_gap}}/N_{\text{RB_alloc}}), 0.5\}$ dB, where $\text{CEIL}\{x, 0.5\}$ means x rounding upwards to closest 0.5dB, $N_{\text{RB_gap}}$ is the total number of unallocated RBs between allocated RBs and $N_{\text{RB_alloc}}$ is the total number of allocated RBs, and the parameter L_{CRB} is replaced by $N_{\text{RB_alloc}} + N_{\text{RB_gap}}$ in specifying the RB allocation regions.

Unless otherwise specified, $\pi/2$ BPSK in following A-MPR tables refers to both variants of $\pi/2$ BPSK referenced in 6.2.2 Table 6.2.2.3-1.

Table 6.2.3.3.1-1: Additional maximum power reduction (A-MPR)

Network signalling label	Requirements (subclause)	NR Band	Channel bandwidth (MHz)	Resources blocks (N_{RB})	A-MPR (dB)
NS_01		Table 5.2-1 (NOTE 8)	5, 10, 15, 20, 25, 30, 40, 50, 60, 70, 80, 90, 100	Table 5.3.2-1	N/A
NS_03	6.5.2.3.3.3	n2, n25, n66, n70, n86			Clause 6.2.3.3.7
NS_03U	6.5.2.3.3.3, 6.5.2.4.2.3	n2, n25, n66, n86			Clause 6.2.3.3.7
NS_04	6.5.2.3.3.2, 6.5.3.3.3.1	n41	10, 15, 20, 30, 40, 50, 60, 70, 80, 90, 100		Clause 6.2.3.3.2
NS_05	6.5.3.3.3.4	n1, n65, n84	5, 10, 15, 20 (Note 2)		Clause 6.2.3.3.4 (NOTE 7)
NS_05U	6.5.3.3.3.4, 6.5.2.4.2.3	n1, n65, n84	5, 10, 15, 20		Clause 6.2.3.3.4 (NOTE 7)
NS_06	6.5.2.3.3.4	n12	5, 10, 15		N/A
		n14	5, 10		
NS_10		n20	15, 20	Table 6.2.3.3.3-1	Table 6.2.3.3.3-1
NS_12	6.5.3.3.17	n26	5, 10	Table 6.2.3.3.21-1	Table 6.2.3.3.21-2
NS_13	6.5.3.3.18	n26	5	Table 6.2.3.3.22-1	Table 6.2.3.3.22-2
NS_14	6.5.3.3.19	n26	10, 15, 20	Table 6.2.3.3.23-1	Table 6.2.3.3.23-2
NS_15	6.5.3.3.20	n26	5, 10, 15, 20	Table 6.2.3.3.24-1	Table 6.2.3.3.24-2
NS_17	6.5.3.3.3.2	n28, n83	5, 10	Table 5.3.2-1	N/A
NS_18	6.5.3.3.3.3	n28, n83	5		Table 6.2.3.3.13-1, A1
			10, 15, 20		Table 6.2.3.3.13-1, A2
			30		Table 6.2.3.3.13-1, A3, A4, A5
NS_21	6.5.3.3.3.12	n30	5, 10		Table 6.5.3.3.3.12-1
NS_24	6.5.3.3.3.13	n65 (Note 4)	5, 10, 15, 20	Table 6.2.3.3.15-1	Subclause 6.2.3.3.15
NS_27	6.5.2.3.3.8, 6.5.3.3.3.14	n48	5, 10, 15, 20, 40	Table 6.2.3.3.16-1	Table 6.2.3.3.16-2
NS_35	6.5.2.3.3.1	n71	5, 10, 15, 20	Table 5.3.2-1	N/A
NS_37	6.5.3.3.3.6	n74 (Note 3)	10, 15	Table 6.2.3.3.8-1	Table 6.2.3.3.8-1
NS_38	6.5.3.3.3.7	n74	5, 10, 15, 20	Table 6.2.3.3.9-1	Table 6.2.3.3.9-1
NS_39	6.5.3.3.3.8	n74	10, 15, 20	Table 6.2.3.3.10-1	Table 6.2.3.3.10-1
NS_40	6.5.3.3.3.9	n51	5		Table 6.2.3.3.5-1
NS_41	6.5.3.3.3.10	n50	5, 10, 15, 20, 40, 50, 60		Table 6.2.3.3.11-1
NS_42	6.5.3.3.3.11	n50	5, 10, 15, 20, 40, 50, 60		Table 6.2.3.3.12-1
NS_43	6.5.3.3.3.5	n8, n81	5, 10, 15		Clause 6.2.3.3.6
NS_43U	6.5.3.3.3.5, 6.5.2.4.2.3	n8, n81	5, 10, 15		Clause 6.2.3.3.6

NS_44	6.5.3.3.24	n38	25,30,40	Table 6.2.3.3.20-1	Table 6.2.3.3.20-1
-------	------------	-----	----------	--------------------	--------------------

Network signalling label	Requirements (subclause)	NR Band	Channel bandwidth (MHz)	Resources blocks (N_{RB})	A-MPR (dB)
NS_45	6.5.3.3.3.21	n53	5, 10		Clause 6.2.3.3.25
NS_46	6.5.3.3.3.25	n7	25, 30, 40, 50	Table 6.2.3.3.17-1	Table 6.2.3.3.17-2
NS_47	6.5.3.3.3.15	n41 (Note 5)	30	Table 6.2.3.3.18-1	Table 6.2.3.3.18-2
NS_48	6.5.3.3.3.22	n1 and n84	10, 15, 20, 25, 30, 40, 45, 50	Table 6.2.3.3.26-1, Table 6.2.3.3.26-3	Table 6.2.3.3.26-2, Table 6.2.3.3.26-4 (NOTE 7)
NS_49	6.5.3.3.3.23	n1 and n84	25, 30, 40, 50	Table 6.2.3.3.27-1	Table 6.2.3.3.27-1
NS_50	6.5.3.3.3.16	n39	10, 15, 20, 25, 30, 40		Clause 6.2.3.3.19
NS_55	NOTE 6	n77	10, 15, 20, 25, 30, 40, 50, 60, 70, 80, 90, 100		N/A
NS_56	6.5.3.3.3.27	n24, n99	5, 10	Table 6.2.3.3.30	Clause 6.2.3.3.30
NS_100	6.5.2.4.2.3	n1, n2, n3, n5, n8, n25, n26, n66, n80, n81, n84, n86 (Note 1)			Table 6.2.3.3.1-2

NOTE 1: This NS can be signalled for NR bands that have UTRA services deployed.

NOTE 2: No A-MPR is applied for 5 MHz $BW_{channel}$ where the lower channel edge is ≥ 1930 MHz, 10 MHz $BW_{channel}$ where the lower channel edge is ≥ 1950 MHz and 15 MHz $BW_{channel}$ where the lower channel edge is ≥ 1955 MHz.

NOTE 3: Applicable when the NR carrier is within 1447.9 – 1462.9 MHz.

NOTE 4: Applicable when the upper edge of the channel bandwidth frequency is greater than 1980 MHz.

NOTE 5: Applicable when the NR carrier is within 2545 – 2575 MHz.

NOTE 6: This NS value is applicable for cells in the range 3450 – 3550 MHz for operations in the USA. This NS value does not indicate any additional spurious emission and maximum output power reduction requirements.

NOTE 7: The 1Tx architecture is assumed. For power class 2 UE indicating *txDiversity-r16* [TS 38.306], the additional relaxation of [2] dB is applicable.

NOTE 8: The NS_01 label with the field *additionalPmax* [7] absent is default for all NR bands.

Table 6.2.3.3.1-1A: Mapping of Network Signalling label

NR band	Value of <i>additionalSpectrumEmission</i>							
	0	1	2	3	4	5	6	7
n1	NS_01	NS_100	NS_05	NS_05U	NS_48	NS_49		
n2	NS_01	NS_100	NS_03	NS_03U				
n3	NS_01	NS_100						
n5	NS_01	NS_100						
n7	NS_01	NS_46						
n8	NS_01	NS_100	NS_43	NS_43U				
n12	NS_01	NS_06						
n14	NS_01	NS_06						
n20	NS_01	Void	NS_10					
n24	NS_01	NS_56						
n25	NS_01	NS_100	NS_03	NS_03U				
n26	NS_01	NS_100	NS_12	NS_13	NS_14	NS_15		
n28	NS_01	NS_17	NS_18					
n30	NS_01	NS_21						
n34	NS_01							
n38	NS_01	NS_44						
n39	NS_01	NS_50						
n40	NS_01							
n41	NS_01	NS_04	NS_47					
n48	NS_01	NS_27						
n50	NS_01	NS_41	NS_42					
n51	NS_01	NS_40						
n53	NS_01	NS_45						
n65	NS_01	NS_24	NS_100	NS_05	NS_05U			
n66	NS_01	NS_100	NS_03	NS_03U				
n70	NS_01	NS_03						
n71	NS_01	NS_35						
n74	NS_01	NS_37	NS_38	NS_39				
n77	NS_01	NS_55						
n78	NS_01							
n79	NS_01							
n80	NS_01	NS_100						
n81	NS_01	NS_100	NS_43	NS_43U				
n82	NS_01	Void						
n83	NS_01	NS_17	NS_18					
n84	NS_01	NS_100	NS_05	NS_05U				
n86	NS_01	NS_100	NS_03	NS_03U				
n95	NS_01							
n99	NS_01	NS_56						

NOTE: *additionalSpectrumEmission* corresponds to an information element of the same name defined in clause 6.3.2 of TS 38.331 [6].

Table 6.2.3.3.1-2: A-MPR for NS_100 (UTRA protection)

Modulation/Waveform		Outer (dB)
DFT-s-OFDM	Pi/2 BPSK	≤ 2
	QPSK	≤ 2
	16 QAM	≤ 2.5
	64 QAM	≤ 3
	256 QAM	≤ 4.5
CP-OFDM	QPSK	≤ 4
	16 QAM	≤ 4
	64 QAM	≤ 4
	256 QAM	≤ 6.5

The normative reference for this requirement is TS 38.101-1 [2] clause 6.2.3.1.

6.2.3.3.2 A-MPR for NS_04

For NS_04, A-MPR is not added to MPR. Also, when NS_04 is signalled, MPR shall be set to zero in the P_{CMAX} equations to avoid double-counting MPR.

Allowed maximum power reduction is defined as $A\text{-MPR} = \max(\text{MPR}, A\text{-MPR}')$,

Note that $A\text{-MPR}' = 0$ dB means only MPR is applied,

where $A\text{-MPR}'$ is defined as

if $RB_{\text{start}} \leq f_{\text{start,max,IMD3}} / (12 \cdot \text{SCS})$ and $L_{\text{CRB}} \leq AW_{\text{max,IMD3}} / (12 \cdot \text{SCS})$ and $F_{\text{C}} - BW_{\text{Channel}}/2 < F_{\text{UL,low}} + \text{offset}_{\text{IMD3}}$, then

the $A\text{-MPR}'$ is defined according to Table 6.2.3.3.2-2 PC3_A2 relative to 23 dBm for power class 3, PC2_A4 relative to 26 dBm for power class 2, and PC1.5_A6 relative to 29 dBm for power class 1.5,

else,

if $RB_{\text{start}} \leq L_{\text{CRB}}/2 + \Delta_{\text{start}} / (12 \cdot \text{SCS})$ and $L_{\text{CRB}} \leq AW_{\text{max,regrowth}} / (12 \cdot \text{SCS})$ and $F_{\text{C}} - BW_{\text{Channel}}/2 < F_{\text{UL,low}} + \text{offset}_{\text{regrowth}}$, then

the $A\text{-MPR}'$ is defined according to Table 6.2.3.3.2-2 PC3_A1 relative to 23 dBm for power class 3, PC2_A3 relative to 26 dBm for power class 2, and PC1.5_A5 relative to 29 dBm for power class 1.5,

else

$A\text{-MPR}' = 0$ dB and apply MPR.

With the parameters defined in Table 6.2.3.3.2-1.

Table 6.2.3.3.2-1: Parameters for region edges and frequency offsets

Parameter	Symbol	Value		Related condition
		CP-OFDM	DFT-s-OFDM	
Max allocation start in IMD3 region	$f_{\text{start,max,IMD3}}$	0.33 BW_{Channel}		$RB_{\text{start}} \leq f_{\text{start,max,IMD3}} / (12\text{SCS})$
Max allocation BW in IMD3 region	$AW_{\text{max,IMD3}}$	4 MHz		$LCRB \leq AW_{\text{max,IMD3}} / (12\text{SCS})$
Freq. offset required to avoid A-MPR in IMD3 region	$\text{offset}_{\text{IMD3}}$	$BW_{\text{Channel}} - 6 \text{ MHz}$		$F_C - BW_{\text{Channel}}/2 \geq F_{\text{UL_low}} + \text{offset}_{\text{IMD3}}$
Right edge of regrowth region	Δ_{start}	0.08 BW_{Channel}		$RB_{\text{start}} \leq LCRB/2 + \Delta_{\text{start}} / (12\text{SCS})$
Max allocation BW in regrowth region	$AW_{\text{max,regrowth}}$	100 MHz		$LCRB \leq \text{Min}(LCRB_{\text{Max}}, AW_{\text{max,regrowth}} / (12\text{SCS}))$
Freq. offset required to avoid A-MPR in regrowth region	$\text{offset}_{\text{regrowth}}$	Max (10 MHz, 0.25* BW_{Channel} MHz)	Max (10 MHz, 0.45* BW_{Channel} MHz)	$F_C - BW_{\text{Channel}}/2 \geq F_{\text{UL_low}} + \text{offset}_{\text{regrowth}}$

Table 6.2.3.3.2-2: A-MPR' values Access

Modulation/Waveform		A-MPR' (dB)					
		PC3_A1	PC3_A2	PC2_A3	PC2_A4	PC1.5_A5'	PC1.5_A6'
DFT-s-OFDM	Pi/2-BPSK	≤ 3.5	≤ 3.5	≤ 3.5	≤ 5.5	≤ 5	≤ 7
	QPSK	≤ 4	≤ 4	≤ 4.5	≤ 6	≤ 6	≤ 7.5
	16-QAM	≤ 4	≤ 4	≤ 5	≤ 6	≤ 6.5	≤ 7.5
	64-QAM	≤ 4	≤ 4.5	≤ 5	≤ 6.5	≤ 6.5	≤ 8
	256-QAM	≤ 4.5	≤ 6	≤ 6.5	≤ 8	≤ 8	≤ 9.5
CP-OFDM	QPSK	≤ 5.5	≤ 5.5	≤ 6.5	≤ 7.5	≤ 8	≤ 9
	16-QAM	≤ 5.5	≤ 5.5	≤ 6.5	≤ 7.5	≤ 8	≤ 9
	64-QAM	≤ 5.5	≤ 5.5	≤ 6.5	≤ 7.5	≤ 8	≤ 9
	256-QAM	≤ 6.5	≤ 8	≤ 7.5	≤ 10	≤ 9	≤ 11.5

NOTE 1: PC1.5 assumes dual Tx.

The normative reference for this requirement is TS 38.101-1 [2] clause 6.2.3.2.

6.2.3.3.3

A-MPR for NS_10

Table 6.2.3.3.3-1: A-MPR for NS_10

Channel bandwidth [MHz]	Parameters	Region A
15	RB _{start}	0 – 10
	L _{CRB} (RBs)	1 – 20
	A (dB)	≤ 3 ⁶
20	RB _{start}	0 – 15
	L _{CRB} (RBs)	1 – 20
	A (dB)	≤ 6 ⁶
<p>NOTE 1: RB_{start} indicates the lowest RB index of transmitted resource blocks</p> <p>NOTE 2: L_{CRB} is the length of a contiguous resource block allocation</p> <p>NOTE 3: For intra-subframe frequency hopping which intersects Region A, notes 1 and 2 apply on a per slot basis. For intra-slot or intra-subslot frequency hopping which intersects Region A, notes 1 and 2 apply on a T_{no_hopping} basis.</p> <p>NOTE 4: For intra-subframe frequency hopping which intersect Region A, the larger A-MPR value may be applied for both slots in the subframe. For intra-slot frequency hopping which intersects Region A, the larger A-MPR value may be applied for the slot. For intra-subslot frequency hopping which intersects Region A, the larger A-MPR value may be applied for the subslot.</p> <p>NOTE 5: The A-MPR for DFT-s-OFDM is the total backoff and is obtained by taking the maximum value of MPR + A-MPR specified in Table 6.2.3.3.1-1 and Table 6.2.4-1 in TS 36.521-1 [21] and A value specified in Table 6.2.3.3.3-1.</p> <p>NOTE 6: The A-MPR for CP-OFDM is the total backoff and is obtained by adding the A value in Table 6.2.3.3.3-1 to the corresponding MPR specified in Table 6.2.2.3-1.</p>		

The normative reference for this requirement is TS 38.101-1 [2] clause 6.2.3.3.

6.2.3.3.4

A-MPR for NS_05 and NS_05U

Table 6.2.3.3.4-1: A-MPR regions for NS_05 and NS_05U

Channel Bandwidth (MHz)	Carrier Centre Frequency, F_c (MHz)	Region A			Region B			Region C		
		RB_{start}	LCRB	A-MPR	RB_{start}	LCRB	A-MPR	RB_{start}	LCRB	A-MPR
5	$1922.5 \leq F_c < 1927.5$	$<1.62\text{MHz}/12/\text{SCS}$	$>2.52\text{MHz}/12/\text{SCS}$	A3						
10	$1925 \leq F_c < 1935$	$<1.62\text{MHz}/12/\text{SCS}$	>0	A1	$>1.62\text{MHz}/12/\text{SCS}$ $\leq 3.60\text{MHz}/12/\text{SCS}$	$>5.4\text{MHz}/12/\text{SCS}$	A7	$\geq 7.2\text{MHz}/12/\text{SCS}$	$\leq 1.08\text{MHz}/12/\text{SCS}$	A2
10	$1935 \leq F_c < 1945$		$>4.5\text{MHz}/12/\text{SCS}$	A4						
15	$1927.5 \leq F_c < 1932.5$	$<3.24\text{MHz}/12/\text{SCS}$	>0	A1	$>3.24\text{MHz}/12/\text{SCS}$ $\leq 5.40\text{MHz}/12/\text{SCS}$	$>8.1\text{MHz}/12/\text{SCS}$	A7	$\geq 10.08\text{MHz}/12/\text{SCS}$	$\leq 1.08\text{MHz}/12/\text{SCS}$	A2
15	$1932.5 \leq F_c < 1942.5$	$<1.62\text{MHz}/12/\text{SCS}$	>0	A1				$\geq 12.24\text{MHz}/12/\text{SCS}$	$\leq 1.08\text{MHz}/12/\text{SCS}$	A2
15	$1942.5 \leq F_c < 1947.5$		$>7.2\text{MHz}/12/\text{SCS}$	A5						
20	$1930 \leq F_c < 1950$	$<4.86\text{MHz}/12/\text{SCS}$	>0	A1	$>4.86\text{MHz}/12/\text{SCS}$ $\leq 7.20\text{MHz}/12/\text{SCS}$	$>9.0\text{MHz}/12/\text{SCS}$	A7	$\geq 13.68\text{MHz}/12/\text{SCS}$	$\leq 1.08\text{MHz}/12/\text{SCS}$	A2
20	$1950 \leq F_c < 1960$		$>9.0\text{MHz}/12/\text{SCS}$	A6						

NOTE 1: The A-MPR values are specified in Table 6.2.3.3.4-2 and 6.2.3.3.4-3.
NOTE 2: Void.

Table 6.2.3.3.4-2: A-MPR for NS_05 and NS_05U

Modulation/Waveform		A1 (dB)	A2 (dB)	A3 (dB)	
		Outer/Inner	Outer/Inner	Outer	Inner
DFT-s-OFDM	PI/2 BPSK	≤ 10	≤ 5	≤ 4	
	QPSK	≤ 10	≤ 5	≤ 4.5	
	16 QAM	≤ 10	≤ 5	≤ 6	
	64 QAM	≤ 11	≤ 5	≤ 6	
	256 QAM	≤ 13	≤ 5	≤ 7	
CP-OFDM	QPSK	≤ 10	≤ 5	≤ 7.5	≤ 2
	16 QAM	≤ 10	≤ 5	≤ 7.5	
	64 QAM	≤ 11	≤ 5	≤ 8	
	256 QAM	≤ 13		≤ 10	

NOTE 1: Void
NOTE 2: Void

Table 6.2.3.3.4-3: A-MPR for NS_05

Modulation/Waveform		A4 (dB)		A5 (dB)		A6 (dB)		A7 (dB)
		Outer	Inner	Outer	Inner	Outer	Inner	Outer/Inner
DFT-s-OFDM	Pi/2 BPSK	≤ 1	N/A	≤ 1		≤ 1	N/A	≤ 6
	QPSK			≤ 1.5		≤ 1.5		≤ 6
	16 QAM							≤ 6
	64 QAM							≤ 6
	256 QAM							≤ 6
CP-OFDM	QPSK	≤ 3.5		≤ 3.5	≤ 3.5	≤ 6		
	16 QAM	≤ 3.5		≤ 3.5	≤ 3.5	≤ 6		
	64 QAM			≤ 4		≤ 6		
	256 QAM					≤ 6		
NOTE 1: Void								
NOTE 2: Void								

Table 6.2.3.3.4-4: A-MPR for modulation and waveform type for NS_05U

Modulation/Waveform		A4 (dB)		A5 (dB)		A6 (dB)		A7 (dB)
		Outer	Inner	Outer	Inner	Outer	Inner	Outer/Inner
DFT-s-OFDM	Pi/2 BPSK	≤ 2	N/A	≤ 2		≤ 2	N/A	≤ 6
	QPSK	≤ 2		≤ 2		≤ 2		≤ 6
	16 QAM	≤ 2.5		≤ 2.5		≤ 2.5		≤ 6
	64 QAM	≤ 3		≤ 3		≤ 3		≤ 6
	256 QAM	≤ 4.5		≤ 4.5		≤ 4.5		≤ 6
CP-OFDM	QPSK	≤ 4		≤ 4	≤ 4	≤ 6		
	16 QAM	≤ 4		≤ 4	≤ 4	≤ 6		
	64 QAM	≤ 4		≤ 4	≤ 4	≤ 6		
	256 QAM	≤ 6.5		≤ 6.5	≤ 6.5	≤ 6.5		
NOTE 1: Void								
NOTE 2: Void								

The normative reference for this requirement is TS 38.101-1 [2] clause 6.2.3.4.

6.2.3.3.5 A-MPR for NS_40

Table 6.2.3.3.5-1: A-MPR for NS_40

Modulation/Waveform		A (dB)	
		Channel bandwidth: 5 MHz	
		Outer	Inner
DFT-s-OFDM	QPSK	≤ 15.5	≤ 12
	16 QAM	≤ 14.5	≤ 11
	64 QAM	≤ 14.5	≤ 10
	256 QAM	≤ 12.5	≤ 7.5
CP-OFDM	QPSK	≤ 14.5	≤ 10
	16 QAM	≤ 14.5	≤ 10
	64 QAM	≤ 14	≤ 8
	256 QAM	≤ 11	≤ 5.5
NOTE 1: The A-MPR for NS_40 is the total backoff and is obtained by taking the maximum value of MPR + A-MPR specified in Table 6.2.3.3.1-1 and Table 6.2.4-30a in TS 36.101 and MPR+A specified in Table 6.2.2.3-1 and Table 6.2.3.3.5-1.			

The normative reference for this requirement is TS 38.101-1 [2] clause 6.2.3.5.

6.2.3.3.6 A-MPR for NS_43 and NS_43U

Table 6.2.3.3.6-1: A-MPR regions for NS_43

Channel Bandwidth (MHz)	Carrier Centre Frequency, F_c (MHz)	Region A			Region B		
		RB _{start}	LCRB	A-MPR	RB _{start}	LCRB	A-MPR
5 MHz	$902.5 \leq F_c < 912.5$		> 15	A1			
10 MHz	$F_c = 910$		> 40	A2		> 5.4 MHz/12/SCS	A4
			> 45	A3		> 7.2 MHz/12/SCS	A5
15 MHz	$F_c = 907.5$	< 1.8 MHz/12/SCS > 12.24 MHz/12/SCS	> 0	A6	> 1.8 MHz/12/SCS < 6.12 MHz/12/SCS	≥ 7.2 MHz/12/SCS	A6

NOTE 1: The A-MPR values are specified in Table 6.2.3.3.6-2.
 NOTE 2: 15 kHz SCS unless otherwise stated
 NOTE 3: Void

Table 6.2.3.3.6-2: A-MPR for NS_43

Modulation/Waveform		A1 (dB)		A2 (dB)		A3 (dB)		A4 (dB)		A5 (dB)		A6 (dB)	
		Outer	Inner	Outer	Inner	Outer	Inner	Outer	Inner	Outer	Inner	Outer / Inner	
DFT-s-OFDM	Pi/2 BPSK		N/A	≤ 1.5	N/A		N/A		N/A		N/A	≤ 9	
	QPSK	≤ 2						≤ 2.5				≤ 9	
	16 QAM									≤ 2.5			≤ 9
	64 QAM												≤ 9
CP-OFDM	256 QAM											≤ 9	
	QPSK	≤ 3.5								≤ 4		≤ 9	
	16 QAM	≤ 3.5								≤ 4		≤ 9	
	64 QAM					≤ 4						≤ 9	
	256 QAM											≤ 9	

Table 6.2.3.3.6-3: Void

When NS_43U is signalled for 5 and 10 MHz channel bandwidths A-MPR is defined in Table 6.2.3.3.1-2 except for DFT-s-OFDM QPSK when L_{CRB} > 5.4 MHz/12/SCS the A-MPR is 2.5 dB. For 15 MHz channel bandwidth Table 6.2.3.3.6-4 applies.

Table 6.2.3.3.6-4: A-MPR for NS_43U

Modulation/Waveform		15 MHz
		Outer / Inner (dB)
DFT-s-OFDM	Pi/2 BPSK	≤ 9
	QPSK	≤ 9
	16 QAM	≤ 9
	64 QAM	≤ 9
	256 QAM	≤ 9
CP-OFDM	QPSK	≤ 9
	16 QAM	≤ 9
	64 QAM	≤ 9
	256 QAM	≤ 9

The normative reference for this requirement is TS 38.101-1 [2] clause 6.2.3.6.

6.2.3.3.7

A-MPR for NS_03 and NS_03U

Table 6.2.3.3.7-1: A-MPR for NS_03

Modulation/Waveform		Outer (dB)	Inner (dB)
DFT-s-OFDM	Pi/2 BPSK	≤ 1.5	N/A
	QPSK	≤ 2	
	16 QAM	≤ 3	
	64 QAM	≤ 3.5	
	256 QAM	≤ 5.5	
CP-OFDM	QPSK	≤ 4	
	16 QAM	≤ 4	
	64 QAM	≤ 4.5	
	256 QAM	≤ 7.5	
NOTE 1: Void			
NOTE 2: Void			

In case UE operates in a band where NS_03U applies and it receives *additionalSpectrumEmission* value of 3 then A-MPR values specified in Table 6.2.3.3.7-1 apply with an exception that DFT-s-OFDM Pi/2 BPSK A-MPR is 2 dB.

6.2.3.3.8

A-MPR for NS_37

Table 6.2.3.3.8-1: A-MPR regions for B11/B21 protection (NS_37) (1447.9 - 1462.9 MHz)

Channel Bandwidth (MHz)	Carrier Centre Frequency, F_c (MHz)	Region A (Outer/Inner)			Region B (Outer/Inner)			Region C (Outer/Inner)		
		RB_{start}	LCRB	A-MPR	RB_{start}	LCRB	A-MPR	RB_{start}	LCRB	A-MPR
10	$1452.9 < F_c \leq 1457.9$	≥ 0	> 7.2 MHz/12/SCS	$\leq A1$	N/A	N/A	N/A	N/A	N/A	N/A
15	$F_c = 1455.4$	≥ 0	> 9.9 MHz/12/SCS	$\leq A1$	< 0.54 MHz/12/SCS	< 1.08 MHz/12/SCS	$\leq A2$	> 13.86 MHz/12/SCS	< 1.08 MHz/12/SCS	$\leq A2$

NOTE 1: The A-MPR values are specified in Table 6.2.3.3.8-2.

NOTE 2: Void

NOTE 3: Void

NOTE 4: No A-MPR for SCS = 60 kHz for region B and C only.

Table 6.2.3.3.8-2: A-MPR for NS_37

Modulation/Waveform		A1 (dB)		A2 (dB)
		Outer	Inner	Outer/Inner
DFT-s-OFDM	Pi/2 BPSK	≤ 1	N/A	≤ 3
	QPSK	≤ 1.5		≤ 3
	16 QAM	≤ 2.5		≤ 3
	64 QAM	≤ 3		≤ 3
	256 QAM			
CP-OFDM	QPSK	≤ 3.5		≤ 3
	16 QAM	≤ 3.5		≤ 3
	64 QAM			
	256 QAM			
NOTE 1: Void				
NOTE 2: Void				

The normative reference for this requirement is TS 38.101-1 [2] clause 6.2.3.8.

6.2.3.3.9

A-MPR for NS_38

Table 6.2.3.3.9-1: A-MPR for EESS (NS_38) Protection (1430 – 1470 MHz)

Channel Bandwidth (MHz)	Carrier Centre Frequency, F_c (MHz)	Region A Outer/Inner			Region B Outer/Inner	
		RB_{start}	LCRB	A-MPR (dB)	$RB_{start}+LCRB$	A-MPR (dB)
5	$1432.5 \leq F_c < 14347.5$	$\leq -1.8 \text{ MHz}/12/\text{SCS} + \text{LCRB}/2$	$> 3.6 \text{ MHz}/12/\text{SCS}$	≤ 7	$\leq 2.16 \text{ MHz}/12/\text{SCS}$	≤ 5.5
10	$1435 \leq F_c < 1442$	$\leq -1.8 \text{ MHz}/12/\text{SCS} + \text{LCRB}/2$	$> 3.6 \text{ MHz}/12/\text{SCS}$	≤ 12	$\leq 2.16 \text{ MHz}/12/\text{SCS}$	≤ 9
15	$1437.5 \leq F_c < 1447.5$	$\leq -1.8 \text{ MHz}/12/\text{SCS} + \text{LCRB}/2$	$> 3.6 \text{ MHz}/12/\text{SCS}$	≤ 13	$\leq 3.6 \text{ MHz}/12/\text{SCS}$	≤ 10
20	$1440 \leq F_c < 1450$	$\leq -1.8 \text{ MHz}/12/\text{SCS} + \text{LCRB}/2$	$> 3.6 \text{ MHz}/12/\text{SCS}$	≤ 13	$\leq 5.4 \text{ MHz}/12/\text{SCS}$	≤ 10
NOTE 1 - 4: Void						

The normative reference for this requirement is TS 38.101-1 [2] clause 6.2.3.9.

6.2.3.3.10

A-MPR for NS_39

Table 6.2.3.3.10-1: A-MPR for own RX (NS_39) Protection (1440 – 1470 MHz)

Channel Bandwidth, MHz	Carrier Centre Frequency, F_c , MHz	Region A (Outer/Inner)	
		$RB_{start}+LCRB$	A-MPR (dB)
10	$1460 < F_c \leq 1465$	$> 7.9 \text{ MHz}/12/\text{SCS}$	≤ 6
15	$1452.5 < F_c \leq 1462.5$	$> 11.2 \text{ MHz}/12/\text{SCS}$	≤ 6
20	$1450 < F_c \leq 1460$	$> 14.4 \text{ MHz}/12/\text{SCS}$	≤ 6
NOTE 1 - 4: Void			

The normative reference for this requirement is TS 38.101-1 [2] clause 6.2.3.10.

6.2.3.3.11

A-MPR for NS_41

Table 6.2.3.3.11-1: A-MPR for NS_41

Channel Bandwidth (MHz)	Carrier Centre Frequency, F_c (MHz)	Region A (Outer/Inner)			Region B (Outer/Inner)	
		RB_{start}	$LCRB$	A-MPR (dB)	$RB_{start}+LCRB$	A-MPR (dB)
5	-	-	-	-	-	-
10	$1437 \leq F_c < 1442$	$\leq -4.5 \text{ MHz}/12/\text{SCS} + LCRB$	$> 4.5 \text{ MHz}/12/\text{SCS}$	≤ 9	$< 1.8\text{MHz}/12/\text{SCS}$	≤ 9
15	$1439.5 \leq F_c < 1447.5$	$\leq -5.4 \text{ MHz}/12/\text{SCS} + LCRB$	$> 5.4 \text{ MHz}/12/\text{SCS}$	≤ 11	$< 3.42 \text{ MHz}/12/\text{SCS}$	≤ 9
20	$1442 \leq F_c < 1450$	$\leq -5.4 \text{ MHz}/12/\text{SCS} + LCRB$	$> 5.4 \text{ MHz}/12/\text{SCS}$	≤ 12	$< 5.04 \text{ MHz}/12/\text{SCS}$	≤ 9
40	$1452 \leq F_c < 1497$	$\leq -7.2 \text{ MHz}/12/\text{SCS} + LCRB$	$> 7.2 \text{ MHz}/12/\text{SCS}$	≤ 13.5	$< 11.7 \text{ MHz}/12/\text{SCS}$	≤ 13.5
50	$1457 \leq F_c < 1492$	$\leq -7.2 \text{ MHz}/12/\text{SCS} + LCRB$	$> 7.2 \text{ MHz}/12/\text{SCS}$	≤ 13.5	$< 15.12 \text{ MHz}/12/\text{SCS}$	≤ 13.5
60	$1462 \leq F_c < 1487$	$\leq -7.2 \text{ MHz}/12/\text{SCS} + LCRB$	$> 7.2 \text{ MHz}/12/\text{SCS}$	≤ 13.5	$< 18.72 \text{ MHz}/12/\text{SCS}$	≤ 13.5
NOTE 1 - 4: Void						

The normative reference for this requirement is TS 38.101-1 [2] clause 6.2.3.11.

6.2.3.3.12

A-MPR for NS_42

Table 6.2.3.3.12-1: A-MPR for NS_42

Channel Bandwidth (MHz)	Carrier Centre Frequency, F_c (MHz)	Region A		Region B			
		$RB_{start}+LCRB$	A-MPR Outer/Inner (dB)	RB_{start}	$RB_{start}+LCRB$	A-MPR Inner (dB)	A-MPR Outer (dB)
5	$1512 \leq F_c \leq 1514.5$	$>3.1 \text{ MHz} / 12 / \text{SCS}$	≤ 7	$<0.9 \text{ MHz} / 12 / \text{SCS}$	$\leq 3.1 \text{ MHz} / 12 / \text{SCS}$	≤ 1.5	≤ 4
10	$1497 \leq F_c \leq 1512$	$>6.2 \text{ MHz} / 12 / \text{SCS}$	≤ 8	$<0.9 \text{ MHz} / 12 / \text{SCS}$	$\leq 6.2 \text{ MHz} / 12 / \text{SCS}$	≤ 1.5	≤ 5
15	$1502 F_c \leq 1509.5$	$>9.3 \text{ MHz} / 12 / \text{SCS}$	≤ 8	$<3.06 \text{ MHz} / 12 / \text{SCS}$	$\leq 9.3 \text{ MHz} / 12 / \text{SCS}$	≤ 1.5	≤ 5
20	$1497 \leq F_c \leq 1507$	$>12.4 \text{ MHz} / 12 / \text{SCS}$	≤ 8	$<4.5 \text{ MHz} / 12 / \text{SCS}$	$\leq 12.4 \text{ MHz} / 12 / \text{SCS}$	≤ 1.5	≤ 5
40	$1477 \leq F_c \leq 1497$	$>24.8 \text{ MHz} / 12 / \text{SCS}$	≤ 8	$<5.4 \text{ MHz} / 12 / \text{SCS}$	$\leq 24.8 \text{ MHz} / 12 / \text{SCS}$	≤ 1.5	≤ 5
50	$1467 \leq F_c \leq 1492$	$>31 \text{ MHz} / 12 / \text{SCS}$	≤ 8	$<7.2 \text{ MHz} / 12 / \text{SCS}$	$\leq 31 \text{ MHz} / 12 / \text{SCS}$	≤ 1.5	≤ 5
60	$1462 \leq F_c \leq 1487$	$>37.2 \text{ MHz} / 12 / \text{SCS}$	≤ 8	$<7.2 \text{ MHz} / 12 / \text{SCS}$	$\leq 37.2 \text{ MHz} / 12 / \text{SCS}$	≤ 1.5	≤ 5
NOTE 1 - 5: Void							

The normative reference for this requirement is TS 38.101-1 [2] clause 6.2.3.12.

6.2.3.3.13 A-MPR for NS_18

Table 6.2.3.3.13-0: Band n28 and n83 30MHz A-MPR regions for NS_18

Channel Bandwidth, MHz	Frequency range of UL transmission bandwidth configuration, MHz	Regions		A-MPR
		RB _{start} *12*SCS MHz	LCRB*12*SCS MHz	
30	703~733	$>(\text{LCRB} \cdot 12 \cdot \text{SCS})/2 + 5.22$	$\geq \text{Max}(0, 12 \cdot \text{SCS} \cdot N_{\text{RB}} - 1.8 - \text{RB}_{\text{start}} \cdot 12 \cdot \text{SCS})$	A3
		$\leq (\text{LCRB} \cdot 12 \cdot \text{SCS})/2 + 5.22$	≥ 5.4	A4
		≤ 7.92	< 5.4	A5

Table 6.2.3.3.13-1: A-MPR for NS_18

Modulation/Waveform		A1 (dB)		A2 (dB)	A3 (dB)	A4 (dB)	A5 (dB)
		Outer	Inner	Inner/Outer	Outer/Inner	Outer/Inner	Outer/Inner
DFT-s-OFDM	Pi/2 BPSK	≤ 2	N/A	≤ 5	3	8	3
	QPSK	≤ 2		≤ 5	3	8	3
	16 QAM	≤ 3		≤ 6	3	8	3
	64 QAM	≤ 4		≤ 7	3	8	4.5
	256 QAM	≤ 6		≤ 9	3	8	5.5
CP-OFDM	QPSK	≤ 5		≤ 6.5	4.5	9.5	5
	16 QAM	≤ 5		≤ 7	4.5	9.5	5
	64 QAM	≤ 5.5		≤ 8.5	4.5	9.5	5.5
	256 QAM	≤ 8.5		≤ 11.5	4.5	9.5	7.5

NOTE 1: Void
NOTE 2: Void

The normative reference for this requirement is TS 38.101-1 [2] clause 6.2.3.13.

6.2.3.3.14 A-MPR for NS_21

Table 6.2.3.3.14-1: A-MPR for "NS_21"

Channel Bandwidth (MHz)	Modulation/Waveform		Region A1a	Region A1b	Region A2	Region A3b	Region A3a
			RB _{start} \leq 1.44MHz/12/SCS LCRB \leq [0.54] MHz/12/SCS	RB _{start} \leq 1.44MHz/12/SCS LCRB $>$ [0.54] MHz/12/SCS LCRB \leq 2.16MHz/12/SCS	LCRB $>$ 5.4MHz/12/SCS	RB _{end} \geq 7.74MHz/12/SCS LCRB $>$ [0.54] MHz/12/SCS LCRB \leq 2.16MHz/12/SCS	RB _{end} \geq 7.74MHz/12/SCS LCRB \leq [0.54] MHz/12/SCS
			Outer/Inner	Outer	Outer/Inner	Outer/Inner	
10	DFT-s-OFDM	Pi/2 BPSK	6	3	4	3	6
		QPSK	6	3	4	3	6
		16 QAM	6	3	4	3	6
		64 QAM	6	3	4	3	6
		256 QAM	6	3	4	3	6
	CP-OFDM	QPSK	6	4	5.5	4	6
		16 QAM	6	4	5.5	4	6
		64 QAM	6	4	5.5	4	6
		256 QAM	6	4	5.5	4	6

The normative reference for this requirement is TS 38.101-1 [2] clause 6.2.3.14.

6.2.3.3.15

A-MPR for NS_24

Table 6.2.3.3.15-1: A-MPR for NS_24

Channel Bandwidth, MHz	Carrier Centre Frequency, F _c , MHz	Region A			Region B			Region C		
		Rbend*12* SCS MHz	LCRB*12* SCS MHz	A-MPR	Rbend*12* SCS MHz	LCRB*12* SCS MHz	A-MPR	Rbend*12* SCS MHz	LCRB*12* SCS MHz	A-MPR
5MHz	F _c =1992.5		>3.24	A7						
5MHz	F _c =1997.5		>3.24	A4						
5MHz	F _c =2002.5		>2.16	A1	>3.78	≤1.98	A2	≤3.6	≤1.98	A3
10MHz	F _c =1985	>5.4		A4						
10MHz	F _c =1995		>4.5	A1	>7.56	≤4.32	A2	≤7.38	≤4.32	A3
10MHz	F _c =2000	>6.84		A5	<2.88		A5	≥3.06 ≤6.66	>1.44	A6
15MHz	F _c =1987.5		>7.02	A1	>11.52	≤6.84	A2	≤11.34	≤6.84	A3
15MHz	F _c =1997.5	>9.36		A5	<3.6		A5	≥3.78 ≤9.18	>1.44	A6
20MHz	F _c =1990	>13.5		A5	<4.5		A5	≥4.68 ≤13.32	>2.16	A6
20MHz	F _c =1995	>12.6		A5	<5.4		A5	≥5.58 ≤12.42	>1.44	A6

NOTE 1: The A-MPR values are listed in Table 6.2.3.3.15-2.

NOTE 2: For any undefined region, MPR applies

Table 6.2.3.3.15-2: A-MPR for modulation and waveform type

Modulation/Waveform	A1	A2	A3	A4	A5	A6	A7
	Outer/Inner	Outer/Inner	Outer/Inner	Outer	Outer/Inner	Outer/Inner	Outer
DFT-s-OFDM PI/2 BPSK	≤ 11	≤ 5	≤ 4	≤ 8.5	≤ 18	≤ 10	≤ 3.5
DFT-s-OFDM QPSK	≤ 11	≤ 5	≤ 4	≤ 8.5	≤ 18	≤ 10	≤ 3.5
DFT-s-OFDM 16 QAM	≤ 11	≤ 5	≤ 4	≤ 8.5	≤ 18	≤ 10	≤ 3.5
DFT-s-OFDM 64 QAM	≤ 11	≤ 5	≤ 4	≤ 8.5	≤ 19	≤ 10	≤ 3.5
DFT-s-OFDM 256 QAM	≤ 11	≤ 5		≤ 8.5	≤ 20	≤ 10	
CP-OFDM QPSK	≤ 13	≤ 6.5	≤ 4	≤ 8.5	≤ 19	≤ 12	≤ 5.5
CP-OFDM 16 QAM	≤ 13	≤ 6.5	≤ 4	≤ 8.5	≤ 19	≤ 12	≤ 5.5
CP-OFDM 64 QAM	≤ 13	≤ 6.5	≤ 4	≤ 8.5	≤ 19	≤ 12	≤ 5.5
CP-OFDM 256 QAM	≤ 13	≤ 6.5		≤ 8.5	≤ 20	≤ 12	

NOTE 1: The backoff applied is max(MPR, A-MPR) where MPR is defined in Table 6.2.2.3-1

NOTE 2: Outer and inner allocations are defined in clause 6.1

The normative reference for this requirement is TS 38.101-1 [2] clause 6.2.3.15.

6.2.3.3.16

A-MPR for NS_27

Table 6.2.3.3.16-1: A-MPR for NS_27

Channel Bandwidth, MHz	Carrier Centre Frequency, F _c , MHz	Region A				Region B	
		RBstart*12* SCS	RBend*12* SCS	LCRB*12* SCS	A-MPR	LCRB*12* SCS	A-MPR
15 MHz	3557.5 ≤ F _c < 3562.5	<1.8 MHz			A3	≥10.8 MHz	A3
	3687.5 < F _c ≤ 3692.5	>11.52 MHz					
15 MHz	3562.5 ≤ F _c < 3567.5	≤1.08 MHz		<1.44 MHz	A4	≥11.52 MHz	2
	3682.5 < F _c ≤ 3687.5		≥13.22 MHz				
20 MHz	3560 ≤ F _c < 3570	<3.6 MHz			A5	≥10.8 MHz	A5
	3680 < F _c ≤ 3690	>12.96 MHz					
20 MHz	3570 ≤ F _c < 3580	≤2.16 MHz		<1.44 MHz	A6	≥14.4 MHz	2
	3670 < F _c ≤ 3680		≥16.92				
40 MHz	3570 ≤ F _c < 3600	<11.34 MHz			A7		
		≥11.34 MHz		≥18 MHz	A2		
		≤31.0 MHz		<18 MHz	A1		
		>31.0 MHz		<1.8 MHz	A7		

	3650 < F _c ≤ 3680		>24.48 MHz z		A7		
			≤24.48 MHz z, ≥6.48 MHz	≥18 MHz	A2		
			<6.48 MHz	<1.8 MHz	A1		
40 MHz	3600 ≤ F _c ≤ 3650	≤6.12 MHz		<1.44 MHz z	A8	>20 MHz	4.5
			≥ 32.76				

Table 6.2.3.3.16-2: A-MPR for modulation and waveform type

Modulation/Waveform		A1	A2	A3	A4	A5	A6	A7	A8
		Outer r	Outer r	Outer/Inne r	Outer/Inne r	Outer/Inne r	Outer/Inne r	Outer/Inne r	Outer/Inne r
DFT-s-OFDM	PI/2 BPSK	4.5	6	4	4	4	4	10.5	4
	QPSK	4.5	6	4	4	4	4	10.5	4
	16 QAM	4.5	6	5	4	5	4	11	4
	64 QAM	4.5	6	5	4	5	4	11	4
	256 QAM		6					11	
CP-OFDM	QPSK	5.5	7	6	4	6	4	11.5	4
	16 QAM	5.5	7	6	4	6	4	11.5	4
	64 QAM	5.5	7	6	4	6	4	11.5	4
	256 QAM		7					11.5	

NOTE 1: The backoff applied is max (MPR, A-MPR) where MPR is defined in Table 6.2.2-1
 NOTE 2: Outer and inner allocations are defined in clause 6.2.2

The normative reference for this requirement is TS 38.101-1 [2] clause 6.2.3.16.

6.2.3.3.17 A-MPR for NS_46

Table 6.2.3.3.17-1: A-MPR regions for NS_46

Channel Bandwidth, MHz	Carrier Center Frequency, F _c , MHz	Regions		A-MPR
		RB _{end} *12*SCS MHz	L _{CRB} *12*SCS MHz	
25 MHz	2534.5 ≤ F _c ≤ 2557.5		Note 1	A3
30 MHz	2515 ≤ F _c ≤ 2555	≥0, <1.44	>0	A4
		≥1.44, <13.5	>max (0, 12*SCS*RB _{end} -1.8)	A5
		≥13.5, <19.8	>11.52	A6
		≥19.8, <25.92	>6.3	A7
		≥25.92	>0	A8
40 MHz	2520 ≤ F _c ≤ 2550	≥0, <4.14	>0	A4
		≥4.14, <18	>max (0, 12*SCS*RB _{end} - 4.5)	A5
		≥18, <25.74	>13.5	A6
		≥25.74, <32.4	>12.6	A7
50 MHz	2525 ≤ F _c ≤ 2545	≥32.4	>0	A8
		≥0, <9	>0	A4
		≥9, <21.6	>max (0, 12*SCS*RB _{end} - 7.2)	A5
		≥21.6, <31.5	>18	A6
		≥31.5, <39.6	>16.2	A7
		≥39.6	>0	A8

NOTE 1: > 9.72 MHz for DFT-s-OFDM, > 16.02 MHz for CP-OFDM.

Table 6.2.3.3.17-2: A-MPR for NS_46

Modulation/Waveform		A3	A4	A5	A6	A7	A8
		Outer	Outer/Inner	Outer/Inner	Outer/Inner	Outer/Inner	Outer/Inner
DFT-s-OFDM	PI/2 BPSK	4.5	5	2	3.5	6	10
	QPSK	4.5	5	2	3.5	6	10
	16 QAM	4.5	5	2	3.5	6	10
	64 QAM	4.5	5		3.5	6	10
	256 QAM					6	10
CP-OFDM	QPSK	6	5	3.5	5.5	7	11
	16 QAM	6	5	3.5	5.5	7	11
	64 QAM	6	5	3.5	5.5	7	11
	256 QAM	6				7	11

The normative reference for this requirement is TS 38.101-1 [2] clause 6.2.3.17.

6.2.3.3.18 A-MPR for NS_47

Table 6.2.3.3.18-1: A-MPR regions for NS_47

Channel Bandwidth, (MHz)	Carrier Centre Frequency, Fc, (MHz)	RBstart*12*SCS (MHz)	LCRB*12*SCS (MHz)	A-MPR
30MHz	Fc=2560-2560.020	≤5.04	≤1.44	A1
		>5.04, ≤9.6	≤1.44	A2
		>24.48	≤1.44	A3
		≤9.6	>21	A2
			>14.4, <21	A4
		≤6.12	>10, ≤14.4	A4
	>1.44, <10	A2		

NOTE: The A-MPR values are listed in Table 6.2.3.3.18-2.

Table 6.2.3.3.18-2: A-MPR for modulation and waveform type

Modulation/Waveform	A1(dB)		A2(dB)		A3(dB)		A4(dB)	
	PC3	PC2	PC3	PC2	PC3	PC2	PC3	PC2
	Outer/Inner	Outer/Inner	Outer/Inner	Outer/Inner	Outer/Inner	Outer/Inner	Outer/Inner	Outer/Inner
DFT-s-OFDM PI/2 BPSK	≤ 7	≤ 10	≤ 5.5	≤ 8.5	≤ 2	≤ 5	≤ 3	≤ 6
DFT-s-OFDM QPSK	≤ 7	≤ 10	≤ 5.5	≤ 8.5	≤ 2	≤ 5	≤ 3	≤ 6
DFT-s-OFDM 16 QAM	≤ 7	≤ 10	≤ 5.5	≤ 8.5		≤ 5	≤ 3	≤ 6
DFT-s-OFDM 64 QAM	≤ 7	≤ 10	≤ 6	≤ 8.5		≤ 5	≤ 3	≤ 6
DFT-s-OFDM 256 QAM	≤ 7	≤ 10	≤ 6	≤ 8.5		≤ 5		≤ 6
CP-OFDM QPSK	≤ 7	≤ 10	≤ 7	≤ 10		≤ 5	≤ 4	≤ 7
CP-OFDM 16 QAM	≤ 7	≤ 10	≤ 7	≤ 10		≤ 5	≤ 4	≤ 7
CP-OFDM 64 QAM	≤ 7	≤ 10	≤ 7	≤ 10		≤ 5		≤ 7
CP-OFDM 256 QAM	≤ 7	≤ 10	≤ 7	≤ 10				≤ 7

The normative reference for this requirement is TS 38.101-1 [2] clause 6.2.3.18.

6.2.3.3.19 A-MPR for NS_50

Table 6.2.3.3.19-1: A-MPR regions for NS_50 (Power Class 3)

Channel Bandwidth (MHz)	$RB_{start} * 12 * SCS$ (MHz)	$L_{CRB} * 12 * SCS$ (MHz)	A-MPR
25 MHz	$\leq L_{CRB} * 12 * SCS - 5$	> 5	A7
	≤ 6.48	≤ 1.44	A8
		≤ 3.6	A9
30 MHz	$\leq L_{CRB} * 12 * SCS - 5$	> 5	A7
	≤ 8.64	≤ 1.44	A8
		≤ 3.6	A9
40 MHz	≤ 4.32	> 0	A1
	$> 4.32, \leq 10.44$	≤ 10.8	A3
	$> 4.32, \leq 18$	> 10.8	A2
	$> 18, \leq 31.68$	$> \max(31.68 - RB_{start} * 12 * SCS, 0)$	A6
	> 31.68	> 0	A5

NOTE 1: The A-MPR values are specified in Table 6.2.3.3.19-2.

Table 6.2.3.3.19-2: A-MPR for NS_50 (Power Class 3)

Modulation/Waveform	A1 (dB)	A2 (dB)	A3 (dB)	A5 (dB)	A6 (dB)	A7 (dB)	A8 (dB)	A9 (dB)
	Outer/Inner	Outer/Inner	Outer/Inner	Outer/Inner	Outer/Inner	Outer/Inner	Outer/Inner	Inner
DFT-s-OFDM	Pi/2 BPSK	≤ 11	≤ 7	≤ 3	≤ 5	≤ 2	≤ 4	≤ 2
	QPSK	≤ 11	≤ 7	≤ 3	≤ 5	≤ 2	≤ 5	≤ 2
	16 QAM	≤ 11	≤ 7	≤ 3	≤ 5	≤ 2	≤ 5	≤ 2.5
	64 QAM	≤ 11	≤ 7	≤ 3	≤ 5		≤ 5	
	256 QAM	≤ 11	≤ 7		≤ 5		≤ 5	
CP-OFDM	QPSK	≤ 12	≤ 8	≤ 4.5	≤ 5	≤ 3.5	≤ 6.5	≤ 3.0
	16 QAM	≤ 12	≤ 8	≤ 4.5	≤ 5	≤ 3.5	≤ 6.5	≤ 3.0
	64 QAM	≤ 12	≤ 8	≤ 4.5	≤ 5		≤ 6.5	
	256 QAM	≤ 12	≤ 8				≤ 6.5	

Table 6.2.3.3.19-3: A-MPR regions for NS_50 (Power Class 2)

Channel Bandwidth (MHz)	$RB_{start} * 12 * SCS$ (MHz)	$L_{CRB} * 12 * SCS$ (MHz)	A-MPR
10 MHz	≤ 1.44	< 1.44	A5
	≤ 1.8	$\geq 2.7 + 2 * RB_{start} * 12 * SCS$	A4
	> 1.8	$\geq 8.1 - RB_{start} * 12 * SCS$	A4
15 MHz	≤ 2.88	< 2.7	A5
	≤ 3.24	$\geq 2.7 + 2 * RB_{start} * 12 * SCS$	A3
	> 3.24	$\geq 12.42 - RB_{start} * 12 * SCS$	A4
20 MHz	≤ 4.32	< 3.6	A5
	≤ 4.5	$\geq 3.6 + 2 * RB_{start} * 12 * SCS$	A3
	> 4.5	$\geq 17.1 - RB_{start} * 12 * SCS$	A4
25 MHz	$\leq L_{CRB} * 12 * SCS - 5$	> 5	A2
	≤ 6.3	≤ 1.44	A5
	> 8.28	$> \max(21.6 - RB_{start} * 12 * SCS, 0)$, $< RB_{start} * 12 * SCS + 5$	A4
	$> 1.8, \leq 6.12$	$> 1.44, \leq 3.6$	A6
	$> L_{CRB} * 12 * SCS - 5, \leq 5.04$	> 1.44	A4
30 MHz	$\leq L_{CRB} * 12 * SCS - 5$	> 5	A2
	≤ 7.56	≤ 1.44	A5
	$> 1.8, \leq 7.56$	$> 1.44, \leq 3.6$	A6
	≤ 1.8	$> 1.44, < RB_{start} * 12 * SCS + 5$	A4
	> 10.8	$> \max(26.64 - RB_{start} * 12 * SCS, 0)$, $< RB_{start} * 12 * SCS + 5$	A4
40 MHz	≤ 4.32	> 0	A1
	> 4.32	$> RB_{start} * 12 * SCS + 11.88$	A1
	$> 4.32, \leq 12.96$	≤ 10.8	A3
	$> 4.32, \leq 18$	$> 10.8, \leq RB_{start} * 12 * SCS + 11.88$	A7
	$> 18, \leq 31.68$	$> \max(31.68 - RB_{start} * 12 * SCS, 0)$	A4
	> 31.68	> 0	A1

NOTE 1: The A-MPR values are specified in Table 6.2.3.3.19-4.

Table 6.2.3.3.19-4: A-MPR for NS_50 (Power Class 2)

Modulation/Waveform		A1 (dB)	A2 (dB)	A3 (dB)	A4 (dB)	A5 (dB)	A6 (dB)	A7 (dB)
		Outer/Inner	Outer/Inner	Outer/Inner	Outer/Inner	Outer/Inner	Outer/Inner	Outer/Inner
DFT-s-OFDM	Pi/2 BPSK	≤ 11.5	≤ 4.5	≤ 4	≤ 2.5	≤ 4	≤ 1	≤ 3.5
	QPSK	≤ 11.5	≤ 5.5	≤ 4	≤ 2.5	≤ 4	≤ 1	≤ 3.5
	16 QAM	≤ 11.5	≤ 5.5	≤ 4	≤ 2.5	≤ 4	≤ 1.5	≤ 3.5
	64 QAM	≤ 11.5	≤ 5.5	≤ 4		≤ 4		
	256 QAM	≤ 11.5	≤ 5.5					
CP-OFDM	QPSK	≤ 12.5	≤ 7	≤ 5.5	≤ 4	≤ 4	≤ 2	≤ 5
	16 QAM	≤ 12.5	≤ 7	≤ 5.5	≤ 4	≤ 4		≤ 5
	64 QAM	≤ 12.5	≤ 7	≤ 5.5	≤ 4	≤ 4		≤ 5
	256 QAM	≤ 12.5	≤ 7					

6.2.3.3.20 A-MPR for NS_44

Table 6.2.3.3.20-1: A-MPR regions for NS_44

Channel Bandwidth, MHz	Carrier Center Frequency, F _c , MHz	Regions		A-MPR
		RB _{end} *12*SCS MHz	L _{CRB} *12*SCS MHz	
25 MHz	2582.5 ≤ F _c ≤ 2602.5	<18.0	>max(0, 12*SCS* RB _{end} - 3.6)	A3
		≥18.0	<7.2	A3
		≥18.0	≥7.2	A6
30 MHz	2585 ≤ F _c ≤ 2600	<21.6	>max(0, 12*SCS* RB _{end} - 3.6)	A3
		≥21.6	<12.6	A3
		≥21.6	≥12.6	A6
40 MHz	2590 ≤ F _c ≤ 2595	≥0, <2.88	>0	A1
		≥2.88, <14.4	>max (0, 12*SCS*RB _{end} - 3.6)	A2
		≥14.4, <23.4	>10.8	A3
		≥23.4, <32.4	>16.2	A4
		≥32.4	>0	A5

Table 6.2.3.3.20-2: A-MPR for NS_44

Modulation/Waveform		A1	A2	A3	A4	A5	A6
		Outer/Inner	Outer/Inner	Outer/Inner	Outer/Inner	Outer/Inner	Outer/Inner
DFT-s-OFDM	PI/2 BPSK	5	2	3	7	12	4
	QPSK	5	2	3	7	12	4
	16 QAM	5	2	3	7	12	4
	64 QAM	5		3	7	12	4
	256 QAM	5			7	12	
CP-OFDM	QPSK	5	4	5	8	12	6
	16 QAM	5	4	5	8	12	6
	64 QAM	5	4	5	8	12	6
	256 QAM				8	12	

6.2.3.3.21 A-MPR for NS_12

Table 6.2.3.3.21-1: A-MPR regions for NS_12

Channel BW	RB _{Start} *12*SCS (MHz)	L _{CRB} *12*SCS (MHz)	A-MPR
5MHz	≤1.8	>0	A1
10MHz	≤3.6	>0	A1

Table 6.2.3.3.21-2: A-MPR for NS_12

Modulation/Waveform	A1
	Outer/Inner
DFT-s-OFDM PI/2 BPSK	≤ 5
DFT-s-OFDM QPSK	≤ 5
DFT-s-OFDM 16 QAM	≤ 5.5
DFT-s-OFDM 64 QAM	≤ 5.5
DFT-s-OFDM 256 QAM	≤ 9.5
CP-OFDM QPSK	≤ 7
CP-OFDM 16 QAM	≤ 7
CP-OFDM 64 QAM	≤ 7
CP-OFDM 256 QAM	≤ 9.5

6.2.3.3.22

A-MPR for NS_13

Table 6.2.3.3.22-1: A-MPR regions for NS_13

Channel BW	Carrier Frequency, F_c , MHz	$RB_{Start} * 12 * SCS$ (MHz)	$L_{CRB} * 12 * SCS$ (MHz)	A-MPR
5MHz	$819.5 \leq F_c < 821.5$	≤ 1.44	< 1.08	A1
		≤ 1.44	≥ 1.08	A2
5MHz	$F_c \geq 821.5$	≤ 0.54	< 1.08	A1
			≥ 3.24	A3

Table 6.2.3.3.22-2: A-MPR for NS_13

Modulation/Waveform	A1	A2	A3
	Outer/Inner	Outer/Inner	Outer
DFT-s-OFDM PI/2 BPSK	≤ 3.5	≤ 4.5	≤ 3
DFT-s-OFDM QPSK	≤ 3.5	≤ 4.5	≤ 3
DFT-s-OFDM 16 QAM	≤ 3.5	≤ 5	≤ 3
DFT-s-OFDM 64 QAM	≤ 4.5	≤ 5	≤ 3
DFT-s-OFDM 256 QAM	≤ 8	≤ 6	
CP-OFDM QPSK	≤ 5	≤ 6.5	≤ 4.5
CP-OFDM 16 QAM	≤ 5	≤ 6.5	≤ 4.5
CP-OFDM 64 QAM	≤ 6	≤ 6.5	≤ 4.5
CP-OFDM 256 QAM	≤ 8	≤ 8	

6.2.3.3.23

A-MPR for NS_14

Table 6.2.3.3.23-1: A-MPR regions for NS_14

Channel BW	$RB_{Start} * 12 * SCS$ (MHz)	$L_{CRB} * 12 * SCS$ (MHz)	A-MPR
10MHz	≤ 0.18	< 1.08	A1
	≥ 0	≥ 9	A2
15MHz	≤ 1.8	< 1.8	A1
	≥ 0	≥ 9	A2
20MHz	≤ 3.42	< 1.8	A3
	≥ 0	≥ 9	A2

Table 6.2.3.3.23-2: A-MPR for NS_14

Modulation/Waveform	A1	A2	A3
	Outer/Inner	Outer	Outer/Inner
DFT-s-OFDM PI/2 BPSK	≤ 3	≤ 2	≤ 3
DFT-s-OFDM QPSK	≤ 3	≤ 2	≤ 3
DFT-s-OFDM 16 QAM	≤ 3	≤ 2	≤ 3
DFT-s-OFDM 64 QAM	≤ 3		≤ 3
DFT-s-OFDM 256 QAM			≤ 8
CP-OFDM QPSK	≤ 5	≤ 4	≤ 5
CP-OFDM 16 QAM	≤ 5	≤ 4	≤ 5
CP-OFDM 64 QAM	≤ 6		≤ 6
CP-OFDM 256 QAM	≤ 8		≤ 8

6.2.3.3.24

A-MPR for NS₁₅

Table 6.2.3.3.24-1: A-MPR regions for NS₁₅

Channel BW	Carrier Frequency, F _c , MHz	R _{Bend} *12*SCS (MHz)	L _{CRB} *12*SCS (MHz)	A-MPR
5MHz	840.5 < F _c ≤ 846.5	≥3.24	>0	A1
		<3.24, ≥2.52	≥1.44	A2
		<0.9	≤0.36	A3
10MHz	840 < F _c ≤ 844	≥5.76	>1.08	A1
		≥5.76	≤1.08	A4
		<5.76, ≥4.14	≥2.7	A2
	835 < F _c ≤ 840	<2.52	≤0.36	A3
		≥7.2	>0	A1
		<7.2, ≥5.22	≥4.32	A2
15MHz	837.5 < F _c ≤ 841.5	<1.08	≤0.36	A3
		≥9.36	>1.08	A1
		≥9.36	≤1.08	A4
		<9.36, ≥4.68	≥3.6	A2
	831.5 < F _c ≤ 837.5	<3.96	≤0.36	A3
		≥10.8	>1.08	A1
		≥10.8	≤1.08	A4
		<10.8, ≥6.48	≥3.6	A2
	F _c ≤ 831.5	<2.7	≤0.36	A3
		≥13.14	>0	A1
		<13.14, ≥7.92	≥3.6	A2
		<0.72	≤0.36	A3
20MHz	835 < F _c ≤ 839	≥12.24	>1.08	A1
		≥12.24	≤1.08	A4
		<12.24, ≥8.46	≥5.4	A2
		<5.58	≤0.36	A3
	F _c ≤ 835	≥13.68	>1.08	A1
		≥13.68	≤1.08	A4
		<13.68, ≥8.46	≥5.4	A2
		<4.32	≤0.36	A3

Table 6.2.3.3.24-2: A-MPR for NS₁₅

Modulation/Waveform	A1	A2	A3	A4
	Outer/Inner	Outer/Inner	Outer/Inner	Outer/Inner
DFT-s-OFDM PI/2 BPSK	≤ 9	≤ 5	≤ 4	≤ 9
DFT-s-OFDM QPSK	≤ 9	≤ 5	≤ 4	≤ 9
DFT-s-OFDM 16 QAM	≤ 9	≤ 5	≤ 4	≤ 9
DFT-s-OFDM 64 QAM	≤ 9	≤ 5	≤ 4	≤ 9
DFT-s-OFDM 256 QAM	≤ 9	≤ 5	≤ 9	≤ 13.5
CP-OFDM QPSK	≤ 10.5	≤ 6.5	≤ 4	≤ 10.5
CP-OFDM 16 QAM	≤ 10.5	≤ 6.5	≤ 4	≤ 10.5
CP-OFDM 64 QAM	≤ 10.5	≤ 6.5	≤ 4	≤ 10.5
CP-OFDM 256 QAM	≤ 10.5	≤ 6.5	≤ 9	≤ 13.5

6.2.3.3.25

A-MPR for NS₄₅

Table 6.2.3.3.25-1: A-MPR for NS₄₅

Modulation/Waveform		Outer
DFT-s-OFDM	Pi/2 BPSK	≤ 1.5
	QPSK	≤ 2
	16 QAM	≤ 2.5
	64 QAM	≤ 3

6.2.3.3.26

A-MPR for NS_48

Table 6.2.3.3.26-1: A-MPR regions for NS_48 (Power Class 3)

Channel Bandwidth, MHz	Carrier Center Frequency, F_c , MHz	Regions		A-MPR
		$RB_{end} * 12 * SCS$ MHz	$L_{CRB} * 12 * SCS$ MHz	
25 MHz	$1932.5 \leq F_c \leq 1967.5$	≥ 0	≥ 9.72	A3
		≥ 18.72	< 1.08	A3
30 MHz	$1935 \leq F_c \leq 1965$	≥ 0	≥ 13.5	A3
		≥ 21.6	$< 1.08 < 1.08$	A5
40 MHz	$1940 \leq F_c \leq 1960$	$\geq 0, < 2.88$	≥ 0	A2
		$\geq 2.88, < 17.1$	$\geq \max(0, 12 * SCS * RB_{end} - 3.6)$	A3
		$\geq 17.1, < 27.36$	≥ 13.5	A4
		$\geq 27.36, < 34.56$	≥ 13.5	A2
		$\geq 27.36, < 34.56$	< 1.08	A3
45 MHz	$1942.5 \leq F_c \leq 1957.5$	≥ 34.56	≥ 0	A1
		$\geq 0, < 4.86$	> 0	A2
		$\geq 4.86, < 19$	$\geq \max(0, 12 * SCS * RB_{end} - 3.6)$	A4
		$\geq 19, < 37.44$	≥ 15.4	A2
		$\geq 30.96, < 37.44$	< 1.08	A5
50 MHz	$1945 \leq F_c \leq 1955$	≥ 37.44	> 0	A1
		$\geq 0, < 6.12$	> 0	A2
		$\geq 6.12, < 20.7$	$\geq \max(0, 12 * SCS * RB_{end} - 3.6)$	A4
		$\geq 20.7, < 41.04$	≥ 17.1	A2
		$\geq 33.84, < 41.04$	< 1.08	A5
		≥ 41.04	> 0	A1

Table 6.2.3.3.26-2: A-MPR for NS_48 (Power Class 3)

Modulation/Waveform		A1	A2	A3	A4	A5
		Outer/Inner	Outer/Inner	Outer/Inner	Outer/Inner	Outer/Inner
DFT-s-OFDM	PI/2 BPSK	≤ 10	≤ 6	≤ 3	≤ 4	≤ 5
	QPSK	≤ 10	≤ 6	≤ 3	≤ 4	≤ 5
	16 QAM	≤ 10	≤ 6	≤ 3	≤ 4	≤ 5
	64 QAM	≤ 10	≤ 6	≤ 3	≤ 4	≤ 5
	256 QAM	≤ 10	≤ 6	≤ 3	≤ 4	≤ 5
CP-OFDM	QPSK	≤ 11	≤ 7	≤ 4.5	≤ 5.5	≤ 5
	16 QAM	≤ 11	≤ 7	≤ 4.5	≤ 5.5	≤ 5
	64 QAM	≤ 11	≤ 7	≤ 4.5	≤ 5.5	≤ 5
	256 QAM	≤ 11	≤ 7	≤ 4.5	≤ 5.5	≤ 5

6.2.3.3.27 A-MPR for NS_49

Table 6.2.3.3.27-1: A-MPR regions for NS_49

Channel Bandwidth (MHz)	Carrier Center Frequency, F _c (MHz)	Regions		A-MPR
		RB _{end} *12*SCS (MHz)	L _{CRB} *12*SCS (MHz)	
25 MHz	1932.5 ≤ F _c ≤ 1967.5	≥0	≥9.72	A3
		≥18.72	<1.08	A3
		≤3.96	<1.08	A3
30 MHz	1935 ≤ F _c ≤ 1965	≥0, <3.6	≥0	A1
		≥3.6, <6.48	≥0	A5
		≥6.48, <14.4	≥max (0, 12*SCS* RB _{end} - 3.6)	A3
		≥14.4, <21.6	≥10.8	A4
		≥21.6	≥10.8	A2
		≥21.6	<1.08	A5
40 MHz	1940 ≤ F _c ≤ 1960	≥0, <7.2	≥0	A1
		≥7.2, <10.44	<1.08	A5
		≥7.2, <18	≥max (0, 12*SCS*RB _{end} - 3.6)	A4
		≥18, <34.56	≥14.4, <28.8	A2
		≥27.36, <34.56	<1.08	A5
		<34.56	≥28.8	A1
		≥34.56	≥0	A1
50 MHz	1945 ≤ F _c ≤ 1955	≥7.74, <14.4	< min (1.08, max(0, 12*SCS* RB _{end} -7.74))	A5
		≥36, <39.6	<1.08	A5
		<39.6	≥18, <max (0, 12*SCS*RB _{end} - 7.74)	A2
		<39.6	≥max (0, 12*SCS*RB _{end} - 7.74)	A1
		≥39.6	>0	A1

Table 6.2.3.3.27-2: A-MPR for NS_49

Modulation/Waveform		A1	A2	A3	A4	A5
		Outer/Inner	Outer/Inner	Outer/Inner	Outer/Inner	Outer/Inner
DFT-s-OFDM	Pi/2 BPSK	≤10	≤6	≤3	≤4	≤5
	QPSK	≤10	≤6	≤3	≤4	≤5
	16 QAM	≤10	≤6	≤3	≤4	≤5
	64 QAM	≤10	≤6	≤3	≤4	≤5
	256 QAM	≤10	≤6	≤3	≤4	≤5
CP-OFDM	QPSK	≤11	≤7	≤4.5	≤5.5	≤5
	16 QAM	≤11	≤7	≤4.5	≤5.5	≤5
	64 QAM	≤11	≤7	≤4.5	≤5.5	≤5
	256 QAM	≤11	≤7	≤4.5	≤5.5	≤5

6.2.3.3.28 A-MPR for NS_51

Table 6.2.3.3.28: void

6.2.3.3.29 A-MPR for NS_07

FFS

6.2.3.3.30 A-MPR for NS_56

For 5 MHz channel centred on frequencies (F_c) = 1630.0, 1630.3 MHz, A-MPR is defined as

if RB_{start} ≤ ceil{3/SCS/15 kHz} and L_{CRB} ≤ ceil{17/SCS/15 kHz},

then

the A-MPR = 14 dB for SCS = 15 kHz and AMPR = 8 dB for SCS ≥ 30 kHz,

else,
 if $RB_{\text{start}} \leq \text{ceil}\{3/(SCS/15 \text{ kHz})\}$ and $L_{\text{CRB}} > \text{ceil}\{17/(SCS/15 \text{ kHz})\}$,
 then
 the A-MPR = 6 dB,
 else,
 if $RB_{\text{start}} \leq \text{ceil}\{8/(SCS/15 \text{ kHz})\}$,
 then
 the A-MPR = 4 dB.

For 5 MHz channel centred on frequencies (F_c) = 1635.0, 1649.0, 1654.0 MHz, no A-MPR is needed.

For Channel 10 MHz with centre frequency of 1632.5 MHz, A-MPR is defined as

if $RB_{\text{start}} < \text{ceil}\{3/(SCS/15 \text{ kHz})\}$ and $L_{\text{CRB}} \leq \text{ceil}\{8/(SCS/15 \text{ kHz})\}$,
 then
 the A-MPR = 12 dB for SCS = 15 kHz and AMPR = 8 dB for SCS \geq 30 kHz,
 else,
 if $RB_{\text{start}} < \text{ceil}\{9/(SCS/15 \text{ kHz})\}$, and $L_{\text{CRB}} > \text{ceil}\{8/(SCS/15 \text{ kHz})\}$,
 then
 the A-MPR = 8 dB,
 else,
 if $RB_{\text{start}} \leq \text{ceil}\{18/(SCS/15 \text{ kHz})\}$,
 then
 the A-MPR = 6 dB,
 else,
 if $RB_{\text{start}} \geq \text{floor}\{40/(SCS/15 \text{ kHz})\}$, and $L_{\text{CRB}} \leq \text{ceil}\{7/(SCS/15 \text{ kHz})\}$,
 then
 the A-MPR = 5 dB,
 else,
 if $RB_{\text{start}} \geq \text{floor}\{40/(SCS/15 \text{ kHz})\}$ and $L_{\text{CRB}} > \text{ceil}\{7/(SCS/15 \text{ kHz})\}$,
 then
 the A-MPR = 3 dB,
 else,
 if $RB_{\text{start}} \geq \text{floor}\{35/(SCS/15 \text{ kHz})\}$ and $L_{\text{CRB}} \leq \text{ceil}\{7/(SCS/15 \text{ kHz})\}$,
 then
 the A-MPR = 4 dB,
 else,
 if $RB_{\text{start}} \geq \text{floor}\{35/(SCS/15 \text{ kHz})\}$ and $L_{\text{CRB}} > \text{ceil}\{7/(SCS/15 \text{ kHz})\}$,

then

the A-MPR = 2 dB.

For 10 MHz channel centered on frequency of 1651.5 MHz, no A-MPR is needed.

6.2.3.4 Test description

6.2.3.4.1 Initial conditions

Initial conditions are a set of test configurations the UE needs to be tested in and the steps for the SS to take with the UE to reach the correct measurement state.

The initial test configurations consist of environmental conditions, test frequencies, test channel bandwidths and sub-carrier spacing based on NR operating bands specified in table 5.3.5-1. All of these configurations shall be tested with applicable test parameters for each combination of test channel bandwidth and sub-carrier spacing, and are shown in tables 6.2.3.4.1-1 to 6.2.3.4.1-30. The details of the uplink reference measurement channels (RMCs) are specified in Annex A.2. Configurations of PDSCH and PDCCH before measurement are specified in Annex C.2

Network signalling value NS_10 is not tested. The relaxation specified under NS_10 is for the purpose to control / mitigate self-desensitization of the UE's own receiver, but no corresponding REFSENS requirements are specified. There is no need to test A-MPR requirements for its own.

Table 6.2.3.4.1-1: Test Configuration table for NS_06 and NS_35

Initial Conditions						
Test Environment as specified in TS 38.508-1 [5] subclause 4.1				Normal		
Test Frequencies as specified in TS 38.508-1 [5] subclause 4.3.1				Low range, High range		
Test Channel Bandwidths as specified in TS 38.508-1 [5] subclause 4.3.1				Lowest, Highest		
Test SCS as specified in Table 5.3.5-1				Lowest, Highest		
A-MPR test parameters for NS_35						
Test ID	Freq	ChBw	SCS	Downlink Configuration	Uplink Configuration	
				N/A for A-MPR testing.	Modulation (NOTE 2)	RB allocation (NOTE 1)
1	Low	Default	Default		DFT-s-OFDM PI/2 BPSK	Edge_1RB_Left
2	High				DFT-s-OFDM PI/2 BPSK	Edge_1RB_Right
3	Default				DFT-s-OFDM PI/2 BPSK	Outer Full
4	Low				DFT-s-OFDM QPSK	Edge_1RB_Left
5	High				DFT-s-OFDM QPSK	Edge_1RB_Right
6	Default				DFT-s-OFDM QPSK	Outer Full
7	Low				DFT-s-OFDM 16 QAM	Edge_1RB_Left
8	High				DFT-s-OFDM 16 QAM	Edge_1RB_Right
9	Default				DFT-s-OFDM 16 QAM	Outer Full
10	Low				DFT-s-OFDM 64 QAM	Edge_1RB_Left
11	High				DFT-s-OFDM 64 QAM	Edge_1RB_Right
12	Default				DFT-s-OFDM 64 QAM	Outer Full
13	Low				DFT-s-OFDM 256 QAM	Edge_1RB_Left
14	High				DFT-s-OFDM 256 QAM	Edge_1RB_Right
15	Default				DFT-s-OFDM 256 QAM	Outer Full
16	Low				CP-OFDM QPSK	Edge_1RB_Left
17	High				CP-OFDM QPSK	Edge_1RB_Right
18	Default				CP-OFDM QPSK	Outer Full
19	Low				CP-OFDM 16 QAM	Edge_1RB_Left
20	High				CP-OFDM 16 QAM	Edge_1RB_Right
21	Default				CP-OFDM 16 QAM	Outer Full
22	Low				CP-OFDM 64 QAM	Edge_1RB_Left
23	High				CP-OFDM 64 QAM	Edge_1RB_Right
24	Default				CP-OFDM 64 QAM	Outer Full
25	Low				CP-OFDM 256 QAM	Edge_1RB_Left
26	High				CP-OFDM 256 QAM	Edge_1RB_Right
27	Default				CP-OFDM 256 QAM	Outer Full

NOTE 1: The specific configuration of each RB allocation is defined in Table 6.1-1.
 NOTE 2: DFT-s-OFDM PI/2 BPSK test applies only for UEs which supports half Pi BPSK in FR1.
 NOTE 3: Void
 NOTE 4: This configuration is only applicable for NS_06 power class 1 UE.

Table 6.2.3.4.1-2: Test Configuration table for NS_04

Initial Conditions				
Test Environment as specified in TS 38.508-1 [5] subclause 4.1			Normal	
Test Frequencies as specified in TS 38.508-1 [5] subclause 4.3.1			(See Freq column)	
Test Channel Bandwidths as specified in TS 38.508-1 [5] subclause 4.3.1			Lowest, Highest	
Test SCS as specified in Table 5.3.5-1			Lowest, Highest	
A-MPR test parameters for NS_04				
Test ID	Freq	Downlink Configuration	Uplink Configuration	
			Modulation (NOTE 2)	RB allocation (NOTE 1)
1 (Note 3)	Low	N/A for A-MPR testing	DFT-s-OFDM PI/2 BPSK	Edge_1RB_Left
2 (Note 3, 5)	Table 6.2.3.4.1-2a - Table 6.2.3.4.1-2c		DFT-s-OFDM PI/2 BPSK	Edge_1RB_Left
3 (Note 3)	Table 6.2.3.4.1-2d - Table 6.2.3.4.1-2f		DFT-s-OFDM PI/2 BPSK	Edge_1RB_Left
4 (Note 3)	Low		DFT-s-OFDM PI/2 BPSK	Outer Full
5 (Note 3)	High		DFT-s-OFDM PI/2 BPSK	Edge_1RB_Right
6 (Note 3)	High		DFT-s-OFDM PI/2 BPSK	Outer Full
7 (Note 4)	Low		DFT-s-OFDM PI/2 BPSK	Edge_1RB_Left
8 (Note 4, 5)	Table 6.2.3.4.1-2a - Table 6.2.3.4.1-2c		DFT-s-OFDM PI/2 BPSK	Edge_1RB_Left
9 (Note 4)	Table 6.2.3.4.1-2d - Table 6.2.3.4.1-2f		DFT-s-OFDM PI/2 BPSK	Edge_1RB_Left
10 (Note 4)	Low		DFT-s-OFDM PI/2 BPSK	Outer Full
11 (Note 4)	High		DFT-s-OFDM PI/2 BPSK	Edge_1RB_Right
12 (Note 4)	High		DFT-s-OFDM PI/2 BPSK	Outer Full
13	Low		DFT-s-OFDM QPSK	Edge_1RB_Left
14 (Note 5)	Table 6.2.3.4.1-2a - Table 6.2.3.4.1-2c		DFT-s-OFDM QPSK	Edge_1RB_Left
15	Table 6.2.3.4.1-2d - Table 6.2.3.4.1-2f		DFT-s-OFDM QPSK	Edge_1RB_Left
16	Low		DFT-s-OFDM QPSK	Outer Full
17	High		DFT-s-OFDM QPSK	Edge_1RB_Right
18	High		DFT-s-OFDM QPSK	Outer Full
19	Low		DFT-s-OFDM 16 QAM	Edge_1RB_Left
20 (Note 5)	Table 6.2.3.4.1-2a - Table 6.2.3.4.1-2c		DFT-s-OFDM 16 QAM	Edge_1RB_Left
21	Table 6.2.3.4.1-2d - Table 6.2.3.4.1-2f		DFT-s-OFDM 16 QAM	Edge_1RB_Left
22	Low		DFT-s-OFDM 16 QAM	Outer Full
23	High		DFT-s-OFDM 16 QAM	Edge_1RB_Right
24	High		DFT-s-OFDM 16 QAM	Outer Full
25	Low		DFT-s-OFDM 64 QAM	Edge_1RB_Left
26 (Note 5)	Table 6.2.3.4.1-2a - Table 6.2.3.4.1-2c		DFT-s-OFDM 64 QAM	Edge_1RB_Left
27	Table 6.2.3.4.1-2d - Table 6.2.3.4.1-2f		DFT-s-OFDM 64 QAM	Edge_1RB_Left
28	Low		DFT-s-OFDM 64 QAM	Outer Full
29	High		DFT-s-OFDM 64 QAM	Edge_1RB_Right
30	High		DFT-s-OFDM 64 QAM	Outer Full
31	Low		DFT-s-OFDM 256 QAM	Edge_1RB_Left
32 (Note 5)	Table 6.2.3.4.1-2a - Table 6.2.3.4.1-2c		DFT-s-OFDM 256 QAM	Edge_1RB_Left
33	Table 6.2.3.4.1-2d - Table 6.2.3.4.1-2f		DFT-s-OFDM 256 QAM	Edge_1RB_Left
34	Low		DFT-s-OFDM 256 QAM	Outer Full
35	High		DFT-s-OFDM 256 QAM	Edge_1RB_Right
36	High		DFT-s-OFDM 256 QAM	Outer Full
37	Low		CP-OFDM QPSK	Edge_1RB_Left
38 (Note 5)	Table 6.2.3.4.1-2a - Table 6.2.3.4.1-2c		CP-OFDM QPSK	Edge_1RB_Left
39	Table 6.2.3.4.1-2d - Table 6.2.3.4.1-2f		CP-OFDM QPSK	Edge_1RB_Left
40	Low		CP-OFDM QPSK	Outer Full
41	High		CP-OFDM QPSK	Edge_1RB_Right
42	High		CP-OFDM QPSK	Outer Full
43	Low		CP-OFDM 16 QAM	Edge_1RB_Left
44 (Note 5)	Table 6.2.3.4.1-2a - Table 6.2.3.4.1-2c		CP-OFDM 16 QAM	Edge_1RB_Left
45	Table 6.2.3.4.1-2d - Table 6.2.3.4.1-2f		CP-OFDM 16 QAM	Edge_1RB_Left
46	Low		CP-OFDM 16 QAM	Outer Full
47	High		CP-OFDM 16 QAM	Edge_1RB_Right
48	High		CP-OFDM 16 QAM	Outer Full
49	Low		CP-OFDM 64 QAM	Edge_1RB_Left

A-MPR test parameters for NS_04				
Test ID	Freq	Downlink Configuration	Uplink Configuration	
			Modulation (NOTE 2)	RB allocation (NOTE 1)
50 (Note 5)	Table 6.2.3.4.1-2a - Table 6.2.3.4.1-2c	N/A for A-MPR testing	CP-OFDM 64 QAM	Edge_1RB_Left
51	Table 6.2.3.4.1-2d - Table 6.2.3.4.1-2f		CP-OFDM 64 QAM	Edge_1RB_Left
52	Low		CP-OFDM 64 QAM	Outer Full
53	High		CP-OFDM 64 QAM	Edge_1RB_Right
54	High		CP-OFDM 64 QAM	Outer Full
55	Low		CP-OFDM 256 QAM	Edge_1RB_Left
56 (Note 5)	Table 6.2.3.4.1-2a - Table 6.2.3.4.1-2c		CP-OFDM 256 QAM	Edge_1RB_Left
57	Table 6.2.3.4.1-2d - Table 6.2.3.4.1-2f		CP-OFDM 256 QAM	Edge_1RB_Left
58	Low		CP-OFDM 256 QAM	Outer Full
59	High		CP-OFDM 256 QAM	Edge_1RB_Right
60	High		CP-OFDM 256 QAM	Outer Full

NOTE 1: The specific configuration of each RB allocation is defined in Table 6.1-1.

NOTE 2: DFT-s-OFDM PI/2 BPSK test applies only for UEs which supports half Pi BPSK in FR1.

NOTE 3: UE operating in TDD mode with Pi/2 BPSK modulation and UE indicates support for UE capability *powerBoosting-pi2BPSK* and the IE *powerBoostPi2BPSK* is set to 1 for band n41.

NOTE 4: UE operating in FDD mode, or in TDD mode in bands other than n41, or in TDD mode the IE *powerBoostPi2BPSK* is set to 0 for bands n41.

NOTE 5: Only applicable for 10 MHz and 15 MHz channel bandwidth

Table 6.2.3.4.1-2a: Additional test frequencies for NS_04 (SCS=15 kHz, $\Delta F_{\text{Raster}} = 15$ kHz)

CBW [MHz]	carrier Bandwidth [PRBs]	Range	Carrier centre [MHz]	Carrier centre [ARFCN]	point A [MHz]	absolute FrequencyPoint A [ARFCN]	offsetTo Carrier [Carrier PRBs]	SS block SCS [kHz]	GSCN	absolute FrequencySSB [ARFCN]	k_{SSB}	Offset Carrier CORE SET#0 [RBs] Note 2	CORE SET#0 Index (Offset [RBs]) Note 1	offsetTo PointA (SIB1) [PRBs] Note 1
10	52		2505	501000	2500.32	500064	0	15	6255	500430	2	0	0 (0)	0
15	79		2512.5	502500	2505.39	501078	0	15	6270	501630	4	1	2 (4)	5

ZZ

Table 6.2.3.4.1-2b: Additional test frequencies for NS_04 (SCS=30 kHz, $\Delta F_{\text{Raster}} = 30$ kHz)

CBW [MHz]	carrier Bandwidth [PRBs]	Range	Carrier centre [MHz]	Carrier centre [ARFCN]	point A [MHz]	absolute FrequencyPoint A [ARFCN]	offsetTo Carrier [Carrier PRBs]	SS block SCS [kHz]	GSCN	absolute FrequencySSB [ARFCN]	k_{SSB}	Offset Carrier CORE SET#0 [RBs] Note 2	CORE SET#0 Index (Offset [RBs]) Note 1	offsetTo PointA (SIB1) [PRBs] Note 1
10	24		2505	501000	2500.68	500136	0	30	6261	500910	18	0	0 (0)	0
15	38		2512.5	502500	2505.66	501132	0	30	6273	501870	6	0	0 (0)	0

Table 6.2.3.4.1-2c: Additional test frequencies for NS_04 (SCS=60 kHz, $\Delta F_{\text{Raster}} = 15$ kHz, without CORESET#0)

CBW [MHz]	carrier Bandwidth [PRBs]	Range	Carrier centre [MHz]	Carrier centre [ARFCN]	point A [MHz]	absolute FrequencyPoint A [ARFCN]	offsetTo Carrier [Carrier PRBs]	SS block SCS [kHz]	GSCN	absolute FrequencySSB [ARFCN]
10	11		2505	501000	2501.04	500208	0	15	-	500568
15	18		2512.5	502500	2506.02	501204	0	15	-	501564

Table 6.2.3.4.1-2d: Additional test frequencies for NS_04 (SCS=15 kHz, $\Delta F_{\text{Raster}} = 15$ kHz)

CBW [MHz]	carrier Bandwidth [PRBs]	Range	Carrier centre [MHz]	Carrier centre [ARFCN]	point A [MHz]	absolute FrequencyPoint A [ARFCN]	offsetTo Carrier [Carrier PRBs]	SS block SCS [kHz]	GSCN	absolute FrequencySSB [ARFCN]	k_{SSB}	Offset Carrier CORE SET#0 [RBs] Note 2	CORE SET#0 Index (Offset [RBs]) Note 1	offsetTo PointA (SIB1) [PRBs] Note 1
10	52		2511	502200	2506.32	501264	0	15	6270	501630	2	0	0 (0)	0
15	79		2513.505	502701	2506.395	501279	0	15	6273	501870	5	2	2 (4)	6
20	106		2520	504000	2510.46	502092	0	15	6282	502590	10	1	1 (2)	3
30	160		2535	507000	2520.6	504120	0	15	6306	504510	10	0	0 (0)	0
40	216		2550	510000	2530.56	506112	0	15	6333	506670	6	1	2 (4)	5
50	270		2565	513000	2540.7	508140	0	15	6357	508590	6	0	1 (2)	2

Table 6.2.3.4.1-2e: Additional test frequencies for NS_04 (SCS=30 kHz, $\Delta F_{\text{Raster}} = 30$ kHz)

CBW [MHz]	carrier Bandwidth [PRBs]	Range	Carrier centre [MHz]	Carrier centre [ARFCN]	point A [MHz]	absolute FrequencyPoint A [ARFCN]	offsetTo Carrier [Carrier PRBs]	SS block SCS [kHz]	GSCN	absolute FrequencySSB [ARFCN]	k_{SSB}	Offset Carrier CORE SET#0 [RBs] Note 2	CORE SET#0 Index (Offset [RBs]) Note 1	offsetTo PointA (SIB1) [PRBs] Note 1
10	24		2511	502200	2506.68	501336	0	30	6276	502110	18	0	0 (0)	0
15	38		2513.52	502704	2506.68	501336	0	30	6276	502110	18	0	0 (0)	0
20	51		2520	504000	2510.82	502164	0	30	6288	503070	14	0	2 (2)	4
30	78		2535	507000	2520.96	504192	0	30	6312	504990	2	0	1 (1)	2
40	106		2550	510000	2530.92	506184	0	30	6336	506910	2	0	0 (0)	0
50	133		2565	513000	2541.06	508212	0	30	6363	509070	22	0	1 (1)	2
60	162		2580	516000	2550.84	510168	0	30	6387	510990	10	0	1 (1)	2
70	189		2595	519000	2560.98	512196	0	30	6414	513150	6	0	3 (3)	6
80	217		2610	522000	2570.94	514188	0	30	6438	515070	6	0	2 (2)	4
90	245		2625	525000	2580.9	516180	0	30	6462	516990	6	0	1 (1)	2
100	273		2640	528000	2590.86	518172	0	30	6486	518910	6	0	0 (0)	0

Table 6.2.3.4.1-2f: Additional test frequencies for NS_04 (SCS=60 kHz, $\Delta F_{\text{Raster}} = 15$ kHz, without CORESET#0)

CBW [MHz]	carrier Bandwidth [PRBs]	Range	Carrier centre [MHz]	Carrier centre [ARFCN]	point A [MHz]	absolute FrequencyPoint A [ARFCN]	offsetTo Carrier [Carrier PRBs]	SS block SCS [kHz]	GSCN	absolute FrequencySSB [ARFCN]
10	11		2511	502200	2507.04	501408	0	15	-	501768
15	18		2513.52	502704	2507.04	501408	0	15	-	501768
20	24		2520	504000	2511.36	502272	0	15	-	502632
30	38		2535	507000	2521.32	504264	0	15	-	504624
40	51		2550	510000	2531.64	506328	0	15	-	506688
50	65		2550	510000	2526.6	505320	0	15	-	505680
60	79		2580	516000	2551.56	510312	0	15	-	510672
70	93		2595	519000	2561.52	512304	0	15	-	512664
80	107		2610	522000	2571.48	514296	0	15	-	514656
90	121		2625	525000	2581.44	516288	0	15	-	516648
100	135		2640	528000	2591.4	518280	0	15	-	518640

Table 6.2.3.4.1-3: Test Configuration table for NS_03, NS_03U and NS_100

Initial Conditions							
Test Environment as specified in TS 38.508-1 [5] subclause 4.1						Normal	
Test Frequencies as specified in TS 38.508-1 [5] subclause 4.3.1						Low range, High range	
Test Channel Bandwidths as specified in TS 38.508-1 [5] subclause 4.3.1						Lowest, Highest	
Test SCS as specified in Table 5.3.5-1						Lowest, Highest	
A-MPR test parameters for NS_03, NS_03U and NS_100							
Test ID	Freq	ChBw	SCS	Downlink Configuration	Uplink Configuration		
					Modulation (Note 2)	RB allocation (Note 1)	
1	Low	Default	Default	N/A for A-MPR test cases	DFT-s OFDM	Edge_1RB_Left	
2	High	Default	Default			PI/2 BPSK	Edge_1RB_Right
3	Default	Default	Default			PI/2 BPSK	Outer_Full
4	Low	Default	Default			QPSK	Edge_1RB_Left
5	High	Default	Default			QPSK	Edge_1RB_Right
6	Default	Default	Default			QPSK	Outer_Full
7	Low	Default	Default			16 QAM	Edge_1RB_Left
8	High	Default	Default			16 QAM	Edge_1RB_Right
9	Default	Default	Default			16 QAM	Outer_Full
10	Low	Default	Default			64 QAM	Edge_1RB_Left
11	High	Default	Default			64 QAM	Edge_1RB_Right
12	Default	Default	Default			64 QAM	Outer_Full
13	Low	Default	Default			256 QAM	Edge_1RB_Left
14	High	Default	Default			256 QAM	Edge_1RB_Right
15	Default	Default	Default			256 QAM	Outer_Full
16	Low	Default	Default		CP-s OFDM	QPSK	Edge_1RB_Left
17	High	Default	Default			QPSK	Edge_1RB_Right
18	Default	Default	Default			QPSK	Outer_Full
19	Low	Default	Default			16 QAM	Edge_1RB_Left
20	High	Default	Default			16 QAM	Edge_1RB_Right
21	Default	Default	Default			16 QAM	Outer_Full
22	Low	Default	Default			64 QAM	Edge_1RB_Left
23	High	Default	Default			64 QAM	Edge_1RB_Right
24	Default	Default	Default			64 QAM	Outer_Full
25	Low	Default	Default			256 QAM	Edge_1RB_Left
26	High	Default	Default			256 QAM	Edge_1RB_Right
27	Default	Default	Default			256 QAM	Outer_Full

NOTE 1: The specific configuration of each RB allocation is defined in Table 6.1-1 unless otherwise stated in this table.
 NOTE 2: DFT-s-OFDM PI/2 BPSK test applies only for UEs which supports half Pi BPSK in FR1.
 NOTE 3: Void.
 NOTE 4: Void

Table 6.2.3.4.1-4: Test Configuration table for NS_05

Initial Conditions									
Test Environment as specified in TS 38.508-1 [5] subclause 4.1				Normal					
Test Frequencies as specified in TS 38.508-1 [5] subclause 4.3.1				Use uplink carrier centre frequency (Fc) as specified in test parameters					
Test Channel Bandwidths as specified in TS 38.508-1 [5] subclause 4.3.1				5 MHz, 10 MHz, 15 MHz, 20 MHz					
Test SCS as specified in Table 5.3.5-1				Lowest, Highest unless otherwise specified in test parameters.					
A-MPR test parameters for NS_05									
Test ID	Fc (MHz)	ChBw (MHz)	SCS (kHz)	Downlink Config.	A-MPR	Uplink Configuration			
						Modulation (NOTE 2)	RB allocation (Note 1)		
							SCS 15 kHz	SCS 30 kHz	SCS 60 kHz
1	1922.5	5	15	N/A for A-MPR testing	A3	PI/2 BPSK	Outer_Full		
2	1925	10	Default		A1	PI/2 BPSK	Outer_Full		
3	1925	10	Default		A7	PI/2 BPSK	40@10	18@5	8@3
4	1925	10	Default		A2	PI/2 BPSK	6@40	3@20	1@10
5	1935	10	Default		A4	PI/2 BPSK	Outer_Full		
6	1927.5	15	Default		A1	PI/2 BPSK	Outer_Full		
7	1927.5	15	Default		A7	PI/2 BPSK	60@19	27@10	12@5
8	1927.5	15	Default		A2	PI/2 BPSK	6@56	3@28	1@14
9	1932.5	15	Default		A1	PI/2 BPSK	Outer_Full		
10	1932.5	15	Default		A2	PI/2 BPSK	6@68	3@34	1@17
11	1942.5	15	Default		A5	PI/2 BPSK	Outer_Full		
12	1930	20	Default		A1	PI/2 BPSK	Outer_Full		
13	1930	20	Default		A7	PI/2 BPSK	72@28	36@14	16@7
14	1930	20	Default		A2	PI/2 BPSK	6@76	3@38	1@19
15	1950	20	Default		A6	PI/2 BPSK	Outer_Full		
16	1922.5	5	15		A3	QPSK	Outer_Full		
17	1925	10	Default		A1	QPSK	Outer_Full		
18	1925	10	Default		A7	QPSK	40@10	18@5	8@3
19	1925	10	Default		A2	QPSK	6@40	3@20	1@10
20	1927.5	15	Default		A1	QPSK	Outer_Full		
21	1927.5	15	Default		A7	QPSK	60@19	27@10	12@5
22	1927.5	15	Default		A2	QPSK	6@56	3@28	1@14
23	1932.5	15	Default		A1	QPSK	Outer_Full		
24	1932.5	15	Default		A2	QPSK	6@68	3@34	1@17
25	1942.5	15	Default		A5	QPSK	Outer_Full		
26	1930	20	Default		A1	QPSK	Outer_Full		
27	1930	20	Default		A7	QPSK	72@28	36@14	16@7
28	1930	20	Default		A2	QPSK	6@76	3@38	1@19
29	1950	20	Default		A6	QPSK	Outer_Full		
30	1922.5	5	15		A3	16 QAM	Outer_Full		
31	1925	10	Default		A1	16 QAM	Outer_Full		
32	1925	10	Default		A7	16 QAM	40@10	18@5	8@3
33	1925	10	Default		A2	16 QAM	6@40	3@20	1@10
34	1927.5	15	Default		A1	16 QAM	Outer_Full		
35	1927.5	15	Default		A7	16 QAM	60@19	27@10	12@5
36	1927.5	15	Default		A2	16 QAM	6@56	3@28	1@14
37	1932.5	15	Default		A1	16 QAM	Outer_Full		
38	1932.5	15	Default		A2	16 QAM	6@68	3@34	1@17
39	1930	20	Default		A1	16 QAM	Outer_Full		
40	1930	20	Default		A7	16 QAM	72@28	36@14	16@7
41	1930	20	Default		A2	16 QAM	6@76	3@38	1@19
42	1922.5	5	15		A3	64 QAM	Outer_Full		
43	1925	10	Default		A1	64 QAM	Outer_Full		
44	1925	10	Default		A7	64 QAM	40@10	18@5	8@3
45	1925	10	Default		A2	64 QAM	6@40	3@20	1@10
46	1927.5	15	Default		A1	64 QAM	Outer_Full		
47	1927.5	15	Default		A7	64 QAM	60@19	27@10	12@5
48	1927.5	15	Default		A2	64 QAM	6@56	3@28	1@14
49	1932.5	15	Default		A1	64 QAM	Outer_Full		
50	1932.5	15	Default		A2	64 QAM	6@68	3@34	1@17

A-MPR test parameters for NS_05									
Test ID	Fc (MHz)	ChBw (MHz)	SCS (kHz)	Downlink Config.	A-MPR	Uplink Configuration			
						Modulation (NOTE 2)	RB allocation (Note 1)		
							SCS 15 kHz	SCS 30 kHz	SCS 60 kHz
51	1930	20	Default		A1	64 QAM	Outer_Full		
52	1930	20	Default		A7	64 QAM	72@28	36@14	16@7
53	1930	20	Default		A2	64 QAM	6@76	3@38	1@19
54	1922.5	5	15		A3	256 QAM	Outer_Full		
55	1925	10	Default		A1	256 QAM	Outer_Full		
56	1925	10	Default		A7	256 QAM	40@10	18@5	8@3
57	1925	10	Default		A2	256 QAM	6@40	3@20	1@10
58	1927.5	15	Default		A1	256 QAM	Outer_Full		
59	1927.5	15	Default		A7	256 QAM	60@19	27@10	12@5
60	1927.5	15	Default		A2	256 QAM	6@56	3@28	1@14
61	1932.5	15	Default		A1	256 QAM	Outer_Full		
62	1932.5	15	Default		A2	256 QAM	6@68	3@34	1@17
63	1930	20	Default		A1	256 QAM	Outer_Full		
64	1930	20	Default		A7	256 QAM	72@28	36@14	16@7
65	1930	20	Default		A2	256 QAM	6@76	3@38	1@19
66	1922.5	5	15		A3	QPSK	Outer_Full		
67	1925	10	Default		A1	QPSK	Outer_Full		
68	1925	10	Default		A7	QPSK	42@10	18@5	8@3
69	1925	10	Default		A2	QPSK	6@40	3@20	1@10
70	1935	10	Default		A4	QPSK	Outer_Full		
71	1927.5	15	Default		A1	QPSK	Outer_Full		
72	1927.5	15	Default		A7	QPSK	60@19	28@10	12@5
73	1927.5	15	Default		A2	QPSK	6@56	3@28	1@14
74	1932.5	15	Default		A1	QPSK	Outer_Full		
75	1932.5	15	Default		A2	QPSK	6@68	3@34	1@17
76	1942.5	15	Default		A5	QPSK	Outer_Full		
77	1930	20	Default		A1	QPSK	Outer_Full		
78	1930	20	Default		A7	QPSK	78@28	37@14	17@7
79	1930	20	Default		A2	QPSK	6@76	3@38	1@19
80	1950	20	Default		A6	QPSK	Outer_Full		
81	1922.5	5	15		A3	16 QAM	Outer_Full		
82	1925	10	Default		A1	16 QAM	Outer_Full		
83	1925	10	Default		A7	16 QAM	42@10	18@5	8@3
84	1925	10	Default		A2	16 QAM	6@40	3@20	1@10
85	1935	10	Default		A4	16 QAM	Outer_Full		
86	1927.5	15	Default		A1	16 QAM	Outer_Full		
87	1927.5	15	Default		A7	16 QAM	60@19	28@10	12@5
88	1927.5	15	Default		A2	16 QAM	6@56	3@28	1@14
89	1932.5	15	Default		A1	16 QAM	Outer_Full		
90	1932.5	15	Default		A2	16 QAM	6@68	3@34	1@17
91	1942.5	15	Default		A5	16 QAM	Outer_Full		
92	1930	20	Default		A1	16 QAM	Outer_Full		
93	1930	20	Default		A7	16 QAM	78@28	37@14	17@7
94	1930	20	Default		A2	16 QAM	6@76	3@38	1@19
95	1950	20	Default		A6	16 QAM	Outer_Full		
96	1922.5	5	15		A3	64 QAM	Outer_Full		
97	1925	10	Default		A1	64 QAM	Outer_Full		
98	1925	10	Default		A7	64 QAM	42@10	18@5	8@3
99	1925	10	Default		A2	64 QAM	6@40	3@20	1@10
100	1927.5	15	Default		A1	64 QAM	Outer_Full		
101	1927.5	15	Default		A7	64 QAM	60@19	28@10	12@5
102	1927.5	15	Default		A2	64 QAM	6@56	3@28	1@14
103	1932.5	15	Default		A1	64 QAM	Outer_Full		
104	1932.5	15	Default		A2	64 QAM	6@68	3@34	1@17
105	1930	20	Default		A1	64 QAM	Outer_Full		
106	1930	20	Default		A7	64 QAM	78@28	37@14	17@7
107	1930	20	Default		A2	64 QAM	6@76	3@38	1@19

A-MPR test parameters for NS_05									
Test ID	Fc (MHz)	ChBw (MHz)	SCS (kHz)	Downlink Config.	A-MPR	Uplink Configuration			
						Modulation (NOTE 2)	RB allocation (Note 1)		
							SCS 15 kHz	SCS 30 kHz	SCS 60 kHz
108	1922.5	5	15		A3	256 QAM	Outer_Full		
109	1925	10	Default		A1	256 QAM	Outer_Full		
110	1925	10	Default		A7	256 QAM	42@10	18@5	8@3
111	1927.5	15	Default		A1	256 QAM	Outer_Full		
112	1927.5	15	Default		A7	256 QAM	60@19	28@10	12@5
113	1932.5	15	Default		A1	256 QAM	Outer_Full		
114	1930	20	Default		A1	256 QAM	Outer_Full		
115	1930	20	Default		A7	256 QAM	78@28	37@14	17@7

NOTE 1: The specific configuration of each RB allocation is defined in Table 6.1-1 unless otherwise stated in this table.
NOTE 2: DFT-s-OFDM PI/2 BPSK test applies only for UEs which supports half Pi BPSK in FR1.

Table 6.2.3.4.1-5: Test Configuration table for NS_05U

Initial Conditions									
Test Environment as specified in TS 38.508-1 [5] subclause 4.1				Normal					
Test Frequencies as specified in TS 38.508-1 [5] subclause 4.3.1				Use uplink carrier centre frequency (Fc) as specified in test parameters					
Test Channel Bandwidths as specified in TS 38.508-1 [5] subclause 4.3.1				5 MHz, 10 MHz, 15 MHz, 20 MHz					
Test SCS as specified in Table 5.3.5-1				Lowest, Highest unless otherwise specified in test parameters.					
A-MPR test parameters for NS_05U									
Test ID	Fc (MHz)	ChBw (MHz)	SCS (kHz)	Downlink Config.	A-MPR	Uplink Configuration			
						Modulation (NOTE 2)	RB allocation (Note 1)		
							SCS 15 kHz	SCS 30 kHz	SCS 60 kHz
1	1922.5	5	15	N/A for A-MPR testing.	A3	PI/2 BPSK	Outer_Full		
2	1925	10	Default		A1	PI/2 BPSK	Outer_Full		
3	1925	10	Default		A7	PI/2 BPSK	40@10	18@5	8@3
4	1925	10	Default		A2	PI/2 BPSK	6@40	3@20	1@10
5	1935	10	Default		A4	PI/2 BPSK	Outer_Full		
6	1927.5	15	Default		A1	PI/2 BPSK	Outer_Full		
7	1927.5	15	Default		A7	PI/2 BPSK	60@19	27@10	12@5
8	1927.5	15	Default		A2	PI/2 BPSK	6@56	3@28	1@14
9	1932.5	15	Default		A1	PI/2 BPSK	Outer_Full		
10	1932.5	15	Default		A2	PI/2 BPSK	6@68	3@34	1@17
11	1942.5	15	Default		A5	PI/2 BPSK	Outer_Full		
12	1930	20	Default		A1	PI/2 BPSK	Outer_Full		
13	1930	20	Default		A7	PI/2 BPSK	72@28	36@14	16@7
14	1930	20	Default		A2	PI/2 BPSK	6@76	3@38	1@19
15	1950	20	Default		A6	PI/2 BPSK	Outer_Full		
16	1922.5	5	15		A3	QPSK	Outer_Full		
17	1925	10	Default		A1	QPSK	Outer_Full		
18	1925	10	Default		A7	QPSK	40@10	18@5	8@3
19	1925	10	Default		A2	QPSK	6@40	3@20	1@10
20	1935	10	Default		A4	QPSK	Outer_Full		
21	1927.5	15	Default		A1	QPSK	Outer_Full		
22	1927.5	15	Default		A7	QPSK	60@19	27@10	12@5
23	1927.5	15	Default		A2	QPSK	6@56	3@28	1@14
24	1932.5	15	Default		A1	QPSK	Outer_Full		
25	1932.5	15	Default		A2	QPSK	6@68	3@34	1@17
26	1942.5	15	Default		A5	QPSK	Outer_Full		
27	1930	20	Default		A1	QPSK	Outer_Full		
28	1930	20	Default		A7	QPSK	72@28	36@14	16@7
29	1930	20	Default		A2	QPSK	6@76	3@38	1@19
30	1950	20	Default		A6	QPSK	Outer_Full		
31	1922.5	5	15		A3	16 QAM	Outer_Full		
32	1925	10	Default		A1	16 QAM	Outer_Full		
33	1925	10	Default		A7	16 QAM	40@10	18@5	8@3
34	1925	10	Default		A2	16 QAM	6@40	3@20	1@10
35	1935	10	Default		A4	16 QAM	Outer_Full		
36	1927.5	15	Default		A1	16 QAM	Outer_Full		
37	1927.5	15	Default		A7	16 QAM	60@19	27@10	12@5
38	1927.5	15	Default		A2	16 QAM	6@56	3@28	1@14
39	1932.5	15	Default		A1	16 QAM	Outer_Full		
40	1932.5	15	Default		A2	16 QAM	6@68	3@34	1@17
41	1942.5	15	Default		A5	16 QAM	Outer_Full		
42	1930	20	Default		A1	16 QAM	Outer_Full		
43	1930	20	Default		A7	16 QAM	72@28	36@14	16@7
44	1930	20	Default		A2	16 QAM	6@76	3@38	1@19
45	1950	20	Default		A6	16 QAM	Outer_Full		
46	1922.5	5	15		A3	64 QAM	Outer_Full		
47	1925	10	Default		A1	64 QAM	Outer_Full		
48	1925	10	Default		A7	64 QAM	40@10	18@5	8@3
49	1925	10	Default		A2	64 QAM	6@40	3@20	1@10
50	1935	10	Default		A4	64 QAM	Outer_Full		

A-MPR test parameters for NS_05U									
Test ID	Fc (MHz)	ChBw (MHz)	SCS (kHz)	Downlink Config.	A-MPR	Uplink Configuration			
						Modulation (NOTE 2)	RB allocation (Note 1)		
							SCS 15 kHz	SCS 30 kHz	SCS 60 kHz
51	1927.5	15	Default		A1	64 QAM	Outer_Full		
52	1927.5	15	Default		A7	64 QAM	60@19	27@10	12@5
53	1927.5	15	Default		A2	64 QAM	6@56	3@28	1@14
54	1932.5	15	Default		A1	64 QAM	Outer_Full		
55	1932.5	15	Default		A2	64 QAM	6@68	3@34	1@17
56	1942.5	15	Default		A5	64 QAM	Outer_Full		
57	1930	20	Default		A1	64 QAM	Outer_Full		
58	1930	20	Default		A7	64 QAM	72@28	36@14	16@7
59	1930	20	Default		A2	64 QAM	6@76	3@38	1@19
60	1950	20	Default		A6	64 QAM	Outer_Full		
61	1922.5	5	15		A3	256 QAM	Outer_Full		
62	1925	10	Default		A1	256 QAM	Outer_Full		
63	1925	10	Default		A7	256 QAM	40@10	18@5	8@3
64	1925	10	Default		A2	256 QAM	6@40	3@20	1@10
65	1935	10	Default		A4	256 QAM	Outer_Full		
66	1927.5	15	Default		A1	256 QAM	Outer_Full		
67	1927.5	15	Default		A7	256 QAM	60@19	27@10	12@5
68	1927.5	15	Default		A2	256 QAM	6@56	3@28	1@14
69	1932.5	15	Default		A1	256 QAM	Outer_Full		
70	1932.5	15	Default		A2	256 QAM	6@68	3@34	1@17
71	1942.5	15	Default		A5	256 QAM	Outer_Full		
72	1930	20	Default		A1	256 QAM	Outer_Full		
73	1930	20	Default		A7	256 QAM	72@28	36@14	16@7
74	1930	20	Default		A2	256 QAM	6@76	3@38	1@19
75	1950	20	Default		A6	256 QAM	Outer_Full		
76	1922.5	5	15		A3	QPSK	Outer_Full		
77	1925	10	Default		A1	QPSK	Outer_Full		
78	1925	10	Default		A7	QPSK	42@10	18@5	8@3
79	1925	10	Default		A2	QPSK	6@40	3@20	1@10
80	1935	10	Default		A4	QPSK	Outer_Full		
81	1927.5	15	Default		A1	QPSK	Outer_Full		
82	1927.5	15	Default		A7	QPSK	60@19	28@10	12@5
83	1927.5	15	Default		A2	QPSK	6@56	3@28	1@14
84	1932.5	15	Default		A1	QPSK	Outer_Full		
85	1932.5	15	Default		A2	QPSK	6@68	3@34	1@17
86	1942.5	15	Default		A5	QPSK	Outer_Full		
87	1930	20	Default		A1	QPSK	Outer_Full		
88	1930	20	Default		A7	QPSK	78@28	37@14	17@7
89	1930	20	Default		A2	QPSK	6@76	3@38	1@19
90	1950	20	Default		A6	QPSK	Outer_Full		
91	1922.5	5	15		A3	16 QAM	Outer_Full		
92	1925	10	Default		A1	16 QAM	Outer_Full		
93	1925	10	Default		A7	16 QAM	42@10	18@5	8@3
94	1925	10	Default		A2	16 QAM	6@40	3@20	1@10
95	1935	10	Default		A4	16 QAM	Outer_Full		
96	1927.5	15	Default		A1	16 QAM	Outer_Full		
97	1927.5	15	Default		A7	16 QAM	60@19	28@10	12@5
98	1927.5	15	Default		A2	16 QAM	6@56	3@28	1@14
99	1932.5	15	Default		A1	16 QAM	Outer_Full		
100	1932.5	15	Default		A2	16 QAM	6@68	3@34	1@17
101	1942.5	15	Default		A5	16 QAM	Outer_Full		
102	1930	20	Default		A1	16 QAM	Outer_Full		
103	1930	20	Default		A7	16 QAM	78@28	37@14	17@7
104	1930	20	Default		A2	16 QAM	6@76	3@38	1@19
105	1950	20	Default		A6	16 QAM	Outer_Full		
106	1922.5	5	15		A3	64 QAM	Outer_Full		
107	1925	10	Default		A1	64 QAM	Outer_Full		
108	1925	10	Default		A7	64 QAM	42@10	18@5	8@3

A-MPR test parameters for NS_05U									
Test ID	Fc (MHz)	ChBw (MHz)	SCS (kHz)	Downlink Config.	A-MPR	Uplink Configuration			
						Modulation (NOTE 2)	RB allocation (Note 1)		
							SCS 15 kHz	SCS 30 kHz	SCS 60 kHz
109	1925	10	Default		A2	64 QAM	6@40	3@20	1@10
110	1935	10	Default		A4	64 QAM	Outer_Full		
111	1927.5	15	Default		A1	64 QAM	Outer_Full		
112	1927.5	15	Default		A7	64 QAM	60@19	28@10	12@5
113	1927.5	15	Default		A2	64 QAM	6@56	3@28	1@14
114	1932.5	15	Default		A1	64 QAM	Outer_Full		
115	1932.5	15	Default		A2	64 QAM	6@68	3@34	1@17
116	1942.5	15	Default		A5	64 QAM	Outer_Full		
117	1930	20	Default		A1	64 QAM	Outer_Full		
118	1930	20	Default		A7	64 QAM	78@28	37@14	17@7
119	1930	20	Default		A2	64 QAM	6@76	3@38	1@19
120	1950	20	Default		A6	64 QAM	Outer_Full		
121	1922.5	5	15		A3	256 QAM	Outer_Full		
122	1925	10	Default		A1	256 QAM	Outer_Full		
123	1925	10	Default		A7	256 QAM	42@10	18@5	8@3
124	1935	10	Default		A4	256 QAM	Outer_Full		
125	1927.5	15	Default		A1	256 QAM	Outer_Full		
126	1927.5	15	Default		A7	256 QAM	60@19	28@10	12@5
127	1932.5	15	Default		A1	256 QAM	Outer_Full		
128	1942.5	15	Default		A5	256 QAM	Outer_Full		
129	1930	20	Default		A1	256 QAM	Outer_Full		
130	1930	20	Default		A7	256 QAM	78@28	37@14	17@7
131	1950	20	Default		A6	256 QAM	Outer_Full		

NOTE 1: The specific configuration of each RB allocation is defined in Table 6.1-1 unless otherwise stated in this table.
 NOTE 2: DFT-s-OFDM PI/2 BPSK test applies only for UEs which supports half Pi BPSK in FR1.

Table 6.2.3.4.1-6: Test Configuration table for NS_43

Initial Conditions							
Test Environment as specified in TS 38.508-1 [5] subclause 4.1				Normal			
Test Frequencies as specified in TS 38.508-1 [5] subclause 4.3.1				Use uplink carrier centre frequency (F _c) as specified in test parameters			
Test Channel Bandwidths as specified in TS 38.508-1 [5] subclause 4.3.1				5 MHz, 10 MHz, 15 MHz			
Test SCS as specified in Table 5.3.5-1				15 kHz			
A-MPR test parameters for NS_43							
Test ID	F _c (MHz)	Ch BW (MHz)	SCS (kHz)	Downlink Configuration	Uplink Configuration		
					Modulation (Note 2)	RB allocation (Note 1)	
1	910	10	15	N/A for A-MPR	DFT-s-OFDM	PI/2 BPSK	Outer_Full (A2)
2	907.5	15	15			PI/2 BPSK	Edge_1RB_Left (A6)
3	907.5	15	15			PI/2 BPSK	Outer_Full (A6)
4	902.5	5	15			QPSK	Outer_Full (A1)
5	910	10	15			QPSK	Outer_Full (A4)
6	907.5	15	15			QPSK	Edge_1RB_Left (A6)
7	907.5	15	15			QPSK	Outer_Full (A6)
8	910	10	15			16 QAM	Outer_Full (A5)
9	907.5	15	15			16 QAM	Edge_1RB_Left (A6)
10	907.5	15	15			16 QAM	Outer_Full (A6)
11	910	10	15			64 QAM	Outer_Full (A3)
12	907.5	15	15			64 QAM	Edge_1RB_Left (A6)
13	907.5	15	15			64 QAM	Outer_Full (A6)
14	907.5	15	15			256 QAM	Edge_1RB_Left (A6)
15	907.5	15	15		256 QAM	Outer_Full (A6)	
16	902.5	5	15		CP-OFDM	QPSK	Outer_Full (A1)
17	910	10	15			QPSK	Outer_Full (A5)
18	907.5	15	15			QPSK	Edge_1RB_Left (A6)
19	907.5	15	15			QPSK	Outer_Full (A6)
20	902.5	5	15			16 QAM	Outer_Full (A1)
21	910	10	15			16 QAM	Outer_Full (A5)
22	907.5	15	15			16 QAM	Edge_1RB_Left (A6)
23	907.5	15	15			16 QAM	Outer_Full (A6)
24	910	10	15			64 QAM	Outer_Full (A3)
25	907.5	15	15			64 QAM	Edge_1RB_Left (A6)
26	907.5	15	15			64 QAM	Outer_Full (A6)
27	907.5	15	15			256 QAM	Edge_1RB_Left (A6)
28	907.5	15	15			256 QAM	Outer_Full (A6)

NOTE 1: The specific configuration of each RB allocation is defined in Table 6.1-1 unless otherwise stated in this table.

NOTE 2: DFT-s-OFDM PI/2 BPSK test applies only for UEs which supports half Pi BPSK in FR1.

Table 6.2.3.4.1-7: Test Configuration table for NS_43U

Initial Conditions							
Test Environment as specified in TS 38.508-1 [5] subclause 4.1				Normal			
Test Frequencies as specified in TS 38.508-1 [5] subclause 4.3.1				Use uplink carrier centre frequency (F _c) as specified in test parameters			
Test Channel Bandwidths as specified in TS 38.508-1 [5] subclause 4.3.1				5 MHz, 10 MHz, 15 MHz			
Test SCS as specified in Table 5.3.5-1				15 kHz			
A-MPR test parameters for NS_43U							
Test ID	F _c (MHz)	Ch BW (MHz)	SCS (kHz)	Downlink Configuration	Uplink Configuration		
					Modulation (Note 2)	RB allocation (Note 1)	
1	902.5	5	15	N/A for A-MPR	DFT-s-OFDM	PI/2 BPSK	Outer_Full
2	910	10	15			PI/2 BPSK	Outer_Full
3	907.5	15	15			PI/2 BPSK	Edge_1RB_Left
4	907.5	15	15			PI/2 BPSK	Outer_Full
5	902.5	5	15			QPSK	Outer_Full
6	910	10	15			QPSK	Outer_Full
7	907.5	15	15			QPSK	Edge_1RB_Left
8	907.5	15	15			QPSK	Outer_Full
9	902.5	5	15			16 QAM	Outer_Full
10	910	10	15			16 QAM	Outer_Full
11	907.5	15	15			16 QAM	Edge_1RB_Left
12	907.5	15	15			16 QAM	Outer_Full
13	902.5	5	15			64 QAM	Outer_Full
14	910	10	15			64 QAM	Outer_Full
15	907.5	15	15			64 QAM	Edge_1RB_Left
16	907.5	15	15			64 QAM	Outer_Full
17	902.5	5	15			256 QAM	Outer_Full
18	910	10	15			256 QAM	Outer_Full
19	907.5	15	15			256 QAM	Edge_1RB_Left
20	907.5	15	15			256 QAM	Outer_Full
21	902.5	5	15		CP-OFDM	QPSK	Outer_Full
22	910	10	15			QPSK	Outer_Full
23	907.5	15	15			QPSK	Edge_1RB_Left
24	907.5	15	15			QPSK	Outer_Full
25	902.5	5	15			16 QAM	Outer_Full
26	910	10	15			16 QAM	Outer_Full
27	907.5	15	15			16 QAM	Edge_1RB_Left
28	907.5	15	15			16 QAM	Outer_Full
29	902.5	5	15			64 QAM	Outer_Full
30	910	10	15			64 QAM	Outer_Full
31	907.5	15	15			64 QAM	Edge_1RB_Left
32	907.5	15	15			64 QAM	Outer_Full
33	902.5	5	15			256 QAM	Outer_Full
34	910	10	15			256 QAM	Outer_Full
35	907.5	15	15			256 QAM	Edge_1RB_Left
36	907.5	15	15			256 QAM	Outer_Full

NOTE 1: The specific configuration of each RB allocation is defined in Table 6.1-1 unless otherwise stated in this table.

NOTE 2: DFT-s-OFDM PI/2 BPSK test applies only for UEs which supports half Pi BPSK in FR1.

Table 6.2.3.4.1-8: Test Configuration table for NS_37

Initial Conditions								
Test Environment as specified in TS 38.508-1 [5] subclause 4.1				Normal				
Test Frequencies as specified in TS 38.508-1 [5] subclause 4.3.1				Use uplink carrier centre frequency (F_c) as specified in test parameters				
Test Channel Bandwidths as specified in TS 38.508-1 [5] subclause 4.3.1				10 MHz, 15 MHz				
Test SCS as specified in Table 5.3.5-1				Unless otherwise specified in the SCS column select Lowest and Highest.				
A-MPR test parameters for NS_37								
Test ID	F_c (MHz)	Ch BW (MHz)	SCS (kHz)	Downlink Configuration	Uplink Configuration			
					Modulation (Note 2)	RB allocation (Note 1)		
						SCS 15 kHz	SCS 30 kHz	SCS 60 kHz
1	1457.9	10	Default	N/A for A-MPR testing	PI/2 BPSK (A1)	Outer_Full		
2	1455.4	15	Default		PI/2 BPSK (A1)	Outer_Full		
3	1455.4	15	15, 30		PI/2 BPSK (A2)	5@0	2@0	N/A
4	1455.4	15	15, 30		PI/2 BPSK (A2)	Edge_1RB_Right	Edge_1RB_Right	N/A
5	1457.9	10	Default		QPSK (A1)	Outer_Full		
6	1455.4	15	Default		QPSK (A2)	Outer_Full		
7	1455.4	15	15, 30		QPSK (A2)	5@0	2@0	N/A
8	1455.4	15	15, 30		QPSK (A2)	Edge_1RB_Right	Edge_1RB_Right	N/A
9	1457.9	10	Default		16 QAM (A1)	Outer_Full		
10	1455.4	15	Default		16 QAM (A2)	Outer_Full		
11	1455.4	15	15, 30		16 QAM (A2)	5@0	2@0	N/A
12	1455.4	15	15, 30		16 QAM (A2)	Edge_1RB_Right	Edge_1RB_Right	N/A
13	1457.9	10	Default		64 QAM (A1)	Outer_Full		
14	1455.4	15	Default		64 QAM (A2)	Outer_Full		
15	1455.4	15	15, 30		64 QAM (A2)	5@0	2@0	N/A
16	1455.4	15	15, 30		64 QAM (A2)	Edge_1RB_Right	Edge_1RB_Right	N/A
17	1457.9	10	Default		QPSK (A1)	Outer_Full		
18	1455.4	15	Default		QPSK (A2)	Outer_Full		
19	1455.4	15	15, 30		QPSK (A2)	5@0	2@0	N/A
20	1455.4	15	15, 30		QPSK (A2)	Edge_1RB_Right	Edge_1RB_Right	N/A
21	1457.9	10	Default		16 QAM (A1)	Outer_Full		
22	1455.4	15	Default		16 QAM (A2)	Outer_Full		
23	1455.4	15	15, 30		16 QAM (A2)	5@0	2@0	N/A
24	1455.4	15	15, 30		16 QAM (A2)	Edge_1RB_Right	Edge_1RB_Right	N/A

NOTE 1: The specific configuration of each RB allocation is defined in Table 6.1-1 unless otherwise stated in this table.
 NOTE 2: DFT-s-OFDM PI/2 BPSK test applies only for UEs which supports half Pi BPSK in FR1.

Table 6.2.3.4.1-9: Test Configuration table for NS_38

Initial Conditions										
Test Environment as specified in TS 38.508-1 [5] subclause 4.1						Normal				
Test Frequencies as specified in TS 38.508-1 [5] subclause 4.3.1						Use uplink carrier centre frequency (F _c) as specified in test parameters				
Test Channel Bandwidths as specified in TS 38.508-1 [5] subclause 4.3.1						10 MHz, 15 MHz and 20 MHz				
Test SCS as specified in Table 5.3.5-1						Lowest and Highest.				
A-MPR test parameters for NS_38										
Test ID	F _c (MHz)	Ch BW (MHz)	SCS (kHz)	Downlink Configuration	Uplink Configuration					
					Modulation (Note 2)	RB allocation (Note 1)				
						SCS 15 kHz	SCS 30 kHz	SCS 60 kHz		
1	1435	10	Default	N/A for A-MPR testing	DFT-s-OFDM	PI/2 BPSK	Outer_Full			
2	1435	10	Default			PI/2 BPSK	12@0	6@0	3@0	
3	1437.5	15	Default			PI/2 BPSK	Outer_Full			
4	1437.5	15	Default			PI/2 BPSK	20@0	10@0	5@0	
5	1440	20	Default			PI/2 BPSK	Outer_Full			
6	1440	20	Default			PI/2 BPSK	30@0	12@0	6@0	
7	1435	10	Default			QPSK	Outer_Full			
8	1435	10	Default			QPSK	12@0	6@0	3@0	
9	1437.5	15	Default			QPSK	Outer_Full			
10	1437.5	15	Default			QPSK	20@0	10@0	5@0	
11	1440	20	Default			QPSK	Outer_Full			
12	1440	20	Default			QPSK	30@0	12@0	6@0	
13	1435	10	Default			16 QAM	Outer_Full			
14	1435	10	Default			16 QAM	12@0	6@0	3@0	
15	1437.5	15	Default			16 QAM	Outer_Full			
16	1437.5	15	Default			16 QAM	20@0	10@0	5@0	
17	1440	20	Default			16 QAM	Outer_Full			
18	1440	20	Default			16 QAM	30@0	12@0	6@0	
19	1435	10	Default			64 QAM	Outer_Full			
20	1435	10	Default			64 QAM	12@0	6@0	3@0	
21	1437.5	15	Default			64 QAM	Outer_Full			
22	1437.5	15	Default			64 QAM	20@0	10@0	5@0	
23	1440	20	Default			64 QAM	Outer_Full			
24	1440	20	Default			64 QAM	30@0	12@0	6@0	
25	1435	10	Default			256 QAM	Outer_Full			
26	1435	10	Default			256 QAM	12@0	6@0	3@0	
27	1437.5	15	Default			256 QAM	Outer_Full			
28	1437.5	15	Default			256 QAM	20@0	10@0	5@0	
29	1440	20	Default			256 QAM	Outer_Full			
30	1440	20	Default			256 QAM	30@0	12@0	6@0	
31	1435	10	Default			CP-OFDM	QPSK	Outer_Full		
32	1435	10	Default				QPSK	12@0	6@0	3@0
33	1437.5	15	Default				QPSK	Outer_Full		
34	1437.5	15	Default				QPSK	20@0	10@0	5@0
35	1440	20	Default				QPSK	Outer_Full		
36	1440	20	Default				QPSK	30@0	15@0	7@0
37	1435	10	Default				16 QAM	Outer_Full		
38	1435	10	Default				16 QAM	12@0	6@0	3@0
39	1437.5	15	Default				16 QAM	Outer_Full		
40	1437.5	15	Default				16 QAM	20@0	10@0	5@0
41	1440	20	Default				16 QAM	Outer_Full		
42	1440	20	Default				16 QAM	30@0	15@0	7@0
43	1435	10	Default				64 QAM	Outer_Full		
44	1435	10	Default				64 QAM	12@0	6@0	3@0
45	1437.5	15	Default				64 QAM	Outer_Full		
46	1437.5	15	Default				64 QAM	20@0	10@0	5@0

A-MPR test parameters for NS_38								
Test ID	F _c (MHz)	Ch BW (MHz)	SCS (kHz)	Downlink Configuration	Uplink Configuration			
					Modulation (Note 2)	RB allocation (Note 1)		
						SCS 15 kHz	SCS 30 kHz	SCS 60 kHz
47	1440	20	Default		64 QAM	Outer_Full		
48	1440	20	Default		64 QAM	30@0	15@0	7@0
49	1435	10	Default		256 QAM	Outer_Full		
50	1435	10	Default		256 QAM	12@0	6@0	3@0
51	1437.5	15	Default		256 QAM	Outer_Full		
52	1437.5	15	Default		256 QAM	20@0	10@0	5@0
53	1440	20	Default		256 QAM	Outer_Full		
54	1440	20	Default		256 QAM	30@0	15@0	7@0

NOTE 1: The specific configuration of each RB allocation is defined in Table 6.1-1 unless otherwise stated in this table.
 NOTE 2: DFT-s-OFDM PI/2 BPSK test applies only for UEs which supports half Pi BPSK in FR1.
 NOTE 3: There is no need to test this frequency if it has already been tested in the Low Range.

Table 6.2.3.4.1-10: Test Configuration table for NS_39

Initial Conditions						
Test Environment as specified in TS 38.508-1 [5] subclause 4.1					Normal	
Test Frequencies as specified in TS 38.508-1 [5] subclause 4.3.1					Use uplink carrier centre frequency (F_c) as specified in test parameters	
Test Channel Bandwidths as specified in TS 38.508-1 [5] subclause 4.3.1					10 MHz, 15 MHz and 20 MHz	
Test SCS as specified in Table 5.3.5-1					Lowest and Highest.	
A-MPR test parameters for NS_39						
Test ID	F_c (MHz)	Ch BW (MHz)	SCS (kHz)	Downlink Configuration	Uplink Configuration	
					Modulation (Note 2)	RB allocation (Note 1)
1	1465	10	Default	N/A for A-MPR testing	DFT-s-OFDM	Outer_Full
2	1462.5	15	Default			Outer_Full
3	1460	20	Default			Outer_Full
4	1465	10	Default			Outer_Full
5	1462.5	15	Default			Outer_Full
6	1460	20	Default			Outer_Full
7	1465	10	Default			Outer_Full
8	1462.5	15	Default			Outer_Full
9	1460	20	Default			Outer_Full
10	1465	10	Default			Outer_Full
11	1462.5	15	Default			Outer_Full
12	1460	20	Default			Outer_Full
13	1465	10	Default			Outer_Full
14	1462.5	15	Default			Outer_Full
15	1460	20	Default			Outer_Full
16	1465	10	Default		CP-OFDM	Outer_Full
17	1462.5	15	Default			Outer_Full
18	1460	20	Default			Outer_Full
19	1465	10	Default			Outer_Full
20	1462.5	15	Default			Outer_Full
21	1460	20	Default			Outer_Full
22	1465	10	Default			Outer_Full
23	1462.5	15	Default			Outer_Full
24	1460	20	Default			Outer_Full
25	1465	10	Default			Outer_Full
26	1462.5	15	Default			Outer_Full
27	1460	20	Default			Outer_Full

NOTE 1: The specific configuration of each RB allocation is defined in Table 6.1-1 unless otherwise stated in this table.
 NOTE 2: DFT-s-OFDM PI/2 BPSK test applies only for UEs which supports half Pi BPSK in FR1.
 NOTE 3: There is no need to test this frequency if it has already been tested in the Low Range.

Table 6.2.3.4.1-11: Test Configuration table for NS_18

Initial Conditions								
Test Environment as specified in TS 38.508-1 [5] subclause 4.1					Normal			
Test Frequencies as specified in TS 38.508-1 [5] subclause 4.3.1					Low range			
Test Channel Bandwidths as specified in TS 38.508-1 [5] subclause 4.3.1					Use channel bandwidth as specified in test parameters			
Test SCS as specified in Table 5.3.5-1					Lowest, Highest			
A-MPR test parameters for NS_18								
Test ID	Freq	ChBw	SCS	Downlink Configuration	Uplink Configuration			
					Modulation (Note 2)	RB allocation (Note 1)	Commer	
1	Low	5MHz, 10MHz, 20MHz	Default	N/A	DFT-s OFDM	QPSK	Edge_1RB_Left	A1, A2
2						QPSK	Outer_Full	A1, A2
3						16 QAM	Edge_1RB_Left	A1, A2
4						16 QAM	Outer_Full	A1, A2
5						64 QAM	Edge_1RB_Left	A1, A2
6						64 QAM	Outer_Full	A1, A2
7						256 QAM	Edge_1RB_Left	A1, A2
8						256 QAM	Outer_Full	A1, A2
9					CP-s OFDM	QPSK	Edge_1RB_Left	A1, A2
10						QPSK	Outer_Full	A1, A2
11						16 QAM	Edge_1RB_Left	A1, A2
12						16 QAM	Outer_Full	A1, A2
13						64 QAM	Edge_1RB_Left	A1, A2
14						64 QAM	Outer_Full	A1, A2
15						256 QAM	Edge_1RB_Left	A1, A2
16						256 QAM	Outer_Full	A1, A2
17	30MHz	15kHz	DFT-s OFDM	256 QAM	81@70	A3		
18		30kHz		256 QAM	40@35	A3		
19		Default		256 QAM	Edge_1RB_Right	A3		
20		Default		256 QAM	Outer_Full	A4		
21		Default		16QAM	Edge_1RB_Left	A5		
22		Default		64QAM	Edge_1RB_Left	A5		
23		Default		256QAM	Edge_1RB_Left	A5		
24		15kHz	CP-s OFDM	256 QAM	87@73	A3		
25		30kHz		256 QAM	42@36	A3		
26		Default		256 QAM	Edge_1RB_Right	A3		
27		Default		256 QAM	Outer_Full	A4		
28		Default			16QAM	Edge_1RB_Left	A5	
29		Default			64QAM	Edge_1RB_Left	A5	
30		Default			256QAM	Edge_1RB_Left	A5	

NOTE 1: The specific configuration of each RB allocation is defined in Table 6.1-1 unless otherwise stated in this table.

Table 6.2.3.4.1-12: Test Configuration table for NS_24

Initial Conditions									
Test Environment as specified in TS 38.508-1 [5] subclause 4.1			Normal						
Test Frequencies as specified in TS 38.508-1 [5] subclause 4.3.1			Refer to uplink carrier centre frequency (F_c) in test parameters						
Test Channel Bandwidths as specified in TS 38.508-1 [5] subclause 4.3.1			Refer to test parameters (5, 10, 15, 20 MHz)						
Test SCS as specified in Table 5.3.5-1			Lowest						
A-MPR test parameters for NS_24									
Test ID	F_c (MHz)	ChBw (MHz)	SCS	Downlink Configuration	Uplink Configuration				
					Modulation (NOTE 2, 3)	RB allocation (Note 1)			
		Region A	Region B	Region C					
1-3	1992.5	5	Default	N/A for A-MPR testing.	DFT-s-OFDM	PI/2 BPSK QPSK 16 QAM	Outer_Full	N/A	N/A
4-6	1997.5	5	Default			PI/2 BPSK QPSK 16 QAM	Outer_Full	N/A	N/A
7-15	2002.5	5	Default			PI/2 BPSK QPSK 16 QAM	Outer_Full	Edge_1R B_Right	Edge_1RB_Left
16-18	1985	10	Default			PI/2 BPSK QPSK 16 QAM	Edge_1RB_Right	N/A	N/A
19-21	1985	10	Default			PI/2 BPSK QPSK 16 QAM	Outer_Full	N/A	N/A
22-30	1995	10	Default			PI/2 BPSK QPSK 16 QAM	Outer_Full	Edge_1RB_Right	Edge_1RB_Left
31-39	2000	10	Default			PI/2 BPSK QPSK 16 QAM	Edge_1RB_Right	Edge_1RB_Left	36@0
40-42	2000	10	Default			PI/2 BPSK QPSK 16 QAM	Outer_Full	N/A	N/A
43-51	1987.5	15	Default			PI/2 BPSK QPSK 16 QAM	Outer_Full	Edge_1RB_Right	Edge_1RB_Left
52-60	1997.5	15	Default			PI/2 BPSK QPSK 16 QAM	Edge_1RB_Right	Edge_1R B_Left	50@0
61-63	1997.5	15	Default			PI/2 BPSK QPSK 16 QAM	Outer_Full	N/A	N/A
64-72	1990	20	Default			PI/2 BPSK QPSK 16 QAM	Edge_1RB_Right	Edge_1R B_Left	74@0
73-75	1990	20	Default			PI/2 BPSK QPSK 16 QAM	Outer_Full	N/A	N/A
76-84	1995	20	Default			PI/2 BPSK QPSK 16 QAM	Edge_1RB_Right	Edge_1R B_Left	69@0
85-87	1995	20	Default			PI/2 BPSK QPSK 16 QAM	Outer_Full	N/A	N/A
88	1992.5	5	Default			64 QAM	Outer_Full	N/A	N/A
89	1997.5	5	Default			64 QAM	Outer_Full	N/A	N/A
90-92	2002.5	5	Default			64 QAM	Outer_Full	Edge_1R B_Right	Edge_1RB_Left
93	1985	10	Default			64 QAM	Edge_1RB_Right	N/A	N/A
94	1985	10	Default			64 QAM	Outer_Full	N/A	N/A

A-MPR test parameters for NS_24								
Test ID	F _c (MHz)	ChBw (MHz)	SCS	Downlink Configuration	Uplink Configuration			
					Modulation (NOTE 2, 3)	RB allocation (Note 1)		
						Region A	Region B	Region C
95-97	1995	10	Default		64 QAM	Outer_Full	Edge_1R B_Right	Edge_1RB _Left
98-100	2000	10	Default		64 QAM	Edge_1RB_Right	Edge_1R B_Left	36@0
101-102	2000	10	Default		64 QAM	Outer_Full	Outer_Ful l	N/A
103-105	1987.5	15	Default		64 QAM	Outer_Full	Edge_1R B_Right	Edge_1RB _Left
106-108	1997.5	15	Default		64 QAM	Edge_1RB_Right	Edge_1R B_Left	50@0
109	1997.5	15	Default		64 QAM	Outer_Full	N/A	N/A
110-112	1990	20	Default		64 QAM	Edge_1RB_Right	Edge_1R B_Left	74@0
113	1990	20	Default		64 QAM	Outer_Full	N/A	N/A
114-116	1995	20	Default		64 QAM	Edge_1RB_Right	Edge_1R B_Left	69@0
117	1995	20	Default		64 QAM	Outer_Full	N/A	N/A
118	1992.5	5	Default		256 QAM	Outer_Full	N/A	N/A
119	1997.5	5	Default		256 QAM	Outer_Full	N/A	N/A
120-122	2002.5	5	Default		256 QAM	Outer_Full	Edge_1R B_Right	Edge_1RB _Left
123	1985	10	Default		256 QAM	Edge_1RB_Right	N/A	N/A
124	1985	10	Default		256 QAM	Outer_Full	N/A	N/A
125-127	1995	10	Default		256 QAM	Outer_Full	Edge_1R B_Right	Edge_1RB _Left
128-130	2000	10	Default		256 QAM	Edge_1RB_Right	Edge_1R B_Left	36@0
131-132	2000	10	Default		256 QAM	Outer_Full	Outer_Ful l	N/A
133-135	1987.5	15	Default		256 QAM	Outer_Full	Edge_1R B_Right	Edge_1RB _Left
136-138	1997.5	15	Default		256 QAM	Edge_1RB_Right	Edge_1R B_Left	50@0
139	1997.5	15	Default		256 QAM	Outer_Full	N/A	N/A
140-142	1990	20	Default		256 QAM	Edge_1RB_Right	Edge_1R B_Left	74@0
143	1990	20	Default		256 QAM	Outer_Full	N/A	N/A
144-146	1995	20	Default		256 QAM	Edge_1RB_Right	Edge_1R B_Left	69@0
147	1995	20	Default		256 QAM	Outer_Full	N/A	N/A
148-150	1992.5	5	Default		QPSK 16 QAM 64 QAM	Outer_Full	N/A	N/A
151-153	1997.5	5	Default		QPSK 16 QAM 64 QAM	Outer_Full	N/A	N/A
154-162	2002.5	5	Default		QPSK 16 QAM 64 QAM	Outer_Full	Edge_1R B_Right	Edge_1RB _Left
163-165	1985	10	Default		QPSK 16 QAM 64 QAM	Edge_1RB_Right	N/A	N/A
166-168	1985	10	Default		QPSK 16 QAM 64 QAM	Outer_Full	N/A	N/A
169-177	1995	10	Default		QPSK 16 QAM 64 QAM	Outer_Full	Edge_1R B_Right	Edge_1RB _Left

A-MPR test parameters for NS_24								
Test ID	F _c (MHz)	ChBw (MHz)	SCS	Downlink Configuration	Uplink Configuration			
					Modulation (NOTE 2, 3)	RB allocation (Note 1)		
						Region A	Region B	Region C
178-186	2000	10	Default		QPSK 16 QAM 64 QAM	Edge_1RB_Right	Edge_1R B_Left	37@0
187-189	2000	10	Default		QPSK 16 QAM 64 QAM	Outer_Full	N/A	N/A
190-198	1987.5	15	Default		QPSK 16 QAM 64 QAM	Outer_Full	Edge_1R B_Right	Edge_1RB _Left
199-207	1997.5	15	Default		QPSK 16 QAM 64 QAM	Edge_1RB_Right	Edge_1R B_Left	51@0
208-210	1997.5	15	Default		QPSK 16 QAM 64 QAM	Outer_Full	N/A	N/A
211-219	1990	20	Default		QPSK 16 QAM 64 QAM	Edge_1RB_Right	Edge_1R B_Left	74@0
220-222	1990	20	Default		QPSK 16 QAM 64 QAM	Outer_Full	N/A	N/A
223-231	1995	20	Default		QPSK 16 QAM 64 QAM	Edge_1RB_Right	Edge_1R B_Left	69@0
232-234	1995	20	Default		QPSK 16 QAM 64 QAM	Outer_Full	N/A	N/A
235	1992.5	5	Default		256 QAM	Outer_Full	N/A	N/A
236	1997.5	5	Default		256 QAM	Outer_Full	N/A	N/A
237-239	2002.5	5	Default		256 QAM	Outer_Full	Edge_1R B_Right	Edge_1RB _Left
240	1985	10	Default		256 QAM	Edge_1RB_Right	N/A	N/A
241	1985	10	Default		256 QAM	Outer_Full	N/A	N/A
242-244	1995	10	Default		256 QAM	Outer_Full	Edge_1R B_Right	Edge_1RB _Left
245-247	2000	10	Default		256 QAM	Edge_1RB_Right	Edge_1R B_Left	37@0
248-249	2000	10	Default		256 QAM	Outer_Full	Outer_Ful l	N/A
250-252	1987.5	15	Default		256 QAM	Outer_Full	Edge_1R B_Right	Edge_1RB _Left
253-255	1997.5	15	Default		256 QAM	Edge_1RB_Right	Edge_1R B_Left	51@0
256	1997.5	15	Default		256 QAM	Outer_Full	N/A	N/A
257-259	1990	20	Default		256 QAM	Edge_1RB_Right	Edge_1R B_Left	74@0
260	1990	20	Default		256 QAM	Outer_Full	N/A	N/A
261-263	1995	20	Default		256 QAM	Edge_1RB_Right	Edge_1R B_Left	69@0
264	1995	20	Default		256 QAM	Outer_Full	N/A	N/A
265	1992.5	5	Default		QPSK	Edge_1RB_Right	N/A	N/A
266	1997.5	5	Default		16 QAM	Edge_1RB_Right	N/A	N/A
267	1985	10	Default		QPSK	Edge_1RB_Left	N/A	N/A

NOTE 1: The specific configuration of each RB allocation is defined in Table 6.1-1 unless otherwise stated in this table.
 NOTE 2: DFT-s-OFDM PI/2 BPSK test applies only for UEs which supports half Pi BPSK in FR1.
 NOTE 3: In test IDs with multiple modulations, each UL Modulation shall be tested separately against Range A, B, and C.

Table 6.2.3.4.1-13: Test Configuration table for NS_27 (contiguous allocation)

Initial Conditions								
Test Environment as specified in TS 38.508-1 [5] subclause 4.1				Normal				
Test Frequencies				Refer to uplink carrier centre frequency (F _c) in test parameters. Associated parameters defined in Table 6.2.3.4.1-13a and 6.2.3.4.1-13b.				
Test Channel Bandwidths as specified in TS 38.508-1 [5] subclause 4.3.1				Refer to test parameters (15, 20, 40 MHz)				
Test SCS as specified in Table 5.3.5-1				Lowest, Highest (Note 3)				
A-MPR test parameters for NS_27								
Test ID	F _c (MHz)	Ch BW (MHz)	SCS (kHz)	Downlink Configuration	Modulation (Note 2)	Uplink Configuration		
						RB allocation (Note 1)		
						SCS 15 kHz	SCS 30 kHz	SCS 60 kHz
1	3557.5 2	15	Default	N/A for A-MPR testing.	PI/2 BPSK	Edge_1RB_Left (A3)		
2	3557.5 2	15	Default		PI/2 BPSK	Outer_Full (A3)		
3	3692.4 9	15	Default		PI/2 BPSK	Edge_1RB_Right (A3)		
4	3692.4 9	15	Default		PI/2 BPSK	Outer_Full (A3)		
5	3562.5	15	Default		PI/2 BPSK	Edge_1RB_Left (A4)		
6	3562.5	15	Default		PI/2 BPSK	Outer_Full (2)		
7	3687.4 8	15	Default		PI/2 BPSK	Edge_1RB_Right (A4)		
8	3687.4 8	15	Default		PI/2 BPSK	Outer_Full (2)		
9	3560.0 1	20	Default		PI/2 BPSK	Edge_1RB_Left (A5)		
10	3560.0 1	20	Default		PI/2 BPSK	Outer_Full (A5)		
11	3690	20	Default		PI/2 BPSK	Edge_1RB_Right (A5)		
12	3690	20	Default		PI/2 BPSK	Outer_Full (A5)		
13	3570	20	Default		PI/2 BPSK	Edge_1RB_Left (A6)		
14	3570	20	Default		PI/2 BPSK	Outer_Full (2)		
15	3679.9 8	20	Default		PI/2 BPSK	Edge_1RB_Right (A6)		
16	3679.9 8	20	Default		PI/2 BPSK	Outer_Full (2)		
17	3570	40	Default		PI/2 BPSK	Edge_1RB_Left (A7)		
18	3570	40	Default		PI/2 BPSK	150@63 (A2)	72@32 (A2)	32@16 (A2)
19	3570	40	Default		PI/2 BPSK	96@73 (A1)	48@35 (A1)	24@16 (A1)
20	3570	40	Default		PI/2 BPSK	Edge_1RB_Right (A7)		
21	3679.9 8	40	Default		PI/2 BPSK	Edge_1RB_Right (A7)		
22	3679.9 8	40	Default		PI/2 BPSK	135@0 (A2)	64@0 (A2)	32@0 (A2)
23	3679.9 8	40	Default		PI/2 BPSK	96@38 (A1)	48@18 (A1)	24@9 (A1)
24	3679.9 8	40	Default		PI/2 BPSK	Edge_1RB_Left (A7)		
25	3600	40	Default		PI/2 BPSK	Edge_1RB_Left (A8)		
26	3600	40	Default		PI/2 BPSK	Outer_Full (4.5)		
27	3649.9 8	40	Default		PI/2 BPSK	Edge_1RB_Right (A8)		
28	3649.9 8	40	Default		PI/2 BPSK	Outer_Full (4.5)		
29	3557.5 2	15	Default		QPSK	Edge_1RB_Left (A3)		
30	3557.5 2	15	Default		QPSK	Outer_Full (A3)		
31	3692.4 9	15	Default		QPSK	Edge_1RB_Right (A3)		
32	3692.4 9	15	Default		QPSK	Outer_Full (A3)		

A-MPR test parameters for NS_27								
Test ID	F _c (MHz)	Ch BW (MHz)	SCS (kHz)	Downlink Configuration	Uplink Configuration			
					Modulation (Note 2)	RB allocation (Note 1)		
						SCS 15 kHz	SCS 30 kHz	SCS 60 kHz
33	3562.5	15	Default		QPSK	Edge_1RB_Left (A4)		
34	3562.5	15	Default		QPSK	Outer_Full (2)		
35	3687.48	15	Default		QPSK	Edge_1RB_Right (A4)		
36	3687.48	15	Default		QPSK	Outer_Full (2)		
37	3560.01	20	Default		QPSK	Edge_1RB_Left (A5)		
38	3560.01	20	Default		QPSK	Outer_Full (A5)		
39	3690	20	Default		QPSK	Edge_1RB_Right (A5)		
40	3690	20	Default		QPSK	Outer_Full (A5)		
41	3570	20	Default		QPSK	Edge_1RB_Left (A6)		
42	3570	20	Default		QPSK	Outer_Full (2)		
43	3679.98	20	Default		QPSK	Edge_1RB_Right (A6)		
44	3679.98	20	Default		QPSK	Outer_Full (2)		
45	3570	40	Default		QPSK	Edge_1RB_Left (A7)		
46	3570	40	Default		QPSK	150@63 (A2)	72@32 (A2)	32@16 (A2)
47	3570	40	Default		QPSK	96@73 (A1)	48@35 (A1)	24@16 (A1)
48	3570	40	Default		QPSK	Edge_1RB_Right (A7)		
49	3679.98	40	Default		QPSK	Edge_1RB_Right (A7)		
50	3679.98	40	Default		QPSK	135@0 (A2)	64@0 (A2)	32@0 (A2)
51	3679.98	40	Default		QPSK	96@38 (A1)	48@18 (A1)	24@9 (A1)
52	3679.98	40	Default		QPSK	Edge_1RB_Left (A7)		
53	3600	40	Default		QPSK	Edge_1RB_Left (A8)		
54	3600	40	Default		QPSK	Outer_Full (4.5)		
55	3649.98	40	Default		QPSK	Edge_1RB_Right (A8)		
56	3649.98	40	Default		QPSK	Outer_Full (4.5)		
57	3557.52	15	Default		16 QAM	Edge_1RB_Left (A3)		
58	3557.52	15	Default		16 QAM	Outer_Full (A3)		
59	3692.49	15	Default		16 QAM	Edge_1RB_Right (A3)		
60	3692.49	15	Default		16 QAM	Outer_Full (A3)		
61	3562.5	15	Default		16 QAM	Edge_1RB_Left (A4)		
62	3562.5	15	Default		16 QAM	Outer_Full (2)		
63	3687.48	15	Default		16 QAM	Edge_1RB_Right (A4)		
64	3687.48	15	Default		16 QAM	Outer_Full (2)		
65	3560.01	20	Default		16 QAM	Edge_1RB_Left (A5)		
66	3560.01	20	Default		16 QAM	Outer_Full (A5)		
67	3690	20	Default		16 QAM	Edge_1RB_Right (A5)		
68	3690	20	Default		16 QAM	Outer_Full (A5)		
69	3570	20	Default		16 QAM	Edge_1RB_Left (A6)		
70	3570	20	Default		16 QAM	Outer_Full (2)		

A-MPR test parameters for NS_27								
Test ID	F _c (MHz)	Ch BW (MHz)	SCS (kHz)	Downlink Configuratio n	Uplink Configuration			
					Modulation (Note 2)	RB allocation (Note 1)		
						SCS 15 kHz	SCS 30 kHz	SCS 60 kHz
71	3679.98	20	Default		16 QAM	Edge_1RB_Right (A6)		
72	3679.98	20	Default		16 QAM	Outer_Full (2)		
73	3570	40	Default		16 QAM	Edge_1RB_Left (A7)		
74	3570	40	Default		16 QAM	150@63 (A2)	72@32 (A2)	32@16 (A2)
75	3570	40	Default		16 QAM	96@73 (A1)	48@35 (A1)	24@16 (A1)
76	3570	40	Default		16 QAM	Edge_1RB_Right (A7)		
77	3679.98	40	Default		16 QAM	Edge_1RB_Right (A7)		
78	3679.98	40	Default		16 QAM	135@0 (A2)	64@0 (A2)	32@0 (A2)
79	3679.98	40	Default		16 QAM	96@38 (A1)	48@18 (A1)	24@9 (A1)
80	3679.98	40	Default		16 QAM	Edge_1RB_Left (A7)		
81	3600	40	Default		16 QAM	Edge_1RB_Left (A8)		
82	3600	40	Default		16 QAM	Outer_Full (4.5)		
83	3649.98	40	Default		16 QAM	Edge_1RB_Right (A8)		
84	3649.98	40	Default		16 QAM	Outer_Full (4.5)		
85	3557.52	15	Default		64 QAM	Edge_1RB_Left (A3)		
86	3557.52	15	Default		64 QAM	Outer_Full (A3)		
87	3692.49	15	Default		64 QAM	Edge_1RB_Right (A3)		
88	3692.49	15	Default		64 QAM	Outer_Full (A3)		
89	3562.5	15	Default		64 QAM	Edge_1RB_Left (A4)		
90	3562.5	15	Default		64 QAM	Outer_Full (2)		
91	3687.48	15	Default		64 QAM	Edge_1RB_Right (A4)		
92	3687.48	15	Default		64 QAM	Outer_Full (2)		
93	3560.01	20	Default		64 QAM	Edge_1RB_Left (A5)		
94	3560.01	20	Default		64 QAM	Outer_Full (A5)		
95	3690	20	Default		64 QAM	Edge_1RB_Right (A5)		
96	3690	20	Default		64 QAM	Outer_Full (A5)		
97	3570	20	Default		64 QAM	Edge_1RB_Left (A6)		
98	3570	20	Default		64 QAM	Outer_Full (2)		
99	3679.98	20	Default		64 QAM	Edge_1RB_Right (A6)		
100	3679.98	20	Default		64 QAM	Outer_Full (2)		
101	3570	40	Default		64 QAM	Edge_1RB_Left (A7)		
102	3570	40	Default		64 QAM	150@63 (A2)	72@32 (A2)	32@16 (A2)
103	3570	40	Default		64 QAM	96@73 (A1)	48@35 (A1)	24@16 (A1)
104	3570	40	Default		64 QAM	Edge_1RB_Right (A7)		
105	3679.98	40	Default		64 QAM	Edge_1RB_Right (A7)		
106	3679.98	40	Default		64 QAM	135@0 (A2)	64@0 (A2)	32@0 (A2)
107	3679.98	40	Default		64 QAM	96@38 (A1)	48@18 (A1)	24@9 (A1)
108	3679.98	40	Default		64 QAM	Edge_1RB_Left (A7)		

A-MPR test parameters for NS_27								
Test ID	F _c (MHz)	Ch BW (MHz)	SCS (kHz)	Downlink Configuration	Uplink Configuration			
					Modulation (Note 2)	RB allocation (Note 1)		
						SCS 15 kHz	SCS 30 kHz	SCS 60 kHz
109	3600	40	Default		64 QAM	Edge_1RB_Left (A8)		
110	3600	40	Default		64 QAM	Outer_Full (4.5)		
111	3649.98	40	Default		64 QAM	Edge_1RB_Right (A8)		
112	3649.98	40	Default		64 QAM	Outer_Full (4.5)		
113	3557.52	15	Default		256 QAM	Edge_1RB_Left (A3)		
114	3557.52	15	Default		256 QAM	Outer_Full (A3)		
115	3692.49	15	Default		256 QAM	Edge_1RB_Right (A3)		
116	3692.49	15	Default		256 QAM	Outer_Full (A3)		
117	3562.5	15	Default		256 QAM	Edge_1RB_Left (A4)		
118	3562.5	15	Default		256 QAM	Outer_Full (2)		
119	3687.48	15	Default		256 QAM	Edge_1RB_Right (A4)		
120	3687.48	15	Default		256 QAM	Outer_Full (2)		
121	3560.01	20	Default		256 QAM	Edge_1RB_Left (A5)		
122	3560.01	20	Default		256 QAM	Outer_Full (A5)		
123	3690	20	Default		256 QAM	Edge_1RB_Right (A5)		
124	3690	20	Default		256 QAM	Outer_Full (A5)		
125	3570	20	Default		256 QAM	Edge_1RB_Left (A6)		
126	3570	20	Default		256 QAM	Outer_Full (2)		
127	3679.98	20	Default		256 QAM	Edge_1RB_Right (A6)		
128	3679.98	20	Default		256 QAM	Outer_Full (2)		
129	3570	40	Default		256 QAM	Edge_1RB_Left (A7)		
130	3570	40	Default		256 QAM	150@63 (A2)	72@32 (A2)	32@16 (A2)
131	3570	40	Default		256 QAM	96@73 (A1)	48@35 (A1)	24@16 (A1)
132	3570	40	Default		256 QAM	Edge_1RB_Right (A7)		
133	3679.98	40	Default		256 QAM	Edge_1RB_Right (A7)		
134	3679.98	40	Default		256 QAM	135@0 (A2)	64@0 (A2)	32@0 (A2)
135	3679.98	40	Default		256 QAM	96@38 (A1)	48@18 (A1)	24@9 (A1)
136	3679.98	40	Default		256 QAM	Edge_1RB_Left (A7)		
137	3600	40	Default		256 QAM	Edge_1RB_Left (A8)		
138	3600	40	Default		256 QAM	Outer_Full (4.5)		
139	3649.98	40	Default		256 QAM	Edge_1RB_Right (A8)		
140	3649.98	40	Default		256 QAM	Outer_Full (4.5)		
141	3557.52	15	Default		QPSK	Edge_1RB_Left (A3)		
142	3557.52	15	Default		QPSK	Outer_Full (A3)		
143	3692.49	15	Default		QPSK	Edge_1RB_Right (A3)		
144	3692.49	15	Default		QPSK	Outer_Full (A3)		
145	3562.5	15	Default		QPSK	Edge_1RB_Left (A4)		

A-MPR test parameters for NS_27								
Test ID	F _c (MHz)	Ch BW (MHz)	SCS (kHz)	Downlink Configuration	Uplink Configuration			
					Modulation (Note 2)	RB allocation (Note 1)		
						SCS 15 kHz	SCS 30 kHz	SCS 60 kHz
146	3562.5	15	Default		QPSK	Outer_Full (2)		
147	3687.48	15	Default		QPSK	Edge_1RB_Right (A4)		
148	3687.48	15	Default		QPSK	Outer_Full (2)		
149	3560.01	20	Default		QPSK	Edge_1RB_Left (A5)		
150	3560.01	20	Default		QPSK	Outer_Full (A5)		
151	3690	20	Default		QPSK	Edge_1RB_Right (A5)		
152	3690	20	Default		QPSK	Outer_Full (A5)		
153	3570	20	Default		QPSK	Edge_1RB_Left (A6)		
154	3570	20	Default		QPSK	Outer_Full (2)		
155	3679.98	20	Default		QPSK	Edge_1RB_Right (A6)		
156	3679.98	20	Default		QPSK	Outer_Full (2)		
157	3570	40	Default		QPSK	Edge_1RB_Left (A7)		
158	3570	40	Default		QPSK	153@63 (A2)	72@32 (A2)	32@16 (A2)
159	3570	40	Default		QPSK	99@69 (A1)	49@34 (A1)	24@16 (A1)
160	3570	40	Default		QPSK	Edge_1RB_Right (A7)		
161	3679.98	40	Default		QPSK	Edge_1RB_Right (A7)		
162	3679.98	40	Default		QPSK	137@0 (A2)	68@0 (A2)	35@0 (A2)
163	3679.98	40	Default		QPSK	99@38 (A1)	49@18 (A1)	24@9 (A1)
164	3679.98	40	Default		QPSK	Edge_1RB_Left (A7)		
165	3600	40	Default		QPSK	Edge_1RB_Left (A8)		
166	3600	40	Default		QPSK	Outer_Full (4.5)		
167	3649.98	40	Default		QPSK	Edge_1RB_Right (A8)		
168	3649.98	40	Default		QPSK	Outer_Full (4.5)		
169	3557.52	15	Default		16 QAM	Edge_1RB_Left (A3)		
170	3557.52	15	Default		16 QAM	Outer_Full (A3)		
171	3692.49	15	Default		16 QAM	Edge_1RB_Right (A3)		
172	3692.49	15	Default		16 QAM	Outer_Full (A3)		
173	3562.5	15	Default		16 QAM	Edge_1RB_Left (A4)		
174	3562.5	15	Default		16 QAM	Outer_Full (2)		
175	3687.48	15	Default		16 QAM	Edge_1RB_Right (A4)		
176	3687.48	15	Default		16 QAM	Outer_Full (2)		
177	3560.01	20	Default		16 QAM	Edge_1RB_Left (A5)		
178	3560.01	20	Default		16 QAM	Outer_Full (A5)		
179	3690	20	Default		16 QAM	Edge_1RB_Right (A5)		
180	3690	20	Default		16 QAM	Outer_Full (A5)		
181	3570	20	Default		16 QAM	Edge_1RB_Left (A6)		
182	3570	20	Default		16 QAM	Outer_Full (2)		

A-MPR test parameters for NS_27								
Test ID	F _c (MHz)	Ch BW (MHz)	SCS (kHz)	Downlink Configuration	Uplink Configuration			
					Modulation (Note 2)	RB allocation (Note 1)		
						SCS 15 kHz	SCS 30 kHz	SCS 60 kHz
183	3679.98	20	Default		16 QAM	Edge_1RB_Right (A6)		
184	3679.98	20	Default		16 QAM	Outer_Full (2)		
185	3570	40	Default		16 QAM	Edge_1RB_Left (A7)		
186	3570	40	Default		16 QAM	153@63 (A2)	72@32 (A2)	32@16 (A2)
187	3570	40	Default		16 QAM	99@69 (A1)	49@34 (A1)	24@16 (A1)
188	3570	40	Default		16 QAM	Edge_1RB_Right (A7)		
189	3679.98	40	Default		16 QAM	Edge_1RB_Right (A7)		
190	3679.98	40	Default		16 QAM	137@0 (A2)	68@0 (A2)	35@0 (A2)
191	3679.98	40	Default		16 QAM	99@38 (A1)	49@18 (A1)	24@9 (A1)
192	3679.98	40	Default		16 QAM	Edge_1RB_Left (A7)		
193	3600	40	Default		16 QAM	Edge_1RB_Left (A8)		
194	3600	40	Default		16 QAM	Outer_Full (4.5)		
195	3649.98	40	Default		16 QAM	Edge_1RB_Right (A8)		
196	3649.98	40	Default		16 QAM	Outer_Full (4.5)		
197	3557.52	15	Default		64 QAM	Edge_1RB_Left (A3)		
198	3557.52	15	Default		64 QAM	Outer_Full (A3)		
199	3692.49	15	Default		64 QAM	Edge_1RB_Right (A3)		
200	3692.49	15	Default		64 QAM	Outer_Full (A3)		
201	3562.5	15	Default		64 QAM	Edge_1RB_Left (A4)		
202	3562.5	15	Default		64 QAM	Outer_Full (2)		
203	3687.48	15	Default		64 QAM	Edge_1RB_Right (A4)		
204	3687.48	15	Default		64 QAM	Outer_Full (2)		
205	3560.01	20	Default		64 QAM	Edge_1RB_Left (A5)		
206	3560.01	20	Default		64 QAM	Outer_Full (A5)		
207	3690	20	Default		64 QAM	Edge_1RB_Right (A5)		
208	3690	20	Default		64 QAM	Outer_Full (A5)		
209	3570	20	Default		64 QAM	Edge_1RB_Left (A6)		
210	3570	20	Default		64 QAM	Outer_Full (2)		
211	3679.98	20	Default		64 QAM	Edge_1RB_Right (A6)		
212	3679.98	20	Default		64 QAM	Outer_Full (2)		
213	3570	40	Default		64 QAM	Edge_1RB_Left (A7)		
214	3570	40	Default		64 QAM	153@63 (A2)	72@32 (A2)	32@16 (A2)
215	3570	40	Default		64 QAM	99@69 (A1)	49@34 (A1)	24@16 (A1)
216	3570	40	Default		64 QAM	Edge_1RB_Right (A7)		
217	3679.98	40	Default		64 QAM	Edge_1RB_Right (A7)		
218	3679.98	40	Default		64 QAM	137@0 (A2)	68@0 (A2)	35@0 (A2)
219	3679.98	40	Default		64 QAM	99@38 (A1)	49@18 (A1)	24@9 (A1)

A-MPR test parameters for NS_27								
Test ID	F _c (MHz)	Ch BW (MHz)	SCS (kHz)	Downlink Configuration	Uplink Configuration			
					Modulation (Note 2)	RB allocation (Note 1)		
						SCS 15 kHz	SCS 30 kHz	SCS 60 kHz
220	3679.98	40	Default		64 QAM	Edge_1RB_Left (A7)		
221	3600	40	Default		64 QAM	Edge_1RB_Left (A8)		
222	3600	40	Default		64 QAM	Outer_Full (4.5)		
223	3649.98	40	Default		64 QAM	Edge_1RB_Right (A8)		
224	3649.98	40	Default		64 QAM	Outer_Full (4.5)		
225	3557.52	15	Default		256 QAM	Edge_1RB_Left (A3)		
226	3557.52	15	Default		256 QAM	Outer_Full (A3)		
227	3692.49	15	Default		256 QAM	Edge_1RB_Right (A3)		
228	3692.49	15	Default		256 QAM	Outer_Full (A3)		
229	3562.5	15	Default		256 QAM	Edge_1RB_Left (A4)		
230	3562.5	15	Default		256 QAM	Outer_Full (2)		
231	3687.48	15	Default		256 QAM	Edge_1RB_Right (A4)		
232	3687.48	15	Default		256 QAM	Outer_Full (2)		
233	3560.01	20	Default		256 QAM	Edge_1RB_Left (A5)		
234	3560.01	20	Default		256 QAM	Outer_Full (A5)		
235	3690	20	Default		256 QAM	Edge_1RB_Right (A5)		
236	3690	20	Default		256 QAM	Outer_Full (A5)		
237	3570	20	Default		256 QAM	Edge_1RB_Left (A6)		
238	3570	20	Default		256 QAM	Outer_Full (2)		
239	3679.98	20	Default		256 QAM	Edge_1RB_Right (A6)		
240	3679.98	20	Default		256 QAM	Outer_Full (2)		
241	3570	40	Default		256 QAM	Edge_1RB_Left (A7)		
242	3570	40	Default		256 QAM	153@63 (A2)	72@32 (A2)	32@16 (A2)
243	3570	40	Default		256 QAM	99@69 (A1)	49@34 (A1)	24@16 (A1)
244	3570	40	Default		256 QAM	Edge_1RB_Right (A7)		
245	3679.98	40	Default		256 QAM	Edge_1RB_Right (A7)		
246	3679.98	40	Default		256 QAM	137@0 (A2)	68@0 (A2)	35@0 (A2)
247	3679.98	40	Default		256 QAM	99@38 (A1)	49@18 (A1)	24@9 (A1)
248	3679.98	40	Default		256 QAM	Edge_1RB_Left (A7)		
249	3600	40	Default		256 QAM	Edge_1RB_Left (A8)		
250	3600	40	Default		256 QAM	Outer_Full (4.5)		
251	3649.98	40	Default		256 QAM	Edge_1RB_Right (A8)		
252	3649.98	40	Default		256 QAM	Outer_Full (4.5)		

NOTE 1: The specific configuration of each RB allocation is defined in Table 6.1-1 unless otherwise stated in this table.
 NOTE 2: DFT-s-OFDM PI/2 BPSK test applies only for UEs which supports half Pi BPSK in FR1.
 NOTE 3: For FR1 bands where highest supported SCS is 60 kHz the highest tested SCS is limited to 30 kHz as carrier with SCS=60 kHz cannot be used as PCell.

Table 6.2.3.4.1-13a: Test frequencies for NS_27 (SCS=15 kHz, ΔFRaster = 15kHz)

CBW [MHz]	carrier Bandwidth [PRBs]	Carrier centre [MHz]	Carrier centre [ARFCN]	point A [MHz]	absolute FrequencyPointA [ARFCN]	offsetToCarrier [Carrier PRBs]	SS block SCS [kHz]	GSC N	absoluteFrequencySSB [ARFCN]	k_{SSB}	Offset Carrier CORESET#0 [RBs] Note 2	CORESET#0 Index (Offset [RBs]) Note 1	offsetToPointA(SIB1) [PRBs] Note 1
15	79	3557.52	637168	3550.41	636694	0	30	7884	636960	2	0	0 (2)	2
		3562.5	637500	3555.39	637026			7888	637344	6	0	1 (6)	6
		3687.48	645832	3680.37	645358			7975	645696	2	2	1 (6)	8
		3692.49	646166	3685.38	645692			7978	645984	4	2	0 (2)	4
20	106	3560.01	637334	3550.47	636698			7885	637056	10	3	1 (6)	9
		3570	638000	3560.46	637364			7891	637632	4	0	0 (2)	2
		3679.98	645332	3670.44	644696			7968	645024	4	1	1 (6)	7
		3690	646000	3680.46	645364			7975	645696	8	1	1 (6)	7
40	216	3570	638000	3550.56	636704			7885	637056	4	3	1 (6)	9
		3600	640000	3580.56	638704			7905	638976	8	0	0 (2)	2
		3649.98	643332	3630.54	642036			7940	642336	0	3	0 (2)	5
		3679.98	645332	3660.54	644036			7961	644352	4	0	1 (6)	6

NOTE 1: The CORESET#0 Index and the associated CORESET#0 Offset refers to Table 13-1 in TS 38.213 [22]. The value of CORESET#0 Index is signalled in controlResourceSetZero (pdcch-ConfigSIB1) in the MIB. The offsetToPointA IE is expressed in units of resource blocks assuming 15 kHz subcarrier spacing for FR1 and 60 kHz subcarrier spacing for FR2.

NOTE 2: The parameter Offset Carrier CORESET#0 specifies the offset from the lowest subcarrier of the carrier and the lowest subcarrier of CORESET#0. It corresponds to the parameter $\Delta F_{\text{OffsetCORESET-0-Carrier}}$ in Annex C expressed in number of common RBs.

Table 6.2.3.4.1-13b: Test frequencies for NS_27 (SCS=30 kHz, ΔFRaster = 30 kHz)

CBW [MHz]	carrier Bandwidth [PRBs]	Carrier centre [MHz]	Carrier centre [ARFCN]	point A [MHz]	absolute FrequencyPointA [ARFCN]	offsetToCarrier [Carrier PRBs]	SS block SCS [kHz]	GSC N	absoluteFrequencySSB [ARFCN]	k_{SSB}	Offset Carrier CORESET#0 [RBs] Note 2	CORESET#0 Index (Offset [RBs]) Note 1	offsetToPointA(SIB1) [PRBs] Note 1
15	38	3557.52	637168	3550.68	636712	0	30	7884	636960	8	0	0 (0)	0
		3562.5	637500	3555.66	637044			7888	637344	12	0	2 (2)	4
		3687.48	645832	3680.64	645376			7975	645696	8	0	3 (3)	6
		3692.49	646166	3685.65	645710			7978	645984	10	0	1 (1)	2
20	51	3560.01	637334	3550.83	636722			7885	637056	22	0	3 (3)	6
		3570	638000	3560.82	637388			7891	637632	4	0	0 (0)	0
		3679.98	645332	3670.8	644720			7968	645024	16	0	2 (2)	4
		3690	646000	3680.82	645388			7975	645696	20	0	2 (2)	4
40	106	3570	638000	3550.92	636728			7885	637056	16	0	3 (3)	6
		3600	640000	3580.92	638728			7905	638976	8	0	0 (0)	0
		3649.98	643332	3630.9	642060			7940	642336	12	0	1 (1)	2
		3679.98	645332	3660.9	644060			7961	644352	4	0	2 (2)	4

NOTE 1: The CORESET#0 Index and the associated CORESET#0 Offset refers to Table 13-1 in TS 38.213 [22]. The value of CORESET#0 Index is signalled in controlResourceSetZero (pdcch-ConfigSIB1) in the MIB. The offsetToPointA IE is expressed in units of resource blocks assuming 15 kHz subcarrier spacing for FR1 and 60 kHz subcarrier spacing for FR2.

NOTE 2: The parameter Offset Carrier CORESET#0 specifies the offset from the lowest subcarrier of the carrier and the lowest subcarrier of CORESET#0. It corresponds to the parameter $\Delta F_{\text{OffsetCORESET-0-Carrier}}$ in Annex C expressed in number of common RBs.

Table 6.2.3.4.1-14: Test Configuration table for NS_40

Initial Conditions							
Test Environment as specified in TS 38.508-1 [5] subclause 4.1					Normal		
Test Frequencies as specified in TS 38.508-1 [5] subclause 4.3.1					Lowest		
Test Channel Bandwidths as specified in TS 38.508-1 [5] subclause 4.3.1					Lowest (5 MHz)		
Test SCS as specified in Table 5.3.5-1					Lowest, Highest		
A-MPR test parameters for NS_40							
Test ID	Freq	Ch BW	SCS	Downlink Configuration	Uplink Configuration		
					Modulation (Note 2)	RB allocation (Note 1)	
1	Low	Default	Default	N/A for A-MPR testing.	DFT-s-OFDM	Edge_1RB_Left	
2	Default	Default	Default			QPSK	Inner_Full
3	Default	Default	Default			QPSK	Outer_Full
4	Low	Default	Default			16 QAM	Edge_1RB_Left
5	Default	Default	Default			16 QAM	Inner_Full
6	Default	Default	Default			16 QAM	Outer_Full
7	Low	Default	Default			64 QAM	Edge_1RB_Left
8	Default	Default	Default			64 QAM	Inner_Full
9	Default	Default	Default			64 QAM	Outer_Full
10	Low	Default	Default			256 QAM	Edge_1RB_Left
11	Default	Default	Default			256 QAM	Inner_Full
12	Default	Default	Default			256 QAM	Outer_Full
13	Low	Default	Default		CP-s OFDM	Edge_1RB_Left	
14	Default	Default	Default			QPSK	Inner_Full
15	Default	Default	Default			QPSK	Outer_Full
16	Low	Default	Default			16 QAM	Edge_1RB_Left
17	Default	Default	Default			16 QAM	Inner_Full
18	Default	Default	Default			16 QAM	Outer_Full
19	Low	Default	Default			64 QAM	Edge_1RB_Left
20	Default	Default	Default			64 QAM	Inner_Full
21	Default	Default	Default			64 QAM	Outer_Full
22	Low	Default	Default			256 QAM	Edge_1RB_Left
23	Default	Default	Default			256 QAM	Inner_Full
24	Default	Default	Default			256 QAM	Outer_Full

NOTE 1: The specific configuration of each RB allocation is defined in Table 6.1-1 unless otherwise stated in this table.
 NOTE 2: DFT-s-OFDM Pi/2 BPSK test applies only for UEs which supports half Pi BPSK in FR1.

Table 6.2.3.4.1-15: Test Configuration table for NS_41

Initial Conditions								
Test Environment as specified in TS 38.508-1 [5] subclause 4.1					Normal			
Test Frequencies as specified in TS 38.508-1 [5] subclause 4.3.1					Use uplink carrier centre frequency (F _c) as specified in test parameters			
Test Channel Bandwidths as specified in TS 38.508-1 [5] subclause 4.3.1					See Ch BW column			
Test SCS as specified in Table 5.3.5-1					Lowest, Highest			
A-MPR test parameters for NS_41								
Test ID	F _c (MHz)	Ch BW (MHz)	SCS	Downlink Configuration	Uplink Configuration			
					Modulation (Note 2)	RB allocation (Note 1)		
1	1437	10	Default	N/A for A-MPR testing.	DFT-s-OFDM	Outer_Full		
2	1437	10	Default			PI/2 BPSK	Edge_1RB_Left	
3	1439.5	15	Default			PI/2 BPSK	Outer_Full	
4	1439.5	15	Default			PI/2 BPSK	Edge_1RB_Left	
5	1442	20	Default			PI/2 BPSK	Outer_Full	
6	1442	20	Default			PI/2 BPSK	Edge_1RB_Left	
7	(Note 3)	Highest (≤ 60 MHz)	Default			PI/2 BPSK	Outer_Full	
8	(Note 3)	Highest (≤ 60 MHz)	Default			PI/2 BPSK	Edge_1RB_Left	
9	1437	10	Default			QPSK	Outer_Full	
10	1437	10	Default			QPSK	Edge_1RB_Left	
11	1439.5	15	Default			QPSK	Outer_Full	
12	1439.5	15	Default			QPSK	Edge_1RB_Left	
13	1442	20	Default			QPSK	Outer_Full	
14	1442	20	Default			QPSK	Edge_1RB_Left	
15	(Note 3)	Highest (≤ 60 MHz)	Default			QPSK	Outer_Full	
16	(Note 3)	Highest (≤ 60 MHz)	Default			QPSK	Edge_1RB_Left	
17	1437	10	Default			16 QAM	Outer_Full	
18	1437	10	Default			16 QAM	Edge_1RB_Left	
19	1439.5	15	Default			16 QAM	Outer_Full	
20	1439.5	15	Default			16 QAM	Edge_1RB_Left	
21	1442	20	Default			16 QAM	Outer_Full	
22	1442	20	Default			16 QAM	Edge_1RB_Left	
23	(Note 3)	Highest (≤ 60 MHz)	Default			16 QAM	Outer_Full	
24	(Note 3)	Highest (≤ 60 MHz)	Default			16 QAM	Edge_1RB_Left	
25	1437	10	Default			64 QAM	Outer_Full	
26	1437	10	Default			64 QAM	Edge_1RB_Left	
27	1439.5	15	Default			64 QAM	Outer_Full	
28	1439.5	15	Default			64 QAM	Edge_1RB_Left	
29	1442	20	Default			64 QAM	Outer_Full	
30	1442	20	Default			64 QAM	Edge_1RB_Left	
31	(Note 3)	Highest (≤ 60 MHz)	Default			64 QAM	Outer_Full	
32	(Note 3)	Highest (≤ 60 MHz)	Default			64 QAM	Edge_1RB_Left	
33	1437	10	Default			256 QAM	Outer_Full	
34	1437	10	Default			256 QAM	Edge_1RB_Left	
35	1439.5	15	Default			256 QAM	Outer_Full	
36	1439.5	15	Default			256 QAM	Edge_1RB_Left	
37	1442	20	Default			256 QAM	Outer_Full	
38	1442	20	Default			256 QAM	Edge_1RB_Left	
39	(Note 3)	Highest (≤ 60 MHz)	Default			256 QAM	Outer_Full	
40	(Note 3)	Highest (≤ 60 MHz)	Default			256 QAM	Edge_1RB_Left	
41	1437	10	Default			CP-OFDM	QPSK	Outer_Full
42	1437	10	Default				QPSK	Edge_1RB_Left
43	1439.5	15	Default				QPSK	Outer_Full

A-MPR test parameters for NS_41						
Test ID	F _c (MHz)	Ch BW (MHz)	SCS	Downlink Configuration	Uplink Configuration	
					Modulation (Note 2)	RB allocation (Note 1)
44	1439.5	15	Default		QPSK	Edge_1RB_Left
45	1442	20	Default		QPSK	Outer_Full
46	1442	20	Default		QPSK	Edge_1RB_Left
47	(Note 3)	Highest (≤ 60 MHz)	Default		QPSK	Outer_Full
48	(Note 3)	Highest (≤ 60 MHz)	Default		QPSK	Edge_1RB_Left
49	1437	10	Default		16 QAM	Outer_Full
50	1437	10	Default		16 QAM	Edge_1RB_Left
51	1439.5	15	Default		16 QAM	Outer_Full
52	1439.5	15	Default		16 QAM	Edge_1RB_Left
53	1442	20	Default		16 QAM	Outer_Full
54	1442	20	Default		16 QAM	Edge_1RB_Left
55	(Note 3)	Highest (≤ 60 MHz)	Default		16 QAM	Outer_Full
56	(Note 3)	Highest (≤ 60 MHz)	Default		16 QAM	Edge_1RB_Left
57	1437	10	Default		64 QAM	Outer_Full
58	1437	10	Default		64 QAM	Edge_1RB_Left
59	1439.5	15	Default		64 QAM	Outer_Full
60	1439.5	15	Default		64 QAM	Edge_1RB_Left
61	1442	20	Default		64 QAM	Outer_Full
62	1442	20	Default		64 QAM	Edge_1RB_Left
63	(Note 3)	Highest (≤ 60 MHz)	Default		64 QAM	Outer_Full
64	(Note 3)	Highest (≤ 60 MHz)	Default		64 QAM	Edge_1RB_Left
65	1437	10	Default		256 QAM	Outer_Full
66	1437	10	Default		256 QAM	Edge_1RB_Left
67	1439.5	15	Default		256 QAM	Outer_Full
68	1439.5	15	Default		256 QAM	Edge_1RB_Left
69	1442	20	Default		256 QAM	Outer_Full
70	1442	20	Default		256 QAM	Edge_1RB_Left
71	(Note 3)	Highest (≤ 60 MHz)	Default		256 QAM	Outer_Full
72	(Note 3)	Highest (≤ 60 MHz)	Default		256 QAM	Edge_1RB_Left

NOTE 1: The specific configuration of each RB allocation is defined in Table 6.1-1 unless otherwise stated in this table.
 NOTE 2: DFT-s-OFDM PI/2 BPSK test applies only for UEs which supports half Pi BPSK in FR1.
 NOTE 3: Select F_c = 1452 MHz for 40 MHz Ch BW, F_c = 1457 MHz for 50 MHz Ch BW and F_c = 1462 MHz for 60 MHz Ch BW.

Table 6.2.3.4.1-16: Test Configuration table for NS_42

Initial Conditions							
Test Environment as specified in TS 38.508-1 [5] subclause 4.1					Normal		
Test Frequencies as specified in TS 38.508-1 [5] subclause 4.3.1					Use uplink carrier centre frequency (F_c) as specified in test parameters		
Test Channel Bandwidths as specified in TS 38.508-1 [5] subclause 4.3.1					See Ch BW column		
Test SCS as specified in Table 5.3.5-1					Lowest, Highest		
A-MPR test parameters for NS_42							
Test ID	F_c (MHz)	Ch BW (MHz)	SCS	Downlink Configuration	Uplink Configuration		
					Modulation (Note 2)	RB allocation (Note 1, 3)	
1	1514.5	5	Default	N/A for A-MPR testing.	DFT-s-OFDM	PI/2 BPSK	Outer_Full
2	1514.5	5	Default			PI/2 BPSK	Outer (LCRB@RBstart)
3	1514.5	5	Default			PI/2 BPSK	Inner (LCRB@RBstart)
4	(Note 3)	Highest (≤ 60)	Default			PI/2 BPSK	Outer_Full
5	(Note 3)	Highest (≤ 60)	Default			PI/2 BPSK	Outer (LCRB@RBstart)
6	(Note 3)	Highest (≤ 60)	Default			PI/2 BPSK	Inner (LCRB@RBstart)
7	1514.5	5	Default			QPSK	Outer_Full
8	1514.5	5	Default			QPSK	Outer (LCRB@RBstart)
9	1514.5	5	Default			QPSK	Inner (LCRB@RBstart)
10	(Note 3)	Highest (≤ 60)	Default			QPSK	Outer_Full
11	(Note 3)	Highest (≤ 60)	Default			QPSK	Outer (LCRB@RBstart)
12	(Note 3)	Highest (≤ 60)	Default			QPSK	Inner LCRB@RBstart)
13	1514.5	5	Default			16 QAM	Outer_Full
14	1514.5	5	Default			16 QAM	Outer (LCRB@RBstart)
15	1514.5	5	Default			16 QAM	Inner (LCRB@RBstart)
16	(Note 3)	Highest (≤ 60)	Default			16 QAM	Outer_Full
17	(Note 3)	Highest (≤ 60)	Default			16 QAM	Outer (LCRB@RBstart)
18	(Note 3)	Highest (≤ 60)	Default			16 QAM	Inner (LCRB@RBstart)
19	1514.5	5	Default			64 QAM	Outer_Full
20	1514.5	5	Default			64 QAM	Outer (LCRB@RBstart)
21	1514.5	5	Default			64 QAM	Inner (LCRB@RBstart)
22	(Note 3)	Highest (≤ 60)	Default			64 QAM	Outer_Full
23	(Note 3)	Highest (≤ 60)	Default			64 QAM	Outer (LCRB@RBstart)
24	(Note 3)	Highest (≤ 60)	Default			64 QAM	Inner (LCRB@RBstart)
25	1514.5	5	Default			256 QAM	Outer_Full
26	1514.5	5	Default			256 QAM	Outer (LCRB@RBstart)
27	1514.5	5	Default		256 QAM	Inner (LCRB@RBstart)	
28	(Note 3)	Highest (≤ 60)	Default		256 QAM	Outer_Full	
29	(Note 3)	Highest (≤ 60)	Default		256 QAM	Outer (LCRB@RBstart)	
30	(Note 3)	Highest (≤ 60)	Default		256 QAM	Inner (LCRB@RBstart)	
31	1514.5	5	Default		CP-OFDM	QPSK	Outer_Full
32	1514.5	5	Default			QPSK	Outer (LCRB@RBstart)
33	1514.5	5	Default			QPSK	Inner (LCRB@RBstart)
34	(Note 3)	Highest (≤ 60)	Default			QPSK	Outer_Full
35	(Note 3)	Highest (≤ 60)	Default			QPSK	Outer (LCRB@RBstart)
36	(Note 3)	Highest (≤ 60)	Default			QPSK	Inner (LCRB@RBstart)
37	1514.5	5	Default			16 QAM	Outer_Full
38	1514.5	5	Default			16 QAM	Outer (LCRB@RBstart)
39	1514.5	5	Default			16 QAM	Inner (LCRB@RBstart)
40	(Note 3)	Highest (≤ 60)	Default			16 QAM	Outer_Full
41	(Note 3)	Highest (≤ 60)	Default			16 QAM	Outer (LCRB@RBstart)
42	(Note 3)	Highest (≤ 60)	Default			16 QAM	Inner (LCRB@RBstart)
43	1514.5	5	Default			64 QAM	Outer_Full
44	1514.5	5	Default			64 QAM	Outer (LCRB@RBstart)
45	1514.5	5	Default			64 QAM	Inner (LCRB@RBstart)
46	(Note 3)	Highest (≤ 60)	Default			64 QAM	Outer_Full
47	(Note 3)	Highest (≤ 60)	Default			64 QAM	Outer (LCRB@RBstart)
48	(Note 3)	Highest (≤ 60)	Default			64 QAM	Inner (LCRB@RBstart)
49	1514.5	5	Default			256 QAM	Outer_Full
50	1514.5	5	Default			256 QAM	Outer (LCRB@RBstart)

A-MPR test parameters for NS_42						
Test ID	F _c (MHz)	Ch BW (MHz)	SCS	Downlink Configuration	Uplink Configuration	
					Modulation (Note 2)	RB allocation (Note 1, 3)
51	1514.5	5	Default		256 QAM	Inner (LCRB@RBstart)
52	(Note 3)	Highest (≤ 60)	Default		256 QAM	Outer_Full
53	(Note 3)	Highest (≤ 60)	Default		256 QAM	Outer (LCRB@RBstart)
54	(Note 3)	Highest (≤ 60)	Default		256 QAM	Inner (LCRB@RBstart)

NOTE 1: The Outer_Full RB configuration is defined in Table 6.1-1.
 NOTE 2: DFT-s-OFDM PI/2 BPSK test applies only for UEs which supports half Pi BPSK in FR1.
 NOTE 3: For 10 – 60 MHz channel bandwidth the RB allocation and test frequency are specified in Table 6.2.3.4.1-16a.

Table 6.2.3.4.1-16a: Uplink configuration for NS_42

Ch BW (MHz)	F _c (MHz)	SCS (kHz)	OFDM	Outer LCRB@RBstart	Inner LCRB@RBstart
5	1514.5	15	DFT-s	16@0	9@4
			CP	17@0	9@4
		30	DFT-s	8@0	5@2
			CP	8@0	5@2
10	1512.0	15	DFT-s	32@0	9@4
			CP	34@0	9@4
		30	DFT-s	16@0	5@2
			CP	17@0	5@2
		60	DFT-s	8@0	3@1
			CP	8@0	3@1
15	1509.5	15	DFT-s	50@0	32@16
			CP	51@0	33@16
		30	DFT-s	25@0	16@8
			CP	25@0	17@8
		60	DFT-s	12@0	9@4
			CP	12@0	9@4
20	1507.0	15	DFT-s	64@0	48@24
			CP	68@0	49@24
		30	DFT-s	32@0	25@12
			CP	34@0	25@12
		60	DFT-s	16@0	12@6
			CP	17@0	12@6
40	1497.0	15	DFT-s	135@0	54@29
			CP	137@0	59@29
		30	DFT-s	64@0	28@14
			CP	68@0	29@14
		60	DFT-s	32@0	15@7
			CP	34@0	15@7
50	1492.0	15	DFT-s	162@0	75@39
			CP	172@0	79@39
		30	DFT-s	81@0	36@19
			CP	86@0	39@19
		60	DFT-s	40@0	18@9
			CP	43@0	19@9
60	1487.0	30	DFT-s	100@0	36@19
			CP	103@0	39@19
		60	DFT-s	50@0	18@9
			CP	51@0	19@9

Table 6.2.3.4.1-17: Test Configuration table for NS_47 power class 3 (contiguous allocation)

Initial Conditions										
Test Environment as specified in TS 38.508-1 [5] subclause 4.1				Normal						
Test Frequencies				As specified in Table 6.2.3.4.1-18a and 6.2.3.4.1-18b						
Test Channel Bandwidths as specified in TS 38.508-1 [5] subclause 4.3.1				30 MHz						
Test SCS as specified in Table 5.3.5-1				Lowest, Highest (Note 6)						
A-MPR test parameters for NS_47										
Test ID	F _c (MHz)	Ch BW (MHz)	SCS (kHz)	Downlink Configuration	Uplink Configuration					
					Modulation (Note 2)	RB allocation (Note 1)				
						SCS 15 kHz	SCS 30 kHz	SCS 60 kHz		
1 (Note 3)	Default	30	Default	N/A for A-MPR testing.	DFT-s-OFDM	PI/2 BPSK	Edge_1RB_Left (A1)			
2 (Note 3)	Default	30	Default			PI/2 BPSK	1@29 (A2)	1@15 (A2)	1@8 (A2)	
3 (Note 3)	Default	30	Default			PI/2 BPSK	Edge_1RB_Right (A3)			
4 (Note 3)	Default	30	Default			PI/2 BPSK	Outer_Full (A2)			
5 (Note 3)	Default	30	Default			PI/2 BPSK	108@0 (A4)	54@0 (A4)	27@0 (A4)	
6 (Note 3)	Default	30	Default			PI/2 BPSK	80@0 (A4)	40@0 (A4)	20@0 (A4)	
7 (Note 3)	Default	30	Default			PI/2 BPSK	54@0 (A2)	27@0 (A2)	12@0 (A2)	
8 (Note 4)	Default	30	Default			PI/2 BPSK	Edge_1RB_Left (A1)			
9 (Note 4)	Default	30	Default			PI/2 BPSK	1@29 (A2)	1@15 (A2)	1@8 (A2)	
10 (Note 4)	Default	30	Default			PI/2 BPSK	Edge_1RB_Right (A3)			
11 (Note 4)	Default	30	Default			PI/2 BPSK	Outer_Full (A2)			
12 (Note 4)	Default	30	Default			PI/2 BPSK	108@0 (A4)	54@0 (A4)	27@0 (A4)	
13 (Note 4)	Default	30	Default			PI/2 BPSK	80@0 (A4)	40@0 (A4)	20@0 (A4)	
14 (Note 4)	Default	30	Default			PI/2 BPSK	54@0 (A2)	27@0 (A2)	12@0 (A2)	
15	Default	30	Default			QPSK	Edge_1RB_Left (A1)			
16	Default	30	Default			QPSK	1@29 (A2)	1@15 (A2)	1@8 (A2)	
17	Default	30	Default			QPSK	Edge_1RB_Right (A3)			
18	Default	30	Default			QPSK	Outer_Full (A2)			
19	Default	30	Default			QPSK	108@0 (A4)	54@0 (A4)	27@0 (A4)	
20	Default	30	Default			QPSK	80@0 (A4)	40@0 (A4)	20@0 (A4)	
21	Default	30	Default			QPSK	54@0 (A2)	27@0 (A2)	12@0 (A2)	
22	Default	30	Default			16 QAM	Edge_1RB_Left (A1)			
23	Default	30	Default			16 QAM	1@29 (A2)	1@15 (A2)	1@8 (A2)	
24	Default	30	Default			16 QAM	Edge_1RB_Right (A3)			
25	Default	30	Default			16 QAM	Outer_Full (A2)			
26	Default	30	Default			16 QAM	108@0 (A4)	54@0 (A4)	27@0 (A4)	
27	Default	30	Default			16 QAM	80@0 (A4)	40@0 (A4)	20@0 (A4)	
28	Default	30	Default			16 QAM	54@0 (A2)	27@0 (A2)	12@0 (A2)	
29	Default	30	Default			64 QAM	Edge_1RB_Left (A1)			
30	Default	30	Default			64 QAM	1@29 (A2)	1@15 (A2)	1@8 (A2)	
31	Default	30	Default			64 QAM	Edge_1RB_Right (A3)			
32	Default	30	Default			64 QAM	Outer_Full (A2)			
33	Default	30	Default			64 QAM	108@0 (A4)	54@0 (A4)	27@0 (A4)	
34	Default	30	Default			64 QAM	80@0 (A4)	40@0 (A4)	20@0 (A4)	
35	Default	30	Default			64 QAM	54@0 (A2)	27@0 (A2)	12@0 (A2)	
36	Default	30	Default			256 QAM	Edge_1RB_Left (A1)			
37	Default	30	Default			256 QAM	1@29 (A2)	1@15 (A2)	1@8 (A2)	
38	Default	30	Default			256 QAM	Edge_1RB_Right (A3)			
39	Default	30	Default			256 QAM	Outer_Full (A2)			
40	Default	30	Default			256 QAM	108@0 (A4)	54@0 (A4)	27@0 (A4)	
41	Default	30	Default			256 QAM	80@0 (A4)	40@0 (A4)	20@0 (A4)	
42	Default	30	Default			256 QAM	54@0 (A2)	27@0 (A2)	12@0 (A2)	
43	Default	30	Default			CP-OFDM	Edge_1RB_Left (A1)			
44	Default	30	Default				QPSK	1@29 (A2)	1@15 (A2)	1@8 (A2)
45	Default	30	Default				QPSK	Edge_1RB_Right (A3)		
46	Default	30	Default				QPSK	Outer_Full (A2)		
47	Default	30	Default				QPSK	108@0 (A4)	54@0 (A4)	27@0 (A4)

48	Default	30	Default			QPSK	80@0 (A4)	40@0 (A4)	20@0 (A4)
49	Default	30	Default			QPSK	54@0 (A2)	27@0 (A2)	12@0 (A2)
50	Default	30	Default			16 QAM	Edge_1RB_Left (A1)		

A-MPR test parameters for NS_47									
Test ID	F _c (MHz)	Ch BW (MHz)	SCS (kHz)	Downlink Configuration	Uplink Configuration				
					Modulation (Note 2)	RB allocation (Note 1)			
						SCS 15 kHz	SCS 30 kHz	SCS 60 kHz	
51	Default	30	Default		16 QAM	1@29 (A2)	1@15 (A2)	1@8 (A2)	
52	Default	30	Default		16 QAM	Edge_1RB_Right (A3)			
53	Default	30	Default		16 QAM	Outer_Full (A2)			
54	Default	30	Default		16 QAM	108@0 (A4)	54@0 (A4)	27@0 (A4)	
55	Default	30	Default		16 QAM	80@0 (A4)	40@0 (A4)	20@0 (A4)	
56	Default	30	Default		16 QAM	54@0 (A2)	27@0 (A2)	12@0 (A2)	
57	Default	30	Default		64 QAM	Edge_1RB_Left (A1)			
58	Default	30	Default		64 QAM	1@29 (A2)	1@15 (A2)	1@8 (A2)	
59	Default	30	Default		64 QAM	Edge_1RB_Right (A3)			
60	Default	30	Default		64 QAM	Outer_Full (A2)			
61	Default	30	Default		64 QAM	108@0 (A4)	54@0 (A4)	27@0 (A4)	
62	Default	30	Default		64 QAM	80@0 (A4)	40@0 (A4)	20@0 (A4)	
63	Default	30	Default		64 QAM	54@0 (A2)	27@0 (A2)	12@0 (A2)	
64	Default	30	Default		256 QAM	Edge_1RB_Left (A1)			
65	Default	30	Default		256 QAM	1@29 (A2)	1@15 (A2)	1@8 (A2)	
66	Default	30	Default		256 QAM	Edge_1RB_Right (A3)			
67	Default	30	Default		256 QAM	Outer_Full (A2)			
68	Default	30	Default		256 QAM	108@0 (A4)	54@0 (A4)	27@0 (A4)	
69	Default	30	Default		256 QAM	80@0 (A4)	40@0 (A4)	20@0 (A4)	
70	Default	30	Default		256 QAM	54@0 (A2)	27@0 (A2)	12@0 (A2)	

NOTE 1: The specific configuration of each RB allocation is defined in Table 6.1-1 unless otherwise stated in this table.
 NOTE 2: DFT-s-OFDM Pi/2 BPSK test applies only for UEs which supports half Pi BPSK in FR1.
 NOTE 3: UE operating in TDD mode with Pi/2 BPSK modulation and UE indicates support for UE capability *powerBoosting-pi2BPSK* and the IE *powerBoostPi2BPSK* is set to 1 for bands n41.
 NOTE 4: UE operating in FDD mode, or in TDD mode in bands other than n41, or in TDD mode the IE *powerBoostPi2BPSK* is set to 0 for bands n41.
 NOTE 5: Void
 NOTE 6: For FR1 bands where highest supported SCS is 60 kHz the highest tested SCS is limited to 30 kHz as carrier with SCS=60 kHz cannot be used as PCell.

Table 6.2.3.4.1-17a: Test Configuration table for NS_47 power class 3 (almost contiguous allocation)

Initial Conditions						
Test Environment as specified in TS 38.508-1 [5] subclause 4.1				Normal		
Test Frequencies				As specified in Table 6.2.3.4.1-18a and 6.2.3.4.1-18b		
Test Channel Bandwidths as specified in TS 38.508-1 [5] subclause 4.3.1				30 MHz		
Test SCS as specified in Table 5.3.5-1				Lowest, Highest (Note 3)		
A-MPR test parameters for NS_47						
Test ID	F _c (MHz)	Ch BW (MHz)	SCS (kHz)	Downlink Configuration	Uplink Configuration	
					Modulation	RB allocation (Note 1)
1	Default	30	Default	CP-OFDM	QPSK	Outer_Full (A2)
2	Default	30	Default		16 QAM	Outer_Full (A2)
3	Default	30	Default		64 QAM	Outer_Full (A2)
4	Default	30	Default		256 QAM	Outer_Full (A2)
NOTE 1: The specific configuration of each RB allocation is defined in Table 6.2.2.4.1-4.						
NOTE 2: Void						
NOTE 3: For FR1 bands where highest supported SCS is 60 kHz the highest tested SCS is limited to 30 kHz as carrier with SCS=60 kHz cannot be used as PCell.						

Table 6.2.3.4.1-18: Test Configuration table for NS_47 power class 2 (contiguous allocation)

Initial Conditions								
Test Environment as specified in TS 38.508-1 [5] subclause 4.1				Normal				
Test Frequencies				As specified in Table 6.2.3.4.1-18a and 6.2.3.4.1-18b				
Test Channel Bandwidths as specified in TS 38.508-1 [5] subclause 4.3.1				30 MHz				
Test SCS as specified in Table 5.3.5-1				Lowest, Highest (Note 3)				
A-MPR test parameters for NS_47								
Test ID	F _c (MHz)	Ch BW (MHz)	SCS (kHz)	Downlink Configuration	Uplink Configuration			
					Modulation (Note 2)	RB allocation (Note 1)		
						SCS 15 kHz	SCS 30 kHz	SCS 60 kHz
1	Default	30	Default	N/A for A-MPR testing.	PI/2 BPSK	Edge_1RB_Left (A1)		
2	Default	30	Default		PI/2 BPSK	1@29 (A2)	1@15 (A2)	1@8 (A2)
3	Default	30	Default		PI/2 BPSK	Edge_1RB_Right (A3)		
4	Default	30	Default		PI/2 BPSK	Outer_Full (A2)		
5	Default	30	Default		PI/2 BPSK	108@0 (A4)	54@0 (A4)	27@0 (A4)
6	Default	30	Default		PI/2 BPSK	80@0 (A4)	40@0 (A4)	20@0 (A4)
7	Default	30	Default		PI/2 BPSK	54@0 (A2)	27@0 (A2)	12@0 (A2)
8	Default	30	Default		QPSK	Edge_1RB_Left (A1)		
9	Default	30	Default		QPSK	1@29 (A2)	1@15 (A2)	1@8 (A2)
10	Default	30	Default		QPSK	Edge_1RB_Right (A3)		
11	Default	30	Default		QPSK	Outer_Full (A2)		
12	Default	30	Default		QPSK	108@0 (A4)	54@0 (A4)	27@0 (A4)
13	Default	30	Default		QPSK	80@0 (A4)	40@0 (A4)	20@0 (A4)
14	Default	30	Default		QPSK	54@0 (A2)	27@0 (A2)	12@0 (A2)
15	Default	30	Default		16 QAM	Edge_1RB_Left (A1)		
16	Default	30	Default		16 QAM	1@29 (A2)	1@15 (A2)	1@8 (A2)
17	Default	30	Default		16 QAM	Edge_1RB_Right (A3)		
18	Default	30	Default		16 QAM	Outer_Full (A2)		
19	Default	30	Default		16 QAM	108@0 (A4)	54@0 (A4)	27@0 (A4)
20	Default	30	Default		16 QAM	80@0 (A4)	40@0 (A4)	20@0 (A4)
21	Default	30	Default		16 QAM	54@0 (A2)	27@0 (A2)	12@0 (A2)
22	Default	30	Default		64 QAM	Edge_1RB_Left (A1)		
23	Default	30	Default		64 QAM	1@29 (A2)	1@15 (A2)	1@8 (A2)
24	Default	30	Default		64 QAM	Edge_1RB_Right (A3)		
25	Default	30	Default		64 QAM	Outer_Full (A2)		
26	Default	30	Default		64 QAM	108@0 (A4)	54@0 (A4)	27@0 (A4)
27	Default	30	Default		64 QAM	80@0 (A4)	40@0 (A4)	20@0 (A4)
28	Default	30	Default		64 QAM	54@0 (A2)	27@0 (A2)	12@0 (A2)
29	Default	30	Default		256 QAM	Edge_1RB_Left (A1)		
30	Default	30	Default		256 QAM	1@29 (A2)	1@15 (A2)	1@8 (A2)
31	Default	30	Default		256 QAM	Edge_1RB_Right (A3)		
32	Default	30	Default		256 QAM	Outer_Full (A2)		
33	Default	30	Default		256 QAM	108@0 (A4)	54@0 (A4)	27@0 (A4)
34	Default	30	Default		256 QAM	80@0 (A4)	40@0 (A4)	20@0 (A4)
35	Default	30	Default		256 QAM	54@0 (A2)	27@0 (A2)	12@0 (A2)
36	Default	30	Default		QPSK	Edge_1RB_Left (A1)		
37	Default	30	Default		QPSK	1@29 (A2)	1@15 (A2)	1@8 (A2)
38	Default	30	Default		QPSK	Edge_1RB_Right (A3)		
39	Default	30	Default		QPSK	Outer_Full (A2)		
40	Default	30	Default		QPSK	108@0 (A4)	54@0 (A4)	27@0 (A4)
41	Default	30	Default		QPSK	80@0 (A4)	40@0 (A4)	20@0 (A4)
42	Default	30	Default		QPSK	54@0 (A2)	27@0 (A2)	12@0 (A2)
43	Default	30	Default		16 QAM	Edge_1RB_Left (A1)		
44	Default	30	Default		16 QAM	1@29 (A2)	1@15 (A2)	1@8 (A2)
45	Default	30	Default		16 QAM	Edge_1RB_Right (A3)		
46	Default	30	Default		16 QAM	Outer_Full (A2)		
47	Default	30	Default		16 QAM	108@0 (A4)	54@0 (A4)	27@0 (A4)
48	Default	30	Default		16 QAM	80@0 (A4)	40@0 (A4)	20@0 (A4)

49	Default	30	Default			16 QAM	54@0 (A2)	27@0 (A2)	12@0 (A2)
50	Default	30	Default			64 QAM	Edge_1RB_Left (A1)		

A-MPR test parameters for NS_47									
Test ID	F _c (MHz)	Ch BW (MHz)	SCS (kHz)	Downlink Configuration	Uplink Configuration				
					Modulation (Note 2)	RB allocation (Note 1)			
51	Default	30	Default		64 QAM	1@29 (A2)	1@15 (A2)	1@8 (A2)	
52	Default	30	Default		64 QAM	Edge_1RB_Right (A3)			
53	Default	30	Default		64 QAM	Outer_Full (A2)			
54	Default	30	Default		64 QAM	108@0 (A4)	54@0 (A4)	27@0 (A4)	
55	Default	30	Default		64 QAM	80@0 (A4)	40@0 (A4)	20@0 (A4)	
56	Default	30	Default		64 QAM	54@0 (A2)	27@0 (A2)	12@0 (A2)	
57	Default	30	Default		256 QAM	Edge_1RB_Left (A1)			
58	Default	30	Default		256 QAM	1@29 (A2)	1@15 (A2)	1@8 (A2)	
59	Default	30	Default		256 QAM	Edge_1RB_Right (A3)			
60	Default	30	Default		256 QAM	Outer_Full (A2)			
61	Default	30	Default		256 QAM	108@0 (A4)	54@0 (A4)	27@0 (A4)	
62	Default	30	Default		256 QAM	80@0 (A4)	40@0 (A4)	20@0 (A4)	
63	Default	30	Default		256 QAM	54@0 (A2)	27@0 (A2)	12@0 (A2)	

NOTE 1: The specific configuration of each RB allocation is defined in Table 6.1-1 unless otherwise stated in this table.
 NOTE 2: DFT-s-OFDM PI/2 BPSK test applies only for UEs which supports half Pi BPSK in FR1.
 NOTE 3: For FR1 bands where highest supported SCS is 60 kHz the highest tested SCS is limited to 30 kHz as carrier with SCS=60 kHz cannot be used as PCell.

Table 6.2.3.4.1-18a: Test frequencies for NS_47 (SCS=15 kHz, ΔFRaster = 15kHz)

C B W [MHz]	carrier Bandwidth [PRBs]	Carrier centre [MHz]	Carrier centre [ARFCN]	point A [MHz]	absoluteFrequencyPointA[ARFCN]	offsetToCarrier [Carrier PRBs]	S S B O C S [kHz]	G S C N	absolute FrequencySSB [ARFCN]	k s s B	Offset Carrier CORESET#0 [RBs] Note 2	CORESET#0 Index (Offset [RBs]) Note 1	offsetToPointA(SIB1) [PRBs] Note 1
30	160	2560.005	512001	2545.605	509121	0	15	6369	509550	11	1	0 (0)	1

NOTE 1: The CORESET#0 Index and the associated CORESET#0 Offset refers to Table 13-1 in TS 38.213 [22]. The value of CORESET#0 Index is signalled in controlResourceSetZero (pdcch-ConfigSIB1) in the MIB. The offsetToPointA IE is expressed in units of resource blocks assuming 15 kHz subcarrier spacing for FR1 and 60 kHz subcarrier spacing for FR2.
 NOTE 2: The parameter Offset Carrier CORESET#0 specifies the offset from the lowest subcarrier of the carrier and the lowest subcarrier of CORESET#0. It corresponds to the parameter ΔF_{OffsetCORESET-0-Carrier} in Annex C expressed in number of common RBs.

Table 6.2.3.4.1-18b: Test frequencies for NS_47 (SCS=30 kHz, ΔFRaster = 30 kHz)

C B W [M H z]	carrier Bandw idth [PRBs]	Ca rri er ce ntr e [M Hz]	Car rier cen tre [A RF CN]	poi nt A [M Hz]	absoluteFrequ encyPointA[A RFCN]	offsetToCarri er [Carri er PRBs]	S S C N	G S C N	absoluteF requency SSB [ARFCN]	k s s B	Offs et Carri er COR ESE T#0 [RBs] Note 2	COR ESE T#0 Inde x (Offs et [RBs]) Note 1	offsetTo PointA(S IB1) [PRBs] Note 1
30	78	25 60. 02	512 004	25 45. 98	509196	0	3 0	63 75	510030	1 4	0	1 (1)	2

NOTE 1: The CORESET#0 Index and the associated CORESET#0 Offset refers to Table 13-1 in TS 38.213 [22]. The value of CORESET#0 Index is signalled in controlResourceSetZero (pdcch-ConfigSIB1) in the MIB. The offsetToPointA IE is expressed in units of resource blocks assuming 15 kHz subcarrier spacing for FR1 and 60 kHz subcarrier spacing for FR2.

NOTE 2: The parameter Offset Carrier CORESET#0 specifies the offset from the lowest subcarrier of the carrier and the lowest subcarrier of CORESET#0. It corresponds to the parameter $\Delta F_{\text{OffsetCORESET-0-Carrier}}$ in Annex C expressed in number of common RBs.

Table 6.2.3.4.1-19: Test Configuration table for NS_48 (Power class 3)

Initial Conditions								
Test Environment as specified in TS 38.508-1 [5] subclause 4.1				Normal				
Test Frequencies				lowest and highest carrier centre frequency for each CBW in table 6.2.3.3.26-1				
Test Channel Bandwidths as specified in TS 38.508-1 [5] subclause 4.3.1				25 MHz, 30MHz, 40MHz, 45MHz, 50MHz				
Test SCS as specified in Table 5.3.5-1				Lowest, Highest				
A-MPR test parameters for NS_48								
Test ID	F _c (MHz)	Ch BW (MHz)	SCS (kHz)	Downlink Configuration	Uplink Configuration			
					Modulation (Note 2)	RB allocation (Note 1)		
						SCS 15 kHz	SCS 30 kHz	SCS 60 kHz
1	Default	25	Default	N/A for A-MPR testing.	QPSK	Outer_Full (A3)		
2	Default	25	Default		QPSK	Edge_1RB_Right (A3)		
3	Default	30	Default		QPSK	Outer_Full (A3)		
4	Default	30	Default		QPSK	Edge_1RB_Right (A5)		
5	Default	40	Default		QPSK	16@0 (A2)	8@0 (A2)	4@0 (A2)
6	Default	40	Default		QPSK	90@0 (A3)	48@0 (A3)	24@0 (A3)
7	Default	40	Default		QPSK	150@0 (A4)	75@0 (A4)	36@0 (A4)
8	Default	40	Default		QPSK	192@0 (A2)	96@0 (A2)	48@0 (A2)
9	Default	40	Default		QPSK	5@187 (A3)	2@94 (A3)	1@47 (A3)
10	Default	40	Default		QPSK	Outer_Full (A1)		
11	Default	45	Default		QPSK	27@0 (A2)	12@0 (A2)	6@0 (A2)
12	Default	45	Default		QPSK	100@0 (A4)	50@0 (A4)	27@0 (A4)
13	Default	45	Default		QPSK	200@0 (A2)	100@0 (A2)	50@0 (A2)
14	Default	45	Default		QPSK	5@203 (A5)	2@102 (A5)	1@51 (A5)
15	Default	45	Default		QPSK	Outer_Full (A1)		
16	Default	50	Default		QPSK	32@0 (A2)	16@0 (A2)	8@0 (A2)
17	Default	50	Default		QPSK	108@0 (A4)	54@0 (A4)	27@0 (A4)
18	Default	50	Default		QPSK	225@0 (A2)	108@0 (A2)	54@0 (A2)
19	Default	50	Default		QPSK	5@223 (A5)	2@112 (A5)	1@56 (A5)
20	Default	50	Default		QPSK	Outer_Full (A1)		
21	Default	25	Default		256 QAM	Outer_Full (A3)		
22	Default	25	Default		256 QAM	Edge_1RB_Right (A3)		
23	Default	30	Default		256 QAM	Outer_Full (A3)		
24	Default	30	Default		256 QAM	Edge_1RB_Right (A5)		
25	Default	40	Default		256 QAM	16@0 (A2)	8@0 (A2)	4@0 (A2)
26	Default	40	Default		256 QAM	90@0 (A3)	48@0 (A3)	24@0 (A3)
27	Default	40	Default		256 QAM	150@0 (A4)	75@0 (A4)	36@0 (A4)
28	Default	40	Default		256 QAM	192@0 (A2)	96@0 (A2)	48@0 (A2)
29	Default	40	Default		256 QAM	5@187 (A3)	2@94 (A3)	1@47 (A3)
30	Default	40	Default		256 QAM	Outer_Full (A1)		
31	Default	45	Default		256 QAM	27@0 (A2)	12@0 (A2)	6@0 (A2)
32	Default	45	Default		256 QAM	100@0 (A4)	50@0 (A4)	27@0 (A4)
33	Default	45	Default		256 QAM	200@0 (A2)	100@0 (A2)	50@0 (A2)
34	Default	45	Default		256 QAM	5@203 (A5)	2@102 (A5)	1@51 (A5)
35	Default	45	Default		256 QAM	Outer_Full (A1)		
36	Default	50	Default		256 QAM	32@0 (A2)	16@0 (A2)	8@0 (A2)
37	Default	50	Default		256 QAM	108@0 (A4)	54@0 (A4)	27@0 (A4)
38	Default	50	Default		256 QAM	225@0 (A2)	108@0 (A2)	54@0 (A2)
39	Default	50	Default		256 QAM	5@223 (A5)	2@112 (A5)	1@56 (A5)
40	Default	50	Default		256 QAM	Outer_Full (A1)		
41	Default	25	Default		QPSK	Outer_Full (A3)		
42	Default	25	Default		QPSK	Edge_1RB_Right (A3)		
43	Default	30	Default		QPSK	Outer_Full (A3)		
44	Default	30	Default		QPSK	Edge_1RB_Right (A5)		
45	Default	40	Default		QPSK	16@0 (A2)	8@0 (A2)	4@0 (A2)
46	Default	40	Default		QPSK	95@0 (A3)	48@0 (A3)	24@0 (A3)
47	Default	40	Default		QPSK	152@0 (A4)	76@0 (A4)	38@0 (A4)
48	Default	40	Default		QPSK	192@0 (A2)	96@0 (A2)	48@0 (A2)
49	Default	40	Default		QPSK	5@187 (A3)	2@94 (A3)	1@47 (A3)
50	Default	40	Default		QPSK	Outer_Full (A1)		
51	Default	45	Default		QPSK	27@0 (A2)	13@0 (A2)	6@0 (A2)
52	Default	45	Default		QPSK	106@0 (A4)	53@0 (A4)	27@0 (A4)
53	Default	45	Default		QPSK	208@0 (A2)	104@0 (A2)	52@0 (A2)
54	Default	45	Default		QPSK	5@203 (A5)	2@102 (A5)	1@51 (A5)
55	Default	45	Default		QPSK	Outer_Full (A1)		

56	Default	50	Default			QPSK	34@0 (A2)	17@0 (A2)	9@0 (A2)
57	Default	50	Default			QPSK	115@0 (A4)	58@0 (A4)	29@0 (A4)
58	Default	50	Default			QPSK	228@0 (A2)	114@0 (A2)	57@0 (A2)
59	Default	50	Default			QPSK	5@223 (A5)	2@112 (A5)	1@56 (A5)
60	Default	50	Default			QPSK	Outer_Full (A1)		
61	Default	25	Default			256 QAM	Outer_Full (A3)		
62	Default	25	Default			256 QAM	Edge_1RB_Right (A3)		
63	Default	30	Default			256 QAM	Outer_Full (A3)		
64	Default	30	Default			256 QAM	Edge_1RB_Right (A5)		
65	Default	40	Default			256 QAM	16@0 (A2)	8@0 (A2)	4@0 (A2)
66	Default	40	Default			256 QAM	95@0 (A3)	48@0 (A3)	24@0 (A3)
67	Default	40	Default			256 QAM	152@0 (A4)	76@0 (A4)	38@0 (A4)
68	Default	40	Default			256 QAM	192@0 (A2)	96@0 (A2)	48@0 (A2)
69	Default	40	Default			256 QAM	5@187 (A3)	2@94 (A3)	1@47 (A3)
70	Default	40	Default			256 QAM	Outer_Full (A1)		
71	Default	45	Default			256 QAM	27@0 (A2)	13@0 (A2)	6@0 (A2)
72	Default	45	Default			256 QAM	106@0 (A4)	53@0 (A4)	27@0 (A4)
73	Default	45	Default			256 QAM	208@0 (A2)	104@0 (A2)	52@0 (A2)
74	Default	45	Default			256 QAM	5@203 (A5)	2@102 (A5)	1@51 (A5)
75	Default	45	Default			256 QAM	Outer_Full (A1)		
76	Default	50	Default			256 QAM	34@0 (A2)	17@0 (A2)	9@0 (A2)
77	Default	50	Default			256 QAM	115@0 (A4)	58@0 (A4)	29@0 (A4)
78	Default	50	Default			256 QAM	228@0 (A2)	114@0 (A2)	57@0 (A2)
79	Default	50	Default			256 QAM	5@223 (A5)	2@112 (A5)	1@56 (A5)
80	Default	50	Default			256 QAM	Outer_Full (A1)		

NOTE 1: The specific configuration of each RB allocation is defined in Table 6.1-1 unless otherwise stated in this table.

Table 6.2.3.4.1-21: Test Configuration table for NS_12

Initial Conditions							
Test Environment as specified in TS 38.508-1 [5] subclause 4.1				Normal			
Test Frequencies as specified in TS 38.508-1 [5] subclause 4.3.1				Low range, High range			
Test Channel Bandwidths as specified in TS 38.508-1 [5] subclause 4.3.1				Refer to test parameters (5, 10 MHz)			
Test SCS as specified in Table 5.3.5-1				Lowest			
A-MPR test parameters for NS_12							
Test ID	F _c (MHz)	ChBw (MHz)	SCS	Downlink Configuration	Uplink Configuration		
					Modulation (NOTE 2, 3)	RB allocation (Note 1)	
1-3	Default	5	Default	N/A for A-MPR testing.	DFT-s-OFDM	QPSK 64 QAM 256 QAM	Edge_1RB_Left
4-6	Default	5	Default			QPSK 64 QAM 256 QAM	Outer_Full
7-9	Default	10	Default			QPSK 64 QAM 256 QAM	Edge_1RB_Left
10-12	Default	10	Default			QPSK 64 QAM 256 QAM	Outer_Full
13	Default	5	Default			QPSK	12@11
14	Default	10	Default			QPSK	30@21
15-16	Default	5	Default			CP-OFDM	64 QAM 256 QAM
17-18	Default	5	Default		64 QAM 256 QAM		Outer_Full
19-20	Default	10	Default		64 QAM 256 QAM		Edge_1RB_Left
21-22	Default	10	Default		64 QAM 256 QAM		Outer_Full
23	Default	5	Default		QPSK		12@11
24	Default	10	Default		QPSK		30@21

NOTE 1: The specific configuration of each RB allocation is defined in Table 6.1-1 unless otherwise stated in this table.
 NOTE 2: In test IDs with multiple modulations, each UL Modulation shall be tested separately against RB allocation.

Table 6.2.3.4.1-22: Test Configuration table for NS_13

Initial Conditions							
Test Environment as specified in TS 38.508-1 [5] subclause 4.1				Normal			
Test Frequencies as specified in TS 38.508-1 [5] subclause 4.3.1				Refer to uplink carrier center frequency (F_c) in test parameters			
Test Channel Bandwidths as specified in TS 38.508-1 [5] subclause 4.3.1				Refer to test parameters (5 MHz)			
Test SCS as specified in Table 5.3.5-1				Lowest			
A-MPR test parameters for NS_13							
Test ID	F_c (MHz)	ChBw (MHz)	SCS	Downlink Configuration	Uplink Configuration		
					Modulation (NOTE 2, 3)	RB allocation (Note 1)	
1-3	819.5	5	Default	N/A for A-MPR testing.	DFT-s-OFDM	16 QAM 64 QAM 256 QAM	Edge_1RB_Left
4-6	819.5	5	Default			QPSK 64 QAM 256 QAM	Outer_Full
7-9	821.5	5	Default			16 QAM 64 QAM 256 QAM	Edge_1RB_Left
10	High	5	Default			64 QAM	Outer_Full
11	819	5	Default			QPSK	Outer_Full
12-14	819.5	5	Default			16 QAM 64 QAM 256 QAM	Edge_1RB_Left
15-16	819.5	5	Default		CP-OFDM	64 QAM 256 QAM	Outer_Full
17-19	821.5	5	Default			16 QAM 64 QAM 256 QAM	Edge_1RB_Left
20	High	5	Default			64 QAM	Outer_Full
21	819	5	Default			QPSK	Outer_Full

NOTE 1: The specific configuration of each RB allocation is defined in Table 6.1-1 unless otherwise stated in this table.
 NOTE 2: In test IDs with multiple modulations, each UL Modulation shall be tested separately against RB allocation.

Table 6.2.3.4.1-23: Test Configuration table for NS_14

Initial Conditions							
Test Environment as specified in TS 38.508-1 [5] subclause 4.1				Normal			
Test Frequencies as specified in TS 38.508-1 [5] subclause 4.3.1				Low range, High range			
Test Channel Bandwidths as specified in TS 38.508-1 [5] subclause 4.3.1				Refer to test parameters (10, 15, 20 MHz)			
Test SCS as specified in Table 5.3.5-1				Lowest			
A-MPR test parameters for NS_14							
Test ID	F _c (MHz)	ChBw (MHz)	SCS	Downlink Configuration	Uplink Configuration		
					Modulation (NOTE 2, 3)	RB allocation (Note 1)	
1	Default	10	Default	N/A for A-MPR testing.	DFT-s-OFDM	64 QAM	Edge_1RB_Left
2	Default	10	Default			16 QAM	Outer_Full
3	Default	15	Default			64 QAM	Edge_1RB_Left
4	Default	15	Default			16 QAM	Outer_Full
5-6	Default	20	Default			64 QAM 256 QAM	Edge_1RB_Left
7	Default	20	Default			16 QAM	Outer_Full
8	Default	10	Default			QPSK	8@2
9	Default	15	Default			QPSK	8@11
10	Default	20	Default			QPSK	8@20
11-13	Default	10	Default			CP-OFDM	16 QAM 64 QAM 256 QAM
14	Default	10	Default	16 QAM	Outer_Full		
15-17	Default	15	Default	16 QAM 64 QAM 256 QAM	Edge_1RB_Left		
18	Default	15	Default	16 QAM	Outer_Full		
19-21	Default	20	Default	16 QAM 64 QAM 256 QAM	Edge_1RB_Left		
22	Default	20	Default	16 QAM	Outer_Full		
23	Default	10	Default	QPSK	8@2		
24	Default	15	Default	QPSK	8@11		
25	Default	20	Default	QPSK	8@20		

NOTE 1: The specific configuration of each RB allocation is defined in Table 6.1-1 unless otherwise stated in this table.
 NOTE 2: In test IDs with multiple modulations, each UL Modulation shall be tested separately against RB allocation.

Table 6.2.3.4.1-24: Test Configuration table for NS_15

Initial Conditions						
Test Environment as specified in TS 38.508-1 [5] subclause 4.1			Normal			
Test Frequencies as specified in TS 38.508-1 [5] subclause 4.3.1			Refer to uplink carrier center frequency (F_c) in test parameters			
Test Channel Bandwidths as specified in TS 38.508-1 [5] subclause 4.3.1			Refer to test parameters (5, 10, 15, 20 MHz)			
Test SCS as specified in Table 5.3.5-1			Lowest			
A-MPR test parameters for NS_15						
Test ID	F_c (MHz)	ChBw (MHz)	SCS	Downlink Configuration	Uplink Configuration	
					Modulation (NOTE 2, 3)	RB allocation (Note 1)
1	846.5	5	Default	N/A for A-MPR testing.	64 QAM	Edge_1RB_Right
2	846.5	5	Default		64 QAM	Outer_Full
3	846.5	5	Default		64 QAM	8@9
4-5	846.5	5	Default		64 QAM 256 QAM	Edge_1RB_Left
6-7	844	10	Default		64 QAM 256 QAM	Edge_1RB_Right
8	844	10	Default		64 QAM	Outer_Full
9	844	10	Default		64 QAM	15@16
10-11	844	10	Default		64 QAM 256 QAM	Edge_1RB_Left
12-13	840	10	Default		64 QAM 256 QAM	Edge_1RB_Right
14	840	10	Default		64 QAM	Outer_Full
15	840	10	Default		64 QAM	24@15
16-17	840	10	Default		64 QAM 256 QAM	Edge_1RB_Left
18-19	841.5	15	Default		64 QAM 256 QAM	Edge_1RB_Right
20	841.5	15	Default		64 QAM	Outer_Full
21	841.5	15	Default		64 QAM	20@31
22-23	841.5	15	Default		64 QAM 256 QM	Edge_1RB_Left
24-25	837.5	15	Default		64 QAM 256 QAM	Edge_1RB_Right
26	837.5	15	Default		64 QAM	Outer_Full
27	837.5	15	Default		64 QAM	20@39
28-29	837.5	15	Default		64 QAM 256 QAM	Edge_1RB_Left
30-31	831.5	15	Default		64 QAM 256 QAM	Edge_1RB_Right
32	831.5	15	Default		64 QAM	Outer_Full
33	831.5	15	Default		64 QAM	20@52
34-35	831.5	15	Default		64 QAM 256 QAM	Edge_1RB_Left
36-37	839	20	Default		64 QAM 256 QAM	Edge_1RB_Right
38	839	20	Default		64 QAM	Outer_Full
39	839	20	Default		64 QAM	30@37
40-41	839	20	Default		64 QAM 256 QAM	Edge_1RB_Left
42-43	835	20	Default		64 QAM 256 QAM	Edge_1RB_Right
44	835	20	Default		64 QAM	Outer_Full
45	835	20	Default		64 QAM	30@45
46-47	835	20	Default		64 QAM 256 QAM	Edge_1RB_Left
48	840.5	5	Default		QPSK	Outer_Full
49	835	10	Default		QPSK	Outer_Full
50	831.5	15	Default		QPSK	20@23
51	835	20	Default		QPSK	30@16

A-MPR test parameters for NS_15						
Test ID	F _c (MHz)	ChBw (MHz)	SCS	Downlink Configuration	Uplink Configuration	
					Modulation (NOTE 2, 3)	RB allocation (Note 1)
52	846.5	5	Default	CP-OFDM	64 QAM	Edge_1RB_Right
53	846.5	5	Default		64 QAM	Outer_Full
54	846.5	5	Default		64 QAM	8@9
55-56	846.5	5	Default		64 QAM 256 QAM	Edge_1RB_Left
57-58	844	10	Default		64 QAM 256 QAM	Edge_1RB_Right
59	844	10	Default		64 QAM	Outer_Full
60	844	10	Default		64 QAM	15@16
61-62	844	10	Default		64 QAM 256 QAM	Edge_1RB_Left
63-64	840	10	Default		64 QAM 256 QAM	Edge_1RB_Right
65	840	10	Default		64 QAM	Outer_Full
66	840	10	Default		64 QAM	24@15
67-68	840	10	Default		64 QAM 256 QAM	Edge_1RB_Left
69-70	841.5	15	Default		64 QAM 256 QAM	Edge_1RB_Right
71	841.5	15	Default		64 QAM	Outer_Full
72	841.5	15	Default		64 QAM	20@31
73-74	841.5	15	Default		64 QAM 256 QM	Edge_1RB_Left
75-76	837.5	15	Default		64 QAM 256 QAM	Edge_1RB_Right
77	837.5	15	Default		64 QAM	Outer_Full
78	837.5	15	Default		64 QAM	20@39
79-80	837.5	15	Default		64 QAM 256 QAM	Edge_1RB_Left
81-82	831.5	15	Default		64 QAM 256 QAM	Edge_1RB_Right
83	831.5	15	Default		64 QAM	Outer_Full
84	831.5	15	Default		64 QAM	20@52
85-86	831.5	15	Default		64 QAM 256 QAM	Edge_1RB_Left
87-88	839	20	Default		64 QAM 256 QAM	Edge_1RB_Right
89	839	20	Default		64 QAM	Outer_Full
90	839	20	Default		64 QAM	30@37
91-92	839	20	Default		64 QAM 256 QAM	Edge_1RB_Left
93-94	835	20	Default		64 QAM 256 QAM	Edge_1RB_Right
95	835	20	Default		64 QAM	Outer_Full
96	835	20	Default		64 QAM	30@45
97-98	835	20	Default		64 QAM 256 QAM	Edge_1RB_Left
99	840.5	5	Default		QPSK	Outer_Full
100	835	10	Default		QPSK	Outer_Full
101	831.5	15	Default		QPSK	20@23
102	835	20	Default		QPSK	30@16

NOTE 1: The specific configuration of each RB allocation is defined in Table 6.1-1 unless otherwise stated in this table.

NOTE 2: In test IDs with multiple modulations, each UL Modulation shall be tested separately against RB allocation.

Table 6.2.3.4.1-25: Test Configuration table for NS_46

Initial Conditions									
Test Environment as specified in TS 38.508-1 [5] subclause 4.1					Normal				
Test Frequencies as specified in TS 38.508-1 [5] subclause 4.3.1					High range				
Test Channel Bandwidths as specified in TS 38.508-1 [5] subclause 4.3.1					15MHz, 20MHz, 25 MHz, 50MHz				
Test SCS as specified in Table 5.3.5-1					Lowest, Highest				
A-MPR test parameters for NS_46									
Test ID	F _c (MHz)	Ch BW (MHz)	SCS (kHz)	Downlink Configuration	Uplink Configuration				
					Modulation (Note 2)	RB allocation (Note 1)			
		SCS 15 kHz	SCS 30 kHz	SCS 60 kHz					
1				N/A for A-MPR testing.	DFT-s-OFDM				
2									
3	Default	25	Default			64QAM	54@79 (A3)	27@38 (A3)	12@19 (A3)
4	Default	50	Default			64QAM	Edge_1RB_Left (A4)		
5	Default	50	Default			16QAM	120@0 (A5)	60@0 (A5)	30@0 (A5)
6	Default	50	Default			64QAM	175@0 (A6)	81@0 (A6)	40@0 (A6)
7	Default	50	Default			256QAM	216@0 (A7)	108@0 (A7)	54@0 (A7)
8	Default	50	Default			256QAM	Outer_Full (A8)		
9									
10									
11	Default	25	Default		QPSK	90@43 (A3)	45@20 (A3)	23@8 (A3)	
12	Default	25	Default		256QAM	90@43 (A3)	45@20 (A3)	23@8 (A3)	
13	Default	50	Default		QPSK	Edge_1RB_Left (A4)			
14	Default	50	Default		64QAM	Edge_1RB_Left (A4)			
15	Default	50	Default		QPSK	120@0 (A5)	60@0 (A5)	30@0 (A5)	
16	Default	50	Default		64QAM	120@0 (A5)	60@0 (A5)	30@0 (A5)	
17	Default	50	Default		QPSK	176@0 (A6)	88@0 (A6)	44@0 (A6)	
18	Default	50	Default		64QAM	176@0 (A6)	88@0 (A6)	44@0 (A6)	
19	Default	50	Default		QPSK	220@0 (A7)	110@0 (A7)	55@0 (A7)	
20	Default	50	Default		256QAM	220@0 (A7)	110@0 (A7)	55@0 (A7)	
21	Default	50	Default		QPSK	Outer_Full (A8)			
22	Default	50	Default		256QAM	Outer_Full (A8)			
NOTE 1: The specific configuration of each RB allocation is defined in Table 6.1-1 unless otherwise stated in this table.									

Table 6.2.3.4.1-26: Test Configuration table for NS_44

Initial Conditions										
Test Environment as specified in TS 38.508-1 [5] subclause 4.1					Normal					
Test Frequencies as specified in TS 38.508-1 [5] subclause 4.3.1					Defined for each test ID					
Test Channel Bandwidths as specified in TS 38.508-1 [5] subclause 4.3.1					Defined for each test ID					
Test SCS as specified in Table 5.3.5-1					Lowest, Highest					
A-MPR test parameters for NS_44										
Test ID	F _c (MHz)	Ch BW (MHz)	SCS (kHz)	Downlink Configuration	Uplink Configuration					
					Modulation (Note 2)	RB allocation (Note 1)				
						SCS 15 kHz	SCS 30 kHz	SCS 60 kHz		
1	2602.5	25	Default	N/A	DFT-s-OFDM	64 QAM	100@0 (A3)	50@0 (A3)	25@0 (A3)	
2	2602.5	25	Default			64 QAM	36@97 (A3)	18@47 (A3)	9@22 (A3)	
3	2602.5	25	Default			64 QAM	Outer_Full (A6)			
4	2602.5	25	Default			256 QAM	100@0 (A3)	50@0 (A3)	25@0 (A3)	
5	2602.5	25	Default			256 QAM	36@97 (A3)	18@47 (A3)	9@22 (A3)	
6	2602.5	25	Default			256 QAM	Outer_Full (A6)			
7	2600	30	Default			64 QAM	120@0 (A3)	60@0 (A3)	30@0 (A3)	
8	2600	30	Default			64 QAM	64@96 (A5)	32@46 (A5)	16@22 (A5)	
9	2600	30	Default			64 QAM	Outer_Full (A5)			
10	2600	30	Default			256 QAM	120@0 (A3)	60@0 (A3)	30@0 (A3)	
11	2600	30	Default			256 QAM	64@96 (A5)	32@46 (A5)	16@22 (A5)	
12	2600	30	Default			256 QAM	Outer_Full (A5)			
13	2595	40	Default			64 QAM	16@0 (A2)	8@0 (A2)	4@0 (A2)	
14	2595	40	Default			64 QAM	80@0 (A2)	40@0 (A2)	20@0 (A2)	
15	2595	40	Default			64 QAM	128@2 (A3)	64@1 (A3)	32@1 (A3)	
16	2595	40	Default			64 QAM	180@0 (A4)	90@0 (A4)	45@0 (A4)	
17	2595	40	Default			64 QAM	Outer_Full (A5)			
18	2595	40	Default			256 QAM	16@0 (A2)	8@0 (A2)	4@0 (A2)	
19	2595	40	Default			256 QAM	80@0 (A2)	40@0 (A2)	20@0 (A2)	
20	2595	40	Default			256 QAM	128@2 (A3)	64@1 (A3)	32@1 (A3)	
21	2595	40	Default			256 QAM	180@0 (A4)	90@0 (A4)	45@0 (A4)	
22	2595	40	Default			256 QAM	Outer_Full (A5)			
23	2602.5	25	Default			CP-OFDM	64 QAM	100@0 (A3)	50@0 (A3)	25@0 (A3)
24	2602.5	25	Default				64 QAM	39@94 (A3)	19@46 (A3)	9@22 (A3)
25	2602.5	25	Default				64 QAM	Outer_Full (A6)		
26	2602.5	25	Default				256 QAM	100@0 (A3)	50@0 (A3)	25@0 (A3)
27	2602.5	25	Default				256 QAM	39@94 (A3)	19@46 (A3)	9@22 (A3)
28	2602.5	25	Default				256 QAM	Outer_Full (A6)		
29	2600	30	Default				64 QAM	120@0 (A3)	60@0 (A3)	30@0 (A3)
30	2600	30	Default				64 QAM	69@91 (A5)	34@44 (A5)	17@21 (A5)
31	2600	30	Default				64 QAM	Outer_Full (A5)		
32	2600	30	Default				256 QAM	120@0 (A3)	60@0 (A3)	30@0 (A3)
33	2600	30	Default				256 QAM	69@91 (A5)	34@44 (A5)	17@21 (A5)
34	2600	30	Default				256 QAM	Outer_Full (A5)		
35	2595	40	Default				64 QAM	16@0 (A2)	8@0 (A2)	4@0 (A2)
36	2595	40	Default				64 QAM	80@0 (A2)	40@0 (A2)	20@0 (A2)
37	2595	40	Default				64 QAM	130@0 (A3)	65@0 (A3)	33@0 (A3)
38	2595	40	Default				64 QAM	180@0 (A4)	90@0 (A4)	45@0 (A4)
39	2595	40	Default				64 QAM	Outer_Full (A5)		

A-MPR test parameters for NS_44									
Test ID	F _c (MHz)	Ch BW (MHz)	SCS (kHz)	Downlink Configurati on	Uplink Configuration				
					Modulation (Note 2)	RB allocation (Note 1)			
						SCS 15 kHz	SCS 30 kHz	SCS 60 kHz	
40	2595	40	Default		256 QAM	16@0 (A2)	8@0 (A2)	4@0 (A2)	
41	2595	40	Default		256 QAM	80@0 (A2)	40@0 (A2)	20@0 (A2)	
42	2595	40	Default		256 QAM	130@0 (A3)	65@0 (A3)	33@0 (A3)	
43	2595	40	Default		256 QAM	180@0 (A4)	90@0 (A4)	45@0 (A4)	
44	2595	40	Default		256 QAM	Outer_Full (A5)			

NOTE 1: The specific configuration of each RB allocation is defined in Table 6.1-1 unless otherwise stated in this table.

Table 6.2.3.4.1-27: Test Configuration table for NS_21

Initial Conditions									
Test Environment as specified in TS 38.508-1 [5] subclause 4.1						Normal			
Test Frequencies as specified in TS 38.508-1 [5] subclause 4.3.1						Low range, High range			
Test Channel Bandwidths as specified in TS 38.508-1 [5] subclause 4.3.1						Lowest, Highest			
Test SCS as specified in Table 5.3.5-1						Lowest, Highest			
A-MPR test parameters for NS_21									
Test ID	Freq	ChBw	SCS	Downlink Configuration	Uplink Configuration				
					Modulation (Note 2)	RB allocation (Note 1)			
						SCS 15 kHz	SCS 30 kHz		
1	Low	Default	Default	N/A for A-MPR test cases	DFT-s OFDM	PI/2 BPSK	Edge_1RB_Left		
2	High	Default	Default			PI/2 BPSK	Edge_1RB_Right		
3	Default	Default	Default			PI/2 BPSK	Outer_Full		
4	Default	10 MHz	Default			PI/2 BPSK	4@0	2@0	
5	Default	10 MHz	Default			PI/2 BPSK	4@46	2@22	
6	Low	Default	Default			QPSK	Edge_1RB_Left		
7	High	Default	Default			QPSK	Edge_1RB_Right		
8	Default	Default	Default			QPSK	Outer_Full		
9	Default	10 MHz	Default			QPSK	4@0	2@0	
10	Default	10 MHz	Default			QPSK	4@46	2@22	
11	Low	Default	Default			16 QAM	Edge_1RB_Left		
12	High	Default	Default			16 QAM	Edge_1RB_Right		
13	Default	Default	Default			16 QAM	Outer_Full		
14	Default	10 MHz	Default			16 QAM	4@0	2@0	
15	Default	10 MHz	Default			16 QAM	4@46	2@22	
16	Low	Default	Default			64 QAM	Edge_1RB_Left		
17	High	Default	Default			64 QAM	Edge_1RB_Right		
18	Default	Default	Default			64 QAM	Outer_Full		
19	Default	10 MHz	Default			64 QAM	4@0	2@0	
20	Default	10 MHz	Default			64 QAM	4@46	2@22	
21	Low	Default	Default			256 QAM	Edge_1RB_Left		
22	High	Default	Default			256 QAM	Edge_1RB_Right		
23	Default	Default	Default			256 QAM	Outer_Full		
24	Default	10 MHz	Default			256 QAM	4@0	2@0	
25	Default	10 MHz	Default			256 QAM	4@46	2@22	
26	Low	Default	Default			CP-s OFDM	QPSK	Edge_1RB_Left	
27	High	Default	Default				QPSK	Edge_1RB_Right	
28	Default	Default	Default				QPSK	Outer_Full	
29	Default	10 MHz	Default				QPSK	4@0	2@0
30	Default	10 MHz	Default				QPSK	4@48	2@22
31	Low	Default	Default				16 QAM	Edge_1RB_Left	
32	High	Default	Default				16 QAM	Edge_1RB_Right	
33	Default	Default	Default				16 QAM	Outer_Full	
34	Default	10 MHz	Default				16 QAM	4@0	2@0
35	Default	10 MHz	Default				16 QAM	4@48	2@22
36	Low	Default	Default				64 QAM	Edge_1RB_Left	
37	High	Default	Default				64 QAM	Edge_1RB_Right	
38	Default	Default	Default				64 QAM	Outer_Full	
39	Default	10 MHz	Default				64 QAM	4@0	2@0
40	Default	10 MHz	Default				64 QAM	4@48	2@22
41	Low	Default	Default				256 QAM	Edge_1RB_Left	
42	High	Default	Default				256 QAM	Edge_1RB_Right	
43	Default	Default	Default				256 QAM	Outer_Full	
44	Default	10 MHz	Default				256 QAM	4@0	2@0
45	Default	10 MHz	Default				256 QAM	4@48	2@22

NOTE 1: The specific configuration of each RB allocation is defined in Table 6.1-1 unless otherwise stated in this table.

NOTE 2: DFT-s-OFDM PI/2 BPSK test applies only for UEs which supports half Pi BPSK in FR1.

Table 6.2.3.4.1-28: Test Configuration table for NS_45

Initial Conditions						
Test Environment as specified in TS 38.508-1 [5] subclause 4.1					Normal	
Test Frequencies as specified in TS 38.508-1 [5] subclause 4.3.1					Low range, High range	
Test Channel Bandwidths as specified in TS 38.508-1 [5] subclause 4.3.1					Lowest, Highest	
Test SCS as specified in Table 5.3.5-1					Lowest	
A-MPR test parameters for NS_45						
Test ID	Freq	ChBw	SCS	Downlink Configuration	Uplink Configuration	
				N/A for A-MPR testing.	Modulation (NOTE 2)	RB allocation (NOTE 1)
1	Low	Default	Default	N/A for A-MPR testing.	DFT-s-OFDM PI/2 BPSK	Edge_1RB_Left
2	High				DFT-s-OFDM PI/2 BPSK	Edge_1RB_Right
3	Default				DFT-s-OFDM PI/2 BPSK	Outer Full
4	Low				DFT-s-OFDM QPSK	Edge_1RB_Left
5	High				DFT-s-OFDM QPSK	Edge_1RB_Right
6	Default				DFT-s-OFDM QPSK	Outer Full
7	Low				DFT-s-OFDM 16 QAM	Edge_1RB_Left
8	High				DFT-s-OFDM 16 QAM	Edge_1RB_Right
9	Default				DFT-s-OFDM 16 QAM	Outer Full
10	Low				DFT-s-OFDM 64 QAM	Edge_1RB_Left
11	High				DFT-s-OFDM 64 QAM	Edge_1RB_Right
12	Default				DFT-s-OFDM 64 QAM	Outer Full
NOTE 1: The specific configuration of each RB allocation is defined in Table 6.1-1.						
NOTE 2: DFT-s-OFDM PI/2 BPSK test applies only for UEs which supports half Pi BPSK in FR1.						

Table 6.2.3.4.1-29: Test Configuration table for NS_49

Initial Conditions								
Test Environment as specified in TS 38.508-1 [5] subclause 4.1					Normal			
Test Frequencies as specified in TS 38.508-1 [5] subclause 4.3.1					Low range, High range			
Test Channel Bandwidths as specified in TS 38.508-1 [5] subclause 4.3.1					25 MHz, 30MHz, 40MHz, 50MHz			
Test SCS as specified in Table 5.3.5-1					Lowest, Highest			
A-MPR test parameters for NS_49								
Test ID	F _c (MHz)	Ch BW (MHz)	SCS (kHz)	Downlink Configuration	Uplink Configuration			
					Modulation (Note 2)	RB allocation (Note 1)		
						SCS 15 kHz	SCS 30 kHz	SCS 60 kHz
1	Default	25	Default	N/A for A-MPR testing.	QPSK	Outer_Full (A3)		
2	Default	25	Default		QPSK	Edge_1RB_Right (A3)		
3	Default	25	Default		QPSK	Edge_1RB_Left (A3)		
4	Default	30	Default		QPSK	20@0 (A1)	10@0 (A1)	5@0 (A1)
5	Default	30	Default		QPSK	36@0 (A5)	18@0 (A5)	9@0 (A5)
6	Default	30	Default		QPSK	80@0 (A3)	40@0 (A3)	20@0 (A3)
7	Default	30	Default		QPSK	120@0 (A4)	60@0 (A4)	30@0 (A4)
8	Default	30	Default		QPSK	Outer_Full (A2)		
9	Default	30	Default		QPSK	Edge_1RB_Right (A5)		
10	Default	40	Default		QPSK	40@0 (A1)	20@0 (A1)	10@0 (A1)
11	Default	40	Default		QPSK	5@53 (A5)	2@27 (A5)	1@14 (A5)
12	Default	40	Default		QPSK	100@0 (A4)	50@0 (A4)	25@0 (A4)
13	Default	40	Default		QPSK	150@33 (A2)	75@17 (A2)	36@9 (A2)
14	Default	40	Default		QPSK	5@187 (A5)	2@94 (A5)	1@47 (A5)
15	Default	40	Default		QPSK	192@0 (A1)	96@0 (A1)	48@0 (A1)
16	Default	40	Default		QPSK	Outer_Full (A1)		
17	Default	50	Default		QPSK	5@75 (A5)	2@38 (A5)	1@19 (A5)
18	Default	50	Default		QPSK	5@215 (A5)	2@108 (A5)	1@54 (A5)
19	Default	50	Default		QPSK	150@45 (A2)	81@23 (A2)	40@12 (A2)
20	Default	50	Default		QPSK	216@0 (A1)	108@0 (A1)	54@0 (A1)
21	Default	50	Default		QPSK	Outer_Full (A1)		
22	Default	25	Default		256 QAM	Outer_Full (A3)		
23	Default	25	Default		256 QAM	Edge_1RB_Right (A3)		
24	Default	25	Default		256 QAM	Edge_1RB_Left (A3)		
25	Default	30	Default		256 QAM	20@0 (A1)	10@0 (A1)	5@0 (A1)
26	Default	30	Default		256 QAM	36@0 (A5)	18@0 (A5)	9@0 (A5)
27	Default	30	Default		256 QAM	80@0 (A3)	40@0 (A3)	20@0 (A3)
28	Default	30	Default		256 QAM	120@0 (A4)	60@0 (A4)	30@0 (A4)
29	Default	30	Default		256 QAM	Outer_Full (A2)		
30	Default	30	Default		256 QAM	Edge_1RB_Right (A5)		
31	Default	40	Default		256 QAM	40@0 (A1)	20@0 (A1)	10@0 (A1)
32	Default	40	Default		256 QAM	5@53 (A5)	2@27 (A5)	1@14 (A5)
33	Default	40	Default		256 QAM	100@0 (A4)	50@0 (A4)	25@0 (A4)
34	Default	40	Default		256 QAM	150@33 (A2)	75@17 (A2)	36@9 (A2)
35	Default	40	Default		256 QAM	5@187 (A5)	2@94 (A5)	1@47 (A5)
36	Default	40	Default		256 QAM	192@0 (A1)	96@0 (A1)	48@0 (A1)
37	Default	40	Default		256 QAM	Outer_Full (A1)		
38	Default	50	Default		256 QAM	5@75 (A5)	2@38 (A5)	1@19 (A5)
39	Default	50	Default		256 QAM	5@215 (A5)	2@108 (A5)	1@54 (A5)
40	Default	50	Default		256 QAM	150@45 (A2)	81@23 (A2)	40@12 (A2)
41	Default	50	Default		256 QAM	216@0 (A1)	108@0 (A1)	54@0 (A1)
42	Default	50	Default		256 QAM	Outer_Full (A1)		
43	Default	25	Default		QPSK	Outer_Full (A3)		
44	Default	25	Default		QPSK	Edge_1RB_Right (A3)		
45	Default	25	Default		QPSK	Edge_1RB_Left (A3)		
46	Default	30	Default		QPSK	20@0 (A1)	10@0 (A1)	5@0 (A1)
47	Default	30	Default		QPSK	36@0 (A5)	18@0 (A5)	9@0 (A5)
48	Default	30	Default		QPSK	80@0 (A3)	40@0 (A3)	20@0 (A3)
49	Default	30	Default		QPSK	120@0 (A4)	60@0 (A4)	30@0 (A4)
50	Default	30	Default		QPSK	Outer_Full (A2)		
51	Default	30	Default		QPSK	Edge_1RB_Right (A5)		
52	Default	40	Default		QPSK	40@0 (A1)	20@0 (A1)	10@0 (A1)
53	Default	40	Default		QPSK	5@53 (A5)	2@27 (A5)	1@14 (A5)

A-MPR test parameters for NS_49								
Test ID	F _c (MHz)	Ch BW (MHz)	SCS (kHz)	Downlink Configuration	Uplink Configuration			
					Modulation (Note 2)	RB allocation (Note 1)		
						SCS 15 kHz	SCS 30 kHz	SCS 60 kHz
54	Default	40	Default		QPSK	100@0 (A4)	50@0 (A4)	25@0 (A4)
55	Default	40	Default		QPSK	159@33 (A2)	79@17 (A2)	39@9 (A2)
56	Default	40	Default		QPSK	5@187 (A5)	2@94 (A5)	1@47 (A5)
57	Default	40	Default		QPSK	192@0 (A1)	96@0 (A1)	48@0 (A1)
58	Default	40	Default		QPSK	Outer_Full (A1)		
59	Default	50	Default		QPSK	5@75 (A5)	2@38 (A5)	1@19 (A5)
60	Default	50	Default		QPSK	5@215 (A5)	2@108 (A5)	1@54 (A5)
61	Default	50	Default		QPSK	175@45 (A2)	87@23 (A2)	43@12 (A2)
62	Default	50	Default		QPSK	220@0 (A1)	110@0 (A1)	55@0 (A1)
63	Default	50	Default		QPSK	Outer_Full (A1)		
64	Default	25	Default		256 QAM	Outer_Full (A3)		
65	Default	25	Default		256 QAM	Edge_1RB_Right (A3)		
66	Default	25	Default		256 QAM	Edge_1RB_Left (A3)		
67	Default	30	Default		256 QAM	20@0 (A1)	10@0 (A1)	5@0 (A1)
68	Default	30	Default		256 QAM	36@0 (A5)	18@0 (A5)	9@0 (A5)
69	Default	30	Default		256 QAM	80@0 (A3)	40@0 (A3)	20@0 (A3)
70	Default	30	Default		256 QAM	120@0 (A4)	60@0 (A4)	30@0 (A4)
71	Default	30	Default		256 QAM	Outer_Full (A2)		
72	Default	30	Default		256 QAM	Edge_1RB_Right (A5)		
73	Default	40	Default		256 QAM	40@0 (A1)	20@0 (A1)	10@0 (A1)
74	Default	40	Default		256 QAM	5@53 (A5)	2@27 (A5)	1@14 (A5)
75	Default	40	Default		256 QAM	100@0 (A4)	50@0 (A4)	25@0 (A4)
76	Default	40	Default		256 QAM	159@33 (A2)	79@17 (A2)	39@9 (A2)
77	Default	40	Default		256 QAM	5@187 (A5)	2@94 (A5)	1@47 (A5)
78	Default	40	Default		256 QAM	192@0 (A1)	96@0 (A1)	48@0 (A1)
79	Default	40	Default		256 QAM	Outer_Full (A1)		
80	Default	50	Default		256 QAM	5@75 (A5)	2@38 (A5)	1@19 (A5)
81	Default	50	Default		256 QAM	5@215 (A5)	2@108 (A5)	1@54 (A5)
82	Default	50	Default		256 QAM	175@45 (A2)	87@23 (A2)	43@12 (A2)
83	Default	50	Default		256 QAM	220@0 (A1)	110@0 (A1)	55@0 (A1)
84	Default	50	Default		256 QAM	Outer_Full (A1)		

NOTE 1: The specific configuration of each RB allocation is defined in Table 6.1-1 unless otherwise stated in this table.

Table 6.2.3.4.1-30: Test Configuration table for NS_56

Initial Conditions										
Test Environment as specified in TS 38.508-1 [5] subclause 4.1					Normal					
Test Frequencies as specified in TS 38.508-1 [5] subclause 4.3.1					Use uplink carrier center frequency (Fc) as specified in test parameters					
Test Channel Bandwidths as specified in TS 38.508-1 [5] subclause 4.3.1					5 MHz, 10 MHz as specified in test parameters					
Test SCS as specified in Table 5.3.5-1					Lowest, Highest unless otherwise specified in test parameters.					
A-MPR test parameters for NS_56										
Test ID	Fc (MHz)	ChB w (MHz)	SCS (kHz)	Downlink Config.	A-MPR	Uplink Configuration				
						Modulation (NOTE 2)	RB allocation (Note 1)			
							SCS 15 kHz	SCS 30 kHz	SCS 60 kHz	
1	Low	5	15	N/A for A-MPR testing	14	DFT-s-OFDM	PI/2 BPSK	Edge_1RB_Left	N/A	N/A
2	Low	5	30		8		PI/2 BPSK	N/A	Edge_1RB_Left	N/A
3	Low	5	Default		6		PI/2 BPSK	Outer_Full	Outer_Full	N/A
4	Low	5	Default		4		PI/2 BPSK	20@4	8@3	N/A
5	Low	5	Default		4		PI/2 BPSK	1@4	1@3	N/A
6	Low	5	15		14		QPSK	Edge_1RB_Left	N/A	N/A
7	Low	5	30		8		QPSK	N/A	Edge_1RB_Left	N/A
8	Low	5	Default		6		QPSK	Outer_Full	Outer_Full	N/A
9	Low	5	Default		4		QPSK	20@4	8@3	N/A
10	Low	5	Default		4		QPSK	1@4	1@3	N/A
11	Low	5	15		14		16 QAM	Edge_1RB_Left	N/A	N/A
12	Low	5	30		8		16 QAM	N/A	Edge_1RB_Left	N/A
13	Low	5	Default		6		16 QAM	Outer_Full	Outer_Full	N/A
14	Low	5	Default		4		16 QAM	20@4	8@3	N/A
15	Low	5	Default		4		16 QAM	1@4	1@3	N/A
16	Low	5	15		14		64 QAM	Edge_1RB_Left	N/A	N/A
17	Low	5	30		8		64 QAM	N/A	Edge_1RB_Left	N/A
18	Low	5	Default		6		64 QAM	Outer_Full	Outer_Full	N/A
19	Low	5	Default		4		64 QAM	20@4	8@3	N/A
20	Low	5	Default		4		64 QAM	1@4	1@3	N/A
21	Low	5	15		14		256 QAM	Edge_1RB_Left	N/A	N/A
22	Low	5	30		8		256 QAM	N/A	Edge_1RB_Left	N/A
23	Low	5	Default		6		256 QAM	Outer_Full	Outer_Full	N/A
24	Low	5	Default		4		256 QAM	20@4	8@3	N/A
25	Low	5	Default		4		256 QAM	1@4	1@3	N/A
26	Low	10	15		12		PI/2 BPSK	Edge_1RB_Left	N/A	N/A
27	Low	10	Highest		8		PI/2 BPSK	N/A	Edge_1RB_Left	Edge_1RB_Left
28	Low	10	Default		8		PI/2 BPSK	Outer_Full	Outer_Full	Outer_Full
29	Low	10	Default		6		PI/2 BPSK	1@3	1@2	1@1
30	Low	10	Default		6		PI/2 BPSK	40@9	18@5	8@2
31	Low	10	Default		4		PI/2 BPSK	1@35	1@17	1@8
32	Low	10	Default		2		PI/2 BPSK	16@35	5@19	3@8
33	Low	10	Default		5		PI/2 BPSK	Edge_1RB_Right	Edge_1RB_Right	Edge_1RB_Right
34	Low	10	15		5		PI/2 BPSK	1@40	N/A	N/A
35	Low	10	30		5		PI/2 BPSK	N/A	1@20	N/A
36	Low	10	15		3		PI/2 BPSK	8@44	N/A	N/A
37	Low	10	15		12		QPSK	Edge_1RB_Left	N/A	N/A
38	Low	10	Highest		8		QPSK	N/A	Edge_1RB_Left	Edge_1RB_Left
39	Low	10	Default		8		QPSK	Outer_Full	Outer_Full	Outer_Full
40	Low	10	Default		6		QPSK	1@3	1@2	1@1
41	Low	10	Default		6		QPSK	40@9	18@5	8@2
42	Low	10	Default		4		QPSK	1@35	1@17	1@8
43	Low	10	Default		2		QPSK	16@35	5@19	3@8
44	Low	10	Default		5		QPSK	Edge_1RB_Right	Edge_1RB_Right	Edge_1RB_Right
45	Low	10	15		5		QPSK	1@40	N/A	N/A

A-MPR test parameters for NS_56										
Test ID	Fc (MHz)	ChB w (MHz)	SCS (kHz)	Downlink Config.	A-MPR	Uplink Configuration				
						Modulation (NOTE 2)	RB allocation (Note 1)			
							SCS 15 kHz	SCS 30 kHz	SCS 60 kHz	
46	Low	10	30		5		QPSK	N/A	1@20	N/A
47	Low	10	15		3		QPSK	8@44	N/A	N/A
48	Low	10	15		12		16 QAM	Edge_1RB_Left	N/A	N/A
49	Low	10	Highest		8		16 QAM	N/A	Edge_1RB_Left	Edge_1RB_Left
50	Low	10	Default		8		16 QAM	Outer_Full	Outer_Full	Outer_Full
51	Low	10	Default		6		16 QAM	1@3	1@2	1@1
52	Low	10	Default		6		16 QAM	40@9	18@5	8@2
53	Low	10	Default		4		16 QAM	1@35	1@17	1@8
54	Low	10	Default		2		16 QAM	16@35	5@19	3@8
55	Low	10	Default		5		16 QAM	Edge_1RB_Right	Edge_1RB_Right	Edge_1RB_Right
56	Low	10	15		5		16 QAM	1@40	N/A	N/A
57	Low	10	30		5		16 QAM	N/A	1@20	N/A
58	Low	10	15		3		16 QAM	8@44	N/A	N/A
59	Low	10	15		12		64 QAM	Edge_1RB_Left	N/A	N/A
60	Low	10	Highest		8		64 QAM	N/A	Edge_1RB_Left	Edge_1RB_Left
61	Low	10	Default		8		64 QAM	Outer_Full	Outer_Full	Outer_Full
62	Low	10	Default		6		64 QAM	1@3	1@2	1@1
63	Low	10	Default		6		64 QAM	40@9	18@5	8@2
64	Low	10	Default		4		64 QAM	1@35	1@17	1@8
65	Low	10	Default		2		64 QAM	16@35	5@19	3@8
66	Low	10	Default		5		64 QAM	Edge_1RB_Right	Edge_1RB_Right	Edge_1RB_Right
67	Low	10	15		5		64 QAM	1@40	N/A	N/A
68	Low	10	30		5		64 QAM	N/A	1@20	N/A
69	Low	10	15		3		64 QAM	8@44	N/A	N/A
70	Low	10	15		12		256 QAM	Edge_1RB_Left	N/A	N/A
71	Low	10	Highest		8		256 QAM	N/A	Edge_1RB_Left	Edge_1RB_Left
72	Low	10	Default		8		256 QAM	Outer_Full	Outer_Full	Outer_Full
73	Low	10	Default		6		256 QAM	1@3	1@2	1@1
74	Low	10	Default		6		256 QAM	40@9	18@5	8@2
75	Low	10	Default		4		256 QAM	1@35	1@17	1@8
76	Low	10	Default		2		256 QAM	16@35	5@19	3@8
77	Low	10	Default		5		256 QAM	Edge_1RB_Right	Edge_1RB_Right	Edge_1RB_Right
78	Low	10	15		5		256 QAM	1@40	N/A	N/A
79	Low	10	30		5		256 QAM	N/A	1@20	N/A
80	Low	10	15		3		256 QAM	8@44	N/A	N/A
81	Low	5	15		14		QPSK	Edge_1RB_Left	N/A	N/A
82	Low	5	30		8		QPSK	N/A	Edge_1RB_Left	N/A
83	Low	5	Default		6		QPSK	Outer_Full	Outer_Full	N/A
84	Low	5	Default		4		QPSK	21@4	8@3	N/A
85	Low	5	Default		4		QPSK	1@4	1@3	N/A
86	Low	5	15		14		16 QAM	Edge_1RB_Left	N/A	N/A
87	Low	5	30		8		16 QAM	N/A	Edge_1RB_Left	N/A
88	Low	5	Default		6		16 QAM	Outer_Full	Outer_Full	N/A
89	Low	5	Default		4		16 QAM	21@4	8@3	N/A
90	Low	5	Default		4		16 QAM	1@4	1@3	N/A
91	Low	5	15		14		64 QAM	Edge_1RB_Left	N/A	N/A
92	Low	5	30		8		64 QAM	N/A	Edge_1RB_Left	N/A
93	Low	5	Default		6		64 QAM	Outer_Full	Outer_Full	N/A
94	Low	5	Default		4		64 QAM	21@4	8@3	N/A
95	Low	5	Default		4		64 QAM	1@4	1@3	N/A
96	Low	5	15		14		256 QAM	Edge_1RB_Left	N/A	N/A
97	Low	5	30		8		256 QAM	N/A	Edge_1RB_Left	N/A
98	Low	5	Default		6		256 QAM	Outer_Full	Outer_Full	N/A
99	Low	5	Default		4		256 QAM	21@4	8@3	N/A

N/A for A-MPR testing

CP-OFDM

A-MPR test parameters for NS_56									
Test ID	Fc (MHz)	ChB w (MHz)	SCS (kHz)	Downlink Config.	A-MPR	Uplink Configuration			
						Modulation (NOTE 2)	RB allocation (Note 1)		
							SCS 15 kHz	SCS 30 kHz	SCS 60 kHz
100	Low	5	Default		4	256 QAM	1@4	1@3	N/A
101	Low	10	15		12	QPSK	Edge_1RB_Left	N/A	N/A
102	Low	10	Highest		8	QPSK	N/A	Edge_1RB_Left	Edge_1RB_Left
103	Low	10	Default		8	QPSK	Outer_Full	Outer_Full	Outer_Full
104	Low	10	Default		6	QPSK	1@3	1@2	1@1
105	Low	10	Default		6	QPSK	43@9	19@5	8@2
106	Low	10	Default		4	QPSK	1@35	1@17	1@8
107	Low	10	Default		2	QPSK	17@35	5@19	3@8
108	Low	10	Default		5	QPSK	Edge_1RB_Right	Edge_1RB_Right	Edge_1RB_Right
109	Low	10	15		5	QPSK	1@40	N/A	N/A
110	Low	10	30		5	QPSK	N/A	1@20	N/A
111	Low	10	15		3	QPSK	8@44	N/A	N/A
112	Low	10	15		12	16 QAM	Edge_1RB_Left	N/A	N/A
113	Low	10	Highest		8	16 QAM	N/A	Edge_1RB_Left	Edge_1RB_Left
114	Low	10	Default		8	16 QAM	Outer_Full	Outer_Full	Outer_Full
115	Low	10	Default		6	16 QAM	1@3	1@2	1@1
116	Low	10	Default		6	16 QAM	43@9	19@5	8@2
117	Low	10	Default		4	16 QAM	1@35	1@17	1@8
118	Low	10	Default		2	16 QAM	17@35	5@19	3@8
119	Low	10	Default		5	16 QAM	Edge_1RB_Right	Edge_1RB_Right	Edge_1RB_Right
120	Low	10	15		5	16 QAM	1@40	N/A	N/A
121	Low	10	30		5	16 QAM	N/A	1@20	N/A
122	Low	10	15		3	16 QAM	8@44	N/A	N/A
123	Low	10	15		12	64 QAM	Edge_1RB_Left	N/A	N/A
124	Low	10	Highest		8	64 QAM	N/A	Edge_1RB_Left	Edge_1RB_Left
125	Low	10	Default		8	64 QAM	Outer_Full	Outer_Full	Outer_Full
126	Low	10	Default		6	64 QAM	1@3	1@2	1@1
127	Low	10	Default		6	64 QAM	43@9	19@5	8@2
128	Low	10	Default		4	64 QAM	1@35	1@17	1@8
129	Low	10	Default		2	64 QAM	17@35	5@19	3@8
130	Low	10	Default		5	64 QAM	Edge_1RB_Right	Edge_1RB_Right	Edge_1RB_Right
131	Low	10	15		5	64 QAM	1@40	N/A	N/A
132	Low	10	30		5	64 QAM	N/A	1@20	N/A
133	Low	10	15		3	64 QAM	8@44	N/A	N/A
134	Low	10	15		12	256 QAM	Edge_1RB_Left	N/A	N/A
135	Low	10	Highest		8	256 QAM	N/A	Edge_1RB_Left	Edge_1RB_Left
136	Low	10	Default		8	256 QAM	Outer_Full	Outer_Full	Outer_Full
137	Low	10	Default		6	256 QAM	1@3	1@2	1@1
138	Low	10	Default		6	256 QAM	43@9	19@5	8@2
139	Low	10	Default		4	256 QAM	1@35	1@17	1@8
140	Low	10	Default		2	256 QAM	17@35	5@19	3@8
141	Low	10	Default		5	256 QAM	Edge_1RB_Right	Edge_1RB_Right	Edge_1RB_Right
142	Low	10	15		5	256 QAM	1@40	N/A	N/A
143	Low	10	30		5	256 QAM	N/A	1@20	N/A
144	Low	10	15		3	256 QAM	8@44	N/A	N/A

NOTE 1: The specific configuration of each RB allocation is defined in Table 6.1-1 unless otherwise stated in this table.

NOTE 2: DFT-s-OFDM PI/2 BPSK test applies only for UEs which supports half Pi BPSK in FR1.

Editor's note: The following lines belong at the end of subclause 6.2.3.4.1. As new tables are added to this section, these lines should always follow the tables

1. Connect the SS to the UE antenna connectors as shown in TS 38.508-1 [5] Annex A, Figure A.3.1.1.1 for TE diagram and section A.3.2 for UE diagram.
2. The parameter settings for the cell are set up according to TS 38.508-1 [5] subclause 4.4.3.

3. Downlink signals are initially set up according to Annex C.0, C.1, C.2 and uplink signals according Annex G.0, G.1, G.2 and G.3.0.
4. The UL Reference Measurement channels are set according to the applicable table from Table 6.2.3.4.1-1 to Table 6.2.3.4.1-30.
5. Propagation conditions are set according to Annex B.0.
6. Ensure the UE is in state RRC_CONNECTED with generic procedure parameters Connectivity *NR*, Connected without release *On*, Test Mode *On* and Test Loop Function *On* according to TS 38.508-1 [5] clause 4.5. Message contents are defined in clause 6.2.3.4.3.

6.2.3.4.2 Test procedure

1. SS sends uplink scheduling information for each UL HARQ process via PDCCH DCI format 0_1 for C_RNTI to schedule the UL RMC according to the applicable table from Table 6.2.3.4.1-1 to Table 6.2.3.4.1-30. Since the UE has no payload data to send, the UE transmits uplink MAC padding bits on the UL RMC.
2. Send continuously uplink power control "up" commands in the uplink scheduling information to the UE Allow at least 200ms starting from the first TPC command in this step for the UE to reach P_{UMAX} level.
3. Measure the mean power of the UE in the channel bandwidth of the radio access mode. The period of measurement shall be at least the continuous duration one sub-frame (1ms). For TDD, only slots consisting of only UL symbols are under test.
4. For network signalling value "NS_04" and UEs supporting Power Class 2, repeat steps 1~3 on the applicable bands with message exception of P-Max defined in Table 6.2.3.4.3.4-2.

NOTE 1: When switching to DFT-s-OFDM waveform, as specified in the test configuration Table 6.2.3.4.1-1 to Table 6.2.3.4.1-20, send an NR RRCReconfiguration message according to TS 38.508-1 [5] clause 4.6.3 Table 4.6.3-118 PUSCH-Config with TRANSFORM_PRECODER_ENABLED condition.

6.2.3.4.3 Message contents

Message contents are according to TS 38.508-1 [5] subclause 4.6.1, with the following exceptions for each network signalling value.

For almost contiguous allocation testing, message contents are according to TS 38.508-1 [5] subclause 4.6.1 with the following exceptions:

Table 6.2.3.4.3-1: PUSCH-Config

Derivation Path: TS 38.508-1 [5] subclause 4.6.3 Table 4.6.3-118 PUSCH-Config			
Information Element	Value/remark	Comment	Condition
PUSCH-Config ::= SEQUENCE {			
resourceAllocation	resourceAllocationType0		
}			

6.2.3.4.3.1 Message contents exceptions for network signalling value "NS_03"

1. Information element additionalSpectrumEmission is set to NS_03. This can be set in the SIB1 as part of the cell broadcast message. This exception indicates that the UE shall meet the additional spurious emission requirement for a specific deployment scenario.

Table 6.2.3.4.3.1-1: AdditionalSpectrumEmission: Additional spurious emissions test requirement for "NS_03" and NR band n2, n25 and n66

Derivation Path: TS 38.508-1 [5], Table 4.6.3-1			
Information Element	Value/remark	Comment	Condition
additionalSpectrumEmission	2 (NS_03)		

Table 6.2.3.4.3.1-2: AdditionalSpectrumEmission: Additional spurious emissions test requirement for "NS_03" and NR band n70

Derivation Path: TS 38.508-1 [5], Table 4.6.3-1			
Information Element	Value/remark	Comment	Condition
additionalSpectrumEmission	1 (NS_03)		

6.2.3.4.3.2 Message contents exceptions for network signalling value "NS_35"

- Information element additionalSpectrumEmission is set to NS_35. This can be set in the *SIB1* as part of the cell broadcast message. This exception indicates that the UE shall meet the additional spurious emission requirement for a specific deployment scenario.

Table 6.2.3.4.3.2-1: AdditionalSpectrumEmission: Additional spurious emissions test requirement for "NS_35" and NR band n71

Derivation Path: TS 38.508-1 [5], Table 4.6.3-1			
Information Element	Value/remark	Comment	Condition
additionalSpectrumEmission	1 (NS_35)		

6.2.3.4.3.3 Message contents exceptions for network signalling value "NS_03U"

- Information element additionalSpectrumEmission is set to NS_03U. This can be set in the *SIB1* as part of the cell broadcast message. This exception indicates that the UE shall meet the additional spurious emission requirement for a specific deployment scenario.

Table 6.2.3.4.3.3-1: AdditionalSpectrumEmission: Additional spurious emissions test requirement for "NS_03U"

Derivation Path: TS 38.508-1 [5], Table 4.6.3-1			
Information Element	Value/remark	Comment	Condition
additionalSpectrumEmission	3 (NS_03U)		

6.2.3.4.3.4 Message contents exceptions for network signalling value "NS_04"

- Information element additionalSpectrumEmission is set to NS_04. This can be set in the *SIB1* as part of the cell broadcast message. This exception indicates that the UE shall meet the additional spurious emission requirement for a specific deployment scenario.

Table 6.2.3.4.3.4-1: AdditionalSpectrumEmission Additional spurious emissions test requirement for "NS_04"

Derivation Path: TS 38.508-1 [5], Table 4.6.3-1			
Information Element	Value/remark	Comment	Condition
additionalSpectrumEmission	1 (NS_04)		

Table 6.2.3.4.3.4-2: P-Max (Step 4)

Derivation Path: TS 38.508-1 [5], Table 4.6.3-89			
Information Element	Value/remark	Comment	Condition
P-Max	23		PC2 UE

Table 6.2.3.4.3.4-3: Void

6.2.3.4.3.5 Message contents exceptions for network signalling value "NS_05"

- Information element additionalSpectrumEmission is set to NS_05. This can be set in the *SIB1* as part of the cell broadcast message. This exception indicates that the UE shall meet the additional spurious emission requirement for a specific deployment scenario.

Table 6.2.3.4.3.5-1: AdditionalSpectrumEmission: Additional spurious emissions test requirement for "NS_05"

Derivation Path: TS 38.508-1 [5], Table 4.6.3-1			
Information Element	Value/remark	Comment	Condition
additionalSpectrumEmission	2 (NS_05)		

6.2.3.4.3.6 Message contents exceptions for network signalling value "NS_05U"

- Information element additionalSpectrumEmission is set to NS_05U. This can be set in the *SIB1* as part of the cell broadcast message. This exception indicates that the UE shall meet the additional spurious emission requirement for a specific deployment scenario.

Table 6.2.3.4.3.6-1: AdditionalSpectrumEmission: Additional spurious emissions test requirement for "NS_05U"

Derivation Path: TS 38.508-1 [5], Table 4.6.3-1			
Information Element	Value/remark	Comment	Condition
additionalSpectrumEmission	3 (NS_05U)		

6.2.3.4.3.7 Message contents exceptions for network signalling value "NS_06"

- Information element additionalSpectrumEmission is set to NS_06. This can be set in the *SIB1* as part of the cell broadcast message. This exception indicates that the UE shall meet the additional spurious emission requirement for a specific deployment scenario.

Table 6.2.3.4.3.7-1: AdditionalSpectrumEmission: Additional spurious emissions test requirement for "NS_06"

Derivation Path: TS 38.508-1 [5], Table 4.6.3-1			
Information Element	Value/remark	Comment	Condition
additionalSpectrumEmission	1 (NS_06)		

6.2.3.4.3.8 Message contents exceptions for network signalling value "NS_08"

- Information element additionalSpectrumEmission is set to NS_08. This can be set in the *SIB1* as part of the cell broadcast message. This exception indicates that the UE shall meet the additional spurious emission requirement for a specific deployment scenario.

Table 6.2.3.4.3.8-1: AdditionalSpectrumEmission: Additional spurious emissions test requirement for "NS_08"

Derivation Path: TS 38.508-1 [5], Table 4.6.3-1			
Information Element	Value/remark	Comment	Condition
additionalSpectrumEmission	2 (NS_08)		

6.2.3.4.3.9 Message contents exceptions for network signalling value "NS_08U"

- Information element additionalSpectrumEmission is set to NS_08U. This can be set in the *SIB1* as part of the cell broadcast message. This exception indicates that the UE shall meet the additional spurious emission requirement for a specific deployment scenario.

Table 6.2.3.4.3.9-1: AdditionalSpectrumEmission: Additional spurious emissions test requirement for "NS_08U"

Derivation Path: TS 38.508-1 [5], Table 4.6.3-1			
Information Element	Value/remark	Comment	Condition
additionalSpectrumEmission	3 (NS_08U)		

6.2.3.4.3.10 Message contents exceptions for network signalling value "NS_10"

1. Information element `additionalSpectrumEmission` is set to NS_10. This can be set in the *SIB1* as part of the cell broadcast message. This exception indicates that the UE shall meet the additional spurious emission requirement for a specific deployment scenario.

Table 6.2.3.4.3.10-1: *AdditionalSpectrumEmission*: Additional spurious emissions test requirement for "NS_10"

Derivation Path: TS 38.508-1 [5], Table 4.6.3-1			
Information Element	Value/remark	Comment	Condition
<code>additionalSpectrumEmission</code>	2 (NS_10)		

6.2.3.4.3.11 Message contents exceptions for network signalling value "NS_17"

1. Information element `additionalSpectrumEmission` is set to NS_17. This can be set in the *SIB1* as part of the cell broadcast message. This exception indicates that the UE shall meet the additional spurious emission requirement for a specific deployment scenario.

Table 6.2.3.4.3.11-1: *AdditionalSpectrumEmission*: Additional spurious emissions test requirement for "NS_17"

Derivation Path: TS 38.508-1 [5], Table 4.6.3-1			
Information Element	Value/remark	Comment	Condition
<code>additionalSpectrumEmission</code>	1 (NS_17)		

6.2.3.4.3.12 Message contents exceptions for network signalling value "NS_18"

1. Information element `additionalSpectrumEmission` is set to NS_18. This can be set in the *SIB1* as part of the cell broadcast message. This exception indicates that the UE shall meet the additional spurious emission requirement for a specific deployment scenario.

Table 6.2.3.4.3.12-1: *AdditionalSpectrumEmission*: Additional spurious emissions test requirement for "NS_18"

Derivation Path: TS 38.508-1 [5], Table 4.6.3-1			
Information Element	Value/remark	Comment	Condition
<code>additionalSpectrumEmission</code>	2 (NS_18)		

6.2.3.4.3.13 Message contents exceptions for network signalling value "NS_37"

1. Information element `additionalSpectrumEmission` is set to NS_37. This can be set in the *SIB1* as part of the cell broadcast message. This exception indicates that the UE shall meet the additional spurious emission requirement for a specific deployment scenario.

Table 6.2.3.4.3.13-1: *AdditionalSpectrumEmission*: Additional spurious emissions test requirement for "NS_37"

Derivation Path: TS 38.508-1 [5], Table 4.6.3-1			
Information Element	Value/remark	Comment	Condition
<code>additionalSpectrumEmission</code>	1 (NS_37)		

6.2.3.4.3.14 Message contents exceptions for network signalling value "NS_38"

1. Information element `additionalSpectrumEmission` is set to NS_38. This can be set in the *SIB1* as part of the cell broadcast message. This exception indicates that the UE shall meet the additional spurious emission requirement for a specific deployment scenario.

Table 6.2.3.4.3.14-1: AdditionalSpectrumEmission: Additional spurious emissions test requirement for "NS_38"

Derivation Path: TS 38.508-1 [5], Table 4.6.3-1			
Information Element	Value/remark	Comment	Condition
additionalSpectrumEmission	2 (NS_38)		

6.2.3.4.3.15 Message contents exceptions for network signalling value "NS_39"

- Information element additionalSpectrumEmission is set to NS_39. This can be set in the *SIB1* as part of the cell broadcast message. This exception indicates that the UE shall meet the additional spurious emission requirement for a specific deployment scenario.

Table 6.2.3.4.3.15-1: AdditionalSpectrumEmission: Additional spurious emissions test requirement for "NS_39"

Derivation Path: TS 38.508-1 [5], Table 4.6.3-1			
Information Element	Value/remark	Comment	Condition
additionalSpectrumEmission	3 (NS_39)		

6.2.3.4.3.16 Message contents exceptions for network signalling value "NS_40"

- Information element additionalSpectrumEmission is set to NS_40. This can be set in the *SIB1* as part of the cell broadcast message. This exception indicates that the UE shall meet the additional spurious emission requirement for a specific deployment scenario.

Table 6.2.3.4.3.16-1: AdditionalSpectrumEmission: Additional spurious emissions test requirement for "NS_40"

Derivation Path: TS 38.508-1 [5], Table 4.6.3-1			
Information Element	Value/remark	Comment	Condition
additionalSpectrumEmission	1 (NS_40)		

6.2.3.4.3.17 Message contents exceptions for network signalling value "NS_41"

- Information element additionalSpectrumEmission is set to NS_41. This can be set in the *SIB1* as part of the cell broadcast message. This exception indicates that the UE shall meet the additional spurious emission requirement for a specific deployment scenario.

Table 6.2.3.4.3.17-1: AdditionalSpectrumEmission: Additional spurious emissions test requirement for "NS_41"

Derivation Path: TS 38.508-1 [5], Table 4.6.3-1			
Information Element	Value/remark	Comment	Condition
additionalSpectrumEmission	1 (NS_41)		

6.2.3.4.3.18 Message contents exceptions for network signalling value "NS_42"

- Information element additionalSpectrumEmission is set to NS_42. This can be set in the *SIB1* as part of the cell broadcast message. This exception indicates that the UE shall meet the additional spurious emission requirement for a specific deployment scenario.

Table 6.2.3.4.3.18-1: AdditionalSpectrumEmission: Additional spurious emissions test requirement for "NS_42"

Derivation Path: TS 38.508-1 [5], Table 4.6.3-1			
Information Element	Value/remark	Comment	Condition
additionalSpectrumEmission	2 (NS_42)		

6.2.3.4.3.19 Message contents exceptions for network signalling value "NS_100"

1. Information element additionalSpectrumEmission is set to NS_100. This can be set in the *SIB1* as part of the cell broadcast message. This exception indicates that the UE shall meet the additional spurious emission requirement for a specific deployment scenario.

Table 6.2.3.4.3.19-1: AdditionalSpectrumEmission: Additional spurious emissions test requirement for "NS_100"

Derivation Path: TS 38.508-1 [5], Table 4.6.3-1			
Information Element	Value/remark	Comment	Condition
additionalSpectrumEmission	1 (NS_100)		not for band n65
	2 (NS_100)		for band n65

6.2.3.4.3.20 Message contents exceptions for network signalling value "NS_21"

1. Information element additionalSpectrumEmission is set to NS_21. This can be set in the *SIB1* as part of the cell broadcast message. This exception indicates that the UE shall meet the additional spurious emission requirement for a specific deployment scenario.

Table 6.2.3.4.3.20-1: AdditionalSpectrumEmission: Additional spurious emissions test requirement for "NS_21"

Derivation Path: TS 38.508-1 [5], Table 4.6.3-1			
Information Element	Value/remark	Comment	Condition
additionalSpectrumEmission	1 (NS_21)		

6.2.3.4.3.21 Message contents exceptions for network signalling value "NS_24"

1. Information element additionalSpectrumEmission is set to NS_24. This can be set in the *SIB1* as part of the cell broadcast message. This exception indicates that the UE shall meet the additional spurious emission requirement for a specific deployment scenario.

Table 6.2.3.4.3.21-1: AdditionalSpectrumEmission: Additional spurious emissions test requirement for "NS_24"

Derivation Path: TS 38.508-1 [5], Table 4.6.3-1			
Information Element	Value/remark	Comment	Condition
additionalSpectrumEmission	1 (NS_24)		

6.2.3.4.3.22 Message contents exceptions for network signalling value "NS_27"

1. Information element additionalSpectrumEmission is set to NS_27. This can be set in the *SIB1* as part of the cell broadcast message. This exception indicates that the UE shall meet the additional spurious emission requirement for a specific deployment scenario.

Table 6.2.3.4.3.22-1: AdditionalSpectrumEmission: Additional spurious emissions test requirement for "NS_27"

Derivation Path: TS 38.508-1 [5], Table 4.6.3-1			
Information Element	Value/remark	Comment	Condition
additionalSpectrumEmission	1 (NS_27)		

6.2.3.4.3.23 Message contents exceptions for network signalling value "NS_43"

1. Information element additionalSpectrumEmission is set to NS_43. This can be set in the *SIB1* as part of the cell broadcast message. This exception indicates that the UE shall meet the additional spurious emission requirement for a specific deployment scenario.

Table 6.2.3.4.3.23-1: AdditionalSpectrumEmission: Additional spurious emissions test requirement for "NS_43"

Derivation Path: TS 38.508-1 [5], Table 4.6.3-1			
Information Element	Value/remark	Comment	Condition
additionalSpectrumEmission	2 (NS_43)		

6.2.3.4.3.24 Message contents exceptions for network signalling value "NS_47"

- Information element additionalSpectrumEmission is set to NS_47. This can be set in the *SIB1* as part of the cell broadcast message. This exception indicates that the UE shall meet the additional spurious emission requirement for a specific deployment scenario.

Table 6.2.3.4.3.24-1: AdditionalSpectrumEmission: Additional spurious emissions test requirement for "NS_47"

Derivation Path: TS 38.508-1 [5], Table 4.6.3-1			
Information Element	Value/remark	Comment	Condition
additionalSpectrumEmission	2 (NS_47)		

6.2.3.4.3.25 Message contents exceptions for network signalling value "NS_48"

- Information element additionalSpectrumEmission is set to NS_48. This can be set in the *SIB1* as part of the cell broadcast message. This exception indicates that the UE shall meet the additional spurious emission requirement for a specific deployment scenario.

Table 6.2.3.4.3.25-1: AdditionalSpectrumEmission: Additional spurious emissions test requirement for "NS_48"

Derivation Path: TS 38.508-1 [5], Table 4.6.3-1			
Information Element	Value/remark	Comment	Condition
additionalSpectrumEmission	4 (NS_48)		

6.2.3.4.3.26 Message contents exceptions for network signalling value "NS_49"

- Information element additionalSpectrumEmission is set to NS_49. This can be set in the *SIB1* as part of the cell broadcast message. This exception indicates that the UE shall meet the additional spurious emission requirement for a specific deployment scenario.

Table 6.2.3.4.3.26-1: AdditionalSpectrumEmission: Additional spurious emissions test requirement for "NS_49"

Derivation Path: TS 38.508-1 [5], Table 4.6.3-1			
Information Element	Value/remark	Comment	Condition
additionalSpectrumEmission	5 (NS_49)		

6.2.3.4.3.27 Message contents exceptions for network signalling value "NS_12"

- Information element additionalSpectrumEmission is set to NS_12. This can be set in the *SIB1* as part of the cell broadcast message. This exception indicates that the UE shall meet the additional spurious emission requirement for a specific deployment scenario.

Table 6.2.3.4.3.27-1: AdditionalSpectrumEmission: Additional spurious emissions test requirement for "NS_12"

Derivation Path: TS 38.508-1 [5], Table 4.6.3-1			
Information Element	Value/remark	Comment	Condition
additionalSpectrumEmission	2 (NS_12)		

6.2.3.4.3.28 Message contents exceptions for network signalling value "NS_13"

1. Information element additionalSpectrumEmission is set to NS_13. This can be set in the *SIB1* as part of the cell broadcast message. This exception indicates that the UE shall meet the additional spurious emission requirement for a specific deployment scenario.

Table 6.2.3.4.3.28-1: AdditionalSpectrumEmission: Additional spurious emissions test requirement for "NS_13"

Derivation Path: TS 38.508-1 [5], Table 4.6.3-1			
Information Element	Value/remark	Comment	Condition
additionalSpectrumEmission	3 (NS_13)		

6.2.3.4.3.29 Message contents exceptions for network signalling value "NS_14"

1. Information element additionalSpectrumEmission is set to NS_14. This can be set in the *SIB1* as part of the cell broadcast message. This exception indicates that the UE shall meet the additional spurious emission requirement for a specific deployment scenario.

Table 6.2.3.4.3.29-1: AdditionalSpectrumEmission: Additional spurious emissions test requirement for "NS_14"

Derivation Path: TS 38.508-1 [5], Table 4.6.3-1			
Information Element	Value/remark	Comment	Condition
additionalSpectrumEmission	4 (NS_14)		

6.2.3.4.3.30 Message contents exceptions for network signalling value "NS_15"

1. Information element additionalSpectrumEmission is set to NS_15. This can be set in the *SIB1* as part of the cell broadcast message. This exception indicates that the UE shall meet the additional spurious emission requirement for a specific deployment scenario.

Table 6.2.3.4.3.30-1: AdditionalSpectrumEmission: Additional spurious emissions test requirement for "NS_15"

Derivation Path: TS 38.508-1 [5], Table 4.6.3-1			
Information Element	Value/remark	Comment	Condition
additionalSpectrumEmission	5 (NS_15)		

6.2.3.4.3.31 Message contents exceptions for network signalling value "NS_45"

1. Information element additionalSpectrumEmission is set to NS_45. This can be set in the *SIB1* as part of the cell broadcast message. This exception indicates that the UE shall meet the additional spurious emission requirement for a specific deployment scenario.

6.2.3.4.3.32 Message contents exceptions for network signalling value "NS_46"

1. Information element additionalSpectrumEmission is set to NS_46. This can be set in the *SIB1* as part of the cell broadcast message. This exception indicates that the UE shall meet the additional spurious emission requirement for a specific deployment scenario.

Table 6.2.3.4.3.32-1: AdditionalSpectrumEmission: Additional spurious emissions test requirement for "NS_46"

Derivation Path: TS 38.508-1 [5], Table 4.6.3-1			
Information Element	Value/remark	Comment	Condition
additionalSpectrumEmission	1 (NS_46)		

6.2.3.4.3.33 Message contents exceptions for network signalling value "NS_44"

1. Information element `additionalSpectrumEmission` is set to NS_44. This can be set in the *SIB1* as part of the cell broadcast message. This exception indicates that the UE shall meet the additional spurious emission requirement for a specific deployment scenario.

Table 6.2.3.4.3.33-1: *AdditionalSpectrumEmission*: Additional spurious emissions test requirement for "NS_44"

Derivation Path: TS 38.508-1 [5], Table 4.6.3-1			
Information Element	Value/remark	Comment	Condition
<code>additionalSpectrumEmission</code>	1 (NS_44)		

6.2.3.4.3.34 Message contents exceptions for network signalled value "NS_56"

1. Information element `additionalSpectrumEmission` is set to NS_56. This can be set in the *SIB1* as part of the cell broadcast message. This exception indicates that the UE shall meet the additional spurious emission requirement for a specific deployment scenario.

Table 6.2.3.4.3.34-1: *AdditionalSpectrumEmission*: Additional spurious emissions test requirement for "NS_56"

Derivation Path: TS 38.508-1 [5], Table 4.6.3-1			
Information Element	Value/remark	Comment	Condition
<code>additionalSpectrumEmission</code>	1 (NS_56)		

6.2.3.5 Test requirement

The maximum output power, derived in step 3 shall be within the range prescribed by the nominal maximum output power and tolerance in the applicable table from table 6.2.3.5-1. The allowed A-MPR values specified in table 6.2.3.3-1 are in addition to the allowed MPR requirements specified in clause 6.2.2. For the UE maximum output power modified by MPR and/or A-MPR, the power limits specified in table 6.2.1.3-1 apply.

Table 6.2.3.5-0: Test Tolerance (UE additional maximum output power reduction)

	$f \leq 3.0\text{GHz}$	$3.0\text{GHz} < f \leq 4.2\text{GHz}$	$4.2\text{GHz} < f \leq 6.0\text{GHz}$
BW \leq 40MHz	0.7 dB	1.0 dB	1.0 dB
40MHz < BW \leq 100MHz	1.0 dB	1.0 dB	1.0 dB

Table 6.2.3.5-1: UE Power Class 3 test requirements (NS_35) for band n71

Test ID	$P_{\text{PowerClass}}$ (dBm)	MPR (dB)	A-MPR (dB)	$\Delta T_{\text{C,c}}$ (dB)	$P_{\text{CMAX,c}}$ (dBm)	$T(P_{\text{CMAX,L,c}})$ (dB)	$T_{\text{L,c}}$ (dB)	Upper limit (dBm)	Lower limit (dBm)
1	23	0.5	0	0	22.5	2	2.5	25+TT	20-TT
2	23	0.5	0	0	22.5	2	2.5	25+TT	20-TT
3	23	0.5	0	0	22.5	2	2.5	25+TT	20-TT
4	23	1	0	0	22	2	2.5	25+TT	19.5-TT
5	23	1	0	0	22	2	2.5	25+TT	19.5-TT
6	23	1	0	0	22	2	2.5	25+TT	19.5-TT
7	23	2	0	0	21	2	2.5	25+TT	18.5-TT
8	23	2	0	0	21	2	2.5	25+TT	18.5-TT
9	23	2	0	0	21	2	2.5	25+TT	18.5-TT
10	23	2.5	0	0	20.5	2.5	2.5	25+TT	18-TT
11	23	2.5	0	0	20.5	2.5	2.5	25+TT	18-TT
12	23	2.5	0	0	20.5	2.5	2.5	25+TT	18-TT
13	23	4.5	0	0	18.5	4	2.5	25+TT	14.5-TT
14	23	4.5	0	0	18.5	4	2.5	25+TT	14.5-TT
15	23	4.5	0	0	18.5	4	2.5	25+TT	14.5-TT
16	23	3	0	0	20	2.5	2.5	25+TT	17.5-TT
17	23	3	0	0	20	2.5	2.5	25+TT	17.5-TT
18	23	3	0	0	20	2.5	2.5	25+TT	17.5-TT
19	23	3	0	0	20	2.5	2.5	25+TT	17.5-TT
20	23	3	0	0	20	2.5	2.5	25+TT	17.5-TT
21	23	3	0	0	20	2.5	2.5	25+TT	17.5-TT
22	23	3.5	0	0	19.5	3.5	2.5	25+TT	16-TT
23	23	3.5	0	0	19.5	3.5	2.5	25+TT	16-TT
24	23	3.5	0	0	19.5	3.5	2.5	25+TT	16-TT
25	23	6.5	0	0	16.5	5	2.5	25+TT	11.5-TT
26	23	6.5	0	0	16.5	5	2.5	25+TT	11.5-TT
27	23	6.5	0	0	16.5	5	2.5	25+TT	11.5-TT

NOTE 1: $P_{\text{PowerClass}}$ is the maximum UE power specified without taking into account the tolerance.
NOTE 2: TT for each frequency and channel bandwidth is specified in Table 6.2.3.5-0.

Table 6.2.3.5-2: UE Power Class 2 test requirements (NS_04) for band n41 (Step 3)

Test ID	P _{PowerClass} (dBm)	MPR (dB)	A-MPR (dB)	$\Delta T_{C,c}$ (dB)	P _{C_{MAX,c}} (dBm)	T(P _{C_{MAX,L,c}}) (dB)	T _{L,c} (dB)	Upper limit (dBm)	Lower limit (Note 2) (dBm)
7	26	3.5	5.5	0	20.5	2.5	3	28+TT	17.5-TT
8	26	3.5	3.5	0	22.5	2.0	3	28+TT	19.5-TT
9	26	3.5	0	0	22.5	2.0	3	28+TT	19.5-TT
10	26	0.5	3.5	0	22.5	2.0	3	28+TT	19.5-TT
11	26	3.5	0	0	22.5	2.0	3	28+TT	19.5-TT
12	26	0.5	0	0	25.5	2.0	3	28+TT	22.5-TT
13	26	3.5	6	0	20	2.5	3	28+TT	17-TT
14	26	3.5	4.5	0	21	2.0	3	28+TT	18.5-TT
15	26	3.5	0	0	22.5	2.0	3	28+TT	19.5-TT
16	26	1	4.5	0	21.5	2.0	3	28+TT	18.5-TT
17	26	3.5	0	0	22.5	2.0	3	28+TT	19.5-TT
18	26	1	0	0	25	2.0	3	28+TT	22-TT
19	26	3.5	6	0	20	2.5	3	28+TT	17-TT
20	26	3.5	5	0	19.5	2.0	3	28+TT	18-TT
21	26	3.5	0	0	21	2.0	3	28+TT	19.5-TT
22	26	2	5	0	21	2.0	3	28+TT	18-TT
23	26	3.5	0	0	22.5	2.0	3	28+TT	19.5-TT
24	26	2	0	0	24	2.0	3	28+TT	21-TT
25	26	3.5	6.5	0	19.5	3.5	3	28+TT	16-TT
26	26	3.5	5	0	21	2.0	3	28+TT	18-TT
27	26	3.5	0	0	22.5	2.0	3	28+TT	19.5-TT
28	26	2.5	5	0	21	2.0	3	28+TT	18-TT
29	26	3.5	0	0	22.5	2.0	3	28+TT	19.5-TT
30	26	2.5	0	0	23.5	2.0	3	28+TT	20.5-TT
31	26	4.5	8	0	18	4.0	3	28+TT	14-TT
32	26	4.5	6.5	0	19.5	3.5	3	28+TT	16-TT
33	26	4.5	6.5	0	19.5	3.5	3	28+TT	16-TT
34	26	4.5	0	0	21.5	2.0	3	28+TT	18.5-TT
35	26	4.5	0	0	21.5	2.0	3	28+TT	18.5-TT
36	26	4.5	0	0	21.5	2.0	3	28+TT	18.5-TT
37	26	3.5	7.5	0	18.5	4.0	3	28+TT	14.5-TT
38	26	3.5	6.5	0	19.5	3.5	3	28+TT	16-TT
39	26	3.5	0	0	22.5	2.0	3	28+TT	19.5-TT
40	26	3	6.5	0	19.5	3.5	3	28+TT	16-TT
41	26	3.5	0	0	22.5	2.0	3	28+TT	19.5-TT
42	26	3	0	0	23	2.0	3	28+TT	20-TT
43	26	3.5	7.5	0	18.5	4.0	3	28+TT	14.5-TT
44	26	3.5	6.5	0	19.5	3.5	3	28+TT	16-TT
45	26	3.5	0	0	22.5	2.0	3	28+TT	19.5-TT
46	26	3	6.5	0	19.5	3.5	3	28+TT	16-TT
47	26	3.5	0	0	22.5	2.0	3	28+TT	19.5-TT
48	26	3	0	0	23	2.0	3	28+TT	20-TT
49	26	3.5	7.5	0	18.5	4.0	3	28+TT	14.5-TT
50	26	3.5	6.5	0	19.5	3.5	3	28+TT	16-TT
51	26	3.5	0	0	22.5	2.0	3	28+TT	19.5-TT
52	26	3.5	6.5	0	19.5	3.5	3	28+TT	16-TT
53	26	3.5	0	0	22.5	2.0	3	28+TT	19.5-TT
54	26	3.5	0	0	22.5	2.0	3	28+TT	19.5-TT
55	26	6.5	10	0	16	5.0	3	28+TT	11-TT
56	26	6.5	7.5	0	18.5	4.0	3	28+TT	14.5-TT
57	26	6.5	0	0	19.5	3.5	3	28+TT	16-TT
58	26	6.5	7.5	0	18.5	4.0	3	28+TT	14.5-TT
59	26	6.5	0	0	19.5	3.5	3	28+TT	16-TT
60	26	6.5	0	0	19.5	3.5	3	28+TT	16-TT

NOTE 1: P_{PowerClass} is the maximum UE power specified without taking into account the tolerance.

NOTE 2: For Band n41, refers to the transmission bandwidths confined within F_{UL,low} and F_{UL,low} + 4 MHz or F_{UL,high} - 4 MHz and F_{UL,high}, the lower limit shall be decreased by 1.0 dB for CP-OFDM 256 QAM and decreased by 1.5 dB for other modulations.

NOTE 3: TT=0.7 dB for BW_{channel} ≤ 40 MHz; TT=1.0 dB for 40 MHz < BW_{channel} ≤ 100 MHz.

Table 6.2.3.5-3: UE Power Class 3 test requirements (NS_04) for band n41 (Step 3) and UE Power Class 2 test requirements (NS_04) for band n41 (Step 4)

Test ID	P _{PowerClass} (dBm)	ΔP _{PowerClass} (dB)	MPR (dB)	A-MPR (dB)	ΔT _{C,c} (dB)	P _{C_{MAX,c}} (dBm)	T(P _{C_{MAX,L,c}}) (dB)	T _{L,c} (dB)	Upper limit (dBm)	Lower limit (Note 2) (dBm)
1	23	-3	3.5	3.5	0	22.5	2.0	3	28+TT	19.5-TT
2	23	-3	3.5	3.5	0	22.5	2.0	3	28+TT	19.5-TT
3	23	-3	3.5	0	0	22.5	2.0	3	28+TT	19.5-TT
4	23	-3	1.2	3.5	0	22.5	2.0	3	28+TT	19.5-TT
5	23	-3	3.5	0	0	22.5	2.0	3	28+TT	19.5-TT
6	23	-3	1.2	0	0	24.8	2.0	3	28+TT	21.8-TT
7	23	0	0.5	3.5	0	19.5	3.5	3	25+TT	16-TT
8	23	0	0.5	3.5	0	19.5	3.5	3	25+TT	16-TT
9	23	0	0.5	0	0	22.5	2.0	3	25+TT	19.5-TT
10	23	0	0.5	3.5	0	19.5	3.5	3	25+TT	16-TT
11	23	0	0.5	0	0	22.5	2.0	3	25+TT	19.5-TT
12	23	0	0.5	0	0	22.5	2.0	3	25+TT	19.5-TT
13	23	0	1	4	0	19	3.5	3	25+TT	15.5-TT
14	23	0	1	4	0	19	3.5	3	25+TT	15.5-TT
15	23	0	1	0	0	22	2.0	3	25+TT	19-TT
16	23	0	1	4	0	19	3.5	3	25+TT	15.5-TT
17	23	0	1	0	0	22	2.0	3	25+TT	19-TT
18	23	0	1	0	0	22	2.0	3	25+TT	19-TT
19	23	0	2	4	0	19	3.5	3	25+TT	15.5-TT
20	23	0	2	4	0	19	3.5	3	25+TT	15.5-TT
21	23	0	2	0	0	21	2.0	3	25+TT	18-TT
22	23	0	2	4	0	19	3.5	3	25+TT	15.5-TT
23	23	0	2	0	0	21	2.0	3	25+TT	18-TT
24	23	0	2	0	0	21	2.0	3	25+TT	18-TT
25	23	0	2.5	4.5	0	18.5	4.0	3	25+TT	14.5-TT
26	23	0	2.5	4	0	19	3.5	3	25+TT	15.5-TT
27	23	0	2.5	0	0	20.5	2.5	3	25+TT	17.5-TT
28	23	0	2.5	4	0	19	3.5	3	25+TT	15.5-TT
29	23	0	2.5	0	0	20.5	2.5	3	25+TT	17.5-TT
30	23	0	2.5	0	0	20.5	2.5	3	25+TT	17.5-TT
31	23	0	4.5	6	0	17	5.0	3	25+TT	12-TT
32	23	0	4.5	4.5	0	18.5	4.0	3	25+TT	14.5-TT
33	23	0	4.5	0	0	18.5	4.0	3	25+TT	14.5-TT
34	23	0	4.5	4.5	0	18.5	4.0	3	25+TT	14.5-TT
35	23	0	4.5	0	0	18.5	4.0	3	25+TT	14.5-TT
36	23	0	4.5	0	0	18.5	4.0	3	25+TT	14.5-TT
37	23	0	3	5.5	0	17.5	5.0	3	25+TT	12.5-TT
38	23	0	3	5.5	0	17.5	5.0	3	25+TT	12.5-TT

Test ID	P _{PowerClass} (dBm)	ΔP _{PowerClass} (dB)	MPR (dB)	A-MPR (dB)	ΔT _{C,c} (dB)	P _{C_{MAX,c}} (dBm)	T(P _{C_{MAX,L,c}}) (dB)	T _{L,c} (dB)	Upper limit (dBm)	Lower limit (Note 2) (dBm)
39	23	0	3	0	0	20	2.5	3	25+TT	17-TT
40	23	0	3	5.5	0	17.5	5.0	3	25+TT	12.5-TT
41	23	0	3	0	0	20	2.5	3	25+TT	17-TT
42	23	0	3	0	0	20	2.5	3	25+TT	17-TT
43	23	0	3	5.5	0	17.5	5.0	3	25+TT	12.5-TT
44	23	0	3	5.5	0	17.5	5.0	3	25+TT	12.5-TT
45	23	0	3	0	0	20	2.5	3	25+TT	17-TT
46	23	0	3	5.5	0	17.5	5.0	3	25+TT	12.5-TT
47	23	0	3	0	0	20	2.5	3	25+TT	17-TT
48	23	0	3	0	0	20	2.5	3	25+TT	17.5-TT
49	23	0	3.5	5.5	0	17.5	5.0	3	25+TT	12.5-TT
50	23	0	3.5	5.5	0	17.5	5.0	3	25+TT	12.5-TT
51	23	0	3.5	0	0	19.5	3.5	3	25+TT	16-TT
52	23	0	3.5	5.5	0	17.5	5.0	3	25+TT	12.5-TT
53	23	0	3.5	0	0	19.5	3.5	3	25+TT	16-TT
54	23	0	3.5	0	0	19.5	3.5	3	25+TT	16-TT
55	23	0	6.5	8	0	15	5.0	3	25+TT	10-TT
56	23	0	6.5	6.5	0	16.5	5.0	3	25+TT	11.5-TT
57	23	0	6.5	0	0	16.5	5.0	3	25+TT	11.5-TT
58	23	0	6.5	6.5	0	16.5	5.0	3	25+TT	11.5-TT
59	23	0	6.5	0	0	16.5	5.0	3	25+TT	11.5-TT
60	23	0	6.5	0	0	16.5	5.0	3	25+TT	11.5-TT

NOTE 1: P_{PowerClass} is the maximum UE power specified without taking into account the tolerance.

NOTE 2: For Band n41, refers to the transmission bandwidths confined within F_{UL_low} and F_{UL_low} + 4 MHz or F_{UL_high} - 4 MHz and F_{UL_high}, the lower limit shall be decreased by 1.0 dB for CP-OFDM 256 QAM and decreased by 1.5 dB for other modulations.

NOTE 3: TT=0.7 dB for BW_{channel} ≤ 40 MHz; TT=1.0 dB for 40 MHz < BW_{channel} ≤ 100 MHz.

Table 6.2.3.5-4: UE Power Class 3 test requirements (NS_03 and NS_03U) for band n66, n70

Test ID	Network signalling label	P _{PowerClass} (dBm)	MPR (dB)	A-MPR (dB)	$\Delta T_{C,c}$ (dB)	P _{CMAX_L,c} (dBm)	T(P _{CMAX_L,c}) (dB)	T _{L,c} (dB)	Upper limit (dBm)	Lower limit (dBm)
1, 2	NS_03	23	0.5	1.5	0	21.5	2	2	25+TT	19.5-TT
	NS_03U	23	0.5	2	0	21	2	2	25+TT	19-TT
3	NS_03	23	0.5	1.5	0	21.5	2	2	25+TT	19.5-TT
	NS_03U	23	0.5	2	0	21	2	2	25+TT	19-TT
4, 5	NS_03, NS_03U	23	1	2	0	21	2	2	25+TT	19-TT
6	NS_03, NS_03U	23	1	2	0	21	2	2	25+TT	19-TT
7, 8	NS_03, NS_03U	23	2	3	0	20	2.5	2	25+TT	17.5-TT
9	NS_03, NS_03U	23	2	3	0	20	2.5	2	25+TT	17.5-TT
10, 11	NS_03, NS_03U	23	2.5	3.5	0	19.5	3.5	2	25+TT	16-TT
12	NS_03, NS_03U	23	2.5	3.5	0	19.5	3.5	2	25+TT	16-TT
13, 14	NS_03, NS_03U	23	4.5	5.5	0	17.5	5	2	25+TT	12.5-TT
15	NS_03, NS_03U	23	4.5	5.5	0	17.5	5	2	25+TT	12.5-TT
16, 17	NS_03, NS_03U	23	3	4	0	19	3.5	2	25+TT	15.5-TT
18	NS_03, NS_03U	23	3	4	0	19	3.5	2	25+TT	15.5-TT
19, 20	NS_03, NS_03U	23	3	4	0	19	3.5	2	25+TT	15.5-TT
21	NS_03, NS_03U	23	3	4	0	19	3.5	2	25+TT	15.5-TT
22, 23	NS_03, NS_03U	23	3.5	4.5	0	18.5	4	2	25+TT	14.5-TT
24	NS_03, NS_03U	23	3.5	4.5	0	18.5	4	2	25+TT	14.5-TT
25, 26	NS_03, NS_03U	23	6.5	7.5	0	15.5	5	2	25+TT	10.5-TT
27	NS_03, NS_03U	23	6.5	7.5	0	15.5	5	2	25+TT	10.5-TT

NOTE 1: P_{PowerClass} is the maximum UE power specified without taking into account the tolerance.

NOTE 2: TT for each frequency and channel bandwidth is specified in Table 6.2.3.5-0.

Table 6.2.3.5-5: UE Power Class 3 test requirements (NS_03 and NS_03U) for band n2, n25

Test ID	Network signalling label	$P_{\text{PowerClass}}$ (dBm)	MPR (dB)	A-MPR (dB)	$\Delta T_{C,c}$ (dB)	$P_{\text{CMAX}_L,c}$ (dBm)	$T(P_{\text{CMAX}_L,c})$ (dB)	$T_{L,c}$ (dB)	Upper limit (dBm)	Lower limit (dBm)
1, 2	NS_03	23	0.5	1.5	1.5	20	2.5	2	25+TT	17.5-TT
	NS_03U	23	0.5	2	1.5	19.5	3.5	2	25+TT	16-TT
3	NS_03	23	0.5	1.5	0	21.5	2	2	25+TT	19.5-TT
	NS_03U	23	0.5	2	0	21	2	2	25+TT	19-TT
4, 5	NS_03; NS_03U	23	1	2	1.5	19.5	3.5	2	25+TT	16-TT
6	NS_03; NS_03U	23	1	2	0	21	2	2	25+TT	19-TT
7, 8	NS_03; NS_03U	23	2	3	1.5	18.5	4	2	25+TT	14.5-TT
9	NS_03; NS_03U	23	2	3	0	20	2.5	2	25+TT	17.5-TT
10, 11	NS_03; NS_03U	23	2.5	3.5	1.5	18	4	2	25+TT	14-TT
12	NS_03; NS_03U	23	2.5	3.5	0	19.5	3.5	2	25+TT	16-TT
13, 14	NS_03; NS_03U	23	4.5	5.5	1.5	16	5	2	25+TT	11-TT
15	NS_03; NS_03U	23	4.5	5.5	0	17.5	5	2	25+TT	12.5-TT
16, 17	NS_03; NS_03U	23	3	4	1.5	17.5	5	2	25+TT	12.5-TT
18	NS_03; NS_03U	23	3	4	0	19	3.5	2	25+TT	15.5-TT
19, 20	NS_03; NS_03U	23	3	4	1.5	17.5	5	2	25+TT	12.5-TT
21	NS_03; NS_03U	23	3	4	0	19	3.5	2	25+TT	15.5-TT
22, 23	NS_03; NS_03U	23	3.5	4.5	1.5	17	5	2	25+TT	12-TT
24	NS_03; NS_03U	23	3.5	4.5	0	18.5	4	2	25+TT	14.5-TT
25, 26	NS_03; NS_03U	23	6.5	7.5	1.5	14	5	2	25+TT	9-TT
27	NS_03; NS_03U	23	6.5	7.5	0	15.5	5	2	25+TT	10.5-TT

NOTE 1: $P_{\text{PowerClass}}$ is the maximum UE power specified without taking into account the tolerance.

NOTE 2: TT for each frequency and channel bandwidth is specified in Table 6.2.3.5-0.

Table 6.2.3.5-6: UE Power Class 3 test requirements (NS_05) for bands n1, n65

Test ID	P _{PowerClass} (dBm)	Δ P _{PowerClass} (dB)	MPR (dB)	A-MPR (dB)	Δ T _{C,c} (dB)	P _{CMAX_L,c} (dBm)	T(P _{CMAX_L,c}) (dB)	T _{L,c} (dB)	Upper limit (dBm)	Lower limit (dBm)
1	23	0	0.5	4	0	19	3.5	2	25+TT	15.5-TT
2	23	0	0.5	10	0	13	5	2	25+TT	8-TT
3	23	0	0.5	6	0	17	5	2	25+TT	12-TT
4	23	0	0.5	5	0	18	4	2	25+TT	14-TT
5	23	0	0.5	1	0	22	2.0	2	25+TT	20-TT
6	23	0	0.5	10	0	13	5.0	2	25+TT	8-TT
7	23	0	0.5	6	0	17	5.0	2	25+TT	12-TT
8	23	0	0.5	5	0	18	4.0	2	25+TT	14-TT
9	23	0	0.5	10	0	13	5.0	2	25+TT	8-TT
10	23	0	0.5	5	0	18	4.0	2	25+TT	14-TT
11	23	0	0.5	1	0	22	2.0	2	25+TT	20-TT
12	23	0	0.5	10	0	13	5.0	2	25+TT	8-TT
13	23	0	0.5	6	0	17	5.0	2	25+TT	12-TT
14	23	0	0.5	5	0	18	4.0	2	25+TT	14-TT
15	23	0	0.5	1	0	22	2.0	2	25+TT	20-TT
16	23	0	1.0	4.5	0	18.5	4.0	2	25+TT	14.5-TT
17	23	0	1.0	10	0	13	5.0	2	25+TT	8-TT
18	23	0	1.0	6	0	17	5.0	2	25+TT	12-TT
19	23	0	1.0	5	0	18	4.0	2	25+TT	14-TT
20	23	0	1.0	10	0	13	5.0	2	25+TT	8-TT
21	23	0	1.0	6	0	17	5.0	2	25+TT	12-TT
22	23	0	1.0	5	0	18	4.0	2	25+TT	14-TT
23	23	0	1.0	10	0	13	5.0	2	25+TT	8-TT
24	23	0	1.0	5	0	18	4.0	2	25+TT	14-TT
25	23	0	1.0	1.5	0	21.5	2.0	2	25+TT	19.5-TT
26	23	0	1.0	10	0	13	5.0	2	25+TT	8-TT
27	23	0	1.0	6	0	17	5.0	2	25+TT	12-TT
28	23	0	1.0	5	0	18	4.0	2	25+TT	14-TT
29	23	0	1.0	1.5	0	21.5	2.0	2	25+TT	19.5-TT
30	23	0	2.0	6	0	17	5.0	2	25+TT	12-TT
31	23	0	2.0	10	0	13	5.0	2	25+TT	8-TT
32	23	0	2.0	6	0	17	5.0	2	25+TT	12-TT
33	23	0	2.0	5	0	18	4.0	2	25+TT	14-TT
34	23	0	2.0	10	0	13	5.0	2	25+TT	8-TT
35	23	0	2.0	6	0	17	5.0	2	25+TT	12-TT
36	23	0	2.0	5	0	18	4.0	2	25+TT	14-TT
37	23	0	2.0	10	0	13	5.0	2	25+TT	8-TT
38	23	0	2.0	5	0	18	4.0	2	25+TT	14-TT
39	23	0	2.0	10	0	13	5.0	2	25+TT	8-TT
40	23	0	2.0	6	0	17	5.0	2	25+TT	12-TT
41	23	0	2.0	5	0	18	4.0	2	25+TT	14-TT
42	23	0	2.5	6	0	17	5.0	2	25+TT	12-TT
43	23	0	2.5	11	0	12	6.0	2	25+TT	6-TT
44	23	0	2.5	6	0	17	5.0	2	25+TT	12-TT
45	23	0	2.5	5	0	18	4.0	2	25+TT	14-TT
46	23	0	2.5	11	0	12	6.0	2	25+TT	6-TT
47	23	0	2.5	6	0	17	5.0	2	25+TT	12-TT
48	23	0	2.5	5	0	18	4.0	2	25+TT	14-TT
49	23	0	2.5	11	0	12	6.0	2	25+TT	6-TT
50	23	0	2.5	5	0	18	4.0	2	25+TT	14-TT
51	23	0	2.5	11	0	12	6.0	2	25+TT	6-TT
52	23	0	2.5	6	0	17	5.0	2	25+TT	12-TT
53	23	0	2.5	5	0	18	4.0	2	25+TT	14-TT
54	23	0	4.5	7	0	16	5.0	2	25+TT	11-TT
55	23	0	4.5	13	0	10	6.0	2	25+TT	4-TT
56	23	0	4.5	6	0	17	5.0	2	25+TT	12-TT
57	23	0	4.5	5	0	18	4.0	2	25+TT	14-TT
58	23	0	4.5	13	0	10	6.0	2	25+TT	4-TT
59	23	0	4.5	6	0	17	5.0	2	25+TT	12-TT

Test ID	$P_{\text{PowerClass}}$ (dBm)	$\Delta P_{\text{PowerClass}}$ (dB)	MPR (dB)	A-MPR (dB)	$\Delta T_{C,c}$ (dB)	$P_{\text{CMAX}_L,c}$ (dBm)	$T(P_{\text{CMAX}_L,c})$ (dB)	$T_{L,c}$ (dB)	Upper limit (dBm)	Lower limit (dBm)
60	23	0	4.5	5	0	18	4.0	2	25+TT	14-TT
61	23	0	4.5	13	0	10	6.0	2	25+TT	4-TT
62	23	0	4.5	5	0	18	4.0	2	25+TT	14-TT
63	23	0	4.5	13	0	10	6.0	2	25+TT	4-TT
64	23	0	4.5	6	0	17	5.0	2	25+TT	12-TT
65	23	0	4.5	5	0	18	4.0	2	25+TT	14-TT
66	23	0	3.0	7.5	0	15.5	5.0	2	25+TT	10.5-TT
67	23	0	3.0	10	0	13	5.0	2	25+TT	8-TT
68	23	0	3.0	6	0	17	5.0	2	25+TT	12-TT
69	23	0	3.0	5	0	18	4.0	2	25+TT	14-TT
70	23	0	3.0	3.5	0	19.5	3.5	2	25+TT	16-TT
71	23	0	3.0	10	0	13	5.0	2	25+TT	8-TT
72	23	0	3.0	6	0	17	5.0	2	25+TT	12-TT
73	23	0	3.0	5	0	18	4.0	2	25+TT	14-TT
74	23	0	3.0	10	0	13	5.0	2	25+TT	8-TT
75	23	0	3.0	5	0	18	4.0	2	25+TT	14-TT
76	23	0	3.0	3.5	0	19.5	3.5	2	25+TT	16-TT
77	23	0	3.0	10	0	13	5.0	2	25+TT	8-TT
78	23	0	3.0	6	0	17	5.0	2	25+TT	12-TT
79	23	0	3.0	5	0	18	4.0	2	25+TT	14-TT
80	23	0	3.0	3.5	0	19.5	3.5	2	25+TT	16-TT
81	23	0	3.0	7.5	0	15.5	5.0	2	25+TT	10.5-TT
82	23	0	3.0	10	0	13	5.0	2	25+TT	8-TT
83	23	0	3.0	6	0	17	5.0	2	25+TT	12-TT
84	23	0	3.0	5	0	18	4.0	2	25+TT	14-TT
85	23	0	3.0	3.5	0	19.5	3.5	2	25+TT	16-TT
86	23	0	3.0	10	0	13	5.0	2	25+TT	8-TT
87	23	0	3.0	6	0	17	5.0	2	25+TT	12-TT
88	23	0	3.0	5	0	18	4.0	2	25+TT	14-TT
89	23	0	3.0	10	0	13	5.0	2	25+TT	8-TT
90	23	0	3.0	5	0	18	4.0	2	25+TT	14-TT
91	23	0	3.0	3.5	0	19.5	3.5	2	25+TT	16-TT
92	23	0	3.0	10	0	13	5.0	2	25+TT	8-TT
93	23	0	3.0	6	0	17	5.0	2	25+TT	12-TT
94	23	0	3.0	5	0	18	4.0	2	25+TT	14-TT
95	23	0	3.0	3.5	0	19.5	3.5	2	25+TT	16-TT
96	23	0	3.5	8	0	15	5.0	2	25+TT	10-TT
97	23	0	3.5	11	0	12	6.0	2	25+TT	6-TT
98	23	0	3.5	6	0	17	5.0	2	25+TT	12-TT
99	23	0	3.5	5	0	18	4.0	2	25+TT	14-TT
100	23	0	3.5	11	0	12	6.0	2	25+TT	6-TT
101	23	0	3.5	6	0	17	5.0	2	25+TT	12-TT
102	23	0	3.5	5	0	18	4.0	2	25+TT	14-TT
103	23	0	3.5	11	0	12	6.0	2	25+TT	6-TT
104	23	0	3.5	5	0	18	4.0	2	25+TT	14-TT
105	23	0	3.5	11	0	12	6.0	2	25+TT	6-TT
106	23	0	3.5	6	0	17	5.0	2	25+TT	12-TT
107	23	0	3.5	5	0	18	4.0	2	25+TT	14-TT
108	23	0	6.5	10	0	13	5.0	2	25+TT	8-TT
109	23	0	6.5	13	0	10	6.0	2	25+TT	4-TT
110	23	0	6.5	6	0	16.5	5.0	2	25+TT	11.5-TT
111	23	0	6.5	13	0	10	6.0	2	25+TT	4-TT
112	23	0	6.5	6	0	16.5	5.0	2	25+TT	11.5-TT
113	23	0	6.5	13	0	10	6.0	2	25+TT	4-TT
114	23	0	6.5	13	0	10	6.0	2	25+TT	4-TT
115	23	0	6.5	6	0	16.5	5.0	2	25+TT	11.5-TT

NOTE 1: $P_{\text{PowerClass}}$ is the maximum UE power specified without taking into account the tolerance.

NOTE 2: TT for each frequency and channel bandwidth is specified in Table 6.2.3.5-0.

Table 6.2.3.5-7: UE Power Class 3 test requirements (NS_05U) for bands n1, n65

Test ID	P _{PowerClass} (dBm)	ΔP _{PowerClass} (dB)	MPR (dB)	A-MPR (dB)	ΔT _{C,c} (dB)	P _{CMAX_L,c} (dBm)	T(P _{CMAX_L,c}) (dB)	T _{L,c} (dB)	Upper limit (dBm)	Lower limit (dBm)
1	23	0	0.5	4	0	19	3.5	2	25+TT	15.5-TT
2	23	0	0.5	10	0	13	5	2	25+TT	8-TT
3	23	0	0.5	6	0	17	5	2	25+TT	12-TT
4	23	0	0.5	5	0	18	4	2	25+TT	14-TT
5	23	0	0.5	2	0	21	2.0	2	25+TT	19-TT
6	23	0	0.5	10	0	13	5.0	2	25+TT	8-TT
7	23	0	0.5	6	0	17	5.0	2	25+TT	12-TT
8	23	0	0.5	5	0	18	4.0	2	25+TT	14-TT
9	23	0	0.5	10	0	13	5.0	2	25+TT	8-TT
10	23	0	0.5	5	0	18	4.0	2	25+TT	14-TT
11	23	0	0.5	2	0	21	2.0	2	25+TT	19-TT
12	23	0	0.5	10	0	13	5.0	2	25+TT	8-TT
13	23	0	0.5	6	0	17	5.0	2	25+TT	12-TT
14	23	0	0.5	5	0	18	4.0	2	25+TT	14-TT
15	23	0	0.5	2	0	21	2.0	2	25+TT	19-TT
16	23	0	1.0	4.5	0	18.5	4.0	2	25+TT	14.5-TT
17	23	0	1.0	10	0	13	5.0	2	25+TT	8-TT
18	23	0	1.0	6	0	17	5.0	2	25+TT	12-TT
19	23	0	1.0	5	0	18	4.0	2	25+TT	14-TT
20	23	0	1.0	2	0	21	2.0	2	25+TT	19-TT
21	23	0	1.0	10	0	13	5.0	2	25+TT	8-TT
22	23	0	1.0	6	0	17	5.0	2	25+TT	12-TT
23	23	0	1.0	5	0	18	4.0	2	25+TT	14-TT
24	23	0	1.0	10	0	13	5.0	2	25+TT	8-TT
25	23	0	1.0	5	0	18	4.0	2	25+TT	14-TT
26	23	0	1.0	2	0	21	2.0	2	25+TT	19-TT
27	23	0	1.0	10	0	13	5.0	2	25+TT	8-TT
28	23	0	1.0	6	0	17	5.0	2	25+TT	12-TT
29	23	0	1.0	5	0	18	4.0	2	25+TT	14-TT
30	23	0	1.0	2	0	21	2.0	2	25+TT	19-TT
31	23	0	2.0	6	0	17	5.0	2	25+TT	12-TT
32	23	0	2.0	10	0	13	5.0	2	25+TT	8-TT
33	23	0	2.0	6	0	17	5.0	2	25+TT	12-TT
34	23	0	2.0	5	0	18	4.0	2	25+TT	14-TT
35	23	0	2.0	2.5	0	20.5	2.5	2	25+TT	18-TT
36	23	0	2.0	10	0	13	5.0	2	25+TT	8-TT
37	23	0	2.0	6	0	17	5.0	2	25+TT	12-TT
38	23	0	2.0	5	0	18	4.0	2	25+TT	14-TT
39	23	0	2.0	10	0	13	5.0	2	25+TT	8-TT
40	23	0	2.0	5	0	18	4.0	2	25+TT	14-TT
41	23	0	2.0	2.5	0	20.5	2.5	2	25+TT	18-TT
42	23	0	2.0	10	0	13	5.0	2	25+TT	8-TT
43	23	0	2.0	6	0	17	5.0	2	25+TT	12-TT
44	23	0	2.0	5	0	18	4.0	2	25+TT	14-TT
45	23	0	2.0	2.5	0	20.5	2.5	2	25+TT	18-TT
46	23	0	2.5	6	0	17	5.0	2	25+TT	12-TT
47	23	0	2.5	11	0	12	6.0	2	25+TT	6-TT
48	23	0	2.5	6	0	17	5.0	2	25+TT	12-TT
49	23	0	2.5	5	0	18	4.0	2	25+TT	14-TT
50	23	0	2.5	3	0	20	2.5	2	25+TT	17.5-TT
51	23	0	2.5	11	0	12	6.0	2	25+TT	6-TT
52	23	0	2.5	6	0	17	5.0	2	25+TT	12-TT
53	23	0	2.5	5	0	18	4.0	2	25+TT	14-TT
54	23	0	2.5	11	0	12	6.0	2	25+TT	6-TT
55	23	0	2.5	5	0	18	4.0	2	25+TT	14-TT
56	23	0	2.5	3	0	20	2.5	2	25+TT	17.5-TT
57	23	0	2.5	11	0	12	6.0	2	25+TT	6-TT
58	23	0	2.5	6	0	17	5.0	2	25+TT	12-TT
59	23	0	2.5	5	0	18	4.0	2	25+TT	14-TT

Test ID	P _{PowerClass} (dBm)	ΔP _{PowerClass} (dB)	MPR (dB)	A-MPR (dB)	ΔT _{C,c} (dB)	P _{CMAX_L,c} (dBm)	T(P _{CMAX_L,c}) (dB)	T _{L,c} (dB)	Upper limit (dBm)	Lower limit (dBm)
60	23	0	2.5	3	0	20	2.5	2	25+TT	17.5-TT
61	23	0	4.5	7	0	16	5.0	2	25+TT	11-TT
62	23	0	4.5	13	0	10	6.0	2	25+TT	4-TT
63	23	0	4.5	6	0	17	5.0	2	25+TT	12-TT
64	23	0	4.5	5	0	18	4.0	2	25+TT	14-TT
65	23	0	4.5	4.5	0	18.5	4.0	2	25+TT	14.5-TT
66	23	0	4.5	13	0	10	6.0	2	25+TT	4-TT
67	23	0	4.5	6	0	17	5.0	2	25+TT	12-TT
68	23	0	4.5	5	0	18	4.0	2	25+TT	14-TT
69	23	0	4.5	13	0	10	6.0	2	25+TT	4-TT
70	23	0	4.5	5	0	18	4.0	2	25+TT	14-TT
71	23	0	4.5	4.5	0	18.5	4.0	2	25+TT	14.5-TT
72	23	0	4.5	13	0	10	6.0	2	25+TT	4-TT
73	23	0	4.5	6	0	17	5.0	2	25+TT	12-TT
74	23	0	4.5	5	0	18	4.0	2	25+TT	14-TT
75	23	0	4.5	4.5	0	18.5	4.0	2	25+TT	14.5-TT
76	23	0	3.0	7.5	0	15.5	5.0	2	25+TT	10.5-TT
77	23	0	3.0	10	0	13	5.0	2	25+TT	8-TT
78	23	0	3.0	6	0	17	5.0	2	25+TT	12-TT
79	23	0	3.0	5	0	18	4.0	2	25+TT	14-TT
80	23	0	3.0	4	0	19	3.5	2	25+TT	15.5-TT
81	23	0	3.0	10	0	13	5.0	2	25+TT	8-TT
82	23	0	3.0	6	0	17	5.0	2	25+TT	12-TT
83	23	0	3.0	5	0	18	4.0	2	25+TT	14-TT
84	23	0	3.0	10	0	13	5.0	2	25+TT	8-TT
85	23	0	3.0	5	0	18	4.0	2	25+TT	14-TT
86	23	0	3.0	4	0	19	3.5	2	25+TT	15.5-TT
87	23	0	3.0	10	0	13	5.0	2	25+TT	8-TT
88	23	0	3.0	6	0	17	5.0	2	25+TT	12-TT
89	23	0	3.0	5	0	18	4.0	2	25+TT	14-TT
90	23	0	3.0	4	0	19	3.5	2	25+TT	15.5-TT
91	23	0	3.0	7.5	0	15.5	5.0	2	25+TT	10.5-TT
92	23	0	3.0	10	0	13	5.0	2	25+TT	8-TT
93	23	0	3.0	6	0	17	5.0	2	25+TT	12-TT
94	23	0	3.0	5	0	18	4.0	2	25+TT	14-TT
95	23	0	3.0	4	0	19	3.5	2	25+TT	15.5-TT
96	23	0	3.0	10	0	13	5.0	2	25+TT	8-TT
97	23	0	3.0	6	0	17	5.0	2	25+TT	12-TT
98	23	0	3.0	5	0	18	4.0	2	25+TT	14-TT
99	23	0	3.0	10	0	13	5.0	2	25+TT	8-TT
100	23	0	3.0	5	0	18	4.0	2	25+TT	14-TT
101	23	0	3.0	4	0	19	3.5	2	25+TT	15.5-TT
102	23	0	3.0	10	0	13	5.0	2	25+TT	8-TT
103	23	0	3.0	6	0	17	5.0	2	25+TT	12-TT
104	23	0	3.0	5	0	18	4.0	2	25+TT	14-TT
105	23	0	3.0	4	0	19	3.5	2	25+TT	15.5-TT
106	23	0	3.5	8	0	15	5.0	2	25+TT	10-TT
107	23	0	3.5	11	0	12	6.0	2	25+TT	6-TT
108	23	0	3.5	6	0	17	5.0	2	25+TT	12-TT
109	23	0	3.5	5	0	18	4.0	2	25+TT	14-TT
110	23	0	3.5	4	0	19	3.5	2	25+TT	15.5-TT
111	23	0	3.5	11	0	12	6.0	2	25+TT	6-TT
112	23	0	3.5	6	0	17	5.0	2	25+TT	12-TT
113	23	0	3.5	5	0	18	4.0	2	25+TT	14-TT
114	23	0	3.5	11	0	12	6.0	2	25+TT	6-TT
115	23	0	3.5	5	0	18	4.0	2	25+TT	14-TT
116	23	0	3.5	4	0	19	3.5	2	25+TT	15.5-TT
117	23	0	3.5	11	0	12	6.0	2	25+TT	6-TT
118	23	0	3.5	6	0	17	5.0	2	25+TT	12-TT
119	23	0	3.5	5	0	18	4.0	2	25+TT	14-TT

Test ID	P _{PowerClass} (dBm)	ΔP _{PowerClass} (dB)	MPR (dB)	A-MPR (dB)	ΔT _{C,c} (dB)	P _{CMAX_L,c} (dBm)	T(P _{CMAX_L,c}) (dB)	T _{L,c} (dB)	Upper limit (dBm)	Lower limit (dBm)
120	23	0	3.5	4	0	19	3.5	2	25+TT	15.5-TT
121	23	0	6.5	10	0	13	5.0	2	25+TT	8-TT
122	23	0	6.5	13	0	10	6.0	2	25+TT	4-TT
123	23	0	6.5	6.5	0	16.5	5.0	2	25+TT	11.5-TT
124	23	0	6.5	6.5	0	16.5	5.0	2	25+TT	11.5-TT
125	23	0	6.5	13	0	10	6.0	2	25+TT	4-TT
126	23	0	6.5	6.5	0	16.5	5.0	2	25+TT	11.5-TT
127	23	0	6.5	13	0	10	6.0	2	25+TT	4-TT
128	23	0	6.5	6.5	0	16.5	5.0	2	25+TT	11.5-TT
129	23	0	6.5	13	0	10	6.0	2	25+TT	4-TT
130	23	0	6.5	6.5	0	16.5	5.0	2	25+TT	11.5-TT
131	23	0	6.5	6.5	0	16.5	5.0	2	25+TT	11.5-TT

NOTE 1: P_{PowerClass} is the maximum UE power specified without taking into account the tolerance.

NOTE 2: TT for each frequency and channel bandwidth is specified in Table 6.2.3.5-0.

Table 6.2.3.5-8: UE Power Class 3 test requirements (NS_18)

Test ID	ChBw (MHz)	P _{PowerClass} (dBm)	MPR (dB)	A-MPR (dB)	ΔT _{C,c} (dB)	P _{CMAX_L,c} (dBm)	T(P _{CMAX_L,c}) (dB)	T _{L,c} (dB)	Upper limit (dBm)	Lower limit (dBm)
1, 2	5	23	1	2	0	21	2	2.5	25+TT	18.5-TT
	10, 15, 20	23	1	5	0	18	4	2.5	25+TT	14-TT
3, 4	5	23	2	3	0	20	2.5	2.5	25+TT	17.5-TT
	10, 15, 20	23	2	6	0	17	5	2.5	25+TT	12-TT
5, 6	5	23	2.5	4	0	19	3.5	2.5	25+TT	15.5-TT
	10, 15, 20	23	2.5	7	0	16	5	2.5	25+TT	11-TT
7, 8	5	23	4.5	6	0	17	5	2.5	25+TT	12-TT
	10, 15, 20	23	4.5	9	0	14	5	2.5	25+TT	9-TT
9, 10	5	23	3	5	0	18	4	2.5	25+TT	14-TT
	10, 15, 20	23	3	6.5	0	16.5	5	2.5	25+TT	11.5-TT
11, 12	5	23	3	5	0	18	4	2.5	25+TT	14-TT
	10, 15, 20	23	3	7	0	16	5	2.5	25+TT	11-TT
13, 14	5	23	3.5	5.5	0	17.5	5	2.5	25+TT	12.5-TT
	10, 15, 20	23	3.5	8.5	0	14.5	5	2.5	25+TT	9.5-TT
15, 16	5	23	6.5	8.5	0	14.5	5	2.5	25+TT	9.5-TT
	10, 15, 20	23	6.5	11.5	0	11.5	6	2.5	25+TT	5.5-TT
17, 18, 19	30	23	5	3	0	18	4	2.5	25+TT	14-TT
20	30	23	5	8	0	15	5	2.5	25+TT	10-TT
21	30	23	2.5	3	0	20	2.5	2.5	25+TT	17.5-TT
22	30	23	3	4.5	0	18.5	4	2.5	25+TT	14.5-TT
23	30	23	5	5.5	0	17.5	5	2.5	25+TT	12.5-TT
24, 25, 26	30	23	7	4.5	0	16	5	2.5	25+TT	11-TT
27	30	23	7	9.5	0	13.5	5	2.5	25+TT	8.5-TT
28	30	23	3.5	5	0	18	4	2.5	25+TT	14-TT
29	30	23	4	5.5	0	17.5	5	2.5	25+TT	12.5-TT
30	30	23	7	7.5	0	15.5	5	2.5	25+TT	10.5-TT

Table 6.2.3.5-10: UE Power Class 3 test requirements (NS_43)

Test ID	P _{PowerClass} (dBm)	MPR (dB)	A-MPR (dB)	$\Delta T_{C,c}$ (dB)	P _{CMAX_L,c} (dBm)	T(P _{CMAX_L,c}) (dB)	T _{L,c} (dB)	Upper limit (dBm)	Lower limit (dBm)
1	23	0.5	1.5	0	21.5	2	2	25+TT	19.5-TT
2	23	0.5	9	0	14	5	2	25+TT	9-TT
3	23	0.5	9	0	14	5	2	25+TT	9-TT
4	23	1.0	2	0	21	2.0	2	25+TT	19-TT
5	23	1.0	2.5	0	20.5	2.5	2	25+TT	18-TT
6	23	1.0	9	0	14	5.0	2	25+TT	9-TT
7	23	1.0	9	0	14	5.0	2	25+TT	9-TT
8	23	2.0	2.5	0	20.5	2.5	2	25+TT	18-TT
9	23	2.0	9	0	14	5.0	2	25+TT	9-TT
10	23	2.0	9	0	14	5.0	2	25+TT	9-TT
11	23	2.5	2.5	0	20.5	2.5	2	25+TT	18-TT
12	23	2.5	9	0	14	5.0	2	25+TT	9-TT
13	23	2.5	9	0	14	5.0	2	25+TT	9-TT
14	23	4.5	9	0	14	5.0	2	25+TT	9-TT
15	23	4.5	9	0	14	5.0	2	25+TT	9-TT
16	23	3.0	3.5	0	19.5	3.5	2	25+TT	16-TT
17	23	3.0	4	0	19	3.5	2	25+TT	15.5-TT
18	23	3.0	9	0	14	5.0	2	25+TT	9-TT
19	23	3.0	9	0	14	5.0	2	25+TT	9-TT
20	23	3.0	3.5	0	19.5	3.5	2	25+TT	16-TT
21	23	3.0	4	0	19	3.5	2	25+TT	15.5-TT
22	23	3.0	9	0	14	5.0	2	25+TT	9-TT
23	23	3.0	9	0	14	5.0	2	25+TT	9-TT
24	23	3.5	4	0	19	3.5	2	25+TT	15.5-TT
25	23	3.5	9	0	14	5.0	2	25+TT	9-TT
26	23	3.5	9	0	14	5.0	2	25+TT	9-TT
27	23	6.5	9	0	14	5.0	2	25+TT	9-TT
28	23	6.5	9	0	14	5.0	2	25+TT	9-TT

NOTE 1: P_{PowerClass} is the maximum UE power specified without taking into account the tolerance.
NOTE 2: TT for each frequency and channel bandwidth is specified in Table 6.2.3.5-0.

Table 6.2.3.5-11: UE Power Class 3 test requirements (NS_43U)

Test ID	P _{PowerClass} (dBm)	MPR (dB)	A-MPR (dB)	$\Delta T_{C,c}$ (dB)	P _{CMAX_L,c} (dBm)	T(P _{CMAX_L,c}) (dB)	T _{L,c} (dB)	Upper limit (dBm)	Lower limit (dBm)
1	23	0.5	2	0	21	2	2	25+TT	19-TT
2	23	0.5	2	0	21	2	2	25+TT	19-TT
3	23	0.5	9	0	14	5	2	25+TT	9-TT
4	23	0.5	9	0	14	5	2	25+TT	9-TT
5	23	1.0	2	0	21	2.0	2	25+TT	19-TT
6	23	1.0	2.5	0	20.5	2.5	2	25+TT	18-TT
7	23	1.0	9	0	14	5.0	2	25+TT	9-TT
8	23	1.0	9	0	14	5.0	2	25+TT	9-TT
9	23	2.0	2.5	0	20.5	2.5	2	25+TT	18-TT
10	23	2.0	2.5	0	20.5	2.5	2	25+TT	18-TT
11	23	2.0	9	0	14	5.0	2	25+TT	9-TT
12	23	2.0	9	0	14	5.0	2	25+TT	9-TT
13	23	2.5	3	0	20	2.5	2	25+TT	17.5-TT
14	23	2.5	3	0	20	2.5	2	25+TT	17.5-TT
15	23	2.5	9	0	14	5.0	2	25+TT	9-TT
16	23	2.5	9	0	14	5.0	2	25+TT	9-TT
17	23	4.5	4.5	0	18.5	4.0	2	25+TT	14.5-TT
18	23	4.5	4.5	0	18.5	4.0	2	25+TT	14.5-TT
19	23	4.5	9	0	14	5.0	2	25+TT	9-TT
20	23	4.5	9	0	14	5.0	2	25+TT	9-TT
21	23	3.0	4	0	19	3.5	2	25+TT	15.5-TT
22	23	3.0	4	0	19	3.5	2	25+TT	15.5-TT
23	23	3.0	9	0	14	5.0	2	25+TT	9-TT
24	23	3.0	9	0	14	5.0	2	25+TT	9-TT
25	23	3.0	4	0	19	3.5	2	25+TT	15.5-TT
26	23	3.0	4	0	19	3.5	2	25+TT	15.5-TT
27	23	3.0	9	0	14	5.0	2	25+TT	9-TT
28	23	3.0	9	0	14	5.0	2	25+TT	9-TT
29	23	3.5	4	0	19	3.5	2	25+TT	15.5-TT
30	23	3.5	4	0	19	3.5	2	25+TT	15.5-TT
31	23	3.5	9	0	14	5.0	2	25+TT	9-TT
32	23	3.5	9	0	14	5.0	2	25+TT	9-TT
33	23	6.5	6.5	0	16.5	5.0	2	25+TT	11.5-TT
34	23	6.5	6.5	0	16.5	5.0	2	25+TT	11.5-TT
35	23	6.5	9	0	14	5.0	2	25+TT	9-TT
36	23	6.5	9	0	14	5.0	2	25+TT	9-TT

NOTE 1: P_{PowerClass} is the maximum UE power specified without taking into account the tolerance.

NOTE 2: TT for each frequency and channel bandwidth is specified in Table 6.2.3.5-0.

Table 6.2.3.5-12: UE Power Class 3 test requirements (NS_100) for band n1, n5, n18, n65, n66

Test ID	P _{PowerClass} (dBm)	MPR (dB)	A-MPR (dB)	$\Delta T_{C,c}$ (dB)	P _{C_{MAX,L,c}} (dBm)	T(P _{C_{MAX,L,c}}) (dB)	T _{L,c} (dB)	Upper limit (dBm)	Lower limit (dBm)
1, 2	23	0.5	2	0	21	2	2	25+TT	19-TT
3	23	0.5	2	0	21	2	2	25+TT	19-TT
4, 5	23	1	1	0	21	2	2	25+TT	19-TT
6	23	1	1	0	21	2	2	25+TT	19-TT
7, 8	23	2	2.5	0	20.5	2.5	2	25+TT	18-TT
9	23	2	2.5	0	20.5	2.5	2	25+TT	18-TT
10, 11	23	2.5	3	0	20	2.5	2	25+TT	17.5-TT
12	23	2.5	3	0	20	2.5	2	25+TT	17.5-TT
13, 14	23	4.5	4.5	0	18.5	4	2	25+TT	14.5-TT
15	23	4.5	4.5	0	18.5	4	2	25+TT	14.5-TT
16, 17	23	3	4	0	19	3.5	2	25+TT	15.5-TT
18	23	3	4	0	19	3.5	2	25+TT	15.5-TT
19, 20	23	3	4	0	19	3.5	2	25+TT	15.5-TT
21	23	3	4	0	19	3.5	2	25+TT	15.5-TT
22, 23	23	3.5	4	0	19	3.5	2	25+TT	15.5-TT
24	23	3.5	4	0	19	3.5	2	25+TT	15.5-TT
25, 26	23	6.5	6.5	0	16.5	5	2	25+TT	11.5-TT
27	23	6.5	6.5	0	16.5	5	2	25+TT	11.5-TT

NOTE 1: P_{PowerClass} is the maximum UE power specified without taking into account the tolerance.
NOTE 2: TT for each frequency and channel bandwidth is specified in Table 6.2.3.5-0.

Table 6.2.3.5-13: UE Power Class 3 test requirements (NS_100) for band n2, n3, n8, n25 and n26

Test ID	P _{PowerClass} (dBm)	MPR (dB)	A-MPR (dB)	$\Delta T_{C,c}$ (dB)	P _{C_{MAX,L,c}} (dBm)	T(P _{C_{MAX,L,c}}) (dB)	T _{L,c} (dB)	Upper limit (dBm)	Lower limit (dBm)
1, 2	23	0.5	2	1.5	19.5	3.5	2	25+TT	16-TT
3	23	0.5	2	0	21	2	2	25+TT	19-TT
4, 5	23	1	1	1.5	19.5	3.5	2	25+TT	16-TT
6	23	1	1	0	21	2	2	25+TT	19-TT
7, 8	23	2	2.5	1.5	19	3.5	2	25+TT	15.5-TT
9	23	2	2.5	0	20.5	2.5	2	25+TT	18-TT
10, 11	23	2.5	3	1.5	18.5	4	2	25+TT	14.5-TT
12	23	2.5	3	0	20	2.5	2	25+TT	17.5-TT
13, 14	23	4.5	4.5	1.5	17	5	2	25+TT	12-TT
15	23	4.5	4.5	0	18.5	4	2	25+TT	14.5-TT
16, 17	23	3	4	1.5	17.5	5	2	25+TT	12.5-TT
18	23	3	4	0	19	3.5	2	25+TT	15.5-TT
19, 20	23	3	4	1.5	17.5	5	2	25+TT	12.5-TT
21	23	3	4	0	19	3.5	2	25+TT	15.5-TT
22, 23	23	3.5	4	1.5	17.5	5	2	25+TT	12.5-TT
24	23	3.5	4	0	19	3.5	2	25+TT	15.5-TT
25, 26	23	6.5	6.5	1.5	15	5	2	25+TT	10-TT
27	23	6.5	6.5	0	16.5	5	2	25+TT	11.5-TT

NOTE 1: P_{PowerClass} is the maximum UE power specified without taking into account the tolerance.
NOTE 2: TT for each frequency and channel bandwidth is specified in Table 6.2.3.5-0.

Table 6.2.3.5-14: UE Power Class 3 test requirements (NS_37)

Test ID	$P_{\text{PowerClass}}$ (dBm)	$\Delta P_{\text{PowerClass}}$ (dB)	MPR (dB)	A-MPR (dB)	$\Delta T_{C,c}$ (dB)	$P_{\text{C}_{\text{MAX}_L,c}}$ (dBm)	$T(P_{\text{C}_{\text{MAX}_L,c}})$ (dB)	$T_{L,c}$ (dB)	Upper limit (dBm)	Lower limit (dBm)
1	23	0	0.5	1.0	0	22	2	2	25+TT	20-TT
2	23	0	0.5	1.0	0	22	2	2	25+TT	20-TT
3	23	0	0.5	3.0	0	20	2.5	2	25+TT	17.5-TT
4	23	0	0.5	3.0	0	20	2.5	2	25+TT	17.5-TT
5	23	0	1.0	1.5	0	21.5	2.0	2	25+TT	19.5-TT
6	23	0	1.0	1.5	0	21.5	2.0	2	25+TT	19.5-TT
7	23	0	1.0	3.0	0	20	2.5	2	25+TT	17.5-TT
8	23	0	1.0	3.0	0	20	2.5	2	25+TT	17.5-TT
9	23	0	2.0	2.5	0	20.5	2.5	2	25+TT	18-TT
10	23	0	2.0	2.5	0	20.5	2.5	2	25+TT	18-TT
11	23	0	2.0	3.0	0	20	2.5	2	25+TT	17.5-TT
12	23	0	2.0	3.0	0	20	2.5	2	25+TT	17.5-TT
13	23	0	2.5	3.0	0	20	2.5	2	25+TT	17.5-TT
14	23	0	2.5	3.0	0	20	2.5	2	25+TT	17.5-TT
15	23	0	2.5	3.0	0	20	2.5	2	25+TT	17.5-TT
16	23	0	2.5	3.0	0	20	2.5	2	25+TT	17.5-TT
17	23	0	3.0	3.5	0	19.5	3.5	2	25+TT	16-TT
18	23	0	3.0	3.5	0	19.5	3.5	2	25+TT	16-TT
19	23	0	3.0	3.0	0	20	2.5	2	25+TT	17.5-TT
20	23	0	3.0	3.0	0	20	2.5	2	25+TT	17.5-TT
21	23	0	3.0	3.5	0	19.5	3.5	2	25+TT	16-TT
22	23	0	3.0	3.5	0	19.5	3.5	2	25+TT	16-TT
23	23	0	3.0	3.0	0	20	2.5	2	25+TT	17.5-TT
24	23	0	3.0	3.0	0	20	2.5	2	25+TT	17.5-TT

NOTE 1: $P_{\text{PowerClass}}$ is the maximum UE power specified without taking into account the tolerance.

NOTE 2: TT for each frequency and channel bandwidth is specified in Table 6.2.3.5-0.

Table 6.2.3.5-15: UE Power Class 3 test requirements (NS_38)

Test ID	$P_{PowerClass}$ (dBm)	$\Delta P_{PowerClass}$ (dB)	MPR (dB)	A-MPR (dB)	$\Delta T_{C,c}$ (dB)	$P_{C_{MAX_L,c}}$ (dBm)	$T(P_{C_{MAX_L,c}})$ (dB)	$T_{L,c}$ (dB)	Upper limit (dBm)	Lower limit (dBm)
1	23	0	0.5	12	0	11	6.0	2	25+TT	5-TT
2	23	0	0.5	9	0	14	5.0	2	25+TT	9-TT
3	23	0	0.5	13	0	10	6.0	2	25+TT	4-TT
4	23	0	0.5	10	0	13	5.0	2	25+TT	8-TT
5	23	0	0.5	13	0	10	6.0	2	25+TT	4-TT
6	23	0	0.5	10	0	13	5.0	2	25+TT	8-TT
7	23	0	1.0	12	0	11	6.0	2	25+TT	5-TT
8	23	0	1.0	9	0	14	5.0	2	25+TT	9-TT
9	23	0	1.0	13	0	10	6.0	2	25+TT	4-TT
10	23	0	1.0	10	0	13	5.0	2	25+TT	8-TT
11	23	0	1.0	13	0	10	6.0	2	25+TT	4-TT
12	23	0	1.0	10	0	13	5.0	2	25+TT	8-TT
13	23	0	2.0	12	0	11	6.0	2	25+TT	5-TT
14	23	0	2.0	9	0	14	5.0	2	25+TT	9-TT
15	23	0	2.0	13	0	10	6.0	2	25+TT	4-TT
16	23	0	2.0	10	0	13	5.0	2	25+TT	8-TT
17	23	0	2.0	13	0	10	6.0	2	25+TT	4-TT
18	23	0	2.0	10	0	13	5.0	2	25+TT	8-TT
19	23	0	2.5	12	0	11	6.0	2	25+TT	5-TT
20	23	0	2.5	9	0	14	5.0	2	25+TT	9-TT
21	23	0	2.5	13	0	10	6.0	2	25+TT	4-TT
22	23	0	2.5	10	0	13	5.0	2	25+TT	8-TT
23	23	0	2.5	13	0	10	6.0	2	25+TT	4-TT
24	23	0	2.5	10	0	13	5.0	2	25+TT	8-TT
25	23	0	4.5	12	0	11	6.0	2	25+TT	5-TT
26	23	0	4.5	9	0	14	5.0	2	25+TT	9-TT
27	23	0	4.5	13	0	10	6.0	2	25+TT	4-TT
28	23	0	4.5	10	0	13	5.0	2	25+TT	8-TT
29	23	0	4.5	13	0	10	6.0	2	25+TT	4-TT
30	23	0	4.5	10	0	13	5.0	2	25+TT	8-TT
31	23	0	3.0	12	0	11	6.0	2	25+TT	5-TT
32	23	0	3.0	9	0	14	5.0	2	25+TT	9-TT
33	23	0	3.0	13	0	10	6.0	2	25+TT	4-TT
34	23	0	3.0	10	0	13	5.0	2	25+TT	8-TT
35	23	0	3.0	13	0	10	6.0	2	25+TT	4-TT
36	23	0	3.0	10	0	13	5.0	2	25+TT	8-TT
37	23	0	3.0	12	0	11	6.0	2	25+TT	5-TT
38	23	0	3.0	9	0	14	5.0	2	25+TT	9-TT
39	23	0	3.0	13	0	10	6.0	2	25+TT	4-TT
40	23	0	3.0	10	0	13	5.0	2	25+TT	8-TT
41	23	0	3.0	13	0	10	6.0	2	25+TT	4-TT
42	23	0	3.0	10	0	13	5.0	2	25+TT	8-TT
43	23	0	3.5	12	0	11	6.0	2	25+TT	5-TT
44	23	0	3.5	9	0	14	5.0	2	25+TT	9-TT
45	23	0	3.5	13	0	10	6.0	2	25+TT	4-TT

Test ID	P _{PowerClass} (dBm)	ΔP _{PowerClass} (dB)	MPR (dB)	A-MPR (dB)	ΔT _{C,c} (dB)	P _{C_{MAX}L,c} (dBm)	T(P _{C_{MAX}L,c}) (dB)	T _{L,c} (dB)	Upper limit (dBm)	Lower limit (dBm)
46	23	0	3.5	10	0	13	5.0	2	25+TT	8-TT
47	23	0	3.5	13	0	10	6.0	2	25+TT	4-TT
48	23	0	3.5	10	0	13	5.0	2	25+TT	8-TT
49	23	0	6.5	12	0	11	6.0	2	25+TT	5-TT
50	23	0	6.5	9	0	14	5.0	2	25+TT	9-TT
51	23	0	6.5	13	0	10	6.0	2	25+TT	4-TT
52	23	0	6.5	10	0	13	5.0	2	25+TT	8-TT
53	23	0	6.5	13	0	10	6.0	2	25+TT	4-TT
54	23	0	6.5	10	0	13	5.0	2	25+TT	8-TT

NOTE 1: P_{PowerClass} is the maximum UE power specified without taking into account the tolerance.
 NOTE 2: TT for each frequency and channel bandwidth is specified in Table 6.2.3.5-0.

Table 6.2.3.5-16: UE Power Class 3 test requirements (NS_39)

Test ID	P _{PowerClass} (dBm)	ΔP _{PowerClass} (dB)	MPR (dB)	A-MPR (dB)	ΔT _{C,c} (dB)	P _{C_{MAX}L,c} (dBm)	T(P _{C_{MAX}L,c}) (dB)	T _{L,c} (dB)	Upper limit (dBm)	Lower limit (dBm)
1	23	0	0.5	6	0	17	5.0	2	25+TT	12-TT
2	23	0	0.5	6	0	17	5.0	2	25+TT	12-TT
3	23	0	0.5	6	0	17	5.0	2	25+TT	12-TT
4	23	0	1.0	6	0	17	5.0	2	25+TT	12-TT
5	23	0	1.0	6	0	17	5.0	2	25+TT	12-TT
6	23	0	1.0	6	0	17	5.0	2	25+TT	12-TT
7	23	0	2.0	6	0	17	5.0	2	25+TT	12-TT
8	23	0	2.0	6	0	17	5.0	2	25+TT	12-TT
9	23	0	2.0	6	0	17	5.0	2	25+TT	12-TT
10	23	0	2.5	6	0	17	5.0	2	25+TT	12-TT
11	23	0	2.5	6	0	17	5.0	2	25+TT	12-TT
12	23	0	2.5	6	0	17	5.0	2	25+TT	12-TT
13	23	0	4.5	6	0	17	5.0	2	25+TT	12-TT
14	23	0	4.5	6	0	17	5.0	2	25+TT	12-TT
15	23	0	4.5	6	0	17	5.0	2	25+TT	12-TT
16	23	0	3.0	6	0	17	5.0	2	25+TT	12-TT
17	23	0	3.0	6	0	17	5.0	2	25+TT	12-TT
18	23	0	3.0	6	0	17	5.0	2	25+TT	12-TT
19	23	0	3.0	6	0	17	5.0	2	25+TT	12-TT
20	23	0	3.0	6	0	17	5.0	2	25+TT	12-TT
21	23	0	3.0	6	0	17	5.0	2	25+TT	12-TT
22	23	0	3.5	6	0	17	5.0	2	25+TT	12-TT
23	23	0	3.5	6	0	17	5.0	2	25+TT	12-TT
24	23	0	3.5	6	0	17	5.0	2	25+TT	12-TT
25	23	0	6.5	6	0	16.5	5.0	2	25+TT	11.5-TT
26	23	0	6.5	6	0	16.5	5.0	2	25+TT	11.5-TT
27	23	0	6.5	6	0	16.5	5.0	2	25+TT	11.5-TT

NOTE 1: P_{PowerClass} is the maximum UE power specified without taking into account the tolerance.
 NOTE 2: TT for each frequency and channel bandwidth is specified in Table 6.2.3.5-0.

Table 6.2.3.5-17: UE Power Class 3 test requirements (NS_24) for n65

Test ID	P _{PowerClass} (dBm)	MPR (dB)	A-MPR (dB)	$\Delta T_{C,c}$ (dB)	P _{CMAX_L,c} (dBm)	T(P _{CMAX_L,c}) (dB)	T _{L,c} (dB)	Upper limit (dBm)	Lower limit (dBm)
1-3	23	N/A	3.5	0	19.5	3.5	2	25+TT	16-TT
4-6	23	N/A	8.5	0	14.5	5	2	25+TT	9.5-TT
7-15	23	N/A	11	0	12	6	2	25+TT	6-TT
	23	N/A	5	0	18	4	2	25+TT	14-TT
	23	N/A	4	0	19	3.5	2	25+TT	16-TT
16-18	23	N/A	8.5	0	14.5	5	2	25+TT	9.5-TT
19-21	23	N/A	8.5	0	14.5	5	2	25+TT	9.5-TT
22-30	23	N/A	11	0	12	6	2	25+TT	6-TT
	23	N/A	5	0	18	4	2	25+TT	14-TT
	23	N/A	4	0	19	3.5	2	25+TT	15.5-TT
31-39	23	N/A	18	0	5	7	2	25+TT	-2-TT
	23	N/A	18	0	5	7	2	25+TT	-2-TT
	23	N/A	10	0	13	5	2	25+TT	8-TT
40-42	23	N/A	18	0	5	7	2	25+TT	-2-TT
43-51	23	N/A	11	0	12	6	2	25+TT	6-TT
	23	N/A	5	0	18	4	2	25+TT	14-TT
	23	N/A	4	0	19	3.5	2	25+TT	15.5-TT
52-60	23	N/A	18	0	5	7	2	25+TT	-2-TT
	23	N/A	18	0	5	7	2	25+TT	-2-TT
	23	N/A	10	0	13	5	2	25+TT	8-TT
61-63	23	N/A	18	0	5	7	2	25+TT	-2-TT
64-72	23	N/A	18	0	5	7	2	25+TT	-2-TT
	23	N/A	18	0	5	7	2	25+TT	-2-TT
	23	N/A	10	0	13	5	2	25+TT	8-TT
73-75	23	N/A	18	0	5	7	2	25+TT	-2-TT
76-84	23	N/A	18	0	5	7	2	25+TT	-2-TT
	23	N/A	18	0	5	7	2	25+TT	-2-TT
	23	N/A	10	0	13	5	2	25+TT	8-TT
85-87	23	N/A	18	0	5	7	2	25+TT	-2-TT
88	23	N/A	3.5	0	19.5	3.5	2	25+TT	16-TT
89	23	N/A	8.5	0	14.5	5	2	25+TT	9.5-TT
90-92	23	N/A	11	0	12	6	2	25+TT	6-TT
	23	N/A	5	0	18	4	2	25+TT	14-TT
	23	N/A	4	0	19	3.5	2	25+TT	16-TT
93	23	N/A	8.5	0	14.5	5	2	25+TT	9.5-TT
94	23	N/A	8.5	0	14.5	5	2	25+TT	9.5-TT
95-97	23	N/A	11	0	12	6	2	25+TT	6-TT
	23	N/A	5	0	18	4	2	25+TT	14-TT
	23	N/A	4	0	19	3.5	2	25+TT	15.5-TT
98-100	23	N/A	19	0	4	7	2	25+TT	-3-TT
	23	N/A	19	0	4	7	2	25+TT	-3-TT
	23	N/A	10	0	13	5	2	25+TT	8-TT
101-102	23	N/A	19	0	4	7	2	25+TT	-3-TT
	23	N/A	19	0	4	7	2	25+TT	-3-TT

Test ID	P _{PowerClass} (dBm)	MPR (dB)	A-MPR (dB)	$\Delta T_{C,c}$ (dB)	P _{CMAX_L,c} (dBm)	T(P _{CMAX_L,c}) (dB)	T _{L,c} (dB)	Upper limit (dBm)	Lower limit (dBm)
103-105	23	N/A	11	0	12	6	2	25+TT	6-TT
	23	N/A	5	0	18	4	2	25+TT	14-TT
	23	N/A	4	0	19	3.5	2	25+TT	15.5-TT
106-108	23	N/A	19	0	4	7	2	25+TT	-3-TT
	23	N/A	19	0	4	7	2	25+TT	-3-TT
	23	N/A	10	0	13	5	2	25+TT	8-TT
109	23	N/A	19	0	4	7	2	25+TT	-3-TT
110-112	23	N/A	19	0	4	7	2	25+TT	-3-TT
	23	N/A	19	0	4	7	2	25+TT	-3-TT
	23	N/A	10	0	13	5	2	25+TT	8-TT
113	23	N/A	19	0	4	7	2	25+TT	-3-TT
114-116	23	N/A	19	0	4	7	2	25+TT	-3-TT
	23	N/A	19	0	4	7	2	25+TT	-3-TT
	23	N/A	10	0	13	5	2	25+TT	8-TT
117	23	N/A	19	0	4	7	2	25+TT	-3-TT
118	23	4.5		0	18.5	4	2	25+TT	14.5-TT
119	23	N/A	8.5	0	14.5	5	2	25+TT	9.5-TT
120-122	23	N/A	11	0	12	6	2	25+TT	6-TT
	23	N/A	5	0	18	4	2	25+TT	14-TT
	23	4.5		0	18.5	4	2	25+TT	14.5-TT
123	23	N/A	8.5	0	14.5	5	2	25+TT	9.5-TT
124	23	N/A	8.5	0	14.5	5	2	25+TT	9.5-TT
125-127	23	N/A	11	0	12	6	2	25+TT	6-TT
	23	N/A	5	0	18	4	2	25+TT	14-TT
	23	4.5		0	18.5	4	2	25+TT	14.5-TT
128-130	23	N/A	19	0	4	7	2	25+TT	-3-TT
	23	N/A	19	0	4	7	2	25+TT	-3-TT
	23	N/A	10	0	13	5	2	25+TT	8-TT
131-132	23	N/A	19	0	4	7	2	25+TT	-3-TT
	23	N/A	19	0	4	7	2	25+TT	-3-TT
133-135	23	N/A	11	0	12	6	2	25+TT	6-TT
	23	N/A	5	0	18	4	2	25+TT	14-TT
	23	4.5		0	18.5	4	2	25+TT	14.5-TT
136-138	23	N/A	19	0	4	7	2	25+TT	-3-TT
	23	N/A	19	0	4	7	2	25+TT	-3-TT
	23	N/A	10	0	13	5	2	25+TT	8-TT
139	23	N/A	19	0	4	7	2	25+TT	-3-TT
140-142	23	N/A	19	0	4	7	2	25+TT	-3-TT
	23	N/A	19	0	4	7	2	25+TT	-3-TT
	23	N/A	10	0	13	5	2	25+TT	8-TT
143	23	N/A	19	0	4	7	2	25+TT	-3-TT
144-146	23	N/A	19	0	4	7	2	25+TT	-3-TT
	23	N/A	19	0	4	7	2	25+TT	-3-TT
	23	N/A	10	0	13	5	2	25+TT	8-TT
147	23	N/A	19	0	4	7	2	25+TT	-3-TT

Test ID	P _{PowerClass} (dBm)	MPR (dB)	A-MPR (dB)	$\Delta T_{C,c}$ (dB)	P _{C_{MAX}L,c} (dBm)	T(P _{C_{MAX}L,c}) (dB)	T _{L,c} (dB)	Upper limit (dBm)	Lower limit (dBm)
148-150	23	N/A	5.5	0	17.5	5	2	25+TT	12.5-TT
151-153	23	N/A	8.5	0	14.5	5	2	25+TT	9.5-TT
154-162	23	N/A	13	0	10	6	2	25+TT	4-TT
	23	N/A	6.5	0	16.5	5	2	25+TT	11.5-TT
	23	N/A	4	0	19	3.5	2	25+TT	16-TT
163-165	23	N/A	8.5	0	14.5	5	2	25+TT	9.5-TT
166-168	23	N/A	8.5	0	14.5	5	2	25+TT	9.5-TT
169-177	23	N/A	13	0	10	6	2	25+TT	4-TT
	23	N/A	6.5	0	16.5	5	2	25+TT	11.5-TT
	23	N/A	4	0	19	3.5	2	25+TT	15.5-TT
178-186	23	N/A	19	0	4	7	2	25+TT	-3-TT
	23	N/A	19	0	4	7	2	25+TT	-3-TT
	23	N/A	12	0	11	6	2	25+TT	5-TT
187-189	23	N/A	19	0	4	7	2	25+TT	-3-TT
190-198	23	N/A	13	0	10	6	2	25+TT	4-TT
	23	N/A	6.5	0	16.5	5	2	25+TT	11.5-TT
	23	N/A	4	0	19	3.5	2	25+TT	15.5-TT
199-207	23	N/A	19	0	4	7	2	25+TT	-3-TT
	23	N/A	19	0	4	7	2	25+TT	-3-TT
	23	N/A	12	0	11	6	2	25+TT	5-TT
208-210	23	N/A	19	0	4	7	2	25+TT	-3-TT
211-219	23	N/A	19	0	4	7	2	25+TT	-3-TT
	23	N/A	19	0	4	7	2	25+TT	-3-TT
	23	N/A	12	0	11	6	2	25+TT	5-TT
220-222	23	N/A	19	0	4	7	2	25+TT	-3-TT
223-231	23	N/A	19	0	4	7	2	25+TT	-3-TT
	23	N/A	19	0	4	7	2	25+TT	-3-TT
	23	N/A	12	0	11	6	2	25+TT	5-TT
232-234	23	N/A	19	0	4	7	2	25+TT	-3-TT
235	23	6.5		0	16.5	5	2	25+TT	11.5-TT
236	23	N/A	8.5	0	14.5	5	2	25+TT	9.5-TT
237-239	23	N/A	13	0	10	6	2	25+TT	4-TT
	23	N/A	6.5	0	16.5	5	2	25+TT	11.5-TT
	23	6.5		0	16.5	5	2	25+TT	11.5-TT
240	23	N/A	8.5	0	14.5	5	2	25+TT	9.5-TT
241	23	N/A	8.5	0	14.5	5	2	25+TT	9.5-TT
242-244	23	N/A	13	0	10	6	2	25+TT	4-TT
	23	N/A	6.5	0	16.5	5	2	25+TT	11.5-TT
	23	6.5		0	16.5	5	2	25+TT	11.5-TT
245-247	23	N/A	19	0	4	7	2	25+TT	-3-TT
	23	N/A	19	0	4	7	2	25+TT	-3-TT
	23	N/A	12	0	11	6	2	25+TT	5-TT
248-249	23	N/A	19	0	4	7	2	25+TT	-3-TT
	23	N/A	19	0	4	7	2	25+TT	-3-TT

Test ID	P _{PowerClass} (dBm)	MPR (dB)	A-MPR (dB)	$\Delta T_{C,c}$ (dB)	P _{CMAX_L,c} (dBm)	T(P _{CMAX_L,c}) (dB)	T _{L,c} (dB)	Upper limit (dBm)	Lower limit (dBm)
250-252	23	N/A	13	0	10	6	2	25+TT	4-TT
	23	N/A	6.5	0	16.5	5	2	25+TT	11.5-TT
	23	6.5		0	16.5	5	2	25+TT	11.5-TT
253-255	23	N/A	19	0	4	7	2	25+TT	-3-TT
	23	N/A	19	0	4	7	2	25+TT	-3-TT
	23	N/A	12	0	11	6	2	25+TT	5-TT
256	23	N/A	19	0	4	7	2	25+TT	-3-TT
257-259	23	N/A	19	0	4	7	2	25+TT	-3-TT
	23	N/A	19	0	4	7	2	25+TT	-3-TT
	23	N/A	12	0	11	6	2	25+TT	5-TT
260	23	N/A	19	0	4	7	2	25+TT	-3-TT
261-263	23	N/A	19	0	4	7	2	25+TT	-3-TT
	23	N/A	19	0	4	7	2	25+TT	-3-TT
	23	N/A	12	0	11	6	2	25+TT	5-TT
264	23	N/A	19	0	4	7	2	25+TT	-3-TT
265	23	1		0	22	2	2	25+TT	20-TT
266	23	2		0	21	2	2	25+TT	19-TT
267	23	1		0	22	2	2	25+TT	20-TT

NOTE 1: P_{PowerClass} is the maximum UE power specified without taking into account the tolerance.

NOTE 2: TT for each frequency and channel bandwidth is specified in Table 6.2.3.5-0.

Table 6.2.3.5-18: UE Power Class 3 test requirements (NS_27)

Test ID	$P_{\text{PowerClass}}$ (dBm)	$\Delta P_{\text{PowerClass}}$ (dB)	MPR (dB)	A-MPR (dB)	$\Delta T_{C,c}$ (dB)	$P_{\text{C}_{\text{MAX}_L,c}}$ (dBm)	$T(P_{\text{C}_{\text{MAX}_L,c})}$ (dB)	$T_{L,c}$ (dB)	Upper limit (dBm)	Lower limit (dBm)
1	23	0	0.5	4	0	19	3.5	3	25+TT	15.5-TT
2	23	0	0.5	4	0	19	3.5	3	25+TT	15.5-TT
3	23	0	0.5	4	0	19	3.5	3	25+TT	15.5-TT
4	23	0	0.5	4	0	19	3.5	3	25+TT	15.5-TT
5	23	0	0.5	4	0	19	3.5	3	25+TT	15.5-TT
6	23	0	0.5	2	0	21	2.0	3	25+TT	18-TT
7	23	0	0.5	4	0	19	3.5	3	25+TT	15.5-TT
8	23	0	0.5	2	0	21	2.0	3	25+TT	18-TT
9	23	0	0.5	4	0	19	3.5	3	25+TT	15.5-TT
10	23	0	0.5	4	0	19	3.5	3	25+TT	15.5-TT
11	23	0	0.5	4	0	19	3.5	3	25+TT	15.5-TT
12	23	0	0.5	4	0	19	3.5	3	25+TT	15.5-TT
13	23	0	0.5	4	0	19	3.5	3	25+TT	15.5-TT
14	23	0	0.5	2	0	21	2.0	3	25+TT	18-TT
15	23	0	0.5	4	0	19	3.5	3	25+TT	15.5-TT
16	23	0	0.5	2	0	21	2.0	3	25+TT	18-TT
17	23	0	0.5	10.5	0	12.5	6.0	3	25+TT	6.5-TT
18	23	0	0.5	6	0	17	5.0	3	25+TT	12-TT
19	23	0	0	4.5	0	18.5	4.0	3	25+TT	14.5-TT
20	23	0	0.5	10.5	0	12.5	6.0	3	25+TT	6.5-TT
21	23	0	0.5	10.5	0	12.5	6.0	3	25+TT	6.5-TT
22	23	0	0.5	6	0	17	5.0	3	25+TT	12-TT
23	23	0	0.5	4.5	0	18.5	4.0	3	25+TT	14.5-TT
24	23	0	0.5	10.5	0	12.5	6.0	3	25+TT	6.5-TT
25	23	0	0.5	4	0	19	3.5	3	25+TT	15.5-TT
26	23	0	0.5	4.5	0	18.5	4.0	3	25+TT	14.5-TT
27	23	0	0.5	4	0	19	3.5	3	25+TT	15.5-TT
28	23	0	0.5	4.5	0	18.5	4.0	3	25+TT	14.5-TT
29	23	0	1	4	0	19	3.5	3	25+TT	15.5-TT
30	23	0	1	4	0	19	3.5	3	25+TT	15.5-TT
31	23	0	1	4	0	19	3.5	3	25+TT	15.5-TT
32	23	0	1	4	0	19	3.5	3	25+TT	15.5-TT
33	23	0	1	4	0	19	3.5	3	25+TT	15.5-TT
34	23	0	1	2	0	21	2.0	3	25+TT	18-TT
35	23	0	1	4	0	19	3.5	3	25+TT	15.5-TT
36	23	0	1	2	0	21	2.0	3	25+TT	18-TT
37	23	0	1	4	0	19	3.5	3	25+TT	15.5-TT
38	23	0	1	4	0	19	3.5	3	25+TT	15.5-TT
39	23	0	1	4	0	19	3.5	3	25+TT	15.5-TT
40	23	0	1	4	0	19	3.5	3	25+TT	15.5-TT
41	23	0	1	4	0	19	3.5	3	25+TT	15.5-TT
42	23	0	1	2	0	21	2.0	3	25+TT	18-TT
43	23	0	1	4	0	19	3.5	3	25+TT	15.5-TT
44	23	0	1	2	0	21	2.0	3	25+TT	18-TT
45	23	0	1	10.5	0	12.5	6.0	3	25+TT	6.5-TT
46	23	0	1	6	0	17	5.0	3	25+TT	12-TT
47	23	0	0	4.5	0	18.5	4.0	3	25+TT	14.5-TT
48	23	0	1	10.5	0	12.5	6.0	3	25+TT	6.5-TT
49	23	0	1	10.5	0	12.5	6.0	3	25+TT	6.5-TT
50	23	0	1	6	0	17	5.0	3	25+TT	12-TT
51	23	0	1	4.5	0	18.5	4.0	3	25+TT	14.5-TT
52	23	0	1	10.5	0	12.5	6.0	3	25+TT	6.5-TT
53	23	0	1	4	0	19	3.5	3	25+TT	15.5-TT
54	23	0	1	4.5	0	18.5	4.0	3	25+TT	14.5-TT
55	23	0	1	4	0	19	3.5	3	25+TT	15.5-TT
56	23	0	1	4.5	0	18.5	4.0	3	25+TT	14.5-TT
57	23	0	2	5	0	18	4.0	3	25+TT	14-TT
58	23	0	2	5	0	18	4.0	3	25+TT	14-TT
59	23	0	2	5	0	18	4.0	3	25+TT	14-TT

Test ID	P _{PowerClass} (dBm)	ΔP _{PowerClass} (dB)	MPR (dB)	A-MPR (dB)	ΔT _{C,c} (dB)	P _{C_{MAX,L,c}} (dBm)	T(P _{C_{MAX,L,c}}) (dB)	T _{L,c} (dB)	Upper limit (dBm)	Lower limit (dBm)
60	23	0	2	5	0	18	4.0	3	25+TT	14-TT
61	23	0	2	4	0	19	3.5	3	25+TT	15.5-TT
62	23	0	2	2	0	21	2.0	3	25+TT	18-TT
63	23	0	2	4	0	19	3.5	3	25+TT	15.5-TT
64	23	0	2	2	0	21	2.0	3	25+TT	18-TT
65	23	0	2	5	0	18	4.0	3	25+TT	14-TT
66	23	0	2	5	0	18	4.0	3	25+TT	14-TT
67	23	0	2	5	0	18	4.0	3	25+TT	14-TT
68	23	0	2	5	0	18	4.0	3	25+TT	14-TT
69	23	0	2	4	0	19	3.5	3	25+TT	15.5-TT
70	23	0	2	2	0	21	2.0	3	25+TT	18-TT
71	23	0	2	4	0	19	3.5	3	25+TT	15.5-TT
72	23	0	2	2	0	21	2.0	3	25+TT	18-TT
73	23	0	2	11	0	12	6.0	3	25+TT	6-TT
74	23	0	2	6	0	17	5.0	3	25+TT	12-TT
75	23	0	1	4.5	0	18.5	4.0	3	25+TT	14.5-TT
76	23	0	2	11	0	12	6.0	3	25+TT	6-TT
77	23	0	2	11	0	12	6.0	3	25+TT	6-TT
78	23	0	2	6	0	17	5.0	3	25+TT	12-TT
79	23	0	2	4.5	0	18.5	4.0	3	25+TT	14.5-TT
80	23	0	2	11	0	12	6.0	3	25+TT	6-TT
81	23	0	2	4	0	19	3.5	3	25+TT	15.5-TT
82	23	0	2	4.5	0	18.5	4.0	3	25+TT	14.5-TT
83	23	0	2	4	0	19	3.5	3	25+TT	15.5-TT
84	23	0	2	4.5	0	18.5	4.0	3	25+TT	14.5-TT
85	23	0	2.5	5	0	18	4.0	3	25+TT	14-TT
86	23	0	2.5	5	0	18	4.0	3	25+TT	14-TT
87	23	0	2.5	5	0	18	4.0	3	25+TT	14-TT
88	23	0	2.5	5	0	18	4.0	3	25+TT	14-TT
89	23	0	2.5	4	0	19	3.5	3	25+TT	15.5-TT
90	23	0	2.5	2	0	20.5	2.5	3	25+TT	17.5-TT
91	23	0	2.5	4	0	19	3.5	3	25+TT	15.5-TT
92	23	0	2.5	2	0	20.5	2.5	3	25+TT	17.5-TT
93	23	0	2.5	5	0	18	4.0	3	25+TT	14-TT
94	23	0	2.5	5	0	18	4.0	3	25+TT	14-TT
95	23	0	2.5	5	0	18	4.0	3	25+TT	14-TT
96	23	0	2.5	5	0	18	4.0	3	25+TT	14-TT
97	23	0	2.5	4	0	19	3.5	3	25+TT	15.5-TT
98	23	0	2.5	2	0	20.5	2.5	3	25+TT	17.5-TT
99	23	0	2.5	4	0	19	3.5	3	25+TT	15.5-TT
100	23	0	2.5	2	0	20.5	2.5	3	25+TT	17.5-TT
101	23	0	2.5	11	0	12	6.0	3	25+TT	6-TT
102	23	0	2.5	6	0	17	5.0	3	25+TT	12-TT
103	23	0	2.5	4.5	0	18.5	4.0	3	25+TT	14.5-TT
104	23	0	2.5	11	0	12	6.0	3	25+TT	6-TT
105	23	0	2.5	11	0	12	6.0	3	25+TT	6-TT
106	23	0	2.5	6	0	17	5.0	3	25+TT	12-TT
107	23	0	2.5	4.5	0	18.5	4.0	3	25+TT	14.5-TT
108	23	0	2.5	11	0	12	6.0	3	25+TT	6-TT
109	23	0	2.5	4	0	19	3.5	3	25+TT	15.5-TT
110	23	0	2.5	4.5	0	18.5	4.0	3	25+TT	14.5-TT
111	23	0	2.5	4	0	19	3.5	3	25+TT	15.5-TT
112	23	0	2.5	4.5	0	18.5	4.0	3	25+TT	14.5-TT
113	23	0	4.5	0	0	18.5	4.0	3	25+TT	14.5-TT
114	23	0	4.5	0	0	18.5	4.0	3	25+TT	14.5-TT
115	23	0	4.5	0	0	18.5	4.0	3	25+TT	14.5-TT
116	23	0	4.5	0	0	18.5	4.0	3	25+TT	14.5-TT
117	23	0	4.5	0	0	18.5	4.0	3	25+TT	14.5-TT
118	23	0	4.5	2	0	18.5	4.0	3	25+TT	14.5-TT
119	23	0	4.5	0	0	18.5	4.0	3	25+TT	14.5-TT

Test ID	P _{PowerClass} (dBm)	Δ P _{PowerClass} (dB)	MPR (dB)	A-MPR (dB)	Δ T _{C,c} (dB)	P _{C_{MAX,L,c}} (dBm)	T(P _{C_{MAX,L,c}}) (dB)	T _{L,c} (dB)	Upper limit (dBm)	Lower limit (dBm)
120	23	0	4.5	2	0	18.5	4.0	3	25+TT	14.5-TT
121	23	0	4.5	0	0	18.5	4.0	3	25+TT	14.5-TT
122	23	0	4.5	0	0	18.5	4.0	3	25+TT	14.5-TT
123	23	0	4.5	0	0	18.5	4.0	3	25+TT	14.5-TT
124	23	0	4.5	0	0	18.5	4.0	3	25+TT	14.5-TT
125	23	0	4.5	0	0	18.5	4.0	3	25+TT	14.5-TT
126	23	0	4.5	2	0	18.5	4.0	3	25+TT	14.5-TT
127	23	0	4.5	0	0	18.5	4.0	3	25+TT	14.5-TT
128	23	0	4.5	2	0	18.5	4.0	3	25+TT	14.5-TT
129	23	0	4.5	11	0	12	6.0	3	25+TT	6-TT
130	23	0	4.5	6	0	17	5.0	3	25+TT	12-TT
131	23	0	4.5	0	0	18.5	4.0	3	25+TT	14.5-TT
132	23	0	4.5	11	0	12	6.0	3	25+TT	6-TT
133	23	0	4.5	11	0	12	6.0	3	25+TT	6-TT
134	23	0	4.5	6	0	17	5.0	3	25+TT	12-TT
135	23	0	4.5	0	0	18.5	4.0	3	25+TT	14.5-TT
136	23	0	4.5	11	0	12	6.0	3	25+TT	6-TT
137	23	0	4.5	0	0	18.5	4.0	3	25+TT	14.5-TT
138	23	0	4.5	4.5	0	18.5	4.0	3	25+TT	14.5-TT
139	23	0	4.5	0	0	18.5	4.0	3	25+TT	14.5-TT
140	23	0	4.5	4.5	0	18.5	4.0	3	25+TT	14.5-TT
141	23	0	3	6	0	17	5.0	3	25+TT	12-TT
142	23	0	3	6	0	17	5.0	3	25+TT	12-TT
143	23	0	3	6	0	17	5.0	3	25+TT	12-TT
144	23	0	3	6	0	17	5.0	3	25+TT	12-TT
145	23	0	3	4	0	19	3.5	3	25+TT	15.5-TT
146	23	0	3	2	0	20	2.5	3	25+TT	17-TT
147	23	0	3	4	0	19	3.5	3	25+TT	15.5-TT
148	23	0	3	2	0	20	2.5	3	25+TT	17-TT
149	23	0	3	6	0	17	5.0	3	25+TT	12-TT
150	23	0	3	6	0	17	5.0	3	25+TT	12-TT
151	23	0	3	6	0	17	5.0	3	25+TT	12-TT
152	23	0	3	6	0	17	5.0	3	25+TT	12-TT
153	23	0	3	4	0	19	3.5	3	25+TT	15.5-TT
154	23	0	3	2	0	20	2.5	3	25+TT	17-TT
155	23	0	3	4	0	19	3.5	3	25+TT	15.5-TT
156	23	0	3	2	0	20	2.5	3	25+TT	17-TT
157	23	0	3	11.5	0	11.5	6.0	3	25+TT	5.5-TT
158	23	0	3	7	0	16	5.0	3	25+TT	11-TT
159	23	0	1.5	5.5	0	17.5	5.0	3	25+TT	12.5-TT
160	23	0	3	11.5	0	11.5	6.0	3	25+TT	5.5-TT
161	23	0	3	11.5	0	11.5	6.0	3	25+TT	5.5-TT
162	23	0	3	7	0	16	5.0	3	25+TT	11-TT
163	23	0	3	5.5	0	17.5	5.0	3	25+TT	12.5-TT
164	23	0	3	11.5	0	11.5	6.0	3	25+TT	5.5-TT
165	23	0	3	4	0	19	3.5	3	25+TT	15.5-TT
166	23	0	3	4.5	0	18.5	4.0	3	25+TT	14.5-TT
167	23	0	3	4	0	19	3.5	3	25+TT	15.5-TT
168	23	0	3	4.5	0	18.5	4.0	3	25+TT	14.5-TT
169	23	0	3	6	0	17	5.0	3	25+TT	12-TT
170	23	0	3	6	0	17	5.0	3	25+TT	12-TT
171	23	0	3	6	0	17	5.0	3	25+TT	12-TT
172	23	0	3	6	0	17	5.0	3	25+TT	12-TT
173	23	0	3	4	0	19	3.5	3	25+TT	15.5-TT
174	23	0	3	2	0	20	2.5	3	25+TT	17-TT
175	23	0	3	4	0	19	3.5	3	25+TT	15.5-TT
176	23	0	3	2	0	20	2.5	3	25+TT	17-TT
177	23	0	3	6	0	17	5.0	3	25+TT	12-TT
178	23	0	3	6	0	17	5.0	3	25+TT	12-TT
179	23	0	3	6	0	17	5.0	3	25+TT	12-TT

Test ID	P _{PowerClass} (dBm)	ΔP _{PowerClass} (dB)	MPR (dB)	A-MPR (dB)	ΔT _{C,c} (dB)	P _{CMAX,L,c} (dBm)	T(P _{CMAX,L,c}) (dB)	T _{L,c} (dB)	Upper limit (dBm)	Lower limit (dBm)
180	23	0	3	6	0	17	5.0	3	25+TT	12-TT
181	23	0	3	4	0	19	3.5	3	25+TT	15.5-TT
182	23	0	3	2	0	20	2.5	3	25+TT	17-TT
183	23	0	3	4	0	19	3.5	3	25+TT	15.5-TT
184	23	0	3	2	0	20	2.5	3	25+TT	17-TT
185	23	0	3	11.5	0	11.5	6.0	3	25+TT	5.5-TT
186	23	0	3	7	0	16	5.0	3	25+TT	11-TT
187	23	0	2	5.5	0	17.5	5.0	3	25+TT	12.5-TT
188	23	0	3	11.5	0	11.5	6.0	3	25+TT	5.5-TT
189	23	0	3	11.5	0	11.5	6.0	3	25+TT	5.5-TT
190	23	0	3	7	0	16	5.0	3	25+TT	11-TT
191	23	0	3	5.5	0	17.5	5.0	3	25+TT	12.5-TT
192	23	0	3	11.5	0	11.5	6.0	3	25+TT	5.5-TT
193	23	0	3	4	0	19	3.5	3	25+TT	15.5-TT
194	23	0	3	4.5	0	18.5	4.0	3	25+TT	14.5-TT
195	23	0	3	4	0	19	3.5	3	25+TT	15.5-TT
196	23	0	3	4.5	0	18.5	4.0	3	25+TT	14.5-TT
197	23	0	3.5	6	0	17	5.0	3	25+TT	12-TT
198	23	0	3.5	6	0	17	5.0	3	25+TT	12-TT
199	23	0	3.5	6	0	17	5.0	3	25+TT	12-TT
200	23	0	3.5	6	0	17	5.0	3	25+TT	12-TT
201	23	0	3.5	4	0	19	3.5	3	25+TT	15.5-TT
202	23	0	3.5	2	0	19.5	3.5	3	25+TT	16-TT
203	23	0	3.5	4	0	19	3.5	3	25+TT	15.5-TT
204	23	0	3.5	2	0	19.5	3.5	3	25+TT	16-TT
205	23	0	3.5	6	0	17	5.0	3	25+TT	12-TT
206	23	0	3.5	6	0	17	5.0	3	25+TT	12-TT
207	23	0	3.5	6	0	17	5.0	3	25+TT	12-TT
208	23	0	3.5	6	0	17	5.0	3	25+TT	12-TT
209	23	0	3.5	4	0	19	3.5	3	25+TT	15.5-TT
210	23	0	3.5	2	0	19.5	3.5	3	25+TT	16-TT
211	23	0	3.5	4	0	19	3.5	3	25+TT	15.5-TT
212	23	0	3.5	2	0	19.5	3.5	3	25+TT	16-TT
213	23	0	3.5	11.5	0	11.5	6.0	3	25+TT	5.5-TT
214	23	0	3.5	7	0	16	5.0	3	25+TT	11-TT
215	23	0	3.5	5.5	0	17.5	5.0	3	25+TT	12.5-TT
216	23	0	3.5	11.5	0	11.5	6.0	3	25+TT	5.5-TT
217	23	0	3.5	11.5	0	11.5	6.0	3	25+TT	5.5-TT
218	23	0	3.5	7	0	16	5.0	3	25+TT	11-TT
219	23	0	3.5	5.5	0	17.5	5.0	3	25+TT	12.5-TT
220	23	0	3.5	11.5	0	11.5	6	3	25+TT	5.5-TT
221	23	0	3.5	4	0	19	3.5	3	25+TT	15.5-TT
222	23	0	3.5	4.5	0	18.5	4.0	3	25+TT	14.5-TT
223	23	0	3.5	4	0	19	3.5	3	25+TT	15.5-TT
224	23	0	3.5	4.5	0	18.5	4.0	3	25+TT	14.5-TT
225	23	0	6.5	0	0	16.5	5.0	3	25+TT	11.5-TT
226	23	0	6.5	0	0	16.5	5.0	3	25+TT	11.5-TT
227	23	0	6.5	0	0	16.5	5.0	3	25+TT	11.5-TT
228	23	0	6.5	0	0	16.5	5.0	3	25+TT	11.5-TT
229	23	0	6.5	0	0	16.5	5.0	3	25+TT	11.5-TT
230	23	0	6.5	2	0	16.5	5.0	3	25+TT	11.5-TT
231	23	0	6.5	0	0	16.5	5.0	3	25+TT	11.5-TT
232	23	0	6.5	2	0	16.5	5.0	3	25+TT	11.5-TT
233	23	0	6.5	0	0	16.5	5.0	3	25+TT	11.5-TT
234	23	0	6.5	0	0	16.5	5.0	3	25+TT	11.5-TT
235	23	0	6.5	0	0	16.5	5.0	3	25+TT	11.5-TT
236	23	0	6.5	0	0	16.5	5.0	3	25+TT	11.5-TT
237	23	0	6.5	0	0	16.5	5.0	3	25+TT	11.5-TT
238	23	0	6.5	2	0	16.5	5.0	3	25+TT	11.5-TT
239	23	0	6.5	0	0	16.5	5.0	3	25+TT	11.5-TT

Test ID	P _{PowerClass} (dBm)	ΔP _{PowerClass} (dB)	MPR (dB)	A-MPR (dB)	ΔT _{C,c} (dB)	P _{C_{MAX}L,c} (dBm)	T(P _{C_{MAX}L,c}) (dB)	T _{L,c} (dB)	Upper limit (dBm)	Lower limit (dBm)
240	23	0	6.5	2	0	16.5	5.0	3	25+TT	11.5-TT
241	23	0	6.5	11.5	0	11.5	6.0	3	25+TT	5.5-TT
242	23	0	6.5	7	0	16	5.0	3	25+TT	11-TT
243	23	0	6.5	0	0	16.5	5.0	3	25+TT	11.5-TT
244	23	0	6.5	11.5	0	11.5	6.0	3	25+TT	5.5-TT
245	23	0	6.5	11.5	0	11.5	6.0	3	25+TT	5.5-TT
246	23	0	6.5	7	0	16	5.0	3	25+TT	11-TT
247	23	0	6.5	0	0	16.5	5.0	3	25+TT	11.5-TT
248	23	0	6.5	11.5	0	11.5	6.0	3	25+TT	5.5-TT
249	23	0	6.5	0	0	16.5	5.0	3	25+TT	11.5-TT
250	23	0	6.5	4.5	0	16.5	5.0	3	25+TT	11.5-TT
251	23	0	6.5	0	0	16.5	5.0	3	25+TT	11.5-TT
252	23	0	6.5	4.5	0	16.5	5.0	3	25+TT	11.5-TT

NOTE 1: P_{PowerClass} is the maximum UE power specified without taking into account the tolerance.

NOTE 2: TT for each frequency and channel bandwidth is specified in Table 6.2.3.5-0.

Table 6.2.3.5-19: UE Power Class 3 test requirements (NS_40)

Test ID	P _{PowerClass} (dBm)	ΔP _{PowerClass} (dB)	MPR (dB)	A-MPR (dB)	ΔT _{C,c} (dB)	P _{C_{MAX}L,c} (dBm)	T(P _{C_{MAX}L,c}) (dB)	T _{L,c} (dB)	Upper limit (dBm)	Lower limit (dBm)
1	23	0	1	15.5	0	7.5	7.0	2	25+TT	0.5-TT
2	23	0	0	12	0	11	6.0	2	25+TT	5-TT
3	23	0	1	15.5	0	7.5	7.0	2	25+TT	0.5-TT
4	23	0	2	14.5	0	8.5	6.0	2	25+TT	2.5-TT
5	23	0	1	11	0	12	6.0	2	25+TT	6-TT
6	23	0	2	14.5	0	8.5	6.0	2	25+TT	2.5-TT
7	23	0	2.5	14.5	0	8.5	6.0	2	25+TT	2.5-TT
8	23	0	2.5	10	0	13	5.0	2	25+TT	8-TT
9	23	0	2.5	14.5	0	8.5	6.0	2	25+TT	2.5-TT
10	23	0	4.5	12.5	0	10.5	6.0	2	25+TT	4.5-TT
11	23	0	4.5	7.5	0	15.5	5.0	2	25+TT	10.5-TT
12	23	0	4.5	12.5	0	10.5	6.0	2	25+TT	4.5-TT
13	23	0	3	14.5	0	8.5	6.0	2	25+TT	2.5-TT
14	23	0	1.5	10	0	13	5.0	2	25+TT	8-TT
15	23	0	3	14.5	0	8.5	6.0	2	25+TT	2.5-TT
16	23	0	3	14.5	0	8.5	6.0	2	25+TT	2.5-TT
17	23	0	2	10	0	13	5.0	2	25+TT	8-TT
18	23	0	3	14.5	0	8.5	6.0	2	25+TT	2.5-TT
19	23	0	3.5	14	0	9	6.0	2	25+TT	3-TT
20	23	0	3.5	8	0	15	5.0	2	25+TT	10-TT
21	23	0	3.5	14	0	9	6.0	2	25+TT	3-TT
22	23	0	6.5	11	0	12	6.0	2	25+TT	6-TT
23	23	0	6.5	5.5	0	16.5	5.0	2	25+TT	11.5-TT
24	23	0	6.5	11	0	12	6.0	2	25+TT	6-TT

NOTE 1: P_{PowerClass} is the maximum UE power specified without taking into account the tolerance.

NOTE 2: TT for each frequency and channel bandwidth is specified in Table 6.2.3.5-0.

Table 6.2.3.5-20: UE Power Class 3 test requirements (NS_41)

Test ID	P _{PowerClass} (dBm)	ΔP _{PowerClass} (dB)	MPR (dB)	A-MPR (dB)	ΔT _{c,c} (dB)	P _{CMAX_L,c} (dBm)	T(P _{CMAX_L,c}) (dB)	T _{L,c} (dB)	Upper limit (dBm)	Lower limit (dBm)
1	23	0	0.5	9	0	14	5.0	2	25+TT	9-TT
2	23	0	0.5	9	0	14	5.0	2	25+TT	9-TT
3	23	0	0.5	11	0	12	6.0	2	25+TT	6-TT
4	23	0	0.5	11	0	12	6	2	25+TT	6-TT
5	23	0	0.5	12	0	11	6.0	2	25+TT	5-TT
6	23	0	0.5	12	0	11	6.0	2	25+TT	5-TT
7	23	0	0.5	13.5	0	9.5	6.0	2	25+TT	3.5-TT
8	23	0	0.5	13.5	0	9.5	6.0	2	25+TT	3.5-TT
9	23	0	1	9	0	14	5.0	2	25+TT	9-TT
10	23	0	1	9	0	14	5.0	2	25+TT	9-TT
11	23	0	1	11	0	12	6.0	2	25+TT	6-TT
12	23	0	1	11	0	12	6.0	2	25+TT	6-TT
13	23	0	1	12	0	11	6.0	2	25+TT	5-TT
14	23	0	1	12	0	11	6.0	2	25+TT	5-TT
15	23	0	1	13.5	0	9.5	6.0	2	25+TT	3.5-TT
16	23	0	1	13.5	0	9.5	6.0	2	25+TT	3.5-TT
17	23	0	2	9	0	14	5.0	2	25+TT	9-TT
18	23	0	2	9	0	14	5.0	2	25+TT	9-TT
19	23	0	2	11	0	12	6.0	2	25+TT	6-TT
20	23	0	2	11	0	12	6.0	2	25+TT	6-TT
21	23	0	2	12	0	11	6.0	2	25+TT	5-TT
22	23	0	2	12	0	11	6.0	2	25+TT	5-TT
23	23	0	2	13.5	0	9.5	6.0	2	25+TT	3.5-TT
24	23	0	2	13.5	0	9.5	6.0	2	25+TT	3.5-TT
25	23	0	2.5	9	0	14	5.0	2	25+TT	9-TT
26	23	0	2.5	9	0	14	5.0	2	25+TT	9-TT
27	23	0	2.5	11	0	12	6.0	2	25+TT	6-TT
28	23	0	2.5	11	0	12	6.0	2	25+TT	6-TT
29	23	0	2.5	12	0	11	6.0	2	25+TT	5-TT
30	23	0	2.5	12	0	11	6.0	2	25+TT	5-TT
31	23	0	2.5	13.5	0	9.5	6.0	2	25+TT	3.5-TT
32	23	0	2.5	13.5	0	9.5	6.0	2	25+TT	3.5-TT
33	23	0	4.5	9	0	14	5.0	2	25+TT	9-TT
34	23	0	4.5	9	0	14	5.0	2	25+TT	9-TT
35	23	0	4.5	11	0	12	6.0	2	25+TT	6-TT
36	23	0	4.5	11	0	12	6.0	2	25+TT	6-TT
37	23	0	4.5	12	0	11	6.0	2	25+TT	5-TT
38	23	0	4.5	12	0	11	6.0	2	25+TT	5-TT
39	23	0	4.5	13.5	0	9.5	6.0	2	25+TT	3.5-TT
40	23	0	4.5	13.5	0	9.5	6.0	2	25+TT	3.5-TT
41	23	0	3	9	0	14	5.0	2	25+TT	9-TT
42	23	0	3	9	0	14	5.0	2	25+TT	9-TT
43	23	0	3	11	0	12	6.0	2	25+TT	6-TT
44	23	0	3	11	0	12	6.0	2	25+TT	6-TT
45	23	0	3	12	0	11	6.0	2	25+TT	5-TT
46	23	0	3	12	0	11	6.0	2	25+TT	5-TT
47	23	0	3	13.5	0	9.5	6.0	2	25+TT	3.5-TT
48	23	0	3	13.5	0	9.5	6.0	2	25+TT	3.5-TT
49	23	0	3	9	0	14	5.0	2	25+TT	9-TT
50	23	0	3	9	0	14	5.0	2	25+TT	9-TT
51	23	0	3	11	0	12	6.0	2	25+TT	6-TT
52	23	0	3	11	0	12	6.0	2	25+TT	6-TT
53	23	0	3	12	0	11	6.0	2	25+TT	5-TT
54	23	0	3	12	0	11	6.0	2	25+TT	5-TT
55	23	0	3	13.5	0	9.5	6.0	2	25+TT	3.5-TT
56	23	0	3	13.5	0	9.5	6.0	2	25+TT	3.5-TT
57	23	0	3.5	9	0	14	5.0	2	25+TT	9-TT
58	23	0	3.5	9	0	14	5.0	2	25+TT	9-TT
59	23	0	3.5	11	0	12	6.0	2	25+TT	6-TT

Test ID	$P_{\text{PowerClass}}$ (dBm)	$\Delta P_{\text{PowerClass}}$ (dB)	MPR (dB)	A-MPR (dB)	$\Delta T_{C,c}$ (dB)	$P_{\text{CMAX}_L,c}$ (dBm)	$T(P_{\text{CMAX}_L,c})$ (dB)	$T_{L,c}$ (dB)	Upper limit (dBm)	Lower limit (dBm)
60	23	0	3.5	11	0	12	6.0	2	25+TT	6-TT
61	23	0	3.5	12	0	11	6.0	2	25+TT	5-TT
62	23	0	3.5	12	0	11	6.0	2	25+TT	5-TT
63	23	0	3.5	13.5	0	9.5	6.0	2	25+TT	3.5-TT
64	23	0	3.5	13.5	0	9.5	6.0	2	25+TT	3.5-TT
65	23	0	6.5	9	0	14	5.0	2	25+TT	9-TT
66	23	0	6.5	9	0	14	5.0	2	25+TT	9-TT
67	23	0	6.5	11	0	12	6.0	2	25+TT	6-TT
68	23	0	6.5	11	0	12	6.0	2	25+TT	6-TT
69	23	0	6.5	12	0	11	6.0	2	25+TT	5-TT
70	23	0	6.5	12	0	11	6.0	2	25+TT	5-TT
71	23	0	6.5	13.5	0	9.5	6.0	2	25+TT	3.5-TT
72	23	0	6.5	13.5	0	9.5	6.0	2	25+TT	3.5-TT

NOTE 1: $P_{\text{PowerClass}}$ is the maximum UE power specified without taking into account the tolerance.

NOTE 2: TT for each frequency and channel bandwidth is specified in Table 6.2.3.5-0.

Table 6.2.3.5-21: UE Power Class 3 test requirements (NS_42)

Test ID	$P_{\text{PowerClass}}$ (dBm)	$\Delta P_{\text{PowerClass}}$ (dB)	MPR (dB)	A-MPR (dB)	$\Delta T_{C,c}$ (dB)	$P_{\text{CMAX_L,c}}$ (dBm)	$T(P_{\text{CMAX_L,c}})$ (dB)	$T_{L,c}$ (dB)	Upper limit (dBm)	Lower limit (dBm)
1	23	0	0.5	7	0	16	5.0	2	25+TT	11-TT
2	23	0	0.5	4	0	19	3.5	2	25+TT	15.5-TT
3	23	0	0	1.5	0	21.5	2.0	2	25+TT	19.5-TT
4	23	0	0.5	8	0	15	5.0	2	25+TT	10-TT
5	23	0	0.5	5	0	18	4.0	2	25+TT	14-TT
6	23	0	0	1.5	0	21.5	2.0	2	25+TT	19.5-TT
7	23	0	1	7	0	16	5.0	2	25+TT	11-TT
8	23	0	1	4	0	19	3.5	2	25+TT	15.5-TT
9	23	0	0	1.5	0	21.5	2.0	2	25+TT	19.5-TT
10	23	0	1	8	0	15	5.0	2	25+TT	10-TT
11	23	0	1	5	0	18	4.0	2	25+TT	14-TT
12	23	0	0	1.5	0	21.5	2.0	2	25+TT	19.5-TT
13	23	0	2	7	0	16	5.0	2	25+TT	11-TT
14	23	0	2	4	0	19	3.5	2	25+TT	15.5-TT
15	23	0	1	1.5	0	21.5	2.0	2	25+TT	19.5-TT
16	23	0	2	8	0	15	5.0	2	25+TT	10-TT
17	23	0	2	5	0	18	4.0	2	25+TT	14-TT
18	23	0	1	1.5	0	21.5	2.0	2	25+TT	19.5-TT
19	23	0	2.5	7	0	16	5.0	2	25+TT	11-TT
20	23	0	2.5	4	0	19	3.5	2	25+TT	15.5-TT
21	23	0	2.5	1.5	0	20.5	2.5	2	25+TT	18-TT
22	23	0	2.5	8	0	15	5.0	2	25+TT	10-TT
23	23	0	2.5	5	0	18	4.0	2	25+TT	14-TT
24	23	0	2.5	1.5	0	20.5	2.5	2	25+TT	18-TT
25	23	0	4.5	7	0	16	5.0	2	25+TT	11-TT
26	23	0	4.5	4	0	18.5	4.0	2	25+TT	14.5-TT
27	23	0	4.5	1.5	0	18.5	4.0	2	25+TT	14.5-TT
28	23	0	4.5	8	0	15	5.0	2	25+TT	10-TT
29	23	0	4.5	5	0	18	4.0	2	25+TT	14-TT
30	23	0	4.5	1.5	0	18.5	4.0	2	25+TT	14.5-TT
31	23	0	3	7	0	16	5.0	2	25+TT	11-TT
32	23	0	3	4	0	19	3.5	2	25+TT	15.5-TT
33	23	0	1.5	1.5	0	21.5	2.0	2	25+TT	19.5-TT
34	23	0	3	8	0	15	5.0	2	25+TT	10-TT
35	23	0	3	5	0	18	4.0	2	25+TT	14-TT
36	23	0	1.5	1.5	0	21.5	2.0	2	25+TT	19.5-TT
37	23	0	3	7	0	16	5.0	2	25+TT	11-TT
38	23	0	3	4	0	19	3.5	2	25+TT	15.5-TT
39	23	0	2	1.5	0	21	2.0	2	25+TT	19-TT
40	23	0	3	8	0	15	5.0	2	25+TT	10-TT
41	23	0	3	5	0	18	4.0	2	25+TT	14-TT
42	23	0	2	1.5	0	21	2.0	2	25+TT	19-TT
43	23	0	3.5	7	0	16	5.0	2	25+TT	11-TT
44	23	0	3.5	4	0	19	3.5	2	25+TT	15.5-TT
45	23	0	3.5	1.5	0	19.5	3.5	2	25+TT	16-TT
46	23	0	3.5	8	0	15	5.0	2	25+TT	10-TT
47	23	0	3.5	5	0	18	4.0	2	25+TT	14-TT
48	23	0	3.5	1.5	0	19.5	3.5	2	25+TT	16-TT
49	23	0	6.5	7	0	16	5.0	2	25+TT	11-TT
50	23	0	6.5	4	0	16.5	5.0	2	25+TT	11.5-TT
51	23	0	6.5	1.5	0	16.5	5.0	2	25+TT	11.5-TT
52	23	0	6.5	8	0	15	5.0	2	25+TT	10-TT
53	23	0	6.5	5	0	16.5	5.0	2	25+TT	11.5-TT
54	23	0	6.5	1.5	0	16.5	5.0	2	25+TT	11.5-TT

NOTE 1: $P_{\text{PowerClass}}$ is the maximum UE power specified without taking into account the tolerance.

NOTE 2: TT for each frequency and channel bandwidth is specified in Table 6.2.3.5-0.

Table 6.2.3.5-22: UE Power Class 3 test requirements for NS_47 (contiguous allocation)

Test ID	P _{PowerClass} (dBm)	ΔP _{PowerClass} (dB)	MPR (dB)	A-MPR (dB)	ΔT _{C,c} (dB)	P _{C_{MAX}L,c} (dBm)	T(P _{C_{MAX}L,c}) (dB)	T _{L,c} (dB)	Upper limit (dBm)	Lower limit (dBm)
1	23	-3	3.5	7	0	19	3.5	2	28+TT	15.5-TT
2	23	-3	0.2	5.5	0	20.5	2.5	2	28+TT	18-TT
3	23	-3	3.5	2	0	22.5	2.0	2	28+TT	20.5-TT
4	23	-3	1.2	5.5	0	20.5	2.5	2	28+TT	18-TT
5	23	-3	1.2	3	0	23	2.0	2	28+TT	21-TT
6	23	-3	1.2	3	0	23	2.0	2	28+TT	21-TT
7	23	-3	1.2	5.5	0	20.5	2.5	2	28+TT	18-TT
8	23	0	0.5	7	0	16	5.0	2	25+TT	11-TT
9	23	0	0.0	5.5	0	17.5	5.0	2	25+TT	12.5-TT
10	23	0	0.5	2	0	21	2.0	2	25+TT	19-TT
11	23	0	0.5	5.5	0	17.5	5.0	2	25+TT	12.5-TT
12	23	0	0.5	3	0	20	2.5	2	25+TT	17.5-TT
13	23	0	0.5	3	0	20	2.5	2	25+TT	17.5-TT
14	23	0	0.5	5.5	0	17.5	5.0	2	25+TT	12.5-TT
15	23	0	1.0	7	0	16	5.0	2	25+TT	11-TT
16	23	0	0.0	5.5	0	17.5	5.0	2	25+TT	12.5-TT
17	23	0	1.0	2	0	21	2.0	2	25+TT	19-TT
18	23	0	1.0	5.5	0	17.5	5.0	2	25+TT	12.5-TT
19	23	0	1.0	3	0	20	2.5	2	25+TT	17.5-TT
20	23	0	1.0	3	0	20	2.5	2	25+TT	17.5-TT
21	23	0	1.0	5.5	0	17.5	5.0	2	25+TT	12.5-TT
22	23	0	2.0	7	0	16	5.0	2	25+TT	11-TT
23	23	0	1.0	5.5	0	17.5	5.0	2	25+TT	12.5-TT
24	23	0	2.0	0	0	21	2.0	2	25+TT	19-TT
25	23	0	2.0	5.5	0	17.5	5.0	2	25+TT	12.5-TT
26	23	0	2.0	3	0	20	2.5	2	25+TT	17.5-TT
27	23	0	2.0	3	0	20	2.5	2	25+TT	17.5-TT
28	23	0	2.0	5.5	0	17.5	5.0	2	25+TT	12.5-TT
29	23	0	2.5	7	0	16	5.0	2	25+TT	11-TT
30	23	0	2.5	6	0	17	5.0	2	25+TT	12-TT
31	23	0	2.5	0	0	20.5	2.5	2	25+TT	18-TT
32	23	0	2.5	6	0	17	5.0	2	25+TT	12-TT
33	23	0	2.5	3	0	20	2.5	2	25+TT	17.5-TT
34	23	0	2.5	3	0	20	2.5	2	25+TT	17.5-TT
35	23	0	2.5	6	0	17	5.0	2	25+TT	12-TT
36	23	0	4.5	7	0	16	5.0	2	25+TT	11-TT
37	23	0	4.5	6	0	17	5.0	2	25+TT	12-TT
38	23	0	4.5	0	0	18.5	4.0	2	25+TT	14.5-TT
39	23	0	4.5	6	0	17	5.0	2	25+TT	12-TT
40	23	0	4.5	0	0	18.5	4.0	2	25+TT	14.5-TT
41	23	0	4.5	0	0	18.5	4.0	2	25+TT	14.5-TT
42	23	0	4.5	6	0	17	5.0	2	25+TT	12-TT
43	23	0	3	7	0	16	5.0	2	25+TT	11-TT
44	23	0	1.5	7	0	16	5.0	2	25+TT	11-TT
45	23	0	3	0	0	20	2.5	2	25+TT	17.5-TT
46	23	0	3	7	0	16	5.0	2	25+TT	11-TT
47	23	0	3	4	0	19	3.5	2	25+TT	15.5-TT
48	23	0	3	4	0	19	3.5	2	25+TT	15.5-TT
49	23	0	3	7	0	16	5.0	2	25+TT	11-TT
50	23	0	3	7	0	16	5.0	2	25+TT	11-TT
51	23	0	2.0	7	0	16	5.0	2	25+TT	11-TT
52	23	0	3	0	0	20	2.5	2	25+TT	17.5-TT
53	23	0	3	7	0	16	5.0	2	25+TT	11-TT
54	23	0	3	4	0	19	3.5	2	25+TT	15.5-TT
55	23	0	3	4	0	19	3.5	2	25+TT	15.5-TT
56	23	0	3	7	0	16	5.0	2	25+TT	11-TT
57	23	0	3.5	7	0	16	5.0	2	25+TT	11-TT
58	23	0	3.5	7	0	16	5.0	2	25+TT	11-TT
59	23	0	3.5	0	0	19.5	3.5	2	25+TT	16-TT

Test ID	$P_{\text{PowerClass}}$ (dBm)	$\Delta P_{\text{PowerClass}}$ (dB)	MPR (dB)	A-MPR (dB)	$\Delta T_{C,c}$ (dB)	$P_{\text{CMAX}_L,c}$ (dBm)	$T(P_{\text{CMAX}_L,c})$ (dB)	$T_{L,c}$ (dB)	Upper limit (dBm)	Lower limit (dBm)
60	23	0	3.5	7	0	16	5.0	2	25+TT	11-TT
61	23	0	3.5	0	0	19.5	3.5	2	25+TT	16-TT
62	23	0	3.5	0	0	19.5	3.5	2	25+TT	16-TT
63	23	0	3.5	7	0	16	5.0	2	25+TT	11-TT
64	23	0	6.5	7	0	16	5.0	2	25+TT	11-TT
65	23	0	6.5	7	0	16	5.0	2	25+TT	11-TT
66	23	0	6.5	0	0	16.5	5.0	2	25+TT	11.5-TT
67	23	0	6.5	7	0	16	5.0	2	25+TT	11-TT
68	23	0	6.5	0	0	16.5	5.0	2	25+TT	11.5-TT
69	23	0	6.5	0	0	16.5	5.0	2	25+TT	11.5-TT
70	23	0	6.5	7	0	16	5.0	2	25+TT	11-TT

NOTE 1: $P_{\text{PowerClass}}$ is the maximum UE power specified without taking into account the tolerance.

NOTE 2: TT for each frequency and channel bandwidth is specified in Table 6.2.3.5-0.

Table 6.2.3.5-22a: UE Power Class 3 test requirements for NS_47 (almost contiguous allocation)

Test ID	$P_{\text{PowerClass}}$ (dBm)	$\Delta P_{\text{PowerClass}}$ (dB)	MPR (dB)	A-MPR (dB)	MPR & A-MPR increase (dB)	$\Delta T_{C,c}$ (dB)	$P_{\text{CMAX}_L,c}$ (dBm)	$T(P_{\text{CMAX}_L,c})$ (dB)	$T_{L,c}$ (dB)	Upper limit (dBm)	Lower limit (dBm)
1	23	0	3.0	7	1.0	0	15	5.0	2	25+TT	10-TT
2	23	0	3.0	7	1.0	0	15	5.0	2	25+TT	10-TT
3	23	0	3.5	7	1.0	0	15	5.0	2	25+TT	10-TT
4	23	0	6.5	7	1.0	0	15	5.0	2	25+TT	10-TT

NOTE 1: $P_{\text{PowerClass}}$ is the maximum UE power specified without taking into account the tolerance.

NOTE 2: TT for each frequency and channel bandwidth is specified in Table 6.2.3.5-0.

Table 6.2.3.5-23: UE Power Class 2 test requirements for NS_47 (contiguous allocation)

Test ID	$P_{\text{PowerClass}}$ (dBm)	$\Delta P_{\text{PowerClass}}$ (dB)	MPR (dB)	A-MPR (dB)	$\Delta T_{C,c}$ (dB)	$P_{\text{CMAX_L,c}}$ (dBm)	$T(P_{\text{CMAX_L,c}})$ (dB)	$T_{L,c}$ (dB)	Upper limit (dBm)	Lower limit (dBm)
1	26	0	3.5	10	0	16	5	3	28+TT	11-TT
2	26	0	0.0	8.5	0	17.5	5	3	28+TT	12.5-TT
3	26	0	3.5	5	0	21	2	3	28+TT	18-TT
4	26	0	0.5	8.5	0	17.5	5	3	28+TT	12.5-TT
5	26	0	0.5	6	0	20	2.5	3	28+TT	17-TT
6	26	0	0.5	6	0	20	2.5	3	28+TT	17-TT
7	26	0	0.5	8.5	0	17.5	5	3	28+TT	12.5-TT
8	26	0	3.5	10	0	16	5	3	28+TT	11-TT
9	26	0	0.0	8.5	0	17.5	5	3	28+TT	12.5-TT
10	26	0	3.5	5	0	21	2	3	28+TT	18-TT
11	26	0	1.0	8.5	0	17.5	5	3	28+TT	12.5-TT
12	26	0	1.0	6	0	20	2.5	3	28+TT	17-TT
13	26	0	1.0	6	0	20	2.5	3	28+TT	17-TT
14	26	0	1.0	8.5	0	17.5	5	3	28+TT	12.5-TT
15	26	0	3.5	10	0	16	5	3	28+TT	11-TT
16	26	0	1.0	8.5	0	17.5	5	3	28+TT	12.5-TT
17	26	0	3.5	5	0	21	2	3	28+TT	18-TT
18	26	0	2.0	8.5	0	17.5	5	3	28+TT	12.5-TT
19	26	0	2.0	6	0	20	2.5	3	28+TT	17-TT
20	26	0	2.0	6	0	20	2.5	3	28+TT	17-TT
21	26	0	2.0	8.5	0	17.5	5	3	28+TT	12.5-TT
22	26	0	3.5	10	0	16	5	3	28+TT	11-TT
23	26	0	2.5	8.5	0	17.5	5	3	28+TT	12.5-TT
24	26	0	3.5	5	0	21	2	3	28+TT	18-TT
25	26	0	2.5	8.5	0	17.5	5	3	28+TT	12.5-TT
26	26	0	2.5	6	0	20	2.5	3	28+TT	17-TT
27	26	0	2.5	6	0	20	2.5	3	28+TT	17-TT
28	26	0	2.5	8.5	0	17.5	5	3	28+TT	12.5-TT
29	26	0	4.5	10	0	16	5	3	28+TT	11-TT
30	26	0	4.5	8.5	0	17.5	5	3	28+TT	12.5-TT
31	26	0	4.5	5	0	21	2	3	28+TT	18-TT
32	26	0	4.5	8.5	0	17.5	5	3	28+TT	12.5-TT
33	26	0	4.5	6	0	20	2.5	3	28+TT	17-TT
34	26	0	4.5	6	0	20	2.5	3	28+TT	17-TT
35	26	0	4.5	8.5	0	17.5	5	3	28+TT	12.5-TT
36	26	0	3.5	10	0	16	5	3	28+TT	11-TT
37	26	0	1.5	10	0	16	5	3	28+TT	11-TT
38	26	0	3.5	5	0	21	2	3	28+TT	18-TT
39	26	0	3	10	0	16	5	3	28+TT	11-TT
40	26	0	3	7	0	19	3.5	3	28+TT	15.5-TT
41	26	0	3	7	0	19	3.5	3	28+TT	15.5-TT
42	26	0	3	10	0	16	5	3	28+TT	11-TT
43	26	0	3.5	10	0	16	5	3	28+TT	11-TT
44	26	0	2.0	10	0	16	5	3	28+TT	11-TT
45	26	0	3.5	5	0	21	2	3	28+TT	18-TT
46	26	0	3	10	0	16	5	3	28+TT	11-TT
47	26	0	3	7	0	19	3.5	3	28+TT	15.5-TT
48	26	0	3	7	0	19	3.5	3	28+TT	15.5-TT
49	26	0	3	10	0	16	5	3	28+TT	11-TT
50	26	0	3.5	10	0	16	5	3	28+TT	11-TT
51	26	0	3.5	10	0	16	5	3	28+TT	11-TT
52	26	0	3.5	5	0	21	2	3	28+TT	18-TT
53	26	0	3.5	10	0	16	5	3	28+TT	11-TT
54	26	0	3.5	7	0	19	3.5	3	28+TT	15.5-TT
55	26	0	3.5	7	0	19	3.5	3	28+TT	15.5-TT
56	26	0	3.5	10	0	16	5	3	28+TT	11-TT
57	26	0	6.5	10	0	16	5	3	28+TT	11-TT
58	26	0	6.5	10	0	16	5	3	28+TT	11-TT
59	26	0	6.5	0	0	19.5	3.5	3	28+TT	16-TT

Test ID	P _{PowerClass} (dBm)	ΔP _{PowerClass} (dB)	MPR (dB)	A-MPR (dB)	ΔT _{C,c} (dB)	P _{C_{MAX}L,c} (dBm)	T(P _{C_{MAX}L,c}) (dB)	T _{L,c} (dB)	Upper limit (dBm)	Lower limit (dBm)
60	26	0	6.5	10	0	16	5	3	28+TT	11-TT
61	26	0	6.5	7	0	19	3.5	3	28+TT	15.5-TT
62	26	0	6.5	7	0	19	3.5	3	28+TT	15.5-TT
63	26	0	6.5	10	0	16	5	3	28+TT	11-TT

NOTE 1: P_{PowerClass} is the maximum UE power specified without taking into account the tolerance.

NOTE 2: TT for each frequency and channel bandwidth is specified in Table 6.2.3.5-0.

Table 6.2.3.5-23a: UE Power Class 2 test requirements for NS₄₇ (almost contiguous allocation)

Test ID	P _{PowerClass} (dBm)	ΔP _{PowerClass} (dB)	MPR (dB)	A-MPR (dB)	MPR & A-MPR increase (dB)	ΔT _{C,c} (dB)	P _{C_{MAX}L,c} (dBm)	T(P _{C_{MAX}L,c}) (dB)	T _{L,c} (dB)	Upper limit (dBm)	Lower limit (dBm)
1	26	0	3.0	10	1.0	0	16	5.0	3	28+TT	11-TT
2	26	0	3.0	10	1.0	0	16	5.0	3	28+TT	11-TT
3	26	0	3.5	10	1.0	0	16	5.0	3	28+TT	11-TT
4	26	0	6.5	10	1.0	0	16	5.0	3	28+TT	11-TT

NOTE 1: P_{PowerClass} is the maximum UE power specified without taking into account the tolerance.

NOTE 2: TT for each frequency and channel bandwidth is specified in Table 6.2.3.5-0.

Table 6.2.3.5-24: UE Power Class 3 test requirements for NS₄₈ (PC3 contiguous allocation)

Test ID	P _{PowerClass} (dBm)	ΔP _{PowerClass} (dB)	MPR (dB)	A-MPR (dB)	ΔT _{C,c} (dB)	P _{C_{MAX}L,c} (dBm)	T(P _{C_{MAX}L,c}) (dB)	T _{L,c} (dB)	Upper limit (dBm)	Lower limit (dBm)
1	23	0	1	3	0	20	2.5	2	25+TT	17.5-TT
2	23	0	1	3	0	20	2.5	2	25+TT	17.5-TT
3	23	0	1	3	0	20	2.5	2	25+TT	17.5-TT
4	23	0	1	5	0	18	4	2	25+TT	14-TT
5	23	0	1	6	0	17	5	2	25+TT	12-TT
6	23	0	1	3	0	20	2.5	2	25+TT	17.5-TT
7	23	0	1	4	0	19	3.5	2	25+TT	15.5-TT
8	23	0	1	6	0	17	5	2	25+TT	12-TT
9	23	0	0	3	0	20	2.5	2	25+TT	17.5-TT
10	23	0	1	10	0	13	5	2	25+TT	8-TT
11	23	0	1	6	0	17	5	2	25+TT	12-TT
12	23	0	1	4	0	19	3.5	2	25+TT	15.5-TT
13	23	0	1	6	0	17	5	2	25+TT	12-TT
14	23	0	0	5	0	18	4	2	25+TT	14-TT
15	23	0	1	10	0	13	5	2	25+TT	8-TT
16	23	0	1	6	0	17	5	2	25+TT	12-TT
17	23	0	1	4	0	19	3.5	2	25+TT	15.5-TT
18	23	0	1	6	0	17	5	2	25+TT	12-TT
19	23	0	0	5	0	18	4	2	25+TT	14-TT
20	23	0	1	10	0	13	5	2	25+TT	8-TT
21	23	0	4.5	3	0	18.5	4	2	25+TT	14.5-TT
22	23	0	4.5	3	0	18.5	4	2	25+TT	14.5-TT
23	23	0	4.5	3	0	18.5	4	2	25+TT	14.5-TT
24	23	0	4.5	5	0	18	4	2	25+TT	14-TT

Test ID	P _{PowerClass} (dBm)	⊠P _{PowerClass} (dB)	MPR (dB)	A-MPR (dB)	ΔT _{C,c} (dB)	P _{C_{MAX}L,c} (dBm)	T(P _{C_{MAX}L,c}) (dB)	T _{L,c} (dB)	Upper limit (dBm)	Lower limit (dBm)
25	23	0	4.5	6	0	17	5	2	25+TT	12-TT
26	23	0	4.5	3	0	18.5	4	2	25+TT	14.5-TT
27	23	0	4.5	4	0	18.5	4	2	25+TT	14.5-TT
28	23	0	4.5	6	0	17	5	2	25+TT	12-TT
29	23	0	4.5	3	0	18.5	4	2	25+TT	14.5-TT
30	23	0	4.5	10	0	13	5	2	25+TT	8-TT
31	23	0	4.5	6	0	17	5	2	25+TT	12-TT
32	23	0	4.5	4	0	18.5	4	2	25+TT	14.5-TT
33	23	0	4.5	6	0	17	5	2	25+TT	12-TT
34	23	0	4.5	5	0	18	4	2	25+TT	14-TT
35	23	0	4.5	10	0	13	5	2	25+TT	8-TT
36	23	0	4.5	6	0	17	5	2	25+TT	12-TT
37	23	0	4.5	4	0	18.5	4	2	25+TT	14.5-TT
38	23	0	4.5	6	0	17	5	2	25+TT	12-TT
39	23	0	4.5	5	0	18	4	2	25+TT	14-TT
40	23	0	4.5	10	0	13	5	2	25+TT	8-TT
41	23	0	3	4.5	0	18.5	4	2	25+TT	14.5-TT
42	23	0	3	4.5	0	18.5	4	2	25+TT	14.5-TT
43	23	0	3	4.5	0	18.5	4	2	25+TT	14.5-TT
44	23	0	3	5	0	18	4	2	25+TT	14-TT
45	23	0	3	7	0	16	5	2	25+TT	11-TT
46	23	0	3	4.5	0	18.5	4	2	25+TT	14.5-TT
47	23	0	3	5.5	0	17.5	5	2	25+TT	12.5-TT
48	23	0	3	7	0	16	5	2	25+TT	11-TT
49	23	0	1.5	4.5	0	18.5	4	2	25+TT	14.5-TT
50	23	0	3	11	0	12	6	2	25+TT	6-TT
51	23	0	3	7	0	16	5	2	25+TT	11-TT
52	23	0	3	5.5	0	17.5	5	2	25+TT	12.5-TT
53	23	0	3	7	0	16	5	2	25+TT	11-TT
54	23	0	1.5	5	0	18	4	2	25+TT	14-TT
55	23	0	3	11	0	12	6	2	25+TT	6-TT
56	23	0	3	7	0	16	5	2	25+TT	11-TT
57	23	0	3	5.5	0	17.5	5	2	25+TT	12.5-TT
58	23	0	3	7	0	16	5	2	25+TT	11-TT
59	23	0	1.5	5	0	18	4	2	25+TT	14-TT
60	23	0	3	11	0	12	6	2	25+TT	6-TT
61	23	0	6.5	4.5	0	16.5	5	2	25+TT	11.5-TT
62	23	0	6.5	4.5	0	16.5	5	2	25+TT	11.5-TT
63	23	0	6.5	4.5	0	16.5	5	2	25+TT	11.5-TT
64	23	0	6.5	5	0	16.5	5	2	25+TT	11.5-TT
65	23	0	6.5	7	0	16	5	2	25+TT	11-TT
66	23	0	6.5	4.5	0	16.5	5	2	25+TT	11.5-TT
67	23	0	6.5	5.5	0	16.5	5	2	25+TT	11.5-TT
68	23	0	6.5	7	0	16	5	2	25+TT	11-TT
69	23	0	6.5	4.5	0	16.5	5	2	25+TT	11.5-TT
70	23	0	6.5	11	0	12	6	2	25+TT	6-TT
71	23	0	6.5	7	0	16	5	2	25+TT	11-TT
72	23	0	6.5	5.5	0	16.5	5	2	25+TT	11.5-TT
73	23	0	6.5	7	0	16	5	2	25+TT	11-TT
74	23	0	6.5	5	0	16.5	5	2	25+TT	11.5-TT
75	23	0	6.5	11	0	12	6	2	25+TT	6-TT
76	23	0	6.5	7	0	16	5	2	25+TT	11-TT
77	23	0	6.5	5.5	0	16.5	5	2	25+TT	11.5-TT
78	23	0	6.5	7	0	16	5	2	25+TT	11-TT
79	23	0	6.5	5	0	16.5	5	2	25+TT	11.5-TT
80	23	0	6.5	11	0	12	6	2	25+TT	6-TT

NOTE 1: P_{PowerClass} is the maximum UE power specified without taking into account the tolerance.

NOTE 2: TT for each frequency and channel bandwidth is specified in Table 6.2.3.5-0.

Table 6.2.3.5-25: UE Power Class 3 test requirements (NS_12) for n26

Test ID	P _{PowerClass} (dBm)	MPR (dB)	A-MPR (dB)	$\Delta T_{C,c}$ (dB)	P _{CMAX_L,c} (dBm)	T(P _{CMAX_L,c}) (dB)	T _{L,c} (dB)	Upper limit (dBm)	Lower limit (dBm)
1-3	23	N/A	5	1.5	16.5	5	2	25+TT	11.5-TT
	23	N/A	5.5	1.5	16	5	2	25+TT	11-TT
	23	N/A	9.5	1.5	12	6	2	25+TT	6-TT
4-6	23	N/A	5	0	18	4	2	25+TT	14-TT
	23	N/A	5.5	0	17.5	5	2	25+TT	12.5-TT
	23	N/A	9.5	0	13.5	5	2	25+TT	8.5-TT
7-9	23	N/A	5	1.5	16.5	5	2	25+TT	11.5-TT
	23	N/A	5.5	1.5	16	5	2	25+TT	11-TT
	23	N/A	9.5	1.5	12	6	2	25+TT	6-TT
10-12	23	N/A	5	0	18	4	2	25+TT	14-TT
	23	N/A	5.5	0	17.5	5	2	25+TT	12.5-TT
	23	N/A	9.5	0	13.5	5	2	25+TT	8.5-TT
13	23	0	N/A	0	23	2	2	25+TT	21-TT
14	23	0	N/A	0	23	2	2	25+TT	21-TT
15-16	23	N/A	7	1.5	14.5	5	2	25+TT	9.5-TT
	23	N/A	9.5	1.5	12	6	2	25+TT	6-TT
17-18	23	N/A	7	0	16	5	2	25+TT	11-TT
	23	N/A	9.5	0	13.5	5	2	25+TT	8.5-TT
19-20	23	N/A	7	1.5	14.5	5	2	25+TT	9.5-TT
	23	N/A	9.5	1.5	12	6	2	25+TT	6-TT
21-22	23	N/A	7	0	16	5	2	25+TT	11-TT
	23	N/A	9.5	0	13.5	5	2	25+TT	8.5-TT
23	23	1.5	0	0	21.5	2	2	25+TT	19.5-TT
24	23	1.5	0	0	21.5	2	2	25+TT	19.5-TT

NOTE 1: P_{PowerClass} is the maximum UE power specified without taking into account the tolerance.
NOTE 2: TT for each frequency and channel bandwidth is specified in Table 6.2.3.5-0.

Table 6.2.3.5-26: UE Power Class 3 test requirements (NS_13) for n26

Test ID	P _{PowerClass} (dBm)	MPR (dB)	A-MPR (dB)	$\Delta T_{C,c}$ (dB)	P _{CMAX_L,c} (dBm)	T(P _{CMAX_L,c}) (dB)	T _{L,c} (dB)	Upper limit (dBm)	Lower limit (dBm)
1-3	23	N/A	3.5	1.5	18	4	2	25+TT	14-TT
	23	N/A	4.5	1.5	17	5	2	25+TT	12-TT
	23	N/A	8	1.5	13.5	5	2	25+TT	8.5-TT
4-6	23	N/A	4.5	0	18.5	4	2	25+TT	14.5-TT
	23	N/A	5	0	18	4	2	25+TT	14-TT
	23	N/A	6	0	17	5	2	25+TT	12-TT
7-9	23	N/A	3.5	0	19.5	3.5	2	25+TT	16-TT
	23	N/A	4.5	0	18.5	4	2	25+TT	14.5-TT
	23	N/A	8	0	15	5	2	25+TT	10-TT
10	23	N/A	3	0	20	2.5	2	25+TT	17.5-TT
11	23	1	N/A	0	22	2	2	25+TT	20-TT
12-14	23	N/A	5	1.5	16.5	5	2	25+TT	11.5-TT
	23	N/A	6	1.5	15.5	5	2	25+TT	10.5-TT
	23	N/A	8	1.5	13.5	5	2	25+TT	8.5-TT
15-16	23	N/A	6.5	0	16.5	5	2	25+TT	11.5-TT
	23	N/A	8	0	15	5	2	25+TT	10-TT
17-19	23	N/A	5	0	18	4	2	25+TT	14-TT
	23	N/A	6	0	17	5	2	25+TT	12-TT
	23	N/A	8	0	15	5	2	25+TT	10-TT
20	23	N/A	4.5	0	18.5	4	2	25+TT	14.5-TT
21	23	3	N/A	0	20	2.5	2	25+TT	17.5-TT

NOTE 1: P_{PowerClass} is the maximum UE power specified without taking into account the tolerance.
NOTE 2: TT for each frequency and channel bandwidth is specified in Table 6.2.3.5-0.

Table 6.2.3.5-27a: UE Power Class 3 test requirements (NS_14) for n26 low range

Test ID	P _{PowerClass} (dBm)	MPR (dB)	A-MPR (dB)	$\Delta T_{C,c}$ (dB)	P _{CMAX_L,c} (dBm)	T(P _{CMAX_L,c}) (dB)	T _{L,c} (dB)	Upper limit (dBm)	Lower limit (dBm)
1	23	N/A	3	1.5	18.5	4	2	25+TT	14.5-TT
2	23	N/A	2	0	21	2	2	25+TT	19-TT
3	23	N/A	3	1.5	18.5	4	2	25+TT	14.5-TT
4	23	N/A	2	0	21	2	2	25+TT	19-TT
5-6	23	N/A	3	1.5	18.5	4	2	25+TT	14.5-TT
	23	N/A	8	1.5	13.5	5	2	25+TT	8.5-TT
7	23	N/A	2	0	21	2	2	25+TT	19-TT
8	23	0	N/A	1.5	21.5	2	2	25+TT	19.5-TT
9	23	0	N/A	1.5	21.5	2	2	25+TT	19.5-TT
10	23	0	N/A	1.5	21.5	2	2	25+TT	19.5-TT
11-13	23	N/A	5	1.5	16.5	5	2	25+TT	11.5-TT
	23	N/A	6	1.5	15.5	5	2	25+TT	10.5-TT
	23	N/A	8	1.5	13.5	5	2	25+TT	8.5-TT
14	23	N/A	4	0	19	3.5	2	25+TT	15.5-TT
15-17	23	N/A	5	1.5	16.5	5	2	25+TT	11.5-TT
	23	N/A	6	1.5	15.5	5	2	25+TT	10.5-TT
	23	N/A	7	1.5	14.5	5	2	25+TT	9.5-TT
18	23	N/A	4	0	19	3.5	2	25+TT	15.5-TT
19-21	23	N/A	5	1.5	16.5	5	2	25+TT	11.5-TT
	23	N/A	6	1.5	15.5	5	2	25+TT	10.5-TT
	23	N/A	8	1.5	13.5	5	2	25+TT	8.5-TT
22	23	N/A	4	0	19	3.5	2	25+TT	15.5-TT
23	23	1.5	N/A	1.5	20	2.5	2	25+TT	17.5-TT
24	23	1.5	N/A	1.5	20	2.5	2	25+TT	17.5-TT
25	23	1.5	N/A	1.5	20	2.5	2	25+TT	17.5-TT

NOTE 1: P_{PowerClass} is the maximum UE power specified without taking into account the tolerance.
NOTE 2: TT for each frequency and channel bandwidth is specified in Table 6.2.3.5-0.

Table 6.2.3.5-27b: UE Power Class 3 test requirements (NS_14) for n26 high range

Test ID	P _{PowerClass} (dBm)	MPR (dB)	A-MPR (dB)	$\Delta T_{C,c}$ (dB)	P _{CMAX_L,c} (dBm)	T(P _{CMAX_L,c}) (dB)	T _{L,c} (dB)	Upper limit (dBm)	Lower limit (dBm)
1	23	N/A	3	0	20	2.5	2	25+TT	17.5-TT
2	23	N/A	2	0	21	2	2	25+TT	19-TT
3	23	N/A	3	0	20	2.5	2	25+TT	17.5-TT
4	23	N/A	2	0	21	2	2	25+TT	19-TT
5-6	23	N/A	3	0	20	2.5	2	25+TT	17.5-TT
	23	N/A	8	0	15	5	2	25+TT	10-TT
7	23	N/A	2	0	21	2	2	25+TT	19-TT
8	23	0	N/A	0	23	2	2	25+TT	21-TT
9	23	0	N/A	0	23	2	2	25+TT	21-TT
10	23	0	N/A	0	23	2	2	25+TT	21-TT
11-13	23	N/A	5	0	18	4	2	25+TT	14-TT
	23	N/A	6	0	17	5	2	25+TT	12-TT
	23	N/A	8	0	15	5	2	25+TT	10-TT
14	23	N/A	4	0	19	3.5	2	25+TT	15.5-TT
15-17	23	N/A	5	0	18	4	2	25+TT	14-TT
	23	N/A	6	0	17	5	2	25+TT	12-TT
	23	N/A	7	0	16	5	2	25+TT	11-TT
18	23	N/A	4	0	19	3.5	2	25+TT	15.5-TT
19-21	23	N/A	5	0	18	4	2	25+TT	14-TT
	23	N/A	6	0	17	5	2	25+TT	12-TT
	23	N/A	8	0	15	5	2	25+TT	10-TT
22	23	N/A	4	0	19	3.5	2	25+TT	15.5-TT
23	23	1.5	N/A	1.5	20	2.5	2	25+TT	17.5-TT
24	23	1.5	N/A	1.5	20	2.5	2	25+TT	17.5-TT
25	23	1.5	N/A	1.5	20	2.5	2	25+TT	17.5-TT

NOTE 1: P_{PowerClass} is the maximum UE power specified without taking into account the tolerance.

NOTE 2: TT for each frequency and channel bandwidth is specified in Table 6.2.3.5-0.

Table 6.2.3.5-28: UE Power Class 3 test requirements (NS_15) for n26

Test ID	P _{PowerClass} (dBm)	MPR (dB)	A-MPR (dB)	$\Delta T_{C,c}$ (dB)	P _{CMAX_L,c} (dBm)	T(P _{CMAX_L,c}) (dB)	T _{L,c} (dB)	Upper limit (dBm)	Lower limit (dBm)
1	23	N/A	9	0	12.5	6	2	25+TT	6.5-TT
2	23	N/A	9	0	14	5	2	25+TT	9-TT
3	23	N/A	5	0	18	4	2	25+TT	14-TT
4-5	23	N/A	4	0	19	3.5	2	25+TT	15.5-TT
	23	N/A	9	0	14	5	2	25+TT	9-TT
6-7	23	N/A	9	0	12.5	6	2	25+TT	6.5-TT
	23	N/A	13.5	0	8	6	2	25+TT	2-TT
8	23	N/A	9	0	14	5	2	25+TT	9-TT
9	23	N/A	5	0	18	4	2	25+TT	14-TT
10-11	23	N/A	4	0	19	3.5	2	25+TT	15.5-TT
	23	N/A	9	0	14	5	2	25+TT	9-TT
12-13	23	N/A	9	0	14	5	2	25+TT	9-TT
	23	N/A	9	0	14	5	2	25+TT	9-TT
14	23	N/A	9	0	14	5	2	25+TT	9-TT
15	23	N/A	5	0	18	4	2	25+TT	14-TT
16-17	23	N/A	4	0	19	3.5	2	25+TT	15.5-TT
	23	N/A	9	0	14	5	2	25+TT	9-TT
18-19	23	N/A	9	0	12.5	6	2	25+TT	6.5-TT
	23	N/A	13.5	0	8	6	2	25+TT	2-TT
20	23	N/A	9	0	14	5	2	25+TT	9-TT
21	23	N/A	5	0	18	4	2	25+TT	14-TT
22-23	23	N/A	4	0	19	3.5	2	25+TT	15.5-TT
	23	N/A	9	0	14	5	2	25+TT	9-TT
24-25	23	N/A	9	0	14	5	2	25+TT	9-TT
	23	N/A	13.5	0	9.5	6	2	25+TT	3.5-TT
26	23	N/A	9	0	14	5	2	25+TT	9-TT
27	23	N/A	5	0	18	4	2	25+TT	14-TT
28-29	23	N/A	4	0	19	3.5	2	25+TT	15.5-TT
	23	N/A	9	0	14	5	2	25+TT	9-TT
30-31	23	N/A	9	0	14	5	2	25+TT	9-TT
	23	N/A	9	0	14	5	2	25+TT	9-TT
32	23	N/A	9	0	14	5	2	25+TT	9-TT
33	23	N/A	5	0	18	4	2	25+TT	14-TT
34-35	23	N/A	4	0	19	3.5	2	25+TT	15.5-TT
	23	N/A	9	0	14	5	2	25+TT	9-TT
36-37	23	N/A	9	0	12.5	6	2	25+TT	6.5-TT
	23	N/A	13.5	0	8	6	2	25+TT	2-TT
38	23	N/A	9	0	14	5	2	25+TT	9-TT
39	23	N/A	5	0	18	4	2	25+TT	14-TT
40-41	23	N/A	4	0	19	3.5	2	25+TT	15.5-TT
	23	N/A	9	0	14	5	2	25+TT	9-TT
42-43	23	N/A	9	0	14	5	2	25+TT	9-TT
	23	N/A	13.5	0	9.5	6	2	25+TT	3.5-TT
44	23	N/A	9	0	14	5	2	25+TT	9-TT
45	23	N/A	5	0	18	4	2	25+TT	14-TT

Test ID	P _{PowerClass} (dBm)	MPR (dB)	A-MPR (dB)	$\Delta T_{C,c}$ (dB)	P _{C_{MAX}L,c} (dBm)	T(P _{C_{MAX}L,c}) (dB)	T _{L,c} (dB)	Upper limit (dBm)	Lower limit (dBm)
46-47	23	N/A	4	0	19	3.5	2	25+TT	15.5-TT
	23	N/A	9	0	14	5	2	25+TT	9-TT
48	23	1	N/A	0	22	2	2	25+TT	20-TT
49	23	1	N/A	0	22	2	2	25+TT	20-TT
50	23	0	N/A	0	23	2	2	25+TT	21-TT
51	23	0	N/A	0	23	2	2	25+TT	21-TT
52	23	N/A	10.5	0	11	6	2	25+TT	5-TT
53	23	N/A	10.5	0	12.5	6	2	25+TT	6.5-TT
54	23	N/A	6.5	0	16.5	5	2	25+TT	11.5-TT
55-56	23	N/A	4	0	19	3.5	2	25+TT	15.5-TT
	23	N/A	9	0	14	5	2	25+TT	9-TT
57-58	23	N/A	10.5	0	11	6	2	25+TT	5-TT
	23	N/A	13.5	0	8	6	2	25+TT	2-TT
59	23	N/A	10.5	0	12.5	6	2	25+TT	6.5-TT
60	23	N/A	6.5	0	16.5	5	2	25+TT	11.5-TT
61-62	23	N/A	4	0	19	3.5	2	25+TT	15.5-TT
	23	N/A	9	0	14	5	2	25+TT	9-TT
63-64	23	N/A	10.5	0	12.5	6	2	25+TT	6.5-TT
	23	N/A	10.5	0	12.5	6	2	25+TT	6.5-TT
65	23	N/A	10.5	0	12.5	6	2	25+TT	6.5-TT
66	23	N/A	6.5	0	16.5	5	2	25+TT	11.5-TT
67-68	23	N/A	4	0	19	3.5	2	25+TT	15.5-TT
	23	N/A	9	0	14	5	2	25+TT	9-TT
69-70	23	N/A	10.5	0	11	6	2	25+TT	5-TT
	23	N/A	13.5	0	8	6	2	25+TT	2-TT
71	23	N/A	10.5	0	12.5	6	2	25+TT	6.5-TT
72	23	N/A	6.5	0	16.5	5	2	25+TT	11.5-TT
73-74	23	N/A	4	0	19	3.5	2	25+TT	15.5-TT
	23	N/A	9	0	14	5	2	25+TT	9-TT
75-76	23	N/A	10.5	0	12.5	6	2	25+TT	6.5-TT
	23	N/A	13.5	0	9.5	6	2	25+TT	3.5-TT
77	23	N/A	10.5	0	12.5	6	2	25+TT	6.5-TT
78	23	N/A	6.5	0	16.5	5	2	25+TT	11.5-TT
79-80	23	N/A	4	0	19	3.5	2	25+TT	15.5-TT
	23	N/A	9	0	14	5	2	25+TT	9-TT
81-82	23	N/A	10.5	0	12.5	6	2	25+TT	6.5-TT
	23	N/A	10.5	0	12.5	6	2	25+TT	6.5-TT
83	23	N/A	10.5	0	12.5	6	2	25+TT	6.5-TT
84	23	N/A	6.5	0	16.5	5	2	25+TT	11.5-TT
85-86	23	N/A	4	0	19	3.5	2	25+TT	15.5-TT
	23	N/A	9	0	14	5	2	25+TT	9-TT
87-88	23	N/A	10.5	0	11	6	2	25+TT	5-TT
	23	N/A	13.5	0	8	6	2	25+TT	2-TT
89	23	N/A	10.5	0	12.5	6	2	25+TT	6.5-TT

Test ID	P _{PowerClass} (dBm)	MPR (dB)	A-MPR (dB)	$\Delta T_{C,c}$ (dB)	P _{CMAX_L,c} (dBm)	T(P _{CMAX_L,c}) (dB)	T _{L,c} (dB)	Upper limit (dBm)	Lower limit (dBm)
90	23	N/A	6.5	0	16.5	5	2	25+TT	11.5-TT
91-92	23	N/A	4	0	19	3.5	2	25+TT	15.5-TT
	23	N/A	9	0	14	5	2	25+TT	9-TT
93-94	23	N/A	10.5	0	12.5	6	2	25+TT	6.5-TT
	23	N/A	13.5	0	9.5	6	2	25+TT	3.5-TT
95	23	N/A	10.5	0	12.5	6	2	25+TT	6.5-TT
96	23	N/A	6.5	0	16.5	5	2	25+TT	11.5-TT
97-98	23	N/A	4	0	19	3.5	2	25+TT	15.5-TT
	23	N/A	9	0	14	5	2	25+TT	9-TT
99	23	3	N/A	0	20	2.5	2	25+TT	17.5-TT
100	23	3	N/A	0	20	2.5	2	25+TT	17.5-TT
101	23	1.5	N/A	0	21.5	2	2	25+TT	19.5-TT
102	23	1.5	N/A	0	21.5	2	2	25+TT	19.5-TT

NOTE 1: P_{PowerClass} is the maximum UE power specified without taking into account the tolerance.
NOTE 2: TT for each frequency and channel bandwidth is specified in Table 6.2.3.5-0.

Table 6.2.3.5-29: UE Power Class 3 test requirements for NS_45 (contiguous allocation)

Test ID	P _{PowerClass} (dBm)	MPR (dB)	A-MPR (dB)	$\Delta T_{C,c}$ (dB)	P _{CMAX,c} (dBm)	T(P _{CMAX_L,c}) (dB)	T _{L,c} (dB)	Upper limit (dBm)	Lower limit (dBm)
1, 2	23	0.5	1.5	0	21.5	2	2	25+TT	19.5-TT
3	23	0.5	1.5	0	21.5	2	2	25+TT	19.5-TT
4, 5	23	1	2	0	21	2	2	25+TT	19-TT
6	23	1	2	0	21	2	2	25+TT	19-TT
7, 8	23	2	2.5	0	20.5	2.5	2	25+TT	18-TT
9	23	2	2.5	0	20.5	2.5	2	25+TT	18-TT
10, 11	23	2.5	3	0	20	2.5	2	25+TT	17.5-TT
12	23	2.5	3	0	20	2.5	2	25+TT	17.5-TT

NOTE 1: P_{PowerClass} is the maximum UE power specified without taking into account the tolerance.
NOTE 2: TT for each frequency and channel bandwidth is specified in Table 6.2.3.5-0.

Table 6.2.3.5-30: UE Power Class 3 test requirements for NS_46 (contiguous allocation)

Test ID	$P_{\text{PowerClass}}$ (dBm)	$\Delta P_{\text{PowerClass}}$ (dB)	MPR (dB)	A-MPR (dB)	$\Delta T_{C,c}$ (dB)	$P_{C_{\text{MAX_L,c}}}$ (dBm)	$T(P_{C_{\text{MAX_L,c}}})$ (dB)	$T_{L,c}$ (dB)	Upper limit (dBm)	Lower limit (dBm)
1	23	0	2.5	3.5	0	19.5	3.5	2	25+TT	16-TT
2	23	0	2.5	4	0	19	3.5	2	25+TT	15.5-TT
3	23	0	2.5	4.5	0	18.5	4	2	25+TT	14.5-TT
4	23	0	2.5	5	0	18	4	2	25+TT	14-TT
5	23	0	2	2	0	21	2	2	25+TT	19-TT
6	23	0	2.5	3.5	0	19.5	3.5	2	25+TT	16-TT
7	23	0	4.5	6	0	17	5	2	25+TT	12-TT
8	23	0	4.5	10	0	13	5	2	25+TT	8-TT
9	23	0	3	5.5	0	17.5	5	2	25+TT	12.5-TT
10	23	0	3.5	5.5	0	17.5	5	2	25+TT	12.5-TT
11	23	0	3	6	0	17	5	2	25+TT	12-TT
12	23	0	6.5	6	0	16.5	5	2	25+TT	11.5-TT
13	23	0	3	5	0	18	4	2	25+TT	14-TT
14	23	0	3.5	5	0	18	4	2	25+TT	14-TT
15	23	0	3	3.5	0	19.5	3.5	2	25+TT	16-TT
16	23	0	3.5	3.5	0	19.5	3.5	2	25+TT	16-TT
17	23	0	3	5.5	0	17.5	5	2	25+TT	12.5-TT
18	23	0	3.5	5.5	0	17.5	5	2	25+TT	12.5-TT
19	23	0	3	7	0	16	5	2	25+TT	11-TT
20	23	0	6.5	7	0	16	5	2	25+TT	11-TT
21	23	0	3	11	0	12	6	2	25+TT	6-TT
22	23	0	6.5	11	0	12	6	2	25+TT	6-TT

NOTE 1: $P_{\text{PowerClass}}$ is the maximum UE power specified without taking into account the tolerance.
NOTE 2: TT for each frequency and channel bandwidth is specified in Table 6.2.3.5-0.

Table 6.2.3.5-31: UE Power Class 3 test requirements (NS_44) for band n38

Test ID	P _{PowerClass} (dBm)	ΔP _{PowerClass} (dB)	MPR (dB)	A-MPR (dB)	ΔT _{C,c} (dB)	P _{C_{MAX}L,c} (dBm)	T(P _{C_{MAX}L,c}) (dB)	T _{L,c} (dB)	Upper limit (dBm)	Lower limit (dBm)
1	23	0	2.5	3	0	20	2.5	2	25+TT	17.5-TT
2	23	0	2.5	3	0	20	2.5	2	25+TT	17.5-TT
3	23	0	2.5	4	0	19	3.5	2	25+TT	15.5-TT
4	23	0	4.5	0	0	18.5	4	2	25+TT	14.5-TT
5	23	0	4.5	0	0	18.5	4	2	25+TT	14.5-TT
6	23	0	4.5	0	0	18.5	4	2	25+TT	14.5-TT
7	23	0	2.5	3	0	20	2.5	2	25+TT	17.5-TT
8	23	0	2.5	3	0	20	2.5	2	25+TT	17.5-TT
9	23	0	2.5	4	0	19	3.5	2	25+TT	15.5-TT
10	23	0	4.5	0	0	18.5	4	2	25+TT	14.5-TT
11	23	0	4.5	0	0	18.5	4	2	25+TT	14.5-TT
12	23	0	4.5	0	0	18.5	4	2	25+TT	14.5-TT
13	23	0	2.5	0	0	20.5	2.5	2	25+TT	18-TT
14	23	0	2.5	0	0	20.5	2.5	2	25+TT	18-TT
15	23	0	2.5	3	0	20	2.5	2	25+TT	17.5-TT
16	23	0	2.5	7	0	16	5	2	25+TT	11-TT
17	23	0	2.5	12	0	11	6	2	25+TT	5-TT
18	23	0	4.5	0	0	18.5	4	2	25+TT	14.5-TT
19	23	0	4.5	0	0	18.5	4	2	25+TT	14.5-TT
20	23	0	4.5	0	0	18.5	4	2	25+TT	14.5-TT
21	23	0	4.5	7	0	16	5	2	25+TT	11-TT
22	23	0	4.5	12	0	11	6	2	25+TT	5-TT
23	23	0	3.5	5	0	18	4	2	25+TT	14-TT
24	23	0	3.5	5	0	18	4	2	25+TT	14-TT
25	23	0	3.5	0	0	19.5	3.5	2	25+TT	16-TT
26	23	0	6.5	0	0	16.5	5	2	25+TT	11.5-TT
27	23	0	6.5	0	0	16.5	5	2	25+TT	11.5-TT
28	23	0	6.5	0	0	16.5	5	2	25+TT	11.5-TT
29	23	0	3.5	5	0	18	4	2	25+TT	14-TT
30	23	0	3.5	5	0	18	4	2	25+TT	14-TT
31	23	0	3.5	0	0	19.5	3.5	2	25+TT	16-TT
32	23	0	6.5	0	0	16.5	5	2	25+TT	11.5-TT
33	23	0	6.5	0	0	16.5	5	2	25+TT	11.5-TT
34	23	0	6.5	0	0	16.5	5	2	25+TT	11.5-TT
35	23	0	3.5	0	0	19.5	3.5	2	25+TT	16-TT
36	23	0	3.5	4	0	19	3.5	2	25+TT	15.5-TT
37	23	0	3.5	5	0	18	4	2	25+TT	14-TT
38	23	0	3.5	8	0	15	5	2	25+TT	10-TT
39	23	0	3.5	12	0	11	6	2	25+TT	5-TT
40	23	0	6.5	0	0	16.5	5	2	25+TT	11.5-TT
41	23	0	6.5	0	0	16.5	5	2	25+TT	11.5-TT
42	23	0	6.5	0	0	16.5	5	2	25+TT	11.5-TT
43	23	0	6.5	8	0	15	5	2	25+TT	10-TT
44	23	0	6.5	12	0	11	6	2	25+TT	5-TT

NOTE 1: P_{PowerClass} is the maximum UE power specified without taking into account the tolerance.

NOTE 2: TT for each frequency and channel bandwidth is specified in Table 6.2.3.5-0.

Table 6.2.3.5-32: UE Power Class 3 test requirements (NS_21)

Test ID	ChBw (MHz)	P _{PowerClass} (dBm)	MPR (dB)	A-MPR (dB)	ΔT _{C,c} (dB)	P _{C_{MAX}L,c} (dBm)	T(P _{C_{MAX}L,c}) (dB)	T _{L,c} (dB)	Upper limit (dBm)	Lower limit (dBm)
---------	------------	-------------------------------	----------	------------	------------------------	---------------------------------------	------------------------------------------	-----------------------	-------------------	-------------------

1, 2	5	23	0.5	0	0	22.5	2	2	25+TT	20.5-TT
	10	23	0.5	6	0	17	5	2	25+TT	12-TT
3	5	23	0.5	0	0	22.5	2	2	25+TT	20.5-TT
	10	23	0.5	4	0	19	3.5	2	25+TT	15.5-TT
4, 5	10	23	3	3	0	20	2.5	2	25+TT	17.5-TT
6, 7	5	23	1	0	0	22	2	2	25+TT	20-TT
	10	23	1	6	0	17	5	2	25+TT	12-TT
8	5	23	1	0	0	22	2	2	25+TT	20-TT
	10	23	1	4	0	19	3.5	2	25+TT	15.5-TT
9, 10	10	23	1	3	0	20	2.5	2	25+TT	17.5-TT
11, 12	5	23	2	0	0	21	2	2	25+TT	19-TT
	10	23	2	6	0	17	5	2	25+TT	12-TT
13	5	23	2	0	0	21	2	2	25+TT	19-TT
	10	23	2	4	0	19	3.5	2	25+TT	15.5-TT
14, 15	10	23	2	3	0	20	2.5	2	25+TT	17.5-TT
16, 17	5	23	2.5	0	0	20.5	2.5	2	25+TT	18-TT
	10	23	2.5	6	0	17	5	2	25+TT	12-TT
18	5	23	2.5	0	0	20.5	2.5	2	25+TT	18-TT
	10	23	2.5	4	0	19	3.5	2	25+TT	15.5-TT
19, 20	10	23	2.5	3	0	20	2.5	2	25+TT	17.5-TT
21, 22	5	23	4.5	0	0	18.5	4.0	2	25+TT	14.5-TT
	10	23	4.5	6	0	17	5.0	2	25+TT	12-TT
23	5	23	4.5	0	0	18.5	4.0	2	25+TT	14.5-TT
	10	23	4.5	4	0	18.5	4.0	2	25+TT	14.5-TT
24, 25	10	23	4.5	3	0	18.5	4.0	2	25+TT	14.5-TT
26, 27	5	23	3	0	0	20	2.5	2	25+TT	17.5-TT
	10	23	3	6	0	17	5	2	25+TT	12-TT
28	5	23	3	0	0	20	2.5	2	25+TT	17.5-TT
	10	23	3	5.5	0	17.5	5	2	25+TT	12.5-TT
29, 30	10	23	3	4	0	19	3.5	2	25+TT	15.5-TT
31, 32	5	23	3	0	0	20	2.5	2	25+TT	17.5-TT
	10	23	3	6	0	17	5	2	25+TT	12-TT
33	5	23	3	0	0	20	2.5	2	25+TT	17.5-TT
	10	23	3	5.5	0	17.5	5	2	25+TT	12.5-TT
34, 35	10	23	3	4	0	19	3.5	2	25+TT	15.5-TT
36, 37	5	23	3.5	0	0	19.5	3.5	2	25+TT	16-TT
	10	23	3.5	6	0	17	5	2	25+TT	12-TT
38	5	23	3.5	0	0	19.5	3.5	2	25+TT	16-TT
	10	23	3.5	5.5	0	17.5	5	2	25+TT	12.5-TT
39, 40	10	23	3.5	4	0	19	3.5	2	25+TT	15.5-TT
41, 42	5	23	6.5	0	0	16.5	5	2	25+TT	11.5-TT
	10	23	6.5	6	0	16.5	5	2	25+TT	11.5-TT
43	5	23	6.5	0	0	16.5	5	2	25+TT	11.5-TT
44, 45	10	23	6.5	5.5	0	16.5	5	2	25+TT	11.5-TT
	10	23	6.5	4	0	16.5	5	2	25+TT	11.5-TT

NOTE 1: P_{PowerClass} is the maximum UE power specified without taking into account the tolerance.

NOTE 2: TT for each frequency and channel bandwidth is specified in Table 6.2.3.5-0.

Table 6.2.3.5-33: UE Power Class 3 test requirements (NS_49)

Test ID	P _{PowerClass} (dBm)	⊠P _{PowerClass} (dB)	MPR (dB)	A-MPR (dB)	ΔT _{C,c} (dB)	P _{C_{MAX}L,c} (dBm)	T(P _{C_{MAX}L,c}) (dB)	T _{L,c} (dB)	Upper limit (dBm)	Lower limit (dBm)
1	23	0	1	3	0	20	2.5	2	25+TT	17.5-TT
2	23	0	1	3	0	20	2.5	2	25+TT	17.5-TT
3	23	0	1	3	0	20	2.5	2	25+TT	17.5-TT
4	23	0	1	10	0	13	5	2	25+TT	8-TT
5	23	0	1	5	0	18	4	2	25+TT	14-TT
6	23	0	1	3	0	20	2.5	2	25+TT	17.5-TT
7	23	0	1	4	0	19	3.5	2	25+TT	15.5-TT
8	23	0	1	6	0	17	5	2	25+TT	12-TT
9	23	0	1	5	0	18	4	2	25+TT	14-TT
10	23	0	1	10	0	13	5	2	25+TT	8-TT
11	23	0	0	5	0	18	4	2	25+TT	14-TT
12	23	0	1	4	0	19	3.5	2	25+TT	15.5-TT
13	23	0	1	6	0	17	5	2	25+TT	12-TT
14	23	0	0	5	0	18	4	2	25+TT	14-TT
15	23	0	1	10	0	13	5	2	25+TT	8-TT
16	23	0	1	10	0	13	5	2	25+TT	8-TT
17	23	0	0	5	0	18	4	2	25+TT	14-TT
18	23	0	0	5	0	18	4	2	25+TT	14-TT
19	23	0	1	6	0	17	5	2	25+TT	12-TT
20	23	0	1	10	0	13	5	2	25+TT	8-TT
21	23	0	1	10	0	13	5	2	25+TT	8-TT
22	23	0	4.5	3	0	18.5	4	2	25+TT	14.5-TT
23	23	0	4.5	3	0	18.5	4	2	25+TT	14.5-TT
24	23	0	4.5	3	0	18.5	4	2	25+TT	14.5-TT
25	23	0	4.5	10	0	13	5	2	25+TT	8-TT
26	23	0	4.5	5	0	18	4	2	25+TT	14-TT
27	23	0	4.5	3	0	18.5	4	2	25+TT	14.5-TT
28	23	0	4.5	4	0	18.5	4	2	25+TT	14.5-TT
29	23	0	4.5	6	0	17	5	2	25+TT	12-TT
30	23	0	4.5	5	0	18	4	2	25+TT	14-TT
31	23	0	4.5	10	0	13	5	2	25+TT	8-TT
32	23	0	4.5	5	0	18	4	2	25+TT	14-TT
33	23	0	4.5	4	0	18.5	4	2	25+TT	14.5-TT
34	23	0	4.5	6	0	17	5	2	25+TT	12-TT
35	23	0	4.5	5	0	18	4	2	25+TT	14-TT
36	23	0	4.5	10	0	13	5	2	25+TT	8-TT
37	23	0	4.5	10	0	13	5	2	25+TT	8-TT
38	23	0	4.5	5	0	18	4	2	25+TT	14-TT
39	23	0	4.5	5	0	18	4	2	25+TT	14-TT
40	23	0	4.5	6	0	17	5	2	25+TT	12-TT
41	23	0	4.5	10	0	13	5	2	25+TT	8-TT
42	23	0	4.5	10	0	13	5	2	25+TT	8-TT
43	23	0	3	4.5	0	18.5	4	2	25+TT	14.5-TT
44	23	0	3	4.5	0	18.5	4	2	25+TT	14.5-TT
45	23	0	3	4.5	0	18.5	4	2	25+TT	14.5-TT
46	23	0	3	11	0	12	6	2	25+TT	6-TT
47	23	0	3	5	0	18	4	2	25+TT	14-TT
48	23	0	3	4.5	0	18.5	4	2	25+TT	14.5-TT
49	23	0	3	5.5	0	17.5	5	2	25+TT	12.5-TT
50	23	0	3	7	0	16	5	2	25+TT	11-TT
51	23	0	3	5	0	18	4	2	25+TT	14-TT
52	23	0	3	11	0	12	6	2	25+TT	6-TT
53	23	0	1.5	5	0	18	4	2	25+TT	14-TT
54	23	0	3	5.5	0	17.5	5	2	25+TT	12.5-TT
55	23	0	3	7	0	16	5	2	25+TT	11-TT
56	23	0	1.5	5	0	18	4	2	25+TT	14-TT
57	23	0	3	11	0	12	6	2	25+TT	6-TT
58	23	0	3	11	0	12	6	2	25+TT	6-TT
59	23	0	1.5	5	0	18	4	2	25+TT	14-TT

Test ID	$P_{\text{PowerClass}}$ (dBm)	$\bar{P}_{\text{PowerClass}}$ (dB)	MPR (dB)	A-MPR (dB)	$\Delta T_{C,c}$ (dB)	$P_{\text{CMAX}_L,c}$ (dBm)	$T(P_{\text{CMAX}_L,c})$ (dB)	$T_{L,c}$ (dB)	Upper limit (dBm)	Lower limit (dBm)
60	23	0	1.5	5	0	18	4	2	25+TT	14-TT
61	23	0	3	7	0	16	5	2	25+TT	11-TT
62	23	0	3	11	0	12	6	2	25+TT	6-TT
63	23	0	3	11	0	12	6	2	25+TT	6-TT
64	23	0	6.5	4.5	0	16.5	5	2	25+TT	11.5-TT
65	23	0	6.5	4.5	0	16.5	5	2	25+TT	11.5-TT
66	23	0	6.5	4.5	0	16.5	5	2	25+TT	11.5-TT
67	23	0	6.5	11	0	12	6	2	25+TT	6-TT
68	23	0	6.5	5	0	16.5	5	2	25+TT	11.5-TT
69	23	0	6.5	4.5	0	16.5	5	2	25+TT	11.5-TT
70	23	0	6.5	5.5	0	16.5	5	2	25+TT	11.5-TT
71	23	0	6.5	7	0	16	5	2	25+TT	11-TT
72	23	0	6.5	5	0	16.5	5	2	25+TT	11.5-TT
73	23	0	6.5	11	0	12	6	2	25+TT	6-TT
74	23	0	6.5	5	0	16.5	5	2	25+TT	11.5-TT
75	23	0	6.5	5.5	0	16.5	5	2	25+TT	11.5-TT
76	23	0	6.5	7	0	16	5	2	25+TT	11-TT
77	23	0	6.5	5	0	16.5	5	2	25+TT	11.5-TT
78	23	0	6.5	11	0	12	6	2	25+TT	6-TT
79	23	0	6.5	11	0	12	6	2	25+TT	6-TT
80	23	0	6.5	5	0	16.5	5	2	25+TT	11.5-TT
81	23	0	6.5	5	0	16.5	5	2	25+TT	11.5-TT
82	23	0	6.5	7	0	16	5	2	25+TT	11-TT
83	23	0	6.5	11	0	12	6	2	25+TT	6-TT
84	23	0	6.5	11	0	12	6	2	25+TT	6-TT

NOTE 1: $P_{\text{PowerClass}}$ is the maximum UE power specified without taking into account the tolerance.

NOTE 2: TT for each frequency and channel bandwidth is specified in Table 6.2.3.5-0.

Table 6.2.3.5-34: UE Power Class 3 test requirements (NS_06) for band n12 and n14

Test ID	P _{PowerClass} (dBm)	MPR (dB)	A-MPR (dB)	$\Delta T_{C,c}$ (dB)	P _{C_{MAX,c}} (dBm)	T(P _{C_{MAX,L,c}}) (dB)	T _{L,c} (dB)	Upper limit (dBm)	Lower limit (dBm)
1	23	0.5	0	0	22.5	2	2.5	25+TT	20.5-TT
2	23	0.5	0	0	22.5	2	2.5	25+TT	20.5-TT
3	23	0.5	0	0	22.5	2	2.5	25+TT	20.5-TT
4	23	1	0	0	22	2	2.5	25+TT	20-TT
5	23	1	0	0	22	2	2.5	25+TT	20-TT
6	23	1	0	0	22	2	2.5	25+TT	20-TT
7	23	2	0	0	21	2	2.5	25+TT	19-TT
8	23	2	0	0	21	2	2.5	25+TT	19-TT
9	23	2	0	0	21	2	2.5	25+TT	19-TT
10	23	2.5	0	0	20.5	2.5	2.5	25+TT	18-TT
11	23	2.5	0	0	20.5	2.5	2.5	25+TT	18-TT
12	23	2.5	0	0	20.5	2.5	2.5	25+TT	18-TT
13	23	4.5	0	0	18.5	4	2.5	25+TT	14.5-TT
14	23	4.5	0	0	18.5	4	2.5	25+TT	14.5-TT
15	23	4.5	0	0	18.5	4	2.5	25+TT	14.5-TT
16	23	3	0	0	20	2.5	2.5	25+TT	17.5-TT
17	23	3	0	0	20	2.5	2.5	25+TT	17.5-TT
18	23	3	0	0	20	2.5	2.5	25+TT	17.5-TT
19	23	3	0	0	20	2.5	2.5	25+TT	17.5-TT
20	23	3	0	0	20	2.5	2.5	25+TT	17.5-TT
21	23	3	0	0	20	2.5	2.5	25+TT	17.5-TT
22	23	3.5	0	0	19.5	3.5	2.5	25+TT	16-TT
23	23	3.5	0	0	19.5	3.5	2.5	25+TT	16-TT
24	23	3.5	0	0	19.5	3.5	2.5	25+TT	16-TT
25	23	6.5	0	0	16.5	5	2.5	25+TT	11.5-TT
26	23	6.5	0	0	16.5	5	2.5	25+TT	11.5-TT
27	23	6.5	0	0	16.5	5	2.5	25+TT	11.5-TT

NOTE 1: P_{PowerClass} is the maximum UE power specified without taking into account the tolerance.

NOTE 2: TT for each frequency and channel bandwidth is specified in Table 6.2.3.5-0.

Table 6.2.3.5-35: UE Power Class 1 test requirements (NS_06) for band n14

Test ID	P _{PowerClass} (dBm)	MPR (dB)	A-MPR (dB)	$\Delta T_{C,c}$ (dB)	P _{CMAX,c} (dBm)	T(P _{CMAX_L,c}) (dB)	T _{L,c} (dB)	Upper limit (dBm)	Lower limit (dBm)
1	31	0.5	0	0	30.5	2	3	33+TT	27.5-TT
2	31	0.5	0	0	30.5	2	3	33+TT	27.5-TT
3	31	0.5	0	0	30.5	2	3	33+TT	27.5-TT
4	31	1	0	0	30	2	3	33+TT	27-TT
5	31	1	0	0	30	2	3	33+TT	27-TT
6	31	1	0	0	30	2	3	33+TT	27-TT
7	31	2	0	0	29	2	3	33+TT	26-TT
8	31	2	0	0	29	2	3	33+TT	26-TT
9	31	2	0	0	29	2	3	33+TT	26-TT
10	31	2.5	0	0	28.5	2	3	33+TT	25.5-TT
11	31	2.5	0	0	28.5	2	3	33+TT	25.5-TT
12	31	2.5	0	0	28.5	2	3	33+TT	25.5-TT
13	31	4.5	0	0	26.5	2	3	33+TT	23.5-TT
14	31	4.5	0	0	26.5	2	3	33+TT	23.5-TT
15	31	4.5	0	0	26.5	2	3	33+TT	23.5-TT
16	31	3	0	0	28	2	3	33+TT	25-TT
17	31	3	0	0	28	2	3	33+TT	25-TT
18	31	3	0	0	28	2	3	33+TT	25-TT
19	31	3	0	0	28	2	3	33+TT	25-TT
20	31	3	0	0	28	2	3	33+TT	25-TT
21	31	3	0	0	28	2	3	33+TT	25-TT
22	31	3.5	0	0	27.5	2	3	33+TT	24.5-TT
23	31	3.5	0	0	27.5	2	3	33+TT	24.5-TT
24	31	3.5	0	0	27.5	2	3	33+TT	24.5-TT
25	31	6.5	0	0	24.5	2	3	33+TT	21.5-TT
26	31	6.5	0	0	24.5	2	3	33+TT	21.5-TT
27	31	6.5	0	0	24.5	2	3	33+TT	21.5-TT
28	31	0.5	0	0	30.5	2	3	33+TT	27.5-TT
29	31	0.5	0	0	30.5	2	3	33+TT	27.5-TT
30	31	0	0	0	31	2	3	33+TT	28-TT

NOTE 1: P_{PowerClass} is the maximum UE power specified without taking into account the tolerance.

NOTE 2: TT for each frequency and channel bandwidth is specified in Table 6.2.3.5-0.

Table 6.2.3.5-36: UE Power Class 3 test requirements (NS_56) for band n24

Test ID	P ^{PowerClass} (dBm)	MPR (dB)	A-MPR (dB)	$\Delta T_{C,c}$ (dB)	P _{CMAX,c} (dBm)	T(P _{CMAX,L,c}) (dB)	T _{L,c} (dB)	Upper limit (dBm)	Lower limit (dBm)
1	23	0.5	14	0	9	6	3	25+TT	3-TT
2	23	0.5	8	0	15	5	3	25+TT	10-TT
3	23	0.5	6	0	17	5	3	25+TT	12-TT
4	23	0.5	4	0	19	3.5	3	25+TT	15.5-TT
5	23	0	4	0	19	3.5	3	25+TT	15.5-TT
6	23	1	14	0	9	6	3	25+TT	3-TT
7	23	1	8	0	15	5	3	25+TT	10-TT
8	23	1	6	0	17	5	3	25+TT	12-TT
9	23	1	4	0	19	3.5	3	25+TT	15.5-TT
10	23	0	4	0	19	3.5	3	25+TT	15.5-TT
11	23	2	14	0	9	6	3	25+TT	3-TT
12	23	2	8	0	15	5	3	25+TT	10-TT
13	23	2	6	0	17	5	3	25+TT	12-TT
14	23	2	4	0	19	3.5	3	25+TT	15.5-TT
15	23	1	4	0	19	3.5	3	25+TT	15.5-TT
16	23	2.5	14	0	9	6	3	25+TT	3-TT
17	23	2.5	8	0	15	5	3	25+TT	10-TT
18	23	2.5	6	0	17	5	3	25+TT	12-TT
19	23	2.5	4	0	19	3.5	3	25+TT	15.5-TT
20	23	2.5	4	0	19	3.5	3	25+TT	15.5-TT
21	23	4.5	14	0	9	6	3	25+TT	3-TT
22	23	4.5	8	0	15	5	3	25+TT	10-TT
23	23	4.5	6	0	17	5	3	25+TT	12-TT
24	23	4.5	4	0	18.5	3.5	3	25+TT	15-TT
25	23	4.5	4	0	18.5	3.5	3	25+TT	15-TT
26	23	0.5	12	0	11	6	3	25+TT	5-TT
27	23	0.5	8	0	15	5	3	25+TT	10-TT
28	23	0.5	8	0	15	5	3	25+TT	10-TT
29	23	0	6	0	17	5	3	25+TT	12-TT
30	23	0.5	6	0	17	5	3	25+TT	12-TT
31	23	0	4	0	19	3.5	3	25+TT	15.5-TT
32	23	0.5	2	0	21	2	3	25+TT	18-TT
33	23	0.5	5	0	18	4	3	25+TT	14-TT
34	23	0	5	0	18	4	3	25+TT	14-TT
35	23	0	5	0	18	4	3	25+TT	14-TT
36	23	0.5	3	0	20	2.5	3	25+TT	17-TT
37	23	1	12	0	11	6	3	25+TT	5-TT
38	23	1	8	0	15	5	3	25+TT	10-TT
39	23	1	8	0	15	5	3	25+TT	10-TT
40	23	0	6	0	17	5	3	25+TT	12-TT
41	23	1	6	0	17	5	3	25+TT	12-TT
42	23	0	4	0	19	3.5	3	25+TT	15.5-TT
43	23	1	2	0	21	2	3	25+TT	18-TT
44	23	1	5	0	18	4	3	25+TT	14-TT
45	23	0	5	0	18	4	3	25+TT	14-TT
46	23	0	5	0	18	4	3	25+TT	14-TT
47	23	1	3	0	20	2.5	3	25+TT	17-TT
48	23	2	12	0	11	6	3	25+TT	5-TT
49	23	2	8	0	15	5	3	25+TT	10-TT
50	23	2	8	0	15	5	3	25+TT	10-TT
51	23	1	6	0	17	5	3	25+TT	12-TT
52	23	2	6	0	17	5	3	25+TT	12-TT
53	23	1	4	0	19	3.5	3	25+TT	15.5-TT
54	23	2	2	0	21	2	3	25+TT	18-TT
55	23	2	5	0	18	4	3	25+TT	14-TT
56	23	1	5	0	18	4	3	25+TT	14-TT
57	23	1	5	0	18	4	3	25+TT	14-TT
58	23	2	3	0	20	2.5	3	25+TT	17-TT
59	23	2.5	12	0	11	6	3	25+TT	5-TT

Test ID	P _{PowerClass} (dBm)	MPR (dB)	A-MPR (dB)	$\Delta T_{C,c}$ (dB)	P _{C_{MAX,c}} (dBm)	T(P _{C_{MAX,L,c}}) (dB)	T _{L,c} (dB)	Upper limit (dBm)	Lower limit (dBm)
60	23	2.5	8	0	15	5	3	25+TT	10-TT
61	23	2.5	8	0	15	5	3	25+TT	10-TT
62	23	2.5	6	0	17	5	3	25+TT	12-TT
63	23	2.5	6	0	17	5	3	25+TT	12-TT
64	23	2.5	4	0	19	3.5	3	25+TT	15.5-TT
65	23	2.5	2	0	20.5	2.5	3	25+TT	17.5-TT
66	23	2.5	5	0	18	4	3	25+TT	14-TT
67	23	2.5	5	0	18	4	3	25+TT	14-TT
68	23	2.5	5	0	18	4	3	25+TT	14-TT
69	23	2.5	3	0	20	2.5	3	25+TT	17-TT
70	23	4.5	12	0	11	6	3	25+TT	5-TT
71	23	4.5	8	0	15	5	3	25+TT	10-TT
72	23	4.5	8	0	15	5	3	25+TT	10-TT
73	23	4.5	6	0	17	5	3	25+TT	12-TT
74	23	4.5	6	0	17	5	3	25+TT	12-TT
75	23	4.5	4	0	18.5	4	3	25+TT	14.5-TT
76	23	4.5	2	0	18.5	4	3	25+TT	14.5-TT
77	23	4.5	5	0	18	4	3	25+TT	14-TT
78	23	4.5	5	0	18	4	3	25+TT	14-TT
79	23	4.5	5	0	18	4	3	25+TT	14-TT
80	23	4.5	3	0	18.5	4	3	25+TT	14.5-TT
81	23	3	14	0	9	6	3	25+TT	3-TT
82	23	3	8	0	15	5	3	25+TT	10-TT
83	23	3	6	0	17	5	3	25+TT	12-TT
84	23	3	4	0	19	3.5	3	25+TT	15.5-TT
85	23	1.5	4	0	19	3.5	3	25+TT	15.5-TT
86	23	3	14	0	9	6	3	25+TT	3-TT
87	23	3	8	0	15	5	3	25+TT	10-TT
88	23	3	6	0	17	5	3	25+TT	12-TT
89	23	3	4	0	19	3.5	3	25+TT	15.5-TT
90	23	2	4	0	19	3.5	3	25+TT	15.5-TT
91	23	3.5	14	0	9	6	3	25+TT	3-TT
92	23	3.5	8	0	15	5	3	25+TT	10-TT
93	23	3.5	6	0	17	5	3	25+TT	12-TT
94	23	3.5	4	0	19	3.5	3	25+TT	15.5-TT
95	23	3.5	4	0	19	3.5	3	25+TT	15.5-TT
96	23	6.5	14	0	9	6	3	25+TT	3-TT
97	23	6.5	8	0	15	5	3	25+TT	10-TT
98	23	6.5	6	0	16.5	5	3	25+TT	11.5-TT
99	23	6.5	4	0	16.5	5	3	25+TT	11.5-TT
100	23	6.5	4	0	16.5	5	3	25+TT	11.5-TT
101	23	3	12	0	9	6	3	25+TT	5-TT
102	23	3	8	0	11	5	3	25+TT	10-TT
103	23	3	8	0	15	5	3	25+TT	10-TT
104	23	1.5	6	0	17	5	3	25+TT	12-TT
105	23	3	6	0	17	5	3	25+TT	12-TT
106	23	1.5	4	0	19	3.5	3	25+TT	15.5-TT
107	23	3	2	0	20	2.5	3	25+TT	17-TT
108	23	3	5	0	18	4	3	25+TT	14-TT
109	23	1.5	5	0	18	4	3	25+TT	14-TT
110	23	1.5	5	0	18	4	3	25+TT	14-TT
111	23	3	3	0	20	2.5	3	25+TT	17-TT
112	23	3	12	0	11	6	3	25+TT	5-TT
113	23	3	8	0	15	5	3	25+TT	10-TT
114	23	3	8	0	15	5	3	25+TT	10-TT
115	23	2	6	0	17	5	3	25+TT	12-TT
116	23	3	6	0	17	5	3	25+TT	12-TT
117	23	2	4	0	19	3.5	3	25+TT	15.5-TT
118	23	3	2	0	20	2.5	3	25+TT	17-TT
119	23	3	5	0	18	4	3	25+TT	14-TT

Test ID	P _{PowerClass} (dBm)	MPR (dB)	A-MPR (dB)	$\Delta T_{C,c}$ (dB)	P _{C_{MAX,c}} (dBm)	T(P _{C_{MAX,L,c}}) (dB)	T _{L,c} (dB)	Upper limit (dBm)	Lower limit (dBm)
120	23	2	5	0	18	4	3	25+TT	14-TT
121	23	2	5	0	18	4	3	25+TT	14-TT
122	23	3	3	0	20	2.5	3	25+TT	17-TT
123	23	3.5	12	0	11	6	3	25+TT	5-TT
124	23	3.5	8	0	15	5	3	25+TT	10-TT
125	23	3.5	8	0	15	5	3	25+TT	10-TT
126	23	3.5	6	0	17	5	3	25+TT	12-TT
127	23	3.5	6	0	17	5	3	25+TT	12-TT
128	23	3.5	4	0	19	3.5	3	25+TT	15.5-TT
129	23	3.5	2	0	19.5	3.5	3	25+TT	16-TT
130	23	3.5	5	0	18	3.5	3	25+TT	14.5-TT
131	23	3.5	5	0	18	3.5	3	25+TT	14.5-TT
132	23	3.5	5	0	18	3.5	3	25+TT	14.5-TT
133	23	3.5	3	0	19.5	3.5	3	25+TT	16-TT
134	23	6.5	12	0	11	6	3	25+TT	5-TT
135	23	6.5	8	0	15	5	3	25+TT	10-TT
136	23	6.5	8	0	15	5	3	25+TT	10-TT
137	23	6.5	6	0	16.5	5	3	25+TT	11.5-TT
138	23	6.5	6	0	16.5	5	3	25+TT	11.5-TT
139	23	6.5	4	0	16.5	5	3	25+TT	11.5-TT
140	23	6.5	2	0	16.5	5	3	25+TT	11.5-TT
141	23	6.5	5	0	16.5	5	3	25+TT	11.5-TT
142	23	6.5	5	0	16.5	5	3	25+TT	11.5-TT
143	23	6.5	5	0	16.5	5	3	25+TT	11.5-TT
144	23	6.5	3	0	16.5	5	3	25+TT	11.5-TT

NOTE 1: P_{PowerClass} is the maximum UE power specified without taking into account the tolerance.
NOTE 2: TT for each frequency and channel bandwidth is specified in Table 6.2.3.5-0.

For the UE which supports inter-band NR CA configuration, inter-band NR-DC configuration, SUL configuration or inter-band EN-DC configuration, $\Delta T_{IB,c}$ as specified in 6.2A.4.0.2 for NR CA, 6.2B.4.0.2 for NR-DC, clause 6.2C.2 for SUL, or TS 38.521-3 [14] clause 6.2B.4.2 for EN-DC applies. Unless otherwise stated, $\Delta T_{IB,c}$ is set to zero. In case the UE supports more than one of band combinations for CA, NR-DC, SUL or DC, and an operating band belongs to more than one band combinations then

- When the operating band frequency range is ≤ 1 GHz, the applicable additional $\Delta T_{IB,c}$ shall be the average value for all band combinations defined in clause 6.2A.4.0.2, 6.2B.4.0.2, 6.2C.2 in this specification and 6.2B.4.2 in TS 38.521-3 [14], truncated to one decimal place that apply for that operating band among the supported band combinations. In case there is a harmonic relation between low band UL and high band DL, then the maximum $\Delta T_{IB,c}$ among the different supported band combinations involving such band shall be applied
- When the operating band frequency range is > 1 GHz, the applicable additional $\Delta T_{IB,c}$ shall be the maximum value for all band combinations defined in clause 6.2A.4.0.2, 6.2B.4.0.2, 6.2C.2 in this specification and 6.2B.4.2 in TS 38.521-3 [14] for the applicable operating bands.

6.2.4 Configured transmitted power

6.2.4.1 Test purpose

To verify the measured UE configured maximum output power P_{UMAX,f,c} is within the specified bounds.

6.2.4.2 Test applicability

This test case applies to all types of NR Power Class 2 and 3 UE release 15 and forward and NR Power Class 1 UE release 15 and forward in NR Band n14.

6.2.4.3 Minimum conformance requirements

The UE is allowed to set its configured maximum output power P_{C_{MAX,f,c}} for carrier f of serving cell c in each slot. The configured maximum output power P_{C_{MAX,f,c}} is set within the following bounds:

$$P_{C_{MAX,L,f,c}} \leq P_{C_{MAX,f,c}} \leq P_{C_{MAX,H,f,c}} \text{ with}$$

$$P_{\text{CMAX_L,f,c}} = \text{MIN} \{ P_{\text{EMAX,c}} - \Delta T_{\text{C,c}}, (P_{\text{PowerClass}} - \Delta P_{\text{PowerClass}}) - \text{MAX}(\text{MAX}(\text{MPR}_c + \Delta \text{MPR}_c, A - \text{MPR}_c) + \Delta T_{\text{IB,c}} + \Delta T_{\text{C,c}} + \Delta T_{\text{RxSRS}}, P - \text{MPR}_c) \}$$

$$P_{\text{CMAX_H,f,c}} = \text{MIN} \{ P_{\text{EMAX,c}}, P_{\text{PowerClass}} - \Delta P_{\text{PowerClass}} \}$$

where

$P_{\text{EMAX,c}}$ is the value given by either the *p-Max* IE or the field *additionalPmax* of the *NR-NS-PmaxList* IE, whichever is applicable according to TS 38.331[7];

$P_{\text{PowerClass}}$ is the maximum UE power specified in Table 6.2.1.3-1 without taking into account the tolerance specified in the Table 6.2.1.3-1;

When the IE *powerBoostPi2BPSK* is set to 1, $P_{\text{EMAX,c}}$ is increased by +3 dB for a power class 3 capable UE operating in TDD bands n40, n41, n77, n78, and n79 with PI/2 BPSK modulation and UE indicates support for UE capability *powerBoosting-pi2BPSK* and 40% or less slots in radio frame are used for UL transmission when $P_{\text{EMAX,c}} \geq 20$ dBm (The exact evaluation period is no less than one radio frame).

When the IE *powerBoostPi2BPSK* is set to 1, $\Delta P_{\text{PowerClass}} = -3$ dB for a power class 3 capable UE operating in TDD bands n40, n41, n77, n78, and n79 with PI/2 BPSK modulation and UE indicates support for UE capability *powerBoosting-pi2BPSK* and 40% or less slots in radio frame are used for UL transmission.

$\Delta P_{\text{PowerClass}} =$

- 3 dB for a power class 2 capable UE or 6 dB for a power class 1.5 UE when P-max of 23 dBm or lower is indicated; or when the field of UE capability *maxUplinkDutyCycle-PC2-FR1* is absent and the field of UE capability *maxUplinkDutyCycle-MPE-FR1* is absent and the percentage of uplink symbols transmitted in a certain evaluation period is larger than 50%; or when the field of UE capability *maxUplinkDutyCycle-PC2-FR1* is not absent and the percentage of uplink symbols transmitted in a certain evaluation period is larger than *maxUplinkDutyCycle-PC2-FR1* as defined in TS 38.306 (The exact evaluation period is no less than one radio frame); or when the field of UE capability *maxUplinkDutyCycle-MPE-FR1* is not absent and half the percentage of uplink symbols transmitted in a certain evaluation period is larger than *maxUplinkDutyCycle-MPE-FR1* as defined in TS 38.306 (The exact evaluation period is no less than one radio frame).
- 3 dB for a power class 1.5 capable UE when P-max of between 23 dBm and 26 dB is indicated; or when the field of UE capability *maxUplinkDutyCycle-PC2-FR1* is absent and the field of UE capability *maxUplinkDutyCycle-MPE-FR1* is absent and the percentage of uplink symbols transmitted in a certain evaluation period is between 25% and 50%; or when the field of UE capability *maxUplinkDutyCycle-PC2-FR1* is not absent and the percentage of uplink symbols transmitted in a certain evaluation period is between *maxUplinkDutyCycle-PC2-FR1* and *maxUplinkDutyCycle-PC2-FR1/2* as defined in TS 38.306 (The exact evaluation period is no less than one radio frame); or when the field of UE capability *maxUplinkDutyCycle-MPE-FR1* is not absent and the percentage of uplink symbols transmitted in a certain evaluation period is larger than *maxUplinkDutyCycle-MPE-FR1* as defined in TS 38.306 (The exact evaluation period is no less than one radio frame).
- 3dB when the UE is configured with SUL configurations and the requirements of default power class are applied as specified in sub-clause 6.2C.1.3 on the band where UE indicates power class 2;
- 3dB is applied during SRS transmission occasions with usage in SRS-ResourceSet set as 'antennaSwitching' with configured SRS resources in each SRS resource set(s) consisting of one SRS port when PC2 capable UE with *txDiversity-r16* capability or PC1.5 capable UE further indicates SRS-TxSwitch capability 't1r2' or 't1r4' or 't1r1-t1r2' or 't1r1-t1r2-t1r4';
- 0 dB otherwise;

$\Delta T_{\text{IB,c}}$ is the additional tolerance for serving cell c as specified in clause 6.2A.4.0.2 for NR CA, clause 6.2C.2 for SUL, or TS 38.101-3 [4] clause 6.2B.4.2 for EN-DC; $\Delta T_{\text{IB,c}} = 0$ dB otherwise; In case the UE supports more than one of band combinations for V2X operating bands for concurrent operation, CA, SUL or DC, and an operating band belongs to more than one band combinations then

- a) When the operating band frequency range is ≤ 1 GHz, the applicable additional $\Delta T_{\text{IB,c}}$ shall be the average value for all band combinations defined in clause 6.2A.4.0.2 for NR CA, clause 6.2C.2 for SUL in this specification and 6.2B.4.2 in TS 38.101-3 [4] for EN-DC, truncated to one decimal place that apply for that operating band among the supported band combinations. In case there is a harmonic relation between low

band UL and high band DL, then the maximum $\Delta T_{IB,c}$ among the different supported band combinations involving such band shall be applied

- b) When the operating band frequency range is > 1 GHz, the applicable additional $\Delta T_{IB,c}$ shall be the maximum value for all band combinations defined in clause 6.2A.4.0.2 for NR CA, clause 6.2C.2 for SUL in this specification and 6.2B.4.2 in TS 38.101-3 [4] for EN-DC, for the applicable operating bands.

$\Delta T_{C,c} = 1.5\text{dB}$ when NOTE 3 in Table 6.2.1.3-1 in 38.521-1 applies for a serving cell c, otherwise $\Delta T_{C,c} = 0\text{ dB}$;

MPR_c and $A-MPR_c$ for serving cell c are specified in clause 6.2.2.3 and clause 6.2.3.3, respectively;

ΔMPR_c for serving cell c is specified in clause 6.2.2.3.

ΔT_{R_xSRS} is applied during SRS transmission occasions with *usage* in *SRS-ResourceSet* set as 'antennaSwitching' when

- a) UE transmits SRS on the second SRS resource in every configured SRS resource set when the *SRS-TxSwitch* capability is indicated as 't1r2' or 't1r1-t1r2'
- b) UE transmits SRS on the second, third and fourth SRS resources of the total 4 SRS resources from all configured SRS resource set(s) consisting of one SRS port when the *SRS-TxSwitch* capability is indicated as 't1r4' or, 't1r4-t2r4' or 't1r1-t1r2-t1r4' or, 't1r1-t1r2-t2r2-t1r4-t2r4'
- c) UE transmits SRS from the second SRS port pair on the second SRS resource in every configured SRS resource set consisting of two SRS ports when the *SRS-TxSwitch* capability is indicated as 't2r4' or 't1r4-t2r4', or 't1r1-t1r2-t2r2-t2r4' or 't1r1-t1r2-t2r2-t1r4-t2r4', or
- d) UE transmits SRS to a DL-only carrier

The value of ΔT_{R_xSRS} is 4.5dB for bands whose F_{UL_high} is higher than the F_{UL_low} of n79 and 3 dB for bands whose F_{UL_high} is lower than the F_{UL_low} of n79 when the device is capable of power class 3 or power class 5 or power class 1.5 in the band, or when the device is capable of power class 2 in the band and $\Delta P_{PowerClass} = 3\text{ dB}$, or when UE indicating *txDiversity-r16*.

The value of ΔT_{R_xSRS} is 7.5dB for bands whose F_{UL_high} is higher than the F_{UL_low} of n79 and 6 dB for bands whose F_{UL_high} is lower than the F_{UL_low} of n79 during SRS transmission occasions with configured SRS resources consisting of one SRS port when the device is capable of power class 2 in the band and $\Delta P_{PowerClass} = 0\text{ dB}$ and not indicating *txDiversity-r16*.

For other SRS transmissions ΔT_{R_xSRS} is zero;

$P-MPR_c$ is the allowed maximum output power reduction for

- a) ensuring compliance with applicable electromagnetic energy absorption requirements and addressing unwanted emissions / self defence requirements in case of simultaneous transmissions on multiple RAT(s) for scenarios not in scope of 3GPP RAN specifications;
- b) ensuring compliance with applicable electromagnetic energy absorption requirements in case of proximity detection is used to address such requirements that require a lower maximum output power.

The UE shall apply $P-MPR_c$ for serving cell c only for the above cases. For UE conducted conformance testing $P-MPR_c$ shall be 0 dB

NOTE 1: $P-MPR_c$ was introduced in the $P_{CMAX,f,c}$ equation such that the UE can report to the eNB the available maximum output transmit power. This information can be used by the eNB for scheduling decisions.

NOTE 2: $P-MPR_c$ may impact the maximum uplink performance for the selected UL transmission path.

T_{REF} and T_{eval} are specified in Table 6.2.4.3-1. For each T_{REF} , the $P_{CMAX,L,c}$ for serving cell c are evaluated per T_{eval} and given by the minimum value taken over the transmission(s) within the T_{eval} ; the minimum $P_{CMAX,L,f,c}$ over one or more T_{eval} is then applied for the entire T_{REF}

Table 6.2.4.3-1: Evaluation and reference periods for P_{cm}

T_{REF}	T_{eval}	T_{eval} with frequency hopping
-----------	------------	-----------------------------------

Physical channel length	Physical channel length	Min($T_{no_hopping}$, Physical Channel Length)
-------------------------	-------------------------	---------------------------------------------------

The measured configured maximum output power $P_{UMAX,f,c}$ shall be within the following bounds:

$$P_{CMAX,L,f,c} - \text{MAX}\{T_{L,c}, T(P_{CMAX,L,f,c})\} \leq P_{UMAX,f,c} \leq P_{CMAX,H,f,c} + T(P_{CMAX,H,f,c}).$$

where the tolerance $T(P_{CMAX,f,c})$ for applicable values of $P_{CMAX,f,c}$ is specified in Table 6.2.4.3-2. The tolerance $T_{L,c}$ is the absolute value of the lower tolerance for the applicable operating band as specified in Table 6.2.1.3-1.

Table 6.2.4.3-2: P_{CMAX} tolerance

$P_{CMAX,f,c}$ (dBm)	Tolerance $T(P_{CMAX,f,c})$ (dB)
$23 < P_{CMAX,c} \leq 33$	2.0
$21 \leq P_{CMAX,c} \leq 23$	2.0
$20 \leq P_{CMAX,c} < 21$	2.5
$19 \leq P_{CMAX,c} < 20$	3.5
$18 \leq P_{CMAX,c} < 19$	4.0
$13 \leq P_{CMAX,c} < 18$	5.0
$8 \leq P_{CMAX,c} < 13$	6.0
$-40 \leq P_{CMAX,c} < 8$	7.0

The normative reference for this requirement is TS 38.101-1 [2] clause 6.2.4.

6.2.4.4 Test description

6.2.4.4.1 Initial condition

Initial conditions are a set of test configurations the UE needs to be tested in and the steps for the SS to take with the UE to reach the correct measurement state.

The initial test configurations consist of environmental conditions, test frequencies, test channel bandwidths and sub-carrier spacing based on NR operating bands specified in table 5.3.5-1. All of these configurations shall be tested with applicable test parameters for each combination of test channel bandwidth and sub-carrier spacing, and are shown in table 6.2.4.4.1-1. The details of the uplink reference measurement channels (RMCs) are specified in Annexes A.2. Configurations of PDSCH and PDCCH before measurement are specified in Annex C.2.

Table 6.2.4.4.1-1: Test Configuration Table

Initial Conditions			
Test Environment as specified in TS 38.508-1 [5] subclause 4.1		Normal, TL/VL, TL/VH, TH/VL, TH/VH	
Test Frequencies as specified in TS 38.508-1 [5] subclause 4.3.1		Mid range (NOTE 4)	
Test Channel Bandwidths as specified in TS 38.508-1 [5] subclause 4.3.1		Lowest, Mid, Highest	
Test SCS as specified in Table 5.3.5-1		Lowest	
Test Parameters for Channel Bandwidths			
Test ID	Downlink Configuration	Uplink Configuration	
	N/A	Modulation (NOTE 2)	RB allocation (NOTE 1)
1		DFT-s-OFDM Pi/2 BPSK	Inner Full
2		DFT-s-OFDM QPSK	Inner Full
3 ³		DFT-s-OFDM Pi/2 BPSK	Inner Full
NOTE 1: The specific configuration of each RB allocation is defined in Table 6.1-1.			
NOTE 2: DFT-s-OFDM PI/2 BPSK test applies only for UEs which supports half Pi BPSK in FR1.			
NOTE 3: UE operating in TDD mode with PI/2 PBSK modulation and UE indicates support for UE capability <i>powerBoosting-pi2BPSK</i> and the IE <i>powerBoostPi2BPSK</i> is set to 1 for bands n40, n41, n77, n78 and n79.			
NOTE 4: For NR band n28, 30MHz test channel bandwidth is tested with Low range test frequencies.			

1. Connect the SS to the UE antenna connectors as shown in TS 38.508-1 [5] Annex A, Figure A.3.1.1.1 for TE diagram and section A.3.2 for UE diagram.

2. The parameter settings for the cell are set up according to TS 38.508-1 [5] subclause 4.4.3.
3. Downlink signals are initially set up according to Annex C.0, C.1, C.2, and uplink signals according to Annex G.0, G.1, G.2, G.3.0.
4. The UL Reference Measurement Channel is set according to Table 6.2.4.4.1-1.
5. Propagation conditions are set according to Annex B.0.
6. Ensure the UE is in State RRC_CONNECTED with generic procedure parameters Connectivity NR, Connected without release On, Test Mode On and Test Loop Function On according to TS 38.508-1 [5] clause 4.5. Message contents are defined in clause 6.2.4.4.3.

6.2.4.4.2 Test procedure

1. SS sends uplink scheduling information for each UL HARQ process via PDCCH DCI format 0_1 for C_RNTI to schedule the UL RMC according to Table 6.2.4.4.1-1. Since the UE has no payload and no loopback data to send the UE sends uplink MAC padding bits on the UL RMC.
2. Send continuously uplink power control "up" commands in every uplink scheduling information to the UE; allow at least 200ms starting from the first TPC command in this step to ensure that the UE reaches the P_{max} level of the test point.
3. Measure the mean power of the UE in the channel bandwidth for each test point in table 6.2.4.5-1 according to the test configuration from table 6.2.4.4.1-1. The period of measurement shall be at least the continuous duration of one active slot and in the uplink symbols. For TDD slots with transient periods are not under test.

6.2.4.4.3 Message contents

Message contents are according to TS 38.508-1 [5] subclause 4.6 with the following exceptions:

Table 6.2.4.4.3-0: PUSCH-Config

Derivation Path: TS 38.508-1 [5], Table 4.6.3-118 with condition TRANSFORM_PRECODER_ENABLED

Table 6.2.4.4.3-1: FrequencyInfoUL-SIB: Test point 1

Derivation Path: TS 38.508-1 [5] Table 4.6.3-62 FrequencyInfoUL-SIB			
Information Element	Value/remark	Comment	Condition
p-Max	-10		

Table 6.2.4.4.3-2: FrequencyInfoUL-SIB: Test point 2

Derivation Path: TS 38.508-1 [5] Table 4.6.3-62 FrequencyInfoUL-SIB			
Information Element	Value/remark	Comment	Condition
p-Max	10		

Table 6.2.4.4.3-3: FrequencyInfoUL-SIB: Test point 3

Derivation Path: TS 38.508-1 [5] Table 4.6.3-62 FrequencyInfoUL-SIB			
Information Element	Value/remark	Comment	Condition
p-Max	15		

Table 6.2.4.4.3-4: FrequencyInfoUL-SIB: Test point 4

Derivation Path: TS 38.508-1 [5] Table 4.6.3-62 FrequencyInfoUL-SIB			
Information Element	Value/remark	Comment	Condition
p-Max	20		

Table 6.2.4.4.3-5: ServingCellConfig

Derivation Path: TS 38.508-1 [5] Table 4.6.3-167			
Information Element	Value/remark	Comment	Condition
ServingCellConfig ::= SEQUENCE {			
uplinkConfig SEQUENCE {			
powerBoostPi2BPSK	0		Test ID 1, 2
	1		Test ID 3
}			
}			

6.2.4.5 Test requirement

The maximum output power measured shall not exceed the values specified in Table 6.2.4.5-1.

Table 6.2.4.5-1: P_{C_{MAX}} configured UE output power

	Maximum output power	
	Test ID 1,2	Test ID 3
Measured UE output power test point 1	-10 dBm ± (7+TT)	-10 dBm +7+TT/-7.2-TT
Measured UE output power test point 2	10 dBm ± (6+TT)	10 dBm +6+TT/-6.2-TT
Measured UE output power test point 3	15 dBm ± (5+TT)	15 dBm +5+TT/-5.2-TT
Measured UE output power test point 4	Note 3	Note 4
Note 1: TT for each frequency and channel bandwidth is specified in Table 6.2.4.5-2.		
Note 2: Power class 3 is default power class unless otherwise stated.		
Note 3: The maximum output power shall be within the range in Table 6.2.4.5-1a.		
Note 4: The maximum output power shall be within the range in Table 6.2.4.5-1b.		

Table 6.2.4.5-1a: Measured UE output power test point 4 for Test ID 1,2

NR band	Tolerance (dB)
n1	20 dBm $\pm(2.5+TT)$
n2	20 dBm $\pm(2.5^1+TT)$
n3	20 dBm $\pm(2.5^1+TT)$
n5	20 dBm $\pm 2.5\pm TT$
n7	20 dBm $\pm(2.5^1+TT)$
n8	20 dBm $\pm(2.5^1+TT)$
n12	20 dBm $\pm(2.5^1+TT)$
n14	20 dBm $\pm(2.5+TT)$
n20	20 dBm $\pm(2.5^1+TT)$
n24	20 dBm $+ 2.5+TT/-3^1-TT$
n25	20 dBm $\pm(2.5+TT)$
n26	20 dBm $\pm(2.5^1+TT)$
n28	20 dBm $\pm(2.5+TT)$
n30	20 dBm $\pm(2.5+TT)$
n34	20 dBm $\pm(2.5+TT)$
n38	20 dBm $\pm(2.5+TT)$
n39	20 dBm $\pm(2.5+TT)$
n40	20 dBm $\pm(2.5+TT)$
n41	20 dBm $\pm(2.5^1+TT)$
n50	20 dBm $\pm(2.5+TT)$
n51	20 dBm $\pm(2.5+TT)$
n65	20 dBm $\pm(2.5+TT)$
n66	20 dBm $\pm(2.5+TT)$
n70	20 dBm $\pm(2.5+TT)$
n71	20 dBm $\pm(2.5+TT)$
n74	20 dBm $\pm(2.5+TT)$
n77	20 dBm $+ 2.5+TT/-3-TT$
n78	20 dBm $+ 2.5+TT/-3-TT$
n79	20 dBm $+ 2.5+TT/-3-TT$
NOTE 1:	Refers to the transmission bandwidths confined within F_{UL_low} and $F_{UL_low} + 4$ MHz or $F_{UL_high} - 4$ MHz and F_{UL_high} , the maximum output power requirement is relaxed by reducing the lower tolerance limit by 1.0 dB.
NOTE 2:	TT for each frequency and channel bandwidth is specified in Table 6.2.4.5-2.

Table 6.2.4.5-1b: Measured UE output power test point 4 for Test ID 3

NR band	Tolerance (dB)
n40	23 dBm $+2+TT/-2.2-TT$
n41	23 dBm $+2+TT/-2.2-TT$
n77	23 dBm $+2+TT/-3.2-TT$
n78	23 dBm $+2+TT/-3.2-TT$
n79	23 dBm $+2+TT/-3.2-TT$
NOTE 1:	Void
NOTE 2:	TT for each frequency and channel bandwidth is specified in Table 6.2.4.5-2.

Table 6.2.4.5-2: Test Tolerance (Configured transmitted power)

	$f \leq 3.0\text{GHz}$	$3.0\text{GHz} < f \leq 6.0\text{GHz}$
$BW \leq 40\text{MHz}$	0.7 dB	1.0 dB
$40\text{MHz} < BW \leq 100\text{MHz}$	1.0 dB	1.0 dB

For the UE which supports inter-band NR CA configuration, SUL configuration or inter-band EN-DC configuration, $\Delta T_{IB,c}$ as specified in clause 6.2A.4.0.2 for NR CA, clause 6.2C.2 for SUL, or TS 38.521-3 [14] clause 6.2B.4.2 for EN-DC applies. Unless otherwise stated, $\Delta T_{IB,c}$ is set to zero. In case the UE supports more than one of band combinations for CA, SUL or DC, and an operating band belongs to more than one band combinations then

- a) When the operating band frequency range is ≤ 1 GHz, the applicable additional $\Delta T_{IB,c}$ shall be the average value for all band combinations defined in clauses 6.2A.4.0.2, 6.2C.2 in this specification and clause 6.2B.4.2 in TS 38.521-3 [14], truncated to one decimal place that apply for that operating band among the supported band combinations. In case there is a harmonic relation between low band UL and high band DL, then the maximum $\Delta T_{IB,c}$ among the different supported band combinations involving such band shall be applied
- b) When the operating band frequency range is > 1 GHz, the applicable additional $\Delta T_{IB,c}$ shall be the maximum value for all band combinations defined in clauses 6.2A.4.0.2, 6.2C.2 in this specification and clause 6.2B.4.2 in TS 38.521-3 [14] for the applicable operating bands.

6.2A Transmitter power for CA

6.2A.1 UE maximum output power for CA

6.2A.1.0 Minimum conformance requirements

6.2A.1.0.1 Void

6.2A.1.0.2 Void

6.2A.1.0.3 UE maximum output power for Inter-band CA

For inter-band downlink carrier aggregation with one uplink carrier assigned to one NR band, the transmitter power requirements in Table 6.2.1.3-1 apply for power class 3 and other power classes if indicated in clause 5.5A.3.

For inter-band carrier aggregation with two uplink contiguous carrier assigned to one NR band, the transmitter power requirements specified in clause 6.2A.1.0.4 apply.

For inter-band carrier aggregation with two uplink non-contiguous carrier assigned to one NR band, the transmitter power requirements specified in clause 6.2A.1.0.5 apply.

For inter-band uplink carrier aggregation with uplink assigned to two NR bands, UE maximum output power shall be measured over all component carriers from different bands. If each band has separate antenna connectors, maximum output power is defined as the sum of maximum output power from each UE antenna connector. The period of measurement shall be at least one sub frame (1 ms). The maximum output power is specified in Table 6.2A.1.0.3-1.

Table 6.2A.1.0.3-1 UE Power Class for uplink inter-band CA (two bands)

NR CA Configuration	Class 1 (dBm)	Tolerance (dB)	Class 2 (dBm)	Tolerance (dB)	Class 3 (dBm)	Tolerance (dB)	Class 4 (dBm)	Tolerance (dB)
CA_n1A-n3A					23	+2/-3		
CA_n1A-n8A					23	+2/-3		
CA_n1A-n78A			26 ⁶	+2/-3	23	+2/-3		
CA_n1A-n79A					23	+2/-3		
CA_n2A-n5A					23	+2/-3		
CA_n2A-n48A					23	+2/-3		
CA_n2A-n66A					23	+2/-3		
CA_n2A-n77A					23	+2/-3		
CA_n3A-n5A					23	+2/-3		
CA_n3A-n41A			26 ⁶	+2/-3	23	+2/-3		
CA_n3A-n78A			26 ⁶	+2/-3	23	+2/-3		
CA_n3A-n79A					23	+2/-3		
CA_n5A-n7A					23	+2/-3		
CA_n5A-n66A					23	+2/-3		
CA_n5A-n77A					23	+2/-3		
CA_n5A-n78A					23	+2/-3		
CA_n5A-n79A					23	+2/-3		
CA_n7A-n78A					23	+2/-3		
CA_n8A-n78A					23	+2/-3		
CA_n24A-n41A					23	+2/-3		
CA_n24A-n48A					23	+2/-3		
CA_n24A-n77A					23	+2/-3		
CA_n26A-n66A					23	+2/-3		
CA_n26A-n70A					23	+2/-3		
CA_n28A-n41A			26 ⁶	+2/-3	23	+2/-3		
CA_n28A-n79A			26 ⁶	+2/-3	23	+2/-3		
CA_n39A-n41A					23	+2/-3		
CA_n40A-n41A			26 ⁶	+2/-3	23	+2/-3		
CA_n41A-n79A					23	+2/-3		
CA_n48A-n66A					23	+2/-3		
CA_n48A-n70A					23	+2/-3		
CA_n48A-n71A					23	+2/-3		
CA_n50A-n78A					23	+2/-3		
CA_n66A-n71A					23	+2/-3		
CA_n66A-n77A					23	+2/-3		
CA_n70A-n71A					23	+2/-3		

NOTE 1: Void.

NOTE 2: An uplink CA configuration in which at least one of the bands has NOTE 3 in Table 6.2.1.3-1 is allowed to reduce the lower tolerance limit by 1.5dB when the transmission bandwidths of at least one of the bands is confined within F_{UL_low} and $F_{UL_low} + 4$ MHz or $F_{UL_high} - 4$ MHz and F_{UL_high} .NOTE 3: $P_{PowerClass}$ is the maximum UE power specified without taking into account the tolerance.

NOTE 4: For inter-band carrier aggregation the maximum power requirement should apply to the total transmitted power over all component carriers (per UE).

NOTE 5: Power class 3 is the default power class unless otherwise stated.

NOTE 6: The UE supports PC3 within NR FDD band, and supports either PC3 or PC2 within NR TDD band.

Table 6.2A.1.0.3-2: Void**6.2A.1.0.4 UE maximum output power for Intra-band contiguous CA**

For uplink intra-band contiguous carrier aggregation, the maximum output power is specified in Table 6.2A.1.0.4-1.

For downlink intra-band contiguous carrier aggregation with a single uplink component carrier configured in the NR band, the maximum output power is specified in Table 6.2.1.3-1 for power class 3 and other power classes if indicated in clause 5.5A.1.

Table 6.2A.1.0.4-1: UE Power Class for intra-band contiguous CA

NR CA Configuration	Class 1 (dBm)	Tolerance (dB)	Class 2 (dBm)	Tolerance (dB)	Class 3 (dBm)	Tolerance (dB)	Class 4 (dBm)	Tolerance (dB)
CA_n7B					23	+2/-2 ¹		
CA_n41C					23	+2/-2 ¹		
CA_n48B					23	+2/-3		
CA_n77C					23	+2/-3		
CA_n78C					23	+2/-3		
CA_n79C					23	+2/-3		

NOTE 1: If all transmitted resource blocks over all component carriers are confined within F_{UL_low} and $F_{UL_low} + 4$ MHz or/and $F_{UL_high} - 4$ MHz and F_{UL_high} , the maximum output power requirement is relaxed by reducing the lower tolerance limit by 1.5 dB.

NOTE 2: $P_{PowerClass}$ is the maximum UE power specified without taking into account the tolerance.

NOTE 3: For intra-band contiguous carrier aggregation the maximum power requirement shall apply to the total transmitted power over all component carriers (per UE).

6.2A.1.0.5 UE maximum output power for Intra-band non-contiguous CA

For intra-band non-contiguous carrier aggregation with one uplink carrier on the PCC, the requirements in clause 6.2.1 apply for power class 3 and other power classes if indicated in clause 5.5A.2.

For intra-band non-contiguous carrier aggregation with two uplink carriers the maximum output power is specified in Table 6.2A.1.0.5-1.

Table 6.2A.1.0.5-1: UE Power Class for intraband non-contiguous CA

NR CA Configuration	Class 1 (dBm)	Tolerance (dB)	Class 2 (dBm)	Tolerance (dB)	Class 3 (dBm)	Tolerance (dB)	Class 4 (dBm)	Tolerance (dB)
CA_n77(2A)					23	+2/-3		

NOTE 1: For transmission bandwidths confined within F_{UL_low} and $F_{UL_low} + 4$ MHz or $F_{UL_high} - 4$ MHz and F_{UL_high} , the maximum output power requirement is relaxed by reducing the lower tolerance limit by 1.5 dB.

NOTE 2: $P_{PowerClass}$ is the maximum UE power specified without taking into account the tolerance.

NOTE 3: For intra-band non-contiguous carrier aggregation the maximum power requirement shall apply to the total transmitted power over all component carriers (per UE).

6.2A.1.1 UE maximum output power for CA (2UL CA)**Editor's Note:**

No test points are defined for intra-band contiguous UL CA and intra-band non-contiguous UL CA since there is no configuration satisfying $MPR=0$ dB requirements in RAN4. Testing with lowest value of MPR will be covered in 6.2A.2.

6.2A.1.1.1 Test purpose

To verify that the error of the UE maximum output power in two uplink carrier aggregation does not exceed the range prescribed by the specified nominal maximum output power and tolerance.

An excess maximum output power has the possibility to interfere to other channels or other systems. A small maximum output power decreases the coverage area.

6.2A.1.1.2 Test applicability

This test case applies to all types of NR UE release 15 and forward that support NR 2UL CA.

NOTE: Testing for intra-band contiguous CA can't be performed due to lack of appropriate test points.

6.2A.1.1.3 Minimum conformance requirements

The minimum conformance requirements are defined in clause 6.2A.1.0.

6.2A.1.1.4 Test description

6.2A.1.1.4.1 Initial conditions

Initial conditions are a set of test configurations the UE needs to be tested in and the steps for the SS to take with the UE to reach the correct measurement state.

The initial test configurations consist of environmental conditions, test frequencies, test channel bandwidths and sub-carrier spacing based on NR CA configurations specified in 5.5A. All of these configurations shall be tested with applicable test parameters for each combination of test channel bandwidth and sub-carrier spacing, and are shown in table 6.2A.1.1.4.1-1 and table 6.2A.1.1.4.1-2. The details of the uplink reference measurement channels (RMCs) are specified in Annexes A.2. Configurations of PDSCH and PDCCH before measurement are specified in Annex C.2.

Table 6.2A.1.1.4.1-1: Inter-band CA Test Configuration Table

Initial Conditions				
Test Environment as specified in TS 38.508-1 [5] subclause 4.1		Normal, TL/VL, TL/VH, TH/VL, TH/VH		
Test Frequencies as specified in TS 38.508-1 [5] subclause 4.3.1		Low range for PCC and SCC High range for PCC and SCC		
Test Channel Bandwidths as specified in TS 38.508-1 [5] subclause 4.3.1		Lowest N_{RB_agg} , Highest N_{RB_agg}		
Test SCS as specified in Table 5.5A.3-1		Lowest, Highest		
Test Parameters				
Test ID	Downlink Configuration for PCC & SCC	Uplink Configuration		
		Modulation for all CCs (NOTE 2)	RB allocation (NOTE 1)	
			PCC	SCC
1	N/A for this test	DFT-s-OFDM Pi/2 BPSK	Inner Full	Inner Full
2		DFT-s-OFDM Pi/2 BPSK	Inner 1RB Left	Inner 1RB Left
3		DFT-s-OFDM Pi/2 BPSK	Inner 1RB Right	Inner 1RB Right
4		DFT-s-OFDM QPSK	Inner Full	Inner Full
5		DFT-s-OFDM QPSK	Inner 1RB Left	Inner 1RB Left
6		DFT-s-OFDM QPSK	Inner 1RB Right	Inner 1RB Right
NOTE 1: The specific configuration of each RB allocation is defined in Table 6.1-1.				
NOTE 2: DFT-s-OFDM Pi/2 BPSK test applies only for UEs which supports Pi/2 BPSK in FR1.				

Table 6.2A.1.1.4.1-2: Intra-band CA Test Configuration Table

NOTE: No test points are defined since there is no configuration satisfying MPR=0dB requirements in RAN4.

1. Connect the SS to the UE antenna connectors as shown in TS 38.508-1 [5] Annex A, Figure A.3.1.1.3 for TE diagram and section A.3.2 for UE diagram.
2. The parameter settings for the cell are set up according to TS 38.508-1 [5] subclause 4.4.3.
3. Downlink signals for PCC are initially set up according to Annex C.0, C.1, C.2, and uplink signals according to Annex G.0, G.1, G.2, G.3.0.
4. The UL Reference Measurement Channel is set according to Table 6.2A.1.1.4.1-1.
5. Propagation conditions are set according to Annex B.0.
6. Ensure the UE is in state RRC_CONNECTED with generic procedure parameters Connectivity NR, Connected without release On, Test Mode On and Test Loop Function On according to TS 38.508-1 [5] clause 4.5. Message contents are defined in clause 6.2A.1.1.4.3.

6.2A.1.1.4.2 Test procedure

1. Configure SCC according to Annex C.0, C.1, C.2 for all downlink physical channels.
2. The SS shall configure SCC as per TS 38.508-1 [5] clause 5.5.1. Message contents are defined in clause 6.2A.1.1.4.3.
3. SS activates SCC by sending the activation MAC CE (Refer TS 38.321 [18], clauses 5.9, 6.1.3.10). Wait for at least 2 seconds (Refer TS 38.133[19], clause 9.3).
4. SS sends uplink scheduling information for each UL HARQ process via PDCCH DCI format 0_1 for C_RNTI to schedule the UL RMC according to Table 6.2A.1.1.4.1-1 on both PCC and SCC. Since the UE has no payload and no loopback data to send the UE sends uplink MAC padding bits on the UL RMC.
5. Send continuously uplink power control "up" commands in every uplink scheduling information to the UE; allow at least 200ms starting from the first TPC command in this step for the UE to reach P_{UMAX} level.
6. Measure the sum of mean transmitted power over all component carriers in the CA configuration of the radio access mode. The period of measurement shall be at least the continuous duration of one active sub-frame (1ms) and in the uplink symbols. For TDD symbols with transient periods are not under test. For FDD band in inter-band CA with both TDD band and FDD band, only slots overlapping with only UL symbols in TDD are under test.

6.2A.1.1.4.3 Message contents

Message contents are according to TS 38.508-1 [5] subclause 4.6 and 5.4 with the following exceptions.

Table 6.2A.1.1.4.3-1: PUSCH-Config

Derivation Path: TS 38.508-1 [5], Table 4.6.3-118 with condition TRANSFORM_PRECODER_ENABLED

Table 6.2A.1.1.4.3-2: FrequencyInfoUL-SIB

Derivation Path: TS 38.508-1 [5] Table 4.6.3-62 FrequencyInfoUL-SIB			
Information Element	Value/remark	Comment	Condition
p-Max	20		Power class 3 and Inter-band CA

6.2A.1.1.5 Test requirement

The maximum output power for CA, derived in step 6 shall be within the range prescribed by the nominal maximum output power and tolerance in Table 6.2A.1.1.5-1 for Inter-band 2 UL CA configuration. The test requirement of configurations for CA operating band including Band n41 also apply for the corresponding CA operating bands with Band n90 replacing Band n41.

Table 6.2A.1.1.5-1: Maximum Output Power test requirement for Power Class 3

NR CA Configuration	Class 1 (dBm)	Tolerance (dB)	Class 2 (dBm)	Tolerance (dB)	Class 3 (dBm)	Tolerance (dB)	Class 4 (dBm)	Tolerance (dB)
CA_n1A-n3A					23	+2+TT/-3-TT		
CA_n1A-n8A					23	+2+TT/-3-TT		
CA_n1A-n78A					23	+2+TT/-3-TT		
CA_n1A-n79A					23	+2+TT/-3-TT		
CA_n2A-n5A					23	+2+TT/-3-TT		
CA_n2A-n48A					23	+2+TT/-3-TT		
CA_n2A-n66A					23	+2+TT/-3-TT		
CA_n2A-n77A					23	+2+TT/-3-TT		
CA_n3A-n5A					23	+2+TT/-3-TT		
CA_n3A-n41A					23	+2+TT/-3-TT		
CA_n3A-n78A					23	+2+TT/-3-TT		
CA_n3A-n79A					23	+2+TT/-3-TT		
CA_n5A-n7A					23	+2+TT/-3-TT		
CA_n5A-n66A					23	+2+TT/-3-TT		
CA_n5A-n77A					23	+2+TT/-3-TT		
CA_n5A-n78A					23	+2+TT/-3-TT		
CA_n5A-n79A					23	+2+TT/-3-TT		
CA_n7A-n78A					23	+2+TT/-3-TT		
CA_n8A-n78A					23	+2+TT/-3-TT		
CA_n24A-n41A					23	+2+TT/-3-TT		
CA_n24A-n48A					23	+2+TT/-3-TT		
CA_n24A-n77A					23	+2+TT/-3-TT		
CA_n26A-n66A					23	+2+TT/-3-TT		
CA_n26A-n70A					23	+2+TT/-3-TT		
CA_n28A-n41A					23	+2+TT/-3-TT		
CA_n28A-n79A					23	+2+TT/-3-TT		
CA_n39A-n41A					23	+2+TT/-3-TT		
CA_n40A-n41A					23	+2+TT/-3-TT		
CA_n41A-n79A					23	+2+TT/-3-TT		
CA_n48A-n66A					23	+2+TT/-3-TT		
CA_n48A-n70A					23	+2+TT/-3-TT		
CA_n48A-n71A					23	+2+TT/-3-TT		

CA_n50A-n78A					23	+2+TT/-3-TT		
CA_n66A-n71A					23	+2+TT/-3-TT		
CA_n66A-n77A					23	+2+TT/-3-TT		
CA_n70A-n71A					23	+2+TT/-3-TT		

NOTE 1: Void.
 NOTE 2: An uplink CA configuration in which at least one of the bands has NOTE 3 in Table 6.2.1.3-1 is allowed to reduce the lower tolerance limit by 1.5dB when the transmission bandwidths of at least one of the bands is confined within F_{UL_low} and $F_{UL_low} + 4$ MHz or $F_{UL_high} - 4$ MHz and F_{UL_high} .
 NOTE 3: $P_{PowerClass}$ is the maximum UE power specified without taking into account the tolerance.
 NOTE 4: For inter-band carrier aggregation the maximum power requirement should apply to the total transmitted power over all component carriers (per UE).
 NOTE 5: Power class 3 is the default power class unless otherwise stated.
 NOTE 6: The TT for 2UL CA Maximum Output Power is in the maximum TT among all UL CCs. For TT of each UL CC refers to Table 6.2A.1.1.5-2.

Table 6.2A.1.1.5-1a: Maximum Output Power test requirement for Power Class except class 3

NR CA Configuration	Class 1 (dBm)	Tolerance (dB)	Class 2 (dBm)	Tolerance (dB)	Class 3 (dBm)	Tolerance (dB)	Class 4 (dBm)	Tolerance (dB)
CA_n1A-n78A			26 ⁷	+2+TT/-3 ² -TT				
CA_n3A-n41A			26 ⁷	+2+TT/-3 ² -TT				
CA_n3A-n78A			26 ⁷	+2+TT/-3 ² -TT				
CA_n28A-n41A			26 ⁷	+2+TT/-3 ² -TT				
CA_n28A-n79A			26 ⁷	+2+TT/-3 ² -TT				
CA_n40A-n41A			26 ⁷	+2+TT/-3 ² -TT				

NOTE 1: Void.
 NOTE 2: 2 refers to the transmission bandwidths confined within F_{UL_low} and $F_{UL_low} + 4$ MHz or $F_{UL_high} - 4$ MHz and F_{UL_high} , the maximum output power requirement is relaxed by reducing the lower tolerance limit by 1.5 dB
 NOTE 3: $P_{PowerClass}$ is the maximum UE power specified without taking into account the tolerance.
 NOTE 4: For inter-band carrier aggregation the maximum power requirement should apply to the total transmitted power over all component carriers (per UE).
 NOTE 5: Power class 3 is the default power class unless otherwise stated.
 NOTE 6: The TT for 2UL CA Maximum Output Power is in the maximum TT among all UL CCs. For TT of each UL CC refer to Table 6.2A.1.1.5-2.
 NOTE 7: The UE supports PC3 within NR FDD band, and supports either PC3 or PC2 within NR TDD band.

Table 6.2A.1.1.5-2: Test Tolerance (UE maximum output power for CA)

TT for overall output power (dB)						
			PCell			
			BW ≤ 40MHz		40MHz < BW ≤ 100MHz	
			f ≤ 3.0GHz	3.0GHz < f ≤ 6.0GHz	f ≤ 3.0GHz	3.0GHz < f ≤ 6.0GHz
SCell	BW ≤ 40MHz	f ≤ 3.0GHz	0.7	1.0	1.0	1.0
		3.0GHz < f ≤ 6.0GHz	1.0	1.0	1.0	1.0
	40MHz < BW ≤ 100MHz	f ≤ 3.0GHz	1.0	1.0	1.0	1.0
		3.0GHz < f ≤ 6.0GHz	1.0	1.0	1.0	1.0

For the UE which supports inter-band NR CA configuration, inter-band NR-DC configuration, SUL configuration or inter-band EN-DC configuration, $\Delta T_{IB,c}$ as specified in 6.2A.4.0.2 for NR CA, 6.2B.4.0.2 for NR-DC, clause 6.2C.2 for SUL, or TS 38.521-3 [14] clause 6.2B.4.2 for EN-DC applies. Unless otherwise stated, $\Delta T_{IB,c}$ is set to zero. In case the UE supports more than one of band combinations for CA, NR-DC, SUL or DC, and an operating band belongs to more than one band combinations then

- When the operating band frequency range is ≤ 1 GHz, the applicable additional $\Delta T_{IB,c}$ shall be the average value for all band combinations defined in clause 6.2A.4.0.2, 6.2B.4.0.2, 6.2C.2 in this specification and 6.2B.4.2 in TS 38.521-3 [14], truncated to one decimal place that apply for that operating band among the supported band combinations. In case there is a harmonic relation between low band UL and high band DL, then the maximum $\Delta T_{IB,c}$ among the different supported band combinations involving such band shall be applied
- When the operating band frequency range is > 1 GHz, the applicable additional $\Delta T_{IB,c}$ shall be the maximum value for all band combinations defined in clause 6.2A.4.0.2, 6.2B.4.0.2, 6.2C.2 in this specification and 6.2B.4.2 in TS 38.521-3 [14] for the applicable operating bands.

6.2A.2 UE maximum output power reduction for CA

6.2A.2.0 Minimum conformance requirements

6.2A.2.0.1 FFS

6.2A.2.0.2 FFS

6.2A.2.0.3 Maximum Power Reduction for Inter-band CA

For inter-band carrier aggregation with one uplink carrier assigned to one NR band, the requirements in clause 6.2.2.3 apply.

For inter-band carrier aggregation with two uplink contiguous carrier assigned to one NR band, the maximum output power reduction requirements for intra-band contiguous carrier aggregation in clause 6.2A.2.0.4 apply for that band.

For inter-band carrier aggregation with uplink assigned to two NR bands, the requirements in subclause 6.2.2.3 apply for each uplink component carrier.

The normative reference for this requirement is TS38.101-1[2] clause 6.2A.2.

6.2A.2.0.4 Maximum Power Reduction for Intra-band contiguous CA

For intra-band contiguous carrier aggregation the allowed Maximum Power Reduction (MPR) for the maximum output power in Table 6.2A.1.0.4-1 with contiguous RB allocation is specified in Table 6.2A.2.0.4-2 for UE power class 3 CA bandwidth classes B and C.

In case the modulation format is different on different component carriers then the MPR is determined by the rules applied to higher order of those modulations.

Unless otherwise specified, $\pi/2$ BPSK in following A-MPR tables refers to both variants of $\pi/2$ BPSK referenced in clause 6.2.2.3, Table 6.2.2.3-1.

Table 6.2A.2.0.4-1: Contiguous RB allocation for Power Class 3

Modulation		MPR for bandwidth class B(dB)		MPR for bandwidth class C(dB)	
		inner	outer	inner	outer
DFT-s-OFDM	Pi/2 BPSK	1.0	3.5	2.5	7
	QPSK	1.0	3.5	2.5	7
	16QAM	1.5	3.5	2.5	7
	64QAM	3.0	4.0	5	7
	256QAM	5.5	6.0	7	7.5
CP-OFDM	QPSK	2.0	4.0	3.5	8
	16QAM	2.5	4.0	3.5	8
	64QAM	3.5	4.0	5	8
	256QAM	6.5	6.5	7	8

For CA bandwidth class B and bandwidth class C with contiguous RB allocation, the following parameters are defined to specify valid RB allocation ranges for Inner and Outer RB allocations:

An RB allocation is contiguous if $L_{CRB1} = 0$ or $L_{CRB2} = 0$ or ($L_{CRB1} \neq 0$ and $L_{CRB2} \neq 0$ and $RB_{Start1} + L_{CRB1} = N_{RB1}$ and $RB_{Start2} = 0$), where RB_{Start1} , L_{CRB1} , and N_{RB1} are for CC1, RB_{Start2} , L_{CRB2} , and N_{RB2} are for CC2, CC1 is the component carrier with lower frequency.

In contiguous CA, a contiguous allocation is an inner allocation if

$$RB_{Start,Low} \leq RB_{Start,CA} \leq RB_{Start,High}, \text{ and } N_{RB,alloc} \leq \text{ceil}(N_{RB,agg}/2),$$

where

$$RB_{Start,Low} = \max(1, \text{floor}(N_{RB,alloc}/2)), \text{ } RB_{Start,High} = N_{RB,agg} - RB_{Start,Low} - N_{RB,alloc},$$

with

$$N_{RB,alloc} = L_{CRB1} \cdot 2^{\mu_1} + L_{CRB2} \cdot 2^{\mu_2}, \text{ } N_{RB,agg} = (N_{RB1} - RB_{Start1}) \cdot 2^{\mu_1} + (RB_{Start2} + L_{CRB2}) \cdot 2^{\mu_2},$$

$$N_{RB,agg} = N_{RB1} \cdot 2^{\mu_1} + N_{RB2} \cdot 2^{\mu_2}.$$

$$\text{If } L_{CRB1} = 0, \text{ } RB_{Start,CA} = N_{RB1} \cdot 2^{\mu_1} + RB_{Start2} \cdot 2^{\mu_2},$$

$$\text{if } L_{CRB1} > 0, \text{ } RB_{Start,CA} = RB_{Start1} \cdot 2^{\mu_1}.$$

A contiguous allocation that is not an Inner contiguous allocation is an Outer contiguous allocation

For intra-band non-contiguous carrier aggregation the allowed Maximum Power Reduction (MPR) for the maximum output power in Table 6.2A.1.0.4-1 with non-contiguous RB allocation is specified in Table 6.2A.2.0.4-2 for UE power class 3 CA bandwidth classes B and C.

Table 6.2A.2.0.4-2: non-contiguous RB allocation for Power Class 3

Modulation		MPR for bandwidth class B(dB)			MPR for bandwidth class C(dB)		
		inner	Outer1 ¹	Outer2 ²	inner	Outer1 ¹	Outer2 ²
DFT-s-OFDM	Pi/2 BPSK	2	5.5	11.5	2.5	6	13
	QPSK	2	5.5		2.5	6	
	16QAM	2.5	5.5		3	6	
	64QAM	4.5	6		5	6	
	256QAM	6	6.5		6.5	6.5	
CP-OFDM	QPSK	2.5	6.5	12	3.5	7	14
	16QAM	3	7		3.5	7	
	64QAM	5	7		5	7	
	256QAM	7.5	7.5		7.5	7.5	

NOTE 1: Outer 1 MPR for Pi/2 BPSK and QPSK is reduced by 2dB for aggregated allocation bandwidth > 10MHz
NOTE 2: Outer 2 MPR is reduced by 4.5dB for aggregated allocation bandwidth > 10MHz

For CA bandwidth classes B and C with non-contiguous RB allocation, the following parameters are defined to specify valid RB allocation ranges for Inner, Outer1 and Outer2 RB allocations:

Non-Contiguous RB allocation is defined as $RB_{Start1} + L_{CRB1} < N_{RB1}$, or $RB_{Start2} > 0$ when all uplink CCs are activated and allocated with RB(s), where RB_{Start1} , L_{CRB1} , and N_{RB1} are for CC1, RB_{Start2} , L_{CRB2} , and N_{RB2} are for CC2, CC1 is the component carrier with lower frequency.

In contiguous CA, a non-contiguous RB allocation is a non-contiguous Inner RB allocation if the following conditions are met:

$$RB_{Start,Low} \leq RB_{Start,CA} \leq RB_{Start,High} \text{ and } N_{RB_alloc} \leq \text{ceil}((BW_{Channel_CA} / 3 - BW_{gap}) / 0.18\text{MHz}),$$

where

$$N_{RB_alloc} = (N_{RB1} - RB_{Start1}) \cdot 2^{\mu_1} + (RB_{Start2} + L_{CRB2}) \cdot 2^{\mu_2}, RB_{Start,CA} = RB_{Start1} \cdot 2^{\mu_1}$$

$$RB_{Start,Low} = \max(1, \text{floor}(N_{RB_alloc} + (BW_{gap} - BW_{GB,low}) / 0.18\text{MHz}))$$

$$RB_{Start,High} = \text{floor}((BW_{Channel_CA} - 2 \cdot BW_{gap} - BW_{GB,low}) / 0.18\text{MHz} - 2 \cdot N_{RB_alloc})$$

$$BW_{GB,low} = F_{offset,low} - (N_{RB1} \cdot 12 + 1) \cdot SCS_1 / 2$$

BW_{gap} is the bandwidth of the gap between N_{RB1} and N_{RB2} possible allocations of CC1 and CC2 respectively.

In contiguous CA, a non-contiguous RB allocation is a non-contiguous outer 1 RB allocation if the following conditions are met:

$$RB_{Start,Low} \leq RB_{Start,CA} \leq RB_{Start,High} \text{ and } N_{RB_alloc} \leq \text{ceil}((3 \cdot BW_{Channel_CA} / 5 - BW_{gap}) / 0.18\text{MHz})$$

where

$$RB_{Start,Low} = \max(1, 2 \cdot N_{RB_alloc} - \text{floor}((BW_{Channel_CA} - 2 \cdot BW_{gap} + BW_{GB,low}) / 0.18\text{MHz})),$$

$$RB_{Start,High} = \text{floor}((2 \cdot BW_{Channel_CA} - 3 \cdot BW_{gap} - BW_{GB,low}) / 0.18\text{MHz} - 3 \cdot N_{RB_alloc})$$

N_{RB_alloc} , $RB_{Start,CA}$, BW_{gap} and $BW_{GB,low}$ are as defined for the Inner region.

In contiguous CA, a non-contiguous allocation is an Outer 2 allocation if it is neither a non-contiguous Inner allocation nor an Outer 1 allocation.

The normative reference for this requirement is TS 38.101-1 [2] clause 6.2A.2.1.

6.2A.2.0.5 Maximum Power Reduction for Intra-band non-contiguous CA

For intra-band non-contiguous CA, the allowed Maximum Power Reduction (MPR) for the maximum output power is specified into 2 types: MPR to meet -30dBm/MHz and -13dBm/MHz. The UE determines the MPR type as follows:

For intra-band non-contiguous CA, the allowed Maximum Power Reduction (MPR) for the maximum output power is specified into 2 types: MPR to meet -30dBm/MHz and -13dBm/MHz. The UE determines the MPR type as follows:

If AND($F_{IM3,low_block,low} > SEM_{-13,low}$, $F_{IM3,high_block,high} < SEM_{-13,high}$)

MPR_{IM3} defined in Clause 6.2A.2.0.5.2

Else If AND($F_{IM3,low_block,low} > SEM_{-25,low}$, $F_{IM3,high_block,high} < SEM_{-25,high}$)

MPR_{IM3} defined in Clause 6.2A.2.0.5.1

Else

MPR_{IM3} defined in Clause 6.2A.2.0.5.1

where

- $F_{IM3,high_block,high} = (2 * F_{high_alloc,high_edge}) - F_{low_alloc,low_edge}$
- $F_{IM3,low_block,low} = (2 * F_{low_alloc,low_edge}) - F_{high_alloc,high_edge}$

- F_{low_alloc,low_edge} is the lowermost frequency of the lower transmission bandwidth allocation.
- $F_{low_alloc,high_edge}$ is the uppermost frequency of the lower transmission bandwidth allocation.
- F_{high_alloc,low_edge} is the lowermost frequency of the upper transmission bandwidth allocation.
- $F_{high_alloc,high_edge}$ is the uppermost frequency of the upper transmission bandwidth allocation.
- $SEM_{13,low}$ = Threshold frequency where lower spectral emission mask below the lower channel drops from -13 dBm / MHz to -25 dBm / MHz, as specified in Clause 6.5A.2.2.0
- $SEM_{13,high}$ = Threshold frequency where upper spectral emission mask above the upper channel drops from -13 dBm / MHz to -25 dBm / MHz, as specified in Clause 6.5A.2.2.0.
- $SEM_{25,low}$ = Threshold frequency where lower spectral emission mask below the lower channel drops from -25 dBm / MHz to -30 dBm / MHz, as specified in Clause 6.5A.2.2.0.
- $SEM_{25,high}$ = Threshold frequency where upper spectral emission mask above the upper channel drops from -25 dBm / MHz to -30 dBm / MHz, as specified in Clause 6.5A.2.2.0.

6.2A.2.0.5.1 MPRIM3 to meet -30dBm/MHz

MPR in this clause is for intra-band non-contiguous CA power class 3 for UEs indicating IE *dualPA-Architecture* supported. The allowed maximum output power reduction is defined as:

$$MPR = M_A$$

Where M_A is defined as follows:

$M_A =$	15;	$0 \leq B < 1.08$
	14.5;	$1.08 \leq B < 2.16$
	13.5;	$2.16 \leq B < 3.24$
	12.5;	$3.24 \leq B < 5.04$
	11.5;	$5.04 \leq B < 10.08$
	10.5;	$10.08 \leq B < 16.38$
	10;	$16.38 \leq B < 21.78$
	9;	$21.78 \leq B$

Where:

$$B = (L_{CRB_alloc,1} * 12 * SCS_1 + L_{CRB_alloc,2} * 12 * SCS_2) / 1,000,000$$

6.2A.2.0.5.2 MPRIM3 to meet -13dBm/MHz

MPR in this clause is for intra-band non-contiguous CA power class 3 for UEs indicating IE *dualPA-Architecture* supported. The allowed maximum output power reduction is defined as:

$$MPR = M_A$$

Where M_A is defined as follows:

$M_A =$	9 ;	$0 \leq B < 0.54$
	8 ;	$0.54 \leq B < 1.08$
	7 ;	$1.08 \leq B < 2.16$
	6.5 ;	$2.16 \leq B < 3.24$
	5.5 ;	$3.24 \leq B < 5.4$

$$4 \leq B \leq 5.4$$

Where:

$$B = (L_{CRB_alloc,1} * 12 * SCS_1 + L_{CRB_alloc,2} * 12 * SCS_2) / 1,000,000$$

6.2A.2.1 UE maximum output power reduction for CA (2UL CA)

Editor's note: Testing for Intra-band non-contiguous UL CA is not applicable for UE not supporting IE dualPA-Architecture due to the lack of core requirement.

6.2A.2.1.1 Test purpose

The number of RB identified in Table 6.2.2.3-1 is based on meeting the requirements for adjacent channel leakage ratio for CA and the maximum power reduction (MPR) for Inter-band CA due to Cubic Metric (CM).

6.2A.2.1.2 Test applicability

The requirements of this test apply to all types of NR Power class 3 UE release 15 and forward that support 2 UL CA.

NOTE: Test execution is not necessary if TS 38.521-1 6.5A.2.4.1.1 is executed.

6.2A.2.1.3 Minimum conformance requirements

The minimum conformance requirements are defined in subclause 6.2A.2.0.

6.2A.2.1.4 Test description

6.2A.2.1.4.1 Initial conditions

Initial conditions are a set of test configurations the UE needs to be tested in and the steps for the SS to take with the UE to reach the correct measurement state.

The initial test configurations consist of environmental conditions, test frequencies, channel bandwidths and sub-carrier spacing based on NR CA configuration specified in table 5.5A.3.1-1 for inter-band UL CA, table 5.5A.1-1 for intra-band contiguous UL CA and table 5.5A.2-1 for intra-band non-contiguous UL CA. All of these configurations shall be tested with applicable test parameters for each CA configuration of test channel bandwidth and sub-carrier spacing, and are shown in table 6.2A.2.1.4.1-1 to table 6.2A.2.1.4.1-3b. The details of the uplink reference measurement channels (RMCs) are specified in Annexes A.2. Configurations of PDSCH and PDCCH before measurement are specified in Annex C.2.

Table 6.2A.2.1.4.1-1: Inter-band CA Test Configuration Table

Initial Conditions					
Test Environment as specified in TS 38.508-1 [5] subclause 4.1		Normal, TL/VL, TL/VH, TH/VL, TH/VH			
Test Frequencies as specified in TS 38.508-1 [5] subclause 4.3.1		Low range for PCC and SCC High range for PCC and SCC			
Test Channel Bandwidths as specified in TS 38.508-1 [5] subclause 4.3.1		Lowest N_{RB_agg} , Highest N_{RB_agg}			
Test SCS as specified in Table 5.3.5-1		Lowest, Highest			
Test Parameters for Channel Bandwidths					
Test ID	Freq	Downlink Configuration for PCC & SCC	Uplink Configuration		
			Modulation for all CCs (NOTE 2)	RB allocation (NOTE 1)	
				PCC	SCC
1 ³	Default	N/A for Maximum Power Reduction (MPR) test case	DFT-s-OFDM Pi/2 BPSK	Inner Full	Inner Full
2 ³	Low		DFT-s-OFDM Pi/2 BPSK	Edge_1RB_Left	Edge_1RB_Left
3 ³	High		DFT-s-OFDM Pi/2 BPSK	Edge_1RB_Right	Edge_1RB_Right
4 ³	Default		DFT-s-OFDM Pi/2 BPSK	Outer Full	Outer Full
5 ⁴	Default		DFT-s-OFDM Pi/2 BPSK	Inner Full	Inner Full
6 ⁴	Low		DFT-s-OFDM Pi/2 BPSK	Edge_1RB_Left	Edge_1RB_Left
7 ⁴	High		DFT-s-OFDM Pi/2 BPSK	Edge_1RB_Right	Edge_1RB_Right
8 ⁴	Default		DFT-s-OFDM Pi/2 BPSK	Outer Full	Outer Full
9	Default		DFT-s-OFDM QPSK	Inner Full	Inner Full
10	Low		DFT-s-OFDM QPSK	Edge_1RB_Left	Edge_1RB_Left
11	High		DFT-s-OFDM QPSK	Edge_1RB_Right	Edge_1RB_Right
12	Default		DFT-s-OFDM QPSK	Outer Full	Outer Full
13	Default		DFT-s-OFDM 16 QAM	Inner Full	Inner Full
14	Low		DFT-s-OFDM 16 QAM	Edge_1RB_Left	Edge_1RB_Left
15	High		DFT-s-OFDM 16 QAM	Edge_1RB_Right	Edge_1RB_Right
16	Default		DFT-s-OFDM 16 QAM	Outer Full	Outer Full
17	Low		DFT-s-OFDM 64 QAM	Edge_1RB_Left	Edge_1RB_Left
18	High		DFT-s-OFDM 64 QAM	Edge_1RB_Right	Edge_1RB_Right
19	Default		DFT-s-OFDM 64 QAM	Outer Full	Outer Full
20	Low		DFT-s-OFDM 256 QAM	Edge_1RB_Left	Edge_1RB_Left
21	High		DFT-s-OFDM 256 QAM	Edge_1RB_Right	Edge_1RB_Right
22	Default		DFT-s-OFDM 256 QAM	Outer Full	Outer Full
23	Default		CP-OFDM QPSK	Inner Full	Inner Full
24	Low		CP-OFDM QPSK	Edge_1RB_Left	Edge_1RB_Left
25	High		CP-OFDM QPSK	Edge_1RB_Right	Edge_1RB_Right
26	Default		CP-OFDM QPSK	Outer Full	Outer Full
27	Default		CP-OFDM 16 QAM	Inner Full	Inner Full
28	Low		CP-OFDM 16 QAM	Edge_1RB_Left	Edge_1RB_Left
29	High		CP-OFDM 16 QAM	Edge_1RB_Right	Edge_1RB_Right
30	Default		CP-OFDM 16 QAM	Outer Full	Outer Full
31	Low		CP-OFDM 64 QAM	Edge_1RB_Left	Edge_1RB_Left
32	High		CP-OFDM 64 QAM	Edge_1RB_Right	Edge_1RB_Right

Test Parameters for Channel Bandwidths					
Test ID	Freq	Downlink Configuration for PCC & SCC	Uplink Configuration		
			Modulation for all CCs (NOTE 2)	RB allocation (NOTE 1)	
				PCC	SCC
33	Default		CP-OFDM 64 QAM	Outer Full	Outer Full
34	Low		CP-OFDM 256 QAM	Edge_1RB_Left	Edge_1RB_Left
35	High		CP-OFDM 256 QAM	Edge_1RB_Right	Edge_1RB_Right
36	Default		CP-OFDM 256 QAM	Outer Full	Outer Full
37	Default		NOTE 5	Inner Full	Outer Full

NOTE 1: The specific configuration of each RB allocation is defined in Table 6.1-1.
 NOTE 2: DFT-s-OFDM Pi/2 BPSK test applies only for UEs which supports Pi/2 BPSK in FR1.
 NOTE 3: UE operating in TDD mode with Pi/2 BPSK modulation and UE indicates support for UE capability *powerBoosting-pi2BPSK* and the IE *powerBoostPi2BPSK* is set to 1 for bands n40, n41, n77, n78 and n79.
 NOTE 4: UE operating in FDD mode, or in TDD mode in bands other than n40, n41, n77, n78 and n79, or in TDD mode the IE *powerBoostPi2BPSK* is set to 0 for bands n40, n77, n78 and n79.
 NOTE 5: The modulation is DFT-s-OFDM QPSK for PCC and CP-OFDM 256 QAM for SCC.

Table 6.2A.2.1.4.1-2a: Intra-band contiguous CA Test Configuration Table (contiguous RB allocation)

Initial Conditions				
Test Environment as specified in TS 38.508-1 [5] subclause 4.1	Normal, TL/VL, TL/VH, TH/VL, TH/VH			
Test Frequencies as specified in TS 38.508-1 [5] subclause 4.3.1	Low range High range			
Test Channel Bandwidths as specified in TS 38.508-1 [5] subclause 4.3.1	Lowest N_{RB_agg} , Highest N_{RB_agg} (NOTE 1)			
Test SCS as specified in Table 5.3.5-1	Lowest, Highest			
Test Parameters for CA bandwidth class B and C				
Test ID	DL configuration for PCC & SCC	UL configuration		
		Modulations for all CCs (NOTE 2)	RB allocation (NOTE 3)	
1	N/A	DFT-s-OFDM	Pi/2 BPSK	Inner Full
2			Pi/2 BPSK	Outer Full
3			QPSK	Inner Full
4			QPSK	Outer Full
5			16QAM	Inner Full
6			16QAM	Outer Full
7			64QAM	Inner Full
8			64QAM	Outer Full
9			256QAM	Inner Full
10			256QAM	Outer Full
11		CP-OFDM	QPSK	Inner Full
12			QPSK	Outer Full
13			16QAM	Inner Full
14			16QAM	Outer Full
15			64QAM	Inner Full
16			64QAM	Outer Full
17			256QAM	Inner Full
18			256QAM	Outer Full

NOTE 1: The Test CC Combination settings are checked separately for each CA Configuration, which applicable aggregated channel bandwidths are specified in Table 5.5A.1-1.
 NOTE 2: DFT-s-OFDM Pi/2 BPSK test applies only for UEs which supports Pi/2 BPSK in FR1.
 NOTE 3: The specific configuration of each RB allocation is defined in Table 6.1A-1a.
 NOTE 4: If the UE supports multiple CC Combinations in the CA Configuration with the same N_{RB_agg} , only the combination with the highest N_{RB_PCC} is tested.

Table 6.2A.2.1.4.1-2b: Intra-band contiguous CA Test Configuration Table (non-contiguous RB allocation)

Initial Conditions				
Test Environment as specified in TS 38.508-1 [5] subclause 4.1		Normal, TL/VL, TL/VH, TH/VL, TH/VH		
Test Frequencies as specified in TS 38.508-1 [5] subclause 4.3.1		Low range High range		
Test Channel Bandwidths as specified in TS 38.508-1 [5] subclause 4.3.1		Lowest N _{RB_agg} , Highest N _{RB_agg} (NOTE 1)		
Test SCS as specified in Table 5.3.5-1		Lowest, Highest		
Test Parameters for CA bandwidth class B and C				
Test ID	DL configuration for PCC & SCC	UL configuration		
		Modulations for all CCs (NOTE 2)		RB allocation (NOTE 3)
1	N/A	DFT-s-OFDM	Pi/2 BPSK	Inner
2			Pi/2 BPSK	Outer 1
3			Pi/2 BPSK	Outer 2
4			QPSK	Inner
5			QPSK	Outer 1
6			QPSK	Outer 2
7			16QAM	Inner
8			16QAM	Outer 1
9			16QAM	Outer 2
10			64QAM	Inner
11			64QAM	Outer 1
12			64QAM	Outer 2
13			256QAM	Inner
14			256QAM	Outer 1
15			256QAM	Outer 2
16		CP-OFDM	QPSK	Inner
17			QPSK	Outer 1
18			QPSK	Outer 2
19			16QAM	Inner
20			16QAM	Outer 1
21			16QAM	Outer 2
22			64QAM	Inner
23			64QAM	Outer 1
24			64QAM	Outer 2
25			256QAM	Inner
26			256QAM	Outer 1
27			256QAM	Outer 2
NOTE 1: The Test CC Combination settings are checked separately for each CA Configuration, which applicable aggregated channel bandwidths are specified in Table 5.5A.1-1.				
NOTE 2: DFT-s-OFDM Pi/2 BPSK test applies only for UEs which supports Pi/2 BPSK in FR1.				
NOTE 3: The specific configuration of each RB allocation is defined in Table 6.1A-1b.				
NOTE 4: If the UE supports multiple CC Combinations in the CA Configuration with the same N _{RB_agg} , only the combination with the highest N _{RB_PCC} is tested.				

For intra-band non-contiguous CA, the initial condition for MPR is specified by 2 tables. Table 6.2A.2.1.4.1-3a applies for MPR to meet -30dBm/MHz and Table 6.2A.2.1.4.1-3b applies for MPR to meet -13dBm/MHz. UE determines to configure test parameters based on specific channel bandwidth configurations and following rules:

$$\text{If AND} \{ [F_{CC1} - F_{CC2} + X] > (N_{RB1} * SCS_1 * 12 * 0.001) + (0.5 * N_{RB2} * SCS_2 * 12 * 0.001) - 0.5 * CBW_1 ,$$

$$[F_{CC1} - F_{CC2} + Y] > (0.5 * N_{RB1} * SCS_1 * 12 * 0.001) + (N_{RB2} * SCS_2 * 12 * 0.001) - 0.5 * CBW_2 \}$$

Test parameters in table 6.2A.2.1.4.1-3a apply

Else

Test parameters in table 6.2A.2.1.4.1-3b apply

Where

CC₁ is the lower component carrier. And F_{CC1} is the centre frequency of CC₁

CC_2 is the lower component carrier. And F_{CC2} is the centre frequency of CC_2

N_{RB1} and N_{RB2} are defined in table 5.3.2-1 for each carrier bandwidth for CC_1 and CC_2 .

SCS_1 and SCS_2 are the subcarrier spacing for CC_1 and CC_2 .

X is the distance between threshold frequency, where lower spectral emission mask below CC_1 drops from -13 dBm / MHz to -25 dBm / MHz, and the lower edge of CC_1 channel bandwidth. The values of X is listed in table 6.2A.2.1.4.1-3.

Y is the distance between threshold frequency, where upper spectral emission mask above CC_2 drops from -13 dBm / MHz to -25 dBm / MHz, and the upper edge of CC_2 channel bandwidth. The values of Y is listed in table 6.2A.2.1.4.1-3.

Table 6.2A.2.1.4.1-3: Values specified for X and Y for each channel bandwidth

CBW	5 MHz	10 MHz	15 MHz	20 MHz	25 MHz	30 MHz	40 MHz	50 MHz	60 MHz	70 MHz	80 MHz	90 MHz	100 MHz
Value	6	10	15	20	25	30	40	50	60	70	80	90	100

Table 6.2A.2.1.4.1-3a: Intra-band non-contiguous CA Test Configuration Table (MPR_{IM3} to meet - 13dBm/MHz) when UE supporting IE *dualPA-Architecture*

Initial Conditions									
Test Environment as specified in TS 38.508-1 [5] subclause 4.1					Normal, TL/VL, TL/VH, TH/VL, TH/VH				
Test Frequencies as specified in TS 38.508-1 [5] subclause 4.3.1					Low range High range				
Test Channel Bandwidths as specified in TS 38.508-1 [5] subclause 4.3.1					Lowest N _{RB_agg} , Highest N _{RB_agg} (NOTE 1)				
Test SCS as specified in Table 5.5A.3-1					Lowest, Highest				
Test Parameters									
Test ID	DL config for PCC & SCC	UL configuration							
		Modulations for all CCs (NOTE 2)	RB allocation L _{CRB} @RB _{START} (NOTE 2)						
			SCS 15 kHz		SCS 30 kHz		SCS 60 kHz		
			PCC	SCC	PCC	SCC	PCC	SCC	
1	N/A	Pi/2 BPSK	Edge_1RB_Left	Edge_1RB_Right	Edge_1RB_Left	Edge_1RB_Right	Edge_1RB_Left	Edge_1RB_Right	Edge_1RB_Right
2		Pi/2 BPSK	8@0	8@0	4@0	4@0	2@0	2@0	
3		Pi/2 BPSK	24@0	24@0	12@0	12@0	6@0	6@0	
4		Pi/2 BPSK	45@0	45@0	24@0	24@0	12@0	12@0	
5 ³		Pi/2 BPSK	75@0	75@0	40@0	40@0	20@0	20@0	
6 ⁴		Pi/2 BPSK	120@0	120@0	60@0	60@0	30@0	30@0	
7 ⁵		Pi/2 BPSK	150@0	150@0	75@0	75@0	40@0	40@0	
8 ⁵		Pi/2 BPSK	Outer_Full	Outer_Full	Outer_Full	Outer_Full	Outer_Full	Outer_Full	
9		QPSK	Edge_1RB_Left	Edge_1RB_Right	Edge_1RB_Left	Edge_1RB_Right	Edge_1RB_Left	Edge_1RB_Right	
10		QPSK	8@0	8@0	4@0	4@0	2@0	2@0	
11		QPSK	24@0	24@0	12@0	12@0	6@0	6@0	
12		QPSK	45@0	45@0	24@0	24@0	12@0	12@0	
13 ³		QPSK	75@0	75@0	40@0	40@0	20@0	20@0	
14 ⁴		QPSK	120@0	120@0	60@0	60@0	30@0	30@0	
15 ⁵		QPSK	150@0	150@0	75@0	75@0	40@0	40@0	
16 ⁵		QPSK	Outer_Full	Outer_Full	Outer_Full	Outer_Full	Outer_Full	Outer_Full	
17		16QAM	Edge_1RB_Left	Edge_1RB_Right	Edge_1RB_Left	Edge_1RB_Right	Edge_1RB_Left	Edge_1RB_Right	
18		16QAM	8@0	8@0	4@0	4@0	2@0	2@0	
19		16QAM	24@0	24@0	12@0	12@0	6@0	6@0	
20		16QAM	45@0	45@0	24@0	24@0	12@0	12@0	
21 ³		16QAM	75@0	75@0	40@0	40@0	20@0	20@0	
22 ⁴		16QAM	120@0	120@0	60@0	60@0	30@0	30@0	
23 ⁵		16QAM	150@0	150@0	75@0	75@0	40@0	40@0	
24 ⁵		16QAM	Outer_Full	Outer_Full	Outer_Full	Outer_Full	Outer_Full	Outer_Full	
25		64QAM	Edge_1RB_Left	Edge_1RB_Right	Edge_1RB_Left	Edge_1RB_Right	Edge_1RB_Left	Edge_1RB_Right	
26		64QAM	8@0	8@0	4@0	4@0	2@0	2@0	
27		64QAM	24@0	24@0	12@0	12@0	6@0	6@0	
28		64QAM	45@0	45@0	24@0	24@0	12@0	12@0	
29 ³		64QAM	75@0	75@0	40@0	40@0	20@0	20@0	
30 ⁴		64QAM	120@0	120@0	60@0	60@0	30@0	30@0	
31 ⁵		64QAM	150@0	150@0	75@0	75@0	40@0	40@0	
32 ⁵		64QAM	Outer_Full	Outer_Full	Outer_Full	Outer_Full	Outer_Full	Outer_Full	
33		256QAM	Edge_1RB_Left	Edge_1RB_Right	Edge_1RB_Left	Edge_1RB_Right	Edge_1RB_Left	Edge_1RB_Right	
34		256QAM	8@0	8@0	4@0	4@0	2@0	2@0	
35		256QAM	24@0	24@0	12@0	12@0	6@0	6@0	
36		256QAM	45@0	45@0	24@0	24@0	12@0	12@0	
37 ³		256QAM	75@0	75@0	40@0	40@0	20@0	20@0	
38 ⁴		256QAM	120@0	120@0	60@0	60@0	30@0	30@0	
39 ⁵		256QAM	150@0	150@0	75@0	75@0	40@0	40@0	
40 ⁵		256QAM	Outer_Full	Outer_Full	Outer_Full	Outer_Full	Outer_Full	Outer_Full	
41		QPSK	Edge_1RB_Left	Edge_1RB_Right	Edge_1RB_Left	Edge_1RB_Right	Edge_1RB_Left	Edge_1RB_Right	
42		QPSK	8@0	8@0	4@0	4@0	2@0	2@0	
43		QPSK	23@0	23@0	12@0	12@0	6@0	6@0	
44		QPSK	45@0	45@0	23@0	23@0	12@0	12@0	
45 ³		QPSK	75@0	75@0	38@0	38@0	19@0	19@0	

46 ⁴		QPSK	120@0	120@0	60@0	60@0	30@0	30@0
47 ⁵		QPSK	150@0	150@0	75@0	75@0	38@0	38@0
48 ⁵		QPSK	Outer_Full	Outer_Full	Outer_Full	Outer_Full	Outer_Full	Outer_Full
49	C P - O F D M	16QAM	Edge_1RB_Left	Edge_1RB_Right	Edge_1RB_Left	Edge_1RB_Right	Edge_1RB_Left	Edge_1RB_Right
50		16QAM	8@0	8@0	4@0	4@0	2@0	2@0
51		16QAM	23@0	23@0	12@0	12@0	6@0	6@0
52		16QAM	45@0	45@0	23@0	23@0	12@0	12@0
53 ³		16QAM	75@0	75@0	38@0	38@0	19@0	19@0
54 ⁴		16QAM	120@0	120@0	60@0	60@0	30@0	30@0
55 ⁵		16QAM	150@0	150@0	75@0	75@0	38@0	38@0
56 ⁵		16QAM	Outer_Full	Outer_Full	Outer_Full	Outer_Full	Outer_Full	Outer_Full
57		64QAM	Edge_1RB_Left	Edge_1RB_Right	Edge_1RB_Left	Edge_1RB_Right	Edge_1RB_Left	Edge_1RB_Right
58		64QAM	8@0	8@0	4@0	4@0	2@0	2@0
59		64QAM	23@0	23@0	12@0	12@0	6@0	6@0
60		64QAM	45@0	45@0	23@0	23@0	12@0	12@0
61 ³		64QAM	75@0	75@0	38@0	38@0	19@0	19@0
62 ⁴		64QAM	120@0	120@0	60@0	60@0	30@0	30@0
63 ⁵		64QAM	150@0	150@0	75@0	75@0	38@0	38@0
64 ⁵		64QAM	Outer_Full	Outer_Full	Outer_Full	Outer_Full	Outer_Full	Outer_Full
65		256QAM	Edge_1RB_Left	Edge_1RB_Right	Edge_1RB_Left	Edge_1RB_Right	Edge_1RB_Left	Edge_1RB_Right
66		256QAM	8@0	8@0	4@0	4@0	2@0	2@0
67		256QAM	23@0	23@0	12@0	12@0	6@0	6@0
68		256QAM	45@0	45@0	23@0	23@0	12@0	12@0
69 ³		256QAM	75@0	75@0	38@0	38@0	19@0	19@0
70 ⁴	256QAM	120@0	120@0	60@0	60@0	30@0	30@0	
71 ⁵	256QAM	150@0	150@0	75@0	75@0	38@0	38@0	
72 ⁵	256QAM	Outer_Full	Outer_Full	Outer_Full	Outer_Full	Outer_Full	Outer_Full	

NOTE 1: The Test CC Combination settings are checked separately for each CA Configuration, which applicable aggregated channel bandwidths are specified in Table 5.5A.1.

NOTE 2: Edge_1RB_Left, Edge_1RB_Right and Outer_Full RB allocation are specified in table 6.1-1 for each component carrier.

NOTE 3: Only being tested when the channel bandwidth of both carriers are larger than 10 MHz.

NOTE 4: Only being tested when the channel bandwidth of both carriers are larger than 20 MHz.

NOTE 5: Only being tested when the channel bandwidth of both carriers are larger than 25 MHz.

NOTE 6: DFT-s-OFDM Pi/2 BPSK test applies only for UEs which supports Pi/2 BPSK in FR1.

Table 6.2A.2.1.4.1-3b: Intra-band non-contiguous CA Test Configuration Table (MPR_{IM3} to meet - 30dBm/MHz) when UE supporting IE *dualPA-Architecture*

Initial Conditions											
Test Environment as specified in TS 38.508-1 [5] subclause 4.1					Normal, TL/VL, TL/VH, TH/VL, TH/VH						
Test Frequencies as specified in TS 38.508-1 [5] subclause 4.3.1					Low range High range						
Test Channel Bandwidths as specified in TS 38.508-1 [5] subclause 4.3.1					Lowest N _{RB_agg} , Highest N _{RB_agg} (NOTE 1)						
Test SCS as specified in Table 5.5A.3-1					Lowest, Highest						
Test Parameters											
Test ID	DL config for PCC & SCC	UL configuration									
		Modulations for all CCs (NOTE 2)	RB allocation L _{CRB} @R _{START} (NOTE 2)								
			SCS 15 kHz		SCS 30 kHz		SCS 60 kHz				
			PCC	SCC	PCC	SCC	PCC	SCC	PCC	SCC	
1	N/A	Pi/2 BPSK	Edge_1RB_Left	Edge_1RB_Right	Edge_1RB_Left	Edge_1RB_Right	Edge_1RB_Left	Edge_1RB_Right	Edge_1RB_Right		
2		Pi/2 BPSK	15@0	15@0	8@0	8@0	4@0	4@0			
3		Pi/2 BPSK	45@0	45@0	24@0	24@0	12@0	12@0			
4 ³		Pi/2 BPSK	75@0	75@0	40@0	40@0	20@0	20@0			
5 ⁴		Pi/2 BPSK	120@0	120@0	60@0	60@0	30@0	30@0			
6 ⁵		Pi/2 BPSK	216@0	216@0	108@0	108@0	54@0	54@0			
7 ⁵		Pi/2 BPSK	Outer_Full	Outer_Full	Outer_Full	Outer_Full	Outer_Full	Outer_Full			
8		D F T - s - O F D M	QPSK	Edge_1RB_Left	Edge_1RB_Right	Edge_1RB_Left	Edge_1RB_Right	Edge_1RB_Left	Edge_1RB_Right	Edge_1RB_Right	
9			QPSK	15@0	15@0	8@0	8@0	4@0	4@0		
10			QPSK	45@0	45@0	24@0	24@0	12@0	12@0		
11 ³			QPSK	75@0	75@0	40@0	40@0	20@0	20@0		
12 ⁴			QPSK	120@0	120@0	60@0	60@0	30@0	30@0		
13 ⁵			QPSK	216@0	216@0	108@0	108@0	54@0	54@0		
14 ⁵			QPSK	Outer_Full	Outer_Full	Outer_Full	Outer_Full	Outer_Full	Outer_Full		
15			-	16QAM	Edge_1RB_Left	Edge_1RB_Right	Edge_1RB_Left	Edge_1RB_Right	Edge_1RB_Left	Edge_1RB_Right	Edge_1RB_Right
16			s	16QAM	15@0	15@0	8@0	8@0	4@0	4@0	
17			-	16QAM	45@0	45@0	24@0	24@0	12@0	12@0	
18 ³			O	16QAM	75@0	75@0	40@0	40@0	20@0	20@0	
19 ⁴			F	16QAM	120@0	120@0	60@0	60@0	30@0	30@0	
20 ⁵			D	16QAM	216@0	216@0	108@0	108@0	54@0	54@0	
21 ⁵			M	16QAM	Outer_Full	Outer_Full	Outer_Full	Outer_Full	Outer_Full	Outer_Full	
22				64QAM	Edge_1RB_Left	Edge_1RB_Right	Edge_1RB_Left	Edge_1RB_Right	Edge_1RB_Left	Edge_1RB_Right	Edge_1RB_Right
23				64QAM	15@0	15@0	8@0	8@0	4@0	4@0	
24				64QAM	45@0	45@0	24@0	24@0	12@0	12@0	
25 ³				64QAM	75@0	75@0	40@0	40@0	20@0	20@0	
26 ⁴				64QAM	120@0	120@0	60@0	60@0	30@0	30@0	
27 ⁵				64QAM	216@0	216@0	108@0	108@0	54@0	54@0	
28 ⁵				64QAM	Outer_Full	Outer_Full	Outer_Full	Outer_Full	Outer_Full	Outer_Full	
29				256QAM	Edge_1RB_Left	Edge_1RB_Right	Edge_1RB_Left	Edge_1RB_Right	Edge_1RB_Left	Edge_1RB_Right	Edge_1RB_Right
30				256QAM	15@0	15@0	8@0	8@0	4@0	4@0	
31				256QAM	45@0	45@0	24@0	24@0	12@0	12@0	
32 ³				256QAM	75@0	75@0	40@0	40@0	20@0	20@0	
33 ⁴				256QAM	120@0	120@0	60@0	60@0	30@0	30@0	
34 ⁵				256QAM	216@0	216@0	108@0	108@0	54@0	54@0	
35 ⁵				256QAM	Outer_Full	Outer_Full	Outer_Full	Outer_Full	Outer_Full	Outer_Full	
36				QPSK	Edge_1RB_Left	Edge_1RB_Right	Edge_1RB_Left	Edge_1RB_Right	Edge_1RB_Left	Edge_1RB_Right	Edge_1RB_Right
37			QPSK	15@0	15@0	8@0	8@0	4@0	4@0		
38			QPSK	45@0	45@0	23@0	23@0	12@0	12@0		
39 ³			QPSK	75@0	75@0	38@0	38@0	19@0	19@0		

40 ⁴	C P - O F D M	QPSK	115@0	115@0	58@0	58@0	29@0	29@0
41 ⁵		QPSK	210@0	210@0	105@0	105@0	53@0	53@0
42 ⁵		QPSK	Outer_Full	Outer_Full	Outer_Full	Outer_Full	Outer_Full	Outer_Full
43		16QAM	Edge_1RB_Left	Edge_1RB_Right	Edge_1RB_Left	Edge_1RB_Right	Edge_1RB_Left	Edge_1RB_Right
44		16QAM	15@0	15@0	8@0	8@0	4@0	4@0
45		16QAM	45@0	45@0	23@0	23@0	12@0	12@0
46 ³		16QAM	75@0	75@0	38@0	38@0	19@0	19@0
47 ⁴		16QAM	115@0	115@0	58@0	58@0	29@0	29@0
48 ⁵		16QAM	210@0	210@0	105@0	105@0	53@0	53@0
49 ⁵		16QAM	Outer_Full	Outer_Full	Outer_Full	Outer_Full	Outer_Full	Outer_Full
50		64QAM	Edge_1RB_Left	Edge_1RB_Right	Edge_1RB_Left	Edge_1RB_Right	Edge_1RB_Left	Edge_1RB_Right
51		64QAM	15@0	15@0	8@0	8@0	4@0	4@0
52		64QAM	45@0	45@0	23@0	23@0	12@0	12@0
53 ³		64QAM	75@0	75@0	38@0	38@0	19@0	19@0
54 ⁴		64QAM	115@0	115@0	58@0	58@0	29@0	29@0
55 ⁵		64QAM	210@0	210@0	105@0	105@0	53@0	53@0
56 ⁵		64QAM	Outer_Full	Outer_Full	Outer_Full	Outer_Full	Outer_Full	Outer_Full
57		256QAM	Edge_1RB_Left	Edge_1RB_Right	Edge_1RB_Left	Edge_1RB_Right	Edge_1RB_Left	Edge_1RB_Right
58		256QAM	15@0	15@0	8@0	8@0	4@0	4@0
59		256QAM	45@0	45@0	23@0	23@0	12@0	12@0
60 ³		256QAM	75@0	75@0	38@0	38@0	19@0	19@0
61 ⁴		256QAM	115@0	115@0	58@0	58@0	29@0	29@0
62 ⁵		256QAM	210@0	210@0	105@0	105@0	53@0	53@0
63 ⁵		256QAM	Outer_Full	Outer_Full	Outer_Full	Outer_Full	Outer_Full	Outer_Full

NOTE 1: The Test CC Combination settings are checked separately for each CA Configuration, which applicable aggregated channel bandwidths are specified in Table 5.5A.1.

NOTE 2: Edge_1RB_Left, Edge_1RB_Right and Outer_Full RB allocation are specified in table 6.1-1 for each component carrier.

NOTE 3: Only being tested when the channel bandwidth of both carriers are larger than 10 MHz.

NOTE 4: Only being tested when the channel bandwidth of both carriers are larger than 20 MHz.

NOTE 5: Only being tested when the channel bandwidth of both carriers are larger than 25 MHz.

NOTE 6: DFT-s-OFDM Pi/2 BPSK test applies only for UEs which supports Pi/2 BPSK in FR1.

1. Connect the SS to the UE antenna connectors as shown in TS 38.508-1 [5] Annex A, Figure A.3.1.1.3 for TE diagram and section A.3.2 for UE diagram.
2. The parameter settings for the cell are set up according to TS 38.508-1 [5] subclause 4.4.3.
3. Downlink signals are initially set up according to Annex C.0, C.1, C.2, and uplink signals according to Annex G.0, G.1, G.2, G.3.0.
4. The UL Reference Measurement Channel is set according to Tables 6.2A.2.1.4.1-1 to 6.2A.2.1.4.1-3b as appropriate.
5. Propagation conditions are set according to Annex B.0.
6. Ensure the UE is in State RRC_CONNECTED with generic procedure parameters Connectivity NR, Connected without release *On*, Test Mode *On* and Test Loop Function *On* according to TS 38.508-1 [5] clause 4.5. Message contents are defined in clause 6.2A.2.1.4.3.

6.2A.2.1.4.2 Test procedure

1. Configure SCC according to Annex C.0, C.1, and C.2 for all downlink physical channels.
2. The SS shall configure SCC as per TS 38.508-1 [5] clause 5.5.1. Message contents are defined in clause 6.2A.2.1.4.3.
3. SS activates SCC by sending the activation MAC CE (Refer TS 38.321 [18], clauses 5.9, 6.1.3.10). Wait for at least 2 seconds (Refer TS 38.133[19], clause 9.3).
4. SS sends uplink scheduling information for each UL HARQ process via PDCCH DCI format 0_1 for C_RNTI to schedule the UL RMC according to Tables 6.2A.2.1.4.1-1 to 6.2A.2.1.4.1-3b on both PCC and SCC as

appropriate. Since the UE has no payload and no loopback data to send the UE sends uplink MAC padding bits on the UL RMC.

5. Send continuously uplink power control "up" commands in every uplink scheduling information to the UE; allow at least 200ms starting from the first TPC command in this step for the UE to reach P_{UMAX} level corresponding to Power Class 3.
6. Measure the sum of mean transmitted power over all component carriers in the CA configuration of the radio access mode. The period of measurement shall be at least the continuous duration of 1ms uplink. For TDD only slots consisting of only UL symbols are under test. For FDD band in inter-band CA with both TDD band and FDD band, only slots overlapping with only UL symbols in TDD are under test.

NOTE 1: When switching to DFT-s-OFDM waveform, as specified in the test configuration table 6.2A.2.1.4.1-1, send an NR RRCReconfiguration message according to TS 38.508-1 [5] clause 4.6.3 Table 4.6.3-118 PUSCH-Config with TRANSFORM_PRECODER_ENABLED condition.

6.2A.2.1.4.3 Message contents

Message contents are according to TS 38.508-1 [5] subclause 4.6 and 5.4.

Table 6.2A.2.1.4.3-1: FrequencyInfoUL-SIB for inter-band CA

Derivation Path: TS 38.508-1 [5] Table 4.6.3-62 FrequencyInfoUL-SIB			
Information Element	Value/remark	Comment	Condition
p-Max	20		Power class 3 and Inter-band CA Test IDs 1, 4-13, 16, 19, 23, 26, 27, 30, 37
	17		Power class 3 and Inter-band CA Test IDs 14, 15, 17, 18, 33
	16		Power class 3 and Inter-band CA Test IDs 2, 3, 22, 24, 25, 28, 29, 31, 32
	14		Power class 3 and Inter-band CA Test IDs 20, 21, 36
	13		Power class 3 and Inter-band CA Test IDs 34, 35

Table 6.2A.2.1.4.3-2: FrequencyInfoUL-SIB for intra-band contiguous CA (contiguous RB allocation) for CA_n41C

Derivation Path: TS 38.508-1 [5] Table 4.6.3-62 FrequencyInfoUL-SIB			
Information Element	Value/remark	Comment	Condition
p-Max	18		Power class 3 and Test IDs 1, 3, 5
	16		Power class 3 and Test IDs 11, 13
	14		Power class 3 and Test IDs 7, 15
	11		Power class 3 and Test IDs 2, 4, 6, 8, 9, 17
	10		Power class 3 and Test IDs 10, 12, 14, 16, 18

Table 6.2A.2.1.4.3-2a: FrequencyInfoUL-SIB for intra-band contiguous CA (contiguous RB allocation) for CA_n48B

Derivation Path: TS 38.508-1 [5] Table 4.6.3-62 FrequencyInfoUL-SIB			
Information Element	Value/remark	Comment	Condition
p-Max	19		Power class 3 and Test IDs 1, 3, 5
	18		Power class 3 and Test IDs 5, 11
	17		Power class 3 and Test IDs 7, 13
	16		Power class 3 and Test IDs 2, 4, 6, 15
	15		Power class 3 and Test IDs 8, 12, 14, 16
	12		Power class 3 and Test IDs 9, 10
	11		Power class 3 and Test ID 17, 18

Table 6.2A.2.1.4.3-2b: FrequencyInfoUL-SIB for intra-band contiguous CA (contiguous RB allocation) for CA_n77C

Derivation Path: TS 38.508-1 [5] Table 4.6.3-62 FrequencyInfoUL-SIB			
Information Element	Value/remark	Comment	Condition
p-Max	17		Power class 3 and Test IDs 1, 3, 5
	16		Power class 3 and Test IDs 11, 13
	14		Power class 3 and Test IDs 7, 15
	11		Power class 3 and Test IDs 2, 4, 6, 8, 9, 17
	10		Power class 3 and Test IDs 10, 12, 14, 16, 18

6.2A.2.1.5 Test requirement

The maximum output power, derived in step 6 shall be within the range prescribed by the nominal maximum output power and tolerance in Table 6.2A.2.1.5-1 to Table 6.2A.2.1.5-3.

Table 6.2A.2.1.5-1: UE Output Power for inter-band CA (2 UL CA) test requirements

Test ID	P _{PowerClass} (dBm)	MPR _c (dB)		ΔT _{C,c} (dB)		T _L (dB)	P _{CMAX,L} (dBm)	T _{LOW} (P _{CMAX,L}) (dB)	Upper limit (dBm)	Lower limit (dBm)
		PCC	SCC	PCC	SCC					
1	23	0.2	0.2	0 (1.5 ²)	0 (1.5 ²)	3	23	3	25+TT	20-TT
2	23	3.5	3.5	1.5 ²	1.5 ²	3	21 ²	5 ²	25+TT	16-TT ²
3	23	3.5	3.5	1.5 ²	1.5 ²	3	21 ²	5 ²	25+TT	16-TT ²
4	23	1.2	1.2	0	0	3	23	3	25+TT	20-TT
5	23	0	0	0 (1.5 ²)	0 (1.5 ²)	3	23	3	25+TT	20-TT
6	23	0.5	0.5	1.5 ²	1.5 ²	3	23	3	25+TT	20-TT
7	23	0.5	0.5	1.5 ²	1.5 ²	3	23	3	25+TT	20-TT
8	23	0.5	0.5	0	0	3	23	3	25+TT	20-TT
9	23	0	0	0 (1.5 ²)	0 (1.5 ²)	3	23	3	25+TT	20-TT
10	23	1	1	1.5 ²	1.5 ²	3	23	3	25+TT	20-TT
11	23	1	1	1.5 ²	1.5 ²	3	23	3	25+TT	20-TT
12	23	1	1	0	0	3	23	3	25+TT	20-TT
13	23	1	1	0 (1.5 ²)	0 (1.5 ²)	3	23	3	25+TT	20-TT
14	23	2	2	1.5 ²	1.5 ²	3	22.5 ²	5 ²	25+TT	17.5-TT ²
15	23	2	2	1.5 ²	1.5 ²	3	22.5 ²	5 ²	25+TT	17.5-TT ²
16	23	2	2	0	0	3	23	3	25+TT	20-TT
17	23	2.5	2.5	1.5 ²	1.5 ²	3	22.5 ²	5 ²	25+TT	17.5-TT ²
18	23	2.5	2.5	1.5 ²	1.5 ²	3	22.5 ²	5 ²	25+TT	17.5-TT ²
19	23	2.5	2.5	0	0	3	23	3	25+TT	20-TT
20	23	4.5	4.5	1.5 ²	1.5 ²	3	20 ²	6 ²	25+TT	14-TT ²
21	23	4.5	4.5	1.5 ²	1.5 ²	3	20 ²	6 ²	25+TT	14-TT ²
22	23	4.5	4.5	0	0	3	21.5	5	25+TT	16.5-TT
23	23	1.5	1.5	0 (1.5 ²)	0 (1.5 ²)	3	23	3	25+TT	20-TT
24	23	3	3	1.5 ²	1.5 ²	3	21.5 ²	5 ²	25+TT	16.5-TT ²
25	23	3	3	1.5 ²	1.5 ²	3	21.5 ²	5 ²	25+TT	16.5-TT ²
26	23	3	3	0	0	3	23	3	25+TT	20-TT
27	23	2	2	0 (1.5 ²)	0 (1.5 ²)	3	23 (22.5 ²)	3 (5 ²)	25+TT	20-TT (17.5-TT ²)
28	23	3	3	1.5 ²	1.5 ²	3	21.5 ²	5 ²	25+TT	16.5-TT ²
29	23	3	3	1.5 ²	1.5 ²	3	21.5 ²	5 ²	25+TT	16.5-TT ²

Test ID	P _{PowerClass} (dBm)	MPR _c (dB)		ΔT _{C,c} (dB)		T _L (dB)	P _{CMAX_L} (dBm)	T _{LOW} (P _{CMAX_L}) (dB)	Upper limit (dBm)	Lower limit (dBm)
		PCC	SCC	PCC	SCC					
30	23	3	3	0	0	3	23	3	25+TT	20-TT
31	23	3.5	3.5	1.5 ²	1.5 ²	3	21 ²	5 ²	25+TT	16-TT ²
32	23	3.5	3.5	1.5 ²	1.5 ²	3	21 ²	5 ²	25+TT	16-TT ²
33	23	3.5	3.5	0	0	3	22.5	5 ²	25+TT	17.5-TT
34	23	6.5	6.5	1.5 ²	1.5 ²	3	18 ²	5 ²	25+TT	13-TT ²
35	23	6.5	6.5	1.5 ²	1.5 ²	3	18 ²	5 ²	25+TT	13-TT ²
36	23	6.5	6.5	0	0	3	19.5	5	25+TT	14.5-TT
37	23	0	6.5	0	0	3	23	3	25+TT	20-TT

NOTE 1: P_{PowerClass} is the maximum UE power specified without taking into account the tolerance.

NOTE 2: For transmission bandwidths confined within F_{UL_low} and F_{UL_low} + 4 MHz or F_{UL_high} - 4 MHz and F_{UL_high}.

NOTE 3: TT for each frequency and channel bandwidth is specified in Table 6.2A.2.1.5-2.

Table 6.2A.2.1.5-1a: UE Output Power for intra-band contiguous 2 UL CA (contiguous RB allocation) test requirements (for CA_n41C)

Configuration ID	Power Class 3 (dBm)	MPR		ΔT_c	P_{CMAX_L}		$T_L = 2$	$T(P_{CMAX_L})$		Bandwidth class B		Bandwidth class C	
		BW class B	BW class C		BW class B	BW class C		BW class B	BW class C	Upper limit (dBm)	Lower limit (dBm)	Upper limit (dBm)	Lower limit (dBm)
1	23	1	2.5	0	22	20.5	2	2	2.5	25+TT	20-TT	25+TT	18-TT
2	23	3.5	7	0	19.5	16	2	3.5	5	25+TT	16-TT	25+TT	11-TT
3	23	1	2.5	0	22	20.5	2	2	2.5	25+TT	20-TT	25+TT	18-TT
4	23	3.5	7	0	19.5	16	2	3.5	5	25+TT	16-TT	25+TT	11-TT
5	23	1.5	2.5	0	21.5	20.5	2	2	2.5	25+TT	19.5-TT	25+TT	18-TT
6	23	3.5	7	0	19.5	16	2	3.5	5	25+TT	16-TT	25+TT	11-TT
7	23	3	5	0	20	18	2	2.5	4	25+TT	17.5-TT	25+TT	14-TT
8	23	4	7	0	19	16	2	3.5	5	25+TT	15.5-TT	25+TT	11-TT
9	23	5.5	7	0	17.5	16	2	5	5	25+TT	12.5-TT	25+TT	11-TT
10	23	6	7.5	0	17	15.5	2	5	5	25+TT	12-TT	25+TT	10.5-TT
11	23	2	3.5	0	21	19.5	2	2	3.5	25+TT	19-TT	25+TT	16-TT
12	23	4	8	0	19	15	2	3.5	5	25+TT	15.5-TT	25+TT	10-TT
13	23	2.5	3.5	0	20.5	19.5	2	2.5	3.5	25+TT	18-TT	25+TT	16-TT
14	23	4	8	0	19	15	2	3.5	5	25+TT	15.5-TT	25+TT	10-TT
15	23	3.5	5	0	19.5	18	2	3.5	4	25+TT	16-TT	25+TT	14-TT
16	23	4	8	0	19	15	2	3.5	5	25+TT	15.5-TT	25+TT	10-TT
17	23	6.5	7	0	16.5	16	2	5	5	25+TT	11.5-TT	25+TT	11-TT
18	23	6.5	8	0	16.5	15	2	5	5	25+TT	11.5-TT	25+TT	10-TT

NOTE 1: TT for each frequency and channel bandwidth is specified in Table 6.2A.2.1.5-3.

Table 6.2A.2.1.5-1b: UE Output Power for intra-band contiguous 2 UL CA (contiguous RB allocation) test requirements (for CA_n48B, CA_n77C)

Configuration ID	Power Class 3 (dBm)	MPR		ΔT_c	P_{CMAX_L}		$T_L = 2$	$T(P_{CMAX_L})$		Bandwidth class B		Bandwidth class C	
		BW class B	BW class C		BW class B	BW class C		BW class B	BW class C	Upper limit (dBm)	Lower limit (dBm)	Upper limit (dBm)	Lower limit (dBm)
1	23	1	2.5	0	22	20.5	3	2	2.5	25+TT	19-TT	25+TT	17.5-TT
2	23	3.5	7	0	19.5	16	3	3.5	5	25+TT	16-TT	25+TT	11-TT
3	23	1	2.5	0	22	20.5	3	2	2.5	25+TT	19-TT	25+TT	17.5-TT
4	23	3.5	7	0	19.5	16	3	3.5	5	25+TT	16-TT	25+TT	11-TT
5	23	1.5	2.5	0	21.5	20.5	3	2	2.5	25+TT	18.5-TT	25+TT	17.5-TT
6	23	3.5	7	0	19.5	16	3	3.5	5	25+TT	16-TT	25+TT	11-TT
7	23	3	5	0	20	18	3	2.5	4	25+TT	17-TT	25+TT	14-TT
8	23	4	7	0	19	16	3	3.5	5	25+TT	15.5-TT	25+TT	11-TT
9	23	5.5	7	0	17.5	16	3	5	5	25+TT	12.5-TT	25+TT	11-TT
10	23	6	7.5	0	17	15.5	3	5	5	25+TT	12-TT	25+TT	10.5-TT
11	23	2	3.5	0	21	19.5	3	2	3.5	25+TT	18-TT	25+TT	16-TT
12	23	4	8	0	19	15	3	3.5	5	25+TT	15.5-TT	25+TT	10-TT
13	23	2.5	3.5	0	20.5	19.5	3	2.5	3.5	25+TT	17.5-TT	25+TT	16-TT
14	23	4	8	0	19	15	3	3.5	5	25+TT	15.5-TT	25+TT	10-TT
15	23	3.5	5	0	19.5	18	3	3.5	4	25+TT	16-TT	25+TT	14-TT
16	23	4	8	0	19	15	3	3.5	5	25+TT	15.5-TT	25+TT	10-TT
17	23	6.5	7	0	16.5	16	3	5	5	25+TT	11.5-TT	25+TT	11-TT
18	23	6.5	8	0	16.5	15	3	5	5	25+TT	11.5-TT	25+TT	10-TT

NOTE 1: TT for each frequency and channel bandwidth is specified in Table 6.2A.2.1.5-3.

Table 6.2A.2.1.5-1c: UE Output Power for intra-band contiguous 2 UL CA (non-contiguous RB allocation) test requirements (for CA_n41C)

Configuration ID	Power Class 3 (dBm)	MPR		ΔT_c	P_{CMAX_L}		T_L	$T(P_{CMAX_L})$		Bandwidth class B		Bandwidth class C	
		BW class B	BW class C		BW class B	BW class C		BW class B	BW class C	Upper limit (dBm)	Lower limit (dBm)	Upper limit (dBm)	Lower limit (dBm)
1	23	2	2.5	0	21	20.5	2	2	2.5	25+TT	19-TT	25+TT	18-TT
2	23	5.5 (3.5) ¹	6 (4) ¹	0	17.5 (19.5) ¹	17 (19) ¹	2	5 (3.5) ¹	5 (3.5) ¹	25+TT	12.5-TT (16-TT) ¹	25+TT	12-TT (15.5-TT) ¹
3	23	11.5 (7) ²	13 (8.5) ²	0	11.5 (16) ²	10 (14.5) ²	2	6 (5) ²	6 (5) ²	25+TT	5.5-TT (11-TT) ²	25+TT	4-TT (9.5-TT) ²
4	23	2	2.5	0	21	20.5	2	2	2.5	25+TT	19-TT	25+TT	18-TT
5	23	5.5 (3.5) ¹	6 (4) ¹	0	17.5 (19.5) ¹	17 (19) ¹	2	5 (3.5) ¹	5 (3.5) ¹	25+TT	12.5-TT (16-TT) ¹	25+TT	12-TT (15.5-TT) ¹
6	23	11.5 (7) ²	13 (8.5) ²	0	11.5 (16) ²	10 (14.5) ²	2	6 (5) ²	6 (5) ²	25+TT	5.5-TT (11-TT) ²	25+TT	4-TT (9.5-TT) ²
7	23	2.5	3	0	20.5	20	2	2.5	2.5	25+TT	18-TT	25+TT	17.5-TT
8	23	5.5	6	0	17.5	17	2	5	5	25+TT	12.5-TT	25+TT	12-TT
9	23	11.5 (7) ²	13 (8.5) ²	0	11.5 (16) ²	10 (14.5) ²	2	6 (5) ²	6 (5) ²	25+TT	5.5-TT (11-TT) ²	25+TT	4-TT (9.5-TT) ²
10	23	4.5	5	0	18.5	18	2	4	4	25+TT	14.5-TT	25+TT	14-TT
11	23	6	6	0	17	17	2	5	5	25+TT	12-TT	25+TT	12-TT
12	23	11.5 (7) ²	13 (8.5) ²	0	11.5 (16) ²	10 (14.5) ²	2	6 (5) ²	6 (5) ²	25+TT	5.5-TT (11-TT) ²	25+TT	4-TT (9.5-TT) ²
13	23	6	6.5	0	17	16.5	2	5	5	25+TT	12-TT	25+TT	11.5-TT
14	23	6.5	6.5	0	16.5	16.5	2	5	5	25+TT	11.5-TT	25+TT	11.5-TT
15	23	11.5 (7) ²	13 (8.5) ²	0	11.5 (16) ²	10 (14.5) ²	2	6 (5) ²	6 (5) ²	25+TT	5.5-TT (11-TT) ²	25+TT	4-TT (9.5-TT) ²
16	23	2.5	3.5	0	20.5	19.5	2	2.5	3.5	25+TT	18-TT	25+TT	16-TT
17	23	6.5 (4.5) ¹	7 (5) ¹	0	16.5 (18.5) ¹	16 (18) ¹	2	5 (4) ¹	5 (4) ¹	25+TT	11.5-TT (14.5-TT) ¹	25+TT	11-TT (14-TT) ¹
18	23	12 (7.5) ²	14 (9.5) ²	0	11 (15.5) ²	9 (13.5) ²	2	6 (5) ²	6 (5) ²	25+TT	5-TT (10.5-TT) ²	25+TT	3-TT (8.5-TT) ²
19	23	3	3.5	0	20	19.5	2	2.5	3.5	25+TT	17.5-TT	25+TT	16-TT
20	23	7	7	0	16	16	2	5	5	25+TT	11-TT	25+TT	11-TT
21	23	12 (7.5) ²	14 (9.5) ²	0	11 (15.5) ²	9 (13.5) ²	2	6 (5) ²	6 (5) ²	25+TT	5-TT (10.5-TT) ²	25+TT	3-TT (8.5-TT) ²
22	23	5	5	0	18	18	2	4	4	25+TT	14-TT	25+TT	14-TT
23	23	7	7	0	16	16	2	5	5	25+TT	11-TT	25+TT	11-TT
24	23	12 (7.5) ²	14 (9.5) ²	0	11 (15.5) ²	9 (13.5) ²	2	6 (5) ²	6 (5) ²	25+TT	5-TT (10.5-TT) ²	25+TT	3-TT (8.5-TT) ²
25	23	7.5	7.5	0	15.5	15.5	2	5	5	25+TT	10.5-TT	25+TT	10.5-TT
26	23	7.5	7.5	0	15.5	15.5	2	5	5	25+TT	10.5-TT	25+TT	10.5-TT
27	23	12 (7.5) ²	14 (9.5) ²	0	11 (15.5) ²	9 (13.5) ²	2	6 (5) ²	6 (5) ²	25+TT	5-TT (10.5-TT) ²	25+TT	3-TT (8.5-TT) ²

NOTE 1: Outer 1 MPR for Pi/2 BPSK and QPSK is reduced by 2dB for aggregated allocation bandwidth > 10MHz
 NOTE 2: Outer 2 MPR is reduced by 4.5dB for aggregated allocation bandwidth > 10MHz
 NOTE 3: TT for each frequency and channel bandwidth is specified in Table 6.2A.2.1.5-3.

Table 6.2A.2.1.5-1d: UE Output Power for intra-band contiguous 2 UL CA (non-contiguous RB allocation) test requirements (for CA_n48B, CA_n77C)

Configuration ID	Power Class 3 (dBm)	MPR		ΔT_c	P_{CMAX_L}		T_L	$T(P_{CMAX_L})$		Bandwidth class B		Bandwidth class C	
		BW class B	BW class C		BW class B	BW class C		BW class B	BW class C	Upper limit (dBm)	Lower limit (dBm)	Upper limit (dBm)	Lower limit (dBm)
1	23	2	2.5	0	21	20.5	3	2	2.5	25+TT	18-TT	25+TT	17.5-TT
2	23	5.5 (3.5) ¹	6 (4) ¹	0	17.5 (19.5) ¹	17 (19) ¹	3	5 (3.5) ¹	5 (3.5) ¹	25+TT	12.5-TT (16-TT) ¹	25+TT	12-TT (15.5-TT) ¹
3	23	11.5 (7) ²	13 (8.5) ²	0	11.5 (16) ²	10 (14.5) ²	3	6 (5) ²	6 (5) ²	25+TT	5.5-TT (11-TT) ²	25+TT	4-TT (9.5-TT) ²
4	23	2	2.5	0	21	20.5	3	2	2.5	25+TT	18-TT	25+TT	17.5-TT
5	23	5.5 (3.5) ¹	6 (4) ¹	0	17.5 (19.5) ¹	17 (19) ¹	3	5 (3.5) ¹	5 (3.5) ¹	25+TT	12.5-TT (16-TT) ¹	25+TT	12-TT (15.5-TT) ¹
6	23	11.5 (7) ²	13 (8.5) ²	0	11.5 (16) ²	10 (14.5) ²	3	6 (5) ²	6 (5) ²	25+TT	5.5-TT (11-TT) ²	25+TT	4-TT (9.5-TT) ²
7	23	2.5	3	0	20.5	20	3	2.5	2.5	25+TT	17.5-TT	25+TT	17-TT
8	23	5.5	6	0	17.5	17	3	5	5	25+TT	12.5-TT	25+TT	12-TT
9	23	11.5 (7) ²	13 (8.5) ²	0	11.5 (16) ²	10 (14.5) ²	3	6 (5) ²	6 (5) ²	25+TT	5.5-TT (11-TT) ²	25+TT	4-TT (9.5-TT) ²
10	23	4.5	5	0	18.5	18	3	4	4	25+TT	14.5-TT	25+TT	14-TT
11	23	6	6	0	17	17	3	5	5	25+TT	12-TT	25+TT	12-TT
12	23	11.5 (7) ²	13 (8.5) ²	0	11.5 (16) ²	10 (14.5) ²	3	6 (5) ²	6 (5) ²	25+TT	5.5-TT (11-TT) ²	25+TT	4-TT (9.5-TT) ²
13	23	6	6.5	0	17	16.5	3	5	5	25+TT	12-TT	25+TT	11.5-TT
14	23	6.5	6.5	0	16.5	16.5	3	5	5	25+TT	11.5-TT	25+TT	11.5-TT
15	23	11.5 (7) ²	13 (8.5) ²	0	11.5 (16) ²	10 (14.5) ²	3	6 (5) ²	6 (5) ²	25+TT	5.5-TT (11-TT) ²	25+TT	4-TT (9.5-TT) ²
16	23	2.5	3.5	0	20.5	19.5	3	2.5	3.5	25+TT	17.5-TT	25+TT	16-TT
17	23	6.5 (4.5) ¹	7 (5) ¹	0	16.5 (18.5) ¹	16 (18) ¹	3	5 (4) ¹	5 (4) ¹	25+TT	11.5-TT (14.5-TT) ¹	25+TT	11-TT (14-TT) ¹
18	23	12 (7.5) ²	14 (9.5) ²	0	11 (15.5) ²	9 (13.5) ²	3	6 (5) ²	6 (5) ²	25+TT	5-TT (10.5-TT) ²	25+TT	3-TT (8.5-TT) ²
19	23	3	3.5	0	20	19.5	3	2.5	3.5	25+TT	17-TT	25+TT	16-TT
20	23	7	7	0	16	16	3	5	5	25+TT	11-TT	25+TT	11-TT
21	23	12 (7.5) ²	14 (9.5) ²	0	11 (15.5) ²	9 (13.5) ²	3	6 (5) ²	6 (5) ²	25+TT	5-TT (10.5-TT) ²	25+TT	3-TT (8.5-TT) ²
22	23	5	5	0	18	18	3	4	4	25+TT	14-TT	25+TT	14-TT
23	23	7	7	0	16	16	3	5	5	25+TT	11-TT	25+TT	11-TT
24	23	12 (7.5) ²	14 (9.5) ²	0	11 (15.5) ²	9 (13.5) ²	3	6 (5) ²	6 (5) ²	25+TT	5-TT (10.5-TT) ²	25+TT	3-TT (8.5-TT) ²
25	23	7.5	7.5	0	15.5	15.5	3	5	5	25+TT	10.5-TT	25+TT	10.5-TT
26	23	7.5	7.5	0	15.5	15.5	3	5	5	25+TT	10.5-TT	25+TT	10.5-TT
27	23	12 (7.5) ²	14 (9.5) ²	0	11 (15.5) ²	9 (13.5) ²	3	6 (5) ²	6 (5) ²	25+TT	5-TT (10.5-TT) ²	25+TT	3-TT (8.5-TT) ²

NOTE 1: Outer 1 MPR for Pi/2 BPSK and QPSK is reduced by 2dB for aggregated allocation bandwidth > 10MHz
 NOTE 2: Outer 2 MPR is reduced by 4.5dB for aggregated allocation bandwidth > 10MHz
 NOTE 3: TT for each frequency and channel bandwidth is specified in Table 6.2A.2.1.5-3.

Table 6.2A.2.1.5-1e: UE Output Power for intra-band non-contiguous 2 UL CA test requirements (MPR_{IM3} to meet -13dBm/MHz)

Test ID	P ^{PowerClass} _{s, CA} (dBm)	MPR (dB)	ΔT _C (dB)	P _{C_{MAX}L} (dBm)	T(P _{C_{MAX}L}) (dB)	T _L (dB)	Upper limit (dBm)	Lower limit (dBm)
1,2	23	9	0	14	5	3	25+TT	9-TT
3	23	8	0	15	5	3	25+TT	10-TT
4	23	7	0	16	5	3	25+TT	11-TT
5	23	6.5	0	16.5	5	3	25+TT	11.5-TT
6	23	5.5	0	17.5	5	3	25+TT	12.5-TT
7,8	23	4	0	19	3.5	3	25+TT	16.5-TT
9,10	23	9	0	14	5	3	25+TT	9-TT
11	23	8	0	15	5	3	25+TT	10-TT
12	23	7	0	16	5	3	25+TT	11-TT
13	23	6.5	0	16.5	5	3	25+TT	11.5-TT
14	23	5.5	0	17.5	5	3	25+TT	12.5-TT
15,16	23	4	0	19	3.5	3	25+TT	16.5-TT
17,18	23	9	0	14	5	3	25+TT	9-TT
19	23	8	0	15	5	3	25+TT	10-TT
20	23	7	0	16	5	3	25+TT	11-TT
21	23	6.5	0	16.5	5	3	25+TT	11.5-TT
22	23	5.5	0	17.5	5	3	25+TT	12.5-TT
23,24	23	4	0	19	3.5	3	25+TT	16.5-TT
25,26	23	9	0	14	5	3	25+TT	9-TT
27	23	8	0	15	5	3	25+TT	10-TT
28	23	7	0	16	5	3	25+TT	11-TT
29	23	6.5	0	16.5	5	3	25+TT	11.5-TT
30	23	5.5	0	17.5	5	3	25+TT	12.5-TT
31,32	23	4	0	19	3.5	3	25+TT	16.5-TT
33,34	23	9	0	14	5	3	25+TT	9-TT
35	23	8	0	15	5	3	25+TT	10-TT
36	23	7	0	16	5	3	25+TT	11-TT
37	23	6.5	0	16.5	5	3	25+TT	11.5-TT
38	23	5.5	0	17.5	5	3	25+TT	12.5-TT
39,40	23	4	0	19	3.5	3	25+TT	16.5-TT
41,42	23	9	0	14	5	3	25+TT	9-TT
43	23	8	0	15	5	3	25+TT	10-TT
44	23	7	0	16	5	3	25+TT	11-TT
45	23	6.5	0	16.5	5	3	25+TT	11.5-TT
46	23	5.5	0	17.5	5	3	25+TT	12.5-TT
47,48	23	4	0	19	3.5	3	25+TT	16.5-TT
49,50	23	9	0	14	5	3	25+TT	9-TT
51	23	8	0	15	5	3	25+TT	10-TT
52	23	7	0	16	5	3	25+TT	11-TT
53	23	6.5	0	16.5	5	3	25+TT	11.5-TT
54	23	5.5	0	17.5	5	3	25+TT	12.5-TT
55,56	23	4	0	19	3.5	3	25+TT	16.5-TT
57,58	23	9	0	14	5	3	25+TT	9-TT
59	23	8	0	15	5	3	25+TT	10-TT
60	23	7	0	16	5	3	25+TT	11-TT
61	23	6.5	0	16.5	5	3	25+TT	11.5-TT
62	23	5.5	0	17.5	5	3	25+TT	12.5-TT
63,64	23	4	0	19	3.5	3	25+TT	16.5-TT
65,66	23	9	0	14	5	3	25+TT	9-TT
67	23	8	0	15	5	3	25+TT	10-TT
68	23	7	0	16	5	3	25+TT	11-TT
69	23	6.5	0	16.5	5	3	25+TT	11.5-TT
70	23	5.5	0	17.5	5	3	25+TT	12.5-TT
71,72	23	4	0	19	3.5	3	25+TT	16.5-TT

Table 6.2A.2.1.5-1f: UE Output Power for intra-band non-contiguous 2 UL CA test requirements (MPR_{IM3} to meet - 30dBm/MHz)

Test ID	P ^{PowerClass} _{s, CA} (dBm)	MPR (dB)	ΔT _C (dB)	P _{CMAX_L} (dBm)	T(P _{CMAX_L}) (dB)	T _L (dB)	Upper limit (dBm)	Lower limit (dBm)
1,2	23	15	0	8	6	3	25+TT	2-TT
3	23	14.5	0	8.5	6	3	25+TT	2.5-TT
4	23	13.5	0	9.5	6	3	25+TT	3.5-TT
5	23	12.5	0	10.5	6	3	25+TT	4.5-TT
6,7	23	11.5	0	11.5	6	3	25+TT	5.5-TT
8,9	23	15	0	8	6	3	25+TT	2-TT
10	23	14.5	0	8.5	6	3	25+TT	2.5-TT
11	23	13.5	0	9.5	6	3	25+TT	3.5-TT
12	23	12.5	0	10.5	6	3	25+TT	4.5-TT
13,14	23	11.5	0	11.5	6	3	25+TT	5.5-TT
15,16	23	15	0	8	6	3	25+TT	2-TT
17	23	14.5	0	8.5	6	3	25+TT	2.5-TT
18	23	13.5	0	9.5	6	3	25+TT	3.5-TT
19	23	12.5	0	10.5	6	3	25+TT	4.5-TT
20,21	23	11.5	0	11.5	6	3	25+TT	5.5-TT
22,23	23	15	0	8	6	3	25+TT	2-TT
24	23	14.5	0	8.5	6	3	25+TT	2.5-TT
25	23	13.5	0	9.5	6	3	25+TT	3.5-TT
26	23	12.5	0	10.5	6	3	25+TT	4.5-TT
27,28	23	11.5	0	11.5	6	3	25+TT	5.5-TT
29,30	23	15	0	8	6	3	25+TT	2-TT
31	23	14.5	0	8.5	6	3	25+TT	2.5-TT
32	23	13.5	0	9.5	6	3	25+TT	3.5-TT
33	23	12.5	0	10.5	6	3	25+TT	4.5-TT
34,35	23	11.5	0	11.5	6	3	25+TT	5.5-TT
36,37	23	15	0	8	6	3	25+TT	2-TT
38	23	14.5	0	8.5	6	3	25+TT	2.5-TT
39	23	13.5	0	9.5	6	3	25+TT	3.5-TT
40	23	12.5	0	10.5	6	3	25+TT	4.5-TT
41,42	23	11.5	0	11.5	6	3	25+TT	5.5-TT
43,44	23	15	0	8	6	3	25+TT	2-TT
45	23	14.5	0	8.5	6	3	25+TT	2.5-TT
46	23	13.5	0	9.5	6	3	25+TT	3.5-TT
47	23	12.5	0	10.5	6	3	25+TT	4.5-TT
48,49	23	11.5	0	11.5	6	3	25+TT	5.5-TT
50,51	23	15	0	8	6	3	25+TT	2-TT
52	23	14.5	0	8.5	6	3	25+TT	2.5-TT
53	23	13.5	0	9.5	6	3	25+TT	3.5-TT
54	23	12.5	0	10.5	6	3	25+TT	4.5-TT
55,56	23	11.5	0	11.5	6	3	25+TT	5.5-TT
57,58	23	15	0	8	6	3	25+TT	2-TT
59	23	14.5	0	8.5	6	3	25+TT	2.5-TT
60	23	13.5	0	9.5	6	3	25+TT	3.5-TT
61	23	12.5	0	10.5	6	3	25+TT	4.5-TT
62,63	23	11.5	0	11.5	6	3	25+TT	5.5-TT

Table 6.2A.2.1.5-2: Test Tolerance for inter-band CA (Maximum Power Reduction (MPR))

			TT for overall output power (dB)					
			PCell					
			BW ≤ 40MHz			40MHz < BW ≤ 100MHz		
			f ≤ 3.0GHz	3.0GHz < f ≤ 4.2GHz	4.2GHz < f ≤ 6.0GHz	f ≤ 3.0GHz	3.0GHz < f ≤ 4.2GHz	4.2GHz < f ≤ 6.0GHz
SCell	BW ≤ 40MHz	f ≤ 3.0GHz	0.7	1.0	1.0	1.0	1.0	1.0
		3.0GHz < f ≤ 4.2GHz	1.0	1.0	1.0	1.0	1.0	1.0
		4.2GHz < f ≤ 6.0GHz	1.0	1.0	1.0	1.0	1.0	1.0
	40MHz < BW ≤ 100MHz	f ≤ 3.0GHz	1.0	1.0	1.0	1.0	1.0	1.0
		3.0GHz < f ≤ 4.2GHz	1.0	1.0	1.0	1.0	1.0	1.0
		4.2GHz < f ≤ 6.0GHz	1.0	1.0	1.0	1.0	1.0	1.0

Table 6.2A.2.1.5-3: Test Tolerance for intra-band CA (Maximum Power Reduction (MPR))

TT for overall output power (dB)		
Aggregation BW	f ≤ 3.0GHz	3.0GHz < f ≤ 6.0GHz
BW ≤ 40MHz	0.7	1.0
40MHz < BW ≤ 100MHz	1.0	1.0
100MHz < BW ≤ 200MHz	FFS	FFS

For the UE which supports inter-band NR CA configuration, inter-band NR-DC configuration, SUL configuration or inter-band EN-DC configuration, $\Delta T_{IB,c}$ as specified in 6.2A.4.0.2 for NR CA, 6.2B.4.0.2 for NR-DC, clause 6.2C.2 for SUL, or TS 38.521-3 [14] clause 6.2B.4.2 for EN-DC applies. Unless otherwise stated, $\Delta T_{IB,c}$ is set to zero. In case the UE supports more than one of band combinations for CA, NR-DC, SUL or DC, and an operating band belongs to more than one band combinations then

- When the operating band frequency range is ≤ 1 GHz, the applicable additional $\Delta T_{IB,c}$ shall be the average value for all band combinations defined in clause 6.2A.4.0.2, 6.2B.4.0.2, 6.2C.2 in this specification and 6.2B.4.2 in TS 38.521-3 [14], truncated to one decimal place that apply for that operating band among the supported band combinations. In case there is a harmonic relation between low band UL and high band DL, then the maximum $\Delta T_{IB,c}$ among the different supported band combinations involving such band shall be applied
- When the operating band frequency range is > 1 GHz, the applicable additional $\Delta T_{IB,c}$ shall be the maximum value for all band combinations defined in clause 6.2A.4.0.2, 6.2B.4.0.2, 6.2C.2 in this specification and 6.2B.4.2 in TS 38.521-3 [14] for the applicable operating bands.

6.2A.3 UE additional maximum output power reduction for CA

6.2A.3.0 Minimum conformance requirements

6.2A.3.0.1 FFS

6.2A.3.0.2 FFS

6.2A.3.0.3 UE additional maximum output power reduction for inter-band CA

Unless otherwise stated, for inter-band carrier aggregation with uplink assigned to two NR bands, the requirements in subclause 6.2.3 apply for each uplink component carrier.

Unless specified in Table 6.2A.3.0.3-1, for inter-band carrier aggregation with uplink assigned to two NR bands, the requirements in clause 6.2.3 apply only to the indicated carrier. The requirements in Table 6.2A.3.0.3-1 are specified in terms of an additional spectrum emission requirement with their associated network signalling values and the allowed A-MPR. Unless otherwise stated, the combined requirements and allowed A-MPR are applicable on both bands when both component carriers are active. Additional spurious emission requirements are signalled by the network to indicate

that the UE shall meet the additional requirement for a specific deployment scenario as part of the cell handover/broadcast message.

To meet the additional requirements, additional maximum power reduction (A-MPR) is allowed for the maximum output power as specified in Table 6.2.1-1. Unless stated otherwise, the total reduction to UE maximum output power is $\max(\text{MPR}, \text{A-MPR})$ where MPR is defined in clause 6.2.2. In case of a power class 3 UE, when IE `powerBoostPi2BPSK` is set to 1, power class 2 A-MPR values apply.

For almost contiguous allocations in CP-OFDM waveforms in power class 3, the allowed A-MPR defined in clause 6.2.3 is increased by $\text{CEIL}\{ 10 \log_{10}(1 + \text{NRB_gap} / \text{NRB_alloc}), 0.5 \}$ dB, where `NRB_gap` is the total number of unallocated RBs between allocated RBs and `NRB_alloc` is the total number of allocated RBs, and the parameter `LCRB` is replaced by `NRB_alloc + NRB_gap` in specifying the RB allocation regions.

Unless otherwise specified, pi/2 BPSK in following A-MPR tables refers to both variants of pi/2 BPSK referenced in 6.2.2 tables 6.2.2-1.

The emission requirements specified in Table 6.2A.3.0.3-1 also apply for the frequency ranges that are less than F_{OoB} (MHz) in Table 6.5.3.1-1 from the edge of the channel bandwidth.

Table 6.2A.3.0.3-1: Additional Requirements for uplink inter-band carrier aggregation (two-bands)

4	Band	Applied NS	Requirements (clause)	A-MPR (table/clause)	Note
CA_n1-n3	n1	05	6.5.3.3.4	Clause 6.2.3.4	1
		05U	6.5.3.3.4, 6.5.2.4.2	Clause 6.2.3.4	
	n3	100	6.5.2.4.2	Table 6.2.3.1-2	
CA_n1-n8	n1	05	6.5.3.3.4	Clause 6.2.3.4	1
		05U	6.5.3.3.4, 6.5.2.4.2	Clause 6.2.3.4	
	n8	43	6.5.3.3.5	Clause 6.2.3.6	
		43U	6.5.3.3.5, 6.5.2.4.2	Clause 6.2.3.6	
CA_n1-n28	n1	05	6.5.3.3.4	Clause 6.2.3.4	1,2
		05U	6.5.3.3.4, 6.5.2.4.2	Clause 6.2.3.4	
	n28	17	6.5.3.3.2	N/A	
CA_n1-n40	n1	05	6.5.3.3.4	Clause 6.2.3.4	1
		05U	6.5.3.3.4, 6.5.2.4.2	Clause 6.2.3.4	
CA_n1-n41	n1	05	6.5.3.3.4	Clause 6.2.3.4	1
		05U	6.5.3.3.4, 6.5.2.4.2	Clause 6.2.3.4	
	n41	47	6.5.3.3.15	Table 6.2.3.18-2	
CA_n1-n78	n1	05	6.5.3.3.4	Clause 6.2.3.4	1
		05U	6.5.3.3.4, 6.5.2.4.2	Clause 6.2.3.4	
CA_n1-n79	n1	05	6.5.3.3.4	Clause 6.2.3.4	1
		05U	6.5.3.3.4, 6.5.2.4.2	Clause 6.2.3.4	
CA_n3-n8	n3	100	6.5.2.4.2	Table 6.2.3.1-2	1
		n8	43	6.5.3.3.5	
			43U	6.5.3.3.5, 6.5.2.4.2	
CA_n3-n28	n3	100	6.5.2.4.2	Table 6.2.3.1-2	1,2
	n28	17	6.5.3.3.2	N/A	
CA_n3-n40	n3	100	6.5.2.4.2	Table 6.2.3.1-2	1
CA_n3-n41	n3	100	6.5.2.4.2	Table 6.2.3.1-2	1
		n41	47	6.5.3.3.15	
CA_n3-n77	n3	100	6.5.2.4.2	Table 6.2.3.1-2	1
CA_n3-n78	n3	100	6.5.2.4.2	Table 6.2.3.1-2	1
CA_n3-n79	n3	100	6.5.2.4.2	Table 6.2.3.1-2	1
CA_n5-n77	n5	100	6.5.2.4.2	Table 6.2.3.1-2	1
CA_n5-n78	n5	100	6.5.2.4.2	Table 6.2.3.1-2	1
CA_n5-n79	n5	100	6.5.2.4.2	Table 6.2.3.1-2	1
CA_n8-n40	n8	43	6.5.3.3.5	Clause 6.2.3.6	1
		43U	6.5.3.3.5, 6.5.2.4.2	Clause 6.2.3.6	
CA_n8-n41	n8	43	6.5.3.3.5	Clause 6.2.3.6	1
		43U	6.5.3.3.5, 6.5.2.4.2	Clause 6.2.3.6	
	n41	47	6.5.3.3.15	Table 6.2.3.18-2	
CA_n8-n78	n8	43	6.5.3.3.5	Clause 6.2.3.6	1
		43U	6.5.3.3.5, 6.5.2.4.2	Clause 6.2.3.6	
CA_n8-n79	n8	43	6.5.3.3.5	Clause 6.2.3.6	1
		43U	6.5.3.3.5, 6.5.2.4.2	Clause 6.2.3.6	
CA_n24-n41	n24	56	6.5.3.3.3.27	Clause 6.2.3.3.30	
	n41	04	6.5.2.3.3.2, 6.5.3.3.3.1	Clause 6.2.3.3.2	
CA_n24-n48	n24	56	6.5.3.3.3.27	Clause 6.2.3.3.30	
	n48	27	6.5.2.3.3.8, 6.5.3.3.3.14	Clause 6.2.3.3.16	
CA_n24-n77	n24	56	6.5.3.3.3.27	Clause 6.2.3.3.30	
	n77	55	NOTE 6	N/A	
CA_n28-n40	n28	17	6.5.3.3.2	N/A	2
CA_n28-n41	n28	17	6.5.3.3.2	N/A	2
	n41	47	6.5.3.3.15	Table 6.2.3.18-2	
CA_n28-n77	n28	17	6.5.3.3.2	N/A	2
CA_n28-n78	n28	17	6.5.3.3.2	N/A	2
CA_n40-n41	n41	47	6.5.3.3.15	Table 6.2.3.18-2	
CA_n41-n78	n41	47	6.5.3.3.15	Table 6.2.3.18-2	
CA_n41-n79	n41	47	6.5.3.3.15	Table 6.2.3.18-2	

NOTE 1:	NS_05U, NS_43U and NS_100 can be signalled for NR bands that have UTRA services deployed and the requirements in clause 6.5.2.4.2 are only applicable to the signalling carrier.
NOTE 2:	Applicable when the assigned NR carrier is confined within 718 MHz and 748 MHz and when the channel bandwidth used is 5 or 10 MHz.
NOTE 3:	TBD
NOTE 4:	TBD
NOTE 5:	TBD
NOTE 6:	This NS value is applicable for cells in the range 3450 – 3550 MHz for operations in the USA. This NS value does not indicate any additional spurious emission and maximum output power reduction requirements.

6.2A.3.1 UE additional maximum output power reduction for CA (2UL CA)

Editor's note: This clause is complete for AMPR testing. But the following aspects are either missing for not yet determined:

FFS is left in Test applicability since there are no requirements for 6.5A.2.3 Additional Spectrum Emission mask for CA and 6.5A.3.3 Additional Spurious Emissions for CA in In Release-15.

6.2A.3.1.1 Test purpose

Additional emission requirements for CA can be signalled by the network. Each additional emission requirement is associated with a unique network signalling (NS) value indicated in RRC signalling by an NR frequency band number of the applicable operating band and an associated value in the field *additionalSpectrumEmission*. Throughout this specification, the notion of indication or signalling of an NS value refers to the corresponding indication of an NR frequency band number of the applicable operating band, the IE *freqBandIndicatorNR* and an associated value of *additionalSpectrumEmission* in the relevant RRC information elements [6].

To meet the additional requirements, additional maximum power reduction (A-MPR) is allowed for the CA maximum output power as specified in Table 6.2A.1.0.3-1. Unless stated otherwise, the total reduction to UE maximum output power is $\max(\text{MPR}, \text{A-MPR})$ where MPR is defined in clause 6.2A.2. Outer and inner allocation notation used in clause 6.2A.3 is defined in clause 6.2.2. In absence of modulation and waveform types the A-MPR applies to all modulation and waveform types.

6.2A.3.1.2 Test applicability

The requirements of this test apply in test case 6.5A.2.3 Additional Spectrum Emission mask for CA for network signalling values FFS to all types of NR UE release 15 and forward.

The requirements of this test apply in test case 6.5A.3.3 Additional Spurious Emissions for CA for network signalling values FFS to all types of NR UE release 15 and forward.

6.2A.3.1.3 Minimum conformance requirements

The minimum conformance requirements are defined in 6.2A.3.0.

6.2A.3.1.4 Test description

6.2A.3.1.4.1 Initial conditions

Initial conditions are a set of test configurations the UE needs to be tested in and the steps for the SS to take with the UE to reach the correct measurement state. For the UE maximum output power modified by A-MPR specified in table 6.2A.3.0.3-1, the power limits specified in subclause 6.2A.4.1.3 apply.

The initial test configurations consist of environmental conditions, test frequencies, test channel bandwidths and sub-carrier spacing based on NR operating bands specified in table 5.3.5-1. All of these configurations shall be tested with applicable test parameters for each combination of test channel bandwidth and sub-carrier spacing, and are shown in table 6.2A.3.1.4.1-2. The details of the uplink reference measurement channels (RMCs) are specified in Annex A.2. Configurations of PDSCH and PDCCH before measurement are specified in Annex C.2

Table 6.2A.3.1.4.1-1: Test Configuration Table (network signalling value NS_47/NS_01)

Initial Conditions							
Test Environment as specified in TS 38.508-1 [5] clause 4.1				Normal			
Test Frequencies as specified in TS 38.508-1 [5] clause 4.3.1.1.3 for inter band CA in FR1				Low range for PCC and SCC PCC specified in Table 6.2.3.4.1-18a and 6.2.3.4.1-18b			
Test Channel Bandwidths as specified in TS 38.508-1 [5] clause 4.3.1				See Ch BW column for PCC Lowest N_{RB_agg} for SCC			
Test SCS as specified in Table 5.3.5-1				Lowest, Highest			
Test Parameters							
Test ID	DL configuration	UL configuration					
		PCC				SCC	
		F _c (MHz)	Ch BW (MHz)	Modulation	RB allocation	Modulation	RB allocation
1	N/A for A-MPR testing	Default	30	DFT-s-OFDM QPSK	Inner Full	DFT-s-OFDM QPSK	Inner Full
2		Default	30	CP-OFDM 256QAM	Outer Full	CP-OFDM 256QAM	Outer Full
3		Default	30	CP-OFDM 256QAM	Outer Full	DFT-s-OFDM QPSK	Inner Full
NOTE 1: The specific configuration of each RB allocation is defined in Table 6.1-1 unless otherwise stated in this table.							
NOTE 2: DFT-s-OFDM PI/2 BPSK test applies only for UEs which supports half Pi BPSK in FR1.							

Table 6.2A.3.1.4.1-2: Test Configuration Table (network signalling value NS_100/NS_01)

Initial Conditions					
Test Environment as specified in TS 38.508-1 [5] subclause 4.1			Normal		
Test Frequencies as specified in TS 38.508-1 [5] subclause 4.3.1.1.3 for inter band CA in FR1			Low range for PCC and SCC High range for PCC and SCC		
Test Channel Bandwidths as specified in TS 38.508-1 [5] subclause 4.3.1			Lowest N_{RB_agg} for PCC and SCC Highest N_{RB_agg} for PCC and SCC		
Test SCS as specified in Table 5.3.5-1			Lowest, Highest		
Test Parameters					
Test ID	DL configuration	UL configuration			
		Modulation		RB allocation	
		PCC	SCC	PCC	SCC
1	N/A	DFT-s-OFDM QPSK	DFT-s-OFDM QPSK	Inner Full	Inner Full
2		CP-OFDM 256QAM	CP-OFDM 256QAM	Outer Full	Outer Full
3		DFT-s-OFDM QPSK	CP-OFDM 256QAM	Inner Full	Outer Full

Table 6.2A.3.1.4.1-3: Test Configuration Table (network signalling value NS_43/NS_01, NS_43U/NS_01)

Initial Conditions							
Test Environment as specified in TS 38.508-1 [5] subclause 4.1				Normal			
Test Frequencies as specified in TS 38.508-1 [5] subclause 4.3.1.1.3 for inter band CA in FR1				Low range, High range for PCC and SCC unless otherwise stated in F_c column for PCC			
Test Channel Bandwidths as specified in TS 38.508-1 [5] subclause 4.3.1				See Ch BW column for PCC Lowest N_{RB_agg} , Highest N_{RB_agg} for SCC			
Test SCS as specified in Table 5.3.5-1				15kHz			
Test Parameters							
Test ID	DL configuration	UL configuration					
		PCC			SCC		
		F_c (MHz)	Ch BW (MHz)	Modulation	RB allocation	Modulation	RB allocation
1	N/A	910	10MHz	DFT-s-OFDM QPSK	Inner Full	DFT-s-OFDM QPSK	Inner Full
2		907.5	15MHz	CP-OFDM 256QAM	Outer Full	CP-OFDM 256QAM	Outer Full
3		907.5	15MHz	CP-OFDM 256QAM	Outer Full	DFT-s-OFDM QPSK	Inner Full

1. Connect the SS to the UE antenna connectors as shown in TS 38.508-1 [5] Annex A, Figure A.3.1.1.3 for TE diagram and section A.3.2 for UE diagram.
2. The parameter settings for the cell are set up according to TS 38.508-1 [5] subclause 4.4.3.
3. Downlink signals are initially set up according to Annex C.0, C.1, C.2, and uplink signals according to Annex G.0, G.1, G.2, G.3.0.
4. The UL Reference Measurement Channel is set according to Table 6.2A.3.1.4.1-2.
5. Propagation conditions are set according to Annex B.0.
6. Ensure the UE is in State RRC_CONNECTED with generic procedure parameters Connectivity NR, Connected without release *On*, Test Mode *On* and Test Loop Function *On* according to TS 38.508-1 [5] clause 4.5. Message contents are defined in clause 6.2A.3.1.4.3.

6.2A.3.1.4.2 Test procedure

1. Configure SCC according to Annex C.0, C.1, C.2 for all downlink physical channels.
2. The SS shall configure SCC as per TS 38.508-1 [5] clause 5.5.1. Message contents are defined in clause 6.2A.3.1.4.3.
3. SS activates SCC by sending the activation MAC CE (Refer TS 38.321 [18], clauses 5.9, 6.1.3.10). Wait for at least 2 seconds (Refer TS 38.133[19], clause 9.3).
4. SS sends uplink scheduling information for each UL HARQ process via PDCCH DCI format 0_1 for C_RNTI to schedule the UL RMC according to Table 6.2A.3.1.4.1-1, Table 6.2A.3.1.4.1-2, Table 6.2A.3.1.4.1-3 as appropriate on both PCC and SCC. Since the UE has no payload and no loopback data to send the UE sends uplink MAC padding bits on the UL RMC.
5. Send continuously uplink power control "up" commands in every uplink scheduling information to the UE; allow at least 200ms starting from the first TPC command in this step for the UE to reach P_{UMAX} level corresponding to Power Class 3.
6. Measure the sum of mean transmitted power over all component carriers in the CA configuration of the radio access mode. The period of measurement shall be at least the continuous duration of 1ms uplink. For TDD only slots consisting of only UL symbols are under test. For FDD band in inter-band CA with both TDD band and FDD band, only slots overlapping with only UL symbols in TDD are under test.

NOTE 1: When switching to DFT-s-OFDM waveform, as specified in the test configuration Table 6.2A.3.1.4.1-1, Table 6.2A.3.1.4.1-2, Table 6.2A.3.1.4.1 send an NR RRCReconfiguration message according to TS 38.508-1 [5] clause 4.6.3 Table 4.6.3-118 PUSCH-Config with TRANSFORM_PRECODER_ENABLED condition.

6.2A.3.1.4.3 Message contents

Message contents are according to TS 38.508-1 [5] subclause 4.6 and 5.4 with the following exceptions.

6.2A.3.1.4.3.1 Message contents exceptions (network signalling value "NS_100" on PCC)

Table 6.2A.3.1.4.3.1-1: *AdditionalSpectrumEmission*: Additional spurious emissions test requirement for "NS_100" on PCC

Derivation Path: TS 38.508-1 [5] clause 4.6.3, Table 4.6.3-1 <i>AdditionalSpectrumEmission</i>			
Information Element	Value/remark	Comment	Condition
AdditionalSpectrumEmission	1 (NS_100)		not for band n65
	2 (NS_100)		for band n65

6.2A.3.1.4.3.2 Message contents exceptions (network signalling value "NS_43" on PCC)

Table 6.2A.3.1.4.3.2-1: *AdditionalSpectrumEmission*: Additional spurious emissions test requirement for "NS_43" on PCC

Derivation Path: TS 38.508-1 [5] clause 4.6.3, Table 4.6.3-1 <i>AdditionalSpectrumEmission</i>			
Information Element	Value/remark	Comment	Condition
AdditionalSpectrumEmission	2 (NS_43)		

6.2A.3.1.4.3.3 Message contents exceptions (network signalling value "NS_43U" on PCC)

Table 6.2A.3.1.4.3.3-1: *AdditionalSpectrumEmission*: Additional spurious emissions test requirement for "NS_43U" on PCC

Derivation Path: TS 38.508-1 [5] clause 4.6.3, Table 4.6.3-1 <i>AdditionalSpectrumEmission</i>			
Information Element	Value/remark	Comment	Condition
AdditionalSpectrumEmission	3 (NS_43U)		

6.2A.3.1.4.3.4 Message contents exceptions (network signalling value "NS_47" on PCC)

Table 6.2A.3.1.4.3.4-1: *AdditionalSpectrumEmission*: Additional spurious emissions test requirement for "NS_47" on PCC

Derivation Path: TS 38.508-1 [5] clause 4.6.3, Table 4.6.3-1 <i>AdditionalSpectrumEmission</i>			
Information Element	Value/remark	Comment	Condition
AdditionalSpectrumEmission	2 (NS_47)		

6.2A.3.1.5 Test requirement

The maximum output power, derived in step 6 shall be within the range prescribed by the nominal maximum output power and tolerance in Table 6.2A.3.1.5-1, Table 6.2A.3.1.5-2, Table 6.2A.3.1.5-3 as appropriate. For the UE maximum output power modified by MPR and/or A-MPR, the power limits specified in 6.2A.4.0 apply. The test requirement of configurations for CA operating band including Band n41 also apply for the corresponding CA operating bands with Band n90 replacing Band n41.

Table 6.2A.3.1.5-0: Test Tolerance (Additional Maximum Power Reduction (A-MPR))

TT for overall output power (dB)								
			PCell					
			BW ≤ 40MHz			40MHz < BW ≤ 100MHz		
			f ≤ 3.0GHz	3.0GHz < f ≤ 4.2GHz	4.2GHz < f ≤ 6.0GHz	f ≤ 3.0GHz	3.0GHz < f ≤ 4.2GHz	4.2GHz < f ≤ 6.0GHz
SCell	BW ≤ 40MHz	f ≤ 3.0GHz	0.7	1.0	1.0	1.0	1.0	1.0
		3.0GHz < f ≤ 4.2GHz	1.0	1.0	1.0	1.0	1.0	1.0
		4.2GHz < f ≤ 6.0GHz	1.0	1.0	1.0	1.0	1.0	1.0
	40MHz < BW ≤ 100MHz	f ≤ 3.0GHz	1.0	1.0	1.0	1.0	1.0	1.0
		3.0GHz < f ≤ 4.2GHz	1.0	1.0	1.0	1.0	1.0	1.0
		4.2GHz < f ≤ 6.0GHz	1.0	1.0	1.0	1.0	1.0	1.0

Table 6.2A.3.1.5-1: UE Power Class 3 test requirement (network signalling value NS_100/NS_01) for CA_n3-n78 and CA_n8-n78

Test ID	P _{Power class} (dBm)	MPR _c (dB)		AMPR _c (dB)		ΔT _{C,c} (dB)		T _L (dB)	P _{C_{MAX,L}} (dBm)	T _{LOW} (P _{C_{MAX,L}}) (dB)	Upper limit (dBm)	Lower limit (dBm)
		PCC	SCC	PCC	SCC	PCC	SCC					
1	23	0	0	0	0	0 (1.5 ²)	0 (1.5 ²)	3	23	3	25+T _T	20-TT
2	23	6.5	6.5	6.5	0	0	0	3	19.5	5	25+T _T	14.5-TT
3	23	0	6.5	0	0	0 (1.5 ²)	0	3	23 (22.7 ²)	3 (5 ²)	25+T _T	20-TT (17.7-TT ²)

NOTE 1: P_{PowerClass} is the maximum UE power specified in 6.2A.1 without taking into account the tolerance.
 NOTE 2: For transmission bandwidths confined within F_{UL,low} and F_{UL,low} + 4 MHz or F_{UL,high} - 4 MHz and F_{UL,high}.
 NOTE 3: TT for each frequency and channel bandwidth is specified in Table 6.2A.3.1.5-0.

Table 6.2A.3.1.5-2: UE Power Class 3 test requirement (network signalling value NS_43/NS_01, NS_43U/NS_01) for CA_n8-n78

Test ID	P _{Power class} (dBm)	MPR _c (dB)		AMPR _c (dB)		ΔT _{C,c} (dB)		T _L (dB)	P _{C_{MAX,L}} (dBm)	T _{LOW} (P _{C_{MAX,L}}) (dB)	Upper limit (dBm)	Lower limit (dBm)
		PCC	SCC	PCC	SCC	PCC	SCC					
1	23	0	0	0	0	0	0	3	23	3	25+TT	20-TT
2	23	6.5	6.5	9.0	0	0	0	3	18.4	5	25+TT	13.4-TT
3	23	6.5	0	9.0	0	0	0	3	23	3	25+TT	20-TT

NOTE 1: P_{PowerClass} is the maximum UE power specified in 6.2A.1 without taking into account the tolerance.
 NOTE 2: TT for each frequency and channel bandwidth is specified in Table 6.2A.3.1.5-0.

Table 6.2A.3.1.5-3: UE Power Class 3 test requirement (network signalling value NS_47/NS_01) for CA_n41-n79

Test ID	P _{Power class} (dBm)	MPR _c (dB)		AMPR _c (dB)		ΔT _{C,c} (dB)		T _L (dB)	P _{C_{MAX,L}} (dBm)	T _{LOW} (P _{C_{MAX,L}}) (dB)	Upper limit (dBm)	Lower limit (dBm)
		PCC	SCC	PCC	SCC	PCC	SCC					
1	23	0	0	0	0	0	0	3	23	3	25+TT	20+TT
2	23	6.5	6.5	7	0	0	0	3	9.8	7	25+TT	2.8+TT
3	23	6.5	0	7	0	0	0	3	20	6	25+TT	14+TT

For the UE which supports inter-band NR CA configuration, inter-band NR-DC configuration, SUL configuration or inter-band EN-DC configuration, ΔT_{IB,c} as specified in 6.2A.4.0.2 for NR CA, 6.2B.4.0.2 for NR-DC, clause 6.2C.2 for SUL, or TS 38.521-3 [14] clause 6.2B.4.2 for EN-DC applies. Unless otherwise stated, ΔT_{IB,c} is set to zero. In case the

UE supports more than one of band combinations for CA, NR-DC, SUL or DC, and an operating band belongs to more than one band combinations then

- a) When the operating band frequency range is ≤ 1 GHz, the applicable additional $\Delta T_{IB,c}$ shall be the average value for all band combinations defined in clause 6.2A.4.0.2, 6.2B.4.0.2, 6.2C.2 in this specification and 6.2B.4.2 in TS 38.521-3 [14], truncated to one decimal place that apply for that operating band among the supported band combinations. In case there is a harmonic relation between low band UL and high band DL, then the maximum $\Delta T_{IB,c}$ among the different supported band combinations involving such band shall be applied
- b) When the operating band frequency range is > 1 GHz, the applicable additional $\Delta T_{IB,c}$ shall be the maximum value for all band combinations defined in clause 6.2A.4.0.2, 6.2B.4.0.2, 6.2C.2 in this specification and 6.2B.4.2 in TS 38.521-3 [14] for the applicable operating bands.

6.2A.4 Configured output power for CA

6.2A.4.0 Minimum conformance requirements

6.2A.4.0.1 Configured transmitted power level

6.2A.4.0.1.1 Void

6.2A.4.0.1.2 Void

6.2A.4.0.1.3 Configured transmitted power for Inter-band CA

For uplink carrier aggregation the UE is allowed to set its configured maximum output power $P_{CMAX,c}$ for serving cell c and its total configured maximum output power P_{CMAX} .

The configured maximum output power $P_{CMAX,c}$ on serving cell c shall be set as specified in subclause 6.2.4.3.

For uplink inter-band carrier aggregation, MPR_c and A- MPR_c apply per serving cell c and are specified in subclause 6.2.2.3 and subclause 6.2.3.3, respectively. P- MPR_c accounts for power management for serving cell c . $P_{CMAX,c}$ is calculated under the assumption that the transmit power is increased independently on all component carriers.

The total configured maximum output power P_{CMAX} shall be set within the following bounds:

$$P_{CMAX,L} \leq P_{CMAX} \leq P_{CMAX,H}$$

For uplink inter-band carrier aggregation with one serving cell c per operating band when same slot symbol pattern is used in all aggregated serving cells,

$$P_{CMAX,L} = \text{MIN} \{ 10 \log_{10} \sum \text{MIN} [p_{EMAX,c} / (\Delta t_{C,c}), p_{PowerClass} / (\text{MAX}(mpr_c, a-mpr_c) \cdot \Delta t_{C,c} \cdot \Delta t_{IB,c} \cdot \Delta t_{RXSRS,c}), p_{PowerClass} / pmpr_c], P_{EMAX,CA}, P_{PowerClass} \}$$

$$P_{CMAX,H} = \text{MIN} \{ 10 \log_{10} \sum p_{EMAX,c}, P_{EMAX,CA}, P_{PowerClass} \}$$

where

- $p_{EMAX,c}$ is the linear value of $P_{EMAX,c}$ which is given by IE *P-Max* for serving cell c in [6];
- $P_{PowerClass}$ is the maximum UE power specified in Table 6.2A.1.0.3-1 without taking into account the tolerance specified in the Table 6.2A.1.0.3-1; $p_{PowerClass}$ is the linear value of $P_{PowerClass}$;
- mpr_c and $a-mpr_c$ are the linear values of MPR_c and A- MPR_c as specified in subclause 6.2.2.3 and subclause 6.2.3.3, respectively;
- $pmpr_c$ is the linear value of P- MPR_c ;
- $\Delta t_{RXSRS,c}$ is the linear value of $\Delta T_{RXSRS,c}$;
- $\Delta t_{C,c}$ is the linear value of $\Delta T_{C,c}$. $\Delta t_{C,c} = 1.41$ when NOTE 2 in Table 6.2A.1.0.3-1 applies for a serving cell c , otherwise $\Delta t_{C,c} = 1$;
- $\Delta t_{IB,c}$ is the linear value of the inter-band relaxation term $\Delta T_{IB,c}$ of the serving cell c as specified in clause 6.2A.4.0.2 for NR CA, clause 6.2C.2 for SUL, or TS 38.101-3 [4] clause 6.2B.4.2 for EN-DC; otherwise

$\Delta T_{IB,c} = 1$; In case the UE supports more than one of band combinations for CA, SUL or DC, and an operating band belongs to more than one band combinations then

- a) When the operating band frequency range is ≤ 1 GHz, the applicable additional $\Delta T_{IB,c}$ shall be the average value for all band combinations defined in clause 6.2A.4.0.2, 6.2C.2 in this specification and 6.2B.4.2 in TS 38.101-3 [4], truncated to one decimal place that apply for that operating band among the supported band combinations. In case there is a harmonic relation between low band UL and high band DL, then the maximum $\Delta T_{IB,c}$ among the different supported band combinations involving such band shall be applied
 - b) When the operating band frequency range is > 1 GHz, the applicable additional $\Delta T_{IB,c}$ shall be the maximum value for all band combinations defined in clause 6.2A.4.0.2, 6.2C.2 in this specification and 6.2B.4.2 in TS 38.101-3 [4] for the applicable operating bands.
- $P_{EMAX,CA}$ is p-UE-FR1 value signalled by RRC and defined in [6]

For uplink inter-band carrier aggregation with one serving cell c per operating band when at least one different numerology/slot pattern is used in aggregated cells, the UE is allowed to set its configured maximum output power $P_{CMAX,c(i),i}$ for serving cell $c(i)$ of slot numerology type i , and its total configured maximum output power P_{CMAX} .

The configured maximum output power $P_{CMAX,c(i),i}(p)$ in slot p of serving cell $c(i)$ on slot numerology type i shall be set within the following bounds:

$$P_{CMAX_L,f,c(i),i}(p) \leq P_{CMAX,f,c(i),i}(p) \leq P_{CMAX_H,f,c(i),i}(p)$$

where $P_{CMAX_L,f,c(i),i}(p)$ and $P_{CMAX_H,f,c(i),i}(p)$ are the limits for a serving cell $c(i)$ of slot numerology type i as specified in subclause 6.2.4.3.

The total UE configured maximum output power $P_{CMAX}(p,q)$ in a slot p of slot numerology or symbol pattern i , and a slot q of slot numerology or symbol pattern j that overlap in time shall be set within the following bounds unless stated otherwise:

$$P_{CMAX_L}(p,q) \leq P_{CMAX}(p,q) \leq P_{CMAX_H}(p,q)$$

When slots p and q have different transmissions lengths and belong to different cells on different bands:

$$P_{CMAX_L}(p,q) = \text{MIN} \{ 10 \log_{10} [p_{CMAX_L,f,c(i),i}(p) + p_{CMAX_L,f,c(i),j}(q)], P_{PowerClass} \}$$

$$P_{CMAX_H}(p,q) = \text{MIN} \{ 10 \log_{10} [p_{CMAX_H,f,c(i),i}(p) + p_{CMAX_H,f,c(i),j}(q)], P_{PowerClass} \}$$

where $p_{CMAX_L,f,c(i),i}$ and $p_{CMAX_H,f,c(i),i}$ are the respective limits $P_{CMAX_L,f,c(i),i}$ and $P_{CMAX_H,f,c(i),i}$ expressed in linear scale.

T_{REF} and T_{eval} are specified in Table 6.2A.4.0.1.3-0 when same and different slot patterns are used in aggregated carriers. For each T_{REF} , the P_{CMAX_L} is evaluated per T_{eval} and given by the minimum value taken over the transmission(s) within the T_{eval} ; the minimum P_{CMAX_L} over the one or more T_{eval} is then applied for the entire T_{REF} . $P_{PowerClass}$ shall not be exceeded by the UE during any period of time.

Table 6.2A.4.0.1.3-0: P_{CMAX} evaluation window for different slot and channel durations

T_{REF}	T_{eval}	T_{eval} with frequency hopping
T_{REF} of largest slot duration over both UL CCs	Physical channel length	Min($T_{no_hopping}$, Physical Channel Length)

If the UE is configured with multiple TAGs and transmissions of the UE on slot i for any serving cell in one TAG overlap some portion of the first symbol of the transmission on slot $i+1$ for a different serving cell in another TAG, the UE minimum of P_{CMAX_L} for slots i and $i+1$ applies for any overlapping portion of slots i and $i+1$. $P_{PowerClass}$ shall not be exceeded by the UE during any period of time.

The measured maximum output power P_{UMAX} over all serving cells with same slot pattern shall be within the following range:

$$P_{CMAX_L} - \text{MAX}\{T_L, T_{LOW}(P_{CMAX_L})\} \leq P_{UMAX} \leq P_{CMAX_H} + T_{HIGH}(P_{CMAX_H})$$

$$P_{UMAX} = 10 \log_{10} \sum p_{UMAX,c}$$

where $p_{UMAX,c}$ denotes the measured maximum output power for serving cell c expressed in linear scale. The tolerances $T_{LOW}(P_{CMAX})$ and $T_{HIGH}(P_{CMAX})$ for applicable values of P_{CMAX} are specified in Table 6.2A.4.0.1.3-1. The tolerance T_L is the absolute value of the lower tolerance for applicable NR CA configuration as specified in Table 6.2A.1.0.3-1 for inter-band carrier aggregation.

The measured maximum output power P_{UMAX} over all serving cells, when at least one slot has a different transmission numerology or symbol pattern, shall be within the following range:

$$P'_{CMAX_L} - \text{MAX}\{T_L, T_{LOW}(P'_{CMAX_L})\} \leq P'_{UMAX} \leq P'_{CMAX_H} + T_{HIGH}(P'_{CMAX_H})$$

$$P'_{UMAX} = 10 \log_{10} \sum p'_{UMAX,c}$$

where $p'_{UMAX,c}$ denotes the average measured maximum output power for serving cell c expressed in linear scale over T_{REF} . The tolerances $T_{LOW}(P'_{CMAX})$ and $T_{HIGH}(P'_{CMAX})$ for applicable values of P'_{CMAX} are specified in Table 6.2A.4.0.1.3-1 for inter-band carrier aggregation. The tolerance T_L is the absolute value of the lower tolerance for applicable NR CA configuration as specified in Table 6.2A.1.0.3-1 for inter-band carrier aggregation.

where:

$$P'_{CMAX_L} = \text{MIN}\{ \text{MIN}\{ 10 \log_{10} \sum (p_{CMAX_L,f,c(i),i}), P_{PowerClass} \} \text{ over all overlapping slots in } T_{REF} \}$$

$$P'_{CMAX_H} = \text{MAX}\{ \text{MIN}\{ 10 \log_{10} \sum p_{EMAX,c}, P_{PowerClass} \} \text{ over all overlapping slots in } T_{REF} \}$$

Table 6.2A.4.0.1.3-1: P_{CMAX} tolerance for uplink inter-band CA (two bands)

P_{CMAX} (dBm)	Tolerance $T_{LOW}(P_{CMAX})$ (dB)	Tolerance $T_{HIGH}(P_{CMAX})$ (dB)
$P_{CMAX} = 23$	3.0	2.0
$22 \leq P_{CMAX} < 23$	5.0	2.0
$21 \leq P_{CMAX} < 22$	5.0	3.0
$20 \leq P_{CMAX} < 21$	6.0	4.0
$16 \leq P_{CMAX} < 20$	5.0	
$11 \leq P_{CMAX} < 16$	6.0	
$-40 \leq P_{CMAX} < 11$	7.0	

6.2A.4.0.1.4 Configured transmitted power for Intra-band contiguous CA

For uplink carrier aggregation the UE is allowed to set its configured maximum output power $P_{CMAX,c}$ for serving cell c and its total configured maximum output power P_{CMAX} .

The configured maximum output power $P_{CMAX,c}$ on serving cell c shall be set as specified in subclause 6.2.4, MPR_c and $A-MPR_c$ are determined by subclause 6.2.2. There is one power management term for the UE, denoted P-MPR, and $P-MPR_c = P-MPR$.

The total configured maximum output power P_{CMAX} shall be set within the following bounds:

$$P_{CMAX_L} \leq P_{CMAX} \leq P_{CMAX_H}$$

For uplink intra-band contiguous carrier aggregation when same slot pattern is used in all aggregated serving cells,

$$P_{CMAX_L} = \text{MIN}\{ 10 \log_{10} \sum p_{EMAX,c} - \Delta T_C, P_{EMAX,CA}, (P_{PowerClass} - \Delta P_{PowerClass,CA}) - \text{MAX}(\text{MAX}(MPR, A-MPR) + \Delta T_{IB,c} + \Delta T_C + \Delta T_{R\&SRS}, P-MPR_c) \}$$

$$P_{CMAX_H} = \text{MIN}\{ 10 \log_{10} \sum p_{EMAX,c}, P_{EMAX,CA}, P_{PowerClass} - \Delta P_{PowerClass,CA} \}$$

where

- $p_{EMAX,c}$ is the linear value of $P_{EMAX,c}$ which is given by IE *P-Max* for serving cell c in [7];
- $P_{PowerClass}$ is the maximum UE power without taking into account the tolerance;
- MPR and A-MPR are specified in subclause 6.2A.2 respectively;
- $\Delta P_{PowerClass,CA} = 3$ dB for a power class 2 capable UE when $10 \log_{10} \sum p_{EMAX,c}$ of 23 dBm or lower is indicated; or when $P_{EMAX,CA}$ of 23dBm or lower is indicated; or when the field of UE capability *maxUplinkDutyCycle-PC2-*

FRI is absent and the percentage of total uplink symbols transmitted on all UL CCs in a certain evaluation period is larger than 50%; or when the field of UE capability *maxUplinkDutyCycle-PC2-FRI* is not absent and the percentage of total uplink symbols transmitted in a certain evaluation period is larger than *maxUplinkDutyCycle-PC2-FRI* as defined in TS 38.331 (The exact evaluation period is no less than one radio frame); otherwise $\Delta P_{\text{PowerClass,CA}} = 0$ dB;

- $\Delta T_{\text{IB},c}$ is the additional tolerance for serving cell *c* as specified in clause 6.2A.4.0.2 for NR CA, clause 6.2C.2 for SUL, or TS 38.101-3 [4] clause 6.2B.4.2 for EN-DC In case the UE supports more than one of band combinations for CA, SUL or DC, and an operating band belongs to more than one band combinations then
 - a) When the operating band frequency range is ≤ 1 GHz, the applicable additional $\Delta T_{\text{IB},c}$ shall be the average value for all band combinations defined in clause 6.2A.4.0.2, 6.2C.2 in this specification and 6.2B.4.2 in TS 38.101-3 [4], truncated to one decimal place that apply for that operating band among the supported band combinations. In case there is a harmonic relation between low band UL and high band DL, then the maximum $\Delta T_{\text{IB},c}$ among the different supported band combinations involving such band shall be applied
 - b) When the operating band frequency range is > 1 GHz, the applicable additional $\Delta T_{\text{IB},c}$ shall be the maximum value for all band combinations defined in clause 6.2A.4.0.2, 6.2C.2 in this specification and 6.2B.4.2 in TS 38.101-3 [4] for the applicable operating bands.;
- P-MPR is the power management term for the UE;
- ΔT_{C} is the highest value $\Delta T_{\text{C},c}$ among all serving cells *c*;
- ΔT_{RXSRS} is the highest value among all serving cells *c*.

For uplink intra-band contiguous carrier aggregation, when at least one different numerology/slot pattern is used in aggregated cells, the UE is allowed to set its configured maximum output power $P_{\text{CMAX},c(i),i}$ for serving cell *c(i)* of slot numerology type *i*, and its total configured maximum output power P_{CMAX} .

The configured maximum output power $P_{\text{CMAX},c(i),i}(p)$ in slot *p* of serving cell *c(i)* on slot numerology type *i* shall be set within the following bounds:

$$P_{\text{CMAX}_L,f,c(i),i}(p) \leq P_{\text{CMAX},f,c(i),i}(p) \leq P_{\text{CMAX}_H,f,c(i),i}(p)$$

where $P_{\text{CMAX}_L,f,c(i),i}(p)$ and $P_{\text{CMAX}_H,f,c(i),i}(p)$ are the limits for a serving cell *c(i)* of slot numerology type *i* as specified in subclause 6.2.4.

The total UE configured maximum output power $P_{\text{CMAX}}(p,q)$ in a slot *p* of slot numerology or symbol pattern *i*, and a slot *q* of slot numerology or symbol pattern *j* that overlap in time shall be set within the following bounds unless stated otherwise:

$$P_{\text{CMAX}_L}(p,q) \leq P_{\text{CMAX}}(p,q) \leq P_{\text{CMAX}_H}(p,q)$$

When slots *p* and *q* have different transmissions lengths and belong to different cells on different or same bands:

$$P_{\text{CMAX}_L}(p,q) = \text{MIN} \{ 10 \log_{10} [P_{\text{CMAX}_L,f,c(i),i}(p) + P_{\text{CMAX}_L,f,c(i),j}(q)], P_{\text{PowerClass}}, P_{\text{EMAX,CA}} \}$$

$$P_{\text{CMAX}_H}(p,q) = \text{MIN} \{ 10 \log_{10} [P_{\text{CMAX}_H,f,c(i),i}(p) + P_{\text{CMAX}_H,f,c(i),j}(q)], P_{\text{PowerClass}}, P_{\text{EMAX,CA}} \}$$

where $p_{\text{CMAX}_L,f,c(i),i}$ and $p_{\text{CMAX}_H,f,c(i),i}$ are the respective limits $P_{\text{CMAX}_L,f,c(i),i}$ and $P_{\text{CMAX}_H,f,c(i),i}$ expressed in linear scale.

T_{REF} and T_{eval} are specified in Table 6.2A.4.1.4-0 when same and different slot patterns are used in aggregated carriers. For each T_{REF} , the P_{CMAX_L} is evaluated per T_{eval} and given by the minimum value taken over the transmission(s) within the T_{eval} ; the minimum P_{CMAX_L} over the one or more T_{eval} is then applied for the entire T_{REF} . $P_{\text{PowerClass}}$ shall not be exceeded by the UE during any period of time.

Table 6.2A.4.1.4-0: P_{CMAX} evaluation window for different slot and channel durations

T_{REF}	T_{eval}	T_{eval} with frequency hopping
T_{REF} of largest slot duration over both UL CCs	Physical channel length	Min($T_{\text{no_hopping}}$, Physical Channel Length)

If the UE is configured with multiple TAGs and transmissions of the UE on slot *i* for any serving cell in one TAG overlap some portion of the first symbol of the transmission on slot *i* + 1 for a different serving cell in another TAG, the

UE minimum of P_{CMAX_L} for slots i and $i + 1$ applies for any overlapping portion of slots i and $i + 1$. $P_{\text{PowerClass}}$ shall not be exceeded by the UE during any period of time.

The measured maximum output power P_{UMAX} over all serving cells with same slot pattern shall be within the following range:

$$P_{\text{CMAX}_L} - \text{MAX}\{T_L, T_{\text{LOW}}(P_{\text{CMAX}_L})\} \leq P_{\text{UMAX}} \leq P_{\text{CMAX}_H} + T_{\text{HIGH}}(P_{\text{CMAX}_H})$$

$$P_{\text{UMAX}} = 10 \log_{10} \sum p_{\text{UMAX},c}$$

where $p_{\text{UMAX},c}$ denotes the measured maximum output power for serving cell c expressed in linear scale. The tolerances $T_{\text{LOW}}(P_{\text{CMAX}})$ and $T_{\text{HIGH}}(P_{\text{CMAX}})$ for applicable values of P_{CMAX} are specified in Table 6.2A.4.0.1.4-1. The tolerance T_L is the absolute value of the lower tolerance for applicable NR CA configuration as specified in Table 6.2A.1.0.4-1 for intra-band carrier aggregation.

The measured maximum output power P_{UMAX} over all serving cells, when at least one slot has a different transmission numerology or slot pattern, shall be within the following range:

$$P'_{\text{CMAX}_L} - \text{MAX}\{T_L, T_{\text{LOW}}(P'_{\text{CMAX}_L})\} \leq P'_{\text{UMAX}} \leq P'_{\text{CMAX}_H} + T_{\text{HIGH}}(P'_{\text{CMAX}_H})$$

$$P'_{\text{UMAX}} = 10 \log_{10} \sum p'_{\text{UMAX},c}$$

where $p'_{\text{UMAX},c}$ denotes the average measured maximum output power for serving cell c expressed in linear scale over T_{REF} . The tolerances $T_{\text{LOW}}(P'_{\text{CMAX}})$ and $T_{\text{HIGH}}(P'_{\text{CMAX}})$ for applicable values of P'_{CMAX} are specified in Table 6.2A.4.0.1.4-1 for intra-band carrier aggregation. The tolerance T_L is the absolute value of the lower tolerance for applicable NR CA configuration as specified in Table 6.2A.1.0.4-1 for intra-band carrier aggregation.

where:

$$P'_{\text{CMAX}_L} = \text{MIN}\{ \text{MIN}\{10 \log_{10} \sum (p_{\text{CMAX}_L,f,c(i),i}), P_{\text{PowerClass}}\} \text{ over all overlapping slots in } T_{\text{REF}}\}$$

$$P'_{\text{CMAX}_H} = \text{MAX}\{ \text{MIN}\{10 \log_{10} \sum p_{\text{EMAX},c}, P_{\text{PowerClass}}\} \text{ over all overlapping slots in } T_{\text{REF}}\}$$

Table 6.2A.4.0.1.4-1: P_{CMAX} tolerance for uplink intra-band contiguous CA

P_{CMAX} (dBm)	Tolerance $T_{\text{LOW}}(P_{\text{CMAX}})$ (dB)	Tolerance $T_{\text{HIGH}}(P_{\text{CMAX}})$ (dB)
$26 \leq P_{\text{CMAX}} < 23$	3	2
$21 \leq P_{\text{CMAX}} \leq 23$		2.0
$20 \leq P_{\text{CMAX}} < 21$		2.5
$19 \leq P_{\text{CMAX}} < 20$		3.5
$18 \leq P_{\text{CMAX}} < 19$		4.0
$13 \leq P_{\text{CMAX}} < 18$		5.0
$8 \leq P_{\text{CMAX}} < 13$		6.0
$-40 \leq P_{\text{CMAX}} < 8$		7.0

6.2A.4.0.2 $\Delta T_{\text{IB},c}$ for CA

For the UE which supports inter-band NR CA configuration, $\Delta T_{\text{IB},c}$ in tables below applies. Unless otherwise stated, $\Delta T_{\text{IB},c}$ is set to zero.

6.2A.4.0.2.1 FFS

6.2A.4.0.2.2 FFS

6.2A.4.0.2.3 $\Delta T_{IB,c}$ for Inter-band CA

Table 6.2A.4.0.2.3-1: $\Delta T_{IB,c}$ due to NR CA (two bands)

Inter-band CA combination	NR Band	$\Delta T_{IB,c}$ (dB)
CA_n1-n77	n1	0.6
	n77	0.8
CA_n1-n78	n1	0.3
	n78	0.8
CA_n3-n5	n3	0.3
	n5	0.3
CA_n3-n41	n3	0.5
	n41	0.3 ⁴
		0.8 ⁵
CA_n3-n77	n3	0.6
	n77	0.8
CA_n3-n78	n3	0.6
	n78	0.8
CA_n3-n79	n3	0.3
	n79	0.8
CA_n8-n75	n8	0.3
CA_n8-n78	n8	0.6
	n78	0.8
CA_n8-n79	n8	0.8
	n79	0.3
CA_n28-n41	n28	0.3
	n41	0.3
CA_n8-n79	n8	0.3
	n79	0.8
CA_n24-n41	n24	0.3
	n41	0.4 ⁴
0.9 ⁵		
CA_n24-n48	n24	0.6
	n48	0.8
CA_n24-n77	n24	0.6
	n77	0.8
CA_n28-n75	n28	0.3
CA_n28-n78	n28	0.5
	n78	0.8
CA_n39-n41	n39	0 ²
	n41	0 ²
	n39	0.5 ³
	n41	0.5 ³
CA_n41-n78 ¹	n41	0.3
	n78	0.8
CA_n41-n79	n41	0.3
	n79	0.8
CA_n66-n70	n66	0.5
	n70	0.5
CA_n66-n71	n66	0.3
	n71	0.3
CA_n70-n71	n70	0.3
	n71	0.6
CA_n75-n78	n78	0.8
CA_n76-n78	n78	0.8
CA_n77-n79	n77	0.5
	n79	0.5
CA_n78-n79	n78	0.5
		1.5 ⁶
	n79	0.5
		1.5 ⁶

NOTE 1: The requirements only apply when the sub-frame and Tx-Rx timings are synchronized between the component carriers. In the absence of synchronization, the requirements are not within scope of these specifications.

NOTE 2: Only applicable for UE supporting inter-band carrier aggregation with uplink in one NR band and without simultaneous Rx/Tx.

NOTE 3: Applicable for UE supporting inter-band carrier aggregation without simultaneous Rx/Tx.

NOTE 4: The requirement is applied for UE transmitting on the frequency range of 2515-2690 MHz.

NOTE 5: The requirement is applied for UE transmitting on the frequency range of 2496-2515 MHz.

NOTE 6: The requirements only apply for UE supporting inter-band carrier aggregation with simultaneous Rx/Tx capability, and NR UL carrier frequencies are confined to 3700 MHz-3800MHz for n78 and 4400 MHz-4500MHz for n79. Simultaneous Rx/Tx capability does not apply for UEs supporting band n78 with a n77 implementation.

6.2A.4.1 Configured transmitted power for CA (2UL CA)

Editor's Note:

Testing for Intra-band contiguous UL CA non-contiguous RB allocation is FFS.

Testing for intra-band non-contiguous UL CA is FFS.

6.2A.4.1.1 Test purpose

To verify that the total measured UE configured maximum output power P_{UMAX} in two uplink carrier aggregation is within the specified bounds.

6.2A.4.1.2 Test applicability

The requirements of this test apply to all types of NR UE release 15 and forward that support NR 2 UL CA.

6.2A.4.1.3 Minimum conformance requirements

The minimum conformance requirements are defined in subclause 6.2A.4.0.

6.2A.4.1.4 Test description

6.2A.4.1.4.1 Initial conditions

Initial conditions are a set of test configurations the UE needs to be tested in and the steps for the SS to take with the UE to reach the correct measurement state.

The initial test configurations consist of environmental conditions, test frequencies, channel bandwidths and sub-carrier spacing based on NR CA configuration specified in 5.5A. All of these configurations shall be tested with applicable test parameters for each CA configuration of test channel bandwidth and sub-carrier spacing, and are shown in table 6.2A.4.1.4.1-1 to table 6.2A.4.1.4.1-2. The details of the uplink reference measurement channels (RMCs) are specified in Annexes A.2. Configurations of PDSCH and PDCCH before measurement are specified in Annex C.2.

Table 6.2A.4.1.4.1-1: Inter-band CA Test Configuration Table

Initial Conditions				
Test Environment as specified in TS 38.508-1 [5] subclause 4.1		Normal, TL/VL, TL/VH, TH/VL, TH/VH		
Test Frequencies as specified in TS 38.508-1 [5] subclause 4.3.1		Mid range for PCC and SCC (NOTE 3)		
Test Channel Bandwidths as specified in TS 38.508-1 [5] subclause 4.3.1		Lowest N_{RB_agg} , Highest N_{RB_agg}		
Test SCS as specified in 5.3.5-1		Lowest		
Test Parameters for Channel Bandwidths				
Test ID	Downlink Configuration for PCC & SCC	Uplink Configuration		
		Modulation for all CCs (NOTE 2)	RB allocation (NOTE 1)	
			PCC	SCC
1	N/A for minimum output power test case	DFT-s-OFDM Pi/2 BPSK	Inner Full	Inner Full
2		DFT-s-OFDM QPSK	Inner Full	Inner Full
NOTE 1: The specific configuration of each RB allocation is defined in Table 6.1-1.				
NOTE 2: DFT-s-OFDM Pi/2 BPSK test applies only for UEs which supports Pi/2 BPSK in FR1.				
NOTE 3: For NR band n28, 30MHz test channel bandwidth is tested with Low range test frequencies.				

Table 6.2A.4.1.4.1-2: Intra-band contiguous CA (contiguous RB allocation) Test Configuration Table

Initial Conditions			
Test Environment as specified in TS 38.508-1 [5] subclause 4.1		Normal, TL/VL, TL/VH, TH/VL, TH/VH	
Test Frequencies as specified in TS 38.508-1 [5] subclause 4.3.1		Mid range	
Test Channel Bandwidths as specified in TS 38.508-1 [5] subclause 4.3.1		Lowest N_{RB_agg} , Highest N_{RB_agg} (NOTE 1)	
Test SCS as specified in Table 5.3.5-1		Lowest	
Test Parameters for Channel Bandwidths			
Test Parameters for CA bandwidth class B and C			
Test ID	DL configuration for PCC & SCC	UL configuration	
		Modulations for all CCs (NOTE 2)	RB allocation (NOTE 3)
1	N/A	DFT-s-OFDM Pi/2 BPSK	Inner Full
2		DFT-s-OFDM QPSK	Inner Full
NOTE 1: The Test CC Combination settings are checked separately for each CA Configuration, which applicable aggregated channel bandwidths are specified in Table 5.5A.1-1.			
NOTE 2: DFT-s-OFDM Pi/2 BPSK test applies only for UEs which supports Pi/2 BPSK in FR1.			
NOTE 3: The specific configuration of each RB allocation is defined in Table 6.1A-1a.			
NOTE 4: If the UE supports multiple CC Combinations in the CA Configuration with the same N_{RB_agg} , only the combination with the highest N_{RB_PCC} is tested.			

1. Connect the SS to the UE antenna connectors as shown in TS 38.508-1 [5] Annex A, Figure A.3.1.1.3 for TE diagram and section A.3.2 for UE diagram.
2. The parameter settings for the cell are set up according to TS 38.508-1 [5] subclause 4.4.3.
3. Downlink signals are initially set up according to Annex C.0, C.1, C.2, and uplink signals according to Annex G.0, G.1, G.2, G.3.0.
4. The UL Reference Measurement Channel is set according to Table 6.2A.4.1.4.1-1 and Table 6.2A.4.1.4.1-2 as appropriate.
5. Propagation conditions are set according to Annex B.0.
6. Ensure the UE is in State RRC_CONNECTED with generic procedure parameters Connectivity NR, Connected without release *On*, Test Mode *On* and Test Loop Function *On* according to TS 38.508-1 [5] clause 4.5. Message contents are defined in clause 6.2A.4.1.4.3.

6.2A.4.1.4.2 Test procedure

1. Configure SCC according to Annex C.0, C.1, C.2 for all downlink physical channels.
2. The SS shall configure SCC as per TS 38.508-1 [5] clause 5.5.1. Message contents are defined in clause 6.2A.4.1.4.3.
3. SS activates SCC by sending the activation MAC CE (Refer TS 38.321 [18], clauses 5.9, 6.1.3.10). Wait for at least 2 seconds (Refer TS 38.133[19], clause 9.3).
4. SS sends uplink scheduling information for each UL HARQ process via PDCCH DCI format 0_1 for C_RNTI to schedule the UL RMC according to Table 6.2A.4.1.4.1-1 on both PCC and SCC. Since the UE has no payload and no loopback data to send the UE sends uplink MAC padding bits on the UL RMC.

5. Send continuously uplink power control "up" commands in every uplink scheduling information to the UE; allow at least 200ms starting from the first TPC command in this step for the UE to reach P_{UMAX} level of the test point.
6. Measure the sum of mean transmitted power over all component carriers in the CA configuration of the radio access mode. The period of measurement shall be at least the continuous duration of one active sub-frame (1 ms) and in the uplink symbols. For TDD, only slots consisting of only UL symbols are under test. For FDD band in inter-band CA with both TDD band and FDD band, only slots overlapping with only UL symbols in TDD are under test.

6.2A.4.1.4.3 Message contents

Message contents are according to TS 38.508-1 [5] subclause 4.6 with the following exceptions.

Table 6.2A.4.1.4.3-0: PUSCH-Config

Derivation Path: TS 38.508-1 [5], Table 4.6.3-118 with condition TRANSFORM_PRECODER_ENABLED

Table 6.2A.4.1.4.3-1: FrequencyInfoUL: Test point 1

Derivation Path: TS 38.508-1 [5] Table 4.6.3-61 FrequencyInfoUL			
Information Element	Value/remark	Comment	Condition
p-Max	-10		

Table 6.2A.4.1.4.3-1a: FrequencyInfoUL-SIB: Test point 1

Derivation Path: TS 38.508-1 [5] Table 4.6.3-62 FrequencyInfoUL-SIB			
Information Element	Value/remark	Comment	Condition
p-Max	-10		

Table 6.2A.4.1.4.3-2: FrequencyInfoUL: Test point 2

Derivation Path: TS 38.508-1 [5] Table 4.6.3-61 FrequencyInfoUL			
Information Element	Value/remark	Comment	Condition
p-Max	10		

Table 6.2A.4.1.4.3-2a: FrequencyInfoUL-SIB: Test point 2

Derivation Path: TS 38.508-1 [5] Table 4.6.3-62 FrequencyInfoUL-SIB			
Information Element	Value/remark	Comment	Condition
p-Max	10		

Table 6.2A.4.1.4.3-3: FrequencyInfoUL: Test point 3

Derivation Path: TS 38.508-1 [5] Table 4.6.3-61 FrequencyInfoUL			
Information Element	Value/remark	Comment	Condition
p-Max	5		

Table 6.2A.4.1.4.3-3a: FrequencyInfoUL-SIB: Test point 3

Derivation Path: TS 38.508-1 [5] Table 4.6.3-62 FrequencyInfoUL-SIB			
Information Element	Value/remark	Comment	Condition
p-Max	5		

Table 6.2A.4.1.4.3-4: FrequencyInfoUL: Test point 4

Derivation Path: TS 38.508-1 [5] Table 4.6.3-61 FrequencyInfoUL			
Information Element	Value/remark	Comment	Condition
p-Max	15		

Table 6.2A.4.1.4.3-4a: FrequencyInfoUL-SIB: Test point 4

Derivation Path: TS 38.508-1 [5] Table 4.6.3-62 FrequencyInfoUL-SIB			
Information Element	Value/remark	Comment	Condition
p-Max	15		

Test point 3 and Test point 4 are only tested for UL intra-band contiguous CA with contiguous RB allocation.

6.2A.4.1.5 Test requirement

The maximum output power measured shall not exceed the values specified in Table 6.2A.4.1.5-1 to Table 6.2A.4.1.5-3.

Table 6.2A.4.1.5-1: Configured UE Output Power for Inter-band CA

	Maximum output power	
	Lower limit	Upper limit
Measured UE output power test point 1	-14 dBm - TT	0 dBm + TT
Measured UE output power test point 2	7 dBm - TT	19 dBm + TT
Note 1: TT for each frequency and channel bandwidth is specified in Table 6.2A.4.1.5-2.		

Table 6.2A.4.1.5-1a: Configured UE Output Power for Intra-band contiguous CA (contiguous RB allocation)

	Maximum output power	
	Lower limit	Upper limit
Measured UE output power test point 1	-14 dBm - TT	0 dBm + TT
Measured UE output power test point 2	8 dBm - TT	18 dBm + TT
Measured UE output power test point 3	2 dBm - TT	14 dBm + TT
Measured UE output power test point 4	14 dBm - TT	22 dBm + TT
Note 1: TT for each intra-band UL CA configuration is in table 6.2A.4.1.5-3.		

Table 6.2A.4.1.5-2: Test Tolerance for inter-band CA (Configured transmitted power for CA)

TT for overall output power (dB)								
			PCell					
			BW ≤ 40MHz			40MHz < BW ≤ 100MHz		
			f ≤ 3.0GHz	3.0GHz < f ≤ 4.2GHz	4.2GHz < f ≤ 6.0GHz	f ≤ 3.0GHz	3.0GHz < f ≤ 4.2GHz	4.2GHz < f ≤ 6.0GHz
SCell	BW ≤ 40MHz	f ≤ 3.0GHz	0.7	1.0	1.0	1.0	1.0	1.0
		3.0GHz < f ≤ 4.2GHz	1.0	1.0	1.0	1.0	1.0	1.0
		4.2GHz < f ≤ 6.0GHz	1.0	1.0	1.0	1.0	1.0	1.0
	40MHz < BW ≤ 100MHz	f ≤ 3.0GHz	1.0	1.0	1.0	1.0	1.0	1.0
		3.0GHz < f ≤ 4.2GHz	1.0	1.0	1.0	1.0	1.0	1.0
		4.2GHz < f ≤ 6.0GHz	1.0	1.0	1.0	1.0	1.0	1.0

Table 6.2A.4.1.5-3: Test Tolerance for intra-band CA (Configured transmitted power for CA)

TT for overall output power (dB)		
Aggregation BW	$f \leq 3.0\text{GHz}$	$3.0\text{GHz} < f \leq 6.0\text{GHz}$
$\text{BW} \leq 40\text{MHz}$	0.7	1.0
$40\text{MHz} < \text{BW} \leq 100\text{MHz}$	1.0	1.0
$100\text{MHz} < \text{BW} \leq 200\text{MHz}$	FFS	FFS

For the UE which supports inter-band NR CA configuration, inter-band NR-DC configuration, SUL configuration or inter-band EN-DC configuration, $\Delta T_{\text{IB,c}}$ as specified in 6.2A.4.0.2 for NR CA, 6.2B.4.0.2 for NR-DC, clause 6.2C.2 for SUL, or TS 38.521-3 [14] clause 6.2B.4.2 for EN-DC applies. Unless otherwise stated, $\Delta T_{\text{IB,c}}$ is set to zero. In case the UE supports more than one of band combinations for CA, NR-DC, SUL or DC, and an operating band belongs to more than one band combinations then

- When the operating band frequency range is ≤ 1 GHz, the applicable additional $\Delta T_{\text{IB,c}}$ shall be the average value for all band combinations defined in clause 6.2A.4.0.2, 6.2B.4.0.2, 6.2C.2 in this specification and 6.2B.4.2 in TS 38.521-3 [14], truncated to one decimal place that apply for that operating band among the supported band combinations. In case there is a harmonic relation between low band UL and high band DL, then the maximum $\Delta T_{\text{IB,c}}$ among the different supported band combinations involving such band shall be applied
- When the operating band frequency range is > 1 GHz, the applicable additional $\Delta T_{\text{IB,c}}$ shall be the maximum value for all band combinations defined in clause 6.2A.4.0.2, 6.2B.4.0.2, 6.2C.2 in this specification and 6.2B.4.2 in TS 38.521-3 [14] for the applicable operating bands.

6.2B Transmitter power for NR-DC

6.2B.0 General

The requirements apply for inter-band NR-DC with one uplink serving cell configured per CG.

6.2B.1 UE maximum output power for NR-DC

6.2B.1.0 Minimum conformance requirements

6.2B.1.0.1 FFS

6.2B.1.0.2 FFS

6.2B.1.0.3 UE maximum output power for inter-band NR-DC

For inter-band NR-DC with one uplink carrier assigned per NR band, the transmitter power requirements in clause 6.2.1.3 apply per band.

For inter-band NR-DC with one uplink assigned per band, the UE maximum output power shall be measured over all component carriers from different bands. If each band has separate antenna connectors, the maximum output power is defined as the sum of maximum output power from each UE antenna connector. The period of measurement shall be at least one sub frame (1 ms). The maximum output power is specified in Table 6.2B.1.0.3-1.

Table 6.2B.1.0.3-1 UE Power Class for inter-band NR-DC

Uplink DC Configuration	Class 1 (dBm)	Tolerance (dB)	Class 2 (dBm)	Tolerance (dB)	Class 3 (dBm)	Tolerance (dB)	Class 4 (dBm)	Tolerance (dB)
DC_n48A-n70A					23	+2/-3		
NOTE 1: An uplink DC configuration in which at least one of the bands has NOTE 3 in Table 6.2.1.3-1 is allowed to reduce the lower tolerance limit by 1.5 dB when the transmission bandwidths of at least one of the bands is confined within $F_{\text{UL,low}}$ and $F_{\text{UL,low}} + 4$ MHz or $F_{\text{UL,high}} - 4$ MHz and $F_{\text{UL,high}}$. NOTE 2: $P_{\text{PowerClass}}$ is the maximum UE power specified without account of the tolerance NOTE 3: The maximum power requirement applies to the total transmitted power over both the MCG and SCG. NOTE 4: Power class 3 is the default power class unless otherwise stated.								

6.2B.1.1 UE maximum output power for NR-DC

6.2B.1.1.1 Test purpose

To verify that the error of the UE maximum output power in dual connectivity does not exceed the range prescribed by the specified nominal maximum output power and tolerance.

An excess maximum output power has the possibility to interfere to other channels or other systems. A small maximum output power decreases the coverage area.

6.2B.1.1.2 Test applicability

This test case applies to all types of NR UE release 16 and forward that support NR-DC.

6.2B.1.1.3 Minimum conformance requirements

The minimum conformance requirements are defined in clause 6.2B.1.0.

6.2B.1.1.4 Test description

6.2B.1.1.4.1 Initial conditions

Initial conditions are a set of test configurations the UE needs to be tested in and the steps for the SS to take with the UE to reach the correct measurement state.

The initial test configurations consist of environmental conditions, test frequencies, test channel bandwidths and sub-carrier spacing based on NR-DC configurations specified in 5.5B. All of NR-DC configurations shall be tested with applicable test parameters for each combination of test channel bandwidth and sub-carrier spacing, and are shown in table 6.2B.1.1.4.1-1. The details of the uplink reference measurement channels (RMCs) are specified in Annexes A.2. Configurations of PDSCH and PDCCH before measurement are specified in Annex C.2.

Table 6.2B.1.1.4.1-1: Inter-band NR-DC Test Configuration Table

Initial Conditions				
Test Environment as specified in TS 38.508-1 [5] subclause 4.1		Normal, TL/VL, TL/VH, TH/VL, TH/VH		
Test Frequencies as specified in TS 38.508-1 [5] subclause 4.3.1		Low range for PCell and PSCell High range for PCell and PSCell		
Test Channel Bandwidths as specified in TS 38.508-1 [5] subclause 4.3.1		Lowest for PCell and PSCell Highest for PCell and PSCell		
Test SCS as specified in Table 5.3.5-1		Lowest, Highest		
Test Parameters				
Test ID	Downlink Configuration for PCell & PSCell	Uplink Configuration		
		Modulation for all CCs (NOTE 2)	RB allocation (NOTE 1)	
			PCell	PSCell
1	N/A for this test	DFT-s-OFDM Pi/2 BPSK	Inner Full	Inner Full
2		DFT-s-OFDM Pi/2 BPSK	Inner 1RB Left	Inner 1RB Left
3		DFT-s-OFDM Pi/2 BPSK	Inner 1RB Right	Inner 1RB Right
4		DFT-s-OFDM QPSK	Inner Full	Inner Full
5		DFT-s-OFDM QPSK	Inner 1RB Left	Inner 1RB Left
6		DFT-s-OFDM QPSK	Inner 1RB Right	Inner 1RB Right
NOTE 1: The specific configuration of each RB allocation is defined in Table 6.1-1.				
NOTE 2: DFT-s-OFDM Pi/2 BPSK test applies only for UEs which supports Pi/2 BPSK in FR1.				

1. Connect the SS to the UE antenna connectors as shown in TS 38.508-1 [5] Annex A, Figure A.3.1.1.3 for TE diagram and section A.3.2 for UE diagram.
2. The parameter settings for the cell are set up according to TS 38.508-1 [5] subclause 4.4.3.
3. Downlink signals for PCell are initially set up according to Annex C.0, C.1, C.2, and uplink signals according to Annex G.0, G.1, G.2, G.3.0.

4. The UL Reference Measurement Channel is set according to Table 6.2B.1.1.4.1-1.
5. Propagation conditions are set according to Annex B.0.
6. Ensure the UE is in state RRC_CONNECTED with generic procedure parameters Connectivity *NR-DC*, Connected without release *On*, Test Mode *On* and Test Loop Function *On* according to TS 38.508-1 [5] clause 4.5. Message contents are defined in clause 6.2B.1.1.4.3.

6.2B.1.1.4.2 Test procedure

1. SS sends uplink scheduling information for each UL HARQ process via PDCCH DCI format 0_1 for C_RNTI to schedule the UL RMC according to Table 6.2B.1.1.4.1-1 on both PCell and PSCell for inter-band NR-DC. Since the UE has no payload and no loopback data to send the UE sends uplink MAC padding bits on the UL RMC.
2. Send continuously uplink power control "up" commands in every uplink scheduling information to the UE; allow at least 200ms starting from the first TPC command in this step for the UE to reach P_{UMAX} level corresponding to Power Class 3.
3. Measure the sum of mean transmitted power over all component carriers in the NR-DC configuration of the radio access mode. The period of measurement shall be at least the continuous duration of one active sub-frame (1ms) and in the uplink symbols. For TDD symbols with transient periods are not under test.

6.2B.1.1.4.3 Message contents

Message contents are according to TS 38.508-1 [5] subclause 4.6 and 5.4 with the following exceptions.

Table 6.2B.1.1.4.3-1: PUSCH-Config

Derivation Path: TS 38.508-1 [5], Table 4.6.3-118 with condition TRANSFORM_PRECODER_ENABLED

Table 6.2B.1.1.4.3-2: FrequencyInfoUL-SIB

Derivation Path: TS 38.508-1 [5] Table 4.6.3-62 FrequencyInfoUL-SIB			
Information Element	Value/remark	Comment	Condition
p-Max	20		Power class 3 and Inter-band NR-DC

6.2B.1.1.5 Test requirement

The maximum output power for NR-DC, derived in step 3 shall be within the range prescribed by the nominal maximum output power and tolerance in Table 6.2B.1.1.5-1 for NR-DC configuration.

Table 6.2B.1.1.5-1: Maximum Output Power test requirement for NR-DC Power Class 3

Uplink DC Configuration	Class 1 (dBm)	Tolerance (dB)	Class 2 (dBm)	Tolerance (dB)	Class 3 (dBm)	Tolerance (dB)	Class 4 (dBm)	Tolerance (dB)
DC_n48A-n70A					23	+2+TT/-3-TT		
NOTE 1: An uplink DC configuration in which at least one of the bands has NOTE 3 in Table 6.2.1.3-1 is allowed to reduce the lower tolerance limit by 1.5 dB when the transmission bandwidths of at least one of the bands is confined within F_{UL_low} and $F_{UL_low} + 4$ MHz or $F_{UL_high} - 4$ MHz and F_{UL_high} . NOTE 2: $P_{PowerClass}$ is the maximum UE power specified without account of the tolerance NOTE 3: The maximum power requirement applies to the total transmitted power over both the MCG and SCG. NOTE 4: Power class 3 is the default power class unless otherwise stated. NOTE 5: The TT for NR-DC Maximum Output Power is in the maximum TT among all UL CCs. For TT of each UL CC refers to Table 6.2B.1.1.5-2.								

Table 6.2B.1.1.5-2: Test Tolerance (UE maximum output power)

TT for overall output power (dB)						
			PCell			
			BW ≤ 40MHz		40MHz < BW ≤ 100MHz	
			f ≤ 3.0GHz	3.0GHz < f ≤ 6.0GHz	f ≤ 3.0GHz	3.0GHz < f ≤ 6.0GHz
PSCell	BW ≤ 40MHz	f ≤ 3.0GHz	0.7	1.0	1.0	1.0
		3.0GHz < f ≤ 6.0GHz	1.0	1.0	1.0	1.0
	40MHz < BW ≤ 100MHz	f ≤ 3.0GHz	1.0	1.0	1.0	1.0
		3.0GHz < f ≤ 6.0GHz	1.0	1.0	1.0	1.0

For the UE which supports inter-band NR CA configuration, inter-band NR-DC configuration, SUL configuration or inter-band EN-DC configuration, $\Delta T_{IB,c}$ as specified in 6.2A.4.0.2 for NR CA, 6.2B.4.0.2 for NR-DC, clause 6.2C.2 for SUL, or TS 38.521-3 [14] clause 6.2B.4.2 for EN-DC applies. Unless otherwise stated, $\Delta T_{IB,c}$ is set to zero. In case the UE supports more than one of band combinations for CA, NR-DC, SUL or DC, and an operating band belongs to more than one band combinations then

- a) When the operating band frequency range is ≤ 1 GHz, the applicable additional $\Delta T_{IB,c}$ shall be the average value for all band combinations defined in clause 6.2A.4.0.2, 6.2B.4.0.2, 6.2C.2 in this specification and 6.2B.4.2 in TS 38.521-3 [14], truncated to one decimal place that apply for that operating band among the supported band combinations. In case there is a harmonic relation between low band UL and high band DL, then the maximum $\Delta T_{IB,c}$ among the different supported band combinations involving such band shall be applied
- b) When the operating band frequency range is > 1 GHz, the applicable additional $\Delta T_{IB,c}$ shall be the maximum value for all band combinations defined in clause 6.2A.4.0.2, 6.2B.4.0.2, 6.2C.2 in this specification and 6.2B.4.2 in TS 38.521-3 [14] for the applicable operating bands.

6.2B.2 UE maximum output power reduction for NR-DC

6.2B.2.0 Minimum conformance requirements

6.2B.2.0.1 FFS

6.2B.2.0.2 FFS

6.2B.2.0.3 UE maximum output power reduction for Inter-band NR-DC

For inter-band NR-DC with one uplink assigned per band, the requirements in clause 6.2.2.3 apply for each uplink component carrier.

The normative reference for this requirement is TS38.101-1[2] clause 6.2B.2.

6.2B.2.1 UE maximum output power for NR-DC

6.2B.2.1.1 Test purpose

The number of RB identified in Table 6.2.2.3-1 is based on meeting the requirements for adjacent channel leakage ratio for NR-DC and the maximum power reduction (MPR) for Inter-band NR-DC due to Cubic Metric (CM).

6.2B.2.1.2 Test applicability

This test case applies to all types of NR UE release 16 and forward that support NR-DC.

NOTE: Test execution is not necessary if TS 38.521-1 6.5B.2.4.1.1 is executed.

6.2B.2.1.3 Minimum conformance requirements

The minimum conformance requirements are defined in clause 6.2B.2.0.

6.2B.2.1.4 Test description

6.2B.2.1.4.1 Initial conditions

Initial conditions are a set of test configurations the UE needs to be tested in and the steps for the SS to take with the UE to reach the correct measurement state.

The initial test configurations consist of environmental conditions, test frequencies, test channel bandwidths and sub-carrier spacing based on NR-DC configurations specified in 5.5B. All of NR-DC configurations shall be tested with applicable test parameters for each combination of test channel bandwidth and sub-carrier spacing as specified in clause 6.2.2.4.1. The details of the uplink reference measurement channels (RMCs) are specified in Annexes A.2. Configurations of PDSCH and PDCCH before measurement are specified in Annex C.2.

Test configurations tables are specified in clause 6.2.2.4.1

1. Connect the SS to the UE antenna connectors as shown in TS 38.508-1 [5] Annex A, Figure A.3.1.1.3 for TE diagram and section A.3.2 for UE diagram.
2. The parameter settings for the cell are set up according to TS 38.508-1 [5] subclause 4.4.3.
3. Downlink signals for PCell are initially set up according to Annex C.0, C.1, C.2, and uplink signals according to Annex G.0, G.1, G.2, G.3.0.
4. The UL Reference Measurement Channel is set according to test configuration tables in clause 6.2.2.4.1.
5. Propagation conditions are set according to Annex B.0.
6. Ensure the UE is in state RRC_CONNECTED with generic procedure parameters Connectivity *NR-DC*, Connected without release *On*, Test Mode *On* and Test Loop Function *On* according to TS 38.508-1 [5] clause 4.5. Message contents are defined in clause 6.2B.2.1.4.3.

6.2B.2.1.4.2 Test procedure

1. SS sends uplink scheduling information for each UL HARQ process via PDCCH DCI format 0_1 for C_RNTI to schedule the UL RMC according to clause 6.2.2.4.1 on both PCell and PSCell for inter-band NR-DC. Since the UE has no payload and no loopback data to send the UE sends uplink MAC padding bits on the UL RMC.
2. Send continuously uplink power control "up" commands in every uplink scheduling information to the UE; allow at least 200ms starting from the first TPC command in this step for the UE to reach P_{UMAX} level.
3. Measure the mean power of each component carrier of NR-DC configuration in the channel bandwidth of the radio access mode. For PC1.5 the measured power is the sum of the two ports. The period of measurement shall be at least the continuous duration of 1ms over consecutive active uplink slots. For TDD, only slots consisting of only UL symbols are under test.

6.2B.2.1.4.3 Message contents

Message contents are according to TS 38.508-1 [5] subclause 4.6 and 5.4 with the exceptions in clause 6.2.2.4.3.

6.2B.2.1.5 Test requirement

The maximum output power for NR-DC, derived in step 3 shall be within the range prescribed by the nominal maximum output power and tolerance in the applicable table in clause 6.2.2.5.

For the UE which supports inter-band NR CA configuration, inter-band NR-DC configuration, SUL configuration or inter-band EN-DC configuration, $\Delta T_{IB,c}$ as specified in 6.2A.4.0.2 for NR CA, 6.2B.4.0.2 for NR-DC, clause 6.2C.2 for SUL, or TS 38.521-3 [14] clause 6.2B.4.2 for EN-DC applies. Unless otherwise stated, $\Delta T_{IB,c}$ is set to zero. In case the UE supports more than one of band combinations for CA, NR-DC, SUL or DC, and an operating band belongs to more than one band combinations then

- a) When the operating band frequency range is ≤ 1 GHz, the applicable additional $\Delta T_{IB,c}$ shall be the average value for all band combinations defined in clause 6.2A.4.0.2, 6.2B.4.0.2, 6.2C.2 in this specification and 6.2B.4.2 in TS 38.521-3 [14], truncated to one decimal place that apply for that operating band among the supported band combinations. In case there is a harmonic relation between low band UL and high band DL, then the maximum $\Delta T_{IB,c}$ among the different supported band combinations involving such band shall be applied

- b) When the operating band frequency range is > 1 GHz, the applicable additional $\Delta T_{IB,c}$ shall be the maximum value for all band combinations defined in clause 6.2A.4.0.2, 6.2B.4.0.2, 6.2C.2 in this specification and 6.2B.4.2 in TS 38.521-3 [14] for the applicable operating bands.

6.2B.3 UE additional maximum output power reduction for NR-DC

6.2B.3.0 Minimum conformance requirements

6.2B.3.0.1 FFS

6.2B.3.0.2 FFS

6.2B.3.0.3 UE additional maximum output power reduction for inter-band NR-DC

For inter-band NR-DC with one uplink assigned per band, the requirements in clause 6.2.2.3 apply for each uplink component carrier.

Unless otherwise stated, the combined requirements and allowed A-MPR are applicable on both bands when both component carriers are active. Additional spurious emission requirements are signalled by the network to indicate that the UE shall meet the additional requirement for a specific deployment scenario as part of the cell handover/broadcast message.

To meet the additional requirements, additional maximum power reduction (A-MPR) is allowed for the maximum output power as specified in Table 6.2.1.3-1. Unless stated otherwise, the total reduction to UE maximum output power is $\max(\text{MPR}, \text{A-MPR})$ where MPR is defined in clause 6.2.2. In case of a power class 3 UE, when IE *powerBoostPi2BPSK* is set to 1, power class 2 A-MPR values apply.

Unless otherwise specified, $\pi/2$ BPSK refers to both variants of $\pi/2$ BPSK referenced in clause 6.2.2 table 6.2.2.3-1.

6.2B.3.1 UE additional maximum output power reduction for NR-DC

Editor's note: This clause is complete for A-MPR testing. But the following aspects are either missing for not yet determined:

FFS is left in Test applicability since there are no requirements for 6.5B.2.3 Additional Spectrum Emission mask for NR-DC and 6.5B.3.3 Additional Spurious Emissions for NR-DC in Release-16.

6.2B.3.1.1 Test purpose

Additional emission requirements for NR-DC can be signalled by the network. Each additional emission requirement is associated with a unique network signalling (NS) value indicated in RRC signalling by an NR frequency band number of the applicable operating band and an associated value in the field *additionalSpectrumEmission*. Throughout this specification, the notion of indication or signalling of an NS value refers to the corresponding indication of an NR frequency band number of the applicable operating band, the IE *freqBandIndicatorNR* and an associated value of *additionalSpectrumEmission* in the relevant RRC information elements [6].

To meet the additional requirements, additional maximum power reduction (A-MPR) is allowed for the NR-DC maximum output power. Unless stated otherwise, the total reduction to UE maximum output power is $\max(\text{MPR}, \text{A-MPR})$ where MPR is defined in clause 6.2B.2. Outer and inner allocation notation used in clause 6.2B.3 is defined in clause 6.2.2. In absence of modulation and waveform types the A-MPR applies to all modulation and waveform types.

6.2B.3.1.2 Test applicability

The requirements of this test apply in test case 6.5B.2.3 Additional Spectrum Emission mask for NR-DC for network signalling values FFS to all types of NR UE release 16 and forward that support NR-DC.

The requirements of this test apply in test case 6.5B.3.3 Additional Spurious Emissions for NR-DC for network signalling values FFS to all types of NR UE release 16 and forward that support NR-DC.

6.2B.3.1.3 Minimum conformance requirements

The minimum conformance requirements are defined in 6.2B.3.0.

6.2B.3.1.4 Test description

6.2B.3.1.4.1 Initial conditions

Initial conditions are a set of test configurations the UE needs to be tested in and the steps for the SS to take with the UE to reach the correct measurement state.

The initial test configurations consist of environmental conditions, test frequencies, test channel bandwidths and sub-carrier spacing based on NR-DC configurations specified in 5.5B. All of these configurations shall be tested with applicable test parameters for each combination of test channel bandwidth and sub-carrier spacing as specified in clause 6.2.3.4.1. The details of the uplink reference measurement channels (RMCs) are specified in Annex A.2. Configurations of PDSCH and PDCCH before measurement are specified in Annex C.2

Test configurations tables for network signalling values are specified in clause 6.2.3.4.1

1. Connect the SS to the UE antenna connectors as shown in TS 38.508-1 [5] Annex A, Figure A.3.1.1.3 for TE diagram and section A.3.2 for UE diagram.
2. The parameter settings for the cell are set up according to TS 38.508-1 [5] subclause 4.4.3.
3. Downlink signals for PCell are initially set up according to Annex C.0, C.1, C.2, and uplink signals according to Annex G.0, G.1, G.2, G.3.0.
4. The UL Reference Measurement Channel is set according to test configuration tables in clause 6.2.3.4.1.
5. Propagation conditions are set according to Annex B.0.
6. Ensure the UE is in state RRC_CONNECTED with generic procedure parameters Connectivity *NR-DC*, Connected without release *On*, Test Mode *On* and Test Loop Function *On* according to TS 38.508-1 [5] clause 4.5. Message contents are defined in clause 6.2B.3.1.4.3.

6.2B.3.1.4.2 Test procedure

1. SS sends uplink scheduling information for each UL HARQ process via PDCCH DCI format 0_1 for C_RNTI to schedule the UL RMC according to clause 6.2.3.4.1 on both PCell and PSCell for inter-band NR-DC. Since the UE has no payload and no loopback data to send the UE sends uplink MAC padding bits on the UL RMC.
2. Send continuously uplink power control "up" commands in every uplink scheduling information to the UE; allow at least 200ms starting from the first TPC command in this step for the UE to reach P_{UMAX} level.
3. Measure the mean power of each component carrier of NR-DC configuration in the channel bandwidth of the radio access mode. For PC1.5 the measured power is the sum of the two ports. The period of measurement shall be at least the continuous duration of 1ms over consecutive active uplink slots. For TDD, only slots consisting of only UL symbols are under test.

6.2B.3.1.4.3 Message contents

Message contents are according to TS 38.508-1 [5] subclause 4.6 and 5.4. Message contents exceptions for network signalling values are specified in clause 6.2.3.4.3.1.

6.2B.3.1.5 Test requirement

The maximum output power, derived in step 3 shall be within the range prescribed by the nominal maximum output power and tolerance in the applicable table in clause 6.2.3.5. The allowed A-MPR values specified in table 6.2.3.3.1-1 are in addition to the allowed MPR requirements specified in clause 6.2.2. For the UE maximum output power modified by MPR and/or A-MPR, the power limits specified in table 6.2.1.3-1 apply.

For the UE which supports inter-band NR CA configuration, inter-band NR-DC configuration, SUL configuration or inter-band EN-DC configuration, $\Delta T_{IB,c}$ as specified in 6.2A.4.0.2 for NR CA, 6.2B.4.0.2 for NR-DC, clause 6.2C.2 for SUL, or TS 38.521-3 [14] clause 6.2B.4.2 for EN-DC applies. Unless otherwise stated, $\Delta T_{IB,c}$ is set to zero. In case the UE supports more than one of band combinations for CA, NR-DC, SUL or DC, and an operating band belongs to more than one band combinations then

- a) When the operating band frequency range is ≤ 1 GHz, the applicable additional $\Delta T_{IB,c}$ shall be the average value for all band combinations defined in clause 6.2A.4.0.2, 6.2B.4.0.2, 6.2C.2 in this specification and 6.2B.4.2 in TS 38.521-3 [14], truncated to one decimal place that apply for that operating band among the supported band

combinations. In case there is a harmonic relation between low band UL and high band DL, then the maximum $\Delta T_{IB,c}$ among the different supported band combinations involving such band shall be applied

- b) When the operating band frequency range is > 1 GHz, the applicable additional $\Delta T_{IB,c}$ shall be the maximum value for all band combinations defined in clause 6.2A.4.0.2, 6.2B.4.0.2, 6.2C.2 in this specification and 6.2B.4.2 in TS 38.521-3 [14] for the applicable operating bands.

6.2B.4 Configured output power for NR-DC

6.2B.4.0 Minimum conformance requirements

6.2B.4.0.1 Configured transmitted power level for NR-DC

6.2B.4.0.1.1 Void

6.2B.4.0.1.2 Void

6.2B.4.0.1.3 Configured transmitted power for Inter-band NR-DC

The UE is allowed to set its configured maximum output power $P_{CMAX,f,c,MCG}$ and $P_{CMAX,f,c,SCG}$ for the respective MCG and SCG and its total configured maximum output power for NR-DC operation $P_{Total}^{NR-DC} = 10 \log_{10}(\hat{P}_{Total}^{NR-DC})$ with \hat{P}_{Total}^{NR-DC} as specified in clause 7.6.2 of [9]. The UE is configured with an inter-CG power sharing mode by *NR-DC-PC-mode*. The requirements apply for one uplink serving cell configured per CG and for asynchronous and synchronous NR-DC if not otherwise stated.

Unless otherwise stated, the configured maximum output power $P_{CMAX,f,c,MCG}(q)$ in physical-channel q for carrier f of serving cell c shall be set within the bounds if contained in the MCG,

$$P_{CMAX_L,f,c,MCG}(q) \leq P_{CMAX,f,c,MCG}(q) \leq P_{CMAX_H,f,c,MCG}(q)$$

and the corresponding $P_{CMAX_L,f,c,SCG}(q)$ for a serving cell contained in the SCG,

$$P_{CMAX_L,f,c,SCG}(q) \leq P_{CMAX,f,c,SCG}(q) \leq P_{CMAX_H,f,c,SCG}(q)$$

where $P_{CMAX_L,f,c,MCG}$, $P_{CMAX_H,f,c,MCG}$, $P_{CMAX_L,f,c,SCG}$ and $P_{CMAX_H,f,c,SCG}$ are the limits for a serving cell c as specified in clause 6.2.4 modified as follows:

$$P_{CMAX_L,f,c,MCG} = \text{MIN}\{\text{MIN}(P_{EMAX,c}, P_{EMAX,NR-DC}, P_{NR}) - \Delta T_{C,c}, (P_{PowerClass} - \Delta P_{PowerClass}) - \text{MAX}(\text{MAX}(MPR_c + \Delta MPR_c, A - MPR_c) + \Delta T_{IB,c} + \Delta T_{C,c} + \Delta T_{RXSRS}, P - MPR_c)\}$$

$$P_{CMAX_H,f,c,MCG} = \text{MIN}\{P_{EMAX,c}, P_{EMAX,NR-DC}, P_{NR}, P_{PowerClass} - \Delta P_{PowerClass}\}$$

for the MCG and

$$P_{CMAX_L,f,c,SCG} = \text{MIN}\{\text{MIN}(P_{EMAX,c}, P_{EMAX,NR-DC}, P_{NR}) - \Delta T_{C,c}, (P_{PowerClass} - \Delta P_{PowerClass}) - \text{MAX}(\text{MAX}(MPR_c + \Delta MPR_c, A - MPR_c) + \Delta T_{IB,c} + \Delta T_{C,c} + \Delta T_{RXSRS}, P - MPR_c)\}$$

$$P_{CMAX_H,f,c,SCG} = \text{MIN}\{P_{EMAX,c}, P_{EMAX,NR-DC}, P_{NR}, P_{PowerClass} - \Delta P_{PowerClass}\}$$

for the SCG, where

- $P_{EMAX,NR-DC}$ is the value given by the field *p-UE-FRI* of the *PhysicalCellGroupConfig* IE for the MCG as defined in [6];
- P_{NR} is the value given by the field *p-NR-FRI* of the *PhysicalCellGroupConfig* IE as defined in [6];
- $P_{PowerClass}$ is the maximum UE power specified in Table 6.2B.1.0.3-1 without taking into account the tolerance specified in the Table 6.2B.1.0.3-1;
- $\Delta T_{IB,c}$ is the additional tolerance for serving cell c as specified in clause 6.2B.4.0.2 for NR-DC; $\Delta T_{IB,c} = 0$ dB otherwise;
- $\Delta T_{C,c} = 1.5$ dB when NOTE 2 in Table 6.2B.1.0.3-1 applies for a serving cell c , otherwise $\Delta T_{C,c} = 0$ dB;
- ΔMPR_c for serving cell c is specified in clause 6.2.2.

- $\Delta P_{\text{PowerClass}} = 0$ dB for a power class 3 capable UE.

For a UE provided with $NR\text{-}DC\text{-}PC\text{-}mode = \text{Semi-static-mode1}$,

$$P_{\text{Total}}^{NR\text{-}DC} = \text{MIN}\{P_{\text{EMAX, NR-DC}}, P_{\text{PowerClass}}\} + 0.3 \text{ dB}$$

with $P_{\text{PowerClass}}$ set to power class 3 in case the UE indicates a higher power class in any CG. The UE determines the maximum transmission power for the MCG and the SCG using the respective configured maximum power $P_{\text{CMAX,f,c,MCG}}$ and $P_{\text{CMAX,f,c,SCG}}$.

If for synchronous NR-DC operation a UE is provided $NR\text{-}DC\text{-}PC\text{-}mode = \text{Semi-static-mode2}$, the $P_{\text{Total}}^{NR\text{-}DC}$ is determined as above and

- if at least one symbol of slot i_1 of the MCG/SCG is indicated as uplink or flexible to a UE by $tdd\text{-}UL\text{-}DL\text{-}ConfigurationCommon$ and $tdd\text{-}UL\text{-}DL\text{-}ConfigurationDedicated$, if provided, overlaps with a symbol for any ongoing transmission overlapping with slot i_2 of the SCG/MCG, the UE determines a maximum power for the transmission on the SCG/MCG overlapping with slot i_2 using the configured maximum power $P_{\text{CMAX,f,c,SCG}}$ or $P_{\text{CMAX,f,c,MCG}}$ for the SCG or MCG, respectively,
- otherwise (i.e. an ongoing transmission overlapping with slot i_2 of the SCG/MCG overlaps with only semi-static downlink symbols within slot i_1 of the MCG/SCG), the UE determines a maximum power for the transmission on MCG or the SCG overlapping with slot i_2 using the configured maximum power as specified in clause 6.2.4.

If a UE indicates a capability for dynamic power sharing between the MCG and the SCG and is provided with $NR\text{-}DC\text{-}PC\text{-}mode = \text{Dynamic}$,

$$P_{\text{Total}}^{NR\text{-}DC} = \text{MIN}\{P_{\text{EMAX, NR-DC}}, P_{\text{PowerClass}}\}$$

with $P_{\text{PowerClass}}$ set to power class 3 in case the UE indicates a higher power class in any CG. The UE determines the maximum transmission power for the MCG and the SCG using the respective configured maximum power $P_{\text{CMAX,f,c,MCG}}$ and $P_{\text{CMAX,f,c,SCG}}$ except

- if UE transmission(s) in slot i_1 of the MCG or in slot i_2 of the SCG do not overlap in time with any UE transmission(s) on the SCG or the MCG, respectively, the UE determines a maximum transmission power in slot i_1 of the MCG or in slot i_2 of the SCG using the configured maximum power as specified in clause 6.2.4.

If a UE indicates a capability to determine a total transmission power on the SCG at a first symbol of a transmission occasion on the SCG by determining transmissions on the MCG as specified in clause 7.6.2 of [9], and is provided with $NR\text{-}DC\text{-}PC\text{-}mode = \text{Dynamic}$,

$$P_{\text{Total}}^{NR\text{-}DC} = \text{MIN}\{P_{\text{EMAX, NR-DC}}, P_{\text{PowerClass}}\}$$

with $P_{\text{PowerClass}}$ set to power class 3 in case the UE indicates a higher power class in any CG. The UE determines the maximum transmission power for the MCG and the SCG using the respective configured maximum power $P_{\text{CMAX,f,c,MCG}}$ and $P_{\text{CMAX,f,c,SCG}}$.

The measured total maximum output power P_{UMAX} over both CGs measured over the transmission reference time duration is

$$P_{\text{UMAX}} = 10 \log_{10} (p_{\text{UMAX,c,MCG}} + p_{\text{UMAX,c,SCG}}),$$

where $p_{\text{UMAX,c,MSG}}$ and $p_{\text{UMAX,c,SCG}}$ denote the measured output power of serving cells c contained in the respective MSG and SCG expressed in linear scale.

The measured total configured maximum output power P_{UMAX} shall be within the following bounds:

$$P_{\text{CMAX_L}} - T_{\text{LOW}}(P_{\text{CMAX_L}}) \leq P_{\text{UMAX}} \leq P_{\text{CMAX_H}} + T_{\text{HIGH}}(P_{\text{CMAX_H}})$$

with the tolerances $T_{\text{LOW}}(P_{\text{CMAX_H}})$ and $T_{\text{HIGH}}(P_{\text{CMAX_H}})$ for applicable values of P_{CMAX} specified in Table 6.2B.4.0.1.3-2.

When a subframe p on the MSG overlap with a physical-channel q on the SCG, then for P_{UMAX} evaluation, the subframe p on the MCG is taken as reference period T_{REF} and always considered as the reference measurement duration and the following rules are applicable.

T_{REF} and T_{eval} are specified in Table 6.2B.4.0.1.3-1 when same or different subframe and physical-channel durations are used on the carriers. The $P_{\text{PowerClass}}$ shall not be exceeded by the UE during any evaluation period of time.

Table 6.2B.4.0.1.3-1: P_{C_{MAX}} evaluation window

Transmission duration	T _{REF}	T _{eval}
Different transmission duration in different CG carriers	MCG subframe	MIN(T _{no_hopping} , Physical Channel Length)

For each T_{REF}, the P_{C_{MAX}_H} is evaluated per T_{eval} and given by the maximum value over the transmission(s) within the T_{eval} as follows:

$$P_{C_{MAX_H}} = \text{MAX}\{P_{C_{MAX_NR-DC_H}}(p,q), P_{C_{MAX_NR-DC_H}}(p,q+1), \dots, P_{C_{MAX_NR-DC_H}}(p,q+n)\}$$

where P_{C_{MAX}_NR-DC_H} entries are the applicable upper limits for each overlapping scheduling unit pairs (p,q), (p, q+1), up to (p, q+n) for each applicable T_{eval} duration, where q+n is the last physical-channel on the SCG overlapping with subframe p on the MCG, while P_{C_{MAX}_L} is computed as follows:

$$P_{C_{MAX_L}} = \text{MIN}\{P_{C_{MAX_NR-DC_L}}(p,q), P_{C_{MAX_NR-DC_L}}(p,q+1), \dots, P_{C_{MAX_NR-DC_L}}(p,q+n)\}$$

where P_{C_{MAX}_NR-DC_L} entries are the applicable lower limits for each overlapping scheduling unit pairs (p,q), (p, q+1) up to (p, q+n) for each applicable T_{eval} duration, where q+n is the last physical-channel on the SCG overlapping with subframe p on the MCG.

For a UE provided with *NR-DC-PC-mode = Semi-static-mode1* and configured with $p_{NR,MCG} + p_{NR,SCG} \leq \hat{P}_{Total}^{NR-DC}$ with $p_{NR,MCG}$ and $p_{NR,SCG}$ the values of the P_{NR} for the respective MCG and SCG expressed in linear scale

$$P_{C_{MAX_NR-DC_L}}(p,q) = 10 \log_{10} [p_{C_{MAX_L,f,c,MCG}}(p) + p_{C_{MAX_L,f,c,SCG}}(q)]$$

$$P_{C_{MAX_NR-DC_H}}(p,q) = 10 \log_{10} [p_{C_{MAX_H,f,c,MCG}}(p) + p_{C_{MAX_H,f,c,SCG}}(q)]$$

with $p_{C_{MAX_L,f,c,MCG}}$, $p_{C_{MAX_H,f,c,MCG}}$, $p_{C_{MAX_L,f,c,SCG}}$, and $p_{C_{MAX_H,f,c,SCG}}$ the values of the respective P_{C_{MAX}_L,f,c,MCG}, P_{C_{MAX}_H,f,c,MCG}, P_{C_{MAX}_L,f,c,SCG}, and P_{C_{MAX}_H,f,c,SCG} expressed in linear scale, while the measured configured maximum power P_{UMAX} for each CG shall meet the requirements as specified in clause 6.2.4 but with bounds for P_{C_{MAX},f,c,MCG}(p) and P_{C_{MAX},f,c,SCG} as specified in this clause.

If for synchronized NR-DC a UE is provided with *NR-DC-PC-mode = Semi-static-mode2* and configured with $p_{NR,MCG} + p_{NR,SCG} \leq \hat{P}_{Total}^{NR-DC}$ with $p_{NR,MCG}$ and $p_{NR,SCG}$ the linear-scale values of the P_{NR} for the respective MCG and SCG

$$P_{C_{MAX_NR-DC_L}}(p,q) = 10 \log_{10} [p_{C_{MAX_L,f,c,MCG}}(p) + p_{C_{MAX_L,f,c,SCG}}(q)]$$

$$P_{C_{MAX_NR-DC_H}}(p,q) = 10 \log_{10} [p_{C_{MAX_H,f,c,MCG}}(p) + p_{C_{MAX_H,f,c,SCG}}(q)]$$

while the measured configured maximum power P_{UMAX} for each CG shall meet the requirements specified in Table 6.2.4.3-2 but with bounds for P_{C_{MAX},f,c,MCG}(p) and P_{C_{MAX},f,c,SCG} as specified in this clause except

- if an ongoing transmission overlapping with physical channel q of the SCG or subframe p of the MCG overlaps with only semi-static downlink symbols within the respective subframe p of the MCG or physical channel q of the SCG as indicated to a UE by *tdd-UL-DL-ConfigurationCommon* and *tdd-UL-DL-ConfigurationDedicated*, if provided,

then the measured configured maximum power P_{UMAX} for the transmission subframe p on the MCG or physical channel q on the SCG shall meet the requirements as specified in clause 6.2.4 and with bounds for P_{C_{MAX},f,c,MCG}(p) or P_{C_{MAX},f,c,SCG} as specified in clause 6.2.4.

For a UE provided with *NR-DC-PC-mode = Dynamic*,

$$P_{C_{MAX_NR-DC_L}}(p,q) = \text{MIN}\{10 \log_{10} [p_{C_{MAX_L,f,c,MCG}}(p) + p_{C_{MAX_L,f,c,SCG}}(q)], P_{Total}^{NR-DC}\}$$

$$P_{C_{MAX_NR-DC_H}}(p,q) = \text{MIN}\{10 \log_{10} [p_{C_{MAX_H,f,c,MCG}}(p) + p_{C_{MAX_H,f,c,SCG}}(q)], P_{Total}^{NR-DC}\}$$

while the measured configured maximum power P_{UMAX} on the MCG shall meet the requirements as specified in clause 6.2.4.3-2 but with bounds for P_{C_{MAX},f,c,MCG}(p) as specified in this clause, and the P_{UMAX} on the SCG shall be within

$$P_{C_{MAX_L,f,c}} - \text{MAX}\{T_{L,c}, T(P_{C_{MAX_L,f,c}})\} \leq P_{UMAX,f,c} \leq P_{C_{MAX_H,f,c}} + T(P_{C_{MAX_H,f,c}}).$$

where

$$P_{\text{CMAX_L,f,c}} = \text{MIN}\{P_{\text{CMAX_L,f,c,SCG}}(p), 10 \log_{10}(\hat{P}_{\text{Total}}^{\text{NR-DC}} - p_{\text{NR,MSG}})\}$$

$$P_{\text{CMAX_H,f,c}} = \text{MIN}\{P_{\text{CMAX_H,f,c,SCG}}(p), 10 \log_{10}(\hat{P}_{\text{Total}}^{\text{NR-DC}} - p_{\text{NR,MSG}})\}$$

with limits as specified in Table 6.2.4.3-2 and $p_{\text{NR,MCG}}$ the value of the P_{NR} for the MCG expressed in linear scale.

Table 6.2B.4.0.1.3-2: P_{CMAX} tolerance for NR-DC

$P_{\text{CMAX}}(\text{dBm})$	Tolerance $T_{\text{LOW}}(P_{\text{CMAX_L}})$ (dB)	Tolerance $T_{\text{HIGH}}(P_{\text{CMAX_H}})$ (dB)
$23 \leq P_{\text{CMAX}} \leq 33$	3.0	2.0
$22 \leq P_{\text{CMAX}} < 23$	5.0	2.0
$21 \leq P_{\text{CMAX}} < 22$	5.0	3.0
$20 \leq P_{\text{CMAX}} < 21$	6.0	4.0
$16 \leq P_{\text{CMAX}} < 20$	5.0	
$11 \leq P_{\text{CMAX}} < 16$	6.0	
$-40 \leq P_{\text{CMAX}} < 11$	7.0	
NOTE 1: For UEs provided with <i>NR-DC-PC-mode = Semi-static-mode1</i> or with <i>NR-DC-PC-mode = Semi-static-mode2</i> , the upper tolerance T_{high} shall be reduced by 0.3 dB for $P \geq 20$ dBm.		

6.2B.4.0.2 $\Delta T_{\text{IB,c}}$ for NR-DC

For the UE which supports inter-band NR-DC with one uplink carrier assigned per NR band, $\Delta T_{\text{IB,c}}$ in Table 6.2B.4.0.2.3-1 applies. Unless otherwise stated, $\Delta T_{\text{IB,c}}$ is set to zero.

6.2B.4.0.2.1 FFS

6.2B.4.0.2.2 FFS

6.2B.4.0.2.3 $\Delta T_{\text{IB,c}}$ for Inter-band NR-DC

Table 6.2B.4.0.2.3-1: $\Delta T_{\text{IB,c}}$ due to NR-DC (two bands)

Inter-band DC combination	NR Band	$\Delta T_{\text{IB,c}}$ (dB)
DC_n48-n70	n48	0.8
	n70	0.6

6.2B.4.1 Configured transmitted power level for NR-DC

6.2B.4.1.1 Test purpose

To verify that the total measured UE configured maximum output power P_{UMAX} in dual connectivity is within the specified bounds.

6.2B.4.1.2 Test applicability

The requirements of this test apply to all types of NR UE release 16 and forward that support NR-DC.

6.2B.4.1.3 Minimum conformance requirements

The minimum conformance requirements are defined in subclause 6.2B.4.0.

6.2B.4.1.4 Test description

6.2B.4.1.4.1 Initial conditions

Initial conditions are a set of test configurations the UE needs to be tested in and the steps for the SS to take with the UE to reach the correct measurement state.

The initial test configurations consist of environmental conditions, test frequencies, channel bandwidths and sub-carrier spacing based on NR-DC configurations specified in 5.5B. All of these configurations shall be tested with applicable

test parameters for each combination of test channel bandwidth and sub-carrier spacing, and are shown in table 6.2B.4.1.4.1-1. The details of the uplink reference measurement channels (RMCs) are specified in Annexes A.2. Configurations of PDSCH and PDCCH before measurement are specified in Annex C.2.

Table 6.2B.4.1.4.1-1: Inter-band NR-DC Test Configuration Table

Initial Conditions				
Test Environment as specified in TS 38.508-1 [5] subclause 4.1		Normal, TL/VL, TL/VH, TH/VL, TH/VH		
Test Frequencies as specified in TS 38.508-1 [5] subclause 4.3.1		Mid range for PCell and PSCell		
Test Channel Bandwidths as specified in TS 38.508-1 [5] subclause 4.3.1		Lowest for PCell and PSCell Highest for PCell and PSCell		
Test SCS as specified in Table 5.3.5-1		Lowest		
Test Parameters for Channel Bandwidths				
Test ID	Downlink Configuration for PCell & PSCell	Uplink Configuration		
		Modulation for all CCs (NOTE 2)	RB allocation (NOTE 1)	
1	N/A for minimum output power test case	DFT-s-OFDM Pi/2 BPSK	Inner Full	Inner Full
2		DFT-s-OFDM QPSK	Inner Full	Inner Full
NOTE 1: The specific configuration of each RB allocation is defined in Table 6.1-1.				
NOTE 2: DFT-s-OFDM Pi/2 BPSK test applies only for UEs which supports Pi/2 BPSK in FR1.				

1. Connect the SS to the UE antenna connectors as shown in TS 38.508-1 [5] Annex A, Figure A.3.1.1.3 for TE diagram and section A.3.2 for UE diagram.
2. The parameter settings for the cell are set up according to TS 38.508-1 [5] subclause 4.4.3.
3. Downlink signals are initially set up according to Annex C.0, C.1, C.2, and uplink signals according to Annex G.0, G.1, G.2, G.3.0.
4. The UL Reference Measurement Channel is set according to Table 6.2B.4.1.4.1-1 as appropriate.
5. Propagation conditions are set according to Annex B.0.
6. Ensure the UE is in State RRC_CONNECTED with generic procedure parameters Connectivity *NR-DC*, Connected without release *On*, Test Mode *On* and Test Loop Function *On* according to TS 38.508-1 [5] clause 4.5. Message contents are defined in clause 6.2B.4.1.4.3.

6.2B.4.1.4.2 Test procedure

1. SS sends uplink scheduling information for each UL HARQ process via PDCCH DCI format 0_1 for C_RNTI to schedule the UL RMC according to Table 6.2B.4.1.4.1-1 on both PCell and PSCell for inter-band NR-DC. Since the UE has no payload and no loopback data to send the UE sends uplink MAC padding bits on the UL RMC.
2. Send continuously uplink power control "up" commands in every uplink scheduling information to the UE; allow at least 200ms starting from the first TPC command in this step for the UE to reach P_{UMAX} level of the test point.
3. Measure the sum of mean transmitted power over all component carriers in the NR-DC configuration of the radio access mode. The period of measurement shall be at least the continuous duration of one active sub-frame (1ms) and in the uplink symbols. For TDD, only slots consisting of only UL symbols are under test.

6.2B.4.1.4.3 Message contents

Message contents are according to TS 38.508-1 [5] subclause 4.6 with the following exceptions.

Table 6.2B.4.1.4.3-0: PUSCH-Config

Derivation Path: TS 38.508-1 [5], Table 4.6.3-118 with condition TRANSFORM_PRECODER_ENABLED

Table 6.2B.4.1.4.3-1: FrequencyInfoUL: Test point 1

Derivation Path: TS 38.508-1 [5] Table 4.6.3-61 FrequencyInfoUL			
Information Element	Value/remark	Comment	Condition
p-Max	-10		

Table 6.2B.4.1.4.3-1a: FrequencyInfoUL-SIB: Test point 1

Derivation Path: TS 38.508-1 [5] Table 4.6.3-62 FrequencyInfoUL-SIB			
Information Element	Value/remark	Comment	Condition
p-Max	-10		

Table 6.2B.4.1.4.3-2: FrequencyInfoUL: Test point 2

Derivation Path: TS 38.508-1 [5] Table 4.6.3-61 FrequencyInfoUL			
Information Element	Value/remark	Comment	Condition
p-Max	10		

Table 6.2B.4.1.4.3-2a: FrequencyInfoUL-SIB: Test point 2

Derivation Path: TS 38.508-1 [5] Table 4.6.3-62 FrequencyInfoUL-SIB			
Information Element	Value/remark	Comment	Condition
p-Max	10		

6.2B.4.1.5 Test requirement

The maximum output power measured shall not exceed the values specified in Table 6.2B.4.1.5-1.

Table 6.2B.4.1.5-1: Configured UE Output Power for Inter-band NR-DC

	Maximum output power	
	Lower limit	Upper limit
Measured UE output power test point 1	-14 dBm - TT	0 dBm + TT
Measured UE output power test point 2	7 dBm - TT	19 dBm + TT

Note 1: TT for each frequency and channel bandwidth is specified in Table 6.2B.4.1.5-2.

Table 6.2B.4.1.5-2: Test Tolerance for Configured transmitted power for Inter-band NR-DC

TT for overall output power (dB)								
			PCell					
			BW ≤ 40MHz			40MHz < BW ≤ 100MHz		
			f ≤ 3.0GHz	3.0GHz < f ≤ 4.2GHz	4.2GHz < f ≤ 6.0GHz	f ≤ 3.0GHz	3.0GHz < f ≤ 4.2GHz	4.2GHz < f ≤ 6.0GHz
PSCell	BW ≤ 40MHz	f ≤ 3.0GHz	0.7	1.0	1.0	1.0	1.0	1.0
		3.0GHz < f ≤ 4.2GHz	1.0	1.0	1.0	1.0	1.0	1.0
		4.2GHz < f ≤ 6.0GHz	1.0	1.0	1.0	1.0	1.0	1.0
	40MHz < BW ≤ 100MHz	f ≤ 3.0GHz	1.0	1.0	1.0	1.0	1.0	1.0
		3.0GHz < f ≤ 4.2GHz	1.0	1.0	1.0	1.0	1.0	1.0
		4.2GHz < f ≤ 6.0GHz	1.0	1.0	1.0	1.0	1.0	1.0

For the UE which supports inter-band NR CA configuration, inter-band NR-DC configuration, SUL configuration or inter-band EN-DC configuration, $\Delta T_{IB,c}$ as specified in 6.2A.4.0.2 for NR CA, 6.2B.4.0.2 for NR-DC, clause 6.2C.2 for SUL, or TS 38.521-3 [14] clause 6.2B.4.2 for EN-DC applies. Unless otherwise stated, $\Delta T_{IB,c}$ is set to zero. In case the UE supports more than one of band combinations for CA, NR-DC, SUL or DC, and an operating band belongs to more than one band combinations then

- a) When the operating band frequency range is ≤ 1 GHz, the applicable additional $\Delta T_{IB,c}$ shall be the average value for all band combinations defined in clause 6.2A.4.0.2, 6.2B.4.0.2, 6.2C.2 in this specification and 6.2B.4.2 in TS 38.521-3 [14], truncated to one decimal place that apply for that operating band among the supported band combinations. In case there is a harmonic relation between low band UL and high band DL, then the maximum $\Delta T_{IB,c}$ among the different supported band combinations involving such band shall be applied
- b) When the operating band frequency range is > 1 GHz, the applicable additional $\Delta T_{IB,c}$ shall be the maximum value for all band combinations defined in clause 6.2A.4.0.2, 6.2B.4.0.2, 6.2C.2 in this specification and 6.2B.4.2 in TS 38.521-3 [14] for the applicable operating bands.

6.2C Transmitter power for SUL

6.2C.1 Configured transmitted power for SUL

6.2C.1.1 Test purpose

Same test purpose as in clause 6.2.4.1

6.2C.1.2 Test applicability

This test applies to all types of NR UE release 15 and forward that support SUL operating on the SUL bands.

6.2C.1.3 Minimum conformance requirements

When a UE is configured with both NR UL and NR SUL carriers in a serving cell with active transmission either on the UL carrier or SUL carrier, the configured transmit power requirements specified in subclause 6.2.4 are applicable for the UL carrier and the SUL carrier, respectively.

For the UE which supports SUL band combination, $\Delta T_{IB,c}$ in Table 6.2C.2-1 applies.

The normative reference for this requirement is TS 38.101-1 [2] clauses 6.2C.

6.2C.1.4 Test description

Same test description as specified in clause 6.2.4.4 with following exceptions:

Instead of table 5.3.5-1 → use Table 5.5C-1

Instead of table 6.2.4.4-1 → use Table 6.2C.1.4-1

Table 6.2C.1.4-1: Test Configuration Table

Initial Conditions			
Test Environment as specified in TS 38.508-1 [5] subclause 4.1		Normal, TL/VL, TL/VH, TH/VL, TH/VH	
Test Frequencies as specified in TS 38.508-1 [5] subclause 4.3.1		Mid range for both SUL carrier and Non-SUL carrier	
Test Channel Bandwidths as specified in TS 38.508-1 [5] subclause 4.3.1		Lowest, Mid, Highest for SUL carrier Lowest for Non-SUL carrier	
Test SCS as specified in Table 5.3.5-1		15kHz for both SUL carrier and Non-SUL carrier	
Test Parameters for Channel Bandwidths			
Test ID	Downlink Configuration	UL Configuration	SUL Configuration
	N/A	N/A	Modulation
1			DFT-s-OFDM Pi/2 BPSK
2			DFT-s-OFDM QPSK
			RB allocation (NOTE 2)
			Inner Full
			Inner Full
NOTE 1: Test Channel Bandwidths are checked separately for each SUL band combination, the applicable channel bandwidths are specified in Table 5.5C-1.			
NOTE 2: The specific configuration of each RB allocation is defined in Table 6.1-1.			
NOTE 3: DFT-s-OFDM PI/2 BPSK test applies only for UEs which supports half Pi BPSK in FR1.			

- Connect the SS to the UE antenna connectors as shown in TS 38.508-1 [5] Annex A, Figure A.3.1.1.4 for TE diagram and section A.3.2 for UE diagram.
- The parameter setting for the cell are set up according to the TS 38.508-1 [5] subclause 4.4.3.
- Downlink signals are initially setup according to Annex C.0, C.1, C.2 and uplink signals according to Annex G.0, G.1, G.2, and G.3.0 with consideration of supplementary uplink physical channels.

Message contents in initial conditions are according to TS 38.508-1 [5] subclause 4.3.6.1.1.2 ensuring UL/SUL indicator in Table 4.3.6.1.1.2-1 with condition SUL, subclause 4.6 ensuring that for SUL carrier, Tables 4.6.1-28 with condition SUL AND (RF OR RRM), 4.6.3-14 with condition SUL_SUL for SUL carrier and Table 4.6.3-167 with condition PUSCH_PUCCH_ON_SUL, additionally the following exceptions shown in Table 6.2C.1.4-2 ~ Table 6.2C.1.4-4 are considered.

Table 6.2C.1.4-2: SIB1: Test point 1

Derivation Path: TS 38.508-1 [5] Table 4.6.1-28 SIB1 with condition SUL AND RF			
Information Element	Value/remark	Comment	Condition
supplementaryUplink ::= SEQUENCE {			
frequencyInfoUL SEQUENCE {			
p-Max	-10		
}			
}			

Table 6.2C.1.4-3: SIB1: Test point 2

Derivation Path: TS 38.508-1 [5] Table 4.6.1-28 SIB1 with condition SUL AND RF			
Information Element	Value/remark	Comment	Condition
supplementaryUplink ::= SEQUENCE {			
frequencyInfoUL SEQUENCE {			
p-Max	10		
}			
}			

Table 6.2C.1.4-4: SIB1: Test point 3

Derivation Path: TS 38.508-1 [5] Table 4.6.1-28 SIB1 with condition SUL AND RF			
Information Element	Value/remark	Comment	Condition
supplementaryUplink ::= SEQUENCE {			
frequencyInfoUL SEQUENCE {			
p-Max	15		
}			
}			

Table 6.2C.1.4-5: Void

6.2C.1.5 Test requirement

The maximum output power measured on SUL carrier shall not exceed the values specified in Table 6.2C.1.5-1.

Table 6.2C.1.5-1: P_{C_{MAX}} configured UE output power

	Channel bandwidth / maximum output power					
	5 MHz	10 MHz	15 MHz	20 MHz	25 MHz	30 MHz
Measured UE output power test point 1	-10 dBm ± (7+TT)					
Measured UE output power test point 2	10 dBm ± (6+TT)					
Measured UE output power test point 3	15 dBm ± (5+TT)					
Note 1:	TT for each frequency and channel bandwidth is specified in Table 6.2.4.5-2.					
Note 2:	In addition note 3 in Table 6.2.1.3-1 shall apply to the tolerances.					

For the UE which supports inter-band NR CA configuration, SUL configuration or inter-band EN-DC configuration, $\Delta T_{IB,c}$ as specified in 6.2A.4.0.2 for NR CA, clause 6.2C.2 for SUL, or TS 38.521-3 [14] clause 6.2B.4.2 for EN-DC applies. Unless otherwise stated, $\Delta T_{IB,c}$ is set to zero. In case the UE supports more than one of band combinations for CA, SUL or DC, and an operating band belongs to more than one band combinations then

- a) When the operating band frequency range is ≤ 1 GHz, the applicable additional $\Delta T_{IB,c}$ shall be the average value for all band combinations defined in clause 6.2A.4.0.2, 6.2C.2 in this specification and 6.2B.4.2 in TS 38.521-3 [14], truncated to one decimal place that apply for that operating band among the supported band combinations.

In case there is a harmonic relation between low band UL and high band DL, then the maximum $\Delta T_{IB,c}$ among the different supported band combinations involving such band shall be applied

- b) When the operating band frequency range is > 1 GHz, the applicable additional $\Delta T_{IB,c}$ shall be the maximum value for all band combinations defined in clause 6.2A.4.0.2, 6.2C.2 in this specification and 6.2B.4.2 in TS 38.521-3 [14] for the applicable operating bands.

6.2C.2 $\Delta T_{IB,c}$

For the UE which supports SUL band combination, $\Delta T_{IB,c}$ in Tables below applies. Unless otherwise stated, $\Delta T_{IB,c}$ is set to zero.

Table 6.2C.2-1: $\Delta T_{IB,c}$ due to SUL

Band combination for SUL	NR Band	$\Delta T_{IB,c}$ (dB)
SUL_n41-n83	n41	0.3
	n83	0.3
SUL_n78-n80	n78	0.8
	n80	0.6
SUL_n78-n81	n78	0.8
	n81	0.6
SUL_n78-n82	n78	0.8
	n82	0.6
SUL_n78-n83	n78	0.8
	n83	0.5
SUL_n78-n84	n78	0.8
	n84	0.3
SUL_n78-n86	n78	0.8
	n86	0.6
SUL_n79-n83	n79	0.8
	n83	0.5

Table 6.2C.2-2: $\Delta T_{IB,c}$ for SUL band combination (Three bands)

Band combination for SUL	NR Band	$\Delta T_{IB,c}$ (dB)
CA_n1_SUL_n78-n80	n1	0.6
	n78	0.8
	n80	0.6
CA_n1_SUL_n78-n84	n1	0.6
	n78	0.8
	n84	0.6
CA_n3_SUL_n78-n80	n3	0.6
	n78	0.8
	n80	0.6
CA_n28_SUL_n41-n83	n28	0.3
	n41	0.3
	n83	0.3
CA_n28_SUL_n79-n83	n28	0.5
	n79	0.8
	n83	0.5

6.2C.3 UE maximum output power for SUL

6.2C.3.1 Test purpose

Same test purpose as in clause 6.2.1.1

6.2C.3.2 Test applicability

This test applies to all types of NR UE release 15 and forward that support SUL operating on the SUL bands.

6.2C.3.3 Minimum conformance requirements

For a terminal that supports SUL for the band combination specified in Table 5.2C-1, the current version of the specification assumes the terminal is configured with active transmission either on UL carrier or SUL carrier at any time in one serving cell and the UE requirements for single carrier shall apply for the active UL or SUL carrier accordingly.

The normative reference for this requirement is TS 38.101-1 [2] clauses 4.3 and 6.2.1.

6.2C.3.4 Test description

Same test description as specified in clause 6.2.1.4 with following exceptions:

Instead of table 5.3.5-1 → use Table 5.5C-1.

Instead of table 6.2.1.4-1 → use Table 6.2C.3.4-1

Table 6.2C.3.4-1: Test Configuration Table

Initial Conditions			
Test Environment as specified in TS 38.508-1 [5] subclause 4.1		Normal, TL/VL, TL/VH, TH/VL, TH/VH	
Test Frequencies as specified in TS 38.508-1 [5] subclause 4.3.1		Mid range for Non-SUL carrier. Low, Mid, High range for SUL carrier	
Test Channel Bandwidths as specified in TS 38.508-1 [5] subclause 4.3.1		Lowest, Mid, Highest for SUL carrier Lowest for Non-SUL carrier	
Test SCS as specified in Table 5.3.5-1		15kHz for both SUL carrier and Non-SUL carrier	
Test Parameters for Channel Bandwidths			
Test ID	Downlink Configuration	UL Configuration	SUL Configuration
	N/A	N/A	Modulation
1			DFT-s-OFDM PI/2 BPSK
2			DFT-s-OFDM PI/2 BPSK
3			DFT-s-OFDM PI/2 BPSK
4			DFT-s-OFDM QPSK
5			DFT-s-OFDM QPSK
6			DFT-s-OFDM QPSK
			RB allocation (NOTE 2)
			Inner Full
			Inner 1RB Left
			Inner 1RB Right
			Inner Full
			Inner 1RB Left
			Inner 1RB Right
NOTE 1: Test Channel Bandwidths are checked separately for each SUL band combination, the applicable channel bandwidths are specified in Table 5.5C-1.			
NOTE 2: The specific configuration of each RB allocation is defined in Table 6.1-1.			
NOTE 3: DFT-s-OFDM PI/2 BPSK test applies only for UEs which supports half Pi BPSK in FR1.			

- Connect the SS to the UE antenna connectors as shown in TS 38.508-1 [5] Annex A, Figure A.3.1.1.4 for TE diagram and section A.3.2 for UE diagram.
- The parameter setting for the cell are set up according to the TS 38.508-1 [5] subclause 4.4.3.
- Downlink signals are initially setup according to Annex C.0, C.1, C.2 and uplink signals according to Annex G.0, G.1, G.2, and G.3.0 with consideration of supplementary uplink physical channels.

Message contents in initial conditions are according to TS 38.508-1 [5] subclause 4.3.6.1.1.2 ensuring UL/SUL indicator in Table 4.3.6.1.1.2-1 with condition SUL, subclause 4.6 ensuring Table 4.6.1-28 with condition SUL AND (RF OR RRM), Tables 4.6.3-14 with condition SUL_SUL for SUL carrier, and Table 4.6.3-167 with condition PUSCH_PUCCH_ON_SUL, additionally the following exceptions shown in Table 6.2C.3.4-2 is considered.

Table 6.2C.3.4-2: PUSCH-Config

Derivation Path: TS 38.508-1 [5], Table 4.6.3-118 with condition TRANSFORM_PRECODER_ENABLED

Table 6.2C.3.4-3: Void

6.2C.3.5 Test requirement

The maximum output power measured on SUL carrier shall be within the range prescribed by the nominal maximum output power and tolerance in Table 6.2C.3.5-1.

Table 6.2C.3.5-1: Maximum Output Power test requirement for Power Class 3

NR band	Class 1 (dBm)	Tolerance (dB)	Class 2 (dBm)	Tolerance (dB)	Class 3 (dBm)	Tolerance (dB)
n80					23	$\pm 2 \pm TT$
n81					23	$\pm 2 \pm TT$
n82					23	$\pm 2 \pm TT$
n83					23	$+2 + TT / -2.5 - TT$
n84					23	$\pm 2 \pm TT$
n86					23	$\pm 2 \pm TT$
n97					23	$\pm 2 \pm TT$
n99					23	$2 + TT / -3.0^3 - TT$
NOTE 1: $P_{PowerClass}$ is the maximum UE power specified without taking into account the tolerance						
NOTE 2: Power class 3 is default power class unless otherwise stated						
NOTE 3: Refers to the transmission bandwidths confined within F_{UL_low} and $F_{UL_low} + 4$ MHz or $F_{UL_high} - 4$ MHz and F_{UL_high} , the maximum output power requirement is relaxed by reducing the lower tolerance limit by 1.5 dB						
NOTE 4: TT for each frequency and channel bandwidth is specified in Table 6.2.1.5-3						

For the UE which supports inter-band NR CA configuration, inter-band NR-DC configuration, SUL configuration or inter-band EN-DC configuration, $\Delta T_{IB,c}$ as specified in 6.2A.4.0.2 for NR CA, 6.2B.4.0.2 for NR-DC, clause 6.2C.2 for SUL, or TS 38.521-3 [14] clause 6.2B.4.2 for EN-DC applies. Unless otherwise stated, $\Delta T_{IB,c}$ is set to zero. In case the UE supports more than one of band combinations for CA, NR-DC, SUL or DC, and an operating band belongs to more than one band combinations then

- a) When the operating band frequency range is ≤ 1 GHz, the applicable additional $\Delta T_{IB,c}$ shall be the average value for all band combinations defined in clause 6.2A.4.0.2, 6.2B.4.0.2, 6.2C.2 in this specification and 6.2B.4.2 in TS 38.521-3 [14], truncated to one decimal place that apply for that operating band among the supported band combinations. In case there is a harmonic relation between low band UL and high band DL, then the maximum $\Delta T_{IB,c}$ among the different supported band combinations involving such band shall be applied
- b) When the operating band frequency range is > 1 GHz, the applicable additional $\Delta T_{IB,c}$ shall be the maximum value for all band combinations defined in clause 6.2A.4.0.2, 6.2B.4.0.2, 6.2C.2 in this specification and 6.2B.4.2 in TS 38.521-3 [14] for the applicable operating bands.

6.2C.4 UE maximum output power reduction for SUL

6.2C.4.1 Test purpose

Same test purpose as in clause 6.2.2.1

6.2C.4.2 Test applicability

This test applies to all types of NR UE release 15 and forward that support SUL operating on the SUL bands.

NOTE: Test execution is not necessary if TS 38.521-1 6.5C.2.4.1 is executed.

6.2C.4.3 Minimum conformance requirements

For a terminal that supports SUL for the band combination specified in Table 5.2C-1, the current version of the specification assumes the terminal is configured with active transmission either on UL carrier or SUL carrier at any time in one serving cell and the UE requirements for single carrier shall apply for the active UL or SUL carrier accordingly.

The normative reference for this requirement is TS 38.101-1 [2] clauses 4.3 and 6.2.2.

6.2C.4.4 Test description

Same test description as PC 3 with contiguous allocation specified in clause 6.2.2.4 with following exceptions:

Instead of table 5.3.5-1 → use Table 5.5C-1.

Instead of table 6.2.2.4-1 → use Table 6.2C.4.4-1.

Table 6.2C.4.4-1: Test Configuration Table for power class 3 contiguous allocation

Initial Conditions					
Test Environment as specified in TS 38.508-1 [5] subclause 4.1			Normal, TL/VL, TL/VH, TH/VL, TH/VH		
Test Frequencies as specified in TS 38.508-1 [5] subclause 4.3.1			Low range and high range for SUL carrier Mid range for Non-SUL carrier.		
Test Channel Bandwidths as specified in TS 38.508-1 [5] subclause 4.3.1			Lowest, Highest for SUL carrier Lowest for Non-SUL carrier		
Test SCS as specified in Table 5.5C-1			15kHz for both SUL carrier and Non-SUL carrier		
Test Parameters for Channel Bandwidths					
Test ID	Freq	Downlink Configuration	UL Configuration	SUL Configuration	
		N/A	N/A	Modulation	RB allocation (NOTE 2)
1	Default			DFT-s-OFDM Pi/2 BPSK	Inner Full
2	Low			DFT-s-OFDM Pi/2 BPSK	Edge_1RB_Left
3	High			DFT-s-OFDM Pi/2 BPSK	Edge_1RB_Right
4	Default			DFT-s-OFDM Pi/2 BPSK	Outer Full
5	Default			DFT-s-OFDM QPSK	Inner Full
6	Low			DFT-s-OFDM QPSK	Edge_1RB_Left
7	High			DFT-s-OFDM QPSK	Edge_1RB_Right
8	Default			DFT-s-OFDM QPSK	Outer Full
9	Default			DFT-s-OFDM 16 QAM	Inner Full
10	Low			DFT-s-OFDM 16 QAM	Edge_1RB_Left
11	High			DFT-s-OFDM 16 QAM	Edge_1RB_Right
12	Default			DFT-s-OFDM 16 QAM	Outer Full
13	Low			DFT-s-OFDM 64 QAM	Edge_1RB_Left
14	High			DFT-s-OFDM 64 QAM	Edge_1RB_Right
15	Default			DFT-s-OFDM 64 QAM	Outer Full
16	Low			DFT-s-OFDM 256 QAM	Edge_1RB_Left
17	High			DFT-s-OFDM 256 QAM	Edge_1RB_Right
18	Default			DFT-s-OFDM 256 QAM	Outer Full
19	Default			CP-OFDM QPSK	Inner Full
20	Low			CP-OFDM QPSK	Edge_1RB_Left
21	High			CP-OFDM QPSK	Edge_1RB_Right
22	Default			CP-OFDM QPSK	Outer Full
23	Default			CP-OFDM 16 QAM	Inner Full
24	Low			CP-OFDM 16 QAM	Edge_1RB_Left
25	High			CP-OFDM 16 QAM	Edge_1RB_Right
26	Default			CP-OFDM 16 QAM	Outer Full
27	Low			OFDM 64 QAM	Edge_1RB_Left
28	High			OFDM 64 QAM	Edge_1RB_Right
29	Default			CP-OFDM 64 QAM	Outer Full
30	Low			OFDM 256 QAM	Edge_1RB_Left
31	High			OFDM 256 QAM	Edge_1RB_Right
32	Default			CP-OFDM 256 QAM	Outer Full
33 ⁴	Low			DFT-s-OFDM Pi/2 BPSK w Pi/2 BPSK DMRS	Edge_1RB_Left
34 ⁴	High			DFT-s-OFDM Pi/2 BPSK w Pi/2 BPSK DMRS	Edge_1RB_Right
35 ⁴	Default			DFT-s-OFDM Pi/2 BPSK w Pi/2 BPSK DMRS	Outer Full
NOTE 1: Test Channel Bandwidths are checked separately for each SUL band combination, the applicable channel bandwidths are specified in Table 5.5C-1.					
NOTE 2: The specific configuration of each RB allocation is defined in Table 6.1-1.					
NOTE 3: DFT-s-OFDM Pi/2 BPSK test applies only for UEs which supports half Pi BPSK in FR1.					
NOTE 4: Applicable to UEs indicating support for UE capability <i>lowPAPR-DMRS-PUSCHwithPrecoding-r16</i> .					

- Connect the SS to the UE antenna connectors as shown in TS 38.508-1 [5] Annex A, Figure A.3.1.1.4 for TE diagram and section A.3.2 for UE diagram.
- The parameter setting for the cell are set up according to the TS 38.508-1 [5] subclause 4.4.3.
- Downlink signals are initially setup according to Annex C.0, C.1, C.2 and uplink signals according to Annex G.0, G.1, G.2, and G.3.0 with consideration of supplementary uplink physical channels.

Message contents in initial conditions are according to TS 38.508-1 [5] subclause 4.3.6.1.1.2 ensuring UL/SUL indicator in Table 4.3.6.1.1.2-1 with condition SUL, subclause 4.6 ensuring Table 4.6.1-28 with condition SUL AND (RF OR RRM), Table 4.6.3-14 with condition SUL_SUL for SUL carrier, and Table 4.6.3-167 with condition PUSCH_PUCCH_ON_SUL. Message contents in Table 6.2.2.4.3-3 in clause 6.2.2.4.3 only apply to Test ID 33-35 in Table 6.2C.4.4-1.

Table 6.2C.4.4-2: Void

6.2C.4.5 Test requirement

The maximum output power, derived in step 3 shall be within the range prescribed by the nominal maximum output power and tolerance in Table 6.2C.4.5-1 and Table 6.2C.4.5-2.

Table 6.2C.4.5-1: UE Power Class test requirements (for Bands n80, n81, n82, n84, n86, n97) for Power Class 3

Test ID	$P_{\text{PowerClass}}$ (dBm)	$\Delta P_{\text{PowerClass}}$ (dB)	MPR (dB)	$\Delta T_{C,c}$ (dB)	$P_{\text{CMAX_L,f,c}}$ (dBm)	$T(P_{\text{CMAX_L,f,c}})$ (dB)	$T_{L,c}$ (dB)	Upper limit (dBm)	Lower limit (dBm)
1	23	0	0	0	23.0	2.0	2	25.0 + TT	21.0 - TT
2	23	0	0.5	0	22.5	2.0	2	25.0 + TT	20.5 - TT
3	23	0	0.5	0	22.5	2.0	2	25.0 + TT	20.5 - TT
4	23	0	0.5	0	22.5	2.0	2	25.0 + TT	20.5 - TT
5	23	0	0	0	23.0	2.0	2	25.0 + TT	21.0 - TT
6	23	0	1	0	22.0	2.0	2	25.0 + TT	20.0 - TT
7	23	0	1	0	22.0	2.0	2	25.0 + TT	20.0 - TT
8	23	0	1	0	22.0	2.0	2	25.0 + TT	20.0 - TT
9	23	0	1	0	22.0	2.0	2	25.0 + TT	20.0 - TT
10	23	0	2	0	21.0	2.0	2	25.0 + TT	19.0 - TT
11	23	0	2	0	21.0	2.0	2	25.0 + TT	19.0 - TT
12	23	0	2	0	21.0	2.0	2	25.0 + TT	19.0 - TT
13	23	0	2.5	0	20.5	2.5	2	25.0 + TT	18.0 - TT
14	23	0	2.5	0	20.5	2.5	2	25.0 + TT	18.0 - TT
15	23	0	2.5	0	20.5	2.5	2	25.0 + TT	18.0 - TT
16	23	0	4.5	0	18.5	4.0	2	25.0 + TT	14.5 - TT
17	23	0	4.5	0	18.5	4.0	2	25.0 + TT	14.5 - TT
18	23	0	4.5	0	18.5	4.0	2	25.0 + TT	14.5 - TT
19	23	0	1.5	0	21.5	2.0	2	25.0 + TT	19.5 - TT
20	23	0	3	0	20.0	2.5	2	25.0 + TT	17.5 - TT
21	23	0	3	0	20.0	2.5	2	25.0 + TT	17.5 - TT
22	23	0	3	0	20.0	2.5	2	25.0 + TT	17.5 - TT
23	23	0	2	0	21.0	2.0	2	25.0 + TT	19.0 - TT
24	23	0	3	0	20.0	2.5	2	25.0 + TT	17.5 - TT

25	23	0	3	0	20.0	2.5	2	25.0 + TT	17.5 - TT
----	----	---	---	---	------	-----	---	-----------	-----------

Test ID	$P_{\text{PowerClass}}$ (dBm)	$\Delta P_{\text{PowerClass}}$ (dB)	MPR (dB)	$\Delta T_{C,c}$ (dB)	$P_{\text{CMAX_L,f,c}}$ (dBm)	$T(P_{\text{CMAX_L,f,c}})$ (dB)	$T_{L,c}$ (dB)	Upper limit (dBm)	Lower limit (dBm)
26	23	0	3	0	20.0	2.5	2	25.0 + TT	17.5 - TT
27	23	0	3.5	0	19.5	3.5	2	25.0 + TT	16.0 - TT
28	23	0	3.5	0	19.5	3.5	2	25.0 + TT	16.0 - TT
29	23	0	3.5	0	19.5	3.5	2	25.0 + TT	16.0 - TT
30	23	0	6.5	0	16.5	5.0	2	25.0 + TT	11.5 - TT
31	23	0	6.5	0	16.5	5.0	2	25.0 + TT	11.5 - TT
32	23	0	6.5	0	16.5	5.0	2	25.0 + TT	11.5 - TT
33	23	0	0.5	0	22.5	2.0	2	25.0 + TT	20.5- TT
34	23	0	0.5	0	22.5	2.0	2	25.0 + TT	20.5- TT
35	23	0	0	0	23	2.0	2	25.0 + TT	21- TT

NOTE 1: $P_{\text{PowerClass}}$ is the maximum UE power specified without taking into account the tolerance.

NOTE 2: TT for each frequency and channel bandwidth is specified in Table 6.2C.4.5-3.

Table 6.2C.4.5-2: UE Power Class test requirements (for Bands n83 with channel bandwidth other than 30MHz) for Power Class 3

Test ID	$P_{\text{PowerClass}}$ (dBm)	$\Delta P_{\text{PowerClass}}$ (dB)	MPR (dB)	$\Delta T_{\text{C,c}}$ (dB)	$P_{\text{CMAX_L,f,c}}$ (dBm)	$T(P_{\text{CMAX_L,f,c}})$ (dB)	$T_{\text{L,c}}$ (dB)	Upper limit (dBm)	Lower limit (dBm)
1	23	0	0	0	23.0	2.0	2.5	25.0 + TT	20.5 - TT
2	23	0	0.5	0	22.5	2.0	2.5	25.0 + TT	20.0 - TT
3	23	0	0.5	0	22.5	2.0	2.5	25.0 + TT	20.0 - TT
4	23	0	0.5	0	22.5	2.0	2.5	25.0 + TT	20.0 - TT
5	23	0	0	0	23.0	2.0	2.5	25.0 + TT	20.5 - TT
6	23	0	1	0	22.0	2.0	2.5	25.0 + TT	19.5 - TT
7	23	0	1	0	22.0	2.0	2.5	25.0 + TT	19.5 - TT
8	23	0	1	0	22.0	2.0	2.5	25.0 + TT	19.5 - TT
9	23	0	1	0	22.0	2.0	2.5	25.0 + TT	19.5 - TT
10	23	0	2	0	21.0	2.0	2.5	25.0 + TT	18.5 - TT
11	23	0	2	0	21.0	2.0	2.5	25.0 + TT	18.5 - TT
12	23	0	2	0	21.0	2.0	2.5	25.0 + TT	18.5 - TT
13	23	0	2.5	0	20.5	2.5	2.5	25.0 + TT	18.0 - TT
14	23	0	2.5	0	20.5	2.5	2.5	25.0 + TT	18.0 - TT
15	23	0	2.5	0	20.5	2.5	2.5	25.0 + TT	18.0 - TT
16	23	0	4.5	0	18.5	4.0	2.5	25.0 + TT	14.5 - TT
17	23	0	4.5	0	18.5	4.0	2.5	25.0 + TT	14.5 - TT
18	23	0	4.5	0	18.5	4.0	2.5	25.0 + TT	14.5 - TT
19	23	0	1.5	0	21.5	2.0	2.5	25.0 + TT	19.0 - TT
20	23	0	3	0	20.0	2.5	2.5	25.0 + TT	17.5 - TT
21	23	0	3	0	20.0	2.5	2.5	25.0 + TT	17.5 - TT
22	23	0	3	0	20.0	2.5	2.5	25.0 + TT	17.5 - TT
23	23	0	2	0	21.0	2.0	2.5	25.0 + TT	18.5 - TT
24	23	0	3	0	20.0	2.5	2.5	25.0 + TT	17.5 - TT
25	23	0	3	0	20.0	2.5	2.5	25.0 + TT	17.5 - TT
26	23	0	3	0	20.0	2.5	2.5	25.0 + TT	17.5 - TT
27	23	0	3.5	0	19.5	3.5	2.5	25.0 + TT	16.0 - TT
28	23	0	3.5	0	19.5	3.5	2.5	25.0 + TT	16.0 - TT
29	23	0	3.5	0	19.5	3.5	2.5	25.0 + TT	16.0 - TT
30	23	0	6.5	0	16.5	5.0	2.5	25.0 + TT	11.5 - TT
31	23	0	6.5	0	16.5	5.0	2.5	25.0 + TT	11.5 - TT
32	23	0	6.5	0	16.5	5.0	2.5	25.0 + TT	11.5 - TT
33	23	0	0.5	0	22.5	2.0	2.5	25.0 + TT	20.0 - TT
34	23	0	0.5	0	22.5	2.0	2.5	25.0 + TT	20.0 - TT
35	23	0	0	0	23	2.0	2.5	25.0 + TT	20.5 - TT

NOTE 1: $P_{\text{PowerClass}}$ is the maximum UE power specified without taking into account the tolerance.
NOTE 2: TT for each frequency and channel bandwidth is specified in Table 6.2.2.5-5.

Table 6.2C.4.5-3: UE Power Class test requirements (for Bands n83 with 30MHz channel bandwidth) for Power Class 3

Test ID	$P_{\text{PowerClass}}$ (dBm)	$\Delta P_{\text{PowerClass}}$ (dB)	MPR (dB)	$\Delta T_{\text{C,c}}$ (dB)	$P_{\text{CMAX_L,f,c}}$ (dBm)	$T(P_{\text{CMAX_L,f,c}})$ (dB)	$T_{\text{L,c}}$ (dB)	Upper limit (dBm)	Lower limit (dBm)
1	23	0	0.5	0	22.5	2	2.5	25.0 + TT	20-TT
2	23	0	1	0	22	2	2.5	25.0 + TT	19.5-TT
3	23	0	1	0	22	2	2.5	25.0 + TT	19.5-TT
4	23	0	1	0	22	2	2.5	25.0 + TT	19.5-TT
5	23	0	0.5	0	22.5	2	2.5	25.0 + TT	20-TT
6	23	0	1.5	0	21.5	2	2.5	25.0 + TT	19-TT
7	23	0	1.5	0	21.5	2	2.5	25.0 + TT	19-TT
8	23	0	1.5	0	21.5	2	2.5	25.0 + TT	19-TT
9	23	0	1.5	0	21.5	2	2.5	25.0 + TT	19-TT
10	23	0	2.5	0	20.5	2.5	2.5	25.0 + TT	18-TT
11	23	0	2.5	0	20.5	2.5	2.5	25.0 + TT	18-TT
12	23	0	2.5	0	20.5	2.5	2.5	25.0 + TT	18-TT
13	23	0	3	0	20	2.5	2.5	25.0 + TT	17.5-TT
14	23	0	3	0	20	2.5	2.5	25.0 + TT	17.5-TT
15	23	0	3	0	20	2.5	2.5	25.0 + TT	17.5-TT
16	23	0	5	0	18	4	2.5	25.0 + TT	14-TT
17	23	0	5	0	18	4	2.5	25.0 + TT	14-TT
18	23	0	5	0	18	4	2.5	25.0 + TT	14-TT
19	23	0	2	0	21	2	2.5	25.0 + TT	18.5-TT
20	23	0	3.5	0	19.5	3.5	2.5	25.0 + TT	16-TT
21	23	0	3.5	0	19.5	3.5	2.5	25.0 + TT	16-TT
22	23	0	3.5	0	19.5	3.5	2.5	25.0 + TT	16-TT
23	23	0	2.5	0	20.5	2.5	2.5	25.0 + TT	18-TT
24	23	0	3.5	0	19.5	3.5	2.5	25.0 + TT	16-TT
25	23	0	3.5	0	19.5	3.5	2.5	25.0 + TT	16-TT
26	23	0	3.5	0	19.5	3.5	2.5	25.0 + TT	16-TT
27	23	0	4	0	19	3.5	2.5	25.0 + TT	15.5-TT
28	23	0	4	0	19	3.5	2.5	25.0 + TT	15.5-TT
29	23	0	4	0	19	3.5	2.5	25.0 + TT	15.5-TT
30	23	0	7	0	16	5	2.5	25.0 + TT	11-TT
31	23	0	7	0	16	5	2.5	25.0 + TT	11-TT
32	23	0	7	0	16	5	2.5	25.0 + TT	11-TT

NOTE 1: $P_{\text{PowerClass}}$ is the maximum UE power specified without taking into account the tolerance.
NOTE 2: TT for each frequency and channel bandwidth is specified in Table 6.2.2.5-5.

Table 6.2C.4.5-4: UE Power Class test requirements for Band n99 for Power Class 3

Test ID	$P_{\text{PowerClass}}$ (dBm)	$\Delta P_{\text{PowerClass}}$ (dB)	MPR (dB)	$\Delta T_{c,c}$ (dB)	$P_{\text{CMAX_L,f,c}}$ (dBm)	$T(P_{\text{CMAX_L,f,c}})$ (dB)	$T_{L,c}$ (dB)	Upper limit (dBm)	Lower limit (dBm)
5	23	0	0	0 (1.5 ²)	23.0 (21.5 ²)	2.0	3	25.0 + TT	20.0 - TT (17.0 - TT ²)
6	23	0	0.5	0 (1.5 ²)	22.5 (21.0 ²)	2.0	3	25.0 + TT	19.5 - TT (16.5 - TT ²)
7	23	0	0.5	0 (1.5 ²)	22.5 (21.0 ²)	2.0	3	25.0 + TT	19.5 - TT (16.5 - TT ²)
8	23	0	0.5	0 (1.5 ²)	22.5 (21.0 ²)	2.0	3	25.0 + TT	20.5 - TT (16.5 - TT ²)
9	23	0	0	0 (1.5 ²)	23.0 (21.5 ²)	2.0	3	25.0 + TT	20.0 - TT (17.0 - TT ²)
10	23	0	1	0 (1.5 ²)	22.0 (20.5 ²)	2.0 (2.5 ²)	3	25.0 + TT	19.0 - TT (16.0 - TT ²)
11	23	0	1	0 (1.5 ²)	22.0 (20.5 ²)	2.0 (2.5 ²)	3	25.0 + TT	19.0 - TT (16.0 - TT ²)
12	23	0	1	0 (1.5 ²)	22.0 (20.5 ²)	2.0 (2.5 ²)	3	25.0 + TT	19.0 - TT (16.0 - TT ²)
13	23	0	1	0 (1.5 ²)	22.0 (20.5 ²)	2.0 (2.5 ²)	3	25.0 + TT	19.0 - TT (16.0 - TT ²)
14	23	0	2	0 (1.5 ²)	21.0 (19.5 ²)	2.0 (3.5 ²)	3	25.0 + TT	18.0 - TT (15.0 - TT ²)
15	23	0	2	0 (1.5 ²)	21.0 (19.5 ²)	2.0 (3.5 ²)	3	25.0 + TT	18.0 - TT (15.0 - TT ²)
16	23	0	2	0 (1.5 ²)	21.0 (19.5 ²)	2.0 (3.5 ²)	3	25.0 + TT	18.0 - TT (15.0 - TT ²)
17	23	0	2.5	0 (1.5 ²)	20.5 (19.0 ²)	2.5 (3.5 ²)	3	25.0 + TT	17.5 - TT (14.5 - TT ²)
18	23	0	2.5	0 (1.5 ²)	20.5 (19.0 ²)	2.5 (3.5 ²)	3	25.0 + TT	17.5 - TT (14.5 - TT ²)
19	23	0	2.5	0 (1.5 ²)	20.5 (19.0 ²)	2.5 (3.5 ²)	3	25.0 + TT	17.5 - TT (14.5 - TT ²)
20	23	0	4.5	0 (1.5 ²)	18.5 (17.0 ²)	4.0 (5.0 ²)	3	25.0 + TT	14.5 - TT (12.0 - TT ²)
21	23	0	4.5	0 (1.5 ²)	18.5 (17.0 ²)	4.0 (5.0 ²)	3	25.0 + TT	14.5 - TT (12.0 - TT ²)
22	23	0	4.5	0 (1.5 ²)	18.5 (17.0 ²)	4.0 (5.0 ²)	3	25.0 + TT	14.5 - TT (12.0 - TT ²)
23	23	0	1.5	0 (1.5 ²)	21.5 (20.0 ²)	2.0 (2.5 ²)	3	25.0 + TT	18.5 - TT (15.5 - TT ²)

Test ID	P _{PowerClass} (dBm)	$\Delta P_{PowerClass}$ (dB)	MPR (dB)	$\Delta T_{C,c}$ (dB)	P _{C_{MAX}L,f,c} (dBm)	T(P _{C_{MAX}L,f,c}) (dB)	T _{L,c} (dB)	Upper limit (dBm)	Lower limit (dBm)
24	23	0	3	0 (1.5 ²)	20.0 (18.5 ²)	2.5 (4.0 ²)	3	25.0 + TT	17.0 - TT (14.0 - TT ²)
25	23	0	3	0 (1.5 ²)	20.0 (18.5 ²)	2.5 (4.0 ²)	3	25.0 + TT	17.0 - TT (14.0 - TT ²)
26	23	0	3	0 (1.5 ²)	20.0 (18.5 ²)	2.5 (4.0 ²)	3	25.0 + TT	17.0 - TT (14.0 - TT ²)
27	23	0	2	0 (1.5 ²)	21.0 (19.5 ²)	2.0 (3.5 ²)	3	25.0 + TT	18.0 - TT (15.0 - TT ²)
28	23	0	3	0 (1.5 ²)	20.0 (18.5 ²)	2.5 (4.0 ²)	3	25.0 + TT	17.0 - TT (14.0 - TT ²)
29	23	0	3	0 (1.5 ²)	20.0 (18.5 ²)	2.5 (4.0 ²)	3	25.0 + TT	17.0 - TT (14.0 - TT ²)
30	23	0	3	0 (1.5 ²)	20.0 (18.5 ²)	2.5 (4.0 ²)	3	25.0 + TT	17.0 - TT (14.0 - TT ²)
31	23	0	3.5	0 (1.5 ²)	19.5 (18.0 ²)	3.5 (4.0 ²)	3	25.0 + TT	16.0 - TT (13.5 - TT ²)
32	23	0	3.5	0 (1.5 ²)	19.5 (18.0 ²)	3.5 (4.0 ²)	2	25.0 + TT	16.0 - TT (13.5 - TT ²)
33	23	0	3.5	0 (1.5 ²)	19.5 (18.0 ²)	3.5 (4.0 ²)	2	25.0 + TT	16.0 - TT (13.5 - TT ²)
34	23	0	6.5	0 (1.5 ²)	16.5 (15.0 ²)	5.0	2	25.0 + TT	11.5 - TT (10.0 - TT ²)
35	23	0	6.5	0 (1.5 ²)	16.5 (15.0 ²)	5.0	2	25.0 + TT	11.5 - TT (10.0 - TT ²)
36	23	0	6.5	0 (1.5 ²)	16.5 (15.0 ²)	5.0	2	25.0 + TT	11.5 - TT (10.0 - TT ²)
37	23	0	0.5	0 (1.5 ²)	22.5 (21 ²)	2.0	2	25.0 + TT	19.5 - TT (16.5 - TT ²)
38	23	0	0.5	0 (1.5 ²)	22.5 (21 ²)	2.0	2	25.0 + TT	19.5 - TT (16.5 - TT ²)
39	23	0	0	0 (1.5 ²)	23 (21.5 ²)	2.0	2	25.0 + TT	20.0 - TT (17.0 - TT ²)

NOTE 1: P_{PowerClass} is the maximum UE power specified without taking into account the tolerance.

NOTE 2: Transmission bandwidths confined within F_{UL_low} and F_{UL_low} + 4 MHz or F_{UL_high} - 4 MHz and F_{UL_high}.

NOTE 3: TT for each frequency and channel bandwidth is specified in Table 6.2.2.5-5.

For the UE which supports inter-band NR CA configuration, inter-band NR-DC configuration, SUL configuration or inter-band EN-DC configuration, $\Delta T_{IB,c}$ as specified in 6.2A.4.0.2 for NR CA, 6.2B.4.0.2 for NR-DC, clause 6.2C.2 for SUL, or TS 38.521-3 [14] clause 6.2B.4.2 for EN-DC applies. Unless otherwise stated, $\Delta T_{IB,c}$ is set to zero. In case the UE supports more than one of band combinations for CA, NR-DC, SUL or DC, and an operating band belongs to more than one band combinations then

- a) When the operating band frequency range is ≤ 1 GHz, the applicable additional $\Delta T_{IB,c}$ shall be the average value for all band combinations defined in clause 6.2A.4.0.2, 6.2B.4.0.2, 6.2C.2 in this specification and 6.2B.4.2 in TS 38.521-3 [14], truncated to one decimal place that apply for that operating band among the supported band combinations. In case there is a harmonic relation between low band UL and high band DL, then the maximum $\Delta T_{IB,c}$ among the different supported band combinations involving such band shall be applied
- b) When the operating band frequency range is > 1 GHz, the applicable additional $\Delta T_{IB,c}$ shall be the maximum value for all band combinations defined in clause 6.2A.4.0.2, 6.2B.4.0.2, 6.2C.2 in this specification and 6.2B.4.2 in TS 38.521-3 [14] for the applicable operating bands.

6.2C.5 UE additional maximum output power reduction for SUL

Editor's note: Tests for network signalling values NS_17, NS_43 not complete.

6.2C.5.1 Test purpose

Same test purpose as in clause 6.2.3.1

6.2C.5.2 Test applicability

This test applies to all types of NR UE release 15 and forward that support SUL operating on the SUL bands.

6.2C.5.3 Minimum conformance requirements

For a terminal that supports SUL for the band combination specified in Table 5.2C-1, the current version of the specification assumes the terminal is configured with active transmission either on UL carrier or SUL carrier at any time in one serving cell and the UE requirements for single carrier shall apply for the active UL or SUL carrier accordingly.

The normative reference for this requirement is TS 38.101-1 [2] clauses 4.3 and 6.2.3.

6.2C.5.4 Test description

Same test description as specified in clause 6.2.3.4 with following exceptions:

Instead of table 5.3.5-1 → use Table 5.5C-1.

For NS_03: Instead of table 6.2.3.4.1-3 → use Table 6.2C.5.4-1

For NS_18: Instead of table 6.2.3.4.1-11 → use Table 6.2C.5.4-2

For NS_48: Instead of table 6.2.3.4.1-19 → use Table 6.2C.5.4-3

For NS_49: Instead of table 6.2.3.4.1-29 → use Table 6.2C.5.4-4

For NS_05: Instead of table 6.2.3.4.1-4 → use Table 6.2C.5.4-5

For NS_05U: Instead of table 6.2.3.4.1-5 → use Table 6.2C.5.4-6

For NS_100: Instead of table 6.2.3.5-12 → use Table 6.2C.5.4-7

For NS_56: Instead of table 6.2.3.4.1-30 → use Table 6.2C.5.4-8

Table 6.2C.5.4-1: Test Configuration Table for NS_03

Initial Conditions						
Test Environment as specified in TS 38.508-1 [5] subclause 4.1					Normal	
Test Frequencies as specified in TS 38.508-1 [5] subclause 4.3.1					Low range, High range for SUL carrier Mid range for Non-SUL carrier	
Test Channel Bandwidths as specified in TS 38.508-1 [5] subclause 4.3.1					Lowest, Highest for SUL carrier Lowest for Non-SUL carrier	
Test SCS as specified in Table 5.3.5-1					15kHz for both SUL carrier and Non-SUL carrier	
A-MPR test parameters for NS_03						
Test ID	Freq	Downlink Configuration	UL Configuration	SUL Configuration		
				Modulation		RB allocation (Note 2)
1	Low	N/A	N/A	DFT-s OFDM	PI/2 BPSK	Edge_1RB_Left
2	High				PI/2 BPSK	Edge_1RB_Right
3	Default				PI/2 BPSK	Outer_Full
4	Low				QPSK	Edge_1RB_Left
5	High				QPSK	Edge_1RB_Right
6	Default				QPSK	Outer_Full
7	Low				16 QAM	Edge_1RB_Left
8	High				16 QAM	Edge_1RB_Right
9	Default				16 QAM	Outer_Full
10	Low				64 QAM	Edge_1RB_Left
11	High				64 QAM	Edge_1RB_Right
12	Default				64 QAM	Outer_Full
13	Low				256 QAM	Edge_1RB_Left
14	High				256 QAM	Edge_1RB_Right
15	Default			256 QAM	Outer_Full	
16	Low			QPSK	Edge_1RB_Left	
17	High			QPSK	Edge_1RB_Right	
18	Default			QPSK	Outer_Full	
19	Low			16 QAM	Edge_1RB_Left	
20	High			16 QAM	Edge_1RB_Right	
21	Default			16 QAM	Outer_Full	
22	Low			64 QAM	Edge_1RB_Left	
23	High			64 QAM	Edge_1RB_Right	
				CP-s OFDM		

A-MPR test parameters for NS_03						
Test ID	Freq	Downlink Configuration	UL Configuration	SUL Configuration		
				Modulation		RB allocation (Note 2)
24	Default				64 QAM	Outer_Full
25	Low				256 QAM	Edge_1RB_Left
26	High				256 QAM	Edge_1RB_Right
27	Default				256 QAM	Outer_Full

NOTE 1: Test Channel Bandwidths are checked separately for each SUL band combination, the applicable channel bandwidths are specified in Table 5.5C-1.
NOTE 2: The specific configuration of each RB allocation is defined in Table 6.1-1.
NOTE 3: DFT-s-OFDM PI/2 BPSK test applies only for UEs which supports half Pi BPSK in FR1.

Table 6.2C.5.4-2: Test Configuration Table for NS_18

Initial Conditions					
Test Environment as specified in TS 38.508-1 [5] subclause 4.1			Normal		
Test Frequencies as specified in TS 38.508-1 [5] subclause 4.3.1			Low range for SUL carrier Mid range for Non-SUL carrier		
Test Channel Bandwidths as specified in TS 38.508-1 [5] subclause 4.3.1			5MHz 10MHz 20MHz 30MHz for SUL carrier Lowest for Non-SUL carrier		
Test SCS as specified in Table 5.3.5-1			15 kHz for all carriers		
A-MPR test parameters for NS_18					
Test ID	ChBw SCS	Downlink Configuration	SUL Configuration		
			Modulation (Note 2)	RB allocation (Note 1)	Comment

1	5MHz, 10MHz, 20MHz	N/A	DFT-s OFDM	QPSK	Edge_1RB_Left	A1, A2	
2				QPSK	Outer_Full	A1, A2	
3				16 QAM	Edge_1RB_Left	A1, A2	
4				16 QAM	Outer_Full	A1, A2	
5				64 QAM	Edge_1RB_Left	A1, A2	
6				64 QAM	Outer_Full	A1, A2	
7				256 QAM	Edge_1RB_Left	A1, A2	
8				256 QAM	Outer_Full	A1, A2	
9			30MHz	CP-s OFDM	QPSK	Edge_1RB_Left	A1, A2
10					QPSK	Outer_Full	A1, A2
11					16 QAM	Edge_1RB_Left	A1, A2
12					16 QAM	Outer_Full	A1, A2
13					64 QAM	Edge_1RB_Left	A1, A2
14					64 QAM	Outer_Full	A1, A2
15					256 QAM	Edge_1RB_Left	A1, A2
16					256 QAM	Outer_Full	A1, A2
17	DFT-s OFDM		256 QAM	81@70	A3		
18			256 QAM	Outer_Full	A4		
19			CP-s OFDM	256 QAM	87@73	A3	
20				256 QAM	Outer_Full	A4	

NOTE 1: The specific configuration of each RB allocation is defined in Table 6.1-1 unless otherwise stated in this table.

Table 6.2C.5.4-3: Test Configuration Table for NS_48

Initial Conditions							
Test Environment as specified in TS 38.508-1 [5] subclause 4.1				Normal			
Test Frequencies as specified in TS 38.508-1 [5] subclause 4.3.1				Low range, High range for SUL carrier Mid range for non-SUL carrier			
Test Channel Bandwidths as specified in TS 38.508-1 [5] subclause 4.3.1				25 MHz, 30MHz, 40MHz, 50MHz for SUL carrier Lowest for non-SUL carrier			
Test SCS as specified in Table 5.3.5-1				15kHz for all carriers			
A-MPR test parameters for NS_48							
Test ID	F _c (MHz)	Ch BW (MHz)	Uplink Configuration	Downlink Configuration	SUL Configuration		
					Modulation (Note 2)	RB allocation (Note 1)	
1	Default	25	N/A for A-MPR testing.	N/A	DFT-s-OFDM	QPSK	Outer_Full (A3)
2	Default	25				QPSK	Edge_1RB_Right (A3)
3	Default	30				QPSK	Outer_Full (A3)
4	Default	30				QPSK	Edge_1RB_Right (A5)
5	Default	40				QPSK	16@0 (A2)
6	Default	40				QPSK	90@0 (A3)
7	Default	40				QPSK	150@0 (A4)
8	Default	40				QPSK	192@0 (A2)
9	Default	40				QPSK	5@187 (A3)
10	Default	40				QPSK	Outer_Full (A1)
11	Default	50				QPSK	32@0 (A2)
12	Default	50				QPSK	108@0 (A4)
13	Default	50				QPSK	225@0 (A2)
14	Default	50				QPSK	5@223 (A5)
15	Default	50				QPSK	Outer_Full (A1)
16	Default	25				256 QAM	Outer_Full (A3)
17	Default	25				256 QAM	Edge_1RB_Right (A3)
18	Default	30				256 QAM	Outer_Full (A3)
19	Default	30				256 QAM	Edge_1RB_Right (A5)
20	Default	40				256 QAM	16@0 (A2)
21	Default	40				256 QAM	90@0 (A3)
22	Default	40				256 QAM	150@0 (A4)
23	Default	40				256 QAM	192@0 (A2)
24	Default	40				256 QAM	5@187 (A3)
25	Default	40				256 QAM	Outer_Full (A1)
26	Default	50				256 QAM	32@0 (A2)
27	Default	50				256 QAM	108@0 (A4)
28	Default	50				256 QAM	225@0 (A2)
29	Default	50			256 QAM	5@223 (A5)	
30	Default	50			256 QAM	Outer_Full (A1)	
31	Default	25			QPSK	Outer_Full (A3)	
32	Default	25			QPSK	Edge_1RB_Right (A3)	
33	Default	30			QPSK	Outer_Full (A3)	
34	Default	30			QPSK	Edge_1RB_Right (A5)	
35	Default	40			QPSK	16@0 (A2)	
36	Default	40			QPSK	95@0 (A3)	
37	Default	40			QPSK	152@0 (A4)	
38	Default	40			QPSK	192@0 (A2)	
39	Default	40			QPSK	5@187 (A3)	
40	Default	40			QPSK	Outer_Full (A1)	
41	Default	50			QPSK	34@0 (A2)	
42	Default	50			QPSK	115@0 (A4)	
43	Default	50			QPSK	228@0 (A2)	
44	Default	50			QPSK	5@223 (A5)	
45	Default	50			QPSK	Outer_Full (A1)	
46	Default	25			256 QAM	Outer_Full (A3)	
47	Default	25			256 QAM	Edge_1RB_Right (A3)	
48	Default	30			256 QAM	Outer_Full (A3)	
49	Default	30			256 QAM	Edge_1RB_Right (A5)	

A-MPR test parameters for NS_48						
Test ID	F _c (MHz)	Ch BW (MHz)	Uplink Config uration	Downli nk Config uration	SUL Configuration	
					Modulation (Note 2)	RB allocation (Note 1)
50	Default	40			256 QAM	16@0 (A2)
51	Default	40			256 QAM	95@0 (A3)
52	Default	40			256 QAM	152@0 (A4)
53	Default	40			256 QAM	192@0 (A2)
54	Default	40			256 QAM	5@187 (A3)
55	Default	40			256 QAM	Outer_Full (A1)
56	Default	50			256 QAM	34@0 (A2)
57	Default	50			256 QAM	115@0 (A4)
58	Default	50			256 QAM	228@0 (A2)
59	Default	50			256 QAM	5@223 (A5)
60	Default	50			256 QAM	Outer_Full (A1)

NOTE 1: The specific configuration of each RB allocation is defined in Table 6.1-1 unless otherwise stated in this table.

Table 6.2C.5.4-4: Test Configuration Table for NS_49

Initial Conditions							
Test Environment as specified in TS 38.508-1 [5] subclause 4.1			Normal				
Test Frequencies as specified in TS 38.508-1 [5] subclause 4.3.1			Low range, High range for SUL carrier Mid range for non-SUL carrier				
Test Channel Bandwidths as specified in TS 38.508-1 [5] subclause 4.3.1			25 MHz, 30MHz, 40MHz, 50MHz for SUL carrier Lowest for non-SUL carrier				
Test SCS as specified in Table 5.3.5-1			15 kHz for all carriers				
A-MPR test parameters for NS_49							
Test ID	F _c (MHz)	Ch BW (MHz)	Downlink Configuration	Uplink Configuration	SUL Configuration		
					Modulation (Note 2)	RB allocation (Note 1)	
1	Default	25	N/A for A-MPR testing.	N/A	DFT-s-OFDM	QPSK	Outer_Full (A3)
2	Default	25				QPSK	Edge_1RB_Right (A3)
3	Default	25				QPSK	Edge_1RB_Left (A3)
4	Default	30				QPSK	20@0 (A1)
5	Default	30				QPSK	36@0 (A5)
6	Default	30				QPSK	80@0 (A3)
7	Default	30				QPSK	120@0 (A4)
8	Default	30				QPSK	Outer_Full (A2)
9	Default	30				QPSK	Edge_1RB_Right (A5)
10	Default	40				QPSK	40@0 (A1)
11	Default	40				QPSK	5@53 (A5)
12	Default	40				QPSK	100@0 (A4)
13	Default	40				QPSK	150@33 (A2)
14	Default	40				QPSK	5@187 (A5)
15	Default	40				QPSK	192@0 (A1)
16	Default	40				QPSK	Outer_Full (A1)
17	Default	50				QPSK	5@75 (A5)
18	Default	50				QPSK	5@215 (A5)
19	Default	50				QPSK	175@45 (A2)
20	Default	50				QPSK	216@0 (A1)
21	Default	50				QPSK	Outer_Full (A1)

A-MPR test parameters for NS_49						
Test ID	F _c (MHz)	Ch BW (MHz)	Downlink Configuration	Uplink Configuration	SUL Configuration	
					Modulation (Note 2)	RB allocation (Note 1)
22	Default	25			256 QAM	Outer_Full (A3)
23	Default	25			256 QAM	Edge_1RB_Right (A3)
24	Default	25			256 QAM	Edge_1RB_Left (A3)
25	Default	30			256 QAM	20@0 (A1)
26	Default	30			256 QAM	36@0 (A5)
27	Default	30			256 QAM	80@0 (A3)
28	Default	30			256 QAM	120@0 (A4)
29	Default	30			256 QAM	Outer_Full (A2)
30	Default	30			256 QAM	Edge_1RB_Right (A5)
31	Default	40			256 QAM	40@0 (A1)
32	Default	40			256 QAM	5@53 (A5)
33	Default	40			256 QAM	100@0 (A4)
34	Default	40			256 QAM	150@33 (A2)
35	Default	40			256 QAM	5@187 (A5)
36	Default	40			256 QAM	192@0 (A1)
37	Default	40			256 QAM	Outer_Full (A1)
38	Default	50			256 QAM	5@75 (A5)
39	Default	50			256 QAM	5@215 (A5)
40	Default	50			256 QAM	175@45 (A2)
41	Default	50			256 QAM	216@0 (A1)
42	Default	50			256 QAM	Outer_Full (A1)
43	Default	25			QPSK	Outer_Full (A3)
44	Default	25			QPSK	Edge_1RB_Right (A3)
45	Default	25			QPSK	Edge_1RB_Left (A3)
46	Default	30			QPSK	20@0 (A1)
47	Default	30			QPSK	36@0 (A5)
48	Default	30			QPSK	80@0 (A3)
49	Default	30			QPSK	120@0 (A4)

A-MPR test parameters for NS_49						
Test ID	F _c (MHz)	Ch BW (MHz)	Downlink Configuration	Uplink Configuration	SUL Configuration	
					Modulation (Note 2)	RB allocation (Note 1)
50	Default	30			QPSK	Outer_Full (A2)
51	Default	30			QPSK	Edge_1RB_Right (A5)
52	Default	40			QPSK	40@0 (A1)
53	Default	40			QPSK	5@53 (A5)
54	Default	40			QPSK	100@0 (A4)
55	Default	40			QPSK	159@33 (A2)
56	Default	40			QPSK	5@187 (A5)
57	Default	40			QPSK	192@0 (A1)
58	Default	40			QPSK	Outer_Full (A1)
59	Default	50			QPSK	5@75 (A5)
60	Default	50			QPSK	5@215 (A5)
61	Default	50			QPSK	175@45 (A2)
62	Default	50			QPSK	220@0 (A1)
63	Default	50			QPSK	Outer_Full (A1)
64	Default	25			256 QAM	Outer_Full (A3)
65	Default	25			256 QAM	Edge_1RB_Right (A3)
66	Default	25			256 QAM	Edge_1RB_Left (A3)
67	Default	30			256 QAM	20@0 (A1)
68	Default	30			256 QAM	36@0 (A5)
69	Default	30			256 QAM	80@0 (A3)
70	Default	30			256 QAM	120@0 (A4)
71	Default	30			256 QAM	Outer_Full (A2)
72	Default	30			256 QAM	Edge_1RB_Right (A5)
73	Default	40			256 QAM	40@0 (A1)
74	Default	40			256 QAM	5@53 (A5)
75	Default	40			256 QAM	100@0 (A4)
76	Default	40			256 QAM	159@33 (A2)
77	Default	40			256 QAM	5@187 (A5)

A-MPR test parameters for NS_49						
Test ID	F _c (MHz)	Ch BW (MHz)	Downlink Configuration	Uplink Configuration	SUL Configuration	
78	Default	40			256 QAM	192@0 (A1)
79	Default	40			256 QAM	Outer_Full (A1)
80	Default	50			256 QAM	5@75 (A5)
81	Default	50			256 QAM	5@215 (A5)
82	Default	50			256 QAM	175@45 (A2)
83	Default	50			256 QAM	220@0 (A1)
84	Default	50			256 QAM	Outer_Full (A1)

NOTE 1: The specific configuration of each RB allocation is defined in Table 6.1-1 unless otherwise stated in this table.

Table 6.2C.5.4-5: Test Configuration Table for NS_05

Initial Conditions							
Test Environment as specified in TS 38.508-1 [5] subclause 4.1				Normal			
Test Frequencies as specified in TS 38.508-1 [5] subclause 4.3.1				SUL carrier: use Fc as specified in test parameters NUL carrier: Mid range			
Test Channel Bandwidths as specified in TS 38.508-1 [5] subclause 4.3.1				SUL carrier: 5 MHz, 10 MHz, 15 MHz, 20 MHz NUL carrier: Highest			
Test SCS as specified in Table 5.3.5-1				15kHz for both SUL carrier and NUL carrier			
A-MPR test parameters for NS_05							
Test ID	Fc (MHz)	ChBw (MHz)	Downlink Config.	Uplink Config.	A-MPR	SUL Configuration	
						Modulation (NOTE 2)	RB allocation (Note 1)
1	1922.5	5	N/A for A-MPR testing	N/A for A-MPR testing	A3	PI/2 BPSK	Outer_Full
2	1925	10			A1	PI/2 BPSK	Outer_Full
3	1925	10			A7	PI/2 BPSK	40@10
4	1925	10			A2	PI/2 BPSK	6@40
5	1935	10			A4	PI/2 BPSK	Outer_Full
6	1927.5	15			A1	PI/2 BPSK	Outer_Full
7	1927.5	15			A7	PI/2 BPSK	60@19
8	1927.5	15			A2	PI/2 BPSK	6@56
9	1932.5	15			A1	PI/2 BPSK	Outer_Full
10	1932.5	15			A2	PI/2 BPSK	6@68
11	1942.5	15			A5	PI/2 BPSK	Outer_Full
12	1930	20			A1	PI/2 BPSK	Outer_Full
13	1930	20			A7	PI/2 BPSK	72@28
14	1930	20			A2	PI/2 BPSK	6@76
15	1950	20			A6	PI/2 BPSK	Outer_Full
16	1922.5	5			A3	QPSK	Outer_Full
17	1925	10			A1	QPSK	Outer_Full
18	1925	10			A7	QPSK	40@10
19	1925	10			A2	QPSK	6@40
20	1927.5	15			A1	QPSK	Outer_Full
21	1927.5	15			A7	QPSK	60@19
22	1927.5	15			A2	QPSK	6@56
23	1932.5	15			A1	QPSK	Outer_Full
24	1932.5	15			A2	QPSK	6@68
25	1942.5	15			A5	QPSK	Outer_Full
26	1930	20			A1	QPSK	Outer_Full
27	1930	20			A7	QPSK	72@28
28	1930	20			A2	QPSK	6@76
29	1950	20			A6	QPSK	Outer_Full
30	1922.5	5			A3	16 QAM	Outer_Full
31	1925	10			A1	16 QAM	Outer_Full
32	1925	10			A7	16 QAM	40@10
33	1925	10			A2	16 QAM	6@40
34	1927.5	15			A1	16 QAM	Outer_Full
35	1927.5	15			A7	16 QAM	60@19
36	1927.5	15			A2	16 QAM	6@56
37	1932.5	15			A1	16 QAM	Outer_Full
38	1932.5	15			A2	16 QAM	6@68
39	1930	20			A1	16 QAM	Outer_Full
40	1930	20			A7	16 QAM	72@28
41	1930	20			A2	16 QAM	6@76
42	1922.5	5			A3	64 QAM	Outer_Full
43	1925	10			A1	64 QAM	Outer_Full
44	1925	10			A7	64 QAM	40@10

A-MPR test parameters for NS_05							
Test ID	Fc (MHz)	ChBw (MHz)	Downlink Config.	Uplink Config.	A-MPR	SUL Configuration	
						Modulation (NOTE 2)	RB allocation (Note 1)
45	1925	10			A2	64 QAM	6@40
46	1927.5	15			A1	64 QAM	Outer_Full
47	1927.5	15			A7	64 QAM	60@19
48	1927.5	15			A2	64 QAM	6@56
49	1932.5	15			A1	64 QAM	Outer_Full
50	1932.5	15			A2	64 QAM	6@68
51	1930	20			A1	64 QAM	Outer_Full
52	1930	20			A7	64 QAM	72@28
53	1930	20			A2	64 QAM	6@76
54	1922.5	5			A3	256 QAM	Outer_Full
55	1925	10			A1	256 QAM	Outer_Full
56	1925	10			A7	256 QAM	40@10
57	1925	10			A2	256 QAM	6@40
58	1927.5	15			A1	256 QAM	Outer_Full
59	1927.5	15			A7	256 QAM	60@19
60	1927.5	15			A2	256 QAM	6@56
61	1932.5	15			A1	256 QAM	Outer_Full
62	1932.5	15			A2	256 QAM	6@68
63	1930	20			A1	256 QAM	Outer_Full
64	1930	20			A7	256 QAM	72@28
65	1930	20			A2	256 QAM	6@76
66	1922.5	5			A3	QPSK	Outer_Full
67	1925	10			A1	QPSK	Outer_Full
68	1925	10			A7	QPSK	42@10
69	1925	10			A2	QPSK	6@40
70	1935	10			A4	QPSK	Outer_Full
71	1927.5	15			A1	QPSK	Outer_Full
72	1927.5	15			A7	QPSK	60@19
73	1927.5	15			A2	QPSK	6@56
74	1932.5	15			A1	QPSK	Outer_Full
75	1932.5	15			A2	QPSK	6@68
76	1942.5	15			A5	QPSK	Outer_Full
77	1930	20			A1	QPSK	Outer_Full
78	1930	20			A7	QPSK	78@28
79	1930	20			A2	QPSK	6@76
80	1950	20			A6	QPSK	Outer_Full
81	1922.5	5			A3	16 QAM	Outer_Full
82	1925	10			A1	16 QAM	Outer_Full
83	1925	10			A7	16 QAM	42@10
84	1925	10			A2	16 QAM	6@40
85	1935	10			A4	16 QAM	Outer_Full
86	1927.5	15			A1	16 QAM	Outer_Full
87	1927.5	15			A7	16 QAM	60@19
88	1927.5	15			A2	16 QAM	6@56
89	1932.5	15			A1	16 QAM	Outer_Full
90	1932.5	15			A2	16 QAM	6@68
91	1942.5	15			A5	16 QAM	Outer_Full
92	1930	20			A1	16 QAM	Outer_Full
93	1930	20			A7	16 QAM	78@28
94	1930	20			A2	16 QAM	6@76
95	1950	20			A6	16 QAM	Outer_Full
96	1922.5	5			A3	64 QAM	Outer_Full
97	1925	10			A1	64 QAM	Outer_Full
98	1925	10			A7	64 QAM	42@10
99	1925	10			A2	64 QAM	6@40

CP-OFDM

A-MPR test parameters for NS_05							
Test ID	Fc (MHz)	ChBw (MHz)	Downlink Config.	Uplink Config.	A-MPR	SUL Configuration	
						Modulation (NOTE 2)	RB allocation (Note 1)
100	1927.5	15			A1	64 QAM	Outer_Full
101	1927.5	15			A7	64 QAM	60@19
102	1927.5	15			A2	64 QAM	6@56
103	1932.5	15			A1	64 QAM	Outer_Full
104	1932.5	15			A2	64 QAM	6@68
105	1930	20			A1	64 QAM	Outer_Full
106	1930	20			A7	64 QAM	78@28
107	1930	20			A2	64 QAM	6@76
108	1922.5	5			A3	256 QAM	Outer_Full
109	1925	10			A1	256 QAM	Outer_Full
110	1925	10			A7	256 QAM	42@10
111	1927.5	15			A1	256 QAM	Outer_Full
112	1927.5	15			A7	256 QAM	60@19
113	1932.5	15			A1	256 QAM	Outer_Full
114	1930	20			A1	256 QAM	Outer_Full
115	1930	20			A7	256 QAM	78@28

NOTE 1: The specific configuration of each RB allocation is defined in Table 6.1-1 unless otherwise stated in this table.

NOTE 2: DFT-s-OFDM PI/2 BPSK test applies only for UEs which supports half Pi BPSK in FR1.

Table 6.2C.5.4-6: Test Configuration Table for NS_05U

Initial Conditions								
Test Environment as specified in TS 38.508-1 [5] subclause 4.1				Normal				
Test Frequencies as specified in TS 38.508-1 [5] subclause 4.3.1				SUL carrier: Use Fc as specified in test parameters NUL carrier: Mid range				
Test Channel Bandwidths as specified in TS 38.508-1 [5] subclause 4.3.1				SUL carrier: 5 MHz, 10 MHz, 15 MHz, 20 MHz NUL carrier: Highest				
Test SCS as specified in Table 5.3.5-1				15kHz for both SUL and NUL carrier				
AMPR Test parameters for NS_05U								
Test ID	Fc (MHz)	ChBw (MHz)	Downlink Config.	Uplink Config.	A-MPR	SUL Configuration		
						Modulation (NOTE 2)	RB allocation (Note 1)	
1	1922.5	5	N/A	N/A	A3	DFT-s-OFDM	PI/2 BPSK	Outer_Full
2	1925	10			A1		PI/2 BPSK	Outer_Full
3	1925	10			A7		PI/2 BPSK	40@10
4	1925	10			A2		PI/2 BPSK	6@40
5	1935	10			A4		PI/2 BPSK	Outer_Full
6	1927.5	15			A1		PI/2 BPSK	Outer_Full
7	1927.5	15			A7		PI/2 BPSK	60@19
8	1927.5	15			A2		PI/2 BPSK	6@56
9	1932.5	15			A1		PI/2 BPSK	Outer_Full
10	1932.5	15			A2		PI/2 BPSK	6@68
11	1942.5	15			A5		PI/2 BPSK	Outer_Full
12	1930	20			A1		PI/2 BPSK	Outer_Full
13	1930	20			A7		PI/2 BPSK	72@28
14	1930	20			A2		PI/2 BPSK	6@76
15	1950	20			A6		PI/2 BPSK	Outer_Full
16	1922.5	5			A3		QPSK	Outer_Full
17	1925	10			A1		QPSK	Outer_Full
18	1925	10			A7		QPSK	40@10
19	1925	10			A2		QPSK	6@40
20	1935	10			A4		QPSK	Outer_Full
21	1927.5	15			A1		QPSK	Outer_Full
22	1927.5	15			A7		QPSK	60@19
23	1927.5	15			A2		QPSK	6@56
24	1932.5	15			A1		QPSK	Outer_Full
25	1932.5	15			A2		QPSK	6@68
26	1942.5	15			A5		QPSK	Outer_Full
27	1930	20			A1		QPSK	Outer_Full
28	1930	20			A7		QPSK	72@28
29	1930	20			A2		QPSK	6@76
30	1950	20			A6		QPSK	Outer_Full
31	1922.5	5			A3		16 QAM	Outer_Full
32	1925	10			A1		16 QAM	Outer_Full
33	1925	10			A7		16 QAM	40@10
34	1925	10			A2		16 QAM	6@40
35	1935	10			A4		16 QAM	Outer_Full
36	1927.5	15			A1		16 QAM	Outer_Full
37	1927.5	15			A7		16 QAM	60@19
38	1927.5	15			A2		16 QAM	6@56
39	1932.5	15			A1		16 QAM	Outer_Full
40	1932.5	15			A2		16 QAM	6@68
41	1942.5	15			A5		16 QAM	Outer_Full
42	1930	20			A1		16 QAM	Outer_Full
43	1930	20			A7		16 QAM	72@28
44	1930	20			A2		16 QAM	6@76

AMPR Test parameters for NS_05U							
Test ID	Fc (MHz)	ChB w (MHz)	Downlink Config.	Uplink config	AMPR	SUL Configuration	
						Modulation (NOTE 2)	RB allocation (Note 1)
45	1950	20			A6	16 QAM	Outer_Full
46	1922.5	5			A3	64 QAM	Outer_Full
47	1925	10			A1	64 QAM	Outer_Full
48	1925	10			A7	64 QAM	40@10
49	1925	10			A2	64 QAM	6@40
50	1935	10			A4	64 QAM	Outer_Full
51	1927.5	15			A1	64 QAM	Outer_Full
52	1927.5	15			A7	64 QAM	60@19
53	1927.5	15			A2	64 QAM	6@56
54	1932.5	15			A1	64 QAM	Outer_Full
55	1932.5	15			A2	64 QAM	6@68
56	1942.5	15			A5	64 QAM	Outer_Full
57	1930	20			A1	64 QAM	Outer_Full
58	1930	20			A7	64 QAM	72@28
59	1930	20			A2	64 QAM	6@76
60	1950	20			A6	64 QAM	Outer_Full
61	1922.5	5			A3	256 QAM	Outer_Full
62	1925	10			A1	256 QAM	Outer_Full
63	1925	10			A7	256 QAM	40@10
64	1925	10			A2	256 QAM	6@40
65	1935	10			A4	256 QAM	Outer_Full
66	1927.5	15			A1	256 QAM	Outer_Full
67	1927.5	15			A7	256 QAM	60@19
68	1927.5	15			A2	256 QAM	6@56
69	1932.5	15			A1	256 QAM	Outer_Full
70	1932.5	15			A2	256 QAM	6@68
71	1942.5	15			A5	256 QAM	Outer_Full
72	1930	20			A1	256 QAM	Outer_Full
73	1930	20			A7	256 QAM	72@28
74	1930	20			A2	256 QAM	6@76
75	1950	20			A6	256 QAM	Outer_Full
76	1922.5	5			A3	QPSK	Outer_Full
77	1925	10			A1	QPSK	Outer_Full
78	1925	10			A7	QPSK	42@10
79	1925	10			A2	QPSK	6@40
80	1935	10			A4	QPSK	Outer_Full
81	1927.5	15			A1	QPSK	Outer_Full
82	1927.5	15			A7	QPSK	60@19
83	1927.5	15			A2	QPSK	6@56
84	1932.5	15			A1	QPSK	Outer_Full
85	1932.5	15			A2	QPSK	6@68
86	1942.5	15			A5	QPSK	Outer_Full
87	1930	20			A1	QPSK	Outer_Full
88	1930	20			A7	QPSK	78@28
89	1930	20			A2	QPSK	6@76
90	1950	20			A6	QPSK	Outer_Full
91	1922.5	5			A3	16 QAM	Outer_Full
92	1925	10			A1	16 QAM	Outer_Full
93	1925	10			A7	16 QAM	42@10
94	1925	10			A2	16 QAM	6@40
95	1935	10			A4	16 QAM	Outer_Full
96	1927.5	15			A1	16 QAM	Outer_Full
97	1927.5	15			A7	16 QAM	60@19
98	1927.5	15			A2	16 QAM	6@56
99	1932.5	15			A1	16 QAM	Outer_Full

CP-OFDM

AMPR Test parameters for NS_05U							
Test ID	Fc (MHz)	ChBw (MHz)	Downlink Config.	Uplink config.	A-MPR	SUL Configuration	
						Modulation (NOTE 2)	RB allocation (Note 1)
100	1932.5	15			A2	16 QAM	6@68
101	1942.5	15			A5	16 QAM	Outer_Full
102	1930	20			A1	16 QAM	Outer_Full
103	1930	20			A7	16 QAM	78@28
104	1930	20			A2	16 QAM	6@76
105	1950	20			A6	16 QAM	Outer_Full
106	1922.5	5			A3	64 QAM	Outer_Full
107	1925	10			A1	64 QAM	Outer_Full
108	1925	10			A7	64 QAM	42@10
109	1925	10			A2	64 QAM	6@40
110	1935	10			A4	64 QAM	Outer_Full
111	1927.5	15			A1	64 QAM	Outer_Full
112	1927.5	15			A7	64 QAM	60@19
113	1927.5	15			A2	64 QAM	6@56
114	1932.5	15			A1	64 QAM	Outer_Full
115	1932.5	15			A2	64 QAM	6@68
116	1942.5	15			A5	64 QAM	Outer_Full
117	1930	20			A1	64 QAM	Outer_Full
118	1930	20			A7	64 QAM	78@28
119	1930	20			A2	64 QAM	6@76
120	1950	20			A6	64 QAM	Outer_Full
121	1922.5	5			A3	256 QAM	Outer_Full
122	1925	10			A1	256 QAM	Outer_Full
123	1925	10			A7	256 QAM	42@10
124	1935	10			A4	256 QAM	Outer_Full
125	1927.5	15			A1	256 QAM	Outer_Full
126	1927.5	15			A7	256 QAM	60@19
127	1932.5	15			A1	256 QAM	Outer_Full
128	1942.5	15			A5	256 QAM	Outer_Full
129	1930	20			A1	256 QAM	Outer_Full
130	1930	20			A7	256 QAM	78@28
131	1950	20			A6	256 QAM	Outer_Full

NOTE 1: The specific configuration of each RB allocation is defined in Table 6.1-1 unless otherwise stated in this table.

NOTE 2: DFT-s-OFDM PI/2 BPSK test applies only for UEs which supports half Pi BPSK in FR1.

Table 6.2C.5.4-7: Test Configuration Table for NS_100

Initial Conditions						
Test Environment as specified in TS 38.508-1 [5] subclause 4.1			Normal			
Test Frequencies as specified in TS 38.508-1 [5] subclause 4.3.1			SUL carrier: Low range, High range NUL carrier: Mid range			
Test Channel Bandwidths as specified in TS 38.508-1 [5] subclause 4.3.1			SUL carrier: Lowest, Highest NUL carrier: Highest			
Test SCS as specified in Table 5.3.5-1			15kHz for both SUL and NUL carriers			
Test parameters for NS_100						
Test ID	Freq	Down link Configuration	Uplink Configuration	SUL Configuration		
				Modulation (Note 2)	RB allocation (Note 1)	
1	Low	N/A	N/A	DFT-s-OFDM	PI/2 BPSK	Edge_1RB_Left
2	High				PI/2 BPSK	Edge_1RB_Right
3	Default				PI/2 BPSK	Outer_Full
4	Low				QPSK	Edge_1RB_Left
5	High				QPSK	Edge_1RB_Right
6	Default				QPSK	Outer_Full
7	Low				16 QAM	Edge_1RB_Left
8	High				16 QAM	Edge_1RB_Right
9	Default				16 QAM	Outer_Full
10	Low				64 QAM	Edge_1RB_Left
11	High				64 QAM	Edge_1RB_Right
12	Default				64 QAM	Outer_Full
13	Low				256 QAM	Edge_1RB_Left
14	High				256 QAM	Edge_1RB_Right
15	Default				256 QAM	Outer_Full
16	Low			CP-s-OFDM	QPSK	Edge_1RB_Left
17	High				QPSK	Edge_1RB_Right
18	Default				QPSK	Outer_Full
19	Low				16 QAM	Edge_1RB_Left
20	High				16 QAM	Edge_1RB_Right
21	Default				16 QAM	Outer_Full
22	Low				64 QAM	Edge_1RB_Left
23	High				64 QAM	Edge_1RB_Right
24	Default				64 QAM	Outer_Full
25	Low				256 QAM	Edge_1RB_Left
26	High				256 QAM	Edge_1RB_Right
27	Default				256 QAM	Outer_Full

NOTE 1: The specific configuration of each RB allocation is defined in Table 6.1-1 unless otherwise stated in this table.
 NOTE 2: DFT-s-OFDM PI/2 BPSK test applies only for UEs which supports half Pi BPSK in FR1.
 NOTE 3: Void.
 NOTE 4: Void

Table 6.2C.5.4-8: Test Configuration Table for NS_56

Initial Conditions								
Test Environment as specified in TS 38.508-1 [5] subclause 4.1						Normal		
Test Frequencies as specified in TS 38.508-1 [5] subclause 4.3.1						Use uplink carrier center frequency (Fc) as specified in test parameters		
Test Channel Bandwidths as specified in TS 38.508-1 [5] subclause 4.3.1						5 MHz, 10 MHz as specified in test parameters for SUL carrier Lowest for non-SUL carrier		
Test SCS as specified in Table 5.3.5-1						15 kHz for all carriers		
A-MPR test parameters for NS_56								
Test ID	Fc (MHz)	Ch Bw (MHz)	Downlink Configuration	Uplink Configuration	A-MPR	Uplink Configuration		
						Modulation (NOTE 2)	RB allocation (Note 1) SCS 15 kHz	
1	Low	5	N/A for A-MPR testing	N/A	14	DFT-s-OFDM	PI/2 BPSK	Edge_1RB_Left
2	Low	5			6		PI/2 BPSK	Outer_Full
3	Low	5			4		PI/2 BPSK	20@4
4	Low	5			4		PI/2 BPSK	1@4
5	Low	5			14		QPSK	Edge_1RB_Left
6	Low	5			6		QPSK	Outer_Full
7	Low	5			4		QPSK	20@4
8	Low	5			4		QPSK	1@4
9	Low	5			14		16 QAM	Edge_1RB_Left
10	Low	5			6		16 QAM	Outer_Full
11	Low	5			4		16 QAM	20@4
12	Low	5			4		16 QAM	1@4
13	Low	5			14		64 QAM	Edge_1RB_Left
14	Low	5			6		64 QAM	Outer_Full
15	Low	5			4		64 QAM	20@4
16	Low	5			4		64 QAM	1@4
17	Low	5			14		256 QAM	Edge_1RB_Left
18	Low	5			6		256 QAM	Outer_Full
19	Low	5			4		256 QAM	20@4
20	Low	5			4		256 QAM	1@4
21	Low	10			12		PI/2 BPSK	Edge_1RB_Left
22	Low	10			8		PI/2 BPSK	Outer_Full

23	Low	10		6	PI/2 BPSK	1@3
24	Low	10		6	PI/2 BPSK	40@9
25	Low	10		4	PI/2 BPSK	1@35
26	Low	10		2	PI/2 BPSK	16@35
27	Low	10		5	PI/2 BPSK	Edge_1RB_Right
28	Low	10		5	PI/2 BPSK	1@40
29	Low	10		3	PI/2 BPSK	8@44
30	Low	10		12	QPSK	Edge_1RB_Left
31	Low	10		8	QPSK	Outer_Full
32	Low	10		6	QPSK	1@3
33	Low	10		6	QPSK	40@9
34	Low	10		4	QPSK	1@35
35	Low	10		2	QPSK	16@35
36	Low	10		5	QPSK	Edge_1RB_Right
37	Low	10		5	QPSK	1@40
38	Low	10		3	QPSK	8@44
39	Low	10		12	16 QAM	Edge_1RB_Left
40	Low	10		8	16 QAM	Outer_Full
41	Low	10		6	16 QAM	1@3
42	Low	10		6	16 QAM	40@9
43	Low	10		4	16 QAM	1@35
44	Low	10		2	16 QAM	16@35
45	Low	10		5	16 QAM	Edge_1RB_Right
46	Low	10		5	16 QAM	1@40
47	Low	10		3	16 QAM	8@44
48	Low	10		12	64 QAM	Edge_1RB_Left Outer_Full
49	Low	10		8	64 QAM	
50	Low	10		6	64 QAM	1@3 40@9
51	Low	10		6	64 QAM	
52	Low	10		4	64 QAM	1@35
53	Low	10		2	64 QAM	16@35

A-MPR test parameters for NS_56									
Test ID	F _c (MHz)	Ch Bw (MHz)	Downlink Configuration	Uplink Configuration	A-MPR	Uplink Configuration			
						Modulation (NOTE 2)	RB allocation (Note 1) SCS 15 kHz		
54	Low	10			5	64 QAM	Edge_1RB_Right		
55	Low	10			5	64 QAM	1@40		
56	Low	10			3	64 QAM	8@44		
57	Low	10			12	256 QAM	Edge_1RB_Left		
58	Low	10			8	256 QAM	Outer_Full		
59	Low	10			6	256 QAM	1@3		
60	Low	10			6	256 QAM	40@9		
61	Low	10			4	256 QAM	1@35		
62	Low	10			2	256 QAM	16@35		
63	Low	10			5	256 QAM	Edge_1RB_Right		
64	Low	10			5	256 QAM	1@40		
65	Low	10			3	256 QAM	8@44		
66	Low	5			N/A for A-MPR testing	N/A	14	QPSK	Edge_1RB_Left
67	Low	5					6	QPSK	Outer_Full
68	Low	5					4	QPSK	21@4
69	Low	5	4	QPSK			1@4		
70	Low	5	14	16 QAM			Edge_1RB_Left		
71	Low	5	6	16 QAM			Outer_Full		
72	Low	5	4	16 QAM			21@4		
73	Low	5	4	16 QAM			1@4		
74	Low	5	14	64 QAM			Edge_1RB_Left		
75	Low	5	6	64 QAM			Outer_Full		
76	Low	5	4	64 QAM			21@4		
77	Low	5	4	64 QAM			1@4		
78	Low	5	14	256 QAM			Edge_1RB_Left		
79	Low	5	6	256 QAM			Outer_Full		
80	Low	5	4	256 QAM	21@4				
81	Low	5	4	256 QAM	1@4				
82	Low	10	12	QPSK	Edge_1RB_Left				
83	Low	10	8	QPSK	Outer_Full				
84	Low	10	6	QPSK	1@3				

A-MPR test parameters for NS_56							
Test ID	F _c (MHz)	Ch Bw (MHz)	Downlink Configuration	Uplink Configuration	A-MPR	Uplink Configuration	
						Modulation (NOTE 2)	RB allocation (Note 1)
							SCS 15 kHz
85	Low	10			6	QPSK	43@9
86	Low	10			4	QPSK	1@35
87	Low	10			2	QPSK	17@35
88	Low	10			5	QPSK	Edge_1RB_Right
89	Low	10			5	QPSK	1@40
90	Low	10			3	QPSK	8@44
91	Low	10			12	16 QAM	Edge_1RB_Left
92	Low	10			8	16 QAM	Outer_Full
93	Low	10			6	16 QAM	1@3
94	Low	10			6	16 QAM	43@9
95	Low	10			4	16 QAM	1@35
96	Low	10			2	16 QAM	17@35
97	Low	10			5	16 QAM	Edge_1RB_Right
98	Low	10			5	16 QAM	1@40
99	Low	10			3	16 QAM	8@44
100	Low	10			12	64 QAM	Edge_1RB_Left
101	Low	10			8	64 QAM	Outer_Full
102	Low	10			6	64 QAM	1@3
103	Low	10			6	64 QAM	43@9
104	Low	10			4	64 QAM	1@35
105	Low	10			2	64 QAM	17@35
106	Low	10			5	64 QAM	Edge_1RB_Right
107	Low	10			5	64 QAM	1@40
108	Low	10			3	64 QAM	8@44
109	Low	10			12	256 QAM	Edge_1RB_Left

A-MPR test parameters for NS_56							
Test ID	F _c (MHz)	Ch Bw (MHz)	Downlink Configuration	Uplink Configuration	A-MPR	Uplink Configuration	
						Modulation (NOTE 2)	RB allocation (Note 1) SCS 15 kHz
110	Low	10			8	256 QAM	Outer_Full
111	Low	10			6	256 QAM	1@3
112	Low	10			6	256 QAM	43@9
113	Low	10			4	256 QAM	1@35
114	Low	10			2	256 QAM	17@35
115	Low	10			5	256 QAM	Edge_1RB_Right
116	Low	10			5	256 QAM	1@40
117	Low	10			3	256 QAM	8@44

NOTE 1: The specific configuration of each RB allocation is defined in Table 6.1-1 unless otherwise stated in this table.
NOTE 2: DFT-s-OFDM Pi/2 BPSK test applies only for UEs which supports half Pi BPSK in FR1.

Editor's note: The following lines belong at the end of subclause 6.2.3.4.1. As new tables are added to this section, these lines should always follow the tables

- Connect the SS to the UE antenna connectors as shown in TS 38.508-1 [5] Annex A, Figure A.3.1.1.4 for TE diagram and section A.3.2 for UE diagram.
- The parameter setting for the cell are set up according to the TS 38.508-1 [5] subclause 4.4.3.
- Downlink signals are initially setup according to Annex C.0, C.1, C.2 and uplink signals according to Annex G.0, G.1, G.2, and G.3.0 with consideration of supplementary uplink physical channels.

Message contents in initial conditions are according to TS 38.508-1 [5] subclause 4.3.6.1.1.2 ensuring UL/SUL indicator in Table 4.3.6.1.1.2-1 with condition SUL, subclause 4.6 ensuring Table 4.6.1-28 with condition SUL AND (RF OR RRM), Tables 4.6.3-14 with condition SUL_SUL for SUL carrier, and Table 4.6.3-167 with condition PUSCH_PUCCH_ON_SUL. All the AdditionalSpectrumEmission in 6.2.3.4.3 are sent in *SIB1* as part of *supplementaryUplink* instead of *uplinkConfigCommon*.

Table 6.2C.5.4-1: Void

6.2C.5.5 Test requirement

The maximum output power, derived in step 3 shall be within the range prescribed by the nominal maximum output power and tolerance in the applicable table from table 6.2C.5.5-1 to table 6.2C.5.5-8. The allowed A-MPR values specified in table 6.2.3.3-1 are in addition to the allowed MPR requirements specified in clause 6.2C.4. For the UE maximum output power modified by MPR and/or A-MPR, the power limits specified in table 6.2.1.3-1 apply.

Table 6.2C.5.5-1: UE Power Class 3 test requirements (NS_03) for band n86

Test ID	Network signalling label	P _{PowerClass} (dBm)	MPR (dB)	A-MPR (dB)	$\Delta T_{C,c}$ (dB)	P _{CMAX_L,c} (dBm)	T(P _{CMAX_L,c}) (dB)	T _{L,c} (dB)	Upper limit (dBm)	Lower limit (dBm)
1, 2	NS_03	23	0.5	1.5	0	21.5	2	2	25+TT	19.5-TT
3	NS_03	23	0.5	1.5	0	21.5	2	2	25+TT	19.5-TT
4, 5	NS_03	23	1	1	0	21	2	2	25+TT	19-TT
7	NS_03	23	1	1	0	21	2	2	25+TT	19-TT
7, 8	NS_03	23	2	2.5	0	20	2.5	2	25+TT	17.5-TT
9	NS_03	23	2	2.5	0	20	2.5	2	25+TT	17.5-TT
10, 11	NS_03	23	2.5	3	0	19.5	3.5	2	25+TT	16-TT
12	NS_03	23	2.5	3	0	19.5	3.5	2	25+TT	16-TT
13, 14	NS_03	23	4.5	4.5	0	17.5	5	2	25+TT	12.5-TT
15	NS_03	23	4.5	4.5	0	17.5	5	2	25+TT	12.5-TT
16, 17	NS_03	23	3	4	0	19	3.5	2	25+TT	15.5-TT
18	NS_03	23	3	4	0	19	3.5	2	25+TT	15.5-TT
19, 20	NS_03	23	3	4	0	19	3.5	2	25+TT	15.5-TT
21	NS_03	23	3	4	0	19	3.5	2	25+TT	15.5-TT
22, 23	NS_03	23	3.5	4	0	18.5	4	2	25+TT	14.5-TT
24	NS_03	23	3.5	4	0	18.5	4	2	25+TT	14.5-TT
25, 26	NS_03	23	6.5	6.5	0	15.5	5	2	25+TT	10.5-TT
27	NS_03	23	6.5	6.5	0	15.5	5	2	25+TT	10.5-TT

NOTE 1: P_{PowerClass} is the maximum UE power specified without taking into account the tolerance.

NOTE 2: TT for each frequency and channel bandwidth is specified in Table 6.2.3.5-0.

Table 6.2C.5.5-2: UE Power Class 3 test requirements (NS_18) for band n83

Test ID	ChBw (MHz)	P _{PowerClass} (dBm)	MPR (dB)	A-MPR (dB)	$\Delta T_{C,c}$ (dB)	P _{CMAX_L,c} (dBm)	T(P _{CMAX_L,c}) (dB)	T _{L,c} (dB)	Upper limit (dBm)	Lower limit (dBm)
1, 2	5	23	1	2	0	21	2	2.5	25+TT	18.5-TT
	10, 15, 20	23	1	5	0	18	4	2.5	25+TT	14-TT
3, 4	5	23	2	3	0	20	2.5	2.5	25+TT	17.5-TT
	10, 15, 20	23	2	6	0	17	5	2.5	25+TT	12-TT
5, 6	5	23	2.5	4	0	19	3.5	2.5	25+TT	15.5-TT
	10, 15, 20	23	2.5	7	0	16	5	2.5	25+TT	11-TT
7, 8	5	23	4.5	6	0	17	5	2.5	25+TT	12-TT
	10, 15, 20	23	4.5	9	0	14	5	2.5	25+TT	9-TT
9, 10	5	23	3	5	0	18	4	2.5	25+TT	14-TT
	10, 15, 20	23	3	6.5	0	16.5	5	2.5	25+TT	11.5-TT
11, 12	5	23	3	5	0	18	4	2.5	25+TT	14-TT
	10, 15, 20	23	3	7	0	16	5	2.5	25+TT	11-TT
13, 14	5	23	3.5	5.5	0	17.5	5	2.5	25+TT	12.5-TT
	10, 15, 20	23	3.5	8.5	0	14.5	5	2.5	25+TT	9.5-TT
15, 16	5	23	6.5	8.5	0	14.5	5	2.5	25+TT	9.5-TT
	10, 15, 20	23	6.5	11.5	0	11.5	6	2.5	25+TT	5.5-TT
17	30	23	5	3	0	18	4	2.5	25+TT	14-TT
18	30	23	5	8	0	15	5	2.5	25+TT	10-TT
19	30	23	7	4.5	0	16	5	2.5	25+TT	11-TT
20	30	23	7	9.5	0	13.5	5	2.5	25+TT	8.5-TT

NOTE 1: P_{PowerClass} is the maximum UE power specified without taking into account the tolerance.

NOTE 2: TT for each frequency and channel bandwidth is specified in Table 6.2.3.5-0.

Table 6.2C.5.5-3: UE Power Class 3 test requirements (NS_48) for band n84

Test ID	P _{PowerClass} (dBm)	P _{PowerClass} (dB)	MPR (dB)	A-MPR (dB)	$\Delta T_{C,c}$ (dB)	P _{CMAX_L,c} (dBm)	T(P _{CMAX_L,c}) (dB)	T _{L,c} (dB)	Upper limit (dBm)	Lower limit (dBm)
1	23	0	1	3	0	20	2.5	2	25+TT	17.5-TT
2	23	0	1	3	0	20	2.5	2	25+TT	17.5-TT
3	23	0	1	3	0	20	2.5	2	25+TT	17.5-TT
4	23	0	1	5	0	18	4	2	25+TT	14-TT
5	23	0	1	6	0	17	5	2	25+TT	12-TT
6	23	0	1	3	0	20	2.5	2	25+TT	17.5-TT
7	23	0	1	4	0	19	3.5	2	25+TT	15.5-TT
8	23	0	1	6	0	17	5	2	25+TT	12-TT
9	23	0	0	3	0	20	2.5	2	25+TT	17.5-TT
10	23	0	1	10	0	13	5	2	25+TT	8-TT
11	23	0	1	6	0	17	5	2	25+TT	12-TT
12	23	0	1	4	0	19	3.5	2	25+TT	15.5-TT
13	23	0	1	6	0	17	5	2	25+TT	12-TT
14	23	0	0	5	0	18	4	2	25+TT	14-TT
15	23	0	1	10	0	13	5	2	25+TT	8-TT
16	23	0	4.5	3	0	18.5	4	2	25+TT	14.5-TT
17	23	0	4.5	3	0	18.5	4	2	25+TT	14.5-TT
18	23	0	4.5	3	0	18.5	4	2	25+TT	14.5-TT
19	23	0	4.5	5	0	18	4	2	25+TT	14-TT
20	23	0	4.5	6	0	17	5	2	25+TT	12-TT
21	23	0	4.5	3	0	18.5	4	2	25+TT	14.5-TT
22	23	0	4.5	4	0	18.5	4	2	25+TT	14.5-TT
23	23	0	4.5	6	0	17	5	2	25+TT	12-TT
24	23	0	4.5	3	0	18.5	4	2	25+TT	14.5-TT
25	23	0	4.5	10	0	13	5	2	25+TT	8-TT
26	23	0	4.5	6	0	17	5	2	25+TT	12-TT
27	23	0	4.5	4	0	18.5	4	2	25+TT	14.5-TT
28	23	0	4.5	6	0	17	5	2	25+TT	12-TT
29	23	0	4.5	5	0	18	4	2	25+TT	14-TT
30	23	0	4.5	10	0	13	5	2	25+TT	8-TT
31	23	0	3	4.5	0	18.5	4	2	25+TT	14.5-TT
32	23	0	3	4.5	0	18.5	4	2	25+TT	14.5-TT
33	23	0	3	4.5	0	18.5	4	2	25+TT	14.5-TT
34	23	0	3	5	0	18	4	2	25+TT	14-TT
35	23	0	3	7	0	16	5	2	25+TT	11-TT
36	23	0	3	4.5	0	18.5	4	2	25+TT	14.5-TT
37	23	0	3	5.5	0	17.5	5	2	25+TT	12.5-TT
38	23	0	3	7	0	16	5	2	25+TT	11-TT
39	23	0	1.5	4.5	0	18.5	4	2	25+TT	14.5-TT
40	23	0	3	11	0	12	6	2	25+TT	6-TT
41	23	0	3	7	0	16	5	2	25+TT	11-TT
42	23	0	3	5.5	0	17.5	5	2	25+TT	12.5-TT
43	23	0	3	7	0	16	5	2	25+TT	11-TT
44	23	0	1.5	5	0	18	4	2	25+TT	14-TT
45	23	0	3	11	0	12	6	2	25+TT	6-TT
46	23	0	6.5	4.5	0	16.5	5	2	25+TT	11.5-TT
47	23	0	6.5	4.5	0	16.5	5	2	25+TT	11.5-TT
48	23	0	6.5	4.5	0	16.5	5	2	25+TT	11.5-TT
49	23	0	6.5	5	0	16.5	5	2	25+TT	11.5-TT

Test ID	$P_{\text{PowerClass}}$ (dBm)	$\bar{P}_{\text{PowerClass}}$ (dB)	MPR (dB)	A-MPR (dB)	$\Delta T_{C,c}$ (dB)	$P_{\text{CMAX}_L,c}$ (dBm)	$T(P_{\text{CMAX}_L,c})$ (dB)	$T_{L,c}$ (dB)	Upper limit (dBm)	Lower limit (dBm)
50	23	0	6.5	7	0	16	5	2	25+TT	11-TT
51	23	0	6.5	4.5	0	16.5	5	2	25+TT	11.5-TT
52	23	0	6.5	5.5	0	16.5	5	2	25+TT	11.5-TT
53	23	0	6.5	7	0	16	5	2	25+TT	11-TT
54	23	0	6.5	4.5	0	16.5	5	2	25+TT	11.5-TT
55	23	0	6.5	11	0	12	6	2	25+TT	6-TT
56	23	0	6.5	7	0	16	5	2	25+TT	11-TT
57	23	0	6.5	5.5	0	16.5	5	2	25+TT	11.5-TT
58	23	0	6.5	7	0	16	5	2	25+TT	11-TT
59	23	0	6.5	5	0	16.5	5	2	25+TT	11.5-TT
60	23	0	6.5	11	0	12	6	2	25+TT	6-TT

NOTE 1: $P_{\text{PowerClass}}$ is the maximum UE power specified without taking into account the tolerance.

NOTE 2: TT for each frequency and channel bandwidth is specified in Table 6.2.3.5-0.

Table 6.2C.5.5-4: UE Power Class 3 test requirements (NS_49) for band n84

Test ID	P ^{PowerClass} (dBm)	P ^{PowerClass} (dB)	MPR (dB)	A-MPR (dB)	ΔT _{C,c} (dB)	P _{CMAX_L,c} (dBm)	T(P _{CMAX_L,c}) (dB)	T _{L,c} (dB)	Upper limit (dBm)	Lower limit (dBm)
1	23	0	1	3	0	20	2.5	2	25+TT	17.5-TT
2	23	0	1	3	0	20	2.5	2	25+TT	17.5-TT
3	23	0	1	3	0	20	2.5	2	25+TT	17.5-TT
4	23	0	1	10	0	13	5	2	25+TT	8-TT
5	23	0	1	5	0	18	4	2	25+TT	14-TT
6	23	0	1	3	0	20	2.5	2	25+TT	17.5-TT
7	23	0	1	4	0	19	3.5	2	25+TT	15.5-TT
8	23	0	1	6	0	17	5	2	25+TT	12-TT
9	23	0	1	5	0	18	4	2	25+TT	14-TT
10	23	0	1	10	0	13	5	2	25+TT	8-TT
11	23	0	0	5	0	18	4	2	25+TT	14-TT
12	23	0	1	4	0	19	3.5	2	25+TT	15.5-TT
13	23	0	1	6	0	17	5	2	25+TT	12-TT
14	23	0	0	5	0	18	4	2	25+TT	14-TT
15	23	0	1	10	0	13	5	2	25+TT	8-TT
16	23	0	1	10	0	13	5	2	25+TT	8-TT
17	23	0	0	5	0	18	4	2	25+TT	14-TT
18	23	0	0	5	0	18	4	2	25+TT	14-TT
19	23	0	1	6	0	17	5	2	25+TT	12-TT
20	23	0	1	10	0	13	5	2	25+TT	8-TT
21	23	0	1	10	0	13	5	2	25+TT	8-TT
22	23	0	4.5	3	0	18.5	4	2	25+TT	14.5-TT
23	23	0	4.5	3	0	18.5	4	2	25+TT	14.5-TT
24	23	0	4.5	3	0	18.5	4	2	25+TT	14.5-TT
25	23	0	4.5	10	0	13	5	2	25+TT	8-TT
26	23	0	4.5	5	0	18	4	2	25+TT	14-TT
27	23	0	4.5	3	0	18.5	4	2	25+TT	14.5-TT
28	23	0	4.5	4	0	18.5	4	2	25+TT	14.5-TT
29	23	0	4.5	6	0	17	5	2	25+TT	12-TT
30	23	0	4.5	5	0	18	4	2	25+TT	14-TT
31	23	0	4.5	10	0	13	5	2	25+TT	8-TT
32	23	0	4.5	5	0	18	4	2	25+TT	14-TT
33	23	0	4.5	4	0	18.5	4	2	25+TT	14.5-TT
34	23	0	4.5	6	0	17	5	2	25+TT	12-TT
35	23	0	4.5	5	0	18	4	2	25+TT	14-TT
36	23	0	4.5	10	0	13	5	2	25+TT	8-TT
37	23	0	4.5	10	0	13	5	2	25+TT	8-TT
38	23	0	4.5	5	0	18	4	2	25+TT	14-TT
39	23	0	4.5	5	0	18	4	2	25+TT	14-TT
40	23	0	4.5	6	0	17	5	2	25+TT	12-TT
41	23	0	4.5	10	0	13	5	2	25+TT	8-TT
42	23	0	4.5	10	0	13	5	2	25+TT	8-TT
43	23	0	3	4.5	0	18.5	4	2	25+TT	14.5-TT
44	23	0	3	4.5	0	18.5	4	2	25+TT	14.5-TT
45	23	0	3	4.5	0	18.5	4	2	25+TT	14.5-TT
46	23	0	3	11	0	12	6	2	25+TT	6-TT
47	23	0	3	5	0	18	4	2	25+TT	14-TT
48	23	0	3	4.5	0	18.5	4	2	25+TT	14.5-TT
49	23	0	3	5.5	0	17.5	5	2	25+TT	12.5-TT
50	23	0	3	7	0	16	5	2	25+TT	11-TT
51	23	0	3	5	0	18	4	2	25+TT	14-TT
52	23	0	3	11	0	12	6	2	25+TT	6-TT
53	23	0	1.5	5	0	18	4	2	25+TT	14-TT
54	23	0	3	5.5	0	17.5	5	2	25+TT	12.5-TT
55	23	0	3	7	0	16	5	2	25+TT	11-TT
56	23	0	1.5	5	0	18	4	2	25+TT	14-TT
57	23	0	3	11	0	12	6	2	25+TT	6-TT
58	23	0	3	11	0	12	6	2	25+TT	6-TT
59	23	0	1.5	5	0	18	4	2	25+TT	14-TT

Test ID	$P_{\text{PowerClass}}$ (dBm)	$\bar{P}_{\text{PowerClass}}$ (dB)	MPR (dB)	A-MPR (dB)	$\Delta T_{C,c}$ (dB)	$P_{\text{CMAX}_L,c}$ (dBm)	$T(P_{\text{CMAX}_L,c})$ (dB)	$T_{L,c}$ (dB)	Upper limit (dBm)	Lower limit (dBm)
60	23	0	1.5	5	0	18	4	2	25+TT	14-TT
61	23	0	3	7	0	16	5	2	25+TT	11-TT
62	23	0	3	11	0	12	6	2	25+TT	6-TT
63	23	0	3	11	0	12	6	2	25+TT	6-TT
64	23	0	6.5	4.5	0	16.5	5	2	25+TT	11.5-TT
65	23	0	6.5	4.5	0	16.5	5	2	25+TT	11.5-TT
66	23	0	6.5	4.5	0	16.5	5	2	25+TT	11.5-TT
67	23	0	6.5	11	0	12	6	2	25+TT	6-TT
68	23	0	6.5	5	0	16.5	5	2	25+TT	11.5-TT
69	23	0	6.5	4.5	0	16.5	5	2	25+TT	11.5-TT
70	23	0	6.5	5.5	0	16.5	5	2	25+TT	11.5-TT
71	23	0	6.5	7	0	16	5	2	25+TT	11-TT
72	23	0	6.5	5	0	16.5	5	2	25+TT	11.5-TT
73	23	0	6.5	11	0	12	6	2	25+TT	6-TT
74	23	0	6.5	5	0	16.5	5	2	25+TT	11.5-TT
75	23	0	6.5	5.5	0	16.5	5	2	25+TT	11.5-TT
76	23	0	6.5	7	0	16	5	2	25+TT	11-TT
77	23	0	6.5	5	0	16.5	5	2	25+TT	11.5-TT
78	23	0	6.5	11	0	12	6	2	25+TT	6-TT
79	23	0	6.5	11	0	12	6	2	25+TT	6-TT
80	23	0	6.5	5	0	16.5	5	2	25+TT	11.5-TT
81	23	0	6.5	5	0	16.5	5	2	25+TT	11.5-TT
82	23	0	6.5	7	0	16	5	2	25+TT	11-TT
83	23	0	6.5	11	0	12	6	2	25+TT	6-TT
84	23	0	6.5	11	0	12	6	2	25+TT	6-TT

NOTE 1: $P_{\text{PowerClass}}$ is the maximum UE power specified without taking into account the tolerance.

NOTE 2: TT for each frequency and channel bandwidth is specified in Table 6.2.3.5-0.

Table 6.2C.5.5-5: UE Power Class 3 test requirements (NS_05) for band n84

Test ID	P _{PowerClass} (dBm)	Δ P _{PowerClass} (dB)	MPR (dB)	A-MPR (dB)	Δ T _{C,c} (dB)	P _{CMAX_L,c} (dBm)	T(P _{CMAX_L,c}) (dB)	T _{L,c} (dB)	Upper limit (dBm)	Lower limit (dBm)
1	23	0	0.5	4	0	19	3.5	2	25+TT	15.5-TT
2	23	0	0.5	10	0	13	5	2	25+TT	8-TT
3	23	0	0.5	6	0	17	5	2	25+TT	12-TT
4	23	0	0.5	5	0	18	4	2	25+TT	14-TT
5	23	0	0.5	1	0	22	2.0	2	25+TT	20-TT
6	23	0	0.5	10	0	13	5.0	2	25+TT	8-TT
7	23	0	0.5	6	0	17	5.0	2	25+TT	12-TT
8	23	0	0.5	5	0	18	4.0	2	25+TT	14-TT
9	23	0	0.5	10	0	13	5.0	2	25+TT	8-TT
10	23	0	0.5	5	0	18	4.0	2	25+TT	14-TT
11	23	0	0.5	1	0	22	2.0	2	25+TT	20-TT
12	23	0	0.5	10	0	13	5.0	2	25+TT	8-TT
13	23	0	0.5	6	0	17	5.0	2	25+TT	12-TT
14	23	0	0.5	5	0	18	4.0	2	25+TT	14-TT
15	23	0	0.5	1	0	22	2.0	2	25+TT	20-TT
16	23	0	1.0	4.5	0	18.5	4.0	2	25+TT	14.5-TT
17	23	0	1.0	10	0	13	5.0	2	25+TT	8-TT
18	23	0	1.0	6	0	17	5.0	2	25+TT	12-TT
19	23	0	1.0	5	0	18	4.0	2	25+TT	14-TT
20	23	0	1.0	10	0	13	5.0	2	25+TT	8-TT
21	23	0	1.0	6	0	17	5.0	2	25+TT	12-TT
22	23	0	1.0	5	0	18	4.0	2	25+TT	14-TT
23	23	0	1.0	10	0	13	5.0	2	25+TT	8-TT
24	23	0	1.0	5	0	18	4.0	2	25+TT	14-TT
25	23	0	1.0	1.5	0	21.5	2.0	2	25+TT	19.5-TT
26	23	0	1.0	10	0	13	5.0	2	25+TT	8-TT
27	23	0	1.0	6	0	17	5.0	2	25+TT	12-TT
28	23	0	1.0	5	0	18	4.0	2	25+TT	14-TT
29	23	0	1.0	1.5	0	21.5	2.0	2	25+TT	19.5-TT
30	23	0	2.0	6	0	17	5.0	2	25+TT	12-TT
31	23	0	2.0	10	0	13	5.0	2	25+TT	8-TT
32	23	0	2.0	6	0	17	5.0	2	25+TT	12-TT
33	23	0	2.0	5	0	18	4.0	2	25+TT	14-TT
34	23	0	2.0	10	0	13	5.0	2	25+TT	8-TT
35	23	0	2.0	6	0	17	5.0	2	25+TT	12-TT
36	23	0	2.0	5	0	18	4.0	2	25+TT	14-TT
37	23	0	2.0	10	0	13	5.0	2	25+TT	8-TT
38	23	0	2.0	5	0	18	4.0	2	25+TT	14-TT
39	23	0	2.0	10	0	13	5.0	2	25+TT	8-TT
40	23	0	2.0	6	0	17	5.0	2	25+TT	12-TT
41	23	0	2.0	5	0	18	4.0	2	25+TT	14-TT
42	23	0	2.5	6	0	17	5.0	2	25+TT	12-TT
43	23	0	2.5	11	0	12	6.0	2	25+TT	6-TT
44	23	0	2.5	6	0	17	5.0	2	25+TT	12-TT
45	23	0	2.5	5	0	18	4.0	2	25+TT	14-TT
46	23	0	2.5	11	0	12	6.0	2	25+TT	6-TT
47	23	0	2.5	6	0	17	5.0	2	25+TT	12-TT
48	23	0	2.5	5	0	18	4.0	2	25+TT	14-TT
49	23	0	2.5	11	0	12	6.0	2	25+TT	6-TT
50	23	0	2.5	5	0	18	4.0	2	25+TT	14-TT
51	23	0	2.5	11	0	12	6.0	2	25+TT	6-TT
52	23	0	2.5	6	0	17	5.0	2	25+TT	12-TT
53	23	0	2.5	5	0	18	4.0	2	25+TT	14-TT
54	23	0	4.5	7	0	16	5.0	2	25+TT	11-TT
55	23	0	4.5	13	0	10	6.0	2	25+TT	4-TT
56	23	0	4.5	6	0	17	5.0	2	25+TT	12-TT
57	23	0	4.5	5	0	18	4.0	2	25+TT	14-TT
58	23	0	4.5	13	0	10	6.0	2	25+TT	4-TT
59	23	0	4.5	6	0	17	5.0	2	25+TT	12-TT

Test ID	P _{PowerClass} (dBm)	ΔP _{PowerClass} (dB)	MPR (dB)	A-MPR (dB)	ΔT _{C,c} (dB)	P _{CMAX_L,c} (dBm)	T(P _{CMAX_L,c}) (dB)	T _{L,c} (dB)	Upper limit (dBm)	Lower limit (dBm)
60	23	0	4.5	5	0	18	4.0	2	25+TT	14-TT
61	23	0	4.5	13	0	10	6.0	2	25+TT	4-TT
62	23	0	4.5	5	0	18	4.0	2	25+TT	14-TT
63	23	0	4.5	13	0	10	6.0	2	25+TT	4-TT
64	23	0	4.5	6	0	17	5.0	2	25+TT	12-TT
65	23	0	4.5	5	0	18	4.0	2	25+TT	14-TT
66	23	0	3.0	7.5	0	15.5	5.0	2	25+TT	10.5-TT
67	23	0	3.0	10	0	13	5.0	2	25+TT	8-TT
68	23	0	3.0	6	0	17	5.0	2	25+TT	12-TT
69	23	0	3.0	5	0	18	4.0	2	25+TT	14-TT
70	23	0	3.0	3.5	0	19.5	3.5	2	25+TT	16-TT
71	23	0	3.0	10	0	13	5.0	2	25+TT	8-TT
72	23	0	3.0	6	0	17	5.0	2	25+TT	12-TT
73	23	0	3.0	5	0	18	4.0	2	25+TT	14-TT
74	23	0	3.0	10	0	13	5.0	2	25+TT	8-TT
75	23	0	3.0	5	0	18	4.0	2	25+TT	14-TT
76	23	0	3.0	3.5	0	19.5	3.5	2	25+TT	16-TT
77	23	0	3.0	10	0	13	5.0	2	25+TT	8-TT
78	23	0	3.0	6	0	17	5.0	2	25+TT	12-TT
79	23	0	3.0	5	0	18	4.0	2	25+TT	14-TT
80	23	0	3.0	3.5	0	19.5	3.5	2	25+TT	16-TT
81	23	0	3.0	7.5	0	15.5	5.0	2	25+TT	10.5-TT
82	23	0	3.0	10	0	13	5.0	2	25+TT	8-TT
83	23	0	3.0	6	0	17	5.0	2	25+TT	12-TT
84	23	0	3.0	5	0	18	4.0	2	25+TT	14-TT
85	23	0	3.0	3.5	0	19.5	3.5	2	25+TT	16-TT
86	23	0	3.0	10	0	13	5.0	2	25+TT	8-TT
87	23	0	3.0	6	0	17	5.0	2	25+TT	12-TT
88	23	0	3.0	5	0	18	4.0	2	25+TT	14-TT
89	23	0	3.0	10	0	13	5.0	2	25+TT	8-TT
90	23	0	3.0	5	0	18	4.0	2	25+TT	14-TT
91	23	0	3.0	3.5	0	19.5	3.5	2	25+TT	16-TT
92	23	0	3.0	10	0	13	5.0	2	25+TT	8-TT
93	23	0	3.0	6	0	17	5.0	2	25+TT	12-TT
94	23	0	3.0	5	0	18	4.0	2	25+TT	14-TT
95	23	0	3.0	3.5	0	19.5	3.5	2	25+TT	16-TT
96	23	0	3.5	8	0	15	5.0	2	25+TT	10-TT
97	23	0	3.5	11	0	12	6.0	2	25+TT	6-TT
98	23	0	3.5	6	0	17	5.0	2	25+TT	12-TT
99	23	0	3.5	5	0	18	4.0	2	25+TT	14-TT
100	23	0	3.5	11	0	12	6.0	2	25+TT	6-TT
101	23	0	3.5	6	0	17	5.0	2	25+TT	12-TT
102	23	0	3.5	5	0	18	4.0	2	25+TT	14-TT
103	23	0	3.5	11	0	12	6.0	2	25+TT	6-TT
104	23	0	3.5	5	0	18	4.0	2	25+TT	14-TT
105	23	0	3.5	11	0	12	6.0	2	25+TT	6-TT
106	23	0	3.5	6	0	17	5.0	2	25+TT	12-TT
107	23	0	3.5	5	0	18	4.0	2	25+TT	14-TT
108	23	0	6.5	10	0	13	5.0	2	25+TT	8-TT
109	23	0	6.5	13	0	10	6.0	2	25+TT	4-TT
110	23	0	6.5	6	0	16.5	5.0	2	25+TT	11.5-TT
111	23	0	6.5	13	0	10	6.0	2	25+TT	4-TT
112	23	0	6.5	6	0	16.5	5.0	2	25+TT	11.5-TT
113	23	0	6.5	13	0	10	6.0	2	25+TT	4-TT
114	23	0	6.5	13	0	10	6.0	2	25+TT	4-TT
115	23	0	6.5	6	0	16.5	5.0	2	25+TT	11.5-TT

NOTE 1: P_{PowerClass} is the maximum UE power specified without taking into account the tolerance.

NOTE 2: TT for each frequency and channel bandwidth is specified in Table 6.2.3.5-0.

Table 6.2C.5.5-6: UE Power Class 3 test requirements (NS_05U) for band n84

Test ID	P _{PowerClass} (dBm)	Δ P _{PowerClass} (dB)	MPR (dB)	A-MPR (dB)	Δ T _{C,c} (dB)	P _{CMAX_L,c} (dBm)	T(P _{CMAX_L,c}) (dB)	T _{L,c} (dB)	Upper limit (dBm)	Lower limit (dBm)
1	23	0	0.5	4	0	19	3.5	2	25+TT	15.5-TT
2	23	0	0.5	10	0	13	5	2	25+TT	8-TT
3	23	0	0.5	6	0	17	5	2	25+TT	12-TT
4	23	0	0.5	5	0	18	4	2	25+TT	14-TT
5	23	0	0.5	2	0	21	2.0	2	25+TT	19-TT
6	23	0	0.5	10	0	13	5.0	2	25+TT	8-TT
7	23	0	0.5	6	0	17	5.0	2	25+TT	12-TT
8	23	0	0.5	5	0	18	4.0	2	25+TT	14-TT
9	23	0	0.5	10	0	13	5.0	2	25+TT	8-TT
10	23	0	0.5	5	0	18	4.0	2	25+TT	14-TT
11	23	0	0.5	2	0	21	2.0	2	25+TT	19-TT
12	23	0	0.5	10	0	13	5.0	2	25+TT	8-TT
13	23	0	0.5	6	0	17	5.0	2	25+TT	12-TT
14	23	0	0.5	5	0	18	4.0	2	25+TT	14-TT
15	23	0	0.5	2	0	21	2.0	2	25+TT	19-TT
16	23	0	1.0	4.5	0	18.5	4.0	2	25+TT	14.5-TT
17	23	0	1.0	10	0	13	5.0	2	25+TT	8-TT
18	23	0	1.0	6	0	17	5.0	2	25+TT	12-TT
19	23	0	1.0	5	0	18	4.0	2	25+TT	14-TT
20	23	0	1.0	2	0	21	2.0	2	25+TT	19-TT
21	23	0	1.0	10	0	13	5.0	2	25+TT	8-TT
22	23	0	1.0	6	0	17	5.0	2	25+TT	12-TT
23	23	0	1.0	5	0	18	4.0	2	25+TT	14-TT
24	23	0	1.0	10	0	13	5.0	2	25+TT	8-TT
25	23	0	1.0	5	0	18	4.0	2	25+TT	14-TT
26	23	0	1.0	2	0	21	2.0	2	25+TT	19-TT
27	23	0	1.0	10	0	13	5.0	2	25+TT	8-TT
28	23	0	1.0	6	0	17	5.0	2	25+TT	12-TT
29	23	0	1.0	5	0	18	4.0	2	25+TT	14-TT
30	23	0	1.0	2	0	21	2.0	2	25+TT	19-TT
31	23	0	2.0	6	0	17	5.0	2	25+TT	12-TT
32	23	0	2.0	10	0	13	5.0	2	25+TT	8-TT
33	23	0	2.0	6	0	17	5.0	2	25+TT	12-TT
34	23	0	2.0	5	0	18	4.0	2	25+TT	14-TT
35	23	0	2.0	2.5	0	20.5	2.5	2	25+TT	18-TT
36	23	0	2.0	10	0	13	5.0	2	25+TT	8-TT
37	23	0	2.0	6	0	17	5.0	2	25+TT	12-TT
38	23	0	2.0	5	0	18	4.0	2	25+TT	14-TT
39	23	0	2.0	10	0	13	5.0	2	25+TT	8-TT
40	23	0	2.0	5	0	18	4.0	2	25+TT	14-TT
41	23	0	2.0	2.5	0	20.5	2.5	2	25+TT	18-TT
42	23	0	2.0	10	0	13	5.0	2	25+TT	8-TT
43	23	0	2.0	6	0	17	5.0	2	25+TT	12-TT
44	23	0	2.0	5	0	18	4.0	2	25+TT	14-TT
45	23	0	2.0	2.5	0	20.5	2.5	2	25+TT	18-TT
46	23	0	2.5	6	0	17	5.0	2	25+TT	12-TT
47	23	0	2.5	11	0	12	6.0	2	25+TT	6-TT
48	23	0	2.5	6	0	17	5.0	2	25+TT	12-TT
49	23	0	2.5	5	0	18	4.0	2	25+TT	14-TT
50	23	0	2.5	3	0	20	2.5	2	25+TT	17.5-TT
51	23	0	2.5	11	0	12	6.0	2	25+TT	6-TT
52	23	0	2.5	6	0	17	5.0	2	25+TT	12-TT
53	23	0	2.5	5	0	18	4.0	2	25+TT	14-TT
54	23	0	2.5	11	0	12	6.0	2	25+TT	6-TT
55	23	0	2.5	5	0	18	4.0	2	25+TT	14-TT
56	23	0	2.5	3	0	20	2.5	2	25+TT	17.5-TT
57	23	0	2.5	11	0	12	6.0	2	25+TT	6-TT
58	23	0	2.5	6	0	17	5.0	2	25+TT	12-TT
59	23	0	2.5	5	0	18	4.0	2	25+TT	14-TT

Test ID	P _{PowerClass} (dBm)	Δ P _{PowerClass} (dB)	MPR (dB)	A-MPR (dB)	Δ T _{C,c} (dB)	P _{CMAX_L,c} (dBm)	T(P _{CMAX_L,c}) (dB)	T _{L,c} (dB)	Upper limit (dBm)	Lower limit (dBm)
60	23	0	2.5	3	0	20	2.5	2	25+TT	17.5-TT
61	23	0	4.5	7	0	16	5.0	2	25+TT	11-TT
62	23	0	4.5	13	0	10	6.0	2	25+TT	4-TT
63	23	0	4.5	6	0	17	5.0	2	25+TT	12-TT
64	23	0	4.5	5	0	18	4.0	2	25+TT	14-TT
65	23	0	4.5	4.5	0	18.5	4.0	2	25+TT	14.5-TT
66	23	0	4.5	13	0	10	6.0	2	25+TT	4-TT
67	23	0	4.5	6	0	17	5.0	2	25+TT	12-TT
68	23	0	4.5	5	0	18	4.0	2	25+TT	14-TT
69	23	0	4.5	13	0	10	6.0	2	25+TT	4-TT
70	23	0	4.5	5	0	18	4.0	2	25+TT	14-TT
71	23	0	4.5	4.5	0	18.5	4.0	2	25+TT	14.5-TT
72	23	0	4.5	13	0	10	6.0	2	25+TT	4-TT
73	23	0	4.5	6	0	17	5.0	2	25+TT	12-TT
74	23	0	4.5	5	0	18	4.0	2	25+TT	14-TT
75	23	0	4.5	4.5	0	18.5	4.0	2	25+TT	14.5-TT
76	23	0	3.0	7.5	0	15.5	5.0	2	25+TT	10.5-TT
77	23	0	3.0	10	0	13	5.0	2	25+TT	8-TT
78	23	0	3.0	6	0	17	5.0	2	25+TT	12-TT
79	23	0	3.0	5	0	18	4.0	2	25+TT	14-TT
80	23	0	3.0	4	0	19	3.5	2	25+TT	15.5-TT
81	23	0	3.0	10	0	13	5.0	2	25+TT	8-TT
82	23	0	3.0	6	0	17	5.0	2	25+TT	12-TT
83	23	0	3.0	5	0	18	4.0	2	25+TT	14-TT
84	23	0	3.0	10	0	13	5.0	2	25+TT	8-TT
85	23	0	3.0	5	0	18	4.0	2	25+TT	14-TT
86	23	0	3.0	4	0	19	3.5	2	25+TT	15.5-TT
87	23	0	3.0	10	0	13	5.0	2	25+TT	8-TT
88	23	0	3.0	6	0	17	5.0	2	25+TT	12-TT
89	23	0	3.0	5	0	18	4.0	2	25+TT	14-TT
90	23	0	3.0	4	0	19	3.5	2	25+TT	15.5-TT
91	23	0	3.0	7.5	0	15.5	5.0	2	25+TT	10.5-TT
92	23	0	3.0	10	0	13	5.0	2	25+TT	8-TT
93	23	0	3.0	6	0	17	5.0	2	25+TT	12-TT
94	23	0	3.0	5	0	18	4.0	2	25+TT	14-TT
95	23	0	3.0	4	0	19	3.5	2	25+TT	15.5-TT
96	23	0	3.0	10	0	13	5.0	2	25+TT	8-TT
97	23	0	3.0	6	0	17	5.0	2	25+TT	12-TT
98	23	0	3.0	5	0	18	4.0	2	25+TT	14-TT
99	23	0	3.0	10	0	13	5.0	2	25+TT	8-TT
100	23	0	3.0	5	0	18	4.0	2	25+TT	14-TT
101	23	0	3.0	4	0	19	3.5	2	25+TT	15.5-TT
102	23	0	3.0	10	0	13	5.0	2	25+TT	8-TT
103	23	0	3.0	6	0	17	5.0	2	25+TT	12-TT
104	23	0	3.0	5	0	18	4.0	2	25+TT	14-TT
105	23	0	3.0	4	0	19	3.5	2	25+TT	15.5-TT
106	23	0	3.5	8	0	15	5.0	2	25+TT	10-TT
107	23	0	3.5	11	0	12	6.0	2	25+TT	6-TT
108	23	0	3.5	6	0	17	5.0	2	25+TT	12-TT
109	23	0	3.5	5	0	18	4.0	2	25+TT	14-TT

Test ID	P _{PowerClass} (dBm)	ΔP _{PowerClass} (dB)	MPR (dB)	A-MPR (dB)	ΔT _{C,c} (dB)	P _{CMAX_L,c} (dBm)	T(P _{CMAX_L,c}) (dB)	T _{L,c} (dB)	Upper limit (dBm)	Lower limit (dBm)
110	23	0	3.5	4	0	19	3.5	2	25+TT	15.5-TT
111	23	0	3.5	11	0	12	6.0	2	25+TT	6-TT
112	23	0	3.5	6	0	17	5.0	2	25+TT	12-TT
113	23	0	3.5	5	0	18	4.0	2	25+TT	14-TT
114	23	0	3.5	11	0	12	6.0	2	25+TT	6-TT
115	23	0	3.5	5	0	18	4.0	2	25+TT	14-TT
116	23	0	3.5	4	0	19	3.5	2	25+TT	15.5-TT
117	23	0	3.5	11	0	12	6.0	2	25+TT	6-TT
118	23	0	3.5	6	0	17	5.0	2	25+TT	12-TT
119	23	0	3.5	5	0	18	4.0	2	25+TT	14-TT
120	23	0	3.5	4	0	19	3.5	2	25+TT	15.5-TT
121	23	0	6.5	10	0	13	5.0	2	25+TT	8-TT
122	23	0	6.5	13	0	10	6.0	2	25+TT	4-TT
123	23	0	6.5	6.5	0	16.5	5.0	2	25+TT	11.5-TT
124	23	0	6.5	6.5	0	16.5	5.0	2	25+TT	11.5-TT
125	23	0	6.5	13	0	10	6.0	2	25+TT	4-TT
126	23	0	6.5	6.5	0	16.5	5.0	2	25+TT	11.5-TT
127	23	0	6.5	13	0	10	6.0	2	25+TT	4-TT
128	23	0	6.5	6.5	0	16.5	5.0	2	25+TT	11.5-TT
129	23	0	6.5	13	0	10	6.0	2	25+TT	4-TT
130	23	0	6.5	6.5	0	16.5	5.0	2	25+TT	11.5-TT
131	23	0	6.5	6.5	0	16.5	5.0	2	25+TT	11.5-TT

NOTE 1: P_{PowerClass} is the maximum UE power specified without taking into account the tolerance.

NOTE 2: TT for each frequency and channel bandwidth is specified in Table 6.2.3.5-0.

Table 6.2C.5.5-7: UE Power Class 3 test requirements (NS_100) for band n84

Test ID	P _{PowerClass} (dBm)	MPR (dB)	A-MPR (dB)	ΔT _{C,c} (dB)	P _{CMAX_L,c} (dBm)	T(P _{CMAX_L,c}) (dB)	T _{L,c} (dB)	Upper limit (dBm)	Lower limit (dBm)
1, 2	23	0.5	2	0	21	2	2	25+TT	19-TT
3	23	0.5	2	0	21	2	2	25+TT	19-TT
4, 5	23	1	1	0	21	2	2	25+TT	19-TT
6	23	1	1	0	21	2	2	25+TT	19-TT
7, 8	23	2	2.5	0	20.5	2.5	2	25+TT	18-TT
9	23	2	2.5	0	20.5	2.5	2	25+TT	18-TT
10, 11	23	2.5	3	0	20	2.5	2	25+TT	17.5-TT
12	23	2.5	3	0	20	2.5	2	25+TT	17.5-TT
13, 14	23	4.5	4.5	0	18.5	4	2	25+TT	14.5-TT
15	23	4.5	4.5	0	18.5	4	2	25+TT	14.5-TT
16, 17	23	3	4	0	19	3.5	2	25+TT	15.5-TT
18	23	3	4	0	19	3.5	2	25+TT	15.5-TT
19, 20	23	3	4	0	19	3.5	2	25+TT	15.5-TT
21	23	3	4	0	19	3.5	2	25+TT	15.5-TT
22, 23	23	3.5	4	0	19	3.5	2	25+TT	15.5-TT
24	23	3.5	4	0	19	3.5	2	25+TT	15.5-TT
25, 26	23	6.5	6.5	0	16.5	5	2	25+TT	11.5-TT
27	23	6.5	6.5	0	16.5	5	2	25+TT	11.5-TT

NOTE 1: P_{PowerClass} is the maximum UE power specified without taking into account the tolerance.

NOTE 2: TT for each frequency and channel bandwidth is specified in Table 6.2.3.5-0.

Table 6.2C.5.5-8: UE Power Class 3 test requirements (NS_56) for band n99

Test ID	P _{PowerClass} (dBm)	MPR (dB)	A-MPR (dB)	$\Delta T_{C,c}$ (dB)	P _{C_{MAX,c}} (dBm)	T(P _{C_{MAX,L,c}}) (dB)	T _{L,c} (dB)	Upper limit (dBm)	Lower limit (dBm)
1	23	0.5	14	0	9	6	3	25+TT	3-TT
2	23	0.5	6	0	17	5	3	25+TT	12-TT
3	23	0.5	4	0	19	3.5	3	25+TT	15.5-TT
4	23	0	4	0	19	3.5	3	25+TT	15.5-TT
5	23	1	14	0	9	6	3	25+TT	3-TT
6	23	1	6	0	17	5	3	25+TT	12-TT
7	23	1	4	0	19	3.5	3	25+TT	15.5-TT
8	23	0	4	0	19	3.5	3	25+TT	15.5-TT
9	23	2	14	0	9	6	3	25+TT	3-TT
10	23	2	6	0	17	5	3	25+TT	12-TT
11	23	2	4	0	19	3.5	3	25+TT	15.5-TT
12	23	1	4	0	19	3.5	3	25+TT	15.5-TT
13	23	2.5	14	0	9	6	3	25+TT	3-TT
14	23	2.5	6	0	17	5	3	25+TT	12-TT
15	23	2.5	4	0	19	3.5	3	25+TT	15.5-TT
16	23	2.5	4	0	19	3.5	3	25+TT	15.5-TT
17	23	4.5	14	0	9	6	3	25+TT	3-TT
18	23	4.5	6	0	17	5	3	25+TT	12-TT
19	23	4.5	4	0	18.5	3.5	3	25+TT	15-TT
20	23	4.5	4	0	18.5	3.5	3	25+TT	15-TT
21	23	0.5	12	0	11	6	3	25+TT	5-TT
22	23	0.5	8	0	15	5	3	25+TT	10-TT
23	23	0	6	0	17	5	3	25+TT	12-TT
24	23	0.5	6	0	17	5	3	25+TT	12-TT
25	23	0	4	0	19	3.5	3	25+TT	15.5-TT
26	23	0.5	2	0	21	2	3	25+TT	18-TT
27	23	0.5	5	0	18	4	3	25+TT	14-TT
28	23	0	5	0	18	4	3	25+TT	14-TT
29	23	0.5	3	0	20	2.5	3	25+TT	17-TT
30	23	1	12	0	11	6	3	25+TT	5-TT
31	23	1	8	0	15	5	3	25+TT	10-TT
32	23	0	6	0	17	5	3	25+TT	12-TT
33	23	1	6	0	17	5	3	25+TT	12-TT
34	23	0	4	0	19	3.5	3	25+TT	15.5-TT
35	23	1	2	0	21	2	3	25+TT	18-TT
36	23	1	5	0	18	4	3	25+TT	14-TT
37	23	0	5	0	18	4	3	25+TT	14-TT
38	23	1	3	0	20	2.5	3	25+TT	17-TT
39	23	2	12	0	11	6	3	25+TT	5-TT
40	23	2	8	0	15	5	3	25+TT	10-TT
41	23	1	6	0	17	5	3	25+TT	12-TT
42	23	2	6	0	17	5	3	25+TT	12-TT
43	23	1	4	0	19	3.5	3	25+TT	15.5-TT
44	23	2	2	0	21	2	3	25+TT	18-TT
45	23	2	5	0	18	4	3	25+TT	14-TT
46	23	1	5	0	18	4	3	25+TT	14-TT
47	23	2	3	0	20	2.5	3	25+TT	17-TT
48	23	2.5	12	0	11	6	3	25+TT	5-TT
49	23	2.5	8	0	15	5	3	25+TT	10-TT
50	23	2.5	6	0	17	5	3	25+TT	12-TT
51	23	2.5	6	0	17	5	3	25+TT	12-TT
52	23	2.5	4	0	19	3.5	3	25+TT	15.5-TT
53	23	2.5	2	0	20.5	2.5	3	25+TT	17.5-TT
54	23	2.5	5	0	18	4	3	25+TT	14-TT
55	23	2.5	5	0	18	4	3	25+TT	14-TT
56	23	2.5	3	0	20	2.5	3	25+TT	17-TT
57	23	4.5	12	0	11	6	3	25+TT	5-TT

Test ID	P _{PowerClass} (dBm)	MPR (dB)	A-MPR (dB)	$\Delta T_{C,c}$ (dB)	P _{C_{MAX,c}} (dBm)	T(P _{C_{MAX,L,c}}) (dB)	T _{L,c} (dB)	Upper limit (dBm)	Lower limit (dBm)
58	23	4.5	8	0	15	5	3	25+TT	10-TT
59	23	4.5	6	0	17	5	3	25+TT	12-TT
60	23	4.5	6	0	17	5	3	25+TT	12-TT
61	23	4.5	4	0	18.5	4	3	25+TT	14.5-TT
62	23	4.5	2	0	18.5	4	3	25+TT	14.5-TT
63	23	4.5	5	0	18	4	3	25+TT	14-TT
64	23	4.5	5	0	18	4	3	25+TT	14-TT
65	23	4.5	3	0	18.5	4	3	25+TT	14.5-TT
66	23	3	14	0	9	6	3	25+TT	3-TT
67	23	3	6	0	17	5	3	25+TT	12-TT
68	23	3	4	0	19	3.5	3	25+TT	15.5-TT
69	23	1.5	4	0	19	3.5	3	25+TT	15.5-TT
70	23	3	14	0	9	6	3	25+TT	3-TT
71	23	3	6	0	17	5	3	25+TT	12-TT
72	23	3	4	0	19	3.5	3	25+TT	15.5-TT
73	23	2	4	0	19	3.5	3	25+TT	15.5-TT
74	23	3.5	14	0	9	6	3	25+TT	3-TT
75	23	3.5	6	0	17	5	3	25+TT	12-TT
76	23	3.5	4	0	19	3.5	3	25+TT	15.5-TT
77	23	3.5	4	0	19	3.5	3	25+TT	15.5-TT
78	23	6.5	14	0	9	6	3	25+TT	3-TT
79	23	6.5	6	0	16.5	5	3	25+TT	11.5-TT
80	23	6.5	4	0	16.5	5	3	25+TT	11.5-TT
81	23	6.5	4	0	16.5	5	3	25+TT	11.5-TT
82	23	3	12	0	11	6	3	25+TT	5-TT
83	23	3	8	0	15	5	3	25+TT	10-TT
84	23	1.5	6	0	17	5	3	25+TT	12-TT
85	23	3	6	0	17	5	3	25+TT	12-TT
86	23	1.5	4	0	19	3.5	3	25+TT	15.5-TT
87	23	3	2	0	20	2.5	3	25+TT	17-TT
88	23	3	5	0	18	4	3	25+TT	14-TT
89	23	1.5	5	0	18	4	3	25+TT	14-TT
90	23	3	3	0	20	2.5	3	25+TT	17-TT
91	23	3	12	0	11	6	3	25+TT	5-TT
92	23	3	8	0	15	5	3	25+TT	10-TT
93	23	2	6	0	17	5	3	25+TT	12-TT
94	23	3	6	0	17	5	3	25+TT	12-TT
95	23	2	4	0	19	3.5	3	25+TT	15.5-TT
96	23	3	2	0	20	2.5	3	25+TT	17-TT
97	23	3	5	0	18	4	3	25+TT	14-TT
98	23	2	5	0	18	4	3	25+TT	14-TT
99	23	3	3	0	20	2.5	3	25+TT	17-TT
100	23	3.5	12	0	11	6	3	25+TT	5-TT
101	23	3.5	8	0	15	5	3	25+TT	10-TT
102	23	3.5	6	0	17	5	3	25+TT	12-TT
103	23	3.5	6	0	17	5	3	25+TT	12-TT
104	23	3.5	4	0	19	3.5	3	25+TT	15.5-TT
105	23	3.5	2	0	19.5	3.5	3	25+TT	16-TT
106	23	3.5	5	0	18	3.5	3	25+TT	14.5-TT
107	23	3.5	5	0	18	3.5	3	25+TT	14.5-TT
108	23	3.5	3	0	19.5	3.5	3	25+TT	16-TT
109	23	6.5	12	0	11	6	3	25+TT	5-TT

Test ID	P _{PowerClass} (dBm)	MPR (dB)	A-MPR (dB)	$\Delta T_{C,c}$ (dB)	P _{C_{MAX,c}} (dBm)	T(P _{C_{MAX,L,c}}) (dB)	T _{L,c} (dB)	Upper limit (dBm)	Lower limit (dBm)
110	23	6.5	8	0	15	5	3	25+TT	10-TT
111	23	6.5	6	0	16.5	5	3	25+TT	11.5-TT
112	23	6.5	6	0	16.5	5	3	25+TT	11.5-TT
113	23	6.5	4	0	16.5	5	3	25+TT	11.5-TT
114	23	6.5	2	0	16.5	5	3	25+TT	11.5-TT
115	23	6.5	5	0	16.5	5	3	25+TT	11.5-TT
116	23	6.5	5	0	16.5	5	3	25+TT	11.5-TT
117	23	6.5	3	0	16.5	5	3	25+TT	11.5-TT

NOTE 1: P_{PowerClass} is the maximum UE power specified without taking into account the tolerance.
NOTE 2: TT for each frequency and channel bandwidth is specified in Table 6.2.3.5-0.

For the UE which supports inter-band NR CA configuration, inter-band NR-DC configuration, SUL configuration or inter-band EN-DC configuration, $\Delta T_{IB,c}$ as specified in 6.2A.4.0.2 for NR CA, 6.2B.4.0.2 for NR-DC, clause 6.2C.2 for SUL, or TS 38.521-3 [14] clause 6.2B.4.2 for EN-DC applies. Unless otherwise stated, $\Delta T_{IB,c}$ is set to zero. In case the UE supports more than one of band combinations for CA, NR-DC, SUL or DC, and an operating band belongs to more than one band combinations then

- a) When the operating band frequency range is ≤ 1 GHz, the applicable additional $\Delta T_{IB,c}$ shall be the average value for all band combinations defined in clause 6.2A.4.0.2, 6.2B.4.0.2, 6.2C.2 in this specification and 6.2B.4.2 in TS 38.521-3 [14], truncated to one decimal place that apply for that operating band among the supported band combinations. In case there is a harmonic relation between low band UL and high band DL, then the maximum $\Delta T_{IB,c}$ among the different supported band combinations involving such band shall be applied
- b) When the operating band frequency range is > 1 GHz, the applicable additional $\Delta T_{IB,c}$ shall be the maximum value for all band combinations defined in clause 6.2A.4.0.2, 6.2B.4.0.2, 6.2C.2 in this specification and 6.2B.4.2 in TS 38.521-3 [14] for the applicable operating bands.

6.2D Transmitter power for UL MIMO

6.2D.1 UE maximum output power for UL MIMO

Editor's Note:

- No test points are defined for 2-layer UL MIMO since there is no configuration satisfying MPR=0dB requirements in RAN4. Testing with 1.5dB MPR as recommended by RAN4 has been covered in 6.2D.2.
- Implementation to verify '*If UE is configured for transmission on single-antenna port, the requirements in clause 6.2.1 apply*' is still under discussion.

6.2D.1.1 Test purpose

To verify that the error of the UE maximum output power for UL MIMO does not exceed the range prescribed by the specified nominal maximum output power and tolerance.

An excess maximum output power has the possibility to interfere to other channels or other systems. A small maximum output power decreases the coverage area.

6.2D.1.2 Test applicability

This test case applies to all types of NR UE release 15 and forward that support UL MIMO.

6.2D.1.3 Minimum conformance requirements

For UE with two transmit antenna connectors in closed-loop spatial multiplexing scheme, the maximum output power for any transmission bandwidth within the channel bandwidth is specified in Table 6.2D.1.3-1. The requirements shall be met with the UL MIMO configurations specified in Table 6.2D.1.3-2. For UE supporting UL MIMO, the maximum output power is defined as the sum of the maximum output power from both UE antenna connectors. The period of measurement shall be at least one sub frame (1ms).

The requirements shall be met with the UL MIMO configurations of using 2-layer UL MIMO transmission with

codebook of $\frac{1}{\sqrt{2}} \begin{bmatrix} 1 & 0 \\ 0 & 1 \end{bmatrix}$. DCI Format for UE configured in PUSCH transmission mode for uplink single-user MIMO shall be used.

Table 6.2D.1.3-1: UE Power Class for UL MIMO in closed loop spatial multiplexing scheme

NR band	Class 1 (dBm)	Tolerance (dB)	Class 1.5 (dBm)	Tolerance (dB)	Class 2 (dBm)	Tolerance (dB)	Class 3 (dBm)	Tolerance (dB)	Class 4 (dBm)	Tolerance (dB)
n1							23	+2/-3		
n2							23	+2/-3 ¹		
n3							23	+2/-3 ¹		
n7							23	+2/-3 ¹		
n25							23	+2/-3 ¹		
n30							23	+2/-3		
n34					26	+2/-3	23	+2/-3		
n38							23	+2/-3		
n39					26	+2/-3	23	+2/-3		
n40							23	+2/-3		
n41			29	+2/-3 ¹	26	+2/-3 ¹	23	+2/-3 ¹		
n48							23	+2/-3		
n66							23	+2/-3		
n70							23	+2/-3		
n71							23	+2/-3		
n77			29	+2/-3	26	+2/-3	23	+2/-3		
n78			29	+2/-3	26	+2/-3	23	+2/-3		
n79			29	+2/-3	26	+2/-3	23	+2/-3		
n97							23	+2/-3		

NOTE 1: ¹ refers to the transmission bandwidths confined within F_{UL_low} and $F_{UL_low} + 4$ MHz or $F_{UL_high} - 4$ MHz and F_{UL_high} , the maximum output power requirement is relaxed by reducing the lower tolerance limit by 1.5 dB.

NOTE 2: Power class 3 is the default power class unless otherwise stated.

Table 6.2D.1.3-2: UL MIMO configuration in closed-loop spatial multiplexing scheme

Transmission scheme	DCI format	Number of layers	TPMI index
Codebook based uplink	DCI format 0_1	2	0

NOTE 1: The UE is configured with one SRS resource with the parameter *nrofSRS-Ports* set to 2.

For UEs supporting uplink full power transmission (ULFPTx) for UL MIMO, the maximum output power requirements specified in Table 6.2D.1.3-1 shall be met with the PUSCH configurations specified in Table 6.2D.1.3-3, based upon UE's support of uplink full power transmission mode.

Table 6.2D.1.3-3: PUSCH Configuration for uplink full power transmission (ULFPTx)

ULFPTx Mode	Transmission scheme	DCI format	Modulation	Number of layers	Number of Tx Port	TPMI index
Mode-1	Codebook based uplink	DCI format 0_1	DFT-s-OFDM, CP-OFDM ^{NOTE3}	1	2	2
Mode-2	Codebook based uplink	DCI format 0_1	DFT-s-OFDM, CP-OFDM	1	2	0 or 1 ^{NOTE2}
Mode-full power	Codebook based uplink	DCI format 0_1	DFT-s-OFDM, CP-OFDM	1	2	0,1

NOTE 1: The UE is configured with one SRS resource with the parameter *nrofSRS-Ports* set to 2.

NOTE 2: TPMI index selected shall be based upon the full power TPMI reported by the UE [9].

NOTE 3: For PUSCH configured with ULFPTx Mode set to Mode-1, all the transmitter requirement for CP-OFDM based modulation is not needed to be verified if the requirement for UL MIMO has been validated.

If the UE is scheduled for single antenna-port PUSCH transmission by DCI format 0_0 or by DCI format 0_1 for single antenna port codebook based transmission, the requirements in clause 6.2 apply for at least one antenna connector for the power class as indicated by the *ue-PowerClass* field in capability signalling with the following exception: for UEs indicating *txDiversity-r16*, the requirements in clause 6.2G for the power class indicated by the *ue-PowerClass*.

A UE indicating the feature *ul-FullPwrMode-r16* or *ul-FullPwrMode2-TPMIGroup-r16* for a band shall meet the requirement in clause 6.2 for at least one antenna connector when scheduled for single antenna-port transmission by DCI format 0_0 or by DCI format 0_1 for codebook-based transmission on a single antenna port.

The normative reference for this requirement is TS 38.101-1 [2] clause 6.2D.1.

6.2D.1.4 Test description

6.2D.1.4.1 Initial conditions

Initial conditions are a set of test configurations the UE needs to be tested in and the steps for the SS to take with the UE to reach the correct measurement state.

The initial test configurations consist of environmental conditions, test frequencies, test channel bandwidths and sub-carrier spacing based on NR operating bands specified in table 5.3.5-1. All of these configurations shall be tested with applicable test parameters for each combination of test channel bandwidth and sub-carrier spacing, and are shown in Table 6.2D.1.4.1-1 and Table 6.2D.1.4.1-2. The details of the uplink reference measurement channels (RMCs) are specified in Annexes A.2. Configurations of PDSCH and PDCCH before measurement are specified in Annex C.2.

Table 6.2D.1.4.1-1: Test Configuration Table for 2-layer UL MIMO

NOTE: No test points are defined since there is no configuration satisfying MPR=0dB requirements in RAN4.

Table 6.2D.1.4.1-2: Test Configuration Table for uplink full power transmission (ULFPTx)

Initial Conditions			
Test Environment as specified in TS 38.508-1 [5] subclause 4.1		Normal, TL/VL, TL/VH, TH/VL, TH/VH	
Test Frequencies as specified in TS 38.508-1 [5] subclause 4.3.1		Low range, Mid range, High range	
Test Channel Bandwidths as specified in TS 38.508-1 [5] subclause 4.3.1		Lowest, Mid, Highest	
Test SCS as specified in Table 5.3.5-1		Lowest, Highest	
Test Parameters			
Test ID	Downlink Configuration	Uplink Configuration	
	N/A for maximum output power test case	Modulation (NOTE 2)	RB allocation (NOTE 1)
1		DFT-s-OFDM PI/2 BPSK	Inner Full
2		DFT-s-OFDM PI/2 BPSK	Inner 1RB Left
3		DFT-s-OFDM PI/2 BPSK	Inner 1RB Right
4		DFT-s-OFDM QPSK	Inner Full
5		DFT-s-OFDM QPSK	Inner 1RB Left
6		DFT-s-OFDM QPSK	Inner 1RB Right
NOTE 1: The specific configuration of each RB allocation is defined in Table 6.1-1.			
NOTE 2: DFT-s-OFDM PI/2 BPSK test applies only for UEs which supports half Pi BPSK in FR1.			

1. Connect the SS to the UE antenna connectors as shown in TS 38.508-1 [5] Annex A, Figure A.3.1.1.2 for TE diagram and section A.3.2 for UE diagram.
2. The parameter settings for the cell are set up according to TS 38.508-1 [5] subclause 4.4.3.
3. Downlink signals are initially set up according to Annex C.0, C.1, C.2, and uplink signals according to Annex G.0, G.1, G.2, G.3.0.
4. The UL Reference Measurement Channel is set according to Table 6.2D.1.4.1-1 and Table 6.2D.1.4.1-2.
5. Propagation conditions are set according to Annex B.0.
6. Ensure the UE is in state RRC_CONNECTED with generic procedure parameters Connectivity *NR*, Connected without release *On*, Test Mode *On* and Test Loop Function *On* according to TS 38.508-1 [5] clause 4.5. Message contents are defined in clause 6.2D.1.4.3.

6.2D.1.4.2 Test procedure

1. SS sends uplink scheduling information for each UL HARQ process via PDCCH DCI format 0_1 for C_RNTI to schedule the UL RMC according to Table 6.2D.1.4.1-1. Since the UE has no payload and no loopback data to send the UE sends uplink MAC padding bits on the UL RMC. The PDCCH DCI format 0_1 is specified with the condition 2TX_UL_MIMO in 38.508-1 [5] subclause 4.3.6.1.1.2.
2. Send continuously uplink power control "up" commands in every uplink scheduling information to the UE; allow at least 200ms starting from the first TPC command in this step for the UE to reach P_{UMAX} level.

3. Measure the sum of the mean power of the UE at each transmit antenna connector in the channel bandwidth of the radio access mode. The period of measurement shall be at least the continuous duration of 1ms over all active uplink slots and in the uplink symbols. For TDD slots only slots consisting of only UL symbols are under.
4. If UE supports ULFPTx, repeat test steps 1~3 with UL RMC according to Table 6.2D.1.4.1-2. The PDCCH DCI format 0_1 is specified with the condition ULFPTx_Mode1, ULFPTx_Mode2 or ULFPTx_ModeFull in 38.508-1 [5] subclause 4.3.6.1.1.2 depending on UE reported capability. Message contents are according to TS 38.508-1 [5] clause 4.6.3 Table 4.6.3-118 with condition TRANSFORM_PRECODER_ENABLED.

6.2D.1.4.3 Message contents

Message contents are according to TS 38.508-1 [5] subclause 4.6 and 5.4 ensuring Table 4.6.3-182 with the condition 2TX_UL_MIMO.

6.2D.1.5 Test requirement

The maximum output power, derived in step 3 or step 4 shall be within the range prescribed by the nominal maximum output power and tolerance in Table 6.2D.1.5-1.

Table 6.2D.1.5-1: UE Power Class

NR band	Class 1 (dBm)	Tolerance (dB)	Class 1.5 (dBm)	Tolerance (dB)	Class 2 (dBm)	Tolerance (dB)	Class 3 (dBm)	Tolerance (dB)	Class 4 (dBm)	Tolerance (dB)
n1							23	+2+TT/-3-TT		
n2							23	+2+TT/-3 ¹ -TT		
n3							23	+2+TT/-3 ¹ -TT		
n7							23	+2+TT/-3 ¹ -TT		
n25							23	+2+TT/-3 ¹ -TT		
n30							23	+2+TT/-3-TT		
n34					26	+2+TT/-3-TT	23	+2+TT/-3-TT		
n38							23	+2+TT/-3-TT		
n39					26	+2+TT/-3-TT	23	+2+TT/-3-TT		
n40							23	+2+TT/-3-TT		
n41			29	+2+TT/-3 ¹ -TT	26	+2+TT/-3 ¹ -TT	23	+2+TT/-3 ¹ -TT		
n48							23	+2+TT/-3-TT		
n66							23	+2+TT/-3-TT		
n70							23	+2+TT/-3-TT		
n71							23	+2+TT/-3-TT		
n77			29	+2+TT/-3-TT	26	+2+TT/-3-TT	23	+2+TT/-3-TT		
n78			29	+2+TT/-3-TT	26	+2+TT/-3-TT	23	+2+TT/-3-TT		
n79			29	+2+TT/-3-TT	26	+2+TT/-3-TT	23	+2+TT/-3-TT		
n97							23	+2+TT/-3-TT		

NOTE 1: ¹ refers to the transmission bandwidths confined within F_{UL_low} and $F_{UL_low} + 4$ MHz or $F_{UL_high} - 4$ MHz and F_{UL_high} , the maximum output power requirement is relaxed by reducing the lower tolerance limit by 1.5 dB

NOTE 2: TT for each frequency and channel bandwidth is specified in Table 6.2D.1.5-2

Table 6.2D.1.5-2: Test Tolerance (UE maximum output power)

	$f \leq 3.0\text{GHz}$	$3.0\text{GHz} < f \leq 6.0\text{GHz}$
BW \leq 40MHz	0.7 dB	1.0 dB
40MHz < BW \leq 100MHz	1.0 dB	1.0 dB

For the UE which supports inter-band NR CA configuration, inter-band NR-DC configuration, SUL configuration or inter-band EN-DC configuration, $\Delta T_{IB,c}$ as specified in 6.2A.4.0.2 for NR CA, 6.2B.4.0.2 for NR-DC, clause 6.2C.2 for SUL, or TS 38.521-3 [14] clause 6.2B.4.2 for EN-DC applies. Unless otherwise stated, $\Delta T_{IB,c}$ is set to zero. In case the UE supports more than one of band combinations for CA, NR-DC, SUL or DC, and an operating band belongs to more than one band combinations then

- a) When the operating band frequency range is ≤ 1 GHz, the applicable additional $\Delta T_{IB,c}$ shall be the average value for all band combinations defined in clause 6.2A.4.0.2, 6.2B.4.0.2, 6.2C.2 in this specification and 6.2B.4.2 in TS 38.521-3 [14], truncated to one decimal place that apply for that operating band among the supported band combinations. In case there is a harmonic relation between low band UL and high band DL, then the maximum $\Delta T_{IB,c}$ among the different supported band combinations involving such band shall be applied.
- b) When the operating band frequency range is > 1 GHz, the applicable additional $\Delta T_{IB,c}$ shall be the maximum value for all band combinations defined in clause 6.2A.4.0.2, 6.2B.4.0.2, 6.2C.2 in this specification and 6.2B.4.2 in TS 38.521-3 [14] for the applicable operating bands.

6.2D.2 UE maximum output power reduction for UL MIMO

Editor's Note:

- Requirement of PC2 is pending in RAN4. MPR for UL MIMO for PC2 is incomplete and cannot be tested.
- The test case is not completed for Rel-16 ULFPTx UE due to the following aspects are not yet determined:
 - Test requirements for PC 2 are missing

6.2D.2.1 Test purpose

To verify that the power reduction of UE due to higher order modulations and transmit bandwidth configuration does not exceed the specified maximum power reduction.

6.2D.2.2 Test applicability

This test case applies to all types of NR UE release 15 and forward that support UL MIMO.

NOTE: Test execution is not necessary if TS 38.521-1 6.5D.2.4.1 is executed.

6.2D.2.3 Minimum conformance requirements

For UE with two transmit antenna connectors in closed-loop spatial multiplexing scheme, the allowed Maximum Power Reduction (MPR) for the maximum output power in Table 6.2D.1.3-1 is specified in Table 6.2.2.3-1 for PC3, Table 6.2D.2.3-1 for 2Tx PC2, Table 6.2D.2.3-2 and Table 6.2D.2.3-3 for PC1.5 respectively. For UE power class 1.5, the allowed maximum power reduction (MPR) defined in Table 6.2D.2.3-3 is in accordance with the indicated *modifiedMPR-Behavior* specified in Table L.1-1 for channel bandwidths ≤ 100 MHz. The requirements shall be met with UL MIMO configurations defined in Table 6.2D.1.3-2. For UE supporting UL MIMO, the maximum output power is defined as the sum of the maximum output power from both antenna connectors.

For UE support uplink full power transmission (ULFPTx) for UL MIMO, the allowed MPR for the maximum output power in Table 6.2D.1.3-1 is specified in Table 6.2.2.3-1, and the requirements shall be met with the PUSCH configurations specified in Table 6.2D.1.3-3, based upon UE's support of uplink full power transmission mode.

For the UE maximum output power modified by MPR, the power limits specified in subclause 6.2D.4.3 apply.

If UE is configured for transmission on single antenna-port PUSCH transmission by DCI format 0_0 or by DCI format 0_1 for single antenna port codebook based transmission, the requirements in subclause 6.2.2.3 apply for the power class as indicated by the *ue-PowerClass* field in capability signalling.

Table 6.2D.2.3-1 Maximum power reduction (MPR) for power class 2 with dual Tx

Modulation		MPR (dB)		
		Edge RB allocations	Outer RB allocations	Inner RB allocations
DFT-s-OFDM	Pi/2 BPSK	≤ 3.5	≤ 1	0
	QPSK	≤ 3.5	≤ 2	0.5
	16 QAM	≤ 3.5	≤ 2.5	≤ 1.5
	64 QAM	≤ 3.5	≤ 3	
	256 QAM	≤ 5.5		
CP-OFDM	QPSK	≤ 4.0	≤ 3.5	≤ 2
	16 QAM	≤ 4.0	≤ 3.5	≤ 2.5
	64 QAM	≤ 4.5		
	256 QAM	≤ 8.0		

Table 6.2D.2.3-2 Maximum power reduction (MPR) for power class 1.5 with dual Tx

Modulation		MPR (dB)		
		Edge RB allocations	Outer RB allocations	Inner RB allocations
DFT-s-OFDM	Pi/2 BPSK	≤ 6	$\leq [2]$	≤ 0.5
	QPSK	≤ 6.5	$\leq [2.5]$	≤ 0.5
	16 QAM	≤ 6.5	$\leq [3.5]$	≤ 1.5
	64 QAM	≤ 6.5	$\leq [4]$	≤ 3.5
	256 QAM	≤ 6.5	≤ 6.5	$\leq [6.5]$
CP-OFDM	QPSK	≤ 6.5	$\leq [4.5]$	≤ 2
	16 QAM	≤ 6.5	$\leq [4.5]$	≤ 2.5
	64 QAM	≤ 6.5	$\leq [5]$	≤ 4.5
	256 QAM	≤ 8.5	≤ 8.5	$\leq [8.5]$

Table 6.2D.2.3-3 Maximum power reduction (MPR) for power class 1.5 with dual Tx

Modulation		MPR (dB)		
		Edge RB allocations	Outer RB allocations	Inner RB allocations
DFT-s-OFDM	Pi/2 BPSK	≤ 6	≤ 1.5	≤ 0
	QPSK	≤ 6.5	≤ 2	≤ 0
	16 QAM	≤ 6.5	≤ 3	≤ 1
	64 QAM	≤ 6.5	≤ 3.5	≤ 3
	256 QAM	≤ 6.5	≤ 5.5	≤ 5.5
CP-OFDM	QPSK	≤ 6.5	≤ 4	≤ 1.5
	16 QAM	≤ 6.5	≤ 4	≤ 2
	64 QAM	≤ 6.5	≤ 4.5	≤ 4
	256 QAM	≤ 7.5	≤ 7.5	≤ 7.5

NOTE 1: This table is targeted to large FWA form factor with 20 dB or above antenna isolation.

Inner, outer and edge allocations are as defined in section 6.2.2 except for PC1.5 edge allocations which is for $L_{CRB} \leq 4$ RBs instead of $L_{CRB} \leq 2$ RBs for other power classes. The normative reference for this requirement is TS 38.101-1 [2] clause 6.2D.2.

6.2D.2.4 Test description

6.2D.2.4.1 Initial conditions

Initial conditions are a set of test configurations the UE needs to be tested in and the steps for the SS to take with the UE to reach the correct measurement state.

The initial test configurations consist of environmental conditions, test frequencies, test channel bandwidths and sub-carrier spacing based on NR operating bands specified in table 5.3.5-1. All of these configurations shall be tested with applicable test parameters for each combination of test channel bandwidth and sub-carrier spacing, and are shown in table 6.2D.2.4.1-1. The details of the uplink reference measurement channels (RMCs) are specified in Annexes A.2. Configurations of PDSCH and PDCCH before measurement are specified in Annex C.2.

Table 6.2D.2.4.1-1: Test Configuration Table for Power Class 3

Initial Conditions																																	
Test Environment as specified in TS 38.508-1 [5] subclause 4.1		Normal, TL/VL, TL/VH, TH/VL, TH/VH																															
Test Frequencies as specified in TS 38.508-1 [5] subclause 4.3.1		Low range, High range																															
Test Channel Bandwidths as specified in TS 38.508-1 [5] subclause 4.3.1		Lowest, Highest																															
Test SCS as specified in Table 5.3.5-1		Lowest and Highest																															
Test Parameters for Channel Bandwidths																																	
Test ID	Freq	Downlink Configuration	Uplink Configuration																														
		N/A	<table border="1"> <thead> <tr> <th>Modulation</th> <th>RB allocation (NOTE 1)</th> </tr> </thead> <tbody> <tr> <td>CP-OFDM QPSK</td> <td>Inner Full</td> </tr> <tr> <td>CP-OFDM QPSK</td> <td>Edge_1RB_Left</td> </tr> <tr> <td>CP-OFDM QPSK</td> <td>Edge_1RB_Right</td> </tr> <tr> <td>CP-OFDM QPSK</td> <td>Outer Full</td> </tr> <tr> <td>CP-OFDM 16 QAM</td> <td>Inner Full</td> </tr> <tr> <td>CP-OFDM 16 QAM</td> <td>Edge_1RB_Left</td> </tr> <tr> <td>CP-OFDM 16 QAM</td> <td>Edge_1RB_Right</td> </tr> <tr> <td>CP-OFDM 16 QAM</td> <td>Outer Full</td> </tr> <tr> <td>CP-OFDM 64 QAM</td> <td>Edge_1RB_Left</td> </tr> <tr> <td>CP-OFDM 64 QAM</td> <td>Edge_1RB_Right</td> </tr> <tr> <td>CP-OFDM 64 QAM</td> <td>Outer Full</td> </tr> <tr> <td>CP-OFDM 256 QAM</td> <td>Edge_1RB_Left</td> </tr> <tr> <td>CP-OFDM 256 QAM</td> <td>Edge_1RB_Right</td> </tr> <tr> <td>CP-OFDM 256 QAM</td> <td>Outer Full</td> </tr> </tbody> </table>	Modulation	RB allocation (NOTE 1)	CP-OFDM QPSK	Inner Full	CP-OFDM QPSK	Edge_1RB_Left	CP-OFDM QPSK	Edge_1RB_Right	CP-OFDM QPSK	Outer Full	CP-OFDM 16 QAM	Inner Full	CP-OFDM 16 QAM	Edge_1RB_Left	CP-OFDM 16 QAM	Edge_1RB_Right	CP-OFDM 16 QAM	Outer Full	CP-OFDM 64 QAM	Edge_1RB_Left	CP-OFDM 64 QAM	Edge_1RB_Right	CP-OFDM 64 QAM	Outer Full	CP-OFDM 256 QAM	Edge_1RB_Left	CP-OFDM 256 QAM	Edge_1RB_Right	CP-OFDM 256 QAM	Outer Full
Modulation	RB allocation (NOTE 1)																																
CP-OFDM QPSK	Inner Full																																
CP-OFDM QPSK	Edge_1RB_Left																																
CP-OFDM QPSK	Edge_1RB_Right																																
CP-OFDM QPSK	Outer Full																																
CP-OFDM 16 QAM	Inner Full																																
CP-OFDM 16 QAM	Edge_1RB_Left																																
CP-OFDM 16 QAM	Edge_1RB_Right																																
CP-OFDM 16 QAM	Outer Full																																
CP-OFDM 64 QAM	Edge_1RB_Left																																
CP-OFDM 64 QAM	Edge_1RB_Right																																
CP-OFDM 64 QAM	Outer Full																																
CP-OFDM 256 QAM	Edge_1RB_Left																																
CP-OFDM 256 QAM	Edge_1RB_Right																																
CP-OFDM 256 QAM	Outer Full																																
1	Default																																
2	Low																																
3	High																																
4	Default																																
5	Default																																
6	Low																																
7	High																																
8	Default																																
9	Low																																
10	High																																
11	Default																																
12	Low																																
13	High																																
14	Default																																

NOTE 1: The specific configuration of each RB allocation is defined in Table 6.1-1.
NOTE 2: CP-OFDM 256 QAM test applies only for UEs which supports 256QAM in FR1.

Table 6.2D.2.4.1-1a: Test Configuration Table for power class 3 UEs with supporting ULFPTx (contiguous allocation)

Initial Conditions																																																																					
Test Environment as specified in TS 38.508-1 [5] subclause 4.1		Normal, TL/VL, TL/VH, TH/VL, TH/VH																																																																			
Test Frequencies as specified in TS 38.508-1 [5] subclause 4.3.1		Low range, High range																																																																			
Test Channel Bandwidths as specified in TS 38.508-1 [5] subclause 4.3.1		Lowest, Highest																																																																			
Test SCS as specified in Table 5.3.5-1		Lowest, Highest																																																																			
Test Parameters for Channel Bandwidths																																																																					
Test ID	Freq	Downlink Configuration	Uplink Configuration																																																																		
		N/A for Maximum Power Reduction (MPR) test case	<table border="1"> <thead> <tr> <th>Modulation (NOTE 2)</th> <th>RB allocation (NOTE 1)</th> </tr> </thead> <tbody> <tr><td>DFT-s-OFDM Pi/2 BPSK</td><td>Inner Full</td></tr> <tr><td>DFT-s-OFDM Pi/2 BPSK</td><td>Edge_1RB_Left</td></tr> <tr><td>DFT-s-OFDM Pi/2 BPSK</td><td>Edge_1RB_Right</td></tr> <tr><td>DFT-s-OFDM Pi/2 BPSK</td><td>Outer Full</td></tr> <tr><td>DFT-s-OFDM QPSK</td><td>Inner Full</td></tr> <tr><td>DFT-s-OFDM QPSK</td><td>Edge_1RB_Left</td></tr> <tr><td>DFT-s-OFDM QPSK</td><td>Edge_1RB_Right</td></tr> <tr><td>DFT-s-OFDM QPSK</td><td>Outer Full</td></tr> <tr><td>DFT-s-OFDM 16 QAM</td><td>Inner Full</td></tr> <tr><td>DFT-s-OFDM 16 QAM</td><td>Edge_1RB_Left</td></tr> <tr><td>DFT-s-OFDM 16 QAM</td><td>Edge_1RB_Right</td></tr> <tr><td>DFT-s-OFDM 16 QAM</td><td>Outer Full</td></tr> <tr><td>DFT-s-OFDM 64 QAM</td><td>Edge_1RB_Left</td></tr> <tr><td>DFT-s-OFDM 64 QAM</td><td>Edge_1RB_Right</td></tr> <tr><td>DFT-s-OFDM 64 QAM</td><td>Outer Full</td></tr> <tr><td>DFT-s-OFDM 256 QAM</td><td>Edge_1RB_Left</td></tr> <tr><td>DFT-s-OFDM 256 QAM</td><td>Edge_1RB_Right</td></tr> <tr><td>DFT-s-OFDM 256 QAM</td><td>Outer Full</td></tr> <tr><td>CP-OFDM QPSK</td><td>Inner Full</td></tr> <tr><td>CP-OFDM QPSK</td><td>Edge_1RB_Left</td></tr> <tr><td>CP-OFDM QPSK</td><td>Edge_1RB_Right</td></tr> <tr><td>CP-OFDM QPSK</td><td>Outer Full</td></tr> <tr><td>CP-OFDM 16 QAM</td><td>Inner Full</td></tr> <tr><td>CP-OFDM 16 QAM</td><td>Edge_1RB_Left</td></tr> <tr><td>CP-OFDM 16 QAM</td><td>Edge_1RB_Right</td></tr> <tr><td>CP-OFDM 16 QAM</td><td>Outer Full</td></tr> <tr><td>CP-OFDM 64 QAM</td><td>Edge_1RB_Left</td></tr> <tr><td>CP-OFDM 64 QAM</td><td>Edge_1RB_Right</td></tr> <tr><td>CP-OFDM 64 QAM</td><td>Outer Full</td></tr> <tr><td>CP-OFDM 256 QAM</td><td>Edge_1RB_Left</td></tr> <tr><td>CP-OFDM 256 QAM</td><td>Edge_1RB_Right</td></tr> <tr><td>CP-OFDM 256 QAM</td><td>Outer Full</td></tr> </tbody> </table>	Modulation (NOTE 2)	RB allocation (NOTE 1)	DFT-s-OFDM Pi/2 BPSK	Inner Full	DFT-s-OFDM Pi/2 BPSK	Edge_1RB_Left	DFT-s-OFDM Pi/2 BPSK	Edge_1RB_Right	DFT-s-OFDM Pi/2 BPSK	Outer Full	DFT-s-OFDM QPSK	Inner Full	DFT-s-OFDM QPSK	Edge_1RB_Left	DFT-s-OFDM QPSK	Edge_1RB_Right	DFT-s-OFDM QPSK	Outer Full	DFT-s-OFDM 16 QAM	Inner Full	DFT-s-OFDM 16 QAM	Edge_1RB_Left	DFT-s-OFDM 16 QAM	Edge_1RB_Right	DFT-s-OFDM 16 QAM	Outer Full	DFT-s-OFDM 64 QAM	Edge_1RB_Left	DFT-s-OFDM 64 QAM	Edge_1RB_Right	DFT-s-OFDM 64 QAM	Outer Full	DFT-s-OFDM 256 QAM	Edge_1RB_Left	DFT-s-OFDM 256 QAM	Edge_1RB_Right	DFT-s-OFDM 256 QAM	Outer Full	CP-OFDM QPSK	Inner Full	CP-OFDM QPSK	Edge_1RB_Left	CP-OFDM QPSK	Edge_1RB_Right	CP-OFDM QPSK	Outer Full	CP-OFDM 16 QAM	Inner Full	CP-OFDM 16 QAM	Edge_1RB_Left	CP-OFDM 16 QAM	Edge_1RB_Right	CP-OFDM 16 QAM	Outer Full	CP-OFDM 64 QAM	Edge_1RB_Left	CP-OFDM 64 QAM	Edge_1RB_Right	CP-OFDM 64 QAM	Outer Full	CP-OFDM 256 QAM	Edge_1RB_Left	CP-OFDM 256 QAM	Edge_1RB_Right	CP-OFDM 256 QAM	Outer Full
Modulation (NOTE 2)	RB allocation (NOTE 1)																																																																				
DFT-s-OFDM Pi/2 BPSK	Inner Full																																																																				
DFT-s-OFDM Pi/2 BPSK	Edge_1RB_Left																																																																				
DFT-s-OFDM Pi/2 BPSK	Edge_1RB_Right																																																																				
DFT-s-OFDM Pi/2 BPSK	Outer Full																																																																				
DFT-s-OFDM QPSK	Inner Full																																																																				
DFT-s-OFDM QPSK	Edge_1RB_Left																																																																				
DFT-s-OFDM QPSK	Edge_1RB_Right																																																																				
DFT-s-OFDM QPSK	Outer Full																																																																				
DFT-s-OFDM 16 QAM	Inner Full																																																																				
DFT-s-OFDM 16 QAM	Edge_1RB_Left																																																																				
DFT-s-OFDM 16 QAM	Edge_1RB_Right																																																																				
DFT-s-OFDM 16 QAM	Outer Full																																																																				
DFT-s-OFDM 64 QAM	Edge_1RB_Left																																																																				
DFT-s-OFDM 64 QAM	Edge_1RB_Right																																																																				
DFT-s-OFDM 64 QAM	Outer Full																																																																				
DFT-s-OFDM 256 QAM	Edge_1RB_Left																																																																				
DFT-s-OFDM 256 QAM	Edge_1RB_Right																																																																				
DFT-s-OFDM 256 QAM	Outer Full																																																																				
CP-OFDM QPSK	Inner Full																																																																				
CP-OFDM QPSK	Edge_1RB_Left																																																																				
CP-OFDM QPSK	Edge_1RB_Right																																																																				
CP-OFDM QPSK	Outer Full																																																																				
CP-OFDM 16 QAM	Inner Full																																																																				
CP-OFDM 16 QAM	Edge_1RB_Left																																																																				
CP-OFDM 16 QAM	Edge_1RB_Right																																																																				
CP-OFDM 16 QAM	Outer Full																																																																				
CP-OFDM 64 QAM	Edge_1RB_Left																																																																				
CP-OFDM 64 QAM	Edge_1RB_Right																																																																				
CP-OFDM 64 QAM	Outer Full																																																																				
CP-OFDM 256 QAM	Edge_1RB_Left																																																																				
CP-OFDM 256 QAM	Edge_1RB_Right																																																																				
CP-OFDM 256 QAM	Outer Full																																																																				
1 ⁴	Default																																																																				
2 ⁴	Low																																																																				
3 ⁴	High																																																																				
4 ⁴	Default																																																																				
5	Default																																																																				
6	Low																																																																				
7	High																																																																				
8	Default																																																																				
9	Default																																																																				
10	Low																																																																				
11	High																																																																				
12	Default																																																																				
13	Low																																																																				
14	High																																																																				
15	Default																																																																				
16	Low																																																																				
17	High																																																																				
18	Default																																																																				
19	Default																																																																				
20	Low																																																																				
21	High																																																																				
22	Default																																																																				
23	Default																																																																				
24	Low																																																																				
25	High																																																																				
26	Default																																																																				
27	Low																																																																				
28	High																																																																				
29	Default																																																																				
30	Low																																																																				
31	High																																																																				
32	Default																																																																				

NOTE 1: The specific configuration of each RB allocation is defined in Table 6.1-1.
 NOTE 2: DFT-s-OFDM Pi/2 BPSK test applies only for UEs which supports half Pi BPSK in FR1.
 NOTE 3: Test ID 19 ~ 32 with CP-OFDM modulation are not needed if PDCCH DCI format 0_1 indicates ULFPTx_Mode1.
 NOTE 4: UE operating in FDD mode, or in TDD mode in bands other than n40, n41, n77, n78 and n79, or in TDD mode the IE *powerBoostPi2BPSK* is set to 0 for bands n40, n41, n77, n78 and n79.

Table 6.2D.2.4.1-2: Test Configuration Table for Power Class 2

Initial Conditions																																	
Test Environment as specified in TS 38.508-1 [5] subclause 4.1		Normal, TL/VL, TL/VH, TH/VL, TH/VH																															
Test Frequencies as specified in TS 38.508-1 [5] subclause 4.3.1		Low range, High range																															
Test Channel Bandwidths as specified in TS 38.508-1 [5] subclause 4.3.1		Lowest, Highest																															
Test SCS as specified in Table 5.3.5-1		Lowest and Highest																															
Test Parameters for Channel Bandwidths																																	
Test ID	Freq	Downlink Configuration	Uplink Configuration																														
		N/A	<table border="1"> <thead> <tr> <th>Modulation</th> <th>RB allocation (NOTE 1)</th> </tr> </thead> <tbody> <tr><td>CP-OFDM QPSK</td><td>Inner Full</td></tr> <tr><td>CP-OFDM QPSK</td><td>Edge_1RB_Left</td></tr> <tr><td>CP-OFDM QPSK</td><td>Edge_1RB_Right</td></tr> <tr><td>CP-OFDM QPSK</td><td>Outer Full</td></tr> <tr><td>CP-OFDM 16 QAM</td><td>Inner Full</td></tr> <tr><td>CP-OFDM 16 QAM</td><td>Edge_1RB_Left</td></tr> <tr><td>CP-OFDM 16 QAM</td><td>Edge_1RB_Right</td></tr> <tr><td>CP-OFDM 16 QAM</td><td>Outer Full</td></tr> <tr><td>CP-OFDM 64 QAM</td><td>Edge_1RB_Left</td></tr> <tr><td>CP-OFDM 64 QAM</td><td>Edge_1RB_Right</td></tr> <tr><td>CP-OFDM 64 QAM</td><td>Outer Full</td></tr> <tr><td>CP-OFDM 256 QAM</td><td>Edge_1RB_Left</td></tr> <tr><td>CP-OFDM 256 QAM</td><td>Edge_1RB_Right</td></tr> <tr><td>CP-OFDM 256 QAM</td><td>Outer Full</td></tr> </tbody> </table>	Modulation	RB allocation (NOTE 1)	CP-OFDM QPSK	Inner Full	CP-OFDM QPSK	Edge_1RB_Left	CP-OFDM QPSK	Edge_1RB_Right	CP-OFDM QPSK	Outer Full	CP-OFDM 16 QAM	Inner Full	CP-OFDM 16 QAM	Edge_1RB_Left	CP-OFDM 16 QAM	Edge_1RB_Right	CP-OFDM 16 QAM	Outer Full	CP-OFDM 64 QAM	Edge_1RB_Left	CP-OFDM 64 QAM	Edge_1RB_Right	CP-OFDM 64 QAM	Outer Full	CP-OFDM 256 QAM	Edge_1RB_Left	CP-OFDM 256 QAM	Edge_1RB_Right	CP-OFDM 256 QAM	Outer Full
Modulation	RB allocation (NOTE 1)																																
CP-OFDM QPSK	Inner Full																																
CP-OFDM QPSK	Edge_1RB_Left																																
CP-OFDM QPSK	Edge_1RB_Right																																
CP-OFDM QPSK	Outer Full																																
CP-OFDM 16 QAM	Inner Full																																
CP-OFDM 16 QAM	Edge_1RB_Left																																
CP-OFDM 16 QAM	Edge_1RB_Right																																
CP-OFDM 16 QAM	Outer Full																																
CP-OFDM 64 QAM	Edge_1RB_Left																																
CP-OFDM 64 QAM	Edge_1RB_Right																																
CP-OFDM 64 QAM	Outer Full																																
CP-OFDM 256 QAM	Edge_1RB_Left																																
CP-OFDM 256 QAM	Edge_1RB_Right																																
CP-OFDM 256 QAM	Outer Full																																
1	Default																																
2	Low																																
3	High																																
4	Default																																
5	Default																																
6	Low																																
7	High																																
8	Default																																
9	Low																																
10	High																																
11	Default																																
12	Low																																
13	High																																
14	Default																																
NOTE 1: The specific configuration of each RB allocation is defined in Table 6.1-1.																																	
NOTE 2: CP-OFDM 256 QAM test applies only for UEs which supports 256QAM in FR1.																																	

Table 6.2D.2.4.1-2a: Test Configuration Table for power class 2 UEs with supporting ULFPTx (contiguous allocation)

Initial Conditions				
Test Environment as specified in TS 38.508-1 [5] subclause 4.1		Normal, TL/VL, TL/VH, TH/VL, TH/VH		
Test Frequencies as specified in TS 38.508-1 [5] subclause 4.3.1		Low range, High range		
Test Channel Bandwidths as specified in TS 38.508-1 [5] subclause 4.3.1		Lowest, Highest		
Test SCS as specified in Table 5.3.5-1		Lowest, Highest		
Test Parameters for Channel Bandwidths				
Test ID	Freq	Downlink Configuration	Uplink Configuration	
		N/A for Maximum Power Reduction (MPR) test case	Modulation (NOTE 2) DFT-s-OFDM Pi/2 BPSK	RB allocation (NOTE 1) Inner Full
1	Default		DFT-s-OFDM Pi/2 BPSK	Edge_1RB_Left
2	Low		DFT-s-OFDM Pi/2 BPSK	Edge_1RB_Right
3	High		DFT-s-OFDM Pi/2 BPSK	Outer Full
4	Default		DFT-s-OFDM QPSK	Inner Full
5	Low		DFT-s-OFDM QPSK	Edge_1RB_Left
6	High		DFT-s-OFDM QPSK	Edge_1RB_Right
7	Default		DFT-s-OFDM 16 QAM	Outer Full
8	Low		DFT-s-OFDM 16 QAM	Inner Full
9	High		DFT-s-OFDM 16 QAM	Edge_1RB_Left
10	Default		DFT-s-OFDM 16 QAM	Edge_1RB_Right
11	Low		DFT-s-OFDM 16 QAM	Outer Full
12	High		DFT-s-OFDM 64 QAM	Edge_1RB_Left
13	Default		DFT-s-OFDM 64 QAM	Edge_1RB_Right
14	Low		DFT-s-OFDM 64 QAM	Outer Full
15	High		DFT-s-OFDM 256 QAM	Edge_1RB_Left
16	Default		DFT-s-OFDM 256 QAM	Edge_1RB_Right
17	Low		DFT-s-OFDM 256 QAM	Outer Full
18	High		CP-OFDM QPSK	Inner Full
19	Default		CP-OFDM QPSK	Edge_1RB_Left
20	Low		CP-OFDM QPSK	Edge_1RB_Right
21	High		CP-OFDM QPSK	Outer Full
22	Default		CP-OFDM 16 QAM	Inner Full
23	Low		CP-OFDM 16 QAM	Edge_1RB_Left
24	High		CP-OFDM 16 QAM	Edge_1RB_Right
25	Default		CP-OFDM 16 QAM	Outer Full
26	Low		CP-OFDM 64 QAM	Edge_1RB_Left
27	High		CP-OFDM 64 QAM	Edge_1RB_Right
28	Default		CP-OFDM 64 QAM	Outer Full
29	Low		CP-OFDM 256 QAM	Edge_1RB_Left
30	High		CP-OFDM 256 QAM	Edge_1RB_Right
31	Default		CP-OFDM 256 QAM	Outer Full
32	Low	CP-OFDM 256 QAM	Outer Full	

NOTE 1: The specific configuration of each RB allocation is defined in Table 6.1-1.

NOTE 2: DFT-s-OFDM Pi/2 BPSK test applies only for UEs which supports half Pi BPSK in FR1.

NOTE 3: Test ID 19 ~ 32 with CP-OFDM modulation are not needed if PDCCH DCI format 0_1 indicates ULFPTx_Mode1.

1. Connect the SS to the UE antenna connectors as shown in TS 38.508-1 [5] Annex A, Figure A.3.1.1.2 for TE diagram and section A.3.2 for UE diagram.
2. The parameter settings for the cell are set up according to TS 38.508-1 [5] subclause 4.4.3.
3. Downlink signals are initially set up according to Annex C.0, C.1, C.2, and uplink signals according to Annex G.0, G.1, G.2, G.3.0.
4. The UL Reference Measurement Channel is set according to Table 6.2D.2.4.1-1 or Table 6.2D.2.4.1-2.
5. Propagation conditions are set according to Annex B.0.
6. Ensure the UE is in state RRC_CONNECTED with generic procedure parameters Connectivity *NR*, Connected without release *On*, Test Mode *On* and Test Loop Function *On* according to TS 38.508-1 [5] clause 4.5. Message contents are defined in clause 6.2D.2.4.3.

6.2D.2.4.2 Test procedure

1. SS sends uplink scheduling information for each UL HARQ process via PDCCH DCI format 0_1 for C_RNTI to schedule the UL RMC according to Table 6.2D.2.4.1-1. Since the UE has no payload and no loopback data to send the UE sends uplink MAC padding bits on the UL RMC. The PDCCH DCI format 0_1 is specified with the condition 2TX_UL_MIMO in 38.508-1 [5] subclause 4.3.6.1.1.2.
2. Send continuously uplink power control "up" commands in every uplink scheduling information to the UE; allow at least 200ms starting from the first TPC command in this step for the UE to reach P_{UMAX} level.
3. Measure the sum of the mean power of the UE from both transmit antenna connectors in the channel bandwidth of the radio access mode. The period of measurement shall be at least the continuous duration of one active sub-frame (1ms) and in the uplink symbols. For TDD symbol with transient periods are not under test.
4. If UE supports ULFPTx, repeat test steps 1~3 with UL RMC according to Table 6.2D.2.4.1-1a or Table 6.2D.2.4.1-2a. The PDCCH DCI format 0_1 is specified with the condition ULFPTx_Mode1, ULFPTx_Mode2 or ULFPTx_ModeFull in 38.508-1 [5] subclause 4.3.6.1.1.2 depending on UE reported capability. Message contents are according to TS 38.508-1 [5] clause 4.6.3 Table 4.6.3-118 with condition TRANSFORM_PRECODER_ENABLED.

NOTE 1: When switching to DFT-s-OFDM waveform, as specified in the test configuration Table 6.2D.2.4.1-1a or Table 6.2D.2.4.1-2a, send an NR RRCReconfiguration message according to TS 38.508-1 [5] clause 4.6.3 Table 4.6.3-118 PUSCH-Config with TRANSFORM_PRECODER_ENABLED condition.

6.2D.2.4.3 Message contents

Message contents are according to TS 38.508-1 [5] subclause 4.6 and 5.4 ensuring Table 4.6.3-182 with the condition 2TX_UL_MIMO.

6.2D.2.5 Test requirement

The maximum output power, derived in step 3 shall be within the range prescribed by the nominal maximum output power and tolerance in Table 6.2D.2.5-1 and Table 6.2D.2.5-2.

Table 6.2D.2.5-1: UE Power Class test requirements (for Band n1, n2, n3, n7, n25, n30, n34, n38, n39, n40, n41, n48, n66, n70, n71, n77, n78, n79, n97) for Power Class 3

Test ID	$P_{\text{PowerClass}}$ (dBm)	$\Delta P_{\text{PowerClass}}$ (dB)	MPR (dB)	$\Delta T_{C,c}$ (dB)	$P_{\text{CMAX}_{L,f,c}}$ (dBm)	$T(P_{\text{CMAX}_{L,f,c}})$ (dB)	$T_{L,c}$	Upper limit (dBm)	Lower limit (dBm)
1	23	0	1.5	0 (1.5 ²)	21.5 (20.0 ²)	5.0 (6.0 ²)	3	25.0 + TT	16.5 - TT (14.0 - TT ²)
2	23	0	3	0 (1.5 ²)	20.0 (18.5 ²)	6.0 (5.0 ²)	3	25.0 + TT	14.0 - TT (13.5 - TT ²)
3	23	0	3	0 (1.5 ²)	20.0 (18.5 ²)	6.0 (5.0 ²)	3	25.0 + TT	14.0 - TT (13.5 - TT ²)
4	23	0	3	0 (1.5 ²)	20.0 (18.5 ²)	6.0 (5.0 ²)	3	25.0 + TT	14.0 - TT (13.5 - TT ²)
5	23	0	2	0 (1.5 ²)	21.0 (19.5 ²)	5.0 (5.0 ²)	3	25.0 + TT	16.0 - TT (14.5 - TT ²)
6	23	0	3	0 (1.5 ²)	20.0 (18.5 ²)	6.0 (5.0 ²)	3	25.0 + TT	14.0 - TT (13.5 - TT ²)
7	23	0	3	0 (1.5 ²)	20.0 (18.5 ²)	6.0 (5.0 ²)	3	25.0 + TT	14.0 - TT (13.5 - TT ²)
8	23	0	3	0 (1.5 ²)	20.0 (18.5 ²)	6.0 (5.0 ²)	3	25.0 + TT	14.0 - TT (13.5 - TT ²)
9	23	0	3.5	0 (1.5 ²)	19.5 (18.0 ²)	5.0 (5.0 ²)	3	25.0 + TT	14.5 - TT (13.0 - TT ²)
10	23	0	3.5	0 (1.5 ²)	19.5 (18.0 ²)	5.0 (5.0 ²)	3	25.0 + TT	14.5 - TT (13.0 - TT ²)
11	23	0	3.5	0 (1.5 ²)	19.5 (18.0 ²)	5.0 (5.0 ²)	3	25.0 + TT	14.5 - TT (13.0 - TT ²)
12	23	0	6.5	0 (1.5 ²)	16.5 (15.0 ²)	5.0 (6.0 ²)	3	25.0 + TT	11.5 - TT (9.0 - TT ²)
13	23	0	6.5	0 (1.5 ²)	16.5 (15.0 ²)	5.0 (6.0 ²)	3	25.0 + TT	11.5 - TT (9.0 - TT ²)
14	23	0	6.5	0 (1.5 ²)	16.5 (15.0 ²)	5.0 (6.0 ²)	3	25.0 + TT	11.5 - TT (9.0 - TT ²)

NOTE 1: $P_{\text{PowerClass}}$ is the maximum UE power specified without taking into account the tolerance.
NOTE 2: For Band n2, n3, n7, n25, n41, transmission bandwidths confined within F_{UL_low} and $F_{UL_low} + 4$ MHz or $F_{UL_high} - 4$ MHz and F_{UL_high} .
NOTE 3: TT for each frequency and channel bandwidth is specified in Table 6.2D.2.5-3.

Table 6.2D.2.5-2: UE Power Class test requirements (for Bands n41, n77, n78, n79) for Power Class 2

Test ID	$P_{\text{PowerClass}}$ (dBm)	$\Delta P_{\text{PowerClass}}$ (dB)	MPR (dB)	$\Delta T_{c,c}$ (dB)	$P_{\text{CMAX_L,f,c}}$ (dBm)	$T(P_{\text{CMAX_L,f,c}})$ (dB)	$T_{L,c}$ (dB)	Upper limit (dBm)	Lower limit (dBm)
1	26	0	1.5	0 (1.5 ²)	24.5 (23.0 ²)	2.0 (2.5 ²)	3	28.0 + TT	21.5 - TT (20.0 - TT ²)
2	26	0	3.5	0 (1.5 ²)	22.5 (21.0 ²)	5.0 (5.0 ²)	3	28.0 + TT	17.5 - TT (16.0 - TT ²)
3	26	0	3.5	0 (1.5 ²)	22.5 (21.0 ²)	5.0 (5.0 ²)	3	28.0 + TT	17.5 - TT (16.0 - TT ²)
4	26	0	3	0 (1.5 ²)	23.0 (21.5 ²)	3.0 (5.0 ²)	3	28.0 + TT	20.0 - TT (16.5 - TT ²)
5	26	0	2	0 (1.5 ²)	24.0 (22.5 ²)	3.0 (5.0 ²)	3	28.0 + TT	21.0 - TT (17.5 - TT ²)
6	26	0	3.5	0 (1.5 ²)	22.5 (21.0 ²)	5.0 (5.0 ²)	3	28.0 + TT	17.5 - TT (16.0 - TT ²)
7	26	0	3.5	0 (1.5 ²)	22.5 (21.0 ²)	5.0 (5.0 ²)	3	28.0 + TT	17.5 - TT (16.0 - TT ²)
8	26	0	3	0 (1.5 ²)	23.0 (21.5 ²)	3.0 (5.0 ²)	3	28.0 + TT	20.0 - TT (16.5 - TT ²)
9	26	0	3.5	0 (1.5 ²)	22.5 (21.0 ²)	5.0 (5.0 ²)	3	28.0 + TT	17.5 - TT (16.0 - TT ²)
10	26	0	3.5	0 (1.5 ²)	22.5 (21.0 ²)	5.0 (5.0 ²)	3	28.0 + TT	17.5 - TT (16.0 - TT ²)
11	26	0	3.5	0 (1.5 ²)	22.5 (21.0 ²)	5.0 (5.0 ²)	3	28.0 + TT	17.5 - TT (16.0 - TT ²)
12	26	0	6.5	0 (1.5 ²)	19.5 (18.0 ²)	5.0 (5.0 ²)	3	28.0 + TT	14.5 - TT (13.0 - TT ²)
13	26	0	6.5	0 (1.5 ²)	19.5 (18.0 ²)	5.0 (5.0 ²)	3	28.0 + TT	14.5 - TT (13.0 - TT ²)
14	26	0	6.5	0 (1.5 ²)	19.5 (18.0 ²)	5.0 (5.0 ²)	3	28.0 + TT	14.5 - TT (13.0 - TT ²)

NOTE 1: $P_{\text{PowerClass}}$ is the maximum UE power specified without taking into account the tolerance.

NOTE 2: For Band n41, transmission bandwidths confined within $F_{\text{UL_low}}$ and $F_{\text{UL_low}} + 4$ MHz or $F_{\text{UL_high}} - 4$ MHz and $F_{\text{UL_high}}$.

NOTE 3: TT for each frequency and channel bandwidth is specified in Table 6.2D.2.5-3.

The maximum output power, derived in step 4 shall be within the range prescribed by the nominal maximum output power and tolerance in Table 6.2D.2.5-2a and Table 6.2D.2.5-2b.

Table 6.2D.2.5-2a: UE Power Class test requirements (for Band n1, n2, n3, n7, n25, n30, n34, n38, n41, n48, n66, n70, n71, n77, n78, n79) for Power Class 3 with supporting ULFP Tx

Test ID	P _{PowerClass} (dBm)	$\Delta P_{PowerClass}$ (dB)	MPR (dB)	$\Delta T_{c,c}$ (dB)	P _{C_{MAX}L,f,c} (dBm)	T(P _{C_{MAX}L,f,c}) (dB)	T _{L,c} (dB)	Upper limit (dBm)	Lower limit (dBm)
1	23	0	0	0 (1.5 ²)	23.0 (21.5 ²)	3.0 (5.0 ²)	3	25.0 + TT	20.0 - TT (16.5 - TT ²)
2	23	0	0.5	0 (1.5 ²)	22.5 (21.0 ²)	5.0	3	25.0 + TT	17.5 - TT (16.0 - TT ²)
3	23	0	0.5	0 (1.5 ²)	22.5 (21.0 ²)	5.0	3	25.0 + TT	17.5 - TT (16.0 - TT ²)
4	23	0	0.5	0 (1.5 ²)	22.5 (21.0 ²)	5.0	3	25.0 + TT	17.5 - TT (16.0 - TT ²)
5	23	0	0	0 (1.5 ²)	23.0 (21.5 ²)	3.0 (5.0 ²)	3	25.0 + TT	20.0 - TT (16.5 - TT ²)
6	23	0	1	0 (1.5 ²)	22.0 (20.5 ²)	5.0 (6.0 ²)	3	25.0 + TT	17.0 - TT (14.5 - TT ²)
7	23	0	1	0 (1.5 ²)	22.0 (20.5 ²)	5.0 (6.0 ²)	3	25.0 + TT	17.0 - TT (14.5 - TT ²)
8	23	0	1	0 (1.5 ²)	22.0 (20.5 ²)	5.0 (6.0 ²)	3	25.0 + TT	17.0 - TT (14.5 - TT ²)
9	23	0	1	0 (1.5 ²)	22.0 (20.5 ²)	5.0 (6.0 ²)	3	25.0 + TT	17.0 - TT (14.5 - TT ²)
10	23	0	2	0 (1.5 ²)	21.0 (19.5 ²)	5.0	3	25.0 + TT	16.0 - TT (14.5 - TT ²)
11	23	0	2	0 (1.5 ²)	21.0 (19.5 ²)	5.0	3	25.0 + TT	16.0 - TT (14.5 - TT ²)
12	23	0	2	0 (1.5 ²)	21.0 (19.5 ²)	5.0	3	25.0 + TT	16.0 - TT (14.5 - TT ²)
13	23	0	2.5	0 (1.5 ²)	20.5 (19.0 ²)	6.0 (5.0 ²)	3	25.0 + TT	14.5 - TT (14.0 - TT ²)
14	23	0	2.5	0 (1.5 ²)	20.5 (19.0 ²)	6.0 (5.0 ²)	3	25.0 + TT	14.5 - TT (14.0 - TT ²)
15	23	0	2.5	0 (1.5 ²)	20.5 (19.0 ²)	6.0 (5.0 ²)	3	25.0 + TT	14.5 - TT (14.0 - TT ²)
16	23	0	4.5	0 (1.5 ²)	18.5 (17.0 ²)	5.0	3	25.0 + TT	13.5 - TT (12.0 - TT ²)
17	23	0	4.5	0 (1.5 ²)	18.5 (17.0 ²)	5.0	3	25.0 + TT	13.5 - TT (12.0 - TT ²)
18	23	0	4.5	0 (1.5 ²)	18.5 (17.0 ²)	5.0	3	25.0 + TT	13.5 - TT (12.0 - TT ²)
19	23	0	1.5	0 (1.5 ²)	21.5 (20.0 ²)	5.0 (6.0 ²)	3	25.0 + TT	16.5 - TT (14.0 - TT ²)
20	23	0	3	0 (1.5 ²)	20.0 (18.5 ²)	6.0 (5.0 ²)	3	25.0 + TT	14.0 - TT (13.5 - TT ²)
21	23	0	3	0 (1.5 ²)	20.0 (18.5 ²)	6.0 (5.0 ²)	3	25.0 + TT	14.0 - TT (13.5 - TT ²)

22	23	0	3	0	(1.5 ²)	20.0	(18.5 ²)	6.0	(5.0 ²)	3	25.0 + TT	14.0 - TT	(13.5 - TT ²)
23	23	0	2	0	(1.5 ²)	21.0	(19.5 ²)	5.0		3	25.0 + TT	16.0 - TT	(14.5 - TT ²)
24	23	0	3	0	(1.5 ²)	20.0	(18.5 ²)	6.0	(5.0 ²)	3	25.0 + TT	14.0 - TT	(13.5 - TT ²)
25	23	0	3	0	(1.5 ²)	20.0	(18.5 ²)	6.0	(5.0 ²)	3	25.0 + TT	14.0 - TT	(13.5 - TT ²)
26	23	0	3	0	(1.5 ²)	20.0	(18.5 ²)	6.0	(5.0 ²)	3	25.0 + TT	14.0 - TT	(13.5 - TT ²)
27	23	0	3.5	0	(1.5 ²)	19.5	(18.0 ²)	5.0		3	25.0 + TT	14.5 - TT	(13.0 - TT ²)
28	23	0	3.5	0	(1.5 ²)	19.5	(18.0 ²)	5.0		3	25.0 + TT	14.5 - TT	(13.0 - TT ²)
29	23	0	3.5	0	(1.5 ²)	19.5	(18.0 ²)	5.0		3	25.0 + TT	14.5 - TT	(13.0 - TT ²)
30	23	0	6.5	0	(1.5 ²)	16.5	(15.0 ²)	5.0	(6.0 ²)	3	25.0 + TT	11.5 - TT	(9.0 - TT ²)
31	23	0	6.5	0	(1.5 ²)	16.5	(15.0 ²)	5.0	(6.0 ²)	3	25.0 + TT	11.5 - TT	(9.0 - TT ²)
32	23	0	6.5	0	(1.5 ²)	16.5	(15.0 ²)	5.0	(6.0 ²)	3	25.0 + TT	11.5 - TT	(9.0 - TT ²)
NOTE 1: P _{PowerClass} is the maximum UE power specified without taking into account the tolerance.													
NOTE 2: For Band n41, transmission bandwidths confined within F _{UL_low} and F _{UL_low} + 4 MHz or F _{UL_high} - 4 MHz and F _{UL_high} .													
NOTE 3: TT for each frequency and channel bandwidth is specified in Table 6.2D.2.5-3.													

Table 6.2D.2.5-2b: UE Power Class test requirements (for Bands n41, n77, n78, n79) for Power Class 2 with supporting ULFPTx

TBD

Table 6.2D.2.5-3: Test Tolerance (Maximum Power Reduction (MPR))

	f ≤ 3.0GHz	3.0GHz < f ≤ 6.0GHz
BW ≤ 40MHz	0.7	1.0
40MHz < BW ≤ 100MHz	1.0	1.0

For the UE which supports inter-band NR CA configuration, inter-band NR-DC configuration, SUL configuration or inter-band EN-DC configuration, $\Delta T_{IB,c}$ as specified in 6.2A.4.0.2 for NR CA, 6.2B.4.0.2 for NR-DC, clause 6.2C.2 for SUL, or TS 38.521-3 [14] clause 6.2B.4.2 for EN-DC applies. Unless otherwise stated, $\Delta T_{IB,c}$ is set to zero. In case the UE supports more than one of band combinations for CA, NR-DC, SUL or DC, and an operating band belongs to more than one band combinations then

- a) When the operating band frequency range is ≤ 1 GHz, the applicable additional $\Delta T_{IB,c}$ shall be the average value for all band combinations defined in clause 6.2A.4.0.2, 6.2B.4.0.2, 6.2C.2 in this specification and 6.2B.4.2 in TS 38.521-3 [14], truncated to one decimal place that apply for that operating band among the supported band combinations. In case there is a harmonic relation between low band UL and high band DL, then the maximum $\Delta T_{IB,c}$ among the different supported band combinations involving such band shall be applied.
- b) When the operating band frequency range is > 1 GHz, the applicable additional $\Delta T_{IB,c}$ shall be the maximum value for all band combinations defined in clause 6.2A.4.0.2, 6.2B.4.0.2, 6.2C.2 in this specification and 6.2B.4.2 in TS 38.521-3 [14] for the applicable operating bands.

6.2D.3 UE additional maximum output power reduction for UL MIMO

6.2D.3.1 Test purpose

Additional emission requirements can be signalled by the network. Each additional emission requirement is associated a unique with network signalling (NS) value indicated in RRC signalling by an NR frequency band number of the applicable operating band and an associated value in the field *additionalSpectrumEmission*. Throughout this specification, the notion of indication or signalling of an NS value refers to the corresponding indication of an NR frequency band number of the applicable operating band (the IE *freqBandIndicatorNR*) and an associated value of *additionalSpectrumEmission* in the relevant RRC information elements [6].

To meet the additional requirements, additional maximum power reduction (A-MPR) is allowed for the maximum output power as specified in Table 6.2D.1.3-1. Unless stated otherwise, an A-MPR of 0 dB shall be used.

6.2D.3.2 Test applicability

The requirements of this test apply in test case 6.5D.2.3 Additional Spectrum Emission mask for UL MIMO for network signalling value NS_03, NS_03U, NS_04 to all types of NR UE release 15 and forward that support UL MIMO.

The requirements of this test apply in test case 6.5D.2.4.2 Adjacent channel leakage ratio for network signalling values NS_03U, NS_05U, and NS_100 to all types of NR Power Class 2 and 3 UE release 15 and forward.

The requirements of this test apply in test case 6.5D.3.3 Additional Spurious Emissions for network signalling value NS_04 to all types of NR UE release 15 and forward that support UL-MIMO.

6.2D.3.3 Minimum conformance requirements

For UE with two transmit antenna connectors in closed-loop spatial multiplexing scheme, the A-MPR values specified in subclause 6.2.3.3 shall apply to the maximum output power specified in Table 6.2D.1.3-1. The requirements shall be met with the UL MIMO configurations specified in Table 6.2D.1.3-2. For UE supporting UL MIMO, the maximum output power is measured as the sum of the maximum output power at each UE antenna connector. Unless stated otherwise, an A-MPR of 0 dB shall be used.

For the UE maximum output power modified by A-MPR, the power limits specified in subclause 6.2D.4.3 apply.

If UE is configured for transmission on single-antenna port, the requirements in subclause 6.2.3.3 apply.

The normative reference for this requirement is TS 38.101-1 [2] clause 6.2D.3.

- 6.2D.3.4 Test description
- 6.2D.3.4.1 Initial conditions

Initial conditions are a set of test configurations the UE needs to be tested in and the steps for the SS to take with the UE to reach the correct measurement state.

The initial test configurations consist of environmental conditions, test frequencies, test channel bandwidths and sub-carrier spacing based on NR operating bands specified in table 5.3.5-1. All of these configurations shall be tested with applicable test parameters for each combination of test channel bandwidth and sub-carrier spacing, and are shown in tables 6.2D.3.4.1-1 to 6.2D.3.4.1-11. The details of the uplink reference measurement channels (RMCs) are specified in Annex A.2. Configurations of PDSCH and PDCCH before measurement are specified in Annex C.2

Table 6.2D.3.4.1-1: Test Configuration table for NS_04

Initial Conditions					
Test Environment as specified in TS 38.508-1 [5] subclause 4.1				Normal	
Test Frequencies as specified in TS 38.508-1 [5] subclause 4.3.1				(See Freq column)	
Test Channel Bandwidths as specified in TS 38.508-1 [5] subclause 4.3.1				Lowest, Highest	
Test SCS as specified in Table 5.3.5-1				Lowest, Highest	
A-MPR test parameters for NS_04					
		Downlink Configuration		Uplink Configuration	
Test ID	Freq	N/A		Modulation (NOTE 2)	RB allocation (NOTE 1)
1	Low			CP-OFDM QPSK	Edge_1RB_Left
2	$2496 + 3/2 \times BW_{Channel} - 6 \text{ MHz}$			CP-OFDM QPSK	Edge_1RB_Left
3	$2496 + BW_{Channel}/2 +$			CP-OFDM QPSK	Inner Full
4	$MAX(10 \text{ MHz}, 0.25 \times BW_{Channel})$			CP-OFDM QPSK	Outer Full
5	High			CP-OFDM QPSK	Edge_1RB_Right
6	High			CP-OFDM QPSK	Inner Full
7	High			CP-OFDM QPSK	Outer Full
8	Low			CP-OFDM 16 QAM	Edge_1RB_Left
9	$2496 + 3/2 \times BW_{Channel} - 6 \text{ MHz}$			CP-OFDM 16 QAM	Edge_1RB_Left
10	$2496 + BW_{Channel}/2 +$			CP-OFDM 16 QAM	Inner Full
11	$MAX(10 \text{ MHz}, 0.25 \times BW_{Channel})$			CP-OFDM 16 QAM	Outer Full
12	High			CP-OFDM 16 QAM	Edge_1RB_Right
13	High			CP-OFDM 16 QAM	Inner Full
14	High			CP-OFDM 16 QAM	Outer Full
15	Low			CP-OFDM 64 QAM	Edge_1RB_Left
16	$2496 + 3/2 \times BW_{Channel} - 6 \text{ MHz}$			CP-OFDM 64 QAM	Edge_1RB_Left
17	$2496 + BW_{Channel}/2 +$			CP-OFDM 64 QAM	Outer Full
18	$MAX(10 \text{ MHz}, 0.25 \times BW_{Channel})$			CP-OFDM 64 QAM	Edge_1RB_Right
19	High			CP-OFDM 64 QAM	Outer Full
20	Low			CP-OFDM 256 QAM	Edge_1RB_Left
21	$2496 + 3/2 \times BW_{Channel} - 6 \text{ MHz}$			CP-OFDM 256 QAM	Edge_1RB_Left
22	$2496 + BW_{Channel}/2 +$			CP-OFDM 256 QAM	Outer Full
23	$MAX(10 \text{ MHz}, 0.25 \times BW_{Channel})$			CP-OFDM 256 QAM	Edge_1RB_Right
24	High			CP-OFDM 256 QAM	Outer Full

NOTE 1: The specific configuration of each RB allocation is defined in Table 6.1-1.

Table 6.2D.3.4.1-2: Test Configuration table for NS_35

Initial Conditions				
Test Environment as specified in TS 38.508-1 [5] subclause 4.1			Normal	
Test Frequencies as specified in TS 38.508-1 [5] subclause 4.3.1			Low range, High range	
Test Channel Bandwidths as specified in TS 38.508-1 [5] subclause 4.3.1			Lowest, Highest	
Test SCS as specified in Table 5.3.5-1			Lowest, Highest	
A-MPR test parameters for NS_35				
Test ID	Freq	Downlink Configuration	Uplink Configuration	
			Modulation	RB allocation (NOTE 1)
1	Low	N/A	CP-OFDM QPSK	Edge_1RB_Left
2	High		CP-OFDM QPSK	Edge_1RB_Right
3	Default		CP-OFDM QPSK	Outer Full
4	Low		CP-OFDM 16 QAM	Edge_1RB_Left
5	High		CP-OFDM 16 QAM	Edge_1RB_Right
6	Default		CP-OFDM 16 QAM	Outer Full
7	Low		CP-OFDM 64 QAM	Edge_1RB_Left
8	High		CP-OFDM 64 QAM	Edge_1RB_Right
9	Default		CP-OFDM 64 QAM	Outer Full
10	Low		CP-OFDM 256 QAM	Edge_1RB_Left
11	High		CP-OFDM 256 QAM	Edge_1RB_Right
12	Default		CP-OFDM 256 QAM	Outer Full
NOTE 1: The specific configuration of each RB allocation is defined in Table 6.1-1.				

Table 6.2D.3.4.1-3: Test Configuration table for NS_05

Initial Conditions								
Test Environment as specified in TS 38.508-1 [5] subclause 4.1			Normal					
Test Frequencies as specified in TS 38.508-1 [5] subclause 4.3.1			Use uplink carrier center frequency (Fc) as specified in test parameters					
Test Channel Bandwidths as specified in TS 38.508-1 [5] subclause 4.3.1			5 MHz, 10 MHz, 15 MHz, 20 MHz					
Test SCS as specified in Table 5.3.5-1			Lowest, Highest unless otherwise specified in test parameters.					
A-MPR test parameters for NS_05								
Test ID	Fc (MHz)	ChBw (MHz)	SCS (kHz)	A-MPR	Uplink Configuration			
					Modulation (NOTE 2)	RB allocation (Note 1)		
						SCS 15 kHz	SCS 30 kHz	SCS 60 kHz
1	1922.5	5	15	A3	QPSK	Outer_Full		
2	1925	10	Default	A1	QPSK	Outer_Full		
3	1925	10	Default	A7	QPSK	42@10	18@5	8@3
4	1925	10	Default	A2	QPSK	6@40	3@20	1@10
5	1935	10	Default	A4	QPSK	Outer_Full		
6	1927.5	15	Default	A1	QPSK	Outer_Full		
7	1927.5	15	Default	A7	QPSK	60@19	28@10	12@5
8	1927.5	15	Default	A2	QPSK	6@56	3@28	1@14
9	1932.5	15	Default	A1	QPSK	Outer_Full		
10	1932.5	15	Default	A2	QPSK	6@68	3@34	1@17
11	1942.5	15	Default	A5	QPSK	Outer_Full		
12	1930	20	Default	A1	QPSK	Outer_Full		
13	1930	20	Default	A7	QPSK	78@28	37@14	17@7
14	1930	20	Default	A2	QPSK	6@76	3@38	1@19
15	1950	20	Default	A6	QPSK	Outer_Full		
16	1922.5	5	15	A3	16 QAM	Outer_Full		
17	1925	10	Default	A1	16 QAM	Outer_Full		
18	1925	10	Default	A7	16 QAM	42@10	18@5	8@3
19	1925	10	Default	A2	16 QAM	6@40	3@20	1@10
20	1935	10	Default	A4	16 QAM	Outer_Full		
21	1927.5	15	Default	A1	16 QAM	Outer_Full		
22	1927.5	15	Default	A7	16 QAM	60@19	28@10	12@5
23	1927.5	15	Default	A2	16 QAM	6@56	3@28	1@14
24	1932.5	15	Default	A1	16 QAM	Outer_Full		
25	1932.5	15	Default	A2	16 QAM	6@68	3@34	1@17
26	1942.5	15	Default	A5	16 QAM	Outer_Full		
27	1930	20	Default	A1	16 QAM	Outer_Full		
28	1930	20	Default	A7	16 QAM	78@28	37@14	17@7
29	1930	20	Default	A2	16 QAM	6@76	3@38	1@19
30	1950	20	Default	A6	16 QAM	Outer_Full		
31	1922.5	5	15	A3	64 QAM	Outer_Full		
32	1925	10	Default	A1	64 QAM	Outer_Full		
33	1925	10	Default	A7	64 QAM	42@10	18@5	8@3
34	1925	10	Default	A2	64 QAM	6@40	3@20	1@10
35	1927.5	15	Default	A1	64 QAM	Outer_Full		
36	1927.5	15	Default	A7	64 QAM	60@19	28@10	12@5
37	1927.5	15	Default	A2	64 QAM	6@56	3@28	1@14
38	1932.5	15	Default	A1	64 QAM	Outer_Full		
39	1932.5	15	Default	A2	64 QAM	6@68	3@34	1@17
40	1930	20	Default	A1	64 QAM	Outer_Full		
41	1930	20	Default	A7	64 QAM	78@28	37@14	17@7
42	1930	20	Default	A2	64 QAM	6@76	3@38	1@19
43	1922.5	5	15	A3	256 QAM	Outer_Full		
44	1925	10	Default	A1	256 QAM	Outer_Full		
45	1925	10	Default	A7	256 QAM	42@10	18@5	8@3
46	1927.5	15	Default	A1	256 QAM	Outer_Full		
47	1927.5	15	Default	A7	256 QAM	60@19	28@10	12@5
48	1932.5	15	Default	A1	256 QAM	Outer_Full		
49	1930	20	Default	A1	256 QAM	Outer_Full		
50	1930	20	Default	A7	256 QAM	78@28	37@14	17@7

NOTE 1: The specific configuration of each RB allocation is defined in Table 6.1-1 unless otherwise stated in this table.
 NOTE 2: DFT-s-OFDM PI/2 BPSK test applies only for UEs which supports half Pi BPSK in FR1.

Table 6.2D.3.4.1-4: Test Configuration table for NS_05U

Initial Conditions								
Test Environment as specified in TS 38.508-1 [5] subclause 4.1			Normal					
Test Frequencies as specified in TS 38.508-1 [5] subclause 4.3.1			Use uplink carrier center frequency (Fc) as specified in test parameters					
Test Channel Bandwidths as specified in TS 38.508-1 [5] subclause 4.3.1			5 MHz, 10 MHz, 15 MHz, 20 MHz					
Test SCS as specified in Table 5.3.5-1			Lowest, Highest unless otherwise specified in test parameters.					
A-MPR test parameters for NS_05U								
Test ID	Fc (MHz)	ChBw (MHz)	SCS (kHz)	A-MPR	Uplink Configuration			
					Modulation (NOTE 2)	RB allocation (Note 1)		
						SCS 15 kHz	SCS 30 kHz	SCS 60 kHz
1	1922.5	5	15	A3	QPSK	Outer_Full		
2	1925	10	Default	A1	QPSK	Outer_Full		
3	1925	10	Default	A7	QPSK	42@10	18@5	8@3
4	1925	10	Default	A2	QPSK	6@40	3@20	1@10
5	1935	10	Default	A4	QPSK	Outer_Full		
6	1927.5	15	Default	A1	QPSK	Outer_Full		
7	1927.5	15	Default	A7	QPSK	60@19	28@10	12@5
8	1927.5	15	Default	A2	QPSK	6@56	3@28	1@14
9	1932.5	15	Default	A1	QPSK	Outer_Full		
10	1932.5	15	Default	A2	QPSK	6@68	3@34	1@17
11	1942.5	15	Default	A5	QPSK	Outer_Full		
12	1930	20	Default	A1	QPSK	Outer_Full		
13	1930	20	Default	A7	QPSK	78@28	37@14	17@7
14	1930	20	Default	A2	QPSK	6@76	3@38	1@19
15	1950	20	Default	A6	QPSK	Outer_Full		
16	1922.5	5	15	A3	16 QAM	Outer_Full		
17	1925	10	Default	A1	16 QAM	Outer_Full		
18	1925	10	Default	A7	16 QAM	42@10	18@5	8@3
19	1925	10	Default	A2	16 QAM	6@40	3@20	1@10
20	1935	10	Default	A4	16 QAM	Outer_Full		
21	1927.5	15	Default	A1	16 QAM	Outer_Full		
22	1927.5	15	Default	A7	16 QAM	60@19	28@10	12@5
23	1927.5	15	Default	A2	16 QAM	6@56	3@28	1@14
24	1932.5	15	Default	A1	16 QAM	Outer_Full		
25	1932.5	15	Default	A2	16 QAM	6@68	3@34	1@17
26	1942.5	15	Default	A5	16 QAM	Outer_Full		
27	1930	20	Default	A1	16 QAM	Outer_Full		
28	1930	20	Default	A7	16 QAM	78@28	37@14	17@7
29	1930	20	Default	A2	16 QAM	6@76	3@38	1@19
30	1950	20	Default	A6	16 QAM	Outer_Full		
31	1922.5	5	15	A3	64 QAM	Outer_Full		
32	1925	10	Default	A1	64 QAM	Outer_Full		
33	1925	10	Default	A7	64 QAM	42@10	18@5	8@3
34	1925	10	Default	A2	64 QAM	6@40	3@20	1@10
35	1935	10	Default	A4	64 QAM	Outer_Full		
36	1927.5	15	Default	A1	64 QAM	Outer_Full		
37	1927.5	15	Default	A7	64 QAM	60@19	28@10	12@5
38	1927.5	15	Default	A2	64 QAM	6@56	3@28	1@14
39	1932.5	15	Default	A1	64 QAM	Outer_Full		
40	1932.5	15	Default	A2	64 QAM	6@68	3@34	1@17
41	1942.5	15	Default	A5	64 QAM	Outer_Full		
42	1930	20	Default	A1	64 QAM	Outer_Full		
43	1930	20	Default	A7	64 QAM	78@28	37@14	17@7
44	1930	20	Default	A2	64 QAM	6@76	3@38	1@19
45	1950	20	Default	A6	64 QAM	Outer_Full		
46	1922.5	5	15	A3	256 QAM	Outer_Full		
47	1925	10	Default	A1	256 QAM	Outer_Full		
48	1925	10	Default	A7	256 QAM	42@10	18@5	8@3
49	1935	10	Default	A4	256 QAM	Outer_Full		
50	1927.5	15	Default	A1	256 QAM	Outer_Full		
51	1927.5	15	Default	A7	256 QAM	60@19	28@10	12@5
52	1932.5	15	Default	A1	256 QAM	Outer_Full		

Downlink Config.

CP-OFDM

53	1942.5	15	Default		A5	256 QAM	Outer_Full		
54	1930	20	Default		A1	256 QAM	Outer_Full		
55	1930	20	Default		A7	256 QAM	78@28	37@14	17@7
56	1950	20	Default		A6	256 QAM	Outer_Full		

NOTE 1: The specific configuration of each RB allocation is defined in Table 6.1-1 unless otherwise stated in this table.
 NOTE 2: DFT-s-OFDM PI/2 BPSK test applies only for UEs which supports half Pi BPSK in FR1.

Table 6.2D.3.4.1-5: Test Configuration table for NS_48

Initial Conditions									
Test Environment as specified in TS 38.508-1 [5] subclause 4.1						Normal			
Test Frequencies as specified in TS 38.508-1 [5] subclause 4.3.1						Low range, High range			
Test Channel Bandwidths as specified in TS 38.508-1 [5] subclause 4.3.1						25 MHz, 30MHz, 40MHz, 50MHz			
Test SCS as specified in Table 5.3.5-1						Lowest, Highest			
A-MPR test parameters for NS_48									
Test ID	F _c (MHz)	Ch BW (MHz)	SCS (kHz)			Uplink Configuration			
						Modulation (Note 2)	RB allocation (Note 1)		
							SCS 15 kHz	SCS 30 kHz	SCS 60 kHz
1	Default	25	Default	Downlink Configuration	CP-OFDM	QPSK	Outer_Full (A3)		
2	Default	25	Default			QPSK	Edge_1RB_Right (A3)		
3	Default	30	Default			QPSK	Outer_Full (A3)		
4	Default	30	Default			QPSK	Edge_1RB_Right (A5)		
5	Default	40	Default			QPSK	16@0 (A2)	8@0 (A2)	4@0 (A2)
6	Default	40	Default			QPSK	95@0 (A3)	48@0 (A3)	24@0 (A3)
7	Default	40	Default			QPSK	152@0 (A4)	76@0 (A4)	38@0 (A4)
8	Default	40	Default			QPSK	192@0 (A2)	96@0 (A2)	48@0 (A2)
9	Default	40	Default			QPSK	5@187 (A3)	2@94 (A3)	1@47 (A3)
10	Default	40	Default			QPSK	Outer_Full (A1)		
11	Default	50	Default			QPSK	34@0 (A2)	18@0 (A2)	9@0 (A2)
12	Default	50	Default			QPSK	115@0 (A4)	58@0 (A4)	29@0 (A4)
13	Default	50	Default			QPSK	228@0 (A2)	114@0 (A2)	57@0 (A2)
14	Default	50	Default			QPSK	5@223 (A5)	2@112 (A5)	1@56 (A5)
15	Default	50	Default			QPSK	Outer_Full (A1)		
16	Default	25	Default			256 QAM	Outer_Full (A3)		
17	Default	25	Default			256 QAM	Edge_1RB_Right (A3)		
18	Default	30	Default			256 QAM	Outer_Full (A3)		
19	Default	30	Default			256 QAM	Edge_1RB_Right (A5)		
20	Default	40	Default			256 QAM	16@0 (A2)	8@0 (A2)	4@0 (A2)
21	Default	40	Default			256 QAM	95@0 (A3)	48@0 (A3)	24@0 (A3)
22	Default	40	Default			256 QAM	152@0 (A4)	76@0 (A4)	38@0 (A4)
23	Default	40	Default			256 QAM	192@0 (A2)	96@0 (A2)	48@0 (A2)
24	Default	40	Default			256 QAM	5@187 (A3)	2@94 (A3)	1@47 (A3)
25	Default	40	Default			256 QAM	Outer_Full (A1)		
26	Default	50	Default			256 QAM	34@0 (A2)	18@0 (A2)	9@0 (A2)
27	Default	50	Default			256 QAM	115@0 (A4)	58@0 (A4)	29@0 (A4)
28	Default	50	Default			256 QAM	228@0 (A2)	114@0 (A2)	57@0 (A2)
29	Default	50	Default			256 QAM	5@223 (A5)	2@112 (A5)	1@56 (A5)
30	Default	50	Default			256 QAM	Outer_Full (A1)		

NOTE 1: The specific configuration of each RB allocation is defined in Table 6.1-1 unless otherwise stated in this table.

Table 6.2D.3.4.1-6: Test Configuration table for NS_49

Initial Conditions							
Test Environment as specified in TS 38.508-1 [5] subclause 4.1				Normal			
Test Frequencies as specified in TS 38.508-1 [5] subclause 4.3.1				Low range, High range			
Test Channel Bandwidths as specified in TS 38.508-1 [5] subclause 4.3.1				25 MHz, 30MHz, 40MHz, 50MHz			
Test SCS as specified in Table 5.3.5-1				Lowest, Highest			
A-MPR test parameters for NS_49							
Test ID	F _c (MHz)	Ch BW (MHz)	SCS (kHz)	Uplink Configuration			
				Modulation (Note 2)	RB allocation (Note 1)		
					SCS 15 kHz	SCS 30 kHz	SCS 60 kHz
1	Default	25	Default	QPSK	Outer_Full (A3)		
2	Default	25	Default	QPSK	Edge_1RB_Right (A3)		
3	Default	25	Default	QPSK	Edge_1RB_Left (A3)		
4	Default	30	Default	QPSK	20@0 (A1)	10@0 (A1)	5@0 (A1)
5	Default	30	Default	QPSK	36@0 (A5)	18@0 (A5)	9@0 (A5)
6	Default	30	Default	QPSK	80@0 (A3)	40@0 (A3)	20@0 (A3)
7	Default	30	Default	QPSK	120@0 (A4)	60@0 (A4)	30@0 (A4)
8	Default	30	Default	QPSK	Outer_Full (A2)		
9	Default	30	Default	QPSK	Edge_1RB_Right (A5)		
10	Default	40	Default	QPSK	40@0 (A1)	20@0 (A1)	10@0 (A1)
11	Default	40	Default	QPSK	5@53 (A5)	2@27 (A5)	1@14 (A5)
12	Default	40	Default	QPSK	100@0 (A4)	50@0 (A4)	25@0 (A4)
13	Default	40	Default	QPSK	159@33 (A2)	79@17 (A2)	39@9 (A2)
14	Default	40	Default	QPSK	5@187 (A5)	2@94 (A5)	1@47 (A5)
15	Default	40	Default	QPSK	192@0 (A1)	96@0 (A1)	48@0 (A1)
16	Default	40	Default	QPSK	Outer_Full (A1)		
17	Default	50	Default	QPSK	5@75 (A5)	2@38 (A5)	1@19 (A5)
18	Default	50	Default	QPSK	5@215 (A5)	2@108 (A5)	1@54 (A5)
19	Default	50	Default	QPSK	175@45 (A2)	87@23 (A2)	43@12 (A2)
20	Default	50	Default	QPSK	220@0 (A1)	110@0 (A1)	55@0 (A1)
21	Default	50	Default	QPSK	Outer_Full (A1)		
22	Default	25	Default	256 QAM	Outer_Full (A3)		
23	Default	25	Default	256 QAM	Edge_1RB_Right (A3)		
24	Default	25	Default	256 QAM	Edge_1RB_Left (A3)		
25	Default	30	Default	256 QAM	20@0 (A1)	10@0 (A1)	5@0 (A1)
26	Default	30	Default	256 QAM	36@0 (A5)	18@0 (A5)	9@0 (A5)
27	Default	30	Default	256 QAM	80@0 (A3)	40@0 (A3)	20@0 (A3)
28	Default	30	Default	256 QAM	120@0 (A4)	60@0 (A4)	30@0 (A4)
29	Default	30	Default	256 QAM	Outer_Full (A2)		
30	Default	30	Default	256 QAM	Edge_1RB_Right (A5)		
31	Default	40	Default	256 QAM	40@0 (A1)	20@0 (A1)	10@0 (A1)
32	Default	40	Default	256 QAM	5@53 (A5)	2@27 (A5)	1@14 (A5)
33	Default	40	Default	256 QAM	100@0 (A4)	50@0 (A4)	25@0 (A4)
34	Default	40	Default	256 QAM	159@33 (A2)	79@17 (A2)	39@9 (A2)
35	Default	40	Default	256 QAM	5@187 (A5)	2@94 (A5)	1@47 (A5)
36	Default	40	Default	256 QAM	192@0 (A1)	96@0 (A1)	48@0 (A1)
37	Default	40	Default	256 QAM	Outer_Full (A1)		
38	Default	50	Default	256 QAM	5@75 (A5)	2@38 (A5)	1@19 (A5)
39	Default	50	Default	256 QAM	5@215 (A5)	2@108 (A5)	1@54 (A5)
40	Default	50	Default	256 QAM	175@45 (A2)	87@23 (A2)	43@12 (A2)
41	Default	50	Default	256 QAM	220@0 (A1)	110@0 (A1)	55@0 (A1)
42	Default	50	Default	256 QAM	Outer_Full (A1)		

NOTE 1: The specific configuration of each RB allocation is defined in Table 6.1-1 unless otherwise stated in this table.

Table 6.2D.3.4.1-7: Test Configuration table for NS_03, NS_03U and NS_100

Initial Conditions							
Test Environment as specified in TS 38.508-1 [5] subclause 4.1						Normal	
Test Frequencies as specified in TS 38.508-1 [5] subclause 4.3.1						Low range, High range	
Test Channel Bandwidths as specified in TS 38.508-1 [5] subclause 4.3.1						Lowest, Highest	
Test SCS as specified in Table 5.3.5-1						Lowest, Highest	
A-MPR test parameters for NS_03, NS_03U and NS_100							
Test ID	Freq	ChBw	SCS	Downlink Configuration	Uplink Configuration		
					Modulation	RB allocation (Note 1)	
1	Low	Default	Default	N/A for A-MPR test cases	CP-OFDM	QPSK	Edge_1RB_Left
2	High	Default	Default			QPSK	Edge_1RB_Right
3	Default	Default	Default			QPSK	Outer_Full
4	Low	Default	Default			16 QAM	Edge_1RB_Left
5	High	Default	Default			16 QAM	Edge_1RB_Right
6	Default	Default	Default			16 QAM	Outer_Full
7	Low	Default	Default			64 QAM	Edge_1RB_Left
8	High	Default	Default			64 QAM	Edge_1RB_Right
9	Default	Default	Default			64 QAM	Outer_Full
10	Low	Default	Default			256 QAM	Edge_1RB_Left
11	High	Default	Default			256 QAM	Edge_1RB_Right
12	Default	Default	Default			256 QAM	Outer_Full
NOTE 1: The specific configuration of each RB allocation is defined in Table 6.1-1 unless otherwise stated in this table.							

Table 6.2D.3.4.1-8: Test Configuration table for NS_46

Initial Conditions									
Test Environment as specified in TS 38.508-1 [5] subclause 4.1					Normal				
Test Frequencies as specified in TS 38.508-1 [5] subclause 4.3.1					High range				
Test Channel Bandwidths as specified in TS 38.508-1 [5] subclause 4.3.1					15MHz, 20MHz, 25 MHz, 50MHz				
Test SCS as specified in Table 5.3.5-1					Lowest, Highest				
A-MPR test parameters for NS_46									
Test ID	F _c (MHz)	Ch BW (MHz)	SCS (kHz)	Downlink Configuration	Uplink Configuration				
					Modulation Scheme	RB allocation (Note 1)			
	SCS 15 kHz	SCS 30 kHz	SCS 60 kHz						
1	Default	25	Default		CP-OFDM	QPSK	90@43 (A3)	45@20 (A3)	23@8 (A3)
2	Default	25	Default			256QAM	90@43 (A3)	45@20 (A3)	23@8 (A3)
3	Default	50	Default			QPSK	Edge_1RB_Left (A4)		
4	Default	50	Default			64QAM	Edge_1RB_Left (A4)		
5	Default	50	Default			QPSK	120@0 (A5)	60@0 (A5)	30@0 (A5)
6	Default	50	Default			64QAM	120@0 (A5)	60@0 (A5)	30@0 (A5)
7	Default	50	Default			QPSK	176@0 (A6)	88@0 (A6)	44@0 (A6)
8	Default	50	Default			64QAM	176@0 (A6)	88@0 (A6)	44@0 (A6)
9	Default	50	Default			QPSK	220@0 (A7)	110@0 (A7)	55@0 (A7)
10	Default	50	Default	256QAM		220@0 (A7)	110@0 (A7)	55@0 (A7)	
11	Default	50	Default	QPSK		Outer_Full (A8)			
12	Default	50	Default	256QAM		Outer_Full (A8)			

NOTE 1: The specific configuration of each RB allocation is defined in Table 6.1-1 unless otherwise stated in this table.

Table 6.2D.3.4.1-9: Test Configuration table for NS_21

Initial Conditions								
Test Environment as specified in TS 38.508-1 [5] subclause 4.1						Normal		
Test Frequencies as specified in TS 38.508-1 [5] subclause 4.3.1						Low range, High range		
Test Channel Bandwidths as specified in TS 38.508-1 [5] subclause 4.3.1						Lowest, Highest		
Test SCS as specified in Table 5.3.5-1						Lowest, Highest		
A-MPR test parameters for NS_21								
Test ID	Freq	ChBw	SCS	Downlink Configuration	Uplink Configuration			
					Modulation (Note 2)	RB allocation (Note 1)		
						SCS 15 kHz	SCS 30 kHz	
1	Low	Default	Default	N/A	DFT-s-OFDM	QPSK		Edge_1RB_Left
2	High	Default	Default			QPSK	Edge_1RB_Right	
3	Default	Default	Default			QPSK	Outer_Full	
4	Default	10 MHz	Default			QPSK	4@0	2@0
5	Default	10 MHz	Default			QPSK	4@48	2@22
6	Low	Default	Default			16 QAM	Edge_1RB_Left	
7	High	Default	Default			16 QAM	Edge_1RB_Right	
8	Default	Default	Default			16 QAM	Outer_Full	
9	Default	10 MHz	Default			16 QAM	4@0	2@0
10	Default	10 MHz	Default			16 QAM	4@48	2@22
11	Low	Default	Default			64 QAM	Edge_1RB_Left	
12	High	Default	Default			64 QAM	Edge_1RB_Right	
13	Default	Default	Default			64 QAM	Outer_Full	
14	Default	10 MHz	Default			64 QAM	4@0	2@0
15	Default	10 MHz	Default			64 QAM	4@48	2@22
16	Low	Default	Default			256 QAM	Edge_1RB_Left	
17	High	Default	Default			256 QAM	Edge_1RB_Right	
18	Default	Default	Default			256 QAM	Outer_Full	
19	Default	10 MHz	Default			256 QAM	4@0	2@0
20	Default	10 MHz	Default			256 QAM	4@48	2@22

NOTE 1: The specific configuration of each RB allocation is defined in Table 6.1-1 unless otherwise stated in this table.
 NOTE 2: DFT-s-OFDM PI/2 BPSK test applies only for UEs which supports half Pi BPSK in FR1.

Table 6.2D.3.4.1-10: Test Configuration table for NS_44

Initial Conditions								
Test Environment as specified in TS 38.508-1 [5] subclause 4.1					Normal			
Test Frequencies as specified in TS 38.508-1 [5] subclause 4.3.1					Defined for each test ID			
Test Channel Bandwidths as specified in TS 38.508-1 [5] subclause 4.3.1					Defined for each test ID			
Test SCS as specified in Table 5.3.5-1					Lowest, Highest			
A-MPR test parameters for NS_44								
Test ID	F _c (MHz)	Ch BW (MHz)	SCS (kHz)	Downlink Configuration	Uplink Configuration			
					Modulation ϰ ϣ ϣ ϣ	RB allocation (Note 1)		
					SCS 15 kHz	SCS 30 kHz	SCS 60 kHz	
1	2602.5	25	Default	N/A	64 QAM	100@0 (A3)	50@0 (A3)	25@0 (A3)
2	2602.5	25	Default		64 QAM	39@94 (A3)	19@46 (A3)	9@22 (A3)
3	2602.5	25	Default		64 QAM	Outer_Full (A6)		
4	2602.5	25	Default		256 QAM	100@0 (A3)	50@0 (A3)	25@0 (A3)
5	2602.5	25	Default		256 QAM	39@94 (A3)	19@46 (A3)	9@22 (A3)
6	2602.5	25	Default		256 QAM	Outer_Full (A6)		
7	2600	30	Default		64 QAM	120@0 (A3)	60@0 (A3)	30@0 (A3)
8	2600	30	Default		64 QAM	69@91 (A5)	34@44 (A5)	17@21 (A5)
9	2600	30	Default		64 QAM	Outer_Full (A5)		
10	2600	30	Default		256 QAM	120@0 (A3)	60@0 (A3)	30@0 (A3)
11	2600	30	Default		256 QAM	69@91 (A5)	34@44 (A5)	17@21 (A5)
12	2600	30	Default		256 QAM	Outer_Full (A5)		
13	2595	40	Default		64 QAM	16@0 (A2)	8@0 (A2)	4@0 (A2)
14	2595	40	Default		64 QAM	80@0 (A2)	40@0 (A2)	20@0 (A2)
15	2595	40	Default		64 QAM	130@0 (A3)	65@0 (A3)	33@0 (A3)
16	2595	40	Default		64 QAM	180@0 (A4)	90@0 (A4)	45@0 (A4)
17	2595	40	Default		64 QAM	Outer_Full (A5)		
18	2595	40	Default		256 QAM	16@0 (A2)	8@0 (A2)	4@0 (A2)
19	2595	40	Default		256 QAM	80@0 (A2)	40@0 (A2)	20@0 (A2)
20	2595	40	Default		256 QAM	130@0 (A3)	65@0 (A3)	33@0 (A3)
21	2595	40	Default		256 QAM	180@0 (A4)	90@0 (A4)	45@0 (A4)
22	2595	40	Default		256 QAM	Outer_Full (A5)		

NOTE 1: The specific configuration of each RB allocation is defined in Table 6.1-1 unless otherwise stated in this table.

Table 6.2D.3.4.1-11: Test Configuration table for NS_27

Initial Conditions								
Test Environment as specified in TS 38.508-1 [5] subclause 4.1					Normal			
Test Frequencies					Refer to uplink carrier centre frequency (F _c) in test parameters. Associated parameters defined in Table 6.2D.3.4.1-9a and 6.2D.3.4.1-9b.			
Test Channel Bandwidths as specified in TS 38.508-1 [5] subclause 4.3.1					Refer to test parameters (15, 20, 40 MHz)			
Test SCS as specified in Table 5.3.5-1					Lowest, Highest (Note 3)			
A-MPR test parameters for NS_27								
Test ID	F _c (MHz)	Ch BW (MHz)	SCS (kHz)	Downlink Configuration	Uplink Configuration			
					Modulation ଝଞଢଞ	RB allocation (Note 1)		
						SCS 15 kHz	SCS 30 kHz	SCS 60 kHz
1	3557.52	15	Default	N/A	QPSK	Edge_1RB_Left (A3)		
2	3557.52	15	Default		QPSK	Outer_Full (A3)		
3	3692.49	15	Default		QPSK	Edge_1RB_Right (A3)		
4	3692.49	15	Default		QPSK	Outer_Full (A3)		
5	3562.5	15	Default		QPSK	Edge_1RB_Left (A4)		
6	3562.5	15	Default		QPSK	Outer_Full (2)		
7	3687.48	15	Default		QPSK	Edge_1RB_Right (A4)		
8	3687.48	15	Default		QPSK	Outer_Full (2)		
9	3560.01	20	Default		QPSK	Edge_1RB_Left (A5)		
10	3560.01	20	Default		QPSK	Outer_Full (A5)		
11	3690	20	Default		QPSK	Edge_1RB_Right (A5)		
12	3690	20	Default		QPSK	Outer_Full (A5)		
13	3570	20	Default		QPSK	Edge_1RB_Left (A6)		
14	3570	20	Default		QPSK	Outer_Full (2)		
15	3679.98	20	Default		QPSK	Edge_1RB_Right (A6)		
16	3679.98	20	Default		QPSK	Outer_Full (2)		
17	3570	40	Default		QPSK	Edge_1RB_Left (A7)		
18	3570	40	Default		QPSK	153@63 (A2)	72@32 (A2)	32@16 (A2)
19	3570	40	Default		QPSK	99@69 (A1)	49@34 (A1)	24@16 (A1)
20	3570	40	Default		QPSK	Edge_1RB_Right (A7)		
21	3679.98	40	Default		QPSK	Edge_1RB_Right (A7)		
22	3679.98	40	Default		QPSK	137@0 (A2)	68@0 (A2)	35@0 (A2)
23	3679.98	40	Default		QPSK	99@38 (A1)	49@18 (A1)	24@9 (A1)
24	3679.98	40	Default		QPSK	Edge_1RB_Left (A7)		
25	3600	40	Default		QPSK	Edge_1RB_Left (A8)		
26	3600	40	Default		QPSK	Outer_Full (4.5)		
27	3649.98	40	Default		QPSK	Edge_1RB_Right (A8)		
28	3649.98	40	Default		QPSK	Outer_Full (4.5)		
29	3557.52	15	Default		16 QAM	Edge_1RB_Left (A3)		
30	3557.52	15	Default		16 QAM	Outer_Full (A3)		
31	3692.49	15	Default		16 QAM	Edge_1RB_Right (A3)		

32	3692.49	15	Default
33	3562.5	15	Default
34	3562.5	15	Default
35	3687.48	15	Default
36	3687.48	15	Default
37	3560.01	20	Default
38	3560.01	20	Default
39	3690	20	Default
40	3690	20	Default
41	3570	20	Default
42	3570	20	Default
43	3679.98	20	Default
44	3679.98	20	Default
45	3570	40	Default
46	3570	40	Default
47	3570	40	Default
48	3570	40	Default
49	3679.98	40	Default
50	3679.98	40	Default
51	3679.98	40	Default
52	3679.98	40	Default
53	3600	40	Default
54	3600	40	Default
55	3649.98	40	Default
56	3649.98	40	Default
57	3557.52	15	Default
58	3557.52	15	Default
59	3692.49	15	Default
60	3692.49	15	Default
61	3562.5	15	Default
62	3562.5	15	Default
63	3687.48	15	Default
64	3687.48	15	Default
65	3560.01	20	Default
66	3560.01	20	Default
67	3690	20	Default
68	3690	20	Default
69	3570	20	Default
70	3570	20	Default
71	3679.98	20	Default

16 QAM	Outer_Full (A3)		
16 QAM	Edge_1RB_Left (A4)		
16 QAM	Outer_Full (2)		
16 QAM	Edge_1RB_Right (A4)		
16 QAM	Outer_Full (2)		
16 QAM	Edge_1RB_Left (A5)		
16 QAM	Outer_Full (A5)		
16 QAM	Edge_1RB_Right (A5)		
16 QAM	Outer_Full (A5)		
16 QAM	Edge_1RB_Left (A6)		
16 QAM	Outer_Full (2)		
16 QAM	Edge_1RB_Right (A6)		
16 QAM	Outer_Full (2)		
16 QAM	Edge_1RB_Left (A7)		
16 QAM	153@63 (A2)	72@32 (A2)	32@16 (A2)
16 QAM	99@69 (A1)	49@34 (A1)	24@16 (A1)
16 QAM	Edge_1RB_Right (A7)		
16 QAM	Edge_1RB_Right (A7)		
16 QAM	137@0 (A2)	68@0 (A2)	35@0 (A2)
16 QAM	99@38 (A1)	49@18 (A1)	24@9 (A1)
16 QAM	Edge_1RB_Left (A7)		
16 QAM	Edge_1RB_Left (A8)		
16 QAM	Outer_Full (4.5)		
16 QAM	Edge_1RB_Right (A8)		
16 QAM	Outer_Full (4.5)		
64 QAM	Edge_1RB_Left (A3)		
64 QAM	Outer_Full (A3)		
64 QAM	Edge_1RB_Right (A3)		
64 QAM	Outer_Full (A3)		
64 QAM	Edge_1RB_Left (A4)		
64 QAM	Outer_Full (2)		
64 QAM	Edge_1RB_Right (A4)		
64 QAM	Outer_Full (2)		
64 QAM	Edge_1RB_Left (A5)		
64 QAM	Outer_Full (A5)		
64 QAM	Edge_1RB_Right (A5)		
64 QAM	Outer_Full (A5)		
64 QAM	Edge_1RB_Left (A6)		
64 QAM	Outer_Full (2)		
64 QAM	Edge_1RB_Right (A6)		

3GPP TS 38.521-1 version 17.5.0 Release 17

72	3679.98	20	Default
73	3570	40	Default
74	3570	40	Default
75	3570	40	Default
76	3570	40	Default
77	3679.98	40	Default
78	3679.98	40	Default
79	3679.98	40	Default
80	3679.98	40	Default
81	3600	40	Default
82	3600	40	Default
83	3649.98	40	Default
84	3649.98	40	Default
85	3557.52	15	Default
86	3557.52	15	Default
87	3692.49	15	Default
88	3692.49	15	Default
89	3562.5	15	Default
90	3562.5	15	Default
91	3687.48	15	Default
92	3687.48	15	Default
93	3560.01	20	Default
94	3560.01	20	Default
95	3690	20	Default
96	3690	20	Default
97	3570	20	Default
98	3570	20	Default
99	3679.98	20	Default
100	3679.98	20	Default
101	3570	40	Default
102	3570	40	Default
103	3570	40	Default
104	3570	40	Default
105	3679.98	40	Default
106	3679.98	40	Default
107	3679.98	40	Default
108	3679.98	40	Default
109	3600	40	Default
110	3600	40	Default
111	3649.98	40	Default

432

ETSI TS 138 521-1 V17.5.0 (2022-09)

64 QAM	Outer_Full (2)		
64 QAM	Edge_1RB_Left (A7)		
64 QAM	153@63 (A2)	72@32 (A2)	32@16 (A2)
64 QAM	99@69 (A1)	49@34 (A1)	24@16 (A1)
64 QAM	Edge_1RB_Right (A7)		
64 QAM	Edge_1RB_Right (A7)		
64 QAM	137@0 (A2)	68@0 (A2)	35@0 (A2)
64 QAM	99@38 (A1)	49@18 (A1)	24@9 (A1)
64 QAM	Edge_1RB_Left (A7)		
64 QAM	Edge_1RB_Left (A8)		
64 QAM	Outer_Full (4.5)		
64 QAM	Edge_1RB_Right (A8)		
64 QAM	Outer_Full (4.5)		
256 QAM	Edge_1RB_Left (A3)		
256 QAM	Outer_Full (A3)		
256 QAM	Edge_1RB_Right (A3)		
256 QAM	Outer_Full (A3)		
256 QAM	Edge_1RB_Left (A4)		
256 QAM	Outer_Full (2)		
256 QAM	Edge_1RB_Right (A4)		
256 QAM	Outer_Full (2)		
256 QAM	Edge_1RB_Left (A5)		
256 QAM	Outer_Full (A5)		
256 QAM	Edge_1RB_Right (A5)		
256 QAM	Outer_Full (A5)		
256 QAM	Edge_1RB_Left (A6)		
256 QAM	Outer_Full (2)		
256 QAM	Edge_1RB_Right (A6)		
256 QAM	Outer_Full (2)		
256 QAM	Edge_1RB_Left (A7)		
256 QAM	153@63 (A2)	72@32 (A2)	32@16 (A2)
256 QAM	99@69 (A1)	49@34 (A1)	24@16 (A1)
256 QAM	Edge_1RB_Right (A7)		
256 QAM	Edge_1RB_Right (A7)		
256 QAM	137@0 (A2)	68@0 (A2)	35@0 (A2)
256 QAM	99@38 (A1)	49@18 (A1)	24@9 (A1)
256 QAM	Edge_1RB_Left (A7)		
256 QAM	Edge_1RB_Left (A8)		
256 QAM	Outer_Full (4.5)		
256 QAM	Edge_1RB_Right (A8)		

112	3649.98	40	Default		256 QAM	Outer_Full (4.5)
-----	---------	----	---------	--	---------	------------------

NOTE 1: The specific configuration of each RB allocation is defined in Table 6.1-1 unless otherwise stated in this table.
NOTE 2: DFT-s-OFDM PI/2 BPSK test applies only for UEs which supports half Pi BPSK in FR1.
NOTE 3: For FR1 bands where highest supported SCS is 60 kHz the highest tested SCS is limited to 30 kHz as carrier with SCS=60 kHz cannot be used as PCell.

Table 6.2D.3.4.1-11a: Test frequencies for NS_27 (SCS=15 kHz, ΔFRaster = 15kHz)

CBW [MHz]	carrierBandwidth [PRBs]	Carrier centre [MHz]	Carrier centre [ARFCN]	point A [MHz]	absoluteFrequencyPointA [ARFCN]	offsetToCarrier [Carrier PRBs]	SS block SCS [kHz]	GSC N	absoluteFrequencySSB [ARFCN]	k _{SSB}	Offset Carrier CORESET#0 [RBs] Note 2	CORESET#0 Index (Offset [RBs]) Note 1	offsetToPointA(SIB1) [PRBs] Note 1
15	79	3557.52	637168	3550.41	636694	0	30	7884	636960	2	0	0 (2)	2
		3562.5	637500	3555.39	637026			7888	637344	6	0	1 (6)	6
		3687.48	645832	3680.37	645358			7975	645696	2	2	1 (6)	8
		3692.49	646166	3685.38	645692			7978	645984	4	2	0 (2)	4
20	106	3560.01	637334	3550.47	636698			7885	637056	10	3	1 (6)	9
		3570	638000	3560.46	637364			7891	637632	4	0	0 (2)	2
		3679.98	645332	3670.44	644696			7968	645024	4	1	1 (6)	7
		3690	646000	3680.46	645364			7975	645696	8	1	1 (6)	7
40	216	3570	638000	3550.56	636704			7885	637056	4	3	1 (6)	9
		3600	640000	3580.56	638704			7905	638976	8	0	0 (2)	2
		3649.98	643332	3630.54	642036			7940	642336	0	3	0 (2)	5
		3679.98	645332	3660.54	644036			7961	644352	4	0	1 (6)	6

NOTE 1: The CORESET#0 Index and the associated CORESET#0 Offset refers to Table 13-1 in TS 38.213 [22]. The value of CORESET#0 Index is signalled in controlResourceSetZero (pdcc-ConfigSIB1) in the MIB. The offsetToPointA IE is expressed in units of resource blocks assuming 15 kHz subcarrier spacing for FR1 and 60 kHz subcarrier spacing for FR2.
NOTE 2: The parameter Offset Carrier CORESET#0 specifies the offset from the lowest subcarrier of the carrier and the lowest subcarrier of CORESET#0. It corresponds to the parameter ΔF_{OffsetCORESET-0-Carrier} in Annex C expressed in number of common RBs.

Table 6.2D.3.4.1-11b: Test frequencies for NS_27 (SCS=30 kHz, ΔFRaster = 30 kHz)

CBW [MHz]	carrier Bandwidth [PRBs]	Carrier centre [MHz]	Carrier centre [ARFCN]	point A [MHz]	absolute FrequencyPointA [ARFCN]	offsetToCarrier [Carrier PRBs]	SS block SCS [kHz]	GSC N	absoluteFrequencySSB [ARFCN]	k_{SSB}	Offset Carrier CORESET#0 [RBs] Note 2	CORESET#0 Index (Offset [RBs]) Note 1	offsetToPointA(SIB1) [PRBs] Note 1
15	38	3557.52	637168	3550.68	636712	0	30	7884	636960	8	0	0 (0)	0
		3562.5	637500	3555.66	637044			7888	637344	12	0	2 (2)	4
		3687.48	645832	3680.64	645376			7975	645696	8	0	3 (3)	6
		3692.49	646166	3685.65	645710			7978	645984	10	0	1 (1)	2
20	51	3560.01	637334	3550.83	636722			7885	637056	22	0	3 (3)	6
		3570	638000	3560.82	637388			7891	637632	4	0	0 (0)	0
		3679.98	645332	3670.8	644720			7968	645024	16	0	2 (2)	4
		3690	646000	3680.82	645388			7975	645696	20	0	2 (2)	4
40	106	3570	638000	3550.92	636728			7885	637056	16	0	3 (3)	6
		3600	640000	3580.92	638728			7905	638976	8	0	0 (0)	0
		3649.98	643332	3630.9	642060			7940	642336	12	0	1 (1)	2
		3679.98	645332	3660.9	644060			7961	644352	4	0	2 (2)	4

NOTE 1: The CORESET#0 Index and the associated CORESET#0 Offset refers to Table 13-1 in TS 38.213 [22]. The value of CORESET#0 Index is signalled in controlResourceSetZero (pdcch-ConfigSIB1) in the MIB. The offsetToPointA IE is expressed in units of resource blocks assuming 15 kHz subcarrier spacing for FR1 and 60 kHz subcarrier spacing for FR2.

NOTE 2: The parameter Offset Carrier CORESET#0 specifies the offset from the lowest subcarrier of the carrier and the lowest subcarrier of CORESET#0. It corresponds to the parameter $\Delta F_{\text{OffsetCORESET-0-Carrier}}$ in Annex C expressed in number of common RBs.

Editor's note: The following lines belong at the end of subclause 6.2D.3.4.1. As new tables are added to this section, these lines should always follow the tables

1. Connect the SS to the UE antenna connectors as shown in TS 38.508-1 [5] Annex A, Figure A.3.1.1.2 for TE diagram and section A.3.2 for UE diagram.
2. The parameter settings for the cell are set up according to TS 38.508-1 [5] subclause 4.4.3.
3. Downlink signals are initially set up according to Annex C.0, C.1, C.2 and uplink signals according Annex G.0, G.1, G.2 and G.3.0.
4. The UL Reference Measurement channels are set according to the applicable Table 6.2D.3.4.1-1.
5. Propagation conditions are set according to Annex B.0.
6. Ensure the UE is in state RRC_CONNECTED with generic procedure parameters Connectivity *NR*, Connected without release *On*, Test Mode *On* and Test Loop Function *On* according to TS 38.508-1 [5] clause 4.5. Message contents are defined in clause 6.2D.3.4.3.

6.2D.3.4.2 Test procedure

1. SS sends uplink scheduling information for each UL HARQ process via PDCCH DCI format 0_1 for C_RNTI to schedule the UL RMC according to Table 6.2D.3.4.1-1. Since the UE has no payload data to send, the UE transmits uplink MAC padding bits on the UL RMC. The PDCCH DCI format 0_1 is specified with the condition 2TX_UL_MIMO in 38.508-1 [5] subclause 4.3.6.1.1.2.
2. Send continuously uplink power control "up" commands in every uplink scheduling information to the UE. Allow at least 200ms starting from the first TPC command in this step for the UE to reach P_{UMAX} level.
3. Measure the sum of the mean power of the UE at each transmit antenna connector in the channel bandwidth of the radio access mode. The period of measurement shall be at least the continuous duration of 1ms over all active uplink slots and in the uplink symbols. For TDD slots only slots consisting of only UL symbols are under.

6.2D.3.4.3 Message contents

Message contents are according to TS 38.508-1 [5] subclause 4.6.1 ensuring Table 4.6.3-182 with the condition 2TX_UL_MIMO, with the following exceptions for each network signalling value.

6.2D.3.4.3.1 Message contents exceptions for network signalling value "NS_04"

1. Information element additionalSpectrumEmission is set to NS_04. This can be set in the *SIB1* as part of the cell broadcast message. This exception indicates that the UE shall meet the additional spurious emission requirement for a specific deployment scenario.

Table 6.2D.3.4.3.1-1: AdditionalSpectrumEmission: Additional spurious emissions test requirement for "NS_04"

Derivation Path: TS 38.508-1 [5], Table 4.6.3-1			
Information Element	Value/remark	Comment	Condition
additionalSpectrumEmission	1 (NS_04)		

6.2D.3.4.3.2 Message contents exceptions for network signalling value "NS_35"

1. Information element additionalSpectrumEmission is set to NS_35. This can be set in the *SIB1* as part of the cell broadcast message. This exception indicates that the UE shall meet the additional spurious emission requirement for a specific deployment scenario.

Table 6.2D.3.4.3.2-1: AdditionalSpectrumEmission: Additional spurious emissions test requirement for "NS_35" and NR band n71

Derivation Path: TS 38.508-1 [5], Table 4.6.3-1			
Information Element	Value/remark	Comment	Condition
additionalSpectrumEmission	1 (NS_35)		

6.2D.3.4.3.3 Message contents exceptions for network signalling value "NS_05"

1. Information element `additionalSpectrumEmission` is set to NS_05. This can be set in the *SIB1* as part of the cell broadcast message. This exception indicates that the UE shall meet the additional spurious emission requirement for a specific deployment scenario.

Table 6.2D.3.4.3.3-1: *AdditionalSpectrumEmission*: Additional spurious emissions test requirement for "NS_05"

Derivation Path: TS 38.508-1 [5], Table 4.6.3-1			
Information Element	Value/remark	Comment	Condition
<code>additionalSpectrumEmission</code>	2 (NS_05)		

6.2D.3.4.3.4 Message contents exceptions for network signalling value "NS_05U"

1. Information element `additionalSpectrumEmission` is set to NS_05U. This can be set in the *SIB1* as part of the cell broadcast message. This exception indicates that the UE shall meet the additional spurious emission requirement for a specific deployment scenario.

Table 6.2D.3.4.3.4-1: *AdditionalSpectrumEmission*: Additional spurious emissions test requirement for "NS_05U"

Derivation Path: TS 38.508-1 [5], Table 4.6.3-1			
Information Element	Value/remark	Comment	Condition
<code>additionalSpectrumEmission</code>	3 (NS_05U)		

6.2D.3.4.3.5 Message contents exceptions for network signalling value "NS_48"

1. Information element `additionalSpectrumEmission` is set to NS_48. This can be set in the *SIB1* as part of the cell broadcast message. This exception indicates that the UE shall meet the additional spurious emission requirement for a specific deployment scenario.

Table 6.2D.3.4.3.5-1: *AdditionalSpectrumEmission*: Additional spurious emissions test requirement for "NS_48"

Derivation Path: TS 38.508-1 [5], Table 4.6.3-1			
Information Element	Value/remark	Comment	Condition
<code>additionalSpectrumEmission</code>	4 (NS_48)		

6.2D.3.4.3.6 Message contents exceptions for network signalling value "NS_49"

1. Information element `additionalSpectrumEmission` is set to NS_49. This can be set in the *SIB1* as part of the cell broadcast message. This exception indicates that the UE shall meet the additional spurious emission requirement for a specific deployment scenario.

Table 6.2D.3.4.3.6-1: *AdditionalSpectrumEmission*: Additional spurious emissions test requirement for "NS_49"

Derivation Path: TS 38.508-1 [5], Table 4.6.3-1			
Information Element	Value/remark	Comment	Condition
<code>additionalSpectrumEmission</code>	5 (NS_49)		

6.2D.3.4.3.7 Message contents exceptions for network signalling value "NS_100"

1. Information element `additionalSpectrumEmission` is set to NS_100. This can be set in the *SIB1* as part of the cell broadcast message. This exception indicates that the UE shall meet the additional spurious emission requirement for a specific deployment scenario.

Table 6.2D.3.4.3.7-1: AdditionalSpectrumEmission: Additional spurious emissions test requirement for "NS_100"

Derivation Path: TS 38.508-1 [5], Table 4.6.3-1			
Information Element	Value/remark	Comment	Condition
additionalSpectrumEmission	1 (NS_100)		not for band n65
	2 (NS_100)		for band n65

6.2D.3.4.3.8 Message contents exceptions for network signalling value "NS_03"

- Information element additionalSpectrumEmission is set to NS_03. This can be set in the *SIB1* as part of the cell broadcast message. This exception indicates that the UE shall meet the additional spurious emission requirement for a specific deployment scenario.

Table 6.2D.3.4.3.8-1: AdditionalSpectrumEmission: Additional spurious emissions test requirement for "NS_03" and NR band n2, n25 and n66

Derivation Path: TS 38.508-1 [5], Table 4.6.3-1			
Information Element	Value/remark	Comment	Condition
additionalSpectrumEmission	2 (NS_03)		

Table 6.2D.3.4.3.8-2: AdditionalSpectrumEmission: Additional spurious emissions test requirement for "NS_03" and NR band n70

Derivation Path: TS 38.508-1 [5], Table 4.6.3-1			
Information Element	Value/remark	Comment	Condition
additionalSpectrumEmission	1 (NS_03)		

6.2D.3.4.3.9 Message contents exceptions for network signalling value "NS_03U"

- Information element additionalSpectrumEmission is set to NS_03U. This can be set in the *SIB1* as part of the cell broadcast message. This exception indicates that the UE shall meet the additional spurious emission requirement for a specific deployment scenario.

Table 6.2D.3.4.3.9-1: AdditionalSpectrumEmission: Additional spurious emissions test requirement for "NS_03U"

Derivation Path: TS 38.508-1 [5], Table 4.6.3-1			
Information Element	Value/remark	Comment	Condition
additionalSpectrumEmission	3 (NS_03U)		for band n2, n25, n66

6.2D.3.4.3.10 Message contents exceptions for network signalling value "NS_46"

- Information element additionalSpectrumEmission is set to NS_46. This can be set in the *SIB1* as part of the cell broadcast message. This exception indicates that the UE shall meet the additional spurious emission requirement for a specific deployment scenario.

Table 6.2D.3.4.3.10-1: AdditionalSpectrumEmission: Additional spurious emissions test requirement for "NS_46"

Derivation Path: TS 38.508-1 [5], Table 4.6.3-1			
Information Element	Value/remark	Comment	Condition
additionalSpectrumEmission	1 (NS_46)		for band n7

6.2D.3.4.3.11 Message contents exceptions for network signalling value "NS_21"

- Information element additionalSpectrumEmission is set to NS_21. This can be set in the *SIB1* as part of the cell broadcast message. This exception indicates that the UE shall meet the additional spurious emission requirement for a specific deployment scenario.

Table 6.2D.3.4.3.11-1: AdditionalSpectrumEmission: Additional spurious emissions test requirement for "NS_21"

Derivation Path: TS 38.508-1 [5], Table 4.6.3-1			
Information Element	Value/remark	Comment	Condition
additionalSpectrumEmission	1 (NS_21)		

6.2D.3.4.3.12 Message contents exceptions for network signalling value "NS_44"

- Information element additionalSpectrumEmission is set to NS_44. This can be set in the *SIB1* as part of the cell broadcast message. This exception indicates that the UE shall meet the additional spurious emission requirement for a specific deployment scenario.

Table 6.2D.3.4.3.12-1: AdditionalSpectrumEmission: Additional spurious emissions test requirement for "NS_44"

Derivation Path: TS 38.508-1 [5], Table 4.6.3-1			
Information Element	Value/remark	Comment	Condition
additionalSpectrumEmission	1 (NS_44)		

6.2D.3.4.3.13 Message contents exceptions for network signalling value "NS_27"

- Information element additionalSpectrumEmission is set to NS_27. This can be set in the *SIB1* as part of the cell broadcast message. This exception indicates that the UE shall meet the additional spurious emission requirement for a specific deployment scenario.

Table 6.2D.3.4.3.13-1: AdditionalSpectrumEmission: Additional spurious emissions test requirement for "NS_27"

Derivation Path: TS 38.508-1 [5], Table 4.6.3-1			
Information Element	Value/remark	Comment	Condition
additionalSpectrumEmission	1 (NS_27)		

6.2D.3.5 Test requirement

The maximum output power, derived in step 3 shall be within the range prescribed by the nominal maximum output power and tolerance in the applicable table from table 6.2D.3.5-1 to table 6.2D.3.5-14. The allowed A-MPR values specified in table 6.2.3.3.1-1 are in addition to the allowed MPR requirements specified in clause 6.2.2.3. For the UE maximum output power modified by MPR and/or A-MPR, the power limits specified in table 6.2D.1.3-1 apply.

Table 6.2D.3.5-0: Test Tolerance (UE additional maximum output power reduction)

	$f \leq 3.0\text{GHz}$	$3.0\text{GHz} < f \leq 6.0\text{GHz}$
$\text{BW} \leq 40\text{MHz}$	0.7	1.0
$40\text{MHz} < \text{BW} \leq 100\text{MHz}$	1.0	1.0

Table 6.2D.3.5-1: UE Power Class 2 test requirements (NS_04) for band n41

Test ID	P _{PowerClass} (dBm)	MPR (dB)	A-MPR (dB)	$\Delta T_{C,c}$ (dB)	P _{CMAX,c} (dBm)	T(P _{CMAX_L,c}) (dB)	T _{L,c} (dB)	Upper limit (dBm)	Lower limit (Note 2) (dBm)
1	26	0	[7.5]	0	18.5	5	3	28+TT	[13.5-TT]
2	26	0	[7.5]	0	18.5	5	3	28+TT	[13.5-TT]
3	26	0	6.5	0	19.5	5	3	28+TT	14.5-TT
4	26	0	6.5	0	19.5	5	3	28+TT	14.5-TT
5	26	3.5	0	0	22.5	5	3	28+TT	17.5-TT
6	26	1.5	0	0	24.5	3	3	28+TT	21.3-TT
7	26	3	0	0	23	3	3	28+TT	20.0-TT
8	26	0	[7.5]	0	18.5	5	3	28+TT	[13.5-TT]
9	26	0	[7.5]	0	18.5	5	3	28+TT	[13.5-TT]
10	26	0	6.5	0	19.5	5	3	28+TT	14.5-TT
11	26	0	6.5	0	19.5	5	3	28+TT	14.5-TT
12	26	3.5	0	0	22.5	5	3	28+TT	17.5-TT
13	26	2	0	0	24	3	3	28+TT	21.0-TT
14	26	3	0	0	23	3	3	28+TT	20.0-TT
15	26	0	[7.5]	0	18.5	5	3	28+TT	[13.5-TT]
16	26	0	[7.5]	0	18.5	5	3	28+TT	[13.5-TT]
17	26	0	6.5	0	19.5	5	3	28+TT	14.5-TT
18	26	3.5	0	0	22.5	5	3	28+TT	17.5-TT
19	26	3.5	0	0	22.5	5	3	28+TT	17.5-TT
20	26	0	[10]	0	16	5	3	28+TT	[11.0-TT]
21	26	0	[10]	0	16	5	3	28+TT	[11.0-TT]
22	26	0	7.5	0	18.5	5	3	28+TT	13.5-TT
23	26	6.5	0	0	19.5	5	3	28+TT	14.5-TT
24	26	6.5	0	0	19.5	5	3	28+TT	14.5-TT

NOTE 1: P_{PowerClass} is the maximum UE power specified without taking into account the tolerance.

NOTE 2: For Band n41, refers to the transmission bandwidths confined within F_{UL_low} and F_{UL_low} + 4 MHz or F_{UL_high} - 4 MHz and F_{UL_high}, the lower limit shall be decreased by 1.0 dB for CP-OFDM 256 QAM and decreased by 1.5 dB for other modulations.

NOTE 3: TT=0.7 for BW_{channel} ≤ 40 MHz; TT=1.0 for 40 MHz < BW_{channel} ≤ 100 MHz.

Table 6.2D.3.5-2: UE Power Class 3 test requirements (NS_04) for band n41

Test ID	P _{PowerClass} (dBm)	MPR (dB)	A-MPR (dB)	$\Delta T_{C,c}$ (dB)	P _{CMAX,c} (dBm)	T(P _{CMAX,L,c}) (dB)	T _{L,c} (dB)	Upper limit (dBm)	Lower limit (Note 2) (dBm)
1	23	0	5.5	0	17.5	5	3	25+TT	12.5-TT
2	23	0	5.5	0	17.5	5	3	25+TT	12.5-TT
3	23	0	5.5	0	17.5	5	3	25+TT	12.5-TT
4	23	0	5.5	0	17.5	5	3	25+TT	12.5-TT
5	23	3.0	0	0	20.0	6	3	25+TT	14.0-TT
6	23	1.5	0	0	21.5	5	3	25+TT	16.5-TT
7	23	3.0	0	0	20.0	6	3	25+TT	14.0-TT
8	23	0	5.5	0	17.5	5	3	25+TT	12.5-TT
9	23	0	5.5	0	17.5	5	3	25+TT	12.5-TT
10	23	0	5.5	0	17.5	5	3	25+TT	12.5-TT
11	23	0	5.5	0	17.5	5	3	25+TT	12.5-TT
12	23	3.0	0	0	20.0	6	3	25+TT	14.0-TT
13	23	2.0	0	0	21.0	5	3	25+TT	16.0-TT
14	23	3.0	0	0	20.0	6	3	25+TT	14.0-TT
15	23	0	5.5	0	17.5	5	3	25+TT	12.5-TT
16	23	0	5.5	0	17.5	5	3	25+TT	12.5-TT
17	23	0	5.5	0	17.5	5	3	25+TT	12.5-TT
18	23	3.5	0	0	19.5	5	3	25+TT	14.5-TT
19	23	3.5	0	0	19.5	5	3	25+TT	14.5-TT
20	23	0	8	0	15.0	6	3	25+TT	9.0-TT
21	23	0	8	0	15.0	6	3	25+TT	9.0-TT
22	23	0	6.5	0	16.5	5	3	25+TT	11.5-TT
23	23	6.5	0	0	16.5	5	3	25+TT	11.5-TT
24	23	6.5	0	0	16.5	5	3	25+TT	11.5-TT

NOTE 1: P_{PowerClass} is the maximum UE power specified without taking into account the tolerance.
NOTE 2: For Band n41, refers to the transmission bandwidths confined within F_{UL,low} and F_{UL,low} + 4 MHz or F_{UL,high} – 4 MHz and F_{UL,high}, the lower limit shall be decreased by 1.0 dB for CP-OFDM 256 QAM and decreased by 1.5 dB for other modulations.
NOTE 3: TT=0.7 for BW_{channel} ≤ 40 MHz; TT=1.0 for 40 MHz < BW_{channel} ≤ 100 MHz.

Table 6.2D.3.5-3: UE Power Class 3 test requirements (NS_35) for band n71

Test ID	P _{PowerClass} (dBm)	MPR (dB)	A-MPR (dB)	$\Delta T_{C,c}$ (dB)	P _{CMAX,c} (dBm)	T(P _{CMAX,L,c}) (dB)	T _{L,c} (dB)	Upper limit (dBm)	Lower limit (dBm)
1	23	3	0	0	20	6	3	25+TT	14.0 - TT
2	23	3	0	0	20	6	3	25+TT	14.0 - TT
3	23	3	0	0	20	6	3	25+TT	14.0 - TT
4	23	3	0	0	20	6	3	25+TT	14.0 - TT
5	23	3	0	0	20	6	3	25+TT	14.0 - TT
6	23	3	0	0	20	6	3	25+TT	14.0 - TT
7	23	3.5	0	0	19.5	5	3	25+TT	14.5 - TT
8	23	3.5	0	0	19.5	5	3	25+TT	14.5 - TT
9	23	3.5	0	0	19.5	5	3	25+TT	14.5 - TT
10	23	6.5	0	0	16.5	5	3	25+TT	11.5 - TT
11	23	6.5	0	0	16.5	5	3	25+TT	11.5 - TT
12	23	6.5	0	0	16.5	5	3	25+TT	11.5 - TT

NOTE 1: P_{PowerClass} is the maximum UE power specified without taking into account the tolerance.
NOTE 2: TT for each frequency and channel bandwidth is specified in Table 6.2D.3.5-0.

Table 6.2D.3.5-4: UE Power Class 3 test requirements (NS_05) for band n1

Test ID	$P_{\text{PowerClass}}$ (dBm)	$\Delta P_{\text{PowerClass}}$ (dB)	MPR (dB)	A-MPR (dB)	$\Delta T_{C,c}$ (dB)	$P_{\text{CMAX}_L,c}$ (dBm)	$T(P_{\text{CMAX}_L,c})$ (dB)	$T_{L,c}$ (dB)	Upper limit (dBm)	Lower limit (dBm)
1	23	0	3.0	7.5	0	15.5	5.0	2	25+TT	10.5-TT
2	23	0	3.0	10	0	13	5.0	2	25+TT	8-TT
3	23	0	3.0	6	0	17	5.0	2	25+TT	12-TT
4	23	0	3.0	5	0	18	4.0	2	25+TT	14-TT
5	23	0	3.0	3.5	0	19.5	3.5	2	25+TT	16-TT
6	23	0	3.0	10	0	13	5.0	2	25+TT	8-TT
7	23	0	3.0	6	0	17	5.0	2	25+TT	12-TT
8	23	0	3.0	5	0	18	4.0	2	25+TT	14-TT
9	23	0	3.0	10	0	13	5.0	2	25+TT	8-TT
10	23	0	3.0	5	0	18	4.0	2	25+TT	14-TT
11	23	0	3.0	3.5	0	19.5	3.5	2	25+TT	16-TT
12	23	0	3.0	10	0	13	5.0	2	25+TT	8-TT
13	23	0	3.0	6	0	17	5.0	2	25+TT	12-TT
14	23	0	3.0	5	0	18	4.0	2	25+TT	14-TT
15	23	0	3.0	3.5	0	19.5	3.5	2	25+TT	16-TT
16	23	0	3.0	7.5	0	15.5	5.0	2	25+TT	10.5-TT
17	23	0	3.0	10	0	13	5.0	2	25+TT	8-TT
18	23	0	3.0	6	0	17	5.0	2	25+TT	12-TT
19	23	0	3.0	5	0	18	4.0	2	25+TT	14-TT
20	23	0	3.0	3.5	0	19.5	3.5	2	25+TT	16-TT
21	23	0	3.0	10	0	13	5.0	2	25+TT	8-TT
22	23	0	3.0	6	0	17	5.0	2	25+TT	12-TT
23	23	0	3.0	5	0	18	4.0	2	25+TT	14-TT
24	23	0	3.0	10	0	13	5.0	2	25+TT	8-TT
25	23	0	3.0	5	0	18	4.0	2	25+TT	14-TT
26	23	0	3.0	3.5	0	19.5	3.5	2	25+TT	16-TT
27	23	0	3.0	10	0	13	5.0	2	25+TT	8-TT
28	23	0	3.0	6	0	17	5.0	2	25+TT	12-TT
29	23	0	3.0	5	0	18	4.0	2	25+TT	14-TT
30	23	0	3.0	3.5	0	19.5	3.5	2	25+TT	16-TT
31	23	0	3.5	8	0	15	5.0	2	25+TT	10-TT
32	23	0	3.5	11	0	12	6.0	2	25+TT	6-TT
33	23	0	3.5	6	0	17	5.0	2	25+TT	12-TT
34	23	0	3.5	5	0	18	4.0	2	25+TT	14-TT
35	23	0	3.5	11	0	12	6.0	2	25+TT	6-TT
36	23	0	3.5	6	0	17	5.0	2	25+TT	12-TT
37	23	0	3.5	5	0	18	4.0	2	25+TT	14-TT
38	23	0	3.5	11	0	12	6.0	2	25+TT	6-TT
39	23	0	3.5	5	0	18	4.0	2	25+TT	14-TT
40	23	0	3.5	11	0	12	6.0	2	25+TT	6-TT
41	23	0	3.5	6	0	17	5.0	2	25+TT	12-TT
42	23	0	3.5	5	0	18	4.0	2	25+TT	14-TT
43	23	0	6.5	10	0	13	5.0	2	25+TT	8-TT
44	23	0	6.5	13	0	10	6.0	2	25+TT	4-TT
45	23	0	6.5	6	0	16.5	5.0	2	25+TT	11.5-TT
46	23	0	6.5	13	0	10	6.0	2	25+TT	4-TT
47	23	0	6.5	6	0	16.5	5.0	2	25+TT	11.5-TT
48	23	0	6.5	13	0	10	6.0	2	25+TT	4-TT
49	23	0	6.5	13	0	10	6.0	2	25+TT	4-TT
50	23	0	6.5	6	0	16.5	5.0	2	25+TT	11.5-TT

NOTE 1: $P_{\text{PowerClass}}$ is the maximum UE power specified without taking into account the tolerance.

NOTE 2: TT for each frequency and channel bandwidth is specified in Table 6.2.3.5-0.

Table 6.2D.3.5-5: UE Power Class 3 test requirements (NS_05U) for band n1

Test ID	$P_{\text{PowerClass}}$ (dBm)	$\Delta P_{\text{PowerClass}}$ (dB)	MPR (dB)	A-MPR (dB)	$\Delta T_{C,c}$ (dB)	$P_{\text{CMAX}_L,c}$ (dBm)	$T(P_{\text{CMAX}_L,c})$ (dB)	$T_{L,c}$ (dB)	Upper limit (dBm)	Lower limit (dBm)
1	23	0	3.0	7.5	0	15.5	5.0	2	25+TT	10.5-TT
2	23	0	3.0	10	0	13	5.0	2	25+TT	8-TT
3	23	0	3.0	6	0	17	5.0	2	25+TT	12-TT
4	23	0	3.0	5	0	18	4.0	2	25+TT	14-TT
5	23	0	3.0	4	0	19	3.5	2	25+TT	15.5-TT
6	23	0	3.0	10	0	13	5.0	2	25+TT	8-TT
7	23	0	3.0	6	0	17	5.0	2	25+TT	12-TT
8	23	0	3.0	5	0	18	4.0	2	25+TT	14-TT
9	23	0	3.0	10	0	13	5.0	2	25+TT	8-TT
10	23	0	3.0	5	0	18	4.0	2	25+TT	14-TT
11	23	0	3.0	4	0	19	3.5	2	25+TT	15.5-TT
12	23	0	3.0	10	0	13	5.0	2	25+TT	8-TT
13	23	0	3.0	6	0	17	5.0	2	25+TT	12-TT
14	23	0	3.0	5	0	18	4.0	2	25+TT	14-TT
15	23	0	3.0	4	0	19	3.5	2	25+TT	15.5-TT
16	23	0	3.0	7.5	0	15.5	5.0	2	25+TT	10.5-TT
17	23	0	3.0	10	0	13	5.0	2	25+TT	8-TT
18	23	0	3.0	6	0	17	5.0	2	25+TT	12-TT
19	23	0	3.0	5	0	18	4.0	2	25+TT	14-TT
20	23	0	3.0	4	0	19	3.5	2	25+TT	15.5-TT
21	23	0	3.0	10	0	13	5.0	2	25+TT	8-TT
22	23	0	3.0	6	0	17	5.0	2	25+TT	12-TT
23	23	0	3.0	5	0	18	4.0	2	25+TT	14-TT
24	23	0	3.0	10	0	13	5.0	2	25+TT	8-TT
25	23	0	3.0	5	0	18	4.0	2	25+TT	14-TT
26	23	0	3.0	4	0	19	3.5	2	25+TT	15.5-TT
27	23	0	3.0	10	0	13	5.0	2	25+TT	8-TT
28	23	0	3.0	6	0	17	5.0	2	25+TT	12-TT
29	23	0	3.0	5	0	18	4.0	2	25+TT	14-TT
30	23	0	3.0	4	0	19	3.5	2	25+TT	15.5-TT
31	23	0	3.5	8	0	15	5.0	2	25+TT	10-TT
32	23	0	3.5	11	0	12	6.0	2	25+TT	6-TT
33	23	0	3.5	6	0	17	5.0	2	25+TT	12-TT
34	23	0	3.5	5	0	18	4.0	2	25+TT	14-TT
35	23	0	3.5	4	0	19	3.5	2	25+TT	15.5-TT
36	23	0	3.5	11	0	12	6.0	2	25+TT	6-TT
37	23	0	3.5	6	0	17	5.0	2	25+TT	12-TT
38	23	0	3.5	5	0	18	4.0	2	25+TT	14-TT
39	23	0	3.5	11	0	12	6.0	2	25+TT	6-TT
40	23	0	3.5	5	0	18	4.0	2	25+TT	14-TT
41	23	0	3.5	4	0	19	3.5	2	25+TT	15.5-TT
42	23	0	3.5	11	0	12	6.0	2	25+TT	6-TT
43	23	0	3.5	6	0	17	5.0	2	25+TT	12-TT
44	23	0	3.5	5	0	18	4.0	2	25+TT	14-TT
45	23	0	3.5	4	0	19	3.5	2	25+TT	15.5-TT
46	23	0	6.5	10	0	13	5.0	2	25+TT	8-TT
47	23	0	6.5	13	0	10	6.0	2	25+TT	4-TT
48	23	0	6.5	6.5	0	16.5	5.0	2	25+TT	11.5-TT
49	23	0	6.5	6.5	0	16.5	5.0	2	25+TT	11.5-TT
50	23	0	6.5	13	0	10	6.0	2	25+TT	4-TT
51	23	0	6.5	6.5	0	16.5	5.0	2	25+TT	11.5-TT
52	23	0	6.5	13	0	10	6.0	2	25+TT	4-TT
53	23	0	6.5	6.5	0	16.5	5.0	2	25+TT	11.5-TT
54	23	0	6.5	13	0	10	6.0	2	25+TT	4-TT
55	23	0	6.5	6.5	0	16.5	5.0	2	25+TT	11.5-TT
56	23	0	6.5	6.5	0	16.5	5.0	2	25+TT	11.5-TT

NOTE 1: $P_{\text{PowerClass}}$ is the maximum UE power specified without taking into account the tolerance.

NOTE 2: TT for each frequency and channel bandwidth is specified in Table 6.2.3.5-0.

Table 6.2D.3.5-6: UE Power Class 3 test requirements (NS_48) for band n1

Test ID	$P_{\text{PowerClass}}$ (dBm)	$\Delta P_{\text{PowerClass}}$ (dB)	MPR (dB)	A-MPR (dB)	$\Delta T_{C,c}$ (dB)	$P_{\text{C}_{\text{MAX}_L,c}}$ (dBm)	$T(P_{\text{C}_{\text{MAX}_L,c})}$ (dB)	$T_{L,c}$ (dB)	Upper limit (dBm)	Lower limit (dBm)
1	23	0	3	4.5	0	18.5	4	2	25+TT	14.5-TT
2	23	0	3	4.5	0	18.5	4	2	25+TT	14.5-TT
3	23	0	3	4.5	0	18.5	4	2	25+TT	14.5-TT
4	23	0	3	5	0	18	4	2	25+TT	14-TT
5	23	0	3	7	0	16	5	2	25+TT	11-TT
6	23	0	3	4.5	0	18.5	4	2	25+TT	14.5-TT
7	23	0	3	5.5	0	17.5	5	2	25+TT	12.5-TT
8	23	0	3	7	0	16	5	2	25+TT	11-TT
9	23	0	1.5	4.5	0	18.5	4	2	25+TT	14.5-TT
10	23	0	3	11	0	12	6	2	25+TT	6-TT
11	23	0	3	7	0	16	5	2	25+TT	11-TT
12	23	0	3	5.5	0	17.5	5	2	25+TT	12.5-TT
13	23	0	3	7	0	16	5	2	25+TT	11-TT
14	23	0	1.5	5	0	18	4	2	25+TT	14-TT
15	23	0	3	11	0	12	6	2	25+TT	6-TT
16	23	0	6.5	4.5	0	16.5	5	2	25+TT	11.5-TT
17	23	0	6.5	4.5	0	16.5	5	2	25+TT	11.5-TT
18	23	0	6.5	4.5	0	16.5	5	2	25+TT	11.5-TT
19	23	0	6.5	5	0	16.5	5	2	25+TT	11.5-TT
20	23	0	6.5	7	0	16	5	2	25+TT	11-TT
21	23	0	6.5	4.5	0	16.5	5	2	25+TT	11.5-TT
22	23	0	6.5	5.5	0	16.5	5	2	25+TT	11.5-TT
23	23	0	6.5	7	0	16	5	2	25+TT	11-TT
24	23	0	6.5	4.5	0	16.5	5	2	25+TT	11.5-TT
25	23	0	6.5	11	0	12	6	2	25+TT	6-TT
26	23	0	6.5	7	0	16	5	2	25+TT	11-TT
27	23	0	6.5	5.5	0	16.5	5	2	25+TT	11.5-TT
28	23	0	6.5	7	0	16	5	2	25+TT	11-TT
29	23	0	6.5	5	0	16.5	5	2	25+TT	11.5-TT
30	23	0	6.5	11	0	12	6	2	25+TT	6-TT

NOTE 1: $P_{\text{PowerClass}}$ is the maximum UE power specified without taking into account the tolerance.

NOTE 2: TT for each frequency and channel bandwidth is specified in Table 6.2.3.5-0.

Table 6.2D.3.5-7: UE Power Class 3 test requirements (NS_49) for band n1

Test ID	P _{PowerClass} (dBm)	ΔP _{PowerClass} (dB)	MPR (dB)	A-MPR (dB)	ΔT _{C,c} (dB)	P _{C_{MAX}L,c} (dBm)	T(P _{C_{MAX}L,c}) (dB)	T _{L,c} (dB)	Upper limit (dBm)	Lower limit (dBm)
1	23	0	3	4.5	0	18.5	4	2	25+TT	14.5-TT
2	23	0	3	4.5	0	18.5	4	2	25+TT	14.5-TT
3	23	0	3	4.5	0	18.5	4	2	25+TT	14.5-TT
4	23	0	3	11	0	12	6	2	25+TT	6-TT
5	23	0	3	5	0	18	4	2	25+TT	14-TT
6	23	0	3	4.5	0	18.5	4	2	25+TT	14.5-TT
7	23	0	3	5.5	0	17.5	5	2	25+TT	12.5-TT
8	23	0	3	7	0	16	5	2	25+TT	11-TT
9	23	0	3	5	0	18	4	2	25+TT	14-TT
10	23	0	3	11	0	12	6	2	25+TT	6-TT
11	23	0	1.5	5	0	18	4	2	25+TT	14-TT
12	23	0	3	5.5	0	17.5	5	2	25+TT	12.5-TT
13	23	0	3	7	0	16	5	2	25+TT	11-TT
14	23	0	1.5	5	0	18	4	2	25+TT	14-TT
15	23	0	3	11	0	12	6	2	25+TT	6-TT
16	23	0	3	11	0	12	6	2	25+TT	6-TT
17	23	0	1.5	5	0	18	4	2	25+TT	14-TT
18	23	0	1.5	5	0	18	4	2	25+TT	14-TT
19	23	0	3	7	0	16	5	2	25+TT	11-TT
20	23	0	3	11	0	12	6	2	25+TT	6-TT
21	23	0	3	11	0	12	6	2	25+TT	6-TT
22	23	0	6.5	4.5	0	16.5	5	2	25+TT	11.5-TT
23	23	0	6.5	4.5	0	16.5	5	2	25+TT	11.5-TT
24	23	0	6.5	4.5	0	16.5	5	2	25+TT	11.5-TT
25	23	0	6.5	11	0	12	6	2	25+TT	6-TT
26	23	0	6.5	5	0	16.5	5	2	25+TT	11.5-TT
27	23	0	6.5	4.5	0	16.5	5	2	25+TT	11.5-TT
28	23	0	6.5	5.5	0	16.5	5	2	25+TT	11.5-TT
29	23	0	6.5	7	0	16	5	2	25+TT	11-TT
30	23	0	6.5	5	0	16.5	5	2	25+TT	11.5-TT
31	23	0	6.5	11	0	12	6	2	25+TT	6-TT
32	23	0	6.5	5	0	16.5	5	2	25+TT	11.5-TT
33	23	0	6.5	5.5	0	16.5	5	2	25+TT	11.5-TT
34	23	0	6.5	7	0	16	5	2	25+TT	11-TT
35	23	0	6.5	5	0	16.5	5	2	25+TT	11.5-TT
36	23	0	6.5	11	0	12	6	2	25+TT	6-TT
37	23	0	6.5	11	0	12	6	2	25+TT	6-TT
38	23	0	6.5	5	0	16.5	5	2	25+TT	11.5-TT
39	23	0	6.5	5	0	16.5	5	2	25+TT	11.5-TT
40	23	0	6.5	7	0	16	5	2	25+TT	11-TT
41	23	0	6.5	11	0	12	6	2	25+TT	6-TT
42	23	0	6.5	11	0	12	6	2	25+TT	6-TT

NOTE 1: P_{PowerClass} is the maximum UE power specified without taking into account the tolerance.

NOTE 2: TT for each frequency and channel bandwidth is specified in Table 6.2.3.5-0.

Table 6.2D.3.5-8: UE Power Class 3 test requirements (NS_100) for band n1

Test ID	P _{PowerClass} (dBm)	MPR (dB)	A-MPR (dB)	ΔT _{C,c} (dB)	P _{C_{MAX}L,c} (dBm)	T(P _{C_{MAX}L,c}) (dB)	T _{L,c} (dB)	Upper limit (dBm)	Lower limit (dBm)
1, 2	23	3	4	0	19	3.5	2	25+TT	15.5-TT
3	23	3	4	0	19	3.5	2	25+TT	15.5-TT
4, 5	23	3	4	0	19	3.5	2	25+TT	15.5-TT
6	23	3	4	0	19	3.5	2	25+TT	15.5-TT
7, 8	23	3.5	4	0	19	3.5	2	25+TT	15.5-TT
9	23	3.5	4	0	19	3.5	2	25+TT	15.5-TT
10, 11	23	6.5	6.5	0	16.5	5	2	25+TT	11.5-TT
12	23	6.5	6.5	0	16.5	5	2	25+TT	11.5-TT

NOTE 1: P_{PowerClass} is the maximum UE power specified without taking into account the tolerance.

NOTE 2: TT for each frequency and channel bandwidth is specified in Table 6.2.3.5-0.

Table 6.2D.3.5-9: UE Power Class 3 test requirements (NS_100) for band n2, n3, n25

Test ID	P _{PowerClass} (dBm)	MPR (dB)	A-MPR (dB)	$\Delta T_{C,c}$ (dB)	P _{C_{MAX}L,c} (dBm)	T(P _{C_{MAX}L,c}) (dB)	T _{L,c} (dB)	Upper limit (dBm)	Lower limit (dBm)
1, 2	23	3	4	1.5	17.5	5	2	25+TT	12.5-TT
3	23	3	4	0	19	3.5	2	25+TT	15.5-TT
4, 5	23	3	4	1.5	17.5	5	2	25+TT	12.5-TT
6	23	3	4	0	19	3.5	2	25+TT	15.5-TT
7, 8	23	3.5	4	1.5	17.5	5	2	25+TT	12.5-TT
9	23	3.5	4	0	19	3.5	2	25+TT	15.5-TT
10, 11	23	6.5	6.5	1.5	15	5	2	25+TT	10-TT
12	23	6.5	6.5	0	16.5	5	2	25+TT	11.5-TT

NOTE 1: P_{PowerClass} is the maximum UE power specified without taking into account the tolerance.
NOTE 2: TT for each frequency and channel bandwidth is specified in Table 6.2.3.5-0.

Table 6.2D.3.5-10: UE Power Class 3 test requirements (NS_03/NS_03U) for band n66, n70

Test ID	Network signalling label	P _{PowerClass} (dBm)	MPR (dB)	A-MPR (dB)	$\Delta T_{C,c}$ (dB)	P _{C_{MAX}L,c} (dBm)	T(P _{C_{MAX}L,c}) (dB)	T _{L,c} (dB)	Upper limit (dBm)	Lower limit (dBm)
1,2	NS_03, NS_03U	23	3	4	0	19	3.5	2	25+TT	15.5-TT
3	NS_03, NS_03U	23	3	4	0	19	3.5	2	25+TT	15.5-TT
4,5	NS_03, NS_03U	23	3	4	0	19	3.5	2	25+TT	15.5-TT
6	NS_03, NS_03U	23	3	4	0	19	3.5	2	25+TT	15.5-TT
7,8	NS_03, NS_03U	23	3.5	4	0	18.5	4	2	25+TT	14.5-TT
9	NS_03, NS_03U	23	3.5	4	0	18.5	4	2	25+TT	14.5-TT
10,11	NS_03, NS_03U	23	6.5	6.5	0	15.5	5	2	25+TT	10.5-TT
12	NS_03, NS_03U	23	6.5	6.5	0	15.5	5	2	25+TT	10.5-TT

NOTE 1: P_{PowerClass} is the maximum UE power specified without taking into account the tolerance.
NOTE 2: TT for each frequency and channel bandwidth is specified in Table 6.2.3.5-0.

Table 6.2D.3.5-11: UE Power Class 3 test requirements (NS_03/NS_03U) for band n2, n25

Test ID	Network signalling label	P _{PowerClass} (dBm)	MPR (dB)	A-MPR (dB)	$\Delta T_{C,c}$ (dB)	P _{C_{MAX}L,c} (dBm)	T(P _{C_{MAX}L,c}) (dB)	T _{L,c} (dB)	Upper limit (dBm)	Lower limit (dBm)
1,2	NS_03, NS_03U	23	3	4	1.5	17.5	5	2	25+TT	12.5-TT
3	NS_03, NS_03U	23	3	4	0	19	3.5	2	25+TT	15.5-TT
4,5	NS_03, NS_03U	23	3	4	1.5	17.5	5	2	25+TT	12.5-TT
6	NS_03, NS_03U	23	3	4	0	19	3.5	2	25+TT	15.5-TT
7,8	NS_03, NS_03U	23	3.5	4	1.5	17	5	2	25+TT	12-TT
9	NS_03, NS_03U	23	3.5	4	0	18.5	4	2	25+TT	14.5-TT
10,11	NS_03, NS_03U	23	6.5	6.5	1.5	14	5	2	25+TT	9-TT
12	NS_03, NS_03U	23	6.5	6.5	0	15.5	5	2	25+TT	10.5-TT

NOTE 1: P_{PowerClass} is the maximum UE power specified without taking into account the tolerance.
NOTE 2: TT for each frequency and channel bandwidth is specified in Table 6.2.3.5-0.

Table 6.2D.3.5-12: UE Power Class 3 test requirements (NS_46) for band n7

Test ID	P _{PowerClass} (dBm)	ΔP _{PowerClass} (dB)	MPR (dB)	A-MPR (dB)	ΔT _{C,c} (dB)	P _{C_{MAX}L,c} (dBm)	T(P _{C_{MAX}L,c}) (dB)	T _{L,c} (dB)	Upper limit (dBm)	Lower limit (dBm)
1	23	0	3	6	0	17	5	2	25+TT	12-TT
2	23	0	6.5	6	0	16.5	5	2	25+TT	11.5-TT
3	23	0	3	5	0	18	4	2	25+TT	14-TT
4	23	0	3.5	5	0	18	4	2	25+TT	14-TT
5	23	0	3	3.5	0	19.5	3.5	2	25+TT	16-TT
6	23	0	3.5	3.5	0	19.5	3.5	2	25+TT	16-TT
7	23	0	3	5.5	0	17.5	5	2	25+TT	12.5-TT
8	23	0	3.5	5.5	0	17.5	5	2	25+TT	12.5-TT
9	23	0	3	7	0	16	5	2	25+TT	11-TT
10	23	0	6.5	7	0	16	5	2	25+TT	11-TT
11	23	0	3	11	0	12	6	2	25+TT	6-TT
12	23	0	6.5	11	0	12	6	2	25+TT	6-TT

NOTE 1: P_{PowerClass} is the maximum UE power specified without taking into account the tolerance.
 NOTE 2: TT for each frequency and channel bandwidth is specified in Table 6.2.3.5-0.

Table 6.2D.3.5-13: UE Power Class 3 test requirements (NS_21) for band n30

Test ID	ChBw (MHz)	P _{PowerClass} (dBm)	MPR (dB)	A-MPR (dB)	ΔT _{C,c} (dB)	P _{C_{MAX}L,c} (dBm)	T(P _{C_{MAX}L,c}) (dB)	T _{L,c} (dB)	Upper limit (dBm)	Lower limit (dBm)
1,2	5	23	3	0	0	20	2.5	2	25+TT	17.5-TT
	10	23	3	6	0	17	5	2	25+TT	12-TT
3	5	23	3	0	0	20	2.5	2	25+TT	17.5-TT
	10	23	3	5.5	0	17.5	5	2	25+TT	12.5-TT
4,5	10	23	3	4	0	19	3.5	2	25+TT	15.5-TT
6,7	5	23	3	0	0	20	2.5	2	25+TT	17.5-TT
	10	23	3	6	0	17	5	2	25+TT	12-TT
8	5	23	3	0	0	20	2.5	2	25+TT	17.5-TT
	10	23	3	5.5	0	17.5	5	2	25+TT	12.5-TT
9,10	10	23	3	4	0	19	3.5	2	25+TT	15.5-TT
11,12	5	23	3.5	0	0	19.5	3.5	2	25+TT	16-TT
	10	23	3.5	6	0	17	5	2	25+TT	12-TT
13	5	23	3.5	0	0	19.5	3.5	2	25+TT	16-TT
	10	23	3.5	5.5	0	17.5	5	2	25+TT	12.5-TT
14,15	10	23	3.5	4	0	19	3.5	2	25+TT	15.5-TT
16,17	5	23	6.5	0	0	16.5	5	2	25+TT	11.5-TT
	10	23	6.5	6	0	16.5	5	2	25+TT	11.5-TT
18	5	23	6.5	0	0	16.5	5	2	25+TT	11.5-TT
19,20	10	23	6.5	5.5	0	16.5	5	2	25+TT	11.5-TT
	10	23	6.5	4	0	16.5	5	2	25+TT	11.5-TT

NOTE 1: P_{PowerClass} is the maximum UE power specified without taking into account the tolerance.
 NOTE 2: TT for each frequency and channel bandwidth is specified in Table 6.2.3.5-0.

Table 6.2D.3.5-14: UE Power Class 3 test requirements (NS_44) for band n38

Test ID	$P_{\text{PowerClass}}$ (dBm)	$\Delta P_{\text{PowerClass}}$ (dB)	MPR (dB)	A-MPR (dB)	$\Delta T_{C,c}$ (dB)	$P_{\text{C}_{\text{MAX_L,c}}}$ (dBm)	$T(P_{\text{C}_{\text{MAX_L,c}}})$ (dB)	$T_{L,c}$ (dB)	Upper limit (dBm)	Lower limit (dBm)
1	23	0	3.5	5	0	18	4	2	25+TT	14-TT
2	23	0	3.5	5	0	18	4	2	25+TT	14-TT
3	23	0	3.5	0	0	19.5	3.5	2	25+TT	16-TT
4	23	0	6.5	0	0	16.5	5	2	25+TT	11.5-TT
5	23	0	6.5	0	0	16.5	5	2	25+TT	11.5-TT
6	23	0	6.5	0	0	16.5	5	2	25+TT	11.5-TT
7	23	0	3.5	5	0	18	4	2	25+TT	14-TT
8	23	0	3.5	5	0	18	4	2	25+TT	14-TT
9	23	0	3.5	0	0	19.5	3.5	2	25+TT	16-TT
10	23	0	6.5	0	0	16.5	5	2	25+TT	11.5-TT
11	23	0	6.5	0	0	16.5	5	2	25+TT	11.5-TT
12	23	0	6.5	0	0	16.5	5	2	25+TT	11.5-TT
13	23	0	3.5	0	0	19.5	3.5	2	25+TT	16-TT
14	23	0	3.5	4	0	19	3.5	2	25+TT	15.5-TT
15	23	0	3.5	5	0	18	4	2	25+TT	14-TT
16	23	0	3.5	8	0	15	5	2	25+TT	10-TT
17	23	0	3.5	12	0	11	6	2	25+TT	5-TT
18	23	0	6.5	0	0	16.5	5	2	25+TT	11.5-TT
19	23	0	6.5	0	0	16.5	5	2	25+TT	11.5-TT
20	23	0	6.5	0	0	16.5	5	2	25+TT	11.5-TT
21	23	0	6.5	8	0	15	5	2	25+TT	10-TT
22	23	0	6.5	12	0	11	6	2	25+TT	5-TT

NOTE 1: $P_{\text{PowerClass}}$ is the maximum UE power specified without taking into account the tolerance.
NOTE 2: TT for each frequency and channel bandwidth is specified in Table 6.2.3.5-0.

Table 6.2D.3.5-15: UE Power Class 3 test requirements (NS_27) for band n48

Test ID	P _{PowerClass} (dBm)	ΔP _{PowerClass} (dB)	MPR (dB)	A-MPR (dB)	ΔT _{C,c} (dB)	P _{CMAX,L,c} (dBm)	T(P _{CMAX,L,c}) (dB)	T _{L,c} (dB)	Upper limit (dBm)	Lower limit (dBm)
1	23	0	3	6	0	17	5.0	3	25+TT	12-TT
2	23	0	3	6	0	17	5.0	3	25+TT	12-TT
3	23	0	3	6	0	17	5.0	3	25+TT	12-TT
4	23	0	3	6	0	17	5.0	3	25+TT	12-TT
5	23	0	3	4	0	19	3.5	3	25+TT	15.5-TT
6	23	0	3	2	0	20	2.5	3	25+TT	17-TT
7	23	0	3	4	0	19	3.5	3	25+TT	15.5-TT
8	23	0	3	2	0	20	2.5	3	25+TT	17-TT
9	23	0	3	6	0	17	5.0	3	25+TT	12-TT
10	23	0	3	6	0	17	5.0	3	25+TT	12-TT
11	23	0	3	6	0	17	5.0	3	25+TT	12-TT
12	23	0	3	6	0	17	5.0	3	25+TT	12-TT
13	23	0	3	4	0	19	3.5	3	25+TT	15.5-TT
14	23	0	3	2	0	20	2.5	3	25+TT	17-TT
15	23	0	3	4	0	19	3.5	3	25+TT	15.5-TT
16	23	0	3	2	0	20	2.5	3	25+TT	17-TT
17	23	0	3	11.5	0	11.5	6.0	3	25+TT	5.5-TT
18	23	0	3	7	0	16	5.0	3	25+TT	11-TT
19	23	0	3	5.5	0	17.5	5.0	3	25+TT	12.5-TT
20	23	0	3	11.5	0	11.5	6.0	3	25+TT	5.5-TT
21	23	0	3	11.5	0	11.5	6.0	3	25+TT	5.5-TT
22	23	0	3	7	0	16	5.0	3	25+TT	11-TT
23	23	0	3	5.5	0	17.5	5.0	3	25+TT	12.5-TT
24	23	0	3	11.5	0	11.5	6.0	3	25+TT	5.5-TT
25	23	0	3	4	0	19	3.5	3	25+TT	15.5-TT
26	23	0	3	4.5	0	18.5	4.0	3	25+TT	14.5-TT
27	23	0	3	4	0	19	3.5	3	25+TT	15.5-TT
28	23	0	3	4.5	0	18.5	4.0	3	25+TT	14.5-TT
29	23	0	3	6	0	17	5.0	3	25+TT	12-TT
30	23	0	3	6	0	17	5.0	3	25+TT	12-TT
31	23	0	3	6	0	17	5.0	3	25+TT	12-TT
32	23	0	3	6	0	17	5.0	3	25+TT	12-TT
33	23	0	3	4	0	19	3.5	3	25+TT	15.5-TT
34	23	0	3	2	0	20	2.5	3	25+TT	17-TT
35	23	0	3	4	0	19	3.5	3	25+TT	15.5-TT
36	23	0	3	2	0	20	2.5	3	25+TT	17-TT
37	23	0	3	6	0	17	5.0	3	25+TT	12-TT
38	23	0	3	6	0	17	5.0	3	25+TT	12-TT
39	23	0	3	6	0	17	5.0	3	25+TT	12-TT
40	23	0	3	6	0	17	5.0	3	25+TT	12-TT
41	23	0	3	4	0	19	3.5	3	25+TT	15.5-TT
42	23	0	3	2	0	20	2.5	3	25+TT	17-TT
43	23	0	3	4	0	19	3.5	3	25+TT	15.5-TT
44	23	0	3	2	0	20	2.5	3	25+TT	17-TT
45	23	0	3	11.5	0	11.5	6.0	3	25+TT	5.5-TT
46	23	0	3	7	0	16	5.0	3	25+TT	11-TT
47	23	0	3	5.5	0	17.5	5.0	3	25+TT	12.5-TT
48	23	0	3	11.5	0	11.5	6.0	3	25+TT	5.5-TT
49	23	0	3	11.5	0	11.5	6.0	3	25+TT	5.5-TT
50	23	0	3	7	0	16	5.0	3	25+TT	11-TT
51	23	0	3	5.5	0	17.5	5.0	3	25+TT	12.5-TT
52	23	0	3	11.5	0	11.5	6.0	3	25+TT	5.5-TT
53	23	0	3	4	0	19	3.5	3	25+TT	15.5-TT
54	23	0	3	4.5	0	18.5	4.0	3	25+TT	14.5-TT
55	23	0	3	4	0	19	3.5	3	25+TT	15.5-TT
56	23	0	3	4.5	0	18.5	4.0	3	25+TT	14.5-TT
57	23	0	3.5	6	0	17	5.0	3	25+TT	12-TT
58	23	0	3.5	6	0	17	5.0	3	25+TT	12-TT
59	23	0	3.5	6	0	17	5.0	3	25+TT	12-TT
60	23	0	3.5	6	0	17	5.0	3	25+TT	12-TT
61	23	0	3.5	4	0	19	3.5	3	25+TT	15.5-TT
62	23	0	3.5	2	0	19.5	3.5	3	25+TT	16-TT

63	23	0	3.5	4	0	19	3.5	3	25+TT	15.5-TT
64	23	0	3.5	2	0	19.5	3.5	3	25+TT	16-TT
65	23	0	3.5	6	0	17	5.0	3	25+TT	12-TT
66	23	0	3.5	6	0	17	5.0	3	25+TT	12-TT
67	23	0	3.5	6	0	17	5.0	3	25+TT	12-TT
68	23	0	3.5	6	0	17	5.0	3	25+TT	12-TT
69	23	0	3.5	4	0	19	3.5	3	25+TT	15.5-TT
70	23	0	3.5	2	0	19.5	3.5	3	25+TT	16-TT
71	23	0	3.5	4	0	19	3.5	3	25+TT	15.5-TT
72	23	0	3.5	2	0	19.5	3.5	3	25+TT	16-TT
73	23	0	3.5	11.5	0	11.5	6.0	3	25+TT	5.5-TT
74	23	0	3.5	7	0	16	5.0	3	25+TT	11-TT
75	23	0	3.5	5.5	0	17.5	5.0	3	25+TT	12.5-TT
76	23	0	3.5	11.5	0	11.5	6.0	3	25+TT	5.5-TT
77	23	0	3.5	11.5	0	11.5	6.0	3	25+TT	5.5-TT
78	23	0	3.5	7	0	16	5.0	3	25+TT	11-TT
79	23	0	3.5	5.5	0	17.5	5.0	3	25+TT	12.5-TT
80	23	0	3.5	11.5	0	11.5	6	3	25+TT	5.5-TT
81	23	0	3.5	4	0	19	3.5	3	25+TT	15.5-TT
82	23	0	3.5	4.5	0	18.5	4.0	3	25+TT	14.5-TT
83	23	0	3.5	4	0	19	3.5	3	25+TT	15.5-TT
84	23	0	3.5	4.5	0	18.5	4.0	3	25+TT	14.5-TT
85	23	0	6.5	0	0	16.5	5.0	3	25+TT	11.5-TT
86	23	0	6.5	0	0	16.5	5.0	3	25+TT	11.5-TT
87	23	0	6.5	0	0	16.5	5.0	3	25+TT	11.5-TT
88	23	0	6.5	0	0	16.5	5.0	3	25+TT	11.5-TT
89	23	0	6.5	0	0	16.5	5.0	3	25+TT	11.5-TT
90	23	0	6.5	2	0	16.5	5.0	3	25+TT	11.5-TT
91	23	0	6.5	0	0	16.5	5.0	3	25+TT	11.5-TT
92	23	0	6.5	2	0	16.5	5.0	3	25+TT	11.5-TT
93	23	0	6.5	0	0	16.5	5.0	3	25+TT	11.5-TT
94	23	0	6.5	0	0	16.5	5.0	3	25+TT	11.5-TT
95	23	0	6.5	0	0	16.5	5.0	3	25+TT	11.5-TT
96	23	0	6.5	0	0	16.5	5.0	3	25+TT	11.5-TT
97	23	0	6.5	0	0	16.5	5.0	3	25+TT	11.5-TT
98	23	0	6.5	2	0	16.5	5.0	3	25+TT	11.5-TT
99	23	0	6.5	0	0	16.5	5.0	3	25+TT	11.5-TT
100	23	0	6.5	2	0	16.5	5.0	3	25+TT	11.5-TT
101	23	0	6.5	11.5	0	11.5	6.0	3	25+TT	5.5-TT
102	23	0	6.5	7	0	16	5.0	3	25+TT	11-TT
103	23	0	6.5	0	0	16.5	5.0	3	25+TT	11.5-TT
104	23	0	6.5	11.5	0	11.5	6.0	3	25+TT	5.5-TT
105	23	0	6.5	11.5	0	11.5	6.0	3	25+TT	5.5-TT
106	23	0	6.5	7	0	16	5.0	3	25+TT	11-TT
107	23	0	6.5	0	0	16.5	5.0	3	25+TT	11.5-TT
108	23	0	6.5	11.5	0	11.5	6.0	3	25+TT	5.5-TT
109	23	0	6.5	0	0	16.5	5.0	3	25+TT	11.5-TT
110	23	0	6.5	4.5	0	16.5	5.0	3	25+TT	11.5-TT
111	23	0	6.5	0	0	16.5	5.0	3	25+TT	11.5-TT
112	23	0	6.5	4.5	0	16.5	5.0	3	25+TT	11.5-TT

NOTE 1: $P_{PowerClass}$ is the maximum UE power specified without taking into account the tolerance.

NOTE 2: TT for each frequency and channel bandwidth is specified in Table 6.2.3.5-0.

For the UE which supports inter-band NR CA configuration, inter-band NR-DC configuration, SUL configuration or inter-band EN-DC configuration, $\Delta T_{IB,c}$ as specified in 6.2A.4.0.2 for NR CA, 6.2B.4.0.2 for NR-DC, clause 6.2C.2 for SUL, or TS 38.521-3 [14] clause 6.2B.4.2 for EN-DC applies. Unless otherwise stated, $\Delta T_{IB,c}$ is set to zero. In case the UE supports more than one of band combinations for CA, NR-DC, SUL or DC, and an operating band belongs to more than one band combinations then

- a) When the operating band frequency range is ≤ 1 GHz, the applicable additional $\Delta T_{IB,c}$ shall be the average value for all band combinations defined in clause 6.2A.4.0.2, 6.2B.4.0.2, 6.2C.2 in this specification and 6.2B.4.2 in TS 38.521-3 [14], truncated to one decimal place that apply for that operating band among the supported band combinations. In case there is a harmonic relation between low band UL and high band DL, then the maximum $\Delta T_{IB,c}$ among the different supported band combinations involving such band shall be applied.

- b) When the operating band frequency range is > 1 GHz, the applicable additional $\Delta T_{IB,c}$ shall be the maximum value for all band combinations defined in clause 6.2A.4.0.2, 6.2B.4.0.2, 6.2C.2 in this specification and 6.2B.4.2 in TS 38.521-3 [14] for the applicable operating bands.

6.2D.4 Configured transmitted power for UL MIMO

6.2D.4.1 Test purpose

To verify the measured UE configured maximum output power $P_{UMAX,f,c}$ for UL MIMO is within the specified bounds.

6.2D.4.2 Test applicability

This test case applies to all types of NR UE release 15 and forward that support UL MIMO.

6.2D.4.3 Minimum conformance requirements

For UE supporting UL MIMO, the transmitted power is configured per each UE.

The definitions of configured maximum output power $P_{CMAX,c}$, the lower bound $P_{CMAX_L,c}$, and the higher bound $P_{CMAX_H,c}$ specified in subclause 6.2.4 shall apply to UE supporting UL MIMO, where

$P_{PowerClass}$, $\Delta P_{PowerClass}$ and $\Delta T_{C,c}$ are specified in subclause 6.2D.1.3;

MPR_c is specified in subclause 6.2D.2.3;

A- MPR_c is specified in subclause 6.2D.3.3.

The measured configured maximum output power $P_{UMAX,c}$ for serving cell c shall be within the following bounds:

$$P_{CMAX_L,c} - \text{MAX}\{T_L, T_{\text{LOW}}(P_{CMAX_L,c})\} \leq P_{UMAX,c} \leq P_{CMAX_H,c} + T_{\text{HIGH}}(P_{CMAX_H,c})$$

where $T_{\text{LOW}}(P_{CMAX_L,c})$ and $T_{\text{HIGH}}(P_{CMAX_H,c})$ are defined as the tolerance and applies to $P_{CMAX_L,c}$ and $P_{CMAX_H,c}$ separately, while T_L is the absolute value of the lower tolerance in Table 6.2D.1.3-1 for the applicable operating band.

For UE with two transmit antenna connectors in closed-loop spatial amultiplexing scheme, the tolerance is specified in Table 6.2D.4.3-1. The requirements shall be met with UL MIMO configurations specified in Table 6.2D.1.3-2.

For UE support uplink full power transmission (ULFPTx) for UL MIMO, the tolerance is specified in Table 6.2D.4.3-1. The requirements shall be met with the PUSCH configurations specified in Table 6.2D.1.3-3, based upon UE's support of uplink full power transmission mode.

Table 6.2D.4.3-1: $P_{CMAX,c}$ tolerance in closed-loop spatial multiplexing scheme

$P_{CMAX,c}$ (dBm)	Tolerance $T_{\text{LOW}}(P_{CMAX_L,c})$ (dB)	Tolerance $T_{\text{HIGH}}(P_{CMAX_H,c})$ (dB)
$P_{CMAX,c} = 26$	3.0	2.0
$23 \leq P_{CMAX,c} < 26$	3.0	2.0
$22 \leq P_{CMAX,c} < 23$	5.0	2.0
$21 \leq P_{CMAX,c} < 22$	5.0	3.0
$20 \leq P_{CMAX,c} < 21$	6.0	4.0
$16 \leq P_{CMAX,c} < 20$	5.0	
$11 \leq P_{CMAX,c} < 16$	6.0	
$-40 \leq P_{CMAX,c} < 11$	7.0	

If UE is scheduled for single antenna-port PUSCH transmission by DCI format 0_0 or by DCI format 0_1 for single antenna port codebook based transmission, the requirements in clause 6.2.4.3 apply for the power class as indicated by the *ue-PowerClass* field in capability signalling.

The normative reference for this requirement is TS 38.101-1 [2] clause 6.2D.4.

6.2D.4.4 Test description

6.2D.4.4.1 Initial conditions

Initial conditions are a set of test configurations the UE needs to be tested in and the steps for the SS to take with the UE to reach the correct measurement state.

The initial test configurations consist of environmental conditions, test frequencies, test channel bandwidths and sub-carrier spacing based on NR operating bands specified in table 5.3.5-1. All of these configurations shall be tested with applicable test parameters for each combination of test channel bandwidth and sub-carrier spacing, and are shown in table 6.2D.4.4.1-1. The details of the uplink reference measurement channels (RMCs) are specified in Annexes A.2. Configurations of PDSCH and PDCCH before measurement are specified in Annex C.2.

Table 6.2D.4.4.1-1: Test Configuration Table

Initial Conditions			
Test Environment as specified in TS 38.508-1 [5] subclause 4.1		Normal, TL/VL, TL/VH, TH/VL, TH/VH	
Test Frequencies as specified in TS 38.508-1 [5] subclause 4.3.1		Mid range	
Test Channel Bandwidths as specified in TS 38.508-1 [5] subclause 4.3.1		Lowest, Mid, Highest	
Test SCS as specified in Table 5.3.5-1		Lowest	
Test Parameters for Channel Bandwidths			
Test ID	Downlink Configuration	Uplink Configuration	
	N/A	Modulation	RB allocation (NOTE 1)
1		CP-OFDM QPSK	Inner Full
NOTE 1: The specific configuration of each RB allocation is defined in Table 6.1-1.			

Table 6.2D.4.4.1-2: Test Configuration Table for uplink full power transmission (ULFPTx)

Initial Conditions			
Test Environment as specified in TS 38.508-1 [5] subclause 4.1		Normal, TL/VL, TL/VH, TH/VL, TH/VH	
Test Frequencies as specified in TS 38.508-1 [5] subclause 4.3.1		Mid range	
Test Channel Bandwidths as specified in TS 38.508-1 [5] subclause 4.3.1		Lowest, Mid, Highest	
Test SCS as specified in Table 5.3.5-1		Lowest	
Test Parameters for Channel Bandwidths			
Test ID	Downlink Configuration	Uplink Configuration	
	N/A	Modulation (NOTE 2)	RB allocation (NOTE 1)
1		DFT-s-OFDM Pi/2 BPSK	Inner Full
2		DFT-s-OFDM QPSK	Inner Full
3 ³		DFT-s-OFDM Pi/2 BPSK	Inner Full
NOTE 1: The specific configuration of each RB allocation is defined in Table 6.1-1.			
NOTE 2: DFT-s-OFDM PI/2 BPSK test applies only for UEs which supports half Pi BPSK in FR1.			
NOTE 3: UE operating in TDD mode with PI/2 PBSK modulation and UE indicates support for UE capability <i>powerBoosting-pi2BPSK</i> and the IE <i>powerBoostPi2BPSK</i> is set to 1 for bands n40, n41, n77, n78 and n79.			

1. Connect the SS to the UE antenna connectors as shown in TS 38.508-1 [5] Annex A, Figure A.3.1.1.2 for TE diagram and section A.3.2 for UE diagram.
2. The parameter settings for the cell are set up according to TS 38.508-1 [5] subclause 4.4.3.
3. Downlink signals are initially set up according to Annex C.0, C.1, C.2, and uplink signals according to Annex G.0, G.1, G.2, G.3.0.
4. The UL Reference Measurement Channel is set according to Table 6.2D.4.4.1-1.
5. Propagation conditions are set according to Annex B.0.

6. Ensure the UE is in state RRC_CONNECTED with generic procedure parameters Connectivity NR, Connected without release On, Test Mode On and Test Loop Function On according to TS 38.508-1 [5] clause 4.5. Message contents are defined in clause 6.2D.4.4.3.

6.2D.4.4.2 Test procedure

1. SS sends uplink scheduling information for each UL HARQ process via PDCCH DCI format 0_1 for C_RNTI to schedule the UL RMC according to Table 6.2D.4.4.1-1. Since the UE has no payload and no loopback data to send the UE sends uplink MAC padding bits on the UL RMC. The PDCCH DCI format 0_1 is specified with the condition 2TX_UL_MIMO in 38.508-1 [5] subclause 4.3.6.1.1.2.
2. Send continuously uplink power control "up" commands in every uplink scheduling information to the UE; allow at least 200ms starting from the first TPC command in this step for the UE to reach P_{UMAX} level of the test point.
3. Measure the sum of the mean power of the UE at each transmit antenna connector in the channel bandwidth of the radio access mode. The period of measurement shall be at least the continuous duration of 1ms over all active uplink slots and in the uplink symbols. For TDD slots only slots consisting of only UL symbols are under test.
4. If UE supports ULFPTx, repeat test steps 1~3 with UL RMC according to Table 6.2D.4.4.1-2. The PDCCH DCI format 0_1 is specified with the condition ULFPTx_Mode1, ULFPTx_Mode2 or ULFPTx_ModeFull in 38.508-1 [5] subclause 4.3.6.1.1.2 depending on UE reported capability.

6.2D.4.4.3 Message contents

Message contents are according to TS 38.508-1 [5] subclause 4.6 ensuring Table 4.6.3-182 with the condition 2TX_UL_MIMO and following exception.

Table 6.2D.4.4.3-1: FrequencyInfoUL-SIB: Test point 1

Derivation Path: TS 38.508-1 [5] Table 4.6.3-62 FrequencyInfoUL-SIB			
Information Element	Value/remark	Comment	Condition
p-Max	0		

Table 6.2D.4.4.3-2: FrequencyInfoUL-SIB: Test point 2

Derivation Path: TS 38.508-1 [5] Table 4.6.3-62 FrequencyInfoUL-SIB			
Information Element	Value/remark	Comment	Condition
p-Max	14		

Table 6.2D.4.4.3-3: FrequencyInfoUL-SIB: Test point 3

Derivation Path: TS 38.508-1 [5] Table 4.6.3-62 FrequencyInfoUL-SIB			
Information Element	Value/remark	Comment	Condition
p-Max	18		

6.2D.4.5 Test requirement

The maximum output power measured shall not exceed the values specified in Table 6.2D.4.5-1.

Table 6.2D.4.5-1: P_{C_{MAX}} configured UE output power

Configured transmitted power	
Measured UE output power test point 1	0 dBm ± (7+TT)
Measured UE output power test point 2	14 dBm ± (6+TT)
Measured UE output power test point 3	18 dBm ± (5+TT)
Note 1:	TT for each frequency and channel bandwidth is specified in Table 6.2D.4.5-2.
Note 2:	In addition note 2 in Table 6.2D.1.3-1 shall apply to the tolerances.

Table 6.2D.4.5-2: Test Tolerance (Configured transmitted power for UL MIMO)

	$f \leq 3.0\text{GHz}$	$3.0\text{GHz} < f \leq 6.0\text{GHz}$
$BW \leq 40\text{MHz}$	0.7	1.0
$40\text{MHz} < BW \leq 100\text{MHz}$	1.0	1.0

For the UE which supports inter-band NR CA configuration, inter-band NR-DC configuration, SUL configuration or inter-band EN-DC configuration, $\Delta T_{IB,c}$ as specified in 6.2A.4.0.2 for NR CA, 6.2B.4.0.2 for NR-DC, clause 6.2C.2 for SUL, or TS 38.521-3 [14] clause 6.2B.4.2 for EN-DC applies. Unless otherwise stated, $\Delta T_{IB,c}$ is set to zero. In case the UE supports more than one of band combinations for CA, NR-DC, SUL or DC, and an operating band belongs to more than one band combinations then

- a) When the operating band frequency range is ≤ 1 GHz, the applicable additional $\Delta T_{IB,c}$ shall be the average value for all band combinations defined in clause 6.2A.4.0.2, 6.2B.4.0.2, 6.2C.2 in this specification and 6.2B.4.2 in TS 38.521-3 [14], truncated to one decimal place that apply for that operating band among the supported band combinations. In case there is a harmonic relation between low band UL and high band DL, then the maximum $\Delta T_{IB,c}$ among the different supported band combinations involving such band shall be applied.
- b) When the operating band frequency range is > 1 GHz, the applicable additional $\Delta T_{IB,c}$ shall be the maximum value for all band combinations defined in clause 6.2A.4.0.2, 6.2B.4.0.2, 6.2C.2 in this specification and 6.2B.4.2 in TS 38.521-3 [14] for the applicable operating bands.

6.2E Transmitter power for V2X

6.2E.1 UE maximum output power for V2X

6.2E.1.0 Minimum conformance requirements

6.2E.1.0.1 General

When NR V2X UE is configured for NR V2X sidelink transmissions non-concurrent with NR uplink transmissions for NR V2X operating bands specified in Table 5.2E.1-1, the allowed NR V2X UE maximum output power is specified in Table 6.2.1.3-1 in clause 6.2.1.

When a UE is configured for NR V2X sidelink transmissions in NR Band n47, the V2X UE shall meet the following additional requirements for transmission within the frequency ranges 5855-5925 MHz:

- The maximum mean power spectral density shall be restricted to 23 dBm/MHz EIRP when the network signaling value NS_33 is indicated.

where the network signaling values are specified in clause 6.2E.3.0.

NOTE: The PSD limit in EIRP shall be converted to conducted requirement depend on the supported post antenna connector gain $G_{\text{post connector}}$ declared by the UE following the principle described in annex I in [11].

For NR V2X UE supporting SL MIMO, the maximum output power requirements in Table 6.2E.1.0.1-1 shall be met with the SL MIMO configurations specified in Table 6.2D.1.3-2. The maximum output power is defined as the sum of the maximum output power from each UE antenna connector. The period of measurement shall be at least one sub frame (1 ms).

Table 6.2E.1.0.1-1: NR V2X UE Power Class for SL-MIMO

NR band	Class 1 (dBm)	Tolerance (dB)	Class 2 (dBm)	Tolerance (dB)	Class 3 (dBm)	Tolerance (dB)	Class 4 (dBm)	Tolerance (dB)
n38					23	+2/-3		
n47					23	+2/-3		

If the UE transmits on one antenna connector at a time, the requirements in Table 6.2.1.3-1 shall apply to the active antenna connector.

6.2E.1.0.2 UE maximum output power for V2X con-current operation

For the inter-band con-current NR V2X operation, the maximum output power is specified in Table 6.2E.1.0.2-1. The period of measurement shall be at least one sub frame (1ms).

Table 6.2E.1.0.2-1: NR V2X UE Power Class for inter-band con-current combination (two bands)

NR V2X con-current operating band Configuration	Class 1 (dBm)	Tolerance (dB)	Class 2 (dBm)	Tolerance (dB)	Class 3 (dBm)	Tolerance (dB)	Class 4 (dBm)	Tolerance (dB)
V2X_n71A-n47A					23	+2/-3 ⁴		
NOTE 1: The con-current band combinations are used for NR V2X Service. NOTE 2: $P_{PowerClass}$ is the maximum UE power specified without taking into account the tolerance NOTE 3: For inter-band con-current aggregation the maximum power requirement apply to the total transmitted power over all component carriers (per UE). NOTE 4: ⁴ refers to the transmission bandwidths (Figure 5.6-1) confined within F_{UL_low} and $F_{UL_low} + 4$ MHz or $F_{UL_high} - 4$ MHz and F_{UL_high} , the maximum output power requirement is relaxed by reducing the lower tolerance limit by 1.5 dB								

The normative reference for this requirement is TS 38.101-1 [2] clause 6.2E.1

6.2E.1.1 UE maximum output power for V2X / non-concurrent operation

Editor's note: No test points are defined since there is no configuration satisfying MPR=0dB requirements in RAN4.

6.2E.1.1.1 Test purpose

To verify that the error of the UE maximum output power does not exceed the range prescribed by the specified nominal maximum output power and tolerance.

An excess maximum output power has the possibility to interfere to other channels or other systems. A small maximum output power decreases the coverage area.

6.2E.1.1.2 Test applicability

This test case applies to all types of NR UE release 16 and forward that support NR V2X sidelink communication.

NOTE: This test case can't be performed due to lack of appropriate test points.

6.2E.1.1.3 Minimum conformance requirements

The minimum conformance requirements are defined in clause 6.2E.1.0.

6.2E.1.1.4 Test description

6.2E.1.1.4.1 Initial conditions

Initial conditions are a set of test configurations the UE needs to be tested in and the steps for the SS to take with the UE to reach the correct measurement state.

The initial test configurations consist of environmental conditions, test frequencies, test channel bandwidths and sub-carrier spacing based on NR operating bands specified in Table 5.2E.1-1 and Table 5.3.5-1. All of these configurations shall be tested with applicable test parameters for each combination of test channel bandwidth and sub-carrier spacing, and are shown in table 6.2E.1.1.4.1-1. The details of the V2X reference measurement channels (RMCs) are specified in Annex A.7.5 and the GNSS configuration in TS 38.508-1 [5] subclause 4.11.

Table 6.2E.1.1.4.1-1: Test Configuration Table

FFS

NOTE: No test points are defined since there is no configuration satisfying MPR=0dB requirements in RAN4.

1. Connect the SS and GNSS simulator to the UE antenna connectors as shown in TS 38.508-1 [5] Annex A, Figure A.3.1.9.1 for TE diagram and clause A.3.2.7 for UE diagram.

2. The parameter settings for the V2X sidelink transmission over PC5 are pre-configured according to TS 38.508-1 [5] subclause 4.10. Message content exceptions are defined in clause 6.2E.1.1.4.3.
3. The V2X Reference Measurement Channel is set according to Table 6.2E.1.1.4.1-1.
4. The GNSS simulator is configured for Scenario #1: static in Geographical area #1, as defined in TS 38.508-1 [5] Table 4.11.2-2. Geographical area #1 is also pre-configured in the UE.
5. Propagation conditions are set according to Annex B.0.
6. Ensure the UE is in state *Out_of_Coverage* with generic procedure parameters *Sidelink On*, Test Loop Function *On* with UE test loop mode E closed for *Transmit Mode* according to TS 38.508-1 [5] clause 4.5.

6.2E.1.1.4.2 Test procedure

1. The UE starts to perform the V2X sidelink communication according to SL-V2X-Preconfiguration. Since the UE has no payload and no loopback data to send the UE sends uplink MAC padding bits on the V2X RMC.
2. Measure the mean power of the UE in the channel bandwidth for each test point in table 6.2E.1.1.5-1 according to the test configuration from Table 6.2E.1.1.4.1-1. The period of measurement shall be at least continuous duration of one active sub-frame (1ms) and in the uplink symbols.

6.2E.1.1.4.3 Message contents

Message contents are according to TS 38.508-1 [5] subclause 4.10.

6.2E.1.1.5 Test requirement

The maximum output power, derived in step 2 shall be within the range prescribed by the nominal maximum output power and tolerance in Table 6.2E.1.1.5-1.

Table 6.2E.1.1.5-1: Maximum Output Power test requirement for Power Class 3

NR band	Class 1 (dBm)	Tolerance (dB)	Class 2 (dBm)	Tolerance (dB)	Class 3 (dBm)	Tolerance (dB)
n38					23	$\pm 2 \pm TT$
n47					23	$\pm 2 \pm TT$
NOTE 1: $P_{PowerClass}$ is the maximum UE power specified without taking into account the tolerance						
NOTE 2: Power class 3 is default power class unless otherwise stated						
NOTE 3: TT for each frequency and channel bandwidth is specified in Table 6.2.1.5-3						

Table 6.2E.1.1.5-2: Test Tolerance (UE maximum output power)

	$f \leq 3.0\text{GHz}$	$4.2\text{GHz} < f \leq 6.0\text{GHz}$
$BW \leq 40\text{MHz}$	0.7 dB	1.0 dB

6.2E.1.1D UE maximum output power for V2X / non-concurrent operation / SL-MIMO

Editor's Note:

- No test points are defined since there is no configuration satisfying $MPR=0\text{dB}$ requirements in RAN4.
- The test case is not completed due to the following aspects are not yet determined:
 - Uplink RMC is TBD in RAN4
 - Connection diagram is TBD
 - Preconfiguration is TBD in 38.508-1

6.2E.1.1D.1 Test purpose

To verify that the error of the UE maximum output power does not exceed the range prescribed by the specified nominal maximum output power and tolerance.

An excess maximum output power has the possibility to interfere to other channels or other systems. A small maximum output power decreases the coverage area.

6.2E.1.1D.2 Test applicability

This test case applies to all types of NR UE release 16 and forward that support NR V2X sidelink communication and SL-MIMO.

NOTE: This test case can't be performed due to lack of appropriate test points.

6.2E.1.1D.3 Minimum conformance requirements

The minimum conformance requirements are defined in clause 6.2E.1.0.

6.2E.1.1D.4 Test description

6.2E.1.1D.4.1 Initial conditions

Initial conditions are a set of test configurations the UE needs to be tested in and the steps for the SS to take with the UE to reach the correct measurement state.

The initial test configurations consist of environmental conditions, test frequencies, test channel bandwidths and sub-carrier spacing based on NR operating bands specified in Table 5.2E.1-1 and Table 5.3.5-1. All of these configurations shall be tested with applicable test parameters for each combination of test channel bandwidth and sub-carrier spacing, and are shown in table 6.2E.1.1D.4.1-1. The details of the V2X reference measurement channels (RMCs) are specified in Annexes TBD and the GNSS configuration in TS 38.508-1 [5] subclause 4.11.

Table 6.2E.1.1D.4.1-1: Test Configuration Table

FFS

NOTE: No test points are defined since there is no configuration satisfying MPR=0dB requirements in RAN4.

1. Connect the SS and GNSS simulator to the UE antenna connectors as shown in TS 38.508-1 [5] Annex A, Figure TBD for TE diagram and section TBD for UE diagram.
2. The parameter settings for the NR sidelink transmission over PC5 are pre-configured according to TS 38.508-1 [5] subclause 4.10. Message content exceptions are defined in clause 6.2E.1.1D.4.3.
3. The V2X Reference Measurement Channel is set according to Table 6.2E.1.1D.4.1-1.
4. The GNSS simulator is configured for Scenario #1: static in Geographical area #1, as defined in TS 38.508-1 [5] Table 4.11.2-2. Geographical area #1 is also pre-configured in the UE.
5. Propagation conditions are set according to Annex B.0.
6. Ensure the UE is in state 4-A as defined in TS 38.508-1 [4], subclause 4.4A using generic procedure parameter Sidelink (*On*), Cast Type (*Unicast*), GNSS Sync (*On*) and *Transmit Mode with SL-MIMO*.

6.2E.1.1D.4.2 Test procedure

1. The UE starts to perform the NR sidelink communication according to *SL-PreconfigurationNR* with 2-layer MIMO codebook TPMI 0. Since the UE has no payload and no loopback data to send the UE sends uplink MAC padding bits on the NR sidelink RMC.
2. Measure the sum of the mean power of the UE at each transmit antenna connector in the channel bandwidth according to the test configuration from Table 6.2E.1.1D.4.1-1. The period of measurement shall be at least continuous duration of one active sub-frame (1ms) excluding guard symbols.

6.2E.1.1D.4.3 Message contents

Message contents are according to TS 38.508-1 [5] subclause 4.10.

6.2E.1.1D.5 Test requirement

The maximum output power, derived in step 2 shall be within the range prescribed by the nominal maximum output power and tolerance in Table 6.2E.1.1D.5-1.

Table 6.2E.1.1D.5-1: NR V2X UE Maximum Output Power test requirement for SL-MIMO and Power Class 3

NR band	Class 1 (dBm)	Tolerance (dB)	Class 2 (dBm)	Tolerance (dB)	Class 3 (dBm)	Tolerance (dB)	Class 4 (dBm)	Tolerance (dB)
n38					23	+2+TT/-3-TT		
n47					23	+2+TT/-3-TT		

Table 6.2E.1.1D.5-2: Test Tolerance (NR V2X UE maximum output power for SL-MIMO)

	f ≤ 3.0GHz	4.2GHz < f ≤ 6.0GHz
BW ≤ 40MHz	0.7 dB	1.0 dB

6.2E.2 UE maximum output power reduction for V2X

6.2E.2.0 Minimum conformance requirements

6.2E.2.0.1 General

When UE is configured for NR V2X sidelink transmissions non-concurrent with NR uplink transmissions for NR V2X operating bands specified in Table 5.2E.1-1, this clause specifies the allowed Maximum Power Reduction (MPR) power for V2X physical channels and signals due to PSCCH/PSSCH, PSFCH and S-SSB transmission.

6.2E.2.0.2 MPR for Power class 3 V2X UE

For contiguous allocation of PSCCH and PSSCH simultaneous transmission, the allowed MPR for the maximum output power for NR V2X physical channels PSCCH and PSSCH shall be as specified in Table 6.2E.2.0.2-1 for Power class 3 NR V2X UE.

Table 6.2E.2.0.2-1: Maximum Power Reduction (MPR) for power class 3 NR V2X

Modulation		Channel bandwidth/MPR (dB)	
		Outer RB allocations	Inner RB allocations
CP-OFDM	QPSK	≤ 4.5	≤ 2.5
	16QAM	≤ 4.5	≤ 2.5
	64 QAM	≤ 4.5	
	256 QAM	≤ 7.0	

Where the following parameters are defined to specify valid RB allocation ranges for Outer and Inner RB allocations:

N_{RB} is the maximum number of RBs for a given Channel bandwidth and sub-carrier spacing defined in Table 5.3.2-1.

$$RB_{Start,Low} = \max(1, \text{floor}(L_{CRB}/2))$$

where $\max()$ indicates the largest value of all arguments and $\text{floor}(x)$ is the greatest integer less than or equal to x .

$$RB_{Start,High} = N_{RB} - RB_{Start,Low} - L_{CRB}$$

The RB allocation is an Inner RB allocation if the following conditions are met

$$RB_{Start,Low} \leq RB_{Start} \leq RB_{Start,High}, \text{ and}$$

$$L_{CRB} \leq \text{ceil}(N_{RB}/2)$$

where $\text{ceil}(x)$ is the smallest integer greater than or equal to x .

The RB allocation is an Outer RB allocation for all other allocations which are not an Inner RB allocation.

For PSFCH with single RB transmission for PC3 NR V2X UE, the required MPR is defined as follow

$$MPR_{PSFCH} = 3.5 \text{ dB}$$

For contiguous and non-contiguous allocation for simultaneous PSFCH transmission for PC3 NR V2X UE, the required MPR are specified as follow

$$\text{MPR}_{\text{PSFCH}} = \text{CEIL} \{M_{\text{A_PSFCH}}, 0.5\}$$

Where $M_{\text{A_PSFCH}}$ is defined as follows

$$\begin{aligned} M_{\text{A_PSFCH}} &= 7.5 && ; 0.00 < N_{\text{Gap}}/N_{\text{RB}} \leq 0.55 \\ &= 12.0 && ; 0.55 < N_{\text{Gap}}/N_{\text{RB}} \leq 1.0 \end{aligned}$$

Where,

N_{Gap} is the gap RB amount between RB_{start} and RB_{end} for contiguous and non-contiguous allocation simultaneous PSFCH transmission. ($N_{\text{Gap}} = \text{RB}_{\text{end}} - \text{RB}_{\text{start}}$)

$\text{CEIL}\{M_{\text{A}}, 0.5\}$ means rounding upwards to closest 0.5dB.

The allowed MPR for the maximum output power for NR V2X physical channels on S-SSB transmission shall be specified in Table 6.2E.2.0.2-2.

Table 6.2E.2.0.2-2: Maximum Power Reduction (MPR) for S-SSB transmission for power class 3 NR V2X

Channel	MPR _{S-SSB} (dB)	
	Outer RB allocations ¹	Inner RB allocations ¹
S-SSB	≤ 6.0	≤ 2.5

For NR V2X UE with two transmit antenna connectors, the allowed Maximum Power Reduction (MPR) values specified in clause 6.2E.2.0 shall apply to the maximum output power specified in Table 6.2E.1.1.3-1. The requirements shall be met with SL MIMO configurations defined in Table 6.2D.1.3-2. For UE supporting SL MIMO, the maximum output power is defined as the sum of the maximum output power from each UE antenna connector.

For the UE maximum output power modified by MPR, the power limits specified in clause 6.2E.4.0 apply.

6.2E.2.0.3 MPR for Power class 3 V2X con-current operation

For the inter-band con-current NR V2X operation, the allowed maximum power reduction (MPR) for the maximum output power shall be applied per each component carrier. The MPR requirements in clause 6.2.2.3 apply for NR Uu operation in licensed band, and the MPR requirements in in clause 6.2E.2.0 apply for NR sidelink operation in licensed band or Band n47.

The normative reference for this requirement is TS 38.101-1 [2] clause 6.2E.2

6.2E.2.1 UE maximum output power reduction for V2X / non-concurrent operation

Editor's Note: The test case is not completed for PSFCH and PSBCH measurement due to the following aspects are not yet determined:

- Measurement period of PSFCH and PSBCH is FFS.

6.2E.2.1.1 Test purpose

Same test purpose as in 6.2.2.1.

6.2E.2.1.2 Test applicability

This test case applies to all types of UE release 16 and forward that support NR V2X sidelink communication.

NOTE: Test execution is not necessary if TS 38.521-1 6.5E.2.4.1 is executed.

6.2E.2.1.3 Minimum conformance requirements

The minimum conformance requirements are defined in clause 6.2E.2.0.

6.2E.2.1.4 Test description

6.2E.2.1.4.1 Initial conditions

Initial conditions are a set of test configurations the UE needs to be tested in and the steps for the SS to take with the UE to reach the correct measurement state.

The initial test configurations consist of environmental conditions, test frequencies, test channel bandwidths and sub-carrier spacing based on NR operating bands specified in Table 5.2E.1-1 and Table 5.3.5-1. All of these configurations shall be tested with applicable test parameters for each combination of test channel bandwidth and sub-carrier spacing, and are shown in table 6.2E.2.1.4.1-1 to 6.2E.2.1.4.1-3. The details of the V2X reference measurement channels (RMCs) are specified in Annex A.7.5 and the GNSS configuration in TS 38.508-1 [5] subclause 4.11.

Table 6.2E.2.1.4.1-1: Test Configuration Table for contiguous PSCCH and PSSCH allocation

Initial Conditions			
Test Environment as specified in TS 38.508-1 [5] subclause 4.1		Normal, TL/VL, TL/VH, TH/VL, TH/VH	
Test Frequencies as specified in TS 38.508-1 [5] subclause 4.3.1.8		Low range, High range	
Test Channel Bandwidths as specified TS 38.508-1 [5] subclause 4.3.1		Lowest, Highest	
Test SCS as specified in Table 5.3.5-1		Lowest, Highest	
Test Parameters for Channel Bandwidths			
Test ID	Freq	V2X Configuration to Transmit	
		Modulation	PSCCH and PSSCH RB allocation (Note 1)
1	Default	QPSK	Outer_Full
2	Default	QPSK	Inner_Full
3	Default	16QAM	Outer_Full
4	Default	16QAM	Inner_Full
5	Default	64QAM	Outer_Full
6	Default	256QAM	Outer_Full
NOTE 1: The specific configuration of each RB allocation is defined in Table 6.1E-1.			

Table 6.2E.2.1.4.1-2: Test Configuration Table for PSFCH

Initial Conditions			
Test Environment as specified in TS 38.508-1 [5] subclause 4.1		Normal, TL/VL, TL/VH, TH/VL, TH/VH	
Test Frequencies as specified in TS 38.508-1 [5] subclause 4.3.1.8		Low range, High range	
Test Channel Bandwidths as specified TS 38.508-1 [5] subclause 4.3.1		Lowest, Highest	
Test SCS as specified in Table 5.3.5-1		Lowest, Highest	
Test Parameters for Channel Bandwidths			
Test ID	Freq	V2X Configuration to Transmit	
		PSFCH RB allocation (Note 1)	
1	Low range	PSFCH_1RB_Left	
2	High range	PSFCH_1RB_Right	
3	Low range	PSFCH_2RB_Left	
4	High range	PSFCH_2RB_Right	
5	Default	PSFCH_Max_Gap	
NOTE 1: The specific configuration of each RB allocation is defined in Table 6.1E-2.			

Table 6.2E.2.1.4.1-3: Test Configuration Table for S-SSB

Initial Conditions		
Test Environment as specified in TS 38.508-1 [5] subclause 4.1	Normal, TL/VL, TL/VH, TH/VL, TH/VH	
Test Frequencies as specified in TS 38.508-1 [5] subclause 4.3.1.8	Low range, High range	
Test Channel Bandwidths as specified TS 38.508-1 [5] subclause 4.3.1	Lowest, Highest	
Test SCS as specified in Table 5.3.5-1	Lowest, Highest	
Test Parameters for Channel Bandwidths		
Test ID	Freq	V2X Configuration to Transmit S-SSB RB allocation (Note 1)
1	Low range	S-SSB_Low
2	High range	S-SSB_High
3	Default	S-SSB_Mid
NOTE 1: The specific configuration of each RB allocation is defined in Table 6.1E-3.		

1. Connect the SS and GNSS simulator to the UE antenna connectors as shown in TS 38.508-1 [5] Annex A, Figure A.3.1.9.1 for TE diagram and section A.3.2.7 for UE diagram.
2. The parameter settings for the NR sidelink transmission over PC5 are pre-configured according to TS 38.508-1 [5] subclause 4.10. Message content exceptions are defined in clause 6.2E.2.1.4.3.
3. The V2X Reference Measurement Channel is set according to Table 6.2E.2.1.4.1-1 to Table 6.2E.2.1.4.1-3.
4. The GNSS simulator is configured for Scenario #1: static in Geographical area #1, as defined in TS 38.508-1 [5] Table 4.11.2-2. Geographical area #1 is also pre-configured in the UE.
5. Propagation conditions are set according to Annex B.0.

6.2E.2.1.4.2 Test procedure

Subtest 1: PSCCH/PSSCH

1. Ensure the UE is in state *Out_of_Coverage* with generic procedure parameters *Sidelink On*, *Test Loop Function On* with UE test loop mode E closed for *Transmit Mode* according to TS 38.508-1 [5] clause 4.5.
2. The UE starts to perform the NR sidelink communication according to *SL-PreconfigurationNR*. Since the UE has no payload and no loopback data to send the UE sends uplink MAC padding bits on the NR sidelink RMC.
3. Measure the mean power of the UE in the channel bandwidth according to the test configuration from Table 6.2E.2.1.4.1-1. The period of measurement shall be at least continuous duration of one active sub-frame (1ms) excluding guard symbols.

Subtest 2: PSFCH

1. Ensure the UE is in state *Out_of_Coverage* with generic procedure parameters *Sidelink On*, *Cast type Unicast*, *Test Loop Function On* with UE test loop mode E closed for *Receive Mode* according to TS 38.508-1 [5] clause 4.5.
2. The UE starts to perform the NR sidelink reception according to *SL-PreconfigurationNR*.
3. The UE's PSFCH transmission occasion is on slot n according to Table 6.2E.2.1.4.1-2. SS transmits PSSCH on combination of slot and subchannel as below:
 - a) Test ID 1: slot n-6, Lowest sub-channel
 - b) Test ID 2: slot n-3, Highest sub-channel
 - c) Test ID 3: slot n-6 and n-5, Lowest sub-channel
 - d) Test ID 4: slot n-4 and n-3, Highest sub-channel
 - e) Test ID 5: slot n-6, Highest sub-channel and slot n-3, Highest sub-channel

4. Measure the mean power of the UE on slot n in the channel bandwidth according to the test configuration from Table 6.2E.2.1.4.1-2. The period of measurement is FFS.

Subtest 3: S-SSB

1. Ensure the UE is in state *Out_of_Coverage* with generic procedure parameters *Sidelink On* according to TS 38.508-1 [5] clause 4.5. The UE is synchronized to GNSS,
2. The UE transmits PSBCH according *SL-PreconfigurationNR*.
3. Measure the mean power of the S-SSB in the channel bandwidth according to the test configuration from Table 6.2E.2.1.4.1-3. The period of measurement is FFS.

6.2E.2.1.4.3 Message contents

Message contents are according to TS 38.508-1 [5] subclause 4.10 with the following exceptions.

Table 6.2E.2.1.4.3-1: *SL-ResourcePool* for PSCCH/PSSCH Testing

Derivation Path: TS 38.508-1 [5], Table 4.6.6-25			
Information Element	Value/remark	Comment	Condition
SL-ResourcePool-r16 ::= SEQUENCE {			
sl-PSCCH-Config-r16 CHOICE {			
setup SEQUENCE {			
sl-TimeResourcePSCCH-r16	As defined in Table 6.1E-2		
sl-FreqResourcePSCCH-r16	As defined in Table 6.1E-2		
}			
}			
sl-SubchannelSize-r16	As defined in Table 6.1E-2		
sl-StartRB-Subchannel-r16	As defined in Table 6.1E-2		
sl-NumSubchannel-r16	As defined in Table 6.1E-2		
}			

Table 6.2E.2.1.4.3-2: *SL-ResourcePool* for PSFCH Testing

Derivation Path: TS 38.508-1 [5], Table 4.6.6-25			
Information Element	Value/remark	Comment	Condition
SL-ResourcePool-r16 ::= SEQUENCE {			
sl-PSFCH-Config-r16 CHOICE {			
setup SEQUENCE {			
sl-PSFCH-Period-r16	sl4		
sl-PSFCH-RB-Set-r16	As defined in Table 6.1E-2		
sl-NumMuxCS-Pair-r16	n1		
sl-MinTimeGapPSFCH-r16	sl3		
sl-PSFCH-HopID-r16	Not present	Default frequency hopping ID 0 is used	
sl-PSFCH-CandidateResourceType-r16	startSubCH		
}			
}			
sl-SubchannelSize-r16	As defined in Table 6.1E-2		
sl-StartRB-Subchannel-r16	As defined in Table 6.1E-2		
sl-NumSubchannel-r16	As defined in Table 6.1E-2		
}			

Table 6.2E.2.1.4.3-3: SL-FreqConfigCommon for S-SSB Testing

Derivation Path: TS 38.508-1 [5], Table 4.6.6-11			
Information Element	Value/remark	Comment	Condition
SL-FreqConfigCommon-r16 ::= SEQUENCE {			
sl-AbsoluteFrequencySSB-r16	According to section 4.3.1.8 of TS 38.508-1 [5]		
}			

6.2E.2.1.5 Test requirement

The maximum output power, derived in step 3 of Subtest 1, step 4 of Subtest 2 and step 3 of Subtest 3 shall be within the range prescribed by the nominal maximum output power and tolerance in Table 6.2E.2.1.5-1 to Table 6.2E.2.1.5-3.

Table 6.2E.2.1.5-1: UE MPR test requirement for contiguous PSCCH/PSSCH (Bands n38, n47)

Test ID	P _{PowerClass} (dBm)	MPR (dB)	$\Delta T_{C,c}$ (dB)	P _{C_{MAX}L,f,c} (dBm)	T(P _{C_{MAX}L,f,c}) (dB)	Upper limit (dBm)	Lower limit (dBm)
1	23	4.5	0	18.5	4	25.0 + TT	14.5-TT
2	23	2.5	0	20.5	2.5	25.0 + TT	18-TT
3	23	4.5	0	18.5	4	25.0 + TT	14.5-TT
4	23	2.5	0	20.5	2.5	25.0 + TT	18-TT
5	23	4.5	0	18.5	4	25.0 + TT	14.5-TT
6	23	7.0	0	16	5	25.0 + TT	11-TT

NOTE 1: TT for each frequency and channel bandwidth is specified in Table 6.2E.2.1.5-4.

Table 6.2E.2.1.5-2: UE MPR test requirement for PSFCH (Bands n38, n47)

Test ID	P _{PowerClass} (dBm)	MPR (dB)	$\Delta T_{C,c}$ (dB)	P _{C_{MAX}L,f,c} (dBm)	T(P _{C_{MAX}L,f,c}) (dB)	Upper limit (dBm)	Lower limit (dBm)
1	23	3.5	0	19.5	3.5	25.0 + TT	16-TT
2	23	7.5	0	15.5	5	25.0 + TT	10.5-TT
3	23	7.5	0	15.5	5	25.0 + TT	10.5-TT
4	23	12	0	11	6	25.0 + TT	5-TT
5	23	12	0	11	6	25.0 + TT	5-TT

NOTE 1: TT for each frequency and channel bandwidth is specified in Table 6.2E.2.1.5-4.

Table 6.2E.2.1.5-3: UE MPR test requirement for S-SSB (Bands n38, n47)

Test ID	P _{PowerClass} (dBm)	MPR (dB)	$\Delta T_{C,c}$ (dB)	P _{C_{MAX}L,f,c} (dBm)	T(P _{C_{MAX}L,f,c}) (dB)	Upper limit (dBm)	Lower limit (dBm)
1	23	6	0	17	5	25.0 + TT	12-TT
2	23	6	0	17	5	25.0 + TT	12-TT
3	23	2.5	0	20.5	2.5	25.0 + TT	18-TT

NOTE 1: TT for each frequency and channel bandwidth is specified in Table 6.2E.2.1.5-4.

Table 6.2E.2.1.5-4: Test Tolerance (UE maximum output power)

	f ≤ 3.0GHz	4.2GHz < f ≤ 6.0GHz
BW ≤ 40MHz	FFS	FFS

6.2E.2.1D UE maximum output power reduction for V2X / non-concurrent operation / SL-MIMO

Editor’s Note: The test case is not completed due to the following aspects are not yet determined:

- Uplink RMC is TBD in RAN4
- Preconfiguration is not complete in 38.508-1
- Test state and generic procedure are TBD in 38.508-1
- Measurement period of PSFCH and PSBCH is FFS.
- Connection diagram for SL-MIMO is TBD

6.2E.2.1D.1 Test purpose

Same test purpose as in 6.2E.2.1.

6.2E.2.1D.2 Test applicability

This test case applies to all types of UE release 16 and forward that support NR V2X sidelink communication and SL-MIMO.

NOTE: Test execution is not necessary if TS 38.521-1 6.5E.2.4.1D is executed.

6.2E.2.1D.3 Minimum conformance requirements

The minimum conformance requirements are defined in clause 6.2E.2.0.

6.2E.2.1D.4 Test description

6.2E.2.1D.4.1 Initial conditions

Initial conditions are a set of test configurations the UE needs to be tested in and the steps for the SS to take with the UE to reach the correct measurement state.

The initial test configurations consist of environmental conditions, test frequencies, test channel bandwidths and sub-carrier spacing based on NR operating bands specified in table 5.2E.1-1 and table 5.3.5-1. All of these configurations shall be tested with applicable test parameters for each combination of test channel bandwidth and sub-carrier spacing, and are shown in table 6.2E.2.1D.4.1-1. The details of the V2X reference measurement channels (RMCs) are specified in Annexes TBD and the GNSS configuration in TS 38.508-1 [5] subclause 4.11.

Table 6.2E.2.1D.4.1-1: Test Configuration Table for contiguous PSCCH and PSSCH allocation

Initial Conditions			
Test Environment as specified in TS 38.508-1 [5] subclause 4.1		Normal, TL/VL, TL/VH, TH/VL, TH/VH	
Test Frequencies as specified in TS 38.508-1 [5] subclause 4.3.1.8		Low range, High range	
Test Channel Bandwidths as specified TS 38.508-1 [5] subclause 4.3.1		Lowest, Highest	
Test SCS as specified in Table 5.3.5-1		Lowest, Highest	
Test Parameters for Channel Bandwidths			
Test ID	Freq	V2X Configuration to Transmit	
		Modulation	PSCCH and PSSCH RB allocation (Note 1)
1	Default	QPSK	Outer_Full
2	Default	QPSK	Inner_Full
3	Default	16QAM	Outer_Full
4	Default	16QAM	Inner_Full
5	Default	64QAM	Outer_Full
6	Default	256QAM	Outer_Full
NOTE 1: The specific configuration of each RB allocation is defined in Table 6.1E-1.			

1. Connect the SS and GNSS simulator to the UE antenna connectors as shown in TS 38.508-1 [5] Annex A, Figure TBD for TE diagram and section TBD for UE diagram.
2. The parameter settings for the NR sidelink transmission over PC5 are pre-configured according to TS 38.508-1 [5] subclause 4.10. Message content exceptions are defined in clause 6.2E.2.1D.4.3.
3. The V2X Reference Measurement Channel is set according to Table 6.2E.2.1D.4.1-1.
4. The GNSS simulator is configured for Scenario #1: static in Geographical area #1, as defined in TS38.508-1 [5] Table 4.11.2-2. Geographical area #1 is also pre-configured in the UE.
5. Propagation conditions are set according to Annex B.0.
6. Ensure the UE is in state 4-A as defined in TS 38.508-1 [4], subclause 4.4A using generic procedure parameter Sidelink (*On*), Cast Type (*Unicast*), GNSS Sync (*On*) and *Transmit Mode with SL-MIMO*.

6.2E.2.1D.4.2 Test procedure

1. The UE starts to perform the NR sidelink communication according to *SL-PreconfigurationNR* with 2-layer MIMO codebook TPMI 0. Since the UE has no payload and no loopback data to send the UE sends uplink MAC padding bits on the NR sidelink RMC.
2. Measure the sum of mean power of the UE at each transmit antenna connector in the channel bandwidth according to the test configuration from Table 6.2E.2.1D.4.1-1. The period of measurement shall be at least continuous duration of one active sub-frame (1ms) excluding guard symbols.

6.2E.2.1D.4.3 Message contents

Message contents are according to TS 38.508-1 [5] subclause 4.10 with the following exceptions.

Table 6.2E.2.1D.4.3-1: *SL-ResourcePool* for PSCCH/PSSCH Testing

Derivation Path: TS 38.508-1 [5], Table 4.6.6-25			
Information Element	Value/remark	Comment	Condition
SL-ResourcePool-r16 ::= SEQUENCE {			
sl-PSCCH-Config-r16 CHOICE {			
setup SEQUENCE {			
sl-TimeResourcePSCCH-r16	As defined in Table 6.1E-2		
sl-FreqResourcePSCCH-r16	As defined in Table 6.1E-2		
}			
}			
sl-SubchannelSize-r16	As defined in Table 6.1E-2		
sl-StartRB-Subchannel-r16	As defined in Table 6.1E-2		
sl-NumSubchannel-r16	As defined in Table 6.1E-2		
}			

6.2E.2.1D.5 Test requirement

The maximum output power, derived in step 3 shall be within the range prescribed by the nominal maximum output power and tolerance in Table 6.2E.2.1D.5-1.

Table 6.2E.2.1D.5-1: UE MPR test requirement for contiguous PSCCH/PSSCH (Bands n38, n47)

Test ID	P _{PowerClass} (dBm)	MPR (dB)	$\Delta T_{C,c}$ (dB)	P _{C_{MAX}_L,f,c} (dBm)	T(P _{C_{MAX}_L,f,c}) (dB)	TL _c	Upper limit (dBm)	Lower limit (dBm)
1	23	4.5	0	18.5	5	3	25.0 + TT	13.5 + TT
2	23	2.5	0	20.5	6	3	25.0 + TT	14.5 + TT
3	23	4.5	0	18.5	5	3	25.0 + TT	13.5 + TT
4	23	2.5	0	20.5	6	3	25.0 + TT	14.5 + TT
5	23	4.5	0	18.5	5	3	25.0 + TT	13.5 + TT
6	23	7.0	0	16	5	3	25.0 + TT	11.0 + TT

NOTE 1: TT for each frequency and channel bandwidth is specified in Table 6.2E.2.1D.5-2.

Table 6.2E.2.1D.5-2: Test Tolerance (UE maximum output power)

	f ≤ 3.0GHz	4.2GHz < f ≤ 6.0GHz
BW ≤ 40MHz	FFS	FFS

6.2E.2.2 UE maximum output power reduction for V2X / concurrent operation

6.2E.2.2.1 Test purpose

To verify that the reduction of UE transmitted power due to higher order modulations and transmit bandwidth configurations is within the allowed range. An excess maximum output power has the possibility to interfere to other channels or other systems. A small maximum output power decreases the coverage area.

6.2E.2.2.2 Test applicability

This test case applies to all types of NR UE release 16 and forward that support NR V2X sidelink communication.

6.2E.2.2.3 Minimum conformance requirements

The minimum conformance requirements are defined in clause 6.2E.2.0.

6.2E.2.2.4 Test description

6.2E.2.2.4.1 Initial conditions

Initial conditions are a set of test configurations the UE needs to be tested in and the steps for the SS to take with the UE to reach the correct measurement state.

The initial test configurations consist of environmental conditions, test frequencies, test channel bandwidths and sub-carrier spacing based on NR operating bands specified in Table 5.2E.2-1 and Table 5.3.5-1. All of these configurations shall be tested with applicable test parameters for each combination of test channel bandwidth and sub-carrier spacing, and are shown in table 6.2E.2.2.4.1-1. The details of the V2X reference measurement channels (RMCs) are specified in Annexes A.7.5. The details of the uplink reference measurement channels (RMCs) are specified in Annexes A.2. Configurations of PDSCH and PDCCH before measurement are specified in Annex C.2.

Table 6.2E.2.2.4.1-1: Test Configuration Table

Initial Conditions							
Test Environment as specified in TS 38.508-1 [5] subclause 4.1				Normal, TL/VL, TL/VH, TH/VL, TH/VH			
Test Frequencies as specified in TS 38.508-1 [5] subclause 4.3.1				Low range for NR Uu and V2X carrier High range for NR Uu and V2X carrier			
Test Channel Bandwidths as specified TS 38.508-1 [5] subclause 4.3.1				Lowest for NR Uu and V2X carrier Highest for NR Uu and V2X carrier			
Test SCS as specified in Table 5.3.5-1				Lowest for NR Uu and V2X carrier Highest for NR Uu and V2X carrier			
Test Parameters for Channel Bandwidths							
NR Uu Configuration				NR V2X Configuration to Transmit			
	Freq	Downlink Configuration	Uplink Configuration		Freq	Modulation	PSCCH and PSSCH RB allocation (Note 2)
			Modulation	RB allocation (NOTE 1)			
1	Default	N/A	DFT-s-OFDM QPSK	Inner Full	Default	CP-OFDM QPSK	Inner_Full
2	Default		CP-OFDM 256 QAM	Outer Full	Default	CP-OFDM 256QAM	Outer_Full
3	Default		DFT-s-OFDM QPSK	Inner Full	Default	CP-OFDM 256QAM	Outer_Full
4	Default		CP-OFDM 256 QAM	Outer Full	Default	CP-OFDM QPSK	Inner_Full
NOTE 1: The specific configuration of each RB allocation is defined in Table 6.1-1.							
NOTE 2: The specific configuration of each RB allocation is defined in Table 6.1E-1.							

1. Connect the SS to the UE antenna connectors as shown in TS 38.508-1 [5] Annex A, Figure A.3.1.9.3 for TE diagram and clause A.3.2.7 for UE diagram.
2. The parameter settings for the cell are set up according to TS 38.508-1 [5] clause 4.4.3.
3. Downlink signals are initially set up according to Annex C.0, C.1, C.2, and uplink signals according to Annex G.0, G.1, G.2, G.3.0.
4. The V2X Reference Measurement Channel and NR UL Reference Measurement Channel are set according to Table 6.2E.2.2.4.1-1.
5. Propagation conditions are set according to Annex B.0.
6. Ensure the UE is in state RRC_CONNECTED with generic procedure parameter Connectivity NR, Connected without release on, Test Mode On and Sidelink On according to TS 38.508-1 [5] clause 4.5. Message contents are defined in clause 6.2E.2.2.4.3.

6.2E.2.2.4.2 Test procedure

1. SS sends uplink scheduling information for each UL HARQ process via PDCCH DCI format 0_1 for C_RNTI to schedule the UL RMC according to Table 6.2E.2.2.4.1-1. Since the UE has no payload and no loopback data to send the UE sends uplink MAC padding bits on the UL RMC.
2. Send continuously uplink power control "up" commands in every uplink scheduling information to the UE; allow at least 200ms starting from the first TPC command in this step for the UE to reach PUMAX level.
3. SS sends sidelink scheduling information for each SL-HARQ process via PDCCH DCI format 3_0 for C_RNTI to schedule the Sidelink RMC according to Table 6.2E.2.2.4.1-1. UE is configured to transmit at P_{cm} on the sidelink carrier. Since the UE has no payload and no loopback data to send the UE sends MAC padding bits on the Sidelink RMC.
4. Measure the sum of the mean power of the UE at NR Uu carrier and V2X sidelink carrier in the channel bandwidth according to the test configuration from Table 6.2E.2.2.4.1-1. The period of measurement shall be at least continuous duration of one active sub-frame (1ms) excluding guard symbols.

6.2E.2.2.4.3 Message contents

Message contents are according to TS 38.508-1 [5] clause 4.6.

Table 6.2E.2.2.4.3-1: SL-ResourcePool

Derivation Path: TS 38.508-1 [5], Table 4.6.6-25			
Information Element	Value/remark	Comment	Condition
SL-ResourcePool-r16 ::= SEQUENCE {			
sl-PSCCH-Config-r16 CHOICE {			
setup SEQUENCE {			
sl-TimeResourcePSCCH-r16	As defined in Table 6.1E-2		
sl-FreqResourcePSCCH-r16	As defined in Table 6.1E-2		
}			
}			
sl-SubchannelSize-r16	As defined in Table 6.1E-2		
sl-StartRB-Subchannel-r16	As defined in Table 6.1E-2		
sl-NumSubchannel-r16	As defined in Table 6.1E-2		
sl-PowerControl-r16 SEQUENCE {			
sl-MaxTransPower-r16	24		
sl-Alpha-PSSCH-PSCCH-r16	Not present		
dl-Alpha-PSSCH-PSCCH-r16	Not present		
sl-P0-PSSCH-PSCCH-r16	Not present		
dl-P0-PSSCH-PSCCH-r16	Not present		
dl-Alpha-PSFCH-r16	Not present		
dl-P0-PSFCH-r16	Not present		
}			
}			

6.2E.2.2.5 Test requirement

The maximum output power, derived in step 4 shall be within the range prescribed by the nominal maximum output power and tolerance in Table 6.2E.2.2.5-1.

Table 6.2E.2.2.5-1: UE MPR test requirement for inter-band con-current NR V2X operation

	$P_{\text{PowerClass,NR}}$ (dBm)	MPR (dB)	$\Delta T_{C,c}$ (dB)	$P_{\text{CMAX_L,c, NR}}$ (dBm)	$P_{\text{CMAX_H,c, NR}}$ (dB)	$P_{\text{PowerClass,V2X}}$ (dBm)	$P_{\text{CMAX_H,f,c,V2X}}$ (dBm)	$P_{\text{CMAX_L}}$ (dBm)	$P_{\text{CMAX_H}}$ (dBm)	$T(P_{\text{CMAX_L}})$ (dB)	$T(P_{\text{CMAX_H}})$ (dB)	Upper limit (dBm)	Lower limit (dBm)
1	23	0	0	23	23	23	23	23	26	3	2	28+TT	20-TT
2	23	6.5	0	16.5	23	23	23	16.5	26	5	2	28+TT	11.5-TT
3	23	0	0	23	23	23	23	23	26	3	2	28+TT	20-TT
4	23	6.5	0	16.5	23	23	23	16.5	26	5	2	28+TT	11.5-TT

Table 6.2E.2.2.5-2: Test Tolerance (inter-band con-current NR V2X operation)

	$f \leq 3.0\text{GHz}$	$4.2\text{GHz} < f \leq 6.0\text{GHz}$
$BW \leq 40\text{MHz}$	0.7 dB	1.0 dB

6.2F Transmitter power for shared spectrum channel access

6.2F.1 UE maximum output power for shared spectrum channel access

Editor's Note: This test is incomplete. The following aspects are not yet determined:

- No test points are defined since there is no configuration satisfying MPR=0dB requirements in RAN4. Testing with 1.5dB MPR has been covered in [6.2F.2].
- MU and TT for >6GHz (band n96).
- RMC in Annex A.
- Test coverage for UL-MIMO
- Message exceptions
- Test state and generic procedure are TBD in 38.508-1

6.2F.1.1 Test purpose

Same test purpose as in 6.2.1.1

6.2F.1.2 Test applicability

This test case applies to all types of NR UE release 16 and forward that support NR standalone shared spectrum channel access.

6.2F.1.3 Minimum conformance requirements

The following UE Power Classes define the maximum output power for any transmission bandwidth within the channel bandwidth of shared spectrum channel access carrier unless otherwise stated. The period of measurement shall be at least one sub frame (1ms).

Table 6.2F.1.3-1: UE Power Class

NR band	Class 1 (dBm)	Tolerance (dB)	Class 2 (dBm)	Tolerance (dB)	Class 3 (dBm)	Tolerance (dB)	Class 5 (dBm)	Tolerance (dB)
n46							20	+2/-3
n96							20	+2/-3
NOTE 1: $P_{PowerClass}$ is the maximum UE power specified without taking into account the tolerance								
NOTE 2: Power class 5 is default power class unless otherwise stated.								

The UE operating shall meet the following additional requirements for maximum mean transmission power density specified in Table 6.2F.1.3-2 when NS is signalled and when transmission overlaps with any portion of the specified frequency range. In case transmission overlaps multiple frequency ranges, the lowest power density requirement applies.

Table 6.2F.1.3-2: Additional requirements for transmit power density

NR Band	NS value	Channel bandwidth (MHz)	Frequency range (MHz)	Maximum mean power density (dBm/MHz)	
n46	NS_28	20, 40, 60, 80	5150 – 5350	10	
			5470 – 5725		
	NS_29	20	5170 – 5330	10	
			5490 – 5730		
		40	5170 – 5330	7	
			5490 – 5730		
		60, 80	5170 – 5330	4	
			5490 – 5730		
	NS_30	20, 40, 60, 80	5150 – 5350	11	
			5470 – 5725		
	NS_31	20	5150 - 5230	10	
			5250 – 5350		
			5470 – 5725		
			5725 - 5850		
			5230 – 5250		4
			5150 - 5230		
		40	5250 – 5350	7	
			5470 – 5725		
			5725 - 5850		
			5230 – 5250		4
60, 80		5150 - 5230	4		
		5250 – 5350			
		5470 – 5725			
		5725 - 5850			
n96	NS_53	20, 40, 60, 80	5925 – 7125	-1	
			5925 – 6425		
	NS_54	20, 40, 60, 80	6525 – 6875	17	

The normative reference for this requirement is TS 38.101-1 [2] clause 6.2F.1.

6.2F.1.4 Test description

6.2F.1.4.1 Initial conditions

Initial conditions are a set of test configurations the UE needs to be tested in and the steps for the SS to take with the UE to reach the correct measurement state.

The initial test configurations consist of environmental conditions, test frequencies, test channel bandwidths and sub-carrier spacing based on NR operating bands specified in table 5.3.5-1 that are restricted to shared channel access. All of these configurations shall be tested with applicable test parameters for each combination of test channel bandwidth and sub-carrier spacing, and are shown in table 6.2F.1.4.1-1. The details of the uplink reference measurement channels (RMCs) are specified in Annexes A.2. Configurations of PDSCH and PDCCH before measurement are specified in Annex C.2.

Table 6.2F.1.4.1-1: Test Configuration Table

FFS

1. Connect the SS to the UE antenna connectors as shown in TS 38.508-1 [5] Annex A, Figure A.3.1.1.1 for TE diagram and section A.3.2 for UE diagram.
2. The parameter settings for the cell are set up according to TS 38.508-1 [5] subclause 4.4.3.
3. Downlink signals are initially set up according to Annex C.0, C.1, C.2, and uplink signals according to Annex G.0, G.1, G.2, G.3.0.
4. The UL Reference Measurement Channel is set according to Table 6.2F.1.4.1-1.

5. Propagation conditions are set according to Annex B.0.
6. Ensure the UE is in state RRC_CONNECTED with generic procedure parameters Connectivity NR, Connected without release On, Test Mode On and Test Loop Function On according to TS 38.508-1 [5] clause 4.5. Message contents are defined in clause 6.2F.1.4.3.

6.2F.1.4.2 Test procedure

1. SS sends uplink scheduling information for each UL HARQ process via PDCCH DCI format 0_1 for C_RNTI to schedule the UL RMC according to Table 6.2F.1.4.1-1. Since the UE has no payload and no loopback data to send the UE sends uplink MAC padding bits on the UL RMC.
2. Send continuously uplink power control "up" commands in every uplink scheduling information to the UE; allow at least 200ms starting from the first TPC command in this step for the UE to reach P_{UMAX} level.
3. Measure the mean power of the UE in the channel bandwidth of the radio access mode. The period of measurement shall be at least the continuous duration of one active sub-frame (1ms) and in the uplink symbols. Symbols with transient periods are not under test.

6.2F.1.4.3 Message contents

Message contents are according to TS 38.508-1 [5] subclause 4.6 and 5.4 with the following exceptions.

6.2F.1.5 Test requirement

The maximum output power, derived in step 3 shall be within the range prescribed by the nominal maximum output power and tolerance in Table 6.2F.1.5-1.

Table 6.2F.1.5-1: Maximum Output Power test requirement for Power Class 5

NR band	Class 1 (dBm)	Tolerance (dB)	Class 2 (dBm)	Tolerance (dB)	Class 3 (dBm)	Tolerance (dB)	Class 5 (dBm)	Tolerance (dB)
n46							20	+2+TT/-3-TT
n96							20	+2+TT/-3-TT
NOTE 1: P _{PowerClass} is the maximum UE power specified without taking into account the tolerance								
NOTE 2: Power class 5 is default power class unless otherwise stated.								

Table 6.2F.1.5-2: Test Tolerance (UE maximum output power)

	f ≤ 3.0GHz	3.0GHz < f ≤ 4.2GHz	4.2GHz < f ≤ 5.925GHz	5.925GHz < f ≤ 7.125GHz
BW ≤ 40MHz	0.7 dB	1.0 dB	1.0 dB	TBD
40MHz < BW ≤ 100MHz	1.0 dB	1.0 dB	1.0 dB	TBD

For the UE which supports inter-band NR CA configuration, SUL configuration or inter-band EN-DC configuration, ΔT_{IB,c} as specified in 6.2A.4.0.2 for NR CA, clause 6.2C.2 for SUL, or TS 38.101-3 [4] clause 6.2B.4.2 for EN-DC applies. Unless otherwise stated, ΔT_{IB,c} is set to zero. In case the UE supports more than one of band combinations for CA, SUL or DC, and an operating band belongs to more than one band combinations then

Editor's note [IS]: s.t. missing???

6.2F.2 UE maximum output power reduction

FFS

6.2F.3 UE additional maximum output power reduction for shared spectrum access

Editor's Note: This test is incomplete. The following aspects are not yet determined:

- Test points are TBD

- MU and TT for >6GHz (band n96).
- RMC in Annex A.
- Test coverage for UL-MIMO
- Message exceptions
- Test state and generic procedure are TBD in 38.508-1

6.2F.3.1 Test purpose

Same test purpose as in 6.2.3.1

6.2F.3.2 Test applicability

This test case applies to all types of NR UE release 16 and forward that support NR standalone shared spectrum channel access.

6.2F.3.3 Minimum conformance requirements

6.2F.3.3.1 General

Additional emission requirements can be signalled by the network. Each additional emission requirement is associated with a unique network signalling (NS) value indicated in RRC signalling by an NR frequency band number of the applicable operating band and an associated value in the field *additionalSpectrumEmission*. Throughout this specification, the notion of indication or signalling of an NS value refers to the corresponding indication of an NR frequency band number of the applicable operating band, the IE field *freqBandIndicatorNR* and an associated value of *additionalSpectrumEmission* in the relevant RRC information elements [7].

To meet the additional requirements, additional maximum power reduction (A-MPR) is allowed for the maximum output power as specified in Table 6.2F.1.3-1. Unless stated otherwise, the total reduction to UE maximum output power is max (MPR, A-MPR) where MPR is defined in clause 6.2F.2.

Table 6.2F.3.3.1-1 specifies the additional requirements with their associated network signalling values and the allowed A-MPR and applicable operating band(s) for each NS value. The mapping of NR frequency band numbers and values of the *additionalSpectrumEmission* to network signalling labels is specified in Table 6.2F.3.3.1-1A.

Table 6.2F.3.3.1-1: Additional maximum power reduction (A-MPR)

Network signalling label	Requirements (clause)	NR Band	Channel bandwidth (MHz)	Resources blocks (N_{RB})	A-MPR (clause)
NS_01		n46, n96	20, 40, 60, 80		N/A
NS_28		n46	20, 40, 60, 80		6.2F.3.3.2
NS_29		n46	20, 40, 60, 80		6.2F.3.3.3
NS_30		n46	20, 40, 60, 80		6.2F.3.3.4
NS_31		n46	20, 40, 60, 80		6.2F.3.3.5
NS_53		n96	20, 40, 60, 80		6.2F.3.3.6
NS_54		n96	20, 40, 60, 80		6.2F.3.3.7

NOTE 1: The A-MPR shall apply to all active 20 MHz sub-bands contiguously allocated in the channel.

[The NS_01 label with the field *additionalPmax* [7] absent is default for all NR bands.]

Table 6.2F.3.3.1-1A: Mapping of network signalling label

NR band	Value of <i>additionalSpectrumEmission</i>							
	0	1	2	3	4	5	6	7
n46	NS_01	NS_28	NS_29	NS_30	NS_31			
n96	NS_01	NS_53	NS_54					

NOTE: *additionalSpectrumEmission* corresponds to an information element of the same name defined in clause 6.3.2 of TS 38.331 [6].

6.2F.3.3.2 A-MPR for NS_28

When "NS_28" is indicated in the cell, the A-MPR is specified in Table 6.2F.3.3.2-1.

Table 6.2F.3.3.2-1: A-MPR for NS_28 power class 5

Pre-coding	Modulation	RB Allocation (Note 2)		RB Allocation (Note 3)
		Full (dB)	Partial (dB)	Full/Partial
DFT-s-OFDM	QPSK	≤ 4.0	≤ 6.0	See Table 6.2F.2.3-1
	16 QAM	≤ 4.5	≤ 6.0	
	64 QAM	≤ 4.5	≤ 6.5	
	256 QAM	≤ 5.5	≤ 6.5	
CP-OFDM	QPSK	≤ 6.0	≤ 7.0	
	16 QAM	≤ 6.0	≤ 7.5	
	64 QAM	≤ 6.5	≤ 7.5	
	256 QAM	≤ 7.0	≤ 7.5	

NOTE 1: Full allocation A-MPR applies when all RB's in a 20 MHz channel or all RB's in all sub-bands for wideband operation are fully allocated and all sub-bands are transmitted. Partial allocation A-MPR applies when one or more RB's in one or more sub-bands are not allocated or when not all transmitted sub-bands for wideband operation are transmitted.

NOTE 2: Applicable for 20 MHz channels centred at the nearest NR-ARFCN corresponding to 5160, 5340, 5480, and 5700 MHz, 40 MHz channels centered at the nearest NR-ARFCN corresponding to 5170, 5190, 5310, 5330, 5490, and 5510 MHz, 60 MHz channels centred at the nearest NR-ARFCN corresponding to 5180, 5200, 5220, 5280, 5300, 5320, 5500, 5520, 5540, 5680 MHz, and 80 MHz channels centered at the nearest NR-ARFCN corresponding to 5190, 5210, 5290, 5310, 5510, and 5530 MHz.

NOTE 3: Applicable for all valid channels other than those enumerated under NOTE 2.

6.2F.3.3.3 A-MPR for NS_29

When "NS_29" is indicated in the cell, the A-MPR is specified in Table 6.2F.3.3.3-1.

Table 6.2F.3.3.3-1: A-MPR for NS_29 power class 5

Pre-coding	Modulation	Channel bandwidth (Sub-band allocation) / RB Allocation				
		20 MHz	40 MHz		60 MHz, 80 MHz	
			Full/Partial	Full (dB)	Partial (dB)	Full (dB)
DFT-s-OFDM	QPSK	See Table 6.2F.2-1	≤ 2.0	≤ 4.0	≤ 4.0	≤ 6.0
	16 QAM		≤ 2.5	≤ 4.0	≤ 4.0	≤ 6.0
	64 QAM		≤ 3.5	≤ 4.0	≤ 4.5	≤ 6.0
	256 QAM		≤ 5.0	≤ 5.5	≤ 5.5	≤ 6.0
CP-OFDM	QPSK		≤ 3.5	≤ 4.5	≤ 4.0	≤ 6.0
	16 QAM		≤ 4.0	≤ 4.5	≤ 4.0	≤ 6.0
	64 QAM		≤ 5.5	≤ 5.0	≤ 5.5	≤ 6.5
	256 QAM		≤ 7.0	≤ 6.5	≤ 7.0	≤ 7.0

NOTE 1: Full allocation A-MPR applies when all RB's in a 20 MHz channel or all RB's in all sub-bands for wideband operation are fully allocated and all sub-bands are transmitted. Partial allocation A-MPR applies when one or more RB's in one or more sub-bands are not allocated but when all sub-bands within the channel are transmitted. When not all sub-bands within the channel are transmitted, the A-MPR associated with the channel bandwidth according to the bandwidth of the contiguously transmitted sub-bands and according to the allocation type applies.

6.2F.3.3.4 A-MPR for NS_30

When "NS_30" is indicated in the cell, the A-MPR is specified in Table 6.2F.3.3.4-1.

Table 6.2F.3.3.4-1: A-MPR for NS_30 power class 5

Pre-coding	Modulation	RB Allocation (Note 2)		RB Allocation (Note 3)		RB Allocation (Note 4)
		Full (dB)	Partial (dB)	Full (dB)	Partial (dB)	Full/Partial
DFT-s-OFDM	QPSK	≤ 9.0	≤ 15.0	≤ 2.5	≤ 5.0	See Table 6.2F.2.3-1
	16 QAM	≤ 9.0	≤ 15.5	≤ 3.0	≤ 5.0	
	64 QAM	≤ 9.0	≤ 15.5	≤ 4.5	≤ 5.5	
	256 QAM	≤ 9.0	≤ 16.0	≤ 5.5	≤ 5.5	
CP-OFDM	QPSK	≤ 9.0	≤ 14.0	≤ 4.0	≤ 6.0	
	16 QAM	≤ 9.5	≤ 14.5	≤ 4.0	≤ 6.0	
	64 QAM	≤ 9.5	≤ 15.0	≤ 5.5	≤ 6.5	
	256 QAM	≤ 9.5	≤ 15.0	≤ 7.0	≤ 7.0	

NOTE 1: Full allocation A-MPR applies when all RB's in a 20 MHz channel or all RB's in all sub-bands for wideband operation are fully allocated and all sub-bands are transmitted. Partial allocation A-MPR applies when one or more RB's in one or more sub-bands are not allocated or when not all transmitted sub-bands for wideband operation are transmitted.

NOTE 2: Applicable for 20 MHz channels centred at the nearest NR-ARFCN corresponding to 5160, 5340, 5480, and 5700 MHz, 40 MHz channels centred at the nearest NR-ARFCN corresponding to 5170, 5190, 5310, 5330, 5490, and 5510 MHz, 60 MHz channels centred at the nearest NR-ARFCN corresponding to 5180, 5200, 5220, 5280, 5300, 5320, 5500, 5520, 5540, 5680 MHz, and 80 MHz channels centred at the nearest NR-ARFCN corresponding to 5190, 5210, 5290, 5310, 5510, and 5530 MHz.

NOTE 3: Applicable for 20 MHz channels centred at the nearest NR-ARFCN corresponding to 5180 and 5320 MHz, and 40 MHz channels centred at the nearest NR-ARFCN corresponding to 5230 and 5270 MHz.

NOTE 4: Applicable for all valid channels other than those enumerated under NOTE 2 and NOTE 3.

6.2F.3.3.5 A-MPR for NS_31

When "NS_31" is indicated in the cell, the A-MPR is specified in Table 6.2F.3.3.5-1.

Table 6.2F.3.3.5-1: A-MPR for NS_31 power class 5

Pre-coding	Modulation	RB Allocation (Note 2)	RB Allocation (Note 3)	
		Full/Partial	Full (dB)	Partial (dB)
DFT-s-OFDM	QPSK	See Table 6.2F.2-1	≤ 4.0	≤ 6.5
	16 QAM		≤ 4.0	≤ 6.5
	64 QAM		≤ 4.0	≤ 6.5
	256 QAM		≤ 5.0	≤ 6.5
CP-OFDM	QPSK		≤ 5.5	≤ 6.5
	16 QAM		≤ 5.5	≤ 7.0
	64 QAM		≤ 5.5	≤ 7.0
	256 QAM		≤ 7.0	≤ 7.0

NOTE 1: Full allocation A-MPR applies when all RB's in a 20 MHz channel or all RB's in all sub-bands for wideband operation are fully allocated and all sub-bands are transmitted. Partial allocation A-MPR applies when one or more RB's in one or more sub-bands are not allocated or when not all transmitted sub-bands for wideband operation are transmitted.

NOTE 2: Applicable for 20 MHz channels centred at the nearest NR-ARFCN corresponding to 5180, 5200, 5220, 5280, 5300, 5320, 5500, 5520, 5540, 5560, 5580, 5600, 5620, 5640, 5660, 5680, 5745, 5765, 5785, and 5805 MHz.

NOTE 3: Applicable for all valid channels and bandwidths other than those enumerated in NOTE 2.

6.2F.3.3.6 A-MPR for NS_53

When "NS_53" is indicated in the cell, the A-MPR is specified in Table 6.2F.3.3.6-1.

Table 6.2F.3.3.6-1: A-MPR for NS_53 power class 5

Pre-coding	Modulation	Channel bandwidth (Sub-band allocation) / RB Allocation							
		20 MHz		40 MHz		60 MHz		80 MHz	
		Full (dB)	Partial (dB)	Full (dB)	Partial (dB)	Full (dB)	Partial (dB)	Full (dB)	Partial (dB)
DFT-s-ODFM	QPSK	≤ 9.0	≤ 12.0	≤ 6.5	≤ 8.5	≤ 4.5	≤ 6.5	≤ 3.0	≤ 5.5
	16 QAM	≤ 9.0	≤ 12.0	≤ 6.5	≤ 8.5	≤ 4.5	≤ 6.5	≤ 3.0	≤ 5.5
	64 QAM	≤ 9.0	≤ 12.0	≤ 6.5	≤ 8.5	≤ 4.5	≤ 6.5	≤ 4.0	≤ 5.5
	256 QAM	≤ 9.0	≤ 12.0	≤ 6.5	≤ 8.5	≤ 5.0	≤ 7.0	≤ 5.0	≤ 5.5
CP-OFDM	QPSK	≤ 9.0	≤ 12.0	≤ 6.5	≤ 8.5	≤ 4.5	≤ 6.5	≤ 4.0	≤ 5.5
	16 QAM	≤ 9.0	≤ 12.0	≤ 6.5	≤ 8.5	≤ 4.5	≤ 6.5	≤ 4.0	≤ 5.5
	64 QAM	≤ 9.0	≤ 12.0	≤ 6.5	≤ 8.5	≤ 5.5	≤ 6.5	≤ 5.5	≤ 5.5
	256 QAM	≤ 9.0	≤ 12.0	≤ 7.0	≤ 8.5	≤ 7.0	≤ 7.0	≤ 7.0	≤ 7.0

NOTE 1: Full allocation A-MPR applies when all RB's in a 20 MHz channel or all RB's in all sub-bands for wideband operation are fully allocated and all sub-bands are transmitted. Partial allocation A-MPR applies when one or more RB's in one or more sub-bands are not allocated but when all sub-bands within the channel are transmitted. When not all sub-bands within the channel are transmitted, the A-MPR associated with the channel bandwidth according to the bandwidth of the contiguously transmitted sub-bands and according to the allocation type applies.

6.2F.3.3.7 A-MPR for NS_54

When "NS_54" is indicated in the cell, the A-MPR is specified in Table 6.2F.3.3.7-1.

Table 6.2F.3.3.7-1: A-MPR for NS_54 power class 5

Pre-coding	Modulation	RB Allocation (Note 2)	RB Allocation (Note 3)	
		Full/Partial	Full (dB)	Partial (dB)
DFT-s-ODFM	QPSK	See Table 6.2F.2-1	≤ 2.5	≤ 5.0
	16 QAM		≤ 3.0	≤ 5.0
	64 QAM		≤ 3.5	≤ 5.0
	256 QAM		≤ 5.0	≤ 6.0
CP-OFDM	QPSK		≤ 4.5	≤ 6.0
	16 QAM		≤ 4.5	≤ 6.0
	64 QAM		≤ 5.5	≤ 6.0
	256 QAM		≤ 7.0	≤ 7.0

NOTE 1: Full allocation A-MPR applies when all RB's in a 20 MHz channel or all RB's in all sub-bands for wideband operation are fully allocated and all sub-bands are transmitted. Partial allocation A-MPR applies when one or more RB's in one or more sub-bands are not allocated or when not all transmitted sub-bands for wideband operation are transmitted.

NOTE 2: Applicable for all valid channels and bandwidths other than those enumerated in NOTE 3.

NOTE 3: Applicable for 40 MHz channels centred at the nearest NR-ARFCN corresponding to [5965 MHz], 60 MHz channels centred at the nearest NR-ARFCN corresponding to [5975 and 5995 MHz], and 80 MHz channels centred at the nearest NR-ARFCN corresponding to [5985 MHz].

The normative reference for this requirement is TS 38.101-1 [2] clause 6.2F.3.

6.2F.3.4 Test description

6.2F.3.4.1 Initial conditions

Initial conditions are a set of test configurations the UE needs to be tested in and the steps for the SS to take with the UE to reach the correct measurement state.

The initial test configurations consist of environmental conditions, test frequencies, test channel bandwidths and sub-carrier spacing based on NR operating bands specified in table 5.3.5-1 that are restricted to shared channel access. All

of these configurations shall be tested with applicable test parameters for each combination of test channel bandwidth and sub-carrier spacing, and are shown in table 6.2F.3.4.1-1. The details of the uplink reference measurement channels (RMCs) are specified in Annexes A.2. Configurations of PDSCH and PDCCH before measurement are specified in Annex C.2.

Table 6.2F.3.4.1-1: Test Configuration Table

FFS

1. Connect the SS to the UE antenna connectors as shown in TS 38.508-1 [5] Annex A, Figure A.3.1.1.1 for TE diagram and section A.3.2 for UE diagram.
2. The parameter settings for the cell are set up according to TS 38.508-1 [5] subclause 4.4.3.
3. Downlink signals are initially set up according to Annex C.0, C.1, C.2, and uplink signals according to Annex G.0, G.1, G.2, G.3.0.
4. The UL Reference Measurement Channel is set according to Table 6.2F.3.4.1-1.
5. Propagation conditions are set according to Annex B.0.
6. Ensure the UE is in state RRC_CONNECTED with generic procedure parameters Connectivity *NR*, Connected without release *On*, Test Mode *On* and Test Loop Function *On* according to TS 38.508-1 [5] clause 4.5. Message contents are defined in clause 6.2F.3.4.3.

6.2F.3.4.2 Test procedure

1. SS sends uplink scheduling information for each UL HARQ process via PDCCH DCI format 0_1 for C_RNTI to schedule the UL RMC according to Table 6.2F.3.4.1-1. Since the UE has no payload and no loopback data to send the UE sends uplink MAC padding bits on the UL RMC.
2. Send continuously uplink power control "up" commands in every uplink scheduling information to the UE; allow at least 200ms starting from the first TPC command in this step for the UE to reach P_{UMAX} level.
3. Measure the mean power of the UE in the channel bandwidth of the radio access mode. The period of measurement shall be at least the continuous duration of one active sub-frame (1ms) and in the uplink symbols. Symbols with transient periods are not under test.

6.2F.3.4.3 Message contents

Message contents are according to TS 38.508-1 [5] subclause 4.6 and 5.4 with the following exceptions.

Information element additionalSpectrumEmission is set in the *SIB1* as part of the cell broadcast message.

Table 6.2.3.4.3-1: AdditionalSpectrumEmission

Derivation Path: TS 38.508-1 [10] clause 4.6.3, Table 4.6.3-1			
Information Element	Value/remark	Comment	Condition
AdditionalSpectrumEmission	1 (NS_28), 2 (NS_29), 3 (NS_30), 4(NS_31)	for band n46	
AdditionalSpectrumEmission	1 (NS_53), 2 (NS_54)	for band n96	

FFS

6.2F.3.5 Test requirement

The maximum output power, derived in step 3 shall be within the range prescribed by the nominal maximum output power and tolerance in Table 6.2F.3.5-1.

Table 6.2F.3.5-1: Test requirement for Power Class 5

Test ID	$P_{\text{PowerClass}}$ (dBm)	MPR (dB)	A-MPR (dB)	$\Delta T_{\text{C,c}}$ (dB)	$P_{\text{CMAX,c}}$ (dBm)	$T(P_{\text{CMAX,L,c}})$ (dB)	$T_{\text{L,c}}$ (dB)	Upper limit (dBm)	Lower limit (dBm)
TBD									

NOTE 1: $P_{\text{PowerClass}}$ is the maximum UE power specified without taking into account the tolerance.
NOTE 2: TT for each frequency and channel bandwidth is specified in Table 6.2F.3.5-2.

Table 6.2F.3.5-2: Test Tolerance (UE maximum output power)

	$f \leq 3.0\text{GHz}$	$3.0\text{GHz} < f \leq 4.2\text{GHz}$	$4.2\text{GHz} < f \leq 5.925\text{GHz}$	$5.925\text{GHz} < f \leq 7.125\text{GHz}$
BW \leq 40MHz	0.7 dB	1.0 dB	1.0 dB	TBD
40MHz < BW \leq 100MHz	1.0 dB	1.0 dB	1.0 dB	TBD

For the UE which supports inter-band NR CA configuration, SUL configuration or inter-band EN-DC configuration, $\Delta T_{\text{B,c}}$ as specified in 6.2A.4.0.2 for NR CA, clause 6.2C.2 for SUL, or TS 38.101-3 [4] clause 6.2B.4.2 for EN-DC applies. Unless otherwise stated, $\Delta T_{\text{B,c}}$ is set to zero. In case the UE supports more than one of band combinations for CA, SUL or DC, and an operating band belongs to more than one band combinations then

[Editor's note [MCC]: s.t. missing here???]

6.2G Transmitter power for Tx Diversity

6.2G.1 UE maximum output power for Tx Diversity

Editor's Note: The following aspects are either missing or not yet determined:

- No test points are defined for Power Class 1.5 since there is no configuration satisfying MPR=0dB requirements in RAN4. Testing with 0.5dB MPR as recommended by RAN4 has been covered in 6.2G.2.
- The test points for Power Class 1.5 FWA UEs are TBD.
- Tests for Power Class 3 are FFS.

6.2G.1.1 Test purpose

To verify that the error of the UE maximum output power does not exceed the range prescribed by the specified nominal maximum output power and tolerance.

An excess maximum output power has the possibility to interfere to other channels or other systems. A small maximum output power decreases the coverage area.

6.2G.1.2 Test applicability

This test case applies to all types of NR Power Class 1.5, Power Class 2 reporting Tx diversity UE release 15 and forward.

6.2G.1.3 Minimum conformance requirements

For UE supporting Tx Diversity, the maximum output power as indicated by UE power class in Table 6.2G.1.3-1 is defined as the sum of the maximum output power from both UE antenna connectors. The period of measurement shall be at least one sub frame (1 ms).

Table 6.2G.1.3-1: UE Power Class

NR band	Class 1 (dBm)	Tolerance (dB)	Class 1.5 (dBm)	Tolerance (dB)	Class 2 (dBm)	Tolerance (dB)
n34					26	+2/-3
n39					26	+2/-3
n41			29 ⁷	2/-3 ³	26	+2/-3 ³
n77			29 ⁷	2/-3	26	+2/-3
n78			29 ⁷	2/-3	26	+2/-3
n79			29 ⁷	+2/-3	26	+2/-3
<p>NOTE 1: P_{PowerClass} is the maximum UE power specified without taking into account the tolerance.</p> <p>NOTE 2: Power class 3 is default power class unless otherwise stated.</p> <p>NOTE 3: Refers to the transmission bandwidths confined within F_{UL_low} and F_{UL_low} + 4 MHz or F_{UL_high} – 4 MHz and F_{UL_high}, the maximum output power requirement is relaxed by reducing the lower tolerance limit by 1.5 dB.</p> <p>NOTE 4: FFS</p> <p>NOTE 5: FFS</p> <p>NOTE 6: Generally, PC1 UE for Band n14 is not targeted for smartphone form factor. The UE power class 1. Requirements for Band n14 are applicable for public safety scenario only.</p> <p>NOTE 7: Achieved via dual Tx.</p>						

If a UE supports a different power class than the default UE power class for the band and the supported power class enables the higher maximum output power than that of the default power class:

- if the field of UE capability *maxUplinkDutyCycle-PC2-FR1* is absent and the field of UE capability *maxUplinkDutyCycle-MPE-FR1* is absent and the percentage of uplink symbols transmitted in a certain evaluation period is larger than 50% (The exact evaluation period is no less than one radio frame); or
- if the field of UE capability *maxUplinkDutyCycle-PC2-FR1* is not absent and the percentage of uplink symbols transmitted in a certain evaluation period is larger than *maxUplinkDutyCycle-PC2-FR1* as defined in TS 38.306 (The exact evaluation period is no less than one radio frame); or
- if the field of UE capability *maxUplinkDutyCycle-MPE-FR1* is not absent and half the percentage of uplink symbols transmitted in a certain evaluation period is larger than *maxUplinkDutyCycle-MPE-FR1* as defined in TS 38.306 (The exact evaluation period is no less than one radio frame); or
- if the IE P-Max as defined in TS 38.331 [7] is provided and set to the maximum output power of the default power class or lower;
 - shall apply all requirements for the default power class to the supported power class and set the configured transmitted power as specified in clause 6.2.4;
- else if the UE does not support a power class with higher maximum output power than PC2; or
- if the field of UE capability *maxUplinkDutyCycle-PC2-FR1* is absent and the field of UE capability *maxUplinkDutyCycle-MPE-FR1* is absent and the percentage of uplink symbols transmitted in a certain evaluation period is larger than 25% (The exact evaluation period is no less than one radio frame); or
- if the field of UE capability *maxUplinkDutyCycle-PC2-FR1* is not absent and the percentage of uplink symbols transmitted in a certain evaluation period is larger than $0.5 * \text{maxUplinkDutyCycle-PC2-FR1}$ (The exact evaluation period is no less than one radio frame); or
- if the field of UE capability *maxUplinkDutyCycle-MPE-FR1* is not absent and the percentage of uplink symbols transmitted in a certain evaluation period is larger than *maxUplinkDutyCycle-MPE-FR1* as defined in TS 38.306 (The exact evaluation period is no less than one radio frame); or
- if the IE P-Max as defined in TS 38.331 [7] is provided and set to the maximum output power of the power class 2 or lower;
 - shall apply all requirements for power class 2 to the supported power class and set the configured transmitted power as specified in clause 6.2.4;

- else shall apply all requirements for the supported power class and set the configured transmitted power as specified in clause 6.2.4.

The normative reference for this requirement is TS 38.101-1 [2] clause 6.2.1 and 6.2G.1.

6.2G.1.4 Test description

6.2G.1.4.1 Initial conditions

Initial conditions are a set of test configurations the UE needs to be tested in and the steps for the SS to take with the UE to reach the correct measurement state.

The initial test configurations consist of environmental conditions, test frequencies, test channel bandwidths and sub-carrier spacing based on NR operating bands specified in table 5.3.5-1. All of these configurations shall be tested with applicable test parameters for each combination of test channel bandwidth and sub-carrier spacing, and are shown in Table 6.2G.1.4.1-1 and Table 6.2G.1.4.1-2. The details of the uplink reference measurement channels (RMCs) are specified in Annexes A.2. Configurations of PDSCH and PDCCH before measurement are specified in Annex C.2.

Table 6.2G.1.4.1-1: Test Configuration Table for Power Class 2 indicating TxD support

Initial Conditions			
Test Environment as specified in TS 38.508-1 [5] subclause 4.1		Normal, TL/VL, TL/VH, TH/VL, TH/VH	
Test Frequencies as specified in TS 38.508-1 [5] subclause 4.3.1		Low range, Mid range, High range	
Test Channel Bandwidths as specified in TS 38.508-1 [5] subclause 4.3.1		Lowest, Mid, Highest	
Test SCS as specified in Table 5.3.5-1		Lowest, Highest	
Test Parameters			
Test ID	Downlink Configuration	Uplink Configuration	
	N/A for maximum output power test case	Modulation (NOTE 2)	RB allocation (NOTE 1)
1		DFT-s-OFDM PI/2 BPSK	Inner Full
2		DFT-s-OFDM PI/2 BPSK	Inner 1RB Left
3		DFT-s-OFDM PI/2 BPSK	Inner 1RB Right
NOTE 1: The specific configuration of each RB allocation is defined in Table 6.1-1.			
NOTE 2: DFT-s-OFDM PI/2 BPSK test applies only for UEs which supports half Pi BPSK in FR1.			

Table 6.2G.1.4.1-2: Test Configuration Table for Power Class 1.5

NOTE: No test points are defined for Power Class 1.5 since there is no configuration satisfying MPR=0dB requirements in RAN4.

1. Connect the SS to the UE antenna connectors as shown in TS 38.508-1 [5] Annex A, Figure A.3.1.1.1 for TE diagram and section A.3.2 for UE diagram.
2. The parameter settings for the cell are set up according to TS 38.508-1 [5] subclause 4.4.3.
3. Downlink signals are initially set up according to Annex C.0, C.1, C.2, and uplink signals according to Annex G.0, G.1, G.2, G.3.0.
4. The UL Reference Measurement Channel is set according to Table 6.2G.1.4.1-1 and Table 6.2G.1.4.1-2.
5. Propagation conditions are set according to Annex B.0.
6. Ensure the UE is in state RRC_CONNECTED with generic procedure parameters Connectivity *NR*, Connected without release *On*, Test Mode *On* and Test Loop Function *On* according to TS 38.508-1 [5] clause 4.5. Message contents are defined in clause 6.2G.1.4.3.

6.2G.1.4.2 Test procedure

1. SS sends uplink scheduling information for each UL HARQ process via PDCCH DCI format 0_1 for C_RNTI to schedule the UL RMC according to Table 6.2G.1.4.1-1 and Table 6.2G.1.4.1-2. Since the UE has no payload and no loopback data to send the UE sends uplink MAC padding bits on the UL RMC.
2. Send continuously uplink power control "up" commands in every uplink scheduling information to the UE; allow at least 200ms starting from the first TPC command in this step for the UE to reach P_{UMAX} level.

3. Measure the sum of the mean power of the UE at each antenna connector in the channel bandwidth of the radio access mode. The period of measurement shall be at least the continuous duration of one active sub-frame (1ms) and in the uplink symbols. For TDD symbols with transient periods are not under test.

6.2G.1.4.3 Message contents

Message contents are according to TS 38.508-1 [5] subclause 4.6 and 5.4 with the following exceptions.

Table 6.2G.1.4.3-1: PUSCH-Config

Derivation Path: TS 38.508-1 [5], Table 4.6.3-118 with condition TRANSFORM_PRECODER_ENABLED

6.2G.1.5 Test requirement

The maximum output power, derived in step 3 shall be within the range prescribed by the nominal maximum output power and tolerance in Table 6.2G.1.5-1 for Power Class 2 and Table 6.2G.1.5-2 for Power Class 1.5.

Table 6.2G.1.5-1: Maximum Output Power test requirement for Power Class 2

NR band	Class 1 (dBm)	Tolerance (dB)	Class 2 (dBm)	Tolerance (dB)	Class 3 (dBm)	Tolerance (dB)
n34			26	+2+TT/-3-TT		
n39			26	+2+TT/-3-TT		
n41			26	+2+TT/-3 ³ -TT		
n77			26	+2+TT/-3-TT		
n78			26	+2+TT/-3-TT		
n79			26	+2+TT/-3-TT		
NOTE 1: P _{PowerClass} is the maximum UE power specified without taking into account the tolerance						
NOTE 2: Power class 3 is default power class unless otherwise stated						
NOTE 3: Refers to the transmission bandwidths confined within F _{UL_low} and F _{UL_low} + 4 MHz or F _{UL_high} - 4 MHz and F _{UL_high} , the maximum output power requirement is relaxed by reducing the lower tolerance limit by 1.5 dB						
NOTE 4: TT for each frequency and channel bandwidth is specified in Table 6.2G.1.5-3						

Table 6.2G.1.5-2: Maximum Output Power test requirement for Power Class 1.5

NR band	Class 1.5 (dBm)	Tolerance (dB)	Class 2 (dBm)	Tolerance (dB)	Class 3 (dBm)	Tolerance (dB)
n41	29 ⁵	+2+TT/-3 ³ -TT				
n77	29 ⁵	+2+TT/-3-TT				
n78	29 ⁵	+2+TT/-3-TT				
n79	29 ⁵	+2+TT/-3-TT				
NOTE 1: P _{PowerClass} is the maximum UE power specified without taking into account the tolerance						
NOTE 2: Power class 3 is default power class unless otherwise stated						
NOTE 3: Refers to the transmission bandwidths confined within F _{UL_low} and F _{UL_low} + 4 MHz or F _{UL_high} - 4 MHz and F _{UL_high} , the maximum output power requirement is relaxed by reducing the lower tolerance limit by 1.5 dB						
NOTE 4: TT for each frequency and channel bandwidth is specified in Table 6.2G.1.5-3						
NOTE 5: Achieved via dual Tx						
NOTE 6: No test required since there is no satisfying test points defined.						

Table 6.2G.1.5-3: Test Tolerance (UE maximum output power)

	$f \leq 3.0\text{GHz}$	$3.0\text{GHz} < f \leq 4.2\text{GHz}$	$4.2\text{GHz} < f \leq 6.0\text{GHz}$
$BW \leq 40\text{MHz}$	0.7 dB	1.0 dB	1.0 dB
$40\text{MHz} < BW \leq 100\text{MHz}$	1.0 dB	1.0 dB	1.0 dB

6.2G.2 UE maximum output power reduction for Tx Diversity

Editor's Note: The following aspects are either missing or not yet determined:

- The test points for Power Class 1.5 FWA UEs are TBD.
- Tests for Power Class 3 are FFS.

6.2G.2.1 Test purpose

The number of RB identified in Table 6.2D.2.3-1 and Table 6.2D.2.3-2 is based on meeting the requirements for adjacent channel leakage ratio and the maximum power reduction (MPR) due to Cubic Metric (CM).

6.2G.2.2 Test applicability

The requirements of this test apply to all types of NR Power Class 1.5, Power Class 2 reporting TxD UE release 15 and forward.

NOTE: Test execution is not necessary if TS 38.521-1 6.5G.2.3.1 is executed.

6.2G.2.3 Minimum conformance requirements

For UE supporting Tx diversity, the allowed MPR for the maximum output power is specified in Table 6.2.2-1, Table 6.2D.2.3-1, Table 6.2D.2.3-2 and Table 6.2D.2.3-3 for UE power class 3, 2 and 1.5 respectively. For UE power class 1.5, the allowed maximum power reduction (MPR) defined in Table 6.2D.2.3-3 is in accordance with the indicated *modifiedMPR-Behavior* specified in Table L.1-1 for channel bandwidths ≤ 100 MHz. The maximum output power is defined as the sum of the maximum output power at each UE antenna connector.

For the UE maximum output power modified by MPR, the power limits specified in subclause 6.2G.4 apply.

The normative reference for this requirement is TS 38.101-1 [2] clause 6.2G.2.

6.2G.2.4 Test description

6.2G.2.4.1 Initial conditions

Initial conditions are a set of test configurations the UE needs to be tested in and the steps for the SS to take with the UE to reach the correct measurement state.

The initial test configurations consist of environmental conditions, test frequencies, channel bandwidths and sub-carrier spacing based on NR operating bands specified in Table 5.3.5-1. All of these configurations shall be tested with applicable test parameters for each combination of test channel bandwidth and sub-carrier spacing, and are shown in Table 6.2G.2.4.1-1, Table 6.2G.2.4.1-2, and Table 6.2G.2.4.1-3. The details of the uplink reference measurement channels (RMCs) are specified in Annexes A.2. Configurations of PDSCH and PDCCH before measurement are specified in Annex C.2.

Table 6.2G.2.4.1-1: Test Configuration Table for power class 2 (contiguous allocation)

Initial Conditions																																																																					
Test Environment as specified in TS 38.508-1 [5] subclause 4.1		Normal, TL/VL, TL/VH, TH/VL, TH/VH																																																																			
Test Frequencies as specified in TS 38.508-1 [5] subclause 4.3.1		Low range, High range																																																																			
Test Channel Bandwidths as specified in TS 38.508-1 [5] subclause 4.3.1		Lowest, Highest																																																																			
Test SCS as specified in Table 5.3.5-1		Lowest, Highest																																																																			
Test Parameters for Channel Bandwidths																																																																					
Test ID	Freq	Downlink Configuration	Uplink Configuration																																																																		
		N/A for Maximum Power Reduction (MPR) test case	<table border="1"> <thead> <tr> <th>Modulation (NOTE 2)</th> <th>RB allocation (NOTE 1)</th> </tr> </thead> <tbody> <tr><td>DFT-s-OFDM Pi/2 BPSK</td><td>Inner Full</td></tr> <tr><td>DFT-s-OFDM Pi/2 BPSK</td><td>Edge_1RB_Left</td></tr> <tr><td>DFT-s-OFDM Pi/2 BPSK</td><td>Edge_1RB_Right</td></tr> <tr><td>DFT-s-OFDM Pi/2 BPSK</td><td>Outer Full</td></tr> <tr><td>DFT-s-OFDM QPSK</td><td>Inner Full</td></tr> <tr><td>DFT-s-OFDM QPSK</td><td>Edge_1RB_Left</td></tr> <tr><td>DFT-s-OFDM QPSK</td><td>Edge_1RB_Right</td></tr> <tr><td>DFT-s-OFDM QPSK</td><td>Outer Full</td></tr> <tr><td>DFT-s-OFDM 16 QAM</td><td>Inner Full</td></tr> <tr><td>DFT-s-OFDM 16 QAM</td><td>Edge_1RB_Left</td></tr> <tr><td>DFT-s-OFDM 16 QAM</td><td>Edge_1RB_Right</td></tr> <tr><td>DFT-s-OFDM 16 QAM</td><td>Outer Full</td></tr> <tr><td>DFT-s-OFDM 64 QAM</td><td>Edge_1RB_Left</td></tr> <tr><td>DFT-s-OFDM 64 QAM</td><td>Edge_1RB_Right</td></tr> <tr><td>DFT-s-OFDM 64 QAM</td><td>Outer Full</td></tr> <tr><td>DFT-s-OFDM 256 QAM</td><td>Edge_1RB_Left</td></tr> <tr><td>DFT-s-OFDM 256 QAM</td><td>Edge_1RB_Right</td></tr> <tr><td>DFT-s-OFDM 256 QAM</td><td>Outer Full</td></tr> <tr><td>CP-OFDM QPSK</td><td>Inner Full</td></tr> <tr><td>CP-OFDM QPSK</td><td>Edge_1RB_Left</td></tr> <tr><td>CP-OFDM QPSK</td><td>Edge_1RB_Right</td></tr> <tr><td>CP-OFDM QPSK</td><td>Outer Full</td></tr> <tr><td>CP-OFDM 16 QAM</td><td>Inner Full</td></tr> <tr><td>CP-OFDM 16 QAM</td><td>Edge_1RB_Left</td></tr> <tr><td>CP-OFDM 16 QAM</td><td>Edge_1RB_Right</td></tr> <tr><td>CP-OFDM 16 QAM</td><td>Outer Full</td></tr> <tr><td>CP-OFDM 64 QAM</td><td>Edge_1RB_Left</td></tr> <tr><td>CP-OFDM 64 QAM</td><td>Edge_1RB_Right</td></tr> <tr><td>CP-OFDM 64 QAM</td><td>Outer Full</td></tr> <tr><td>CP-OFDM 256 QAM</td><td>Edge_1RB_Left</td></tr> <tr><td>CP-OFDM 256 QAM</td><td>Edge_1RB_Right</td></tr> <tr><td>CP-OFDM 256 QAM</td><td>Outer Full</td></tr> </tbody> </table>	Modulation (NOTE 2)	RB allocation (NOTE 1)	DFT-s-OFDM Pi/2 BPSK	Inner Full	DFT-s-OFDM Pi/2 BPSK	Edge_1RB_Left	DFT-s-OFDM Pi/2 BPSK	Edge_1RB_Right	DFT-s-OFDM Pi/2 BPSK	Outer Full	DFT-s-OFDM QPSK	Inner Full	DFT-s-OFDM QPSK	Edge_1RB_Left	DFT-s-OFDM QPSK	Edge_1RB_Right	DFT-s-OFDM QPSK	Outer Full	DFT-s-OFDM 16 QAM	Inner Full	DFT-s-OFDM 16 QAM	Edge_1RB_Left	DFT-s-OFDM 16 QAM	Edge_1RB_Right	DFT-s-OFDM 16 QAM	Outer Full	DFT-s-OFDM 64 QAM	Edge_1RB_Left	DFT-s-OFDM 64 QAM	Edge_1RB_Right	DFT-s-OFDM 64 QAM	Outer Full	DFT-s-OFDM 256 QAM	Edge_1RB_Left	DFT-s-OFDM 256 QAM	Edge_1RB_Right	DFT-s-OFDM 256 QAM	Outer Full	CP-OFDM QPSK	Inner Full	CP-OFDM QPSK	Edge_1RB_Left	CP-OFDM QPSK	Edge_1RB_Right	CP-OFDM QPSK	Outer Full	CP-OFDM 16 QAM	Inner Full	CP-OFDM 16 QAM	Edge_1RB_Left	CP-OFDM 16 QAM	Edge_1RB_Right	CP-OFDM 16 QAM	Outer Full	CP-OFDM 64 QAM	Edge_1RB_Left	CP-OFDM 64 QAM	Edge_1RB_Right	CP-OFDM 64 QAM	Outer Full	CP-OFDM 256 QAM	Edge_1RB_Left	CP-OFDM 256 QAM	Edge_1RB_Right	CP-OFDM 256 QAM	Outer Full
Modulation (NOTE 2)	RB allocation (NOTE 1)																																																																				
DFT-s-OFDM Pi/2 BPSK	Inner Full																																																																				
DFT-s-OFDM Pi/2 BPSK	Edge_1RB_Left																																																																				
DFT-s-OFDM Pi/2 BPSK	Edge_1RB_Right																																																																				
DFT-s-OFDM Pi/2 BPSK	Outer Full																																																																				
DFT-s-OFDM QPSK	Inner Full																																																																				
DFT-s-OFDM QPSK	Edge_1RB_Left																																																																				
DFT-s-OFDM QPSK	Edge_1RB_Right																																																																				
DFT-s-OFDM QPSK	Outer Full																																																																				
DFT-s-OFDM 16 QAM	Inner Full																																																																				
DFT-s-OFDM 16 QAM	Edge_1RB_Left																																																																				
DFT-s-OFDM 16 QAM	Edge_1RB_Right																																																																				
DFT-s-OFDM 16 QAM	Outer Full																																																																				
DFT-s-OFDM 64 QAM	Edge_1RB_Left																																																																				
DFT-s-OFDM 64 QAM	Edge_1RB_Right																																																																				
DFT-s-OFDM 64 QAM	Outer Full																																																																				
DFT-s-OFDM 256 QAM	Edge_1RB_Left																																																																				
DFT-s-OFDM 256 QAM	Edge_1RB_Right																																																																				
DFT-s-OFDM 256 QAM	Outer Full																																																																				
CP-OFDM QPSK	Inner Full																																																																				
CP-OFDM QPSK	Edge_1RB_Left																																																																				
CP-OFDM QPSK	Edge_1RB_Right																																																																				
CP-OFDM QPSK	Outer Full																																																																				
CP-OFDM 16 QAM	Inner Full																																																																				
CP-OFDM 16 QAM	Edge_1RB_Left																																																																				
CP-OFDM 16 QAM	Edge_1RB_Right																																																																				
CP-OFDM 16 QAM	Outer Full																																																																				
CP-OFDM 64 QAM	Edge_1RB_Left																																																																				
CP-OFDM 64 QAM	Edge_1RB_Right																																																																				
CP-OFDM 64 QAM	Outer Full																																																																				
CP-OFDM 256 QAM	Edge_1RB_Left																																																																				
CP-OFDM 256 QAM	Edge_1RB_Right																																																																				
CP-OFDM 256 QAM	Outer Full																																																																				
1	Default																																																																				
2	Low																																																																				
3	High																																																																				
4	Default																																																																				
5	Default																																																																				
6	Low																																																																				
7	High																																																																				
8	Default																																																																				
9	Default																																																																				
10	Low																																																																				
11	High																																																																				
12	Default																																																																				
13	Low																																																																				
14	High																																																																				
15	Default																																																																				
16	Low																																																																				
17	High																																																																				
18	Default																																																																				
19	Default																																																																				
20	Low																																																																				
21	High																																																																				
22	Default																																																																				
23	Default																																																																				
24	Low																																																																				
25	High																																																																				
26	Default																																																																				
27	Low																																																																				
28	High																																																																				
29	Default																																																																				
30	Low																																																																				
31	High																																																																				
32	Default																																																																				

NOTE 1: The specific configuration of each RB allocation is defined in Table 6.1-1.
 NOTE 2: DFT-s-OFDM Pi/2 BPSK test applies only for UEs which supports Pi/2 BPSK in FR1.

Table 6.2G.2.4.1-2: Test Configuration Table for power class 1.5 (contiguous allocation)

Initial Conditions																																																																													
Test Environment as specified in TS 38.508-1 [5] subclause 4.1		Normal, TL/VL, TL/VH, TH/VL, TH/VH																																																																											
Test Frequencies as specified in TS 38.508-1 [5] subclause 4.3.1		Low range, High range																																																																											
Test Channel Bandwidths as specified in TS 38.508-1 [5] subclause 4.3.1		Lowest, Highest																																																																											
Test SCS as specified in Table 5.3.5-1		Lowest, Highest																																																																											
Test Parameters for Channel Bandwidths																																																																													
Test ID	Freq	Downlink Configuration	Uplink Configuration																																																																										
		N/A for Maximum Power Reduction (MPR) test case	<table border="1"> <thead> <tr> <th>Modulation (NOTE 2)</th> <th>RB allocation (NOTE 1)</th> </tr> </thead> <tbody> <tr><td>DFT-s-OFDM Pi/2 BPSK</td><td>Inner Full</td></tr> <tr><td>DFT-s-OFDM Pi/2 BPSK</td><td>Edge_1RB_Left</td></tr> <tr><td>DFT-s-OFDM Pi/2 BPSK</td><td>Edge_1RB_Right</td></tr> <tr><td>DFT-s-OFDM Pi/2 BPSK</td><td>Outer Full</td></tr> <tr><td>DFT-s-OFDM QPSK</td><td>Inner Full</td></tr> <tr><td>DFT-s-OFDM QPSK</td><td>Edge_1RB_Left</td></tr> <tr><td>DFT-s-OFDM QPSK</td><td>Edge_1RB_Right</td></tr> <tr><td>DFT-s-OFDM QPSK</td><td>Outer Full</td></tr> <tr><td>DFT-s-OFDM 16 QAM</td><td>Inner Full</td></tr> <tr><td>DFT-s-OFDM 16 QAM</td><td>Edge_1RB_Left</td></tr> <tr><td>DFT-s-OFDM 16 QAM</td><td>Edge_1RB_Right</td></tr> <tr><td>DFT-s-OFDM 16 QAM</td><td>Outer Full</td></tr> <tr><td>DFT-s-OFDM_64_QAM</td><td>Inner Full</td></tr> <tr><td>DFT-s-OFDM 64 QAM</td><td>Edge_1RB_Left</td></tr> <tr><td>DFT-s-OFDM 64 QAM</td><td>Edge_1RB_Right</td></tr> <tr><td>DFT-s-OFDM 64 QAM</td><td>Outer Full</td></tr> <tr><td>DFT-s-OFDM_256_QAM</td><td>Inner Full</td></tr> <tr><td>DFT-s-OFDM 256 QAM</td><td>Edge_1RB_Left</td></tr> <tr><td>DFT-s-OFDM 256 QAM</td><td>Edge_1RB_Right</td></tr> <tr><td>DFT-s-OFDM 256 QAM</td><td>Outer Full</td></tr> <tr><td>CP-OFDM QPSK</td><td>Inner Full</td></tr> <tr><td>CP-OFDM QPSK</td><td>Edge_1RB_Left</td></tr> <tr><td>CP-OFDM QPSK</td><td>Edge_1RB_Right</td></tr> <tr><td>CP-OFDM QPSK</td><td>Outer Full</td></tr> <tr><td>CP-OFDM 16 QAM</td><td>Inner Full</td></tr> <tr><td>CP-OFDM 16 QAM</td><td>Edge_1RB_Left</td></tr> <tr><td>CP-OFDM 16 QAM</td><td>Edge_1RB_Right</td></tr> <tr><td>CP-OFDM 16 QAM</td><td>Outer Full</td></tr> <tr><td>CP-OFDM 64 QAM</td><td>Inner Full</td></tr> <tr><td>CP-OFDM 64 QAM</td><td>Edge_1RB_Left</td></tr> <tr><td>CP-OFDM 64 QAM</td><td>Edge_1RB_Right</td></tr> <tr><td>CP-OFDM 64 QAM</td><td>Outer Full</td></tr> <tr><td>CP-OFDM 256 QAM</td><td>Inner Full</td></tr> <tr><td>CP-OFDM 256 QAM</td><td>Edge_1RB_Left</td></tr> <tr><td>CP-OFDM 256 QAM</td><td>Edge_1RB_Right</td></tr> <tr><td>CP-OFDM 256 QAM</td><td>Outer Full</td></tr> </tbody> </table>	Modulation (NOTE 2)	RB allocation (NOTE 1)	DFT-s-OFDM Pi/2 BPSK	Inner Full	DFT-s-OFDM Pi/2 BPSK	Edge_1RB_Left	DFT-s-OFDM Pi/2 BPSK	Edge_1RB_Right	DFT-s-OFDM Pi/2 BPSK	Outer Full	DFT-s-OFDM QPSK	Inner Full	DFT-s-OFDM QPSK	Edge_1RB_Left	DFT-s-OFDM QPSK	Edge_1RB_Right	DFT-s-OFDM QPSK	Outer Full	DFT-s-OFDM 16 QAM	Inner Full	DFT-s-OFDM 16 QAM	Edge_1RB_Left	DFT-s-OFDM 16 QAM	Edge_1RB_Right	DFT-s-OFDM 16 QAM	Outer Full	DFT-s-OFDM_64_QAM	Inner Full	DFT-s-OFDM 64 QAM	Edge_1RB_Left	DFT-s-OFDM 64 QAM	Edge_1RB_Right	DFT-s-OFDM 64 QAM	Outer Full	DFT-s-OFDM_256_QAM	Inner Full	DFT-s-OFDM 256 QAM	Edge_1RB_Left	DFT-s-OFDM 256 QAM	Edge_1RB_Right	DFT-s-OFDM 256 QAM	Outer Full	CP-OFDM QPSK	Inner Full	CP-OFDM QPSK	Edge_1RB_Left	CP-OFDM QPSK	Edge_1RB_Right	CP-OFDM QPSK	Outer Full	CP-OFDM 16 QAM	Inner Full	CP-OFDM 16 QAM	Edge_1RB_Left	CP-OFDM 16 QAM	Edge_1RB_Right	CP-OFDM 16 QAM	Outer Full	CP-OFDM 64 QAM	Inner Full	CP-OFDM 64 QAM	Edge_1RB_Left	CP-OFDM 64 QAM	Edge_1RB_Right	CP-OFDM 64 QAM	Outer Full	CP-OFDM 256 QAM	Inner Full	CP-OFDM 256 QAM	Edge_1RB_Left	CP-OFDM 256 QAM	Edge_1RB_Right	CP-OFDM 256 QAM	Outer Full
Modulation (NOTE 2)	RB allocation (NOTE 1)																																																																												
DFT-s-OFDM Pi/2 BPSK	Inner Full																																																																												
DFT-s-OFDM Pi/2 BPSK	Edge_1RB_Left																																																																												
DFT-s-OFDM Pi/2 BPSK	Edge_1RB_Right																																																																												
DFT-s-OFDM Pi/2 BPSK	Outer Full																																																																												
DFT-s-OFDM QPSK	Inner Full																																																																												
DFT-s-OFDM QPSK	Edge_1RB_Left																																																																												
DFT-s-OFDM QPSK	Edge_1RB_Right																																																																												
DFT-s-OFDM QPSK	Outer Full																																																																												
DFT-s-OFDM 16 QAM	Inner Full																																																																												
DFT-s-OFDM 16 QAM	Edge_1RB_Left																																																																												
DFT-s-OFDM 16 QAM	Edge_1RB_Right																																																																												
DFT-s-OFDM 16 QAM	Outer Full																																																																												
DFT-s-OFDM_64_QAM	Inner Full																																																																												
DFT-s-OFDM 64 QAM	Edge_1RB_Left																																																																												
DFT-s-OFDM 64 QAM	Edge_1RB_Right																																																																												
DFT-s-OFDM 64 QAM	Outer Full																																																																												
DFT-s-OFDM_256_QAM	Inner Full																																																																												
DFT-s-OFDM 256 QAM	Edge_1RB_Left																																																																												
DFT-s-OFDM 256 QAM	Edge_1RB_Right																																																																												
DFT-s-OFDM 256 QAM	Outer Full																																																																												
CP-OFDM QPSK	Inner Full																																																																												
CP-OFDM QPSK	Edge_1RB_Left																																																																												
CP-OFDM QPSK	Edge_1RB_Right																																																																												
CP-OFDM QPSK	Outer Full																																																																												
CP-OFDM 16 QAM	Inner Full																																																																												
CP-OFDM 16 QAM	Edge_1RB_Left																																																																												
CP-OFDM 16 QAM	Edge_1RB_Right																																																																												
CP-OFDM 16 QAM	Outer Full																																																																												
CP-OFDM 64 QAM	Inner Full																																																																												
CP-OFDM 64 QAM	Edge_1RB_Left																																																																												
CP-OFDM 64 QAM	Edge_1RB_Right																																																																												
CP-OFDM 64 QAM	Outer Full																																																																												
CP-OFDM 256 QAM	Inner Full																																																																												
CP-OFDM 256 QAM	Edge_1RB_Left																																																																												
CP-OFDM 256 QAM	Edge_1RB_Right																																																																												
CP-OFDM 256 QAM	Outer Full																																																																												
1	Default																																																																												
2	Low																																																																												
3	High																																																																												
4	Default																																																																												
5	Default																																																																												
6	Low																																																																												
7	High																																																																												
8	Default																																																																												
9	Default																																																																												
10	Low																																																																												
11	High																																																																												
12	Default																																																																												
13	Default																																																																												
14	Low																																																																												
15	High																																																																												
16	Default																																																																												
17	Default																																																																												
18	Low																																																																												
19	High																																																																												
20	Default																																																																												
21	Default																																																																												
22	Low																																																																												
23	High																																																																												
24	Default																																																																												
25	Default																																																																												
26	Low																																																																												
27	High																																																																												
28	Default																																																																												
29	Default																																																																												
30	Low																																																																												
31	High																																																																												
32	Default																																																																												
33	Default																																																																												
34	Low																																																																												
35	High																																																																												
36	Default																																																																												
NOTE 1: The specific configuration of each RB allocation is defined in Table 6.1-1.																																																																													
NOTE 2: DFT-s-OFDM Pi/2 BPSK test applies only for UEs which supports Pi/2 BPSK in FR1.																																																																													

Table 6.2G.2.4.1-3: Test Configuration Table for power class 2 (almost contiguous allocation)

Initial Conditions																	
Test Environment as specified in TS 38.508-1 [5] subclause 4.1		Normal, TL/VL, TL/VH, TH/VL, TH/VH															
Test Frequencies as specified in TS 38.508-1 [5] subclause 4.3.1		Low range, High range															
Test Channel Bandwidths as specified in TS 38.508-1 [5] subclause 4.3.1		Highest															
Test SCS as specified in Table 5.3.5-1		Lowest, Highest															
Test Parameters for Channel Bandwidths																	
Test ID	Freq	Downlink Configuration	Uplink Configuration														
		N/A for Maximum Power	<table border="1"> <thead> <tr> <th>Modulation</th> <th>RB allocation (NOTE 1)</th> </tr> </thead> <tbody> <tr> <td>CP-OFDM QPSK</td> <td>Inner Full</td> </tr> <tr> <td>CP-OFDM QPSK</td> <td>Outer Full</td> </tr> <tr> <td>CP-OFDM 16 QAM</td> <td>Inner Full</td> </tr> <tr> <td>CP-OFDM 16 QAM</td> <td>Outer Full</td> </tr> <tr> <td>CP-OFDM 64 QAM</td> <td>Outer Full</td> </tr> <tr> <td>CP-OFDM 256 QAM</td> <td>Outer Full</td> </tr> </tbody> </table>	Modulation	RB allocation (NOTE 1)	CP-OFDM QPSK	Inner Full	CP-OFDM QPSK	Outer Full	CP-OFDM 16 QAM	Inner Full	CP-OFDM 16 QAM	Outer Full	CP-OFDM 64 QAM	Outer Full	CP-OFDM 256 QAM	Outer Full
Modulation	RB allocation (NOTE 1)																
CP-OFDM QPSK	Inner Full																
CP-OFDM QPSK	Outer Full																
CP-OFDM 16 QAM	Inner Full																
CP-OFDM 16 QAM	Outer Full																
CP-OFDM 64 QAM	Outer Full																
CP-OFDM 256 QAM	Outer Full																
1	Default																
2	Default																
3	Default																
4	Default																
5	Default																
6	Default																
NOTE 1: The specific configuration of each RB allocation is defined in Table 6.2G.2.4.1-4.																	
NOTE 2: Test applies only for UEs which support almost contiguous UL CP-OFDM transmissions. For PC2 UE which support almost contiguous UL CP-OFDM transmissions, test is only applicable for Release 16 and forward.																	

Table 6.2G.2.4.1-4: Uplink configuration for almost contiguous allocation

Channel Bandwidth(MHz)	SCS(kHz)	OFDM	Outer Full		Inner Full	
			Cluster1 RB allocations (LCRB @ RB _{start})	Cluster2 RB allocations (LCRB @ RB _{start})	Cluster1 RB allocations (LCRB @ RB _{start})	Cluster2 RB allocations (LCRB @ RB _{start})
25	15	CP	48@0	53@80	N/A	N/A
	30	CP	24@0	25@40	N/A	N/A
	60	CP	12@0	13@18	N/A	N/A
30	15	CP	64@0	64@96	N/A	N/A
	30	CP	32@0	30@48	N/A	N/A
	60	CP	16@0	14@24	N/A	N/A
40	15	CP	80@0	88@128	N/A	N/A
	30	CP	40@0	42@64	N/A	N/A
	60	CP	20@0	19@32	12@12	8@28
50	15	CP	96@0	110@160	48@64	48@144
	30	CP	48@0	53@80	24@32	24@72
	60	CP	24@0	25@40	12@16	12@36
60	15	CP	N/A	N/A	N/A	N/A
	30	CP	64@0	66@96	32@32	16@80
	60	CP	32@0	31@48	16@16	8@40
70	15	CP	N/A	N/A	N/A	N/A
	30	CP	80@0	77@112	32@32	16@80
	60	CP	40@0	37@56	16@16	8@40
80	15	CP	N/A	N/A	N/A	N/A
	30	CP	80@0	89@128	32@32	16@80
	60	CP	40@0	43@64	16@16	8@40
90	15	CP	N/A	N/A	N/A	N/A
	30	CP	96@0	101@144	32@32	16@80
	60	CP	48@0	49@72	16@16	8@40
100	15	CP	N/A	N/A	N/A	N/A
	30	CP	112@0	97@176	48@64	48@144
	60	CP	48@0	55@80	24@32	24@72

1. Connect the SS to the UE antenna connectors as shown in TS 38.508-1 [5] Annex A, Figure A.3.1.2.1 for TE diagram and section A.3.2 for UE diagram.
2. The parameter settings for the cell are set up according to TS 38.508-1 [5] subclause 4.4.3.
3. Downlink signals are initially set up according to Annex C.0, C.1, C.2, and uplink signals according to Annex G.0, G.1, G.2, G.3.0.
4. The UL Reference Measurement Channel is set according to Table 6.2G.2.4.1-1, Table 6.2G.2.4.1-2 and Table 6.2G.2.4.1-3.
5. Propagation conditions are set according to Annex B.0.
6. Ensure the UE is in State RRC_CONNECTED with generic procedure parameters Connectivity NR, Connected without release On, Test Mode On and Test Loop Function On according to TS 38.508-1 [5] clause 4.5. Message contents are defined in clause 6.2G.2.4.3.

6.2G.2.4.2 Test procedure

1. SS sends uplink scheduling information for each UL HARQ process via PDCCH DCI format 0_1 for C_RNTI to schedule the UL RMC according to Table 6.2G.2.4.1-1, Table 6.2G.2.4.1-2 and Table 6.2G.2.4.1-3. Since the UE has no payload and no loopback data to send the UE sends uplink MAC padding bits on the UL RMC.
2. Send continuously uplink power control "up" commands in every uplink scheduling information to the UE; allow at least 200ms for the UE to reach P_{UMAX} level.
3. Measure the sum of the mean power of the UE at each antenna connector in the channel bandwidth of the radio access mode. The period of measurement shall be at least the continuous duration of 1ms over consecutive active uplink slots. For TDD, only slots consisting of only UL symbols are under test.

NOTE 1: When switching to DFT-s-OFDM waveform, as specified in the test configuration Table 6.2G.2.4.1-1 and Table 6.2G.2.4.1-2, send an NR RRCReconfiguration message according to TS 38.508-1 [5] clause 4.6.3 Table 4.6.3-118 PUSCH-Config with TRANSFORM_PRECODER_ENABLED condition.

6.2G.2.4.3 Message contents

Message contents are according to TS 38.508-1 [5] subclause 4.6 and 5.4 with the following exceptions:

Table 6.2G.2.4.3-1: PUSCH-Config

Derivation Path: TS 38.508-1 [5] subclause 4.6.3 Table 4.6.3-118 PUSCH-Config			
Information Element	Value/remark	Comment	Condition
PUSCH-Config ::= SEQUENCE {			
resourceAllocation	resourceAllocationType0		Almost contiguous allocation
	resourceAllocationType1		Contiguous allocation
}			

6.2G.2.5 Test requirement

The maximum output power, derived in step 3 shall be within the range prescribed by the nominal maximum output power and tolerance in Table 6.2G.2.5-1 to Table 6.2G.2.5-3.

Table 6.2G.2.5-1: UE Power Class test requirements (for Bands n34, n39, n41, n77, n78, n79) for Power Class 2 (contiguous allocation)

Test ID	P _{PowerClass} (dBm)	ΔP _{PowerClass} (dB)	MPR (dB)	ΔT _{c,c} (dB)	P _{C_{MAX}_L,f,c} (dBm)	T(P _{C_{MAX}_L,f,c}) (dB)	T _{L,c} (dB)	Upper limit (dBm)	Lower limit (dBm)
1	26	0	0	0 (1.5 ²)	26.0 (24.5 ²)	3.0	3	28.0 + TT	23.0 - TT (21.5 - TT ²)
2	26	0	3.5	0 (1.5 ²)	22.5 (21.0 ²)	5.0	3	28.0 + TT	17.5 - TT (16.0 - TT ²)
3	26	0	3.5	0 (1.5 ²)	22.5 (21.0 ²)	5.0	3	28.0 + TT	17.5 - TT (16.0 - TT ²)
4	26	0	1	0 (1.5 ²)	25.0 (23.5 ²)	3.0	3	28.0 + TT	22.0 - TT (20.5 - TT ²)
5	26	0	0.5	0 (1.5 ²)	25.5 (24.0 ²)	3.0	3	28.0 + TT	22.5 - TT (21.0 - TT ²)
6	26	0	3.5	0 (1.5 ²)	22.5 (21.0 ²)	5.0	3	28.0 + TT	17.5 - TT (16.0 - TT ²)
7	26	0	3.5	0 (1.5 ²)	22.5 (21.0 ²)	5.0	3	28.0 + TT	17.5 - TT (16.0 - TT ²)
8	26	0	2	0 (1.5 ²)	24.0 (22.5 ²)	3.0 (5.0 ²)	3	28.0 + TT	21.0 - TT (17.5 - TT ²)
9	26	0	1.5	0 (1.5 ²)	24.5 (23.0 ²)	3.0	3	28.0 + TT	21.5 - TT (20.0 - TT ²)
10	26	0	3.5	0 (1.5 ²)	22.5 (21.0 ²)	5.0	3	28.0 + TT	17.5 - TT (16.0 - TT ²)
11	26	0	3.5	0 (1.5 ²)	22.5 (21.0 ²)	5.0	3	28.0 + TT	17.5 - TT (16.0 - TT ²)
12	26	0	2.5	0 (1.5 ²)	23.5 (22.0 ²)	3.0 (5.0 ²)	3	28.0 + TT	20.5 - TT (17.0 - TT ²)
13	26	0	3.5	0 (1.5 ²)	22.5 (21.0 ²)	5.0	3	28.0 + TT	17.5 - TT (16.0 - TT ²)
14	26	0	3.5	0 (1.5 ²)	22.5 (21.0 ²)	5.0	3	28.0 + TT	17.5 - TT (16.0 - TT ²)
15	26	0	3	0 (1.5 ²)	23.0 (21.5 ²)	3.0 (5.0 ²)	3	28.0 + TT	20.0 - TT (16.5 - TT ²)
16	26	0	5.5	0 (1.5 ²)	20.5 (19.0 ²)	6.0 (5.0 ²)	3	28.0 + TT	14.5 - TT (14.0 - TT ²)
17	26	0	5.5	0 (1.5 ²)	20.5 (19.0 ²)	6.0 (5.0 ²)	3	28.0 + TT	14.5 - TT (14.0 - TT ²)
18	26	0	5.5	0 (1.5 ²)	20.5 (19.0 ²)	6.0 (5.0 ²)	3	28.0 + TT	14.5 - TT (14.0 - TT ²)
19	26	0	2	0 (1.5 ²)	24.0 (22.5 ²)	3.0 (5.0 ²)	3	28.0 + TT	21.0 - TT (17.5 - TT ²)
20	26	0	4.0	0 (1.5 ²)	22.0 (20.5 ²)	5.0 (6.0 ²)	3	28.0 + TT	17.0 - TT (14.5 - TT ²)
21	26	0	4.0	0 (1.5 ²)	22.0 (20.5 ²)	5.0 (6.0 ²)	3	28.0 + TT	17.0 - TT (14.5 - TT ²)
22	26	0	3.5	0 (1.5 ²)	22.5 (21.0 ²)	5.0	3	28.0 + TT	17.5 - TT (16.0 - TT ²)
23	26	0	2.5	0 (1.5 ²)	23.5 (22.0 ²)	3.0 (5.0 ²)	3	28.0 + TT	20.5 - TT (17.0 - TT ²)
24	26	0	4.0	0 (1.5 ²)	22.0 (20.5 ²)	5.0 (6.0 ²)	3	28.0 + TT	17.0 - TT (14.5 - TT ²)

Test ID	$P_{\text{PowerClass}}$ (dBm)	$\Delta P_{\text{PowerClass}}$ (dB)	MPR (dB)	$\Delta T_{C,c}$ (dB)	$P_{\text{CMAX}_L,f,c}$ (dBm)	$T(P_{\text{CMAX}_L,f,c})$ (dB)	$T_{L,c}$ (dB)	Upper limit (dBm)	Lower limit (dBm)
25	26	0	4.0	0 (1.5 ²)	22.0 (20.5 ²)	5.0 (6.0 ²)	3	28.0 + TT	17.0 - TT (14.5 - TT ²)
26	26	0	3.5	0 (1.5 ²)	22.5 (21.0 ²)	5.0	3	28.0 + TT	17.5 - TT (16.0 - TT ²)
27	26	0	4.5	0 (1.5 ²)	21.5 (20.0 ²)	5.0 (6.0 ²)	3	28.0 + TT	16.5 - TT (14.0 - TT ²)
28	26	0	4.5	0 (1.5 ²)	21.5 (20.0 ²)	5.0 (6.0 ²)	3	28.0 + TT	16.5 - TT (14.0 - TT ²)
29	26	0	4.5	0 (1.5 ²)	21.5 (20.0 ²)	5.0 (6.0 ²)	3	28.0 + TT	16.5 - TT (14.0 - TT ²)
30	26	0	8.0	0 (1.5 ²)	18.0 (16.5 ²)	5.0	3	28.0 + TT	13.0 - TT (11.5 - TT ²)
31	26	0	8.0	0 (1.5 ²)	18.0 (16.5 ²)	5.0	3	28.0 + TT	13.0 - TT (11.5 - TT ²)
32	26	0	8.0	0 (1.5 ²)	18.0 (16.5 ²)	5.0	3	28.0 + TT	13.0 - TT (11.5 - TT ²)

NOTE 1: $P_{\text{PowerClass}}$ is the maximum UE power specified without taking into account the tolerance.

NOTE 2: For Band n41, transmission bandwidths confined within F_{UL_low} and $F_{UL_low} + 4$ MHz or $F_{UL_high} - 4$ MHz and F_{UL_high} .

NOTE 3: TT for each frequency and channel bandwidth is specified in Table 6.2G.2.5-4.

Table 6.2G.2.5-2: UE Power Class test requirements (for Band n41, n77, n78, n79) for Power Class 1.5 (contiguous allocation)

Test ID	$P_{\text{PowerClass}}$ (dBm)	$\Delta P_{\text{PowerClass}}$ (dB)	MPR (dB)	$\Delta T_{c,c}$ (dB)	$P_{\text{CMAX_L,f,c}}$ (dBm)	$T(P_{\text{CMAX_L,f,c}})$ (dB)	$T_{L,c}$ (dB)	Upper limit (dBm)	Lower limit (dBm)
1	29	0	0.5	0 (1.5 ²)	28.5 (27.0 ²)	3.0	3	31.0 + TT	25.5 - TT (24.0 - TT ²)
2	29	0	6	0 (1.5 ²)	23.0 (21.5 ²)	3.0 (5.0 ²)	3	31.0 + TT	20.0 - TT (16.5 - TT ²)
3	29	0	6	0 (1.5 ²)	23.0 (21.5 ²)	3.0 (5.0 ²)	3	31.0 + TT	20.0 - TT (16.5 - TT ²)
4	29	0	2	0 (1.5 ²)	27.0 (25.5 ²)	3.0	3	31.0 + TT	24.0 - TT (22.5 - TT ²)
5	29	0	0.5	0 (1.5 ²)	28.5 (27.0 ²)	3.0	3	31.0 + TT	25.5 - TT (24.0 - TT ²)
6	29	0	6.5	0 (1.5 ²)	22.5 (21.0 ²)	5.0	3	31.0 + TT	17.5 - TT (16.0 - TT ²)
7	29	0	6.5	0 (1.5 ²)	22.5 (21.0 ²)	5.0	3	31.0 + TT	17.5 - TT (16.0 - TT ²)
8	29	0	2.5	0 (1.5 ²)	26.5 (25.0 ²)	3.0	3	31.0 + TT	23.5 - TT (22.0 - TT ²)
9	29	0	1.5	0 (1.5 ²)	27.5 (26.0 ²)	3.0	3	31.0 + TT	24.5 - TT (23.0 - TT ²)
10	29	0	6.5	0 (1.5 ²)	22.5 (21.0 ²)	5.0	3	31.0 + TT	17.5 - TT (16.0 - TT ²)
11	29	0	6.5	0 (1.5 ²)	22.5 (21.0 ²)	5.0	3	31.0 + TT	17.5 - TT (16.0 - TT ²)
12	29	0	3.5	0 (1.5 ²)	25.5 (24.0 ²)	3.0	3	31.0 + TT	22.5 - TT (21.0 - TT ²)
13	29	0	3.5	0 (1.5 ²)	25.5 (24.0 ²)	3.0	3	31.0 + TT	22.5 - TT (21.0 - TT ²)
14	29	0	6.5	0 (1.5 ²)	22.5 (21.0 ²)	5.0	3	31.0 + TT	17.5 - TT (16.0 - TT ²)
15	29	0	6.5	0 (1.5 ²)	22.5 (21.0 ²)	5.0	3	31.0 + TT	17.5 - TT (16.0 - TT ²)
16	29	0	4	0 (1.5 ²)	25.0 (23.5 ²)	3.0	3	31.0 + TT	22.0 - TT (20.5 - TT ²)
17	29	0	6.5	0 (1.5 ²)	22.5 (21.0 ²)	5.0	3	31.0 + TT	17.5 - TT (16.0 - TT ²)
18	29	0	6.5	0 (1.5 ²)	22.5 (21.0 ²)	5.0	3	31.0 + TT	17.5 - TT (16.0 - TT ²)
19	29	0	6.5	0 (1.5 ²)	22.5 (21.0 ²)	5.0	3	31.0 + TT	17.5 - TT (16.0 - TT ²)
20	29	0	6.5	0 (1.5 ²)	22.5 (21.0 ²)	5.0	3	31.0 + TT	17.5 - TT (16.0 - TT ²)
21	29	0	2	0 (1.5 ²)	27.0 (25.5 ²)	3.0	3	31.0 + TT	24.0 - TT (22.5 - TT ²)
22	29	0	6.5	0 (1.5 ²)	22.5 (21.0 ²)	5.0	3	31.0 + TT	17.5 - TT (16.0 - TT ²)
23	29	0	6.5	0 (1.5 ²)	22.5 (21.0 ²)	5.0	3	31.0 + TT	17.5 - TT (16.0 - TT ²)
24	29	0	4.5	0 (1.5 ²)	24.5 (23.0 ²)	3.0	3	31.0 + TT	21.5 - TT (20.0 - TT ²)
25	29	0	2.5	0 (1.5 ²)	26.5 (25.0 ²)	3.0	3	31.0 + TT	23.5 - TT (22.0 - TT ²)
26	29	0	6.5	0 (1.5 ²)	22.5 (21.0 ²)	5.0	3	31.0 + TT	17.5 - TT (16.0 - TT ²)
27	29	0	6.5	0 (1.5 ²)	22.5 (21.0 ²)	5.0	3	31.0 + TT	17.5 - TT (16.0 - TT ²)

Test ID	P _{PowerClass} (dBm)	Δ P _{PowerClass} (dB)	MPR (dB)	Δ T _{C,c} (dB)	P _{C_{MAX}_L,f,c} (dBm)	T(P _{C_{MAX}_L,f,c}) (dB)	T _{L,c} (dB)	Upper limit (dBm)	Lower limit (dBm)
28	29	0	4.5	0 (1.5 ²)	24.5 (23.0 ²)	3.0	3	31.0 + TT	21.5 - TT (20.0 - TT ²)
29	29	0	4.5	0 (1.5 ²)	24.5 (23.0 ²)	3.0	3	31.0 + TT	21.5 - TT (20.0 - TT ²)
30	29	0	6.5	0 (1.5 ²)	22.5 (21.0 ²)	5.0	3	31.0 + TT	17.5 - TT (16.0 - TT ²)
31	29	0	6.5	0 (1.5 ²)	22.5 (21.0 ²)	5.0	3	31.0 + TT	17.5 - TT (16.0 - TT ²)
32	29	0	5	0 (1.5 ²)	24.0 (22.5 ²)	3.0 (5.0 ²)	3	31.0 + TT	21.0 - TT (17.5 - TT ²)
33	29	0	8.5	0 (1.5 ²)	20.5 (19.0 ²)	6.0 (5.0 ²)	3	31.0 + TT	14.5 - TT (14.0 - TT ²)
34	29	0	8.5	0 (1.5 ²)	20.5 (19.0 ²)	6.0 (5.0 ²)	3	31.0 + TT	14.5 - TT (14.0 - TT ²)
35	29	0	8.5	0 (1.5 ²)	20.5 (19.0 ²)	6.0 (5.0 ²)	3	31.0 + TT	14.5 - TT (14.0 - TT ²)
36	29	0	8.5	0 (1.5 ²)	20.5 (19.0 ²)	6.0 (5.0 ²)	3	31.0 + TT	14.5 - TT (14.0 - TT ²)

NOTE 1: P_{PowerClass} is the maximum UE power specified without taking into account the tolerance.
NOTE 2: For Band n41, transmission bandwidths confined within F_{UL_low} and F_{UL_low} + 4 MHz or F_{UL_high} – 4 MHz and F_{UL_high}.
NOTE 3: TT for each frequency and channel bandwidth is specified in Table 6.2G.2.5-4.

Table 6.2G.2.5-3: UE Power Class test requirements (for Bands n34, n39, n41, n77, n78, n79) for Power Class 2 (almost contiguous allocation)

Test ID	P _{PowerClass} (dBm)	ΔP _{PowerClass} (dB)	MPR (dB)	MPR increase (dB)	ΔT _{C,c} (dB)		P _{C_{MAX}L,f,c} (dBm)		T(P _{C_{MAX}L,f,c}) (dB)		T _{L,c} (dB)	Upper limit (dBm)	Lower limit (dBm)	
					0	1.5 ²	22.5	21.0 ²	5.0	5.0 ²			17.5 - TT	16 - TT ²
1 ⁴	26	0	2	1.5	0	1.5 ²	22.5	21.0 ²	5.0	5.0 ²	3	28.0 + TT	17.5 - TT	16 - TT ²
1 ⁵	26	0	2	1	0	1.5 ²	23.0	21.5 ²	3.0	5.0 ²	3	28.0 + TT	20.0 - TT	16.5 - TT ²
2 ⁶	26	0	3.5	1.5	0	1.5 ²	21.0	19.5 ²	5.0	5.0 ²	3	28.0 + TT	16.0 - TT	14.5 - TT ²
2 ⁷	26	0	3.5	1	0	1.5 ²	21.5	20.0 ²	5.0	6.0 ²	3	28.0 + TT	16.5 - TT	14.0 - TT ²
3 ⁴	26	0	2.5	1.5	0	1.5 ²	22.0	20.5 ²	5.0	6.0 ²	3	28.0 + TT	17.0 - TT	14.5 - TT ²
3 ⁵	26	0	2.5	1	0	1.5 ²	22.5	21.0 ²	5.0	5.0 ²	3	28.0 + TT	17.5 - TT	16.0 - TT ²
4 ⁶	26	0	3.5	1.5	0	1.5 ²	21.0	19.5 ²	5.0	5.0 ²	3	28.0 + TT	16.0 - TT	14.5 - TT ²
4 ⁷	26	0	3.5	1	0	1.5 ²	21.5	20.0 ²	5.0	6.0 ²	3	28.0 + TT	16.5 - TT	14.0 - TT ²
5 ⁶	26	0	4.5	1.5	0	1.5 ²	20.0	18.5 ²	6.0	5.0 ²	3	28.0 + TT	14.0 - TT	13.5 - TT ²
5 ⁷	26	0	4.5	1	0	1.5 ²	20.5	19.0 ²	6.0	5.0 ²	3	28.0 + TT	14.5 - TT	14.0 - TT ²
6 ⁶	26	0	8	1.5	0	1.5 ²	16.5	15 ²	5.0	5.0 ²	3	28.0 + TT	11.5 - TT	10.0 - TT ²
6 ⁷	26	0	8	1	0	1.5 ²	17.0	15.5 ²	5.0	5.0 ²	3	28.0 + TT	12.0 - TT	10.5 - TT ²

NOTE 1: P_{PowerClass} is the maximum UE power specified without taking into account the tolerance.

NOTE 2: For Band n41, transmission bandwidths confined within F_{UL,low} and F_{UL,low} + 4 MHz or F_{UL,high} - 4 MHz and F_{UL,high}.

NOTE 3: TT for each frequency and channel bandwidth is specified in Table 6.2G.2.5-4.

NOTE 4: Applicable for CBW/SCS combinations other than CBW=40MHz when SCS=60kHz.

NOTE 5: Only applicable for CBW 40MHz when SCS is 60kHz.

NOTE 6: Applicable for CBW/SCS combinations other than CBW=30MHz when SCS=15kHz and CBW=30MHz, 60MHz, 90MHz when SCS=30kHz and CBW=25MHz, 60MHz, 90MHz when SCS=60kHz.

NOTE 7: Only applicable for CBW=30MHz when SCS=15kHz and CBW=30MHz, 60MHz, 90MHz when SCS=30kHz and CBW=25MHz, 60MHz, 90MHz when SCS=60kHz.

NOTE 8: Test applies only for UEs which support almost contiguous UL CP-OFDM transmissions. For PC2 UE which support almost contiguous UL CP-OFDM transmissions, test is only applicable for Release 16 and forward.

Table 6.2G.2.5-4: Test Tolerance (Maximum Power Reduction (MPR))

	$f \leq 3.0\text{GHz}$	$3.0\text{GHz} < f \leq 4.2\text{GHz}$	$4.2\text{GHz} < f \leq 6.0\text{GHz}$
BW \leq 40MHz	0.7 dB	1.0 dB	1.0 dB
40MHz < BW \leq 100MHz	1.0 dB	1.0 dB	1.0 dB

6.2G.3 UE additional maximum output power reduction for Tx Diversity

Editor's note: The following aspects are either missing or not yet determined:

- Tests for network signalling values NS_47 for Power Class 2 with contiguous allocation is complete.
- Tests for network signalling values NS_04, NS_50, NS_55 for Power Class 2 and NS_04, NS_47, NS_55 for Power Class 1.5 are FFS.
- The test points for Power Class 1.5 FWA UEs are TBD.
- Tests for Power Class 3 are FFS.

6.2G.3.1 Test purpose

Additional emission requirements can be signalled by the network. Each additional emission requirement is associated with a unique network signalling (NS) value indicated in RRC signalling by an NR frequency band number of the applicable operating band and an associated value in the field *additionalSpectrumEmission*. Throughout this specification, the notion of indication or signalling of an NS value refers to the corresponding indication of an NR frequency band number of the applicable operating band, the IE field *freqBandIndicatorNR* and an associated value of *additionalSpectrumEmission* in the relevant RRC information elements [6].

To meet the additional requirements, additional maximum power reduction (A-MPR) is allowed for the maximum output power as specified in Table 6.2.1.3-1. Unless stated otherwise, the total reduction to UE maximum output power is $\max(\text{MPR}, \text{A-MPR})$ where MPR is defined in clause 6.2G.2. Outer and inner allocation notation used in clause 6.2G.3 is defined in clause 6.2.2. In absence of modulation and waveform types the A-MPR applies to all modulation and waveform types.

6.2G.3.2 Test applicability

The requirements of this test apply in test case 6.5G.2.2 Additional Spectrum Emission mask for Tx Diversity for network signalling value NS_04 to all types of NR Power Class 1.5, Power Class 2 reporting Tx diversity UE release 15 and forward.

The requirements of this test apply in test case 6.5G.3.3 Additional Spurious Emissions Tx Diversity for network signalling values NS_04, NS_47 and NS_50 to all types of NR Power Class 2 reporting Tx diversity UE release 15 and forward.

6.2G.3.3 Minimum conformance requirements

For UE supporting Tx diversity, the A-MPR values specified in clause 6.2.3 shall apply to the maximum output power specified in Table 6.2.1-1, and the maximum output power is defined as the sum of the maximum output power at each UE antenna connector. Unless stated otherwise, an A-MPR of 0 dB shall be used.

Table 6.2G.3.3-1 specifies the additional requirements with their associated network signalling values and the allowed A-MPR and applicable operating band(s) for each NS value. The mapping of NR frequency band numbers and values of the *additionalSpectrumEmission* to network signalling labels is specified in Table 6.2G.3.3-2.

Table 6.2G.3.3-1: Additional maximum power reduction (A-MPR)

Network signalling label	Requirements (subclause)	NR Band	Channel bandwidth (MHz)	Resources blocks (N_{RB})	A-MPR (dB)
NS_01		Table 5.2-1	5, 10, 15, 20, 25, 30, 40, 50, 60, 70, 80, 90, 100	Table 5.3.2-1	N/A
NS_04	6.5G.2.3.3.2, 6.5G.3.3.3.1	n41	10, 15, 20, 30, 40, 50, 60, 70, 80, 90, 100		Clause 6.2.3.3.2
NS_47	6.5G.3.3.3.15	n41 (Note 3)	30	Table 6.2.3.3.18-1	Table 6.2.3.3.18-2
NS_50	6.5G.3.3.3.16	n39	10, 15, 20, 25, 30, 40		Clause 6.2.3.3.19
NS_55	NOTE 4	n77	10, 15, 20, 25, 30, 40, 50, 60, 70, 80, 90, 100		N/A
<p>NOTE 1: This NS can be signalled for NR bands that have UTRA services deployed.</p> <p>NOTE 2: No A-MPR is applied for 5 MHz $BW_{channel}$ where the lower channel edge is ≥ 1930 MHz, 10 MHz $BW_{channel}$ where the lower channel edge is ≥ 1950 MHz and 15 MHz $BW_{channel}$ where the lower channel edge is ≥ 1955 MHz.</p> <p>NOTE 3: Applicable when the NR carrier is within 2545 – 2575 MHz.</p> <p>NOTE 4: This NS value is applicable for cells in the range 3450 – 3550 MHz for operations in the USA. This NS value does not indicate any additional spurious emission and maximum output power reduction requirements.</p>					

Table 6.2G.3.3-2: Mapping of Network Signalling label

NR band	Value of additionalSpectrumEmission							
	0	1	2	3	4	5	6	7
n34	NS_01							
n39	NS_01	NS_50						
n41	NS_01	NS_04	NS_47					
n77	NS_01	NS_55						
n78	NS_01							
n79	NS_01							
NOTE: additionalSpectrumEmission corresponds to an information element of the same name defined in clause 6.3.2 of TS 38.331 [6].								

The normative reference for this requirement is TS 38.101-1 [2] clause 6.2.3.1 and 6.2G.3.

6.2G.3.4 Test description

6.2G.3.4.1 Initial conditions

Initial conditions are a set of test configurations the UE needs to be tested in and the steps for the SS to take with the UE to reach the correct measurement state.

The initial test configurations consist of environmental conditions, test frequencies, test channel bandwidths and sub-carrier spacing based on NR operating bands specified in Table 5.3.5-1. All of these configurations shall be tested with applicable test parameters for each combination of test channel bandwidth and sub-carrier spacing, and are shown in tables 6.2G.3.4.1-1 to 6.2G.3.4.1-2. The details of the uplink reference measurement channels (RMCs) are specified in Annex A.2. Configurations of PDSCH and PDCCH before measurement are specified in Annex C.2

Table 6.2G.3.4.1-1: Test Configuration Table (network signalling value "NS_47") for power class 2

Same test configuration as listed in Table 6.2.3.4.1-18 shall be used.

1. Connect the SS to the UE antenna connectors as shown in TS 38.508-1 [5] Annex A, Figure A.3.1.1.1 for TE diagram and section A.3.2 for UE diagram.

2. The parameter settings for the cell are set up according to TS 38.508-1 [5] subclause 4.4.3.
3. Downlink signals are initially set up according to Annex C.0, C.1, C.2 and uplink signals according Annex G.0, G.1, G.2 and G.3.0.
4. The UL Reference Measurement channels are set according to the applicable table from Table 6.2G.3.4.1-1 to Table 6.2G.3.4.1-2.
5. Propagation conditions are set according to Annex B.0.
6. Ensure the UE is in state RRC_CONNECTED with generic procedure parameters Connectivity *NR*, Connected without release *On*, Test Mode *On* and Test Loop Function *On* according to TS 38.508-1 [5] clause 4.5. Message contents are defined in clause 6.2G.3.4.3.

6.2G.3.4.2 Test procedure

1. SS sends uplink scheduling information for each UL HARQ process via PDCCH DCI format 0_1 for C_RNTI to schedule the UL RMC according to the applicable table from Table 6.2G.3.4.1-1 to Table 6.2G.3.4.1-3. Since the UE has no payload data to send, the UE transmits uplink MAC padding bits on the UL RMC.
2. Send continuously uplink power control "up" commands in the uplink scheduling information to the UE Allow at least 200ms starting from the first TPC command in this step for the UE to reach P_{UMAX} level.
3. Measure the sum of the mean power of the UE at each antenna connector in the channel bandwidth of the radio access mode. The period of measurement shall be at least the continuous duration one sub-frame (1ms). For TDD, only slots consisting of only UL symbols are under test.

NOTE 1: When switching to DFT-s-OFDM waveform, as specified in the test configuration Table 6.2G.3.4.1-1, send an NR RRCReconfiguration message according to TS 38.508-1 [5] clause 4.6.3 Table 4.6.3-118 PUSCH-Config with TRANSFORM_PRECODER_ENABLED condition.

6.2G.3.4.3 Message contents

Message contents are according to TS 38.508-1 [5] subclause 4.6.1, with the following exceptions for each network signalling value.

6.2G.3.4.3.1 Message contents exceptions for network signalling value "NS_47"

1. Information element additionalSpectrumEmission is set to NS_47. This can be set in the *SIB1* as part of the cell broadcast message. This exception indicates that the UE shall meet the additional spurious emission requirement for a specific deployment scenario.

Table 6.2G.3.4.3.1-1: AdditionalSpectrumEmission: Additional spurious emissions test requirement for "NS_47"

Derivation Path: TS 38.508-1 [5], Table 4.6.3-1			
Information Element	Value/remark	Comment	Condition
additionalSpectrumEmission	2 (NS_47)		

6.2G.3.5 Test requirement

The maximum output power, derived in step 3 shall be within the range prescribed by the nominal maximum output power and tolerance in the applicable table from Table 6.2G.3.5-1. The allowed A-MPR values specified in table 6.2G.3.3-1 are in addition to the allowed MPR requirements specified in clause 6.2G.2. For the UE maximum output power modified by MPR and/or A-MPR, the power limits specified in table 6.2G.1.3-1 apply.

Table 6.2G.3.5-0: Test Tolerance (UE additional maximum output power reduction)

	$f \leq 3.0\text{GHz}$	$3.0\text{GHz} < f \leq 4.2\text{GHz}$	$4.2\text{GHz} < f \leq 6.0\text{GHz}$
BW \leq 40MHz	0.7 dB	1.0 dB	1.0 dB
40MHz < BW \leq 100MHz	1.0 dB	1.0 dB	1.0 dB

Table 6.2G.3.5-23: UE Power Class 2 test requirements for NS_47 (contiguous allocation)

Test ID	$P_{\text{PowerClass}}$ (dBm)	$\Delta P_{\text{PowerClass}}$ (dB)	MPR (dB)	A-MPR (dB)	$\Delta T_{C,c}$ (dB)	$P_{\text{CMAX_L,c}}$ (dBm)	$T(P_{\text{CMAX_L,c}})$ (dB)	$T_{L,c}$ (dB)	Upper limit (dBm)	Lower limit (dBm)
1	26	0	3.5	10	0	16	5	3	28+TT	11-TT
2	26	0	0.0	8.5	0	17.5	5	3	28+TT	12.5-TT
3	26	0	3.5	5	0	21	2	3	28+TT	18-TT
4	26	0	0.5	8.5	0	17.5	5	3	28+TT	12.5-TT
5	26	0	0.5	6	0	20	2.5	3	28+TT	17-TT
6	26	0	0.5	6	0	20	2.5	3	28+TT	17-TT
7	26	0	0.5	8.5	0	17.5	5	3	28+TT	12.5-TT
8	26	0	3.5	10	0	16	5	3	28+TT	11-TT
9	26	0	0.0	8.5	0	17.5	5	3	28+TT	12.5-TT
10	26	0	3.5	5	0	21	2	3	28+TT	18-TT
11	26	0	1.0	8.5	0	17.5	5	3	28+TT	12.5-TT
12	26	0	1.0	6	0	20	2.5	3	28+TT	17-TT
13	26	0	1.0	6	0	20	2.5	3	28+TT	17-TT
14	26	0	1.0	8.5	0	17.5	5	3	28+TT	12.5-TT
15	26	0	3.5	10	0	16	5	3	28+TT	11-TT
16	26	0	1.0	8.5	0	17.5	5	3	28+TT	12.5-TT
17	26	0	3.5	5	0	21	2	3	28+TT	18-TT
18	26	0	2.0	8.5	0	17.5	5	3	28+TT	12.5-TT
19	26	0	2.0	6	0	20	2.5	3	28+TT	17-TT
20	26	0	2.0	6	0	20	2.5	3	28+TT	17-TT
21	26	0	2.0	8.5	0	17.5	5	3	28+TT	12.5-TT
22	26	0	3.5	10	0	16	5	3	28+TT	11-TT
23	26	0	2.5	8.5	0	17.5	5	3	28+TT	12.5-TT
24	26	0	3.5	5	0	21	2	3	28+TT	18-TT
25	26	0	2.5	8.5	0	17.5	5	3	28+TT	12.5-TT
26	26	0	2.5	6	0	20	2.5	3	28+TT	17-TT
27	26	0	2.5	6	0	20	2.5	3	28+TT	17-TT
28	26	0	2.5	8.5	0	17.5	5	3	28+TT	12.5-TT
29	26	0	4.5	10	0	16	5	3	28+TT	11-TT
30	26	0	4.5	8.5	0	17.5	5	3	28+TT	12.5-TT
31	26	0	4.5	5	0	21	2	3	28+TT	18-TT
32	26	0	4.5	8.5	0	17.5	5	3	28+TT	12.5-TT
33	26	0	4.5	6	0	20	2.5	3	28+TT	17-TT
34	26	0	4.5	6	0	20	2.5	3	28+TT	17-TT
35	26	0	4.5	8.5	0	17.5	5	3	28+TT	12.5-TT
36	26	0	3.5	10	0	16	5	3	28+TT	11-TT
37	26	0	1.5	10	0	16	5	3	28+TT	11-TT
38	26	0	3.5	5	0	21	2	3	28+TT	18-TT
39	26	0	3	10	0	16	5	3	28+TT	11-TT
40	26	0	3	7	0	19	3.5	3	28+TT	15.5-TT
41	26	0	3	7	0	19	3.5	3	28+TT	15.5-TT
42	26	0	3	10	0	16	5	3	28+TT	11-TT
43	26	0	3.5	10	0	16	5	3	28+TT	11-TT
44	26	0	2.0	10	0	16	5	3	28+TT	11-TT
45	26	0	3.5	5	0	21	2	3	28+TT	18-TT
46	26	0	3	10	0	16	5	3	28+TT	11-TT
47	26	0	3	7	0	19	3.5	3	28+TT	15.5-TT
48	26	0	3	7	0	19	3.5	3	28+TT	15.5-TT
49	26	0	3	10	0	16	5	3	28+TT	11-TT
50	26	0	3.5	10	0	16	5	3	28+TT	11-TT
51	26	0	3.5	10	0	16	5	3	28+TT	11-TT
52	26	0	3.5	5	0	21	2	3	28+TT	18-TT
53	26	0	3.5	10	0	16	5	3	28+TT	11-TT
54	26	0	3.5	7	0	19	3.5	3	28+TT	15.5-TT
55	26	0	3.5	7	0	19	3.5	3	28+TT	15.5-TT
56	26	0	3.5	10	0	16	5	3	28+TT	11-TT
57	26	0	6.5	10	0	16	5	3	28+TT	11-TT
58	26	0	6.5	10	0	16	5	3	28+TT	11-TT
59	26	0	6.5	0	0	19.5	3.5	3	28+TT	16-TT

Test ID	$P_{\text{PowerClass}}$ (dBm)	$\Delta P_{\text{PowerClass}}$ (dB)	MPR (dB)	A-MPR (dB)	$\Delta T_{C,c}$ (dB)	$P_{\text{CMAX}_{L,c}}$ (dBm)	$T(P_{\text{CMAX}_{L,c}})$ (dB)	$T_{L,c}$ (dB)	Upper limit (dBm)	Lower limit (dBm)
60	26	0	6.5	10	0	16	5	3	28+TT	11-TT
61	26	0	6.5	7	0	19	3.5	3	28+TT	15.5-TT
62	26	0	6.5	7	0	19	3.5	3	28+TT	15.5-TT
63	26	0	6.5	10	0	16	5	3	28+TT	11-TT

NOTE 1: $P_{\text{PowerClass}}$ is the maximum UE power specified without taking into account the tolerance.
NOTE 2: TT for each frequency and channel bandwidth is specified in Table 6.2G.3.5-0.

6.2I Transmitter power for RedCap

6.2I.1 UE maximum output power for RedCap

Editor's Note: The test case is not completed due to the following aspects are not yet determined:

- Generic procedure for RedCap UE in 38.508-1 is FFS
- Default message configuration for RedCap UE in 38.508-1 is FFS.

6.2I.1.1 Test purpose

To verify that the error of the UE maximum output power does not exceed the range prescribed by the specified nominal maximum output power and tolerance.

An excess maximum output power has the possibility to interfere to other channels or other systems. A small maximum output power decreases the coverage area.

6.2I.1.2 Test applicability

This test case applies to all types of NR RedCap UE release 17 and forward.

6.2I.1.3 Minimum conformance requirements

For Redcap UE, the requirements for power class 3 specified in clause 6.2.1 apply.

The normative reference for this requirement is TS 38.101-1 [2] clause 6.2.1I.

6.2I.1.4 Test description

6.2I.1.4.1 Initial conditions

Same initial conditions as in 6.2.1 with following exception:

- The test channel bandwidth are specified in TS 38.508-1 [5] subclause 4.3.1 for RedCap.

6.2I.1.4.2 Test procedure

Same test procedure as steps 1~3 of clause 6.2.1.4.2.

6.2I.1.4.3 Message contents

FFS.

6.2I.1.5 Test requirement

The maximum output power, derived in step 3 shall be within the range prescribed by the nominal maximum output power and tolerance in Table 6.2I.1.5-1 for Power Class 3.

Table 6.2I.1.5-1: Maximum Output Power test requirement for Power Class 3

NR band	Class 1 (dBm)	Tolerance (dB)	Class 2 (dBm)	Tolerance (dB)	Class 3 (dBm)	Tolerance (dB)
n1					23	$\pm 2 \pm TT$
n2					23	$\pm 2^3 \pm TT$
n3					23	$\pm 2^3 \pm TT$
n5					23	$\pm 2 \pm TT$
n7					23	$\pm 2^3 \pm TT$
n8					23	$\pm 2^3 \pm TT$
n12					23	$\pm 2^3 \pm TT$
n14					23	$\pm 2 \pm TT$
n20					23	$\pm 2^3 \pm TT$
n24					23	$+2 + TT / -3 \cdot 0^3 - TT$
n25					23	$\pm 2^3 \pm TT$
n26					23	$\pm 2^3 \pm TT$
n28					23	$+2 + TT / -2.5 - TT$
n30					23	$\pm 2 \pm TT$
n34					23	$\pm 2 \pm TT$
n38					23	$\pm 2 \pm TT$
n39					23	$\pm 2 \pm TT$
n40					23	$\pm 2 \pm TT$
n41					23	$\pm 2^3 \pm TT$
n48					23	$+2 + TT / -3 - TT$
n50					23	$\pm 2 \pm TT$
n51					23	$\pm 2 \pm TT$
n53					23	$\pm 2 \pm TT$
n65					23	$\pm 2 \pm TT$
n66					23	$\pm 2 \pm TT$
n70					23	$\pm 2 \pm TT$
n71					23	$+2 + TT / -2.5 - TT$
n74					23	$\pm 2 \pm TT$
n77					23	$+2 + TT / -3 - TT$
n78					23	$+2 + TT / -3 - TT$
n79					23	$+2 + TT / -3 - TT$
NOTE 1: $P_{PowerClass}$ is the maximum UE power specified without taking into account the tolerance						
NOTE 2: Power class 3 is default power class unless otherwise stated						
NOTE 3: Refers to the transmission bandwidths confined within F_{UL_low} and $F_{UL_low} + 4$ MHz or $F_{UL_high} - 4$ MHz and F_{UL_high} , the maximum output power requirement is relaxed by reducing the lower tolerance limit by 1.5 dB						
NOTE 4: TT for each frequency and channel bandwidth is specified in Table 6.2I.1.5-3						

Table 6.2I.1.5-2: Test Tolerance (UE maximum output power)

	$f \leq 3.0\text{GHz}$	$3.0\text{GHz} < f \leq 4.2\text{GHz}$	$4.2\text{GHz} < f \leq 6.0\text{GHz}$
BW $\leq 40\text{MHz}$	0.7 dB	1.0 dB	1.0 dB

For the UE which supports [SUL] configuration, $\Delta T_{IB,c}$ as specified in clause [6.2C.2 for SUL] applies. Unless otherwise stated, $\Delta T_{IB,c}$ is set to zero. In case the UE supports more than one of band combinations, and an operating band belongs to more than one band combinations then

- When the operating band frequency range is ≤ 1 GHz, the applicable additional $\Delta T_{IB,c}$ shall be the average value for all band combinations defined in [clause 6.2C.2] in this specification, truncated to one decimal place that apply for that operating band among the supported band combinations. In case there is a harmonic relation between low band UL and high band DL, then the maximum $\Delta T_{IB,c}$ among the different supported band combinations involving such band shall be applied
- When the operating band frequency range is > 1 GHz, the applicable additional $\Delta T_{IB,c}$ shall be the maximum value for all band combinations defined in [clause 6.2C.2] in this specification for the applicable operating bands.

6.2I.2 UE maximum output power reduction for RedCap

Editor's Note: The test case is not completed due to the following aspects are not yet determined:

- Generic procedure for RedCap UE in 38.508-1 is FFS
- Default message configuration for RedCap UE in 38.508-1 is FFS.

6.2I.2.1 Test purpose

The number of RB identified in Table 6.2I.2.3-1 is based on meeting the requirements for adjacent channel leakage ratio and the maximum power reduction (MPR) due to Cubic Metric (CM).

6.2I.2.2 Test applicability

This test case applies to all types of NR RedCap UE release 17 and forward.

NOTE: Test execution is not necessary if TS 38.521-1 6.5I.2.4.1 is executed.

6.2I.2.3 Minimum conformance requirements

No exceptional requirements are specified for RedCap UE.

The normative reference for this requirement is TS 38.101-1 [2] clause 6.2.2.

6.2I.2.4 Test description

6.2I.2.4.1 Initial conditions

Same initial conditions as in 6.2.2 with following exception:

- Only test configuration tables for PC3 are tested: Table 6.2.2.4.1-1, Table 6.2.2.4.1-3.
- The test channel bandwidth are specified in TS 38.508-1 [5] subclause 4.3.1 for RedCap.

6.2I.2.4.2 Test procedure

Same test procedure as steps 1~3 of clause 6.2.2.4.2.

6.2I.2.4.3 Message contents

FFS.

6.2I.2.5 Test requirement

The maximum output power, derived in step 3 shall be within the range prescribed by the nominal maximum output power and tolerance in Table 6.2I.2.5-1 to Table 6.2I.2.5-7.

6.2I.3 UE additional maximum output power reduction for RedCap

Editor's Note: The test case is not completed due to the following aspects are not yet determined:

- Generic procedure for RedCap UE in 38.508-1 is FFS
- Default message configuration for RedCap UE in 38.508-1 is FFS.

6.2I.3.1 Test purpose

The same test purpose as in 6.2.3.1.

6.2I.3.2 Test applicability

This test case applies to all types of NR RedCap UE release 17 and forward.

NOTE: Test execution is not necessary if TS 38.521-1 6.5I.2.3, 6.5I.2.4.2 and 6.5I.3.3 are executed.

6.21.3.3 Minimum conformance requirements

No exceptional requirements are specified for RedCap UE.

The normative reference for this requirement is TS 38.101-1 [2] clause 6.2.3.

6.21.3.4 Test description

6.21.3.4.1 Initial conditions

Same initial conditions as in 6.2.3 with following exception:

- Only test configuration tables for PC3 with test channel bandwidth ≤ 20 MHz are tested.
- The test channel bandwidth are specified in TS 38.508-1 [5] subclause 4.3.1 for RedCap.

6.21.3.4.2 Test procedure

Same test procedure as steps 1~3 of clause 6.2.3.4.2.

6.21.3.4.3 Message contents

FFS

6.21.3.5 Test requirement

The maximum output power, derived in step 3 shall be within the range prescribed by the nominal maximum output power and tolerance in the applicable tables from Table 6.21.3.5-1 to Table 6.21.3.5-38.

Table 6.21.3.5-0: Test Tolerance (UE additional maximum output power reduction)

	$f \leq 3.0\text{GHz}$	$3.0\text{GHz} < f \leq 4.2\text{GHz}$	$4.2\text{GHz} < f \leq 6.0\text{GHz}$
$\text{BW} \leq 40\text{MHz}$	0.7 dB	1.0 dB	1.0 dB

Table 6.21.3.5-1: UE Power Class 3 test requirements (NS_35) for band n71

Test ID	P _{PowerClass} (dBm)	MPR (dB)	A-MPR (dB)	$\Delta T_{C,c}$ (dB)	P _{C_{MAX,c}} (dBm)	T(P _{C_{MAX,L,c}}) (dB)	T _{L,c} (dB)	Upper limit (dBm)	Lower limit (dBm)
1	23	0.5	0	0	22.5	2	2.5	25+TT	20-TT
2	23	0.5	0	0	22.5	2	2.5	25+TT	20-TT
3	23	0.5	0	0	22.5	2	2.5	25+TT	20-TT
4	23	1	0	0	22	2	2.5	25+TT	19.5-TT
5	23	1	0	0	22	2	2.5	25+TT	19.5-TT
6	23	1	0	0	22	2	2.5	25+TT	19.5-TT
7	23	2	0	0	21	2	2.5	25+TT	18.5-TT
8	23	2	0	0	21	2	2.5	25+TT	18.5-TT
9	23	2	0	0	21	2	2.5	25+TT	18.5-TT
10	23	2.5	0	0	20.5	2.5	2.5	25+TT	18-TT
11	23	2.5	0	0	20.5	2.5	2.5	25+TT	18-TT
12	23	2.5	0	0	20.5	2.5	2.5	25+TT	18-TT
13	23	4.5	0	0	18.5	4	2.5	25+TT	14.5-TT
14	23	4.5	0	0	18.5	4	2.5	25+TT	14.5-TT
15	23	4.5	0	0	18.5	4	2.5	25+TT	14.5-TT
16	23	3	0	0	20	2.5	2.5	25+TT	17.5-TT
17	23	3	0	0	20	2.5	2.5	25+TT	17.5-TT
18	23	3	0	0	20	2.5	2.5	25+TT	17.5-TT
19	23	3	0	0	20	2.5	2.5	25+TT	17.5-TT
20	23	3	0	0	20	2.5	2.5	25+TT	17.5-TT
21	23	3	0	0	20	2.5	2.5	25+TT	17.5-TT
22	23	3.5	0	0	19.5	3.5	2.5	25+TT	16-TT
23	23	3.5	0	0	19.5	3.5	2.5	25+TT	16-TT
24	23	3.5	0	0	19.5	3.5	2.5	25+TT	16-TT
25	23	6.5	0	0	16.5	5	2.5	25+TT	11.5-TT
26	23	6.5	0	0	16.5	5	2.5	25+TT	11.5-TT
27	23	6.5	0	0	16.5	5	2.5	25+TT	11.5-TT

NOTE 1: P_{PowerClass} is the maximum UE power specified without taking into account the tolerance.
NOTE 2: TT for each frequency and channel bandwidth is specified in Table 6.21.3.5-0.

Table 6.21.3.5-2: UE Power Class 3 test requirements (NS_04) for band n41

Test ID	P ^{PowerClass} (dBm)	Δ P ^{PowerClass} (dB)	MPR (dB)	A-MPR (dB)	Δ T _{C,c} (dB)	P _{C^{MAX,c}} (dBm)	T(P _{C^{MAX,L,c}}) (dB)	T _{L,c} (dB)	Upper limit (dBm)	Lower limit (Note 2) (dBm)
1	23	-3	3.5	3.5	1.5	21	2.0	2	28+TT	19-TT
2	23	-3	3.5	3.5	1.5	21	2.0	2	28+TT	19-TT
3	23	-3	3.5	0	1.5	21	2.0	2	28+TT	19-TT
4	23	-3	1.2	0	0	24.8	2.0	2	28+TT	22.8-TT
5	23	-3	3.5	0	1.5	21	2.0	2	28+TT	19-TT
6	23	-3	1.2	0	0	24.8	2.0	2	28+TT	22.8-TT
7	23	0	0.5	3.5	1.5	18	4.0	2	25+TT	14-TT
8	23	0	0.5	3.5	1.5	18	4.0	2	25+TT	14-TT
9	23	0	0.5	0	1.5	21	2.0	2	25+TT	19-TT
10	23	0	0.5	0	0	22.5	2.0	2	25+TT	20.5-TT
11	23	0	0.5	0	1.5	21	2.0	2	25+TT	19-TT
12	23	0	0.5	0	0	22.5	2.0	2	25+TT	20.5-TT
13	23	0	1	4	1.5	17.5	5.0	2	25+TT	12.5-TT
14	23	0	1	4	1.5	17.5	5.0	2	25+TT	12.5-TT
15	23	0	1	0	1.5	20.5	2.5	2	25+TT	18-TT
16	23	0	1	0	0	22	2.0	2	25+TT	20-TT
17	23	0	1	0	1.5	20.5	2.5	2	25+TT	18-TT
18	23	0	1	0	0	22	2.0	2	25+TT	20-TT
19	23	0	2	4	1.5	17.5	5.0	2	25+TT	12.5-TT
20	23	0	2	4	1.5	17.5	5.0	2	25+TT	12.5-TT
21	23	0	2	0	1.5	19.5	3.5	2	25+TT	16-TT
22	23	0	2	0	0	21	2.0	2	25+TT	19-TT
23	23	0	2	0	1.5	19.5	3.5	2	25+TT	16-TT
24	23	0	2	0	0	21	2.0	2	25+TT	19-TT
25	23	0	2.5	4.5	1.5	17	5.0	2	25+TT	12-TT
26	23	0	2.5	4	1.5	17.5	5.0	2	25+TT	12.5-TT
27	23	0	2.5	0	1.5	19	3.5	2	25+TT	15.5-TT
28	23	0	2.5	0	0	20.5	2.5	2	25+TT	18-TT
29	23	0	2.5	0	1.5	19	3.5	2	25+TT	15.5-TT
30	23	0	2.5	0	0	20.5	2.5	2	25+TT	18-TT
31	23	0	4.5	6	1.5	15.5	5.0	2	25+TT	10.5-TT
32	23	0	4.5	4.5	1.5	17	5.0	2	25+TT	12-TT
33	23	0	4.5	0	1.5	17	5.0	2	25+TT	12-TT
34	23	0	4.5	0	0	18.5	4.0	2	25+TT	14.5-TT
35	23	0	4.5	0	1.5	17	5.0	2	25+TT	12-TT
36	23	0	4.5	0	0	18.5	4.0	2	25+TT	14.5-TT
37	23	0	3	5.5	1.5	16	5.0	2	25+TT	11-TT
38	23	0	3	5.5	1.5	16	5.0	2	25+TT	11-TT

Test ID	P _{PowerClass} (dBm)	ΔP _{PowerClass} (dB)	MPR (dB)	A-MPR (dB)	ΔT _{C,c} (dB)	P _{CMAX,c} (dBm)	T(P _{CMAX,L,c}) (dB)	T _{L,c} (dB)	Upper limit (dBm)	Lower limit (Note 2) (dBm)
39	23	0	3	0	1.5	18.5	4.0	2	25+TT	14.5-TT
40	23	0	3	0	0	20	2.5	2	25+TT	17.5-TT
41	23	0	3	0	1.5	18.5	4.0	2	25+TT	14.5-TT
42	23	0	3	0	0	20	2.5	2	25+TT	17.5-TT
43	23	0	3	5.5	1.5	16	5.0	2	25+TT	11-TT
44	23	0	3	5.5	1.5	16	5.0	2	25+TT	11-TT
45	23	0	3	0	1.5	18.5	4.0	2	25+TT	14.5-TT
46	23	0	3	0	0	20	2.5	2	25+TT	17.5-TT
47	23	0	3	0	1.5	18.5	4.0	2	25+TT	14.5-TT
48	23	0	3	0	0	20	2.5	2	25+TT	17.5-TT
49	23	0	3.5	5.5	1.5	16	5.0	2	25+TT	11-TT
50	23	0	3.5	5.5	1.5	16	5.0	2	25+TT	11-TT
51	23	0	3.5	0	1.5	18	4.0	2	25+TT	14-TT
52	23	0	3.5	0	0	19.5	3.5	2	25+TT	16-TT
53	23	0	3.5	0	1.5	18	4.0	2	25+TT	14-TT
54	23	0	3.5	0	0	19.5	3.5	2	25+TT	16-TT
55	23	0	6.5	8	1.5	13.5	5.0	2	25+TT	8.5-TT
56	23	0	6.5	6.5	1.5	15	5.0	2	25+TT	10-TT
57	23	0	6.5	0	1.5	15	5.0	2	25+TT	10-TT
58	23	0	6.5	0	0	16.5	5.0	2	25+TT	11.5-TT
59	23	0	6.5	0	1.5	15	5.0	2	25+TT	10-TT
60	23	0	6.5	0	0	16.5	5.0	2	25+TT	11.5-TT

NOTE 1: P_{PowerClass} is the maximum UE power specified without taking into account the tolerance.
 NOTE 2: For Band n41, refers to the transmission bandwidths confined within F_{UL,low} and F_{UL,low} + 4 MHz or F_{UL,high} - 4 MHz and F_{UL,high}, the lower limit shall be decreased by 1.0 dB for CP-OFDM 256 QAM and decreased by 1.5 dB for other modulations.
 NOTE 3: TT=0.7 dB for BW_{channel} ≤ 40 MHz; TT=1.0 dB for 40 MHz < BW_{channel} ≤ 100 MHz.

Table 6.21.3.5-3: UE Power Class 3 test requirements (NS_03 and NS_03U) for band n66, n70

Test ID	Network signalling label	P _{PowerClass} (dBm)	MPR (dB)	A-MPR (dB)	ΔT _{C,c} (dB)	P _{CMAX,L,c} (dBm)	T(P _{CMAX,L,c}) (dB)	T _{L,c} (dB)	Upper limit (dBm)	Lower limit (dBm)
1, 2	NS_03	23	0.5	1.5	0	21.5	2	2	25+TT	19.5-TT
	NS_03U	23	0.5	2	0	21	2	2	25+TT	19-TT
3	NS_03	23	0.5	1.5	0	21.5	2	2	25+TT	19.5-TT
	NS_03U	23	0.5	2	0	21	2	2	25+TT	19-TT
4, 5	NS_03, NS_03U	23	1	2	0	21	2	2	25+TT	19-TT
6	NS_03, NS_03U	23	1	2	0	21	2	2	25+TT	19-TT
7, 8	NS_03, NS_03U	23	2	3	0	20	2.5	2	25+TT	17.5-TT
9	NS_03, NS_03U	23	2	3	0	20	2.5	2	25+TT	17.5-TT
10, 11	NS_03, NS_03U	23	2.5	3.5	0	19.5	3.5	2	25+TT	16-TT
12	NS_03, NS_03U	23	2.5	3.5	0	19.5	3.5	2	25+TT	16-TT
13, 14	NS_03, NS_03U	23	4.5	5.5	0	17.5	5	2	25+TT	12.5-TT
15	NS_03, NS_03U	23	4.5	5.5	0	17.5	5	2	25+TT	12.5-TT
16, 17	NS_03, NS_03U	23	3	4	0	19	3.5	2	25+TT	15.5-TT
18	NS_03, NS_03U	23	3	4	0	19	3.5	2	25+TT	15.5-TT
19, 20	NS_03, NS_03U	23	3	4	0	19	3.5	2	25+TT	15.5-TT
21	NS_03, NS_03U	23	3	4	0	19	3.5	2	25+TT	15.5-TT
22, 23	NS_03, NS_03U	23	3.5	4.5	0	18.5	4	2	25+TT	14.5-TT
24	NS_03, NS_03U	23	3.5	4.5	0	18.5	4	2	25+TT	14.5-TT
25, 26	NS_03, NS_03U	23	6.5	7.5	0	15.5	5	2	25+TT	10.5-TT
27	NS_03, NS_03U	23	6.5	7.5	0	15.5	5	2	25+TT	10.5-TT

NOTE 1: P_{PowerClass} is the maximum UE power specified without taking into account the tolerance.
 NOTE 2: TT for each frequency and channel bandwidth is specified in Table 6.21.3.5-0.

Table 6.2I.3.5-4: UE Power Class 3 test requirements (NS_03 and NS_03U) for band n2, n25

Test ID	Network signalling label	P _{PowerClass} (dBm)	MPR (dB)	A-MPR (dB)	$\Delta T_{c,c}$ (dB)	P _{CMAX_L,c} (dBm)	T(P _{CMAX_L,c}) (dB)	T _{L,c} (dB)	Upper limit (dBm)	Lower limit (dBm)
1, 2	NS_03	23	0.5	1.5	1.5	20	2.5	2	25+TT	17.5-TT
	NS_03U	23	0.5	2	1.5	19.5	3.5	2	25+TT	16-TT
3	NS_03	23	0.5	1.5	0	21.5	2	2	25+TT	19.5-TT
	NS_03U	23	0.5	2	0	21	2	2	25+TT	19-TT
4, 5	NS_03; NS_03U	23	1	2	1.5	19.5	3.5	2	25+TT	16-TT
6	NS_03; NS_03U	23	1	2	0	21	2	2	25+TT	19-TT
7, 8	NS_03; NS_03U	23	2	3	1.5	18.5	4	2	25+TT	14.5-TT
9	NS_03; NS_03U	23	2	3	0	20	2.5	2	25+TT	17.5-TT
10, 11	NS_03; NS_03U	23	2.5	3.5	1.5	18	4	2	25+TT	14-TT
12	NS_03; NS_03U	23	2.5	3.5	0	19.5	3.5	2	25+TT	16-TT
13, 14	NS_03; NS_03U	23	4.5	5.5	1.5	16	5	2	25+TT	11-TT
15	NS_03; NS_03U	23	4.5	5.5	0	17.5	5	2	25+TT	12.5-TT
16, 17	NS_03; NS_03U	23	3	4	1.5	17.5	5	2	25+TT	12.5-TT
18	NS_03; NS_03U	23	3	4	0	19	3.5	2	25+TT	15.5-TT
19, 20	NS_03; NS_03U	23	3	4	1.5	17.5	5	2	25+TT	12.5-TT
21	NS_03; NS_03U	23	3	4	0	19	3.5	2	25+TT	15.5-TT
22, 23	NS_03; NS_03U	23	3.5	4.5	1.5	17	5	2	25+TT	12-TT
24	NS_03; NS_03U	23	3.5	4.5	0	18.5	4	2	25+TT	14.5-TT
25, 26	NS_03; NS_03U	23	6.5	7.5	1.5	14	5	2	25+TT	9-TT
27	NS_03; NS_03U	23	6.5	7.5	0	15.5	5	2	25+TT	10.5-TT

NOTE 1: P_{PowerClass} is the maximum UE power specified without taking into account the tolerance.

NOTE 2: TT for each frequency and channel bandwidth is specified in Table 6.2I.3.5-0.

Table 6.21.3.5-5: UE Power Class 3 test requirements (NS_05) for bands n1, n65

Test ID	$P_{\text{PowerClass}}$ (dBm)	$\Delta P_{\text{PowerClass}}$ (dB)	MPR (dB)	A-MPR (dB)	$\Delta T_{C,c}$ (dB)	$P_{\text{CMAX}_L,c}$ (dBm)	$T(P_{\text{CMAX}_L,c})$ (dB)	$T_{L,c}$ (dB)	Upper limit (dBm)	Lower limit (dBm)
1	23	0	0.5	4	0	19	3.5	2	25+TT	15.5-TT
2	23	0	0.5	10	0	13	5	2	25+TT	8-TT
3	23	0	0.5	6	0	17	5	2	25+TT	12-TT
4	23	0	0.5	5	0	18	4	2	25+TT	14-TT
5	23	0	0.5	1	0	22	2.0	2	25+TT	20-TT
6	23	0	0.5	10	0	13	5.0	2	25+TT	8-TT
7	23	0	0.5	6	0	17	5.0	2	25+TT	12-TT
8	23	0	0.5	5	0	18	4.0	2	25+TT	14-TT
9	23	0	0.5	10	0	13	5.0	2	25+TT	8-TT
10	23	0	0.5	5	0	18	4.0	2	25+TT	14-TT
11	23	0	0.5	1	0	22	2.0	2	25+TT	20-TT
12	23	0	0.5	10	0	13	5.0	2	25+TT	8-TT
13	23	0	0.5	6	0	17	5.0	2	25+TT	12-TT
14	23	0	0.5	5	0	18	4.0	2	25+TT	14-TT
15	23	0	0.5	1	0	22	2.0	2	25+TT	20-TT
16	23	0	1.0	4.5	0	18.5	4.0	2	25+TT	14.5-TT
17	23	0	1.0	10	0	13	5.0	2	25+TT	8-TT
18	23	0	1.0	6	0	17	5.0	2	25+TT	12-TT
19	23	0	1.0	5	0	18	4.0	2	25+TT	14-TT
20	23	0	1.0	10	0	13	5.0	2	25+TT	8-TT
21	23	0	1.0	6	0	17	5.0	2	25+TT	12-TT
22	23	0	1.0	5	0	18	4.0	2	25+TT	14-TT
23	23	0	1.0	10	0	13	5.0	2	25+TT	8-TT
24	23	0	1.0	5	0	18	4.0	2	25+TT	14-TT
25	23	0	1.0	1.5	0	21.5	2.0	2	25+TT	19.5-TT
26	23	0	1.0	10	0	13	5.0	2	25+TT	8-TT
27	23	0	1.0	6	0	17	5.0	2	25+TT	12-TT
28	23	0	1.0	5	0	18	4.0	2	25+TT	14-TT
29	23	0	1.0	1.5	0	21.5	2.0	2	25+TT	19.5-TT
30	23	0	2.0	6	0	17	5.0	2	25+TT	12-TT
31	23	0	2.0	10	0	13	5.0	2	25+TT	8-TT
32	23	0	2.0	6	0	17	5.0	2	25+TT	12-TT
33	23	0	2.0	5	0	18	4.0	2	25+TT	14-TT
34	23	0	2.0	10	0	13	5.0	2	25+TT	8-TT
35	23	0	2.0	6	0	17	5.0	2	25+TT	12-TT
36	23	0	2.0	5	0	18	4.0	2	25+TT	14-TT
37	23	0	2.0	10	0	13	5.0	2	25+TT	8-TT
38	23	0	2.0	5	0	18	4.0	2	25+TT	14-TT
39	23	0	2.0	10	0	13	5.0	2	25+TT	8-TT
40	23	0	2.0	6	0	17	5.0	2	25+TT	12-TT
41	23	0	2.0	5	0	18	4.0	2	25+TT	14-TT
42	23	0	2.5	6	0	17	5.0	2	25+TT	12-TT
43	23	0	2.5	11	0	12	6.0	2	25+TT	6-TT
44	23	0	2.5	6	0	17	5.0	2	25+TT	12-TT
45	23	0	2.5	5	0	18	4.0	2	25+TT	14-TT
46	23	0	2.5	11	0	12	6.0	2	25+TT	6-TT
47	23	0	2.5	6	0	17	5.0	2	25+TT	12-TT
48	23	0	2.5	5	0	18	4.0	2	25+TT	14-TT
49	23	0	2.5	11	0	12	6.0	2	25+TT	6-TT
50	23	0	2.5	5	0	18	4.0	2	25+TT	14-TT
51	23	0	2.5	11	0	12	6.0	2	25+TT	6-TT
52	23	0	2.5	6	0	17	5.0	2	25+TT	12-TT
53	23	0	2.5	5	0	18	4.0	2	25+TT	14-TT
54	23	0	4.5	7	0	16	5.0	2	25+TT	11-TT
55	23	0	4.5	13	0	10	6.0	2	25+TT	4-TT
56	23	0	4.5	6	0	17	5.0	2	25+TT	12-TT
57	23	0	4.5	5	0	18	4.0	2	25+TT	14-TT
58	23	0	4.5	13	0	10	6.0	2	25+TT	4-TT
59	23	0	4.5	6	0	17	5.0	2	25+TT	12-TT

Test ID	P _{PowerClass} (dBm)	ΔP _{PowerClass} (dB)	MPR (dB)	A-MPR (dB)	ΔT _{C,c} (dB)	P _{CMAX_L,c} (dBm)	T(P _{CMAX_L,c}) (dB)	T _{L,c} (dB)	Upper limit (dBm)	Lower limit (dBm)
60	23	0	4.5	5	0	18	4.0	2	25+TT	14-TT
61	23	0	4.5	13	0	10	6.0	2	25+TT	4-TT
62	23	0	4.5	5	0	18	4.0	2	25+TT	14-TT
63	23	0	4.5	13	0	10	6.0	2	25+TT	4-TT
64	23	0	4.5	6	0	17	5.0	2	25+TT	12-TT
65	23	0	4.5	5	0	18	4.0	2	25+TT	14-TT
66	23	0	3.0	7.5	0	15.5	5.0	2	25+TT	10.5-TT
67	23	0	3.0	10	0	13	5.0	2	25+TT	8-TT
68	23	0	3.0	6	0	17	5.0	2	25+TT	12-TT
69	23	0	3.0	5	0	18	4.0	2	25+TT	14-TT
70	23	0	3.0	3.5	0	19.5	3.5	2	25+TT	16-TT
71	23	0	3.0	10	0	13	5.0	2	25+TT	8-TT
72	23	0	3.0	6	0	17	5.0	2	25+TT	12-TT
73	23	0	3.0	5	0	18	4.0	2	25+TT	14-TT
74	23	0	3.0	10	0	13	5.0	2	25+TT	8-TT
75	23	0	3.0	5	0	18	4.0	2	25+TT	14-TT
76	23	0	3.0	3.5	0	19.5	3.5	2	25+TT	16-TT
77	23	0	3.0	10	0	13	5.0	2	25+TT	8-TT
78	23	0	3.0	6	0	17	5.0	2	25+TT	12-TT
79	23	0	3.0	5	0	18	4.0	2	25+TT	14-TT
80	23	0	3.0	3.5	0	19.5	3.5	2	25+TT	16-TT
81	23	0	3.0	7.5	0	15.5	5.0	2	25+TT	10.5-TT
82	23	0	3.0	10	0	13	5.0	2	25+TT	8-TT
83	23	0	3.0	6	0	17	5.0	2	25+TT	12-TT
84	23	0	3.0	5	0	18	4.0	2	25+TT	14-TT
85	23	0	3.0	3.5	0	19.5	3.5	2	25+TT	16-TT
86	23	0	3.0	10	0	13	5.0	2	25+TT	8-TT
87	23	0	3.0	6	0	17	5.0	2	25+TT	12-TT
88	23	0	3.0	5	0	18	4.0	2	25+TT	14-TT
89	23	0	3.0	10	0	13	5.0	2	25+TT	8-TT
90	23	0	3.0	5	0	18	4.0	2	25+TT	14-TT
91	23	0	3.0	3.5	0	19.5	3.5	2	25+TT	16-TT
92	23	0	3.0	10	0	13	5.0	2	25+TT	8-TT
93	23	0	3.0	6	0	17	5.0	2	25+TT	12-TT
94	23	0	3.0	5	0	18	4.0	2	25+TT	14-TT
95	23	0	3.0	3.5	0	19.5	3.5	2	25+TT	16-TT
96	23	0	3.5	8	0	15	5.0	2	25+TT	10-TT
97	23	0	3.5	11	0	12	6.0	2	25+TT	6-TT
98	23	0	3.5	6	0	17	5.0	2	25+TT	12-TT
99	23	0	3.5	5	0	18	4.0	2	25+TT	14-TT
100	23	0	3.5	11	0	12	6.0	2	25+TT	6-TT
101	23	0	3.5	6	0	17	5.0	2	25+TT	12-TT
102	23	0	3.5	5	0	18	4.0	2	25+TT	14-TT
103	23	0	3.5	11	0	12	6.0	2	25+TT	6-TT
104	23	0	3.5	5	0	18	4.0	2	25+TT	14-TT
105	23	0	3.5	11	0	12	6.0	2	25+TT	6-TT
106	23	0	3.5	6	0	17	5.0	2	25+TT	12-TT
107	23	0	3.5	5	0	18	4.0	2	25+TT	14-TT
108	23	0	6.5	10	0	13	5.0	2	25+TT	8-TT
109	23	0	6.5	13	0	10	6.0	2	25+TT	4-TT
110	23	0	6.5	6	0	16.5	5.0	2	25+TT	11.5-TT
111	23	0	6.5	13	0	10	6.0	2	25+TT	4-TT
112	23	0	6.5	6	0	16.5	5.0	2	25+TT	11.5-TT
113	23	0	6.5	13	0	10	6.0	2	25+TT	4-TT
114	23	0	6.5	13	0	10	6.0	2	25+TT	4-TT
115	23	0	6.5	6	0	16.5	5.0	2	25+TT	11.5-TT

NOTE 1: P_{PowerClass} is the maximum UE power specified without taking into account the tolerance.

NOTE 2: TT for each frequency and channel bandwidth is specified in Table 6.2I.3.5-0.

Table 6.2I.3.5-6: UE Power Class 3 test requirements (NS_05U) for bands n1, n65

Test ID	P _{PowerClass} (dBm)	ΔP _{PowerClass} (dB)	MPR (dB)	A-MPR (dB)	ΔT _{C,c} (dB)	P _{CMAX_L,c} (dBm)	T(P _{CMAX_L,c}) (dB)	T _{L,c} (dB)	Upper limit (dBm)	Lower limit (dBm)
1	23	0	0.5	4	0	19	3.5	2	25+TT	15.5-TT
2	23	0	0.5	10	0	13	5	2	25+TT	8-TT
3	23	0	0.5	6	0	17	5	2	25+TT	12-TT
4	23	0	0.5	5	0	18	4	2	25+TT	14-TT
5	23	0	0.5	2	0	21	2.0	2	25+TT	19-TT
6	23	0	0.5	10	0	13	5.0	2	25+TT	8-TT
7	23	0	0.5	6	0	17	5.0	2	25+TT	12-TT
8	23	0	0.5	5	0	18	4.0	2	25+TT	14-TT
9	23	0	0.5	10	0	13	5.0	2	25+TT	8-TT
10	23	0	0.5	5	0	18	4.0	2	25+TT	14-TT
11	23	0	0.5	2	0	21	2.0	2	25+TT	19-TT
12	23	0	0.5	10	0	13	5.0	2	25+TT	8-TT
13	23	0	0.5	6	0	17	5.0	2	25+TT	12-TT
14	23	0	0.5	5	0	18	4.0	2	25+TT	14-TT
15	23	0	0.5	2	0	21	2.0	2	25+TT	19-TT
16	23	0	1.0	4.5	0	18.5	4.0	2	25+TT	14.5-TT
17	23	0	1.0	10	0	13	5.0	2	25+TT	8-TT
18	23	0	1.0	6	0	17	5.0	2	25+TT	12-TT
19	23	0	1.0	5	0	18	4.0	2	25+TT	14-TT
20	23	0	1.0	2	0	21	2.0	2	25+TT	19-TT
21	23	0	1.0	10	0	13	5.0	2	25+TT	8-TT
22	23	0	1.0	6	0	17	5.0	2	25+TT	12-TT
23	23	0	1.0	5	0	18	4.0	2	25+TT	14-TT
24	23	0	1.0	10	0	13	5.0	2	25+TT	8-TT
25	23	0	1.0	5	0	18	4.0	2	25+TT	14-TT
26	23	0	1.0	2	0	21	2.0	2	25+TT	19-TT
27	23	0	1.0	10	0	13	5.0	2	25+TT	8-TT
28	23	0	1.0	6	0	17	5.0	2	25+TT	12-TT
29	23	0	1.0	5	0	18	4.0	2	25+TT	14-TT
30	23	0	1.0	2	0	21	2.0	2	25+TT	19-TT
31	23	0	2.0	6	0	17	5.0	2	25+TT	12-TT
32	23	0	2.0	10	0	13	5.0	2	25+TT	8-TT
33	23	0	2.0	6	0	17	5.0	2	25+TT	12-TT
34	23	0	2.0	5	0	18	4.0	2	25+TT	14-TT
35	23	0	2.0	2.5	0	20.5	2.5	2	25+TT	18-TT
36	23	0	2.0	10	0	13	5.0	2	25+TT	8-TT
37	23	0	2.0	6	0	17	5.0	2	25+TT	12-TT
38	23	0	2.0	5	0	18	4.0	2	25+TT	14-TT
39	23	0	2.0	10	0	13	5.0	2	25+TT	8-TT
40	23	0	2.0	5	0	18	4.0	2	25+TT	14-TT
41	23	0	2.0	2.5	0	20.5	2.5	2	25+TT	18-TT
42	23	0	2.0	10	0	13	5.0	2	25+TT	8-TT
43	23	0	2.0	6	0	17	5.0	2	25+TT	12-TT
44	23	0	2.0	5	0	18	4.0	2	25+TT	14-TT
45	23	0	2.0	2.5	0	20.5	2.5	2	25+TT	18-TT
46	23	0	2.5	6	0	17	5.0	2	25+TT	12-TT
47	23	0	2.5	11	0	12	6.0	2	25+TT	6-TT
48	23	0	2.5	6	0	17	5.0	2	25+TT	12-TT
49	23	0	2.5	5	0	18	4.0	2	25+TT	14-TT
50	23	0	2.5	3	0	20	2.5	2	25+TT	17.5-TT
51	23	0	2.5	11	0	12	6.0	2	25+TT	6-TT
52	23	0	2.5	6	0	17	5.0	2	25+TT	12-TT
53	23	0	2.5	5	0	18	4.0	2	25+TT	14-TT
54	23	0	2.5	11	0	12	6.0	2	25+TT	6-TT
55	23	0	2.5	5	0	18	4.0	2	25+TT	14-TT
56	23	0	2.5	3	0	20	2.5	2	25+TT	17.5-TT
57	23	0	2.5	11	0	12	6.0	2	25+TT	6-TT
58	23	0	2.5	6	0	17	5.0	2	25+TT	12-TT
59	23	0	2.5	5	0	18	4.0	2	25+TT	14-TT

Test ID	P _{PowerClass} (dBm)	ΔP _{PowerClass} (dB)	MPR (dB)	A-MPR (dB)	ΔT _{C,c} (dB)	P _{CMAX_L,c} (dBm)	T(P _{CMAX_L,c}) (dB)	T _{L,c} (dB)	Upper limit (dBm)	Lower limit (dBm)
60	23	0	2.5	3	0	20	2.5	2	25+TT	17.5-TT
61	23	0	4.5	7	0	16	5.0	2	25+TT	11-TT
62	23	0	4.5	13	0	10	6.0	2	25+TT	4-TT
63	23	0	4.5	6	0	17	5.0	2	25+TT	12-TT
64	23	0	4.5	5	0	18	4.0	2	25+TT	14-TT
65	23	0	4.5	4.5	0	18.5	4.0	2	25+TT	14.5-TT
66	23	0	4.5	13	0	10	6.0	2	25+TT	4-TT
67	23	0	4.5	6	0	17	5.0	2	25+TT	12-TT
68	23	0	4.5	5	0	18	4.0	2	25+TT	14-TT
69	23	0	4.5	13	0	10	6.0	2	25+TT	4-TT
70	23	0	4.5	5	0	18	4.0	2	25+TT	14-TT
71	23	0	4.5	4.5	0	18.5	4.0	2	25+TT	14.5-TT
72	23	0	4.5	13	0	10	6.0	2	25+TT	4-TT
73	23	0	4.5	6	0	17	5.0	2	25+TT	12-TT
74	23	0	4.5	5	0	18	4.0	2	25+TT	14-TT
75	23	0	4.5	4.5	0	18.5	4.0	2	25+TT	14.5-TT
76	23	0	3.0	7.5	0	15.5	5.0	2	25+TT	10.5-TT
77	23	0	3.0	10	0	13	5.0	2	25+TT	8-TT
78	23	0	3.0	6	0	17	5.0	2	25+TT	12-TT
79	23	0	3.0	5	0	18	4.0	2	25+TT	14-TT
80	23	0	3.0	4	0	19	3.5	2	25+TT	15.5-TT
81	23	0	3.0	10	0	13	5.0	2	25+TT	8-TT
82	23	0	3.0	6	0	17	5.0	2	25+TT	12-TT
83	23	0	3.0	5	0	18	4.0	2	25+TT	14-TT
84	23	0	3.0	10	0	13	5.0	2	25+TT	8-TT
85	23	0	3.0	5	0	18	4.0	2	25+TT	14-TT
86	23	0	3.0	4	0	19	3.5	2	25+TT	15.5-TT
87	23	0	3.0	10	0	13	5.0	2	25+TT	8-TT
88	23	0	3.0	6	0	17	5.0	2	25+TT	12-TT
89	23	0	3.0	5	0	18	4.0	2	25+TT	14-TT
90	23	0	3.0	4	0	19	3.5	2	25+TT	15.5-TT
91	23	0	3.0	7.5	0	15.5	5.0	2	25+TT	10.5-TT
92	23	0	3.0	10	0	13	5.0	2	25+TT	8-TT
93	23	0	3.0	6	0	17	5.0	2	25+TT	12-TT
94	23	0	3.0	5	0	18	4.0	2	25+TT	14-TT
95	23	0	3.0	4	0	19	3.5	2	25+TT	15.5-TT
96	23	0	3.0	10	0	13	5.0	2	25+TT	8-TT
97	23	0	3.0	6	0	17	5.0	2	25+TT	12-TT
98	23	0	3.0	5	0	18	4.0	2	25+TT	14-TT
99	23	0	3.0	10	0	13	5.0	2	25+TT	8-TT
100	23	0	3.0	5	0	18	4.0	2	25+TT	14-TT
101	23	0	3.0	4	0	19	3.5	2	25+TT	15.5-TT
102	23	0	3.0	10	0	13	5.0	2	25+TT	8-TT
103	23	0	3.0	6	0	17	5.0	2	25+TT	12-TT
104	23	0	3.0	5	0	18	4.0	2	25+TT	14-TT
105	23	0	3.0	4	0	19	3.5	2	25+TT	15.5-TT
106	23	0	3.5	8	0	15	5.0	2	25+TT	10-TT
107	23	0	3.5	11	0	12	6.0	2	25+TT	6-TT
108	23	0	3.5	6	0	17	5.0	2	25+TT	12-TT
109	23	0	3.5	5	0	18	4.0	2	25+TT	14-TT
110	23	0	3.5	4	0	19	3.5	2	25+TT	15.5-TT
111	23	0	3.5	11	0	12	6.0	2	25+TT	6-TT
112	23	0	3.5	6	0	17	5.0	2	25+TT	12-TT
113	23	0	3.5	5	0	18	4.0	2	25+TT	14-TT
114	23	0	3.5	11	0	12	6.0	2	25+TT	6-TT
115	23	0	3.5	5	0	18	4.0	2	25+TT	14-TT
116	23	0	3.5	4	0	19	3.5	2	25+TT	15.5-TT
117	23	0	3.5	11	0	12	6.0	2	25+TT	6-TT
118	23	0	3.5	6	0	17	5.0	2	25+TT	12-TT
119	23	0	3.5	5	0	18	4.0	2	25+TT	14-TT

Test ID	$P_{\text{PowerClass}}$ (dBm)	$\Delta P_{\text{PowerClass}}$ (dB)	MPR (dB)	A-MPR (dB)	$\Delta T_{C,c}$ (dB)	$P_{\text{CMAX}_L,c}$ (dBm)	$T(P_{\text{CMAX}_L,c})$ (dB)	$T_{L,c}$ (dB)	Upper limit (dBm)	Lower limit (dBm)
120	23	0	3.5	4	0	19	3.5	2	25+TT	15.5-TT
121	23	0	6.5	10	0	13	5.0	2	25+TT	8-TT
122	23	0	6.5	13	0	10	6.0	2	25+TT	4-TT
123	23	0	6.5	6.5	0	16.5	5.0	2	25+TT	11.5-TT
124	23	0	6.5	6.5	0	16.5	5.0	2	25+TT	11.5-TT
125	23	0	6.5	13	0	10	6.0	2	25+TT	4-TT
126	23	0	6.5	6.5	0	16.5	5.0	2	25+TT	11.5-TT
127	23	0	6.5	13	0	10	6.0	2	25+TT	4-TT
128	23	0	6.5	6.5	0	16.5	5.0	2	25+TT	11.5-TT
129	23	0	6.5	13	0	10	6.0	2	25+TT	4-TT
130	23	0	6.5	6.5	0	16.5	5.0	2	25+TT	11.5-TT
131	23	0	6.5	6.5	0	16.5	5.0	2	25+TT	11.5-TT

NOTE 1: $P_{\text{PowerClass}}$ is the maximum UE power specified without taking into account the tolerance.

NOTE 2: TT for each frequency and channel bandwidth is specified in Table 6.2I.3.5-0.

Table 6.2I.3.5-7: UE Power Class 3 test requirements (NS_18)

Test ID	ChBw (MHz)	$P_{\text{PowerClass}}$ (dBm)	MPR (dB)	A-MPR (dB)	$\Delta T_{C,c}$ (dB)	$P_{\text{CMAX}_L,c}$ (dBm)	$T(P_{\text{CMAX}_L,c})$ (dB)	$T_{L,c}$ (dB)	Upper limit (dBm)	Lower limit (dBm)
1, 2	5	23	1	2	0	21	2	2.5	25+TT	18.5-TT
	10, 15, 20	23	1	5	0	18	4	2.5	25+TT	14-TT
3, 4	5	23	2	3	0	20	2.5	2.5	25+TT	17.5-TT
	10, 15, 20	23	2	6	0	17	5	2.5	25+TT	12-TT
5, 6	5	23	2.5	4	0	19	3.5	2.5	25+TT	15.5-TT
	10, 15, 20	23	2.5	7	0	16	5	2.5	25+TT	11-TT
7, 8	5	23	4.5	6	0	17	5	2.5	25+TT	12-TT
	10, 15, 20	23	4.5	9	0	14	5	2.5	25+TT	9-TT
9, 10	5	23	3	5	0	18	4	2.5	25+TT	14-TT
	10, 15, 20	23	3	6.5	0	16.5	5	2.5	25+TT	11.5-TT
11, 12	5	23	3	5	0	18	4	2.5	25+TT	14-TT
	10, 15, 20	23	3	7	0	16	5	2.5	25+TT	11-TT
13, 14	5	23	3.5	5.5	0	17.5	5	2.5	25+TT	12.5-TT
	10, 15, 20	23	3.5	8.5	0	14.5	5	2.5	25+TT	9.5-TT
15, 16	5	23	6.5	8.5	0	14.5	5	2.5	25+TT	9.5-TT
	10, 15, 20	23	6.5	11.5	0	11.5	6	2.5	25+TT	5.5-TT

Table 6.21.3.5-8: UE Power Class 3 test requirements (NS_43)

Test ID	$P_{\text{PowerClass}}$ (dBm)	MPR (dB)	A-MPR (dB)	$\Delta T_{\text{C,c}}$ (dB)	$P_{\text{CMAX_L,c}}$ (dBm)	$T(P_{\text{CMAX_L,c}})$ (dB)	$T_{\text{L,c}}$ (dB)	Upper limit (dBm)	Lower limit (dBm)
1	23	0.5	1.5	0	21.5	2	2	25+TT	19.5-TT
2	23	0.5	9	0	14	5	2	25+TT	9-TT
3	23	0.5	9	0	14	5	2	25+TT	9-TT
4	23	1.0	2	0	21	2.0	2	25+TT	19-TT
5	23	1.0	2.5	0	20.5	2.5	2	25+TT	18-TT
6	23	1.0	9	0	14	5.0	2	25+TT	9-TT
7	23	1.0	9	0	14	5.0	2	25+TT	9-TT
8	23	2.0	2.5	0	20.5	2.5	2	25+TT	18-TT
9	23	2.0	9	0	14	5.0	2	25+TT	9-TT
10	23	2.0	9	0	14	5.0	2	25+TT	9-TT
11	23	2.5	2.5	0	20.5	2.5	2	25+TT	18-TT
12	23	2.5	9	0	14	5.0	2	25+TT	9-TT
13	23	2.5	9	0	14	5.0	2	25+TT	9-TT
14	23	4.5	9	0	14	5.0	2	25+TT	9-TT
15	23	4.5	9	0	14	5.0	2	25+TT	9-TT
16	23	3.0	3.5	0	19.5	3.5	2	25+TT	16-TT
17	23	3.0	4	0	19	3.5	2	25+TT	15.5-TT
18	23	3.0	9	0	14	5.0	2	25+TT	9-TT
19	23	3.0	9	0	14	5.0	2	25+TT	9-TT
20	23	3.0	3.5	0	19.5	3.5	2	25+TT	16-TT
21	23	3.0	4	0	19	3.5	2	25+TT	15.5-TT
22	23	3.0	9	0	14	5.0	2	25+TT	9-TT
23	23	3.0	9	0	14	5.0	2	25+TT	9-TT
24	23	3.5	4	0	19	3.5	2	25+TT	15.5-TT
25	23	3.5	9	0	14	5.0	2	25+TT	9-TT
26	23	3.5	9	0	14	5.0	2	25+TT	9-TT
27	23	6.5	9	0	14	5.0	2	25+TT	9-TT
28	23	6.5	9	0	14	5.0	2	25+TT	9-TT

NOTE 1: $P_{\text{PowerClass}}$ is the maximum UE power specified without taking into account the tolerance.
NOTE 2: TT for each frequency and channel bandwidth is specified in Table 6.21.3.5-0.

Table 6.2I.3.5-9: UE Power Class 3 test requirements (NS_43U)

Test ID	P _{PowerClass} (dBm)	MPR (dB)	A-MPR (dB)	$\Delta T_{C,c}$ (dB)	P _{CMAX_L,c} (dBm)	T(P _{CMAX_L,c}) (dB)	T _{L,c} (dB)	Upper limit (dBm)	Lower limit (dBm)
1	23	0.5	2	0	21	2	2	25+TT	19-TT
2	23	0.5	2	0	21	2	2	25+TT	19-TT
3	23	0.5	9	0	14	5	2	25+TT	9-TT
4	23	0.5	9	0	14	5	2	25+TT	9-TT
5	23	1.0	2	0	21	2.0	2	25+TT	19-TT
6	23	1.0	2.5	0	20.5	2.5	2	25+TT	18-TT
7	23	1.0	9	0	14	5.0	2	25+TT	9-TT
8	23	1.0	9	0	14	5.0	2	25+TT	9-TT
9	23	2.0	2.5	0	20.5	2.5	2	25+TT	18-TT
10	23	2.0	2.5	0	20.5	2.5	2	25+TT	18-TT
11	23	2.0	9	0	14	5.0	2	25+TT	9-TT
12	23	2.0	9	0	14	5.0	2	25+TT	9-TT
13	23	2.5	3	0	20	2.5	2	25+TT	17.5-TT
14	23	2.5	3	0	20	2.5	2	25+TT	17.5-TT
15	23	2.5	9	0	14	5.0	2	25+TT	9-TT
16	23	2.5	9	0	14	5.0	2	25+TT	9-TT
17	23	4.5	4.5	0	18.5	4.0	2	25+TT	14.5-TT
18	23	4.5	4.5	0	18.5	4.0	2	25+TT	14.5-TT
19	23	4.5	9	0	14	5.0	2	25+TT	9-TT
20	23	4.5	9	0	14	5.0	2	25+TT	9-TT
21	23	3.0	4	0	19	3.5	2	25+TT	15.5-TT
22	23	3.0	4	0	19	3.5	2	25+TT	15.5-TT
23	23	3.0	9	0	14	5.0	2	25+TT	9-TT
24	23	3.0	9	0	14	5.0	2	25+TT	9-TT
25	23	3.0	4	0	19	3.5	2	25+TT	15.5-TT
26	23	3.0	4	0	19	3.5	2	25+TT	15.5-TT
27	23	3.0	9	0	14	5.0	2	25+TT	9-TT
28	23	3.0	9	0	14	5.0	2	25+TT	9-TT
29	23	3.5	4	0	19	3.5	2	25+TT	15.5-TT
30	23	3.5	4	0	19	3.5	2	25+TT	15.5-TT
31	23	3.5	9	0	14	5.0	2	25+TT	9-TT
32	23	3.5	9	0	14	5.0	2	25+TT	9-TT
33	23	6.5	6.5	0	16.5	5.0	2	25+TT	11.5-TT
34	23	6.5	6.5	0	16.5	5.0	2	25+TT	11.5-TT
35	23	6.5	9	0	14	5.0	2	25+TT	9-TT
36	23	6.5	9	0	14	5.0	2	25+TT	9-TT

NOTE 1: P_{PowerClass} is the maximum UE power specified without taking into account the tolerance.

NOTE 2: TT for each frequency and channel bandwidth is specified in Table 6.2I.3.5-0.

Table 6.2I.3.5-10: UE Power Class 3 test requirements (NS_100) for band n1, n5, n18, n65, n66

Test ID	P _{PowerClass} (dBm)	MPR (dB)	A-MPR (dB)	$\Delta T_{C,c}$ (dB)	P _{C_{MAX}L,c} (dBm)	T(P _{C_{MAX}L,c}) (dB)	T _{L,c} (dB)	Upper limit (dBm)	Lower limit (dBm)
1, 2	23	0.5	2	0	21	2	2	25+TT	19-TT
3	23	0.5	2	0	21	2	2	25+TT	19-TT
4, 5	23	1	1	0	21	2	2	25+TT	19-TT
6	23	1	1	0	21	2	2	25+TT	19-TT
7, 8	23	2	2.5	0	20.5	2.5	2	25+TT	18-TT
9	23	2	2.5	0	20.5	2.5	2	25+TT	18-TT
10, 11	23	2.5	3	0	20	2.5	2	25+TT	17.5-TT
12	23	2.5	3	0	20	2.5	2	25+TT	17.5-TT
13, 14	23	4.5	4.5	0	18.5	4	2	25+TT	14.5-TT
15	23	4.5	4.5	0	18.5	4	2	25+TT	14.5-TT
16, 17	23	3	4	0	19	3.5	2	25+TT	15.5-TT
18	23	3	4	0	19	3.5	2	25+TT	15.5-TT
19, 20	23	3	4	0	19	3.5	2	25+TT	15.5-TT
21	23	3	4	0	19	3.5	2	25+TT	15.5-TT
22, 23	23	3.5	4	0	19	3.5	2	25+TT	15.5-TT
24	23	3.5	4	0	19	3.5	2	25+TT	15.5-TT
25, 26	23	6.5	6.5	0	16.5	5	2	25+TT	11.5-TT
27	23	6.5	6.5	0	16.5	5	2	25+TT	11.5-TT

NOTE 1: P_{PowerClass} is the maximum UE power specified without taking into account the tolerance.
NOTE 2: TT for each frequency and channel bandwidth is specified in Table 6.2I.3.5-0.

Table 6.2I.3.5-11: UE Power Class 3 test requirements (NS_100) for band n2, n3, n8, n25 and n26

Test ID	P _{PowerClass} (dBm)	MPR (dB)	A-MPR (dB)	$\Delta T_{C,c}$ (dB)	P _{C_{MAX}L,c} (dBm)	T(P _{C_{MAX}L,c}) (dB)	T _{L,c} (dB)	Upper limit (dBm)	Lower limit (dBm)
1, 2	23	0.5	2	1.5	19.5	3.5	2	25+TT	16-TT
3	23	0.5	2	0	21	2	2	25+TT	19-TT
4, 5	23	1	1	1.5	19.5	3.5	2	25+TT	16-TT
6	23	1	1	0	21	2	2	25+TT	19-TT
7, 8	23	2	2.5	1.5	19	3.5	2	25+TT	15.5-TT
9	23	2	2.5	0	20.5	2.5	2	25+TT	18-TT
10, 11	23	2.5	3	1.5	18.5	4	2	25+TT	14.5-TT
12	23	2.5	3	0	20	2.5	2	25+TT	17.5-TT
13, 14	23	4.5	4.5	1.5	17	5	2	25+TT	12-TT
15	23	4.5	4.5	0	18.5	4	2	25+TT	14.5-TT
16, 17	23	3	4	1.5	17.5	5	2	25+TT	12.5-TT
18	23	3	4	0	19	3.5	2	25+TT	15.5-TT
19, 20	23	3	4	1.5	17.5	5	2	25+TT	12.5-TT
21	23	3	4	0	19	3.5	2	25+TT	15.5-TT
22, 23	23	3.5	4	1.5	17.5	5	2	25+TT	12.5-TT
24	23	3.5	4	0	19	3.5	2	25+TT	15.5-TT
25, 26	23	6.5	6.5	1.5	15	5	2	25+TT	10-TT
27	23	6.5	6.5	0	16.5	5	2	25+TT	11.5-TT

NOTE 1: P_{PowerClass} is the maximum UE power specified without taking into account the tolerance.
NOTE 2: TT for each frequency and channel bandwidth is specified in Table 6.2I.3.5-0.

Table 6.21.3.5-12: UE Power Class 3 test requirements (NS_37)

Test ID	$P_{\text{PowerClass}}$ (dBm)	$\Delta P_{\text{PowerClass}}$ (dB)	MPR (dB)	A-MPR (dB)	$\Delta T_{C,c}$ (dB)	$P_{\text{C}_{\text{MAX}_L,c}}$ (dBm)	$T(P_{\text{C}_{\text{MAX}_L,c})}$ (dB)	$T_{L,c}$ (dB)	Upper limit (dBm)	Lower limit (dBm)
1	23	0	0.5	1.0	0	22	2	2	25+TT	20-TT
2	23	0	0.5	1.0	0	22	2	2	25+TT	20-TT
3	23	0	0.5	3.0	0	20	2.5	2	25+TT	17.5-TT
4	23	0	0.5	3.0	0	20	2.5	2	25+TT	17.5-TT
5	23	0	1.0	1.5	0	21.5	2.0	2	25+TT	19.5-TT
6	23	0	1.0	1.5	0	21.5	2.0	2	25+TT	19.5-TT
7	23	0	1.0	3.0	0	20	2.5	2	25+TT	17.5-TT
8	23	0	1.0	3.0	0	20	2.5	2	25+TT	17.5-TT
9	23	0	2.0	2.5	0	20.5	2.5	2	25+TT	18-TT
10	23	0	2.0	2.5	0	20.5	2.5	2	25+TT	18-TT
11	23	0	2.0	3.0	0	20	2.5	2	25+TT	17.5-TT
12	23	0	2.0	3.0	0	20	2.5	2	25+TT	17.5-TT
13	23	0	2.5	3.0	0	20	2.5	2	25+TT	17.5-TT
14	23	0	2.5	3.0	0	20	2.5	2	25+TT	17.5-TT
15	23	0	2.5	3.0	0	20	2.5	2	25+TT	17.5-TT
16	23	0	2.5	3.0	0	20	2.5	2	25+TT	17.5-TT
17	23	0	3.0	3.5	0	19.5	3.5	2	25+TT	16-TT
18	23	0	3.0	3.5	0	19.5	3.5	2	25+TT	16-TT
19	23	0	3.0	3.0	0	20	2.5	2	25+TT	17.5-TT
20	23	0	3.0	3.0	0	20	2.5	2	25+TT	17.5-TT
21	23	0	3.0	3.5	0	19.5	3.5	2	25+TT	16-TT
22	23	0	3.0	3.5	0	19.5	3.5	2	25+TT	16-TT
23	23	0	3.0	3.0	0	20	2.5	2	25+TT	17.5-TT
24	23	0	3.0	3.0	0	20	2.5	2	25+TT	17.5-TT

NOTE 1: $P_{\text{PowerClass}}$ is the maximum UE power specified without taking into account the tolerance.

NOTE 2: TT for each frequency and channel bandwidth is specified in Table 6.21.3.5-0.

Table 6.21.3.5-13: UE Power Class 3 test requirements (NS_38)

Test ID	$P_{\text{PowerClass}}$ (dBm)	$\Delta P_{\text{PowerClass}}$ (dB)	MPR (dB)	A-MPR (dB)	$\Delta T_{C,c}$ (dB)	$P_{\text{C}_{\text{MAX}_L,c}}$ (dBm)	$T(P_{\text{C}_{\text{MAX}_L,c})}$ (dB)	$T_{L,c}$ (dB)	Upper limit (dBm)	Lower limit (dBm)
1	23	0	0.5	12	0	11	6.0	2	25+TT	5-TT
2	23	0	0.5	9	0	14	5.0	2	25+TT	9-TT
3	23	0	0.5	13	0	10	6.0	2	25+TT	4-TT
4	23	0	0.5	10	0	13	5.0	2	25+TT	8-TT
5	23	0	0.5	13	0	10	6.0	2	25+TT	4-TT
6	23	0	0.5	10	0	13	5.0	2	25+TT	8-TT
7	23	0	1.0	12	0	11	6.0	2	25+TT	5-TT
8	23	0	1.0	9	0	14	5.0	2	25+TT	9-TT
9	23	0	1.0	13	0	10	6.0	2	25+TT	4-TT
10	23	0	1.0	10	0	13	5.0	2	25+TT	8-TT
11	23	0	1.0	13	0	10	6.0	2	25+TT	4-TT
12	23	0	1.0	10	0	13	5.0	2	25+TT	8-TT
13	23	0	2.0	12	0	11	6.0	2	25+TT	5-TT
14	23	0	2.0	9	0	14	5.0	2	25+TT	9-TT
15	23	0	2.0	13	0	10	6.0	2	25+TT	4-TT
16	23	0	2.0	10	0	13	5.0	2	25+TT	8-TT
17	23	0	2.0	13	0	10	6.0	2	25+TT	4-TT
18	23	0	2.0	10	0	13	5.0	2	25+TT	8-TT
19	23	0	2.5	12	0	11	6.0	2	25+TT	5-TT
20	23	0	2.5	9	0	14	5.0	2	25+TT	9-TT
21	23	0	2.5	13	0	10	6.0	2	25+TT	4-TT
22	23	0	2.5	10	0	13	5.0	2	25+TT	8-TT
23	23	0	2.5	13	0	10	6.0	2	25+TT	4-TT
24	23	0	2.5	10	0	13	5.0	2	25+TT	8-TT
25	23	0	4.5	12	0	11	6.0	2	25+TT	5-TT
26	23	0	4.5	9	0	14	5.0	2	25+TT	9-TT
27	23	0	4.5	13	0	10	6.0	2	25+TT	4-TT
28	23	0	4.5	10	0	13	5.0	2	25+TT	8-TT
29	23	0	4.5	13	0	10	6.0	2	25+TT	4-TT
30	23	0	4.5	10	0	13	5.0	2	25+TT	8-TT
31	23	0	3.0	12	0	11	6.0	2	25+TT	5-TT
32	23	0	3.0	9	0	14	5.0	2	25+TT	9-TT
33	23	0	3.0	13	0	10	6.0	2	25+TT	4-TT
34	23	0	3.0	10	0	13	5.0	2	25+TT	8-TT
35	23	0	3.0	13	0	10	6.0	2	25+TT	4-TT
36	23	0	3.0	10	0	13	5.0	2	25+TT	8-TT
37	23	0	3.0	12	0	11	6.0	2	25+TT	5-TT
38	23	0	3.0	9	0	14	5.0	2	25+TT	9-TT
39	23	0	3.0	13	0	10	6.0	2	25+TT	4-TT
40	23	0	3.0	10	0	13	5.0	2	25+TT	8-TT
41	23	0	3.0	13	0	10	6.0	2	25+TT	4-TT
42	23	0	3.0	10	0	13	5.0	2	25+TT	8-TT
43	23	0	3.5	12	0	11	6.0	2	25+TT	5-TT
44	23	0	3.5	9	0	14	5.0	2	25+TT	9-TT
45	23	0	3.5	13	0	10	6.0	2	25+TT	4-TT

Test ID	P _{PowerClass} (dBm)	ΔP _{PowerClass} (dB)	MPR (dB)	A-MPR (dB)	ΔT _{C,c} (dB)	P _{C_{MAX}L,c} (dBm)	T(P _{C_{MAX}L,c}) (dB)	T _{L,c} (dB)	Upper limit (dBm)	Lower limit (dBm)
46	23	0	3.5	10	0	13	5.0	2	25+TT	8-TT
47	23	0	3.5	13	0	10	6.0	2	25+TT	4-TT
48	23	0	3.5	10	0	13	5.0	2	25+TT	8-TT
49	23	0	6.5	12	0	11	6.0	2	25+TT	5-TT
50	23	0	6.5	9	0	14	5.0	2	25+TT	9-TT
51	23	0	6.5	13	0	10	6.0	2	25+TT	4-TT
52	23	0	6.5	10	0	13	5.0	2	25+TT	8-TT
53	23	0	6.5	13	0	10	6.0	2	25+TT	4-TT
54	23	0	6.5	10	0	13	5.0	2	25+TT	8-TT

NOTE 1: P_{PowerClass} is the maximum UE power specified without taking into account the tolerance.
 NOTE 2: TT for each frequency and channel bandwidth is specified in Table 6.2I.3.5-0.

Table 6.2I.3.5-14: UE Power Class 3 test requirements (NS_39)

Test ID	P _{PowerClass} (dBm)	ΔP _{PowerClass} (dB)	MPR (dB)	A-MPR (dB)	ΔT _{C,c} (dB)	P _{C_{MAX}L,c} (dBm)	T(P _{C_{MAX}L,c}) (dB)	T _{L,c} (dB)	Upper limit (dBm)	Lower limit (dBm)
1	23	0	0.5	6	0	17	5.0	2	25+TT	12-TT
2	23	0	0.5	6	0	17	5.0	2	25+TT	12-TT
3	23	0	0.5	6	0	17	5.0	2	25+TT	12-TT
4	23	0	1.0	6	0	17	5.0	2	25+TT	12-TT
5	23	0	1.0	6	0	17	5.0	2	25+TT	12-TT
6	23	0	1.0	6	0	17	5.0	2	25+TT	12-TT
7	23	0	2.0	6	0	17	5.0	2	25+TT	12-TT
8	23	0	2.0	6	0	17	5.0	2	25+TT	12-TT
9	23	0	2.0	6	0	17	5.0	2	25+TT	12-TT
10	23	0	2.5	6	0	17	5.0	2	25+TT	12-TT
11	23	0	2.5	6	0	17	5.0	2	25+TT	12-TT
12	23	0	2.5	6	0	17	5.0	2	25+TT	12-TT
13	23	0	4.5	6	0	17	5.0	2	25+TT	12-TT
14	23	0	4.5	6	0	17	5.0	2	25+TT	12-TT
15	23	0	4.5	6	0	17	5.0	2	25+TT	12-TT
16	23	0	3.0	6	0	17	5.0	2	25+TT	12-TT
17	23	0	3.0	6	0	17	5.0	2	25+TT	12-TT
18	23	0	3.0	6	0	17	5.0	2	25+TT	12-TT
19	23	0	3.0	6	0	17	5.0	2	25+TT	12-TT
20	23	0	3.0	6	0	17	5.0	2	25+TT	12-TT
21	23	0	3.0	6	0	17	5.0	2	25+TT	12-TT
22	23	0	3.5	6	0	17	5.0	2	25+TT	12-TT
23	23	0	3.5	6	0	17	5.0	2	25+TT	12-TT
24	23	0	3.5	6	0	17	5.0	2	25+TT	12-TT
25	23	0	6.5	6	0	16.5	5.0	2	25+TT	11.5-TT
26	23	0	6.5	6	0	16.5	5.0	2	25+TT	11.5-TT
27	23	0	6.5	6	0	16.5	5.0	2	25+TT	11.5-TT

NOTE 1: P_{PowerClass} is the maximum UE power specified without taking into account the tolerance.
 NOTE 2: TT for each frequency and channel bandwidth is specified in Table 6.2I.3.5-0.

Table 6.21.3.5-15: UE Power Class 3 test requirements (NS_24) for n65

Test ID	P _{PowerClass} (dBm)	MPR (dB)	A-MPR (dB)	$\Delta T_{C,c}$ (dB)	P _{CMAX_L,c} (dBm)	T(P _{CMAX_L,c}) (dB)	T _{L,c} (dB)	Upper limit (dBm)	Lower limit (dBm)
1-3	23	N/A	3.5	0	19.5	3.5	2	25+TT	16-TT
4-6	23	N/A	8.5	0	14.5	5	2	25+TT	9.5-TT
7-15	23	N/A	11	0	12	6	2	25+TT	6-TT
	23	N/A	5	0	18	4	2	25+TT	14-TT
	23	N/A	4	0	19	3.5	2	25+TT	16-TT
16-18	23	N/A	8.5	0	14.5	5	2	25+TT	9.5-TT
19-21	23	N/A	8.5	0	14.5	5	2	25+TT	9.5-TT
22-30	23	N/A	11	0	12	6	2	25+TT	6-TT
	23	N/A	5	0	18	4	2	25+TT	14-TT
	23	N/A	4	0	19	3.5	2	25+TT	15.5-TT
31-39	23	N/A	18	0	5	7	2	25+TT	-2-TT
	23	N/A	18	0	5	7	2	25+TT	-2-TT
	23	N/A	10	0	13	5	2	25+TT	8-TT
40-42	23	N/A	18	0	5	7	2	25+TT	-2-TT
43-51	23	N/A	11	0	12	6	2	25+TT	6-TT
	23	N/A	5	0	18	4	2	25+TT	14-TT
	23	N/A	4	0	19	3.5	2	25+TT	15.5-TT
52-60	23	N/A	18	0	5	7	2	25+TT	-2-TT
	23	N/A	18	0	5	7	2	25+TT	-2-TT
	23	N/A	10	0	13	5	2	25+TT	8-TT
61-63	23	N/A	18	0	5	7	2	25+TT	-2-TT
64-72	23	N/A	18	0	5	7	2	25+TT	-2-TT
	23	N/A	18	0	5	7	2	25+TT	-2-TT
	23	N/A	10	0	13	5	2	25+TT	8-TT
73-75	23	N/A	18	0	5	7	2	25+TT	-2-TT
76-84	23	N/A	18	0	5	7	2	25+TT	-2-TT
	23	N/A	18	0	5	7	2	25+TT	-2-TT
	23	N/A	10	0	13	5	2	25+TT	8-TT
85-87	23	N/A	18	0	5	7	2	25+TT	-2-TT
88	23	N/A	3.5	0	19.5	3.5	2	25+TT	16-TT
89	23	N/A	8.5	0	14.5	5	2	25+TT	9.5-TT
90-92	23	N/A	11	0	12	6	2	25+TT	6-TT
	23	N/A	5	0	18	4	2	25+TT	14-TT
	23	N/A	4	0	19	3.5	2	25+TT	16-TT
93	23	N/A	8.5	0	14.5	5	2	25+TT	9.5-TT
94	23	N/A	8.5	0	14.5	5	2	25+TT	9.5-TT
95-97	23	N/A	11	0	12	6	2	25+TT	6-TT
	23	N/A	5	0	18	4	2	25+TT	14-TT
	23	N/A	4	0	19	3.5	2	25+TT	15.5-TT
98-100	23	N/A	19	0	4	7	2	25+TT	-3-TT
	23	N/A	19	0	4	7	2	25+TT	-3-TT
	23	N/A	10	0	13	5	2	25+TT	8-TT
101-102	23	N/A	19	0	4	7	2	25+TT	-3-TT
	23	N/A	19	0	4	7	2	25+TT	-3-TT

Test ID	P ^{PowerClass} (dBm)	MPR (dB)	A-MPR (dB)	$\Delta T_{C,c}$ (dB)	P _{CMAX_L,c} (dBm)	T(P _{CMAX_L,c}) (dB)	T _{L,c} (dB)	Upper limit (dBm)	Lower limit (dBm)
103-105	23	N/A	11	0	12	6	2	25+TT	6-TT
	23	N/A	5	0	18	4	2	25+TT	14-TT
	23	N/A	4	0	19	3.5	2	25+TT	15.5-TT
106-108	23	N/A	19	0	4	7	2	25+TT	-3-TT
	23	N/A	19	0	4	7	2	25+TT	-3-TT
	23	N/A	10	0	13	5	2	25+TT	8-TT
109	23	N/A	19	0	4	7	2	25+TT	-3-TT
110-112	23	N/A	19	0	4	7	2	25+TT	-3-TT
	23	N/A	19	0	4	7	2	25+TT	-3-TT
	23	N/A	10	0	13	5	2	25+TT	8-TT
113	23	N/A	19	0	4	7	2	25+TT	-3-TT
114-116	23	N/A	19	0	4	7	2	25+TT	-3-TT
	23	N/A	19	0	4	7	2	25+TT	-3-TT
	23	N/A	10	0	13	5	2	25+TT	8-TT
117	23	N/A	19	0	4	7	2	25+TT	-3-TT
118	23	4.5		0	18.5	4	2	25+TT	14.5-TT
119	23	N/A	8.5	0	14.5	5	2	25+TT	9.5-TT
120-122	23	N/A	11	0	12	6	2	25+TT	6-TT
	23	N/A	5	0	18	4	2	25+TT	14-TT
	23	4.5		0	18.5	4	2	25+TT	14.5-TT
123	23	N/A	8.5	0	14.5	5	2	25+TT	9.5-TT
124	23	N/A	8.5	0	14.5	5	2	25+TT	9.5-TT
125-127	23	N/A	11	0	12	6	2	25+TT	6-TT
	23	N/A	5	0	18	4	2	25+TT	14-TT
	23	4.5		0	18.5	4	2	25+TT	14.5-TT
128-130	23	N/A	19	0	4	7	2	25+TT	-3-TT
	23	N/A	19	0	4	7	2	25+TT	-3-TT
	23	N/A	10	0	13	5	2	25+TT	8-TT
131-132	23	N/A	19	0	4	7	2	25+TT	-3-TT
	23	N/A	19	0	4	7	2	25+TT	-3-TT
133-135	23	N/A	11	0	12	6	2	25+TT	6-TT
	23	N/A	5	0	18	4	2	25+TT	14-TT
	23	4.5		0	18.5	4	2	25+TT	14.5-TT
136-138	23	N/A	19	0	4	7	2	25+TT	-3-TT
	23	N/A	19	0	4	7	2	25+TT	-3-TT
	23	N/A	10	0	13	5	2	25+TT	8-TT
139	23	N/A	19	0	4	7	2	25+TT	-3-TT
140-142	23	N/A	19	0	4	7	2	25+TT	-3-TT
	23	N/A	19	0	4	7	2	25+TT	-3-TT
	23	N/A	10	0	13	5	2	25+TT	8-TT
143	23	N/A	19	0	4	7	2	25+TT	-3-TT
144-146	23	N/A	19	0	4	7	2	25+TT	-3-TT
	23	N/A	19	0	4	7	2	25+TT	-3-TT
	23	N/A	10	0	13	5	2	25+TT	8-TT
147	23	N/A	19	0	4	7	2	25+TT	-3-TT

Test ID	P _{PowerClass} (dBm)	MPR (dB)	A-MPR (dB)	$\Delta T_{C,c}$ (dB)	P _{CMAX_L,c} (dBm)	T(P _{CMAX_L,c}) (dB)	T _{L,c} (dB)	Upper limit (dBm)	Lower limit (dBm)
148-150	23	N/A	5.5	0	17.5	5	2	25+TT	12.5-TT
151-153	23	N/A	8.5	0	14.5	5	2	25+TT	9.5-TT
154-162	23	N/A	13	0	10	6	2	25+TT	4-TT
	23	N/A	6.5	0	16.5	5	2	25+TT	11.5-TT
	23	N/A	4	0	19	3.5	2	25+TT	16-TT
163-165	23	N/A	8.5	0	14.5	5	2	25+TT	9.5-TT
166-168	23	N/A	8.5	0	14.5	5	2	25+TT	9.5-TT
169-177	23	N/A	13	0	10	6	2	25+TT	4-TT
	23	N/A	6.5	0	16.5	5	2	25+TT	11.5-TT
	23	N/A	4	0	19	3.5	2	25+TT	15.5-TT
178-186	23	N/A	19	0	4	7	2	25+TT	-3-TT
	23	N/A	19	0	4	7	2	25+TT	-3-TT
	23	N/A	12	0	11	6	2	25+TT	5-TT
187-189	23	N/A	19	0	4	7	2	25+TT	-3-TT
190-198	23	N/A	13	0	10	6	2	25+TT	4-TT
	23	N/A	6.5	0	16.5	5	2	25+TT	11.5-TT
	23	N/A	4	0	19	3.5	2	25+TT	15.5-TT
199-207	23	N/A	19	0	4	7	2	25+TT	-3-TT
	23	N/A	19	0	4	7	2	25+TT	-3-TT
	23	N/A	12	0	11	6	2	25+TT	5-TT
208-210	23	N/A	19	0	4	7	2	25+TT	-3-TT
211-219	23	N/A	19	0	4	7	2	25+TT	-3-TT
	23	N/A	19	0	4	7	2	25+TT	-3-TT
	23	N/A	12	0	11	6	2	25+TT	5-TT
220-222	23	N/A	19	0	4	7	2	25+TT	-3-TT
223-231	23	N/A	19	0	4	7	2	25+TT	-3-TT
	23	N/A	19	0	4	7	2	25+TT	-3-TT
	23	N/A	12	0	11	6	2	25+TT	5-TT
232-234	23	N/A	19	0	4	7	2	25+TT	-3-TT
235	23	6.5		0	16.5	5	2	25+TT	11.5-TT
236	23	N/A	8.5	0	14.5	5	2	25+TT	9.5-TT
237-239	23	N/A	13	0	10	6	2	25+TT	4-TT
	23	N/A	6.5	0	16.5	5	2	25+TT	11.5-TT
	23	6.5		0	16.5	5	2	25+TT	11.5-TT
240	23	N/A	8.5	0	14.5	5	2	25+TT	9.5-TT
241	23	N/A	8.5	0	14.5	5	2	25+TT	9.5-TT
242-244	23	N/A	13	0	10	6	2	25+TT	4-TT
	23	N/A	6.5	0	16.5	5	2	25+TT	11.5-TT
	23	6.5		0	16.5	5	2	25+TT	11.5-TT
245-247	23	N/A	19	0	4	7	2	25+TT	-3-TT
	23	N/A	19	0	4	7	2	25+TT	-3-TT
	23	N/A	12	0	11	6	2	25+TT	5-TT
248-249	23	N/A	19	0	4	7	2	25+TT	-3-TT
	23	N/A	19	0	4	7	2	25+TT	-3-TT

Test ID	P _{PowerClass} (dBm)	MPR (dB)	A-MPR (dB)	$\Delta T_{C,c}$ (dB)	P _{CMAX_L,c} (dBm)	T(P _{CMAX_L,c}) (dB)	T _{L,c} (dB)	Upper limit (dBm)	Lower limit (dBm)
250-252	23	N/A	13	0	10	6	2	25+TT	4-TT
	23	N/A	6.5	0	16.5	5	2	25+TT	11.5-TT
	23	6.5		0	16.5	5	2	25+TT	11.5-TT
253-255	23	N/A	19	0	4	7	2	25+TT	-3-TT
	23	N/A	19	0	4	7	2	25+TT	-3-TT
	23	N/A	12	0	11	6	2	25+TT	5-TT
256	23	N/A	19	0	4	7	2	25+TT	-3-TT
257-259	23	N/A	19	0	4	7	2	25+TT	-3-TT
	23	N/A	19	0	4	7	2	25+TT	-3-TT
	23	N/A	12	0	11	6	2	25+TT	5-TT
260	23	N/A	19	0	4	7	2	25+TT	-3-TT
261-263	23	N/A	19	0	4	7	2	25+TT	-3-TT
	23	N/A	19	0	4	7	2	25+TT	-3-TT
	23	N/A	12	0	11	6	2	25+TT	5-TT
264	23	N/A	19	0	4	7	2	25+TT	-3-TT
265	23	1		0	22	2	2	25+TT	20-TT
266	23	2		0	21	2	2	25+TT	19-TT
267	23	1		0	22	2	2	25+TT	20-TT

NOTE 1: P_{PowerClass} is the maximum UE power specified without taking into account the tolerance.

NOTE 2: TT for each frequency and channel bandwidth is specified in Table 6.21.3.5-0.

Table 6.21.3.5-16: UE Power Class 3 test requirements (NS_27)

Test ID	$P_{\text{PowerClass}}$ (dBm)	$\Delta P_{\text{PowerClass}}$ (dB)	MPR (dB)	A-MPR (dB)	$\Delta T_{C,c}$ (dB)	$P_{\text{C}_{\text{MAX}_L,c}}$ (dBm)	$T(P_{\text{C}_{\text{MAX}_L,c})}$ (dB)	$T_{L,c}$ (dB)	Upper limit (dBm)	Lower limit (dBm)
1	23	0	0.5	4	0	19	3.5	3	25+TT	15.5-TT
2	23	0	0.5	4	0	19	3.5	3	25+TT	15.5-TT
3	23	0	0.5	4	0	19	3.5	3	25+TT	15.5-TT
4	23	0	0.5	4	0	19	3.5	3	25+TT	15.5-TT
5	23	0	0.5	4	0	19	3.5	3	25+TT	15.5-TT
6	23	0	0.5	2	0	21	2.0	3	25+TT	18-TT
7	23	0	0.5	4	0	19	3.5	3	25+TT	15.5-TT
8	23	0	0.5	2	0	21	2.0	3	25+TT	18-TT
9	23	0	0.5	4	0	19	3.5	3	25+TT	15.5-TT
10	23	0	0.5	4	0	19	3.5	3	25+TT	15.5-TT
11	23	0	0.5	4	0	19	3.5	3	25+TT	15.5-TT
12	23	0	0.5	4	0	19	3.5	3	25+TT	15.5-TT
13	23	0	0.5	4	0	19	3.5	3	25+TT	15.5-TT
14	23	0	0.5	2	0	21	2.0	3	25+TT	18-TT
15	23	0	0.5	4	0	19	3.5	3	25+TT	15.5-TT
16	23	0	0.5	2	0	21	2.0	3	25+TT	18-TT
29	23	0	1	4	0	19	3.5	3	25+TT	15.5-TT
30	23	0	1	4	0	19	3.5	3	25+TT	15.5-TT
31	23	0	1	4	0	19	3.5	3	25+TT	15.5-TT
32	23	0	1	4	0	19	3.5	3	25+TT	15.5-TT
33	23	0	1	4	0	19	3.5	3	25+TT	15.5-TT
34	23	0	1	2	0	21	2.0	3	25+TT	18-TT
35	23	0	1	4	0	19	3.5	3	25+TT	15.5-TT
36	23	0	1	2	0	21	2.0	3	25+TT	18-TT
37	23	0	1	4	0	19	3.5	3	25+TT	15.5-TT
38	23	0	1	4	0	19	3.5	3	25+TT	15.5-TT
39	23	0	1	4	0	19	3.5	3	25+TT	15.5-TT
40	23	0	1	4	0	19	3.5	3	25+TT	15.5-TT
41	23	0	1	4	0	19	3.5	3	25+TT	15.5-TT
42	23	0	1	2	0	21	2.0	3	25+TT	18-TT
43	23	0	1	4	0	19	3.5	3	25+TT	15.5-TT
44	23	0	1	2	0	21	2.0	3	25+TT	18-TT
57	23	0	2	5	0	18	4.0	3	25+TT	14-TT
58	23	0	2	5	0	18	4.0	3	25+TT	14-TT
59	23	0	2	5	0	18	4.0	3	25+TT	14-TT

Test ID	P _{PowerClass} (dBm)	Δ P _{PowerClass} (dB)	MPR (dB)	A-MPR (dB)	Δ T _{C,c} (dB)	P _{C_{MAX}L,c} (dBm)	T(P _{C_{MAX}L,c}) (dB)	T _{L,c} (dB)	Upper limit (dBm)	Lower limit (dBm)
60	23	0	2	5	0	18	4.0	3	25+TT	14-TT
61	23	0	2	4	0	19	3.5	3	25+TT	15.5-TT
62	23	0	2	2	0	21	2.0	3	25+TT	18-TT
63	23	0	2	4	0	19	3.5	3	25+TT	15.5-TT
64	23	0	2	2	0	21	2.0	3	25+TT	18-TT
65	23	0	2	5	0	18	4.0	3	25+TT	14-TT
66	23	0	2	5	0	18	4.0	3	25+TT	14-TT
67	23	0	2	5	0	18	4.0	3	25+TT	14-TT
68	23	0	2	5	0	18	4.0	3	25+TT	14-TT
69	23	0	2	4	0	19	3.5	3	25+TT	15.5-TT
70	23	0	2	2	0	21	2.0	3	25+TT	18-TT
71	23	0	2	4	0	19	3.5	3	25+TT	15.5-TT
72	23	0	2	2	0	21	2.0	3	25+TT	18-TT
85	23	0	2.5	5	0	18	4.0	3	25+TT	14-TT
86	23	0	2.5	5	0	18	4.0	3	25+TT	14-TT
87	23	0	2.5	5	0	18	4.0	3	25+TT	14-TT
88	23	0	2.5	5	0	18	4.0	3	25+TT	14-TT
89	23	0	2.5	4	0	19	3.5	3	25+TT	15.5-TT
90	23	0	2.5	2	0	20.5	2.5	3	25+TT	17.5-TT
91	23	0	2.5	4	0	19	3.5	3	25+TT	15.5-TT
92	23	0	2.5	2	0	20.5	2.5	3	25+TT	17.5-TT
93	23	0	2.5	5	0	18	4.0	3	25+TT	14-TT
94	23	0	2.5	5	0	18	4.0	3	25+TT	14-TT
95	23	0	2.5	5	0	18	4.0	3	25+TT	14-TT
96	23	0	2.5	5	0	18	4.0	3	25+TT	14-TT
97	23	0	2.5	4	0	19	3.5	3	25+TT	15.5-TT
98	23	0	2.5	2	0	20.5	2.5	3	25+TT	17.5-TT
99	23	0	2.5	4	0	19	3.5	3	25+TT	15.5-TT
100	23	0	2.5	2	0	20.5	2.5	3	25+TT	17.5-TT
113	23	0	4.5	0	0	18.5	4.0	3	25+TT	14.5-TT
114	23	0	4.5	0	0	18.5	4.0	3	25+TT	14.5-TT
115	23	0	4.5	0	0	18.5	4.0	3	25+TT	14.5-TT
116	23	0	4.5	0	0	18.5	4.0	3	25+TT	14.5-TT
117	23	0	4.5	0	0	18.5	4.0	3	25+TT	14.5-TT
118	23	0	4.5	2	0	18.5	4.0	3	25+TT	14.5-TT
119	23	0	4.5	0	0	18.5	4.0	3	25+TT	14.5-TT

Test ID	P _{PowerClass} (dBm)	ΔP _{PowerClass} (dB)	MPR (dB)	A-MPR (dB)	ΔT _{C,c} (dB)	P _{CMAX_L,c} (dBm)	T(P _{CMAX_L,c}) (dB)	T _{L,c} (dB)	Upper limit (dBm)	Lower limit (dBm)
120	23	0	4.5	2	0	18.5	4.0	3	25+TT	14.5-TT
121	23	0	4.5	0	0	18.5	4.0	3	25+TT	14.5-TT
122	23	0	4.5	0	0	18.5	4.0	3	25+TT	14.5-TT
123	23	0	4.5	0	0	18.5	4.0	3	25+TT	14.5-TT
124	23	0	4.5	0	0	18.5	4.0	3	25+TT	14.5-TT
125	23	0	4.5	0	0	18.5	4.0	3	25+TT	14.5-TT
126	23	0	4.5	2	0	18.5	4.0	3	25+TT	14.5-TT
127	23	0	4.5	0	0	18.5	4.0	3	25+TT	14.5-TT
128	23	0	4.5	2	0	18.5	4.0	3	25+TT	14.5-TT
141	23	0	3	6	0	17	5.0	3	25+TT	12-TT
142	23	0	3	6	0	17	5.0	3	25+TT	12-TT
143	23	0	3	6	0	17	5.0	3	25+TT	12-TT
144	23	0	3	6	0	17	5.0	3	25+TT	12-TT
145	23	0	3	4	0	19	3.5	3	25+TT	15.5-TT
146	23	0	3	2	0	20	2.5	3	25+TT	17-TT
147	23	0	3	4	0	19	3.5	3	25+TT	15.5-TT
148	23	0	3	2	0	20	2.5	3	25+TT	17-TT
149	23	0	3	6	0	17	5.0	3	25+TT	12-TT
150	23	0	3	6	0	17	5.0	3	25+TT	12-TT
151	23	0	3	6	0	17	5.0	3	25+TT	12-TT
152	23	0	3	6	0	17	5.0	3	25+TT	12-TT
153	23	0	3	4	0	19	3.5	3	25+TT	15.5-TT
154	23	0	3	2	0	20	2.5	3	25+TT	17-TT
155	23	0	3	4	0	19	3.5	3	25+TT	15.5-TT
156	23	0	3	2	0	20	2.5	3	25+TT	17-TT
169	23	0	3	6	0	17	5.0	3	25+TT	12-TT
170	23	0	3	6	0	17	5.0	3	25+TT	12-TT
171	23	0	3	6	0	17	5.0	3	25+TT	12-TT
172	23	0	3	6	0	17	5.0	3	25+TT	12-TT
173	23	0	3	4	0	19	3.5	3	25+TT	15.5-TT
174	23	0	3	2	0	20	2.5	3	25+TT	17-TT
175	23	0	3	4	0	19	3.5	3	25+TT	15.5-TT
176	23	0	3	2	0	20	2.5	3	25+TT	17-TT
177	23	0	3	6	0	17	5.0	3	25+TT	12-TT
178	23	0	3	6	0	17	5.0	3	25+TT	12-TT
179	23	0	3	6	0	17	5.0	3	25+TT	12-TT

Test ID	$P_{\text{PowerClass}}$ (dBm)	$\Delta P_{\text{PowerClass}}$ (dB)	MPR (dB)	A-MPR (dB)	$\Delta T_{C,c}$ (dB)	$P_{\text{CMAX}_L,c}$ (dBm)	$T(P_{\text{CMAX}_L,c})$ (dB)	$T_{L,c}$ (dB)	Upper limit (dBm)	Lower limit (dBm)
180	23	0	3	6	0	17	5.0	3	25+TT	12-TT
181	23	0	3	4	0	19	3.5	3	25+TT	15.5-TT
182	23	0	3	2	0	20	2.5	3	25+TT	17-TT
183	23	0	3	4	0	19	3.5	3	25+TT	15.5-TT
184	23	0	3	2	0	20	2.5	3	25+TT	17-TT
197	23	0	3.5	6	0	17	5.0	3	25+TT	12-TT
198	23	0	3.5	6	0	17	5.0	3	25+TT	12-TT
199	23	0	3.5	6	0	17	5.0	3	25+TT	12-TT
200	23	0	3.5	6	0	17	5.0	3	25+TT	12-TT
201	23	0	3.5	4	0	19	3.5	3	25+TT	15.5-TT
202	23	0	3.5	2	0	19.5	3.5	3	25+TT	16-TT
203	23	0	3.5	4	0	19	3.5	3	25+TT	15.5-TT
204	23	0	3.5	2	0	19.5	3.5	3	25+TT	16-TT
205	23	0	3.5	6	0	17	5.0	3	25+TT	12-TT
206	23	0	3.5	6	0	17	5.0	3	25+TT	12-TT
207	23	0	3.5	6	0	17	5.0	3	25+TT	12-TT
208	23	0	3.5	6	0	17	5.0	3	25+TT	12-TT
209	23	0	3.5	4	0	19	3.5	3	25+TT	15.5-TT
210	23	0	3.5	2	0	19.5	3.5	3	25+TT	16-TT
211	23	0	3.5	4	0	19	3.5	3	25+TT	15.5-TT
212	23	0	3.5	2	0	19.5	3.5	3	25+TT	16-TT
225	23	0	6.5	0	0	16.5	5.0	3	25+TT	11.5-TT
226	23	0	6.5	0	0	16.5	5.0	3	25+TT	11.5-TT
227	23	0	6.5	0	0	16.5	5.0	3	25+TT	11.5-TT
228	23	0	6.5	0	0	16.5	5.0	3	25+TT	11.5-TT
229	23	0	6.5	0	0	16.5	5.0	3	25+TT	11.5-TT
230	23	0	6.5	2	0	16.5	5.0	3	25+TT	11.5-TT
231	23	0	6.5	0	0	16.5	5.0	3	25+TT	11.5-TT
232	23	0	6.5	2	0	16.5	5.0	3	25+TT	11.5-TT
233	23	0	6.5	0	0	16.5	5.0	3	25+TT	11.5-TT
234	23	0	6.5	0	0	16.5	5.0	3	25+TT	11.5-TT
235	23	0	6.5	0	0	16.5	5.0	3	25+TT	11.5-TT
236	23	0	6.5	0	0	16.5	5.0	3	25+TT	11.5-TT
237	23	0	6.5	0	0	16.5	5.0	3	25+TT	11.5-TT
238	23	0	6.5	2	0	16.5	5.0	3	25+TT	11.5-TT
239	23	0	6.5	0	0	16.5	5.0	3	25+TT	11.5-TT

Test ID	$P_{\text{PowerClass}}$ (dBm)	$\Delta P_{\text{PowerClass}}$ (dB)	MPR (dB)	A-MPR (dB)	$\Delta T_{C,c}$ (dB)	$P_{\text{CMAX}_L,c}$ (dBm)	$T(P_{\text{CMAX}_L,c})$ (dB)	$T_{L,c}$ (dB)	Upper limit (dBm)	Lower limit (dBm)
240	23	0	6.5	2	0	16.5	5.0	3	25+TT	11.5-TT

NOTE 1: $P_{\text{PowerClass}}$ is the maximum UE power specified without taking into account the tolerance.
NOTE 2: TT for each frequency and channel bandwidth is specified in Table 6.21.3.5-0.

Table 6.21.3.5-17: UE Power Class 3 test requirements (NS_40)

Test ID	$P_{\text{PowerClass}}$ (dBm)	$\Delta P_{\text{PowerClass}}$ (dB)	MPR (dB)	A-MPR (dB)	$\Delta T_{C,c}$ (dB)	$P_{\text{C}_{\text{MAX}_L,c}}$ (dBm)	$T(P_{\text{C}_{\text{MAX}_L,c}})$ (dB)	$T_{L,c}$ (dB)	Upper limit (dBm)	Lower limit (dBm)
1	23	0	1	15.5	0	7.5	7.0	2	25+TT	0.5-TT
2	23	0	0	12	0	11	6.0	2	25+TT	5-TT
3	23	0	1	15.5	0	7.5	7.0	2	25+TT	0.5-TT
4	23	0	2	14.5	0	8.5	6.0	2	25+TT	2.5-TT
5	23	0	1	11	0	12	6.0	2	25+TT	6-TT
6	23	0	2	14.5	0	8.5	6.0	2	25+TT	2.5-TT
7	23	0	2.5	14.5	0	8.5	6.0	2	25+TT	2.5-TT
8	23	0	2.5	10	0	13	5.0	2	25+TT	8-TT
9	23	0	2.5	14.5	0	8.5	6.0	2	25+TT	2.5-TT
10	23	0	4.5	12.5	0	10.5	6.0	2	25+TT	4.5-TT
11	23	0	4.5	7.5	0	15.5	5.0	2	25+TT	10.5-TT
12	23	0	4.5	12.5	0	10.5	6.0	2	25+TT	4.5-TT
13	23	0	3	14.5	0	8.5	6.0	2	25+TT	2.5-TT
14	23	0	1.5	10	0	13	5.0	2	25+TT	8-TT
15	23	0	3	14.5	0	8.5	6.0	2	25+TT	2.5-TT
16	23	0	3	14.5	0	8.5	6.0	2	25+TT	2.5-TT
17	23	0	2	10	0	13	5.0	2	25+TT	8-TT
18	23	0	3	14.5	0	8.5	6.0	2	25+TT	2.5-TT
19	23	0	3.5	14	0	9	6.0	2	25+TT	3-TT
20	23	0	3.5	8	0	15	5.0	2	25+TT	10-TT
21	23	0	3.5	14	0	9	6.0	2	25+TT	3-TT
22	23	0	6.5	11	0	12	6.0	2	25+TT	6-TT
23	23	0	6.5	5.5	0	16.5	5.0	2	25+TT	11.5-TT
24	23	0	6.5	11	0	12	6.0	2	25+TT	6-TT

NOTE 1: $P_{\text{PowerClass}}$ is the maximum UE power specified without taking into account the tolerance.

NOTE 2: TT for each frequency and channel bandwidth is specified in Table 6.21.3.5-0.

Table 6.21.3.5-18: UE Power Class 3 test requirements (NS_41)

Test ID	$P_{\text{PowerClass}}$ (dBm)	$\Delta P_{\text{PowerClass}}$ (dB)	MPR (dB)	A-MPR (dB)	$\Delta T_{c,c}$ (dB)	$P_{\text{CMAX_L,c}}$ (dBm)	$T(P_{\text{CMAX_L,c}})$ (dB)	$T_{L,c}$ (dB)	Upper limit (dBm)	Lower limit (dBm)
1	23	0	0.5	9	0	14	5.0	2	25+TT	9-TT
2	23	0	0.5	9	0	14	5.0	2	25+TT	9-TT
3	23	0	0.5	11	0	12	6.0	2	25+TT	6-TT
4	23	0	0.5	11	0	12	6	2	25+TT	6-TT
5	23	0	0.5	12	0	11	6.0	2	25+TT	5-TT
6	23	0	0.5	12	0	11	6.0	2	25+TT	5-TT
7	23	0	0.5	13.5	0	9.5	6.0	2	25+TT	3.5-TT
8	23	0	0.5	13.5	0	9.5	6.0	2	25+TT	3.5-TT
9	23	0	1	9	0	14	5.0	2	25+TT	9-TT
10	23	0	1	9	0	14	5.0	2	25+TT	9-TT
11	23	0	1	11	0	12	6.0	2	25+TT	6-TT
12	23	0	1	11	0	12	6.0	2	25+TT	6-TT
13	23	0	1	12	0	11	6.0	2	25+TT	5-TT
14	23	0	1	12	0	11	6.0	2	25+TT	5-TT
15	23	0	1	13.5	0	9.5	6.0	2	25+TT	3.5-TT
16	23	0	1	13.5	0	9.5	6.0	2	25+TT	3.5-TT
17	23	0	2	9	0	14	5.0	2	25+TT	9-TT
18	23	0	2	9	0	14	5.0	2	25+TT	9-TT
19	23	0	2	11	0	12	6.0	2	25+TT	6-TT
20	23	0	2	11	0	12	6.0	2	25+TT	6-TT
21	23	0	2	12	0	11	6.0	2	25+TT	5-TT
22	23	0	2	12	0	11	6.0	2	25+TT	5-TT
23	23	0	2	13.5	0	9.5	6.0	2	25+TT	3.5-TT
24	23	0	2	13.5	0	9.5	6.0	2	25+TT	3.5-TT
25	23	0	2.5	9	0	14	5.0	2	25+TT	9-TT
26	23	0	2.5	9	0	14	5.0	2	25+TT	9-TT
27	23	0	2.5	11	0	12	6.0	2	25+TT	6-TT
28	23	0	2.5	11	0	12	6.0	2	25+TT	6-TT
29	23	0	2.5	12	0	11	6.0	2	25+TT	5-TT
30	23	0	2.5	12	0	11	6.0	2	25+TT	5-TT
31	23	0	2.5	13.5	0	9.5	6.0	2	25+TT	3.5-TT
32	23	0	2.5	13.5	0	9.5	6.0	2	25+TT	3.5-TT
33	23	0	4.5	9	0	14	5.0	2	25+TT	9-TT
34	23	0	4.5	9	0	14	5.0	2	25+TT	9-TT
35	23	0	4.5	11	0	12	6.0	2	25+TT	6-TT
36	23	0	4.5	11	0	12	6.0	2	25+TT	6-TT
37	23	0	4.5	12	0	11	6.0	2	25+TT	5-TT
38	23	0	4.5	12	0	11	6.0	2	25+TT	5-TT
39	23	0	4.5	13.5	0	9.5	6.0	2	25+TT	3.5-TT
40	23	0	4.5	13.5	0	9.5	6.0	2	25+TT	3.5-TT
41	23	0	3	9	0	14	5.0	2	25+TT	9-TT
42	23	0	3	9	0	14	5.0	2	25+TT	9-TT
43	23	0	3	11	0	12	6.0	2	25+TT	6-TT
44	23	0	3	11	0	12	6.0	2	25+TT	6-TT
45	23	0	3	12	0	11	6.0	2	25+TT	5-TT
46	23	0	3	12	0	11	6.0	2	25+TT	5-TT
47	23	0	3	13.5	0	9.5	6.0	2	25+TT	3.5-TT
48	23	0	3	13.5	0	9.5	6.0	2	25+TT	3.5-TT
49	23	0	3	9	0	14	5.0	2	25+TT	9-TT
50	23	0	3	9	0	14	5.0	2	25+TT	9-TT
51	23	0	3	11	0	12	6.0	2	25+TT	6-TT
52	23	0	3	11	0	12	6.0	2	25+TT	6-TT
53	23	0	3	12	0	11	6.0	2	25+TT	5-TT
54	23	0	3	12	0	11	6.0	2	25+TT	5-TT
55	23	0	3	13.5	0	9.5	6.0	2	25+TT	3.5-TT
56	23	0	3	13.5	0	9.5	6.0	2	25+TT	3.5-TT
57	23	0	3.5	9	0	14	5.0	2	25+TT	9-TT
58	23	0	3.5	9	0	14	5.0	2	25+TT	9-TT
59	23	0	3.5	11	0	12	6.0	2	25+TT	6-TT

Test ID	$P_{\text{PowerClass}}$ (dBm)	$\Delta P_{\text{PowerClass}}$ (dB)	MPR (dB)	A-MPR (dB)	$\Delta T_{C,c}$ (dB)	$P_{\text{CMAX}_L,c}$ (dBm)	$T(P_{\text{CMAX}_L,c})$ (dB)	$T_{L,c}$ (dB)	Upper limit (dBm)	Lower limit (dBm)
60	23	0	3.5	11	0	12	6.0	2	25+TT	6-TT
61	23	0	3.5	12	0	11	6.0	2	25+TT	5-TT
62	23	0	3.5	12	0	11	6.0	2	25+TT	5-TT
63	23	0	3.5	13.5	0	9.5	6.0	2	25+TT	3.5-TT
64	23	0	3.5	13.5	0	9.5	6.0	2	25+TT	3.5-TT
65	23	0	6.5	9	0	14	5.0	2	25+TT	9-TT
66	23	0	6.5	9	0	14	5.0	2	25+TT	9-TT
67	23	0	6.5	11	0	12	6.0	2	25+TT	6-TT
68	23	0	6.5	11	0	12	6.0	2	25+TT	6-TT
69	23	0	6.5	12	0	11	6.0	2	25+TT	5-TT
70	23	0	6.5	12	0	11	6.0	2	25+TT	5-TT
71	23	0	6.5	13.5	0	9.5	6.0	2	25+TT	3.5-TT
72	23	0	6.5	13.5	0	9.5	6.0	2	25+TT	3.5-TT

NOTE 1: $P_{\text{PowerClass}}$ is the maximum UE power specified without taking into account the tolerance.

NOTE 2: TT for each frequency and channel bandwidth is specified in Table 6.21.3.5-0.

Table 6.21.3.5-19: UE Power Class 3 test requirements (NS_42)

Test ID	$P_{\text{PowerClass}}$ (dBm)	$\Delta P_{\text{PowerClass}}$ (dB)	MPR (dB)	A-MPR (dB)	$\Delta T_{C,c}$ (dB)	$P_{\text{CMAX_L,c}}$ (dBm)	$T(P_{\text{CMAX_L,c}})$ (dB)	$T_{L,c}$ (dB)	Upper limit (dBm)	Lower limit (dBm)
1	23	0	0.5	7	0	16	5.0	2	25+TT	11-TT
2	23	0	0.5	4	0	19	3.5	2	25+TT	15.5-TT
3	23	0	0	1.5	0	21.5	2.0	2	25+TT	19.5-TT
4	23	0	0.5	8	0	15	5.0	2	25+TT	10-TT
5	23	0	0.5	5	0	18	4.0	2	25+TT	14-TT
6	23	0	0	1.5	0	21.5	2.0	2	25+TT	19.5-TT
7	23	0	1	7	0	16	5.0	2	25+TT	11-TT
8	23	0	1	4	0	19	3.5	2	25+TT	15.5-TT
9	23	0	0	1.5	0	21.5	2.0	2	25+TT	19.5-TT
10	23	0	1	8	0	15	5.0	2	25+TT	10-TT
11	23	0	1	5	0	18	4.0	2	25+TT	14-TT
12	23	0	0	1.5	0	21.5	2.0	2	25+TT	19.5-TT
13	23	0	2	7	0	16	5.0	2	25+TT	11-TT
14	23	0	2	4	0	19	3.5	2	25+TT	15.5-TT
15	23	0	1	1.5	0	21.5	2.0	2	25+TT	19.5-TT
16	23	0	2	8	0	15	5.0	2	25+TT	10-TT
17	23	0	2	5	0	18	4.0	2	25+TT	14-TT
18	23	0	1	1.5	0	21.5	2.0	2	25+TT	19.5-TT
19	23	0	2.5	7	0	16	5.0	2	25+TT	11-TT
20	23	0	2.5	4	0	19	3.5	2	25+TT	15.5-TT
21	23	0	2.5	1.5	0	20.5	2.5	2	25+TT	18-TT
22	23	0	2.5	8	0	15	5.0	2	25+TT	10-TT
23	23	0	2.5	5	0	18	4.0	2	25+TT	14-TT
24	23	0	2.5	1.5	0	20.5	2.5	2	25+TT	18-TT
25	23	0	4.5	7	0	16	5.0	2	25+TT	11-TT
26	23	0	4.5	4	0	18.5	4.0	2	25+TT	14.5-TT
27	23	0	4.5	1.5	0	18.5	4.0	2	25+TT	14.5-TT
28	23	0	4.5	8	0	15	5.0	2	25+TT	10-TT
29	23	0	4.5	5	0	18	4.0	2	25+TT	14-TT
30	23	0	4.5	1.5	0	18.5	4.0	2	25+TT	14.5-TT
31	23	0	3	7	0	16	5.0	2	25+TT	11-TT
32	23	0	3	4	0	19	3.5	2	25+TT	15.5-TT
33	23	0	1.5	1.5	0	21.5	2.0	2	25+TT	19.5-TT
34	23	0	3	8	0	15	5.0	2	25+TT	10-TT
35	23	0	3	5	0	18	4.0	2	25+TT	14-TT
36	23	0	1.5	1.5	0	21.5	2.0	2	25+TT	19.5-TT
37	23	0	3	7	0	16	5.0	2	25+TT	11-TT
38	23	0	3	4	0	19	3.5	2	25+TT	15.5-TT
39	23	0	2	1.5	0	21	2.0	2	25+TT	19-TT
40	23	0	3	8	0	15	5.0	2	25+TT	10-TT
41	23	0	3	5	0	18	4.0	2	25+TT	14-TT
42	23	0	2	1.5	0	21	2.0	2	25+TT	19-TT
43	23	0	3.5	7	0	16	5.0	2	25+TT	11-TT
44	23	0	3.5	4	0	19	3.5	2	25+TT	15.5-TT
45	23	0	3.5	1.5	0	19.5	3.5	2	25+TT	16-TT
46	23	0	3.5	8	0	15	5.0	2	25+TT	10-TT
47	23	0	3.5	5	0	18	4.0	2	25+TT	14-TT
48	23	0	3.5	1.5	0	19.5	3.5	2	25+TT	16-TT
49	23	0	6.5	7	0	16	5.0	2	25+TT	11-TT
50	23	0	6.5	4	0	16.5	5.0	2	25+TT	11.5-TT
51	23	0	6.5	1.5	0	16.5	5.0	2	25+TT	11.5-TT
52	23	0	6.5	8	0	15	5.0	2	25+TT	10-TT
53	23	0	6.5	5	0	16.5	5.0	2	25+TT	11.5-TT
54	23	0	6.5	1.5	0	16.5	5.0	2	25+TT	11.5-TT

NOTE 1: $P_{\text{PowerClass}}$ is the maximum UE power specified without taking into account the tolerance.

NOTE 2: TT for each frequency and channel bandwidth is specified in Table 6.21.3.5-0.

Table 6.21.3.5-20: UE Power Class 3 test requirements (NS_12) for n26

Test ID	P _{PowerClass} (dBm)	MPR (dB)	A-MPR (dB)	$\Delta T_{C,c}$ (dB)	P _{C_{MAX}L,c} (dBm)	T(P _{C_{MAX}L,c}) (dB)	T _{L,c} (dB)	Upper limit (dBm)	Lower limit (dBm)
1-3	23	N/A	5	1.5	16.5	5	2	25+TT	11.5-TT
	23	N/A	5.5	1.5	16	5	2	25+TT	11-TT
	23	N/A	9.5	1.5	12	6	2	25+TT	6-TT
4-6	23	N/A	5	0	18	4	2	25+TT	14-TT
	23	N/A	5.5	0	17.5	5	2	25+TT	12.5-TT
	23	N/A	9.5	0	13.5	5	2	25+TT	8.5-TT
7-9	23	N/A	5	1.5	16.5	5	2	25+TT	11.5-TT
	23	N/A	5.5	1.5	16	5	2	25+TT	11-TT
	23	N/A	9.5	1.5	12	6	2	25+TT	6-TT
10-12	23	N/A	5	0	18	4	2	25+TT	14-TT
	23	N/A	5.5	0	17.5	5	2	25+TT	12.5-TT
	23	N/A	9.5	0	13.5	5	2	25+TT	8.5-TT
13	23	0	N/A	0	23	2	2	25+TT	21-TT
14	23	0	N/A	0	23	2	2	25+TT	21-TT
15-16	23	N/A	7	1.5	14.5	5	2	25+TT	9.5-TT
	23	N/A	9.5	1.5	12	6	2	25+TT	6-TT
17-18	23	N/A	7	0	16	5	2	25+TT	11-TT
	23	N/A	9.5	0	13.5	5	2	25+TT	8.5-TT
19-20	23	N/A	7	1.5	14.5	5	2	25+TT	9.5-TT
	23	N/A	9.5	1.5	12	6	2	25+TT	6-TT
21-22	23	N/A	7	0	16	5	2	25+TT	11-TT
	23	N/A	9.5	0	13.5	5	2	25+TT	8.5-TT
23	23	1.5	0	0	21.5	2	2	25+TT	19.5-TT
24	23	1.5	0	0	21.5	2	2	25+TT	19.5-TT

NOTE 1: P_{PowerClass} is the maximum UE power specified without taking into account the tolerance.
NOTE 2: TT for each frequency and channel bandwidth is specified in Table 6.21.3.5-0.

Table 6.21.3.5-21: UE Power Class 3 test requirements (NS_13) for n26

Test ID	P _{PowerClass} (dBm)	MPR (dB)	A-MPR (dB)	$\Delta T_{C,c}$ (dB)	P _{CMAX_L,c} (dBm)	T(P _{CMAX_L,c}) (dB)	T _{L,c} (dB)	Upper limit (dBm)	Lower limit (dBm)
1-3	23	N/A	3.5	1.5	18	4	2	25+TT	14-TT
	23	N/A	4.5	1.5	17	5	2	25+TT	12-TT
	23	N/A	8	1.5	13.5	5	2	25+TT	8.5-TT
4-6	23	N/A	4.5	0	18.5	4	2	25+TT	14.5-TT
	23	N/A	5	0	18	4	2	25+TT	14-TT
	23	N/A	6	0	17	5	2	25+TT	12-TT
7-9	23	N/A	3.5	0	19.5	3.5	2	25+TT	16-TT
	23	N/A	4.5	0	18.5	4	2	25+TT	14.5-TT
	23	N/A	8	0	15	5	2	25+TT	10-TT
10	23	N/A	3	0	20	2.5	2	25+TT	17.5-TT
11	23	1	N/A	0	22	2	2	25+TT	20-TT
12-14	23	N/A	5	1.5	16.5	5	2	25+TT	11.5-TT
	23	N/A	6	1.5	15.5	5	2	25+TT	10.5-TT
	23	N/A	8	1.5	13.5	5	2	25+TT	8.5-TT
15-16	23	N/A	6.5	0	16.5	5	2	25+TT	11.5-TT
	23	N/A	8	0	15	5	2	25+TT	10-TT
17-19	23	N/A	5	0	18	4	2	25+TT	14-TT
	23	N/A	6	0	17	5	2	25+TT	12-TT
	23	N/A	8	0	15	5	2	25+TT	10-TT
20	23	N/A	4.5	0	18.5	4	2	25+TT	14.5-TT
21	23	3	N/A	0	20	2.5	2	25+TT	17.5-TT

NOTE 1: P_{PowerClass} is the maximum UE power specified without taking into account the tolerance.
NOTE 2: TT for each frequency and channel bandwidth is specified in Table 6.21.3.5-0.

Table 6.21.3.5-22: UE Power Class 3 test requirements (NS_14) for n26 low range

Test ID	P _{PowerClass} (dBm)	MPR (dB)	A-MPR (dB)	$\Delta T_{C,c}$ (dB)	P _{CMAX_L,c} (dBm)	T(P _{CMAX_L,c}) (dB)	T _{L,c} (dB)	Upper limit (dBm)	Lower limit (dBm)
1	23	N/A	3	1.5	18.5	4	2	25+TT	14.5-TT
2	23	N/A	2	0	21	2	2	25+TT	19-TT
3	23	N/A	3	1.5	18.5	4	2	25+TT	14.5-TT
4	23	N/A	2	0	21	2	2	25+TT	19-TT
5-6	23	N/A	3	1.5	18.5	4	2	25+TT	14.5-TT
	23	N/A	8	1.5	13.5	5	2	25+TT	8.5-TT
7	23	N/A	2	0	21	2	2	25+TT	19-TT
8	23	0	N/A	1.5	21.5	2	2	25+TT	19.5-TT
9	23	0	N/A	1.5	21.5	2	2	25+TT	19.5-TT
10	23	0	N/A	1.5	21.5	2	2	25+TT	19.5-TT
11-13	23	N/A	5	1.5	16.5	5	2	25+TT	11.5-TT
	23	N/A	6	1.5	15.5	5	2	25+TT	10.5-TT
	23	N/A	8	1.5	13.5	5	2	25+TT	8.5-TT
14	23	N/A	4	0	19	3.5	2	25+TT	15.5-TT
15-17	23	N/A	5	1.5	16.5	5	2	25+TT	11.5-TT
	23	N/A	6	1.5	15.5	5	2	25+TT	10.5-TT
	23	N/A	7	1.5	14.5	5	2	25+TT	9.5-TT
18	23	N/A	4	0	19	3.5	2	25+TT	15.5-TT
19-21	23	N/A	5	1.5	16.5	5	2	25+TT	11.5-TT
	23	N/A	6	1.5	15.5	5	2	25+TT	10.5-TT
	23	N/A	8	1.5	13.5	5	2	25+TT	8.5-TT
22	23	N/A	4	0	19	3.5	2	25+TT	15.5-TT
23	23	1.5	N/A	1.5	20	2.5	2	25+TT	17.5-TT
24	23	1.5	N/A	1.5	20	2.5	2	25+TT	17.5-TT
25	23	1.5	N/A	1.5	20	2.5	2	25+TT	17.5-TT

NOTE 1: P_{PowerClass} is the maximum UE power specified without taking into account the tolerance.
NOTE 2: TT for each frequency and channel bandwidth is specified in Table 6.21.3.5-0.

Table 6.21.3.5-23: UE Power Class 3 test requirements (NS_14) for n26 high range

Test ID	P _{PowerClass} (dBm)	MPR (dB)	A-MPR (dB)	$\Delta T_{C,c}$ (dB)	P _{CMAX_L,c} (dBm)	T(P _{CMAX_L,c}) (dB)	T _{L,c} (dB)	Upper limit (dBm)	Lower limit (dBm)
1	23	N/A	3	0	20	2.5	2	25+TT	17.5-TT
2	23	N/A	2	0	21	2	2	25+TT	19-TT
3	23	N/A	3	0	20	2.5	2	25+TT	17.5-TT
4	23	N/A	2	0	21	2	2	25+TT	19-TT
5-6	23	N/A	3	0	20	2.5	2	25+TT	17.5-TT
	23	N/A	8	0	15	5	2	25+TT	10-TT
7	23	N/A	2	0	21	2	2	25+TT	19-TT
8	23	0	N/A	0	23	2	2	25+TT	21-TT
9	23	0	N/A	0	23	2	2	25+TT	21-TT
10	23	0	N/A	0	23	2	2	25+TT	21-TT
11-13	23	N/A	5	0	18	4	2	25+TT	14-TT
	23	N/A	6	0	17	5	2	25+TT	12-TT
	23	N/A	8	0	15	5	2	25+TT	10-TT
14	23	N/A	4	0	19	3.5	2	25+TT	15.5-TT
15-17	23	N/A	5	0	18	4	2	25+TT	14-TT
	23	N/A	6	0	17	5	2	25+TT	12-TT
	23	N/A	7	0	16	5	2	25+TT	11-TT
18	23	N/A	4	0	19	3.5	2	25+TT	15.5-TT
19-21	23	N/A	5	0	18	4	2	25+TT	14-TT
	23	N/A	6	0	17	5	2	25+TT	12-TT
	23	N/A	8	0	15	5	2	25+TT	10-TT
22	23	N/A	4	0	19	3.5	2	25+TT	15.5-TT
23	23	1.5	N/A	1.5	20	2.5	2	25+TT	17.5-TT
24	23	1.5	N/A	1.5	20	2.5	2	25+TT	17.5-TT
25	23	1.5	N/A	1.5	20	2.5	2	25+TT	17.5-TT

NOTE 1: P_{PowerClass} is the maximum UE power specified without taking into account the tolerance.

NOTE 2: TT for each frequency and channel bandwidth is specified in Table 6.21.3.5-0.

Table 6.21.3.5-24: UE Power Class 3 test requirements (NS_15) for n26

Test ID	P _{PowerClass} (dBm)	MPR (dB)	A-MPR (dB)	$\Delta T_{C,c}$ (dB)	P _{CMAX_L,c} (dBm)	T(P _{CMAX_L,c}) (dB)	T _{L,c} (dB)	Upper limit (dBm)	Lower limit (dBm)
1	23	N/A	9	0	12.5	6	2	25+TT	6.5-TT
2	23	N/A	9	0	14	5	2	25+TT	9-TT
3	23	N/A	5	0	18	4	2	25+TT	14-TT
4-5	23	N/A	4	0	19	3.5	2	25+TT	15.5-TT
	23	N/A	9	0	14	5	2	25+TT	9-TT
6-7	23	N/A	9	0	12.5	6	2	25+TT	6.5-TT
	23	N/A	13.5	0	8	6	2	25+TT	2-TT
8	23	N/A	9	0	14	5	2	25+TT	9-TT
9	23	N/A	5	0	18	4	2	25+TT	14-TT
10-11	23	N/A	4	0	19	3.5	2	25+TT	15.5-TT
	23	N/A	9	0	14	5	2	25+TT	9-TT
12-13	23	N/A	9	0	14	5	2	25+TT	9-TT
	23	N/A	9	0	14	5	2	25+TT	9-TT
14	23	N/A	9	0	14	5	2	25+TT	9-TT
15	23	N/A	5	0	18	4	2	25+TT	14-TT
16-17	23	N/A	4	0	19	3.5	2	25+TT	15.5-TT
	23	N/A	9	0	14	5	2	25+TT	9-TT
18-19	23	N/A	9	0	12.5	6	2	25+TT	6.5-TT
	23	N/A	13.5	0	8	6	2	25+TT	2-TT
20	23	N/A	9	0	14	5	2	25+TT	9-TT
21	23	N/A	5	0	18	4	2	25+TT	14-TT
22-23	23	N/A	4	0	19	3.5	2	25+TT	15.5-TT
	23	N/A	9	0	14	5	2	25+TT	9-TT
24-25	23	N/A	9	0	14	5	2	25+TT	9-TT
	23	N/A	13.5	0	9.5	6	2	25+TT	3.5-TT
26	23	N/A	9	0	14	5	2	25+TT	9-TT
27	23	N/A	5	0	18	4	2	25+TT	14-TT
28-29	23	N/A	4	0	19	3.5	2	25+TT	15.5-TT
	23	N/A	9	0	14	5	2	25+TT	9-TT
30-31	23	N/A	9	0	14	5	2	25+TT	9-TT
	23	N/A	9	0	14	5	2	25+TT	9-TT
32	23	N/A	9	0	14	5	2	25+TT	9-TT
33	23	N/A	5	0	18	4	2	25+TT	14-TT
34-35	23	N/A	4	0	19	3.5	2	25+TT	15.5-TT
	23	N/A	9	0	14	5	2	25+TT	9-TT
36-37	23	N/A	9	0	12.5	6	2	25+TT	6.5-TT
	23	N/A	13.5	0	8	6	2	25+TT	2-TT
38	23	N/A	9	0	14	5	2	25+TT	9-TT
39	23	N/A	5	0	18	4	2	25+TT	14-TT
40-41	23	N/A	4	0	19	3.5	2	25+TT	15.5-TT
	23	N/A	9	0	14	5	2	25+TT	9-TT
42-43	23	N/A	9	0	14	5	2	25+TT	9-TT
	23	N/A	13.5	0	9.5	6	2	25+TT	3.5-TT
44	23	N/A	9	0	14	5	2	25+TT	9-TT
45	23	N/A	5	0	18	4	2	25+TT	14-TT

Test ID	P ^{PowerClass} (dBm)	MPR (dB)	A-MPR (dB)	$\Delta T_{C,c}$ (dB)	P _{CMAX_L,c} (dBm)	T(P _{CMAX_L,c}) (dB)	T _{L,c} (dB)	Upper limit (dBm)	Lower limit (dBm)
46-47	23	N/A	4	0	19	3.5	2	25+TT	15.5-TT
	23	N/A	9	0	14	5	2	25+TT	9-TT
48	23	1	N/A	0	22	2	2	25+TT	20-TT
49	23	1	N/A	0	22	2	2	25+TT	20-TT
50	23	0	N/A	0	23	2	2	25+TT	21-TT
51	23	0	N/A	0	23	2	2	25+TT	21-TT
52	23	N/A	10.5	0	11	6	2	25+TT	5-TT
53	23	N/A	10.5	0	12.5	6	2	25+TT	6.5-TT
54	23	N/A	6.5	0	16.5	5	2	25+TT	11.5-TT
55-56	23	N/A	4	0	19	3.5	2	25+TT	15.5-TT
	23	N/A	9	0	14	5	2	25+TT	9-TT
57-58	23	N/A	10.5	0	11	6	2	25+TT	5-TT
	23	N/A	13.5	0	8	6	2	25+TT	2-TT
59	23	N/A	10.5	0	12.5	6	2	25+TT	6.5-TT
60	23	N/A	6.5	0	16.5	5	2	25+TT	11.5-TT
61-62	23	N/A	4	0	19	3.5	2	25+TT	15.5-TT
	23	N/A	9	0	14	5	2	25+TT	9-TT
63-64	23	N/A	10.5	0	12.5	6	2	25+TT	6.5-TT
	23	N/A	10.5	0	12.5	6	2	25+TT	6.5-TT
65	23	N/A	10.5	0	12.5	6	2	25+TT	6.5-TT
66	23	N/A	6.5	0	16.5	5	2	25+TT	11.5-TT
67-68	23	N/A	4	0	19	3.5	2	25+TT	15.5-TT
	23	N/A	9	0	14	5	2	25+TT	9-TT
69-70	23	N/A	10.5	0	11	6	2	25+TT	5-TT
	23	N/A	13.5	0	8	6	2	25+TT	2-TT
71	23	N/A	10.5	0	12.5	6	2	25+TT	6.5-TT
72	23	N/A	6.5	0	16.5	5	2	25+TT	11.5-TT
73-74	23	N/A	4	0	19	3.5	2	25+TT	15.5-TT
	23	N/A	9	0	14	5	2	25+TT	9-TT
75-76	23	N/A	10.5	0	12.5	6	2	25+TT	6.5-TT
	23	N/A	13.5	0	9.5	6	2	25+TT	3.5-TT
77	23	N/A	10.5	0	12.5	6	2	25+TT	6.5-TT
78	23	N/A	6.5	0	16.5	5	2	25+TT	11.5-TT
79-80	23	N/A	4	0	19	3.5	2	25+TT	15.5-TT
	23	N/A	9	0	14	5	2	25+TT	9-TT
81-82	23	N/A	10.5	0	12.5	6	2	25+TT	6.5-TT
	23	N/A	10.5	0	12.5	6	2	25+TT	6.5-TT
83	23	N/A	10.5	0	12.5	6	2	25+TT	6.5-TT
84	23	N/A	6.5	0	16.5	5	2	25+TT	11.5-TT
85-86	23	N/A	4	0	19	3.5	2	25+TT	15.5-TT
	23	N/A	9	0	14	5	2	25+TT	9-TT
87-88	23	N/A	10.5	0	11	6	2	25+TT	5-TT
	23	N/A	13.5	0	8	6	2	25+TT	2-TT
89	23	N/A	10.5	0	12.5	6	2	25+TT	6.5-TT

Test ID	P _{PowerClass} (dBm)	MPR (dB)	A-MPR (dB)	$\Delta T_{C,c}$ (dB)	P _{CMAX_L,c} (dBm)	T(P _{CMAX_L,c}) (dB)	T _{L,c} (dB)	Upper limit (dBm)	Lower limit (dBm)
90	23	N/A	6.5	0	16.5	5	2	25+TT	11.5-TT
91-92	23	N/A	4	0	19	3.5	2	25+TT	15.5-TT
	23	N/A	9	0	14	5	2	25+TT	9-TT
93-94	23	N/A	10.5	0	12.5	6	2	25+TT	6.5-TT
	23	N/A	13.5	0	9.5	6	2	25+TT	3.5-TT
95	23	N/A	10.5	0	12.5	6	2	25+TT	6.5-TT
96	23	N/A	6.5	0	16.5	5	2	25+TT	11.5-TT
97-98	23	N/A	4	0	19	3.5	2	25+TT	15.5-TT
	23	N/A	9	0	14	5	2	25+TT	9-TT
99	23	3	N/A	0	20	2.5	2	25+TT	17.5-TT
100	23	3	N/A	0	20	2.5	2	25+TT	17.5-TT
101	23	1.5	N/A	0	21.5	2	2	25+TT	19.5-TT
102	23	1.5	N/A	0	21.5	2	2	25+TT	19.5-TT

NOTE 1: P_{PowerClass} is the maximum UE power specified without taking into account the tolerance.
NOTE 2: TT for each frequency and channel bandwidth is specified in Table 6.21.3.5-0.

Table 6.21.3.5-25: UE Power Class 3 test requirements for NS_45 (contiguous allocation)

Test ID	P _{PowerClass} (dBm)	MPR (dB)	A-MPR (dB)	$\Delta T_{C,c}$ (dB)	P _{CMAX,c} (dBm)	T(P _{CMAX_L,c}) (dB)	T _{L,c} (dB)	Upper limit (dBm)	Lower limit (dBm)
1, 2	23	0.5	1.5	0	21.5	2	2	25+TT	19.5-TT
3	23	0.5	1.5	0	21.5	2	2	25+TT	19.5-TT
4, 5	23	1	2	0	21	2	2	25+TT	19-TT
6	23	1	2	0	21	2	2	25+TT	19-TT
7, 8	23	2	2.5	0	20.5	2.5	2	25+TT	18-TT
9	23	2	2.5	0	20.5	2.5	2	25+TT	18-TT
10, 11	23	2.5	3	0	20	2.5	2	25+TT	17.5-TT
12	23	2.5	3	0	20	2.5	2	25+TT	17.5-TT

NOTE 1: P_{PowerClass} is the maximum UE power specified without taking into account the tolerance.
NOTE 2: TT for each frequency and channel bandwidth is specified in Table 6.21.3.5-0.

Table 6.21.3.5-26: UE Power Class 3 test requirements (NS_21)

Test ID	ChBw (MHz)	P _{PowerClass} (dBm)	MPR (dB)	A-MPR (dB)	ΔT _{C,c} (dB)	P _{C_{MAX}L,c} (dBm)	T(P _{C_{MAX}L,c}) (dB)	T _{L,c} (dB)	Upper limit (dBm)	Lower limit (dBm)
1, 2	5	23	0.5	0	0	22.5	2	2	25+TT	20.5-TT
	10	23	0.5	6	0	17	5	2	25+TT	12-TT
3	5	23	0.5	0	0	22.5	2	2	25+TT	20.5-TT
	10	23	0.5	4	0	19	3.5	2	25+TT	15.5-TT
4, 5	10	23	3	3	0	20	2.5	2	25+TT	17.5-TT
6, 7	5	23	1	0	0	22	2	2	25+TT	20-TT
	10	23	1	6	0	17	5	2	25+TT	12-TT
8	5	23	1	0	0	22	2	2	25+TT	20-TT
	10	23	1	4	0	19	3.5	2	25+TT	15.5-TT
9, 10	10	23	1	3	0	20	2.5	2	25+TT	17.5-TT
11, 12	5	23	2	0	0	21	2	2	25+TT	19-TT
	10	23	2	6	0	17	5	2	25+TT	12-TT
13	5	23	2	0	0	21	2	2	25+TT	19-TT
	10	23	2	4	0	19	3.5	2	25+TT	15.5-TT
14, 15	10	23	2	3	0	20	2.5	2	25+TT	17.5-TT
16, 17	5	23	2.5	0	0	20.5	2.5	2	25+TT	18-TT
	10	23	2.5	6	0	17	5	2	25+TT	12-TT
18	5	23	2.5	0	0	20.5	2.5	2	25+TT	18-TT
	10	23	2.5	4	0	19	3.5	2	25+TT	15.5-TT
19, 20	10	23	2.5	3	0	20	2.5	2	25+TT	17.5-TT
21, 22	5	23	4.5	0	0	18.5	4.0	2	25+TT	14.5-TT
	10	23	4.5	6	0	17	5.0	2	25+TT	12-TT
23	5	23	4.5	0	0	18.5	4.0	2	25+TT	14.5-TT
	10	23	4.5	4	0	18.5	4.0	2	25+TT	14.5-TT
24, 25	10	23	4.5	3	0	18.5	4.0	2	25+TT	14.5-TT
26, 27	5	23	3	0	0	20	2.5	2	25+TT	17.5-TT
	10	23	3	6	0	17	5	2	25+TT	12-TT
28	5	23	3	0	0	20	2.5	2	25+TT	17.5-TT
	10	23	3	5.5	0	17.5	5	2	25+TT	12.5-TT
29, 30	10	23	3	4	0	19	3.5	2	25+TT	15.5-TT
31, 32	5	23	3	0	0	20	2.5	2	25+TT	17.5-TT
	10	23	3	6	0	17	5	2	25+TT	12-TT
33	5	23	3	0	0	20	2.5	2	25+TT	17.5-TT
	10	23	3	5.5	0	17.5	5	2	25+TT	12.5-TT
34, 35	10	23	3	4	0	19	3.5	2	25+TT	15.5-TT
36, 37	5	23	3.5	0	0	19.5	3.5	2	25+TT	16-TT
	10	23	3.5	6	0	17	5	2	25+TT	12-TT
38	5	23	3.5	0	0	19.5	3.5	2	25+TT	16-TT
	10	23	3.5	5.5	0	17.5	5	2	25+TT	12.5-TT
39, 40	10	23	3.5	4	0	19	3.5	2	25+TT	15.5-TT
41, 42	5	23	6.5	0	0	16.5	5	2	25+TT	11.5-TT
	10	23	6.5	6	0	16.5	5	2	25+TT	11.5-TT
43	5	23	6.5	0	0	16.5	5	2	25+TT	11.5-TT
44, 45	10	23	6.5	5.5	0	16.5	5	2	25+TT	11.5-TT
	10	23	6.5	4	0	16.5	5	2	25+TT	11.5-TT

NOTE 1: P_{PowerClass} is the maximum UE power specified without taking into account the tolerance.

NOTE 2: TT for each frequency and channel bandwidth is specified in Table 6.21.3.5-0.

Table 6.2I.3.5-27: UE Power Class 3 test requirements (NS_06) for band n12 and n14

Test ID	P _{PowerClass} (dBm)	MPR (dB)	A-MPR (dB)	$\Delta T_{C,c}$ (dB)	P _{C_{MAX,c}} (dBm)	T(P _{C_{MAX,L,c}}) (dB)	T _{L,c} (dB)	Upper limit (dBm)	Lower limit (dBm)
1	23	0.5	0	0	22.5	2	2.5	25+TT	20.5-TT
2	23	0.5	0	0	22.5	2	2.5	25+TT	20.5-TT
3	23	0.5	0	0	22.5	2	2.5	25+TT	20.5-TT
4	23	1	0	0	22	2	2.5	25+TT	20-TT
5	23	1	0	0	22	2	2.5	25+TT	20-TT
6	23	1	0	0	22	2	2.5	25+TT	20-TT
7	23	2	0	0	21	2	2.5	25+TT	19-TT
8	23	2	0	0	21	2	2.5	25+TT	19-TT
9	23	2	0	0	21	2	2.5	25+TT	19-TT
10	23	2.5	0	0	20.5	2.5	2.5	25+TT	18-TT
11	23	2.5	0	0	20.5	2.5	2.5	25+TT	18-TT
12	23	2.5	0	0	20.5	2.5	2.5	25+TT	18-TT
13	23	4.5	0	0	18.5	4	2.5	25+TT	14.5-TT
14	23	4.5	0	0	18.5	4	2.5	25+TT	14.5-TT
15	23	4.5	0	0	18.5	4	2.5	25+TT	14.5-TT
16	23	3	0	0	20	2.5	2.5	25+TT	17.5-TT
17	23	3	0	0	20	2.5	2.5	25+TT	17.5-TT
18	23	3	0	0	20	2.5	2.5	25+TT	17.5-TT
19	23	3	0	0	20	2.5	2.5	25+TT	17.5-TT
20	23	3	0	0	20	2.5	2.5	25+TT	17.5-TT
21	23	3	0	0	20	2.5	2.5	25+TT	17.5-TT
22	23	3.5	0	0	19.5	3.5	2.5	25+TT	16-TT
23	23	3.5	0	0	19.5	3.5	2.5	25+TT	16-TT
24	23	3.5	0	0	19.5	3.5	2.5	25+TT	16-TT
25	23	6.5	0	0	16.5	5	2.5	25+TT	11.5-TT
26	23	6.5	0	0	16.5	5	2.5	25+TT	11.5-TT
27	23	6.5	0	0	16.5	5	2.5	25+TT	11.5-TT

NOTE 1: P_{PowerClass} is the maximum UE power specified without taking into account the tolerance.
NOTE 2: TT for each frequency and channel bandwidth is specified in Table 6.2I.3.5-0.

Table 6.2I.3.5-28: UE Power Class 3 test requirements (NS_56) for band n24

Test ID	P ^{PowerClass} (dBm)	MPR (dB)	A-MPR (dB)	$\Delta T_{C,c}$ (dB)	P _{CMAX,c} (dBm)	T(P _{CMAX,L,c}) (dB)	T _{L,c} (dB)	Upper limit (dBm)	Lower limit (dBm)
1	23	0.5	14	0	9	6	3	25+TT	3-TT
2	23	0.5	8	0	15	5	3	25+TT	10-TT
3	23	0.5	6	0	17	5	3	25+TT	12-TT
4	23	0.5	4	0	19	3.5	3	25+TT	15.5-TT
5	23	0	4	0	19	3.5	3	25+TT	15.5-TT
6	23	1	14	0	9	6	3	25+TT	3-TT
7	23	1	8	0	15	5	3	25+TT	10-TT
8	23	1	6	0	17	5	3	25+TT	12-TT
9	23	1	4	0	19	3.5	3	25+TT	15.5-TT
10	23	0	4	0	19	3.5	3	25+TT	15.5-TT
11	23	2	14	0	9	6	3	25+TT	3-TT
12	23	2	8	0	15	5	3	25+TT	10-TT
13	23	2	6	0	17	5	3	25+TT	12-TT
14	23	2	4	0	19	3.5	3	25+TT	15.5-TT
15	23	1	4	0	19	3.5	3	25+TT	15.5-TT
16	23	2.5	14	0	9	6	3	25+TT	3-TT
17	23	2.5	8	0	15	5	3	25+TT	10-TT
18	23	2.5	6	0	17	5	3	25+TT	12-TT
19	23	2.5	4	0	19	3.5	3	25+TT	15.5-TT
20	23	2.5	4	0	19	3.5	3	25+TT	15.5-TT
21	23	4.5	14	0	9	6	3	25+TT	3-TT
22	23	4.5	8	0	15	5	3	25+TT	10-TT
23	23	4.5	6	0	17	5	3	25+TT	12-TT
24	23	4.5	4	0	18.5	3.5	3	25+TT	15-TT
25	23	4.5	4	0	18.5	3.5	3	25+TT	15-TT
26	23	0.5	12	0	11	6	3	25+TT	5-TT
27	23	0.5	8	0	15	5	3	25+TT	10-TT
28	23	0.5	8	0	15	5	3	25+TT	10-TT
29	23	0	6	0	17	5	3	25+TT	12-TT
30	23	0.5	6	0	17	5	3	25+TT	12-TT
31	23	0	4	0	19	3.5	3	25+TT	15.5-TT
32	23	0.5	2	0	21	2	3	25+TT	18-TT
33	23	0.5	5	0	18	4	3	25+TT	14-TT
34	23	0	5	0	18	4	3	25+TT	14-TT
35	23	0	5	0	18	4	3	25+TT	14-TT
36	23	0.5	3	0	20	2.5	3	25+TT	17-TT
37	23	1	12	0	11	6	3	25+TT	5-TT
38	23	1	8	0	15	5	3	25+TT	10-TT
39	23	1	8	0	15	5	3	25+TT	10-TT
40	23	0	6	0	17	5	3	25+TT	12-TT
41	23	1	6	0	17	5	3	25+TT	12-TT
42	23	0	4	0	19	3.5	3	25+TT	15.5-TT
43	23	1	2	0	21	2	3	25+TT	18-TT
44	23	1	5	0	18	4	3	25+TT	14-TT
45	23	0	5	0	18	4	3	25+TT	14-TT
46	23	0	5	0	18	4	3	25+TT	14-TT
47	23	1	3	0	20	2.5	3	25+TT	17-TT
48	23	2	12	0	11	6	3	25+TT	5-TT
49	23	2	8	0	15	5	3	25+TT	10-TT
50	23	2	8	0	15	5	3	25+TT	10-TT
51	23	1	6	0	17	5	3	25+TT	12-TT
52	23	2	6	0	17	5	3	25+TT	12-TT
53	23	1	4	0	19	3.5	3	25+TT	15.5-TT
54	23	2	2	0	21	2	3	25+TT	18-TT
55	23	2	5	0	18	4	3	25+TT	14-TT
56	23	1	5	0	18	4	3	25+TT	14-TT
57	23	1	5	0	18	4	3	25+TT	14-TT
58	23	2	3	0	20	2.5	3	25+TT	17-TT
59	23	2.5	12	0	11	6	3	25+TT	5-TT

Test ID	P _{PowerClass} (dBm)	MPR (dB)	A-MPR (dB)	$\Delta T_{C,c}$ (dB)	P _{C_{MAX,c}} (dBm)	T(P _{C_{MAX,L,c}}) (dB)	T _{L,c} (dB)	Upper limit (dBm)	Lower limit (dBm)
60	23	2.5	8	0	15	5	3	25+TT	10-TT
61	23	2.5	8	0	15	5	3	25+TT	10-TT
62	23	2.5	6	0	17	5	3	25+TT	12-TT
63	23	2.5	6	0	17	5	3	25+TT	12-TT
64	23	2.5	4	0	19	3.5	3	25+TT	15.5-TT
65	23	2.5	2	0	20.5	2.5	3	25+TT	17.5-TT
66	23	2.5	5	0	18	4	3	25+TT	14-TT
67	23	2.5	5	0	18	4	3	25+TT	14-TT
68	23	2.5	5	0	18	4	3	25+TT	14-TT
69	23	2.5	3	0	20	2.5	3	25+TT	17-TT
70	23	4.5	12	0	11	6	3	25+TT	5-TT
71	23	4.5	8	0	15	5	3	25+TT	10-TT
72	23	4.5	8	0	15	5	3	25+TT	10-TT
73	23	4.5	6	0	17	5	3	25+TT	12-TT
74	23	4.5	6	0	17	5	3	25+TT	12-TT
75	23	4.5	4	0	18.5	4	3	25+TT	14.5-TT
76	23	4.5	2	0	18.5	4	3	25+TT	14.5-TT
77	23	4.5	5	0	18	4	3	25+TT	14-TT
78	23	4.5	5	0	18	4	3	25+TT	14-TT
79	23	4.5	5	0	18	4	3	25+TT	14-TT
80	23	4.5	3	0	18.5	4	3	25+TT	14.5-TT
81	23	3	14	0	9	6	3	25+TT	3-TT
82	23	3	8	0	15	5	3	25+TT	10-TT
83	23	3	6	0	17	5	3	25+TT	12-TT
84	23	3	4	0	19	3.5	3	25+TT	15.5-TT
85	23	1.5	4	0	19	3.5	3	25+TT	15.5-TT
86	23	3	14	0	9	6	3	25+TT	3-TT
87	23	3	8	0	15	5	3	25+TT	10-TT
88	23	3	6	0	17	5	3	25+TT	12-TT
89	23	3	4	0	19	3.5	3	25+TT	15.5-TT
90	23	2	4	0	19	3.5	3	25+TT	15.5-TT
91	23	3.5	14	0	9	6	3	25+TT	3-TT
92	23	3.5	8	0	15	5	3	25+TT	10-TT
93	23	3.5	6	0	17	5	3	25+TT	12-TT
94	23	3.5	4	0	19	3.5	3	25+TT	15.5-TT
95	23	3.5	4	0	19	3.5	3	25+TT	15.5-TT
96	23	6.5	14	0	9	6	3	25+TT	3-TT
97	23	6.5	8	0	15	5	3	25+TT	10-TT
98	23	6.5	6	0	16.5	5	3	25+TT	11.5-TT
99	23	6.5	4	0	16.5	5	3	25+TT	11.5-TT
100	23	6.5	4	0	16.5	5	3	25+TT	11.5-TT
101	23	3	12	0	9	6	3	25+TT	5-TT
102	23	3	8	0	11	5	3	25+TT	10-TT
103	23	3	8	0	15	5	3	25+TT	10-TT
104	23	1.5	6	0	17	5	3	25+TT	12-TT
105	23	3	6	0	17	5	3	25+TT	12-TT
106	23	1.5	4	0	19	3.5	3	25+TT	15.5-TT
107	23	3	2	0	20	2.5	3	25+TT	17-TT
108	23	3	5	0	18	4	3	25+TT	14-TT
109	23	1.5	5	0	18	4	3	25+TT	14-TT
110	23	1.5	5	0	18	4	3	25+TT	14-TT
111	23	3	3	0	20	2.5	3	25+TT	17-TT
112	23	3	12	0	11	6	3	25+TT	5-TT
113	23	3	8	0	15	5	3	25+TT	10-TT
114	23	3	8	0	15	5	3	25+TT	10-TT
115	23	2	6	0	17	5	3	25+TT	12-TT
116	23	3	6	0	17	5	3	25+TT	12-TT
117	23	2	4	0	19	3.5	3	25+TT	15.5-TT
118	23	3	2	0	20	2.5	3	25+TT	17-TT
119	23	3	5	0	18	4	3	25+TT	14-TT

Test ID	P _{PowerClass} (dBm)	MPR (dB)	A-MPR (dB)	$\Delta T_{C,c}$ (dB)	P _{C_{MAX,c}} (dBm)	T(P _{C_{MAX,L,c}}) (dB)	T _{L,c} (dB)	Upper limit (dBm)	Lower limit (dBm)
120	23	2	5	0	18	4	3	25+TT	14-TT
121	23	2	5	0	18	4	3	25+TT	14-TT
122	23	3	3	0	20	2.5	3	25+TT	17-TT
123	23	3.5	12	0	11	6	3	25+TT	5-TT
124	23	3.5	8	0	15	5	3	25+TT	10-TT
125	23	3.5	8	0	15	5	3	25+TT	10-TT
126	23	3.5	6	0	17	5	3	25+TT	12-TT
127	23	3.5	6	0	17	5	3	25+TT	12-TT
128	23	3.5	4	0	19	3.5	3	25+TT	15.5-TT
129	23	3.5	2	0	19.5	3.5	3	25+TT	16-TT
130	23	3.5	5	0	18	3.5	3	25+TT	14.5-TT
131	23	3.5	5	0	18	3.5	3	25+TT	14.5-TT
132	23	3.5	5	0	18	3.5	3	25+TT	14.5-TT
133	23	3.5	3	0	19.5	3.5	3	25+TT	16-TT
134	23	6.5	12	0	11	6	3	25+TT	5-TT
135	23	6.5	8	0	15	5	3	25+TT	10-TT
136	23	6.5	8	0	15	5	3	25+TT	10-TT
137	23	6.5	6	0	16.5	5	3	25+TT	11.5-TT
138	23	6.5	6	0	16.5	5	3	25+TT	11.5-TT
139	23	6.5	4	0	16.5	5	3	25+TT	11.5-TT
140	23	6.5	2	0	16.5	5	3	25+TT	11.5-TT
141	23	6.5	5	0	16.5	5	3	25+TT	11.5-TT
142	23	6.5	5	0	16.5	5	3	25+TT	11.5-TT
143	23	6.5	5	0	16.5	5	3	25+TT	11.5-TT
144	23	6.5	3	0	16.5	5	3	25+TT	11.5-TT

NOTE 1: P_{PowerClass} is the maximum UE power specified without taking into account the tolerance.
NOTE 2: TT for each frequency and channel bandwidth is specified in Table 6.2I.3.5-0.

For the UE which supports [SUL configuration], $\Delta T_{IB,c}$ as specified in [clause 6.2C.2 for SUL] applies. Unless otherwise stated, $\Delta T_{IB,c}$ is set to zero. In case the UE supports more than one of band combinations, and an operating band belongs to more than one band combinations then

- a) When the operating band frequency range is ≤ 1 GHz, the applicable additional $\Delta T_{IB,c}$ shall be the average value for all band combinations defined in [clause 6.2C.2] in this specification, truncated to one decimal place that apply for that operating band among the supported band combinations. In case there is a harmonic relation between low band UL and high band DL, then the maximum $\Delta T_{IB,c}$ among the different supported band combinations involving such band shall be applied
- b) When the operating band frequency range is > 1 GHz, the applicable additional $\Delta T_{IB,c}$ shall be the maximum value for all band combinations defined in [clause 6.2C.2] in this specification for the applicable operating bands.

6.2I.4 Configured transmitted power for RedCap

Editor's Note: The test case is not completed due to the following aspects are not yet determined:

- Generic procedure for RedCap UE in 38.508-1 is FFS
- Default message configuration for RedCap UE in 38.508-1 is FFS.

6.2I.4.1 Test purpose

The same test purpose as in 6.2.4.1.

6.2I.4.2 Test applicability

This test case applies to all types of NR RedCap UE release 17 and forward.

6.2I.4.3 Minimum conformance requirements

No exceptional requirements are specified for RedCap UE.

The normative reference for this requirement is TS 38.101-1 [2] clause 6.2.4.

6.2I.4.4 Test description

6.2I.4.4.1 Initial conditions

Same initial conditions as in 6.2.4 with following exception:

- The test channel bandwidth are specified in TS 38.508-1 [5] subclause 4.3.1 for RedCap.

6.2I.4.4.2 Test procedure

Same test procedure as clause 6.2.4.4.2.

6.2I.4.4.3 Message contents

FFS.

6.2I.4.5 Test requirement

The maximum output power measured shall not exceed the values specified in Table 6.2I.4.5-1.

Table 6.2I.4.5-0: Test Tolerance (Configured transmitted power)

	$f \leq 3.0\text{GHz}$	$3.0\text{GHz} < f \leq 6.0\text{GHz}$
BW \leq 40MHz	0.7 dB	1.0 dB

Table 6.2I.4.5-1: P_{C_{MAX}} configured UE output power

	Maximum output power	
	Test ID 1,2	Test ID 3
Measured UE output power test point 1	-10 dBm \pm (7+TT)	-10 dBm +7+TT/-7.2-TT
Measured UE output power test point 2	10 dBm \pm (6+TT)	10 dBm +6+TT/-6.2-TT
Measured UE output power test point 3	15 dBm \pm (5+TT)	15 dBm +5+TT/-5.2-TT
Measured UE output power test point 4	Note 3	Note 4
Note 1: TT for each frequency and channel bandwidth is specified in Table 6.2I.4.5-0.		
Note 2: The maximum output power shall be within the range in Table 6.2I.4.5-2.		
Note 3: The maximum output power shall be within the range in Table 6.2I.4.5-3.		

6.3 Output power dynamics

6.3.1 Minimum output power

6.3.1.1 Test purpose

To verify the UE's ability to transmit with a broadband output power below the value specified in the test requirement when the power is set to a minimum value.

6.3.1.2 Test applicability

This test case applies to all types of NR UE release 15 and forward.

6.3.1.3 Minimum conformance requirements

The minimum controlled output power of the UE is defined as the power in the channel bandwidth for all transmit bandwidth configurations (resource blocks), when the power is set to a minimum value.

The minimum output power is defined as the mean power in at least one sub-frame 1 ms. The minimum output power shall not exceed the values specified in Table 6.3.1.3-1.

Table 6.3.1.3-1: Minimum output power

Channel bandwidth (MHz)	Minimum output power (dBm)	Measurement bandwidth (MHz)
5	-40	4.515
10	-40	9.375
15	-40	14.235
20	-40	19.095
25	-39	23.955
30	-38.2	28.815
40	-37	38.895
45	-36.5	43.575
50	-36	48.615
60	-35.2	58.35
70	-34.6	68.07
80	-34	78.15
90	-33.5	88.23
100	-33	98.31

The normative reference for this requirement is TS 38.101-1 [2] clause 6.3.1.

6.3.1.4 Test description

6.3.1.4.1 Initial condition

Initial conditions are a set of test configurations the UE needs to be tested in and the steps for the SS to take with the UE to reach the correct measurement state.

The initial test configurations consist of environmental conditions, test frequencies, test channel bandwidths and sub-carrier spacing based on NR operating bands specified in table 5.3.5-1. All of these configurations shall be tested with applicable test parameters for each combination of test channel bandwidth and sub-carrier spacing, and are shown in table 6.3.1.4.1-1. The details of the uplink reference measurement channels (RMCs) are specified in Annexes A.2. Configurations of PDSCH and PDCCH before measurement are specified in Annex C.2.

Table 6.3.1.4.1-1: Test Configuration Table

Initial Conditions			
Test Environment as specified in TS 38.508-1 [5] subclause 4.1		Normal, TL/VL, TL/VH, TH/VL, TH/VH	
Test Frequencies as specified in TS 38.508-1 [5] subclause 4.3.1		Low range, Mid range, High range (NOTE 2)	
Test Channel Bandwidths as specified in TS 38.508-1 [5] subclause 4.3.1		Lowest, Mid, Highest	
Test SCS as specified in Table 5.3.5-1		Highest	
Test Parameters for Channel Bandwidths			
Test ID	Downlink Configuration	Uplink Configuration	
	N/A for minimum output power test case	Modulation	RB allocation (NOTE 1)
1		DFT-s-OFDM QPSK	Outer Full
NOTE 1: The specific configuration of each RB allocation is defined in Table 6.1-1.			
NOTE 2: For NR band n28, 30MHz test channel bandwidth is tested with Low range and High range test frequencies.			

1. Connect the SS to the UE antenna connectors as shown in TS 38.508-1 [5] Annex A, Figure A.3.1.1.1 for TE diagram and section A.3.2 for UE diagram.
2. The parameter settings for the cell are set up according to TS 38.508-1 [5] subclause 4.4.3.
3. Downlink signals are initially set up according to Annex C.0, C.1, C.2, and uplink signals according to Annex G.0, G.1, G.2, G.3.0.
4. The UL Reference Measurement Channel is set according to Table 6.3.1.4.1-1.

5. Propagation conditions are set according to Annex B.0.
6. Ensure the UE is in State RRC_CONNECTED with generic procedure parameters Connectivity NR, Connected without release *On*, Test Mode *On* and Test Loop Function *On* according to TS 38.508-1 [5] clause 4.5. Message contents are defined in clause 6.3.1.4.3.

6.3.1.4.2 Test procedure

1. SS sends uplink scheduling information for each UL HARQ process via PDCCH DCI format 0_1 for C_RNTI to schedule the UL RMC according to Table 6.3.1.4.1-1. Since the UE has no payload and no loopback data to send the UE sends uplink MAC padding bits on the UL RMC.
2. Send continuously uplink power control "down" commands in every uplink scheduling information to the UE; allow at least 200ms starting from the first TPC command in this step to ensure that the UE transmits at its minimum output power.
3. Measure the mean power of the UE in the associated measurement channel bandwidth specified in Table 6.3.1.5-1 for the specific channel bandwidth under test. The period of measurement shall be at least the continuous duration of one active sub-frame (1ms) and in the uplink symbols. For TDD symbols with transient periods are not under test.

6.3.1.4.3 Message contents

Message contents are according to TS 38.508-1 [5] subclause 4.6 with following exception.

Table 6.3.1.4.3-1: PUSCH-Config

Derivation Path: TS 38.508-1 [5], Table 4.6.3-118 with condition TRANSFORM_PRECODER_ENABLED

6.3.1.5 Test requirement

The minimum output power, derived in step 3 shall not exceed the values specified in Table 6.3.1.5-1.

Table 6.3.1.5-1: Minimum output power

Channel bandwidth (MHz)	Minimum output power (dBm)	Measurement bandwidth (MHz)
5	-40+TT	4.515
10	-40+TT	9.375
15	-40+TT	14.235
20	-40+TT	19.095
25	-39+TT	23.955
30	-38.2+TT	28.815
40	-37+TT	38.895
45	-36.5+TT	43.575
50	-36+TT	48.615
60	-35.2+TT	58.35
70	-34.6+TT	68.07
80	-34+TT	78.15
90	-33.5+TT	88.23
100	-33+TT	98.31

NOTE 1: TT for each frequency and channel bandwidth is specified in Table 6.3.1.5-2

Table 6.3.1.5-2: Test Tolerance (Minimum output power)

	$f \leq 3.0\text{GHz}$	$3.0\text{GHz} < f \leq 6.0\text{GHz}$
$\text{BW} \leq 40\text{MHz}$	1.0 dB	1.3 dB
$40\text{MHz} < \text{BW} \leq 100\text{MHz}$	1.3 dB	1.3 dB

6.3.2 Transmit OFF power

6.3.2.1 Test purpose

To verify that the UE transmit OFF power is lower than the value specified in the test requirement.

An excess Transmit OFF power potentially increases the Rise Over Thermal (RoT) and therefore reduces the cell coverage area for other UEs.

6.3.2.2 Test applicability

The requirements of this test apply in test cases 6.3.3 Transmit ON/OFF time mask to all types of NR UE release 15 and forward.

6.3.2.3 Minimum conformance requirements

Transmit OFF power is defined as the mean power in the channel bandwidth when the transmitter is OFF. The transmitter is considered OFF when the UE is not allowed to transmit on any of its ports.

The Transmit OFF power is defined as the mean power in a duration of at least one sub-frame (1ms) excluding any transient periods. The Transmit OFF power shall not exceed the values specified in Table 6.3.2.3-1.

Table 6.3.2.3-1: Transmit OFF power

Channel bandwidth	(MHz)	5,10,15,20,25,30,35,40,45,50	60,70,80,90,100
REF_SCS	(kHz)	15	30
Transmit OFF power	(dBm)	-50	
Measurement bandwidth	(MHz)	$MBW=REF_SCS*(12*N_{RB}+1)/1000$	

The normative reference for this requirement is TS 38.101-1 [2] clause 6.3.2.

6.3.2.4 Test description

This test is covered by clause 6.3.3 Transmit ON/OFF time mask.

6.3.2.5 Test requirement

The requirement for the Transmit OFF power shall not exceed the values specified in Table 6.3.2.5-1.

Table 6.3.2.5-1: Transmit OFF power

Channel bandwidth (MHz)	Transmit OFF power (dBm)	Measurement bandwidth (MHz)
5	-50+TT	4.515
10	-50+TT	9.375
15	-50+TT	14.235
20	-50+TT	19.095
25	-50+TT	23.955
30	-50+TT	28.815
40	-50+TT	38.895
45	-50+TT	43.575
50	-50+TT	48.615
60	-50+TT	58.35
70	-50+TT	68.07
80	-50+TT	78.15
90	-50+TT	88.23
100	-50+TT	98.31

NOTE 1: TT for each frequency and channel bandwidth is specified in Table 6.3.2.5-2

Table 6.3.2.5-2: Test Tolerance (Transmit OFF power)

	$f \leq 3.0\text{GHz}$	$3.0\text{GHz} < f \leq 6.0\text{GHz}$
$\text{BW} \leq 40\text{MHz}$	1.5 dB	1.8 dB
$40\text{MHz} < \text{BW} \leq 100\text{MHz}$	1.7 dB	1.8 dB

6.3.3 Transmit ON/OFF time mask

6.3.3.1 General

The transmit power time mask defines the transient period(s) allowed

- between transmit OFF power as defined in sub-clause 6.3.2 and transmit ON power symbols (transmit ON/OFF)
- between continuous ON-power transmissions with power change or RB hopping is applied.

When a UE signals the transient period capability, the transient period value (tp) can be 2, 4, or 7 μs . If no capability is signalled, the default transient period value of 10 μs applies.

In case of RB hopping, and in following figures where tp_{start} is specified, the transient period is shared symmetrically when the transient period is 10 μs . If the UE signals a transient period (tp) of 2, 4 or 7 μs , the transient period start position is given by tp_{start} in Table 6.3.3.1-1.

Table 6.3.3.1-1: tp_{start} values

tp (μs)	tp_{start} (μs)
2	-0.5
4	-1
7	-2.7
NOTE 1: Negative values mean that the transient period starts before the symbol boundary	

Unless otherwise stated the minimum requirements in clause 6.5 apply also in transient periods.

In the following sub-clauses, following definitions apply:

- A slot or long subslot transmission is a transmission with more than 2 symbols.
- A short subslot transmission is a transmission with 1 or 2 symbols.

6.3.3.2 General ON/OFF time mask

6.3.3.2.1 Test purpose

To verify that the general ON/OFF time mask meets the requirements given in 6.3.3.2.5.

The transmit power time mask for transmit ON/OFF defines the transient period(s) allowed between transmit OFF power as defined in sub-clause 6.3.2 and transmit ON power symbols (transmit ON/OFF)

Transmission of the wrong power increases interference to other channels, or increases transmission errors in the uplink channel.

6.3.3.2.2 Test applicability

This test case applies to all types of NR UE release 15 and forward.

6.3.3.2.3 Minimum conformance requirements

The general ON/OFF time mask defines the observation period between transmit OFF and ON power and between transmit ON and OFF power for each SCS. ON/OFF scenarios include: the beginning or end of DTX, measurement gap, contiguous, and non-contiguous transmission, etc.

The OFF power measurement period is defined in a duration of at least one slot excluding any transient periods. The ON power is defined as the mean power over one slot excluding any transient period.

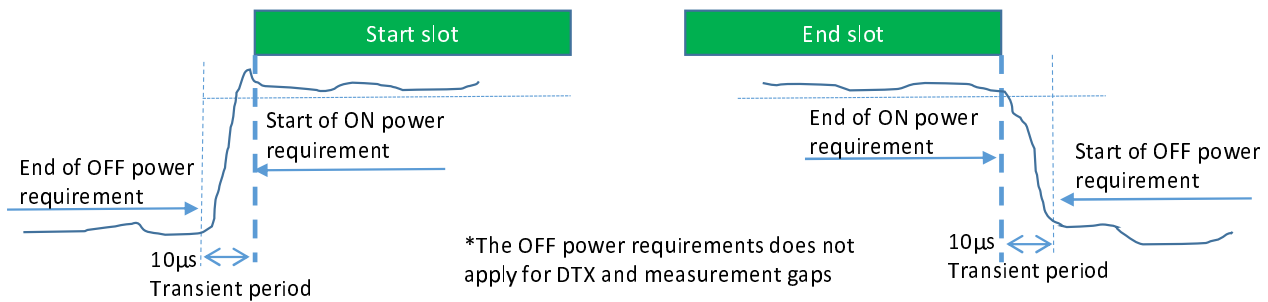

Figure 6.3.3.2.3-1: General ON/OFF time mask for NR UL transmission in FR1

The normative reference for this requirement is TS 38.101-1 [2] clause 6.3.3.2.

6.3.3.2.4 Test description

6.3.3.2.4.1 Initial condition

Initial conditions are a set of test configurations the UE needs to be tested in and the steps for the SS to take with the UE to reach the correct measurement state.

The initial test configurations consist of environmental conditions, test frequencies, test channel bandwidths and sub-carrier spacing based on NR operating bands specified in table 5.3.5-1. All of these configurations shall be tested with applicable test parameters for each combination of channel bandwidth and sub-carrier spacing, and are shown in table 6.3.3.2.4.1-1. The details of the uplink reference measurement channels (RMCs) are specified in Annex A.2. Configurations of PDSCH and PDCCH before measurement are specified in Annex C.2.

Table 6.3.3.2.4.1-1: Test Configuration Table

Initial Conditions			
Test Environment as specified in TS 38.508-1 [5] subclause 4.1		Normal, TL/VL, TL/VH, TH/VL, TH/VH	
Test Frequencies as specified in TS 38.508-1 [5] subclause 4.3.1		Low range, Mid range, High range (NOTE 2)	
Test Channel Bandwidths as specified in TS 38.508-1 [5] subclause 4.3.1		Lowest, Mid, Highest	
Test SCS as specified in Table 5.3.5-1		Lowest, Highest	
Test Parameters for Channel Bandwidths			
Test ID	Downlink Configuration	Uplink Configuration	
	N/A for minimum output power	Modulation	RB allocation (NOTE 1)
1	test case	DFT-s-OFDM QPSK	Inner Full
NOTE 1: The specific configuration of each RB allocation is defined in Table 6.1-1.			
NOTE 2: For NR band n28, 30MHz test channel bandwidth is tested with Low range and High range test frequencies.			

1. Connect the SS to the UE antenna connectors as shown in TS 38.508-1 [5] Annex A, Figure A.3.1.1.1 for TE diagram and section A.3.2 for UE diagram.
2. The parameter settings for the cell are set up according to TS 38.508-1 [5] subclause 4.4.3.
3. Downlink signals are initially set up according to Annex C.0, C.1, C.2, and uplink signals according to Annex G.0, G.1, G.2, G.3.0.
4. The UL Reference Measurement Channel is set according to Table 6.3.3.2.4.1-1.
5. Propagation conditions are set according to Annex B.0.

- 6. Ensure the UE is in State RRC_CONNECTED with generic procedure parameters Connectivity NR, Connected without release On, Test Mode On and Test Loop Function On according to TS 38.508-1 [5] clause 4.5. Message contents are defined in clause 6.3.3.2.4.3.

6.3.3.2.4.2 Test procedure

- 1. SS sends uplink scheduling information via PDCCH DCI format 0_1 for C_RNTI to schedule the UL RMC according to Table 6.3.3.2.4.1-1. Since the UE has no payload and no loopback data to send the UE sends uplink MAC padding bits on the UL RMC. The UL assignment is such that the UE transmits on slots 8 for 15kHz SCS, on slots 8 and 18 for 30kHz SCS and on slots 17 and 37 for 60kHz SCS.
- 2. Send continuously uplink power control "up" commands in every uplink scheduling information to the UE; allow at least 200ms starting from the first TPC command in this step for the UE to reach P_{UMAX} level.
- 3. ON power sub test:
 - 3.1. Measure the output power of the UE PUSCH transmission during one slot.
- 4. OFF power sub test:
 - 4.1. Measure the UE transmission OFF power during the slot prior to the PUSCH transmission, excluding a transient period of 10 μs in the end of the slot.
 - 4.2. Measure the UE transmission OFF power during the slot following the PUSCH transmission, excluding a transient period of 10 μs at the beginning of the slot.

6.3.3.2.4.3 Message contents

Message contents are according to TS 38.508-1 [5] subclause 4.6 with following exceptions.

Table 6.3.3.2.4.3-1: PUSCH-ConfigCommon

Derivation Path: TS 38.508-1[5], Table 4.6.3-119			
Information Element	Value/remark	Comment	Condition
PUSCH-ConfigCommon ::= SEQUENCE {			
p0-NominalWithGrant	-100		
}			

Table 6.3.3.2.4.3-2: *Void*

Table 6.3.3.2.4.3-3: TDD-UL-DL-Config

Derivation Path: TS 38.508-1[5], Table 4.6.3-192			
Information Element	Value/remark	Comment	Condition
TDD-UL-DL-ConfigCommon ::= SEQUENCE {			
referenceSubcarrierSpacing	SubcarrierSpacing		
pattern1 SEQUENCE {			
dl-UL-TransmissionPeriodicity	ms5		FR1
	ms10		FR1_15kHz
nrofDownlinkSlots	6		FR1_15kHz
	6		FR1_30kHz
	14		FR1_60kHz
nrofDownlinkSymbols	10		FR1_15kHz
	6		FR1_30kHz
	12		FR1_60kHz
nrofUplinkSlots	3		FR1_15kHz, FR1_30kHz
	4		FR1_60kHz
nrofUplinkSymbols	4		FR1_30kHz
	2		FR1_15kHz,
	8		FR1_60kHz
}			
pattern2	Not present		
}			

Table 6.3.3.2.4.3-4: PUSCH-TimeDomainResourceAllocationList

Derivation Path: TS 38.508-1[5], Table 4.6.3-122			
Information Element	Value/remark	Comment	Condition
PUSCH-TimeDomainResourceAllocationList ::= SEQUENCE (SIZE(1..maxNrofUL-Allocations)) OF {	2 entries		
PUSCH-TimeDomainResourceAllocation[1]			
SEQUENCE {			
k2	4		FR1_15kHz, FR1_30kHz
	6		FR1_60kHz
mappingType	typeA		
startSymbolAndLength	27	Start symbol(S)=0, Length(L)=14	
}			
PUSCH-TimeDomainResourceAllocation[2]		addressed by Msg3 PUSCH time resource allocation field of the Random Access Response acc. to TS 38.213 [22] Table 8.2-1.	
SEQUENCE {			
k2	2	K ₂ + Δ=4 acc. to TS 38.214 [21] Table 6.1.2.1.1-5 (NOTE 1)	FR1_15kHz
	6	K ₂ + Δ=9 acc. to TS 38.214 [21] Table 6.1.2.1.1-5 (NOTE 1)	FR1_30kHz

mappingType	typeA		
startSymbolAndLength	27	Start symbol(S)=0, Length(L)=14	
}			
}			
NOTE 1: Values are chosen so that first slot of a TDD-UL-DL slot configuration period can be used for the Random Access Response and the last slot (of the same or another period) for the corresponding Msg3.			

Condition	Explanation
FR1_15kHz	FR1 is used under the test. SCS is set to 15kHz.
FR1_30kHz	FR1 is used under the test. SCS is set to 30kHz.
FR1_60kHz	FR1 is used under the test. SCS is set to 60kHz.

Table 6.3.3.2.4.3-5: ServingCellConfigCommon

Derivation Path: 38.508-1[5], Table 4.6.3-168			
Information Element	Value/remark	Comment	Condition
ServingCellConfigCommon ::= SEQUENCE {			
ss-PBCH-BlockPower	18		SCS_15kHz
	21		SCS_30kHz
}			

Condition	Explanation
SCS_15kHz	SCS=15kHz for SS/PBCH block
SCS_30kHz	SCS=30kHz for SS/PBCH block

Table 6.3.3.2.4.3-6: PUSCH-Config

Derivation Path: TS 38.508-1 [5], Table 4.6.3-118 with condition TRANSFORM_PRECODER_ENABLED

Table 6.3.3.2.4.3-7: P-Max

Derivation Path: TS 38.508-1 [5], Table 4.6.3-89			
Information Element	Value/remark	Comment	Condition
P-Max	23		

6.3.3.2.5 Test requirement

The requirement for the power measured in steps 2, 3 and 4 of the test procedure shall not exceed the values specified in Table 6.3.3.2.5-1.

Table 6.3.3.2.5-1: General ON/OFF time mask

	Channel bandwidth / minimum output power / measurement bandwidth													
	5 MHz	10 MHz	15 MHz	20 MHz	25 MHz	30 MHz	40 MHz	45 MHz	50 MHz	60 MHz	70 MHz	80 MHz	90 MHz	100 MHz
Transmit OFF power	$\leq -50+TT$ dBm													
Transmission OFF Measurement bandwidth	4.515	9.375	14.235	19.095	23.955	28.815	38.895	43.575	48.615	58.35	68.07	78.15	88.23	98.31
Transmit ON power	Same as Table 6.2.1.5-1													
NOTE 1: TT for each frequency and channel bandwidth is specified in Table 6.3.3.2.5-2														

Table 6.3.3.2.5-2: Test Tolerance for OFF power

	$f \leq 3.0\text{GHz}$	$3.0\text{GHz} < f \leq 6\text{GHz}$
$BW \leq 40\text{MHz}$	1.5 dB	1.8 dB
$40\text{MHz} < BW \leq 100\text{MHz}$	1.7 dB	1.8 dB

Table 6.3.3.2.5-3: Test Tolerance for ON power

	$f \leq 3.0\text{GHz}$	$3.0\text{GHz} < f \leq 6\text{GHz}$
$BW \leq 40\text{MHz}$	1.5 dB	1.8 dB
$40\text{MHz} < BW \leq 100\text{MHz}$	1.7 dB	1.8 dB

6.3.3.3 Transmit power time mask for slot and short or subslot boundaries

No test case details are specified. Current test procedures for time masks are based on power measurement in relatively long period compared with transient period. For time masks between 2 active time slots with different power level, the test procedure can't provide enough resolution to identify non-conformant UEs. Therefore, the minimum requirement is not testable.

6.3.3.4 PRACH time mask

6.3.3.4.1 Test purpose

To verify that the PRACH time mask meets the requirements given in 6.3.3.4.5.

The time mask for PRACH time mask defines the transient period(s) allowed between transmit OFF power and transmit ON power when transmitting the PRACH.

Transmission of the wrong power increases interference to other channels, or increases transmission errors in the uplink channel.

6.3.3.4.2 Test applicability

This test case applies to all types of NR UE release 15 and forward.

6.3.3.4.3 Minimum conformance requirements

The PRACH ON power is specified as the mean power over the PRACH measurement period excluding any transient periods as shown in Figure 6.3.3.4.3-1. The measurement period for different PRACH preamble format is specified in Table 6.3.3.4.3-1.

Table 6.3.3.4.3-1: PRACH ON power measurement period

PRACH preamble format	SCS (kHz)	Measurement period (ms)
0	1.25	0.903125
1	1.25	2.284375
2	1.25	3.352604
3	5	0.903125
A1	15	0.142708
	30	0.071354
A2	15	0.285417
	30	0.142708
A3	15	0.428125
	30	0.2140625
B1	15	0.140365
	30	0.070182
B4	15	0.83046875
	30	0.415234375
A1/B1	15	0.142708 ms for first six occasion 0.140365 ms for the last occasion
	30	0.071354 ms for first six occasion 0.070182 ms for the last occasion
A2/B2	15	0.285417 ms for first two occasion 0.278385 ms for the third occasion
	30	0.142708 ms for first two occasion 0.1391925 ms for the third occasion
A3/B3	15	0.428125 ms for the first occasion 0.41640625 ms for the second occasion
	30	0.2140625 ms for the first occasion 0.208203125 ms for the second occasion
C0	15	0.10703125
	30	0.053515625
C2	15	0.333333
	30	0.166667

NOTE: For PRACH on PRACH occasion start from the beginning of 0.5ms or span the boundary of 0.5ms of the subframe, the measurement period will plus 0.032552μs

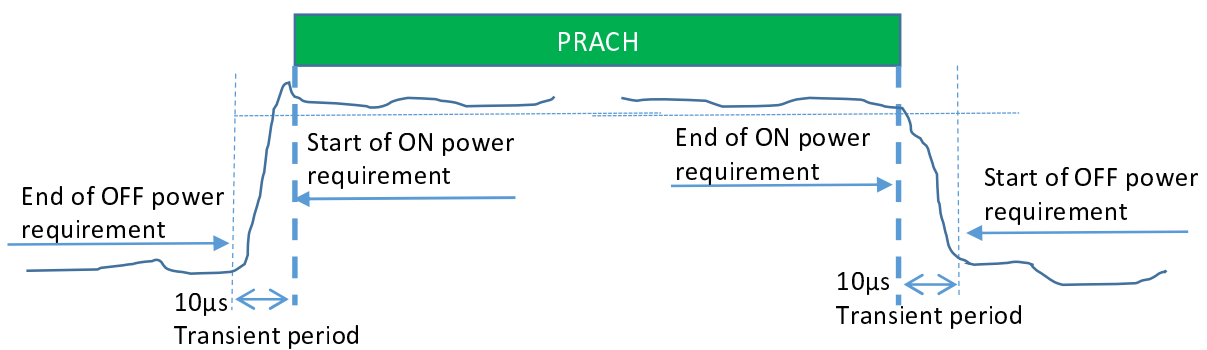

Figure 6.3.3.4.3-1: PRACH ON/OFF time mask

The normative reference for this requirement is TS 38.101-1 [2] clause 6.3.3.4.

6.3.3.4.4 Test description

6.3.3.4.4.1 Initial condition

Initial conditions are a set of test configurations the UE needs to be tested in and the steps for the SS to take with the UE to reach the correct measurement state.

The initial test configurations consist of environmental conditions, test frequencies, test channel bandwidths and sub-carrier spacing based on NR operating bands specified in table 5.2-1. All of these configurations shall be tested with

applicable test parameters for each combination of test channel bandwidth and sub-carrier spacing, and are shown in table 6.3.3.4.4.1-1. The details of the uplink reference measurement channels (RMCs) are specified in Annexes [TBD]. Configurations of PDSCH and PDCCH before measurement are specified in Annex C.2.

Table 6.3.3.4.4.1-1: Test Configuration Table

Initial Conditions		
Test Environment as specified in TS 38.508-1 [5] subclause 4.1	Normal, TL/VL, TL/VH, TH/VL, TH/VH	
Test Frequencies as specified in TS 38.508-1 [5] subclause 4.3.1	Mid range (NOTE 1)	
Test Channel Bandwidths as specified in TS 38.508-1 [5] subclause 4.3.1	Lowest, Mid, Highest	
Test SCS as specified in Table 5.3.5-1	SCS defined in TS 38.211 [8] subclause 6.3.3.2 determined by PRACH Configuration Index for long sequence Lowest, Highest for short sequence	
PRACH preamble format		
	Paired Spectrum	Unpaired Spectrum
PRACH Configuration Index for test point 1	4 (long sequence)	12 (long sequence)
PRACH Configuration Index for test point 2	160 (short sequence)	123 (short sequence)
NOTE 1: For NR band n28, 30MHz test channel bandwidth is tested with Low range test frequencies.		

1. Connect the SS to the UE antenna connectors as shown in TS 38.508-1 [5] Annex A, Figure A.3.1.1.1 for TE diagram and section A.3.2 for UE diagram.
2. The parameter settings for the cell are set up according to TS 38.508-1 [5] subclause 4.4.3.
3. Downlink signals are initially set up according to Annex C.0, C.1, C.2, and uplink signals according to Annex G.0, G.1, G.2, G.3.0.
4. Propagation conditions are set according to Annex B.0.
5. Ensure the UE is in State RRC_CONNECTED with generic procedure parameters Connectivity NR, Connected without release On, Test Mode On and Test Loop Function On according to TS 38.508-1 [5] clause 4.5. Message contents are defined in clause 6.3.3.4.4.3.

6.3.3.4.4.2 Test procedure

1. The SS shall signal a Random Access Preamble ID via a PDCCH order to the UE and initiate a Non-contention based Random Access procedure.
2. The UE shall send the signalled preamble to the SS.
3. The SS measure the UE transmission OFF power during the slot preceding the PRACH preamble excluding a transient period of 10 μ s according to Figure 6.3.3.4.3-1.
4. Measure the output power of the transmitted PRACH preamble according to Figure 6.3.3.4.3-1.
5. Measure the UE transmission OFF power, starting 10 μ s after the PRACH preamble ends for a measurement period.

6.3.3.4.4.3 Message contents

Message contents are according to TS 38.508-1 [5] subclause 4.6.3 with the following exceptions:

Table 6.3.3.4.4.3-1: RACH-ConfigCommon: PRACH measurement

Derivation Path: TS 38.508-1[5], Table 4.6.3-128			
Information Element	Value/remark	Comment	Condition
RACH-ConfigCommon::= SEQUENCE {			
prach-RootSequenceIndex CHOICE {			
1139	Set according to table 4.4.2-2 for the NR Cell.		PRACH Format A3
1839	0	NR Cell 1	PRACH Format 0
	TBD	Other than NR Cell 1	PRACH Format 0
}			
}			

Table 6.3.3.4.4.3-2: RACH-ConfigGeneric: PRACH measurement

Derivation Path: TS 38.508-1[5], Table 4.6.3-130			
Information Element	Value/remark	Comment	Condition
RACH-ConfigGeneric ::= SEQUENCE {			
prach-ConfigurationIndex	4	Paired Spectrum	PRACH Format 0
	160	Paired Spectrum	PRACH Format A3
	12	Unpaired Spectrum	PRACH Format 0
	123	Unpaired Spectrum	PRACH Format A3
msg1-FDM	four		FR1
	one		FR1 5MHz PRACH Format A3 for SCS 15 kHz OR FR1 10MHz PRACH Format A3 for SCS 30 kHz OR FR1 10MHz PRACH Format A3 for SCS 60 kHz
preambleReceivedTargetPower	-118		PRACH Format 0
	-122		PRACH Format A3 for SCS 15 kHz
	-124		PRACH Format A3 for SCS 30 kHz
	-128		PRACH Format A3 for SCS 60kHz
powerRampingStep	dB0		
ra-ResponseWindow	sl20		
}			

Table 6.3.3.4.4.3-3: ServingCellConfigCommonSIB: PRACH measurement

Derivation Path: TS 38.508-1[5], Table 4.6.3-169			
Information Element	Value/remark	Comment	Condition
ServingCellConfigCommonSIB ::= SEQUENCE {			
ss-PBCH-BlockPower	32		SCS_15kHz
	35		SCS_30kHz
}			

Table 6.3.3.4.4.3-4: PUSCH-TimeDomainResourceAllocationList: PRACH measurement

Derivation Path: TS 38.508-1[5], Table 4.6.3-122			
Information Element	Value/remark	Comment	Condition
PUSCH-TimeDomainResourceAllocationList ::= SEQUENCE (SIZE(1..maxNrofUL-Allocations)) OF PUSCH-TimeDomainResourceAllocation {	2 entries		
PUSCH-TimeDomainResourceAllocation[2]		entry 2 addressed by Msg3 PUSCH time resource allocation field of the Random Access Response acc. to TS 38.213 [22] Table 8.2-1.	
k2	6	K2+ $\Delta=8$ acc. to TS 38.214 [21] Table 6.1.2.1.1-5	Unpaired Spectrum for SCS15kHz and PRACH Format 0
}			
}			

6.3.3.4.5 Test requirement

The requirement for the power measured in steps (3), (4) and (5) of the test procedure shall not exceed the values specified in Table 6.3.3.4.5-1.

Table 6.3.3.4.5-1: PRACH time mask

	Channel bandwidth / minimum output power / measurement bandwidth												
	5 MHz	10 MHz	15 MHz	20 MHz	25 MHz	30 MHz	40 MHz	50 MHz	60 MHz	70 MHz	80 MHz	90 MHz	100 MHz
Transmit OFF power	≤ -50+TT dBm												
Transmission OFF Measurement bandwidth	4.515	9.375	14.235	19.095	23.955	28.815	38.895	48.615	58.35	68.07	78.15	88.23	98.31
Expected PRACH Transmission ON Measured Power for PRACH Format 0 and PRACH Format A3 for SCS 30kHz	-1 dBm	-1 dBm	-1 dBm	-1 dBm	-1 dBm	-1 dBm	-1 dBm	-1 dBm	-1 dBm	-1 dBm	-1 dBm	-1 dBm	-1 dBm
Expected PRACH Transmission ON Measured Power for PRACH Format A3 for SCS 15kHz and SCS 60kHz	-2 dBm	-2 dBm	-2 dBm	-2 dBm	-2 dBm	-2 dBm	-2 dBm	-2 dBm	-2 dBm	-2 dBm	-2 dBm	-2 dBm	-2 dBm
ON Power Tolerance	± (9+TT)dB												
NOTE 1: TT for each frequency and channel bandwidth is specified in Table 6.3.3.4.5-2													

Table 6.3.3.4.5-2: Test Tolerance (Transmit OFF power and PRACH time mask)

	$f \leq 3.0\text{GHz}$	$3.0\text{GHz} < f \leq 6.0\text{GHz}$
$\text{BW} \leq 40\text{MHz}$	1.5 dB	1.8 dB
$40\text{MHz} < \text{BW} \leq 100\text{MHz}$	1.7 dB	1.8 dB

6.3.3.5 Void

6.3.3.6 SRS time mask

6.3.3.6.1 Test purpose

To verify that the SRS time mask meets the requirements given in 6.3.3.6.5.

The time mask for SRS time mask defines the transient period(s) allowed between transmit OFF power and transmit ON power when transmitting the SRS.

Transmission of the wrong power increases interference to other channels, or increases transmission errors in the uplink channel.

6.3.3.6.2 Test applicability

This test case applies to all types of NR UE release 15 and forward.

6.3.3.6.3 Minimum conformance requirements

For SRS transmission mapped to one OFDM symbol, the ON power is defined as the mean power over the symbol duration excluding any transient period; See Figure 6.3.3.6.3-1

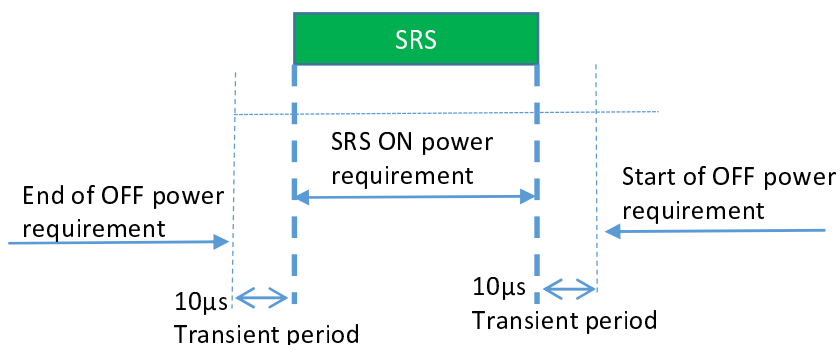

Figure 6.3.3.6.3-1: Single SRS time mask for NR UL transmission

For SRS transmission mapped to two or more OFDM symbols the ON power is defined as the mean power for each symbol duration excluding any transient period. For consecutive SRS transmissions without power change, Figure 6.3.3.6.3-2 applies.

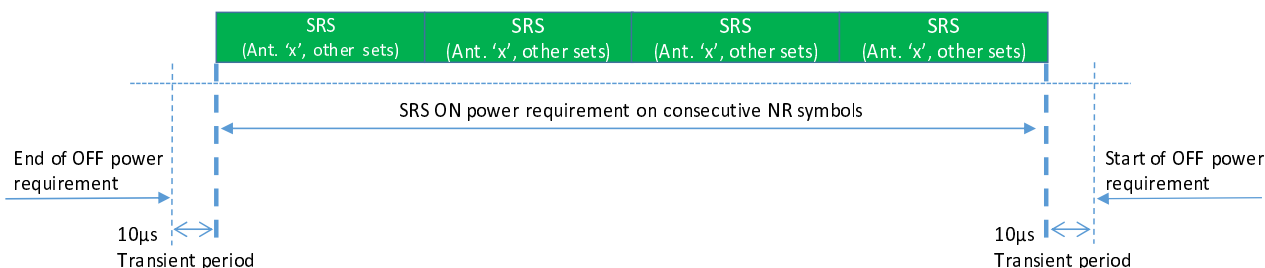

Figure 6.3.3.6.3-2: Consecutive SRS time mask for the case when no power change is required with SRS usage other than antenna switching

When power change between consecutive SRS transmissions is required, then Figure 6.3.3.6.3-3 and Figure 6.3.3.6.3-4 apply.

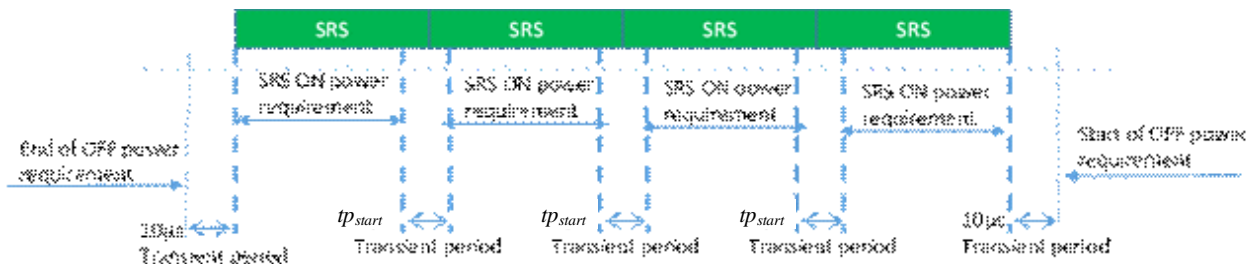

Figure 6.3.3.6.3-3: Consecutive SRS time mask for the case when power change is required and when 15kHz and 30kHz SCS is used in FR1 with SRS usage other than antenna switching

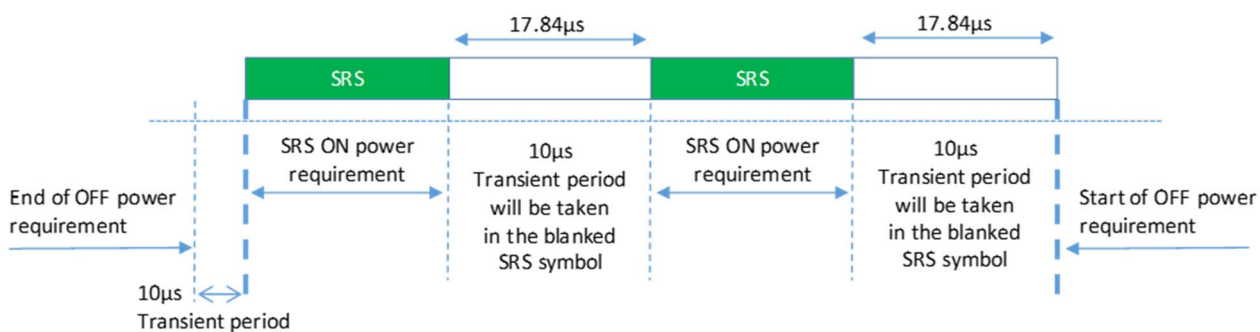

Figure 6.3.3.6.3-4: Consecutive SRS time mask for the case when power change is required and when 60kHz SCS is used in FR1

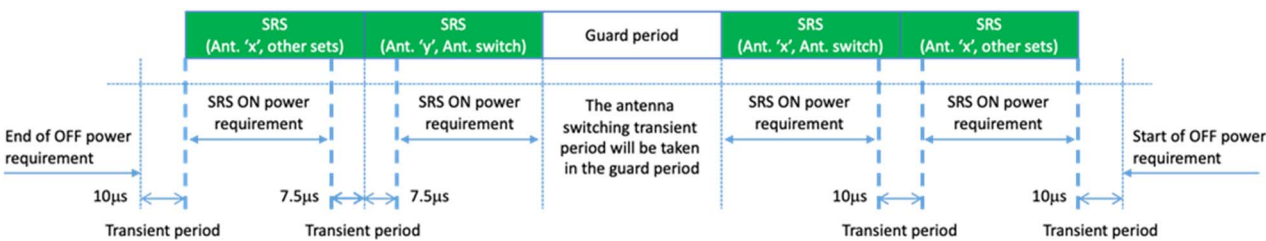

Figure 6.3.3.6.3-5: FR1 Time mask for 15 kHz and 30 kHz SCS for the case when consecutive SRS switching usage is between antenna switching & other sets

where “other sets” belongs to a “usage set” other than the set for antenna switching. The usage sets for SRS switching are defined in section 6.2.1 of TS 38.214 [12].

NOTE: Guard period of one symbol is defined between two SRS resources of an SRS resource set for antenna switching for 15kHz, 30kHz and 60kHz SCS in Table 6.2.1.2-1 of TS 38.214 [10].

The above transient period applies to all the transmit CCs in CA with the CC sounding SRS. UE RF requirements do not apply during this transient period.

The normative reference for this requirement is TS 38.101-1 [2] clause 6.3.3.6.

6.3.3.6.4 Test description

6.3.3.6.4.1 Initial condition

Initial conditions are a set of test configurations the UE needs to be tested in and the steps for the SS to take with the UE to reach the correct measurement state.

The initial test configurations consist of environmental conditions, test frequencies, test channel bandwidths and sub-carrier spacing based on NR operating bands specified in table 5.3.5-1. All of these configurations shall be tested with applicable test parameters for each combination of channel bandwidth and sub-carrier spacing, and are shown in table 6.3.3.6.4.1-1. The details of the uplink reference measurement channels (RMCs) are specified in Annex A.2. Configurations of PDSCH and PDCCH before measurement are specified in Annex C.2.

Table 6.3.3.6.4.1-1: Test Configuration Table

Initial Conditions		
Test Environment as specified in TS 38.508-1 [5] subclause 4.1	Normal, TL/VL, TL/VH, TH/VL, TH/VH	
Test Frequencies as specified in TS 38.508-1 [5] subclause 4.3.1	Mid range (NOTE 1)	
Test Channel Bandwidths as specified in TS 38.508-1 [5] subclause 4.3.1	Lowest, Mid, Highest	
Test SCS as specified in Table 5.3.5-1	Lowest, Highest	
SRS configuration	Paired Spectrum	Unpaired Spectrum
c-SRS (SRS bandwidth configuration)	7 (24 RB for BW 5 MHz) 14 (52 RB for BW 10 MHz) 20 (76 RB for BW 15 MHz) 25 (104 RB for BW 20 MHz) 33 (132 RB for BW 25 MHz) 42 (160 RB for BW 30 MHz) 51 (216 RB for BW 40MHz) 60 (264 RB for BW 50MHz) for SCS 15 KHz	7 (for BW 5 MHz) 13 (for BW 10 MHz) 19 (for BW 15 MHz) 25 (for BW 20 MHz) 30 (for BW 25 MHz) 40 (for BW 30 MHz) 51 (for BW 40MHz) 60 (for BW 50MHz) for SCS 15 KHz
	1 (8 RB for BW 5 MHz) 7 (24 RB for BW 10 MHz) 10 (36 RB for BW 15 MHz) 13 (48 RB for BW 20 MHz) 17 (64 RB for BW 25 MHz) 20 (76 RB for BW 30 MHz) 25 (104 RB for BW 40MHz) 33 (132 RB for BW 50MHz) 42 (160 RB for BW 60MHz) 45 (184 RB for BW 70MHz) 51 (216 RB for BW 80MHz) 56 (240 RB for BW 90MHz) 63 (272 RB for BW 100MHz) for SCS 30 KHz	1 (for BW 5 MHz) 6 (for BW 10 MHz) 10 (for BW 15 MHz) 12 (for BW 20 MHz) 17 (for BW 25 MHz) 20 (for BW 30 MHz) 25 (for BW 40MHz) 30 (for BW 50MHz) 40 (for BW 60MHz) 45 (for BW 70MHz) 51 (for BW 80MHz) 53 (for BW 90MHz) 61 (for BW 100MHz) for SCS 30 KHz
	1 (8 RB for BW 10 MHz) 4 (16 RB for BW 15 MHz) 7 (24 RB for BW 20 MHz) 8 (28 RB for BW 25 MHz) 10 (36 RB for BW 30 MHz) 13 (48 RB for BW 40MHz) 17 (64 RB for BW 50MHz) 20 (76 RB for BW 60MHz) 22 (88 RB for BW 70MHz) 25 (104 RB for BW 80MHz) 29 (120 RB for BW 90MHz) 33 (132 RB for BW 100MHz) for SCS 60 KHz	1 (for BW 10 MHz) 4 (for BW 15 MHz) 7 (for BW 20, 25 MHz) 9 (for BW 30 MHz) 13 (for BW 40MHz) 17 (for BW 50MHz) 19 (for BW 60MHz) 22 (for BW 70MHz) 25 (for BW 80MHz) 27 (for BW 90MHz) 30 (for BW 100MHz) for SCS 60 KHz
b-SRS	0	0
b-hop	3	0
freqDomainPosition	0	0
SRS-PeriodicityAndOffset	sl10 for SCS 15 KHz	sl10 for SCS 15 KHz
	sl20 for SCS 30 KHz	sl20 for SCS 30 KHz
	sl40 for SCS 60 KHz	sl40 for SCS 60 KHz
transmissionComb	n2	n2
CombOffset	0	0
cyclicShift	0	0
startPosition	0	0
nrofSymbols	n1	n1
NOTE 1: For NR band n28, 30MHz test channel bandwidth is tested with Low range test frequencies.		

1. Connect the SS to the UE antenna connectors as shown in TS 38.508-1 [5] Annex A, Figure A.3.1.1.1 for TE diagram and section A.3.2 for UE diagram.
2. The parameter settings for the cell are set up according to TS 38.508-1 [5] subclause 4.4.3.
3. Downlink signals are initially set up according to Annex C.0, C.1, C.2, and uplink signals according to Annex G.0, G.1, G.2, G.3.0.
4. Propagation conditions are set according to Annex B.0.
5. Ensure the UE is in State RRC_CONNECTED with generic procedure parameters Connectivity *NR*, Connected without release *On*, Test Mode *On* and Test Loop Function *On* according to TS 38.508-1 [5] clause 4.5. Message contents are defined in clause 6.3.3.6.4.3.

6.3.3.6.4.2 Test procedure

1. SS sends uplink scheduling information via PDCCH DCI format 0_1 for C_RNTI to schedule the UL RMC according to Table 6.3.3.2.4.1-1. Since the UE has no payload and no loopback data to send the UE sends uplink MAC padding bits on the UL RMC. The UL assignment is such that the UE transmits on slot 4 for 15kHz SCS, on slot 8 for 30kHz SCS and on slot 16 for 60kHz SCS. PUSCH is transmitted in the first half of the frame.
2. Send continuously uplink power control "up" commands in every uplink scheduling information to the UE; allow at least 200ms starting from the first TPC command in this step for the UE to reach P_{UMAX} level.
3. ON power sub test:
 - 3.1. Measure the output power of the transmitted SRS transmission during 1 OFDM symbol. The SRS transmission in the second half of the frame is used for measurement since there is no PUSCH transmission before and after.
4. OFF power sub test:
 - 4.1. The SS measure the UE transmission OFF power during the 13 OFDM symbols, preceding the SRS symbol excluding a transient period of 10 μs.
 - 4.2. Measure the UE transmission OFF power during the slot following the SRS under test, excluding a transient period of 10 μs

6.3.3.6.4.3 Message contents

Message contents are according to TS 38.508-1 [5] subclause 4.6.3 with the following exceptions:

Table 6.3.3.6.4.3-0: BWP-UplinkDedicated

Derivation Path: TS 38.508-1[5], Table 4.6.3-15			
Information Element	Value/remark	Comment	Condition
BWP-UplinkDedicated ::= SEQUENCE {			
srs-Config	SRS-Config in Table 6.3.3.6.4.3-1		
}			
Note: This message exception is only valid for the initial BWP and not for an additional BWP inside BWP-Uplink.			

Table 6.3.3.6.4.3-1: SRS-Config: SRS time mask measurement

Derivation Path: TS 38.508-1[5], Table 4.6.3-182			
Information Element	Value/remark	Comment	Condition
SRS-Config ::= SEQUENCE {			
srs-ResourceSetToAddModList SEQUENCE (SIZE(0..maxNrofSRS-ResourceSets)) OF SEQUENCE {	1 entry		
resourceType CHOICE {			
periodic SEQUENCE {			
}			
}			
alpha	alpha08		
p0	0		
}			
srs-ResourceToAddModList SEQUENCE (SIZE(1..maxNrofSRS-Resources)) OF SEQUENCE {	1 entry		
resourceMapping SEQUENCE {			
startPosition	0		
nrofSymbols	n1		
repetitionFactor	n1		
}			
freqHopping SEQUENCE {			
c-SRS			
	7 (for BW 5 MHz) 14 (for BW 10 MHz) 20 (for BW 15 MHz) 25 (for BW 20 MHz) 33 (for BW 25 MHz) 42 (for BW 30 MHz) 51 (for BW 40MHz) 60 (for BW 50MHz)		Paired Spectrum for SCS 15 KHz
	1 (for BW 5 MHz) 7 (for BW 10 MHz) 10 (for BW 15 MHz) 13 (for BW 20 MHz) 17 (for BW 25 MHz) 20 (for BW 30 MHz) 25 (for BW 40MHz) 33 (for BW 50MHz) 42 (for BW 60MHz) 45 (for BW 70MHz) 51 (for BW 80MHz) 56 (for BW 90MHz)		Paired Spectrum for SCS 30 KHz
	1 (for BW 10 MHz) 4 (for BW 15 MHz) 7 (for BW 20 MHz) 8 (for BW 25 MHz) 10 (for BW 30 MHz) 13 (for BW 40MHz) 17 (for BW 50MHz) 20 (for BW 60MHz) 22 (for BW 70MHz) 25 (for BW 80MHz) 29 (for BW 90MHz) 33 (for BW 100MHz)		Paired Spectrum for SCS 60 KHz
	7 (for BW 5 MHz) 13 (for BW 10 MHz) 19 (for BW 15 MHz) 25 (for BW 20 MHz) 30 (for BW 25 MHz) 40 (for BW 30 MHz) 51 (for BW 40MHz) 60 (for BW 50MHz)		Unpaired Spectrum for SCS 15 KHz

	1 (for BW 5 MHz) 6 (for BW 10 MHz) 10 (for BW 15 MHz) 12 (for BW 20 MHz) 17 (for BW 25 MHz) 20 (for BW 30 MHz) 25 (for BW 40MHz) 30 (for BW 50MHz) 40 (for BW 60MHz) 45 (for BW 70MHz) 51 (for BW 80MHz) 53 (for BW 90MHz) 61 (for BW 100MHz)		Unpaired Spectrum for SCS 30 KHz
	1 (for BW 10 MHz) 4 (for BW 15 MHz) 7 (for BW 20, 25 MHz) 9 (for BW 30 MHz) 13 (for BW 40MHz) 17 (for BW 50MHz) 19 (for BW 60MHz) 22 (for BW 70MHz) 25 (for BW 80MHz) 27 (for BW 90MHz) 30 (for BW 100MHz)		Unpaired Spectrum for SCS 60 KHz
b-SRS	0		
b-hop	3		Paired Spectrum
	0		Unpaired Spectrum
}			
resourceType CHOICE {			
periodic SEQUENCE {			
periodicityAndOffset-p CHOICE{			
sl10	9		SCS 15 KHz
sl20	18		SCS 30KHz
sl40	36		SCS 60 KHz
}			
}			
}			
}			
}			

Table 6.3.3.6.4.3-2: ServingCellConfigCommon

Derivation Path: 38.508-1[5], Table 4.6.3-168			
Information Element	Value/remark	Comment	Condition
ServingCellConfigCommon ::= SEQUENCE {			
ss-PBCH-BlockPower	18		SCS_15kHz
	21		SCS_30kHz
}			

Condition	Explanation
SCS_15kHz	SCS=15kHz for SS/PBCH block
SCS_30kHz	SCS=30kHz for SS/PBCH block

6.3.3.6.5 Test requirement

The requirement for the power measured in steps (1), (2) and (3) of the test procedure shall not exceed the values specified in Table 6.3.3.6.5-1.

Table 6.3.3.6.5-1: SRS time mask

	Channel bandwidth / minimum output power / measurement bandwidth												
	5 MHz	10 MHz	15 MHz	20 MHz	25 MHz	30 MHz	40 MHz	50 MHz	60 MHz	70 MHz	80 MHz	90 MHz	100 MHz
Transmit OFF power	$\leq -50+TT$ dBm												
Transmission OFF Measurement bandwidth	4.515	9.375	14.235	19.095	23.955	28.815	38.895	48.615	58.35	68.07	78.15	88.23	98.31
Transmit ON power	Same as Table 6.2.1.5-1												
NOTE 1: TT for each frequency and channel bandwidth is specified in Table 6.3.3.6.5-2													

Table 6.3.3.6.5-2: Test Tolerance (Transmit OFF power and SRS time mask)

	$f \leq 3.0\text{GHz}$	$3.0\text{GHz} < f \leq 6\text{GHz}$
$\text{BW} \leq 40\text{MHz}$	1.5 dB	1.8 dB
$40\text{MHz} < \text{BW} \leq 100\text{MHz}$	1.7 dB	1.8 dB

6.3.3.7 PUSCH-PUCCH and PUSCH-SRS time masks

No test case details are specified. Current test procedures for time masks are based on power measurement in relatively long period compared with transient period. For time masks between 2 active time slots with different power level, the test procedure can't provide enough resolution to identify non-conformant UEs. Therefore the minimum requirement is not testable.

6.3.3.8 Transmit power time mask for consecutive slot or long subslot transmission and short subslot transmission boundaries

No test case details are specified. Current test procedures for time masks are based on power measurement in relatively long period compared with transient period. For time masks between 2 active time slots with different power level, the test procedure can't provide enough resolution to identify non-conformant UEs. Therefore the minimum requirement is not testable.

6.3.3.9 Transmit power time mask for consecutive short subslot transmissions boundaries

No test case details are specified. Current test procedures for time masks are based on power measurement in relatively long period compared with transient period. For time masks between 2 active time slots with different power level, the test procedure can't provide enough resolution to identify non-conformant UEs. Therefore the minimum requirement is not testable.

6.3.4 Power control

6.3.4.1 General

The requirements on power control accuracy apply under normal conditions.

6.3.4.2 Absolute power tolerance

6.3.4.2.1 Test purpose

To verify the ability of the UE transmitter to set its initial output power to a specific value at the start of a contiguous transmission or non-contiguous transmission with a long transmission gap, i.e. transmission gap is larger than 20ms.

6.3.4.2.2 Test applicability

This test case applies to all types of NR UE release 15 and forward.

6.3.4.2.3 Minimum conformance requirements

The absolute power tolerance is the ability of the UE transmitter to set its initial output power to a specific value for the first sub-frame(1ms) at the start of a contiguous transmission or non-contiguous transmission with a transmission gap larger than 20ms. The tolerance includes the channel estimation error.

The minimum requirement specified in Table 6.3.4.2.3-1 apply in the power range bounded by the minimum output power as specified in sub-clause 6.3.1 and the maximum output power as specified in sub-clause 6.2.1.

Table 6.3.4.2.3-1: Absolute power tolerance

Conditions	Tolerance
Normal	± 9.0 dB

The normative reference for this requirement is TS 38.101-1 [2] clause 6.3.4.2

6.3.4.2.4 Test description

6.3.4.2.4.1 Initial conditions

Initial conditions are a set of test configurations the UE needs to be tested in and the steps for the SS to take with the UE to reach the correct measurement state.

The initial test configurations consist of environmental conditions, test frequencies, test channel bandwidths and sub-carrier spacing based on NR operating bands specified in table 5.3.5-1. All of these configurations shall be tested with applicable test parameters for each combination of test channel bandwidth and sub-carrier spacing, and are shown in table 6.3.4.2.4.1-1. The details of the uplink reference measurement channels (RMCs) are specified in Annexes A.2. Configurations of PDSCH and PDCCH before measurement are specified in Annex C.2.

Table 6.3.4.2.4.1-1: Test Configuration Table

Initial Conditions				
Test Environment as specified in TS 38.508-1 [5] subclause 4.1			Normal	
Test Frequencies as specified in TS 38.508-1 [5] subclause 4.3.1			Mid range (NOTE 2)	
Test Channel Bandwidths as specified in TS 38.508-1 [5] subclause 4.3.1			Lowest, Mid, Highest	
Test SCS as specified in Table 5.3.5-1			Lowest, Highest	
Test Parameters				
Test ID	Downlink Configuration		Uplink Configuration	
	Modulation	RB allocation	Modulation	RB allocation (NOTE 1)
1	N/A for Absolute power tolerance test case		CP-OFDM QPSK	Outer_Full
NOTE 1: The specific configuration of each RF allocation is defined in Table 6.1-1.				
NOTE 2: For NR band n28, 30MHz test channel bandwidth is tested with Low range test frequencies.				

1. Connect the SS to the UE antenna connectors as shown in TS 38.508-1 [5] Annex A, Figure A.3.1.1.1 for TE diagram and section A.3.2 for UE diagram.
2. The parameter settings for the cell are set up according to TS 38.508-1 [5] subclause 4.4.3.
3. Downlink signals are initially set up according to Annex C.0, C.1, C.2, and uplink signals according to Annex G.0, G.1, G.2, G.3.0.
4. The UL Reference Measurement Channel is set according to Table 6.3.4.2.4.1-1.
5. Propagation conditions are set according to Annex B.0.
6. Ensure the UE is in state RRC_CONNECTED with generic procedure parameters Connectivity NR, Connected without release On, Test Mode On and Test Loop Function On according to TS 38.508-1 [5] clause 4.5. Message contents are defined in clause 6.3.4.2.4.3. Note that PDCCH DCI format 0_1 sent after resetting uplink power with RRC Connection Reconfiguration, should have TPC command 0dB.

6.3.4.2.4.2 Test procedure

1. SS sends uplink scheduling information for each UL HARQ process via PDCCH DCI format 0_1 with TPC command 0dB for C_RNTI to schedule the UL RMC according to Table 6.3.4.2.4.1-1. Since the UE has no payload and no loopback data to send the UE sends uplink MAC padding bits on the UL RMC.
2. Measure the initial output power of the first sub-frame (1ms) of UE PUSCH first transmission.
3. Repeat for the two test points as indicated in section 6.3.4.2.4.3. The timing of the execution between the two test points shall be larger than 20ms.

6.3.4.2.4.3 Message contents

Message contents are according to TS 38.508-1 [5] subclause 4.6 with the following exceptions:

Table 6.3.4.2.4.3-1: UplinkPowerControlCommon: Test point 1

Derivation Path: TS 38.508-1 [5] subclause 4.6.3 Table 4.6.3-119 PUSCH-ConfigCommon			
Information Element	Value/remark	Comment	Condition
PUSCH-ConfigCommon ::= SEQUENCE {			
p0-NominalWithGrant	-114	Test point 1 to verify a UE relative low initial power transmission	
}			

Table 6.3.4.2.4.3-2: UplinkPowerControlCommon: Test point 2

Derivation Path: TS 38.508-1 [5] subclause 4.6.3 Table 4.6.3-119 PUSCH-ConfigCommon			
Information Element	Value/remark	Comment	Condition
PUSCH-ConfigCommon ::= SEQUENCE {			
p0-NominalWithGrant	-100	Test point 2 to verify a UE relative high initial power transmission	
}			

Table 6.3.4.2.4.3-3: Void

Table 6.3.4.2.4.3-4: ServingCellConfigCommon

Derivation Path: 38.508-1[5], Table 4.6.3-168			
Information Element	Value/remark	Comment	Condition
ServingCellConfigCommon ::= SEQUENCE {			
ss-PBCH-BlockPower	18		SCS_15kHz
	21		SCS_30kHz
}			

Condition	Explanation
SCS_15kHz	SCS=15kHz for SS/PBCH block
SCS_30kHz	SCS=30kHz for SS/PBCH block

6.3.4.2.5 Test requirement

The requirement for the power measured in step (2) of the test procedure is not to exceed the values specified in Table 6.3.4.2.5-1 and 6.3.4.2.5-2.

Table 6.3.4.2.5-1: Absolute power tolerance: test point 1

		Channel bandwidth / expected output power (dBm)												
		5 MHz	10 MHz	15 MHz	20 MHz	25 MHz	30 MHz	40 MHz	50 MHz	60 MHz	70 MHz	80 MHz	90 MHz	100 MHz
Expected Measured power	SCS15	-17.6	-14.4	-12.6	-11.3	-10.4	-9.6	-8.3	-7.3	N/A	N/A	N/A	N/A	N/A
	SCS30	-18.2	-14.8	-12.8	-11.5	-10.5	-9.7	-8.3	-7.4	-6.5	-5.8	-5.2	-4.7	-4.2
	SCS60		-15.2	-13.0	-11.8	-10.7	-9.8	-8.5	-7.5	-6.6	-5.9	-5.3	-4.8	-4.3
Power tolerance		± (9+TT)dB												
Note 1:		The lower power limit shall not exceed the minimum output power requirements defined in sub-clause 6.3.2.3												
Note 2:		TT for each duplex, Sub-Carrier Spacing, frequency and channel bandwidth is specified in Table 6.3.4.2.5-3.												

Table 6.3.4.2.5-2: Absolute power tolerance: test point 2

		Channel bandwidth / expected output power (dBm)												
		5 MHz	10 MHz	15 MHz	20 MHz	25 MHz	30 MHz	40 MHz	50 MHz	60 MHz	70 MHz	80 MHz	90 MHz	100 MHz
Expected Measured power	SCS15	-3.6	0.4	1.4	2.7	3.6	4.4	5.7	6.7	N/A	N/A	N/A	N/A	N/A
	SCS30	-4.2	-0.8	1.2	2.5	3.5	4.3	5.7	6.6	7.5	8.2	8.8	9.3	9.8
	SCS60	N/A	-1.2	1.0	2.2	3.3	4.2	5.5	6.5	7.4	8.1	8.7	9.2	9.7
Power tolerance		± (9+TT)dB												
Note 1:		The higher power limit shall not exceed the maximum output power requirements defined in sub-clause 6.2.1.3												
Note 2:		TT for each duplex, Sub-Carrier Spacing, frequency and channel bandwidth is specified in Table 6.3.4.2.5-3.												

Table 6.3.4.2.5-3: Test Tolerance

	$f \leq 3.0\text{GHz}$	$3.0\text{GHz} < f \leq 4.2\text{GHz}$	$4.2\text{GHz} < f \leq 6.0\text{GHz}$
BW \leq 40MHz	1.0 dB	1.4 dB	1.4 dB
40MHz < BW \leq 100MHz	1.4 dB	1.4 dB	1.4 dB

6.3.4.3 Relative power tolerance

6.3.4.3.1 Test purpose

To verify the ability of the UE transmitter to set its output power in a target sub-frame(1ms) relatively to the power of the most recently transmitted reference sub-frame if the transmission gap between these sub-frames is less than or equal to 20ms.

6.3.4.3.2 Test applicability

This test applies to all types of NR UE release 15 and forward.

6.3.4.3.3 Minimum conformance requirement

The UE shall meet the requirements specified in Table 6.3.4.3.3-1.

The minimum requirements specified in Table 6.3.4.3.3-1 apply when the power of the target and reference sub-frames are within the power range bounded by the minimum output power as defined in sub-clause 6.3.1 and the measured P_{UMAX} as defined in sub-clause 6.2.1.

To account for RF Power amplifier mode changes, 2 exceptions are allowed for each of two test patterns. The test patterns are a monotonically increasing power sweep and a monotonically decreasing power sweep over a range bounded by the requirements of minimum power and maximum power specified in subclauses 6.3.1 and 6.2.1, respectively. For those exceptions, the power tolerance limit is a maximum of ± 6.0 dB in Table 6.3.4.3.3-1.

Table 6.3.4.3.3-1: Relative Power Tolerance

Power step ΔP (Up or down) (dB)	All combinations of PUSCH and PUCCH transitions (dB)	All combinations of PUSCH/PUCCH and SRS transitions between sub- frames (dB)	PRACH (dB)
$\Delta P < 2$	± 2.0 (NOTE)	± 2.5	± 2.0
$2 \leq \Delta P < 3$	± 2.5	± 3.5	± 2.5
$3 \leq \Delta P < 4$	± 3.0	± 4.5	± 3.0
$4 \leq \Delta P \leq 10$	± 3.5	± 5.5	± 3.5
$10 \leq \Delta P < 15$	± 4.0	± 7.0	± 4.0
$15 \leq \Delta P$	± 5.0	± 8.0	± 5.0
NOTE: For PUSCH to PUSCH transitions with the allocated resource blocks fixed in frequency and no transmission gaps other than those generated by downlink subframes, DwPTS fields or Guard Periods: for a power step $\Delta P \leq 1$ dB, the relative power tolerance for transmission is ± 0.7 dB.			

The normative reference for this requirement is TS 38.101-1 [2] clause 6.3.4.3.

6.3.4.3.4 Test description

6.3.4.3.4.1 Initial conditions

Initial conditions are a set of test configurations the UE needs to be tested in and the steps for the SS to take with the UE to reach the correct measurement state.

The initial test configurations consist of environmental conditions, test frequencies, test channel bandwidths and sub-carrier spacing based on NR operating bands specified in table 5.3.5-1. All of these configurations shall be tested with applicable test parameters for each combination of test channel bandwidth and sub-carrier spacing, and are shown in

table 6.3.4.3.4.1-1. The details of the uplink reference measurement channels (RMCs) are specified in Annexes A.2. Configurations of PDSCH and PDCCH before measurement are specified in Annex C.2.

Table 6.3.4.3.4.1-1: Test Configuration Table

Initial Conditions				
Test Environment as specified in TS 38.508-1 [5] subclause 4.3.1			Normal, TL/VL, TL/VH, TH/VL, TH/VH	
Test Frequencies as specified in TS 38.508-1 [5] subclause 4.3.1			Low range	
Test Channel Bandwidths as specified in TS 38.508-1 [5] subclause 4.3.1			Lowest, Mid, Highest	
Test SCS as specified in TS 38.508-1 [5] subclause 4.3.1			Lowest, Highest	
Test Parameters				
Ch BW	Downlink Configuration		Uplink Configuration	
	Modulation	RB Allocation	Modulation	RB allocation (NOTE 1)
5MHz	N/A for Relative power tolerance test case		DFT-s-OFDM QPSK	See Table 6.3.4.3.5-1 See Table 6.3.4.3.5-2 See Table 6.3.4.3.5-7
10MHz			DFT-s-OFDM QPSK	See Table 6.3.4.3.5-3 See Table 6.3.4.3.5-4 See Table 6.3.4.3.5-7
15MHz			DFT-s-OFDM QPSK	See Table 6.3.4.3.5-3 See Table 6.3.4.3.5-4 See Table 6.3.4.3.5-7
20MHz			DFT-s-OFDM QPSK	See Table 6.3.4.3.5-3 See Table 6.3.4.3.5-4 See Table 6.3.4.3.5-7
25MHz			DFT-s-OFDM QPSK	See Table 6.3.4.3.5-3 See Table 6.3.4.3.5-4 See Table 6.3.4.3.5-7
30MHz			DFT-s-OFDM QPSK	See Table 6.3.4.3.5-3 See Table 6.3.4.3.5-4 See Table 6.3.4.3.5-7
40MHz			DFT-s-OFDM QPSK	See Table 6.3.4.3.5-3 See Table 6.3.4.3.5-4 See Table 6.3.4.3.5-7
50MHz			DFT-s-OFDM QPSK	See Table 6.3.4.3.5-3 See Table 6.3.4.3.5-4 See Table 6.3.4.3.5-7
60MHz			DFT-s-OFDM QPSK	See Table 6.3.4.3.5-5 See Table 6.3.4.3.5-6 See Table 6.3.4.3.5-7
70MHz			DFT-s-OFDM QPSK	See Table 6.3.4.3.5-5 See Table 6.3.4.3.5-6 See Table 6.3.4.3.5-7
80MHz			DFT-s-OFDM QPSK	See Table 6.3.4.3.5-5 See Table 6.3.4.3.5-6 See Table 6.3.4.3.5-7
90MHz			DFT-s-OFDM QPSK	See Table 6.3.4.3.5-5 See Table 6.3.4.3.5-6 See Table 6.3.4.3.5-7
100MHz	DFT-s-OFDM QPSK	See Table 6.3.4.3.5-5 See Table 6.3.4.3.5-6 See Table 6.3.4.3.5-7		
Note 1: The starting resource block shall be RB# 0				

1. Connect the SS to the UE antenna connectors as shown in TS 38.508-1 [5] Annex A, Figure A.3.1.1.1 for TE diagram and section A.3.2 for UE diagram.

2. The parameter settings for the cell are set up according to TS 38.508-1 [5] subclause 4.4.3.
3. Downlink signals are initially set up according to Annex C.0, C.1, C.2, and uplink signals according to Annex G.0, G.1, G.2, G.3.0.
4. The UL Reference Measurement Channel is set according to Table 6.3.4.3.4.1-1.
5. Propagation conditions are set according to Annex B.0.
6. Ensure the UE is in state RRC_CONNECTED with generic procedure parameters Connectivity NR, Connected without release *On*, Test Mode *On* and Test Loop Function *On* according to TS 38.508-1 [5] clause 4.5 Message contents are defined in clause 6.3.4.3.4.3.

6.3.4.3.4.2 Test procedure

The procedure is separated in various subtests to verify different aspects of relative power control. The power patterns of the subtests are described in figure 6.3.4.3.4.2-1 thru figure 6.3.4.3.4.2-5.

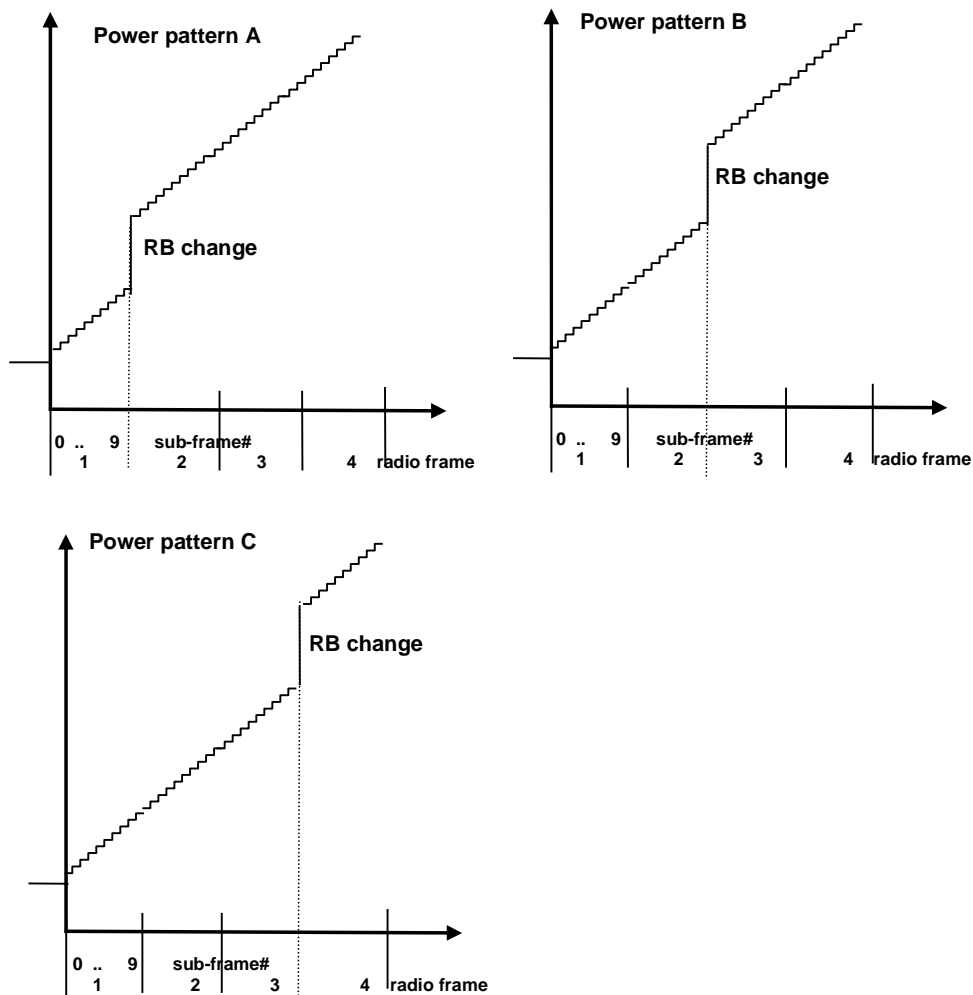

Figure 6.3.4.3.4.2-1: FDD ramping up test power patterns

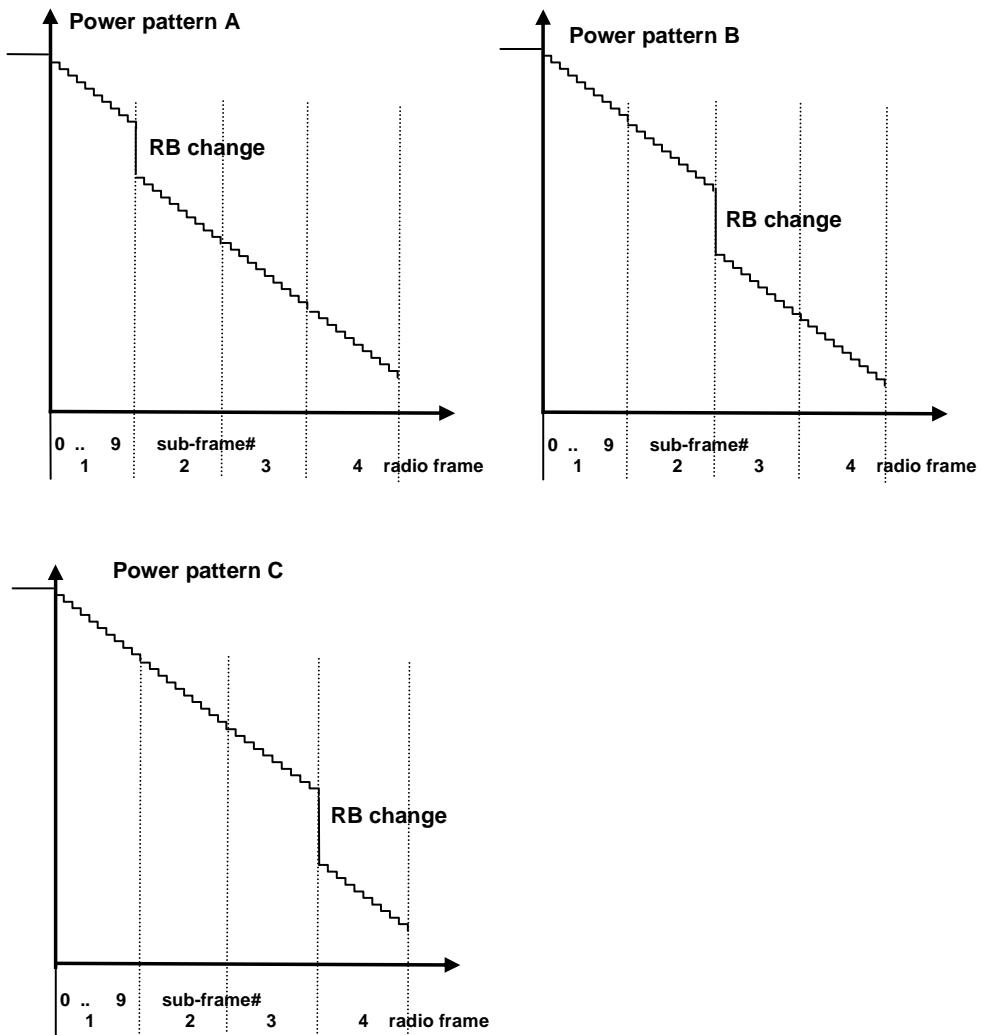

Figure 6.3.4.3.4.2-2: FDD ramping down test power patterns

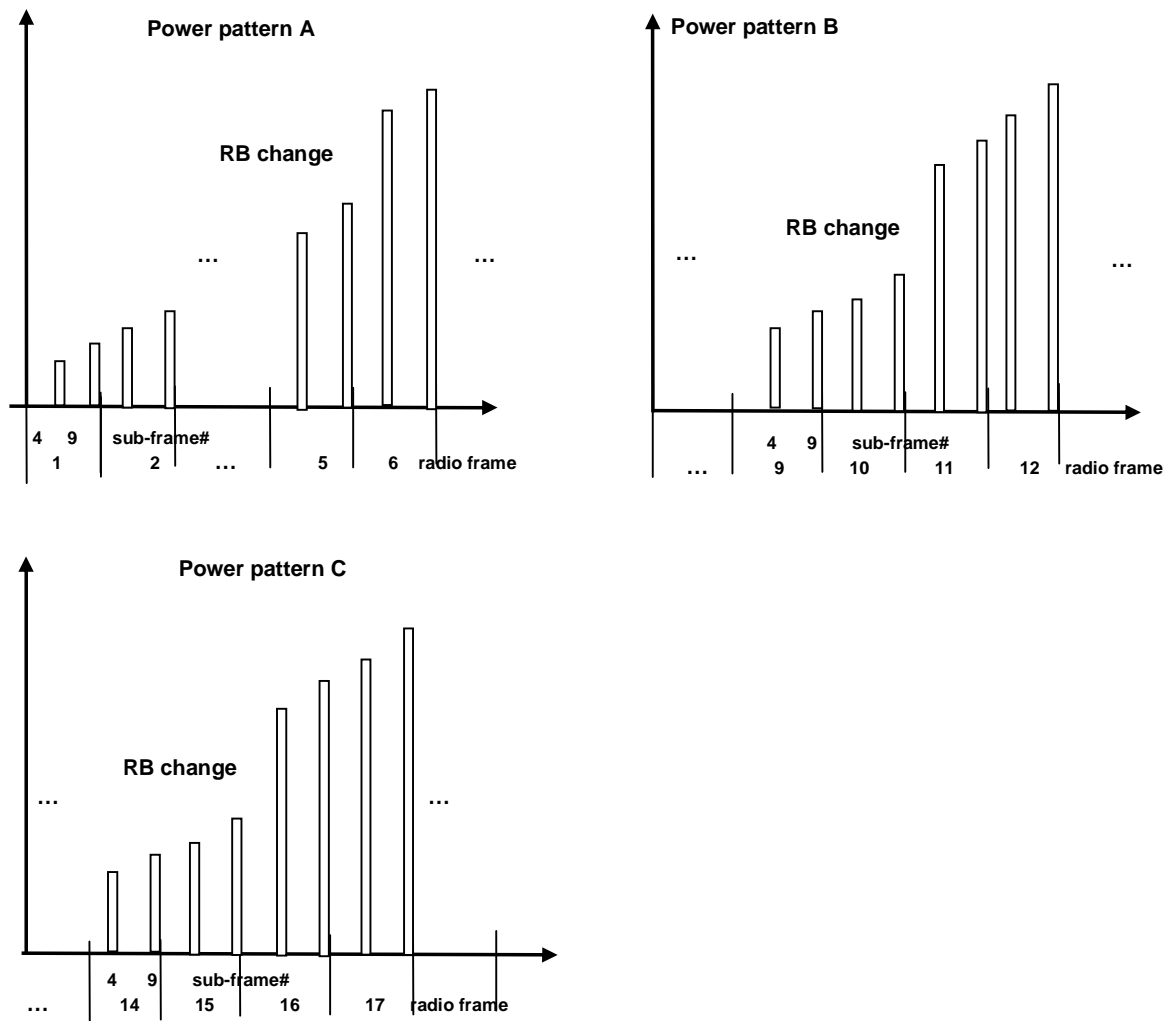

Figure 6.3.4.3.4.2-3: TDD ramping up test power patterns

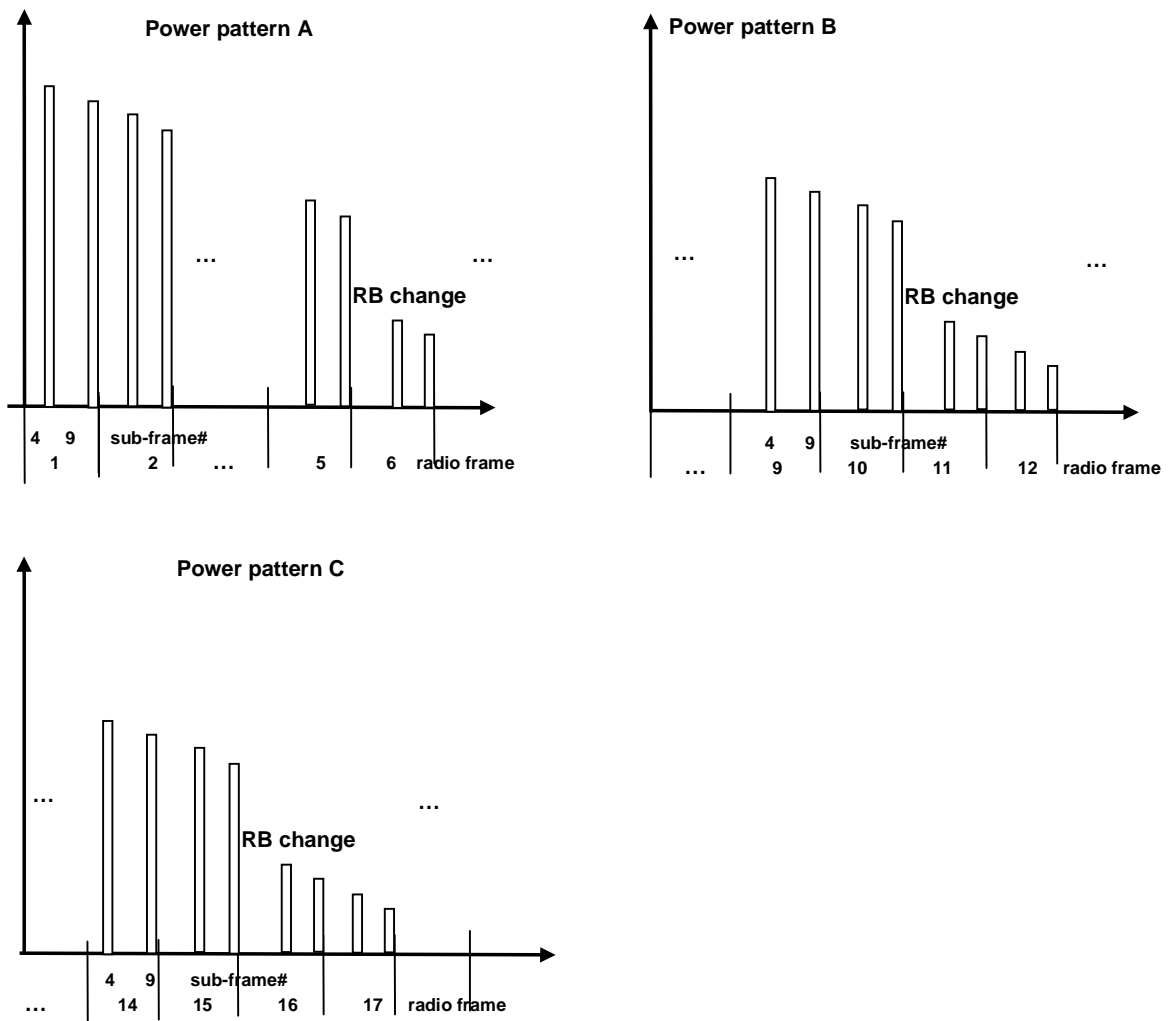

Figure 6.3.4.3.4.2-4: TDD ramping down test power patterns

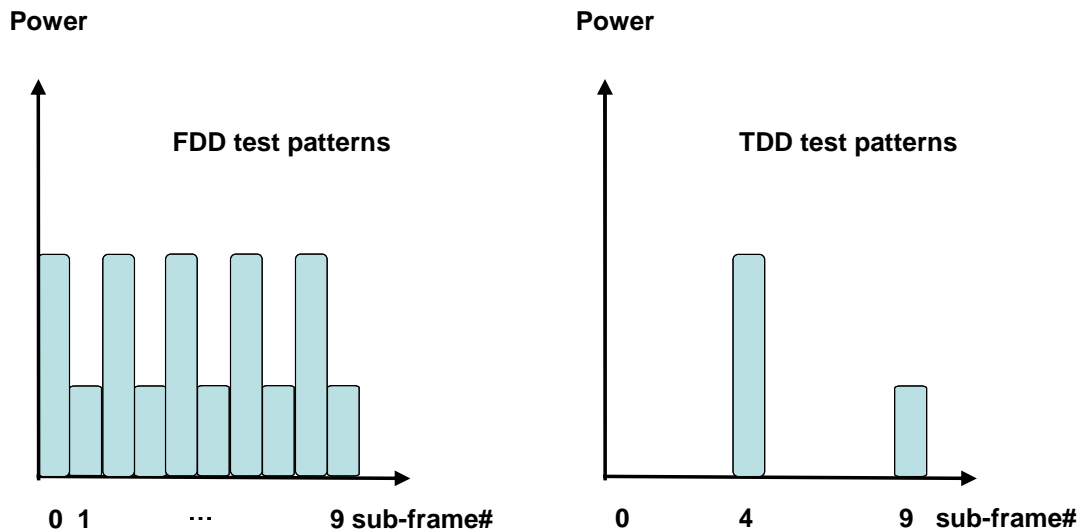

Figure 6.3.4.3.4.2-5: Alternating Test Power patterns

1. Sub test: ramping up pattern

- 1.1. SS sends uplink scheduling information for each UL HARQ process via PDCCH DCI format 0_1 for C_RNTI to schedule the UL RMC according to Table 6.3.4.3.4.1-1. Since the UE has no payload and no loopback data to send the UE sends uplink MAC padding bits on the UL RMC. Send uplink power control commands to the UE using 1dB power step size to ensure that the UE output power measured by the test system is within the Uplink power control window, defined as $+MU$ to $+(MU + \text{Uplink power control window size})$ dB of the target power level -33 dBm, where:
 - MU is the test system uplink power measurement uncertainty and is specified in Table F.1.2-1 for the carrier frequency f and the channel bandwidth BW .
 - Uplink power control window size = 1dB (UE power step size) + 0.7dB (UE power step tolerance) + (Test system relative power measurement uncertainty), where, the UE power step tolerance is specified in TS 38.101-1 [2], Table 6.3.4.3-1 and is 0.7dB for 1dB power step size, and the Test system relative power measurement uncertainty is specified in Table F.1.2-1.
- 1.2. Schedule the UE's PUSCH data transmission as described in Figure 6.3.4.3.4.2-1 (FDD pattern A: sub-test is divided in 4 arbitrary radio frames with 10 active uplink sub-frames per radio frame) and Figure 6.3.4.3.4.2-3 (TDD pattern A: sub-test is divided in 20 arbitrary radio frames with 2 active uplink sub-frames per radio frame). Uplink RB allocation as defined in table 6.3.4.3.5-1/6.3.4.3.5-3/ 6.3.4.3.5-5 depending on channel bandwidth. On the PDCCH format 0_1 for the scheduling of the PUSCH the SS will transmit a +1dB TPC command for every first slot in a sub-frame. Note that the measurement need not be done continuously, provided that interruptions are whole numbers of frames, and TPC commands of 0dB are sent during the interruption.
- 1.3. Measure the power of PUSCH transmissions to verify the UE relative power control meet test requirements 6.3.4.3.5. For power transients between sub-frames, transient periods of 20us between sub-frames are excluded.
- 1.4. Repeat the subtest different pattern B, C to move the RB allocation change at different points in the pattern as described in Table 6.3.4.3.5-1/6.3.4.3.5-3/ 6.3.4.3.5-5 to force bigger UE power steps at various points in the power range.

NOTE: The purpose of the Uplink power control window is to ensure that the actual UE output power is no less than the target power level, and as close as possible to the target power level. The relationship between the Uplink power control window, the target power level and the corresponding possible actual UE Uplink power window is illustrated in Annex F, clause F.4.2.

2. Sub test: ramping down pattern

2.1. SS sends uplink scheduling information for each UL HARQ process via PDCCH DCI format 0_1 for C_RNTI to schedule the UL RMC according to Table 6.3.4.3.4.1-1. Send uplink power control commands to the UE using 1dB power step size to ensure that the UE output power measured by the test system is within the Uplink power control window, defined as $-(\text{MU} + \text{Uplink power control window size})$ to $-\text{MU}$ dB of the target power level 20.7 dBm, where:

- MU is the test system uplink power measurement uncertainty and is specified in Table F.1.2-1 for the carrier frequency f and the channel bandwidth BW.
- Uplink power control window size is same as defined in step 1.1.

2.2. Schedule the UE's PUSCH data transmission as described in Figure 6.3.4.3.4.2-2 (FDD pattern A: sub-test is divided in 4 arbitrary radio frames with 10 active uplink slots per radio frame) and Figure 6.3.4.3.4.2-4 (TDD pattern A: sub-test is divided in 20 arbitrary radio frames with 2 active uplink sub-frames per radio frame). Uplink RB allocation as defined in table 6.3.4.3.5-2/6.3.4.3.5-4/ 6.3.4.3.5-6 depending on channel bandwidth. On the PDCCH format 0_1 for the scheduling of the PUSCH the SS will transmit a -1dB TPC command for every first slot in a sub-frame. Note that the measurement need not be done continuously, provided that interruptions are whole numbers of frames, and TPC commands of 0dB are sent during the interruption.

2.3. Measure the power of PUSCH transmissions to verify the UE relative power control meet test requirements 6.3.4.4.5. For power transients between sub-frames, transient periods of 20us between sub-frames are excluded.

2.4. Repeat the subtest different pattern B, C to move the RB allocation change at different points in the pattern as described in Table 6.3.4.3.5-2/6.3.4.3.5-4/ 6.3.4.3.5-6 to force bigger UE power steps at various points in the power range.

NOTE: The purpose of the Uplink power control window is to ensure that the actual UE output power is no greater than the target power level, and as close as possible to the target power level. The relationship between the Uplink power control window, the target power level and the corresponding possible actual UE Uplink power window is illustrated in Annex F, clause F.4.3.

3. Sub test: alternating pattern

3.1. SS sends uplink scheduling information for each UL HARQ process via PDCCH DCI format 0_1 for C_RNTI to schedule the UL RMC according to Table 6.3.4.3.4.1-1. Since the UE has no payload and no loopback data to send the UE sends uplink MAC padding bits on the UL RMC. Send uplink power control commands for PUSCH to the UE using 1dB power step size to ensure that the UE output power measured by the test system is within the Uplink power control window, defined as $-(\text{Uplink power control window size} / 2)$ dB to $+(\text{Uplink power control window size} / 2)$ dB of the target power level -10 dBm, where:

- Uplink power control window size is same as defined in step 1.1.

3.2. Schedule the UE's PUSCH data transmission as described in Figure 6.3.5.2.4.2-5 for 10 sub-frames an uplink RB allocation alternating pattern as defined in table 6.3.4.3.5-7 while transmitting 0dB TPC command for PUSCH via the PDCCH.

3.3. Measure the power of PUSCH transmissions to verify the UE relative power control meet test requirements specified in clause 6.3.4.3.5. For power transients between sub-frames, transient periods of 20us between sub-frames are excluded.

NOTE: The purpose of the Uplink power control window is to ensure that the actual UE output power is as close as possible to the target power level. The relationship between the Uplink power control window, the target power level and the corresponding possible actual UE Uplink power window is illustrated in Annex F.4.4.

6.3.4.3.4.3 Message contents

Message contents are according to TS 38.508-1 [5] subclause 4.6 with the following exceptions:

Table 6.3.4.3.4.3-1: PUSCH-Config

Derivation Path: TS 38.508-1 [5], Table 4.6.3-118 with condition TRANSFORM_PRECODER_ENABLED

6.3.4.3.5 Test requirement

Each UE power step measured in the test procedure 6.3.4.3.4.2 should satisfy the test requirements specified in Table 6.3.4.3.5-1 thru 6.3.4.3.5-7.

To account for RF Power amplifier mode changes 2 exceptions are allowed for each of ramping up and ramping down test patterns. For these exceptions the power tolerance limit is a maximum of $\pm (6.0 + TT)$ dB. If there is an exception in the power step caused by the RB change for all test patterns (A, B, C) then fail the UE.

Table 6.3.4.3.5-1: Test Requirements Relative Power Tolerance for Transmission, channel BW 5MHz, ramp up sub-test

Test SCS [kHz]	Sub-test ID	Applicable sub-frames	Uplink RB allocation	TPC command	Expected power step size (Up) ΔP [dB]	Power step size range (Up) ΔP [dB]	PUSCH [dB]
15	1	Sub-frames before RB change	Fixed = 1	TPC=+1dB	1	$\Delta P \leq 1$ dB	1 +/- (0.7 + TT)
		RB change	1RB to 5 RBs	TPC=+1dB	7.99	$4\text{dB} \leq \Delta P < 10\text{dB}$	7.99 +/- (3.5 + TT)
		Sub-frames after RB change	Fixed = 5	TPC=+1dB	1	$\Delta P \leq 1$ dB	1 +/- (0.7 + TT)
	2	Sub-frames before RB change	Fixed = 1	TPC=+1dB	1	$\Delta P \leq 1$ dB	1 +/- (0.7 + TT)
		RB change	1RB to 15 RBs	TPC=+1dB	12.76	$10\text{dB} \leq \Delta P < 15\text{dB}$	12.76 +/- (4 + TT)
		Sub-frames after RB change	Fixed = 15	TPC=+1dB	1	$\Delta P \leq 1$ dB	1 +/- (0.7 + TT)
30	1	Sub-frames before RB change	Fixed = 1	TPC=+1dB	1	$\Delta P \leq 1$ dB	1 +/- (0.7 + TT)
		RB change	1RB to 5 RBs	TPC=+1dB	7.99	$4\text{dB} \leq \Delta P < 10\text{dB}$	7.99 +/- (3.5 + TT)
		Sub-frames after RB change	Fixed = 5	TPC=+1dB	1	$\Delta P \leq 1$ dB	1 +/- (0.7 + TT)
	2	Sub-frames before RB change	Fixed = 1	TPC=+1dB	1	$\Delta P \leq 1$ dB	1 +/- (0.7 + TT)
		RB change	1RB to 10 RBs	TPC=+1dB	11.00	$10\text{dB} \leq \Delta P < 15\text{dB}$	11.00 +/- (4 + TT)
		Sub-frames after RB change	Fixed = 10	TPC=+1dB	1	$\Delta P \leq 1$ dB	1 +/- (0.7 + TT)
<p>Note 1: Position of RB change: Pattern A the position of RB uplink allocation change is after 10 active uplink Sub-frames Pattern B the position of RB uplink allocation change is after 20 active uplink Sub-frames Pattern C the position of RB uplink allocation change is after 30 active uplink Sub-frames</p> <p>Note 2: The starting resource block shall be RB# 0.</p> <p>Note 3: TT=0.7dB</p> <p>Note 4: Applicable if $P_{\text{UMAX}} \geq P \geq P_{\text{min}}$. P_{min} as defined in sub-clause 6.3.1.</p>							

Table 6.3.4.3.5-2: Test Requirements Relative Power Tolerance for Transmission, channel BW 5MHz, ramp down sub-test

Test SCS [kHz]	Sub-test ID	Applicable sub-frames	Uplink RB allocation	TPC command	Expected power step size (Down) ΔP [dB]	Power step size range (Down) ΔP [dB]	PUSCH [dB]
15	1	Sub-frames before RB change	Fixed = 5	TPC=-1dB	1	$\Delta P \leq 1$ dB	1 +/- (0.7 + TT)
		RB change	5 RBs to 1 RB	TPC=-1dB	7.99	$4\text{dB} \leq \Delta P < 10\text{dB}$	7.99 +/- (3.5 + TT)
		Sub-frames after RB change	Fixed = 1	TPC=-1dB	1	$\Delta P \leq 1$ dB	1 +/- (0.7 + TT)
	2	Sub-frames before RB change	Fixed = 15	TPC=-1dB	1	$\Delta P \leq 1$ dB	1 +/- (0.7 + TT)
		RB change	15 RBs to 1 RB	TPC=-1dB	12.76	$10\text{dB} \leq \Delta P < 15\text{dB}$	12.76 +/- (3.5 + TT)
		Sub-frames after RB change	Fixed = 1	TPC=-1dB	1	$\Delta P \leq 1$ dB	1 +/- (0.7 + TT)
30	1	Sub-frames before RB change	Fixed = 5	TPC=-1dB	1	$\Delta P \leq 1$ dB	1 +/- (0.7 + TT)
		RB change	5 RBs to 1 RB	TPC=-1dB	7.99	$4\text{dB} \leq \Delta P < 10\text{dB}$	7.99 +/- (3.5 + TT)
		Sub-frames after RB change	Fixed = 1	TPC=-1dB	1	$\Delta P \leq 1$ dB	1 +/- (0.7 + TT)
	2	Sub-frames before RB change	Fixed = 10	TPC=-1dB	1	$\Delta P \leq 1$ dB	1 +/- (0.7 + TT)
		RB change	10 RBs to 1 RB	TPC=-1dB	11.00	$10\text{dB} \leq \Delta P < 15\text{dB}$	11.00 +/- (4 + TT)
		Sub-frames after RB change	Fixed = 1	TPC=-1dB	1	$\Delta P \leq 1$ dB	1 +/- (0.7 + TT)
<p>Note 1: Position of RB change: Pattern A the position of RB uplink allocation change is after 10 active uplink Sub-frames Pattern B the position of RB uplink allocation change is after 20 active uplink Sub-frames Pattern C the position of RB uplink allocation change is after 30 active uplink Sub-frames</p> <p>Note 2: The starting resource block shall be RB# 0.</p> <p>Note 3: TT=0.7dB</p> <p>Note 4: Applicable if $P_{\text{UMAX}} \geq P \geq P_{\text{min}}$. P_{min} as defined in sub-clause 6.3.1.</p>							

Table 6.3.4.3.5-3: Test Requirements Relative Power Tolerance for Transmission, channel BW 10MHz, 15MHz, 20MHz, 25MHz, 30MHz, 40MHz, 50MHz ramp up sub-test

Test SCS [kHz]	Sub-test ID	Applicable sub-frames	Uplink RB allocation	TPC command	Expected power step size (Up) ΔP [dB]	Power step size range (Up) ΔP [dB]	PUSCH [dB]
15	1	Subframes before RB change	1RB	TPC=+1dB	1	$\Delta P \leq 1$ dB	1 +/- (0.7 + TT)
		RB change	1RB to 5 RBs	TPC=+1dB	7.99	$4\text{dB} \leq \Delta P < 10\text{dB}$	7.99 +/- (3.5 + TT)
		Subframes after RB change	Fixed = 5	TPC=+1dB	1	$\Delta P \leq 1$ dB	1 +/- (0.7 + TT)
	2	Subframes before RB change	1RB	TPC=+1dB	1	$\Delta P \leq 1$ dB	1 +/- (0.7 + TT)
		RB change	1RB to 20 RBs	TPC=+1dB	14.01	$10\text{dB} \leq \Delta P < 15\text{dB}$	14.01 +/- (4 + TT)
		Subframes after RB change	Fixed = 20	TPC=+1dB	1	$\Delta P \leq 1$ dB	1 +/- 0.7 + TT
	3	Subframes before RB change	1RB	TPC=+1dB	1	$\Delta P \leq 1$ dB	1 +/- (0.7 + TT)
		RB change	1RB to 50 RBs	TPC=+1dB	17.99	$15\text{dB} \leq \Delta P$	17.99 +/- (5 + TT)
		Subframes after RB change	Fixed = 50	TPC=+1dB	1	$\Delta P \leq 1$ dB	1 +/- (0.7 + TT)
30	1	Subframes before RB change	1RB	TPC=+1dB	1	$\Delta P \leq 1$ dB	1 +/- (0.7 + TT)
		RB change	1RB to 5 RBs	TPC=+1dB	7.99	$4\text{dB} \leq \Delta P < 10\text{dB}$	7.99 +/- (3.5 + TT)
		Subframes after RB change	Fixed = 5	TPC=+1dB	1	$\Delta P \leq 1$ dB	1 +/- (0.7 + TT)
	2	Subframes before RB change	1RB	TPC=+1dB	1	$\Delta P \leq 1$ dB	1 +/- 0.7 + TT
		RB change	1RB to 24 RBs	TPC=+1dB	14.80	$10\text{dB} \leq \Delta P < 15\text{dB}$	14.80 +/- (4 + TT)
		Subframes after RB change	Fixed = 24	TPC=+1dB	1	$\Delta P \leq 1$ dB	1 +/- (0.7 + TT)
60	1	Subframes before RB change	1RB	TPC=+1dB	1	$\Delta P \leq 1$ dB	1 +/- 0.7 + TT
		RB change	1RB to 5 RBs	TPC=+1dB	7.99	$4\text{dB} \leq \Delta P < 10\text{dB}$	7.99 +/- (3.5 + TT)
		Subframes after RB change	Fixed = 5	TPC=+1dB	1	$\Delta P \leq 1$ dB	1 +/- (0.7 + TT)
	2	Subframes before RB change	1RB	TPC=+1dB	1	$\Delta P \leq 1$ dB	1 +/- (0.7 + TT)
		RB change	1RB to 10 RBs	TPC=+1dB	11.00	$10\text{dB} \leq \Delta P < 15\text{dB}$	11.00 +/- (4 + TT)
		Subframes after RB change	Fixed = 10	TPC=+1dB	1	$\Delta P \leq 1$ dB	1 +/- (0.7 + TT)
Note 1:	Position of RB change: Pattern A the position of RB uplink allocation change is after 10 active uplink Subframes. Pattern B the position of RB uplink allocation change is after 20 active uplink Subframes. Pattern C the position of RB uplink allocation change is after 30 active uplink Subframes.						
Note 2:	The starting resource block shall be RB# 0.						
Note 3:	TT=0.7dB						
Note 4:	Applicable if $P_{\text{UMAX}} \geq P \geq P_{\text{min}}$. P_{min} as defined in sub-clause 6.3.1.						

Table 6.3.4.3.5-4: Test Requirements Relative Power Tolerance for Transmission, channel BW 10MHz, 15MHz, 20MHz, 25MHz, 30MHz, 40MHz, 50MHz ramp down sub-test

Test SCS [kHz]	Sub-test ID	Applicable sub-frames	Uplink RB allocation	TPC command	Expected power step size (Down) ΔP [dB]	Power step size range (Down) ΔP [dB]	PUSCH [dB]
15	1	Subframes before RB change	Fixed = 5	TPC=-1dB	1	$\Delta P \leq 1$ dB	1 +/- (0.7 + TT)
		RB change	5 RBs to 1RBs	TPC=-1dB	7.99	4dB $\leq \Delta P < 10$ dB	7.99 +/- (3.5 + TT)
		Subframes after RB change	Fixed = 1	TPC=-1dB	1	$\Delta P \leq 1$ dB	1 +/- (0.7 + TT)
	2	Subframes before RB change	Fixed = 20	TPC=-1dB	1	$\Delta P \leq 1$ dB	1 +/- (0.7 + TT)
		RB change	20 RBs to 1 RB	TPC=-1dB	14.01	10dB $\leq \Delta P < 15$ dB	14.01 +/- (4 + TT)
		Subframes after RB change	Fixed = 1	TPC=-1dB	1	$\Delta P \leq 1$ dB	1 +/- (0.7 + TT)
	3	Subframes before RB change	Fixed = 50	TPC=-1dB	1	$\Delta P \leq 1$ dB	1 +/- (0.7 + TT)
		RB change	50 RBs to 1 RB	TPC=-1dB	17.99	15dB $\leq \Delta P$	17.99 +/- (5 + TT)
		Subframes after RB change	Fixed = 1	TPC=-1dB	1	$\Delta P \leq 1$ dB	1 +/- (0.7 + TT)
30	1	Subframes before RB change	Fixed = 5	TPC=-1dB	1	$\Delta P \leq 1$ dB	1 +/-0.7 + TT
		RB change	5 RBs to 1 RB	TPC=-1dB	7.99	4dB $\leq \Delta P < 10$ dB	7.99 +/- (3.5 + TT)
		Subframes after RB change	Fixed = 1	TPC=-1dB	1	$\Delta P \leq 1$ dB	1 +/- (0.7 + TT)
	2	Subframes before RB change	Fixed = 24	TPC=-1dB	1	$\Delta P \leq 1$ dB	1 +/-0.7 + TT
		RB change	24 RBs to 1 RB	TPC=-1dB	14.80	10dB $\leq \Delta P < 15$ dB	14.80 +/- (4 + TT)
		Subframes after RB change	Fixed = 1	TPC=-1dB	1	$\Delta P \leq 1$ dB	1 +/- (0.7 + TT)
60	1	Subframes before RB change	Fixed = 5	TPC=-1dB	1	$\Delta P \leq 1$ dB	1 +/- (0.7 + TT)
		RB change	5 RBs to 1 RB	TPC=-1dB	7.99	4dB $\leq \Delta P < 10$ dB	7.99 +/- (3.5 + TT)
		Subframes after RB change	Fixed = 1	TPC=-1dB	1	$\Delta P \leq 1$ dB	1 +/- (0.7 + TT)
	2	Subframes before RB change	Fixed = 10	TPC=-1dB	1	$\Delta P \leq 1$ dB	1 +/-0.7 + TT
		RB change	10 RBs to 1 RB	TPC=-1dB	11.00	10dB $\leq \Delta P < 15$ dB	11.00 +/- (4 + TT)
		Subframes after RB change	Fixed = 1	TPC=-1dB	1	$\Delta P \leq 1$ dB	1 +/- (0.7 + TT)
Note 1:	Position of RB change: Pattern A the position of RB uplink allocation change is after 10 active uplink Subframes. Pattern B the position of RB uplink allocation change is after 20 active uplink Subframes. Pattern C the position of RB uplink allocation change is after 30 active uplink Subframes.						
Note 2:	The starting resource block shall be RB# 0.						
Note 3:	TT=0.7dB						
Note 4:	Applicable if PUMAX $\geq P \geq P_{min}$. Pmin as defined in sub-clause 6.3.1.						

Table 6.3.4.3.5-5: Test Requirements Relative Power Tolerance for Transmission, channel BW 60MHz, 70MHz, 80MHz, 90MHz, 100MHz ramp up sub-test

Test SCS [kHz]	Sub-test ID	Applicable sub-frames	Uplink RB allocation	TPC command	Expected power step size (Up) ΔP [dB]	Power step size range (Up) ΔP [dB]	PUSCH [dB]
30	1	Subframes before RB change	1RB	TPC=+1dB	1	$\Delta P \leq 1$ dB	1 +/- (0.7 + TT)
		RB change	1RB to 5 RBs	TPC=+1dB	7.99	4dB $\leq \Delta P < 10$ dB	7.99 +/- (3.5 + TT)
		Subframes after RB change	Fixed = 5	TPC=+1dB	1	$\Delta P \leq 1$ dB	1 +/- (0.7 + TT)
	2	Subframes before RB change	1RB	TPC=+1dB	1	$\Delta P \leq 1$ dB	1 +/- (0.7 + TT)
		RB change	1RB to 24 RBs	TPC=+1dB	14.80	10dB $\leq \Delta P < 15$ dB	14.80 +/- (4 + TT)
		Subframes after RB change	Fixed = 24	TPC=+1dB	1	$\Delta P \leq 1$ dB	1 +/- (0.7 + TT)
	3	Subframes before RB change	1RB	TPC=+1dB	1	$\Delta P \leq 1$ dB	1 +/- (0.7 + TT)
		RB change	1RB to 81 RBs	TPC=+1dB	20.08	15dB $< \Delta P$	20.08 +/- (5 + TT)
		Subframes after RB change	Fixed = 81	TPC=+1dB	1	$\Delta P \leq 1$ dB	1 +/- (0.7 + TT)
60	1	Subframes before RB change	1RB	TPC=+1dB	1	$\Delta P \leq 1$ dB	1 +/- (0.7 + TT)
		RB change	1RB to 5 RBs	TPC=+1dB	7.99	4dB $\leq \Delta P < 10$ dB	7.99 +/- (3.5 + TT)
		Subframes after RB change	Fixed = 5	TPC=+1dB	1	$\Delta P \leq 1$ dB	1 +/- (0.7 + TT)
	2	Subframes before RB change	1RB	TPC=+1dB	1	$\Delta P \leq 1$ dB	1 +/- (0.7 + TT)
		RB change	1RB to 75 RBs	TPC=+1dB	19.75	15dB $< \Delta P$	19.75 +/- (5 + TT)
		Subframes after RB change	Fixed = 75	TPC=+1dB	1	$\Delta P \leq 1$ dB	1 +/- (0.7 + TT)
Note 1:	Position of RB change: Pattern A the position of RB uplink allocation change is after 10 active uplink Subframes. Pattern B the position of RB uplink allocation change is after 20 active uplink Subframes Pattern C the position of RB uplink allocation change is after 30 active uplink Subframes.						
Note 2:	The starting resource block shall be RB# 0.						
Note 3:	TT=0.7dB						
Note 4:	Applicable if PUMAX $\geq P \geq P_{min}$. Pmin as defined in sub-clause 6.3.1.						

Table 6.3.4.3.5-6: Test Requirements Relative Power Tolerance for Transmission, channel BW 60MHz, 70MHz, 80MHz, 90MHz, 100MHz ramp down sub-test

Test SCS [kHz]	Sub-test ID	Applicable sub-frames	Uplink RB allocation	TPC command	Expected power step size (Down) ΔP [dB]	Power step size range (Down) ΔP [dB]	PUSCH [dB]
30	1	Subframes before RB change	Fixed = 5	TPC=-1dB	1	$\Delta P \leq 1 \text{ dB}$	1 +/-0.7 + TT
		RB change	5 RBs to 1 RB	TPC=-1dB	7.99	$4\text{dB} \leq \Delta P < 10\text{dB}$	7.99 +/- (3.5 + TT)
		Subframes after RB change	Fixed = 1	TPC=-1dB	1	$\Delta P \leq 1 \text{ dB}$	1 +/- (0.7 + TT)
	2	Subframes before RB change	Fixed = 24	TPC=-1dB	1	$\Delta P \leq 1 \text{ dB}$	1 +/- (0.7 + TT)
		RB change	24 RBs to 1 RB	TPC=-1dB	14.80	$10\text{dB} \leq \Delta P < 15\text{dB}$	14.80 +/- (4 + TT)
		Subframes after RB change	Fixed = 1	TPC=-1dB	1	$\Delta P \leq 1 \text{ dB}$	1 +/- (0.7 + TT)
	3	Subframes before RB change	Fixed = 81	TPC=-1dB	1	$\Delta P \leq 1 \text{ dB}$	1 +/- (0.7 + TT)
		RB change	81 RBs to 1 RB	TPC=-1dB	20.08	$15\text{dB} < \Delta P$	20.08 +/- (5 + TT)
		Subframes after RB change	Fixed = 1	TPC=-1dB	1	$\Delta P \leq 1 \text{ dB}$	1 +/- (0.7 + TT)
60	1	Subframes before RB change	Fixed = 5	TPC=-1dB	1	$\Delta P \leq 1 \text{ dB}$	1 +/- (0.7 + TT)
		RB change	5 RBs to 1 RB	TPC=-1dB	7.99	$4\text{dB} \leq \Delta P < 10\text{dB}$	7.99 +/- (3.5 + TT)
		Subframes after RB change	Fixed = 1	TPC=-1dB	1	$\Delta P \leq 1 \text{ dB}$	1 +/- (0.7 + TT)
	2	Subframes before RB change	Fixed = 75	TPC=-1dB	1	$\Delta P \leq 1 \text{ dB}$	1 +/- (0.7 + TT)
		RB change	75 RBs to 1 RB	TPC=-1dB	19.75	$15\text{dB} < \Delta P$	19.75 +/- (5 + TT)
		Subframes after RB change	Fixed = 1	TPC=-1dB	1	$\Delta P \leq 1 \text{ dB}$	1 +/- (0.7 + TT)
<p>Note 1: Position of RB change: Pattern A the position of RB uplink allocation change is after 10 active uplink Subframes. Pattern B the position of RB uplink allocation change is after 20 active uplink Subframes Pattern C the position of RB uplink allocation change is after 30 active uplink Subframes.</p> <p>Note 2: The starting resource block shall be RB# 0.</p> <p>Note 3: TT=0.7dB</p> <p>Note 4: Applicable if $P_{UMAX} \geq P \geq P_{min}$. P_{min} as defined in sub-clause 6.3.1.</p>							

Table 6.3.4.3.5-7: Test Requirements Relative Power Tolerance for Transmission, alternating sub-test

BW	Test SCS [kHz]	Sub-test ID	Uplink RB allocation	TPC command	Expected power step size (Up or Down) ΔP [dB]	Power step size range (Up or Down) ΔP [dB]	PUSCH [dB]	
5	15	1	Alternating 1 and 2	TPC=0dB	3.01	$3\text{dB} \leq \Delta P < 4\text{dB}$	$3.01 \pm (3 + TT)$	
		2	Alternating 1 and 5	TPC=0dB	6.99	$4\text{dB} \leq \Delta P < 10\text{dB}$	$6.99 \pm (3.5 + TT)$	
		3	Alternating 1 and 15	TPC=0dB	11.76	$10\text{dB} \leq \Delta P < 15\text{dB}$	$11.76 \pm (4 + TT)$	
	30	1	Alternating 1 and 2	TPC=0dB	3.01	$3\text{dB} \leq \Delta P < 4\text{dB}$	$3.01 \pm (3 + TT)$	
		2	Alternating 1 and 10	TPC=0dB	10.00	$10\text{dB} \leq \Delta P < 15\text{dB}$	$10.00 \pm (4 + TT)$	
	10,15,20,25,30,40,50	15	1	Alternating 1 and 2	TPC=0dB	3.01	$3\text{dB} \leq \Delta P < 4\text{dB}$	$3.01 \pm (3 + TT)$
2			Alternating 1 and 5	TPC=0dB	6.99	$4\text{dB} \leq \Delta P < 10\text{dB}$	$6.99 \pm (3.5 + TT)$	
3			Alternating 1 and 20	TPC=0dB	13.01	$10\text{dB} \leq \Delta P < 15\text{dB}$	$13.01 \pm (4 + TT)$	
4			Alternating 1 and 50	TPC=0dB	16.99	$15\text{dB} \leq \Delta P$	$16.99 \pm (5 + TT)$	
30		1	Alternating 1 and 2	TPC=0dB	3.01	$3\text{dB} \leq \Delta P < 4\text{dB}$	$3.01 \pm (3 + TT)$	
		2	Alternating 1 and 5	TPC=0dB	6.99	$4\text{dB} \leq \Delta P < 10\text{dB}$	$6.99 \pm (3.5 + TT)$	
		3	Alternating 1 and 24	TPC=0dB	13.80	$10\text{dB} \leq \Delta P < 15\text{dB}$	$13.80 \pm (4 + TT)$	
60		1	Alternating 1 and 5	TPC=0dB	6.99	$4\text{dB} \leq \Delta P < 10\text{dB}$	$6.99 \pm (3.5 + TT)$	
		2	Alternating 1 and 10	TPC=0dB	10.00	$10\text{dB} \leq \Delta P < 15\text{dB}$	$10.00 \pm (4 + TT)$	
60,70,80,90,100		30	1	Alternating 1 and 2	TPC=0dB	3.01	$3\text{dB} \leq \Delta P < 4\text{dB}$	$3.01 \pm (3 + TT)$
			2	Alternating 1 and 5	TPC=0dB	6.99	$4\text{dB} \leq \Delta P < 10\text{dB}$	$6.99 \pm (3.5 + TT)$
			3	Alternating 1 and 81	TPC=0dB	19.08	$15\text{dB} < \Delta P$	$19.08 \pm (5 + TT)$
	60	1	Alternating 1 and 2	TPC=0dB	3.01	$3\text{dB} \leq \Delta P < 4\text{dB}$	$3.01 \pm (3 + TT)$	
		2	Alternating 1 and 5	TPC=0dB	6.99	$4\text{dB} \leq \Delta P < 10\text{dB}$	$6.99 \pm (3.5 + TT)$	
		3	Alternating 1 and 75	TPC=0dB	18.75	$15\text{dB} < \Delta P$	$18.75 \pm (5 + TT)$	
Note 1: The starting resource block shall be RB# 0.								
Note 2: TT=0.7dB								
Note 3: Applicable if PUMAX $\geq P \geq P_{min}$. Pmin as defined in sub-clause 6.3.1.								

6.3.4.4 Aggregate power tolerance

6.3.4.4.1 Test purpose

To verify the ability of the UE transmitter to maintain its power during non-contiguous transmissions within 21ms in response to 0 dB commands with respect to the first UE transmission and all other power control parameters as specified in 38.213 kept constant.

6.3.4.4.2 Test applicability

This test case applies to all types of NR UE release 15 and forward.

6.3.4.4.3 Minimum conformance requirements

The aggregate power control tolerance is the ability of the UE transmitter to maintain its power in a sub-frame(1ms) during non-contiguous transmissions within 21ms in response to 0 dB commands with respect to the first UE transmission and all other power control parameters as specified in 38.213 kept constant.

The minimum requirement specified in Table 6.3.4.4.3-1 apply in the power range bounded by the minimum output power as specified in sub-clause 6.3.1 and the maximum output power as specified in sub-clause 6.2.2.

Table 6.3.4.4.3-1: Aggregate power tolerance

TPC command	UL channel	Aggregate power tolerance within 21ms
0 dB	PUCCH	± 2.5 dB
0 dB	PUSCH	± 3.5 dB

The normative reference for this requirement is TS 38.01-1 [2] clause 6.3.4.4

6.3.4.4.4 Test description

6.3.4.4.4.1 Initial conditions

Initial conditions are a set of test configurations the UE needs to be tested in and the steps for the SS to take with the UE to reach the correct measurement state.

The initial test configurations consist of environmental conditions, test frequencies, test channel bandwidths and sub-carrier spacing based on NR operating bands specified in table 5.3.5-1. All of these configurations shall be tested with applicable test parameters for each combination of test channel bandwidth and sub-carrier spacing, and are shown in table 6.3.4.4.4.1-1 and table 6.3.4.4.4.1-2. The details of the uplink reference measurement channels (RMCs) are specified in Annexes A.2. Configurations of PDSCH and PDCCH before measurement are specified in Annex C.2.

Table 6.3.4.4.4.1-1: Test Configuration Table: PUCCH sub-test

Initial Conditions		
Test Environment as specified in TS 38.508-1 [5] subclause 4.1	Normal	
Test Frequencies as specified in TS 38.508-1 [5] subclause 4.3.1	Mid range (NOTE 1)	
Test Channel Bandwidths as specified in TS 38.508-1 [5] subclause 4.3.1	Lowest, Mid, Highest	
Test SCS as specified in Table 5.3.5-1	Lowest, Highest	
Test Parameters for Channel Bandwidths		
Test ID	Downlink Configuration	Uplink Configuration
1	N/A for aggregate power tolerance testcase	PUCCH format = Format 1 Length in OFDM symbols = 14
NOTE 1: For NR band n28, 30MHz test channel bandwidth is tested with Low range test frequencies.		

Table 6.3.4.4.1-2: Test Configuration Table: PUSCH sub-test

Initial Conditions			
Test Environment as specified in TS 38.508-1 [5] subclause 4.1		Normal	
Test Frequencies as specified in TS 38.508-1 [5] subclause 4.3.1		Mid range (NOTE 2)	
Test Channel Bandwidths as specified in TS 38.508-1 [5] subclause 4.3.1		Lowest, Mid, Highest	
Test SCS as specified in Table 5.3.5-1		Lowest, Highest	
Test Parameters for Channel Bandwidths			
Test ID	Downlink Configuration	Uplink Configuration	
	N/A for aggregate power tolerance testcase	Modulation	RB allocation (NOTE 1)
1		CP-OFDM QPSK	Outer_Full
NOTE 1: The specific configuration of each RF allocation is defined in Table 6.1-1.			
NOTE 2: For NR band n28, 30MHz test channel bandwidth is tested with Low range test frequencies.			

1. Connect the SS to the UE antenna connectors as shown in TS 38.508-1 [5] Annex A, Figure A.3.1.1.1 for TE diagram and section A.3.2 for UE diagram.
2. The parameter settings for the cell are set up according to TS 38.508-1 [5] subclause 4.4.3.
3. Downlink signals are initially set up according to Annex C.0, C.1, C.2, and uplink signals according to G.0, G.1, G.2, G.3.0.
4. The UL and DL Reference Measurement channels are set according to Table 6.3.4.4.1-1 (PUCCH sub-test) and Table 6.3.4.4.1-2 (PUSCH sub-test)
5. Propagation conditions are set according to Annex B.0.
6. Ensure the UE is in state RRC_CONNECTED with generic procedure parameters Connectivity NR, Connected without release On, Test Mode On and Test Loop Function On according to TS 38.508-1 [5] clause 4.5. Message contents are defined in clause 6.3.4.4.4.3.

6.3.4.4.4.2 Test procedure

The procedure is separated in two subtests to verify PUCCH and PUSCH aggregate power control tolerance respectively. The uplink transmission patterns are described in figure 6.3.4.4.4.2-1.

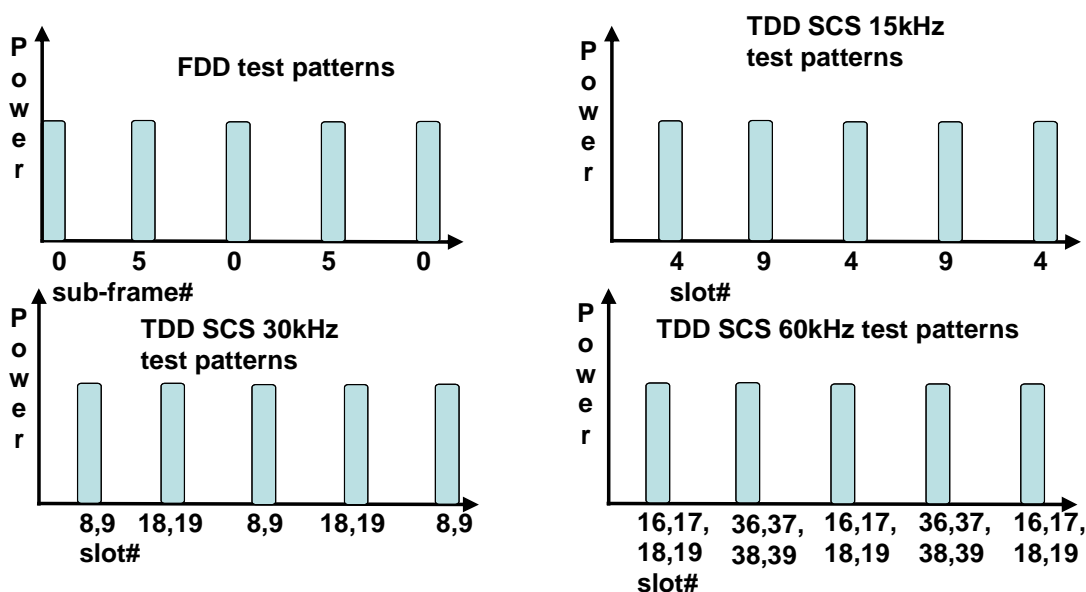

Figure 6.3.4.4.4.2-1 Test uplink transmission

1. PUCCH sub test:

- 1.1. The SS transmits PDSCH via PDCCH DCI format 0_1 for C_RNTI to transmit the DL RMC according to Table 6.3.4.4.1-1. The SS sends downlink MAC padding bits on the DL RMC. The transmission of PDSCH will make the UE send uplink ACK/NACK using PUCCH. Send uplink power control commands for PUCCH to the UE using 1dB power step size to ensure that the UE output power measured by the test system is within the Uplink power control window, defined as $-(\text{Uplink power control window size} / 2)$ dB to $+(\text{Uplink power control window size} / 2)$ dB of the target power level + 0 dBm, where:
 - Uplink power control window size = 1dB (UE power step size) + 2.0dB (UE power step tolerance) + (Test system relative power measurement uncertainty), where, the UE power step tolerance is specified in TS 38.101-1 [2], Table 6.3.4.3-1 and is 2.0dB for PUCCH with 1dB power step size, and the Test system relative power measurement uncertainty is specified in Table F.1.2-1.
- 1.2. Every 5 sub-frames (5ms) transmit to the UE downlink PDSCH MAC padding bits as well as 0 dB TPC command for PUCCH via the PDCCH to make the UE transmit ACK/NACK on the PUCCH for 1 sub-frame(1ms). The downlink transmission is scheduled in the appropriate slots to make the UE transmit PUCCH as described in figure 6.3.4.4.2-1
- 1.3. Measure the power of 5 consecutive PUCCH transmissions to verify the UE transmitted PUCCH power is maintained within 21ms.

2. PUSCH sub test:

- 2.1. The SS sends uplink scheduling information via PDCCH DCI format 0_1 for C_RNTI to schedule the PUSCH. Since the UE has no payload and no loopback data to send the UE sends uplink MAC padding bits on the UL RMC. Send uplink power control commands for PUSCH to the UE using 1dB power step size to ensure that the UE output power measured by the test system is within the Uplink power control window, defined as $-(\text{Uplink power control window size} / 2)$ dB to $+(\text{Uplink power control window size} / 2)$ dB of the target power level + 0 dBm, where:
 - Uplink power control window size = 1dB (UE power step size) + 0.7dB (UE power step tolerance) + (Test system relative power measurement uncertainty), where, the UE power step tolerance is specified in TS 38.101-1 [2], Table 6.3.4.3-1 and is 0.7dB for PUSCH with 1dB power step size, and the Test system relative power measurement uncertainty is specified in Table F.1.2-1.

NOTE: The purpose of the Uplink power control window is to ensure that the actual UE output power is as close as possible to the target power level. The relationship between the Uplink power control window, the target power level and the corresponding possible actual UE Uplink power window is illustrated in Annex F.4.4.

- 2.2. Every 5 sub-frames (5ms) schedule the UE's PUSCH data transmission for 1 sub-frame(1ms), and transmit 0 dB TPC command for PUSCH via the PDCCH to make the UE transmit PUSCH. The uplink transmission patterns are described in figure 6.3.4.4.2-1,
- 2.3. Measure the power of 5 consecutive PUSCH transmissions to verify the UE transmitted PUSCH power is maintained within 21ms transmissions.

6.3.4.4.3 Message contents

Message contents are according to TS 38.508-1 [5] subclause 4.6.

6.3.4.4.5 Test requirement

The requirement for the power measurements made in step (1.3) and (2.3) of the test procedure shall not exceed the values specified in Table 6.3.4.4.5-1. The power measurement period shall be 1 sub-frame(1ms).

Table 6.3.4.4.5-1: Power control tolerance

TPC command	UL channel	Test requirement measured power
0 dB	PUCCH	Given 5 power measurements in the pattern, the 2 nd , and later measurements shall be within $\pm (2.5 + TT)$ dB of the 1 st measurement.
0 dB	PUSCH	Given 5 power measurements in the pattern, the 2 nd , and later measurements shall be within $\pm (3.5 + TT)$ dB of the 1 st measurement.
Note 1:	For SCS 30kHz 1 sub-frame corresponds to 2 slots and for SCS 60kHz 1 sub-frame corresponds to 4 slots, so 2 TPC commands will be sent for a single measurement period.	
Note 2:	TT=0.7dB.	

6.3A Output power dynamics for CA

6.3A.1 Minimum output power for CA

6.3A.1.0 Minimum conformance requirements

For inter-band carrier aggregation with uplink assigned to two NR bands, the minimum output power is defined per carrier and the requirement is specified in subclause 6.3.1.

For intra-band non-contiguous carrier aggregation, the minimum output power is defined per carrier and the requirement is specified in clause 6.3.1.

For intra-band contiguous carrier aggregation, the minimum output power is defined per carrier and the requirement is specified in clause 6.3.1.

The normative reference for this requirement is TS 38.101-1 [2] clause 6.3A.1.

6.3A.1.1 Minimum output power for CA (2UL CA)

6.3A.1.1.1 Test purpose

To verify the UE's ability to transmit with a broadband output power for 2UL CA below the value specified in the test requirement when the power is set to a minimum value.

6.3A.1.1.2 Test applicability

This test case applies to all types of NR UE release 15 and forward that support 2UL CA.

6.3A.1.1.3 Minimum conformance requirements

The minimum conformance requirements are defined in clause 6.3A.1.0.

6.3A.1.1.4 Test description

6.3A.1.1.4.1 Initial condition

Initial conditions are a set of test configurations the UE needs to be tested in and the steps for the SS to take with the UE to reach the correct measurement state.

The initial test configurations consist of environmental conditions, test frequencies, test channel bandwidths and sub-carrier spacing based on NR CA configurations specified in 5.5A. All of these configurations shall be tested with applicable test parameters for each CA configuration, and are shown in table 6.3A.1.1.4.1-1 or 6.3A.1.1.4.1-2. The details of the uplink reference measurement channels (RMCs) are specified in Annexes A.2 and A.3. Configurations of PDSCH and PDCCH before measurement are specified in Annex C.2.

Table 6.3A.1.1.4.1-1: Test Configuration Table for inter-band CA

Initial Conditions				
Test Environment as specified in TS 38.508-1 [5] subclause 4.1		Normal, TL/VL, TL/VH, TH/VL, TH/VH		
Test Frequencies as specified in TS 38.508-1 [5] subclause 4.3.1		Low range for PCC and SCC High range for PCC and SCC		
Test Channel Bandwidths as specified in TS 38.508-1 [5] subclause 4.3.1		Lowest N_{RB_agg} , Highest N_{RB_agg}		
Test SCS as specified in Table 5.3.5-1		Highest		
Test Parameters				
Test ID	Downlink Configuration for PCC & SCC	Uplink Configuration		
		Modulation for all CCs	RB allocation (NOTE 1)	
			PCC	SCC
1	N/A for this test	DFT-s-OFDM QPSK	Outer Full	Outer Full
NOTE 1: The specific configuration of each RB allocation is defined in Table 6.1-1.				
NOTE 2: Test Channel Bandwidths and Test SCS are checked separately for each NR CA band combination, which applicable channel bandwidths and SCS are specified in Table 5.5A.3-1.				

Table 6.3A.1.1.4.1-2: Test Configuration Table for intra-band contiguous CA

Initial Conditions				
Test Environment as specified in TS 38.508-1 [5] subclause 4.1		Normal, TL/VL, TL/VH, TH/VL, TH/VH		
Test Frequencies as specified in TS 38.508-1 [5] subclause 4.3.1		Low range High range		
Test Channel Bandwidths as specified in TS 38.508-1 [5] subclause 4.3.1		Lowest N_{RB_agg} , Highest N_{RB_agg}		
Test SCS as specified in Table 5.3.5-1		Highest		
Test Parameters				
Test ID	Downlink Configuration for PCC & SCC	Uplink Configuration		
		Modulation for all CCs	RB allocation (NOTE 1)	
			PCC	SCC
1	N/A for this test	DFT-s-OFDM QPSK	Outer Full	Outer Full
NOTE 1: The specific configuration of each RB allocation is defined in 6.1A-1a				
NOTE 2: Test Channel Bandwidths and Test SCS are checked separately for each NR CA band combination, which applicable channel bandwidths and SCS are specified in Table 5.5A.3-1.				

1. Connect the SS to the UE antenna connectors as shown in TS 38.508-1 [5] Annex A, Figure A.3.1.1.3 for TE diagram and section A.3.2 for UE diagram.
2. The parameter settings for the cell are set up according to TS 38.508-1 [5] subclause 4.4.3.
3. Downlink signals are initially set up according to Annex C.0, C.1, C.2, and uplink signals according to Annex G.0, G.1, G.2, G.3.0.
4. The UL Reference Measurement Channel is set according to Table 6.3A.1.1.4.1-1.
5. Propagation conditions are set according to Annex B.0.
6. Ensure the UE is in State RRC_CONNECTED with generic procedure parameters Connectivity NR, Connected without release On, Test Mode On and Test Loop Function On according to TS 38.508-1 [5] clause 4.5. Message contents are defined in clause 6.3A.1.1.4.3.

6.3A.1.1.4.2 Test procedure

1. Configure SCC according to Annex C.0, C.1, C.2 for all downlink physical channels.
2. The SS shall configure SCC as per TS 38.508-1 [5] clause 5.5.1. Message contents are defined in clause 6.3A.1.1.4.3.

3. SS activates SCC by sending the activation MAC CE (Refer TS 38.321 [18], clauses 5.9, 6.1.3.10). Wait for at least 2 seconds (Refer TS 38.133 [19], clause 9.3).
4. SS sends uplink scheduling information for each UL HARQ process via PDCCH DCI format 0_1 for C_RNTI to schedule the UL RMC according to Table 6.3A.1.1.4.1-1 or 6.3A.1.1.4.1-2 on both PCC and SCC. Since the UE has no payload and no loopback data to send the UE sends uplink MAC padding bits on the UL RMC.
5. Send continuously uplink power control "down" commands for both carriers in every uplink scheduling information to the UE; allow at least 200ms starting from the first TPC command in this step to ensure that the UE transmits at its minimum output power.
6. Measure the mean power of the UE for each component carrier in the associated measurement channel bandwidth specified in Table 6.3A.1.1.5-1 for the specific channel bandwidth under test. The period of measurement shall be at least the continuous duration of 1ms in all active uplink slots and in the uplink symbols. For TDD, only slots consisting of only UL symbols are under test.

6.3A.1.1.4.3 Message contents

Message contents are according to TS 38.508-1 [5] subclause 4.6 with following exception.

Table 6.3A.1.1.4.3-1: PUSCH-Config

Derivation Path: TS 38.508-1 [5], Table 4.6.3-118 with condition TRANSFORM_PRECODER_ENABLED

6.3A.1.1.5 Test requirement

The minimum output power of each component carrier, derived in step 6 shall not exceed the values specified in Table 6.3A.1.1.5-1.

Table 6.3A.1.1.5-1: Minimum output power

Channel bandwidth (MHz)	Minimum output power (dBm)	Measurement bandwidth (MHz)
5	-40+TT	4.515
10	-40+TT	9.375
15	-40+TT	14.235
20	-40+TT	19.095
25	-39+TT	23.955
30	-38.2+TT	28.815
40	-37+TT	38.895
50	-36+TT	48.615
60	-35.2+TT	58.35
70	-34.6+TT	68.07
80	-34+TT	78.15
90	-33.5+TT	88.23
100	-33+TT	98.31

NOTE 1: TT for each frequency and channel bandwidth is specified in Table 6.3A.1.1.5-2

Table 6.3A.1.1.5-2: Test Tolerance (Minimum output power)

	$f \leq 3.0\text{GHz}$	$3.0\text{GHz} < f \leq 6.0\text{GHz}$
$\text{BW} \leq 40\text{MHz}$	1.0	1.3
$40\text{MHz} < \text{BW} \leq 100\text{MHz}$	1.3	1.3

6.3A.2 Transmit OFF power for CA

6.3A.2.0 Minimum conformance requirements

For inter-band carrier aggregation with uplink assigned to two NR bands, the transmit OFF power specified in subclause 6.3.2 is applicable for each component carrier when the transmitter is OFF on all component carriers. The transmitter is considered to be OFF when the UE is not allowed to transmit on any of its ports.

For intra-band contiguous carrier aggregation, the transmit OFF power specified in clause 6.3.2 is applicable for each component carrier when the transmitter is OFF on all component carriers. The transmitter is considered to be OFF when the UE is not allowed to transmit on any of its ports.

For intra-band non-contiguous carrier aggregation, the transmit OFF power specified in clause 6.3.2 is applicable for each component carrier when the transmitter is OFF on all component carriers. The transmitter is considered to be OFF when the UE is not allowed to transmit on any of its ports.

The normative reference for this requirement is TS 38.101-1 [2] clause 6.3A.2

6.3A.2.1 Transmit OFF power for CA (2UL CA)

6.3A.2.1.1 Test purpose

To verify that the UE transmit OFF power for 2UL CA is lower than the value specified in the test requirement.

6.3A.2.1.2 Test applicability

The requirements of 6.3A.2.1 apply in test cases 6.3A.3.1 Transmit ON/OFF time mask for CA (2UL CA) to all types of NR UE release 15 and forward that support 2UL CA. Therefore, no test case description and requirements are specified.

6.3A.2.1.3 Minimum conformance requirements

The minimum conformance requirements are defined in clause 6.3A.2.0.

6.3A.2.1.4 Test description

This test is covered by clause 6.3A.3.1 Transmit ON/OFF time mask for 2UL CA.

6.3A.2.1.5 Test requirement

The requirement for the transmit OFF power of each component carrier shall not exceed the values specified in Table 6.3A.2.1.5-1.

Table 6.3A.2.1.5-1: Transmit OFF power

Channel bandwidth (MHz)	Transmit OFF power (dBm)	Measurement bandwidth (MHz)
5	-50+TT	4.515
10	-50+TT	9.375
15	-50+TT	14.235
20	-50+TT	19.095
25	-50+TT	23.955
30	-50+TT	28.815
40	-50+TT	38.895
50	-50+TT	48.615
60	-50+TT	58.35
80	-50+TT	78.15
100	-50+TT	88.23
NOTE 1: TT for each frequency and channel bandwidth is specified in Table 6.3A.2.1.5-2		

Table 6.3A.2.1.5-2: Test Tolerance (Transmit OFF power)

	$f \leq 3.0\text{GHz}$	$3.0\text{GHz} < f \leq 6.0\text{GHz}$
BW \leq 40MHz	FFS	FFS
40MHz < BW \leq 100MHz	FFS	FFS

6.3A.3 Transmit ON/OFF time mask for CA

6.3A.3.0 Minimum conformance requirements

6.3A.3.0.1 Transmit ON/OFF time mask for intra-band contiguous CA

For s intra-band contiguous carrier aggregation, the general output power ON/OFF time mask specified in clause 6.3.3.2 is applicable for each component carrier during the ON power period and the transient periods. The OFF period as specified in clause 6.3.3.2 shall only be applicable for each component carrier when all the component carriers are OFF.

6.3A.3.0.2 Transmit ON/OFF time mask for intra-band non-contiguous CA

For s intra-band non-contiguous carrier aggregation, the general output power ON/OFF time mask specified in clause 6.3.3.1 is applicable for each component carrier during the ON power period and the transient periods. The OFF period as specified in clause 6.3.3.1 shall only be applicable for each component carrier when all the component carriers are OFF.

6.3A.3.0.3 Transmit ON/OFF time mask for inter-band CA

6.3A.3.0.3.1 General

For inter-band carrier aggregation with uplink assigned to two NR bands, the general output power ON/OFF time mask specified in clause 6.3.3.1 is applicable for each component carrier during the ON power period and the transient periods. The OFF period as specified in clause 6.3.3.1 shall only be applicable for each component carrier when all the component carriers are OFF.

6.3A.3.0.3.2 Time mask for switching between two uplink carriers

In addition to the requirements in 6.3A.3.0.3.1 and the maximum output power requirement specified in Table 6.2A.1.3-1 with uplink assigned to two NR bands, the switching time mask specified in this clause is applicable for an uplink band pair of an inter-band UL CA configuration when the capability *uplinkTxSwitchingPeriod* is present, and is only applicable for uplink switching mechanisms specified in clause 6.1.6 of TS 38.214 [10], where NR UL carrier 1 is capable of one transmit antenna connector and NR UL carrier 2 is capable of two transmit antenna connectors with 3dB boosting on the maximum output power when the capability *uplinkTxSwitchingPowerBoosting* is present and the IE *uplinkTxSwitchingPowerBoosting* is enabled, and the two uplink carriers are in different bands with different carrier frequencies. The UE shall support the switch between single layer transmission with one antenna port and two-layer transmission with two antenna ports on the two uplink carriers following the scheduling commands and rank adaptation, i.e., both single layer and two-layer transmission with 2 antenna ports, and single layer transmission with 1 antenna port shall be supported on NR UL carrier 2.

The switching periods described in Figure 6.3A.3.0.3.2-1a and Figure 6.3A.3.0.3.2-1b are located in either NR carrier 1 or carrier 2 as indicated in RRC signalling *uplinkTxSwitchingPeriodLocation* [7], and the length of uplink switching period *X* is less than the value indicated by UE capability *uplinkTxSwitchingPeriod*.

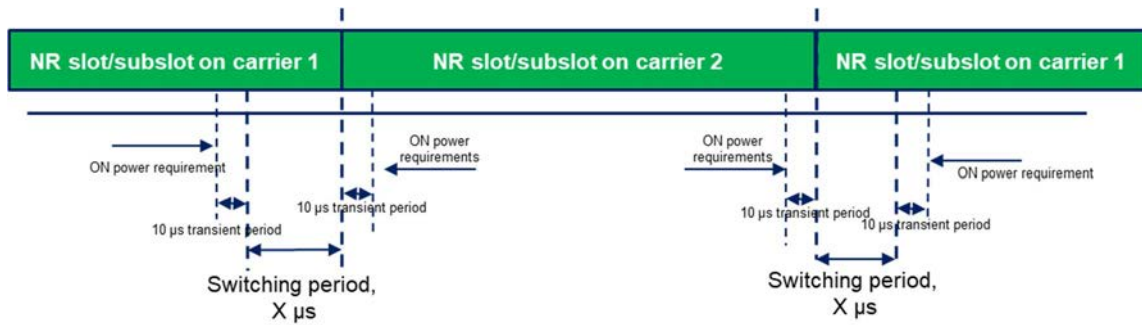

Figure 6.3A.3.0.3.2-1a: Time mask for switching between UL carrier 1 and UL Carrier 2, where the switching period is located in carrier 1

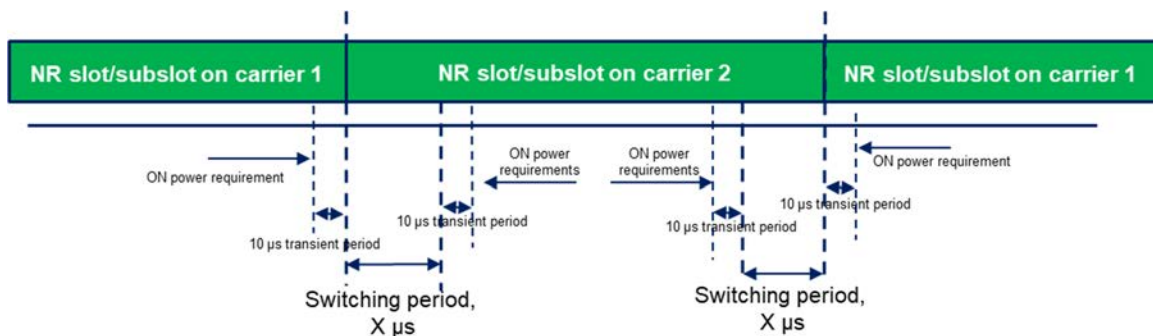

Figure 6.3A.3.0.3.2-1b: Time mask for switching between UL carrier 1 and UL Carrier 2, where the switching period is located in carrier 2

The requirements apply for the case of co-located and synchronized network deployment for the two uplink carriers.

The requirements apply for the case of single TAG for the two uplink carriers, i.e., the same uplink timing for the two carriers as described in clause 4.2 of TS 38.213 [8].

The normative reference for this requirement is TS 38.101-1 [2] clause 6.3A.3.

6.3A.3.1 Transmit ON/OFF time mask for CA (2UL CA)

6.3A.3.1.1 Test purpose

To verify that the general ON/OFF time mask for CA (2UL CA) meets the requirements given in 6.3A.3.1.5

The transmit power time mask for transmit ON/OFF defines the transient period(s) allowed between transmit OFF power and transmit ON power symbols for CA.

Transmission of the wrong power increases interference to other channels, or increases transmission errors in the uplink channel.

6.3A.3.1.2 Test applicability

This test case applies to all types of NR UE release 15 and forward that support 2UL CA.

6.3A.3.1.3 Minimum conformance requirements

The minimum conformance requirements are defined in clause 6.3A.3.0.

6.3A.3.1.4 Test description

6.3A.3.1.4.1 Initial condition

Initial conditions are a set of test configurations the UE needs to be tested in and the steps for the SS to take with the UE to reach the correct measurement state.

The initial test configurations consist of environmental conditions, test frequencies, test channel bandwidths and sub-carrier spacing based on NR CA configuration specified in 5.5A. All of these configurations shall be tested with applicable test parameters for each CA configuration, and are shown in table 6.3A.3.1.4.1-1 or 6.3A.3.1.4.1-2. The details of the uplink reference measurement channels (RMCs) are specified in Annex A.2 and A.3. Configurations of PDSCH and PDCCH before measurement are specified in Annex C.2.

Table 6.3A.3.1.4.1-1: Test Configuration Table for inter-band CA

Initial Conditions				
Test Environment as specified in TS 38.508-1 [5] subclause 4.1		Normal, TL/VL, TL/VH, TH/VL, TH/VH		
Test Frequencies as specified in TS 38.508-1 [5] subclause 4.3.1.1.3 for inter band CA in FR1		Low range for PCC and SCC High range for PCC and SCC		
Test Channel Bandwidths as specified in TS 38.508-1 [5] subclause 4.3.1		Lowest N_{RB_agg} , Highest N_{RB_agg}		
Test SCS as specified in Table 5.5A.3-1		Lowest, Highest		
Test Parameters				
Test ID	Downlink Configuration for PCC & SCC	Uplink Configuration		
		Modulation for all CCs	RB allocation (NOTE 1)	
			PCC	SCC
1	N/A for this test	DFT-s-OFDM QPSK	Inner Full	Inner Full
NOTE 1: The specific configuration of each RB allocation is defined in Table 6.1-1.				
NOTE 2: Test Channel Bandwidths and Test SCS are checked separately for each NR CA band combination, which applicable channel bandwidths and SCS are specified in Table 5.5A.3-1.				

Table 6.3A.3.1.4.1-2: Test Configuration Table for intra-band contiguous CA

Initial Conditions				
Test Environment as specified in TS 38.508-1 [5] subclause 4.1		Normal, TL/VL, TL/VH, TH/VL, TH/VH		
Test Frequencies as specified in TS 38.508-1 [5] subclause 4.3.1.1.3 for inter band CA in FR1		Low range High range		
Test Channel Bandwidths as specified in TS 38.508-1 [5] subclause 4.3.1		Lowest N_{RB_agg} , Highest N_{RB_agg}		
Test SCS as specified in Table 5.5A.3-1		Lowest, Highest		
Test Parameters				
Test ID	Downlink Configuration for PCC & SCC	Uplink Configuration		
		Modulation for all CCs	RB allocation (NOTE 1)	
			PCC	SCC
1	N/A for this test	DFT-s-OFDM QPSK	Inner Full	Inner Full
NOTE 1: The specific configuration of each RB allocation is defined in 6.1A-1a NOTE 2: Test Channel Bandwidths and Test SCS are checked separately for each NR CA band combination, which applicable channel bandwidths and SCS are specified in Table 5.5A.3-1.				

1. Connect the SS to the UE antenna connectors as shown in TS 38.508-1 [5] Annex A, Figure A.3.1.1.3 for TE diagram and section A.3.2 for UE diagram.
2. The parameter settings for the cell are set up according to TS 38.508-1 [5] subclause 4.4.3.

3. Downlink signals are initially set up according to Annex C.0, C.1, C.2, and uplink signals according to Annex G.0, G.1, G.2, G.3.0.
4. The UL Reference Measurement Channel is set according to Table 6.3A.3.1.4.1-1.
5. Propagation conditions are set according to Annex B.0.
6. Ensure the UE is in State RRC_CONNECTED with generic procedure parameters Connectivity NR, Connected without release On, Test Mode On and Test Loop Function On according to TS 38.508-1 [5] clause 4.5. Message contents are defined in clause 6.3A.3.1.4.3.

6.3A.3.1.4.2 Test procedure

1. Configure SCC according to Annex C.0, C.1, C.2 for all downlink physical channels.
2. The SS shall configure SCC as per TS 38.508-1 [5] clause 5.5.1. Message contents are defined in clause 6.3A.3.1.4.3.
3. SS activates SCC by sending the activation MAC CE (Refer TS 38.321 [18], clauses 5.9, 6.1.3.10). Wait for at least 2 seconds (Refer TS 38.133 [19], clause 9.3).
4. SS sends uplink scheduling information via PDCCH DCI format 0_1 for C_RNTI to schedule the UL RMC according to Table 6.3A.3.1.4.1-1 or 6.3A.3.1.4.1-2 on both PCC and SCC. Since the UE has no payload and no loopback data to send the UE sends uplink MAC padding bits on the UL RMC. The UL assignment is such that the UE transmits on slots 8 for 15kHz SCS, on slots 8 and 18 for 30kHz SCS and on slots 17 and 37 for 60kHz SCS.
5. Send continuously uplink power control "up" commands for both carriers in every uplink scheduling information to the UE; allow at least 200ms starting from the first TPC command in this step for the UE to reach P_{UMAX} level.
6. On power sub test:
 - 6.1. Measure the sum of mean output power over all component carriers in the CA configuration of the UE PUSCH transmission during one slot of the radio access mode. For FDD band in inter-band CA with both TDD band and FDD band, only slots overlapping with only UL symbols in TDD are under test.
7. OFF power sub test:
 - 7.1. Measure the UE transmission OFF power for each component carrier during the slot prior to the PUSCH transmission, excluding a transient period of 10 μs in the end of the slot.
 - 7.2. Measure the UE transmission OFF power of each component carrier during the slot following the PUSCH transmission, excluding a transient period of 10 μs at the beginning of the slot.

6.3A.3.1.4.3 Message contents

Message contents are according to TS 38.508-1 [5] subclause 4.6 with following exceptions.

Table 6.3A.3.1.4.3-1: PUSCH-ConfigCommon

Derivation Path: TS 38.508-1[5], Table 4.6.3-90			
Information Element	Value/remark	Comment	Condition
PUSCH-ConfigCommon ::= SEQUENCE {			
p0-NominalWithGrant	-100		
}			

Table 6.3A.3.1.4.3-2: TDD-UL-DL-Config

Derivation Path: TS 38.508-1[5], Table 4.6.3-192			
Information Element	Value/remark	Comment	Condition
TDD-UL-DL-ConfigCommon ::= SEQUENCE {			
referenceSubcarrierSpacing	SubcarrierSpacing		
pattern1 SEQUENCE {			
dl-UL-TransmissionPeriodicity	ms5		FR1
	ms10		FR1_15kHz
nrofDownlinkSlots	6		FR1_15kHz
	6		FR1_30kHz
	14		FR1_60kHz
nrofDownlinkSymbols	10		FR1_15kHz
	6		FR1_30kHz
	12		FR1_60kHz
nrofUplinkSlots	3		FR1_15kHz, FR1_30kHz
	4		FR1_60kHz
nrofUplinkSymbols	4		FR1_30kHz
	2		FR1_15kHz,
	8		FR1_60kHz
}			
pattern2	Not present		
}			

Table 6.3A.3.1.4.3-3: PUSCH-TimeDomainResourceAllocationList

Derivation Path: TS 38.508-1[5], Table 4.6.3-122			
Information Element	Value/remark	Comment	Condition
PUSCH-TimeDomainResourceAllocationList ::= SEQUENCE (SIZE(1..maxNrofUL-Allocations)) OF {	2 entries		
PUSCH-TimeDomainResourceAllocation[1]			
SEQUENCE {			
k2	4		FR1_15kHz, FR1_30kHz
	6		FR1_60kHz
mappingType	typeA		
startSymbolAndLength	27	Start symbol(S)=0, Length(L)=14	
}			
PUSCH-TimeDomainResourceAllocation[2]		addressed by Msg3 PUSCH time resource allocation field of the Random Access Response acc. to TS 38.213 [22] Table 8.2-1.	
k2	2	$K_2 + \Delta = 4$ acc. to TS 38.214 [21] Table 6.1.2.1.1-5 (NOTE 1)	FR1_15kHz
	6	$K_2 + \Delta = 9$ acc. to TS 38.214 [21] Table 6.1.2.1.1-5 (NOTE 1)	FR1_30kHz

mappingType	typeA		
startSymbolAndLength	27	Start symbol(S)=0, Length(L)=14	
}			
}			
NOTE 1: Values are chosen so that first slot of a TDD-UL-DL slot configuration period can be used for the Random Access Response and the last slot (of the same or another period) for the corresponding Msg3.			

Condition	Explanation
FR1_15kHz	FR1 is used under the test. SCS is set to 15kHz.
FR1_30kHz	FR1 is used under the test. SCS is set to 30kHz.
FR1_60kHz	FR1 is used under the test. SCS is set to 60kHz.

Table 6.3A.3.1.4.3-4: ServingCellConfigCommon

Derivation Path: 38.508-1[5], Table 4.6.3-168			
Information Element	Value/remark	Comment	Condition
ServingCellConfigCommon ::= SEQUENCE {			
ss-PBCH-BlockPower	18		SCS_15kHz
	21		SCS_30kHz
}			

Condition	Explanation
SCS_15kHz	SCS=15kHz for SS/PBCH block
SCS_30kHz	SCS=30kHz for SS/PBCH block

Table 6.3A.3.1.4.3-5: PUSCH-Config

Derivation Path: TS 38.508-1 [5], Table 4.6.3-118 with condition TRANSFORM_PRECODER_ENABLED

Table 6.3A.3.1.4.3-6: FrequencyInfoUL-SIB

Derivation Path: TS 38.508-1 [5] Table 4.6.3-62 FrequencyInfoUL-SIB			
Information Element	Value/remark	Comment	Condition
p-Max	20		Inter-band CA
	19		intra-band contiguous for CA_n48B
	18		intra-band contiguous for CA_n41C
	17		intra-band contiguous for CA_n77C

6.3A.3.1.5 Test requirement

The requirement for the transmit ON power and transmit OFF power for CA measured in steps 5, 6 and 7 of the test procedure shall not exceed the values specified in Table 6.3A.3.1.5-1.

Table 6.3A.3.1.5-1: General ON/OFF time mask

	Channel bandwidth / minimum output power / measurement bandwidth												
	5 MHz	10 MHz	15 MHz	20 MHz	25 MHz	30 MHz	40 MHz	50 MHz	60 MHz	70 MHz	80 MHz	90 MHz	100 MHz
Transmit OFF power	$\leq -50+TT$ dBm												
Transmission OFF Measurement bandwidth	4.515	9.375	14.235	19.095	23.955	28.815	38.895	48.615	58.35	68.07	78.15	88.23	98.31
Transmit ON power	For inter-band CA configurations, The test requirement of transmit on power of 2UL CA is the same as Test ID 9 of Table 6.2A.2.1.5-1 as appropriate For intra-band contiguous CA configurations, The test requirement of transmit on power of 2UL CA is the same as Test ID 3 of Table 6.2A.2.1.5-1a, Table 6.2A.2.1.5-1b and 6.2A.2.1.5-1c as appropriate												
NOTE 1: TT for each frequency and channel bandwidth of OFF power is specified in Table 6.3A.3.1.5-2.													
NOTE 2: TT or each frequency and channel bandwidth of Transmit ON power is specified in Table 6.2A.2.1.5-3													

Table 6.3A.3.1.5-2: Test Tolerance for OFF power

	$f \leq 3.0\text{GHz}$	$3.0\text{GHz} < f \leq 6\text{GHz}$
$BW \leq 40\text{MHz}$	1.5	1.8
$40\text{MHz} < BW \leq 100\text{MHz}$	1.7	1.8

6.3A.3.1_1 Time mask for switching between two uplink carriers

Editor’s Note: This clause is incomplete. The following aspects are either missing or not yet determined:

The test procedure need further discussion.

MU and TT is FFS

6.3A.3.1_1.1 Test purpose

To verify that the time mask for switching between two uplink carriers meets the requirements given in 6.3A.3.0.3.2.

The time mask for switching between two uplink carriers defines the transient period(s) allowed between two uplink carriers for an uplink band pair of an inter-band UL CA configuration when the capability *uplinkTxSwitchingPeriod* is present.

6.3A.3.1_1.2 Test applicability

This test case applies to all types of NR UE release 16 and forward that support 2UL inter-band CA and dynamic UL Tx switching.

6.3A.3.1_1.3 Minimum conformance requirements

The minimum conformance requirements are defined in clause 6.3A.3.0.3.2.

6.3A.3.1_1.4 Test description

6.3A.3.1_1.4.1 Initial condition

Initial conditions are a set of test configurations the UE needs to be tested in and the steps for the SS to take with the UE to reach the correct measurement state.

The initial test configurations consist of environmental conditions, test frequencies, test channel bandwidths and sub-carrier spacing based on NR CA configuration specified in 5.5A. All of these configurations shall be tested with applicable test parameters for each CA configuration, and are shown in table 6.3A.3.1_1.4.1-1. The details of the uplink reference measurement channels (RMCs) are specified in Annexe A.2 and A.3. Configurations of PDSCH and PDCCH before measurement are specified in Annex C.2.

Table 6.3A.3.1_1.4.1-1: Test Configuration Table for inter-band CA Uplink switching

Initial Conditions				
Test Environment as specified in TS 38.508-1 [5] subclause 4.1		Normal		
Test Frequencies as specified in TS 38.508-1 [5] subclause 4.3.1.1.3 for inter band CA in FR1		Mid range for PCC and SCC		
Test Channel Bandwidths as specified in TS 38.508-1 [5] subclause 4.3.1		Highest N_{RB_agg}		
Test SCS as specified in Table 5.5A.3-1		Highest		
Test Parameters				
Test ID	Downlink Configuration for PCC & SCC	Uplink Configuration		
		Modulation for all CCs	RB allocation (NOTE 2)	
			PCC	SCC
1	N/A for this test	CP-OFDM QPSK	Outer Full	Outer Full
NOTE 1: PCC is the component carrier with lower center frequency between two component carriers. PCC is configured as Carrier 1 and SCC is configured as Carrier2.				
NOTE 2: The specific configuration of each RB allocation is defined in Table 6.1-1.				
NOTE 3: Test Channel Bandwidths and Test SCS are checked separately for each NR CA band combination, which applicable channel bandwidths and SCS are specified in Table 5.5A.3-1.				

1. Connect the SS to the UE antenna connectors as shown in TS 38.508-1 [5] Annex A, Figure A.3.1.1.2 for TE diagram and section A.3.2 for UE diagram.

2. The parameter settings for the cell are set up according to TS 38.508-1 [5] subclause 4.4.3.
3. Downlink signals are initially set up according to Annex C.0, C.1, C.2, and uplink signals according to Annex G.0, G.1, G.2, G.3.0.
4. The UL Reference Measurement Channel is set according to Table 6.3A.3.1_1.4.1-1.
5. Propagation conditions are set according to Annex B.0.
6. Ensure the UE is in State RRC_CONNECTED with generic procedure parameters Connectivity NR, Connected without release On, Test Mode On and Test Loop Function On according to TS 38.508-1 [5] clause 4.5. Message contents are defined in clause 6.3A.3.1_1.4.3.

6.3A.3.1_1.4.2 Test procedure

1. Sub test 1: Switching period located in Carrier 1

- 1.1. Configure SCC according to Annex C.0, C.1, C.2 for all downlink physical channels.
- 1.2. The SS shall configure SCC as per TS 38.508-1 [5] clause 5.5.1. Message contents are defined in clause 6.3A.3.1_1.4.3 with *uplinkTxSwitchingPeriodLocation-r16* configured TRUE on carrier1 and FALSE on carrier 2.
- 1.3. SS activates SCC by sending the activation MAC CE (Refer TS 38.321 [18], clauses 5.9, 6.1.3.10). Wait for at least 2 seconds (Refer TS 38.133 [19], clause 9.3).
- 1.4. SS sends uplink scheduling information via PDCCH DCI format 0_1 with TPC command 0dB for C_RNTI to schedule the UL RMC according to Table 6.3A.3.1_1.4.1-1 on carrier 1 on slot n-1, where slot n is an uplink slot for carrier 2 and $n-1 \geq 20$ when SCS=15 kHz ($n-1 \geq 40$ when SCS=30 kHz, $n-1 \geq 80$ when SCS=60 kHz). Since the UE has no payload and no loopback data to send the UE sends uplink MAC padding bits on the UL RMC.
- 1.5. The SS sends uplink scheduling information via DCI format 0_1 with TPC command 0dB for C_RNTI to schedule the UL RMC according to Table 6.3A.3.1_1.4.1-1 on carrier 2 starting on slot n and slot m, with both slot n and slot m being uplink slots for carrier 2 and $m \geq n+20$ when SCS=15kHz ($m \geq n+40$ when SCS=30 kHz, $m \geq n+80$ when SCS=60 kHz). Since the UE has no payload and no loopback data to send the UE sends uplink MAC padding bits on the UL RMC. The PDCCH DCI format 0_1 is specified with the condition 2TX_UL_MIMO in 38.508-1 [5] subclause 4.3.6.1.1.2.
- 1.6. Measure the output power of UE PUSCH transmission for carrier 1 during slot n-1 excluding a transient period of 10 μ s and a Switching period X μ s in the end of slot n-1. The length of uplink switching period X is indicated by UE capability *uplinkTxSwitchingPeriod*.
- 1.7. Measure the sum of output power of UE PUSCH transmission on carrier 2 over all antenna connectors during slot n and slot m excluding a transient period of 10 μ s in the beginning of slot n and in the end of slot m.
- 1.8. SS sends uplink scheduling information via PDCCH DCI format 0_1 with TPC command 0dB for C_RNTI to schedule the UL RMC according to Table 6.3A.3.1_1.4.1-1 on carrier 1 on slot m+1. Since the UE has no payload and no loopback data to send the UE sends uplink MAC padding bits on the UL RMC.
- 1.9. Measure the output power of UE PUSCH transmission for carrier 1 during slot m+1 excluding a switching period X and a transient period of 10 μ s in the beginning of slot m+1. The length of uplink switching period X is indicated by UE capability *uplinkTxSwitchingPeriod*.

2. Sub test 2: Switching period located in Carrier 2

- 2.1. Configure SCC according to Annex C.0, C.1, C.2 for all downlink physical channels.
- 2.2. The SS shall configure SCC as per TS 38.508-1 [5] clause 5.5.1. Message contents are defined in clause 6.3A.3.1_1.4.3 with *uplinkTxSwitchingPeriodLocation-r16* configured TRUE on carrier 2 and FALSE on carrier 1.

- 2.3. SS activates SCC by sending the activation MAC CE (Refer TS 38.321 [18], clauses 5.9, 6.1.3.10). Wait for at least 2 seconds (Refer TS 38.133 [19], clause 9.3).
- 2.4. SS sends uplink scheduling information via PDCCH DCI format 0_1 with TPC command 0dB for C_RNTI to schedule the UL RMC according to Table 6.3A.3.1_1.4.1-1 on carrier 1 on slot n-1, where slot n is an uplink slot for carrier 2 and $n-1 \geq 20$ when SCS=15 kHz ($n-1 \geq 40$ when SCS=30 kHz, $n-1 \geq 80$ when SCS=60 kHz). Since the UE has no payload and no loopback data to send the UE sends uplink MAC padding bits on the UL RMC.
- 2.5. The SS sends uplink scheduling information via DCI format 0_1 with TPC command 0dB for C_RNTI to schedule the UL RMC according to Table 6.3A.3.1_1.4.1-1 on carrier 2 on slot n ($n \geq 1$) and slot m, with both slot n and slot m being uplink slots for carrier 2 and $m \geq n+20$ when SCS=15kHz ($m \geq n+40$ when SCS=30 kHz, $m \geq n+80$ when SCS=60 kHz). Since the UE has no payload and no loopback data to send the UE sends uplink MAC padding bits on the UL RMC. The PDCCH DCI format 0_1 is specified with the condition 2TX_UL_MIMO in 38.508-1 [5] subclause 4.3.6.1.1.2.
- 2.6. Measure the output power of UE PUSCH transmission for carrier 1 during slot n-1, for carrier 1 excluding a transient period of 10 μ s in the end of slot n-1.
- 2.7. Measure the sum of output power of UE PUSCH transmission on carrier 2 over all antenna connectors during during slot n and slot m excluding a switching period X and a transient period of 10 μ s in the beginning of slot n and in the end of slot m. The length of uplink switching period X is indicated by UE capability *uplinkTxSwitchingPeriod*.
- 2.8. SS sends uplink scheduling information via PDCCH DCI format 0_1 with TPC command 0dB for C_RNTI to schedule the UL RMC according to Table 6.3A.3.1_1.4.1-1 on carrier 1 on slot m+1. Since the UE has no payload and no loopback data to send the UE sends uplink MAC padding bits on the UL RMC
- 2.9. Measure the output power of UE PUSCH transmission for carrier 1 during slot m+1 excluding a transient period of 10 μ s in the beginning of slot m+1.

6.3A.3.1_1.4.3 Message contents

Message contents are according to TS 38.508-1 [5] subclause 4.6 with following exceptions.

Table 6.3A.3.1_1.4.3-1: CellGroupConfig

Derivation Path: TS 38.508-1[5], Table 4.6.3-19			
Information Element	Value/remark	Comment	Condition
CellGroupConfig ::= SEQUENCE {			
uplinkTxSwitchingOption-r16	switchedUL		switchedUL OR Both
	dualUL		dualUL
}			

Condition	Explanation
switchedUL	UE indicated supporting of switchedUL in uplinkTxSwitching-OptionSupport-r16
dualUL	UE indicated supporting of dualUL in uplinkTxSwitching-OptionSupport-r16
Both	UE indicated supporting of both in uplinkTxSwitching-OptionSupport-r16

Table 6.3A.3.1_1.4.3-2: PUSCH-ConfigCommon

Derivation Path: TS 38.508-1[5], Table 4.6.3-90			
Information Element	Value/remark	Comment	Condition
PUSCH-ConfigCommon ::= SEQUENCE {			
p0-NominalWithGrant	-100		
}			

Table 6.3A.3.1_1.4.3-3: ServingCellConfig

Derivation Path: 38.508-1[5], Table 4.6.3-167			
Information Element	Value/remark	Comment	Condition
ServingCellConfig ::= SEQUENCE {			
uplinkConfig SEQUENCE {			
uplinkTxSwitching-r16 CHOICE {			
setup SEQUENCE {			
uplinkTxSwitchingPeriodLocation-r16	TRUE		PL
	FALSE		noPL
uplinkTxSwitchingCarrier-r16	carrier1		1TxCC
	carrier2		2TxCC
}			
}			
}			
}			

Condition	Explanation
PL	The location of UL Tx switching period is configured in this carrier
noPL	The location of UL Tx switching period is not configured in this carrier
1TxCC	The carrier is capable of one transmit antenna connector
2TxCC	The carrier is capable of two transmit antenna connectors

Table 6.3A.3.1_1.4.3-4: ServingCellConfigCommon

Derivation Path: 38.508-1[5], Table 4.6.3-168			
Information Element	Value/remark	Comment	Condition
ServingCellConfigCommon ::= SEQUENCE {			
ss-PBCH-BlockPower	18		SCS_15kHz
	21		SCS_30kHz
}			

Condition	Explanation
SCS_15kHz	SCS=15kHz for SS/PBCH block
SCS_30kHz	SCS=30kHz for SS/PBCH block

6.3A.3.1_1.5 Test requirement

The requirement for the power of carrier 1 measured in step 1.6, 1.9, 2.6, 2.9 of the test procedure and the power of carrier 2 measured in step 1.7 and 2.7 shall not exceed the values specified in table 6.3A.3.1_1.5-1.

Table 6.3A.3.1_1.5-1: Time mask for switching between two uplink carriers (On power)

	SCS [kHz]	Channel bandwidth / minimum output power / measurement bandwidth												
		5 MHz	10 MHz	15 MHz	20 MHz	25 MHz	30 MHz	40 MHz	50 MHz	60 MHz	70 MHz	80 MHz	90 MHz	100 MHz
Expected Transmission ON Measured power for CP-OFDM	15	-3.6	0.4	1.4	2.7	3.6	4.4	5.7	6.7	N/A	N/A	N/A	N/A	N/A
	30	-4.2	-0.8	1.2	2.5	3.5	4.3	5.7	6.6	7.5	8.2	8.8	9.3	9.8
	60	N/A	-1.2	1.0	2.2	3.3	4.2	5.5	6.5	7.4	8.1	8.7	9.2	9.7
ON Power Tolerance		± (9+TT)dB												
NOTE 1: TT for each frequency and channel bandwidth is specified in 6.3A.3.1_1.5-2														

Table 6.3A.3.1_1.5-2: Test Tolerance

	$f \leq 3.0\text{GHz}$	$3.0\text{GHz} < f \leq 6\text{GHz}$
BW ≤ 40MHz	FFS	FFS
40MHz < BW ≤ 100MHz	FFS	FFS

6.3A.4 Power control for CA

6.3A.4.1 Absolute power tolerance for CA

6.3A.4.1.0 Minimum conformance requirements

The absolute power tolerance is the ability of the UE transmitter to set its initial output power to a specific value for the first sub-frame at the start of a contiguous transmission or non-contiguous transmission with a transmission gap on each active component carriers larger than 20ms. The requirement can be tested by time aligning any transmission gaps on the component carriers.

For intra-band contiguous carrier aggregation the absolute power control tolerance per component carrier is given in Table 6.3.4.2.3-1.

For intra-band non-contiguous carrier aggregation the absolute power control tolerance per component carrier is given in Table 6.3.4.2.3-1.

The normative reference for this requirement is TS 38.101-1 [2] clause 6.3A.4.

6.3A.4.1.1 Absolute power tolerance for CA (2UL CA)

Editor's Note:

This test case is incomplete when signalling is absent for dualPA-Architecture IE due to lack of core requirements.

6.3A.4.1.1.1 Test purpose

To verify the ability of the UE transmitter for 2UL CA to set its initial output power to a specific value at the start of a contiguous transmission or non-contiguous transmission on each active component carrier with a long transmission gap, i.e. transmission gap is larger than 20ms.

6.3A.4.1.1.2 Test applicability

This test case applies to all types of NR UE release 15 and forward that support intra-band contiguous and non-contiguous 2UL CA.

6.3A.4.1.1.3 Minimum conformance requirements

The minimum conformance requirements are defined in clause 6.3A.4.1.0.

6.3A.4.1.1.4 Test description

6.3A.4.1.1.4.1 Initial condition

Initial conditions are a set of test configurations the UE needs to be tested in and the steps for the SS to take with the UE to reach the correct measurement state.

The initial test configurations consist of environmental conditions, test frequencies, test channel bandwidths and sub-carrier spacing based on NR CA configurations specified in 5.5A. All of these configurations shall be tested with applicable test parameters for each CA configuration, and are shown in table 6.3A.4.1.1.4.1-1 for intra-band contiguous CA and table 6.3A.4.1.1.4.1-2 for intra-band non-contiguous CA. The details of the uplink reference measurement channels (RMCs) are specified in Annexes A.2 and A.3. Configurations of PDSCH and PDCCH before measurement are specified in Annex C.2.

Table 6.3A.4.1.1.4.1-1: Test Configuration Table for intra-band contiguous CA

Initial Conditions				
Test Environment as specified in TS 38.508-1 [5] subclause 4.1		Normal		
Test Frequencies as specified in TS 38.508-1 [5] subclause 4.3.1		Mid range		
Test Channel Bandwidths as specified in TS 38.508-1 [5] subclause 4.3.1		Lowest N_{RB_agg} , Highest N_{RB_agg}		
Test SCS as specified in Table 5.3.5-1		Lowest, Highest		
Test Parameters				
Test ID	Downlink Configuration for PCC & SCC	Uplink Configuration		
		Modulation for all CCs	RB allocation (NOTE 1)	
			PCC	SCC
1	N/A for this test	CP-OFDM QPSK	Outer_Full	Outer_Full
NOTE 1: The specific configuration of each RB allocation is defined in 6.1A-1a for contiguous RB allocation.				
NOTE 2: Test Channel Bandwidths and Test SCS are checked separately for each NR CA band combination, which applicable channel bandwidths and SCS are specified in Table 5.5A.1-1.				
NOTE 3: If the UE supports multiple CC Combinations in the CA Configuration with the same N_{RB_agg} , only the combination with the highest N_{RB_PCC} is tested.				

Table 6.3A.4.1.1.4.1-2: Test Configuration Table for intra-band non-contiguous CA

Initial Conditions												
Test Environment as specified in TS 38.508-1 [5] subclause 4.1				Normal								
Test Frequencies as specified in TS 38.508-1 [5] subclause 4.3.1				For test frequencies refer to "Range" columns								
Test Channel Bandwidths as specified in TS 38.508-1 [5] subclause 4.3.1				Refer to "PCC N_{RB} " and "SCC N_{RB} " columns								
Test SCS as specified in Table 5.3.5-1				Lowest, Highest								
Test Parameters												
ID	CA config / CBW							DL config	UL config			
	PCC		SCC		PCC N_{RB}	W_{gap}	SCC N_{RB}		CC MOD	RB allocation (NOTE 1)		
	Band	Range	Band	Range						PCC	SCC	
2	nX	CC1	nX	CC2	Highest N_{RB}	Max (NOTE 4)	Highest N_{RB}	N/A	CP-OFDM QPSK	Outer_Full	Outer_Full	
NOTE 1: The RB allocation is defined in table 6.1-1 for each CC.												
NOTE 2: Test Channel Bandwidths and Test SCS are checked separately for each NR CA band combination, which applicable channel bandwidths and SCS are specified in Table 5.5A.2-1.												
NOTE 3: If the UE supports multiple CC Combinations in the CA Configuration with the same N_{RB_agg} , only the combination with the highest N_{RB_PCC} is tested.												
NOTE 4: The W_{gap} is defined to be widest possible on band based on the PCC and SCC configuration												

1. Connect the SS to the UE antenna connectors as shown in TS 38.508-1 [5] Annex A, Figure A.3.1.1.3 for TE diagram and section A.3.2 for UE diagram.
2. The parameter settings for the cell are set up according to TS 38.508-1 [5] subclause 4.4.3.
3. Downlink signals are initially set up according to Annex C.0, C.1, C.2, and uplink signals according to Annex G.0, G.1, G.2, G.3.0.
4. The UL Reference Measurement Channel is set according to Table 6.3A.1.1.4.1-1 and Table 6.3A.1.1.4.1-2 as appropriate.
5. Propagation conditions are set according to Annex B.0.

6. Ensure the UE is in State RRC_CONNECTED with generic procedure parameters Connectivity NR, Connected without release On, Test Mode On and Test Loop Function On according to TS 38.508-1 [5] clause 4.5. Message contents are defined in clause 6.3A.4.1.1.4.3. Note that PDCCH DCI format 0_1 sent after resetting uplink power with RRC Connection Reconfiguration, should have TPC command 0dB.

6.3A.4.1.1.4.2 Test procedure

1. Configure SCC according to Annex C.0, C.1, C.2 for all downlink physical channels.
2. The SS shall configure SCC as per TS 38.508-1 [5] clause 5.5.1. Message contents are defined in clause 6.3A.4.1.1.4.3. Any PDCCH DCI format 0_1 sent to the UE during the configuration should have TPC command 0dB.
3. SS activates SCC by sending the activation MAC CE (Refer TS 38.321 [18], clauses 5.9, 6.1.3.10). Wait for at least 2 seconds (Refer TS 38.133 [19], clause 9.3).
4. SS sends uplink scheduling information for each UL HARQ process via PDCCH DCI format 0_1 with TPC command 0dB for C_RNTI to schedule the UL RMC according to Table 6.3A.4.1.1.4.1-1 on both PCC and SCC. Since the UE has no payload and no loopback data to send the UE sends uplink MAC padding bits on the UL RMC.
5. Measure the initial output power of the first subframe of UE PUSCH first transmission for each component carrier.
6. Repeat for the two test points as indicated in section 6.3A.4.1.1.4.3. The timing of the execution between the two test points shall be larger than 20ms.

6.3A.4.1.1.4.3 Message contents

Message contents are according to TS 38.508-1 [5] subclause 4.6 with the following exceptions:

Table 6.3A.4.1.1.4.3-0: ServingCellConfigCommon

Derivation Path: 38.508-1[5], Table 4.6.3-168			
Information Element	Value/remark	Comment	Condition
ServingCellConfigCommon ::= SEQUENCE {			
ss-PBCH-BlockPower	18		SCS_15kHz
	21		SCS_30kHz
}			

Condition	Explanation
SCS_15kHz	SCS=15kHz for SS/PBCH block
SCS_30kHz	SCS=30kHz for SS/PBCH block

Table 6.3A.4.1.1.4.3-1: UplinkPowerControlCommon: Test point 1

Derivation Path: TS 38.508-1 [5] subclause 4.6.3 Table 4.6.3-119 PUSCH-ConfigCommon			
Information Element	Value/remark	Comment	Condition
PUSCH-ConfigCommon ::= SEQUENCE {			
p0-NominalWithGrant	-114	Test point 1 to verify a UE relative low initial power transmission	
}			

Table 6.3A.4.1.1.4.3-2: UplinkPowerControlCommon: Test point 2

Derivation Path: TS 38.508-1 [5] subclause 4.6.3 Table 4.6.3-119 PUSCH-ConfigCommon			
Information Element	Value/remark	Comment	Condition
PUSCH-ConfigCommon::= SEQUENCE { p0-NominalWithGrant	-108	Test point 2 to verify a UE relative high initial power transmission	
}			

6.3A.4.1.1.5 Test requirement

For intra-band contiguous CA, the absolute power control tolerance per component carrier measured in step (5) of the test procedure is not to exceed the values specified in Table 6.3A.4.1.1.5-1 and 6.3A.4.1.1.5-2.

Table 6.3A.4.1.1.5-1: Absolute power tolerance: test point 1

		Channel bandwidth / expected output power (dBm)											
		5 MHz	10 MHz	15 MHz	20 MHz	25 MHz	30 MHz	40 MHz	50 MHz	60 MHz	70 MHz	80 MHz	90 MHz
Expected Measured power	SCS15	-17.6	-14.4	-12.6	-11.3	-10.4	-9.6	-8.3	-7.3	N/A	N/A	N/A	N/A
	SCS30	-18.2	-14.8	-12.8	-11.5	-10.5	-9.7	-8.3	-7.4	-6.5	-5.8	-5.2	-4.7
	SCS60		-15.2	-13.0	-11.8	-10.7	-9.8	-8.5	-7.5	-6.6	-5.9	-5.3	-4.8
Power tolerance		± (9+TT)dB											
Note 1: TT for each duplex, Sub-Carrier Spacing, frequency and channel bandwidth is specified in Table 6.3A.4.1.1.5-3.													

Table 6.3A.4.1.1.5-2: Absolute power tolerance: test point 2

		Channel bandwidth / expected output power (dBm)											
		5 MHz	10 MHz	15 MHz	20 MHz	25 MHz	30 MHz	40 MHz	50 MHz	60 MHz	70 MHz	80 MHz	90 MHz
Expected Measured power	SCS15	-11.6	-7.6	-6.6	-5.3	-4.4	-3.6	-2.3	-1.3	N/A	N/A	N/A	N/A
	SCS30	-12.2	-8.8	-6.8	-5.5	-4.5	-3.7	-2.3	-1.4	-0.5	0.2	0.8	1.3
	SCS60	N/A	-9.2	-7	-5.8	-4.7	-3.8	-2.5	-1.5	-0.6	0.1	0.7	1.2
Power tolerance		± (9+TT)dB											
Note 1: TT for each duplex, Sub-Carrier Spacing, frequency and channel bandwidth is specified in Table 6.3A.4.1.1.5-3.													

Table 6.3A.4.1.1.5-3: Test Tolerance

	f ≤ 3.0GHz	3.0GHz < f ≤ 4.2GHz	4.2GHz < f ≤ 6.0GHz
BW ≤ 40MHz	1.0 dB	1.4 dB	1.4 dB
40MHz < BW ≤ 100MHz	1.4 dB	1.4 dB	1.4 dB

6.3A.4.2 Relative power tolerance for CA

6.3A.4.2.0 Minimum conformance requirements

For intra-band contiguous and non-contiguous carrier aggregation, the requirements apply when the power of the target and reference sub-frames on each component carrier exceed the minimum output power as defined in subclause 6.3A.1.0 and the total power is limited by P_{UMAX} as defined in subclause 6.2A.4.0. The UE shall meet the following

requirements for transmission on both assigned component carriers when the average transmit power per PRB is aligned across both assigned carriers in the reference sub-frame:

- a) for all possible combinations of PUSCH and PUCCH transitions per component carrier, the corresponding requirements given in Table 6.3.4.3.3-1;
- b) for SRS transitions on each component carrier, the requirements for combinations of PUSCH/PUCCH and SRS transitions given in Table 6.3.4.3.3-1 with simultaneous SRS of constant SRS bandwidth allocated in the target and reference subframes;
- c) for RACH on the primary component carrier, the requirements given in Table 6.3.4.3.3-1 for PRACH.

For a) and b) above, the power step ΔP between the reference and target subframes shall be set by a TPC command and/or an uplink scheduling grant transmitted by means of an appropriate DCI Format.

The normative reference for this requirement is TS 38.101-1 [2] clause 6.3A.4.

6.3A.4.2.1 Relative power tolerance for CA (2UL CA)

Editor's Note: This test case is incomplete for UL intra-band non-contiguous CA because MPR and $P_{\text{CMAX,L}}$ are not evaluated.

6.3A.4.2.1.1 Test purpose

To verify the ability of the UE transmitter to set its output power of each component carrier in a target sub-frame(1ms) relatively to the power of the most recently transmitted reference sub-frame if the transmission gap between these sub-frames is less than or equal to 20ms.

6.3A.4.2.1.2 Test applicability

This test case applies to all types of NR UE release 15 and forward that support intra-band contiguous 2UL CA.

6.3A.4.2.1.3 Minimum conformance requirements

The minimum conformance requirements are defined in clause 6.3A.4.2.0.

6.3A.4.2.1.4 Test description

6.3A.4.2.1.4.1 Initial condition

Initial conditions are a set of test configurations the UE needs to be tested in and the steps for the SS to take with the UE to reach the correct measurement state.

The initial test configurations consist of environmental conditions, test frequencies, test channel bandwidths and sub-carrier spacing based on NR CA configurations specified in 5.5A. All of these configurations shall be tested with applicable test parameters for each CA configuration, and are shown in table 6.3A.4.2.1.4.1-1 and table 6.3A.4.2.1.4.1-2. The details of the uplink reference measurement channels (RMCs) are specified in Annexes A.2 and A.3. Configurations of PDSCH and PDCCH before measurement are specified in Annex C.2.

Table 6.3A.4.2.1.4.1-1: Test Configuration Table for intra-band contiguous CA

Initial Conditions				
Test Environment as specified in TS 38.508-1 [5] subclause 4.1		Normal		
Test Frequencies as specified in TS 38.508-1 [5] subclause 4.3.1		Mid range		
Test Channel Bandwidths as specified in TS 38.508-1 [5] subclause 4.3.1		Lowest N_{RB_agg} , Highest N_{RB_agg}		
Test SCS as specified in Table 5.3.5-1		Lowest, Highest		
Test Parameters				
Test ID	Downlink Configuration for PCC & SCC		Uplink Configuration	
			Modulation for all CCs	RB allocations (Note 3) (L_{CRB} @ RB_{start})
				PCC
1	N/A for this test		DFT-s-OFDM QPSK	5@($N_{RB}-5$) 5@($N_{RB}-5$) 1@($N_{RB}-1$) 8@($N_{RB}-8$)
NOTE 1: Test Channel Bandwidths and Test SCS are checked separately for each NR CA band combination, which applicable channel bandwidths and SCS are specified in Table 5.5A.1-1.				
NOTE 2: If the UE supports multiple CC Combinations in the CA Configuration with the same N_{RB_agg} , only the combination with the highest N_{RB_PCC} is tested.				
NOTE 3: The UL allocation is changed as part of the test procedure. The Test Configuration Table entries list the combinations used, with the sequence of usage as determined by the test procedure for each sub-test.				

Table 6.3A.4.2.1.4.1-2: Test Configuration Table for intra-band non-contiguous CA

Initial Conditions						
Test Environment as specified in TS 38.508-1 [5] subclause 4.1		Normal				
Test Frequencies as specified in TS 38.508-1 [5] subclause 4.3.1		Refer to Range column				
Test Channel Bandwidths as specified in TS 38.508-1 [5] subclause 4.3.1		Lowest N_{RB_agg} , Highest N_{RB_agg}				
Test SCS as specified in Table 5.3.5-1		Lowest, Highest				
Test Parameters						
Test ID	Range			DL Config	Uplink Configuration	
					Modulation for all CCs	RB allocations (Note 3) (L_{CRB} @ RB_{start})
						PCC
1	CC1	Max Wgap	CC2	N/A	DFT-s-OFDM QPSK	5@0 5@0 1@0 8@0
NOTE 1: Test Channel Bandwidths and Test SCS are checked separately for each NR CA band combination, which applicable channel bandwidths and SCS are specified in Table 5.5A.2-1.						
NOTE 2: If the UE supports multiple CC Combinations in the CA Configuration with the same N_{RB_agg} , only the combination with the highest N_{RB_PCC} is tested.						
NOTE 3: The UL allocation is changed as part of the test procedure. The Test Configuration Table entries list the combinations used, with the sequence of usage as determined by the test procedure for each sub-test.						

1. Connect the SS to the UE antenna connectors as shown in TS 38.508-1 [5] Annex A, Figure A.3.1.1.3 for TE diagram and section A.3.2 for UE diagram.
2. The parameter settings for the cell are set up according to TS 38.508-1 [5] subclause 4.4.3.
3. Downlink signals are initially set up according to Annex C.0, C.1, C.2, and uplink signals according to Annex G.0, G.1, G.2, G.3.0.

4. The UL Reference Measurement Channel is set according to Table 6.3A.4.2.1.4.1-1 and Table 6.3A.4.2.1.4.1-2 as appropriate.
5. Propagation conditions are set according to Annex B.0.
6. Ensure the UE is in State RRC_CONNECTED with generic procedure parameters Connectivity *NR*, Connected without release *On*, Test Mode *On* and Test Loop Function *On* according to TS 38.508-1 [5] clause 4.5. Message contents are defined in clause 6.3A.4.2.1.4.3.

6.3A.4.2.1.4.2 Test procedure

1. Configure SCC according to Annex C.0, C.1, C.2 for all downlink physical channels.
2. The SS shall configure SCC as per TS 38.508-1 [5] clause 5.5.1. Message contents are defined in clause 6.3A.4.2.1.4.3.
3. SS activates SCC by sending the activation MAC CE (Refer TS 38.321 [18], clauses 5.9, 6.1.3.10). Wait for at least 2 seconds (Refer TS 38.133, clause 9.3).
4. The procedure is separated in various subtests to verify different aspects of relative power control. The power changes of the subtests are shown by diagrams in the Test Procedure. In this test case, the term $P_{\text{CMAX}_L} - \text{MAX}\{T_L, T_{\text{LOW}}(P_{\text{CMAX}_L})\}$ defined in TS 38.101 [2] clause 6.2.4A is used, to ensure the UE is not tested outside its power capability.
5. Sub test: SCC power increase
 - 5.1. SS sends uplink scheduling information for each UL HARQ process via PDCCH DCI format 0_1 for C_RNTI to schedule the UL RMC according to Table 6.3A.4.2.1.4.1-1 for intra-band contiguous CA and Table 6.3A.4.2.1.4.1-2 for intra-band non-contiguous CA on both PCC and SCC. Since the UE has no payload and no loopback data to send the UE sends uplink MAC padding bits on the UL RMC. Send the appropriate TPC commands for PUSCH on each component carrier to the UE to ensure that the UE transmits PUSCH on the PCC and on the SCC with powers nearest to $P_{\text{CCRefSet}, 0}$ and $P_{\text{SCCRefSet}, 0}$ respectively, as defined in Table 6.3A.4.2.1.4.2-1. The powers and allocations are chosen so the average transmit power per PRB is aligned across both assigned carriers in the reference sub-frame. Measure $P_{\text{CCRefMeas}, 0}$ and $P_{\text{SCCRefMeas}, 0}$ in the Reference subframe, and after the SCC allocation is increased, measure $P_{\text{CCTargetMeas}, 0}$ and $P_{\text{SCCTargetMeas}, 0}$ in the Target subframe.

Table 6.3A.4.2.1.4.2-1: Power settings and RB allocations for SCC power increase, step n=0

PCC		SCC	
Parameter	Value	Parameter	Value
Reference subframe			
$P_{\text{CCRefSet}, 0}$, dBm/N _{RB alloc}	$(P_{\text{SCCRefSet}, 0}) + 7$	$P_{\text{SCCRefSet}, 0}$, dBm/N _{RB alloc}	-17
PCC allocation, N _{RB alloc}	5	SCC allocation, N _{RB alloc}	1
Measured power, dBm/N _{RB alloc}	$P_{\text{CCRefMeas}, 0}$	Measured power, dBm/N _{RB alloc}	$P_{\text{SCCRefMeas}, 0}$
Target subframe			
$P_{\text{CCTargetSet}, 0}$, dBm/N _{RB alloc}	$(P_{\text{SCCRefSet}, 0}) + 7$	$P_{\text{SCCTargetSet}, 0}$, dBm/N _{RB alloc}	$(P_{\text{SCCRefSet}, 0}) + 9$
PCC allocation, N _{RB alloc}	5	SCC allocation, N _{RB alloc}	8
Measured power, dBm/N _{RB alloc}	$P_{\text{CCTargetMeas}, 0}$	Measured power, dBm/N _{RB alloc}	$P_{\text{SCCTargetMeas}, 0}$

- 5.2. Calculate the Total uplink power across both CCs in dBm as $10\log_{10}((P_{\text{CCTargetMeas}, n} \text{ in mW}) + (P_{\text{SCCTargetMeas}, n} \text{ in mW}))$. If $(P_{\text{CMAX}_L} - \text{MAX}\{T_L, T_{\text{LOW}}(P_{\text{CMAX}_L})\} - \text{Total uplink power}) > 1\text{dB}$, continue to step 5.3. Otherwise, go to step 5.6.

- 5.3. For the PCC, calculate the change in power as $(PCC_{TargetMeas, n} - PCC_{RefMeas, n})$ and compare to the PCC Test requirement specified in Table 6.3A.4.2.1.5-1. If the result meets the Test requirement, continue to step 5.4. Otherwise, fail the UE for this subtest.
- 5.4. For the SCC, calculate the change in power as $(SCC_{TargetMeas, n} - SCC_{RefMeas, n})$ and compare to the SCC Test requirement specified in Table 6.3A.4.2.1.5-1. If the result meets the Test requirement, continue to step 5.5. Otherwise, fail the UE for this subtest.
- 5.5. Send the appropriate TPC commands for PUSCH on each component carrier to the UE to ensure that the UE transmits PUSCH on the PCC and on the SCC with powers nearest to $PCC_{RefSet, n+1}$ and $SCC_{RefSet, n+1}$ respectively, as defined in Table 6.3A.4.2.1.4.2-2. Measure $PCC_{RefMeas, n}$ and $SCC_{RefMeas, n}$ in the Reference subframe, and after the SCC allocation is increased, measure $PCC_{TargetMeas, n}$ and $SCC_{TargetMeas, n}$ in the Target subframe. Repeat steps 5.2 to 5.4.

Table 6.3A.4.2.1.4.2-2: Power settings and RB allocations for SCC power increase, step n+1

PCC		SCC	
Parameter	Value	Parameter	Value
Reference subframe			
$PCC_{RefSet, n+1}$, dBm/N _{RB} alloc	$(SCC_{RefSet, n+1}) + 7$	$SCC_{RefSet, n+1}$, dBm/N _{RB} alloc	$SCC_{TargetMeas, n} + 2\text{dB}$
PCC allocation, N _{RB} alloc	5	SCC allocation, N _{RB} alloc	1
Measured power, dBm/N _{RB} alloc	$PCC_{RefMeas, n+1}$	Measured power, dBm/N _{RB} alloc	$SCC_{RefMeas, n+1}$
Target subframe			
$PCC_{TargetSet, n+1}$, dBm/N _{RB} alloc	$(SCC_{RefSet, n+1}) + 7$	$SCC_{TargetSet, n+1}$, dBm/N _{RB} alloc	$(SCC_{RefSet, n+1}) + 9$
PCC allocation, N _{RB} alloc	5	SCC allocation, N _{RB} alloc	8
Measured power, dBm/N _{RB} alloc	$PCC_{TargetMeas, n+1}$	Measured power, dBm/N _{RB} alloc	$SCC_{TargetMeas, n+1}$

- 5.6. If the requirements specified in Table 6.3A.4.2.1.5-1 are all met, pass the UE for this subtest.

6. Sub test: SCC power decrease

- 6.1. SS sends uplink scheduling information for each UL HARQ process via PDCCH DCI format 0_1 for C_RNTI to schedule the UL RMC according to Table 6.3A.4.2.1.4.1-1 for intra-band contiguous CA and Table 6.3A.4.2.1.4.1-2 for intra-band non-contiguous CA on both PCC and SCC. Since the UE has no payload and no loopback data to send the UE sends uplink MAC padding bits on the UL RMC. Send the appropriate TPC commands for PUSCH on each component carrier to the UE to ensure that the UE transmits PUSCH on the PCC and on the SCC with powers nearest to $PCC_{RefSet, 0}$ and $SCC_{RefSet, 0}$ respectively, as defined in Table 6.3A.4.2.1.4.2-3. The powers and allocations are chosen so the average transmit power per PRB is aligned across both assigned carriers in the reference sub-frame. Measure $PCC_{RefMeas, 0}$ and $SCC_{RefMeas, 0}$ in the Reference subframe, and after the SCC allocation is decreased, measure $PCC_{TargetMeas, 0}$ and $SCC_{TargetMeas, 0}$ in the Target subframe.

Table 6.3A.4.2.1.4.2-3: Power settings and RB allocations for SCC power decrease, step n=0

PCC		SCC	
Parameter	Value	Parameter	Value
Reference subframe			
$PCC_{RefSet, 0}$, dBm/N _{RB alloc}	$(SCC_{RefSet, 0}) - 2$	$SCC_{RefSet, 0}$, dBm/N _{RB alloc}	$P_{CMAX_L} - \text{MAX}\{T_L, T_{LOW}(P_{CMAX_L})\} - 5$
PCC allocation, N _{RB alloc}	5	SCC allocation, N _{RB alloc}	8
Measured power, dBm/N _{RB alloc}	$PCC_{RefMeas, 0}$	Measured power, dBm/N _{RB alloc}	$SCC_{RefMeas, 0}$
Target subframe			
$PCC_{TargetSet, 0}$, dBm/N _{RB alloc}	$(SCC_{RefSet, 0}) - 2$	$SCC_{TargetSet, 0}$, dBm/N _{RB alloc}	$(SCC_{RefSet, 0}) - 9$
PCC allocation, N _{RB alloc}	5	SCC allocation, N _{RB alloc}	1
Measured power, dBm/N _{RB alloc}	$PCC_{TargetMeas, 0}$	Measured power, dBm/N _{RB alloc}	$SCC_{TargetMeas, 0}$

- 6.2. If the uplink (power for each CC – (-20dBm)) is > 1dB, continue to step 6.3. Otherwise, go to step 6.6.
- 6.3. For the PCC, calculate the change in power as $(PCC_{TargetMeas, n} - PCC_{RefMeas, n})$ and compare to the PCC Test requirement specified in Table 6.3A.4.2.1.5-2. If the result meets the Test requirement, continue to step 6.4. Otherwise, fail the UE for this subtest.
- 6.4. For the SCC, calculate the change in power as $(SCC_{TargetMeas, n} - SCC_{RefMeas, n})$ and compare to the SCC Test requirement specified in Table 6.3A.4.2.1.5-2. If the result meets the Test requirement, continue to step 6.5. Otherwise, fail the UE for this subtest.
- 6.5. Send the appropriate TPC commands for PUSCH on each component carrier to the UE to ensure that the UE transmits PUSCH on the PCC and on the SCC with powers nearest to $PCC_{RefSet, n+1}$ and $SCC_{RefSet, n+1}$ respectively, as defined in Table 6.3A.4.2.1.4.2-4. Measure $PCC_{RefMeas, n}$ and $SCC_{RefMeas, n}$ in the Reference subframe, and after the SCC allocation is decreased, measure $PCC_{TargetMeas, n}$ and $SCC_{TargetMeas, n}$ in the Target subframe. Repeat steps 6.2 to 6.4.

Table 6.3A.4.2.1.4.2-4: Power settings and RB allocations for SCC power decrease, step n+1

PCC		SCC	
Parameter	Value	Parameter	Value
Reference subframe			
$PCC_{RefSet, n+1}$, dBm/N _{RB alloc}	$(SCC_{RefSet, n+1}) - 2$	$SCC_{RefSet, n+1}$, dBm/N _{RB alloc}	$SCC_{TargetMeas, n} - 2\text{dB}$
PCC allocation, N _{RB alloc}	5	SCC allocation, N _{RB alloc}	8
Measured power, dBm/N _{RB alloc}	$PCC_{RefMeas, n+1}$	Measured power, dBm/N _{RB alloc}	$SCC_{RefMeas, n+1}$
Target subframe			
$PCC_{TargetSet, n+1}$, dBm/N _{RB alloc}	$(SCC_{RefSet, n+1}) - 2$	$SCC_{TargetSet, n+1}$, dBm/N _{RB alloc}	$(SCC_{RefSet, n+1}) - 9$
PCC allocation, N _{RB alloc}	5	SCC allocation, N _{RB alloc}	1
Measured power, dBm/N _{RB alloc}	$PCC_{TargetMeas, n+1}$	Measured power, dBm/N _{RB alloc}	$SCC_{TargetMeas, n+1}$

- 6.6. If the requirements specified in Table 6.3A.4.2.1.5-2 are all met, pass the UE for this subtest.
7. Sub test: PCC and SCC power increase together

- 7.1. SS sends uplink scheduling information for each UL HARQ process via PDCCH DCI format 0_1 for C_RNTI to schedule the UL RMC according to Table 6.3A.4.2.1.4.1-1 for intra-band contiguous CA and Table 6.3A.4.2.1.4.1-2 for intra-band non-contiguous CA on both PCC and SCC. Since the UE has no payload and no loopback data to send the UE sends uplink MAC padding bits on the UL RMC. Send the appropriate TPC commands for PUSCH on each component carrier to the UE to ensure that the UE transmits PUSCH on the PCC and on the SCC with powers nearest to $PCC_{RefSet, 0}$ and $SCC_{RefSet, 0}$ respectively, as defined in Table 6.3A.4.2.1.4.2-5. The powers and allocations are chosen so the average transmit power per PRB is aligned across both assigned carriers in the reference sub-frame. Measure $PCC_{RefMeas, 0}$ and $SCC_{RefMeas, 0}$ in the Reference subframe, and after the PCC and SCC allocation are increased, measure $PCC_{TargetMeas, 0}$ and $SCC_{TargetMeas, 0}$ in the Target subframe.

Table 6.3A.4.2.1.4.2-5: Power settings and RB allocations for PCC and SCC power increase, step n=0

PCC		SCC	
Parameter	Value	Parameter	Value
Reference subframe			
$PCC_{RefSet, 0}$, dBm/N _{RB alloc}	-17	$SCC_{RefSet, 0}$, dBm/N _{RB alloc}	-17
PCC allocation, N _{RB alloc}	1	SCC allocation, N _{RB alloc}	1
Measured power, dBm/N _{RB alloc}	$PCC_{RefMeas, 0}$	Measured power, dBm/N _{RB alloc}	$SCC_{RefMeas, 0}$
Target subframe			
$PCC_{TargetSet, 0}$, dBm/N _{RB alloc}	$(PCC_{RefSet, 0}) +9$	$SCC_{TargetSet, 0}$, dBm/N _{RB alloc}	$(SCC_{RefSet, 0}) +9$
PCC allocation, N _{RB alloc}	8	SCC allocation, N _{RB alloc}	8
Measured power, dBm/N _{RB alloc}	$PCC_{TargetMeas, 0}$	Measured power, dBm/N _{RB alloc}	$SCC_{TargetMeas, 0}$

- 7.2. Calculate the Total uplink power across both CCs in dBm as $10\log_{10}((PCC_{TargetMeas, n}$ in mW) + ($SCC_{TargetMeas, n}$ in mW)). If $(P_{CMAX_L} - \text{MAX}\{T_L, T_{LOW}(P_{CMAX_L})\} - \text{Total uplink power}) > 1\text{dB}$, continue to step 7.3. Otherwise, go to step 7.6.
- 7.3. For the PCC, calculate the change in power as $(PCC_{TargetMeas, n} - PCC_{RefMeas, n})$ and compare to the PCC Test requirement specified in Table 6.3A.4.2.1.5-3. If the result meets the Test requirement, continue to step 7.4. Otherwise, fail the UE for this subtest.
- 7.4. For the SCC, calculate the change in power as $(SCC_{TargetMeas, n} - SCC_{RefMeas, n})$ and compare to the SCC Test requirement specified in Table 6.3A.4.2.1.5-3. If the result meets the Test requirement, continue to step 7.5. Otherwise, fail the UE for this subtest.
- 7.5. Send the appropriate TPC commands for PUSCH on each component carrier to the UE to ensure that the UE transmits PUSCH on the PCC and on the SCC with powers nearest to $PCC_{RefSet, n+1}$ and $SCC_{RefSet, n+1}$ respectively, as defined in Table 6.3A.4.2.1.4.2-6. Measure $PCC_{RefMeas, n}$ and $SCC_{RefMeas, n}$ in the Reference subframe, and after the PCC and SCC allocation are increased, measure $PCC_{TargetMeas, n}$ and $SCC_{TargetMeas, n}$ in the Target subframe. Repeat steps 7.2 to 7.4.

Table 6.3A.4.2.1.4.2-6: Power settings and RB allocations for PCC and SCC power increase, step n+1

PCC		SCC	
Parameter	Value	Parameter	Value
Reference subframe			
PCC _{RefSet, n+1} , dBm/N _{RB alloc}	(Max (PCC _{TargetMeas, n} , SCC _{TargetMeas, n})) +2dB	SCC _{RefSet, n+1} , dBm/N _{RB alloc}	(Max (PCC _{TargetMeas, n} , SCC _{TargetMeas, n})) +2dB
PCC allocation, N _{RB alloc}	1	SCC allocation, N _{RB alloc}	1
Measured power, dBm/N _{RB alloc}	PCC _{RefMeas, n+1}	Measured power, dBm/N _{RB alloc}	SCC _{RefMeas, n+1}
Target subframe			
PCC _{TargetSet, n+1} , dBm/N _{RB alloc}	(SCC _{RefSet, n+1}) +9	SCC _{TargetSet, n+1} , dBm/N _{RB alloc}	(SCC _{RefSet, n+1}) +9
PCC allocation, N _{RB alloc}	8	SCC allocation, N _{RB alloc}	8
Measured power, dBm/N _{RB alloc}	PCC _{TargetMeas, n+1}	Measured power, dBm/N _{RB alloc}	SCC _{TargetMeas, n+1}

7.6. If the requirements specified in Table 6.3A.4.2.1.5-3 are all met, pass the UE for this subtest.

8. Sub test: PCC and SCC power decrease together

8.1. SS sends uplink scheduling information for each UL HARQ process via PDCCH DCI format 0_1 for C_RNTI to schedule the UL RMC according to Table 6.3A.4.2.1.4.1-1 for intra-band contiguous CA and Table 6.3A.4.2.1.4.1-2 for intra-band non-contiguous CA on both PCC and SCC. Since the UE has no payload and no loopback data to send the UE sends uplink MAC padding bits on the UL RMC. Send the appropriate TPC commands for PUSCH on each component carrier to the UE to ensure that the UE transmits PUSCH on the PCC and on the SCC with powers nearest to PCC_{RefSet, 0} and SCC_{RefSet, 0} respectively, as defined in Table 6.3A.4.2.1.4.2-7. The powers and allocations are chosen so the average transmit power per PRB is aligned across both assigned carriers in the reference sub-frame. Measure PCC_{RefMeas, 0} and SCC_{RefMeas, 0} in the Reference subframe, and after the PCC and SCC allocation are decreased, measure PCC_{TargetMeas, 0} and SCC_{TargetMeas, 0} in the Target subframe.

Table 6.3A.4.2.1.4.2-7: Power settings and RB allocations for PCC and SCC power decrease, step n=0

PCC		SCC	
Parameter	Value	Parameter	Value
Reference subframe			
PCC _{RefSet, 0} , dBm/N _{RB alloc}	$P_{CMAX_L} - \text{MAX}\{T_L, T_{LOW}(P_{CMAX_L})\} - 6$	SCC _{RefSet, 0} , dBm/N _{RB alloc}	$P_{CMAX_L} - \text{MAX}\{T_L, T_{LOW}(P_{CMAX_L})\} - 6$
PCC allocation, N _{RB alloc}	8	SCC allocation, N _{RB alloc}	8
Measured power, dBm/N _{RB alloc}	PCC _{RefMeas, 0}	Measured power, dBm/N _{RB alloc}	SCC _{RefMeas, 0}
Target subframe			
PCC _{TargetSet, 0} , dBm/N _{RB alloc}	(PCC _{RefSet, 0}) -9	SCC _{TargetSet, 0} , dBm/N _{RB alloc}	(SCC _{RefSet, 0}) -9
PCC allocation, N _{RB alloc}	1	SCC allocation, N _{RB alloc}	1
Measured power, dBm/N _{RB alloc}	PCC _{TargetMeas, 0}	Measured power, dBm/N _{RB alloc}	SCC _{TargetMeas, 0}

8.2. If the uplink (power for each CC – (-20dBm)) is > 1dB, continue to step 8.3. Otherwise, go to step 8.6.

- 8.3. For the PCC, calculate the change in power as $(PCC_{TargetMeas, n} - PCC_{RefMeas, n})$ and compare to the PCC Test requirement specified in Table 6.3A.4.2.1.5-4. If the result meets the Test requirement, continue to step 8.4. Otherwise, fail the UE for this subtest.
- 8.4. For the SCC, calculate the change in power as $(SCC_{TargetMeas, n} - SCC_{RefMeas, n})$ and compare to the SCC Test requirement specified in Table 6.3A.4.2.1.5-4. If the result meets the Test requirement, continue to step 8.5. Otherwise, fail the UE for this subtest.
- 8.5. Send the appropriate TPC commands for PUSCH on each component carrier to the UE to ensure that the UE transmits PUSCH on the PCC and on the SCC with powers nearest to $PCC_{RefSet, n+1}$ and $SCC_{RefSet, n+1}$ respectively, as defined in Table 6.3A.4.2.1.4.2-8. Measure $PCC_{RefMeas, n}$ and $SCC_{RefMeas, n}$ in the Reference subframe, and after the PCC and SCC allocation are decreased, measure $PCC_{TargetMeas, n}$ and $SCC_{TargetMeas, n}$ in the Target subframe. Repeat steps 8.2 to 8.4.

Table 6.3A.4.2.1.4.2-8: Power settings and RB allocations for PCC and SCC power decrease, step n+1

PCC		SCC	
Parameter	Value	Parameter	Value
Reference subframe			
$PCC_{RefSet, n+1}$, dBm/N _{RB alloc}	(Min ($PCC_{TargetMeas, n}$, $SCC_{TargetMeas, n}$)) -2dB	$SCC_{RefSet, n+1}$, dBm/N _{RB alloc}	(Min ($PCC_{TargetMeas, n}$, $SCC_{TargetMeas, n}$)) -2dB
PCC allocation, N _{RB alloc}	8	SCC allocation, N _{RB alloc}	8
Measured power, dBm/N _{RB alloc}	$PCC_{RefMeas, n+1}$	Measured power, dBm/N _{RB alloc}	$SCC_{RefMeas, n+1}$
Target subframe			
$PCC_{TargetSet, n+1}$, dBm/N _{RB alloc}	$(SCC_{RefSet, n+1}) -9$	$SCC_{TargetSet, n+1}$, dBm/N _{RB alloc}	$(SCC_{RefSet, n+1}) -9$
PCC allocation, N _{RB alloc}	1	SCC allocation, N _{RB alloc}	1
Measured power, dBm/N _{RB alloc}	$PCC_{TargetMeas, n+1}$	Measured power, dBm/N _{RB alloc}	$SCC_{TargetMeas, n+1}$

- 8.6. If the requirements specified in Table 6.3A.4.2.1.5-4 are all met, pass the UE for this subtest.

6.3A.4.2.1.4.3 Message contents

Message contents are according to TS 38.508-1 [5] subclause 4.6 with the following exception:

Table 6.3A.4.2.1.4.3-1: PUSCH-Config

Derivation Path: TS 38.508-1 [5], Table 4.6.3-118 with condition TRANSFORM_PRECODER_ENABLED

6.3A.4.2.1.5 Test requirement

For intra-band contiguous carrier aggregation bandwidth class C and intra-band non-contiguous CA, the relative power control tolerance per component carrier measured in steps 5, 6, 7 and 8 of the test procedures should satisfy the applicable test requirements specified in Tables 6.3A.4.2.1.5-1 to 6.3A.4.2.1.5-5.

Table 6.3A.4.2.1.5-1: Test requirements for SCC power increase

Parameter	Condition	Unit	Minimum	Maximum
$(PCC_{TargetMeas, n} - PCC_{RefMeas, n})$	Normal	dB	-0.7-TT	0.7+TT
$(SCC_{TargetMeas, n} - SCC_{RefMeas, n})$	Normal	dB	5.5-TT	12.5+TT

Table 6.3A.4.2.1.5-2: Test requirements for SCC power decrease

Parameter	Condition	Unit	Minimum	Maximum
$(PCC_{TargetMeas, n} - PCC_{RefMeas, n})$	Normal	dB	-0.7-TT	0.7+TT
$(SCC_{TargetMeas, n} - SCC_{RefMeas, n})$	Normal	dB	-12.5-TT	-5.5+TT

Table 6.3A.4.2.1.5-3: Test requirements for PCC and SCC power increase together

Parameter	Condition	Unit	Minimum	Maximum
$(PCC_{TargetMeas, n} - PCC_{RefMeas, n})$	Normal	dB	5.5-TT	12.5+TT
$(SCC_{TargetMeas, n} - SCC_{RefMeas, n})$	Normal	dB	5.5-TT	12.5+TT

Table 6.3A.4.2.1.5-4: Test requirements for PCC and SCC power decrease together

Parameter	Condition	Unit	Minimum	Maximum
$(PCC_{TargetMeas, n} - PCC_{RefMeas, n})$	Normal	dB	-12.5-TT	-5.5+TT
$(SCC_{TargetMeas, n} - SCC_{RefMeas, n})$	Normal	dB	-12.5-TT	-5.5+TT

Table 6.3A.4.2.1.5-5: Test Tolerance

	$f \leq 6.0\text{GHz}$
$BW \leq 100\text{MHz}$	0.7 dB

6.3A.4.3 Aggregate power tolerance for CA

6.3A.4.3.0 Minimum conformance requirements

For intra-band contiguous and non-contiguous carrier aggregation, the aggregate power tolerance per component carrier is given in Table 6.3A.4.3-1. The average power per PRB shall be aligned across both assigned carriers before the start of the test. The requirement can be tested with the transmission gaps time aligned between component carriers.

The normative reference for this requirement is TS 38.101-1 [2] clause 6.3A.4.

6.3A.4.3.1 Aggregate power tolerance for CA (2UL CA)

Editor's Note: This test case is incomplete when signalling is absent for dualPA-Architecture IE due to lack of core requirements.

6.3A.4.3.1.1 Test purpose

To verify the ability of the UE transmitter to maintain its power during non-contiguous transmissions within 21ms in response to 0 dB commands with respect to the first UE transmission and all other power control parameters as specified in 38.213 kept constant on all active component carriers.

6.3A.4.3.1.2 Test applicability

This test case applies to all types of NR UE release 15 and forward that support intra-band contiguous 2UL CA.

6.3A.4.3.1.3 Minimum conformance requirements

The minimum conformance requirements are defined in clause 6.3A.4.3.0.

6.3A.4.3.1.4 Test description

6.3A.4.3.1.4.1 Initial condition

Initial conditions are a set of test configurations the UE needs to be tested in and the steps for the SS to take with the UE to reach the correct measurement state.

The initial test configurations consist of environmental conditions, test frequencies, test channel bandwidths and sub-carrier spacing based on NR CA configurations specified in 5.5A. All of these configurations shall be tested with applicable test parameters for each CA configuration, and are shown in table 6.3A.4.3.1.4.1-2 and 6.3A.4.3.1.4.1-3. The details of the uplink reference measurement channels (RMCs) are specified in Annexes A.2 and A.3. Configurations of PDSCH before measurement is specified in Annex C.2.

Table 6.3A.4.3.1.4.1-1: Void

Table 6.3A.4.3.1.4.1-2: Test Configuration Table for intra-band contiguous CA: PUSCH sub-test

Initial Conditions					
Test Environment as specified in TS 38.508-1 [5] subclause 4.1		Normal			
Test Frequencies as specified in TS 38.508-1 [5] subclause 4.3.1		Mid range			
Test Channel Bandwidths as specified in TS 38.508-1 [5] subclause 4.3.1		Lowest N_{RB_agg} , Highest N_{RB_agg}			
Test SCS as specified in Table 5.3.5-1		Lowest, Highest			
Test Parameters					
Test ID	Downlink Configuration for PCC & SCC		Uplink Configuration		
			Modulation for all CCs	RB allocation (NOTE 1)	
	PCC	SCC			
1	N/A for this test		CP-OFDM QPSK	Outer Full	Outer Full
NOTE 1: The specific configuration of each RB allocation is defined in 6.1A-1a for contiguous RB alloc.					
NOTE 2: Test Channel Bandwidths and Test SCS are checked separately for each NR CA band combination, which applicable channel bandwidths and SCS are specified in Table 5.5A.1-1.					
NOTE 3: If the UE supports multiple CC Combinations in the CA Configuration with the same N_{RB_agg} , only the combination with the highest N_{RB_PCC} is tested.					

Table 6.3A.4.3.1.4.1-3: Test Configuration Table for intra-band non-contiguous CA

Initial Conditions												
Test Environment as specified in TS 38.508-1 [5] subclause 4.1				Normal								
Test Frequencies as specified in TS 38.508-1 [5] subclause 4.3.1				For test frequencies refer to "Range" columns								
Test Channel Bandwidths as specified in TS 38.508-1 [5] subclause 4.3.1				Refer to PCC N_{RB} and "SCC N_{RB} " columns								
Test SCS as specified in Table 5.3.5-1				Lowest, Highest								
Test Parameters												
ID	CA config / CBW							DL con fig	UL config			
	PCC		SCC		PCC N_{RB}	W_{gap}	SCC N_{RB}		CC MOD	RB allocation (NOTE 1)		
	Band	Range	Band	Range						PCC	SCC	
1	nX	CC1	nX	CC2	Lowest N_{RB_agg}	Max (NOTE 4)	Lowest N_{RB_agg}	N/A	CP-OFDM QPSK	Outer_Full	Outer_Full	
2	nX	CC1	nX	CC2	Highest N_{RB_agg}	Max (NOTE 4)	Highest N_{RB_agg}			Outer_Full	Outer_Full	
NOTE 1: RB allocation is defined in table 6.1-1 for each CC.												
NOTE 2: Test Channel Bandwidths and Test SCS are checked separately for each NR CA band combination, which applicable channel bandwidths and SCS are specified in Table 5.5A.2-1.												
NOTE 3: If the UE supports multiple CC Combinations in the CA Configuration with the same N_{RB_agg} , only the combination with the highest N_{RB_PCC} is tested.												
NOTE 4: The W_{gap} is defined to be widest possible on band based on the PCC and SCC configuration												

1. Connect the SS to the UE antenna connectors as shown in TS 38.508-1 [5] Annex A, Figure A.3.1.1.3 for TE diagram and section A.3.2 for UE diagram.
2. The parameter settings for the cell are set up according to TS 38.508-1 [5] subclause 4.4.3.
3. Downlink signals are initially set up according to Annex C.0, C.1, C.2, and uplink signals according to Annex G.0, G.1, G.2, G.3.0.
4. The UL Reference Measurement Channel is set according to Table 6.3A.3.1.4.1-1 for intra-band contiguous CA and Table 6.3A.3.1.4.1-3 for intra-band non-contiguous CA.
5. Propagation conditions are set according to Annex B.0.
6. Ensure the UE is in State RRC_CONNECTED with generic procedure parameters Connectivity NR, Connected without release *On*, Test Mode *On* and Test Loop Function *On* according to TS 38.508-1 [5] clause 4.5. Message contents are defined in clause 6.3A.4.3.1.4.3.

6.3A.4.3.1.4.2 Test procedure

For intra-band contiguous UL CA:

The procedure is separated in two subtests to verify PUCCH and PUSCH aggregate power control tolerance respectively. The uplink transmission patterns for each component carrier are described in figure 6.3A.4.3.1.4.2-1.

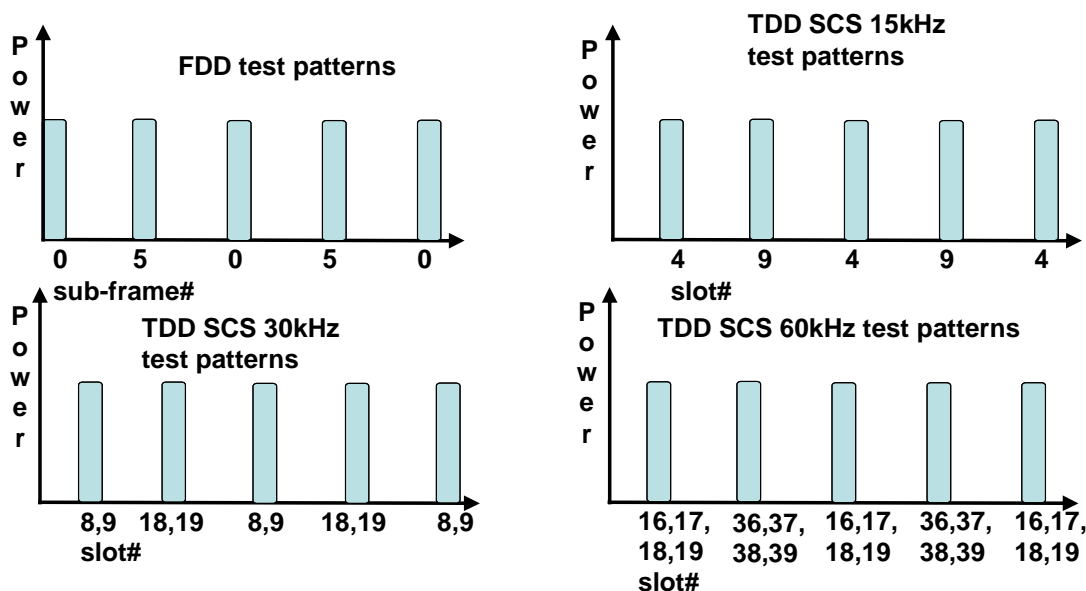

Figure 6.3A.4.3.1.4.2-1 Test uplink transmission

1. Configure SCC according to Annex C.0, C.1, C.2 for all downlink physical channels.
2. The SS shall configure SCC as per TS 38.508-1 [5] clause 5.5.1. Message contents are defined in clause 6.3A.4.3.1.4.3. Any PDCCH DCI format 0_1 sent to the UE during the configuration should have TPC command 0dB.
3. SS activates SCC by sending the activation MAC CE (Refer TS 38.321 [18], clauses 5.9, 6.1.3.10). Wait for at least 2 seconds (Refer TS 38.133 [19], clause 9.3)
4. PUSCH sub test:
 - 4.1. The SS sends uplink scheduling information for each UL HARQ process via PDCCH DCI format 0_1 for C_RNTI to schedule the PUSCH according to Table 6.3A.4.3.1.4.1-1 on PCC and SCC. Since the UE has no payload and no loopback data to send the UE sends uplink MAC padding bits on the UL RMC. Send uplink power control commands for PUSCH to the UE using 1dB power step size to ensure that the UE

output power on PCC and SCC measured by the test system is within the Uplink power control window, defined as $-(\text{Uplink power control window size} / 2)$ dB to $+(\text{Uplink power control window size} / 2)$ dB of the target power level + 0 dBm, where:

- Uplink power control window size = 1dB (UE power step size) + 0.7dB (UE power step tolerance) + (Test system relative power measurement uncertainty), where, the UE power step tolerance is specified in TS 38.101-1 [2], Table 6.3.4.3-1 and is 0.7dB for PUSCH with 1dB power step size, and the Test system relative power measurement uncertainty is specified in Table F.1.2-1.

NOTE: The purpose of the Uplink power control window is to ensure that the actual UE output power is as close as possible to the target power level. The relationship between the Uplink power control window, the target power level and the corresponding possible actual UE Uplink power window is illustrated in Annex F.4.4.

- 4.2. Every 5 sub-frames (5ms) schedule the UE's PUSCH data transmission for 1 sub-frame(1ms), and transmit 0 dB TPC command for PUSCH via the PDCCH to make the UE transmit PUSCH. The uplink transmission patterns are described in figure 6.3A.4.3.1.4.2-1,
- 4.3. Measure the power on both PCC and SCC of 5 consecutive PUSCH transmissions to verify the UE transmitted PUSCH power is maintained within 21ms transmissions on each component carrier.

For intra-band non-contiguous UL CA:

1. Configure SCC according to Annex C.0, C.1, C.2 for all downlink physical channels.
2. The SS shall configure SCC as per TS 38.508-1 [5] clause 5.5.1. Message contents are defined in clause 6.3A.4.3.1.4.3. Any PDCCH DCI format 0_1 sent to the UE during the configuration should have TPC command 0dB.
3. SS activates SCC by sending the activation MAC CE (Refer TS 38.321 [18], clauses 5.9, 6.1.3.10). Wait for at least 2 seconds (Refer TS 38.133 [19], clause 9.3)
4. The SS sends uplink scheduling information for each UL HARQ process via PDCCH DCI format 0_1 for C_RNTI to schedule the PUSCH according to Table 6.3A.4.3.1.4.1-3 on PCC and SCC. Since the UE has no payload and no loopback data to send the UE sends uplink MAC padding bits on the UL RMC. Send uplink power control commands for PUSCH to the UE using 1dB power step size to ensure that the UE output power on PCC and SCC measured by the test system is within the Uplink power control window, defined as $-(\text{Uplink power control window size} / 2)$ dB to $+(\text{Uplink power control window size} / 2)$ dB of the target power level + 0 dBm, where:
5. Uplink power control window size = 1dB (UE power step size) + 0.7dB (UE power step tolerance) + (Test system relative power measurement uncertainty), where, the UE power step tolerance is specified in TS 38.101-1 [2], Table 6.3.4.3-1 and is 0.7dB for PUSCH with 1dB power step size, and the Test system relative power measurement uncertainty is specified in Table F.1.2-1.

NOTE: The purpose of the Uplink power control window is to ensure that the actual UE output power is as close as possible to the target power level. The relationship between the Uplink power control window, the target power level and the corresponding possible actual UE Uplink power window is illustrated in Annex F.4.4.

6. Every 5 sub-frames (5ms) schedule the UE's PUSCH data transmission for 1 sub-frame(1ms), and transmit 0 dB TPC command for PUSCH via the PDCCH to make the UE transmit PUSCH. The uplink transmission patterns are described in figure 6.3A.4.3.1.4.2-1.
7. Measure the power on both PCC and SCC of 5 consecutive PUSCH transmissions to verify the UE transmitted PUSCH power is maintained within 21ms transmissions on each component carrier.

6.3A.4.3.1.4.3 Message contents

Message contents are according to TS 38.508-1 [5] subclause 4.6 with the following exceptions:

Table 6.3A.4.3.1.4.3-1: Void**6.3A.4.3.1.5 Test requirement**

For intra-band contiguous CA, the aggregate power control tolerance per component carrier measured in step (4.3) and step (5.3) of the test procedure is not to exceed the values specified in Table 6.3A.4.3.1.5-1.

For intra-band non-contiguous CA, the aggregate power control tolerance per component carrier measured in step 7 of the test procedure is not to exceed the values specified in Table 6.3A.4.3.1.5-1.

Table 6.3A.4.3.1.5-1: Aggregate power tolerance for CA

TPC command	UL channel	Test requirement measured power
0 dB	PUSCH on PCC and SCC	Given 5 power measurements in the pattern, the 2 nd , and later measurements shall be within $\pm (3.5 + TT)$ dB of the 1 st measurement.
Note 1:	For SCS 30kHz 1 sub-frame corresponds to 2 slots and for SCS 60kHz 1 sub-frame corresponds to 4 slots, so 2 TPC commands will be sent for a single measurement period.	
Note 2:	TT = 0.7dB.	

6.3B Output power dynamics for NR-DC

For inter-band NR-DC with one uplink carrier assigned per NR band, the output power dynamics for the corresponding inter-band CA configuration as specified in subclause 6.3A applies.

Note: For NR-DC testing, replace CA by NR-DC, PCC by PCell, and SCC by PSCell in clause 6.3A.

6.3B.1 Minimum output power for NR-DC

For inter-band dual connectivity, the minimum output power for the corresponding inter-band CA configuration as specified in clause 6.3A.1 applies.

Note: For NR-DC testing, replace CA by NR-DC, PCC by PCell, and SCC by PSCell in clause 6.3A.1.

6.3B.2 Transmit OFF power for NR-DC

For inter-band dual connectivity, the transmit OFF power for the corresponding inter-band CA configuration as specified in clause 6.3A.2 applies.

Note: For NR-DC testing, replace CA by NR-DC, PCC by PCell, and SCC by PSCell in clause 6.3A.2.

6.3B.3 Transmit ON/OFF time mask for NR-DC

For inter-band dual connectivity, the transmit ON/OFF time mask for the corresponding inter-band CA configuration as specified in clause 6.3A.3 applies.

Note: For NR-DC testing, replace CA by NR-DC, PCC by PCell, and SCC by PSCell in clause 6.3A.3.

6.3C Output power dynamics for SUL**6.3C.1 Minimum output power for SUL****6.3C.1.1 Test purpose**

Same test purpose as in clause 6.3.1.1

6.3C.1.2 Test applicability

This test case applies to all types of NR UE release 15 and forward that support SUL operating on the SUL bands.

6.3C.1.3 Minimum conformance requirements

For a terminal that supports SUL for the band combination specified in Table 5.2C-1, the current version of the specification assumes the terminal is configured with active transmission either on UL carrier or SUL carrier at any time in one serving cell and the UE requirements for single carrier shall apply for the active UL or SUL carrier accordingly.

The normative reference for this requirement is TS 38.101-1 [2] clauses 4.3 and 6.3.1.

6.3C.1.4 Test description

Same test description as specified in clause 6.3.1.4 with following exceptions:

Instead of table 5.3.5-1 → use Table 5.5C-1.

Instead of table 6.3.1.4.1-1 → use Table 6.3C.1.4-1

Table 6.3C.1.4-1: Test Configuration Table

Initial Conditions				
Test Environment as specified in TS 38.508-1 [5] subclause 4.1		Normal, TL/VL, TL/VH, TH/VL, TH/VH		
Test Frequencies as specified in TS 38.508-1 [5] subclause 4.3.1		Low, Mid, High range for SUL carrier Mid-range for Non-SUL carrier		
Test Channel Bandwidths as specified in TS 38.508-1 [5] subclause 4.3.1		Lowest, Mid, Highest for SUL carrier Lowest for Non-SUL carrier		
Test SCS as specified in Table 5.3.5-1		15kHz for both SUL carrier and Non-SUL carrier		
Test Parameters for Channel Bandwidths				
Test ID	Downlink Configuration	Uplink Configuration	SUL Configuration	
	N/A	N/A	Modulation	RB allocation (NOTE 2)
1			DFT-s-OFDM QPSK	Outer Full
NOTE 1: Test Channel Bandwidths are checked separately for each SUL band combination, the applicable channel bandwidths are specified in Table 5.5C-1.				
NOTE 2: The specific configuration of each RB allocation is defined in Table 6.1-1.				
NOTE 3: DFT-s-OFDM PI/2 BPSK test applies only for UEs which supports half Pi BPSK in FR1.				

- Connect the SS to the UE antenna connectors as shown in TS 38.508-1 [5] Annex A, Figure A.3.1.1.4 for TE diagram and section A.3.2 for UE diagram.
- The parameter setting for the cell are set up according to the TS 38.508-1 [5] subclause 4.4.3.
- Downlink signals are initially setup according to Annex C.0, C.1, C.2 and uplink signals according to Annex G.0, G.1, G.2, and G.3.0 with consideration of supplementary uplink physical channels.

Message contents in initial conditions are according to TS 38.508-1 [5] subclause 4.3.6.1.1.2 ensuring UL/SUL indicator in Table 4.3.6.1.1.2-1 with condition SUL, subclause 4.6 ensuring Table 4.6.1-28 with condition SUL AND (RF OR RRM), Tables 4.6.3-14 with condition SUL_SUL for SUL carrier, and Table 4.6.3-167 with condition PUSCH_PUCCH_ON_SUL, additionally the following exception shown in Table 6.3C.1.4-2 is considered.

Table 6.3C.1.4-2: PUSCH-Config

Derivation Path: TS 38.508-1 [5], Table 4.6.3-118 with condition TRANSFORM_PRECODER_ENABLED

Table 6.3C.1.4-3: Void

6.3C.1.5 Test requirement

The minimum output power, derived in step 3 shall not exceed the values specified in Table 6.3C.1.5-1.

Table 6.3C.1.5-1: Minimum output power

Channel bandwidth (MHz)	Minimum output power (dBm)	Measurement bandwidth (MHz)
5	-40+TT	4.515
10	-40+TT	9.375
15	-40+TT	14.235
20	-40+TT	19.095
25	-39+TT	23.955
30	-38.2+TT	28.815
40	-37+TT	38.895

NOTE 1: TT for each frequency and channel bandwidth is specified in Table 6.3C.1.5-2

Table 6.3C.1.5-2: Test Tolerance (Minimum output power)

	$f \leq 3.0\text{GHz}$	$3.0\text{GHz} < f \leq 6.0\text{GHz}$
$BW \leq 40\text{MHz}$	1.0 dB	1.3 dB
$40\text{MHz} < BW \leq 100\text{MHz}$	1.3 dB	1.3 dB

6.3C.2 Transmit OFF power for SUL

6.3C.2.1 Test purpose

Same test purpose as in clause 6.3.2.1

6.3C.2.2 Test applicability

The requirements of this test apply in test cases 6.3C.3 Transmit ON/OFF time mask for SUL to all types of NR UE release 15 and forward that support SUL operating on the SUL bands.

6.3C.2.3 Minimum conformance requirements

For a terminal that supports SUL for the band combination specified in Table 5.2C-1, the current version of the specification assumes the terminal is configured with active transmission either on UL carrier or SUL carrier at any time in one serving cell and the UE requirements for single carrier shall apply for the active UL or SUL carrier accordingly.

The normative reference for this requirement is TS 38.101-1 [2] clauses 4.3 and 6.3.2.

6.3C.2.4 Test description

This test is covered by clause 6.3C.3 Transmit ON/OFF time mask for SUL.

6.3C.2.5 Test requirement

The requirement for the transmit OFF power for SUL shall not exceed the values specified in Table 6.3C.2.5-1.

Table 6.3C.2.5-1: Transmit OFF power

Channel bandwidth (MHz)	Transmit OFF power (dBm)	Measurement bandwidth (MHz)
5	-50+TT	4.515
10	-50+TT	9.375
15	-50+TT	14.235
20	-50+TT	19.095
25	-50+TT	23.955
30	-50+TT	28.815
40	-50+TT	38.895

NOTE 1: TT for each frequency and channel bandwidth is specified in Table 6.3C.2.5-2

Table 6.3C.2.5-2: Test Tolerance (Transmit OFF power)

	f ≤ 3.0GHz	3.0GHz < f ≤ 6.0GHz
BW ≤ 40MHz	1.5 dB	1.8 dB

6.3C.3 Transmit ON/OFF time mask for SUL

6.3C.3.1 Test purpose

Same test purpose as in clause 6.3.3.2.1

6.3C.3.2 Test applicability

This test case applies to all types of NR UE release 15 and forward that support SUL operating on the SUL bands.

6.3C.3.3 Minimum conformance requirements

For a terminal that supports SUL for the band combination specified in Table 5.2C-1, the current version of the specification assumes the terminal is configured with active transmission either on UL carrier or SUL carrier at any time in one serving cell and the UE requirements for single carrier shall apply for the active UL or SUL carrier accordingly.

The normative reference for this requirement is TS 38.101-1 [2] clauses 4.3 and 6.3.3.2

6.3C.3.4 Test description

Same test description as specified in clause 6.3.3.2.4 with following exceptions:

Instead of table 5.3.5-1 → use Table 5.5C-1.

Instead of table 6.3.3.2.4.1-1 → use Table 6.3C.3.4-1

Table 6.3C.3.4-1: Test Configuration Table

Initial Conditions				
Test Environment as specified in TS 38.508-1 [5] subclause 4.1		Normal, TL/VL, TL/VH, TH/VL, TH/VH		
Test Frequencies as specified in TS 38.508-1 [5] subclause 4.3.1		Low, Mid, High range for SUL carrier Mid-range for Non-SUL carrier		
Test Channel Bandwidths as specified in TS 38.508-1 [5] subclause 4.3.1		Lowest, Mid, Highest for SUL carrier Lowest for Non-SUL carrier		
Test SCS as specified in Table 5.3.5-1		15kHz for both SUL carrier and Non-SUL carrier		
Test Parameters for Channel Bandwidths				
Test ID	Downlink Configuration	Uplink Configuration	SUL Configuration	
	N/A	N/A	Modulation	RB allocation (NOTE 2)
1			DFT-s-OFDM QPSK	Inner Full
NOTE 1: Test Channel Bandwidths are checked separately for each SUL band combination, the applicable channel bandwidths are specified in Table 5.5C-1.				
NOTE 2: The specific configuration of each RB allocation is defined in Table 6.1-1.				

- Connect the SS to the UE antenna connectors as shown in TS 38.508-1 [5] Annex A, Figure A.3.1.1.4 for TE diagram and section A.3.2 for UE diagram.
- The parameter setting for the cell are set up according to the TS 38.508-1 [5] subclause 4.4.3.
- Downlink signals are initially setup according to Annex C.0, C.1, C.2 and uplink signals according to Annex G.0, G.1, G.2, and G.3.0 with consideration of supplementary uplink physical channels.

Message contents in initial conditions are according to TS 38.508-1 [5] subclause 4.3.6.1.1.2 ensuring UL/SUL indicator in Table 4.3.6.1.1.2-1 with condition SUL, subclause 4.6 ensuring Table 4.6.1-28 with condition SUL AND

(RF OR RRM), Tables 4.6.3-14 with condition SUL_SUL for SUL carrier, and Table 4.6.3-167 with condition PUSCH_PUCCH_ON_SUL.

Table 6.3C.3.4-2: Void

6.3C.3.1.5 Test requirement

The requirement for the power measured in steps 2, 3 and 4 of the test procedure shall not exceed the values specified in Table 6.3C.3.5-1.

Table 6.3C.3.5-1: General ON/OFF time mask

	Channel bandwidth / minimum output power / measurement bandwidth						
	5 MHz	10 MHz	15 MHz	20 MHz	25 MHz	30 MHz	40 MHz
Transmit OFF power	$\leq -50+TT$ dBm						
Transmission OFF Measurement bandwidth	4.515	9.375	14.235	19.095	23.955	28.815	38.895
Transmitted ON Power	Same as Table 6.2.1.5-1						
NOTE 1: TT for each frequency and channel bandwidth is specified in Table 6.3C.3.5-2 and Table 6.2.1.5-3.							

Table 6.3C.3.5-2: Test Tolerance for OFF power

	$f \leq 3.0\text{GHz}$	$3.0\text{GHz} < f \leq 6\text{GHz}$
$\text{BW} \leq 40\text{MHz}$	1.5 dB	1.8 dB

Table 6.3C.3.5-3: Void

6.3C.4 Power control for SUL

6.3C.4.1 Absolute power tolerance for SUL

6.3C.4.1.1 Test purpose

Same test purpose as in clause 6.3.4.2.1

6.3C.4.1.2 Test applicability

This test case applies to all types of NR UE release 15 and forward that support SUL operating on the SUL bands.

6.3C.4.1.3 Minimum conformance requirements

For a terminal that supports SUL for the band combination specified in Table 5.2C-1, the current version of the specification assumes the terminal is configured with active transmission either on UL carrier or SUL carrier at any time in one serving cell and the UE requirements for single carrier shall apply for the active UL or SUL carrier accordingly.

The normative reference for this requirement is TS 38.101-1 [2] clauses 4.3 and 6.3.4.2.

6.3C.4.1.4 Test description

Same test description as specified in clause 6.3.4.2.4 with following exceptions:

Instead of table 5.3.5-1 → use Table 5.5C-1.

Instead of table 6.3.4.2.4.1-1 → use Table 6.3C.4.1.4-1

Table 6.3C.4.1.4-1: Test Configuration Table

Initial Conditions				
Test Environment as specified in TS 38.508-1 [5] subclause 4.1			Normal	
Test Frequencies as specified in TS 38.508-1 [5] subclause 4.3.1			Mid-range for SUL and Non-SUL carrier	
Test Channel Bandwidths as specified in TS 38.508-1 [5] subclause 4.3.1			Lowest, Mid, Highest for SUL carrier Lowest for Non-SUL carrier	
Test SCS as specified in Table 5.3.5-1			15kHz for both SUL carrier and Non-SUL carrier	
Test Parameters				
Test ID	Downlink Configuration	Uplink Configuration	SUL Configuration	
			Modulation	RB allocation (NOTE 2)
1	N/A	N/A	CP-OFDM QPSK	Outer_Full
NOTE 1: Test Channel Bandwidths are checked separately for each SUL band combination, the applicable channel bandwidths are specified in Table 5.5C-1.				
NOTE 2: The specific configuration of each RF allocation is defined in Table 6.1-1.				

- Connect the SS to the UE antenna connectors as shown in TS 38.508-1 [5] Annex A, Figure A.3.1.1.4 for TE diagram and section A.3.2 for UE diagram.
- The parameter setting for the cell are set up according to the TS 38.508-1 [5] subclause 4.4.3.
- Downlink signals are initially setup according to Annex C.0, C.1, C.2 and uplink signals according to Annex G.0, G.1, G.2, and G.3.0 with consideration of supplementary uplink physical channels.

Message contents in initial conditions are according to TS 38.508-1 [5] subclause 4.3.6.1.1.2 ensuring UL/SUL indicator in Table 4.3.6.1.1.2-1 with condition SUL, subclause 4.6 ensuring Table 4.6.1-28 with condition SUL AND (RF OR RRM), Tables 4.6.3-14 with condition SUL_SUL for SUL carrier, and Table 4.6.3-167 with condition PUSCH_PUCCH_ON_SUL.

Table 6.3C.4.1.4-2: Void**6.3C.4.1.5 Test requirement**

The requirement for the power measured in step (2) of the test procedure is not to exceed the values specified in Table 6.3C.4.1.5-1 and 6.3C.4.1.5-2.

Table 6.3C.4.1.5-1: Absolute power tolerance: test point 1

	Channel bandwidth / expected output power (dBm)						
	5 MHz	10 MHz	15 MHz	20 MHz	25 MHz	30 MHz	40 MHz
Expected Measured power	-17.6	-14.4	-12.6	-11.3	-10.4	-9.6	-8.3
Power tolerance	$\pm (9+TT)$ dB						
Note 1:	The lower power limit shall not exceed the minimum output power requirements defined in sub-clause 6.3C.1.3						
Note 2:	TT for each duplex, Sub-Carrier Spacing, frequency and channel bandwidth is specified in Table 6.3C.4.1.5-3.						

Table 6.3C.4.1.5-2: Absolute power tolerance: test point 2

	Channel bandwidth / expected output power (dBm)						
	5 MHz	10 MHz	15 MHz	20 MHz	25 MHz	30 MHz	40 MHz
Expected Measured power	-3.6	0.4	1.4	2.7	3.6	4.4	5.7
Power tolerance	$\pm (9+TT)$ dB						
Note 1:	The higher power limit shall not exceed the maximum output power requirements defined in sub-clause 6.2C.3.3						
Note 2:	TT for each duplex, Sub-Carrier Spacing, frequency and channel bandwidth is specified in Table 6.3C.4.1.5-3.						

Table 6.3C.4.1.5-3: Test Tolerance

	$f \leq 3.0\text{GHz}$	$3.0\text{GHz} < f \leq 4.2\text{GHz}$	$4.2\text{GHz} < f \leq 6.0\text{GHz}$
BW \leq 40MHz	1.0 dB	1.4 dB	1.4 dB

6.3C.4.2 Relative power tolerance for SUL**6.3C.4.2.1 Test purpose**

Same test purpose as in clause 6.3.4.3.1

6.3C.4.2.2 Test applicability

This test case applies to all types of NR UE release 15 and forward that support SUL operating on the SUL bands.

6.3C.4.2.3 Minimum conformance requirements

For a terminal that supports SUL for the band combination specified in Table 5.2C-1, the current version of the specification assumes the terminal is configured with active transmission either on UL carrier or SUL carrier at any time in one serving cell and the UE requirements for single carrier shall apply for the active UL or SUL carrier accordingly.

The normative reference for this requirement is TS 38.101-1 [2] clauses 4.3 and 6.3.4.3.

6.3C.4.2.4 Test description

Same test description as specified in clause 6.3.4.3.4 with following exceptions:

Instead of table 5.3.5-1 → use Table 5.5C-1.

Instead of table 6.3.4.3.4.1-1 → use Table 6.3C.4.2.4-1

Table 6.3C.4.2.4-1: Test Configuration Table

Initial Conditions				
Test Environment as specified in TS 38.508-1 [5] subclause 4.3.1		Normal, TL/VL, TL/VH, TH/VL, TH/VH		
Test Frequencies as specified in TS 38.508-1 [5] subclause 4.3.1		Low range for SUL carrier Mid-range for Non-SUL carrier		
Test Channel Bandwidths as specified in TS 38.508-1 [5] subclause 4.3.1		Lowest, Mid, Highest for SUL carrier Lowest for Non-SUL carrier		
Test SCS as specified in table 5.3.5-1		15kHz for both SUL carrier and Non-SUL carrier		
Test Parameters				
Ch BW	Downlink Configuration	Uplink Configuration	SUL Configuration	
			Modulation	RB allocation (NOTE 1)
5MHz	N/A		DFT-s-OFDM QPSK	See Table 6.3C.4.2.5-1 See Table 6.3C.4.2.5-2 See Table 6.3C.4.2.5-5
10MHz			DFT-s-OFDM QPSK	See Table 6.3C.4.2.5-3 See Table 6.3C.4.2.5-4 See Table 6.3C.4.2.5-5
15MHz			DFT-s-OFDM QPSK	See Table 6.3C.4.2.5-3 See Table 6.3C.4.2.5-4 See Table 6.3C.4.2.5-5
20MHz			DFT-s-OFDM QPSK	See Table 6.3C.4.2.5-3 See Table 6.3C.4.2.5-4 See Table 6.3C.4.2.5-5
25MHz			DFT-s-OFDM QPSK	See Table 6.3C.4.2.5-3 See Table 6.3C.4.2.5-4 See Table 6.3C.4.2.5-5
30MHz			DFT-s-OFDM QPSK	See Table 6.3C.4.2.5-3 See Table 6.3C.4.2.5-4 See Table 6.3C.4.2.5-5
40MHz			DFT-s-OFDM QPSK	See Table 6.3C.4.2.5-3 See Table 6.3C.4.2.5-4 See Table 6.3C.4.2.5-5
NOTE 1: The starting resource block shall be RB# 0				
NOTE 2: Test Channel Bandwidths are checked separately for each SUL band combination, the applicable channel bandwidths are specified in Table 5.5C-1.				

- Connect the SS to the UE antenna connectors as shown in TS 38.508-1 [5] Annex A, Figure A.3.1.1.4 for TE diagram and section A.3.2 for UE diagram.
- The parameter setting for the cell are set up according to the TS 38.508-1 [5] subclause 4.4.3.

- Downlink signals are initially setup according to Annex C.0, C.1, C.2 and uplink signals according to Annex G.0, G.1, G.2, and G.3.0 with consideration of supplementary uplink physical channels.

Message contents in initial conditions are according to TS 38.508-1 [5] subclause 4.3.6.1.1.2 ensuring UL/SUL indicator in Table 4.3.6.1.1.2-1 with condition SUL, subclause 4.6 ensuring Table 4.6.1-28 with condition SUL AND (RF OR RRM), Tables 4.6.3-14 with condition SUL_SUL for SUL carrier, and Table 4.6.3-167 with condition PUSCH_PUCCH_ON_SUL.

Table 6.3C.4.2.4-2: Void**6.3C.4.2.5 Test requirement**

Each UE power step measured in the test procedure 6.3.4.3.4.2 should satisfy the test requirements specified in Table 6.3C.4.2.5-1 thru 6.3C.4.2.5-5.

To account for RF Power amplifier mode changes 2 exceptions are allowed for each of ramping up and ramping down test patterns. For these exceptions the power tolerance limit is a maximum of $\pm (6.0 + TT)$ dB. If there is an exception in the power step caused by the RB change for all test patterns (A, B, C) then fail the UE.

Table 6.3C.4.2.5-1: Test Requirements Relative Power Tolerance for Transmission, channel BW 5MHz, ramp up sub-test

Test SCS [kHz]	Sub-test ID	Applicable sub-frames	Uplink RB allocation	TPC command	Expected power step size (Up) ΔP [dB]	Power step size range (Up) ΔP [dB]	PUSCH [dB]
15	1	Sub-frames before RB change	Fixed = 1	TPC=+1dB	1	$\Delta P \leq 1$ dB	1 +/- (0.7 + TT)
		RB change	1RB to 5 RBs	TPC=+1dB	7.99	$4\text{dB} \leq \Delta P < 10\text{dB}$	7.99 +/- (3.5 + TT)
		Sub-frames after RB change	Fixed = 5	TPC=+1dB	1	$\Delta P \leq 1$ dB	1 +/- (0.7 + TT)
	2	Sub-frames before RB change	Fixed = 1	TPC=+1dB	1	$\Delta P \leq 1$ dB	1 +/- (0.7 + TT)
		RB change	1RB to 15 RBs	TPC=+1dB	12.76	$10\text{dB} \leq \Delta P < 15\text{dB}$	12.76 +/- (4 + TT)
		Sub-frames after RB change	Fixed = 15	TPC=+1dB	1	$\Delta P \leq 1$ dB	1 +/- (0.7 + TT)
Note 1: Position of RB change: Pattern A the position of RB uplink allocation change is after 10 active uplink Sub-frames Pattern B the position of RB uplink allocation change is after 20 active uplink Sub-frames Pattern C the position of RB uplink allocation change is after 30 active uplink Sub-frames Note 2: The starting resource block shall be RB# 0. Note 3: TT=0.7dB Note 4: Applicable if $P_{\text{UMAX}} \geq P \geq P_{\text{min}}$. P_{min} as defined in sub-clause 6.3C.1.							

Table 6.3C.4.2.5-2: Test Requirements Relative Power Tolerance for Transmission, channel BW 5MHz, ramp down sub-test

Test SCS [kHz]	Sub-test ID	Applicable sub-frames	Uplink RB allocation	TPC command	Expected power step size (Down) ΔP [dB]	Power step size range (Down) ΔP [dB]	PUSCH [dB]
15	1	Sub-frames before RB change	Fixed = 5	TPC=-1dB	1	$\Delta P \leq 1$ dB	1 +/- (0.7 + TT)
		RB change	5 RBs to 1 RB	TPC=-1dB	7.99	$4\text{dB} \leq \Delta P < 10\text{dB}$	7.99 +/- (3.5 + TT)
		Sub-frames after RB change	Fixed = 1	TPC=-1dB	1	$\Delta P \leq 1$ dB	1 +/- (0.7 + TT)
	2	Sub-frames before RB change	Fixed = 15	TPC=-1dB	1	$\Delta P \leq 1$ dB	1 +/- (0.7 + TT)
		RB change	15 RBs to 1 RB	TPC=-1dB	12.76	$10\text{dB} \leq \Delta P < 15\text{dB}$	12.76 +/- (3.5 + TT)
		Sub-frames after RB change	Fixed = 1	TPC=-1dB	1	$\Delta P \leq 1$ dB	1 +/- (0.7 + TT)
Note 1:	Position of RB change: Pattern A the position of RB uplink allocation change is after 10 active uplink Sub-frames Pattern B the position of RB uplink allocation change is after 20 active uplink Sub-frames Pattern C the position of RB uplink allocation change is after 30 active uplink Sub-frames						
Note 2:	The starting resource block shall be RB# 0.						
Note 3:	TT=0.7dB						
Note 4:	Applicable if $P_{\text{UMAX}} \geq P \geq P_{\text{min}}$. P_{min} as defined in sub-clause 6.3C.1.						

Table 6.3C.4.2.5-3: Test Requirements Relative Power Tolerance for Transmission, channel BW 10MHz, 15MHz, 20MHz, 25MHz, 30MHz, 40MHz ramp up sub-test

Test SCS [kHz]	Sub-test ID	Applicable sub-frames	Uplink RB allocation	TPC command	Expected power step size (Up) ΔP [dB]	Power step size range (Up) ΔP [dB]	PUSCH [dB]
15	1	Subframes before RB change	1RB	TPC=+1dB	1	$\Delta P \leq 1$ dB	1 +/- (0.7 + TT)
		RB change	1RB to 5 RBs	TPC=+1dB	7.99	$4\text{dB} \leq \Delta P < 10\text{dB}$	7.99 +/- (3.5 + TT)
		Subframes after RB change	Fixed = 5	TPC=+1dB	1	$\Delta P \leq 1$ dB	1 +/- (0.7 + TT)
	2	Subframes before RB change	1RB	TPC=+1dB	1	$\Delta P \leq 1$ dB	1 +/- (0.7 + TT)
		RB change	1RB to 20 RBs	TPC=+1dB	14.01	$10\text{dB} \leq \Delta P < 15\text{dB}$	14.01 +/- (4 + TT)
		Subframes after RB change	Fixed = 20	TPC=+1dB	1	$\Delta P \leq 1$ dB	1 +/- 0.7 + TT
	3	Subframes before RB change	1RB	TPC=+1dB	1	$\Delta P \leq 1$ dB	1 +/- (0.7 + TT)
		RB change	1RB to 50 RBs	TPC=+1dB	17.99	$15\text{dB} \leq \Delta P$	17.99 +/- (5 + TT)
		Subframes after RB change	Fixed = 50	TPC=+1dB	1	$\Delta P \leq 1$ dB	1 +/- (0.7 + TT)
Note 1:	Position of RB change: Pattern A the position of RB uplink allocation change is after 10 active uplink Subframes. Pattern B the position of RB uplink allocation change is after 20 active uplink Subframes. Pattern C the position of RB uplink allocation change is after 30 active uplink Subframes.						
Note 2:	The starting resource block shall be RB# 0.						
Note 3:	TT=0.7dB						
Note 4:	Applicable if $P_{\text{UMAX}} \geq P \geq P_{\text{min}}$. P_{min} as defined in sub-clause 6.3C.1.						

Table 6.3C.4.2.5-4: Test Requirements Relative Power Tolerance for Transmission, channel BW 10MHz, 15MHz, 20MHz, 25MHz, 30MHz, 40MHz ramp down sub-test

Test SCS [kHz]	Sub-test ID	Applicable sub-frames	Uplink RB allocation	TPC command	Expected power step size (Down) ΔP [dB]	Power step size range (Down) ΔP [dB]	PUSCH [dB]
15	1	Subframes before RB change	Fixed = 5	TPC=-1dB	1	$\Delta P \leq 1$ dB	1 +/- (0.7 + TT)
		RB change	5 RBs to 1RBs	TPC=-1dB	7.99	$4\text{dB} \leq \Delta P < 10\text{dB}$	7.99 +/- (3.5 + TT)
		Subframes after RB change	Fixed = 1	TPC=-1dB	1	$\Delta P \leq 1$ dB	1 +/- (0.7 + TT)
	2	Subframes before RB change	Fixed = 20	TPC=-1dB	1	$\Delta P \leq 1$ dB	1 +/- (0.7 + TT)
		RB change	20 RBs to 1 RB	TPC=-1dB	14.01	$10\text{dB} \leq \Delta P < 15\text{dB}$	14.01 +/- (4 + TT)
		Subframes after RB change	Fixed = 1	TPC=-1dB	1	$\Delta P \leq 1$ dB	1 +/- (0.7 + TT)
	3	Subframes before RB change	Fixed = 50	TPC=-1dB	1	$\Delta P \leq 1$ dB	1 +/- (0.7 + TT)
		RB change	50 RBs to 1 RB	TPC=-1dB	17.99	$15\text{dB} \leq \Delta P$	17.99 +/- (5 + TT)
		Subframes after RB change	Fixed = 1	TPC=-1dB	1	$\Delta P \leq 1$ dB	1 +/- (0.7 + TT)
Note 1:	Position of RB change: Pattern A the position of RB uplink allocation change is after 10 active uplink Subframes. Pattern B the position of RB uplink allocation change is after 20 active uplink Subframes. Pattern C the position of RB uplink allocation change is after 30 active uplink Subframes.						
Note 2:	The starting resource block shall be RB# 0.						
Note 3:	TT=0.7dB						
Note 4:	Applicable if $P_{\text{UMAX}} \geq P \geq P_{\text{min}}$. P_{min} as defined in sub-clause 6.3C.1.						

Table 6.3C.4.2.5-5: Test Requirements Relative Power Tolerance for Transmission, alternating sub-test

BW	Test SCS [kHz]	Sub-test ID	Uplink RB allocation	TPC command	Expected power step size (Up or Down) ΔP [dB]	Power step size range (Up or Down) ΔP [dB]	PUSCH [dB]
5	15	1	Alternating 1 and 2	TPC=0dB	3.01	$3\text{dB} \leq \Delta P < 4\text{dB}$	$3.01 \pm (3 + TT)$
		2	Alternating 1 and 5	TPC=0dB	6.99	$4\text{dB} \leq \Delta P < 10\text{dB}$	$6.99 \pm (3.5 + TT)$
		3	Alternating 1 and 15	TPC=0dB	11.76	$10\text{dB} \leq \Delta P < 15\text{dB}$	$11.76 \pm (4 + TT)$
10,15,20,25,30,40	15	1	Alternating 1 and 2	TPC=0dB	3.01	$3\text{dB} \leq \Delta P < 4\text{dB}$	$3.01 \pm (3 + TT)$
		2	Alternating 1 and 5	TPC=0dB	6.99	$4\text{dB} \leq \Delta P < 10\text{dB}$	$6.99 \pm (3.5 + TT)$
		3	Alternating 1 and 20	TPC=0dB	13.01	$10\text{dB} \leq \Delta P < 15\text{dB}$	$13.01 \pm (4 + TT)$
		4	Alternating 1 and 50	TPC=0dB	16.99	$15\text{dB} \leq \Delta P$	$16.99 \pm (5 + TT)$

Note 1: The starting resource block shall be RB# 0.
Note 2: $TT=0.7\text{dB}$
Note 3: Applicable if $P_{\text{UMAX}} \geq P \geq P_{\text{min}}$. P_{min} as defined in sub-clause 6.3C.1.

6.3C.4.3 Aggregate power tolerance for SUL

6.3C.4.3.1 Test purpose

Same test purpose as in clause 6.3.4.3.1

6.3C.4.3.2 Test applicability

This test case applies to all types of NR UE release 15 and forward that support SUL operating on the SUL bands.

6.3C.4.3.3 Minimum conformance requirements

For a terminal that supports SUL for the band combination specified in Table 5.2C-1, the current version of the specification assumes the terminal is configured with active transmission either on UL carrier or SUL carrier at any time in one serving cell and the UE requirements for single carrier shall apply for the active UL or SUL carrier accordingly.

The normative reference for this requirement is TS 38.101-1 [2] clauses 4.3 and 6.3.4.4.

6.3C.4.3.4 Test description

Same test description as specified in clause 6.3.4.4.4 with following exceptions:

Instead of table 5.3.5-1 → use Table 5.5C-1.

Instead of table 6.3.4.4.4.1-1 → use Table 6.3C.4.3.4-1

Instead of table 6.3.4.4.4.1-2 → use Table 6.3C.4.3.4-2

Table 6.3C.4.3.4-1: Test Configuration Table: PUCCH sub-test

Initial Conditions			
Test Environment as specified in TS 38.508-1 [5] subclause 4.1		Normal	
Test Frequencies as specified in TS 38.508-1 [5] subclause 4.3.1		Mid range for SUL and Non-SUL carrier	
Test Channel Bandwidths as specified in TS 38.508-1 [5] subclause 4.3.1		Lowest, Mid, Highest for SUL carrier Lowest for Non-SUL carrier	
Test SCS as specified in Table 5.3.5-1		15kHz for both SUL carrier and Non-SUL carrier	
Test Parameters for Channel Bandwidths			
Test ID	Downlink Configuration	Uplink Configuration	SUL Configuration
1	N/A	N/A	PUCCH format = Format 1 Length in OFDM symbols = 14

Table 6.3C.4.3.4-2: Test Configuration Table: PUSCH sub-test

Initial Conditions			
Test Environment as specified in TS 38.508-1 [5] subclause 4.1		Normal	
Test Frequencies as specified in TS 38.508-1 [5] subclause 4.3.1		Mid range for SUL and Non-SUL carrier	
Test Channel Bandwidths as specified in TS 38.508-1 [5] subclause 4.3.1		Lowest, Mid, Highest for SUL carrier Lowest for Non-SUL carrier	
Test SCS as specified in Table 5.3.5-1		15kHz for both SUL carrier and Non-SUL carrier	
Test Parameters for Channel Bandwidths			
Test ID	Downlink Configuration	Uplink Configuration	SUL Configuration
1	N/A	N/A	Modulation CP-OFDM QPSK
			RB allocation (NOTE 1) Outer_Full

NOTE 1: The specific configuration of each RF allocation is defined in Table 6.1-1.
NOTE 2: Test Channel Bandwidths are checked separately for each SUL band combination, the applicable channel bandwidths are specified in Table 5.5C-1.

- Connect the SS to the UE antenna connectors as shown in TS 38.508-1 [5] Annex A, Figure A.3.1.1.4 for TE diagram and section A.3.2 for UE diagram.

- The parameter setting for the cell are set up according to the TS 38.508-1 [5] subclause 4.4.3.
- Downlink signals are initially setup according to Annex C.0, C.1, C.2 and uplink signals according to Annex G.0, G.1, G.2, and G.3.0 with consideration of supplementary uplink physical channels.

Message contents in initial conditions are according to TS 38.508-1 [5] subclause 4.3.6.1.1.2 ensuring UL/SUL indicator in Table 4.3.6.1.1.2-1 with condition SUL, subclause 4.6 ensuring Table 4.6.1-28 with condition SUL AND (RF OR RRM), Tables 4.6.3-14 with condition SUL_SUL for SUL carrier, and Table 4.6.3-167 with condition PUSCH_PUCCH_ON_SUL.

Table 6.3C.4.3.4-2: Void**6.3C.4.3.5 Test requirement**

The requirement for the power measurements made in step (1.3) and (2.3) of the test procedure shall not exceed the values specified in Table 6.3C.4.3.5-1. The power measurement period shall be 1 sub-frame(1ms).

Table 6.3C.4.3.5-1: Power control tolerance

TPC command	UL channel	Test requirement measured power
0 dB	PUCCH	Given 5 power measurements in the pattern, the 2 nd , and later measurements shall be within $\pm (2.5 + TT)$ dB of the 1 st measurement.
0 dB	PUSCH	Given 5 power measurements in the pattern, the 2 nd , and later measurements shall be within $\pm (3.5 + TT)$ dB of the 1 st measurement.
Note 1: TT=0.7dB.		

6.3D Output power dynamics for UL MIMO**6.3D.1 Minimum output power for UL MIMO****6.3D.1.1 Test purpose**

To verify the UE's ability to transmit with a UL MIMO broadband output power below the value specified in the test requirement when the power is set to a minimum value.

6.3D.1.2 Test applicability

This test case applies to all types of NR UE release 15 and forward that support UL MIMO.

6.3D.1.3 Minimum conformance requirements

For UE with two transmit antenna connectors in closed-loop spatial multiplexing scheme, the minimum output power is defined as the sum of the mean power at each UE antenna connector in one sub-frame (1ms). The minimum output power shall not exceed the values specified in Table 6.3D.1.3-1.

Table 6.3D.1.3-1: Minimum output power

Channel bandwidth (MHz)	Minimum output power (dBm)	Measurement bandwidth (MHz)
5	-40	4.515
10	-40	9.375
15	-40	14.235
20	-40	19.095
25	-39	23.955
30	-38.2	28.815
40	-37	38.895
45	-36.5	43.575
50	-36	48.615
60	-35.2	58.35
70	-34.6	68.07
80	-34	78.15
90	-33.5	88.23
100	-33	98.31

The normative reference for this requirement is TS 38.101-1 [2] clause 6.3D.1.

6.3D.1.4 Test description

6.3D.1.4.1 Initial condition

Initial conditions are a set of test configurations the UE needs to be tested in and the steps for the SS to take with the UE to reach the correct measurement state.

The initial test configurations consist of environmental conditions, test frequencies, and channel bandwidths and sub-carrier spacing based on NR operating bands specified in table 5.3.5-1. All of these configurations shall be tested with applicable test parameters for each combination of test channel bandwidth and sub-carrier spacing, and are shown in table 6.3D.1.4.1-1. The details of the uplink reference measurement channels (RMCs) are specified in Annexes A.2. Configurations of PDSCH and PDCCH before measurement are specified in Annex C.2.

Table 6.3D.1.4.1-1: Test Configuration Table

Initial Conditions			
Test Environment as specified in TS 38.508-1 [5] subclause 4.1		Normal, TL/VL, TL/VH, TH/VL, TH/VH	
Test Frequencies as specified in TS 38.508-1 [5] subclause 4.3.1		Low range, Mid range, High range	
Test Channel Bandwidths as specified in TS 38.508-1 [5] subclause 4.3.1		Lowest, Mid, Highest	
Test SCS as specified in Table 5.3.5-1		Lowest, Highest	
Test Parameters for Channel Bandwidths			
Test ID	Downlink Configuration	Uplink Configuration	
	N/A for minimum output power test case	Modulation	RB allocation (NOTE 1)
1		CP-OFDM QPSK	Outer Full
NOTE 1: The specific configuration of each RB allocation is defined in Table 6.1-1.			

1. Connect the SS to the UE antenna connectors as shown in TS 38.508-1 [5] Annex A, Figure A.3.1.1.2 for TE diagram and section A.3.2 for UE diagram.
2. The parameter settings for the cell are set up according to TS 38.508-1 [5] subclause 4.4.3.
3. Downlink signals are initially set up according to Annex C.0, C.1, C.2, and uplink signals according to Annex G.0, G.1, G.2, G.3.0.
4. The UL Reference Measurement Channel is set according to Table 6.3D.1.4.1-1.
5. Propagation conditions are set according to Annex B.0.
6. Ensure the UE is in State RRC_CONNECTED with generic procedure parameters Connectivity *NR*, Connected without release *On*, Test Mode *On* and Test Loop Function *On* according to TS 38.508-1 [5] clause 4.5. Message contents are defined in clause 6.3D.1.4.3.

6.3D.1.4.2 Test procedure

1. SS sends uplink scheduling information for each UL HARQ process via PDCCH DCI format 0_1 for C_RNTI to schedule the UL RMC according to Table 6.3D.1.4.1-1. Since the UE has no payload and no loopback data to send the UE sends uplink MAC padding bits on the UL RMC. The PDCCH DCI format 0_1 is specified with the condition 2TX_UL_MIMO in 38.508-1 [5] subclause 4.3.6.1.1.2.
2. Send continuously uplink power control "down" commands in every uplink scheduling information to the UE; allow at least 200ms starting from the first TPC command in this step to ensure that the UE transmits at its minimum output power.
3. Measure the sum of mean power of the UE at each UE antenna connector in the associated measurement channel bandwidth specified in Table 6.3D.1.5-1 for the specific channel bandwidth under test. The period of measurement shall be at least the continuous duration of 1ms over all active uplink slots and in the uplink symbols. For TDD, only slots consisting of only UL symbols are under test.

6.3D.1.4.3 Message contents

Message contents are according to TS 38.508-1 [5] subclause 4.6 ensuring Table 4.6.3-182 with condition 2TX_UL_MIMO.

6.3D.1.5 Test requirement

The minimum output power, derived in step 3 shall not exceed the values specified in Table 6.3D.1.5-1.

Table 6.3D.1.5-1: Minimum output power

Channel bandwidth (MHz)	Minimum output power (dBm)	Measurement bandwidth (MHz)
5	-40+TT	4.515
10	-40+TT	9.375
15	-40+TT	14.235
20	-40+TT	19.095
25	-39+TT	23.955
30	-38.2+TT	28.815
40	-37+TT	38.895
45	-36.5+TT	43.575
50	-36+TT	48.615
60	-35.2+TT	58.35
70	-34.6+TT	68.07+TT
80	-34+TT	78.15
90	-33.5+TT	88.23
100	-33+TT	98.31

NOTE 1: TT for each frequency and channel bandwidth is specified in Table 6.3D.1.5-2

Table 6.3D.1.5-2: Test Tolerance (Minimum output power)

	$f \leq 3.0\text{GHz}$	$3.0\text{GHz} < f \leq 6.0\text{GHz}$
$\text{BW} \leq 40\text{MHz}$	1.0 dB	1.3 dB
$40\text{MHz} < \text{BW} \leq 100\text{MHz}$	1.3 dB	1.3 dB

6.3D.2 Transmit OFF power for UL MIMO

6.3D.2.1 Test purpose

To verify that the UE transmit OFF power for UL MIMO is lower than the value specified in the test requirement.

An excess Transmit OFF power potentially increases the Rise Over Thermal (RoT) and therefore reduces the cell coverage area for other UEs.

6.3D.2.2 Test applicability

The requirements of this test apply in test cases 6.3D.3 Transmit ON/OFF time mask for UL MIMO to all types of NR UE release 15 and forward that support UL MIMO.

6.3D.2.3 Minimum conformance requirements

The transmit OFF power is defined as the mean power at each transmit connector in a duration of at least one sub-frame (1ms) excluding any transient periods.

The transmit OFF power at each transmit connector shall not exceed the values specified in Table 6.3D.2.3-1.

Table 6.3D.2.3-1: Transmit OFF power

Channel bandwidth	(MHz)	5,10,15,20,25,30,35,40,45,50	60,70,80,90,100
REF_SCS	(kHz)	15	30
Transmit OFF power	(dBm)	-50	
Measurement bandwidth	(MHz)	$MBW=REF_SCS*(12*N_{RB}+1)/1000$	

The normative reference for this requirement is TS 38.101-1 [2] clause 6.3D.2.

6.3D.2.4 Test description

This test is covered by clause 6.3D.3 Transmit ON/OFF time mask for UL MIMO.

6.3D.2.5 Test requirement

The requirement for the transmit OFF power at each transmit antenna connector shall not exceed the values specified in Table 6.3D.2.5-1.

Table 6.3D.2.5-1: Transmit OFF power

Channel bandwidth (MHz)	Transmit OFF power (dBm)	Measurement bandwidth (MHz)
5	-50+TT	4.515
10	-50+TT	9.375
15	-50+TT	14.235
20	-50+TT	19.095
25	-50+TT	23.955
30	-50+TT	28.815
40	-50+TT	38.895
45	-50+TT	43.575
50	-50+TT	48.615
60	-50+TT	58.35
70	-50+TT	68.07
80	-50+TT	78.15
90	-50+TT	88.23
100	-50+TT	98.31

NOTE 1: TT for each frequency and channel bandwidth is specified in Table 6.3D.2.5-2

Table 6.3D.2.5-2: Test Tolerance (Transmit OFF power)

	$f \leq 3.0\text{GHz}$	$3.0\text{GHz} < f \leq 6\text{GHz}$
$BW \leq 40\text{MHz}$	1.5 dB	1.8 dB
$40\text{MHz} < BW \leq 100\text{MHz}$	1.7 dB	1.8 dB

6.3D.3 Transmit ON/OFF time mask for UL MIMO

6.3D.3.1 Test purpose

To verify that the general ON/OFF time mask for UL MIMO meets the requirements given in 6.3D.3.5

The transmit power time mask for transmit ON/OFF defines the transient period(s) allowed between transmit OFF power as defined in sub-clause 6.3D.2 and transmit ON power symbols (transmit ON/OFF)

Transmission of the wrong power increases interference to other channels, or increases transmission errors in the uplink channel.

6.3D.3.2 Test applicability

This test case applies to all types of NR UE release 15 and forward that support UL MIMO.

6.3D.3.3 Minimum conformance requirements

For UE supporting UL MIMO, the ON/OFF time mask requirements in subclause 6.3.3.2.3 apply to each transmit antenna connector.

For UE with two transmit antenna connectors in closed-loop spatial multiplexing scheme, the general ON/OFF time mask requirements specified in subclause 6.3.3.2.3 apply to each transmit antenna connector with the UL MIMO configurations specified in Table 6.3D.3.3-1.

Table 6.3D.3.3-1: UL MIMO configuration in closed-loop spatial multiplexing scheme

Transmission scheme	DCI format	Codebook Index
Codebook based uplink	DCI format 0_1	Codebook index 0

The normative reference for this requirement is TS 38.101-1 [2] clause 6.3D.3

6.3D.3.4 Test description

6.3D.3.4.1 Initial condition

Initial conditions are a set of test configurations the UE needs to be tested in and the steps for the SS to take with the UE to reach the correct measurement state.

The initial test configurations consist of environmental conditions, test frequencies, test channel bandwidths and sub-carrier spacing based on NR operating bands specified in table 5.3.5-1. All of these configurations shall be tested with applicable test parameters for each combination of channel bandwidth and sub-carrier spacing, and are shown in table 6.3D.3.4.1-1. The details of the uplink reference measurement channels (RMCs) are specified in Annex A.2. Configurations of PDSCH and PDCCH before measurement are specified in Annex C.2.

Table 6.3D.3.4.1-1: Test Configuration Table

Initial Conditions			
Test Environment as specified in TS 38.508-1 [5] subclause 4.1		Normal, TL/VL, TL/VH, TH/VL, TH/VH	
Test Frequencies as specified in TS 38.508-1 [5] subclause 4.3.1		Low range, Mid range, High range	
Test Channel Bandwidths as specified in TS 38.508-1 [5] subclause 4.3.1		Lowest, Mid, Highest	
Test SCS as specified in Table 5.3.5-1		Lowest, Highest	
Test Parameters for Channel Bandwidths			
Test ID	Downlink Configuration	Uplink Configuration	
	N/A for minimum output power test case	Modulation	RB allocation (NOTE 1)
1		CP-OFDM QPSK	Inner Full
NOTE 1: The specific configuration of each RB allocation is defined in Table 6.1-1.			

1. Connect the SS to the UE antenna connectors as shown in TS 38.508-1 [5] Annex A, Figure A.3.1.1.2 for TE diagram and section A.3.2 for UE diagram.
2. The parameter settings for the cell are set up according to TS 38.508-1 [5] subclause 4.4.3.
3. Downlink signals are initially set up according to Annex C.0, C.1, C.2, and uplink signals according to Annex G.0, G.1, G.2, G.3.0.
4. The UL Reference Measurement Channel is set according to Table 6.3D.3.4.1-1.
5. Propagation conditions are set according to Annex B.0.
6. Ensure the UE is in State RRC_CONNECTED with generic procedure parameters Connectivity *NR*, Connected without release *On*, Test Mode *On* and Test Loop Function *On* according to TS 38.508-1 [5] clause 4.5. Message contents are defined in clause 6.3D.3.4.3.

6.3D.3.4.2 Test procedure

1. SS sends uplink scheduling information via PDCCH DCI format 0_1 for C_RNTI to schedule the UL RMC according to Table 6.3D.3.4.1-1. Since the UE has no payload and no loopback data to send the UE sends uplink MAC padding bits on the UL RMC. The UL assignment is such that the UE transmits on slots 8 for 15kHz SCS, on slots 8 and 18 for 30kHz SCS and on slots 17 and 37 for 60kHz SCS. The PDCCH DCI format 0_1 is specified with the condition 2TX_UL_MIMO in 38.508-1 [5] subclause 4.3.6.1.1.2.
2. Send continuously uplink power control "up" commands in every uplink scheduling information to the UE; allow at least 200ms starting from the first TPC command in this step for the UE to reach P_{UMAX} level.
3. On power sub test:
 - 3.1. Measure the sum output power at two transmit antenna connectors of the UE PUSCH transmission during one slot.
4. OFF power sub test:
 - 4.1. Measure the UE transmission OFF power at each antenna connectors during the slot prior to the PUSCH transmission, excluding a transient period of 10 μs at the end of the slot.
 - 4.2. Measure the UE transmission OFF power at each antenna connectors during the slot following the PUSCH transmission, excluding a transient period of 10 μs at the beginning of the slot.

6.3D.3.4.3 Message contents

Message contents are according to TS 38.508-1 [5] subclause 4.6 ensuring Table 4.6.3-182 with condition 2TX_UL_MIMO and following exceptions.

Table 6.3D.3.4.3-1: PUSCH-ConfigCommon

Derivation Path: TS 38.508-1[5], Table 4.6.3-119			
Information Element	Value/remark	Comment	Condition
PUSCH-ConfigCommon ::= SEQUENCE {			
p0-NominalWithGrant	-100		
}			

Table 6.3D.3.4.3-2: TDD-UL-DL-Config

Derivation Path: TS 38.508-1[5], Table 4.6.3-192			
Information Element	Value/remark	Comment	Condition
TDD-UL-DL-ConfigCommon ::= SEQUENCE {			
referenceSubcarrierSpacing	SubcarrierSpacing		
pattern1 SEQUENCE {			
dl-UL-TransmissionPeriodicity	ms5		FR1
	ms10		FR1_15kHz
nrofDownlinkSlots	6		FR1_15kHz
	6		FR1_30kHz
	14		FR1_60kHz
nrofDownlinkSymbols	10		FR1_15kHz
	6		FR1_30kHz
	12		FR1_60kHz
nrofUplinkSlots	3		FR1_15kHz, FR1_30kHz
	4		FR1_60kHz
nrofUplinkSymbols	4		FR1_30kHz
	2		FR1_15kHz,
	8		FR1_60kHz
}			
pattern2	Not present		
}			

Table 6.3D.3.4.3-3: PUSCH-TimeDomainResourceAllocationList

Derivation Path: TS 38.508-1[5], Table 4.6.3-122			
Information Element	Value/remark	Comment	Condition
PUSCH-TimeDomainResourceAllocationList ::= SEQUENCE (SIZE(1..maxNrofUL-Allocations)) OF {	2 entries		
PUSCH-TimeDomainResourceAllocation[1]			
SEQUENCE {			
k2	4		FR1_15kHz, FR1_30kHz
	6		FR1_60kHz
mappingType	typeA		
startSymbolAndLength	27	Start symbol(S)=0, Length(L)=14	
}			
PUSCH-TimeDomainResourceAllocation[2]		addressed by Msg3 PUSCH time resource allocation field of the Random Access Response acc. to TS 38.213 [22] Table 8.2-1.	
k2	2	$K_2 + \Delta = 4$ acc. to TS 38.214 [21] Table 6.1.2.1.1-5 (NOTE 1)	FR1_15kHz
	6	$K_2 + \Delta = 9$ acc. to TS 38.214 [21] Table 6.1.2.1.1-5 (NOTE 1)	FR1_30kHz

mappingType	typeA		
startSymbolAndLength	27	Start symbol(S)=0, Length(L)=14	
}			
}			
NOTE 1: Values are chosen so that first slot of a TDD-UL-DL slot configuration period can be used for the Random Access Response and the last slot (of the same or another period) for the corresponding Msg3.			

Condition	Explanation
FR1_15kHz	FR1 is used under the test. SCS is set to 15kHz.
FR1_30kHz	FR1 is used under the test. SCS is set to 30kHz.
FR1_60kHz	FR1 is used under the test. SCS is set to 60kHz.

Table 6.3D.3.4.3-4: ServingCellConfigCommon

Derivation Path: 38.508-1[5], Table 4.6.3-168			
Information Element	Value/remark	Comment	Condition
ServingCellConfigCommon ::= SEQUENCE {			
ss-PBCH-BlockPower	18		SCS_15kHz
	21		SCS_30kHz
}			

Condition	Explanation
SCS_15kHz	SCS=15kHz for SS/PBCH block
SCS_30kHz	SCS=30kHz for SS/PBCH block

Table 6.3D.3.4.3-5: P-Max

Derivation Path: TS 38.508-1 [5], Table 4.6.3-89			
Information Element	Value/remark	Comment	Condition
P-Max	23		Power class 2 or power class 1.5

6.3D.3.5 Test requirement

The requirement for the power measured in steps 2, 3 and 4 of the test procedure shall not exceed the values specified in Table 6.3D.3.5-1.

Table 6.3D.3.5-1: General ON/OFF time mask

	Channel bandwidth / minimum output power / measurement bandwidth													
	5 MHz	10 MHz	15 MHz	20 MHz	25 MHz	30 MHz	40 MHz	45 MHz	50 MHz	60 MHz	70 MHz	80 MHz	90 MHz	100 MHz
Transmit OFF power	$\leq -50+TT$ dBm													
Transmission OFF Measurement bandwidth	4.515	9.375	14.235	19.095	23.955	28.815	38.895	43.575	48.615	58.35	68.07	78.15	88.23	98.31
Transmit ON power	Same as Table 6.2.1.5-1													
NOTE 1: TT for each frequency and channel bandwidth is specified in Table 6.3.3.2.5-2														

Table 6.3D.3.5-2: Test Tolerance for OFF power

	$f \leq 3.0\text{GHz}$	$3.0\text{GHz} < f \leq 6\text{GHz}$
BW $\leq 40\text{MHz}$	1.5 dB	1.8 dB
$40\text{MHz} < \text{BW} \leq 100\text{MHz}$	1.7 dB	1.8 dB

Table 6.3D.3.5-3: Void

6.3D.4 Power control for UL MIMO

6.3D.4.1 Absolute power tolerance for UL MIMO

6.3D.4.1.1 Test purpose

To verify the ability of the UE transmitter for UL MIMO to set its initial output power to a specific value at the start of a contiguous transmission or non-contiguous transmission with a long transmission gap, i.e. transmission gap is larger than 20ms.

6.3D.4.1.2 Test applicability

This test case applies to all types of NR UE release 15 and forward that support UL MIMO.

6.3D.4.1.3 Minimum conformance requirements

For UE supporting UL MIMO, the power control tolerance applies to the sum of output power at each transmit antenna connector.

The power control requirements specified in subclause 6.3.4.2 apply to UE with two transmit antenna connectors in closed-loop spatial multiplexing scheme. The requirements shall be met with UL MIMO configurations described in Table 6.3D.4.1.3-1

Table 6.3D.4.1.3-1: UL MIMO configuration in closed-loop spatial multiplexing scheme

Transmission scheme	DCI format	Codebook Index
Codebook based uplink	DCI format 0_1	Codebook index 0

The normative reference for this requirement is TS 38.101-1 [2] clause 6.3D.4.

6.3D.4.1.4 Test description

6.3D.4.1.4.1 Initial conditions

Initial conditions are a set of test configurations the UE needs to be tested in and the steps for the SS to take with the UE to reach the correct measurement state.

The initial test configurations consist of environmental conditions, test frequencies, test channel bandwidths and sub-carrier spacing based on NR operating bands specified in table 5.3.5-1. All of these configurations shall be tested with applicable test parameters for each combination of test channel bandwidth and sub-carrier spacing, and are shown in table 6.3D.4.1.4.1-1. The details of the uplink reference measurement channels (RMCs) are specified in Annexes A.2. Configurations of PDSCH and PDCCH before measurement are specified in Annex C.2.

Table 6.3D.4.1.4.1-1: Test Configuration Table

Initial Conditions				
Test Environment as specified in TS 38.508-1 [5] subclause 4.1		Normal		
Test Frequencies as specified in TS 38.508-1 [5] subclause 4.3.1		Mid range		
Test Channel Bandwidths as specified in TS 38.508-1 [5] subclause 4.3.1		Lowest, Mid, Highest		
Test SCS as specified in Table 5.3.5-1		Lowest, Highest		
Test Parameters				
Test ID	Downlink Configuration		Uplink Configuration	
	Modulation	RB Allocation	Modulation	RB allocation (NOTE 1)
1	N/A for Absolute power tolerance test case		CP-OFDM QPSK	Outer_Full
NOTE 1: The specific configuration of each RF allocation is defined in Table 6.1-1.				

1. Connect the SS to the UE antenna connectors as shown in TS 38.508-1 [5] Annex A, Figure A.3.1.1.2 for TE diagram and section A.3.2 for UE diagram.

2. The parameter settings for the cell are set up according to TS 38.508-1 [5] subclause 4.4.3.
3. Downlink signals are initially set up according to Annex C.0, C.1, C.2, and uplink signals according to Annex G.0, G.1, G.2, G.3.0.
4. The UL Reference Measurement Channel is set according to Table 6.3D.4.1.4.1-1.
5. Propagation conditions are set according to Annex B.0.
6. Ensure the UE is in state RRC_CONNECTED with generic procedure parameters Connectivity NR, Connected without release On, Test Mode On and Test Loop Function On according to TS 38.508-1 [5] clause 4.5. Message contents are defined in clause 6.3D.4.1.4.3. Note that PDCCH DCI format 0_1 sent after resetting uplink power with RRC Connection Reconfiguration, should have TPC command 0dB.

6.3D.4.1.4.2 Test procedure

Same test procedure as clause 6.3.4.2.4.2 with following exceptions.

The power of UE PUSCH first transmissions should be measured as the sum power at each antenna connector.

6.3D.4.1.4.3 Message contents

Message contents are according to TS 38.508-1 [5] subclause 4.6 ensuring Table 4.6.3-182 with condition 2TX_UL_MIMO and following exceptions.

Table 6.3D.4.1.4.3-1: UplinkPowerControlCommon: Test point 1

Derivation Path: TS 38.508-1 [5] subclause 4.6.3 Table 4.6.3-119 PUSCH-ConfigCommon			
Information Element	Value/remark	Comment	Condition
PUSCH-ConfigCommon ::= SEQUENCE {			
p0-NominalWithGrant	-114	Test point 1 to verify a UE relative low initial power transmission	
}			

Table 6.3D.4.1.4.3-2: UplinkPowerControlCommon: Test point 2

Derivation Path: TS 38.508-1 [5] subclause 4.6.3 Table 4.6.3-119 PUSCH-ConfigCommon			
Information Element	Value/remark	Comment	Condition
PUSCH-ConfigCommon ::= SEQUENCE {			
p0-NominalWithGrant	-100	Test point 2 to verify a UE relative high initial power transmission	
}			

Table 6.3D.4.1.4.3-3: ServingCellConfigCommon

Derivation Path: 38.508-1[5], Table 4.6.3-168			
Information Element	Value/remark	Comment	Condition
ServingCellConfigCommon ::= SEQUENCE {			
ss-PBCH-BlockPower	18		SCS_15kHz
	21		SCS_30kHz
}			

Condition	Explanation
SCS_15kHz	SCS=15kHz for SS/PBCH block
SCS_30kHz	SCS=30kHz for SS/PBCH block

6.3D.4.1.5 Test requirement

The requirement for the power measured in step (2) of the test procedure is not to exceed the values specified in Table 6.3D.4.1.5-1 and 6.3D.4.1.5-2.

Table 6.3D.4.1.5-1: Absolute power tolerance: test point 1

		Channel bandwidth / expected output power (dBm)												
		5 MHz	10 MHz	15 MHz	20 MHz	25 MHz	30 MHz	40 MHz	50 MHz	60 MHz	70 MHz	80 MHz	90 MHz	100 MHz
Expected Measured power	SCS15	-17.6	-14.4	-12.6	-11.3	-10.4	-9.6	-8.3	-7.3	N/A	N/A	N/A	N/A	N/A
	SCS30	-18.2	-14.8	-12.8	-11.5	-10.5	-9.7	-8.3	-7.4	-6.5	-5.8	-5.2	-4.7	-4.2
	SCS60		-15.2	-13.0	-11.8	-10.7	-9.8	-8.5	-7.5	-6.6	-5.9	-5.3	-4.8	-4.3
Power tolerance		± (9+TT)dB												
Note 1: The lower power limit shall not exceed the minimum output power requirements defined in sub-clause 6.3.2.3														
Note 2: TT for each duplex, Sub-Carrier Spacing, frequency and channel bandwidth is specified in Table 6.3D.4.1.5-3.														

Table 6.3D.4.1.5-2: Absolute power tolerance: test point 2

		Channel bandwidth / expected output power (dBm)												
		5 MHz	10 MHz	15 MHz	20 MHz	25 MHz	30 MHz	40 MHz	50 MHz	60 MHz	70 MHz	80 MHz	90 MHz	100 MHz
Expected Measured power	SCS15	-3.6	0.4	1.4	2.7	3.6	4.4	5.7	6.7	N/A	N/A	N/A	N/A	N/A
	SCS30	-4.2	-0.8	1.2	2.5	3.5	4.3	5.7	6.6	7.5	8.2	8.8	9.3	9.8
	SCS60	N/A	-1.2	1.0	2.2	3.3	4.2	5.5	6.5	7.4	8.1	8.7	9.2	9.7
Power tolerance		± (9+TT)dB												
Note 1: The higher power limit shall not exceed the maximum output power requirements defined in sub-clause 6.2.1.3														
Note 2: TT for each duplex, Sub-Carrier Spacing, frequency and channel bandwidth is specified in Table 6.3D.4.1.5-3.														

Table 6.3D.4.1.5-3: Test Tolerance

	f ≤ 3.0GHz	3.0GHz < f ≤ 6.0GHz
BW ≤ 40MHz	1.0 dB	1.4 dB
40MHz < BW ≤ 100MHz	1.4 dB	1.4 dB

6.3D.4.2 Relative power tolerance for UL MIMO

6.3D.4.2.1 Test purpose

To verify the ability of the UE transmitter to set its output power in a target sub-frame relatively to the power of the most recently transmitted reference sub-frame if the transmission gap between these sub-frames is ≤ 20ms.

6.3D.4.2.2 Test applicability

This test case applies to all types of NR UE release 15 and forward that support UL MIMO.

6.3D.4.2.3 Minimum conformance requirements

For UE supporting UL MIMO, the power control tolerance applies to the sum of output power at each transmit antenna connector.

The power control requirements specified in subclause 6.3.4.3 apply to UE with two transmit antenna connectors in closed-loop spatial multiplexing scheme. The requirements shall be met with UL MIMO configurations described in Table 6.3D.4.2.3-1

Table 6.3D.4.2.3-1: UL MIMO configuration in closed-loop spatial multiplexing scheme

Transmission scheme	DCI format	Codebook Index
Codebook based uplink	DCI format 0_1	Codebook index 0

The normative reference for this requirement is TS 38.101-1 [2] clause 6.3D.4

6.3D.4.2.4 Test description

6.3D.4.2.4.1 Initial conditions

Initial conditions are a set of test configurations the UE needs to be tested in and the steps for the SS to take with the UE to reach the correct measurement state.

The initial test configurations consist of environmental conditions, test frequencies, test channel bandwidths and sub-carrier spacing based on NR operating bands specified in table 5.3.5-1. All of these configurations shall be tested with applicable test parameters for each combination of test channel bandwidth and sub-carrier spacing, and are shown in table 6.3D.4.2.4.1-1. The details of the uplink reference measurement channels (RMCs) are specified in Annexes A.2. Configurations of PDSCH and PDCCH before measurement are specified in Annex C.2.

Table 6.3D.4.2.4.1-1: Test Configuration Table

Initial Conditions				
Test Environment as specified in TS 38.508-1 [5] subclause 4.3.1			Normal	
Test Frequencies as specified in TS 38.508-1 [5] subclause 4.3.1			Low range	
Test Channel Bandwidths as specified in TS 38.508-1 [5] subclause 4.3.1			Lowest, Mid, Highest	
Test SCS as specified in TS 38.508-1 [5] subclause 4.3.1			Lowest, Highest	
Test Parameters				
Ch BW	Downlink Configuration		Uplink Configuration	
	Modulation	RB Allocation	Modulation	RB allocation (NOTE 1)
5MHz	N/A for Relative power tolerance test case		CP-OFDM QPSK	See Table 6.3D.4.2.5-1 See Table 6.3D.4.2.5-2 See Table 6.3D.4.2.5-7
10MHz			CP-OFDM QPSK	See Table 6.3D.4.2.5-3 See Table 6.3D.4.2.5-4 See Table 6.3D.4.2.5-7
15MHz			CP-OFDM QPSK	See Table 6.3D.4.2.5-3 See Table 6.3D.4.2.5-4 See Table 6.3D.4.2.5-7
20MHz			CP-OFDM QPSK	See Table 6.3D.4.2.5-3 See Table 6.3D.4.2.5-4 See Table 6.3D.4.2.5-7
25MHz			CP-OFDM QPSK	See Table 6.3D.4.2.5-3 See Table 6.3D.4.2.5-4 See Table 6.3D.4.2.5-7
30MHz			CP-OFDM QPSK	See Table 6.3D.4.2.5-3 See Table 6.3D.4.2.5-4 See Table 6.3D.4.2.5-7
40MHz			CP-OFDM QPSK	See Table 6.3D.4.2.5-3 See Table 6.3D.4.2.5-4 See Table 6.3D.4.2.5-7
50MHz			CP-OFDM QPSK	See Table 6.3D.4.2.5-3 See Table 6.3D.4.2.5-4 See Table 6.3D.4.2.5-7
60MHz			CP-OFDM QPSK	See Table 6.3D.4.2.5-5 See Table 6.3D.4.2.5-6 See Table 6.3D.4.2.5-7
70MHz			CP-OFDM QPSK	See Table 6.3.4.3.5-5 See Table 6.3.4.3.5-6 See Table 6.3.4.3.5-7
80MHz			CP-OFDM QPSK	See Table 6.3D.4.2.5-5 See Table 6.3D.4.2.5-6 See Table 6.3D.4.2.5-7
90MHz			CP-OFDM QPSK	See Table 6.3D.4.2.5-5 See Table 6.3D.4.2.5-6 See Table 6.3D.4.2.5-7
100MHz			CP-OFDM QPSK	See Table 6.3D.4.2.5-5 See Table 6.3D.4.2.5-6 See Table 6.3D.4.2.5-7
Note 1: The starting resource block shall be RB# 0				

1. Connect the SS to the UE antenna connectors as shown in TS 38.508-1 [5] Annex A, Figure A.3.1.1.2 for TE diagram and section A.3.2 for UE diagram.
2. The parameter settings for the cell are set up according to TS 38.508-1 [5] subclause 4.4.3.

3. Downlink signals are initially set up according to Annex C.0, C.1, C.2, and uplink signals according to Annex G.0, G.1, G.2, G.3.0.
4. The UL Reference Measurement Channel is set according to Table 6.3D.4.2.4.1-1.
5. Propagation conditions are set according to Annex B.0.
6. Ensure the UE is in state RRC_CONNECTED with generic procedure parameters Connectivity *NR*, Connected without release *On*, Test Mode *On* and Test Loop Function *On* according to TS 38.508-1 [5] clause 4.5. Message contents are defined in clause 6.3D.4.2.4.3.

6.3D.4.2.4.2 Test procedure

Same test procedure as clause 6.3.4.3.4.2 with following exceptions.

The power of PUSCH transmissions should be measured as the sum power at each antenna connector.

Step 1.1 in ramping up pattern sub test should be changed into following description:

- 1.1 SS sends uplink scheduling information for each UL HARQ process via PDCCH DCI format 0_1 for C_RNTI to schedule the UL RMC according to Table 6.3.4.3.4.1-1. Since the UE has no payload and no loopback data to send the UE sends uplink MAC padding bits on the UL RMC. Send the appropriate TPC commands for PUSCH to the UE to ensure that the UE transmits PUSCH at $-31.8 \text{ dBm} \pm 2.7 \text{ dB}$.

6.3D.4.2.4.3 Message contents

Message contents are according to TS 38.508-1 [5] subclause 4.6 ensuring Table 4.6.3-182 with condition 2TX_UL_MIMO.

6.3D.4.2.5 Test requirement

Each UE power step measured in the test procedure 6.3D.4.2.4.2 should satisfy the test requirements specified in Table 6.3D.4.2.5-1 thru 6.3D.4.2.5-7.

Table 6.3D.4.2.5-1: Test Requirements Relative Power Tolerance for Transmission, channel BW 5MHz, ramp up sub-test

Test SCS [kHz]	Sub-test ID	Applicable sub-frames	Uplink RB allocation	TPC command	Expected power step size (Up) ΔP [dB]	Power step size range (Up) ΔP [dB]	PUSCH [dB]
15	1	Sub-frames before RB change	Fixed = 1	TPC=+1dB	1	$\Delta P \leq 1$ dB	1 +/- (0.7 + TT)
		RB change	1RB to 5 RBs	TPC=+1dB	7.99	$4\text{dB} \leq \Delta P < 10\text{dB}$	7.99 +/- (3.5 + TT)
		Sub-frames after RB change	Fixed = 5	TPC=+1dB	1	$\Delta P \leq 1$ dB	1 +/- (0.7 + TT)
	2	Sub-frames before RB change	Fixed = 1	TPC=+1dB	1	$\Delta P \leq 1$ dB	1 +/- (0.7 + TT)
		RB change	1RB to 15 RBs	TPC=+1dB	12.76	$10\text{dB} \leq \Delta P < 15\text{dB}$	12.76 +/- (4 + TT)
		Sub-frames after RB change	Fixed = 15	TPC=+1dB	1	$\Delta P \leq 1$ dB	1 +/- (0.7 + TT)
30	1	Sub-frames before RB change	Fixed = 1	TPC=+1dB	1	$\Delta P \leq 1$ dB	1 +/- (0.7 + TT)
		RB change	1RB to 5 RBs	TPC=+1dB	7.99	$4\text{dB} \leq \Delta P < 10\text{dB}$	7.99 +/- (3.5 + TT)
		Sub-frames after RB change	Fixed = 5	TPC=+1dB	1	$\Delta P \leq 1$ dB	1 +/- (0.7 + TT)
	2	Sub-frames before RB change	Fixed = 1	TPC=+1dB	1	$\Delta P \leq 1$ dB	1 +/- (0.7 + TT)
		RB change	1RB to 10 RBs	TPC=+1dB	11.00	$10\text{dB} \leq \Delta P < 15\text{dB}$	11.00 +/- (4 + TT)
		Sub-frames after RB change	Fixed = 10	TPC=+1dB	1	$\Delta P \leq 1$ dB	1 +/- (0.7 + TT)
<p>Note 1: Position of RB change: Pattern A the position of RB uplink allocation change is after 10 active uplink Sub-frames Pattern B the position of RB uplink allocation change is after 20 active uplink Sub-frames Pattern C the position of RB uplink allocation change is after 30 active uplink Sub-frames</p> <p>Note 2: The starting resource block shall be RB# 0.</p> <p>Note 3: TT=0.7dB</p> <p>Note 4: Applicable if $P_{\text{UMAX}} \geq P \geq P_{\text{min}}$. P_{min} as defined in sub-clause 6.3.1.</p>							

Table 6.3D.4.2.5-2: Test Requirements Relative Power Tolerance for Transmission, channel BW 5MHz, ramp down sub-test

Test SCS [kHz]	Sub-test ID	Applicable sub-frames	Uplink RB allocation	TPC command	Expected power step size (Down) ΔP [dB]	Power step size range (Down) ΔP [dB]	PUSCH [dB]
15	1	Sub-frames before RB change	Fixed = 5	TPC=-1dB	1	$\Delta P \leq 1$ dB	1 +/- (0.7 + TT)
		RB change	5 RBs to 1 RB	TPC=-1dB	7.99	$4\text{dB} \leq \Delta P < 10\text{dB}$	7.99 +/- (3.5 + TT)
		Sub-frames after RB change	Fixed = 1	TPC=-1dB	1	$\Delta P \leq 1$ dB	1 +/- (0.7 + TT)
	2	Sub-frames before RB change	Fixed = 15	TPC=-1dB	1	$\Delta P \leq 1$ dB	1 +/- (0.7 + TT)
		RB change	15 RBs to 1 RB	TPC=-1dB	12.76	$10\text{dB} \leq \Delta P < 15\text{dB}$	12.76 +/- (3.5 + TT)
		Sub-frames after RB change	Fixed = 1	TPC=-1dB	1	$\Delta P \leq 1$ dB	1 +/- (0.7 + TT)
30	1	Sub-frames before RB change	Fixed = 5	TPC=-1dB	1	$\Delta P \leq 1$ dB	1 +/- (0.7 + TT)
		RB change	5 RBs to 1 RB	TPC=-1dB	7.99	$4\text{dB} \leq \Delta P < 10\text{dB}$	7.99 +/- (3.5 + TT)
		Sub-frames after RB change	Fixed = 1	TPC=-1dB	1	$\Delta P \leq 1$ dB	1 +/- (0.7 + TT)
	2	Sub-frames before RB change	Fixed = 10	TPC=-1dB	1	$\Delta P \leq 1$ dB	1 +/- (0.7 + TT)
		RB change	10 RBs to 1 RB	TPC=-1dB	11.00	$10\text{dB} \leq \Delta P < 15\text{dB}$	11.00 +/- (4 + TT)
		Sub-frames after RB change	Fixed = 1	TPC=-1dB	1	$\Delta P \leq 1$ dB	1 +/- (0.7 + TT)
<p>Note 1: Position of RB change: Pattern A the position of RB uplink allocation change is after 10 active uplink Sub-frames Pattern B the position of RB uplink allocation change is after 20 active uplink Sub-frames Pattern C the position of RB uplink allocation change is after 30 active uplink Sub-frames</p> <p>Note 2: The starting resource block shall be RB# 0.</p> <p>Note 3: TT=0.7dB</p> <p>Note 4: Applicable if $P_{\text{UMAX}} \geq P \geq P_{\text{min}}$. P_{min} as defined in sub-clause 6.3.1.</p>							

**Table 6.3D.4.2.5-3: Test Requirements Relative Power Tolerance for Transmission, channel BW
10MHz, 15MHz, 20MHz, 25MHz, 30MHz, 40MHz, 50MHz ramp up sub-test**

Test SCS [kHz]	Sub-test ID	Applicable sub-frames	Uplink RB allocation	TPC command	Expected power step size (Up) ΔP [dB]	Power step size range (Up) ΔP [dB]	PUSCH [dB]
15	1	Subframes before RB change	1RB	TPC=+1dB	1	$\Delta P \leq 1$ dB	1 +/- (0.7 + TT)
		RB change	1RB to 5 RBs	TPC=+1dB	7.99	4dB $\leq \Delta P < 10$ dB	7.99 +/- (3.5 + TT)
		Subframes after RB change	Fixed = 5	TPC=+1dB	1	$\Delta P \leq 1$ dB	1 +/- (0.7 + TT)
	2	Subframes before RB change	1RB	TPC=+1dB	1	$\Delta P \leq 1$ dB	1 +/- (0.7 + TT)
		RB change	1RB to 20 RBs	TPC=+1dB	14.01	10dB $\leq \Delta P < 15$ dB	14.01 +/- (4 + TT)
		Subframes after RB change	Fixed = 20	TPC=+1dB	1	$\Delta P \leq 1$ dB	1 +/- (0.7 + TT)
	3	Subframes before RB change	1RB	TPC=+1dB	1	$\Delta P \leq 1$ dB	1 +/- (0.7 + TT)
		RB change	1RB to 50 RBs	TPC=+1dB	17.99	15dB $\leq \Delta P$	17.99 +/- (5 + TT)
		Subframes after RB change	Fixed = 50	TPC=+1dB	1	$\Delta P \leq 1$ dB	1 +/- (0.7 + TT)
30	1	Subframes before RB change	1RB	TPC=+1dB	1	$\Delta P \leq 1$ dB	1 +/- (0.7 + TT)
		RB change	1RB to 5 RBs	TPC=+1dB	7.99	4dB $\leq \Delta P < 10$ dB	7.99 +/- (3.5 + TT)
		Subframes after RB change	Fixed = 5	TPC=+1dB	1	$\Delta P \leq 1$ dB	1 +/- (0.7 + TT)
	2	Subframes before RB change	1RB	TPC=+1dB	1	$\Delta P \leq 1$ dB	1 +/- (0.7 + TT)
		RB change	1RB to 24 RBs	TPC=+1dB	14.80	10dB $\leq \Delta P < 15$ dB	14.80 +/- (4 + TT)
		Subframes after RB change	Fixed = 24	TPC=+1dB	1	$\Delta P \leq 1$ dB	1 +/- (0.7 + TT)
60	1	Subframes before RB change	1RB	TPC=+1dB	1	$\Delta P \leq 1$ dB	1 +/- (0.7 + TT)
		RB change	1RB to 5 RBs	TPC=+1dB	7.99	4dB $\leq \Delta P < 10$ dB	7.99 +/- (3.5 + TT)
		Subframes after RB change	Fixed = 5	TPC=+1dB	1	$\Delta P \leq 1$ dB	1 +/- (0.7 + TT)
	2	Subframes before RB change	1RB	TPC=+1dB	1	$\Delta P \leq 1$ dB	1 +/- (0.7 + TT)
		RB change	1RB to 10 RBs	TPC=+1dB	11.00	10dB $\leq \Delta P < 15$ dB	11.00 +/- (4 + TT)
		Subframes after RB change	Fixed = 10	TPC=+1dB	1	$\Delta P \leq 1$ dB	1 +/- (0.7 + TT)

- | | |
|---------|-----------------------------------------------------------------------------------------------------------------------------------------------------------------------------------------------------------------------------------------------------------------------------------------------------------------|
| Note 1: | Position of RB change:
Pattern A the position of RB uplink allocation change is after 10 active uplink Subframes.
Pattern B the position of RB uplink allocation change is after 20 active uplink Subframes
Pattern C the position of RB uplink allocation change is after 30 active uplink Subframes. |
| Note 2: | The starting resource block shall be RB# 0. |
| Note 3: | TT=0.7dB |
| Note 4: | Applicable if $P_{UMAX} \geq P \geq P_{min}$. P_{min} as defined in sub-clause 6.3.1. |

**Table 6.3D.4.2.5-4: Test Requirements Relative Power Tolerance for Transmission, channel BW
10MHz, 15MHz, 20MHz, 25MHz, 30MHz, 40MHz, 50MHz ramp down sub-test**

Test SCS [kHz]	Sub-test ID	Applicable sub-frames	Uplink RB allocation	TPC command	Expected power step size (Down) ΔP [dB]	Power step size range (Down) ΔP [dB]	PUSCH [dB]
15	1	Subframes before RB change	Fixed = 5	TPC=-1dB	1	$\Delta P \leq 1$ dB	1 +/- (0.7 + TT)
		RB change	5 RBs to 1RBs	TPC=-1dB	7.99	4dB $\leq \Delta P < 10$ dB	7.99 +/- (3.5 + TT)
		Subframes after RB change	Fixed = 1	TPC=-1dB	1	$\Delta P \leq 1$ dB	1 +/- (0.7 + TT)
	2	Subframes before RB change	Fixed = 20	TPC=-1dB	1	$\Delta P \leq 1$ dB	1 +/- (0.7 + TT)
		RB change	20 RBs to 1 RB	TPC=-1dB	14.01	10dB $\leq \Delta P < 15$ dB	14.01 +/- (4 + TT)
		Subframes after RB change	Fixed = 1	TPC=-1dB	1	$\Delta P \leq 1$ dB	1 +/- (0.7 + TT)
	3	Subframes before RB change	Fixed = 50	TPC=-1dB	1	$\Delta P \leq 1$ dB	1 +/- (0.7 + TT)
		RB change	50 RBs to 1 RB	TPC=-1dB	17.99	15dB $\leq \Delta P$	17.99 +/- (5 + TT)
		Subframes after RB change	Fixed = 1	TPC=-1dB	1	$\Delta P \leq 1$ dB	1 +/- (0.7 + TT)
30	1	Subframes before RB change	Fixed = 5	TPC=-1dB	1	$\Delta P \leq 1$ dB	1 +/- (0.7 + TT)
		RB change	5 RBs to 1 RB	TPC=-1dB	7.99	4dB $\leq \Delta P < 10$ dB	7.99 +/- (3.5 + TT)
		Subframes after RB change	Fixed = 1	TPC=-1dB	1	$\Delta P \leq 1$ dB	1 +/- (0.7 + TT)
	2	Subframes before RB change	Fixed = 24	TPC=-1dB	1	$\Delta P \leq 1$ dB	1 +/- (0.7 + TT)
		RB change	24 RBs to 1 RB	TPC=-1dB	14.80	10dB $\leq \Delta P < 15$ dB	14.80 +/- (4 + TT)
		Subframes after RB change	Fixed = 1	TPC=-1dB	1	$\Delta P \leq 1$ dB	1 +/- (0.7 + TT)
60	1	Subframes before RB change	Fixed = 5	TPC=-1dB	1	$\Delta P \leq 1$ dB	1 +/- (0.7 + TT)
		RB change	5 RBs to 1 RB	TPC=-1dB	7.99	4dB $\leq \Delta P < 10$ dB	7.99 +/- (3.5 + TT)
		Subframes after RB change	Fixed = 1	TPC=-1dB	1	$\Delta P \leq 1$ dB	1 +/- (0.7 + TT)
	2	Subframes before RB change	Fixed = 10	TPC=-1dB	1	$\Delta P \leq 1$ dB	1 +/- (0.7 + TT)
		RB change	10 RBs to 1 RB	TPC=-1dB	11.00	10dB $\leq \Delta P < 15$ dB	11.00 +/- (4 + TT)
		Subframes after RB change	Fixed = 1	TPC=-1dB	1	$\Delta P \leq 1$ dB	1 +/- (0.7 + TT)

Note 1: Position of RB change:
 Pattern A the position of RB uplink allocation change is after 10 active uplink Subframes.
 Pattern B the position of RB uplink allocation change is after 20 active uplink Subframes
 Pattern C the position of RB uplink allocation change is after 30 active uplink Subframes.
 Note 2: The starting resource block shall be RB# 0.
 Note 3: TT=0.7dB
 Note 4: Applicable if $P_{UMAX} \geq P \geq P_{min}$. P_{min} as defined in sub-clause 6.3.1.

Table 6.3D.4.2.5-5: Test Requirements Relative Power Tolerance for Transmission, channel BW 60MHz, 70MHz, 80MHz, 90MHz, 100MHz ramp up sub-test

Test SCS [kHz]	Sub-test ID	Applicable sub-frames	Uplink RB allocation	TPC command	Expected power step size (Up) ΔP [dB]	Power step size range (Up) ΔP [dB]	PUSCH [dB]
30	1	Subframes before RB change	1RB	TPC=+1dB	1	$\Delta P \leq 1$ dB	1 +/- (0.7 + TT)
		RB change	1RB to 5 RBs	TPC=+1dB	7.99	4dB $\leq \Delta P < 10$ dB	7.99 +/- (3.5 + TT)
		Subframes after RB change	Fixed = 5	TPC=+1dB	1	$\Delta P \leq 1$ dB	1 +/- (0.7 + TT)
	2	Subframes before RB change	1RB	TPC=+1dB	1	$\Delta P \leq 1$ dB	1 +/- (0.7 + TT)
		RB change	1RB to 24 RBs	TPC=+1dB	14.80	10dB $\leq \Delta P < 15$ dB	14.80 +/- (4 + TT)
		Subframes after RB change	Fixed = 24	TPC=+1dB	1	$\Delta P \leq 1$ dB	1 +/- (0.7 + TT)
	3	Subframes before RB change	1RB	TPC=+1dB	1	$\Delta P \leq 1$ dB	1 +/- (0.7 + TT)
		RB change	1RB to 81 RBs	TPC=+1dB	20.08	15dB $< \Delta P$	20.08 +/- (5 + TT)
		Subframes after RB change	Fixed = 81	TPC=+1dB	1	$\Delta P \leq 1$ dB	1 +/- (0.7 + TT)
60	1	Subframes before RB change	1RB	TPC=+1dB	1	$\Delta P \leq 1$ dB	1 +/- (0.7 + TT)
		RB change	1RB to 5 RBs	TPC=+1dB	7.99	4dB $\leq \Delta P < 10$ dB	7.99 +/- (3.5 + TT)
		Subframes after RB change	Fixed = 5	TPC=+1dB	1	$\Delta P \leq 1$ dB	1 +/- (0.7 + TT)
	2	Subframes before RB change	1RB	TPC=+1dB	1	$\Delta P \leq 1$ dB	1 +/- (0.7 + TT)
		RB change	1RB to 75 RBs	TPC=+1dB	19.75	15dB $< \Delta P$	19.75 +/- (5 + TT)
		Subframes after RB change	Fixed = 75	TPC=+1dB	1	$\Delta P \leq 1$ dB	1 +/- (0.7 + TT)

Note 1: Position of RB change:
 Pattern A the position of RB uplink allocation change is after 10 active uplink Subframes.
 Pattern B the position of RB uplink allocation change is after 20 active uplink Subframes
 Pattern C the position of RB uplink allocation change is after 30 active uplink Subframes.
 Note 2: The starting resource block shall be RB# 0.
 Note 3: TT=0.7dB
 Note 4: Applicable if $P_{UMAX} \geq P \geq P_{min}$. P_{min} as defined in sub-clause 6.3.1.

Table 6.3D.4.2.5-6: Test Requirements Relative Power Tolerance for Transmission, channel BW 60MHz, 70MHz, 80MHz, 90MHz, 100MHz ramp down sub-test

Test SCS [kHz]	Sub-test ID	Applicable sub-frames	Uplink RB allocation	TPC command	Expected power step size (Down) ΔP [dB]	Power step size range (Down) ΔP [dB]	PUSCH [dB]
30	1	Subframes before RB change	Fixed = 5	TPC=-1dB	1	$\Delta P \leq 1$ dB	1 +/- (0.7 + TT)
		RB change	5 RBs to 1 RB	TPC=-1dB	7.99	4dB $\leq \Delta P < 10$ dB	7.99 +/- (3.5 + TT)
		Subframes after RB change	Fixed = 1	TPC=-1dB	1	$\Delta P \leq 1$ dB	1 +/- (0.7 + TT)
	2	Subframes before RB change	Fixed = 24	TPC=-1dB	1	$\Delta P \leq 1$ dB	1 +/- (0.7 + TT)
		RB change	24 RBs to 1 RB	TPC=-1dB	14.80	10dB $\leq \Delta P < 15$ dB	14.80 +/- (4 + TT)
		Subframes after RB change	Fixed = 1	TPC=-1dB	1	$\Delta P \leq 1$ dB	1 +/- (0.7 + TT)
	3	Subframes before RB change	Fixed = 81	TPC=-1dB	1	$\Delta P \leq 1$ dB	1 +/- (0.7 + TT)
		RB change	81 RBs to 1 RB	TPC=-1dB	20.08	15dB $< \Delta P$	20.08 +/- (5 + TT)
		Subframes after RB change	Fixed = 1	TPC=-1dB	1	$\Delta P \leq 1$ dB	1 +/- (0.7 + TT)
60	1	Subframes before RB change	Fixed = 5	TPC=-1dB	1	$\Delta P \leq 1$ dB	1 +/- (0.7 + TT)
		RB change	5 RBs to 1 RB	TPC=-1dB	7.99	4dB $\leq \Delta P < 10$ dB	7.99 +/- (3.5 + TT)
		Subframes after RB change	Fixed = 1	TPC=-1dB	1	$\Delta P \leq 1$ dB	1 +/- (0.7 + TT)
	2	Subframes before RB change	Fixed = 75	TPC=-1dB	1	$\Delta P \leq 1$ dB	1 +/- (0.7 + TT)
		RB change	75 RBs to 1 RB	TPC=-1dB	19.75	15dB $< \Delta P$	19.75 +/- (5 + TT)
		Subframes after RB change	Fixed = 1	TPC=-1dB	1	$\Delta P \leq 1$ dB	1 +/- (0.7 + TT)
<p>Note 1: Position of RB change: Pattern A the position of RB uplink allocation change is after 10 active uplink Subframes. Pattern B the position of RB uplink allocation change is after 20 active uplink Subframes. Pattern C the position of RB uplink allocation change is after 30 active uplink Subframes.</p> <p>Note 2: The starting resource block shall be RB# 0.</p> <p>Note 3: TT=0.7dB</p> <p>Note 4: Applicable if $P_{UMAX} \geq P \geq P_{min}$. P_{min} as defined in sub-clause 6.3.1.</p>							

Table 6.3D.4.2.5-7: Test Requirements Relative Power Tolerance for Transmission, alternating sub-test

BW	Test SCS [kHz]	Sub-test ID	Uplink RB allocation	TPC command	Expected power step size (Up or Down) ΔP [dB]	Power step size range (Up or Down) ΔP [dB]	PUSCH [dB]	
5	15	1	Alternating 1 and 2	TPC=0dB	3.01	$3\text{dB} \leq \Delta P < 4\text{dB}$	3.01 +/- (3 + TT)	
		2	Alternating 1 and 5	TPC=0dB	6.99	$4\text{dB} \leq \Delta P < 10\text{dB}$	6.99 +/- (3.5 + TT)	
		3	Alternating 1 and 15	TPC=0dB	11.76	$10\text{dB} \leq \Delta P < 15\text{dB}$	11.76 +/- (4 + TT)	
	30	1	Alternating 1 and 2	TPC=0dB	3.01	$3\text{dB} \leq \Delta P < 4\text{dB}$	3.01 +/- (3 + TT)	
		2	Alternating 1 and 10	TPC=0dB	10.00	$10\text{dB} \leq \Delta P < 15\text{dB}$	10.00 +/- (4 + TT)	
	10,15,20,25,30,40,50	15	1	Alternating 1 and 2	TPC=0dB	3.01	$3\text{dB} \leq \Delta P < 4\text{dB}$	3.01 +/- (3 + TT)
2			Alternating 1 and 5	TPC=0dB	6.99	$4\text{dB} \leq \Delta P < 10\text{dB}$	6.99 +/- (3.5 + TT)	
3			Alternating 1 and 20	TPC=0dB	13.01	$10\text{dB} \leq \Delta P < 15\text{dB}$	13.01 +/- (4 + TT)	
4			Alternating 1 and 50	TPC=0dB	16.99	$15\text{dB} \leq \Delta P$	16.99 +/- (5 + TT)	
30		1	Alternating 1 and 2	TPC=0dB	3.01	$3\text{dB} \leq \Delta P < 4\text{dB}$	3.01 +/- (3 + TT)	
		2	Alternating 1 and 5	TPC=0dB	6.99	$4\text{dB} \leq \Delta P < 10\text{dB}$	6.99 +/- (3.5 + TT)	
		3	Alternating 1 and 24	TPC=0dB	13.80	$10\text{dB} \leq \Delta P < 15\text{dB}$	13.80 +/- (4 + TT)	
60		1	Alternating 1 and 5	TPC=0dB	6.99	$4\text{dB} \leq \Delta P < 10\text{dB}$	6.99 +/- (3.5 + TT)	
		2	Alternating 1 and 10	TPC=0dB	10.00	$10\text{dB} \leq \Delta P < 15\text{dB}$	10.00 +/- (4 + TT)	
60,70,80,90,100		30	1	Alternating 1 and 2	TPC=0dB	3.01	$3\text{dB} \leq \Delta P < 4\text{dB}$	3.01 +/- (3 + TT)
			2	Alternating 1 and 5	TPC=0dB	6.99	$4\text{dB} \leq \Delta P < 10\text{dB}$	6.99 +/- (3.5 + TT)
			3	Alternating 1 and 81	TPC=0dB	19.08	$15\text{dB} < \Delta P$	19.08 +/- (5 + TT)
	60	1	Alternating 1 and 2	TPC=0dB	3.01	$3\text{dB} \leq \Delta P < 4\text{dB}$	3.01 +/- (3 + TT)	
		2	Alternating 1 and 5	TPC=0dB	6.99	$4\text{dB} \leq \Delta P < 10\text{dB}$	6.99 +/- (3.5 + TT)	
		3	Alternating 1 and 75	TPC=0dB	18.75	$15\text{dB} < \Delta P$	18.75 +/- (5 + TT)	
Note 1: The starting resource block shall be RB# 0.								
Note 2: TT=0.7dB								
Note 3: Applicable if $P_{\text{UMAX}} \geq P \geq P_{\text{min}}$. P_{min} as defined in sub-clause 6.3.1.								

6.3D.4.3 Aggregate power tolerance for UL MIMO

6.3D.4.3.1 Test purpose

To verify the ability of the UE with UL MIMO to maintain its power during non-contiguous transmissions within 21ms in response to 0 dB commands with respect to the first UE transmission and all other power control parameters as specified in 38.213 kept constant.

6.3D.4.3.2 Test applicability

This test case applies to all types of NR UE release 15 and forward that support UL MIMO.

6.3D.4.3.3 Minimum conformance requirements

For UE supporting UL MIMO, the power control tolerance applies to the sum of output power at each transmit antenna connector.

The power control requirements specified in subclause 6.3.4.4 apply to UE with two transmit antenna connectors in closed-loop spatial multiplexing scheme. The requirements shall be met with UL MIMO configurations described in Table 6.3D.4.3.3-1

Table 6.3D.4.3.3-1: UL MIMO configuration in closed-loop spatial multiplexing scheme

Transmission scheme	DCI format	Codebook Index
Codebook based uplink	DCI format 0_1	Codebook index 0

The normative reference for this requirement is TS 38.101-1 [2] clause 6.3D.4

6.3D.4.3.4 Test description

6.3D.4.3.4.1 Initial conditions

Initial conditions are a set of test configurations the UE needs to be tested in and the steps for the SS to take with the UE to reach the correct measurement state.

The initial test configurations consist of environmental conditions, test frequencies, test channel bandwidths and sub-carrier spacing based on NR operating bands specified in table 5.3.5-1. All of these configurations shall be tested with applicable test parameters for each combination of test channel bandwidth and sub-carrier spacing, and are shown in table 6.3D.4.3.4.1-1 and table 6.3D.4.3.4.1-2. The details of the uplink reference measurement channels (RMCs) are specified in Annexes A.2. Configurations of PDSCH and PDCCH before measurement are specified in Annex C.2.

Table 6.3D.4.3.4.1-1: Test Configuration Table: PUCCH sub-test

Initial Conditions		
Test Environment as specified in TS 38.508-1 [5] subclause 4.1	Normal	
Test Frequencies as specified in TS 38.508-1 [5] subclause 4.3.1	Mid range	
Test Channel Bandwidths as specified in TS 38.508-1 [5] subclause 4.3.1	Lowest, Mid, Highest	
Test SCS as specified in Table 5.3.5-1	Lowest, Highest	
Test Parameters for Channel Bandwidths		
Test ID	Downlink Configuration	Uplink Configuration
1	N/A for aggregate power tolerance testcase	PUCCH format = Format 1 Length in OFDM symbols = 14

Table 6.3D.4.3.4.1-2: Test Configuration Table: PUSCH sub-test

Initial Conditions			
Test Environment as specified in TS 38.508-1 [5] subclause 4.1		Normal	
Test Frequencies as specified in TS 38.508-1 [5] subclause 4.3.1		Mid range	
Test Channel Bandwidths as specified in TS 38.508-1 [5] subclause 4.3.1		Lowest, Mid, Highest	
Test SCS as specified in Table 5.3.5-1		Lowest, Highest	
Test Parameters for Channel Bandwidths			
Test ID	Downlink Configuration	Uplink Configuration	
	N/A for aggregate power tolerance testcase	Modulation	RB allocation (NOTE 1)
1		CP-OFDM QPSK	Outer_Full
NOTE 1: The specific configuration of each RF allocation is defined in Table 6.1-1.			

1. Connect the SS to the UE antenna connectors as shown in TS 38.508-1 [5] Annex A, Figure A.3.1.1.2 for TE diagram and section A.3.2 for UE diagram.
2. The parameter settings for the cell are set up according to TS 38.508-1 [5] subclause 4.4.3.
3. Downlink signals are initially set up according to Annex C.0, C.1, C.2, and uplink signals according to Annex G.0, G.1, G.2, G.3.0.
4. The UL and DL Reference Measurement channels are set according to Table 6.3D.4.3.4.1-1 (PUCCH sub-test) and Table 6.3D.4.3.4.1-2 (PUSCH sub-test)
5. Propagation conditions are set according to Annex B.0.
6. Ensure the UE is in state RRC_CONNECTED with generic procedure parameters Connectivity *NR*, Connected without release *On*, Test Mode *On* and Test Loop Function *On* according to TS 38.508-1 [5] clause 4.5. Message contents are defined in clause 6.3D.4.3.4.3.

6.3D.4.3.4.2 Test procedure

Same test procedure as clause 6.3.4.4.2 with following exceptions.

The power of PDCCH /PUSCH transmissions should be measured as the sum power at each antenna connector.

6.3D.4.3.4.3 Message contents

Message contents are according to TS 38.508-1 [5] subclause 4.6 ensuring Table 4.6.3-182 with condition 2TX_UL_MIMO.

6.3D.4.3.5 Test requirement

The requirement for the power measurements made in step (1.3) and (2.3) of the test procedure shall not exceed the values specified in Table 6.3D.4.3.5-1. The power measurement period shall be 1 sub-frame.

Table 6.3D.4.3.5-1: Power control tolerance

TPC commands	UL channel	Test requirement measured power
0 dB	PUCCH	Given 5 power measurements in the pattern, the 2 nd , and later measurements shall be within $\pm (2.5\text{dB} + \text{TT})$ of the 1 st measurement.
0 dB	PUSCH	Given 5 power measurements in the pattern, the 2 nd , and later measurements shall be within $\pm (3.5\text{dB} + \text{TT})$ of the 1 st measurement.
Note 1: For SCS 30kHz 1 sub-frame corresponds to 2 slots, so 2 TPC commands will be sent for a single measurement period. For SCS 60kHz 1 sub-frame corresponds to 4 slot, so 4 TPC commands will be sent for a single measurement period.		

6.3E Output power dynamics for V2X

6.3E.1 Minimum output power for V2X

6.3E.1.0 Minimum conformance requirements

6.3E.1.0.1 General

When UE is configured for NR V2X sidelink transmissions non-concurrent with NR uplink transmissions for NR V2X operating bands in Table 5.2E-1, the minimum output power is specified in Table 6.3E.1.0.1-1. The minimum output power is defined as the mean power in at least one sub-frame 1 ms.

Table 6.3E.1.0.1-1: Minimum output power

Channel bandwidth (MHz)	Minimum output power (dBm)	Measurement bandwidth (MHz)
10	-30	9.375
20	-30	19.095
30	-28.2	28.815
40	-27	38.895

For NR V2X UE with two transmit antenna connectors, the minimum output power is defined as the sum of the mean power at each transmit connector in one sub-frame (1 ms). The minimum output power shall not exceed the values specified for single carrier.

If the UE transmits on one antenna connector at a time, the requirements specified for single carrier shall apply to the active antenna connector.

6.3E.1.0.2 Minimum output power for V2X con-current operation

For the inter-band con-current NR V2X operation, the requirements specified in subclause 6.3.1.3 shall apply for the uplink in licensed band and the requirements specified in subclause 6.3E.1.0 shall apply for the sidelink in licensed band or Band n47.

The normative reference for this requirement is TS 38.101-1 [2] clause 6.3E.1

6.3E.1.1 Minimum output power for V2X / non-concurrent operation

6.3E.1.1.1 Test purpose

Same test purpose as in 6.3.1.1.

6.3E.1.1.2 Test applicability

This test case applies to all types of UE release 16 and forward that support NR V2X sidelink communication.

6.3E.1.1.3 Minimum conformance requirements

The minimum conformance requirements are defined in clause 6.3E.1.0.

6.3E.1.1.4 Test description

6.3E.1.1.4.1 Initial conditions

Initial conditions are a set of test configurations the UE needs to be tested in and the steps for the SS to take with the UE to reach the correct measurement state.

The initial test configurations consist of environmental conditions, test frequencies, test channel bandwidths and sub-carrier spacing based on NR operating bands specified in table 5.2E.1-1 and table 5.3.5-1. All of these configurations shall be tested with applicable test parameters for each combination of test channel bandwidth and sub-carrier spacing, and are shown in table 6.3E.1.1.4.1-1. The details of the V2X reference measurement channels (RMCs) are specified in Annex A.7.5 and the GNSS configuration in TS 38.508-1 [5] subclause 4.11.

Table 6.3E.1.1.4.1-1: Test Configuration Table for minimum output power

Initial Conditions			
Test Environment as specified in TS 38.508-1 [5] subclause 4.1		Normal, TL/VL, TL/VH, TH/VL, TH/VH	
Test Frequencies as specified in TS 38.508-1 [5] subclause 4.3.1.8		Low range, High range	
Test Channel Bandwidths as specified TS 38.508-1 [5] subclause 4.3.1		Lowest, Highest	
Test SCS as specified in Table 5.3.5-1		Lowest, Highest	
Test Parameters for Channel Bandwidths			
Test ID	Freq	V2X Configuration to Transmit	
		Modulation	PSCCH and PSSCH RB allocation (Note 1)
1	Default	QPSK	Outer_Full
3	Default	16QAM	Outer_Full
5	Default	64QAM	Outer_Full
6	Default	256QAM	Outer_Full
NOTE 1: The specific configuration of each RB allocation is defined in Table 6.1E-1.			

1. Connect the SS and GNSS simulator to the UE antenna connectors as shown in TS 38.508-1 [5] Annex A, Figure A.3.1.9.1 for TE diagram and section A.3.2.7 for UE diagram.
2. The parameter settings for the NR sidelink transmission over PC5 are pre-configured according to TS 38.508-1 [5] subclause 4.10. Message content exceptions are defined in clause 6.3E.1.1.4.3.
3. The V2X Reference Measurement Channel is set according to Table 6.3E.1.1.4.1-1.
4. The GNSS simulator is configured for Scenario #1: static in Ge ographical area #1, as defined in TS38.508-1 [5] Table 4.11.2-2. Geographical area #1 is also pre-configured in the UE.
5. Propagation conditions are set according to Annex B.0.
6. Ensure the UE is in state Out_of_Coverage with generic procedure parameters Sidelink On, Test Loop Function On with UE test loop mode E closed for *Transmit Mode* according to TS 38.508-1 [5] clause 4.5.

6.3E.1.1.4.2 Test procedure

1. The UE starts to perform the NR sidelink communication according to *SL-PreconfigurationNR*. Since the UE has no payload and no loopback data to send the UE sends uplink MAC padding bits on the NR sidelink RMC.
2. Measure the mean power of the UE in the channel bandwidth according to the test configuration from Table 6.3E.1.1.4.1-1. The period of measurement shall be at least continuous duration of one active sub-frame (1ms) excluding guard symbols.

6.3E.1.1.4.3 Message contents

Message contents are according to TS 38.508-1 [5] subclause 4.10 with the following exceptions.

Table 6.3E.1.1.4.3-1: SL-ResourcePool

Derivation Path: TS 38.508-1 [5], Table 4.6.6-25			
Information Element	Value/remark	Comment	Condition
SL-ResourcePool-r16 ::= SEQUENCE {			
sl-PSCCH-Config-r16 CHOICE {			
setup SEQUENCE {			
sl-TimeResourcePSCCH-r16	As defined in Table 6.1E-2		
sl-FreqResourcePSCCH-r16	As defined in Table 6.1E-2		
}			
}			
sl-SubchannelSize-r16	As defined in Table 6.1E-2		
sl-StartRB-Subchannel-r16	As defined in Table 6.1E-2		
sl-NumSubchannel-r16	As defined in Table 6.1E-2		
}			

Table 6.3E.1.1.4.3-2: SL-TxPower

Derivation Path: TS 38.508-1 [5], Table 4.6.6-33			
Information Element	Value/remark	Comment	Condition
SL-TxPower-r16 ::= CHOICE {			
txPower	-30		
}			

6.3E.1.1.5 Test requirement

The minimum output power, derived in step 2 shall not exceed the values specified in Table 6.3E.1.1.5-1.

Table 6.3E.1.1.5-1: Minimum output power

Channel bandwidth (MHz)	Minimum output power (dBm)	Measurement bandwidth (MHz)
10	-30+TT	9.375
20	-30+TT	19.095
30	-28.2+TT	28.815
40	-27+TT	38.895

NOTE 1: TT for each frequency and channel bandwidth is specified in Table 6.3.1.5-2

Table 6.3E.1.1.5-2: Test Tolerance (Minimum output power)

	f ≤ 3.0GHz	3.0GHz < f ≤ 6.0GHz
BW ≤ 40MHz	1.0 dB	1.3 dB

6.3E.1.1D Minimum output power for V2X / non-concurrent operation / SL-MIMO

Editor's Note: The test case is not completed due to the following aspects are not yet determined:

- Uplink RMC is TBD in RAN4
- Preconfiguration is not complete in 38.508-1
- Test state and generic procedure are TBD in 38.508-1
- Measurement period of PSFCH and PSBCH is FFS.
- Connection diagram for SL-MIMO is TBD

6.3E.1.1D.1 Test purpose

Same test purpose as in 6.3E.1.1.

6.3E.1.1D.2 Test applicability

This test case applies to all types of UE release 16 and forward that support NR V2X sidelink communication and SL-MIMO.

6.3E.1.1D.3 Minimum conformance requirements

The minimum conformance requirements are defined in clause 6.3E.1.0.

6.3E.1.1D.4 Test description

6.3E.1.1D.4.1 Initial conditions

Initial conditions are a set of test configurations the UE needs to be tested in and the steps for the SS to take with the UE to reach the correct measurement state.

The initial test configurations consist of environmental conditions, test frequencies, test channel bandwidths and sub-carrier spacing based on NR operating bands specified in table 5.2E.1-1 and table 5.3.5-1. All of these configurations shall be tested with applicable test parameters for each combination of test channel bandwidth and sub-carrier spacing, and are shown in table 6.3E.1.1D.4.1-1. The details of the V2X reference measurement channels (RMCs) are specified in Annexes TBD and the GNSS configuration in TS 38.508-1 [5] subclause 4.11.

Table 6.3E.1.1D.4.1-1: Test Configuration Table for minimum output power for SL-MIMO

Initial Conditions			
Test Environment as specified in TS 38.508-1 [5] subclause 4.1		Normal, TL/VL, TL/VH, TH/VL, TH/VH	
Test Frequencies as specified in TS 38.508-1 [5] subclause 4.3.1.8		Low range, High range	
Test Channel Bandwidths as specified TS 38.508-1 [5] subclause 4.3.1		Lowest, Highest	
Test SCS as specified in Table 5.3.5-1		Lowest, Highest	
Test Parameters for Channel Bandwidths			
Test ID	Freq	V2X Configuration to Transmit	
		Modulation	PSCCH and PSSCH RB allocation (Note 1)
1	Default	QPSK	Outer_Full
2	Default	16QAM	Outer_Full
3	Default	64QAM	Outer_Full
4	Default	256QAM	Outer_Full
NOTE 1: The specific configuration of each RB allocation is defined in Table 6.1E-1.			

1. Connect the SS and GNSS simulator to the UE antenna connectors as shown in TS 38.508-1 [5] Annex A, Figure TBD for TE diagram and section TBD for UE diagram.
2. The parameter settings for the NR sidelink transmission over PC5 are pre-configured according to TS 38.508-1 [5] subclause 4.10. Message content exceptions are defined in clause 6.3E.1.1D.4.3.
3. The V2X Reference Measurement Channel is set according to Table 6.3E.1.1D.4.1-1.
4. The GNSS simulator is configured for Scenario #1: static in Geographical area #1, as defined in TS38.508-1 [5] Table 4.11.2-2. Geographical area #1 is also pre-configured in the UE.
5. Propagation conditions are set according to Annex B.0.
6. Ensure the UE is in state 4-A as defined in TS 38.508-1 [4], subclause 4.4A using generic procedure parameter Sidelink (*On*), Cast Type (*Unicast*), GNSS Sync (*On*) and *Transmit Mode with SL-MIMO*.

6.3E.1.1D.4.2 Test procedure

1. The UE starts to perform the NR sidelink communication according to *SL-PreconfigurationNR* with 2-layer MIMO codebook TPMI 0. Since the UE has no payload and no loopback data to send the UE sends uplink MAC padding bits on the NR sidelink RMC.
2. Measure the sum of mean power of the UE at each transmit antenna connector in the channel bandwidth according to the test configuration from Table 6.3E.1.1D.4.1-1. The period of measurement shall be at least continuous duration of one active sub-frame (1ms) excluding guard symbols.

6.3E.1.1D.4.3 Message contents

Message contents are according to TS 38.508-1 [5] subclause 4.10 with the following exceptions.

Table 6.3E.1.1D.4.3-1: *SL-ResourcePool*

Derivation Path: TS 38.508-1 [5], Table 4.6.6-25			
Information Element	Value/remark	Comment	Condition
SL-ResourcePool-r16 ::= SEQUENCE {			
sl-PSCCH-Config-r16 CHOICE {			
setup SEQUENCE {			
sl-TimeResourcePSCCH-r16	As defined in Table 6.1E-2		
sl-FreqResourcePSCCH-r16	As defined in Table 6.1E-2		
}			
}			
sl-SubchannelSize-r16	As defined in Table 6.1E-2		
sl-StartRB-Subchannel-r16	As defined in Table 6.1E-2		
sl-NumSubchannel-r16	As defined in Table 6.1E-2		
}			

Table 6.3E.1.1D.4.3-2: *SL-TxPower*

Derivation Path: TS 38.508-1 [5], Table 4.6.6-33			
Information Element	Value/remark	Comment	Condition
SL-TxPower-r16 ::= CHOICE {			
txPower	-30		
}			

6.3E.1.1D.5 Test requirement

The minimum output power, derived in step 2 shall not exceed the values specified in Table 6.3E.1.1D.5-1.

Table 6.3E.1.1D.5-1: Minimum output power

Channel bandwidth (MHz)	Minimum output power (dBm)	Measurement bandwidth (MHz)
10	-30+TT	9.375
20	-30+TT	19.095
30	-28.2+TT	28.815
40	-27+TT	38.895

NOTE 1: TT for each frequency and channel bandwidth is specified in Table 6.3E.1.1D.5-2

Table 6.3E.1.1D.5-2: Test Tolerance (UE maximum output power)

	f ≤ 3.0GHz	4.2GHz < f ≤ 6.0GHz
BW ≤ 40MHz	FFS	FFS

6.3E.2 Transmit OFF power for V2X

6.3E.2.0 Minimum conformance requirements

6.3E.2.0.1 General

When UE is configured for NR V2X sidelink transmissions non-concurrent with NR uplink transmissions for NR V2X operating bands in Table 5.2E.1-1, the requirements specified in Table 6.3E.2.0.1-1 apply.

Table 6.3E.2.0.1-1: Transmit OFF power

Channel bandwidth (MHz)	Transmit OFF power (dBm)	Measurement bandwidth (MHz)
10	-50	9.375
20	-50	19.095
30	-50	28.815
40	-50	38.895

For NR V2X UE supporting SL MIMO, the transmit OFF power at each transmit antenna connector shall not exceed the values specified in Table 6.3E.2.0.1-1 for single carrier. Transmit off power is defined as the mean power in at least one sub-frame 1 ms.

6.3E.2.0.2 Transmit OFF power for V2X con-current operation

For the inter-band con-current NR V2X operation, the requirements specified in clause 6.3.2 shall apply for the uplink in licensed band and the requirements specified in Table 6.3E.2.0.1-1 shall apply for the sidelink in licensed band or Band n47.

The normative reference for this requirement is TS 38.101-1 [2] clause 6.3E.2.

6.3E.2.1 Transmit OFF power for V2X / non-concurrent operation

Editor's Note: This test is incomplete. The following aspects are not yet determined:

- 6.3E.3.2.1 General time mask for V2X / non-concurrent operation is FFS.

6.3E.2.1.1 Test purpose

To verify that the UE transmit OFF power is lower than the value specified in the test requirement.

An excess Transmit OFF power potentially increases the Rise Over Thermal (RoT) and therefore reduces the cell coverage area for other UEs.

6.3E.2.1.2 Test applicability

The requirements of this test apply in test case 6.3E.3.2.1 General time mask for V2X / non-concurrent operation to all types of NR UE release 16 and forward that support NR V2X sidelink communication.

6.3E.2.1.3 Minimum conformance requirements

The minimum conformance requirements are defined in clause 6.3E.2.0.

6.3E.2.1.4 Test description

This test is covered by clause 6.3E.3.2.1 General time mask for V2X / non-concurrent operation.

6.3E.2.1.5 Test requirement

The requirement for the Transmit OFF power shall not exceed the values specified in Table 6.3E.2.1.5-1.

Table 6.3E.2.1.5-1: Transmit OFF power

Channel bandwidth (MHz)	Transmit OFF power (dBm)	Measurement bandwidth (MHz)
10	-50+TT	9.375
20	-50+TT	19.095
30	-50+TT	28.815
40	-50+TT	38.895

NOTE 1: TT for each frequency and channel bandwidth is specified in Table 6.3E.2.1.5-2

Table 6.3E.2.1.5-2: Test Tolerance (Transmit OFF power)

	$f \leq 3.0\text{GHz}$	$3.0\text{GHz} < f \leq 6.0\text{GHz}$
$\text{BW} \leq 40\text{MHz}$	1.5 dB	1.8 dB

6.3E.2.1D Transmit OFF power for V2X / non-concurrent operation / SL-MIMO

Editor's Note: This test is incomplete. The following aspects are not yet determined:

- 6.3E.3.2.1D General time mask for V2X / non-concurrent operation / SL-MIMO is FFS.

6.3E.2.1D.1 Test purpose

To verify that the UE transmit OFF power is lower than the value specified in the test requirement.

An excess Transmit OFF power potentially increases the Rise Over Thermal (RoT) and therefore reduces the cell coverage area for other UEs.

6.3E.2.1D.2 Test applicability

The requirements of this test apply in test case 6.3E.3.2.1D General time mask for V2X / non-concurrent operation / SL-MIMO to all types of NR UE release 16 and forward that support NR V2X sidelink communication and SL-MIMO.

6.3E.2.1D.3 Minimum conformance requirements

The minimum conformance requirements are defined in clause 6.3E.2.0.

6.3E.2.1D.4 Test description

This test is covered by clause 6.3E.3.2.1D General time mask for V2X / non-concurrent operation / SL-MIMO.

6.3E.2.1D.5 Test requirement

The requirement for the Transmit OFF power shall not exceed the values specified in Table 6.3E.2.1D.5-1.

Table 6.3E.2.1D.5-1: Transmit OFF power

Channel bandwidth (MHz)	Transmit OFF power (dBm)	Measurement bandwidth (MHz)
10	-50+TT	9.375
20	-50+TT	19.095
30	-50+TT	28.815
40	-50+TT	38.895

NOTE 1: TT for each frequency and channel bandwidth is specified in Table 6.3E.2.1D.5-2

Table 6.3E.2.1D.5-2: Test Tolerance (Transmit OFF power)

	$f \leq 3.0\text{GHz}$	$3.0\text{GHz} < f \leq 6.0\text{GHz}$
BW \leq 40MHz	1.5 dB	1.8 dB

6.3E.2.2 Transmit OFF power for V2X / con-current operation

Editor's Note: This test is incomplete. The following aspects are not yet determined:

- 6.3E.3.2.2 General time mask for V2X / con-current operation is FFS.

6.3E.2.2.1 Test purpose

To verify that the UE transmit OFF power is lower than the value specified in the test requirement.

An excess Transmit OFF power potentially increases the Rise Over Thermal (RoT) and therefore reduces the cell coverage area for other UEs.

6.3E.2.2.2 Test applicability

The requirements of this test apply in test case 6.3E.3.2.2 General time mask for V2X / con-current operation to all types of NR UE release 16 and forward that support NR V2X sidelink communication.

6.3E.2.2.3 Minimum conformance requirements

The minimum conformance requirements are defined in clause 6.3E.2.0.

6.3E.2.2.4 Test description

This test is covered by clause 6.3E.3.2.2 General time mask for V2X / con-current operation.

6.3E.2.2.5 Test requirement

The requirement for the Transmit OFF power shall not exceed the values specified in Table 6.3E.2.2.5-1.

Table 6.3E.2.2.5-1: Transmit OFF power

Channel bandwidth (MHz)	Transmit OFF power (dBm)	Measurement bandwidth (MHz)
10	-50+TT	9.375
20	-50+TT	19.095
30	-50+TT	28.815
40	-50+TT	38.895
NOTE 1: TT for each frequency and channel bandwidth is specified in Table 6.3E.2.2.5-2		

Table 6.3E.2.2.5-2: Test Tolerance (Transmit OFF power)

	$f \leq 3.0\text{GHz}$	$3.0\text{GHz} < f \leq 6.0\text{GHz}$
BW \leq 40MHz	1.5 dB	1.8 dB

6.3F Output power dynamics for shared spectrum channel access

6.3F.1 Minimum output power

6.3F.2 Transmit OFF power for shared spectrum channel access

6.3F.2.1 Test purpose

To verify that the UE transmit OFF power is lower than the value specified in the test requirement.

An excess Transmit OFF power potentially increases the Rise Over Thermal (RoT) and therefore reduces the cell coverage area for other UEs.

6.3F.2.2 Test applicability

The requirements of this test apply in test case 6.3F.3 Transmit ON/OFF time mask for shared spectrum channel access to all types of NR UE release 16 and forward that support NR standalone shared spectrum channel access.

6.3F.2.3 Minimum conformance requirements

Transmit OFF power is defined as the mean power in the channel bandwidth when the transmitter is OFF. The transmitter is considered OFF when the UE is not allowed to transmit on any of its ports.

The Transmit OFF power is defined as the mean power in a duration of at least one sub-frame (1ms) excluding any transient periods. The Transmit OFF power shall not exceed the values specified in Table 6.3F.2.3-1.

Table 6.3F.2.3-1: Transmit OFF power

Channel bandwidth (MHz)	Transmit OFF power (dBm)	Measurement bandwidth (MHz)
5	-50	4.515
10	-50	9.375
15	-50	14.235
20	-50	19.095
25	-50	23.955
30	-50	28.815
40	-50	38.895
50	-50	48.615
60	-50	58.35
70	-50	68.07
80	-50	78.15
90	-50	88.23
100	-50	98.31

The normative reference for this requirement is TS 38.101-1 [2] clause 6.3F.2 and 6.3.2.

6.3F.2.4 Test description

This test is covered by clause 6.3F.3 Transmit ON/OFF time mask.

6.3F.2.5 Test requirement

The requirement for the Transmit OFF power shall not exceed the values specified in Table 6.3F.2.5-1.

Table 6.3F.2.5-1: Transmit OFF power

Channel bandwidth (MHz)	Transmit OFF power (dBm)	Measurement bandwidth (MHz)
10	-50+TT	9.375
20	-50+TT	19.095
40	-50+TT	38.895
60	-50+TT	58.35
80	-50+TT	78.15

NOTE 1: TT for each frequency and channel bandwidth is specified in Table 6.3F.2.5-2

Table 6.3F.2.5-2: Test Tolerance (Transmit OFF power)

	4.2GHz < f ≤ 5.925GHz	5.925GHz < f ≤ 7.125GHz
BW ≤ 40MHz	1.8 dB	TBD
40MHz < BW ≤ 100MHz	1.8 dB	TBD

6.3F.3 Transmit ON/OFF time mask for shared spectrum channel access

6.3F.3.1 General

The transmit power time mask defines the transient period(s) allowed between transmit OFF power as defined in clause 6.3F.2 and transmit ON power symbols (transmit ON/OFF). The transmit power ON/OFF time mask specified in clause 6.3F.3.2 supersedes the ON/OFF masks specified in clause 6.3.3; however, between continuous ON-power transmissions the requirements in clause 6.3.3 apply. Unless otherwise stated the requirements in clause 6.5F apply also in transient periods.

6.3F.3.2 General ON/OFF time mask

Editor's Note: This test is incomplete. The following aspects are not yet determined:

- Test points are TBD
- MU and TT for >6GHz (band n96).
- RMC in Annex A.
- Test coverage for UL-MIMO
- Message exceptions
- Test state and generic procedure are TBD in 38.508-1

6.3F.3.2.1 Test purpose

To verify that the general ON/OFF time mask meets the requirements given in 6.3F.3.2.5.

The transmit power time mask for transmit ON/OFF defines the transient period(s) allowed between transmit OFF power as defined in sub-clause 6.3F.2 and transmit ON power symbols (transmit ON/OFF)

Transmission of the wrong power increases interference to other channels, or increases transmission errors in the uplink channel.

6.3F.3.2.2 Test applicability

This test case applies to all types of NR UE release 16 and forward that support NR standalone shared spectrum channel access.

6.3F.3.2.3 Minimum conformance requirements

The general ON/OFF time mask defines the observation period between transmit OFF and ON power and between transmit ON and OFF power for each SCS as illustrated below in Figure 6.3F.3.2.3-1. ON/OFF scenarios include: contiguous, and non-contiguous transmission, etc.

The OFF power measurement period is defined in a duration of at least one slot excluding any transient periods. The ON power is defined as the mean power over the duration of at least one slot excluding any transient period and non-transmitted symbols. The leading transient period starts 5µs before the beginning of the first symbol of transmission and extends 10µs into the transmission including the CP extension if applicable. The trailing transient period starts 5µs before the end of transmission and extends 5µs beyond the end of transmission.

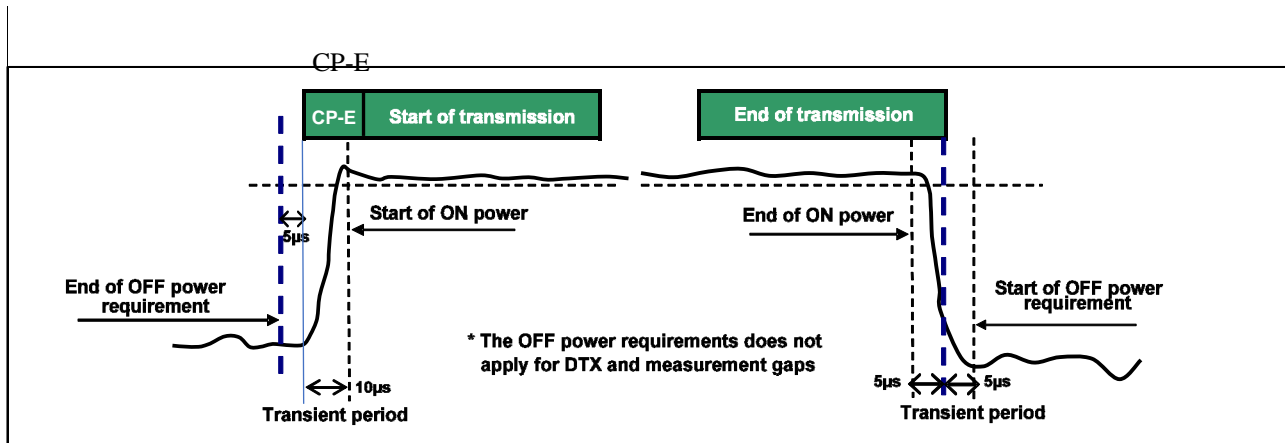

Figure 6.3F.3.2.3-1: General ON/OFF time mask for shared spectrum channel access

The normative reference for this requirement is TS 38.101-1 [2] clause 6.3F.3.2.

6.3F.3.2.4 Test description

6.3F.3.2.4.1 Initial condition

Initial conditions are a set of test configurations the UE needs to be tested in and the steps for the SS to take with the UE to reach the correct measurement state.

The initial test configurations consist of environmental conditions, test frequencies, test channel bandwidths and sub-carrier spacing based on NR operating bands specified in table 5.3.5-1. All of these configurations shall be tested with applicable test parameters for each combination of channel bandwidth and sub-carrier spacing, and are shown in table 6.3F.3.2.4.1-1. The details of the uplink reference measurement channels (RMCs) are specified in Annex A.2. Configurations of PDSCH and PDCCH before measurement are specified in Annex C.2.

Table 6.3F.3.2.4.1-1: Test Configuration Table

FFS

1. Connect the SS to the UE antenna connectors as shown in TS 38.508-1 [5] Annex A, Figure A.3.1.1.1 for TE diagram and section A.3.2 for UE diagram.
2. The parameter settings for the cell are set up according to TS 38.508-1 [5] subclause 4.4.3.
3. Downlink signals are initially set up according to Annex C.0, C.1, C.2, and uplink signals according to Annex G.0, G.1, G.2, G.3.0.
4. The UL Reference Measurement Channel is set according to Table 6.3F.3.2.4.1-1.
5. Propagation conditions are set according to Annex B.0.
6. Ensure the UE is in State RRC_CONNECTED with generic procedure parameters Connectivity NR, Connected without release On, Test Mode On and Test Loop Function On according to TS 38.508-1 [5] clause 4.5. Message contents are defined in clause 6.3F.3.2.4.3.

6.3F.3.2.4.2 Test procedure

1. SS sends uplink scheduling information via PDCCH DCI format 0_1 for C_RNTI to schedule the UL RMC according to Table 6.3F.3.2.4.1-1. Since the UE has no payload and no loopback data to send the UE sends uplink MAC padding bits on the UL RMC. The UL assignment is such that the UE transmits on slots TBD.
2. Send continuously uplink power control "up" commands in every uplink scheduling information to the UE; allow at least 200ms starting from the first TPC command in this step for the UE to reach P_{UMAX} level.

3. ON power sub test:

3.1. Measure the output power of the UE PUSCH transmission during one slot, excluding a transient period of 10 μ s in the beginning of the slot and 5 μ s in the end of the slot.

4. OFF power sub test:

4.1. Measure the UE transmission OFF power during the slot prior to the PUSCH transmission, excluding a transient period of 5 μ s in the end of the slot.

4.2. Measure the UE transmission OFF power during the slot following the PUSCH transmission, excluding a transient period of 5 μ s at the beginning of the slot.

6.3F.3.2.4.3 Message contents

Message contents are according to TS 38.508-1 [5] subclause 4.6 with following exceptions.

FFS

6.3F.3.2.5 Test requirement

The requirement for the power measured in steps 2, 3 and 4 of the test procedure shall not exceed the values specified in Table 6.3F.3.2.5-1.

Table 6.3F.3.2.5-1: General ON/OFF time mask

	Channel bandwidth / minimum output power / measurement bandwidth				
	10 MHz	20 MHz	40 MHz	60 MHz	80 MHz
Transmit OFF power	$\leq -50+TT$ dBm				
Transmission OFF Measurement bandwidth	9.375	19.095	38.895	58.35	78.15
Transmit ON power	TBD				
NOTE 1: TT for each frequency and channel bandwidth is specified in Table 6.3F.3.2.5-2					

Table 6.3F.3.2.5-2: Test Tolerance for OFF power

	4.2GHz < f ≤ 5.925GHz	5.925GHz < f ≤ 7.125GHz
BW ≤ 40MHz	1.8 dB	TBD
40MHz < BW ≤ 100MHz	1.8 dB	TBD

Table 6.3F.3.2.5-3: Test Tolerance for ON power

	4.2GHz < f ≤ 5.925GHz	5.925GHz < f ≤ 7.125GHz
BW ≤ 40MHz	1.8 dB	TBD
40MHz < BW ≤ 100MHz	1.8 dB	TBD

6.4 Transmit signal quality

In this clause a multitude of results are derived, all using one common algorithm returning these results: Global In-Channels TX-Test Annex E. Each sub clause of this clause contains a procedure and test requirements described for a specific measurement. If all relevant test parameters in different sub clauses are the same, then the results, returned by the Global In-Channel TX-Test, may be used across the applicable sub clauses.

6.4.1 Frequency error

6.4.1.1 Test purpose

This test verifies the ability of both, the receiver and the transmitter, to process frequency correctly.

Receiver: to extract the correct frequency from the stimulus signal, offered by the System simulator, under ideal propagation conditions and low level.

Transmitter: to derive the correct modulated carrier frequency from the results, gained by the receiver.

6.4.1.2 Test applicability

This test case applies to all types of NR UE release 15 and forward.

6.4.1.3 Minimum conformance requirements

The UE basic measurement interval of modulated carrier frequency is 1 UL slot. The mean value of basic measurements of UE modulated carrier frequency shall be accurate to within ± 0.1 PPM observed over a period of 1 ms of cumulated measurement intervals compared to the carrier frequency received from the NR Node B.

The normative reference for this requirement is TS 38.101-1 [2] clause 6.4.1

6.4.1.4 Test description

6.4.1.4.1 Initial condition

Initial conditions are a set of test configurations the UE needs to be tested in and the steps for the SS to take with the UE to reach the correct measurement state.

The initial test configurations consist of environmental conditions, test frequencies, test channel bandwidths and sub-carrier spacing based on NR operating bands specified in Table 5.3.5-1. All of these configurations shall be tested with applicable test parameters for each combination of channel bandwidth and sub-carrier spacing, are shown in table 6.4.1.4.1-1. The details of the uplink and downlink reference measurement channels (RMCs) are specified in Annexes A.2 and A.3. Configurations of PDSCH and PDCCH before measurement are specified in Annex C.2.

Table 6.4.1.4.1-1: Test Configuration Table

Initial Conditions				
Test Environment as specified in TS 38.508-1 [5] subclause 4.1			Normal, TL/VL, TL/VH, TH/VL, TH/VH	
Test Frequencies as specified in TS 38.508-1 [5] subclause 4.3.1			Mid range (NOTE 3)	
Test Channel Bandwidths as specified in TS 38.508-1 [5] subclause 4.3.1			Highest	
Test SCS as specified in Table 5.3.5-1			Lowest	
Test Parameters				
Test ID	Downlink Configuration		Uplink Configuration	
	Modulation	RB allocation	Modulation	RB allocation
1	CP-OFDM QPSK	Full RB (NOTE 1)	DFT-s-OFDM QPSK	REFSENS (NOTE 2)
NOTE 1: Full RB allocation shall be used per each SCS and channel BW as specified in Table 7.3.2.4.1-2				
NOTE 2: REFSENS refers to Table 7.3.2.4.1-3 which defines uplink RB configuration and start RB location for each SCS, channel BW and NR band.				
NOTE 3: For NR band n28, 30MHz test channel bandwidth is tested with Low range test frequencies.				

1. Connect the SS to the UE antenna connectors as shown in TS 38.508-1 [5] Annex A, in Figure A.3.1.1.1 for TE diagram and section A.3.2 for UE diagram.
2. The parameter settings for the cell are set up according to TS 38.508-1 [5] subclause 4.4.3.
3. Downlink signals are initially set up according to Annex C.0, C.1, C.2, and uplink signals according to Annex G.0, G.1, G.2, G.3.0.
4. The DL and UL Reference Measurement channels are set according to Table 6.4.1.4.1-1.
5. Propagation conditions are set according to Annex B.0.
6. Ensure the UE is in state RRC_CONNECTED with generic procedure parameters Connectivity *NR*, Connected without release *On*, Test Mode *On* and Test Loop Function *On* according to TS 38.508-1 [5] clause 4.5. Message contents are defined in clause 6.4.1.4.3

6.4.1.4.2 Test procedure

1. SS transmits PDSCH via PDCCH DCI format 1_1 for C_RNTI to transmit the DL RMC according to Table 6.4.1.4.1-1. The SS sends downlink MAC padding bits on the DL RMC.
2. SS sends uplink scheduling information for each UL HARQ process via PDCCH DCI format 0_1 for C_RNTI to schedule the UL RMC according to Table 6.4.1.4.1-1. Since the UL has no payload and no loopback data to send the UE sends uplink MAC padding bits on the UL RMC.
3. Set the Downlink signal level to the appropriate REFSENS value defined in Table 7.3.2.5-1. Send continuously uplink power control "up" commands to the UE in every uplink scheduling information to the UE so that the UE transmits at P_{UMAX} level for the duration of the test. Allow at least 200ms starting from the first TPC command in this step for the UE to reach P_{UMAX} level.

4. Measure the Frequency Error using Global In-Channel Tx-Test (Annex E). For TDD, only slots consisting of only UL symbols are under test.
5. For UEs supporting DSS, repeat steps 1~4 on the applicable bands as specified in Section 5.4.2.1 with message contents being according to TS 38.508-1 [5] subclause 4.6 ensuring Table 4.6.3-61 and Table 4.6.3-62 with condition DSS.

6.4.1.4.3 Message contents

Message contents are according to TS 38.508-1 [5] subclause 4.6.

6.4.1.5 Test requirement

The 10 frequency error Δf results must fulfil the test requirement:

$$|\Delta f| \leq (0.1 \text{ PPM} + 15 \text{ Hz})$$

6.4.2 Transmit modulation quality

Transmit modulation quality defines the modulation quality for expected in-channel RF transmissions from the UE. The transmit modulation quality is specified in terms of:

- Error Vector Magnitude (EVM) for the allocated resource blocks (RBs),
- EVM equalizer spectrum flatness derived from the equalizer coefficients generated by the EVM measurement process
- Carrier leakage
- In-band emissions for the non-allocated RB

All the parameters defined in subclause 6.4.2 are defined using the measurement methodology specified in Annex E.

In case the parameter 3300 or 3301 is reported from UE via *txDirectCurrentLocation* IE (as defined in TS 38.331 [6]), carrier leakage measurement requirement in subclause 6.4.2.2 and 6.4.2.3 shall be waived, and the RF correction with regard to the carrier leakage and IQ image shall be omitted during the calculation of transmit modulation quality.

6.4.2.1 Error Vector Magnitude

6.4.2.1.1 Test Purpose

The Error Vector Magnitude is a measure of the difference between the reference waveform and the measured waveform. This difference is called the error vector. Before calculating the EVM the measured waveform is corrected by the sample timing offset and RF frequency offset. Then the carrier leakage shall be removed from the measured waveform before calculating the EVM.

The measured waveform is further equalised using the channel estimates subjected to the EVM equaliser spectrum flatness requirement specified in sub-clause 6.4.2.4.3. For DFT-s-OFDM waveforms, the EVM result is defined after the front-end FFT and IDFT as the square root of the ratio of the mean error vector power to the mean reference power expressed as a %. For CP-OFDM waveforms, the EVM result is defined after the front-end FFT as the square root of the ratio of the mean error vector power to the mean reference power expressed as a %.

The basic EVM measurement interval in the time domain is one preamble sequence for the PRACH and the duration of PUCCH/PUSCH channel, or one hop, if frequency hopping is enabled for PUCCH and PUSCH in the time domain. The EVM measurement interval is reduced by any symbols that contains an allowable power transient as defined in subclause 6.3.3.3.

6.4.2.1.2 Test applicability

This test case applies to all types of NR UE release 15 and forward.

6.4.2.1.3 Minimum conformance requirements

The RMS average of the basic EVM measurements for 10 sub-frames excluding any transient period for the average EVM case, and 60 sub-frames excluding any transient period for the reference signal EVM case, for the different

modulation schemes shall not exceed the values specified in Table 6.4.2.1.3-1 for the parameters defined in Table 6.4.2.1.3-2. For EVM evaluation purposes, all PRACH preamble formats 0-4 and all 5 PUCCH formats are considered to have the same EVM requirement as QPSK modulated.

Table 6.4.2.1.3-1: Requirements for Error Vector Magnitude

Parameter	Unit	Average EVM Level
Pi/2-BPSK	%	30
QPSK	%	17.5
16 QAM	%	12.5
64 QAM	%	8
256 QAM	%	3.5

Table 6.4.2.1.3-2: Parameters for Error Vector Magnitude

Parameter	Unit	Level
UE Output Power	dBm	\geq Table 6.3.1.3-1
UE Output Power for 256 QAM	dBm	\geq Table 6.3.1-1 + 10 dB
Operating conditions		Normal conditions

The normative reference for this requirement is TS 38.101 [2] clause 6.4.2.1.

6.4.2.1.4 Test description

6.4.2.1.4.1 Initial conditions

Initial conditions are a set of test configurations the UE needs to be tested in and the steps for the SS to take with the UE to reach the correct measurement state.

The initial test configurations consist of environmental conditions, test frequencies, test channel bandwidths and sub-carrier spacing based on NR operating bands specified in Table 5.3.5-1. All of these configurations shall be tested with applicable test parameters for each combination of channel bandwidth and sub-carrier spacing, are shown in table 6.4.2.1.4.1-1. The details of the uplink and downlink reference measurement channels (RMCs) are specified in Annexes A.2 and A.3. Configurations of PDSCH and PDCCH before measurement are specified in Annex C.2.

Table 6.4.2.1.4.1-1: Test Configuration Table for PUSCH

Initial Conditions			
Test Environment as specified in TS 38.508-1 [5] subclause 4.1		Normal	
Test Frequencies as specified in TS 38.508-1 [5] subclause 4.3.1		Low range, Mid range, High range (NOTE 4)	
Test Channel Bandwidths as specified in TS 38.508-1 [5] subclause 4.3.1		Lowest, Highest	
Test SCS as specified in Table 5.3.5-1		All	
Test Parameters			
Test ID	Downlink Configuration	Uplink Configuration	
		Modulation (NOTE 3)	RB allocation (NOTE 1)
	N/A	DFT-s-OFDM PI/2 BPSK	Inner Full
1 ³		DFT-s-OFDM PI/2 BPSK	Outer Full
2 ³		DFT-s-OFDM QPSK	Inner Full
3		DFT-s-OFDM QPSK	Outer Full
4		DFT-s-OFDM 16 QAM	Inner Full
5		DFT-s-OFDM 16 QAM	Outer Full
6		DFT-s-OFDM 64 QAM	Outer Full
7		DFT-s-OFDM 256 QAM	Outer Full
8		CP-OFDM QPSK	Inner Full
9		CP-OFDM QPSK	Outer Full
10		CP-OFDM 16 QAM	Inner Full
11		CP-OFDM 16 QAM	Outer Full
12		CP-OFDM 64 QAM	Outer Full
13		CP-OFDM 256 QAM	Outer Full
14			
NOTE 1: The specific configuration of each RB allocation is defined in Table 6.1-1.			
NOTE 2: Test Channel Bandwidths are checked separately for each NR band, which applicable channel bandwidths are specified in Table 5.3.5-1.			
NOTE 3: DFT-s-OFDM PI/2 BPSK test applies only for UEs which supports half Pi BPSK in FR1.			
NOTE 4: For NR band n28, 30MHz test channel bandwidth is tested with Low range and High range test frequencies.			

Table 6.4.2.1.4.1-2: Test Configuration Table for PUCCH

Initial Conditions					
Test Environment as specified in TS 38.508-1 [5] subclause 4.1		Normal			
Test Frequencies as specified in TS 38.508-1 [5] subclause 4.3.1		See Table 6.4.2.1.4.1-1			
Test Channel Bandwidths as specified in TS 38.508-1 [5] subclause 4.3.1		See Table 6.4.2.1.4.1-1			
Test SCS as specified in Table 5.3.5-1		See Table 6.4.2.1.4.1-1			
Test Parameters					
ID	Downlink Configuration		Uplink Configuration		
	Modulation	RB allocation	Waveform	PUCCH format	RB index
1	CP-OFDM QPSK	Full RB (Note 1)	CP-OFDM	PUCCH format = Format 1 (Note 4) Length in OFDM symbols = 14	0
2	CP-OFDM QPSK	Full RB (Note 1)	CP-OFDM	PUCCH format = Format (Note 4)1 Length in OFDM symbols = 14	$N_{RB}-1$
3	CP-OFDM QPSK	Full RB (Note 1)	DFT-s-OFDM	PUCCH format = Format 3 (Note 3) Length in OFDM symbols = 14	0
4	CP-OFDM QPSK	Full RB (Note 1)	DFT-s-OFDM	PUCCH format = Format 3 (Note 3) Length in OFDM symbols = 14	$N_{RB}-1$
NOTE 1: Full RB allocation shall be used per each SCS and channel BW as specified in Table 7.3.2.4.1-2.					
NOTE 2: Test Channel Bandwidths are checked separately for each NR band, which applicable channel bandwidths are specified in Table 5.3.5-1.					
NOTE 3: For FDD, set K1 value (PDSCH-to-HARQ-timing-indicator) as follows: $K1 = 2$ if $\text{mod}(i,5) = 0$ $K1 = 2$ if $\text{mod}(i,5) = 1$ $K1 = 4$ if $\text{mod}(i,5) = 2$ $K1 = 3$ if $\text{mod}(i,5) = 3$ $K1 = 2$ if $\text{mod}(i,5) = 4$ where i is slot index per frame					
NOTE 4: For PUCCH format = Format 1, TDD and SCS 30 kHz, schedule the DL RMC as follows: if $\text{mod}(i,10) = 3$: Scheduled Other slots: Not scheduled where i is slot index per frame					

Table 6.4.2.1.4.1-3: Test Configuration for PRACH

Initial Conditions		
Test Environment as specified in TS 38.508-1 [5] subclause 4.1		Normal
Test Frequencies as specified in TS 38.508-1 [5] subclause 4.3.1		See Table 6.4.2.1.4.1-1
Test Channel Bandwidths as specified in TS 38.508-1 [5] subclause 4.3.1		See Table 6.4.2.1.4.1-1
Test SCS as specified in Table 5.3.5-1		SCS defined in TS 38.211 [8] subclause 6.3.3.2 determined by PRACH Configuration Index
PRACH preamble format		
	FDD	TDD
PRACH Configuration Index	17	12
RS EPRE setting for test point 1 (dBm/15kHz)	-71	
RS EPRE setting for test point 2 (dBm/15kHz)	-86	

1. Connect the SS to the UE antenna connectors as shown in TS 38.508-1 [5] Annex A, in Figure A.3.1.1.1 for TE diagram and section A.3.2 for UE diagram.
2. The parameter settings for the cell are set up according to TS 38.508-1 [5] subclause 4.4.3.
3. Downlink signals are initially set up according to Annex C.0, C.1, C.2, and uplink signals according to Annex G.0, G.1, G.2, G.3.0.

4. The UL Reference Measurement channels are set according to Table 6.4.2.1.4.1-1.
5. Propagation conditions are set according to Annex B.0.
6. Ensure the UE is in state RRC_CONNECTED with generic procedure parameters Connectivity *NR*, Connected without release *On*, Test Mode *On* and Test Loop Function *On* according to TS 38.508-1 [5] clause 4.5. Message contents are defined in clause 6.4.2.1.4.3

6.4.2.1.4.2 Test procedure

Test procedure for PUSCH:

- 1.1. SS sends uplink scheduling information for each UL HARQ process via PDCCH DCI format 0_1 for C_RNTI to schedule the UL RMC according to Table 6.4.2.1.4.1-1. Since the UE has no payload data to send, the UE transmits uplink MAC padding bits on the UL RMC.
- 1.2. Send continuously uplink power control "up" commands in the uplink scheduling information to the UE until the UE transmits at P_{UMAX} level, allow at least 200ms starting from the first TPC command in this step for the UE to reach P_{UMAX} level.
- 1.3. Measure the EVM and \overline{EVM}_{DMRS} using Global In-Channel Tx-Test (Annex E). For TDD, only slots consisting of only UL symbols are under test.
- 1.4. For modulations except 256QAM, send uplink power control commands to the UE using 1dB power step size to ensure that the UE output power measured by the test system is within the Uplink power control window, defined as +MU to +(MU + Uplink power control window size) dB of the target power level P_{min} , where:
 - P_{min} is the minimum output power according to Table 6.3.1.3-1.
 - MU is the test system uplink power measurement uncertainty and is specified in Table F.1.2-1 for the carrier frequency f and the channel bandwidth BW.
 - Uplink power control window size = 1dB (UE power step size) + 0.7dB (UE power step tolerance) + (Test system relative power measurement uncertainty), where, the UE power step tolerance is specified in TS 38.101-1 [2], Table 6.3.4.3-1 and is 0.7dB for 1dB power step size, and the Test system relative power measurement uncertainty is specified in Table F.1.2-1.

For 256 QAM, send uplink power control commands to the UE using 1dB power step size to ensure that the UE output power measured by the test system is within the Uplink power control window, defined as +MU to +(MU + Uplink power control window size) dB of the target power level $P_{min} + 10$ dB, where P_{min} , MU and Uplink power control window size are defined above.

- 1.5. Measure the EVM and \overline{EVM}_{DMRS} using Global In-Channel Tx-Test (Annex E). For TDD, only slots consisting of only UL symbols are under test.

NOTE1: When switching to DFT-s-OFDM waveform, as specified in the test configuration table 6.4.2.1.4.1-1, send an NR RRCReconfiguration message according to TS 38.508-1 [5] clause 4.6.3 Table 4.6.3-118 PUSCH-Config with TRANSFORM_PRECODER_ENABLED condition.

NOTE2: The purpose of the Uplink power control window is to ensure that the actual UE output power is no less than the target power level, and as close as possible to the target power level. The relationship between the Uplink power control window, the target power level and the corresponding possible actual UE Uplink power window is illustrated in Annex F.4.2.

Table 6.4.2.1.4.2-1: Void

Test procedure for PUCCH:

- 2.1. PUCCH is set according to Table 6.4.2.1.4.1-2.

- 2.2. SS transmits PDSCH via PDCCH DCI format 1_1 for C_RNTI to transmit the DL RMC according to Table 6.4.2.1.4.1-2. The SS sends downlink MAC padding bits on the DL RMC. The transmission of PDSCH will make the UE send uplink ACK/NACK using PUCCH. There is no PUSCH transmission.
- 2.3. SS send appropriate TPC commands for PUCCH to the UE until the UE transmit PUCCH at P_{UMAX} level. Allow at least 200ms starting from the first TPC command in this step for the UE to reach P_{UMAX} level.
- 2.4. Measure PUCCH EVM using Global In-Channel Tx-Test (Annex E).
- 2.5. Send uplink power control commands for PUCCH to the UE using 1dB power step size to ensure that the UE PUCCH output power measured by the test system is within the Uplink power control window, defined as $+MU$ to $+(MU + \text{Uplink power control window size})$ dB of the target power level P_{min} , where:
 - P_{min} is the minimum output power according to Table 6.3.1.3-1.
 - MU is the test system uplink power measurement uncertainty and is specified in Table F.1.2-1 for the carrier frequency f and the channel bandwidth BW .
 - Uplink power control window size = 1dB (UE power step size) + 2.0dB (UE power step tolerance) + (Test system relative power measurement uncertainty), where, the UE power step tolerance is specified in TS 38.101-1 [2], Table 6.3.4.3-1 and is 2.0dB for 1dB power step size, and the Test system relative power measurement uncertainty is specified in Table F.1.2-1.
- 2.6. Measure PUCCH EVM using Global In-Channel Tx-Test (Annex E).

NOTE1: When switching to DFT-s-OFDM waveform, as specified in the test configuration table 6.4.2.1.4.1-2, send an NR RRCReconfiguration message according to TS 38.508-1 [5] clause 4.6.3 Table 4.6.3-118 PUSCH-Config with TRANSFORM_PRECODER_ENABLED condition.

NOTE2: The purpose of the Uplink power control window is to ensure that the actual UE output power is no less than the target power level, and as close as possible to the target power level. The relationship between the Uplink power control window, the target power level and the corresponding possible actual UE Uplink power window is illustrated in Annex F.4.2.

Test procedure for PRACH:

- 3.1. The SS shall set RS EPRE according to Table 6.4.2.1.4.1-3.
- 3.2. PRACH is set according to Table 6.4.2.1.4.1-3.
- 3.3. The SS shall signal a Random Access Preamble ID via a PDCCH order to the UE and initiate a Non-contention based Random Access procedure.
- 3.4. The UE shall send the signalled preamble to the SS.
- 3.5. In response to the preamble, the SS shall transmit a random access response not corresponding to the transmitted random access preamble, or send no response.
- 3.6. The UE shall consider the random access response reception not successful then re-transmit the preamble with the calculated PRACH transmission power.
- 3.7. Repeat step 5 and 6 until the SS collect enough PRACH preambles. Measure the EVM in PRACH channel using Global In-Channel Tx-Test (Annex E).

6.4.2.1.4.3 Message contents

Message contents are according to TS 38.508-1 [5] subclause 4.6 with the following exceptions:

Table 6.4.2.1.4.3-1: RACH-ConfigCommon: PRACH measurement

Derivation Path: TS 38.508-1[5], Table 4.6.3-128			
Information Element	Value/remark	Comment	Condition
RACH-ConfigCommon ::= SEQUENCE {			
rach-ConfigGeneric	RACH-ConfigGeneric		
totalNumberOfRA-Preambles	Not present		
ssb-perRACH-OccasionAndCB-PreamblesPerSSB CHOICE {			
one	n8		FR1
}			
groupBconfigured	Not present		
ra-ContentionResolutionTimer	sf64		
rsrp-ThresholdSSB	RSRP-Range		
rsrp-ThresholdSSB-SUL	Not present		
	RSRP-Range		SUL
prach-RootSequenceIndex CHOICE {			
l139	Set according to table 4.4.2-2 for the NR Cell.		PRACH Format A3
l839	0	NR Cell 1	PRACH Format 0
	TBD	Other than NR Cell 1	PRACH Format 0
}			
msg1-SubcarrierSpacing	SubcarrierSpacing		
restrictedSetConfig	unrestrictedSet		
msg3-transformPrecoder	Not present	transform precoding is disabled for Msg3 PUSCH transmission and any PUSCH transmission scheduled with DCI format 0_0	
}			

Table 6.4.2.1.4.3-2: RACH-ConfigGeneric: PRACH measurement

Derivation Path: TS 38.508-1[5], Table 4.6.3-130			
Information Element	Value/remark	Comment	Condition
RACH-ConfigGeneric ::= SEQUENCE {			
prach-ConfigurationIndex	17	Paired Spectrum	PRACH Format 0
	12	Unpaired Spectrum	PRACH Format 0
msg1-FDM	four		FR1
msg1-FrequencyStart	0		
zeroCorrelationZoneConfig	15		
preambleReceivedTargetPower	-92		Test point 1
	-74		Test point 2
preambleTransMax	n7		
powerRampingStep	dB0		
ra-ResponseWindow	sl20		
}			

Table 6.4.2.1.4.3-3: PUSCH-TimeDomainResourceAllocationList: PRACH measurement

Derivation Path: TS 38.508-1[5], Table 4.6.3-122			
Information Element	Value/remark	Comment	Condition
PUSCH-TimeDomainResourceAllocationList ::= SEQUENCE (SIZE(1..maxNrofUL-Allocations)) OF PUSCH-TimeDomainResourceAllocation {	2 entries		
PUSCH-TimeDomainResourceAllocation[2]		entry 2 addressed by Msg3 PUSCH time resource allocation field of the Random Access Response acc. to TS 38.213 [22] Table 8.2-1.	
SEQUENCE {			
k2	6	K2+ Δ=8 acc. to TS 38.214 [21] Table 6.1.2.1.1-5	Unpaired Spectrum for SCS15kHz and PRACH Format 0
}			
}			

Table 6.4.2.1.4.3-4: PDSCH-ServingCellConfig: PUCCH format3 measurement

Derivation Path: TS 38.508-1[15], Table 4.6.3-102			
Information Element	Value/remark	Comment	Condition
PDSCH-ServingCellConfig ::= SEQUENCE {			
codeBlockGroupTransmission	Not present		
xOverhead	Not present		
nrofHARQ-ProcessesForPDSCH	n6		FDD
pucch-Cell	Not present		
maxMIMO-Layers	Not present		
processingType2Enabled	Not present		
pdsch-CodeBlockGroupTransmissionList-r16	Not present		
}			

6.4.2.1.5 Test requirement

The PUSCH EVM, derived in Annex E.4.2, shall not exceed the values in Table 6.4.2.1.5-1.

The PUSCH \overline{EVM}_{DMRS} , derived in Annex E.4.6.2, shall not exceed the values in Table 6.4.2.1.5-1 when embedded with data symbols of the respective modulation scheme.

Table 6.4.2.1.5-1: Test requirements for Error Vector Magnitude

Parameter	Unit	Average EVM Level
Pi/2-BPSK	%	30 + TT
QPSK	%	17.5 + TT
16 QAM	%	12.5 + TT
64 QAM	%	8 + TT
256 QAM	%	3.5 + TT
Note 1: TT is defined in Table 6.4.2.1.5-2.		

Table 6.4.2.1.5-2: Test Tolerance

Parameter	Unit	Average EVM Level
Pi/2-BPSK	%	0
QPSK	%	0
16 QAM	%	0
64 QAM	%	0
256 QAM	%	0.3 for 15 dBm < P _{UL} 0.8 for -25 dBm < P _{UL} ≤ 15 dBm 1.1 for -40dBm ≤ P _{UL} ≤ -25dBm

The PUCCH EVM derived in Annex E.5.9.2 shall not exceed 17.5 %.

The PRACH EVM derived in Annex E.6.9.2 shall not exceed 17.5%.

6.4.2.1a Error Vector Magnitude including symbols with transient period

6.4.2.1a.1 Test Purpose

The Error Vector Magnitude is a measure of the difference between the reference waveform and the measured waveform. This difference is called the error vector. Before calculating the EVM the measured waveform is corrected by the sample timing offset and RF frequency offset. Then the carrier leakage shall be removed from the measured waveform before calculating the EVM.

6.4.2.1a.2 Test applicability

This test case applies to all types of NR UE release 16 and forward that support short transient period capability.

6.4.2.1a.3 Minimum conformance requirements

In 6.4.2.1, EVM has been defined by excluding the symbols which have a transient period. In this section, measurement interval is defined for the symbols with a transient period to include these symbols in the RMS average EVM computation when the UE reports a transient period capability other than the default. Before calculating the EVM, the measured waveform is corrected for sample timing offset and RF frequency offset. Then the carrier leakage shall be removed from the measured waveform before calculating the EVM. The symbols with transient period should not be used for equalization. Only CP-OFDM waveform is used for conformance testing.

In the case of PUSCH or PUCCH transmissions when the mean power, modulation or RB allocation across slot or subslot boundaries is expected to change the EVM result over the symbols where the transient occurs is calculated according to Table 6.4.2.1a.3-1.

Table 6.4.2.1a.3-1: EVM definition for reported transient period

Reported transient capability (us)	EVM definition	tp _{start} (μs)	SCS ⁴
2	$EVM_{after} = \max(\overline{EVM_{l,tp}}, \overline{EVM_h})$ $EVM_{before} = \max(\overline{EVM_l}, \overline{EVM_{h,tp}})$	-0.5	15kHz or 30kHz ⁵
4	$EVM_{after} = \max(\overline{EVM_{l,tp}}, \overline{EVM_h})$ $EVM_{before} = \max(\overline{EVM_l}, \overline{EVM_{h,tp}})$	-1	15kHz
7	$EVM_{after} = \min(\overline{EVM_{l,tp}}, \overline{EVM_h})$ $EVM_{before} = \max(\overline{EVM_l}, \overline{EVM_{h,tp}})$	-2.7	15kHz

NOTE 1: $\overline{EVM_l}$, $\overline{EVM_h}$, $\overline{EVM_{l,tp}}$, and $\overline{EVM_{h,tp}}$ are defined in Annex E.4.7
NOTE 2: EVM_{after} is the EVM for a symbol right after a transition; EVM_{before} is the EVM for a symbol right before a transition
NOTE 3: tp_{start} denotes the start position of the EVM exclusion window as shown in Annex E.4.7
NOTE 4: SCS denotes the SCS that can be used in the conformance test
NOTE 5: 30kHz shall be used in the conformance test unless the UE signals in *supportedSubCarrierSpacingUL* in *FeatureSetPerCC* that it only supports 15kHz in the corresponding band

The RMS average of the basic EVM measurements over 108 subframes for the symbols where the transient occurs for the different modulation schemes shall not exceed the values specified in Table 6.4.2.1a.3-2 for the parameters defined in Table 6.4.2.1a.3-3. This requirement can be verified with 64 QAM and 256 QAM modulation.

Table 6.4.2.1a.3-2: Requirements for Error Vector Magnitude

Parameter	Unit	Average EVM Level
64 QAM	%	10
256 QAM	%	8

Table 6.4.2.1a.3-3: Parameters for Error Vector Magnitude

Parameter	Unit	Level
UE Output Power	dBm	≥ Table 6.3.1-1
UE Output Power for 256 QAM	dBm	≥ Table 6.3.1-1 + 10 dB
Operating conditions		Normal conditions

The normative reference for this requirement is TS 38.101 [2] clause 6.4.2.1a.

6.4.2.1a.4 Test description

6.4.2.1a.4.1 Initial conditions

Initial conditions are a set of test configurations the UE needs to be tested in and the steps for the SS to take with the UE to reach the correct measurement state.

The initial test configurations consist of environmental conditions, test frequencies, test channel bandwidths and sub-carrier spacing based on NR operating bands specified in Table 5.3.5-1. All of these configurations shall be tested with applicable test parameters for each combination of channel bandwidth and sub-carrier spacing, are shown in table 6.4.2.1a.4.1-1. The details of the uplink and downlink reference measurement channels (RMCs) are specified in Annexes A.2 and A.3. Configurations of PDSCH and PDCCH before measurement are specified in Annex C.2.

Table 6.4.2.1a.4.1-1: Test Configuration Table for PUSCH

Initial Conditions			
Test Environment as specified in TS 38.508-1 [5] subclause 4.1		Normal	
Test Frequencies as specified in TS 38.508-1 [5] subclause 4.3.1		Low range, Mid range, High range (NOTE 4)	
Test Channel Bandwidths as specified in TS 38.508-1 [5] subclause 4.3.1		Lowest, Highest	
Test SCS as specified in Table 5.3.5-1		15 kHz (Note 3)	
Test Parameters			
Test ID	Downlink Configuration	Uplink Configuration	
	N/A	Modulation	RB allocation (NOTE 1)
1		CP-OFDM 64 QAM	Outer Full
2		CP-OFDM 256 QAM	Outer Full
NOTE 1: The specific configuration of each RB allocation is defined in Table 6.1-1.			
NOTE 2: Test Channel Bandwidths are checked separately for each NR band, which applicable channel bandwidths are specified in Table 5.3.5-1.			
NOTE 3: For UE supporting 2 us transient period, 30kHz shall be used in the conformance test unless the UE signals in <i>supportedSubCarrierSpacingUL</i> in <i>FeatureSetPerCC</i> that it only supports 15kHz in the corresponding band.			
NOTE 4: For NR band n28, 30MHz test channel bandwidth is tested with Low range and High range test frequencies.			

1. Connect the SS to the UE antenna connectors as shown in TS 38.508-1 [5] Annex A, in Figure A.3.1.1.1 for TE diagram and section A.3.2 for UE diagram.
2. The parameter settings for the cell are set up according to TS 38.508-1 [5] subclause 4.4.3.

3. Downlink signals are initially set up according to Annex C.0, C.1, C.2, and uplink signals according to Annex G.0, G.1, G.2, G.3.0.
4. The UL Reference Measurement channels are set according to Table 6.4.2.1a.4.1-1.
5. Propagation conditions are set according to Annex B.0.
6. Ensure the UE is in state RRC_CONNECTED with generic procedure parameters Connectivity *NR*, Connected without release *On*, Test Mode *On* and Test Loop Function *On* according to TS 38.508-1 [5] clause 4.5. Message contents are defined in clause 6.4.2.1a.4.3

6.4.2.1a.4.2 Test procedure

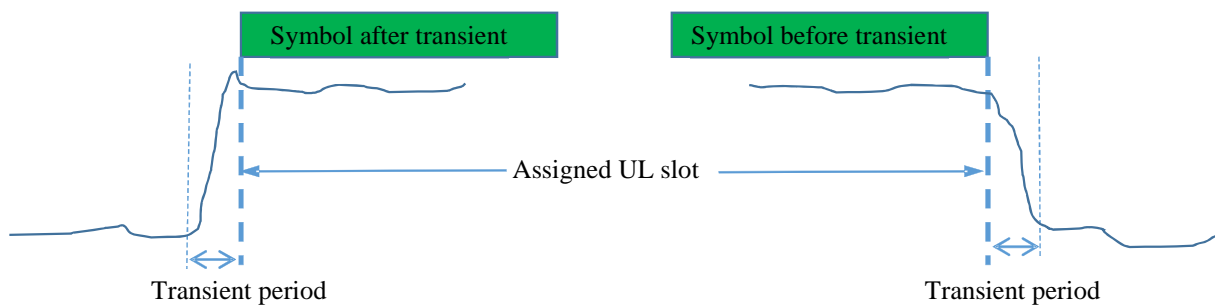

Figure 6.4.2.1a.4.2-1: Error Vector Magnitude including symbols with transient period

1. SS sends uplink scheduling information for each UL HARQ process via PDCCH DCI format 0_1 for C_RNTI to schedule the UL RMC according to Table 6.4.2.1a.4.1-1. Since the UE has no payload data to send, the UE transmits uplink MAC padding bits on the UL RMC. The UL assignment is such that the UE transmits on slots 8 for 15 kHz SCS, on slots 8 and 18 for 30 kHz SCS and on slots 17 and 37 for 60 kHz SCS.
2. Send continuously uplink power control "up" commands in the uplink scheduling information to the UE until the UE transmits at P_{UMAX} level, allow at least 200ms starting from the first TPC command in this step for the UE to reach P_{UMAX} level.
3. Measure the EVM and \overline{EVM}_{DMRS} using Global In-Channel Tx-Test (Annex E) applying tp_{start} of Table 6.4.2.1a.3-1 according to the declared enhanced transient capability. For TDD, only slots consisting of only UL symbols are under test as indicated in Figure 6.4.2.1a.4.2-1.
4. For CP-OFDM 64 QAM modulations, send uplink power control commands to the UE using 1dB power step size to ensure that the UE output power measured by the test system is within the Uplink power control window, defined as $+MU$ to $+(MU + \text{Uplink power control window size})$ dB of the target power level P_{min} , where:
 - P_{min} is the minimum output power according to Table 6.3.1.3-1.
 - MU is the test system uplink power measurement uncertainty and is specified in Table F.1.2-1 for the carrier frequency f and the channel bandwidth BW .
 - Uplink power control window size = 1dB (UE power step size) + 0.7dB (UE power step tolerance) + (Test system relative power measurement uncertainty), where the UE power step tolerance is specified in TS 38.101-1 [2], Table 6.3.4.3-1 and is 0.7dB for 1dB power step size, and the Test system relative power measurement uncertainty is specified in Table F.1.2-1.

For CP-OFDM 256 QAM modulations, send uplink power control commands to the UE using 1dB power step size to ensure that the UE output power measured by the test system is within the Uplink power control window, defined as $+MU$ to $+(MU + \text{Uplink power control window size})$ dB of the target power level $P_{min} + 10$ dB, where P_{min} , MU and Uplink power control window size are defined above.

5. Measure the EVM and \overline{EVM}_{DMRS} using Global In-Channel Tx-Test (Annex E) applying tp_{start} of Table 6.4.2.1a.3-1 according to the declared enhanced transient capability. For TDD, only slots consisting of only UL symbols are under test.

NOTE: The purpose of the Uplink power control window is to ensure that the actual UE output power is no less than the target power level, and as close as possible to the target power level. The relationship between the Uplink power control window, the target power level and the corresponding possible actual UE Uplink power window is illustrated in Annex F.4.2.

6.4.2.1a.4.3 Message contents

Message contents are according to TS 38.508-1 [5] subclause 4.6 with the following exceptions:

Table 6.4.2.1a.4.3-1: TDD-UL-DL-Config

Derivation Path: TS 38.508-1[5], Table 4.6.3-192			
Information Element	Value/remark	Comment	Condition
TDD-UL-DL-ConfigCommon ::= SEQUENCE {			
referenceSubcarrierSpacing	SubcarrierSpacing		
pattern1 SEQUENCE {			
dl-UL-TransmissionPeriodicity	ms5		FR1
	ms10		FR1_15kHz
nrofDownlinkSlots	6		FR1_15kHz
	6		FR1_30kHz
	14		FR1_60kHz
nrofDownlinkSymbols	10		FR1_15kHz
	6		FR1_30kHz
	12		FR1_60kHz
nrofUplinkSlots	3		FR1_15kHz, FR1_30kHz
	4		FR1_60kHz
nrofUplinkSymbols	4		FR1_30kHz
	2		FR1_15kHz,
	8		FR1_60kHz
}			
pattern2	Not present		
}			

6.4.2.1a.5 Test requirement

The PUSCH EVM, derived in Annex E.4.2, shall not exceed the values in Table 6.4.2.1a.5-1.

The PUSCH \overline{EVM}_{DMRS} , derived in Annex E.4.6.2, shall not exceed the values in Table 6.4.2.1a.5-1 when embedded with data symbols of the respective modulation scheme.

Table 6.4.2.1a.5-1: Test requirements for Error Vector Magnitude

Parameter	Unit	Average EVM Level
64 QAM	%	10 + TT
256 QAM	%	8 + TT
Note 1: TT is defined in Table 6.4.2.1a.5-2.		

Table 6.4.2.1a.5-2: Test Tolerance

Parameter	Unit	Average EVM Level
64 QAM	%	0
256 QAM	%	0.3 for $15 \text{ dBm} < P_{UL}$ 0.8 for $-25 \text{ dBm} < P_{UL} \leq 15 \text{ dBm}$ 1.1 for $-40 \text{ dBm} \leq P_{UL} \leq -25 \text{ dBm}$

6.4.2.2 Carrier leakage

6.4.2.2.1 Test purpose

Carrier leakage expresses itself as unmodulated sine wave with the carrier frequency or centre frequency of aggregated transmission bandwidth configuration. It is an interference of approximately constant amplitude and independent of the amplitude of the wanted signal.

The purpose of this test is to exercise the UE transmitter to verify its modulation quality in terms of carrier leakage.

6.4.2.2.2 Test applicability

This test case applies to all types of NR UE release 15 and forward.

6.4.2.2.3 Minimum conformance requirements

Carrier leakage is an additive sinusoid waveform whose frequency is the same as the modulated waveform carrier frequency. The measurement interval is one slot in the time domain.

In the case that uplink sharing, the carrier leakage may have 7.5 kHz shift with the carrier frequency.

The relative carrier leakage power is a power ratio of the additive sinusoid waveform and the modulated waveform. The relative carrier leakage power shall not exceed the values specified in Table 6.4.2.2.3-1.

Table 6.4.2.2.3-1: Requirements for Carrier Leakage

Parameter	Relative Limit (dBc)
Output power > 10 dBm	-28
$0 \text{ dBm} \leq \text{Output power} \leq 10 \text{ dBm}$	-25
$-30 \text{ dBm} \leq \text{Output power} < 0 \text{ dBm}$	-20
$-40 \text{ dBm} \leq \text{Output power} < -30 \text{ dBm}$	-10

The normative reference for this requirement is TS 38.101-1 [2] clause 6.4.2.2.

6.4.2.2.4 Test description

6.4.2.2.4.1 Initial condition

Initial conditions are a set of test configurations the UE needs to be tested in and the steps for the SS to take with the UE to reach the correct measurement state.

The initial test configurations consist of environmental conditions, test frequencies, test channel bandwidths and sub-carrier spacing based on NR operating bands specified in Table 5.3.5-1. All of these configurations shall be tested with applicable test parameters for each combination of channel bandwidth and sub-carrier spacing, are shown in table 6.4.2.2.4.1-1. The details of the uplink and downlink reference measurement channels (RMCs) are specified in Annexes A.2 and A.3. Configurations of PDSCH and PDCCH before measurement are specified in Annex C.2.

Table 6.4.2.2.4.1-1: Test Configuration

Initial Conditions			
Test Environment as specified in TS 38.508-1 [5] subclause 4.1		Normal	
Test Frequencies as specified in TS 38.508-1 [5] subclause 4.3.1		Low range, Mid range, High range	
Test Channel Bandwidths as specified in TS 38.508-1 [5] subclause 4.3.1		Mid	
Test SCS as specified in Table 5.3.5-1		Lowest	
Test Parameters			
Test ID	Downlink Configuration	Uplink Configuration	
	N/A	Modulation	RB allocation (NOTE 1, 3)
1		DFT-s-OFDM QPSK	Inner_1RB_Left
NOTE 1: The specific configuration of each RB allocation is defined in Table 6.1-1.			
NOTE 2: Test Channel Bandwidths are checked separately for each NR band, which applicable channel bandwidths are specified in Table 5.3.5-1.			
NOTE 3: When the signalled DC carrier position is at Inner_1RB_Left, use Inner_1RB_Right for UL RB allocation.			

1. Connect the SS to the UE antenna connectors as shown in TS 38.508-1 [5] Annex A, in Figure A.3.1.1.1 for TE diagram and section A.3.2 for UE diagram.
2. The parameter settings for the cell are set up according to TS 38.508-1 [5] subclause 4.4.3.
3. Downlink signals are initially set up according to Annex C.0, C.1, C.2 and uplink signals according to Annex G.0, G.1, G.2, G.3.0.
4. The UL Reference Measurement channels are set according to Table 6.4.2.2.4.1-1.
5. Propagation conditions are set according to Annex B.0.
6. Ensure the UE is in state RRC_CONNECTED with generic procedure parameters Connectivity NR, Connected without release On, Test Mode On and Test Loop Function On according to TS 38.508-1 [5] clause 4.5. Message contents are defined in clause 6.4.2.2.4.3.
7. In case the parameter 3300 or 3301 is reported from the UE via *txDirectCurrentLocation* IE, do not proceed to test procedure and mark the test not applicable with reasoning in the test report.

6.4.2.2.4.2 Test procedure

1. SS sends uplink scheduling information for each UL HARQ process via PDCCH DCI format 0_1 for C_RNTI to schedule the UL RMC according to Table 6.4.2.2.4.1-1. Since the UE has no payload and no loopback data to send the UE sends uplink MAC padding bits on the UL RMC.
2. Send uplink power control commands to the UE using 1dB power step size to ensure that the UE output power measured by the test system is within the Uplink power control window, defined as +MU to +(MU + Uplink power control window size) dB of the target power level 10 dBm, where:
 - MU is the test system uplink power measurement uncertainty and is specified in Table F.1.2-1 for the carrier frequency f and the channel bandwidth BW.
 - Uplink power control window size = 1dB (UE power step size) + 0.7 dB (UE power step tolerance) + (Test system relative power measurement uncertainty), where, the UE power step tolerance is specified in TS 38.101-1 [2], Table 6.3.4.3-1 and is 0.7dB for 1dB power step size, and the Test system relative power measurement uncertainty is specified in Table F.1.2-1.
3. Measure carrier leakage using Global In-Channel Tx-Test (Annex E). For TDD, only slots consisting of only UL symbols are under test.
4. Send uplink power control commands to the UE using 1dB power step size to ensure that the UE output power measured by the test system is within the Uplink power control window, defined as +MU to +(MU + Uplink

power control window size) dB of the target power level 0 dBm, where MU and Uplink power control window size are defined above.

5. Measure carrier leakage using Global In-Channel Tx-Test (Annex E). For TDD, only slots consisting of only UL symbols are under test.
6. Send uplink power control commands to the UE using 1dB power step size to ensure that the UE output power measured by the test system is within the Uplink power control window, defined as +MU to +(MU + Uplink power control window size) dB of the target power level -30 dBm, where MU and Uplink power control window size are defined above.
7. Measure carrier leakage using Global In-Channel Tx-Test (Annex E). For TDD, only slots consisting of only UL symbols are under test.
8. Send uplink power control commands to the UE using 1dB power step size to ensure that the UE output power measured by the test system is within the Uplink power control window, defined as +MU to +(MU + Uplink power control window size) dB of the target power level P_{min} , where MU and Uplink power control window size are defined above, P_{min} is the minimum output power according to Table 6.3.1.3-1.
9. Measure carrier leakage using Global In-Channel Tx-Test (Annex E). For TDD, only slots consisting of only UL symbols are under test.

NOTE: The purpose of the Uplink power control window is to ensure that the actual UE output power is no less than the target power level, and as close as possible to the target power level. The relationship between the Uplink power control window, the target power level and the corresponding possible actual UE Uplink power window is illustrated in Annex F.4.2.

Table 6.4.2.2.4.2-1: Void

Table 6.4.2.1.4.2-2: Void

6.4.2.2.4.3 Message contents

Message contents are according to TS 38.508-1 [5] subclause 4.6 with the following exception:

Table 6.4.2.2.4.3-1: *PUSCH-Config*

Derivation Path: TS 38.508-1 [5], Table 4.6.3-118 with condition <code>TRANSFORM_PRECODER_ENABLED</code>

6.4.2.2.5 Test requirement

Each of the n carrier leakage results, derived in Annex E.3.1, shall not exceed the values in table 6.4.2.2.5-1. Allocated RBs are not under test.

Table 6.4.2.5-1: Test requirements for Relative Carrier Leakage Power

Parameters UE output power	Relative limit (dBc)
10 + MU to 10 + (MU + Uplink power control window size) dBm	-28 + TT
0 + MU to 0 + (MU + Uplink power control window size) dBm	-25 + TT
-30 + MU to -30 + (MU + Uplink power control window size) dBm	-20 + TT
Pmin + MU to Pmin + (MU + Uplink power control window size) dBm	-10 + TT
<p>NOTE 1: The measurement bandwidth is 1 RB and the limit is expressed as a ratio of measured power in one non-allocated RB to the measured total power in all allocated RBs.</p> <p>NOTE 2: The applicable frequencies for this limit depend on the parameter <i>txDirectCurrentLocation</i> in <i>UplinkTxDirectCurrent</i> IE, and are those that are enclosed either in the RBs containing the carrier leakage frequency, or in the two RBs immediately adjacent to the carrier leakage frequency but excluding any allocated RB.</p> <p>NOTE 3: N_{RB} is the Transmission Bandwidth Configuration (see Section 5.3).</p> <p>NOTE 4: MU is the test system uplink power measurement uncertainty and is specified in Table F.1.2-1 for the carrier frequency <i>f</i> and the channel bandwidth BW.</p> <p>NOTE 5: Uplink power control window size = 1dB (UE power step size) + 0.7dB (UE power step tolerance) + (Test system relative power measurement uncertainty), where, the UE power step tolerance is specified in TS 38.101-1 [2], Table 6.3.4.3-1 and is 0.7dB for 1dB power step size, and the Test system relative power measurement uncertainty is specified in Table F.1.2-1.</p> <p>NOTE 6: Test tolerance TT = 0.8 dB.</p> <p>NOTE 7: Pmin is the minimum output power according to Table 6.3.1.3-1.</p>	

6.4.2.3 In-band emissions

6.4.2.3.1 Test purpose

The in-band emissions are a measure of the interference falling into the non-allocated resources blocks

The in-band emission is defined as the average emission across 12 sub-carriers and as a function of the RB offset from the edge of the allocated UL transmission bandwidth. The in-band emission is measured as the ratio of the UE output power in a non-allocated RB to the UE output power in an allocated RB.

The basic in-band emissions measurement interval is defined over one slot in the time domain, however, the minimum requirement applies when the in-band emission measurement is averaged over 10 sub-frames. When the PUSCH or PUCCH transmission slot is shortened due to multiplexing with SRS, the in-band emissions measurement interval is reduced by one or more symbols, accordingly.

The purpose of this test is to exercise the UE transmitter to verify its modulation quality in terms of in-band emissions.

6.4.2.3.2 Test applicability

This test case applies to all types of NR UE release 15 and forward.

6.4.2.3.3 Minimum conformance requirements

The average of the basic in-band emission measurement over 10 sub-frames shall not exceed the values specified in Table 6.4.2.3.3-1.

Table 6.4.2.3.3-1: Requirements for in-band emissions

Parameter description	Unit	Limit (NOTE 1)		Applicable Frequencies
General	dB	$\max \left\{ -25 - 10 \cdot \log_{10} (N_{RB} / L_{CRB}), \right.$ $20 \cdot \log_{10} EVM - 3 - 5 \cdot (\Delta_{RB} - 1) / L_{CRB},$ $\left. -57 \text{ dBm} + 10 \log_{10} (SCS / 15 \text{ kHz}) - \overline{P_{RB}} \right\}$		Any non-allocated (NOTE 2)
IQ Image	dB	-28	Image frequencies when output power > 10 dBm	Image frequencies (NOTES 2, 3)
		-25	Image frequencies when output power ≤ 10 dBm	
Carrier leakage	dBc	-28	Output power > 10 dBm	Carrier leakage frequency (NOTES 4, 5)
		-25	0 dBm ≤ Output power ≤ 10 dBm	
		-20	-30 dBm ≤ Output power < 0 dBm	
		-10	-40 dBm ≤ Output power < -30 dBm	
<p>NOTE 1: An in-band emissions combined limit is evaluated in each non-allocated RB. For each such RB, the minimum requirement is calculated as the higher of $P_{RB} - 30$ dB and the power sum of all limit values (General, IQ Image or Carrier leakage) that apply. P_{RB} is defined in NOTE 10.</p> <p>NOTE 2: The measurement bandwidth is 1 RB and the limit is expressed as a ratio of measured power in one non-allocated RB to the measured average power per allocated RB, where the averaging is done across all allocated RBs.</p> <p>NOTE 3: The applicable frequencies for this limit are those that are enclosed in the reflection of the allocated bandwidth, based on symmetry with respect to the carrier leakage frequency, but excluding any allocated RBs.</p> <p>NOTE 4: The measurement bandwidth is 1 RB and the limit is expressed as a ratio of measured power in one non-allocated RB to the measured total power in all allocated RBs.</p> <p>NOTE 5: The applicable frequencies for this limit depend on the parameter <i>txDirectCurrentLocation</i> in <i>UplinkTxDirectCurrent</i> IE, and are those that are enclosed either in the RBs containing the carrier leakage frequency, or in the two RBs immediately adjacent to the carrier leakage frequency but excluding any allocated RB.</p> <p>NOTE 6: L_{CRB} is the Transmission Bandwidth (see Section 5.3).</p> <p>NOTE 7: N_{RB} is the Transmission Bandwidth Configuration (see Section 5.3).</p> <p>NOTE 8: EVM is the limit specified in Table 6.4.2.1.3-1 for the modulation format used in the allocated RBs.</p> <p>NOTE 9: Δ_{RB} is the starting frequency offset between the allocated RB and the measured non-allocated RB (e.g. $\Delta_{RB} = 1$ or $\Delta_{RB} = -1$ for the first adjacent RB outside of the allocated bandwidth).</p> <p>NOTE 10: $\overline{P_{RB}}$ is an average of the transmitted power over 10 sub-frames normalized by the number of allocated RBs, measured in dBm.</p>				

The normative reference for this requirement is TS 38.101-1 [2] clause 6.4.2.3.

6.4.2.3.4 Test description

6.4.2.3.4.1 Initial condition

Initial conditions are a set of test configurations the UE needs to be tested in and the steps for the SS to take with the UE to reach the correct measurement state.

The initial test configurations consist of environmental conditions, test frequencies, test channel bandwidths and sub-carrier spacing based on NR operating bands specified in Table 5.3.5-1. All of these configurations shall be tested with applicable test parameters for each combination of channel bandwidth and sub-carrier spacing, are shown in table 6.4.2.3.4.1-1. The details of the uplink and downlink reference measurement channels (RMCs) are specified in Annexes A.2 and A.3. Configurations of PDSCH and PDCCH before measurement are specified in Annex C.2.

Table 6.4.2.3.4.1-1: Test Configuration Table for PUSCH

Initial Conditions				
Test Environment as specified in TS 38.508-1 [5] subclause 4.1		Normal		
Test Frequencies as specified in TS 38.508-1 [5] subclause 4.3.1		Low range, Mid range, High range (NOTE 3)		
Test Channel Bandwidths as specified in TS 38.508-1 [5] subclause 4.3.1		Lowest, Mid, Highest		
Test SCS as specified in Table 5.3.5-1		Lowest		
Test Parameters				
Test ID	Downlink Configuration		Uplink Configuration	
	N/A		Modulation	RB allocation (NOTE 1)
1			DFT-s-OFDM QPSK	Inner_1RB_Left
2			DFT-s-OFDM QPSK	Inner_1RB_Right
3			CP-OFDM QPSK	Inner_1RB_Left
4			CP-OFDM QPSK	Inner_1RB_Right
NOTE 1: The specific configuration of each RB allocation is defined in Table 6.1-1.				
NOTE 2: Test Channel Bandwidths are checked separately for each NR band, which applicable channel bandwidths are specified in Table 5.3.5-1.				
NOTE 3: For NR band n28, 30MHz test channel bandwidth is tested with Low range and High range test frequencies.				

Table 6.4.2.3.4.1-2: Test Configuration Table for PUCCH

Initial Conditions					
Test Environment as specified in TS 38.508-1 [5] subclause 4.1		See Table 6.4.2.3.4.1-1			
Test Frequencies as specified in TS 38.508-1 [5] subclause 4.3.1		See Table 6.4.2.3.4.1-1			
Test Channel Bandwidths as specified in TS 38.508-1 [5] subclause 4.3.1		See Table 6.4.2.3.4.1-1			
Test SCS as specified in Table 5.3.5-1		See Table 6.4.2.3.4.1-1			
Test Parameters					
ID	Downlink Configuration		Uplink Configuration		
	Modulation	RB allocation	Waveform	PUCCH format	RB index
1	CP-OFDM QPSK	Full RB (Note 1)	DFT-s-OFDM	PUCCH format = Format 3 (Note 4) Length in OFDM symbols = 14	0
2	CP-OFDM QPSK	Full RB (Note 1)	DFT-s-OFDM	PUCCH format = Format 3 (Note 4) Length in OFDM symbols = 14	N _{RB} -1
3	CP-OFDM QPSK	Full RB (Note 1)	CP-OFDM	PUCCH format = Format 1 (Note 5) Length in OFDM symbols = 14	0
4	CP-OFDM QPSK	Full RB (Note 1)	CP-OFDM	PUCCH format = Format 1 (Note 5) Length in OFDM symbols = 14	N _{RB} -1
NOTE 1: Full RB allocation shall be used per each SCS and channel BW as specified in Table 7.3.2.4.1-2.					
NOTE 2: Test Channel Bandwidths are checked separately for each NR band, which applicable channel bandwidths are specified in Table 5.3.5-1.					
NOTE 3: DFT-s-OFDM PI/2 BPSK test applies only for UEs which supports half Pi BPSK in FR1.					
NOTE 4: For FDD, set K1 value (PDSCH-to-HARQ-timing-indicator) as follows: K1 = 2 if mod(i,5) = 0 K1 = 2 if mod(i,5) = 1 K1 = 4 if mod(i,5) = 2 K1 = 3 if mod(i,5) = 3 K1 = 2 if mod(i,5) = 4 where i is slot index per frame					
NOTE 5: For TDD and SCS 30 kHz, schedule the DL RMC as follows: if mod(i,10) = 3: Scheduled Other slots: Not scheduled where i is slot index per frame					

1. Connect the SS to the UE antenna connectors as shown in TS 38.508-1 [5] Annex A, in Figure A.3.1.1.1 for TE diagram and section A.3.2 for UE diagram.
2. The parameter settings for the cell are set up according to TS 38.508-1 [5] subclause 4.4.3.
3. Downlink signals are initially set up according to Annex C.0, C.1, C.2, and uplink signals according to Annex G.0, G.1, G.2, G.3.0.
4. The UL Reference Measurement channels are set according to Table 6.4.2.3.4.1-1.
5. Propagation conditions are set according to Annex B.0.
6. Ensure the UE is in state RRC_CONNECTED with generic procedure parameters Connectivity *NR*, Connected without release *On*, Test Mode *On* and Test Loop Function *On* according to TS 38.508-1 [5] clause 4.5. Message contents are defined in clause 6.4.2.3.4.3

6.4.2.3.4.2 Test procedure

Test procedure for PUSCH:

- 1.1. SS sends uplink scheduling information for each UL HARQ process via PDCCH DCI format 0_1 for C_RNTI to schedule the UL RMC according to Table 6.4.2.3.4.1-1. Since the UE has no payload and no loopback data to send the UE sends uplink MAC padding bits on the UL RMC.
- 1.2. Send uplink power control commands to the UE using 1dB power step size to ensure that the UE output power measured by the test system is within the Uplink power control window, defined as +MU to +(MU + Uplink power control window size) dB of the target power level 10 dBm, where:
 - MU is the test system uplink power measurement uncertainty and is specified in Table F.1.2-1 for the carrier frequency *f* and the channel bandwidth *BW*.
 - Uplink power control window size = 1dB (UE power step size) + 0.7dB (UE power step tolerance) + (Test system relative power measurement uncertainty), where, the UE power step tolerance is specified in TS 38.101-1 [2], Table 6.3.4.3-1 and is 0.7dB for 1dB power step size, and the Test system relative power measurement uncertainty is specified in Table F.1.2-1.
- 1.3. Measure In-band emission using Global In-Channel Tx-Test (Annex E). For TDD, only slots consisting of only UL symbols are under test.
- 1.4. Send uplink power control commands to the UE using 1dB power step size to ensure that the UE output power measured by the test system is within the Uplink power control window, defined as +MU to +(MU + Uplink power control window size) dB of the target power level 0 dBm, where MU and Uplink power control window size are defined above.
- 1.5. Measure In-band emission using Global In-Channel Tx-Test (Annex E). For TDD, only slots consisting of only UL symbols are under test.
- 1.6. Send uplink power control commands to the UE using 1dB power step size to ensure that the UE output power measured by the test system is within the Uplink power control window, defined as +MU to +(MU + Uplink power control window size) dB of the target power level -30 dBm, where MU and Uplink power control window size are defined above.
- 1.7. Measure In-band emission using Global In-Channel Tx-Test (Annex E). For TDD, only slots consisting of only UL symbols are under test.
- 1.8. Send uplink power control commands to the UE using 1dB power step size to ensure that the UE output power measured by the test system is within the Uplink power control window, defined as +MU to +(MU + Uplink power control window size) dB of the target power level *P_{min}*, where MU and Uplink power control window size are defined above and *P_{min}* is the minimum output power according to Table 6.3.1.3-1.
- 1.9. Measure In-band emission using Global In-Channel Tx-Test (Annex E). For TDD, only slots consisting of only UL symbols are under test.

NOTE1: When switching to DFT-s-OFDM waveform, as specified in the test configuration table 6.4.2.3.4.1-1, send an NR RRCReconfiguration message according to TS 38.508-1 [5] clause 4.6.3 Table 4.6.3-118 PUSCH-Config with TRANSFORM_PRECODER_ENABLED condition.

NOTE2: The purpose of the Uplink power control window is to ensure that the actual UE output power is no less than the target power level, and as close as possible to the target power level. The relationship between the Uplink power control window, the target power level and the corresponding possible actual UE Uplink power window is illustrated in Annex F.4.2.

Test procedure for PUCCH:

- 2.1. PUCCH is set according to Table 6.4.2.3.4.1-2. SS transmits PDSCH via PDCCH DCI format 1-1 for C_RNTI to transmit the DL RMC according to Table 6.4.2.3.4.1-2. The SS sends downlink MAC padding bits on the DL RMC. The transmission of PDSCH will make the UE send uplink ACK/NACK using PUCCH.
- 2.2. Send uplink power control commands for PUCCH to the UE using 1dB power step size to ensure that the UE output power measured by the test system is within the Uplink power control window, defined as +MU to +(MU + Uplink power control window size) dB of the target power level 10 dBm, where:
 - MU is the test system uplink power measurement uncertainty and is specified in Table F.1.2-1 for the carrier frequency f and the channel bandwidth BW.
 - Uplink power control window size = 1dB (UE power step size) + 2.0 dB (UE power step tolerance) + (Test system relative power measurement uncertainty), where, the UE power step tolerance is specified in TS 38.101-1 [2], Table 6.3.4.3-1 and is 0.7dB for 1dB power step size and the Test system relative power measurement uncertainty is specified in Table F.1.2-1.
- 2.3. Measure In-band emission using Global In-Channel Tx-Test (Annex E)
- 2.4. Send uplink power control commands for PUCCH to the UE using 1dB power step size to ensure that the UE output power measured by the test system is within the Uplink power control window, defined as +MU to +(MU + Uplink power control window size) dB of the target power level 0 dBm, where MU and Uplink power control window size are defined above.
- 2.5. Measure In-band emission using Global In-Channel Tx-Test (Annex E)
- 2.6. Send uplink power control commands for PUCCH to the UE using 1dB power step size to ensure that the UE output power measured by the test system is within the Uplink power control window, defined as +MU to +(MU + Uplink power control window size) dB of the target power level -30 dBm, where MU and Uplink power control window size are defined above.
- 2.7. Measure In-band emission using Global In-Channel Tx-Test (Annex E)
- 2.8. Send uplink power control commands for PUCCH to the UE using 1dB power step size to ensure that the UE output power measured by the test system is within the Uplink power control window, defined as +MU to +(MU + Uplink power control window size) dB of the target power level P_{min} , where MU and Uplink power control window size are defined above and P_{min} is the minimum output power according to Table 6.3.1.3-1.
- 2.9. Measure In-band emission using Global In-Channel Tx-Test (Annex E)

NOTE1: When switching to DFT-s-OFDM waveform, as specified in the test configuration table 6.4.2.3.4.1-2, send an NR RRCReconfiguration message according to TS 38.508-1 [5] clause 4.6.3 Table 4.6.3-118 PUSCH-Config with TRANSFORM_PRECODER_ENABLED condition.

NOTE2: The purpose of the Uplink power control window is to ensure that the actual UE output power is no less than the target power level, and as close as possible to the target power level. The relationship between the Uplink power control window, the target power level and the corresponding possible actual UE Uplink power window is illustrated in Annex F.4.2.

Table 6.4.2.3.4.2-1: Void

Table 6.4.2.3.4.2-2: Void

6.4.2.3.4.3 Message contents

Message contents are according to TS 38.508-1 [5] subclause 4.6 with the following exceptions:

Table 6.4.2.3.4.3-1: PDSCH-ServingCellConfig: PUCCH format3 measurement

Derivation Path: TS 38.508-1[15], Table 4.6.3-102			
Information Element	Value/remark	Comment	Condition
PDSCH-ServingCellConfig ::= SEQUENCE {			
codeBlockGroupTransmission	Not present		
xOverhead	Not present		
nrofHARQ-ProcessesForPDSCCH	n6		FDD
pucch-Cell	Not present		
maxMIMO-Layers	Not present		
processingType2Enabled	Not present		
pdsch-CodeBlockGroupTransmissionList-r16	Not present		
}			

6.4.2.3.5 Test requirement

The averaged In-band emission result, derived in Annex E.4.3 shall not exceed the corresponding values in Tables 6.4.2.3.5-1.

Table 6.4.2.3.5-1: Test requirements for in-band emissions

Parameter description	Unit	Limit (NOTE 1)		Applicable Frequencies
General (NOTE 12)	dB	$\max \left\{ -25 - 10 \cdot \log_{10} (N_{RB} / L_{CRB}), \right.$ $20 \cdot \log_{10} EVM - 3 - 5 \cdot (\Delta_{RB} - 1) / L_{CRB},$ $\left. -57 \text{ dBm} + 10 \log_{10} (SCS / 15 \text{ kHz}) - \overline{P_{RB}} \right\} + TT$		Any non-allocated (NOTE 2)
IQ Image (NOTE 12)	dB	-28 + TT	Image frequencies when output power > 10 dBm	Image frequencies (NOTES 2, 3)
		-25 + TT	Image frequencies when output power ≤ 10 dBm	
Carrier leakage (NOTE 12)	dBc	-28 + TT	Output power > 10 dBm	Carrier leakage frequency (NOTES 4, 5)
		-25 + TT	0 dBm ≤ Output power ≤ 10 dBm	
		-20 + TT	-30 dBm ≤ Output power < 0 dBm	
		-10 + TT	-40 dBm ≤ Output power < -30 dBm	

- NOTE 1: An in-band emissions combined limit is evaluated in each non-allocated RB. For each such RB, the minimum requirement is calculated as the higher of $P_{RB} - 30$ dB and the power sum of all limit values (General, IQ Image or Carrier leakage) that apply. P_{RB} is defined in NOTE 10.
- NOTE 2: The measurement bandwidth is 1 RB and the limit is expressed as a ratio of measured power in one non-allocated RB to the measured average power per allocated RB, where the averaging is done across all allocated RBs.
- NOTE 3: The applicable frequencies for this limit are those that are enclosed in the reflection of the allocated bandwidth, based on symmetry with respect to the carrier leakage frequency, but excluding any allocated RBs.
- NOTE 4: The measurement bandwidth is 1 RB and the limit is expressed as a ratio of measured power in one non-allocated RB to the measured total power in all allocated RBs.
- NOTE 5: The applicable frequencies for this limit depend on the parameter *txDirectCurrentLocation* in *UplinkTxDirectCurrent* IE, and are those that are enclosed either in the RBs containing the carrier leakage frequency, or in the two RBs immediately adjacent to the carrier leakage frequency, but excluding any allocated RB.
- NOTE 6: L_{CRB} is the Transmission Bandwidth (see Section 5.3).
- NOTE 7: N_{RB} is the Transmission Bandwidth Configuration (see Section 5.3).
- NOTE 8: EVM is the limit specified in Table 6.4.2.1.3-1 for the modulation format used in the allocated RBs.
- NOTE 9: Δ_{RB} is the starting frequency offset between the allocated RB and the measured non-allocated RB (e.g. $\Delta_{RB} = 1$ or $\Delta_{RB} = -1$ for the first adjacent RB outside of the allocated bandwidth).
- NOTE 10: $\overline{P_{RB}}$ is an average of the transmitted power over 10 sub-frames normalized by the number of allocated RBs, measured in dBm.
- NOTE 11: Test tolerance TT = 0.8 dB.
- NOTE 12: In case the parameter 3300 or 3301 is reported from UE via *txDirectCurrentLocation* IE, IQ Image and Carrier leakage limit do not apply and General limit applies for all non-allocated frequencies.

6.4.2.4 EVM equalizer spectrum flatness

6.4.2.4.1 Test purpose

The zero-forcing equalizer correction applied in the EVM measurement process (as described in Annex E) must meet a spectral flatness requirement for the EVM measurement to be valid. The EVM equalizer spectrum flatness is defined in terms of the maximum peak-to-peak ripple of the equalizer coefficients (dB) across the allocated uplink block, at which the equalizer coefficients are generated by the EVM measurement process. The basic measurement interval is the same as for EVM.

The EVM equalizer spectrum flatness requirement does not limit the correction applied to the signal in the EVM measurement process but for the EVM result to be valid, the equalizer correction that was applied must meet the EVM equalizer spectrum flatness minimum requirements.

6.4.2.4.2 Test applicability

This test case applies to all types of NR UE release 15 and forward.

6.4.2.4.3 Minimum conformance requirements

The peak-to-peak variation of the EVM equalizer coefficients contained within the frequency range of the uplink allocation shall not exceed the maximum ripple specified in Table 6.4.2.4.3-1 for normal conditions. For uplink allocations contained within both Range 1 and Range 2, the coefficients evaluated within each of these frequency ranges shall meet the corresponding ripple requirement and the following additional requirement: the relative difference between the maximum coefficient in Range 1 and the minimum coefficient in Range 2 must not be larger than 5 dB, and the relative difference between the maximum coefficient in Range 2 and the minimum coefficient in Range 1 must not be larger than 7 dB (see Figure 6.4.2.4.3-1).

The EVM equalizer spectral flatness shall not exceed the values specified in Table 6.4.2.4.3-2 for extreme conditions. For uplink allocations contained within both Range 1 and Range 2, the coefficients evaluated within each of these frequency ranges shall meet the corresponding ripple requirement and the following additional requirement: the relative difference between the maximum coefficient in Range 1 and the minimum coefficient in Range 2 must not be larger

than 6 dB, and the relative difference between the maximum coefficient in Range 2 and the minimum coefficient in Range 1 must not be larger than 10 dB (see Figure 6.4.2.4.3-1).

Table 6.4.2.4.3-1: Requirements for EVM equalizer spectrum flatness (normal conditions)

Frequency range	Maximum ripple (dB)
$F_{UL_Meas} - F_{UL_Low} \geq 3$ MHz and $F_{UL_High} - F_{UL_Meas} \geq 3$ MHz (Range 1)	4 (p-p)
$F_{UL_Meas} - F_{UL_Low} < 3$ MHz or $F_{UL_High} - F_{UL_Meas} < 3$ MHz (Range 2)	8 (p-p)
NOTE 1: F_{UL_Meas} refers to the sub-carrier frequency for which the equalizer coefficient is evaluated	
NOTE 2: F_{UL_Low} and F_{UL_High} refer to each E-UTRA frequency band specified in Table 5.5-1	

Table 6.4.2.4.3-2: Minimum requirements for EVM equalizer spectrum flatness (extreme conditions)

Frequency range	Maximum Ripple (dB)
$F_{UL_Meas} - F_{UL_Low} \geq 5$ MHz and $F_{UL_High} - F_{UL_Meas} \geq 5$ MHz (Range 1)	4 (p-p)
$F_{UL_Meas} - F_{UL_Low} < 5$ MHz or $F_{UL_High} - F_{UL_Meas} < 5$ MHz (Range 2)	12 (p-p)
NOTE 1: F_{UL_Meas} refers to the sub-carrier frequency for which the equalizer coefficient is evaluated	
NOTE 2: F_{UL_Low} and F_{UL_High} refer to each E-UTRA frequency band specified in Table 5.5-1	

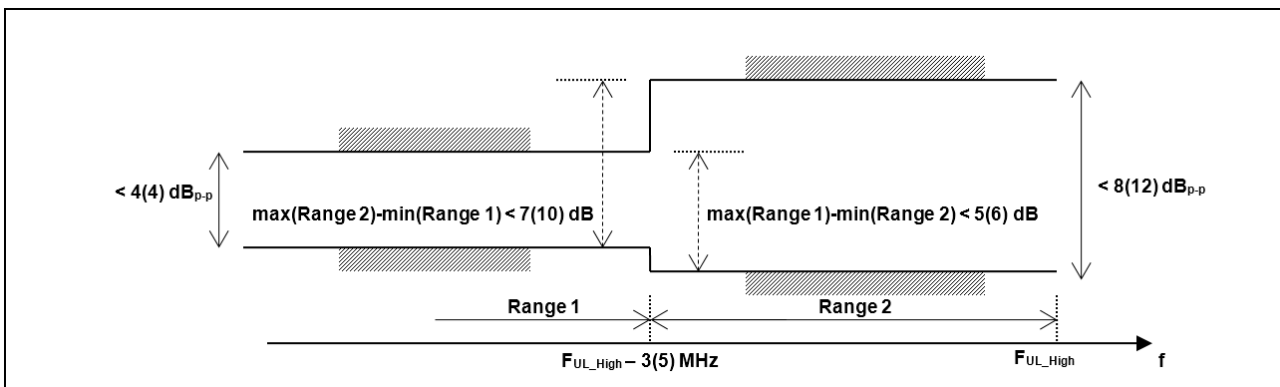

Figure 6.4.2.4.3-1: The limits for EVM equalizer spectral flatness with the maximum allowed variation of the coefficients indicated (the ETC minimum requirement are within brackets)

The normative reference for this requirement is TS 38.101-1 [2] clause 6.4.2.4.

6.4.2.4.4 Test description

6.4.2.4.4.1 Initial condition

Initial conditions are a set of test configurations the UE needs to be tested in and the steps for the SS to take with the UE to reach the correct measurement state.

The initial test configurations consist of environmental conditions, test frequencies, test channel bandwidths and sub-carrier spacing based on NR operating bands specified in Table 5.3.5-1. All of these configurations shall be tested with applicable test parameters for each combination of channel bandwidth and sub-carrier spacing, are shown in table 6.4.2.4.4.1-1. The details of the uplink and downlink reference measurement channels (RMCs) are specified in Annexes A.2 and A.3. Configurations of PDSCH and PDCCH before measurement are specified in Annex C.2.

Table 6.4.2.4.4.1-1: Test Configuration

Initial Conditions			
Test Environment as specified in TS 38.508-1 [5] subclause 4.1		Normal, TL/VL, TL/VH, TH/VL, TH/VH	
Test Frequencies as specified in TS 38.508-1 [5] subclause 4.3.1		Low range, Mid range, High range (NOTE 3)	
Test Channel Bandwidths as specified in TS 38.508-1 [5] subclause 4.3.1		Lowest, Mid, Highest	
Test SCS as specified in Table 5.3.5-1		Lowest	
Test Parameters			
Test ID	Downlink Configuration	Uplink Configuration	
	N/A	Modulation	RB allocation (NOTE 1)
1		DFT-s-OFDM QPSK	Outer Full
2		CP-OFDM QPSK	Outer Full
NOTE 1: The specific configuration of each RB allocation is defined in Table 6.1-1.			
NOTE 2: Test Channel Bandwidths are checked separately for each NR band, which applicable channel bandwidths are specified in Table 5.3.5-1.			
NOTE 3: For NR band n28, 30MHz test channel bandwidth is tested with Low range and High range test frequencies.			

1. Connect the SS to the UE antenna connectors as shown in TS 38.508-1 [5] Annex A, in Figure A.3.1.1.1 for TE diagram and section A.3.2 for UE diagram.
2. The parameter settings for the cell are set up according to TS 38.508-1 [5] subclause 4.4.3.
3. Downlink signals are initially set up according to Annex C.0, C.1, C.2, and uplink signals according to Annex G.0, G.1, G.2, G.3.0.
4. The UL Reference Measurement channels are set according to Table 6.4.2.4.4.1-1.
5. Propagation conditions are set according to Annex B.0.
6. Ensure the UE is in state RRC_CONNECTED with generic procedure parameters Connectivity *NR*, Connected without release *On*, Test Mode *On* and Test Loop Function *On* according to TS 38.508-1 [5] clause 4.5. Message contents are defined in clause 6.4.2.4.4.3.

6.4.2.4.4.2 Test procedure

1. SS sends uplink scheduling information for each UL HARQ process via PDCCH DCI format 0_1 for C_RNTI to schedule the UL RMC according to Table 6.4.2.4.4.1-1. Since the UE has no payload and no loopback data to send the UE sends uplink MAC padding bits on the UL RMC.
2. Send continuously uplink power control "up" commands in the uplink scheduling information to the UE until the UE transmits at P_{UMAX} level. Allow at least 200ms starting from the first TPC command in this step for the UE to reach P_{UMAX} level.
3. Measure spectrum flatness using Global In-Channel Tx-Test (Annex E). For TDD, only slots consisting of only UL symbols are under test.

NOTE1: When switching to DFT-s-OFDM waveform, as specified in the test configuration table 6.4.2.1.4.1-1, send an NR RRCReconfiguration message according to TS 38.508-1 [5] clause 4.6.3 Table 4.6.3-118 PUSCH-Config with TRANSFORM_PRECODER_ENABLED condition.

6.4.2.4.4.3 Message contents

Message contents are according to TS 38.508-1 [5] subclause 4.6.

6.4.2.4.4.5 Test requirement

Each of the n spectrum flatness functions, shall derive four ripple results in Annex E.4.4.1. The derived results shall not exceed the values in Figure 6.4.2.4.5-1:

For normal conditions, the maximum ripple in Range 1 and Range 2 shall not exceed the values specified in Table 6.4.2.4.5-1 and the following additional requirement: the relative difference between the maximum coefficient in Range 1 and the minimum coefficient in Range 2 must not be larger than 6.4 dB, and the relative difference between the maximum coefficient in Range 2 and the minimum coefficient in Range 1 must not be larger than 8.4 dB (see Figure 6.4.2.4.5-1).

For normal conditions, the peak-to-peak variation of the EVM equalizer coefficients contained within the frequency range of the uplink allocation shall not exceed the maximum ripple specified in Table 6.4.2.4.5-1. For uplink allocations contained within both Range 1 and Range 2, the coefficients evaluated within each of these frequency ranges shall meet the corresponding ripple requirement and the following additional requirement: the relative difference between the maximum coefficient in Range 1 and the minimum coefficient in Range 2 must not be larger than 6.4 dB, and the relative difference between the maximum coefficient in Range 2 and the minimum coefficient in Range 1 must not be larger than 8.4 dB (see Figure 6.4.2.4.5-1).

For extreme conditions, the EVM equalizer spectral flatness shall not exceed the values specified in Table 6.4.2.4.5-2. For uplink allocations contained within both Range 1 and Range 2, the coefficients evaluated within each of these frequency ranges shall meet the corresponding ripple requirement and the following additional requirement: the relative difference between the maximum coefficient in Range 1 and the minimum coefficient in Range 2 must not be larger than 7.4 dB, and the relative difference between the maximum coefficient in Range 2 and the minimum coefficient in Range 1 must not be larger than 11.4 dB (see Figure 6.4.2.4.5-1).

Table 6.4.2.4.5-1: Requirements for EVM equalizer spectrum flatness (normal conditions)

Frequency range	Maximum ripple [dB]
$F_{UL_Meas} - F_{UL_Low} \geq 3 \text{ MHz}$ and $F_{UL_High} - F_{UL_Meas} \geq 3 \text{ MHz}$ (Range 1)	4 + TT (p-p)
$F_{UL_Meas} - F_{UL_Low} < 3 \text{ MHz}$ or $F_{UL_High} - F_{UL_Meas} < 3 \text{ MHz}$ (Range 2)	8 + TT (p-p)
NOTE 1: F_{UL_Meas} refers to the sub-carrier frequency for which the equalizer coefficient is evaluated	
NOTE 2: F_{UL_Low} and F_{UL_High} refer to each E-UTRA frequency band specified in Table 5.5-1	
NOTE 3: Test tolerance TT = 1.4 dB.	

Table 6.4.2.4.5-2: Minimum requirements for EVM equalizer spectrum flatness (extreme conditions)

Frequency range	Maximum Ripple [dB]
$F_{UL_Meas} - F_{UL_Low} \geq 5 \text{ MHz}$ and $F_{UL_High} - F_{UL_Meas} \geq 5 \text{ MHz}$ (Range 1)	4 + TT (p-p)
$F_{UL_Meas} - F_{UL_Low} < 5 \text{ MHz}$ or $F_{UL_High} - F_{UL_Meas} < 5 \text{ MHz}$ (Range 2)	12 + TT (p-p)
NOTE 1: F_{UL_Meas} refers to the sub-carrier frequency for which the equalizer coefficient is evaluated	
NOTE 2: F_{UL_Low} and F_{UL_High} refer to each E-UTRA frequency band specified in Table 5.5-1	
NOTE 3: Test tolerance TT = 1.4 dB.	

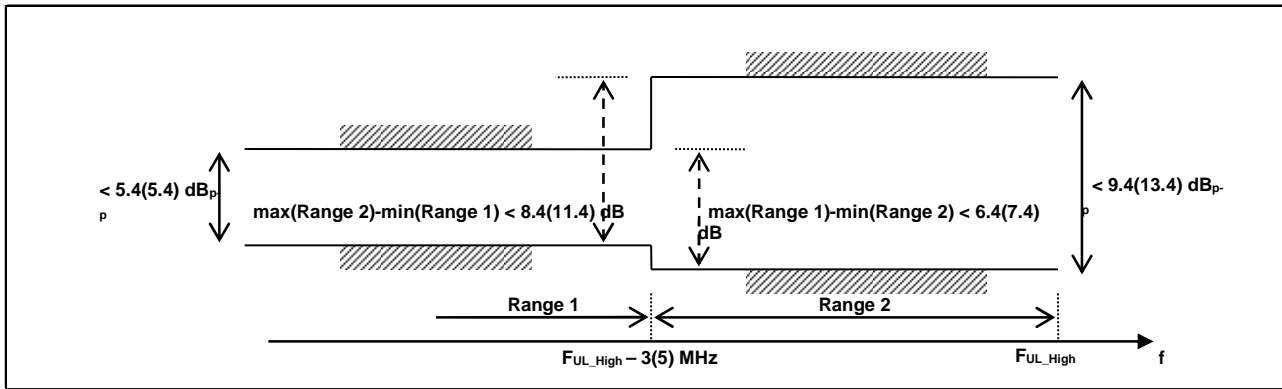

Figure 6.4.2.4.5-1: The test requirements for EVM equalizer spectral flatness with the maximum allowed variation of the coefficients indicated for unshaped modulations (the ETC test requirements are within brackets)

6.4.2.5 EVM equalizer spectrum flatness for Pi/2 BPSK

Editor's Note: The following aspects are either missing or not yet determined:

6.4.2.5.1 Test purpose

The zero-forcing equalizer correction applied in the EVM measurement process (as described in Annex E) must meet a spectral flatness requirement for the EVM measurement to be valid. The EVM equalizer spectrum flatness is defined in terms of the maximum peak-to-peak ripple of the equalizer coefficients (dB) across the allocated uplink block, at which the equalizer coefficients are generated by the EVM measurement process. The basic measurement interval is the same as for EVM.

6.4.2.5.2 Test applicability

This test case applies to all types of power class 3 capable NR UE release 15 and forward indicating support for UE capability *powerBoosting-pi2BPSK* and operating in TDD bands n40, n41, n77, n78 and n79.

This test case applies to all types of NR UE release 16 and forward indicating support for UE capability *lowPAPR-DMRS-PUSCHwithPrecoding-r16*.

6.4.2.5.3 Minimum conformance requirements

These requirements apply if the IE *powerBoostPi2BPSK* is set to 1 for power class 3 capable UE operating in TDD bands n40, n41, n77, n78 and n79 with pi/2 BPSK modulation and UE indicates support for UE capability *powerBoosting-pi2BPSK* and 40 % or less slots in radio frame are used for UL transmission. These requirements also apply if the IE *dmrs-UplinkTransformPrecoding-r16* is configured and UE indicates support for UE capability *lowPAPR-DMRS-PUSCHwithPrecoding-r16*. Otherwise the requirements for EVM equalizer spectrum flatness defined in clause 6.4.2.4.3 apply.

The EVM equalizer coefficients across the allocated uplink block shall be modified to fit inside the mask specified in Table 6.4.2.5.3-1 for normal conditions, prior to the calculation of EVM. The limiting mask shall be placed to minimize the change in equalizer coefficients in a sum of squares sense.

Table 6.4.2.5.3-1: Mask for EVM equalizer coefficients for Pi/2 BPSK, normal conditions

Frequency range	Parameter	Maximum ripple (dB)
$ F_{UL_Meas} - F_center \leq X$ MHz (Range 1)	X1	6 (p-p)
$ F_{UL_Meas} - F_center > X$ MHz (Range 2)	X2	14 (p-p)

NOTE 1: F_{UL_Meas} refers to the sub-carrier frequency for which the equalizer coefficient is evaluated
 NOTE 2: F_center refers to the center frequency of an allocated block of PRBs
 NOTE 3: X, in MHz, is equal to 25% of the bandwidth of the PRB allocation
 NOTE 4: See Figure 6.4.2.5.3-1 for description of X1, X2

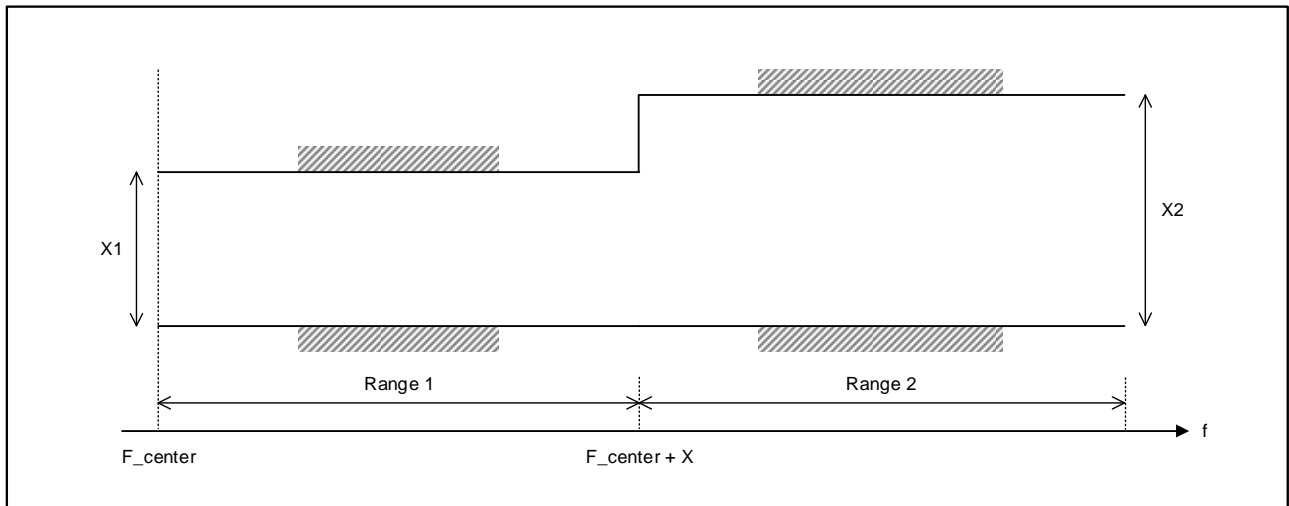

Figure 6.4.2.5.3-1: The limits for EVM equalizer spectral flatness with the maximum allowed variation. F_center denotes the center frequency of the allocated block of PRBs. X, in MHz, is equal to 25 % of the bandwidth of the PRB allocation.

For pi/2 BPSK modulation the UE shall be allowed to employ spectral shaping and the shaping filter shall be restricted so that the impulse response of the shaping filter itself shall meet

$$|\tilde{a}_i(t,0)| \geq |\tilde{a}_i(t,\tau)| \quad \forall \tau \neq 0$$

$$20\log_{10} |\tilde{a}_i(t,\tau)| < -15 \text{ dB} \quad 1 < \tau < M - 1,$$

where, $|\tilde{a}_i(t,\tau)| = IDFT\{|\tilde{a}_i(t,f)| e^{j\varphi(t,f)}\}$, f is the frequency of the M allocated subcarriers, $\tilde{a}_i(t,f)$ and $\varphi(t,f)$ are the amplitude and phase response.

0dB reference is defined as $20\log_{10} |\tilde{a}_i(t,0)|$.

The normative reference for this requirement is TS 38.101-1 [2] clause 6.4.2.4.1.

6.4.2.5.4 Test description

6.4.2.5.4.1 Initial condition

Same initial conditions as in clause 6.4.2.4.4.1 with following exceptions:

- Instead of Table 6.4.2.4.4.1-1 → use Table 6.4.2.5.4.1-1

Table 6.4.2.5.4.1-1: Test Configuration

Initial Conditions			
Test Environment as specified in TS 38.508-1 [5] subclause 4.1		Normal	
Test Frequencies as specified in TS 38.508-1 [5] subclause 4.3.1		Low range, Mid range, High range (NOTE 3)	
Test Channel Bandwidths as specified in TS 38.508-1 [5] subclause 4.3.1		Lowest, Mid, Highest	
Test SCS as specified in Table 5.3.5-1		Lowest	
Test Parameters			
Test ID	Downlink Configuration	Uplink Configuration	
	N/A	Modulation	RB allocation (NOTE 1)
1 ⁴		DFT-s-OFDM Pi/2 BPSK	Outer Full
2 ⁵		DFT-s-OFDM Pi/2 BPSK w Pi/2 BPSK DMRS	Outer Full
NOTE 1: The specific configuration of each RB allocation is defined in Table 6.1-1.			
NOTE 2: Test Channel Bandwidths are checked separately for each NR band, which applicable channel bandwidths are specified in Table 5.3.5-1.			
NOTE 3: For NR band n28, 30MHz test channel bandwidth is tested with Low range and High range test frequencies.			
NOTE 4: UEs indicating support for UE capability <i>powerBoosting-pi2BPSK</i> .			
NOTE 5: Applicable to UEs indicating support for UE capability <i>lowPAPR-DMRS-PUSCHwithPrecoding-r16</i> .			

6.4.2.5.4.2 Test procedure

1. SS sends uplink scheduling information for each UL HARQ process via PDCCH DCI format 0_1 for C_RNTI to schedule the UL RMC according to Table 6.4.2.5.4.1-1. Since the UE has no payload and no loopback data to send the UE sends uplink MAC padding bits on the UL RMC.
2. Send continuously uplink power control "up" commands in the uplink scheduling information to the UE until the UE transmits at P_{UMAX} level. Allow at least 200ms starting from the first TPC command in this step for the UE to reach P_{UMAX} level.
3. Measure spectrum flatness using Global In-Channel Tx-Test (Annex E). For TDD, only slots consisting of only UL symbols are under test.

6.4.2.5.4.3 Message contents

Message contents are according to TS 38.508-1 [5] subclause 4.6 with the following exception:

Table 6.4.2.5.4.3-1: ServingCellConfig (Test ID 1 in Table 6.4.2.5.4.1-1)

Derivation Path: TS 38.508-1 [5] clause 4.6.3, Table 4.6.3-167			
Information Element	Value/remark	Comment	Condition
uplinkConfig SEQUENCE {			
initialUplinkBWP	BWP-UplinkDedicated		
uplinkBWP-ToReleaseList	Not present		
uplinkBWP-ToAddModList	Not present		
firstActiveUplinkBWP-Id	BWP-Id		
pusch-ServingCellConfig CHOICE {			
setup	PUSCH-ServingCellConfig		
}			
carrierSwitching	Not present		
powerBoostPi2BPSK	enabled		
}			

Table 6.4.2.5.4.3-2: DMRS-UplinkConfig (Test ID 2 in Table 6.4.2.5.4.1-1)

Derivation Path: TS 38.508-1 [5], Table 4.6.3-51			
Information Element	Value/remark	Comment	Condition
DMRS-UplinkConfig ::= SEQUENCE {			
transformPrecodingEnabled SEQUENCE			
{			
nPUSCH-Identity	Not present		
sequenceGroupHopping	Not present		
sequenceHopping	Not present		
dmrs-UplinkTransformPrecoding-r16			
SEQUENCE {			
pi2BPSK-ScramblingID0	Not present		
pi2BPSK-ScramblingID1	Not present		
}			
}			
}			
}			

6.4.2.5.5 Test requirement

Each of the n spectrum flatness functions, shall derive four ripple results in Annex E.4.4.1 The derived results shall not exceed the values in Figure 6.4.2.5.5-1:

Table 6.4.2.5.5-1: Mask for EVM equalizer coefficients for Pi/2 BPSK, normal conditions

Frequency range	Parameter	Maximum ripple (dB)
$ F_{UL_Meas} - F_{center} \leq X$ MHz (Range 1)	X1	6 + TT (p-p)
$ F_{UL_Meas} - F_{center} > X$ MHz (Range 2)	X2	14 + TT (p-p)

NOTE 1: F_{UL_Meas} refers to the sub-carrier frequency for which the equalizer coefficient is evaluated
 NOTE 2: F_{center} refers to the center frequency of an allocated block of PRBs
 NOTE 3: X, in MHz, is equal to 25% of the bandwidth of the PRB allocation
 NOTE 4: See Figure 6.4.2.5.5-1 for description of X1, X2
 NOTE 5: Test tolerance TT = 1.4 dB.

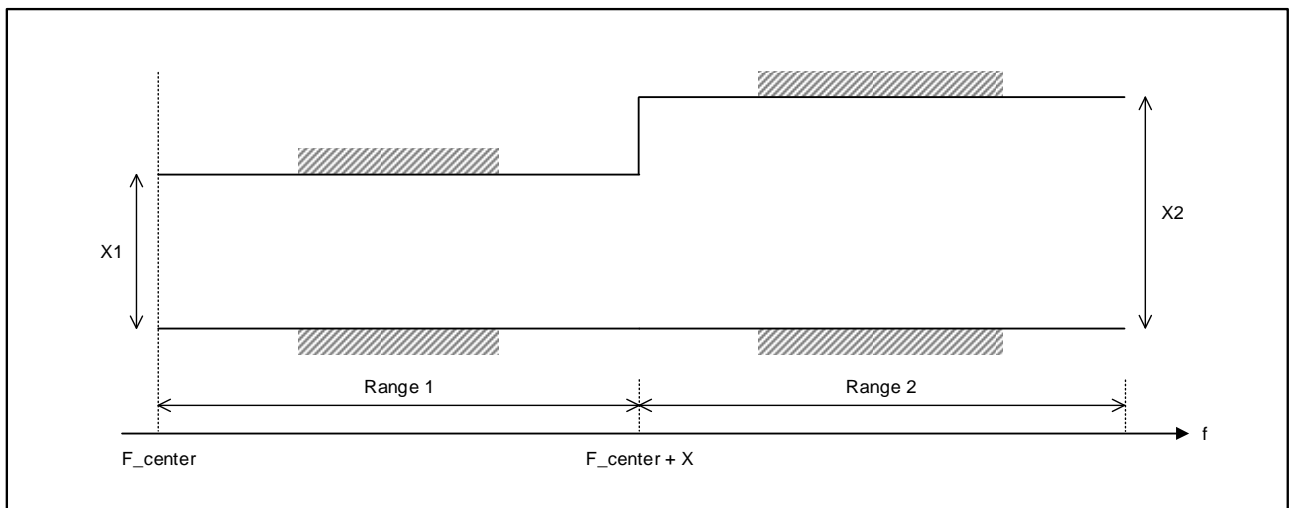

Figure 6.4.2.5.5-1: The limits for EVM equalizer spectral flatness with the maximum allowed variation. F_{center} denotes the center frequency of the allocated block of PRBs. X, in MHz, is equal to 25 % of the bandwidth of the PRB allocation.

Each of the n spectrum flatness functions shall derive an impulse response of the spectral shaping filter in Annex E.4.4.2. The derived results shall fulfill:

$$|\tilde{a}(0)| \geq |\tilde{a}(\tau)| \quad \forall \tau \neq 0$$

$$20 \log_{10} |\tilde{a}(\tau)| < -15 \text{dB} + TT \quad 1 < \tau < M - 1,$$

where $TT = 1.4$ dB.

6.4A Transmit signal quality for CA

6.4A.1 Frequency error for CA

Editor's note: The following aspects are either missing or not yet determined:

- Extending the coverage of the TCs with intra-band CA scenarios is FFS

6.4A.1.0 Minimum conformance requirements

For inter-band carrier aggregation with uplink assigned to two NR bands, the minimum conformance requirements specified in subclause 6.4.1.3 shall apply on each component carrier with all component carriers active.

6.4A.1.1 Frequency error for CA (2UL CA)

6.4A.1.1.1 Test purpose

This test verifies the ability of both, the receiver and the transmitter, to process frequency for 2UL CA correctly.

Receiver: to extract the correct frequency from the stimulus signal, offered by the System simulator, under ideal propagation conditions and low level.

Transmitter: to derive the correct modulated carrier frequency from the results, gained by the receiver.

6.4A.1.1.2 Test applicability

This test case applies to all types of NR UE release 15 and forward that supports 2UL CA.

6.4A.1.1.3 Minimum conformance requirements

The minimum conformance requirements are defined in clause 6.4A.1.0.

6.4A.1.1.4 Test description

6.4A.1.1.4.1 Initial condition

Initial conditions are a set of test configurations the UE needs to be tested in and the steps for the SS to take with the UE to reach the correct measurement state. The initial test configurations consist of environmental conditions, test frequencies, test channel bandwidths and sub-carrier spacing based on NR CA configuration specified in clause 5.5A. All of these configurations shall be tested with applicable test parameters for each CA configuration, and are shown in Table 6.4A.1.1.4.1-1. The details of the uplink and downlink reference measurement channels (RMCs) are specified in Annexes A.2 and A.3. Configurations of PDSCH and PDCCH before measurement are specified in Annex C.2.

Table 6.4A.1.1.4.1-1: Inter band CA Test Configuration Table

Initial Conditions				
Test Environment as specified in TS 38.508-1 [5] subclause 4.1		Normal, TL/VL, TL/VH, TH/VL, TH/VH		
Test Frequencies as specified in TS 38.508-1 [5] subclause 4.3.1.1.3 for inter band CA in FR1		Mid range for PCC and SCC (NOTE 3)		
Test Channel Bandwidths as specified in TS 38.508-1 [5] subclause 4.3.1		Highest N_{RB_agg} for both PCC and SCC		
Test SCS as specified in Table 5.5A.3-1		Lowest		
Test Parameters				
Test ID	Downlink Configuration		Uplink Configuration	
	Modulation	RB allocation	Modulation	RB allocation
1	CP-OFDM QPSK	Full RB (NOTE 1)	DFT-s-OFDM QPSK	REFSENS (NOTE 2)
NOTE 1: Full RB allocation shall be used per each SCS and channel BW as specified in Table 7.3.2.4.1-2.				
NOTE 2: REFSENS refers to Table 7.3.2.4.1-3 which defines uplink RB configuration and start RB location for each SCS, channel BW and NR band belongs to inter-band CA combination.				
NOTE 3: For NR band n28, 30MHz test channel bandwidth is tested with Low range test frequencies.				

1. Connect the SS to the UE antenna connectors as shown in TS 38.508-1 [5] Annex A, in Figure 3.1.1.3 for TE diagram and section A.3.2 for UE diagram.
2. The parameter settings for the cell are set up according to TS 38.508-1 [5] subclause 4.4.3.
3. Downlink signals for PCC are initially set up according to Annex C.0, C.1, C.2, and uplink signals according to Annex G.0, G.1, G.2, G.3.0.
4. The DL and UL Reference Measurement channels are set according to Table 6.4A.1.1.4.1-1.
5. Propagation conditions are set according to Annex B.0.
6. Ensure the UE is in state RRC_CONNECTED with generic procedure parameters Connectivity *NR*, Connected without release *On*, Test Mode *On* and Test Loop Function *On* according to TS 38.508-1 [5] clause 4.5. Message contents are defined in clause 6.4A.1.1.4.3

6.4A.1.1.4.2 Test procedure

1. Configure SCC according to Annex C.0, C.1, C.2 for all downlink physical channels.
2. The SS shall configure SCC as per TS 38.508-1 [5] clause 5.5.1. Message contents are defined in clause 6.4A.1.1.4.3
3. SS activates SCC by sending the activation MAC CE (Refer TS 38.321 [18], clauses 5.9, 6.1.3.10). Wait for at least 2 seconds (Refer TS 38.133[19], clause 9.3).
4. SS transmits PDSCH via PDCCH DCI format 1_1 for C_RNTI to transmit the DL RMC according to Table 6.4A.1.1.4.1-1 on both PCC and SCC. The SS sends downlink MAC padding bits on the DL RMC.
5. SS sends uplink scheduling information for each UL HARQ process via PDCCH DCI format 0_1 for C_RNTI to schedule the UL RMC according to Table 6.4A.1.1.4.1-1 on both PCC and SCC. Since the UL has no payload and no loopback data to send the UE sends uplink MAC padding bits on the UL RMC.
6. Set the Downlink signal level to the appropriate REFSENS value defined in subclauses 7.3A.1.5. Send continuously uplink power control "up" commands in every uplink scheduling information to the UE so that the UE transmits at P_{UMAX} level for the duration of the test. Allow at least 200ms starting from the first TPC command in this step for the UE to reach P_{UMAX} level.
7. Measure the Frequency Error on PCC and SCC using Global In-Channel Tx-Test (Annex E) respectively. For TDD slots with transient periods are not under test.

8. For UEs supporting DSS, repeat steps 1~7 on the applicable bands as specified in Section 5.4.2.1 with message contents being according to TS 38.508-1 [5] subclause 4.6 ensuring Table 4.6.3-61 and Table 4.6.3-62 with condition DSS.

NOTE 1: When switching to DFT-s-OFDM waveform, as specified in the test configuration table 6.5.2.2.4.1-1, send an NR RRCReconfiguration message according to TS 38.508-1 [5] clause 4.6.3 Table 4.6.3-118 PUSCH-Config with TRANSFORM_PRECODER_ENABLED condition.

6.4A.1.1.4.3 Message contents

Message contents are according to TS 38.508-1 [5] subclause 4.6 with following exception.

Table 6.4A.1.1.4.3-1 FrequencyInfoUL-SIB for inter-band CA

Derivation Path: TS 38.508-1 [5] Table 4.6.3-62 FrequencyInfoUL-SIB			
Information Element	Value/remark	Comment	Condition
p-Max	20		

6.4A.1.1.5 Test requirement

The 10 frequency error Δf results must fulfil the test requirement:

$$|\Delta f| \leq (0.1 \text{ PPM} + \text{TT}) \text{ for each test point}$$

where PPM refers to each CC UL frequency.

Table 6.4A.1.1.5-1: Test Tolerance for frequency error

	$f \leq 3.0\text{GHz}$	$3.0\text{GHz} < f \leq 6\text{GHz}$
$\text{BW} \leq 40\text{MHz}$	15Hz	15Hz
$40\text{MHz} < \text{BW} \leq 100\text{MHz}$	15Hz	15Hz

6.4A.2 Transmit modulation quality for CA

Editor's note: This clause is incomplete. The following aspects are either missing or not yet determined:

- Extending the coverage of the TCs with intra-band CA scenarios is FFS

The requirements in this clause apply with PCC and SCC in the UL configured and activated: PCC with PRB allocation and SCC without PRB allocation and without CSI reporting and SRS configured.

6.4A.2.1 Error Vector Magnitude for CA

6.4A.2.1.0 Minimum conformance requirements

For Inter-band carrier aggregation, EVM measurements are evaluated for each component carrier, and for the different modulations schemes, the EVM requirements shall not exceed the values specified in Table 6.4.2.1.3-1 for the parameters defined in Table 6.4.2.1.3-2, if CA is configured in uplink.

For the intra-band non-contiguous carrier aggregation, EVM measurements are evaluated for each component carrier, and for the different modulations schemes, the EVM requirements shall not exceed the values specified in Table 6.4A.2.1.0-1, if CA is configured in uplink.

For the intra-band contiguous carrier aggregation, EVM measurements are evaluated for each component carrier, and for the different modulations schemes, the EVM requirements shall not exceed the values specified in Table 6.4A.2.1.0-1, if CA is configured in uplink.

When a single component carrier is configured Table 6.4.2.1.3-1 apply.

The EVM requirements are according to Table 6.4A.2.1.0-1 if CA is configured in uplink with the parameters defined in Table 6.4.2.1.3-2.

Table 6.4A.2.1.0-1: Minimum requirements for Error Vector Magnitude

Parameter	Unit	Average EVM Level per CC
Pi/2-BPSK	%	30
QPSK	%	17.5
16 QAM	%	12.5
64 QAM	%	8
256 QAM	%	3.5

The normative reference for this requirement is TS 38.101 [2] clause 6.4A.2.1

6.4A.2.1.1 Error Vector Magnitude for CA (2UL CA)

Editor's note: The following aspects are either missing or not yet determined:

- **The minimum requirements for intra-band contiguous CA and intra-band non-contiguous CA have not been defined.**

6.4A.2.1.1.1 Test Purpose

For 2UL carrier aggregation, the Error Vector Magnitude requirement should be defined for each component carrier. Requirement applies for the allocated component carrier, when all other component carriers are activated, but not allocated.

Similar transmitter impairment removal procedures are applied for CA waveform before EVM calculation as is specified for non-CA waveform in clause 6.4.2.1.

6.4A.2.1.1.2 Test applicability

This test case applies to all types of NR UE release 15 and forward that supports 2UL CA.

6.4A.2.1.1.3 Minimum conformance requirements

The minimum conformance requirements are defined in clause 6.4A.2.1.0.

6.4A.2.1.1.4 Test description

6.4A.2.1.1.4.1 Initial conditions

Initial conditions are a set of test configurations the UE needs to be tested in and the steps for the SS to take with the UE to reach the correct measurement state.

The initial test configurations consist of environmental conditions, test frequencies, test channel bandwidths and sub-carrier spacing based on NR CA configuration specified in clause 5.5A. All of these configurations shall be tested with applicable test parameters for each CA configuration, and are shown in Table 6.4A.2.1.1.4.1-1. The details of the uplink and downlink reference measurement channels (RMCs) are specified in Annexes A.2 and A.3. Configurations of PDSCH and PDCCH before measurement are specified in Annex C.2.

Table 6.4A.2.1.1.4.1-1: Inter band CA Test Configuration Table

Initial Conditions				
Test Environment as specified in TS 38.508-1 [5] subclause 4.1		Normal		
Test Frequencies as specified in TS 38.508-1 [5] subclause 4.3.1.1.3 for inter band CA in FR1		Low range for PCC and SCC High range for PCC and SCC		
Test Channel Bandwidths as specified in TS 38.508-1 [5] subclause 4.3.1		Lowest N_{RB_agg} for both PCC and SCC Highest N_{RB_agg} for both PCC and SCC		
Test SCS as specified in Table 5.5A.3-1		Smallest and biggest supported SCS per Channel Bandwidth		
Test Parameters				
Test ID	Downlink Configuration	Uplink Configuration		
		Modulation (NOTE 3)	RB allocation (NOTE 1)	
			PCC	SCC
1 ³	N/A	DFT-s-OFDM PI/2 BPSK	Inner Full	0
2 ³		DFT-s-OFDM PI/2 BPSK	Outer Full	0
3		DFT-s-OFDM QPSK	Inner Full	0
4		DFT-s-OFDM QPSK	Outer Full	0
5		DFT-s-OFDM 16 QAM	Inner Full	0
6		DFT-s-OFDM 16 QAM	Outer Full	0
7		DFT-s-OFDM 64 QAM	Outer Full	0
8		DFT-s-OFDM 256 QAM	Outer Full	0
9		CP-OFDM QPSK	Inner Full	0
10		CP-OFDM QPSK	Outer Full	0
11		CP-OFDM 16 QAM	Inner Full	0
12		CP-OFDM 16 QAM	Outer Full	0
13		CP-OFDM 64 QAM	Outer Full	0
14		CP-OFDM 256 QAM	Outer Full	0
NOTE 1: The specific configuration of each RB allocation is defined in Table 6.1-1.				
NOTE 2: Test Channel Bandwidths and Test SCS are checked separately for each NR CA band combination, which applicable channel bandwidths and SCS are specified in Table 5.5A3-1.				
NOTE 3: DFT-s-OFDM PI/2 BPSK test applies only for UEs which supports half Pi BPSK in FR1.				
NOTE 4: The frequencies of PCC and SCC shall be switched and tested in each configuration.				

1. Connect the SS to the UE antenna connectors as shown in TS 38.508-1 [5] Annex A, in Figure A.3.1.1.3 for TE diagram and section A.3.2 for UE diagram.
2. The parameter settings for the cell are set up according to TS 38.508-1 [5] subclause 4.4.3.
3. Downlink signals for PCC are initially set up according to Annex C.0, C.1, C.2, and uplink signals according to Annex G.0, G.1, G.2, G.3.0.
4. The UL Reference Measurement channels are set according to Table 6.4A.2.1.1.4.1-1.
5. Propagation conditions are set according to Annex B.0.
6. Ensure the UE is in state RRC_CONNECTED with generic procedure parameters Connectivity *NR*, Connected without release *On*, Test Mode *On* and Test Loop Function *On* according to TS 38.508-1 [5] clause 4.5. Message contents are defined in clause 6.4A.2.1.1.4.3

6.4A.2.1.1.4.2 Test procedure

1. Configure SCC according to Annex C.0, C.1, C.2 for all downlink physical channels.
2. The SS shall configure SCC as per TS 38.508-1 [5] clause 5.5.1. Message contents are defined in clause 6.4A.2.1.1.4.3.
3. SS activates SCC by sending the activation MAC CE (Refer TS 38.321 [18], clauses 5.9, 6.1.3.10). Wait for at least 2 seconds (Refer TS 38.133[19], clause 9.3).

4. SS sends uplink scheduling information for each UL HARQ process via PDCCH DCI format 0_1 for C_RNTI to schedule the UL RMC according to Table 6.4A.2.1.1.4.1-1. Since the UE has no payload data to send, the UE transmits uplink MAC padding bits on the UL RMC.
5. Send continuously uplink power control "up" commands in the uplink scheduling information to the UE until the UE transmits at P_{UMAX} level, allow at least 200ms starting from the first TPC command in this step for the UE to reach P_{UMAX} level.
6. Measure the EVM and \overline{EVM}_{DMRS} on PCC using Global In-Channel Tx-Test (Annex E).
7. For modulations except 256QAM, send uplink power control commands to the UE using 1dB power step size to ensure that the UE output power measured by the test system is within the Uplink power control window, defined as +MU to +(MU + Uplink power control window size) dB of the target power level Pmin, where:
 - Pmin is the minimum output power according to Table 6.3.1.3-1.
 - MU is the test system uplink power measurement uncertainty and is specified in Table F.1.2-1 for the carrier frequency f and the channel bandwidth BW.
 - Uplink power control window size = 1dB (UE power step size) + 0.7dB (UE power step tolerance) + (Test system relative power measurement uncertainty), where, the UE power step tolerance is specified in TS 38.101-1 [2], Table 6.3.4.3-1 and is 0.7dB for 1dB power step size, and the Test system relative power measurement uncertainty is specified in Table F.1.2-1.

For 256 QAM, send uplink power control commands to the UE using 1dB power step size to ensure that the UE output power measured by the test system is within the Uplink power control window, defined as +MU to +(MU + Uplink power control window size) dB of the target power level Pmin + 10 dB, where Pmin, MU and Uplink power control window size are defined above.

8. Measure the EVM and \overline{EVM}_{DMRS} on PCC using Global In-Channel Tx-Test (Annex E).

NOTE 1: When switching to DFT-s-OFDM waveform, as specified in the test configuration table 6.5.2.2.4.1-1, send an NR RRCReconfiguration message according to TS 38.508-1 [5] clause 4.6.3 Table 4.6.3-118 PUSCH-Config with TRANSFORM_PRECODER_ENABLED condition.

NOTE2: The purpose of the Uplink power control window is to ensure that the actual UE output power is no less than the target power level, and as close as possible to the target power level. The relationship between the Uplink power control window, the target power level and the corresponding possible actual UE Uplink power window is illustrated in Annex F.4.2.

6.4A.2.1.1.4.3 Message contents

Message contents are according to TS 38.508-1 [5] subclause 4.6.

6.4A.2.1.1.5 Test requirement

The PUSCH EVM, derived in Annex E.4.2, shall not exceed the values in Table 6.4A.2.1.1.5-1.

The PUSCH \overline{EVM}_{DMRS} , derived in Annex E.4.6.2, shall not exceed the values in Table 6.4A.2.1.1.5-1 when embedded with data symbols of the respective modulation scheme.

Table 6.4A.2.1.1.5-1: Test requirements for Error Vector Magnitude

Parameter	Unit	Average EVM Level
Pi/2-BPSK	%	30+TT
QPSK	%	17.5+TT
16QAM	%	12.5+TT
64QAM	%	8+TT
256 QAM	%	3.8+TT for 15 dBm < P _{UL} 4.3+TT for -25 dBm < P _{UL} ≤ 15 dBm 4.6+TT for -40dBm ≤ P _{UL} ≤ -25dBm

Table 6.4A.2.1.1.5-2: Test Tolerance for Error Vector Magnitude

Parameter	f ≤ 6.0GHz, BW ≤ 100MHz		
	15dBm < P _{UL}	-25dBm < P _{UL} ≤ 15dBm	-40dBm ≤ P _{UL} ≤ -25dBm
Pi/2-BPSK	0%	0%	0%
QPSK	0%	0%	0%
16QAM	0%	0%	0%
64QAM	0%	0%	0%
256 QAM	0.3%	0.8%	1.1%

6.4A.2.2 Carrier leakage for CA

6.4A.2.2.0 Minimum conformance requirements

6.4A.2.2.0.1 Minimum conformance requirements for intra-band contiguous CA

FFS

6.4A.2.2.0.2 Minimum conformance requirements for intra-band non-contiguous CA

FFS

6.4A.2.2.0.3 Minimum conformance requirements for inter-band CA

For inter-band carrier aggregation, the carrier leakage shall not exceed the values specified in Table 6.4A.2.2.0.3-1.

In the case that uplink sharing, the carrier leakage may have 7.5 kHz shift with the carrier frequency.

Table 6.4A.2.2.0.3-1: Requirements for carrier leakage

Parameter description	Unit	Limit		Applicable Frequencies
Carrier leakage	dBc	-28	Output power > 10 dBm	Carrier leakage frequency (NOTES 1, 2)
		-25	0 dBm ≤ Output power ≤ 10 dBm	
		-20	-30 dBm ≤ Output power ≤ 0 dBm	
		-10	-40 dBm ≤ Output power < -30 dBm	
NOTE 1: The measurement bandwidth is 1 RB and the limit is expressed as a ratio of measured power in one non-allocated RB to the measured total power in all allocated RBs.				
NOTE 2: The applicable frequencies for this limit depend on the parameter <i>txDirectCurrentLocation</i> in <i>UplinkTxDirectCurrent</i> IE, and are those that are enclosed either in the RBs containing the carrier leakage frequency, or in the two RBs immediately adjacent to the carrier leakage frequency but excluding any allocated RB.				

The normative reference for this requirement is TS 38.101-1 [2] clauses 6.4A.2.3.

6.4A.2.2.1 Carrier leakage for CA (2UL CA)

Editor's note: The following aspects are either missing or not yet determined:

- The minimum requirements for intra-band contiguous CA and intra-band non-contiguous CA have not been defined.

6.4A.2.2.1.1 Test purpose

Carrier leakage is an additive sinusoid waveform that is confined within the aggregated transmission bandwidth configuration. The carrier leakage requirement for 2UL CA is defined for each component carrier and is measured on the component carrier with PRBs allocated.

6.4A.2.2.1.2 Test applicability

This test case applies to all types of NR UE release 15 and forward that supports 2UL CA.

6.4A.2.2.1.3 Minimum conformance requirements

The minimum conformance requirements are defined in clause 6.4A.2.2.0.

6.4A.2.2.1.4 Test description

6.4A.2.2.1.4.1 Initial condition

Initial conditions are a set of test configurations the UE needs to be tested in and the steps for the SS to take with the UE to reach the correct measurement state.

The initial test configurations consist of environmental conditions, test frequencies, test channel bandwidths and sub-carrier spacing based on NR CA configuration specified in clause 5.5A. All of these configurations shall be tested with applicable test parameters for each CA configuration, and are shown in Table 6.4A.2.2.1.4.1-1. The details of the uplink and downlink reference measurement channels (RMCs) are specified in Annexes A.2 and A.3. Configurations of PDSCH and PDCCH before measurement are specified in Annex C.2.

Table 6.4A.2.2.1.4.1-1: Inter band CA Test Configuration Table

Initial Conditions				
Test Environment as specified in TS 38.508-1 [5] subclause 4.1		Normal		
Test Frequencies as specified in TS 38.508-1 [5] subclause 4.3.1.1.3 for inter band CA in FR1		Low range for PCC and SCC High range for PCC and SCC		
Test Channel Bandwidths as specified in TS 38.508-1 [5] subclause 4.3.1		Mid N_{RB_agg} for both PCC and SCC		
Test SCS as specified in Table 5.5A.3-1		Smallest supported SCS per Channel Bandwidth		
Test Parameters				
Test ID	Downlink Configuration	Uplink Configuration		
		Modulation	RB allocation (NOTE 1, 3)	
			PCC	SCC
1	N/A	DFT-s-OFDM QPSK	Inner_1RB_Left	0
NOTE 1: The specific configuration of each RB allocation is defined in Table 6.1-1.				
NOTE 2: Test Channel Bandwidths and Test SCS are checked separately for each NR CA band combination, which applicable channel bandwidths and SCS are specified in Table 5.5A3-1.				
NOTE 3: When the signalled DC carrier position is at Inner_1RB_Left, use Inner_1RB_Right for UL RB allocation.				
NOTE 4: The frequencies of PCC and SCC shall be switched and tested in each configuration.				

1. Connect the SS to the UE antenna connectors as shown in TS 38.508-1 [5] Annex A, in Figure 3.1.1.3 for TE diagram and section A.3.2 for UE diagram.
2. The parameter settings for the cell are set up according to TS 38.508-1 [5] subclause 4.4.3.
3. Downlink signals for PCC are initially set up according to Annex C.0, C.1, C.2 and uplink signals according to Annex G.0, G.1, G.2, G.3.0.
4. The UL Reference Measurement channels are set according to Table 6.4A.2.2.1.4.1-1.
5. Propagation conditions are set according to Annex B.0.
6. Ensure the UE is in state RRC_CONNECTED with generic procedure parameters Connectivity NR, Connected without release On, Test Mode On and Test Loop Function On according to TS 38.508-1 [5] clause 4.5. Message contents are defined in clause 6.4A.2.2.1.4.3.

6.4A.2.2.1.4.2 Test procedure

1. Configure SCC according to Annex C.0, C.1, C.2 for all downlink physical channels.
2. The SS shall configure SCC as per TS 38.508-1 [5] clause 5.5.1. Message contents are defined in clause 6.4A.2.2.1.4.3.
3. SS activates SCC by sending the activation MAC CE (Refer TS 38.321 [18], clauses 5.9, 6.1.3.10). Wait for at least 2 seconds (Refer TS 38.133[19], clause 9.3).

4. SS sends uplink scheduling information for each UL HARQ process via PDCCH DCI format 0_1 for C_RNTI to schedule the UL RMC according to Table 6.4A.2.2.1.4.1-1. Since the UE has no payload and no loopback data to send the UE sends uplink MAC padding bits on the UL RMC.
5. Send uplink power control commands to the UE using 1dB power step size to ensure that the UE output power measured by the test system is within the Uplink power control window, defined as +MU to +(MU + Uplink power control window size) dB of the target power level 10 dBm, where:
 - MU is the test system uplink power measurement uncertainty and is specified in Table F.1.2-1 for the carrier frequency f and the channel bandwidth BW.
 - Uplink power control window size = 1dB (UE power step size) + 0.7dB (UE power step tolerance) + (Test system relative power measurement uncertainty), where, the UE power step tolerance is specified in TS 38.101-1 [2], Table 6.3.4.3-1 and is 0.7dB for 1dB power step size, and the Test system relative power measurement uncertainty is specified in Table F.1.2-1.
6. Measure carrier leakage using Global In-Channel Tx-Test (Annex E). For TDD slots with transient periods are not under test.
7. Send uplink power control commands to the UE using 1dB power step size to ensure that the UE output power measured by the test system is within the Uplink power control window, defined as +MU to +(MU + Uplink power control window size) dB of the target power level 0 dBm, where MU and Uplink power control window size are defined above.
8. Measure carrier leakage on PCC using Global In-Channel Tx-Test (Annex E). For TDD slots with transient periods are not under test.
9. Send uplink power control commands to the UE using 1dB power step size to ensure that the UE output power measured by the test system is within the Uplink power control window, defined as +MU to +(MU + Uplink power control window size) dB of the target power level -30 dBm, where MU and Uplink power control window size are defined above.
10. Measure carrier leakage on PCC using Global In-Channel Tx-Test (Annex E). For TDD slots with transient periods are not under test.
11. Send uplink power control commands to the UE using 1dB power step size to ensure that the UE output power measured by the test system is within the Uplink power control window, defined as +MU to +(MU + Uplink power control window size) dB of the target power level P_{min} , where MU and Uplink power control window size are defined above, and P_{min} is the minimum output power according to Table 6.3.1.3-1.
12. Measure carrier leakage on PCC using Global In-Channel Tx-Test (Annex E). For TDD slots with transient periods are not under test.

NOTE 1: When switching to DFT-s-OFDM waveform, as specified in the test configuration table 6.5.2.2.4.1-1, send an NR RRCReconfiguration message according to TS 38.508-1 [5] clause 4.6.3 Table 4.6.3-118 PUSCH-Config with TRANSFORM_PRECODER_ENABLED condition.

NOTE2: The purpose of the Uplink power control window is to ensure that the actual UE output power is no less than the target power level, and as close as possible to the target power level. The relationship between the Uplink power control window, the target power level and the corresponding possible actual UE Uplink power window is illustrated in Annex F.4.2.

Table 6.4A.2.2.1.4.2-1: Void

Table 6.4A.2.2.1.4.2-2: Void

6.4A.2.2.1.4.3 Message contents

Message contents are according to TS 38.508-1 [5] subclause 4.6.

6.4A.2.2.1.5 Test requirement

Each of the [20] carrier leakage results, derived in Annex E.3.1, shall not exceed the values in table 6.4A.2.2.1.5-1. Allocated RBs are not under test.

Table 6.4A.2.2.1.5-1: Test requirements for Carrier Leakage

LO Leakage	Parameters UE output power	Relative limit (dBc)
	10 + MU to 10 + (MU + Uplink power control window size) dBm	-28+TT
	0 + MU to 0 + (MU + Uplink power control window size) dBm	-25+TT
	-30 + MU to -30 + (MU + Uplink power control window size) dBm	-20+TT
	Pmin + MU to Pmin + (MU + Uplink power control window size) dBm	-10+TT

NOTE 1: The measurement bandwidth is 1 RB and the limit is expressed as a ratio of measured power in one non-allocated RB to the measured total power in all allocated RBs.

NOTE 2: The applicable frequencies for this limit depend on the parameter *txDirectCurrentLocation* in *UplinkTxDirectCurrent* IE, and are those that are enclosed in the RBs containing the carrier leakage frequency, or in the two RBs immediately adjacent to the carrier leakage frequency but excluding any allocated RB.

NOTE 3: N_{RB} is the Transmission Bandwidth Configuration (see Section 5.3).

NOTE 4: Void

NOTE 5: MU is the test system uplink power measurement uncertainty and is specified in Table F.1.2-1 for the carrier frequency *f* and the channel bandwidth BW.

NOTE 6: Uplink power control window size = 1dB (UE power step size) + 0.7dB (UE power step tolerance) + (Test system relative power measurement uncertainty), where, the UE power step tolerance is specified in TS 38.101-1 [2], Table 6.3.4.3-1 and is 0.7dB for 1dB power step size, and the Test system relative power measurement uncertainty is specified in Table F.1.2-1.

NOTE 7: Pmin is the minimum output power according to Table 6.3.1.3-1.

Table 6.4A.2.2.1.5-2: Test Tolerance for Carrier Leakage

	$f \leq 3.0\text{GHz}$	$3.0\text{GHz} < f \leq 6\text{GHz}$
$\text{BW} \leq 40\text{MHz}$	0.8dB	0.8dB
$40\text{MHz} < \text{BW} \leq 100\text{MHz}$	0.8dB	0.8dB

6.4A.2.3 In-band emissions for CA

6.4A.2.3.0 Minimum conformance requirements

For inter-band carrier aggregation with uplink assigned to two NR bands, the requirements shall apply on each component carrier as defined in clause 6.4.2 with all component carriers active.

The requirements in Table 6.4A.2.3.0-1 apply with PCC and SCC in the UL configured and activated: PCC with PRB allocation and SCC without PRB allocation and without CSI reporting and SRS configured.

Table 6.4A.2.3.0-1: Inter band CA Requirements for in-band emissions

Parameter description	Unit	Limit (NOTE 1)		Applicable Frequencies
General	dB	$\max \left\{ -25 - 10 \cdot \log_{10} (N_{RB} / L_{CRB}), \right.$ $20 \cdot \log_{10} EVM - 3 - 5 \cdot (\Delta_{RB} - 1) / L_{CRB},$ $\left. -57 \text{ dBm} + 10 \log_{10} (SCS / 15 \text{ kHz}) - P_{RB} \right\}$		Any non-allocated (NOTE 2)
IQ Image	dB	-28	Image frequencies when output power > 10 dBm	Image frequencies (NOTES 2, 3)
		-25	Image frequencies when output power ≤ 10 dBm	
Carrier leakage	dBc	-28	Output power > 10 dBm	Carrier leakage frequency (NOTES 4, 5)
		-25	0 dBm ≤ Output power ≤ 10 dBm	
		-20	-30 dBm ≤ Output power ≤ 0 dBm	
		-10	-40 dBm ≤ Output power < -30 dBm	
<p>NOTE 1: An in-band emissions combined limit is evaluated in each non-allocated RB. For each such RB, the minimum requirement is calculated as the higher of $P_{RB} - 30$ dB and the power sum of all limit values (General, IQ Image or Carrier leakage) that apply. P_{RB} is defined in NOTE 10.</p> <p>NOTE 2: The measurement bandwidth is 1 RB and the limit is expressed as a ratio of measured power in one non-allocated RB to the measured average power per allocated RB, where the averaging is done across all allocated RBs.</p> <p>NOTE 3: The applicable frequencies for this limit are those that are enclosed in the reflection of the allocated bandwidth, based on symmetry with respect to the carrier leakage frequency, but excluding any allocated RBs.</p> <p>NOTE 4: The measurement bandwidth is 1 RB and the limit is expressed as a ratio of measured power in one non-allocated RB to the measured total power in all allocated RBs.</p> <p>NOTE 5: The applicable frequencies for this limit depend on the parameter <i>txDirectCurrentLocation</i> in <i>UplinkTxDirectCurrent</i> IE, and are those that are enclosed either in the RBs containing the carrier leakage frequency, or in the two RBs immediately adjacent to the carrier leakage frequency but excluding any allocated RB.</p> <p>NOTE 6: L_{CRB} is the Transmission Bandwidth (see Section 5.3).</p> <p>NOTE 7: N_{RB} is the Transmission Bandwidth Configuration (see Section 5.3).</p> <p>NOTE 8: EVM is the limit specified in Table 6.4A.2.3.1.3-1 for the modulation format used in the allocated RBs.</p> <p>NOTE 9: Δ_{RB} is the starting frequency offset between the allocated RB and the measured non-allocated RB (e.g. $\Delta_{RB} = 1$ or $\Delta_{RB} = -1$ for the first adjacent RB outside of the allocated bandwidth).</p> <p>NOTE 10: P_{RB} is the transmitted power normalized by the number of allocated RBs, measured in dBm.</p>				

The normative reference for this requirement is TS 38.101-1 [2] clause 6.4A.2.3.

6.4A.2.3.1 In-band emissions for CA (2UL CA)

6.4A.2.3.1.1 Test purpose

The in-band emissions are a measure of the interference falling into the non-allocated resources blocks.

For an allocated component carrier, the in-band emission is defined as the average across 12 sub-carrier and as a function of the RB offset from the edge of the allocated UL transmission bandwidth. The in-band emission is measured as the ratio of the UE output power in a non-allocated RB to the UE output power in an allocated RB. The basic in-band emissions measurement interval is defined over one slot in the time domain, however, the minimum requirement applies when the in-band emission measurement is averaged over 10 sub-frames. When the PUSCH or PUCCH transmission slot is shortened due to multiplexing with SRS, the in-band emissions measurement interval is reduced by one or more symbols, accordingly.

For a non allocated component carrier a spectral measurement is specified.

6.4A.2.3.1.2 Test applicability

This test case applies to all types of NR UE release 15 and forward that supports 2UL CA.

6.4A.2.3.1.3 Minimum conformance requirements

The minimum conformance requirements are defined in clause 6.4A.2.3.0.

6.4A.2.3.1.4 Test description

6.4A.2.3.1.4.1 Initial condition

Initial conditions are a set of test configurations the UE needs to be tested in and the steps for the SS to take with the UE to reach the correct measurement state.

The initial test configurations consist of environmental conditions, test frequencies, test channel bandwidths and sub-carrier spacing based on NR CA configuration specified in clause 5.5A. All of these configurations shall be tested with applicable test parameters for each CA configuration, and are shown in Table 6.4A.2.3.1.4.1-1. The details of the uplink and downlink reference measurement channels (RMCs) are specified in Annexes A.2 and A.3. Configurations of PDSCH and PDCCH before measurement are specified in Annex C.2.

Table 6.4A.2.3.1.4.1-1: Test Configuration Table

Initial Conditions				
Test Environment as specified in TS 38.508-1 [5] subclause 4.1		Normal		
Test Frequencies as specified in TS 38.508-1 [5] subclause 4.3.1.1.3 for inter band CA in FR1		Low range for PCC and SCC High range for PCC and SCC		
Test Channel Bandwidths as specified in TS 38.508-1 [5] subclause 4.3.1		Lowest N_{RB_agg} for both PCC and SCC Highest N_{RB_agg} for both PCC and SCC		
Test SCS as specified in Table 5.5A.3-1		Smallest supported SCS per Channel Bandwidth		
Test Parameters				
Test ID	Downlink Configuration	Uplink Configuration		
		Modulation	RB allocation (NOTE 1)	
			PCC	SCC
1	N/A	DFT-s-OFDM QPSK	Inner_1RB_Left	0
2		DFT-s-OFDM QPSK	Inner_1RB_Right	0
3		CP-OFDM QPSK	Inner_1RB_Left	0
4		CP-OFDM QPSK	Inner_1RB_Right	0
NOTE 1: The specific configuration of each RB allocation is defined in Table 6.1-1.				
NOTE 2: Test Channel Bandwidths are checked separately for each NR band, which applicable channel bandwidths are specified in Table 5.5A3-1.				
NOTE 3: The frequencies of PCC and SCC shall be switched and tested in each configuration.				

1. Connect the SS to the UE antenna connectors as shown in TS 38.508-1 [5] Annex A, in Figure A.3.1.1.3 for TE diagram and section A.3.2 for UE diagram.
2. The parameter settings for the cell are set up according to TS 38.508-1 [5] subclause 4.4.3.
3. Downlink signals for PCC are initially set up according to Annex C.0, C.1, C.2, and uplink signals according to Annex G.0, G.1, G.2, G.3.0.
4. The UL Reference Measurement channels are set according to Table 6.4A.2.3.1.4.1-1.
5. Propagation conditions are set according to Annex B.0.
6. Ensure the UE is in state RRC_CONNECTED with generic procedure parameters Connectivity *NR*, Connected without release *On*, Test Mode *On* and Test Loop Function *On* according to TS 38.508-1 [5] clause 4.5. Message contents are defined in clause 6.4A.2.3.1.4.3.

6.4A.2.3.1.4.2 Test procedure

1. Configure SCC according to Annex C.0, C.1, C.2 for all downlink physical channels.
2. The SS shall configure SCC as per TS 38.508-1 [5] clause 5.5.1. Message contents are defined in clause 6.4A.2.3.1.4.3.

3. SS activates SCC by sending the activation MAC CE (Refer TS 38.321 [18], clauses 5.9, 6.1.3.10). Wait for at least 2 seconds (Refer TS 38.133[19], clause 9.3).
4. SS sends uplink scheduling information for each UL HARQ process via PDCCH DCI format 0_1 for C_RNTI to schedule the UL RMC according to Table 6.4A.2.3.1.4.1-1. Since the UE has no payload and no loopback data to send the UE sends uplink MAC padding bits on the UL RMC.
5. Send uplink power control commands to the UE using 1dB power step size to ensure that the UE output power measured by the test system is within the Uplink power control window, defined as +MU to +(MU + Uplink power control window size) dB of the target power level 10 dBm, where:
 - MU is the test system uplink power measurement uncertainty and is specified in Table F.1.2-1 for the carrier frequency f and the channel bandwidth BW.
 - Uplink power control window size = 1dB (UE power step size) + 0.7dB (UE power step tolerance) + (Test system relative power measurement uncertainty), where, the UE power step tolerance is specified in TS 38.101-1 [2], Table 6.3.4.3-1 and is 0.7dB for 1dB power step size, and the Test system relative power measurement uncertainty is specified in Table F.1.2-1.
6. Measure In-band emission on PCC using Global In-Channel Tx-Test (Annex E). Measure power spectral density on the SCC. For TDD slots with transient periods are not under test.
7. Send uplink power control commands to the UE using 1dB power step size to ensure that the UE output power measured by the test system is within the Uplink power control window, defined as +MU to +(MU + Uplink power control window size) dB of the target power level 0 dBm, where MU and Uplink power control window size are defined above.
8. Measure In-band emission on PCC using Global In-Channel Tx-Test (Annex E). Measure power spectral density on the SCC. For TDD slots with transient periods are not under test.
9. Send uplink power control commands to the UE using 1dB power step size to ensure that the UE output power measured by the test system is within the Uplink power control window, defined as +MU to +(MU + Uplink power control window size) dB of the target power level -30 dBm, where MU and Uplink power control window size are defined above.
10. Measure In-band emission on PCC using Global In-Channel Tx-Test (Annex E). Measure power spectral density on the SCC. For TDD slots with transient periods are not under test.
11. Send uplink power control commands to the UE using 1dB power step size to ensure that the UE output power measured by the test system is within the Uplink power control window, defined as +MU to +(MU + Uplink power control window size) dB of the target power level P_{min} , where MU and Uplink power control window size are defined above, and P_{min} is the minimum output power according to Table 6.3.1.3-1.
12. Measure In-band emission on PCC using Global In-Channel Tx-Test (Annex E). Measure power spectral density on the SCC. For TDD slots with transient periods are not under test.

NOTE 1: When switching to DFT-s-OFDM waveform, as specified in the test configuration table 6.5.2.2.4.1-1, send an NR RRCReconfiguration message according to TS 38.508-1 [5] clause 4.6.3 Table 4.6.3-118 PUSCH-Config with TRANSFORM_PRECODER_ENABLED condition.

NOTE2: The purpose of the Uplink power control window is to ensure that the actual UE output power is no less than the target power level, and as close as possible to the target power level. The relationship between the Uplink power control window, the target power level and the corresponding possible actual UE Uplink power window is illustrated in Annex F.4.2.

Table 6.4A.2.3.1.4.2-1: Void

Table 6.4A.2.3.1.4.2-2: Void

6.4A.2.3.1.4.3 Message contents

Message contents are according to TS 38.508-1 [5] subclause 4.6.

6.4A.2.3.1.5 Test requirement

The averaged In-band emission result, derived in Annex E.4.3, shall not exceed the corresponding values in Table 6.4A.2.3.1.5-1. n is 10 for 15kHz SCS, 20 for 30kHz SCS and 40 for 60kHz SCS..

Table 6.4A.2.3.1.5-1: Test requirements for in-band emissions

Parameter description	Unit	Limit (NOTE 1)		Applicable Frequencies
General	dB	$\max \left\{ -25 - 10 \cdot \log_{10} (N_{RB} / L_{CRB}), \right.$ $20 \cdot \log_{10} EVM - 3 - 5 \cdot (\Delta_{RB} - 1) / L_{CRB},$ $\left. -57 \text{ dBm} + 10 \log_{10} (SCS / 15 \text{ kHz}) - P_{RB} \right\} + TT$		Any non-allocated (NOTE 2)
IQ Image	dB	-28+TT	Image frequencies when output power > 10 dBm	Image frequencies (NOTES 2, 3)
		-25+TT	Image frequencies when output power ≤ 10 dBm	
Carrier leakage	dBc	-28+TT	Output power > 10 dBm	Carrier leakage frequency (NOTES 4, 5)
		-25+TT	0 dBm ≤ Output power ≤ 10 dBm	
		-20+TT	-30 dBm ≤ Output power ≤ 0 dBm	
		-10+TT	-40 dBm ≤ Output power < -30 dBm	
<p>NOTE 1: An in-band emissions combined limit is evaluated in each non-allocated RB. For each such RB, the minimum requirement is calculated as the higher of $P_{RB} - 30$ dB and the power sum of all limit values (General, IQ Image or Carrier leakage) that apply. P_{RB} is defined in NOTE 10.</p> <p>NOTE 2: The measurement bandwidth is 1 RB and the limit is expressed as a ratio of measured power in one non-allocated RB to the measured average power per allocated RB, where the averaging is done across all allocated RBs.</p> <p>NOTE 3: The applicable frequencies for this limit are those that are enclosed in the reflection of the allocated bandwidth, based on symmetry with respect to the carrier leakage frequency, but excluding any allocated RBs.</p> <p>NOTE 4: The measurement bandwidth is 1 RB and the limit is expressed as a ratio of measured power in one non-allocated RB to the measured total power in all allocated RBs.</p> <p>NOTE 5: The applicable frequencies for this limit depend on the parameter <i>txDirectCurrentLocation</i> in <i>UplinkTxDirectCurrent</i> IE, and are those that are enclosed either in the RBs containing the carrier leakage frequency, or in the two RBs immediately adjacent to the carrier leakage frequency but excluding any allocated RB.</p> <p>NOTE 6: L_{CRB} is the Transmission Bandwidth (see Section 5.3).</p> <p>NOTE 7: N_{RB} is the Transmission Bandwidth Configuration (see Section 5.3).</p> <p>NOTE 8: EVM is the limit specified in Table 6.4.2.1.3-1 for the modulation format used in the allocated RBs.</p> <p>NOTE 9: Δ_{RB} is the starting frequency offset between the allocated RB and the measured non-allocated RB (e.g. $\Delta_{RB} = 1$ or $\Delta_{RB} = -1$ for the first adjacent RB outside of the allocated bandwidth).</p> <p>NOTE 10: P_{RB} is the transmitted power normalized by the number of allocated RBs, measured in dBm.</p>				

Table 6.4A.2.3.1.5-2: Test Tolerance for In-band emission

	$f \leq 3.0\text{GHz}$	$3.0\text{GHz} < f \leq 6\text{GHz}$
$BW \leq 40\text{MHz}$	0.8dB	0.8dB
$40\text{MHz} < BW \leq 100\text{MHz}$	0.8dB	0.8dB

6.4B Transmit signal quality for NR-DC

For inter-band NR-DC with one uplink carrier assigned per NR band, the transmit signal quality for the corresponding inter-band CA configuration as specified in clause 6.4A applies.

Note: For NR-DC testing, replace CA by NR-DC, PCC by PCell, and SCC by PSCell in clause 6.4A.

6.4B.1 Frequency error for NR-DC

For inter-band dual connectivity, the frequency error for the corresponding inter-band CA configuration as specified in clause 6.4A.1 applies.

Note: For NR-DC testing, replace CA by NR-DC, PCC by PCell, and SCC by PSCell in clause 6.4A.1.

6.4B.2 Transmit modulation quality for NR-DC

For inter-band dual connectivity, the transmit modulation quality for the corresponding inter-band CA configuration as specified in clause 6.4A.2 applies.

Note: For NR-DC testing, replace CA by NR-DC, PCC by PCell, and SCC by PSCell in clause 6.4A.2.

6.4B.2.1 Error Vector Magnitude for NR-DC

For inter-band dual connectivity, the Error Vector Magnitude for the corresponding inter-band CA configuration as specified in clause 6.4A.2.1 applies.

Note: For NR-DC testing, replace CA by NR-DC, PCC by PCell, and SCC by PSCell in clause 6.4A.2.1.

6.4B.2.2 Carrier leakage for NR-DC

For inter-band dual connectivity, the carrier leakage for the corresponding inter-band CA configuration as specified in clause 6.4A.2.2 applies.

Note: For NR-DC testing, replace CA by NR-DC, PCC by PCell, and SCC by PSCell in clause 6.4A.2.2.

6.4B.2.3 In-band emissions for NR-DC

For inter-band dual connectivity, the in-band emissions for the corresponding inter-band CA configuration as specified in clause 6.4A.2.3 applies.

Note: For NR-DC testing, replace CA by NR-DC, PCC by PCell, and SCC by PSCell in clause 6.4A.2.3.

6.4C Transmit signal quality for SUL

6.4C.1 Frequency error for SUL

6.4C.1.1 Test purpose

Same test purpose as in clause 6.4.1.1

6.4C.1.2 Test applicability

This test applies to all types of NR UE release 15 and forward that support SUL operating on the SUL bands.

6.4C.1.3 Minimum conformance requirements

For a terminal that supports SUL for the band combination specified in Table 5.2C-1, the current version of the specification assumes the terminal is configured with active transmission either on UL carrier or SUL carrier at any time in one serving cell and the UE requirements for single carrier shall apply for the active UL or SUL carrier accordingly.

The normative reference for this requirement is TS 38.101-1 [2] clauses 4.3 and 6.4.1.

6.4C.1.4 Test description

Same test description as specified in clause 6.4.1.4 with following exceptions:

Instead of table 5.3.5-1 → use Table 5.5C-1.

Instead of table 6.4.1.4-1 → use Table 6.4C.1.4-1

Table 6.4C.1.4-1: Test Configuration Table

Initial Conditions					
Test Environment as specified in TS 38.508-1 [5] subclause 4.1			Normal, TL/VL, TL/VH, TH/VL, TH/VH		
Test Frequencies as specified in TS 38.508-1 [5] subclause 4.3.1			Mid range for both SUL carrier and Non-SUL carrier		
Test Channel Bandwidths as specified in TS 38.508-1 [5] subclause 4.3.1			Highest for SUL carrier Lowest for Non-SUL carrier		
Test SCS as specified in Table 5.3.5-1			15kHz for both SUL carrier and Non-SUL carrier		
Test Parameters for Channel Bandwidths					
Test ID	Downlink Configuration		UL Configuration	SUL Configuration	
	Modulation	RB allocation	N/A	Modulation	RB allocation
1	CP-OFDM QPSK	Full RB (NOTE 1)		DFT-s-OFDM QPSK	SUL REFSSENS (NOTE 2)
NOTE 1: Full RB allocation shall be used per each SCS and channel BW as specified in Table 7.3.2.4.1-2					
NOTE 2: SUL REFSSENS refers to Table 7.3C.2.4.1-1a which defines SUL RB configuration and start RB location for each SCS, channel BW and NR band.					

- Connect the SS to the UE antenna connectors as shown in TS 38.508-1 [5] Annex A, Figure A.3.1.1.4 for TE diagram and section A.3.2 for UE diagram.
- The parameter setting for the cell are set up according to the TS 38.508-1 [5] subclause 4.4.3.
- Downlink signals are initially setup according to Annex C.0, C.1, C.2 and uplink signals according to Annex G.0, G.1, G.2, and G.3.0 with consideration of supplementary uplink physical channels.

Message contents in initial conditions are according to TS 38.508-1 [5] subclause 4.3.6.1.1.2 ensuring UL/SUL indicator in Table 4.3.6.1.1.2-1 with condition SUL, subclause 4.6 ensuring Table 4.6.1-28 with condition SUL AND (RF OR RRM), Tables 4.6.3-14 with condition SUL_SUL for SUL carrier, and Table 4.6.3-167 with condition PUSCH_PUCCH_ON_SUL.

Table 6.4C.1.4-1: Void

6.4C.1.5 Test requirement

The 10 frequency error Δf results measured on the SUL carrier must fulfil the test requirement:

$$|\Delta f| \leq (0.1 \text{ PPM} + 15 \text{ Hz})$$

6.4C.2 Transmit modulation quality for SUL

6.4C.2.1 Error Vector Magnitude for SUL

6.4C.2.1.1 Test purpose

Same test purpose as in clause 6.4.2.1

6.4C.2.1.2 Test applicability

This test applies to all types of NR UE release 15 and forward that support SUL operating on the SUL bands.

6.4C.2.1.3 Minimum conformance requirements

For a terminal that supports SUL for the band combination specified in Table 5.2C-1, the current version of the specification assumes the terminal is configured with active transmission either on UL carrier or SUL carrier at any time in one serving cell and the UE requirements for single carrier shall apply for the active UL or SUL carrier accordingly.

The normative reference for this requirement is TS 38.101-1 [2] clauses 4.3 and 6.4.2.1.

6.4C.2.1.4 Test description

Same test description as specified in clause 6.4.2.1.4 with following exceptions:

Instead of table 5.3.5-1 → use Table 5.5C-1.

Instead of table 6.4.2.1.4-1, table 6.4.2.1.4-2, table 6.4.2.1.4-3 → use Table 6.4C.2.1.4-1, table 6.4C.2.1.4-2, table 6.4C.2.1.4-3

Table 6.4C.2.1.4-1: Test Configuration Table for PUSCH

Initial Conditions			
Test Environment as specified in TS 38.508-1 [5] subclause 4.1		Normal	
Test Frequencies as specified in TS 38.508-1 [5] subclause 4.3.1		Low, Mid, High range for SUL carrier Mid range for Non-SUL carrier	
Test Channel Bandwidths as specified in TS 38.508-1 [5] subclause 4.3.1		Lowest, Highest for SUL carrier Lowest for Non-SUL carrier	
Test SCS as specified in Table 5.3.5-1		15kHz for both SUL carrier and Non-SUL carrier	
Test Parameters for Channel Bandwidths			
Test ID	Downlink Configuration	UL Configuration	SUL Configuration
	N/A	N/A	Modulation RB allocation (NOTE 2)
1 ³			DFT-s-OFDM PI/2 BPSK Inner Full
2 ³			DFT-s-OFDM PI/2 BPSK Outer Full
3			DFT-s-OFDM QPSK Inner Full
4			DFT-s-OFDM QPSK Outer Full
5			DFT-s-OFDM 16 QAM Inner Full
6			DFT-s-OFDM 16 QAM Outer Full
7			DFT-s-OFDM 64 QAM Outer Full
8			DFT-s-OFDM 256 QAM Outer Full
9			CP-OFDM QPSK Inner Full
10			CP-OFDM QPSK Outer Full
11			CP-OFDM 16 QAM Inner Full
12			CP-OFDM 16 QAM Outer Full
13			CP-OFDM 64 QAM Outer Full
14			CP-OFDM 256 QAM Outer Full
NOTE 1: The specific configuration of each RB allocation is defined in Table 6.1-1.			
NOTE 2: Test Channel Bandwidths are checked separately for each SUL band combination, the applicable channel bandwidths are specified in Table 5.5C-1.			
NOTE 3: DFT-s-OFDM PI/2 BPSK test applies only for UEs which supports half Pi BPSK in FR1.			

Table 6.4C.2.1.4-2: Test Configuration Table for PUCCH

Initial Conditions						
Test Environment as specified in TS 38.508-1 [5] subclause 4.1			See Table 6.4C.2.1.4.1-1			
Test Frequencies as specified in TS 38.508-1 [5] subclause 4.3.1			See Table 6.4C.2.1.4.1-1			
Test Channel Bandwidths as specified in TS 38.508-1 [5] subclause 4.3.1			See Table 6.4C.2.1.4.1-1			
Test SCS as specified in Table 5.3.5-1			See Table 6.4C.2.1.4.1-1			
Test Parameters						
ID	Downlink Configuration		Uplink Configuration	SUL Configuration		
	Modulation	RB allocation	N/A	Waveform	PUCCH format	RB index

1	CP-OFDM QPSK	Full RB (Note 1)	CP-OFDM	PUCCH format = Format 1 Length in OFDM symbols = 14	0
2	CP-OFDM QPSK	Full RB (Note 1)	CP-OFDM	PUCCH format = Format 1 Length in OFDM symbols = 14	$N_{RB}-1$
3	CP-OFDM QPSK	Full RB (Note 1)	DFT-s-OFDM	PUCCH format = Format 3 Length in OFDM symbols = 14	0
4	CP-OFDM QPSK	Full RB (Note 1)	DFT-s-OFDM	PUCCH format = Format 3 Length in OFDM symbols = 14	$N_{RB}-1$

NOTE 1: Full RB allocation shall be used per each SCS and channel BW as specified in Table 7.3.2.4.1-2.
 NOTE 2: Test Channel Bandwidths are checked separately for each SUL band combination, the applicable channel bandwidths are specified in Table 5.5C-1.
 NOTE 3: DFT-s-OFDM PI/2 BPSK test applies only for UEs which supports half Pi BPSK in FR1.

Table 6.4C.2.1.4-3: Test Configuration Table for PRACH

Initial Conditions	
Test Environment as specified in TS 38.508-1 [5] subclause 4.1	Normal
Test Frequencies as specified in TS 38.508-1 [5] subclause 4.3.1	See Table 6.4C.2.1.4.1-1
Test Channel Bandwidths as specified in TS 38.508-1 [5] subclause 4.3.1	See Table 6.4C.2.1.4.1-1
Test SCS as specified in Table 5.3.5-1	See Table 6.4C.2.1.4.1-1
PRACH preamble format	
	SUL
PRACH Configuration Index	17
RS EPRE setting for test point 1 (dBm/15kHz)	-71
RS EPRE setting for test point 2 (dBm/15kHz)	-86

- Connect the SS to the UE antenna connectors as shown in TS 38.508-1 [5] Annex A, Figure A.3.1.1.4 for TE diagram and section A.3.2 for UE diagram.
- The parameter setting for the cell are set up according to the TS 38.508-1 [5] subclause 4.4.3.
- Downlink signals are initially setup according to Annex C.0, C.1, C.2 and uplink signals according to Annex G.0, G.1, G.2, and G.3.0 with consideration of supplementary uplink physical channels.

Message contents in initial conditions are according to TS 38.508-1 [5] subclause 4.3.6.1.1.2 ensuring UL/SUL indicator in Table 4.3.6.1.1.2-1 with condition SUL, subclause 4.6 ensuring Table 4.6.1-28 with condition SUL AND (RF OR RRM), Tables 4.6.3-14 with condition SUL_SUL for SUL carrier, and Table 4.6.3-167 with condition PUSCH_PUCCH_ON_SUL. Additionally the following exceptions shown in Table 6.4C.2.1.4-2 is considered.

Table 6.4C.2.1.4-1: Void

Table 6.4C.2.1.4-2: BWP-UplinkCommon: PRACH measurement

Derivation Path: TS 38.508-1 [5], Table 4.6.3-14			
Information Element	Value/remark	Comment	Condition
BWP-UplinkCommon ::= SEQUENCE {			
rach-ConfigCommon CHOICE {			SUL_SUL AND RF
setup	RACH-ConfigCommon		
}			
}			

6.4C.2.1.5 Test requirement

Same test requirement for EVM measured on the SUL carrier as specified in 6.4.2.1.5.

6.4C.2.2 Carrier leakage for SUL

6.4C.2.2.1 Test purpose

Same test purpose as in clause 6.4.2.2.1.

6.4C.2.2.2 Test applicability

This test applies to all types of NR UE release 15 and forward that support SUL operating on the SUL bands.

6.4C.2.2.3 Minimum conformance requirements

For a terminal that supports SUL for the band combination specified in Table 5.2C-1, the current version of the specification assumes the terminal is configured with active transmission either on UL carrier or SUL carrier at any time in one serving cell and the UE requirements for single carrier shall apply for the active UL or SUL carrier accordingly.

The normative reference for this requirement is TS 38.101-1 [2] clauses 4.3 and 6.4.2.2.

6.4C.2.2.4 Test description

Same test description as specified in clause 6.4.2.2.4 with following exceptions:

Instead of table 5.3.5-1 → use Table 5.5C-1.

Instead of table 6.4.2.2.4-1 → use Table 6.4C.2.2.4-1

Table 6.4C.2.2.4-1: Test Configuration Table

Initial Conditions				
Test Environment as specified in TS 38.508-1 [5] subclause 4.1		Normal		
Test Frequencies as specified in TS 38.508-1 [5] subclause 4.3.1		Low, Mid, High range for SUL carrier Mid range for Non-SUL carrier		
Test Channel Bandwidths as specified in TS 38.508-1 [5] subclause 4.3.1		Mid for SUL carrier Lowest for Non-SUL carrier		
Test SCS as specified in Table 5.3.5-1		15kHz for both SUL carrier and Non-SUL carrier		
Test Parameters for Channel Bandwidths				
Test ID	Downlink Configuration	UL Configuration	SUL Configuration	
	N/A	N/A	Modulation	RB allocation (NOTE 1)
1			DFT-s-OFDM QPSK	Inner_1RB_Left
NOTE 1: The specific configuration of each RB allocation is defined in Table 6.1-1.				
NOTE 2: Test Channel Bandwidths are checked separately for each SUL band combination, the applicable channel bandwidths are specified in Table 5.5C-1.				
NOTE 3: When the signalled DC carrier position is at Inner_1RB_Left, use Inner_1RB_Right for UL RB allocation..				

- Connect the SS to the UE antenna connectors as shown in TS 38.508-1 [5] Annex A, Figure A.3.1.1.4 for TE diagram and section A.3.2 for UE diagram.
- The parameter setting for the cell are set up according to the TS 38.508-1 [5] subclause 4.4.3.
- Downlink signals are initially setup according to Annex C.0, C.1, C.2 and uplink signals according to Annex G.0, G.1, G.2, and G.3.0 with consideration of supplementary uplink physical channels.

Message contents in initial conditions are according to TS 38.508-1 [5] subclause 4.3.6.1.1.2 ensuring UL/SUL indicator in Table 4.3.6.1.1.2-1 with condition SUL, subclause 4.6 ensuring Table 4.6.1-28 with condition SUL AND (RF OR RRM), Table 4.6.3-14 with condition SUL_SUL for SUL carrier, and Table 4.6.3-167 with condition PUSCH_ON_SUL.

Table 6.4C.2.2.4-1: Void

6.4C.2.2.5 Test requirement

Same test requirement for carrier leakage measured on the SUL carrier as specified in 6.4.2.2.5.

6.4C.2.3 In-band emissions for SUL

6.4C.2.3.1 Test purpose

Same test purpose as in clause 6.4.2.3.1.

6.4C.2.3.2 Test applicability

This test applies to all types of NR UE release 15 and forward that support SUL operating on the SUL bands.

6.4C.2.3.3 Minimum conformance requirements

For a terminal that supports SUL for the band combination specified in Table 5.2C-1, the current version of the specification assumes the terminal is configured with active transmission either on UL carrier or SUL carrier at any time in one serving cell and the UE requirements for single carrier shall apply for the active UL or SUL carrier accordingly.

The normative reference for this requirement is TS 38.101-1 [2] clauses 4.3 and 6.4.2.3.

6.4C.2.3.4 Test description

Same test description as specified in clause 6.4.2.3.4 with following exceptions:

Instead of table 5.3.5-1 → use Table 5.5C-1.

Instead of table 6.4.2.3.4-1 → use Table 6.4C.2.3.4-1

Table 6.4C.2.3.4-1: Test Configuration Table for PUSCH

Initial Conditions				
Test Environment as specified in TS 38.508-1 [5] subclause 4.1		Normal		
Test Frequencies as specified in TS 38.508-1 [5] subclause 4.3.1		Low range, Mid range, High range for SUL carrier Mid range for Non-SUL carrier		
Test Channel Bandwidths as specified in TS 38.508-1 [5] subclause 4.3.1		Lowest, Mid, Highest for SUL carrier Lowest for Non-SUL carrier		
Test SCS as specified in Table 5.3.5-1		15kHz for both SUL carrier and Non-SUL carrier		
Test Parameters for Channel Bandwidths				
Test ID	Downlink Configuration	UL Configuration	SUL Configuration	
	N/A	N/A	Modulation	RB allocation (NOTE 1)
1			DFT-s-OFDM QPSK	Inner_1RB_Left
2			DFT-s-OFDM QPSK	Inner_1RB_Right
3			CP-OFDM QPSK	Inner_1RB_Left
4			CP-OFDM QPSK	Inner_1RB_Right
NOTE 1: The specific configuration of each RB allocation is defined in Table 6.1-1.				
NOTE 2: Test Channel Bandwidths are checked separately for each SUL band combination, the applicable channel bandwidths are specified in Table 5.5C-1.				

Table 6.4.2.3.4.1-2: Test Configuration Table for PUCCH

Initial Conditions						
Test Environment as specified in TS 38.508-1 [5] subclause 4.1			See Table 6.4C.2.3.4.1-1			
Test Frequencies as specified in TS 38.508-1 [5] subclause 4.3.1			See Table 6.4C.2.3.4.1-1			
Test Channel Bandwidths as specified in TS 38.508-1 [5] subclause 4.3.1			See Table 6.4C.2.3.4.1-1			
Test SCS as specified in Table 5.3.5-1			See Table 6.4C.2.3.4.1-1			
Test Parameters						
ID	Downlink Configuration		Uplink Configuration	SUL Configuration		
	Modulation	RB allocation	N/A	Waveform	PUCCH format	RB index
1	CP-OFDM QPSK	Full RB (Note 1)		DFT-s-OFDM	PUCCH format = Format 3 Length in OFDM symbols = 14	0
2	CP-OFDM QPSK	Full RB (Note 1)		DFT-s-OFDM	PUCCH format = Format 3 Length in OFDM symbols = 14	$N_{RB}-1$
3	CP-OFDM QPSK	Full RB (Note 1)		CP-OFDM	PUCCH format = Format 1 Length in OFDM symbols = 14	0
4	CP-OFDM QPSK	Full RB (Note 1)		CP-OFDM	PUCCH format = Format 1 Length in OFDM symbols = 14	$N_{RB}-1$
NOTE 1: Full RB allocation shall be used per each SCS and channel BW as specified in Table 7.3.2.4.1-2.						
NOTE 2: Test Channel Bandwidths are checked separately for each SUL band combination, the applicable channel bandwidths are specified in Table 5.5C-1.						
NOTE 3: DFT-s-OFDM PI/2 BPSK test applies only for UEs which supports half Pi BPSK in FR1.						

- Connect the SS to the UE antenna connectors as shown in TS 38.508-1 [5] Annex A, Figure A.3.1.1.4 for TE diagram and section A.3.2 for UE diagram.
- The parameter setting for the cell are set up according to the TS 38.508-1 [5] subclause 4.4.3.
- Downlink signals are initially setup according to Annex C.0, C.1, C.2 and uplink signals according to Annex G.0, G.1, G.2, and G.3.0 with consideration of supplementary uplink physical channels.

Message contents in initial conditions are according to TS 38.508-1 [5] subclause 4.3.6.1.1.2 ensuring UL/SUL indicator in Table 4.3.6.1.1.2-1 with condition SUL, subclause 4.6 ensuring Table 4.6.1-28 with condition SUL AND (RF OR RRM), Tables 4.6.3-14 with condition SUL_SUL for SUL carrier, and Table 4.6.3-167 with condition PUSCH_PUCCH_ON_SUL.

Table 6.4C.2.3.4-1: Void

6.4C.2.3.5 Test requirement

Same test requirement for carrier leakage measured on the SUL carrier as specified in 6.4.2.3.5.

6.4C.2.4 EVM equalizer spectrum flatness for SUL

6.4C.2.4.1 Test purpose

Same test purpose as in clause 6.4.2.4.1.

6.4C.2.4.2 Test applicability

This test applies to all types of NR UE release 15 and forward that support SUL operating on the SUL bands.

6.4C.2.4.3 Minimum conformance requirements

For a terminal that supports SUL for the band combination specified in Table 5.2C-1, the current version of the specification assumes the terminal is configured with active transmission either on UL carrier or SUL carrier at any

time in one serving cell and the UE requirements for single carrier shall apply for the active UL or SUL carrier accordingly.

The normative reference for this requirement is TS 38.101-1 [2] clauses 4.3 and 6.4.2.4.

6.4C.2.4.4 Test description

Same test description as specified in clause 6.4.2.4.4 with following exceptions:

Instead of table 5.3.5-1 → use Table 5.5C-1.

Instead of table 6.4.2.4.4-1 → use Table 6.4C.2.4.4-1

Table 6.4C.2.4.4-1: Test Configuration Table

Initial Conditions				
Test Environment as specified in TS 38.508-1 [5] subclause 4.1		Normal, TL/VL, TL/VH, TH/VL, TH/VH		
Test Frequencies as specified in TS 38.508-1 [5] subclause 4.3.1		Low range, Mid range, High range for SUL carrier Mid range for Non-SUL carrier		
Test Channel Bandwidths as specified in TS 38.508-1 [5] subclause 4.3.1		Lowest, Mid, Highest for SUL carrier Lowest for Non-SUL carrier		
Test SCS as specified in Table 5.5C-1		15kHz for both SUL carrier and Non-SUL carrier		
Test Parameters for Channel Bandwidths				
Test ID	Downlink Configuration	UL Configuration	SUL Configuration	
	N/A	N/A	Modulation	RB allocation (NOTE 1)
1			DFT-s-OFDM QPSK	Outer Full
2			CP-OFDM QPSK	Outer Full
NOTE 1: The specific configuration of each RB allocation is defined in Table 6.1-1.				
NOTE 2: Test Channel Bandwidths are checked separately for each SUL band combination, the applicable channel bandwidths are specified in Table 5.5C-1.				

- Connect the SS to the UE antenna connectors as shown in TS 38.508-1 [5] Annex A, Figure A.3.1.1.4 for TE diagram and section A.3.2 for UE diagram.
- The parameter setting for the cell are set up according to the TS 38.508-1 [5] subclause 4.4.3.
- Downlink signals are initially setup according to Annex C.0, C.1, C.2 and uplink signals according to Annex G.0, G.1, G.2, and G.3.0 with consideration of supplementary uplink physical channels.

Message contents in initial conditions are according to TS 38.508-1 [5] subclause 4.3.6.1.1.2 ensuring UL/SUL indicator in Table 4.3.6.1.1.2-1 with condition SUL, subclause 4.6 ensuring Table 4.6.1-28 with condition SUL AND (RF OR RRM), Table 4.6.3-14 with condition SUL_SUL for SUL carrier, and Table 4.6.3-167 with condition PUSCH_PUCCH_ON_SUL.

Table 6.4C.2.4.4-1: Void

6.4C.2.4.5 Test requirement

Same test requirement for EVM equalizer spectrum flatness measured on the SUL carrier as specified in 6.4.2.4.5.

6.4C.2.5 EVM equalizer spectrum flatness for Pi/2 BPSK for SUL

6.4C.2.5.1 Test purpose

Same test purpose as in clause 6.4.2.5.1.

6.4C.2.5.2 Test applicability

This test applies to all types of NR UE release 16 and forward that support SUL operating on the SUL bands and indicate support for UE capability *lowPAPR-DMRS-PUSCHwithPrecoding-r16*.

6.4C.2.5.3 Minimum conformance requirements

For a terminal that supports SUL for the band combination specified in Table 5.2C-1, the current version of the specification assumes the terminal is configured with active transmission either on UL carrier or SUL carrier at any time in one serving cell and the UE requirements for single carrier shall apply for the active UL or SUL carrier accordingly.

The normative reference for this requirement is TS 38.101-1 [2] clauses 4.3 and 6.4.2.4.1.

6.4C.2.5.4 Test description

6.4C.2.5.4.1 Initial condition

Initial conditions are a set of test configurations the UE needs to be tested in and the steps for the SS to take with the UE to reach the correct measurement state.

The initial test configurations consist of environmental conditions, test frequencies, test channel bandwidths and sub-carrier spacing based on NR operating bands specified in Table 5.5C-1. All of these configurations shall be tested with applicable test parameters for each combination of channel bandwidth and sub-carrier spacing, are shown in table 6.4C.2.5.4.1-1. The details of the uplink and downlink reference measurement channels (RMCs) are specified in Annexes A.2 and A.3. Configurations of PDSCH and PDCCH before measurement are specified in Annex C.2.

Table 6.4C.2.5.4.1-1: Test Configuration Table

Initial Conditions				
Test Environment as specified in TS 38.508-1 [5] subclause 4.1		Normal		
Test Frequencies as specified in TS 38.508-1 [5] subclause 4.3.1		Low range, Mid range, High range for SUL carrier Mid range for Non-SUL carrier		
Test Channel Bandwidths as specified in TS 38.508-1 [5] subclause 4.3.1		Lowest, Mid, Highest for SUL carrier Lowest for Non-SUL carrier		
Test SCS as specified in Table 5.5C-1		15kHz for both SUL carrier and Non-SUL carrier		
Test Parameters for Channel Bandwidths				
Test ID	Downlink Configuration	UL Configuration	SUL Configuration	
	N/A	N/A	Modulation	RB allocation (NOTE 1)
1			DFT-s-OFDM Pi/2 BPSK w Pi/2 BPSK DMRS	Outer Full
NOTE 1: The specific configuration of each RB allocation is defined in Table 6.1-1.				
NOTE 2: Test Channel Bandwidths are checked separately for each SUL band combination, the applicable channel bandwidths are specified in Table 5.5C-1.				

1. Connect the SS to the UE antenna connectors as shown in TS 38.508-1 [5] Annex A, Figure A.3.1.1.4 for TE diagram and section A.3.2 for UE diagram.
2. The parameter settings for the cell are set up according to TS 38.508-1 [5] subclause 4.4.3.
3. Downlink signals are initially set up according to Annex C.0, C.1, C.2, and uplink signals according to Annex G.0, G.1, G.2, G.3.0.
4. The UL Reference Measurement channels are set according to Table 6.4C.2.5.4.1-1.
5. Propagation conditions are set according to Annex B.0.
6. Ensure the UE is in state RRC_CONNECTED with generic procedure parameters Connectivity *NR*, Connected without release *On*, Test Mode *On* and Test Loop Function *On* according to TS 38.508-1 [5] clause 4.5. Message contents are defined in clause 6.4C.2.5.4.3.

6.4C.2.5.4.2 Test procedure

Same as in 6.4.2.5.4.2.

6.4C.2.5.4.3 Message contents

Message contents are according to TS 38.508-1 [5] subclause 4.3.6.1.1.2 ensuring UL/SUL indicator in Table 4.3.6.1.1.2-1 with condition SUL, subclause 4.6 ensuring Tables 4.6.1-28 with condition SUL AND (RF OR RRM), Table 4.6.3-14 with condition SUL_SUL for SUL carrier, and Table 4.6.3-167 with condition PUSCH_PUCCH_ON_SUL with the following exception:

Table 6.4C.2.5.4.3-1: DMRS-UplinkConfig

Derivation Path: TS 38.508-1 [5], Table 4.6.3-51			
Information Element	Value/remark	Comment	Condition
DMRS-UplinkConfig ::= SEQUENCE {			
transformPrecodingEnabled SEQUENCE			
{			
dmrs-UplinkTransformPrecoding-r16			
SEQUENCE {			
pi2BPSK-ScramblingID0	Not present		
pi2BPSK-ScramblingID1	Not present		
}			
}			
}			

6.4C.2.5.5 Test requirement

Each of the *n* spectrum flatness functions, shall derive four ripple results in Annex E.4.4.1 The derived results shall not exceed the values in Figure 6.4C.2.5.5-1:

Table 6.4C.2.5.5-1: Mask for EVM equalizer coefficients for Pi/2 BPSK, normal conditions

Frequency range	Parameter	Maximum ripple (dB)
$ F_{UL_Meas} - F_{center} \leq X$ MHz (Range 1)	X1	6 + TT (p-p)
$ F_{UL_Meas} - F_{center} > X$ MHz (Range 2)	X2	14 + TT (p-p)

NOTE 1: F_{UL_Meas} refers to the sub-carrier frequency for which the equalizer coefficient is evaluated
 NOTE 2: F_{center} refers to the center frequency of an allocated block of PRBs
 NOTE 3: X, in MHz, is equal to 25% of the bandwidth of the PRB allocation
 NOTE 4: See Figure 6.4C.2.5.5-1 for description of X1, X2
 NOTE 5: Test tolerance TT = 1.4 dB.

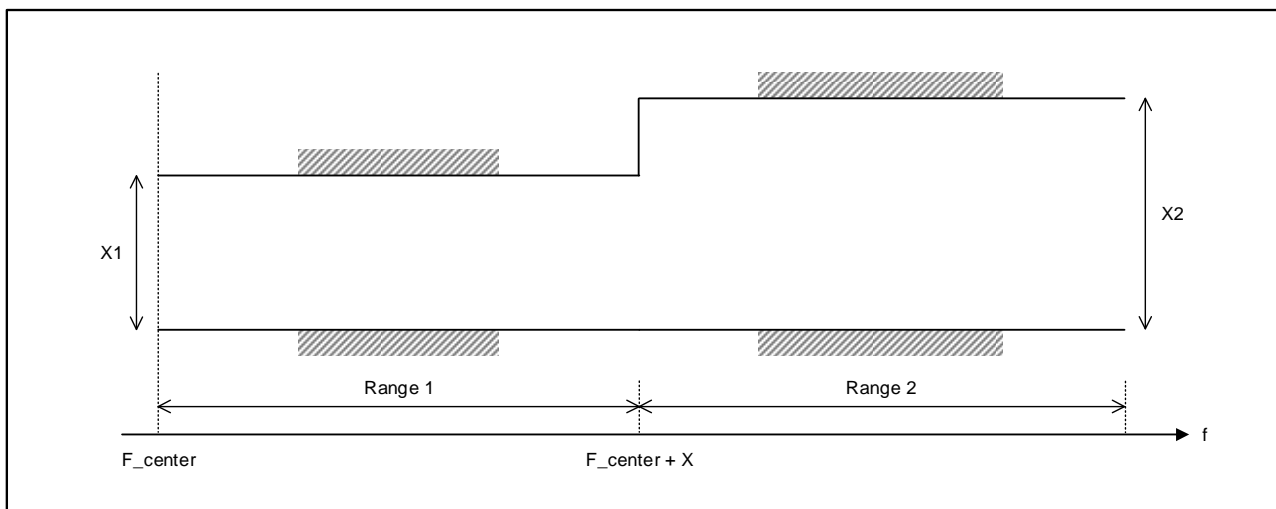

Figure 6.4C.2.5.5-1: The limits for EVM equalizer spectral flatness with the maximum allowed variation. F_{center} denotes the center frequency of the allocated block of PRBs. X, in MHz, is equal to 25 % of the bandwidth of the PRB allocation.

Each of the n spectrum flatness functions shall derive an impulse response of the spectral shaping filter in Annex E.4.4.2. The derived results shall fulfill:

$$|\tilde{a}(0)| \geq |\tilde{a}(\tau)| \quad \forall \tau \neq 0$$

$$20 \log_{10} |\tilde{a}(\tau)| < -15 \text{ dB} + \text{TT} \quad 1 < \tau < M - 1,$$

where $\text{TT} = 1.4 \text{ dB}$. 6.4D Transmit signal quality for UL MIMO.

6.4D Transmit signal quality for UL MIMO

6.4D.1 Frequency error for UL MIMO

6.4D.1.1 Test purpose

This test verifies the ability of both, the receiver and the transmitter for UL MIMO, to process frequency correctly.

Receiver: to extract the correct frequency from the stimulus signal, offered by the System simulator, under ideal propagation conditions and low level.

Transmitter: to derive the correct modulated carrier frequency for each antenna connector from the results, gained by the receiver.

6.4D.1.2 Test applicability

This test case applies to all types of NR UE release 15 and forward that support UL MIMO.

6.4D.1.3 Minimum conformance requirements

For UE(s) supporting UL MIMO, the basic measurement interval of modulated carrier frequency is 1 UL slot. The mean value of basic measurements of UE modulated carrier frequency at each transmit antenna connector shall be accurate to within ± 0.1 PPM observed over a period of 1 ms of cumulated measurement intervals compared to the carrier frequency received from the NR Node B.

The normative reference for this requirement is TS 38.101-1 [2] clause 6.4D.1.

6.4D.1.4 Test description

6.4D.1.4.1 Initial conditions

Initial conditions are a set of test configurations the UE needs to be tested in and the steps for the SS to take with the UE to reach the correct measurement state.

The initial test configurations consist of environmental conditions, test frequencies, test channel bandwidths and sub-carrier spacing based on NR operating bands specified in table 5.3.5-1. All of these configurations shall be tested with applicable test parameters for each combination of test channel bandwidth and sub-carrier spacing, and are shown in table 6.4D.1.4.1-1. The details of the uplink and downlink reference measurement channels (RMCs) are specified in Annexes A.2 and A.3. Configurations of PDSCH and PDCCH before measurement are specified in Annex C.2.

Table 6.4D.1.4.1-1: Test Configuration Table

Initial Conditions				
Test Environment as specified in TS 38.508-1 [5] subclause 4.1			Normal, TL/VL, TL/VH, TH/VL, TH/VH	
Test Frequencies as specified in TS 38.508-1 [5] subclause 4.3.1			Mid range	
Test Channel Bandwidths as specified in TS 38.508-1 [5] subclause 4.3.1			Highest	
Test SCS as specified in Table 5.3.5-1			Lowest	
Test Parameters				
Test ID	Downlink Configuration		Uplink Configuration	
	Modulation	RB allocation	Modulation	RB allocation
1	CP-OFDM QPSK	Full RB (NOTE 1)	CP-OFDM QPSK	REFSENS (NOTE 2)
NOTE 1: Full RB allocation shall be used per each SCS and channel BW as specified in Table 7.3.2.4.1-2				
NOTE 2: REFSENS refers to Table 7.3.2.4.1-3 which defines uplink RB configuration and start RB location for each SCS, channel BW and NR band.				

1. Connect the SS to the UE antenna connectors as shown in TS 38.508-1 [5] Annex A, Figure A.3.1.2.2 for TE diagram and section A.3.2 for UE diagram.
2. The parameter settings for the cell are set up according to TS 38.508-1 [5] subclause 4.4.3.
3. Downlink signals are initially set up according to Annex C.0, C.1, C.2, and uplink signals according to Annex G.0, G.1, G.2, G.3.0.
4. The UL Reference Measurement Channel is set according to Table 6.4D.1.4.1-1.
5. Propagation conditions are set according to Annex B.0.
6. Ensure the UE is in state RRC_CONNECTED with generic procedure parameters Connectivity NR, Connected without release On, Test Mode On and Test Loop Function On according to TS 38.508-1 [5] clause 4.5. Message contents are defined in clause 6.4D.1.4.3.

6.4D.1.4.2 Test procedure

1. SS transmits PDSCH via PDCCH DCI format 1_1 for C_RNTI to transmit the DL RMC according to Table 6.4D.1.4.1-1. The SS sends downlink MAC padding bits on the DL RMC.
2. SS sends uplink scheduling information for each UL HARQ process via PDCCH DCI format 0_1 for C_RNTI to schedule the UL RMC according to Table 6.4D.1.4.1-1. Since the UE has no payload and no loopback data to send the UE sends uplink MAC padding bits on the UL RMC. The PDCCH DCI format 0_1 is specified with the condition 2TX_UL_MIMO in 38.508-1 [5] subclause 4.3.6.1.1.2
3. Set the Downlink signal level to the appropriate REFSENS value defined in 7.3D.2.5. Send continuously uplink power control "up" commands to the UE in every uplink scheduling information to the UE so that the UE transmits at P_{UMAX} level for the duration of the test. Allow at least 200ms starting from the first TPC command in this step for the UE to reach P_{UMAX} level.
4. Measure the Frequency Error using Global In-Channel Tx-Test (Annex E) at each transmit antenna connector of the UE. For TDD, only slots consisting of only UL symbols are under test.
5. For UEs supporting DSS, repeat steps 1~4 on the applicable bands as specified in Section 5.4.2.1 with message contents being according to TS 38.508-1 [5] subclause 4.6 ensuring Table 4.6.3-61 and Table 4.6.3-62 with condition DSS.

6.4D.1.4.3 Message contents

Message contents are according to TS 38.508-1 [5] subclause 4.6 ensuring Table 4.6.3-182 with condition 2TX_UL_MIMO.

6.4D.1.5 Test requirement

The requirements apply to each transmit antenna connector.

The 10 frequency error Δf results must fulfil the test requirement:

$$|\Delta f| \leq (0.1\text{PPM} + 15 \text{ Hz})$$

6.4D.2 Transmit modulation quality for UL MIMO

For UE supporting UL-MIMO, the transmit modulation quality requirements are specified at each transmit antenna connector.

If UE is configured for transmission on single-antenna port, the requirements specified for single carrier apply.

The transmit modulation quality is specified in terms of:

- Error Vector Magnitude (EVM) for the allocated resource blocks (RBs)
- EVM equalizer spectrum flatness derived from the equalizer coefficients generated by the EVM measurement process
- Carrier leakage (caused by IQ offset)
- In-band emissions for the non-allocated RB

6.4D.2.1 Error Vector Magnitude for UL MIMO

6.4D.2.1.1 Test purpose

The Error Vector Magnitude is a measure of the difference between the reference waveform and the measured waveform. This difference is called the error vector. Before calculating the EVM the measured waveform is corrected by the sample timing offset and RF frequency offset. Then the carrier leakage shall be removed from the measured waveform before calculating the EVM.

The measured waveform is further equalised using the channel estimates subjected to the EVM equaliser spectrum flatness requirement specified in sub-clause 6.4D.2.4.3. For DFT-s-OFDM waveforms, the EVM result is defined after the front-end FFT and IDFT as the square root of the ratio of the mean error vector power to the mean reference power expressed as a %. For CP-OFDM waveforms, the EVM result is defined after the front-end FFT as the square root of the ratio of the mean error vector power to the mean reference power expressed as a %.

The basic EVM measurement interval in the time domain is the duration of PUSCH channel, or one hop, if frequency hopping is enabled for PUSCH in the time domain. The EVM measurement interval is reduced by any symbols that contains an allowable power transient as defined in subclause 6.3D.3.3.

6.4D.2.1.2 Test applicability

This test case applies to all types of NR UE release 15 and forward that support UL MIMO.

6.4D.2.1.3 Minimum conformance requirements

For UE with two transmit antenna connectors in closed-loop spatial multiplexing scheme, the Error Vector Magnitude requirements specified in Table 6.4.2.1.3-1 which is defined in subclause 6.4.2.1.3 apply at each transmit antenna connector. The requirements shall be met with the UL MIMO configurations specified in Table 6.2D.1.3-2

The normative reference for this requirement is TS 38.101-1 [2] clause 6.4D.2.1.

6.4D.2.1.4 Test description

6.4D.2.1.4.1 Initial conditions

Initial conditions are a set of test configurations the UE needs to be tested in and the steps for the SS to take with the UE to reach the correct measurement state.

The initial test configurations consist of environmental conditions, test frequencies, test channel bandwidths and sub-carrier spacing based on NR operating bands specified in table 5.3.5-1. All of these configurations shall be tested with applicable test parameters for each combination of test channel bandwidth and sub-carrier spacing, and are shown in table 6.4D.2.1.4.1-1. The details of the uplink and downlink reference measurement channels (RMCs) are specified in Annexes A.2 and A.3. Configurations of PDSCH and PDCCH before measurement are specified in Annex C.2.

Table 6.4D.2.1.4.1-1: Test Configuration Table

Initial Conditions			
Test Environment as specified in TS 38.508-1 [5] subclause 4.1		Normal	
Test Frequencies as specified in TS 38.508-1 [5] subclause 4.3.1		Low range, Mid range, High range	
Test Channel Bandwidths as specified in TS 38.508-1 [5] subclause 4.3.1		Lowest, Highest	
Test SCS as specified in Table 5.3.5-1		All	
Test Parameters			
Test ID	Downlink Configuration	Uplink Configuration	
	N/A	Modulation	RB allocation (NOTE 1)
1		CP-OFDM QPSK	Inner Full
2		CP-OFDM QPSK	Outer Full
3		CP-OFDM 16 QAM	Inner Full
4		CP-OFDM 16 QAM	Outer Full
5		CP-OFDM 64 QAM	Outer Full
6		CP-OFDM 256 QAM	Outer Full
NOTE 1: The specific configuration of each RB allocation is defined in Table 6.1-1.			
NOTE 2: Test Channel Bandwidths are checked separately for each NR band, which applicable channel bandwidths are specified in Table 5.3.5-1.			

1. Connect the SS to the UE antenna connectors as shown in TS 38.508-1 [5] Annex A, Figure A.3.1.1.2 for TE diagram and section A.3.2 for UE diagram.
2. The parameter settings for the cell are set up according to TS 38.508-1 [5] subclause 4.4.3.
3. Downlink signals are initially set up according to Annex C.0, C.1, C.2, and uplink signals according to Annex G.0, G.1, G.2, G.3.0.
4. The UL Reference Measurement Channel is set according to Table 6.4D.2.1.4.1-1.
5. Propagation conditions are set according to Annex B.0.
6. Ensure the UE is in state RRC_CONNECTED with generic procedure parameters Connectivity *NR*, Connected without release *On*, Test Mode *On* and Test Loop Function *On* according to TS 38.508-1 [5] clause 4.5. Message contents are defined in clause 6.4D.2.1.4.3.

6.4D.2.1.4.2 Test procedure

Test procedure for PUSCH:

- 1.1. SS sends uplink scheduling information for each UL HARQ process via PDCCH DCI format 0_1 for C_RNTI to schedule the UL RMC according to Table 6.4D.2.1.4.1-1. Since the UE has no payload data to send, the UE transmits uplink MAC padding bits on the UL RMC. The PDCCH DCI format 0_1 is specified with the condition 2TX_UL_MIMO in 38.508-1 [5] subclause 4.3.6.1.1.2
- 1.2. Send continuously uplink power control "up" commands in the uplink scheduling information to the UE until the UE transmits at $P_{UMAX\ level}$, allow at least 200ms starting from the first TPC command in this step for the UE to reach $P_{UMAX\ level}$.
- 1.3. Measure the EVM and \overline{EVM}_{DMRS} using Global In-Channel Tx-Test (Annex E) for each of transmit antenna of the UE. For TDD, only slots consisting of only UL symbols are under test.

1.4. For modulations except 256QAM, send uplink power control commands to the UE using 1dB power step size to ensure that the UE output power at each antenna connector under measurement measured by the test system is within the Uplink power control window, defined as +MU to +(MU + Uplink power control window size) dB of the target power level Pmin, where:

- Pmin is the minimum output power according to Table 6.3.1.3-1.
- MU is the test system uplink power measurement uncertainty and is specified in Table F.1.2-1 for the carrier frequency f and the channel bandwidth BW.
- Uplink power control window size = 1dB (UE power step size) + 0.7dB (UE power step tolerance) + (Test system relative power measurement uncertainty), where, the UE power step tolerance is specified in TS 38.101-1 [2], Table 6.3.4.3-1 and is 0.7dB for 1dB power step size, and the Test system relative power measurement uncertainty is specified in Table F.1.2-1.

For 256 QAM, send uplink power control commands to the UE using 1dB power step size to ensure that the UE output power at each antenna connector under measurement measured by the test system is within the Uplink power control window, defined as +MU to +(MU + Uplink power control window size) dB of the target power level Pmin + 10 dB, where MU and Uplink power control window size are defined above. Pmin is the minimum output power according to Table 6.3D.1.3-1.

1.5. Measure the EVM and \overline{EVM}_{DMRS} using Global In-Channel Tx-Test (Annex E) for each of transmit antennas of the UE. For TDD, only slots consisting of only UL symbols are under test.

NOTE1: Void.

NOTE2: The purpose of the Uplink power control window is to ensure that the actual UE output power at each antenna connector under measurement is no less than the target power level, and as close as possible to the target power level. The relationship between the Uplink power control window, the target power level and the corresponding possible actual UE Uplink power window is illustrated in Annex F.4.2.

NOTE3: For the UE which the output power at each antenna connector can reach the Uplink power control window at the same time, execute measurement for each of antenna connectors. For the UE which the output power at each antenna connector cannot reach the Uplink power control window at the same time, execute measurement for the one antenna connector which the output power is within Uplink power control window. And then ensure output power of the other antenna connector is within Uplink power control window and execute measurement for this antenna connector.

Table 6.4D.2.1.4.2-1: Void

6.4D.2.1.4.3 Message contents

Message contents are according to TS 38.508-1 [5] subclause 4.6 with the condition 2TX_UL_MIMO.

6.4D.2.1.5 Test requirement

The requirements apply to each transmit antenna connector.

The PUSCH EVM, derived in Annex E.4.2, shall not exceed the values in Table 6.4D.2.1.5-1.

The PUSCH \overline{EVM}_{DMRS} , derived in Annex E.4.6.2, shall not exceed the values in Table 6.4D.2.1.5-1 when embedded with data symbols of the respective modulation scheme.

Table 6.4D.2.1.5-1: Test requirements for Error Vector Magnitude

Parameter	Unit	Average EVM Level
Pi/2-BPSK	%	30 + TT
QPSK	%	17.5 + TT
16 QAM	%	12.5 + TT
64 QAM	%	8 + TT
256 QAM	%	3.5 + TT
Note 1: TT is defined in Table 6.4D.2.1.5-2.		

Table 6.4D.2.1.5-2: Test Tolerance

Parameter	Unit	Average EVM Level
Pi/2-BPSK	%	0
QPSK	%	0
16 QAM	%	0
64 QAM	%	0
256 QAM	%	0.3 for $15 \text{ dBm} < P_{UL}$ 0.8 for $-25 \text{ dBm} < P_{UL} \leq 15 \text{ dBm}$ 1.1 for $-40 \text{ dBm} \leq P_{UL} \leq -25 \text{ dBm}$

6.4D.2.2 Carrier leakage for UL MIMO

6.4D.2.2.1 Test purpose

The purpose of this test is to exercise the UE transmitter for UL MIMO to verify its modulation quality in terms of carrier leakage.

6.4D.2.2.2 Test applicability

This test case applies to all types of NR UE release 15 and forward that support UL MIMO.

6.4D.2.2.3 Minimum conformance requirements

For UE with two transmit antenna connectors in closed-loop spatial multiplexing scheme, the Relative Carrier Leakage Power requirements specified in Table 6.4.2.2.3-1 which is defined in subclause 6.4.2.2.3 apply at each transmit antenna connector. The requirements shall be met with the UL MIMO configurations specified in Table 6.2D.1.3-2

The normative reference for this requirement is TS 38.101-1 [2] clause 6.4D.2.2.

6.4D.2.2.4 Test description

6.4D.2.2.4.1 Initial conditions

Initial conditions are a set of test configurations the UE needs to be tested in and the steps for the SS to take with the UE to reach the correct measurement state.

The initial test configurations consist of environmental conditions, test frequencies, test channel bandwidths and sub-carrier spacing based on NR operating bands specified in table 5.3.5-1. All of these configurations shall be tested with applicable test parameters for each combination of test channel bandwidth and sub-carrier spacing, and are shown in table 6.4D.2.2.4.1-1. The details of the uplink and downlink reference measurement channels (RMCs) are specified in Annexes A.2 and A.3. Configurations of PDSCH and PDCCH before measurement are specified in Annex C.2.

Table 6.4D.2.2.4.1-1: Test Configuration Table

Initial Conditions			
Test Environment as specified in TS 38.508-1 [5] subclause 4.1		Normal	
Test Frequencies as specified in TS 38.508-1 [5] subclause 4.3.1		Low range, Mid range, High range	
Test Channel Bandwidths as specified in TS 38.508-1 [5] subclause 4.3.1		Mid	
Test SCS as specified in Table 5.3.5-1		Lowest	
Test Parameters			
Test ID	Downlink Configuration	Uplink Configuration	
	N/A	Modulation	RB allocation (NOTE 1, 3)
1		CP-OFDM QPSK	Inner_1RB_Left
NOTE 1: The specific configuration of each RB allocation is defined in Table 6.1-1.			
NOTE 2: Test Channel Bandwidths are checked separately for each NR band, which applicable channel bandwidths are specified in Table 5.3.5-1.			
NOTE 3: When the signalled DC carrier position is at Inner_1RB_Left, use Inner_1RB_Right for UL RB allocation.			

1. Connect the SS to the UE antenna connectors as shown in TS 38.508-1 [5] Annex A, Figure A.3.1.1.2 for TE diagram and section A.3.2 for UE diagram.
2. The parameter settings for the cell are set up according to TS 38.508-1 [5] subclause 4.4.3.
3. Downlink signals are initially set up according to Annex C.0, C.1, C.2, and uplink signals according to Annex G.0, G.1, G.2, G.3.0.
4. The UL Reference Measurement Channel is set according to Table 6.4D.2.2.4.1-1.
5. Propagation conditions are set according to Annex B.0.
6. Ensure the UE is in state RRC_CONNECTED with generic procedure parameters Connectivity NR, Connected without release On, Test Mode On and Test Loop Function On according to TS 38.508-1 [5] clause 4.5. Message contents are defined in clause 6.4D.2.2.4.3.

6.4D.2.2.4.2 Test procedure

1. SS sends uplink scheduling information for each UL HARQ process via PDCCH DCI format 0_1 for C_RNTI to schedule the UL RMC according to Table 6.4D.2.2.4.1-1. Since the UE has no payload and no loopback data to send the UE sends uplink MAC padding bits on the UL RMC. The PDCCH DCI format 0_1 is specified with the condition 2TX_UL_MIMO in 38.508-1 [5] subclause 4.3.6.1.1.2.
2. Send uplink power control commands to the UE using 1dB power step size to ensure that the UE output power at each antenna connector under measurement measured by the test system is within the Uplink power control window, defined as +MU to +(MU + Uplink power control window size) dB of the target power level 10 dBm, where:
 - MU is the test system uplink power measurement uncertainty and is specified in Table F.1.2-1 for the carrier frequency f and the channel bandwidth BW.
 - Uplink power control window size = 1dB (UE power step size) + 0.7dB (UE power step tolerance) + (Test system relative power measurement uncertainty), where, the UE power step tolerance is specified in TS 38.101-1 [2], Table 6.3.4.3-1 and is 0.7dB for 1dB power step size, and the Test system relative power measurement uncertainty is specified in Table F.1.2-1.
3. Measure carrier leakage using Global In-Channel Tx-Test (Annex E) for each of transmit antenna of the UE. For TDD, only slots consisting of only UL symbols are under test.
4. Send uplink power control commands to the UE using 1dB power step size to ensure that the UE output power at each antenna connector under measurement measured by the test system is within the Uplink power control window, defined as +MU to +(MU + Uplink power control window size) dB of the target power level 0 dBm, where MU and Uplink power control window size are defined above.

5. Measure carrier leakage using Global In-Channel Tx-Test (Annex E) for each of transmit antenna of the UE. For TDD, only slots consisting of only UL symbols are under test.
6. Send uplink power control commands to the UE using 1dB power step size to ensure that the UE output power at each antenna connector under measurement measured by the test system is within the Uplink power control window, defined as $+MU$ to $+(MU + \text{Uplink power control window size})$ dB of the target power level -30 dBm, where MU and Uplink power control window size are defined above.
7. Measure carrier leakage using Global In-Channel Tx-Test (Annex E) for each of transmit antenna of the UE. For TDD, only slots consisting of only UL symbols are under test.
8. Send uplink power control commands to the UE using 1dB power step size to ensure that the UE output power at each antenna connector under measurement measured by the test system is within the Uplink power control window, defined as $+MU$ to $+(MU + \text{Uplink power control window size})$ dB of the target power level P_{min} , where MU and Uplink power control window size are defined above. P_{min} is the minimum output power according to Table 6.3D.1.3-1..
9. Measure carrier leakage using Global In-Channel Tx-Test (Annex E) for each of transmit antenna of the UE. For TDD, only slots consisting of only UL symbols are under test.

NOTE: The purpose of the Uplink power control window is to ensure that the actual UE output power at each antenna connector under measurement is no less than the target power level, and as close as possible to the target power level. The relationship between the Uplink power control window, the target power level and the corresponding possible actual UE Uplink power window is illustrated in Annex F.4.2.

NOTE2: For the UE which the output power at each antenna connector can reach the Uplink power control window at the same time, execute measurement for each of antenna connectors. For the UE which the output power at each antenna connector cannot reach the Uplink power control window at the same time, execute measurement for the one antenna connector which the output power is within Uplink power control window. And then ensure output power of the other antenna connector is within Uplink power control window and execute measurement for this antenna connector.

Table 6.4D.2.2.4.2-1: Void

Table 6.4D.2.1.4.2-2: Void

6.4D.2.2.4.3 Message contents

Message contents are according to TS 38.508-1 [5] subclause 4.6 with the condition 2TX_UL_MIMO.

6.4D.2.2.5 Test requirement

The requirements apply to each transmit antenna connector.

Each of the n carrier leakage results, derived in Annex E.3.1, shall not exceed the values in table 6.4D.2.2.5-1. Allocated RBs are not under test. n is 10 for 15kHz SCS, 20 for 30kHz SCS and 30 for 60kHz SCS.

Table 6.4D.2.2.5-1: Test requirements for Relative Carrier Leakage Power

LO Leakage	Parameters UE output power	Relative limit (dBc)
	10 + MU to 10 + (MU + Uplink power control window size) dBm	-28 + TT
	0 + MU to 0 + (MU + Uplink power control window size) dBm	-25 + TT
	-30 + MU to -30 + (MU + Uplink power control window size) dBm	-20 + TT
	-40 + MU to -40 + (MU + Uplink power control window size) dBm	-10 + TT

NOTE 1:	The measurement bandwidth is 1 RB and the limit is expressed as a ratio of measured power in one non-allocated RB to the measured total power in all allocated RBs.
NOTE 2:	The applicable frequencies for this limit depend on the parameter <i>txDirectCurrentLocation</i> in <i>UplinkTxDirectCurrent</i> IE, and are those that are enclosed either in the RBs containing the carrier leakage frequency, or in the two RBs immediately adjacent to the carrier leakage frequency but excluding any allocated RB.
NOTE 3:	N_{RB} is the Transmission Bandwidth Configuration (see Section 5.3).
NOTE 4:	Void
NOTE 5:	MU is the test system uplink power measurement uncertainty and is specified in Table F.1.2-1 for the carrier frequency f and the channel bandwidth BW.
NOTE 6:	Uplink power control window size = 1dB (UE power step size) + 0.7dB (UE power step tolerance) + (Test system relative power measurement uncertainty), where, the UE power step tolerance is specified in TS 38.101-1 [2], Table 6.3.4.3-1 and is 0.7dB for 1dB power step size, and the Test system relative power measurement uncertainty is specified in Table F.1.2-1.
NOTE 7:	Test tolerance TT = 0.8 dB.

Table 6.4D.2.2.5-2: Void

6.4D.2.3 In-band emissions for UL MIMO

6.4D.2.3.1 Test purpose

The purpose of this test is to exercise the UE transmitter for UL MIMO to verify its modulation quality in terms of in-band emissions.

6.4D.2.3.2 Test applicability

This test case applies to all types of NR UE release 15 and forward that support UL MIMO.

6.4D.2.3.3 Minimum conformance requirements

For UE with two transmit antenna connectors in closed-loop spatial multiplexing scheme, the In-band Emission requirements specified in Table 6.4.2.3.3-1 which is defined in subclause 6.4.2.3.3 apply at each transmit antenna connector. The requirements shall be met with the uplink MIMO configurations specified in Table 6.2D.1.3-2.

The normative reference for this requirement is TS 38.101-1 [2] clause 6.4D.2.3.

6.4D.2.3.4 Test description

6.4D.2.3.4.1 Initial conditions

Initial conditions are a set of test configurations the UE needs to be tested in and the steps for the SS to take with the UE to reach the correct measurement state.

The initial test configurations consist of environmental conditions, test frequencies, test channel bandwidths and sub-carrier spacing based on NR operating bands specified in table 5.3.5-1. All of these configurations shall be tested with applicable test parameters for each combination of test channel bandwidth and sub-carrier spacing, and are shown in table 6.4D.2.3.4.1-1. The details of the uplink and downlink reference measurement channels (RMCs) are specified in Annexes A.2 and A.3. Configurations of PDSCH and PDCCH before measurement are specified in Annex C.2.

Table 6.4D.2.3.4.1-1: Test Configuration Table

Initial Conditions			
Test Environment as specified in TS 38.508-1 [5] subclause 4.1		Normal	
Test Frequencies as specified in TS 38.508-1 [5] subclause 4.3.1		Low range, Mid range, High range	
Test Channel Bandwidths as specified in TS 38.508-1 [5] subclause 4.3.1		Lowest, Mid, Highest	
Test SCS as specified in Table 5.3.5-1		Lowest	
Test Parameters			
Test ID	Downlink Configuration	Uplink Configuration	
	N/A	Modulation	RB allocation (NOTE 1)
1		CP-OFDM QPSK	Inner_1RB_Left
2		CP-OFDM QPSK	Inner_1RB_Right
NOTE 1: The specific configuration of each RB allocation is defined in Table 6.1-1.			
NOTE 2: Test Channel Bandwidths are checked separately for each NR band, which applicable channel bandwidths are specified in Table 5.3.5-1.			

1. Connect the SS to the UE antenna connectors as shown in TS 38.508-1 [5] Annex A, Figure A.3.1.1.2 for TE diagram and section A.3.2 for UE diagram.
2. The parameter settings for the cell are set up according to TS 38.508-1 [5] subclause 4.4.3.
3. Downlink signals are initially set up according to Annex C.0, C.1, C.2, and uplink signals according to Annex G.0, G.1, G.2, G.3.0.
4. The UL Reference Measurement Channel is set according to Table 6.4D.2.3.4.1-1.
5. Propagation conditions are set according to Annex B.0.
6. Ensure the UE is in state RRC_CONNECTED with generic procedure parameters Connectivity *NR*, Connected without release *On*, Test Mode *On* and Test Loop Function *On* according to TS 38.508-1 [5] clause 4.5. Message contents are defined in clause 6.4D.2.3.4.3.

6.4D.2.3.4.2 Test procedure

Test procedure for PUSCH:

- 1.1. SS sends uplink scheduling information for each UL HARQ process via PDCCH DCI format 0_1 for C_RNTI to schedule the UL RMC according to Table 6.4D.2.3.4.1-1. Since the UE has no payload and no loopback data to send the UE sends uplink MAC padding bits on the UL RMC. The PDCCH DCI format 0_1 is specified with the condition 2TX_UL_MIMO in 38.508-1 [5] subclause 4.3.6.1.1.2.
- 1.2. Send uplink power control commands to the UE using 1dB power step size to ensure that the UE output power at each antenna connector under measurement measured by the test system is within the Uplink power control window, defined as +MU to +(MU + Uplink power control window size) dB of the target power level 10 dBm, where:
 - MU is the test system uplink power measurement uncertainty and is specified in Table F.1.2-1 for the carrier frequency f and the channel bandwidth BW.
 - Uplink power control window size = 1dB (UE power step size) + 0.7dB (UE power step tolerance) + (Test system relative power measurement uncertainty), where, the UE power step tolerance is specified in TS 38.101-1 [2], Table 6.3.4.3-1 and is 0.7dB for 1dB power step size, and the Test system relative power measurement uncertainty is specified in Table F.1.2-1.
- 1.3. Measure In-band emission using Global In-Channel Tx-Test (Annex E) for each of transmit antennas of the UE. For TDD, only slots consisting of only UL symbols are under test.
- 1.4. Send uplink power control commands to the UE using 1dB power step size to ensure that the UE output power at each antenna connector under measurement measured by the test system is within the Uplink power control

window, defined as $+MU$ to $+(MU + \text{Uplink power control window size})$ dB of the target power level 0 dBm, where MU and Uplink power control window size are defined above.

- 1.5. Measure In-band emission using Global In-Channel Tx-Test (Annex E) for each of transmit antennas of the UE. For TDD, only slots consisting of only UL symbols are under test.
- 1.6. Send uplink power control commands to the UE using 1dB power step size to ensure that the UE output power at each antenna connector under measurement measured by the test system is within the Uplink power control window, defined as $+MU$ to $+(MU + \text{Uplink power control window size})$ dB of the target power level -30 dBm, where MU and Uplink power control window size are defined above.
- 1.7. Measure In-band emission using Global In-Channel Tx-Test (Annex E) for each of transmit antennas of the UE. For TDD, only slots consisting of only UL symbols are under test.
- 1.8. Send uplink power control commands to the UE using 1dB power step size to ensure that the UE output power at each antenna connector under measurement measured by the test system is within the Uplink power control window, defined as $+MU$ to $+(MU + \text{Uplink power control window size})$ dB of the target power level P_{min} , where MU and Uplink power control window size are defined above. P_{min} is the minimum output power according to Table 6.3D.1.3-1.
- 1.9. Measure In-band emission using Global In-Channel Tx-Test (Annex E) for each of transmit antennas of the UE. For TDD, only slots consisting of only UL symbols are under test.

NOTE1: Void.

NOTE2: The purpose of the Uplink power control window is to ensure that the actual UE output power at each antenna connector under measurement is no less than the target power level, and as close as possible to the target power level. The relationship between the Uplink power control window, the target power level and the corresponding possible actual UE Uplink power window is illustrated in Annex F.4.2.

NOTE3: For the UE which the output power at each antenna connector can reach the Uplink power control window at the same time, execute measurement for each of antenna connectors. For the UE which the output power at each antenna connector cannot reach the Uplink power control window at the same time, execute measurement for the one antenna connector which the output power is within Uplink power control window. And then ensure output power of the other antenna connector is within Uplink power control window and execute measurement for this antenna connector.

Table 6.4D.2.3.4.2-1: Void

Table 6.4D.2.3.4.2-2: Void

6.4D.2.3.4.3 Message contents

Message contents are according to TS 38.508-1 [5] subclause 4.6 with the condition 2TX_UL_MIMO.

6.4D.2.3.5 Test requirement

The requirements apply to each transmit antenna connector.

The averaged In-band emissions result, derived in Annex E.4.3, shall not exceed the corresponding values in Tables 6.4D.2.3.5-1. n is 10 for 15kHz SCS, 20 for 30kHz SCS and 40 for 60kHz SCS.

Table 6.4D.2.3.5-1: Test requirements for in-band emissions

Parameter description	Unit	Limit (NOTE 1)		Applicable Frequencies
General	dB	$\max \left\{ -25 - 10 \cdot \log_{10} (N_{RB} / L_{CRB}), \right.$ $20 \cdot \log_{10} EVM - 3 - 5 \cdot (\Delta_{RB} - 1) / L_{CRB},$ $\left. -57 \text{ dBm} + 10 \log_{10} (SCS / 15 \text{ kHz}) - P_{RB} \right\} + TT$		Any non-allocated (NOTE 2)
IQ Image	dB	-28 + TT	Image frequencies when output power > 10 dBm	Image frequencies (NOTES 2, 3)
		-25 + TT	Image frequencies when output power ≤ 10 dBm	
Carrier leakage	dBc	-28 + TT	Output power > 10 dBm	Carrier leakage frequency (NOTES 4, 5)
		-25 + TT	0 dBm ≤ Output power ≤ 10 dBm	
		-20 + TT	-30 dBm ≤ Output power ≤ 0 dBm	
		-10 + TT	-40 dBm ≤ Output power < -30 dBm	
<p>NOTE 1: An in-band emissions combined limit is evaluated in each non-allocated RB. For each such RB, the minimum requirement is calculated as the higher of $P_{RB} - 30$ dB and the power sum of all limit values (General, IQ Image or Carrier leakage) that apply. P_{RB} is defined in NOTE 10.</p> <p>NOTE 2: The measurement bandwidth is 1 RB and the limit is expressed as a ratio of measured power in one non-allocated RB to the measured average power per allocated RB, where the averaging is done across all allocated RBs.</p> <p>NOTE 3: The applicable frequencies for this limit are those that are enclosed in the reflection of the allocated bandwidth, based on symmetry with respect to the carrier leakage frequency, but excluding any allocated RBs.</p> <p>NOTE 4: The measurement bandwidth is 1 RB and the limit is expressed as a ratio of measured power in one non-allocated RB to the measured total power in all allocated RBs.</p> <p>NOTE 5: The applicable frequencies for this limit depend on the parameter <i>txDirectCurrentLocation</i> in <i>UplinkTxDirectCurrent</i> IE, and are those that are enclosed either in the RB containing the carrier leakage frequency, or in the two RBs immediately adjacent to the carrier leakage frequency but excluding any allocated RB.</p> <p>NOTE 6: L_{CRB} is the Transmission Bandwidth (see Section 5.3).</p> <p>NOTE 7: N_{RB} is the Transmission Bandwidth Configuration (see Section 5.3).</p> <p>NOTE 8: EVM is the limit specified in Table 6.4.2.1.3-1 for the modulation format used in the allocated RBs.</p> <p>NOTE 9: Δ_{RB} is the starting frequency offset between the allocated RB and the measured non-allocated RB (e.g. $\Delta_{RB} = 1$ or $\Delta_{RB} = -1$ for the first adjacent RB outside of the allocated bandwidth).</p> <p>NOTE 10: P_{RB} is an average of the transmitted power over 10 sub-frames normalized by the number of allocated RBs, measured in dBm.</p> <p>NOTE 11: Test tolerance TT = 0.8 dB.</p>				

Table 6.4D.2.3.5-2: Void

6.4D.2.4 EVM equalizer spectrum flatness for UL MIMO

6.4D.2.4.1 Test purpose

The purpose of this test is to verify the zero-forcing equalizer correction applied in the EVM measurement process (as described in Annex E) meets a spectrum flatness requirement for the EVM measurement to be valid.

6.4D.2.4.2 Test applicability

This test case applies to all types of NR UE release 15 and forward that support UL MIMO.

6.4D.2.4.3 Minimum conformance requirements

For UE with two transmit antenna connectors in closed-loop spatial multiplexing scheme, the EVM Equalizer Spectrum Flatness requirements specified in Table 6.4.2.4.3-1 and Table 6.4.2.4.3-2 which are defined in subclause 6.4.2.4.3 apply at each transmit antenna connector. The requirements shall be met with the UL MIMO configurations specified in Table 6.2D.1.3-2

The normative reference for this requirement is TS 38.101-1 [2] clause 6.4D.2.4.

6.4D.2.4.4 Test description

6.4D.2.4.4.1 Initial conditions

Initial conditions are a set of test configurations the UE needs to be tested in and the steps for the SS to take with the UE to reach the correct measurement state.

The initial test configurations consist of environmental conditions, test frequencies, test channel bandwidths and sub-carrier spacing based on NR operating bands specified in table 5.3.5-1. All of these configurations shall be tested with applicable test parameters for each combination of test channel bandwidth and sub-carrier spacing, and are shown in table 6.4D.2.4.4.1-1. The details of the uplink and downlink reference measurement channels (RMCs) are specified in Annexes A.2 and A.3. Configurations of PDSCH and PDCCH before measurement are specified in Annex C.2.

Table 6.4D.2.4.4.1-1: Test Configuration Table

Initial Conditions			
Test Environment as specified in TS 38.508-1 [5] subclause 4.1		Normal, TL/VL, TL/VH, TH/VL, TH/VH	
Test Frequencies as specified in TS 38.508-1 [5] subclause 4.3.1		Low range, Mid range, High range	
Test Channel Bandwidths as specified in TS 38.508-1 [5] subclause 4.3.1		Lowest, Mid, Highest	
Test SCS as specified in Table 5.3.5-1		Lowest	
Test Parameters			
Test ID	Downlink Configuration	Uplink Configuration	
	N/A	Modulation	RB allocation (NOTE 1)
1		CP-OFDM QPSK	Outer Full
NOTE 1: The specific configuration of each RB allocation is defined in Table 6.1-1.			
NOTE 2: Test Channel Bandwidths are checked separately for each NR band, which applicable channel bandwidths are specified in Table 5.3.5-1.			

1. Connect the SS to the UE antenna connectors as shown in TS 38.508-1 [5] Annex A, Figure A.3.1.2.2 for TE diagram and section A.3.2 for UE diagram.
2. The parameter settings for the cell are set up according to TS 38.508-1 [5] subclause 4.4.3.
3. Downlink signals are initially set up according to Annex C.0, C.1, C.2, and uplink signals according to Annex G.0, G.1, G.2, G.3.0.
4. The UL Reference Measurement Channel is set according to Table 6.4D.2.4.4.1-1.
5. Propagation conditions are set according to Annex B.0.
6. Ensure the UE is in state RRC_CONNECTED with generic procedure parameters Connectivity *NR*, Connected without release *On*, Test Mode *On* and Test Loop Function *On* according to TS 38.508-1 [5] clause 4.5. Message contents are defined in clause 6.4D.2.4.4.3.

6.4D.2.4.4.2 Test procedure

1. SS sends uplink scheduling information for each UL HARQ process via PDCCH DCI format 0_1 for C_RNTI to schedule the UL RMC according to Table 6.4D.2.4.4.1-1. Since the UE has no payload and no loopback data to send the UE sends uplink MAC padding bits on the UL RMC. The PDCCH DCI format 0_1 is specified with the condition 2TX_UL_MIMO in 38.508-1 [5] subclause 4.3.6.1.1.2.
2. Send continuously uplink power control "up" commands in the uplink scheduling information to the UE until the UE transmits at P_{UMAX} level. Allow at least 200ms starting from the first TPC command in this step for the UE to reach P_{UMAX} level.
3. Measure spectrum flatness using Global In-Channel Tx-Test (Annex E) for each of transmit antennas of the UE. For TDD, only slots consisting of only UL symbols are under test.

6.4D.2.4.4.3 Message contents

Message contents are according to TS 38.508-1 [5] subclause 4.6 with the condition 2TX_UL_MIMO.

6.4D.2.4.5 Test requirement

The requirements apply to each transmit antenna connector.

Each of the n spectrum flatness functions, shall derive four ripple results in Annex E.4.4.1. The derived results shall not exceed the values in Figure 6.4D.2.4.5-1:

For shaped Pi/2-BPSK modulated waveforms, the test requirements are TBD.

For normal conditions and unshaped modulated waveforms, the maximum ripple in Range 1 and Range 2 shall not exceed the values specified in Table 6.4D.2.4.5-1 and the following additional requirement: the relative difference between the maximum coefficient in Range 1 and the minimum coefficient in Range 2 must not be larger than 6.4 dB, and the relative difference between the maximum coefficient in Range 2 and the minimum coefficient in Range 1 must not be larger than 8.4 dB (see Figure 6.4D.2.4.5-1).

For normal conditions and for unshaped modulated waveforms, the peak-to-peak variation of the EVM equalizer coefficients contained within the frequency range of the uplink allocation shall not exceed the maximum ripple specified in Table 6.4D.2.4.5-1. For uplink allocations contained within both Range 1 and Range 2, the coefficients evaluated within each of these frequency ranges shall meet the corresponding ripple requirement and the following additional requirement: the relative difference between the maximum coefficient in Range 1 and the minimum coefficient in Range 2 must not be larger than 6.4 dB, and the relative difference between the maximum coefficient in Range 2 and the minimum coefficient in Range 1 must not be larger than 8.4 dB (see Figure 6.4D.2.4.5-1).

For extreme conditions, the EVM equalizer spectral flatness shall not exceed the values specified in Table 6.4D.2.4.5-2. For uplink allocations contained within both Range 1 and Range 2, the coefficients evaluated within each of these frequency ranges shall meet the corresponding ripple requirement and the following additional requirement: the relative difference between the maximum coefficient in Range 1 and the minimum coefficient in Range 2 must not be larger than 7.4 dB, and the relative difference between the maximum coefficient in Range 2 and the minimum coefficient in Range 1 must not be larger than 11.4 dB (see Figure 6.4D.2.4.5-1).

Table 6.4D.2.4.5-1: Requirements for EVM equalizer spectrum flatness for unshaped modulations (normal conditions)

Frequency range	Maximum ripple [dB]
$F_{UL_Meas} - F_{UL_Low} \geq 3$ MHz and $F_{UL_High} - F_{UL_Meas} \geq 3$ MHz (Range 1)	4 + TT (p-p)
$F_{UL_Meas} - F_{UL_Low} < 3$ MHz or $F_{UL_High} - F_{UL_Meas} < 3$ MHz (Range 2)	8 + TT (p-p)
NOTE 1: F_{UL_Meas} refers to the sub-carrier frequency for which the equalizer coefficient is evaluated	
NOTE 2: F_{UL_Low} and F_{UL_High} refer to each E-UTRA frequency band specified in Table 5.5-1	
NOTE 3: Test tolerance TT = 1.4 dB.	

Table 6.4D.2.4.5-2: Minimum requirements for EVM equalizer spectrum flatness for unshaped modulations (extreme conditions)

Frequency range	Maximum Ripple [dB]
$F_{UL_Meas} - F_{UL_Low} \geq 5$ MHz and $F_{UL_High} - F_{UL_Meas} \geq 5$ MHz (Range 1)	4 + TT (p-p)
$F_{UL_Meas} - F_{UL_Low} < 5$ MHz or $F_{UL_High} - F_{UL_Meas} < 5$ MHz (Range 2)	12 + TT (p-p)
NOTE 1: F_{UL_Meas} refers to the sub-carrier frequency for which the equalizer coefficient is evaluated	
NOTE 2: F_{UL_Low} and F_{UL_High} refer to each E-UTRA frequency band specified in Table 5.5-1	
NOTE 3: Test tolerance TT = 1.4 dB.	

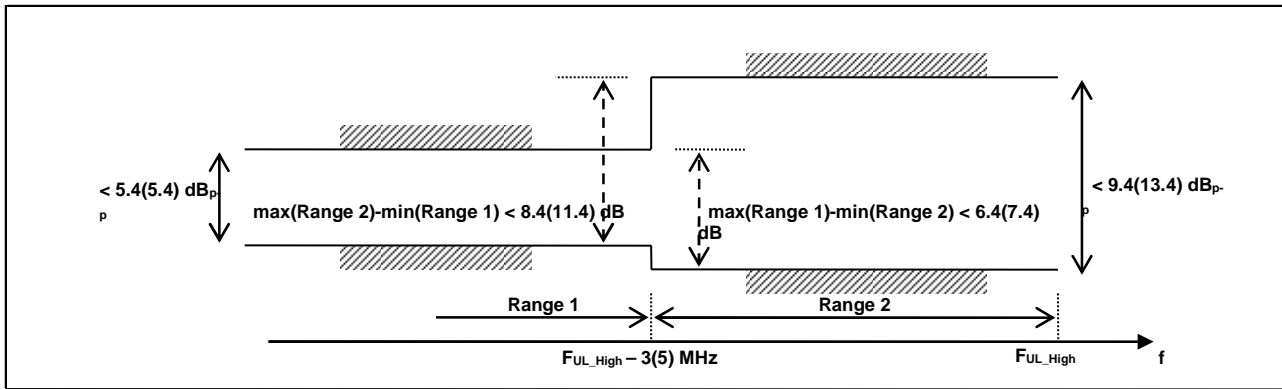

Figure 6.4D.2.4.5-1: The test requirements for EVM equalizer spectral flatness with the maximum allowed variation of the coefficients indicated for unshaped modulations (the ETC test requirements are within brackets)

6.4D.3 Time alignment error for UL MIMO

6.4D.3.1 Test purpose

To verify that the error of time alignment in UL MIMO does not exceed the range prescribed by the specified UL MIMO Time Alignment Error (TAE) and tolerance.

An excess time alignment error has the possibility to interfere to other channels or other systems and decrease UL MIMO performance because of the timing unsynchronization.

6.4D.3.2 Test applicability

This test case applies to all types of NR UE release 15 and forward that support UL MIMO.

6.4D.3.3 Minimum conformance requirements

For UE(s) with multiple transmit antenna connectors supporting UL MIMO, this requirement applies to frame timing differences between transmissions on multiple transmit antenna connectors in the closed-loop spatial multiplexing scheme.

The time alignment error (TAE) is defined as the average frame timing difference between any two transmissions on different transmit antenna connectors.

For UE(s) with multiple transmit antenna connectors, the Time Alignment Error (TAE) shall not exceed 130 ns.

The normative reference for this requirement is TS 38.101-1 [2] clause 6.4D.3.

6.4D.3.4 Test description

6.4D.3.4.1 Initial condition

Initial conditions are a set of test configurations the UE needs to be tested in and the steps for the SS to take with the UE to reach the correct measurement state.

The initial test configurations consist of environmental conditions, test frequencies, test channel bandwidths and sub-carrier spacing based on NR operating bands specified in Table 5.3.5-1. All of these configurations shall be tested with applicable test parameters for each combination of channel bandwidth and sub-carrier spacing, are shown in table 6.4D.3.4.1-1. The details of the uplink reference measurement channels (RMCs) are specified in Annexes A.2. Configurations of PDSCH and PDCCH before measurement are specified in Annex C.2.

Table 6.4D.3.4.1-1: Test Configuration Table

Initial Conditions			
Test Environment as specified in TS 38.508-1 [5] subclause 4.1		Normal	
Test Frequencies as specified in TS 38.508-1 [5] subclause 4.3.1		Mid range	
Test Channel Bandwidths as specified in TS 38.508-1 [5] subclause 4.3.1		Lowest, Mid, Highest	
Test SCS as specified in Table 5.3.5-1		Lowest, Highest	
Test Parameters for Channel Bandwidths			
Test ID	Downlink Configuration	Uplink Configuration	
	N/A for Time alignment error for UL MIMO	Modulation	RB allocation (NOTE 1)
1	test case	CP-OFDM QPSK	Outer Full
NOTE 1: The specific configuration of each RB allocation is defined in Table 6.1-1.			

1. Connect the SS to the UE antenna connectors as shown in TS 38.508-1 [5] Annex A, in Figure A.3.1.1.2 for TE diagram and section A.3.2 for UE diagram.
2. The parameter settings for the cell are set up according to TS 38.508-1 [5] subclause 4.4.3.
3. Downlink signals are initially set up according to Annex C.0, C.1, C.2, and uplink signals according to Annex G.0, G.1, G.2, G.3.0.
4. The UL Reference Measurement channels are set according to Table 6.4D.3.4.1-1.
5. Propagation conditions are set according to Annex B.0.
6. Ensure the UE is in state RRC_CONNECTED with generic procedure parameters Connectivity *NR*, Connected without release *On*, Test Mode *On* and Test Loop Function *On* according to TS 38.508-1 [5] clause 4.5. Message contents are defined in clause 6.4D.3.4.3.

6.4D.3.4.2 Test procedure

1. SS sends uplink scheduling information for each UL HARQ process via PDCCH DCI format 0_1 for C_RNTI to schedule the UL RMC according to Table 6.4D.3.4.1-1. Since the UE has no payload and no loopback data to send the UE sends uplink MAC padding bits on the UL RMC. The PDCCH DCI format 0_1 is specified with the condition 2TX_UL_MIMO in 38.508-1 [5] subclause 4.3.6.1.1.2.
2. Send continuously uplink power control "up" commands in every uplink scheduling information to the UE; allow at least 200ms from the first TPC command in this step for the UE to reach P_{UMAX} level.
3. Measure the timing of one sub-frame at each antenna connector.

6.4D.3.4.3 Message contents

Message contents are according to TS 38.508-1 [5] subclause 4.6 ensuring Table 4.6.3-182 with condition 2TX_UL_MIMO.

6.4D.3.5 Test requirement

For UE(s) with multiple transmit antenna connectors, the Time Alignment Error (TAE) shall not exceed $130 + TT$ ns.

Table 6.4D.3.5-1: Test Tolerance (Time alignment error for UL MIMO)

Test Tolerance
25ns

6.4D.4 Requirements for coherent UL MIMO

Editor's note: This clause is incomplete. The following aspects are either missing or not yet determined:

- Test config table is still FFS.
- Scheduling pattern within 20ms measurement window is FFS
- The test procedure is FFS.
- MU and TT value are still FFS

6.4D.4.1 Test purpose

To verify that the difference of relative phase error and the difference of relative power error between antenna ports in coherent UL MIMO do not exceed the range prescribed by the specified requirements for coherent UL MIMO and tolerance.

An excess relative phase error or excess relative power error has the possibility to interfere to other channels and decrease UL MIMO performance because of the timing unsynchronization.

6.4D.4.2 Test applicability

This test case applies to all types of NR UE release 15 and forward that support coherent UL MIMO.

6.4D.4.3 Minimum conformance requirements

For coherent UL MIMO, Table 6.4D.4.3-1 lists the maximum allowable difference between the measured relative power and phase errors between different antenna ports in any slot within the specified time window from the last transmitted SRS on the same antenna ports, for the purpose of uplink transmission (codebook or non-codebook usage) and those measured at that last SRS. The requirements in Table 6.4D.4.3-1 apply when the UL transmission power at each antenna port is larger than 0 dBm for SRS transmission and for the duration of time window.

Table 6.4D.4.3-1: Maximum allowable difference of relative phase and power errors in a given slot compared to those measured at last SRS transmitted

Difference of relative phase error	Difference of relative power error	Time window
40 degrees	4 dB	20 msec

The above requirements when all the following conditions are met within the specified time window:

- UE is not signaled with a change in number of SRS ports in SRS-config, or a change in PUSCH-config
- UE remains in DRX active time (UE does not enter DRX OFF time)
- No measurement gap occurs
- No instance of SRS transmission with the usage antenna switching occurs
- Active BWP remains the same
- EN-DC and CA configuration is not changed for the UE (UE is not configured or de-configured with PScell or SCell(s))

The normative reference for this requirement is TS 38.101-1 [2] clause 6.4D.4

6.4D.4.4 Test description

6.4D.4.4.1 Initial condition

Initial conditions are a set of test configurations the UE needs to be tested in and the steps for the SS to take with the UE to reach the correct measurement state.

The initial test configurations consist of environmental conditions, test frequencies, test channel bandwidths and sub-carrier spacing based on NR operating bands specified in Table 5.3.5-1. All of these configurations shall be tested with applicable test parameters for each combination of channel bandwidth and sub-carrier spacing, are shown in table

6.4D.4.4.1-1. The details of the uplink reference measurement channels (RMCs) are specified in Annexes A.2. Configurations of PDSCH and PDCCH before measurement are specified in Annex C.2.

Table 6.4D.4.4.1-1: Test Configuration Table

FFS

1. Connect the SS to the UE antenna connectors as shown in TS 38.508-1 [5] Annex A, in Figure A.3.1.1.2 for TE diagram and section A.3.2 for UE diagram.
2. The parameter settings for the cell are set up according to TS 38.508-1 [5] subclause 4.4.3.
3. Downlink signals are initially set up according to Annex C.0, C.1, C.2, and uplink signals according to Annex G.0, G.1, G.2, G.3.0.
4. The UL Reference Measurement channels are set according to Table 6.4D.4.4.1-1.
5. Propagation conditions are set according to Annex B.0.
6. Ensure the UE is in state RRC_CONNECTED with generic procedure parameters Connectivity *NR*, Connected without release *On*, Test Mode *On* and Test Loop Function *On* according to TS 38.508-1 [5] clause 4.5. Message contents are defined in clause 6.4D.4.4.3

6.4D.4.4.2 Test procedure

1. SS sends uplink scheduling information for each UL HARQ process via PDCCH DCI format 0_1 for C_RNTI to schedule the UL RMC according to Table 6.4D.4.4.1-1. Since the UE has no payload and no loopback data to send the UE sends uplink MAC padding bits on the UL RMC.
2. Send continuously uplink power control "up" commands in every uplink scheduling information to the UE; allow at least 200ms starting from the first TPC command in this step to ensure that the UE reaches the P_{max} level of the test point.
3. Measure the mean power of the UE on each antenna port on SRS symbol in the SRS channel bandwidth according to the test configuration from table 6.4D.4.4.1-1. Calculate the power difference between antenna ports and save this value as 'Power_ref'.
4. On the slots within 20ms following the SRS symbol, measure the mean power of the UE on each antenna port in the channel bandwidth according to the test configuration from table 6.2.4.4.1-1. The period of measurement shall be at least the continuous duration of one active slot and in the uplink symbols. For TDD slots with transient periods are not under test. Calculate the power difference between antenna ports and save this value as 'Power_meas'.

6.4D.4.4.3 Message contents

Message contents are according to TS 38.508-1 [5] subclause 4.6 and 5.4 ensuring Table 4.6.3-182 with the condition 2TX_UL_MIMO.

6.4D.4.5 Test requirement

Maximum allowable difference of 'power_ref' measured in step 3 and 'power_meas' measured in step 4 shall not exceed the described relative power error in Table 6.4D.4.5-1.

Table 6.4D.4.5-1: Maximum allowable difference of relative phase and power errors in a given slot compared to those measured at last SRS transmitted

Difference of relative phase error	Difference of relative power error	Time window
40+TT degrees	4+TT ¹ dB	20 msec
NOTE 1: TT for relative power for each frequency and channel bandwidth is specified in Table 6.4D.4.5-2.		

Table 6.4D.4.5-2: Test Tolerance

	$f \leq 3.0\text{GHz}$	$3.0\text{GHz} < f \leq 6\text{GHz}$
$\text{BW} \leq 40\text{MHz}$	FFS	FFS
$40\text{MHz} < \text{BW} \leq 100\text{MHz}$	FFS	FFS

6.4E Transmit signal quality for V2X

6.4E.1 Frequency error for V2X

6.4E.2 Transmit modulation quality for V2X

6.4E.2.1 General

The transmit modulation quality requirements in this clause apply to V2X sidelink transmissions.

For NR V2X UE supporting SL MIMO, the transmit modulation quality requirements for single carrier shall apply to each transmit antenna connector.

If V2X UE transmits on one-antenna connector at a time, the requirements specified for single carrier apply to the active antenna connector.

6.4E.2.2 Error Vector Magnitude for V2X

6.4E.2.2.1 Error Vector Magnitude for V2X / non-concurrent operation

Editor's Note:

- The test case is not completed due to the following aspects are not yet determined:
- Test configuration is TBD
- Target power level is TBD

6.4E.2.2.1.1 Test purpose

The Error Vector Magnitude is a measure of the difference between the reference waveform and the measured waveform. This difference is called the error vector. Before calculating the EVM the measured waveform is corrected by the sample timing offset and RF frequency offset. Then the carrier leakage shall be removed from the measured waveform before calculating the EVM.

The measured waveform is further equalised using the channel estimates subjected to the EVM equaliser spectrum flatness requirement specified in sub-clause 6.4E.2.5.1.3. For CP-OFDM waveforms, the EVM result is defined after the front-end FFT as the square root of the ratio of the mean error vector power to the mean reference power expressed as a %.

6.4E.2.2.1.2 Test applicability

This test case applies to all types of NR UE release 16 and forward that support NR V2X sidelink communication.

6.4E.2.2.1.3 Minimum conformance requirements

For V2X sidelink physical channels PSCCH and PSSCH, the Error Vector Magnitude requirements shall be as specified for PUSCH in Table 6.4.2.1-1 except pi/2-BPSK for NR V2X operating bands in Table 5.2E.1-1. When sidelink transmissions are shortened due to transmission gap of 1 symbol at the end of the slot, the EVM measurement interval is reduced by one symbol, accordingly.

The normative reference for this requirement is TS 38.101-1 [2] clause 6.4E.2.2.

6.4E.2.2.1.4 Test description

6.4E.2.2.1.4.1 Initial condition

Initial conditions are a set of test configurations the UE needs to be tested in and the steps for the SS to take with the UE to reach the correct measurement state.

The initial test configurations consist of environmental conditions, test frequencies, test channel bandwidths and sub-carrier spacing based on NR operating bands specified in Table 5.2E.1-1 and Table 5.3.5-1. All of these configurations shall be tested with applicable test parameters for each combination of test channel bandwidth and sub-carrier spacing, and are shown in table 6.4E.2.2.1.4.1-1. The details of the V2X reference measurement channels (RMCs) are specified in Annex A.7.5 and the GNSS configuration in TS 38.508-1 [5] subclause 4.11.

Table 6.4E.2.2.1.4.1-1: Test Configuration Table for PSSCH and PSCCH

FFS

1. Connect the SS and GNSS simulator to the UE antenna connectors as shown in TS 38.508-1 [5] Annex A, Figure A.3.1.9.1 for TE diagram and section A.3.2.7 for UE diagram.
2. The parameter settings for the V2X sidelink transmission over PC5 are pre-configured according to TS 38.508-1 [5] subclause 4.10. Message content exceptions are defined in clause 6.4E.2.2.1.4.3.
3. The V2X Reference Measurement Channel is set according to Table 6.4E.2.2.1.4.1-1.
4. The GNSS simulator is configured for Scenario #1: static in Geographical area #1, as defined in TS38.508-1 [5] Table 4.11.2-2. Geographical area #1 is also pre-configured in the UE.
5. Propagation conditions are set according to Annex B.0.
6. Ensure the UE is in state *Out_of_Coverage* with generic procedure parameters *Sidelink On*, *Test Loop Function On* with UE test loop mode E closed for *Transmit Mode* according to TS 38.508-1 [5] clause 4.5.

6.4E.2.2.1.4.2 Test procedure

1. The UE starts to perform the V2X sidelink communication according to [SL-V2X-Preconfiguration]. Since the UE has no payload and no loopback data to send the UE sends uplink MAC padding bits on the V2X RMC.
2. Configure the UE to transmit at P_{UMAX} level.
3. Measure the EVM and \overline{EVM}_{DMRS} using Global In-Channel Tx-Test (Annex E). The measurement period is [15] subframes. When V2X transmissions are shortened due to transmission gap of 1 symbol at the end of the subframe, the EVM measurement interval is reduced by one symbol, accordingly.
4. Modify SL-V2X-Preconfiguration to ensure the UE to transmit at a relative low power, according to Table [TBD].
5. Ensure the UE is in State [TBD] in Transmit Mode according to TS 38.508-1 [5] clause [TBD] using the new UL power control setting.
6. The UE starts to perform the V2X sidelink communication according to [SL-V2X-Preconfiguration]. Since the UE has no payload and no loopback data to send the UE sends uplink MAC padding bits on the V2X RMC.
7. Measure EVM and \overline{EVM}_{DMRS} using Global In-Channel Tx-Test (Annex E). The measurement period is [15] subframes. When V2X transmissions are shortened due to transmission gap of 1 symbol at the end of the subframe, the EVM measurement interval is reduced by one symbol, accordingly.

6.4E.2.2.1.4.3 Message contents

Message contents are according to TS 38.508-1 [5] subclause 4.6 and 5.4 with the following exceptions:

FFS

6.4E.2.2.1.5 Test requirement

FFS

6.4E.2.2.1D Error Vector Magnitude for V2X / non-concurrent operation / SL-MIMO

Editor's Note:

- No test points are defined since there is no configuration satisfying MPR=0dB requirements in RAN4.
- The test case is not completed due to the following aspects are not yet determined:
 - Uplink RMC is TBD in RAN4
 - Connection diagram is TBD
 - Preconfiguration is TBD in 38.508-1
 - Test state and generic procedure are TBD in 38.508-1

6.4E.2.2.1D.1 Test purpose

The Error Vector Magnitude is a measure of the difference between the reference waveform and the measured waveform. This difference is called the error vector. Before calculating the EVM the measured waveform is corrected by the sample timing offset and RF frequency offset. Then the carrier leakage shall be removed from the measured waveform before calculating the EVM.

The measured waveform is further equalised using the channel estimates subjected to the EVM equaliser spectrum flatness requirement specified in sub-clause 6.4E.2.5.1D.3. For CP-OFDM waveforms, the EVM result is defined after the front-end FFT as the square root of the ratio of the mean error vector power to the mean reference power expressed as a %.

6.4E.2.2.1D.2 Test applicability

This test case applies to all types of NR UE release 16 and forward that support NR V2X sidelink MIMO communication with non-concurrent operation.

NOTE: This test case can't be performed due to lack of appropriate test points.

6.4E.2.2.1D.3 Minimum conformance requirements

For NR V2X UE with two transmit antenna connectors, the requirements specified for single carrier described in clause 6.4E.2.2.1.3 shall apply to each transmit antenna connector.

The normative reference for this requirement is TS 38.101-1 [2] clause 6.4E.2.2.

6.4E.2.2.1D.4 Test description

6.4E.2.2.1D.4.1 Initial condition

Initial conditions are a set of test configurations the UE needs to be tested in and the steps for the SS to take with the UE to reach the correct measurement state.

The initial test configurations consist of environmental conditions, test frequencies, test channel bandwidths and sub-carrier spacing based on NR operating bands specified in Table 5.3.5-1. All of these configurations shall be tested with applicable test parameters for each combination of test channel bandwidth and sub-carrier spacing, and are shown in table 6.4E.2.2.1D.4.1-1. The details of the V2X reference measurement channels (RMCs) are specified in Annexes TBD.

Table 6.4E.2.2.1D.4.1-1: Test Configuration Table for PSSCH and PSCCH

FFS

NOTE: No test points are defined since there is no configuration satisfying MPR=0dB requirements in RAN4.

1. Connect the SS and GNSS simulator to the UE antenna connectors as shown in TS 38.508-1 [5] Annex A, Figure [TBD] for TE diagram and section [TBD] for UE diagram.
2. The parameter settings for the V2X sidelink transmission over PC5 are pre-configured according to TS 38.508-1 [5] subclause [TBD]. Message content exceptions are defined in clause 6.4E.2.2.1D.4.3.
3. The V2X Reference Measurement Channel is set according to Table 6.4E.2.2.1D.4.1-1.
4. The GNSS simulator is configured for Scenario #1: static in Geographical area #1, as defined in TS38.508-1 [5] Table [TBD]. Geographical area #1 is also pre-configured in the UE.
5. Propagation conditions are set according to Annex B.0.
6. Ensure the UE is in state [TBD].

6.4E.2.2.1D.4.2 Test procedure

1. The UE starts to perform the V2X sidelink communication according to [SL-V2X-Preconfiguration]. Since the UE has no payload and no loopback data to send the UE sends uplink MAC padding bits on the V2X RMC.
2. Configure the UE to transmit at P_{UMAX} level.
3. Measure the EVM and \overline{EVM}_{DMRS} using Global In-Channel Tx-Test (Annex E) for each of transmit antenna. The measurement period is [15] subframes. When V2X transmissions are shortened due to transmission gap of 1 symbol at the end of the subframe, the EVM measurement interval is reduced by one symbol, accordingly.
4. Modify SL-V2X-Preconfiguration to ensure the UE to transmit at a relative low power, according to Table [TBD].
5. Ensure the UE is in State [TBD] in Transmit Mode according to TS 38.508-1 [5] clause [TBD] using the new UL power control setting.
6. The UE starts to perform the V2X sidelink communication according to [SL-V2X-Preconfiguration]. Since the UE has no payload and no loopback data to send the UE sends uplink MAC padding bits on the V2X RMC.
7. Measure EVM and \overline{EVM}_{DMRS} using Global In-Channel Tx-Test (Annex E) for each of transmit antenna. The measurement period is [15] subframes. When V2X transmissions are shortened due to transmission gap of 1 symbol at the end of the subframe, the EVM measurement interval is reduced by one symbol, accordingly.

6.4E.2.2.1D.4.3 Message contents

Message contents are according to TS 38.508-1 [5] subclause 4.6 and 5.4 with the following exceptions:

FFS

6.4E.2.2.1D.5 Test requirement

FFS

6.4E.2.4 In-band emissions for V2X

6.4E.2.4.1 In-band emissions for V2X / non-concurrent operation

Editor's Note:

- The test case is not completed due to the following aspects are not yet determined:
- Test configuration is TBD
- Target power level is TBD

6.4E.2.4.1.1 Test purpose

The in-band emissions are a measure of the interference falling into the non-allocated resources blocks, this is to verify that the in-band emissions of V2X sidelink non-concurrent operation satisfy the minimum requirements.

6.4E.2.4.1.2 Test applicability

This test case applies to all types of NR UE release 16 and forward that support NR V2X sidelink communication with non-concurrent operation.

6.4E.2.4.1.3 Minimum conformance requirements

For V2X sidelink physical channels PSCCH, PSSCH and PSBCH, the In-band emissions requirements shall be as specified for PUSCH in subclause 6.4.2.3 for the corresponding modulation and transmission bandwidth. When V2X transmissions are shortened due to transmission gap of one symbol at the end of the subframe, the In-band emissions measurement interval is reduced by one symbol, accordingly.

Consequently, the relative in-band emission of each sidelink physical channel shall not exceed the values specified in Table 6.4E.2.4.1.3-1.

Table 6.4E.2.4.1.3-1: Minimum requirements for in-band emissions

Parameter description	Unit	Limit (NOTE 1)		Applicable Frequencies
General	dB	$\max \left\{ -25 - 10 \cdot \log_{10} (N_{RB} / L_{CRB}), \right.$ $20 \cdot \log_{10} EVM - 3 - 5 \cdot (\Delta_{RB} - 1) / L_{CRB},$ $\left. -57 \text{ dBm} + 10 \log_{10} (SCS / 15 \text{ kHz}) - \overline{P_{RB}} \right\}$		Any non-allocated (NOTE 2)
IQ Image	dB	-28	Image frequencies when output power > 10 dBm	Image frequencies (NOTES 2, 3)
		-25	Image frequencies when output power ≤ 10 dBm	
Carrier leakage	dBc	-28	Output power > 10 dBm	Carrier leakage frequency (NOTES 4, 5)
		-25	0 dBm ≤ Output power ≤ 10 dBm	
		-20	-30 dBm ≤ Output power < 0 dBm	
		-10	-40 dBm ≤ Output power < -30 dBm	
<p>NOTE 1: An in-band emissions combined limit is evaluated in each non-allocated RB. For each such RB, the minimum requirement is calculated as the higher of $\overline{P_{RB}} - 30$ dB and the power sum of all limit values (General, IQ Image or Carrier leakage) that apply. $\overline{P_{RB}}$ is defined in NOTE 10.</p> <p>NOTE 2: The measurement bandwidth is 1 RB and the limit is expressed as a ratio of measured power in one non-allocated RB to the measured average power per allocated RB, where the averaging is done across all allocated RBs. For pi/2 BPSK with Spectrum Shaping, the limit is expressed as a ratio of measured power in one non-allocated RB to the measured power in the allocated RB with highest PSD.</p> <p>NOTE 3: The applicable frequencies for this limit are those that are enclosed in the reflection of the allocated bandwidth, based on symmetry with respect to the carrier leakage frequency, but excluding any allocated RBs.</p> <p>NOTE 4: The measurement bandwidth is 1 RB and the limit is expressed as a ratio of measured power in one non-allocated RB to the measured total power in all allocated RBs.</p> <p>NOTE 5: The applicable frequencies for this limit depend on the parameter <i>txDirectCurrentLocation</i> in <i>UplinkTxDirectCurrent</i> IE, and are those that are enclosed either in the RB containing the carrier leakage frequency, or in the two RBs immediately adjacent to the carrier leakage frequency but excluding any allocated RB.</p> <p>NOTE 6: L_{CRB} is the Transmission Bandwidth (see clause 5.3).</p> <p>NOTE 7: N_{RB} is the Transmission Bandwidth Configuration (see clause 5.3).</p> <p>NOTE 8: EVM is the limit specified in Table 6.4.2.1-1 for the modulation format used in the allocated RBs.</p> <p>NOTE 9: Δ_{RB} is the starting frequency offset between the allocated RB and the measured non-allocated RB (e.g. $\Delta_{RB} = 1$ or $\Delta_{RB} = -1$ for the first adjacent RB outside of the allocated bandwidth).</p> <p>NOTE 10: $\overline{P_{RB}}$ is an average of the transmitted power over 10 sub-frames normalized by the number of allocated RBs, measured in dBm.</p> <p>NOTE 11: For almost contiguous allocations defined in clause 6.2.2, $L_{CRB} = N_{RB_alloc} + N_{RB_gap}$ with no in-gap emission requirement.</p>				

The normative reference for this requirement is TS 38.101-1 [2] clause 6.4E.2.4.

6.4E.2.4.1.4 Test description

6.4E.2.4.1.4.1 Initial condition

Initial conditions are a set of test configurations the UE needs to be tested in and the steps for the SS to take with the UE to reach the correct measurement state.

The initial test configurations consist of environmental conditions, test frequencies, test channel bandwidths and sub-carrier spacing based on NR operating bands specified in Table 5.2E.1-1 and Table 5.3.5-1. All of these configurations shall be tested with applicable test parameters for each combination of test channel bandwidth and sub-carrier spacing, and are shown in table 6.4E.2.4.1.4.1-1 and 6.4E.2.4.1.4.1-2. The details of the V2X reference measurement channels (RMCs) are specified in Annex A.7.5 and the GNSS configuration in TS 38.508-1 [5] subclause 4.11.

Table 6.4E.2.4.1.4.1-1: Test Configuration Table for PSSCH and PSCCH

FFS

Table 6.4E.2.4.1.4.1-2: Test Configuration Table for PSBCH

FFS

1. Connect the SS and GNSS simulator to the UE antenna connectors as shown in TS 38.508-1 [5] Annex A, Figure A.3.1.9.1 for TE diagram and section A.3.2.7 for UE diagram.
2. The parameter settings for the V2X sidelink transmission over PC5 are pre-configured according to TS 38.508-1 [5] subclause 4.10. Message content exceptions are defined in clause 6.4E.2.4.1.4.3.
3. The V2X Reference Measurement Channel is set according to Table 6.4E.2.4.1.4.1-1.
4. The GNSS simulator is configured for Scenario #1: static in Geographical area #1, as defined in TS 38.508-1 [5] Table 4.11.2-2. Geographical area #1 is also pre-configured in the UE.
5. Propagation conditions are set according to Annex B.0.
6. Ensure the UE is in state *Out_of_Coverage* with generic procedure parameters *Sidelink On*, Test Loop Function *On* with UE test loop mode E closed for *Transmit Mode* according to TS 38.508-1 [5] clause 4.5.

6.4E.2.4.1.4.2 Test procedure

Test procedure for PSCCH+PSSCH:

1. Set the V2X sidelink communication parameters for both the V2X sidelink capable UE (hereinafter referred to as V2X UE) and SS according to *SL-PreconfigurationNR* in [TBD].
2. V2X UE schedules the V2X RMC according to *SL-PreconfigurationNR* which is in line with the test configuration in Table 6.4E.2.4.1.4.1-1.
3. Measure the V2X UE output power to make sure V2X UE transmission power to be [TBD]
4. Measure In-band emission using Global In-Channel Tx-Test (Annex E)

[TP2: V2X UE output power within (0 -30) dBm]

Repeat the above steps 1~4 with the exception that making sure V2X UE transmission power to be -25.5dBm+/- 4.5dB for carrier frequency $f > 5\text{GHz}$ in step3.

Test procedure for PSBCH:

1. Set the V2X sidelink communication parameters for both the V2X sidelink capable UE (hereinafter referred to as V2X UE) and SS according to *SL-PreconfigurationNR* in [TBD].
2. V2X UE schedules the V2X RMC according to *SL-PreconfigurationNR* which is in line with the test configuration in Table 6.4E.2.4.1.4.1-2.
3. Measure the V2X UE output power to make sure V2X UE transmission power to be [TBD]

4. Measure In-band emission using Global In-Channel Tx-Test (Annex E)

[TP2: V2X UE output power within (0 -30) dBm]

Repeat the above steps 1~4 with the exception that making sure V2X UE transmission power to be -25.5dBm+/-4.5 dB for carrier frequency $f > 5\text{GHz}$ in step3.

6.4E.2.4.1.4.3 Message contents

Message contents are according to TS 38.508-1 [5] subclause 4.6 and 5.4 with the following exceptions:

FFS

6.4E.2.4.1.5 Test requirement

FFS

6.4E.2.4.1D In-band emissions for V2X / non-concurrent operation / SL-MIMO

Editor's Note:

- The test case is not completed due to the following aspects are not yet determined:
- Uplink RMC is TBD in RAN4
- Connection diagram is TBD
- Preconfiguration is TBD in 38.508-1
- Test state and generic procedure are TBD in 38.508-1

6.4E.2.4.1D.1 Test purpose

The in-band emissions are a measure of the interference falling into the non-allocated resources blocks, this is to verify that the in-band emissions of V2X sidelink non-concurrent operation satisfy the minimum requirements.

6.4E.2.4.1D.2 Test applicability

This test case applies to all types of NR UE release 16 and forward that support NR V2X sidelink MIMO communication with non-concurrent operation.

NOTE: This test case can't be performed due to lack of appropriate test points.

6.4E.2.4.1D.3 Minimum conformance requirements

For NR V2X UE with two transmit antenna connectors, the requirements specified for single carrier described in clause 6.4E.2.4.1.3 shall apply to each transmit antenna connector.

The normative reference for this requirement is TS 38.101-1 [2] clause 6.4E.2.4.

6.4E.2.4.1D.4 Test description

6.4E.2.4.1D.4.1 Initial condition

Initial conditions are a set of test configurations the UE needs to be tested in and the steps for the SS to take with the UE to reach the correct measurement state.

The initial test configurations consist of environmental conditions, test frequencies, test channel bandwidths and sub-carrier spacing based on NR operating bands specified in Table 5.3.5-1. All of these configurations shall be tested with applicable test parameters for each combination of test channel bandwidth and sub-carrier spacing, and are shown in table 6.4E.2.4.1D.4.1-1 and 6.4E.2.4.1D.4.1-2. The details of the V2X reference measurement channels (RMCs) are specified in Annexes TBD.

Table 6.4E.2.4.1D.4.1-1: Test Configuration Table for PSSCH and PSCCH

FFS

Table 6.4E.2.4.1D.4.1-2: Test Configuration Table for PSBCH

FFS

1. Connect the SS and GNSS simulator to the UE antenna connectors as shown in TS 38.508-1 [5] Annex A, Figure [TBD] for TE diagram and section [TBD] for UE diagram.
2. The parameter settings for the V2X sidelink transmission over PC5 are pre-configured according to TS 38.508-1 [5] subclause [TBD]. Message content exceptions are defined in clause 6.4E.2.4.1D.4.3.
3. The V2X Reference Measurement Channel is set according to Table 6.4E.2.4.1D.4.1-1.
4. The GNSS simulator is configured for Scenario #1: static in Geographical area #1, as defined in TS38.508-1 [5] Table [TBD]. Geographical area #1 is also pre-configured in the UE.
5. Propagation conditions are set according to Annex B.0.
6. Ensure the UE is in state [TBD].

6.4E.2.4.1D.4.2 Test procedure

Test procedure for PSCCH+PSSCH:

1. Set the V2X sidelink communication parameters for both the V2X sidelink capable UE (hereinafter referred to as V2X UE) and SS according to *SL-PreconfigurationNR* in [TBD].
2. V2X UE schedules the V2X RMC according to *SL-PreconfigurationNR* which is in line with the test configuration in Table 6.4E.2.4.1D.4.1-1.
3. Measure the V2X UE output power to make sure V2X UE transmission power to be [TBD].
4. Measure In-band emission using Global In-Channel Tx-Test (Annex E) for each of transmit antenna.

Test procedure for PSBCH:

1. Set the V2X sidelink communication parameters for both the V2X sidelink capable UE (hereinafter referred to as V2X UE) and SS according to *SL-PreconfigurationNR* in [TBD].
2. V2X UE schedules the V2X RMC according to *SL-PreconfigurationNR* which is in line with the test configuration in Table 6.4E.2.4.1D.4.1-2.
3. Measure the V2X UE output power to make sure V2X UE transmission power to be [TBD].
4. Measure In-band emission using Global In-Channel Tx-Test (Annex E) for each of transmit antenna.

6.4E.2.4.1D.4.3 Message contents

Message contents are according to TS 38.508-1 [5] subclause 4.6 and 5.4 with the following exceptions:

FFS

6.4E.2.4.1D.5 Test requirement

FFS

6.4E.2.4.2 In-band emissions for V2X / con-current operation**Editor's Note:**

- The test case is not completed due to the following aspects are not yet determined:
- Uplink RMC is TBD in RAN4
- Connection diagram is TBD
- Preconfiguration is TBD in 38.508-1
- Test state and generic procedure are TBD in 38.508-1

6.4E.2.4.2.1 Test purpose

The in-band emissions are a measure of the interference falling into the non-allocated resources blocks, this is to verify that the in-band emissions of V2X sidelink con-current operation satisfy the minimum requirements.

6.4E.2.4.2.2 Test applicability

This test case applies to all types of NR UE release 16 and forward that support NR V2X sidelink communication with con-current operation.

NOTE: This test case can't be performed due to lack of appropriate test points.

6.4E.2.4.2.3 Minimum conformance requirements

For V2X sidelink physical channels PSCCH, PSSCH and PSBCH, the In-band emissions requirements shall be as specified for PUSCH in subclause 6.4.2.3 for the corresponding modulation and transmission bandwidth. When V2X transmissions are shortened due to transmission gap of one symbol at the end of the subframe, the In-band emissions measurement interval is reduced by one symbol, accordingly.

The normative reference for this requirement is TS 38.101-1 [2] clause 6.4E.2.4.

6.4E.2.4.2.4 Test description

6.4E.2.4.2.4.1 Initial condition

Initial conditions are a set of test configurations the UE needs to be tested in and the steps for the SS to take with the UE to reach the correct measurement state.

The initial test configurations consist of environmental conditions, test frequencies, test channel bandwidths and sub-carrier spacing based on NR operating bands specified in Table 5.3.5-1. All of these configurations shall be tested with applicable test parameters for each combination of test channel bandwidth and sub-carrier spacing, and are shown in table 6.4E.2.4.2.4.1-1 and 6.4E.2.4.2.4.1-2. The details of the V2X reference measurement channels (RMCs) are specified in Annexes TBD.

Table 6.4E.2.4.2.4.1-1: Test Configuration Table for PSSCH and PSCCH

FFS

Table 6.4E.2.4.2.4.1-2: Test Configuration Table for PSBCH

FFS

1. Connect the SS and GNSS simulator to the UE antenna connectors as shown in TS 38.508-1 [5] Annex A, Figure [TBD] for TE diagram and section [TBD] for UE diagram.
2. The parameter settings for the V2X sidelink transmission over PC5 are pre-configured according to TS 38.508-1 [5] subclause [TBD]. Message content exceptions are defined in clause 6.4E.2.4.2.4.3.
3. The V2X Reference Measurement Channel is set according to Table 6.4E.2.4.2.4.1-1.
4. The GNSS simulator is configured for Scenario #1: static in Geographical area #1, as defined in TS38.508-1 [5] Table [TBD]. Geographical area #1 is also pre-configured in the UE.
5. Propagation conditions are set according to Annex B.0.
6. Ensure the UE is in state [TBD].

6.4E.2.4.2.4.2 Test procedure

Test procedure for PSCCH+PSSCH:

1. Set the V2X sidelink communication parameters for both the V2X sidelink capable UE (hereinafter referred to as V2X UE) and SS according to *SL-PreconfigurationNR* in [TBD].
2. V2X UE schedules the V2X RMC according to *SL-PreconfigurationNR* which is in line with the test configuration in Table 6.4E.2.4.2.4.1-1.

3. Measure the V2X UE output power to make sure V2X UE transmission power to be [TBD].
4. Measure In-band emission using Global In-Channel Tx-Test (Annex E) for each of transmit antenna.

Test procedure for PSBCH:

1. Set the V2X sidelink communication parameters for both the V2X sidelink capable UE (hereinafter referred to as V2X UE) and SS according to *SL-PreconfigurationNR* in [TBD].
2. V2X UE schedules the V2X RMC according to *SL-PreconfigurationNR* which is in line with the test configuration in Table 6.4E.2.4.2.4.1-2.
3. Measure the V2X UE output power to make sure V2X UE transmission power to be [TBD].
4. Measure In-band emission using Global In-Channel Tx-Test (Annex E) for each of transmit antenna.

6.4E.2.4.2.4.3 Message contents

Message contents are according to TS 38.508-1 [5] subclause 4.6 and 5.4 with the following exceptions:

FFS

6.4E.2.4.2.5 Test requirement

FFS

6.4E.2.5 EVM equalizer spectrum flatness for V2X

6.4E.2.5.1 EVM equalizer spectrum flatness for V2X / non-concurrent operation

Editor's Note:

- The test case is not completed due to the following aspects are not yet determined:
- Test configuration is TBD
- Target power level is TBD

6.4E.2.5.1.1 Test purpose

The zero-forcing equalizer correction applied in the EVM measurement process (as described in Annex E) must meet a spectrum flatness requirement for the EVM measurement to be valid. The EVM equalizer spectrum flatness is defined in terms of the maximum peak-to-peak ripple of the equalizer coefficients (dB) across the V2X sidelink allocated block variation in dB of the equalizer coefficients generated by the EVM measurement process. The EVM equalizer spectrum flatness requirement does not limit the correction applied to the signal in the EVM measurement process but for the EVM result to be valid, the equalizer correction that was applied must meet the EVM equalizer spectrum flatness minimum requirements. The basic measurement interval is the same as for EVM.

6.4E.2.5.1.2 Test applicability

This test case applies to all types of NR UE release 16 and forward that support NR V2X sidelink communication.

NOTE: This test case can't be performed due to lack of appropriate test points.

6.4E.2.5.1.3 Minimum conformance requirements

The peak-to-peak variation of the EVM equalizer coefficients contained within the frequency range of the V2X sidelink allocation shall not exceed the maximum ripple. The EVM equalizer spectrum flatness shall not exceed the values specified in Table 6.4E.2.5.1.3-1 for normal conditions. For V2X sidelink allocations contained within both Range 1 and Range 2, the coefficients evaluated within each of these frequency ranges shall meet the corresponding ripple requirement and the following additional requirement: the relative difference between the maximum coefficient in Range 1 and the minimum coefficient in Range 2 must not be larger than 5 dB, and the relative difference between the maximum coefficient in Range 2 and the minimum coefficient in Range 1 must not be larger than 7 dB (see Figure 6.4E.2.5.1.3-1).

The EVM equalizer spectrum flatness shall not exceed the values specified in Table 6.4E.2.5.1.3-2 for extreme conditions. For uplink allocations contained within both Range 1 and Range 2, the coefficients evaluated within each of these frequency ranges shall meet the corresponding ripple requirement and the following additional requirement: the relative difference between the maximum coefficient in Range 1 and the minimum coefficient in Range 2 must not be larger than 6 dB, and the relative difference between the maximum coefficient in Range 2 and the minimum coefficient in Range 1 must not be larger than 10 dB (see Figure 6.4E.2.5.1.3-1).

For V2X sidelink physical channels PSCCH, PSSCH and PSBCH, the EVM equalizer spectrum flatness requirements shall be as specified for PUSCH in clause 6.4.2.4 for the corresponding modulation and transmission bandwidth.

Table 6.4E.2.5.1.3-1: Minimum requirements for EVM equalizer spectrum flatness (normal conditions)

Frequency range	Maximum ripple (dB)
$F_{UL_Meas} - F_{UL_Low} \geq 3$ MHz and $F_{UL_High} - F_{UL_Meas} \geq 3$ MHz (Range 1)	4 (p-p)
$F_{UL_Meas} - F_{UL_Low} < 3$ MHz or $F_{UL_High} - F_{UL_Meas} < 3$ MHz (Range 2)	8 (p-p)
NOTE 1: F_{UL_Meas} refers to the sub-carrier frequency for which the equalizer coefficient is evaluated	
NOTE 2: F_{UL_Low} and F_{UL_High} refer to each NR frequency band specified in Table 5.2-1	

Table 6.4E.2.5.1.3-2: Minimum requirements for EVM equalizer spectrum flatness (extreme conditions)

Frequency range	Maximum Ripple (dB)
$F_{UL_Meas} - F_{UL_Low} \geq 5$ MHz and $F_{UL_High} - F_{UL_Meas} \geq 5$ MHz (Range 1)	4 (p-p)
$F_{UL_Meas} - F_{UL_Low} < 5$ MHz or $F_{UL_High} - F_{UL_Meas} < 5$ MHz (Range 2)	12 (p-p)
NOTE 1: F_{UL_Meas} refers to the sub-carrier frequency for which the equalizer coefficient is evaluated	
NOTE 2: F_{UL_Low} and F_{UL_High} refer to each NR frequency band specified in Table 5.2-1	

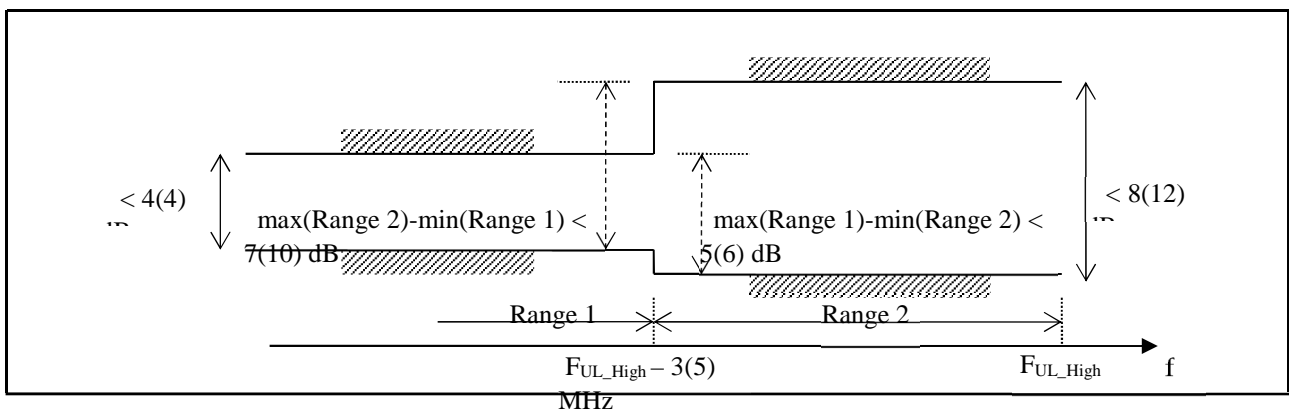

Figure 6.4E.2.5.1.3-1: The limits for EVM equalizer spectral flatness with the maximum allowed variation of the coefficients indicated (the ETC minimum requirement are within brackets).

The normative reference for this requirement is TS 38.101-1 [2] clause 6.4E.2.5.

6.4E.2.5.1.4 Test description

6.4E.2.5.1.4.1 Initial condition

Initial conditions are a set of test configurations the UE needs to be tested in and the steps for the SS to take with the UE to reach the correct measurement state.

The initial test configurations consist of environmental conditions, test frequencies, test channel bandwidths and sub-carrier spacing based on NR operating bands specified in Table 5.2E.1-1 and Table 5.3.5-1. All of these configurations shall be tested with applicable test parameters for each combination of test channel bandwidth and sub-carrier spacing, and are shown in table 6.4E.2.5.1.4.1-1. The details of the V2X reference measurement channels (RMCs) are specified in Annex A.7.5 and the GNSS configuration in TS 38.508-1 [5] subclause 4.11.

Table 6.4E.2.5.1.4.1-1: Test Configuration Table for PSSCH and PSCCH

FFS

1. Connect the SS and GNSS simulator to the UE antenna connectors as shown in TS 38.508-1 [5] Annex A, Figure A.3.1.9.1 for TE diagram and section A.3.2.7 for UE diagram.
2. The parameter settings for the V2X sidelink transmission over PC5 are pre-configured according to TS 38.508-1 [5] subclause 4.10. Message content exceptions are defined in clause 6.4E.2.5.1.4.3.
3. The V2X Reference Measurement Channel is set according to Table 6.4E.2.5.1.4.1-1.
4. The GNSS simulator is configured for Scenario #1: static in Geographical area #1, as defined in TS38.508-1 [5] Table 4.11.2-2. Geographical area #1 is also pre-configured in the UE.
5. Propagation conditions are set according to Annex B.0.
6. Ensure the UE is in state *Out_of_Coverage* with generic procedure parameters *Sidelink On*, *Test Loop Function On* with UE test loop mode E closed for *Transmit Mode* according to TS 38.508-1 [5] clause 4.5.

6.4E.2.5.1.4.2 Test procedure

1. The V2X UE schedules the V2X RMC with transmission power at P_{UMAX} level according to *SL-PreconfigurationNR* which is in line with the test configuration in Table 6.4E.2.5.1.4.1-1;
2. Measure spectrum flatness using Global In-Channel Tx-Test (Annex E). For TDD slots with transient periods are not under test.

6.4E.2.5.1.4.3 Message contents

Message contents are according to TS 38.508-1 [5] subclause 4.6 and 5.4 with the following exceptions:

FFS

6.4E.2.5.1.5 Test requirement

FFS

6.4E.2.5.1D EVM equalizer spectrum flatness for V2X / non-concurrent operation / SL-MIMO

Editor's Note:

- The test case is not completed due to the following aspects are not yet determined:
- Uplink RMC is TBD in RAN4
- Connection diagram is TBD
- Preconfiguration is TBD in 38.508-1
- Test state and generic procedure are TBD in 38.508-1

6.4E.2.5.1D.1 Test purpose

The zero-forcing equalizer correction applied in the EVM measurement process (as described in Annex E) must meet a spectrum flatness requirement for the EVM measurement to be valid. The EVM equalizer spectrum flatness is defined in terms of the maximum peak-to-peak ripple of the equalizer coefficients (dB) across the V2X sidelink allocated block variation in dB of the equalizer coefficients generated by the EVM measurement process. The EVM equalizer spectrum flatness requirement does not limit the correction applied to the signal in the EVM measurement process but for the

EVM result to be valid, the equalizer correction that was applied must meet the EVM equalizer spectrum flatness minimum requirements. The basic measurement interval is the same as for EVM.

6.4E.2.5.1D.2 Test applicability

This test case applies to all types of NR UE release 16 and forward that support NR V2X sidelink MIMO communication with non-concurrent operation.

NOTE: This test case can't be performed due to lack of appropriate test points.

6.4E.2.5.1D.3 Minimum conformance requirements

For NR V2X UE with two transmit antenna connectors, the requirements specified for single carrier described in clause 6.4E.2.5.1.3 shall apply to each transmit antenna connector.

The normative reference for this requirement is TS 38.101-1 [2] clause 6.4E.2.5.

6.4E.2.5.1D.4 Test description

6.4E.2.5.1D.4.1 Initial condition

Initial conditions are a set of test configurations the UE needs to be tested in and the steps for the SS to take with the UE to reach the correct measurement state.

The initial test configurations consist of environmental conditions, test frequencies, test channel bandwidths and sub-carrier spacing based on NR operating bands specified in Table 5.3.5-1. All of these configurations shall be tested with applicable test parameters for each combination of test channel bandwidth and sub-carrier spacing, and are shown in table 6.4E.2.5.1.4.1-1. The details of the V2X reference measurement channels (RMCs) are specified in Annexes TBD.

Table 6.4E.2.5.1D.4.1-1: Test Configuration Table for PSSCH and PSCCH

FFS

1. Connect the SS and GNSS simulator to the UE antenna connectors as shown in TS 38.508-1 [5] Annex A, Figure [TBD] for TE diagram and section [TBD] for UE diagram.
2. The parameter settings for the V2X sidelink transmission over PC5 are pre-configured according to TS 38.508-1 [5] subclause [TBD]. Message content exceptions are defined in clause 6.4E.2.5.1.4.3.
3. The V2X Reference Measurement Channel is set according to Table 6.4E.2.5.1.4.1-1.
4. The GNSS simulator is configured for Scenario #1: static in Geographical area #1, as defined in TS38.508-1 [5] Table [TBD]. Geographical area #1 is also pre-configured in the UE.
5. Propagation conditions are set according to Annex B.0.
6. Ensure the UE is in state [TBD].

6.4E.2.5.1D.4.2 Test procedure

1. The V2X UE schedules the V2X RMC with transmission power at P_{UMAX} level according to *SL-PreconfigurationNR* which is in line with the test configuration in Table 6.4E.2.5.1D.4.1-1;
2. Measure spectrum flatness using Global In-Channel Tx-Test (Annex E). For TDD slots with transient periods are not under test.

6.4E.2.5.1D.4.3 Message contents

Message contents are according to TS 38.508-1 [5] subclause 4.6 and 5.4 with the following exceptions:

FFS

6.4E.2.5.1D.5 Test requirement

FFS

6.4E.2.5.2 EVM equalizer spectrum flatness for V2X / con-current operation

Editor's Note:

- The test case is not completed due to the following aspects are not yet determined:
- Uplink RMC is TBD in RAN4
- Connection diagram is TBD
- Preconfiguration is TBD in 38.508-1
- Test state and generic procedure are TBD in 38.508-1

6.4E.2.5.2.1 Test purpose

The zero-forcing equalizer correction applied in the EVM measurement process (as described in Annex E) must meet a spectrum flatness requirement for the EVM measurement to be valid. The EVM equalizer spectrum flatness is defined in terms of the maximum peak-to-peak ripple of the equalizer coefficients (dB) across the V2X sidelink allocated block variation in dB of the equalizer coefficients generated by the EVM measurement process. The EVM equalizer spectrum flatness requirement does not limit the correction applied to the signal in the EVM measurement process but for the EVM result to be valid, the equalizer correction that was applied must meet the EVM equalizer spectrum flatness minimum requirements. The basic measurement interval is the same as for EVM.

6.4E.2.5.2.2 Test applicability

This test case applies to all types of NR UE release 16 and forward that support NR V2X sidelink communication with con-current operation.

NOTE: This test case can't be performed due to lack of appropriate test points.

6.4E.2.5.2.3 Minimum conformance requirements

For V2X sidelink physical channels PSCCH, PSSCH and PSBCH, the EVM equalizer spectrum flatness requirements shall be as specified for PUSCH in clause 6.4.2.4 for the corresponding modulation and transmission bandwidth.

The normative reference for this requirement is TS 38.101-1 [2] clause 6.4E.2.5.

6.4E.2.5.2.4 Test description

6.4E.2.5.2.4.1 Initial condition

Initial conditions are a set of test configurations the UE needs to be tested in and the steps for the SS to take with the UE to reach the correct measurement state.

The initial test configurations consist of environmental conditions, test frequencies, test channel bandwidths and sub-carrier spacing based on NR operating bands specified in Table 5.3.5-1. All of these configurations shall be tested with applicable test parameters for each combination of test channel bandwidth and sub-carrier spacing, and are shown in table 6.4E.2.5.1.4.1-1. The details of the V2X reference measurement channels (RMCs) are specified in Annexes TBD.

Table 6.4E.2.5.2.4.1-1: Test Configuration Table for PSSCH and PSCCH

FFS

1. Connect the SS and GNSS simulator to the UE antenna connectors as shown in TS 38.508-1 [5] Annex A, Figure [TBD] for TE diagram and section [TBD] for UE diagram.
2. The parameter settings for the V2X sidelink transmission over PC5 are pre-configured according to TS 38.508-1 [5] subclause [TBD]. Message content exceptions are defined in clause 6.4E.2.5.2.4.3.
3. The V2X Reference Measurement Channel is set according to Table 6.4E.2.5.2.4.1-1.
4. The GNSS simulator is configured for Scenario #1: static in Geographical area #1, as defined in TS38.508-1 [5] Table [TBD]. Geographical area #1 is also pre-configured in the UE.
5. Propagation conditions are set according to Annex B.0.

6. Ensure the UE is in state [TBD].

6.4E.2.5.2.4.2 Test procedure

1. The V2X UE schedules the V2X RMC with transmission power at P_{UMAX} level according to *SL-PreconfigurationNR* which is in line with the test configuration in Table 6.4E.2.5.2.4.1-1;
2. Measure spectrum flatness using Global In-Channel Tx-Test (Annex E). For TDD slots with transient periods are not under test.

6.4E.2.5.2.4.3 Message contents

Message contents are according to TS 38.508-1 [5] subclause 4.6 and 5.4 with the following exceptions:

FFS

6.4E.2.5.2.5 Test requirement

FFS

6.5 Output RF spectrum emissions

6.5.0 General

Unwanted emissions are divided into "Out-of-band emission" and "Spurious emissions" in 3GPP RF specifications. This notation is in line with ITU-R recommendations such as SM.329-10 and the Radio Regulations [22].

ITU defines:

Out-of-band emission = Emission on a frequency or frequencies immediately outside the necessary bandwidth which results from the modulation process, but excluding spurious emissions.

Spurious emission = Emission on a frequency, or frequencies, which are outside the necessary bandwidth and the level of which may be reduced without affecting the corresponding transmission of information. Spurious emissions include harmonic emissions, parasitic emissions, intermodulation products and frequency conversion products but exclude out-of-band emissions.

Unwanted emissions = Consist of spurious emissions and out-of-band emissions.

The UE transmitter spectrum emission consists of the three components; the occupied bandwidth (channel bandwidth), the Out Of Band (OOB) emissions and the far out spurious emission domain.

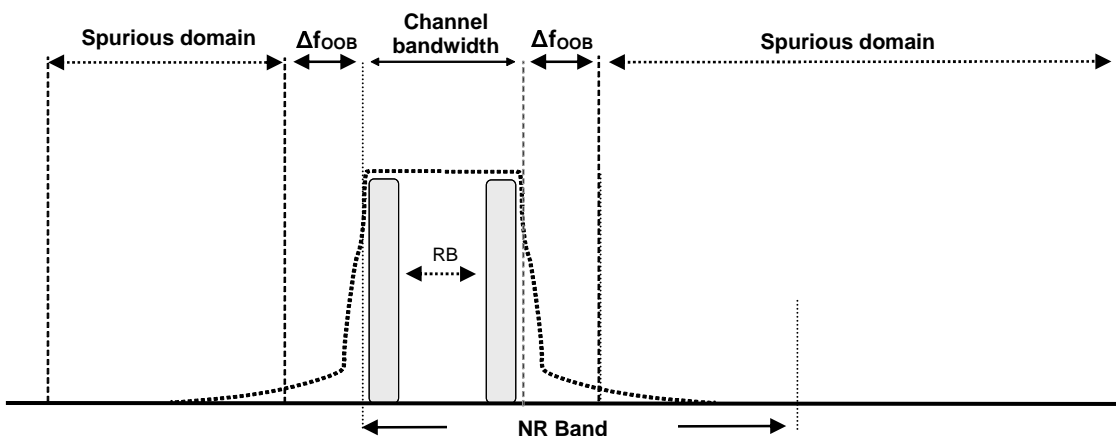

Figure 6.5.0-1: Transmitter RF spectrum

6.5.1 Occupied bandwidth

6.5.1.1 Test purpose

To verify that the UE occupied bandwidth for all transmission bandwidth configurations supported by the UE are less than their specific limits.

6.5.1.2 Test applicability

This test applies to all types of NR UE release 15 and forward.

6.5.1.3 Minimum conformance requirements

Occupied bandwidth is defined as the bandwidth containing 99 % of the total integrated mean power of the transmitted spectrum on the assigned channel. The occupied bandwidth for all transmission bandwidth configurations (Resources Blocks) shall be less than the channel bandwidth specified in Table 6.5.1.3-1.

Table 6.5.1.3-1: Occupied channel bandwidth

	NR channel bandwidth												
	5 MHz	10 MHz	15 MHz	20 MHz	25 MHz	30 MHz	40 MHz	50 MHz	60 MHz	70 MHz	80 MHz	90 MHz	100 MHz
Occupied channel bandwidth (MHz)	5	10	15	20	25	30	40	50	60	70	80	90	100

The normative reference for this requirement is TS 38.101-1 [2] clause 6.5.1.

6.5.1.4 Test description

6.5.1.4.1 Initial conditions

Initial conditions are a set of test configurations the UE needs to be tested in and the steps for the SS to take with the UE to reach the correct measurement state.

The initial test configurations consist of environmental conditions, test frequencies, test channel bandwidths and sub-carrier spacing based on NR operating bands specified in table 5.3.5-1. All of these configurations shall be tested with applicable test parameters for each combination of channel bandwidth and sub-carrier spacing, are shown in table 6.5.1.4.1-1. The details of the uplink reference measurement channels (RMCs) are specified in Annexes A.2. Configurations of PDSCH and PDCCH before measurement are specified in Annex C.2.

Table 6.5.1.4.1-1: Test Configuration Table

Initial Conditions			
Test Environment as specified in TS 38.508-1 [5] subclause 4.1		Normal	
Test Frequencies as specified in TS 38.508-1 [5] subclause 4.3.1		Mid range by default, exceptions listed in Table 6.5.1.4.1-2	
Test Channel Bandwidths as specified in TS 38.508-1 [5] subclause 4.3.1		All	
Test SCS as specified in Table 5.3.5-1		Lowest	
Test Parameters			
Test ID	Downlink Configuration	Uplink Configuration	
	N/A for occupied bandwidth test case	Modulation	RB allocation (NOTE 1)
1		CP-OFDM QPSK	Outer_full
NOTE 1: The specific configuration of each RB allocation is defined in Table 6.1-1.			

Table 6.5.1.4.1-2: Test frequency exceptions for Occupied Bandwidth

5G NR Band	Test Frequency
n77	Low Range, Mid Range, High Range
n78	Low Range, Mid Range, High Range
n79	Low Range, Mid Range, High Range
n28	Low Range for 30MHz channel bandwidth

1. Connect the SS to the UE antenna connectors as shown in TS 38.508-1 [5] Annex A, Figure A.3.1.1.1 for TE diagram and section A.3.2 for UE diagram.
2. The parameter settings for the cell are set up according to TS 38.508-1 [5] subclause 4.4.3.
3. Downlink signals are initially set up according to Annex C.0, C.1, C.2, and uplink signals according to Annex G.0, G.1, G.2, G.3.0.
4. The UL Reference Measurement channels are set according to Table 6.5.1.4.1-1.
5. Propagation conditions are set according to Annex B.0 -
6. Ensure the UE is in state RRC_CONNECTED with generic procedure parameters Connectivity *NR*, Connected without release *On*, Test Mode *On* and Test Loop Function *On* according to TS 38.508-1 [5] clause 4.5. Message contents are defined in clause 6.5.1.4.3

6.5.1.4.2 Test procedure

1. SS sends uplink scheduling information for each UL HARQ process via PDCCH DCI format 0_1 for C_RNTI to schedule the UL RMC according to Table 6.5.1.4.1-1. Since the UL has no payload and no loopback data to send the UE sends uplink MAC padding bits on the UL RMC.
2. Send continuously power control “up” commands to the UE until the UE transmits at PUMAX level. Allow at least 200ms for the UE to reach PUMAX level.
3. Measure the power spectrum distribution within two times or more range over the requirement for Occupied Bandwidth specification centring on the current carrier frequency. The characteristics of the filter shall be approximately Gaussian (typical spectrum analyser filter). Other methods to measure the power spectrum distribution are allowed. The measuring duration is at least 1ms over consecutive active uplink slots.
4. Calculate the total power within the range of all frequencies measured in step 3 and save this value as “Total power”.
5. Identify the measurement window whose centre is aligned on the centre of the channel for which the sum of the power measured is 99% of the “Total power”.
6. The “Occupied Bandwidth” is the width of the measurement window obtained in step 5.

6.5.1.4.3 Message contents

Message contents are according to TS 38.508-1 [5] subclause 4.6.

6.5.1.5 Test requirement

The measured Occupied Bandwidth shall not exceed values in Table 6.5.1.5-1.

Table 6.5.1.5-1: Occupied channel bandwidth

	NR channel bandwidth												
	5 MHz	10 MHz	15 MHz	20 MHz	25 MHz	30 MHz	40 MHz	50 MHz	60 MHz	70 MHz	80 MHz	90 MHz	100 MHz
Occupied channel bandwidth (MHz)	5	10	15	20	25	30	40	50	60	70	80	90	100

6.5.2 Out of band emission

6.5.2.1 General

The Out of band emissions are unwanted emissions immediately outside the assigned channel bandwidth resulting from the modulation process and non-linearity in the transmitter but excluding spurious emissions. This out of band emission limit is specified in terms of a spectrum emission mask and an adjacent channel leakage power ratio.

To improve measurement accuracy, sensitivity and efficiency, the resolution bandwidth may be smaller than the measurement bandwidth. When the resolution bandwidth is smaller than the measurement bandwidth, the result should be integrated over the measurement bandwidth in order to obtain the equivalent noise bandwidth of the measurement bandwidth.

6.5.2.2 Spectrum emission mask

Editor's Note: The following aspects are either missing or not yet determined:

- PC1 requirements for NR operating bands other than Band n14 are not defined in RAN4 Rel-15 and Rel-16 specifications.

6.5.2.2.1 Test purpose

To verify that the power of any UE emission shall not exceed specified level for the specified channel bandwidth.

6.5.2.2.2 Test applicability

This test case applies to all types of NR UE release 15 and forward.

6.5.2.2.3 Minimum conformance requirements

The spectrum emission mask of the UE applies to frequencies (Δf_{OoB}) starting from the \pm edge of the assigned NR channel bandwidth. For frequencies offset greater than Δf_{OoB} , the spurious requirements in subclause 6.5.3 are applicable.

NOTE: For measurement conditions at the edge of each frequency range, the lowest frequency of the measurement position in each frequency range should be set at the lowest boundary of the frequency range plus MBW/2. The highest frequency of the measurement position in each frequency range should be set at the highest boundary of the frequency range minus MBW/2. MBW denotes the measurement bandwidth defined for the protected band.

The power of any UE emission shall not exceed the levels specified in Table 6.5.2.2.3-1 for the specified channel bandwidth.

Table 6.5.2.2.3-1: General NR spectrum emission mask

Spectrum emission limit (dBm) / Channel bandwidth														
Δf_{foob} (MHz)	5 MHz	10 MHz	15 MHz	20 MHz	25 MHz	30 MHz	40 MHz	50 MHz	60 MHz	70 MHz	80 MHz	90 MHz	100 MHz	Measurement bandwidth
$\pm 0-1$	-13	-13	-13	-13	-13	-13	-13							1 % channel bandwidth
$\pm 0-1$								-24	-24	-24	-24	-24	-24	30 kHz
$\pm 1-5$	-10	-10	-10	-10	-10	-10	-10	-10	-10	-10	-10	-10	-10	1 MHz
$\pm 5-6$	-13	-13	-13	-13	-13	-13	-13	-13	-13	-13	-13	-13	-13	
$\pm 6-10$	-25													
$\pm 10-15$		-25												
$\pm 15-20$			-25											
$\pm 20-25$				-25										
$\pm 25-30$					-25									
$\pm 30-35$						-25								
$\pm 35-40$														
$\pm 40-45$							-25							
$\pm 45-50$														
$\pm 50-55$								-25						
$\pm 55-60$														
$\pm 60-65$									-25					
$\pm 65-70$														
$\pm 70-75$										-25				
$\pm 75-80$														
$\pm 80-85$											-25			
$\pm 85-90$														
$\pm 90-95$												-25		
$\pm 95-100$														
$\pm 100-105$													-25	

The normative reference for this requirement is TS 38.101-1 [2] clause 6.5.2.2

6.5.2.2.4 Test description

6.5.2.2.4.1 Initial conditions

Initial conditions are a set of test configurations the UE needs to be tested in and the steps for the SS to take with the UE to reach the correct measurement state.

The initial test configurations consist of environmental conditions, test frequencies, test channel bandwidths and sub-carrier spacing based on NR operating bands specified in table 5.3.5-1. All of these configurations shall be tested with applicable test parameters for each combination of channel bandwidth and sub-carrier spacing, are shown in table 6.5.2.2.4.1-1, 6.5.2.2.4.1-2, 6.5.2.2.4.1-2a and Table 6.5.2.2.4.1-3. The details of the uplink reference measurement channels (RMCs) are specified in Annexes A.2. Configurations of PDSCH and PDCCH before measurement are specified in Annex C.2

Table 6.5.2.2.4.1-1: Test Configuration Table for power class 3 (contiguous allocation)

Default Conditions						
Test Environment as specified in TS 38.508-1 [5] subclause 4.1				Normal		
Test Frequencies as specified in TS 38.508-1 [5] subclause 4.3.1				Low range, High range		
Test Channel Bandwidths as specified in TS 38.508-1 [5] subclause 4.3.1				Lowest, Highest		
Test SCS as specified in Table 5.3.5-1				Lowest, Highest		
Test Parameters for Channel Bandwidths						
Test ID	Freq	ChBw	SCS	Downlink Configuration	Uplink Configuration	
		Default	Default	N/A for Spectrum Emission Mask test case	Modulation (NOTE 2)	RB allocation (NOTE 1)
1 ³	Low				DFT-s-OFDM PI/2 BPSK	Edge_1RB_Left
2 ³	High				DFT-s-OFDM PI/2 BPSK	Edge_1RB_Right
3 ³	Default				DFT-s-OFDM PI/2 BPSK	Outer_Full
4 ⁴	Low				DFT-s-OFDM PI/2 BPSK	Edge_1RB_Left
5 ⁴	High				DFT-s-OFDM PI/2 BPSK	Edge_1RB_Right
6 ⁴	Default				DFT-s-OFDM PI/2 BPSK	Outer_Full
7	Low				DFT-s-OFDM QPSK	Edge_1RB_Left
8	High				DFT-s-OFDM QPSK	Edge_1RB_Right
9	Default				DFT-s-OFDM QPSK	Outer_Full
10	Low				DFT-s-OFDM 16 QAM	Edge_1RB_Left
11	High				DFT-s-OFDM 16 QAM	Edge_1RB_Right
12	Default				DFT-s-OFDM 16 QAM	Outer_Full
13	Low				DFT-s-OFDM 64 QAM	Edge_1RB_Left
14	High				DFT-s-OFDM 64 QAM	Edge_1RB_Right
15	Default				DFT-s-OFDM 64 QAM	Outer_Full
16	Low				DFT-s-OFDM 256 QAM	Edge_1RB_Left
17	High				DFT-s-OFDM 256 QAM	Edge_1RB_Right
18	Default				DFT-s-OFDM 256 QAM	Outer_Full
19	Low				CP-OFDM QPSK	Edge_1RB_Left
20	High				CP-OFDM QPSK	Edge_1RB_Right
21	Default				CP-OFDM QPSK	Outer_Full
22	Low				CP-OFDM 16 QAM	Edge_1RB_Left
23	High				CP-OFDM 16 QAM	Edge_1RB_Right
24	Default	CP-OFDM 16 QAM	Outer_Full			

25	Low				CP-OFDM 64 QAM	Edge_1RB_Left
26	High				CP-OFDM 64 QAM	Edge_1RB_Right
27	Default				CP-OFDM 64 QAM	Outer_Full
28	Low				CP-OFDM 256 QAM	Edge_1RB_Left
29	High				CP-OFDM 256 QAM	Edge_1RB_Right
30	Default				CP-OFDM 256 QAM	Outer_Full
31 ^{5,6}	Low				DFT-s-OFDM Pi/2 BPSK w Pi/2 BPSK DMRS	Edge_1RB_Left
32 ^{5,6}	High				DFT-s-OFDM Pi/2 BPSK w Pi/2 BPSK DMRS	Edge_1RB_Right
33 ^{5,6}	Default				DFT-s-OFDM Pi/2 BPSK w Pi/2 BPSK DMRS	Outer Full
<p>NOTE 1: The specific configuration of each RF allocation is defined in Table 6.1-1.</p> <p>NOTE 2: DFT-s-OFDM Pi/2 BPSK test applies only for UEs which supports half Pi BPSK in FR1.</p> <p>NOTE 3: UE operating in TDD mode with Pi/2 BPSK modulation and UE indicates support for UE capability <i>powerBoosting-pi2BPSK</i> and the IE <i>powerBoostPi2BPSK</i> is set to 1 for bands n40, n41, n77, n78 and n79.</p> <p>NOTE 4: UE operating in FDD mode, or in TDD mode in bands other than n40, n41, n77, n78 and n79, or in TDD mode the IE <i>powerBoostPi2BPSK</i> is set to 0 for bands n40, n41, n77, n78 and n79.</p> <p>NOTE 5: For Power Class 3 testing, UE operating in FDD mode, or in TDD mode in bands other than n40, n41, n77, n78 and n79, or in TDD mode the IE <i>powerBoostPi2BPSK</i> is set to 0 for bands n40, n77, n78 and n79.</p> <p>NOTE 6: Applicable to UEs indicating support for UE capability <i>lowPAPR-DMRS-PUSCHwithPrecoding-r16</i>.</p>						

Table 6.5.2.2.4.1-2: Test Configuration Table for power class 2 (contiguous allocation)

Initial Conditions				
Test Environment as specified in TS 38.508-1 [5] subclause 4.1		Normal		
Test Frequencies as specified in TS 38.508-1 [5] subclause 4.3.1		Low range, High range		
Test Channel Bandwidths as specified in TS 38.508-1 [5] subclause 4.3.1		Lowest, Highest		
Test SCS as specified in Table 5.3.5-1		Lowest, Highest		
Test Parameters for Channel Bandwidths				
Test ID	Freq	Downlink Configuration	Uplink Configuration	
		N/A	Modulation (NOTE 2)	
			RB allocation (NOTE 1)	
1	Low		DFT-s-OFDM Pi/2 BPSK	Edge_1RB_Left
2	High		DFT-s-OFDM Pi/2 BPSK	Edge_1RB_Right
3	Default		DFT-s-OFDM Pi/2 BPSK	Outer Full
4	Low		DFT-s-OFDM QPSK	Edge_1RB_Left
5	High		DFT-s-OFDM QPSK	Edge_1RB_Right
6	Default		DFT-s-OFDM QPSK	Outer Full
7	Low		DFT-s-OFDM 16 QAM	Edge_1RB_Left
8	High		DFT-s-OFDM 16 QAM	Edge_1RB_Right
9	Default		DFT-s-OFDM 16 QAM	Outer Full
10	Low		DFT-s-OFDM 64 QAM	Edge_1RB_Left
11	High		DFT-s-OFDM 64 QAM	Edge_1RB_Right
12	Default		DFT-s-OFDM 64 QAM	Outer Full
13	Low		DFT-s-OFDM 256 QAM	Edge_1RB_Left
14	High		DFT-s-OFDM 256 QAM	Edge_1RB_Right
15	Default		DFT-s-OFDM 256 QAM	Outer Full
16	Low		CP-OFDM QPSK	Edge_1RB_Left
17	High		CP-OFDM QPSK	Edge_1RB_Right
18	Default		CP-OFDM QPSK	Outer Full
19	Low		CP-OFDM 16 QAM	Edge_1RB_Left
20	High		CP-OFDM 16 QAM	Edge_1RB_Right
21	Default		CP-OFDM 16 QAM	Outer Full
22	Low		CP-OFDM 64 QAM	Edge_1RB_Left
23	High		CP-OFDM 64 QAM	Edge_1RB_Right
24	Default		CP-OFDM 64 QAM	Outer Full
25	Low		CP-OFDM 256 QAM	Edge_1RB_Left
26	High	CP-OFDM 256 QAM	Edge_1RB_Right	
27	Default	CP-OFDM 256 QAM	Outer Full	
NOTE 1: The specific configuration of each RB allocation is defined in Table 6.1-1.				
NOTE 2: DFT-s-OFDM Pi/2 BPSK test applies only for UEs which supports half Pi BPSK in FR1.				
NOTE 3: It is essential that all test points in this table also exist in table 6.2.2.4.1-2.				

Table 6.5.2.2.4.1-2a: Test Configuration Table for power class 1 for Band n14 (contiguous allocation)

Initial Conditions																																																																											
Test Environment as specified in TS 38.508-1 [5] subclause 4.1		Normal																																																																									
Test Frequencies as specified in TS 38.508-1 [5] subclause 4.3.1		Low range, High range																																																																									
Test Channel Bandwidths as specified in TS 38.508-1 [5] subclause 4.3.1		Lowest, Highest																																																																									
Test SCS as specified in Table 5.3.5-1		Lowest, Highest																																																																									
Test Parameters for Channel Bandwidths																																																																											
Test ID	Freq	Downlink Configuration	Uplink Configuration																																																																								
		N/A for Spectrum Emission Mask test case	<table border="1"> <thead> <tr> <th>Modulation (NOTE 2)</th> <th>RB allocation (NOTE 1)</th> </tr> </thead> <tbody> <tr><td>DFT-s-OFDM Pi/2 BPSK</td><td>Inner Full</td></tr> <tr><td>DFT-s-OFDM Pi/2 BPSK</td><td>Edge_1RB_Left</td></tr> <tr><td>DFT-s-OFDM Pi/2 BPSK</td><td>Edge_1RB_Right</td></tr> <tr><td>DFT-s-OFDM Pi/2 BPSK</td><td>Outer Full</td></tr> <tr><td>DFT-s-OFDM QPSK</td><td>Inner Full</td></tr> <tr><td>DFT-s-OFDM QPSK</td><td>Edge_1RB_Left</td></tr> <tr><td>DFT-s-OFDM QPSK</td><td>Edge_1RB_Right</td></tr> <tr><td>DFT-s-OFDM QPSK</td><td>Outer Full</td></tr> <tr><td>DFT-s-OFDM 16 QAM</td><td>Inner Full</td></tr> <tr><td>DFT-s-OFDM 16 QAM</td><td>Edge_1RB_Left</td></tr> <tr><td>DFT-s-OFDM 16 QAM</td><td>Edge_1RB_Right</td></tr> <tr><td>DFT-s-OFDM 16 QAM</td><td>Outer Full</td></tr> <tr><td>DFT-s-OFDM 64 QAM</td><td>Edge_1RB_Left</td></tr> <tr><td>DFT-s-OFDM 64 QAM</td><td>Edge_1RB_Right</td></tr> <tr><td>DFT-s-OFDM 64 QAM</td><td>Outer Full</td></tr> <tr><td>DFT-s-OFDM 256 QAM</td><td>Edge_1RB_Left</td></tr> <tr><td>DFT-s-OFDM 256 QAM</td><td>Edge_1RB_Right</td></tr> <tr><td>DFT-s-OFDM 256 QAM</td><td>Outer Full</td></tr> <tr><td>CP-OFDM QPSK</td><td>Inner Full</td></tr> <tr><td>CP-OFDM QPSK</td><td>Edge_1RB_Left</td></tr> <tr><td>CP-OFDM QPSK</td><td>Edge_1RB_Right</td></tr> <tr><td>CP-OFDM QPSK</td><td>Outer Full</td></tr> <tr><td>CP-OFDM 16 QAM</td><td>Inner Full</td></tr> <tr><td>CP-OFDM 16 QAM</td><td>Edge_1RB_Left</td></tr> <tr><td>CP-OFDM 16 QAM</td><td>Edge_1RB_Right</td></tr> <tr><td>CP-OFDM 16 QAM</td><td>Outer Full</td></tr> <tr><td>CP-OFDM 64 QAM</td><td>Edge_1RB_Left</td></tr> <tr><td>CP-OFDM 64 QAM</td><td>Edge_1RB_Right</td></tr> <tr><td>CP-OFDM 64 QAM</td><td>Outer Full</td></tr> <tr><td>CP-OFDM 256 QAM</td><td>Edge_1RB_Left</td></tr> <tr><td>CP-OFDM 256 QAM</td><td>Edge_1RB_Right</td></tr> <tr><td>CP-OFDM 256 QAM</td><td>Outer Full</td></tr> <tr><td>DFT-s-OFDM Pi/2 BPSK w Pi/2 BPSK DMRS</td><td>Edge_1RB_Left</td></tr> <tr><td>DFT-s-OFDM Pi/2 BPSK w Pi/2 BPSK DMRS</td><td>Edge_1RB_Right</td></tr> <tr><td>DFT-s-OFDM Pi/2 BPSK w Pi/2 BPSK DMRS</td><td>Outer Full</td></tr> </tbody> </table>	Modulation (NOTE 2)	RB allocation (NOTE 1)	DFT-s-OFDM Pi/2 BPSK	Inner Full	DFT-s-OFDM Pi/2 BPSK	Edge_1RB_Left	DFT-s-OFDM Pi/2 BPSK	Edge_1RB_Right	DFT-s-OFDM Pi/2 BPSK	Outer Full	DFT-s-OFDM QPSK	Inner Full	DFT-s-OFDM QPSK	Edge_1RB_Left	DFT-s-OFDM QPSK	Edge_1RB_Right	DFT-s-OFDM QPSK	Outer Full	DFT-s-OFDM 16 QAM	Inner Full	DFT-s-OFDM 16 QAM	Edge_1RB_Left	DFT-s-OFDM 16 QAM	Edge_1RB_Right	DFT-s-OFDM 16 QAM	Outer Full	DFT-s-OFDM 64 QAM	Edge_1RB_Left	DFT-s-OFDM 64 QAM	Edge_1RB_Right	DFT-s-OFDM 64 QAM	Outer Full	DFT-s-OFDM 256 QAM	Edge_1RB_Left	DFT-s-OFDM 256 QAM	Edge_1RB_Right	DFT-s-OFDM 256 QAM	Outer Full	CP-OFDM QPSK	Inner Full	CP-OFDM QPSK	Edge_1RB_Left	CP-OFDM QPSK	Edge_1RB_Right	CP-OFDM QPSK	Outer Full	CP-OFDM 16 QAM	Inner Full	CP-OFDM 16 QAM	Edge_1RB_Left	CP-OFDM 16 QAM	Edge_1RB_Right	CP-OFDM 16 QAM	Outer Full	CP-OFDM 64 QAM	Edge_1RB_Left	CP-OFDM 64 QAM	Edge_1RB_Right	CP-OFDM 64 QAM	Outer Full	CP-OFDM 256 QAM	Edge_1RB_Left	CP-OFDM 256 QAM	Edge_1RB_Right	CP-OFDM 256 QAM	Outer Full	DFT-s-OFDM Pi/2 BPSK w Pi/2 BPSK DMRS	Edge_1RB_Left	DFT-s-OFDM Pi/2 BPSK w Pi/2 BPSK DMRS	Edge_1RB_Right	DFT-s-OFDM Pi/2 BPSK w Pi/2 BPSK DMRS	Outer Full
Modulation (NOTE 2)	RB allocation (NOTE 1)																																																																										
DFT-s-OFDM Pi/2 BPSK	Inner Full																																																																										
DFT-s-OFDM Pi/2 BPSK	Edge_1RB_Left																																																																										
DFT-s-OFDM Pi/2 BPSK	Edge_1RB_Right																																																																										
DFT-s-OFDM Pi/2 BPSK	Outer Full																																																																										
DFT-s-OFDM QPSK	Inner Full																																																																										
DFT-s-OFDM QPSK	Edge_1RB_Left																																																																										
DFT-s-OFDM QPSK	Edge_1RB_Right																																																																										
DFT-s-OFDM QPSK	Outer Full																																																																										
DFT-s-OFDM 16 QAM	Inner Full																																																																										
DFT-s-OFDM 16 QAM	Edge_1RB_Left																																																																										
DFT-s-OFDM 16 QAM	Edge_1RB_Right																																																																										
DFT-s-OFDM 16 QAM	Outer Full																																																																										
DFT-s-OFDM 64 QAM	Edge_1RB_Left																																																																										
DFT-s-OFDM 64 QAM	Edge_1RB_Right																																																																										
DFT-s-OFDM 64 QAM	Outer Full																																																																										
DFT-s-OFDM 256 QAM	Edge_1RB_Left																																																																										
DFT-s-OFDM 256 QAM	Edge_1RB_Right																																																																										
DFT-s-OFDM 256 QAM	Outer Full																																																																										
CP-OFDM QPSK	Inner Full																																																																										
CP-OFDM QPSK	Edge_1RB_Left																																																																										
CP-OFDM QPSK	Edge_1RB_Right																																																																										
CP-OFDM QPSK	Outer Full																																																																										
CP-OFDM 16 QAM	Inner Full																																																																										
CP-OFDM 16 QAM	Edge_1RB_Left																																																																										
CP-OFDM 16 QAM	Edge_1RB_Right																																																																										
CP-OFDM 16 QAM	Outer Full																																																																										
CP-OFDM 64 QAM	Edge_1RB_Left																																																																										
CP-OFDM 64 QAM	Edge_1RB_Right																																																																										
CP-OFDM 64 QAM	Outer Full																																																																										
CP-OFDM 256 QAM	Edge_1RB_Left																																																																										
CP-OFDM 256 QAM	Edge_1RB_Right																																																																										
CP-OFDM 256 QAM	Outer Full																																																																										
DFT-s-OFDM Pi/2 BPSK w Pi/2 BPSK DMRS	Edge_1RB_Left																																																																										
DFT-s-OFDM Pi/2 BPSK w Pi/2 BPSK DMRS	Edge_1RB_Right																																																																										
DFT-s-OFDM Pi/2 BPSK w Pi/2 BPSK DMRS	Outer Full																																																																										
1	Default																																																																										
2	Low																																																																										
3	High																																																																										
4	Default																																																																										
5	Default																																																																										
6	Low																																																																										
7	High																																																																										
8	Default																																																																										
9	Default																																																																										
10	Low																																																																										
11	High																																																																										
12	Default																																																																										
13	Low																																																																										
14	High																																																																										
15	Default																																																																										
16	Low																																																																										
17	High																																																																										
18	Default																																																																										
19	Default																																																																										
20	Low																																																																										
21	High																																																																										
22	Default																																																																										
23	Default																																																																										
24	Low																																																																										
25	High																																																																										
26	Default																																																																										
27	Low																																																																										
28	High																																																																										
29	Default																																																																										
30	Low																																																																										
31	High																																																																										
32	Default																																																																										
33 ³	Low																																																																										
34 ³	High																																																																										
35 ³	Default																																																																										

NOTE 1: The specific configuration of each RB allocation is defined in Table 6.1-1.
 NOTE 2: DFT-s-OFDM Pi/2 BPSK test applies only for UEs which supports half Pi BPSK in FR1.
 NOTE 3: Applicable to UEs indicating support for UE capability *lowPAPR-DMRS-PUSCHwithPrecoding-r16*.
 NOTE 4: It is essential that all test points in this table also exist in table 6.2.2.4.1-2.

Table 6.5.2.2.4.1-3: Test Configuration Table for power class 2&3 (almost contiguous allocation)

Initial Conditions				
Test Environment as specified in TS 38.508-1 [5] subclause 4.1		Normal		
Test Frequencies as specified in TS 38.508-1 [5] subclause 4.3.1		Low range, High range		
Test Channel Bandwidths as specified in TS 38.508-1 [5] subclause 4.3.1		Highest		
Test SCS as specified in Table 5.3.5-1		Lowest, Highest		
Test Parameters for Channel Bandwidths				
Test ID	Freq	Downlink Configuration	Uplink Configuration	
		N/A	Modulation	
			RB allocation (NOTE 1)	
1	Default		CP-OFDM QPSK	Inner Full
2	Default		CP-OFDM QPSK	Outer Full
3	Default		CP-OFDM 16 QAM	Inner Full
4	Default		CP-OFDM 16 QAM	Outer Full
5	Default		CP-OFDM 64 QAM	Outer Full
6	Default	CP-OFDM 256 QAM	Outer Full	
NOTE 1: The specific configuration of each RB allocation is defined in Table 6.5.2.2.4.1-4.				
NOTE 2: It is essential that all test points in this table also exist in table 6.2.2.4.1-3.				
NOTE 3: Test applies only for UEs which support almost contiguous UL CP-OFDM transmissions. For PC2 UE which support almost contiguous UL CP-OFDM transmissions, test is only applicable for Release 16 and forward.				

Table 6.5.2.2.4.1-4: Uplink configuration for almost contiguous allocation

Channel Bandwidth (MHz)	SCS(kHz)	OFDM	Outer Full		Inner Full	
			Cluster1 RB allocations (LCRB @ RB _{start})	Cluster2 RB allocations (LCRB @ RB _{start})	Cluster1 RB allocations (LCRB @ RB _{start})	Cluster2 RB allocations (LCRB @ RB _{start})
25	15	CP	48@0	53@80	N/A	N/A
	30	CP	24@0	25@40	N/A	N/A
	60	CP	12@0	13@18	N/A	N/A
30	15	CP	64@0	64@96	N/A	N/A
	30	CP	32@0	30@48	N/A	N/A
	60	CP	16@0	14@24	N/A	N/A
40	15	CP	80@0	88@128	N/A	N/A
	30	CP	40@0	42@64	N/A	N/A
	60	CP	20@0	19@32	12@12	8@28
50	15	CP	96@0	110@160	48@64	48@144
	30	CP	48@0	53@80	24@32	24@72
	60	CP	24@0	25@40	12@16	12@36
60	15	CP	N/A	N/A	N/A	N/A
	30	CP	64@0	66@96	32@32	16@80
	60	CP	32@0	31@48	16@16	8@40
70	15	CP	N/A	N/A	N/A	N/A
	30	CP	80@0	77@112	32@32	16@80
	60	CP	40@0	37@56	16@16	8@40
80	15	CP	N/A	N/A	N/A	N/A
	30	CP	80@0	89@128	32@32	16@80
	60	CP	40@0	43@64	16@16	8@40
90	15	CP	N/A	N/A	N/A	N/A
	30	CP	96@0	101@144	32@32	16@80
	60	CP	48@0	49@72	16@16	8@40
100	15	CP	N/A	N/A	N/A	N/A
	30	CP	112@0	97@176	48@64	48@144
	60	CP	48@0	55@80	24@32	24@72

1. Connect the SS to the UE antenna connectors as shown in TS 38.508-1 [5] Annex A, Figure A.3.1.1.1 for TE diagram and section A.3.2 for UE diagram.
2. The parameter settings for the cell are set up according to TS 38.508-1 [5] subclause 4.4.3.
3. Downlink signals are initially set up according to Annex C.0, C.1, C.2 and uplink signals according to Annex G.0, G.1, G.2, G.3.0.
4. The UL Reference Measurement channels are set according to Table 6.5.2.2.4.1-1.
5. Propagation conditions are set according to Annex B.0.
6. Ensure the UE is in state RRC_CONNECTED with generic procedure parameters Connectivity *NR*, Connected without release *On*, Test Mode *On* and Test Loop Function *On* according to TS 38.508-1 [5] clause 4.5. Message contents are defined in clause 6.5.2.2.4.3.

6.5.2.2.4.2 Test procedure

1. SS sends uplink scheduling information for each UL HARQ process via PDCCH DCI format 0_1 for C_RNTI to schedule the UL RMC according to Table 6.5.2.2.4.1-1, Table 6.5.2.2.4.1-2, Table 6.5.2.2.4.1-2a and Table 6.5.2.2.4.1-3. Since the UL has no payload and no loopback data to send the UE sends uplink MAC padding bits on the UL RMC.
2. Send continuously power control “up” commands to the UE until the UE transmits at PUMAX level. Allow at least 200ms for the UE to reach PUMAX level.
3. Measure the mean power of the UE in the channel bandwidth of the radio access mode according to the test configuration, which shall meet the requirements described in Table 6.2.2.5-1 to 6.2.2.5-9. The period of the measurement shall be at least the continuous duration of 1ms over consecutive active uplink slots. For TDD, only slots consisting of only UL symbols are under test.
4. Measure the power of the transmitted signal with a measurement filter of bandwidths according to table 6.5.2.2.5-1. The centre frequency of the filter shall be stepped in continuous steps according to the same table. The measured power shall be recorded for each step. The measurement period shall capture the active TSs.

NOTE 1: When switching to DFT-s-OFDM waveform, as specified in the test configuration table 6.5.2.2.4.1-1, table 6.5.2.2.4.1-2, and table 6.5.2.2.4.1-2a, send an NR RRCReconfiguration message according to TS 38.508-1 [5] clause 4.6.3 Table 4.6.3-118 PUSCH-Config with TRANSFORM_PRECODER_ENABLED condition.

6.5.2.2.4.3 Message contents

Message contents are according to TS 38.508-1 [5] subclause 4.6 with the following exceptions:

Table 6.5.2.2.4.3-1: PUSCH-Config

Derivation Path: TS 38.508-1 [5] subclause 4.6.3 Table 4.6.3-118 PUSCH-Config			
Information Element	Value/remark	Comment	Condition
PUSCH-Config ::= SEQUENCE {			
resourceAllocation	resourceAllocationType0		Almost contiguous allocation
	resourceAllocationType1		Contiguous allocation
}			

Table 6.5.2.2.4.3-2: DMRS-UplinkConfig (Test ID 28 – 30 in Table 6.5.2.2.4.1-1)

Derivation Path: TS 38.508-1 [5], Table 4.6.3-51			
Information Element	Value/remark	Comment	Condition
DMRS-UplinkConfig ::= SEQUENCE {			
transformPrecodingEnabled SEQUENCE {			
dmrs-UplinkTransformPrecoding-r16 SEQUENCE {			
pi2BPSK-ScramblingID0	Not present		
pi2BPSK-ScramblingID1	Not present		
}			
}			
}			

6.5.2.2.5 Test requirement

The measured UE mean power in the channel bandwidth, derived in step 3, shall fulfil requirements in Tables 6.2.2.5-1 to 6.2.2.5-9 as appropriate, and the power of any UE emission shall fulfil requirements in Table 6.5.2.2.5-1.

Table 6.5.2.2.5-1: General NR spectrum emission mask

Spectrum emission limit (dBm) / Channel bandwidth														
Δf_{OoB} (MHz)	5 MHz	10 MHz	15 MHz	20 MHz	25 MHz	30 MHz	40 MHz	50 MHz	60 MHz	70 MHz	80 MHz	90 MHz	100 MHz	Measurement bandwidth
$\pm 0-1$	-13 + TT	-13 + TT	-13 + TT	-13 + TT	-13 + TT	-13 + TT	-13 + TT							1 % channel bandwidth
$\pm 0-1$								-24 + TT	-24 + TT	-24 + TT	-24 + TT	-24 + TT	-24 + TT	30 kHz
$\pm 1-5$	-10 + TT	-10 + TT	-10 + TT	-10 + TT	-10 + TT	-10 + TT	-10 + TT	-10 + TT	-10 + TT	-10 + TT	-10 + TT	-10 + TT	-10 + TT	1 MHz
$\pm 5-6$	-13 + TT	-13 + TT	-13 + TT	-13 + TT	-13 + TT	-13 + TT	-13 + TT	-13 + TT	-13 + TT	-13 + TT	-13 + TT	-13 + TT	-13 + TT	
$\pm 6-10$	-25 + TT													
$\pm 10-15$		-25 + TT												
$\pm 15-20$			-25 + TT											
$\pm 20-25$				-25 + TT										
$\pm 25-30$					-25 + TT									
$\pm 30-35$						-25 + TT								
$\pm 35-40$														
$\pm 40-45$							-25 + TT							
$\pm 45-50$														
$\pm 50-55$								-25 + TT						
$\pm 55-60$														
$\pm 60-65$									-25 + TT					
$\pm 65-70$														
$\pm 70-75$										-25 + TT				
$\pm 75-80$														
$\pm 80-85$											-25 + TT			
$\pm 85-90$														
$\pm 90-95$												-25 + TT		
$\pm 95-100$														
$\pm 100-105$												-25 + TT		

Note 1: The first and last measurement position with a 30 kHz filter is at Δf_{OoB} equals to 0.015 MHz and 0.985 MHz.
 Note 2: At the boundary of spectrum emission limit, the first and last measurement position with a 1 MHz filter is the inside of +0.5MHz and -0.5MHz, respectively.
 Note 3: The measurements are to be performed above the upper edge of the channel and below the lower edge of the channel.
 Note 4: TT for each frequency and channel bandwidth is specified in Table 6.5.2.2.5-2.

Table 6.5.2.2.5-2: Test Tolerance (Spectrum Emission Mask)

	$f \leq 3.0\text{GHz}$	$3.0\text{GHz} < f \leq 4.2\text{GHz}$	$4.2\text{GHz} < f \leq 6.0\text{GHz}$
BW $\leq 100\text{MHz}$	1.5 dB	1.8 dB	1.8 dB

NOTE: As a general rule, the resolution bandwidth of the measuring equipment should be equal to the measurement bandwidth. However, to improve measurement accuracy, sensitivity and efficiency, the resolution bandwidth may be smaller than the measurement bandwidth. When the resolution bandwidth is smaller than the measurement bandwidth, the result should be integrated over the measurement bandwidth in order to obtain the equivalent noise bandwidth of the measurement bandwidth.

6.5.2.3 Additional spectrum emission mask

Editor's Note: The following aspects are either missing or not yet determined:

- NS_07 test requirements is not complete.

6.5.2.3.1 Test purpose

To verify that the power of any UE emission shall not exceed specified level for the specified channel bandwidth under the deployment scenarios where additional requirements are specified.

6.5.2.3.2 Test applicability

This test case applies to all types of NR UE release 15 and forward.

6.5.2.3.3 Minimum conformance requirements

6.5.2.3.3.1 Minimum requirement for "NS_35"

Additional spectrum emission requirements are signalled by the network to indicate that the UE shall meet an additional requirement for a specific deployment scenario as part of the cell handover/broadcast message.

When "NS_35" is indicated in the cell, the power of any UE emission shall not exceed the levels specified in Table 6.5.2.2.3.3.1-1.

Table 6.5.2.2.3.3.1-1: Additional requirements for "NS_35"

Spectrum emission limit (dBm) / Channel bandwidth					
Δf_{OBS} (MHz)	5 MHz	10 MHz	15 MHz	20 MHz	Measurement bandwidth (unless otherwise stated)
$\pm 0-0.1$	-15	-18	-20	-21	30 kHz
$\pm 0.1-6$	-13	-13	-13	-13	100 kHz
$\pm 6-10$	-25 ¹	-13	-13	-13	100 kHz
$\pm 10-15$		-25 ¹	-13	-13	100 kHz
$\pm 15-20$			-25 ¹	-13	100 kHz
$\pm 20-25$				-25	1 MHz
NOTE 1: The measurement bandwidth shall be 1 MHz					

NOTE: As a general rule, the resolution bandwidth of the measuring equipment should be equal to the measurement bandwidth. However, to improve measurement accuracy, sensitivity and efficiency, the resolution bandwidth may be smaller than the measurement bandwidth. When the resolution bandwidth is smaller than the measurement bandwidth, the result should be integrated over the measurement bandwidth in order to obtain the equivalent noise bandwidth of the measurement bandwidth.

The normative reference for this requirement is TS 38.101-1 [2] clause 6.5.2.3.1.

6.5.2.3.3.2 Requirements for network signalling value "NS_04"

Additional spectrum emission requirements are signalled by the network to indicate that the UE shall meet an additional requirement for a specific deployment scenario as part of the cell handover/broadcast message.

The n41 SEM transition point from -13 dBm/MHz to -25 dBm/MHz is based on the emission bandwidth. The emission bandwidth is defined as the width of the signal between two points, one below the carrier centre frequency and one above the carrier c frequency, outside of which all emissions are attenuated at least 26 dB below the transmitter power.

Since the 26-dB emission bandwidth is implementation dependent, the maximum transmission bandwidths in MHz ($N_{RB} * SCS * 12 / 1,000,000$) is used for the SEM.

Table 6.5.2.3.3.2-1: n41 maximum transmission bandwidths (MHz) for CP-OFDM

SCS (kHz)	Channel bandwidths (MHz)										
	10	15	20	30	40	50	60	70	80	90	100
15	9.36	14.22	19.08	28.80	38.88	48.6	N/A	N/A	N/A	N/A	N/A
30	8.64	13.68	18.36	28.08	38.16	47.88	58.32	68.04	78.12	88.02	98.28
60	7.92	12.96	17.28	27.36	36.72	46.8	56.88	66.96	77.04	87.12	97.20

Table 6.5.2.3.3.2-2: n41 maximum transmission bandwidths (MHz) for DFT-S-OFDM

SCS (kHz)	Channel bandwidths (MHz)										
	10	15	20	30	40	50	60	70	80	90	100
15	9.00	13.50	18.00	28.80	38.88	48.60	N/A	N/A	N/A	N/A	N/A
30	8.64	12.96	18.00	27.00	36.00	46.08	58.32	64.80	77.76	87.48	97.20
60	7.20	12.96	17.28	25.92	36.00	46.08	54.00	64.80	72.00	86.40	97.20

When "NS_04" is indicated in the cell, the power of any UE emission shall not exceed the levels specified in Table 6.5.2.3.3.2-3.

Table 6.5.2.3.3.2-3: n41 SEM with "NS_04"

Δf_{oob} MHz	Spectrum emission limit (dBm) / measurement bandwidth											Measurement bandwidth
	for each channel bandwidth (MHz)											
	10	15	20	30	40	50	60	70	80	90	100	
$\pm 0 - 1$	-10	-10	-10	-10	-10							2 % channel bandwidth
												1 MHz
$\pm 1 - 5$												1 MHz
$\pm 5 - X$												
$\pm X - (BW_{Channel} + 5 \text{ MHz})$												
NOTE: X is defined in Table 6.5.2.3.3.2-1 for CP-OFDM and 6.5.2.3.3.2-2 for DFT-S-OFDM												

The normative reference for this requirement is TS 38.101-1 [2] clause 6.5.2.3.2.

6.5.2.3.3.3 Requirements for network signalling value "NS_03" and "NS_21"

Additional spectrum emission requirements are signalled by the network to indicate that the UE shall meet an additional requirement for a specific deployment scenario as part of the cell handover/broadcast message.

When "NS_03" or "NS_21", is indicated in the cell, the power of any UE emission shall not exceed the levels specified in Table 6.5.2.3.3.3-1.

Table 6.5.2.3.3.3-1: Additional requirements for "NS_03" and "NS_21"

Δf_{foob} MHz	Channel bandwidth (MHz) / Spectrum emission limit (dBm)							Measurement bandwidth
	5	10	15	20	25	30	40	
$\pm 0-1$	-13	-13	-13	-13	-13	-13	-13	1 % of channel BW
$\pm 1-6$	-13	-13	-13	-13	-13	-13	-13	1 MHz
$\pm 6-10$	-25	-13	-13	-13	-13	-13	-13	1 MHz
$\pm 10-15$		-25	-13	-13	-13	-13	-13	1 MHz
$\pm 15-20$			-25	-13	-13	-13	-13	1 MHz
$\pm 20-25$				-25	-13	-13	-13	1 MHz
$\pm 25-30$					-25	-13	-13	1 MHz
$\pm 30-35$						-25	-13	1 MHz
$\pm 35-40$							-13	1 MHz
$\pm 40-45$							-25	1 MHz

NOTE: As a general rule, the resolution bandwidth of the measuring equipment should be equal to the measurement bandwidth. However, to improve measurement accuracy, sensitivity and efficiency, the resolution bandwidth may be smaller than the measurement bandwidth. When the resolution bandwidth is smaller than the measurement bandwidth, the result should be integrated over the measurement bandwidth in order to obtain the equivalent noise bandwidth of the measurement bandwidth.

The normative reference for this requirement is TS 38.101-1 [2] clause 6.5.2.3.3.

6.5.2.3.3.4 Requirements for network signalling value "NS_06"

Additional spectrum emission requirements are signalled by the network to indicate that the UE shall meet an additional requirement for a specific deployment scenario as part of the cell handover/broadcast message.

When "NS_06" is indicated in the cell, the power of any UE emission shall not exceed the levels specified in Table 6.5.2.3.3.4-1.

Table 6.5.2.3.3.4-1: Additional requirements for "NS_06"

Spectrum emission limit (dBm) / Channel bandwidth				
Δf_{foob} (MHz)	5 MHz	10 MHz	15 MHz	Measurement bandwidth
$\pm 0 - 0.1$	-15	-18	-20	30 kHz
$\pm 0.1 - 1$	-13	-13	-13	100 kHz
$\pm 1 - 6$	-13	-13	-13	1 MHz
$\pm 6 - 10$	-25			
$\pm 10 - 15$		-25		
$\pm 15 - 20$		-25		

NOTE: As a general rule, the resolution bandwidth of the measuring equipment should be equal to the measurement bandwidth. However, to improve measurement accuracy, sensitivity and efficiency, the resolution bandwidth may be smaller than the measurement bandwidth. When the resolution bandwidth is smaller than the measurement bandwidth, the result should be integrated over the measurement.

The normative reference for this requirement is TS 38.101-1 [2] clause 6.5.2.3.4.

6.5.2.3.3.5 Void

6.5.2.3.3.6 Void

6.5.2.3.3.7 Void

6.5.2.3.3.8 Requirements for network signalling value "NS_27"

Additional spectrum emission requirements are signalled by the network to indicate that the UE shall meet an additional requirement for a specific deployment scenario as part of the cell handover/broadcast message.

When "NS_27" is indicated in the cell, the power of any UE emission shall not exceed the levels specified in Table 6.5.2.3.3.8-1.

Table 6.5.2.3.3.8-1: Additional requirements for "NS_27"

Δf_{OoB} MHz	Channel bandwidth (MHz) / Spectrum emission limit (dBm)					Measurement bandwidth
	5	10	15	20	40	
$\pm 0 - 1$	-13					1 % channel bandwidth
$\pm 1 - X$	-13					1 MHz
$< - X$ or $> X$	-25					
NOTE 1: X is occupied channel bandwidth as defined in Table 6.5.1.3-1.						
NOTE 2: The requirements apply only at the frequency range from 3540 MHz to 3710 MHz.						

NOTE: As a general rule, the resolution bandwidth of the measuring equipment should be equal to the measurement bandwidth. However, to improve measurement accuracy, sensitivity and efficiency, the resolution bandwidth may be smaller than the measurement bandwidth. When the resolution bandwidth is smaller than the measurement bandwidth, the result should be integrated over the measurement.

The normative reference for this requirement is TS 38.101-1 [2] clause 6.5.2.3.8.

6.5.2.3.4 Test description

6.5.2.3.4.1 Initial conditions

Initial conditions are a set of test configurations the UE needs to be tested in and the steps for the SS to take with the UE to reach the correct measurement state.

The initial test configurations consist of environmental conditions, test frequencies, test channel bandwidths and sub-carrier spacing based on NR operating bands specified in table 5.3.5-1. All of these configurations shall be tested with applicable test parameters for each combination of test channel bandwidth and sub-carrier spacing, and are shown in clause 6.2.3.4.1. The details of the uplink reference measurement channels (RMCs) are specified in Annex A.2. Configurations of PDSCH and PDCCH before measurement are specified in Annex C.2.

1. Connect the SS to the UE antenna connectors as shown in TS 38.508-1 [5] Annex A, Figure A.3.1.1.1 for TE diagram and section A.3.2 for UE diagram.
2. The parameter settings for the cell are set up according to TS 38.508-1 [5] subclause 4.4.3.
3. Downlink signals are initially set up according to Annex C.0, C.1, C.2 and uplink signals according Annex G.0, G.1, G.2, G.3.0.
4. The UL Reference Measurement channels are set according to the applicable test configuration table in clause 6.2.3.4.1.
5. Propagation conditions are set according to Annex B.0.
6. Ensure the UE is in state RRC_CONNECTED with generic procedure parameters Connectivity NR, Connected without release On, Test Mode On and Test Loop Function On according to TS 38.508-1 [5] clause 4.5. Message contents are defined in clause 6.5.2.3.4.3.

6.5.2.3.4.2 Test procedure

1. SS sends uplink scheduling information for each UL HARQ process via PDCCH DCI format 0_1 for C_RNTI to schedule the UL RMC according to the applicable test configuration table in clause 6.2.3.4.1. Since the UE has no payload data to send, the UE transmits uplink MAC padding bits on the UL RMC.
2. Send continuously uplink power control "up" commands in the uplink scheduling information to the UE. Allow at least 200ms starting from the first TPC command in this step for the UE to reach P_{UMAX} level.

3. Measure the mean power of the UE in the channel bandwidth of the radio access mode according to the test configuration, which shall meet the requirements described in applicable table from Table 6.2.3.5-1 to Table 6.2.3.5-35. The period of measurement shall be at least the continuous duration one sub-frame (1ms). For TDD slots with transient periods are not under test.
4. Measure the power of the transmitted signal with a measurement filter of bandwidths according to applicable test configuration tables in subclause 6.5.2.3.5. The centre frequency of the filter shall be stepped in continuous steps according to the applicable test requirement table. The measured power shall be recorded for each step. The measurement period shall capture the active TSs.

NOTE 1: When switching to DFT-s-OFDM waveform, as specified in the test configuration Table 6.2.3.4.1-1 through 6.2.3.4.1-2, send an NR RRCReconfiguration message according to TS 38.508-1 [5] clause 4.6.3 Table 4.6.3-118 PUSCH-Config with TRANSFORM_PRECODER_ENABLED condition.

6.5.2.3.4.3 Message contents

Message contents are according to TS 38.508-1 [5] subclause 4.6, with the following exceptions for each network signalling value.

6.5.2.3.4.3.1 Message contents exceptions (network signalling value "NS_35")

For "NS_35" see A-MPR test case in table 6.2.3.4.3.2-1.

6.5.2.3.4.3.2 Message contents exceptions (network signalling value "NS_04")

For "NS_04" see A-MPR test case in table 6.2.3.4.3.4-1.

6.5.2.3.4.3.3 Message contents exceptions (network signalling value "NS_03")

For "NS_03" see A-MPR test case in table 6.2.3.4.3.1-1.

6.5.2.3.4.3.4 Message contents exceptions (network signalling value "NS_03U")

For "NS_03U" see A-MPR test case in table 6.2.3.4.3.3-1.

6.5.2.3.4.3.5 Message contents exceptions (network signalling value "NS_06")

For "NS_06" see A-MPR test case in table 6.2.3.4.3.7-1.

6.5.2.3.4.3.6 Message contents exceptions (network signalling value "NS_21")

For "NS_21" see A-MPR test case in table 6.2.3.4.3.20-1.

6.5.2.3.5 Test requirement

Table 6.5.2.3.5-1: Test Tolerance (Additional spectrum emission mask)

	$f \leq 3.0\text{GHz}$	$3.0\text{GHz} < f \leq 4.2\text{GHz}$	$4.2\text{GHz} < f \leq 6.0\text{GHz}$
$BW \leq 100\text{MHz}$	1.5 dB	1.8 dB	1.8 dB

6.5.2.3.5.1 Test requirements (network signalling value "NS_35")

When "NS_35" is indicated in the cell:

- the measured UE mean power in the channel bandwidth, derived in step 3, shall fulfil requirements in table 6.2.3.5-1 as appropriate for a NR UE.

and

- the power of any UE emission shall fulfil requirements in table 6.5.2.3.5.1-1, as applicable.

Table 6.5.2.3.5.1-1: Additional test requirements "NS_35"

Spectrum emission limit (dBm) / Channel bandwidth					
Δf_{OoB} (MHz)	5 MHz	10 MHz	15 MHz	20 MHz	Measurement bandwidth (unless otherwise stated)
$\pm 0-0.1$	-15.0 + TT	-18.0 + TT	-20.0 + TT	-21.0 + TT	30 kHz
$\pm 0.1-6$	-13.0 + TT	-13.0 + TT	-13.0 + TT	-13.0 + TT	100 kHz
$\pm 6-10$	-25 ¹ + TT	-13.0 + TT	-13.0 + TT	-13.0 + TT	100 kHz
$\pm 10-15$		-25 ¹ 0 + TT	-13.0 + TT	-13.0 + TT	100 kHz
$\pm 15-20$			-25 ¹ 0 + TT	-13.0 + TT	100 kHz
$\pm 20-25$				-25 + TT	1 MHz

NOTE 1: The measurement bandwidth shall be 1 MHz.
 NOTE 2: TT for each frequency and channel bandwidth is specified in Table 6.5.2.3.5-1.

NOTE: As a general rule, the resolution bandwidth of the measuring equipment should be equal to the measurement bandwidth. However, to improve measurement accuracy, sensitivity and efficiency, the resolution bandwidth may be smaller than the measurement bandwidth. When the resolution bandwidth is smaller than the measurement bandwidth, the result should be integrated over the measurement bandwidth in order to obtain the equivalent noise bandwidth of the measurement bandwidth.

6.5.2.3.5.2 Test requirements (network signalling value "NS_04")

When "NS_04" is indicated in the cell:

- the measured UE mean power in the channel bandwidth, derived in step 3, shall fulfil requirements in Table 6.2.3.5-2 for UE power class 2 or Table 6.2.3.5-3 UE power class 3.

and

- the power of any UE emission shall fulfil requirements in table 6.5.2.3.5.2-1.

Table 6.5.2.3.5.2-1: Additional test requirements for "NS_04"

Δf_{OoB} MHz	Spectrum emission limit (dBm) / measurement bandwidth for each channel bandwidth (MHz)											Measurement bandwidth
	10	15	20	30	40	50	60	70	80	90	100	
$\pm 0 - 1$	-10+TT	-10+TT	-10+TT	-10+TT	-10+TT							2 % channel bandwidth
						-10						1 MHz
$\pm 1 - 5$	-10 + TT											1 MHz
$\pm 5 - X$	-13 + TT											
$\pm X -$ (BW _{Channel} + 5 MHz)	-25 + TT											

NOTE 1: X is defined in Table 6.5.2.3.3.2-1 for CP-OFDM and 6.5.2.3.3.2-2 for DFT-S-OFDM.
 NOTE 2: TT for each frequency and channel bandwidth is specified in Table 6.5.2.3.5-1.

6.5.2.3.5.3 Test requirements (network signalling value "NS_03" and "NS_21")

When "NS_03" or "NS_21" is indicated in the cell:

- the measured UE mean power in the channel bandwidth, derived in step 3, shall fulfil requirements in table 6.2.3.5-4 or 6.2.3.5-5 as appropriate for a NR UE.

and

- the power of any UE emission shall fulfil requirements in table 6.5.2.3.5.3-1, as applicable.

Table 6.5.2.3.5.3-1: Additional requirements for "NS_03" and "NS_21"

Δf_{OoB} MHz	Channel bandwidth (MHz) / Spectrum emission limit (dBm)							Measurement bandwidth
	5	10	15	20	25	30	40	
$\pm 0-1$	-13 + TT	-13 + TT	-13 + TT	-13 + TT	-13 + TT	-13 + TT	-13 + TT	1 % of channel BW
$\pm 1-6$	-13 + TT	-13 + TT	-13 + TT	-13 + TT	-13 + TT	-13 + TT	-13 + TT	1 MHz
$\pm 6-10$	-25 + TT	-13 + TT	-13 + TT	-13 + TT	-13 + TT	-13 + TT	-13 + TT	1 MHz
$\pm 10-15$		-25 + TT	-13 + TT	-13 + TT	-13 + TT	-13 + TT	-13 + TT	1 MHz
$\pm 15-20$			-25 + TT	-13 + TT	-13 + TT	-13 + TT	-13 + TT	1 MHz
$\pm 20-25$				-25 + TT	-13 + TT	-13 + TT	-13 + TT	1 MHz
$\pm 25-30$					-25 + TT	-13 + TT	-13 + TT	1 MHz
$\pm 30-35$						-25 + TT	-13 + TT	1 MHz
$\pm 35-40$							-13 + TT	1 MHz
$\pm 40-45$							-25 + TT	1 MHz

NOTE 1: TT for each frequency and channel bandwidth is specified in Table 6.5.2.3.5-1.

NOTE: As a general rule, the resolution bandwidth of the measuring equipment should be equal to the measurement bandwidth. However, to improve measurement accuracy, sensitivity and efficiency, the resolution bandwidth may be smaller than the measurement bandwidth. When the resolution bandwidth is smaller than the measurement bandwidth, the result should be integrated over the measurement bandwidth in order to obtain the equivalent noise bandwidth of the measurement bandwidth.

6.5.2.3.5.4 Test requirements (network signalling value "NS_06")

When "NS_06" is indicated in the cell:

- the measured UE mean power in the channel bandwidth, derived in step 3, shall fulfil requirements in table 6.2.3.5-34 as appropriate for a NR UE

and

- the power of any UE emission shall fulfil requirements in table 6.5.2.3.5.4-1, as applicable.

Table 6.5.2.3.5.4-1: Additional requirements for "NS_06"

Δf_{OoB} (MHz)	Spectrum emission limit (dBm) / Channel bandwidth			Measurement bandwidth
	5 MHz	10 MHz	15 MHz	
$\pm 0 - 0.1$	-15 + TT	-18 + TT	-20 + TT	30 kHz
$\pm 0.1 - 1$	-13 + TT	-13 + TT	-13 + TT	100 kHz
$\pm 1 - 6$	-13 + TT	-13 + TT	-13 + TT	1 MHz
$\pm 6 - 10$	-25 + TT	-13 + TT	-13 + TT	1 MHz
$\pm 10 - 15$		-25 + TT	-13 + TT	1 MHz
$\pm 15 - 20$			-25 + TT	1 MHz

NOTE 1: TT for each frequency and channel bandwidth is specified in Table 6.5.2.3.5-1.

NOTE: As a general rule, the resolution bandwidth of the measuring equipment should be equal to the measurement bandwidth. However, to improve measurement accuracy, sensitivity and efficiency, the resolution bandwidth may be smaller than the measurement bandwidth. When the resolution bandwidth is smaller than the measurement bandwidth, the result should be integrated over the measurement bandwidth in order to obtain the equivalent noise bandwidth of the measurement bandwidth.

6.5.2.4 Adjacent channel leakage ratio

Adjacent channel leakage power Ratio (ACLR) is the ratio of the filtered mean power centred on the assigned channel frequency to the filtered mean power centred on an adjacent channel frequency.

6.5.2.4.1 NR ACLR

6.5.2.4.1.1 Test purpose

To verify that UE transmitter does not cause unacceptable interference to adjacent channels in terms of Adjacent Channel Leakage power Ratio (ACLR).

6.5.2.4.1.2 Test applicability

This test case applies to all types of NR Power Class 3 UE release 15 and forward and NR Power Class 1 UE release 15 and forward in NR Band n14.

This test case applies to all types of NR Power Class 2 UE not supporting txDiversity-r16 release 15 and forward.

6.5.2.4.1.3 Minimum conformance requirements

NR adjacent channel leakage power ratio (NR_{ACLR}) is the ratio of the filtered mean power centred on the assigned NR channel frequency to the filtered mean power centred on an adjacent NR channel frequency at nominal channel spacing.

The assigned NR channel power and adjacent NR channel power are measured with rectangular filters with measurement bandwidths specified in Table 6.5.2.4.1.3-1.

If the measured adjacent channel power is greater than -50 dBm then the NR_{ACLR} shall be higher than the value specified in Table 6.5.2.4.1.3-2.

Table 6.5.2.4.1.3-1: NR ACLR measurement bandwidth

Channel bandwidth	(MHz)	5,10,15,20,25,30,35,40,45,50	60,70,80,90,100
REF_SCS	(kHz)	15	30
NR ACLR measurement bandwidth	(MHz)	$MBW=REF_SCS*(12*N_{RB}+1)/1000$	

Table 6.5.2.4.1.3-2: NR ACLR requirement

	Power class 1 ¹	Power class 1.5	Power class 2	Power class 3
NR ACLR	37 dB ¹	31 dB	31 dB	30 dB
NOTE 1: Applicable for power class 1 UE operating in Band n14.				

The normative reference for this requirement is TS 38.101-1 [2] clause 6.5.2.4.1.

6.5.2.4.1.4 Test description

6.5.2.4.1.4.1 Initial conditions

Initial conditions are a set of test configurations the UE needs to be tested in and the steps for the SS to take with the UE to reach the correct measurement state.

The initial test configurations consist of environmental conditions, test frequencies, test channel bandwidths and sub-carrier spacing based on NR operating bands specified in Table 5.3.5-1. All of these configurations shall be tested with

applicable test parameters for each combination of channel bandwidth and sub-carrier spacing, are shown in the test configuration tables in clause 6.2.2.4.1. The details of the uplink reference measurement channels (RMCs) are specified in Annexes A.2. Configurations of PDSCH and PDCCH before measurement are specified in Annex C.2

Table 6.5.2.4.1.4.1-1: Void

Table 6.5.2.4.1.4.1-2: Void

Table 6.5.2.4.1.4.1-2a: Void

Table 6.5.2.4.1.4.1-3: Void

Table 6.5.2.4.1.4.1-4: Void

1. Connect the SS to the UE antenna connectors as shown in TS 38.508-1 [5] Annex A, Figure A.3.1.1.1 for TE diagram and section A.3.2 for UE diagram.
2. The parameter settings for the cell are set up according to TS 38.508-1 [5] subclause 4.4.3.
3. Downlink signals are initially set up according to Annex C.0, C.1, C.2, and uplink signals according to Annex G.0, G.1, G.2, G.3.0.
4. The UL Reference Measurement channels are set according to the test configuration tables in clause 6.2.2.4.1.
5. Propagation conditions are set according to Annex B.0.
6. Ensure the UE is in state RRC_CONNECTED with generic procedure parameters Connectivity NR, Connected without release On, Test Mode On and Test Loop Function On according to TS 38.508-1 [5] clause 4.5. Message contents are defined in clause 6.5.2.4.1.4.3.

6.5.2.4.1.4.2 Test procedure

1. SS sends uplink scheduling information for each UL HARQ process via PDCCH DCI format 0_1 for C_RNTI to schedule the UL RMC according to the test configuration tables in clause 6.2.2.4.1T. Since the UL has no payload and no loopback data to send the UE sends uplink MAC padding bits on the UL RMC.
2. Send continuously power control “up” commands to the UE until the UE transmits at P_{UMAX} level. Allow at least 200ms for the UE to reach P_{UMAX} level.
3. Measure the mean power of the UE in the channel bandwidth of the radio access mode according to the test configuration, as measured in step 3of 6.2.2.4.2, which shall meet the requirements described in clause 6.2.2.5 as appropriate.
4. Measure the rectangular filtered mean power for the assigned NR channel.
5. Measure the rectangular filtered mean power of the first NR adjacent channel on both lower and upper side of the assigned NR channel, respectively.
6. Calculate the ratios of the power between the values measured in step 4 over step 5 for lower and upper NR ACLR, respectively.
7. For UEs supporting Power Class 1 in Band n14 and Power Class 2, repeat steps 1~6 for Test ID 22 and 36 in Table 6.2.2.4.1-1 on the applicable bands with message exception of P-Max defined in Table 6.5.2.4.1.4.3-1.

NOTE 1: When switching to DFT-s-OFDM waveform, as specified in the test configuration tables in clause 6.2.2.4.1, send an NR RRCReconfiguration message according to TS 38.508-1 [5] clause 4.6.3 Table 4.6.3-118 PUSCH-Config with TRANSFORM_PRECODER_ENABLED condition.

6.5.2.4.1.4.3 Message contents

Message contents are according to TS 38.508-1 [5] subclause 4.6 and 5.4 with the following exceptions:

Table 6.5.2.4.1.4.3-1: *P-Max* (Step 7)

Derivation Path: TS 38.508-1 [5], Table 4.6.3-89			
Information Element	Value/remark	Comment	Condition
P-Max	23		PC2 UE or PC1 UE

Table 6.5.2.4.1.4.3-1a: Void

Table 6.5.2.4.1.4.3-2: *PUSCH-Config*

Derivation Path: TS 38.508-1 [5] subclause 4.6.3 Table 4.6.3-118 PUSCH-Config			
Information Element	Value/remark	Comment	Condition
PUSCH-Config ::= SEQUENCE {			
resourceAllocation	resourceAllocationType0		Almost contiguous allocation
	resourceAllocationType1		Contiguous allocation
}			

Table 6.5.2.4.1.4.3-3: *DMRS-UplinkConfig* (Test ID 37 – 39 in Table 6.2.2.4.1-1)

Derivation Path: TS 38.508-1 [5], Table 4.6.3-51			
Information Element	Value/remark	Comment	Condition
DMRS-UplinkConfig ::= SEQUENCE {			
transformPrecodingEnabled SEQUENCE {			
dmrs-UplinkTransformPrecoding-r16 {			
Setup SEQUENCE {			
pi2BPSK-ScramblingID0	Not present		
pi2BPSK-ScramblingID1	Not present		
}			
}			
}			
}			

Table 6.5.2.4.1.4.3-4: *ServingCellConfig*

Derivation Path: TS 38.508-1 [5] Table 4.6.3-167			
Information Element	Value/remark	Comment	Condition
ServingCellConfig ::= SEQUENCE {			
uplinkConfig SEQUENCE {			
powerBoostPi2BPSK	1		Test IDs where NOTE 3 in Table 6.2.2.4.1-1 applies.
	0		Test IDs where NOTE 4 in Table 6.2.2.4.1-1 applies.
}			
}			

6.5.2.4.1.5 Test requirement

The measured UE mean power in the channel bandwidth, derived in step 3, shall fulfil requirements in clause 6.2.2.5 as appropriate, and if the measured adjacent channel power is greater than -50 dBm then the measured NR ACLR, derived in step 6, shall be higher than the limits in Table 6.5.2.4.1.5-2.

The measured UE mean power in the channel bandwidth, derived in step 7, shall fulfil power class 3 requirements in Tables 6.2.2.5-1 and 6.2.2.5-3 as appropriate, and if the measured adjacent channel power is greater than -50 dBm then the measured NR ACLR, derived in step 7, shall be higher than the power class 3 limits in Table 6.5.2.4.1.5-2.

Table 6.5.2.4.1.5-1: NR ACLR measurement bandwidth

NR channel bandwidth / NR ACLR measurement bandwidth													
	5 MHz	10 MHz	15 MHz	20 MHz	25 MHz	30 MHz	40 MHz	50 MHz	60 MHz	70 MHz	80 MHz	90 MHz	100 MHz
NR ACLR measurement bandwidth (MHz)	4.515	9.375	14.235	19.095	23.955	28.815	38.895	48.615	58.35	68.07	78.15	88.23	98.31

Table 6.5.2.4.1.5-2: NR ACLR requirement

	Power class 1 ²	Power class 1.5	Power class 2	Power class 3
NR ACLR	37 - TT dB ²	31 - TT dB	31 - TT dB	30 - TT dB
NOTE 1: TT for each frequency and channel bandwidth is specified in Table 6.5.2.4.1.5-3.				
NOTE 2: Applicable for power class 1 UE operating in Band n14.				

Table 6.5.2.4.1.5-3: Test Tolerance (NR ACLR)

	$f \leq 3.0\text{GHz}$	$3.0\text{GHz} < f \leq 4.2\text{GHz}$	$4.2\text{GHz} < f \leq 6.0\text{GHz}$
BW $\leq 100\text{MHz}$	0.8 dB	0.8 dB	0.8 dB

6.5.2.4.2 UTRA ACLR

6.5.2.4.2.1 Test purpose

To verify that UE transmitter does not cause unacceptable interference to adjacent channels in terms of Adjacent Channel Leakage power Ratio (ACLR).

6.5.2.4.2.2 Test applicability

This test case applies for network signalling values NS_3U, NS_5U, NS_43U, and NS_100 to all types of NR Power Class 3 UE release 15 and forward.

6.5.2.4.2.3 Minimum conformance requirements

UTRA adjacent channel leakage power ratio ($UTRA_{ACLR}$) is the ratio of the filtered mean power centred on the assigned NR channel frequency to the filtered mean power centred on an adjacent(s) UTRA channel frequency.

$UTRA_{ACLR}$ is specified for the first adjacent UTRA channel ($UTRA_{ACLR1}$) which centre frequency is ± 2.5 MHz from NR channel edge and for the 2nd adjacent UTRA channel ($UTRA_{ACLR2}$) which centre frequency is ± 7.5 MHz from NR channel edge.

The UTRA channel power is measured with an RRC filter with roll-off factor $\alpha = 0.22$ and bandwidth of 3.84 MHz. The assigned NR channel power is measured with a rectangular filter with measurement bandwidth specified in Table 6.5.2.4.1.3-1.

If the measured adjacent channel power is greater than -50 dBm then the $UTRA_{ACLR1}$ and $UTRA_{ACLR2}$ shall be higher than the value specified in Table 6.5.2.4.2.3-1.

$UTRA_{ACLR}$ is not applicable to the power class 3 UE operating in Band n12, n14, n17, and n30.

$UTRA_{ACLR}$ is not applicable to the power class 1 UE operating in Band n14.

Table 6.5.2.4.2.3-1: UTRA ACLR requirement

	Power class 3
UTRA _{ACLR1}	33 dB
UTRA _{ACLR2}	36 dB

UTRA ACLR requirement is applicable when signalled by the network with network signalling value indicated by the field *additionalSpectrumEmission*.

The normative reference for this requirement is TS 38.101-1 [2] clause 6.5.2.4.2.

6.5.2.4.2.4 Test description

6.5.2.4.2.4.1 Initial conditions

Same as in subclause 6.2.3.4.1 with the following exception;

- Only network signalling values NS_3U, NS_5U, NS_43U, and NS_100 with the corresponding band defined in Table 6.2.3.3.1-1 need to perform UTRA ACLR test.
- Message contents in step 6 are defined in clause 6.5.2.4.2.4.3.

6.5.2.4.2.4.2 Test procedure

1. SS sends uplink scheduling information for each UL HARQ process via PDCCH DCI format 0_1 for C_RNTI to schedule the UL RMC according to the applicable test configuration table in clause 6.2.3.4.1. Since the UL has no payload and no loopback data to send the UE sends uplink MAC padding bits on the UL RMC.
2. Send continuously power control “up” commands to the UE until the UE transmits at P_{UMAX} level. Allow at least 200ms for the UE to reach P_{UMAX} level.
3. Measure the mean power of the UE in the channel bandwidth of the radio access mode according to the test configuration, which shall meet the requirements described in 6.2.3.5 as appropriate. The period of the measurement shall be at least the continuous duration of one active sub-frame (1 ms) and in the uplink symbols. For TDD slots with transient periods are not under test.
4. Measure the rectangular filtered mean power for the assigned NR channel.
5. Measure the RRC filtered mean power of the first and the second UTRA adjacent channel on both lower and upper side of the NR channel, respectively.
6. Calculate the ratios of the power between the values measured in step 4 over step 5 for lower and upper UTRA ACLR, respectively.

NOTE 1: When switching to DFT-s-OFDM waveform, as specified in the test configuration tables in 6.2.3.4.1 as appropriate, send an NR RRCReconfiguration message according to TS 38.508-1 [5] clause 4.6.3 Table 4.6.3-118 PUSCH-Config with TRANSFORM_PRECODER_ENABLED condition.

6.5.2.4.2.4.3 Message contents

Message contents are according to TS 38.508-1 [5] subclause 4.6 with the following exceptions:

Table 6.5.2.4.2.4.3-1: AdditionalSpectrumEmission

Derivation Path: 38.508-1 [5] clause 4.6.3, Table 4.6.3-1 AdditionalSpectrumEmission			
Information Element	Value/remark	Comment	Condition
AdditionalSpectrumEmission	3 (NS_03U) 3 (NS_05U) 3 (NS_43U) 1 (NS_100)	for band n2, n25, n66, n86 for band n1, n84 for band n8, n81 for band n1, n2, n3, n5, n8, n25, n66 (NOTE1)	
NOTE 1: This NS can be signalled for NR bands that have UTRA services deployed			

6.5.2.4.2.5 Test requirement

The measured UE mean power in the channel bandwidth, derived in step 3, shall fulfil requirements described in 6.2.3.5 as appropriate, and if the measured adjacent channel power is greater than -50 dBm then the measured UTRA ACLR, derived in step 6, shall be higher than the limits in table 6.5.2.4.2.5-2.

Table 6.5.2.4.2.5-1: Void

Table 6.5.2.4.2.5-2: UTRA ACLR requirement

	Power class 3
$UTRA_{ACLR1}$	33 dB - TT
$UTRA_{ACLR2}$	36 dB - TT
NOTE 1: TT = 0.8 dB	

6.5.3 Spurious emissions

Spurious emissions are emissions which are caused by unwanted transmitter effects such as harmonics emission, parasitic emissions, intermodulation products and frequency conversion products, but exclude out of band emissions unless otherwise stated. The spurious emission limits are specified in terms of general requirements in line with SM.329 [22] and NR operating band requirement to address UE co-existence.

To improve measurement accuracy, sensitivity and efficiency, the resolution bandwidth may be smaller than the measurement bandwidth. When the resolution bandwidth is smaller than the measurement bandwidth, the result should be integrated over the measurement bandwidth in order to obtain the equivalent noise bandwidth of the measurement bandwidth.

NOTE: For measurement conditions at the edge of each frequency range, the lowest frequency of the measurement position in each frequency range should be set at the lowest boundary of the frequency range plus MBW/2. The highest frequency of the measurement position in each frequency range should be set at the highest boundary of the frequency range minus MBW/2. MBW denotes the measurement bandwidth defined for the protected band.

6.5.3.1 General spurious emissions

6.5.3.1.1 Test purpose

To verify that UE transmitter does not cause unacceptable interference to other channels or other systems in terms of transmitter spurious emissions.

6.5.3.1.2 Test applicability

This test case applies to all types of NR UE release 15 and forward.

6.5.3.1.3 Minimum conformance requirements

This clause specifies the requirements for the specified NR band for Transmitter Spurious emissions requirement with frequency range as indicated in Table 6.5.3.1.3-2.

Unless otherwise stated, the spurious emission limits apply for the frequency ranges that are more than F_{OOB} (MHz) in Table 6.5.3.1.3-1 from the edge of the channel bandwidth. The spurious emission limits in Table 6.5.3.1.3-2 apply for all transmitter band configurations (N_{RB}) and channel bandwidths.

NOTE: For measurement conditions at the edge of each frequency range, the lowest frequency of the measurement position in each frequency range should be set at the lowest boundary of the frequency range plus MBW/2. The highest frequency of the measurement position in each frequency range should be set at the highest boundary of the frequency range minus MBW/2. MBW denotes the measurement bandwidth defined for the protected band.

Table 6.5.3.1.3-1: Boundary between NR out of band and general spurious emission domain

Channel bandwidth	OOB boundary F_{OOB} (MHz)
$BW_{Channel}$	$BW_{Channel} + 5$

Table 6.5.3.1.3-2: Requirement for general spurious emissions limits

Frequency Range	Maximum Level	Measurement bandwidth	NOTE
$9 \text{ kHz} \leq f < 150 \text{ kHz}$	-36 dBm	1 kHz	
$150 \text{ kHz} \leq f < 30 \text{ MHz}$	-36 dBm	10 kHz	
$30 \text{ MHz} \leq f < 1000 \text{ MHz}$	-36 dBm	100 kHz	
$1 \text{ GHz} \leq f < 12.75 \text{ GHz}$	-30 dBm	1 MHz	4
	-25 dBm	1 MHz	3
12.75 GHz $\leq f <$ 5th harmonic of the upper frequency edge of the UL operating band in GHz	-30 dBm	1 MHz	1
$12.75 \text{ GHz} < f < 26 \text{ GHz}$	-30 dBm	1 MHz	2
NOTE 1: Applies for Band for which the upper frequency edge of the UL Band is greater than 2.55 GHz and less than or equal to 5.2 GHz			
NOTE 2: Applies for Band that the upper frequency edge of the UL Band more than 5.2 GHz			
NOTE 3: Applies for Band n41, CA configurations including Band n41, and EN-DC configurations that include n41 specified in sub-clause 5.2B of [4] when NS_04 is signalled.			
NOTE 4: Does not apply for Band n41, CA configurations including Band n41, and EN-DC configurations that include n41 specified in subclause 5.2B of TS 38.101-3 [4] when NS_04 is signalled.			

The normative reference for this requirement is TS 38.101-1 [2] subclause 6.5.3.1

6.5.3.1.4 Test description

6.5.3.1.4.1 Initial conditions

Initial conditions are a set of test configurations the UE needs to be tested in and the steps for the SS to take with the UE to reach the correct measurement state.

The initial test configurations consist of environmental conditions, test frequencies, test channel bandwidths and sub-carrier spacing based on NR operating bands specified in Table 5.3.5-1. All of these configurations shall be tested with applicable test parameters for each combination of channel bandwidth and sub-carrier spacing, are shown in Table 6.5.3.1.4.1-1. The details of the uplink reference measurement channels (RMCs) are specified in Annexes A.2. Configurations of PDSCH and PDCCH before measurement are specified in Annex C.2.

Table 6.5.3.1.4.1-1: Test Configuration Table

Initial Conditions			
Test Environment as specified in TS 38.508-1 [5] subclause 4.1.		Normal	
Test Frequencies as specified in TS 38.508-1 [5] subclause 4.3.1.		Low range, Mid range, High range (NOTE 2)	
Test Channel Bandwidths as specified in TS 38.508-1 [5] subclause 4.3.1.		Lowest, Mid, Highest	
Test SCS as specified in Table 5.3.5-1		Lowest	
Test Parameters			
Test ID	Downlink Configuration	Uplink Configuration	
		Modulation	RB allocation (NOTE 1)
1	N/A for Spurious Emissions testing	CP-OFDM QPSK	OuterFull
2		CP-OFDM QPSK	Edge_1RB_Left
3		CP-OFDM QPSK	Edge_1RB_Right
NOTE 1: The specific configuration of each RB allocation is defined in Table 6.1-1 Common UL configuration.			
NOTE 2: For NR band n28, 30MHz test channel bandwidth is tested with Low range and High range test frequencies.			

1. Connect the SS to the UE antenna connectors as shown in TS 38.508-1 [5] Annex A, Figure A.3.1.1.1 for TE diagram and section A.3.2 for UE diagram.
2. The parameter settings for the cell are set up according to TS 38.508-1 [5] subclause 4.4.3.
3. Downlink signals are initially set up according to Annex C.0, C.1 and C.2, and uplink signals according to Annex G.0, G.1, G.2, G.3.0.
4. The UL Reference Measurement channels are set according to Table 6.5.3.1.4.1-1.
5. Propagation conditions are set according to Annex B.0.
6. Ensure the UE is in state RRC_CONNECTED with generic procedure parameters Connectivity *NR*, Connected without release *On*, Test Mode *On* and Test Loop Function *On* according to TS 38.508-1 [5] clause 4.5. Message contents are defined in clause 6.5.3.1.4.3 with no exceptions.

6.5.3.1.4.2 Test procedure

1. SS sends uplink scheduling information for each UL HARQ process via PDCCH DCI format 0_1 for C_RNTI to schedule the UL RMC according to Table 6.5.3.1.4.1-1. Since the UE has no payload data to send, the UE transmits uplink MAC padding bits on the UL RMC.
2. Send continuously uplink power control "up" commands in the uplink scheduling information to the UE until the UE transmits at P_{UMAX} level.
3. Measure the power of the transmitted signal with a measurement filter of bandwidths according to Table 6.5.3.1.5-1. The centre frequency of the filter shall be stepped in contiguous steps according to Table 6.5.3.1.5-1. The measured power shall be verified for each step. The measurement period shall capture the active time slots.
4. For UE operating on Band n41, redo the test for frequency range $1\text{ GHz} \leq f < 12.75\text{ GHz}$ with the message content in step 6 of initial conditions with exceptions defined in clause 6.5.3.1.4.3.

6.5.3.1.4.3 Message contents

Message contents are according to TS 38.508-1 [5] subclause 4.6.

Exception for step 4 in test procedure:

Table 6.5.3.1.4.3-1: Message contents

Derivation Path: TS 38.508-1 [5], Table 4.6.3-1			
Information Element	Value/remark	Comment	Condition
additionalSpectrumEmission	1 (NS_04)		

6.5.3.1.5 Test requirement

This clause specifies the requirements for the specified NR band for Transmitter Spurious emissions requirement with frequency range as indicated in Table 6.5.3.1.5-1.

Unless otherwise stated, the spurious emission limits apply for the frequency ranges that are more than F_{OOB} (MHz) in Table 6.5.3.1.3-1 from the edge of the channel bandwidth. The spurious emission limits in Table 6.5.3.1.5-1 apply for all transmitter band configurations (NRB) and channel bandwidths.

The measured average power of spurious emission, derived in step 3, shall not exceed the described value in Table 6.5.3.1.5-1.

Table 6.5.3.1.5-1: General spurious emissions test requirements

Frequency Range	Maximum Level	Measurement bandwidth	NOTE
$9 \text{ kHz} \leq f < 150 \text{ kHz}$	-36 dBm	1 kHz	
$150 \text{ kHz} \leq f < 30 \text{ MHz}$	-36 dBm	10 kHz	
$30 \text{ MHz} \leq f < 1000 \text{ MHz}$	-36 dBm	100 kHz	
$1 \text{ GHz} \leq f < 12.75 \text{ GHz}$	-30 dBm	1 MHz	4
	-25 dBm	1 MHz	3
12.75 GHz $\leq f <$ 5th harmonic of the upper frequency edge of the UL operating band in GHz	-30 dBm	1 MHz	1
$12.75 \text{ GHz} < f < 26 \text{ GHz}$	-30 dBm	1 MHz	2
NOTE 1: Applies for Band for which the upper frequency edge of the UL Band is greater than 2.55 GHz and less than or equal to 5.2 GHz			
NOTE 2: Applies for Band that the upper frequency edge of the UL Band more than 5.2 GHz			
NOTE 3: Applies for Band n41, CA configurations including Band n41, and EN-DC configurations that include n41 specified in sub-clause 5.2B of 38.101-3 [4] when NS_04 is signalled.			
NOTE 4: Does not apply for Band n41, CA configurations including Band n41, and EN-DC configurations that include n41 specified in subclause 5.2B of TS 38.101-3 [4] when NS_04 is signalled.			

6.5.3.2 Spurious emissions for UE co-existence

6.5.3.2.1 Test purpose

To verify that UE transmitter does not cause unacceptable interference to co-existing systems for the specified bands which has specific requirements in terms of transmitter spurious emissions.

6.5.3.2.2 Test applicability

This test case applies to all types of NR UE release 15 and forward.

6.5.3.2.3 Minimum conformance requirements

This clause specifies the requirements for the specified NR band for coexistence with protected bands as indicated in Tables 6.5.3.2.3-1 to 6.5.3.2.3-3.

NOTE: For measurement conditions at the edge of each frequency range, the lowest frequency of the measurement position in each frequency range should be set at the lowest boundary of the frequency range plus $MBW/2$. The highest frequency of the measurement position in each frequency range should be set at the highest boundary of the frequency range minus $MBW/2$. MBW denotes the measurement bandwidth defined for the protected band.

Table 6.5.3.2.3-1: Requirements for spurious emissions for UE co-existence Rel-15

NR Band	Spurious emission for UE co-existence						
	Protected band	Frequency range (MHz)			Maximum Level (dBm)	MBW (MHz)	NOTE
n1, n84	E-UTRA Band 1, 5, 7, 8, 11, 18, 19, 20, 21, 22, 26, 27, 28, 31, 32, 38, 40, 41, 42, 43, 44, 45, 50, 51, 52, 65, 67, 68, 69, 72, 73, 74, 75, 76 NR Band n78, n79	F _{DL_low}	--	F _{DL_high}	-50	1	
	NR Band n77	F _{DL_low}	-	F _{DL_high}	-50	1	2
	E-UTRA Band 3, 34	F _{DL_low}	-	F _{DL_high}	-50	1	15
	Frequency range	1880	-	1895	-40	1	15, 27
	Frequency range	1895	-	1915	-15.5	5	15, 26, 27
	Frequency range	1915	-	1920	+1.6	5	15, 26, 27
n2	E-UTRA Band 4, 5, 12, 13, 14, 17, 24, 26, 27, 28, 29, 30, 41, 42, 48, 50, 51, 53, 66, 70, 71, 74, 85	F _{DL_low}	-	F _{DL_high}	-50	1	
	E-UTRA Band 2, 25	F _{DL_low}	-	F _{DL_high}	-50	1	15
	E-UTRA Band 43	F _{DL_low}	-	F _{DL_high}	-50	1	2
n3, n80	E-UTRA Band 1, 5, 7, 8, 20, 26, 27, 28, 31, 32, 33, 34, 38, 39, 40, 41, 43, 44, 45, 50, 51, 65, 67, 68, 69, 72, 73, 74, 75, 76 NR Band n79	F _{DL_low}	-	F _{DL_high}	-50	1	
	E-UTRA Band 3	F _{DL_low}	-	F _{DL_high}	-50	1	15
	E-UTRA Band 11, 18, 19, 21	F _{DL_low}	-	F _{DL_high}	-50	1	
	E-UTRA Band 22, 42, 52 NR Band n77, n78	F _{DL_low}	-	F _{DL_high}	-50	1	2
	Frequency range	1884.5	-	1915.7	-41	0.3	8
n5	E-UTRA Band 1, 2, 3, 4, 5, 7, 8, 12, 13, 14, 17, 18, 19, 24, 25, 26, 28, 29, 30, 31, 34, 38, 40, 42, 43, 45, 48, 50, 51, 65, 66, 70, 71, 73, 74, 85 NR Band n79	F _{DL_low}	-	F _{DL_high}	-50	1	
	E-UTRA Band 41, 52, 53 NR Band n77, n78	F _{DL_low}	-	F _{DL_high}	-50	1	2
	E-UTRA Band 11, 21	F _{DL_low}	-	F _{DL_high}	-50	1	
	Frequency range	1884.5	-	1915.7	-41	0.3	8
n7	E-UTRA Band 1, 2, 3, 4, 5, 7, 8, 12, 13, 14, 17, 20, 22, 26, 27, 28, 29, 30, 31, 32, 33, 34, 40, 42, 43, 50, 51, 52, 65, 66, 67, 68, 72, 74, 75, 76, 85, NR Band n77, n78	F _{DL_low}	-	F _{DL_high}	-50	1	
	Frequency range	2570	-	2575	+1.6	5	15, 21, 26
	Frequency range	2575	-	2595	-15.5	5	15, 21, 26
	Frequency range	2595	-	2620	-40	1	15, 21
n8, n81	E-UTRA Band 1, 20, 28, 31, 32, 33, 34, 38, 39, 40, 45, 50, 51, 65, 67, 68, 69, 72, 73, 74, 75, 76	F _{DL_low}	-	F _{DL_high}	-50	1	
	E-UTRA band 3, 7, 22, 41, 42, 43, 52, NR Band n77, n78, n79	F _{DL_low}	-	F _{DL_high}	-50	1	2

	E-UTRA 8	F _{DL_low}	-	F _{DL_high}	-50	1	15
	E-UTRA Band 11, 21	F _{DL_low}	-	F _{DL_high}	-50	1	
	Frequency range	1884.5	-	1915.7	-41	0.3	8
n12	E-UTRA Band 2, 5, 13, 14, 17, 24, 25, 26, 27, 30, 41, 50, 53, 70, 71, 74	F _{DL_low}	-	F _{DL_high}	-50	1	
	E-UTRA Band 4, 48, 51, 66	F _{DL_low}	-	F _{DL_high}	-50	1	2
	E-UTRA Band 12, 85	F _{DL_low}	-	F _{DL_high}	-50	1	15
n20, n82	E-UTRA Band 1, 3, 7, 8, 22, 31, 32, 33, 34, 40, 43, 50, 51, 65, 67, 68, 72, 74, 75, 76	F _{DL_low}	-	F _{DL_high}	-50	1	
	E-UTRA Band 20	F _{DL_low}	-	F _{DL_high}	-50	1	15
	E-UTRA Band 38, 42, 52, 69 NR Band n77, n78	F _{DL_low}	-	F _{DL_high}	-50	1	2
	Frequency range	758	-	788	-50	1	
n25	E-UTRA Band 4, 5, 12, 13, 14, 17, 24, 26, 27, 28, 29, 30, 41, 42, 48, 53, 66, 70, 71, 85	F _{DL_low}	-	F _{DL_high}	-50	1	
	E-UTRA Band 2	F _{DL_low}	-	F _{DL_high}	-50	1	15
	E-UTRA Band 25	F _{DL_low}	-	F _{DL_high}	-50	1	15
	E-UTRA Band 43	F _{DL_low}	-	F _{DL_high}	-50	1	2
n28, n83	E-UTRA Band 1, 4, 22, 32, 42, 43, 50, 51, 65, 66, 74, 75, 76 NR Band n77, n78	F _{DL_low}	-	F _{DL_high}	-50	1	2
	E-UTRA Band 1	F _{DL_low}	-	F _{DL_high}	-50	1	19, 25
	E-UTRA Band 2, 3, 5, 7, 8, 18, 19, 20, 25, 26, 27, 31, 34, 38, 40, 41, 52, 72, 73 NR Band n79	F _{DL_low}	-	F _{DL_high}	-50	1	
	E-UTRA Band 11, 21	F _{DL_low}	-	F _{DL_high}	-50	1	19, 24
	Frequency range	470	-	694	-42	8	15, 35
	Frequency range	470	-	710	-26.2	6	34
	Frequency range	662	-	694	-26.2	6	15
	Frequency range	758	-	773	-32	1	15
	Frequency range	773	-	803	-50	1	
	Frequency range	1884.5	-	1915.7	-41	0.3	8, 19
n34	E-UTRA Band 1, 3, 7, 8, 11, 18, 19, 20, 21, 22, 26, 28, 31, 32, 33, 38, 39, 40, 41, 42, 43, 44, 45, 50, 51, 52, 65, 67, 69, 72, 74, 75, 76 NR Band n78, n79	F _{DL_low}	-	F _{DL_high}	-50	1	5
	NR Band n77	F _{DL_low}	-	F _{DL_high}	-50	1	2
	Frequency range	1884.5	-	1915.7	-41	0.3	8
n38	E-UTRA Band 1, 2, 3, 4, 5, 8, 12, 13, 14, 17, 20, 22, 27, 28, 29, 30, 31, 32, 33, 34, 40, 42, 43, 50, 51, 52, 65, 66, 67, 68, 72, 74, 75, 76, 85,	F _{DL_low}	-	F _{DL_high}	-50	1	
	Frequency range	2620	-	2645	-15.5	5	15, 22, 26
	Frequency range	2645	-	2690	-40	1	15, 22
n39	E-UTRA Band 1, 8, 22, 26, 34, 40, 41, 42, 44, 45, 50, 51, 52, 74 NR Band n79	F _{DL_low}	-	F _{DL_high}	-50		
	NR Band n77, n78	F _{DL_low}	-	F _{DL_high}	-50	1	2
	Frequency range	1805	-	1855	-40	1	33
	Frequency range	1855	-	1880	-15.5	5	15, 26, 33

n40	E-UTRA Band 1, 3, 5, 7, 8, 11, 18, 19, 20, 21, 22, 26, 27, 28, 31, 32, 33, 34, 38, 39, 41, 42, 43, 44, 45, 50, 51, 52, 65, 67, 68, 69, 72, 74, 75, 76 NR Band n77, n78	F _{DL_low}	-	F _{DL_high}	-50	1	
	NR Band n79	F _{DL_low}	-	F _{DL_high}	-50	1	2
	Frequency range	1884.5		1915.7	-41	0.3	8
n41	E-UTRA Band 1, 2, 3, 4, 5, 8, 12, 13, 14, 17, 24, 25, 26, 27, 28, 29, 30, 34, 39, 42, 44, 45, 48, 50, 51, 52, 65, 66, 70, 71, 73, 74, 85, NR Band n77, n78	F _{DL_low}	-	F _{DL_high}	-50	1	
	NR Band n79	F _{DL_low}	-	F _{DL_high}	-50	1	2
	E-UTRA Band 11, 18, 19, 21	F _{DL_low}	-	F _{DL_high}	-50	1	
	Frequency range	1884.5		1915.7	-41	0.3	8
n50	E-UTRA Band 1, 2, 3, 4, 5, 7, 8, 12, 13, 17, 20, 26, 28, 29, 31, 34, 38, 39, 40, 41, 42, 43, 48, 52, 65, 66, 67, 68, 85	F _{DL_low}	-	F _{DL_high}	-50	1	
n51	E-UTRA Band 1, 2, 3, 4, 5, 7, 8, 12, 13, 17, 20, 26, 28, 29, 31, 34, 38, 39, 40, 41, 42, 43, 48, 65, 66, 67, 68	F _{DL_low}	-	F _{DL_high}	-50	1	
n66, n86	E-UTRA Band 2, 4, 5, 7, 12, 13, 14, 17, 25, 26, 27, 28, 29, 30, 38, 41, 43, 50, 51, 53, 66, 70, 71, 74, 85	F _{DL_low}	-	F _{DL_high}	-50	1	
	E-UTRA Band 42, 48	F _{DL_low}	-	F _{DL_high}	-50	1	2
n70	E-UTRA Band 2, 4, 5, 12, 13, 14, 17, 24, 25, 26, 29, 30, 41, 48, 66, 70, 71, 85	F _{DL_low}	-	F _{DL_high}	-50	1	2
n71	E-UTRA Band 4, 5, 12, 13, 14, 17, 24, 26, 30, 48, 53, 66, 85	F _{DL_low}	-	F _{DL_high}	-50	1	
	E-UTRA Band 2, 25, 41, 70	F _{DL_low}	-	F _{DL_high}	-50	1	2
	E-UTRA Band 29	F _{DL_low}	-	F _{DL_high}	-38	1	15
	E-UTRA Band 71	F _{DL_low}	-	F _{DL_high}	-50	1	15
n74	E-UTRA Band 1, 2, 3, 4, 5, 7, 8, 12, 13, 17, 18, 19, 20, 26, 28, 29, 31, 34, 38, 39, 40, 41, 42, 43, 48, 52, 65, 66, 67, 68, 85 NR Band n77, n78	F _{DL_low}	-	F _{DL_high}	-50	1	
	NR Band n79	F _{DL_low}	-	F _{DL_high}	-50	1	2
	Frequency range	1884.5	-	1915.7	-41	0.3	8
	Frequency range	1400	-	1427	-32	27	15, 41
	Frequency range	1475	-	1488	-50	1	42
	Frequency range	1475	-	1488	-28	1	15, 42
	Frequency range	1475	-	1488	-50	1	15, 45
	Frequency range	1475.9	-	1510.9	-35	1	15, 46
n77	E-UTRA Band 1, 3, 5, 7, 8, 11, 18, 19, 20, 21, 26, 28, 34, 39, 40, 41, 65, 74	F _{DL_low}	--	F _{DL_high}	-50	1	
	Frequency range	1884.5	--	1915.7	-41	0.3	8
n78	E-UTRA Band 1, 3, 5, 7, 8, 11, 18, 19, 20, 21, 26, 28, 32, 34, 39, 40, 41, 65, 74, 75, 76	F _{DL_low}	-	F _{DL_high}	-50	1	
	Frequency range	1884.5	-	1915.7	-41	0.3	8
n79	E-UTRA Band 1, 3, 5, 8, 11, 18, 19, 21, 28, 34, 39, 40, 41, 42, 65, 74	F _{DL_low}	--	F _{DL_high}	-50	¹	

	Frequency range	1884.5	--	1915.7	-41	0.3	
--	-----------------	--------	----	--------	-----	-----	--

- NOTE 1: F_{DL_low} and F_{DL_high} refer to each frequency band specified in Table 5.2-1 for NR band, Table 5.2-1 in TS 36.521-1 [21] for E-UTRA band.
- NOTE 2: As exceptions, measurements with a level up to the applicable requirements defined in Table 6.5.3.1.3-2 are permitted for each assigned NR carrier used in the measurement due to 2nd, 3rd, 4th or 5th harmonic spurious emissions. Due to spreading of the harmonic emission the exception is also allowed for the first 1 MHz frequency range immediately outside the harmonic emission on both sides of the harmonic emission. This results in an overall exception interval centred at the harmonic emission of $(2\text{MHz} + N \times \text{LCRB} \times \text{RBSizekHz})$, where N is 2, 3, 4, [5] for the 2nd, 3rd, 4th [or 5th] harmonic respectively. The exception is allowed if the measurement bandwidth (MBW) totally or partially overlaps the overall exception interval.
- NOTE 3: 15 kHz SCS is assumed when RB is mentioned in the note when channel bandwidth is less than or equal to 50MHz, lowest SCS is assumed when channel bandwidth is larger than 50MHz. The transmission bandwidth in terms of RB position and range is not limited to 15 kHz SCS and shall scale with SCS accordingly.
- NOTE 4: Void
- NOTE 5: For non synchronised TDD operation to meet these requirements some restriction will be needed for either the operating band or protected band.
- NOTE 6: N/A
- NOTE 7: Void.
- NOTE 8: Applicable when co-existence with PHS system operating in 1884.5 -1915.7MHz.
- NOTE 9: Void
- NOTE 10: Void
- NOTE 11: Void
- NOTE 12: Void
- NOTE 13: Void.
- NOTE 14: Void
- NOTE 15: These requirements also apply for the frequency ranges that are less than F_{OoB} (MHz) in Table 6.5.3.1.3-1 from the edge of the channel bandwidth.
- NOTE 16: Void
- NOTE 17: Void
- NOTE 18: Void
- NOTE 19: Applicable when the assigned NR carrier is confined within 718 MHz and 748 MHz and when the channel bandwidth used is 5 or 10 MHz.
- NOTE 20: Void
- NOTE 21: This requirement is applicable for any channel bandwidths within the range 2500 - 2570 MHz with the following restriction: for carriers of 15 MHz bandwidth when carrier centre frequency is within the range 2560.5 - 2562.5 MHz and for carriers of 20 MHz bandwidth when carrier centre frequency is within the range 2552 - 2560 MHz the requirement is applicable only for an uplink transmission bandwidth less than or equal to 54 RB.
- NOTE 22: This requirement is applicable for power class 3 UE for any channel bandwidths within the range 2570 - 2615 MHz with the following restriction: for carriers of 15 MHz bandwidth when carrier centre frequency is within the range 2605.5 - 2607.5 MHz and for carriers of 20 MHz bandwidth when carrier centre frequency is within the range 2597 - 2605 MHz the requirement is applicable only for an uplink transmission bandwidth less than or equal to 54 RB. For power class 2 UE for any channel bandwidths within the range 2570 - 2615 MHz, NS_44 shall apply. For power class 2 or 3 UE for carriers with channel bandwidth overlapping the frequency range 2615 - 2620 MHz the requirement applies with the maximum output power configured to +19 dBm in the IE P-Max.
- NOTE 23: Void.
- NOTE 24: As exceptions, measurements with a level up to the applicable requirement of -38 dBm/MHz is permitted for each assigned NR carrier used in the measurement due to 2nd harmonic spurious emissions. An exception is allowed if there is at least one individual RB within the transmission bandwidth (see Figure 5.3.1-1) for which the 2nd harmonic totally or partially overlaps the measurement bandwidth (MBW).
- NOTE 25: As exceptions, measurements with a level up to the applicable requirement of -36 dBm/MHz is permitted for each assigned NR carrier used in the measurement due to 3rd harmonic spurious emissions. An exception is allowed if there is at least one individual RB within the transmission bandwidth (see Figure 5.3.1-1) for which the 3rd harmonic totally or partially overlaps the measurement bandwidth (MBW).
- NOTE 26: For these adjacent bands, the emission limit could imply risk of harmful interference to UE(s) operating in the protected operating band.
- NOTE 27: This requirement is applicable for any channel bandwidths within the range 1920 - 1980 MHz with the following restriction: for carriers of 15 MHz bandwidth when carrier centre frequency is within the range 1927.5 - 1929.5 MHz and for carriers of 20 MHz bandwidth when carrier centre

<p>frequency is within the range 1930 - 1938 MHz the requirement is applicable only for an uplink transmission bandwidth less than or equal to 54 RB.</p> <p>NOTE 28: Void</p> <p>NOTE 29: Void</p> <p>NOTE 30: Void</p> <p>NOTE 31: Void</p> <p>NOTE 32: Void</p> <p>NOTE 33: This requirement is only applicable for carriers with bandwidth up to 20MHz and confined within 1885-1920 MHz (requirement for carriers with at least 1RB confined within 1880 - 1885 MHz is not specified). This requirement applies for an uplink transmission bandwidth less than or equal to 54 RB for carriers of 15 MHz bandwidth when carrier centre frequency is within the range 1892.5 - 1894.5 MHz and for carriers of 20 MHz bandwidth when carrier centre frequency is within the range 1895 - 1903 MHz.</p> <p>NOTE 34: This requirement is applicable for 5 and 10 MHz NR channel bandwidth allocated within 718-728MHz. For carriers of 10 MHz bandwidth, this requirement applies for an uplink transmission bandwidth less than or equal to 30 RB with $RB_{start} > 1$ and $RB_{start} < 48$.</p> <p>NOTE 35: This requirement is applicable in the case of a 10 MHz NR carrier confined within 703 MHz and 733 MHz, otherwise the requirement of -25 dBm with a measurement bandwidth of 8 MHz applies.</p> <p>NOTE 36: Void</p> <p>NOTE 37: Void</p> <p>NOTE 38: Void</p> <p>NOTE 39: Void.</p> <p>NOTE 40: Void</p> <p>NOTE 41: Applicable for cases when the lower edge of the assigned NR UL channel bandwidth frequency is greater than or equal to 1427 MHz + the channel BW assigned for 5 and 10 MHz bandwidth, and when the lower edge of the assigned NR UL channel bandwidth frequency is greater than or equal to 1440 MHz for 15 and 20 MHz bandwidth. This requirement shall be verified with UE transmission power of 15 dBm.</p> <p>NOTE 42: Applicable when upper edge of the assigned NR UL channel bandwidth frequency is more than 1460MHz and more than 1460MHz and less than or equal to 1470MHz for 5 MHz bandwidth, and when the upper edge of the assigned NR UL channel bandwidth frequency is less than or equal to 1465 MHz for 10 MHz bandwidth.</p> <p>NOTE 43: Void</p> <p>NOTE 44: Void</p> <p>NOTE 45: Applicable when upper edge of the assigned NR UL channel bandwidth frequency is equal to or less than 1460MHz.</p> <p>NOTE 46: Applicable for 5MHz bandwidth and when the NR carrier is within 1447.9 – 1462.9 MHz.</p>

NOTE: To simplify Table 6.5.3.2.3-1, E-UTRA band numbers are listed for bands which are specified only for E-UTRA operation or both E-UTRA and NR operation. NR band numbers are listed for bands which are specified only for NR operation.

Table 6.5.3.2.3-2 Requirements for spurious emissions for UE co-existence Rel-16 specifies the requirements for NR bands for coexistence with protected bands.

Table 6.5.3.2.3-2: Requirements for spurious emissions for UE co-existence Rel-16

NR Band	Spurious emission for UE co-existence						
	Protected band	Frequency range (MHz)			Maximum Level (dBm)	MBW (MHz)	NOTE
n1, n84	E-UTRA Band 1, 5, 7, 8, 11, 18, 19, 20, 21, 22, 26, 27, 28, 31, 32, 38, 40, 41, 42, 43, 44, 45, 50, 51, 52, 65, 67, 68, 69, 72, 73, 74, 75, 76 NR Band n78, n79	F _{DL_low}	--	F _{DL_high}	-50	1	
	NR Band n77	F _{DL_low}	-	F _{DL_high}	-50	1	2
	E-UTRA Band 3, 34	F _{DL_low}	-	F _{DL_high}	-50	1	15
	Frequency range	1880	-	1895	-40	1	15, 27
	Frequency range	1895	-	1915	-15.5	5	15, 26, 27
	Frequency range	1915	-	1920	+1.6	5	15, 26, 27
n2	E-UTRA Band 4, 5, 12, 13, 14, 17, 24, 26, 27, 28, 29, 30, 41, 42, 48, 50, 51, 53, 66, 70, 71, 74, 85	F _{DL_low}	-	F _{DL_high}	-50	1	
	E-UTRA Band 2, 25	F _{DL_low}	-	F _{DL_high}	-50	1	15
	E-UTRA Band 43 NR Band n77	F _{DL_low}	-	F _{DL_high}	-50	1	2
n3, n80	E-UTRA Band 1, 5, 7, 8, 20, 26, 27, 28, 31, 32, 33, 34, 38, 39, 40, 41, 43, 44, 45, 50, 51, 65, 67, 68, 69, 72, 73, 74, 75, 76 NR Band n79	F _{DL_low}	-	F _{DL_high}	-50	1	
	E-UTRA Band 3	F _{DL_low}	-	F _{DL_high}	-50	1	15
	E-UTRA Band 11, 18, 19, 21	F _{DL_low}	-	F _{DL_high}	-50	1	13
	E-UTRA Band 22, 42, 52 NR Band n77, n78	F _{DL_low}	-	F _{DL_high}	-50	1	2
	Frequency range	1884.5	-	1915.7	-41	0.3	13
n5, n89	E-UTRA Band 1, 2, 3, 4, 5, 7, 8, 12, 13, 14, 17, 18, 19, 24, 25, 26, 28, 29, 30, 31, 34, 38, 40, 42, 43, 45, 48, 50, 51, 65, 66, 70, 71, 73, 74, 85	F _{DL_low}	-	F _{DL_high}	-50	1	
	E-UTRA Band 41, 52, 53 NR Band n77, n78	F _{DL_low}	-	F _{DL_high}	-50	1	2
	E-UTRA Band 11, 21	F _{DL_low}	-	F _{DL_high}	-50	1	39
	Frequency range	1884.5	-	1915.7	-41	0.3	8, 39
n7	E-UTRA Band 1, 2, 3, 4, 5, 7, 8, 12, 13, 14, 17, 20, 22, 26, 27, 28, 29, 30, 31, 32, 33, 34, 40, 42, 43, 50, 51, 52, 65, 66, 67, 68, 72, 74, 75, 76, 85, NR Band n77, n78	F _{DL_low}	-	F _{DL_high}	-50	1	
	Frequency range	2570	-	2575	+1.6	5	15, 21, 26
	Frequency range	2575	-	2595	-15.5	5	15, 21, 26
	Frequency range	2595	-	2620	-40	1	15, 21
n8, n81	E-UTRA Band 1, 20, 28, 31, 32, 33, 34, 38, 39, 40, 45, 50, 51, 65, 67, 68, 69, 72, 73, 74, 75, 76	F _{DL_low}	-	F _{DL_high}	-50	1	
	E-UTRA band 3, 7, 22, 41, 42, 43, 52, NR Band n77, n78, n79	F _{DL_low}	-	F _{DL_high}	-50	1	2

	E-UTRA 8	F _{DL_low}	-	F _{DL_high}	-50	1	15
	E-UTRA Band 11, 21	F _{DL_low}	-	F _{DL_high}	-50	1	
	Frequency range	1884.5	-	1915.7	-41	0.3	8
n12	E-UTRA Band 2, 5, 13, 14, 17, 24, 25, 26, 27, 30, 41, 50, 53, 70, 71, 74	F _{DL_low}	-	F _{DL_high}	-50	1	
	E-UTRA Band 4, 48, 51, 66 NR Band n77	F _{DL_low}	-	F _{DL_high}	-50	1	2
	E-UTRA Band 12, 85	F _{DL_low}	-	F _{DL_high}	-50	1	15
n14	E-UTRA Band 2, 4, 5, 12, 13, 14, 17, 23, 24, 25, 26, 27, 29, 30, 41, 48, 53, 66, 70, 71, 85	F _{DL_low}	-	F _{DL_high}	-50	1	
	NR Band n77	F _{DL_low}	-	F _{DL_high}	-50	1	2
	Frequency range	769	-	775	-35	0.0062 5	12, 15
	Frequency range	799	-	805	-35	0.0062 5	11, 12, 15
n18	E-UTRA Band 1, 3, 11, 21, 34, 40, 42, 65 NR Band n79	F _{DL_low}	-	F _{DL_high}	-50	1	
	NR Band n77, n78	F _{DL_low}	-	F _{DL_high}	-50	1	2
	Frequency range	758	-	799	-50	1	
	Frequency range	799	-	803	-40	1	
	Frequency range	860	-	890	-40	1	
	Frequency range	945	-	960	-50	1	
	Frequency range	1884.5	-	1915.7	-41	0.3	8
	Frequency range	2545	-	2575	-50	1	
	Frequency range	2595	-	2645	-50	1	
n20, n82	E-UTRA Band 1, 3, 7, 8, 22, 31, 32, 33, 34, 40, 43, 50, 51, 65, 67, 68, 72, 74, 75, 76	F _{DL_low}	-	F _{DL_high}	-50	1	
	E-UTRA Band 20	F _{DL_low}	-	F _{DL_high}	-50	1	15
	E-UTRA Band 38, 42, 69 NR Band n77, n78	F _{DL_low}	-	F _{DL_high}	-50	1	2
	Frequency range	758	-	788	-50	1	
n25	E-UTRA Band 4, 5, 12, 13, 14, 17, 24, 26, 27, 28, 29, 30, 41, 42, 48, 53, 66, 70, 71, 85	F _{DL_low}	-	F _{DL_high}	-50	1	
	E-UTRA Band 2	F _{DL_low}	-	F _{DL_high}	-50	1	15
	E-UTRA Band 25	F _{DL_low}	-	F _{DL_high}	-50	1	15
	E-UTRA Band 43, NR Band n77	F _{DL_low}	-	F _{DL_high}	-50	1	2
n26	E-UTRA Band 1, 2, 3, 4, 5, 11, 12, 13, 14, 17, 18, 19, 21, 24, 25, 26, 29, 30, 31, 34, 39, 40, 42, 43, 48, 50, 51, 65, 66, 70, 71, 73, 74, 85	F _{DL_low}	-	F _{DL_high}	-50	1	
	E-UTRA Band 41, 53 NR Band n77, n78, n79	F _{DL_low}	-	F _{DL_high}	-50	1	2
	Frequency range	703	-	799	-50	1	
	Frequency range	799	-	803	-40	1	15
	Frequency range	945	-	960	-50	1	
	Frequency range	1884.5	-	1915.7	-41	0.3	8
n28, n83	E-UTRA Band 1, 4, 22, 32, 42, 43, 50, 51, 65, 66, 74, 75, 76 NR Band n77, n78	F _{DL_low}	-	F _{DL_high}	-50	1	2
	E-UTRA Band 1	F _{DL_low}	-	F _{DL_high}	-50	1	19, 25

	E-UTRA Band 2, 3, 5, 7, 8, 18, 19, 20, 25, 26, 27, 31, 34, 38, 39, 40, 41, 52, 72, 73 NR Band n79	FDL_low	-	FDL_high	-50	1	
	E-UTRA Band 11, 21	FDL_low	-	FDL_high	-50	1	19, 24
	Frequency range	470	-	694	-42	8	15, 35
	Frequency range	470	-	710	-26.2	6	34
	Frequency range	662	-	694	-26.2	6	15
	Frequency range	758	-	773	-32	1	15
	Frequency range	773	-	803	-50	1	
	Frequency range	1884.5	-	1915.7	-41	0.3	8, 19
n30	E-UTRA Band 2, 4, 5, 7, 12, 13, 14, 17, 24, 25, 26, 27, 29, 30, 38, 41, 48, 53, 66, 70, 71, 85, NR Band n77	FDL_low	-	FDL_high	-50	1	
n34	E-UTRA Band 1, 3, 7, 8, 11, 18, 19, 20, 21, 22, 26, 28, 31, 32, 33, 38, 39, 40, 41, 42, 43, 44, 45, 50, 51, 52, 65, 67, 69, 72, 74, 75, 76 NR Band n78, n79	FDL_low	-	FDL_high	-50	1	5
	NR Band n77	FDL_low	-	FDL_high	-50	1	2
	Frequency range	1884.5	-	1915.7	-41	0.3	8
n38	E-UTRA Band 1, 2, 3, 4, 5, 8, 12, 13, 14, 17, 20, 22, 27, 28, 29, 30, 31, 32, 33, 34, 40, 42, 43, 50, 51, 52, 65, 66, 67, 68, 72, 74, 75, 76, 85, NR Band n77, n78	FDL_low	-	FDL_high	-50	1	
	Frequency range	2620	-	2645	-15.5	5	15, 22, 26
	Frequency range	2645	-	2690	-40	1	15, 22
n39	E-UTRA Band 1, 8, 22, 26, 28, 34, 40, 41, 42, 44, 45, 50, 51, 52, 74 NR Band n79	FDL_low	-	FDL_high	-50		
	NR Band n77, n78	FDL_low	-	FDL_high	-50	1	2
	Frequency range	1805	-	1855	-40	1	33
	Frequency range	1855	-	1880	-15.5	5	15, 26, 33
n40	E-UTRA Band 1, 3, 5, 7, 8, 11, 18, 19, 20, 21, 22, 26, 27, 28, 31, 32, 33, 34, 38, 39, 41, 42, 43, 44, 45, 50, 51, 52, 65, 67, 68, 69, 72, 74, 75, 76 NR Band n77, n78	FDL_low	-	FDL_high	-50	1	
	NR Band n79	FDL_low	-	FDL_high	-50	1	2
	Frequency range	1884.5		1915.7	-41	0.3	8
n41	E-UTRA Band 1, 2, 3, 4, 5, 8, 12, 13, 14, 17, 24, 25, 26, 27, 28, 29, 30, 34, 39, 42, 44, 45, 48, 50, 51, 52, 65, 66, 70, 71, 73, 74, 85, NR Band n77, n78	FDL_low	-	FDL_high	-50	1	
	NR Band n79	FDL_low	-	FDL_high	-50	1	2
	E-UTRA Band 9, 11, 18, 19, 21	FDL_low	-	FDL_high	-50	1	30
	Frequency range	1884.5		1915.7	-41	0.3	8, 30
n47	E-UTRA Band 1, 3, 5, 7, 8, 22, 26, 28, 34, 39, 40, 41, 42, 44, 45, 65, 68, 72, 73 NR Band n71, n77, n78, n79	FDL_low	-	FDL_high	-50	1	
		FDL_low	-	FDL_high	-50	1	

n48	E-UTRA Band 2, 4, 5, 12, 13, 14, 17, 24, 25, 26, 29, 30, 41, 50, 51, 66, 70, 71, 74, 85	FDL_low	-	FDL_high	-50	1	
n50	E-UTRA Band 1, 2, 3, 4, 5, 7, 8, 12, 13, 17, 20, 26, 28, 29, 31, 34, 38, 39, 40, 41, 42, 43, 48, 65, 66, 67, 68	FDL_low	-	FDL_high	-50	1	
n51	E-UTRA Band 1, 2, 3, 4, 5, 7, 8, 12, 13, 17, 20, 26, 28, 29, 31, 34, 38, 39, 40, 41, 42, 43, 48, 52, 65, 66, 67, 68, 85	FDL_low	-	FDL_high	-50	1	
n53	E-UTRA Band 2, 4, 5, 12, 13, 14, 17, 24, 25, 26, 29, 30, 48, 66, 70, 71, 85, NR Band n77	FDL_low	-	FDL_high	-50	1	
n65	E-UTRA Band 1, 3, 5, 7, 8, 11, 18, 19, 20, 21, 22, 26, 27, 28, 31, 32, 38, 40, 41, 42, 43, 50, 51, 65, 68, 69, 72, 74, 75, 76, NR Band n78, n79	FDL_low	-	FDL_high	-50	1	
	NR Band n77	FDL_low	-	FDL_high	-50	1	2
	E-UTRA Band 34	FDL_low	-	FDL_high	-50	1	43
	Frequency range	1900	-	1915	-15.5	5	15, 26, 27
	Frequency range	1915	-	1920	+1.6	5	15, 26, 27
n66, n86	E-UTRA Band 2, 4, 5, 7, 12, 13, 14, 17, 25, 26, 27, 28, 29, 30, 38, 41, 43, 50, 51, 53, 66, 70, 71, 74, 85	FDL_low	-	FDL_high	-50	1	
	E-UTRA Band 42, 48 NR Band n47, n77	FDL_low	-	FDL_high	-50	1	2
n70	E-UTRA Band 2, 4, 5, 12, 13, 14, 17, 24, 25, 26, 29, 30, 41, 48, 66, 70, 71, 85	FDL_low	-	FDL_high	-50	1	2
	NR Band n77	FDL_low	-	FDL_high	-50	1	2
n71	E-UTRA Band 4, 5, 12, 13, 14, 17, 24, 26, 30, 48, 53, 66, 85	FDL_low	-	FDL_high	-50	1	
	E-UTRA Band 2, 25, 41, 70 NR Band n77	FDL_low	-	FDL_high	-50	1	2
	E-UTRA Band 29	FDL_low	-	FDL_high	-38	1	15
	E-UTRA Band 71	FDL_low	-	FDL_high	-50	1	15
n74	E-UTRA Band 1, 2, 3, 4, 5, 7, 8, 12, 13, 17, 18, 19, 20, 26, 28, 29, 31, 34, 38, 39, 40, 41, 42, 43, 48, 52, 65, 66, 67, 68, 85 NR Band n77, n78	FDL_low	-	FDL_high	-50	1	
	NR Band n79	FDL_low	-	FDL_high	-50	1	2
	Frequency range	1884.5	-	1915.7	-41	0.3	8
	Frequency range	1400	-	1427	-32	27	15, 41
	Frequency range	1475	-	1488	-28	1	15, 42
	Frequency range	1475	-	1488	-50	1	15, 45
	Frequency range	1475.9	-	1510.9	-35	1	15, 46
	Frequency range	1488	-	1518	-50	1	15
n77	E-UTRA Band 1, 2, 3, 4, 5, 7, 8, 11, 12, 13, 14, 17, 18, 19, 20, 21, 24, 25, 26, 27, 28, 29, 30, 34, 39, 40, 41, 53, 65, 66, 70, 71, 74, 85	FDL_low	-	FDL_high	-50	1	
	Frequency range	1884.5	-	1915.7	-41	0.3	8

n78	E-UTRA Band 1, 3, 5, 7, 8, 11, 18, 19, 20, 21, 26, 28, 34, 39, 40, 41, 65, 75, 76	F _{DL_low}	-	F _{DL_high}	-50	1	
	Frequency range	1884.5	-	1915.7	-41	0.3	8
n79	E-UTRA Band 1, 3, 5, 8, 11, 18, 19, 21, 28, 34, 39, 40, 41, 42, 65, 74	F _{DL_low}	-	F _{DL_high}	-50	1	
	Frequency range	1884.5	-	1915.7	-41	0.3	8
n95	E-UTRA Band 1, 3, 5, 8, 28, 39, 40, 41	F _{DL_low}	-	F _{DL_high}	-50	1	5
	NR Band n78, n79						
	NR Band n77	F _{DL_low}	-	F _{DL_high}	-50	1	2
	Frequency range	1884.5	-	1915.7	-41	0.3	8

- NOTE 1: F_{DL_low} and F_{DL_high} refer to each frequency band specified in Table 5.2-1 for NR band, Table 5.2-1 in TS 36.521-1 [21] for E-UTRA band.
- NOTE 2: As exceptions, measurements with a level up to the applicable requirements defined in Table 6.5.3.1.3-2 are permitted for each assigned NR carrier used in the measurement due to 2nd, 3rd, 4th or 5th harmonic spurious emissions. Due to spreading of the harmonic emission the exception is also allowed for the first 1 MHz frequency range immediately outside the harmonic emission on both sides of the harmonic emission. This results in an overall exception interval centred at the harmonic emission of $(2\text{MHz} + N \times L_{CRB} \times R_{BSize} \text{ kHz})$, where N is 2, 3, 4, 5 for the 2nd, 3rd, 4th or 5th harmonic respectively. The exception is allowed if the measurement bandwidth (MBW) totally or partially overlaps the overall exception interval.
- NOTE 3: 15 kHz SCS is assumed when RB is mentioned in the note when channel bandwidth is less than or equal to 50MHz, lowest SCS is assumed when channel bandwidth is larger than 50MHz. The transmission bandwidth in terms of RB position and range is not limited to 15 kHz SCS and shall scale with SCS accordingly.
- NOTE 4: Void
- NOTE 5: For non-synchronised TDD operation to meet these requirements some restriction will be needed for either the operating band or protected band.
- NOTE 6: N/A
- NOTE 7: Void.
- NOTE 8: Applicable when co-existence with PHS system operating in 1884.5 -1915.7MHz.
- NOTE 9: Void
- NOTE 10: Void
- NOTE 11: Void
- NOTE 12: The emissions measurement shall be sufficiently power averaged to ensure a standard deviation < 0.5 dB
- NOTE 13: Void.
- NOTE 14: Void
- NOTE 15: These requirements also apply for the frequency ranges that are less than F_{OOB} (MHz) in Table 6.5.3.1.3-1 from the edge of the channel bandwidth.
- NOTE 16: Void
- NOTE 17: Void
- NOTE 18: Void
- NOTE 19: Applicable when the assigned NR carrier is confined within 718 MHz and 748 MHz and when the channel bandwidth used is 5 or 10 MHz.
- NOTE 20: Void
- NOTE 21: This requirement is applicable for any channel bandwidths within the range 2500 - 2570 MHz with the following restriction: for carriers of 15 MHz bandwidth when carrier centre frequency is within the range 2560.5 - 2562.5 MHz and for carriers of 20 MHz bandwidth when carrier centre frequency is within the range 2552 - 2560 MHz the requirement is applicable only for an uplink transmission bandwidth less than or equal to 54 RB.
- NOTE 22: This requirement is applicable for power class 3 UE for any channel bandwidths up to 20 MHz. For channel bandwidth within the range 2570 - 2615 MHz with the following restriction: for carriers of 15 MHz bandwidth when carrier centre frequency is within the range 2605.5 - 2607.5 MHz and for carriers of 20 MHz bandwidth when carrier centre frequency is within the range 2597 - 2605 MHz the requirement is applicable only for an uplink transmission bandwidth less than or equal to 54 RB. For carriers overlapping the frequency range 2615 - 2620 MHz the requirement applies with the maximum output power configured to +19 dBm in the IE P-Max.
- NOTE 23: Void.
- NOTE 24: As exceptions, measurements with a level up to the applicable requirement of -38 dBm/MHz is permitted for each assigned NR carrier used in the measurement due to 2nd harmonic spurious emissions. An exception is allowed if there is at least one individual RB within the transmission bandwidth (see Figure 5.3.1-1) for which the 2nd harmonic totally or partially overlaps the measurement bandwidth (MBW).
- NOTE 25: As exceptions, measurements with a level up to the applicable requirement of -36 dBm/MHz is permitted for each assigned NR carrier used in the measurement due to 3rd harmonic spurious emissions. An exception is allowed if there is at least one individual RB within the transmission bandwidth (see Figure 5.3.1-1) for which the 3rd harmonic totally or partially overlaps the measurement bandwidth (MBW).
- NOTE 26: For these adjacent bands, the emission limit could imply risk of harmful interference to UE(s) operating in the protected operating band.
- NOTE 27: This requirement is applicable for channel bandwidths up to 20MHz within the range 1920 - 1980 MHz with the following restriction: for carriers of 15 MHz bandwidth when the carrier centre frequency is within the range 1927.5 - 1929.5 MHz and for carriers of 20 MHz bandwidth when the

<p>carrier centre frequency is within the range 1930 - 1938 MHz the requirement is applicable only for an uplink transmission bandwidth less than or equal to 54 RB.</p> <p>NOTE 28: Void</p> <p>NOTE 29: Void</p> <p>NOTE 30: Void</p> <p>NOTE 31: Void</p> <p>NOTE 32: Void</p> <p>NOTE 33: This requirement is only applicable for carriers with bandwidth up to 20MHz and confined within 1885-1920 MHz (requirement for carriers with at least 1RB confined within 1880 - 1885 MHz is not specified). This requirement applies for an uplink transmission bandwidth less than or equal to 54 RB for carriers of 15 MHz bandwidth when carrier centre frequency is within the range 1892.5 - 1894.5 MHz and for carriers of 20 MHz bandwidth when carrier centre frequency is within the range 1895 - 1903 MHz.</p> <p>NOTE 34: This requirement is applicable for 5 and 10 MHz NR channel bandwidth allocated within 718-728 MHz. For carriers of 10 MHz bandwidth, this requirement applies for an uplink transmission bandwidth less than or equal to 30 RB with $RB_{start} > 1$ and $RB_{start} < 48$.</p> <p>NOTE 35: This requirement is applicable in the case of a 10 MHz NR carrier confined within 703 MHz and 733 MHz, otherwise the requirement of -25 dBm with a measurement bandwidth of 8 MHz applies.</p> <p>NOTE 36: Void</p> <p>NOTE 37: Void</p> <p>NOTE 38: Void</p> <p>NOTE 39: Void.</p> <p>NOTE 40: Void</p> <p>NOTE 41: Applicable for cases when the lower edge of the assigned NR UL channel bandwidth frequency is greater than or equal to 1427 MHz + the channel BW assigned for 5 and 10 MHz bandwidth, and when the lower edge of the assigned NR UL channel bandwidth frequency is greater than or equal to 1440 MHz for 15 and 20 MHz bandwidth. This requirement shall be verified with UE transmission power of 15 dBm.</p> <p>NOTE 42: Applicable when upper edge of the assigned NR UL channel bandwidth frequency is more than 1460MHz and more than 1460MHz and less than or equal to 1470MHz for 5 MHz bandwidth, and when the upper edge of the assigned NR UL channel bandwidth frequency is less than or equal to 1465 MHz for 10 MHz bandwidth.</p> <p>NOTE 43: This requirement is applicable for NR channel bandwidth allocated within 1920-1980 MHz.</p> <p>NOTE 44: As exceptions, for 90 and 100 MHz channel bandwidth, -40 dBm/MHz is applicable in the frequency range of 2496 – 2505 MHz</p> <p>NOTE 45: Applicable when upper edge of the assigned NR UL channel bandwidth frequency is equal to or less than 1460MHz.</p> <p>NOTE 46: Applicable for 5MHz bandwidth and when the NR carrier is within 1447.9 – 1462.9 MHz.</p>

Table 6.5.3.2.3-3: Requirements for spurious emissions for UE co-existence Rel-17

NR Band	Spurious emission for UE co-existence						
	Protected band	Frequency range (MHz)			Maximum Level (dBm)	MBW (MHz)	NOTE
n1, n84	E-UTRA Band 1, 5, 7, 8, 11, 18, 19, 20, 21, 22, 26, 27, 28, 31, 32, 38, 40, 41, 42, 43, 44, 45, 50, 51, 52, 65, 67, 68, 69, 72, 73, 74, 75, 76, NR Band n78, n79	F _{DL_low}	-	F _{DL_high}	-50	1	
	NR Band n77	F _{DL_low}	-	F _{DL_high}	-50	1	2
	E-UTRA Band 3, 34	F _{DL_low}	-	F _{DL_high}	-50	1	15
	Frequency range	1880	-	1895	-40	1	15, 27
	Frequency range	1895	-	1915	-15.5	5	15, 26, 27
	Frequency range	1915	-	1920	+1.6	5	15, 26, 27
n2	E-UTRA Band 4, 5, 12, 13, 14, 17, 24, 26, 27, 28, 29, 30, 41, 42, 48, 50, 51, 53, 66, 70, 71, 74, 85	F _{DL_low}	-	F _{DL_high}	-50	1	
	E-UTRA Band 2, 25	F _{DL_low}	-	F _{DL_high}	-50	1	15
	E-UTRA Band 43, NR Band n77	F _{DL_low}	-	F _{DL_high}	-50	1	2
n3, n80	E-UTRA Band 1, 5, 7, 8, 20, 26, 27, 28, 31, 32, 33, 34, 38, 39, 40, 41, 43, 44, 45, 50, 51, 65, 67, 68, 69, 72, 73, 74, 75, 76. NR Band n79	F _{DL_low}	-	F _{DL_high}	-50	1	
	E-UTRA Band 3	F _{DL_low}	-	F _{DL_high}	-50	1	15
	E-UTRA Band 11, 18, 19, 21	F _{DL_low}	-	F _{DL_high}	-50	1	
	E-UTRA Band 22, 42, 52, NR Band n77, n78	F _{DL_low}	-	F _{DL_high}	-50	1	2
	Frequency range	1884.5	-	1915.7	-41	0.3	8
n5, n89	E-UTRA Band 1, 2, 3, 4, 5, 7, 8, 12, 13, 14, 17, 18, 19, 24, 25, 26, 28, 29, 30, 31, 34, 38, 40, 42, 43, 45, 48, 50, 51, 65, 66, 70, 71, 73, 74, 85 NR Band n79	F _{DL_low}	-	F _{DL_high}	-50	1	
	E-UTRA Band 41, 52, 53 NR Band n77, n78	F _{DL_low}	-	F _{DL_high}	-50	1	2
	E-UTRA Band 11, 21	F _{DL_low}	-	F _{DL_high}	-50	1	
	Frequency range	1884.5	-	1915.7	-41	0.3	8
n7	E-UTRA Band 1, 2, 3, 4, 5, 7, 8, 12, 13, 14, 17, 20, 22, 26, 27, 28, 29, 30, 31, 32, 33, 34, 40, 42, 43, 50, 51, 52, 65, 66, 67, 68, 72, 74, 75, 76, 85, NR Band n77, n78	F _{DL_low}	-	F _{DL_high}	-50	1	
	Frequency range	2570	-	2575	+1.6	5	15, 21, 26
	Frequency range	2575	-	2595	-15.5	5	15, 21, 26
	Frequency range	2595	-	2620	-40	1	15, 21
n8, n81	E-UTRA Band 1, 20, 28, 31, 32, 33, 34, 38, 39, 40, 45, 50, 51, 65, 67, 68, 69, 72, 73, 74, 75, 76	F _{DL_low}	-	F _{DL_high}	-50	1	
	E-UTRA band 3, 7, 22, 41, 42, 43, 52, NR Band n77, n78, n79	F _{DL_low}	-	F _{DL_high}	-50	1	2

NR Band	Spurious emission for UE co-existence						
	Protected band	Frequency range (MHz)			Maximum Level (dBm)	MBW (MHz)	NOTE
	E-UTRA 8	F _{DL_low}	-	F _{DL_high}	-50	1	15
	E-UTRA Band 11, 21	F _{DL_low}	-	F _{DL_high}	-50	1	
	Frequency range	1884.5	-	1915.7	-41	0.3	8
n12	E-UTRA Band 2, 5, 13, 14, 17, 24, 25, 26, 27, 30, 41, 50, 53, 70, 71, 74	F _{DL_low}	-	F _{DL_high}	-50	1	
	E-UTRA Band 4, 48, 51, 66 NR Band n77	F _{DL_low}	-	F _{DL_high}	-50	1	2
	E-UTRA Band 12, 85	F _{DL_low}	-	F _{DL_high}	-50	1	15
n13	E-UTRA Band 2, 4, 5, 12, 13, 17, 25, 26, 27, 29, 41, 48, 50, 51, 53, 66, 70, 71, 74, 85	F _{DL_low}	-	F _{DL_high}	-50	1	
	E-UTRA Band 14	F _{DL_low}	-	F _{DL_high}	-50	1	15
	E-UTRA Band 24, 30 NR Band n77	F _{DL_low}	-	F _{DL_high}	-50	1	2
	Frequency range	769	-	775	-35	0.0062 5	15
	Frequency range	799	-	805	-35	0.0062 5	11, 15
n14	E-UTRA Band 2, 4, 5, 12, 13, 14, 17, 23, 24, 25, 26, 27, 29, 30, 41, 48, 53, 66, 70, 71, 85	F _{DL_low}	-	F _{DL_high}	-50	1	
	NR Band n77	F _{DL_low}	-	F _{DL_high}	-50	1	2
	Frequency range	769	-	775	-35	0.0062 5	12, 15
	Frequency range	799	-	805	-35	0.0062 5	11, 12, 15
n18	E-UTRA Band 1, 3, 11, 21, 34, 40, 42, 65 NR Band n79	F _{DL_low}	-	F _{DL_high}	-50	1	
	NR Band n77, n78	F _{DL_low}	-	F _{DL_high}	-50	1	2
	Frequency range	758	-	799	-50	1	
	Frequency range	799	-	803	-40	1	
	Frequency range	860	-	890	-40	1	
	Frequency range	945	-	960	-50	1	
	Frequency range	1884.5	-	1915.7	-41	0.3	8
	Frequency range	2545	-	2575	-50	1	
n20, n82	E-UTRA Band 1, 3, 7, 8, 22, 31, 32, 33, 34, 40, 43, 50, 51, 65, 67, 68, 72, 74, 75, 76	F _{DL_low}	-	F _{DL_high}	-50	1	
	E-UTRA Band 20	F _{DL_low}	-	F _{DL_high}	-50	1	15
	E-UTRA Band 38, 42, 52, 69, NR Band n77, n78	F _{DL_low}	-	F _{DL_high}	-50	1	2
	Frequency range	758	-	788	-50	1	
n24, n99	E-UTRA Band 2, 4, 5, 10, 12, 13, 14, 17, 24, 25, 26, 29, 30, 41, 48, 66, 70, 71, 85	F _{DL_low}	-	F _{DL_high}	-50	1	
	NR Band n77	F _{DL_low}	-	F _{DL_high}	-50	1	2
n25	E-UTRA Band 4, 5, 12, 13, 14, 17, 24, 26, 27, 28, 29, 30, 41, 42, 48, 53, 66, 70, 71, 85	F _{DL_low}	-	F _{DL_high}	-50	1	
	E-UTRA Band 2	F _{DL_low}	-	F _{DL_high}	-50	1	15
	E-UTRA Band 25	F _{DL_low}	-	F _{DL_high}	-50	1	15
	E-UTRA Band 43, NR Band n77	F _{DL_low}	-	F _{DL_high}	-50	1	2

NR Band	Spurious emission for UE co-existence						
	Protected band	Frequency range (MHz)			Maximum Level (dBm)	MBW (MHz)	NOTE
n26	E-UTRA Band 1, 2, 3, 4, 5, 11, 12, 13, 14, 17, 18,19, 21, 24, 25, 26, 29, 30, 31, 34, 39, 40, 42, 43, 48, 50, 51, 65, 66, 70, 71, 73,74, 85	F _{DL_low}	-	F _{DL_high}	-50	1	
	E-UTRA Band 41, 53 NR Band n77, n78, n79	F _{DL_low}	-	F _{DL_high}	-50	1	2
	Frequency range	703	-	799	-50	1	
	Frequency range	799	-	803	-40	1	15
	Frequency range	945	-	960	-50	1	
	Frequency range	1884.5	-	1915.7	-41	0.3	8
n28, n83	E-UTRA Band 1, 4, 22, 32, 42, 43, 50, 51, 65, 66, 74, 75, 76, NR Band n77, n78	F _{DL_low}	-	F _{DL_high}	-50	1	2
	E-UTRA Band 1	F _{DL_low}	-	F _{DL_high}	-50	1	19, 25
	E-UTRA Band 2, 3, 5, 7, 8, 18, 19, 20, 25, 26, 27, 31, 34, 38, 39, 40, 41, 52, 72, 73 NR Band n79	F _{DL_low}	-	F _{DL_high}	-50	1	
	E-UTRA Band 11, 21	F _{DL_low}	-	F _{DL_high}	-50	1	19, 24
	Frequency range	470	-	694	-42	8	15, 35
	Frequency range	470	-	710	-26.2	6	34
	Frequency range	662	-	694	-26.2	6	15
	Frequency range	758	-	773	-32	1	15
	Frequency range	773	-	803	-50	1	
	Frequency range	1884.5	-	1915.7	-41	0.3	8, 19
n30	E-UTRA Band 2, 4, 5, 7, 12, 13, 14, 17, 24, 25, 26, 27, 29, 30, 38, 41, 48, 53, 66, 70, 71, 85, NR Band n77	F _{DL_low}	-	F _{DL_high}	-50	1	
n34	E-UTRA Band 1, 3, 7, 8, 11, 18, 19, 20, 21, 22, 26, 28, 31, 32, 33, 38,39, 40, 41, 42, 43, 44, 45, 50, 51, 52, 65, 67, 69, 72, 74, 75, 76, NR Band n78, n79	F _{DL_low}	-	F _{DL_high}	-50	1	5
	NR Band n77	F _{DL_low}	-	F _{DL_high}	-50	1	2
	Frequency range	1884.5	-	1915.7	-41	0.3	8
n38	E-UTRA Band 1, 2, 3, 4, 5, 8, 12, 13, 14, 17, 20, 22, 27, 28, 29, 30, 31, 32, 33, 34, 40, 42, 43, 50, 51, 52, 65, 66, 67, 68, 72, 74, 75, 76, 85	F _{DL_low}	-	F _{DL_high}	-50	1	
	NR Band n77, n78, n79	F _{DL_low}	-	F _{DL_high}	-50	1	
	Frequency range	2620	-	2645	-15.5	5	15, 22, 26
	Frequency range	2645	-	2690	-40	1	15, 22
n39, n98	E-UTRA Band 1, 8, 22, 26, 28, 34, 40, 41, 42, 44, 45, 50, 51, 52, 74, NR Band n79	F _{DL_low}	-	F _{DL_high}	-50	1	
	NR Band n77, n78	F _{DL_low}	-	F _{DL_high}	-50	1	2
	Frequency range	1805	-	1855	-40	1	33
	Frequency range	1855	-	1880	-15.5	5	15, 26, 33

NR Band	Spurious emission for UE co-existence						
	Protected band	Frequency range (MHz)			Maximum Level (dBm)	MBW (MHz)	NOTE
n40, n97	E-UTRA Band 1, 3, 5, 7, 8, 11, 18, 19, 20, 21, 22, 26, 27, 28, 31, 32, 33, 34, 38, 39, 41, 42, 43, 44, 45, 50, 51, 52, 65, 67, 68, 69, 72, 74, 75, 76, NR Band n77, n78	F _{DL_low}	-	F _{DL_high}	-50	1	44
	NR Band n79	F _{DL_low}	-	F _{DL_high}	-50	1	2
	Frequency range	1884.5	-	1915.7	-41	0.3	8
n41	E-UTRA Band 1, 2, 3, 4, 5, 8, 12, 13, 14, 17, 24, 25, 26, 27, 28, 29, 30, 34, 39, 42, 44, 45, 48, 50, 51, 52, 65, 66, 70, 71, 73, 74, 85, NR Band n77, n78	F _{DL_low}	-	F _{DL_high}	-50	1	
	E-UTRA Band 40	F _{DL_low}	-	F _{DL_high}	-40	1	
	NR Band n79	F _{DL_low}	-	F _{DL_high}	-50	1	2
	E-UTRA Band 11, 18, 19, 21	F _{DL_low}	-	F _{DL_high}	-50	1	
	Frequency range	1884.5	-	1915.7	-41	0.3	8
n47	E-UTRA Band 1, 3, 5, 7, 8, 22, 26, 28, 34, 39, 40, 41, 42, 44, 45, 65, 68, 72, 73	F _{DL_low}	-	F _{DL_high}	-50	1	
	NR Band n71, n77, n78, n79	F _{DL_low}	-	F _{DL_high}	-50	1	
n48	E-UTRA Band 2, 4, 5, 12, 13, 14, 17, 24, 25, 26, 29, 30, 41, 50, 51, 66, 70, 71, 74, 85	F _{DL_low}	-	F _{DL_high}	-50	1	
n50	E-UTRA Band 1, 2, 3, 4, 5, 7, 8, 12, 13, 17, 20, 26, 28, 29, 31, 34, 38, 39, 40, 41, 42, 43, 48, 65, 66, 67, 68	F _{DL_low}	-	F _{DL_high}	-50	1	
n51	E-UTRA Band 1, 2, 3, 4, 5, 7, 8, 12, 13, 17, 20, 26, 28, 29, 31, 34, 38, 39, 40, 41, 42, 43, 48, 52, 65, 66, 67, 68, 85	F _{DL_low}	-	F _{DL_high}	-50	1	
n53	E-UTRA Band 2, 4, 5, 12, 13, 14, 17, 24, 25, 26, 29, 30, 48, 66, 70, 71, 85, NR Band n77	F _{DL_low}	-	F _{DL_high}	-50	1	
n65	E-UTRA Band 1, 3, 5, 7, 8, 11, 18, 19, 20, 21, 22, 26, 27, 28, 31, 32, 38, 40, 41, 42, 43, 50, 51, 65, 68, 69, 72, 74, 75, 76, NR Band n78, n79	F _{DL_low}	-	F _{DL_high}	-50	1	
	NR Band n77	F _{DL_low}	-	F _{DL_high}	-50	1	2
	E-UTRA Band 34	F _{DL_low}	-	F _{DL_high}	-50	1	43
	Frequency range	1900	-	1915	-15.5	5	15, 26, 27
	Frequency range	1915	-	1920	+1.6	5	15, 26, 27
n66, n86	E-UTRA Band 2, 4, 5, 7, 12, 13, 14, 17, 25, 26, 27, 28, 29, 30, 38, 41, 43, 50, 51, 53, 66, 70, 71, 74, 85	F _{DL_low}	-	F _{DL_high}	-50	1	
	E-UTRA Band 42, 48, NR Band n77	F _{DL_low}	-	F _{DL_high}	-50	1	2

NR Band	Spurious emission for UE co-existence						
	Protected band	Frequency range (MHz)			Maximum Level (dBm)	MBW (MHz)	NOTE
n70	E-UTRA Band 2, 4, 5, 12, 13, 14, 17, 24, 25, 26, 29, 30, 41, 48, 66, 70, 71, 85	F _{DL_low}	-	F _{DL_high}	-50	1	
	NR Band n47, n77	F _{DL_low}	-	F _{DL_high}	-50	1	2
n71	E-UTRA Band 4, 5, 12, 13, 14, 17, 24, 26, 30, 48, 53, 66, 85	F _{DL_low}	-	F _{DL_high}	-50	1	
	E-UTRA Band 2, 25, 41, 70, NR Band n77	F _{DL_low}	-	F _{DL_high}	-50	1	2
	E-UTRA Band 29	F _{DL_low}	-	F _{DL_high}	-38	1	15
	E-UTRA Band 71	F _{DL_low}	-	F _{DL_high}	-50	1	15
n74	E-UTRA Band 1, 2, 3, 4, 5, 7, 8, 12, 13, 17, 18, 19, 20, 26, 28, 29, 31, 34, 38, 39, 40, 41, 42, 43, 48, 52, 65, 66, 67, 68, 85 NR Band n77, n78, 103	F _{DL_low}	-	F _{DL_high}	-50	1	
	NR Band n79	F _{DL_low}	-	F _{DL_high}	-50	1	2
	Frequency range	1884.5	-	1915.7	-41	0.3	8
	Frequency range	1400	-	1427	-32	27	15, 41
	Frequency range	1475	-	1488	-28	1	15, 42
	Frequency range	1475	-	1488	-50	1	15, 45
	Frequency range	1475.9	-	1510.9	-35	1	15, 46
	Frequency range	1488	-	1518	-50	1	15
n77	E-UTRA Band 1, 2, 3, 4, 5, 7, 8, 11, 12, 13, 14, 17, 18, 19, 20, 21, 24, 25, 26, 27, 28, 29, 30, 34, 39, 40, 41, 53, 65, 66, 70, 71, 74, 85, 103	F _{DL_low}	-	F _{DL_high}	-50	1	
	Frequency range	1884.5	-	1915.7	-41	0.3	8
n78	E-UTRA Band 1, 3, 5, 7, 8, 11, 18, 19, 20, 21, 26, 28, 34, 39, 40, 41, 65, 75, 76	F _{DL_low}	-	F _{DL_high}	-50	1	
	Frequency range	1884.5	-	1915.7	-41	0.3	8
n79	E-UTRA Band 1, 3, 5, 8, 11, 18, 19, 21, 28, 34, 39, 40, 41, 42, 65, 74	F _{DL_low}	-	F _{DL_high}	-50	1	
	Frequency range	1884.5	-	1915.7	-41	0.3	8
n85	E-UTRA Band 2, 5, 13, 14, 17, 24, 25, 26, 27, 30, 41, 53, 70, 71, 74, 103	F _{DL_low}	-	F _{DL_high}	-50	1	
	E-UTRA Band 4, 48, 51, 66 NR Band n77, n78	F _{DL_low}	-	F _{DL_high}	-50	1	2
	E-UTRA Band 12, 85	F _{DL_low}	-	F _{DL_high}	-50	1	15
n95	E-UTRA Band 1, 3, 5, 8, 28, 39, 40, 41, NR Band n78, n79	F _{DL_low}	-	F _{DL_high}	-50	1	5
	NR Band n77	F _{DL_low}	-	F _{DL_high}	-50	1	2
	Frequency range	1884.5	-	1915.7	-41	0.3	8
n101	E-UTRA Band 1, 3, 8, 20, 22, 28, 31, 32, 33, 34, 38, 40, 43, 50, 51, 52, 65, 67, 68, 69, 72, 74, 75, 76	F _{DL_low}	-	F _{DL_high}	-50	1	
	E-UTRA Band 7, 41, 42	F _{DL_low}	-	F _{DL_high}	-50	1	2
	NR Band n77, n78						
	Frequency range	758	-	788	-50	1	

- NOTE 1: F_{DL_low} and F_{DL_high} refer to each frequency band specified in Table 5.2-1 in TS 38.101-1 [2] or Table 5.5-1 in TS 36.101
- NOTE 2: As exceptions, measurements with a level up to the applicable requirements defined in Table 6.5.3.1-2 are permitted for each assigned NR carrier used in the measurement due to 2nd, 3rd, 4th or 5th harmonic spurious emissions. Due to spreading of the harmonic emission the exception is also allowed for the first 1 MHz frequency range immediately outside the harmonic emission on both sides of the harmonic emission. This results in an overall exception interval centred at the harmonic emission of $(2 \text{ MHz} + N \times L_{CRB} \times RB_{size} \text{ kHz})$, where N is 2, 3, 4, 5 for the 2nd, 3rd, 4th or 5th harmonic respectively. The exception is allowed if the measurement bandwidth (MBW) totally or partially overlaps the overall exception interval.
- NOTE 3: 15 kHz SCS is assumed when RB is mentioned in the note when channel bandwidth is less than or equal to 50 MHz, lowest SCS is assumed when channel bandwidth is larger than 50 MHz. The transmission bandwidth in terms of RB position and range is not limited to 15 kHz SCS and shall scale with SCS accordingly.
- NOTE 4: Void
- NOTE 5: For non-synchronised TDD operation to meet these requirements some restriction will be needed for either the operating band or protected band
- NOTE 6: N/A
- NOTE 7: Void
- NOTE 8: Applicable when co-existence with PHS system operating in 1884.5 - 1915.7 MHz.
- NOTE 9: Void
- NOTE 10: Void
- NOTE 11: Void
- NOTE 12: The emissions measurement shall be sufficiently power averaged to ensure a standard deviation $< 0.5 \text{ dB}$
- NOTE 13: Void
- NOTE 14: Void
- NOTE 15: These requirements also apply for the frequency ranges that are less than F_{OOB} (MHz) in Table 6.5.3.1-1 from the edge of the channel bandwidth.
- NOTE 16: Void
- NOTE 17: Void
- NOTE 18: Void
- NOTE 19: Applicable when the assigned NR carrier is confined within 718 MHz and 748 MHz and when the channel bandwidth used is 5 or 10 MHz.
- NOTE 20: Void
- NOTE 21: This requirement is applicable for any channel bandwidths up to 20MHz within the range 2500 - 2570 MHz with the following restriction: for carriers of 15 MHz bandwidth when carrier centre frequency is within the range 2560.5 - 2562.5 MHz and for carriers of 20 MHz bandwidth when carrier centre frequency is within the range 2552 - 2560 MHz the requirement is applicable only for an uplink transmission bandwidth less than or equal to 54 RB.
- NOTE 22: This requirement is applicable for power class 3 UE for any channel bandwidths up to 20 MHz. For channel bandwidth within the range 2570 - 2615 MHz with the following restriction: for carriers of 15 MHz bandwidth when the carrier centre frequency is within the range 2605.5 - 2607.5 MHz and for carriers of 20 MHz bandwidth when the carrier centre frequency is within the range 2597 - 2605 MHz the requirement is applicable only for an uplink transmission bandwidth less than or equal to 54 RB. For carriers overlapping the frequency range 2615 - 2620 MHz the requirement applies with the maximum output power configured to +19 dBm in the IE P-Max.
- NOTE 23: Void
- NOTE 24: As exceptions, measurements with a level up to the applicable requirement of -38 dBm/MHz is permitted for each assigned NR carrier used in the measurement due to 2nd harmonic spurious emissions. An exception is allowed if there is at least one individual RB within the transmission bandwidth (see Figure 5.3.1-1) for which the 2nd harmonic totally or partially overlaps the measurement bandwidth (MBW).
- NOTE 25: As exceptions, measurements with a level up to the applicable requirement of -36 dBm/MHz is permitted for each assigned NR carrier used in the measurement due to 3rd harmonic spurious emissions. An exception is allowed if there is at least one individual RB within the transmission bandwidth (see Figure 5.3.1-1) for which the 3rd harmonic totally or partially overlaps the measurement bandwidth (MBW).
- NOTE 26: For these adjacent bands, the emission limit could imply risk of harmful interference to UE(s) operating in the protected operating band.
- NOTE 27: This requirement is applicable for channel bandwidths up to 20 MHz within the range 1920 - 1980 MHz with the following restriction: for carriers of 15 MHz bandwidth when the carrier centre frequency is within the range 1927.5 - 1929.5 MHz and for carriers of 20 MHz bandwidth when the

NR Band	Spurious emission for UE co-existence			
	Protected band	Frequency range (MHz)	Maximum Level (dBm)	MBW (MHz)
	carrier centre frequency is within the range 1930 - 1938 MHz the requirement is applicable only for an uplink transmission bandwidth less than or equal to 54 RB.			
	NOTE 28: Void			
	NOTE 29: Void			
	NOTE 30: Void			
	NOTE 31: Void			
	NOTE 32: Void			
	NOTE 33: This requirement is only applicable for carriers with bandwidth up to 20MHz and confined within 1885-1920 MHz (requirement for carriers with at least 1RB confined within 1880 - 1885 MHz is not specified). This requirement applies for an uplink transmission bandwidth less than or equal to 54 RB for carriers of 15 MHz bandwidth when carrier center frequency is within the range 1892.5 - 1894.5 MHz and for carriers of 20 MHz bandwidth when carrier center frequency is within the range 1895 - 1903 MHz.			
	NOTE 34: This requirement is applicable for 5 and 10 MHz NR channel bandwidth allocated within 718-728 MHz. For carriers of 10 MHz bandwidth, this requirement applies for an uplink transmission bandwidth less than or equal to 30 RB with $RB_{start} > 1$ and $RB_{start} < 48$.			
	NOTE 35: This requirement is applicable in the case of a 10 MHz NR carrier confined within 703 MHz and 733 MHz, otherwise the requirement of -25 dBm with a measurement bandwidth of 8 MHz applies.			
	NOTE 36: Void			
	NOTE 37: Void			
	NOTE 38: Void			
	NOTE 39: Void			
	NOTE 40: Void			
	NOTE 41: Applicable for cases and when the lower edge of the assigned NR UL channel bandwidth frequency is greater than or equal to 1427 MHz + the channel BW assigned for 5 and 10 MHz bandwidth, and when the lower edge of the assigned NR UL channel bandwidth frequency is greater than or equal to 1440 MHz for 15 and 20 MHz bandwidth. This requirement shall be verified with UE transmission power of 15 dBm.			
	NOTE 42: Applicable when upper edge of the assigned NR UL channel bandwidth frequency is more than 1460MHz and more than 1460MHz and less than or equal to 1470MHz for 5 MHz bandwidth, and when the upper edge of the assigned NR UL channel bandwidth frequency is less than or equal to 1465 MHz for 10 MHz bandwidth.			
	NOTE 43: This requirement is applicable for NR channel bandwidth allocated within 1920-1980 MHz.			
	NOTE 44: As exceptions, for 90 and 100 MHz channel bandwidth, -40 dBm/MHz is applicable in the frequency range of 2496 – 2505 MHz.			
	NOTE 45: Applicable when upper edge of the assigned NR UL channel bandwidth frequency is equal to or less than 1460MHz.			
	NOTE 46: Applicable for 5MHz bandwidth and when the NR carrier is within 1447.9 – 1462.9 MHz.			

NOTE: To simplify Table 6.5.3.2.3-2 and 6.5.3.2.3-3, E-UTRA band numbers are listed for bands which are specified only for E-UTRA operation or both E-UTRA and NR operation. NR band numbers are listed for bands which are specified only for NR operation.

The normative reference for this requirement is TS 38.101-1 [2] subclause 6.5.3.2. This test use minimum requirements from many releases of TS 38.101-1 [2] due to release independence defined in TS 38.307 [23].

6.5.3.2.4 Test description

6.5.3.2.4.1 Initial conditions

Initial conditions are a set of test configurations the UE needs to be tested in and the steps for the SS to take with the UE to reach the correct measurement state.

The initial test configurations consist of environmental conditions, test frequencies, test channel bandwidths and sub-carrier spacing based on NR operating bands specified in Table 5.3.5-1. All of these configurations shall be tested with applicable test parameters for each combination of channel bandwidth and sub-carrier spacing, are shown in Table

6.5.3.2.4.1-1. The details of the uplink reference measurement channels (RMCs) are specified in Annexes A.2. Configurations of PDSCH and PDCCH before measurement are specified in Annex C.2.

Table 6.5.3.2.4.1-1: Test Configuration Table

Initial Conditions			
Test Environment as specified in TS 38.508-1 [5] subclause 4.1.		Normal	
Test Frequencies as specified in TS 38.508-1 [5] subclause 4.3.1.		Low range, Mid range, High range (NOTE 2)	
Test Channel Bandwidths as specified in TS 38.508-1 [5] subclause 4.3.1.		Lowest, Mid, Highest	
Test SCS as specified in Table 5.3.5-1		Lowest	
Test Parameters			
Test ID	Downlink Configuration	Uplink Configuration	
		Modulation	RB allocation (NOTE 1)
1	N/A	CP-OFDM QPSK	Outer_Full
2		CP-OFDM QPSK	Edge_1RB_Left
3		CP-OFDM QPSK	Edge_1RB_Right
NOTE 1: The specific configuration of each RB allocation is defined in Table 6.1-1 Common UL configuration.			
NOTE 2: For NR band n28, 30MHz test channel bandwidth is tested with Low range and High range test frequencies.			

1. Connect the SS to the UE antenna connectors as shown in TS 38.508-1 [5] Annex A, Figure A.3.1.1.1 for TE diagram and section A.3.2 for UE diagram.
2. The parameter settings for the cell are set up according to TS 38.508-1 [5] subclause 4.4.3.
3. Downlink signals are initially set up according to Annex C.0, C.1, C.2, and uplink signals according to Annex G.0, G.1, G.2, G.3.0.
4. The UL Reference Measurement channels are set according to Table 6.5.3.2.4.1-1.
5. Propagation conditions are set according to Annex B.0.
6. Ensure the UE is in state RRC_CONNECTED with generic procedure parameters Connectivity *NR*, Connected without release *On*, Test Mode *On* and Test Loop Function *On* according to TS 38.508-1 [5] clause 4.5. Message contents are defined in clause 6.5.3.2.4.3.

6.5.3.2.4.2 Test procedure

1. SS sends uplink scheduling information for each UL HARQ process via PDCCH DCI format 0_1 for C_RNTI to schedule the UL RMC according to Table 6.5.3.2.4.1-1. Since the UE has no payload data to send, the UE transmits uplink MAC padding bits on the UL RMC.
2. Send continuously uplink power control "up" commands in the uplink scheduling information to the UE until the UE transmits at P_{UMAX} level.
3. Measure the power of the transmitted signal with a measurement filter of bandwidths according to Tables 6.5.3.2.3-1 to 6.5.3.2.3-3. The centre frequency of the filter shall be stepped in contiguous steps according to Tables 6.5.3.2.3-1 to 6.5.3.2.3-3. The measured power shall be verified for each step. The measurement period shall capture the active time slots.

6.5.3.2.4.3 Message contents

Message contents are according to TS 38.508-1 [5] subclause 4.6.

6.5.3.2.5 Test requirement

Test requirements for Spurious Emissions UE Co-existence are the same as the minimum requirements and are not repeated in this section.

Unless otherwise stated, the spurious emission limits apply for the frequency ranges that are more than F_{OOB} (MHz) in Tables 6.5.3.1.3-1 from the edge of the channel bandwidth. The spurious emission limits in Tables 6.5.3.2.3-1 to 6.5.3.2.3-3 apply for all transmitter band configurations (NRB) and channel bandwidths.

The measured average power of spurious emission, derived in step 3, shall not exceed the described value in Table 6.5.3.2.3-1 to 6.5.3.2.3-3 for difference releases.

The requirements for the UE are release specific and can be found in Tables 6.5.3.2.3-1 to 6.5.3.2.3-3. If the UE support a band, which is not defined in the table corresponding UE's release, the requirements for this band are taken from the table of earliest release where requirements for this band are defined. This has been described in following Table 6.5.3.2.5-1.

Table 6.5.3.2.5-1: UE Requirements according to UE NR release and supported E-UTRA and NR band

UE Requirements per release			
NR Band	Rel-15	Rel-16	R17
n1	Table 6.5.3.2.3-1	Table 6.5.3.2.3-2	Table 6.5.3.2.3-3
n2	Table 6.5.3.2.3-1	Table 6.5.3.2.3-2	Table 6.5.3.2.3-3
n3	Table 6.5.3.2.3-1	Table 6.5.3.2.3-2	Table 6.5.3.2.3-3
n5	Table 6.5.3.2.3-1	Table 6.5.3.2.3-2	Table 6.5.3.2.3-3
n7	Table 6.5.3.2.3-1	Table 6.5.3.2.3-2	Table 6.5.3.2.3-3
n8	Table 6.5.3.2.3-1	Table 6.5.3.2.3-2	Table 6.5.3.2.3-3
n12	Table 6.5.3.2.3-1	Table 6.5.3.2.3-2	Table 6.5.3.2.3-3
n14	Table 6.5.3.2.3-2	Table 6.5.3.2.3-2	Table 6.5.3.2.3-3
n18	Table 6.5.3.2.3-2	Table 6.5.3.2.3-2	Table 6.5.3.2.3-3
n20	Table 6.5.3.2.3-1	Table 6.5.3.2.3-2	Table 6.5.3.2.3-3
n24	Table 6.5.3.2.3-3	Table 6.5.3.2.3-3	Table 6.5.3.2.3-3
n25	Table 6.5.3.2.3-1	Table 6.5.3.2.3-2	Table 6.5.3.2.3-3
n26	Table 6.5.3.2.3-2	Table 6.5.3.2.3-2	Table 6.5.3.2.3-3
n28	Table 6.5.3.2.3-1	Table 6.5.3.2.3-2	Table 6.5.3.2.3-3
n30	Table 6.5.3.2.3-2	Table 6.5.3.2.3-2	Table 6.5.3.2.3-3
n34	Table 6.5.3.2.3-1	Table 6.5.3.2.3-2	Table 6.5.3.2.3-3
n38	Table 6.5.3.2.3-1	Table 6.5.3.2.3-2	Table 6.5.3.2.3-3
n39	Table 6.5.3.2.3-1	Table 6.5.3.2.3-2	Table 6.5.3.2.3-3
n40	Table 6.5.3.2.3-1	Table 6.5.3.2.3-2	Table 6.5.3.2.3-3
n41	Table 6.5.3.2.3-1	Table 6.5.3.2.3-2	Table 6.5.3.2.3-3
n48	Table 6.5.3.2.3-2	Table 6.5.3.2.3-2	Table 6.5.3.2.3-3
n50	Table 6.5.3.2.3-1	Table 6.5.3.2.3-2	Table 6.5.3.2.3-3
n51	Table 6.5.3.2.3-1	Table 6.5.3.2.3-2	Table 6.5.3.2.3-3
n53	Table 6.5.3.2.3-2	Table 6.5.3.2.3-2	Table 6.5.3.2.3-3
n65	Table 6.5.3.2.3-2	Table 6.5.3.2.3-2	Table 6.5.3.2.3-3
n66	Table 6.5.3.2.3-1	Table 6.5.3.2.3-2	Table 6.5.3.2.3-3
n70	Table 6.5.3.2.3-1	Table 6.5.3.2.3-2	Table 6.5.3.2.3-3
n71	Table 6.5.3.2.3-1	Table 6.5.3.2.3-2	Table 6.5.3.2.3-3
n74	Table 6.5.3.2.3-1	Table 6.5.3.2.3-2	Table 6.5.3.2.3-3
n77, n78	Table 6.5.3.2.3-1	Table 6.5.3.2.3-2	Table 6.5.3.2.3-3
n79	Table 6.5.3.2.3-1	Table 6.5.3.2.3-2	Table 6.5.3.2.3-3
NOTE 1: The frequency range applicable with network signalling values of NS_04, NS_17, NS_18, NS_05, NS_43, NS_37, NS_38, NS_39, NS_40, NS_41, NS_42, NS_45 and NS_56 are covered in subclause 6.5.3.3 Additional Spurious Emissions			
NOTE 2: The restriction on the maximum uplink transmission to 54 RB in Notes 21 and 22 of Tables 6.5.3.2.3-1 to 6.5.3.2.3-3 is intended for conformance testing and may be applied to network operation to facilitate coexistence when the aggressor and victim bands are deployed in the same geographical area. The applicable spurious emission requirement of -15.5 dBm/5MHz is a least restrictive technical condition for FDD/TDD coexistence and may have to be revised in the future.			

6.5.3.3 Additional spurious emissions

Editor's note: This clause is incomplete. The following aspects are either missing or not yet determined

Initial conditions for NS_37, NS_38, NS_39, NS_40, NS_41, NS_42 and NS_45 are incomplete.

The requirements of this test case for NS_44, NS_46, NS_47, NS_48, and NS_49 apply to all types of NR UE release 16 forward, and release 15 if the corresponding channel bandwidths are supported.

6.5.3.3.1 Test purpose

To verify that UE transmitter does not cause unacceptable interference to other channels or other systems in terms of transmitter spurious emissions under the deployment scenarios where additional requirements are specified.

6.5.3.3.2 Test applicability

This test case applies to all types of NR UE release 15 and forward.

6.5.3.3.3 Minimum conformance requirements

These requirements are specified in terms of an additional spectrum emission requirement. Additional spurious emission requirements are signalled by the network to indicate that the UE shall meet an additional requirement for a specific deployment scenario as part of the cell handover/broadcast message.

6.5.3.3.3.1 Minimum conformance requirements (network signalling value "NS_04")

When "NS_04" is indicated in the cell, the power of any UE emission shall not exceed the levels specified in Table 6.5.3.3.3.1-1. This requirement also applies for the frequency ranges that are less than F_{OOB} (MHz) in Table 6.5.3.1.3-1 from the edge of the channel bandwidth.

Table 6.5.3.3.3.1-1: Additional requirements for "NS_04"

Frequency band (MHz)	Channel bandwidth (MHz) / Spectrum emission limit (dBm)	Measurement bandwidth
	10, 15, 20, 30, 40, 50, 60, 70, 80, 90, 100	
$2495 \leq f < 2496$	-13	1% of Channel BW
$2490.5 \leq f < 2495$	-13	1 MHz
$0.009 < f < 2490.5$	-25	1 MHz

The normative reference for this requirement is TS 38.101-1 [2] subclause 6.5.3.3.1.

6.5.3.3.3.2 Minimum conformance requirements (network signalling value "NS_17")

When "NS_17" is indicated in the cell, the power of any UE emission shall not exceed the levels specified in Table 6.5.3.3.3.2-1. This requirement also applies for the frequency ranges that are less than F_{OOB} (MHz) in Table 6.5.3.1.3-1 from the edge of the channel bandwidth.

Table 6.5.3.3.3.2-1: Additional requirements for "NS_17"

Frequency band (MHz)	Channel bandwidth (MHz) / Spectrum emission limit (dBm)	Measurement bandwidth	NOTE
	5, 10		
$470 \leq f \leq 710$	-26.2	6 MHz	1
NOTE 1: Applicable when the assigned NR carrier is confined within 718 MHz and 748 MHz and when the channel bandwidth is 5 or 10 MHz.			

The normative reference for this requirement is TS 38.101-1 [2] subclause 6.5.3.3.2.

6.5.3.3.3.3 Minimum conformance requirements (network signalling value "NS_18")

When "NS_18" is indicated in the cell, the power of any UE emission shall not exceed the levels specified in Table 6.5.3.3.3-1. This requirement also applies for the frequency ranges that are less than F_{OOB} (MHz) in Table 6.5.3.1.3-1 from the edge of the channel bandwidth.

Table 6.5.3.3.3-1: Additional requirements for "NS_18"

Frequency band (MHz)	Channel bandwidth (MHz)/ Spectrum emission limit (dBm)	Measurement bandwidth	
	5, 10, 15, 20, 30		
692-698	-26.2	6 MHz	

The normative reference for this requirement is TS 38.101-1 [2] subclause 6.5.3.3.3.

6.5.3.3.3.4 Minimum conformance requirements (network signalling value "NS_05")

When "NS_05" is indicated in the cell, the power of any UE emission shall not exceed the levels specified in Table 6.5.3.3.4-1. This requirement also applies for the frequency ranges that are less than F_{OOB} (MHz) in Table 6.5.3.1.3-1 from the edge of the channel bandwidth.

Table 6.5.3.3.4-1: Additional requirements for "NS_05"

Frequency band (MHz)	Channel bandwidth (MHz) / Spectrum emission limit (dBm)	Measurement bandwidth	NOTE
	5, 10, 15, 20		
$1884.5 \leq f \leq 1915.7$	-41	300 kHz	

The normative reference for this requirement is TS 38.101-1 [2] subclause 6.5.3.3.4.

6.5.3.3.3.5 Minimum conformance requirements (network signalling value "NS_43")

When "NS_43" is indicated in the cell, the power of any UE emission shall not exceed the levels specified in Table 6.5.3.3.5-1. This requirement also applies for the frequency ranges that are less than F_{OOB} (MHz) in Table 6.5.3.1.3-1 from the edge of the channel bandwidth.

Table 6.5.3.3.5-1: Additional requirement for "NS_43"

Frequency band (MHz)	Channel bandwidth (MHz) / Spectrum emission limit (dBm)	Measurement bandwidth
	5, 10, 15	
$860 \leq f \leq 890$	-40	1 MHz
NOTE 1: Applicable for 5 MHz and 15 MHz channel BW confined between 900 MHz and 915 MHz and for 10 MHz channel BW confined between 905 MHz and 915 MHz		

The normative reference for this requirement is TS 38.101-1 [2] subclause 6.5.3.3.5.

6.5.3.3.3.6 Minimum conformance requirements (network signalling value "NS_37")

When "NS_37" is indicated in the cell, the power of any UE emission shall not exceed the levels specified in Table 6.5.3.3.6-1. This requirement also applies for the frequency ranges that are less than F_{OOB} (MHz) in Table 6.5.3.1.3-1 from the edge of the channel bandwidth.

Table 6.5.3.3.6-1: Additional requirement for "NS_37"

Frequency band (MHz)	Channel bandwidth (MHz) / Spectrum emission limit (dBm)	Measurement bandwidth
$1475.9 \leq f \leq 1510.9$	-35	1 MHz

The normative reference for this requirement is TS 38.101-1 [2] subclause 6.5.3.3.6.

6.5.3.3.3.7 Minimum conformance requirements (network signalling value "NS_38")

When "NS 38" is indicated in the cell, the power of any UE emission shall not exceed the levels specified in Table 6.5.3.3.7-1. This requirement also applies for the frequency ranges that are less than F_{OOB} (MHz) in Table 6.5.3.1.3-1 from the edge of the channel bandwidth.

Table 6.5.3.3.7-1: Additional requirements for "NS_38"

Frequency band (MHz)	Channel bandwidth (MHz) / Spectrum emission limit (dBm)	Measurement bandwidth
$1400 \leq f \leq 1427$	-32	27 MHz
NOTE 1: This requirement shall be verified with UE transmission power of 15 dBm.		

The normative reference for this requirement is TS 38.101-1 [2] subclause 6.5.3.3.7.

6.5.3.3.3.8 Minimum conformance requirements (network signalling value "NS_39")

When "NS 39" is indicated in the cell, the power of any UE emission shall not exceed the levels specified in Table 6.5.3.3.8-1. This requirement also applies for the frequency ranges that are less than F_{OOB} (MHz) in Table 6.5.3.1.3-1 from the edge of the channel bandwidth.

Table 6.5.3.3.8-1: Additional requirements for "NS_39"

Frequency band (MHz)	Channel bandwidth (MHz) / Spectrum emission limit (dBm)	Measurement bandwidth
$1475 \leq f \leq 1488$	-28	1MHz

The normative reference for this requirement is TS 38.101-1 [2] subclause 6.5.3.3.8.

6.5.3.3.3.9 Requirement for network signalling value "NS_40"

When "NS_40" is indicated in the cell, the power of any UE emission shall not exceed the levels specified in Table 6.5.3.3.9-1. This requirement also applies for the frequency ranges that are less than F_{OOB} (MHz) in Table 6.5.3.1.3-1 from the edge of the channel bandwidth.

Table 6.5.3.3.9-1: Additional requirements for NR channels assigned within 1427-1452MHz for "NS_40"

Frequency band (MHz)	Channel bandwidth (MHz) / Spectrum emission limit (dBm)	Measurement bandwidth
$1400 \leq f \leq 1427$	-32	27 MHz
NOTE 1: This requirement shall be verified with UE transmission power of 15 dBm.		

The normative reference for this requirement is TS 38.101-1 [2] subclause 6.5.3.3.9.

6.5.3.3.3.10 Requirement for network signalling value "NS_41"

When "NS_41" is indicated in the cell, the power of any UE emission shall not exceed the levels specified in Table 6.5.3.3.3.10-1. This requirement also applies for the frequency ranges that are less than F_{OOB} (MHz) in Table 6.5.3.1.3-1 from the edge of the channel bandwidth.

Table 6.5.3.3.3.10-1: Additional requirements for NR channels assigned within 1432-1517 MHz for "NS_41"

Frequency band (MHz)	Channel bandwidth (MHz) / Spectrum emission limit (dBm)	Measurement bandwidth
	5, 10, 15, 20, 40, 50, 60	
$1400 \leq f \leq 1427$	-32	27 MHz
NOTE 1: This requirement shall be verified with UE transmission power of 15 dBm.		

The normative reference for this requirement is TS 38.101-1 [2] subclause 6.5.3.3.10.

6.5.3.3.3.11 Requirement for network signalling value "NS_42"

When "NS_42" is indicated in the cell, the power of any UE emission shall not exceed the levels specified in Table 6.5.3.3.3.11-1. This requirement also applies for the frequency ranges that are less than F_{OOB} (MHz) in Table 6.5.3.1.3-1 from the edge of the channel bandwidth.

Table 6.5.3.3.3.11-1: Additional requirements for NR channels assigned within 1432-1517MHz for "NS_42"

Frequency band (MHz)	Channel bandwidth (MHz) / Spectrum emission limit (dBm)	Measurement bandwidth
	5, 10, 15, 20, 40, 50, 60	
$1518 \leq f \leq 1520$	-0.8	1 MHz
$1520 < f \leq 1559$	-30	1 MHz

The normative reference for this requirement is TS 38.101-1 [2] subclause 6.5.3.3.11.

6.5.3.3.3.12 Requirement for network signalling value "NS_21"

When "NS_21" is indicated in the cell, the power of any UE emission shall not exceed the levels specified in Table 6.5.3.3.3.12-1. These requirements also apply for the frequency ranges that are less than F_{OOB} (MHz) in Table 6.5.3.1.3-1 from the edge of the channel bandwidth.

Table 6.5.3.3.3.12-1: Additional requirements for "NS_21"

Frequency band (MHz)	Channel bandwidth (MHz) / Spectrum emission limit (dBm)	Measurement bandwidth
	5, 10	
$2200 \leq f < 2288$	-40	1 MHz
$2288 \leq f < 2292$	-37	1 MHz
$2292 \leq f < 2296$	-31	1 MHz
$2296 \leq f < 2300$	-25	1 MHz
$2320 \leq f < 2324$	-25	1 MHz
$2324 \leq f < 2328$	-31	1 MHz
$2328 \leq f < 2332$	-37	1 MHz
$2332 \leq f \leq 2395$	-40	1 MHz

The normative reference for this requirement is TS 38.101-1 [2] subclause 6.5.3.3.12.

6.5.3.3.3.13 Requirement for network signalling value "NS_24"

When "NS 24" is indicated in the cell, the power of any UE emission shall not exceed the levels specified in Table 6.5.3.3.3.13-1. This requirement also applies for the frequency ranges that are less than F_{OOB} (MHz) in Table 6.5.3.1.3-1 from the edge of the channel bandwidth.

Table 6.5.3.3.3.13-1: Additional requirements

Frequency band (MHz)	Channel bandwidth (MHz) / Spectrum emission limit (dBm)	Measurement bandwidth
	5, 10, 15, 20	
$2010 \leq f \leq 2025$	-50	1 MHz
NOTE 1: This requirement applies at a frequency offset equal or larger than 5 MHz from the upper edge of the channel bandwidth, whenever these frequencies overlap with the specified frequency band.		

The normative reference for this requirement is TS 38.101-1 [2] subclause 6.5.3.3.13.

6.5.3.3.3.14 Requirement for network signalling value "NS_27"

When "NS 27" is indicated in the cell, the power of any UE emission shall not exceed the levels specified in Table 6.5.3.3.3.14-1. This requirement also applies for the frequency ranges that are less than F_{OOB} (MHz) in Table 6.5.3.1.3-1 from the edge of the channel bandwidth.

Table 6.5.3.3.3.14-1: Additional requirements for "NS_27"

Frequency range (MHz)	Channel bandwidth (MHz) / Spectrum emission limit (dBm)	Measurement bandwidth
	5, 10, 15, 20, 40	
9 kHz – 3530 MHz	-40	1 MHz
3530 MHz – 3540 MHz	-25	
3710 MHz – 3720 MHz	-25	
3720 MHz – 12.75 GHz	-40	

The normative reference for this requirement is TS 38.101-1 [2] subclause 6.5.3.3.14.

6.5.3.3.3.15 Requirement for network signalling value "NS_47"

When "NS_47" is indicated in the cell, the power of any UE emission shall not exceed the levels specified in Table 6.5.3.3.3.15-1. This requirement also applies for the frequency ranges that are less than F_{OOB} (MHz) in Table 6.5.3.1.3-1 from the edge of the channel bandwidth.

Table 6.5.3.3.3.15-1: Additional requirements for NR channels assigned within 2545 - 2575 MHz for "NS_47"

Frequency band (MHz)	Channel bandwidth (MHz) / Spectrum emission limit (dBm)	Measurement bandwidth
	30	
$2530 \leq f \leq 2535$	-25	1 MHz
$2505 \leq f \leq 2530$	-30	1 MHz

6.5.3.3.3.16 Requirement for network signalling value "NS_50"

When "NS_50" is indicated in the cell, the power of any UE emission shall not exceed the levels specified in Table 6.5.3.3.3.16-1. This requirement also applies for the frequency ranges that are less than F_{OOB} (MHz) in Table 6.5.3.1.3-1 from the edge of the channel bandwidth.

Table 6.5.3.3.16-1: Additional requirements for “NS_50”

Protected band	Frequency range (MHz)			Maximum Level (dBm)	MBW (MHz)	NOTE
Frequency range	1805	-	1855	-40	1	1
Frequency range	1855	-	1880	-15.5	5	1, 2, 3
NOTE 1: This requirement is applicable for carriers with aggregated channel bandwidths confined in 1885-1920 MHz for ≤ 30 MHz channel BWs and confined in 1880-1920 MHz for 40 MHz channel BW.						
NOTE 2: The requirement also applies for the frequency ranges that are less than F_{OOB} (MHz) in Table 6.5.3.1.3-1 from the edge of the channel bandwidth.						
NOTE 3: For these adjacent bands, the emission limit could imply risk of harmful interference to UE(s) operating in the protected operating band.						

6.5.3.3.3.17 Requirement for network signalling value "NS_12"

When "NS_12" is indicated in the cell, the power of any UE emission shall not exceed the levels specified in Table 6.5.3.3.3.17-1. This requirement also applies for the frequency ranges that are less than F_{OOB} (MHz) in Table 6.5.3.1.3-1 from the edge of the channel bandwidth.

Table 6.5.3.3.3.17-1: Additional requirements for “NS_12”

Frequency band (MHz)	Channel bandwidth / Spectrum emission limit (dBm)	Measurement bandwidth
	5 MHz, 10 MHz	
$806 \leq f \leq 813.5$	-42	6.25 kHz
NOTE 1: The requirement applies for NR carriers with lower channel edge at or above 814 MHz.		
NOTE 2: The emissions measurement shall be sufficiently power averaged to ensure a standard deviation < 0.5 dB.		

6.5.3.3.3.18 Requirement for network signalling value "NS_13"

When "NS_13" is indicated in the cell, the power of any UE emission shall not exceed the levels specified in Table 6.5.3.3.3.18-1. This requirement also applies for the frequency ranges that are less than F_{OOB} (MHz) in Table 6.5.3.1.3-1 from the edge of the channel bandwidth.

Table 6.5.3.3.3.18-1: Additional requirements for “NS_13”

Frequency band (MHz)	Channel bandwidth / Spectrum emission limit (dBm)	Measurement bandwidth
	5 MHz	
$806 \leq f \leq 816$	-42	6.25 kHz
NOTE 1: The requirement applies for NR carriers with lower channel edge at or above 817 MHz.		
NOTE 2: The emissions measurement shall be sufficiently power averaged to ensure a standard deviation < 0.5 dB.		

6.5.3.3.3.19 Requirement for network signalling value "NS_14"

When "NS_14" is indicated in the cell, the power of any UE emission shall not exceed the levels specified in Table 6.5.3.3.3.19-1. This requirement also applies for the frequency ranges that are less than F_{OOB} (MHz) in Table 6.5.3.1.3-1 from the edge of the channel bandwidth.

Table 6.5.3.3.3.19-1: Additional requirements for “NS_14”

Frequency band (MHz)	Channel bandwidth / Spectrum emission limit (dBm)	Measurement bandwidth
	10 MHz, 15 MHz, 20 MHz	

$806 \leq f \leq 816$	-42	6.25 kHz
NOTE 1: The requirement applies for NR carriers with lower channel edge at or above 824 MHz.		
NOTE 2: The emissions measurement shall be sufficiently power averaged to ensure a standard deviation < 0.5 dB.		

6.5.3.3.3.20 Requirement for network signalling value "NS_15"

TBD

6.5.3.3.3.21 Requirement for network signalling value "NS_45"

When "NS_45" is indicated in the cell, the power of any UE emission shall not exceed the levels specified in Table 6.5.3.3.3.21-1. This requirement also applies for the frequency ranges that are less than F_{OOB} (MHz) in Table 6.5.3.1.3-1 from the edge of the channel bandwidth.

Table 6.5.3.3.3.21-1: Additional requirements

Frequency band (MHz)	Channel bandwidth / Spectrum emission limit (dBm)		Measurement bandwidth
	5 MHz	10 MHz	
$0.009 < f \leq 2473.5$	-25	-25	1 MHz
$2473.5 < f \leq 2477.5$	-25	-13	1 MHz
$2477.5 < f \leq 2478.5$	-13	-13	1 MHz
$2478.5 < f \leq 2483.5$	-10	-10	1 MHz
$2495 \leq f < 2496$	-13	-13	1% of Channel Bandwidth
$2496 \leq f < 2501$	-13	-13	1 MHz
$2501 < f \leq 2505$	-25	-13	1 MHz
$2505 \leq f \leq 5^{\text{th}}$ harmonic of the upper frequency edge of the UL operating band	-25	-25	1 MHz

6.5.3.3.3.22 Requirement for network signalling value "NS_48" and "NS_51"

When "NS_48" or "NS_51" is indicated in the cell, the power of any UE emission shall not exceed the levels specified in Table 6.5.3.3.3.22-1. This requirement also applies for the frequency ranges that are less than F_{OOB} (MHz) in Table 6.5.3.1.3-1 from the edge of the channel bandwidth.

Table 6.5.3.3.3.22-1: Additional requirements for "NS_48"

Protected band	Frequency range (MHz)			Maximum Level (dBm)	MBW (MHz)	NOTE
E-UTRA band 34 – NR band n34	F_{DL_low}	-	F_{DL_high}	-50	1	
Frequency range	1900	-	1915	-15.5	5	1
Frequency range	1915	-	1920	+1.6	5	1
NOTE 1: For these adjacent bands, the emission limit could imply risk of harmful interference to UE(s) operating in the protected operating band.						

6.5.3.3.3.23 Requirement for network signalling value "NS_49"

When "NS_49" is indicated in the cell, the power of any UE emission shall not exceed the levels specified in Table 6.5.3.3.3.23-1. This requirement also applies for the frequency ranges that are less than F_{OOB} (MHz) in Table 6.5.3.1.3-1 from the edge of the channel bandwidth.

Table 6.5.3.3.23-1: Additional requirements for “NS_49”

Protected band	Frequency range (MHz)			Maximum Level (dBm)	MBW (MHz)	NOTE
E-UTRA band 34 - NR band n34	F _{DL_low}	-	F _{DL_high}	-50	1	
Frequency range	1880	-	1895	-40	1	
Frequency range	1895	-	1915	-15.5	5	1
Frequency range	1915	-	1920	1.6	5	1
NOTE 1: For these adjacent bands, the emission limit could imply risk of harmful interference to UE(s) operating in the protected operating band.						

The normative reference for this requirement is TS 38.101-1 [2] subclause 6.5.3.3.23.

6.5.3.3.3.24 Requirement for network signalling value "NS_44"

When "NS_44" is indicated in the cell, the power of any UE emission shall not exceed the levels specified in Table 6.5.3.3.3.24-1. This requirement also applies for the frequency ranges that are less than F_{OOB} (MHz) in Table 6.5.3.1.3-1 from the edge of the channel bandwidth.

Table 6.5.3.3.3.24-1: Additional requirements for “NS_44”

Protected band	Frequency range (MHz)			Maximum Level (dBm)	MBW (MHz)	NOTE
Frequency range	2620	-	2645	-15.5	5	1, 2
Frequency range	2645	-	2690	-40	1	1
NOTE 1: This requirement is applicable for carriers confined in 2570-2615 MHz.						
NOTE 2: For these adjacent bands, the emission limit could imply risk of harmful interference to UE(s) operating in the protected operating band.						

6.5.3.3.3.25 Requirement for network signalling value "NS_46"

When "NS_46" is indicated in the cell, the power of any UE emission shall not exceed the levels specified in Table 6.5.3.3.25-1. This requirement also applies for the frequency ranges that are less than F_{OOB} (MHz) in Table 6.5.3.1-1 from the edge of the channel bandwidth.

Table 6.5.3.3.25-1: Additional requirements for “NS_46”

Protected band	Frequency range (MHz)			Maximum Level (dBm)	MBW (MHz)	NOTE
Frequency range	2570	-	2575	+1.6	5	1, 2
Frequency range	2575	-	2595	-15.5	5	1, 2
Frequency range	2595	-	2620	-40	1	1
NOTE 1: This requirement is applicable for all carriers confined in 2500-2570 MHz. Special restrictions apply for channel bandwidths up to 20MHz: For carriers of 15 MHz bandwidth when carrier centre frequency is within the range 2560.5 - 2562.5 MHz and for carriers of 20 MHz bandwidth when carrier centre frequency is within the range 2552 - 2560 MHz the requirement is applicable only for an uplink transmission bandwidth less than or equal to 54 RB with the minimum supported SCS of 15KHz.						
NOTE 2: For these adjacent bands, the emission limit could imply risk of harmful interference to UE(s) operating in the protected operating band.						

Table 6.5.3.3.25-1: TBD

6.5.3.3.3.26 Requirement for network signalling value "NS_07"

TBD

6.5.3.3.3.27 Requirement for network signalling value "NS_56"

When "NS_56" is indicated in the cell, the power of any UE emission shall not exceed the levels specified in Table 6.5.3.3.3.27-1. This requirement also applies for the frequency ranges that are less than F_{OOB} (MHz) in Table 6.5.3.1.3-1 from the edge of the channel bandwidth.

Table 6.5.3.3.27-1: Additional requirements

Frequency band (MHz)	Channel bandwidth / Spectrum emission limit ¹ (dBm)	Measurement bandwidth	NOTE
	5 MHz, 10MHz		
$1541 \leq f \leq 1559$	-102	2kHz	Averaged over any 2 millisecond active transmission interval
$1559 \leq f \leq 1608$	-85	700Hz	
$1608 \leq f \leq 1610$	$-85 + 5/2 (f-1608)$	700Hz	
$1610 \leq f \leq 1625$	$-80 + 66/15 (f-1610)$	700Hz	
$1541 \leq f \leq 1608$	-75	1MHz	Averaged over any 2 millisecond active transmission interval
$1608 \leq f \leq 1610$	$-75 + 5/2 (f-1608)$	1MHz	
$1610 \leq f \leq 1627.5$	$-70 + 57/17.5 (f-1610)$	1MHz	
1627.5	-37	4kHz	
$1638.5 \leq f \leq 1645.5$	-28	4kHz	
$1657.5 \leq f \leq 1660.5$	-28	4kHz	
NOTE 1: The EIRP requirement in regulation is converted to conducted requirement using a 0 dBi antenna.			

6.5.3.3.4 Test description

6.5.3.3.4.1 Initial conditions

Initial conditions are a set of test configurations the UE needs to be tested in and the steps for the SS to take with the UE to reach the correct measurement state.

The initial test configurations consist of environmental conditions, test frequencies, test channel bandwidths and sub-carrier spacing based on NR operating bands specified in Table 5.3.5-1. All these configurations shall be tested with applicable test parameters for each channel bandwidth and sub-carrier spacing, are shown in Tables 6.5.3.3.4.1-1 through Table 6.5.3.3.4.1-27 for different NS values. The details of the uplink reference measurement channels (RMCs) are specified in Annex A.2.2. Configurations of PDSCH and PDCCH before measurement are specified in Annex C.2.

Table 6.5.3.3.4.1-1: Test Configuration Table (network signalling value "NS_04")

Same test configuration as listed in Table 6.2.3.4.1-2 shall be used with the following exceptions:

Test Channel Bandwidths shall be: 10, 15, 20, 30, 40, 50, 60, 70, 80, 90, and 100 MHz.

Test SCS shall be: Lowest.

Table 6.5.3.3.4.1-2: Test Configuration Table (network signalling value "NS_17")

Initial Conditions			
Test Environment as specified in TS 38.508-1 [5] subclause 4.1		Normal	
Test Frequencies as specified in TS 38.508-1 [5] subclause 4.3.1		Mid range	
Test Channel Bandwidths as specified in TS 38.508-1 [5] subclause 4.3.1		5MHz, 10MHz	
Test SCS as specified in Table 5.3.5-1		Lowest	
Test Parameters			
Test ID	Downlink Configuration	Uplink Configuration	
		Modulation	RB allocation (NOTE 1)
1	N/A	CP-OFDM QPSK	OuterFull
2		CP-OFDM QPSK	Edge_1RB_Left
NOTE 1: The specific configuration of each RB allocation is defined in Table 6.1-1 Common UL configuration			

Table 6.5.3.3.4.1-3: Test Configuration Table (network signalling value "NS_18")

Same test configuration as listed in Table 6.2.3.4.1-11 shall be used with the following exceptions:

Test Channel Bandwidths shall be: 5, 10, 20 and 30 MHz.

Test SCS shall be: Lowest.

Table 6.5.3.3.4.1-4: Test Configuration Table (network signalling value "NS_05")

Same test configuration as listed in Table 6.2.3.4.1-4 shall be used with the following exceptions:

- Test SCS shall be: [Lowest].

Table 6.5.3.3.4.1-5: Test Configuration Table (network signalling value "NS_43")

Same test configuration as listed in Table 6.2.3.4.1-6 shall be used with the following exceptions:

- Test Channel Bandwidths shall be: [5, 10, and 15] MHz
- Test SCS shall be: [Lowest].

Table 6.5.3.3.4.1-6: Test Configuration Table (network signalling value "NS_37")

Same test configuration as listed in Table 6.2.3.4.1-8 shall be used with the following exceptions:

- Test SCS shall be: [Lowest].

Table 6.5.3.3.4.1-7: Test Configuration Table (network signalling value "NS_38")

Initial Conditions			
Test Environment as specified in TS 38.508-1 [5] subclause 4.1		Normal	
Test Frequencies as specified in TS 38.508-1 [5] subclause 4.3.1		[TBD]	
Test Channel Bandwidths as specified in TS 38.508-1 [5] subclause 4.3.1		[TBD]	
Test SCS as specified in Table 5.3.5-1		[TBD]	
Test Parameters			
Test ID	Downlink Configuration	Uplink Configuration	
		Modulation	RB allocation (NOTE 1)
1	N/A for Spurious Emissions testing	FFS	FFS
2		FFS	FFS
3		FFS	FFS
NOTE 1: The specific configuration of each RB allocation is defined in Table 6.1-1 Common UL configuration			

Table 6.5.3.3.4.1-8: Test Configuration Table (network signalling value "NS_39")

Initial Conditions			
Test Environment as specified in TS 38.508-1 [5] subclause 4.1		Normal	
Test Frequencies as specified in TS 38.508-1 [5] subclause 4.3.1		[TBD]	
Test Channel Bandwidths as specified in TS 38.508-1 [5] subclause 4.3.1		[TBD]	
Test SCS as specified in Table 5.3.5-1		[TBD]	
Test Parameters			
Test ID	Downlink Configuration	Uplink Configuration	
	N/A for Spurious Emissions testing	Modulation	RB allocation (NOTE 1)
1		FFS	FFS
2		FFS	FFS
3		FFS	FFS
NOTE 1: The specific configuration of each RB allocation is defined in Table 6.1-1 Common UL configuration			

Table 6.5.3.3.4.1-9: Test Configuration Table (network signalling value "NS_40")

TBD

Table 6.5.3.3.4.1-10: Test Configuration Table (network signalling value "NS_41")

TBD

Table 6.5.3.3.4.1-11: Test Configuration Table (network signalling value "NS_42")

TBD

Table 6.5.3.3.4.1-12: Test Configuration Table (network signalling value "NS_45")

Same test configuration as listed in Table 6.2.3.4.1-20 shall be used.

Table 6.5.3.3.4.1-13: Test Configuration Table (network signalling value "NS_24")

Same test configuration as listed in Table 6.2.3.4.1-12 shall be used.

Table 6.5.3.3.4.1-14: Test Configuration Table (network signalling value "NS_27")

Same test configuration as listed in Table 6.2.3.4.1-13 shall be used with the following exceptions:

- Test SCS shall be: Lowest.

Table 6.5.3.3.4.1-15: Test Configuration Table (network signalling value "NS_47")

Same test configuration as listed in Table 6.2.3.4.1-17, Table 6.2.3.4.1-17a and Table 6.2.3.4.1-18 shall be used with the following exceptions:

Test Channel Bandwidths shall be: 30 MHz.

Test SCS shall be: Lowest. **Table 6.5.3.3.4.1-16: Test Configuration Table (network signalling value "NS_50")**

TBD

Table 6.5.3.3.4.1-17: Test Configuration Table (network signalling value "NS_12")

Same test configuration as listed in Table 6.2.3.4.1-20 shall be used.

Table 6.5.3.3.4.1-18: Test Configuration Table (network signalling value "NS_13")

Same test configuration as listed in Table 6.2.3.4.1-21 shall be used.

Table 6.5.3.3.4.1-19: Test Configuration Table (network signalling value "NS_14")

Same test configuration as listed in Table 6.2.3.4.1- shall be used.

Table 6.5.3.3.4.1-20: Test Configuration Table (network signalling value "NS_15")

Same test configuration as listed in Table 6.2.3.4.1-23 shall be used.

Table 6.5.3.3.4.1-21: Test Configuration Table (network signalling value "NS_45")

TBD

Table 6.5.3.3.4.1-22: Test Configuration Table (network signalling value "NS_48")

Same test configuration as listed in Table 6.2.3.4.1-19 shall be used with the following exceptions:

- Test Channel Bandwidths shall be: 25, 30, 40, 45 and 50 MHz
- Test SCS shall be: Lowest.

Table 6.5.3.3.4.1-23: Test Configuration Table (network signalling value "NS_49")

Same test configuration as listed in Table 6.2.3.4.1-29 shall be used with the following exceptions:

- Test Channel Bandwidths shall be: 25, 30, 40, and 50 MHz
- Test SCS shall be: Lowest.

Table 6.5.3.3.4.1-24: Test Configuration Table (network signalling value "NS_44")

Same test configuration as listed in Table 6.2.3.4.1-26 shall be used with the following exceptions:

- Test SCS shall be: Lowest.

Table 6.5.3.3.4.1-25: Test Configuration Table (network signalling value "NS_21")

Same test configuration as listed in Table 6.2.3.4.1-27 shall be used with the following exceptions:

Test SCS shall be: Lowest.

Table 6.5.3.3.4.1-27: Test Configuration Table (network signalling value "NS_56")

Same test configuration as listed in Table 6.2.3.4.1-30 shall be used.

Table 6.5.3.3.4.1-28: Test Configuration Table (network signalling value "NS_46")

Same test configuration as listed in Table 6.2.3.4.1-25 shall be used with the following exceptions:

- Test SCS shall be: Lowest.
 - Test Channel Bandwidths shall be: 25 and 50 MHz
1. Connect the SS to the UE to the UE antenna connectors as shown in TS 38.508-1 [5] Annex A, Figure A.3.1.1.1 for TE diagram and section A.3.2 for UE diagram.
 2. The parameter settings for the cell are set up according to TS 38.508-1 [5] subclause 4.4.3.
 3. Downlink signals are initially set up according to Annex C.0, C.1, C.2, and uplink signals according to Annex G.0, G.1, G.2, G.3.0.
 4. The UL Reference Measurement channels are set according to Table 6.5.3.3.4.1-1 through Table 6.5.3.3.4.1-27.
 5. Propagation conditions are set according to Annex B.0.
 6. Ensure the UE is in state RRC_CONNECTED with generic procedure parameters Connectivity NR, Connected without release *On*, Test Mode *On* and Test Loop Function *On* according to TS 38.508-1 [5] clause 4.5. Message contents are defined in clause 6.5.3.3.4.3.

6.5.3.3.4.2 Test procedure

1. SS sends uplink scheduling information for each UL HARQ process via PDCCH DCI format 0_1 for C_RNTI to schedule the UL RMC according to Table 6.5.3.3.4.1-1 through Table 6.5.3.3.4.1-27. Since the UE has no payload data to send, the UE transmits uplink MAC padding bits on the UL RMC.
2. Send continuously uplink power control "up" commands in the uplink scheduling information to the UE until the UE transmits at P_{UMAX} level.
3. Measure the mean power of the UE in the channel bandwidth of the radio access mode according to the test configuration in Tables 6.5.3.3.4.1-1 through 6.5.3.3.4.1-27 as appropriate, which shall meet the requirements in clause 6.5.3.3.5 with allowed A-MPR values if specified in Tables 6.2.3.5-1 through 6.2.3.5-27 as appropriate per test condition specified in Tables 6.2.3.4.1-1 through 6.2.3.4.1-30 as appropriate. The measured power shall be verified for each step. The measurement period shall capture the active time slots.
4. Measure the power of the transmitted signal with a measurement filter of bandwidths according to clauses 6.5.3.3.3.1 to 6.5.3.3.3.27 as appropriate. The centre frequency of the filter shall be stepped in contiguous steps according to the same table.

6.5.3.3.4.3 Message contents

6.5.3.3.4.3.1 Message contents exceptions (network signalling value "NS_04")

Message contents are according to TS 38.508-1 [5] subclause 4.6, with the following exceptions:

1. Information element `additionalSpectrumEmission` is set to NS_04. This can be set in *SIB1* as part of the cell broadcast message. This exception indicates that the UE shall meet the additional spurious emission requirement for a specific deployment scenario.

Table 6.5.3.3.4.3.1-1: *AdditionalSpectrumEmission*: Additional spurious emissions test requirement for "NS_04"

Derivation Path: TS 38.508-1 [5] clause 4.6.3, Table 4.6.3-1			
Information Element	Value/remark	Comment	Condition
<code>additionalSpectrumEmission</code>	1 (NS_04)		

6.5.3.3.4.3.2 Message contents exceptions (network signalling value "NS_17")

Message contents are according to TS 38.508-1 [5] subclause 4.6, with the following exceptions:

1. Information element `additionalSpectrumEmission` is set to NS_17. This can be set in *SIB1* as part of the cell broadcast message. This exception indicates that the UE shall meet the additional spurious emission requirement for a specific deployment scenario.

Table 6.5.3.3.4.3.2-1: *AdditionalSpectrumEmission*: Additional spurious emissions test requirement for "NS_17"

Derivation Path: TS 38.508-1 [5] clause 4.6.3, Table 4.6.3-1			
Information Element	Value/remark	Comment	Condition
<code>additionalSpectrumEmission</code>	1 (NS_17)		

6.5.3.3.4.3.3 Message contents exceptions (network signalling value "NS_18")

Message contents are according to TS 38.508-1 [5] subclause 4.6, with the following exceptions:

1. Information element `additionalSpectrumEmission` is set to NS_18. This can be set in *SIB1* as part of the cell broadcast message. This exception indicates that the UE shall meet the additional spurious emission requirement for a specific deployment scenario.

Table 6.5.3.3.4.3.3-1: AdditionalSpectrumEmission: Additional spurious emissions test requirement for "NS_18"

Derivation Path: TS 38.508-1 [5] clause 4.6.3, Table 4.6.3-1			
Information Element	Value/remark	Comment	Condition
additionalSpectrumEmission	2 (NS_18)		

6.5.3.3.4.3.4 Message contents exceptions (network signalling value "NS_05")

Message contents are according to TS 38.508-1 [5] subclause 4.6, with the following exceptions:

1. Information element additionalSpectrumEmission is set to NS_05. This can be set in *SIB1* as part of the cell broadcast message. This exception indicates that the UE shall meet the additional spurious emission requirement for a specific deployment scenario.

Table 6.5.3.3.4.3.4-1: AdditionalSpectrumEmission: Additional spurious emissions test requirement for "NS_05"

Derivation Path: TS 38.508-1 [5] clause 4.6.3, Table 4.6.3-1			
Information Element	Value/remark	Comment	Condition
additionalSpectrumEmission	2 (NS_05)		

6.5.3.3.4.3.5 Message contents exceptions (network signalling value "NS_43")

Message contents are according to TS 38.508-1 [5] subclause 4.6, with the following exceptions:

1. Information element additionalSpectrumEmission is set to NS_43. This can be set in *SIB1* as part of the cell broadcast message. This exception indicates that the UE shall meet the additional spurious emission requirement for a specific deployment scenario.

Table 6.5.3.3.4.3.5-1: AdditionalSpectrumEmission: Additional spurious emissions test requirement for "NS_43"

Derivation Path: TS 38.508-1 [5] clause 4.6.3, Table 4.6.3-1			
Information Element	Value/remark	Comment	Condition
additionalSpectrumEmission	2 (NS_43)		

6.5.3.3.4.3.6 Message contents exceptions (network signalling value "NS_37")

Message contents are according to TS 38.508-1 [5] subclause 4.6, with the following exceptions:

1. Information element additionalSpectrumEmission is set to NS_37. This can be set in *SIB1* as part of the cell broadcast message. This exception indicates that the UE shall meet the additional spurious emission requirement for a specific deployment scenario.

Table 6.5.3.3.4.3.6-1: AdditionalSpectrumEmission: Additional spurious emissions test requirement for "NS_37"

Derivation Path: TS 38.508-1 [5] clause 4.6.3, Table 4.6.3-1			
Information Element	Value/remark	Comment	Condition
additionalSpectrumEmission	1 (NS_37)		

6.5.3.3.4.3.7 Message contents exceptions (network signalling value "NS_38")

Message contents are according to TS 38.508-1 [5] subclause 4.6, with the following exceptions:

1. Information element additionalSpectrumEmission is set to NS_38. This can be set in *SIB1* as part of the cell broadcast message. This exception indicates that the UE shall meet the additional spurious emission requirement for a specific deployment scenario.

Table 6.5.3.3.4.3.7-1: AdditionalSpectrumEmission: Additional spurious emissions test requirement for "NS_38"

Derivation Path: TS 38.508-1 [5] clause 4.6.3, Table 4.6.3-1			
Information Element	Value/remark	Comment	Condition
additionalSpectrumEmission	2 (NS_38)		

6.5.3.3.4.3.8 Message contents exceptions (network signalling value "NS_39")

Message contents are according to TS 38.508-1 [5] subclause 4.6, with the following exceptions:

1. Information element additionalSpectrumEmission is set to NS_39. This can be set in *SIB1* as part of the cell broadcast message. This exception indicates that the UE shall meet the additional spurious emission requirement for a specific deployment scenario.

Table 6.5.3.3.4.3.8-1: AdditionalSpectrumEmission: Additional spurious emissions test requirement for "NS_39"

Derivation Path: TS 38.508-1 [5] clause 4.6.3, Table 4.6.3-1			
Information Element	Value/remark	Comment	Condition
additionalSpectrumEmission	3 (NS_39)		

6.5.3.3.4.3.9 Message contents exceptions (network signalling value "NS_40")

Message contents are according to TS 38.508-1 [5] subclause 4.6, with the following exceptions:

1. Information element additionalSpectrumEmission is set to NS_40. This can be set in *SIB1* as part of the cell broadcast message. This exception indicates that the UE shall meet the additional spurious emission requirement for a specific deployment scenario.

Table 6.5.3.3.4.3.9-1: AdditionalSpectrumEmission: Additional spurious emissions test requirement for "NS_40"

Derivation Path: TS 38.508-1 [5] clause 4.6.3, Table 4.6.3-1			
Information Element	Value/remark	Comment	Condition
additionalSpectrumEmission	1 (NS_40)		

6.5.3.3.4.3.10 Message contents exceptions (network signalling value "NS_41")

Message contents are according to TS 38.508-1 [5] subclause 4.6, with the following exceptions:

1. Information element additionalSpectrumEmission is set to NS_41. This can be set in *SIB1* as part of the cell broadcast message. This exception indicates that the UE shall meet the additional spurious emission requirement for a specific deployment scenario.

Table 6.5.3.3.4.3.10-1: AdditionalSpectrumEmission: Additional spurious emissions test requirement for "NS_41"

Derivation Path: TS 38.508-1 [5] clause 4.6.3, Table 4.6.3-1			
Information Element	Value/remark	Comment	Condition
additionalSpectrumEmission	1 (NS_41)		

6.5.3.3.4.3.11 Message contents exceptions (network signalling value "NS_42")

Message contents are according to TS 38.508-1 [5] subclause 4.6, with the following exceptions:

1. Information element additionalSpectrumEmission is set to NS_42. This can be set in *SIB1* as part of the cell broadcast message. This exception indicates that the UE shall meet the additional spurious emission requirement for a specific deployment scenario.

Table 6.5.3.3.4.3.11-1: AdditionalSpectrumEmission: Additional spurious emissions test requirement for "NS_42"

Derivation Path: TS 38.508-1 [5] clause 4.6.3, Table 4.6.3-1			
Information Element	Value/remark	Comment	Condition
additionalSpectrumEmission	2 (NS_42)		

6.5.3.3.4.3.12 Message contents exceptions (network signalling value "NS_21")

Message contents are according to TS 38.508-1 [5] subclause 4.6, with the following exceptions:

1. Information element additionalSpectrumEmission is set to NS_21. This can be set in *SIB1* as part of the cell broadcast message. This exception indicates that the UE shall meet the additional spurious emission requirement for a specific deployment scenario.

Table 6.5.3.3.4.3.12-1: AdditionalSpectrumEmission: Additional spurious emissions test requirement for "NS_21"

Derivation Path: TS 38.508-1 [5] clause 4.6.3, Table 4.6.3-1			
Information Element	Value/remark	Comment	Condition
additionalSpectrumEmission	1 (NS_21)		

6.5.3.3.4.3.13 Message contents exceptions (network signalling value "NS_24")

Message contents are according to TS 38.508-1 [5] subclause 4.6, with the following exceptions:

1. Information element additionalSpectrumEmission is set to NS_24. This can be set in *SIB1* as part of the cell broadcast message. This exception indicates that the UE shall meet the additional spurious emission requirement for a specific deployment scenario.

Table 6.5.3.3.4.3.13-1: AdditionalSpectrumEmission: Additional spurious emissions test requirement for "NS_24"

Derivation Path: TS 38.508-1 [5] clause 4.6.3, Table 4.6.3-1			
Information Element	Value/remark	Comment	Condition
additionalSpectrumEmission	1 (NS_24)		

6.5.3.3.4.3.14 Message contents exceptions (network signalling value "NS_27")

Message contents are according to TS 38.508-1 [5] subclause 4.6, with the following exceptions:

1. Information element additionalSpectrumEmission is set to NS_27. This can be set in *SIB1* as part of the cell broadcast message. This exception indicates that the UE shall meet the additional spurious emission requirement for a specific deployment scenario.

Table 6.5.3.3.4.3.14-1: AdditionalSpectrumEmission: Additional spurious emissions test requirement for "NS_27"

Derivation Path: TS 38.508-1 [5] clause 4.6.3, Table 4.6.3-1			
Information Element	Value/remark	Comment	Condition
additionalSpectrumEmission	1 (NS_27)		

6.5.3.3.4.3.15 Message contents exceptions (network signalling value "NS_47")

1. Information element additionalSpectrumEmission is set to NS_47. This can be set in the *SIB1* as part of the cell broadcast message. This exception indicates that the UE shall meet the additional spurious emission requirement for a specific deployment scenario.

Table 6.5.3.3.4.3.15-1: AdditionalSpectrumEmission: Additional spurious emissions test requirement for "NS_47"

Derivation Path: TS 38.508-1 [5], Table 4.6.3-1			
Information Element	Value/remark	Comment	Condition
additionalSpectrumEmission	2 (NS_47)		

6.5.3.3.4.3.16 Message contents exceptions (network signalling value "NS_50")

Message contents are according to TS 38.508-1 [5] subclause 4.6, with the following exceptions:

1. Information element additionalSpectrumEmission is set to NS_50. This can be set in *SIB1* as part of the cell broadcast message. This exception indicates that the UE shall meet the additional spurious emission requirement for a specific deployment scenario.

Table 6.5.3.3.4.3.16-1: AdditionalSpectrumEmission: Additional spurious emissions test requirement for "NS_50"

Derivation Path: TS 38.508-1 [5] clause 4.6.3, Table 4.6.3-1			
Information Element	Value/remark	Comment	Condition
additionalSpectrumEmission	1 (NS_50)		

6.5.3.3.4.3.17 Message contents exceptions (network signalling value "NS_12")

Message contents are according to TS 38.508-1 [5] subclause 4.6, with the following exceptions:

1. Information element additionalSpectrumEmission is set to NS_12. This can be set in *SIB1* as part of the cell broadcast message. This exception indicates that the UE shall meet the additional spurious emission requirement for a specific deployment scenario.

Table 6.5.3.3.4.3.17-1: AdditionalSpectrumEmission: Additional spurious emissions test requirement for "NS_12"

Derivation Path: TS 38.508-1 [5] clause 4.6.3, Table 4.6.3-1			
Information Element	Value/remark	Comment	Condition
additionalSpectrumEmission	1 (NS_12)		

6.5.3.3.4.3.18 Message contents exceptions (network signalling value "NS_13")

Message contents are according to TS 38.508-1 [5] subclause 4.6, with the following exceptions:

1. Information element additionalSpectrumEmission is set to NS_13. This can be set in *SIB1* as part of the cell broadcast message. This exception indicates that the UE shall meet the additional spurious emission requirement for a specific deployment scenario.

Table 6.5.3.3.4.3.18-1: AdditionalSpectrumEmission: Additional spurious emissions test requirement for "NS_13"

Derivation Path: TS 38.508-1 [5] clause 4.6.3, Table 4.6.3-1			
Information Element	Value/remark	Comment	Condition
additionalSpectrumEmission	1 (NS_13)		

6.5.3.3.4.3.19 Message contents exceptions (network signalling value "NS_14")

Message contents are according to TS 38.508-1 [5] subclause 4.6, with the following exceptions:

1. Information element `additionalSpectrumEmission` is set to `NS_14`. This can be set in *SIB1* as part of the cell broadcast message. This exception indicates that the UE shall meet the additional spurious emission requirement for a specific deployment scenario.

Table 6.5.3.3.4.3.19-1: *AdditionalSpectrumEmission*: Additional spurious emissions test requirement for "NS_14"

Derivation Path: TS 38.508-1 [5] clause 4.6.3, Table 4.6.3-1			
Information Element	Value/remark	Comment	Condition
<code>additionalSpectrumEmission</code>	1 (NS_14)		

6.5.3.3.4.3.20 Message contents exceptions (network signalling value "NS_15")

Message contents are according to TS 38.508-1 [5] subclause 4.6, with the following exceptions:

1. Information element `additionalSpectrumEmission` is set to `NS_15`. This can be set in *SIB1* as part of the cell broadcast message. This exception indicates that the UE shall meet the additional spurious emission requirement for a specific deployment scenario.

Table 6.5.3.3.4.3.20-1: *AdditionalSpectrumEmission*: Additional spurious emissions test requirement for "NS_15"

Derivation Path: TS 38.508-1 [5] clause 4.6.3, Table 4.6.3-1			
Information Element	Value/remark	Comment	Condition
<code>additionalSpectrumEmission</code>	1 (NS_15)		

6.5.3.3.4.3.21 Message contents exceptions (network signalling value "NS_45")

Message contents are according to TS 38.508-1 [5] subclause 4.6, with the following exceptions:

1. Information element `additionalSpectrumEmission` is set to `NS_45`. This can be set in *SIB1* as part of the cell broadcast message. This exception indicates that the UE shall meet the additional spurious emission requirement for a specific deployment scenario.

Table 6.5.3.3.4.3.21-1: *AdditionalSpectrumEmission*: Additional spurious emissions test requirement for "NS_45"

Derivation Path: TS 38.508-1 [5], Table 4.6.3-1			
Information Element	Value/remark	Comment	Condition
<code>additionalSpectrumEmission</code>	1 (NS_45)		

6.5.3.3.4.3.22 Message contents exceptions (network signalling value "NS_48")

Message contents are according to TS 38.508-1 [5] subclause 4.6, with the following exceptions:

1. Information element `additionalSpectrumEmission` is set to `NS_48`. This can be set in *SIB1* as part of the cell broadcast message. This exception indicates that the UE shall meet the additional spurious emission requirement for a specific deployment scenario.

Table 6.5.3.3.4.3.22-1: *AdditionalSpectrumEmission*: Additional spurious emissions test requirement for "NS_48"

Derivation Path: TS 38.508-1 [5] clause 4.6.3, Table 4.6.3-1			
Information Element	Value/remark	Comment	Condition
<code>additionalSpectrumEmission</code>	4 (NS_48)		

6.5.3.3.4.3.23 Message contents exceptions (network signalling value "NS_49")

Message contents are according to TS 38.508-1 [5] subclause 4.6, with the following exceptions:

1. Information element `additionalSpectrumEmission` is set to `NS_49`. This can be set in *SIB1* as part of the cell broadcast message. This exception indicates that the UE shall meet the additional spurious emission requirement for a specific deployment scenario.

Table 6.5.3.3.4.3.23-1: *AdditionalSpectrumEmission*: Additional spurious emissions test requirement for "NS_49"

Derivation Path: TS 38.508-1 [5] clause 4.6.3, Table 4.6.3-1			
Information Element	Value/remark	Comment	Condition
<code>additionalSpectrumEmission</code>	5 (NS_49)		

6.5.3.3.4.3.24 Message contents exceptions (network signalling value "NS_44")

Message contents are according to TS 38.508-1 [5] subclause 4.6, with the following exceptions:

1. Information element `additionalSpectrumEmission` is set to `NS_44`. This can be set in *SIB1* as part of the cell broadcast message. This exception indicates that the UE shall meet the additional spurious emission requirement for a specific deployment scenario.

Table 6.5.3.3.4.3.24-1: *AdditionalSpectrumEmission*: Additional spurious emissions test requirement for "NS_44"

Derivation Path: TS 38.508-1 [5] clause 4.6.3, Table 4.6.3-1			
Information Element	Value/remark	Comment	Condition
<code>additionalSpectrumEmission</code>	1 (NS_44)		

6.5.3.3.4.3.25 Message contents exceptions (network signalling value "NS_46")

Message contents are according to TS 38.508-1 [5] subclause 4.6, with the following exceptions:

1. Information element `additionalSpectrumEmission` is set to `NS_46`. This can be set in *SIB1* as part of the cell broadcast message. This exception indicates that the UE shall meet the additional spurious emission requirement for a specific deployment scenario.

Table 6.5.3.3.4.3.25-1: *AdditionalSpectrumEmission*: Additional spurious emissions test requirement for "NS_46"

Derivation Path: TS 38.508-1 [5] clause 4.6.3, Table 4.6.3-1			
Information Element	Value/remark	Comment	Condition
<code>additionalSpectrumEmission</code>	1 (NS_46)		

6.5.3.3.4.3.26 Message contents exceptions (network signalling value "NS_07")

FFS.

6.5.3.3.4.3.27 Message contents exceptions (network signalling value "NS_56")

Message contents are according to TS 38.508-1 [5] subclause 4.6, with the following exceptions:

1. Information element `additionalSpectrumEmission` is set to `NS_56`. This can be set in *SIB1* as part of the cell broadcast message. This exception indicates that the UE shall meet the additional spurious emission requirement for a specific deployment scenario.

Table 6.5.3.3.4.3.27-1: *AdditionalSpectrumEmission*: Additional spurious emissions test requirement for "NS_56"

Derivation Path: TS 38.508-1 [5] clause 4.6.3, Table 4.6.3-1			
Information Element	Value/remark	Comment	Condition
<code>additionalSpectrumEmission</code>	1 (NS_56)		

6.5.3.3.5 Test requirement

This clause specifies the requirements for the specified NR band for an additional spectrum emission requirement with protected bands as indicated from Table 6.5.3.3.5.1 to Table 6.5.3.3.5.27 for different NS_values.

NOTE: For measurement conditions at the edge of each frequency range, the lowest frequency of the measurement position in each frequency range should be set at the lowest boundary of the frequency range plus MBW/2. The highest frequency of the measurement position in each frequency range should be set at the highest boundary of the frequency range minus MBW/2. MBW denotes the measurement bandwidth defined for the protected band.

6.5.3.3.5.1 Test requirement (network signalling value "NS_04")

When "NS_04" is indicated in the cell,

The measured UE mean power in the channel bandwidth, derived in step 3, shall fulfil requirements in Table 6.2.3.5-2 for power class 2 UE, and Table 6.2.3.5-3 for power class 3 UE.

The power of any UE emission shall not exceed the levels specified in Table 6.5.3.3.5.1-1. This requirement also applies for the frequency ranges that are less than F_{OOB} (MHz) in Table 6.5.3.1.3-1 from the edge of the channel bandwidth.

Table 6.5.3.3.5.1-1: Additional requirements

Frequency band (MHz)	Channel bandwidth / Spectrum emission limit (dBm)	Measurement bandwidth
	10, 15, 20, 30, 40, 50, 60, 70, 80, 90, 100 (MHz)	
$2495 \leq f < 2496$	-13	1% of Channel BW
$2490.5 \leq f < 2495$	-13	1 MHz
$0.009 < f < 2490.5$	-25	1 MHz

6.5.3.3.5.2 Test requirement (network signalling value "NS_17")

When "NS_17" is indicated in the cell,

The power of any UE emission shall not exceed the levels specified in Table 6.5.3.3.5.2-1. This requirement also applies for the frequency ranges that are less than F_{OOB} (MHz) in Table 6.5.3.1.3-1 and Table 6.5.3.1.3-2 from the edge of the channel bandwidth.

Table 6.5.3.3.5.2-1: Additional requirements for "NS_17"

Frequency band (MHz)	Channel bandwidth / Spectrum emission limit (dBm)	Measurement bandwidth	NOTE
	5, 10 MHz		
$470 \leq f \leq 710$	-26.2	6 MHz	1
NOTE 1: Applicable when the assigned E-UTRA carrier is confined within 718 MHz and 748 MHz and when the channel bandwidth used is 5 or 10 MHz.			

6.5.3.3.5.3 Test requirement (network signalling value "NS_18")

When "NS_18" is indicated in the cell,

The measured UE mean power in the channel bandwidth, derived in step 3, shall fulfil requirements in Table 6.2.3.5-8 for power class 3 UE.

The power of any UE emission shall not exceed the levels specified in Table 6.5.3.3.5.3-1. This requirement also applies for the frequency ranges that are less than F_{OOB} (MHz) in Table 6.5.3.1.3-1 from the edge of the channel bandwidth.

Table 6.5.3.3.5.3-1: Additional requirements for "NS_18"

Frequency range (MHz)	Channel bandwidth / Spectrum emission limit (dBm)	Measurement bandwidth	
	5, 10, 15, 20, 30 MHz		
692-698	-26.2	6 MHz	

6.5.3.3.5.4 Test requirement (network signalling value "NS_05")

When "NS_05" is indicated in the cell,

The measured UE mean power in the channel bandwidth, derived in step 3, shall fulfil requirements in Table 6.2.3.5-6 for power class 3 UE.

The power of any UE emission shall not exceed the levels specified in Table 6.5.3.3.5.4-1. This requirement also applies for the frequency ranges that are less than F_{OOB} (MHz) in Table 6.5.3.1.3-1 from the edge of the channel bandwidth.

Table 6.5.3.3.5.4-1: Additional requirements for "NS_05"

Frequency band (MHz)	Channel bandwidth / Spectrum emission limit (dBm)	Measurement bandwidth	
	5, 10, 15, 20 MHz		
$1884.5 \leq f \leq 1915.7$	-41	300 kHz	

6.5.3.3.5.5 Test requirement (network signalling value "NS_43")

When "NS_43" is indicated in the cell,

The measured UE mean power in the channel bandwidth, derived in step 3, shall fulfil requirements in Table 6.2.3.5-10 for power class 3 UE.

The power of any UE emission shall not exceed the levels specified in Table 6.5.3.3.5.5-1. This requirement also applies for the frequency ranges that are less than F_{OOB} (MHz) in Table 6.5.3.1.3-1 from the edge of the channel bandwidth.

Table 6.5.3.3.5.5-1: Additional requirement for "NS_43"

Frequency range (MHz)	Channel bandwidth / Spectrum emission limit (dBm)	Measurement bandwidth
	5, 10, 15 MHz	
$860 \leq f \leq 890$	-40	1 MHz
NOTE 1: Applicable for 5 MHz and 15 MHz channel BW confined between 900 MHz and 915 MHz and for 10 MHz channel BW confined between 905 MHz and 915 MHz		

6.5.3.3.5.6 Test requirement (network signalling value "NS_37")

When "NS_37" is indicated in the cell,

The measured UE mean power in the channel bandwidth, derived in step 3, shall fulfil requirements in Table 6.2.3.5-14 for power class 3 UE.

The power of any UE emission shall not exceed the levels specified in Table 6.5.3.3.5.6-1. This requirement also applies for the frequency ranges that are less than F_{OOB} (MHz) in Table 6.5.3.1.3-1 from the edge of the channel bandwidth.

Table 6.5.3.3.5.6-1: Additional requirement for "NS_37"

Frequency band (MHz)	Channel bandwidth (MHz) / Spectrum emission limit (dBm)	Measurement bandwidth
	5, 10, 15, 20	
$1475.9 \leq f \leq 1510.9$	-35	1 MHz

6.5.3.3.5.7 Test requirement (network signalling value "NS_38")

TBD

6.5.3.3.5.8 Test requirement (network signalling value "NS_39")

TBD

6.5.3.3.5.9 Test requirement (network signalling value "NS_40")

TBD

6.5.3.3.5.10 Test requirement (network signalling value "NS_41")

TBD

6.5.3.3.5.11 Test requirement (network signalling value "NS_42")

TBD

6.5.3.3.5.12 Test requirement (network signalling value "NS_21")

When "NS_21" is indicated in the cell, the power of any UE emission shall not exceed the levels specified in Table 6.5.3.3.5.12-1. These requirements also apply for the frequency ranges that are less than F_{OOB} (MHz) in Table 6.5.3.1.3-1 from the edge of the channel bandwidth.

Table 6.5.3.3.5.12-1: Additional requirements for "NS_21"

Frequency band (MHz)	Channel bandwidth (MHz) / Spectrum emission limit (dBm)	Measurement bandwidth
	5, 10	
$2200 \leq f < 2288$	-40	1 MHz
$2288 \leq f < 2292$	-37	1 MHz
$2292 \leq f < 2296$	-31	1 MHz
$2296 \leq f < 2300$	-25	1 MHz
$2320 \leq f < 2324$	-25	1 MHz
$2324 \leq f < 2328$	-31	1 MHz
$2328 \leq f < 2332$	-37	1 MHz
$2332 \leq f \leq 2395$	-40	1 MHz

6.5.3.3.5.13 Test requirement (network signalling value "NS_24")

When "NS_24" is indicated in the cell,

The measured UE mean power in the channel bandwidth, derived in step 3, shall fulfil requirements in Table 6.2.3.5-17.

The power of any UE emission shall not exceed the levels specified in Table 6.5.3.3.5.13-1. This requirement also applies for the frequency ranges that are less than F_{OOB} (MHz) in Table 6.5.3.1.3-1 from the edge of the channel bandwidth.

Table 6.5.3.3.5.13-1: Additional requirements

Frequency band (MHz)	Channel bandwidth / Spectrum emission limit (dBm)	Measurement bandwidth
	5 MHz, 10 MHz, 15 MHz, 20 MHz	
$2010 \leq f \leq 2025$	-50	1 MHz
NOTE 1: This requirement applies at a frequency offset equal or larger than 5 MHz from the upper edge of the channel bandwidth, whenever these frequencies overlap with the specified frequency band.		

6.5.3.3.5.14 Test requirement (network signalling value "NS_27")

When "NS_27" is indicated in the cell,

The measured UE mean power in the channel bandwidth, derived in step 3, shall fulfil requirements in Table 6.2.3.5-18 for power class 3 UE.

The power of any UE emission shall not exceed the levels specified in Table 6.5.3.3.5.14-1. This requirement also applies for the frequency ranges that are less than F_{OOB} (MHz) in Table 6.5.3.1.3-1 from the edge of the channel bandwidth.

Table 6.5.3.3.5.14-1: Additional requirement for "NS_27"

Frequency range (MHz)	Channel bandwidth (MHz) / Spectrum emission limit (dBm)	Measurement bandwidth
	5, 10, 15, 20, 40	
9 kHz – 3530 MHz	-40	1 MHz
3530 MHz – 3540 MHz	-25	
3710 MHz – 3720 MHz	-25	
3720 MHz – 12.75 GHz	-40	

6.5.3.3.5.15 Test requirement (network signalling value "NS_47")

When "NS_47" is indicated in the cell, the power of any UE emission shall not exceed the levels specified in Table 6.5.3.3.5.15-1. This requirement also applies for the frequency ranges that are less than F_{OOB} (MHz) in Table 6.5.3.1.3-1 from the edge of the channel bandwidth.

Table 6.5.3.3.5.15-1: Additional requirement for "NS_47"

Frequency band (MHz)	Channel bandwidth (MHz) / Spectrum emission limit (dBm)	Measurement bandwidth
	30	
$2530 \leq f \leq 2535$	-25	1 MHz
$2505 \leq f \leq 2530$	-30	1 MHz

6.5.3.3.5.16 Test requirement (network signalling value "NS_50")

When "NS_50" is indicated in the cell, the power of any UE emission shall not exceed the levels specified in Table 6.5.3.3.5.16-1. This requirement also applies for the frequency ranges that are less than F_{OOB} (MHz) in Table 6.5.3.1.3-1 from the edge of the channel bandwidth.

Table 6.5.3.3.5.16-1: Additional requirements for "NS_50"

Protected band	Frequency range (MHz)			Maximum Level (dBm)	MBW (MHz)	NOTE
Frequency range	1805	-	1855	-40	1	1
Frequency range	1855	-	1880	-15.5	5	1, 2, 3
NOTE 1: This requirement is applicable for carriers with aggregated channel bandwidths confined in 1885-1920 MHz for ≤ 30 MHz channel BWs and confined in 1880-1920 MHz for 40 MHz channel BW.						
NOTE 2: The requirement also applies for the frequency ranges that are less than F_{00B} (MHz) in Table 6.5.3.1.3-1 from the edge of the channel bandwidth.						
NOTE 3: For these adjacent bands, the emission limit could imply risk of harmful interference to UE(s) operating in the protected operating band.						

6.5.3.3.5.17 Test requirement (network signalling value "NS_12")

Table 6.5.3.3.5.17-1: Additional requirements for "NS_12"

Frequency band (MHz)	Channel bandwidth / Spectrum emission limit (dBm)	Measurement bandwidth
	5 MHz, 10 MHz	
$806 \leq f \leq 813.5$	-42	6.25 kHz
NOTE 1: The requirement applies for E-UTRA carriers with lower channel edge at or above 814 MHz.		
NOTE 2: The emissions measurement shall be sufficiently power averaged to ensure a standard deviation < 0.5 dB.		

6.5.3.3.5.18 Test requirement (network signalling value "NS_13")

Table 6.5.3.3.5.18-1: Additional requirements for "NS_13"

Frequency band (MHz)	Channel bandwidth / Spectrum emission limit (dBm)	Measurement bandwidth
	5 MHz	
$806 \leq f \leq 816$	-42	6.25 kHz
NOTE 1: The requirement applies for E-UTRA carriers with lower channel edge at or above 817 MHz.		
NOTE 2: The emissions measurement shall be sufficiently power averaged to ensure a standard deviation < 0.5 dB.		

6.5.3.3.5.19 Test requirement (network signalling value "NS_14")

Table 6.5.3.3.5.19-1: Additional requirements for "NS_14"

Frequency band (MHz)	Channel bandwidth / Spectrum emission limit (dBm)	Measurement bandwidth
	10 MHz, 15 MHz, 20 MHz	
$806 \leq f \leq 816$	-42	6.25 kHz
NOTE 1: The requirement applies for E-UTRA carriers with lower channel edge at or above 817 MHz.		
NOTE 2: The emissions measurement shall be sufficiently power averaged to ensure a standard deviation < 0.5 dB.		

6.5.3.3.5.20 Test requirement (network signalling value "NS_15")

Table 6.5.3.3.5.20-1: Additional requirements for "NS_15"

Frequency band (MHz)	Channel bandwidth / Spectrum emission limit (dBm)	Measurement bandwidth
	5 MHz, 10 MHz, 15 MHz, 20 MHz	
$851 \leq f \leq 859$	-53	6.25 kHz
NOTE 1: The emissions measurement shall be sufficiently power averaged to ensure a standard deviation < 0.5 dB.		

6.5.3.3.5.21 Test requirement (network signalling value "NS_45")

When "NS 45" is indicated in the cell,

The measured UE mean power in the channel bandwidth, derived in step 3, shall fulfil requirements in Table 6.2.3.5-29.

The power of any UE emission shall not exceed the levels specified in Table 6.5.3.3.5.21-1. This requirement also applies for the frequency ranges that are less than F_{OoB} (MHz) in Table 6.5.3.1.3-1 from the edge of the channel bandwidth.

Table 6.5.3.3.5.21-1: Additional requirements

Frequency band (MHz)	Channel bandwidth / Spectrum emission limit (dBm)		Measurement bandwidth
	5 MHz	10 MHz	
$0.009 < f \leq 2473.5$	-25	-25	1 MHz
$2473.5 < f \leq 2477.5$	-25	-13	1 MHz
$2477.5 < f \leq 2478.5$	-13	-13	1 MHz
$2478.5 < f \leq 2483.5$	-10	-10	1 MHz
$2495 \leq f < 2496$	-13	-13	1% of Channel Bandwidth
$2496 \leq f < 2501$	-13	-13	1 MHz
$2501 < f \leq 2505$	-25	-13	1 MHz
$2505 \leq f \leq 5^{\text{th}}$ harmonic of the upper frequency edge of the UL operating band	-25	-25	1 MHz

6.5.3.3.5.22 Test requirement (network signalling value "NS_48")

When "NS 48" is indicated in the cell,

The measured UE mean power in the channel bandwidth, derived in step 3, shall fulfil requirements in Table 6.2.3.5-24.

The power of any UE emission shall not exceed the levels specified in Table 6.5.3.3.5.22-1. This requirement also applies for the frequency ranges that are less than F_{OoB} (MHz) in Table 6.5.3.1.3-1 from the edge of the channel bandwidth.

Table 6.5.3.3.5.22-1: Additional requirements

Protected band	Frequency range (MHz)			Maximum Level (dBm)	MBW (MHz)	NOTE
E-UTRA band 34 – NR band n34	F_{DL_low}	-	F_{DL_high}	-50	1	
Frequency range	1900	-	1915	-15.5	5	1
Frequency range	1915	-	1920	+1.6	5	1
NOTE 1: For these adjacent bands, the emission limit could imply risk of harmful interference to UE(s) operating in the protected operating band.						

6.5.3.3.5.23 Test requirement (network signalling value "NS_49")

When "NS 49" is indicated in the cell,

The measured UE mean power in the channel bandwidth, derived in step 3, shall fulfil requirements in Table 6.2.3.5-33.

The power of any UE emission shall not exceed the levels specified in Table 6.5.3.3.5.23-1. This requirement also applies for the frequency ranges that are less than F_{OOB} (MHz) in Table 6.5.3.1.3-1 from the edge of the channel bandwidth.

Table 6.5.3.3.5.23-1: Additional requirements

Protected band	Frequency range (MHz)			Maximum Level (dBm)	MBW (MHz)	NOTE
E-UTRA band 34 - NR band n34	F_{DL_low}	-	F_{DL_high}	-50	1	
Frequency range	1880	-	1895	-40	1	
Frequency range	1895	-	1915	-15.5	5	1
Frequency range	1915	-	1920	1.6	5	1
NOTE 1: For these adjacent bands, the emission limit could imply risk of harmful interference to UE(s) operating in the protected operating band.						

6.5.3.3.5.24 Test requirement (network signalling value "NS_44")

When "NS 44" is indicated in the cell,

The measured UE mean power in the channel bandwidth, derived in step 3, shall fulfil requirements in Table 6.2.3.5-31.

The power of any UE emission shall not exceed the levels specified in Table 6.5.3.3.5.24-1. This requirement also applies for the frequency ranges that are less than F_{OOB} (MHz) in Table 6.5.3.1.3-1 from the edge of the channel bandwidth.

Table 6.5.3.3.5.24-1: Additional requirements

Protected band	Frequency range (MHz)			Maximum Level (dBm)	MBW (MHz)	NOTE
Frequency range	2620	-	2645	-15.5	5	1, 2
Frequency range	2645	-	2690	-40	1	1
NOTE 1: This requirement is applicable for carriers confined in 2570-2615 MHz.						
NOTE 2: For these adjacent bands, the emission limit could imply risk of harmful interference to UE(s) operating in the protected operating band.						

6.5.3.3.5.25 Test requirement (network signalling value "NS_46")

When "NS_46" is indicated in the cell, the measured UE mean power in the channel bandwidth, derived in step 3, shall fulfil requirements in Table 6.2.3.5-30. The power of any UE emission shall not exceed the levels specified in Table 6.5.3.3.5.25-1. This requirement also applies for the frequency ranges that are less than F_{OOB} (MHz) in Table 6.5.3.1.3-1 from the edge of the channel bandwidth.

Table 6.5.3.3.25-1: Additional requirements for “NS_46”

Protected band	Frequency range (MHz)			Maximum Level (dBm)	MBW (MHz)	NOTE
Frequency range	2570	-	2575	+1.6	5	1, 2
Frequency range	2575	-	2595	-15.5	5	1, 2
Frequency range	2595	-	2620	-40	1	1
NOTE 1: This requirement is applicable for all carriers confined in 2500-2570 MHz. Sepcial restrictions apply for channel bandwidths up to 20MHz: For carriers of 15 MHz bandwidth when carrier centre frequency is within the range 2560.5 - 2562.5 MHz and for carriers of 20 MHz bandwidth when carrier centre frequency is within the range 2552 - 2560 MHz the requirement is applicable only for an uplink transmission bandwidth less than or equal to 54 RB with the minimum supported SCS of 15KHz.						
NOTE 2: For these adjacent bands, the emission limit could imply risk of harmful interference to UE(s) operating in the protected operating band.						

6.5.3.3.5.26 Test requirement (network signalling value “NS_07”)

FFS

6.5.3.3.5.27 Test requirement (network signalling value “NS_56”)

When "NS 56" is indicated in the cell,

The measured UE mean power in the channel bandwidth, derived in step 3, shall fulfil requirements in Table 6.2.3.5-36.

The power of any UE emission shall not exceed the levels specified in Table 6.5.3.3.5.27-1. This requirement also applies for the frequency ranges that are less than F_{OoB} (MHz) in Table 6.5.3.1.3-1 from the edge of the channel bandwidth.

Table 6.5.3.3.5.27-1: Additional requirements

Frequency band (MHz)	Channel bandwidth / Spectrum emission limit ¹ (dBm)	Measurement bandwidth	NOTE
	5 MHz, 10MHz		
$1541 \leq f \leq 1559$	-102	2kHz	Averaged over any 2millisecond active transmission interval
$1559 \leq f \leq 1608$	-85	700Hz	
$1608 \leq f \leq 1610$	$-85 + 5/2 (f-1608)$	700Hz	
$1610 \leq f \leq 1625$	$-80 + 66/15 (f-1610)$	700Hz	
$1541 \leq f \leq 1608$	-75	1MHz	Averaged over any 2millisecond active transmission interval
$1608 \leq f \leq 1610$	$-75 + 5/2 (f-1608)$	1MHz	
$1610 \leq f \leq 1627.5$	$-70 + 57/17.5 (f-1610)$	1MHz	
1627.5	-37	4kHz	
$1638.5 \leq f \leq 1645.5$	-28	4kHz	
$1657.5 \leq f \leq 1660.5$	-28	4kHz	
NOTE 1: The EIRP requirement in regulation is converted to conducted requirement using a 0 dBi antenna.			

6.5.4 Transmit intermodulation

6.5.4.1 Test purpose

To verify that the UE transmit intermodulation does not exceed the described value in the test requirement.

The transmit intermodulation performance is a measure of the capability of the transmitter to inhibit the generation of signals in its non-linear elements caused by presence of the wanted signal and an interfering signal reaching the transmitter via the antenna.

6.5.4.2 Test applicability

This test case applies to all types of NR UE release 15 and forward.

6.5.4.3 Minimum conformance requirements

UE transmit intermodulation is defined by the ratio of the mean power of the wanted signal to the mean power of the intermodulation product when an interfering CW signal is added at a level below the wanted signal at each transmitter antenna port with the other antenna port(s) if any terminated. Both the wanted signal power and the intermodulation product power are measured through NR rectangular filter with measurement bandwidth shown in Table 6.5.4.3-1.

The requirement of transmit intermodulation is specified in Table 6.5.4.3-1.

Table 6.5.4.3-1: Transmit Intermodulation

Wanted signal channel bandwidth	BW_{Channel}	
Interference signal frequency offset from channel centre	BW_{Channel}	$2 \cdot BW_{\text{Channel}}$
Interference CW signal level	-40dBc	
Intermodulation product	< -29dBc	< -35dBc
Measurement bandwidth	The maximum transmission bandwidth configuration among the different SCSs for the channel BW as defined in Table 6.5.2.4.1.3-1	
Measurement offset from channel centre	BW_{Channel} and $2 \cdot BW_{\text{Channel}}$	$2 \cdot BW_{\text{Channel}}$ and $4 \cdot BW_{\text{Channel}}$

The normative reference for this requirement is TS 38.101-1 [2] clause 6.5.4.

6.5.4.4 Test description

6.5.4.4.1 Initial conditions

Initial conditions are a set of test configurations the UE needs to be tested in and the steps for the SS to take with the UE to reach the correct measurement state.

The initial test configurations consist of environmental conditions, test frequencies, test channel bandwidths and sub-carrier spacing based on NR operating bands specified in table 5.3.5-1. All of these configurations shall be tested with applicable test parameters for each combination of channel bandwidth and sub-carrier spacing, and are shown in table 6.5.4.4.1-1. The details of the uplink reference measurement channels (RMCs) are specified in Annexes A.2.

Configurations of PDSCH and PDCCH before measurement are specified in Annex C.2.

Table 6.5.4.4.1-1: Test Configuration Table

Initial Conditions			
Test Environment as specified in TS 38.508-1 [5] subclause 4.1		Normal	
Test Frequencies as specified in TS 38.508-1 [5] subclause 4.3.1		Mid range (NOTE 2)	
Test Channel Bandwidths as specified in TS 38.508-1 [5] subclause 4.3.1		Mid, Highest	
Test SCS as specified in Table 5.3.5-1		Lowest, Highest	
Test Parameters			
Test ID	Downlink Configuration	Uplink Configuration	
	N/A for transmit intermodulation test case	Modulation	RB allocation (NOTE 1)
1		DFT-s-OFDM PI/2 BPSK	Inner Full
2		DFT-s-OFDM QPSK	Inner Full
NOTE 1: The specific configuration of each RB allocation is defined in Table 6.1-1.			
NOTE 2: For NR band n28, 30MHz test channel bandwidth is tested with Low range test frequencies.			

1. Connect the SS to the UE antenna connectors as shown in TS 38.508-1 [5] Annex A, in Figure A.3.1.3.1 for TE diagram and section A.3.2 for UE diagram.
2. The parameter settings for the cell are set up according to TS 38.508-1 [5] subclause 4.4.3.
3. Downlink signals are initially set up according to Annex C.0, C.1, C.2, and uplink signals according to Annex G.0, G.1, G.2, G.3.0.
4. The UL Reference Measurement channels are set according to Table 6.5.4.4.1-1.
5. Propagation conditions are set according to Annex B.0.
6. Ensure the UE is in State RRC_CONNECTED with generic procedure parameters Connectivity *NR*, Connected without release *On*, Test Mode *On* and Test Loop Function *On* according to TS 38.508-1 [5] clause 4.5. Message contents are defined in clause 6.5.4.4.3.

6.5.4.4.2 Test procedure

1. SS sends uplink scheduling information for each UL HARQ process via PDCCH DCI format 0_1 for C_RNTI to schedule the UL RMC according to Table 6.5.4.4.1-1. Since the UE has no payload and no loopback data to send the UE sends uplink MAC padding bits on the UL RMC.
2. Send continuously uplink power control "up" commands to the UE until the UE transmits at its P_{UMAX} level.
3. Measure the rectangular filtered mean power of the UE. For TDD, only slots consisting of only UL symbols are under test for the wanted signal and for the intermodulation product.
4. Set the interference signal frequency below the UL carrier frequency using the first offset in table 6.5.4.5-1.
5. Set the interference CW signal level according to table 6.5.4.5-1.
6. Search the intermodulation product signals below and above the UL carrier frequency, then measure the rectangular filtered mean power of transmitting intermodulation for both signals, and calculate the ratios with the power measured in step 3.
7. Set the interference signal frequency above the UL carrier frequency using the first offset in table 6.5.4.5-1.
8. Search the intermodulation product signals below and above the UL carrier frequency, then measure the rectangular filtered mean power of transmitting intermodulation for both signals, and calculate the ratios with the power measured in step 3.
9. Repeat the measurement using the second offset in table 6.5.4.5-1.

6.5.4.4.3 Message contents

Message contents are according to TS 38.508-1 [5] subclause 4.6 with the following exception:

Table 6.5.4.4.3-1: PUSCH-Config

Derivation Path: TS 38.508-1 [5], Table 4.6.3-118 with condition TRANSFORM_PRECODER_ENABLED

6.5.4.5 Test requirement

The ratio derived in step 6 and 8, shall not exceed the described value in table 6.5.4.5-1.

Table 6.5.4.5-1: Transmit Intermodulation

Wanted signal channel bandwidth	BW_{Channel}	
Interference signal frequency offset from channel centre	BW_{Channel}	$2 \cdot BW_{\text{Channel}}$
Interference CW signal level	-40dBc	
Intermodulation product	< -29dBc	< -35dBc
Measurement bandwidth	The maximum transmission bandwidth configuration among the different SCSs for the channel BW as defined in Table 6.5.2.4.1.5-1	
Measurement offset from channel centre	BW_{Channel} and $2 \cdot BW_{\text{Channel}}$	$2 \cdot BW_{\text{Channel}}$ and $4 \cdot BW_{\text{Channel}}$
Note 1:	The test requirements do not apply when the interfering signal overlaps with the channel bandwidth of the downlink signal.	

6.5A Output RF spectrum emissions for CA

6.5A.1 Occupied bandwidth for CA

6.5A.1.0 Minimum conformance requirements

6.5A.1.0.1 Void

6.5A.1.0.1a Occupied bandwidth for Intra-band contiguous CA

For intra-band contiguous carrier aggregation the occupied bandwidth is a measure of the bandwidth containing 99 % of the total integrated power of the transmitted spectrum. The OBW shall be less than the aggregated channel bandwidth defined in subclause 5.3A.3.

6.5A.1.0.2 Occupied bandwidth for Intra-band non-contiguous CA

For intra-band non-contiguous carrier aggregation, the OBW requirement is met when the ratio of the transmitted power in all sub-blocks of the uplink CA configuration to the total integrated power of the transmitted spectrum is greater than 99%.

6.5A.1.0.3 Occupied bandwidth for Inter-band CA

For inter-band carrier aggregation with uplink assigned to two NR bands, the occupied bandwidth is defined per component carrier. Occupied bandwidth is the bandwidth containing 99 % of the total integrated mean power of the transmitted spectrum on assigned channel bandwidth on the component carrier. The occupied bandwidth shall be less than the channel bandwidth specified in Table 6.5.1.3-1.

6.5A.1.1 Occupied bandwidth for CA (2UL CA)

Editor's Note:

- Due to lack of MPR requirements in core specification, this test case is incomplete for intra-band contiguous UL CA for power class 2 UEs indicating IE dualPA-Architecture supported, and incomplete for intra-band non-contiguous UL CA for power class 2 UEs, and power class 3 UEs when signalling is absent for dualPA-Architecture.

- MU needs to be reassessed.

6.5A.1.1.1 Test purpose

To verify that the UE occupied bandwidth for all transmission bandwidth configurations supported by the UE are less than their specific limits for 2 UL CA

6.5A.1.1.2 Test applicability

This test case applies to all types of NR UE release 15 and forward that supports 2UL CA

6.5A.1.1.3 Minimum conformance requirements

The minimum conformance requirements are defined in subclause 6.5A.1.0.

6.5A.1.1.4 Test description

6.5A.1.1.4.1 Initial conditions

Initial conditions are a set of test configurations the UE needs to be tested in and the steps for the SS to take with the UE to reach the correct measurement state.

The initial test configurations consist of environmental conditions, test frequencies, test channel bandwidths and sub-carrier spacing based on NR CA configuration specified in clause 5.5A. All of these configurations shall be tested with applicable test parameters for each CA configuration, are shown in Table 6.5A.1.1.4.1-1 for inter-band UL CA, table 6.5A.1.1.4.1-2 for intra-band contiguous CA and table 6.5A.1.1.4.1-3 for intra-band non-contiguous CA. The details of the uplink reference measurement channels (RMCs) are specified in Annexes A.2. Configurations of PDSCH and PDCCH before measurement are specified in Annex C.2.

Table 6.5A.1.1.4.1-1: Inter band CA Test Configuration Table

Initial Conditions				
Test Environment as specified in TS 38.508-1 [5] subclause 4.1		Normal		
Test Frequencies as specified in TS 38.508-1 [5] subclause 4.3.1		Mid range for both PCC and SCC (NOTE 4)		
Test Channel Bandwidths as specified in TS 38.508-1 [5] subclause 4.3.1		Lowest N_{RB_agg} for both PCC and SCC Highest N_{RB_agg} for both PCC and SCC		
Test SCS as specified in Table 5.3.5-1		Smallest supported SCS per Channel Bandwidth		
Test Parameters				
Test ID	Downlink Configuration for PCC & SCC	Uplink Configuration		
		Modulation for all CCs (NOTE 2)	RB allocation (NOTE 1)	
			PCC	SCC
1	N/A for this test	CP-OFDM QPSK	Outer_Full	Outer_Full
NOTE 1: The specific configuration of each RB allocation is defined in Table 6.1-1.				
NOTE 2: CA Configuration Test CC Combination settings are checked separately for each CA Configuration, which applicable aggregated channel bandwidths are specified in Table 5.3A.4-1.				
NOTE 3: Test Channel Bandwidths and Test SCS are checked separately for each NR CA band combination, which applicable channel bandwidths and SCS are specified in Table 5.5A.3-1.				
NOTE 4: For NR band n28, 30MHz test channel bandwidth is tested with Low range test frequencies.				

Table 6.5A.1.1.4.1-2: Intra band contiguous CA Test Configuration Table

Initial Conditions			
Test Environment as specified in TS 38.508-1 [5] subclause 4.1		Normal	
Test Frequencies as specified in TS 38.508-1 [5] subclause 4.3.1		Mid range	
Test Channel Bandwidths as specified in TS 38.508-1 [5] subclause 4.3.1		All aggregated channel bandwidth	
Test SCS as specified in Table 5.3.5-1		Smallest supported SCS per Channel Bandwidth	
Test Parameters			
Test ID	Downlink Configuration for PCC & SCC	Uplink Configuration	
		Modulation for all CCs (NOTE 2)	RB allocation (NOTE 1)
1	N/A for this test	CP-OFDM QPSK	Outer_Full
NOTE 1: The specific configuration of each RB allocation is defined in Table 6.1A-1a.			
NOTE 2: CA Configuration Test CC Combination settings are checked separately for each CA Configuration, which applicable aggregated channel bandwidths are specified in Table 5.5A.1-1.			
NOTE 3: If the UE supports multiple CC Combinations in the CA Configuration with the same N_{RB_agg} , only the combination with the highest N_{RB_PCC} is tested.			

Table 6.5A.1.1.4.1-3: Intra band non-contiguous CA Test Configuration Table

Initial Conditions									
Test Environment as specified in TS 38.508-1 [5] subclause 4.1					Normal				
Test Frequencies as specified in TS 38.508-1 [5] subclause 4.3.1					For test frequencies refer to "Range" columns				
Test Channel Bandwidths as specified in TS 38.508-1 [5] subclause 4.3.1					All aggregated channel bandwidth				
Test SCS as specified in Table 5.3.5-1					Smallest supported SCS per Channel Bandwidth				
Test Parameters									
ID	CA config					DL config	UL config		
	PCC		SCC		W_{gap}		CC MOD	RB allocation (NOTE 1)	
	Band	Range	Band	Range				PCC	SCC
1	nX	CC1	nX	CC2	Max (NOTE 4)	N/A	CP-OFDM QPSK	Outer_Full	Outer_Full
NOTE 1: The RB allocation is defined in table 6.1-1 for each CC.									
NOTE 2: Test Channel Bandwidths and Test SCS are checked separately for each NR CA band combination, which applicable channel bandwidths and SCS are specified in Table 5.5A.2-1.									
NOTE 3: If the UE supports multiple CC Combinations in the CA Configuration with the same N_{RB_agg} , only the combination with the highest N_{RB_PCC} is tested.									
NOTE 4: The W_{gap} is defined to be widest possible on band based on the PCC and SCC configuration									

1. Connect the SS to the UE antenna connectors as shown in TS 38.508-1 [5] Annex A, in Figure A.3.1.1.3 for TE diagram and section A.3.2.1 for UE diagram.
2. The parameter settings for the cell are set up according to TS 38.508-1 [5] subclause 4.4.3.
3. Downlink signals for PCC are initially set up according to Annex C.0, C.1 and C.2, and uplink signals according to Annex G.0, G.1, G.2, G.3.0.
4. The UL Reference Measurement channels are set according to Table 6.5A.1.1.4.1-1 to Table 6.5A.1.1.4.1-3.
5. Propagation conditions are set according to Annex B.0.
6. Ensure the UE is in state RRC_CONNECTED with generic procedure parameters Connectivity NR, Connected without release On, Test Mode On and Test Loop Function On according to TS 38.508-1 [5] clause 4.5. Message contents are defined in clause 6.5A.1.1.4.3.

6.5A.1.1.4.2 Test procedure

1. Configure SCC according to Annex C.0, C.1, C.2 for all downlink physical channels.
2. The SS shall configure SCC as per TS 38.508-1 [5] clause 5.5.1. Message contents are defined in clause 6.5A.1.1.4.3.
3. SS activates SCC by sending the activation MAC CE (Refer TS 38.321 [18], clauses 5.9, 6.1.3.10). Wait for at least 2 seconds (Refer TS 38.133[19], clause 9.3).
4. SS sends uplink scheduling information for each UL HARQ process via PDCCH DCI format 0_1 for C_RNTI to schedule the UL RMC according to Table 6.5A.1.1.4.1-1 or Table 6.5A.1.1.4.1-2 as appropriate. Since the UL has no payload and no loopback data to send the UE sends uplink MAC padding bits on the UL RMC.
5. Send continuously power control “up” commands to the UE until the UE transmits at PUMAX level. Allow at least 200ms for the UE to reach PUMAX level.
6. **For inter-band CA:** measure the power spectrum distribution of both PCC and SCC within two times or more range over the requirement for Occupied Bandwidth specification centring on the current carrier frequency.

For Intra-band contiguous CA: measure the power spectrum distribution over all component carriers within two times or more range over the aggregated channel bandwidth requirement for Occupied Bandwidth specification centring on the centre of aggregated channel bandwidth. The characteristics of the filter shall be approximately Gaussian (typical spectrum analyser filter). Other methods to measure the power spectrum distribution are allowed. The measuring duration is at least 1ms over consecutive active uplink slots.

For intra-band non-contiguous CA: measure the power spectrum distribution of each sub-block over all component carriers within the requirement for Occupied Bandwidth for CA specification, centring on the carrier frequency of each sub-block in CA configuration. The characteristic of the filter shall be approximately Gaussian (typical spectrum analyzer filter). Other methods to measure the power spectrum distribution are allowed. The measuring duration is one active uplink subframe. For TDD slots with transient periods are not under test.

7. Calculate the total power within the range of all frequencies measured in step 6 and save this value as “Total power”. “Total power” is calculated for each CC separately for inter-band carrier aggregation, and for all CCs together for intra-band contiguous and non-contiguous carrier aggregation.
8. Identify the measurement window whose centre is aligned on the centre of the channel bandwidth on each carrier for inter-band carrier aggregation, or on the centre of the aggregated channel bandwidth for intra-band contiguous carrier aggregation or centring on each carrier frequency of each sub-block for which the sum of the power measured is 99% of the “Total power”.
9. The “Occupied Bandwidth” is the width of the measurement window obtained in step 8.

6.5A.1.1.4.3 Message contents

Message contents are according to TS 38.508-1 [5] subclause 4.6 with following exception.

Table 6.5A.1.1.4.3-1: FrequencyInfoUL-SIB for inter-band CA

Derivation Path: TS 38.508-1 [5] Table 4.6.3-62 FrequencyInfoUL-SIB			
Information Element	Value/remark	Comment	Condition
p-Max	20		Power class 3 and Inter-band CA

Table 6.5A.1.1.4.3-2: FrequencyInfoUL-SIB for intra-band contiguous CA (contiguous RB allocation)

Derivation Path: TS 38.508-1 [5] Table 4.6.3-62 FrequencyInfoUL-SIB			
Information Element	Value/remark	Comment	Condition
p-Max	15		Power class 3 and Bandwidth class B
	10		Power class 3 and Bandwidth class C

6.5A.1.1.5 Test requirements

For inter-band carrier aggregation, the measured Occupied Bandwidth for each component carrier shall not exceed values in Table 6.5A.1.1.5-1.

Table 6.5A.1.1.5-1: Occupied channel bandwidth

	NR channel bandwidth												
	5 MHz	10 MHz	15 MHz	20 MHz	25 MHz	30 MHz	40 MHz	50 MHz	60 MHz	70 MHz	80 MHz	90 MHz	100 MHz
Occupied channel bandwidth (MHz)	5	10	15	20	25	30	40	50	60	70	80	90	100

For intra-band contiguous carrier aggregation, the measured Occupied Bandwidth shall not exceed the aggregated channel bandwidth as defined in subclause 5.3A.3.

For intra-band non-contiguous carrier aggregation, the measured Occupied Bandwidth shall not exceed values of channel bandwidth as defined in section 5.5A.2.

6.5A.2 Out of band emission for CA

6.5A.2.1 General

This clause contains requirements for out of band emissions for UE configured of carrier aggregation.

6.5A.2.2 Spectrum emission mask

Editor's note: The following aspects are either missing or not yet determined:

- This test case is incomplete when signalling is absent for dualPA-Architecture IE due to lack of core requirements.

6.5A.2.2.0 Minimum conformance requirements

For intra-band contiguous carrier aggregation the spectrum emission mask of the UE applies to frequencies (Δf_{OOB}) starting from the \pm edge of the aggregated channel bandwidth. For intra-band contiguous carrier aggregation, the power of any UE emission shall not exceed the levels specified in Table 6.5A.2.2.0-1 for the specified channel bandwidth.

Table 6.5A.2.2.0-1: General NR CA spectrum emission mask

Δf_{OOB} (MHz)	Spectrum emission limit(dBm)	MBW(MHz)
$\pm 0 - 1$	-13	Min(0.01* $BW_{\text{channel_CA}}$, 0.4)
$\pm 1 - 5$	-10	1MHz
$\pm 5 - BW_{\text{channel_CA}}$	-13	1MHz
$\pm BW_{\text{channel_CA}} - BW_{\text{channel_CA}} + 5$	-25	1MHz

For intra-band non-contiguous carrier aggregation the spectrum emission mask requirement is defined as a composite spectrum emissions mask. Composite spectrum emission mask applies to frequencies up to Δf_{OOB} starting from the edges of the sub-blocks. Composite spectrum emission mask is defined as follows:

- Composite spectrum emission mask is a combination of individual sub-block spectrum emissions masks
- In case the sub-block consist of one component carrier the sub-block general spectrum emission mask is defined in subclause 6.5.2.2
- If for some frequency sub-block spectrum emission masks overlap then spectrum emission mask allowing higher power spectral density applies for that frequency

- d) If for some frequency a sub-block spectrum emission mask overlaps with the sub-block bandwidth of another sub-block, then the emission mask does not apply for that frequency.

When signalling for dualPA-Architecture IE is absent, carrier leakage or I/Q image may land inside the gap spectrum between 2 UL CCs when UL CCs are synchronized with frequencies in the gap.

For inter-band carrier aggregation with uplink assigned to two NR bands, the minimum conformance requirements specified in subclause 6.5.2.2 shall apply on each component carrier with all component carriers active. If for some frequency spectrum emission masks of component carriers overlap then spectrum emission mask allowing higher power spectral density applies for that frequency. If for some frequency a component carrier spectrum emission mask overlaps with the channel bandwidth of another component carrier, then the emission mask does not apply for that frequency.

6.5A.2.2.1 Spectrum emission mask for CA (2UL CA)

6.5A.2.2.1.1 Test purpose

To verify that the power of any UE emission shall not exceed specified level for the specified channel bandwidth for 2UL CA.

6.5A.2.2.1.2 Test applicability

This test case applies to all types of NR UE release 15 and forward that supports 2UL CA.

6.5A.2.2.1.3 Minimum conformance requirements

The minimum conformance requirements are defined in subclause 6.5A.2.2.0.

6.5A.2.2.1.4 Test description

6.5A.2.2.1.4.1 Initial conditions

Initial conditions are a set of test configurations the UE needs to be tested in and the steps for the SS to take with the UE to reach the correct measurement state.

The initial test configurations consist of environmental conditions, test frequencies, test channel bandwidths and sub-carrier spacing based on NR CA configuration specified in clause 5.5A. All of these configurations shall be tested with applicable test parameters for each CA configuration, are shown in Tables 6.5A.2.2.1.4.1-1 through 6.5A.2.2.1.4.1-3. The details of the uplink reference measurement channels (RMCs) are specified in Annexes A.2. Configurations of PDSCH and PDCCH before measurement are specified in Annex C.2.

Table 6.5A.2.2.1.4.1-1: Inter band CA Test Configuration Table

Initial Conditions					
Test Environment as specified in TS 38.508-1 [5] subclause 4.1			Normal		
Test Frequencies as specified in TS 38.508-1 [5] subclause 4.3.1.1.3 for inter band CA in FR1			Low range for PCC and SCC High range for PCC and SCC		
Test Channel Bandwidths as specified in TS 38.508-1 [5] subclause 4.3.1			Lowest N_{RB_agg} for both PCC and SCC Highest N_{RB_agg} for both PCC and SCC		
Test SCS as specified in Table 5.5A.3-1			Smallest and biggest supported SCS per Channel Bandwidth		
Test Parameters					
Test ID	Freq	Downlink Configuration	Uplink Configuration		
			Modulation (NOTE 3)	RB allocation (NOTE 1)	
				PCC	SCC
1 ³	Low	N/A	DFT-s-OFDM PI/2 BPSK	Edge_1RB_Left	Edge_1RB_Left
2 ³	High	N/A	DFT-s-OFDM PI/2 BPSK	Edge_1RB_Right	Edge_1RB_Right
3	Low	N/A	DFT-s-OFDM QPSK	Edge_1RB_Left	Edge_1RB_Left
4	High	N/A	DFT-s-OFDM QPSK	Edge_1RB_Right	Edge_1RB_Right
5	Low	N/A	DFT-s-OFDM 16 QAM	Edge_1RB_Left	Edge_1RB_Left
6	High	N/A	DFT-s-OFDM 16 QAM	Edge_1RB_Right	Edge_1RB_Right
7	Default	N/A	DFT-s-OFDM 64 QAM	Outer_Full	Outer_Full
8	Default	N/A	DFT-s-OFDM 256 QAM	Outer_Full	Outer_Full
9	Low	N/A	CP-OFDM QPSK	Edge_1RB_Left	Edge_1RB_Left
10	High	N/A	CP-OFDM QPSK	Edge_1RB_Right	Edge_1RB_Right
11	Low	N/A	CP-OFDM 16 QAM	Edge_1RB_Left	Edge_1RB_Left
12	High	N/A	CP-OFDM 16 QAM	Edge_1RB_Right	Edge_1RB_Right
13	Default	N/A	CP-OFDM 64 QAM	Outer_Full	Outer_Full
14	Default	N/A	CP-OFDM 256 QAM	Outer_Full	Outer_Full
NOTE 1: The specific configuration of each RB allocation is defined in Table 6.1-1.					
NOTE 2: Test Channel Bandwidths and Test SCS are checked separately for each NR CA band combination, which applicable channel bandwidths and SCS are specified in Table 5.5A3-1.					
NOTE 3: DFT-s-OFDM PI/2 BPSK test applies only for UEs which supports half Pi BPSK in FR1.					

Table 6.5A.2.2.1.4.1-2: Intra-band contiguous CA Test Configuration Table

Initial Conditions				
Test Environment as specified in TS 38.508-1 [5] subclause 4.1		Normal		
Test Frequencies as specified in TS 38.508-1 [5] subclause 4.3.1		Low range High range		
Test Channel Bandwidths as specified in TS 38.508-1 [5] subclause 4.3.1		Lowest N_{RB_agg} , Highest N_{RB_agg} (NOTE 1)		
Test SCS as specified in Table 5.5A.3-1		Lowest, Highest		
Test Parameters for CA bandwidth class B and C				
Test ID	DL configuration for PCC & SCC	UL configuration		
		Modulations for all CCs (NOTE 2)		RB allocation (NOTE 3)
1	N/A	DFT-s-OFDM	Pi/2 BPSK	Outer Full
2			QPSK	Outer Full
3			16QAM	Outer Full
4			64QAM	Outer Full
5			256QAM	Outer Full
6		CP-OFDM	QPSK	Outer Full
7			16QAM	Outer Full
8			64QAM	Outer Full
9			256QAM	Outer Full
NOTE 1: The Test CC Combination settings are checked separately for each CA Configuration, which applicable aggregated channel bandwidths are specified in Table 5.5A.1-1.				
NOTE 2: DFT-s-OFDM Pi/2 BPSK test applies only for UEs which supports Pi/2 BPSK in FR1.				
NOTE 3: The specific configuration of each RB allocation is defined in Table 6.1A-1a.				
NOTE 4: If the UE supports multiple CC Combinations in the CA Configuration with the same N_{RB_agg} , only the combination with the highest N_{RB_PCC} is tested.				

Table 6.5A.2.2.1.4.1-3: Intra-band non-contiguous CA Test Configuration Table

Initial Conditions				
Test Environment as specified in TS 38.508-1 [5] subclause 4.1		Normal		
Test Frequencies as specified in TS 38.508-1 [5] subclause 4.3.1.1.3 for inter band CA in FR1		Low range for PCC and SCC High range for PCC and SCC		
Test Channel Bandwidths as specified in TS 38.508-1 [5] subclause 4.3.1		Lowest for both PCC and SCC Highest for both PCC and SCC		
Test SCS as specified in Table 5.5A.3-1		Smallest and biggest supported SCS per Channel Bandwidth		
Test Parameters				
Test ID	Downlink Configuration	Uplink Configuration		
		Modulation (NOTE 4)	RB allocation (NOTE 2)	
			PCC	SCC
1	N/A	DFT-s-OFDM Pi/2 BPSK	Edge_1RB_Left	Edge_1RB_Right
2		DFT-s-OFDM QPSK	Edge_1RB_Left	Edge_1RB_Right
3		DFT-s-OFDM 16 QAM	Edge_1RB_Left	Edge_1RB_Right
4		DFT-s-OFDM 64 QAM	Edge_1RB_Left	Edge_1RB_Right
5		DFT-s-OFDM 256 QAM	Edge_1RB_Left	Edge_1RB_Right
6		CP-OFDM QPSK	Edge_1RB_Left	Edge_1RB_Right
7		CP-OFDM 16 QAM	Edge_1RB_Left	Edge_1RB_Right
8		CP-OFDM 64 QAM	Edge_1RB_Left	Edge_1RB_Right
9		CP-OFDM 256 QAM	Edge_1RB_Left	Edge_1RB_Right
NOTE 1: This test configuration is only applicable for UEs indicating IE <i>dualPA-Architecture</i> supported				
NOTE 2: The specific configuration of each RB allocation is defined in Table 6.1-1.				
NOTE 3: Test Channel Bandwidths and Test SCS are checked separately for each NR CA band combination, which applicable channel bandwidths and SCS are specified in Table 5.5A3-1.				
NOTE 4: DFT-s-OFDM Pi/2 BPSK test applies only for UEs which supports half Pi BPSK in FR1.				

1. Connect the SS to the UE antenna connectors as shown in TS 38.508-1 [5] Annex A, in Figure A.3.1.1.3 for TE diagram and section A.3.2 for UE diagram.
2. The parameter settings for the cell are set up according to TS 38.508-1 [5] subclause 4.4.3.
3. Downlink signals for PCC are initially set up according to Annex C.0, C.1, C.2, and uplink signals according to Annex G.0, G.1, G.2, G.3.0.
4. The UL Reference Measurement channels are set according to Tables 6.5A.2.2.1.4.1-1 through 6.5A.2.2.1.4.1-3 as appropriate.
5. Propagation conditions are set according to Annex B.0.
6. Ensure the UE is in state RRC_CONNECTED with generic procedure parameters Connectivity *NR*, Connected without release *On*, Test Mode *On* and Test Loop Function *On* according to TS 38.508-1 [5] clause 4.5. Message contents are defined in clause 6.5A.2.2.1.4.3.

6.5A.2.2.1.4.2 Test procedure

1. Configure SCC according to Annex C.0, C.1, C.2 for all downlink physical channels.
2. The SS shall configure SCC as per TS 38.508-1 [5] clause 5.5.1. Message contents are defined in clause 6.5A.2.2.1.4.3.
3. SS activates SCC by sending the activation MAC CE (Refer TS 38.321 [18], clauses 5.9, 6.1.3.10). Wait for at least 2 seconds (Refer TS 38.133[19], clause 9.3).
4. SS sends uplink scheduling information for each UL HARQ process via PDCCH DCI format 0_1 for C_RNTI to schedule the UL RMC according to Tables 6.5A.2.2.1.4.1-1 through 6.5A.2.2.1.4.1-3 on both PCC and SCC as appropriate. Since the UL has no payload and no loopback data to send the UE sends uplink MAC padding bits on the UL RMC.
5. Send continuously power control “up” commands in every uplink scheduling information to the UE until the UE transmits at PUMAX level. Allow at least 200ms for the UE to reach PUMAX level.
6. For inter-band CA: measure the mean power of the UE in the channel bandwidth of the radio access mode for each CC according to the test configuration, which shall meet the requirements described in clause 6.2A.2. The period of the measurement shall be at least the continuous duration of one active sub-frame (1ms) and in the uplink symbols. For TDD slots with transient periods are not under test.

For intra-band CA: measure the mean power over all component carriers in the CA configuration of the radio access mode, which shall meet the requirements described in clause 6.2A.2. The period of the measurement shall be at least the continuous duration of one active sub-frame (1ms) and in the uplink symbols. For TDD slots with transient periods are not under test.

7. For inter-band CA: measure the power of the transmitted signal with a measurement filter of bandwidths for each CC according to Table 6.5A.2.2.1.5-1. The centre frequency of the filter shall be stepped in continuous steps according to the same table. The measured power shall be recorded for each step. The measurement period shall capture the active TSs.

For intra-band contiguous CA: measure the power of the transmitted signal with a measurement filter of bandwidths according to table 6.5A.2.2.1.5-3. The centre frequency of the filter shall be stepped in continuous steps according to the same table. The measured power shall be recorded for each step. The measurement period shall capture the active TSs.

For intra-band non-contiguous CA: measure the power of the transmitted signal with a measurement filter of bandwidths for each CC according to Table 6.5A.2.2.1.5-1 except the Wgap area. The centre frequency of the filter shall be stepped in continuous steps according to the same table. The measured power shall be recorded for each step. The measurement period shall capture the active TSs.

NOTE 1: When switching to DFT-s-OFDM waveform, as specified in the test configuration table 6.5.2.2.4.1-1, send an NR RRCReconfiguration message according to TS 38.508-1 [5] clause 4.6.3 Table 4.6.3-118 PUSCH-Config with TRANSFORM_PRECODER_ENABLED condition.

6.5A.2.2.1.4.3 Message contents

Message contents are according to TS 38.508-1 [5] subclause 4.6 with following exception.

Table 6.5A.2.2.1.4.3-1: FrequencyInfoUL-SIB

Derivation Path: TS 38.508-1 [5] Table 4.6.3-62 FrequencyInfoUL-SIB			
Information Element	Value/remark	Comment	Condition
p-Max	20		Power class 3 and Inter-band CA Test IDs 3, 4, 7
	17		Power class 3 and Inter-band CA Test IDs 5, 6, 13
	16		Power class 3 and Inter-band CA Test IDs 1, 2, 8-12
	14		Power class 3 and Inter-band CA Test IDs 14

6.5A.2.2.1.5 Test requirement

The measured UE mean power in the channel bandwidth for each CC, derived in step 6, shall fulfil requirements in clause 6.2A.2 as appropriate, and the power of any UE emission for each CC, derived in step 7, shall fulfil requirements in Table 6.5A.2.2.1.5-1 for inter-band CA and table 6.5A.2.2.1.5-3 for intra-band contiguous CA. If for some frequency spectrum emission masks of component carriers overlap then spectrum emission mask allowing higher power spectral density applies for that frequency. If for some frequency a component carrier spectrum emission mask overlaps with the channel bandwidth of another component carrier, then the emission mask does not apply for that frequency.

Table 6.5A.2.2.1.5-1: NR General spectrum emission mask

Spectrum emission limit (dBm) / Channel bandwidth														
Δf_{OOB} (MHz)	5 MHz	10 MHz	15 MHz	20 MHz	25 MHz	30 MHz	40 MHz	50 MHz	60 MHz	70 MHz	80 MHz	90 MHz	100 MHz	Measurement bandwidth
$\pm 0-1$	-13	-13	-13	-13	-13	-13	-13							1 % channel bandwidth
$\pm 0-1$								-24	-24	-24	-24	-24	-24	30 kHz
$\pm 1-5$	-10	-10	-10	-10	-10	-10	-10	-10	-10	-10	-10	-10	-10	1 MHz
$\pm 5-6$	-13	-13	-13	-13	-13	-13	-13	-13	-13	-13	-13	-13	-13	
$\pm 6-10$	-25													
$\pm 10-15$	-25													
$\pm 15-20$			-25	-25	-25	-25	-13	-13	-13	-13	-13	-13		
$\pm 20-25$														
$\pm 25-30$					-25									
$\pm 30-35$						-25								
$\pm 35-40$														
$\pm 40-45$							-25							
$\pm 45-50$														
$\pm 50-55$								-25						
$\pm 55-60$														
$\pm 60-65$									-25					
$\pm 65-70$														
$\pm 70-75$										-25				
$\pm 75-80$														
$\pm 80-85$											-25			
$\pm 85-90$														
$\pm 90-95$												-25		
$\pm 95-100$														
$\pm 100-105$													-25	

Note 1: The first and last measurement position with a 30 kHz filter is at Δf_{OOB} equals to 0.015 MHz and 0.985 MHz.
 Note 2: At the boundary of spectrum emission limit, the first and last measurement position with a 1 MHz filter is the inside of +0.5MHz and -0.5MHz, respectively.
 Note 3: The measurements are to be performed above the upper edge of the channel and below the lower edge of the channel.

Table 6.5A.2.2.1.5-2: Test Tolerance for Spectrum emission mask

	$f \leq 3.0\text{GHz}$	$3.0\text{GHz} < f \leq 6\text{GHz}$
BW \leq 40MHz	1.5dB	1.8dB
40MHz < BW \leq 100MHz	1.5dB	1.8dB

Table 6.5A.2.2.1.5-3: NR General spectrum emission mask for intra-band contiguous CA

Δf_{OoB} (MHz)	Spectrum emission limit (dBm)	MBW (MHz)
$\pm 0 - 1$	-13	Min(0.01*BW _{channel_CA} , 0.4)
$\pm 1 - 5$	-10	1MHz
$\pm 5 - \text{BW}_{\text{channel_CA}}$	-13	1MHz
$\pm \text{BW}_{\text{channel_CA}} - \text{BW}_{\text{channel_CA}} + 5$	-25	1MHz

NOTE: As a general rule, the resolution bandwidth of the measuring equipment should be equal to the measurement bandwidth. However, to improve measurement accuracy, sensitivity and efficiency, the resolution bandwidth may be smaller than the measurement bandwidth. When the resolution bandwidth is smaller than the measurement bandwidth, the result should be integrated over the measurement bandwidth in order to obtain the equivalent noise bandwidth of the measurement bandwidth.

6.5A.2.4 Adjacent channel leakage ratio

6.5A.2.4.1 NR ACLR

6.5A.2.4.1.0 Minimum conformance requirements

6.5A.2.4.1.0.1 NR ACLR for intra-band contiguous CA

For intra-band contiguous carrier aggregation the carrier aggregation the Adjacent Channel Leakage power Ratio is the ratio of the filtered mean power centred on the aggregated channel bandwidth to the filtered mean power centred on an adjacent aggregated channel bandwidth at nominal channel spacing. The assigned aggregated channel bandwidth power and adjacent aggregated channel bandwidth power are measured with rectangular filters with measurement bandwidths specified in Table 6.5A.2.4.1.0.1-1. If the measured adjacent channel power is greater than -50dBm then the NR_{ACLR} shall be higher than the value specified in Table 6.5A.2.4.1.0.1-1.

Table 6.5A.2.4.1.0.1-1: General requirements for intra-band contiguous CA ACLR

	ACLR / Measurement bandwidth
CA ACLR	30 dB
CA Measurement bandwidth (NOTE 1)	Nominal channel space+ $\text{MBW}_{\text{ACLR,low}}/2 + \text{MBW}_{\text{ACLR,high}}/2$
Adjacent channel centre frequency offset (in MHz)	$+ \text{BW}_{\text{Channel_CA}}$ / $- \text{BW}_{\text{Channel_CA}}$
Difference between ACLR MBW center and $F_{c,\text{low}}$	$\text{MBW}_{\text{shift}} = (\text{MBW}_{\text{ACLR_CA}} - \text{MBW}_{\text{ACLR,low}})/2$
NOTE 1: $\text{MBW}_{\text{ACLR,low}}$ and $\text{MBW}_{\text{ACLR,high}}$ are the single-channel ACLR measurement bandwidths specified for channel bandwidths $\text{BW}_{\text{channel}(\text{low})}$ and $\text{BW}_{\text{channel}(\text{high})}$ in 6.5.2.4.1.3, respectively.	

6.5A.2.4.1.0.2 NR ACLR for intra-band non-contiguous CA

For intra-band non-contiguous carrier aggregation, CA Adjacent Channel Leakage power Ratio(CA_{ACLR}) is the ratio of the sum of the filtered mean power centred on each assigned channel frequency to the filtered mean power centred on an adjacent NR channel frequency at nominal channel spacing. In case the gap bandwidth W_{gap} between 2 uplink CCs is smaller than maximum of the 2 uplink channel bandwidths then no CA_{ACLR} requirement is set for the gap. Each assigned NR channel power and adjacent NR channel power are measured with rectangular filters with measurement

bandwidths specified in Table 6.5.2.4.1.3-1. If the measured adjacent channel power is greater than -50dBm then the ACLR shall be higher than the value specified in Table 6.5A.2.4.1.0.2-1.

Table 6.5A.2.4.1.0.2-1: General requirements for intra-band non-contiguous CA ACLR

	ACLR / Measurement bandwidth
CA ACLR	30 dB
CA Measurement bandwidth for each sub block (NOTE 1)	MBW_{ACLR}
Adjacent channel centre frequency offset (in MHz)	+ $\text{BW}_{\text{Channel}}$ / - $\text{BW}_{\text{Channel}}$
NOTE 1: MBW_{ACLR} is the single-channel ACLR measurement bandwidths specified in 6.5.2.4.1.3.	

When the signalling is absent for dualPA-Architecture IE, if carrier leakage or I/Q image lands inside the gap spectrum between 2 UL CCs when UL CCs are synchronized with frequencies in the gap, exception to the ACLR requirement with 3dB relaxation applies.

6.5A.2.4.1.0.3 NR ACLR for Inter-band CA

For inter-band carrier aggregation with uplink assigned to two NR bands, the NR Adjacent Channel Leakage power Ratio (NRACLR) is defined per component carrier while both component carriers are active and the requirement is specified in clause 6.5.2.4.1.3.

6.5A.2.4.1.1 NR ACLR for CA (2UL CA)

Editor's Note: The following aspects are not yet determined:

- **MU and TT for aggregate BW > 100MHz are FFS.**

6.5A.2.4.1.1.1 Test purpose

To verify that UE transmitter does not cause unacceptable interference to adjacent channels in terms of Adjacent Channel Leakage power Ratio (ACLR) for 2UL CA.

6.5A.2.4.1.1.2 Test applicability

This test case applies to all types of NR UE release 15 and forward that supports 2UL CA.

6.5A.2.4.1.1.3 Minimum conformance requirements

The minimum conformance requirements are defined in subclause 6.5A.2.4.1.0.

6.5A.2.4.1.1.4 Test description

6.5A.2.4.1.1.4.1 Initial conditions

Initial conditions are a set of test configurations the UE needs to be tested in and the steps for the SS to take with the UE to reach the correct measurement state.

The initial test configurations consist of environmental conditions, test frequencies, test channel bandwidths and sub-carrier spacing based on NR CA configuration specified in clause 5.5A. All of these configurations shall be tested with applicable test parameters for each CA configuration, are shown in the test configuration tables in clause 6.2A.2.1.4.1. The details of the uplink reference measurement channels (RMCs) are specified in Annexes A.2. Configurations of PDSCH and PDCCH before measurement are specified in Annex C.2

Table 6.5A.2.4.1.1.4.1-1: Void

Table 6.5A.2.4.1.1.4.1-2: Void

Table 6.5A.2.4.1.1.4.1-3: Void

1. Connect the SS to the UE antenna connectors as shown in TS 38.508-1 [5] Annex A, in Figure A.3.1.1.3 for TE diagram and section A.3.2 for UE diagram.
2. The parameter settings for the cell are set up according to TS 38.508-1 [5] subclause 4.4.3.
3. Downlink signals for PCC are initially set up according to Annex C.0, C.1, C.2, and uplink signals according to Annex G.0, G.1, G.2, G.3.0.
4. The UL Reference Measurement channels are set according to the test configuration tables in clause 6.2A.2.1.4.1.
5. Propagation conditions are set according to Annex B.0
6. Ensure the UE is in state RRC_CONNECTED with generic procedure parameters Connectivity *NR*, Connected without release *On*, Test Mode *On* and Test Loop Function *On* according to TS 38.508-1 [5] clause 4.5. Message contents are defined in clause 6.5A.2.4.1.1.4.3

6.5A.2.4.1.1.4.2 Test procedure

1. Configure SCC according to Annex C.0, C.1, C.2 for all downlink physical channels.
2. The SS shall configure SCC as per TS 38.508-1 [5] clause 5.5.1. Message contents are defined in clause 6.5A.2.4.1.1.4.3.
3. SS activates SCC by sending the activation MAC CE (Refer TS 38.321 [18], clauses 5.9, 6.1.3.10). Wait for at least 2 seconds (Refer TS 38.133[19], clause 9.3).
4. SS sends uplink scheduling information for each UL HARQ process via PDCCH DCI format 0_1 for C_RNTI to schedule the UL RMC according to the test configuration tables in clause 6.2A.2.1.4.1 on both PCC and SCC. Since the UL has no payload and no loopback data to send the UE sends uplink MAC padding bits on the UL RMC.
5. Send continuously power control “up” commands in every uplink scheduling information to the UE until the UE transmits at P_{UMAX} level. Allow at least 200ms for the UE to reach P_{UMAX} level.
6. Measure the sum of mean transmitted power over all component carriers in the CA configuration of the radio access mode, as measured in step 6 of 6.2A.2.1.4.2, which shall meet the requirements in clause 6.2A.2.1.5 as appropriate.
7. For intra-band contiguous 2UL CA UE, execute 7a) to 7c):
 - 7a) Measure the rectangular filtered mean power for the assigned NR aggregated channel bandwidth.
 - 7b) Measure the rectangular filtered mean power of the first NR adjacent aggregated channel on both lower and upper side of the assigned NR channel, respectively.
 - 7c) Calculate the ratios of the power between the values measured in step 7a) over step 7b) for lower and upper CA NR_{ACLR} , respectively.
8. For intra-band non-contiguous 2UL CA UE, execute 8a) to 8e):
 - 8a) Measure the rectangular filtered mean power for the assigned NR channel on the lowest sub-block and highest sub-block respectively.
 - 8b) Measure the rectangular filtered mean power of the first NR adjacent channel on lower side of the lowest sub-block, and the higher side of the highest sub-block (out of gap measurement).
 - 8c) If W_{gap} is larger or equal to either of the sub-block bandwidths, perform this step, otherwise continue to next step. Measure the rectangular filtered mean power of the first NR adjacent channel on higher side of the lowest sub-block, and/or the lower side of the highest sub-block (in gap measurement).
 - 8d) Calculate the ratio of the power between the values measured in step 8a) over step 8b) for CA NR_{ACLR} (out of gap measurement).

- 8e) Calculate the ratio of the power between the values measured in step 8a) over step 8c) for CA NR_{ACLR} (in gap measurement).
- 9. For inter-band 2UL CA UE, execute 9a) to 9f):
 - 9a) Measure the rectangular filtered mean power for the assigned NR channel on PCC.
 - 9b) Measure the rectangular filtered mean power of the first NR adjacent channel on both lower and upper side of the assigned NR channel on PCC, respectively.
 - 9c) Calculate the ratios of the power between the values measured in step 7 over step 8 for lower and upper NR ACLR, respectively.
 - 9d) Measure the rectangular filtered mean power for the assigned NR channel on SCC.
 - 9e) Measure the rectangular filtered mean power of the first NR adjacent channel on both lower and upper side of the assigned NR channel on SCC, respectively.
 - 9f) Calculate the ratios of the power between the values measured in step 9d over step 9e for lower and upper NR ACLR, respectively.

NOTE 1: When switching to DFT-s-OFDM waveform, as specified in the test configuration tables in clause 6.2A.2.1.4.1, send an NR RRCReconfiguration message according to TS 38.508-1 [5] clause 4.6.3 Table 4.6.3-118 PUSCH-Config with TRANSFORM_PRECODER_ENABLED condition.

6.5A.2.4.1.1.4.3 Message contents

Message contents are same as 6.2A.2.1.4.3.

Table 6.5A.2.4.1.1.4.3-1: Void

6.5A.2.4.1.1.5 Test requirement

The measured UE mean power in the channel bandwidth, derived in step 6, shall fulfil requirements in clause 6.2A.2.1 as appropriate, and if the measured adjacent channel power is greater than -50 dBm, then the measured NR ACLR derived in step 7c, step 8e, step 6c and step 9f, shall be higher than the limits in Table 6.5A.2.4.1.1.5-1, 6.5A.2.4.1.1.5-2 and 6.5A.2.4.1.1.5-3 respectively.

Table 6.5A.2.4.1.1.5-1: General requirements for intra-band contiguous CA ACLR

	ACLR / Measurement bandwidth
CA ACLR	30 - TT dB
CA Measurement bandwidth (NOTE 1)	Nominal channel space + MBW _{ACLR,low} /2 + MBW _{ACLR,high} /2
Adjacent channel centre frequency offset (in MHz)	+ BW _{Channel_CA} / - BW _{Channel_CA}
Difference between ACLR MBW center and F _{c,low}	MBW _{shift} = (MBW _{ACLR_CA} - MBW _{ACLR,low}) / 2
NOTE 1: MBW _{ACLR,low} and MBW _{ACLR,high} are the single-channel ACLR measurement bandwidths specified for channel bandwidths BW _{channel(low)} and BW _{channel(high)} in 6.5.2.4.1, respectively.	

Table 6.5A.2.4.1.1.5-2: General requirements for intra-band non-contiguous CA ACLR

	ACLR / Measurement bandwidth
CA ACLR	30 - TT dB
CA Measurement bandwidth for each sub block (NOTE 1)	MBW _{ACLR}
Adjacent channel centre frequency offset (in MHz)	+ BW _{Channel} / - BW _{Channel}
NOTE 1: MBW _{ACLR} is the single-channel ACLR measurement bandwidths specified in 6.5.2.4.1.	

Table 6.5A.2.4.1.1.5-3: General requirements for inter-band CA ACLR

	Power class 1	Power class 2	Power class 3
NR ACLR		31 - TT dB	30 - TT dB

Table 6.5A.2.4.1.1.5-4: NR ACLR measurement bandwidth for inter-band CA

NR channel bandwidth / NR ACLR measurement bandwidth												
	5 MHz	10 MHz	15 MHz	20 MHz	25 MHz	30 MHz	40 MHz	50 MHz	60 MHz	80 MHz	90 MHz	100 MHz
NR ACLR measurement bandwidth	4.515	9.375	14.235	19.095	23.955	28.815	38.895	48.615	58.35	78.15	88.23	98.31

Table 6.5A.2.4.1.1.5-5: Test Tolerance for NR ACLR

	f ≤ 3.0GHz	3.0GHz < f ≤ 6GHz
BW ≤ 100MHz	0.8dB	0.8dB
Aggregated BW ≤ 200MHz	FFS	FFS

6.5A.2.4.2 UTRA ACLR

Editor's note:

- No UTRA ACLR minimum requirements for intra-band CA are specified in RAN4

6.5A.2.4.2.0 Minimum conformance requirements

For inter-band carrier aggregation with uplink assigned to two NR bands, the UTRA Adjacent Channel Leakage power Ratio (UTRA ACLR) is defined per component carrier while both component carrier are active and the requirement is specified in clause 6.5.2.4.2.3.

The normative reference for this requirement is TS 38.101-1 [2] clause 6.5A.2.4.2.

6.5A.2.4.2.1 UTRA ACLR for CA (2UL CA)

6.5A.2.4.2.1.1 Test purpose

To verify that UE transmitter does not cause unacceptable interference to adjacent UTRA channels in terms of Adjacent Channel Leakage power Ratio (UTRA ACLR) for 2UL CA.

6.5A.2.4.2.1.2 Test applicability

This test case applies for network signalling values NS_3U, NS_5U, NS_43U, and NS_100 to all types of NR UE release 15 and forward that supports 2UL inter-band CA.

6.5A.2.4.2.1.3 Minimum conformance requirements

The minimum conformance requirements are defined in subclause 6.5A.2.4.2.0.

6.5A.2.4.2.1.4 Test description

6.5A.2.4.2.1.4.1 Initial conditions

Same as in subclause 6.2A.3.1.4.1 with the following exception;

- Only network signalling values NS_3U, NS_5U, NS_43U, and NS_100 with the corresponding CA configuration defined in Table 6.2A.3.1.4.1-1 need to perform UTRA ACLR test.
- Message contents in step 6 are defined in clause 6.5A.2.4.2.1.4.3.

6.5A.2.4.2.1.4.2 Test procedure

1. Configure SCC according to Annex C.0, C.1, C.2 for all downlink physical channels.
2. The SS shall configure SCC as per TS 38.508-1 [5] clause 5.5.1. Message contents are defined in clause 6.5A.2.4.2.1.4.3.
3. SS activates SCC by sending the activation MAC CE (Refer TS 38.321 [18], clauses 5.9, 6.1.3.10). Wait for at least 2 seconds (Refer TS 38.133[19], clause 9.3).
4. SS sends uplink scheduling information for each UL HARQ process via PDCCH DCI format 0_1 for C_RNTI to schedule the UL RMC according to the applicable test configuration tables in clause 6.2A.3.1.4.1 on both PCC and SCC. Since the UL has no payload and no loopback data to send the UE sends uplink MAC padding bits on the UL RMC.
5. Send continuously power control “up” commands in every uplink scheduling information to the UE until the UE transmits at P_{UMAX} level. Allow at least 200ms for the UE to reach P_{UMAX} level.
6. Measure the sum of mean transmitted power over all component carriers in the CA configuration of the radio access mode. The period of measurement shall be at least the continuous duration of 1ms uplink. For TDD only slots consisting of only UL symbols are under test. For FDD band in inter-band CA with both TDD band and FDD band, only slots overlapping with only UL symbols in TDD are under test.
7. Measure the rectangular filtered mean power for the assigned NR channel on PCC.
8. Measure the RRC filtered mean power of the first and the second UTRA adjacent channel on both lower and upper side of the assigned NR channel on PCC, respectively.
9. Calculate the ratios of the power between the values measured in step 7 over step 8 for lower and upper UTRA ACLR, respectively.
10. Measure the rectangular filtered mean power for the assigned NR channel on SCC.
11. Measure the RRC filtered mean power of the first and the second UTRA adjacent channel on both lower and upper side of the assigned NR channel on SCC, respectively.
12. Calculate the ratios of the power between the values measured in step 10 over step 11 for lower and upper UTRA ACLR, respectively.

NOTE 1: When switching to DFT-s-OFDM waveform, as specified in the test configuration table 6.5.2.2.4.1-1, send an NR RRCReconfiguration message according to TS 38.508-1 [5] clause 4.6.3 Table 4.6.3-118 PUSCH-Config with TRANSFORM_PRECODER_ENABLED condition.

6.5A.2.4.2.1.4.3 Message contents

Message contents are according to TS 38.508-1 [5] subclause 4.6 with the following exceptions:

6.5A.2.4.2.1.4.3.1 Message contents exceptions (network signalling value "NS_100" on PCC)

Table 6.5A.2.4.2.1.4.3.1-1: AdditionalSpectrumEmission: Additional spurious emissions test requirement for "NS_100" on PCC

Derivation Path: TS 38.508-1 [5] clause 4.6.3, Table 4.6.3-1 AdditionalSpectrumEmission			
Information Element	Value/remark	Comment	Condition
AdditionalSpectrumEmission	1 (NS_100)		not for band n65
	2 (NS_100)		for band n65

6.5A.2.4.2.1.4.3.2 Message contents exceptions (network signalling value "NS_43U" on PCC)

Table 6.5A.2.4.2.1.4.3.2-1: AdditionalSpectrumEmission: Additional spurious emissions test requirement for "NS_43U" on PCC

Derivation Path: TS 38.508-1 [5] clause 4.6.3, Table 4.6.3-1 AdditionalSpectrumEmission			
Information Element	Value/remark	Comment	Condition
AdditionalSpectrumEmission	3 (NS_43U)		

6.5A.2.4.2.1.5 Test requirement

The measured UE mean power in the channel bandwidth, derived in step 6, shall fulfil requirements in clause 6.2A.3.1 as appropriate, and if the measured adjacent channel power is greater than -50 dBm, then the measured UTRA ACLR for each CC, derived in step 9 and step 13, shall be higher than the limits in Table 6.5A.2.4.2.1.5-2.

Table 6.5A.2.4.2.1.5-1: Measurement bandwidth for NR carrier

	NR channel bandwidth / UTRA ACLR measurement bandwidth												
	5 MH z	10 MH z	15 MH z	20 MH z	25 MH z	30 MH z	40 MH z	50 MH z	60 MH z	70 MH z	80 MH z	90 MH z	100 MH z
NR channel measurement bandwidth (MHz)	4.5 15	9.3 75	14. 235	19. 095	23. 955	28. 815	38. 895	48. 615	58. 35	68. 07	78. 15	88. 23	98. 31
UTRA channel Measurement bandwidth (MHz)	3.84												
1 st Adjacent channel centre frequency offset	± 2.5 MHz from NR channel edge												
2 nd Adjacent channel centre frequency offset	± 7.5 MHz from NR channel edge												

Table 6.5A.2.4.2.1.5-2: UTRA ACLR requirement

	Power class 3
UTRA _{ACLR1}	33 dB - TT
UTRA _{ACLR2}	36 dB - TT

Table 6.5A.2.4.2.1.5-3: Test Tolerance for UTRA ACLR

	$f \leq 3.0\text{GHz}$	$3.0\text{GHz} < f \leq 6\text{GHz}$
$\text{BW} \leq 100\text{MHz}$	0.8dB	0.8dB

6.5A.3 Spurious emission for CA

6.5A.3.1 General spurious emissions for CA

Editor's Note: The following aspects are either missing or not yet determined:

- Extending the coverage of the TCs with intra-band CA scenarios is FFS

6.5A.3.1.0 Minimum conformance requirements

For inter-band carrier aggregation with uplink assigned to two NR bands, the spurious emission requirement Table 6.5.3.1.3-2 apply for the frequency ranges that are more than F_{OOB} as defined in Table 6.5.3.1.3-1 away from edges of the assigned channel bandwidth on a component carrier. If for some frequency a spurious emission requirement of individual component carrier overlaps with the spectrum emission mask or channel bandwidth of another component carrier then it does not apply.

NOTE 1: For inter-band carrier aggregation with uplink assigned to two NR bands the requirements in Table 6.5.3.1.3-2 could be verified by measuring spurious emissions at the specific frequencies where second and third order intermodulation products generated by the two transmitted carriers can occur; in that case, the requirements for remaining applicable frequencies in Table 6.5.3.1.3-2 would be considered to be verified by the measurements verifying the one uplink inter-band CA spurious emission requirement.

For intra-band contiguous carrier aggregation the spurious emission limits apply for the frequency ranges that are more than $FOOB$ (MHz) in Table 6.5A.3.1.0-1 from the edge of the aggregated channel bandwidth. For frequencies Δf_{OOB} greater than $FOOB$ as specified in Table 6.5A.3.1.0-1 the spurious emission requirements in Table 6.5.3.1.3-2 are applicable.

Table 6.5A.3.1.0-1: Boundary between out of band and spurious emission domain for intra-band contiguous carrier aggregation

Aggregated Channel bandwidth	OOB boundary F_{OOB} (MHz)
$BW_{Channel_CA}$	$BW_{Channel_CA} + 5$

For intra-band non-contiguous carrier aggregation transmission the spurious emission requirement is defined as a composite spurious emission requirement. Composite spurious emission requirement applies to frequency ranges that are more than $FOOB$ away from the edges of each carrier in the gap and out of the gap. Composite spurious emission requirement is defined as follows

- Composite spurious emission requirement is a combination of individual sub-block spurious emission requirements
- In case the sub-block consist of one component carrier the sub-lock spurious emission requirement and $FOOB$ are defined in subclause 6.5.3.1
- If for some frequency an individual sub-block spurious emission requirement overlaps with the general spectrum emission mask or the sub-block bandwidth of another sub-block then it does not apply

For the signalling is absent for dualPA-Architecture IE, if carrier leakage or I/Q image lands inside the gap spectrum between 2 UL CCs when UL CCs are synchronized with frequencies in the gap, exception to the general spurious requirement applies.

The normative reference for this requirement is TS 38.101-1 [2] subclause 6.5A.3.1

6.5A.3.1.1 General spurious emissions for CA (2UL CA)

6.5A.3.1.1.1 Test purpose

To verify that UE transmitter does not cause unacceptable interference to other channels or other systems in terms of transmitter spurious emissions.

6.5A.3.1.1.2 Test applicability

This test case applies to all types of NR UE release 15 and forward that supports 2UL CA.

6.5A.3.1.1.3 Minimum conformance requirements

The minimum conformance requirements are defined in subclause 6.5A.3.1.0.

6.5A.3.1.1.4 Test description

6.5A.3.1.1.4.1 Initial conditions

Initial conditions are a set of test configurations the UE needs to be tested in and the steps for the SS to take with the UE to reach the correct measurement state.

The initial test configurations consist of environmental conditions, test frequencies, test channel bandwidths and sub-carrier spacing based on NR CA configuration specified in clause 5.5A. All of these configurations shall be tested with applicable test parameters for each CA configuration, are shown in Table 6.5A.3.1.1.4.1-1. The details of the uplink reference measurement channels (RMCs) are specified in Annexes A.2. Configurations of PDSCH and PDCCH before measurement are specified in Annex C.2.

Table 6.5A.3.1.1.4.1-1: Inter band CA Test Configuration Table

Initial Conditions				
Test Environment as specified in TS 38.508-1 [5] subclause 4.1		Normal		
Test Frequencies as specified in TS 38.508-1 [5] subclause 4.3.1.1.3 for inter band CA in FR1		Low range for PCC and SCC High range for PCC and SCC		
Test Channel Bandwidths as specified in TS 38.508-1 [5] subclause 4.3.1		Lowest N_{RB_agg} for both PCC and SCC Highest N_{RB_agg} for both PCC and SCC		
Test SCS as specified in Table 5.5A.3-1		Lowest		
Test Parameters				
Test ID	Downlink Configuration	Uplink Configuration		
		Modulation	RB allocation (NOTE 1)	
			PCC	SCC
1	N/A	CP-OFDM QPSK	Outer_Full	Outer_Full
2		CP-OFDM QPSK	Edge_1RB_Left	Edge_1RB_Left
3		CP-OFDM QPSK	Edge_1RB_Right	Edge_1RB_Right
NOTE 1: The specific configuration of each RB allocation is defined in Table 6.1-1.				
NOTE 2: Test Channel Bandwidths and Test SCS are checked separately for each NR CA band combination, which applicable channel bandwidths and SCS are specified in Table 5.5A3-1.				

1. Connect the SS to the UE antenna connectors as shown in TS 38.508-1 [5] Annex A, in Figure A.3.1.1.3 for TE diagram and section A.3.2 for UE diagram.
2. The parameter settings for the cell are set up according to TS 38.508-1 [5] subclause 4.4.3.
3. Downlink signals for PCC are initially set up according to Annex C.0, C.1 and C.2, and uplink signals according to Annex G.0, G.1, G.2, G.3.0.
4. The UL Reference Measurement channels are set according to Table 6.5A.3.1.1.4.1-1.
5. Propagation conditions are set according to Annex B.0.
6. Ensure the UE is in state RRC_CONNECTED with generic procedure parameters Connectivity *NR*, Connected without release *On*, Test Mode *On* and Test Loop Function *On* according to TS 38.508-1 [5] clause 4.5. Message contents are defined in clause 6.5A.3.1.1.4.3.

6.5A.3.1.1.4.2 Test procedure

1. Configure SCC according to Annex C.0, C.1, C.2 for all downlink physical channels.
2. The SS shall configure SCC as per TS 38.508-1 [5] clause 5.1.1. Message contents are defined in clause 6.5A.3.1.1.4.3.
3. SS activates SCC by sending the activation MAC CE (Refer TS 38.321 [18], clauses 5.9, 6.1.3.10). Wait for at least 2 seconds (Refer TS 38.133[19], clause 9.3).
4. SS sends uplink scheduling information for each UL HARQ process via PDCCH DCI format 0_1 for C_RNTI to schedule the UL RMC according to Table 6.5A.3.1.1.4.1-1 on both PCC and SCC. Since the UE has no payload data to send, the UE transmits uplink MAC padding bits on the UL RMC.

5. Send continuously uplink power control "up" commands in every uplink scheduling information to the UE until the UE transmits at P_{UMAX} level.
6. Measure the power of the transmitted signal with a measurement filter of bandwidths according to Table 6.5A.3.1.1.5-1. The centre frequency of the filter shall be stepped in contiguous steps according to Table 6.5A.3.1.1.5-1. The measured power shall be verified for each step. The measurement period shall capture the active time slots.

6.5A.3.1.1.4.3 Message contents

Message contents are according to TS 38.508-1 [5] subclause 4.6 with following exception.

Table 6.5A.3.1.1.4.3-1: FrequencyInfoUL-SIB

Derivation Path: TS 38.508-1 [5] Table 4.6.3-62 FrequencyInfoUL-SIB			
Information Element	Value/remark	Comment	Condition
p-Max	16		Power class 3 and Inter-band CA

6.5A.3.1.1.5 Test requirement

This clause specifies the requirements for the specified NR band for Transmitter Spurious emissions requirement with frequency range as indicated in Table 6.5A.3.1.1.5-1. The test requirement of configurations for CA operating band including Band n41 also apply for the corresponding CA operating bands with Band n90 replacing Band n41.

Unless otherwise stated, the spurious emission limits apply for the frequency ranges that are more than Δf_{OOB} (MHz) in Table 6.5.3.1.3-1 from the edge of the channel bandwidth. If for some frequency a spurious emission requirement of individual component carrier overlaps with the spectrum emission mask or channel bandwidth of another component carrier then it does not apply.

The measured average power of spurious emission, derived in step 6, shall not exceed the described value in Table 6.5A.3.1.1.5-1.

Table 6.5A.3.1.1.5-1: General spurious emissions test requirements

Frequency Range	Maximum Level	Measurement Bandwidth	Notes
Test requirements for CA_n3A-n78A Configuration			
270 MHz ≤ f ≤ 380 MHz	-36 dBm+TT	100 kHz	
1515MHz ≤ f ≤ 2090 MHz 3270 MHz ≤ f ≤ 3830 MHz 4815 MHz ≤ f ≤ 5890 MHz 6720 MHz ≤ f ≤ 7370 MHz 8310 MHz ≤ f ≤ 9385 MHz	-30 dBm+TT	1 MHz	
Test requirements for CA_n8A-n78A Configuration			
780 MHz ≤ f ≤ 1000 MHz	-36 dBm+TT	100 kHz	
1000MHz ≤ f ≤ 1015 MHz 1470 MHz ≤ f ≤ 2040 MHz 2385 MHz ≤ f ≤ 2920 MHz 3290 MHz ≤ f ≤ 3810 MHz 4180 MHz ≤ f ≤ 4715 MHz 5060 MHz ≤ f ≤ 5630 MHz 5685 MHz ≤ f ≤ 6720 MHz 7480 MHz ≤ f ≤ 8515 MHz	-30 dBm+TT	1 MHz	
Test requirements for CA_n24A-n41A Configuration			
563 MHz ≤ f ≤ 825 MHz 835.5 MHz ≤ f ≤ 1000 MHz	-36 dBm+TT	100 kHz	
1000 MHz ≤ f ≤ 1063.5 MHz 3331.5 MHz ≤ f ≤ 3753.5 MHz 4122.5 MHz ≤ f ≤ 4350.5 MHz 5749 MHz ≤ f ≤ 6011 MHz 6618.5 MHz ≤ f ≤ 7040.5 MHz	-25 dBm+TT	1 MHz	
Test requirements for CA_n24A-n48A Configuration			
229 MHz ≤ f ≤ 447 MHz	-36 dBm+TT	100 kHz	
1889.5 MHz ≤ f ≤ 2073.5 MHz 5176.5 MHz ≤ f ≤ 5360.5 MHz 5439.5 MHz ≤ f ≤ 5773.5 MHz 6803 MHz ≤ f ≤ 7021 MHz 8726.5 MHz ≤ f ≤ 9060.5 MHz	-30 dBm+TT	1 MHz	
Test requirements for CA_n24A-n77A Configuration			
21 MHz ≤ f < 30 MHz	-36 dBm+TT	10 kHz	
30 MHz ≤ f < 947 MHz	-36 dBm+TT	100 kHz	
1639.5 MHz ≤ f ≤ 2573.5 MHz 4926.5 MHz ≤ f ≤ 7521 MHz 8226.5 MHz ≤ f ≤ 10060.5 MHz	-30 dBm+TT	1 MHz	
Test requirements for CA_n28A-n41A Configuration			
1000MHz ≤ f ≤ 1284 MHz 1748MHz ≤ f ≤ 1987 MHz 3199MHz ≤ f ≤ 3438 MHz 3902MHz ≤ f ≤ 4186 MHz 4244MHz ≤ f ≤ 4677 MHz 5695MHz ≤ f ≤ 6128MHz	-25 dBm+TT	1MHz	
Test requirements for CA_n41A-n79A Configuration			
8 MHz ≤ f ≤ 30 MHz	-36 dBm+TT	10kHz	
30 MHz ≤ f ≤ 980 MHz	-36 dBm+TT	100kHz	
1710MHz ≤ f ≤ 2504MHz	-30 dBm+TT	1MHz	
6110MHz ≤ f ≤ 7690MHz			
9392MHz ≤ f ≤ 10380MHz			
11296MHz ≤ f ≤ 12690MHz			

Table 6.5A.3.1.1.5-2: Test Tolerance for General spurious emissions

	$f \leq 3.0\text{GHz}$	$3.0\text{GHz} < f \leq 6\text{GHz}$
$\text{BW} \leq 40\text{MHz}$	0	0
$40\text{MHz} < \text{BW} \leq 100\text{MHz}$	0	0

6.5A.3.2 Spurious emission for UE co-existence

Editor's note: The following aspects are either missing or not yet determined:

- Extending the coverage of the TCs with intra-band CA scenarios is FFS.

6.5A.3.2.0 Minimum conformance requirements

6.5A.3.2.0.1 Spurious emissions for UE co-existence for intra-band contiguous CA

This clause specifies the requirements for the specified intra-band contiguous carrier aggregation configurations for coexistence with protected bands, the requirements in Table 6.5A.3.2.0.1-1 apply.

NOTE: For measurement conditions at the edge of each frequency range, the lowest frequency of the measurement position in each frequency range should be set at the lowest boundary of the frequency range plus $\text{MBW}/2$. The highest frequency of the measurement position in each frequency range should be set at the highest boundary of the frequency range minus $\text{MBW}/2$. MBW denotes the measurement bandwidth defined for the protected band.

Table 6.5A.3.2.0.1-1: Requirements for uplink intra-band contiguous carrier aggregation

NR CA combination	Spurious emission						
	Protected Band	Frequency range (MHz)			Maximum Level (dBm)	MBW (MHz)	NOTE
CA_n7	E-UTRA Band 1, 2, 3, 4, 5, 7, 8, 10, 12, 13, 14, 17, 20, 22, 26, 27, 28, 29, 30, 31, 32, 33, 34, 40, 42, 43, 50, 51, 52, 65, 66, 67, 68, 72, 74, 75, 76, 85, NR Band n77, n78	F _{DL_low}	-	F _{DL_high}	-50	1	
	Frequency range	2570	-	2575	+1.6	5	1, 2, 3
	Frequency range	2575	-	2595	-15.5	5	1, 2, 3
	Frequency range	2595	-	2620	-40	1	1, 2
CA_n41	E-UTRA Band 1, 2, 3, 4, 5, 8, 10, 12, 13, 14, 17, 24, 25, 26, 27, 28, 29, 30, 34, 39, 42, 44, 45, 48, 50, 51, 52, 65, 66, 70, 71, 73, 74, 85, NR Band n77, n78	F _{DL_low}	-	F _{DL_high}	-50	1	
	NR Band n79	F _{DL_low}	-	F _{DL_high}	-50	1	2, 4
	E-UTRA Band 9, 11, 18, 19, 21	F _{DL_low}	-	F _{DL_high}	-50	1	6
	E-UTRA Band 40	F _{DL_low}	-	F _{DL_high}	-40	1	
	Frequency range	1884.5	-	1915.7	-41	0.3	5, 6
CA_n48	E-UTRA Band 2, 4, 5, 12, 13, 14, 17, 24, 25, 26, 29, 30, 41, 50, 51, 66, 70, 71, 74, 85	F _{DL_low}	-	F _{DL_high}	-50	1	
CA_n77	E-UTRA Band 1, 3, 5, 7, 8, 11, 18, 19, 20, 21, 26, 28, 34, 39, 40, 41, 65	F _{DL_low}	-	F _{DL_high}	-50	1	
	Frequency range	1884.5	-	1915.7	-41	0.3	5
CA_n78	E-UTRA Band 1, 3, 5, 7, 8, 11, 18, 19, 20, 21, 26, 28, 34, 39, 40, 41, 65	F _{DL_low}	-	F _{DL_high}	-50	1	
	Frequency range	1884.5	-	1915.7	-41	0.3	5
CA_n79	E-UTRA Band 1, 3, 5, 8, 11, 18, 19, 21, 28, 34, 39, 40, 41, 42, 65	F _{DL_low}	-	F _{DL_high}	-50	1	
	Frequency range	1884.5	-	1915.7	-41	0.3	5
NOTE 1: These requirements also apply for the frequency ranges that are less than F _{OOB} (MHz) in Table 6.5.3.1-1 from the edge of the channel bandwidth.							
NOTE 2: This requirement is applicable for any channel bandwidths within the range 2500 - 2570 MHz with the following restriction: for carriers of 15 MHz bandwidth when carrier centre frequency is within the range 2560.5 - 2562.5 MHz and for carriers of 20 MHz bandwidth when carrier centre frequency is within the range 2552 - 2560 MHz the requirement is applicable only for an uplink transmission bandwidth less than or equal to 54 RB.							
NOTE 3: For these adjacent bands, the emission limit could imply risk of harmful interference to UE(s) operating in the protected operating band.							
NOTE 4: As exceptions, measurements with a level up to the applicable requirements defined in Table 6.5.3.1-2 are permitted for each assigned NR carrier used in the measurement due to 2nd, 3rd, 4th or 5th harmonic spurious emissions. Due to spreading of the harmonic emission the exception is also allowed for the first 1 MHz frequency range immediately outside the harmonic emission on both sides of the harmonic emission. This results in an overall exception interval centred at the harmonic emission of (2 MHz + N x L _{CRB} x RB _{size} kHz), where N is 2, 3, 4, 5 for the 2nd, 3rd, 4th or 5th harmonic respectively. The exception is allowed if the measurement bandwidth (MBW) totally or partially overlaps the overall exception interval.							
NOTE 5: Applicable when co-existence with PHS system operating in 1884.5 - 1915.7 MHz.							
NOTE 6: This requirement applies when the NR carrier is confined within 2545 – 2575 MHz or 2595 – 2645 MHz and the channel bandwidth is 10 or 20 MHz							

6.5A.3.2.0.2 Void

6.5A.3.2.0.3 Spurious emissions for UE co-existence for Inter-band CA

For inter-band carrier aggregation with the uplink assigned to two NR bands, the requirements in Table 6.5A.3.2.0.3-1 and Table 6.5A.3.2.0.3-2 apply on each component carrier with both component carriers are active.

NOTE: For inter-band carrier aggregation with uplink assigned to two NR bands, the requirements in Table 6.5A.3.2.0.3-1 and Table 6.5A.3.2.0.3-2 could be verified by measuring spurious emissions at the specific frequencies where second and third order intermodulation products generated by the two transmitted carriers can occur; in that case, the requirements for remaining applicable frequencies in Table 6.5A.3.2.0.3-1 and Table 6.5A.3.2.0.3-2 would be considered to be verified by the measurements verifying the one uplink inter-band CA UE to UE co-existence requirements.

Table 6.5A.3.2.0.3-1: Requirements for uplink inter-band carrier aggregation (two bands)

NR CA combination	Spurious emission						
	Protected Band	Frequency range (MHz)			Maximum Level (dBm)	MBW (MHz)	NOTE
CA_n1-n28	E-UTRA Band 5, 7, 8, 18, 19, 20, 26, 27, 31, 38, 40, 41, 72, 73 NR band n79	F _{DL_low}	-	F _{DL_high}	-50	1	
	E-UTRA Band 1, 22, 32, 42, 43, 50, 51, 52, 65, 74, 75, 76 NR band n77, n78	F _{DL_low}	-	F _{DL_high}	-50	1	2
	E-UTRA Band 3, 34	F _{DL_low}	-	F _{DL_high}	-50	1	4
	E-UTRA Band 11, 21	F _{DL_low}	-	F _{DL_high}	-50	1	11, 12
	E-UTRA Band 1, 65	F _{DL_low}	-	F _{DL_high}	-50	1	11, 15
	Frequency range	470	-	694	-42	8	4, 14
	Frequency range	470	-	710	-26.2	6	15
	Frequency range	758	-	773	-30	1	4
	Frequency range	773	-	803	-50	1	
	Frequency range	662	-	694	-26.2	6	4
	Frequency range	1880	-	1895	-40	1	4, 6
	Frequency range	1895	-	1915	-15.5	5	4, 6, 7
Frequency range	1915	-	1920	+1.6	5	4, 6, 7	
CA_n1-n40	E-UTRA Band 1, 5, 7, 8, 11, 18, 19, 20, 21, 22, 26, 27, 28, 31, 32, 38, 41, 42, 43, 44, 45, 50, 51, 52, 65, 67, 68, 69, 72, 73, 74, 75, 76 NR band n78	F _{DL_low}	-	F _{DL_high}	-50	1	
	Band 3, 34	F _{DL_low}	-	F _{DL_high}	-50	1	4
	NR band n77, n79	F _{DL_low}	-	F _{DL_high}	-50	1	2
	Frequency range	1880	-	1895	-40	1	4, 14
	Frequency range	1895	-	1915	-15.5	5	4, 7, 14
	Frequency range	1915	-	1920	+1.6	5	4, 7, 14
	Frequency range	1884.5	-	1915.7	-41	0.3	3
CA_n1-n78	E-UTRA Band 1, 3, 5, 7, 8, 11, 18, 19, 20, 21, 26, 28, 34, 40, 41, 65, 74	F _{DL_low}	-	F _{DL_high}	-50	1	
	Frequency range	1880	-	1895	-40	1	4, 6
	Frequency range	1895	-	1915	-15.5	5	4, 6, 7
	Frequency range	1915	-	1920	+1.6	5	4, 6, 7
CA_n1-n79	E-UTRA Band 1, 3, 5, 7, 8, 11, 18, 19, 21, 26, 28, 34, 40, 41, 42, 65, 74	F _{DL_low}	-	F _{DL_high}	-50	1	
	Frequency range	1880	-	1895	-40	1	4, 6
	Frequency range	1895	-	1915	-15.5	5	4, 6, 7
	Frequency range	1915	-	1920	+1.6	5	4, 6, 7
CA_n3-n28	E-UTRA Band 5, 7, 8, 18, 19, 20, 26, 27, 31, 38, 40, 41, 72	F _{DL_low}	-	F _{DL_high}	-50	1	
	E-UTRA Band 32, 42, 43, 50, 51, 74, 75, 76 NR band n77, n78, n79	F _{DL_low}	-	F _{DL_high}	-50	1	2
	E-UTRA Band 3, 34	F _{DL_low}	-	F _{DL_high}	-50	1	4
	E-UTRA Band 11, 21	F _{DL_low}	-	F _{DL_high}	-50	1	11, 12
	E-UTRA Band 1, 65	F _{DL_low}	-	F _{DL_high}	-50	1	11, 15
	Frequency range	470	-	694	-42	8	4, 14
	Frequency range	470	-	710	-26.2	6	15
	Frequency range	758	-	773	-30	1	4
	Frequency range	773	-	803	-50	1	
	Frequency range	662	-	694	-26.2	6	4
	Frequency range	1880	-	1895	-40	1	4, 6
	Frequency range	1895	-	1915	-15.5	5	4, 6, 7

	Frequency range	1915	-	1920	+1.6	5	4, 6, 7
	Frequency range	1839.9	-	1879.9	-50	1	4
	Frequency range	1884.5	-	1915.7	-41	0.3	3, 11
CA_n3-n40	E-UTRA Band 1, 5, 7, 8, 11, 18, 19, 20, 21, 26, 27, 28, 31, 32, 33, 34, 38, 39, 41, 43, 44, 45, 50, 51, 65, 67, 68, 69, 72, 73, 74, 75, 76	F _{DL_low}	-	F _{DL_high}	-50	1	
	E-UTRA Band 3	F _{DL_low}	-	F _{DL_high}	-50	1	4
	UTRA Band 22, 42, 52 NR Band n77, n78, n79	F _{DL_low}	-	F _{DL_high}	-50	1	2
	Frequency range	1884.5	-	1915.7	-41	0.3	3
CA_n3-n78	E-UTRA Band 1, 3, 5, 7, 8, 11, 18, 19, 20, 21, 26, 28, 34, 39, 40, 41, 65	F _{DL_low}	-	F _{DL_high}	-50	1	
	Frequency range	1884.5	-	1915.7	-41	0.3	3
CA_n8-n78	E-UTRA Band 1, 8, 11, 20, 21, 28, 34, 39, 40, 65, 74	F _{DL_low}	-	F _{DL_high}	-50	1	
	E-UTRA Band 3, 7, 41	F _{DL_low}	-	F _{DL_high}	-50	1	2
	Frequency range	1884.5	-	1915.7	-41	0.3	3
CA_n40-n78	UTRA Band 1, 3, 5, 7, 8, 11, 18, 19, 20, 21, 26, 27, 28, 31, 32, 33, 34, 38, 39, 41, 44, 45, 50, 51, 65, 67, 68, 69, 72, 73, 74, 75, 76	F _{DL_low}	-	F _{DL_high}	-50	1	
	NR Band n79	F _{DL_low}	-	F _{DL_high}	-50	1	2
	Frequency range	1884.5	-	1915.7	-41	0.3	3
CA_n40-n79	E-UTRA Band 1, 3, 5, 8, 11, 18, 19, 21, 26, 28, 34, 39, 41, 42, 65, 74, NR band n78	F _{DL_low}	-	F _{DL_high}	-50	1	
	Frequency range	1884.5	-	1915.7	-41	0.3	3
CA_n78-n79	E-UTRA Band 1, 3, 5, 8, 11, 18, 19, 21, 28, 34, 40, 41, 65, 74	F _{DL_low}	-	F _{DL_high}	-50	1	
	Frequency range	1884.5	-	1915.7	-41	0.3	3
NOTE 1: F _{DL_low} and F _{DL_high} refer to each frequency band specified in Table 5.2-1 in TS 38.101-1 or Table 5.5-1 in TS 36.101							
NOTE 2: As exceptions, measurements with a level up to the applicable requirements defined in Table 6.5.3.1-2 are permitted for each assigned NR carrier used in the measurement due to 2nd, 3rd, 4th or 5 th harmonic spurious emissions. Due to spreading of the harmonic emission the exception is also allowed for the first 1 MHz frequency range immediately outside the harmonic emission on both sides of the harmonic emission. This results in an overall exception interval centred at the harmonic emission of (2 MHz + N x L _{CRB} x 180kHz), where N is 2, 3, 4, 5 for the 2nd, 3rd, 4th or 5th harmonic respectively. The exception is allowed if the measurement bandwidth (MBW) totally or partially overlaps the overall exception interval.							
NOTE 3: Applicable when co-existence with PHS system operating in 1884.5 -1915.7 MHz							
NOTE 4: These requirements also apply for the frequency ranges that are less than F _{00B} (MHz) in Table 6.5.3.1-1 from the edge of the channel bandwidth.							
NOTE 5: Void.							

NOTE: To simplify Table 6.5A.3.2.0.3-1, E-UTRA band numbers are listed for bands which are specified only for E-UTRA operation or both E-UTRA and NR operation. NR band numbers are listed for bands which are specified only for NR operation.

Table 6.5A.3.2.0.3-2: Requirements for uplink inter-band carrier aggregation (two bands) Rel-16

NR CA Configuration	Spurious emission						
	Protected Band	Frequency range (Mhz)			Maximum Level (dBm)	MBW (MHz)	NOTE
CA_n1-n28	E-UTRA Band 5, 7, 8, 18, 19, 20, 26, 27, 31, 38, 40, 41, 72, 73 NR band n79	F _{DL_low}	-	F _{DL_high}	-50	1	
	E-UTRA Band 1, 22, 32, 42, 43, 50, 51, 52, 65, 74, 75, 76 NR band n77, n78	F _{DL_low}	-	F _{DL_high}	-50	1	2
	E-UTRA Band 3, 34	F _{DL_low}	-	F _{DL_high}	-50	1	4
	E-UTRA Band 11, 21	F _{DL_low}	-	F _{DL_high}	-50	1	11, 12
	E-UTRA Band 1, 65	F _{DL_low}	-	F _{DL_high}	-50	1	11, 15
	Frequency range	470	-	694	-42	8	4, 14
	Frequency range	470	-	710	-26.2	6	15
	Frequency range	758	-	773	-30	1	4
	Frequency range	773	-	803	-50	1	
	Frequency range	662	-	694	-26.2	6	4
	Frequency range	1880	-	1895	-40	1	4, 6
	Frequency range	1895	-	1915	-15.5	5	4, 6, 7
Frequency range	1915	-	1920	+1.6	5	4, 6, 7	
CA_n1-n40	E-UTRA Band 1, 5, 7, 8, 11, 18, 19, 20, 21, 22, 26, 27, 28, 31, 32, 38, 41, 42, 43, 44, 45, 50, 51, 52, 65, 67, 68, 69, 72, 73, 74, 75, 76 NR band n78	F _{DL_low}	-	F _{DL_high}	-50	1	
	Band 3, 34	F _{DL_low}	-	F _{DL_high}	-50	1	4
	NR band n77, n79	F _{DL_low}	-	F _{DL_high}	-50	1	2
	Frequency range	1880		1895	-40	1	4, 14
	Frequency range	1895		1915	-15.5	5	4, 7, 14
	Frequency range	1915		1920	+1.6	5	4, 7, 14
	Frequency range	1884.5	-	1915.7	-41	0.3	3
CA_n1-n78	E-UTRA Band 1, 3, 5, 7, 8, 11, 18, 19, 20, 21, 26, 28, 34, 40, 41, 65, 74	F _{DL_low}	-	F _{DL_high}	-50	1	
	Frequency range	1880	-	1895	-40	1	4, 6
	Frequency range	1895	-	1915	-15.5	5	4, 6, 7
	Frequency range	1915	-	1920	+1.6	5	4, 6, 7

CA_n1-n79	E-UTRA Band 1, 3, 5, 7, 8, 11, 18, 19, 21, 26, 28, 34, 40, 41, 42, 65, 74	F _{DL_low}	-	F _{DL_high}	-50	1	
	Frequency range	1880	-	1895	-40	1	4, 6
	Frequency range	1895	-	1915	-15.5	5	4, 6, 7
	Frequency range	1915	-	1920	+1.6	5	4, 6, 7
CA_n3-n40	E-UTRA Band 1, 5, 7, 8, 11, 18, 19, 20, 21, 26, 27, 28, 31, 32, 33, 34, 38, 39, 41, 43, 44, 45, 50, 51, 65, 67, 68, 69, 72, 73, 74, 75, 76	F _{DL_low}	-	F _{DL_high}	-50	1	
	E-UTRA Band 3	F _{DL_low}	-	F _{DL_high}	-50	1	4
	UTRA Band 22, 42, 52 NR Band n77, n78, n79	F _{DL_low}	-	F _{DL_high}	-50	1	2
	Frequency range	1884.5	-	1915.7	-41	0.3	3
CA_n3-n41	E-UTRA Band 1, 5, 8, 11, 18, 19, 20, 21, 26, 27, 28, 34, 39, 44, 45, 50, 51, 65, 73, 74	F _{DL_low}	-	F _{DL_high}	-50	1	
	E-UTRA Band 40	F _{DL_low}	-	F _{DL_high}	-40	1	
	E-UTRA Band 3	F _{DL_low}	-	F _{DL_high}	-50	1	4
	E-UTRA Band 42, NR Band n77, n78, n79	F _{DL_low}	-	F _{DL_high}	-50	1	2
	Frequency range	1884.5	-	1915.7	-41	0.3	3
CA_n3-n78	E-UTRA Band 1, 3, 5, 7, 8, 11, 18, 19, 20, 21, 26, 28, 34, 39, 40, 41, 65, 74	F _{DL_low}	-	F _{DL_high}	-50	1	
	Frequency range	1884.5	-	1915.7	-41	0.3	3
CA_n5-n77	E-UTRA Band 1, 2, 3, 4, 8, 11, 12, 13, 14, 17, 18, 19, 21, 25, 26, 28, 29, 30, 34, 40, 65, 66, 70, 71, 74	F _{DL_low}	-	F _{DL_high}	-50	1	
	E-UTRA Band 41	F _{DL_low}	-	F _{DL_high}	-50	1	2
	Frequency range	1884.5	-	1915.7	-41	0.3	3
CA_n8-n39	E-UTRA Band 1, 34, 40, 50, 51, 74	F _{DL_low}	-	F _{DL_high}	-50	1	
	E-UTRA Band 22, 41, 42 NR Band n77, n78, n79	F _{DL_low}	-	F _{DL_high}	-50	1	2
	E-UTRA Band 8	F _{DL_low}	-	F _{DL_high}	-50	1	4
CA_n8-n40	E-UTRA Bands 1, 5, 11, 18, 19, 20, 21, 26, 28, 31, 32, 33, 34, 38, 39, 45, 50, 51, 65, 67, 68, 69, 72, 73, 74, 75, 76	F _{DL_low}	-	F _{DL_high}	-50	1	
	E-UTRA Bands 3, 7, 22, 41, 42, 43, 52 NR Bands n77, n78, n79	F _{DL_low}	-	F _{DL_high}	-50	1	2
	E-UTRA Band 8	F _{DL_low}	-	F _{DL_high}	-50	1	4
	Frequency range	1884.5	-	1915.7	-41	0.3	3
CA_n8-n78	E-UTRA Band 1, 8, 11, 20, 21, 28, 34, 39, 40, 65, 74	F _{DL_low}	-	F _{DL_high}	-50	1	
	E-UTRA Band 3, 7, 41	F _{DL_low}	-	F _{DL_high}	-50	1	2
	Frequency range	1884.5	-	1915.7	-41	0.3	3
CA_n28-n40	E-UTRA Band 1, 3, 5, 7, 8, 18, 19, 20, 26, 27, 28, 31, 34, 38, 41, 72	F _{DL_low}	-	F _{DL_high}	-50	1	
	E-UTRA Band 11, 21, 22, 32, 42, 43, 50, 51, 52, 65, 73, 74, 75, 76 NR band n77, n78, n79	F _{DL_low}	-	F _{DL_high}	-50	1	2
	Frequency range	1884.5	-	1915.7	-41	0.3	3
CA_n28-n41	E-UTRA Band 2, 3, 5, 8, 25, 26, 27, 34	F _{DL_low}	-	F _{DL_high}	-50	1	

	E-UTRA Band 4, 42, 50, 51, 52, 65, 66, 73, 74 NR Band n77, n78, n79	F _{DL_low}	-	F _{DL_high}	-50	1	2
	E-UTRA Band 18, 19	F _{DL_low}	-	F _{DL_high}	-50	1	11
	E-UTRA Band 1	F _{DL_low}	-	F _{DL_high}	-50	1	11, 15
	E-UTRA Band 11, 21	F _{DL_low}	-	F _{DL_high}	-50	1	11, 12
	Frequency range	470	-	694	-42	8	4, 14
	Frequency range	470	-	710	-26.2	6	13
	Frequency range	662	-	694	-26.2	6	4
	Frequency range	758	-	773	-32	1	4
	Frequency range	773	-	803	-50	1	
	Frequency range	1884.5	-	1915.7	-41	0.3	3, 11
CA_n39-n40	E-UTRA Band 1, 8, 22, 26, 28, 34, 41, 42, 44, 45, 50, 51, 52, 73, 74	F _{DL_low}	-	F _{DL_high}	-50	1	
	NR Band n77, n78, n79	F _{DL_low}	-	F _{DL_high}	-50	1	2
	Frequency range	1805	-	1855	-40	1	8
	Frequency range	1855	-	1880	-15.5	5	4, 7, 8
CA_n39-n41	E-UTRA Band 1, 8, 26, 28, 34, 40, 42, 44, 45, 50, 51, 74	F _{DL_low}	-	F _{DL_high}	-50	1	
	NR Band n77, n78, n79	F _{DL_low}	-	F _{DL_high}	-50	1	2
	Frequency range	1805	-	1855	-40	1	4
	Frequency range	1855	-	1880	-15.5	5	4, 7, 8
CA_n39-n79	E-UTRA Band 1, 8, 28, 34, 40, 41, 44, 45	F _{DL_low}	-	F _{DL_high}	-50	1	
	NR Band n78	F _{DL_low}	-	F _{DL_high}	-50	1	2
	Frequency range	1805	-	1855	-40	1	4, 8
	Frequency range	1855	-	1880	-15.5	5	4, 7, 8
CA_n40-n41	E-UTRA Band 1, 3, 5, 8, 11, 18, 19, 21, 26, 27, 28, 34, 39, 42, 44, 45, 50, 51, 65, 73, 74, NR Band n77, n78	F _{DL_low}	-	F _{DL_high}	-50	1	
	NR Band n79	F _{DL_low}	-	F _{DL_high}	-50	1	2
	Frequency range	1884.5	-	1915.7	-41	0.3	3
CA_n40-n78	UTRA Band 1, 3, 5, 7, 8, 11, 18, 19, 20, 21, 26, 27, 28, 31, 32, 33, 34, 38, 39, 41, 44, 45, 50, 51, 65, 67, 68, 69, 72, 73, 74, 75, 76	F _{DL_low}	-	F _{DL_high}	-50	1	
	NR Band n79	F _{DL_low}	-	F _{DL_high}	-50	1	2
	Frequency range	1884.5	-	1915.7	-41	0.3	3
CA_n40-n79	E-UTRA Band 1, 3, 5, 8, 11, 18, 19, 21, 26, 28, 34, 39, 41, 42, 65, 74, NR band n78	F _{DL_low}	-	F _{DL_high}	-50	1	
	Frequency range	1884.5	-	1915.7	-41	0.3	3
CA_n41-n79	E-UTRA Band 1, 3, 5, 8, 11, 18, 19, 21, 28, 34, 42, 44, 45, 65	F _{DL_low}	-	F _{DL_high}	-50	1	
	E-UTRA Band 40	F _{DL_low}	-	F _{DL_high}	-40	1	
	Frequency range	1884.5	-	1915.7	-41	0.3	3
CA_n48-n66	E-UTRA Band 2, 4, 5, 7, 12, 13, 14, 17, 24, 25, 26, 27, 29, 30, 41, 50, 51, 66, 70, 71, 74, 85	F _{DL_low}	-	F _{DL_high}	-50	1	
CA_n66-n71	E-UTRA Band 4, 5, 12, 13, 14, 17, 26, 27, 30, 43, 50, 51, 53, 66, 74, 85	F _{DL_low}	-	F _{DL_high}	-50	1	
	E-UTRA Band 2, 25, 41, 42, 48, 70 NR Band n77	F _{DL_low}	-	F _{DL_high}	-50	1	2
	E-UTRA Band 29	F _{DL_low}	-	F _{DL_high}	-38	1	4

	E-UTRA Band 71	F _{DL_low}	-	F _{DL_high}	-50	1	4
CA_n70-n71	E-UTRA Band 4, 5, 12, 13, 14, 17, 26, 27, 30, 48, 66, 74, 85	F _{DL_low}	-	F _{DL_high}	-50	1	
	E-UTRA Band 2, 7, 25, 41, 70, NR Band n77	F _{DL_low}	-	F _{DL_high}	-50	1	2
	E-UTRA Band 29	F _{DL_low}	-	F _{DL_high}	-38	1	4
	E-UTRA Band 71	F _{DL_low}	-	F _{DL_high}	-38	1	4
NOTE 1: FDL_low and FDL_high refer to each frequency band specified in Table 5.2-1 or Table 5.5-1 in TS 36.101							
NOTE 2: As exceptions, measurements with a level up to the applicable requirements defined in Table 6.5.3.1-2 are permitted for each assigned NR carrier used in the measurement due to 2nd, 3rd, 4th or 5th harmonic spurious emissions. Due to spreading of the harmonic emission the exception is also allowed for the first 1 MHz frequency range immediately outside the harmonic emission on both sides of the harmonic emission. This results in an overall exception interval centred at the harmonic emission of (2MHz + N x LCRB x 180kHz), where N is 2, 3, 4, 5 for the 2nd, 3rd, 4th or 5th harmonic respectively. The exception is allowed if the measurement bandwidth (MBW) totally or partially overlaps the overall exception interval.							
NOTE 3: Applicable when co-existence with PHS system operating in 1884.5 -1915.7MHz							
NOTE 4: These requirements also apply for the frequency ranges that are less than F _{OOB} (MHz) in Table 6.5.3.1-1 and Table 6.5A.3.1-1 from the edge of the channel bandwidth.							
NOTE 5: Void.							
NOTE 6: This requirement is applicable for any channel bandwidths within the range 1920 – 1980 MHz with the following restriction: for carriers of 15 MHz bandwidth when carrier centre frequency is within the range 1927.5 - 1929.5 MHz and for carriers of 20 MHz bandwidth when carrier centre frequency is within the range 1930 – 1938 MHz the requirement is applicable only for an uplink transmission bandwidth less than or equal to 54 RB.							
NOTE 7: For these adjacent bands, the emission limit could imply risk of harmful interference to UE(s) operating in the protected operating band.							
NOTE 8: This requirement is only applicable for carriers with bandwidth confined within 1885-1920 MHz (requirement for carriers with at least 1RB confined within 1880 - 1885 MHz is not specified). This requirement applies for an uplink transmission bandwidth less than or equal to 54 RB for carriers of 15 MHz bandwidth when carrier centre frequency is within the range 1892.5 - 1894.5 MHz and for carriers of 20 MHz bandwidth when carrier centre frequency is within the range 1895 - 1903 MHz.							
NOTE 9: Void.							
NOTE 10: Void.							
NOTE 11: Applicable when the assigned NR carrier is confined within 718 MHz and 748 MHz and when the channel bandwidth used is 5 or 10 MHz.							
NOTE 12: As exceptions, measurements with a level up to the applicable requirement of -38 dBm/MHz is permitted for each assigned NR carrier used in the measurement due to 2 nd harmonic spurious emissions. An exception is allowed if there is at least one individual RB within the transmission bandwidth (see Figure 5.3.1-1) for which the 2 nd harmonic totally or partially overlaps the measurement bandwidth (MBW).							
NOTE 13: This requirement is applicable for 5 and 10 MHz NR channel bandwidth allocated within 718 - 728 MHz. For carriers of 10 MHz bandwidth, this requirement applies for an uplink transmission bandwidth less than or equal to 30 RB with RBstart > 1 and RBstart < 48.							
NOTE 14: This requirement is applicable in the case of a 10 MHz NR carrier confined within 703 MHz and 733 MHz, otherwise the requirement of -25 dBm with a measurement bandwidth of 8 MHz applies.							
NOTE 15: As exceptions, measurements with a level up to the applicable requirement of -36 dBm/MHz is permitted for each assigned E-UTRA carrier used in the measurement due to 3rd harmonic spurious emissions. An exception is allowed if there is at least one individual RB within the transmission bandwidth (see Figure 5.6-1) for which the 3rd harmonic totally or partially overlaps the measurement bandwidth (MBW).							

Table 6.5A.3.2.0.3-3: Requirements for uplink inter-band carrier aggregation (two bands) Rel-17

NR CA Configuration	Spurious emission						
	Protected Band	Frequency range (Mhz)			Maximum Level (dBm)	MBW (MHz)	NOTE
CA_n1-n78	E-UTRA Band 1, 3, 5, 7, 8, 11, 18, 19, 20, 21, 26, 28, 34, 40, 41, 65, 74	F _{DL_low}	-	F _{DL_high}	-50	1	
	Frequency range	1880	-	1895	-40	1	4, 6
	Frequency range	1895	-	1915	-15.5	5	4, 6, 7
	Frequency range	1915	-	1920	+1.6	5	4, 6, 7

CA_n1-n79	E-UTRA Band 1, 3, 5, 7, 8, 11, 18, 19, 21, 26, 28, 34, 40, 41, 42, 65, 74	F _{DL_low}	-	F _{DL_high}	-50	1	
	Frequency range	1880	-	1895	-40	1	4, 6
	Frequency range	1895	-	1915	-15.5	5	4, 6, 7
	Frequency range	1915	-	1920	+1.6	5	4, 6, 7
CA_n3-n78	E-UTRA Band 1, 3, 5, 7, 8, 11, 18, 19, 20, 21, 26, 28, 34, 39, 40, 41, 65, 74	F _{DL_low}	-	F _{DL_high}	-50	1	
	Frequency range	1884.5	-	1915.7	-41	0.3	3
CA_n8-n39	E-UTRA Band 1, 34, 40, 50, 51, 74	F _{DL_low}	-	F _{DL_high}	-50	1	
	E-UTRA Band 22, 41, 42 NR Band n77, n78, n79	F _{DL_low}	-	F _{DL_high}	-50	1	2
	E-UTRA Band 8	F _{DL_low}	-	F _{DL_high}	-50	1	4
CA_n8-n78	E-UTRA Band 1,8, 11, 20, 21, 28, 34, 39, 40, 65, 74	F _{DL_low}	-	F _{DL_high}	-50	1	
	E-UTRA Band 3, 7, 41	F _{DL_low}	-	F _{DL_high}	-50	1	2
	Frequency range	1884.5	-	1915.7	-41	0.3	3
CA_n24-n41	E-UTRA Band 2, 4, 5, 10, 12, 13, 14, 17, 25, 26, 29, 30, 48, 66, 70, 71, 85	F _{DL_low}	-	F _{DL_high}	-50	1	
	NR Band n77	F _{DL_low}	-	F _{DL_high}	-50	1	2
CA_n24-n48	E-UTRA Band 2, 4, 5, 10, 12, 13, 14, 17, 25, 26, 29, 30, 41, 66, 70, 71, 85	F _{DL_low}	-	F _{DL_high}	-50	1	
CA_n24-n77	E-UTRA Band 2, 4, 5, 10, 12, 13, 14, 17, 25, 26, 29, 30, 41, 66, 70, 71, 85	F _{DL_low}	-	F _{DL_high}	-50	1	
CA_n26-n66	E-UTRA Band 2, 4, 5, 10, 12, 13, 14, 17, 24, 25, 26, 29, 30, 43, 47, 50, 51, 66, 70, 71, 74, 85	F _{DL_low}	-	F _{DL_high}	-50	1	
	E-UTRA Band 41, 42, 48, 53 NR band 77	F _{DL_low}	-	F _{DL_high}	-50	1	2
	Frequency range	1884.5	-	1915.7	-41	0.3	3
CA_n26-n70	E-UTRA Band 2, 5, 10, 12, 13, 14, 17, 24, 25, 29, 30, 48, 66, 70, 71, 85	F _{DL_low}	-	F _{DL_high}	-50	1	
	E-UTRA Band 41, 53	F _{DL_low}	-	F _{DL_high}	-50	1	2
	Frequency range	1884.5	-	1915.7	-41	0.3	3
CA_n28-n41	E-UTRA Band 2, 3, 5, 8, 25, 26, 27, 34	F _{DL_low}	-	F _{DL_high}	-50	1	
	E-UTRA Band 4, 42, 50, 51, 52, 65, 66, 73, 74 NR Band n77, n78, n79	F _{DL_low}	-	F _{DL_high}	-50	1	2
	E-UTRA Band 18, 19	F _{DL_low}	-	F _{DL_high}	-50	1	11
	E-UTRA Band 1	F _{DL_low}	-	F _{DL_high}	-50	1	11, 15
	E-UTRA Band 11, 21	F _{DL_low}	-	F _{DL_high}	-50	1	11, 12
	Frequency range	470	-	694	-42	8	4, 14
	Frequency range	470	-	710	-26.2	6	13
	Frequency range	662	-	694	-26.2	6	4
	Frequency range	758	-	773	-32	1	4
	Frequency range	773	-	803	-50	1	
Frequency range	1884.5	-	1915.7	-41	0.3	3, 11	
CA_n39-n40	E-UTRA Band 1, 8, 22, 26, 28, 34, 41, 42, 44, 45, 50, 51, 52, 73, 74	F _{DL_low}	-	F _{DL_high}	-50	1	
	NR Band n77, n78, n79	F _{DL_low}	-	F _{DL_high}	-50	1	2
	Frequency range	1805		1855	-40	1	8
	Frequency range	1855		1880	-15.5	5	4, 7, 8

CA_n39-n41	E-UTRA Band 1, 8, 26, 28, 34, 40, 42, 44, 45, 50, 51, 74	F _{DL_low}	-	F _{DL_high}	-50	1	
	NR Band n77, n78, n79	F _{DL_low}	-	F _{DL_high}	-50	1	2
	Frequency range	1805	-	1855	-40	1	4
	Frequency range	1855	-	1880	-15.5	5	4, 7, 8
CA_n39-n79	E-UTRA Band 1, 8, 28, 34, 40, 41, 44, 45	F _{DL_low}	-	F _{DL_high}	-50	1	
	NR Band n78	F _{DL_low}	-	F _{DL_high}	-50	1	2
	Frequency range	1805	-	1855	-40	1	4, 8
	Frequency range	1855	-	1880	-15.5	5	4, 7, 8
CA_n41-n79	E-UTRA Band 1, 3, 5, 8, 11, 18, 19, 21, 28, 34, 42, 44, 45, 65	F _{DL_low}	-	F _{DL_high}	-50	1	
	E-UTRA Band 40	F _{DL_low}	-	F _{DL_high}	-40	1	
	Frequency range	1884.5	-	1915.7	-41	0.3	3
CA_n48-n66	E-UTRA Band 2, 4, 5, 7, 12, 13, 14, 17, 24, 25, 26, 27, 29, 30, 41, 50, 51, 66, 70, 71, 74, 85	F _{DL_low}	-	F _{DL_high}	-50	1	
CA_n48-n70	E-UTRA Band 2, 4, 5, 12, 13, 14, 17, 24, 25, 26, 29, 30, 66, 70, 71, 85	F _{DL_low}	-	F _{DL_high}	-50	1	16
	E-UTRA Band 41	F _{DL_low}	-	F _{DL_high}	-50	1	2, 16
CA_n48-n71	E-UTRA Band 4, 5, 12, 13, 14, 17, 24, 26, 30, 50, 51, 53, 66, 74, 85	F _{DL_low}	-	F _{DL_high}	-50	1	
	E-UTRA Band 2, 25, 41, 70	F _{DL_low}	-	F _{DL_high}	-50	1	2
	E-UTRA Band 29	F _{DL_low}	-	F _{DL_high}	-38	1	15
	E-UTRA Band 71	F _{DL_low}	-	F _{DL_high}	-50	1	15
CA_n66-n71	E-UTRA Band 4, 5, 12, 13, 14, 17, 26, 27, 30, 43, 50, 51, 53, 66, 74, 85	F _{DL_low}	-	F _{DL_high}	-50	1	
	E-UTRA Band 2, 25, 41, 42, 48, 70 NR Band n77	F _{DL_low}	-	F _{DL_high}	-50	1	2
	E-UTRA Band 29	F _{DL_low}	-	F _{DL_high}	-38	1	4
	E-UTRA Band 71	F _{DL_low}	-	F _{DL_high}	-50	1	4
CA_n70-n71	E-UTRA Band 4, 5, 12, 13, 14, 17, 26, 27, 30, 48, 66, 74, 85	F _{DL_low}	-	F _{DL_high}	-50	1	
	E-UTRA Band 2, 7, 25, 41, 70, NR Band n77	F _{DL_low}	-	F _{DL_high}	-50	1	2
	E-UTRA Band 29	F _{DL_low}	-	F _{DL_high}	-38	1	4
	E-UTRA Band 71	F _{DL_low}	-	F _{DL_high}	-38	1	4

NOTE 1:	FDL_low and FDL_high refer to each frequency band specified in Table 5.2-1 or Table 5.5-1 in TS 36.101
NOTE 2:	As exceptions, measurements with a level up to the applicable requirements defined in Table 6.5.3.1-2 are permitted for each assigned NR carrier used in the measurement due to 2nd, 3rd, 4th or 5 th harmonic spurious emissions. Due to spreading of the harmonic emission the exception is also allowed for the first 1 MHz frequency range immediately outside the harmonic emission on both sides of the harmonic emission. This results in an overall exception interval centred at the harmonic emission of $(2\text{MHz} + N \times \text{LCRB} \times 180\text{kHz})$, where N is 2, 3, 4, 5 for the 2nd, 3rd, 4th or 5th harmonic respectively. The exception is allowed if the measurement bandwidth (MBW) totally or partially overlaps the overall exception interval.
NOTE 3:	Applicable when co-existence with PHS system operating in 1884.5 -1915.7MHz
NOTE 4:	These requirements also apply for the frequency ranges that are less than F_{OoB} (MHz) in Table 6.5.3.1-1 and Table 6.5A.3.1-1 from the edge of the channel bandwidth.
NOTE 5:	Void.
NOTE 6:	This requirement is applicable for any channel bandwidths within the range 1920 – 1980 MHz with the following restriction: for carriers of 15 MHz bandwidth when carrier centre frequency is within the range 1927.5 - 1929.5 MHz and for carriers of 20 MHz bandwidth when carrier centre frequency is within the range 1930 – 1938 MHz the requirement is applicable only for an uplink transmission bandwidth less than or equal to 54 RB.
NOTE 7:	For these adjacent bands, the emission limit could imply risk of harmful interference to UE(s) operating in the protected operating band.
NOTE 8:	This requirement is only applicable for carriers with bandwidth confined within 1885-1920 MHz (requirement for carriers with at least 1RB confined within 1880 - 1885 MHz is not specified). This requirement applies for an uplink transmission bandwidth less than or equal to 54 RB for carriers of 15 MHz bandwidth when carrier centre frequency is within the range 1892.5 - 1894.5 MHz and for carriers of 20 MHz bandwidth when carrier centre frequency is within the range 1895 - 1903 MHz.
NOTE 9:	Void.
NOTE 10:	Void.
NOTE 11:	Applicable when the assigned NR carrier is confined within 718 MHz and 748 MHz and when the channel bandwidth used is 5 or 10 MHz.
NOTE 12:	As exceptions, measurements with a level up to the applicable requirement of -38 dBm/MHz is permitted for each assigned NR carrier used in the measurement due to 2 nd harmonic spurious emissions. An exception is allowed if there is at least one individual RB within the transmission bandwidth (see Figure 5.3.1-1) for which the 2 nd harmonic totally or partially overlaps the measurement bandwidth (MBW).
NOTE 13:	This requirement is applicable for 5 and 10 MHz NR channel bandwidth allocated within 718 - 728 MHz. For carriers of 10 MHz bandwidth, this requirement applies for an uplink transmission bandwidth less than or equal to 30 RB with $\text{RB}_{\text{start}} > 1$ and $\text{RB}_{\text{start}} < 48$.
NOTE 14:	This requirement is applicable in the case of a 10 MHz NR carrier confined within 703 MHz and 733 MHz, otherwise the requirement of -25 dBm with a measurement bandwidth of 8 MHz applies.
NOTE 15:	As exceptions, measurements with a level up to the applicable requirement of -36 dBm/MHz is permitted for each assigned E-UTRA carrier used in the measurement due to 3rd harmonic spurious emissions. An exception is allowed if there is at least one individual RB within the transmission bandwidth (see Figure 5.6-1) for which the 3rd harmonic totally or partially overlaps the measurement bandwidth (MBW).
NOTE 16:	The same configuration applies to corresponding NR-DC configuration in Table 4.3.1.1.7.1-1 in [5]. If UE supporting NR-DC configuration do not support the corresponding CA configuration, NR-DC configuration is used in this test.

The normative reference for this requirement is TS 38.101-1 [2] subclause 6.5A.3.2.

6.5A.3.2.1 Spurious emissions for UE co-existence for CA (2UL CA)

6.5A.3.2.1.1 Test purpose

To verify that UE transmitter does not cause unacceptable interference to co-existing systems for the specified bands which has specific requirements in terms of transmitter spurious emissions for 2UL CA.

6.5A.3.2.1.2 Test applicability

This test case applies to all types of NR UE release 15 and forward that support 2UL CA.

6.5A.3.2.1.3 Minimum conformance requirements

The minimum conformance requirements are defined in subclause 6.5A.3.2.0.

6.5A.3.2.1.4 Test description

6.5A.3.2.1.4.1 Initial conditions

Initial conditions are a set of test configurations the UE needs to be tested in and the steps for the SS to take with the UE to reach the correct measurement state.

The initial test configurations consist of environmental conditions, test frequencies, test channel bandwidths and sub-carrier spacing based on NR CA configuration specified in clause 5.5A. All of these configurations shall be tested with applicable test parameters for each CA configuration, are shown in Table 6.5A.3.2.1.4.1-1. The details of the uplink reference measurement channels (RMCs) are specified in Annexes A.2. Configurations of PDSCH and PDCCH before measurement are specified in Annex C.2.

Table 6.5A.3.2.1.4.1-1: Inter band CA Test Configuration Table

Initial Conditions												
Test Environment as specified in TS 38.508-1 [5] subclause 4.1								Normal				
Test Frequencies as specified in TS 38.508-1 [5] subclause 4.3.1.1.3 for inter band CA in FR1								For test frequencies refer to "Range" columns.				
Test Channel Bandwidths as specified in TS 38.508-1 [5] subclause 4.3.1								Refer to "PCC N _{RB} @SCS" and "SCC N _{RB} @SCS" columns				
Test SCS as specified in Table 5.5A.3-1								Lowest SCS for default test points. CA configuration specific test points: Refer to "PCC N _{RB} @SCS" and "SCC N _{RB} @SCS" columns				
Test Parameters for CA Configurations												
ID	CA Configuration / N _{RB_agg} (Note 4)						DL Allocation			UL Allocation (Note 2,3)		
	CA Configuration				PCC N _{RB} @SCS	SCC N _{RB} @SCS	CC MOD	PCC & SCC RB allocation		CC MOD	PCC & SCC RB allocations (L _{CRB} @ RB _{start})	
	PCC		SCC					PCC	SCC			
	Band	Range	Band	Range								
Default Test Settings for a CA_XA-YA Configuration												
1	X	Low	Y	Low	Highest N _{RB} @SCS	Highest N _{RB} @SCS	CP-OFDM QPSK	NA	CP-OFDM QPSK	1@0	1@0	
2	X	High	Y	High	Highest N _{RB} @SCS	Highest N _{RB} @SCS	CP-OFDM QPSK	NA	CP-OFDM QPSK	1@RB _{max}	1@RB _{max}	
Test Settings for CA_n1A-n78A Configuration												
1	n1	High	n78	High	106@15kHz	273@30kHz	CP-OFDM QPSK	NA	CP-OFDM QPSK	1@105	1@272	
2	n1	Low	n78	3455MHz	106@15kHz	273@30kHz	CP-OFDM QPSK	NA	CP-OFDM QPSK	1@0	1@0	
3	n1	Low	n78	3475MHz	106@15kHz	273@30kHz	CP-OFDM QPSK	NA	CP-OFDM QPSK	1@0	1@0	
4	n1	High	n78	High	106@15kHz	106@30kHz	CP-OFDM QPSK	NA	CP-OFDM QPSK	1@105	106@0	
5	n1	Low	n78	High	106@15kHz	106@30kHz	CP-OFDM QPSK	NA	CP-OFDM QPSK	1@0	106@0	
Test Settings for CA_n3A-n78A Configuration												
1	n3	Mid	n78	Mid	160@15kHz	270@15kHz	CP-OFDM QPSK	NA	CP-OFDM QPSK	1@160	1@270	
2	n3	Mid	n78	Mid	78@30kHz	273@30kHz	CP-OFDM QPSK	NA	CP-OFDM QPSK	1@78	1@273	
3	n3	Mid	n78	Mid	38@60kHz	135@60kHz	CP-OFDM QPSK	NA	CP-OFDM QPSK	1@38	1@135	
Test Settings for CA_n24A-n41A Configuration												
1	n24	High	n41	Low	52@15kHz	273@30kHz	CP-OFDM QPSK	NA	CP-OFDM QPSK	1@0	1@136	
2	n24	Low	n41	Low	52@15kHz	273@30kHz	CP-OFDM QPSK	NA	CP-OFDM QPSK	1@52	1@108	

3	n24	High	n41	Low	52@15kHz	273@30kHz	CP-OFDM QPSK	NA	CP-OFDM QPSK	1@0	1@136
4	n24	Low	n41	Low	52@15kHz	273@30kHz	CP-OFDM QPSK	NA	CP-OFDM QPSK	1@0	1@94
5	n24	High	n41	High	52@15kHz	273@30kHz	CP-OFDM QPSK	NA	CP-OFDM QPSK	1@0	1@192
Test Settings for CA_n24A-n48A Configuration											
1	n24	High	n48	Mid	52@15kHz	273@30kHz	CP-OFDM QPSK	NA	CP-OFDM QPSK	1@0	1@136
2	n24	High	n48	High	52@15kHz	273@30kHz	CP-OFDM QPSK	NA	CP-OFDM QPSK	1@0	1@0
Test Settings for CA_n24A-n77A Configuration											
1	n24	Low	n77	Mid	52@15kHz	273@30kHz	CP-OFDM QPSK	NA	CP-OFDM QPSK	1@0	1@136
2	n24	Low	n77	3930 MHz	52@15kHz	273@30kHz	CP-OFDM QPSK	NA	CP-OFDM QPSK	1@0	1@273
3	n24	Low	n77	3930 MHz	52@15kHz	273@30kHz	CP-OFDM QPSK	NA	CP-OFDM QPSK	1@0	1@262
4	n24	Low	n77	3930 MHz	52@15kHz	273@30kHz	CP-OFDM QPSK	NA	CP-OFDM QPSK	1@52	1@196
Test Settings for CA_n8A-n78A Configuration											
1	n8	Mid	n78	Mid	106@15kHz	270@15kHz	CP-OFDM QPSK	NA	CP-OFDM QPSK	1@0	1@0
2	n8	Mid	n78	Mid	106@15kHz	270@15kHz	CP-OFDM QPSK	NA	CP-OFDM QPSK	1@106	1@270
3	n8	Low	n78	Low	51@30kHz	273@30kHz	CP-OFDM QPSK	NA	CP-OFDM QPSK	1@51	1@273
4	n8	Mid	n78	Mid	51@30kHz	273@30kHz	CP-OFDM QPSK	NA	CP-OFDM QPSK	1@51	1@273
Test Settings for CA_n28A-n41A Configuration											
1	n28	High	n41	High	106@15kHz	273@30kHz	CP-OFDM QPSK	NA	CP-OFDM QPSK	1@105	1@272
2	n28	Low	n41	Mid	106@15kHz	273@30kHz	CP-OFDM QPSK	NA	CP-OFDM QPSK	1@0	1@0
3	n28	Low	n41	High	106@15kHz	273@30kHz	CP-OFDM QPSK	NA	CP-OFDM QPSK	1@0	1@272
4	n28	Low	n41	High	106@15kHz	273@30kHz	CP-OFDM QPSK	NA	CP-OFDM QPSK	1@0	1@0
Test Settings for CA_n41A-n79A Configuration											
1	n41	High	n79	4870MHz	273@30kHz	273@30kHz	QPSK	NA	QPSK / CP-OFDM QPSK	1@272	1@0

2	n41	Mid	n79	Low	273@30KHz	273@30KHz	QPSK	NA	QPSK / CP-OFDM QPSK	1@136	1@136
3	n41	High	n79	Low	273@30KHz	273@30KHz	QPSK	NA	QPSK / CP-OFDM QPSK	1@272	1@272
4	n41	High	n79	4450MHz	273@30KHz	273@30KHz	QPSK	NA	QPSK / CP-OFDM QPSK	1@272	1@136
5	n41	High	n79	4500MHz	273@30KHz	273@30KHz	QPSK	NA	QPSK / CP-OFDM QPSK	1@272	1@136
6	n41	Mid	n79	Low	273@30KHz	273@30KHz	QPSK	NA	QPSK / CP-OFDM QPSK	1@136	1@0
7	n41	High	n79	Mid	273@30KHz	273@30KHz	QPSK	NA	QPSK / CP-OFDM QPSK	1@272	1@136

1. Connect the SS to the UE antenna connectors as shown in TS 38.508-1 [5] Annex A, in Figure A.3.1.1.3 for TE diagram and section A.3.2 for UE diagram.
2. The parameter settings for the cell are set up according to TS 38.508-1 [6] subclause 4.4.3.
3. Downlink signals for PCC are initially set up according to Annex C.0, C.1, C.2, and uplink signals according to Annex G.0, G.1, G.2, G.3.0.
4. The UL Reference Measurement channels are set according to Table 6.5A.3.2.1.4.1-1.
5. Propagation conditions are set according to Annex B.0.
6. Ensure the UE is in state RRC_CONNECTED with generic procedure parameters Connectivity NR, Connected without release On, Test Mode On and Test Loop Function On according to TS 38.508-1 [5] clause 4.5. Message contents are defined in clause 6.5A.3.2.1.4.3.

6.5A.3.2.1.4.2 Test procedure

1. Configure SCC according to Annex C.0, C.1, and Annex C.2 for all downlink physical channels.
2. The SS shall configure SCC as per TS 38.508-1 [5] clause 5.5.1. Message contents are defined in clause 6.5A.3.2.1.4.3.
3. SS activates SCC by sending the activation MAC CE (Refer TS 38.321 [18], clauses 5.9, 6.1.3.10). Wait for at least 2 seconds (Refer TS 38.133[19], clause 9.3).
4. SS sends uplink scheduling information for each UL HARQ process via PDCCH DCI format 0_1 for C_RNTI to schedule the UL RMC according to Table 6.5A.3.2.1.4.1-1 on both PCC and SCC. Since the UE has no payload data to send, the UE transmits uplink MAC padding bits on the UL RMC.
5. Send continuously uplink power control "up" commands in every uplink scheduling information to the UE until the UE transmits at P_{UMAX} level.
6. Measure the power of the transmitted signal with a measurement filter of bandwidths according to Table 6.5.3.2.3-1. The centre frequency of the filter shall be stepped in contiguous steps according to Table 6.5.3.2.3-1. The measured power shall be verified for each step. The measurement period shall capture the active time slots.

6.5A.3.2.1.4.3 Message contents

Message contents are according to TS 38.508-1 [5] subclause 4.6 with following exception.

Table 6.5A.3.2.1.4.3-1: FrequencyInfoUL-SIB

Derivation Path: TS 38.508-1 [5] Table 4.6.3-62 FrequencyInfoUL-SIB			
Information Element	Value/remark	Comment	Condition
p-Max	16		Power class 3 and Inter-band CA

6.5A.3.2.1.5 Test requirement

Test requirements for Spurious Emissions UE Co-existence are the same as the minimum requirements. The measured average power of spurious emission, derived in step 6, shall not exceed the described value in Tables 6.5A.3.2.1.5-1, 6.5A.3.2.1.5-1a (Rel-16) and 6.5A.3.2.1.5-1 (Rel-17). The test requirement of configurations for CA operating band including Band n41 also apply for the corresponding CA operating bands with Band n90 replacing Band n41.

Table 6.5A.3.2.1.5-1: Requirements for uplink inter-band carrier aggregation (two bands) Rel-15

NR CA Configuration	Spurious emission						
	Protected Band	Frequency range (Mhz)			Maximum Level (dBm)	MBW (MHz)	NOTE
CA_n1-n28	E-UTRA Band 5, 7, 8, 18, 19, 20, 26, 27, 31, 38, 40, 41, 72, 73 NR band n79	F _{DL_low}	-	F _{DL_high}	-50+TT	1	
	E-UTRA Band 1, 22, 32, 42, 43, 50, 51, 52, 65, 74, 75, 76 NR band n77, n78	F _{DL_low}	-	F _{DL_high}	-50+TT	1	2
	E-UTRA Band 3, 34	F _{DL_low}	-	F _{DL_high}	-50+TT	1	4
	E-UTRA Band 11, 21	F _{DL_low}	-	F _{DL_high}	-50+TT	1	11, 12
	E-UTRA Band 1, 65	F _{DL_low}	-	F _{DL_high}	-50+TT	1	11, 15
	Frequency range	470	-	694	-42+TT	8	4, 14
	Frequency range	470	-	710	-26.2+TT	6	15
	Frequency range	758	-	773	-30+TT	1	4
	Frequency range	773	-	803	-50+TT	1	
	Frequency range	662	-	694	-26.2+TT	6	4
	Frequency range	1880	-	1895	-40+TT	1	4, 6
	Frequency range	1895	-	1915	-15.5+TT	5	4, 6, 7
	Frequency range	1915	-	1920	+1.6+TT	5	4, 6, 7
CA_n1-n40	E-UTRA Band 1, 5, 7, 8, 11, 18, 19, 20, 21, 22, 26, 27, 28, 31, 32, 38, 41, 42, 43, 44, 45, 50, 51, 52, 65, 67, 68, 69, 72, 73, 74, 75, 76 NR band n78	F _{DL_low}	-	F _{DL_high}	-50+TT	1	
	Band 3, 34	F _{DL_low}	-	F _{DL_high}	-50+TT	1	4
	NR band n77, n79	F _{DL_low}	-	F _{DL_high}	-50+TT	1	2
	Frequency range	1880	-	1895	-40+TT	1	4, 14
	Frequency range	1895	-	1915	-15.5+TT	5	4, 7, 14
	Frequency range	1915	-	1920	+1.6+TT	5	4, 7, 14
	Frequency range	1884.5	-	1915.7	-41+TT	0.3	3
CA_n1-n78	E-UTRA Band 1, 3, 5, 7, 8, 11, 18, 19, 20, 21, 26, 28, 34, 40, 41, 65, 74	F _{DL_low}	-	F _{DL_high}	-50+TT	1	
	Frequency range	1880	-	1895	-40+TT	1	4, 6
	Frequency range	1895	-	1915	-15.5+TT	5	4, 6, 7
	Frequency range	1915	-	1920	+1.6+TT	5	4, 6, 7
CA_n1-n79	E-UTRA Band 1, 3, 5, 7, 8, 11, 18, 19, 21, 26, 28, 34, 40, 41, 42, 65, 74	F _{DL_low}	-	F _{DL_high}	-50+TT	1	
	Frequency range	1880	-	1895	-40+TT	1	4, 6
	Frequency range	1895	-	1915	-15.5+TT	5	4, 6, 7
	Frequency range	1915	-	1920	+1.6+TT	5	4, 6, 7
CA_n3-n28	E-UTRA Band 5, 7, 8, 18, 19, 20, 26, 27, 31, 38, 40, 41, 72	F _{DL_low}	-	F _{DL_high}	-50+TT	1	
	E-UTRA Band 32, 42, 43, 50, 51, 74, 75, 76 NR band n77, n78, n79	F _{DL_low}	-	F _{DL_high}	-50+TT	1	2
	E-UTRA Band 3, 34	F _{DL_low}	-	F _{DL_high}	-50+TT	1	4
	E-UTRA Band 11, 21	F _{DL_low}	-	F _{DL_high}	-50+TT	1	11, 12
	E-UTRA Band 1, 65	F _{DL_low}	-	F _{DL_high}	-50+TT	1	11, 15
	Frequency range	470	-	694	-42+TT	8	4, 14
	Frequency range	470	-	710	-26.2+TT	6	15
	Frequency range	758	-	773	-30+TT	1	4
	Frequency range	773	-	803	-50+TT	1	
	Frequency range	662	-	694	-26.2+TT	6	4
	Frequency range	1880	-	1895	-40+TT	1	4, 6
	Frequency range	1895	-	1915	-15.5+TT	5	4, 6, 7

	Frequency range	1915	-	1920	+1.6+TT	5	4, 6, 7
	Frequency range	1839.9	-	1879.9	-50+TT	1	4
	Frequency range	1884.5	-	1915.7	-41+TT	0.3	3, 11
CA_n3-n40	E-UTRA Band 1, 5, 7, 8, 11, 18, 19, 20, 21, 26, 27, 28, 31, 32, 33, 34, 38, 39, 41, 43, 44, 45, 50, 51, 65, 67, 68, 69, 72, 73, 74, 75, 76	F _{DL_low}	-	F _{DL_high}	-50+TT	1	
	E-UTRA Band 3	F _{DL_low}	-	F _{DL_high}	-50+TT	1	4
	UTRA Band 22, 42, 52 NR Band n77, n78, n79	F _{DL_low}	-	F _{DL_high}	-50+TT	1	2
	Frequency range	1884.5	-	1915.7	-41+TT	0.3	3
CA_n3-n78	E-UTRA Band 3, 34, 39	F _{DL_low}	-	F _{DL_high}	-50+TT	1	
	Frequency range	1884.5	-	1915.7	-41+TT	0.3	3
CA_n8-n78	E-UTRA Band 8, 20, 28, 34, 39, 40	F _{DL_low}	-	F _{DL_high}	-50+TT	1	
	E-UTRA Band 3, 7,41	F _{DL_low}	-	F _{DL_high}	-50+TT	1	2
	Frequency range	1884.5	-	1915.7	-41+TT	0.3	3
CA_n40-n78	UTRA Band 1, 3, 5, 7, 8, 11, 18, 19, 20, 21, 26, 27, 28, 31, 32, 33, 34, 38, 39, 41, 44, 45, 50, 51, 65, 67, 68, 69, 72, 73, 74, 75, 76	F _{DL_low}	-	F _{DL_high}	-50+TT	1	
	NR Band n79	F _{DL_low}	-	F _{DL_high}	-50+TT	1	2
	Frequency range	1884.5	-	1915.7	-41+TT	0.3	3
CA_n40-n79	E-UTRA Band 1, 3, 5, 8, 11, 18, 19, 21, 26, 28, 34, 39, 41, 42, 65, 74, NR band n78	F _{DL_low}	-	F _{DL_high}	-50+TT	1	
	Frequency range	1884.5	-	1915.7	-41+TT	0.3	3
CA_n78-n79	E-UTRA Band 1, 3, 5, 8, 11, 18, 19, 21, 28, 34, 40, 41, 65, 74	F _{DL_low}	-	F _{DL_high}	-50+TT	1	
	Frequency range	1884.5	-	1915.7	-41+TT	0.3	3
NOTE 1: F _{DL_low} and F _{DL_high} refer to each frequency band specified in Table 5.2-1 or Table 5.5-1 in TS 36.101							
NOTE 2: As exceptions, measurements with a level up to the applicable requirements defined in Table 6.5.3.1-2 are permitted for each assigned NR carrier used in the measurement due to 2nd, 3rd, 4th or 5 th harmonic spurious emissions. Due to spreading of the harmonic emission the exception is also allowed for the first 1 MHz frequency range immediately outside the harmonic emission on both sides of the harmonic emission. This results in an overall exception interval centred at the harmonic emission of (2MHz + N x LCRB x 180kHz), where N is 2, 3, 4, 5 for the 2nd, 3rd, 4th or 5th harmonic respectively. The exception is allowed if the measurement bandwidth (MBW) totally or partially overlaps the overall exception interval.							
NOTE 3: Applicable when co-existence with PHS system operating in 1884.5 -1915.7MHz							
NOTE 4: These requirements also apply for the frequency ranges that are less than F _{oob} (MHz) in Table 6.5.3.1-1 and Table 6.5A.3.1-1 from the edge of the channel bandwidth.							

Table 6.5A.3.2.1.5-1a: Requirements for uplink inter-band carrier aggregation (two bands) Rel-16

NR CA Configuration	Spurious emission						
	Protected Band	Frequency range (Mhz)			Maximum Level (dBm)	MBW (MHz)	NOTE
CA_n1-n28	E-UTRA Band 5, 7, 8, 18, 19, 20, 26, 27, 31, 38, 40, 41, 72, 73 NR band n79	F _{DL_low}	-	F _{DL_high}	-50+TT	1	
	E-UTRA Band 1, 22, 32, 42, 43, 50, 51, 52, 65, 74, 75, 76 NR band n77, n78	F _{DL_low}	-	F _{DL_high}	-50+TT	1	2
	E-UTRA Band 3, 34	F _{DL_low}	-	F _{DL_high}	-50+TT	1	4
	E-UTRA Band 11, 21	F _{DL_low}	-	F _{DL_high}	-50+TT	1	11, 12
	E-UTRA Band 1, 65	F _{DL_low}	-	F _{DL_high}	-50+TT	1	11, 15
	Frequency range	470	-	694	-42+TT	8	4, 14
	Frequency range	470	-	710	-26.2+TT	6	15
	Frequency range	758	-	773	-30+TT	1	4
	Frequency range	773	-	803	-50+TT	1	
	Frequency range	662	-	694	-26.2+TT	6	4
	Frequency range	1880	-	1895	-40+TT	1	4, 6
	Frequency range	1895	-	1915	-15.5+TT	5	4, 6, 7
	Frequency range	1915	-	1920	+1.6+TT	5	4, 6, 7
CA_n1-n40	E-UTRA Band 1, 5, 7, 8, 11, 18, 19, 20, 21, 22, 26, 27, 28, 31, 32, 38, 41, 42, 43, 44, 45, 50, 51, 52, 65, 67, 68, 69, 72, 73, 74, 75, 76 NR band n78	F _{DL_low}	-	F _{DL_high}	-50+TT	1	
	Band 3, 34	F _{DL_low}	-	F _{DL_high}	-50+TT	1	4
	NR band n77, n79	F _{DL_low}	-	F _{DL_high}	-50+TT	1	2
	Frequency range	1880		1895	-40+TT	1	4, 14
	Frequency range	1895		1915	-15.5+TT	5	4, 7, 14
	Frequency range	1915		1920	+1.6+TT	5	4, 7, 14
	Frequency range	1884.5	-	1915.7	-41+TT	0.3	3
CA_n1-n78	E-UTRA Band 1, 3, 5, 7, 8, 11, 18, 19, 20, 21, 26, 28, 34, 40, 41, 65, 74	F _{DL_low}	-	F _{DL_high}	-50+TT	1	
	Frequency range	1880	-	1895	-40+TT	1	4, 6
	Frequency range	1895	-	1915	-15.5+TT	5	4, 6, 7
	Frequency range	1915	-	1920	+1.6+TT	5	4, 6, 7

CA_n1-n79	E-UTRA Band 1, 3, 5, 7, 8, 11, 18, 19, 21, 26, 28, 34, 40, 41, 42, 65, 74	FDL_low	-	FDL_high	-50+TT	1	
	Frequency range	1880	-	1895	-40+TT	1	4, 6
	Frequency range	1895	-	1915	-15.5+TT	5	4, 6, 7
	Frequency range	1915	-	1920	+1.6+TT	5	4, 6, 7
CA_n3-n40	E-UTRA Band 1, 5, 7, 8, 11, 18, 19, 20, 21, 26, 27, 28, 31, 32, 33, 34, 38, 39, 41, 43, 44, 45, 50, 51, 65, 67, 68, 69, 72, 73, 74, 75, 76	FDL_low	-	FDL_high	-50	1	
	E-UTRA Band 3	FDL_low	-	FDL_high	-50	1	4
	UTRA Band 22, 42, 52 NR Band n77, n78, n79	FDL_low	-	FDL_high	-50	1	2
	Frequency range	1884.5	-	1915.7	-41	0.3	3
CA_n3-n78	E-UTRA Band 1, 3, 5, 7, 8, 11, 18, 19, 20, 21, 26, 28, 34, 39, 40, 41, 65, 74	FDL_low	-	FDL_high	-50+TT	1	
	Frequency range	1884.5	-	1915.7	-41+TT	0.3	3
CA_n5-n77	E-UTRA Band 1, 2, 3, 4, 8, 11, 12, 13, 14, 17, 18, 19, 21, 25, 26, 28, 29, 30, 34, 40, 65, 66, 70, 71, 74	FDL_low	-	FDL_high	-50	1	
	E-UTRA Band 41	FDL_low	-	FDL_high	-50	1	2
	Frequency range	1884.5	-	1915.7	-41	0.3	3
CA_n8-n39	E-UTRA Band 1, 34, 40, 50, 51, 74	FDL_low	-	FDL_high	-50+TT	1	
	E-UTRA Band 22, 41, 42 NR Band n77, n78, n79	FDL_low	-	FDL_high	-50+TT	1	2
	E-UTRA Band 8	FDL_low	-	FDL_high	-50+TT	1	4
CA_n8-n40	E-UTRA Bands 1, 5, 11, 18, 19, 20, 21, 26, 28, 31, 32, 33, 34, 38, 39, 45, 50, 51, 65, 67, 68, 69, 72, 73, 74, 75, 76	FDL_low	-	FDL_high	-50	1	
	E-UTRA Bands 3, 7, 22, 41, 42, 43, 52 NR Bands n77, n78, n79	FDL_low	-	FDL_high	-50	1	2
	E-UTRA Band 8	FDL_low	-	FDL_high	-50	1	4
	Frequency range	1884.5	-	1915.7	-41	0.3	3
CA_n8-n78	E-UTRA Band 1, 8, 11, 20, 21, 28, 34, 39, 40, 65, 74	FDL_low	-	FDL_high	-50+TT	1	
	E-UTRA Band 3, 7, 41	FDL_low	-	FDL_high	-50+TT	1	2
	Frequency range	1884.5	-	1915.7	-41+TT	0.3	3
CA_n28-n40	E-UTRA Band 1, 3, 5, 7, 8, 18, 19, 20, 26, 27, 28, 31, 34, 38, 41, 72	FDL_low	-	FDL_high	-50	1	
	E-UTRA Band 11, 21, 22, 32, 42, 43, 50, 51, 52, 65, 73, 74, 75, 76 NR band n77, n78, n79	FDL_low	-	FDL_high	-50	1	2
	Frequency range	1884.5	-	1915.7	-41	0.3	3
CA_n28-n41	E-UTRA Band 2, 3, 5, 8, 25, 26, 27, 34	FDL_low	-	FDL_high	-50	1	
	E-UTRA Band 4, 42, 50, 51, 52, 65, 66, 73, 74 NR Band n77, n78, n79	FDL_low	-	FDL_high	-50	1	2
	E-UTRA Band 18, 19	FDL_low	-	FDL_high	-50	1	11
	E-UTRA Band 1	FDL_low	-	FDL_high	-50	1	11, 15
	E-UTRA Band 11, 21	FDL_low	-	FDL_high	-50	1	11, 12
	Frequency range	470	-	694	-42	8	4, 14
	Frequency range	470	-	710	-26.2	6	13
Frequency range	662	-	694	-26.2	6	4	

	Frequency range	758	-	773	-32	1	4
	Frequency range	773	-	803	-50	1	
	Frequency range	1884.5	-	1915.7	-41	0.3	3, 11
CA_n39-n40	E-UTRA Band 1, 8, 22, 26, 28, 34, 41, 42, 44, 45, 50, 51, 52, 73, 74	F _{DL_low}	-	F _{DL_high}	-50	1	
	NR Band n77, n78, n79	F _{DL_low}	-	F _{DL_high}	-50	1	2
	Frequency range	1805	-	1855	-40	1	8
	Frequency range	1855	-	1880	-15.5	5	4, 7, 8
CA_n39-n41	E-UTRA Band 1, 8, 26, 28, 34, 40, 42, 44, 45, 50, 51, 74	F _{DL_low}	-	F _{DL_high}	-50	1	
	NR Band n77, n78, n79	F _{DL_low}	-	F _{DL_high}	-50	1	2
	Frequency range	1805	-	1855	-40	1	4
	Frequency range	1855	-	1880	-15.5	5	4, 7, 8
CA_n39-n79	E-UTRA Band 1, 8, 28, 34, 40, 41, 44, 45	F _{DL_low}	-	F _{DL_high}	-50	1	
	NR Band n78	F _{DL_low}	-	F _{DL_high}	-50	1	2
	Frequency range	1805	-	1855	-40	1	4, 8
	Frequency range	1855	-	1880	-15.5	5	4, 7, 8
CA_n40-n41	E-UTRA Band 1, 3, 5, 8, 11, 18, 19, 21, 26, 27, 28, 34, 39, 42, 44, 45, 50, 51, 65, 73, 74, NR Band n77, n78	F _{DL_low}	-	F _{DL_high}	-50	1	
	NR Band n79	F _{DL_low}	-	F _{DL_high}	-50	1	2
	Frequency range	1884.5	-	1915.7	-41	0.3	3
CA_n40-n78	UTRA Band 1, 3, 5, 7, 8, 11, 18, 19, 20, 21, 26, 27, 28, 31, 32, 33, 34, 38, 39, 41, 44, 45, 50, 51, 65, 67, 68, 69, 72, 73, 74, 75, 76	F _{DL_low}	-	F _{DL_high}	-50	1	
	NR Band n79	F _{DL_low}	-	F _{DL_high}	-50	1	2
	Frequency range	1884.5	-	1915.7	-41	0.3	3
CA_n40-n79	E-UTRA Band 1, 3, 5, 8, 11, 18, 19, 21, 26, 28, 34, 39, 41, 42, 65, 74, NR band n78	F _{DL_low}	-	F _{DL_high}	-50	1	
	Frequency range	1884.5	-	1915.7	-41	0.3	3
CA_n41-n79	E-UTRA Band 1, 3, 5, 8, 11, 18, 19, 21, 28, 34, 42, 44, 45, 65	F _{DL_low}	-	F _{DL_high}	-50	1	
	E-UTRA Band 40	F _{DL_low}	-	F _{DL_high}	-40	1	
	Frequency range	1884.5	-	1915.7	-41	0.3	3
CA_n48-n66	E-UTRA Band 2, 4, 5, 7, 12, 13, 14, 17, 24, 25, 26, 27, 29, 30, 41, 50, 51, 66, 70, 71, 74, 85	F _{DL_low}	-	F _{DL_high}	-50+TT	1	
CA_n66-n71	E-UTRA Band 4, 5, 12, 13, 14, 17, 26, 27, 30, 43, 50, 51, 53, 66, 74, 85	F _{DL_low}	-	F _{DL_high}	-50+TT	1	
	E-UTRA Band 2, 25, 41, 42, 48, 70 NR Band n77	F _{DL_low}	-	F _{DL_high}	-50+TT	1	2
	E-UTRA Band 29	F _{DL_low}	-	F _{DL_high}	-38+TT	1	4
	E-UTRA Band 71	F _{DL_low}	-	F _{DL_high}	-50+TT	1	4
CA_n70-n71	E-UTRA Band 4, 5, 12, 13, 14, 17, 26, 27, 30, 48, 66, 74, 85	F _{DL_low}	-	F _{DL_high}	-50+TT	1	
	E-UTRA Band 2, 7, 25, 41, 70, NR Band n77	F _{DL_low}	-	F _{DL_high}	-50+TT	1	2
	E-UTRA Band 29	F _{DL_low}	-	F _{DL_high}	-38+TT	1	4
	E-UTRA Band 71	F _{DL_low}	-	F _{DL_high}	-38+TT	1	4

NOTE 1: FDL_low and FDL_high refer to each frequency band specified in Table 5.2-1 or Table 5.5-1 in TS 36.101

NOTE 2: As exceptions, measurements with a level up to the applicable requirements defined in Table 6.5.3.1-2 are permitted for each assigned NR carrier used in the measurement due to 2nd, 3rd, 4th or 5th harmonic spurious emissions. Due to spreading of the harmonic emission the exception is also allowed for the first 1 MHz frequency range immediately outside the harmonic emission on both sides of the harmonic emission. This results in an overall exception interval centred at the harmonic emission of $(2\text{MHz} + N \times \text{LCRB} \times 180\text{kHz})$, where N is 2, 3, 4, 5 for the 2nd, 3rd, 4th or 5th harmonic respectively. The exception is allowed if the measurement bandwidth (MBW) totally or partially overlaps the overall exception interval.

NOTE 3: Applicable when co-existence with PHS system operating in 1884.5 -1915.7MHz

NOTE 4: These requirements also apply for the frequency ranges that are less than F_{OoB} (MHz) in Table 6.5.3.1-1 and Table 6.5A.3.1-1 from the edge of the channel bandwidth.

NOTE 5: This requirement is applicable only for the following cases: - for carriers of 5 MHz channel bandwidth when carrier centre frequency (F_c) is within the range $902.5 \text{ MHz} \leq F_c < 907.5 \text{ MHz}$ with an uplink transmission bandwidth less than or equal to 20 RB - for carriers of 5 MHz channel bandwidth when carrier centre frequency (F_c) is within the range $907.5 \text{ MHz} \leq F_c \leq 912.5 \text{ MHz}$ without any restriction on uplink transmission bandwidth. - for carriers of 10 MHz channel bandwidth when carrier centre frequency (F_c) is $F_c = 910 \text{ MHz}$ with an uplink transmission bandwidth less than or equal to 32 RB with $\text{RB}_{\text{start}} > 3$.

NOTE 6: This requirement is applicable for any channel bandwidths within the range 1920 – 1980 MHz with the following restriction: for carriers of 15 MHz bandwidth when carrier centre frequency is within the range 1927.5 - 1929.5 MHz and for carriers of 20 MHz bandwidth when carrier centre frequency is within the range 1930 – 1938 MHz the requirement is applicable only for an uplink transmission bandwidth less than or equal to 54 RB.

NOTE 7: For these adjacent bands, the emission limit could imply risk of harmful interference to UE(s) operating in the protected operating band.

NOTE 8: This requirement is only applicable for carriers with bandwidth confined within 1885-1920 MHz (requirement for carriers with at least 1RB confined within 1880 - 1885 MHz is not specified). This requirement applies for an uplink transmission bandwidth less than or equal to 54 RB for carriers of 15 MHz bandwidth when carrier centre frequency is within the range 1892.5 - 1894.5 MHz and for carriers of 20 MHz bandwidth when carrier centre frequency is within the range 1895 - 1903 MHz.

NOTE 9: Void.

NOTE 10: Void.

NOTE 11: Applicable when the assigned NR carrier is confined within 718 MHz and 748 MHz and when the channel bandwidth used is 5 or 10 MHz.

NOTE 12: As exceptions, measurements with a level up to the applicable requirement of -38 dBm/MHz is permitted for each assigned NR carrier used in the measurement due to 2nd harmonic spurious emissions. An exception is allowed if there is at least one individual RB within the transmission bandwidth (see Figure 5.3.1-1) for which the 2nd harmonic totally or partially overlaps the measurement bandwidth (MBW).

NOTE 13: This requirement is applicable for 5 and 10 MHz NR channel bandwidth allocated within 718 - 728 MHz. For carriers of 10 MHz bandwidth, this requirement applies for an uplink transmission bandwidth less than or equal to 30 RB with $\text{RB}_{\text{start}} > 1$ and $\text{RB}_{\text{start}} < 48$.

NOTE 14: This requirement is applicable in the case of a 10 MHz NR carrier confined within 703 MHz and 733 MHz, otherwise the requirement of -25 dBm with a measurement bandwidth of 8 MHz applies.

NOTE 15: As exceptions, measurements with a level up to the applicable requirement of -36 dBm/MHz is permitted for each assigned E-UTRA carrier used in the measurement due to 3rd harmonic spurious emissions. An exception is allowed if there is at least one individual RB within the transmission bandwidth (see Figure 5.6-1) for which the 3rd harmonic totally or partially overlaps the measurement bandwidth (MBW).

Table 6.5A.3.2.1.5-1b: Requirements for uplink inter-band carrier aggregation (two bands) Rel-17

NR CA Configuration	Spurious emission					NOTE	
	Protected Band	Frequency range (Mhz)			Maximum Level (dBm)		MBW (MHz)
CA_n1-n78	E-UTRA Band 1, 3, 5, 7, 8, 11, 18, 19, 20, 21, 26, 28, 34, 40, 41, 65, 74	FDL_low	-	FDL_high	-50+TT	1	
	Frequency range	1880	-	1895	-40+TT	1	4, 6
	Frequency range	1895	-	1915	-15.5+TT	5	4, 6, 7
	Frequency range	1915	-	1920	+1.6+TT	5	4, 6, 7

CA_n1-n79	E-UTRA Band 1, 3, 5, 7, 8, 11, 18, 19, 21, 26, 28, 34, 40, 41, 42, 65, 74	F _{DL_low}	-	F _{DL_high}	-50+TT	1	
	Frequency range	1880	-	1895	-40+TT	1	4, 6
	Frequency range	1895	-	1915	-15.5+TT	5	4, 6, 7
	Frequency range	1915	-	1920	+1.6+TT	5	4, 6, 7
CA_n3-n78	E-UTRA Band 1, 3, 5, 7, 8, 11, 18, 19, 20, 21, 26, 28, 34, 39, 40, 41, 65, 74	F _{DL_low}	-	F _{DL_high}	-50+TT	1	
	Frequency range	1884.5	-	1915.7	-41+TT	0.3	3
CA_n8-n39	E-UTRA Band 1, 34, 40, 50, 51, 74	F _{DL_low}	-	F _{DL_high}	-50+TT	1	
	E-UTRA Band 22, 41, 42 NR Band n77, n78, n79	F _{DL_low}	-	F _{DL_high}	-50+TT	1	2
	E-UTRA Band 8	F _{DL_low}	-	F _{DL_high}	-50+TT	1	4
CA_n8-n78	E-UTRA Band 1, 8, 11, 20, 21, 28, 34, 39, 40, 65, 74	F _{DL_low}	-	F _{DL_high}	-50+TT	1	
	E-UTRA Band 3, 7,41	F _{DL_low}	-	F _{DL_high}	-50+TT	1	2
	Frequency range	1884.5	-	1915.7	-41+TT	0.3	3
CA_n24-n41	E-UTRA Band 2, 4, 5, 10, 12, 13, 14, 17, 25, 26, 29, 30, 48, 66, 70, 71, 85	F _{DL_low}	-	F _{DL_high}	-50+TT	1	
	NR Band n77	F _{DL_low}	-	F _{DL_high}	-50+TT	1	2
CA_n24-n48	E-UTRA Band 2, 4, 5, 10, 12, 13, 14, 17, 25, 26, 29, 30, 41, 66, 70, 71, 85	F _{DL_low}	-	F _{DL_high}	-50+TT	1	
CA_n24-n77	E-UTRA Band 2, 4, 5, 10, 12, 13, 14, 17, 25, 26, 29, 30, 41, 66, 70, 71, 85	F _{DL_low}	-	F _{DL_high}	-50+TT	1	
CA_n26-n66	E-UTRA Band 2, 4, 5, 10, 12, 13, 14, 17, 24, 25, 26, 29, 30, 43, 47, 50, 51, 66, 70, 71, 74, 85	F _{DL_low}	-	F _{DL_high}	-50+TT	1	
	E-UTRA Band 41, 42, 48, 53 NR band 77	F _{DL_low}	-	F _{DL_high}	-50+TT	1	2
	Frequency range	1884.5	-	1915.7	-41+TT	0.3	3
CA_n26-n70	E-UTRA Band 2, 5, 10, 12, 13, 14, 17, 24, 25, 29, 30, 48, 66, 70, 71, 85	F _{DL_low}	-	F _{DL_high}	-50+TT	1	
	E-UTRA Band 41, 53	F _{DL_low}	-	F _{DL_high}	-50+TT	1	2
	Frequency range	1884.5	-	1915.7	-41+TT	0.3	3
CA_n28-n41	E-UTRA Band 2, 3, 5, 8, 25, 26, 27, 34	F _{DL_low}	-	F _{DL_high}	-50	1	
	E-UTRA Band 4, 42, 50, 51, 52, 65, 66, 73, 74 NR Band n77, n78, n79	F _{DL_low}	-	F _{DL_high}	-50	1	2
	E-UTRA Band 18, 19	F _{DL_low}	-	F _{DL_high}	-50	1	11
	E-UTRA Band 1	F _{DL_low}	-	F _{DL_high}	-50	1	11, 15
	E-UTRA Band 11, 21	F _{DL_low}	-	F _{DL_high}	-50	1	11, 12
	Frequency range	470	-	694	-42	8	4, 14
	Frequency range	470	-	710	-26.2	6	13
	Frequency range	662	-	694	-26.2	6	4
	Frequency range	758	-	773	-32	1	4
	Frequency range	773	-	803	-50	1	
	Frequency range	1884.5	-	1915.7	-41	0.3	3, 11
CA_n39-n40	E-UTRA Band 1, 8, 22, 26, 28, 34, 41, 42, 44, 45, 50, 51, 52, 73, 74	F _{DL_low}	-	F _{DL_high}	-50	1	
	NR Band n77, n78, n79	F _{DL_low}	-	F _{DL_high}	-50	1	2
	Frequency range	1805		1855	-40	1	8
	Frequency range	1855		1880	-15.5	5	4, 7, 8

CA_n39-n41	E-UTRA Band 1, 8, 26, 28, 34, 40, 42, 44, 45, 50, 51, 74	F _{DL_low}	-	F _{DL_high}	-50	1	
	NR Band n77, n78, n79	F _{DL_low}	-	F _{DL_high}	-50	1	2
	Frequency range	1805	-	1855	-40	1	4
	Frequency range	1855	-	1880	-15.5	5	4, 7, 8
CA_n39-n79	E-UTRA Band 1, 8, 28, 34, 40, 41, 44, 45	F _{DL_low}	-	F _{DL_high}	-50	1	
	NR Band n78	F _{DL_low}	-	F _{DL_high}	-50	1	2
	Frequency range	1805	-	1855	-40	1	4, 8
	Frequency range	1855	-	1880	-15.5	5	4, 7, 8
CA_n41-n79	E-UTRA Band 1, 3, 5, 8, 11, 18, 19, 21, 28, 34, 42, 44, 45, 65	F _{DL_low}	-	F _{DL_high}	-50	1	
	E-UTRA Band 40	F _{DL_low}	-	F _{DL_high}	-40	1	
	Frequency range	1884.5	-	1915.7	-41	0.3	3
CA_n48-n66	E-UTRA Band 2, 4, 5, 7, 12, 13, 14, 17, 24, 25, 26, 27, 29, 30, 41, 50, 51, 66, 70, 71, 74, 85	F _{DL_low}	-	F _{DL_high}	-50+TT	1	
CA_n48-n70	E-UTRA Band 2, 4, 5, 12, 13, 14, 17, 24, 25, 26, 29, 30, 66, 70, 71, 85	F _{DL_low}	-	F _{DL_high}	-50+TT	1	16
	E-UTRA Band 41	F _{DL_low}	-	F _{DL_high}	-50+TT	1	2, 16
CA_n48-n71	E-UTRA Band 4, 5, 12, 13, 14, 17, 24, 26, 30, 50, 51, 53, 66, 74, 85	F _{DL_low}	-	F _{DL_high}	-50+TT	1	
	E-UTRA Band 2, 25, 41, 70	F _{DL_low}	-	F _{DL_high}	-50+TT	1	2
	E-UTRA Band 29	F _{DL_low}	-	F _{DL_high}	-38+TT	1	15
	E-UTRA Band 71	F _{DL_low}	-	F _{DL_high}	-50+TT	1	15
CA_n66-n71	E-UTRA Band 4, 5, 12, 13, 14, 17, 26, 27, 30, 43, 50, 51, 53, 66, 74, 85	F _{DL_low}	-	F _{DL_high}	-50+TT	1	
	E-UTRA Band 2, 25, 41, 42, 48, 70 NR Band n77	F _{DL_low}	-	F _{DL_high}	-50+TT	1	2
	E-UTRA Band 29	F _{DL_low}	-	F _{DL_high}	-38+TT	1	4
	E-UTRA Band 71	F _{DL_low}	-	F _{DL_high}	-50+TT	1	4
CA_n70-n71	E-UTRA Band 4, 5, 12, 13, 14, 17, 26, 27, 30, 48, 66, 74, 85	F _{DL_low}	-	F _{DL_high}	-50+TT	1	
	E-UTRA Band 2, 7, 25, 41, 70, NR Band n77	F _{DL_low}	-	F _{DL_high}	-50+TT	1	2
	E-UTRA Band 29	F _{DL_low}	-	F _{DL_high}	-38+TT	1	4
	E-UTRA Band 71	F _{DL_low}	-	F _{DL_high}	-38+TT	1	4

NOTE 1: FDL_low and FDL_high refer to each frequency band specified in Table 5.2-1 or Table 5.5-1 in TS 36.101

NOTE 2: As exceptions, measurements with a level up to the applicable requirements defined in Table 6.5.3.1-2 are permitted for each assigned NR carrier used in the measurement due to 2nd, 3rd, 4th or 5th harmonic spurious emissions. Due to spreading of the harmonic emission the exception is also allowed for the first 1 MHz frequency range immediately outside the harmonic emission on both sides of the harmonic emission. This results in an overall exception interval centred at the harmonic emission of $(2\text{MHz} + N \times \text{LCRB} \times 180\text{kHz})$, where N is 2, 3, 4, 5 for the 2nd, 3rd, 4th or 5th harmonic respectively. The exception is allowed if the measurement bandwidth (MBW) totally or partially overlaps the overall exception interval.

NOTE 3: Applicable when co-existence with PHS system operating in 1884.5 -1915.7MHz

NOTE 4: These requirements also apply for the frequency ranges that are less than F_{OoB} (MHz) in Table 6.5.3.1-1 and Table 6.5A.3.1-1 from the edge of the channel bandwidth.

NOTE 5: This requirement is applicable only for the following cases: - for carriers of 5 MHz channel bandwidth when carrier centre frequency (F_c) is within the range $902.5 \text{ MHz} \leq F_c < 907.5 \text{ MHz}$ with an uplink transmission bandwidth less than or equal to 20 RB - for carriers of 5 MHz channel bandwidth when carrier centre frequency (F_c) is within the range $907.5 \text{ MHz} \leq F_c \leq 912.5 \text{ MHz}$ without any restriction on uplink transmission bandwidth. - for carriers of 10 MHz channel bandwidth when carrier centre frequency (F_c) is $F_c = 910 \text{ MHz}$ with an uplink transmission bandwidth less than or equal to 32 RB with $\text{RB}_{\text{start}} > 3$.

NOTE 6: This requirement is applicable for any channel bandwidths within the range 1920 – 1980 MHz with the following restriction: for carriers of 15 MHz bandwidth when carrier centre frequency is within the range 1927.5 - 1929.5 MHz and for carriers of 20 MHz bandwidth when carrier centre frequency is within the range 1930 – 1938 MHz the requirement is applicable only for an uplink transmission bandwidth less than or equal to 54 RB.

NOTE 7: For these adjacent bands, the emission limit could imply risk of harmful interference to UE(s) operating in the protected operating band.

NOTE 8: This requirement is only applicable for carriers with bandwidth confined within 1885-1920 MHz (requirement for carriers with at least 1RB confined within 1880 - 1885 MHz is not specified). This requirement applies for an uplink transmission bandwidth less than or equal to 54 RB for carriers of 15 MHz bandwidth when carrier centre frequency is within the range 1892.5 - 1894.5 MHz and for carriers of 20 MHz bandwidth when carrier centre frequency is within the range 1895 - 1903 MHz.

NOTE 9: Void.

NOTE 10: Void.

NOTE 11: Applicable when the assigned NR carrier is confined within 718 MHz and 748 MHz and when the channel bandwidth used is 5 or 10 MHz.

NOTE 12: As exceptions, measurements with a level up to the applicable requirement of -38 dBm/MHz is permitted for each assigned NR carrier used in the measurement due to 2nd harmonic spurious emissions. An exception is allowed if there is at least one individual RB within the transmission bandwidth (see Figure 5.3.1-1) for which the 2nd harmonic totally or partially overlaps the measurement bandwidth (MBW).

NOTE 13: This requirement is applicable for 5 and 10 MHz NR channel bandwidth allocated within 718 - 728 MHz. For carriers of 10 MHz bandwidth, this requirement applies for an uplink transmission bandwidth less than or equal to 30 RB with $\text{RB}_{\text{start}} > 1$ and $\text{RB}_{\text{start}} < 48$.

NOTE 14: This requirement is applicable in the case of a 10 MHz NR carrier confined within 703 MHz and 733 MHz, otherwise the requirement of -25 dBm with a measurement bandwidth of 8 MHz applies.

NOTE 15: As exceptions, measurements with a level up to the applicable requirement of -36 dBm/MHz is permitted for each assigned E-UTRA carrier used in the measurement due to 3rd harmonic spurious emissions. An exception is allowed if there is at least one individual RB within the transmission bandwidth (see Figure 5.6-1) for which the 3rd harmonic totally or partially overlaps the measurement bandwidth (MBW).

NOTE 16: The same configuration applies to corresponding NR-DC configuration in Table 4.3.1.1.7.1-1 in [5]. If UE supporting NR-DC configuration do not support the corresponding CA configuration, NR-DC configuration is used in this test.

Table 6.5A.3.2.1.5-2: Test Tolerance for uplink inter-band carrier aggregation (two bands)

	$f \leq 3.0\text{GHz}$	$3.0\text{GHz} < f \leq 6\text{GHz}$
$\text{BW} \leq 40\text{MHz}$	0	0
$40\text{MHz} < \text{BW} \leq 100\text{MHz}$	0	0

Unless otherwise stated, the spurious emission limits apply for the frequency ranges that are more than Δf_{OoB} (MHz) in Table 6.5.3.2.3-1 from the edge of the channel bandwidth. The spurious emission limits in Table 6.5.3.2.3-1 apply for all transmitter band configurations (NRB) and channel bandwidths for all CC combinations.

6.5A.4 Transmit intermodulation for CA

Editor's Note: The following aspects are either missing or not yet determined:

- Extending the coverage of the TCs with intra-band CA scenarios is FFS

6.5A.4.0 Minimum conformance requirements

For inter-band carrier aggregation with uplink assigned to two NR bands, the transmit intermodulation requirement is specified in Table 6.5.4-1 which shall apply on each component carrier with both component carriers active.

6.5A.4.1 Transmit intermodulation for CA (2UL CA)

6.5A.4.1.1 Test purpose

To verify that the UE transmit intermodulation does not exceed the described value in the test requirement.

The transmit intermodulation performance is a measure of the capability of the transmitter to inhibit the generation of signals in its non-linear elements caused by presence of the wanted signal and an interfering signal reaching the transmitter via the antenna.

6.5A.4.1.2 Test applicability

This test case applies to all types of NR UE release 15 and forward that supports 2UL CA.

6.5A.4.1.3 Minimum conformance requirements

The minimum conformance requirements are defined in subclause 6.5A.4.0.

6.5A.4.1.4 Test description

6.5A.4.1.4.1 Initial conditions

Initial conditions are a set of test configurations the UE needs to be tested in and the steps for the SS to take with the UE to reach the correct measurement state.

The initial test configurations consist of environmental conditions, test frequencies, test channel bandwidths and sub-carrier spacing based on NR CA configuration specified in clause 5.5A. All of these configurations shall be tested with applicable test parameters for each CA configuration, are shown in Table 6.5A.4.1.4.1-1. The details of the uplink reference measurement channels (RMCs) are specified in Annexes A.2. Configurations of PDSCH and PDCCH before measurement are specified in Annex C.2.

Table 6.5A.4.1.4.1-1: Inter-band CA Test Configuration Table

Initial Conditions				
Test Environment as specified in TS 38.508-1 [5] subclause 4.1		Normal		
Test Frequencies as specified in TS 38.508-1 [5] subclause 4.3.1.1.3 for inter band CA in FR1		Mid range for PCC and SCC (NOTE 4)		
Test Channel Bandwidths as specified in TS 38.508-1 [5] subclause 4.3.1		Lowest N_{RB_agg} for both PCC and SCC Highest N_{RB_agg} for both PCC and SCC		
Test SCS as specified in Table 5.5A.3-1		Smallest and biggest supported SCS per Channel Bandwidth		
Test Parameters				
Test ID	Downlink Configuration	Uplink Configuration		
		Modulation(NOTE 3)	RB allocation (NOTE 1)	
			PCC	SCC
1 ³	N/A	DFT-s-OFDM PI/2 BPSK	Inner Full	Inner Full
2		DFT-s-OFDM QPSK	Inner Full	Inner Full
NOTE 1: The specific configuration of each RB allocation is defined in Table 6.1-1.				
NOTE 2: Test Channel Bandwidths and Test SCS are checked separately for each NR CA band combination, which applicable channel bandwidths and SCS are specified in Table 5.5A3-1.				
NOTE 3: DFT-s-OFDM PI/2 BPSK test applies only for UEs which supports half Pi BPSK in FR1.				
NOTE 4: For NR band n28, 30MHz test channel bandwidth is tested with Low range test frequencies.				

1. Connect the SS to the UE antenna connectors as shown in TS 38.508-1 [5] Annex A, in Figure A.3.1.1.3 for TE diagram and section A.3.2 for UE diagram.
2. The parameter settings for the cell are set up according to TS 38.508-1 [5] subclause 4.4.3.
3. Downlink signals for PCC are initially set up according to Annex C.0, C.1, C.2, and uplink signals according to Annex G.0, G.1, G.2, G.3.0.
4. The UL Reference Measurement channels are set according to Table 6.5A.4.1.4.1-1.
5. Propagation conditions are set according to Annex B.0.
6. Ensure the UE is in State RRC_CONNECTED with generic procedure parameters Connectivity NR, Connected without release On, Test Mode On and Test Loop Function On according to TS 38.508-1 [5] clause 4.5. Message contents are defined in clause 6.5A.4.1.4.3.

6.5A.4.1.4.2 Test procedure

1. Configure SCC according to Annex C.0, C.1, C.2 for all downlink physical channels.
2. The SS shall configure SCC as per TS 38.508-1 [5] clause 5.5.1. Message contents are defined in clause 6.5A.4.1.4.3.
3. SS activates SCC by sending the activation MAC CE (Refer TS 38.321 [18], clauses 5.9, 6.1.3.10). Wait for at least 2 seconds (Refer TS 38.133[19], clause 9.3).
4. SS sends uplink scheduling information for each UL HARQ process via PDCCH DCI format 0_1 for C_RNTI to schedule the UL RMC according to Table 6.5A.4.1.4.1-1 on both PCC and SCC. Since the UE has no payload and no loopback data to send the UE sends uplink MAC padding bits on the UL RMC.
5. Send continuously uplink power control "up" commands on PCC and SCC to the UE until the UE transmits at its P_{UMAX} level; allow at least 200ms starting from the first TPC command in this step for the UE to reach P_{UMAX} level
6. Measure the rectangular filtered mean power of the UE. For TDD slots with transient periods are not under test for the wanted signal and for the intermodulation product.
7. Set the interference signal frequency below the UL carrier frequency of the PCC using the first offset in Table 6.5A.4.1.5-1.

8. Set the interference CW signal level according to Table 6.5A.4.1.5-1.
9. Search the intermodulation product signals below and above the UL carrier frequency of the PCC, then measure the rectangular filtered mean power of transmitting intermodulation for both signals, and calculate the ratios with the power measured in step 6.
10. Set the interference signal frequency above the UL carrier frequency of the PCC using the first offset in Table 6.5A.4.1.5-1.
11. Search the intermodulation product signals below and above the UL carrier frequency of the PCC, then measure the rectangular filtered mean power of transmitting intermodulation for both signals, and calculate the ratios with the power measured in step 6.
12. Set the interference signal frequency below the UL carrier frequency of the SCC using the first offset in Table 6.5A.4.1.5-1.
13. Search the intermodulation product signals below and above the UL carrier frequency of the SCC, then measure the rectangular filtered mean power of transmitting intermodulation for both signals, and calculate the ratios with the power measured in step 6.
14. Set the interference signal frequency above the UL carrier frequency of the SCC using the first offset in Table 6.5A.4.1.5-1.
15. Search the intermodulation product signals below and above the UL carrier frequency of the SCC, then measure the rectangular filtered mean power of transmitting intermodulation for both signals, and calculate the ratios with the power measured in step 6.
16. Repeat the measurement using the second offset in Table 6.5A.4.1.5-1.

NOTE 1: When switching to DFT-s-OFDM waveform, as specified in the test configuration table 6.5.2.2.4.1-1, send an NR RRCReconfiguration message according to TS 38.508-1 [5] clause 4.6.3 Table 4.6.3-118 PUSCH-Config with TRANSFORM_PRECODER_ENABLED condition.

6.5A.4.1.4.3 Message contents

Message contents are according to TS 38.508-1 [5] subclause 4.6.

6.5A.4.1.5 Test requirement

The ratio derived in steps 9, 11, 13 and 15, shall not exceed the described value in Table 6.5A.4.1.5-1.

Table 6.5A.4.1.5-1: Transmit Intermodulation

Wanted signal channel bandwidth	BW_{Channel}	
Interference signal frequency offset from channel centre	BW_{Channel}	$2 \cdot BW_{\text{Channel}}$
Interference CW signal level	-40dBc	
Intermodulation product	$< -29\text{dBc} + TT$	$< -35\text{dBc} + TT$
Measurement bandwidth	The maximum transmission bandwidth configuration among the different SCSs for the channel BW as defined in Table 6.5.2.2.3-1	
Measurement offset from channel centre	BW_{Channel} and $2 \cdot BW_{\text{Channel}}$	$2 \cdot BW_{\text{Channel}}$ and $4 \cdot BW_{\text{Channel}}$

Table 6.5A.4.1.5-2: Test Tolerance for Transmit Intermodulation

	$f \leq 3.0\text{GHz}$	$3.0\text{GHz} < f \leq 6\text{GHz}$
$BW \leq 40\text{MHz}$	0dB	0dB
$40\text{MHz} < BW \leq 100\text{MHz}$	0dB	0dB

6.5B Output RF spectrum emissions for NR-DC

For inter-band NR-DC with one uplink carrier assigned per NR band, the output RF spectrum emissions for the corresponding inter-band CA configuration as specified in clause 6.5A applies.

Note: For NR-DC testing, replace CA by NR-DC, PCC by PCell, and SCC by PSCell in clause 6.5A.

6.5B.1 Occupied bandwidth for NR-DC

For inter-band dual connectivity, the occupied bandwidth for the corresponding inter-band CA configuration as specified in clause 6.5A.1 applies.

Note: For NR-DC testing, replace CA by NR-DC, PCC by PCell, and SCC by PSCell in clause 6.5A.1.

6.5B.2 Out of band emission for NR-DC

6.5B.2.1 General

This clause contains requirements for out of band emissions for UE configured of dual connectivity.

6.5B.2.2 Spectrum emission mask

For inter-band dual connectivity, the Spectrum emission mask for the corresponding inter-band CA configuration as specified in clause 6.5A.2.2 applies.

Note: For NR-DC testing, replace CA by NR-DC, PCC by PCell, and SCC by PSCell in clause 6.5A.2.2.

6.5B.2.4 Adjacent channel leakage ratio

For inter-band dual connectivity, the Adjacent Channel Leakage power Ratio (ACLR) for the corresponding inter-band CA configuration as specified in clause 6.5A.2.4 applies.

Note: For NR-DC testing, replace CA by NR-DC, PCC by PCell, and SCC by PSCell in clause 6.5A.2.4.

6.5B.3 Spurious emission for NR-DC

For inter-band dual connectivity, the spurious emissions for the corresponding inter-band CA configuration as specified in clause 6.5A.3 applies.

Note: For NR-DC testing, replace CA by NR-DC, PCC by PCell, and SCC by PSCell in clause 6.5A.3.

6.5B.4 Transmit intermodulation for NR-DC

For inter-band dual connectivity, the transmit intermodulation for the corresponding inter-band CA configuration as specified in clause 6.5A.4 applies.

Note: For NR-DC testing, replace CA by NR-DC, PCC by PCell, and SCC by PSCell in clause 6.5A.4.

6.5C Output RF spectrum emissions for SUL

For a terminal that supports SUL for the band combination specified in Table 5.2C-1, the current version of the specification assumes the terminal is configured with active transmission either on UL carrier or SUL carrier at any time in one serving cell and the UE requirements for single carrier shall apply for the active UL or SUL carrier accordingly

6.5C.1 Occupied bandwidth for SUL

6.5C.1.1 Test purpose

To verify that the UE occupied bandwidth for all transmission bandwidth configurations supported by the UE supporting SUL are less than their specific limits when UE is configured using SUL transmission.

6.5C.1.2 Test applicability

This test applies to all types of NR UE release 15 and forward that support SUL operating on the SUL bands.

6.5C.1.3 Minimum conformance requirements

Same minimum conformance requirements as in clause 6.5.1.3

6.5C.1.4 Test description

Same test description as specified in clause 6.5.1.4 with following exceptions:

- Instead of table 5.3.5-1 → use Table 5.5C-1
- Instead of table 6.5.1.4.1-1 → use Table 6.5C.1.4-1

Table 6.5C.1.4.1-1: Test Configuration Table

Initial Conditions				
Test Environment as specified in TS 38.508-1 [5] subclause 4.1			Normal	
Test Frequencies as specified in TS 38.508-1 [5] subclause 4.3.1			Low Range, Mid Range, High Range for SUL carrier Mid Range for Non-SUL carrier	
Test Channel Bandwidths as specified in TS 38.508-1 [5] subclause 4.3.1			All for SUL carrier Lowest for Non-SUL carrier	
Test SCS as specified in Table 5.3.5-1			15kHz for both SUL carrier and Non-SUL carrier	
Test Parameters for Channel Bandwidths				
	Downlink Configuration	UL Configuration	SUL Configuration	
Test ID	N/A	N/A	Modulation	RB allocation
1			CP-OFDM QPSK	Outer_full
Note 1: Test Channel Bandwidths are checked separately for each SUL band combination, the applicable channel bandwidths are specified in Table 5.5C-1.				
Note 2: The specific configuration of each RB allocation is defined in Table 6.1-1.				

- Connect the SS to the UE antenna connectors as shown in TS 38.508-1 [5] Annex A, Figure A.3.1.1.4 for TE diagram and section A.3.2 for UE diagram.
- The parameter setting for the cell are set up according to the TS 38.508-1 [5] subclause 4.4.3
- Downlink signals are initially setup according to Annex C.0, C.1, C.2 and uplink signals according to Annex G.0, G.1, G.2, and G.3.0 with consideration of supplementary uplink physical channels.
- Message contents in initial conditions are according to TS 38.508-1 [5] subclause 4.3.6.1.1.2 ensuring UL/SUL indicator in Table 4.3.6.1.1.2-1 with condition SUL, subclause 4.6 ensuring Tables 4.6.1-28 with condition SUL AND (RF OR RRM), 4.6.3-14 with condition SUL_SUL for SUL carrier, with condition SUL, and Table 4.6.3-167 with condition PUSCH_PUCCH_ON_SUL.

6.5C.1.5 Test requirement

The measured Occupied Bandwidth on SUL carrier shall not exceed values in Table 6.5C.1.5-1.

Table 6.5C.1.5-1: Occupied channel bandwidth

	NR channel bandwidth												
	5 MHz	10 MHz	15 MHz	20 MHz	25 MHz	30 MHz	40 MHz	50 MHz	60 MHz	70 MHz	80 MHz	90 MHz	100 MHz
Occupied channel bandwidth (MHz)	5	10	15	20	25	30	40	50	60	70	80	90	100

6.5C.2 Out of band emission for SUL

6.5C.2.1 General

Void

6.5C.2.2 Spectrum emission mask for SUL

The spectrum emission mask of the UE applies to frequencies (Δf_{OOB}) starting from the \pm edge of the assigned NR channel bandwidth. For frequencies greater than (Δf_{OOB}) the spurious requirements in subclause 6.5.3 are applicable.

NOTE: For measurement conditions at the edge of each frequency range, the lowest frequency of the measurement position in each frequency range should be set at the lowest boundary of the frequency range plus MBW/2. The highest frequency of the measurement position in each frequency range should be set at the highest boundary of the frequency range minus MBW/2. MBW denotes the measurement bandwidth defined for the protected band.

6.5C.2.2.1 Test purpose

To verify that the power of any UE emission shall not exceed specified level for the specified channel bandwidth.

6.5C.2.2.2 Test applicability

This test applies to all types of NR UE release 15 and forward that support SUL operating on the SUL bands.

6.5C.2.2.3 Minimum conformance requirements

Same minimum conformance requirements as in the clause 6.5.2.2.3.

6.5C.2.2.4 Test description

Same test description as PC 3 with contiguous allocation specified in clause 6.5.2.2 with following exceptions:

- Instead of table 5.3.5-1 → use Table 5.5C-1
- Instead of table 6.5.2.2.4.1-1 → use Table 6.5C.2.2.4.1-1

Table 6.5C.2.2.4.1-1: Test Configuration Table

Initial Conditions					
Test Environment as specified in TS 38.508-1 [5] subclause 4.1			Normal		
Test Frequencies as specified in TS 38.508-1 [5] subclause 4.3.1			Low range, High range for SUL carrier Mid range for Non-SUL carrier		
Test Channel Bandwidths as specified in TS 38.508-1 [5] subclause 4.3.1			Lowest, Highest for SUL carrier Lowest for Non-SUL carrier		
Test SCS as specified in Table 5.5C-1			15kHz for both SUL carrier and Non-SUL carrier		
Test Parameters for Channel Bandwidths					
Test ID	Freq	Downlink Configuration	UL Configuration	SUL Configuration	
		N/A	N/A	Modulation	RB allocation
1	Low			DFT-s-OFDM PI/2 BPSK	Edge_1RB_Left
2	High			DFT-s-OFDM PI/2 BPSK	Edge_1RB_Right
3	Default			DFT-s-OFDM PI/2 BPSK	Outer_Full
4	Low			DFT-s-OFDM QPSK	Edge_1RB_Left
5	High			DFT-s-OFDM QPSK	Edge_1RB_Right
6	Default			DFT-s-OFDM QPSK	Outer_Full
7	Low			DFT-s-OFDM 16 QAM	Edge_1RB_Left
8	High			DFT-s-OFDM 16 QAM	Edge_1RB_Right
9	Default			DFT-s-OFDM 16 QAM	Outer_Full
10	Low			DFT-s-OFDM 64 QAM	Edge_1RB_Left
11	High			DFT-s-OFDM 64 QAM	Edge_1RB_Right
12	Default			DFT-s-OFDM 64 QAM	Outer_Full
13	Low			DFT-s-OFDM 256 QAM	Edge_1RB_Left
14	High			DFT-s-OFDM 256 QAM	Edge_1RB_Right
15	Default			DFT-s-OFDM 256 QAM	Outer_Full
16	Low			CP-OFDM QPSK	Edge_1RB_Left
17	High			CP-OFDM QPSK	Edge_1RB_Right
18	Default			CP-OFDM QPSK	Outer_Full
19	Low			CP-OFDM 16 QAM	Edge_1RB_Left
20	High			CP-OFDM 16 QAM	Edge_1RB_Right
21	Default			CP-OFDM 16 QAM	Outer_Full
22	Low			CP-OFDM 64 QAM	Edge_1RB_Left
23	High			CP-OFDM 64 QAM	Edge_1RB_Right
24	Default			CP-OFDM 64 QAM	Outer_Full
25	Low			CP-OFDM 256 QAM	Edge_1RB_Left
26	High			CP-OFDM 256 QAM	Edge_1RB_Right
27	Default			CP-OFDM 256 QAM	Outer_Full

28 ⁴	Low		DFT-s-OFDM Pi/2 BPSK w Pi/2 BPSK DMRS	Edge_1RB_Left
29 ⁴	High		DFT-s-OFDM Pi/2 BPSK w Pi/2 BPSK DMRS	Edge_1RB_Right
30 ⁴	Default		DFT-s-OFDM Pi/2 BPSK w Pi/2 BPSK DMRS	Outer Full
<p>Note 1: Test Channel Bandwidths are checked separately for each SUL band combination, the applicable channel bandwidths are specified in Table 5.5C-1.</p> <p>Note 2: The specific configuration of each RF allocation is defined in Table 6.1-1.</p> <p>Note 3: DFT-s-OFDM PI/2 BPSK test applies only for UEs which supports half Pi BPSK in FR1.</p> <p>Note 4: Applicable to UEs indicating support for UE capability <i>lowPAPR-DMRS-PUSCHwithPrecoding-r16</i>.</p>				

- Connect the SS to the UE antenna connectors as shown in TS 38.508-1 [5] Annex A, Figure A.3.1.1.4 for TE diagram and section A.3.2 for UE diagram.
- The parameter setting for the cell are set up according to the TS 38.508-1 [5] subclause 4.4.3
- Downlink signals are initially setup according to Annex C.0, C.1, C.2 and uplink signals according to Annex G.0, G.1, G.2, and G.3.0 with consideration of supplementary uplink physical channels.
- Message contents in initial conditions are according to TS 38.508-1 [5] subclause 4.3.6.1.1.2 ensuring UL/SUL indicator in Table 4.3.6.1.1.2-1 with condition SUL, subclause 4.6 ensuring Table 4.6.1-28 with condition SUL AND (RF OR RRM), Tables 4.6.3-14 with condition SUL_NUL for SUL carrier, and Table 4.6.3-167 with condition PUSCH_PUCCH_ON_SUL. Message contents in Table 6.5.2.2.4.3-2 in clause 6.5.2.2 only apply to Test ID 28-30 in Table 6.5C.2.2.4.1-1.

6.5C.2.2.5 Test requirement

The measured sum of the UE mean power in the channel bandwidth on the SUL carrier, derived in step 3, shall fulfil requirements in Tables 6.2C.4.5-1 as appropriate, and the power of any UE emission shall fulfil requirements in Table 6.5C.2.2.5-1.

Table 6.5C.2.2.5-1: NR General spectrum emission mask

Spectrum emission limit (dBm) / Channel bandwidth														
Δf_{OoB} (MHz)	5 MHz	10 MHz	15 MHz	20 MHz	25 MHz	30 MHz	40 MHz	50 MHz	60 MHz	70 MHz	80 MHz	90 MHz	100 MHz	Measurement bandwidth
$\pm 0-1$	-13	-13	-13	-13	-13	-13	-13							1 % channel bandwidth
$\pm 0-1$								-24	-24	-24	-24	-24	-24	30 kHz
$\pm 1-5$	-10	-10	-10	-10	-10	-10	-10	-10	-10	-10	-10	-10	-10	1 MHz
$\pm 5-6$	-13	-13	-13	-13	-13	-13	-13	-13	-13	-13	-13	-13	-13	
$\pm 6-10$	-25													
$\pm 10-15$		-25												
$\pm 15-20$			-25											
$\pm 20-25$				-25										
$\pm 25-30$					-25									
$\pm 30-35$						-25								
$\pm 35-40$														
$\pm 40-45$							-25							
$\pm 45-50$														
$\pm 50-55$								-25						
$\pm 55-60$														
$\pm 60-65$									-25					
$\pm 65-70$														
$\pm 70-75$										-25				
$\pm 75-80$														
$\pm 80-85$											-25			
$\pm 85-90$														
$\pm 90-95$												-25		
$\pm 95-100$														
$\pm 100-105$													-25	

Note 1: The first and last measurement position with a 30 kHz filter is at Δf_{OoB} equals to 0.015 MHz and 0.985 MHz.
Note 2: At the boundary of spectrum emission limit, the first and last measurement position with a 1 MHz filter is the inside of +0.5MHz and -0.5MHz, respectively.
Note 3: The measurements are to be performed above the upper edge of the channel and below the lower edge of the channel.
Note 4: TT = 1.5 dB for $f \leq 3\text{GHz}$, TT = 1.8 dB for $3\text{GHz} < f \leq 4.2\text{GHz}$, TT = 1.8 dB for $4.2\text{GHz} < f \leq 6.0\text{GHz}$.

NOTE: As a general rule, the resolution bandwidth of the measuring equipment should be equal to the measurement bandwidth. However, to improve measurement accuracy, sensitivity and efficiency, the resolution bandwidth may be smaller than the measurement bandwidth. When the resolution bandwidth is smaller than the measurement bandwidth, the result should be integrated over the measurement bandwidth in order to obtain the equivalent noise bandwidth of the measurement bandwidth.

6.5C.2.3 Additional spectrum emission mask for SUL

6.5C.2.3.1 Test purpose

Same test purpose as in clause 6.5.2.3.1

6.5C.2.3.2 Test applicability

This test applies to all types of NR UE release 15 and forward that support SUL operating on the SUL bands.

6.5C.2.3.3 Minimum conformance requirements

Same minimum conformance requirements as in the clause 6.5.2.3.3 with consideration of the NS_03 applicable to the SUL bands.

6.5C.2.3.4 Test description

Same test description as specified in clause 6.5.2.3.4 with following exceptions:

- Instead of table 5.3.5-1 → use Table 5.5C-1

- Connect the SS to the UE antenna connectors as shown in TS 38.508-1 [5] Annex A, Figure A.3.1.1.4 for TE diagram and section A.3.2 for UE diagram.
- The parameter setting for the cell are set up according to the TS 38.508-1 [5] subclause [4.4.3]
- Downlink signals are initially setup according to Annex C.0, C.1, C.2 and uplink signals according to Annex G.0, G.1, G.2, and G.3.0 with consideration of supplementary uplink physical channels.
- Message contents in initial conditions are according to TS 38.508-1 [5] subclause 4.3.6.1.1.2 ensuring UL/SUL indicator in Table 4.3.6.1.1.2-1 with condition SUL, subclause 4.6 ensuring Tables 4.6.1-28 with condition SUL AND (RF OR RRM), 4.6.3-14 with condition SUL_SUL for SUL carrier, and Table 4.6.3-167 with condition PUSCH_PUCCH_ON_SUL. All the AdditionalSpectrumEmission in 6.2.3.4.3 are sent in *SIB1* as part of *supplementaryUplink* instead of *uplinkConfigCommon*.

6.5C.2.3.5 Test requirement

6.5C.2.3.5.1 Test requirements (network signalling value "NS_03")

When "NS_03" is indicated in the cell:

- the measured UE mean power in the channel bandwidth, derived in step 3, shall fulfil requirements in table 6.2C.5.5-1 for a NR UE.

and

- the power of any UE emission shall fulfil requirements in table 6.5C.2.3.5-1, as applicable.

Table 6.5C.2.3.5-1: Additional requirements for "NS_03"

Spectrum emission limit (dBm)/ Channel bandwidth						
Δf_{OOB} (MHz)	5 MHz	10 MHz	15 MHz	20 MHz	40 MHz	Measurement bandwidth
$\pm 0-1$	-13 + TT	-13 + TT	-13 + TT	-13 + TT	-13 + TT	1 % of channel BW
$\pm 1-6$	-13 + TT	-13 + TT	-13 + TT	-13 + TT	-13 + TT	1 MHz
$\pm 6-10$	-25+ TT	-13+ TT	-13 + TT	-13 + TT	-13 + TT	1 MHz
$\pm 10-15$		-25+ TT	-13 + TT	-13 + TT	-13 + TT	1 MHz
$\pm 15-20$			-25+ TT	-13 + TT	-13 + TT	1 MHz
$\pm 20-25$				-25+ TT	-13+ TT	1 MHz
$\pm 25-40$					-13+ TT	1 MHz
$\pm 40-45$					-25+ TT	1 MHz

NOTE 1: TT for each frequency and channel bandwidth is specified in Table 6.5.2.3.5-1.

NOTE: As a general rule, the resolution bandwidth of the measuring equipment should be equal to the measurement bandwidth. However, to improve measurement accuracy, sensitivity and efficiency, the resolution bandwidth may be smaller than the measurement bandwidth. When the resolution bandwidth is smaller than the measurement bandwidth, the result should be integrated over the measurement bandwidth in order to obtain the equivalent noise bandwidth of the measurement bandwidth.

6.5C.2.4 Adjacent channel leakage ratio for SUL

Adjacent channel leakage power Ratio (ACLR) is the ratio of the filtered mean power centred on the assigned channel frequency to the filtered mean power centred on an adjacent channel frequency.

6.5C.2.4.1 NR ACLR for SUL

6.5C.2.4.1.1 Test purpose

To verify that UE transmitter does not cause unacceptable interference to adjacent channels in terms of Adjacent Channel Leakage power Ratio (ACLR).

6.5C.2.4.1.2 Test applicability

This test applies to all types of NR UE release 15 and forward that support SUL operating on the SUL bands.

6.5C.2.4.1.3 Minimum conformance requirements

The minimum conformance requirements specified in Clause 6.5.2.4.1.3 applies to the UE that support SUL operating on the SUL bands.

The normative reference for this requirement is TS 38.101-1 clauses 6.5.2.4.1.

6.5C.2.4.1.4 Test description

Same test description as PC 3 with contiguous allocation specified in clause 6.5.2.4.1.4 with following exceptions:

- Instead of Table 5.3.5-1 → use Table 5.5C-1
- Instead of the test configuration tables in clause 6.2.2.4.1 → use the test configuration tables in clause 6.2C.4.4
- Instead of the requirements described in clause 6.2.2.5 → use the requirements described in clause 6.2C.4.5

Table 6.5C.2.4.1.4-1: Void

- Connect the SS to the UE antenna connectors as shown in TS 38.508-1 [5] Annex A, Figure A.3.1.1.4 for TE diagram and section A.3.2 for UE diagram.
- The parameter setting for the cell are set up according to the TS 38.508-1 [5] subclause 4.4.3
- Downlink signals are initially setup according to Annex C.0, C.1, C.2 and uplink signals according to Annex G.0, G.1, G.2, and G.3.0 with consideration of supplementary uplink physical channels.
- Message contents in initial conditions are according to TS 38.508-1 [5] subclause 4.3.6.1.1.2 ensuring UL/SUL indicator in Table 4.3.6.1.1.2-1 with condition SUL, subclause 4.6 ensuring Table 4.6.1-28 with condition SUL AND (RF OR RRM), Tables 4.6.3-14 with condition SUL_SUL for SUL carrier, and Table 4.6.3-167 with condition PUSCH_PUCCH_ON_SUL. Message contents in Table 6.5.2.4.1.4.3-3 in clause 6.5.2.4.1.4 only apply to Test ID 33-35 in Table 6.2C.4.4-1.

6.5C.2.4.1.5 Test requirement

The measured UE mean power in the channel bandwidth on SUL carrier, derived in step 3, shall fulfil requirements in Clause 6.2C.4.5 as appropriate, and if the measured adjacent channel power is greater than -50 dBm then the measured NR ACLR, derived in step 6, shall be higher than the limits in Table 6.5C.2.4.1.5-1.

Table 6.5C.2.4.1.5-1: NR ACLR measurement bandwidth

NR channel bandwidth / NR ACLR measurement bandwidth												
	5 MHz	10 MHz	15 MHz	20 MHz	25 MHz	30 MHz	40 MHz	50 MHz	60 MHz	80 MHz	90 MHz	100 MHz
NR ACLR measurement bandwidth	4.515	9.375	14.235	19.095	23.955	28.815	38.895	48.615	58.35	78.15	88.23	98.31

Table 6.5C.2.4.1.5-2: NR ACLR requirement

	Power class 1	Power class 2	Power class 3
NR ACLR			30 + TT dB
NOTE 1: TT = 0.8 dB for $f \leq 4.0$ GHz, TT = 1.0 dB for 4.0 GHz < $f \leq 6.0$ GHz,			

6.5C.2.4.2 UTRA ACLR for SUL

6.5C.2.4.2.1 Test purpose

To verify that UE transmitter does not cause unacceptable interference to adjacent channels in terms of Adjacent Channel Leakage power Ratio (ACLR).

6.5C.2.4.2.2 Test applicability

This test applies for network signalling values NS_3U, NS_5U, NS_43U, and NS_100 to all types of NR UE release 15 and forward that support SUL operating on the SUL bands.

6.5C.2.4.2.3 Minimum conformance requirements

The minimum conformance requirements specified in Clause 6.5.2.4.2.3 applies to the UE that support SUL operating on the SUL bands.

The normative reference for this requirement is TS 38.101-clause 6.5.2.4.2.

6.5C.2.4.2.4 Test description

Same test description as specified in clause 6.5.2.4.2.4 with following exceptions:

Initial conditions are same as in subclause 6.2C.5.4 with the following exceptions:

- Only network signalling values NS_3U, NS_5U, NS_43U, and NS_100 with the corresponding SUL band defined in Table 6.2.3.3.1-1 need to perform UTRA ACLR test.
- Message contents in initial conditions are according to TS 38.508-1 [5] subclause 4.6 ensuring Tables 4.6.1-28 with condition SUL AND (RF OR RRM), Tables 4.6.3-14 with condition SUL_SUL for SUL carrier, and Table 4.6.3-167 with condition PUSCH_PUCCH_ON_SUL, together with the exceptions as specified in Table 6.5C.2.4.2.4-2

Table 6.5C.2.4.2.4-2: AdditionalSpectrumEmission

Derivation Path: TS 38.508-1 [5] clause 4.6.3, Table 4.6.3-1 <i>AdditionalSpectrumEmission</i>			
Information Element	Value/remark	Comment	Condition
AdditionalSpectrumEmission	3 (NS_03U) 3 (NS_05U) 1 (NS_100)	For SUL band n86 For SUL band n84 For SUL band n84 and n86	

6.5C.2.4.2.5 Test requirement

UTRA ACLR requirement is applicable when signalled by the network with network signalling value indicated by the field *additionalSpectrumEmission*.

The measured UE mean total power in the channel bandwidth on SUL carrier, derived in step 3, shall fulfil requirements in Clause 6.2C.5.5 as appropriate, and if the measured adjacent channel power is greater than -50 dBm then the measured UTRA ACLR, derived in step 6, shall be higher than the limits in Table 6.5C.2.4.2.5-1.

Table 6.5C.2.4.2.5-1: NR ACLR requirement

	Power class 3
UTRA _{ACLR1}	33 dB - TT
UTRA _{ACLR2}	36 dB - TT
NOTE 1: TT = 0.8 dB	

6.5C.3 Spurious emissions for SUL

6.5C.3.1 General spurious emissions for SUL

6.5C.3.1.1 Test purpose

To verify that UE transmitter does not cause unacceptable interference to other channels or other systems in terms of transmitter spurious emissions.

6.5C.3.1.2 Test applicability

This test applies to all types of NR UE release 15 and forward that support SUL operating on the SUL bands.

6.5C.3.1.3 Minimum conformance requirements

The general spurious emission requirement specified in clause 6.5.3.1.3 applies to the UE that support SUL operating on the SUL bands.

The normative reference for this requirement is TS 38.101-1 [2] subclauses 6.5.3.1

6.5C.3.1.4 Test description

Same test description as specified in clause 6.5.3.1.4 with following exceptions:

- Instead of table 5.3.5-1 → use Table 5.5C-1
- Instead of table 6.5.3.1.4.1-1 → use Table 6.5C.3.1.4-1

Table 6.5C.3.1.4-1: Test Configuration Table

Initial Conditions			
Test Environment as specified in TS 38.508-1 [5] subclause 4.1		Normal	
Test Frequencies as specified in TS 38.508-1 [5] subclause 4.3.1		Low range, Mid range, High range for SUL carrier Mid range for Non-SUL carrier	
Test Channel Bandwidths as specified in TS 38.508-1 [5] subclause 4.3.1		Lowest, Mid, Highest for SUL carrier Lowest for Non-SUL carrier	
Test SCS as specified in Table 5.3.5-1		15kHz for both SUL carrier and Non-SUL carrier	
Test Parameters for Channel Bandwidths			
Test ID	Downlink Configuration	UL Configuration	SUL Configuration
	N/A	N/A	Modulation
1			CP-OFDM QPSK
2			CP-OFDM QPSK
3			CP-OFDM QPSK
RB allocation (NOTE 2)			
			OuterFull
			Edge_1RB_Left
			Edge_1RB_Right
NOTE 1: Test Channel Bandwidths are checked separately for each SUL band combination, the applicable channel bandwidths are specified in Table 5.5C-1.			
NOTE 2: The specific configuration of each RB allocation is defined in Table 6.1-1.			
NOTE 3: Void			

- Connect the SS to the UE antenna connectors as shown in TS 38.508-1 [5] Annex A, Figure A.3.1.1.4 for TE diagram and section A.3.2 for UE diagram.
- The parameter setting for the cell are set up according to the TS 38.508-1 [5] subclause 4.4.3
- Downlink signals are initially setup according to Annex C.0, C.1, C.2 and uplink signals according to Annex G.0, G.1, G.2, and G.3.0 with consideration of supplementary uplink physical channels.
- Message contents in initial conditions are according to TS 38.508-1 [5] subclause 4.3.6.1.1.2 ensuring UL/SUL indicator in Table 4.3.6.1.1.2-1 with condition SUL, subclause 4.6 ensuring Tables 4.6.1-28 with condition SUL AND (RF OR RRM), 4.6.3-14 with condition SUL_SUL for SUL carrier, and Table 4.6.3-167 with condition PUSCH_PUCCH_ON_SUL.

6.5C.3.1.5 Test requirement

The measured average power of spurious emission on the SUL carrier, derived in step 3, shall not exceed the described value in Table 6.5C.3.1.5-1.

The spurious emission limits apply for the frequency ranges that are more than Δf_{OOB} (MHz) in Table 6.5.3.1.3-1 from the edge of the channel bandwidth.

Table 6.5C.3.1.5-1: General spurious emissions test requirements

Frequency Range	Maximum Level	Measurement bandwidth	NOTE
$9 \text{ kHz} \leq f < 150 \text{ kHz}$	-36 dBm	1 kHz	
$150 \text{ kHz} \leq f < 30 \text{ MHz}$	-36 dBm	10 kHz	
$30 \text{ MHz} \leq f < 1000 \text{ MHz}$	-36 dBm	100 kHz	
$1 \text{ GHz} \leq f < 12.75 \text{ GHz}$	-30 dBm	1 MHz	
12.75 GHz $\leq f < 5$ th harmonic of the upper frequency edge of the UL operating band in GHz	-30 dBm	1 MHz	1
$12.75 \text{ GHz} < f < 26 \text{ GHz}$	-30 dBm	1 MHz	2
NOTE 1: Applies for Band that the upper frequency edge of the UL Band more than 2.69 GHz			
NOTE 2: Applies for Band that the upper frequency edge of the UL Band more than 5.2 GHz			

6.5C.3.2 Spurious emissions for UE co-existence for SUL

6.5C.3.2.1 Test purpose

To verify that UE transmitter does not cause unacceptable interference to co-existing systems for the specified bands which has specific requirements in terms of transmitter spurious emissions.

6.5C.3.2.2 Test applicability

This test applies to all types of NR UE release 15 and forward that support SUL operating on the SUL bands.

6.5C.3.2.3 Minimum conformance requirements

The requirements for NR bands for coexistence with protected bands specified in subclause 6.5.3.2.3 apply to the UE that support SUL operating on the SUL bands

The normative reference for this requirement is TS 38.101-1 [2] subclause 6.5.3.2.

6.5C.3.2.4 Test description

Same test description as specified in clause 6.5.3.2.4 with following exceptions:

- Instead of table 5.3.5-1 → use Table 5.5C-1
- Instead of table 6.5.3.2.4.1-1 → use Table 6.5C.3.2.4-1

Table 6.5C.3.2.4-1: Test Configuration Table

Initial Conditions			
Test Environment as specified in TS 38.508-1 [5] subclause 4.1		Normal	
Test Frequencies as specified in TS 38.508-1 [5] subclause 4.3.1		Low range, Mid range, High range for SUL carrier Mid range for Non-SUL carrier	
Test Channel Bandwidths as specified in TS 38.508-1 [5] subclause 4.3.1		Lowest, Mid, Highest for SUL carrier Lowest for Non-SUL carrier	
Test SCS as specified in Table 5.3.5-1		15kHz for both SUL carrier and Non-SUL carrier	
Test Parameters for Channel Bandwidths			
Test ID	Downlink Configuration	UL Configuration	SUL Configuration
	N/A	N/A	Modulation
1			CP-OFDM QPSK
2			CP-OFDM QPSK
3			CP-OFDM QPSK
			RB allocation (NOTE 1)
			OuterFull
			Edge_1RB_Left
			Edge_1RB_Right
NOTE 1: The specific configuration of each RB allocation is defined in Table 6.1-1 Common UL configuration.			
NOTE 2: Test Channel Bandwidths are checked separately for each SUL band combination, the applicable channel bandwidths are specified in Table 5.5C-1.			

- Connect the SS to the UE antenna connectors as shown in TS 38.508-1 [5] Annex A, Figure A.3.1.1.4 for TE diagram and section A.3.2 for UE diagram.
- The parameter setting for the cell are set up according to the TS 38.508-1 [5] subclause 4.4.3
- Downlink signals are initially setup according to Annex C.0, C.1, C.2 and uplink signals according to Annex G.0, G.1, G.2, and G.3.0 with consideration of supplementary uplink physical channels.
- Message contents in initial conditions are according to TS 38.508-1 [5] subclause 4.3.6.1.1.2 ensuring UL/SUL indicator in Table 4.3.6.1.1.2-1 with condition SUL, subclause 4.6 ensuring Tables 4.6.1-28 with condition SUL AND (RF OR RRM), 4.6.3-14 with condition SUL_SUL for SUL carrier, and Table 4.6.3-167 with condition PUSCH_PUCCH_ON_SUL.

6.5C.3.2.5 Test requirement

Test requirements for Spurious Emissions UE Co-existence are the same as specified in clause 6.5.3.2.3.

The measured average power of spurious emission, derived in step 3, shall not exceed the described value in Table 6.5.3.2.3-1 to Table 6.5.3.2.3-3. If the UE support a band, which is not defined in the table corresponding UE's release, the requirements for this band are taken from the table of earliest release where requirements for this band are defined. This has been described in following Table 6.5C.3.2.5-1.

Table 6.5C.3.2.5-1: UE Requirements according to UE NR release and supported NR band

UE Requirements per release			
NR Band	Rel-15	Rel-16	R17
n80	Table 6.5.3.2.3-1	Table 6.5.3.2.3-2	Table 6.5.3.2.3-3
n81	Table 6.5.3.2.3-1	Table 6.5.3.2.3-2	Table 6.5.3.2.3-3
n82	Table 6.5.3.2.3-1	Table 6.5.3.2.3-2	Table 6.5.3.2.3-3
n83	Table 6.5.3.2.3-1	Table 6.5.3.2.3-2	Table 6.5.3.2.3-3
n84	Table 6.5.3.2.3-1	Table 6.5.3.2.3-2	Table 6.5.3.2.3-3
n86	Table 6.5.3.2.3-1	Table 6.5.3.2.3-2	Table 6.5.3.2.3-3
n89	Table 6.5.3.2.3-2	Table 6.5.3.2.3-2	Table 6.5.3.2.3-3
n95	Table 6.5.3.2.3-2	Table 6.5.3.2.3-2	Table 6.5.3.2.3-3
n97	Table 6.5.3.2.3-3	Table 6.5.3.2.3-3	Table 6.5.3.2.3-3
n98	Table 6.5.3.2.3-3	Table 6.5.3.2.3-3	Table 6.5.3.2.3-3
n99	Table 6.5.3.2.3-3	Table 6.5.3.2.3-3	Table 6.5.3.2.3-3

6.5C.3.3 Additional spurious emissions for SUL

6.5C.3.3.1 Test purpose

To verify that UE transmitter does not cause unacceptable interference to other channels or other systems in terms of transmitter spurious emissions under the deployment scenarios where additional requirements are specified.

6.5C.3.3.2 Test applicability

This test applies to all types of NR UE release 15 and forward that support SUL operating on the SUL bands.

6.5C.3.3.3 Minimum conformance requirements

The additional spurious emission requirements specified in 6.5.3.3.3 apply to the UE operating on SUL bands.

The normative reference for this requirement is TS 38.101-1 [2] clause 6.5.3.3

6.5C.3.3.4 Test description

Same test description as specified in clause 6.5.3.3.4 with following exceptions:

- Instead of table 5.3.5-1 → use Table 5.5C-1
- For NS_05, instead of table 6.5.3.3.4.1-4 → use Table 6.5C.3.3.4-1
- For NS_43, instead of table 6.5.3.3.4.1-5 → use Table 6.5C.3.3.4-2
- For NS_18, instead of table 6.5.3.3.4.1-3 → use Table 6.5C.3.3.4-3
- For NS_48, instead of table 6.5.3.3.4.1-22 → use Table 6.5C.3.3.4-4
- For NS_49, instead of table 6.5.3.3.4.1-23 → use Table 6.5C.3.3.4-5
- For NS_56, instead of table 6.5.3.3.4.1-27 → use Table 6.5C.3.3.4-6

Table 6.5C.3.3.4-1: Test Configuration Table (network signalling value “NS_05”)

Initial Conditions								
Test Environment as specified in TS 38.508-1 [5] subclause 4.1			Normal					
Test Frequencies as specified in TS 38.508-1 [5] subclause 4.3.1			Use centre frequency (Fc) as specified in test parameters for SUL carrier Mid range for Non-SUL carrier					
Test Channel Bandwidths as specified in TS 38.508-1 [5] subclause 4.3.1			5 MHz, 10 MHz, 15 MHz, 20 MHz for SUL carrier Lowest for Non-SUL carrier					
Test SCS as specified in Table 5.3.5-1			15kHz for both SUL carrier and Non-SUL carrier					
Additional Spurious for SUL test parameters for NS_05								
Test ID	Fc (MHz)	SUL ChBw (MHz)	Downlink Config.	Uplink Config	A-MPR	SUL Configuration		
						Modulation (NOTE 2)	RB allocation (Note 1)	
1	1922.5	5	N/A	N/A	A3		DFT-s-OFDM	PI/2 BPSK
2	1925	10			A1	PI/2 BPSK		Outer_Full
3	1925	10			A7	PI/2 BPSK		40@10
4	1925	10			A2	PI/2 BPSK		6@40
5	1935	10			A4	PI/2 BPSK		Outer_Full
6	1927.5	15			A1	PI/2 BPSK		Outer_Full
7	1927.5	15			A7	PI/2 BPSK		60@19
8	1927.5	15			A2	PI/2 BPSK		6@56
9	1932.5	15			A1	PI/2 BPSK		Outer_Full
10	1932.5	15			A2	PI/2 BPSK		6@68
11	1942.5	15			A5	PI/2 BPSK		Outer_Full
12	1930	20			A1	PI/2 BPSK		Outer_Full
13	1930	20			A7	PI/2 BPSK		72@28
14	1930	20			A2	PI/2 BPSK		6@76
15	1950	20			A6	PI/2 BPSK		Outer_Full
16	1922.5	5			A3	QPSK		Outer_Full
17	1925	10			A1	QPSK		Outer_Full
18	1925	10			A7	QPSK		40@10
19	1925	10			A2	QPSK		6@40
20	1927.5	15			A1	QPSK		Outer_Full
21	1927.5	15			A7	QPSK		60@19
22	1927.5	15			A2	QPSK		6@56
23	1932.5	15			A1	QPSK		Outer_Full

24	1932.5	15			A 2	QPSK	6@68
25	1942.5	15			A 5	QPSK	Outer_Full
26	1930	20			A 1	QPSK	Outer_Full
27	1930	20			A 7	QPSK	72@28
28	1930	20			A 2	QPSK	6@76
29	1950	20			A 6	QPSK	Outer_Full
30	1922.5	5			A 3	16 QAM	Outer_Full
31	1925	10			A 1	16 QAM	Outer_Full
32	1925	10			A 7	16 QAM	40@10
33	1925	10			A 2	16 QAM	6@40
34	1927.5	15			A 1	16 QAM	Outer_Full
35	1927.5	15			A 7	16 QAM	60@19
36	1927.5	15			A 2	16 QAM	6@56
37	1932.5	15			A 1	16 QAM	Outer_Full
38	1932.5	15			A 2	16 QAM	6@68
39	1930	20			A 1	16 QAM	Outer_Full
40	1930	20			A 7	16 QAM	72@28
41	1930	20			A 2	16 QAM	6@76
42	1922.5	5			A 3	64 QAM	Outer_Full
43	1925	10			A 1	64 QAM	Outer_Full
44	1925	10			A 7	64 QAM	40@10
45	1925	10			A 2	64 QAM	6@40
46	1927.5	15			A 1	64 QAM	Outer_Full
47	1927.5	15			A 7	64 QAM	60@19
48	1927.5	15			A 2	64 QAM	6@56
49	1932.5	15			A 1	64 QAM	Outer_Full
50	1932.5	15			A 2	64 QAM	6@68
51	1930	20			A 1	64 QAM	Outer_Full
52	1930	20			A 7	64 QAM	72@28
53	1930	20			A 2	64 QAM	6@76
54	1922.5	5			A 3	256 QAM	Outer_Full

55	1925	10			A 1	256 QAM	Outer_Full
56	1925	10			A 7	256 QAM	40@10
57	1925	10			A 2	256 QAM	6@40
58	1927.5	15			A 1	256 QAM	Outer_Full
59	1927.5	15			A 7	256 QAM	60@19
60	1927.5	15			A 2	256 QAM	6@56
61	1932.5	15			A 1	256 QAM	Outer_Full
62	1932.5	15			A 2	256 QAM	6@68
63	1930	20			A 1	256 QAM	Outer_Full
64	1930	20			A 7	256 QAM	72@28
65	1930	20			A 2	256 QAM	6@76
66	1922.5	5			A 3	QPSK	Outer_Full
67	1925	10			A 1	QPSK	Outer_Full
68	1925	10			A 7	QPSK	42@10
69	1925	10			A 2	QPSK	6@40
70	1935	10			A 4	QPSK	Outer_Full
71	1927.5	15			A 1	QPSK	Outer_Full
72	1927.5	15			A 7	QPSK	60@19
73	1927.5	15			A 2	QPSK	6@56
74	1932.5	15			A 1	QPSK	Outer_Full
75	1932.5	15			A 2	QPSK	6@68
76	1942.5	15			A 5	QPSK	Outer_Full
77	1930	20			A 1	QPSK	Outer_Full
78	1930	20			A 7	QPSK	78@28
79	1930	20			A 2	QPSK	6@76
80	1950	20			A 6	QPSK	Outer_Full
81	1922.5	5			A 3	16 QAM	Outer_Full
82	1925	10			A 1	16 QAM	Outer_Full
83	1925	10			A 7	16 QAM	42@10
84	1925	10			A 2	16 QAM	6@40
85	1935	10			A 4	16 QAM	Outer_Full

CP-OFDM

86	1927.5	15			A 1	16 QAM	Outer_Full
87	1927.5	15			A 7	16 QAM	60@19
88	1927.5	15			A 2	16 QAM	6@56
89	1932.5	15			A 1	16 QAM	Outer_Full
90	1932.5	15			A 2	16 QAM	6@68
91	1942.5	15			A 5	16 QAM	Outer_Full
92	1930	20			A 1	16 QAM	Outer_Full
93	1930	20			A 7	16 QAM	78@28
94	1930	20			A 2	16 QAM	6@76
95	1950	20			A 6	16 QAM	Outer_Full
96	1922.5	5			A 3	64 QAM	Outer_Full
97	1925	10			A 1	64 QAM	Outer_Full
98	1925	10			A 7	64 QAM	42@10
99	1925	10			A 2	64 QAM	6@40
100	1927.5	15			A 1	64 QAM	Outer_Full
101	1927.5	15			A 7	64 QAM	60@19
102	1927.5	15			A 2	64 QAM	6@56
103	1932.5	15			A 1	64 QAM	Outer_Full
104	1932.5	15			A 2	64 QAM	6@68
105	1930	20			A 1	64 QAM	Outer_Full
106	1930	20			A 7	64 QAM	78@28
107	1930	20			A 2	64 QAM	6@76
108	1922.5	5			A 3	256 QAM	Outer_Full
109	1925	10			A 1	256 QAM	Outer_Full
110	1925	10			A 7	256 QAM	42@10
111	1927.5	15			A 1	256 QAM	Outer_Full
112	1927.5	15			A 7	256 QAM	60@19
113	1932.5	15			A 1	256 QAM	Outer_Full
114	1930	20			A 1	256 QAM	Outer_Full
115	1930	20			A 7	256 QAM	78@28

NOTE 1: The specific configuration of each RB allocation is defined in Table 6.1-1 unless otherwise stated in this table.
 NOTE 2: DFT-s-OFDM PI/2 BPSK test applies only for UEs which supports half Pi BPSK in FR1.
 NOTE 3: AMPR requirement for NS_05 is specified in 6.2.3.3.4.

Table 6.5C.3.3.4-2: Test Configuration Table (network signalling value “NS_43”)

Initial Conditions							
Test Environment as specified in TS 38.508-1 [5] subclause 4.1			Normal				
Test Frequencies as specified in TS 38.508-1 [5] subclause 4.3.1			Use carrier centre frequency (F _c) as specified in test parameters for SUL carrier Mid range for Non-SUL carrier				
Test Channel Bandwidths as specified in TS 38.508-1 [5] subclause 4.3.1			5 MHz, 10 MHz, 15 MHz for SUL carrier Lowest for Non-SUL carrier				
Test SCS as specified in Table 5.3.5-1			15 kHz for both SUL carrier and Non-SUL carrier				
Additional Spurious for SUL test parameters for NS_43							
Test ID	F _c (MHz)	SUL Ch BW (MHz)	Downlink Configuration	Uplink Configuration	SUL Configuration		
					Modulation (Note 2)	RB allocation (Note 1)	
1	910	10	N/A	N/A	DFT-s-OFDM	PI/2 BPSK	Outer_Full (A2)
2	907.5	15				PI/2 BPSK	Edge_1RB_Left (A6)
3	907.5	15				PI/2 BPSK	Outer_Full (A6)
4	902.5	5				QPSK	Outer_Full (A1)
5	910	10				QPSK	Outer_Full (A4)
6	907.5	15				QPSK	Edge_1RB_Left (A6)
7	907.5	15				QPSK	Outer_Full (A6)
8	910	10				16 QAM	Outer_Full (A5)
9	907.5	15				16 QAM	Edge_1RB_Left (A6)
10	907.5	15				16 QAM	Outer_Full (A6)
11	910	10				64 QAM	Outer_Full (A3)
12	907.5	15				64 QAM	Edge_1RB_Left (A6)
13	907.5	15				64 QAM	Outer_Full (A6)
14	907.5	15				256 QAM	Edge_1RB_Left (A6)
15	907.5	15				256 QAM	Outer_Full (A6)
16	902.5	5				CP-OFDM	QPSK
17	910	10			QPSK		Outer_Full (A5)
18	907.5	15			QPSK		Edge_1RB_Left (A6)
19	907.5	15			QPSK		Outer_Full (A6)
20	902.5	5			16 QAM		Outer_Full (A1)
21	910	10			16 QAM		Outer_Full (A5)
22	907.5	15			16 QAM		Edge_1RB_Left (A6)
23	907.5	15			16 QAM		Outer_Full (A6)
24	910	10			64 QAM		Outer_Full (A3)
25	907.5	15			64 QAM		Edge_1RB_Left (A6)
26	907.5	15			64 QAM		Outer_Full (A6)
27	907.5	15			256 QAM		Edge_1RB_Left (A6)
28	907.5	15			256 QAM	Outer_Full (A6)	

NOTE 1: The specific configuration of each RB allocation is defined in Table 6.1-1 unless otherwise stated in this table.
 NOTE 2: DFT-s-OFDM PI/2 BPSK test applies only for UEs which supports half Pi BPSK in FR1.
 NOTE 2: AMPR requirement for NS_43 is specified in 6.2.3.3.6.

Table 6.5C.3.3.4-3: Test Configuration Table (network signalling value “NS_18”)

Initial Conditions						
Test Environment as specified in TS 38.508-1 [5] subclause 4.1				Normal		
Test Frequencies as specified in TS 38.508-1 [5] subclause 4.3.1				Low range for SUL carrier Mid range for Non-SUL carrier		
Test Channel Bandwidths as specified in TS 38.508-1 [5] subclause 4.3.1				5MHz 10MHz 20MHz 30MHz for SUL carrier Lowest for Non-SUL carrier		
Test SCS as specified in Table 5.3.5-1				15 kHz for all carriers		
A-MPR test parameters for NS_18						
Test ID	ChBw SCS	Downlink Configuration	SUL Configuration			
			Modulation (Note 2)		RB allocation (Note 1)	Comment
1	5MHz, 10MHz, 20MHz	N/A	DFT-s OFDM	QPSK	Edge_1RB_Left	A1, A2
2				QPSK	Outer_Full	A1, A2
3				16 QAM	Edge_1RB_Left	A1, A2
4				16 QAM	Outer_Full	A1, A2
5				64 QAM	Edge_1RB_Left	A1, A2
6				64 QAM	Outer_Full	A1, A2
7				256 QAM	Edge_1RB_Left	A1, A2
8				256 QAM	Outer_Full	A1, A2
9			CP-s OFDM	QPSK	Edge_1RB_Left	A1, A2
10				QPSK	Outer_Full	A1, A2
11				16 QAM	Edge_1RB_Left	A1, A2
12				16 QAM	Outer_Full	A1, A2
13				64 QAM	Edge_1RB_Left	A1, A2
14				64 QAM	Outer_Full	A1, A2
15				256 QAM	Edge_1RB_Left	A1, A2
16				256 QAM	Outer_Full	A1, A2
17	30MHz	N/A	DFT-s OFDM	256 QAM	81@70	A3
18				256 QAM	Outer_Full	A4
19			CP-s OFDM	256 QAM	87@73	A3
20				256 QAM	Outer_Full	A4

NOTE 1: The specific configuration of each RB allocation is defined in Table 6.1-1 unless otherwise stated in this table.

Table 6.5C.3.3.4-4: Test Configuration Table (network signalling value “NS_48”)

Initial Conditions							
Test Environment as specified in TS 38.508-1 [5] subclause 4.1				Normal			
Test Frequencies as specified in TS 38.508-1 [5] subclause 4.3.1				Low range, High range for SUL carrier Mid range for non-SUL carrier			
Test Channel Bandwidths as specified in TS 38.508-1 [5] subclause 4.3.1				25 MHz, 30MHz, 40MHz, 50MHz for SUL carrier Lowest for non-SUL carrier			
Test SCS as specified in Table 5.3.5-1				15kHz for all carriers			
A-MPR test parameters for NS_48							
Test ID	F _c (MHz)	Ch BW (MHz)	Uplink Configuration	Downlink Configuration	SUL Configuration		
					Modulation (Note 2)	RB allocation (Note 1)	
1	Default	25	N/A	N/A	DFT-s-OFDM	QPSK	Outer_Full (A3)
2	Default	25				QPSK	Edge_1RB_Right (A3)
3	Default	30				QPSK	Outer_Full (A3)
4	Default	30				QPSK	Edge_1RB_Right (A5)
5	Default	40				QPSK	16@0 (A2)
6	Default	40				QPSK	90@0 (A3)
7	Default	40				QPSK	150@0 (A4)
8	Default	40				QPSK	192@0 (A2)
9	Default	40				QPSK	5@187 (A3)
10	Default	40				QPSK	Outer_Full (A1)
11	Default	50				QPSK	32@0 (A2)
12	Default	50				QPSK	108@0 (A4)
13	Default	50				QPSK	225@0 (A2)
14	Default	50				QPSK	5@223 (A5)
15	Default	50				QPSK	Outer_Full (A1)
16	Default	25				256 QAM	Outer_Full (A3)
17	Default	25				256 QAM	Edge_1RB_Right (A3)
18	Default	30				256 QAM	Outer_Full (A3)
19	Default	30				256 QAM	Edge_1RB_Right (A5)
20	Default	40				256 QAM	16@0 (A2)
21	Default	40				256 QAM	90@0 (A3)
22	Default	40				256 QAM	150@0 (A4)
23	Default	40				256 QAM	192@0 (A2)
24	Default	40				256 QAM	5@187 (A3)
25	Default	40				256 QAM	Outer_Full (A1)
26	Default	50				256 QAM	32@0 (A2)
27	Default	50				256 QAM	108@0 (A4)
28	Default	50				256 QAM	225@0 (A2)
29	Default	50				256 QAM	5@223 (A5)
30	Default	50				256 QAM	Outer_Full (A1)
31	Default	25			QPSK	Outer_Full (A3)	
32	Default	25			QPSK	Edge_1RB_Right (A3)	
33	Default	30			QPSK	Outer_Full (A3)	
34	Default	30			QPSK	Edge_1RB_Right (A5)	
35	Default	40			QPSK	16@0 (A2)	
36	Default	40			QPSK	95@0 (A3)	
37	Default	40			QPSK	152@0 (A4)	
38	Default	40			QPSK	192@0 (A2)	
39	Default	40			QPSK	5@187 (A3)	
40	Default	40			QPSK	Outer_Full (A1)	
41	Default	50			QPSK	34@0 (A2)	
42	Default	50			QPSK	115@0 (A4)	
43	Default	50			QPSK	228@0 (A2)	
44	Default	50			QPSK	5@223 (A5)	
45	Default	50			QPSK	Outer_Full (A1)	
46	Default	25			256 QAM	Outer_Full (A3)	
47	Default	25			256 QAM	Edge_1RB_Right (A3)	
					CP-OFDM		

48	Default	30				256 QAM	Outer_Full (A3)
49	Default	30				256 QAM	Edge_1RB_Right (A5)
50	Default	40				256 QAM	16@0 (A2)
51	Default	40				256 QAM	95@0 (A3)
52	Default	40				256 QAM	152@0 (A4)
53	Default	40				256 QAM	192@0 (A2)
54	Default	40				256 QAM	5@187 (A3)
55	Default	40				256 QAM	Outer_Full (A1)
56	Default	50				256 QAM	34@0 (A2)
57	Default	50				256 QAM	115@0 (A4)
58	Default	50				256 QAM	228@0 (A2)
59	Default	50				256 QAM	5@223 (A5)
60	Default	50				256 QAM	Outer_Full (A1)
NOTE 1: The specific configuration of each RB allocation is defined in Table 6.1-1 unless otherwise stated in this table.							

Table 6.5C.3.3.4-5: Test Configuration Table (network signalling value “NS_49”)

Initial Conditions							
Test Environment as specified in TS 38.508-1 [5] subclause 4.1			Normal				
Test Frequencies as specified in TS 38.508-1 [5] subclause 4.3.1			Low range, High range for SUL carrier Mid range for non-SUL carrier				
Test Channel Bandwidths as specified in TS 38.508-1 [5] subclause 4.3.1			25 MHz, 30MHz, 40MHz, 50MHz for SUL carrier Lowest for non-SUL carrier				
Test SCS as specified in Table 5.3.5-1			15 kHz for all carriers				
A-MPR test parameters for NS_49							
Test ID	F _c (MHz)	Ch BW (MHz)	Downlink Configuration	Uplink Configuration	SUL Configuration		
					Modulation (Note 2)	RB allocation (Note 1)	
1	Default	25	N/A	N/A	DFT-s-OFDM	QPSK	Outer_Full (A3)
2	Default	25				QPSK	Edge_1RB_Right (A3)
3	Default	25				QPSK	Edge_1RB_Left (A3)
4	Default	30				QPSK	20@0 (A1)
5	Default	30				QPSK	36@0 (A5)
6	Default	30				QPSK	80@0 (A3)
7	Default	30				QPSK	120@0 (A4)
8	Default	30				QPSK	Outer_Full (A2)
9	Default	30				QPSK	Edge_1RB_Right (A5)
10	Default	40				QPSK	40@0 (A1)
11	Default	40				QPSK	5@53 (A5)
12	Default	40				QPSK	100@0 (A4)
13	Default	40				QPSK	150@33 (A2)
14	Default	40				QPSK	5@187 (A5)
15	Default	40				QPSK	192@0 (A1)
16	Default	40				QPSK	Outer_Full (A1)
17	Default	50				QPSK	5@75 (A5)
18	Default	50				QPSK	5@215 (A5)
19	Default	50				QPSK	162@45 (A2)
20	Default	50				QPSK	220@0 (A1)
21	Default	50				QPSK	Outer_Full (A1)
22	Default	25				256 QAM	Outer_Full (A3)
23	Default	25				256 QAM	Edge_1RB_Right (A3)
24	Default	25				256 QAM	Edge_1RB_Left (A3)
25	Default	30				256 QAM	20@0 (A1)
26	Default	30				256 QAM	36@0 (A5)
27	Default	30				256 QAM	80@0 (A3)
28	Default	30				256 QAM	120@0 (A4)
29	Default	30				256 QAM	Outer_Full (A2)
30	Default	30				256 QAM	Edge_1RB_Right (A5)
31	Default	40				256 QAM	40@0 (A1)
32	Default	40				256 QAM	5@53 (A5)
33	Default	40				256 QAM	100@0 (A4)
34	Default	40				256 QAM	150@33 (A2)
35	Default	40				256 QAM	5@187 (A5)
36	Default	40				256 QAM	192@0 (A1)
37	Default	40				256 QAM	Outer_Full (A1)
38	Default	50				256 QAM	5@75 (A5)
39	Default	50				256 QAM	5@215 (A5)
40	Default	50				256 QAM	162@45 (A2)
41	Default	50				256 QAM	216@0 (A1)
42	Default	50				256 QAM	Outer_Full (A1)
43	Default	25				QPSK	Outer_Full (A3)
44	Default	25				QPSK	Edge_1RB_Right (A3)
45	Default	25				QPSK	Edge_1RB_Left (A3)
46	Default	30				QPSK	20@0 (A1)
47	Default	30				QPSK	36@0 (A5)
48	Default	30				QPSK	80@0 (A3)

49	Default	30				QPSK	120@0 (A4)
50	Default	30				QPSK	Outer_Full (A2)
51	Default	30				QPSK	Edge_1RB_Right (A5)
52	Default	40				QPSK	40@0 (A1)
53	Default	40				QPSK	5@53 (A5)
54	Default	40				QPSK	100@0 (A4)
55	Default	40				QPSK	159@33 (A2)
56	Default	40				QPSK	5@187 (A5)
57	Default	40				QPSK	192@0 (A1)
58	Default	40				QPSK	Outer_Full (A1)
59	Default	50				QPSK	5@75 (A5)
60	Default	50				QPSK	5@215 (A5)
61	Default	50				QPSK	175@45 (A2)
62	Default	50				QPSK	216@0 (A1)
63	Default	50				QPSK	Outer_Full (A1)
64	Default	25				256 QAM	Outer_Full (A3)
65	Default	25				256 QAM	Edge_1RB_Right (A3)
66	Default	25				256 QAM	Edge_1RB_Left (A3)
67	Default	30				256 QAM	20@0 (A1)
68	Default	30				256 QAM	36@0 (A5)
69	Default	30				256 QAM	80@0 (A3)
70	Default	30				256 QAM	120@0 (A4)
71	Default	30				256 QAM	Outer_Full (A2)
72	Default	30				256 QAM	Edge_1RB_Right (A5)
73	Default	40				256 QAM	40@0 (A1)
74	Default	40				256 QAM	5@53 (A5)
75	Default	40				256 QAM	100@0 (A4)
76	Default	40				256 QAM	150@33 (A2)
77	Default	40				256 QAM	5@187 (A5)
78	Default	40				256 QAM	192@0 (A1)
79	Default	40				256 QAM	Outer_Full (A1)
80	Default	50				256 QAM	5@75 (A5)
81	Default	50				256 QAM	5@215 (A5)
82	Default	50				256 QAM	175@45 (A2)
83	Default	50				256 QAM	220@0 (A1)
84	Default	50				256 QAM	Outer_Full (A1)

NOTE 1: The specific configuration of each RB allocation is defined in Table 6.1-1 unless otherwise stated in this table.

Table 6.5C.3.3.4-6: Test Configuration Table (network signalled value “NS_56”)

Initial Conditions								
Test Environment as specified in TS 38.508-1 [5] subclause 4.1						Normal		
Test Frequencies as specified in TS 38.508-1 [5] subclause 4.3.1						Use uplink carrier centre frequency (Fc) as specified in test parameters		
Test Channel Bandwidths as specified in TS 38.508-1 [5] subclause 4.3.1						5 MHz, 10 MHz as specified in test parameters for SUL carrier Lowest for non-SUL carrier		
Test SCS as specified in Table 5.3.5-1						15 kHz for all carriers		
A-MPR test parameters for NS_56								
Test ID	Fc (MHz)	ChB w (MHz)	Downlink Configuration	Uplink Configuration	A-MPR	Uplink Configuration		
						Modulation (NOTE 2)	RB allocation (Note 1) SCS 15 kHz	
1	Low	5	N/A for A-MPR testing	N/A	14	DFT-s-OFDM	PI/2 BPSK	Edge_1RB_Left
2	Low	5			6		PI/2 BPSK	Outer_Full
3	Low	5			4		PI/2 BPSK	20@4
4	Low	5			4		PI/2 BPSK	1@4
5	Low	5			14		QPSK	Edge_1RB_Left
6	Low	5			6		QPSK	Outer_Full
7	Low	5			4		QPSK	20@4
8	Low	5			4		QPSK	1@4
9	Low	5			14		16 QAM	Edge_1RB_Left
10	Low	5			6		16 QAM	Outer_Full
11	Low	5			4		16 QAM	20@4
12	Low	5			4		16 QAM	1@4
13	Low	5			14		64 QAM	Edge_1RB_Left
14	Low	5			6		64 QAM	Outer_Full
15	Low	5			4		64 QAM	20@4
16	Low	5			4		64 QAM	1@4
17	Low	5			14		256 QAM	Edge_1RB_Left
18	Low	5			6		256 QAM	Outer_Full
19	Low	5			4		256 QAM	20@4
20	Low	5			4		256 QAM	1@4
21	Low	10			12		PI/2 BPSK	Edge_1RB_Left
22	Low	10			8		PI/2 BPSK	Outer_Full
23	Low	10			6		PI/2 BPSK	1@3
24	Low	10			6		PI/2 BPSK	40@9
25	Low	10			4		PI/2 BPSK	1@35
26	Low	10			2		PI/2 BPSK	16@35
27	Low	10			5		PI/2 BPSK	Edge_1RB_Right
28	Low	10			5		PI/2 BPSK	1@40
29	Low	10			3		PI/2 BPSK	8@44
30	Low	10			12		QPSK	Edge_1RB_Left
31	Low	10			8		QPSK	Outer_Full
32	Low	10			6		QPSK	1@3
33	Low	10			6		QPSK	40@9
34	Low	10			4		QPSK	1@35
35	Low	10			2		QPSK	16@35
36	Low	10			5		QPSK	Edge_1RB_Right
37	Low	10			5		QPSK	1@40
38	Low	10			3		QPSK	8@44
39	Low	10			12		16 QAM	Edge_1RB_Left
40	Low	10			8		16 QAM	Outer_Full
41	Low	10			6		16 QAM	1@3
42	Low	10			6		16 QAM	40@9
43	Low	10			4		16 QAM	1@35
44	Low	10			2		16 QAM	16@35
45	Low	10			5		16 QAM	Edge_1RB_Right
46	Low	10			5		16 QAM	1@40
47	Low	10			3		16 QAM	8@44
48	Low	10			12		64 QAM	

49	Low	10			8	64 QAM	Edge_1RB_Left Outer_Full
50	Low	10			6	64 QAM	1@3
51	Low	10			6	64 QAM	40@9
52	Low	10			4	64 QAM	1@35
53	Low	10			2	64 QAM	16@35
54	Low	10			5	64 QAM	Edge_1RB_Right
55	Low	10			5	64 QAM	1@40
56	Low	10			3	64 QAM	8@44
57	Low	10			12	256 QAM	Edge_1RB_Left
58	Low	10			8	256 QAM	Outer_Full
59	Low	10			6	256 QAM	1@3
60	Low	10			6	256 QAM	40@9
61	Low	10			4	256 QAM	1@35
62	Low	10			2	256 QAM	16@35
63	Low	10			5	256 QAM	Edge_1RB_Right
64	Low	10			5	256 QAM	1@40
65	Low	10			3	256 QAM	8@44
66	Low	5			14	QPSK	Edge_1RB_Left
67	Low	5			6	QPSK	Outer_Full
68	Low	5			4	QPSK	21@4
69	Low	5			4	QPSK	1@4
70	Low	5			14	16 QAM	Edge_1RB_Left
71	Low	5			6	16 QAM	Outer_Full
72	Low	5			4	16 QAM	21@4
73	Low	5			4	16 QAM	1@4
74	Low	5			14	64 QAM	Edge_1RB_Left
75	Low	5			6	64 QAM	Outer_Full
76	Low	5			4	64 QAM	21@4
77	Low	5			4	64 QAM	1@4
78	Low	5			14	256 QAM	Edge_1RB_Left
79	Low	5			6	256 QAM	Outer_Full
80	Low	5			4	256 QAM	21@4
81	Low	5			4	256 QAM	1@4
82	Low	10			12	QPSK	Edge_1RB_Left
83	Low	10			8	QPSK	Outer_Full
84	Low	10			6	QPSK	1@3
85	Low	10			6	QPSK	43@9
86	Low	10			4	QPSK	1@35
87	Low	10			2	QPSK	17@35
88	Low	10			5	QPSK	Edge_1RB_Right
89	Low	10			5	QPSK	1@40
90	Low	10			3	QPSK	8@44
91	Low	10			12	16 QAM	Edge_1RB_Left
92	Low	10			8	16 QAM	Outer_Full
93	Low	10			6	16 QAM	1@3
94	Low	10			6	16 QAM	43@9
95	Low	10			4	16 QAM	1@35
96	Low	10			2	16 QAM	17@35
97	Low	10			5	16 QAM	Edge_1RB_Right
98	Low	10			5	16 QAM	1@40
99	Low	10			3	16 QAM	8@44
100	Low	10			12	64 QAM	Edge_1RB_Left
101	Low	10			8	64 QAM	Outer_Full
102	Low	10			6	64 QAM	1@3
103	Low	10			6	64 QAM	43@9
104	Low	10			4	64 QAM	1@35
105	Low	10			2	64 QAM	17@35
106	Low	10			5	64 QAM	Edge_1RB_Right
107	Low	10			5	64 QAM	1@40
108	Low	10			3	64 QAM	8@44

N/A for A-MPR testing

N/A

CP-OFDM

109	Low	10			12		256 QAM	Edge_1RB_Left
110	Low	10			8		256 QAM	Outer_Full
111	Low	10			6		256 QAM	1@3
112	Low	10			6		256 QAM	43@9
113	Low	10			4		256 QAM	1@35
114	Low	10			2		256 QAM	17@35
115	Low	10			5		256 QAM	Edge_1RB_Right
116	Low	10			5		256 QAM	1@40
117	Low	10			3		256 QAM	8@44
NOTE 1: The specific configuration of each RB allocation is defined in Table 6.1-1 unless otherwise stated in this table.								
NOTE 2: DFT-s-OFDM PI/2 BPSK test applies only for UEs which supports half Pi BPSK in FR1.								

- Connect the SS to the UE antenna connectors as shown in TS 38.508-1 [5] Annex A, Figure A.3.1.1.4 for TE diagram and section A.3.2 for UE diagram.
- The parameter setting for the cell are set up according to the TS 38.508-1 [5] subclause 4.4.3
- Downlink signals are initially setup according to Annex C.0, C.1, C.2 and uplink signals according to Annex G.0, G.1, G.2, and G.3.0 with consideration of supplementary uplink physical channels.

Message contents in initial conditions are according to TS 38.508-1 [5] subclause 4.3.6.1.1.2 ensuring UL/SUL indicator in Table 4.3.6.1.1.2-1 with condition SUL, subclause 4.6 ensuring Table 4.6.1-28 with condition SUL AND (RF OR RRM), Tables 4.6.3-14 with condition SUL_SUL for SUL carrier, and Table 4.6.3-167 with condition PUSCH_PUCCH_ON_SUL, together with exceptions as specified in clause 6.5.3.3.4.3 as appropriate for different NS values.

Table 6.5C.3.3.4-2: Void

6.5C.3.3.5 Test requirement

For SUL operation, the Additional Spurious emission requirement specified in clause 6.5.3.3.5 shall be met for specific NS values.

Table 6.5C.3.3.5-1: Void

6.5C.4 Transmit intermodulation for SUL

6.5C.4.1 Test purpose

To verify that the UE transmit intermodulation does not exceed the described value in the test requirement.

The transmit intermodulation performance is a measure of the capability of the transmitter to inhibit the generation of signals in its non-linear elements caused by presence of the wanted signal and an interfering signal reaching the transmitter via the antenna.

6.5C.4.2 Test applicability

This test applies to all types of NR UE release 15 and forward that support SUL operating on the SUL bands.

6.5C.4.3 Minimum conformance requirements

The requirements in subclause 6.5.4 apply to the UE operating on SUL bands

The normative reference for this requirement is TS 38.101-1 [2] clause 6.5.4.

6.5C.4.4 Test description

Same test description as specified in clause 6.2.4.4 with following exceptions:

- Instead of table 5.3.5-1 → use Table 5.5C-1
- Instead of table 6.5.4.4.1-1 → use Table 6.5C.4.4-1

Table 6.5C.4.4-1: Test Configuration Table

Initial Conditions				
Test Environment as specified in TS 38.508-1 [5] subclause 4.1		Normal		
Test Frequencies as specified in TS 38.508-1 [5] subclause 4.3.1		Mid range for both SUL carrier and Non-SUL carrier		
Test Channel Bandwidths as specified in TS 38.508-1 [5] subclause 4.3.1		Mid, Highest for SUL carrier Lowest for Non-SUL carrier		
Test SCS as specified in Table 5.3.5-1		15kHz for both SUL carrier and Non-SUL carrier		
Test Parameters for Channel Bandwidths				
Test ID	Downlink Configuration	UL Configuration	SUL Configuration	
	N/A	N/A	Modulation	RB allocation (NOTE 2)
1			DFT-s-OFDM Pi/2 BPSK	Inner Full
2			DFT-s-OFDM QPSK	Inner Full
NOTE 1: Test Channel Bandwidths are checked separately for each SUL band combination, the applicable channel bandwidths are specified in Table 5.5C-1.				
NOTE 2: The specific configuration of each RB allocation is defined in Table 6.1-1.				
NOTE 3: DFT-s-OFDM PI/2 BPSK test applies only for UEs which supports half Pi BPSK in FR1.				

- Connect the SS to the UE antenna connectors as shown in TS 38.508-1 [5] Annex A, Figure A.3.1.3.4 for TE diagram and section A.3.2 for UE diagram.
- The parameter setting for the cell are set up according to the TS 38.508-1 [5] subclause 4.4.3
- Downlink signals are initially setup according to Annex C.0, C.1, C.2 and uplink signals according to Annex G.0, G.1, G.2, and G.3.0 with consideration of supplementary uplink physical channels.
- Instead of table 6.5.4.5-1 → use Table 6.5C.4.5-1
- Message contents in initial conditions are according to TS 38.508-1 [5] subclause 4.3.6.1.1.2 ensuring UL/SUL indicator in Table 4.3.6.1.1.2-1 with condition SUL, subclause 4.6 ensuring Tables 4.6.1-28 with condition SUL AND (RF OR RRM), 4.6.3-14 with condition SUL_SUL for SUL carrier, and Table 4.6.3-167 with condition PUSCH_PUCCH_ON_SUL.

6.5C.4.5 Test requirement

The ratio derived in step 6 and 8, shall not exceed the described value in table 6.5C.4.5-1.

Table 6.5C.4.5-1: Transmit Intermodulation

Wanted signal channel bandwidth	$BW_{Channel}$	
Interference signal frequency offset from channel centre	$BW_{Channel}$	$2 * BW_{Channel}$
Interference CW signal level	-40dBc	
Intermodulation product	< -29dBc	< -35dBc
Measurement bandwidth	The maximum transmission bandwidth configuration among the different SCSs for the channel BW as defined in Table 6.5.2.4.1.3-1	
Measurement offset from channel centre	$BW_{Channel}$ and $2 * BW_{Channel}$	$2 * BW_{Channel}$ and $4 * BW_{Channel}$

6.5D Output RF spectrum emissions for UL MIMO

6.5D.1 Occupied bandwidth for UL MIMO

6.5D.1.1 Test purpose

To verify that the UE occupied bandwidth for all transmission bandwidth configurations supported by the UE supporting UL MIMO are less than their specific limits when UE is configured using UL MIMO transmission.

6.5D.1.2 Test applicability

This test applies to all types of NR UE release 15 and forward that support UL MIMO.

6.5D.1.3 Minimum conformance requirements

For UE supporting UL MIMO, the requirements for occupied bandwidth apply to the sum of the powers from both UE transmit antenna connectors. The occupied bandwidth is defined as the bandwidth containing 99 % of the total integrated mean power of the transmitted spectrum on the assigned channel at each transmit antenna connector.

For UE with two transmit antenna connectors in closed-loop spatial multiplexing scheme, the occupied bandwidth at each transmitter antenna shall be less than the channel bandwidth specified in table 6.5.1.3-1. The requirements shall be met with UL MIMO configurations described in sub-clause 6.2D.1.3.

If UE is configured for transmission on single-antenna port by DCI format 0_0 or by DCI format 0_1 for single antenna port codebook based transmission, the requirements in subclause 6.5.1.3 apply

The normative reference for this requirement is TS 38.101-1 [2] clause 6.5D.1.

6.5D.1.4 Test description

6.5D.1.4.1 Initial conditions

Initial conditions are a set of test configurations the UE needs to be tested in and the steps for the SS to take with the UE to reach the correct measurement state.

The initial test configurations consist of environmental conditions, test frequencies, test channel bandwidths and sub-carrier spacing based on NR operating bands specified in table 5.3.5-1. All of these configurations shall be tested with applicable test parameters for each combination of channel bandwidth and sub-carrier spacing, are shown in table 6.5D.1.4.1-1. The details of the uplink reference measurement channels (RMCs) are specified in Annexes A.2. Configurations of PDSCH and PDCCH before measurement are specified in Annex C.2.

Table 6.5D.1.4.1-1: Test Configuration Table

Initial Conditions			
Test Environment as specified in TS 38.508-1 [5] subclause 4.1		Normal	
Test Frequencies as specified in TS 38.508-1 [5] subclause 4.3.1		Mid range by default, exceptions listed in Table 6.5D.1.4.1-2	
Test Channel Bandwidths as specified in TS 38.508-1 [5] subclause 4.3.1		All	
Test SCS as specified in Table 5.3.5-1		Lowest SCS	
Test Parameters			
Test ID	Downlink Configuration	Uplink Configuration	
1	N/A for occupied bandwidth test case	Modulation	RB allocation (NOTE 1)
		CP-OFDM QPSK	Outer_full
NOTE 1: The specific configuration of each RB allocation is defined in Table 6.1-1.			

Table 6.5D.1.4.1-2: Test frequency exceptions for Occupied Bandwidth

5G NR Band	Test Frequency
n77	Low Range, Mid Range, High Range
n78	Low Range, Mid Range, High Range
n79	Low Range, Mid Range, High Range

1. Connect the SS to the UE antenna connectors as shown in TS 38.508-1 [5] Annex A, Figure A.3.1.1.2 for TE diagram and section A.3.2 for UE diagram.
2. The parameter settings for the cell are set up according to TS 38.508-1 [5] subclause 4.4.3.
3. Downlink signals are initially set up according to Annex C.0, C.1, C.2, and uplink signals according to Annex G.0, G.1, G.2, G.3.0.
4. The UL Reference Measurement channels are set according to Table 6.5D.1.4.1-1.
5. Propagation conditions are set according to Annex B.0.
6. Ensure the UE is in state RRC_CONNECTED with generic procedure parameters Connectivity NR, Connected without release On, Test Mode On and Test Loop Function On according to TS 38.508-1 [5] clause 4.5. Message contents are defined in clause 6.5D.1.4.3

6.5D.1.4.2 Test procedure

1. SS sends uplink scheduling information for each UL HARQ process via PDCCH DCI format 0_1 for C_RNTI to schedule the UL RMC according to Table 6.5D.1.4.1-1. Since the UL has no payload and no loopback data to send the UE sends uplink MAC padding bits on the UL RMC. The PDCCH DCI format 0_1 is specified with condition 2TX_UL_MIMO in 38.508-1 [5] subclause 4.3.6.1.1.2
2. Send continuously power control “up” commands to the UE until the UE transmits at P_{UMAX} level. Allow at least 200ms for the UE to reach P_{UMAX} level.
3. Measure the power spectrum distribution as the sum of the powers from both UE transmit antenna connectors within two times or more range over the requirement for Occupied Bandwidth specification centring on the current carrier frequency. The characteristics of the filter shall be approximately Gaussian (typical spectrum analyser filter). Other methods to measure the power spectrum distribution are allowed. The measuring duration is 1ms over consecutive active uplink slots. For TDD, only slots consisting of only UL symbols are under test.
4. Calculate the total power within the range of all frequencies measured in step 3 and save this value as “Total power”.
5. Sum up the power upward from the lower boundary of the measured frequency range in step 3 and seek the limit frequency point by which this sum becomes 0.5% of “Total power” and save this point as “Lower Frequency”.
6. Sum up the power downward from the upper boundary of the measured frequency range in step 3 and seek the limit frequency point by which this sum becomes 0.5% of “Total power” and save this point as “Upper Frequency”.
7. Calculate the difference “Upper Frequency” – “Lower Frequency” = “Occupied Bandwidth” between the two limit frequencies obtained in step 5 and step 6.
8. Repeat step 3 until step 7 for each of transmit antenna of the UE.

6.5D.1.4.3 Message contents

Message contents are according to TS 38.508-1 [5] subclause 4.6 ensuring Table 4.6.3-182 with condition 2TX_UL_MIMO

6.5D.1.5 Test requirement

The measured Occupied Bandwidth in step 7 for each antenna shall not exceed values in Table 6.5D.1.5-1.

Table 6.5D.1.5-1: Occupied channel bandwidth

	Occupied channel bandwidth / NR Channel bandwidth												
	5 MHz	10 MHz	15 MHz	20 MHz	25 MHz	30 MHz	40 MHz	50 MHz	60 MHz	70 MHz	80 MHz	90 MHz	100 MHz
Channel bandwidth (MHz)	5	10	15	20	25	30	40	50	60	70	80	90	100
Note 1: TT = 0.													

6.5D.1_1 Void

6.5D.2 Out of band emission for UL MIMO

6.5D.2.1 General

For UE supporting UL MIMO, the requirements for Out of band emissions resulting from the modulation process and non-linearity in the transmitters are specified as the sum of the emissions from both UE transmit antenna connectors.

For UEs with two transmit antenna connectors in closed-loop spatial multiplexing scheme, the requirements in subclause 6.5.2 apply. The requirements shall be met with UL MIMO configurations described in sub-clause 6.2D.1.3

If UE is scheduled for single antenna-port PUSCH transmission by DCI format 0_0 or by DCI format 0_1 for single antenna port codebook based transmission, the requirements in subclause 6.5.2 apply.

6.5D.2.2 Spectrum emission mask for UL MIMO

6.5D.2.2.1 Test purpose

To verify that the power of any UE emission shall not exceed specified level for the specified channel bandwidth.

6.5D.2.2.2 Test applicability

This test case applies to all types of NR UE release 15 and forward that supports UL MIMO.

6.5D.2.2.3 Minimum conformance requirements

The sum of power of any UE emission shall not exceed the levels specified in Table 6.5.2.2.3-1 for the specified channel bandwidth from both transmit antenna connectors.

For UE support uplink full power transmission (ULFPTx) for UL MIMO, the requirements in clause 6.5.2.2 shall apply. The requirements shall be met with the PUSCH configurations specified in Table 6.2D.1.3-3, based upon UE's support of uplink full power transmission mode.

If UE is scheduled for single antenna-port PUSCH transmission by DCI format 0_0 or by DCI format 0_1 for single antenna port codebook based transmission, the requirements in clause 6.5.2.2 apply.

The normative reference for this requirement is TS 38.101-1 [2] clause 6.5D.2 and 6.5.2.2

6.5D.2.2.4 Test description

6.5D.2.2.4.1 Initial conditions

Initial conditions are a set of test configurations the UE needs to be tested in and the steps for the SS to take with the UE to reach the correct measurement state.

The initial test configurations consist of environmental conditions, test frequencies, test channel bandwidths and sub-carrier spacing based on NR operating bands specified in table 5.3.5-1. All of these configurations shall be tested with applicable test parameters for each combination of channel bandwidth and sub-carrier spacing, and are shown in tables 6.5D.2.2.4.1-1 to 6.5D.2.2.4.1-3. The details of the uplink reference measurement channels (RMCs) are specified in Annexes A.2. Configurations of PDSCH and PDCCH before measurement are specified in Annex C.2

Table 6.5D.2.2.4.1-1: Test Configuration Table for power class 3 and power class 2

Default Conditions						
Test Environment as specified in TS 38.508-1 [5] subclause 4.1				Normal		
Test Frequencies as specified in TS 38.508-1 [5] subclause 4.3.1				Low range, High range		
Test Channel Bandwidths as specified in TS 38.508-1 [5] subclause 4.3.1				Lowest, Highest		
Test SCS as specified in Table 5.3.5-1				Lowest and Highest		
Test Parameters for Channel Bandwidths						
Test ID	Freq	ChBw	SCS	Downlink Configuration	Uplink Configuration	
		Default	Default	N/A for Spectrum Emission Mask test case	Modulation	RB allocation (NOTE 1)
1	Low				CP-OFDM QPSK	Edge_1RB_Left
2	High				CP-OFDM QPSK	Edge_1RB_Right
3	Default				CP-OFDM QPSK	Outer_Full
4	Low				CP-OFDM 16 QAM	Edge_1RB_Left
5	High				CP-OFDM 16 QAM	Edge_1RB_Right
6	Default				CP-OFDM 16 QAM	Outer_Full
7	Low				CP-OFDM 64 QAM	Edge_1RB_Left
8	High				CP-OFDM 64 QAM	Edge_1RB_Right
9	Default				CP-OFDM 64 QAM	Outer_Full
10	Low				CP-OFDM 256 QAM	Edge_1RB_Left
11	High				CP-OFDM 256 QAM	Edge_1RB_Right
12	Default				CP-OFDM 256 QAM	Outer_Full
NOTE 1: The specific configuration of each RF allocation is defined in Table 6.1-1.						

Table 6.5D.2.2.4.1-2: Test Configuration Table for power class 3 with supporting ULFP Tx

Initial Conditions				
Test Environment as specified in TS 38.508-1 [5] subclause 4.1		Normal		
Test Frequencies as specified in TS 38.508-1 [5] subclause 4.3.1		Low range, High range		
Test Channel Bandwidths as specified in TS 38.508-1 [5] subclause 4.3.1		Lowest, Highest		
Test SCS as specified in Table 5.3.5-1		Lowest, Highest		
Test Parameters for Channel Bandwidths				
Test ID	Freq	Downlink Configuration	Uplink Configuration	
		N/A for Maximum Power Reduction (MPR) test case	Modulation (NOTE 2)	
			RB allocation (NOTE 1)	
1 ⁴	Low		DFT-s-OFDM Pi/2 BPSK	Edge_1RB_Left
2 ⁴	High		DFT-s-OFDM Pi/2 BPSK	Edge_1RB_Right
3 ⁴	Default		DFT-s-OFDM Pi/2 BPSK	Outer Full
4 ⁴	Low		DFT-s-OFDM QPSK	Edge_1RB_Left
5	High		DFT-s-OFDM QPSK	Edge_1RB_Right
6	Default		DFT-s-OFDM QPSK	Outer Full
7	Low		DFT-s-OFDM 16 QAM	Edge_1RB_Left
8	High		DFT-s-OFDM 16 QAM	Edge_1RB_Right
9	Default		DFT-s-OFDM 16 QAM	Outer Full
10	Low		DFT-s-OFDM 64 QAM	Edge_1RB_Left
11	High		DFT-s-OFDM 64 QAM	Edge_1RB_Right
12	Default		DFT-s-OFDM 64 QAM	Outer Full
13	Low		DFT-s-OFDM 256 QAM	Edge_1RB_Left
14	High		DFT-s-OFDM 256 QAM	Edge_1RB_Right
15	Default		DFT-s-OFDM 256 QAM	Outer Full
16	Low		CP-OFDM QPSK	Edge_1RB_Left
17	High		CP-OFDM QPSK	Edge_1RB_Right
18	Default		CP-OFDM QPSK	Outer Full
19	Low		CP-OFDM 16 QAM	Edge_1RB_Left
20	High		CP-OFDM 16 QAM	Edge_1RB_Right
21	Default		CP-OFDM 16 QAM	Outer Full
22	Low		CP-OFDM 64 QAM	Edge_1RB_Left
23	High		CP-OFDM 64 QAM	Edge_1RB_Right
24	Default		CP-OFDM 64 QAM	Outer Full
25	Low		CP-OFDM 256 QAM	Edge_1RB_Left
26	High	CP-OFDM 256 QAM	Edge_1RB_Right	
27	Default	CP-OFDM 256 QAM	Outer Full	
NOTE 1: The specific configuration of each RB allocation is defined in Table 6.1-1.				
NOTE 2: DFT-s-OFDM Pi/2 BPSK test applies only for UEs which supports half Pi BPSK in FR1.				
NOTE 3: Test ID 16 ~ 27 with CP-OFDM modulation are not needed if PDCCH DCI format 0_1 indicates ULFP Tx_Mode1.				
NOTE 4: UE operating in FDD mode, or in TDD mode in bands other than n40, n41, n77, n78 and n79, or in TDD mode the IE <i>powerBoostPi2BPSK</i> is set to 0 for bands n40, n41, n77, n78 and n79.				

Table 6.5D.2.2.4.1-3: Test Configuration Table for power class 2 with supporting ULFP Tx

Initial Conditions																																																											
Test Environment as specified in TS 38.508-1 [5] subclause 4.1		Normal																																																									
Test Frequencies as specified in TS 38.508-1 [5] subclause 4.3.1		Low range, High range																																																									
Test Channel Bandwidths as specified in TS 38.508-1 [5] subclause 4.3.1		Lowest, Highest																																																									
Test SCS as specified in Table 5.3.5-1		Lowest, Highest																																																									
Test Parameters for Channel Bandwidths																																																											
Test ID	Freq	Downlink Configuration	Uplink Configuration																																																								
		N/A for Maximum Power Reduction (MPR) test case	<table border="1"> <thead> <tr> <th>Modulation (NOTE 2)</th> <th>RB allocation (NOTE 1)</th> </tr> </thead> <tbody> <tr><td>DFT-s-OFDM Pi/2 BPSK</td><td>Edge_1RB_Left</td></tr> <tr><td>DFT-s-OFDM Pi/2 BPSK</td><td>Edge_1RB_Right</td></tr> <tr><td>DFT-s-OFDM Pi/2 BPSK</td><td>Outer Full</td></tr> <tr><td>DFT-s-OFDM QPSK</td><td>Edge_1RB_Left</td></tr> <tr><td>DFT-s-OFDM QPSK</td><td>Edge_1RB_Right</td></tr> <tr><td>DFT-s-OFDM QPSK</td><td>Outer Full</td></tr> <tr><td>DFT-s-OFDM 16 QAM</td><td>Edge_1RB_Left</td></tr> <tr><td>DFT-s-OFDM 16 QAM</td><td>Edge_1RB_Right</td></tr> <tr><td>DFT-s-OFDM 16 QAM</td><td>Outer Full</td></tr> <tr><td>DFT-s-OFDM 64 QAM</td><td>Edge_1RB_Left</td></tr> <tr><td>DFT-s-OFDM 64 QAM</td><td>Edge_1RB_Right</td></tr> <tr><td>DFT-s-OFDM 64 QAM</td><td>Outer Full</td></tr> <tr><td>DFT-s-OFDM 256 QAM</td><td>Edge_1RB_Left</td></tr> <tr><td>DFT-s-OFDM 256 QAM</td><td>Edge_1RB_Right</td></tr> <tr><td>DFT-s-OFDM 256 QAM</td><td>Outer Full</td></tr> <tr><td>CP-OFDM QPSK</td><td>Edge_1RB_Left</td></tr> <tr><td>CP-OFDM QPSK</td><td>Edge_1RB_Right</td></tr> <tr><td>CP-OFDM QPSK</td><td>Outer Full</td></tr> <tr><td>CP-OFDM 16 QAM</td><td>Edge_1RB_Left</td></tr> <tr><td>CP-OFDM 16 QAM</td><td>Edge_1RB_Right</td></tr> <tr><td>CP-OFDM 16 QAM</td><td>Outer Full</td></tr> <tr><td>CP-OFDM 64 QAM</td><td>Edge_1RB_Left</td></tr> <tr><td>CP-OFDM 64 QAM</td><td>Edge_1RB_Right</td></tr> <tr><td>CP-OFDM 64 QAM</td><td>Outer Full</td></tr> <tr><td>CP-OFDM 256 QAM</td><td>Edge_1RB_Left</td></tr> <tr><td>CP-OFDM 256 QAM</td><td>Edge_1RB_Right</td></tr> <tr><td>CP-OFDM 256 QAM</td><td>Outer Full</td></tr> </tbody> </table>	Modulation (NOTE 2)	RB allocation (NOTE 1)	DFT-s-OFDM Pi/2 BPSK	Edge_1RB_Left	DFT-s-OFDM Pi/2 BPSK	Edge_1RB_Right	DFT-s-OFDM Pi/2 BPSK	Outer Full	DFT-s-OFDM QPSK	Edge_1RB_Left	DFT-s-OFDM QPSK	Edge_1RB_Right	DFT-s-OFDM QPSK	Outer Full	DFT-s-OFDM 16 QAM	Edge_1RB_Left	DFT-s-OFDM 16 QAM	Edge_1RB_Right	DFT-s-OFDM 16 QAM	Outer Full	DFT-s-OFDM 64 QAM	Edge_1RB_Left	DFT-s-OFDM 64 QAM	Edge_1RB_Right	DFT-s-OFDM 64 QAM	Outer Full	DFT-s-OFDM 256 QAM	Edge_1RB_Left	DFT-s-OFDM 256 QAM	Edge_1RB_Right	DFT-s-OFDM 256 QAM	Outer Full	CP-OFDM QPSK	Edge_1RB_Left	CP-OFDM QPSK	Edge_1RB_Right	CP-OFDM QPSK	Outer Full	CP-OFDM 16 QAM	Edge_1RB_Left	CP-OFDM 16 QAM	Edge_1RB_Right	CP-OFDM 16 QAM	Outer Full	CP-OFDM 64 QAM	Edge_1RB_Left	CP-OFDM 64 QAM	Edge_1RB_Right	CP-OFDM 64 QAM	Outer Full	CP-OFDM 256 QAM	Edge_1RB_Left	CP-OFDM 256 QAM	Edge_1RB_Right	CP-OFDM 256 QAM	Outer Full
Modulation (NOTE 2)	RB allocation (NOTE 1)																																																										
DFT-s-OFDM Pi/2 BPSK	Edge_1RB_Left																																																										
DFT-s-OFDM Pi/2 BPSK	Edge_1RB_Right																																																										
DFT-s-OFDM Pi/2 BPSK	Outer Full																																																										
DFT-s-OFDM QPSK	Edge_1RB_Left																																																										
DFT-s-OFDM QPSK	Edge_1RB_Right																																																										
DFT-s-OFDM QPSK	Outer Full																																																										
DFT-s-OFDM 16 QAM	Edge_1RB_Left																																																										
DFT-s-OFDM 16 QAM	Edge_1RB_Right																																																										
DFT-s-OFDM 16 QAM	Outer Full																																																										
DFT-s-OFDM 64 QAM	Edge_1RB_Left																																																										
DFT-s-OFDM 64 QAM	Edge_1RB_Right																																																										
DFT-s-OFDM 64 QAM	Outer Full																																																										
DFT-s-OFDM 256 QAM	Edge_1RB_Left																																																										
DFT-s-OFDM 256 QAM	Edge_1RB_Right																																																										
DFT-s-OFDM 256 QAM	Outer Full																																																										
CP-OFDM QPSK	Edge_1RB_Left																																																										
CP-OFDM QPSK	Edge_1RB_Right																																																										
CP-OFDM QPSK	Outer Full																																																										
CP-OFDM 16 QAM	Edge_1RB_Left																																																										
CP-OFDM 16 QAM	Edge_1RB_Right																																																										
CP-OFDM 16 QAM	Outer Full																																																										
CP-OFDM 64 QAM	Edge_1RB_Left																																																										
CP-OFDM 64 QAM	Edge_1RB_Right																																																										
CP-OFDM 64 QAM	Outer Full																																																										
CP-OFDM 256 QAM	Edge_1RB_Left																																																										
CP-OFDM 256 QAM	Edge_1RB_Right																																																										
CP-OFDM 256 QAM	Outer Full																																																										
1	Low																																																										
2	High																																																										
3	Default																																																										
4	Low																																																										
5	High																																																										
6	Default																																																										
7	Low																																																										
8	High																																																										
9	Default																																																										
10	Low																																																										
11	High																																																										
12	Default																																																										
13	Low																																																										
14	High																																																										
15	Default																																																										
16	Low																																																										
17	High																																																										
18	Default																																																										
19	Low																																																										
20	High																																																										
21	Default																																																										
22	Low																																																										
23	High																																																										
24	Default																																																										
25	Low																																																										
26	High																																																										
27	Default																																																										
NOTE 1: The specific configuration of each RB allocation is defined in Table 6.1-1.																																																											
NOTE 2: DFT-s-OFDM Pi/2 BPSK test applies only for UEs which supports half Pi BPSK in FR1.																																																											
NOTE 3: Test ID 16 ~ 27 with CP-OFDM modulation are not needed if PDCCH DCI format 0_1 indicates ULFP Tx_Mode1.																																																											

1. Connect the SS to the UE antenna connectors as shown in TS 38.508-1 [5] Annex A, Figure A.3.1.1.2 for TE diagram and section A.3.2 for UE diagram.
2. The parameter settings for the cell are set up according to TS 38.508-1 [5] subclause 4.4.3.
3. Downlink signals are initially set up according to Annex C.0, C.1, C.2, and uplink signals according to Annex G.0, G.1, G.2, G.3.0.
4. The UL Reference Measurement channels are set according to tables 6.5D.2.2.4.1-1 to 6.5D.2.2.4.1-3.
5. Propagation conditions are set according to Annex B.0.

6. Ensure the UE is in state RRC_CONNECTED with generic procedure parameters Connectivity *NR*, Connected without release *On*, Test Mode *On* and Test Loop Function *On* according to TS 38.508-1 [5] clause 4.5. Message contents are defined in clause 6.5D.2.2.4.3

6.5D.2.2.4.2 Test procedure

1. SS sends uplink scheduling information for each UL HARQ process via PDCCH DCI format 0_1 for C_RNTI to schedule the UL RMC according to Table 6.5D.2.2.4.1-1. Since the UL has no payload and no loopback data to send the UE sends uplink MAC padding bits on the UL RMC. The PDCCH DCI format 0_1 is specified with condition 2TX_UL_MIMO in 38.508-1 [5] subclause 4.3.6.1.1.2
2. Send continuously power control “up” commands to the UE until the UE transmits at P_{UMAX} level. Allow at least 200ms for the UE to reach P_{UMAX} level.
3. Measure the sum of the mean power of the UE in the channel bandwidth of the radio access mode according to the test configuration, which shall meet the requirements described in Tables 6.2D.2.5-1 or 6.2D.2.5-2 as appropriate. The period of the measurement shall be at least the continuous duration of 1ms over consecutive active uplink slots and uplink symbols. For TDD, only slots consisting of only UL symbols are under test.
4. Measure the sum of power of the transmitted signal from both antenna connectors with a measurement filter of bandwidths according to Table 6.5D.2.2.5-1. The centre frequency of the filter shall be stepped in continuous steps according to the same table. The measured power shall be recorded for each step. The measurement period shall capture the active TSs.
5. If UE supports ULFPTx, repeat test steps 1~3 with UL RMC according to Table 6.5D.2.2.4.1-2 and Table 6.5D.2.2.4.1-3 as appropriate. The PDCCH DCI format 0_1 is specified with the condition ULFPTx_Mode1, ULFPTx_Mode2 or ULFPTx_ModeFull in 38.508-1 [5] subclause 4.3.6.1.1.2 depending on UE reported capability. Message contents are according to TS 38.508-1 [5] clause 4.6.3 Table 4.6.3-118 with condition TRANSFORM_PRECODER_ENABLED.NOTE 1: When switching to DFT-s-OFDM waveform, as specified in the test configuration Table 6.5D.2.2.4.1-2, send an NR RRCReconfiguration message according to TS 38.508-1 [5] clause 4.6.3 Table 4.6.3-118 PUSCH-Config with TRANSFORM_PRECODER_ENABLED condition.

6.5D.2.2.4.3 Message contents

Message contents are according to TS 38.508-1 [5] subclause 4.6 and 5.4 ensuring Table 4.6.3-182 with condition 2TX_UL_MIMO.

6.5D.2.2.5 Test requirement

The measured sum of the UE mean power in the channel bandwidth, derived in step 3, shall fulfill requirements in Tables 6.2D.2.5-1, 6.2D.2.5-2, 6.2D.2.5-2a and 6.2D.2.5-2b as appropriate, and the sum of power of any UE emission measured from both antennas in step 4 and step 5 shall fulfill requirements in Table 6.5D.2.2.5-1.

Table 6.5D.2.2.5-1: NR General spectrum emission mask

Spectrum emission limit (dBm) / Channel bandwidth														
Δf_{OBS} (MHz)	5 MHz	10 MHz	15 MHz	20 MHz	25 MHz	30 MHz	40 MHz	50 MHz	60 MHz	70 MHz	80 MHz	90 MHz	100 MHz	Measurement bandwidth
$\pm 0-1$	-13 + TT	-13 + TT	-13 + TT	-13 + TT	-13 + TT	-13 + TT	-13 + TT							1 % channel bandwidth
$\pm 0-1$								-24 + TT	-24 + TT	-24 + TT	-24 + TT	-24 + TT	-24 + TT	30 kHz
$\pm 1-5$	-10 + TT	-10 + TT	-10 + TT	-10 + TT	-10 + TT	-10 + TT	-10 + TT	-10 + TT	-10 + TT	-10 + TT	-10 + TT	-10 + TT	-10 + TT	1 MHz
$\pm 5-6$	-13 + TT	-13 + TT	-13 + TT	-13 + TT	-13 + TT	-13 + TT	-13 + TT	-13 + TT	-13 + TT	-13 + TT	-13 + TT	-13 + TT	-13 + TT	
$\pm 6-10$	-25 + TT													
$\pm 10-15$		-25 + TT												
$\pm 15-20$			-25 + TT											
$\pm 20-25$				-25 + TT										
$\pm 25-30$					-25 + TT									
$\pm 30-35$						-25 + TT								
$\pm 35-40$														
$\pm 40-45$							-25 + TT							
$\pm 45-50$														
$\pm 50-55$								-25 + TT						
$\pm 55-60$														
$\pm 60-65$									-25 + TT					
$\pm 65-70$														
$\pm 70-75$										-25 + TT				
$\pm 75-80$														
$\pm 80-85$											-25 + TT			
$\pm 85-90$														
$\pm 90-95$												-25 + TT		
$\pm 95-100$														
$\pm 100-105$													-25 + TT	

- Note 1: The first and last measurement position with a 30 kHz filter is at Δf_{OBS} equals to 0.015 MHz and 0.985 MHz.
- Note 2: At the boundary of spectrum emission limit, the first and last measurement position with a 1 MHz filter is the inside of +0.5MHz and -0.5MHz, respectively.
- Note 3: The measurements are to be performed above the upper edge of the channel and below the lower edge of the channel.
- Note 4: TT = 1.5 dB for $f \leq 3\text{GHz}$, TT = 1.8 dB for $3\text{GHz} < f \leq 4.2\text{GHz}$, TT = 1.8 dB for $4.2\text{GHz} < f \leq 6.0\text{GHz}$.

NOTE: As a general rule, the resolution bandwidth of the measuring equipment should be equal to the measurement bandwidth. However, to improve measurement accuracy, sensitivity and efficiency, the resolution bandwidth may be smaller than the measurement bandwidth. When the resolution bandwidth is smaller than the measurement bandwidth, the result should be integrated over the measurement bandwidth in order to obtain the equivalent noise bandwidth of the measurement bandwidth.

6.5D.2.3 Additional spectrum emission mask for UL MIMO

Editor's note:

-Test coverage for the NS_XXs other than NS_03, NS_03U, NS_04 and NS_35 is FFS

6.5D.2.3.1 Test purpose

To verify that the sum of power of any UE emission from both transmit antennas shall not exceed specified lever for the specified channel bandwidth under the deployment scenarios where additional requirements are specified.

6.5D.2.3.2 Test applicability

This test case applies to all types of NR UE release 15 and forward that supports UL MIMO.

6.5D.2.3.3 Minimum conformance requirements

The sum of power of any UE emission shall not exceed the levels specified in Table 6.5.2.3.3-1 for NS_35, Table 6.5.2.3.3.2-1 for NS_04, and Table 6.5.2.3.3.3 for NS_03 and NS_03U for the specified channel bandwidth from both transmit antenna connectors.

The normative reference for this requirement is TS 38.101-1 [2] clause 6.5D.2 and 6.5.2.3

6.5D.2.3.4 Test description

6.5D.2.3.4.1 Initial conditions

Initial conditions are a set of test configurations the UE needs to be tested in and the steps for the SS to take with the UE to reach the correct measurement state.

The initial test configurations consist of environmental conditions, test frequencies, test channel bandwidths and sub-carrier spacing based on NR operating bands specified in table 5.3.5-1. All of these configurations shall be tested with applicable test parameters for each combination of channel bandwidth and sub-carrier spacing, and are shown in table 6.5D.2.3.4.1-1. The details of the uplink reference measurement channels (RMCs) are specified in Annexes A.2. Configurations of PDSCH and PDCCH before measurement are specified in Annex C.2.

Table 6.5D.2.3.4.1-1: Test Configuration Table for NS_35 for band n71

Initial Conditions						
Test Environment as specified in TS 38.508-1 [5] subclause 4.1					Normal	
Test Frequencies as specified in TS 38.508-1 [5] subclause 4.3.1					Low range and High range	
Test Channel Bandwidths as specified in TS 38.508-1 [5] subclause 4.3.1					Lowest and Highest (NOTE 2)	
Test SCS as specified in Table 5.3.5-1					Lowest and Highest	
A-MPR test parameters for NS_35						
Downlink Configuration				Uplink Configuration		
Test ID	Freq	ChBw	SCS	N/A for A-MPR testing.	Modulation	RB allocation (NOTE 1)
1	Low				CP-OFDM QPSK	Edge_1RB_Left
2	High				CP-OFDM QPSK	Edge_1RB_Right
3	Default				CP-OFDM QPSK	Outer Full
4	Low				CP-OFDM 16 QAM	Edge_1RB_Left
5	High				CP-OFDM 16 QAM	Edge_1RB_Right
6	Default				CP-OFDM 16 QAM	Outer Full
7	Low				CP-OFDM 64 QAM	Edge_1RB_Left
8	High				CP-OFDM 64 QAM	Edge_1RB_Right
9	Default				CP-OFDM 64 QAM	Outer Full
10	Low				CP-OFDM 256 QAM	Edge_1RB_Left
11	High				CP-OFDM 256 QAM	Edge_1RB_Right
12	Default				CP-OFDM 256 QAM	Outer Full
NOTE 1: The specific configuration of each RB allocation is defined in Table 6.1-1.						
NOTE 2: Confining to channel bandwidths of 5MHz, 10MHz, 15MHz and 20MHz, which are applicable to NS_35 according to TS 38.101-1[2] Table 6.2.3.1-1.						

Table 6.5D.2.3.4.1-2: Test Configuration Table for NS_04 for band n41

Initial Conditions				
Test Environment as specified in TS 38.508-1 [5] subclause 4.1			Normal	
Test Frequencies as specified in TS 38.508-1 [5] subclause 4.3.1			(See Freq column)	
Test Channel Bandwidths as specified in TS 38.508-1 [5] subclause 4.3.1			Lowest, Highest	
Test SCS as specified in Table 5.3.5-1			Lowest, Highest	
A-SEM test parameters for NS_04				
Test ID	Freq	Downlink Configuration	Uplink Configuration	
			Modulation	RB allocation (NOTE 1)
1	Low	N/A	CP-OFDM QPSK	Edge_1RB_Left
2	$2496 + 3/2 \times BW_{Channel} - 6 \text{ MHz}$		CP-OFDM QPSK	Edge_1RB_Left
3	$2496 + BW_{Channel} / 2 +$		CP-OFDM QPSK	Inner Full
4	$MAX(10 \text{ MHz}, 0.25 \times BW_{Channel})$		CP-OFDM QPSK	Outer Full
5	High		CP-OFDM QPSK	Edge_1RB_Right
6	High		CP-OFDM QPSK	Inner Full
7	High		CP-OFDM QPSK	Outer Full
8	Low		CP-OFDM 16 QAM	Edge_1RB_Left
9	$2496 + 3/2 \times BW_{Channel} - 6 \text{ MHz}$		CP-OFDM 16 QAM	Edge_1RB_Left
10	$2496 + BW_{Channel} / 2 +$		CP-OFDM 16 QAM	Inner Full
11	$MAX(10 \text{ MHz}, 0.25 \times BW_{Channel})$		CP-OFDM 16 QAM	Outer Full
12	High		CP-OFDM 16 QAM	Edge_1RB_Right
13	High		CP-OFDM 16 QAM	Inner Full
14	High		CP-OFDM 16 QAM	Outer Full
15	Low		CP-OFDM 64 QAM	Edge_1RB_Left
16	$2496 + 3/2 \times BW_{Channel} - 6 \text{ MHz}$		CP-OFDM 64 QAM	Edge_1RB_Left
17	$2496 + BW_{Channel} / 2 +$ $MAX(10 \text{ MHz}, 0.25 \times BW_{Channel})$		CP-OFDM 64 QAM	Outer Full
18	High		CP-OFDM 64 QAM	Edge_1RB_Right
19	High		CP-OFDM 64 QAM	Outer Full
20	Low		CP-OFDM 256 QAM	Edge_1RB_Left
21	$2496 + 3/2 \times BW_{Channel} - 6 \text{ MHz}$		CP-OFDM 256 QAM	Edge_1RB_Left
22	$2496 + BW_{Channel} / 2 +$ $MAX(10 \text{ MHz}, 0.25 \times BW_{Channel})$		CP-OFDM 256 QAM	Outer Full
23	High		CP-OFDM 256 QAM	Edge_1RB_Right
24	High		CP-OFDM 256 QAM	Outer Full

NOTE 1: The specific configuration of each RB allocation is defined in Table 6.1-1.

Table 6.5D.2.3.4.1-3: Test Configuration table for NS_03 and NS_03U

Initial Conditions							
Test Environment as specified in TS 38.508-1 [5] subclause 4.1						Normal	
Test Frequencies as specified in TS 38.508-1 [5] subclause 4.3.1						Low range, High range	
Test Channel Bandwidths as specified in TS 38.508-1 [5] subclause 4.3.1						Lowest, Highest	
Test SCS as specified in Table 5.3.5-1						Lowest, Highest	
A-MPR test parameters for NS_03 and NS_03U							
Test ID	Freq	ChBw	SCS	Downlink Configuration	Uplink Configuration		
					Modulation	RB allocation (Note 1)	
1	Low	Default	Default	N/A for A-MPR test cases	CP-OFDM	QPSK	Edge_1RB_Left
2	High	Default	Default			QPSK	Edge_1RB_Right
3	Default	Default	Default			QPSK	Outer_Full
4	Low	Default	Default			16 QAM	Edge_1RB_Left
5	High	Default	Default			16 QAM	Edge_1RB_Right
6	Default	Default	Default			16 QAM	Outer_Full
7	Low	Default	Default			64 QAM	Edge_1RB_Left
8	High	Default	Default			64 QAM	Edge_1RB_Right
9	Default	Default	Default			64 QAM	Outer_Full
10	Low	Default	Default			256 QAM	Edge_1RB_Left
11	High	Default	Default			256 QAM	Edge_1RB_Right
12	Default	Default	Default			256 QAM	Outer_Full
NOTE 1: The specific configuration of each RB allocation is defined in Table 6.1-1 unless otherwise stated in this table.							

1. Connect the SS to the UE antenna connectors as shown in TS 38.508-1 [5] Annex A, Figure A.3.1.1.2 for TE diagram and section A.3.2 for UE diagram.
2. The parameter settings for the cell are set up according to TS 38.508-1 [5] subclause 4.4.3.
3. Downlink signals are initially set up according to Annex C.0, C.1, C.2, and uplink signals according to Annex G.0, G.1, G.2, G.3.0.
4. The UL Reference Measurement channels are set according to Tables 6.5D.2.3.4.1-1 as appropriate for NS_35.
5. Propagation conditions are set according to Annex B.0.
6. Ensure the UE is in state RRC_CONNECTED with generic procedure parameters Connectivity NR, Connected without release On, Test Mode On and Test Loop Function On according to TS 38.508-1 [5] clause 4.5. Message contents are defined in clause 6.5D.2.3.4.3.

6.5D.2.3.4.2 Test procedure

Same test procedure as defined in clause 6.5D.2.2.4.2 with the following exceptions:

- Instead of Table 6.2D.2.5-1, Table 6.2D.3.5-1 and table 6.2D.3.5-2 for NS_04 as appropriate and table 6.2D.3.5-3 for NS_35 are applied in step 3;
- Instead of Table 6.5D.2.2.5-1, table 6.5D.2.3.5-1 for NS_35 and table 6.5D.2.3.—3 for NS_04 and table 6.5D.2.3.5-2 are applied in step 4;

6.5D.2.3.4.3 Message contents

Message contents are according to TS 38.508-1 [5] subclause 4.6 ensuring Table 4.6.3-182 with condition 2TX_UL_MIMO and exceptions listed in clause 6.2D.3.4.3.

6.5D.2.3.5 Test requirement

The measured sum of the UE mean power in the channel bandwidth, derived in step 3 shall fulfill the requirements as specified in clause 6.2D.3.5 for NS_35 and NS_04 as appropriate, and the sum of power of any UE emission measured

from both antennas in step 4 shall fulfill requirements in Table 6.5D.2.3.5-1 for NS_35 and Table 6.5D.2.3.5-3 for NS_04.

Table 6.5D.2.3.5-1: Additional requirements for “NS_35”

Spectrum emission limit (dBm) / Channel bandwidth					
Δf_{OoB} (MHz)	5 MHz	10 MHz	15 MHz	20 MHz	Measurement bandwidth (unless otherwise stated)
$\pm 0-0.1$	-15 + TT	-18 + TT	-20 + TT	-21 + TT	30 kHz
$\pm 0.1-6$	-13 + TT	-13 + TT	-13 + TT	-13 + TT	100 kHz
$\pm 6-10$	-25 ¹ + TT	-13 + TT	-13 + TT	-13 + TT	100 kHz
$\pm 10-15$		-25 ¹ + TT	-13 + TT	-13 + TT	100 kHz
$\pm 15-20$			-25 ¹ + TT	-13 + TT	100 kHz
$\pm 20-25$				-25 + TT	1 MHz

NOTE 1: The measurement bandwidth shall be 1 MHz;
NOTE 2: TT for each frequency and channel bandwidth is specified in Table 6.5D.2.3.5-2

Table 6.5D.2.3.5-2: Test Tolerance (Spectrum Emission Mask)

	$f \leq 3.0\text{GHz}$	$3.0\text{GHz} < f \leq 4.2\text{GHz}$	$4.2\text{GHz} < f \leq 6.0\text{GHz}$
BW $\leq 100\text{MHz}$	1.5 dB	1.8 dB	1.8 dB

Table 6.5D.2.3.5-3: Additional requirements for “NS_04”

Δf_{OoB} MHz	Spectrum emission limit (dBm) / measurement bandwidth for each channel bandwidth									Measurement bandwidth
	10 MHz	15 MHz	20 MHz	40 MHz	50 MHz	60 MHz	80 MHz	90 MHz	100 MHz	
$\pm 0 - 1$	-10 + TT	-10 + TT	-10 + TT	-10 + TT						2 % channel bandwidth
					-10 + TT					1 MHz
$\pm 1 - 5$	-10 + TT									1 MHz
$\pm 5 - X$	-13 + TT									
$\pm X - (BW_{\text{Channel}} + 5 \text{ MHz})$	-25 + TT									

NOTE 1: X is defined in Table 6.5D.2.3.5-3a for CP-OFDM
NOTE 2: TT for each frequency and channel bandwidth is specified in Table 6.5D.2.3.5-2.

Table 6.5D.2.3.5-3a: n41 maximum transmission bandwidths (MHz) for CP-OFDM

SCS (kHz)	Channel bandwidths (MHz)								
	10	15	20	40	50	60	80	90	100
15	9.36	14.22	19.08	38.88	48.6	N/A	N/A	N/A	N/A
30	8.64	13.68	18.36	38.16	47.88	58.32	78.12	88.02	98.28
60	7.92	12.96	17.28	36.72	46.8	56.88	77.04	87.12	97.20

Table 6.5D.2.3.5-4: Additional requirements for “NS_03 and NS_03U”

Δf_{OoB} MHz	Channel bandwidth (MHz) / Spectrum emission limit (dBm)							Measurement bandwidth
	5	10	15	20	25	30	40	
$\pm 0-1$	-13 + TT	-13 + TT	-13 + TT	-13 + TT	-13 + TT	-13 + TT	-13 + TT	1 % of channel BW
$\pm 1-6$	-13 + TT	-13 + TT	-13 + TT	-13 + TT	-13 + TT	-13 + TT	-13 + TT	1 MHz
$\pm 6-10$	-25 + TT	-13 + TT	-13 + TT	-13 + TT	-13 + TT	-13 + TT	-13 + TT	1 MHz
$\pm 10-15$		-25 + TT	-13 + TT	-13 + TT	-13 + TT	-13 + TT	-13 + TT	1 MHz
$\pm 15-20$			-25 + TT	-13 + TT	-13 + TT	-13 + TT	-13 + TT	1 MHz
$\pm 20-25$				-25 + TT	-13 + TT	-13 + TT	-13 + TT	1 MHz
$\pm 25-30$					-25 + TT	-13 + TT	-13 + TT	1 MHz
$\pm 30-35$						-25 + TT	-13 + TT	1 MHz
$\pm 35-40$							-13 + TT	1 MHz
$\pm 40-45$							-25 + TT	1 MHz

NOTE 1: TT for each frequency and channel bandwidth is specified in Table 6.5.2.3.5-1.

NOTE: As a general rule, the resolution bandwidth of the measuring equipment should be equal to the measurement bandwidth. However, to improve measurement accuracy, sensitivity and efficiency, the resolution bandwidth may be smaller than the measurement bandwidth. When the resolution bandwidth is smaller than the measurement bandwidth, the result should be integrated over the measurement bandwidth in order to obtain the equivalent noise bandwidth of the measurement bandwidth.

6.5D.2.4 Adjacent channel leakage ratio for UL MIMO

Adjacent channel leakage power Ratio (ACLR) is the ratio of the filtered mean power centred on the assigned channel frequency to the filtered mean power centred on an adjacent channel frequency.

6.5D.2.4.1 NR ACLR for UL MIMO

6.5D.2.4.1.1 Test purpose

To verify that UE transmitter does not cause unacceptable interference to adjacent channels in terms of Adjacent Channel Leakage power Ratio (ACLR).

6.5D.2.4.1.2 Test applicability

This test case applies to all types of NR UE release 15 and forward that supports UL MIMO.

6.5D.2.4.1.3 Minimum conformance requirements

For UE supporting UL MIMO, the requirements for Out of band emissions resulting from the modulation process and non-linearity in the transmitters is defined as the sum of the emissions from both UE transmit antenna connectors.

For UEs with two transmit antenna connectors in closed-loop spatial multiplexing scheme, the requirements in subclause 6.5.2.4.2.3 apply. The requirements shall be met with UL MIMO configurations described in clause 6.2D.1.3.

For UE support uplink full power transmission (ULFPTx) for UL MIMO, the requirements in clause 6.5.2.4.2.3 shall apply. The requirements shall be met with the PUSCH configurations specified in Table 6.2D.1.3-3, based upon UE's support of uplink full power transmission mode.

If UE is scheduled for single antenna-port PUSCH transmission by DCI format 0_0 or by DCI format 0_1 for single antenna port codebook based transmission, the requirements in clause 6.5.2.4.2.3 apply.

The normative reference for this requirement is TS 38.101-1 [2] clauses and 6.5D.2 and 6.5.2.4.1.

6.5D.2.4.1.4 Test description

6.5D.2.4.1.4.1 Initial conditions

Initial conditions are a set of test configurations the UE needs to be tested in and the steps for the SS to take with the UE to reach the correct measurement state.

The initial test configurations consist of environmental conditions, test frequencies, test channel bandwidths and sub-carrier spacing based on NR operating bands specified in Table 5.3.5-1. All of these configurations shall be tested with applicable test parameters for each combination of channel bandwidth and sub-carrier spacing, are shown in the test configuration tables in clause 6.2D.2. 4.1. The details of the uplink reference measurement channels (RMCs) are specified in Annexes A.2. Configurations of PDSCH and PDCCH before measurement are specified in Annex C.2

Table 6.5D.2.4.1.4.1-1: Void

1. Connect the SS to the UE antenna connectors as shown in TS 38.508-1 [5] Annex A, Figure A.3.1.1.2 for TE diagram and section A.3.2 for UE diagram.
2. The parameter settings for the cell are set up according to TS 38.508-1 [5] subclause 4.4.3.
3. Downlink signals are initially set up according to Annex C.0, C.1, C.2, and uplink signals according to Annex G.0, G.1, G.2, G.3.0.
4. The UL Reference Measurement channels are set according to the test configuration tables in clause 6.2D.2.4.1.
5. Propagation conditions are set according to Annex B.0
6. Ensure the UE is in state RRC_CONNECTED with generic procedure parameters Connectivity *NR*, Connected without release *On*, Test Mode *On* and Test Loop Function *On* according to TS 38.508-1 [5] clause 4.5. Message contents are defined in clause 6.5D.2.4.1.4.3 (If UE supports ULFPTx. The PDCCH DCI format 0_1 is specified with the condition ULFPTx_Mode1, ULFPTx_Mode2 or ULFPTx_ModeFull in 38.508-1 [5] subclause 4.3.6.1.1.2 depending on UE reported capability.)

6.5D.2.4.1.4.2 Test procedure

1. SS sends uplink scheduling information for each UL HARQ process via PDCCH DCI format 0_1 for C_RNTI to schedule the UL RMC according to the test configuration tables in clause 6.2D.2. 4.1. Since the UL has no payload and no loopback data to send the UE sends uplink MAC padding bits on the UL RMC. The PDCCH DCI format 0_1 is specified with condition 2TX_UL_MIMO in 38.508-1 [5] subclause 4.3.6.1.1.2
2. Send continuously power control “up” commands to the UE until the UE transmits at P_{UMAX} level. Allow at least 200ms for the UE to reach P_{UMAX} level.
3. Measure the sum of the mean power of the UE at from both antenna connectors in the channel bandwidth of the radio access mode according to the test configuration, as measured in step 3 of 6.2D.2.4.2, which shall meet the requirements described in clauses 6.2D.2.5 as appropriate.
4. Measure the sum of the rectangular filtered mean power for the assigned NR channel at each antenna connector of UE.
5. Measure the sum of rectangular filtered mean power of the first NR adjacent channel at each antenna connector of UE on both lower and upper side of the assigned NR channel, respectively.
6. Calculate the ratios of the power between the values measured in step 4 over step 5 for lower and upper NR ACLR at each antenna connector of UE, respectively.
7. If UE supports ULFPTx, repeat test steps 1~6 with UL RMC according to Table 6.2D.2.4.1-1a. The PDCCH DCI format 0_1 is specified with the condition ULFPTx_Mode1, ULFPTx_Mode2 or ULFPTx_ModeFull in 38.508-1 [5] subclause 4.3.6.1.1.2 depending on UE reported capability.

6.5D.2.4.1.4.3 Message contents

Message contents are according to TS 38.508-1 [5] subclause 4.6 ensuring Table 4.6.3-182 with condition 2TX_UL_MIMO.

6.5D.2.4.1.5 Test requirement

The measured UE mean total power derived in step 3, shall fulfil requirements in Clause 6.2D.2.5 as appropriate, and if the measured adjacent channel power is greater than -50 dBm then the measured NR ACLR, derived in step 6 for each antenna connector, shall be higher than the limits in Table 6.5D.2.4.1.5-2.

Table 6.5D.2.4.1.5-1: Void

Table 6.5D.2.4.1.5-2: NR ACLR requirement

	Power class 1	Power class 2	Power class 3
NR ACLR		31 - TT dB	30 - TT dB
NOTE 1: TT = 0.8 dB			

6.5D.2.4.2 UTRA ACLR for UL MIMO

Editor's note: This clause is incomplete. The following aspects are either missing or not yet determined:

- Test point analysis for NS_05U and NS_100 is FFS

6.5D.2.4.2.1 Test purpose

To verify that UE transmitter does not cause unacceptable interference to adjacent channels in terms of Adjacent Channel Leakage power Ratio (ACLR).

6.5D.2.4.2.2 Test applicability

This test case applies for NS_03U, NS_05U, and NS_100 to all types of NR UE release 15 and forward that supports UL MIMO.

6.5D.2.4.2.3 Minimum conformance requirements

For UE supporting UL MIMO, the requirements for Out of band emissions resulting from the modulation process and non-linearity in the transmitters is defined as the sum of the emissions from both UE transmit antenna connectors.

For UEs with two transmit antenna connectors in closed-loop spatial multiplexing scheme, the requirements in subclause 6.5.2.4.2.3 apply. The requirements shall be met with UL MIMO configurations described in clause 6.2D.1.3.

For UE support uplink full power transmission (ULFPTx) for UL MIMO, the requirements in clause 6.5.2.4.2.3 shall apply. The requirements shall be met with the PUSCH configurations specified in Table 6.2D.1.3-3, based upon UE's support of uplink full power transmission mode.

If UE is scheduled for single antenna-port PUSCH transmission by DCI format 0_0 or by DCI format 0_1 for single antenna port codebook based transmission, the requirements in clause 6.5.2.4.2.3 apply.

The normative reference for this requirement is TS 38.101-1 [2] clauses 6.5D.2 and 6.5.2.4.2.

6.5D.2.4.2.4 Test description

6.5D.2.4.2.4.1 Initial conditions

Initial conditions are a set of test configurations the UE needs to be tested in and the steps for the SS to take with the UE to reach the correct measurement state.

The initial test configurations consist of environmental conditions, test frequencies, test channel bandwidths and sub-carrier spacing based on NR operating bands specified in table 5.3.5-1. All of these configurations shall be tested with applicable test parameters for each combination of channel bandwidth and sub-carrier spacing, are shown in table

6.5D.2.4.2.4.1-1. The details of the uplink reference measurement channels (RMCs) are specified in Annexes A.2. Configurations of PDSCH and PDCCH before measurement are specified in Annex C.2

Table 6.5D.2.4.2.4.1-1: Test Configuration Table for NS_03U

Default Conditions						
Test Environment as specified in TS 38.508-1 [5] subclause 4.1				Normal		
Test Frequencies as specified in TS 38.508-1 [5] subclause 4.3.1				Low range, High range		
Test Channel Bandwidths as specified in TS 38.508-1 [5] subclause 4.3.1				Lowest, Highest		
Test SCS as specified in Table 5.3.5-1				Lowest, Highest		
Test Parameters for Channel Bandwidths						
Test ID	Freq	ChBw	SCS	Downlink Configuration	Uplink Configuration	
					Modulation	RB allocation (NOTE 1)
1	Low	Default	Default	N/A for Adjacent Channel Leakage Ratio test case	CP-OFDM QPSK	Edge_1RB_Left
2	High				CP-OFDM QPSK	Edge_1RB_Right
3	Default				CP-OFDM QPSK	Outer_Full
4	Low				CP-OFDM 16 QAM	Edge_1RB_Left
5	High				CP-OFDM 16 QAM	Edge_1RB_Right
6	Default				CP-OFDM 16 QAM	Outer_Full
7	Low				CP-OFDM 64 QAM	Edge_1RB_Left
8	High				CP-OFDM 64 QAM	Edge_1RB_Right
9	Default				CP-OFDM 64 QAM	Outer_Full
10	Low				CP-OFDM 256 QAM	Edge_1RB_Left
11	High				CP-OFDM 256 QAM	Edge_1RB_Right
12	Default				CP-OFDM 256 QAM	Outer_Full
NOTE 1: The specific configuration of each RF allocation is defined in Table 6.1-1.						

Table 6.5D.2.4.2.4.1-2: Test Configuration Table for NS_03U for UEs supporting ULFPTx

Initial Conditions							
Test Environment as specified in TS 38.508-1 [5] subclause 4.1						Normal	
Test Frequencies as specified in TS 38.508-1 [5] subclause 4.3.1						Low range, High range	
Test Channel Bandwidths as specified in TS 38.508-1 [5] subclause 4.3.1						Lowest, Highest	
Test SCS as specified in Table 5.3.5-1						Lowest, Highest	
Test parameters for NS_03U							
Test ID	Freq	ChBw	SCS	Downlink Configuration	Uplink Configuration		
					Modulation (Note 2)	RB allocation (Note 1)	
1	Low	Default	Default	N/A	DFT-s OFDM	PI/2 BPSK	Edge_1RB_Left
2	High	Default	Default			PI/2 BPSK	Edge_1RB_Right
3	Default	Default	Default			PI/2 BPSK	Outer_Full
4	Low	Default	Default			QPSK	Edge_1RB_Left
5	High	Default	Default			QPSK	Edge_1RB_Right
6	Default	Default	Default			QPSK	Outer_Full
7	Low	Default	Default			16 QAM	Edge_1RB_Left
8	High	Default	Default			16 QAM	Edge_1RB_Right
9	Default	Default	Default			16 QAM	Outer_Full
10	Low	Default	Default			64 QAM	Edge_1RB_Left
11	High	Default	Default			64 QAM	Edge_1RB_Right
12	Default	Default	Default			64 QAM	Outer_Full
13	Low	Default	Default			256 QAM	Edge_1RB_Left
14	High	Default	Default			256 QAM	Edge_1RB_Right
15	Default	Default	Default		256 QAM	Outer_Full	
16	Low	Default	Default		CP-s OFDM	QPSK	Edge_1RB_Left
17	High	Default	Default			QPSK	Edge_1RB_Right
18	Default	Default	Default			QPSK	Outer_Full
19	Low	Default	Default			16 QAM	Edge_1RB_Left
20	High	Default	Default			16 QAM	Edge_1RB_Right
21	Default	Default	Default			16 QAM	Outer_Full
22	Low	Default	Default			64 QAM	Edge_1RB_Left
23	High	Default	Default			64 QAM	Edge_1RB_Right
24	Default	Default	Default			64 QAM	Outer_Full
25	Low	Default	Default			256 QAM	Edge_1RB_Left
26	High	Default	Default			256 QAM	Edge_1RB_Right
27	Default	Default	Default			256 QAM	Outer_Full

NOTE 1: The specific configuration of each RB allocation is defined in Table 6.1-1 unless otherwise stated in this table.
 NOTE 2: DFT-s-OFDM PI/2 BPSK test applies only for UEs which supports half Pi BPSK in FR1.
 NOTE 3: Void.
 NOTE 4: Void

1. Connect the SS to the UE antenna connectors as shown in TS 38.508-1 [5] Annex A, Figure A.3.1.1.2 for TE diagram and section A.3.2 for UE diagram.
2. The parameter settings for the cell are set up according to TS 38.508-1 [5] subclause 4.4.3.
3. Downlink signals are initially set up according to Annex C.0, C.1, C.2, and uplink signals according to Annex G.0, G.1, G.2, G.3.0.
4. The UL Reference Measurement channels are set according to Table 6.5D.2.4.2.4.1-1.
5. Propagation conditions are set according to Annex B.0
6. Ensure the UE is in state RRC_CONNECTED with generic procedure parameters Connectivity NR, Connected without release On, Test Mode On and Test Loop Function On according to TS 38.508-1 [5] clause 4.5. Message contents are defined in clause 6.5D.2.4.2.4.3

6.5D.2.4.2.4.2 Test procedure

1. SS sends uplink scheduling information for each UL HARQ process via PDCCH DCI format 0_1 for C_RNTI to schedule the UL RMC according to Table 6.5D.2.4.2.4.1-1. Since the UL has no payload and no loopback data to send the UE sends uplink MAC padding bits on the UL RMC. The PDCCH DCI format 0_1 is specified with condition 2TX_UL_MIMO in 38.508-1 [5] subclause 4.3.6.1.1.2
2. Send continuously power control “up” commands to the UE until the UE transmits at P_{UMAX} level. Allow at least 200ms for the UE to reach P_{UMAX} level.
3. Measure the sum of the mean power of the UE at each antenna connector in the channel bandwidth of the radio access mode according to the test configuration, which shall meet the requirements described in clause 6.2D.3.5 as appropriate. The period of the measurement shall be at least the continuous duration of 1ms over consecutive active uplink slots and uplink symbols. For TDD, only slots consisting of only UL symbols are under test.
4. Measure the sum of the rectangular filtered mean power for the assigned NR channel at each antenna connector of UE.
5. Measure the sum of the RRC filtered mean power of the first and the second UTRA adjacent channel at each antenna connector of UE on both lower and upper side of the assigned NR channel, respectively.
6. Calculate the ratio of the power between the values measured in step 4 over step 5 for UTRA_{ACLR1}, UTRA_{ACLR2} for both lower an upper side of the assigned NR channel, respectively.
7. If UE supports ULFPTx, repeat test steps 1~6 with UL RMC according to Table 6.2D.4.4.1-2. The PDCCH DCI format 0_1 is specified with the condition ULFPTx_Mode1, ULFPTx_Mode2 or ULFPTx_ModeFull in 38.508-1 [5] subclause 4.3.6.1.1.2 depending on UE reported capability.

6.5D.2.4.2.4.3 Message contents

Message contents are according to TS 38.508-1 [5] subclause 4.6 ensuring Table 4.6.3-182 with condition 2TX_UL_MIMO and with the exception specified in Table 6.5D.2.4.2.4.3 - 1

Table 6.5D.2.4.2.4.3-1: AdditionalSpectrumEmission: UTRA ACLR test requirement for "NS_XX"

Derivation Path: TS 38.508-1 [5] clause 4.6.3, Table 4.6.3-1 AdditionalSpectrumEmission from SIB1			
Information Element	Value/remark	Comment	Condition
AdditionalSpectrumEmission	1(NS_100)	NS_100 for band n1, n2, n3, n5, n8, n20, n25, n66, n80, n81, n82, n84 NOTE1	
	3(NS_03U)	NS_03U for n2, n25, n66, n86 NS_05U for n1, n84 NS_43U for n8, n81	
NOTE 1: This NS can be signalled for NR bands that have UTRA services deployed			

6.5D.2.4.2.5 Test requirement

UTRA ACLR requirement is applicable when signalled by the network with network signalling value indicated by the field *additionalSpectrumEmission*.

The measured UE mean total power in the channel bandwidth at all the antenna connectors, derived in step 3, shall fulfil requirements in [Clause 6.2D.3.5] as appropriate, and if the measured adjacent channel power is greater than -50 dBm then the measured UTRA ACLR, derived in step 6 for each antenna connector, shall be higher than the limits in Table 6.5D.2.4.2.5-1.

Table 6.5D.2.4.2.5-1: UTRA ACLR requirement

	Power class 3
UTRA_{ACLR1}	33 dB - TT
UTRA_{ACLR2}	36 dB - TT
NOTE 1: TT = 0.8 dB	

6.5D.2_1 Void

6.5D.3 Spurious emissions for UL MIMO

For UE supporting UL MIMO, the requirements for Spurious emissions which are caused by unwanted transmitter effects such as harmonics emission, parasitic emissions, intermodulation products and frequency conversion products are specified at each transmit antenna connector.

For UEs with two transmit antenna connectors in closed-loop spatial multiplexing scheme, the requirements specified in subclause 6.5.3 apply to each transmit antenna connector. The requirements shall be met with the UL MIMO configurations described in sub-clause 6.2D.1.3.

If UE is configured for transmission on single-antenna port, the requirements in subclause 6.5.3 apply.

The normative reference for this requirement is TS 38.101-1 [2] clause 6.5D.3

6.5D.3.1 General spurious emissions for UL MIMO

6.5D.3.1.1 Test purpose

To verify that UE transmitter does not cause unacceptable interference to other channels or other systems in terms of transmitter spurious emissions.

6.5D.3.1.2 Test applicability

This test case applies to all types of NR UE release 15 that support UL MIMO.

6.5D.3.1.3 Minimum conformance requirements

The general spurious emission requirement specified in clause 6.5.3.1.3 applies to each antenna connector of the UE.

The normative reference for this requirement is TS 38.101-1 [2] subclauses 6.5D.3 and 6.5.3.1.

6.5D.3.1.4 Test description

6.5D.3.1.4.1 Initial conditions

Initial conditions are a set of test configurations the UE needs to be tested in and the steps for the SS to take with the UE to reach the correct measurement state.

The initial test configurations consist of environmental conditions, test frequencies, test channel bandwidths and sub-carrier spacing based on NR operating bands specified in Table 5.3.5-1. All of these configurations shall be tested with applicable test parameters for each combination of channel bandwidth and sub-carrier spacing, are shown in table 6.5D.3.1.4.1-1. The details of the uplink reference measurement channels (RMCs) are specified in Annexes A.2. Configurations of PDSCH and PDCCH before measurement are specified in Annex C.2.

Table 6.5D.3.1.4.1-1: Test Configuration Table

Initial Conditions			
Test Environment as specified in TS 38.508-1 [5] subclause 4.1.		Normal	
Test Frequencies as specified in TS 38.508-1 [5] subclause 4.3.1.		Low range, Mid range, High range	
Test Channel Bandwidths as specified in TS 38.508-1 [5] subclause 4.3.1.		Lowest, Mid, Highest	
Test SCS as specified in Table 5.3.5-1		Lowest	
Test Parameters			
Test ID	Downlink Configuration	Uplink Configuration	
		Modulation	RB allocation (NOTE 1)
1	N/A for Spurious Emissions testing	CP-OFDM QPSK	OuterFull
2		CP-OFDM QPSK	Edge_1RB_Left
3		CP-OFDM QPSK	Edge_1RB_Right
NOTE 1: The specific configuration of each RB allocation is defined in Table 6.1-1 Common UL configuration			

1. Connect the SS to the UE antenna connectors as shown in TS 38.508-1 [5] Annex [A, Figure A.3.1.2.2 for TE diagram and section A.3.2 for UE diagram.
2. The parameter settings for the cell are set up according to TS 38.508-1 [5] subclause 4.4.3.
3. Downlink signals are initially set up according to Annex C.0, C.1 and C.2, and uplink signals according to Annex G.0, G.1, G.2, and G.3.0.
4. The UL Reference Measurement channels are set according to Table 6.5.3.1.4.1-1.
5. Propagation conditions are set according to Annex B.0.
6. Ensure the UE is in state RRC_CONNECTED with generic procedure parameters Connectivity *NR*, Connected without release *On*, Test Mode *On* and Test Loop Function *On* according to TS 38.508-1 [5] clause 4.5. Message contents are defined in clause 6.5D.3.1.4.3.

6.5D.3.1.4.2 Test procedure

1. SS sends uplink scheduling information for each UL HARQ process via PDCCH DCI format 0_1 for C_RNTI to schedule the UL RMC according to Table 6.5D.3.1.4.1-1. Since the UE has no payload data to send, the UE transmits uplink MAC padding bits on the UL RMC. The PDCCH DCI format 0_1 is specified with condition 2TX_UL_MIMO in 38.508-1 [5] subclause 4.3.6.1.1.2.
2. Send continuously uplink power control "up" commands in the uplink scheduling information to the UE until the UE transmits at P_{UMAX} level.
3. Measure the power of the transmitted signal at each antenna connector with a measurement filter of bandwidths according to table 6.5D.3.1.5-1. The centre frequency of the filter shall be stepped in contiguous steps according to table 6.5D.3.1.5-1. The measured power shall be verified for each step. The measurement period shall capture the active time slots.

6.5D.3.1.4.3 Message contents

Message contents are according to TS 38.508-1 [5] subclause 4.6 ensuring Table 4.6.3-182 with condition 2TX_UL_MIMO.

6.5D.3.1.5 Test requirement

The measured average power of spurious emission at each antenna connector, derived in step 3, shall not exceed the described value in Table 6.5D.3.1.5-1.

The spurious emission limits apply for the frequency ranges that are more than Δf_{OOB} (MHz) in Table 6.5.3.1.3-1 from the edge of the channel bandwidth.

Table 6.5D.3.1.5-1: General spurious emissions test requirements

Frequency Range	Maximum Level	Measurement bandwidth	NOTE
$9 \text{ kHz} \leq f < 150 \text{ kHz}$	-36 dBm	1 kHz	
$150 \text{ kHz} \leq f < 30 \text{ MHz}$	-36 dBm	10 kHz	
$30 \text{ MHz} \leq f < 1000 \text{ MHz}$	-36 dBm	100 kHz	
$1 \text{ GHz} \leq f < 12.75 \text{ GHz}$	-30 dBm	1 MHz	
12.75 GHz $\leq f < 5$ th harmonic of the upper frequency edge of the UL operating band in GHz	-30 dBm	1 MHz	1
$12.75 \text{ GHz} < f < 26 \text{ GHz}$	-30 dBm	1 MHz	2
NOTE 1: Applies for Band that the upper frequency edge of the UL Band more than 2.69 GHz			
NOTE 2: Applies for Band that the upper frequency edge of the UL Band more than 5.2 GHz			

6.5D.3.2 Spurious emissions for UE co-existence for UL MIMO

6.5D.3.2.1 Test purpose

To verify that UE transmitter does not cause unacceptable interference to co-existing systems for the specified bands which has specific requirements in terms of transmitter spurious emissions.

6.5D.3.2.2 Test applicability

This test case applies to all types of NR UE release 15 that support UL MIMO.

6.5D.3.2.3 Minimum conformance requirements

The requirements for NR bands for coexistence with protected bands specified in subclause 6.5.3.2.3 apply to each UE transmit antenna connector

The normative reference for this requirement is TS 38.101-1 [2] subclauses 6.5.3.2 and 6.5D.3.

6.5D.3.2.4 Test description

6.5D.3.2.4.1 Initial conditions

Initial conditions are a set of test configurations the UE needs to be tested in and the steps for the SS to take with the UE to reach the correct measurement state.

The initial test configurations consist of environmental conditions, test frequencies, test channel bandwidths and sub-carrier spacing based on NR operating bands specified in Table 5.3.5-1. All of these configurations shall be tested with applicable test parameters for each combination of channel bandwidth and sub-carrier spacing, are shown in table 6.5D.3.2.4.1-1. The details of the uplink reference measurement channels (RMCs) are specified in Annexes A.2. Configurations of PDSCH and PDCCH before measurement are specified in Annex C.2.

Table 6.5D.3.2.4.1-1: Test Configuration Table

Initial Conditions			
Test Environment as specified in TS 38.508-1 [5] subclause 4.1.		Normal	
Test Frequencies as specified in TS 38.508-1 [5] subclause 4.3.1.		Low range, Mid range, High range	
Test Channel Bandwidths as specified in TS 38.508-1 [5] subclause 4.3.1.		Lowest, Mid, Highest	
Test SCS as specified in Table 5.3.5-1		Lowest	
Test Parameters			
Test ID	Downlink Configuration	Uplink Configuration	
	N/A for Spurious Emissions testing	Modulation	RB allocation (NOTE 1)
1		CP-OFDM QPSK	Outer_Full
2		CP-OFDM QPSK	Edge_1RB_Left
3		CP-OFDM QPSK	Edge_1RB_Right
NOTE 1: The specific configuration of each RB allocation is defined in Table 6.1-1 Common UL configuration.			

1. Connect the SS to the UE antenna connectors as shown in TS 38.508-1 [5] Annex A, Figure A.3.1.2.2 for TE diagram and section A.3.2 for UE diagram.
2. The parameter settings for the cell are set up according to TS 38.508-1 [6] subclause 4.4.3..
3. Downlink signals are initially set up according to Annex C.0, C.1, C.2, and uplink signals according to Annex G.0, G.1, G.2, G.3.0.
4. The UL Reference Measurement channels are set according to Table 6.5D.3.2.4.1-1.
5. Propagation conditions are set according to Annex B.0.
6. Ensure the UE is in state RRC_CONNECTED with generic procedure parameters Connectivity NR, Connected without release On, Test Mode On and Test Loop Function On according to TS 38.508-1 [5] clause 4.5. Message contents are defined in clause 6.5D.3.2.4.3.

6.5D.3.2.4.2 Test procedure

1. SS sends uplink scheduling information for each UL HARQ process via PDCCH DCI format 0_1 for C_RNTI to schedule the UL RMC according to Table 6.5D.3.2.4.1-1. Since the UE has no payload data to send, the UE transmits uplink MAC padding bits on the UL RMC. The PDCCH DCI format 0_1 is specified with condition 2TX_UL_MIMO in 38.508-1 [5] subclause 4.3.6.1.1.2.
2. Send continuously uplink power control "up" commands in the uplink scheduling information to the UE until the UE transmits at P_{UMAX} level.
3. Measure the power of the transmitted signal at each UE antenna connector with a measurement filter of bandwidths according to table 6.5.3.2.3-1. The centre frequency of the filter shall be stepped in contiguous steps according to table 6.5.3.2.3-1. The measured power shall be verified for each step. The measurement period shall capture the active time slots.

6.5D.3.2.4.3 Message contents

Message contents are according to TS 38.508-1 [5] subclause 4.6 ensuring Table 4.6.3-182 with condition 2TX_UL_MIMO.

6.5D.3.2.5 Test requirement

The measured average power of spurious emission, derived in step 3 at each UE antenna connector, shall not exceed the described value in Table 6.5.3.2.3-1.

6.5D.3.3 Additional spurious emissions for UL MIMO

Editor's note: This clause is incomplete. The following aspects are either missing or not yet determined:

- There are NS-XXs other than NS_04, NS_21 and NS_47 that are FFS:

6.5D.3.3.1 Test purpose

To verify that UE transmitter does not cause unacceptable interference to other channels or other systems in terms of transmitter spurious emissions under the deployment scenarios where additional requirements are specified.

6.5D.3.3.2 Test applicability

This test case applies to all types of NR UE release 15 that support UL MIMO.

6.5D.3.3.3 Minimum conformance requirements

The additional spurious emission requirements specified in 6.5.3.3.3 apply to each UE antenna connector.

The normative reference for this requirement is TS 38.101-1 [2] clauses 6.5D.3 and 6.5.3.3

6.5D.3.3.4 Test description

6.5D.3.3.4.1 Initial conditions

Initial conditions are a set of test configurations the UE needs to be tested in and the steps for the SS to take with the UE to reach the correct measurement state.

The initial test configurations consist of environmental conditions, test frequencies, test channel bandwidths and sub-carrier spacing based on NR operating bands specified in Table 5.3.5-1. All these configurations shall be tested with applicable test parameters for each combination of channel bandwidth and sub-carrier spacing, and are shown in Table 6.5D.3.3.4.1-1 through Table 6.5D.3.3.4.1-4. The details of the uplink reference measurement channels (RMCs) are specified in Annex A.2.2. Configurations of PDSCH and PDCCH before measurement are specified in Annex C.2.

Table 6.5D.3.3.4.1-1: Test Configuration Table (network signalling value "NS_04")

Initial Conditions					
Test Environment as specified in TS 38.508-1 [5] subclause 4.1			Normal		
Test Frequencies as specified in TS 38.508-1 [5] subclause 4.3.1			(See Freq column)		
Test Channel Bandwidths as specified in TS 38.508-1 [5] subclause 4.3.1			Lowest, Highest		
Test SCS as specified in Table 5.3.5-1			Lowest		
Additional spurious emissions test parameters for NS_04					
			Downlink Configuration	Uplink Configuration	
Test ID	Freq		N/A for A-MPR testing	Modulation (NOTE 2)	RB allocation (NOTE 1)
1	Low			CP-OFDM QPSK	Edge_1RB_Left
2	2496 + 3/2 × BW _{Channel} – 6 MHz			CP-OFDM QPSK	Edge_1RB_Left
4	2496 + BW _{Channel} /2 +			CP-OFDM QPSK	Inner Full
4	MAX(10 MHz, 0.25 × BW _{Channel})			CP-OFDM QPSK	Outer Full
5	High			CP-OFDM QPSK	Edge_1RB_Right
6	High			CP-OFDM QPSK	Inner Full
7	High			CP-OFDM QPSK	Outer Full
8	Low			CP-OFDM 16 QAM	Edge_1RB_Left
9	2496 + 3/2 × BW _{Channel} – 6 MHz			CP-OFDM 16 QAM	Edge_1RB_Left
10	2496 + BW _{Channel} /2 +			CP-OFDM 16 QAM	Inner Full
11	MAX(10 MHz, 0.25 × BW _{Channel})			CP-OFDM 16 QAM	Outer Full
12	High			CP-OFDM 16 QAM	Edge_1RB_Right
13	High			CP-OFDM 16 QAM	Inner Full
14	High			CP-OFDM 16 QAM	Outer Full
15	Low			CP-OFDM 64 QAM	Edge_1RB_Left
16	2496 + 3/2 × BW _{Channel} – 6 MHz			CP-OFDM 64 QAM	Edge_1RB_Left
17	2496 + BW _{Channel} /2 + MAX(10 MHz, 0.25 × BW _{Channel})			CP-OFDM 64 QAM	Outer Full
18	High			CP-OFDM 64 QAM	Edge_1RB_Right
19	High			CP-OFDM 64 QAM	Outer Full
20	Low			CP-OFDM 256 QAM	Edge_1RB_Left
21	2496 + 3/2 × BW _{Channel} – 6 MHz			CP-OFDM 256 QAM	Edge_1RB_Left
22	2496 + BW _{Channel} /2 + MAX(10 MHz, 0.25 × BW _{Channel})			CP-OFDM 256 QAM	Outer Full
23	High			CP-OFDM 256 QAM	Edge_1RB_Right
24	High			CP-OFDM 256 QAM	Outer Full

NOTE 1: The specific configuration of each RB allocation is defined in Table 6.1-1.

Table 6.5D.3.3.4.1-2: Test Configuration table for NS_47 power class 3 (contiguous allocation)

Initial Conditions								
Test Environment as specified in TS 38.508-1 [5] subclause 4.1					Normal			
Test Frequencies					As specified in Table 6.2.3.4.1-19 and 6.2.3.4.1-20			
Test Channel Bandwidths as specified in TS 38.508-1 [5] subclause 4.3.1					30 MHz			
Test SCS as specified in Table 5.3.5-1					Lowest			
A-MPR test parameters for NS_47								
Test ID	F _c (MHz)	Ch BW (MHz)	SCS (kHz)	Downlink Configuration	Uplink Configuration			
					Modulation (Note 2)	RB allocation (Note 1)		
					SCS 15 kHz	SCS 30 kHz	SCS 60 kHz	
43	Default	30	Default	CP-OFDM	QPSK	Edge_1RB_Left (A1)		
44	Default	30	Default		QPSK	1@29 (A2)	1@15 (A2)	1@8 (A2)
45	Default	30	Default		QPSK	Edge_1RB_Right (A3)		
46	Default	30	Default		QPSK	Outer_Full (A2)		
47	Default	30	Default		QPSK	108@0 (A4)	54@0 (A4)	27@0 (A4)
48	Default	30	Default		QPSK	80@0 (A4)	40@0 (A4)	20@0 (A4)
49	Default	30	Default		QPSK	54@0 (A2)	27@0 (A2)	12@0 (A2)
50	Default	30	Default		16 QAM	Edge_1RB_Left (A1)		
51	Default	30	Default		16 QAM	1@29 (A2)	1@15 (A2)	1@8 (A2)
52	Default	30	Default		16 QAM	Edge_1RB_Right (A3)		
53	Default	30	Default		16 QAM	Outer_Full (A2)		
54	Default	30	Default		16 QAM	108@0 (A4)	54@0 (A4)	27@0 (A4)
55	Default	30	Default		16 QAM	80@0 (A4)	40@0 (A4)	20@0 (A4)
56	Default	30	Default		16 QAM	54@0 (A2)	27@0 (A2)	12@0 (A2)
57	Default	30	Default		64 QAM	Edge_1RB_Left (A1)		
58	Default	30	Default		64 QAM	1@29 (A2)	1@15 (A2)	1@8 (A2)
59	Default	30	Default		64 QAM	Edge_1RB_Right (A3)		
60	Default	30	Default		64 QAM	Outer_Full (A2)		
61	Default	30	Default		64 QAM	108@0 (A4)	54@0 (A4)	27@0 (A4)
62	Default	30	Default		64 QAM	80@0 (A4)	40@0 (A4)	20@0 (A4)
63	Default	30	Default		64 QAM	54@0 (A2)	27@0 (A2)	12@0 (A2)
64	Default	30	Default		256 QAM	Edge_1RB_Left (A1)		
65	Default	30	Default		256 QAM	1@29 (A2)	1@15 (A2)	1@8 (A2)
66	Default	30	Default		256 QAM	Edge_1RB_Right (A3)		
67	Default	30	Default		256 QAM	Outer_Full (A2)		
68	Default	30	Default		256 QAM	108@0 (A4)	54@0 (A4)	27@0 (A4)
69	Default	30	Default		256 QAM	80@0 (A4)	40@0 (A4)	20@0 (A4)
70	Default	30	Default		256 QAM	54@0 (A2)	27@0 (A2)	12@0 (A2)

NOTE 1: The specific configuration of each RB allocation is defined in Table 6.1-1 unless otherwise stated in this table.
 NOTE 2: DFT-s-OFDM Pi/2 BPSK test applies only for UEs which supports half Pi BPSK in FR1.
 NOTE 3: UE operating in TDD mode with Pi/2 BPSK modulation and UE indicates support for UE capability *powerBoosting-pi2BPSK* and the IE *powerBoostPi2BPSK* is set to 1 for bands n41.
 NOTE 4: UE operating in FDD mode, or in TDD mode in bands other than n41, or in TDD mode the IE *powerBoostPi2BPSK* is set to 0 for bands n41.
 NOTE 5: Void

Table 6.5D.3.3.4.1-3: Test Configuration table for NS_47 power class 3 (almost contiguous allocation)

Initial Conditions							
Test Environment as specified in TS 38.508-1 [5] subclause 4.1					Normal		
Test Frequencies					As specified in Table 6.2.3.4.1-19 and 6.2.3.4.1-20		
Test Channel Bandwidths as specified in TS 38.508-1 [5] subclause 4.3.1					30 MHz		
Test SCS as specified in Table 5.3.5-1					Lowest		
A-MPR test parameters for NS_47							
Test ID	F _c (MHz)	Ch BW (MHz)	SCS (kHz)	Downlink Configuration	Uplink Configuration		
					Modulation	RB allocation (Note 1)	
1	Default	30	Default		CP-OFDM	QPSK	Outer_Full (A2)
2	Default	30	Default			16 QAM	Outer_Full (A2)
3	Default	30	Default			64 QAM	Outer_Full (A2)
4	Default	30	Default			256 QAM	Outer_Full (A2)
NOTE 1: The specific configuration of each RB allocation is defined in Table 6.2.2.4.1-4.							
NOTE 2: Void.							

Table 6.5D.3.3.4.1-4: Test Configuration table for NS_47 power class 2 (contiguous allocation)

Initial Conditions								
Test Environment as specified in TS 38.508-1 [5] subclause 4.1					Normal			
Test Frequencies					As specified in Table 6.2.3.4.1-19 and 6.2.3.4.1-20			
Test Channel Bandwidths as specified in TS 38.508-1 [5] subclause 4.3.1					30 MHz			
Test SCS as specified in Table 5.3.5-1					Lowest			
A-MPR test parameters for NS_47								
Test ID	F _c (MHz)	Ch BW (MHz)	SCS (kHz)	Downlink Configuration	Uplink Configuration			
					Modulation (Note 2)	RB allocation (Note 1)		
					SCS 15 kHz	SCS 30 kHz	SCS 60 kHz	
36	Default	30	Default	CP-OFDM	QPSK	Edge_1RB_Left (A1)		
37	Default	30	Default		QPSK	1@29 (A2)	1@15 (A2)	1@8 (A2)
38	Default	30	Default		QPSK	Edge_1RB_Right (A3)		
39	Default	30	Default		QPSK	Outer_Full (A2)		
40	Default	30	Default		QPSK	108@0 (A4)	54@0 (A4)	27@0 (A4)
41	Default	30	Default		QPSK	80@0 (A4)	40@0 (A4)	20@0 (A4)
42	Default	30	Default		QPSK	54@0 (A2)	27@0 (A2)	12@0 (A2)
43	Default	30	Default		16 QAM	Edge_1RB_Left (A1)		
44	Default	30	Default		16 QAM	1@29 (A2)	1@15 (A2)	1@8 (A2)
45	Default	30	Default		16 QAM	Edge_1RB_Right (A3)		
46	Default	30	Default		16 QAM	Outer_Full (A2)		
47	Default	30	Default		16 QAM	108@0 (A4)	54@0 (A4)	27@0 (A4)
48	Default	30	Default		16 QAM	80@0 (A4)	40@0 (A4)	20@0 (A4)
49	Default	30	Default		16 QAM	54@0 (A2)	27@0 (A2)	12@0 (A2)
50	Default	30	Default		64 QAM	Edge_1RB_Left (A1)		
51	Default	30	Default		64 QAM	1@29 (A2)	1@15 (A2)	1@8 (A2)
52	Default	30	Default		64 QAM	Edge_1RB_Right (A3)		
53	Default	30	Default		64 QAM	Outer_Full (A2)		
54	Default	30	Default		64 QAM	108@0 (A4)	54@0 (A4)	27@0 (A4)
55	Default	30	Default		64 QAM	80@0 (A4)	40@0 (A4)	20@0 (A4)
56	Default	30	Default		64 QAM	54@0 (A2)	27@0 (A2)	12@0 (A2)
57	Default	30	Default		256 QAM	Edge_1RB_Left (A1)		
58	Default	30	Default		256 QAM	1@29 (A2)	1@15 (A2)	1@8 (A2)
59	Default	30	Default		256 QAM	Edge_1RB_Right (A3)		
60	Default	30	Default		256 QAM	Outer_Full (A2)		
61	Default	30	Default		256 QAM	108@0 (A4)	54@0 (A4)	27@0 (A4)
62	Default	30	Default		256 QAM	80@0 (A4)	40@0 (A4)	20@0 (A4)
63	Default	30	Default		256 QAM	54@0 (A2)	27@0 (A2)	12@0 (A2)

NOTE 1: The specific configuration of each RB allocation is defined in Table 6.1-1 unless otherwise stated in this table.
 NOTE 2: DFT-s-OFDM PI/2 BPSK test applies only for UEs which supports half Pi BPSK in FR1.
 NOTE 3: Void

Table 6.5D.3.3.4.1-5: Test Configuration table for NS_21

Initial Conditions								
Test Environment as specified in TS 38.508-1 [5] subclause 4.1						Normal		
Test Frequencies as specified in TS 38.508-1 [5] subclause 4.3.1						Low range, High range		
Test Channel Bandwidths as specified in TS 38.508-1 [5] subclause 4.3.1						Lowest, Highest		
Test SCS as specified in Table 5.3.5-1						Lowest		
A-MPR test parameters for NS_21								
Test ID	Freq	ChBw	SCS	Downlink Configuration	Uplink Configuration			
					Modulation (Note 2)	RB allocation (Note 1)		
						SCS 15 kHz	SCS 30 kHz	
26	Low	Default	Default	N/A for A-MPR test cases	CP-s OFDM	QPSK	Edge_1RB_Left	
27	High	Default	Default			QPSK	Edge_1RB_Right	
28	Default	Default	Default			QPSK	Outer_Full	
29	Default	10 MHz	Default			QPSK	4@0	2@0
30	Default	10 MHz	Default			QPSK	4@48	2@22
31	Low	Default	Default			16 QAM	Edge_1RB_Left	
32	High	Default	Default			16 QAM	Edge_1RB_Right	
33	Default	Default	Default			16 QAM	Outer_Full	
34	Default	10 MHz	Default			16 QAM	4@0	2@0
35	Default	10 MHz	Default			16 QAM	4@48	2@22
36	Low	Default	Default			64 QAM	Edge_1RB_Left	
37	High	Default	Default			64 QAM	Edge_1RB_Right	
38	Default	Default	Default			64 QAM	Outer_Full	
39	Default	10 MHz	Default			64 QAM	4@0	2@0
40	Default	10 MHz	Default			64 QAM	4@48	2@22
41	Low	Default	Default			256 QAM	Edge_1RB_Left	
42	High	Default	Default			256 QAM	Edge_1RB_Right	
43	Default	Default	Default			256 QAM	Outer_Full	
44	Default	10 MHz	Default			256 QAM	4@0	2@0
45	Default	10 MHz	Default			256 QAM	4@48	2@22

NOTE 1: The specific configuration of each RB allocation is defined in Table 6.1-1 unless otherwise stated in this table.

NOTE 2: DFT-s-OFDM PI/2 BPSK test applies only for UEs which supports half Pi BPSK in FR1.

1. Connect the SS to the UE to the UE antenna connectors as shown in TS 38.508-1 [5] Annex A Figure A.3.1.2.2 for TE diagram and section A.3.2 for UE diagram.
2. The parameter settings for the cell are set up according to TS 38.508-1 [5] subclause 4.4.3.
3. Downlink signals are initially set up according to Annex C.0, C.1, C.2, and uplink signals according to Annex G.0, G.1, G.2, G.3.0.
4. The UL Reference Measurement channels are set according to Table 6.5D.3.3.4.1-1 for NS_04 and to Table 6.5D.3.3.4.1-2 to 6.5D.3.3.4.1-4 for NS_47.
5. Propagation conditions are set according to Annex B.0.
6. Ensure the UE is in state RRC_CONNECTED with generic procedure parameters Connectivity NR, Connected without release On, Test Mode On and Test Loop Function On according to TS 38.508-1 [5] clause 4.5. Message contents are defined in clause 6.5D.3.3.4.3.

6.5D.3.3.4.2 Test procedure

- 1 SS sends uplink scheduling information for each UL HARQ process via PDCCH DCI format 0_1 for C_RNTI to schedule the UL RMC according to Table 6.5D.3.3.4.1-1 as appropriate for NS_04. Since the UE has no payload data to send, the UE transmits uplink MAC padding bits on the UL RMC. The PDCCH DCI format 0_1 is specified with condition 2TX_UL_MIMO in 38.508-1 [5] subclause 4.3.6.1.1.2.

2. Send continuously uplink power control "up" commands in the uplink scheduling information to the UE until the UE transmits at P_{UMAX} level.
3. Measure the sum of the mean power at each UE antenna connector in the channel bandwidth of the radio access mode, which shall meet the requirements described in Clauses from 6.2D.2.5, or 6.2D.3.5 as appropriate for NS_04 and NS_47. The period of measurement shall be at least the continuous duration of 1ms over consecutive active uplink slots and uplink symbols. For TDD, only slots consisting of only UL symbols are under test.
4. Measure the power of the transmitted signal at each UE antenna connector with a measurement filter of bandwidths according to Tables 6.5.3.3.5.1-1 as appropriate for NS_04, Table 6.5.3.3.3.151 as appropriate for NS_47, and Table 6.5.3.3.3.12-1 as appropriate for NS_21. The centre frequency of the filter shall be stepped in contiguous steps according to the same table the measured power shall be verified for each step. The measurement period shall capture the active time slots.

6.5D.3.3.4.3 Message contents

Message contents are according to TS 38.508-1 [5] subclause 4.6 ensuring Table 4.6.3-182 with condition 2TX_UL_MIMO and same exceptions listed in clause 6.5.3.3.4.3

6.5D.3.3.5 Test requirement

The measured power at each UE antenna connector derived in step 4 shall meet the requirements for the specified NR band for an additional spurious emission requirement with protected bands as indicated in clause 6.5.3.3.5 for different NS values.

NOTE: For measurement conditions at the edge of each frequency range, the lowest frequency of the measurement position in each frequency range should be set at the lowest boundary of the frequency range plus $MBW/2$. The highest frequency of the measurement position in each frequency range should be set at the highest boundary of the frequency range minus $MBW/2$. MBW denotes the measurement bandwidth defined for the protected band.

6.5D.3_1 Spurious emissions for UL MIMO (Rel-16 onward)

6.5D.3_1.1 General spurious emissions for UL MIMO (Rel-16 onward)

6.5D.3_1.1.1 Test purpose

To verify that UE transmitter does not cause unacceptable interference to other channels or other systems in terms of transmitter spurious emissions.

6.5D.3_1.1.2 Test applicability

This test case applies to all types of NR UE release 16 and forward that support UL MIMO.

6.5D.3_1.1.3 Minimum conformance requirements

For UE supporting UL MIMO, the requirements for spurious emissions which are caused by unwanted transmitter effects such as harmonics emission, parasitic emissions, intermodulation products and frequency conversion products is defined as the sum of the emissions from both UE transmit antenna connectors.

The general spurious emission requirements specified in clause 6.5.3.1.3 apply. For UEs with two transmit antenna connectors in closed-loop spatial multiplexing scheme, the requirements shall be met with the UL MIMO configurations described in clause 6.2D.1. For UEs supporting ULFPTx for UL MIMO, the requirements shall be met with the PUSCH configurations specified in Table 6.2D.1.3-3, based upon UE's support of uplink full power transmission mode.

If UE is scheduled for single antenna-port PUSCH transmission by DCI format 0_0 or by DCI format 0_1 for single antenna port codebook based transmission, the requirements in clause 6.5.3 apply.

The normative reference for this requirement is TS 38.101-1 [2] subclauses 6.5D.3 and 6.5.3.1.

6.5D.3_1.1.4 Test description

6.5D.3_1.1.4.1 Initial conditions

Same initial conditions as in clause 6.5D.3.1.4.1.

6.5D.3_1.1.4.2 Test procedure

1. SS sends uplink scheduling information for each UL HARQ process via PDCCH DCI format 0_1 for C_RNTI to schedule the UL RMC according to Table 6.5D.3.1.4.1-1. Since the UE has no payload data to send, the UE transmits uplink MAC padding bits on the UL RMC. The PDCCH DCI format 0_1 is specified with condition 2TX_UL_MIMO in 38.508-1 [5] subclause 4.3.6.1.1.2.
2. Send continuously uplink power control "up" commands in the uplink scheduling information to the UE until the UE transmits at P_{UMAX} level.
3. Measure the sum of transmitted power at each antenna connector with a measurement filter of bandwidths according to table 6.5D.3_1.1.5-1. The centre frequency of the filter shall be stepped in contiguous steps according to table 6.5D.3_1.1.5-1. The measured power shall be verified for each step. The measurement period shall capture the active time slots.
4. If UE supports ULFPTx Mode-2 or Mode-full power, repeat test steps 1~3 with the exception that the PDCCH DCI format 0_1 is specified with the condition ULFPTx_Mode2 or ULFPTx_ModeFull in 38.508-1 [5] subclause 4.3.6.1.1.2 depending on UE reported capability.

6.5D.3_1.1.4.3 Message contents

Message contents are according to TS 38.508-1 [5] subclause 4.6 and 5.4 ensuring Table 4.6.3-182 with the condition 2TX_UL_MIMO.

6.5D.3_1.1.5 Test requirement

The measured average power of spurious emission, derived in step 3 or step 4, shall not exceed the described value in Table 6.5D.3_1.1.5-1.

The spurious emission limits apply for the frequency ranges that are more than Δf_{OOB} (MHz) in Table 6.5.3.1.3-1 from the edge of the channel bandwidth.

Table 6.5D.3_1.1.5-1: General spurious emissions test requirements

Frequency Range	Maximum Level	Measurement bandwidth	NOTE
$9 \text{ kHz} \leq f < 150 \text{ kHz}$	-36 dBm	1 kHz	
$150 \text{ kHz} \leq f < 30 \text{ MHz}$	-36 dBm	10 kHz	
$30 \text{ MHz} \leq f < 1000 \text{ MHz}$	-36 dBm	100 kHz	
$1 \text{ GHz} \leq f < 12.75 \text{ GHz}$	-30 dBm	1 MHz	
12.75 GHz $\leq f <$ 5th harmonic of the upper frequency edge of the UL operating band in GHz	-30 dBm	1 MHz	1
$12.75 \text{ GHz} < f < 26 \text{ GHz}$	-30 dBm	1 MHz	2
NOTE 1: Applies for Band that the upper frequency edge of the UL Band more than 2.69 GHz			
NOTE 2: Applies for Band that the upper frequency edge of the UL Band more than 5.2 GHz			

6.5D.3_1.2 Spurious emission for UE co-existence for UL MIMO (Rel-16 onward)

6.5D.3_1.2.1 Test purpose

To verify that UE transmitter does not cause unacceptable interference to co-existing systems for the specified bands which has specific requirements in terms of transmitter spurious emissions.

6.5D.3_1.2.2 Test applicability

This test case applies to all types of NR UE release 16 and forward that support UL MIMO.

6.5D.3_1.2.3 Minimum conformance requirements

For UE supporting UL MIMO, the requirements for Spurious emissions which are caused by unwanted transmitter effects such as harmonics emission, parasitic emissions, intermodulation products and frequency conversion products is defined as the sum of the emissions from both UE transmit antenna connectors.

The spurious emission for UE co-existence requirements specified in clause 6.5.3.2.3 apply. For UEs with two transmit antenna connectors in closed-loop spatial multiplexing scheme, the requirements shall be met with the UL MIMO configurations described in clause 6.2D.1. For UEs supporting ULFPTx for UL MIMO, the requirements shall be met with the PUSCH configurations specified in Table 6.2D.1.3-3, based upon UE's support of uplink full power transmission mode.

The normative reference for this requirement is TS 38.101-1 [2] subclauses 6.5.3.2 and 6.5D.3.

6.5D.3_1.2.4 Test description

6.5D.3_1.2.4.1 Initial conditions

Same initial conditions as in clause 6.5D.3.2.4.1.

6.5D.3_1.2.4.2 Test procedure

- 1 SS sends uplink scheduling information for each UL HARQ process via PDCCH DCI format 0_1 for C_RNTI to schedule the UL RMC according to Table 6.5D.3.2.4.1-1. Since the UE has no payload data to send, the UE transmits uplink MAC padding bits on the UL RMC. The PDCCH DCI format 0_1 is specified with condition 2TX_UL_MIMO in 38.508-1 [5] subclause 4.3.6.1.1.2.
2. Send continuously uplink power control "up" commands in the uplink scheduling information to the UE until the UE transmits at P_{UMAX} level.
3. Measure the sum of transmitted power at each UE antenna connector with a measurement filter of bandwidths according to table 6.5.3.2.3-1. The centre frequency of the filter shall be stepped in contiguous steps according to table 6.5.3.2.3-1. The measured power shall be verified for each step. The measurement period shall capture the active time slots.
4. If UE supports ULFPTx Mode-2 or Mode-full power, repeat test steps 1~3 with the exception that the PDCCH DCI format 0_1 is specified with the condition ULFPTx_Mode2 or ULFPTx_ModeFull in 38.508-1 [5] subclause 4.3.6.1.1.2 depending on UE reported capability.

6.5D.3_1.2.4.3 Message contents

Message contents are according to TS 38.508-1 [5] subclause 4.6 and 5.4 ensuring Table 4.6.3-182 with the condition 2TX_UL_MIMO.

6.5D.3_1.2.5 Test requirement

The measured average power of spurious emission, derived in step 3 or step 4 from both UE antenna connectors, shall not exceed the described value in Table 6.5.3.2.3-1.

6.5D.3_1.3 Additional spurious emissions for UL MIMO (Rel-16 onward)

6.5D.3_1.3.1 Test purpose

To verify that UE transmitter does not cause unacceptable interference to other channels or other systems in terms of transmitter spurious emissions under the deployment scenarios where additional requirements are specified.

6.5D.3_1.3.2 Test applicability

This test case applies to all types of NR UE release 16 and forward that support UL MIMO.

6.5D.3_1.3.3 Minimum conformance requirements

For UE supporting UL MIMO, the requirements for Spurious emissions which are caused by unwanted transmitter effects such as harmonics emission, parasitic emissions, intermodulation products and frequency conversion products is defined as the sum of the emissions from both UE transmit antenna connectors.

The additional spurious emission requirements specified in clause 6.5.3.3.3 apply. For UEs with two transmit antenna connectors in closed-loop spatial multiplexing scheme, the requirements shall be met with the UL MIMO configurations described in clause 6.2D.1. For UEs supporting ULFPTx for UL MIMO, the requirements shall be met with the PUSCH configurations specified in Table 6.2D.1.3-3, based upon UE's support of uplink full power transmission mode.

The normative reference for this requirement is TS 38.101-1 [2] clauses 6.5D.3 and 6.5.3.3

6.5D.3_1.3.4 Test description

6.5D.3_1.3.4.1 Initial conditions

Same initial conditions as in clause 6.5D.3.3.4.1 together with tables 6.5D.3_1.3.4-1 to 6.5D.3_1.3.4-3.

Table 6.5D.3_1.3.4.1-1: Test Configuration table for NS_05

Same test configuration as listed in Table 6.2.3.4.1-4 shall be used with the following exceptions:

- Test SCS shall be: [Lowest].
- Only Test IDs 66 to 115 shall be tested.

Table 6.5D.3_1.3.4.1-2: Test Configuration table for NS_48

Same test configuration as listed in Table 6.2.3.4.1-19 shall be used with the following exceptions:

- Test Channel Bandwidths shall be: 25, 30, 40, and 50 MHz
- Test SCS shall be: Lowest.
- Only Test IDs 31 to 60 shall be tested.

Table 6.5D.3_1.3.4.1-3: Test Configuration table for NS_49

Same test configuration as listed in Table 6.2.3.4.1-29 shall be used with the following exceptions:

- Test Channel Bandwidths shall be: 25, 30, 40, and 50 MHz
- Test SCS shall be: Lowest.
- Only Test IDs 43 to 84 shall be tested.

Table 6.5D.3_1.3.4.1-4: Test Configuration table for NS_46

Same test configuration as listed in Table 6.2.3.4.1-25 shall be used with the following exceptions:

- Test SCS shall be: Lowest.
- Only Test IDs 11 to 22 shall be tested.

Table 6.5D.3_1.3.4.1-5: Test Configuration table for NS_21

Same test configuration as listed in Table 6.2.3.4.1-27 shall be used with the following exceptions:

- Test SCS shall be: Lowest.
- Only Test IDs 26 to 45 shall be tested.

Table 6.5D.3_1.3.4.1-6: Test Configuration table for NS_44

Same test configuration as listed in Table 6.2.3.4.1-26 shall be used with the following exceptions:

- Test SCS shall be: Lowest.
- Only Test IDs 23 to 44 shall be tested.

Table 6.5D.3_1.3.4.1-7: Test Configuration table for NS_27

Same test configuration as listed in Table 6.2.3.4.1-13 shall be used with the following exceptions:

- Test SCS shall be: Lowest.
- Only Test IDs 141 to 252 shall be tested.

6.5D.3_1.3.4.2 Test procedure

- 1 SS sends uplink scheduling information for each UL HARQ process via PDCCH DCI format 0_1 for C_RNTI to schedule the UL RMC according to tables in clause 6.5D.3_1.3.4.1 as appropriate. Since the UE has no payload data to send, the UE transmits uplink MAC padding bits on the UL RMC. The PDCCH DCI format 0_1 is specified with condition 2TX_UL_MIMO in 38.508-1 [5] subclause 4.3.6.1.1.2.
2. Send continuously uplink power control "up" commands in the uplink scheduling information to the UE until the UE transmits at P_{UMAX} level.
3. Measure the sum of the mean power at each UE antenna connector in the channel bandwidth of the radio access mode according to the test configurations in clause 6.5D.3_1.3.4.1, which shall meet the requirements described in clauses 6.2D.3.5 as appropriate for each network signalling. The period of measurement shall be at least the continuous duration of 1ms over consecutive active uplink slots and uplink symbols. For TDD, only slots consisting of only UL symbols are under test.
4. Measure the sum of transmitted power at each UE antenna connector with a measurement filter of bandwidths according to clauses 6.5.3.3.3.1 to 6.5.3.3.3.25 as appropriate. The centre frequency of the filter shall be stepped in contiguous steps according to the same table the measured power shall be verified for each step. The measurement period shall capture the active time slots.
5. If UE supports ULFPTx Mode-2 or Mode-full power, repeat test steps 1~4 with the exception that the PDCCH DCI format 0_1 is specified with the condition ULFPTx_Mode2 or ULFPTx_ModeFull in 38.508-1 [5] subclause 4.3.6.1.1.2 depending on UE reported capability.

6.5D.3_1.3.4.3 Message contents

Message contents are according to TS 38.508-1 [5] subclause 4.6 and 5.4 ensuring Table 4.6.3-182 with condition 2TX_UL_MIMO and same exceptions listed in clause 6.5.3.3.4.3.

6.5D.3_1.3.5 Test requirement

The measured power from both UE antenna connector derived in step 4 or step 5 shall meet the requirements for the specified NR band for an additional spectrum emission requirement with protected bands as indicated in clause 6.5.3.3.5.

NOTE: For measurement conditions at the edge of each frequency range, the lowest frequency of the measurement position in each frequency range should be set at the lowest boundary of the frequency range plus $\text{MBW}/2$. The highest frequency of the measurement position in each frequency range should be set at the highest boundary of the frequency range minus $\text{MBW}/2$. MBW denotes the measurement bandwidth defined for the protected band.

6.5D.4 Transmit intermodulation for UL MIMO

6.5D.4.1 Test purpose

To verify that the UE transmit intermodulation does not exceed the described value in the test requirement.

The transmit intermodulation performance is a measure of the capability of the transmitter to inhibit the generation of signals in its non-linear elements caused by presence of the wanted signal and an interfering signal reaching the transmitter via the antenna.

6.5D.4.2 Test applicability

This test case applies to all types of NR UE release 15 and forward that support UL MIMO.

6.5D.4.3 Minimum conformance requirements

For UE supporting UL MIMO, the transmit intermodulation requirements are specified at each transmit antenna connector and the wanted signal is defined as the sum of output power at each transmit antenna connector.

For UEs with two transmit antenna connectors in closed-loop spatial multiplexing scheme, the requirements specified in subclause 6.5.4 apply to each transmit antenna connector. The requirements shall be met with the UL MIMO configurations described in sub-clause 6.2D.1.

If UE is configured for transmission on single-antenna port, the requirements in subclause 6.5.4 apply.

The normative reference for this requirement is TS 38.101-1 [2] clauses 6.5D.4 and 6.5.4.

6.5D.4.4 Test description

6.5D.4.4.1 Initial conditions

Initial conditions are a set of test configurations the UE needs to be tested in and the steps for the SS to take with the UE to reach the correct measurement state.

The initial test configurations consist of environmental conditions, test frequencies, test channel bandwidths and sub-carrier spacing based on NR operating bands specified in table 5.3.5-1. All of these configurations shall be tested with applicable test parameters for each combination of channel bandwidth and sub-carrier spacing, and are shown in table 6.5D.4.4.1-1. The details of the uplink reference measurement channels (RMCs) are specified in Annexes A.2. Configurations of PDSCH and PDCCH before measurement are specified in Annex C.2.

Table 6.5D.4.4.1-1: Test Configuration Table

Initial Conditions			
Test Environment as specified in TS 38.508-1 [5] subclause 4.1		Normal	
Test Frequencies as specified in TS 38.508-1 [5] subclause 4.3.1		Mid range	
Test Channel Bandwidths as specified in TS 38.508-1 [5] subclause 4.3.1		Mid, Highest	
Test SCS as specified in Table 5.3.5-1		Lowest, Highest	
Test Parameters			
Test ID	Downlink Configuration	Uplink Configuration	
	N/A for transmit intermodulation test case	Modulation	RB allocation (NOTE 1)
1		CP-OFDM QPSK	Inner Full
NOTE 1: The specific configuration of each RB allocation is defined in Table 6.1-1.			

1. Connect the SS to the UE antenna connectors as shown in TS 38.508-1 [5] Annex A, in Figure A.3.1.3.2 for TE diagram and section A.3.2 for UE diagram.
2. The parameter settings for the cell are set up according to TS 38.508-1 [5] subclause 4.4.3.
3. Downlink signals are initially set up according to Annex C.0, C.1, C.2, and uplink signals according to Annex G.0, G.1, G.2, G.3.0.
4. The UL Reference Measurement channels are set according to Table 6.5D.4.4.1-1.
5. Propagation conditions are set according to Annex B.0.
6. Ensure the UE is in State RRC_CONNECTED with generic procedure parameters Connectivity *NR*, Connected without release *On*, Test Mode *On* and Test Loop Function *On* according to TS 38.508-1 [5] clause 4.5. Message contents are defined in clause 6.5D.4.4.3.

6.5D.4.4.2 Test procedure

1. SS sends uplink scheduling information for each UL HARQ process via PDCCH DCI format 0_1 for C_RNTI to schedule the UL RMC according to Table 6.5D.4.4.1-1. Since the UE has no payload and no loopback data to send the UE sends uplink MAC padding bits on the UL RMC. The PDCCH DCI format 0_1 is specified with condition 2TX_UL_MIMO in 38.508-1 [5] subclause 4.3.6.1.1.2
2. Send continuously uplink power control "up" commands to the UE until the UE transmits at its P_{UMAX} level.
3. Measure the rectangular filtered mean power at each antenna connector of the UE. For TDD, only slots consisting of only UL symbols are under test.
4. Set the interference signal frequency below the UL carrier frequency using the first offset in table 6.5D.4.5-1.
5. Set the interference CW signal level according to table 6.5D.4.5-1.
6. Search the intermodulation product signals below and above the UL carrier frequency at each UE antenna connector, then measure the rectangular filtered mean power of transmitting intermodulation for both signals, and calculate the ratios for each UE antenna connector with the power measured in step 3.
7. Set the interference signal frequency above the UL carrier frequency using the first offset in table 6.5D.4.5-1.
8. Search the intermodulation product signals below and above the UL carrier frequency at each UE antenna connector, then measure the rectangular filtered mean power of transmitting intermodulation for both signals, and calculate the ratios for each UE antenna with the power measured in step 3.
9. Repeat the measurement using the second offset in table 6.5D.4.5-1.
10. Repeat step 3) until 9) for each of transmit antenna of the UE.

6.5D.4.4.3 Message contents

Message contents are according to TS 38.508-1 [5] subclause 4.6 ensuring Table 4.6.3-182 with condition 2TX_UL_MIMO.

6.5D.4.5 Test requirement

The ratio derived in step 6 and 8, shall not exceed the described value in table 6.5D.4.5-1.

Table 6.5D.4.5-1: Transmit Intermodulation

Wanted signal channel bandwidth	$BW_{Channel}$	
Interference signal frequency offset from channel centre	$BW_{Channel}$	$2 * BW_{Channel}$
Interference CW signal level	-40dBc	
Intermodulation product	< -29dBc	< -35dBc
Measurement bandwidth	The maximum transmission bandwidth configuration among the different SCSs for the channel BW as defined in Table 6.5.2.4.1.5-1	
Measurement offset from channel centre	$BW_{Channel}$ and $2 * BW_{Channel}$	$2 * BW_{Channel}$ and $4 * BW_{Channel}$

6.5E Output RF spectrum emissions for V2X

6.5E.1 Occupied bandwidth for V2X

6.5E.2 Out of band emission for V2X

6.5E.2.1 General

When UE is configured for NR V2X sidelink transmissions non-concurrent with NR uplink transmissions for NR V2X operating bands specified in Table 5.2E.1-1, the requirements in clause 6.5E.2 apply for NR V2X sidelink transmission.

For NR V2X UE with two transmit antenna connectors, the requirements specified for single carrier shall apply to each transmit antenna connector. The requirements shall be met with SL MIMO configurations described in clause 6.2D.1.

6.5E.2.2 Spectrum emission mask for V2X

6.5E.2.2.1 Spectrum emission mask for V2X / non-concurrent operation

Editor's Note: This clause is incomplete for PSFCH and PSBCH measurement. The following aspects are either missing or not yet determined:

- Measurement period of PSFCH and PSBCH is FFS.

6.5E.2.2.1.1 Test purpose

To verify that the power of any UE emission shall not exceed specified level for the specified channel bandwidth when UE is configured for NR V2X sidelink transmissions non-concurrent with NR uplink transmissions.

6.5E.2.2.1.2 Test applicability

This test case applies to all types of NR UE release 16 and forward that support NR V2X sidelink communication with non-concurrent operation.

6.5E.2.2.1.3 Minimum conformance requirements

For NR V2X UE, the existing NR general spectrum emission mask in clause 6.5.2.2 applied for all supporting NR V2X channel bandwidths. The spectrum emission mask of the UE applies to frequencies (Δf_{OOB}) starting from the \pm edge of the assigned NR channel bandwidth. For frequencies greater than (Δf_{OOB}), the power of any UE emission shall not exceed the levels specified in Table 6.5.2.2.3-1 for the specified channel bandwidth for NR V2X operating bands in Table 5.2E.1-1.

The normative reference for this requirement is TS 38.101-1 [2] clause 6.5E.2.2.

6.5E.2.2.1.4 Test description

6.5E.2.2.1.4.1 Initial conditions

Initial conditions are a set of test configurations the UE needs to be tested in and the steps for the SS to take with the UE to reach the correct measurement state.

The initial test configurations consist of environmental conditions, test frequencies, test channel bandwidths and sub-carrier spacing based on NR operating bands specified in Table 5.2E.1-1 and Table 5.3.5-1. All of these configurations shall be tested with applicable test parameters for each combination of test channel bandwidth and sub-carrier spacing, and are shown in table 6.5E.2.2.1.4.1-1. The details of the V2X reference measurement channels (RMCs) are specified in Annexe A.7.5 and the GNSS configuration in TS 38.508-1 [5] subclause 4.11.

Table 6.5E.2.2.1.4.1-1: Test Configuration Table for contiguous PSCCH and PSSCH allocation

Initial Conditions			
Test Environment as specified in TS 38.508-1 [5] subclause 4.1		Normal	
Test Frequencies as specified in TS 38.508-1 [5] subclause 4.3.1.8		Low range, High range	
Test Channel Bandwidths as specified TS 38.508-1 [5] subclause 4.3.1		Lowest, Highest	
Test SCS as specified in Table 5.3.5-1		Lowest, Highest	
Test Parameters for Channel Bandwidths			
Test ID	Freq	V2X Configuration to Transmit	
		Modulation	PSSCH RB allocation (Note 1)
1	Default	QPSK	Outer_Full
2	Default	QPSK	Inner_Full
3	Default	16QAM	Outer_Full
4	Default	16QAM	Inner_Full
5	Default	64QAM	Outer_Full
6	Default	256QAM	Outer_Full
NOTE 1: The specific configuration of each RB allocation is defined in Table 6.1E-1.			

Table 6.5E.2.2.1.4.1-2: Test Configuration Table for PSFCH

Initial Conditions			
Test Environment as specified in TS 38.508-1 [5] subclause 4.1		Normal	
Test Frequencies as specified in TS 38.508-1 [5] subclause 4.3.1.8		Low range, High range	
Test Channel Bandwidths as specified TS 38.508-1 [5] subclause 4.3.1		Lowest, Highest	
Test SCS as specified in Table 5.3.5-1		Lowest, Highest	
Test Parameters for Channel Bandwidths			
Test ID	Freq	V2X Configuration to Transmit	
		PSFCH RB allocation (Note 1)	
1	Low range	PSFCH_1RB_Left	
2	High range	PSFCH_1RB_Right	
3	Low range	PSFCH_2RB_Left	
4	High range	PSFCH_2RB_Right	
5	Default	PSFCH_Max_Gap	
NOTE 1: The specific configuration of each RB allocation is defined in Table 6.1E-2.			

Table 6.5E.2.2.1.4.1-3: Test Configuration Table for S-SSB

Initial Conditions		
Test Environment as specified in TS 38.508-1 [5] subclause 4.1	Normal	
Test Frequencies as specified in TS 38.508-1 [5] subclause 4.3.1.8	Low range, High range	
Test Channel Bandwidths as specified TS 38.508-1 [5] subclause 4.3.1	Lowest, Highest	
Test SCS as specified in Table 5.3.5-1	Lowest, Highest	
Test Parameters for Channel Bandwidths		
Test ID	Freq	V2X Configuration to Transmit S-SSB RB allocation (Note 1)
1	Low range	S-SSB_Low
2	High range	S-SSB_High
3	Default	S-SSB_Mid
NOTE 1: The specific configuration of each RB allocation is defined in Table 6.1E-3.		

1. Connect the SS and GNSS simulator to the UE antenna connectors as shown in TS 38.508-1 [5] Annex A, Figure A.3.1.9.1 for TE diagram and section A.3.2.7 for UE diagram.
2. The parameter settings for the NR sidelink transmission over PC5 are pre-configured according to TS 38.508-1 [5] subclause 4.10. Message content exceptions are defined in clause 6.5E.2.2.1.4.3.
3. The V2X Reference Measurement Channel is set according to Table 6.5E.2.2.1.4.1-1.
4. The GNSS simulator is configured for Scenario #1: static in Geographical area #1, as defined in TS 38.508-1 [5] Table 4.11.2-2. Geographical area #1 is also pre-configured in the UE.
5. Propagation conditions are set according to Annex B.0.

6.5E.2.2.1.4.2 Test procedure

Subtest 1: PSCCH/PSSCH

1. Ensure the UE is in state *Out_of_Coverage* with generic procedure parameters *Sidelink On*, Test Loop Function *On* with UE test loop mode E closed for *Transmit Mode* according to TS 38.508-1 [5] clause 4.5.
2. The UE starts to perform the NR sidelink communication according to *SL-PreconfigurationNR*. Since the UE has no payload and no loopback data to send the UE sends uplink MAC padding bits on the NR sidelink RMC.
3. Measure the mean power of the UE in the channel bandwidth of the radio access mode according to the test configuration from Table 6.5E.2.2.1.4.1-1, which shall meet the requirements described in Table 6.2E.2.1.5-1 for Power Class 3 UEs. The period of measurement shall be at least continuous duration of one active sub-frame (1ms) excluding guard symbols.
4. Measure the power of the transmitted signal with a measurement filter of bandwidths according to Table 6.5E.2.2.1.5-1. The centre frequency of the filter shall be stepped in continuous steps according to the same table. The measured power shall be recorded for each step. The measurement period shall capture the active TSs.

Subtest 2: PSFCH

1. Ensure the UE is in state *Out_of_Coverage* with generic procedure parameters *Sidelink On*, Cast type *Unicast*, Test Loop Function *On* with UE test loop mode E closed for *Receive Mode* according to TS 38.508-1 [5] clause 4.5.
2. The UE starts to perform the NR sidelink reception according to *SL-PreconfigurationNR*.
3. The UE's PSFCH transmission occasion is on slot n according to Table 6.5E.2.2.1.4.1-2. SS transmits PSSCH on combination of slot and subchannel as below:
 - a) Test ID 1: slot n-6, Lowest sub-channel

- b) Test ID 2: slot n-3, Highest sub-channel
 - c) Test ID 3: slot n-6 and n-5, Lowest sub-channel
 - d) Test ID 4: slot n-4 and n-3, Highest sub-channel
 - e) Test ID 5: slot n-6, Highest sub-channel and slot n-3, Highest sub-channel
4. Measure the mean power of the UE on slot n in the channel bandwidth according to the test configuration from Table 6.5E.2.2.1.4.1-2, which shall meet the requirements described in Table 6.2E.2.1.5-2 for Power Class 3 UEs. The period of measurement is FFS.
 5. Measure the power of the transmitted signal with a measurement filter of bandwidths according to Table 6.5E.2.2.1.5-1. The centre frequency of the filter shall be stepped in continuous steps according to the same table. The measured power shall be recorded for each step. The measurement period shall capture the active TSs.

Subtest 3: S-SSB

1. Ensure the UE is in state *Out_of_Coverage* with generic procedure parameters *Sidelink On* according to TS 38.508-1 [5] clause 4.5. The UE is synchronized to GNSS,
2. The UE transmits PSBCH according *SL-PreconfigurationNR*.
3. Measure the mean power of the S-SSB in the channel bandwidth according to the test configuration from Table 6.5E.2.2.1.4.1-3, which shall meet the requirements described in Table 6.2E.2.1.5-3 for Power Class 3 UEs. The period of measurement is FFS.
4. Measure the power of the transmitted signal with a measurement filter of bandwidths according to Table 6.5E.2.2.1.5-1. The centre frequency of the filter shall be stepped in continuous steps according to the same table. The measured power shall be recorded for each step. The measurement period shall capture the active TSs.

6.5E.2.2.1.4.3 Message contents

Message contents are according to TS 38.508-1 [5] subclause 4.10.

6.5E.2.2.1.5 Test requirement

The measured UE mean power in the channel bandwidth, derived in step 4 of Subtest 1, step 5 of Subtest 2 and step 4 of Subtest 3, shall fulfil requirements in Table 6.2E.2.2.1.5-1 as appropriate, and the power of any UE emission shall fulfil requirements in Table 6.5E.2.2.1.5-1.

Table 6.5E.2.2.1.5-1: General NR spectrum emission mask for V2X / non-concurrent operation

Spectrum emission limit (dBm) / Channel bandwidth													
Δf_{OOB} (MHz)	5 MHz	10 MHz	15 MHz	20 MHz	25 MHz	30 MHz	40 MHz	50 MHz	60 MHz	80 MHz	90 MHz	100 MHz	Measurement bandwidth
$\pm 0-1$	-13 + TT	-13 + TT	-13 + TT	-13 + TT	-13 + TT	-13 + TT	-13 + TT						1 % channel bandwidth
$\pm 0-1$								-24 + TT	-24 + TT	-24 + TT	-24 + TT	-24 + TT	30 kHz
$\pm 1-5$	-10 + TT	-10 + TT	-10 + TT	-10 + TT	-10 + TT	-10 + TT	-10 + TT	-10 + TT	-10 + TT	-10 + TT	-10 + TT	-10 + TT	1 MHz
$\pm 5-6$	-13 + TT	-13 + TT	-13 + TT	-13 + TT	-13 + TT	-13 + TT	-13 + TT	-13 + TT	-13 + TT	-13 + TT	-13 + TT	-13 + TT	
$\pm 6-10$	-25 + TT												
$\pm 10-15$		-25 + TT											
$\pm 15-20$			-25 + TT										
$\pm 20-25$				-25 + TT									
$\pm 25-30$					-25 + TT								
$\pm 30-35$						-25 + TT							
$\pm 35-40$													
$\pm 40-45$							-25 + TT						
$\pm 45-50$													
$\pm 50-55$								-25 + TT					
$\pm 55-60$													
$\pm 60-65$									-25 + TT				
$\pm 65-80$													
$\pm 80-85$										-25 + TT			
$\pm 85-90$													
$\pm 90-95$											-25 + TT		
$\pm 95-100$													
$\pm 100-105$												-25 + TT	

Note 1: The first and last measurement position with a 30 kHz filter is at Δf_{OOB} equals to 0.015 MHz and 0.985 MHz.
 Note 2: At the boundary of spectrum emission limit, the first and last measurement position with a 1 MHz filter is the inside of +0.5MHz and -0.5MHz, respectively.
 Note 3: The measurements are to be performed above the upper edge of the channel and below the lower edge of the channel.
 Note 4: TT for each frequency and channel bandwidth is specified in Table 6.5E.2.2.1.5-2.

Table 6.5E.2.2.1.5-2: Test Tolerance

FFS

NOTE: As a general rule, the resolution bandwidth of the measuring equipment should be equal to the measurement bandwidth. However, to improve measurement accuracy, sensitivity and efficiency, the resolution bandwidth may be smaller than the measurement bandwidth. When the resolution bandwidth is smaller than the measurement bandwidth, the result should be integrated over the measurement bandwidth in order to obtain the equivalent noise bandwidth of the measurement bandwidth.

6.5E.2.2.1D Spectrum emission mask for V2X / non-concurrent operation / SL-MIMO

Editor's Note:

- Test config table is FFS
- Uplink RMC is TBD in RAN4
- Connection diagram is TBD
- Preconfiguration is TBD in 38.508-1
- Test state and generic procedure are TBD in 38.508-1

6.5E.2.2.1D.1 Test purpose

To verify that the power of any UE emission shall not exceed specified level for the specified channel bandwidth when UE is configured for NR V2X sidelink MIMO transmissions non-concurrent with NR uplink transmissions.

6.5E.2.2.1D.2 Test applicability

This test case applies to all types of NR UE release 16 and forward that support NR V2X sidelink MIMO communication with non-concurrent operation.

6.5E.2.2.1D.3 Minimum conformance requirements

For NR V2X UE with two transmit antenna connectors, the requirements specified for single carrier shall apply to each transmit antenna connector. The requirements shall be met with SL MIMO configurations described in clause 6.2D.1.

The normative reference for this requirement is TS 38.101-1 [2] clause 6.5E.2.

6.5E.2.2.1D.4 Test description

6.5E.2.2.1D.4.1 Initial conditions

Initial conditions are a set of test configurations the UE needs to be tested in and the steps for the SS to take with the UE to reach the correct measurement state.

The initial test configurations consist of environmental conditions, test frequencies, test channel bandwidths and sub-carrier spacing based on NR operating bands specified in Table 5.3.5-1. All of these configurations shall be tested with applicable test parameters for each combination of test channel bandwidth and sub-carrier spacing, and are shown in table 6.5E.2.2.1D.4.1-1. The details of the V2X reference measurement channels (RMCs) are specified in Annexes TBD.

Table 6.5E.2.2.1D.4.1-1: Test Configuration Table

FFS

1. Connect the SS and GNSS simulator to the UE antenna connectors as shown in TS 38.508-1 [5] Annex A, Figure TBD for TE diagram and section TBD for UE diagram.
2. The parameter settings for the V2X sidelink transmission over PC5 are pre-configured according to TS 38.508-1 [5] subclause TBD. Message content exceptions are defined in clause 6.5E.2.2.1D.4.3.
3. The V2X Reference Measurement Channel is set according to Table 6.5E.2.2.1D.4.1-1.
4. The GNSS simulator is configured for Scenario #1: static in Geographical area #1, as defined in TS36.508 [25] Table 4.11.2-2. Geographical area #1 is also pre-configured in the UE.
5. Propagation conditions are set according to Annex B.0.
6. Ensure the UE is in state TBD.

6.5E.2.2.1D.4.2 Test procedure

1. The V2X UE schedules the V2X RMC with transmission power at P_{UMAX} level according to *SL-V2X-Preconfiguration* which is in line with the test configuration in Table 6.5E.2.2.1D.4.1-1.

2. Measure the sum of mean power of each antenna connector in the channel bandwidth of the radio access mode according to the test configuration, which shall meet the requirements described in [TBD] for Power Class 3 UEs. The period of the measurement shall be at least the continuous duration of one sub-frame (1ms). For TDD slots with transient periods are not under test.
3. Measure the power of each antenna connector of the transmitted signal with a measurement filter of bandwidths according to Table 6.5E.2.2.1D.5-1. The centre frequency of the filter shall be stepped in continuous steps according to the same table. The measured power shall be recorded for each step. The measurement period shall capture the active TSs.

6.5E.2.2.1D.4.3 Message contents

Message contents are according to TS 38.508-1 [5] subclause 4.6 and 5.4.

6.5E.2.2.1D.5 Test requirement

The measured sum of mean power of each antenna connector in the channel bandwidth, derived in step 2, shall fulfil requirements in [TBD] as appropriate, and the power of any UE emission at each antenna connector shall fulfil requirements in Table 6.5E.2.2.1D.5-1.

Table 6.5E.2.2.1D.5-1: General NR spectrum emission mask for V2X / non-concurrent operation / SL-MIMO

Spectrum emission limit (dBm) / Channel bandwidth													
Δf_{OoB} (MHz)	5 MHz	10 MHz	15 MHz	20 MHz	25 MHz	30 MHz	40 MHz	50 MHz	60 MHz	80 MHz	90 MHz	100 MHz	Measurement bandwidth
$\pm 0-1$	-13 + TT	-13 + TT	-13 + TT	-13 + TT	-13 + TT	-13 + TT	-13 + TT						1 % channel bandwidth
$\pm 0-1$								-24 + TT	-24 + TT	-24 + TT	-24 + TT	-24 + TT	30 kHz
$\pm 1-5$	-10 + TT	-10 + TT	-10 + TT	-10 + TT	-10 + TT	-10 + TT	-10 + TT	-10 + TT	-10 + TT	-10 + TT	-10 + TT	-10 + TT	1 MHz
$\pm 5-6$	-13 + TT	-13 + TT	-13 + TT	-13 + TT	-13 + TT	-13 + TT	-13 + TT	-13 + TT	-13 + TT	-13 + TT	-13 + TT	-13 + TT	
$\pm 6-10$	-25 + TT												
$\pm 10-15$		-25 + TT											
$\pm 15-20$			-25 + TT										
$\pm 20-25$				-25 + TT									
$\pm 25-30$					-25 + TT								
$\pm 30-35$						-25 + TT							
$\pm 35-40$													
$\pm 40-45$							-25 + TT						
$\pm 45-50$													
$\pm 50-55$								-25 + TT					
$\pm 55-60$													
$\pm 60-65$									-25 + TT				
$\pm 65-80$													
$\pm 80-85$										-25 + TT			
$\pm 85-90$													
$\pm 90-95$											-25 + TT		
$\pm 95-100$													
$\pm 100-105$												-25 + TT	

Note 1: The first and last measurement position with a 30 kHz filter is at Δf_{OoB} equals to 0.015 MHz and 0.985 MHz.
 Note 2: At the boundary of spectrum emission limit, the first and last measurement position with a 1 MHz filter is the inside of +0.5MHz and -0.5MHz, respectively.
 Note 3: The measurements are to be performed above the upper edge of the channel and below the lower edge of the channel.
 Note 4: TT for each frequency and channel bandwidth is specified in Table 6.5E.2.2.5-2.

Table 6.5E.2.2.1D.5-2: Test Tolerance

FFS

6.5E.2.3 Additional Spectrum emission mask for V2X

6.5E.2.3.1 Additional Spectrum emission mask for V2X / non-concurrent operation

Editor's Note:

- Test config table is FFS

6.5E.2.3.1.1 Test purpose

To verify that the power of NR V2X UE emission shall not exceed specified level for the specified channel bandwidth under the deployment scenarios where additional requirements are specified.

6.5E.2.3.1.2 Test applicability

This test case applies to all types of NR UE release 16 and forward that support NR V2X sidelink communication with non-concurrent operation.

6.5E.2.3.1.3 Minimum conformance requirements

6.5E.2.3.1.3.1 Requirements for network signalling value "NS_33"

The additional spectrum mask in Table 6.5E.2.3.1.3.1-1 applies for NR V2X UE within 5 855 MHz to 5 950 MHz according to ETSI EN 302 571. Additional spectrum emission requirements are signalled by the network to indicate that the UE shall meet an additional requirement for a specific deployment scenario as part of the cell handover/broadcast message.

When "NS_33" is indicated in the cell or pre-configured radio parameters, the power of any V2X UE emission shall not exceed the levels specified in Table 6.5E.2.3.1.3.1-1.

Table 6.5E.2.3.1.3.1-1: Additional spectrum mask requirements for 10MHz channel bandwidth

Spectrum emission limit (dBm EIRP)/ Channel bandwidth		
Δf_{OOB} (MHz)	10 MHz	Measurement bandwidth
$\pm 0-0.5$	$[-13 - 12 \left(\frac{ \Delta f_{\text{OOB}} }{\text{MHz}} \right)]$	100 kHz
$\pm 0.5-5$	$[-19 - \frac{16}{9} \left(\frac{ \Delta f_{\text{OOB}} }{\text{MHz}} - 0.5 \right)]$	100 kHz
$\pm 5-10$	$[-27 - 2 \left(\frac{ \Delta f_{\text{OOB}} }{\text{MHz}} - 5.0 \right)]$	100 kHz

NOTE 1: As a general rule, the resolution bandwidth of the measuring equipment should be equal to the measurement bandwidth. However, to improve measurement accuracy, sensitivity and efficiency, the resolution bandwidth may be smaller than the measurement bandwidth. When the resolution bandwidth is smaller than the measurement bandwidth, the result should be integrated over the measurement bandwidth in order to obtain the equivalent noise bandwidth of the measurement bandwidth.

NOTE 2: Additional SEM for NR V2X overrides any other requirements in frequency range 5855-5950MHz.

NOTE 3: The EIRP requirement is converted to conducted requirement depend on the supported post antenna connector gain $G_{\text{post connector}}$ declared by the UE following the principle described in annex I in [11].

6.5E.2.3.1.3.2 Requirements for network signalling value "NS_52"

The additional spectrum mask in Table 6.5E.2.3.1.3.2-1 applies for NR V2X UE within 5 765 MHz to 6 005 MHz according to FCC regulation. Additional spectrum emission requirements are signalled by the network to indicate that the UE shall meet an additional requirement for a specific deployment scenario as part of the cell handover/broadcast message.

When "NS_52" is indicated in the cell or pre-configured radio parameters, the power of any V2X UE emission shall not exceed the levels specified in Table 6.5E.2.3.1.3.2-1.

Table 6.5E.2.3.1.3.2-1: Additional spectrum mask requirements for 40MHz channel bandwidth ($f_c = 5885\text{MHz}$)

Δf_{OoB} (MHz)	Emission Limit (dBm)	Measurement Bandwidth
$\pm 0-2$	-32	100kHz
$\pm 2-10$	-36	100kHz
$\pm 10-20$	-38	100kHz
$\pm 20-40$	-43	100kHz
$\pm 40-100$	-50	100kHz

The normative reference for this requirement is TS 38.101-1 [2] clause 6.5E.2.3.

6.5E.2.3.1.4 Test description

6.5E.2.3.1.4.1 Initial conditions

Initial conditions are a set of test configurations the UE needs to be tested in and the steps for the SS to take with the UE to reach the correct measurement state.

The initial test configurations consist of environmental conditions, test frequencies, test channel bandwidths and sub-carrier spacing based on NR operating bands specified in Table 5.2E.1-1 and Table 5.3.5-1. All of these configurations shall be tested with applicable test parameters for each combination of test channel bandwidth and sub-carrier spacing, and are shown in table 6.5E.2.3.1.4.1-1. The details of the V2X reference measurement channels (RMCs) are specified in Annexe A.7.5 and the GNSS configuration in TS 38.508-1 [5] subclause 4.11.

Table 6.5E.2.3.1.4.1-1: Test Configuration Table

FFS

1. Connect the SS and GNSS simulator to the UE antenna connectors as shown in TS 38.508-1 [5] Annex A, Figure A.3.1.9.1 for TE diagram and section A.3.2.7 for UE diagram.
2. The parameter settings for the NR sidelink transmission over PC5 are pre-configured according to TS 38.508-1 [5] subclause 4.10. Message content exceptions are defined in clause 6.5E.2.3.1.4.3.
3. The V2X Reference Measurement Channel is set according to Table 6.5E.2.3.1.4.1-1.
4. The GNSS simulator is configured for Scenario #1: static in Geographical area #1, as defined in TS 38.508-1 [5] Table 4.11.2-2. Geographical area #1 is also pre-configured in the UE.
5. Propagation conditions are set according to Annex B.0.
6. Ensure the UE is in state *Out_of_Coverage* with generic procedure parameters *Sidelink On*, *Test Loop Function On* with UE test loop mode E closed for *Transmit Mode* according to TS 38.508-1 [5] clause 4.5.

6.5E.2.3.1.4.2 Test procedure

1. The V2X UE schedules the V2X RMC with transmission power at P_{UMAX} level according to *SL-PreconfigurationNR* which is in line with the test configuration in Table 6.5E.2.3.1.4.1-1.
2. Measure the mean power of the UE in the channel bandwidth of the radio access mode according to the test configuration, which shall meet the requirements described in Table 6.2E.2.1.5-1 for Power Class 3 UEs. The period of the measurement shall be at least the continuous duration of one sub-frame (1ms). For TDD slots with transient periods are not under test.
3. Measure the power of the transmitted signal with a measurement filter of bandwidths according to Table 6.5E.2.3.1.5.1-1 or Table 6.5E.2.3.1.5.2-1. The centre frequency of the filter shall be stepped in continuous steps according to the same table. The measured power shall be recorded for each step. The measurement period shall capture the active TSs.

6.5E.2.3.1.4.3 Message contents

Message contents are according to TS 38.508-1 [5] subclause 4.10 with following exceptions.

6.5E.2.3.1.4.3.1 Message contents exceptions (network signalling value "NS_33")

Table 6.5E.2.3.1.4.3.1-1: Network signalling value "NS_33"

Derivation Path: TS 38.508-1 [5] clause 4.6.3, Table 4.6.3-1			
Information Element	Value/remark	Comment	Condition
additionalSpectrumEmission	1 (NS_33)		

6.5E.2.3.1.4.3.2 Message contents exceptions (network signalling value "NS_52")

Table 6.5E.2.3.1.4.3.2-1: Network signalling value "NS_52"

Derivation Path: TS 38.508-1 [5] clause 4.6.3, Table 4.6.3-1			
Information Element	Value/remark	Comment	Condition
additionalSpectrumEmission	1 (NS_52)		

6.5E.2.3.1.5 Test requirement

Table 6.5E.2.3.1.5-1: Test Tolerance (Additional spectrum emission mask)

FFS

6.5E.2.3.1.5.1 Requirements for network signalling value "NS_33"

When "NS_33" is indicated in the cell, the power of any NR V2X UE emission shall fulfil requirements in Table 6.5E.2.3.1.5.1-1.

Table 6.5E.2.3.1.5.1-1: Additional spectrum mask requirements for 10MHz channel bandwidth

Spectrum emission limit (dBm EIRP)/ Channel bandwidth		
Δf_{OOB} (MHz)	10 MHz	Measurement bandwidth
$\pm 0-0.5$	$[-13 - 12 \left(\frac{ \Delta f_{OOB} }{MHz} \right)] + TT$	100 kHz
$\pm 0.5-5$	$[-19 - \frac{16}{9} \left(\frac{ \Delta f_{OOB} }{MHz} - 0.5 \right)] + TT$	100 kHz
$\pm 5-10$	$[-27 - 2 \left(\frac{ \Delta f_{OOB} }{MHz} - 5.0 \right)] + TT$	100 kHz

NOTE 1: TT for each frequency and channel bandwidth is specified in Table 6.5E.2.3.1.5-1.

6.5E.2.3.1.5.2 Requirements for network signalling value "NS_52"

When "NS_52" is indicated in the cell, the power of any NR V2X UE emission shall fulfil requirements in Table 6.5E.2.3.1.5.2-1.

Table 6.5E.2.3.1.5.2-1: Additional spectrum mask requirements for 40MHz channel bandwidth (fc = 5885MHz)

Δf_{OOB} (MHz)	Emission Limit (dBm)	Measurement Bandwidth
$\pm 0-2$	-32+TT	100kHz
$\pm 2-10$	-36+TT	100kHz
$\pm 10-20$	-38+TT	100kHz
$\pm 20-40$	-43+TT	100kHz
$\pm 40-100$	-50+TT	100kHz

NOTE 1: TT for each frequency and channel bandwidth is specified in Table 6.5E.2.3.1.5-1.

6.5E.2.3.1D Additional Spectrum emission mask for V2X / non-concurrent operation / SL-MIMO

Editor's Note:

- Test config table is FFS
- Uplink RMC is TBD in RAN4
- Connection diagram is TBD
- Preconfiguration is TBD in 38.508-1
- Test state and generic procedure are TBD in 38.508-1

6.5E.2.3.1D.1 Test purpose

To verify that the power of NR V2X UE emission shall not exceed specified level for the specified channel bandwidth under the deployment scenarios where additional requirements are specified.

6.5E.2.3.1D.2 Test applicability

This test case applies to all types of NR UE release 16 and forward that support NR V2X sidelink MIMO communication with non-concurrent operation.

6.5E.2.3.1D.3 Minimum conformance requirements

For NR V2X UE with two transmit antenna connectors, the requirements specified for single carrier described in clause 6.5E.2.3.1.3 shall apply to each transmit antenna connector.

The normative reference for this requirement is TS 38.101-1 [2] clause 6.5E.2.2.

6.5E.2.3.1D.4 Test description

6.5E.2.3.1D.4.1 Initial conditions

Initial conditions are a set of test configurations the UE needs to be tested in and the steps for the SS to take with the UE to reach the correct measurement state.

The initial test configurations consist of environmental conditions, test frequencies, test channel bandwidths and sub-carrier spacing based on NR operating bands specified in Table 5.3.5-1. All of these configurations shall be tested with applicable test parameters for each combination of test channel bandwidth and sub-carrier spacing, and are shown in table 6.5E.2.3.1D.4.1-1. The details of the V2X reference measurement channels (RMCs) are specified in Annexes TBD.

Table 6.5E.2.3.1D.4.1-1: Test Configuration Table

FFS

1. Connect the SS and GNSS simulator to the UE antenna connectors as shown in TS 38.508-1 [5] Annex A, Figure TBD for TE diagram and section TBD for UE diagram.
2. The parameter settings for the V2X sidelink transmission over PC5 are pre-configured according to TS 38.508-1 [5] subclause TBD. Message content exceptions are defined in clause 6.5E.2.3.1D.4.3.
3. The V2X Reference Measurement Channel is set according to Table 6.5E.2.3.1D.4.1-1.
4. The GNSS simulator is configured for Scenario #1: static in Geographical area #1, as defined in TS36.508 [25] Table 4.11.2-2. Geographical area #1 is also pre-configured in the UE.
5. Propagation conditions are set according to Annex B.0.
6. Ensure the UE is in state TBD.

6.5E.2.3.1D.4.2 Test procedure

1. The V2X UE schedules the V2X RMC with transmission power at P_{UMAX} level according to *SL-V2X-Preconfiguration* which is in line with the test configuration in Table 6.5E.2.3.1.4.1-1.
2. Measure the mean power of the UE in the channel bandwidth of the radio access mode according to the test configuration, which shall meet the requirements described in [TBD] for Power Class 3 UEs. The period of the measurement shall be at least the continuous duration of one sub-frame (1ms). For TDD slots with transient periods are not under test.
3. Measure the power of the transmitted signal with a measurement filter of bandwidths according to Table 6.5E.2.3.1.5.1-1 or Table 6.5E.2.3.1.5.2-1. The centre frequency of the filter shall be stepped in continuous steps according to the same table. The measured power shall be recorded for each step. The measurement period shall capture the active TSs.

6.5E.2.3.1D.4.3 Message contents

Message contents are according to TS 38.508-1 [5] subclause 4.6 and 5.4.

6.5E.2.3.1D.5 Test requirement

Table 6.5E.2.3.1D.5-1: Test Tolerance

FFS

6.5E.2.3.1D.5.1 Requirements for network signalling value "NS_33"

When "NS_33" is indicated in the cell, the power of any NR V2X UE emission at each antenna connector shall fulfil requirements in Table 6.5E.2.3.1D.5.1-1.

Table 6.5E.2.3.1D.5.1-1: Additional spectrum mask requirements for 10MHz channel bandwidth

Spectrum emission limit (dBm EIRP)/ Channel bandwidth		
Δf_{OOB} (MHz)	10 MHz	Measurement bandwidth
$\pm 0-0.5$	$[-13 - 12 \left(\frac{ \Delta f_{OOB} }{MHz} \right)] + TT$	100 kHz
$\pm 0.5-5$	$[-19 - \frac{16}{9} \left(\frac{ \Delta f_{OOB} }{MHz} - 0.5 \right)] + TT$	100 kHz
$\pm 5-10$	$[-27 - 2 \left(\frac{ \Delta f_{OOB} }{MHz} - 5.0 \right)] + TT$	100 kHz
NOTE 1: TT for each frequency and channel bandwidth is specified in Table 6.5E.2.3.1D.5-1.		

6.5E.2.3.1D.5.2 Requirements for network signalling value "NS_52"

When "NS_52" is indicated in the cell, the power of any NR V2X UE emission at each antenna connector shall fulfil requirements in Table 6.5E.2.3.1D.5.2-1.

Table 6.5E.2.3.1D.5.2-1: Additional spectrum mask requirements for 40MHz channel bandwidth (fc = 5885MHz)

Δf_{OOB} (MHz)	Emission Limit (dBm)	Measurement Bandwidth
$\pm 0-2$	-32+TT	100kHz
$\pm 2-10$	-36+TT	100kHz
$\pm 10-20$	-38+TT	100kHz
$\pm 20-40$	-43+TT	100kHz
$\pm 40-100$	-50+TT	100kHz
NOTE 1: TT for each frequency and channel bandwidth is specified in Table 6.5E.2.3.1D.5-1.		

6.5E.2.4 Adjacent channel leakage ratio for V2X

6.5E.2.4.1 Adjacent channel leakage ratio for V2X / non-concurrent operation

Editor's Note: This clause is incomplete for PSFCH and PSBCH measurement. The following aspects are either missing or not yet determined:

- Measurement period of PSFCH and PSBCH is FFS.

6.5E.2.4.1.1 Test purpose

To verify that V2X UE transmitter does not cause unacceptable interference to adjacent channels in terms of Adjacent Channel Leakage Power Ratio (ACLR) when UE is configured for NR V2X sidelink transmissions non-concurrent with NR uplink transmissions.

6.5E.2.4.1.2 Test applicability

This test case applies to all types of NR UE release 16 and forward that support NR V2X sidelink communication with non-concurrent operation.

6.5E.2.4.1.3 Minimum conformance requirements

Adjacent Channel Leakage power Ratio (ACLR) is the ratio of the filtered mean power centred on the assigned channel frequency to the filtered mean power centred on an adjacent channel frequency.

For NR V2X UE, the existing ACLR requirement for NR uplink transmission in clause 6.5.2.4 are applied for NR V2X UE for NR V2X operating bands in 5.2E.1-1.

The normative reference for this requirement is TS 38.101-1 [2] clause 6.5E.2.4.

6.5E.2.4.1.4 Test description

6.5E.2.4.1.4.1 Initial conditions

Initial conditions are a set of test configurations the UE needs to be tested in and the steps for the SS to take with the UE to reach the correct measurement state.

The initial test configurations consist of environmental conditions, test frequencies, test channel bandwidths and sub-carrier spacing based on NR operating bands specified in Table 5.2E.1-1 and Table 5.3.5-1. All of these configurations shall be tested with applicable test parameters for each combination of test channel bandwidth and sub-carrier spacing, and are shown in the test configuration tables in clause 6.2E.2.1.4. The details of the V2X reference measurement channels (RMCs) are specified in Annex A.7.5 and the GNSS configuration in TS 38.508-1 [5] subclause 4.11.

Table 6.5E.2.4.1.4.1-1: Void

1. Connect the SS and GNSS simulator to the UE antenna connectors as shown in TS 38.508-1 [5] Annex A, Figure A.3.1.9.1 for TE diagram and section A.3.2.7 for UE diagram.
2. The parameter settings for the NR sidelink transmission over PC5 are pre-configured according to TS 38.508-1 [5] subclause 4.10. Message content exceptions are defined in clause 6.5E.2.4.1.4.3.
3. The V2X Reference Measurement Channel is set according to the test configuration tables in clause 6.2E.2.1.4.1.
4. The GNSS simulator is configured for Scenario #1: static in Geographical area #1, as defined in TS 38.508-1 [5] Table 4.11.2-2. Geographical area #1 is also pre-configured in the UE.
5. Propagation conditions are set according to Annex B.0.

6.5E.2.4.1.4.2 Test procedure

Subtest 1: PSCCH/PSSCH

1. Ensure the UE is in state *Out_of_Coverage* with generic procedure parameters *Sidelink On*, *Test Loop Function On* with UE test loop mode E closed for *Transmit Mode* according to TS 38.508-1 [5] clause 4.5.

2. The UE starts to perform the NR sidelink communication according to *SL-PreconfigurationNR*. Since the UE has no payload and no loopback data to send the UE sends uplink MAC padding bits on the NR sidelink RMC.
3. Measure the mean power of the UE in the channel bandwidth of the radio access mode according to the test configuration from Table 6.2E.2.1.4.1-1, which shall meet the requirements described in Table 6.2E.2.1.5-1 for Power Class 3 UEs. The period of measurement shall be at least continuous duration of one active sub-frame (1ms) excluding guard symbols.
4. Measure the rectangular filtered mean power for assigned NR V2X sidelink.
5. Measure the rectangular filtered mean power of the first NR adjacent channel on both lower and upper side of the assigned NR V2X sidelink channel, respectively.
6. Calculate the ratios of the power between the values measured in step 4 over step 5 for lower and upper NR_{ACLR} .

Subtest 2: PSFCH

1. Ensure the UE is in state *Out_of_Coverage* with generic procedure parameters *Sidelink On*, Cast type *Unicast*, Test Loop Function *On* with UE test loop mode E closed for *Receive Mode* according to TS 38.508-1 [5] clause 4.5.
2. The UE starts to perform the NR sidelink reception according to *SL-PreconfigurationNR*.
3. The UE's PSFCH transmission occasion is on slot n according to Table 6.2E.2.1.4.1-2. SS transmits PSSCH on combination of slot and subchannel as below:
 - a) Test ID 1: slot n-6, Lowest sub-channel
 - b) Test ID 2: slot n-3, Highest sub-channel
 - c) Test ID 3: slot n-6 and n-5, Lowest sub-channel
 - d) Test ID 4: slot n-4 and n-3, Highest sub-channel
 - e) Test ID 5: slot n-6, Highest sub-channel and slot n-3, Highest sub-channel
4. Measure the mean power of the UE on slot n in the channel bandwidth according to the test configuration from Table 6.2E.2.1.4.1-2, which shall meet the requirements described in Table 6.2E.2.1.5-2 for Power Class 3 UEs. The period of measurement is FFS.
5. Measure the rectangular filtered mean power for assigned NR V2X sidelink.
6. Measure the rectangular filtered mean power of the first NR adjacent channel on both lower and upper side of the assigned NR V2X sidelink channel, respectively.
7. Calculate the ratios of the power between the values measured in step 5 over step 6 for lower and upper NR_{ACLR} .

Subtest 3: S-SSB

1. Ensure the UE is in state *Out_of_Coverage* with generic procedure parameters *Sidelink On* according to TS 38.508-1 [5] clause 4.5. The UE is synchronized to GNSS,
2. The UE transmits PSBCH according *SL-PreconfigurationNR*.
3. Measure the mean power of the S-SSB in the channel bandwidth according to the test configuration from Table 6.2E.2.1.4.1-3, which shall meet the requirements described in Table 6.2E.2.1.5-3 for Power Class 3 UEs. The period of measurement is FFS.
4. Measure the rectangular filtered mean power for assigned NR V2X sidelink.
5. Measure the rectangular filtered mean power of the first NR adjacent channel on both lower and upper side of the assigned NR V2X sidelink channel, respectively.
6. Calculate the ratios of the power between the values measured in step 4 over step 5 for lower and upper NR_{ACLR} .

6.5E.2.4.1.4.3 Message contents

Message contents are according to TS 38.508-1 [5] subclause 4.10.

6.5E.2.4.1.5 Test requirement

The measured mean power of V2X UE in the channel bandwidth, derived in step 6 of Subtest 1, step 7 of Subtest 2 and step 6 of Subtest 3, shall fulfil requirements in clause 6.2E.2.1.5, and if the measured adjacent channel power is greater than -50 dBm then the measured NR ACLR, derived in step 5, shall be higher than the limits in Table 6.5E.2.4.1.5-2.

Table 6.5E.2.4.1.5-1: Measurement bandwidth

NR channel bandwidth / NR ACLR measurement bandwidth												
	5 MHz	10 MHz	15 MHz	20 MHz	25 MHz	30 MHz	40 MHz	50 MHz	60 MHz	80 MHz	90 MHz	100 MHz
NR ACLR measurement bandwidth	4.515	9.375	14.235	19.095	23.955	28.815	38.895	48.615	58.35	78.15	88.23	98.31

Table 6.5E.2.4.1.5-2: NR ACLR requirement for V2X / non-concurrent operation

	Power class 1	Power class 2	Power class 3
NR ACLR			30 - TT dB
NOTE 1: TT for each frequency and channel bandwidth is specified in Table 6.5E.2.4.1.5-3.			

Table 6.5E.2.4.1.5-3: Test Tolerance

FFS

6.5E.2.4.1D Adjacent channel leakage ratio for V2X / non-concurrent operation / SL-MIMO

Editor's Note:

- Test config table is FFS
- Uplink RMC is TBD in RAN4
- Connection diagram is TBD
- Preconfiguration is TBD in 38.508-1
- Test state and generic procedure are TBD in 38.508-1

6.5E.2.4.1D.1 Test purpose

To verify that V2X UE transmitter does not cause unacceptable interference to adjacent channels in terms of Adjacent Channel Leakage Power Ratio (ACLR) when UE is configured for NR V2X sidelink MIMO transmissions non-concurrent with NR uplink transmissions.

6.5E.2.4.1D.2 Test applicability

This test case applies to all types of NR UE release 16 and forward that support NR V2X sidelink MIMO communication with non-concurrent operation.

6.5E.2.4.1D.3 Minimum conformance requirements

For NR V2X UE with two transmit antenna connectors, the requirements specified for single carrier shall apply to each transmit antenna connector. The requirements shall be met with SL MIMO configurations described in clause 6.2D.1.

If V2X UE transmits on one antenna connector at a time, the requirements specified for single carrier shall apply to the active antenna connector.

The normative reference for this requirement is TS 38.101-1 [2] clause 6.5E.2.4.

6.5E.2.4.1D.4 Test description

6.5E.2.4.1D.4.1 Initial conditions

Initial conditions are a set of test configurations the UE needs to be tested in and the steps for the SS to take with the UE to reach the correct measurement state.

The initial test configurations consist of environmental conditions, test frequencies, test channel bandwidths and sub-carrier spacing based on NR operating bands specified in Table 5.3.5-1. All of these configurations shall be tested with applicable test parameters for each combination of test channel bandwidth and sub-carrier spacing, and are shown in the test configuration tables in clause 6.2E.2.1D.4.1. The details of the V2X reference measurement channels (RMCs) are specified in Annexes TBD.

Table 6.5E.2.4.1D.4.1-1: Void

1. Connect the SS and GNSS simulator to the UE antenna connectors as shown in TS 38.508-1 [5] Annex A, Figure TBD for TE diagram and section TBD for UE diagram.
2. The parameter settings for the V2X sidelink transmission over PC5 are pre-configured according to TS 38.508-1 [5] subclause TBD. Message content exceptions are defined in clause 6.5E.2.4.1.4.3.
3. The V2X Reference Measurement Channel is set according to the test configuration tables in clause 6.2E.2.1D.4.1.
4. The GNSS simulator is configured for Scenario #1: static in Geographical area #1, as defined in TS36.508 [25] Table 4.11.2-2. Geographical area #1 is also pre-configured in the UE.
5. Propagation conditions are set according to Annex B.0.
6. Ensure the UE is in state TBD.

6.5E.2.4.1D.4.2 Test procedure

1. The V2X UE schedules the V2X RMC with transmission power at P_{UMAX} level according to *SL-V2X-Preconfiguration* which is in line with the test configuration in the test configuration tables in clause 6.2E.2.1D.4.1;
2. Measure the sum of mean power of the UE at both antenna connector in the channel bandwidth of the radio access mode according to the test configuration, as measured in 6.2E.2.1D.4.2, which shall meet the requirements in clause 6.2E.2.1D.5 as appropriate.
3. Measure the rectangular filtered mean power for assigned NR V2X sidelink at each antenna connector.
4. Measure the rectangular filtered mean power of the first NR adjacent channel on both lower and upper side of the assigned NR V2X sidelink channel at each antenna connector, respectively.
5. Calculate the ratios of the power between the values measured in step 3 over step 4 for lower and upper NR_{ACLR} for each antenna connector.

6.5E.2.4.1D.4.3 Message contents

Message contents are according to TS 38.508-1 [5] subclause 4.6 and 5.4.

6.5E.2.4.1D.5 Test requirement

The measured sum of mean power of V2X UE at both antenna connector in the channel bandwidth, derived in step 2, shall fulfil requirements in clause 6.2E.2.1D.5, and if the measured adjacent channel power is greater than -50 dBm then the measured NR ACLR for each antenna connector, derived in step 5, shall be higher than the limits in Table 6.5E.2.4.1D.5-2.

Table 6.5E.2.4.1D.5-1: Measurement bandwidth

NR channel bandwidth / NR ACLR measurement bandwidth												
	5 MHz	10 MHz	15 MHz	20 MHz	25 MHz	30 MHz	40 MHz	50 MHz	60 MHz	80 MHz	90 MHz	100 MHz
NR ACLR measurement bandwidth	4.515	9.375	14.235	19.095	23.955	28.815	38.895	48.615	58.35	78.15	88.23	98.31

Table 6.5E.2.4.1D.5-2: NR ACLR requirement for V2X / non-concurrent operation / SL-MIMO

	Power class 1	Power class 2	Power class 3
NR ACLR			30 - TT dB
NOTE 1: TT for each frequency and channel bandwidth is specified in Table 6.5E.2.4.1D.5-3.			

Table 6.5E.2.4.1D.5-3: Test Tolerance

FFS

6.5E.3 Spurious emissions for V2X

6.5E.3.1 General spurious emissions for V2X

6.5E.3.2 Spurious emissions for UE co-existence for V2X

6.5E.3.2.1 Spurious emissions for UE co-existence for V2X / non-concurrent operation

Editor's Note:

- Test config table is FFS

6.5E.3.2.1.1 Test purpose

To verify that UE transmitter does not cause unacceptable interference to co-existing systems for the specified bands which has specific requirements in terms of transmitter spurious emissions.

6.5E.3.2.1.2 Test applicability

This test case applies to all types of NR UE release 16 and forward that support NR V2X sidelink communication with non-concurrent operation.

6.5E.3.2.1.3 Minimum conformance requirements

When UE is configured for NR V2X sidelink transmissions non-concurrent with NR uplink transmissions for NR V2X operating bands specified in Table 5.2E.1-1, the requirements in clause 6.5.3.2 shall apply for NR V2X sidelink transmission.

The normative reference for this requirement is TS 38.101-1 [2] clause 6.5E.3.2.

6.5E.3.2.1.4 Test description

6.5E.3.2.1.4.1 Initial conditions

Initial conditions are a set of test configurations the UE needs to be tested in and the steps for the SS to take with the UE to reach the correct measurement state.

The initial test configurations consist of environmental conditions, test frequencies, test channel bandwidths and sub-carrier spacing based on NR operating bands specified in Table 5.2E.1-1 and Table 5.3.5-1. All of these configurations shall be tested with applicable test parameters for each combination of test channel bandwidth and sub-carrier spacing, and are shown in table 6.5E.3.2.1.4.1-1. The details of the V2X reference measurement channels (RMCs) are specified in Annexes A.7.5 and the GNSS configuration in TS 38.508-1 [5] subclause 4.11.

Table 6.5E.3.2.1.4.1-1: Test Configuration Table

FFS

1. Connect the SS and GNSS simulator to the UE antenna connectors as shown in TS 38.508-1 [5] Annex A, Figure A.3.1.9.1 for TE diagram and section A.3.2.7 for UE diagram.
2. The parameter settings for the NR sidelink transmission over PC5 are pre-configured according to TS 38.508-1 [5] subclause 4.10. Message content exceptions are defined in clause 6.5E.3.2.1.4.3.
3. The V2X Reference Measurement Channel is set according to Table 6.5E.3.2.1.4.1-1.
4. The GNSS simulator is configured for Scenario #1: static in Geographical area #1, as defined in TS 38.508-1 [5] Table 4.11.2-2. Geographical area #1 is also pre-configured in the UE.
5. Propagation conditions are set according to Annex B.0.
6. Ensure the UE is in state *Out_of_Coverage* with generic procedure parameters *Sidelink On*, *Test Loop Function On* with UE test loop mode E closed for *Transmit Mode* according to TS 38.508-1 [5] clause 4.5.

6.5E.3.2.1.4.2 Test procedure

1. The V2X UE schedules the V2X RMC with transmission power at P_{UMAX} level according to *SL-PreconfigurationNR* which is in line with the test configuration in Table 6.5E.3.2.1.4.1-1.
2. Measure the power of the transmitted signal with a measurement filter of bandwidths according to Table 6.5.3.2.3-2. The centre frequency of the filter shall be stepped in contiguous steps according to Table 6.5.3.2.3-2. The measured power shall be verified for each step. The measurement period shall capture the active time slots.

6.5E.3.2.1.4.3 Message contents

Message contents are according to TS 38.508-1 [5] subclause 4.10.

6.5E.3.2.1.5 Test requirement

Unless otherwise stated, the spurious emission limits apply for the frequency ranges that are more than Δf_{OOB} (MHz) in Tables 6.5.3.2.3-2 from the edge of the channel bandwidth. The spurious emission limits in Tables 6.5.3.2.3-2 apply for all transmitter band configurations (NRB) and channel bandwidths.

The measured average power of spurious emission, derived in step 2, shall not exceed the described value in Table 6.5.3.2.3-2.

6.5E.3.2.1D Spurious emissions for UE co-existence for V2X / non-concurrent operation / SL-MIMO

Editor's Note:

- Test config table is FFS
- Uplink RMC is TBD in RAN4
- Connection diagram is TBD
- Preconfiguration is TBD in 38.508-1
- Test state and generic procedure are TBD in 38.508-1

6.5E.3.2.1.1D Test purpose

To verify that UE transmitter does not cause unacceptable interference to co-existing systems for the specified bands which has specific requirements in terms of transmitter spurious emissions.

6.5E.3.2.1.2D Test applicability

This test case applies to all types of NR UE release 16 and forward that support NR V2X sidelink MIMO communication with non-concurrent operation.

6.5E.3.2.1.3D Minimum conformance requirements

For NR V2X UE with two transmit antenna connectors, the requirements specified for single carrier shall apply to each transmit antenna connector. The requirements shall be met with the SL MIMO configurations described in clause 6.2D.1.

The normative reference for this requirement is TS 38.101-1 [2] clause 6.5E.3.2.

6.5E.3.2.1D.4 Test description

6.5E.3.2.1D.4.1 Initial conditions

Initial conditions are a set of test configurations the UE needs to be tested in and the steps for the SS to take with the UE to reach the correct measurement state.

The initial test configurations consist of environmental conditions, test frequencies, test channel bandwidths and sub-carrier spacing based on NR operating bands specified in Table 5.3.5-1. All of these configurations shall be tested with applicable test parameters for each combination of test channel bandwidth and sub-carrier spacing, and are shown in table 6.5E.3.2.1D.4.1-1. The details of the V2X reference measurement channels (RMCs) are specified in Annexes TBD.

Table 6.5E.3.2.1D.4.1-1: Test Configuration Table

FFS

1. Connect the SS and GNSS simulator to the UE antenna connectors as shown in TS 38.508-1 [5] Annex A, Figure TBD for TE diagram and section TBD for UE diagram.
2. The parameter settings for the V2X sidelink transmission over PC5 are pre-configured according to TS 38.508-1 [5] subclause TBD. Message content exceptions are defined in clause 6.5E.3.2.1D.4.3.
3. The V2X Reference Measurement Channel is set according to Table 6.5E.3.2.1D.4.1-1.
4. The GNSS simulator is configured for Scenario #1: static in Geographical area #1, as defined in TS36.508 [25] Table 4.11.2-2. Geographical area #1 is also pre-configured in the UE.
5. Propagation conditions are set according to Annex B.0.
6. Ensure the UE is in state TBD.

6.5E.3.2.1D.4.2 Test procedure

1. The V2X UE schedules the V2X RMC with transmission power at P_{UMAX} level according to *SL-V2X-Preconfiguration* which is in line with the test configuration in Table 6.5E.3.2.1D.4.1-1.
2. Measure the power of the transmitted signal at each antenna connector with a measurement filter of bandwidths according to Table 6.5.3.2.3-2. The centre frequency of the filter shall be stepped in contiguous steps according to Table 6.5.3.2.3-2. The measured power shall be verified for each step. The measurement period shall capture the active time slots.

6.5E.3.2.1D.4.3 Message contents

Message contents are according to TS 38.508-1 [5] subclause 4.6 and 5.4.

6.5E.3.2.1D.5 Test requirement

Unless otherwise stated, the spurious emission limits apply for the frequency ranges that are more than Δf_{OOB} (MHz) in Tables 6.5.3.2.3-2 from the edge of the channel bandwidth. The spurious emission limits in Tables 6.5.3.2.3-2 apply for all transmitter band configurations (NRB) and channel bandwidths.

The measured average power of spurious emission at each antenna connector, derived in step 2, shall not exceed the described value in Table 6.5.3.2.3-2.

6.5E.3.3 Additional spurious emissions requirements for V2X

6.5E.3.3.1 Additional spurious emissions requirements for V2X / non-concurrent operation

Editor's Note:

- Test config table is FFS

6.5E.3.3.1.1 Test purpose

To verify that UE transmitter does not cause unacceptable interference to other channels or other systems in terms of transmitter spurious emissions under the deployment scenarios where additional requirements are specified.

6.5E.3.3.1.2 Test applicability

This test case applies to all types of NR UE release 16 and forward that support NR V2X sidelink communication with non-concurrent operation.

6.5E.3.3.1.3 Minimum conformance requirements

Table 6.5E.3.3.1.3-1: Additional requirements for "NS_33"

Protected band	Frequency range (MHz)			Maximum Level (EIRP ²)	MBW (MHz)	NOTE
Frequency range	5925	-	5950	-30	1	1
Frequency range	5815	-	5855	-30	1	3
NOTE 1: In the frequency range x-5950MHz, SE requirement of -30dBm/MHz should be applied; where x = max (5925, fc + 15), where fc is the channel centre frequency.						
NOTE 2: The EIRP requirement is converted to conducted requirement depend on the supported post antenna connector gain $G_{\text{post connector}}$ declared by the UE following the principle described in annex I in [11].						
NOTE 3: Resolution BW is 10% of the measurement BW and the result should be integrated to achieve the measurement bandwidth. The sweep time shall be set larger than (symbol length)*(number of points in sweep) to improve the measurement accuracy.						

When "NS_33" is configured from pre-configured radio parameters or the cell, and the indication from upper layers has indicated that the UE is within the protection zone of CEN DSRC devices or HDR DSRC devices, the power of any NR V2X UE emission shall fulfil either one of the two sets of conditions.

Table 6.5E.3.3.1.3-2: Requirements for spurious emissions to protect CEN DSRC for V2X UE

	Maximum Transmission Power (dBm EIRP)	Emission Limit in Frequency Range 5795-5815 (dBm/MHz EIRP)
Condition 1	10	-65
Condition 2	10	-45

The normative reference for this requirement is TS 38.101-1 [2] clause 6.5E.3.4.

6.5E.3.3.1.4 Test description

6.5E.3.3.1.4.1 Initial conditions

Initial conditions are a set of test configurations the UE needs to be tested in and the steps for the SS to take with the UE to reach the correct measurement state.

The initial test configurations consist of environmental conditions, test frequencies, test channel bandwidths and sub-carrier spacing based on NR operating bands specified in Table 5.2E.1-1 and Table 5.3.5-1. All of these configurations shall be tested with applicable test parameters for each combination of test channel bandwidth and sub-carrier spacing, and are shown in table 6.5E.3.3.1.4.1-1. The details of the V2X reference measurement channels (RMCs) are specified in Annexes A.7.5 and the GNSS configuration in TS 38.508-1 [5] subclause 4.11.

Table 6.5E.3.3.1.4.1-1: Test Configuration Table for "NS_33"

FFS

1. Connect the SS and GNSS simulator to the UE antenna connectors as shown in TS 38.508-1 [5] Annex A, Figure A.3.1.9.1 for TE diagram and section A.3.2.7 for UE diagram.
2. The parameter settings for the NR sidelink transmission over PC5 are pre-configured according to TS 38.508-1 [5] subclause 4.10. Message content exceptions are defined in clause 6.5E.3.3.1.4.3.
3. The V2X Reference Measurement Channel is set according to Table 6.5E.3.3.1.4.1-1.
4. The GNSS simulator is configured for Scenario #1: static in Geographical area #1, as defined in TS 38.508-1 [5] Table 4.11.2-2. Geographical area #1 is also pre-configured in the UE.
5. Propagation conditions are set according to Annex B.0.
6. Ensure the UE is in state *Out_of_Coverage* with generic procedure parameters *Sidelink On*, *Test Loop Function On* with UE test loop mode E closed for *Transmit Mode* according to TS 38.508-1 [5] clause 4.5.

6.5E.3.3.1.4.2 Test procedure

1. The V2X UE schedules the V2X RMC with transmission power at P_{UMAX} level according to *SL-PreconfigurationNR* which is in line with the test configuration in Table 6.5E.3.3.1.4.1-1.
2. Measure the power of the transmitted signal with a measurement filter of bandwidths according to Table 6.5E.3.3.1.3-1. The centre frequency of the filter shall be stepped in contiguous steps according to Table 6.5E.3.3.1.3-1. The measured power shall be verified for each step. The measurement period shall capture the active time slots.

6.5E.3.3.1.4.3 Message contents

Message contents are according to TS 38.508-1 [5] subclause 4.10 with following exceptions.

Table 6.5E.3.3.1.4.3-1: AdditionalSpectrumEmission: Additional spurious emissions test requirement for "NS_33"

Derivation Path: TS 38.508-1 [5] clause 4.6.3, Table 4.6.3-1			
Information Element	Value/remark	Comment	Condition
additionalSpectrumEmission	1 (NS_33)		

6.5E.3.3.1.5 Test requirement

6.5E.3.3.1.5.1 Message contents exceptions (network signalling value "NS_33")

The transmitted spurious emission power derived in step 2 should be converted to EIRP value depend on the supported post antenna connector gain $G_{\text{post connector}}$ declared by the UE following the principle described in annex I in [11]. The EIRP value should not exceed test requirements in Table 6.5E.3.3.1.5.1-1.

Table 6.5E.3.3.1.5.1-1: Test requirements for "NS_33"

Protected band	Frequency range (MHz)			Maximum Level (EIRP ²)	MBW (MHz)
Frequency range	5925	-	5950	-30	1
Frequency range	5815	-	5855	-30	1

6.5F Output RF spectrum emissions for shared spectrum channel access

6.5F.1 Occupied bandwidth for shared spectrum channel access

FFS

6.5F.2 Out of band emission for shared spectrum channel access

6.5F.2.1 General

The Out of band emissions are unwanted emissions immediately outside the assigned channel bandwidth resulting from the modulation process and non-linearity in the transmitter but excluding spurious emissions. This out of band emission limit is specified in terms of a spectrum emission mask and an adjacent channel leakage power ratio.

To improve measurement accuracy, sensitivity and efficiency, the resolution bandwidth may be smaller than the measurement bandwidth. When the resolution bandwidth is smaller than the measurement bandwidth, the result should be integrated over the measurement bandwidth in order to obtain the equivalent noise bandwidth of the measurement bandwidth.

6.5F.2.2 Spectrum emission mask for operation with shared spectrum channel access

Editor's Note:

- Test config table is FFS

- Message content is TBD

The spectrum emission mask of the UE applies to frequencies (Δf_{OOB}) starting from the \pm edge of the assigned NR channel bandwidth. For frequencies offset greater than Δf_{OOB} , the spurious requirements in subclause 6.5.3 are applicable.

NOTE: For measurement conditions at the edge of each frequency range, the lowest frequency of the measurement position in each frequency range should be set at the lowest boundary of the frequency range plus MBW/2. The highest frequency of the measurement position in each frequency range should be set at the highest boundary of the frequency range minus MBW/2. MBW denotes the measurement bandwidth defined for the protected band.

6.5F.2.2.1 Test purpose

To verify that the power of any UE emission shall not exceed specified level for the specified channel bandwidth when UE is operating with shared spectrum channel access.

6.5F.2.2.2 Test applicability

This test case applies to all types of NR UE release 16 and forward that support NR standalone shared spectrum channel access.

6.5F.2.2.3 Minimum conformance requirements

Instead of the general spectrum emission mask requirement in clause 6.5.2.2, when operating with shared spectrum channel access the relative power of any UE emission shall not exceed the levels specified in Table 6.5F.2.2.3-1 for the specified channel bandwidth or -30 dBm/MHz whichever is the greatest. The spectrum emission mask for operation with shared spectrum channel access is defined relative to the maximum power density in a 1 MHz measurement bandwidth within the channel bandwidth.

The spectrum emission mask for operation with shared spectrum channel access applies to frequencies (Δf_{OOB}) starting from the \pm edge of the assigned channel bandwidth. For frequencies offset greater than Δf_{OOB} , the spurious requirements in clause 6.5.3 are applicable.

Table 6.5F.2.2.3-1: Spectrum emission mask for operation with shared spectrum channel access

Spectrum emission limit (dBr) / Channel bandwidth						
Δf_{OOB} (MHz)	10 MHz	20 MHz	40 MHz	60 MHz	80 MHz	Measurement bandwidth (MBW)
$\pm 0-1$	$-20 \Delta f_{OOB} $					$[100\text{kHz}]^3$
$\pm 1-5$	NOTE 1	NOTE 1	NOTE 1	NOTE 1	NOTE 1	1 MHz
$\pm 5-10$	NOTE 2					
$\pm 10-20$	-40	NOTE 2				
$\pm 20-30$		-40	NOTE 2			
$\pm 30-40$				NOTE 2		
$\pm 40-50$			-40	NOTE 2		
$\pm 50-60$						
$\pm 60-70$				-40		
$\pm 70-80$						
$\pm 80-100$					-40	
NOTE 1: Given as: $-20 - \left(\frac{8}{A}\right) \Delta f_{OOB} - 1 $ where $A = \left(\text{Channel Bandwidth}/2\right) - 1$ NOTE 2: Given as: $-16 - \left(\frac{12}{B}\right) \Delta f_{OOB} $ where $B = \left(\text{Channel Bandwidth}/2\right)$ NOTE 3: The measured value shall be scaled by a factor equal to the ratio of the reference bandwidth (1 MHz) to the measurement bandwidth before the emission limit (dBr) is applied. NOTE 4: The carrier leakage exceptions from Table 6.4F.2.3-1 apply and carrier leakage contribution shall be removed prior to setting the 0dBr level of the mask, the reported carrier frequency location in <i>txDirectCurrentLocation</i> field of the <i>UplinkTxDirectCurrentBWP</i> can be used to cancel the carrier leakage contribution. If <i>txDirectCurrentLocation</i> is not available or is reported with value 3300 or 3301, a carrier frequency location at the centre of the channel shall be assumed.						

For measurement conditions at the edge of each frequency range, the lowest frequency of the measurement position in each frequency range should be set at the lowest boundary of the frequency range plus MBW/2. The highest frequency of the measurement position in each frequency range should be set at the highest boundary of the frequency range minus MBW/2.

6.5F.2.2.3.1 Spectrum emission mask for non-transmitted channels

In the case of non-transmitted 20 MHz channel(s) on the edges of an assigned channel bandwidth the spectrum emission mask for operation with shared spectrum channel access, specified in Table 6.5F.2.2.3-1, is applied by using the total bandwidth of the remaining transmitted channels. The spectrum emission mask for non-transmitted channels is floored at -28dBr.

The relative power of any UE emission shall not exceed the most stringent levels given by the spectrum emission mask for operation with shared spectrum channel access with full channel bandwidth and the spectrum emission mask for non-transmitted channels with the channel bandwidth of the transmitted channels in the case of non-transmitted channels at the edge of an assigned channel bandwidth.

An exception to the spectrum emission mask for non-transmitted channels allows a single [2] MHz bandwidth to extend to [-28] dBc relative to total transmit power, or [-20] dBm, whichever is the greatest.

The normative reference for this requirement is TS 38.101-1 [2] clause 6.5F.2.2.

6.5F.2.2.4 Test description

6.5F.2.2.4.1 Initial conditions

Initial conditions are a set of test configurations the UE needs to be tested in and the steps for the SS to take with the UE to reach the correct measurement state.

The initial test configurations consist of environmental conditions, test frequencies, test channel bandwidths and sub-carrier spacing based on NR operating bands with shared spectrum channel access specified in table 5.3.5-1. All of these configurations shall be tested with applicable test parameters for each combination of channel bandwidth and sub-carrier spacing, are shown in table 6.5F.2.2.4.1-1. The details of the uplink reference measurement channels (RMCs) are specified in Annexes A.2. Configurations of PDSCH and PDCCH before measurement are specified in Annex C.2.

Table 6.5F.2.2.4.1-1: Test Configuration Table

Default Conditions						
Test Environment as specified in TS 38.508-1 [5] subclause 4.1					Normal	
Test Frequencies as specified in TS 38.508-1 [5] subclause 4.3.1					FFS	
Test Channel Bandwidths as specified in TS 38.508-1 [5] subclause 4.3.1					FFS	
Test SCS as specified in Table 5.3.5-1					FFS	
Test Parameters for Channel Bandwidths						
Test ID	Freq	ChBw	SCS	Downlink Configuration	Uplink Configuration	
		Default	Default	N/A for Spectrum Emission Mask test case	Modulation	RB allocation

1. Connect the SS to the UE antenna connectors as shown in TS 38.508-1 [5] Annex A, Figure A.3.1.1.1 for TE diagram and section A.3.2 for UE diagram.
2. The parameter settings for the cell are set up according to TS 38.508-1 [5] subclause 4.4.3.
3. Downlink signals are initially set up according to Annex C.0, C.1, C.2 and uplink signals according to Annex G.0, G.1, G.2, G.3.0.
4. The UL Reference Measurement channels are set according to Table 6.5F.2.2.4.1-1.
5. Propagation conditions are set according to Annex B.0.
6. Ensure the UE is in state RRC_CONNECTED with generic procedure parameters Connectivity *NR*, Connected without release *On*, Test Mode *On* and Test Loop Function *On* according to TS 38.508-1 [5] clause 4.5. Message contents are defined in clause 6.5F.2.2.4.3

6.5F.2.2.4.2 Test procedure

1. SS sends uplink scheduling information for each UL HARQ process via PDCCH DCI format 0_1 for C_RNTI to schedule the UL RMC according to Table 6.5F.2.2.4.1-1. Since the UL has no payload and no loopback data to send the UE sends uplink MAC padding bits on the UL RMC.
2. Send continuously power control “up” commands to the UE until the UE transmits at PUMAX level. Allow at least 200ms for the UE to reach PUMAX level.
3. Measure the mean power of the UE in the channel bandwidth of the radio access mode according to the test configuration, which shall meet the requirements described in Table 6.2F.1.5-1. The period of the measurement shall be at least the continuous duration of 1ms over consecutive active uplink slots.

4. Measure the power of the transmitted signal with a measurement filter of bandwidths according to table 6.5F.2.2.5-1. The centre frequency of the filter shall be stepped in continuous steps according to the same table. The measured power shall be recorded for each step. The measurement period shall capture the active TSs.

NOTE 1: When switching to DFT-s-OFDM waveform, as specified in the test configuration Table 6.5F.2.2.4.1-1, send an NR RRCReconfiguration message according to TS 38.508-1 [5] clause 4.6.3 Table 4.6.3-118 PUSCH-Config with TRANSFORM_PRECODER_ENABLED condition.

6.5F.2.2.4.3 Message contents

Message contents are according to TS 38.508-1 [5] subclause 4.6 with the following exceptions:

FFS

6.5F.2.2.5 Test requirement

The measured UE mean power in the channel bandwidth, derived in step 3, shall fulfil requirements in Table 6.2F.1.5-1, and the power of any UE emission shall fulfil requirements in Table 6.5F.2.2.5-1.

Table 6.5F.2.2.5-1: General NR spectrum emission mask

FFS

Table 6.5F.2.2.5-2: Test Tolerance (Spectrum Emission Mask)

	$f \leq 3.0\text{GHz}$	$3.0\text{GHz} < f \leq 4.2\text{GHz}$	$4.2\text{GHz} < f \leq 6.0\text{GHz}$	$6.0\text{GHz} < f \leq 7.125\text{GHz}$
BW \leq 100MHz	1.5 dB	1.8 dB	1.8 dB	TBD

NOTE: As a general rule, the resolution bandwidth of the measuring equipment should be equal to the measurement bandwidth. However, to improve measurement accuracy, sensitivity and efficiency, the resolution bandwidth may be smaller than the measurement bandwidth. When the resolution bandwidth is smaller than the measurement bandwidth, the result should be integrated over the measurement bandwidth in order to obtain the equivalent noise bandwidth of the measurement bandwidth.

6.5F.2.4 Adjacent channel leakage ratio for operation with shared spectrum channel access

Adjacent Channel Leakage power Ratio (ACLR) is the ratio of the filtered mean power centred on the assigned channel frequency to the filtered mean power centred on an adjacent channel frequency.

To improve measurement accuracy, sensitivity and efficiency, the resolution bandwidth may be smaller than the measurement bandwidth. When the resolution bandwidth is smaller than the measurement bandwidth, the result should be integrated over the measurement bandwidth in order to obtain the equivalent noise bandwidth of the measurement bandwidth.

6.5F.2.4.1 Shared spectrum channel access ACLR

Editor's Note: The following aspects are not yet determined:

- The referred test case MPR(6.2F.2) is TBD
- Test configuration and TP analysis are TBD
- MU and TT for >6GHz (band n96) are TBD.
- RMC in Annex A.
- Test coverage for UL-MIMO
- Message exceptions

- Test state and generic procedure are TBD in 38.508-1

6.5F.2.4.1.1 Test purpose

To verify that UE transmitter does not cause unacceptable interference to adjacent channels in terms of Adjacent Channel Leakage power Ratio (ACLR).

6.5F.2.4.1.2 Test applicability

This test case applies to all types of NR UE release 16 and forward that support NR standalone operation with shared spectrum channel access.

6.5F.2.4.1.3 Minimum conformance requirements

The Adjacent Channel Leakage power Ratio is the ratio of the filtered mean power centred on the assigned channel frequency to the filtered mean power centred on an adjacent channel frequency at nominal channel spacing. The assigned channel power and adjacent channel power are measured with rectangular filters with measurement bandwidths specified in Table 6.5.2.4.1.3-1.

Instead of the general ACLR requirement in clause 6.5.2.4, if the measured adjacent channel power is greater than -47 dBm then the ACLR shall be higher than the value specified in Table 6.5F.2.4.1.3-1.

Table 6.5F.2.4.1.3-1: Shared spectrum channel access ACLR requirement

	Power class 5
ACLR	27 dB

The normative reference for this requirement is TS 38.101-1 [2] clause 6.5F.2.4.1.

6.5F.2.4.1.4 Test description

6.5F.2.4.1.4.1 Initial conditions

Initial conditions are a set of test configurations the UE needs to be tested in and the steps for the SS to take with the UE to reach the correct measurement state.

The initial test configurations consist of environmental conditions, test frequencies, test channel bandwidths and sub-carrier spacing based on NR operating bands specified in Table 5.3.5-1. All of these configurations shall be tested with applicable test parameters for each combination of channel bandwidth and sub-carrier spacing, are shown in the test configuration tables in clause 6.2F.2.4.1[TBD]. The details of the uplink reference measurement channels (RMCs) are specified in Annexes A.2. Configurations of PDSCH and PDCCH before measurement are specified in Annex C.2

Table 6.5F.2.4.1.4.1-1: Void

1. Connect the SS to the UE antenna connectors as shown in TS 38.508-1 [5] Annex A, Figure A.3.1.1.1 for TE diagram and section A.3.2 for UE diagram.
2. The parameter settings for the cell are set up according to TS 38.508-1 [5] subclause 4.4.3.
3. Downlink signals are initially set up according to Annex C.0, C.1, C.2, and uplink signals according to Annex G.0, G.1, G.2, G.3.0.
4. The UL Reference Measurement channels are set according to the test configuration tables in clause 6.2F.2.4.1[TBD].
5. Propagation conditions are set according to Annex B.0.
6. Ensure the UE is in state RRC_CONNECTED with generic procedure parameters Connectivity *NR*, Connected without release *On*, Test Mode *On* and Test Loop Function *On* according to TS 38.508-1 [5] clause 4.5. Message contents are defined in clause 6.5F.2.4.1.4.3.

6.5F.2.4.1.4.2 Test procedure

1. SS sends uplink scheduling information for each UL HARQ process via PDCCH DCI format 0_1 for C_RNTI to schedule the UL RMC according to the test configuration tables in clause 6.2F.2.4.1[TBD]. Since the UL has no payload and no loopback data to send the UE sends uplink MAC padding bits on the UL RMC.
2. Send continuously power control “up” commands to the UE until the UE transmits at P_{UMAX} level. Allow at least 200ms for the UE to reach P_{UMAX} level.
3. Measure the mean power of the UE in the channel bandwidth of the radio access mode according to the test configuration, as measured in step 3 of 6.2F.2.4.2[TBD], which shall meet the requirements in clause 6.2F.2.5[TBD] as appropriate.
4. Measure the rectangular filtered mean power for the assigned NR channel.
5. Measure the rectangular filtered mean power of the first NR adjacent channel on both lower and upper side of the assigned NR channel, respectively.
6. Calculate the ratios of the power between the values measured in step 4 over step 5 for lower and upper NR ACLR, respectively.

NOTE 1: When switching to DFT-s-OFDM waveform, as specified in the test configuration tables in clause 6.2F.2.4.1[TBD], send an NR RRCReconfiguration message according to TS 38.508-1 [5] clause 4.6.3 Table 4.6.3-118 PUSCH-Config with TRANSFORM_PRECODER_ENABLED condition.

6.5F.2.4.1.4.3 Message contents

Message contents are according to TS 38.508-1 [5] subclause 4.6 and 5.4 with the following exceptions:

FFS

6.5F.2.4.1.5 Test requirement

The measured UE mean power in the channel bandwidth, derived in step 3, shall fulfil requirements in clause 6.2F.2.5[TBD], and if the measured adjacent channel power is greater than -50 dBm then the measured NR ACLR, derived in step 6, shall be higher than the limits in Table 6.5F.2.4.1.5-2.

Table 6.5F.2.4.1.5-1: NR ACLR measurement bandwidth

NR channel bandwidth / NR ACLR measurement bandwidth													
	5 MHz	10 MHz	15 MHz	20 MHz	25 MHz	30 MHz	40 MHz	50 MHz	60 MHz	70 MHz	80 MHz	90 MHz	100 MHz
NR ACLR measurement bandwidth (MHz)	4.515	9.375	14.235	19.095	23.955	28.815	38.895	48.615	58.35	68.07	78.15	88.23	98.31

Table 6.5.2.4.1.5-2: NR ACLR requirement

	Power class 5
NR ACLR	27 - TT dB
NOTE 1: TT for each frequency and channel bandwidth is specified in Table 6.5.2.4.1.5-3.	

Table 6.5.2.4.1.5-3: Test Tolerance (TT) (NR ACLR)

	f ≤ 3.0GHz	3.0GHz < f ≤ 4.2GHz	4.2GHz < f ≤ 5.925GHz	5.925GHz < f ≤ 7.125GHz
BW ≤ 100MHz	0.8 dB	0.8 dB	0.8 dB	TBD

6.5F.3 Spurious emissions for shared spectrum channel access

Spurious emissions are emissions which are caused by unwanted transmitter effects such as harmonics emission, parasitic emissions, intermodulation products and frequency conversion products, but exclude out of band emissions unless otherwise stated. The spurious emission limits are specified in terms of general requirements in line with SM.329 [9] and NR operating band requirement to address UE co-existence.

To improve measurement accuracy, sensitivity and efficiency, the resolution bandwidth may be smaller than the measurement bandwidth. When the resolution bandwidth is smaller than the measurement bandwidth, the result should be integrated over the measurement bandwidth in order to obtain the equivalent noise bandwidth of the measurement bandwidth.

NOTE: For measurement conditions at the edge of each frequency range, the lowest frequency of the measurement position in each frequency range should be set at the lowest boundary of the frequency range plus MBW/2. The highest frequency of the measurement position in each frequency range should be set at the highest boundary of the frequency range minus MBW/2. MBW denotes the measurement bandwidth defined for the protected band.

6.5F.3.1 General spurious emissions

Editor's Note: This clause is incomplete. The following aspects are either missing or not yet determined

- Test configuration table is FFS

- TP analysis is TBD

- Test state and generic procedure are TBD in 38.508-1

6.5F.3.1.1 Test purpose

To verify that UE transmitter does not cause unacceptable interference to other channels or other systems in terms of transmitter spurious emissions.

6.5F.3.1.2 Test applicability

This test case applies to all types of NR UE release 16 and forward that support NR standalone shared spectrum channel access.

6.5F.3.1.3 Minimum conformance requirements

The requirements for general spurious emission requirements in clause 6.5.3.1 apply.

The normative reference for this requirement is TS 38.101-1 [2] subclause 6.5F.3.1.

6.5F.3.1.4 Test description

6.5F.3.1.4.1 Initial conditions

Initial conditions are a set of test configurations the UE needs to be tested in and the steps for the SS to take with the UE to reach the correct measurement state.

The initial test configurations consist of environmental conditions, test frequencies, test channel bandwidths and sub-carrier spacing based on NR operating bands specified in Table 5.3.5-1. All of these configurations shall be tested with applicable test parameters for each combination of channel bandwidth and sub-carrier spacing, are shown in table 6.5F.3.1.4.1-1. The details of the uplink reference measurement channels (RMCs) are specified in Annexes A.2. Configurations of PDSCH and PDCCH before measurement are specified in Annex C.2.

Table 6.5F.3.1.4.1-1: Test Configuration Table

FFS

1. Connect the SS to the UE antenna connectors as shown in TS 38.508-1 [5] Annex A, Figure A.3.1.1.1 for TE diagram and section A.3.2 for UE diagram.
2. The parameter settings for the cell are set up according to TS 38.508-1 [5] subclause 4.4.3.

3. Downlink signals are initially set up according to Annex C.0, C.1 and C.2, and uplink signals according to Annex G.0, G.1, G.2, G.3.0.
4. The UL Reference Measurement channels are set according to Table 6.5F.3.1.4.1-1.
5. Propagation conditions are set according to Annex B.0.
6. Ensure the UE is in state RRC_CONNECTED with generic procedure parameters Connectivity *NR*, Connected without release *On*, Test Mode *On* and Test Loop Function *On* according to TS 38.508-1 [5] clause 4.5. Message contents are defined in clause 6.5F.3.1.4.3.

6.5F.3.1.4.2 Test procedure

1. SS sends uplink scheduling information for each UL HARQ process via PDCCH DCI format 0_1 for C_RNTI to schedule the UL RMC according to Table 6.5F.3.1.4.1-1. Since the UE has no payload data to send, the UE transmits uplink MAC padding bits on the UL RMC.
2. Send continuously uplink power control "up" commands in the uplink scheduling information to the UE until the UE transmits at P_{UMAX} level.
3. Measure the power of the transmitted signal with a measurement filter of bandwidths according to table 6.5F.3.1.5-1. The centre frequency of the filter shall be stepped in contiguous steps according to table 6.5F.3.1.5-1. The measured power shall be verified for each step. The measurement period shall capture the active time slots.

6.5F.3.1.4.3 Message contents

Message contents are according to TS 38.508-1 [5] subclause 4.6.

6.5F.3.1.5 Test requirement

This clause specifies the requirements for the specified NR standalone shared spectrum channel access for Transmitter Spurious emissions requirement with frequency range as indicated in table 6.5F.3.1.5-1.

Unless otherwise stated, the spurious emission limits apply for the frequency ranges that are more than F_{OOB} (MHz) in Table 6.5.3.1.3-1 from the edge of the channel bandwidth. The spurious emission limits in Table 6.5F.3.1.5-1 apply for all transmitter band configurations (NRB) and channel bandwidths for shared spectrum channel access.

The measured average power of spurious emission, derived in step 3, shall not exceed the described value in Table 6.5F.3.1.5-1.

Table 6.5F.3.1.5-1: General spurious emissions test requirements

Frequency Range	Maximum Level	Measurement bandwidth	NOTE
$9 \text{ kHz} \leq f < 150 \text{ kHz}$	-36 dBm	1 kHz	
$150 \text{ kHz} \leq f < 30 \text{ MHz}$	-36 dBm	10 kHz	
$30 \text{ MHz} \leq f < 1000 \text{ MHz}$	-36 dBm	100 kHz	
$1 \text{ GHz} \leq f < 12.75 \text{ GHz}$	-30 dBm	1 MHz	4
	-25 dBm	1 MHz	3
12.75 GHz \leq f < 5th harmonic of the upper frequency edge of the UL operating band in GHz	-30 dBm	1 MHz	1
$12.75 \text{ GHz} < f < 26 \text{ GHz}$	-30 dBm	1 MHz	2
NOTE 1: Applies for Band that the upper frequency edge of the UL Band more than 2.69 GHz			
NOTE 2: Applies for Band that the upper frequency edge of the UL Band more than 5.2 GHz			

6.5F.3.2 Spurious emissions for UE co-existence

Spurious emissions requirements for UE coexistence are not applicable to bands restricted to stand-alone operation with shared spectrum channel access as identified in Table 5.2-1

6.5G

6.5G.1

6.5G.2

6.5G.2.1

6.5G.2.2

6.5G.2.3 Adjacent channel leakage ratio for Tx Diversity

If UE indicates IE [*txDiversity-r16*], Adjacent Channel Leakage power Ratio (ACLR) is defined as the ratio of sum of the filtered mean power at each antenna connector centred on the assigned channel frequency to sum of the filtered mean power at each antenna connector centred on an adjacent channel frequency.

6.5G.2.3.1 NR ACLR for Tx Diversity

Editor's Note: The following aspects are either missing or not yet determined:

- The test points for Power Class 1.5 FWA UEs are TBD.
- Tests for Power Class 3 are FFS.

6.5G.2.3.1.1 Test purpose

To verify that UE transmitter does not cause unacceptable interference to adjacent channels in terms of Adjacent Channel Leakage power Ratio (ACLR).

6.5G.2.3.1.2 Test applicability

This test case applies to all types of NR Power Class 1.5, Power Class 2 reporting TxD UE release 15 and forward.

6.5G.2.3.1.3 Minimum conformance requirements

NR adjacent channel leakage power ratio (NR_{ACLR}) is the ratio of sum of the filtered mean power at each antenna connector centred on the assigned NR channel frequency to sum of the filtered mean power at each antenna connector centred on an adjacent NR channel frequency at nominal channel spacing.

The assigned NR channel power and adjacent NR channel power are measured with rectangular filters with measurement bandwidths specified in Table 6.5G.2.3.1.3-1.

If the measured adjacent channel power is greater than -50dBm then the NR_{ACLR} shall be higher than the value specified in Table 6.5G.2.3.1.3-2.

Table 6.5G.2.3.1.3-1: NR ACLR measurement bandwidth

Channel bandwidth	(MHz)	5,10,15,20,25,30,35,40,45,50	60,70,80,90,100
REF_SCS	(kHz)	15	30
NR ACLR measurement bandwidth	(MHz)	$MBW=REF_SCS*(12*N_{RB}+1)/1000$	

Table 6.5G.2.3.1.3-2: NR ACLR requirement

	Power class 1.5	Power class 2
NR ACLR	31 dB	31 dB

The normative reference for this requirement is TS 38.101-1 [2] clause 6.5G.2.3.1.

6.5G.2.3.1.4 Test description

6.5G.2.3.1.4.1 Initial conditions

Same initial conditions as 6.2G.2.4.1.

6.5G.2.3.1.4.2 Test procedure

1. SS sends uplink scheduling information for each UL HARQ process via PDCCH DCI format 0_1 for C_RNTI to schedule the UL RMC according to the test configuration tables in clause 6.2.2.4.1. Since the UL has no payload and no loopback data to send the UE sends uplink MAC padding bits on the UL RMC.
2. Send continuously power control “up” commands to the UE until the UE transmits at P_{UMAX} level. Allow at least 200ms for the UE to reach P_{UMAX} level.
3. Measure the sum of the mean power of the UE at each antenna connector in the channel bandwidth of the radio access mode according to the test configuration, as measured in step 3 of 6.2G.2.4.2, which shall meet the requirements described in clause 6.2G.2.5 as appropriate.
4. Measure the sum of the rectangular filtered mean power at each antenna connector for the assigned NR channel.
5. Measure the sum of the rectangular filtered mean power at each antenna connector of the first NR adjacent channel on both lower and upper side of the assigned NR channel, respectively.
6. Calculate the ratios of the power between the values measured in step 4 over step 5 for lower and upper NR ACLR, respectively.

NOTE 1: When switching to DFT-s-OFDM waveform, as specified in the test configuration tables in clause 6.2.2.4.1, send an NR RRCReconfiguration message according to TS 38.508-1 [5] clause 4.6.3 Table 4.6.3-118 PUSCH-Config with TRANSFORM_PRECODER_ENABLED condition.

6.5G.2.3.1.4.3 Message contents

Message contents are according to TS 38.508-1 [5] subclause 4.6 and 5.4 with the following exceptions:

Table 6.5G.2.3.1.4.3-1: PUSCH-Config

Derivation Path: TS 38.508-1 [5] subclause 4.6.3 Table 4.6.3-118 PUSCH-Config			
Information Element	Value/remark	Comment	Condition
PUSCH-Config ::= SEQUENCE {			
resourceAllocation	resourceAllocationType0		Almost contiguous allocation
	resourceAllocationType1		Contiguous allocation
}			

6.5G.2.3.1.5 Test requirement

The measured UE mean power in the channel bandwidth, derived in step 3, shall fulfil requirements in clause 6.2G.2.5 as appropriate, and if the measured adjacent channel power is greater than -50 dBm then the measured NR ACLR, derived in step 6, shall be higher than the limits in Table 6.5G.2.3.1.5-2 with TT applying for the sum of power at each of UE antenna connector.

Table 6.5G.2.3.1.5-1: NR ACLR measurement bandwidth

NR channel bandwidth / NR ACLR measurement bandwidth													
	5 MHz	10 MHz	15 MHz	20 MHz	25 MHz	30 MHz	40 MHz	50 MHz	60 MHz	70 MHz	80 MHz	90 MHz	100 MHz
NR ACLR measurement bandwidth (MHz)	4.515	9.375	14.235	19.095	23.955	28.815	38.895	48.615	58.35	68.07	78.15	88.23	98.31

Table 6.5G.2.3.1.5-2: NR ACLR requirement for Tx Diversity

	Power class 1.5	Power class 2
NR ACLR	31 - TT dB	31 - TT dB
NOTE 1: TT for each frequency and channel bandwidth is specified in Table 6.5G.2.3.1.5-3.		
NOTE 2: TT for the sum of power at each of UE antenna connector.		

Table 6.5G.2.3.1.5-3: Test Tolerance (NR ACLR)

	$f \leq 3.0\text{GHz}$	$3.0\text{GHz} < f \leq 4.2\text{GHz}$	$4.2\text{GHz} < f \leq 6.0\text{GHz}$
BW \leq 100MHz	0.8 dB	0.8 dB	0.8 dB

7 Receiver characteristics

TBD

7.1 General

Unless otherwise stated the receiver characteristics are specified at the antenna connector(s) of the UE. For UE(s) with an integral antenna only, a reference antenna(s) with a gain of 0 dBi is assumed for each antenna port(s). UE with an integral antenna(s) may be taken into account by converting these power levels into field strength requirements, assuming a 0 dBi gain antenna. For UEs with more than one receiver antenna connector, identical interfering signals shall be applied to each receiver antenna port if more than one of these is used (diversity).

The levels of the test signal applied to each of the antenna connectors shall be as defined in the respective clauses below.

Unless otherwise stated, Channel Bandwidth shall be prioritized in the selecting of test points. Subcarrier spacing shall be selected after Test Channel Bandwidth is selected.

The applicability of receiver requirements for Band n90 is in accordance with that for Band n41; a UE supporting Band n90 shall meet the minimum requirements for Band n41.

With the exception of clause 7.3, the requirements shall be verified with the network signalling value NS_01 configured (Table 6.2.3.3-1).

All the parameters in clause 7 are defined using the UL reference measurement channels specified in Annexes A.2.2 and A.2.3, the DL reference measurement channels specified in Annex A.3.2 and A.3.3, and using the set-up specified in Annex C.3.1.

The minimum requirements specified in clauses 7.5, 7.6, 7.7 and 7.8 for NR band n48 refer to the minimum requirements for NR bands < 2.7 GHz.

For the additional requirements for intra-band non-contiguous carrier aggregation of two or more sub-blocks, an in-gap test refers to the case when the interfering signal is located at a negative offset with respect to the assigned lowest channel frequency of the highest sub-block and located at a positive offset with respect to the assigned highest channel frequency of the lowest sub-block.

For the additional requirements for intra-band non-contiguous carrier aggregation of two or more sub-blocks, an out-of-gap test refers to the case when the interfering signal(s) is (are) located at a positive offset with respect to the assigned channel frequency of the highest carrier frequency, or located at a negative offset with respect to the assigned channel frequency of the lowest carrier frequency.

For the additional requirements for intra-band non-contiguous carrier aggregation of two or more sub-blocks with channel bandwidth larger than or equal to 5 MHz, the existing adjacent channel selectivity requirements, in-band blocking requirements (for each case), and narrow band blocking requirements apply for in-gap tests only if the corresponding interferer frequency offsets with respect to the two measured carriers satisfy the following condition in relation to the sub-block gap size W_{gap} for at least one of these carriers $j = 1, 2$, so that the interferer frequency position does not change the nature of the core requirement tested:

$$W_{\text{gap}} \geq 2 \cdot |F_{\text{Interferer (offset)}_j} - BW_{\text{Channel}(j)}|$$

where $F_{\text{Interferer (offset)}_j}$ for a sub-block with a single component carrier is the interferer frequency offset with respect to carrier j as specified in clause 7.5, clause 7.6.2 and clause 7.6.4 for the respective requirement and $BW_{\text{Channel}(j)}$ the channel bandwidth of carrier j . $F_{\text{Interferer (offset)}_j}$ for a sub-block with two or more contiguous component carriers is the interference frequency offset with respect to the carrier adjacent to the gap is specified in clause 7.5A, 7.6A.2 and 7.6A.3. The interferer frequency offsets for adjacent channel selectivity, each in-band blocking case and narrow-band blocking shall be tested separately with a single in-gap interferer at a time.

7.1A General

The minimum requirements for band combinations including Band n41 also apply for the corresponding band combinations with Band n90 replacing Band n41 but with otherwise identical parameters. For brevity the said band combinations with Band n90 are not listed in the tables below but are covered by this specification.

The minimum requirements specified in clauses 7.5A, 7.6A, 7.7A and 7.8A for NR band n48 refer to the minimum requirements for NR bands < 2.7 GHz.

7.11 General

For a Redcap UE the requirements in Section 7 shall be verified with the channel bandwidth up to 20MHz and REFSSENS specified in clause 7.3I.

7.2 Diversity characteristics

The UE is required to be equipped with a minimum of two Rx antenna ports in all operating bands except for the bands n7, n38, n41, n77, n78, n79 where the UE is required to be equipped with a minimum of four Rx antenna ports. An exception is allowed for two Rx vehicular UE to be equipped with a minimum of two Rx antenna ports in bands n7, n38, n41, n77, n78, n79. This requirement applies when the band is used as a standalone band or as part of a band combination.

For the single carrier REFSSENS requirements in clause 7, the UE shall be verified with two Rx antenna ports in all supported frequency bands, additional requirements for four Rx ports shall be verified in operating bands where the UE is equipped with four Rx antenna ports.

For Rx requirements other than single carrier REFSSENS in Clause 7, the UE shall be verified with four Rx antenna ports and skip two Rx antenna ports requirements in operating bands where the UE is equipped with four Rx antenna ports, otherwise, the UE shall be verified with two Rx antenna ports.

The above rules apply for all subclasses with the exception of clause 7.9.

For a Redcap UE the requirements in Section 7 assume that the receiver is equipped with a minimum of single Rx antenna port.

7.3 Reference sensitivity

7.3.1 General

The reference sensitivity power level REFSSENS is the minimum mean power applied to each one of the UE antenna ports for all UE categories, at which the throughput shall meet or exceed the requirements for the specified reference measurement channel.

In later clauses of Clause 7 where the value of REFSSENS is used as a reference to set the corresponding requirement:

In all bands, the UE shall be verified against those requirements by applying the REFSSENS value in Table 7.3.2.3-1a and in Table 7.3.2.3-1b with 2 Rx antenna ports tested;

For bands where the UE is required to be equipped with 4 Rx antenna ports, the UE shall additionally be verified against those requirements by applying the resulting REFSSENS value derived from the requirement in Table 7.3.2.3-2 with 4 Rx antenna ports tested.

7.3.2 Reference sensitivity power level

7.3.2.1 Test purpose

The test purpose is to verify the ability of the UE to receive data with a given average throughput for a specified reference measurement channel, under conditions of low signal level, ideal propagation and no added noise.

7.3.2.2 Test applicability

This test case applies to all types of NR UE release 15 and forward.

7.3.2.3 Minimum conformance requirements

The reference sensitivity power level REFSSENS is the minimum mean power applied to each one of the UE antenna ports for all UE categories, at which the throughput shall meet or exceed the requirements for the specified reference measurement channel.

The throughput shall be $\geq 95\%$ of the maximum throughput of the reference measurement channels as specified in Annexes A.2.2.2, A.2.3.2, A.3.2 and A.3.3 (with one sided dynamic OCNG Pattern OP.1 FDD/TDD for the DL-signal as described in Annex A.5.1.1/A.5.2.1) with parameters specified in Table 7.3.2.3-1a, 7.3.2.3-1b and Table 7.3.2.3-2.

Table 7.3.2.3-1a: Two antenna port reference sensitivity QPSK P_{REFSENS} for FDD bands

Operating band / SCS / Channel bandwidth											
Operating Band	SCS kHz	5 MHz (dBm)	10 MHz (dBm)	15 MHz (dBm)	20 MHz (dBm)	25 MHz (dBm)	30 MHz (dBm)	35 MHz (dBm)	40 MHz (dBm)	45 MHz (dBm)	50 MHz (dBm)
n1	15	-100.0	-96.8	-95.0	-93.8	-92.7	-91.9		-90.6	-90.1	-89.6
	30		-97.1	-95.1	-94.0	-92.8	-92.0		-90.7	-90.2	-89.7
	60		-97.5	-95.4	-94.2	-93.0	-92.1		-90.9	-90.3	-89.7
n2	15	-98	-94.8	-93	-91.8	-90.7	-84.1		-81.5		
	30		-95.1	-93.1	-92	-90.8	-84.2		-81.6		
	60		-95.5	-93.4	-92.2	-90.9	-84.3		-81.7		
n3	15	-97.0	-93.8	-92.0	-90.8	-89.7	-88.9		-82.3		-79.7
	30		-94.1	-92.1	-91.0	-89.8	-89.0		-82.4		-79.8
	60		-94.5	-92.4	-91.2	-90.0	-89.1		-82.6		-79.9
n5	15	-98.0	-94.8	-93.0	-86.8	-84.8					
	30		-95.1	-93.1	-88.6	-84.9					
n7 ¹	15	-98.0	-94.8	-93.0	-91.8						
	30		-95.1	-93.1	-92.0						
	60		-95.5	-93.4	-92.2						
n8	15	-97.0	-93.8	-91.4	-85.8						
	30		-94.1	-91.7	-87.2						
n12	15	-97.0	-93.8	-84.0							
	30		-94.1	-84.1							
n14	15	-97.0	-93.8								
	30		-94.1								
n20	15	-97.0	-93.8	-91.0	-89.8						
	30		-94.1	-91.1	-90.0						
n24	15	-100.0	-96.8								
	30		-97.1								
	60		-97.5								
n25	15	-96.5	-93.3	-91.5	-90.3	-89.3	-82.2		-79.5		
	30		-93.6	-91.6	-90.5	-89.4	-82.3		-79.6		
	60		-94.0	-91.9	-90.7	-89.6	-82.4		-79.7		
n26	15	-97.5 ⁶	-94.5 ⁶	-92.7 ⁶	-87.6						
	30		-94.8 ⁶	-92.7 ⁶	-87.7						
n28	15	-98.5	-95.5	-93.5	-90.8		-78.5				
	30		-95.6	-93.6	-91.0		-78.6				
n30	15	-99.0	-95.8								
	30		-96.1								
n65	15	-99.5	-96.3	-94.5	-93.3						-89.2
	30		-96.6	-94.6	-93.5						-89.3
	60		-97.0	-94.9	-93.7						-89.4
n66	15	-99.5	-96.3	-94.5	-93.3	-92.2	-91.4		-90.1	-89.6	
	30		-96.6	-94.6	-93.5	-92.3	-91.5		-90.2	-89.7	
	60		-97.0	-94.9	-93.7	-92.5	-91.6		-90.4	-89.8	
n70	15	-100.0	-96.8	-95.0	-93.8	-92.7					
	30		-97.1	-95.1	-94.0	-92.8					
	60		-97.5	-95.4	-94.2	-93.0					
n71	15	-97.2	-94.0	-91.6	-86.0						
	30		-94.3	-91.9	-87.4						
n74	15	-99.5 ³	-96.3 ³	-94.5 ³	-89.3 ³						
	30		-96.6 ³	-94.6 ³	-89.5 ³						
	60		-97.0 ³	-94.9 ³	-89.6 ³						

NOTE 1: Four Rx antenna ports shall be the baseline for this operating band except for two Rx vehicular UE.

NOTE 2: The transmitter shall be set to P_{UMAX} as defined in clause 6.2.4

NOTE 3: The requirement is modified by -0.5 dB when the assigned NR channel bandwidth is confined within 1475.9 - 1510.9 MHz.

NOTE 4: Void

NOTE 5: Void

NOTE 6: Values are modified by -0.5dB when carrier channel BW is between 865MHz and 894MHz.

NOTE 7: Void.

Table 7.3.2.3-1b: Two antenna port reference sensitivity QPSK PREFSENS for TDD, SDL and FDD with variable duplex operation bands

Operating band / SCS / Channel bandwidth / REFSENS				
Operating band	SCS kHz	Channel bandwidth (MHz)	REFSENS (dBm) ⁸	Duplex Mode
n34	15	5, 10, 15	$-100 + 10\log_{10}(N_{RB}/25)$	TDD
	30	10, 15	$-97.1 + 10\log_{10}(N_{RB}/24)$	
	60	10, 15	$-97.5 + 10\log_{10}(N_{RB}/11)$	
n38 ¹	15	5, 10, 15, 20, 25, 30, 40	$-100 + 10\log_{10}(N_{RB}/25)$	TDD
	30	10, 15, 20, 25, 30, 40	$-97.1 + 10\log_{10}(N_{RB}/24)$	
	60	10, 15, 20, 25, 30, 40	$-97.5 + 10\log_{10}(N_{RB}/11)$	
n39	15	5, 10, 15, 20, 25, 30, 40	$-100 + 10\log_{10}(N_{RB}/25)$	TDD
	30	10, 15, 20, 25, 30, 40	$-97.1 + 10\log_{10}(N_{RB}/24)$	
	60	10, 15, 20, 25, 30, 40	$-97.5 + 10\log_{10}(N_{RB}/11)$	
n40	15	5, 10, 15, 20, 25, 30, 40, 50	$-100 + 10\log_{10}(N_{RB}/25)$	TDD
	30	10, 15, 20, 25, 30, 40, 50, 60, 80, 90, 100	$-97.1 + 10\log_{10}(N_{RB}/24)$	
	60	10, 15, 20, 25, 30, 40, 50, 60, 80, 90, 100	$-97.5 + 10\log_{10}(N_{RB}/11)$	
n41 ¹	15	10, 15, 20, 30, 40, 50	$-94.8 + 10\log_{10}(N_{RB}/50)$	TDD
	30	10, 15, 20, 30, 40, 50, 60, 70, 80, 90, 100	$-95.1 + 10\log_{10}(N_{RB}/24)$	
	60	10, 15, 20, 30, 40, 50, 60, 70, 80, 90, 100	$-95.5 + 10\log_{10}(N_{RB}/11)$	
n48 ¹	15	5, 10, 15, 20, 30, 40, 50 ⁵	$-99 + 10\log_{10}(N_{RB}/25)$	TDD
	30	10, 15, 20, 30, 40, 50 ⁵ , 60 ⁵ , 70 ⁵ , 80 ⁵ , 90 ⁵ , 100 ⁵	$-96.1 + 10\log_{10}(N_{RB}/24)$	
	60	10, 15, 20, 30, 40, 50 ⁵ , 60 ⁵ , 70 ⁵ , 80 ⁵ , 90 ⁵ , 100 ⁵	$-96.5 + 10\log_{10}(N_{RB}/11)$	
n50	15	5, 10, 15, 20, 30, 40, 50	$-100 + 10\log_{10}(N_{RB}/25)$	TDD
	30	10, 15, 20, 30, 40, 50, 60, 80	$-97.1 + 10\log_{10}(N_{RB}/24)$	
	60	10, 15, 20, 30, 40, 50, 60, 80	$-97.5 + 10\log_{10}(N_{RB}/11)$	
n51	15	5	-100	TDD
n53	15	5, 10	$-100 + 10\log_{10}(N_{RB}/25)$	TDD
	30	10	-97.1	
	60	10	-97.5	
n75 ⁷	15	5, 10, 15, 20	$-100 + 10\log_{10}(N_{RB}/25)$	SDL
	30	10, 15, 20	$-97.1 + 10\log_{10}(N_{RB}/24)$	
	60	10, 15, 20	$-97.5 + 10\log_{10}(N_{RB}/11)$	
n76 ⁷	15	5	-100	SDL
n77 ^{1,4}	15	10, 15, 20, 40, 50	$-95.3 + 10\log_{10}(N_{RB}/50)$	TDD
	30	10, 15, 20, 40, 50, 60, 70, 80, 90, 100	$-95.6 + 10\log_{10}(N_{RB}/24)$	
	60	10, 15, 20, 40, 50, 60, 70, 80, 90, 100	$-96.0 + 10\log_{10}(N_{RB}/11)$	
n78 ¹	15	10, 15, 20, 40, 50	$-95.8 + 10\log_{10}(N_{RB}/50)$	TDD
	30	10, 15, 20, 40, 50, 60, 70, 80, 90, 100	$-96.1 + 10\log_{10}(N_{RB}/24)$	
	60	10, 15, 20, 40, 50, 60, 70, 80, 90, 100	$-96.5 + 10\log_{10}(N_{RB}/11)$	
n79 ¹	15	40, 50	$-89.6 + 10\log_{10}(N_{RB}/216)$	TDD
	30	40, 50, 60, 80, 100	$-89.7 + 10\log_{10}(N_{RB}/106)$	
	60	40, 50, 60, 80, 100	$-89.9 + 10\log_{10}(N_{RB}/51)$	
<p>NOTE 1: Four Rx antenna ports shall be the baseline for this operating band except for two Rx vehicular UE.</p> <p>NOTE 2: The transmitter shall be set to P_{UMAX} as defined in clause 6.2.4.</p> <p>NOTE 3: Void</p> <p>NOTE 4: The requirement is modified by -0.5 dB when the assigned UE channel bandwidth is confined within 3300 - 3800 MHz.</p> <p>NOTE 5: For these bandwidths, the minimum requirements are restricted to operation when carrier is configured as a downlink carrier part of CA configuration.</p> <p>NOTE 6: Void</p> <p>NOTE 7: For SDL bands, the reference sensitivity requirements shall be verified by inter-band CA combinations with SDL band, which are supported by UE.</p> <p>NOTE 8: The REFSENS value is rounded to the nearest number down to one decimal point. "N_{RB}" in REFSENS formula is the maximum transmission bandwidth configuration as defined in Table 5.3.2-1.</p>				

For UE(s) equipped with 4 Rx antenna ports, reference sensitivity for 2Rx antenna ports in Table 7.3.2.3-1a and in Table 7.3.2.3-1b shall be modified by the amount given in $\Delta R_{IB,4R}$ in Table 7.3.2.3-2 for the applicable operating bands.

Table 7.3.2.3-2: Four antenna port reference sensitivity allowance $\Delta R_{IB,4R}$

Operating band	$\Delta R_{IB,4R}$ (dB)
n28, n71	-2.7 ¹
n1, n2, n3, n30, n40, n7, n34, n38, n39, n41, n66, n70	-2.7
n48, n77, n78, n79	-2.2
NOTE 1: 4 Rx operation is targeted for FWA form factor	

The reference sensitivity (REFSENS) requirement specified in Table 7.3.2.3-1a, Table 7.3.2.3-1b and Table 7.3.2.3-2 shall be met with uplink transmission bandwidth less than or equal to that specified in Table 7.3.2.3-3.

Table 7.3.2.3-3: Uplink configuration for reference sensitivity

Operating band / SCS (kHz) / Channel bandwidth (MHz) / Duplex mode

	5	10	15	20	25	30	35	40	45	50	60	70	80	90
	25	50 ¹	75 ¹	100 ¹	128 ¹	128 ¹		128 ¹	128 ¹	128 ¹				
		24	36 ¹	50 ¹	64 ¹	64 ¹		64 ¹	64 ¹	64 ¹				
		10 ¹	18	24	30 ¹	30 ¹		30 ¹	30 ¹	30 ¹				
	25	50 ¹	50 ¹	50 ¹	50 ¹	48 ¹		40 ¹						
	10 ¹	24	24 ¹	24 ¹	24 ¹	24 ¹		20 ¹						
		10 ¹	10 ¹	10 ¹	10 ¹	10 ¹		10 ¹						
	25	50 ¹	50 ¹	50 ¹	50 ¹	50 ¹		50 ¹		50 ¹				
		24	24 ¹	24 ¹	24 ¹	24 ¹		24 ¹		24 ¹				
		10 ¹	10 ¹	10 ¹	10 ¹	10 ¹		10 ¹		10 ¹				
	25	25 ¹	25 ¹	25 ¹	Note 5									
		10 ¹	10 ¹	10 ¹	Note 5									
	25	50 ¹	75 ¹	75 ¹										
		24	36 ¹	36 ¹										
		10 ¹	18	18 ¹										
	25	25 ¹	25 ¹	25 ¹										
		10 ¹	10 ¹	10 ¹										
	20 ¹	20 ¹	20 ¹											
		10 ¹	10 ¹											
	20 ¹	20 ¹												
		10 ¹												
	25	20 ¹	20 ²	20 ²										
		10 ¹	10 ²	10 ²										
	25	50												
		24												
		10												
	25	50 ¹	50 ¹	50 ¹	50 ¹	48 ¹		40 ¹						
		24	24 ¹	24 ¹	24 ¹	24 ¹		20 ¹						
		10 ¹	10 ¹	10 ¹	10 ¹	10 ¹		10 ¹						
	25	25 ¹	25 ¹	25 ¹										
		12 ¹	12 ¹	12 ¹										
	25	25 ¹	25 ¹	25 ¹		25 ¹								
		10 ¹	10 ¹	10 ¹		10 ¹								
	20 ¹	20 ¹												
		10 ¹												
	25	50	75											
		24	36											
		10	18											
	25	50	75	100	128	160		216						
		24	36	50	64	75		100						
		10	18	24	30	36		50						
	25	50	75	100	128	160		216						
		24	36	50	64	75		100						
		10	18	24	30	36		50						
	25	50	75	100	128	160		216		270				
		24	36	50	64	75		100		128	162		216	
		10	18	24	30	36		50		64	75		100	
		50	75	100		160		216		270				
		24	36	50		75		100		128	162	180	216f	243
		10	18	24		36		50		64	75	90	100	120
	25	50	75	100		160		216						
		24	36	50		75		100						
		10	18	24		36		50						
	25	50	75	100		160		216		270				
		24	36	50		75		100		128	162		Note 3	
		10	18	24		36		50		64	75		Note 3	
	25													
	25	50												
		24												
		10												
	25	50 ¹	75 ¹	100 ¹										

Operating band / SCS (kHz) / Channel bandwidth (MHz) / Duplex mode														
5	10	15	20	25	30	35	40	45	50	60	70	80	90	
	24	36 ¹	50 ¹											
	10 ¹	18	24											
25	50 ¹	75 ¹	100 ¹	128 ¹	160		216							
	24	36 ¹	50 ¹	64 ¹	75 ¹		100 ¹							
	10 ¹	18	24	30 ¹	36 ¹		50 ¹							
25	50 ¹	75 ¹	Note 3	Note 3										
	24	36 ¹	Note 3	Note 3										
	10 ¹	18	Note 3	Note 3										
25	25 ¹	20 ¹	20 ¹											
	12 ¹	10 ¹	10 ¹											
25	25 ¹	25 ¹	25 ¹											
	10 ¹	10 ¹	10 ¹											
	5 ¹	5 ¹	5 ¹											
	50	75	100				216		270					
	24	36	50				100		128	162	180	216	243	
	10	18	24				50		64	75	90	100	120	
	50	75	100				216		270					
	24	36	50				100		128	162	180	216	243	
	10	18	24				50		64	75	90	100	120	
							216		270					
							100		128	162		216		
							50		64	75		100		

Resource blocks shall be located as close as possible to the downlink operating band but confined within the transmission bandwidth configuration for the operating band (see Table 5.3.6-1).

For 15kHz SCS, in the case of 15MHz channel bandwidth, the UL resource blocks shall be located at RB_{start} 11 and in the case of 20MHz channel bandwidth, the UL resource blocks shall be located at RB_{start} 16; for 30kHz SCS, in the case of 15MHz channel bandwidth, the UL resource blocks shall be located at RB_{start} 8; for 60kHz SCS, in the case of 15MHz channel bandwidth, the UL resource blocks shall be located at RB_{start} 3 and in the case of 20MHz channel bandwidth, the UL resource blocks shall be located at RB_{start} 4.

For channel bandwidths that do not have symmetric UL channel bandwidth, highest valid UL configuration with lowest duplex distance shall be used.

For channel bandwidth, the UL configuration of the highest UL channel bandwidth specified in Table 5.3.6-1 and the default Tx-Rx frequency separation shall be used.

Unless given by Table 7.3.2.3-4, the minimum requirements specified in Tables 7.3.2.3-1 and 7.3.2.3-2 shall be verified with the network signalling value NS_01 (Table 6.2.3.3-1) configured.

Table 7.3.2.3-4: Network signalling value for reference sensitivity

Operating band	Network Signalling value
n2	NS_03
n12	NS_06
n14	NS_06
n24	NS_56
n25	NS_03
n30	NS_21
n48	NS_27
n53	NS_45
n66	NS_03
n70	NS_03
n71	NS_35

For the UE which supports inter-band carrier aggregation, the minimum requirement for reference sensitivity in Table 7.3.2.3-1 shall be increased by the amount given in $\Delta R_{IB,c}$ defined in subclause 7.3.3 for the applicable operating bands.

The normative reference for this requirement is TS 38.101-1 [2] clause 7.3.2.

7.3.2.4 Test description

7.3.2.4.1 Initial conditions

Initial conditions are a set of test configurations the UE needs to be tested in and the steps for the SS to take with the UE to reach the correct measurement state.

The initial test configurations consist of environmental conditions, test frequencies, and channel bandwidths based on NR operating bands specified in Table 5.3.5-1. All of these configurations shall be tested with applicable test parameters for each channel bandwidth, and are shown in Table 7.3.2.4.1-1, Table 7.3.2.4.1-2, and Table 7.3.2.4.1-3. The details of the uplink reference measurement channels (RMCs) are specified in Annex A2.2. Configurations of PDSCH and PDCCH before measurement are specified in Annex C.2.

Table 7.3.2.4.1-1: Test Configuration Table

Initial Conditions				
Test Environment as specified in TS 38.508-1 [5] subclause 4.1		Normal, TL/VL, TL/VH, TH/VL, TH/VH		
Test Frequencies as specified in TS 38.508-1 [5] subclause 4.3.1		Low range, Mid range, High range (NOTE 4)		
Test Channel Bandwidths as specified in TS 38.508-1 [5] subclause 4.3.1		Lowest, Mid, Highest (NOTE 4) Lowest UL / Lowest DL, Lowest UL / Highest DL (NOTE 3)		
Test SCS as specified in Table 5.3.5-1		Lowest		
Test Parameters				
Test ID	Downlink Configuration		Uplink Configuration	
	Modulation	RB allocation	Modulation	RB allocation
1	CP-OFDM QPSK	Full RB (NOTE 1)	DFT-s-OFDM QPSK	REFSENS (NOTE 2)
NOTE 1: Full RB allocation shall be used per each SCS and channel BW as specified in Table 7.3.2.4.1-2.				
NOTE 2: REFSENS refers to Table 7.3.2.4.1-3 which defines uplink RB configuration and start RB location for each SCS, channel BW and NR band.				
NOTE 3: Additional test points selected according to asymmetric channel bandwidths specified in clause 5.3.6. DL channel bandwidth shall be selected first.				
NOTE 4: For NR band n28, 30MHz test channel bandwidth is tested with Low range and High range test frequencies.				
NOTE 5: In a band where UE supports 4Rx, the test needs to be repeated with only 2Rx antennas connected and the other antennas terminated.				

Table 7.3.2.4.1-2: Downlink Configuration of each RB allocation

Channel Bandwidth	SCS(kHz)	LCRBmax	Outer RB allocation / Normal RB allocation
5MHz	15	25	25@0
	30	11	11@0
	60	N/A	N/A
10MHz	15	52	52@0
	30	24	24@0
	60	11	11@0
15MHz	15	79	79@0
	30	38	38@0
	60	18	18@0
20MHz	15	106	106@0
	30	51	51@0
	60	24	24@0
25MHz	15	133	133@0
	30	65	65@0
	60	31	31@0
30MHz	15	160	160@0
	30	78	78@0
	60	38	38@0
40MHz	15	216	216@0
	30	106	106@0
	60	51	51@0
45MHz	15	128	128@0
	30	64	64@0
	60	30	30@0
50MHz	15	270	270@0
	30	133	133@0
	60	65	65@0
60MHz	15	N/A	N/A
	30	162	162@0
	60	79	79@0
70MHz	15	N/A	N/A
	30	189	189@0
	60	93	93@0
80MHz	15	N/A	N/A
	30	217	217@0
	60	107	107@0
90MHz	15	N/A	N/A
	30	245	245@0
	60	121	121@0
100MHz	15	N/A	N/A
	30	273	273@0
	60	135	135@0

NOTE 1: Test Channel Bandwidths are checked separately for each NR band, the applicable channel bandwidths are specified in Table 5.3.5-1.

Table 7.3.2.4.1-3: Uplink configuration for reference sensitivity, LCRB @ RBstart format

Operating Band	SCS kHz	5 MHz	10 MHz	15 MHz	20 MHz	25 MHz	30 MHz	35 MHz	40 MHz	45 MHz	50 MHz	60 MHz	70 MHz	80 MHz	90 MHz	100 MHz	Duplex Mode
n1	15	25@0	50@2 ¹	75@4 ¹	100@6 ₁	128@5 ₁	128@3 ₂ ¹		128@8 ₈ ¹	128@11 ₄ ¹	128@14 ₂ ¹						FDD
	30		24@0	36@2 ¹	50@1 ¹	64@1 ¹	64@14 ¹		64@42 ¹	64@55 ¹	64@69 ¹						
	60		10@1 ¹	18@0	24@0	30@1 ¹	30@8 ¹		30@21 ¹	30@28 ¹	30@35 ¹						
n2	15	25@0	50@2 ¹	50@29 ₁	50@56 ₁	50@83 ₁	48@11 ₂ ¹		40@17 ₆ ¹								FDD
	30	10@1 ₁	24@0	24@14 ₁	24@27 ₁	24@41 ₁	24@54 ¹		20@86 ¹								
	60		10@1 ¹	10@8 ¹	10@14 ₁	10@21 ₁	10@28 ¹		10@41 ¹								
n3	15	25@0	50@2 ¹	50@29 ₁	50@56 ₁	50@83 ₁	50@11 ₀ ¹		50@16 ₆ ¹		50@220 ¹						FDD
	30		24@0	24@14 ₁	24@27 ₁	24@41 ₁	24@54 ¹		24@82 ¹		24@109 ¹						
	60		10@1 ¹	10@8 ¹	10@14 ₁	10@21 ₁	10@28 ¹		10@41 ¹		10@55 ¹						
n5	15	25@0	25@27 ₁	25@54 ₁	25@81 ₁	Note 5											FDD
	30		10@14 ₁	10@28 ₁	10@41 ₁	Note 5											
	60																
n7	15	25@0	50@2 ¹	75@4 ¹	75@31 ₁												FDD
	30		24@0	36@2 ¹	36@15 ₁												
	60		10@1 ¹	18@0	18@6 ¹												
n8	15	25@0	25@27 ₁	25@54 ₁	25@81 ₁												FDD
	30		10@14 ₁	10@28 ₁	10@41 ₁												
	60																
n12	15	20@5 ₁	20@32 ₁	20@59 ₁													FDD
	30		10@14 ₁	10@28 ₁													
	60																
n14	15	20@5 ₁	20@32 ₁														FDD

	30		10@14 ₁															
	60																	
n20	15	25@0	20@0 ¹	20@11 ₂	20@16 ₂													FDD
	30		10@0 ¹	10@6 ²	10@8 ²													
	60																	
n24	15	25@0	50@0															FDD
	30		24@0															
	60		10@0															
n25	15	25@0	50@0	50@29 ₁	50@56 ₁	50@83 ₁	48@11 ₂ ¹	40@17 ₆ ¹										FDD
	30		24@0	24@14 ₁	24@27 ₁	24@41 ₁	24@54 ¹	20@86 ¹										
	60		10@0	10@8 ¹	10@14 ₁	10@21 ₁	10@28 ¹	10@41 ¹										
n26	15	25@0	25@27 ₁	25@54 ₁	25@81 ₁													FDD
	30		12@12 ₁	12@26 ₁	12@39 ₁													
n28	15	25@0	25@27 ₁	25@54 ₁	25@81 ₁		25@13 ₅ ¹											FDD
	30		10@14 ₁	10@28 ₁	10@41 ₁		10@68 ¹											
	60																	
n30	15	20@5 ₁	20@32 ₁															FDD
	30		10@14 ₁															
	60																	
n34	15	25@0	50@0	75@0														TDD
	30		24@0	36@0														
	60		10@0	18@0														
n38	15	25@0	50@0	75@0	100@0	128@0	160@0	216@0										TDD
	30		24@0	36@0	50@0	64@0	75@0	100@0										
	60		10@0	18@0	24@0	30@0	36@0	50@0										
n39	15	25@0	50@0	75@0	100@0	128@0	160@0	216@0										TDD
	30		24@0	36@0	50@0	64@0	75@0	100@0										
	60		10@0	18@0	24@0	30@0	36@0	50@0										
n40	15	25@0	50@0	75@0	100@0	128@0	160@0	216@0		270@0							TDD	

	30		24@0	36@0	50@0	64@0	75@0		100@0		128@0	162@0		216@0			
	60		10@0	18@0	24@0	30@0	36@0		50@0		64@0	75@0		100@0			
n41	15		50@0	75@0	100@0		160@0		216@0		270@0						
	30		24@0	36@0	50@0		75@0		100@0		128@0	162@0	180@0	216@0	243@0	270@0	TDD
	60		10@0	18@0	24@0		36@0		50@0		64@0	75@0	90@0	100@0	120@0	135@0	
n48	15	25@0	50@0	75@0	100@0		160@0		216@0								
	30		24@0	36@0	50@0		75@0		100@0								TDD
	60		10@0	18@0	24@0		36@0		50@0								
n50	15	25@0	50@0	75@0	100@0				216@0		270@0						
	30		24@0	36@0	50@0				100@0		128@0	162@0		NOTE 3			TDD
	60		10@0	18@0	24@0				50@0		64@0	75@0		NOTE 3			
n51	15	25@0															
	30																TDD
	60																
n53	15	25@0	50@0														
	30		24@0														TDD
	60		10@0														
n65	15	25@0	50@2 ¹	75@4 ¹	100@6 ₁												
	30		24@0	36@2 ¹	50@1 ¹												FDD
	60		10@1 ¹	18@0	24@0												
n66	15	25@0	50@2 ¹	75@4 ¹	100@6 ₁	128@5 ₁	160@0		216@0								
	30		24@0	36@2 ¹	50@1 ¹	64@1 ¹	75@3 ¹		100@6 ¹								FDD
	60		10@1 ¹	18@0	24@0	30@1 ¹	36@2 ¹		50@1 ¹								
n70	15	25@0	50@2 ¹	75@4 ¹	NOTE 3	NOTE 3											
	30		24@0	36@2 ¹	NOTE 3	NOTE 3											FDD
	60		10@1 ¹	18@0	NOTE 3	NOTE 3											
n71	15	25@0	25@01	20@01	20@01												
	30		12@01	10@01	10@01												FDD
	60																

n74	15	25@0	25@27 ₁	25@54 ₁	25@81 ₁												FDD	
	30		10@14 ₁	10@28 ₁	10@41 ₁													
	60		5@6 ¹	5@13 ¹	5@19 ¹													
n77	15		50@0	75@0	100@0			216@0		270@0							TDD	
	30		24@0	36@0	50@0			100@0		128@0	162@0	180@0	216@0	243@0	270@0			
	60	-	10@0	18@0	24@0			50@0		64@0	75@0	90@0	100@0	120@0	135@0			
n78	15		50@0	75@0	100@0			216@0		270@0							TDD	
	30		24@0	36@0	50@0			100@0		128@0	162@0	180@0	216@0	243@0	270@0			
	60		10@0	18@0	24@0			50@0		64@0	75@0	90@0	100@0	120@0	135@0			
n79	15							216@0		270@0							TDD	
	30							100@0		128@0	162@0		216@0		270@0			
	60							50@0		64@0	75@0		100@0		135@0			

NOTE 1: UL resource blocks shall be located as close as possible to the downlink operating band but confined within the transmission bandwidth configuration for the channel bandwidth (Table 5.3.2-1).

NOTE 2: For Band 20; for 15kHz SCS, in the case of 15MHz channel bandwidth, the UL resource blocks shall be located at RBstart 11 and in the case of 20MHz channel bandwidth, the UL resource blocks shall be located at RBstart 16; for 30kHz SCS, in the case of 15MHz channel bandwidth, the UL resource blocks shall be located at RBstart 6 and in the case of 20MHz channel bandwidth, the UL resource blocks shall be located at RBstart 8; for 60kHz SCS, in the case of 15MHz channel bandwidth, the UL resource blocks shall be located at RBstart 3 and in the case of 20MHz channel bandwidth, the UL resource blocks shall be located at RBstart 4.

NOTE 3: For DL channel bandwidths that do not have symmetric UL channel bandwidth, highest valid UL configuration with lowest duplex distance shall be used.

NOTE 4: Reserved.

NOTE 5: For this DL channel bandwidth, the UL configuration of the highest UL channel bandwidth specified in Table 5.3.6-1 and the default Tx-Rx frequency separation specified in Table 5.4.4-1 shall be used.

1. Connect the SS to the UE antenna connectors as shown in TS 38.508-1 [5] Annex A, Figure A.3.1.1.1 for TE diagram and section A.3.2 for UE diagram.
2. The parameter settings for the cell are set up according to TS 38.508-1 [5] subclause 4.4.3.
3. Downlink signals are initially set up according to Annex C.0, C.1, C.2, and C.3.1, and uplink signals according to Annex G.0, G.1, G.2, and G.3.1.
4. The UL and Reference Measurement Channel is set according to Table 7.3.2.4.1-1, Table 7.3.2.4.1-2, and Table 7.3.2.4.1-3.
5. Propagation conditions are set according to Annex B.0.
6. Ensure the UE is in State RRC_CONNECTED with generic procedure parameters Connectivity *NR*, Connected without release *On*, Test Mode *On* and Test Loop Function *On* according to TS 38.508-1 [5] clause 4.5. Message contents are defined in clause 7.3.2.4.3.

7.3.2.4.2 Test procedure

1. SS transmits PDSCH via PDCCH DCI format 1_1 for C_RNTI to transmit the DL RMC according to Table 7.3.2.4.1-1. The SS sends downlink MAC padding bits on the DL RMC.
2. SS sends uplink scheduling information for each UL HARQ process via PDCCH DCI format 0_1 for C_RNTI to schedule the UL RMC according to Tables 7.3.2.4.1-1. Since the UE has no payload data to send, the UE transmits uplink MAC padding bits on the UL RMC.
3. Set the Downlink signal level to the appropriate REFSSENS value defined in Table 7.3.2.5-1 if 2Rx antennas connected or Table 7.3.2.5-2 if 4Rx antennas connected. Send continuously uplink power control "up" commands in the uplink scheduling information to the UE to ensure the UE transmits PUMAX level for at least the duration of the Throughput measurement.
4. Measure the average throughput for a duration sufficient to achieve statistical significance according to Annex H.2

7.3.2.4.3 Message contents

Message contents are according to TS 38.508-1 [5] clause 4.6 ensuring Table 4.6.3-118 with condition TRANSFORM_PRECODER_ENABLED for NR band.

Message contents are according to TS 38.508-1[5] subclause 4.6 with the following exceptions for each network signalling value.

7.3.2.4.3.1 Message contents exceptions (network signalled value "NS_01")

Message contents according to TS 38.508-1 [5] subclause 4.6 can be used without exceptions.

7.3.2.4.3.2 Message contents exceptions (network signalled value "NS_03")

1. Information element additionalSpectrumEmission is set to NS_03. This can be set in *SIB1* as part of the cell broadcast message. This exception indicates that the UE shall meet the additional spurious emission requirement for a specific deployment scenario.

Table 7.3.2.4.3.2-1: AdditionalSpectrumEmission: Additional spurious emissions test requirement for "NS_03" and NR band n2, n25 and n66

Derivation Path: TS 38.508-1 [5] clause 4.6.3, Table 4.6.3-1			
Information Element	Value/remark	Comment	Condition
additionalSpectrumEmission	2 (NS_03)		

Table 7.3.2.4.3.2-2: AdditionalSpectrumEmission: Additional spurious emissions test requirement for "NS_03" and NR band n70

Derivation Path: TS 38.508-1 [5] clause 4.6.3, Table 4.6.3-1			
Information Element	Value/remark	Comment	Condition
additionalSpectrumEmission	1 (NS_03)		

7.3.2.4.3.3 Message contents exceptions (network signalled value "NS_06")

1. Information element additionalSpectrumEmission is set to NS_06. This can be set in *SIB1* as part of the cell broadcast message. This exception indicates that the UE shall meet the additional spurious emission requirement for a specific deployment scenario.

Table 7.3.2.4.3.3-1: AdditionalSpectrumEmission: Additional spurious emissions test requirement for "NS_06" and NR band n12 and n14

Derivation Path: TS 38.508-1 [5] clause 4.6.3, Table 4.6.3-1			
Information Element	Value/remark	Comment	Condition
additionalSpectrumEmission	1 (NS_06)		

7.3.2.4.3.4 Message contents exceptions (network signalled value "NS_35")

1. Information element additionalSpectrumEmission is set to NS_35. This can be set in *SIB1* as part of the cell broadcast message. This exception indicates that the UE shall meet the additional spurious emission requirement for a specific deployment scenario.

Table 7.3.2.4.3.4-1: AdditionalSpectrumEmission: Additional spurious emissions test requirement for "NS_35" and NR band n71

Derivation Path: TS 38.508-1 [5] clause 4.6.3, Table 4.6.3-1			
Information Element	Value/remark	Comment	Condition
additionalSpectrumEmission	1 (NS_35)		

7.3.2.4.3.5 Message contents exceptions (network signalled value "NS_27")

1. Information element additionalSpectrumEmission is set to NS_27. This can be set in *SIB1* as part of the cell broadcast message. This exception indicates that the UE shall meet the additional spurious emission requirement for a specific deployment scenario.

Table 7.3.2.4.3.5-1: AdditionalSpectrumEmission: Additional spurious emissions test requirement for "NS_27" and NR band n48

Derivation Path: TS 38.508-1 [5] clause 4.6.3, Table 4.6.3-1			
Information Element	Value/remark	Comment	Condition
additionalSpectrumEmission	1 (NS_27)		

7.3.2.4.3.6 Message contents exceptions (network signalled value "NS_21")

1. Information element additionalSpectrumEmission is set to NS_21. This can be set in *SIB1* as part of the cell broadcast message. This exception indicates that the UE shall meet the additional spurious emission requirement for a specific deployment scenario.

Table 7.3.2.4.3.6-1: AdditionalSpectrumEmission: Additional spurious emissions test requirement for "NS_21" and NR band n30

Derivation Path: TS 38.508-1 [5] clause 4.6.3, Table 4.6.3-1			
Information Element	Value/remark	Comment	Condition
additionalSpectrumEmission	1 (NS_21)		

7.3.2.4.3.7 Message contents exceptions (network signalled value "NS_45")

1. Information element additionalSpectrumEmission is set to NS_45. This can be set in *SIB1* as part of the cell broadcast message. This exception indicates that the UE shall meet the additional spurious emission requirement for a specific deployment scenario.

Table 7.3.2.4.3.7-1: AdditionalSpectrumEmission: Additional spurious emissions test requirement for "NS_45" and NR band n53

Derivation Path: TS 38.508-1 [5], Table 4.6.3-1			
Information Element	Value/remark	Comment	Condition
additionalSpectrumEmission	1 (NS_45)		

7.3.2.4.3.8 Message contents exceptions (network signalled value "NS_56")

1. Information element additionalSpectrumEmission is set to NS_56. This can be set in *SIB1* as part of the cell broadcast message. This exception indicates that the UE shall meet the additional spurious emission requirement for a specific deployment scenario.

Table 7.3.2.4.3.8-1: AdditionalSpectrumEmission: Additional spurious emissions test requirement for "NS_56" and NR band n24

Derivation Path: TS 38.508-1 [5], Table 4.6.3-1			
Information Element	Value/remark	Comment	Condition
additionalSpectrumEmission	1 (NS_56)		

7.3.2.5 Test requirement

The throughput shall be $\geq 95\%$ of the maximum throughput of the reference measurement channels as specified in Annex A3.2 with reference receive power level specified in Tables 7.3.2.5-1a and Tables 7.3.2.5-1b for 2 Rx antenna port, Tables 7.3.2.5-2 a and Tables 7.3.2.5-2b for 4 Rx antenna port, and parameters specified Tables 7.3.2.4.1-1, Tables 7.3.2.4.1-2 and Tables 7.3.2.4.1-3.

Table 7.3.2.5-1 a: Two antenna port Reference sensitivity QPSK P_{REFSENS} for FDD bands

Operating band / SCS / Channel bandwidth / Duplex-mode												
Operating Band	SCS kHz	5 MHz (dBm)	10 MHz (dBm)	15 MHz (dBm)	20 MHz (dBm)	25 MHz (dBm)	30 MHz (dBm)	35 MHz (dBm)	40 MHz (dBm)	45 MHz (dBm)	50 MHz (dBm)	Duplex Mode
n1	15	-100.0 +TT	-96.8 +TT	-95.0 +TT	-93.8 +TT	-92.7 +TT	-91.9 +TT		-90.6 +TT	-90.1 +TT	-89.6 +TT	FDD
	30		-97.1 +TT	-95.1 +TT	-94.0 +TT	-92.8 +TT	-92.0 +TT		-90.7 +TT	-90.2 +TT	-89.7 +TT	
	60		-97.5 +TT	-95.4 +TT	-94.2 +TT	-93.0 +TT	-92.1 +TT		-90.9 +TT	-90.3 +TT	-89.7 +TT	
n2	15	-98.0 +TT	-94.8 +TT	-93.0 +TT	-91.8 +TT	-90.7 +TT	-84.1 +TT		-81.5 +TT			FDD
	30		-95.1 +TT	-93.1 +TT	-92.0 +TT	-90.8 +TT	-84.2 +TT		-81.6 +TT			
	60		-95.5 +TT	-93.4 +TT	-92.2 +TT	-90.9 +TT	-84.3 +TT		-81.7 +TT			
n3	15	-97.0 +TT	-93.8 +TT	-92.0 +TT	-90.8 +TT	-89.7 +TT	-88.9 +TT		-87.6 +TT		-79.7 +TT	FDD
	30		-94.1 +TT	-92.1 +TT	-91.0 +TT	-89.8 +TT	-89.0 +TT		-87.7 +TT		-79.8 +TT	
	60		-94.5 +TT	-92.4 +TT	-91.2 +TT	-90.0 +TT	-89.1 +TT		-87.9 +TT		-79.9 +TT	
n5	15	-98.0 +TT	-94.8 +TT	-93.0 +TT	-90.8 +TT	-84.8 +TT						FDD
	30		-95.1 +TT	-93.1 +TT	-91.0 +TT	-84.9 +TT						
	60											
n7 ¹	15	-98.0 +TT	-94.8 +TT	-93.0 +TT	-91.8 +TT							FDD
	30		-95.1 +TT	-93.1 +TT	-92.0 +TT							
	60		-95.5 +TT	-93.4 +TT	-92.2 +TT							
n8	15	-97.0 +TT	-93.8 +TT	-92.0 +TT	-90.0 +TT							FDD
	30		-94.1 +TT	-92.1 +TT	-90.2 +TT							
	60											
n12	15	-97.0 +TT	-93.8 +TT	-84.0 +TT								FDD
	30		-94.1 +TT	-84.1 +TT								
	60											
n14	15	-97.0 +TT	-93.8 +TT									FDD
	30		-94.1 +TT									
	60											

n20	15	-97.0 +TT	-93.8 +TT	-91.0 +TT	-89.8 +TT								FDD
	30		-94.1 +TT	-91.1 +TT	-90.0 +TT								
	60												
n24	15	-100.0 +TT	-96.8 +TT										FDD
	30		-97.1 +TT										
	60		-97.5 +TT										
n25	15	-96.5 +TT	-93.3 +TT	-91.5 +TT	-90.3 +TT	-89.3 +TT	-82.2 +TT		-79.5 +TT				FDD
	30		-93.6 +TT	-91.6 +TT	-90.5 +TT	-89.4 +TT	-82.3 +TT		-79.6 +TT				
	60		-94.0 +TT	-91.9 +TT	-90.7 +TT	-89.6 +TT	-82.4 +TT		-79.7 +TT				
n26	15	-97.5 +TT	-94.5 +TT	-92.7 +TT	-87.6 +TT								
	30		-94.8 +TT	-92.7 +TT	-87.7 +TT								
n28	15	-98.5 +TT	-95.5 +TT	-93.5 +TT	-90.8 +TT		-78.5 +TT						FDD
	30		-95.6 +TT	-93.6 +TT	-91.0 +TT		-78.6 +TT						
	60												
n30	15	-99.0 +TT	-95.8 +TT										FDD
	30		-96.1 +TT										
	60												
n65	15	-99.5+TT	-96.3+TT	-94.5+TT	-93.3+TT								FDD
	30		-96.6+TT	-94.6+TT	-93.5+TT								
	60		-97.0+TT	-94.9+TT	-93.7+TT								
n66	15	-99.5 +TT	-96.3 +TT	-94.5 +TT	-93.3 +TT	-92.2 +TT	-91.4 +TT		-90.1 +TT				FDD
	30		-96.6 +TT	-94.6 +TT	-93.5 +TT	-92.3 +TT	-91.5 +TT		-90.2 +TT				
	60		-97.0 +TT	-94.9 +TT	-93.7 +TT	-92.5 +TT	-91.6 +TT		-90.4 +TT				
n70	15	-100.0 +TT	-96.8 +TT	-95.0 +TT	-93.8 +TT	-92.7 +TT							FDD
	30		-97.1 +TT	-95.1 +TT	-94.0 +TT	-92.8 +TT							
	60		-97.5 +TT	-95.4 +TT	-94.2 +TT	-93.0 +TT							
n71	15	-97.2 +TT	-94.0 +TT	-91.6 +TT	-86.0 +TT								FDD
	30		-94.3 +TT	-91.9 +TT	-87.4 +TT								
	60	-											
n74	15	-99.5 ³ +TT	-96.3 ³ +TT	-94.5 ³ +TT	-93.3 ³ +TT								FDD

	30		-96.6 ³ +TT	-94.6 ³ +TT	-93.5 ³ +TT						
	60		-97.0 ³ +TT	-94.9 ³ +TT	-93.7 ³ +TT						

NOTE 1: Four Rx antenna ports shall be the baseline for this operating band except for two Rx vehicular UE.
 NOTE 2: The transmitter shall be set to P_{UMAX} as defined in subclause 6.2.4
 NOTE 3: ³ indicates that the requirement is modified by -0.5 dB when the assigned NR channel bandwidth is confined within 1475.9-1510.9 MHz.
 NOTE 4: Void
 NOTE 5: Void
 NOTE 6: TT for each frequency and channel bandwidth is specified in Table 7.3.2.5-3.

Table 7.3.2.5-1b: Two antenna port reference sensitivity QPSK P_{REFSENS} for TDD, SDL and FDD with variable duplex operation bands

Operating band / SCS / Channel bandwidth / REFSENS				
Operating band	SCS kHz	Channel bandwidth (MHz)	REFSENS (dBm) ⁸	Duplex Mode
n34	15	5, 10, 15	-100 + 10log ₁₀ (N _{RB} /25)+TT	TDD
	30	10, 15	-97.1 + 10log ₁₀ (N _{RB} /24)+TT	
	60	10, 15	-97.5 + 10log ₁₀ (N _{RB} /11)+TT	
n38 ¹	15	5, 10, 15, 20, 25, 30, 40	-100 + 10log ₁₀ (N _{RB} /25)+TT	TDD
	30	10, 15, 20, 25, 30, 40	-97.1 + 10log ₁₀ (N _{RB} /24)+TT	
	60	10, 15, 20, 25, 30, 40	-97.5 + 10log ₁₀ (N _{RB} /11)+TT	
n39	15	5, 10, 15, 20, 25, 30, 40	-100 + 10log ₁₀ (N _{RB} /25)+TT	TDD
	30	10, 15, 20, 25, 30, 40	-97.1 + 10log ₁₀ (N _{RB} /24)+TT	
	60	10, 15, 20, 25, 30, 40	-97.5 + 10log ₁₀ (N _{RB} /11)+TT	
n40	15	5, 10, 15, 20, 25, 30, 40, 50	-100 + 10log ₁₀ (N _{RB} /25)+TT	TDD
	30	10, 15, 20, 25, 30, 40, 50, 60, 80, 90, 100	-97.1 + 10log ₁₀ (N _{RB} /24)+TT	
	60	10, 15, 20, 25, 30, 40, 50, 60, 80, 90, 100	-97.5 + 10log ₁₀ (N _{RB} /11)+TT	
n41 ¹	15	10, 15, 20, 30, 40, 50	-94.8 + 10log ₁₀ (N _{RB} /50)+TT	TDD
	30	10, 15, 20, 30, 40, 50, 60, 70, 80, 90, 100	-95.1 + 10log ₁₀ (N _{RB} /24)+TT	
	60	10, 15, 20, 30, 40, 50, 60, 70, 80, 90, 100	-95.5 + 10log ₁₀ (N _{RB} /11)+TT	

n48 ¹	15	5, 10, 15, 20, 30, 40, 50 ⁵	$-99 + 10\log_{10}(N_{RB}/25) + TT$	TDD
	30	10, 15, 20, 30, 40, 50 ⁵ , 60 ⁵ , 70 ⁵ , 80 ⁵ , 90 ⁵ , 100 ⁵	$-96.1 + 10\log_{10}(N_{RB}/24) + TT$	
	60	10, 15, 20, 30, 40, 50 ⁵ , 60 ⁵ , 70 ⁵ , 80 ⁵ , 90 ⁵ , 100 ⁵	$-96.5 + 10\log_{10}(N_{RB}/11) + TT$	
n50	15	5, 10, 15, 20, 30, 40, 50	$-100 + 10\log_{10}(N_{RB}/25) + TT$	TDD
	30	10, 15, 20, 30, 40, 50, 60, 80	$-97.1 + 10\log_{10}(N_{RB}/24) + TT$	
	60	10, 15, 20, 30, 40, 50, 60, 80	$-97.5 + 10\log_{10}(N_{RB}/11) + TT$	
n51	15	5	$-100 + TT$	TDD
n53	15	5, 10	$-100 + 10\log_{10}(N_{RB}/25) + TT$	TDD
	30	10	$-97.1 + TT$	
	60	10	$-97.5 + TT$	
n77 ^{1,4}	15	10, 15, 20, 40, 50	$-95.3 + 10\log_{10}(N_{RB}/50) + TT$	TDD
	30	10, 15, 20, 40, 50, 60, 70, 80, 90, 100	$-95.6 + 10\log_{10}(N_{RB}/24) + TT$	
	60	10, 15, 20, 40, 50, 60, 70, 80, 90, 100	$-96.0 + 10\log_{10}(N_{RB}/11) + TT$	
n78 ¹	15	10, 15, 20, 40, 50	$-95.8 + 10\log_{10}(N_{RB}/50) + TT$	TDD
	30	10, 15, 20, 40, 50, 60, 70, 80, 90, 100	$-96.1 + 10\log_{10}(N_{RB}/24) + TT$	
	60	10, 15, 20, 40, 50, 60, 70, 80, 90, 100	$-96.5 + 10\log_{10}(N_{RB}/11) + TT$	
n79 ¹	15	40, 50	$-89.6 + 10\log_{10}(N_{RB}/216) + TT$	TDD
	30	40, 50, 60, 80, 100	$-89.7 + 10\log_{10}(N_{RB}/106) + TT$	
	60	40, 50, 60, 80, 100	$-89.9 + 10\log_{10}(N_{RB}/51) + TT$	

NOTE 1: Four Rx antenna ports shall be the baseline for this operating band except for two Rx vehicular UE.

NOTE 2: The transmitter shall be set to P_{UMAX} as defined in clause 6.2.4.

NOTE 3: Void

NOTE 4: The requirement is modified by -0.5 dB when the assigned UE channel bandwidth is confined within 3300 - 3800 MHz.

NOTE 5: For these bandwidths, the minimum requirements are restricted to operation when carrier is configured as a downlink carrier part of CA configuration.

NOTE 6: Void

NOTE 7: For SDL bands, the reference sensitivity requirements shall be verified by inter-band CA combinations with SDL band, which are supported by UE.

NOTE 8: The REFSSENS value is rounded to the nearest number down to one decimal point. " N_{RB} " in REFSSENS formula is the maximum transmission bandwidth configuration as defined in Table 5.3.2-1.

NOTE 9: TT for each frequency and channel bandwidth is specified in Table 7.3.2.5-3.

Table 7.3.2.5-2a: Four antenna port Reference sensitivity QPSK $P_{REFSENS}$ FDD bands

Operating Band	SCS kHz	5 MHz (dBm)	10 MHz (dBm)	15 MHz (dBm)	20 MHz (dBm)	25 MHz (dBm)	30 MHz (dBm)	35 MHz (dBm)	40 MHz (dBm)	45 MHz (dBm)	50 MHz (dBm)	Duplex Mode
n1	15	-102.7 +TT	-99.5 +TT	-97.7 +TT	-96.5 +TT	-95.4 +TT	-94.6 +TT		-93.3 +TT	-92.8 +TT	-92.3 +TT	FDD
	30		-99.8 +TT	-97.8 +TT	-96.7 +TT	-95.5 +TT	-94.7 +TT		-93.4 +TT	-92.9 +TT	-92.4 +TT	
	60		-100.2 +TT	-98.1 +TT	-96.9 +TT	-95.7 +TT	-94.8 +TT		-93.6 +TT	-93 +TT	-92.4 +TT	
n2	15	-100.7 +TT	-97.5 +TT	-95.7 +TT	-94.5 +TT	-93.4 +TT	-86.8 +TT		-84.2 +TT			FDD
	30		-97.8 +TT	-95.8 +TT	-94.7 +TT	-93.5 +TT	-86.9 +TT		-83.3 +TT			
	60		-98.2 +TT	-96.1 +TT	-94.9 +TT	-93.6 +TT	-87.0 +TT		-84.4 +TT			
n3	15	-99.7 +TT	-96.5 +TT	-94.7 +TT	-93.5 +TT	-92.4 +TT	-91.6 +TT		-90.3 +TT		-82.4 +TT	FDD
	30		-96.8 +TT	-94.8 +TT	-93.7 +TT	-92.5 +TT	-91.7 +TT		-90.4 +TT		-82.5 +TT	
	60		-97.2 +TT	-95.1 +TT	-93.9 +TT	-92.7 +TT	-91.8 +TT		-90.6 +TT		-82.6 +TT	
n7	15	-100.7 +TT	-97.5 +TT	-95.7 +TT	-94.5 +TT							FDD
	30		-97.8 +TT	-95.8 +TT	-94.7 +TT							

	60		-98.2 +TT	-97.1 +TT	-94.9 +TT							
n30	15	-101.7 +TT	-98.5 +TT									FDD
	30		-98.8 +TT									
	60											
n66	15	-102.2 +TT	-99.0 +TT	-97.2 +TT	-96.0 +TT	-94.9 +TT	-94.1 +TT		-92.8 +TT			FDD
	30		-99.3 +TT	-97.3 +TT	-96.2 +TT	-95.0 +TT	-94.2 +TT		-92.9 +TT			
	60		-99.7 +TT	-97.6 +TT	-96.4 +TT	-95.2 +TT	-94.3 +TT		-93.1 +TT			
n70	15	-102.7 +TT	-99.5 +TT	-97.7 +TT	-96.5 +TT	-95.4 +TT						FDD
	30		-99.8 +TT	-97.8 +TT	-96.7 +TT	-95.5 +TT						
	60		-100.2 +TT	-98.1 +TT	-96.9 +TT	-95.7 +TT						
NOTE 1: Four Rx antenna ports shall be the baseline for above listed operating band except for two Rx vehicular UE.												
NOTE 2: The requirement is modified by -0.5 dB when the assigned UE channel bandwidth is confined within 3300 - 3800 MHz.												
NOTE 3: For these bandwidths, the minimum requirements are restricted to operation when carrier is configured as a downlink carrier part of CA configuration.												
NOTE 4: TT for each frequency and channel bandwidth is specified in Table 7.3.2.5-3.												

Table 7.3.2.5-2b: Four antenna port Reference sensitivity QPSK P_{REFSENS} for TDD, SDL and FDD with variable duplex operation bands

Operating band / SCS / Channel bandwidth / REFSENS				
Operating band	SCS kHz	Channel bandwidth (MHz)	REFSENS (dBm) ⁸	Duplex Mode
n34	15	5, 10, 15	-100 + 10log ₁₀ (N _{RB} /25) - 2.7 +TT	TDD
	30	10, 15	-97.1 + 10log ₁₀ (N _{RB} /24) - 2.7 TT	
	60	10, 15	-97.5 + 10log ₁₀ (N _{RB} /11) - 2.7 +TT	
n38 ¹	15	5, 10, 15, 20, 25, 30, 40	-100 + 10log ₁₀ (N _{RB} /25) - 2.7 +TT	TDD
	30	10, 15, 20, 25, 30, 40	-97.1 + 10log ₁₀ (N _{RB} /24) - 2.7 +TT	
	60	10, 15, 20, 25, 30, 40	-97.5 + 10log ₁₀ (N _{RB} /11) - 2.7 +TT	
n39	15	5, 10, 15, 20, 25, 30, 40	-100 + 10log ₁₀ (N _{RB} /25) - 2.7 +TT	TDD

	30	10, 15, 20, 25, 30, 40	$-97.1 + 10\log_{10}(N_{RB}/24) - 2.7 + TT$	
	60	10, 15, 20, 25, 30, 40	$-97.5 + 10\log_{10}(N_{RB}/11) - 2.7 + TT$	
n40	15	5, 10, 15, 20, 25, 30, 40, 50	$-100 + 10\log_{10}(N_{RB}/25) - 2.7 + TT$	TDD
	30	10, 15, 20, 25, 30, 40, 50, 60, 80, 90, 100	$-97.1 + 10\log_{10}(N_{RB}/24) - 2.7 + TT$	
	60	10, 15, 20, 25, 30, 40, 50, 60, 80, 90, 100	$-97.5 + 10\log_{10}(N_{RB}/11) - 2.7 + TT$	
n41 ¹	15	10, 15, 20, 30, 40, 50	$-94.8 + 10\log_{10}(N_{RB}/50) - 2.7 + TT$	TDD
	30	10, 15, 20, 30, 40, 50, 60, 70, 80, 90, 100	$-95.1 + 10\log_{10}(N_{RB}/24) - 2.7 + TT$	
	60	10, 15, 20, 30, 40, 50, 60, 70, 80, 90, 100	$-95.5 + 10\log_{10}(N_{RB}/11) - 2.7 + TT$	
n48 ¹	15	5, 10, 15, 20, 30, 40, 50 ⁵	$-99 + 10\log_{10}(N_{RB}/25) - 2.2 + TT$	TDD
	30	10, 15, 20, 40, 50 ⁵ , 60 ⁵ , 70 ⁵ , 80 ⁵ , 90 ⁵ , 100 ⁵	$-96.1 + 10\log_{10}(N_{RB}/24) - 2.2 + TT$	
	60	10, 15, 20, 40, 50 ⁵ , 60 ⁵ , 70 ⁵ , 80 ⁵ , 90 ⁵ , 100 ⁵	$-96.5 + 10\log_{10}(N_{RB}/11) - 2.2 + TT$	
n77 ^{1,4}	15	10, 15, 20, 40, 50	$-95.3 + 10\log_{10}(N_{RB}/50) - 2.2 + TT$	TDD
	30	10, 15, 20, 40, 50, 60, 70, 80, 90, 100	$-95.6 + 10\log_{10}(N_{RB}/24) - 2.2 + TT$	
	60	10, 15, 20, 40, 50, 60, 70, 80, 90, 100	$-96.0 + 10\log_{10}(N_{RB}/11) - 2.2 + TT$	
n78 ¹	15	10, 15, 20, 40, 50	$-95.8 + 10\log_{10}(N_{RB}/50) - 2.2 + TT$	TDD
	30	10, 15, 20, 40, 50, 60, 70, 80, 90, 100	$-96.1 + 10\log_{10}(N_{RB}/24) - 2.2 + TT$	
	60	10, 15, 20, 40, 50, 60, 70, 80, 90, 100	$-96.5 + 10\log_{10}(N_{RB}/11) - 2.2 + TT$	
n79 ¹	15	40, 50	$-89.6 + 10\log_{10}(N_{RB}/216) - 2.2 + TT$	TDD
	30	40, 50, 60, 80, 100	$-89.7 + 10\log_{10}(N_{RB}/106) - 2.2 + TT$	
	60	40, 50, 60, 80, 100	$-89.9 + 10\log_{10}(N_{RB}/51) - 2.2 + TT$	

- NOTE 1: Four Rx antenna ports shall be the baseline for this operating band except for two Rx vehicular UE.
- NOTE 2: The transmitter shall be set to P_{UMAX} as defined in clause 6.2.4.
- NOTE 3: Void
- NOTE 4: The requirement is modified by -0.5 dB when the assigned UE channel bandwidth is confined within 3300 - 3800 MHz.
- NOTE 5: For these bandwidths, the minimum requirements are restricted to operation when carrier is configured as a downlink carrier part of CA configuration.
- NOTE 6: Void
- NOTE 7: For SDL bands, the reference sensitivity requirements shall be verified by inter-band CA combinations with SDL band, which are supported by UE.
- NOTE 8: The REFSENS value is rounded to the nearest number down to one decimal point. " N_{RB} " in REFSENS formula is the maximum transmission bandwidth configuration as defined in Table 5.3.2-1.
- NOTE 9: TT for each frequency and channel bandwidth is specified in Table 7.3.2.5-3.

Table 7.3.2.5-3: Test Tolerance (TT) for RX sensitivity level

$f \leq 3.0\text{GHz}$	$3.0\text{GHz} < f \leq 6.0\text{ GHz}$
0.7 dB	1.0 dB

For the UE which supports inter-band carrier aggregation, the minimum requirement for reference sensitivity in Table 7.3.2.5-1 a and Table 7.3.2.5-1b shall be increased by the amount given in $\Delta R_{IB,c}$ defined in subclause 7.3.3 for the applicable operating bands.

7.3.3 $\Delta R_{IB,c}$

For a UE supporting CA, SUL or DC band combination, the minimum requirement for reference sensitivity in Table 7.3.2.3-1 shall be increased by the amount given by $\Delta R_{IB,c}$ defined in subclause 7.3A.0.3, 7.3C.0.3, 7.3B in this specification and 7.3A, 7.3B in TS 38.101-3 [4] for the applicable operating bands.

In case the UE supports more than one of band combinations for CA, SUL or DC, and an operating band belongs to more than one band combinations then

- When the operating band frequency range is ≤ 1 GHz, the applicable additional $\Delta R_{IB,c}$ shall be the average value for all band combinations defined in subclause 7.3A.0.3, 7.3C.0.3, 7.3B in this specification and 7.3A, 7.3B in TS 38.101-3 [4], truncated to one decimal place that apply for that operating band among the supported band combinations. In case there is a harmonic relation between low band UL and high band DL, then the maximum $\Delta R_{IB,c}$ among the different supported band combinations involving such band shall be applied
- When the operating band frequency range is > 1 GHz, the applicable additional $\Delta R_{IB,c}$ shall be the maximum value for all band combinations defined in subclause 7.3A.0.3, 7.3C.0.3, 7.3B in this specification and 7.3A, 7.3B in TS 38.101-3 [4] for the applicable operating bands.

7.3A Reference sensitivity for CA

Editor's Note: This clause is incomplete. The following aspects are either missing or not yet determined:

Test requirement table for 2DL/2UL is not complete.

- Reference sensitivity power level for 4DL_CA and 5DL_CA are FFS.

- Test description for exceptional cases are incomplete.

7.3A.0 Minimum conformance requirements

7.3A.0.1 General

The reference sensitivity power level REFSENS is the minimum mean power applied to each one of the UE antenna ports for all UE categories, at which the throughput shall meet or exceed the requirements for the specified reference measurement channel.

7.3A.0.2 Reference sensitivity power level for CA

7.3A.0.2.1 Reference sensitivity power level for Intra-band contiguous CA

For intra-band contiguous carrier aggregation, the throughput of each component carrier shall be $\geq 95\%$ of the maximum throughput of the reference measurement channels as specified in Annex A.2.2.2, A.2.3.2, A.3.2, and A.3.3 (with one sided dynamic OCNG Pattern OP.1 FDD/TDD for the DL-signal as described in Annex A.5.1.1/A.5.2.1) with parameters specified in Table 7.3.2.3-1, Table 7.3.2.3-2, and Table 7.3.2.3-3.

For UE(s) supporting one uplink carrier, the uplink configuration of the PCC shall be in accordance with Table 7.3.2.3-3 and the downlink PCC carrier centre frequency shall be configured closer to uplink operating band than any of the downlink SCC centre frequency.

7.3A.0.2.2 Reference sensitivity power level for Intra-band non-contiguous CA

For intra-band non-contiguous carrier aggregation with one uplink carrier and two or more downlink sub-blocks, throughput of each downlink component carrier shall be $\geq 95\%$ of the maximum throughput of the reference

measurement channels as specified in Annexes A.2.2, A.2.3 and A.3.2 (with one sided dynamic OCNG Pattern OP.1 FDD/TDD for the DL-signal as described in Annex A.5.1.1/A.5.2.1) and parameters specified in Table 7.3.2.3-1, Table 7.3.2.3-2, and Table 7.3A.0.2.2-1 with the reference sensitivity power level increased by ΔR_{IBNC} given in Table 7.3A.0.2.2-1 for the SCC(s). For aggregation of two or more downlink FDD carriers with one uplink carrier the reference sensitivity is defined only for the specific uplink and downlink test points which are specified in Table 7.3A.0.2.2-1. The requirements apply with all downlink carriers active. Unless given by Table 7.3.2.3-4, the reference sensitivity requirements shall be verified with the network signalling value NS_01 (Table 6.2.3.3.1-1) configured.

Table 7.3A.0.2.2-1: Intra-band non-contiguous CA with one uplink configuration for reference sensitivity

CA configuration	SCS (PCC/SCC) (kHz)	Aggregated channel bandwidth (PCC+SCC)	W_{gap} / [MHz]	UL PCC allocation	ΔR_{IBNC} (dB)	Duplex mode
CA_n66(2A)	N/A	NOTE 1	NOTE 2	NOTE 3, NOTE 4	0.0	FDD
CA_n71(2A)	15/15	5MHz + 5MHz	$W_{gap} = 25.0$	5	4.0	FDD
			$W_{gap} = 5.0$	20	0.0	
		10MHz + 5MHz	$W_{gap} = 20.0$	5 ($R_{Bstart} = 9$)	4.6	
			$W_{gap} = 5.0$	20 ($R_{Bstart} = 9$)	2.3	
		15MHz + 10MHz	$W_{gap} = 10.0$	5 ($R_{Bstart} = 2$)	22.2	
			$W_{gap} = 5.0$	20 ($R_{Bstart} = 19$)	5.2	
CA_n77(2A)		NOTE 1	NOTE 2	NOTE 3	0.0	TDD
CA_n78(2A)		NOTE 1	NOTE 2	NOTE 3	0.0	TDD
NOTE 1: All combinations of channel bandwidths defined in Table 5.5A.2-1. NOTE 2: All applicable sub-block gap sizes. NOTE 3: The PCC allocation is same as Transmission bandwidth configuration N_{RB} as defined in Table 5.3.2-1. NOTE 4: The carrier centre frequency of PCC in the DL operating band is configured closer to the UL operating band. NOTE 5: W_{gap} is the sub-block gap between the two sub-blocks.						

7.3A.0.2.3 Reference sensitivity power level for Inter-band CA

For inter-band carrier aggregation with one component carrier per operating band and the uplink assigned to one NR band the throughput shall be $\geq 95\%$ of the maximum throughput of the reference measurement channels as specified in Annexes A.2.2.2, A.2.3.2, A.3.2, and A.3.3 (with one sided dynamic OCNG Pattern OP.1 FDD/TDD for the DL-signal as described in Annex A.5.1.1/A.5.2.1 with parameters specified in Table 7.3.2.3-1, Table 7.3.2.3-2 and Table 7.3.2.3-3 modified in accordance with subclause 7.3A.0.3.2. The reference sensitivity is defined to be met with all downlink component carriers active and one of the uplink carriers active. Exceptions to reference sensitivity are allowed in accordance with subclause 7.3A.0.4.

7.3A.0.2.4 Reference sensitivity power level for SDL bands

For band combinations including operating bands without uplink band (as noted in Table 5.2-1), the requirements are specified in Table 7.3A.0.2.4-1 and for any band with uplink the uplink configuration specified in Table 7.3.2.3-3. The throughput of each carrier shall be $\geq 95\%$ of the maximum throughput of the reference measurement channels, as specified in Annexes A.2.2, A.2.3, A.3.2, and A.3.3 (with one-sided dynamic OCNG Pattern OP.1 FDD/TDD for the DL-signal, as described in Annex A.5.1.1/A.5.2.1). The reference sensitivity is defined to be met with all downlink component carriers active and one of the uplink carriers active. Exceptions to reference sensitivity are allowed in accordance with clause 7.3A.0.4.

Table 7.3A.0.2.4-1: Reference sensitivity for SDL bands

NR CA Configuration	NR band	SCS (kHz)	NR Band/Channel bandwidth											
			5 MHz dB	10 MHz dB	15 MHz dB	20 MHz dB	25 MHz dB	30 MHz dB	40 MHz dB	50 MHz dB	60 MHz dB	80 MHz dB	90 MHz dB	100 MHz dB
CA_n8A-n75A	n8	15	-97.0	-93.8	-92.0	-90.0								
		30		-94.1	-92.1	-90.2								
		60												
	n75	15	-100	-96.8	-95.0	-93.8								
		30		-97.1	-95.1	-94.0								
		60		-97.5	-95.4	-94.2								
CA_n28A-n75A	n28	15	-98.5	-95.5	-93.5	-90.8								
		30		-95.6	-93.6	-91.0								
		60												
	n75	15	-100	-96.8	-95.0	-93.8								
		30		-97.1	-95.1	-94.0								
		60		-97.5	-95.4	-94.2								
CA_n29A-n66A CA_n29A-n66B CA_n29A-n66(2A)	n29	15	-97.0	-93.8										
		30		-94.1										
		60												
	n66	15	-99.5	-96.3	-94.5	-93.3			-90.1					
		30		-96.6	-94.6	-93.5			-90.2					
		60		-97.0	-94.9	-93.7			-90.4					
CA_n29A-n70A	n29	15	-97.0	-93.8										
		30		-94.1										
		60												
	n70	15	-100	-96.8	-95.0	-93.8	-92.7							
		30		-97.1	-95.1	-94.0	-92.8							
		60		-97.5	-95.4	-94.2	-93.0							
CA_n29A-n71A	n29	15	-97.0 ³	-93.8 ³										
		30		-94.1 ³										
		60												
	n71	15	-97.2	-94.0	-91.6	-86.0								
		30		-94.3	-91.9	-87.4								
		60												
CA_n75A-n78A ¹	n75	15	-100	-96.8	-95.0	-93.8								
		30		-97.1	-95.1	-94.0								
		60		-97.5	-95.4	-94.2								
	n78	15		-95.8	-94.0	-92.7			-89.6	-88.6				
		30		-96.1	-94.1	-92.9			-89.7	-88.7	-87.9	-86.6	-86.1	-85.6
		60		-96.5	-94.4	-93.1			-89.9	-88.8	-88.0	-86.7	-86.2	-85.7

NR Band/Channel bandwidth														
NR CA Configuration	NR band	SCS (kHz)	5 MHz	10 MHz	15 MHz	20 MHz	25 MHz	30 MHz	40 MHz	50 MHz	60 MHz	80 MHz	90 MHz	100 MHz
CA_n76A-n78A ¹	n76	15	-100											
		30												
		60												
	n78	15		-95.8	-94.0	-92.7			-89.6	-88.6				
		30		-96.1	-94.1	-92.9			-89.7	-88.7	-87.9	-86.6	-86.1	-85.6
		60		-96.5	-94.4	-93.1			-89.9	-88.8	-88.0	-86.7	-86.2	-85.7

NOTE 1: The transmitter shall be set to P_{UMAX} , as defined in subclause 6.2.4.

NOTE 2: Four Rx antenna ports shall be the baseline for this operating band, except for two Rx vehicular UE.

NOTE 3: For CA_n29-n71 MSD due to cross band isolation exception specified in Table 7.3A.0.6-1 is applied

7.3A.0.3 $\Delta R_{IB,c}$ for CA

7.3A.0.3.1 General

For a UE supporting a CA configuration, the $\Delta R_{IB,c}$ applies for both SC and CA operation.

7.3A.0.3.2 $\Delta R_{IB,c}$ for Inter-band CA

For the UE which supports inter-band carrier aggregation, the minimum requirement for reference sensitivity in subclause 7.3A.0 shall be increased by the amount given by $\Delta R_{IB,c}$ defined in subclause 7.3A.0.3.2 for the applicable operating bands. Unless otherwise stated, $\Delta R_{IB,c}$ is set to zero.

In case the UE supports more than one of band combinations for CA, SUL or DC, and an operating band belongs to more than one band combinations then

- When the operating band frequency range is ≤ 1 GHz, the applicable additional $\Delta R_{IB,c}$ shall be the average value for all band combinations defined in subclause 7.3A, 7.3B, 7.3C in this specification and 7.3A, 7.3B in TS 38.521-3 [14], truncated to one decimal place that apply for that operating band among the supported band combinations. In case there is a harmonic relation between low band UL and high band DL, then the maximum $\Delta R_{IB,c}$ among the different supported band combinations involving such band shall be applied.
- When the operating band frequency range is > 1 GHz, the applicable additional $\Delta R_{IB,c}$ shall be the maximum value for all band combinations defined in subclause 7.3A, 7.3B, 7.3C in this specification and 7.3A, 7.3B in TS 38.521-3 [14] for the applicable operating bands.

7.3A.0.3.2.1

 $\Delta R_{IB,c}$ for two bandsTable 7.3A.0.3.2.1-1: $\Delta R_{IB,c}$ due to CA (two bands)

Inter-band CA configuration	NR Band	$\Delta R_{IB,c}$ (dB)
CA_n1-n77	n1	0.2
	n77	0.5
CA_n1-n78	n78	0.5
CA_n3-n41	n41	0 ²
		0.5 ³
CA_n3-n77	n3	0.2
	n77	0.5
CA_n3-n78	n3	0.2
	n78	0.5
CA_n3-n79	n79	0.5
CA_n5-n78	n5	0.2
	n78	0.5
CA_n7-n78	n7	0.5
	n78	0.5
CA_n8-n78	n8	0.2
	n78	0.5
CA_n8-n79	n79	0.5
CA_n24-n48	n24	0.2
	n48	0.5
CA_n24-n77	n24	0.2
	n77	0.5
CA_n28-n75	n28	0.2
CA_n28-n78	n28	0.2
	n78	0.5
CA_n28-n79	n28	0.2
	n79	0.5
CA_n41-n78 ¹	n78	0.5
CA_n41-n79	n41	0.5
	n79	0.5
CA_n48-n66	n48	0.5
	n66	0.2
CA_n48-n70	n48	0.5
	n70	0.2
CA_n75-n78	n78	0.5
CA_n76-n78	n78	0.5

NOTE 1: The requirements only apply when the sub-frame and Tx-Rx timings are synchronized between the component carriers. In the absence of synchronization, the requirements are not within scope of these specifications.

NOTE 2: The requirement is applied for UE transmitting on the frequency range of 2515 – 2690 MHz.

NOTE 3: The requirement is applied for UE transmitting on the frequency range of 2496 – 2515 MHz.

7.3A.0.3.2.2 Void

7.3A.0.3.2.3 $\Delta R_{IB,c}$ for three bands

Table 7.3A.0.3.2.3-1: $\Delta R_{IB,c}$ due to CA (three bands)

Inter-band CA combination	NR Band	$\Delta R_{IB,c}$ (dB)
CA_n1-n78-n79	n78	0.5
CA_n26-n66-n70	n26	0
	n66	0
	n70	0
CA_n26-n70-n71	n26	0
	n70	0
	n71	0
CA_n48-n66-n70	n48	0.5
	n66	0.2
	n70	0.2
CA_n48-n66-n71	n48	0.2
	n70	0.2
	n71	0.2
CA_n48-n70-n71	n48	0.2
	n70	0.2
	n71	0.2
CA_n66-n70-n71	n66	0
	n70	0
	n71	0

7.3A.0.3.2.4 $\Delta R_{IB,c}$ for four bands

Table 7.3A.0.3.2.4-1: $\Delta R_{IB,c}$ due to CA (four bands)

Inter-band CA combination	NR Band	$\Delta R_{IB,c}$ (dB)
---------------------------	---------	------------------------

7.3A.0.4 Reference sensitivity exceptions due to UL harmonic interference for CA

Sensitivity degradation is allowed for a band in frequency range 1 if it is impacted by UL harmonic interference from another band in frequency range 1 of the same CA configuration. Reference sensitivity exceptions are specified in Table 7.3A.0.4-1 with uplink configuration specified in Table 7.3A.0.4-2.

Table 7.3A.0.4-1: Reference sensitivity exceptions due to UL harmonic for NR CA FR1

MSD due to harmonic exception for the DL band													
UL band	DL band	5 MHz	10 MHz	15 MHz	20 MHz	25 MHz	30 MHz	40 MHz	50 MHz	60 MHz	80 MHz	90 MHz	100 MHz
		dB	dB	dB	dB	dB	dB	dB	dB	dB	dB	dB	dB

n1	n77 ^{1,2}		23.9	22.1	20.9			17.9	16.8	16.0	14.8	14.3	13.8
	n77 ³		1.1	0.8	0.3								
n3	n77 ^{1,2}		23.9	22.1	20.9			17.9	16.9	16.1	14.8	14.3	13.8
	n77 ³		1.1	0.8	0.3								
n3	n78 ^{1,2}		23.9	22.1	20.9			17.9	16.9	16.1	14.8	14.3	13.8
	n78 ³		1.1	0.8	0.3								
n5	n774,5,13		10.5	8.9	7.8	7.2	6.5	5.1	4.2	3.5	2.8	2.3	2.1
n5	n776,7,13		10.4	8.9	7.8	6.7	6.0	4.7	3.7	3	2.3	1.7	1.2
n5	n78 ^{4,5}		10.5	8.9	7.8	7.1	6.5	5.4	4.2	3.5	2.3	2.1	1.4
n8	n78 ^{4,5}		10.8	9.1	8.0			5.1	4.2	3.5	2.3	2.1	1.4
n8	n79 ^{6,7}							[6.8]	6.2	[5.6]	4.9		4.4
n24	n77 ^{1,2,13}		23.9	22.1	20.9	19.8	19.0	17.9	16.8	16.0	14.8	14.3	13.8
	n77 ^{3,13}		1.1	0.8	0.3	0.1							
n28	n75 ^{1,2}	28.1	25.3	24.0	22.8								
	n78 ^{6,7}		[10.4]	[8.9]	[7.8]			[4.7]	[3.7]	[3]	[1.7]	[1.2]	[0.7]
n66	n48 ^{1,2}	27.1	23.9	22.1	20.9			17.9	16.9 ¹²	16.1 ¹²		14.8 ¹²	14.3 ¹²
	n48 ³	1.9	1.1	0.8	0.3								
n71	n70 ^{8,9}	9.9	7.1	6.7	4.9	4.1							

- NOTE 1: These requirements apply when there is at least one individual RE within the uplink transmission bandwidth of the aggressor (lower) band for which the 2nd transmitter harmonic is within the downlink transmission bandwidth of a victim (higher) band and a range ΔF_{HD} above and below the edge of this downlink transmission bandwidth. The value ΔF_{HD} depends on the band combination: $\Delta F_{HD} = 10$ MHz for CA_n1-n77, CA_n3-n77, CA_n3-n78.
- NOTE 2: The requirements should be verified for UL NR-ARFCN of the aggressor (lower) band (superscript LB) such that $f_{UL}^{LB} = \lfloor f_{DL}^{HB} / 0.2 \rfloor 0.1$ in MHz and $F_{UL_low}^{LB} + BW_{Channel}^{LB} / 2 \leq f_{UL}^{LB} \leq F_{UL_high}^{LB} - BW_{Channel}^{LB} / 2$ with f_{DL}^{HB} carrier frequency in the victim (higher) band in MHz and $BW_{Channel}^{LB}$ the channel bandwidth configured in the lower band.
- NOTE 3: The requirements are only applicable to channel bandwidths no larger than 20 MHz and with a carrier frequency at $\pm (20 + BW_{Channel}^{HB} / 2)$ MHz offset from $2f_{UL}^{LB}$ in the victim (higher band) with $F_{UL_low}^{LB} + BW_{Channel}^{LB} / 2 \leq f_{UL}^{LB} \leq F_{UL_high}^{LB} - BW_{Channel}^{LB} / 2$, where $BW_{Channel}^{LB}$ and $BW_{Channel}^{HB}$ are the channel bandwidths configured in the aggressor (lower) and victim (higher) bands in MHz, respectively.
- NOTE 4: These requirements apply when there is at least one individual RE within the uplink transmission bandwidth of a low band for which the 4th transmitter harmonic is within the downlink transmission bandwidth of a high band.
- NOTE 5: The requirements should be verified for UL NR-ARFCN of a low band (superscript LB) such that $f_{UL}^{LB} = \lfloor f_{DL}^{HB} / 0.4 \rfloor 0.1$ in MHz and $F_{UL_low}^{LB} + BW_{Channel}^{LB} / 2 \leq f_{UL}^{LB} \leq F_{UL_high}^{LB} - BW_{Channel}^{LB} / 2$ with f_{DL}^{HB} the carrier frequency of a high band in MHz and $BW_{Channel}^{LB}$ the channel bandwidth configured in the low band.
- NOTE 6: These requirements apply when there is at least one individual RE within the uplink transmission bandwidth of a low band for which the 5th transmitter harmonic is within the downlink transmission bandwidth of a high band.
- NOTE 7: The requirements should be verified for UL NR-ARFCN of a low band (superscript LB) such that $f_{UL}^{LB} = \lfloor f_{DL}^{HB} / 0.5 \rfloor 0.1$ in MHz and $F_{UL_low}^{LB} + BW_{Channel}^{LB} / 2 \leq f_{UL}^{LB} \leq F_{UL_high}^{LB} - BW_{Channel}^{LB} / 2$ with f_{DL}^{HB} the carrier frequency of a high band in MHz and $BW_{Channel}^{LB}$ the channel bandwidth configured in the low band.
- NOTE 8: These requirements apply when there is at least one individual RE within the uplink transmission bandwidth of the aggressor (lower) band for which the 3rd transmitter harmonic is within the downlink transmission bandwidth of a victim (higher) band.
- NOTE 9: The requirements should be verified for UL NR-ARFCN of the aggressor (lower) band (superscript LB) such that $f_{UL}^{LB} = \lfloor f_{DL}^{HB} / 0.3 \rfloor 0.1$ in MHz and $F_{UL_low}^{LB} + BW_{Channel}^{LB} / 2 \leq f_{UL}^{LB} \leq F_{UL_high}^{LB} - BW_{Channel}^{LB} / 2$ with f_{DL}^{HB} carrier frequency in the victim (higher) band in MHz and $BW_{Channel}^{LB}$ the channel bandwidth configured in the lower band.
- NOTE 10: These requirements apply when the lower edge frequency of the 10 MHz, 15 MHz, or 20 MHz uplink channel in Band 71 is located at or below 668 MHz and the downlink channel in Band n25 is located with its upper edge at 1995 MHz.
- NOTE 11: No requirements apply when there is at least one individual RE within the uplink transmission bandwidth of the low band for which the 2nd transmitter harmonic is within the downlink transmission bandwidth of the high band. The reference sensitivity for all active downlink component carriers is only verified when this is not the case (the requirements specified in clause 7.3.2 apply unless otherwise specified).
- NOTE 12: For these bandwidths, the minimum requirements are restricted to operation when carrier is configured as a downlink carrier part of CA configuration.
- NOTE 13: For a UE which supports this band combination only when the Band n77 frequency range restriction defined in NOTE 12 of Table 5.2-1 applies, the MSD test point(s) cannot be verified for the band combination and the test point(s) can be skipped.

Table 7.3A.0.4-2: Uplink configuration for reference sensitivity exceptions due to UL harmonic interference for NR CA, FR1

NR Band / Channel bandwidth of the high band													
UL band	DL band	5 MHz	10 MHz	15 MHz	20 MHz	25 MHz	30 MHz	40 MHz	50 MHz	60 MHz	80 MHz	90 MHz	100 MHz
n1	n77		25	36	50			100	100	100	100	100	100
n3	n77		25	36	50			50	50	50	50	50	50
n3	n78		25	36	50			50	50	50	50	50	50
n5	n78		16	25	25	25	25	25	25	25	25	25	25
n8	n78		16	25	25			25	25	25	25	25	25
n8	n79							25	25	25	25		25
n24	n77	12	25	25	25	25	25	25	25	25	25	25	25
n28	n75	12	25	36	50								
n28	n78		10	15	20			25	25	25	25	25	25
n66	n48	12	25	36	50			100	128	160		200	200
n71	n70	8	16	20	20	20							

NOTE 1: 15kHz SCS is assumed for UL band.
 NOTE 2: The UL configuration applies regardless of the channel bandwidth of the low band unless the UL resource blocks exceed that specified in Table 7.3.2.3-3 for the uplink bandwidth in which case the allocation according to Table 7.3.2.3-3 applies.
 NOTE 3: Unless stated otherwise, UL resource blocks shall be centred within the transmission bandwidth configuration for the channel bandwidth.

Table 7.3A.0.4-3: Void

Table 7.3A.0.4-3a: Void

Sensitivity degradation is allowed for a band if it is impacted by receiver harmonic mixing due to another band part of the same CA configuration. Reference sensitivity exceptions are specified in Table 7.3A.0.4-4 with uplink configuration specified in Table 7.3A.0.4-4a.

Table 7.3A.0.4-4: Reference sensitivity exceptions due to harmonic mixing for CA in NR FR1

UL band	DL band	5 MHz (dB)	10 MHz (dB)	15 MHz (dB)	20 MHz (dB)	25 MHz (dB)	40 MHz (dB)	50 MHz (dB)	60 MHz (dB)	80 MHz (dB)	90 MHz (dB)	100 MHz (dB)
n41	n78 ¹		8.3	8.0	6.9		3.9	3	2.3	1.2		0.4
n78	n41 ²		10.4	10.4	10.4		7.2	6.2	5.5	4.5		4.5

NOTE 1: The requirements should be verified for UL EARFCN of the aggressor (lower) band (superscript LB) such that $f_{UL}^{LB} = \lfloor f_{DL}^{HB} / 0.15 \rfloor \cdot 0.1$ in MHz and $F_{UL_low}^{LB} + BW_{Channel}^{LB} / 2 \leq f_{UL}^{LB} \leq F_{UL_high}^{LB} - BW_{Channel}^{LB} / 2$ with f_{DL}^{HB} carrier frequency in the victim (higher) band in MHz and $BW_{Channel}^{LB}$ the channel bandwidth configured in the lower band.
 NOTE 2: The requirements should be verified for UL EARFCN of the aggressor (high) band (superscript HB) such that $f_{UL}^{LB} = \lfloor 15 * f_{DL}^{HB} \rfloor \cdot 0.1$ in MHz and $F_{UL_low}^{HB} + BW_{Channel}^{HB} / 2 \leq f_{UL}^{LB} \leq f_{UL_high}^{HB} - BW_{Channel}^{HB} / 2$ with f_{DL}^{LB} carrier frequency in the victim (lower) band in MHz and $BW_{Channel}^{LB}$ the channel bandwidth configured in the higher band.

Table 7.3A.0.4-4a: Uplink configuration for reference sensitivity exceptions due to receiver harmonic mixing for CA in NR FR1

UL band	DL band	SCS (kHz)	5 MHz	10 MHz	15 MHz	20 MHz	25 MHz	40 MHz	50 MHz	60 MHz	80 MHz	90 MHz	100 MHz
n41	n78	30		24	24	24		24	24	24	24	24	24
n78	n41	30		50	50	50		50	50	50	50	50	50

NOTE 1: The UL configuration applies regardless of the channel bandwidth of the UL band unless the UL resource blocks exceed that specified in Table 7.3.2.3-3 for the uplink bandwidth in which case the allocation according to Table 7.3.2.3-3 applies.

7.3A.0.5 Reference sensitivity exceptions due to intermodulation interference due to 2UL CA

For inter-band carrier aggregation with uplink assigned to two NR bands given in Table 7.3A.0.5-1 the reference sensitivity is defined only for the specific uplink and downlink test points specified in Table 7.3A.0.5-1. For these test points the reference sensitivity requirement specified in Table 7.3.2.3-1 and Table 7.3.2.3-2 are relaxed by the amount of the corresponding parameter MSD given in Table 7.3A.0.5-1.

Table 7.3A.0.5-1: 2DL/2UL interband Reference sensitivity QPSK $P_{REFSENS}$ and uplink/downlink configurations

Band / Channel bandwidth / N_{RB} / Duplex mode								Source of IMD
NR CA Configuration	NR band	UL F_c (MHz)	UL/DL BW (MHz)	UL C_{LRB}	DL F_c (MHz)	MSD (dB)	Duplex mode	
CA_n1A-n3A	n1	1950	5	25	2140	23	FDD	IMD3
	n3	1760	5	25	1855	N/A	FDD	N/A
CA_n1-n8	n1	1965	5	25	2155	6.0	FDD	IMD4
	n8	887.5	5	25	932.5	N/A	FDD	N/A
CA_n1A-n78A	n1	1950	5	25	2140	8.0	FDD	IMD4
						10.7 ⁵		
CA_n3A-n5A	n78	3710	10	50	3710	N/A	TDD	N/A
	n3	1771	10	50	1866	4	FDD	IMD4
CA_n3A-n5A	n5	838	5	25	883	N/A	FDD	N/A
	n3	1721	10	50	1816	N/A	FDD	N/A
CA_n3A-n5A	n5	838	5	25	883	24	FDD	IMD2 ³
	n3	1740	5	25	1835	[26] [28.7 ⁵]	FDD	IMD2 ⁴
CA_n3A-n78A	n78	3575	10	25	3575	N/A	TDD	N/A
	n3	1765	5	25	1860	[8.0] [10.7 ⁵]	FDD	IMD4 ⁴
CA_n5A-n77A ⁶	n78	3435	10	25	3435	N/A	TDD	N/A
	n5	844	5	25	889	8.3	FDD	IMD4
	n77	3421	10	50	3421	N/A	TDD	N/A
	n5	829	5	25	874	5.5	FDD	IMD5
CA_n8A-n78A	n77	4190	10	50	4190	N/A	TDD	N/A
	n8	897.5	5	25	942.5	8.3	FDD	IMD4
CA_n24-n77 ¹⁰	n78	3635	10	50	3635	N/A	TDD	N/A
	n24	N/A	N/A	N/A	N/A	N/A	FDD	IMD4
CA_n26A-n66A	n77	N/A	N/A	N/A	N/A	N/A	TDD	N/A
	n26	838	5	25	883	30	FDD	IMD2 ⁴
CA_n26A-n70A	n66	1721	5	25	2121	N/A	FDD	N/A
	n26	838	5	25	883	30	FDD	IMD2 ⁴
CA_n48A-n66A	n70	1710	5	25	2020	N/A	FDD	N/A
	n48	3660	5	25	3660	N/A	TDD	N/A
CA_n48A-n70A	n66	1730	5	25	2130	5.0	FDD	IMD5
	n70	1697.5	25/15	25	1997.5	26 28.7 ⁵	FDD	IMD2 ⁴
CA_n66A-n71A CA_n66(2A)-n71A CA_n66B-n71A	n48	3695	10	50	3695	N/A	TDD	N/A
	n66	1750	5	25	2150	5	FDD	IMD4
CA_n66A-n77A	n71	675	5	25	629	N/A	FDD	N/A
	n66	1775	5	25	2175	31	FDD	IMD2
	n77	3950	10	50	3950	N/A	TDD	N/A
	n66	1760	5	25	2160	5.0	FDD	IMD5
CA_n70A-n71A	n77	3720	10	50	3720	N/A	TDD	N/A
	n70	1697.5	5	25	1997.5	5	FDD	IMD4
	n71	695.5	5	25	649.5	N/A	FDD	N/A

NOTE 1: Both of the transmitters shall be set $\min(+20 \text{ dBm}, P_{CMAX_L,f,c})$ as defined in subclause 6.2A.4
 NOTE 2: $RB_{START} = 0$, 15kHz SCS is assumed.
 NOTE 3: No requirements apply when there is at least one individual RE within the intermodulation generated by the dual uplink is within the downlink transmission bandwidth of the FDD band. The reference sensitivity should only be verified when this is not the case (the requirements specified in clause 7.3 apply).
 NOTE 4: This band is subject to IMD5 also which MSD is not specified.
 NOTE 5: Applicable only if operation with 4 antenna ports is supported in the band with carrier aggregation configured.
 NOTE 6: TBD
 NOTE 7: TBD
 NOTE 8: TBD
 NOTE 9: TBD
 NOTE 10: There is no IMD4 product in band n24 downlink for n77 operating in 3450 – 3980 MHz and n24 uplink restricted to between 1627.5 – 1637.5 MHz and between 1646.5 – 1656.5 MHz.

Table 7.3A.0.5-2: 3DL/2UL interband Reference sensitivity QPSK P_{REFSENS} and uplink/downlink configurations

Band / Channel bandwidth / N_{RB} / Duplex mode								Source of IMD	
NR CA band combination	NR band	UL F_c (MHz)	UL/DL BW (MHz)	UL C_{LRB}	DL F_c (MHz)	MSD (dB)	Duplex mode		
CA_n1-n3-n28	n1	1975	5	25	2165	N/A	FDD	N/A	
	n28	710.5	5	25	765.5	N/A	FDD	N/A	
	n3	1723.5	5	25	1818.5	4.0	FDD	IMD5	
	n3	1780	5	25	1875	N/A	FDD	N/A	
	n28	710.5	5	25	765.5	N/A	FDD	N/A	
CA_n1-n3-n41	n1	1949	5	25	2139	11.0	FDD	IMD4	
	n1	1977.5	5	25	2167.5	N/A	FDD	N/A	
	n3	1712.5	5	25	1807.5	N/A	FDD	N/A	
CA_n1-n3-n78	n41	2507.5	10	25	2507.5	5.0	TDD	IMD5	
	n1	1950	5	25	2140	N/A	FDD	N/A	
	n3	1750	5	25	1845	N/A	FDD	N/A	
	n78	3700	10	52	3700	28.4	TDD	IMD2	
	n1	1950	5	25	2140	N/A	FDD	N/A	
	n3	1770	5	25	1865	N/A	FDD	N/A	
	n78	3360	10	52	3360	11.2	TDD	IMD4	
	n1	1950	5	25	2140	N/A	FDD	N/A	
CA_n1-n5-n7	n3	1735	5	25	1830	27.9	FDD	IMD2	
	n78	3780	10	52	3780	N/A	TDD	N/A	
	n1	1968	5	25	2158	N/A	FDD	N/A	
	n7	2512	10	50	2632	N/A	FDD	N/A	
	n5	835	5	25	880	1.0	FDD	IMD5	
	CA_n1-n5-n78	n1	1932	5	25	2122	18.1	FDD	IMD3
		n5	829	5	25	874	N/A	FDD	N/A
n78		3780	10	50	3780	N/A	TDD	N/A	
n1		1975	5	25	2165	N/A	FDD	N/A	
n5		840	5	25	885	3.1	FDD	IMD5	
n78		3405	10	50	3405	N/A	TDD	N/A	
n1		1950	5	25	2140	N/A	FDD	N/A	
n5		830	5	25	875	N/A	FDD	N/A	
CA_n1-n7-n28	n78	3610	10	50	3610	15.7	TDD	IMD3	
	n1	1935	5	25	2125	N/A	FDD	N/A	
	n7	2533	10	50	2653	30.0	FDD	IMD2	
	n28	718	5	25	773	N/A	FDD	N/A	
	n1	1935	5	25	2125	N/A	FDD	N/A	
	n7	2510	10	50	2630	N/A	FDD	N/A	
	n28	730	10	50	785	4.5	FDD	IMD5	
CA_n1-n7-n78	n1	1977.5	5	25	2167.5	N/A	FDD	N/A	
	n7	2507.5	5	25	2627.5	9.1	FDD	IMD4	
	n78	3305	10	50	3305	N/A	TDD	N/A	
	n1	1950	5	25	2140	8.7	FDD	IMD4	
	n7	2510	10	50	2630	N/A	FDD	N/A	
	n78	3580	10	50	3580	N/A	TDD	N/A	
	n1	1970	5	25	2160	N/A	FDD	N/A	
	n7	2520	5	25	2640	N/A	FDD	N/A	
CA_n1-n28-n78	n78	3390	10	50	3390	10.1	TDD	IMD4	
	n1	1960	5	25	2150	15.7	FDD	IMD3	
	n28	740	5	25	795	N/A	FDD	N/A	
	n78	3630	10	50	3630	N/A	TDD	N/A	
	n1	1970	5	25	2160	N/A	FDD	N/A	
	n28	739	5	25	794	4.2	FDD	IMD5	
	n78	3352	10	50	3352	N/A	TDD	N/A	
	n1	1950	5	25	2140	N/A	FDD	N/A	
CA_n1-n77-n79	n28	733	5	25	788	N/A	FDD	N/A	
	n78	3416	10	50	3416	15.7	TDD	IMD3	
	n1	1950	5	25	2140	6.0	FDD	IMD3 ^{1,2}	
	n77	3400	10	50	3400	N/A	TDD	N/A	
CA_n1-n77-n79	n79	4660	40	216	4660	N/A	TDD	N/A	

Band / Channel bandwidth / N _{RB} / Duplex mode								Source of IMD
NR CA band combination	NR band	UL F _c (MHz)	UL/DL BW (MHz)	UL C _{LRB}	DL F _c (MHz)	MSD (dB)	Duplex mode	
CA_n1-n78-n79	n1	1950	5	25	2140	N/A	FDD	N/A
	n78	3410	10	50	3410	N/A	TDD	N/A
	n79	4870	40	216	4870	15.9	TDD	IMD3 ^{1,3}
	n1	1950	5	25	2140	N/A	FDD	N/A
	n78	3490	10	50	3490	4.6	TDD	IMD5 ³
	n79	4670	40	216	4670	N/A	TDD	N/A
	n1	1950	5	25	2140	15.6	FDD	IMD3 ^{1,2}
	n78	3400	10	50	3400	N/A	TDD	N/A
CA_n2-n5-n30	n2	1870	5	25	1959	N/A	FDD	N/A
	n5	835	5	25	880	9.7	FDD	IMD4
	n30	2310	10	50	2355	N/A	FDD	N/A
CA_n2-n5-n66	n2	1900	5	25	1980	N/A	FDD	N/A
	n5	830	5	25	875	N/A	FDD	N/A
	n66	1740	5	25	2140	7.2	FDD	IMD4
CA_n2-n5-n77	n2	1907.5	5	25	1987.5	N/A	FDD	N/A
	n5	842.5	5	25	887.5	3.8	FDD	IMD5
	n77	3305	5	25	3305	N/A	TDD	N/A
	n2	1907	5	25	1987	16.5	FDD	IMD3
	n5	846.5	5	25	891.5	N/A	FDD	N/A
	n77	3680	5	25	3680	N/A	TDD	N/A
	n2	1880	5	25	1960	N/A	FDD	N/A
	n5	830	5	25	875	N/A	FDD	N/A
CA_n2-n12-n77	n77	3540	10	50	3540	16.0	TDD	IMD3 ¹
	n2	1880	5	25	1960	16.5	FDD	IMD3 ²
	n12	707.5	5	25	737.5	N/A	FDD	N/A
	n77	3375	10	50	3375	N/A	TDD	N/A
	n2	1900	5	25	1980	N/A	FDD	N/A
	n12	707.5	5	25	737.5	N/A	FDD	N/A
CA_n2-n14-n66	n77	3315	10	50	3315	16.0	TDD	IMD3 ^{1,2}
	n2	1874	5	25	1954	N/A	FDD	N/A
	n14	793	5	25	763	N/A	FDD	N/A
	n66	1762	5	25	2162	7.6	FDD	IMD4
	n2	1874	5	25	1954	7.2	FDD	IMD4
	n14	793	5	25	763	N/A	FDD	N/A
CA_n2-n14-n77	n66	1770	5	25	2170	N/A	FDD	N/A
	n2	1880	5	25	1960	16.5	FDD	IMD3
	n14	793	5	25	763	N/A	FDD	N/A
	n77	3546	10	50	3546	N/A	TDD	N/A
	n2	1880	5	25	1960	N/A	FDD	N/A
	n14	793	5	25	763	N/A	FDD	N/A
CA_n2-n30-n77	n77	3466	10	50	3466	16.0	TDD	IMD3 ¹
	n2	1906	5	25	1986	8.6	FDD	IMD4
	n30	2312	5	25	2357	N/A	FDD	N/A
	n77	3305	10	50	3305	N/A	TDD	N/A
	n2	1905	5	25	1985	N/A	FDD	N/A
	n30	2309	5	25	2354	10.6	FDD	IMD4 ¹
	n77	3361	10	50	3361	N/A	TDD	N/A
	n2	1870	5	25	1950	N/A	FDD	N/A
CA_n2-n30-n77	n30	2310	5	25	2355	N/A	FDD	N/A
	n77	4180	10	50	4180	29.4	TDD	IMD2 ²

Band / Channel bandwidth / N _{RB} / Duplex mode								Source of IMD
NR CA band combination	NR band	UL F _c (MHz)	UL/DL BW (MHz)	UL C _{LRB}	DL F _c (MHz)	MSD (dB)	Duplex mode	
CA_n2-n66-n77	n2	1880	5	25	1960	N/A	FDD	N/A
	n66	1740	5	25	2140	N/A	FDD	N/A
	n77	3620	10	50	3620	29.4	TDD	IMD2
	n2	1880	5	25	1960	N/A	FDD	N/A
	n66	1740	5	25	2140	N/A	FDD	N/A
	n77	3340	10	50	3340	8.9	TDD	IMD4
	n2	1860	5	25	1940	N/A	FDD	N/A
	n66	1750	5	25	2150	31.2	FDD	IMD2
	n77	4010	10	50	4010	N/A	TDD	N/A
	n2	1880	5	25	1960	N/A	FDD	N/A
	n66	1760	5	25	2160	10.3	FDD	IMD4
	n77	3480	10	50	3480	N/A	TDD	N/A
	n2	1860	5	25	1940	N/A	FDD	N/A
	n66	1740	5	25	2140	2.8	FDD	IMD5
	n77	3860	10	50	3860	N/A	TDD	N/A
	n2	1880	5	25	1960	32.1	FDD	IMD2
	n66	1740	5	25	2140	N/A	FDD	N/A
	n77	3700	10	50	3700	N/A	TDD	N/A
	n2	1880	5	25	1960	9.1	FDD	IMD4
	n66	1770	5	25	2170	N/A	FDD	N/A
n77	3350	10	50	3350	N/A	TDD	N/A	
n2	1880	5	25	1960	2.1	FDD	IMD5	
n66	1760	5	25	2160	N/A	FDD	N/A	
n77	3620	10	50	3620	N/A	TDD	N/A	
CA_n3-n5-n7	n3	1780	5	25	1875	N/A	FDD	N/A
	n5	845	5	25	890	N/A	FDD	N/A
	n7	2505	10	50	2625	30.0	FDD	IMD2 ⁴
	n3	1720	5	25	1815	N/A	FDD	N/A
	n5	835	5	25	880	19.0	FDD	IMD3
	n7	2560	10	50	2680	N/A	FDD	N/A
CA_n3-n5-n78	n3	1730	5	25	1825	N/A	FDD	N/A
	n5	839	5	25	884	N/A	FDD	N/A
	n78	3408	10	50	3408	16.1	TDD	IMD3
	n3	1730	5	25	1825	N/A	FDD	N/A
	n5	839	5	25	884	N/A	FDD	N/A
	n78	3512	10	50	3512	4.5	TDD	IMD5
	n3	1767	5	25	1862	15.7	FDD	IMD3
	n5	839	5	25	884	N/A	FDD	N/A
n78	3540	10	50	3540	N/A	TDD	N/A	
CA_n3-n7-n28	n3	1747	5	25	1842	N/A	FDD	N/A
	n7	2543	5	25	2663	N/A	FDD	N/A
	n28	741	5	25	796	20.0	FDD	IMD2
	n3	1712.5	5	25	1807.5	N/A	FDD	N/A
	n7	2562	5	25	2682	17.0	FDD	IMD3
	n28	743	5	25	798	N/A	FDD	N/A
	n3	1737.5	5	25	1832.5	16.5	FDD	IMD2
	n7	2543	5	25	2663	N/A	FDD	N/A
	n28	710.5	5	25	765.5	N/A	FDD	N/A
CA_n3-n7-n78	n3	1725	5	25	1820	17.6	FDD	IMD3
	n7	2565	5	25	2685	N/A	FDD	N/A
	n78	3310	10	50	3310	N/A	TDD	N/A
	n3	1725	5	25	1820	8.6	FDD	IMD4
	n7	2565	5	25	2685	N/A	FDD	N/A
	n78	3475	10	50	3475	N/A	TDD	N/A
	n3	1730	5	25	1825	N/A	FDD	N/A
	n7	2560	5	25	2680	N/A	FDD	N/A
n78	3390	10	50	3390	16.1	TDD	IMD3	

Band / Channel bandwidth / N _{RB} / Duplex mode								Source of IMD
NR CA band combination	NR band	UL F _c (MHz)	UL/DL BW (MHz)	UL C _{LRB}	DL F _c (MHz)	MSD (dB)	Duplex mode	
CA_n3-n8-n78	n3	1730	5	25	1825	N/A	FDD	N/A
	n8	910	5	25	955	N/A	FDD	N/A
	n78	3550	10	50	3550	16.1	TDD	IMD3
	n3	1730	5	25	1825	N/A	FDD	N/A
	n8	910	5	25	955	N/A	FDD	N/A
	n78	3370	10	50	3370	4.5	TDD	IMD5
	n3	1725	5	25	1820	15.7	FDD	IMD3
	n8	910	5	25	955	N/A	FDD	N/A
CA_n3-n18-n41	n18	820	5	25	865	N/A	FDD	N/A
	n3	1720	5	25	1815	N/A	FDD	N/A
	n41	2540	10	50	2540	[N/A]1	TDD	IMD2
	n18	820	5	25	865	N/A	FDD	N/A
	n3	1725	5	25	1820	N/A	FDD	N/A
	n41	2630	10	50	2630	16.0	TDD	IMD3
	n18	820	5	25	865	28.9	FDD	IMD2
	n3	1765	5	25	1860	N/A	FDD	N/A
	n41	2630	10	50	2630	N/A	TDD	N/A
	n18	830	5	25	875	[19.0]	FDD	IMD3
	n3	1725	5	25	1820	N/A	FDD	N/A
	n41	2670	5	25	2670	N/A	TDD	N/A
	n3	1755	5	25	1850	28.8	FDD	IMD2
	n41	2670	10	50	2670	N/A	TDD	N/A
CA_n3-n28-n41	n3	1715	5	25	1810	N/A	FDD	N/A
	n28	743	5	25	798	N/A	FDD	N/A
	n41	2518	5	25	2518	27.4	TDD	IMD2
	n3	1715	5	25	1810	N/A	FDD	N/A
	n28	743	5	25	798	N/A	FDD	N/A
	n41	2687	5	25	2687	15.9	TDD	IMD3
CA_n3-n28-n77	n3	1720	5	25	1815	N/A	FDD	N/A
	n28	733	5	25	788	N/A	FDD	N/A
	n77	4173	10	50	4173	15.9	TDD	IMD3
	n28	735	5	25	790	N/A	FDD	N/A
	n77	3320	10	50	3320	N/A	TDD	N/A
	n3	1755	5	25	1850	17.0	FDD	IMD3
	n3	1712.5	5	25	1807.5	N/A	FDD	N/A
	n77	4195	10	50	4195	N/A	TDD	N/A
CA_n3-n28-n78	n28	715	5	25	770	15.3	FDD	IMD3
	n28	735	5	25	790	N/A	FDD	N/A
	n78	3320	10	50	3320	N/A	TDD	IMD3
	n3	1755	5	25	1850	17.3	FDD	N/A
	n3	1750	5	25	1845	N/A	FDD	N/A
	n28	743	5	25	798	N/A	FDD	N/A
	n78	3764	10	50	3764	4.5	TDD	IMD5
CA_n3-n28-n79	n3	1770	5	25	1865	N/A	N/A	n3
	n28	725	5	25	780	N/A	N/A	n28
	n79	4585	40	216	4585	9.4	IMD4 ¹⁾	n79
	n3	1770	5	25	1865	N/A	N/A	n3
	n79	4530	40	216	4530	N/A	N/A	n79
	n28	725	5	25	780	10.3	IMD4	n28
	n28	725	5	25	780	N/A	N/A	n28
	n79	4770	40	216	4770	N/A	N/A	n79
n3	1775	5	25	1870	5.7	IMD5	n3	

Band / Channel bandwidth / N _{RB} / Duplex mode								Source of IMD
NR CA band combination	NR band	UL F _c (MHz)	UL/DL BW (MHz)	UL C _{LRB}	DL F _c (MHz)	MSD (dB)	Duplex mode	
CA_n3-40-n41	n3	1747.5	5	25	1842.5	1.0	FDD	IMD5
	n40	2347.5	5	25	2347.5	N/A	TDD	N/A
	n41	2600	10	50	2600	N/A	TDD	N/A
CA_n3-n41-n77	n3	1720	5	25	1815	N/A	FDD	N/A
	n77	3900	10	50	3900	N/A	TDD	N/A
	n41	2640	5	25	2640	5.3	TDD	IMD5
	n41	2620	5	25	2620	N/A	TDD	N/A
	n77	3400	10	50	3400	N/A	TDD	N/A
	n3	1745	5	25	1840	16.4	FDD	IMD3
	n41	2580	5	25	2580	N/A	TDD	N/A
	n3	1720	5	25	1815	N/A	FDD	N/A
	n77	3440	10	50	3440	16.8	TDD	IMD31
CA_n3-n41-n78	n3	1730	5	25	1825	N/A	FDD	N/A
	n41	2560	10	50	2560	N/A	TDD	N/A
	n78	3390	10	50	3390	16.4	TDD	IMD3
	n3	1745	5	25	1840	16.4	TDD	IMD3
	n41	2620	5	25	2620	N/A	FDD	N/A
	n78	3400	10	50	3400	N/A	TDD	N/A
CA_n3-n77-n79	n77	TBD	TBD	TBD	TBD	N/A	FDD	N/A
	n79	TBD	TBD	TBD	TBD	N/A	TDD	N/A
	n3	TBD	TBD	TBD	TBD	TBD	TDD	IMD3 ^{1, 2}
CA_n5-n7-n78	n5	834	5	25	879	30.2	FDD	IMD2
	n7	2550	5	25	2670	N/A	FDD	N/A
	n78	3429	10	50	3429	N/A	TDD	N/A
	n5	830	5	25	875	3.3	FDD	IMD5
	n7	2525	5	25	2645	N/A	FDD	N/A
	n78	3350	10	50	3350	N/A	TDD	N/A
	n5	844	5	25	889	N/A	FDD	N/A
	n7	2525	5	25	2645	30.1	FDD	IMD2
	n78	3489	10	50	3489	N/A	TDD	N/A
	n5	835	5	25	880	N/A	FDD	N/A
	n7	2540	5	25	2660	N/A	FDD	N/A
	n78	3375	10	50	3375	29.7	TDD	IMD2
	n5	835	5	25	880	N/A	FDD	N/A
	n7	2550	5	25	2670	N/A	FDD	N/A
n78	3430	10	50	3430	9.7	TDD	IMD4	

Band / Channel bandwidth / N _{RB} / Duplex mode								Source of IMD
NR CA band combination	NR band	UL F _c (MHz)	UL/DL BW (MHz)	UL C _{LRB}	DL F _c (MHz)	MSD (dB)	Duplex mode	
CA_n5-n12-n77	n5	835	5	25	880	3.9	FDD	IMD5
	n12	707.5	5	25	737.5	N/A	FDD	N/A
	n77	3710	10	50	3710	N/A	TDD	N/A
	n5	835	5	25	880	N/A	FDD	N/A
	n12	710	5	25	740	4.4	FDD	IMD5
	n77	4080	10	50	4080	N/A	TDD	N/A
	n5	830	5	25	875	N/A	FDD	N/A
	n12	707.5	5	25	737.5	N/A	FDD	N/A
CA_n5-n14-n77	n5	835	5	25	880	3.9	FDD	IMD5
	n14	793	5	25	763	N/A	FDD	N/A
	n77	4052	10	50	4052	N/A	TDD	N/A
	n5	846.5	5	25	891.5	N/A	FDD	N/A
	n14	795.5	5	25	765.5	11.6	FDD	IMD4 ¹
	n77	3305	10	50	3305	N/A	TDD	N/A
	n5	835	5	25	880	N/A	FDD	N/A
	n14	793	5	25	763	N/A	FDD	N/A
CA_n5-n25-n66	n5	834	5	25	879	N/A	FDD	N/A
	n25	1900	5	25	1980	N/A	FDD	N/A
	n66	1712	5	25	2132	7.2	FDD	IMD4
	n77	3298	10	50	3298	10.3	TDD	IMD4 ¹
CA_n5-n25-n77	n5	830	5	25	875	N/A	FDD	N/A
	n25	1880	5	25	1960	N/A	FDD	N/A
	n77	3540	10	50	3540	16.0	TDD	IMD3
	n5	844	5	25	889	3.8	FDD	IMD5
	n25	1907	5	25	1987	N/A	FDD	N/A
	n77	3305	10	50	3305	N/A	TDD	N/A
	n5	846.5	5	25	891.5	N/A	FDD	N/A
	n25	1907	5	25	1987	16.5	FDD	IMD3
	n77	3680	10	25	3680	N/A	TDD	N/A
CA_n5-n25-n78	n5	830	5	25	875	N/A	FDD	N/A
	n25	1900	5	25	1980	N/A	FDD	N/A
	n78	3560	10	50	3560	16.1	TDD	IMD3
CA_n5-n30-n66	n5	830	5	25	875	N/A	FDD	N/A
	n30	2307.5	5	25	2352.5	N/A	FDD	N/A
	n66	1725	5	25	2125	4	FDD	IMD5
CA_n5-n30-n77	n5	835	5	25	880	15.2	FDD	IMD3
	n30	2310	5	25	2355	N/A	FDD	N/A
	n77	3740	10	50	3740	N/A	TDD	N/A
	n5	835	5	25	880	N/A	FDD	N/A
	n30	2310	5	25	2355	13.2	FDD	IMD3
	n77	4025	10	50	4025	N/A	TDD	N/A
	n5	840	5	25	885	N/A	FDD	N/A
	n30	2310	5	25	2355	N/A	FDD	N/A
n77	3780	10	50	3780	16.1	TDD	IMD3	

Band / Channel bandwidth / N _{RB} / Duplex mode								Source of IMD
NR CA band combination	NR band	UL F _c (MHz)	UL/DL BW (MHz)	UL C _{LRB}	DL F _c (MHz)	MSD (dB)	Duplex mode	
CA_n5-n66-n77	n5	830	5	25	875	N/A	FDD	N/A
	n66	1750	5	25	2150	N/A	FDD	N/A
	n77	3410	10	50	3410	16.1	TDD	IMD3
	n5	826.5	5	25	871.5	N/A	FDD	N/A
	n66	1712.5	5	25	2112.5	N/A	FDD	N/A
	n77	4192	10	50	4192	8.2	TDD	IMD4
	n5	830	5	25	875	N/A	FDD	N/A
	n66	1750	5	25	2150	N/A	FDD	N/A
	n77	3590	10	50	3590	3.3	TDD	IMD5
	n5	830	5	25	875	N/A	FDD	N/A
n66	1730	5	25	2130	14.4	FDD	IMD3	
n77	3790	10	50	3790	N/A	TDD	N/A	
CA_n5-n66-n78	n5	830	5	25	875	N/A	FDD	N/A
	n66	1720	5	25	2120	N/A	FDD	N/A
	n78	3380	10	50	3380	16.1	TDD	IMD3
CA_n5-n66-n78	n5	830	5	25	875	N/A	FDD	N/A
	n66	1720	5	25	2120	13.2	FDD	IMD3
	n78	3780	10	50	3780	N/A	TDD	N/A
CA_n7-n25-n78	n7	2550	5	25	2670	N/A	FDD	N/A
	n25	1870	5	25	1950	8.6	FDD	IMD4
	n78	3525	10	50	3525	N/A	TDD	N/A
	n7	2520	5	25	2640	N/A	FDD	N/A
	n25	1905	5	25	1985	N/A	FDD	N/A
	n78	3750	10	50	3750	4.5	TDD	IMD5
CA_n7-n28-n78	n7	2567.5	5	25	2687.5	N/A	FDD	N/A
	n28	727.5	5	25	782.5	28.8	FDD	IMD2
	n78	3350	10	50	3350	N/A	TDD	N/A
	n7	2567.5	5	25	2687.5	N/A	FDD	N/A
	n28	727.5	5	25	782.5	3.0	FDD	IMD5
	n78	3460	10	50	3460	N/A	TDD	N/A
	n7	2530	5	25	2650	30.5	FDD	IMD2
	n28	740	5	25	795	N/A	FDD	N/A
	n78	3390	10	50	3390	N/A	TDD	N/A
	n7	2565	5	25	2685	N/A	FDD	N/A
	n28	745	5	25	800	N/A	FDD	N/A
	n78	3310	10	50	3310	29.7	TDD	IMD2
	n7	2550	5	25	2670	N/A	FDD	N/A
	n28	720	5	25	775	N/A	FDD	N/A
	n78	3714	10	50	3714	9.7	TDD	IMD4
CA_n7-n66-n77	n7	2560	5	25	2680	N/A	FDD	N/A
	n66	1730	5	25	2130	N/A	FDD	N/A
	n77	3390	10	50	3390	16.1	TDD	IMD3
	n7	2550	5	25	2670	N/A	FDD	N/A
	n66	1750	5	25	2150	8.7	FDD	IMD4
	n77	3625	10	50	3625	N/A	TDD	N/A
	n7	2520	5	25	2640	3.4	FDD	IMD5
	n66	1720	5	25	2120	N/A	FDD	N/A
	n77	3900	10	50	3900	N/A	TDD	N/A
	n7	2520	5	25	2640	N/A	FDD	N/A
	n66	1760	5	25	2160	N/A	FDD	N/A
n77	4040	10	50	4040	4.2	TDD	IMD5	
CA_n7-n66-n78	n7	2560	5	25	2680	N/A	FDD	N/A
	n66	1730	5	25	2130	N/A	FDD	N/A
	n78	3390	10	50	3390	16.1	TDD	IMD3
	n7	2550	5	25	2670	N/A	FDD	N/A
	n66	1750	5	25	2150	8.7	FDD	IMD4
n78	3625	10	50	3625	N/A	TDD	N/A	

Band / Channel bandwidth / N _{RB} / Duplex mode								Source of IMD
NR CA band combination	NR band	UL F _c (MHz)	UL/DL BW (MHz)	UL C _{LRB}	DL F _c (MHz)	MSD (dB)	Duplex mode	
CA_n12-n30-n77	n12	710	5	25	740	15.2	FDD	IMD3 ¹
	n30	2310	5	25	2355	N/A	FDD	N/A
	n77	3880	10	50	3880	N/A	TDD	N/A
	n12	707.5	5	25	737.5	N/A	FDD	N/A
	n30	2310	5	25	2355	13.2	FDD	IMD3
	n77	3770	10	50	3770	N/A	TDD	N/A
	n12	707	5	25	737	N/A	FDD	N/A
	n30	2310	5	25	2355	N/A	FDD	N/A
CA_n12-n66-n77	n77	3913	10	50	3913	16.0	TDD	IMD3
	n12	710	5	25	740	15.2	FDD	IMD3
	n66	1720	5	25	2120	N/A	FDD	N/A
	n77	4180	10	50	4180	N/A	TDD	N/A
	n12	707	5	25	737	N/A	FDD	N/A
	n66	1746	5	25	2146	13.2	FDD	IMD3
	n77	3560	10	50	3560	N/A	TDD	N/A
	n12	704	5	25	734	N/A	FDD	N/A
CA_n13-n25-n66	n66	1723	5	25	2123	N/A	FDD	N/A
	n77	4150	10	50	4150	16.0	TDD	IMD3 ^{1,2}
	n13	782	5	25	751	N/A	FDD	N/A
	n66	1736	5	25	2156	7.2	FDD	IMD4
	n25	1860	5	25	1940	N/A	FDD	N/A
	n13	780	10	50	749	N/A	FDD	N/A
	n25	1860	5	25	1940	6.2	FDD	IMD4
	n66	1750	5	25	2150	N/A	FDD	N/A
CA_n13-n25-n77	n13	782	5	25	751	N/A	FDD	N/A
	n25	1880	5	25	1960	N/A	FDD	N/A
	n77	3444	10	50	3444	17.3	TDD	IMD3 ^{1,2}
	n13	782	5	25	751	N/A	FDD	N/A
	n25	1880	5	25	1960	16.0	FDD	IMD3
	n77	3524	10	50	3524	N/A	TDD	N/A
CA_n13-n66-n77	n13	782	5	25	751	N/A	FDD	N/A
	n66	1736	5	25	2136	17.1	FDD	IMD3
	n77	3700	10	50	3700	N/A	TDD	N/A
	n13	781	5	25	750	15.2	FDD	IMD3
	n66	1710	5	25	2110	N/A	FDD	N/A
	n77	4170	10	50	4170	N/A	TDD	N/A
	n13	782	5	25	751	N/A	FDD	N/A
	n66	1770	5	25	2170	N/A	FDD	N/A
CA_n14-n30-n77	n77	3334	10	50	3334	16.3	TDD	IMD3 ^{1,2}
	n14	793	5	25	763	15.2	FDD	IMD3 ¹
	n30	2310	5	25	2355	N/A	FDD	N/A
	n77	3857	10	50	3857	N/A	TDD	N/A
	n14	793	5	25	763	N/A	FDD	N/A
	n30	2310	5	25	2355	13.2	FDD	IMD3
	n77	3941	10	50	3941	N/A	TDD	N/A
	n14	793	5	25	763	N/A	FDD	N/A
CA_n14-n66-n77	n30	2310	5	25	2355	N/A	FDD	N/A
	n77	3896	10	50	3896	16.0	TDD	IMD3
	n14	793	5	25	763	15.2	FDD	IMD3
	n66	1712.5	5	25	2112.5	N/A	FDD	N/A
	n77	4188	10	50	4188	N/A	TDD	N/A
	n14	793	5	25	763	N/A	FDD	N/A
	n66	1755	5	25	2155	13.2	FDD	IMD3
	n77	3741	10	50	3741	N/A	TDD	N/A
CA_n14-n66-n77	n14	793	5	25	763	N/A	FDD	N/A
	n66	1755	5	25	2155	N/A	FDD	N/A
	n77	3341	10	50	3341	16.0	TDD	IMD3 ^{1,2}
	n77	3341	10	50	3341	16.0	TDD	IMD3 ^{1,2}

Band / Channel bandwidth / N _{RB} / Duplex mode								Source of IMD
NR CA band combination	NR band	UL F _c (MHz)	UL/DL BW (MHz)	UL C _{LRB}	DL F _c (MHz)	MSD (dB)	Duplex mode	
CA_n25-n38-n78	n25	1852.5	5	25	1932.5	16.4	FDD	IMD3
	n38	2617.5	5	25	2617.5	N/A	TDD	N/A
	n78	3305	10	50	3305	N/A	TDD	N/A
	n25	1870	5	25	1950	N/A	FDD	N/A
	n38	2610	5	25	2610	N/A	TDD	N/A
	n78	3350	10	50	3350	14.8	TDD	IMD3
	n25	1880	5	25	1960	8.6	TDD	IMD4
	n38	2570	5	25	2570	N/A	FDD	N/A
CA_n25-n41-n66	n78	3550	10	50	3550	N/A	TDD	N/A
	n25	1860	5	25	1940	11.0	FDD	IMD4
	n41	2685	10	50	2685	N/A	TDD	N/A
CA_n25-n41-n77	n66	1715	5	25	2115	N/A	FDD	N/A
	n25	1870	5	25	1950	N/A	FDD	N/A
	n41	2610	5	25	2610	N/A	TDD	N/A
	n77	3350	10	50	3350	14.8	TDD	IMD3
	n25	1900	5	25	1980	N/A	FDD	N/A
	n41	2525	5	25	2645	N/A	TDD	N/A
	n77	3775	10	50	3775	4.2	TDD	IMD5
	n25	1870	5	25	1950	N/A	FDD	N/A
	n41	2640	5	25	2640	5.3	TDD	IMD5
	n77	4125	10	50	4125	N/A	TDD	N/A
	n25	1870	5	25	1950	17.6	FDD	IMD3
	n41	2565	5	25	2565	N/A	TDD	N/A
	n77	3180	10	50	3310	N/A	TDD	N/A
	n25	1870	5	25	1950	8.6	FDD	IMD4
CA_n25-n41-n78	n41	2550	5	25	2685	N/A	TDD	N/A
	n77	3525	10	50	3475	N/A	TDD	N/A
	n25	1870	5	25	1950	N/A	FDD	N/A
	n41	2610	5	25	2610	N/A	TDD	N/A
	n78	3350	10	50	3350	14.8	TDD	IMD3
	n25	1900	5	25	1980	N/A	FDD	N/A
	n41	2525	5	25	2645	N/A	TDD	N/A
	n78	3775	10	50	3775	4.2	TDD	IMD5
	n25	1870	5	25	1950	17.6	FDD	IMD3
	n41	2565	5	25	2565	N/A	TDD	N/A
	n78	3180	10	50	3310	N/A	TDD	N/A
CA_n25-n48-n66	n25	1870	5	25	1950	8.6	FDD	IMD4
	n41	2550	5	25	2685	N/A	TDD	N/A
	n78	3525	10	50	3475	N/A	TDD	N/A
	n25	1900	5	25	1980	N/A	FDD	N/A
	n48	3540	10	50	3540	N/A	TDD	N/A
	n66	1760	5	25	2160	10.4	FDD	IMD4
	n25	1880	5	25	1960	N/A	FDD	N/A
	n48	3620	10	50	3620	29.4	TDD	IMD2
CA_n25-n48-n66	n66	1740	5	25	2140	N/A	FDD	N/A
	n25	1880	5	25	1960	32.1	FDD	IMD2 ¹
	n48	3700	10	50	3700	N/A	TDD	N/A
	n66	1740	5	25	2140	N/A	FDD	N/A
	n25	1880	5	25	1960	N/A	FDD	N/A

Band / Channel bandwidth / N _{RB} / Duplex mode								Source of IMD
NR CA band combination	NR band	UL F _c (MHz)	UL/DL BW (MHz)	UL C _{LRB}	DL F _c (MHz)	MSD (dB)	Duplex mode	
CA_n25-n66-n77	n25	1900	5	25	1980	N/A	FDD	N/A
	n66	1760	5	25	2160	29.2	FDD	IMD2
	n77	4060	10	50	4060	N/A	TDD	N/A
	n25	1900	5	25	1980	N/A	FDD	N/A
	n66	1760	5	25	2160	10.4	FDD	IMD4
	n77	3540	10	50	3540	10	TDD	N/A
	n25	1900	5	25	1980	N/A	FDD	N/A
	n66	1760	5	25	2160	4.0	FDD	IMD5
	n77	3930	10	50	3930	N/A	TDD	N/A
	n25	1880	5	25	1960	32.1	FDD	IMD2
	n66	1740	5	25	2140	N/A	FDD	N/A
	n77	3700	10	50	3700	N/A	TDD	N/A
	n25	1880	5	25	1960	9.1	FDD	IMD4
	n66	1770	5	25	2170	N/A	FDD	N/A
	n77	3350	10	50	3350	N/A	TDD	N/A
	n25	1880	5	25	1960	2.1	FDD	IMD5
	n66	1760	5	25	2160	N/A	FDD	N/A
	n77	3620	10	50	3620	N/A	TDD	N/A
	n25	1880	5	25	1960	N/A	FDD	N/A
	n66	1740	5	25	2140	N/A	FDD	N/A
n77	3620	10	50	3620	29.4	TDD	IMD2	
n25	1880	5	25	1960	N/A	FDD	N/A	
n66	1740	5	25	2140	N/A	FDD	N/A	
n77	3340	10	50	3340	8.9	TDD	IMD4	
CA_n25-n66-n78	n25	1880	5	25	1960	N/A	FDD	N/A
	n66	1740	5	25	2140	N/A	FDD	N/A
	n78	3620	10	50	3620	29.4	TDD	IMD2
CA_n25-n71-n77	n25	1907.5	5	25	1987.5	N/A	FDD	N/A
	n71	695.5	5	25	649.5	N/A	FDD	N/A
	n77	3305	10	50	3305	8.0	TDD	IMD3 ^{1,2}
	n25	1874	5	25	1954	16.5	FDD	IMD3 ²
	n71	693	5	25	647	N/A	FDD	N/A
n77	3340	10	50	3340	N/A	TDD	N/A	
CA_n25-n71-n78	n25	1907.5	5	25	1987.5	N/A	FDD	N/A
	n71	695.5	5	25	649.5	N/A	FDD	N/A
	n78	3305	10	50	3305	8.0	TDD	IMD3
	n25	1874	5	25	1954	16.5	FDD	IMD3
	n71	693	5	25	647	N/A	FDD	N/A
	n78	3340	10	50	3340	N/A	TDD	N/A

Band / Channel bandwidth / N _{RB} / Duplex mode								Source of IMD
NR CA band combination	NR band	UL F _c (MHz)	UL/DL BW (MHz)	UL C _{LRB}	DL F _c (MHz)	MSD (dB)	Duplex mode	
CA_n28-n41-n77	n41	2642	5	25	2642	N/A	TDD	N/A
	n77	3440	10	50	3440	N/A	TDD	N/A
	n28	743	5	25	798	30.8	FDD	IMD2 ⁴
	n41	2567.5	10	50	2567.5	N/A	TDD	N/A
	n77	3460	10	50	3460	N/A	TDD	N/A
	n28	727.5	5	25	782.5	3.0	FDD	IMD5
	n28	738	5	25	793	N/A	FDD	N/A
	n77	3380	10	50	3380	N/A	TDD	N/A
	n41	2642	5	25	2642	29.5	TDD	IMD2
	n41	2580	5	25	2580	N/A	TDD	N/A
	n28	743	5	25	798	N/A	FDD	N/A
n77	3323	10	50	3323	28.2	TDD	IMD2 ⁴	
CA_n28-n41-n78	n28	738	5	25	793	N/A	FDD	N/A
	n78	3380	10	50	3380	N/A	TDD	N/A
	n41	2642	5	25	2642	29.5	TDD	IMD2
	n41	2642	5	25	2642	N/A	TDD	N/A
	n78	3440	10	50	3440	N/A	TDD	N/A
	n28	743	5	25	798	30.8	FDD	IMD2 ¹
	n41	2565	5	25	2565	N/A	TDD	N/A
	n28	745	5	25	800	N/A	FDD	N/A
n78	3310	10	50	3310	29.7	TDD	IMD2 ²	
CA_n28-n41-n79	n28	725	5	25	780	13.0	FDD	IMD3 ¹
	n41	2600	10	50	2600	N/A	TDD	N/A
	n79	4600	40	216	4600	N/A	TDD	N/A
	n28	720	5	25	780	N/A	FDD	N/A
	n41	2600	10	50	2600	N/A	TDD	N/A
	n79	4480	40	216	4600	10.1	TDD	IMD3 ²
	n28	735	5	25	790	N/A	FDD	N/A
	n41	2645	10	50	2645	10.4	TDD	IMD4
n79	4850	40	216	4850	N/A	TDD	N/A	
CA_n28-n77-n79	n77	3620	10	52	3620	N/A	N/A	n77
	n79	4420	40	216	4420	N/A	N/A	n79
	n28	745	5	25	800	16.2	IMD2 ^{1,2}	n28
CA_n30-n66-n77	n30	2310	5	25	2355	29.2	FDD	IMD2 ¹
	n66	1745	5	25	2145	N/A	FDD	N/A
	n77	4100	10	50	4100	N/A	TDD	N/A
	n30	2310	5	25	2355	N/A	FDD	N/A
	n66	1760	5	25	2160	8.7	FDD	IMD4
	n77	3390	10	50	3390	N/A	TDD	N/A
	n30	2310	5	25	2355	N/A	FDD	N/A
	n66	1745	5	25	2145	N/A	FDD	N/A
n77	4055	10	50	4055	28.4	TDD	IMD2 ¹	
CA_n38-n66-n78	n38	2550	5	25	2550	N/A	TDD	N/A
	n66	1750	5	25	2150	8.7	FDD	IMD4
	n78	3625	10	50	3625	N/A	TDD	N/A
	n38	2610	5	25	2610	N/A	TDD	N/A
	n66	1760	5	25	2160	N/A	FDD	N/A
	n78	3460	10	50	3460	15.0	TDD	IMD3
CA_n39-n40-n79	n39	1917.5	5	25	1917.5	N/A	TDD	N/A
	n40	2302.5	5	25	2302.5	N/A	TDD	N/A
	n79	4980	40	216	4980	5.8	TDD	IMD4
CA_n40-n41-n79	n40	2340	5	25	2340	N/A	TDD	N/A
	n41	2600	10	50	2600	N/A	TDD	N/A
	n79	4940	40	216	4940	30.5	TDD	IMD2

Band / Channel bandwidth / N _{RB} / Duplex mode								Source of IMD
NR CA band combination	NR band	UL F _c (MHz)	UL/DL BW (MHz)	UL C _{LRB}	DL F _c (MHz)	MSD (dB)	Duplex mode	
CA_n41-n66-n77	n41	2560	5	25	2560	N/A	TDD	N/A
	n66	1730	5	25	2130	N/A	FDD	N/A
	n77	3390	10	50	3390	16.1	TDD	IMD3 ^{1,2}
	n41	2670	5	25	2670	5.2	TDD	IMD5
	n66	1715	5	25	2115	N/A	FDD	N/A
	n77	4190	10	50	4190	N/A	TDD	N/A
	n41	2530	5	25	2530	N/A	TDD	N/A
CA_n41-n66-n78	n66	1760	5	25	2160	9.0	FDD	IMD4
	n77	3610	10	50	3610	N/A	TDD	N/A
	n41	2560	5	25	2560	N/A	TDD	N/A
	n66	1730	5	25	2130	N/A	FDD	N/A
	n77	3390	10	50	3390	16.1	TDD	IMD3 ¹
	n41	2530	5	25	2530	N/A	TDD	N/A
CA_n41-n71-n77	n66	1760	5	25	2160	9.0	FDD	IMD4
	n77	3610	10	50	3610	N/A	TDD	N/A
	n41	2615	5	25	2615	N/A	TDD	N/A
	n71	693	5	25	647	N/A	FDD	N/A
	n77	3308	10	50	3308	29.1	TDD	IMD2 ¹
	n41	2615	5	25	2615	N/A	TDD	N/A
	n71	693	5	25	647	N/A	FDD	N/A
	n77	4001	10	50	4001	16.3	TDD	IMD3 ¹
	n41	2580	5	25	2580	N/A	TDD	N/A
	n71	693	5	25	647	N/A	FDD	N/A
	n77	3774	10	50	3774	10.3	TDD	IMD4 ¹
	n41	2615	5	25	2615	28.7	TDD	IMD2
	n71	693	5	25	647	N/A	FDD	N/A
	n77	3308	10	50	3308	N/A	TDD	N/A
	n41	2615	5	25	2615	15.5	TDD	IMD3
	n71	693	5	25	647	N/A	FDD	N/A
	n77	4001	10	50	4001	N/A	TDD	N/A
CA_n41-n71-n78	41	2642	5	25	2642	N/A	TDD	N/A
	n71	743	5	25	798	30.8	FDD	IMD2
	n77	3440	10	50	3440	N/A	TDD	N/A
	n41	2615	5	25	2615	N/A	TDD	N/A
	n71	693	5	25	647	N/A	FDD	N/A
	n78	3308	10	50	3308	29.1	TDD	IMD2 ¹
	n41	2580	5	25	2580	N/A	TDD	N/A
	n71	693	5	25	647	N/A	FDD	N/A
	n77	3774	10	50	3774	10.3	TDD	IMD4 ¹
	n41	2615	5	25	2615	28.7	TDD	IMD2
CA_n48-n66-n70	n71	693	5	25	647	N/A	FDD	N/A
	n77	3308	10	50	3308	N/A	TDD	N/A
	41	2642	5	25	2642	N/A	TDD	N/A
	n71	743	5	25	798	30.8	FDD	IMD2
	n77	3440	10	50	3440	N/A	TDD	N/A
	n48	3625	10	50	3625	N/A	TDD	N/A
	n66	1742.5	5	25	2142.5	2.8	FDD	IMD5
CA_n48-n66-n71	n70	1702.5	5	25	2002.5	N/A	FDD	N/A
	n48	3552.5	10	50	3552.5	N/A	TDD	N/A
	n66	1761.5	5	25	2161.5	14.4	FDD	IMD3
	n71	695.5	5	25	649.5	N/A	FDD	N/A
	n48	3695	10	50	3695	5.2	TDD	IMD4
CA_n48-n66-n71	n66	1712.5	5	25	2112.5	N/A	FDD	N/A
	n71	665.5	5	25	619.5	N/A	FDD	N/A

Band / Channel bandwidth / N _{RB} / Duplex mode								Source of IMD
NR CA band combination	NR band	UL F _c (MHz)	UL/DL BW (MHz)	UL C _{LRB}	DL F _c (MHz)	MSD (dB)	Duplex mode	
CA_n48-n70-n71	n48	3694	10	50	3694	9	TDD	IMD4 ¹
	n70	1697.5	5	25	1997.5	N/A	FDD	N/A
	n71	665.5	5	25	619.5	N/A	FDD	N/A
CA_n66-n71-n77	n66	1720	5	25	2120	N/A	FDD	N/A
	n71	668	5	25	622	N/A	FDD	N/A
	n77	4108	10	50	4108	15.9	TDD	IMD3 ^{1,2}
	n66	1760	5	25	2160	15.5	FDD	IMD3 ²
	n71	693	5	25	647	N/A	FDD	N/A
	n77	3546	10	50	3546	N/A	TDD	N/A
	n66	1720	5	25	2120	N/A	FDD	N/A
	n71	686	5	25	640	15.3	FDD	IMD3
	n77	4080	10	50	4080	N/A	TDD	N/A
CA_n66-n71-n78	n66	1720	5	25	2120	N/A	FDD	N/A
	n71	668	5	25	622	N/A	FDD	N/A
	n78	3724	10	50	3724	9	TDD	IMD4 ¹
	n66	1760	5	25	2160	15.5	FDD	IMD3
	n71	693	5	25	647	N/A	FDD	N/A
	n78	3546	10	50	3546	N/A	TDD	N/A

NOTE 1: This band is subject to IMD5 also which MSD is not specified.
NOTE 2: This band is subject to IMD4 also which MSD is not specified.
NOTE 3: The requirements only apply for UEs supporting inter-band carrier aggregation with simultaneous Rx/Tx capability. Simultaneous Rx/Tx capability does not apply for UEs supporting band n78 with a n77 implementation.
NOTE 4: This band is subject to IMD3 also which MSD is not specified.
NOTE 5: Both of the transmitters shall be set min(+20 dBm, P_{C_{MAX},L,f,c}) as defined in clause 6.2A.4

7.3A.0.6 Reference sensitivity exceptions due to cross band isolation for CA

Sensitivity degradation is allowed for a band if it is impacted by UL of another band part of the same NR CA configuration due to cross band isolation issues. Reference sensitivity exceptions for the victim band are specified in Table 7.3A.0.6-1 with uplink configuration of the aggressor band specified in Table 7.3A.0.6-2.

Table 7.3A.0.6-1: Reference sensitivity exceptions (MSD) due to cross band isolation for NR CA FR1

NR Band / Channel bandwidth of the affected DL band													
UL band	DL band	5 MHz (dB)	10 MHz (dB)	15 MHz (dB)	20 MHz (dB)	25 MHz (dB)	30 MHz (dB)	40 MHz (dB)	50 MHz (dB)	60 MHz (dB)	80 MHz (dB)	90 MHz (dB)	100 MHz (dB)
n1	n3	3	2.2	1.9	1.7	1.6	1.5	1.4					
n71	n29	17.5	16.0										
n78	n7 ¹	4.5	4.5	4.5	4.5	4.5	4.5	4.5	4.5				
n78	n41 ¹		4.5	4.5	4.5			4.5	4.5				
n78	n79							2	2	2	2		2
n79	n78		2.6	2.6	2.6			2.6	2.6	2.6	2.6	2.6	2.6
NOTE 1: Applicable only when harmonic mixing MSD for this combination is not applied.													
NOTE 2: The requirements only apply for UEs supporting inter-band carrier aggregation with simultaneous Rx/Tx capability. Simultaneous Rx/Tx capability does not apply for UEs supporting band n78 with a n77 implementation.													

Table 7.3A.0.6-2: Uplink configuration for reference sensitivity exceptions due to cross band isolation for NR CA FR1

NR Band / SCS / Channel bandwidth of the affected DL band														
UL band	DL band	SCS of UL band (kHz)	5 MHz	10 MHz	15 MHz	20 MHz	25 MHz	30 MHz	40 MHz	50 MHz	60 MHz	80 MHz	90 MHz	100 MHz
n1	n3	15	25	25	25	25	25	25	25					
n71	n29	15	20	20										
n78	n7	30	270	270	270	270	270	270	270	270				
n78	n41	30		270	270	270			270	270	270	270	270	270
n78	n79	30							270 ²	270 ²	270 ²	270 ²		270 ²
n79	n78	30		270 ²	270 ²	270 ²			270 ²	270 ²	270 ²	270 ²	270 ²	270 ²
NOTE 1: The UL configuration applies regardless of the channel bandwidth of the UL band unless the UL resource blocks exceed that specified in Table 7.3.2.3-3 for the uplink bandwidth in which case the allocation according to Table 7.3.2.3-3 applies.														
NOTE 2: Refers to the UL resource blocks shall be located as close as possible to the downlink operating band but confined within the transmission bandwidth configuration for the channel bandwidth in Table 5.3.2-1.														
NOTE 3: The requirements only apply for UEs supporting inter-band carrier aggregation with simultaneous Rx/Tx capability. Simultaneous Rx/Tx capability does not apply for UEs supporting band n78 with a n77 implementation.														

The normative reference for this requirement is TS 38.101-1 [2] clause 7.3.A.

7.3A.1 Reference sensitivity power level for 2DL CA without exception

7.3A.1.1 Test purpose

To verify the ability of UE that support CA to receive data with a given average throughput for a specified reference measurement channel, under conditions of low signal level, ideal propagation and no added noise when no CA exceptions are allowed and single carrier requirements apply.

A UE unable to meet the throughput requirement under these conditions will decrease the effective coverage area.

7.3A.1.2 Test applicability

This test case applies to all types of NR UE release 15 and forward that support NR 2DL CA.

7.3A.1.3 Minimum requirements

The minimum conformance requirements are defined in clause 7.3A.0.

7.3A.1.4 Test description

7.3A.1.4.1 Initial conditions

Initial conditions are a set of test configurations the UE needs to be tested in and the steps for the SS to take with the UE to reach the correct measurement state.

The initial test configurations consist of environmental conditions, test frequencies, and channel bandwidths based on NR operating bands specified in Table 5.2-1. All of these configurations shall be tested with applicable test parameters for each channel bandwidth, and are shown in Table 7.3A.1.4.1-1, 7.3A.1.4.1-2 and 7.3A.1.4.1-3. The details of the uplink reference measurement channels (RMCs) are specified in Annex A2.2. Configurations of PDSCH and PDCCH before measurement are specified in Annex C.2.

Table 7.3A.1.4.1-1: Test Configuration Table for intra-band contiguous 2DL CA without exception

Initial Conditions						
Test Environment as specified in TS 38.508-1 [5] subclause 4.1			Normal, TL/VL, TL/VH, TH/VL, TH/VH			
Test Frequencies as specified in TS 38.508-1 [5] subclause 4.3.1			Low range, High range			
Test CC Combination setting (N_{RB_agg}) as specified in subclause Table 5.5A.1-1 for the CA Configuration across bandwidth combination sets supported by the UE.			Lowest N_{RB_agg} , Highest N_{RB_agg} (NOTE 3)			
Test SCS as specified in Table 5.3.5-1			Lowest			
Test Parameters CA Configurations						
CA Configuration /NRB		DL Allocation		UL Allocation		
PCC NRB	SCC NRB	CC MOD	PCC & SCC RB allocation	CC MOD	PCC & SCC RB allocations (LCRB @ RB _{start})	
Lowest N_{RB_agg} (NOTE 4)	Lowest N_{RB_agg} (NOTE 4)	CP-OFDM QPSK	Full RB	DFT-s-OFDM QPSK	REFSENS	-
Highest N_{RB_agg} (NOTE 4)	Highest N_{RB_agg} (NOTE 4)	CP-OFDM QPSK	Full RB	DFT-s-OFDM QPSK	REFSENS	-
Note 1: Full RB allocation shall be used per each SCS and channel BW as specified in Table 7.3.2.4.1-2.						
Note 2: REFSENS refers to the single carrier Uplink RB allocation for reference sensitivity according to table 7.3.2.4.1-3.						
Note 3: If the UE supports multiple CC Combinations in the CA Configuration with the same N_{RB_agg} , only the combination with the highest NRB_PCC is tested						
Note 4: In CA_n66B configuration with the same N_{RB_agg} CC combination, PCC shall be selected as the lower CH BW						
Note 5: In a band where UE supports 4Rx, the test needs to be performed only with 4Rx antennas connected.						

Table 7.3A.1.4.1-2: Test Configuration Table for inter-band 2DL CA without exception

Initial Conditions												
Test Environment as specified in TS 38.508-1 [5] subclause 4.1				Normal, TL/VL, TL/VH, TH/VL, TH/VH								
Test Frequencies as specified in TS 38.508-1 [5] subclause 4.3.1				Mid range for PCC and SCC with exceptions for CA configurations containing the following band combinations (Note 8): CA_n1-n77: Mid in band n1 and Low in band n77 CA_n3-n77: TBD in band 3 and TBD in band 77. CA_n8-nX: Low range for PCC in Band 8 CA_n70-n71: High range for PCC in band 71. CA_n3-n78: Mid in band 3 and High in band 78. CA_n5-n78: Mid in band 5 and High in band 78 CA_n29-n71: Low in band 29 and High in band 71..								
Test CC Combination setting (CBW) as specified in subclause Table 5.5A.3.1-1 for the CA Configuration across bandwidth combination sets supported by the UE.				Refer to "PCC N _{RB} " and "SCC N _{RB} " columns								
Test SCS as specified in Table 5.3.5-1				Lowest								
Network signalling value				NS_01 Unless given by Table 7.3.2.3-4 for the band with active uplink carrier								
Test Parameters for CA Configurations												
ID	CA Configuration / CBW				DL Allocation		UL Allocation (Note 2,3)					
	CA Configuration				PCC N _{RB}	SCC N _{RB}	CC MOD	PCC & SCC RB allocation	CC MOD	PCC & SCC RB allocations (LCRB @ RB _{start})		
	PCC		SCC								PCC	SCC
	Band	Range	Band	Range								

Default Test Settings for a CA_nXA-nYA Configuration											
1	nX	default	nY	default	Highest (Note 6)	Highest	CP-OFDM QPSK	Full RB	DFT-s-OFDM QPSK	REFSENS	-
2	nY	default	nX	default	Highest (Note 6)	Highest	CP-OFDM QPSK	Full RB	DFT-s-OFDM QPSK	REFSENS	-
<p>Note 1: CA Configuration Test CC Combination test settings are checked separately for each CA Configuration.</p> <p>Note 2: Use CA Configuration – specific test points if present in the table, otherwise use test points from matching Group Test Settings, if present in the table. Otherwise use the Default Test Settings test points.</p> <p>Note 3: X,Y correspond to the different bands in the CA Configuration. E.g. for CA_n1A-n3A, X=1, Y=3.</p> <p>Note 4: REFSENS refers to the PCC bands and PCC N_{RB}'s single carrier Uplink RB allocation for reference sensitivity according to table 7.3.2.4.1-3.</p> <p>Note 5: For band combinations including operating band without uplink band (as noted in Table 5.2-1), only the CA configuration where PCC band has uplink band shall be tested.</p> <p>Note 6: For NR band n70, DL 25 MHz / UL 15 MHz shall be configured (as specified in clause 5.3.6).</p> <p>Note 7: In a band where UE supports 4Rx, the test needs to be performed only with 4Rx antennas connected.</p> <p>Note 8: For NR band n28, 30MHz test channel bandwidth is tested with Low range test frequencies.</p> <p>Note 9: CA_n29A-n71A is tested according to reference sensitivity levels specified in Clause 7.3A.1_1.5 due to cross band isolation exception specified in Table 7.3A.0.6-1</p>											

Table 7.3A.1.4.1-3: Test Configuration Table for intra-band non-contiguous 2DL CA without exception

Initial Conditions								
Test Environment as specified in TS 38.508-1 [5] subclause 4.1				Normal, TL/VL, TL/VH, TH/VL, TH/VH				
Test Frequencies as specified in TS 38.508-1 [5] subclause 4.3.1				For test frequencies refer to “Range” columns.				
Test CC Combination setting (CBW) as specified in subclause Table 5.5A.3.1-1 for the CA Configuration across bandwidth combination sets supported by the UE.				Refer to “PCC N _{RB} ” and “SCC N _{RB} ” columns				
Test SCS as specified in Table 5.3.5-1				Lowest				
Network signalling value				NS_01 Unless given by Table 7.3.2.3-4 for the band with active uplink carrier				
Test Parameters for CA Configurations								
ID	CA Configuration / CBW			DL Allocation			UL Allocation (Note 2,3)	
	CA Configuration	PCC	W _{gap} / [MHz]	SCC	CC MOD	PCC & SCC RB allocation	CC MOD	PCC & SCC RB allocations (L _{CRB} @ RB _{start})

	PCC		SCC						PCC	SCC		
	Band	Range	Band	Range								
Default Test Settings for a CA_nX(2A) Configuration												
1	nX	CC1	nX	CC2	Highest	Max (NOTE 4)	Lowest	CP-OFDM QPSK	Full RB	DFT-s-OFDM QPSK	REFSENS	-
2	nX	CC1	nX	CC2	Highest N _{RB_agg} (NOTE 5)	Max (NOTE 4)	Highest N _{RB_agg} (NOTE 5)	CP-OFDM QPSK	Full RB	DFT-s-OFDM QPSK	REFSENS	-
Test Settings for a CA_n71(2A) Configuration												
1	n71	CC1	n71	CC2	5MHz	5.0	5MHz	CP-OFDM QPSK	Full RB	DFT-s-OFDM QPSK	20@0	-
<p>Note 1: CA Configuration Test CC Combination test settings are checked separately for each CA Configuration.</p> <p>Note 2: Use CA Configuration – specific test points if present in the table, otherwise use test points from matching Group Test Settings, if present in the table. Otherwise use the Default Test Settings test points.</p> <p>Note 3: REFSENS refers to the PCC bands and PCC N_{RB} 's single carrier Uplink RB allocation for reference sensitivity according to table 7.3.2.4.1-3.</p> <p>Note 4: The W_{gap} is defined to be widest possible on band based on the PCC and SCC configuration</p> <p>Note 5: If the UE supports multiple CC Combinations in the CA Configuration with the same N_{RB_agg}, only the combination with the highest N_{RB_PCC} is tested</p> <p>Note 6: In a band where UE supports 4Rx, the test needs to be performed only with 4Rx antennas connected.</p>												

1. Connect the SS to the UE antenna connectors as shown in TS 38.508-1 [5] Annex A, Figure A.3.1.1.3 for TE diagram and section A.3.2 for UE diagram.
2. The parameter settings for the cell are set up according to TS 38.508-1 [5] subclause 4.4.3.
3. Downlink signals for PCC are initially set up according to Annex C.0, C.1, C.2, and C.3.1, and uplink signals according to Annex G.0, G.1, G.2, and G.3.1.
4. The UL and Reference Measurement Channel is set according to Tables 7.3A.1.4.1-1, 7.3A.1.4.1-2 and 7.3A.1.4.1-3.
5. Propagation conditions are set according to Annex B.0.
6. Ensure the UE is in State RRC_CONNECTED with generic procedure parameters Connectivity *NR*, Connected without release *On*, Test Mode *On* and Test Loop Function *On* according to TS 38.508-1 [5] clause 4.5. Message contents are defined in clause 7.3A.1.4.3.

7.3A.1.4.2 Test procedure

1. Configure SCC according to Annex C.0, C.1, C.2 for all downlink physical channels.
2. The SS shall configure SCC as per TS 38.508-1 [5] clause 5.5.1. Message contents are defined in clause 7.3A.1.4.3.
3. SS activates SCC by sending the activation MAC CE (Refer TS 38.321 [18], clauses 5.9, 6.1.3.10). Wait for at least 2 seconds (Refer TS 38.133[19], clause 9.3).
4. SS transmits PDSCH via PDCCH DCI format 1-1 for C_RNTI to transmit the DL RMC according to Tables 7.3A.1.4.1-1, 7.3A.1.4.1-2 and 7.3A.1.4.1-3 on both PCC and SCC. The SS sends downlink MAC padding bits on the DL RMC.
5. SS sends uplink scheduling information for each UL HARQ process via PDCCH DCI format 0_1 for C_RNTI to schedule the UL RMC according to Table 7.3A.1.4.1-1, 7.3A.1.4.1-2 and 7.3A.1.4.1-3 on PCC. Since the UE has no payload and no loopback data to send the UE sends uplink MAC padding bits on the UL RMC.
6. Set the Downlink signal level to the appropriate REFSENS value defined in Tables 7.3.2.5-1, 7.3.2.5-2. Send continuously uplink power control "up" commands in every uplink scheduling information to the UE to ensure the UE transmits P_{UMAX} level for at least the duration of the throughput measurement. Allow at least 200ms starting from the first TPC command in this step for the UE to reach P_{UMAX} level.
7. Measure the average throughput for each component carrier for a duration sufficient to achieve statistical significance according to Annex H.2A.

7.3A.1.4.3 Message contents

Message contents are according to TS 38.508-1 [5] subclause 4.6 Table 4.6.3-118 with condition TRANSFORM_PRECODER_ENABLED.

7.3A.1.5 Test requirement

For 2DL carrier aggregation, test parameters are specified in table 7.3A.1.4.1-1, 7.3A.1.4.1-2 and 7.3A.1.4.1-3. For the CA configurations listed in table 7.3A.1.5-1, the throughput of each component carrier shall be $\geq 95\%$ of the maximum throughput of the reference measurement channels as specified in Annexes A.2.2, A.2.3 and A.3.2 (with one sided dynamic OCNG Pattern OP.1 FDD/TDD for the DL-signal as described in Annex A.5.1.1/A.5.2.1) with reference power level specified in table 7.3.2.5-1 for non-SDL carrier for 2 Rx antenna port, in table 7.3.2.5-2 for non-SDL carrier for 4 Rx antenna port and in table 7.3A.1.5-2 for SDL carrier with following additional requirements:

The test requirement of configurations for CA operating band including Band n41 also apply for the corresponding CA operating bands with Band n90 replacing Band n41.

For the UE which supports inter-band carrier aggregation, the test requirement for reference sensitivity shall be increased by the amount given by $\Delta R_{IB,c}$ defined in clause 7.3A.0.3 for the applicable operating bands. Unless otherwise stated, $\Delta R_{IB,c}$ is set to zero.

For intra-band non-contiguous 2 DL CA, the test requirement for shall be increased by ΔR_{IBNC} given in Table 7.3A.0.2.2-1 for the SCC. Unless given by Table 7.3.2.3-4, the reference sensitivity requirements shall be verified with the network signalling value NS_01 (Table 6.2.3.1-1) configured.

Table 7.3A.1.5-1: Reference sensitivity requirement for 2DL CA

Carrier aggregation type	DL CA configuration	UL CA configuration
Intra-band contiguous 2DL CA	CA_n40B	-
	CA_n41C	-
	CA_n66B	-
	CA_n78B	-
	CA_n78C	-
Intra-band non-contiguous 2DL CA	CA_n66(2A)	-
	CA_n77(2A)	-
	CA_n78(2A)	-
	CA_n71(2A)	-
Inter-band 2DL CA	CA_n1A-n3A	-
	CA_n1A-n77A	-
	CA_n1A-n78A	-
	CA_n3A-n5A	-
	CA_n3A-n41A	-
	CA_n3A-n77A	-
	CA_n3A-n78A	-
	CA_n5A-n78A	-
	CA_n8A-n78A	-
	CA_n24A-n41A	-
	CA_n24A-n48A	-
	CA_n24A-n77A	-
	CA_n28A-n41A	-
	CA_n28A-n79A	-
	CA_n41A-n79A	-
	CA_n66A-n70A	-
	CA_n66A-n71A	-
	CA_n70A-n71A	-
SDL configuration	CA_n29A-n66A	-
	CA_n29A-n70A	-
	CA_n29A-n71A (NOTE 1)	-
Note 1: CA_n29A-71A reference sensitivity requirement is tested in Clause 7.3A.1_1 due to cross band isolation exception specified in Table 7.3A.0.6-1. Other Rx cases shall be tested with reference sensitivity levels defined in Clause 7.3A.1_1.5.		

Table 7.3A.1.5-2: Reference sensitivity for SDL bands

NR band	SCS (kHz)	5 MHz	10 MHz	15 MHz	20 MHz	25 MHz	30 MHz	40 MHz	50 MHz	60 MHz	80 MHz	90 MHz	100 MHz
		dB	dB	dB	dB	dB	dB	dB	dB	dB	dB	dB	dB
n29	15	-97.0 +TT	-93.8 +TT										
	30		-94.1 +TT										
Note 1: TT for each frequency and channel bandwidth is specified in Table 7.3.2.5-3.													

For intra-band non-contiguous carrier aggregation with one uplink carrier and two or more downlink sub-blocks, throughput of each downlink component carrier shall be $\geq 95\%$ of the maximum throughput of the reference measurement channels as specified in Annexes A.2.2, A.2.3 and A.3.2 (with one sided dynamic OCNG Pattern OP.1 FDD/TDD for the DL-signal as described in Annex A.5.1.1/A.5.2.1) and parameters specified in Table 7.3.2.4.1-1, Table 7.3.2.4.1-2, Table 7.3.2.4.1-3, Table 7.3.2.5-1, Table 7.3.2.5-2 and Table 7.3A.1.4-1 with the reference sensitivity power level increased by ΔR_{IBNC} given in Table 7.3A.0.2.2-1 for the SCC(s). For aggregation of two downlink FDD carriers with one uplink carrier the reference sensitivity is defined only for the specific uplink and downlink test points which are specified in Table 7.3A.0.2.2-1. The requirements apply with all downlink carriers active. Unless given by Table 7.3.2.3-4, the reference sensitivity requirements shall be verified with the network signalling value NS_01 (Table 6.2.3.1-1) configured.

For band combinations including operating bands without uplink band (as noted in Table 5.2-1), the requirements are specified in Table 7.3A.1.5-1 and for any band with uplink the uplink configuration specified in Table 7.3.2.4.1-2. The throughput of each carrier shall be $\geq 95\%$ of the maximum throughput of the reference measurement channels, as specified in Annexes A.2.2, A.2.3, A.3.2, and A.3.3 (with one-sided dynamic OCNG Pattern OP.1 FDD/TDD for the

DL-signal, as described in Annex A.5.1.1/A.5.2.1). The reference sensitivity is defined to be met with all downlink component carriers active and one of the uplink carriers active.

7.3A.1_1 Reference sensitivity power level for 2DL CA exceptions

Editor's Note: The following aspects are either missing or not yet determined:

- Test point analysis for CA_n3A-n5A IMD2 and IMD4 is currently missing in TR 38.905.

7.3A.1_1.1 Test purpose

To verify the ability of UE that support CA to receive data with a given average throughput for a specified reference measurement channel, under conditions of low signal level, ideal propagation and no added noise when CA exceptions are allowed.

A UE unable to meet the throughput requirement under these conditions will decrease the effective coverage area.

7.3A.1_1.2 Test applicability

This test case applies to all types of NR UE release 15 and forward that support NR 2DL CA

7.3A.1_1.3 Minimum requirements

The minimum conformance requirements are defined in clause 7.3A.0.

7.3A.1_1.4 Test description

7.3A.1_1.4.1 Initial conditions

Initial conditions are a set of test configurations the UE needs to be tested in and the steps for the SS to take with the UE to reach the correct measurement state.

The initial test configurations consist of environmental conditions, test frequencies, and channel bandwidths based on NR operating bands specified in Table 5.2-1. All of these configurations shall be tested with applicable test parameters for each channel bandwidth, and are shown in Table 7.3A.1_1.4.1-1. The details of the uplink reference measurement channels (RMCs) are specified in Annex A2.2. Configurations of PDSCH and PDCCH before measurement are specified in Annex C.2.

Table 7.3A.1_1.4.1-1: Test Configuration Table for inter-band 2DL CA exceptions

Initial Conditions											
Test Environment as specified in TS 38.508-1 [5] subclause 4.1						Normal, TL/VL, TL/VH, TH/VL, TH/VH					
Test Frequencies as specified in TS 38.508-1 [5] subclause 4.3.1						For test frequencies refer to "Range" columns.					
Test CC Combination setting (CBW) as specified in subclause Table 5.5A.3.1-1 for the CA Configuration across bandwidth combination sets supported by the UE.						Refer to "PCC N _{RB} " and "SCC N _{RB} " columns					
Test SCS as specified in Table 5.3.5-1						Lowest					
Network signalling value						NS_01 Unless given by Table 7.3.2.3-4 for the band with active uplink carrier					
Test Parameters for CA Configurations											
ID	CA Configuration / CBW					DL Allocation			UL Allocation (Note 2)		
	CA Configuration				PCC	SCC	CC MOD	PCC & SCC RB allocation		CC MOD	PCC & SCC RB allocations (L _{CRB} @ RB _{start})
	PCC		SCC					PCC	SCC		
	Band	Range	Band	Range							
Test Settings for CA_n1A-n3A Configuration											
1	n1	1950 MHz (UL)	n3	1760 MHz	5MHz	5MHz	CP-OFDM QPSK	Full RB	DFT-S-OFDM QPSK	REFSENS_CA_3	REFSENS_CA_3
	n1	Low	n3	High	5MHz	Highest	CP-OFDM QPSK	Full RB	DFT-S-OFDM QPSK	REFSENS_CA_4	
Test Settings for CA_n1A-n8A Configuration											
1	n1	1965 MHz (UL)	n8	887,5 MHz	5MHz	5MHz	CP-OFDM QPSK	Full RB	DFT-S-OFDM QPSK	REFSENS_CA_3	REFSENS_CA_3
Test Settings for CA_n1A-n77A Configuration											
1	n1	Mid	n77	3900 MHz	20 MHz	Highest	CP-OFDM QPSK	Full RB	DFT-S-OFDM QPSK	REFSENS_CA_1	-
2	n1	Mid	n77	3870 MHz	20 MHz	20 MHz	CP-OFDM QPSK	Full RB	DFT-S-OFDM QPSK	REFSENS_CA_1	-

Test Parameters for CA Configurations												
ID	CA Configuration / CBW					DL Allocation			UL Allocation (Note 2)			
	CA Configuration				PCC	SCC	CC MOD	PCC & SCC RB allocation		CC MOD	PCC & SCC RB allocations (LCRB @ RB _{start})	
	PCC		SCC					PCC	SCC			
	Band	Range	Band	Range								
Test Settings for CA_n1A-n78A Configuration												
1	n1	1950 MHz (UL)	n78	3710 MHz	5 MHz	10 MHz	CP-OFDM QPSK	Full RB	DFT-s-OFDM QPSK	REFSENS_CA_3	REFSENS_CA_3	
Test Settings for CA_n3A-n5A Configuration												
1	n3	TBD	n77	TBD	Highest	Highest	CP-OFDM QPSK	Full RB	DFT-s-OFDM QPSK	REFSENS_CA_1	-	
2	n3	1721 MHz (UL)	n5	838 MHz	10 MHz	5 MHz	CP-OFDM QPSK	Full RB	DFT-s-OFDM QPSK	REFSENS_CA_3	REFSENS_CA_3	
Test Settings for CA_n3A-n77A Configuration												
1	n3	TBD	n77	TBD	Highest	Highest	CP-OFDM QPSK	Full RB	DFT-s-OFDM QPSK	REFSENS_CA_1	-	
2	n3	TBD	n77	TBD	Highest	20 MHz	CP-OFDM QPSK	Full RB	DFT-s-OFDM QPSK	REFSENS_CA_1	-	
Test Settings for CA_n70A-n71A Configuration												
1	n71	Low	n70	Low	10 MHz	Highest	CP-OFDM QPSK	Full RB	DFT-s-OFDM QPSK	REFSENS_CA_1 with RB start 10	-	
2	n71	Low	n70	Low	5 MHz	5 MHz	CP-OFDM QPSK	Full RB	DFT-s-OFDM QPSK	REFSENS_CA_1 with RB start 10	-	
3	n70	1697.5 MHz (UL)	n71	695.5 MHz (UL)	5 MHz	5 MHz	CP-OFDM QPSK	Full RB	DFT-s-OFDM QPSK	REFSENS_CA_3	REFSENS_CA_3	

Test Parameters for CA Configurations									
ID	CA Configuration / CBW				DL Allocation			UL Allocation (Note 2)	
	CA Configuration				PCC	SCC	CC MOD	PCC & SCC RB allocation	CC MOD
	PCC		SCC						
	Band	Range	Band	Range	PCC	SCC	PCC & SCC RB allocations (LCRB @ RB _{start})		

Test Settings for CA_n3A-n78A Configuration											
1	n3	Mid	n78	3495 MHz	Highest	Highest	CP-OFDM QPSK	Full RB	DFT-s-OFDM QPSK	REFSENS_CA_1	-
2	n3	Mid	n78	3465 MHz	20 MHz	20 MHz	CP-OFDM QPSK	Full RB	DFT-s-OFDM QPSK	REFSENS_CA_1	-
3	n3	1740 MHz (UL)	n78	3575 MHz	5 MHz	10 MHz	CP-OFDM QPSK	Full RB	DFT-s-OFDM QPSK	REFSENS_CA_3	REFSENS_CA_3
4	n3	1765 MHz (UL)	n78	3435 MHz	5 MHz	10 MHz	CP-OFDM QPSK	Full RB	DFT-s-OFDM QPSK	REFSENS_CA_3	REFSENS_CA_3
Test Settings for CA_n5A-n78A Configuration											
1	n5	Mid	n78	3346 MHz	Highest	Highest	CP-OFDM QPSK	Full RB	DFT-s-OFDM QPSK	REFSENS_CA_1	-
2	n5	Mid	n78	3316 MHz	20 MHz	20 MHz	CP-OFDM QPSK	Full RB	DFT-s-OFDM QPSK	REFSENS_CA_1	-
Test Settings for CA_n7A-n78A Configuration											
1	n7	High	n78	Low	50 MHz	Highest	CP-OFDM QPSK	Full RB	DFT-s-OFDM QPSK	REFSENS_CA_4	-
Test Settings for CA_n8A-n78A Configuration											
1	n8	Mid	n78	3590 MHz	Highest	Highest	CP-OFDM QPSK	Full RB	DFT-s-OFDM QPSK	REFSENS_CA_1	-
2	n8	897.5 MHz (UL)	n78	3635 MHz	5 MHz	10 MHz	CP-OFDM QPSK	Full RB	DFT-s-OFDM QPSK	REFSENS_CA_3	REFSENS_CA_3
Test Settings for CA_n26A-n66A Configuration											
1	n66	1721 MHz (UL)	n26	838 MHz (UL)	5 MHz	5 MHz	CP-OFDM QPSK	Full RB	DFT-s-OFDM QPSK	REFSENS_CA_3	REFSENS_CA_3
Test Settings for CA_n29A-n71A Configuration											
1	n71	High	n29	Low	Highest	5 MHz	CP-OFDM QPSK	Full RB	DFT-s-OFDM QPSK	REFSENS_CA_4	
2	n71	High	n29	Low	Highest	10 MHz	CP-OFDM QPSK	Full RB	DFT-s-OFDM QPSK	REFSENS_CA_4	

Test Parameters for CA Configurations												
ID	CA Configuration / CBW				DL Allocation			UL Allocation (Note 2)				
	CA Configuration				PCC	SCC	CC MOD	PCC & SCC RB allocation		CC MOD	PCC & SCC RB allocations (LCRB @ RB _{start})	
	PCC		SCC					PCC	SCC			
	Band	Range	Band	Range								
Test Settings for CA_n26A-n70A Configuration												
1	n70	1707.5 MHz (UL)	n26	838 MHz (UL)	5 MHz UL / 25 MHz DL	5 MHz	CP-OFDM QPSK	Full RB	DFT-s-OFDM QPSK	REFSENS_CA_3	REFSENS_CA_3	
Test Settings for CA_n48A-n66A Configuration												
1	n48	3660 MHz (UL)	n66	1750 MHz (UL)	5 MHz	5 MHz	CP-OFDM QPSK	Full RB	DFT-s-OFDM QPSK	REFSENS_CA_3	REFSENS_CA_3	
2	n66	High	n48	Low	5 MHz	10 MHz	CP-OFDM QPSK	Full RB	DFT-s-OFDM QPSK	REFSENS_CA_1	-	
3	n66	High	n48	Low	5 MHz	60 MHz	CP-OFDM QPSK	Full RB	DFT-s-OFDM QPSK	REFSENS_CA_1	-	
4	n66	High	n48	Mid	5 MHz	10 MHz	CP-OFDM QPSK	Full RB	DFT-s-OFDM QPSK	REFSENS_CA_1	-	
Test Settings for CA_n48A-n70A Configuration												
1	n48	3695 MHz (UL)	n70	1697.5 MHz (UL)	10 MHz	15 MHz UL / 25 MHz DL	CP-OFDM QPSK	Full RB	DFT-s-OFDM QPSK	REFSENS_CA_3	REFSENS_CA_3	
Test Settings for CA_n66A-n71A Configuration												
2	n66	1750 MHz (UL)	n71	675 MHz (UL)	5 MHz	5 MHz	CP-OFDM QPSK	Full RB	DFT-s-OFDM QPSK	REFSENS_CA_3	REFSENS_CA_3	
<p>Note 1: CA Configuration Test CC Combination test settings are checked separately for each CA Configuration.</p> <p>Note 2: REFSENS refers to the PCC bands and PCC N_{RB} 's single carrier Uplink RB allocation for reference sensitivity according to table 7.3.2.4.1-3. REFSENS_CA_1 refers to the Uplink RB allocation for reference sensitivity exceptions due to UL harmonic interference according to table 7.3A.0.4-2. REFSENS_CA_2 refers to the Uplink RB allocation for reference sensitivity exceptions due to receiver harmonic mixing according to table 7.3A.0.4-4a. REFSENS_CA_3 refers to the Uplink RB allocation for reference sensitivity exceptions due to intermodulation interference due to 2UL CA according to table 7.3A.0.5-1. REFSENS_CA_4 refers to the Uplink RB allocation for reference sensitivity exceptions due to cross band isolation for NR CA FR1 according to table 7.3A.0.6-2.</p> <p>Note 3: In a band where UE supports 4Rx, the test needs to be performed only with 4Rx antennas connected.</p>												

Table 7.3A.1_1.4.1-2: Test Configuration Table for intra-band non-contiguous 2DL CA exceptions

Initial Conditions												
Test Environment as specified in TS 38.508-1 [5] subclause 4.1					NC, TL/VL, TL/VH, TH/VL, TH/VH							
Test Frequencies as specified in TS 38.508-1 [5] subclause 4.3.1					For test frequencies refer to "Range" columns.							
Test CC Combination setting (CBW) as specified in subclause Table 5.5A.3.1-1 for the CA Configuration across bandwidth combination sets supported by the UE.					Refer to "PCC N _{RB} " and "SCC N _{RB} " columns							
Test SCS as specified in Table 5.3.5-1					Lowest							
Network signalling value					NS_01 Unless given by Table 7.3.2.3-4 for the band with active uplink carrier							
Test Parameters for CA Configurations												
ID	CA Configuration / CBW					DL Allocation				UL Allocation (Note 2,3)		
	CA Configuration				PCC	W _{gap} / [MHz]	SCC	CC MOD	PCC & SCC RB allocation		CC MOD	PCC & SCC RB allocations (LCRB @ RB _{start})
	PCC		SCC						PCC	SCC		
Band	Range	Band	Range									
Test Settings for a CA_n71(2A) Configuration												
1	n71	CC1	n71	CC2	5MHz	25.0	5MHz	CP-OFDM QPSK	Full RB	DFT-s-OFDM QPSK	5@0	-
2	n71	CC1	n71	CC2	15MHz	10.0	10MHz	CP-OFDM QPSK	Full RB	DFT-s-OFDM QPSK	5@2	-
3	n71	CC1	n71	CC2	15MHz	5.0	10MHz	CP-OFDM QPSK	Full RB	DFT-s-OFDM QPSK	20@19	-
Note 1:	CA Configuration Test CC Combination test settings are checked separately for each CA Configuration.											
Note 2:	Use CA Configuration – specific test points if present in the table, otherwise use test points from matching Group Test Settings, if present in the table. Otherwise use the Default Test Settings test points.											
Note 3:	REFSENS_CA_1 refers to the Uplink RB allocation for reference sensitivity exceptions according to table 7.3A.0.2.2-1											
Note 4:	The W _{gap} is defined to be widest possible on band based on the PCC and SCC configuration											
Note 5:	If the UE supports multiple CC Combinations in the CA Configuration with the same NRB _{agg} , only the combination with the highest NRB_PCC is tested											
Note 6:	In a band where UE supports 4Rx, the test needs to be performed only with 4Rx antennas connected.											

1. Connect the SS to the UE antenna connectors as shown in TS 38.508-1 [5] Annex A, Figure A.3.1.1.3 for TE diagram and section A.3.2 for UE diagram.
2. The parameter settings for the cell are set up according to TS 38.508-1 [5] subclause 4.4.3.
3. Downlink signals for PCC are initially set up according to Annex C.0, C.1, C.2, and C.3.1, and uplink signals according to Annex G.0, G.1, G.2, and G.3.1.
4. The UL and Reference Measurement Channel is set according to Tables 7.3A.1_1.4.1-1 and 7.3A.1_1.4.1-2.
5. Propagation conditions are set according to Annex B.0.
6. Ensure the UE is in State RRC_CONNECTED with generic procedure parameters Connectivity NR, Connected without release On, Test Mode On and Test Loop Function On according to TS 38.508-1 [5] clause 4.5. Message contents are defined in clause 7.3A.1_1.4.3.

7.3A.1_1.4.2 Test procedure

1. Configure SCC according to Annex C.0, C.1, C.2 for all downlink physical channels.
2. The SS shall configure SCC as per TS 38.508-1 [5] clause 5.5.1. Message contents are defined in clause 7.3A.1_1.4.3.

3. SS activates SCC by sending the activation MAC CE (Refer TS 38.321 [18], clauses 5.9, 6.1.3.10). Wait for at least 2 seconds (Refer TS 38.133[19], clause 9.3).
4. SS transmits PDSCH via PDCCH DCI format 1_1 for C_RNTI to transmit the DL RMC according to Tables 7.3A.1_1.4.1-1 and 7.3A.1_1.4.1-2. on both PCC and SCC. The SS sends downlink MAC padding bits on the DL RMC
5. SS sends uplink scheduling information for each UL HARQ process via PDCCH DCI format 0_1 for C_RNTI to schedule the UL RMC according to Table 6.2A.1.1.4.1-1 on both PCC and SCC. Since the UE has no payload and no loopback data to send the UE sends uplink MAC padding bits on the UL RMC.
6. Set the Downlink signal level to the appropriate REFSENS value defined in Table 7.3A.1_1.5-1 and 7.3A.1_1.5-2. Send continuously uplink power control "up" commands in every uplink scheduling information to the UE to ensure the UE transmits P_{UMAX} level for at least the duration of the throughput measurement. Allow at least 200ms starting from the first TPC command in this step for the UE to reach P_{UMAX} level.
7. Measure the average throughput for each component carrier for a duration sufficient to achieve statistical significance according to Annex H.2A.

7.3A.1_1.4.3 Message contents

Message contents are according to TS 38.508-1 [5] subclause 4.6 Table 4.6.3-118 with condition TRANSFORM_PRECODER_ENABLED and following exception:

For test points with "REFSENS_CA_3" UL configuration in table 7.3A.1_1.4.1-1, message exception in table 7.3A.1_1.4.3-1 applies.

Table 7.3A.1_1.4.3-1: FrequencyInfoUL-SIB

Derivation Path: TS 38.508-1 [5] Table 4.6.3-62 FrequencyInfoUL-SIB			
Information Element	Value/remark	Comment	Condition
p-Max	20		Power class 3 and Inter-band 2UL CA
	23		Power class 2 and Inter-band 2UL CA

7.3A.1_1.5 Test requirement

For inter-band carrier aggregation the throughput shall be $\geq 95\%$ of the maximum throughput of the reference measurement channels as specified in Annex A.2.2 with parameters specified in Table 7.3A.1_1.5-1. The test requirement of configurations for CA operating band including Band n41 also apply for the corresponding CA operating bands with Band n90 replacing Band n41.

Table 7.3A.1_1.5-1: Reference sensitivity requirement for inter band CA

CA configuration	Test ID	NR band	SCS kHz	Channel Bandwidth													
				5 MHz (dBm)	10 MHz (dBm)	15 MHz (dBm)	20 MHz (dBm)	25 MHz (dBm)	30 MHz (dBm)	40 MHz (dBm)	50 MHz (dBm)	60 MHz (dBm)	70 MHz (dBm)	80 MHz (dBm)	90 MHz (dBm)	100 MHz (dBm)	
CA_n1A-n3A	1	n1	15	-100+23+TT													
				-100 -2.7 +23+TT ⁴													
	1	n3	15	-97+TT													
				--97-2.7+TT ⁴													
	2	n3	15								-82.3+1.4+TT						
											-82.3-2.7+1.4+TT ⁴						
CA_n1A-n8A	1	n1	15	-100+6+TT													
				-100 -2.7 +6+TT ⁴													
	1	n8	15	-97+TT													
				-97-2.7+TT ⁴													
CA_n1A-n77A	all	n1	15				-93.8 +TT										
							-93.8 -2.7+TT ⁴										
	1	n77	30														-85.1 +13.8+TT
	2	n77	15				-92.2 +0.3+TT										
							-92.2 -2.2+0.3+TT ⁴										
CA_n1A-n78A	1	n1	15	-100 +8+TT													
				-100 -2.7 +10.7+TT ⁴													
	1	n78	15		-95.8 +TT												
					-95.8 -2.2 +TT ⁴												

CA configuration	Test ID	NR band	SCS kHz	Channel Bandwidth												
				5 MHz (dBm)	10 MHz (dBm)	15 MHz (dBm)	20 MHz (dBm)	25 MHz (dBm)	30 MHz (dBm)	40 MHz (dBm)	50 MHz (dBm)	60 MHz (dBm)	70 MHz (dBm)	80 MHz (dBm)	90 MHz (dBm)	100 MHz (dBm)
CA_n3A-n77A	All	n3	15						-88.9 +TT							
	1	n77	30													-85.1 +13.8 +TT
2	n77	15		-95.3 +0.3 +TT												
				-95.3 -2.2 +0.3 +TT ⁴												
CA_n70A-n71A	1	n70	15						-92.7 +4.1 +TT							
	2	n70	15		-100.0 +9.9 +TT											
					-100.0 -2.7 +9.9 +TT ⁴											
	3	n70	15		-100.0 +5 +TT											
				-100.0 -2.7 +5 +TT ⁴												
All	n71	15		-97.2 +TT	-94.0 +TT											

CA configuration	Test ID	NR band	SCS kHz	Channel Bandwidth															
				5 MHz (dBm)	10 MHz (dBm)	15 MHz (dBm)	20 MHz (dBm)	25 MHz (dBm)	30 MHz (dBm)	40 MHz (dBm)	50 MHz (dBm)	60 MHz (dBm)	70 MHz (dBm)	80 MHz (dBm)	90 MHz (dBm)	100 MHz (dBm)			
CA_n3A-n78A	1, 2	n3	15				-90.8 +TT		-88.9 +TT										
							-90.8 -2.7 +TT ⁴		-88.9 -2.7 +TT ⁴										
	1	n78	30														-85.6 +13.8 +TT		
																		-85.6 -2.2 +13.8 +TT ⁴	
	2	n78	15				-92.7 +0.3 +TT												
							-92.7 -2.2 +0.3 +TT ⁴												
	3	n3	15	-97.0 +[26] +TT															
				-97.0 -2.7 +[28.7] +TT ⁴															
	4	n3	15	-97.0 +[8] +TT															
				-97.0 -2.7 +[10.7] +TT ⁴															
3, 4	n78	15		-95.8 +TT															
				-95.8 -2.2 +TT ⁴															

CA configuration	Test ID	NR band	SCS kHz	Channel Bandwidth																
				5 MHz (dBm)	10 MHz (dBm)	15 MHz (dBm)	20 MHz (dBm)	25 MHz (dBm)	30 MHz (dBm)	40 MHz (dBm)	50 MHz (dBm)	60 MHz (dBm)	70 MHz (dBm)	80 MHz (dBm)	90 MHz (dBm)	100 MHz (dBm)				
CA_n5A-n78A	1, 2	n5	15	-90.8 +TT																
				-90.8 -2.7 +TT4																
	1	n78	30															-85.6 +1.4 +TT		
																			-85.6 - 2.2 +1.4 +TT4	
	2	n78	15				-92.7 +7.8 +TT													
							-92.7 - 2.2 +7.8 +TT4													
CA_n7A-n78A	1	n7	30									-81.5 +4.5 +TT								
												-81.5 - 2.7 +4.5 +TT ⁴								
CA_n8A-n78A	1	n8	15				-85.8 + TT													
	1	n78	30																-85.6 +1.4 +TT	
																			-85.6 -2.2 +1.4 +TT ⁴	
	2	n8	15	-97.0 + 8.3 +TT																
	2	n78	15																	
CA_n26A-n66A	1	n26	15	-97.5 ⁵ + 30 +TT																
	1	n66	15	-99.5 +TT																
CA_n26A-n70A	1	n26	15	-97.5 ⁵ + 30 +TT																
	1	n70	15						-92.7 + TT											

									-92.7 - 2.7 +TT ⁴							
CA_n29A- n71A	1	n29	15	-97.0 + 17.5 + TT												
	1	n71	15				-86.0 + TT									
	2	n29	15			-93.8 + 16.0 +TT										
	2	n71	15				-86.0 + TT									

CA configuration	Test ID	NR band	SC S kHz	Channel Bandwidth												
				5 MHz (dBm)	10 MHz (dBm)	15 MHz (dBm)	20 MHz (dBm)	25 MHz (dBm)	30 MHz (dBm)	40 MHz (dBm)	50 MHz (dBm)	60 MHz (dBm)	70 MHz (dBm)	80 MHz (dBm)	90 MHz (dBm)	100 MHz (dBm)
CA_n48A- n66A	1	n48	15	-99.0 + TT												
	1	n66	15	-99.5 + 5.0 + TT												
				-99.5 +5.0 - 2.7 +TT												
	2	n48	15		-95.8 + 23.9 + TT											
	2	n66	15	-99.5 +TT												
				-99.5 -2.7 +TT												
	3	n48	15									-90.1 ³ + 16.1 +TT				
	3	n66	15	-99.5 +TT												
				-99.5 -2.7 +TT												
	4	n48	15		-95.8 + 1.1. + TT											
4	n66	15	-99.5 +TT													
			-99.5 -2.7 +TT													

CA configuration	Test ID	NR band	SCS kHz	Channel Bandwidth													
				5 MHz (dBm)	10 MHz (dBm)	15 MHz (dBm)	20 MHz (dBm)	25 MHz (dBm)	30 MHz (dBm)	40 MHz (dBm)	50 MHz (dBm)	60 MHz (dBm)	70 MHz (dBm)	80 MHz (dBm)	90 MHz (dBm)	100 MHz (dBm)	
CA_n48A-n70A	1	n48	15		-95.8 + TT												
	1	n70	15					-92.7 +26 +TT									
								-92.7 - 2.7 +28.4 +TT ⁴									
CA_n66A-n71A	1	n66	15	-99.5 +5 +TT													
				-99.5 -2.7 +5 +TT ⁴													
	1	n71	15	-97.2 +TT													

Note 1: The transmitter shall be set to maximum output power level (Table 7.3A.3.5-2)

Note 2: The reference measurement channel is specified in Annex A2.2. Configurations of PDSCH and PDCCH before measurement are specified in Annex C.2.

Note 3: TT for each frequency and channel bandwidth is specified in Table 7.3.2.5-3.

Note 4: Applicable only if operation with 4 antenna ports is supported in the band with carrier aggregation configured.

Note 5: Values are modified by -0.5dB when carrier channel BW is between 865MHz and 894MHz.

Table 7.3A.1_1.5-2: Reference sensitivity requirement for intraband non-contiguous CA

CA configuration	Test ID	NR band	SCS kHz	Channel Bandwidth												
				5 MHz (dBm)	10 MHz (dBm)	15 MHz (dBm)	20 MHz (dBm)	25 MHz (dBm)	30 MHz (dBm)	40 MHz (dBm)	50 MHz (dBm)	60 MHz (dBm)	70 MHz (dBm)	80 MHz (dBm)	90 MHz (dBm)	100 MHz (dBm)
CA_n71(2A)	1	n71	15	-97.2 +TT for PCC -97.2 + 4.0 +TT for SCC												
	2	n71	15		-94.0 +22.2 +TT	-91.6 +TT										
	3	n71	15		-94.0 +5.2 +TT	-91.6 +TT										
Note 1:				The transmitter shall be set to maximum output power level (Table 7.3A.3.5-2)												
Note 2:				The reference measurement channel is specified in Annexe A2.2. Configurations of PDSCH and PDCCH before measurement are specified in Annex C.2.												
Note 3:				TT for each frequency and channel bandwidth is specified in Table 7.3.2.5-3.												

7.3A.2 Reference sensitivity power level for 3DL CA

7.3A.2.1 Test purpose

To verify the ability of UE that support CA to receive data with a given average throughput for a specified reference measurement channel, under conditions of low signal level, ideal propagation and no added noise.

A UE unable to meet the throughput requirement under these conditions will decrease the effective coverage area.

7.3A.2.2 Test applicability

This test case applies to all types of NR UE release 16 and forward that support NR 3DL CA.

7.3A.2.3 Minimum requirements

The minimum conformance requirements are defined in clause 7.3A.0.

7.3A.2.4 Test description

7.3A.2.4.1 Initial conditions

Initial conditions are a set of test configurations the UE needs to be tested in and the steps for the SS to take with the UE to reach the correct measurement state.

The initial test configurations consist of environmental conditions, test frequencies, and channel bandwidths based on NR operating bands specified in Table 5.2-1. All of these configurations shall be tested with applicable test parameters for each channel bandwidth, and are shown in Table 7.2A.2.4.1-1. The details of the uplink reference measurement channels (RMCs) are specified in Annex A2.2. Configurations of PDSCH and PDCCH before measurement are specified in Annex C.2.

Table 7.3A.2.4.1-1: Test Configuration Table for 3DL CA

Initial conditions																			
Test Environment as specified in TS 38.508-1 [5] subclause 4.1									Normal, TL/VL, TL/VH, TH/VL, TH/VH										
Test Frequencies as specified in TS 38.508-1 [5] subclause 4.3.1									For test frequencies refer to "Range" columns. For Inter-band CA: CA_nXA-nYA-nZA: Mid range for PCC and SCC with exceptions (Note 11): CA_nXC-nYA and CA_nXB-nYA :Low range, High Range for nXC and nXB, mid range for nYA for PCC and SCC with exceptions : CA configurations containing the following band combinations: CA_n1-n77: Mid in band n1 and Low in band n77 CA_n3-n77: TBD in band 3 and TBD in band 77. CA_n3-n78: Mid in band 3 and High in band 78. CA_n8-nX: Low range for PCC in Band 8 CA_n70-n71: High range for PCC in band 71										
Test CC Combination setting (CBW) as specified in subclause Table 5.5A.3.1-1 for the CA Configuration across bandwidth combination sets supported by the UE.									Refer to "PCC N _{RB} " and "SCC N _{RB} " columns										
Test SCS as specified in Table 5.3.5-1									Lowest										
Network signalling value									NS_01 Unless given by Table 7.3.2.3-4 for the band with active uplink carrier										
Test Parameters for CA Configurations																			
I D	CA Configuration / channel BW											DL Allocation		UL allocation (NOTE2 to NOTE 5)					
	CA configuration											PCC	SCC1	SCC2	CC Mod	PCC & SCC RB allocation		CC Mod	PCC & SCC RB allocation
	PCC		Wgap1	SCC1		Wgap2	SCC2		PC C	SC C									
	Band	Range		Band	Range		Band	Range											
Default Test Settings for a CA_nXD Configuration (Intra-band contiguous)																			
1	nX	Low CC1	N/A	nX	Low CC2	N/A	nX	Low CC3	Highest N _{RB_agg}	Highest N _{RB_agg}	Highest N _{RB_agg}	CP-OFDM QPSK	Full RB	DFT-s-OFDM QPSK	REFSEN S	-			
2	nX	High CC1	N/A	nX	High CC2	N/A	nX	High CC3	Highest N _{RB_agg}	Highest N _{RB_agg}	Highest N _{RB_agg}	CP-OFDM QPSK	Full RB	DFT-s-OFDM QPSK	REFSEN S	-			

Test Parameters for CA Configurations																
ID	CA Configuration / channel BW											DL Allocation		UL allocation (NOTE2 to NOTE 5)		
	CA configuration								PCC	SCC1	SCC2	CC Mod	PCC & SCC RB allocation		CC Mod	PCC & SCC RB allocation
	PCC		Wgap1	SCC1		Wgap2	SCC2						PC C	SC C		
	Band	Range		Band	Range		Band	Range								
Default Test Settings for a CA_nXA-nYA-nZA Configuration (Inter-band)																
1	nX	default	N/A	nY	default	NA	nZ	default	Highest	Highest	Highest	CP-OFDM QPSK	Full RB	DFT-s-OFDM QPSK	REFSEN S	-
2	nY	default	N/A	nZ	default	NA	nX	default	Highest	Highest	Highest	CP-OFDM QPSK	Full RB	DFT-s-OFDM QPSK	REFSEN S	-
3	nZ	default	N/A	nY	default	NA	nX	default	Highest	Highest	Highest	CP-OFDM QPSK	Full RB	DFT-s-OFDM QPSK	REFSEN S	-
Default Test Settings for a CA_nXC-nYA, CA_nYA-nXC, CA_nYA-nXB and CA_nXB-nYA Configurations (Intra-band contiguous + Inter-band)																
1	nX	default	N/A	nX	default	NA	nY	default	Highest N _{RB_agg}	Highest N _{RB_agg}	Highest	CP-OFDM QPSK	Full RB	DFT-s-OFDM QPSK	REFSEN S	-
2	nY	default	N/A	nX	default	NA	nX	default	Highest	Highest N _{RB_agg}	Highest N _{RB_agg}	CP-OFDM QPSK	Full RB	DFT-s-OFDM QPSK	REFSEN S	-

Test Parameters for CA Configurations																	
ID	CA Configuration / channel BW											DL Allocation		UL allocation (NOTE2 to NOTE 5)			
	CA configuration									PCC	SCC1	SCC2	CC Mod	PCC & SCC RB allocation		CC Mod	PCC & SCC RB allocation
	PCC		Wgap1	SCC1		Wgap2	SCC2		PC C					SC C			
	Band	Range		Band	Range		Band	Range									
Default Test Settings for a CA_nX(2A)-nYA Configuration (Intra-band non-contiguous + Inter-band)																	
1	nX	CC1	Max (NOTE 7)	nX	CC2	N/A	nY	Mid	Highest NRB_agg (NOTE 6)	Highest NRB_agg (NOTE 6)	Highest	CP-OFDM QPSK	Full RB	DFT-s-OFDM QPSK	REFSENS	-	
2	nY	Mid	NA	nX	CC1	Max (NOTE 7)	nX	CC2	Highest	Highest NRB_agg	Highest NRB_agg	CP-OFDM QPSK	Full RB	DFT-s-OFDM QPSK	REFSENS	-	
<p>Note 1: CA Configuration Test CC Combination test settings are checked separately for each CA Configuration.</p> <p>Note 2.0: REFSENS refers to the single carrier Uplink RB allocation for reference sensitivity according to table 7.3.2.4.1-3.</p> <p>Note 2: Use CA Configuration – specific test points if present in the table, otherwise use test points from matching Group Test Settings, if present in the table. Otherwise use the Default Test Settings test points.</p> <p>Note 3: Inter-band: X,Y,Z correspond to the different bands in the CA Configuration. E.g. for CA_n1A-n3A-n8A, X=1, Y=3, Z=8.</p> <p>Note 4: Intra-band contiguous + Inter-band: X,Y correspond to the different bands in the CA Configuration, e.g. for CA_1C-3A, X=1,Y=3</p> <p>Note 5: Intra-band non-contiguous + Inter-band: X and Y correspond to the different bands in the CA Configuration. E.g. for CA_n1A-n1A-n8A, X=1, Y =8.</p> <p>Note 6: If the UE supports multiple CC Combinations in the CA Configuration with the same NRB_agg, only the combination with the highest NRB_PCC is tested</p> <p>Note 7: The Wgap is defined to be widest possible on band based on the PCC and SCC configuration for Intra-band non-contiguous</p> <p>Note 8: For band combinations including operating bands without uplink band (as noted in Table 5.2-1), only the CA configurations where PCC band has uplink band shall be tested</p> <p>Note 9: The fallback configuration CA_XA-YA for 3CA configurations XC-YA and XB-YA does not need to be tested even if the test frequency differs</p> <p>Note 10: In a band where UE supports 4Rx, the test needs to be performed only with 4Rx antennas connected.</p> <p>Note 11: For NR band n28, 30MHz test channel bandwidth is tested with Low range test frequencies.</p>																	

Table 7.3A.2.4.1-2: Void**Table 7.3A.2.4.1-3: Void**

1. Connect the SS to the UE antenna connectors as shown in TS 38.508-1 [5] Annex A, Figure A.3.1.1.3 for TE diagram and section A.3.2 for UE diagram.
2. The parameter settings for the cell are set up according to TS 38.508-1 [5] subclause 4.4.3.
3. Downlink signals for PCC are initially set up according to Annex C.0, C.1, C.2, and C.3.1, and uplink signals according to Annex G.0, G.1, G.2, and G.3.1.
4. The UL and Reference Measurement Channel is set according to Tables 7.3A.2.1.4.1-1.
5. Propagation conditions are set according to Annex B.0.
6. Ensure the UE is in State RRC_CONNECTED with generic procedure parameters Connectivity *NR*, Connected without release *On*, Test Mode *On* and Test Loop Function *On* according to TS 38.508-1 [5] clause 4.5. Message contents are defined in clause 7.3A.2.1.4.3.

7.3A.2.4.2 Test procedure

1. Configure SCCs according to Annex C.0, C.1, C.2 for all downlink physical channels.
2. The SS shall configure SCCs as per TS 38.508-1 [5] clause 5.5.1. Message contents are defined in clause 7.3A.2.1.4.3.
3. SS activates SCCs by sending the activation MAC CE (Refer TS 38.321 [18], clauses 5.9, 6.1.3.10). Wait for at least 2 seconds (Refer TS 38.133[19], clause 9.3).
4. SS transmits PDSCH via PDCCH DCI format 1-1 for C_RNTI to transmit the DL RMC according to Tables 7.3A.1.4.1-1 on both PCC and SCC. The SS sends downlink MAC padding bits on the DL RMC
5. SS sends uplink scheduling information for each UL HARQ process via PDCCH DCI format 0_1 for C_RNTI to schedule the UL RMC according to Table 7.3A.2.4.1-1 on PCC. Since the UE has no payload and no loopback data to send the UE sends uplink MAC padding bits on the UL RMC.
6. Set the Downlink signal level to the appropriate REFSENS value defined in Tables 7.3.2.5-1 and 7.3.2.5-2 as appropriate. Send continuously uplink power control "up" commands in every uplink scheduling information to the UE to ensure the UE transmits P_{UMAX} level for at least the duration of the throughput measurement. Allow at least 200ms starting from the first TPC command in this step for the UE to reach P_{UMAX} level.
7. Measure the average throughput for each component carrier for a duration sufficient to achieve statistical significance according to Annex H.2A.

7.3A.2.4.3 Message contents

Message contents are according to TS 38.508-1 [5] subclause 4.6 Table 4.6.3-118 with condition TRANSFORM_PRECODER_ENABLED.

7.3A.2.5 Test requirement

For 3DL carrier aggregation, test parameters are specified in table 7.3A.2.4.1-1. For the CA configurations listed in table 7.3A.2.5-1, the throughput of each component carrier shall be $\geq 95\%$ of the maximum throughput of the reference measurement channels as specified in Annexes A.2.2, A.2.3 and A.3.2 (with one sided dynamic OCNG Pattern OP.1 FDD/TDD for the DL-signal as described in Annex A.5.1.1/A.5.2.1) with reference power level specified in table 7.3.2.5-1 for each non-SDL carrier for 2 Rx antenna port, in table 7.3.2.5-2 for each non-SDL carrier for 4 Rx antenna port and in table 7.3A.1.5-2 for SDL carrier with following additional requirements:

The test requirement of configurations for CA operating band including Band n41 also apply for the corresponding CA operating bands with Band n90 replacing Band n41.

For the UE which supports inter-band carrier aggregation, the test requirement for reference sensitivity shall be increased by the amount given by $\Delta R_{IB,c}$ defined in clause 7.3A.0.3.2 for the applicable operating bands. Unless otherwise stated, $\Delta R_{IB,c}$ is set to zero.

For intra-band non-contiguous CA with one uplink carrier and two or more downlink sub-blocks, the test requirement for SCC(s) shall be increased by ΔR_{IBNC} given in Table 7.3A.0.2.2-1. Unless given by Table 7.3.2.3-4, the reference sensitivity requirements shall be verified with the network signalling value NS_01 (Table 6.2.3.1-1) configured.

Table 7.3A.2.5-1: Reference sensitivity requirement for 3DL CA

Carrier aggregation type	DL CA configuration	UL CA configuration
Intra-band contiguous 3DL CA	CA_n77D	-
	CA_n78D	-
Intra-band non-contiguous 3DL CA	CA_n48(3A)	-
	CA_n1A-n78(2A)	-
Inter-band 3DL CA	CA_n1A-n78A-n79A	-
	CA_n26A-n66-n70A	
	CA_n26A-n66(2A)	
	CA_n48A-n66(2A)	
	CA_n48A-n71(2A)	
	CA_n48B-n66A	
	CA_n48B-n70A	
	CA_n48B-n71A	
	CA_n48(2A)-n66A	
	CA_n48(2A)-n70A	
	CA_n48(2A)-n71A	
	CA_n48A-n66A-n70A	
	CA_n48A-n66A-n71A	
	CA_n48A-n70A-n71A	
	CA_n66A-n70A-n71A	-
	CA_n66A-n71(2A)	
	CA_n66(2A)-n70A	-
	CA_n66(2A)-n71A	-
	CA_n66B-n70A	-
	CA_n66B-n71A	-
	CA_n70A-n71A(2A)	
	CA_n1A-n78C	
	SDL configuration	CA_n29A-n66A-n70A
CA_n29A-n66B		-
CA_n29A-n66(2A)		-

7.3A.3 Reference sensitivity power level for 4DL CA

NOTE: Intra-band contiguous and 4 band inter-band 4DL CA are FFS

7.3A.3.1 Test purpose

To verify the ability of UE that support CA to receive data with a given average throughput for a specified reference measurement channel, under conditions of low signal level, ideal propagation and no added noise.

A UE unable to meet the throughput requirement under these conditions will decrease the effective coverage area.

7.3A.3.2 Test applicability

This test case applies to all types of NR UE release 15 and forward that support NR 4DL CA.

7.3A.3.3 Minimum requirements

The minimum conformance requirements are defined in clause 7.3A.0.

7.3A.3.4 Test description

7.3A.3.4.1 Initial conditions

Initial conditions are a set of test configurations the UE needs to be tested in and the steps for the SS to take with the UE to reach the correct measurement state.

The initial test configurations consist of environmental conditions, test frequencies, and channel bandwidths based on NR operating bands specified in Table 5.2-1. All of these configurations shall be tested with applicable test parameters

for each channel bandwidth, and are shown in Table 7.3A.3.4.1-1. The details of the uplink reference measurement channels (RMCs) are specified in Annex A2.2. Configurations of PDSCH and PDCCH before measurement are specified in Annex C.2.

Table 7.3A.3.4.1-1: Test Configuration Table for 4DL CA

Initial conditions	
Content as specified in TS 38.508-1 [5] subclause 4.1	Normal, TL/VL, TL/VH, TH/VL, TH/VH
Details as specified in TS 38.508-1 [5] subclause 4.3.1	For test frequencies refer to "Range" columns. For Inter-band CA: CA_nX(2A)-nYA-nZA: Mid range for PCC and SCC with exceptions. CA_nXC-nYA-nZA and CA_nXB-nYA-nZA : Low range, High Range for nXC and nXB range for nYA for PCC and SCC with exceptions. Exceptions for CA configurations containing the following band combinations: CA_n1-n77: Mid in band n1 and Low in band n77 CA_n3-n77: TBD in band 3 and TBD in band 77. CA_n3-n78: Mid in band 3 and High in band 78. CA_n8-nX: Low range for PCC in Band 8 CA_n70-n71: High range for PCC in band 71
Combination setting (CBW) as specified in subclause Table 5.5A.3.1-1 for the CA Configuration across bandwidths supported by the UE.	Refer to "PCC N _{RB} " and "SCC N _{RB} " columns
Details as specified in Table 5.3.5-1	Lowest
Minimum value	NS_01
	Unless given by Table 7.3.2.3-4 for the band with active uplink carrier

Test Parameters for CA Configurations

CA Configuration / channel BW										DL Allocation				UL allocation (NR)				
CA configuration										PCC	SCC1	SCC2	SCC3	CC Mod	PCC & SCC RB allocation		CC Mod	PCC & SCC allocation
SCC	Wgap1	SCC1		Wgap2	SCC2		Wgap3	SCC3							PC C	SC C		
Range		Band	Range		Band	Range		Band	Range									
Default Test Settings for a CA_nXC-nYA-nZA and CA_nXB-nYA-nZA Configurations (Intra-band contiguous + Inter-band)																		
default	N/A	nX	default	N/A	nY	default	N/A	nZ	default	Highest NRB_ag	Highest NRB_ag	Highest	Highest	CP-OFDM QPSK	Full RB	DFT-s-OFDM QPSK	REFSEN S	
default	N/A	nX	default	N/A	nX	default	N/A	nZ	default	Highest	Highest NRB_ag	Highest NRB_ag	Highest	CP-OFDM QPSK	Full RB	DFT-s-OFDM QPSK	REFSEN S	
default	N/A	nX	default	N/A	nX	default	N/A	nY	default	Highest	Highest NRB_ag	Highest NRB_ag	Highest	CP-OFDM QPSK	Full RB	DFT-s-OFDM QPSK	REFSEN S	

Test Parameters for CA Configurations

CA Configuration / channel BW										PCC	SCC1	SCC2	SCC3	DL Allocation		UL allocation (N)		
CA configuration														CC Mod	PCC & SCC RB allocation		CC Mod	PCC & alloc
CC	Wgap1	SCC1		Wgap2	SCC2		Wgap3	SCC3							PC C	SC C		
Range		Band	Range		Band	Range		Band	Range									
Default Test Settings for a CA_nX(2A)-nYA-nZA Configuration (Intra-band non-contiguous + Inter-band)																		
CC1	Max (NOTE 7)	nX	CC2	N/A	nY	N/A	N/A	nZ	default	Highest NRB_agg (NOTE 6)	Highest NRB_agg (NOTE 6)	Highest	Highest	CP-OFDM QPSK	Full RB	DFT-s-OFDM QPSK	REFSENS	
default	N/A	nX	CC1	Max (NOTE 7)	nX	CC2	N/A	nZ	default	Highest	Highest NRB_agg	Highest NRB_agg	Highest	CP-OFDM QPSK	Full RB	DFT-s-OFDM QPSK	REFSENS	
default	N/A	nX	CC1	Max (NOTE 7)	nX	CC2	N/A	Ny	default	Highest	Highest NRB_agg	Highest NRB_agg	Highest	CP-OFDM QPSK	Full RB	DFT-s-OFDM QPSK	REFSENS	
Default Test Settings for a CA_nX(2A)-nY(2A) Configuration (Intra-band non-contiguous + Intra-band non-contiguous)																		
CC1	Max (NOTE 7)	nX	CC2	N/A	nY	CC1	Max (NOTE 7)	nY	CC2	Highest NRB_agg (NOTE 6)	Highest NRB_agg (NOTE 6)	Highest NRB_agg (NOTE 6)	Highest NRB_agg (NOTE 6)	CP-OFDM QPSK	Full RB	DFT-s-OFDM QPSK	REFSENS	
CC1	Max (NOTE 7)	nY	CC2	N/A	nX	CC1	Max (NOTE 7)	nX	CC2	Highest NRB_agg (NOTE 6)	Highest NRB_agg (NOTE 6)	Highest NRB_agg (NOTE 6)	Highest NRB_agg (NOTE 6)	CP-OFDM QPSK	Full RB	DFT-s-OFDM QPSK	REFSENS	

Configuration Test CC Combination test settings are checked separately for each CA Configuration.

REFSENS refers to the single carrier Uplink RB allocation for reference sensitivity according to table 7.3.2.4.1-3.

CA Configuration – specific test points if present in the table, otherwise use test points from matching Group Test Settings, if present in the table. Otherwise use the Default Test Settings test points.

Inter-band: X,Y,Z correspond to the different bands in the CA Configuration. E.g. for CA_n1A-n3A-n8A, X=1, Y=3, Z=8.

Intra-band contiguous + Inter-band: X,Y,Z correspond to the different bands in the CA Configuration, e.g. for CA_n1C-n3A-n8A, X=1,Y=3, Z = 8

Intra-band non-contiguous + Inter-band: X, Y and Z correspond to the different bands in the CA Configuration. E.g. for CA_n1A-n1A-n8A-n28A, X=1, Y =8, Z = 28.

UE supports multiple CC Combinations in the CA Configuration with the same NRB_agg, only the combination with the highest NRB_PCC is tested

Wgap is defined to be widest possible on band based on the PCC and SCC configuration for Intra-band non-contiguous

band combinations including operating bands without uplink band (as noted in Table 5.2-1), only the CA configurations where PCC band has uplink band shall be tested

fallback configurations including CA_XA-YA for 4CA configurations XC-YA-ZA and XB-YA-ZA do not need to be tested even if the test frequency differs. 7.3A.1_1 shall be tested for all XA-YA combinations

options.

band where UE supports 4Rx, the test needs to be performed only with 4Rx antennas connected.

1. Connect the SS to the UE antenna connectors as shown in TS 38.508-1 [5] Annex A, Figure A.3.1.1.3 for TE diagram and section A.3.2 for UE diagram.
2. The parameter settings for the cell are set up according to TS 38.508-1 [5] subclause 4.4.3.
3. Downlink signals for PCC are initially set up according to Annex C.0, C.1, C.2, and C.3.1, and uplink signals according to Annex G.0, G.1, G.2, and G.3.1.
4. The UL and Reference Measurement Channel is set according to Table 7.3A.3.4.1-1.
5. Propagation conditions are set according to Annex B.0.
6. Ensure the UE is in State RRC_CONNECTED with generic procedure parameters Connectivity *NR*, Connected without release *On*, Test Mode *On* and Test Loop Function *On* according to TS 38.508-1 [5] clause 4.5. Message contents are defined in clause 7.3A.2.1.4.3.

7.3A.3.4.2 Test procedure

1. Configure SCCs according to Annex C.0, C.1, C.2 for all downlink physical channels.
2. The SS shall configure SCCs as per TS 38.508-1 [5] clause 5.5.1. Message contents are defined in clause 7.3A.3.1.4.3.
3. SS activates SCCs by sending the activation MAC CE (Refer TS 38.321 [18], clauses 5.9, 6.1.3.10). Wait for at least 2 seconds (Refer TS 38.133[19], clause 9.3).
4. SS transmits PDSCH via PDCCH DCI format 1-1 for C_RNTI to transmit the DL RMC according to Table 7.3A.3.4.1-1 on both PCC and SCC. The SS sends downlink MAC padding bits on the DL RMC
5. SS sends uplink scheduling information for each UL HARQ process via PDCCH DCI format 0_1 for C_RNTI to schedule the UL RMC according to Table 7.3A.3.4.1-1 on PCC. Since the UE has no payload and no loopback data to send the UE sends uplink MAC padding bits on the UL RMC.
6. Set the Downlink signal level to the appropriate REFSENS value defined in Tables 7.3.2.5-1 and 7.3.2.5-2 as appropriate. Send continuously uplink power control "up" commands in every uplink scheduling information to the UE to ensure the UE transmits P_{UMAX} level for at least the duration of the throughput measurement. Allow at least 200ms starting from the first TPC command in this step for the UE to reach P_{UMAX} level.
7. Measure the average throughput for each component carrier for a duration sufficient to achieve statistical significance according to Annex H.2A.

7.3A.3.4.3 Message contents

Message contents are according to TS 38.508-1 [5] subclause 4.6 Table 4.6.3-118 with condition TRANSFORM_PRECODER_ENABLED.

7.3A.3.5 Test requirement

For 4DL carrier aggregation, test parameters are specified in table 7.3A.3.4.1-1. For the CA configurations listed in table 7.3A.3.5-1, the throughput of each component carrier shall be $\geq 95\%$ of the maximum throughput of the reference measurement channels as specified in Annexes A.2.2, A.2.3 and A.3.2 (with one sided dynamic OCNG Pattern OP.1 FDD/TDD for the DL-signal as described in Annex A.5.1.1/A.5.2.1) with reference sensitivity power level specified in table 7.3.2.5-1 for each non-SDL carrier for 2 Rx antenna port, in table 7.3.2.5-2 for each non-SDL carrier for 4 Rx antenna port and in table 7.3A.1.5-2 for SDL carrier with following additional requirements:

For the UE which supports inter-band carrier aggregation, the test requirement for reference sensitivity shall be increased by the amount given by $\Delta R_{IB,c}$ defined in clause 7.3A.0.3.2 for the applicable operating bands. Unless otherwise stated, $\Delta R_{IB,c}$ is set to zero.

For intra-band non-contiguous CA with one uplink carrier and two or more downlink sub-blocks, the test requirement for SCC(s) shall be increased by ΔR_{IBNC} given in Table 7.3A.0.2.2-1. Unless given by Table 7.3.2.3-4, the reference sensitivity requirements shall be verified with the network signalling value NS_01 (Table 6.2.3.1-1) configured.

Table 7.3A.3.5-1: Reference sensitivity requirement for 4DL CA

Carrier aggregation type	DL CA configuration	UL CA configuration
Inter-band 4DL CA	CA_n66A-n70A-n71(2A)	-
	CA_n66B-n70A-n71A	-
	CA_n66(2A)-n70A-n71A	-
	CA_n66(2A)-n71(2A)	-
SDL configuration	CA_n29A-n66B-n70A	-
	CA_n29A-n66(2A)-n70	-

7.3A.4 Reference sensitivity power level for 5DL CA

FFS

7.3B Void

7.3C Reference sensitivity for SUL

7.3C.0 Minimum conformance requirements

7.3C.0.1 General

The reference sensitivity power level REFSSENS is the minimum mean power applied to each one of the UE antenna ports for all UE categories, at which the throughput shall meet or exceed the requirements for the specified reference measurement channel.

7.3C.0.2 Minimum conformance requirements for Reference sensitivity power level

For SUL operation, the reference receive sensitivity (REFSENS) requirement for downlink bands specified in Table 7.3.2.3-1 and 7.3.2.3-2 shall be met for an uplink transmission bandwidth less than or equal to that specified in Table 7.3.2.3-1 or supplementary uplink transmission bandwidth less than or equal to that specified in Table 7.3C.0.2-1 with reference measurement channels as specified in Annexes A.2.2.2, A.2.3.2, A.3.2, and A.3.3 (with one sided dynamic OCNG Pattern OP.1 FDD/TDD for the DL-signal as described in Annex A.5.1.1/A.5.2.1), unless sensitivity degradation is allowed in this section of this specification. These exceptions also apply to any higher order CA or DC combination containing one of the exception combinations in this section as subset.

For SUL operation with downlink CA, the reference receive sensitivity (REFSENS) requirement for downlink bands specified in clause 7.3A.2 shall be met for an uplink transmission bandwidth less than or equal to that specified in Table 7.3.2-3 or supplementary uplink transmission bandwidth less than or equal to that specified in Table 7.3C.2-1 with reference measurement channels as specified in Annexes A.2.2.2, A.2.3.2, A.3.2, and A.3.3 (with one sided dynamic OCNG Pattern OP.1 FDD/TDD for the DL-signal as described in Annex A.5.1.1/A.5.2.1), unless sensitivity degradation is allowed in this clause of this specification. These exceptions also apply to any higher order CA or DC combination containing one of the exception combinations in this clause as subset.

Table 7.3C.0.2-1: Supplementary uplink configuration for reference sensitivity

DL band	UL band	SCS of UL band (kHz)	5 MHz	10 MHz	15 MHz	20 MHz	25 MHz	30 MHz	40 MHz	50 MHz	60 MHz	70 MHz	80 MHz	90 MHz	100 MHz
n41	n83	15		100	100	100		100	100	100	100		100	100	100
		30		50	50	50		50	50	50	50		50	50	50
n78	n80	15	25	50	75	100			100	100					
n78	n81	15	25	50	75	100			100	100					
n78	n82	15	25	50	75	100			100	100					
n78	n83	15	25	50	75	100			100	100					
n78	n84	15	25	50	75	100	100	100	100	100		100			
n78	n86	15	25	50	75	100			100	100					
n79	n80	15	25	50	75	100			100	100					
n79	n81	15	25	50	75	100			100	100					
n79	n83	15							100	100	100		100		100
		30							50	50	50		50		50

For the UE that supports any of the SUL operation given in Table 7.3C.0.2-2, exceptions to the requirements specified in Table 7.3.2.3-1 are allowed when the uplink is active in a lower frequency band and is within a specified frequency range such that transmitter harmonics fall within the downlink transmission bandwidth assigned in a higher band as noted in Table 7.3C.0.2-2. For these exceptions, the UE shall meet the requirements specified in Table 7.3C.0.2-2 and Supplementary Uplink configuration (exceptions due to harmonic issue given in Table 7.3C.0.2-3).

Table 7.3C.0.2-2: Reference sensitivity for SUL operation (exceptions due to harmonic issue)

NR Band / Channel bandwidth of the high band													
UL band	DL band	5 MHz	10 MHz	15 MHz	20 MHz	25 MHz	30 MHz	40 MHz	50 MHz	60 MHz	80 MHz	90 MHz	100 MHz
		dB	dB	dB	dB	dB	dB	dB	dB	dB	dB	dB	dB
n80	n78 ^{1,2}		23.9	22.1	20.9			17.9	16.8	16.0	14.8	14.3	13.8
	n78 ³		1.1	0.8	0.3			0	0	0	0	0	0
n82	n78 ^{4,5}		10.8	9.1	8			6	4.0	3.2	2.0	1.5	1.0
n81	n78 ^{4,5}		10.8	9.1	8			5.1	4.2	3.5	2.3	1.5	1.4
n83	n78 ^{6,7}		10.4	8.9	7.8			4.7	3.7	3	1.7	1.2	0.7
n86	n78 ^{1,2}		23.9	22.1	20.9			17.9	16.8	16.0	14.8	14.3	13.8
	n78 ³		1.1	0.8	0.3			0	0	0	0	0	0
n81	n79 ^{6,7}							[6.8]	6.2	[5.6]	4.9		4.4

NOTE 1: These requirements apply when there is at least one individual RE within the uplink transmission bandwidth of the aggressor (lower) band for which the 2nd transmitter harmonic is within the downlink transmission bandwidth of a victim (higher) band and a range ΔF_{HD} above and below the edge of this downlink transmission bandwidth. The value ΔF_{HD} depends on the band combination: $\Delta F_{HD} = 10$ MHz for SUL_n78-n80, SUL_n78-n86.

NOTE 2: The requirements should be verified for UL EARFCN of the aggressor (lower) band (superscript LB) such that $f_{UL}^{LB} = \lfloor f_{DL}^{HB} / 0.2 \rfloor \cdot 0.1$ in MHz and $F_{UL_low}^{LB} + BW_{Channel}^{LB} / 2 \leq f_{UL}^{LB} \leq F_{UL_high}^{LB} - BW_{Channel}^{LB} / 2$ with f_{DL}^{HB} carrier frequency in the victim (higher) band in MHz and $BW_{Channel}^{LB}$ the channel bandwidth configured in the lower band.

NOTE 3: The requirements are only applicable to channel bandwidths no larger than 20 MHz and with a carrier frequency at $\pm (20 + BW_{Channel}^{HB} / 2)$ MHz offset from $2f_{UL}^{LB}$ in the victim (higher) band with $F_{UL_low}^{LB} + BW_{Channel}^{LB} / 2 \leq f_{UL}^{LB} \leq F_{UL_high}^{LB} - BW_{Channel}^{LB} / 2$, where $BW_{Channel}^{LB}$ and $BW_{Channel}^{HB}$ are the channel bandwidths configured in the aggressor (lower) and victim (higher) bands in MHz, respectively.

NOTE 4: These requirements apply when there is at least one individual RE within the uplink transmission bandwidth of the aggressor (lower) band for which the 4th transmitter harmonic is within the downlink transmission bandwidth of a victim (higher) band.

NOTE 5: The requirements should be verified for UL EARFCN of the aggressor (lower) band (superscript LB) such that $f_{UL}^{LB} = \lfloor f_{DL}^{HB} / 0.4 \rfloor \cdot 0.1$ in MHz and $F_{UL_low}^{LB} + BW_{Channel}^{LB} / 2 \leq f_{UL}^{LB} \leq F_{UL_high}^{LB} - BW_{Channel}^{LB} / 2$ with f_{DL}^{HB} carrier frequency in the victim (higher) band in MHz and $BW_{Channel}^{LB}$ the channel bandwidth configured in the lower band.

NOTE 6: These requirements apply when there is at least one individual RE within the uplink transmission bandwidth of the aggressor (lower) band for which the 5th transmitter harmonic is within the downlink transmission bandwidth of a victim (higher) band.

NOTE 7: The requirements should be verified for UL NR-ARFCN of the aggressor (lower) band (superscript LB) such that $f_{UL}^{LB} = \lfloor f_{DL}^{HB} / 0.5 \rfloor \cdot 0.1$ in MHz and $F_{UL_low}^{LB} + BW_{Channel}^{LB} / 2 \leq f_{UL}^{LB} \leq F_{UL_high}^{LB} - BW_{Channel}^{LB} / 2$ with f_{DL}^{HB} carrier frequency in the victim (higher) band in MHz and $BW_{Channel}^{LB}$ the channel bandwidth configured in the lower band.

Table 7.3C.0.2-3: Supplementary uplink configuration (exceptions due to harmonic issue)

NR Band / Channel bandwidth of the high band													
UL band	DL band	5 MHz (N _{RB})	10 MHz (N _{RB})	15 MHz (N _{RB})	20 MHz (N _{RB})	25 MHz (N _{RB})	30 MHz (N _{RB})	40 MHz (N _{RB})	50 MHz (N _{RB})	60 MHz (N _{RB})	80 MHz (N _{RB})	90 MHz (N _{RB})	100 MHz (N _{RB})
n80	n78		25	36	50			50	50	50	50	50	50
n81	n78		16	25	25			25	25	25	25	25	25
n81	n79							25	25	25	25		25
n82	n78		16	20	20			20	20	20	20	20	20
n83	n78		10	15	20			25	25	25	25	25	25
n86	n78		25	36	50			100	100	100	100	100	100

NOTE 1: 15kHz SCS is assumed for UL band.
NOTE 2: The UL configuration applies regardless of the channel bandwidth of the low band unless the UL resource blocks exceed that specified in Table 7.3.2.3-3 for the uplink bandwidth in which case the allocation according to Table 7.3.2.3-3 applies.
NOTE 3: Unless stated otherwise, UL resource blocks shall be centred within the transmission bandwidth configuration for the channel bandwidth.

7.3C.0.3 $\Delta R_{IB,c}$ for SUL

7.3C.0.3.1 General

For a UE supporting a SUL configuration, the $\Delta R_{IB,c}$ applies for both SC and SUL operation.

7.3C.0.3.2 SUL band combination

For the UE which supports SUL band combination, the minimum requirement for reference sensitivity in subclause 7.3C.0 shall be increased by the amount given in $\Delta R_{IB,c}$ defined in subclause 7.3C.0.3 for the applicable operating bands. Unless otherwise stated, $\Delta R_{IB,c}$ is set to zero.

In case the UE supports more than one of band combinations for CA, SUL or DC, and an operating band belongs to more than one band combinations then

- When the operating band frequency range is ≤ 1 GHz, the applicable additional $\Delta R_{IB,c}$ shall be the average value for all band combinations defined in subclause 7.3A, 7.3B, 7.3C in this specification and 7.3A, 7.3B in TS 38.521-3 [14], truncated to one decimal place that apply for that operating band among the supported band combinations. In case there is a harmonic relation between low band UL and high band DL, then the maximum $\Delta R_{IB,c}$ among the different supported band combinations involving such band shall be applied
- When the operating band frequency range is > 1 GHz, the applicable additional $\Delta R_{IB,c}$ shall be the maximum value for all band combinations defined in subclause 7.3A, 7.3B, 7.3C in this specification and 7.3A, 7.3B in TS 38.521-3 [14] for the applicable operating bands.

7.3C.0.3.2.1 $\Delta R_{IB,c}$ for two bands

Table 7.3C.0.3.2.1-1: $\Delta R_{IB,c}$ due to SUL (two bands)

Band combination for SUL	NR Band	$\Delta R_{IB,c}$ [dB]
SUL_n78-n80	n78	0.5
SUL_n78-n81	n78	0.5
SUL_n78-n82	n78	0.5
SUL_n78-n83	n78	0.5
SUL_n78-n84	n78	0.5
SUL_n78-n86	n78	0.5
SUL_n79-n83	n79	0.5

7.3C.0.3.2.2 $\Delta R_{IB,c}$ for three bands**Table 7.3C.0.3.2.2-1: $\Delta R_{IB,c}$ due to SUL (three bands)**

Band combination for SUL	NR Band	$\Delta R_{IB,c}$ (dB)
CA_n1_SUL_n78-n80	n1	0.2
	n78	0.5
CA_n1_SUL_n78-n84	n1	0.2
	n78	0.5
CA_n3_SUL_n78-n80	n3	0.2
	n78	0.5
CA_n28_SUL_n41-n83	n28	0.2
CA_n28_SUL_n79-n83	n28	0.2
	n79	0.5

The normative reference for this requirement is TS 38.101-1 [2] clause 7.3C.2 and 7.3C.3.

7.3C.1 General

The reference sensitivity power level REFSSENS is the minimum mean power applied to each one of the UE antenna ports for all UE categories, at which the throughput shall meet or exceed the requirements for the specified reference measurement channel.

7.3C.2 Reference sensitivity power level for SUL

Editor's Note: The following aspects are either missing or not yet determined:

- Exceptional test points for configurations except SUL_n78-n80 is FFS

7.3C.2.1 Test purpose

The test purpose is to verify the ability of the UE to receive data with a given average throughput for a specified reference measurement channel, under SUL operation and conditions of low signal level, ideal propagation and no added noise.

7.3C.2.2 Test applicability

This test case applies to all types of NR UE release 15 and forward that supports SUL operation on the SUL bands.

7.3C.2.3 Minimum conformance requirement

The minimum conformance requirements are defined in clause 7.3C.0.

7.3C.2.4 Test description

7.3C.2.4.1 Initial conditions

Initial conditions are a set of test configurations the UE needs to be tested in and the steps for the SS to take with the UE to reach the correct measurement state.

The initial test configurations consist of environmental conditions, test frequencies, and channel bandwidths based on NR operating bands specified in Table 5.2-1. All of these configurations shall be tested with applicable test parameters for each channel bandwidth, and are shown in Table 7.3C.2.4.1-1 and 7.3C.2.4.1-2. The details of the uplink reference measurement channels (RMCs) are specified in Annex A2.2. Configurations of PDSCH and PDCCH before measurement are specified in Annex C.2.

Table 7.3C.2.4.1-1: Test Configuration Table for SUL without exceptions

Initial Conditions					
Test Environment as specified in TS 38.508-1 [5] subclause 4.1			Normal, TL/VL, TL/VH, TH/VL, TH/VH		
Test Frequencies as specified in TS 38.508-1 [5] subclause 4.3.1			Mid range for SUL carrier. Low, Mid, High range for non-SUL carrier With following exceptions: SUL_n78-n80: High in band n78		
Test Channel Bandwidths as specified in TS 38.508-1 [5] subclause 4.3.1			Lowest, Mid, Highest for Non-SUL carrier For SUL band: n80: 30 MHz n81: 20 MHz n82: 20 MHz n83: 20 MHz n84: 20 MHz n86: 40 MHz n95: 15 MHz		
Test SCS as specified in Table 5.5C-1			15kHz for SUL carrier Lowest for Non-SUL carrier		
Test Parameters					
Test ID	Downlink Configuration		UL Configuration	SUL Configuration	
	Modulation	RB allocation		Modulation	RB allocation (NOTE 2)
1	CP-OFDM QPSK	Full RB (NOTE 1)	N/A	DFT-s-OFDM QPSK	REFSENS (NOTE 2)
NOTE 1: Full RB allocation shall be used per each SCS and channel BW as specified in Table 7.3.2.4.1-2.					
NOTE 2: REFSENS refers to Table 7.3C.2.4.1-1a which defines uplink RB configuration and start RB location for each SCS, channel BW and NR band.					
NOTE 3: In a band where UE supports 4Rx, the test needs to be repeated with only 2Rx antennas connected and the other antennas terminated.					

Table 7.3C.2.4.1-1a: SUL configuration for reference sensitivity, LCRB @ RBstart format (without exception)

NR Band / SCS of SUL band / Channel bandwidth of the DL band / LCRB@RBstart of SUL band														
DL band	SUL band	SCS of SUL band (kHz)	5 MHz	10 MHz	15 MHz	20 MHz	25 MHz	30 MHz	40 MHz	50 MHz	60 MHz	80 MHz	90 MHz	100 MHz
n41	n80	15		160@0	160@0	160@0			160@0	160@0	160@0	160@0	160@0	160@0
n41	n81	15		100@0	100@0	100@0			100@0	100@0	100@0	100@0	100@0	100@0
n41	n83	15		100@0	100@0	100@0		100@0	100@0	100@0	100@0	100@0	100@0	100@0
		30		50@0	50@0	50@0		50@0	50@0	50@0	50@0	50@0	50@0	50@0
n41	n95	15		75@0	75@0	75@0		75@0	75@0	75@0	75@0	75@0	75@0	75@0
n77	n80	15		160@0	160@0	160@0			160@0	160@0	160@0	160@0	160@0	160@0
n77	n84	15		100@0	100@0	100@0			100@0	100@0	100@0	100@0	100@0	100@0
n78	n80	15		160@0	160@0	160@0			160@0	160@0	160@0	160@0	160@0	160@0
n78	n81	15		100@0	100@0	100@0			100@0	100@0	100@0	100@0	100@0	100@0
n78	n82	15		100@0	100@0	100@0			100@0	100@0	100@0	100@0	100@0	100@0
n78	n83	15		100@0	100@0	100@0			100@0	100@0	100@0	100@0	100@0	100@0
n78	n84	15		100@0	100@0	100@0			100@0	100@0	100@0	100@0	100@0	100@0
n78	n86	15		216@0	216@0	216@0			216@0	216@0	216@0	216@0	216@0	216@0
n79	n83	15							100@0	100@0	100@0	100@0		100@0
		30							50@0	50@0	50@0	50@0		50@0
n79	n80	15							160@0	160@0	160@0	160@0		160@0
n79	n81	15							100@0	100@0	100@0	100@0		100@0
n79	n84	15							100@0	100@0	100@0	100@0		100@0
n79	n95	15							75@0	75@0	75@0	75@0		75@0

Table 7.3C.2.4.1-2: Test configurations table for SUL operation exceptions due to UL harmonic issue

Initial Conditions											
Test Environment as specified in TS 38.508-1 [5] subclause 4.1						Normal, TL/VL, TL/VH, TH/VL, TH/VH					
Test Frequencies as specified in TS 38.508-1 [5] subclause 4.3.1						See range column for each CC					
Test Channel Bandwidths as specified in TS 38.508-1 [5] subclause 4.3.1						See CBW column for each CC					
Test SCS as specified in Table 5.5C-1						15kHz for SUL carrier Lowest for Non-SUL carrier					
Test Parameters											
ID	Downlink Configuration					UL Configuration	SUL Configuration				
	Band	Range	CBW	Mod	RB alloc (NOTE 1)		Band	Range	CBW	Mod	RB alloc (NOTE 2)
Test settings for SUL_n78-n80											
1	n78	3560	Highest	CP-OFDM QPSK	Full RB	N/A	n80	High	10 MHz	DFT-s-OFDM QPSK	REFSENS_SUL
2	n78	3530	20 MHz	CP-OFDM QPSK	Full RB	N/A	n80	High	10 MHz	DFT-s-OFDM QPSK	REFSENS_SUL
NOTE 1: Full RB allocation shall be used per each SCS and channel BW as specified in Table 7.3.2.4.1-2.											
NOTE 2: REFSENS_SUL refers to the Uplink RB allocation for reference sensitivity exceptions due to UL harmonic interference according to table 7.3C.0.2-3.											

1. Connect the SS to the UE antenna connectors as shown in TS 38.508-1 [5] Annex A, Figure A.3.1.1.4 for TE diagram and section A.3.2 for UE diagram.
2. The parameter settings for the cell are set up according to TS 38.508-1 [5] subclause 4.4.3.
3. Downlink signals are initially set up according to Annex C0, C.1, C.2, C3.1, and uplink signals according to Annex G.0, G.1, G.2, G.3.0 with consideration of supplementary uplink physical channels.
4. The UL and DL Reference Measurement Channel shall be set according to Table 7.3C.2.4.1-1 or 7.3C.2.4.1-2.
5. The UL Reference Measurement Channel shall be set according to Table 7.3C.2.4.1-1 for REFSENS without exceptions and Table 7.3C.2.4.1-2 when testing is performed with SUL/DL band combination listed in Table 7.3C.0.2-2 for exceptions due to harmonic issue.
5. Propagation conditions are set according to Annex B.0.
6. Ensure the UE is in State RRC_CONNECTED with generic procedure parameters Connectivity NR, Connected without release On, Test Mode On and Test Loop Function On according to TS 38.508-1 [5] clause 4.5. Message contents are defined in clause 7.3C.2.4.3

7.3C.2.4.2 Test procedure

1. SS transmits PDSCH via PDCCH DCI format 1_1 for C_RNTI to transmit the DL RMC according to Table 7.3C.2.4.1-1. The SS sends downlink MAC padding bits on the DL RMC.
2. SS sends uplink scheduling information for each UL HARQ process via PDCCH DCI format 0_1 for C_RNTI to schedule the UL RMC on SUL band according to Tables 7.3C.2.4.1-1. Since the UE has no payload data to send, the UE transmits uplink MAC padding bits on the UL RMC.
3. Set the Downlink signal level to the appropriate REFSENS value defined in Table 7.3C.2.5-1 for 2Rx and table 7.3C.2.5-2 for 4Rx. Send continuously uplink power control "up" commands in the uplink scheduling information to the UE to ensure the UE transmits P_{UMAX} level for at least the duration of the Throughput measurement.
4. Measure the average throughput for a duration sufficient to achieve statistical significance according to Annex H.2.

5. For configurations listed in table 7.3C.2.4.1-2, repeat step 1-4 with table 7.3C.2.4.1-2 replacing table 7.3C.2.4.1-1 in step 1 and step 2, table 7.3C.2.5.1-1 replacing 7.3C.2.5-1 and table 7.3C.2.5-2 in step 3.

7.3C.2.4.3 Message contents

Message contents are according to TS 38.508-1 [5] subclause 4.3.6.1.1.2 ensuring UL/SUL indicator in Table 4.3.6.1.1.2-1 with condition SUL, subclause 4.6 ensuring Tables 4.6.1-28 with condition SUL AND (RF OR RRM), 4.6.3-14 with condition SUL_SUL for SUL carrier, and Table 4.6.3-167 with condition PUSCH_PUCCH_ON_SUL, additionally the following exception shown in Table 7.3C.2.4.3-1 is considered.

Table 7.3C.2.4.3-1: PUSCH-Config

Derivation Path: TS 38.508-1 [5], Table 4.6.3-118 with condition TRANSFORM_PRECODER_ENABLED

7.3C.2.5 Test requirement

The throughput measured in step 4 shall be $\geq 95\%$ of the maximum throughput of the reference measurement channels as specified in Annex A3.2 for REFSSENS without exception testing with receive power level specified in Tables 7.3C.2.5-1 for 2Rx antenna port and Tables 7.3C.2.5-2 for 4 Rx antenna port, and parameters specified in table 7.3C.2.4.1-1.

Table 7.3C.2.5-0: Test Tolerance (TT) for RX sensitivity level

$f \leq 3.0\text{GHz}$	$3.0\text{GHz} < f \leq 6.0\text{ GHz}$
0.7 dB	1.0 dB

Table 7.3C.2.5-1: Reference sensitivity QPSK P_{REFSENS} for 2Rx

Operating band / SCS / Channel bandwidth / Duplex-mode														
Operating Band	SCS kHz	5 MHz (dBm)	10 MHz (dBm)	15 MHz (dBm)	20 MHz (dBm)	25 MHz (dBm)	30 MHz (dBm)	40 MHz (dBm)	50 MHz (dBm)	60 MHz (dBm)	80 MHz (dBm)	90 MHz (dBm)	100 MHz (dBm)	Duplex Mode
n1	15	-100.0 +TT	-96.8 +TT	-95.0 +TT	-93.8 +TT	-92.7 +TT	-91.9 +TT	-90.6 +TT	-89.6 +TT					FDD
	30		-97.1 +TT	-95.1 +TT	-94.0 +TT	-92.8 +TT	-92.0 +TT	-90.7 +TT	-89.7 +TT					
	60		-97.5 +TT	-95.4 +TT	-94.2 +TT	-93.0 +TT	-92.1 +TT	-90.9 +TT	-89.7 +TT					
n2	15	-98.0 +TT	-94.8 +TT	-93.0 +TT	-91.8 +TT									FDD
	30		-95.1 +TT	-93.1 +TT	-92.0 +TT									
	60		-95.5 +TT	-93.4 +TT	-92.2 +TT									
n3	15	-97.0 +TT	-93.8 +TT	-92.0 +TT	-90.8 +TT	-89.7 +TT	-88.9 +TT	-87.6 +TT						FDD
	30		-94.1 +TT	-92.1 +TT	-91.0 +TT	-89.8 +TT	-89.0 +TT	-87.7 +TT						
	60		-94.5 +TT	-92.4 +TT	-91.2 +TT	-90.0 +TT	-89.1 +TT	-87.9 +TT						
n5	15	-98.0 +TT	-94.8 +TT	-93.0 +TT	-90.8 +TT									FDD
	30		-95.1 +TT	-93.1 +TT	-91.0 +TT									
	60													
n7 ¹	15	-98.0 +TT	-94.8 +TT	-93.0 +TT	-91.8 +TT									FDD
	30		-95.1 +TT	-93.1 +TT	-92.0 +TT									
	60		-95.5 +TT	-93.4 +TT	-92.2 +TT									
n8	15	-97.0 +TT	-93.8 +TT	-92.0 +TT	-90.0 +TT									FDD
	30		-94.1 +TT	-92.1 +TT	-90.2 +TT									
	60													

Operating Band	SCS kHz	Operating band / SCS / Channel bandwidth / Duplex-mode											Duplex Mode	
		5 MHz (dBm)	10 MHz (dBm)	15 MHz (dBm)	20 MHz (dBm)	25 MHz (dBm)	30 MHz (dBm)	40 MHz (dBm)	50 MHz (dBm)	60 MHz (dBm)	80 MHz (dBm)	90 MHz (dBm)		100 MHz (dBm)
n12	15	-97.0 +TT	-93.8 +TT	-84.0 +TT										FDD
	30		-94.1 +TT	-84.1 +TT										
	60													
n14	15	-97.0 +TT	-93.8 +TT											FDD
	30		-94.1 +TT											
	60													
n20	15	-97.0 +TT	-93.8 +TT	-91.0 +TT	-89.8 +TT									FDD
	30		-94.1 +TT	-91.1 +TT	-90.0 +TT									
	60													
n25	15	-96.5 +TT	-93.3 +TT	-91.5 +TT	-90.3 +TT									FDD
	30		-93.6 +TT	-91.6 +TT	-90.5 +TT									
	60		-94.0 +TT	-91.9 +TT	-90.7 +TT									
n26	15	-97.5 +TT	-94.5 +TT	-92.7 +TT	-87.6 +TT									
	30		-94.8 +TT	-92.7 +TT	-87.7 +TT									
n28	15	-98.5 +TT	-95.5 +TT	-93.5 +TT	-90.8 +TT		-78.5 +TT							FDD
	30		-95.6 +TT	-93.6 +TT	-91.0 +TT		-78.6 +TT							
	60													
n30	15	-99.0 +TT	-95.8 +TT											FDD
	30		-96.1 +TT											
	60													

Operating Band	SCS kHz	Operating band / SCS / Channel bandwidth / Duplex-mode												Duplex Mode
		5 MHz (dBm)	10 MHz (dBm)	15 MHz (dBm)	20 MHz (dBm)	25 MHz (dBm)	30 MHz (dBm)	40 MHz (dBm)	50 MHz (dBm)	60 MHz (dBm)	80 MHz (dBm)	90 MHz (dBm)	100 MHz (dBm)	
n34	15	-100.0 +TT	-96.8 +TT	-95.0 +TT										TDD
	30		-97.1 +TT	-95.1 +TT										
	60		-97.5 +TT	-95.4 +TT										
n38	15	-100.0 +TT	-96.8 +TT	-95.0 +TT	-93.8 +TT			-90.6 +TT						TDD
	30		-97.1 +TT	-95.1 +TT	-94.0 +TT			-90.7 +TT						
	60		-97.5 +TT	-95.4 +TT	-94.2 +TT			-90.9 +TT						
n39	15	-100.0 +TT	-96.8 +TT	-95.0 +TT	-93.8 +TT	-92.7 +TT	-91.9 +TT	-90.6 +TT						TDD
	30		-97.1 +TT	-95.1 +TT	-94.0 +TT	-92.8 +TT	-92.0 +TT	-90.7 +TT						
	60		-97.5 +TT	-95.4 +TT	-94.2 +TT	-93.0 +TT	-92.1 +TT	-90.9 +TT						
n40	15	-100.0 +TT	-96.8 +TT	-95.0 +TT	-93.8 +TT	-92.7 +TT	-91.9 +TT	-90.6 +TT	-89.6 +TT					TDD
	30		-97.1 +TT	-95.1 +TT	-94.0 +TT	-92.8 +TT	-92.0 +TT	-90.7 +TT	-89.7 +TT	-88.9 +TT	-87.6 +TT			
	60		-97.5 +TT	-95.4 +TT	-94.2 +TT	-93.0 +TT	-92.1 +TT	-90.9 +TT	-89.8 +TT	-89.1 +TT	-87.6 +TT			
n41 ¹	15		-94.8 +TT	-93.0 +TT	-91.8 +TT		-89.9 +TT	-88.6 +TT	-87.6 +TT					TDD
	30		-95.1 +TT	-93.1 +TT	-92.0 +TT		-90.0 +TT	-88.7 +TT	-87.7 +TT	-86.9 +TT	-85.6 +TT	-85.1 +TT	-84.7 +TT	
	60		-95.5 +TT	-93.4 +TT	-92.2 +TT		-90.1 +TT	-88.9 +TT	-87.8 +TT	-87.1 +TT	-85.6 +TT	-85.1 +TT	-84.7 +TT	
n48 ¹	15	-99.0 +TT	-95.8 +TT	-94.0 +TT	-92.7 +TT			-89.6 +TT	-88.6 ⁵ +TT					TDD
	30		-96.1 +TT	-94.1 +TT	-92.9 +TT			-89.7 +TT	-88.7 ⁵ +TT	-87.9 ⁵ +TT	-86.6 ⁵ +TT	-86.1 ⁵ +TT	-85.6 ⁵ +TT	
	60		-96.5 +TT	-94.4 +TT	-93.1 +TT			-89.9 +TT	-88.8 ⁵ +TT	-88.0 ⁵ +TT	-86.7 ⁵ +TT	-86.2 ⁵ +TT	-85.7 ⁵ +TT	

Operating band / SCS / Channel bandwidth / Duplex-mode														
Operating Band	SCS kHz	5 MHz (dBm)	10 MHz (dBm)	15 MHz (dBm)	20 MHz (dBm)	25 MHz (dBm)	30 MHz (dBm)	40 MHz (dBm)	50 MHz (dBm)	60 MHz (dBm)	80 MHz (dBm)	90 MHz (dBm)	100 MHz (dBm)	Duplex Mode
n50	15	-100.0 +TT	-96.8 +TT	-95.0 +TT	-93.8 +TT		-91.9 +TT	-90.6 +TT	-89.6 +TT					TDD
	30		-97.1 +TT	-95.1 +TT	-94.0 +TT		-92.0 +TT	-90.7 +TT	-89.7 +TT	-88.9 +TT	-87.6 +TT			
	60		-97.5 +TT	-95.4 +TT	-94.2 +TT		-92.1 +TT	-90.9 +TT	-89.8 +TT	-89.1 +TT	-87.6 +TT			
n51	15	-100.0 +TT												TDD
	30													
	60													
n53	15	-100.0 +TT	-96.8 +TT											TDD
	30		-97.1 +TT											
	60		-97.5 +TT											
n65	15	- 99.5+TT	- 96.3+TT	- 94.5+TT	- 93.3+TT									FDD
	30		- 96.6+TT	- 94.6+TT	- 93.5+TT									
	60		- 97.0+TT	- 94.9+TT	- 93.7+TT									
n66	15	-99.5 +TT	-96.3 +TT	-94.5 +TT	-93.3 +TT	-92.2 +TT	-91.4 +TT	-90.1 +TT						FDD
	30		-96.6 +TT	-94.6 +TT	-93.5 +TT	-92.3 +TT	-91.5 +TT	-90.2 +TT						
	60		-97.0 +TT	-94.9 +TT	-93.7 +TT	-92.5 +TT	-91.6 +TT	-90.4 +TT						
n70	15	-100.0 +TT	-96.8 +TT	-95.0 +TT	-93.8 +TT	-92.7 +TT								FDD
	30		-97.1 +TT	-95.1 +TT	-94.0 +TT	-92.8 +TT								
	60		-97.5 +TT	-95.4 +TT	-94.2 +TT	-93.0 +TT								

Operating band / SCS / Channel bandwidth / Duplex-mode														
Operating Band	SCS kHz	5 MHz (dBm)	10 MHz (dBm)	15 MHz (dBm)	20 MHz (dBm)	25 MHz (dBm)	30 MHz (dBm)	40 MHz (dBm)	50 MHz (dBm)	60 MHz (dBm)	80 MHz (dBm)	90 MHz (dBm)	100 MHz (dBm)	Duplex Mode
n71	15	-97.2 +TT	-94.0 +TT	-91.6 +TT	-86.0 +TT									FDD
	30		-94.3 +TT	-91.9 +TT	-87.4 +TT									
	60	-												
n74	15	-99.5 ³ +TT	-96.3 ³ +TT	-94.5 ³ +TT	-93.3 ³ +TT									FDD
	30		-96.6 ³ +TT	-94.6 ³ +TT	-93.5 ³ +TT									
	60		-97.0 ³ +TT	-94.9 ³ +TT	-93.7 ³ +TT									
n77 ^{1,4}	15		-95.3 +TT	-93.5 +TT	-92.2 +TT			-89.1 +TT	-88.1 +TT					TDD
	30		-95.6 +TT	-93.6 +TT	-92.4 +TT			-89.2 +TT	-88.2 +TT	-87.4 +TT	-86.1 +TT	-85.6 +TT	-85.1 +TT	
	60	-	-96.0 +TT	-93.9 +TT	-92.6 +TT			-89.4 +TT	-88.3 +TT	-87.5 +TT	-86.2 +TT	-85.7 +TT	-85.2 +TT	
n78 ¹	15		-95.8 +TT	-94.0 +TT	-92.7 +TT			-89.6 +TT	-88.6 +TT					TDD
	30		-96.1 +TT	-94.1 +TT	-92.9 +TT			-89.7 +TT	-88.7 +TT	-87.9 +TT	-86.6 +TT	-86.1 +TT	-85.6 +TT	
	60		-96.5 +TT	-94.4 +TT	-93.1 +TT			-89.9 +TT	-88.8 +TT	-88.0 +TT	-86.7 +TT	-86.2 +TT	-85.7 +TT	
n79 ¹	15							-89.6 +TT	-88.6 +TT					TDD
	30							-89.7 +TT	-88.7 +TT	-87.9 +TT	-86.6 +TT		-85.6 +TT	
	60							-89.9 +TT	-88.8 +TT	-88.0 +TT	-86.7 +TT		-85.7 +TT	

NOTE 1: Four Rx antenna ports shall be the baseline for this operating band except for two Rx vehicular UE.

NOTE 2: The transmitter shall be set to P_{UMAX} as defined in subclause 6.2C.1

NOTE 3: ³ indicates that the requirement is modified by -0.5 dB when the assigned NR channel bandwidth is confined within 1475.9-1510.9 MHz.

NOTE 4: The requirement is modified by -0.5 dB when the assigned UE channel bandwidth is confined within 3300 - 3800 MHz.

NOTE 5: For these bandwidths, the minimum requirements are restricted to operation when carrier is configured as a downlink carrier part of CA configuration.

NOTE 6: TT for each frequency and channel bandwidth is specified in Table 7.3C.2.5-0.

Table 7.3C.2.5-2: Reference sensitivity QPSK P_{REFSENS} for Four Rx antenna ports

Operating band / SCS / Channel bandwidth / Duplex-mode														
Operating Band	SCS kHz	5 MHz (dBm)	10 MHz (dBm)	15 MHz (dBm)	20 MHz (dBm)	25 MHz (dBm)	30 MHz (dBm)	40 MHz (dBm)	50 MHz (dBm)	60 MHz (dBm)	80 MHz (dBm)	90 MHz (dBm)	100 MHz (dBm)	Duplex Mode
n1	15	-102.7 +TT	-99.5 +TT	-97.7 +TT	-96.5 +TT	-95.4 +TT	-94.6 +TT	-93.3 +TT	-92.3 +TT					FDD
	30		-99.8 +TT	-97.8 +TT	-96.7 +TT	-95.5 +TT	-94.7 +TT	-93.4 +TT	-92.4 +TT					
	60		-100.2 +TT	-98.1 +TT	-96.9 +TT	-95.7 +TT	-94.8 +TT	-93.6 +TT	-92.4 +TT					
n2	15	-100.7 +TT	-97.5 +TT	-95.7 +TT	-94.5 +TT									FDD
	30		-97.8 +TT	-95.8 +TT	-94.7 +TT									
	60		-98.2 +TT	-96.1 +TT	-94.9 +TT									
n3	15	-99.7 +TT	-96.5 +TT	-94.7 +TT	-93.5 +TT	-92.4 +TT	-91.6 +TT	-90.3 +TT						FDD
	30		-96.8 +TT	-94.8 +TT	-93.7 +TT	-92.5 +TT	-91.7 +TT	-90.4 +TT						
	60		-97.2 +TT	-95.1 +TT	-93.9 +TT	-92.7 +TT	-91.8 +TT	-90.6 +TT						
n7	15	-100.7 +TT	-97.5 +TT	-95.7 +TT	-94.5 +TT									FDD
	30		-97.8 +TT	-95.8 +TT	-94.7 +TT									
	60		-98.2 +TT	-97.1 +TT	-94.9 +TT									
n30	15	-101.7 +TT	-98.5 +TT											FDD
	30		-98.8 +TT											
	60													
n34	15	-102.7 +TT	-99.5 +TT	-97.7 +TT										TDD
	30		-99.8 +TT	-97.8 +TT										
	60		-100.2 +TT	-98.1 +TT										

Operating band / SCS / Channel bandwidth / Duplex-mode														
Operating Band	SCS kHz	5 MHz (dBm)	10 MHz (dBm)	15 MHz (dBm)	20 MHz (dBm)	25 MHz (dBm)	30 MHz (dBm)	40 MHz (dBm)	50 MHz (dBm)	60 MHz (dBm)	80 MHz (dBm)	90 MHz (dBm)	100 MHz (dBm)	Duplex Mode
n38	15	-102.7 +TT	-99.5 +TT	-97.7 +TT	-96.5 +TT			-93.3 +TT						TDD
	30		-99.8 +TT	-97.8 +TT	-96.7 +TT			-93.4 +TT						
	60		-100.2 +TT	-98.1 +TT	-96.9 +TT			-93.6 +TT						
n39	15	-102.7 +TT	-99.5 +TT	-97.7 +TT	-96.5 +TT	-95.4 +TT	-94.6 +TT	-93.3 +TT						TDD
	30		-99.8 +TT	-97.8 +TT	-96.7 +TT	-95.5 +TT	-94.7 +TT	-93.4 +TT						
	60		-100.2 +TT	-98.1 +TT	-96.9 +TT	-95.7 +TT	-94.8 +TT	-93.6 +TT						
n40	15	-102.7 +TT	-99.5 +TT	-97.7 +TT	-96.5 +TT	-95.4 +TT	-94.6 +TT	-93.3 +TT	-92.3 +TT					TDD
	30		-99.8 +TT	-97.8 +TT	-96.7 +TT	-95.5 +TT	-94.7 +TT	-93.4 +TT	-92.4 +TT	-91.6 +TT	-90.3 +TT			
	60		-100.2 +TT	-98.1 +TT	-96.9 +TT	-95.7 +TT	-94.8 +TT	-93.6 +TT	-92.5 +TT	-91.8 +TT	-90.3 +TT			
n41	15		-97.5 +TT	-95.7 +TT	-94.5 +TT		-92.6 +TT	-91.3 +TT	-90.3 +TT					TDD
	30		-97.8 +TT	-95.8 +TT	-94.7 +TT		-92.7 +TT	-91.4 +TT	-90.4 +TT	-89.6 +TT	-88.3 +TT	-87.8 +TT	-87.4 +TT	
	60		-98.2 +TT	-96.1 +TT	-94.9 +TT		-92.8 +TT	-91.6 +TT	-90.5 +TT	-89.8 +TT	-88.3 +TT	-87.8 +TT	-87.4 +TT	
n48	15	-101.2 +TT	-98.0 +TT	-96.2 +TT	-94.9 +TT			-91.8 +TT	-90.8 ³ +TT					TDD
	30		-98.3 +TT	-96.3 +TT	-95.1 +TT			-91.9 +TT	-90.9 ³ +TT	-90.1 ³ +TT	-88.8 ³ +TT	-88.3 ³ +TT	-87.8 ³ +TT	
	60		-98.7 +TT	-96.6 +TT	-95.3 +TT			-92.1 +TT	-91.0 ³ +TT	-90.2 ³ +TT	-88.9 ³ +TT	-88.4 ³ +TT	-87.9 ³ +TT	
n66	15	-102.2 +TT	-99.0 +TT	-97.2 +TT	-96.0 +TT	-94.9 +TT	-94.1 +TT	-92.8 +TT						FDD
	30		-99.3 +TT	-97.3 +TT	-96.2 +TT	-95.0 +TT	-94.2 +TT	-92.9 +TT						
	60		-99.7 +TT	-97.6 +TT	-96.4 +TT	-95.2 +TT	-94.3 +TT	-93.1 +TT						

Operating band / SCS / Channel bandwidth / Duplex-mode														
Operating Band	SCS kHz	5 MHz (dBm)	10 MHz (dBm)	15 MHz (dBm)	20 MHz (dBm)	25 MHz (dBm)	30 MHz (dBm)	40 MHz (dBm)	50 MHz (dBm)	60 MHz (dBm)	80 MHz (dBm)	90 MHz (dBm)	100 MHz (dBm)	Duplex Mode
n70	15	-102.7 +TT	-99.5 +TT	-97.7 +TT	-96.5 +TT	-95.4 +TT								FDD
	30		-99.8 +TT	-97.8 +TT	-96.7 +TT	-95.5 +TT								
	60		-100.2 +TT	-98.1 +TT	-96.9 +TT	-95.7 +TT								
n77 ⁴	15		-97.5 +TT	-95.7 +TT	-94.4 +TT			-91.3 +TT	-90.3 +TT					TDD
	30		-97.8 +TT	-95.8 +TT	-94.6 +TT			-91.4 +TT	-90.4 +TT	-89.6 +TT	-88.3 +TT	-87.8 +TT	-87.3 +TT	
	60	-	-98.2 +TT	-96.1 +TT	-94.8 +TT			-91.6 +TT	-90.5 +TT	-89.7 +TT	-88.4 +TT	-87.9 +TT	-87.4 +TT	
n78	15		-98.0 +TT	-96.2 +TT	-94.9 +TT			-91.8 +TT	-90.8 +TT					TDD
	30		-98.3 +TT	-96.3 +TT	-95.1 +TT			-91.9 +TT	-90.9 +TT	-90.1 +TT	-88.8 +TT	-88.3 +TT	-87.8 +TT	
	60		-98.7 +TT	-96.6 +TT	-95.3 +TT			-92.1 +TT	-91.0 +TT	-90.2 +TT	-88.9 +TT	-88.4 +TT	-87.9 +TT	
n79	15							-91.8 +TT	-90.8 +TT					TDD
	30							-91.9 +TT	-90.9 +TT	-90.1 +TT	-88.8 +TT		-87.8 +TT	
	60							-92.1 +TT	-91.0 +TT	-90.2 +TT	-88.9 +TT		-87.9 +TT	
NOTE 1: Four Rx antenna ports shall be the baseline for above listed operating band except for two Rx vehicular UE. NOTE 2: The requirement is modified by -0.5 dB when the assigned UE channel bandwidth is confined within 3300 - 3800 MHz. NOTE 3: For these bandwidths, the minimum requirements are restricted to operation when carrier is configured as a downlink carrier part of CA configuration. NOTE 4: TT for each frequency and channel bandwidth is specified in Table 7.3C.2.5-0. NOTE 4: The requirement is modified by -0.5 dB when the assigned UE channel bandwidth is confined within 3300 - 3800 MHz.														

For the UE that supports any of the SUL operation given in Table 7.3C.0.2-2, exceptions to the requirements specified in Table 7.3C.2.5-1 or Table 7.3C.2.5-2 are allowed when the uplink is active in a lower frequency band and is within a specified frequency range such that transmitter harmonics fall within the downlink transmission bandwidth assigned in a higher band as noted in Table 7.3C.0.2-2. For these exceptions, the UE shall meet the requirements specified in clause 7.3C.2.5.1.

7.3C.2.5.1 Reference sensitivity exceptions due to harmonic issue

For SUL operation with DL band listed in Table 7.3C.0.2.3-2 with supplementary uplink transmission bandwidth less than or equal to that specified in Table 7.3C.0.2.3-1, the reference receive sensitivity (REFSENS) requirement for downlink bands specified in Table 7.3C.2.5.1-1 due to harmonic exceptions.

Table 7.3C.2.5.1-1: Reference sensitivity for SUL operation (exceptions due to harmonic issue)

SUL band	DL band	Test ID	SCS	Downlink Channel Bandwidth / REFSENS requirement												
				5 MHz	10 MHz	15 MHz	20 MHz	25 MHz	30 MHz	40 MHz	50 MHz	60 MHz	80 MHz	90 MHz	1	
			kHz	dBm	dBm	dBm	dBm	dBm	dBm	dBm	dBm	dBm	dBm	dBm		
n80	n78 ¹	1	30													
		2	15				-92.7 +0.3 +TT									

NOTE 1: Four Rx antenna ports shall be the baseline for this operating band except for two Rx vehicular UE.

NOTE 2: The transmitter shall be set to P_{UMAX} as defined in subclause 6.2C.1

NOTE 3: Applicable only if operation with 4 antenna ports is supported in the band with SUL configured

Table 7.3C.2.5.1-2: Void

For the UE which supports SUL band combination, the test requirement for reference sensitivity in Tables 7.3C.2.5-1, 7.3C.2.5-2 and 7.3C.2.5.1-1, 7.3C.2.3-1 shall be increased by the amount given in ΔR_{IB,c} defined in subclause 7.3C.0.3.

7.3C.3 Reference sensitivity power level for SUL (3CC)

Editor's Note:

- No test points defined for Reference sensitivity power level testing for SUL with DL CA. This test case is covered by 7.3.2 and 7.3C.2.

7.3C.3.1 Test purpose

The test purpose is to verify the ability of the UE to receive data with a given average throughput for a specified reference measurement channel, under SUL and 2 DL CA operation and conditions of low signal level, ideal propagation and no added noise.

7.3C.3.2 Test applicability

This test case applies to all types of NR UE release 15 and forward that supports SUL operation on the SUL bands with 2DL CA.

7.3C.3.3 Minimum conformance requirement

The minimum conformance requirements are defined in clause 7.3C.0.

7.3C.3.4 Test description

NOTE: No testing needs to be performed since the testing has been covered in test case 7.3.2 and 7.3C.2.

For band combination CA_nX_SUL_nY-nZ, test the REFSENS of SUL configuration or NR band as listed in table 7.3C.3.4-1.

Table 7.3C.3.4-1: Test band combinations and configuration

Band configuration	Verifying REFSENS of SUL configurations/ NR band	Subtest case	Table with test parameters to select
CA_n1A_SUL_n78A-n80A	SUL_n78A-n80A	7.3C.2	Table 7.3C.2.4.1-1
	n1	7.3.2	Table 7.3.2.4.1-1
CA_n1A_SUL_n78A-n84A	SUL_n78A-n84A	7.3C.2	Table 7.3C.2.4.1-1
	n1	7.3.2	Table 7.3.2.4.1-1
CA_n3A_SUL_n78A-n80A	SUL_n78A-n80A	7.3C.2	Table 7.3C.2.4.1-1
	n3	7.3.2	Table 7.3.2.4.1-1
CA_n28A_SUL_n41A-n83A	SUL_n41A-n83A	7.3C.2	Table 7.3C.2.4.1-1
	n28	7.3.2	Table 7.3.2.4.1-1
SUL_n79C-n83A	SUL_n79A-n83A	7.3C.2	Table 7.3C.2.4.1-1
CA_n28A_SUL_n79A-n83A	SUL_n79A-n83A	7.3C.2	Table 7.3C.2.4.1-1
	n28	7.3.2	Table 7.3.2.4.1-1

7.3C.3.5 Test requirement

Same test requirement as clause 7.3.2 and 7.3C.2 for each band or band combinations listed in table 7.3C.3.4-1.

7.3D Reference sensitivity for UL MIMO

7.3D.1 General

For UE with two transmitter antenna connectors in closed-loop spatial multiplexing scheme, the minimum requirements specified in subclause 7.3 shall be met with the UL MIMO configurations described in clause 6.2D.1. For UL MIMO, the parameter P_{UMAX} is the total transmitter power over the two transmits power over the two transmit antenna connectors.

The normative reference for this requirement is TS 38.101-1 [2] clauses 7.3D

7.3D.2 Reference sensitivity power level for UL MIMO

7.3D.2.1 Test purpose

The test purpose is to verify the ability of the UE to receive data with a given average throughput for a specified reference measurement channel, under conditions of low signal level, ideal propagation and no added noise.

7.3D.2.2 Test applicability

This test case applies to all types of NR UE release 15 and forward that support UL MIMO on FDD bands.

7.3D.2.3 Minimum conformance requirements

For UE with two transmitter antenna connectors in closed-loop spatial multiplexing scheme, the minimum requirements specified in subclause 7.3 shall be met with the UL MIMO configurations described in clause 6.2D.1. For UL MIMO, the parameter P_{UMAX} is the total transmitter power over the two transmits power over the two transmit antenna connectors

The normative reference for this requirement is TS 38.101-1 [2] clauses 7.3D and 7.3.

7.3D.2.4 Test description

7.3D.2.4.1 Initial conditions

Initial conditions are a set of test configurations the UE needs to be tested in and the steps for the SS to take with the UE to reach the correct measurement state.

The initial test configurations consist of environmental conditions, test frequencies, and channel bandwidths based on NR operating bands specified in Table 5.2-1. All of these configurations shall be tested with applicable test parameters for each channel bandwidth, and are shown in Table 7.3D.2.4.1-1, Table 7.3D.2.4.1-2, and Table 7.3D.2.4.1-3. The details of the uplink and downlink reference measurement channels (RMCs) are specified in Annex A.2 and A.3. Configurations of PDSCH and PDCCH before measurement are specified in Annex C.2.

Table 7.3D.2.4.1-1: Test Configuration Table

Initial Conditions				
Test Environment as specified in TS 38.508-1 [5] subclause 4.1		Normal, TL/VL, TL/VH, TH/VL, TH/VH		
Test Frequencies as specified in TS 38.508-1 [5] subclause 4.3.1		Low range, Mid range, High range		
Test Channel Bandwidths as specified in TS 38.508-1 [5] subclause 4.3.1		Lowest, Mid, Highest		
Test SCS as specified in Table 5.3.5-1		Lowest		
Test Parameters				
Test ID	Downlink Configuration		Uplink Configuration	
	Modulation	RB allocation	Modulation	RB allocation
1	CP-OFDM QPSK	Full RB (NOTE 1)	CP-OFDM QPSK	REFSENS (NOTE 2)
NOTE 1: Full RB allocation shall be used per each SCS and channel BW as specified in Table 7.3.2.4.1-2.				
NOTE 2: REFSENS refers to Table 7.3.2.4.1-3 which defines uplink RB configuration and start RB location for each SCS, channel BW and NR band.				
NOTE 3: In a band where UE supports 4Rx, the test shall be performed only with 4Rx antennas ports connected and 4Rx REFSENS requirement (Table 7.3.2.5-2) is used in the test requirements.				

1. Connect the SS to the UE antenna connectors as shown in TS 38.508-1 [5] Annex A Figure A.3.1.1.2 for TE diagram and section A.3.2 for UE diagram.
2. The parameter settings for the cell are set up according to TS 38.508-1 [5] subclause 4.4.3.
3. Downlink signals are initially set up according to Annex C.0, C.1, C.2, and C.3.1, and uplink signals according to Annex G.0, G.1, G.2, and G.3.1.
4. The UL and DL Reference Measurement Channel is set according to Table 7.3D.2.4.1-1, Table 7.3.2.4.1-2, and Table 7.3.2.4.1-3.

5. Propagation conditions are set according to Annex B.0.
6. Ensure the UE is in State RRC_CONNECTED with generic procedure parameters Connectivity NR, Connected without release *On*, Test Mode *On* and Test Loop Function *On* according to TS 38.508-1 [5] clause 4.5. Message contents are defined in clause 7.3D.2.4.3.

7.3D.2.4.2 Test procedure

Same test procedure as specified in 7.3.2.4.2 with the following exception:

Step 2: SS sends uplink scheduling information for each UL HARQ process via PDCCH DCI format 0_1 for C_RNTI to schedule the UL RMC according to Table 7.3D.2.4.1-1. Since the UE has no payload data to send, the UE transmits uplink MAC padding bits on the UL RMC. The PDCCH DCI format 0_1 is specified with condition 2TX_UL_MIMO in 38.508-1 [5] subclause 4.3.6.1.1.2.

7.3D.2.4.3 Message contents

Message contents are according to TS 38.508-1 [5] subclause 4.6 ensuring Table 4.6.3-182 with condition 2TX_UL_MIMO and exceptions listed in clause 7.3.2.4.3

7.3D.2.5 Test requirement

The throughput shall be $\geq 95\%$ of the maximum throughput of the reference measurement channels as specified in Annex A3.2 with reference receive power level specified in Tables 7.3.2.5-1 and parameters specified Tables 7.3D.2.4.1-1, Tables 7.3.2.4.1-2 and Tables 7.3.2.4.1-3.

7.3E Reference sensitivity for V2X

7.3E.1 General

The reference sensitivity power level $P_{\text{REFSENS_V2X}}$ is the minimum mean power applied to each one of the UE antenna ports for V2X UE, at which the throughput shall meet or exceed the requirements for the specified reference measurement channel.

7.3E.2 Reference sensitivity for V2X / non-concurrent operation

Editor's Note: The following aspects are not yet determined:

- TP analysis is FFS

7.3E.2.1 Test purpose

The test purpose is to verify the ability of the UE to receive V2X physical channel data with a given average throughput for a specified reference measurement channel, under conditions of low signal level, ideal propagation and no added noise.

7.3E.2.2 Test applicability

This test case applies to all types of NR UE release 16 and forward that support NR V2X sidelink communication.

7.3E.2.3 Minimum conformance requirements

When UE is configured for NR V2X reception non-concurrent with NR uplink transmissions for NR V2X operating bands specified in Table 5.2E-1, the throughput shall be $\geq 95\%$ of the maximum throughput of the reference measurement channels as specified in Annexes A.7.2 with parameters specified in Table 7.3E.2.3-1.

Table 7.3E.2.3-1: Reference sensitivity of NR V2X Bands (PC5)

NR V2X Band	SCS kHz	Channel bandwidth / P _{REFSENS_V2X} (dBm)				Duplex Mode
		10 MHz	20 MHz	30 MHz	40 MHz	
n38	15	-96.5	-93.2	-91.4	-90.1	HD
	30	-96.1	-93.4	-91.7	-90.2	HD
	60	-96.9	-93.1	-91.9	-90.4	HD
n47	15	-92.5	-89.2	-87.4	-86.1	HD
	30	-92.1	-89.4	-87.7	-86.2	HD
	60	-92.9	-89.1	-87.9	-86.4	HD

NOTE 1: Reference measurement channel is defined in A.7.2.
 NOTE 2: The signal power is specified per antenna port.
 NOTE 3: Void.

Table 7.3E.2.3-2: Sidelink TX configuration for reference sensitivity of NR V2X Bands (PC5)

NR Band / SCS / Channel bandwidth / Duplex mode						
NR V2X Band	SCS kHz	10 MHz	20 MHz	30 MHz	40 MHz	Duplex Mode
n38	15	50	105	160	216	HD
	30	24	50	75	105	HD
	60	10 ²	24	36	50	HD
n47	15	50	105	160	216	HD
	30	24	50	75	105	HD
	60	10 ²	24	36	50	HD

NOTE 1: The sidelink allocated RB (L_{CRB}) size could be adjusted according to resource pool configuration in [6].
 NOTE 2: For the case, 11 RB is allowed for S-SS/PSBCH Block.

The normative reference for this requirement is TS 38.101-1 [2] clauses 7.3E.2.

7.3E.2.4 Test description

7.3E.2.4.1 Initial conditions

Initial conditions are a set of test configurations the UE needs to be tested in and the steps for the SS to take with the UE to reach the correct measurement state.

The initial test configurations consist of environmental conditions, test frequencies, and channel bandwidths based on NR operating bands specified in Table 5.2E.1-1 and Table 5.3.5-1. All of these configurations shall be tested with applicable test parameters for each channel bandwidth, and are shown in Table 7.3E.2.4.1-1. The details of the V2X reference measurement channels (RMCs) are specified in Annex A.7.2 and the GNSS configuration in TS 38.508-1 [5] subclause 4.11.

Table 7.3E.2.4.1-1: Test Configuration Table

Initial Conditions	
Test Environment as specified in TS 38.508-1 [5] subclause 4.1	[Normal, TL/VL, TL/VH, TH/VL, TH/VH]
Test Frequencies as specified in TS 38.508-1 [5] subclause 4.3.1	[Mid range]
Test Channel Bandwidths as specified in TS 38.508-1 [5] subclause 4.3.1	[Lowest, Highest]
Test SCS as specified in Table 5.3.5-1	[Lowest]
Test Parameters	
Test ID	V2X Configuration to receive
	Modulation
1	[CP-OFDM QPSK]
	RB allocation
	[Full RB (NOTE 1)]

NOTE 1: Full RB allocation shall be used per each SCS and channel BW as specified in Table 7.3E.2.4.1-2.

Table 7.3E.2.4.1-2: PSSCH Configuration for REFSENS

Channel Bandwidth	SCS(kHz)	LCRBmax	Outer RB allocation / Normal RB allocation
10MHz	15	52	50@0
	30	24	24@0
	60	11	10@0
20MHz	15	106	105@0
	30	51	50@0
	60	24	24@0
30MHz	15	160	160@0
	30	78	75@0
	60	38	36@0
40MHz	15	216	216@0
	30	106	105@0
	60	51	50@0
NOTE 1: Test Channel Bandwidths are checked separately for each NR band, the applicable channel bandwidths are specified in Table 5.3.5-1.			

1. Connect the SS to the UE antenna connectors and connect the GNSS simulator to the UE GNSS RX antenna connector as shown in TS 38.508-1 [5] Annex A, Figure A.3.1.9.1 for TE diagram and section A.3.2.7 for UE diagram.
2. The parameter settings for the NR sidelink transmission over PC5 are pre-configured according to TS 38.508-1 [5] subclause 4.10. Message content exceptions are defined in clause 7.3E.2.4.3.
3. The V2X Reference Measurement Channel is set according to Table 6.2E.1.1.4.1-1.
4. The GNSS simulator is configured for Scenario #1: static in Geographical area #1, as defined in TS 38.508-1 [5] Table 4.11.2-2. Geographical area #1 is also pre-configured in the UE.
5. Propagation conditions are set according to Annex B.0.
6. Ensure the UE is in State Out_of_Coverage with generic procedure parameters Sidelink On, Test Loop Function On with UE test loop mode E closed for *Transmit Mode* according to TS 38.508-1 [5] clause 4.5.
7. Trigger the UE to reset UTC time. (NOTE: The UTC time reset may be performed by MMI or AT command (+CUTCR).)
8. The GNSS simulator is triggered to start step 1 of Scenario #1 to simulate a location in the centre of Geographical area #1. Wait for the UE to acquire the GNSS signal and start to transmit.

7.3E.2.4.2 Test procedure

1. The UE starts to perform the NR V2X sidelink communication according to SL-V2X-Preconfiguration and to schedule the V2X RMC according to Table 7.3G.1.4.1-1.
2. Set the signal level of V2X to the appropriate REFSENS value defined in Table 7.3G.1.3-1.
3. Measure the average throughput for a duration sufficient to achieve statistical significance according to Annex G.2.

7.3E.2.4.3 Message contents

Message contents are according to TS 38.508-1 [5] subclause 4.6 and 5.4.

7.3E.2.5 Test requirement

When UE is configured for NR V2X reception non-concurrent with NR uplink transmissions for NR V2X operating bands specified in Table 5.2E-1, the throughput shall be $\geq 95\%$ of the maximum throughput of the reference measurement channels as specified in Annexes A.7.2 with parameters specified in Table 7.3E.2.5-1.

Table 7.3E.2.5-1: Reference sensitivity of NR V2X Bands (PC5)

NR V2X Band	SCS kHz	Channel bandwidth / $P_{\text{REFSENS_V2X}}$ (dBm)				Duplex Mode
		10 MHz	20 MHz	30 MHz	40 MHz	
n38	15	-96.5+TT	-93.2+TT	-91.4+TT	-90.1+TT	HD
	30	-96.1+TT	-93.4+TT	-91.7+TT	-90.2+TT	HD
	60	-96.9+TT	-93.1+TT	-91.9+TT	-90.4+TT	HD
n47	15	-92.5+TT	-89.2+TT	-87.4+TT	-86.1+TT	HD
	30	-92.1+TT	-89.4+TT	-87.7+TT	-86.2+TT	HD
	60	-92.9+TT	-89.1+TT	-87.9+TT	-86.4+TT	HD

NOTE 1: Reference measurement channel is defined in A.8.
 NOTE 2: The signal power is specified per antenna port.
 NOTE 3: TT for each frequency and channel bandwidth is specified in Table 7.3.2.5-3.

7.3F Reference sensitivity for shared spectrum channel access

7.3F.1 General

The reference sensitivity power level REFSENS is the minimum mean power applied to each one of the UE antenna ports, at which the throughput shall meet or exceed the requirements for the specified reference measurement channel.

In later clauses of Clause 7 where the value of REFSENS is used as a reference to set the corresponding requirement, the UE shall be verified against those requirements by applying the REFSENS value in Table 7.3G.2-1 with 2 Rx antenna ports tested.

7.3F.2 Reference sensitivity power level

Editor's Note: The following aspects are not yet determined:

- Message content for NS_53 is FFS

- TT for $5.925\text{GHz} < f \leq 7.125\text{GHz}$ is TBD

7.3F.2.1 Test purpose

The test purpose is to verify the ability of the UE to receive data with a given average throughput for a specified reference measurement channel, under conditions of low signal level, ideal propagation and no added noise.

7.3F.2.2 Test applicability

This test case applies to all types of NR UE release 16 and forward that support NR standalone shared spectrum channel access.

7.3F.2.3 Minimum conformance requirements

The throughput shall be $\geq 95\%$ of the maximum throughput of the reference measurement channels as specified in Annexes A.2.2.2, A.3.2 and A.3.3 (with one sided dynamic OCN Pattern OP.1 FDD/TDD for the DL-signal as described in Annex A.5.1.1/A.5.2.1) with parameters specified in Table 7.3F.2.3-1, Table 7.3F.2.3-2, and Table 7.3F.2.3-3.

Table 7.3F.2.3-1: Two antenna port reference sensitivity QPSK PREFSENS

Operating band / SCS / Channel bandwidth					
Operating Band	SCS kHz	20 MHz (dBm)	40 MHz (dBm)	60 MHz (dBm)	80 MHz (dBm)
n46	15	-89.7	-86.6		
	30	-89.9	-86.7	-84.8	-83.6
	60	-90.1	-86.9	-85.0	-83.6
n96	15	-89.2	-86.1		
	30	-89.4	-86.2	-84.3	-83.1
	60	-89.6	-86.4	-84.5	-83.1

For UE(s) equipped with 4 Rx antenna ports, reference sensitivity for 2Rx antenna ports in Table 7.3F.2.3-1 shall be modified by the amount given in $\Delta R_{IB,4R}$ in Table 7.3F.2.3-2 for the applicable operating bands.

Table 7.3F.2.3-2: Four antenna port reference sensitivity allowance $\Delta R_{IB,4R}$

Operating band	$\Delta R_{IB,4R}$ (dB)
n46, n96	-2.2

The reference receive sensitivity (REFSENS) requirement specified in Table 7.3F.2.3-1 and Table 7.3F.2.3-2 shall be met with uplink transmission bandwidth less than or equal to that specified in Table 7.3F.2.3-3.

Table 7.3F.2.3-3: Uplink configuration for reference sensitivity

Operating band / SCS / Channel bandwidth					
Operating Band	SCS kHz	20 MHz (dBm)	40 MHz (dBm)	60 MHz (dBm)	80 MHz (dBm)
n46	15	100	216		
	30	50	100	162	216
	60	24	50	75	100
n96	15	100	216		
	30	50	100	162	216
	60	24	50	75	100

Unless given by Table 7.3F.2.3-4, the minimum requirements specified in Tables 7.3F.2.3-1 and 7.3F.2.3-2 shall be verified with the network signalling value NS_01 (Table 6.2F.3.1-1) configured.

Table 7.3F.2.3-4: Network signalling value for reference sensitivity

Operating band	Network Signalling value
n46	NS_01
n96	NS_53

The normative reference for this requirement is TS 38.101-1 [2] clause 7.3F.2.

7.3F.2.4 Test description

7.3F.2.4.1 Initial conditions

Initial conditions are a set of test configurations the UE needs to be tested in and the steps for the SS to take with the UE to reach the correct measurement state.

The initial test configurations consist of environmental conditions, test frequencies, and channel bandwidths based on NR operating bands specified in Table 5.3.5-1. All of these configurations shall be tested with applicable test parameters for each channel bandwidth, and are shown in Table 7.3F.2.4.1-1, Table 7.3F.2.4.1-2, and Table 7.3F.2.4.1-3. The details of the uplink reference measurement channels (RMCs) are specified in Annex A2.2. Configurations of PDSCH and PDCCH before measurement are specified in Annex C.2.

Table 7.3F.2.4.1-1: Test Configuration Table

Initial Conditions				
Test Environment as specified in TS 38.508-1 [5] subclause 4.1		Normal, TL/VL, TL/VH, TH/VL, TH/VH		
Test Frequencies as specified in TS 38.508-1 [5] subclause 4.3.1		Low range, Mid range, High range		
Test Channel Bandwidths as specified in TS 38.508-1 [5] subclause 4.3.1		Lowest, Mid, Highest (NOTE 4) Lowest UL / Lowest DL, Lowest UL / Highest DL (NOTE 3)		
Test SCS as specified in Table 5.3.5-1		Lowest		
Test Parameters				
Test ID	Downlink Configuration		Uplink Configuration	
	Modulation	RB allocation	Modulation	RB allocation
1	CP-OFDM QPSK	Full RB (NOTE 1)	DFT-s-OFDM QPSK	REFSENS (NOTE 2)
NOTE 1: Full RB allocation shall be used per each SCS and channel BW as specified in Table 7.3F.2.4.1-2.				
NOTE 2: REFSENS refers to Table 7.3F.2.4.1-3 which defines uplink RB configuration and start RB location for each SCS, channel BW and NR band.				
NOTE 5: For a band where UE supports 4Rx, the test needs to be repeated with only 2Rx antennas connected and the other antennas terminated.				

Table 7.3F.2.4.1-2: Downlink Configuration of each RB allocation

Channel Bandwidth	SCS(kHz)	LCRBmax	Outer RB allocation / Normal RB allocation
20MHz	15	106	106@0
	30	51	51@0
	60	24	24@0
40MHz	15	216	216@0
	30	106	106@0
	60	51	51@0
60MHz	15	N/A	N/A
	30	162	162@0
	60	79	79@0
80MHz	15	N/A	N/A
	30	217	217@0
	60	107	107@0
NOTE 1: Test Channel Bandwidths are checked separately for each NR band, the applicable channel bandwidths are specified in Table 5.3.5-1.			

Table 7.3F.2.4.1-3: Uplink configuration for reference sensitivity, LCRB @ RBstart format

Operating Band	Operating band / SCS / Channel bandwidth					Duplex Mode
	SCS kHz	20 MHz (dBm)	40 MHz (dBm)	60 MHz (dBm)	80 MHz (dBm)	
n46	15	100@0	216@0			TDD
	30	50@0	100@0	162@0	216@0	
	60	24@0	50@0	75@0	100@0	
n96	15	100@0	216@0			TDD
	30	50@0	100@0	162@0	216@0	
	60	24@0	50@0	75@0	100@0	

1. Connect the SS to the UE antenna connectors as shown in TS 38.508-1 [5] Annex A, Figure A.3.1.1.1 for TE diagram and section A.3.2 for UE diagram.
2. The parameter settings for the cell are set up according to TS 38.508-1 [5] subclause 4.4.3.

3. Downlink signals are initially set up according to Annex C.0, C.1, C.2, and C.3.1, and uplink signals according to Annex G.0, G.1, G.2, and G.3.1.
4. The UL and Reference Measurement Channel is set according to Table 7.3F.2.4.1-1, Table 7.3F.2.4.1-2, and Table 7.3F.2.4.1-3.
5. Propagation conditions are set according to Annex B.0.
6. Ensure the UE is in State RRC_CONNECTED with generic procedure parameters Connectivity NR, Connected without release On, Test Mode On and Test Loop Function On according to TS 38.508-1 [5] clause 4.5. Message contents are defined in clause 7.3F.2.4.3.

7.3F.2.4.2 Test procedure

1. SS transmits PDSCH via PDCCH DCI format 1_1 for C_RNTI to transmit the DL RMC according to Table 7.3F.2.4.1-1. The SS sends downlink MAC padding bits on the DL RMC.
2. SS sends uplink scheduling information for each UL HARQ process via PDCCH DCI format 0_1 for C_RNTI to schedule the UL RMC according to Tables 7.3F.2.4.1-1. Since the UE has no payload data to send, the UE transmits uplink MAC padding bits on the UL RMC.
3. Set the Downlink signal level to the appropriate REFSSENS value defined in Table 7.3F.2.5-1 if 2Rx antennas connected or Table 7.3F.2.5-2 if 4Rx antennas connected. Send continuously uplink power control "up" commands in the uplink scheduling information to the UE to ensure the UE transmits PUMAX level for at least the duration of the Throughput measurement.
4. Measure the average throughput for a duration sufficient to achieve statistical significance according to Annex H.2

7.3F.2.4.3 Message contents

Message contents are according to TS 38.508-1 [5] clause 4.6 ensuring Table 4.6.3-118 with condition TRANSFORM_PRECODER_ENABLED for NR band.

Message contents are according to TS 38.508-1[5] subclause 4.6 with the following exceptions for each network signalling value.

7.3F.2.4.3.1 Message contents exceptions (network signalled value "NS_01")

Message contents according to TS 38.508-1 [5] subclause 4.6 can be used without exceptions.

7.3F.2.4.3.2 Message contents exceptions (network signalled value "NS_53")

FFS

7.3F.2.5 Test requirement

The throughput shall be $\geq 95\%$ of the maximum throughput of the reference measurement channels as specified in Annex A3.2 with reference receive power level specified in Tables 7.3F.2.5-1 for 2 Rx antenna port, Tables 7.3F.2.5-2 for 4 Rx antenna port, and parameters specified Tables 7.3F.2.4.1-1, Tables 7.3F.2.4.1-2 and Tables 7.3F.2.4.1-3.

Table 7.3F.2.5-1: Reference sensitivity QPSK P_{REFSENS}

Operating band / SCS / Channel bandwidth / Duplex-mode						
Operating Band	SCS kHz	20 MHz (dBm)	40 MHz (dBm)	60 MHz (dBm)	80 MHz (dBm)	Duplex Mode
n46	15	-89.7+TT	-86.6+TT			TDD
	30	-89.9+TT	-86.7+TT	-84.8+TT	-83.6+TT	
	60	-90.1+TT	-86.9+TT	-85.0+TT	-83.6+TT	
n96	15	-89.2+TT	-86.1+TT			TDD
	30	-89.4+TT	-86.2+TT	-84.3+TT	-83.1+TT	
	60	-89.6+TT	-86.4+TT	-84.5+TT	-83.1+TT	

NOTE 1: The transmitter shall be set to P_{UMAX} as defined in subclause 6.2F.4
NOTE 2: TT for each frequency and channel bandwidth is specified in Table 7.3F.2.5-3.

Table 7.3F.2.5-2: Reference sensitivity QPSK P_{REFSENS} for Four Rx antenna ports

Operating band / SCS / Channel bandwidth / Duplex-mode						
Operating Band	SCS kHz	20 MHz (dBm)	40 MHz (dBm)	60 MHz (dBm)	80 MHz (dBm)	Duplex Mode
n46	15	-91.9+TT	-88.8+TT			TDD
	30	-92.1+TT	-88.9+TT	-87.0+TT	-85.8+TT	
	60	-92.3+TT	-89.1+TT	-87.2+TT	-85.8+TT	
n96	15	-91.4+TT	-88.3+TT			TDD
	30	-91.6+TT	-88.4+TT	-86.5+TT	-85.3+TT	
	60	-91.8+TT	-88.6+TT	-86.7+TT	-85.3+TT	

NOTE 1: Four Rx antenna ports shall be the baseline for above listed operating band except for two Rx vehicular UE.
NOTE 4: TT for each frequency and channel bandwidth is specified in Table 7.3F.2.5-3.

Table 7.3F.2.5-3: Test Tolerance (TT) for RX sensitivity level

$f \leq 3.0\text{GHz}$	$3.0\text{GHz} < f \leq 6.0 \text{ GHz}$	$5.925\text{GHz} < f \leq 7.125\text{GHz}$
0.7 dB	1.0 dB	TBD

For the UE which supports inter-band carrier aggregation, the minimum requirement for reference sensitivity in Table 7.3F.2.5-1 shall be increased by the amount given in $\Delta R_{\text{IB,c}}$ defined in subclause 7.3F.3 for the applicable operating bands.

7.3F.3 $\Delta R_{\text{IB,c}}$

For a UE supporting CA or DC band combination, the minimum requirement for reference sensitivity in Table 7.3F.2.3-1 shall be increased by the amount given by $\Delta R_{\text{IB,c}}$ defined in Table 7.3F.3-1. Unless otherwise stated, $\Delta R_{\text{IB,c}}$ is set to zero.

Table 7.3F.3-1: $\Delta R_{\text{IB,c}}$ due to CA (two bands)

Inter-band CA combination	Operating Band	$\Delta R_{\text{IB,c}}$ (dB)
CA_n46-n48	n46	0
	n48	0.5

In case the UE supports more than one of band combinations for CA or DC, and an operating band belongs to more than one band combinations then the applicable additional $\Delta R_{\text{IB,c}}$ shall be the maximum value for all band combinations

defined in clause 7.3A and 7.3F.3 in this specification and 7.3A, 7.3B in TS 38.101-3 [4] for the applicable operating bands.

7.3I Reference sensitivity for RedCap

7.3I.1 General

The reference sensitivity power level REFSSENS is the minimum mean power applied to each one of the UE antenna ports for all UE categories, at which the throughput shall meet or exceed the requirements for the specified reference measurement channel.

7.3I.2 Reference sensitivity power level

Editor's Note: The test case is not completed due to the following aspects are not yet determined:

- Generic procedure for RedCap UE in TS 38.508-1 is FFS
- Default message configuration for RedCap UE in TS 38.508-1 is FFS.
- PICS for HD-FDD RedCap UE in TS 38.508-2 is FFS.

7.3I.2.1 Test purpose

The test purpose is to verify the ability of the UE to receive data with a given average throughput for a specified reference measurement channel, under conditions of low signal level, ideal propagation and no added noise.

The test purpose is to verify the ability of the UE to receive data with a given average throughput for a specified reference measurement channel, under conditions of low signal level, ideal propagation and no added noise.

7.3I.2.2 Test applicability

This test case applies to all types of NR UE release 17 and forward that support NR RedCap.

7.3I.2.3 Minimum conformance requirements

For a RedCap UE equipped with 2 Rx antenna ports, the throughput shall be ≥ 95 % of the maximum throughput of the reference measurement channels as specified in Annexes A.2.2.2, A.3.2 and A.3.3 (with one sided dynamic OCNG Pattern OP.1 FDD/TDD for the DL-signal as described in Annex A.5.1.1/A.5.2.1) with parameters specified in Table 7.3.2.3-1a and Table 7.3.2.3-1b for the applicable operating bands. The reference sensitivity (REFSENS) requirement specified for a RedCap UE equipped with 2 Rx antenna ports shall be met with uplink transmission bandwidth less than or equal to that specified in Table 7.3.2.3-3 and, for FDD bands, with the Tx-Rx separation as defined in clause 5.4.4 for the applicable band and UE channel bandwidth.

For a RedCap UE equipped with 1 Rx antenna ports, reference sensitivity for 2Rx antenna ports in Table 7.3.2.3-1a and in Table 7.3.2.3-1b shall be modified by the amount given in ΔR_{1R} in Table 7.3I.2.3-1 for the applicable operating bands. The reference sensitivity (REFSENS) requirement specified for a RedCap UE equipped with 1 Rx antenna ports shall be met with uplink transmission bandwidth less than or equal to that specified in Table 7.3.2.3-3 and, for FDD bands, with the Tx-Rx separation as defined in clause 5.4.4 for the applicable band and UE channel bandwidth.

Table 7.3I.2.3-1: Single antenna port reference sensitivity allowance ΔR_{1R}

Operating band	Channel bandwidth (MHz)	ΔR_{1R} (dB)
TDD band	5, 10, 15, 20	2,5
FDD band	5	2.5
FDD band	10, 15, 20	3

For a RedCap UE equipped with 2 Rx antenna ports operating in HD-FDD mode, reference sensitivity for 2Rx antenna ports in Table 7.3I.2.3-2 shall be met with uplink transmission bandwidth less than or equal to that specified in Table 7.3I.2.3-5.

Table 7.3I.2.3-2: HD-FDD RedCap UE with 2 Rx antenna port reference sensitivity

Operating band / SCS / Channel bandwidth					
Operating Band	SCS kHz	5 MHz (dBm)	10 MHz (dBm)	15 MHz (dBm)	20 MHz (dBm)
n1	15	-100.0	-96.8	-95.0	-93.7
	30		-97.2	-95.2	-93.9
	60		-97.5	-95.4	-94.2
n2	15	-98.8	-95.6	-93.8	-92.5
	30		-96.0	-94.0	-92.7
	60		-96.3	-94.2	-93.0
n3	15	-97.8	-94.6	-92.8	-91.5
	30		-95.0	-93.0	-91.7
	60		-95.3	-93.2	-92.0
n5	15	-98.8	-95.6	-93.8	-92.5
	30		-96.0	-94.0	-92.7
n7	15	-98.8	-95.6	-93.8	-92.5
	30		-96.0	-94.0	-92.7
	60		-96.3	-94.2	-93.0
n8	15	-97.8	-94.6	-92.8	-91.5
	30		-95.0	-93.0	-91.7
n12	15	-97.8	-94.6	-92.8	
	30		-95.0	-93.0	
n13	15	-97.8	-94.6		
	30		-95.0		
n14	15	-97.8	-94.6		
	30		-95.0		
n18	15	-100.0	-96.8	-95.0	
	30		-97.2	-95.2	
n20	15	-97.8	-94.6	-92.8	-91.5
	30		-95.0	-93.0	-91.7
n24	15	-100.0	-96.8		
	30		-97.2		
	60		-97.5		
n25	15	-97.3	-94.1	-92.3	-91.0
	30		-94.5	-92.5	-91.2
	60		-94.8	-92.7	-91.5
n26	15	-98.3	-95.1	-93.3	-92.0
	30		-95.5	-93.5	-92.2
n28	15	-99.3	-96.1	-94.3	-93.0
	30		-96.5	-94.5	-93.2
n30	15	-99.5	-96.3		
	30		-96.7		
n65	15	-100.0	-96.8	-95.0	-93.7
	30		-97.2	-95.2	-93.9
	60		-97.5	-95.4	-94.2
n66	15	-100.0	-96.8	-95.0	-93.7
	30		-97.2	-95.2	-93.9
	60		-97.5	-95.4	-94.2
n70	15	-100.0	-96.8	-95.0	-93.7
	30		-97.2	-95.2	-93.9
	60		-97.5	-95.4	-94.2
n71	15	-98.0	-94.8	-93.0	-91.7
	30		-95.2	-93.2	-91.9
n74	15	-100.0	-96.8	-95.0	-93.7
	30		-97.2	-95.2	-93.9
	60		-97.5	-95.4	-94.2
n85	15	-97.8	-94.6	-92.8	
	30		-95.0	-93.0	
n91	15	-100.0			
n92	15	-100.0	-96.8	-95.0	-93.7
	30		-97.2	-95.2	-93.9
n93	15	-100.0			
n94	15	-100.0	-96.8	-95.0	-93.7
	30		-97.2	-95.2	-93.9

For a RedCap UE equipped with 1 Rx antenna ports and operating in HD-FDD mode, reference sensitivity for 1Rx antenna ports in Table 7.3I.2.3-4 shall be met with uplink transmission bandwidth less than or equal to that specified in Table 7.3I.2.3-5.

Table 7.3I.2.3-4: HD-FDD RedCap UE with 1 Rx antenna port reference sensitivity

Operating band / SCS / Channel bandwidth					
Operating Band	SCS kHz	5 MHz (dBm)	10 MHz (dBm)	15 MHz (dBm)	20 MHz (dBm)
n1	15	-97.5	-94.3	-92.5	-91.2
	30		-94.7	-92.7	-91.4
	60		-95.0	-92.9	-91.7
n2	15	-96.3	-93.1	-91.3	-90.0
	30		-93.5	-91.5	-90.2
	60		-93.8	-91.7	-90.5
n3	15	-95.3	-92.1	-90.3	-89.0
	30		-92.5	-90.5	-89.2
	60		-92.8	-90.7	-89.5
n5	15	-96.3	-93.1	-91.3	-90.0
	30		-93.5	-91.5	-90.2
n7	15	-96.3	-93.1	-91.3	-90.0
	30		-93.5	-91.5	-90.2
	60		-93.8	-91.7	-90.5
n8	15	-95.3	-92.1	-90.3	-89.0
	30		-92.5	-90.5	-89.2
n12	15	-95.3	-92.1	-90.3	
	30		-92.5	-90.5	
n13	15	-95.3	-92.1		
	30		-92.5		
n14	15	-95.3	-92.1		
	30		-92.5		
n18	15	-97.5	-94.3	-92.5	
	30		-94.7	-92.7	
n20	15	-95.3	-92.1	-90.3	-89.0
	30		-92.5	-90.5	-89.2
n24	15	-97.5	-94.3		
	30		-94.7		
	60		-95.0		
n25	15	-94.8	-91.6	-89.8	-88.5
	30		-92.0	-90.0	-88.7
	60		-92.3	-90.2	-89.0
n26	15	-95.8	-92.6	-90.8	-89.5
	30		-93.0	-91.0	-89.7
n28	15	-96.8	-93.6	-91.8	-90.5
	30		-94.0	-92.0	-90.7
n30	15	-97.0	-93.8		
	30		-94.2		
n65	15	-97.5	-94.3	-92.5	-91.2
	30		-94.7	-92.7	-91.4
	60		-95.0	-92.9	-91.7
n66	15	-97.5	-94.3	-92.5	-91.2
	30		-94.7	-92.7	-91.4
	60		-95.0	-92.9	-91.7
n70	15	-97.5	-94.3	-92.5	-91.2
	30		-94.7	-92.7	-91.4
	60		-95.0	-92.9	-91.7
n71	15	-95.5	-92.3	-90.5	-89.2
	30		-92.7	-90.7	-89.4
n74	15	-97.5	-94.3	-92.5	-91.2
	30		-94.7	-92.7	-91.4
	60		-95.0	-92.9	-91.7
n85	15	-95.3	-92.1	-90.3	
	30		-92.5	-90.5	
n91	15	-97.5			
n92	15	-97.5	-94.3	-92.5	-91.2
	30		-94.7	-92.7	-91.4
n93	15	-97.5			
n94	15	-97.5	-94.3	-92.5	-91.2
	30		-94.7	-92.7	-91.4

Table 7.3I.2.3-5: Uplink configuration for HD-FDD reference sensitivity

Operating band / SCS / Channel bandwidth					
Operating Band	SCS kHz	5 MHz	10 MHz	15 MHz	20 MHz
n1	15	25	50	75	100
	30		24	36	50
	60		10	18	24
n2	15	25	50	75	100
	30		24	36	50
	60		10	18	24
n3	15	25	50	75	100
	30		24	36	50
	60		10	18	24
n5	15	25	50	75	100
	30		24	36	50
n7	15	25	50	75	100
	30		24	36	50
			10	18	24
n8	15	25	50	75	100
	30		24	36	50
n12	15	25	50	75	
	30		24	36	
n13	15	25	50		
	30		24		
n14	15	25	50		
	30		24		
n18	15	25	50	75	
	30		24	36	
n20	15	25	50	75	100
	30		24	36	50
n24	15	25	50		
	30		24		
			10		
n25	15	25	50	75	100
	30		24	36	50
	60		10	18	24
n26	15	25	50	75	100
	30		24	36	50
n28	15	25	50	75	100
	30		24	36	50
n30	15	25	50		
	30		24		
n65	15	25	50	75	100
	30		24	36	50
			10	18	24
n66	15	25	50	75	100
	30		24	36	50
			10	18	24
n70	15	25	50	75	100
	30		24	36	50
			10	18	24
n71	15	25	50	75	100
	30		24	36	50
n74	15	25	50	75	100
	30		24	36	50
			10	18	24
n85	15	25	50	75	
	30		24	36	
n91	15	25			
n92	15	25	50	75	100
	30		24	36	50
n93	15	25			
n94	15	25	50	75	100
	30		24	36	50

The normative reference for this requirement is TS 38.101-1 [2] clause 7.3I.2.

7.3I.2.4 Test description

7.3I.2.4.1 Initial conditions

For RedCap UE with 1Rx or 2 Rx antenna ports, same initial conditions as in 7.3.2.4.1 with following exception:

- The test channel bandwidth are specified in TS 38.508-1 [5] subclause 4.3.1 for RedCap.

For HD-FDD RedCap UE with 1 Rx or 2 Rx antenna ports, same initial conditions as in 7.3.2.4.1 with following exception:

- The test channel bandwidth are specified in TS 38.508-1 [5] subclause 4.3.1 for RedCap.
- The RB allocation for uplink configuration in Table 7.3.2.4.1-1 refers to Table 7.3I.2.4.1-1 for each SCS, channel BW and NR band.

Table 7.31.2.4.1-1: Uplink configuration for reference sensitivity of HD-FDD RedCap UE, L_{CRB} @ RBstart format

Operating Band	SCS kHz	5 MHz	10 MHz	15 MHz	20 MHz	Duplex Mode
n1	15	25@0	50@2	75@4	100@6	HD-FDD
	30		24@0	36@2	50@1	
	60		10@1	18@0	24@0	
n2	15	25@0	50@2	75@4	100@6	HD-FDD
	30		24@0	36@2	50@1	
	60		10@1	18@0	24@0	
n3	15	25@0	50@2	75@4	100@6	HD-FDD
	30		24@0	36@2	50@1	
	60		10@1	18@0	24@0	
n5	15	25@0	50@2	75@4	100@6	HD-FDD
	30		24@0	36@2	50@1	
n7	15	25@0	50@2	75@4	100@6	HD-FDD
	30		24@0	36@2	50@1	
	60		10@1	18@0	24@0	
n8	15	25@0	50@2	75@4	100@6	HD-FDD
	30		24@0	36@2	50@1	
n12	15	25@0	50@2	75@4		HD-FDD
	30		24@0	36@2		
n14	15	25@0	50@0			HD-FDD
	30		24@0			
n20	15	25@0	50@0	75@0	100@0	HD-FDD
	30		24@0	36@0	50@0	
n24	15	25@0	50@0			HD-FDD
	30		24@0			
	60		10@0			
n25	15	25@0	50@2	75@4	100@6	HD-FDD
	30		24@0	36@2	50@1	
	60		10@1	18@0	24@0	
n26	15	25@0	50@2	75@4	100@6	HD-FDD
	30		24@0	36@2	50@1	
n28	15	25@0	50@2	75@4	100@6	HD-FDD
	30		24@0	36@2	50@1	
n30	15	25@0	50@2			HD-FDD
	30		24@0			
n65	15	25@0	50@2	75@4	100@6	HD-FDD
	30		24@0	36@2	50@1	
	60		10@1	18@0	24@0	
n66	15	25@0	50@2	75@4	100@6	HD-FDD
	30		24@0	36@2	50@1	
	60		10@1	18@0	24@0	
n70	15	25@0	50@2	75@4	100@6	HD-FDD
	30		24@0	36@2	50@1	
	60		10@1	18@0	24@0	
n71	15	25@0	50@0	75@0	100@0	HD-FDD
	30		24@0	36@0	50@0	
n74	15	25@0	50@2	75@4	100@6	HD-FDD
	30		24@0	36@2	50@1	
	60		10@1	18@0	24@0	

7.3I.2.4.2 Test procedure

Same test procedure as steps 1~4 of clause 7.3.2.4.2 with the following exceptions of step 3.

- Set the Downlink signal level to the appropriate REFSENS value defined in Tables 7.3I.2.5-1, 7.3I.2.5-2 and 7.3I.2.5-5 if 2Rx antennas connected or Tables 7.3I.2.5-3, 7.3I.2.5-4 and 7.3I.2.5-6 if 1Rx antennas connected.

7.3I.2.4.3 Message contents

FFS

7.3I.2.5 Test requirement

The throughput shall be $\geq 95\%$ of the maximum throughput of the reference measurement channels as specified in Annex A3.2 with reference receive power level specified in Table 7.3I.2.5-1 and Table 7.3I.2.5-2 for RedCap UE with 2 Rx antenna port, Tables 7.3I.2.5-3 and Table 7.3I.2.5-4 for RedCap UE with single antenna port, Table 7.3I.2.5-5 for HD-FDD RedCap UE with 2 Rx antenna port, Table 7.3I.2.5-6 for HD-FDD RedCap UE single antenna port, and parameters specified Table 7.3.2.4.1-1, Table 7.3.2.4.1-2 and Table 7.3I.2.4.1-1.

Table 7.3I.2.5-1: Two antenna port Reference sensitivity QPSK P_{REFSENS} for FDD bands

Operating band / SCS / Channel bandwidth / REFSSENS / Duplex Mode						
Operating Band	SCS kHz	5 MHz	10 MHz	15 MHz	20 MHz	Duplex Mode
n1	15	-100.0 +TT	-96.8 +TT	-95.0 +TT	-93.8 +TT	FDD
	30		-97.1 +TT	-95.1 +TT	-94.0 +TT	
	60		-97.5 +TT	-95.4 +TT	-94.2 +TT	
n2	15	-98.0 +TT	-94.8 +TT	-93.0 +TT	-91.8 +TT	FDD
	30		-95.1 +TT	-93.1 +TT	-92.0 +TT	
	60		-95.5 +TT	-93.4 +TT	-92.2 +TT	
n3	15	-97.0 +TT	-93.8 +TT	-92.0 +TT	-90.8 +TT	FDD
	30		-94.1 +TT	-92.1 +TT	-91.0 +TT	
	60		-94.5 +TT	-92.4 +TT	-91.2 +TT	
n5	15	-98.0 +TT	-94.8 +TT	-93.0 +TT	-90.8 +TT	FDD
	30		-95.1 +TT	-93.1 +TT	-91.0 +TT	
n7	15	-98.0 +TT	-94.8 +TT	-93.0 +TT	-91.8 +TT	FDD
	30		-95.1 +TT	-93.1 +TT	-92.0 +TT	
	60		-95.5 +TT	-93.4 +TT	-92.2 +TT	
n8	15	-97.0 +TT	-93.8 +TT	-92.0 +TT	-90.0 +TT	FDD
	30		-94.1 +TT	-92.1 +TT	-90.2 +TT	
n12	15	-97.0 +TT	-93.8 +TT	-84.0 +TT		FDD
	30		-94.1 +TT	-84.1 +TT		
n14	15	-97.0 +TT	-93.8 +TT			FDD
	30		-94.1 +TT			
n20	15	-97.0 +TT	-93.8 +TT	-91.0 +TT	-89.8 +TT	FDD
	30		-94.1 +TT	-91.1 +TT	-90.0 +TT	
n24	15	-100.0 +TT	-96.8 +TT			FDD
	30		-97.1 +TT			
	60		-97.5 +TT			
n25	15	-96.5 +TT	-93.3 +TT	-91.5 +TT	-90.3 +TT	FDD
	30		-93.6 +TT	-91.6 +TT	-90.5 +TT	
	60		-94.0 +TT	-91.9 +TT	-90.7 +TT	
n26	15	-97.5 +TT	-94.5 +TT	-92.7 +TT	-87.6 +TT	FDD
	30		-94.8 +TT	-92.7 +TT	-87.7 +TT	
n28	15	-98.5 +TT	-95.5 +TT	-93.5 +TT	-90.8 +TT	FDD

	30		-95.6 +TT	-93.6 +TT	-91.0 +TT	
n30	15	-99.0 +TT	-95.8 +TT			FDD
	30		-96.1 +TT			
n65	15	- 99.5+TT	- 96.3+TT	- 94.5+TT	- 93.3+TT	FDD
	30		- 96.6+TT	- 94.6+TT	- 93.5+TT	
	60		- 97.0+TT	- 94.9+TT	- 93.7+TT	
n66	15	-99.5 +TT	-96.3 +TT	-94.5 +TT	-93.3 +TT	FDD
	30		-96.6 +TT	-94.6 +TT	-93.5 +TT	
	60		-97.0 +TT	-94.9 +TT	-93.7 +TT	
n70	15	-100.0 +TT	-96.8 +TT	-95.0 +TT	-93.8 +TT	FDD
	30		-97.1 +TT	-95.1 +TT	-94.0 +TT	
	60		-97.5 +TT	-95.4 +TT	-94.2 +TT	
n71	15	-97.2 +TT	-94.0 +TT	-91.6 +TT	-86.0 +TT	FDD
	30		-94.3 +TT	-91.9 +TT	-87.4 +TT	
n74	15	-99.5 ³ +TT	-96.3 ³ +TT	-94.5 ³ +TT	-93.3 ³ +TT	FDD
	30		-96.6 ³ +TT	-94.6 ³ +TT	-93.5 ³ +TT	
	60		-97.0 ³ +TT	-94.9 ³ +TT	-93.7 ³ +TT	
NOTE 1: Void NOTE 2: The transmitter shall be set to P _{UMAX} as defined in subclause 6.2.4 NOTE 3: ³ indicates that the requirement is modified by -0.5 dB when the assigned NR channel bandwidth is confined within 1475.9-1510.9 MHz. NOTE 4: TT for each frequency and channel bandwidth is specified in Table 7.31.2.5-7.						

Table 7.31.2.5-2: Two antenna port reference sensitivity QPSK PREFSENS for TDD bands

Operating band / SCS / Channel bandwidth / REFSSENS / Duplex Mode				
Operating band	SCS kHz	Channel bandwidth (MHz)	REFSENS (dBm) ⁸	Duplex Mode

n34	15	5, 10, 15	-100 + $10\log_{10}(N_{RB}/25)+TT$	TDD
	30	10, 15	-97.1 + $10\log_{10}(N_{RB}/24)+TT$	
	60	10, 15	-97.5 + $10\log_{10}(N_{RB}/11)+TT$	
n38 ¹	15	5, 10, 15, 20	-100 + $10\log_{10}(N_{RB}/25)+TT$	TDD
	30	10, 15, 20,	-97.1 + $10\log_{10}(N_{RB}/24)+TT$	
	60	10, 15, 20	-97.5 + $10\log_{10}(N_{RB}/11)+TT$	
n39	15	5, 10, 15, 20	-100 + $10\log_{10}(N_{RB}/25)+TT$	TDD
	30	10, 15, 20	-97.1 + $10\log_{10}(N_{RB}/24)+TT$	
	60	10, 15, 20,	-97.5 + $10\log_{10}(N_{RB}/11)+TT$	
n40	15	5, 10, 15, 20	-100 + $10\log_{10}(N_{RB}/25)+TT$	TDD
	30	10, 15, 20	-97.1 + $10\log_{10}(N_{RB}/24)+TT$	
	60	10, 15, 20	-97.5 + $10\log_{10}(N_{RB}/11)+TT$	
n41 ¹	15	10, 15, 20	-94.8 + $10\log_{10}(N_{RB}/50)+TT$	TDD
	30	10, 15, 20	-95.1 + $10\log_{10}(N_{RB}/24)+TT$	
	60	10, 15, 20	-95.5 + $10\log_{10}(N_{RB}/11)+TT$	
n48 ¹	15	5, 10, 15, 20,	-99 + $10\log_{10}(N_{RB}/25)+TT$	TDD
	30	10, 15, 20,	-96.1 + $10\log_{10}(N_{RB}/24)$ +TT	
	60	10, 15, 20,	-96.5 + $10\log_{10}(N_{RB}/11)+TT$	
n50	15	5, 10, 15, 20	-100 + $10\log_{10}(N_{RB}/25)+TT$	TDD
	30	10, 15, 20	-97.1 + $10\log_{10}(N_{RB}/24)+TT$	
	60	10, 15, 20	-97.5 + $10\log_{10}(N_{RB}/11)+TT$	
n51	15	5	-100+TT	TDD
n53	15	5, 10	-100 + $10\log_{10}(N_{RB}/25)+TT$	TDD
	30	10	-97.1+TT	
	60	10	-97.5+TT	
n77 ^{1,4}	15	10, 15, 20,	-95.3 + $10\log_{10}(N_{RB}/50)+TT$	TDD
	30	10, 15, 20	-95.6 + $10\log_{10}(N_{RB}/24)+TT$	
	60	10, 15, 20	-96.0 + $10\log_{10}(N_{RB}/11)+TT$	
n78 ¹	15	10, 15, 20	-95.8 + $10\log_{10}(N_{RB}/50)$ +TT	TDD
	30	10, 15, 20	-96.1 + $10\log_{10}(N_{RB}/24)$ +TT	
	60	10, 15, 20	-96.5 + $10\log_{10}(N_{RB}/11)+TT$	
n79 ¹	15	10, 20,	-89.6 + $10\log_{10}(N_{RB}/216)+TT$	TDD
	30	10, 20,	-89.7 + $10\log_{10}(N_{RB}/106)$ +TT	
	60	10, 20	-89.9 + $10\log_{10}(N_{RB}/51)$ +TT	

- NOTE 1: Void.
- NOTE 2: The transmitter shall be set to P_{UMAX} as defined in clause 6.2.4.
- NOTE 3: Void
- NOTE 4: The requirement is modified by -0.5 dB when the assigned UE channel bandwidth is confined within 3300 - 3800 MHz.
- NOTE 5: Void
- NOTE 6: Void
- NOTE 7: Void
- NOTE 8: The REFSENS value is rounded to the nearest number down to one decimal point. "N_{RB}" in REFSENS formula is the maximum transmission bandwidth configuration as defined in Table 5.3.2-1.
- NOTE 9: TT for each frequency and channel bandwidth is specified in Table 7.31.2.5-7.

Table 7.3l.2.5-3: Single antenna port Reference sensitivity QPSK PREFSENS for FDD bands

Operating band / SCS / Channel bandwidth / Duplex-mode						
Operating Band	SCS kHz	5 MHz	10 MHz	15 MHz	20 MHz	Duplex Mode
n1	15	- 100.0+2.5 +TT	-96.8 +3 +TT	-95.0 +3 +TT	-93.8 +3 +TT	FDD
	30		-97.1 +3 +TT	-95.1 +3 +TT	-94.0 +3 +TT	
	60		-97.5 +TT	-95.4 +TT	-94.2 +TT	
n2	15	-98.0 +2.5+TT	-94.8 +3 +TT	-93.0 +3 +TT	-91.8 +3 +TT	FDD
	30		-95.1 +3 +TT	-93.1 +3 +TT	-92.0 +3 +TT	
	60		-95.5 +3 +TT	-93.4 +3 +TT	-92.2 +3 +TT	
n3	15	-97.0+2.5 +TT	-93.8 +3 +TT	-92.0 +3 +TT	-90.8 +3 +TT	FDD
	30		-94.1 +3 +TT	-92.1 +3 +TT	-91.0 +3 +TT	
	60		-94.5 +3 +TT	-92.4 +3 +TT	-91.2 +3 +TT	
n5	15	-98.0+2.5 +TT	-94.8 +3 +TT	-93.0 +3 +TT	-90.8 +3 +TT	FDD
	30		-95.1 +3 +TT	-93.1 +3 +TT	-91.0 +3 +TT	
n7	15	-98.0+2.5 +TT	-94.8 +3 +TT	-93.0 +3 +TT	-91.8 +3 +TT	FDD
	30		-95.1 +3 +TT	-93.1 +3 +TT	-92.0 +3 +TT	
	60		-95.5 +3 +TT	-93.4 +3 +TT	-92.2 +3 +TT	
n8	15	-97.0+2.5 +TT	-93.8 +3 +TT	-92.0 +3 +TT	-90.0 +3 +TT	FDD
	30		-94.1 +3 +TT	-92.1 +3 +TT	-90.2 +3 +TT	
n12	15	-97.0 +2.5+TT	-93.8 +3 +TT	-84.0 +3 +TT		FDD
	30		-94.1 +3 +TT	-84.1 +3 +TT		
n14	15	-97.0+2.5 +TT	-93.8 +3 +TT			FDD
	30		-94.1 +3 +TT			
n20	15	-97.0 +2.5+TT	-93.8 +3 +TT	-91.0 +3 +TT	-89.8 +3 +TT	FDD
	30		-94.1 +3 +TT	-91.1 +3 +TT	-90.0 +3 +TT	
n24	15	-100.0 +2.5+TT	-96.8 +3 +TT			FDD
	30		-97.1 +3 +TT			
	60		-97.5 +3 +TT			
n25	15	-96.5 +2.5+TT	-93.3 +3 +TT	-91.5 +3 +TT	-90.3 +3 +TT	FDD
	30		-93.6 +3 +TT	-91.6 +3 +TT	-90.5 +3 +TT	
	60		-94.0 +3 +TT	-91.9 +3 +TT	-90.7 +3 +TT	
n26	15	-97.5+2.5 +TT	-94.5 +3 +TT	-92.7 +3 +TT	-87.6 +3 +TT	FDD
	30		-94.8 +3 +TT	-92.7 +3 +TT	-87.7 +3 +TT	
n28	15	-98.5 +2.5+TT	-95.5 +3 +TT	-93.5 +3 +TT	-90.8 +3 +TT	FDD

	30		-95.6 +3 +TT	-93.6 +3 +TT	-91.0 +3 +TT	
n30	15	-99.0 +2.5+TT	-95.8 +3 +TT			FDD
	30		-96.1 +3 +TT			
n65	15	-99.5 +2.5+TT	-96.3 +3+TT	-94.5 +3+TT	-93.3 +3+TT	FDD
	30		-96.6 +3 +TT	-94.6 +3 +TT	-93.5 +3 +TT	
	60		-97.0 +3+TT	-94.9 +3+TT	-93.7 +3+TT	
n66	15	-99.5 +2.5+TT	-96.3 +3+TT	-94.5 +3 +TT	-93.3 +3 +TT	FDD
	30		-96.6 +3 +TT	-94.6 +3 +TT	-93.5 +3+TT	
	60		-97.0 +3 +TT	-94.9 +3 +TT	-93.7 +3 +TT	
n70	15	-100.0 +2.5 +TT	-96.8 +3 +TT	-95.0 +3+TT	-93.8 +3 +TT	FDD
	30		-97.1 +3 +TT	-95.1 +3 +TT	-94.0 +3 +TT	
	60		-97.5 +3 +TT	-95.4 +3 +TT	-94.2 +3 +TT	
n71	15	-97.2+2.5 +TT	-94.0 +3 +TT	-91.6 +3 +TT	-86.0 +3 +TT	FDD
	30		-94.3 +3 +TT	-91.9 +3 +TT	-87.4 +3 +TT	
n74	15	-99.5 ³ +2.5 +TT	-96.3 ³ +3+TT	-94.5 ³ +3+TT	-93.3 ³ +3+TT	FDD
	30		-96.6 ³ +3+TT	-94.6 ³ +3+TT	-93.5 ³ +3 +TT	
	60		-97.0 ³ +3+TT	-94.9 ³ +3+TT	-93.7 ³ +3+TT	
<p>NOTE 1: Void</p> <p>NOTE 2: The transmitter shall be set to P_{UMAX} as defined in subclause 6.2.4</p> <p>NOTE 3: ³ indicates that the requirement is modified by -0.5 dB when the assigned NR channel bandwidth is confined within 1475.9-1510.9 MHz.</p> <p>NOTE 4: TT for each frequency and channel bandwidth is specified in Table 7.31.2.5-7.</p>						

Table 7.3F.2.5-4: Single antenna port reference sensitivity QPSK PREFSENS for TDD bands

Operating band / SCS / Channel bandwidth / REFSSENS/Duplex Mode				
Operating band	SCS kHz	Channel bandwidth (MHz)	REFSENS (dBm) ⁸	Duplex Mode
n34	15	5, 10, 15	-100 + 10log ₁₀ (N _{RB} /25) +2.5+TT	TDD
	30	10, 15	-97.1 + 10log ₁₀ (N _{RB} /24) +2.5+TT	
	60	10, 15	-97.5 + 10log ₁₀ (N _{RB} /11) +2.5+TT	
n38 ¹	15	5, 10, 15, 20,	-100 + 10log ₁₀ (N _{RB} /25) +2.5+TT	TDD
	30	10, 15, 20,	-97.1 + 10log ₁₀ (N _{RB} /24) +2.5+TT	
	60	10, 15, 20	-97.5 + 10log ₁₀ (N _{RB} /11) +2.5+TT	
n39	15	5, 10, 15, 20	-100 + 10log ₁₀ (N _{RB} /25) +2.5+TT	TDD
	30	10, 15, 20,	-97.1 + 10log ₁₀ (N _{RB} /24) +2.5+TT	
	60	10, 15, 20,	-97.5 + 10log ₁₀ (N _{RB} /11) +2.5+TT	

n40	15	5, 10, 15, 20	$-100 + 10\log_{10}(N_{RB}/25) + 2.5 + TT$	TDD
	30	10, 15, 20	$-97.1 + 10\log_{10}(N_{RB}/24) + 2.5 + TT$	
	60	10, 15, 20	$-97.5 + 10\log_{10}(N_{RB}/11) + 2.5 + TT$	
n41 ¹	15	10, 15, 20	$-94.8 + 10\log_{10}(N_{RB}/50) + 2.5 + TT$	TDD
	30	10, 15, 20	$-95.1 + 10\log_{10}(N_{RB}/24) + 2.5 + TT$	
	60	10, 15, 20	$-95.5 + 10\log_{10}(N_{RB}/11) + 2.5 + TT$	
n48 ¹	15	5, 10, 15, 20,	$-99 + 10\log_{10}(N_{RB}/25) + 2.5 + TT$	TDD
	30	10, 15, 20,	$-96.1 + 10\log_{10}(N_{RB}/24) + 2.5 + TT$	
	60	10, 15, 20,	$-96.5 + 10\log_{10}(N_{RB}/11) + 2.5 + TT$	
n50	15	5, 10, 15, 20	$-100 + 10\log_{10}(N_{RB}/25) + 2.5 + TT$	TDD
	30	10, 15, 20	$-97.1 + 10\log_{10}(N_{RB}/24) + 2.5 + TT$	
	60	10, 15, 20	$-97.5 + 10\log_{10}(N_{RB}/11) + 2.5 + TT$	
n51	15	5	$-100 + 2.5 + TT$	TDD
n53	15	5, 10	$-100 + 10\log_{10}(N_{RB}/25) + 2.5 + TT$	TDD
	30	10	$-97.1 + 2.5 + TT$	
	60	10	$-97.5 + 2.5 + TT$	
n77 ^{1,4}	15	10, 15, 20,	$-95.3 + 10\log_{10}(N_{RB}/50) + 2.5 + TT$	TDD
	30	10, 15, 20	$-95.6 + 10\log_{10}(N_{RB}/24) + 2.5 + TT$	
	60	10, 15, 20	$-96.0 + 10\log_{10}(N_{RB}/11) + 2.5 + TT$	
n78 ¹	15	10, 15, 20	$-95.8 + 10\log_{10}(N_{RB}/50) + 2.5 + TT$	TDD
	30	10, 15, 20	$-96.1 + 10\log_{10}(N_{RB}/24) + 2.5 + TT$	
	60	10, 15, 20	$-96.5 + 10\log_{10}(N_{RB}/11) + 2.5 + TT$	
n79 ¹	15	10, 20,	$-89.6 + 10\log_{10}(N_{RB}/216) + 2.5 + TT$	TDD
	30	10, 20,	$-89.7 + 10\log_{10}(N_{RB}/106) + 2.5 + TT$	
	60	10, 20	$-89.9 + 10\log_{10}(N_{RB}/51) + 2.5 + TT$	
<p>NOTE 1: Void.</p> <p>NOTE 2: The transmitter shall be set to P_{UMAX} as defined in clause 6.2.4.</p> <p>NOTE 3: Void</p> <p>NOTE 4: The requirement is modified by -0.5 dB when the assigned UE channel bandwidth is confined within 3300 - 3800 MHz.</p> <p>NOTE 5: Void</p> <p>NOTE 6: Void</p> <p>NOTE 7: Void</p> <p>NOTE 8: The REFSENS value is rounded to the nearest number down to one decimal point. "N_{RB}" in REFSENS formula is the maximum transmission bandwidth configuration as defined in Table 5.3.2-1.</p> <p>NOTE 9: TT for each frequency and channel bandwidth is specified in Table 7.31.2.5-7.</p>				

Table 7.3I.2.5-5: Two antenna port reference sensitivity QPSK PREFSENS for HD-FDD operation

Operating band / SCS / Channel bandwidth/ REFSENS / Duplex Mode						
Operating Band	SCS kHz	5 MHz (dBm)	10 MHz (dBm)	15 MHz (dBm)	20 MHz (dBm)	Duplex Mode
n1	15	-100.0 +TT	-96.8 +TT	-95.0 +TT	-93.7 +TT	HD-FDD
	30		-97.2 +TT	-95.2 +TT	-93.9 +TT	
	60		-97.5 +TT	-95.4 +TT	-94.2 +TT	
n2	15	-98.8 +TT	-95.6 +TT	-93.8 +TT	-92.5 +TT	HD-FDD
	30		-96.0 +TT	-94.0 +TT	-92.7 +TT	
	60		-96.3 +TT	-94.2 +TT	-93.0 +TT	
n3	15	-97.8 +TT	-94.6 +TT	-92.8 +TT	-91.5 +TT	HD-FDD
	30		-95.0 +TT	-93.0 +TT	-91.7 +TT	
	60		-95.3 +TT	-93.2 +TT	-92.0 +TT	
n5	15	-98.8 +TT	-95.6 +TT	-93.8 +TT	-92.5 +TT	HD-FDD
	30		-96.0 +TT	-94.0 +TT	-92.7 +TT	
n7	15	-98.8 +TT	-95.6 +TT	-93.8 +TT	-92.5 +TT	HD-FDD
	30		-96.0 +TT	-94.0 +TT	-92.7 +TT	
	60		-96.3 +TT	-94.2 +TT	-93.0 +TT	
n8	15	-97.8 +TT	-94.6 +TT	-92.8 +TT	-91.5 +TT	HD-FDD
	30		-95.0 +TT	-93.0 +TT	-91.7 +TT	
n12	15	-97.8 +TT	-94.6 +TT	-92.8 +TT		HD-FDD
	30		-95.0 +TT	-93.0 +TT		
n13	15	-97.8 +TT	-94.6 +TT			HD-FDD
	30		-95.0 +TT			
n14	15	-97.8 +TT	-94.6 +TT			HD-FDD
	30		-95.0 +TT			
n18	15	-100.0 +TT	-96.8 +TT	-95.0 +TT		HD-FDD
	30		-97.2 +TT	-95.2 +TT		
n20	15	-97.8 +TT	-94.6 +TT	-92.8 +TT	-91.5 +TT	HD-FDD
	30		-95.0 +TT	-93.0 +TT	-91.7 +TT	
n24	15	-100.0 +TT	-96.8 +TT			HD-FDD
	30		-97.2 +TT			
	60		-97.5 +TT			
n25	15	-97.3 +TT	-94.1 +TT	-92.3 +TT	-91.0 +TT	HD-FDD
	30		-94.5 +TT	-92.5 +TT	-91.2 +TT	

Operating band / SCS / Channel bandwidth/ REFSENS / Duplex Mode						
Operating Band	SCS kHz	5 MHz (dBm)	10 MHz (dBm)	15 MHz (dBm)	20 MHz (dBm)	Duplex Mode
	60		-94.8 +TT	-92.7 +TT	-91.5 +TT	
n26	15	-98.3 +TT	-95.1 +TT	-93.3 +TT	-92.0 +TT	HD-FDD
	30		-95.5 +TT	-93.5 +TT	-92.2 +TT	
n28	15	-99.3 +TT	-96.1 +TT	-94.3 +TT	-93.0 +TT	HD-FDD
	30		-96.5 +TT	-94.5 +TT	-93.2 +TT	
n30	15	-99.5 +TT	-96.3 +TT			HD-FDD
	30		-96.7 +TT			
n65	15	-100.0 +TT	- 96.8+TT	-95.0 +TT	-93.7 +TT	HD-FDD
	30		-97.2 +TT	-95.2 +TT	-93.9 +TT	
	60		-97.5 +TT	-95.4 +TT	-94.2 +TT	
n66	15	-100.0 +TT	-96.8 +TT	-95.0 +TT	-93.7 +TT	HD-FDD
	30		-97.2 +TT	-95.2 +TT	-93.9 +TT	
	60		-97.5 +TT	-95.4 +TT	-94.2 +TT	
n70	15	-100.0 +TT	-96.8 +TT	-95.0 +TT	-93.7 +TT	HD-FDD
	30		-97.2 +TT	-95.2 +TT	-93.9 +TT	
	60		-97.5 +TT	-95.4 +TT	-94.2 +TT	
n71	15	-98.0 +TT	-94.8	-93.0 +TT	-91.7 +TT	HD-FDD
	30		-95.2 +TT	-93.2 +TT	-91.9 +TT	
n74	15	-100.0 +TT	-96.8 +TT	-95.0 +TT	-93.7 +TT	HD-FDD
	30		-97.2 +TT	-95.2 +TT	-93.9 +TT	
	60		-97.5 +TT	-95.4 +TT	-94.2 +TT	
n85	15	-97.8 +TT	-94.6 +TT	-92.8 +TT		HD-FDD
	30		-95.0 +TT	-93.0 +TT		
n91	15	-100.0 +TT				HD-FDD
n92	15	-100.0 +TT	-96.8 +TT	-95.0 +TT	-93.7 +TT	HD-FDD
	30		-97.2 +TT	-95.2 +TT	-93.9 +TT	
n93	15	-100.0 +TT				HD-FDD
n94	15	-100.0 +TT	-96.8 +TT	-95.0 +TT	-93.7 +TT	HD-FDD
	30		-97.2 +TT	-95.2 +TT	-93.9 +TT	

Operating band / SCS / Channel bandwidth/ REFSENS / Duplex Mode						
Operating Band	SCS kHz	5 MHz (dBm)	10 MHz (dBm)	15 MHz (dBm)	20 MHz (dBm)	Duplex Mode
NOTE 1: The transmitter shall be set to P_{UMAX} as defined in clause 6.2.4.						
NOTE 2: TT for each frequency and channel bandwidth is specified in Table 7.3l.2.5-7.						

Table 7.3I.2.5-6: Single antenna port Reference sensitivity QPSK PREFSENS for HD-FDD operation

Operating band / SCS / Channel bandwidth/ REFSENS / Duplex Mode						
Operating Band	SCS kHz	5 MHz (dBm)	10 MHz (dBm)	15 MHz (dBm)	20 MHz (dBm)	Duplex Mode
n1	15	-97.5 +TT	-94.3 +TT	-92.5 +TT	-91.2 +TT	HD-FDD
	30		-94.7 +TT	-92.7 +TT	-91.4 +TT	
	60		-95.0 +TT	-92.9 +TT	-91.7 +TT	
n2	15	-96.3 +TT	-93.1 +TT	-91.3 +TT	-90.0 +TT	HD-FDD
	30		-93.5 +TT	-91.5	-90.2	
	60		-93.8 +TT	-91.7 +TT	-90.5 +TT	
n3	15	-95.3 +TT	-92.1 +TT	-90.3 +TT	-89.0 +TT	HD-FDD
	30		-92.5 +TT	-90.5 +TT	-89.2 +TT	
	60		-92.8 +TT	-90.7 +TT	-89.5 +TT	
n5	15	-96.3 +TT	-93.1 +TT	-91.3 +TT	-90.0 +TT	HD-FDD
	30		-93.5 +TT	-91.5 +TT	-90.2 +TT	
n7	15	-96.3 +TT	-93.1 +TT	-91.3 +TT	-90.0 +TT	HD-FDD
	30		-93.5 +TT	-91.5 +TT	-90.2 +TT	
	60		-93.8 +TT	-91.7 +TT	-90.5 +TT	
n8	15	-95.3 +TT	-92.1 +TT	-90.3 +TT	-89.0 +TT	HD-FDD
	30		-92.5 +TT	-90.5 +TT	-89.2 +TT	
n12	15	-95.3 +TT	-92.1 +TT	-90.3 +TT		HD-FDD
	30		-92.5 +TT	-90.5 +TT		
n13	15	-95.3 +TT	-92.1 +TT			HD-FDD
	30		-92.5 +TT			
n14	15	-95.3 +TT	-92.1 +TT			HD-FDD
	30		-92.5 +TT			
n18	15	-97.5 +TT	-94.3 +TT	-92.5 +TT		HD-FDD
	30		-94.7 +TT	-92.7 +TT		
n20	15	-95.3 +TT	-92.1 +TT	-90.3 +TT	-89.0 +TT	HD-FDD
	30		-92.5 +TT	-90.5 +TT	-89.2 +TT	
n24	15	-97.5 +TT	-94.3 +TT			HD-FDD
	30		-94.7 +TT			
	60		-95.0 +TT			
n25	15	-94.8 +TT	-91.6 +TT	-89.8 +TT	-88.5 +TT	HD-FDD
	30		-92.0 +TT	-90.0 +TT	-88.7 +TT	
	60		-92.3 +TT	-90.2 +TT	-89.0 +TT	

Operating band / SCS / Channel bandwidth/ REFSENS / Duplex Mode						
Operating Band	SCS kHz	5 MHz (dBm)	10 MHz (dBm)	15 MHz (dBm)	20 MHz (dBm)	Duplex Mode
n26	15	-95.8 +TT	-92.6 +TT	-90.8 +TT	-89.5 +TT	HD-FDD
	30		-93.0 +TT	-91.0 +TT	-89.7 +TT	
n28	15	-96.8 +TT	-93.6 +TT	-91.8 +TT	-90.5 +TT	HD-FDD
	30		-94.0 +TT	-92.0 +TT	-90.7 +TT	
n30	15	-97.0 +TT	-93.8 +TT			HD-FDD
	30		-94.2 +TT			
n65	15	-97.5 +TT	-94.3 +TT	-92.5 +TT	-91.2 +TT	HD-FDD
	30		-94.7 +TT	-92.7 +TT	-91.4 +TT	
	60		-95.0 +TT	-92.9 +TT	-91.7 +TT	
n66	15	-97.5 +TT	-94.3 +TT	-92.5 +TT	-91.2 +TT	HD-FDD
	30		-94.7 +TT	-92.7 +TT	-91.4 +TT	
	60		-95.0 +TT	-92.9 +TT	-91.7 +TT	
n70	15	-97.5 +TT	-94.3 +TT	-92.5 +TT	-91.2 +TT	HD-FDD
	30		-94.7 +TT	-92.7 +TT	-91.4 +TT	
	60		-95.0 +TT	-92.9 +TT	-91.7 +TT	
n71	15	-95.5 +TT	-92.3 +TT	-90.5 +TT	-89.2 +TT	HD-FDD
	30		-92.7 +TT	-90.7 +TT	-89.4 +TT	
n74	15	-97.5 +TT	-94.3 +TT	-92.5 +TT	-91.2 +TT	HD-FDD
	30		-94.7 +TT	-92.7 +TT	-91.4 +TT	
	60		-95.0 +TT	-92.9 +TT	-91.7 +TT	
n85	15	-95.3 +TT	-92.1 +TT	-90.3 +TT		HD-FDD
	30		-92.5 +TT	-90.5 +TT		
n91	15	-97.5 +TT				HD-FDD
n92	15	-97.5 +TT	-94.3 +TT	-92.5 +TT	-91.2 +TT	HD-FDD
	30		-94.7 +TT	-92.7 +TT	-91.4 +TT	
n93	15	-97.5 +TT				HD-FDD
n94	15	-97.5 +TT	-94.3 +TT	-92.5 +TT	-91.2 +TT	HD-FDD
	30		-94.7 +TT	-92.7 +TT	-91.4 +TT	

NOTE 1: The transmitter shall be set to P_{UMAX} as defined in clause 6.2.4.
NOTE 2: TT for each frequency and channel bandwidth is specified in Table 7.31.2.5-7.

Table 7.31.2.5-7: Test Tolerance (TT) for RX sensitivity level for RedCap UE

$f \leq 3.0\text{GHz}$	$3.0\text{GHz} < f \leq 6.0\text{ GHz}$
0.7 dB	1.0 dB

7.4 Maximum input level

7.4.1 Test purpose

Maximum input level tests the UE's ability to receive data with a given average throughput for a specified reference measurement channel, under conditions of high signal level, ideal propagation and no added noise.

A UE unable to meet the throughput requirement under these conditions will decrease the coverage area near to a g-NodeB.

7.4.2 Test applicability

This test applies to all types of NR UE release 15 and forward.

7.4.3 Minimum conformance requirements

Maximum input level is defined as the maximum mean power received at the UE antenna port, at which the specified relative throughput shall meet or exceed the minimum requirements for the specified reference measurement channel. The throughput shall be $\geq 95\%$ of the maximum throughput of the reference measurement channels as specified in Annex A.3.2 and A.3.3 (with one sided dynamic OCNG Pattern OP.1 FDD/TDD as described in Annex A.5.1.1/A.5.2.1) with parameters specified in Table 7.4.3-1.

Table 7.4.3-1: Maximum input level

Rx Parameter	Units	Channel bandwidth (MHz)		
		5, 10, 15, 20	25, 30, 35, 40, 45, 50	60, 70, 80, 90, 100
Power in Transmission Bandwidth Configuration ⁴	dBm	-25 ²	$-25 + 10\log_{10}(\text{BW}_{\text{Channel}}/20)^{\text{Note 2}}$	-20 ²
		-27 ^{3,5}	$-27 + 10\log_{10}(\text{BW}_{\text{Channel}}/20)^{\text{Note 3,5}}$	-22 ^{3,5}
NOTE 1: The transmitter shall be set to 4 dB below $P_{\text{CMAX_L,f,c}}$ at the minimum uplink configuration specified in Table 7.3.2-3 with $P_{\text{CMAX_L,f,c}}$ as defined in clause 6.2.4.				
NOTE 2: Reference measurement channel is A.3.2.3 or A.3.3.3 for 64 QAM.				
NOTE 3: Reference measurement channel is A.3.2.4 or A.3.3.4 for 256 QAM.				
NOTE 4: Power in transmission bandwidth configuration value is rounded to the nearest 0.5dB value.				
NOTE 5: Reference measurement channel is A.3.2.x for 1024 QAM.				

The normative reference for this requirement is TS 38.101-1 [2] clause 7.4.

7.4.4 Test description

7.4.4.1 Initial conditions

Initial conditions are a set of test configurations the UE needs to be tested in and the steps for the SS to take with the UE to reach the correct measurement state.

The initial test configurations consist of environmental conditions, test frequencies, test channel bandwidths and sub-carrier spacing based on NR operating bands specified in table 5.3.5-1. All of these configurations shall be tested with applicable test parameters for each combination of channel bandwidth and sub-carrier spacing, are shown in table 7.4.4.1-1. The details of the uplink and downlink reference measurement channels (RMC) are specified in Annexes A.2 and A.3. The details of the OCNG patterns used are specified in Annex A.5. Configurations of PDSCH and PDCCH before measurement are specified in Annex C.2.

Table 7.4.4.1-1: Test Configuration Table

Initial Conditions			
Test Environment as specified in TS 38.508-1 [5] subclause 4.1		Normal	
Test Frequencies as specified in TS 38.508-1 [5] subclause 4.3.1		Mid range (NOTE 5)	
Test Channel Bandwidths as specified in TS 38.508-1 [5] subclause 4.3.1		Lowest, Mid, Highest (NOTE 4)	
Test SCS as specified in Table 5.3.5-1		Lowest	
Test Parameters for Channel Bandwidths			
Downlink Configuration		Uplink Configuration	
Modulation	RB allocation	Modulation	RB allocation
CP-OFDM 64 QAM	NOTE 1	DFT-s-OFDM QPSK	NOTE 2
CP-OFDM 256 QAM	NOTE 1	DFT-s-OFDM QPSK	NOTE 2
NOTE 1: The specific configuration of downlink RB allocation is defined in Table 7.3.2.4.1-2.			
NOTE 2: The specific configuration of uplink RB allocation is defined in Table 7.3.2.4.1-3.			
NOTE 3: In a band where UE supports 4Rx, the test shall be performed only with 4Rx antennas ports connected.			
NOTE 4: For n70, highest test channel bandwidth shall be Highest UL / Highest DL according to asymmetric channel bandwidths specified in clause 5.3.6.			
NOTE 5: For NR band n28, 30MHz test channel bandwidth is tested with Low range test frequencies.			

1. Connect the SS to the UE antenna connectors as shown in TS 38.508-1 [5] Annex A, Figure A.3.1.1.1 for TE diagram and section A.3.2 for UE diagram.
2. The parameter settings for the cell are set up according to TS 38.508-1 [5] subclause 4.4.3.
3. Downlink signals are initially set up according to Annex C.0, C.1, C.2, and C.3.1, and uplink signals according to Annex G.0, G.1, G.2, and G.3.1.
4. The DL and UL Reference Measurement Channels are set according to Table 7.4.4.1-1.
5. Propagation conditions are set according to Annex B.0.
6. Ensure the UE is in State RRC_CONNECTED with generic procedure parameters Connectivity NR, Connected without release On, Test Mode On and Test Loop Function On according to TS 38.508-1 [5] clause 4.5. Message contents are defined in clause 7.4.4.3.

7.4.4.2 Test procedure

1. SS transmits PDSCH via PDCCH DCI format 1_1 for C_RNTI to transmit the DL RMC according to Table 7.4.4.1-1. The SS sends downlink MAC padding bits on the DL RMC.
2. SS sends uplink scheduling information for each UL HARQ process via PDCCH DCI format 0_1 for C_RNTI to schedule the UL RMC according to Tables 7.4.4.1-1. Since the UE has no payload data and no loopback data to send, the UE sends uplink MAC padding bits on the UL RMC.
3. Set the Downlink signal level to the value as defined in Table 7.4.5-1. Send uplink power control commands to the UE using 1dB power step size to ensure that the UE output power measured by the test system is within the Uplink power control window, defined as $-\text{MU}$ to $-(\text{MU} + \text{Uplink power control window size})$ dB of the target power level in Table 7.4.5-1 for at least the duration of the Throughput measurement, where:
 - MU is the test system uplink power measurement uncertainty and is specified in Table F.1.3-1 for the carrier frequency f and the channel bandwidth BW
 - Uplink power control window size = 1dB (UE power step size) + 0.7dB (UE power step tolerance) + (Test system relative power measurement uncertainty), where, the UE power step tolerance is specified in TS 38.101-1 [2], Table 6.3.4.3-1 and is 0.7dB for 1dB power step size, and the Test system relative power measurement uncertainty is specified for test case 6.3.4.3 in Table F.1.2-1.
4. Measure the average throughput for a duration sufficient to achieve statistical significance according to Annex H.2

NOTE: The purpose of the Uplink power control window is to ensure that the actual UE output power is no greater than the target power level, and as close as possible to the target power level. The relationship between the Uplink power control window, the target power level and the corresponding possible actual UE Uplink power window is illustrated in Annex F.4.3.

7.4.4.3 Message contents

Message contents are according to TS 38.508-1 [5] subclause 4.6 Table 4.6.3-118 with condition TRANSFORM_PRECODER_ENABLED.

7.4.5 Test requirement

The throughput measurement derived in test procedure shall be $\geq 95\%$ of the maximum throughput of the reference measurement channels as specified in Annex A.3.2 and A.3.3 with parameters specified in Tables 7.4.5-1.

Table 7.4.5-1: Maximum input level

Rx Parameter	Units	Channel bandwidth (MHz)		
		5, 10, 15, 20	25, 30, 35, 40, 45, 50	60, 70, 80, 90, 100
Power in Transmission Bandwidth Configuration ⁴	dBm	-25 ² -TT	-25 + 10log ₁₀ (BW _{Channel} /20) ^{Note 2} -TT	-20 ² -TT
		-27 ^{3,5} -TT	-27 + 10log ₁₀ (BW _{Channel} /20) ^{Note 3,5} -TT	-22 ^{3,5} -TT

NOTE 1: The transmitter shall be set to 4 dB below P_{C_{MAX}L,f,c} at the minimum uplink configuration specified in Table 7.3.2-3 with P_{C_{MAX}L,f,c} as defined in clause 6.2.4.

NOTE 2: Reference measurement channel is A.3.2.3 or A.3.3.3 for 64 QAM.

NOTE 3: Reference measurement channel is A.3.2.4 or A.3.3.4 for 256 QAM.

NOTE 4: Power in transmission bandwidth configuration value is rounded to the nearest 0.5dB value.

NOTE 5: Reference measurement channel is A.3.2.x for 1024 QAM.

Table 7.4.5-2: Void

Table 7.4.5-3: Test Tolerance (Maximum input level)

f ≤ 3.0GHz	3.0GHz < f ≤ 6.0GHz
0.7 dB	1.0 dB

7.4A Maximum input level for CA

7.4A.0 Minimum conformance requirements

7.4A.0.1 Maximum input level for Intra-band contiguous CA

For intra-band contiguous carrier aggregation maximum input level is defined as the maximum mean power received at the UE antenna port, over the Transmission bandwidth configuration of each CC.

The throughput shall be $\geq 95\%$ of the maximum throughput of the reference measurement channels as specified in Annexes A.3.2 and A.3.3 (with one sided dynamic OCNG Pattern OP.1 FDD/TDD as described in Annex A.5.1.1/A.5.2.1) with parameters specified in Table 7.4A.0.1-1 for each component carrier.

Table 7.4A.0.1-1: Maximum input level for Intra-band contiguous CA

Rx Parameter	Units	NR CA Bandwidth Class		
		B	C	D
Power in largest transmission bandwidth configuration CC, P _{largest BW}	dBm	-23 ²	-23 ²	-25 ²
		-25 ³	-25 ³	-27 ³

Power in each other CC	dBm	$P_{\text{largest BW}} + 10 \cdot \log\left\{\frac{(N_{\text{RB},c} \cdot \text{SCS}_c)}{(N_{\text{RB},\text{largest BW}} \cdot \text{SCS}_{\text{largest BW}})}\right\}$
NOTE 1: The transmitter shall be set to 4 dB below $P_{\text{CMAX_L,f,c}}$ at the minimum uplink configuration specified in Table 7.3.2.3-3 with $P_{\text{CMAX_L,f,c}}$ as defined in subclause 6.2.4.3.		
NOTE 2: Reference measurement channel is A.3.2.3 or A.3.3.3 for 64 QAM.		
NOTE 3: Reference measurement channel is A.3.2.4 or A.3.3.4 for 256 QAM.		

7.4A.0.2 Maximum input level for Intra-band non-contiguous CA

For intra-band non-contiguous carrier aggregation with one uplink carrier and two or more downlink sub-blocks, each larger than or equal to 5 MHz, the maximum input level requirements are defined with the uplink configuration in accordance with 7.3A.0.2.2-1. For this uplink configuration, the UE shall meet the requirements for each sub-block as specified subclause 7.4.3 and Table 7.4A.0.1-1 for one component carrier and two component carriers per sub-block, respectively. The throughput of each downlink component carrier shall be $\geq 95\%$ of the maximum throughput of the specified reference measurement channel as specified in Annex A.3.2 and A.3.3 (with one sided dynamic OCNG Pattern OP.1 FDD/TDD as described in Annex A.5.1.1 and A.5.2.1). The requirements apply with all downlink carriers active.

The normative reference for this requirement is TS 38.101-1 [2] clause 7.4A.

7.4A.0.3 Maximum input level for Inter-band CA

For inter-band carrier aggregation with one component carrier per operating band and the uplink assigned to one NR band, the maximum input level is defined with the uplink active on the band(s) other than the band whose downlink is being tested. The UE shall meet the requirements specified in subclause 7.4.3 for each component carrier while all downlink carriers are active.

The throughput shall be $\geq 95\%$ of the maximum throughput of the reference measurement channels as specified in Annexes A.3.2 and A.3.3 (with one sided dynamic OCNG Pattern OP.1 FDD/TDD as described in Annex A.5.1.1/A.5.2.1) for each component carrier.

The normative reference for this requirement is TS 38.101-1 [2] clause 7.4A.

7.4A.1 Maximum input level for CA (2DL CA)

7.4A.1.1 Test purpose

The same test purpose as defined in 7.4.1.

7.4A.1.2 Test applicability

This test case applies to all types of NR UE release 15 and forward that supports 2DL CA.

7.4A.1.3 Minimum conformance requirements

The minimum conformance requirements are defined in clause 7.4A.0.

7.4A.1.4 Test description

7.4A.1.4.1 Initial conditions

Initial conditions are a set of test configurations the UE needs to be tested in and the steps for the SS to take with the UE to reach the correct measurement state. The initial test configurations consist of environmental conditions, test frequencies, test channel bandwidths and sub-carrier spacing based on NR CA configurations specified in clause 5.5A. All of these configurations shall be tested with applicable test parameters for each CA configuration, are shown in table 7.4A.1.4.1-1 or 7.4A.1.4.1-2. The details of the uplink and downlink reference measurement channels (RMC) are specified in Annexes A.2 and A.3. Configurations of PDSCH and PDCCCH before measurement are specified in Annex C.2.

Table 7.4A.1.4.1-1: Test configuration table for Intra-band contiguous CA

Default Conditions					
Test Environment as specified in TS 38.508-1 [5] subclause 4.1			Normal		
Test Frequencies as specified in TS 38.508-1 [5] subclause 4.3.1			Mid range		
Test CC Combination setting (N_{RB_agg}) as specified in Table 5.5A.1-1 for the CA Configuration across bandwidth combination sets supported by the UE.			NOTE 1		
Test SCS as specified in Table 5.3.5-1			Lowest		
Test Parameters					
Test ID	Downlink Configuration			Uplink Configuration	
	CC Mod'n	PCC RB allocation	SCC RB allocation	CC Mod'n	PCC RB allocation
1	CP-OFDM 64QAM	NOTE 1	NOTE 1	DFT-s-OFDM QPSK	NOTE 1
2	CP-OFDM 256QAM	NOTE 1	NOTE 1	DFT-s-OFDM QPSK	NOTE 1
NOTE 1: The specific configuration of uplink and downlink are defined in Table 7.3A.1.4.1-1.					
NOTE 2: In a band where UE supports 4Rx, the test shall be performed only with 4Rx antennas ports connected and 4Rx REFSSENS requirement (Table 7.3.2.5-2) is used in the test requirements.					

Table 7.4A.1.4.1-2: Test configuration table for Inter-band CA

Default Conditions					
Test Environment as specified in TS 38.508-1 [5] subclause 4.1			Normal		
Test Frequencies as specified in TS 38.508-1 [5] subclause 4.3.1			NOTE 1, NOTE 3		
Test CC Combination setting (N_{RB_agg}) as specified in Table 5.5A.3.1-1 for the CA Configuration across bandwidth combination sets supported by the UE.			NOTE 1, NOTE 4		
Test SCS as specified in Table 5.3.5-1			Lowest		
Test Parameters					
Test ID	Downlink Configuration			Uplink Configuration	
	CC Mod'n	PCC RB allocation	SCC RB allocation	CC Mod'n	PCC RB allocation
1	CP-OFDM 64QAM	NOTE 1	NOTE 1	DFT-s-OFDM QPSK	NOTE 1
2	CP-OFDM 256QAM	NOTE 1	NOTE 1	DFT-s-OFDM QPSK	NOTE 1
NOTE 1: The specific configuration of uplink and downlink are defined in Table 7.3A.1.4.1-2. Only test points verifying non-exceptional REFSSENS requirements are used for maximum input level.					
NOTE 2: In a band where UE supports 4Rx, the test shall be performed only with 4Rx antennas ports connected and 4Rx REFSSENS requirement (Table 7.3.2.5-2) is used in the test requirements.					
NOTE 3: For NR band n28, 30MHz test channel bandwidth is tested with Low range test frequencies.					
NOTE 4: If the UE supports multiple CC Combinations in the CA Configuration with the same N_{RB_agg} , only the combination with the highest N_{RB_PCC} is tested.					

Table 7.4A.1.4.1-3: Test configuration table for Intra-band non-contiguous CA

Default Conditions					
Test Environment as specified in TS 38.508-1 [5] subclause 4.1		Normal			
Test Frequencies as specified in TS 38.508-1 [5] subclause 4.3.1		NOTE 1			
Test CC Combination setting (N_{RB_agg}) as specified in Table 5.5A.2-1 for the CA Configuration across bandwidth combination sets supported by the UE.		NOTE 1, NOTE 3			
Test SCS as specified in Table 5.3.5-1		Lowest			
Test Parameters					
Test ID	Downlink Configuration			Uplink Configuration	
	CC Mod'n	PCC RB allocation	SCC RB allocation	CC Mod'n	PCC RB allocation
1	CP-OFDM 64QAM	NOTE 1	NOTE 1	DFT-s-OFDM QPSK	NOTE 1
2	CP-OFDM 256QAM	NOTE 1	NOTE 1	DFT-s-OFDM QPSK	NOTE 1
NOTE 1: The specific configuration of uplink and downlink are defined in Table 7.3A.1.4.1-3. Only test points verifying non-exceptional REFSENS requirements are used for maximum input level.					
NOTE 2: In a band where UE supports 4Rx, the test shall be performed only with 4Rx antennas ports connected and 4Rx REFSENS requirement (Table 7.3.2.5-2) is used in the test requirements.					
NOTE 3: If the UE supports multiple CC Combinations in the CA Configuration with the same N_{RB_agg} , only the combination with the highest N_{RB_PCC} is tested.					

1. Connect the SS to the UE antenna connectors as shown in TS 38.508-1 [5] Annex A, Figure A.3.1.1.3 for TE diagram and section A.3.2 for UE diagram.
2. The parameter settings for the cell are set up according to TS 38.508-1 [5] subclause 4.4.3.
3. Downlink signals are initially set up according to Annex C.0, C.1, C.2, and C.3.1, and uplink signals according to Annex G.0, G.1, G.2, and G.3.1.
4. The DL and UL Reference Measurement Channels are set according to Table 7.4A.1.4.1-1, Table 7.4A.1.4.1-2 or Table 7.4A.1.4.1-3.
5. Propagation conditions are set according to Annex B.0.
6. Ensure the UE is in State RRC_CONNECTED with generic procedure parameters Connectivity *NR*, Connected without release *On*, Test Mode *On* and Test Loop Function *On* according to TS 38.508-1 [5] clause 4.5. Message contents are defined in clause 7.4A.1.4.3.

7.4A.1.4.2 Test procedure

1. Configure SCC according to Annex C.0, C.1 and C.2 for all downlink physical channels.
2. The SS shall configure SCC as per TS 38.508-1 [5] clause 5.5.1. Message contents are defined in clause 7.4A.1.4.3.
3. SS activates SCC by sending the activation MAC-CE (Refer TS 38.321 [18], clauses 5.9, 6.1.3.10). Wait for at least 2 seconds (Refer TS 38.133[19], clause 9.3).
4. SS transmits PDSCH via PDCCH DCI format 1_1 for C_RNTI to transmit the DL RMC according to Table 7.4A.1.4.1-1 for intra-band contiguous CA, 7.4A.1.4.1-2 for inter-band CA or 7.4A.1.4.1-3 for intra-band non-contiguous CA on both PCC and SCC. The SS sends downlink MAC padding bits on the DL RMC.
5. SS sends uplink scheduling information for each UL HARQ process via PDCCH DCI format 0_1 for C_RNTI to schedule the UL RMC according to Tables 7.4A.1.4.1-1 for intra-band contiguous CA, 7.4A.1.4.1-2 for inter-band CA or 7.4A.1.4.1-3 for intra-band non-contiguous CA. Since the UE has no payload data and no loopback data to send, the UE sends uplink MAC padding bits on the UL RMC.
6. Set the Downlink signal level for PCC and SCC to the value as defined in Table 7.4A.1.5-1 for intra-band contiguous CA, Table 7.4A.1.5-2 for inter-band CA or Table 7.4A.1.5-3 for intra-band non-contiguous CA. Send uplink power control commands to the UE using 1dB step size to ensure that the UE output power measured by the test system is within the Uplink power control window, defined as $-MU$ to $-(MU + \text{Uplink power control})$

window size) dB of the target power level in Table 7.4A.1.5-1 for intra-band contiguous CA, Table 7.4A.1.5-2 for inter-band CA or 7.4A.1.5-3 for intra-band non-contiguous CA for at least the duration of the Throughput measurement , where:

- MU is the test system uplink power measurement uncertainty and is specified in Table F.1.3-1 for the carrier frequency f and the channel bandwidth BW
 - Uplink power control window size = 1dB (UE power step size) + 0.7dB (UE power step tolerance) + (Test system relative power measurement uncertainty), where, the UE power step tolerance is specified in TS 38.101-1 [2], Table 6.3.4.3-1 and is 0.7dB for 1dB power step size, and the Test system relative power measurement uncertainty is specified for test case 6.3.4.3 in Table F.1.2-1.
7. For intra-band contiguous and non-contiguous CA: measure the average throughput of each component carrier for a duration sufficient to achieve statistical significance according to Annex H.2A.
- For inter-band CA: measure the average throughput of SCC for a duration sufficient to achieve statistical significance according to Annex H.2A.
8. For Inter-band CA only: Repeat steps from 1 to 7 setting the original PCell as SCell and the original SCell as PCell in the corresponding CA configuration, except for operating bands without uplink band.

7.4A.1.4.3 Message contents

Message contents are according to TS 38.508-1 [5] subclause 4.6 Table 4.6.3-118 with condition TRANSFORM_PRECODER_ENABLED.

7.4A.1.5 Test requirement

The throughput measurement derived in test procedure shall be ≥ 95% of the maximum throughput of the reference measurement channels as specified in Annex A.3 with parameters specified in Table 7.4A.1.5-1 for intra-band contiguous CA or Table 7.4A.1.5-2 for inter-band CA.

Table 7.4A.1.5-1: Maximum input level for Intra-band contiguous CA

Rx Parameter	Units	NR CA Bandwidth Class		
		B	CD	E
Power in largest transmission bandwidth configuration CC, P _{largest BW}	dBm	-23 ² -TT	-23 ² -TT-25 ² -TT	-26 ² -TT
		-25 ³ -TT	-25 ³ -TT-27 ³ -TT	-28 ³ -TT
Power in each other CC	dBm	P _{largest BW} +10*log ₁₀ ((N _{RB,c} *SCS _c)/(N _{RB, largest BW} *SCS _{largest BW})) -TT		

NOTE 1: The transmitter shall be set to 4 dB below P_{CMAX_L,f,c} at the minimum uplink configuration specified in Table 7.3.2.3-3 with P_{CMAX_L,f,c} as defined in subclause 6.2.4.3.
 NOTE 2: Reference measurement channel is A.3.2.3 or A.3.3.3 for 64 QAM.
 NOTE 3: Reference measurement channel is A.3.2.4 or A.3.3.4 for 256 QAM.
 NOTE 4: TT for each frequency is specified in Table 7.4A.1.5-5.

Table 7.4A.1.5-2: Maximum input level for inter-band

Rx Parameter	Units	Channel bandwidth												
		5 MHz	10 MHz	15 MHz	20 MHz	25 MHz	30 MHz	40 MHz	50 MHz	60 MHz	70 MHz	80 MHz	90 MHz	100 MHz
Power in Transmission Bandwidth Configuration	dBm	-25 ² -TT				-24 ² -TT	-23 ² -TT	-22 ² -TT	-21 ² -TT	-20 ² -TT				
		-27 ³ -TT				-26 ³ -TT	-25 ³ -TT	-24 ³ -TT	-23 ³ -TT	-22 ³ -TT				

NOTE 1: The transmitter shall be set to 4dB below P_{CMAX_L} at the minimum uplink configuration specified in Table 7.3.2.3-3 with P_{CMAX_L} as defined in subclause 6.2.4.
 NOTE 2: Reference measurement channel is Annex A.3.2.3/A.3.3.3 for 64-QAM.
 NOTE 3: Reference measurement channel is Annex A.3.2.4/A.3.3.4 for 256-QAM.
 NOTE 4: TT for each frequency is specified in Table 7.4A.1.5-5.

Table 7.4A.1.5-3: Maximum input level for intra-band non-contiguous

Rx Parameter	Units	Channel bandwidth												
		5 MHz	10 MHz	15 MHz	20 MHz	25 MHz	30 MHz	40 MHz	50 MHz	60 MHz	70 MHz	80 MHz	90 MHz	100 MHz
Power in Transmission Bandwidth Configuration	dBm	-25 ² -TT				-24 ² -TT	-23 ² -TT	-22 ² -TT	-21 ² -TT	-20 ² -TT				
		-27 ³ -TT				-26 ³ -TT	-25 ³ -TT	-24 ³ -TT	-23 ³ -TT	-22 ³ -TT				
NOTE 1: The transmitter shall be set to 4dB below P _{CMAX,L} at the minimum uplink configuration specified in Table 7.3.2.3-3 with P _{CMAX,L} as defined in subclause 6.2.4.														
NOTE 2: Reference measurement channel is Annex A.3.2.3/A.3.3.3 for 64-QAM.														
NOTE 3: Reference measurement channel is Annex A.3.2.4/A.3.3.4 for 256-QAM.														
NOTE 4: TT for each frequency is specified in Table 7.4A.1.5-5.														

Table 7.4A.1.5-4: Void**Table 7.4A.1.5-5: Test Tolerance (Maximum input level)**

$f \leq 3.0\text{GHz}$	$3.0\text{GHz} < f \leq 6.0\text{GHz}$
0.7 dB	1.0 dB

7.4A.2 Maximum input level for CA (3DL CA)

7.4A.2.1 Test purpose

The same test purpose as defined in 7.4.1.

7.4A.2.2 Test applicability

This test case applies to all types of NR UE release 15 and forward that supports 3DL CA.

7.4A.2.3 Minimum conformance requirements

The minimum conformance requirements are defined in clause 7.4A.0.

7.4A.2.4 Test description

7.4A.2.4.1 Initial conditions

Initial conditions are a set of test configurations the UE needs to be tested in and the steps for the SS to take with the UE to reach the correct measurement state. The initial test configurations consist of environmental conditions, test frequencies, test channel bandwidths and sub-carrier spacing based on NR CA configurations specified in clause 5.5A. All of these configurations shall be tested with applicable test parameters for each CA configuration, are shown in table 7.4A.2.4.1-1, 7.4A.2.4.1-2 or 7.4A.2.4.1-3. The details of the uplink and downlink reference measurement channels (RMC) are specified in Annexes A.2 and A.3. Configurations of PDSCH and PDCCH before measurement are specified in Annex C.2.

Table 7.4A.2.4.1-1: Test Configuration Table for 3DL CA

Default Conditions						
Test Environment as specified in TS 38.508-1 [5] subclause 4.1		Normal				
Test Frequencies as specified in TS 38.508-1 [5] subclause 4.3.1		Intra-band contiguous: Mid range for PCC and SCCs Inter-band: NOTE 1, NOTE 5 Intra-band contiguous + Inter-band: NOTE 1, NOTE 5 Intra-band non-contiguous + Inter-band: NOTE 1 with Wgap for intra-band non-contiguous defined in table 7.3A.2.4.1-1 (NOTE 5)				
Test CC Combination setting (N_{RB_agg}) as specified in Tables 5.5A.1-1, 5.5A.2-1, or tables in clauses 5.5A.3.x for the CA Configuration across bandwidth combination sets supported by the UE.		NOTE 1, NOTE 6				
Test SCS as specified in Table 5.3.5-1		Lowest for PCC and SCCs				
Network signalling value		NS_01 by default				
Test Parameters						
Test ID	Downlink Configuration			Uplink Configuration		
	CC Mod'n	PCC RB allocation	SCC ₁ RB allocation	SCC ₂ RB allocation	CC Mod'n	PCC RB allocation
Default Test Settings for a CA_nXD Configuration (Intra-band contiguous)						
1	CP-OFDM 64QAM	NOTE 1	NOTE 1	NOTE 1	DFT-s-OFDM QPSK	NOTE 1
2	CP-OFDM 256QAM	NOTE 1	NOTE 1	NOTE 1	DFT-s-OFDM QPSK	NOTE 1
Default Test Settings for a CA_nXA-nYA-nZA Configuration (Inter-band)						
1	CP-OFDM 64QAM	NOTE 1	NOTE 1	NOTE 1	DFT-s-OFDM QPSK	NOTE 1
2	CP-OFDM 256QAM	NOTE 1	NOTE 1	NOTE 1	DFT-s-OFDM QPSK	NOTE 1
Default Test Settings for a CA_nXC-nYA, CA_nYA-nXC, CA_nYA-nXB and CA_nXB-nYA Configurations (Intra-band contiguous + Inter-band)						
1	CP-OFDM 64QAM	NOTE 1	NOTE 1	NOTE 1	DFT-s-OFDM QPSK	NOTE 1
2	CP-OFDM 256QAM	NOTE 1	NOTE 1	NOTE 1	DFT-s-OFDM QPSK	NOTE 1
Default Test Settings for a CA_nX(2A)-nYA Configuration (Intra-band non-contiguous + Inter-band)						
1	CP-OFDM 64QAM	NOTE 1	NOTE 1	NOTE 1	DFT-s-OFDM QPSK	NOTE 1
2	CP-OFDM 256QAM	NOTE 1	NOTE 1	NOTE 1	DFT-s-OFDM QPSK	NOTE 1
NOTE 1: The specific configuration of uplink and downlink are defined in Table 7.3A.2.4.1-1. Only test points verifying non-exceptional REFSSENS requirements are used for maximum input level testing.						
NOTE 2: CA Configuration Test CC Combination test settings are checked separately for each CA Configuration.						
NOTE 3: Inter-band: X,Y,Z correspond to the different bands in the CA Configuration. E.g. for CA_n1A-n3A-n8A, X=1, Y=3, Z=8; Intra-band contiguous + Inter-band: X,Y correspond to the different bands in the CA Configuration, e.g. for CA_1C-3A, X=1,Y=3; Intra-band non-contiguous + Inter-band: X and Y correspond to the different bands in the CA Configuration. E.g. for CA_n1A-n1A-n8A, X=1, Y=8.						
NOTE 4: In a band where UE supports 4Rx, the test shall be performed only with 4Rx antennas ports connected and 4Rx REFSSENS requirement (Table 7.3.2.5-2) is used in the test requirements.						
NOTE 5: For NR band n28, 30MHz test channel bandwidth is tested with Low range test frequencies.						
NOTE 6: If the UE supports multiple CC Combinations in the CA Configuration with the same N_{RB_agg} , only the combination with the highest N_{RB_PCC} is tested.						

Table 7.4A.2.4.1-2: Void**Table 7.4A.2.4.1-3: Void**

1. Connect the SS to the UE antenna connectors as shown in TS 38.508-1 [5] Annex A, Figure A.3.1.1.3 for TE diagram and section A.3.2 for UE diagram.
2. The parameter settings for the cell are set up according to TS 38.508-1 [5] subclause 4.4.3.
3. Downlink signals are initially set up according to Annex C.0, C.1, C.2, and C.3.1, and uplink signals according to Annex G.0, G.1, G.2, and G.3.1.
4. The DL and UL Reference Measurement Channels are set according to Table 7.4A.2.4.1-1.
5. Propagation conditions are set according to Annex B.0.
6. Ensure the UE is in State RRC_CONNECTED with generic procedure parameters Connectivity *NR*, Connected without release *On*, Test Mode *On* and Test Loop Function *On* according to TS 38.508-1 [5] clause 4.5. Message contents are defined in clause 7.4A.2.4.3.

7.4A.2.4.2 Test procedure

1. Configure SCC according to Annex C.0, C.1 and C.2 for all downlink physical channels.
2. The SS shall configure SCC as per TS 38.508-1 [5] clause 5.5.1. Message contents are defined in clause 7.4A.2.4.3.
3. SS activates SCC by sending the activation MAC-CE (Refer TS 38.321 [18], clauses 5.9, 6.1.3.10). Wait for at least 2 seconds (Refer TS 38.133[19], clause 9.3).
4. SS transmits PDSCH via PDCCH DCI format 1_1 for C_RNTI to transmit the DL RMC according to Table 7.4A.2.4.1-1 to Table 7.4A.2.4.1-3 as appropriate for PCC and SCCs. The SS sends downlink MAC padding bits on the DL RMC.
5. SS sends uplink scheduling information for each UL HARQ process via PDCCH DCI format 0_1 for C_RNTI to schedule the UL RMC according to Tables 7.4A.2.4.1-1. Since the UE has no payload data and no loopback data to send, the UE sends uplink MAC padding bits on the UL RMC.
6. Set the Downlink signal level for PCC and SCCs to the value as defined in Table 7.4A.2.5-1 and Table 7.4A.2.5-2 according to the type of CA. Send uplink power control commands to the UE using 1dB step size to ensure that the PCC output power measured by the test system is within the Uplink power control window, defined as $-\text{MU}$ to $-(\text{MU} + \text{Uplink power control window size})$ dB of the target power level in Table 7.4A.2.5-1 or Table 7.4A.2.5-2 as appropriate for at least the duration of the Throughput measurement, where:
 - MU is the test system uplink power measurement uncertainty and is specified in Table F.1.3-1 for the carrier frequency f and the channel bandwidth BW
 - Uplink power control window size = 1dB (UE power step size) + 0.7dB (UE power step tolerance) + (Test system relative power measurement uncertainty), where, the UE power step tolerance is specified in TS 38.101-1 [2], Table 6.3.4.3-1 and is 0.7dB for 1dB power step size, and the Test system relative power measurement uncertainty is specified for test case 6.3.4.3 in Table F.1.2-1.
7. Measure the average throughput for the carrier(s) indicated in table 7.4A.2.4.2-1 for duration sufficient to achieve statistical significance according to Annex H.2A.
8. Repeat steps 6 to 7 for all component carriers indicated in Table 7.4A.2.4.2-1.

Table 7.4A.2.4.2-1: Test repetition and measurement configuration

CA configuration	Test ID (NOTE1)	CA configuration ID in REFSENS	Throughput measured on	Table with test parameters to select
Intra-band contiguous	1,2	1 ⁵	PCC,SCC ₁ , SCC ₂	Table 7.4A.2.5-1
Inter-band	1,2	1 ² , 2 ² , 3 ²	SCC ₁ , SCC ₂	Table 7.4A.2.5-2
Intra-band contiguous + Inter-band	1,2	1 ³	SCC ₂	Table 7.4A.2.5-2
		2 ³	SCC ₁ , SCC ₂	Table 7.4A.2.5-1
Intra-band non-contiguous + Inter-band	1,2	1 ⁴ , 2 ⁴	SCC ₂	Table 7.4A.2.5-2
		3 ⁴	SCC ₁ , SC ₂	Table 7.4A.2.5-2

NOTE 1: Refers to Test IDs in Table 7.4A.2.4.1-1
 NOTE 2: CA configuration ID as defined in "Default Test Settings for a CA_nXA-nYA-nZA Configuration (Inter-band)" in table 7.3A.2.4.1-11.
 NOTE 3: CA configuration ID as defined in "Default Test Settings for a CA_nXC-YA, CA_nYA-nXC, CA_nYA-nXB and CA_nXB-nYA Configurations (Intra-band contiguous + Inter-band)" in table 7.3A.2.4.1-2.
 NOTE 4: CA configuration ID as defined in "Default Test Settings for a CA_nX(2A)-nYA Configuration (Intra-band non-contiguous + Inter-band)" in table 7.3A.2.4.1-1.
 NOTE 5: CA configuration ID as defined in "Default Test Settings for a CA_nXD Configuration (Intra-band contiguous)" in table 7.3A.2.4.1-1.

7.4A.2.4.3 Message contents

Message contents are according to TS 38.508-1 [5] subclause 4.6 Table 4.6.3-118 with condition TRANSFORM_PRECODER_ENABLED.

7.4A.2.5 Test requirement

The throughput measurement derived in test procedure shall be ≥ 95% of the maximum throughput of the reference measurement channels as specified in Annex A.3 with parameters specified in Table 7.4A.2.5-1 and Table 7.4A.2.5-2 as applicable.

Table 7.4A.2.5-1: Maximum input level for 3DL CA (Intra-band contiguous)

Rx Parameter	Units	NR CA Bandwidth Class			
		B	C	D	
Power in largest transmission bandwidth configuration CC, P _{largest BW}	dBm	-23 ² -TT	-23 ² -TT	-25 ² -TT	
		-25 ³ -TT	-25 ³ -TT	-27 ³ -TT	
Power in each other CC	dBm	$P_{largest\ BW} + 10 \cdot \log\{(N_{RB,c} \cdot SCS_c) / (N_{RB, largest\ BW} \cdot SCS_{largest\ BW})\}$			

NOTE 1: The transmitter shall be set to 4 dB below P_{C_{MAX}_L,f,c} at the minimum uplink configuration specified in Table 7.3.2-3 with P_{C_{MAX}_L,f,c} as defined in clause 6.2.4.
 NOTE 2: Reference measurement channel is A.3.2.3 or A.3.3.3 for 64 QAM.
 NOTE 3: Reference measurement channel is A.3.2.4 or A.3.3.4 for 256 QAM.
 NOTE 4: TT for each frequency is specified in Table 7.4A.2.5-3 for each CC.

Table 7.4A.2.5-2: Maximum input level for 3DL CA (Intra-band non-contiguous, Inter-band), per CC

Rx Parameter	Units	Channel bandwidth													
		5 MHz	10 MHz	15 MHz	20 MHz	25 MHz	30 MHz	40 MHz	50 MHz	60 MHz	70 MHz	80 MHz	90 MHz	100 MHz	
Power in Transmission Bandwidth Configuration	dBm	-25 ² -TT				-	-	-	-	-20 ² -TT					
		-27 ³ -TT				24 ² -TT	23 ² -TT	22 ² -TT	21 ² -TT	-22 ³ -TT					

NOTE 1: The transmitter shall be set to 4 dB below P_{CMAX,L,f,c} at the minimum uplink configuration specified in Table 7.3.2-3 with P_{CMAX,L,f,c} as defined in clause 6.2.4.
 NOTE 2: Reference measurement channel is A.3.2.3 or A.3.3.3 for 64 QAM.
 NOTE 3: Reference measurement channel is A.3.2.4 or A.3.3.4 for 256 QAM.
 NOTE 4: TT for each frequency is specified in Table 7.4A.2.5-3 for each CC.

Table 7.4A.2.5-3: Test Tolerance (Maximum input level), per CC

f ≤ 3.0GHz	3.0GHz < f ≤ 6.0GHz
0.7 dB	1.0 dB

7.4A.3 Maximum input level for CA (4DL CA)

7.4A.3.1 Test purpose

The same test purpose as defined in 7.4.1.

7.4A.3.2 Test applicability

This test case applies to all types of NR UE release 15 and forward that supports 4DL CA.

7.4A.3.3 Minimum conformance requirements

The minimum conformance requirements are defined in clause 7.4A.0.

7.4A.3.4 Test description

7.4A.3.4.1 Initial conditions

Initial conditions are a set of test configurations the UE needs to be tested in and the steps for the SS to take with the UE to reach the correct measurement state. The initial test configurations consist of environmental conditions, test frequencies, test channel bandwidths and sub-carrier spacing based on NR CA configurations specified in clause 5.5A. All of these configurations shall be tested with applicable test parameters for each CA configuration, are shown in table 7.4A.3.4.1-1. The details of the uplink and downlink reference measurement channels (RMC) are specified in Annexes A.2 and A.3. Configurations of PDSCH and PDCCH before measurement are specified in Annex C.2.

Table 7.4A.3.4.1-1: Test Configuration Table for 4DL CA

Default Conditions							
Test Environment as specified in TS 38.508-1 [5] subclause 4.1		Normal					
Test Frequencies as specified in TS 38.508-1 [5] subclause 4.3.1		NOTE 1					
Test CC Combination setting (NRB_agg) as specified in Tables 5.5A.1-1, 5.5A.2-1, or tables in clauses 5.5A.3.x for the CA Configuration across bandwidth combination sets supported by the UE.		NOTE 1, NOTE 5					
Test SCS as specified in Table 5.3.5-1		Lowest for PCC and SCCs					
Network signalling value		NS_01 by default					
Test Parameters							
Test ID	Downlink Configuration					Uplink Configuration	
	CC Mod'n	PCC RB allocation	SCC1 RB allocation	SCC2 RB allocation	SCC3 RB allocation	CC Mod'n	PCC RB allocation
Default Test Settings for a CA_nXE Configuration (Intra-band contiguous)							
1	CP-OFDM 64QAM	NOTE 1	NOTE 1			DFT-s-OFDM QPSK	NOTE 1
2	CP-OFDM 256QAM	NOTE 1	NOTE 1			DFT-s-OFDM QPSK	NOTE 1
Default Test Settings for a CA_nXA-nYA-nZA Configuration (Inter-band)							
1	CP-OFDM 64QAM	NOTE 1	NOTE 1			DFT-s-OFDM QPSK	NOTE 1
2	CP-OFDM 256QAM	NOTE 1	NOTE 1			DFT-s-OFDM QPSK	NOTE 1
Default Test Settings for a CA_nXC-nYA-nZA and CA_nXB-nYA-nZA Configurations (Intra-band contiguous + Inter-band)							
1	CP-OFDM 64QAM	NOTE 1	NOTE 1			DFT-s-OFDM QPSK	NOTE 1
2	CP-OFDM 256QAM	NOTE 1	NOTE 1			DFT-s-OFDM QPSK	NOTE 1
Default Test Settings for a CA_nX(2A)-nYA-nZA Configuration (Intra-band non-contiguous + Inter-band)							
1	CP-OFDM 64QAM	NOTE 1	NOTE 1			DFT-s-OFDM QPSK	NOTE 1
2	CP-OFDM 256QAM	NOTE 1	NOTE 1			DFT-s-OFDM QPSK	NOTE 1
Default Test Settings for a CA_nX(2A)-nY(2A) Configuration (Intra-band non-contiguous + Intra-band non-contiguous)							
1	CP-OFDM 64QAM	NOTE 1	NOTE 1			DFT-s-OFDM QPSK	NOTE 1
2	CP-OFDM 256QAM	NOTE 1	NOTE 1			DFT-s-OFDM QPSK	NOTE 1

NOTE 1: The specific configuration of uplink and downlink are defined in Table 7.3A.3.4.1-1. Only test points verifying non-exceptional REFSENS requirements are used for maximum input level testing.
NOTE 2: CA Configuration Test CC Combination test settings are checked separately for each CA Configuration.
NOTE 3: Inter-band: X,Y,Z correspond to the different bands in the CA Configuration. E.g. for CA_n1A-n3A-n8A, X=1, Y=3, Z=8; Intra-band contiguous + Inter-band: X,Y correspond to the different bands in the CA Configuration, e.g. for CA_1C-3A, X=1,Y=3; Intra-band non-contiguous + Inter-band: X and Y correspond to the different bands in the CA Configuration. E.g. for CA_n1A-n1A-n8A, X=1, Y=8.
NOTE 4: In a band where UE supports 4Rx, the test shall be performed only with 4Rx antennas ports connected and 4Rx REFSENS requirement (Table 7.3.2.5-2) is used in the test requirements.
NOTE 5: If the UE supports multiple CC Combinations in the CA Configuration with the same N_{RB_agg} , only the combination with the highest NRB_PCC is tested.

1. Connect the SS to the UE antenna connectors as shown in TS 38.508-1 [5] Annex A, Figure A.3.1.1.3 for TE diagram and section A.3.2 for UE diagram.
2. The parameter settings for the cell are set up according to TS 38.508-1 [5] subclause 4.4.3.
3. Downlink signals are initially set up according to Annex C.0, C.1, C.2, and C.3.1, and uplink signals according to Annex G.0, G.1, G.2, and G.3.1.
4. The DL and UL Reference Measurement Channels are set according to Table 7.4A.3.4.1-1.
5. Propagation conditions are set according to Annex B.0.
6. Ensure the UE is in State RRC_CONNECTED with generic procedure parameters Connectivity *NR*, Connected without release *On*, Test Mode *On* and Test Loop Function *On* according to TS 38.508-1 [5] clause 4.5. Message contents are defined in clause 7.4A.3.4.3.

7.4A.3.4.2 Test procedure

1. Configure SCC according to Annex C.0, C.1 and C.2 for all downlink physical channels.
2. The SS shall configure SCC as per TS 38.508-1 [5] clause 5.5.1. Message contents are defined in clause 7.4A.2.4.3.
3. SS activates SCC by sending the activation MAC-CE (Refer TS 38.321 [18], clauses 5.9, 6.1.3.10). Wait for at least 2 seconds (Refer TS 38.133[19], clause 9.3).
4. SS transmits PDSCH via PDCCH DCI format 1_1 for C_RNTI to transmit the DL RMC according to Table 7.4A.3.4.1-1 as appropriate for PCC and SCCs. The SS sends downlink MAC padding bits on the DL RMC.
5. SS sends uplink scheduling information for each UL HARQ process via PDCCH DCI format 0_1 for C_RNTI to schedule the UL RMC according to Tables 7.4A.3.4.1-1. Since the UE has no payload data and no loopback data to send, the UE sends uplink MAC padding bits on the UL RMC.
6. Set the Downlink signal level for PCC and SCCs to the value as defined in Table 7.4A.3.5-1 and Table 7.4A.3.5-2 according to the type of CA. Send uplink power control commands to the UE using 1dB step size to ensure that the PCC output power measured by the test system is within the Uplink power control window, defined as $-MU$ to $-(MU + \text{Uplink power control window size})$ dB of the target power level in Table 7.4A.3.5-1 or Table 7.4A.3.5-2 as appropriate for at least the duration of the Throughput measurement ,where:
 - MU is the test system uplink power measurement uncertainty and is specified in Table F.1.3-1 for the carrier frequency f and the channel bandwidth BW
 - Uplink power control window size = 1dB (UE power step size) + 0.7dB (UE power step tolerance) + (Test system relative power measurement uncertainty), where, the UE power step tolerance is specified in TS 38.101-1 [2], Table 6.3.4.3-1 and is 0.7dB for 1dB power step size, and the Test system relative power measurement uncertainty is specified for test case 6.3.4.3 in Table F.1.2-1.
7. Measure the average throughput for the component carrier(s) indicated in table 7.4A.3.4.2-1 for duration sufficient to achieve statistical significance according to Annex H.2A.
8. Repeat steps 6 to 7 for all component carriers indicated in Table 7.4A.3.4.2-1.

Table 7.4A.3.4.2-1: Test repetition and measurement configuration

CA configuration	Test ID (NOTE1)	CA configuration ID in REFSSENS	Throughput measured on	Table with test parameters to select
Intra-band contiguous	1,2	1 ⁵	PCC,SCC1, SCC2, SCC3	Table 7.4A.3.5-1
Inter-band	1,2	1 ² , 2 ² , 3 ²	SCC1, SCC2, SCC3	Table 7.4A..5-2
Intra-band contiguous + Inter-band	1,2,3	1 ³	SCC2, SCC3	Table 7.4A. .5-2
		2 ³	SCC1, SCC2, SCC3	Table 7.4A.3.5-1
		3 ³	SCC1, SCC2, SCC3	Table 7.4A.3.5-1
Intra-band non-contiguous + Inter-band	1,2,3	1 ⁴	SCC2, SCC3	Table 7.4A.3.5-2
		2 ⁴	SCC1, SCC2, SCC3	Table 7.4A.3.5-2
		3 ⁴	SCC1, SCC2, SCC3	Table 7.4A.3.5-2
Intra-band non-contiguous + Intra-band non-contiguous	1,2	1	SCC2, SCC3	Table 7.4A.3.5-2
		2	SCC2, SCC3	Table 7.4A.3.5-2

NOTE 1: Refers to Test IDs in Table 7.4A.2.4.1-1
 NOTE 2: CA configuration ID as defined in "Default Test Settings for a CA_nXA-nYA-nZA-nVA Configuration (Inter-band)" in table 7.3A.2.4.1-1.
 NOTE 3: CA configuration ID as defined in "Default Test Settings for a CA_XC-YA-ZA and CA_XB-YA-ZA Configurations (Intra-band contiguous + Inter-band)" in table 7.3A.2.4.1-1.
 NOTE 4: CA configuration ID as defined in "Default Test Settings for a CA_nX(2A)-nYA-ZA Configuration (Intra-band non-contiguous + Inter-band)" in table 7.3A.2.4.1-1.
 NOTE 5: CA configuration ID as defined in "Default Test Settings for a CA_nXE Configuration (Intra-band contiguous)" in table 7.3A.2.4.1-1.
 NOTE 6: CA configuration ID as defined in "Default Test Settings for a CA_nX(2A)-nY(2A) Configuration (Intra-band non-contiguous + Intra-band non-contiguous)" in table 7.3A.2.4.1-1.

7.4A.3.4.3 Message contents

Message contents are according to TS 38.508-1 [5] subclause 4.6 Table 4.6.3-118 with condition TRANSFORM_PRECODER_ENABLED.

7.4A.3.5 Test requirement

The throughput measurement derived in test procedure shall be ≥ 95% of the maximum throughput of the reference measurement channels as specified in Annex A.3 with parameters specified in Table 7.4A.3.5-1 and Table 7.4A.3.5-2 as applicable.

Table 7.4A.3.5-1: Maximum input level for 4DL CA (Intra-band contiguous)

Rx Parameter	Units	NR CA Bandwidth Class		
		B	C	D
Power in largest transmission bandwidth configuration CC, P _{largest BW}	dBm	-23 ² -TT	-23 ² -TT	-25 ² -TT
		-25 ³ -TT	-25 ³ -TT	-27 ³ -TT
Power in each other CC	dBm	$P_{largest\ BW} + 10 \cdot \log\{(N_{RB,c} \cdot SCS_c) / (N_{RB, largest\ BW} \cdot SCS_{largest\ BW})\}$		

NOTE 1: The transmitter shall be set to 4 dB below P_{C_{MAX},L,f,c} at the minimum uplink configuration specified in Table 7.3.2-3 with P_{C_{MAX},L,f,c} as defined in clause 6.2.4.
 NOTE 2: Reference measurement channel is A.3.2.3 or A.3.3.3 for 64 QAM.
 NOTE 3: Reference measurement channel is A.3.2.4 or A.3.3.4 for 256 QAM.
 NOTE 4: TT for each frequency is specified in Table 7.4A.3.5-3 for each CC.

Table 7.4A.3.5-2: Maximum input level for 4DL CA (Intra-band non-contiguous, Inter-band), per CC

Rx Parameter	Units	Channel bandwidth													
		5 MHz	10 MHz	15 MHz	20 MHz	25 MHz	30 MHz	40 MHz	50 MHz	60 MHz	70 MHz	80 MHz	90 MHz	100 MHz	
Power in Transmission Bandwidth Configuration	dBm	-25 ² -TT				-	-	-	-	-20 ² -TT					
		-27 ³ -TT				-	-	-	-	-22 ³ -TT					
NOTE 1: The transmitter shall be set to 4 dB below P _{CMAX_L,f,c} at the minimum uplink configuration specified in Table 7.3.2-3 with P _{CMAX_L,f,c} as defined in clause 6.2.4. NOTE 2: Reference measurement channel is A.3.2.3 or A.3.3.3 for 64 QAM. NOTE 3: Reference measurement channel is A.3.2.4 or A.3.3.4 for 256 QAM. NOTE 4: TT for each frequency is specified in Table 7.4A.3.5-3 for each CC.															

Table 7.4A.3.5-3: Test Tolerance (Maximum input level), per CC

f ≤ 3.0GHz	3.0GHz < f ≤ 6.0GHz
0.7 dB	1.0 dB

7.4D Maximum input level for UL MIMO

7.4D.1 Test purpose

Maximum input level tests the ability of UE that supports UL MIMO to receive data with a given average throughput for a specified reference measurement channel, under conditions of high signal level, ideal propagation and no added noise.

A UE unable to meet the throughput requirement under these conditions will decrease the coverage area near to an e-NodeB.

7.4D.2 Test applicability

This test case applies to all types of NR UE release 15 and forward that support UL MIMO on FDD bands.

7.4D.3 Minimum conformance requirements

For UE with two transmitter antenna connectors in closed-loop spatial multiplexing, the minimum requirements specified in sub-clause 7.4 shall be met with the UL MIMO configurations described in sub-clause 6.2D.1. For UL MIMO, the parameter P_{CMAX_L} is defined as the total transmitter power over the two transmit antenna connectors.

The normative reference for this requirement is TS 38.101-1 [2] clauses 7.4D and 7.4.

7.4D.4 Test description

7.4D.4.1 Initial conditions

Initial conditions are a set of test configurations the UE needs to be tested in and the steps for the SS to take with the UE to reach the correct measurement state.

The initial test configurations consist of environmental conditions, test frequencies, and channel bandwidths based on NR operating bands specified in Table 5.2-1. All of these configurations shall be tested with applicable test parameters for each channel bandwidth, and are shown in Table 7.4D.4.1-1. The details of the uplink and downlink reference measurement channels (RMCs) are specified in Annex A.2 and Annex A.3 respectively. Configurations of PDSCH and PDCCH before measurement are specified in Annex C.2.

Table 7.4D.4.1-1: Test Configuration Table

Initial Conditions			
Test Environment as specified in TS 38.508-1 [5] subclause 4.1		Normal	
Test Frequencies as specified in TS 38.508-1 [5] subclause 4.3.1		Mid range	
Test Channel Bandwidths as specified in TS 38.508-1 [5] subclause 4.3.1		Lowest, Mid, Highest	
Test SCS as specified in Table 5.3.5-1		Lowest	
Test Parameters for Channel Bandwidths			
Downlink Configuration		Uplink Configuration	
Modulation	RB allocation	Modulation	RB allocation
CP-OFDM 64 QAM	NOTE 1	CP-OFDM QPSK	NOTE 2
CP-OFDM 256 QAM	NOTE 1	CP-OFDM QPSK	NOTE 2
NOTE 1: The specific configuration of downlink RB allocation is defined in Table 7.3.2.4.1-2. NOTE 2: The specific configuration of uplink RB allocation is defined in Table 7.3.2.4.1-3. NOTE 3: In a band where UE supports 4Rx, the test shall be performed only with 4Rx antennas ports connected.			

1. Connect the SS to the UE antenna connectors as shown in TS 38.508-1 [5] Annex A Figure A.3.1.1.2 for TE diagram and section A.3.2 for UE diagram.
2. The parameter settings for the cell are set up according to TS 38.508-1 [5] subclause 4.4.3.
3. Downlink signals are initially set up according to Annex C.0, C.1, C.2, and C.3.1, and uplink signals according to Annex G.0, G.1, G.2, and G.3.1.
4. The UL and DL Reference Measurement Channel is set according to Table 7.4D.4.1-1.
5. Propagation conditions are set according to Annex B.0.
6. Ensure the UE is in State RRC_CONNECTED with generic procedure parameters Connectivity *NR*, Connected without release *On*, Test Mode *On* and Test Loop Function *On* according to TS 38.508-1 [5] clause 4.5. Message contents are defined in clause 7.4D.4.3.

7.4D.4.2 Test procedure

1. SS transmits PDSCH via PDCCH DCI format 1_1 for C_RNTI to transmit the DL RMC according to Table 7.4D.4.1-1. The SS sends downlink MAC padding bits on the DL RMC.
2. SS sends uplink scheduling information for each UL HARQ process via PDCCH DCI format 0_1 for C_RNTI to schedule the UL RMC according to Tables 7.4D.4.1-1. Since the UE has no payload data to send, the UE transmits uplink MAC padding bits on the UL RMC. The PDCCH DCI format 0_1 is specified with condition 2TX_UL_MIMO in 38.508-1 [5] subclause 4.3.6.1.1.2
3. Set the Downlink signal level to the value defined in Table 7.4D.5-1. Send uplink power control commands to the UE using 1dB power step size to ensure that the UE output power measured by the test system is within the Uplink power control window, defined as $-(\text{MU})$ to $-(\text{MU} + \text{Uplink power control window size})$ dB of the target power level in Table 7.4D.5-1 for at least the duration of the Throughput measurement, where:
 - MU is the test system uplink power measurement uncertainty and is specified in Table F.1.3-1 for the carrier frequency f and the channel bandwidth BW
 - Uplink power control window size = 1dB (UE power step size) + 0.7dB (UE power step tolerance) + (Test system relative power measurement uncertainty), where, the UE power step tolerance is specified in TS 38.101-1 [2], Table 6.3.4.3-1 and is 0.7dB for 1dB power step size, and the Test system relative power measurement uncertainty is specified for test case 6.3.4.3 in Table F.1.2-1.
4. Measure the average throughput for a duration sufficient to achieve statistical significance according to Annex H.2

NOTE: The purpose of the Uplink power control window is to ensure that the actual UE output power is no greater than the target power level, and as close as possible to the target power level. The relationship between the Uplink power control window, the target power level and the corresponding possible actual UE Uplink power window is illustrated in Annex F.4.3.

Table 7.4D.4-2-1: Void

7.4D.4.3 Message contents

Message contents are according to TS 38.508-1 [5] subclause 4.6 ensuring Table 4.6.3-182 with condition 2TX_UL_MIMO

7.4D.5 Test requirement

The throughput shall be $\geq 95\%$ of the maximum throughput of the reference measurement channels as specified in Annex A.3.2 and A3.3 with parameters specified in Table 7.4D.5-1.

Table 7.4D.5-1 Maximum input level

Rx Parameter	Units	Channel bandwidth												
		5 MHz	10 MHz	15 MHz	20 MHz	25 MHz	30 MHz	40 MHz	50 MHz	60 MHz	70 MHz	80 MHz	90 MHz	100 MHz
Power in Transmission Bandwidth Configuration	dBm	-25 ² -TT				-24 ² -TT	-23 ² -TT	-22 ² -TT	-21 ² -TT	-20 ² -TT				
		-27 ³ -TT				-26 ³ -TT	-25 ³ -TT	-24 ³ -TT	-23 ³ -TT	-22 ³ -TT				

NOTE 1: The transmitter shall be set to 4dB below $P_{\text{CMAX_L}}$ at the minimum uplink configuration specified in Table 7.3.2.3-3 with $P_{\text{CMAX_L}}$ as defined in subclause 6.2.4.

NOTE 2: Reference measurement channel is Annex A.3.2.3 or A.3.3.3 for 64 QAM.

NOTE 3: Reference measurement channel is Annex A.3.2.4 or A.3.3.4 for 256 QAM.

NOTE 4: TT for each frequency is specified in Table 7.4D.5-2

Table 7.4D.5-2: Test Tolerance (Maximum input level)

$f \leq 3.0\text{GHz}$	$3.0\text{GHz} < f \leq 6.0\text{GHz}$
0.7 dB	1.0 dB

7.5 Adjacent channel selectivity

7.5.1 Test purpose

Adjacent channel selectivity (ACS) is a measure of a receiver's ability to receive an NR signal at its assigned channel frequency in the presence of an adjacent channel signal at a given frequency offset from the centre frequency of the assigned channel. ACS is the ratio of the receive filter attenuation on the assigned channel frequency to the receive filter attenuation on the adjacent channel(s).

7.5.2 Test applicability

This test applies to all types of NR UE release 15 and forward.

7.5.3 Minimum conformance requirements

The UE shall fulfil the minimum requirements specified in Table 7.5.3-1 for NR bands with $F_{\text{DL_high}} < 2700$ MHz and $F_{\text{UL_high}} < 2700$ MHz and the minimum requirements specified in Table 7.5.3-2. for NR bands with $F_{\text{DL_low}} \geq 3300$ MHz and $F_{\text{UL_low}} \geq 3300$ MHz. These requirements apply for all values of an adjacent channel interferer up to -25 dBm and for any SCS specified for the channel bandwidth of the wanted signal. However, it is not possible to directly measure the ACS; instead the lower and upper range of test parameters are chosen as in Table 7.5.3-3 and Table 7.5.3-4 for verification of the requirements specified in Table 7.5.3-1 and as in Table 7.5.3-5, and Table 7.5.3-6 for verification of the requirements specified in Table 7.5.3-2. For these test parameters, the throughput shall be $\geq 95\%$ of the maximum throughput of the reference measurement channels as specified in Annexes A.2.2, A.2.3, A.3.2 and A.3.3(with one

sided dynamic OCNNG Pattern OP.1 FDD/TDD for the DL-signal as described in Annex A.5). For operating bands with an unpaired DL part (as noted in Table 5.2-1), the requirements only apply for carriers assigned in the paired part.

Table 7.5.3-1: ACS for NR bands with $F_{DL_high} < 2700$ MHz and $F_{UL_high} < 2700$ MHz

RX parameter	Units	Channel bandwidth (MHz)		
		5, 10	15	20, 25, 30, 35, 40, 45, 50, 60, 70, 80, 90, 100
ACS	dB	33	30	$27 - 10\log_{10}(BW_{Channel}/20)$
NOTE1: ACS value is rounded to the next higher 0.5dB value				

Table 7.5.3-2: ACS for NR bands with $F_{DL_low} \geq 3300$ MHz and $F_{UL_low} \geq 3300$ MHz

RX parameter	Units	Channel bandwidth (MHz)
		10, 15, 20, 25, 30, 35, 40, 45, 50, 60, 70, 80, 90, 100
ACS	dB	33

Table 7.5.3-3: Test parameters for NR bands with $F_{DL_high} < 2700$ MHz and $F_{UL_high} < 2700$ MHz, case 1

RX parameter	Units	Channel bandwidth (MHz)		
		5, 10	15	20, 25, 30, 35, 40, 45, 50, 60, 70, 80, 90, 100
Power in transmission bandwidth configuration	dBm	REFSENS + 14 dB		
$P_{interferer}^4$	dBm	REFSENS + 45.5 dB	REFSENS + 42.5 dB	REFSENS + 39.5 – $10\log_{10}(BW_{Channel}/20)$
$BW_{interferer}$	MHz	5		
$F_{interferer}$ (offset)	MHz	$BW_{Channel}/2 + 2.5$ / $-(BW_{Channel}/2 + 2.5)$		
NOTE 1: The transmitter shall be set to 4 dB below $P_{CMAX_L,f,c}$ at the minimum UL configuration specified in Table 7.3.2.3-3 with $P_{CMAX_L,f,c}$ defined in clause 6.2.4.				
NOTE 2: The absolute value of the interferer offset $F_{interferer}$ (offset) shall be further adjusted to $(\lceil F_{interferer} / SCS \rceil + 0.5) SCS$ MHz with SCS the sub-carrier spacing of the wanted signal in MHz. The interferer is an NR signal with 15 kHz SCS.				
NOTE 3: The interferer consists of the NR interferer RMC specified in Annexes A.3.2.2 and A.3.3.2 with one sided dynamic OCNNG Pattern OP.1 FDD/TDD for the DL-signal as described in Annex A.5.1.1/A.5.2.1.				
NOTE 4: $P_{interferer}$ shall be rounded to the next higher 0.5dB value.				

Table 7.5.3-4: Test parameters for NR bands with $F_{DL_high} < 2700$ MHz and $F_{UL_high} < 2700$ MHz, case 2

RX parameter	Units	Channel bandwidth (MHz)		
		5, 10	15	20, 25, 30, 35, 40, 45, 50, 60, 70, 80, 90, 100
Power in transmission bandwidth configuration ⁴	dBm	-56.5	-53.5	$-50.5 + 10\log_{10}(BW_{Channel} / 20)$
$P_{interferer}$	dBm	-25		
$BW_{interferer}$	MHz	5		
$F_{interferer}$ (offset)	MHz	$\frac{BW_{Channel} / 2 + 2.5}{-(BW_{Channel} / 2 + 2.5)}$		
NOTE 1: The transmitter shall be set to 24 dB below $P_{CMAX_L,f,c}$ at the minimum UL configuration specified in Table 7.3.2.3-3 with $P_{CMAX_L,f,c}$ defined in clause 6.2.4.				
NOTE 2: The absolute value of the interferer offset $F_{interferer}$ (offset) shall be further adjusted to $(\lceil F_{interferer} / SCS \rceil + 0.5) SCS$ MHz with SCS the sub-carrier spacing of the wanted signal in MHz. The interferer is an NR signal with 15 kHz SCS.				
NOTE 3: The interferer consists of the RMC specified in Annexes A.3.2.2 and A.3.3.2 with one sided dynamic OCNG Pattern OP.1 FDD/TDD for the DL-signal as described in Annex A.5.1.1/A.5.2.1				
NOTE 4: Power in transmission bandwidth configuration shall be rounded to the next higher 0.5dB value.				

Table 7.5.3-5: Test parameters for NR bands with $F_{DL_low} \geq 3300$ MHz and $F_{UL_low} \geq 3300$ MHz, case 1

RX parameter	Units	Channel bandwidth (MHz)		
		10, 15, 20, 25, 30, 35, 40, 45, 50, 60, 70, 80, 90, 100		
Power in transmission bandwidth configuration	dBm	REFSENS + 14 dB		
$P_{interferer}$	dBm	REFSENS + 45.5 dB		
$BW_{interferer}$	MHz	$BW_{Channel}$		
$F_{interferer}$ (offset)	MHz	$\frac{BW_{Channel}}{-BW_{Channel}}$		
NOTE 1: The transmitter shall be set to 4 dB below $P_{CMAX_L,f,c}$ at the minimum UL configuration specified in Table 7.3.2.3-3 with $P_{CMAX_L,f,c}$ defined in clause 6.2.4.				
NOTE 2: The absolute value of the interferer offset $F_{interferer}$ (offset) shall be further adjusted to $(\lceil F_{interferer} / SCS \rceil + 0.5) SCS$ MHz with SCS the sub-carrier spacing of the wanted signal in MHz. The interferer is an NR signal with an SCS equal to that of the wanted signal.				
NOTE 3: The interferer consists of the RMC specified in Annexes A.3.2.2 and A.3.3.2 with one sided dynamic OCNG Pattern OP.1 FDD/TDD for the DL-signal as described in Annex A.5.1.1/A.5.2.1.				

Table 7.5.3-6: Test parameters for NR bands with $F_{DL_low} \geq 3300$ MHz and $F_{UL_low} \geq 3300$ MHz, case 2

RX parameter	Units	Channel bandwidth (MHz)		
		10, 15, 20, 25, 30, 35, 40, 45, 50, 60, 70, 80, 90, 100		
Power in transmission bandwidth configuration	dBm	-56.5		
$P_{interferer}$	dBm	-25		
$BW_{interferer}$	MHz	$BW_{Channel}$		
$F_{interferer}$ (offset)	MHz	$\frac{BW_{Channel}}{-BW_{Channel}}$		
NOTE 1: The transmitter shall be set to 24 dB below $P_{CMAX_L,f,c}$ at the minimum UL configuration specified in Table 7.3.2.3-3 with $P_{CMAX_L,f,c}$ defined in clause 6.2.4.				
NOTE 2: The absolute value of the interferer offset $F_{interferer}$ (offset) shall be further adjusted to $(\lceil F_{interferer} / SCS \rceil + 0.5) SCS$ MHz with SCS the sub-carrier spacing of the wanted signal in MHz. The interferer is an NR signal with an SCS equal to that of the wanted signal.				
NOTE 3: The interferer consists of the RMC specified in Annexes A.3.2.2 and A.3.3.2 with one sided dynamic OCNG Pattern OP.1 FDD/TDD for the DL-signal as described in Annex A.5.1.1/A.5.2.1.				

The normative reference for this requirement is TS 38.101-1 [2] clause 7.5.

7.5.4 Test description

7.5.4.1 Initial conditions

Initial conditions are a set of test configurations the UE needs to be tested in and the steps for the SS to take with the UE to reach the correct measurement state.

The initial test configurations consist of environmental conditions, test frequencies, test channel bandwidths and sub-carrier spacing based on NR operating bands specified in Table 5.3.5-1. All of these configurations shall be tested with applicable test parameters for each combination of channel bandwidth and sub-carrier spacing, are shown in table 7.5.4.1-1. The details of the uplink and downlink reference measurement channels (RMC) are specified in Annexes A.2 and A.3. Configuration of PDSCH and PDCCH before measurement are specified in Annex C.2.

Table 7.5.4.1-1: Test Configuration Table

Default Conditions				
Test Environment as specified in TS 38.508-1 [5] subclause 4.1			Normal	
Test Frequencies as specified in TS 38.508-1 [5] subclause 4.3.1			Mid range (NOTE 4)	
Test Channel Bandwidths as specified in TS 38.508-1 [5] subclause 4.3.1			Lowest, Mid, Highest (NOTE 3)	
Test SCS as specified in Table 5.3.5-1			Lowest	
Test Parameters				
Test ID	Downlink Configuration		Uplink Configuration	
	Mod'n	RB allocation	Mod'n	RB allocation
1	CP-OFDM QPSK	NOTE 1	DFT-s-OFDM QPSK	NOTE 1
NOTE 1: The specific configuration of uplink and downlink are defined in Table 7.3.2.4.1-1.				
NOTE 2: In a band where UE supports 4Rx, the test shall be performed only with 4Rx antennas ports connected and 4Rx REFSSENS requirement (Table 7.3.2.5-2) is used in the test requirements.				
NOTE 3: For n70, highest test channel bandwidth shall be Highest UL / Highest DL according to asymmetric channel bandwidths specified in clause 5.3.6.				
NOTE 4: For NR band n28, 30MHz test channel bandwidth is tested with Low range test frequencies.				

1. Connect the SS to the UE antenna connectors as shown in TS 38.508-1 [5] Annex A, in Figure A.3.1.4.1 for TE diagram and section A.3.2 for UE diagram.
2. The parameter settings for the cell are set up according to TS 38.508-1 [5] subclause 4.4.3.
3. Downlink signals are initially set up according to Annex C.0, C.1, C.2, C.3.1, and uplink signals according to Annex G.0, G.1, G.2, G.3.1.
4. The DL and UL Reference Measurement channels are set according to Table 7.5.4.1-1.
5. Propagation conditions are set according to Annex B.0.
6. Ensure the UE is in state RRC_CONNECTED with generic procedure parameters Connectivity NR, Connected without release On, Test Mode On and Test Loop Function On according to TS 38.508-1 [5] clause 4.5. Message content are defined in clause 7.5.4.3.

7.5.4.2 Test procedure

1. SS transmits PDSCH via PDCCH DCI format 1_1 for C_RNTI to transmit the DL RMC according to Table 7.5.4.1-1. The SS sends downlink MAC padding bits on the DL RMC.
2. SS sends uplink scheduling information for each UL HARQ process via PDCCH DCI format 0_1 for C_RNTI to schedule the UL RMC according to Table 7.5.4.1-1. Since the UL has no payload and no loopback data to send the UE sends uplink MAC padding bits on the UL RMC.
3. Set the Downlink signal level to the value as defined in Table 7.5.5-2 or Table 7.5.5-5 as appropriate (Case 1). Send uplink power control commands to the UE using 1dB power step size to ensure that the UE output power measured by the test system is within the Uplink power control window, defined as -MU to -(MU + Uplink

power control window size) dB of the target power level in Table 7.5.5-2 or Table 7.5.5-5 for at least the duration of the Throughput measurement, where:

- MU is the test system uplink power measurement uncertainty and is specified in Table F.1.3-1 for the carrier frequency f and the channel bandwidth BW
 - Uplink power control window size = 1dB (UE power step size) + 0.7dB (UE power step tolerance) + (Test system relative power measurement uncertainty), where, the UE power step tolerance is specified in TS 38.101-1 [2], Table 6.3.4.3-1 and is 0.7dB for 1dB power step size, and the Test system relative power measurement uncertainty is specified in Table F.1.3-1.
4. Set the Interferer signal level to the value as defined in Table 7.5.5-2 or Table 7.5.5-5 as appropriate (Case 1) and frequency below the wanted signal, using a modulated interferer bandwidth as defined in Annex D.
 5. Measure the average throughput for a duration sufficient to achieve statistical significance according to Annex H.
 6. Repeat steps from 3 to 5, using an interfering signal above the wanted signal in Case 1 at step 4.
 7. Set the Downlink signal level to the value as defined in Table 7.5.5-3 or Table 7.5.5-6 as appropriate (Case 2). Send uplink power control commands to the UE using 1dB power step size to ensure that the UE output power measured by the test system is within the Uplink power control window, defined as $-\text{MU}$ to $-(\text{MU} + \text{Uplink power control window size})$ dB of the target power level in Table 7.5.5-3 or Table 7.5.5-6 for at least the duration of the Throughput measurement, where MU and Uplink power control window size are defined above.
 8. Set the Interferer signal level to the value as defined in Table 7.5.5-3 or Table 7.5.5-6 as appropriate (Case 2) and frequency below the wanted signal, using a modulated interferer bandwidth as defined in Annex D.
 9. Measure the average throughput for a duration sufficient to achieve statistical significance according to Annex H.
 10. Repeat steps from 7 to 9, using an interfering signal above the wanted signal in Case 2 at step 8.
 11. Repeat for applicable channel bandwidths and operating band combinations in both Case 1 and Case 2.

NOTE: The purpose of the Uplink power control window is to ensure that the actual UE output power is no greater than the target power level, and as close as possible to the target power level. The relationship between the Uplink power control window, the target power level and the corresponding possible actual UE Uplink power window is illustrated in Annex F.4.3.

7.5.4.3 Message contents

Message contents are according to TS 38.508-1 [5] subclause 4.6 with TRANSFORM_PRECODER_ENABLED condition in Table 4.6.3-118 PUSCH-Config.

7.5.5 Test requirement

For NR bands with $F_{\text{DL_high}} < 2700$ MHz and $F_{\text{UL_high}} < 2700$ MHz, the throughput measurement derived in test procedure shall be $\geq 95\%$ of the maximum throughput of the reference measurement channels as specified in Annexes A.2.2, A.2.3, A.3.2 and A.3.3 (with one sided dynamic OCNG Pattern OP.1 FDD/TDD for the DL-signal as described in Annex A.5.1.1/A.5.2.1) with parameters specified in Tables 7.5.5-2 and 7.5.5-3.

Table 7.5.5-1: ACS for NR bands with $F_{\text{DL_high}} < 2700$ MHz and $F_{\text{UL_high}} < 2700$ MHz

RX parameter	Units	Channel bandwidth (MHz)		
		5, 10	15	20, 25, 30, 35, 40, 45, 50, 60, 70, 80, 90, 100
ACS	dB	33	30	$27 - 10\log_{10}(\text{BW}_{\text{Channel}}/20)$
NOTE1: ACS value is rounded to the next higher 0.5dB value				

Table 7.5.5-2: Test parameters for NR bands with $F_{DL_high} < 2700$ MHz and $F_{UL_high} < 2700$ MHz, case 1

RX parameter	Units	Channel bandwidth (MHz)		
		5, 10	15	20, 25, 30, 35, 40, 45, 50, 60, 70, 80, 90, 100
Power in transmission bandwidth configuration	dBm	REFSENS + 14 dB		
$P_{interferer}^4$	dBm	REFSENS + 45.5 dB	REFSENS + 42.5 dB	REFSENS + 39.5 – $10\log_{10}(BW_{Channel}/20)$
$BW_{interferer}$	MHz	5		
$F_{interferer}$ (offset)	MHz	$BW_{Channel}/2 + 2.5$ / $-(BW_{Channel}/2 + 2.5)$		
NOTE 1: The transmitter shall be set to 4 dB below $P_{CMAX_L,f,c}$ at the minimum UL configuration specified in Table 7.3.2.3-3 with $P_{CMAX_L,f,c}$ defined in clause 6.2.4.				
NOTE 2: The absolute value of the interferer offset $F_{interferer}$ (offset) shall be further adjusted to $(\lceil F_{interferer} / SCS \rceil + 0.5)SCS$ MHz with SCS the sub-carrier spacing of the wanted signal in MHz. The interferer is an NR signal with 15 kHz SCS.				
NOTE 3: The interferer consists of the NR interferer RMC specified in Annexes A.3.2.2 and A.3.3.2 with one sided dynamic OCNG Pattern OP.1 FDD/TDD for the DL-signal as described in Annex A.5.1.1/A.5.2.1.				
NOTE 4: $P_{interferer}$ shall be rounded to the next higher 0.5dB value.				

Table 7.5.5-3: Test parameters for NR bands with $F_{DL_high} < 2700$ MHz and $F_{UL_high} < 2700$ MHz, case 2

RX parameter	Units	Channel bandwidth (MHz)		
		5, 10	15	20, 25, 30, 35, 40, 45, 50, 60, 70, 80, 90, 100
Power in transmission bandwidth configuration ⁴	dBm	-56.5	-53.5	$-50.5 + 10\log_{10}(BW_{Channel}/20)$
$P_{interferer}$	dBm	-25		
$BW_{interferer}$	MHz	5		
$F_{interferer}$ (offset)	MHz	$BW_{Channel}/2 + 2.5$ / $-(BW_{Channel}/2 + 2.5)$		
NOTE 1: The transmitter shall be set to 24 dB below $P_{CMAX_L,f,c}$ at the minimum UL configuration specified in Table 7.3.2.3-3 with $P_{CMAX_L,f,c}$ defined in clause 6.2.4.				
NOTE 2: The absolute value of the interferer offset $F_{interferer}$ (offset) shall be further adjusted to $(\lceil F_{interferer} / SCS \rceil + 0.5)SCS$ MHz with SCS the sub-carrier spacing of the wanted signal in MHz. The interferer is an NR signal with 15 kHz SCS.				
NOTE 3: The interferer consists of the RMC specified in Annexes A.3.2.2 and A.3.3.2 with one sided dynamic OCNG Pattern OP.1 FDD/TDD for the DL-signal as described in Annex A.5.1.1/A.5.2.1				
NOTE 4: Power in transmission bandwidth configuration shall be rounded to the next higher 0.5dB value.				

For NR bands with $F_{DL_high} \geq 3300$ MHz and $F_{UL_high} \geq 3300$ MHz, the throughput measurement derived in test procedure shall be $\geq 95\%$ of the maximum throughput of the reference measurement channels as specified in [Annexes A.2.2, A.2.3 and A.3.2 (with one sided dynamic OCNG Pattern OP.1 FDD/TDD for the DL-signal as described in Annex A.5.1.1/A.5.2.1)] with parameters specified in Tables 7.5.5-5 and 7.5.5-6.

Table 7.5.5-4: ACS for NR bands with $F_{DL_low} \geq 3300$ MHz and $F_{UL_low} \geq 3300$ MHz

RX parameter	Units	Channel bandwidth (MHz)
		10, 15, 20, 25, 30, 35, 40, 45, 50, 60, 70, 80, 90, 100
ACS	dB	33

Table 7.5.5-5: Test parameters for NR bands with $F_{DL_low} \geq 3300$ MHz and $F_{UL_low} \geq 3300$ MHz, case 1

RX parameter	Units	Channel bandwidth (MHz)
		10, 15, 20, 25, 30, 35, 40, 45, 50, 60, 70, 80, 90, 100
Power in transmission bandwidth configuration	dBm	REFSENS + 14 dB
$P_{interferer}$	dBm	REFSENS + 45.5 dB
$BW_{interferer}$	MHz	$BW_{Channel}$
$F_{interferer}$ (offset)	MHz	$BW_{Channel}$ / $-BW_{Channel}$
NOTE 1: The transmitter shall be set to 4 dB below $P_{CMAX_L,f,c}$ at the minimum UL configuration specified in Table 7.3.2.3-3 with $P_{CMAX_L,f,c}$ defined in clause 6.2.4.		
NOTE 2: The absolute value of the interferer offset $F_{interferer}$ (offset) shall be further adjusted to $(\lceil F_{interferer} / SCS \rceil + 0.5) SCS$ MHz with SCS the sub-carrier spacing of the wanted signal in MHz. The interferer is an NR signal with an SCS equal to that of the wanted signal.		
NOTE 3: The interferer consists of the RMC specified in Annexes A.3.2.2 and A.3.3.2 with one sided dynamic OCNG Pattern OP.1 FDD/TDD for the DL-signal as described in Annex A.5.1.1/A.5.2.1.		

Table 7.5.5-6: Test parameters for NR bands with $F_{DL_low} \geq 3300$ MHz and $F_{UL_low} \geq 3300$ MHz, case 2

RX parameter	Units	Channel bandwidth (MHz)
		10, 15, 20, 25, 30, 35, 40, 45, 50, 60, 70, 80, 90, 100
Power in transmission bandwidth configuration	dBm	-56.5
$P_{interferer}$	dBm	-25
$BW_{interferer}$	MHz	$BW_{Channel}$
$F_{interferer}$ (offset)	MHz	$BW_{Channel}$ / $-BW_{Channel}$
NOTE 1: The transmitter shall be set to 24 dB below $P_{CMAX_L,f,c}$ at the minimum UL configuration specified in Table 7.3.2.3-3 with $P_{CMAX_L,f,c}$ defined in clause 6.2.4.		
NOTE 2: The absolute value of the interferer offset $F_{interferer}$ (offset) shall be further adjusted to $(\lceil F_{interferer} / SCS \rceil + 0.5) SCS$ MHz with SCS the sub-carrier spacing of the wanted signal in MHz. The interferer is an NR signal with an SCS equal to that of the wanted signal.		
NOTE 3: The interferer consists of the RMC specified in Annexes A.3.2.2 and A.3.3.2 with one sided dynamic OCNG Pattern OP.1 FDD/TDD for the DL-signal as described in Annex A.5.1.1/A.5.2.1.		

Table 7.5.5-7: Void

7.5A Adjacent channel selectivity for CA

7.5A.0 Minimum conformance requirements

7.5A.0.1 Adjacent channel selectivity for Intra-band contiguous CA

For intra-band contiguous carrier aggregation the downlink SCC(s) shall be configured at nominal channel spacing to the PCC. The UE shall fulfil the minimum requirement specified in Table 7.5A.0.1-1 and 7.5A.0.1-1a for an adjacent channel interferer on either side of the aggregated downlink signal at a specified frequency offset and for an interferer power up to -25 dBm.

The throughput of each carrier shall be $\geq 95\%$ of the maximum throughput of the reference measurement channels as specified in Annexes A.2.2, A.2.3, A.3.2 and A.3.3 (with one sided dynamic OCNG Pattern OP.1 FDD/TDD for the DL-signal as described in Annex A.5.1.1/A.5.2.1) with parameters specified in Tables 7.5A.0.1-2, 7.5A.0.1-2a, 7.5A.0.1-3 and 7.5A.0.1-3a.

Table 7.5A.0.1-1: ACS for intra-band contiguous CA with $F_{DL_low} \geq 3300$ MHz and $F_{UL_low} \geq 3300$ MHz

Rx Parameter	Units	CA Bandwidth Class		
		B	C	D
ACS	dB	26.0	33.0	25.2

Table 7.5A.0.1-1a: ACS for intra-band contiguous CA with $F_{DL_low} < 2700$ MHz and $F_{UL_low} < 2700$ MHz

Rx Parameter	Units	CA Bandwidth Class	
		B	C
ACS	dB	20.0	17.0

Table 7.5A.0.1-2: Test parameters for intra-band contiguous CA with $F_{DL_low} \geq 3300$ MHz and $F_{UL_low} \geq 3300$ MHz, case 1

Rx Parameter	Units	CA Bandwidth Class		
		B	C	D
Pw in Transmission Bandwidth Configuration, per CC	dBm	REFSENS + 14 dB	REFSENS + 14 dB	REFSENS + 14 dB
$P_{Interferer}$	dBm	Aggregated power + 24.5 dB	Aggregated power + 31.5 dB	Aggregated power + 23.7 dB
$BW_{Interferer}$	MHz	20	$BW_{channel\ CA}$	50
$F_{Interferer}$ (offset)	MHz	$10 + F_{offset}$ / $-10 - F_{offset}$	$BW_{channel\ CA}$ / $-BW_{channel\ CA}$	$25 + F_{offset}$ / $-25 - F_{offset}$
NOTE 1: The transmitter shall be set to 4 dB below $P_{C_{MAX_L,f,c}}$ at the minimum UL configuration specified in Table 7.3.2-3 with $P_{C_{MAX_L,f,c}}$ defined in clause 6.2.4.				
NOTE 2: The absolute value of the interferer offset $F_{interferer}$ (offset) shall be further adjusted to $(\lceil F_{interferer} / SCS \rceil + 0.5) SCS$ MHz with SCS the sub-carrier spacing of the wanted signal in MHz. The interferer is an NR signal with an SCS equal to that of the wanted signal.				
NOTE 3: The interferer consists of the RMC specified in Annexes A.3.2.2 and A.3.3.2 with one sided dynamic OCNG Pattern OP.1 FDD/TDD for the DL-signal as described in Annex A.5.1.1/A.5.2.1.				

Table 7.5A.0.1-2a: Test parameters for intra-band contiguous CA with $F_{DL_low} < 2700$ MHz and $F_{UL_low} < 2700$ MHz, case 1

Rx Parameter	Units	CA Bandwidth Class	
		B	C
Pw in Transmission Bandwidth Configuration, per CC	dBm	REFSENS + 14 dB	REFSENS + 14 dB
$P_{Interferer}$	dBm	Aggregated power + 18.5dB	Aggregated power + 15.5dB
$BW_{Interferer}$	MHz	5	5
$F_{Interferer}$ (offset)	MHz	$2.5 + F_{offset}$ / $-2.5 - F_{offset}$	$2.5 + F_{offset}$ / $-2.5 - F_{offset}$
NOTE 1: The transmitter shall be set to 4 dB below $P_{C_{MAX_L,f,c}}$ at the minimum UL configuration specified in Table 7.3.2-3 with $P_{C_{MAX_L,f,c}}$ defined in clause 6.2.4.			
NOTE 2: The absolute value of the interferer offset $F_{interferer}$ (offset) shall be further adjusted to $(\lceil F_{interferer} / SCS \rceil + 0.5) SCS$ MHz with SCS the sub-carrier spacing of the wanted signal in MHz. The interferer is an NR signal with an SCS equal to that of the wanted signal.			
NOTE 3: The interferer consists of the RMC specified in Annexes A.3.2.2 and A.3.3.2 with one sided dynamic OCNG Pattern OP.1 FDD/TDD for the DL-signal as described in Annex A.5.1.1/A.5.2.1.			

Table 7.5A.0.1-3: Test parameters for intra-band contiguous CA with $F_{DL_low} \geq 3300$ MHz and $F_{UL_low} \geq 3300$ MHz, case 2

Rx Parameter	Units	CA Bandwidth Class		
		B	C	D
Pw in Transmission Bandwidth Configuration, per CC	dBm	-49.5 + $10\log(N_{RB,c}/N_{RB_agg})$	-56.5	-48.7 + $10\log(N_{RB,c}/N_{RB_agg})$
$P_{Interferer}$	dBm	-25	-25	-25
$BW_{Interferer}$	MHz	20	$BW_{channel\ CA}$	50
$F_{Interferer}$ (offset)	MHz	$10 + F_{offset}$ / $-10 - F_{offset}$	$BW_{channel\ CA}$ / $-BW_{channel\ CA}$	$25 + F_{offset}$ / $-25 - F_{offset}$
NOTE 1: The transmitter shall be set to 24 dB below $P_{CMAX_L,f,c}$ at the minimum UL configuration specified in Table 7.3.2-3 with $P_{CMAX_L,f,c}$ defined in clause 6.2.4.				
NOTE 2: The absolute value of the interferer offset $F_{interferer}$ (offset) shall be further adjusted to $(\lceil F_{interferer} / SCS \rceil + 0.5) SCS$ MHz with SCS the sub-carrier spacing of the wanted signal in MHz. The interferer is an NR signal with an SCS equal to that of the wanted signal.				
NOTE 3: The interferer consists of the RMC specified in Annexes A.3.2.2 and A.3.3.2 with one sided dynamic OCNG Pattern OP.1 FDD/TDD for the DL-signal as described in Annex A.5.1.1/A.5.2.1.				

Table 7.5A.0.1-3a: Test parameters for intra-band contiguous CA with $F_{DL_low} < 2700$ MHz and $F_{UL_low} < 2700$ MHz, case 2

Rx Parameter	Units	CA Bandwidth Class	
		B	C
Pw in Transmission Bandwidth Configuration, per CC	dBm	-43.5+ $10\log(N_{RB,c}/N_{RB_agg})$	-40.5+ $10\log(N_{RB,c}/N_{RB_agg})$
$P_{Interferer}$	dBm	-25	-25
$BW_{Interferer}$	MHz	5	5
$F_{Interferer}$ (offset)	MHz	$2.5+ F_{offset}$ / $-2.5- F_{offset}$	$2.5+ F_{offset}$ / $-2.5- F_{offset}$
NOTE 1: The transmitter shall be set to 24 dB below $P_{CMAX_L,f,c}$ at the minimum UL configuration specified in Table 7.3.2-3 with $P_{CMAX_L,f,c}$ defined in clause 6.2.4.			
NOTE 2: The absolute value of the interferer offset $F_{interferer}$ (offset) shall be further adjusted to $(\lceil F_{interferer} / SCS \rceil + 0.5) SCS$ MHz with SCS the sub-carrier spacing of the wanted signal in MHz. The interferer is an NR signal with an SCS equal to that of the wanted signal.			
NOTE 3: The interferer consists of the RMC specified in Annexes A.3.2.2 and A.3.3.2 with one sided dynamic OCNG Pattern OP.1 FDD/TDD for the DL-signal as described in Annex A.5.1.1/A.5.2.1.			

7.5A.0.2 Adjacent channel selectivity Intra-band non-contiguous CA

For intra-band non-contiguous carrier aggregation with $F_{DL_low} < 2700$ MHz and $F_{UL_low} < 2700$ MHz with one uplink carrier and two or more downlink sub-blocks, each larger than or equal to 5 MHz, the adjacent channel selectivity requirements are defined with the uplink configuration in accordance with Table 7.3A.0.2.2-1. For this uplink configuration, the UE shall meet the requirements for each sub-block as specified in subclauses 7.5.3 and 7.5A.0.1 for one component carrier and two component carriers per sub-block, respectively. The UE shall fulfil the minimum requirements all values of a single adjacent channel interferer in-gap and out-of-gap up to a -25 dBm interferer power while all downlink carriers are active. For the lower range of test parameters (Case 1), the interferer power $P_{interferer}$ shall be set to the maximum of the levels given by the carriers of the respective sub-blocks as specified in Table 7.5.3-3 and Table 7.5A.0.1-2a for one component carrier and two component carriers per sub-block, respectively. The wanted signal power levels for the carriers of each sub-block shall then be adjusted relative to $P_{interferer}$ in accordance with the ACS requirement for each sub-block (Table 7.5.3-1 and Table 7.5A.0.1-1a). For the upper range of test parameters (Case 2) for which the interferer power $P_{interferer}$ is -25 dBm (Table 7.5.3-4 and Table 7.5A.0.1-3a) the wanted signal power levels for the carriers of each sub-block shall be adjusted relative to $P_{interferer}$ like for Case 1.

For intra-band non-contiguous carrier aggregation with $F_{DL_low} \geq 3300$ MHz and $F_{UL_low} \geq 3300$ MHz with one uplink carrier and two or more downlink sub-blocks, each larger than or equal to 5 MHz, the adjacent channel selectivity requirements are defined with the uplink configuration in accordance with Table 7.3A.0.2.2-1. For this uplink configuration, the UE shall meet the requirements for each sub-block as specified in subclauses 7.5.3 and 7.5A.0.1 for

one component carrier and two component carriers per sub-block, respectively. The UE shall fulfil the minimum requirements all values of a single adjacent channel interferer in-gap and out-of-gap up to a -25 dBm interferer power while all downlink carriers are active. For the lower range of test parameters (Case 1), the interferer power $P_{\text{interferer}}$ shall be set to the maximum of the levels given by the carriers of the respective sub-blocks as specified in Table 7.5.3-3 and Table 7.5A.0.1-2 for one component carrier and two component carriers per sub-block, respectively. The wanted signal power levels for the carriers of each sub-block shall then be adjusted relative to $P_{\text{interferer}}$ in accordance with the ACS requirement for each sub-block (Table 7.5.3-1 and Table 7.5A.0.1-1). For the upper range of test parameters (Case 2) for which the interferer power $P_{\text{interferer}}$ is -25 dBm (Table 7.5.3 and Table 7.5A.0.1-3) the wanted signal power levels for the carriers of each sub-block shall be adjusted relative to $P_{\text{interferer}}$ like for Case 1.

The throughput of each carrier shall be ≥ 95 % of the maximum throughput of the reference measurement channels as specified in Annexes A.2.2, A.2.3, A.3.2, and A.3.3 (with one sided dynamic OCNG Pattern OP.1 FDD/TDD for the DL-signal as described in Annex A.5.1.1/A.5.2.1).

7.5A.0.3 Adjacent channel selectivity Inter-band CA

For inter-band carrier aggregation with one component carrier per operating band and the uplink assigned to one NR band, the adjacent channel requirements are defined with the uplink active on the band(s) other than the band whose downlink is being tested. For NR CA configurations including an operating band without uplink operation or an operating band with an unpaired DL part (as noted in Table 5.2-1), the requirements for all downlinks shall be met with the single uplink carrier active in each band capable of UL operation. The UE shall meet the requirements specified in subclause 7.5.3 for each component carrier while all downlink carriers are active.

The throughput of each carrier shall be ≥ 95 % of the maximum throughput of the reference measurement channels as specified in Annexes A.2.2, A.2.3, A.3.2 and A.3.3 (with one sided dynamic OCNG Pattern OP.1 FDD/TDD for the DL-signal as described in Annex A.5.1.1/A.5.2.1).

7.5A.1 Adjacent channel selectivity for CA (2DL CA)

7.5A.1.1 Test Purpose

Adjacent channel selectivity for 2DL CA verifies the receiver's ability to receive a wanted 2DL carrier aggregated at its assigned channel frequency in the presence of an adjacent channel signal at a given frequency offset from the centre frequency of the assigned channel.

7.5A.1.2 Test Applicability

This test case applies to all types of NR UE release 15 and forward that support 2DL CA.

7.5A.1.3 Minimum Conformance Requirements

The minimum conformance requirements are defined in clause 7.5A.0.

7.5A.1.4 Test Description

7.5A.1.4.1 Initial Conditions

Initial conditions are a set of test configurations the UE needs to be tested in and the steps for the SS to take with the UE to reach the correct measurement state.

The initial test configurations consist of environmental conditions, test frequencies, test channel bandwidths and sub-carrier spacing based on NR CA configuration specified in clause 5.5A. All of these configurations shall be tested with applicable test parameters for each CA configuration, are shown in Table 7.5A.1.4.1-1, Table 7.5A.1.4.1-2 or Table 7.5A.1.4.1-3. The details of the uplink and downlink reference measurement channels (RMC) are specified in Annexes A.2 and A.3. Configuration of PDSCH and PDCCH before measurement are specified in Annex C.2.

Table 7.5A.1.4.1-1: Test Configuration Table for intra-band contiguous 2DL CA

Default Conditions					
Test Environment as specified in TS 38.508-1 [5] subclause 4.1			Normal		
Test Frequencies as specified in TS 38.508-1 [5] subclause 4.3.1			Mid range		
Test CC Combination setting (N_{RB_agg}) as specified in Table 5.5A.1-1 for the CA Configuration across bandwidth combination sets supported by the UE.			Lowest N_{RB_agg} , Highest N_{RB_agg} NOTE 3		
Test SCS as specified in Table 5.3.5-1			Lowest		
Test Parameters					
Test ID	Downlink Configuration			Uplink Configuration	
	CC Mod'n	PCC RB allocation	SCC RB allocation	CC Mod'n	PCC RB allocation
1	CP-OFDM QPSK	NOTE 1	NOTE 1	DFT-s-OFDM QPSK	NOTE 1
NOTE 1: The specific configuration of uplink and downlink are defined in Table 7.3A.1.4.1-1.					
NOTE 2: In a band where UE supports 4Rx, the test shall be performed only with 4Rx antennas ports connected and 4Rx REFSSENS requirement (Table 7.3.2.5-2) is used in the test requirements.					
NOTE 3: If the UE supports multiple CC Combinations in the CA Configuration with the same N_{RB_agg} , only the combination with the highest N_{RB_PCC} is tested					

Table 7.5A.1.4.1-2: Test Configuration Table for inter-band 2DL CA

Default Conditions					
Test Environment as specified in TS 38.508-1 [5] subclause 4.1			Normal		
Test Frequencies as specified in TS 38.508-1 [5] subclause 4.3.1			NOTE 1, NOTE 3		
Test CC Combination setting (N_{RB_agg}) as specified in Table 5.5A.3.1-1 for the CA Configuration across bandwidth combination sets supported by the UE.			Highest N_{RB_agg} NOTE 4		
Test SCS as specified in Table 5.3.5-1			Lowest		
Test Parameters					
Test ID	Downlink Configuration			Uplink Configuration	
	CC Mod'n	PCC RB allocation	SCC RB allocation	CC Mod'n	PCC RB allocation
1	CP-OFDM QPSK	NOTE 1	NOTE 1	DFT-s-OFDM QPSK	NOTE 1
NOTE 1: The specific configuration of uplink and downlink are defined in Table 7.3A.1.4.1-2.					
NOTE 2: In a band where UE supports 4Rx, the test shall be performed only with 4Rx antennas ports connected and 4Rx REFSSENS requirement (Table 7.3.2.5-2) is used in the test requirements.					
NOTE 3: For NR band n28, 30MHz test channel bandwidth is tested with Low range test frequencies.					
NOTE 4: If the UE supports multiple CC Combinations in the CA Configuration with the same N_{RB_agg} , only the combination with the highest N_{RB_PCC} is tested.					

Table 7.5A.1.4.1-3: Test Configuration Table for intra-band non-congruous 2DL CA

Default Conditions					
Test Environment as specified in TS 38.508-1 [5] subclause 4.1			Normal		
Test Frequencies as specified in TS 38.508-1 [5] subclause 4.3.1			NOTE 1		
Test CC Combination setting (N_{RB_agg}) as specified in Table 5.5A.2-1 for the CA Configuration across bandwidth combination sets supported by the UE.			NOTE 1, NOTE 3		
Test SCS as specified in Table 5.3.5-1			Lowest		
Test Parameters					
Test ID	Downlink Configuration			Uplink Configuration	
	CC Mod'n	PCC RB allocation	SCC RB allocation	CC Mod'n	PCC RB allocation
1	CP-OFDM QPSK	NOTE 1	NOTE 1	DFT-s-OFDM QPSK	NOTE 1
NOTE 1: The specific configuration of uplink and downlink are defined in Table 7.3A.1.4.1-3. NOTE 2: In a band where UE supports 4Rx, the test shall be performed only with 4Rx antennas ports connected and 4Rx REFSSENS requirement (Table 7.3.2.5-2) is used in the test requirements. NOTE 3: If the UE supports multiple CC Combinations in the CA Configuration with the same N_{RB_agg} , only the combination with the highest N_{RB_PCC} is tested.					

1. Connect the SS to the UE antenna connectors as shown in TS 38.508-1 [5] Annex A, in Figure A.3.1.4.7 for TE diagram and section A.3.2 for UE diagram.
2. The parameter settings for the cell are set up according to TS 38.508-1 [5] subclause 4.4.3.
3. Downlink signals are initially set up according to Annex C.0, C.1, C.2, C.3.1, and uplink signals according to Annex G.0, G.1, G.2, G.3.1.
4. The DL and UL Reference Measurement channels are set according to Table 7.5A.1.4.1-1, Table 7.5A.1.4.1-2 or Table 7.5A.1.4.1-3.
5. Propagation conditions are set according to Annex B.0.
6. Ensure the UE is in state RRC_CONNECTED with generic procedure parameters Connectivity NR, Connected without release on according to TS 38.508-1 [5] clause 4.5. Message content are defined in clause 7.5A.1.4.3.

7.5A.1.4.2 Test Procedure

1. Intra-band contiguous CA test:
 - 1.1. Configure SCC according to Annex C.0, C.1, C.2 for all downlink physical channels.
 - 1.2. The SS shall configure SCC as per TS 38.508-1 [5] clause 5.1.1. Message contents are defined in clause 7.5A.1.4.3.
 - 1.3. SS activates SCC by sending the activation MAC CE (Refer TS 38.321 [18], clauses 5.9, 6.1.3.10). Wait for at least 2 seconds (Refer TS 38.133[19], clause 9.3).
 - 1.4. SS transmits PDSCH via PDCCH DCI format 1_1 for C_RNTI to transmit the DL RMC according to Table 7.5A.1.4.1-1 on both PCC and SCC. The SS sends downlink MAC padding bits on the DL RMC.
 - 1.5. SS sends uplink scheduling information for each UL HARQ process via PDCCH DCI format 0_1 for C_RNTI to schedule the UL RMC according to Table 7.5A.1.4.1-1. Since the UL has no payload and no loopback data to send the UE sends uplink MAC padding bits on the UL RMC.
 - 1.6. Set the Downlink signal level for PCC and SCC to the value as defined in Table 7.5A.1.5-2 or 7.5A.1.5-2a as appropriate (Case 1). Send uplink power control commands to the UE using 1dB power step size to ensure that the UE output power measured by the test system is within the Uplink power control window, defined as $-MU$ to $-(MU + \text{Uplink power control window size})$ dB of the target power level in Table 7.5A.1.5-2 or Table 7.5A.1.5-2a for at least the duration of the Throughput measurement, where:

- MU is the test system uplink power measurement uncertainty and is specified in Table F.1.3-1 for the carrier frequency f and the channel bandwidth BW
 - Uplink power control window size = 1dB (UE power step size) + 0.7dB (UE power step tolerance) + (Test system relative power measurement uncertainty), where, the UE power step tolerance is specified in TS 38.101-1 [2], Table 6.3.4.3-1 and is 0.7dB for 1dB power step size, and the Test system relative power measurement uncertainty is specified for test case 6.3.4.3 in Table F.1.2-1.
- 1.7. Set the Interferer signal level to the value as defined in Table 7.5A.1.5-2 or 7.5A.1.5-2a as appropriate (Case 1) and frequency below the wanted signal, using a modulated interferer bandwidth as defined in Annex D.
 - 1.8. Measure the average throughput for each component carrier for a duration sufficient to achieve statistical significance according to Annex H.2A.
 - 1.9. Repeat steps from 1.6 to 1.8, using an interfering signal above the wanted signal in Case 1 at step 1.7.
 - 1.10. Set the Downlink signal level for PCC and SCC to the value as defined in Table 7.5A.1.5-3 or 7.5A.1.5-3a as appropriate (Case 2). Send uplink power control commands to the UE using 1dB power step size to ensure that the UE output power measured by the test system is within the Uplink power control window, defined as $-MU$ to $-(MU + \text{Uplink power control window size})$ dB of the target power level in Table 7.5A.1.5-3 or Table 7.5A.1.5-3a for at least the duration of the Throughput measurement, where MU and Uplink power control window size are defined above.
 - 1.11. Set the Interferer signal level to the value as defined in Table 7.5A.1.5-3 or 7.5A.1.5-3a as appropriate (Case 2) and frequency below the wanted signal, using a modulated interferer bandwidth as defined in Annex D.
 - 1.12. Measure the average throughput for each component carrier for a duration sufficient to achieve statistical significance according to Annex H.2A.
 - 1.13. Repeat steps from 1.10 to 1.12, using an interfering signal above the wanted signal in Case 2 at step 1.11.
 - 1.14. Repeat for applicable channel bandwidths and operating band combinations in both Case 1 and Case 2.
2. Inter-band CA test:
- 2.1. Configure SCC according to Annex C.0, C.1, C.2 for all downlink physical channels.
 - 2.2. The SS shall configure SCC as per TS 38.508-1 [5] clause 5.1.1. Message contents are defined in clause 7.5A.1.4.3.
 - 2.3. SS activates SCC by sending the activation MAC CE (Refer TS 38.321 [18], clauses 5.9, 6.1.3.10). Wait for at least 2 seconds (Refer TS 38.133[19], clause9.3).
 - 2.4. SS transmits PDSCH via PDCCH DCI format 1_1 for C_RNTI to transmit the DL RMC according to Table 7.5A.1.4.1-2 on both PCC and SCC. The SS sends downlink MAC padding bits on the DL RMC.
 - 2.5. SS sends uplink scheduling information for each UL HARQ process via PDCCH DCI format 0_1 for C_RNTI to schedule the UL RMC according to Table 7.5A.1.4.1-2. Since the UL has no payload and no loopback data to send the UE sends uplink MAC padding bits on the UL RMC.
 - 2.6. Set the Downlink signal level for PCC and SCC to the value as defined in Table 7.5A.1.5-5 or 7.5A.1.5-8 as appropriate (Case 1). Send uplink power control commands to the UE using 1dB power step size to ensure that the UE output power measured by the test system is within the Uplink power control window, defined as $-MU$ to $-(MU + \text{Uplink power control window size})$ dB of the target power level in Table 7.5A.1.5-5 or Table 7.5A.1.5-8 for at least the duration of the Throughput measurement, where:
 - MU is the test system uplink power measurement uncertainty and is specified in Table F.1.3-1 for the carrier frequency f and the channel bandwidth BW
 - Uplink power control window size = 1dB (UE power step size) + 0.7dB (UE power step tolerance) + (Test system relative power measurement uncertainty), where, the UE power step tolerance is specified in

TS 38.101-1 [2], Table 6.3.4.3-1 and is 0.7dB for 1dB power step size, and the Test system relative power measurement uncertainty is specified for test case 6.3.4.3 in Table F.1.2-1.

- 2.7. Set the Interferer signal level to the value as defined in Table 7.5A.1.5-5 or 7.5A.1.5-8 as appropriate (Case 1) and frequency below the wanted signal, using a modulated interferer bandwidth as defined in Annex D.
 - 2.8. Measure the average throughput of SCC for a duration sufficient to achieve statistical significance according to Annex H.2A.
 - 2.9. Repeat steps from 2.6 to 2.8, using an interfering signal above the wanted signal in Case 1 at step 2.7.
 - 2.10. Set the Downlink signal level for PCC and SCC to the value as defined in Table 7.5A.1.5-6 or 7.5A.1.5-9 as appropriate (Case 2). Send uplink power control commands to the UE using 1dB power step size to ensure that the UE output power measured by the test system is within the Uplink power control window, defined as $-MU$ to $-(MU + \text{Uplink power control window size})$ dB of the target power level in Table 7.5A.1.5-6 or Table 7.5A.1.5-9 for at least the duration of the Throughput measurement, where MU and Uplink power control window size are defined above.
 - 2.11. Set the Interferer signal level to the value as defined in Table 7.5A.1.5-6 or 7.5A.1.5-9 as appropriate (Case 2) and frequency below the wanted signal, using a modulated interferer bandwidth as defined in Annex D.
 - 2.12. Measure the average throughput of SCC for a duration sufficient to achieve statistical significance according to Annex H.2A.
 - 2.13. Repeat steps from 2.10 to 2.12, using an interfering signal above the wanted signal in Case 2 at step 2.11.
 - 2.14. Repeat for applicable channel bandwidths and operating band combinations in both Case 1 and Case 2.
 - 2.15. Repeat steps from 2.1 to 2.14 setting the original PCell as SCell and the original SCell as PCell in the corresponding CA configuration, except for operating bands without uplink band.
3. Intra-band non-contiguous CA test:
- 3.1. Configure SCC according to Annex C.0, C.1, C.2 for all downlink physical channels.
 - 3.2. The SS shall configure SCC as per TS 38.508-1 [5] clause 5.1.1. Message contents are defined in clause 7.5A.1.4.3.
 - 3.3. SS activates SCC by sending the activation MAC CE (Refer TS 38.321 [18], clauses 5.9, 6.1.3.10). Wait for at least 2 seconds (Refer TS 38.133[19], clause 9.3).
 - 3.4. SS transmits PDSCH via PDCCH DCI format 1_1 for C_RNTI to transmit the DL RMC according to Table 7.5A.1.4.1-3 on both PCC and SCC. The SS sends downlink MAC padding bits on the DL RMC.
 - 3.5. SS sends uplink scheduling information for each UL HARQ process via PDCCH DCI format 0_1 for C_RNTI to schedule the UL RMC according to Table 7.5A.1.4.1-3. Since the UL has no payload and no loopback data to send the UE sends uplink MAC padding bits on the UL RMC.
 - 3.6. Set the Downlink signal level for PCC and SCC to the value as defined in Table 7.5A.1.5-11 or 7.5A.1.5-14 as appropriate (Case 1). Send uplink power control commands to the UE using 1dB power step size to ensure that the UE output power measured by the test system is within the Uplink power control window, defined as $-MU$ to $-(MU + \text{Uplink power control window size})$ dB of the target power level in Table 7.5A.1.5-11 or Table 7.5A.1.5-14 for at least the duration of the Throughput measurement, where:
 - MU is the test system uplink power measurement uncertainty and is specified in Table F.1.3-1 for the carrier frequency f and the channel bandwidth BW
 - Uplink power control window size = 1dB (UE power step size) + 0.7dB (UE power step tolerance) + (Test system relative power measurement uncertainty), where, the UE power step tolerance is specified in TS 38.101-1 [2], Table 6.3.4.3-1 and is 0.7dB for 1dB power step size, and the Test system relative power measurement uncertainty is specified for test case 6.3.4.3 in Table F.1.2-1.

- 3.7. Set the Interferer signal level to the value as defined in Table 7.5A.1.5-11 or 7.5A.1.5-14 as appropriate (Case 1) and frequency below the wanted signal, using a modulated interferer bandwidth as defined in Annex D.
- 3.8. Measure the average throughput of SCC for a duration sufficient to achieve statistical significance according to Annex H.2A.
- 3.9. Repeat steps from 3.6 to 3.8, using an interfering signal above the wanted signal in Case 1 at step 3.7.
- 3.10. Set the Downlink signal level for PCC and SCC to the value as defined in Table 7.5A.1.5-12 or 7.5A.1.5-15 as appropriate (Case 2). Send uplink power control commands to the UE using 1dB power step size to ensure that the UE output power measured by the test system is within the Uplink power control window, defined as $-MU$ to $-(MU + \text{Uplink power control window size})$ dB of the target power level in Table 7.5A.1.5-6 or Table 7.5A.1.5-9 for at least the duration of the Throughput measurement, where MU and Uplink power control window size are defined above.
- 3.11. Set the Interferer signal level to the value as defined in Table 7.5A.1.5-12 or 7.5A.1.5-15 as appropriate (Case 2) and frequency below the wanted signal, using a modulated interferer bandwidth as defined in Annex D.
- 3.12. Measure the average throughput of SCC for a duration sufficient to achieve statistical significance according to Annex H.2A.
- 3.13. Repeat steps from 3.10 to 3.12, using an interfering signal above the wanted signal in Case 2 at step 3.11.
- 3.14. Repeat for applicable channel bandwidths and operating band combinations in both Case 1 and Case 2.

NOTE: The purpose of the Uplink power control window is to ensure that the actual UE output power is no greater than the target power level, and as close as possible to the target power level. The relationship between the Uplink power control window, the target power level and the corresponding possible actual UE Uplink power window is illustrated in Annex F.4.3.

Table 7.5A.1.4.2-1: Void

7.5A.1.4.3 Message Contents

Message contents are according to TS 38.508-1 [5] subclause 4.6 with TRANSFORM_PRECODER_ENABLED condition in Table 4.6.3-118 PUSCH-Config.

7.5A.1.5 Test Requirement

The throughput of each carrier shall be $\geq 95\%$ of the maximum throughput of the reference measurement channels as specified in Annexes A.2.2, A.2.3, A.3.2 and A.3.3 (with one sided dynamic OCNG Pattern for the DL-signal as described in Annex A.5.1.1/A.5.2.1) with parameters specified in Tables 7.5A.1.5-2, 7.5A.1.5-2a, 7.5A.1.5-3 and 7.5A.1.5-3a.

Table 7.5A.1.5-1: ACS for intra-band contiguous 2DL CA with $F_{DL_low} \geq 3300$ MHz and $F_{UL_low} \geq 3300$ MHz

Rx Parameter	Units	CA Bandwidth Class	
		B	C
ACS	dB	26.0	33.0

Table 7.5A.1.5-1a: ACS for intra-band contiguous CA with $F_{DL_low} < 2700$ MHz and $F_{UL_low} < 2700$ MHz

Rx Parameter	Units	CA Bandwidth Class	
		B	C
ACS	dB	20.0	17.0

Table 7.5A.1.5-2: Test parameters for intra-band contiguous 2DL CA with $F_{DL_low} \geq 3300$ MHz and $F_{UL_low} \geq 3300$ MHz, case 1

Rx Parameter	Units	CA Bandwidth Class	
		B	C
Pw in Transmission Bandwidth Configuration, per CC	dBm	REFSENS + 14 dB	REFSENS + 14 dB
$P_{Interferer}$	dBm	Aggregated power + 24.5 dB	Aggregated power + 31.5 dB
$BW_{Interferer}$	MHz	20	$BW_{channel\ CA}$
$F_{Interferer}$ (offset)	MHz	$10 + F_{offset}$ / $-10 - F_{offset}$	$BW_{channel\ CA}$ / $-BW_{channel\ CA}$
<p>NOTE 1: The transmitter shall be set to 4 dB below $P_{CMAX_L,f,c}$ at the minimum UL configuration specified in Table 7.3.2.3-3 with $P_{CMAX_L,f,c}$ defined in clause 6.2.4.3.</p> <p>NOTE 2: The absolute value of the interferer offset $F_{interferer}$ (offset) shall be further adjusted to $(\lceil F_{interferer} / SCS \rceil + 0.5)SCS$ MHz with SCS the sub-carrier spacing of the wanted signal in MHz. The interferer is an NR signal with an SCS equal to that of the wanted signal.</p> <p>NOTE 3: The interferer consists of the RMC specified in Annexes A.3.2.2 and A.3.3.2 with one sided dynamic OCNG Pattern OP.1 FDD/TDD for the DL-signal as described in Annex A.5.1.1/A.5.2.1.</p>			

Table 7.5A.1.5-2a: Test parameters for intra-band contiguous CA with $F_{DL_low} < 2700$ MHz and $F_{UL_low} < 2700$ MHz, case 1

Rx Parameter	Units	CA Bandwidth Class	
		B	C
Pw in Transmission Bandwidth Configuration, per CC	dBm	REFSENS + 14 dB	REFSENS + 14 dB
$P_{Interferer}$	dBm	Aggregated power + 18.5 dB	Aggregated power + 15.5 dB
$BW_{Interferer}$	MHz	5	5
$F_{Interferer}$ (offset)	MHz	$2.5 + F_{offset}$ / $-2.5 - F_{offset}$	$2.5 + F_{offset}$ / $-2.5 - F_{offset}$
<p>NOTE 1: The transmitter shall be set to 4 dB below $P_{CMAX_L,f,c}$ at the minimum UL configuration specified in Table 7.3.2-3 with $P_{CMAX_L,f,c}$ defined in clause 6.2.4.</p> <p>NOTE 2: The absolute value of the interferer offset $F_{interferer}$ (offset) shall be further adjusted to $(\lceil F_{interferer} / SCS \rceil + 0.5)SCS$ MHz with SCS the sub-carrier spacing of the wanted signal in MHz. The interferer is an NR signal with an SCS equal to that of the wanted signal.</p> <p>NOTE 3: The interferer consists of the RMC specified in Annexes A.3.2.2 and A.3.3.2 with one sided dynamic OCNG Pattern OP.1 FDD/TDD for the DL-signal as described in Annex A.5.1.1/A.5.2.1.</p>			

Table 7.5A.1.5-3: Test parameters for intra-band contiguous 2DL CA with $F_{DL_low} \geq 3300$ MHz and $F_{UL_low} \geq 3300$ MHz, case 2

Rx Parameter	Units	CA Bandwidth Class	
		B	C
Pw in Transmission Bandwidth Configuration, per CC	dBm	$-49.5 + 10\log(N_{RB,c}/N_{RB_agg})$	-56.5
$P_{Interferer}$	dBm	-25	-25
$BW_{Interferer}$	MHz	20	$BW_{channel\ CA}$
$F_{Interferer}$ (offset)	MHz	$10 + F_{offset}$ / $-10 - F_{offset}$	$BW_{channel\ CA}$ / $-BW_{channel\ CA}$
<p>NOTE 1: The transmitter shall be set to 24 dB below $P_{CMAX_L,f,c}$ at the minimum UL configuration specified in Table 7.3.2.3-3 with $P_{CMAX_L,f,c}$ defined in clause 6.2.4.3.</p> <p>NOTE 2: The absolute value of the interferer offset $F_{interferer}$ (offset) shall be further adjusted to $(\lceil F_{interferer} / SCS \rceil + 0.5)SCS$ MHz with SCS the sub-carrier spacing of the wanted signal in MHz. The interferer is an NR signal with an SCS equal to that of the wanted signal.</p> <p>NOTE 3: The interferer consists of the RMC specified in Annexes A.3.2.2 and A.3.3.2 with one sided dynamic OCNG Pattern OP.1 FDD/TDD for the DL-signal as described in Annex A.5.1.1/A.5.2.1.</p>			

Table 7.5A.1.5-3a: Test parameters for intra-band contiguous CA with $F_{DL_low} < 2700$ MHz and $F_{UL_low} < 2700$ MHz, case 2

Rx Parameter	Units	CA Bandwidth Class	
		B	C
Pw in Transmission Bandwidth Configuration, per CC	dBm	$-43.5 + 10\log(N_{RB,c}/N_{RB_agg})$	$-40.5 + 10\log(N_{RB,c}/N_{RB_agg})$
$P_{Interferer}$	dBm	-25	-25
$BW_{Interferer}$	MHz	5	5
$F_{Interferer}$ (offset)	MHz	$2.5 + F_{offset}$ / $-2.5 - F_{offset}$	$2.5 + F_{offset}$ / $-2.5 - F_{offset}$
NOTE 1: The transmitter shall be set to 24 dB below $P_{CMAX_L,f,c}$ at the minimum UL configuration specified in Table 7.3.2-3 with $P_{CMAX_L,f,c}$ defined in clause 6.2.4.			
NOTE 2: The absolute value of the interferer offset $F_{interferer}$ (offset) shall be further adjusted to $(\lceil F_{interferer} / SCS \rceil + 0.5) SCS$ MHz with SCS the sub-carrier spacing of the wanted signal in MHz. The interferer is an NR signal with an SCS equal to that of the wanted signal.			
NOTE 3: The interferer consists of the RMC specified in Annexes A.3.2.2 and A.3.3.2 with one sided dynamic OCNG Pattern OP.1 FDD/TDD for the DL-signal as described in Annex A.5.1.1/A.5.2.1.			

For NR SCC of inter-band CA with $F_{DL_high} < 2700$ MHz and $F_{UL_high} < 2700$ MHz, the throughput measurement derived in test procedure shall be $\geq 95\%$ of the maximum throughput of the reference measurement channels as specified in [Annexes A.2.2, A.2.3 and A.3.2 (with one sided dynamic OCNG Pattern OP.1 FDD/TDD for the DL-signal as described in Annex A.5.1.1/A.5.2.1)] with parameters specified in Tables 7.5A.1.5-5 and 7.5A.1.5-6.

Table 7.5A.1.5-4: ACS for NR band with $F_{DL_high} < 2700$ MHz and $F_{UL_high} < 2700$ MHz

RX parameter	Units	Channel bandwidth				
		5 MHz	10 MHz	15 MHz	20 MHz	25 MHz
ACS	dB	33	33	30	27	26
RX parameter	Units	Channel bandwidth				
		30 MHz	40 MHz	50 MHz	60 MHz	80 MHz
ACS	dB	25.5	24	23	22.5	21
RX parameter	Units	Channel bandwidth				
		90 MHz	100 MHz			
ACS	dB	20.5	20			

Table 7.5A.1.5-5: Test parameters for NR inter-band CA with $F_{DL_high} < 2700$ MHz and $F_{UL_high} < 2700$ MHz, case 1

RX parameter	Units	Channel bandwidth				
		5 MHz	10 MHz	15 MHz	20 MHz	25 MHz
Pw in Transmission Bandwidth Configuration, per CC	dBm	REFSENS + 14 dB				
$P_{interferer}$	dBm	REFSENS for SCC + 45.5 dB	REFSENS for SCC + 45.5 dB	REFSENS for SCC + 42.5 dB	REFSENS for SCC + 39.5 dB	REFSENS for SCC + 38.5 dB
$BW_{interferer}$	MHz	5	5	5	5	5
$F_{interferer}$ (offset from SCC)	MHz	5 / -5	7.5 / -7.5	10 / -10	12.5 / -12.5	15 / -15
RX parameter	Units	Channel bandwidth				
		30 MHz	40 MHz	50 MHz	60 MHz	80 MHz
Pw in Transmission Bandwidth Configuration, per CC	dBm	REFSENS + 14 dB				
$P_{interferer}$	dBm	REFSENS for SCC + 38 dB	REFSENS for SCC + 36.5 dB	REFSENS for SCC + 35.5 dB	REFSENS for SCC + 35 dB	REFSENS for SCC + 33.5 dB
$BW_{interferer}$	MHz	5	5	5	5	5
$F_{interferer}$ (offset from SCC)	MHz	17.5 / -17.5	22.5 / -22.5	27.5 / -27.5	32.5 / -32.5	42.5 / -42.5
RX parameter	Units	Channel bandwidth				
		90 MHz	100 MHz			
Pw in Transmission Bandwidth Configuration, per CC	dBm	REFSENS + 14 dB				
$P_{interferer}$	dBm	REFSENS for SCC + 33 dB	REFSENS for SCC + 32.5 dB			
$BW_{interferer}$	MHz	5	5			
$F_{interferer}$ (offset from SCC)	MHz	47.5 / -47.5	52.5 / -52.5			
<p>NOTE 1: The transmitter shall be set to 4dB below $P_{CMAX_L,f,c}$ at the minimum UL configuration specified in Table 7.3.2.3-3 with $P_{CMAX_L,f,c}$ defined in clause 6.2.4.</p> <p>NOTE 2: The absolute value of the interferer offset $F_{interferer}$ (offset) shall be further adjusted to $(\lceil F_{interferer} / SCS \rceil + 0.5) SCS$ MHz with SCS the sub-carrier spacing of the wanted signal in MHz. The interferer is an NR signal with an SCS equal to that of the wanted signal.</p> <p>NOTE 3: The interferer consists of the NR interferer RMC specified in Annexes A.3.2.2 and A.3.3.2 with one sided dynamic OCNNG Pattern OP.1 FDD/TDD for the DL-signal as described in Annex A.5.1.1/A.5.2.1.</p>						

Table 7.5A.1.5-6: Test parameters for NR inter-band CA with $F_{DL_high} < 2700$ MHz and $F_{UL_high} < 2700$ MHz, case 2

RX parameter	Units	Channel bandwidth				
		5 MHz	10 MHz	15 MHz	20 MHz	25 MHz
Pw in Transmission Bandwidth Configuration, per CC	dBm	-56.5	-56.5	-53.5	-50.5	-49.5
$P_{interferer}$	dBm	-25				
$BW_{interferer}$	MHz	5	5	5	5	5
$F_{interferer}$ (offset from SCC)	MHz	5 / -5	7.5 / -7.5	10 / -10	12.5 / -12.5	15 / -15
RX parameter	Units	Channel bandwidth				
		30 MHz	40 MHz	50 MHz	60 MHz	80 MHz
Pw in Transmission Bandwidth Configuration, per CC	dBm	-49	-47	-46.5	-46	-44.5
$P_{interferer}$	dBm	-25				
$BW_{interferer}$	MHz	5	5	5	5	5
$F_{interferer}$ (offset from SCC)	MHz	17.5 / -17.5	22.5 / -22.5	27.5 / -27.5	32.5 / -32.5	42.5 / -42.5
RX parameter	Units	Channel bandwidth				
		90 MHz	100 MHz			
Pw in Transmission Bandwidth Configuration, per CC	dBm	-44	-43.5			
$P_{interferer}$	dBm	-25				
$BW_{interferer}$	MHz	5	5			
$F_{interferer}$ (offset from SCC)	MHz	47.5 / -47.5	52.5 / -52.5			
NOTE 1: The transmitter shall be set to 24 dB below $P_{CMAX_L,f,c}$ at the minimum UL configuration specified in Table 7.3.2.3-3 with $P_{CMAX_L,f,c}$ defined in clause 6.2.4.						
NOTE 2: The absolute value of the interferer offset $F_{interferer}$ (offset) shall be further adjusted to $(\lceil F_{interferer} / SCS \rceil + 0.5) SCS$ MHz with SCS the sub-carrier spacing of the wanted signal in MHz. The interferer is an NR signal with an SCS equal to that of the wanted signal.						
NOTE 3: The interferer consists of the RMC specified in Annexes A.3.2.2 and A.3.3.2 with one sided dynamic OCNB Pattern OP.1 FDD/TDD for the DL-signal as described in Annex A.5.1.1/A.5.2.1.						

For NR SCC of inter-band CA with $F_{DL_low} \geq 3300$ MHz and $F_{UL_low} \geq 3300$ MHz, the throughput measurement derived in test procedure shall be $\geq 95\%$ of the maximum throughput of the reference measurement channels as specified in [Annexes A.2.2, A.2.3 and A.3.2 (with one sided dynamic OCNB Pattern OP.1 FDD/TDD for the DL-signal as described in Annex A.5.1.1/A.5.2.1)] with parameters specified in Tables 7.5A.1.5-8 and 7.5A.1.5-9.

Table 7.5A.1.5-7: ACS for NR bands with $F_{DL_low} \geq 3300$ MHz and $F_{UL_low} \geq 3300$ MHz

RX parameter	Units	Channel bandwidth				
		10 MHz	15 MHz	20 MHz	40 MHz	50 MHz
ACS	dB	33	33	33	33	33
RX parameter	Units	Channel bandwidth				
		60 MHz	80 MHz	90 MHz	100 MHz	
ACS	dB	33	33	33	33	

Table 7.5A.1.5-8: Test parameters for NR inter-band CA with $F_{DL_low} \geq 3300$ MHz and $F_{UL_low} \geq 3300$ MHz, case 1

RX parameter	Units	Channel bandwidth				
		10 MHz	15 MHz	20 MHz	40 MHz	50 MHz
Pw in Transmission Bandwidth Configuration, per CC	dBm	REFSENS + 14 dB				
$P_{interferer}$	dBm	REFSENS for SCC + 45.5 dB				
$BW_{interferer}$	MHz	10	15	20	40	50
$F_{interferer}$ (offset from SCC)	MHz	10 / -10	15 / -15	20 / -20	40 / -40	50 / -50
RX parameter	Units	Channel bandwidth				
		60 MHz	80 MHz	90 MHz	100 MHz	
Pw in Transmission Bandwidth Configuration, per CC	dBm	REFSENS + 14 dB				
$P_{interferer}$	dBm	REFSENS for SCC + 45.5 dB	REFSENS for SCC + 45.5 dB	REFSENS for SCC + 45.5 dB	REFSENS for SCC + 45.5 dB	
$BW_{interferer}$	MHz	60	80	90	100	
$F_{interferer}$ (offset from SCC)	MHz	60 / -60	80 / -80	90 / -90	100 / -100	
<p>NOTE 1: The transmitter shall be set to 4dB below $P_{CMAX_L,f,c}$ at the minimum UL configuration specified in Table 7.3.2.3-3 with $P_{CMAX_L,f,c}$ defined in clause 6.2.4.</p> <p>NOTE 2: The absolute value of the interferer offset $F_{interferer}$ (offset) shall be further adjusted to $(\lceil F_{interferer} / SCS \rceil + 0.5) SCS$ MHz with SCS the sub-carrier spacing of the wanted signal in MHz. The interferer is an NR signal with an SCS equal to that of the wanted signal.</p> <p>NOTE 3: The interferer consists of the RMC specified in Annexes A.3.2.2 and A.3.3.2 with one sided dynamic OCNG Pattern OP.1 FDD/TDD for the DL-signal as described in Annex A.5.1.1/A.5.2.1.</p>						

Table 7.5A.1.5-9: Test parameters for NR inter-band CA with $F_{DL_low} \geq 3300$ MHz and $F_{UL_low} \geq 3300$ MHz, case 2

RX parameter	Units	Channel bandwidth				
		10 MHz	15 MHz	20 MHz	40 MHz	50 MHz
Pw in Transmission Bandwidth Configuration, per CC	dBm	-56.5				
$P_{interferer}$	dBm	-25				
$BW_{interferer}$	MHz	10	15	20	40	50
$F_{interferer}$ (offset from SCC)	MHz	10 / -10	15 / -15	20 / -20	40 / -40	50 / -50
RX parameter	Units	Channel bandwidth				
		60 MHz	80 MHz	90 MHz	100 MHz	
Pw in Transmission Bandwidth Configuration, per CC	dBm	-56.5				
$P_{interferer}$	dBm	-25	-25	-25	-25	
$BW_{interferer}$	MHz	60	80	90	100	
$F_{interferer}$ (offset from SCC)	MHz	60 / -60	80 / -80	90 / -90	100 / -100	
<p>NOTE 1: The transmitter shall be set to 24 dB below $P_{CMAX_L,f,c}$ at the minimum UL configuration specified in Table 7.3.2.3-3 with $P_{CMAX_L,f,c}$ defined in clause 6.2.4.</p> <p>NOTE 2: The absolute value of the interferer offset $F_{interferer}$ (offset) shall be further adjusted to $(\lceil F_{interferer} / SCS \rceil + 0.5) SCS$ MHz with SCS the sub-carrier spacing of the wanted signal in MHz. The interferer is an NR signal with an SCS equal to that of the wanted signal.</p> <p>NOTE 3: The interferer consists of the RMC specified in Annexes A.3.2.2 and A.3.3.2 with one sided dynamic OCNG Pattern OP.1 FDD/TDD for the DL-signal as described in Annex A.5.1.1/A.5.2.1.</p>						

For NR SCC of intra-band non-contiguous CA with $F_{DL_high} < 2700$ MHz and $F_{UL_high} < 2700$ MHz, the throughput measurement derived in test procedure shall be $\geq 95\%$ of the maximum throughput of the reference measurement channels as specified in Annexes A.2.2, A.2.3 and A.3.2 with parameters specified in Tables 7.5A.1.5-11 and 7.5A.1.5-12.

Table 7.5A.1.5-10: ACS for NR band with $F_{DL_high} < 2700$ MHz and $F_{UL_high} < 2700$ MHz

RX parameter	Units	Channel bandwidth				
		5 MHz	10 MHz	15 MHz	20 MHz	25 MHz
ACS	dB	33	33	30	27	26
RX parameter	Units	Channel bandwidth				
		30 MHz	40 MHz	50 MHz	60 MHz	80 MHz
ACS	dB	25.5	24	23	22.5	21
RX parameter	Units	Channel bandwidth				
		90 MHz	100 MHz			
ACS	dB	20.5	20			

Table 7.5A.1.5-11: Test parameters for NR intra-band non-contiguous CA with $F_{DL_high} < 2700$ MHz and $F_{UL_high} < 2700$ MHz, case 1

RX parameter	Units	Channel bandwidth				
		5 MHz	10 MHz	15 MHz	20 MHz	25 MHz
Pw in Transmission Bandwidth Configuration, per CC	dBm	REFSENS + 14 dB				
$P_{interferer}$	dBm	REFSENS for SCC + 45.5 dB	REFSENS for SCC + 45.5 dB	REFSENS for SCC + 42.5 dB	REFSENS for SCC + 39.5 dB	REFSENS for SCC + 38.5 dB
$BW_{interferer}$	MHz	5	5	5	5	5
$F_{interferer}$ (offset from SCC)	MHz	5 / -5	7.5 / -7.5	10 / -10	12.5 / -12.5	15 / -15
RX parameter	Units	Channel bandwidth				
		30 MHz	40 MHz	50 MHz	60 MHz	80 MHz
Pw in Transmission Bandwidth Configuration, per CC	dBm	REFSENS + 14 dB				
$P_{interferer}$	dBm	REFSENS for SCC + 38 dB	REFSENS for SCC + 36.5 dB	REFSENS for SCC + 35.5 dB	REFSENS for SCC + 35 dB	REFSENS for SCC + 33.5 dB
$BW_{interferer}$	MHz	5	5	5	5	5
$F_{interferer}$ (offset from SCC)	MHz	17.5 / -17.5	22.5 / -22.5	27.5 / -27.5	32.5 / -32.5	42.5 / -42.5
RX parameter	Units	Channel bandwidth				
		90 MHz	100 MHz			
Pw in Transmission Bandwidth Configuration, per CC	dBm	REFSENS + 14 dB				
$P_{interferer}$	dBm	REFSENS for SCC + 33 dB	REFSENS for SCC + 32.5 dB			
$BW_{interferer}$	MHz	5	5			
$F_{interferer}$ (offset from SCC)	MHz	47.5 / -47.5	52.5 / -52.5			
<p>NOTE 1: The transmitter shall be set to 4dB below $P_{CMAX_L,f,c}$ at the minimum UL configuration specified in Table 7.3.2.3-3 with $P_{CMAX_L,f,c}$ defined in clause 6.2.4.</p> <p>NOTE 2: The absolute value of the interferer offset $F_{interferer}$ (offset) shall be further adjusted to $(\lceil F_{interferer} / SCS \rceil + 0.5) SCS$ MHz with SCS the sub-carrier spacing of the wanted signal in MHz. The interferer is an NR signal with an SCS equal to that of the wanted signal.</p> <p>NOTE 3: The interferer consists of the NR interferer RMC specified in Annexes A.3.2.2 and A.3.3.2 with one sided dynamic OCN Pattern OP.1 FDD/TDD for the DL-signal as described in Annex A.5.1.1/A.5.2.1.</p>						

Table 7.5A.1.5-12: Test parameters for NR intra-band non-contiguous CA with $F_{DL_high} < 2700$ MHz and $F_{UL_high} < 2700$ MHz, case 2

RX parameter	Units	Channel bandwidth				
		5 MHz	10 MHz	15 MHz	20 MHz	25 MHz
Pw in Transmission Bandwidth Configuration, per CC	dBm	-56.5	-56.5	-53.5	-50.5	-49.5
$P_{interferer}$	dBm	-25				
$BW_{interferer}$	MHz	5	5	5	5	5
$F_{interferer}$ (offset from SCC)	MHz	5 / -5	7.5 / -7.5	10 / -10	12.5 / -12.5	15 / -15
RX parameter	Units	Channel bandwidth				
		30 MHz	40 MHz	50 MHz	60 MHz	80 MHz
Pw in Transmission Bandwidth Configuration, per CC	dBm	-49	-47	-46.5	-46	-44.5
$P_{interferer}$	dBm	-25				
$BW_{interferer}$	MHz	5	5	5	5	5
$F_{interferer}$ (offset from SCC)	MHz	17.5 / -17.5	22.5 / -22.5	27.5 / -27.5	32.5 / -32.5	42.5 / -42.5
RX parameter	Units	Channel bandwidth				
		90 MHz	100 MHz			
Pw in Transmission Bandwidth Configuration, per CC	dBm	-44	-43.5			
$P_{interferer}$	dBm	-25				
$BW_{interferer}$	MHz	5	5			
$F_{interferer}$ (offset from SCC)	MHz	47.5 / -47.5	52.5 / -52.5			
NOTE 1: The transmitter shall be set to 24 dB below $P_{C_{MAX_L,f,c}}$ at the minimum UL configuration specified in Table 7.3.2.3-3 with $P_{C_{MAX_L,f,c}}$ defined in clause 6.2.4.						
NOTE 2: The absolute value of the interferer offset $F_{interferer}$ (offset) shall be further adjusted to $(\lceil F_{interferer} / SCS \rceil + 0.5) SCS$ MHz with SCS the sub-carrier spacing of the wanted signal in MHz. The interferer is an NR signal with an SCS equal to that of the wanted signal.						
NOTE 3: The interferer consists of the RMC specified in Annexes A.3.2.2 and A.3.3.2 with one sided dynamic OCNB Pattern OP.1 FDD/TDD for the DL-signal as described in Annex A.5.1.1/A.5.2.1.						

For NR SCC of intra-band non-contiguous CA with $F_{DL_low} \geq 3300$ MHz and $F_{UL_low} \geq 3300$ MHz, the throughput measurement derived in test procedure shall be $\geq 95\%$ of the maximum throughput of the reference measurement channels as specified in Annexes A.2.2, A.2.3 and A.3.2 with parameters specified in Tables 7.5A.1.5-14 and 7.5A.1.5-15.

Table 7.5A.1.5-13: ACS for NR bands with $F_{DL_low} \geq 3300$ MHz and $F_{UL_low} \geq 3300$ MHz

RX parameter	Units	Channel bandwidth				
		10 MHz	15 MHz	20 MHz	40 MHz	50 MHz
ACS	dB	33	33	33	33	33
RX parameter	Units	Channel bandwidth				
		60 MHz	80 MHz	90 MHz	100 MHz	
ACS	dB	33	33	33	33	

Table 7.5A.1.5-14: Test parameters for NR intra-band non-contiguous CA with $F_{DL_low} \geq 3300$ MHz and $F_{UL_low} \geq 3300$ MHz, case 1

RX parameter	Units	Channel bandwidth				
		10 MHz	15 MHz	20 MHz	40 MHz	50 MHz
Pw in Transmission Bandwidth Configuration, per CC	dBm	REFSENS + 14 dB				
$P_{interferer}$	dBm	REFSENS for SCC + 45.5 dB				
$BW_{interferer}$	MHz	10	15	20	40	50
$F_{interferer}$ (offset from SCC)	MHz	10 / -10	15 / -15	20 / -20	40 / -40	50 / -50
RX parameter	Units	Channel bandwidth				
		60 MHz	80 MHz	90 MHz	100 MHz	
Pw in Transmission Bandwidth Configuration, per CC	dBm	REFSENS + 14 dB				
$P_{interferer}$	dBm	REFSENS for SCC + 45.5 dB	REFSENS for SCC + 45.5 dB	REFSENS for SCC + 45.5 dB	REFSENS for SCC + 45.5 dB	
$BW_{interferer}$	MHz	60	80	90	100	
$F_{interferer}$ (offset from SCC)	MHz	60 / -60	80 / -80	90 / -90	100 / -100	
<p>NOTE 1: The transmitter shall be set to 4dB below $P_{CMAX_L,f,c}$ at the minimum UL configuration specified in Table 7.3.2.3-3 with $P_{CMAX_L,f,c}$ defined in clause 6.2.4.</p> <p>NOTE 2: The absolute value of the interferer offset $F_{interferer}$ (offset) shall be further adjusted to $(\lceil F_{interferer} / SCS \rceil + 0.5) SCS$ MHz with SCS the sub-carrier spacing of the wanted signal in MHz. The interferer is an NR signal with an SCS equal to that of the wanted signal.</p> <p>NOTE 3: The interferer consists of the RMC specified in Annexes A.3.2.2 and A.3.3.2 with one sided dynamic OCNG Pattern OP.1 FDD/TDD for the DL-signal as described in Annex A.5.1.1/A.5.2.1.</p>						

Table 7.5A.1.5-15: Test parameters for NR intra-band non-contiguous CA with $F_{DL_low} \geq 3300$ MHz and $F_{UL_low} \geq 3300$ MHz, case 2

RX parameter	Units	Channel bandwidth				
		10 MHz	15 MHz	20 MHz	40 MHz	50 MHz
Pw in Transmission Bandwidth Configuration, per CC	dBm	-56.5				
$P_{interferer}$	dBm	-25				
$BW_{interferer}$	MHz	10	15	20	40	50
$F_{interferer}$ (offset from SCC)	MHz	10 / -10	15 / -15	20 / -20	40 / -40	50 / -50
RX parameter	Units	Channel bandwidth				
		60 MHz	80 MHz	90 MHz	100 MHz	
Pw in Transmission Bandwidth Configuration, per CC	dBm	-56.5				
$P_{interferer}$	dBm	-25	-25	-25	-25	
$BW_{interferer}$	MHz	60	80	90	100	
$F_{interferer}$ (offset from SCC)	MHz	60 / -60	80 / -80	90 / -90	100 / -100	
NOTE 1: The transmitter shall be set to 24 dB below $P_{CMAX_L,f,c}$ at the minimum UL configuration specified in Table 7.3.2.3-3 with $P_{CMAX_L,f,c}$ defined in clause 6.2.4.						
NOTE 2: The absolute value of the interferer offset $F_{interferer}$ (offset) shall be further adjusted to $(\lceil F_{interferer} / SCS \rceil + 0.5) SCS$ MHz with SCS the sub-carrier spacing of the wanted signal in MHz. The interferer is an NR signal with an SCS equal to that of the wanted signal.						
NOTE 3: The interferer consists of the RMC specified in Annexes A.3.2.2 and A.3.3.2 with one sided dynamic OCNG Pattern OP.1 FDD/TDD for the DL-signal as described in Annex A.5.1.1/A.5.2.1.						

7.5A.2 Adjacent channel selectivity for 3DL CA

7.5A.2.1 Test Purpose

Adjacent channel selectivity for 3DL CA verifies the receiver's ability to receive a wanted 3DL carrier aggregated at its assigned channel frequency in the presence of an adjacent channel signal at a given frequency offset from the centre frequency of the assigned channel.

7.5A.2.2 Test Applicability

This test case applies to all types of NR UE release 15 and forward that support 3DL CA.

7.5A.2.3 Minimum Conformance Requirements

The minimum conformance requirements are defined in clause 7.5A.0.

7.5A.2.4 Test Description

7.5A.2.4.1 Initial Conditions

Same as in clause 7.5A.1.4.1 with following exceptions:

- Instead of Table 7.5A.1.4.1-1 → use Table 7.5A.2.4.1-1.
- Instead of Table 7.5A.1.4.1-2 → use Table 7.5A.2.4.1-1.
- Instead of Table 7.5A.1.4.1-3 → use Table 7.5A.2.4.1-1.

Table 7.5A.2.4.1-1: Test Configuration Table for 3DL CA

Default Conditions						
Test Environment as specified in TS 38.508-1 [5] subclause 4.1		Normal				
Test Frequencies as specified in TS 38.508-1 [5] subclause 4.3.1		Intra-band contiguous: Mid range for PCC and SCCs Inter-band CA: NOTE 1, NOTE 5 Inter-band + Intra-band contiguous : NOTE 1, NOTE 5 Inter-band + Intra-band non-contiguous : NOTE 1 with Wgap for intra-band non-contiguous defined in table 7.3A.2.4.1-1(NOTE 5)				
Test CC Combination setting (N_{RB_agg}) as specified in Tables 5.5A.1-1, 5.5A.2-1, or tables in clauses 5.5A.3.x for the CA Configuration across bandwidth combination sets supported by the UE.		Intra-band contiguous: Lowest N_{RB_agg} , Highest N_{RB_agg} Inter-band: Highest N_{RB_agg} Inter-band + Intra-band contiguous : Highest N_{RB_agg} Inter-band + Intra-band non-contiguous : Highest N_{RB_agg} NOTE 6				
Test SCS as specified in Table 5.3.5-1		Lowest for PCC and SCCs				
Network signalling value		NS_01 Unless given by Table 7.3.2.3-4 for the band with active uplink carrier				
Test Parameters						
Downlink Configuration				Uplink Configuration		
Test ID	CC Mod'n	PCC RB allocation	SCC ₁ RB allocation	SCC ₂ RB allocation	CC Mod'n	PCC RB allocation
Default Test Settings for a CA_nXD Configuration (Intra-band contiguous)						
1	CP-OFDM QPSK	NOTE 1	NOTE 1	NOTE 1	DFT-s-OFDM QPSK	NOTE 1
Default Test Settings for a CA_nXA-nYA-nZA Configuration (Inter-band)						
1	CP-OFDM QPSK	NOTE 1	NOTE 1	NOTE 1	DFT-s-OFDM QPSK	NOTE 1
Default Test Settings for a CA_nXC-nYA, CA_nYA-nXC, CA_nYA-nXB and CA_nXB-nYA Configurations (Intra-band contiguous + Inter-band)						
1	CP-OFDM QPSK	NOTE 1	NOTE 1	NOTE 1	DFT-s-OFDM QPSK	NOTE 1
Default Test Settings for a CA_nX(2A)-nYA Configuration (Intra-band non-contiguous + Inter-band)						
1	CP-OFDM QPSK	NOTE 1	NOTE 1	NOTE 1	DFT-s-OFDM QPSK	NOTE 1
NOTE 1: The specific configuration of uplink and downlink are defined in Table 7.3A.2.4.1-1. Only test points verifying non-exceptional REFSSENS requirements are used for ACS.						
NOTE 2: CA Configuration Test CC Combination test settings are checked separately for each CA Configuration.						
NOTE 3: Inter-band: X,Y,Z correspond to the different bands in the CA Configuration. E.g. for CA_n1A-n3A-n8A, X=1, Y=3, Z=8; Intra-band contiguous + Inter-band: X,Y correspond to the different bands in the CA Configuration, e.g. for CA_1C-3A, X=1,Y=3; Intra-band non-contiguous + Inter-band: X and Y correspond to the different bands in the CA Configuration. E.g. for CA_n1A-n1A-n8A, X=1, Y=8						
NOTE 4: In a band where UE supports 4Rx, the test shall be performed only with 4Rx antennas ports connected and 4Rx REFSSENS requirement (Table 7.3.2.5-2) is used in the test requirements.						
NOTE 5: For NR band n28, 30MHz test channel bandwidth is tested with Low range test frequencies.						
NOTE 6: If the UE supports multiple CC Combinations in the CA Configuration with the same N_{RB_agg} , only the combination with the highest N_{RB_PCC} is tested.						

1. Connect the SS to the UE antenna connectors as shown in TS 38.508-1 [5] Annex A, Figure A.3.1.1.3 for TE diagram and section A.3.2 for UE diagram.
2. The parameter settings for the cell are set up according to TS 38.508-1 [5] subclause 4.4.3.
3. Downlink signals are initially set up according to Annex C.0, C.1, C.2, and C.3.1, and uplink signals according to Annex G.0, G.1, G.2, and G.3.1.
4. The DL and UL Reference Measurement Channels are set according to Table 7.5A.2.4.1-1.

5. Propagation conditions are set according to Annex B.0.
6. Ensure the UE is in State RRC_CONNECTED with generic procedure parameters Connectivity NR, Connected without release On, Test Mode On and Test Loop Function On according to TS 38.508-1 [5] clause 4.5. Message contents are defined in clause 7.5A.2.4.3.

Table 7.5A.2.4.1-2: Void

Table 7.5A.2.4.1-3: Void

7.5A.2.4.2 Test Procedure

1. Configure SCCs according to Annex C.0, C.1, C.2 for all downlink physical channels.
2. The SS shall configure SCCs as per TS 38.508-1 [5] clause 5.1.1. Message contents are defined in clause 7.5A.2.4.3.
3. SS activates SCCs by sending the activation MAC CE (Refer TS 38.321 [18], clauses 5.9, 6.1.3.10). Wait for at least 2 seconds (Refer TS 38.133[19], clause 9.3).
4. SS transmits PDSCH via PDCCH DCI format 1_1 for C_RNTI to transmit the DL RMC according to Table 7.5A.2.4.1-1 on both PCC and SCCs. The SS sends downlink MAC padding bits on the DL RMC.
5. SS sends uplink scheduling information for each UL HARQ process via PDCCH DCI format 0_1 for C_RNTI to schedule the UL RMC according to Table 7.5A.2.4.1-1 on PCC. Since the UL has no payload and no loopback data to send the UE sends uplink MAC padding bits on the UL RMC.
6. Set the Downlink signal level according to Table 7.5A.2.4.2-1 as appropriate (Case 1). Send uplink power control commands to the UE using 1dB power step size to ensure that the UE output power measured by the test system is within the Uplink power control window, defined as $-(\text{MU})$ to $-(\text{MU} + \text{Uplink power control window size})$ dB of the target power level in Table 7.5A.2.4.2-1 for at least the duration of the Throughput measurement, where:
 - MU is the test system uplink power measurement uncertainty and is specified in Table F.1.3-1 for the carrier frequency f and the channel bandwidth BW
 - Uplink power control window size = 1dB (UE power step size) + 0.7dB (UE power step tolerance) + (Test system relative power measurement uncertainty), where, the UE power step tolerance is specified in TS 38.101-1 [2], Table 6.3.4.3-1 and is 0.7dB for 1dB power step size, and the Test system relative power measurement uncertainty is specified for test case 6.3.4.3 in Table F.1.2-1.
7. Set the Interferer signal level to the value as defined in Table 7.5A.2.4.2-1 as appropriate (Case 1) and frequency below the wanted signal, using a modulated interferer bandwidth as defined in Annex D.
8. Measure the average throughput for the carrier(s) indicated in Table 7.5A.2.4.2-1 for a duration sufficient to achieve statistical significance according to Annex H.2A.
9. Repeat steps from 6 to 8, using an interfering signal above the wanted signal in Case 1 at step 7.
10. Set the Downlink signal level according to Table 7.5A.2.4.2-1 as appropriate (Case 2). Send uplink power control commands to the UE using 1dB power step size to ensure that the UE output power measured by the test system is within the Uplink power control window, defined as $-(\text{MU})$ to $-(\text{MU} + \text{Uplink power control window size})$ dB of the target power level in Table 7.5A.2.4.2-1 for at least the duration of the Throughput measurement, where MU and Uplink power control window size are defined above.
11. Set the Interferer signal level to the value as defined in 7.5A.2.4.2-1 as appropriate (Case 2) and frequency below the wanted signal, using a modulated interferer bandwidth as defined in Annex D.
12. Measure the average throughput for the carrier(s) indicated in Table 7.5A.2.4.2-1 for a duration sufficient to achieve statistical significance according to Annex H.2A.
13. Repeat steps from 10 to 12, using an interfering signal above the wanted signal in Case 2 at step 11.
14. Repeat for applicable channel bandwidths and operating band combinations in both Case 1 and Case 2.

NOTE: The purpose of the Uplink power control window is to ensure that the actual UE output power is no greater than the target power level, and as close as possible to the target power level. The relationship between the Uplink power control window, the target power level and the corresponding possible actual UE Uplink power window is illustrated in Annex F.4.3.

Table 7.5A.2.4.2-1: Test repetition and measurement configuration

CA configuration	CA configuration ID in REFSENS	Throughput measured on	Table with test parameters to select
Intra-band contiguous	1 ⁶	PCC, SCC1, SCC2	7.5A.2.5-1 ⁴ 7.5A.2.5-2 ⁴ 7.5A.2.5-3 ⁴
Inter-band	1 ¹	SCC1, SCC2	7.5A.2.5-4
	2 ¹		7.5A.2.5-5
	3 ¹		7.5A.2.5-6 7.5A.2.5-7 7.5A.2.5-8 7.5A.2.5-9
Intra-band contiguous + Inter-band	1 ²	SCC2	7.5A.2.5-4 7.5A.2.5-5 7.5A.2.5-6 7.5A.2.5-7 7.5A.2.5-8 7.5A.2.5-9
	2 ²	SCC1, SCC2	7.5A.2.5-1 ⁵ 7.5A.2.5-1a ⁵ 7.5A.2.5-2 ⁵ 7.5A.2.5-2a ⁵ 7.5A.2.5-3 ⁵ 7.5A.2.5-3a ⁵
Intra-band non-contiguous + Inter-band	1 ³	SCC2	7.5A.2.5-4 7.5A.2.5-5 7.5A.2.5-6 7.5A.2.5-7 7.5A.2.5-8 7.5A.2.5-9
	2 ³	SCC1, SCC2	7.5A.2.5-4 7.5A.2.5-5 7.5A.2.5-6 7.5A.2.5-7 7.5A.2.5-8 7.5A.2.5-9
NOTE 1: CA configuration ID as defined in "Default Test Settings for a CA_nXA-nYA-nZA Configuration (Inter-band)" in table 7.3A.2.4.1-1			
NOTE 2: CA configuration ID as defined in "Default Test Settings for a CA_nXC-YA, CA_nYA-nXC, CA_nYA-nXB and CA_nXB-nYA Configurations (Intra-band contiguous + Inter-band)" in table 7.3A.2.4.1-1.			
NOTE 3: CA configuration ID as defined in "Default Test Settings for a CA_nX(2A)-nYA Configuration (Intra-band non-contiguous + Inter-band)" in table 7.3A.2.4.1-1.			
NOTE 4: Test requirements and parameters refer to CA bandwidth D.			
NOTE 5: Test requirements and parameters refer to CA bandwidth B or C.			
NOTE 6: CA configuration ID as defined in "Default Test Settings for a CA_nXD Configuration (Intra-band contiguous)" in table 7.3A.2.4.1-1			

7.5A.2.4.3 Message Contents

Message contents are according to TS 38.508-1 [5] subclause 4.6 with TRANSFORM_PRECODER_ENABLED condition in Table 4.6.3-118 PUSCH-Config.

7.5A.2.5 Test Requirement

The throughput of each carrier shall be $\geq 95\%$ of the maximum throughput of the reference measurement channels as specified in Annexes A.2.2, A.2.3, A.3.2 and A.3.3 (with one sided dynamic OCNG Pattern for the DL-signal as described in Annex A.5.1.1/A.5.2.1) with parameters specified in Tables 7.5A.2.5-2 and 7.5A.2.5-3.

Table 7.5A.2.5-1: ACS for intra-band contiguous CA with $F_{DL_low} \geq 3300$ MHz and $F_{UL_low} \geq 3300$ MHz

Rx Parameter	Units	NR CA bandwidth class		
		B	C	D
ACS	dB	26.0	33.0	25.2

Table 7.5A.2.5-1a: ACS for intra-band contiguous CA with $F_{DL_low} < 2700$ MHz and $F_{UL_low} < 2700$ MHz

Rx Parameter	Units	NR CA bandwidth class	
		B	C
ACS	dB	20.0	17.0

Table 7.5A.2.5-2: Test parameters for intra-band contiguous CA with $F_{DL_low} \geq 3300$ MHz and $F_{UL_low} \geq 3300$ MHz, case 1

Rx Parameter	Units	NR CA bandwidth class		
		B	C	D
P_w in Transmission Bandwidth Configuration, per CC	dBm	REFSENS + 14 dB	REFSENS + 14 dB	REFSENS + 14 dB
$P_{interferer}$	dBm	Aggregated power + 24.5 dB	Aggregated power + 31.5 dB	Aggregated power + 23.7 dB
$BW_{interferer}$	MHz	20	$BW_{channel\ CA}$	50
$F_{interferer}$ (offset)	MHz	10 + F_{offset} / -10 - F_{offset}	$BW_{channel\ CA}$ / - $BW_{channel\ CA}$	25 + F_{offset} / -25 - F_{offset}

OTE 1: The transmitter shall be set to 4 dB below $P_{CMAX_L,f,c}$ at the minimum UL configuration specified in Table 7.3.2-3 with $P_{CMAX_L,f,c}$ defined in clause 6.2.4.

OTE 2: The absolute value of the interferer offset $F_{interferer}$ (offset) shall be further adjusted to $(\lceil F_{interferer} / SCS \rceil + 0.5) SCS$ MHz with SCS the sub-carrier spacing of the carrier closest to the interferer in MHz. The interferer is an NR signal with an SCS equal to that of the closest carrier.

OTE 3: The interferer consists of the RMC specified in Annexes A.3.2.2 and A.3.3.2 with one sided dynamic OCNG Pattern OP.1 FDD/TDD for the DL-signal as described in Annex A.5.1.1/A.5.2.1.

Table 7.5A.2.5-2a: Test parameters for intra-band contiguous CA with $F_{DL_low} < 2700$ MHz and $F_{UL_low} < 2700$ MHz, case 1

Rx Parameter	Units	NR CA bandwidth class	
		B	C
P_w in Transmission Bandwidth Configuration, per CC	dBm	REFSENS + 14 dB	REFSENS + 14 dB
$P_{interferer}$	dBm	Aggregated power + 18.5 dB	Aggregated power + 15.5 dB
$BW_{interferer}$	MHz	5	5
$F_{interferer}$ (offset)	MHz	2.5 + F_{offset} / -2.5 - F_{offset}	2.5 + F_{offset} / -2.5 - F_{offset}

NOTE 1: The transmitter shall be set to 4 dB below $P_{CMAX_L,f,c}$ at the minimum UL configuration specified in Table 7.3.2-3 with $P_{CMAX_L,f,c}$ defined in clause 6.2.4.

NOTE 2: The absolute value of the interferer offset $F_{interferer}$ (offset) shall be further adjusted to $(\lceil F_{interferer} / SCS \rceil + 0.5) SCS$ MHz with SCS the sub-carrier spacing of the carrier closest to the interferer in MHz. The interferer is an NR signal with 15 kHz SCS.

NOTE 3: The interferer consists of the RMC specified in Annexes A.3.2.2 and A.3.3.2 with one sided dynamic OCNG Pattern OP.1 FDD/TDD for the DL-signal as described in Annex A.5.1.1/A.5.2.1.

Table 7.5A.2.5-3: Test parameters for intra-band contiguous CA with $F_{DL_low} \geq 3300$ MHz and $F_{UL_low} \geq 3300$ MHz, case 2

Rx Parameter	Units	NR CA bandwidth class		
		B	C	D
Pw in Transmission Bandwidth Configuration, per CC	dBm	$-49.5 + 10\log(N_{RB,c}/N_{RB_agg})$	-56.5	$-48.7 + 10\log(N_{RB,c}/N_{RB_agg})$
$P_{Interferer}$	dBm	-25	-25	-25
$BW_{Interferer}$	MHz	20	$BW_{channel\ CA}$	50
$F_{Interferer}$ (offset)	MHz	$10 + F_{offset}$ / $-10 - F_{offset}$	$BW_{channel\ CA}$ / $-BW_{channel\ CA}$	$25 + F_{offset}$ / $-25 - F_{offset}$

NOTE 1: The transmitter shall be set to 24 dB below $P_{CMAX_L,f,c}$ at the minimum UL configuration specified in Table 7.3.2-3 with $P_{CMAX_L,f,c}$ defined in clause 6.2.4.

NOTE 2: The absolute value of the interferer offset $F_{interferer}$ (offset) shall be further adjusted to $(\lceil F_{interferer} / SCS \rceil + 0.5) SCS$ MHz with SCS the sub-carrier spacing of the carrier closest to the interferer in MHz. The interferer is an NR signal with an SCS equal to that of the closest carrier.

NOTE 3: The interferer consists of the RMC specified in Annexes A.3.2.2 and A.3.3.2 with one sided dynamic OCNG Pattern OP.1 FDD/TDD for the DL-signal as described in Annex A.5.1.1/A.5.2.1.

Table 7.5A.2.5-3a: Test parameters for intra-band contiguous CA with $F_{DL_low} < 2700$ MHz and $F_{UL_low} < 2700$ MHz, case 2

Rx Parameter	Units	NR CA Bandwidth Class	
		B	C
Pw in Transmission Bandwidth Configuration, per CC	dBm	$-43.5 + 10\log(N_{RB,c}/N_{RB_agg})$	$-40.5 + 10\log(N_{RB,c}/N_{RB_agg})$
$P_{Interferer}$	dBm	-25	-25
$BW_{Interferer}$	MHz	5	5
$F_{Interferer}$ (offset)	MHz	$2.5 + F_{offset}$ / $-2.5 - F_{offset}$	$2.5 + F_{offset}$ / $-2.5 - F_{offset}$

NOTE 1: The transmitter shall be set to 24 dB below $P_{CMAX_L,f,c}$ at the minimum UL configuration specified in Table 7.3.2-3 with $P_{CMAX_L,f,c}$ defined in clause 6.2.4.

NOTE 2: The absolute value of the interferer offset $F_{interferer}$ (offset) shall be further adjusted to $(\lceil F_{interferer} / SCS \rceil + 0.5) SCS$ MHz with SCS the sub-carrier spacing of the carrier closest to the interferer in MHz. The interferer is an NR signal with 15 kHz SCS.

NOTE 3: The interferer consists of the RMC specified in Annexes A.3.2.2 and A.3.3.2 with one sided dynamic OCNG Pattern OP.1 FDD/TDD for the DL-signal as described in Annex A.5.1.1/A.5.2.1.

For NR SCC of inter-band and intra-band non-contiguous CA with $F_{DL_high} < 2700$ MHz and $F_{UL_high} < 2700$ MHz, the throughput measurement derived in test procedure shall be $\geq 95\%$ of the maximum throughput of the reference measurement channels as specified in Annexes A.2.2, A.2.3 and A.3.2 (with one sided dynamic OCNG Pattern OP.1 FDD/TDD for the DL-signal as described in Annex A.5.1.1/A.5.2.1) with parameters specified in Tables 7.5A.2.5-5 and 7.5A.2.5-6.

Table 7.5A.2.5-4: ACS for NR bands with $F_{DL_high} < 2700$ MHz and $F_{UL_high} < 2700$ MHz (inter-band, intra-band non-contiguous)

RX parameter	Units	Channel bandwidth				
		5 MHz	10 MHz	15 MHz	20 MHz	25 MHz
ACS	dB	33	33	30	27	26
RX parameter	Units	Channel bandwidth				
		30 MHz	40 MHz	50 MHz	60 MHz	80 MHz
ACS	dB	25.5	24	23	22.5	21
RX parameter	Units	Channel bandwidth				
		90 MHz	100 MHz			
ACS	dB	20.5	20			

Table 7.5A.2.5-5: Test parameters for NR bands with $F_{DL_high} < 2700$ MHz and $F_{UL_high} < 2700$ MHz, case 1 (inter-band, intra-band non-contiguous)

RX parameter	Units	Channel bandwidth				
		5 MHz	10 MHz	15 MHz	20 MHz	25 MHz
Pw in Transmission Bandwidth Configuration, per CC	dBm	REFSENS + 14 dB				
$P_{interferer}$	dBm	REFSENS for SCC + 45.5 dB	REFSENS for SCC + 45.5 dB	REFSENS for SCC + 42.5 dB	REFSENS for SCC + 39.5 dB	REFSENS for SCC + 38.5 dB
$BW_{interferer}$	MHz	5	5	5	5	5
$F_{interferer}$ (offset from SCC)	MHz	5 / -5	7.5 / -7.5	10 / -10	12.5 / -12.5	15 / -15
RX parameter	Units	Channel bandwidth				
		30 MHz	40 MHz	50 MHz	60 MHz	80 MHz
Pw in Transmission Bandwidth Configuration, per CC	dBm	REFSENS + 14 dB				
$P_{interferer}$	dBm	REFSENS for SCC + 38 dB	REFSENS for SCC + 36.5 dB	REFSENS for SCC + 35.5 dB	REFSENS for SCC + 35 dB	REFSENS for SCC + 33.5 dB
$BW_{interferer}$	MHz	5	5	5	5	5
$F_{interferer}$ (offset from SCC)	MHz	17.5 / -17.5	22.5 / -22.5	27.5 / -27.5	32.5 / -32.5	42.5 / -42.5
RX parameter	Units	Channel bandwidth				
		90 MHz	100 MHz			
Pw in Transmission Bandwidth Configuration, per CC	dBm	REFSENS + 14 dB				
$P_{interferer}$	dBm	REFSENS for SCC + 33 dB	REFSENS for SCC + 32.5 dB			
$BW_{interferer}$	MHz	5	5			
$F_{interferer}$ (offset from SCC)	MHz	47.5 / -47.5	52.5 / -52.5			
<p>NOTE 1: The transmitter shall be set to 4dB below $P_{C_{MAX_L,f,c}}$ at the minimum UL configuration specified in Table 7.3.2.3-3 with $P_{C_{MAX_L,f,c}}$ defined in clause 6.2.4.</p> <p>NOTE 2: The absolute value of the interferer offset $F_{interferer}$ (offset) shall be further adjusted to $(\lceil F_{interferer} / SCS \rceil + 0.5) SCS$ MHz with SCS the sub-carrier spacing of the wanted signal in MHz. The interferer is an NR signal with an SCS equal to that of the wanted signal.</p> <p>NOTE 3: The interferer consists of the NR interferer RMC specified in Annexes A.3.2.2 and A.3.3.2 with one sided dynamic OCN Pattern OP.1 FDD/TDD for the DL-signal as described in Annex A.5.1.1/A.5.2.1.</p>						

Table 7.5A.2.5-6: Test parameters for NR bands with $F_{DL_high} < 2700$ MHz and $F_{UL_high} < 2700$ MHz, case 2 (inter-band, intra-band non-contiguous)

RX parameter	Units	Channel bandwidth				
		5 MHz	10 MHz	15 MHz	20 MHz	25 MHz
Pw in Transmission Bandwidth Configuration, per CC	dBm	-56.5	-56.5	-53.5	-50.5	-49.5
$P_{interferer}$	dBm	-25				
$BW_{interferer}$	MHz	5	5	5	5	5
$F_{interferer}$ (offset from SCC)	MHz	5 / -5	7.5 / -7.5	10 / -10	12.5 / -12.5	15 / -15
RX parameter	Units	Channel bandwidth				
		30 MHz	40 MHz	50 MHz	60 MHz	80 MHz
Pw in Transmission Bandwidth Configuration, per CC	dBm	-49	-47	-46.5	-46	-44.5
$P_{interferer}$	dBm	-25				
$BW_{interferer}$	MHz	5	5	5	5	5
$F_{interferer}$ (offset from SCC)	MHz	17.5 / -17.5	22.5 / -22.5	27.5 / -27.5	32.5 / -32.5	42.5 / -42.5
RX parameter	Units	Channel bandwidth				
		90 MHz	100 MHz			
Pw in Transmission Bandwidth Configuration, per CC	dBm	-44	-43.5			
$P_{interferer}$	dBm	-25				
$BW_{interferer}$	MHz	5	5			
$F_{interferer}$ (offset from SCC)	MHz	47.5 / -47.5	52.5 / -52.5			
NOTE 1: The transmitter shall be set to 24 dB below $P_{C_{MAX_L,f,c}}$ at the minimum UL configuration specified in Table 7.3.2.3-3 with $P_{C_{MAX_L,f,c}}$ defined in clause 6.2.4.						
NOTE 2: The absolute value of the interferer offset $F_{interferer}$ (offset) shall be further adjusted to $(\lceil F_{interferer} / SCS \rceil + 0.5) SCS$ MHz with SCS the sub-carrier spacing of the wanted signal in MHz. The interferer is an NR signal with an SCS equal to that of the wanted signal.						
NOTE 3: The interferer consists of the RMC specified in Annexes A.3.2.2 and A.3.3.2 with one sided dynamic OCNB Pattern OP.1 FDD/TDD for the DL-signal as described in Annex A.5.1.1/A.5.2.1.						

For NR SCC of inter-band and intra-band non-contiguous CA with $F_{DL_low} \geq 3300$ MHz and $F_{UL_low} \geq 3300$ MHz, the throughput measurement derived in test procedure shall be $\geq 95\%$ of the maximum throughput of the reference measurement channels as specified in Annexes A.2.2, A.2.3 and A.3.2 (with one sided dynamic OCNB Pattern OP.1 FDD/TDD for the DL-signal as described in Annex A.5.1.1/A.5.2.1) with parameters specified in Tables 7.5A.2.5-8 and 7.5A.2.5-9.

Table 7.5A.2.5-7: ACS for NR bands with $F_{DL_low} \geq 3300$ MHz and $F_{UL_low} \geq 3300$ MHz (inter-band, intra-band non-contiguous)

RX parameter	Units	Channel bandwidth				
		10 MHz	15 MHz	20 MHz	40 MHz	50 MHz
ACS	dB	33	33	33	33	33
RX parameter	Units	Channel bandwidth				
		60 MHz	80 MHz	90 MHz	100 MHz	
ACS	dB	33	33	33	33	

Table 7.5A.2.5-8: Test parameters for NR bands with $F_{DL_low} \geq 3300$ MHz and $F_{UL_low} \geq 3300$ MHz, case 1 (inter-band, intra-band non-contiguous)

RX parameter	Units	Channel bandwidth				
		10 MHz	15 MHz	20 MHz	40 MHz	50 MHz
Pw in Transmission Bandwidth Configuration, per CC	dBm	REFSENS + 14 dB				
$P_{interferer}$	dBm	REFSENS for SCC + 45.5 dB				
$BW_{interferer}$	MHz	10	15	20	40	50
$F_{interferer}$ (offset from SCC)	MHz	10 / -10	15 / -15	20 / -20	40 / -40	50 / -50
RX parameter	Units	Channel bandwidth				
		60 MHz	80 MHz	90 MHz	100 MHz	
Pw in Transmission Bandwidth Configuration, per CC	dBm	REFSENS + 14 dB				
$P_{interferer}$	dBm	REFSENS for SCC + 45.5 dB	REFSENS for SCC + 45.5 dB	REFSENS for SCC + 45.5 dB	REFSENS for SCC + 45.5 dB	
$BW_{interferer}$	MHz	60	80	90	100	
$F_{interferer}$ (offset from SCC)	MHz	60 / -60	80 / -80	90 / -90	100 / -100	
<p>NOTE 1: The transmitter shall be set to 4dB below $P_{CMAX_L,f,c}$ at the minimum UL configuration specified in Table 7.3.2.3-3 with $P_{CMAX_L,f,c}$ defined in clause 6.2.4.</p> <p>NOTE 2: The absolute value of the interferer offset $F_{interferer}$ (offset) shall be further adjusted to $(\lceil F_{interferer} / SCS \rceil + 0.5) SCS$ MHz with SCS the sub-carrier spacing of the wanted signal in MHz. The interferer is an NR signal with an SCS equal to that of the wanted signal.</p> <p>NOTE 3: The interferer consists of the RMC specified in Annexes A.3.2.2 and A.3.3.2 with one sided dynamic OCN Pattern OP.1 FDD/TDD for the DL-signal as described in Annex A.5.1.1/A.5.2.1.</p>						

Table 7.5A.2.5-9: Test parameters for NR bands with $F_{DL_low} \geq 3300$ MHz and $F_{UL_low} \geq 3300$ MHz, case 2 (inter-band, intra-band non-contiguous)

RX parameter	Units	Channel bandwidth				
		10 MHz	15 MHz	20 MHz	40 MHz	50 MHz
Pw in Transmission Bandwidth Configuration, per CC	dBm	-56.5				
$P_{interferer}$	dBm	-25				
$BW_{interferer}$	MHz	10	15	20	40	50
$F_{interferer}$ (offset from SCC)	MHz	10 / -10	15 / -15	20 / -20	40 / -40	50 / -50
RX parameter	Units	Channel bandwidth				
		60 MHz	80 MHz	90 MHz	100 MHz	
Pw in Transmission Bandwidth Configuration, per CC	dBm	-56.5				
$P_{interferer}$	dBm	-25	-25	-25	-25	
$BW_{interferer}$	MHz	60	80	90	100	
$F_{interferer}$ (offset from SCC)	MHz	60 / -60	80 / -80	90 / -90	100 / -100	
NOTE 1: The transmitter shall be set to 24 dB below $P_{CMAX_L,f,c}$ at the minimum UL configuration specified in Table 7.3.2.3-3 with $P_{CMAX_L,f,c}$ defined in clause 6.2.4.						
NOTE 2: The absolute value of the interferer offset $F_{interferer}$ (offset) shall be further adjusted to $(\lceil F_{interferer} / SCS \rceil + 0.5) SCS$ MHz with SCS the sub-carrier spacing of the wanted signal in MHz. The interferer is an NR signal with an SCS equal to that of the wanted signal.						
NOTE 3: The interferer consists of the RMC specified in Annexes A.3.2.2 and A.3.3.2 with one sided dynamic OCNG Pattern OP.1 FDD/TDD for the DL-signal as described in Annex A.5.1.1/A.5.2.1.						

7.5A.3 Adjacent channel selectivity for 4DL CA

Editor's note: - part content of Table 7.5A.3.4.2-1 is FFS.

7.5A.3.1 Test Purpose

Adjacent channel selectivity for 4DL CA verifies the receiver's ability to receive a wanted 4DL carrier aggregated at its assigned channel frequency in the presence of an adjacent channel signal at a given frequency offset from the centre frequency of the assigned channel.

7.5A.3.2 Test Applicability

This test case applies to all types of NR UE release 15 and forward that support 4DL CA.

7.5A.3.3 Minimum Conformance Requirements

The minimum conformance requirements are defined in clause 7.5A.0.

7.5A.3.4 Test Description

7.5A.3.4.1 Initial Conditions

Same as in clause 7.5A.1.4.1 with following exceptions:

- Instead of Table 7.5A.1.4.1-1 → use Table 7.5A.3.4.1-1.
- Instead of Table 7.5A.1.4.1-2 → use Table 7.5A.3.4.1-2.
- Instead of Table 7.5A.1.4.1-3 → use Table 7.5A.3.4.1-3.

Table 7.5A.3.4.1-1: Test Configuration Table for 4DL CA

Default Conditions							
Test Environment as specified in TS 38.508-1 [5] subclause 4.1				Normal			
Test Frequencies as specified in TS 38.508-1 [5] subclause 4.3.1				Intra-band contiguous: Mid range for PCC and SCCs Inter-band CA: NOTE 1, NOTE 5 Inter-band + Intra-band contiguous : NOTE 1, NOTE 5 Inter-band + Intra-band non-contiguous : NOTE 1 with Wgap for intra-band non-contiguous defined in table 7.3A.3.4.1-1(NOTE 5)			
Test CC Combination setting (NRB_agg) as specified in Tables 5.5A.1-1, 5.5A.2-1, or tables in clauses 5.5A.3.x for the CA Configuration across bandwidth combination sets supported by the UE.				Intra-band contiguous: Lowest NRB_agg, Highest NRB_agg Inter-band: Highest NRB_agg Inter-band + Intra-band contiguous : Highest NRB_agg Inter-band + Intra-band non-contiguous : Highest NRB_agg NOTE 6			
Test SCS as specified in Table 5.3.5-1				Lowest for PCC and SCCs			
Network signalling value				NS_01 Unless given by Table 7.3.2.3-4 for the band with active uplink carrier			
Test Parameters							
Test ID	Downlink Configuration					Uplink Configuration	
	CC Mod'n	PCC RB allocation	SCC ₁ RB allocation	SCC ₂ RB allocation	SCC ₃ RB allocation	CC Mod'n	PCC RB allocation
Default Test Settings for a CA_nXE Configuration (intra-band contiguous)							
1	CP-OFDM QPSK	NOTE 1	NOTE 1	NOTE 1	NOTE 1	DFT-s-OFDM QPSK	NOTE 1
Default Test Settings for a CA_nXA-nYA-nZA-nVA Configuration (Inter-band)							
1	CP-OFDM QPSK	NOTE 1	NOTE 1	NOTE 1	NOTE 1	DFT-s-OFDM QPSK	NOTE 1
Default Test Settings for a CA_nXA-nYB-nZA, CA_nXA-nYA-nZB, CA_nXD-nYA, CA_nXC-nYB, CA_nXC-nYC and CA_nXB-nYB Configurations (Intra-band contiguous + Inter-band)							
1	CP-OFDM QPSK	NOTE 1	NOTE 1	NOTE 1	NOTE 1	DFT-s-OFDM QPSK	NOTE 1
Default Test Settings for a CA_nXA-nYA-nZ(2A), CA_nXA-nY(3A) and CA_nX(2A)-nY(2A) Configuration (Intra-band non-contiguous + Inter-band)							
1	CP-OFDM QPSK	NOTE 1	NOTE 1	NOTE 1	NOTE 1	DFT-s-OFDM QPSK	NOTE 1
Default Test Settings for a CA_nX(4A) Configuration intra-band non-contiguous)							
1	CP-OFDM QPSK	NOTE 1	NOTE 1	NOTE 1	NOTE 1	DFT-s-OFDM QPSK	NOTE 1
NOTE 1: The specific configuration of uplink and downlink are defined in Table 7.3A.3.4.1-1. Only test points verifying non-exceptional REFSENS requirements are used for ACS.							
NOTE 2: CA Configuration Test CC Combination test settings are checked separately for each CA Configuration.							
NOTE 3: Inter-band: X,Y,Z,V correspond to the different bands in the CA Configuration. E.g. for CA_n1A-n3A-n7A-n28A, X=1, Y=3, Z=7,V=28; Intra-band contiguous + Inter-band: X,Y,Z correspond to the different bands in the CA Configuration, E.g. for CA_n3A-n7B-n28A, X=1,Y=3,z=28; Intra-band non-contiguous + Inter-band: X,Y,Z correspond to the different bands in the CA Configuration. E.g. for CA_n2A-n66A-n77(2A), X=2, Y=66,Z=77;							
NOTE 4: In a band where UE supports 4Rx, the test shall be performed only with 4Rx antennas ports connected and 4Rx REFSENS requirement (Table 7.3.2.5-2) is used in the test requirements.							
NOTE 5: For NR band n28, 30MHz test channel bandwidth is tested with Low range test frequencies.							
NOTE 6: If the UE supports multiple CC Combinations in the CA Configuration with the same NRB_agg, only the combination with the highest NRB_PCC is tested.							

Table 7.5A.3.4.1-2: Void**Table 7.5A.3.4.1-3: Void****7.5A.3.4.2 Test Procedure**

1. Configure SCCs according to Annex C.0, C.1, C.2 for all downlink physical channels.
2. The SS shall configure SCCs as per TS 38.508-1 [5] clause 5.1.1. Message contents are defined in clause 7.5A.3.4.3.
3. SS activates SCCs by sending the activation MAC CE (Refer TS 38.321 [18], clauses 5.9, 6.1.3.10). Wait for at least 2 seconds (Refer TS 38.133[19], clause 9.3).
4. SS transmits PDSCH via PDCCH DCI format 1_1 for C_RNTI to transmit the DL RMC according to Table 7.5A.3.4.1-1 on both PCC and SCCs. The SS sends downlink MAC padding bits on the DL RMC.
5. SS sends uplink scheduling information for each UL HARQ process via PDCCH DCI format 0_1 for C_RNTI to schedule the UL RMC according to Table 7.5A.3.4.2-1 on PCC. Since the UL has no payload and no loopback data to send the UE sends uplink MAC padding bits on the UL RMC.
6. Set the Downlink signal level according to Table 7.5A.3.4.2-1 as appropriate (Case 1). Send uplink power control commands to the UE using 1dB power step size to ensure that the UE output power measured by the test system is within the Uplink power control window, defined as $-(\text{MU} + \text{Uplink power control window size})$ dB of the target power level in Table 7.5A.3.4.2-1 for at least the duration of the Throughput measurement, where:
 - MU is the test system uplink power measurement uncertainty and is specified in Table F.1.3-1 for the carrier frequency f and the channel bandwidth BW
 - Uplink power control window size = $1\text{dB (UE power step size)} + 0.7\text{dB (UE power step tolerance)} + (\text{Test system relative power measurement uncertainty})$, where, the UE power step tolerance is specified in TS 38.101-1 [2], Table 6.3.4.3-1 and is 0.7dB for 1dB power step size, and the Test system relative power measurement uncertainty is specified for test case 6.3.4.3 in Table F.1.2-1.
7. Set the Interferer signal level to the value as defined in Table 7.5A.3.4.2-1 as appropriate (Case 1) and frequency below the wanted signal, using a modulated interferer bandwidth as defined in Annex D.
8. Measure the average throughput for each component carrier for a duration sufficient to achieve statistical significance according to Annex H.2A.
9. Repeat steps from 6 to 8, using an interfering signal above the wanted signal in Case 1 at step 7.
10. Set the Downlink signal level according to Table 7.5A.3.4.2-1 as appropriate (Case 2). Send uplink power control commands to the UE using 1dB power step size to ensure that the UE output power measured by the test system is within the Uplink power control window, defined as $-(\text{MU} + \text{Uplink power control window size})$ dB of the target power level in Table 7.5A.3.4.2-1 for at least the duration of the Throughput measurement, where MU and Uplink power control window size are defined above.
11. Set the Interferer signal level to the value as defined in Table 7.5A.3.4.2-1 as appropriate (Case 2) and frequency below the wanted signal, using a modulated interferer bandwidth as defined in Annex D.
12. Measure the average throughput for each component carrier for a duration sufficient to achieve statistical significance according to Annex H.2A.
13. Repeat steps from 10 to 12, using an interfering signal above the wanted signal in Case 2 at step 11.
14. Repeat for applicable channel bandwidths and operating band combinations in both Case 1 and Case 2.

NOTE: The purpose of the Uplink power control window is to ensure that the actual UE output power is no greater than the target power level, and as close as possible to the target power level. The relationship between the Uplink power control window, the target power level and the corresponding possible actual UE Uplink power window is illustrated in Annex F.4.3.

Table 7.5A.3.4.2-1: Test repetition and measurement configuration

CA configuration	CA configuration ID in REFSSENS	Throughput measured on	Table with test parameters to select
Intra-band contiguous	1 ⁴	PCC, SCC1, SCC2, SCC3	TBD
Inter-band	1 ¹	TBD	TBD
	2 ¹		
	3 ¹		
Intra-band contiguous + Inter-band	1 ²	TBD	TBD
	2 ²		
	3 ²		
Intra-band non-contiguous + Inter-band	1 ³	TBD	TBD
	2 ³		
	3 ³		
Intra-band non-contiguous	1 ⁵	TBD	TBD
NOTE 1: CA configuration ID as defined in "Default Test Settings for a CA_nXA-nYA-nZA-nVA Configuration (Inter-band)" in table 7.3A.3.4.1-1.			
NOTE 2: CA configuration ID as defined in "Default Test Settings for a CA_nXA-nYB-nZA, CA_nXA-nYA-nZB, CA_nXD-nYA, CA_nXC-nYB, CA_nXC-nYC and CA_nXB-nYB Configurations (Intra-band contiguous + Inter-band)" in table 7.3A.3.4.1-1.			
NOTE 3: CA configuration ID as defined in "Default Test Settings for a CA_nXA-nYA-nZ(2A), CA_nXA-nY(3A) and CA_nX(2A)-nY(2A) Configuration (Intra-band non-contiguous + Inter-band)" in table 7.3A.3.4.1-1.			
NOTE 4: CA configuration ID as defined in "Default Test Settings for a CA_nXE Configuration (Intra-band contiguous)" in table 7.3A.3.4.1-1.			
NOTE 5: CA configuration ID as defined in "Default Test Settings for a CA_nX(4A) Configuration intra-band non-contiguous)" in table 7.3A.3.4.1-1.			

7.5A.3.4.3 Message Contents

Message contents are according to TS 38.508-1 [5] subclause 4.6 with TRANSFORM_PRECODER_ENABLED condition in Table 4.6.3-118 PUSCH-Config.

7.5A.3.5 Test Requirement

The throughput of each carrier shall be $\geq 95\%$ of the maximum throughput of the reference measurement channels as specified in Annexes A.2.2, A.2.3, A.3.2 and A.3.3 (with one sided dynamic OCNG Pattern for the DL-signal as described in Annex A.5.1.1/A.5.2.1) with parameters specified in Tables 7.5A.3.5-2, 7.5A.3.5-2a, 7.5A.3.5-3, 7.5A.3.5-3a.

Table 7.5A.3.5-1: ACS for intra-band contiguous CA with $F_{DL_low} \geq 3300$ MHz and $F_{UL_low} \geq 3300$ MHz

Rx Parameter	Units	NR CA bandwidth class		
		B	C	D
ACS	dB	26.0	33.0	25.2

Table 7.5A.3.5-1a: ACS for intra-band contiguous CA with $F_{DL_low} < 2700$ MHz and $F_{UL_low} < 2700$ MHz

Rx Parameter	Units	NR CA bandwidth class	
		B	C
ACS	dB	20.0	17.0

Table 7.5A.3.5-2: Test parameters for intra-band contiguous CA with $F_{DL_low} \geq 3300$ MHz and $F_{UL_low} \geq 3300$ MHz, case 1

Rx Parameter	Units	NR CA bandwidth class		
		B	C	D
Pw in Transmission Bandwidth Configuration, per CC	dBm	REFSENS + 14 dB	REFSENS + 14 dB	REFSENS + 14 dB
$P_{Interferer}$	dBm	Aggregated power + 24.5 dB	Aggregated power + 31.5 dB	Aggregated power + 23.7 dB
$BW_{Interferer}$	MHz	20	$BW_{channel\ CA}$	50
$F_{Interferer}$ (offset)	MHz	10 + Foffset / -10 - Foffset	$BW_{channel\ CA}$ / - $BW_{channel\ CA}$	25 + Foffset / -25 - Foffset

OTE 1: The transmitter shall be set to 4 dB below $P_{CMAX_L,f,c}$ at the minimum UL configuration specified in Table 7.3.2-3 with $P_{CMAX_L,f,c}$ defined in clause 6.2.4.

OTE 2: The absolute value of the interferer offset $F_{interferer}$ (offset) shall be further adjusted to $(\lceil |F_{interferer}| / SCS \rceil + 0.5) SCS$ MHz with SCS the sub-carrier spacing of the carrier closest to the interferer in MHz. The interferer is an NR signal with an SCS equal to that of the closest carrier.

OTE 3: The interferer consists of the RMC specified in Annexes A.3.2.2 and A.3.3.2 with one sided dynamic OCNG Pattern OP.1 FDD/TDD for the DL-signal as described in Annex A.5.1.1/A.5.2.1.

Table 7.5A.3.5-2a: Test parameters for intra-band contiguous CA with $F_{DL_low} < 2700$ MHz and $F_{UL_low} < 2700$ MHz, case 1

Rx Parameter	Units	NR CA bandwidth class	
		B	C
Pw in Transmission Bandwidth Configuration, per CC	dBm	REFSENS + 14 dB	REFSENS + 14 dB
$P_{Interferer}$	dBm	Aggregated power + 18.5 dB	Aggregated power + 15.5 dB
$BW_{Interferer}$	MHz	5	5
$F_{Interferer}$ (offset)	MHz	2.5 + Foffset / -2.5 - Foffset	2.5 + Foffset / -2.5 - Foffset

NOTE 1: The transmitter shall be set to 4 dB below $P_{CMAX_L,f,c}$ at the minimum UL configuration specified in Table 7.3.2-3 with $P_{CMAX_L,f,c}$ defined in clause 6.2.4.

NOTE 2: The absolute value of the interferer offset $F_{interferer}$ (offset) shall be further adjusted to $(\lceil |F_{interferer}| / SCS \rceil + 0.5) SCS$ MHz with SCS the sub-carrier spacing of the carrier closest to the interferer in MHz. The interferer is an NR signal with 15 kHz SCS.

NOTE 3: The interferer consists of the RMC specified in Annexes A.3.2.2 and A.3.3.2 with one sided dynamic OCNG Pattern OP.1 FDD/TDD for the DL-signal as described in Annex A.5.1.1/A.5.2.1.

Table 7.5A.3.5-3: Test parameters for intra-band contiguous CA with $F_{DL_low} \geq 3300$ MHz and $F_{UL_low} \geq 3300$ MHz, case 2

Rx Parameter	Units	NR CA bandwidth class		
		B	C	D

Pw in Transmission Bandwidth Configuration, per CC	dBm	-49.5 + 10log(N _{RB,c} /N _{RB_agg})	-56.5	-48.7 + 10log(N _{RB,c} /N _{RB_agg})	
P _{Interferer}	dBm	-25	-25	-25	
BW _{Interferer}	MHz	20	BW _{channel CA}	50	
F _{Interferer (offset)}	MHz	10 + F _{offset} / -10 - F _{offset}	BW _{channel CA} / -BW _{channel CA}	25 + F _{offset} / -25 - F _{offset}	

NOTE 1: The transmitter shall be set to 24 dB below P_{C_{MAX}_L,f,c} at the minimum UL configuration specified in Table 7.3.2-3 with P_{C_{MAX}_L,f,c} defined in clause 6.2.4.

NOTE 2: The absolute value of the interferer offset F_{interferer (offset)} shall be further adjusted to $(\lceil |F_{interferer}| / SCS \rceil + 0.5) SCS$ MHz with SCS the sub-carrier spacing of the carrier closest to the interferer in MHz. The interferer is an NR signal with an SCS equal to that of the closest carrier.

NOTE 3: The interferer consists of the RMC specified in Annexes A.3.2.2 and A.3.3.2 with one sided dynamic OCNG Pattern OP.1 FDD/TDD for the DL-signal as described in Annex A.5.1.1/A.5.2.1.

Table 7.5A.3.5-3a: Test parameters for intra-band contiguous CA with F_{DL_low} < 2700 MHz and F_{UL_low} < 2700 MHz, case 2

Rx Parameter	Units	NR CA Bandwidth Class	
		B	C
Pw in Transmission Bandwidth Configuration, per CC	dBm	-43.5 + 10log(N _{RB,c} /N _{RB_agg})	-40.5 + 10log(N _{RB,c} /N _{RB_agg})
P _{Interferer}	dBm	-25	-25
BW _{Interferer}	MHz	5	5
F _{Interferer (offset)}	MHz	2.5 + F _{offset} / -2.5 - F _{offset}	2.5 + F _{offset} / -2.5 - F _{offset}

NOTE 1: The transmitter shall be set to 24 dB below P_{C_{MAX}_L,f,c} at the minimum UL configuration specified in Table 7.3.2-3 with P_{C_{MAX}_L,f,c} defined in clause 6.2.4.

NOTE 2: The absolute value of the interferer offset F_{interferer (offset)} shall be further adjusted to $(\lceil |F_{interferer}| / SCS \rceil + 0.5) SCS$ MHz with SCS the sub-carrier spacing of the carrier closest to the interferer in MHz. The interferer is an NR signal with 15 kHz SCS.

NOTE 3: The interferer consists of the RMC specified in Annexes A.3.2.2 and A.3.3.2 with one sided dynamic OCNG Pattern OP.1 FDD/TDD for the DL-signal as described in Annex A.5.1.1/A.5.2.1.

For NR PCC and SCCs of inter-band and intra-band non-contiguous CA with F_{DL_high} < 2700 MHz and F_{UL_high} < 2700 MHz, the throughput measurement derived in test procedure shall be ≥ 95% of the maximum throughput of the reference measurement channels as specified in Annexes A.2.2, A.2.3 and A.3.2 (with one sided dynamic OCNG Pattern OP.1 FDD/TDD for the DL-signal as described in Annex A.5.1.1/A.5.2.1) with parameters specified in Tables 7.5A.3.5-5 and 7.5A.3.5-6.

Table 7.5A.3.5-4: ACS for NR bands with F_{DL_high} < 2700 MHz and F_{UL_high} < 2700 MHz (inter-band, intra-band non-contiguous)

RX parameter	Units	Channel bandwidth				
		5 MHz	10 MHz	15 MHz	20 MHz	25 MHz
ACS	dB	33	33	30	27	26
RX parameter	Units	Channel bandwidth				
		30 MHz	40 MHz	50 MHz	60 MHz	80 MHz
ACS	dB	25.5	24	23	22.5	21
RX parameter	Units	Channel bandwidth				
		90 MHz	100 MHz			
ACS	dB	20.5	20			

Table 7.5A.3.5-5: Test parameters for NR bands with $F_{DL_high} < 2700$ MHz and $F_{UL_high} < 2700$ MHz, case 1 (inter-band, intra-band non-contiguous)

RX parameter	Units	Channel bandwidth				
		5 MHz	10 MHz	15 MHz	20 MHz	25 MHz
Pw in Transmission Bandwidth Configuration, per CC	dBm	REFSENS + 14 dB				
$P_{interferer}$	dBm	REFSENS for SCC + 45.5 dB	REFSENS for SCC + 45.5 dB	REFSENS for SCC + 42.5 dB	REFSENS for SCC + 39.5 dB	REFSENS for SCC + 38.5 dB
$BW_{interferer}$	MHz	5	5	5	5	5
$F_{interferer}$ (offset from SCC)	MHz	5 / -5	7.5 / -7.5	10 / -10	12.5 / -12.5	15 / -15
RX parameter	Units	Channel bandwidth				
		30 MHz	40 MHz	50 MHz	60 MHz	80 MHz
Pw in Transmission Bandwidth Configuration, per CC	dBm	REFSENS + 14 dB				
$P_{interferer}$	dBm	REFSENS for SCC + 38 dB	REFSENS for SCC + 36.5 dB	REFSENS for SCC + 35.5 dB	REFSENS for SCC + 35 dB	REFSENS for SCC + 33.5 dB
$BW_{interferer}$	MHz	5	5	5	5	5
$F_{interferer}$ (offset from SCC)	MHz	17.5 / -17.5	22.5 / -22.5	27.5 / -27.5	32.5 / -32.5	42.5 / -42.5
RX parameter	Units	Channel bandwidth				
		90 MHz	100 MHz			
Pw in Transmission Bandwidth Configuration, per CC	dBm	REFSENS + 14 dB				
$P_{interferer}$	dBm	REFSENS for SCC + 33 dB	REFSENS for SCC + 32.5 dB			
$BW_{interferer}$	MHz	5	5			
$F_{interferer}$ (offset from SCC)	MHz	47.5 / -47.5	52.5 / -52.5			
<p>NOTE 1: The transmitter shall be set to 4dB below $P_{C_{MAX_L,f,c}}$ at the minimum UL configuration specified in Table 7.3.2.3-3 with $P_{C_{MAX_L,f,c}}$ defined in clause 6.2.4.</p> <p>NOTE 2: The absolute value of the interferer offset $F_{interferer}$ (offset) shall be further adjusted to $(\lceil F_{interferer} / SCS \rceil + 0.5) SCS$ MHz with SCS the sub-carrier spacing of the wanted signal in MHz. The interferer is an NR signal with an SCS equal to that of the wanted signal.</p> <p>NOTE 3: The interferer consists of the NR interferer RMC specified in Annexes A.3.2.2 and A.3.3.2 with one sided dynamic OCN Pattern OP.1 FDD/TDD for the DL-signal as described in Annex A.5.1.1/A.5.2.1.</p>						

Table 7.5A.3.5-6: Test parameters for NR bands with $F_{DL_high} < 2700$ MHz and $F_{UL_high} < 2700$ MHz, case 2 (inter-band, intra-band non-contiguous)

RX parameter	Units	Channel bandwidth				
		5 MHz	10 MHz	15 MHz	20 MHz	25 MHz
Pw in Transmission Bandwidth Configuration, per CC	dBm	-56.5	-56.5	-53.5	-50.5	-49.5
$P_{interferer}$	dBm	-25				
$BW_{interferer}$	MHz	5	5	5	5	5
$F_{interferer}$ (offset from SCC)	MHz	5 / -5	7.5 / -7.5	10 / -10	12.5 / -12.5	15 / -15
RX parameter	Units	Channel bandwidth				
		30 MHz	40 MHz	50 MHz	60 MHz	80 MHz
Pw in Transmission Bandwidth Configuration, per CC	dBm	-49	-47	-46.5	-46	-44.5
$P_{interferer}$	dBm	-25				
$BW_{interferer}$	MHz	5	5	5	5	5
$F_{interferer}$ (offset from SCC)	MHz	17.5 / -17.5	22.5 / -22.5	27.5 / -27.5	32.5 / -32.5	42.5 / -42.5
RX parameter	Units	Channel bandwidth				
		90 MHz	100 MHz			
Pw in Transmission Bandwidth Configuration, per CC	dBm	-44	-43.5			
$P_{interferer}$	dBm	-25				
$BW_{interferer}$	MHz	5	5			
$F_{interferer}$ (offset from SCC)	MHz	47.5 / -47.5	52.5 / -52.5			
NOTE 1: The transmitter shall be set to 24 dB below $P_{C_{MAX_L,f,c}}$ at the minimum UL configuration specified in Table 7.3.2.3-3 with $P_{C_{MAX_L,f,c}}$ defined in clause 6.2.4.						
NOTE 2: The absolute value of the interferer offset $F_{interferer}$ (offset) shall be further adjusted to $(\lceil F_{interferer} / SCS \rceil + 0.5) SCS$ MHz with SCS the sub-carrier spacing of the wanted signal in MHz. The interferer is an NR signal with an SCS equal to that of the wanted signal.						
NOTE 3: The interferer consists of the RMC specified in Annexes A.3.2.2 and A.3.3.2 with one sided dynamic OCNG Pattern OP.1 FDD/TDD for the DL-signal as described in Annex A.5.1.1/A.5.2.1.						

For NR PCC and SCCs of inter-band and intra-band non-contiguous CA with $F_{DL_low} \geq 3300$ MHz and $F_{UL_low} \geq 3300$ MHz, the throughput measurement derived in test procedure shall be $\geq 95\%$ of the maximum throughput of the reference measurement channels as specified in Annexes A.2.2, A.2.3 and A.3.2 (with one sided dynamic OCNG Pattern OP.1 FDD/TDD for the DL-signal as described in Annex A.5.1.1/A.5.2.1) with parameters specified in Tables 7.5A.3.5-8 and 7.5A.3.5-9.

Table 7.5A.3.5-7: ACS for NR bands with $F_{DL_low} \geq 3300$ MHz and $F_{UL_low} \geq 3300$ MHz (inter-band, intra-band non-contiguous)

RX parameter	Units	Channel bandwidth				
		10 MHz	15 MHz	20 MHz	40 MHz	50 MHz
ACS	dB	33	33	33	33	33
RX parameter	Units	Channel bandwidth				
		60 MHz	80 MHz	90 MHz	100 MHz	
ACS	dB	33	33	33	33	

Table 7.5A.3.5-8: Test parameters for NR bands with $F_{DL_low} \geq 3300$ MHz and $F_{UL_low} \geq 3300$ MHz, case 1 (inter-band,intra-band non-contiguous)

RX parameter	Units	Channel bandwidth				
		10 MHz	15 MHz	20 MHz	40 MHz	50 MHz
Pw in Transmission Bandwidth Configuration, per CC	dBm	REFSENS + 14 dB				
$P_{interferer}$	dBm	REFSENS for SCC + 45.5 dB				
$BW_{interferer}$	MHz	10	15	20	40	50
$F_{interferer}$ (offset from SCC)	MHz	10 / -10	15 / -15	20 / -20	40 / -40	50 / -50
RX parameter	Units	Channel bandwidth				
		60 MHz	80 MHz	90 MHz	100 MHz	
Pw in Transmission Bandwidth Configuration, per CC	dBm	REFSENS + 14 dB				
$P_{interferer}$	dBm	REFSENS for SCC + 45.5 dB	REFSENS for SCC + 45.5 dB	REFSENS for SCC + 45.5 dB	REFSENS for SCC + 45.5 dB	
$BW_{interferer}$	MHz	60	80	90	100	
$F_{interferer}$ (offset from SCC)	MHz	60 / -60	80 / -80	90 / -90	100 / -100	
<p>NOTE 1: The transmitter shall be set to 4dB below $P_{CMAX_L,f,c}$ at the minimum UL configuration specified in Table 7.3.2.3-3 with $P_{CMAX_L,f,c}$ defined in clause 6.2.4.</p> <p>NOTE 2: The absolute value of the interferer offset $F_{interferer}$ (offset) shall be further adjusted to $(\lceil F_{interferer} / SCS \rceil + 0.5) SCS$ MHz with SCS the sub-carrier spacing of the wanted signal in MHz. The interferer is an NR signal with an SCS equal to that of the wanted signal.</p> <p>NOTE 3: The interferer consists of the RMC specified in Annexes A.3.2.2 and A.3.3.2 with one sided dynamic OCNB Pattern OP.1 FDD/TDD for the DL-signal as described in Annex A.5.1.1/A.5.2.1.</p>						

Table 7.5A.3.5-9: Test parameters for NR bands with $F_{DL_low} \geq 3300$ MHz and $F_{UL_low} \geq 3300$ MHz, case 2 (inter-band, intra-band non-contiguous)

RX parameter	Units	Channel bandwidth				
		10 MHz	15 MHz	20 MHz	40 MHz	50 MHz
Pw in Transmission Bandwidth Configuration, per CC	dBm	-56.5				
$P_{interferer}$	dBm	-25				
$BW_{interferer}$	MHz	10	15	20	40	50
$F_{interferer}$ (offset from SCC)	MHz	10 / -10	15 / -15	20 / -20	40 / -40	50 / -50
RX parameter	Units	Channel bandwidth				
		60 MHz	80 MHz	90 MHz	100 MHz	
Pw in Transmission Bandwidth Configuration, per CC	dBm	-56.5				
$P_{interferer}$	dBm	-25	-25	-25	-25	
$BW_{interferer}$	MHz	60	80	90	100	
$F_{interferer}$ (offset from SCC)	MHz	60 / -60	80 / -80	90 / -90	100 / -100	
NOTE 1: The transmitter shall be set to 24 dB below $P_{CMAX_L,f,c}$ at the minimum UL configuration specified in Table 7.3.2.3-3 with $P_{CMAX_L,f,c}$ defined in clause 6.2.4.						
NOTE 2: The absolute value of the interferer offset $F_{interferer}$ (offset) shall be further adjusted to $(\lceil F_{interferer} / SCS \rceil + 0.5) SCS$ MHz with SCS the sub-carrier spacing of the wanted signal in MHz. The interferer is an NR signal with an SCS equal to that of the wanted signal.						
NOTE 3: The interferer consists of the RMC specified in Annexes A.3.2.2 and A.3.3.2 with one sided dynamic OCNG Pattern OP.1 FDD/TDD for the DL-signal as described in Annex A.5.1.1/A.5.2.1.						

7.5D Adjacent channel selectivity for UL MIMO

7.5D.1 Test purpose

Adjacent channel selectivity (ACS) is a measure of a receiver's ability to receive an NR signal at its assigned channel frequency in the presence of an adjacent channel signal at a given frequency offset from the centre frequency of the assigned channel. ACS is the ratio of the receive filter attenuation on the assigned channel frequency to the receive filter attenuation on the adjacent channel(s).

7.5D.2 Test applicability

This test case applies to all types of NR UE release 15 and forward that support UL MIMO on FDD bands.

7.5D.3 Minimum conformance requirements

For UE(s) with two transmitter antenna connectors in closed-loop spatial multiplexing scheme, the minimum requirements specified in sub-clause 7.5 shall be met with the UL MIMO configurations described in sub-clause 6.2D.1. For UL MIMO, the parameter P_{CMAX_L} is defined as the total transmitter power over the two transmit antenna connectors.

The normative reference for this requirement is TS 38.101-1 [2] clauses 7.5D and 7.5.

7.5D.4 Test description

7.5D.4.1 Initial conditions

Initial conditions are a set of test configurations the UE needs to be tested in and the steps for the SS to take with the UE to reach the correct measurement state.

The initial test configurations consist of environmental conditions, test frequencies, and channel bandwidths based on NR operating bands specified in Table 5.2-1. All of these configurations shall be tested with applicable test parameters for each channel bandwidth, and are shown in Table 7.5D.4.1-1. The details of the uplink and downlink reference measurement channels (RMCs) are specified in Annex A.2 and Annex A.3 respectively. Configurations of PDSCH and PDCCH before measurement are specified in Annex C.2.

Table 7.5D.4.1-1: Test Configuration Table

Default Conditions				
Test Environment as specified in TS 38.508-1 [5] subclause 4.1		Normal		
Test Frequencies as specified in TS 38.508-1 [5] subclause 4.3.1		Mid range		
Test Channel Bandwidths as specified in TS 38.508-1 [5] subclause 4.3.1		Lowest, Mid and Highest		
Test SCS as specified in Table 5.3.5-1		Lowest		
Test Parameters				
Test ID	Downlink Configuration		Uplink Configuration	
	Mod'n	RB allocation	Mod'n	RB allocation
1	CP-OFDM QPSK	NOTE 1	CP-OFDM QPSK	NOTE 1
NOTE 1: The specific configuration of uplink and downlink are defined in Table 7.3.2.4.1-2 and 7.3.2.4.1-3 for Downlink and Uplink respectively.				
NOTE 2: In a band where UE supports 4Rx, the test shall be performed only with 4Rx antennas ports connected and 4Rx REFSSENS requirement (Table 7.3.2.5-2) is used in the test requirements.				

1. Connect the SS to the UE antenna connectors as shown in TS 38.508-1 [5] Annex A, in Figure A.3.1.4.4 for TE diagram and section A.3.2.3 for UE diagram.
2. The parameter settings for the cell are set up according to TS 38.508-1 [5] subclause 4.4.3.
3. Downlink signals are initially set up according to Annex C.0, C.1, C.2, C.3.1, and uplink signals according to Annex G.0, G.1, G.2, G.3.1.
4. The DL and UL Reference Measurement channels are set according to Table 7.5D.4.1-1.
5. Propagation conditions are set according to Annex B.0.
6. Ensure the UE is in state RRC_CONNECTED with generic procedure parameters Connectivity NR, Connected without release *On* and Test Loop Function On according to TS 38.508-1 [5] clause 4.5. Message content are defined in clause 7.5D.4.3.

7.5D.4.2 Test procedure

Same test procedure as specified in 7.5.2.4.2 with the following exception:

- Instead of Table 7.5.4.1-1, use Table 7.5D.4.1-1 in step 1.
- Step 2: SS sends uplink scheduling information for each UL HARQ process via PDCCH DCI format 0_1 for C_RNTI to schedule the UL RMC according to Table 7.5D.4.1-1. Since the UE has no payload data to send, the UE transmits uplink MAC padding bits on the UL RMC. The PDCCH DCI format 0_1 is specified with condition 2TX_UL_MIMO in 38.508-1 [5] subclause 4.3.6.1.1.2.

7.5D.4.3 Message contents

Message contents are according to TS 38.508-1 [5] subclause 4.6 ensuring Table 4.6.3-182 with condition 2TX_UL_MIMO

7.5D.5 Test requirement

Same test requirement as defined in Clause 7.5.5.

7.5F Adjacent channel selectivity

7.5F.1 Adjacent channel selectivity for shared spectrum channel access

Editor's note: This clause is incomplete. The following aspects are either missing or not yet determined:

- Test Configuration Table is FFS
- Message content for NS_53 is FFS
- TP analysis is TBD
- TT for $5.925\text{GHz} < f \leq 7.125\text{GHz}$ is TBD

7.5F.1.1 Test purpose

Adjacent channel selectivity (ACS) is a measure of a receiver's ability to receive an NR signal at its assigned channel frequency in the presence of an adjacent channel signal at a given frequency offset from the centre frequency of the assigned channel. ACS is the ratio of the receive filter attenuation on the assigned channel frequency to the receive filter attenuation on the adjacent channel(s).

7.5F.1.2 Test applicability

This test case applies to all types of NR UE release 16 and forward that support NR standalone shared spectrum channel access.

7.5F.1.3 Minimum conformance requirements

Instead of the general ACS requirements specified in clause 7.5, the UE shall fulfil the minimum requirements specified in Table 7.5F.1.3-1. These requirements apply for any SCS specified for the channel bandwidth of the wanted signal. For the test parameters specified in Table 7.5F.1.3-2, the throughput shall be $\geq 95\%$ of the maximum throughput of the reference measurement channels as specified in Annexes A.2.2, A.3.2, and A.3.3 (with one sided dynamic OCNG Pattern OP.1 FDD/TDD for the DL-signal as described in Annex A.5.1.1/A.5.2.1).

Table 7.5F.1.3-1: ACS for shared spectrum channel access bands

RX parameter	Units	Channel bandwidth			
		20 MHz	40 MHz	60 MHz	80 MHz
ACS	dB	24	21	19.2	18

Table 7.5F.1.3-2: Test parameters for shared spectrum channel access bands

RX parameter	Units	Channel bandwidth			
		20 MHz	40 MHz	60 MHz	80 MHz
Power in transmission bandwidth configuration	dBm	REFSENS + 14 dB			
$P_{\text{interferer}}$	dBm	REFSENS + 36.5 dB	REFSENS + 33.5 dB	REFSENS + 31.7 dB	REFSENS + 30.5 dB
$BW_{\text{interferer}}$	MHz	20			
$F_{\text{interferer}}$ (offset)	MHz	20 / -20			
NOTE 1: The transmitter shall be set to 4 dB below $P_{\text{CMAX_L,f,c}}$ at the minimum UL configuration specified in Table 7.3.2-3 with $P_{\text{CMAX_L,f,c}}$ defined in clause 6.2.4.					
NOTE 2: The absolute value of the interferer offset $F_{\text{interferer}}$ (offset) shall be further adjusted to $(\lceil F_{\text{interferer}} / SCS \rceil + 0.5) SCS$ MHz with SCS the sub-carrier spacing of the wanted signal in MHz. The interferer is an NR signal with an SCS equal to that of the wanted signal.					
NOTE 3: The interferer consists of the RMC specified in Annexes A.3.2.2 and A.3.3.2 with one sided dynamic OCNG Pattern OP.1 FDD/TDD for the DL-signal as described in Annex A.5.1.1/A.5.2.1.					

The normative reference for this requirement is TS 38.101-1 [2] clause 7.5F.1.

7.5F.1.4	Test description
7.5F.1.4.1	Initial conditions

Initial conditions are a set of test configurations the UE needs to be tested in and the steps for the SS to take with the UE to reach the correct measurement state.

The initial test configurations consist of environmental conditions, test frequencies, test channel bandwidths and sub-carrier spacing based on NR operating bands specified in Table 5.3.5-1. All of these configurations shall be tested with applicable test parameters for each combination of channel bandwidth and sub-carrier spacing, are shown in table 7.5F1..4.1-1. The details of the uplink and downlink reference measurement channels (RMC) are specified in Annexes A.2 and A.3. Configuration of PDSCH and PDCCH before measurement are specified in Annex C.2.

Table 7.5F.1.4.1-1: Test Configuration Table

FFS

1. Connect the SS to the UE antenna connectors as shown in TS 38.508-1 [5] Annex A, in Figure A.3.1.4.1 for TE diagram and section A.3.2 for UE diagram.
2. The parameter settings for the cell are set up according to TS 38.508-1 [5] subclause 4.4.3.
3. Downlink signals are initially set up according to Annex C.0, C.1, C.2, C.3.1, and uplink signals according to Annex G.0, G.1, G.2, G.3.1.
4. The DL and UL Reference Measurement channels are set according to Table 7.5F.1.4.1-1.
5. Propagation conditions are set according to Annex B.0.
6. Ensure the UE is in state RRC_CONNECTED with generic procedure parameters Connectivity *NR*, Connected without release *On*, Test Mode *On* and Test Loop Function *On* according to TS 38.508-1 [5] clause 4.5. Message content are defined in clause 7.5F.1.4.3.

7.5F.1.4.2 Test procedure

1. SS transmits PDSCH via PDCCH DCI format [1_1] for C_RNTI to transmit the DL RMC according to Table 7.5F.1.4.1-1. The SS sends downlink MAC padding bits on the DL RMC.
2. SS sends uplink scheduling information for each UL HARQ process via PDCCH DCI format [0_1] for C_RNTI to schedule the UL RMC according to Table 7.5F.1.4.1-1. Since the UL has no payload and no loopback data to send the UE sends uplink MAC padding bits on the UL RMC.
3. Set the Downlink signal level to the value as defined in Table 7.5F.1.5-2. Send uplink power control commands to the UE using 1dB power step size to ensure that the UE output power measured by the test system is within the Uplink power control window, defined as $-(MU)$ to $-(MU + \text{Uplink power control window size})$ dB of the target power level in Table 7.5F.1.5-2 for at least the duration of the Throughput measurement, where:
 - MU is the test system uplink power measurement uncertainty and is specified in Table F.1.3-1 for the carrier frequency f and the channel bandwidth BW
 - Uplink power control window size = 1dB (UE power step size) + 0.7dB (UE power step tolerance) + (Test system relative power measurement uncertainty), where, the UE power step tolerance is specified in TS 38.101-1 [2], Table 6.3.4.3-1 and is 0.7dB for 1dB power step size, and the Test system relative power measurement uncertainty is specified in Table F.1.3-1.
4. Set the Interferer signal level to the value as defined in Table 7.5F.1.5-2 and frequency below the wanted signal, using a modulated interferer bandwidth as defined in Annex D.
5. Measure the average throughput for a duration sufficient to achieve statistical significance according to Annex H.

NOTE: The purpose of the Uplink power control window is to ensure that the actual UE output power is no greater than the target power level, and as close as possible to the target power level. The relationship between the Uplink power control window, the target power level and the corresponding possible actual UE Uplink power window is illustrated in Annex F.4.3.

7.5F.1.4.3 Message contents

Message contents are according to TS 38.508-1 [5] subclause 4.6 with TRANSFORM_PRECODER_ENABLED condition in Table 4.6.3-118 PUSCH-Config.

7.5F.1.5 Test requirement

For NR bands under test, the throughput measurement derived in test procedure shall be $\geq 95\%$ of the maximum throughput of the reference measurement channels as specified in Annexes A.2.2, A.2.3, A.3.2 and A.3.3 (with one sided dynamic OCNG Pattern OP.1 FDD/TDD for the DL-signal as described in Annex A.5.1.1/A.5.2.1) with parameters specified in Tables 7.5F.1.5-2.

Table 7.5F.1.5-1: ACS for shared spectrum channel access bands

RX parameter	Units	Channel bandwidth			
		20 MHz	40 MHz	60 MHz	80 MHz
ACS	dB	24	21	19.2	18

Table 7.5F.1.5-2: Test parameters for shared spectrum channel access bands

RX parameter	Units	Channel bandwidth			
		20 MHz	40 MHz	60 MHz	80 MHz
Power in transmission bandwidth configuration	dBm	REFSENS + 14 dB			
$P_{\text{interferer}}$	dBm	REFSENS + 36.5 dB	REFSENS + 33.5 dB	REFSENS + 31.7 dB	REFSENS + 30.5 dB
$BW_{\text{interferer}}$	MHz	20			
$F_{\text{interferer}}$ (offset)	MHz	20 / -20			
NOTE 1: The transmitter shall be set to 4 dB below $P_{\text{CMAX_L,f,c}}$ at the minimum UL configuration specified in Table 7.3.2-3 with $P_{\text{CMAX_L,f,c}}$ defined in clause 6.2.4.					
NOTE 2: The absolute value of the interferer offset $F_{\text{interferer}}$ (offset) shall be further adjusted to $(\lceil F_{\text{interferer}} / SCS \rceil + 0.5) SCS$ MHz with SCS the sub-carrier spacing of the wanted signal in MHz. The interferer is an NR signal with an SCS equal to that of the wanted signal.					
NOTE 3: The interferer consists of the RMC specified in Annexes A.3.2.2 and A.3.3.2 with one sided dynamic OCNG Pattern OP.1 FDD/TDD for the DL-signal as described in Annex A.5.1.1/A.5.2.1.					

7.6 Blocking characteristics

The blocking characteristic is a measure of the receiver's ability to receive a wanted signal at its assigned channel frequency in the presence of an unwanted interferer on frequencies other than those of the spurious response or the adjacent channels, without this unwanted input signal causing a degradation of the performance of the receiver beyond a specified limit. The blocking performance shall apply at all frequencies except those at which a spurious response occurs.

7.6.1 General

The blocking characteristic is a measure of the receiver's ability to receive a wanted signal at its assigned channel frequency in the presence of an unwanted interferer on frequencies other than those of the spurious response or the adjacent channels, without this unwanted input signal causing a degradation of the performance of the receiver beyond a specified limit. The blocking performance shall apply at all frequencies except those at which a spurious response occurs.

FFS

7.6.2 In-band blocking

7.6.2.1 Test purpose

In band blocking is defined for an unwanted interfering signal falling into the range from 15 MHz below to 15 MHz above the UE receive band, with $F_{DL_high} < 2700$ MHz and $F_{UL_high} < 2700$ MHz, or into an immediately adjacent frequency range up 3CBW below or above the UE receive band, with $F_{DL_low} \geq 3300$ MHz and $F_{UL_low} \geq 3300$ MHz, at which the relative throughput shall meet or exceed the requirement for the specified measurement channel.

7.6.2.2 Test applicability

This test applies to all types of NR UE release 15 and forward.

7.6.2.3 Minimum conformance requirements

For NR bands with $F_{DL_high} < 2700$ MHz and $F_{UL_high} < 2700$ MHz, in-band blocking (IBB) is defined for an unwanted interfering signal falling into the UE receive band or into the first 15 MHz below or above the UE receive band. The throughput of the wanted signal shall be $\geq 95\%$ of the maximum throughput of the reference measurement channels as specified in Annexes A.2.2, A.2.3, A.3.2 and A.3.3 (with one sided dynamic OCNG Pattern OP.1 FDD/TDD for the DL signal as described in Annex A.5) with parameters specified in Table 7.6.2.3-1 and Table 7.6.2.3-2. The relative throughput shall be met for any SCS specified for the channel bandwidth of the wanted signal. For operating bands with an unpaired DL part (as noted in Table 5.2-1), the requirements only apply for carriers assigned in the paired part.

Table 7.6.2.3-1: In-band blocking parameters for NR bands with $F_{DL_high} < 2700$ MHz and $F_{UL_high} < 2700$ MHz

RX parameter	Units	Channel bandwidth (MHz)		
		5, 10	15	20, 25, 30, 35, 40, 45, 50, 60, 70, 80, 90, 100
Power in transmission bandwidth configuration ³	dBm	REFSENS + 6 dB	REFSENS + 7 dB	REFSENS + (9 + 10log ₁₀ (BW _{Channel} / 20)) dB
BW _{interferer}	MHz	5		
F _{offset, case 1}	MHz	7.5		
F _{offset, case 2}	MHz	12.5		
NOTE 1: The transmitter shall be set to 4 dB below P _{C_{MAX}L,f,c} at the minimum UL configuration specified in Table 7.3.2.3-3 with P _{C_{MAX}L,f,c} defined in clause 6.2.4.				
NOTE 2: The interferer consists of the RMC specified in Annexes A.3.2.2 and A.3.3.2 with one sided dynamic OCNG Pattern OP.1 FDD/TDD for the DL-signal as described in Annex A.5.1.1/A.5.2.1 and 15 kHz SCS.				
NOTE 3: Power in transmission bandwidth configuration shall be rounded to the next higher 0.5dB value.				

Table 7.6.2.3-2: In-band blocking for NR bands with $F_{DL_high} < 2700$ MHz and $F_{UL_high} < 2700$ MHz

NR band	Parameter	Unit	Case 1	Case 2	Case 3	Case 4
	$P_{interferer}$		dBm	-56	-44	-15
	$F_{interferer}$ (offset)	MHz	$-BW_{Channel}/2 - F_{offset, case 1}$ and $BW_{Channel}/2 + F_{offset, case 1}$	$\leq -BW_{Channel}/2 - F_{offset, case 2}$ and $\geq BW_{Channel}/2 + F_{offset, case 2}$		$-BW_{Channel}/2 - 11$
n1, n2, n3, n5, n7, n8, n12, n13, n14, n18, n20, n24, n25, n26, n28, n34, n38, n39, n40, n41, n48 ³ , n50, n51, n53, n65, n66, n67, n70, n74, n75, n76, n85, n91, n92, n93, n94	$F_{interferer}$	MHz	NOTE 2	$F_{DL_low} - 15$ to $F_{DL_high} + 15$		
n30	$F_{interferer}$	MHz	NOTE 2	$F_{DL_low} - 15$ to $F_{DL_high} + 15$		$F_{DL_low} - 11$
n71	$F_{interferer}$	MHz	NOTE 2	$F_{DL_low} - 12$ to $F_{DL_high} + 15$	$F_{DL_low} - 12$	
<p>NOTE 1: The absolute value of the interferer offset $F_{interferer}$ (offset) shall be further adjusted to $(\lceil F_{interferer} / SCS \rceil + 0.5) SCS$ MHz with SCS the sub-carrier spacing of the wanted signal in MHz. The interferer is an NR signal with 15 kHz SCS.</p> <p>NOTE 2: For each carrier frequency, the requirement applies for two interferer carrier frequencies: a: $-BW_{Channel}/2 - F_{offset, case 1}$; b: $BW_{Channel}/2 + F_{offset, case 1}$</p> <p>NOTE 3: n48 follows the requirement in this frequency range according to the general requirement defined in Clause 7.1.</p>						

For NR bands with $F_{DL_low} \geq 3300$ MHz and $F_{UL_low} \geq 3300$ MHz, in-band blocking (IBB) is defined for an unwanted interfering signal falling into the UE receive band or into an immediately adjacent frequency range up to 3CBW below or above the UE receive band where CBW is the bandwidth of the wanted signal. The throughput of the wanted signal shall be $\geq 95\%$ of the maximum throughput of the reference measurement channels as specified in Annexes A.2.2, A.2.3, A.3.2 and A.3.3 (with one sided dynamic OCNG Pattern OP.1 FDD/TDD for the DL-signal as described in Annex A.5.1.1/A.5.2.1) with parameters specified in Table 7.6.2.3-3 and Table 7.6.2.3-4. The relative throughput requirement shall be met for any SCS specified for the channel bandwidth of the wanted signal.

Table 7.6.2.3-3: In-band blocking parameters for NR bands with $F_{DL_low} \geq 3300$ MHz and $F_{UL_low} \geq 3300$ MHz

RX parameter	Units	Channel bandwidth (MHz)
		10, 15, 20, 25, 30, 35, 40, 45, 50, 60, 70, 80, 90, 100
Power in transmission bandwidth configuration	dBm	REFSENS + 6 dB
$BW_{interferer}$	MHz	$BW_{Channel}$
$F_{offset, case 1}$	MHz	$(3/2) * BW_{Channel}$
$F_{offset, case 2}$	MHz	$(5/2) * BW_{Channel}$
<p>NOTE 1: The transmitter shall be set to 4 dB below $P_{CMAX_L,f,c}$ at the minimum UL configuration specified in Table 7.3.2.3-3 with $P_{CMAX_L,f,c}$ defined in clause 6.2.4.</p> <p>NOTE 2: The interferer consists of the RMC specified in Annexes A.3.2.2 and A.3.3.2 with one sided dynamic OCNG Pattern OP.1 FDD/TDD for the DL-signal as described in Annex A.5.1.1/A.5.2.1</p>		

Table 7.6.2.3-4: In-band blocking for NR bands with $F_{DL_low} \geq 3300$ MHz and $F_{UL_low} \geq 3300$ MHz

NR band	Parameter	Unit	Case 1	Case 2
		$P_{interferer}$	dBm	-56
n77, n78, n79	$F_{interferer}$ (offset)	MHz	$-BW_{Channel}/2 - F_{offset, case 1}$ and $BW_{Channel}/2 + F_{offset, case 1}$	$\leq -BW_{Channel}/2 - F_{offset, case 2}$ and $\geq BW_{Channel}/2 + F_{offset, case 2}$
	$F_{interferer}$		NOTE 2	$F_{DL_low} - 3 * BW_{Channel}$ to $F_{DL_high} + 3 * BW_{Channel}$
NOTE 1: The absolute value of the interferer offset $F_{interferer}$ (offset) shall be further adjusted to $(\lceil F_{interferer} / SCS \rceil + 0.5) SCS$ MHz with SCS the sub-carrier spacing of the wanted signal in MHz. The interferer is an NR signal with an SCS equal to that of the wanted signal.				
NOTE 2: For each carrier frequency, the requirement applies for two interferer carrier frequencies: a: $-BW_{Channel}/2 - F_{offset, case 1}$; b: $BW_{Channel}/2 + F_{offset, case 1}$				
NOTE 3: $BW_{Channel}$ denotes the channel bandwidth of the wanted signal				

The normative reference for this requirement is TS 38.101-1 [2] clause 7.6.2.

7.6.2.4 Test description

7.6.2.4.1 Initial conditions

Initial conditions are a set of test configurations the UE needs to be tested in and the steps for the SS to take with the UE to reach the correct measurement state.

The initial test configurations consist of environmental conditions, test frequencies, test channel bandwidths and sub-carrier spacing based on NR operating bands specified in Table 5.3.5-1. All of these configurations shall be tested with applicable test parameters for each combination of channel bandwidth and sub-carrier spacing, are shown in table 7.6.2.4.1-1. The details of the uplink and downlink reference measurement channels (RMC) are specified in Annexes A.2 and A.3. Configuration of PDSCH and PDCCH before measurement are specified in Annex C.2.

Table 7.6.2.4.1-1: Test Configuration Table

Default Conditions				
Test Environment as specified in TS 38.508-1 [5] subclause 4.1		Normal		
Test Frequencies as specified in TS 38.508-1 [5] subclause 4.3.1		Mid range (NOTE 4)		
Test Channel Bandwidths as specified in TS 38.508-1 [5] subclause 4.3.1		Lowest, Mid, Highest (NOTE 3)		
Test SCS as specified in Table 5.3.5-1		Lowest		
Test Parameters				
Test ID	Downlink Configuration		Uplink Configuration	
	Mod'n	RB allocation	Mod'n	RB allocation
1	CP-OFDM QPSK	NOTE 1	DFT-s-OFDM QPSK	NOTE 1
NOTE 1: The specific configuration of uplink and downlink are defined in Table 7.3.2.4.1-1.				
NOTE 2: In a band where UE supports 4Rx, the test shall be performed only with 4Rx antennas ports connected and 4Rx REFSSENS requirement (Table 7.3.2.5-2) is used in the test requirements.				
NOTE 3: For n70, highest test channel bandwidth shall be Highest UL / Highest DL according to asymmetric channel bandwidths specified in clause 5.3.6.				
NOTE 4: For NR band n28, 30MHz test channel bandwidth is tested with Low range test frequencies.				

1. Connect the SS to the UE antenna connectors as shown in TS 38.508-1 [5] Annex A, in Figure A.3.1.4.1 for TE diagram and section A.3.2 for UE diagram.
2. The parameter settings for the cell are set up according to TS 38.508-1 [5] subclause 4.4.3.

3. Downlink signals are initially set up according to Annex C.0, C.1, C.2, C.3.1, and uplink signals according to Annex G.0, G.1, G.2, G.3.1.
4. The DL and UL Reference Measurement channels are set according to Table 7.6.2.4.1-1.
5. Propagation conditions are set according to Annex B.0.
6. Ensure the UE is in state RRC_CONNECTED with generic procedure parameters Connectivity *NR*, Connected without release *On*, Test Mode *On* and Test Loop Function *On* according to TS 38.508-1 [5] clause 4.5. Message content are defined in clause 7.6.2.4.3.

7.6.2.4.2 Test procedure

1. SS transmits PDSCH via PDCCH DCI format 1_1 for C_RNTI to transmit the DL RMC according to Table 7.6.2.4.1-1. The SS sends downlink MAC padding bits on the DL RMC.
2. SS sends uplink scheduling information for each UL HARQ process via PDCCH DCI format 0_1 for C_RNTI to schedule the UL RMC according to Table 7.6.2.4.1-1. Since the UL has no payload and no loopback data to send the UE sends uplink MAC padding bits on the UL RMC.
3. Set the parameters of the signal generator for an interfering signal below the wanted signal in Case 1 according to Tables 7.6.2.5-1 and 7.6.2.5-2 or Tables 7.6.2.5-3 and 7.6.2.5-4 as appropriate depending on NR band.
4. Set the downlink signal level according to the table 7.6.2.5-1 or 7.6.2.5-3 as appropriate. Send uplink power control commands to the UE using 1dB power step size to ensure that the UE output power measured by the test system is within the Uplink power control window, defined as $-(MU)$ to $-(MU + \text{Uplink power control window size})$ dB of the target power level in Table 7.6.2.5-1 or Table 7.6.2.5-3 for at least the duration of the Throughput measurement, where:
 - MU is the test system uplink power measurement uncertainty and is specified in Table F.1.3-1 for the carrier frequency f and the channel bandwidth BW .
 - Uplink power control window size = 1dB (UE power step size) + 0.7dB (UE power step tolerance) + (Test system relative power measurement uncertainty), where, the UE power step tolerance is specified in TS 38.101-1 [2], Table 6.3.4.3-1 and is 0.7dB for 1dB power step size, and the Test system relative power measurement uncertainty is specified for test case 6.3.4.3 in Table F.1.2-1.
5. Measure the average throughput for a duration sufficient to achieve statistical significance according to Annex H.
6. Repeat steps from 3 to 5, using an interfering signal above the wanted signal in Case 1 at step 3.
7. Repeat steps from 3 to 6, using interfering signals in Case 2 at step 3 and 6. The ranges of case 2 are covered in steps equal to the interferer bandwidth. Interferer frequencies should be chosen starting with an offset nearest to the centre frequency and sweep outwards towards the band edges. In order to ensure that full range is tested for interferer frequency, run last test steps at frequency equal to $F_{\text{Interferer}}$ range limit defined at the corresponding band edge.
8. If applicable based on NR band, repeat steps from 3 to 5, using interfering signals in Case 3 at step 3.
9. If applicable based on NR band, repeat steps from 3 to 5, using interfering signals in Case 4 at step 3.

NOTE: The purpose of the Uplink power control window is to ensure that the actual UE output power is no greater than the target power level, and as close as possible to the target power level. The relationship between the Uplink power control window, the target power level and the corresponding possible actual UE Uplink power window is illustrated in Annex F.4.3.

7.6.2.4.3 Message contents

Message contents are according to TS 38.508-1 [5] subclause 4.6 with TRANSFORM_PRECODER_ENABLED condition in Table 4.6.3-118 PUSCH-Config.

7.6.2.5 Test requirement

For NR bands with $F_{DL_high} < 2700$ MHz and $F_{UL_high} < 2700$ MHz, the throughput measurement derived in test procedure shall be $\geq 95\%$ of the maximum throughput of the reference measurement channels as specified in Annex in Annexes A.2.2, A.2.3 and A.3.2 with parameters specified in Tables 7.6.2.5-1 and 7.6.2.5-2.

Table 7.6.2.5-1: In-band blocking parameters for NR bands with $F_{DL_high} < 2700$ MHz and $F_{UL_high} < 2700$ MHz

RX parameter	Units	Channel bandwidth (MHz)		
		5, 10	15	20, 25, 30, 35, 40, 45, 50, 60, 70, 80, 90, 100
Power in transmission bandwidth configuration ³	dBm	REFSENS + 6 dB	REFSENS + 7 dB	REFSENS + (9 + 10log ₁₀ (BW _{Channel} /20)) dB
BW _{interferer}	MHz	5		
F _{offset, case 1}	MHz	7.5		
F _{offset, case 2}	MHz	12.5		
NOTE 1: The transmitter shall be set to 4 dB below P _{CMAX_L,f,c} at the minimum UL configuration specified in Table 7.3.2.3-3 with P _{CMAX_L,f,c} defined in clause 6.2.4.				
NOTE 2: The interferer consists of the RMC specified in Annexes A.3.2.2 and A.3.3.2 with one sided dynamic OCNG Pattern OP.1 FDD/TDD for the DL-signal as described in Annex A.5.1.1/A.5.2.1 and 15 kHz SCS.				
NOTE 3: Power in transmission bandwidth configuration shall be rounded to the next higher 0.5dB value.				

Table 7.6.2.5-2: In-band blocking for NR bands with $F_{DL_high} < 2700$ MHz and $F_{UL_high} < 2700$ MHz

NR band	Parameter	Unit	Case 1	Case 2	Case 3	Case 4
	P _{interferer}	dBm	-56	-44	-15	-38
	F _{interferer (offset)}	MHz	-BW _{Channel} /2 – F _{offset, case 1} and BW _{Channel} /2 + F _{offset, case 1}	≤ -BW _{Channel} /2 – F _{offset, case 2} and ≥ BW _{Channel} /2 + F _{offset, case 2}		-BW _{Channel} /2-11
n1, n2, n3, n5, n7, n8, n12, n13, n14, n18, n20, n24, n25, n26, n28, n34, n38, n39, n40, n41, n48 ³ , n50, n51, n53, n65, n66, n67, n70, n74, n75, n76, n85, n91, n92, n93, n94	F _{interferer}	MHz	NOTE 2	F _{DL_low} – 15 to F _{DL_high} + 15		
n30	F _{interferer}	MHz	NOTE 2	F _{DL_low} – 15 to F _{DL_high} + 15		F _{DL_low} – 11
n71	F _{interferer}	MHz	NOTE 2	F _{DL_low} – 12 to F _{DL_high} + 15	F _{DL_low} – 12	
NOTE 1: The absolute value of the interferer offset F _{interferer (offset)} shall be further adjusted to $(\lceil F_{interferer} / SCS \rceil + 0.5) SCS$ MHz with SCS the sub-carrier spacing of the wanted signal in MHz. The interferer is an NR signal with 15 kHz SCS.						
NOTE 2: For each carrier frequency, the requirement applies for two interferer carrier frequencies: a: -BW _{Channel} /2 – F _{offset, case 1} ; b: BW _{Channel} /2 + F _{offset, case 1}						
NOTE 3: n48 follows the requirement in this frequency range according to the general requirement defined in Clause 7.1.						

For NR bands with $F_{DL_low} \geq 3300$ MHz and $F_{UL_low} \geq 3300$ MHz, the throughput measurement derived in test procedure shall be $\geq 95\%$ of the maximum throughput of the reference measurement channels as specified in Annex A.2 and A.3 with parameters specified in Tables 7.6.2.5-3 and 7.6.2.5-4.

Table 7.6.2.5-3: In-band blocking parameters for NR bands with $F_{DL_low} \geq 3300$ MHz and $F_{UL_low} \geq 3300$ MHz

RX parameter	Units	Channel bandwidth (MHz)
		10, 15, 20, 25, 30, 35, 40, 45, 50, 60, 70, 80, 90, 100
Power in transmission bandwidth configuration	dBm	REFSENS + 6 dB
$BW_{interferer}$	MHz	$BW_{Channel}$
$F_{offset, case 1}$	MHz	$(3/2) * BW_{Channel}$
$F_{offset, case 2}$	MHz	$(5/2) * BW_{Channel}$
NOTE 1: The transmitter shall be set to 4 dB below $P_{CMAX_L,f,c}$ at the minimum UL configuration specified in Table 7.3.2.3-3 with $P_{CMAX_L,f,c}$ defined in clause 6.2.4.		
NOTE 2: The interferer consists of the RMC specified in Annexes A.3.2.2 and A.3.3.2 with one sided dynamic OCNG Pattern OP.1 FDD/TDD for the DL-signal as described in Annex A.5.1.1/A.5.2.1		

Table 7.6.2.5-4: In-band blocking for NR bands with $F_{DL_low} \geq 3300$ MHz and $F_{UL_low} \geq 3300$ MHz

NR band	Parameter	Unit	Case 1	Case 2
	$P_{interferer}$	dBm	-56	-44
n77, n78, n79	$F_{interferer}$ (offset)	MHz	$-BW_{Channel}/2 - F_{offset, case 1}$ and $BW_{Channel}/2 + F_{offset, case 1}$	$\leq -BW_{Channel}/2 - F_{offset, case 2}$ and $\geq BW_{Channel}/2 + F_{offset, case 2}$
	$F_{interferer}$		NOTE 2	$F_{DL_low} - 3 * BW_{Channel}$ to $F_{DL_high} + 3 * BW_{Channel}$
NOTE 1: The absolute value of the interferer offset $F_{interferer}$ (offset) shall be further adjusted to $(\lceil F_{interferer} / SCS \rceil + 0.5) SCS$ MHz with SCS the sub-carrier spacing of the wanted signal in MHz. The interferer is an NR signal with an SCS equal to that of the wanted signal.				
NOTE 2: For each carrier frequency, the requirement applies for two interferer carrier frequencies: a: $-BW_{Channel}/2 - F_{offset, case 1}$; b: $BW_{Channel}/2 + F_{offset, case 1}$				
NOTE 3: $BW_{Channel}$ denotes the channel bandwidth of the wanted signal				

Table 7.6.2.5-5: Void

7.6.3 Out-of-band blocking

7.6.3.1 Test Purpose

Out-of-band band blocking is defined for an unwanted CW interfering signal falling outside a frequency range 15 MHz below or above the UE receive band, with $F_{DL_high} < 2700$ MHz and $F_{UL_high} < 2700$ MHz, or falling outside a frequency range up to $3 * BW_{Channel}$ below or from $3 * BW_{Channel}$ above the UE receive band, with $F_{DL_low} \geq 3300$ MHz and $F_{UL_low} \geq 3300$ MHz, at which a given average throughput shall meet or exceed the requirement for the specified measurement channels.

7.6.3.2 Test Applicability

This test applies to all types of NR UE release 15 and forward.

7.6.3.3 Minimum Conformance Requirements

For NR bands with $F_{DL_high} < 2700$ MHz and $F_{UL_high} < 2700$ MHz out-of-band band blocking is defined for an unwanted CW interfering signal falling outside a frequency range 15 MHz below or above the UE receive band. The throughput

of the wanted signal shall be $\geq 95\%$ of the maximum throughput of the reference measurement channels as specified in Annexes A.2.2, A.2.3, A.3.2 and A.3.3 (with one sided dynamic OCN Pattern OP.1 FDD/TDD for the DL-signal as described in Annex A.5.1.1/A.5.2.1) with parameters specified in Table 7.6.3.3-1 and Table 7.6.3.3-2. The relative throughput requirement shall be met for any SCS specified for the channel bandwidth of the wanted signal. For operating bands with an unpaired DL part (as noted in Table 5.2-1), the requirements only apply for carriers assigned in the paired part.

Table 7.6.3.3-1: Out-of-band blocking parameters for NR bands with $F_{DL_high} < 2700$ MHz and $F_{UL_high} < 2700$ MHz

RX parameter	Units	Channel bandwidth (MHz)		
		5, 10	15	20, 25, 30, 35, 40, 45, 50, 60, 70, 80, 90, 100
Power in transmission bandwidth configuration ²	dBm	REFSENS + 6 dB	REFSENS + 7 dB	REFSENS + (9 + 10log ₁₀ (BW _{Channel} / 20)) dB
NOTE 1: The transmitter shall be set to 4 dB below P _{CMAX_L,f,c} at the minimum UL configuration specified in Table 7.3.2.3-3 with P _{CMAX_L,f,c} defined in clause 6.2.4.				
NOTE 2: Power in transmission bandwidth configuration shall be rounded to the next higher 0.5dB value.				

Table 7.6.3.3-2: Out of-band blocking for NR bands with $F_{DL_high} < 2700$ MHz and $F_{UL_high} < 2700$ MHz

NR band	Parameter	Unit	Range 1	Range 2	Range 3
n1, n2, n3, n5, n7, n8, n12, n14, n20, n24, n25, n26, n30, n28, n34, n38, n39, n40, n41, n48 ⁵ , n50, n51, n53 ⁸ , n65, n66, n70, n71, n74, n75, n76	P _{interferer}	dBm	-44	-30	-15
	F _{interferer} (CW)	MHz	-60 < f – F _{DL_low} < -15 or 15 < f – F _{DL_high} < 60	-85 < f – F _{DL_low} ≤ -60 or 60 ≤ f – F _{DL_high} < 85	1 ≤ f ≤ F _{DL_low} – 85 or F _{DL_high} + 85 ≤ f ≤ 12750
NOTE 1: The power level of the interferer (P _{interferer}) for Range 3 shall be modified to -20 dBm for F _{interferer} > 6000 MHz.					
NOTE 2: For band 51 the F _{DL_high} of band 50 is applied as F _{DL_high} for band 51. For band 50, the F _{DL_low} of band 51 is applied as F _{DL_low} for band 50.					
NOTE 3: For band 76 the F _{DL_high} of band 75 is applied as F _{DL_high} for band 76. For band 75, the F _{DL_low} of band 76 is applied as F _{DL_low} for band 75.					
NOTE 4: For UEs supporting both bands 38 and 41, the F _{DL_high} and F _{DL_low} of band 41 is applied as F _{DL_high} and F _{DL_low} for band 38.					
NOTE 5: n48 follows the requirement in this frequency range according to the general requirement defined in Clause 7.1. The power level of the interferer (P _{interferer}) for Range 3 shall be modified to -20 dBm for F _{interferer} > 2700 MHz and F _{interferer} < 4800 MHz.					
NOTE 6: Void.					
NOTE 7: For UE supporting both bands 25 and 70, the F _{DL_high} of band 70 is applied as F _{DL_high} for band 25, and the F _{DL_low} of band 25 is applied as F _{DL_low} for band 70.					
NOTE 8: The power level of the interferer (P _{interferer}) for Range 3 shall be modified to -20 dBm for F _{interferer} > 2580 MHz and F _{interferer} < 2775 MHz.					

For interferer frequencies across ranges 1, 2 and 3 in Table 7.6.3.3-2, a maximum of

$$\lfloor \max\{24,6 \cdot \lceil n \cdot N_{RB} / 6 \rceil\} / \min\{\lfloor n \cdot N_{RB} / 10 \rfloor, 5\} \rfloor$$

exceptions are allowed for spurious response frequencies in each assigned frequency channel when measured using a step size of $\min(\lfloor BW_{channel} / 2 \rfloor, 5)$ MHz with N_{RB} the number of resource blocks in the downlink transmission bandwidth configuration, $BW_{channel}$ is the bandwidth of the frequency channel in MHz and $n = 1,2,3$ for SCS = 15,30,60 kHz, respectively. For these exceptions, the requirements in subclause 7.7 apply.

For NR bands with $F_{DL_low} \geq 3300$ MHz and $F_{UL_low} \geq 3300$ MHz out-of-band band blocking is defined for an unwanted CW interfering signal falling outside a frequency range up to $3 \cdot BW_{Channel}$ below or from $3 \cdot BW_{Channel}$ above the UE receive band, where $BW_{Channel}$ is the channel bandwidth. The throughput of the wanted signal shall be $\geq 95\%$ of the maximum throughput of the reference measurement channels as specified in Annexes A.2.2, A.2.3, A.3.2 and A.3.3 (with one sided dynamic OCN Pattern OP.1 FDD/TDD for the DL-signal as described in Annex A.5.1.1/A.5.2.1) with parameters specified in Table 7.6.3.3-3 and Table 7.6.3.3-4. The relative throughput requirement shall be met for any SCS specified for the channel bandwidth of the wanted signal.

Table 7.6.3.3-3: Out-of-band blocking parameters for NR bands with $F_{DL_low} \geq 3300$ MHz and $F_{UL_low} \geq 3300$ MHz

RX parameter	Units	Channel bandwidth (MHz)		
		10	15	20, 25, 30, 35, 40, 45, 50, 60, 70, 80, 90, 100
Power in transmission bandwidth configuration	dBm	REFSENS + 6 dB	REFSENS + 7 dB	REFSENS + 9 dB
NOTE: The transmitter shall be set to 4 dB below $P_{CMAX_L,f,c}$ at the minimum UL configuration specified in Table 7.3.2.3-3 with $P_{CMAX_L,f,c}$ defined in clause 6.2.4.				

Table 7.6.3.3-4: Out of-band blocking for NR bands with $F_{DL_low} \geq 3300$ MHz and $F_{UL_low} \geq 3300$ MHz

NR band	Parameter	Unit	Range1	Range 2	Range 3
n77, n78 (NOTE 3)	$P_{interferer}$	dBm	-44	-30	-15
	$F_{interferer}$ (CW)	MHz	$-60 < f - F_{DL_low} \leq -3 \cdot BW_{Channel}$ or $3 \cdot BW_{Channel} \leq f - F_{DL_high} < 60$	$-200 < f - F_{DL_low} \leq -$ $MAX(60, 3 \cdot BW_{Channel})$ or $MAX(60, 3 \cdot BW_{Channel}) \leq f - F_{DL_high} < 200$	$1 \leq f \leq F_{DL_low} -$ $MAX(200, 3 \cdot BW_{Channel})$) or $F_{DL_high} +$ $MAX(200, 3 \cdot BW_{Channel})$) $\leq f \leq 12750$
n79 (NOTE 4)	$F_{interferer}$ (CW)	MHz	N/A	$-150 < f - F_{DL_low} \leq -$ $MAX(60, 3 \cdot BW_{Channel})$ or $MAX(60, 3 \cdot BW_{Channel}) \leq f - F_{DL_high} < 150$	$1 \leq f \leq F_{DL_low} -$ $MAX(150, 3 \cdot BW_{Channel})$) or $F_{DL_high} +$ $MAX(150, 3 \cdot BW_{Channel})$) $\leq f \leq 12750$
NOTE 1: The power level of the interferer ($P_{interferer}$) for Range 3 shall be modified to -20 dBm for $F_{interferer} > 6000$ MHz.					
NOTE 2: $BW_{Channel}$ denotes the channel bandwidth of the wanted signal					
NOTE 3: The power level of the interferer ($P_{interferer}$) for Range 3 shall be modified to -20 dBm, for $F_{interferer} > 2700$ MHz and $F_{interferer} < 4800$ MHz. For $BW_{Channel} > 15$ MHz, the requirement for Range 1 is not applicable and Range 2 applies from the frequency offset of $3 \cdot BW_{Channel}$ from the band edge. For $BW_{Channel}$ larger than 60 MHz, the requirement for Range 2 is not applicable and Range 3 applies from the frequency offset of $3 \cdot BW_{Channel}$ from the band edge.					
NOTE 4: The power level of the interferer ($P_{interferer}$) for Range 3 shall be modified to -20 dBm, for $F_{interferer} > 3650$ MHz and $F_{interferer} < 5750$ MHz. For $BW_{Channel} \geq 40$ MHz, the requirement for Range 2 is not applicable and Range 3 applies from the frequency offset of $3 \cdot BW_{Channel}$ from the band edge.					

For interferer frequencies across ranges 1, 2 and 3 in Table 7.6.3.3-4, a maximum of

$$\lfloor \max\{24, 6 \cdot \lceil n \cdot N_{RB} / 6 \rceil\} / \min\{\lfloor n \cdot N_{RB} / 10 \rfloor, 5\} \rfloor$$

exceptions are allowed for spurious response frequencies in each assigned frequency channel when measured using a step size of $\min(\lfloor BW_{channel} / 2 \rfloor, 5)$ MHz with N_{RB} the number of resource blocks in the downlink transmission bandwidth configuration, $BW_{Channel}$ the bandwidth of the frequency channel in MHz and $n = 1, 2, 3$ for SCS = 15, 30, 60 kHz, respectively. For these exceptions, the requirements in subclause 7.7 apply.

The normative reference for this requirement is TS 38.101-1 [2] clause 7.6.3.

7.6.3.4 Test Description

7.6.3.4.1 Initial Conditions

Initial conditions are a set of test configurations the UE needs to be tested in and the steps for the SS to take with the UE to reach the correct measurement state.

The initial test configurations consist of environmental conditions, test frequencies, and channel bandwidths based on NR operating bands specified in table 5.3.5-1. All of these configurations shall be tested with applicable test parameters for each combination of channel bandwidth and sub-carrier spacing, and are shown in table 7.6.3.4.1-1. The details of the uplink and downlink reference measurement channels (RMCs) are specified in Annexes A.2 and A.3 respectively. The details of the OCNG patterns used are specified in Annex A.5. Configurations of PDSCH and PDCCH before measurement are specified in Annex C.3.

Table 7.6.3.4.1-1: Test Configuration Table

Default Conditions				
Test Environment as specified in TS 38.508-1 [5] subclause 4.1			Normal	
Test Frequencies as specified in TS 38.508-1 [5] subclause 4.3.1			One frequency chosen arbitrarily from low or high range	
Test Channel Bandwidths as specified in TS 38.508-1 [5] subclause 4.3.1			Lowest, Mid, Highest (NOTE 3)	
Test SCS as specified in TS 38.508-1 [5] subclause 4.3.1			Lowest	
Test Parameters				
Test ID	Downlink Configuration		Uplink Configuration	
	Mod'n	RB allocation	Mod'n	RB allocation
1	CP-OFDM QPSK	NOTE 1	DFT-s-OFDM QPSK	NOTE 1
NOTE 1: The specific configuration of uplink and downlink are defined in Table 7.3.2.4.1-1.				
NOTE 2: In a band where UE supports 4Rx, the test shall be performed only with 4Rx antennas ports connected and 4Rx REFSSENS requirement (Table 7.3.2.5-2) is used in the test requirements.				
NOTE 3: For n70, highest test channel bandwidth shall be Highest UL / Highest DL according to asymmetric channel bandwidths specified in clause 5.3.6.				

1. Connect the SS to the UE antenna connectors as shown in TS 38.508 [5] Annex A, in Figure A.3.1.4.2 for TE diagram and section A.3.2 for UE diagram.
2. The parameter settings for the cell are set up according to TS 38.508 [5] subclause 4.4.3.
3. Downlink signals are initially set up according to Annex C.0, C.1, C.2, C.3.1, and uplink signals according to Annex G.0, G.1, G.2, and G.3.1.
4. The UL and DL Reference Measurement channels are set according to Table 7.6.3.4.1-1.
5. Propagation conditions are set according to Annex B.0.
6. Ensure the UE is in State RRC_CONNECTED with generic procedure parameters Connectivity *NR*, Connected without release *On*, Test Mode *On* and Test Loop Function *On* according to TS 38.508-1 [5] clause 4.5. Message contents are defined in clause 7.6.3.4.3.

7.6.3.4.2 Test Procedure

1. SS transmits PDSCH via PDCCH DCI format 1_1 for C_RNTI to transmit the DL RMC according to Table 7.6.3.4.1-1. The SS sends downlink MAC padding bits on the DL RMC.
2. SS sends uplink scheduling information for each UL HARQ process via PDCCH DCI format 0_1 for C_RNTI to schedule the UL RMC according to Table 7.6.3.4.1-1. Since the UE has no payload data to send, the UE transmits uplink MAC padding bits on the UL RMC.
3. Set the parameters of the CW signal generator for an interfering signal below the wanted signal according to Table 7.6.3.5-2 or 7.6.3.5-4. The frequency step size is $\min(\lfloor BW_{channel} / 2 \rfloor, 5)$ MHz.

4. Set the downlink signal level according to the table 7.6.3.5-1 or 7.6.3.5-3. Send uplink power control commands to the UE using 1dB power step size to ensure that the UE output power measured by the test system is within the Uplink power control window, defined as $-(\text{MU})$ to $-(\text{MU} + \text{Uplink power control window size})$ dB of the target power level in Table 7.6.3.5-1 or Table 7.6.3.5-3 for at least the duration of the Throughput measurement, where:
 - MU is the test system uplink power measurement uncertainty and is specified in Table F.1.3-1 for the carrier frequency f and the channel bandwidth BW
 - Uplink power control window size = 1dB (UE power step size) + 0.7dB (UE power step tolerance) + (Test system relative power measurement uncertainty), where, the UE power step tolerance is specified in TS 38.101-1 [2], Table 6.3.4.3-1 and is 0.7dB for 1dB power step size, and the Test system relative power measurement uncertainty is specified for test case 6.3.4.3 in Table F.1.2-1.
5. Measure the average throughput for a duration sufficient to achieve statistical significance according to Annex H.
6. Record the frequencies for which the throughput doesn't meet the requirements.
7. Repeat steps from 3 to 6, using an interfering signal above the wanted signal at step 3.

NOTE: The purpose of the Uplink power control window is to ensure that the actual UE output power is no greater than the target power level, and as close as possible to the target power level. The relationship between the Uplink power control window, the target power level and the corresponding possible actual UE Uplink power window is illustrated in Annex F.4.3.

7.6.3.4.3 Message Contents

Message contents are according to TS 38.508-1 [5] subclause 4.6.

7.6.3.5 Test Requirement

For NR bands with $F_{\text{DL_high}} < 2700$ MHz and $F_{\text{UL_high}} < 2700$ MHz, the throughput measurement derived in test procedure shall be $\geq 95\%$ of the maximum throughput of the reference measurement channels as specified in Annex A.3.2 and A.3.3 with parameters specified in Tables 7.6.3.5-1 and 7.6.3.5-2.

For NR bands with $F_{\text{DL_high}} < 2700$ MHz and $F_{\text{UL_high}} < 2700$ MHz, the number of spurious response frequencies recorded in the final step of test procedure shall not exceed $\lfloor \max\{24,6 \cdot \lceil n \cdot N_{\text{RB}} / 6 \rceil / \min\{\lfloor n \cdot N_{\text{RB}} / 10 \rfloor, 5\} \rfloor$ in each assigned frequency channel when measured using a $\min(\lfloor BW_{\text{channel}} / 2 \rfloor, 5)$ MHz step size. For these exceptions the requirements of clause 7.7 Spurious Response are applicable.

Table 7.6.3.5-1: Out-of-band blocking parameters for NR bands with $F_{\text{DL_high}} < 2700$ MHz and $F_{\text{UL_high}} < 2700$ MHz

RX parameter	Units	Channel bandwidth (MHz)		
		5, 10	15	20, 25, 30, 35, 40, 45, 50, 60, 70, 80, 90, 100
Power in transmission bandwidth configuration ²	dBm	REFSENS + 6 dB	REFSENS + 7 dB	REFSENS + (9 + 10log ₁₀ (BW _{Channel} / 20)) dB
NOTE 1: The transmitter shall be set to 4 dB below P _{C_{MAX}L,f,c} at the minimum UL configuration specified in Table 7.3.2.3-3 with P _{C_{MAX}L,f,c} defined in clause 6.2.4.				
NOTE 2: Power in transmission bandwidth configuration shall be rounded to the next higher 0.5dB value.				

Table 7.6.3.5-2: Out of-band blocking for NR bands with $F_{DL_high} < 2700$ MHz and $F_{UL_high} < 2700$ MHz

NR band	Parameter	Unit	Range 1	Range 2	Range 3
n1, n2, n3, n5, n7, n8, n12, n14, n20, n24, n25, n26, n28, n30, n34, n38, n39, n40, n41, n48 ⁵ , n50, n51, n53 ⁸ , n65, n66, n70, n71, n74	$P_{interferer}$	dBm	-44	-30	-15
	$F_{interferer}$ (CW)	MHz	$-60 < f - F_{DL_low} < -15$ or $15 < f - F_{DL_high} < 60$	$-85 < f - F_{DL_low} \leq -60$ or $60 \leq f - F_{DL_high} < 85$	$1 \leq f \leq F_{DL_low} - 85$ or $F_{DL_high} + 85 \leq f \leq 12750$
<p>NOTE 1: The power level of the interferer ($P_{interferer}$) for Range 3 shall be modified to -20 dBm for $F_{interferer} > 6000$ MHz.</p> <p>NOTE 2: For band 51 the F_{DL_high} of band 50 is applied as F_{DL_high} for band 51. For band 50, the F_{DL_low} of band 51 is applied as F_{DL_low} for band 50.</p> <p>NOTE 3: For band 76 the F_{DL_high} of band 75 is applied as F_{DL_high} for band 76. For band 75, the F_{DL_low} of band 76 is applied as F_{DL_low} for band 75.</p> <p>NOTE 4: For UEs supporting both bands 38 and 41, the F_{DL_high} and F_{DL_low} of band 41 is applied as F_{DL_high} and F_{DL_low} for band 38.</p> <p>NOTE 5: n48 follows the requirement in this frequency range according to the general requirement defined in Clause 7.1. The power level of the interferer ($P_{interferer}$) for Range 3 shall be modified to -20 dBm for $F_{interferer} > 2700$ MHz and $F_{interferer} < 4800$ MHz.</p> <p>NOTE 6: Void.</p> <p>NOTE 7: For UE supporting both bands 25 and 70, the F_{DL_high} of band 70 is applied as F_{DL_high} for band 25, and the F_{DL_low} of band 25 is applied as F_{DL_low} for band 70.</p> <p>NOTE 8: The power level of the interferer ($P_{interferer}$) for Range 3 shall be modified to -20 dBm for $F_{interferer} > 2580$ MHz and $F_{interferer} < 2775$ MHz.</p>					

For NR bands with $F_{DL_low} \geq 3300$ MHz and $F_{UL_low} \geq 3300$ MHz, the throughput measurement derived in test procedure shall be $\geq 95\%$ of the maximum throughput of the reference measurement channels as specified in Annex A.3.2 and A.3.3 with parameters specified in Tables 7.6.3.5-3 and 7.6.3.5-4.

For NR bands with $F_{DL_low} \geq 3300$ MHz and $F_{UL_low} \geq 3300$ MHz, the number of spurious response frequencies recorded in the final step of test procedure shall not exceed $\lfloor \max\{24, 6 \cdot \lceil n \cdot N_{RB} / 6 \rceil\} / \min\{\lfloor n \cdot N_{RB} / 10 \rfloor, 5\} \rfloor$ in each assigned frequency channel when measured using a $\min(\lfloor BW_{channel} / 2 \rfloor, 5)$ MHz step size. For these exceptions the requirements of clause 7.7 Spurious Response are applicable.

Table 7.6.3.5-3: Out-of-band blocking parameters for NR bands with $F_{DL_low} \geq 3300$ MHz and $F_{UL_low} \geq 3300$ MHz

RX parameter	Units	Channel bandwidth (MHz)		
		10	15	20, 25, 30, 35, 40, 45, 50, 60, 70, 80, 90, 100
Power in transmission bandwidth configuration	dBm	REFSENS + 6 dB	REFSENS + 7 dB	REFSENS + 9 dB
NOTE: The transmitter shall be set to 4 dB below $P_{CMAX_L,f,c}$ at the minimum UL configuration specified in Table 7.3.2.3-3 with $P_{CMAX_L,f,c}$ defined in clause 6.2.4.				

Table 7.6.3.5-4: Out of-band blocking for NR bands with $F_{DL_low} \geq 3300$ MHz and $F_{UL_low} \geq 3300$ MHz

NR band	Parameter	Unit	Range1	Range 2	Range 3
n77, n78 (NOTE 3)	$P_{interferer}$	dBm	-44	-30	-15
	$F_{interferer}$ (CW)	MHz	$-60 < f - F_{DL_low} \leq -3 \cdot BW_{Channel}$ or $3 \cdot BW_{Channel} \leq f - F_{DL_high} < 60$	$-200 < f - F_{DL_low} \leq -$ $MAX(60, 3 \cdot BW_{Channel})$ or $MAX(60, 3 \cdot BW_{Channel}) \leq f - F_{DL_high} < 200$	$1 \leq f \leq F_{DL_low} -$ $MAX(200, 3 \cdot BW_{Channel})$) or $F_{DL_high} +$ $MAX(200, 3 \cdot BW_{Channel})$) $\leq f \leq 12750$
n79 (NOTE 4)	$F_{interferer}$ (CW)	MHz	N/A	$-150 < f - F_{DL_low} \leq -$ $MAX(60, 3 \cdot BW_{Channel})$ or $MAX(60, 3 \cdot BW_{Channel}) \leq f - F_{DL_high} < 150$	$1 \leq f \leq F_{DL_low} -$ $MAX(150, 3 \cdot BW_{Channel})$) or $F_{DL_high} +$ $MAX(150, 3 \cdot BW_{Channel})$) $\leq f \leq 12750$
NOTE 1: The power level of the interferer ($P_{interferer}$) for Range 3 shall be modified to -20 dBm for $F_{interferer} > 6000$ MHz. NOTE 2: $BW_{Channel}$ denotes the channel bandwidth of the wanted signal NOTE 3: The power level of the interferer ($P_{interferer}$) for Range 3 shall be modified to -20 dBm, for $F_{interferer} > 2700$ MHz and $F_{interferer} < 4800$ MHz. For $BW_{Channel} > 15$ MHz, the requirement for Range 1 is not applicable and Range 2 applies from the frequency offset of $3 \cdot BW_{Channel}$ from the band edge. For $BW_{Channel}$ larger than 60 MHz, the requirement for Range 2 is not applicable and Range 3 applies from the frequency offset of $3 \cdot BW_{Channel}$ from the band edge. NOTE 4: The power level of the interferer ($P_{interferer}$) for Range 3 shall be modified to -20 dBm, for $F_{interferer} > 3650$ MHz and $F_{interferer} < 5750$ MHz. For $BW_{Channel} \geq 40$ MHz, the requirement for Range 2 is not applicable and Range 3 applies from the frequency offset of $3 \cdot BW_{Channel}$ from the band edge.					

Table 7.6.3.5-5: Void

7.6.4 Narrow band blocking

7.6.4.1 Test Purpose

Verifies a receiver's ability to receive a NR signal at its assigned channel frequency in the presence of an unwanted narrow band CW interferer at a frequency, which is less than the nominal channel spacing.

The lack of narrow-band blocking ability will decrease the coverage area when other NR Node B transmitters exist (except in the adjacent channels and spurious response).

7.6.4.2 Test Applicability

This test applies to all types of NR UE release 15 and forward.

7.6.4.3 Minimum Conformance Requirements

The relative throughput shall be $\geq 95\%$ of the maximum throughput of the reference measurement channels as specified in Annexes A.2.2, A.2.3, A.3.2 and A.3.3 (with one sided dynamic OCNG Pattern OP.1 FDD/TDD for the DL-signal as described in Annex A.5.1.1/A.5.2.1) with parameters specified in Table 7.6.4.3-1. For operating bands with an unpaired DL part (as noted in Table 5.2-1), the requirements only apply for carriers assigned in the paired part.

Table 7.6.4.3-1: Narrow Band Blocking

NR band	Parameter	Unit	Channel Bandwidth (MHz)						
			5	10	15	20	25, 30, 35, 40, 45, 50, 60, 70, 80, 90, 100		
n1, n2, n3, n5, n7, n8, n12, n13, n14, n18, n20, n24, n25, n26, n28, n30, n34, n38, n39, n40, n41, n48, n50, n51, n53, n65, n66, n67, n70, n71, n74, n75, n76	P _w	dBm	P _{REFSENS} + channel-bandwidth specific value below						
			16	13	14	16	16		
	P _{uw} (CW)	dBm	-55						
	F _{uw} (offset SCS= 15 kHz) ⁴	MHz	$\left(\left[\frac{\frac{BW_{channel}}{2} + 0.2}{SCS} + 0.5 \right] + 0.5 \right) SCS$			NA			
F _{uw} (offset SCS= 30 kHz) ⁴	MHz	NA			$\left(\left[\frac{\frac{BW_{channel}}{2} + BW_{GB,channel}}{SCS} + 0.5 \right] + 0.5 \right) SCS$				

NOTE 1: The transmitter shall be set a 4 dB below P_{C_{MAX},L,f,c} at the minimum UL configuration specified in Table 7.3.2.3-3 with P_{C_{MAX},L,f,c} defined in clause 6.2.4

NOTE 2: Reference measurement channel is specified in Annexes A.3.2 and A.3.3 with one sided dynamic OCNG Pattern OP.1 FDD/TDD as described in Annex A.5.1.1/A.5.2.1.

NOTE 3: The P_{REFSENS} power level is specified in Table 7.3.2-1 and Table 7.3.2-2 for two and four antenna ports, respectively.

NOTE 4: F_{uw} shall be rounded to half of SCS.

The normative reference for this requirement is TS 38.101-1 [2] clause 7.6.4.

7.6.4.4 Test Description

7.6.4.4.1 Initial Conditions

Initial conditions are a set of test configurations the UE needs to be tested in and the steps for the SS to take with the UE to reach the correct measurement state.

The initial test configurations consist of environmental conditions, test frequencies, and channel bandwidths based on NR operating bands specified in table 5.3.5-1. All of these configurations shall be tested with applicable test parameters for each combination of channel bandwidth and sub-carrier spacing, and are shown in table 7.6.4.4.1-1. The details of the uplink and downlink reference measurement channels (RMCs) are specified in Annexes A.2 and A.3 respectively. The details of the OCNG patterns used are specified in Annex A.5. Configurations of PDSCH and PDCCH before measurement are specified in Annex C.2.

Table 7.6.4.4.1-1: Test Configuration Table

Default Conditions				
Test Environment as specified in TS 38.508-1 [5] subclause 4.1		Normal		
Test Frequencies as specified in TS 38.508-1 [5] subclause 4.3.1		Mid range (NOTE 4)		
Test Channel Bandwidths as specified in TS 38.508-1 [5] subclause 4.3.1		Lowest, Mid and Highest (NOTE 2)		
Test SCS as specified in TS 38.508-1 [5] subclause 4.3.1		According to CH BW SCS in table 7.6.4.3-1		
Test Parameters				
Test ID	Downlink Configuration		Uplink Configuration	
	Mod'n	RB allocation	Mod'n	RB allocation
1	CP-OFDM QPSK	NOTE 1	DFT-s-OFDM QPSK	NOTE 1
NOTE 1: The specific configuration of uplink and downlink are defined in Table 7.3.2.4.1-1.				
NOTE 2: For n70, highest test channel bandwidth shall be Highest UL / Highest DL according to asymmetric channel bandwidths specified in clause 5.3.6.				
NOTE 3: In a band where UE supports 4Rx, the test shall be performed only with 4Rx antennas ports connected and 4Rx REFSENS requirement (Table 7.3.2.5-2) is used in the test requirements.				
NOTE 4: For NR band n28, 30MHz test channel bandwidth is tested with Low range test frequencies.				

1. Connect the SS to the UE antenna connectors as shown in TS 38.508-1 [5] Annex A, in Figure A.3.1.4.2 for TE diagram and section A.3.2 for UE diagram.
2. The parameter settings for the cell are set up according to TS 38.508-1 [5] subclause 4.4.3.
3. Downlink signals are initially set up according to Annex C.0, C.1, C.2, and C.3.1, and uplink signals according to Annex G.0, G.1, G.2, and G.3.1.
4. The UL and DL Reference Measurement channels are set according to Table 7.6.4.4.1-1.
5. Propagation conditions are set according to Annex B.0.
6. Ensure the UE is in State RRC_CONNECTED with generic procedure parameters Connectivity NR according to TS 38.508-1 [5] clause 4.5. Message contents are defined in clause 7.6.4.4.3.

7.6.4.4.2 Test Procedure

1. SS transmits PDSCH via PDCCH DCI format 1_1 for C_RNTI to transmit the DL RMC according to Table 7.6.4.4.1-1. The SS sends downlink MAC padding bits on the DL RMC.
2. SS sends uplink scheduling information for each UL HARQ process via PDCCH DCI format 0_1 for C_RNTI to schedule the UL RMC according to Table 7.6.4.4.1-1. Since the UE has no payload and no loopback data to send, the UE transmits uplink MAC padding bits on the UL RMC.
3. Set the parameters of the CW signal generator for an interfering signal below the wanted signal according to Table 7.6.4.5-1.
4. Set the downlink signal level according to the table 7.6.4.5-1. Send uplink power control commands to the UE using 1dB power step size to ensure that the UE output power measured by the test system is within the Uplink power control window, defined as $-(\text{MU})$ to $-(\text{MU} + \text{Uplink power control window size})$ dB of the target power level in Table 7.6.4.5-1 for at least the duration of the Throughput measurement, where:
 - MU is the test system uplink power measurement uncertainty and is specified in Table F.1.3-1 for the carrier frequency f and the channel bandwidth BW
 - Uplink power control window size = 1dB (UE power step size) + 0.7dB (UE power step tolerance) + (Test system relative power measurement uncertainty), where, the UE power step tolerance is specified in TS 38.101-1 [2], Table 6.3.4.3-1 and is 0.7dB for 1dB power step size, and the Test system relative power measurement uncertainty is specified for test case 6.3.4.3 in Table F.1.2-1.
5. Measure the average throughput for a duration sufficient to achieve statistical significance according to Annex H.2.
6. Repeat steps from 3 to 5, using an interfering signal above the wanted signal at step 3.

NOTE: The purpose of the Uplink power control window is to ensure that the actual UE output power is no greater than the target power level, and as close as possible to the target power level. The relationship between the Uplink power control window, the target power level and the corresponding possible actual UE Uplink power window is illustrated in Annex F.4.3.

7.6.4.4.3 Message Contents

Message contents are according to TS 38.508-1 [5] subclause 4.6.

7.6.4.5 Test Requirement

The throughput measurement derived in test procedure shall be $\geq 95\%$ of the maximum throughput of the reference measurement channels as specified in Annex A.3.2 and A.3.3 with parameters specified in Table 7.6.4.5-1.

Table 7.6.4.5-1: Narrow-band blocking

NR band	Parameter	Unit	Channel Bandwidth (MHz)						
			5	10	15	20	25, 30, 35, 40, 45, 50, 60, 70, 80, 90, 100		
n1, n2, n3, n5, n7, n8, n12, n13, n14, n18, n20, n24, n25, n26, n28, n30, n34, n38, n39, n40, n41, n48, n50, n51, n53, n65, n66, n67, n70, n71, n74, n75, n76	P _w	dBm	P _{REFSENS} + channel-bandwidth specific value below						
	P _{uw} (CW)	dBm	16	13	14	16	16		
	F _{uw} (offset SCS= 15 kHz) ⁴	MHz	$\left(\left(\frac{BW_{channel}}{2} + 0.2 \right) / SCS + 0.5 \right) SCS$			NA			
	F _{uw} (offset SCS= 30 kHz) ⁴	MHz	NA			$\left(\left(\frac{BW_{channel}}{2} + BW_{GB,channel} \right) / SCS + 0.5 \right) SCS$			

NOTE 1: The transmitter shall be set a 4 dB below P_{C_{MAX}L,f,c} at the minimum UL configuration specified in Table 7.3.2.3-3 with P_{C_{MAX}L,f,c} defined in clause 6.2.4

NOTE 2: Reference measurement channel is specified in Annexes A.3.2 and A.3.3 with one sided dynamic OCNG Pattern OP.1 FDD/TDD as described in Annex A.5.1.1/A.5.2.1.

NOTE 3: The P_{REFSENS} power level is specified in Table 7.3.2-1 and Table 7.3.2-2 for two and four antenna ports, respectively.

NOTE 4: F_{uw} shall be rounded to half of SCS.

Table 7.6.4.5-2 Void

7.6A Blocking characteristics for CA

7.6A.1 General

7.6A.2 Inband blocking for CA

7.6A.2.0 Minimum requirements

7.6A.2.0.1 In-band blocking for Intra-band contiguous CA

For intra-band contiguous carrier aggregation the downlink SCC(s) shall be configured at nominal channel spacing to the PCC. The UE shall fulfil the minimum requirement specified in Table 7.6A.2.0.1-1a for an adjacent channel interferer on either side of the aggregated downlink signal at a specified frequency offset and for an interferer power up to -25 dBm. The throughput of each carrier shall be ≥ 95% of the maximum throughput of the reference measurement channels as specified in Annexes A.2.2, A.2.3, A.3.2, and A.3.3 (with one sided dynamic OCNG Pattern OP.1 FDD/TDD for the DL-signal as described in Annex A.5.1.1/A.5.2.1).

Table 7.6A.2.0.1-1: In-band blocking parameters for intra-band contiguous CA with F_{DL_low} ≥ 3300 MHz and F_{UL_low} ≥ 3300 MHz

Rx Parameter	Units	NR CA bandwidth class		
		B	C	D
P _w in Transmission Bandwidth Configuration, per CC	dB	REFSENS + CA bandwidth class specific value below		
		10.0	6	13.8
BW _{interferer}	MHz	20	BW _{channel CA}	50
F _{offset, case 1}	MHz	30	BW _{channel CA+} BW _{channel CA/2}	75
F _{offset, case 2}	MHz	50	BW _{interferer} + F _{offset, case 1}	125

NOTE 1: The transmitter shall be set to 4dB below P_{C_{MAX}L,f,c} at the minimum UL configuration specified in Table 7.3.2-3 with P_{C_{MAX}L,f,c} defined in clause 6.2.4.

NOTE 2: The interferer consists of the Reference measurement channel specified in Annexes A.3.2 and A.3.3 with one sided dynamic OCNG Pattern OP.1 FDD/TDD as described in Annex A.5.1.1/A.5.2.1 and set-up according to Annex C.3.1

Table 7.6A.2.0.1-1a: In-band blocking parameters for intra-band contiguous CA with $F_{DL_low} < 2700$ MHz and $F_{UL_low} < 2700$ MHz

Rx Parameter	Units	NR CA bandwidth class	
		B	C
Pw in Transmission Bandwidth Configuration, per CC	dBm	REFSENS + NR CA bandwidth class specific value below	REFSENS + NR CA bandwidth class specific value below
		16.0	19.0
BW _{Interferer}	MHz	5	5
F _{Ioffset, case 1}	MHz	7.5	7.5
F _{Ioffset, case 2}	MHz	12.5	12.5

NOTE 1: The transmitter shall be set to 4 dB below P_{CMAX_L,f,c} at the minimum UL configuration specified in Table 7.3.2.3-3 with P_{CMAX_L,f,c} defined in clause 6.2.4.

NOTE 2: The interferer consists of the Reference measurement channel specified in Annexes A.3.2 and A.3.3 with one sided dynamic OCNG Pattern OP.1 FDD/TDD as described in Annex A.5.1.1/A.5.2.1 and set-up according to Annex C.3.1

Table 7.6A.2.0.1-2: In-band blocking for intra-band contiguous CA with $F_{DL_low} \geq 3300$ MHz and $F_{UL_low} \geq 3300$ MHz

NR band	Parameter	Unit	Case 1	Case 2
			-56	-44
n77, n78, n79	F _{interferer} (offset)	MHz	-BW _{channel CA/2} - F _{Ioffset, case 1} and BW _{channel CA/2} + F _{Ioffset, case 1}	$\leq -BW_{channel CA/2} - F_{Ioffset, case 2}$ and $\geq BW_{channel CA/2} + F_{Ioffset, case 2}$
	F _{interferer}	MHz	NOTE 2	F _{DL_low} - 3BW _{channel CA} to F _{DL_high} + 3BW _{channel CA}

NOTE 1: The absolute value of the interferer offset F_{interferer} (offset) shall be further adjusted to $(\lceil |F_{interferer}| / SCS \rceil + 0.5) SCS$ MHz with SCS the sub-carrier spacing of the carrier closest to the interferer in MHz. The interferer is an NR signal with an SCS equal to that of the closest carrier.

NOTE 2: For each carrier frequency, the requirement applies for two interferer carrier frequencies: a: -BW_{channel CA/2} - F_{Ioffset, case 1}; b: BW_{channel CA/2} + F_{Ioffset, case 1}

NOTE 3: BW_{channel CA} denotes the aggregated channel bandwidth of the wanted signal

Table 7.6A.2.0.1-2a: In-band blocking for intra-band contiguous CA with $F_{DL_low} < 2700$ MHz and $F_{UL_low} < 2700$ MHz

NR band	Parameter	Unit	Case 1	Case 2	Case 3
			-56	-44	
n66 n41 n48 ⁴ n40	F _{interferer} (offset)	MHz	-BW _{channel CA/2} - F _{Ioffset, case 1} and BW _{channel CA/2} + F _{Ioffset, case 1}	$\leq -BW_{channel CA/2} - F_{Ioffset, case 2}$ and $\geq BW_{channel CA/2} + F_{Ioffset, case 2}$	
	F _{interferer}	MHz	NOTE 2	F _{DL_low} - 15 to F _{DL_high} + 15	
n71	F _{interferer}	MHz	NOTE 2	F _{DL_low} - 12 to F _{DL_high} + 15	F _{DL_low} - 12

NOTE 1: The absolute value of the interferer offset F_{interferer} (offset) shall be further adjusted to $(\lceil |F_{interferer}| / SCS \rceil + 0.5) SCS$ MHz with SCS the sub-carrier spacing of the carrier closest to the interferer in MHz. The interferer is an NR signal with 15 kHz SCS.

NOTE 2: For each carrier frequency, the requirement applies for two interferer carrier frequencies: a: -BW_{channel CA/2} - F_{Ioffset, case 1}; b: BW_{channel CA/2} + F_{Ioffset, case 1}

NOTE 3: BW_{channel CA} denotes the aggregated channel bandwidth of the wanted signal.

NOTE 4: n48 follows the requirement in this frequency range according to the general requirement defined in Clause 7.1A.

7.6A.2.0.2 In-band blocking for Intra-band non-contiguous CA

For intra-band non-contiguous carrier aggregation with one uplink carrier and two or more downlink sub-blocks, each larger than or equal to 5 MHz, the in-band blocking requirements are defined with the uplink configuration in

accordance with Table 7.3A.0.3.2-1. For this uplink configuration, the UE shall meet the requirements for each sub-block as specified in subclause 7.6.2 and in this subclause for one component carrier and two component carriers per sub-block, respectively. The requirements apply for in-gap and out-of-gap interferers while all downlink carriers are active.

The throughput of each carrier shall be $\geq 95\%$ of the maximum throughput of the reference measurement channels as specified in Annexes A.2.2, A.2.3, A.3.2, and A.3.3 (with one sided dynamic OCNG Pattern OP.1 FDD/TDD for the DL-signal as described in Annex A.5.1.1/A.5.2.1).

7.6A.2.0.3 In-band blocking for Inter-band CA

For inter-band carrier aggregation with one component carrier per operating band and the uplink assigned to one NR band, the in-band blocking requirements are defined with the uplink active on the band(s) other than the band whose downlink is being tested. The UE shall meet the requirements specified in subclause 7.6.2 for each component carrier while all downlink carriers are active.

For the UE which supports inter-band CA configuration in Table 7.3A.0.3.2.1-1, $P_{\text{interferer}}$ power defined in Table 7.6.2.3-2 and 7.6.2.3-4 is increased by the amount given by $\Delta R_{\text{IB,c}}$ in Table 7.3A.0.3.2.1-1.

For E-UTRA CA configurations including an operating band without uplink operation or an operating band with an unpaired DL part (as noted in Table 5.2-1), the requirements for all downlinks shall be met with the single uplink carrier active in each band capable of UL operation. The requirements for the component carrier configured in the operating band without uplink operation are specified in Table 7.6A.2.3-1.

Table 7.6A.2.3-1: In-band blocking parameters for additional NR operating bands for carrier aggregation with $F_{\text{DL_high}} < 2700$ MHz and $F_{\text{UL_high}} < 2700$ MHz

NR band	Parameter	Unit	Case 1	Case 2
		$P_{\text{interferer}}$	dBm	-56
	$F_{\text{interferer}}$ (offset)	MHz	$-\text{CBW}/2 - F_{\text{offset, case 1}}$ and $\text{CBW}/2 + F_{\text{offset, case 1}}$	$\leq -\text{CBW}/2 - F_{\text{offset, case 2}}$ and $\geq \text{CBW}/2 + F_{\text{offset, case 2}}$
n29	$F_{\text{interferer}}$	MHz	NOTE 2	$F_{\text{DL_low}} - 15$ to $F_{\text{DL_high}} + 15$
NOTE 1: For certain bands, the unwanted modulated interfering signal may not fall inside the UE receive band, but within the first 15 MHz below or above the UE receive band				
NOTE 2: For each carrier frequency, the requirement applies for two interferer carrier frequencies: a: $-\text{CBW}/2 - F_{\text{offset, case 1}}$; b: $\text{CBW}/2 + F_{\text{offset, case 1}}$				
NOTE 3: The absolute value of the interferer offset $F_{\text{interferer}}$ (offset) shall be further adjusted to $(\lceil F_{\text{interferer}} / \text{SCS} \rceil + 0.5) \text{SCS}$ MHz with SCS the sub-carrier spacing of the wanted signal in MHz. The interferer is an NR signal with an SCS equal to that of the wanted signal				
NOTE 4: CBW denotes the channel bandwidth of the wanted signal				

The throughput of each carrier shall be $\geq 95\%$ of the maximum throughput of the reference measurement channels as specified in Annexes A.2.2, A.2.3, A.3.2, and A.3.3 (with one sided dynamic OCNG Pattern OP.1 FDD/TDD for the DL-signal as described in Annex A.5.1.1/A.5.2.1).

The normative reference for this requirement is TS 38.101-1 [2] clause 7.6A.2.

7.6A.2.1 In-band blocking for CA (2DL CA)

7.6A.2.1.1 Test purpose

Inband blocking is defined for an unwanted interfering signal falling into the range from 15 MHz below to 15 MHz above the UE receive band, with $F_{\text{DL_high}} < 2700$ MHz and $F_{\text{UL_high}} < 2700$ MHz, or into an immediately adjacent frequency range up 3CBW below or above the UE receive band, with $F_{\text{DL_high}} \geq 3300$ MHz and $F_{\text{UL_high}} \geq 3300$ MHz, at which the relative throughput shall meet or exceed the requirement for the specified measurement channel.

7.6A.2.1.2 Test applicability

This test applies to all types of NR UE release 15 and forward that support 2DL CA.

7.6A.2.1.3 Minimum conformance requirements

Minimum requirements are defined in clause 7.6A.2.0.

7.6A.2.1.4 Test description

7.6A.2.1.4.1 Initial conditions

Initial conditions are a set of test configurations the UE needs to be tested in and the steps for the SS to take with the UE to reach the correct measurement state.

The initial test configurations consist of environmental conditions, test frequencies, test channel bandwidths and sub-carrier spacing based on NR CA configuration specified in clause 5.5A. All of these configurations shall be tested with applicable test parameters for each CA configuration, are shown in table 7.6A.2.1.4.1-1, 7.6A.2.1.4.1-2 or 7.6A.2.1.4.1-3. The details of the uplink and downlink reference measurement channels (RMC) are specified in Annexes A.2 and A.3. Configuration of PDSCH and PDCCH before measurement are specified in Annex C.2..

Table 7.6A.2.1.4.1-1: Test configuration table for Intra-band contiguous CA

Default Conditions					
Test Environment as specified in TS 38.508-1 [5] subclause 4.1		Normal			
Test Frequencies as specified in TS 38.508-1 [5] subclause 4.3.1		Mid range			
Test CC Combination setting (N_{RB_agg}) as specified in Table 5.5A.1-1 for the CA Configuration across bandwidth combination sets supported by the UE.		Highest N_{RB_agg} , NOTE 1, NOTE 3			
Test SCS as specified in Table 5.3.5-1		Lowest			
Test Parameters					
Test ID	Downlink Configuration			Uplink Configuration	
	CC Mod'n	PCC RB allocation	SCC RB allocation	CC Mod'n	PCC RB allocation
1	CP-OFDM QPSK	NOTE 1	NOTE 1	DFT-s-OFDM QPSK	NOTE 1
NOTE 1: The specific configuration of uplink and downlink are defined in Table 7.3A.1.4.1-1.					
NOTE 2: In a band where UE supports 4Rx, the test shall be performed only with 4Rx antennas ports connected and 4Rx REFSSENS requirement (Table 7.3.2.5-2) is used in the test requirements.					
NOTE 3: If the UE supports multiple CC Combinations in the CA Configuration with the same N_{RB_agg} , only the combination with the highest N_{RB_PCC} is tested					

Table 7.6A.2.1.4.1-2: Test configuration table for Inter-band CA

Default Conditions					
Test Environment as specified in TS 38.508-1 [5] subclause 4.1			Normal		
Test Frequencies as specified in TS 38.508-1 [5] subclause 4.3.1			NOTE 1, NOTE 3		
Test CC Combination setting (N_{RB_agg}) as specified in Table 5.5A.3.1-1 for the CA Configuration across bandwidth combination sets supported by the UE.			Highest N_{RB_agg} NOTE 1, NOTE 4		
Test SCS as specified in Table 5.3.5-1			Lowest		
Test Parameters					
Test ID	Downlink Configuration			Uplink Configuration	
	CC Mod'n	PCC RB allocation	SCC RB allocation	CC Mod'n	PCC RB allocation
1	CP-OFDM QPSK	NOTE 1	NOTE 1	DFT-s-OFDM QPSK	NOTE 1
NOTE 1: The specific configuration of uplink and downlink are defined in Table 7.3A.1.4.1-2. Only test points verifying non-exceptional REFSENS requirements are used for in-band blocking.					
NOTE 2: In a band where UE supports 4Rx, the test shall be performed only with 4Rx antennas ports connected and 4Rx REFSENS requirement (Table 7.3.2.5-2) is used in the test requirements.					
NOTE 3: For NR band n28, 30MHz test channel bandwidth is tested with Low range test frequencies.					
NOTE 4: If the UE supports multiple CC Combinations in the CA Configuration with the same N_{RB_agg} , only the combination with the highest N_{RB_PCC} is tested.					

Table 7.6A.2.1.4.1-3: Test configuration table for Inband non-contiguous CA

Default Conditions					
Test Environment as specified in TS 38.508-1 [5] subclause 4.1			Normal		
Test Frequencies as specified in TS 38.508-1 [5] subclause 4.3.1			NOTE 1		
Test CC Combination setting (N_{RB_agg}) as specified in Table 5.5A.2-1 for the CA Configuration across bandwidth combination sets supported by the UE.			Highest N_{RB_agg} NOTE 1, NOTE 3		
Test SCS as specified in Table 5.3.5-1			Lowest		
Test Parameters					
Test ID	Downlink Configuration			Uplink Configuration	
	CC Mod'n	PCC RB allocation	SCC RB allocation	CC Mod'n	PCC RB allocation
1	CP-OFDM QPSK	NOTE 1	NOTE 1	DFT-s-OFDM QPSK	NOTE 1
NOTE 1: The specific configuration of uplink and downlink are defined in Table 7.3A.1.4.1-3. Only test points verifying non-exceptional REFSENS requirements are used for in-band blocking.					
NOTE 2: In a band where UE supports 4Rx, the test shall be performed only with 4Rx antennas ports connected and 4Rx REFSENS requirement (Table 7.3.2.5-2) is used in the test requirements.					
NOTE 3: If the UE supports multiple CC Combinations in the CA Configuration with the same N_{RB_agg} , only the combination with the highest N_{RB_PCC} is tested.					

1. Connect the SS to the UE antenna connectors as shown in TS 38.508-1 [5] Annex A, in Figure A.3.1.4.7 for TE diagram and section A.3.2 for UE diagram.
2. The parameter settings for the cell are set up according to TS 38.508-1 [5] subclause 4.4.3.
3. Downlink signals are initially set up according to Annex C.0, C.1, C.2, C.3.1, and uplink signals according to Annex G.0, G.1, G.2, G.3.1.
4. The DL and UL Reference Measurement channels are set according to Table 7.6A.2.1.4.1-1, 7.6A.2.1.4.1-2 or 7.6A.2.1.4.1-3.
5. Propagation conditions are set according to Annex B.0.
6. Ensure the UE is in state RRC_CONNECTED with generic procedure parameters Connectivity *NR*, Connected without release *On*, Test Mode *On* and Test Loop Function *On* according to TS 38.508-1 [5] clause 4.5. Message content are defined in clause 7.6A.2.1.4.3.

7.6A.2.1.4.2 Test procedure

1. Configure SCC according to Annex C.0, C.1, C.2 for all downlink physical channels.
2. The SS shall configure SCC as per TS 38.508-1 [5] clause 5.5.1. Message contents are defined in clause 7.6A.2.1.4.3.
3. SS activates SCC by sending the activation MAC CE (Refer TS 38.321 [18], clauses 5.9, 6.1.3.10). Wait for at least 2 seconds (Refer TS 38.133[19], clause 9.3).
4. SS transmits PDSCH via PDCCH DCI format 1_1 for C_RNTI to transmit the DL RMC according to Tables 7.6A.2.1.4.1-1, 7.6A.2.1.4.1-2 or 7.6A.2.1.4.1-3 on both SCC and PCC. The SS sends downlink MAC padding bits on the DL RMC.
5. SS sends uplink scheduling information for each UL HARQ process via PDCCH DCI format 0_1 for C_RNTI to schedule the UL RMC according to Tables 7.6A.2.1.4.1-1, 7.6A.2.1.4.1-2 or 7.6A.2.1.4.1-3 on PCC. Since the UL has no payload and no loopback data to send the UE sends uplink MAC padding bits on the UL RMC.
6. For Intra-band contiguous CA: Set the parameters of the signal generator for an interfering signal below the aggregated component carriers in Case 1 according to Tables 7.6A.2.1.5.1-1 and 7.6A.2.1.5.1-2 or Tables 7.6A.2.1.5.1-1a and 7.6A.2.1.5.1-2a as appropriate depending on NR band.

For Inter-band CA: Set the parameters of the signal generator for an interfering signal below the SCC's wanted signal in Case 1 according to Tables 7.6A.2.1.5.3-1 and 7.6A.2.1.5.3-2 or Tables 7.6A.2.1.5.3-1a and 7.6A.2.1.5.3-2a as appropriate depending on NR band.

For Intra-band non-contiguous CA: Set the parameters of the signal generator for an interfering signal below the PCC's wanted signal in Case 1 according to 7.6A.2.1.5.3-1 and 7.6A.2.1.5.3-2 or Tables 7.6A.2.1.5.3-1a and 7.6A.2.1.5.3-2a as appropriate depending on NR bands as appropriate, excluding frequencies where the interferer centre frequency falls within SCC carrier $\pm(BW/2 + F_{\text{offset,case 1}})$, where BW & offset refer to SCC.

7. Set the downlink signal level on both carriers according to the table 7.6A.2.1.5.1-1, 7.6A.2.1.5.1-1a or 7.6A.2.1.5.3-1, 7.6A.2.1.5.3-1a as appropriate. Send uplink power control commands to the UE using 1dB power step size to ensure that the UE output power measured by the test system is within the Uplink power control window, defined as $-(MU + \text{Uplink power control window size})$ dB of the target power level in table 7.6A.2.1.5.1-1, 7.6A.2.1.5.1-1a or 7.6A.2.1.5.3-1, 7.6A.2.1.5.3-1a for at least the duration of the Throughput measurement, where:
 - MU is the test system uplink power measurement uncertainty and is specified in Table F.1.3-1 for the carrier frequency f and the channel bandwidth BW
 - Uplink power control window size = 1dB (UE power step size) + 0.7dB (UE power step tolerance) + (Test system relative power measurement uncertainty), where, the UE power step tolerance is specified in TS 38.101-1 [2], Table 6.3.4.3-1 and is 0.7dB for 1dB power step size, and the Test system relative power measurement uncertainty is specified for test case 6.3.4.3 in Table F.1.2-1.
8. For Intra-band contiguous CA: Measure the average throughput of both carriers for a duration sufficient to achieve statistical significance according to Annex H.2A.

For Inter-band CA: Measure the average throughput of SCC for a duration sufficient to achieve statistical significance according to Annex H.2A.

For Intra-band non-contiguous CA: Measure the average throughput of PCC for a duration sufficient to achieve statistical significance according to Annex H.2A.
9. Repeat steps from 6 to 8, using an interfering signal above the wanted signal in Case 1 at step 6.
10. For Intra-band non-contiguous only: Repeat steps from 6 to 9, using an interfering signal below and above the SCC in Case 1 and measuring SCC instead of PCC in step 8, excluding the frequencies where the interferer centre frequency falls within PCC carrier $\pm(BW/2 + F_{\text{offset,case 1}})$, where BW & offset refer to PCC.
11. Repeat steps from 6 to 10, using interfering signals in Case 2 at step 6 and 9. The ranges of case 2 are covered in steps equal to the interferer bandwidth.
12. Repeat steps from 6 to 10, using interfering signals in Case 3 as applicable at step 6 and 9. The ranges of case 3 are covered in steps equal to the interferer bandwidth.

13. For Inter-band CA only: Repeat steps from 1 to 12 setting the original PCell as SCell and the original SCell as PCell in the corresponding CA configuration, except for operating bands without uplink band.

NOTE: The purpose of the Uplink power control window is to ensure that the actual UE output power is no greater than the target power level, and as close as possible to the target power level. The relationship between the Uplink power control window, the target power level and the corresponding possible actual UE Uplink power window is illustrated in Annex F.4.3.

7.6A.2.1.4.3 Message contents

Message contents are according to TS 38.508-1 [5] subclause 4.6 with TRANSFORM_PRECODER_ENABLED condition in Table 4.6.3-118 PUSCH-Config.

7.6A.2.1.5 Test requirement

7.6A.2.1.5.1 Intra-band contiguous 2DL CA

The throughput of each carrier shall be $\geq 95\%$ of the maximum throughput of the reference measurement channels as specified in Annexes A.2.2, A.2.3, A.3.2, and A.3.3 (with one sided dynamic OCNG Pattern OP.1 FDD/TDD for the DL-signal as described in Annex A.5.1.1/A.5.2.1) with parameters defined in 7.6A.2.1.5.1-1a and 7.6A.2.1.5.1-2a. The test requirement of configurations for CA operating band including Band n41 also apply for the corresponding CA operating bands with Band n90 replacing Band n41.

Table 7.6A.2.1.5.1-1: In-band blocking parameters for intra-band contiguous CA with $F_{DL_low} \geq 3300$ MHz and $F_{UL_low} \geq 3300$ MHz

Rx Parameter	Units	NR CA bandwidth class		
		B	C	
Pw in Transmission Bandwidth Configuration, per CC	dBm	REFSENS + CA bandwidth class specific value below		
		10.0	6	
$BW_{Interferer}$	MHz	20	$BW_{channel\ CA}$	
$F_{offset, case\ 1}$	MHz	30	$BW_{channel\ CA} + BW_{channel\ CA}/2$	
$F_{offset, case\ 2}$	MHz	50	$BW_{interferer} + F_{offset, case\ 1}$	
NOTE 1: The transmitter shall be set to 4dB below $P_{CMAX_L,f,c}$ at the minimum UL configuration specified in Table 7.3.2-3 with $P_{CMAX_L,f,c}$ defined in clause 6.2.4.				
NOTE 2: The interferer consists of the Reference measurement channel specified in Annexes A.3.2 and A.3.3 with one sided dynamic OCNG Pattern OP.1 FDD/TDD as described in Annex A.5.1.1/A.5.2.1 and set-up according to Annex C.3.1				

Table 7.6A.2.1.5.1-1a: In-band blocking parameters for intra-band contiguous CA with $F_{DL_low} < 2700$ MHz and $F_{UL_low} < 2700$ MHz

Rx Parameter	Units	NR CA bandwidth class	
		B	C
Pw in Transmission Bandwidth Configuration, per CC	dBm	REFSENS + NR CA bandwidth class specific value below	
		16.0	19.0
$BW_{Interferer}$	MHz	5	5
$F_{offset, case\ 1}$	MHz	7.5	7.5
$F_{offset, case\ 2}$	MHz	12.5	12.5
NOTE 1: The transmitter shall be set to 4 dB below $P_{CMAX_L,f,c}$ at the minimum UL configuration specified in Table 7.3.2.3-3 with $P_{CMAX_L,f,c}$ defined in clause 6.2.4.			
NOTE 2: The interferer consists of the Reference measurement channel specified in Annexes A.3.2 and A.3.3 with one sided dynamic OCNG Pattern OP.1 FDD/TDD as described in Annex A.5.1.1/A.5.2.1 and set-up according to Annex C.3.1			

Table 7.6A.2.1.5.1-2: In-band blocking for intra-band contiguous CA with $F_{DL_low} \geq 3300$ MHz and $F_{UL_low} \geq 3300$ MHz

NR band	Parameter	Unit	Case 1	Case 2
	$P_{interferer}$	dBm	-56	-44
n77, n78, n79	$F_{interferer}$ (offset)	MHz	$-BW_{channel\ CA/2} - F_{offset, case\ 1}$ and $BW_{channel\ CA/2} + F_{offset, case\ 1}$	$\leq -BW_{channel\ CA/2} - F_{offset, case\ 2}$ and $\geq BW_{channel\ CA/2} + F_{offset, case\ 2}$
	$F_{interferer}$	MHz	NOTE 2	$F_{DL_low} - 3BW_{channel\ CA}$ to $F_{DL_high} + 3BW_{channel\ CA}$
NOTE 1: The absolute value of the interferer offset $F_{interferer}$ (offset) shall be further adjusted to $(\lceil F_{interferer} / SCS \rceil + 0.5) SCS$ MHz with SCS the sub-carrier spacing of the carrier closest to the interferer in MHz. The interferer is an NR signal with an SCS equal to that of the closest carrier.				
NOTE 2: For each carrier frequency, the requirement applies for two interferer carrier frequencies: a: $-BW_{channel\ CA/2} - F_{offset, case\ 1}$; b: $BW_{channel\ CA/2} + F_{offset, case\ 1}$				
NOTE 3: $BW_{channel\ CA}$ denotes the aggregated channel bandwidth of the wanted signal				

Table 7.6A.2.1.5.1-2a: In-band blocking for intra-band contiguous CA with $F_{DL_low} < 2700$ MHz and $F_{UL_low} < 2700$ MHz

NR band	Parameter	Unit	Case 1	Case 2	Case 3
	$P_{interferer}$	dBm	-56	-44	
n66 n41 n48 ⁴	$F_{interferer}$ (offset)	MHz	$-BW_{channel\ CA/2} - F_{offset, case\ 1}$ and $BW_{channel\ CA/2} + F_{offset, case\ 1}$	$\leq -BW_{channel\ CA/2} - F_{offset, case\ 2}$ and $\geq BW_{channel\ CA/2} + F_{offset, case\ 2}$	
	$F_{interferer}$	MHz	NOTE 2	$F_{DL_low} - 15$ to $F_{DL_high} + 15$	
n71	$F_{interferer}$	MHz	NOTE 2	$F_{DL_low} - 12$ to $F_{DL_high} + 15$	$F_{DL_low} - 12$
NOTE 1: The absolute value of the interferer offset $F_{interferer}$ (offset) shall be further adjusted to $(\lceil F_{interferer} / SCS \rceil + 0.5) SCS$ MHz with SCS the sub-carrier spacing of the carrier closest to the interferer in MHz. The interferer is an NR signal with 15 kHz SCS.					
NOTE 2: For each carrier frequency, the requirement applies for two interferer carrier frequencies: a: $-BW_{channel\ CA/2} - F_{offset, case\ 1}$; b: $BW_{channel\ CA/2} + F_{offset, case\ 1}$					
NOTE 3: $BW_{channel\ CA}$ denotes the aggregated channel bandwidth of the wanted signal					
NOTE 4: n48 follows the requirement in this frequency range according to the general requirement defined in Clause 7.1A					

7.6A.2.1.5.2 In-band blocking for Intra-band non-contiguous CA

For intra-band non-contiguous carrier aggregation with one uplink carrier and two or more downlink sub-blocks, each larger than or equal to 5 MHz, the in-band blocking requirements are defined with the uplink configuration in accordance with Table 7.3A.2.2-1. For this uplink configuration, the UE shall meet the requirements for each sub-block as specified in subclause 7.6.2. The requirements apply for in-gap and out-of-gap interferers while all downlink carriers are active.

The throughput of each carrier shall be ≥ 95 % of the maximum throughput of the reference measurement channels as specified in Annexes A.2.2, A.2.3, A.3.2, and A.3.3 (with one sided dynamic OCNG Pattern OP.1 FDD/TDD for the DL-signal as described in Annex A.5.1.1/A.5.2.1) with parameters defined in 7.6A.2.1.5.3-1 and 7.6A.2.1.5.3-2.

The test requirement of configurations for CA operating band including Band n41 also apply for the corresponding CA operating bands with Band n90 replacing Band n41.

7.6A.2.1.5.3 In-band blocking for Inter-band CA

For inter-band carrier aggregation with one component carrier per operating band and the uplink assigned to one NR band, the in-band blocking requirements are defined with the uplink active on the band(s) other than the band whose downlink is being tested. The UE shall meet the requirements for each component carrier, when operated as SCell, while all downlink carriers are active.

The throughput of each carrier shall be $\geq 95\%$ of the maximum throughput of the reference measurement channels as specified in Annexes A.2.2, A.2.3, A.3.2, and A.3.3 (with one sided dynamic OCNG Pattern OP.1 FDD/TDD for the DL-signal as described in Annex A.5.1.1/A.5.2.1) with parameters defined in 7.6A.2.1.5.3-1 and 7.6A.2.1.5.3-2. The test requirement of configurations for CA operating band including Band n41 also apply for the corresponding CA operating bands with Band n90 replacing Band n41.

Table 7.6A.2.1.5.3-1: In-band blocking parameters for NR bands with FDL_high < 2700 MHz and FUL_high < 2700 MHz

RX parameter	Units	Channel bandwidth				
		5 MHz	10 MHz	15 MHz	20 MHz	25 MHz
Power in transmission bandwidth configuration	dBm	REFSENS + channel specific value below				
	dB	6	6	7	9	10
BW _{interferer}	MHz	5				
F _{offset, case 1}	MHz	7.5				
F _{offset, case 2}	MHz	12.5				
RX parameter	Units	Channel bandwidth				
		30 MHz	40 MHz	50 MHz	60 MHz	80 MHz
Power in transmission bandwidth configuration	dBm	REFSENS + channel specific value below				
	dB	11	12	13	14	15
BW _{interferer}	MHz	5				
F _{offset, case 1}	MHz	7.5				
F _{offset, case 2}	MHz	12.5				
RX parameter	Units	Channel bandwidth				
		90 MHz	100 MHz			
Power in transmission bandwidth configuration	dBm	REFSENS + channel specific value below				
	dB	15.5	16			
BW _{interferer}	MHz	5				
F _{offset, case 1}	MHz	7.5				
F _{offset, case 2}	MHz	12.5				
NOTE 1: The transmitter shall be set to 4dB below P _{CMAX_L,f,c} at the minimum UL configuration specified in Table 7.3.2.3-3 with P _{CMAX_L,f,c} defined in clause 6.2.4.						
NOTE 2: The interferer consists of the RMC specified in Annexes A.3.2.2 and A.3.3.2 with one sided dynamic OCNG Pattern OP.1 FDD/TDD for the DL-signal as described in Annex A.5.1.1/A.5.2.1 and 15 kHz SCS..						

Table 7.6A.2.1.5.3-1a: In-band blocking parameters for NR bands with $F_{DL_low} \geq 3300$ MHz and $F_{UL_low} \geq 3300$ MHz

RX parameter	Units	Channel bandwidth				
		10 MHz	15 MHz	20 MHz	40 MHz	50 MHz
Power in transmission bandwidth configuration	dBm	REFSENS + channel specific value below				
	dB	6				
$BW_{interferer}$	MHz	10	15	20	40	50
$F_{offset, case 1}$	MHz	15	22.5	30	60	75
$F_{offset, case 2}$	MHz	25	37.5	50	100	125
RX parameter	Units	Channel bandwidth				
		60 MHz	80 MHz	90 MHz	100 MHz	
Power in transmission bandwidth configuration	dBm	REFSENS + channel specific value below				
	dB	6				
$BW_{interferer}$	MHz	60	80	90	100	
$F_{offset, case 1}$	MHz	90	120	135	150	
$F_{offset, case 2}$	MHz	150	200	225	250	
NOTE 1: The transmitter shall be set to 4dB below $P_{CMAX_L,f,c}$ at the minimum UL configuration specified in Table 7.3.2.3-3 with $P_{CMAX_L,f,c}$ defined in clause 6.2.4.						
NOTE 2: The interferer consists of the RMC specified in Annexes A.3.2.2 and A.3.3.2 with one sided dynamic OCNG Pattern OP.1 FDD/TDD for the DL-signal as described in Annex A.5.1.1/A.5.2.1.						

Table 7.6A.2.1.5.3-2: In-band blocking for NR bands with $F_{DL_high} < 2700$ MHz and $F_{UL_high} < 2700$ MHz

NR band	Parameter	Unit	Case 1	Case 2	Case 3
			$P_{interferer}$	$P_{interferer}$	$P_{interferer}$
n1, n2, n3, n5, n7, n8, n12, n20, n28, n38, n39, n40, n41, n48 ³ , n50, n51, n66, n70, n74, n75, n76	$F_{interferer}$ (offset)	MHz	$-CBW/2 - F_{offset, case 1}$ and $CBW/2 + F_{offset, case 1}$	$\leq -CBW/2 - F_{offset, case 2}$ and $\geq CBW/2 + F_{offset, case 2}$	
	$F_{interferer}$	MHz	NOTE 2	$F_{DL_low} - 15$ to $F_{DL_high} + 15$	
n71	$F_{interferer}$	MHz	NOTE 2	$F_{DL_low} - 12$ to $F_{DL_high} + 15$	$F_{DL_low} - 12$
NOTE 1: The absolute value of the interferer offset $F_{interferer}$ (offset) shall be further adjusted to $(\lceil F_{interferer} / SCS \rceil + 0.5) SCS$ MHz with SCS the sub-carrier spacing of the wanted signal in MHz. The interferer is an NR signal with 15 kHz SCS.					
NOTE 2: For each carrier frequency, the requirement applies for two interferer carrier frequencies: a: $-CBW/2 - F_{offset, case 1}$; b: $CBW/2 + F_{offset, case 1}$					
NOTE 3: n48 follows the requirement in this frequency range according to the general requirement defined in Clause 7.1A.					

Table 7.6A.2.1.5.3-2a: In-band blocking for NR bands with $F_{DL_low} \geq 3300$ MHz and $F_{UL_low} \geq 3300$ MHz

NR band	Parameter	Unit	Case 1	Case 2
	$P_{interferer}$			-56
n77, n78, n79	$F_{interferer}$ (offset)	MHz	$-\text{CBW}/2 - F_{\text{offset, case 1}}$ and $\text{CBW}/2 + F_{\text{offset, case 1}}$	$\leq -\text{CBW}/2 - F_{\text{offset, case 2}}$ and $\geq \text{CBW}/2 + F_{\text{offset, case 2}}$
	$F_{interferer}$		NOTE 2	$F_{DL_low} - 3\text{CBW}$ to $F_{DL_high} + 3\text{CBW}$
NOTE 1: The absolute value of the interferer offset $F_{interferer}$ (offset) shall be further adjusted to $(\lceil F_{interferer} / \text{SCS} \rceil + 0.5) \text{SCS}$ MHz with SCS the sub-carrier spacing of the wanted signal in MHz. The interferer is an NR signal with an SCS equal to that of the wanted signal.				
NOTE 2: For each carrier frequency, the requirement applies for two interferer carrier frequencies: a: $-\text{CBW}/2 - F_{\text{offset, case 1}}$; b: $\text{CBW}/2 + F_{\text{offset, case 1}}$				
NOTE 3: CBW denotes the channel bandwidth of the wanted signal				

Table 7.6A.2.1.5.3-2b: In-band blocking parameters for additional NR operating bands for carrier aggregation with $F_{DL_high} < 2700$ MHz and $F_{UL_high} < 2700$ MHz

NR band	Parameter	Unit	Case 1	Case 2
	$P_{interferer}$			-56
	$F_{interferer}$ (offset)	MHz	$-\text{CBW}/2 - F_{\text{offset, case 1}}$ and $\text{CBW}/2 + F_{\text{offset, case 1}}$	$\leq -\text{CBW}/2 - F_{\text{offset, case 2}}$ and $\geq \text{CBW}/2 + F_{\text{offset, case 2}}$
	$F_{interferer}$	MHz	NOTE 2	$F_{DL_low} - 15$ to $F_{DL_high} + 15$
NOTE 1: For certain bands, the unwanted modulated interfering signal may not fall inside the UE receive band, but within the first 15 MHz below or above the UE receive band				
NOTE 2: For each carrier frequency, the requirement applies for two interferer carrier frequencies: a: $-\text{CBW}/2 - F_{\text{offset, case 1}}$; b: $\text{CBW}/2 + F_{\text{offset, case 1}}$				
NOTE 3: The absolute value of the interferer offset $F_{interferer}$ (offset) shall be further adjusted to $(\lceil F_{interferer} / \text{SCS} \rceil + 0.5) \text{SCS}$ MHz with SCS the sub-carrier spacing of the wanted signal in MHz. The interferer is an NR signal with an SCS equal to that of the wanted signal				
NOTE 4: CBW denotes the channel bandwidth of the wanted signal				

For the UE which supports inter-band CA configuration in Table 7.3A.0.3.2-1, $P_{interferer}$ power defined in Table 7.6A.2.1.5.3-2 and 7.6A.2.1.5.3-2a is increased by the amount given by $\Delta R_{IB,c}$ in Table 7.3A.0.3.2-1.

7.6A.2.2 In-band Blocking for CA (3DL CA)

7.6A.2.2.1 Test purpose

Same test purpose as in clause 7.6A.2.1.

7.6A.2.2.2 Test applicability

This test applies to all types of NR UE release 15 and forward that support 3DL CA.

7.6A.2.2.3 Minimum conformance requirements

Minimum requirements are defined in clause 7.6A.2.0.

7.6A.2.2.4 Test description

7.6A.2.2.4.1 Initial conditions

Initial conditions are a set of test configurations the UE needs to be tested in and the steps for the SS to take with the UE to reach the correct measurement state.

The initial test configurations consist of environmental conditions, test frequencies, test channel bandwidths and sub-carrier spacing based on NR CA configuration specified in clause 5.5A. All of these configurations shall be tested with applicable test parameters for each CA configuration, are shown in table 7.6A.2.2.4.1-1, 7.6A.2.2.4.1-2 or 7.6A.2.2.4.1-3. The details of the uplink and downlink reference measurement channels (RMC) are specified in Annexes A.2 and A.3. Configuration of PDSCH and PDCCH before measurement are specified in Annex C.2.

Table 7.6A.2.2.4.1-1: Test Configuration Table for 3DL CA

Default Conditions						
Test Environment as specified in TS 38.508-1 [5] subclause 4.1		Normal				
Test Frequencies as specified in TS 38.508-1 [5] subclause 4.3.1		Intra-band contiguous: Mid range for all CCs Inter-band: NOTE 1, NOTE 5 Intra-band contiguous + Inter-band: NOTE 1, NOTE 5 Intra-band non-contiguous + Inter-band: NOTE 1 with Wgap for intra-band non-contiguous defined in table 7.3A.2.4.1-1 (NOTE 5)				
Test CC Combination setting (N _{RB_agg}) as specified in Tables 5.5A.1-1, 5.5A.2-1, or tables in clauses 5.5A.3.x for the CA Configuration across bandwidth combination sets supported by the UE.		Highest N _{RB_agg} , NOTE 1, NOTE 6				
Test SCS as specified in Table 5.3.5-1		Lowest for PCC and SCCs				
Network signalling value		NS_01 Unless given by Table 7.3.2.3-4 for the band with active uplink carrier				
Test Parameters						
Downlink Configuration				Uplink Configuration		
Test ID	CC Mod'n	PCC RB allocation	SCC ₁ RB allocation	SCC ₂ RB allocation	CC Mod'n	PCC RB allocation
Default Test Settings for a CA_nXD Configuration (Intra-band contiguous CA)						
1	CP-OFDM QPSK	NOTE 1	NOTE 1		DFT-s-OFDM QPSK	NOTE 1
Default Test Settings for a CA_nXA-nYA-nZA Configuration (Inter-band)						
1	CP-OFDM QPSK	NOTE 1	NOTE 1		DFT-s-OFDM QPSK	NOTE 1
Default Test Settings for a CA_nXC-nYA, CA_nYA-nXC, CA_nYA-nXB and CA_nXB-nYA Configurations (Intra-band contiguous + Inter-band)						
1	CP-OFDM QPSK	NOTE 1	NOTE 1		DFT-s-OFDM QPSK	NOTE 1
Default Test Settings for a CA_nX(2A)-nYA Configurations (Intra-band non-contiguous + Inter-band)						
1	CP-OFDM QPSK	NOTE 1	NOTE 1		DFT-s-OFDM QPSK	NOTE 1
NOTE 1: The specific configuration of uplink and downlink are defined in Table 7.3A.2.4.1-1. Only test points verifying non-exceptional REFSSENS requirements are used for in-band blocking testing.						
NOTE 2: CA Configuration Test CC Combination test settings are checked separately for each CA Configuration.						
NOTE 3: Inter-band: X,Y,Z correspond to the different bands in the CA Configuration. E.g. for CA_n1A-n3A-n8A, X=1, Y=3, Z=8; Intra-band contiguous + Inter-band: X,Y correspond to the different bands in the CA Configuration, e.g. for CA_1C-3A, X=1,Y=3; Intra-band non-contiguous + Inter-band: X and Y correspond to the different bands in the CA Configuration. E.g. for CA_n1A-n1A-n8A, X=1, Y =8						
NOTE 4: In a band where UE supports 4Rx, the test shall be performed only with 4Rx antennas ports connected and 4Rx REFSSENS requirement (Table 7.3.2.5-2) is used in the test requirements.						
NOTE 5: For NR band n28, 30MHz test channel bandwidth is tested with Low range test frequencies.						
NOTE 6: If the UE supports multiple CC Combinations in the CA Configuration with the same N _{RB_agg} , only the combination with the highest N _{RB_PCC} is tested.						

Table 7.6A.2.2.4.1-2: Void

Table 7.6A.2.2.4.1-3: Void

1. Connect the SS to the UE antenna connectors as shown in TS 38.508-1 [5] Annex A, Figure A.3.1.4.7 for TE diagram and section A.3.2 for UE diagram.
2. The parameter settings for the cell are set up according to TS 38.508-1 [5] subclause 4.4.3.

3. Downlink signals for PCC are initially set up according to Annex C.0, C.1, C.2, and C.3.1, and uplink signals according to Annex G.0, G.1, G.2, and G.3.1.
4. The UL and Reference Measurement Channel is set according to Tables 7.6A.2.2.4.1-1.
5. Propagation conditions are set according to Annex B.0.
6. Ensure the UE is in State RRC_CONNECTED with generic procedure parameters Connectivity NR, Connected without release On, Test Mode On and Test Loop Function On according to TS 38.508-1 [5] clause 4.5. Message contents are defined in clause 7.6A.2.2.4.3.

7.6A.2.2.4.2 Test procedure

1. Configure SCC according to Annex C.0, C.1, C.2 for all downlink physical channels.
2. The SS shall configure SCC as per TS 38.508-1 [5] clause 5.5.1. Message contents are defined in clause 7.6A.2.2.4.3.
3. SS activates SCC by sending the activation MAC CE (Refer TS 38.321 [18], clauses 5.9, 6.1.3.10). Wait for at least 2 seconds (Refer TS 38.133[19], clause 9.3).
4. SS transmits PDSCH via PDCCH DCI format [1_1] for C_RNTI to transmit the DL RMC according to Tables 7.6A.2.2.4.1-1, 7.6A.2.2.4.1-2 or 7.6A.2.2.4.1-3 on both SCC and PCC. The SS sends downlink MAC padding bits on the DL RMC.
5. SS sends uplink scheduling information for each UL HARQ process via PDCCH DCI format [0_1] for C_RNTI to schedule the UL RMC according to Tables 7.6A.2.2.4.1-1, 7.6A.2.2.4.1-2 or 7.6A.2.2.4.1-3 on PCC. Since the UL has no payload and no loopback data to send the UE sends uplink MAC padding bits on the UL RMC.
6. Set the parameters of the signal generator for an interfering signal below the aggregated component carriers in Case 1 according to Table 7.6A.2.2.4.2-1.
7. Set the downlink signal level according to the Table 7.6A.2.2.4.2-1. Send uplink power control commands to the UE using 1dB power step size to ensure that the UE output power measured by the test system is within the Uplink power control window, defined as $-(\text{MU})$ to $-(\text{MU} + \text{Uplink power control window size})$ dB of the target power level in table 7.6A.2.2.4.2-1 for at least the duration of the Throughput measurement, where:
 - MU is the test system uplink power measurement uncertainty and is specified in Table F.1.3-1 for the carrier frequency f and the channel bandwidth BW
 - Uplink power control window size = 1dB (UE power step size) + 0.7dB (UE power step tolerance) + (Test system relative power measurement uncertainty), where, the UE power step tolerance is specified in TS 38.101-1 [2], Table 6.3.4.3-1 and is 0.7dB for 1dB power step size, and the Test system relative power measurement uncertainty is specified for test case 6.3.4.3 in Table F.1.2-1.
8. Measure the average throughput for the carrier(s) indicated in Table 7.6A.2.2.4.2-1 for duration sufficient to achieve statistical significance according to Annex H.2A.
9. Repeat steps from 6 to 8, using an interfering signal above the measured carrier(s) according to Table 7.6A.2.2.4.2-1 in Case 1 at step 6.
10. Repeat steps from 6 to 9, using interfering signals in Case 2 at step 6 and 9. The ranges of case 2 are covered in steps equal to the interferer bandwidth.
11. Repeat steps 1 to 10 for all component carriers listed in Table 7.6A.2.2.4.2-1.

NOTE: The purpose of the Uplink power control window is to ensure that the actual UE output power is no greater than the target power level, and as close as possible to the target power level. The relationship between the Uplink power control window, the target power level and the corresponding possible actual UE Uplink power window is illustrated in Annex F.4.3.

Table 7.6A.2.2.4.2-1: Test repetition and measurement configuration

CA configuration	CA configuration ID in REFSENS	Throughput measured on	Table with test parameters to select
Intra-band contiguous	1	PCC, SCC ₁ , SCC ₂	7.6A.2.2.5-3 7.6A.2.2.5-3a 7.6A.2.2.5-4 7.6A.2.2.5-4a
Inter-band	1 ¹	SCC ₁ , SCC ₂	7.6A.2.2.5-1 7.6A.2.2.5-1a 7.6A.2.2.5-1b
	2 ¹		7.6A.2.2.5-2 7.6A.2.2.5-2a
	3 ¹		
Intra-band contiguous + Inter-band	1 ²	SCC ₂	7.6A.2.2.5-1 7.6A.2.2.5-1a 7.6A.2.2.5-1b 7.6A.2.2.5-2 7.6A.2.2.5-2a
	2 ²	SCC ₁ , SCC ₂	7.6A.2.2.5-3 7.6A.2.2.5-3a 7.6A.2.2.5-4 7.6A.2.2.5-4a
Intra-band non-contiguous + Inter-band	2 ³	SCC ₂	7.6A.2.2.5-1 7.6A.2.2.5-1a 7.6A.2.2.5-1b 7.6A.2.2.5-2 7.6A.2.2.5-2a
	3 ³	SCC ₁ , SCC ₂	7.6A.2.2.5-1 7.6A.2.2.5-1a 7.6A.2.2.5-2 7.6A.2.2.5-2a
NOTE 1: CA configuration ID as defined in "Default Test Settings for a CA_nXA-nYA-nZA Configuration (Inter-band)" in table 7.3A.2.4.1-1.			
NOTE 2: CA configuration ID as defined in "Default Test Settings for a CA_nXC-nYA, CA_nYA-nXC, CA_nYA-nXB and CA_nXB-nYA Configurations (Intra-band contiguous + Inter-band)" in table 7.3A.2.4.1-1.			
NOTE 3: CA configuration ID as defined in "Default Test Settings for a CA_nX(2A)-nYA Configuration (Intra-band non-contiguous + Inter-band)" in table 7.3A.2.4.1-3.			

7.6A.2.2.4.3 Message Contents

Message contents are according to TS 38.508-1 [5] subclause 4.6 with TRANSFORM_PRECODER_ENABLED condition in Table 4.6.3-118 PUSCH-Config.

7.6A.2.2.5 Test requirement

The throughput measurement of each carrier derived in test procedure shall be $\geq 95\%$ of the maximum throughput of the reference measurement channels as specified in Annex A.2.2, A.2.3, A.3.2, and A.3.3 (with one sided dynamic OCNG Pattern OP.1 FDD/TDD for the DL-signal as described in Annex A.5.1.1/A.5.2.1) with parameters specified in Tables below, according to the type of CA. The test requirement of configurations for CA operating band including Band n41 also apply for the corresponding CA operating bands with Band n90 replacing Band n41.

Table 7.6A.2.2.5-1: In-band blocking parameters for NR bands with $F_{DL_high} < 2700$ MHz and $F_{UL_high} < 2700$ MHz (inter-band, intra-band non-contiguous)

RX parameter	Units	Channel bandwidth				
		5 MHz	10 MHz	15 MHz	20 MHz	25 MHz
Power in transmission bandwidth configuration	dBm	REFSENS + channel bandwidth specific value below				
	dB	6	6	7	9	10
$BW_{interferer}$	MHz	5				
$F_{offset, case 1}$	MHz	7.5				
$F_{offset, case 2}$	MHz	12.5				
RX parameter	Units	Channel bandwidth				
		30 MHz	40 MHz	50 MHz	60 MHz	80 MHz
Power in transmission bandwidth configuration	dBm	REFSENS + channel bandwidth specific value below				
	dB	11	12	13	14	15
$BW_{interferer}$	MHz	5				
$F_{offset, case 1}$	MHz	7.5				
$F_{offset, case 2}$	MHz	12.5				
RX parameter	Units	Channel bandwidth				
		90 MHz	100 MHz			
Power in transmission bandwidth configuration	dBm	REFSENS + channel bandwidth specific value below				
	dB	15.5	16			
$BW_{interferer}$	MHz	5				
$F_{offset, case 1}$	MHz	7.5				
$F_{offset, case 2}$	MHz	12.5				
NOTE 1: The transmitter shall be set to 4 dB below $P_{CMAX_L,f,c}$ at the minimum UL configuration specified in Table 7.3.2.3-3 with $P_{CMAX_L,f,c}$ defined in clause 6.2.4.						
NOTE 2: The interferer consists of the RMC specified in Annexes A.3.2.2 and A.3.3.2 with one sided dynamic OCNG Pattern OP.1 FDD/TDD for the DL-signal as described in Annex A.5.1.1/A.5.2.1 and 15 kHz SCS.						

Table 7.6A.2.2.5-1a: In-band blocking for NR bands with $F_{DL_high} < 2700$ MHz and $F_{UL_high} < 2700$ MHz (inter-band, intra-band non-contiguous)

NR band	Parameter	Unit	Case 1	Case 2	Case 3	Case 4
	$P_{interferer}$		dBm	-56	-44	-15
	$F_{interferer}$ (offset)	MHz	$-CBW/2 - F_{offset, case 1}$ and $CBW/2 + F_{offset, case 1}$	$\leq -CBW/2 - F_{offset, case 2}$ and $\geq CBW/2 + F_{offset, case 2}$		$-CBW/2 - 11$
n1, n2, n3, n5, n7, n8, n12, n14, n18, n20, n25, n26, n28, n34, n38, n39, n40, n41, n48 ³ , n50, n51, n53, n65, n66, n70, n74, n75, n76	$F_{interferer}$	MHz	NOTE 2	$F_{DL_low} - 15$ to $F_{DL_high} + 15$		
n30	$F_{interferer}$	MHz	NOTE 2	$F_{DL_low} - 15$ to $F_{DL_high} + 15$		$F_{DL_low} - 11$
n71	$F_{interferer}$	MHz	NOTE 2	$F_{DL_low} - 12$ to $F_{DL_high} + 15$	$F_{DL_low} - 12$	
<p>NOTE 1: The absolute value of the interferer offset $F_{interferer}$ (offset) shall be further adjusted to $(\lceil F_{interferer} / SCS \rceil + 0.5) SCS$ MHz with SCS the sub-carrier spacing of the wanted signal in MHz. The interferer is an NR signal with 15 kHz SCS.</p> <p>NOTE 2: For each carrier frequency, the requirement applies for two interferer carrier frequencies: a: $-CBW/2 - F_{offset, case 1}$; b: $CBW/2 + F_{offset, case 1}$</p> <p>NOTE 3: n48 follows the requirement in this frequency range according to the general requirement defined in Clause 7.1.</p>						

7.6A.2.2.5-1b: In-band blocking for additional NR operating bands for carrier aggregation with $F_{DL_high} < 2700$ MHz and $F_{UL_high} < 2700$ MHz (inter-band)

NR band	Parameter	Unit	Case 1	Case 2
	$P_{interferer}$		dBm	-56
	$F_{interferer}$ (offset)	MHz	$-CBW/2 - F_{offset, case 1}$ and $CBW/2 + F_{offset, case 1}$	$\leq -CBW/2 - F_{offset, case 2}$ and $\geq CBW/2 + F_{offset, case 2}$
n29	$F_{interferer}$	MHz	NOTE 2	$F_{DL_low} - 15$ to $F_{DL_high} + 15$
<p>NOTE 1: For certain bands, the unwanted modulated interfering signal may not fall inside the UE receive band, but within the first 15 MHz below or above the UE receive band</p> <p>NOTE 2: For each carrier frequency, the requirement applies for two interferer carrier frequencies: a: $-CBW/2 - F_{offset, case 1}$; b: $CBW/2 + F_{offset, case 1}$</p> <p>NOTE 3: The absolute value of the interferer offset $F_{interferer}$ (offset) shall be further adjusted to $(\lceil F_{interferer} / SCS \rceil + 0.5) SCS$ MHz with SCS the sub-carrier spacing of the wanted signal in MHz. The interferer is an NR signal with an SCS equal to that of the wanted signal</p> <p>NOTE 4: CBW denotes the channel bandwidth of the wanted signal</p>				

Table 7.6A.2.2.5-2: In-band blocking parameters for NR bands with $F_{DL_low} \geq 3300$ MHz and $F_{UL_low} \geq 3300$ MHz (inter-band, intra-band non-contiguous)

RX parameter	Units	Channel bandwidth				
		10 MHz	15 MHz	20 MHz	25 MHz	30 MHz
Power in transmission bandwidth configuration	dBm	REFSENS + channel bandwidth specific value below				
	dB	6				
$BW_{interferer}$	MHz	10	15	20	25	30
$F_{offset, case 1}$	MHz	15	22.5	30	37.5	45
$F_{offset, case 2}$	MHz	25	37.5	50	62.5	75
RX parameter	Units	Channel bandwidth				
		40 MHz	50 MHz	60 MHz	70 MHz	80 MHz
Power in transmission bandwidth configuration	dBm	REFSENS + channel bandwidth specific value below				
	dB	6				
$BW_{interferer}$	MHz	40	50	60	70	80
$F_{offset, case 1}$	MHz	60	75	90	105	120
$F_{offset, case 2}$	MHz	100	125	150	175	200
RX parameter	Units	Channel bandwidth				
		90 MHz	100 MHz			
Power in transmission bandwidth configuration	dBm	REFSENS + channel bandwidth specific value below				
	dB	6				
$BW_{interferer}$	MHz	90	100			
$F_{offset, case 1}$	MHz	135	150			
$F_{offset, case 2}$	MHz	225	250			
NOTE 1: The transmitter shall be set to 4 dB below $P_{CMAX_L,f,c}$ at the minimum UL configuration specified in Table 7.3.2.3-3 with $P_{CMAX_L,f,c}$ defined in clause 6.2.4.						
NOTE 2: The interferer consists of the RMC specified in Annexes A.3.2.2 and A.3.3.2 with one sided dynamic OCN Pattern OP.1 FDD/TDD for the DL-signal as described in Annex A.5.1.1/A.5.2.1						

Table 7.6A.2.2.5-2a: In-band blocking for NR bands with $F_{DL_low} \geq 3300$ MHz and $F_{UL_low} \geq 3300$ MHz (inter-band, intra-band non-contiguous)

NR band	Parameter	Unit	Case 1	Case 2
	$P_{interferer}$	dBm	-56	-44
n77, n78, n79	$F_{interferer}$ (offset)	MHz	$-\text{CBW}/2 - F_{offset, case 1}$ and $\text{CBW}/2 + F_{offset, case 1}$	$\leq -\text{CBW}/2 - F_{offset, case 2}$ and $\geq \text{CBW}/2 + F_{offset, case 2}$
	$F_{interferer}$		NOTE 2	$F_{DL_low} - 3\text{CBW}$ to $F_{DL_high} + 3\text{CBW}$
NOTE 1: The absolute value of the interferer offset $F_{interferer}$ (offset) shall be further adjusted to $(\lceil F_{interferer} / SCS \rceil + 0.5) SCS$ MHz with SCS the sub-carrier spacing of the wanted signal in MHz. The interferer is an NR signal with an SCS equal to that of the wanted signal.				
NOTE 2: For each carrier frequency, the requirement applies for two interferer carrier frequencies: a: $-\text{CBW}/2 - F_{offset, case 1}$; b: $\text{CBW}/2 + F_{offset, case 1}$				
NOTE 3: CBW denotes the channel bandwidth of the wanted signal				

Table 7.6A.2.2.5-3: In-band blocking parameters with $F_{DL_low} \geq 3300$ MHz and $F_{UL_low} \geq 3300$ MHz (intra-band contiguous CA)

Rx Parameter	Units	NR CA bandwidth class		
		B	C	D
Pw in Transmission Bandwidth Configuration, per CC	dB	REFSENS + CA bandwidth class specific value below		
		10.0	6	13.8
BW _{interferer}	MHz	20	BW _{channel CA}	50
F _{offset, case 1}	MHz	30	BW _{channel CA} + BW _{channel CA/2}	75
F _{offset, case 2}	MHz	50	BW _{interferer} + F _{offset, case 1}	125

NOTE 1: The transmitter shall be set to 4dB below P_{CMAX_L,f,c} at the minimum UL configuration specified in Table 7.3.2.3-3 with P_{CMAX_L,f,c} defined in clause 6.2.4.

NOTE 2: The interferer consists of the Reference measurement channel specified in Annexes A.3.2 and A.3.3 with one sided dynamic OCNG Pattern OP.1 FDD/TDD as described in Annex A.5.1.1/A.5.2.1 and set-up according to Annex C.3.1

Table 7.6A.2.2.5-3a: In-band blocking parameters with $F_{DL_low} < 2700$ MHz and $F_{UL_low} < 2700$ MHz (intra-band contiguous CA)

Rx Parameter	Units	NR CA bandwidth class	
		B	C
Pw in Transmission Bandwidth Configuration, per CC	dBm	REFSENS + NR CA bandwidth class specific value below	
		16.0	19.0
BW _{interferer}	MHz	5	5
F _{offset, case 1}	MHz	7.5	7.5
F _{offset, case 2}	MHz	12.5	12.5

NOTE 1: The transmitter shall be set to 4 dB below P_{CMAX_L,f,c} at the minimum UL configuration specified in Table 7.3.2.3-3 with P_{CMAX_L,f,c} defined in clause 6.2.4.

NOTE 2: The interferer consists of the Reference measurement channel specified in Annexes A.3.2 and A.3.3 with one sided dynamic OCNG Pattern OP.1 FDD/TDD as described in Annex A.5.1.1/A.5.2.1 and set-up according to Annex C.3.1

Table 7.6A.2.2.5-4: In-band blocking with $F_{DL_low} \geq 3300$ MHz and $F_{UL_low} \geq 3300$ MHz (intra-band contiguous CA)

NR band	Parameter	Unit	Case 1	Case 2
		P _{interferer}	dBm	-56
n77, n78, n79	F _{interferer (offset)}	MHz	-BW _{channel CA/2} - F _{offset, case 1} and BW _{channel CA/2} + F _{offset, case 1}	≤ -BW _{channel CA/2} - F _{offset, case 2} and ≥ BW _{channel CA/2} + F _{offset, case 2}
	F _{interferer}	MHz	NOTE 2	F _{DL_low} - 3BW _{channel CA} to F _{DL_high} + 3BW _{channel CA}

NOTE 1: The absolute value of the interferer offset F_{interferer (offset)} shall be further adjusted to $(\lceil |F_{interferer}| / SCS \rceil + 0.5) SCS$ MHz with SCS the sub-carrier spacing of the carrier closest to the interferer in MHz. The interferer is an NR signal with an SCS equal to that of the closest carrier.

NOTE 2: For each carrier frequency, the requirement applies for two interferer carrier frequencies: a: -BW_{channel CA/2} - F_{offset, case 1}; b: BW_{channel CA/2} + F_{offset, case 1}

NOTE 3: BW_{channel CA} denotes the aggregated channel bandwidth of the wanted signal

Table 7.6A.2.2.5-4a: In-band blocking with $F_{DL_low} < 2700$ MHz and $F_{UL_low} < 2700$ MHz (intra-band contiguous CA)

NR band	Parameter	Unit	Case 1	Case 2	Case 3
	$P_{interferer}$	dBm	-56	-44	
n41, n66, n48 ⁴ , n40	$F_{interferer}$ (offset)	MHz	$-BW_{channel\ CA/2} - F_{offset, case\ 1}$ and $BW_{channel\ CA/2} + F_{offset, case\ 1}$	$\leq -BW_{channel\ CA/2} - F_{offset, case\ 2}$ and $\geq BW_{channel\ CA/2} + F_{offset, case\ 2}$	
	$F_{interferer}$	MHz	NOTE 2	$F_{DL_low} - 15$ to $F_{DL_high} + 15$	
n71	$F_{interferer}$	MHz	NOTE 2	$F_{DL_low} - 12$ to $F_{DL_high} + 15$	$F_{DL_low} - 12$
<p>NOTE 1: The absolute value of the interferer offset $F_{interferer}$ (offset) shall be further adjusted to $(\lceil F_{interferer} / SCS \rceil + 0.5) SCS$ MHz with SCS the sub-carrier spacing of the carrier closest to the interferer in MHz. The interferer is an NR signal with 15 kHz SCS.</p> <p>NOTE 2: For each carrier frequency, the requirement applies for two interferer carrier frequencies: a: $-BW_{channel\ CA/2} - F_{offset, case\ 1}$; b: $BW_{channel\ CA/2} + F_{offset, case\ 1}$</p> <p>NOTE 3: $BW_{channel\ CA}$ denotes the aggregated channel bandwidth of the wanted signal</p> <p>NOTE 4: n48 follows the requirement in this frequency range according to the general requirement defined in Clause 7.1A.</p>					

For the UE which supports inter-band CA configuration in Table 7.3A.3.2.3-1, $P_{interferer}$ power defined in Table 7.6A.2.2.5-1a and Table 7.6A.2.2.5-2a is increased by the amount given by $\Delta R_{IB,c}$ in Table 7.3A.3.2.3-1.

7.6A.2.3 In-band Blocking for CA (4DL CA)

7.6A.2.3.1 Test purpose

Same test purpose as in clause 7.6A.2.1.

7.6A.2.3.2 Test applicability

This test applies to all types of NR UE release 15 and forward that support 4DL CA.

7.6A.2.3.3 Minimum conformance requirements

Minimum requirements are defined in clause 7.6A.2.0.

7.6A.2.3.4 Test description

7.6A.2.3.4.1 Initial conditions

Initial conditions are a set of test configurations the UE needs to be tested in and the steps for the SS to take with the UE to reach the correct measurement state.

The initial test configurations consist of environmental conditions, test frequencies, test channel bandwidths and sub-carrier spacing based on NR CA configuration specified in clause 5.5A. All of these configurations shall be tested with applicable test parameters for each CA configuration, are shown in table 7.6A.2.3.4.1-1. The details of the uplink and downlink reference measurement channels (RMC) are specified in Annexes A.2 and A.3. Configuration of PDSCH and PDCCH before measurement are specified in Annex C.2.

Table 7.6A.2.3.4.1-1: Test Configuration Table for 4DL CA

Default Conditions							
Test Environment as specified in TS 38.508-1 [5] subclause 4.1		Normal					
Test Frequencies as specified in TS 38.508-1 [5] subclause 4.3.1		NOTE 1					
Test CC Combination setting (N_{RB_agg}) as specified in Tables 5.5A.1-1, 5.5A.2-1, or tables in clauses 5.5A.3.x for the CA Configuration across bandwidth combination sets supported by the UE.		Highest N_{RB_agg} , NOTE 1, NOTE 5					
Test SCS as specified in Table 5.3.5-1		Lowest for PCC and SCCs					
Network signalling value		NS_01 Unless given by Table 7.3.2.3-4 for the band with active uplink carrier					
Test Parameters							
Test ID	Downlink Configuration					Uplink Configuration	
	CC Mod'n	PCC RB allocation	SCC1 RB allocation	SCC2 RB allocation	SCC3 RB allocation	CC Mod'n	PCC RB allocation
Default Test Settings for a CA_nXE Configuration (Intra-band contiguous CA)							
1	CP-OFDM QPSK	NOTE 1	NOTE 1			DFT-s-OFDM QPSK	NOTE 1
Default Test Settings for a CA_nXA-nYA-nZA Configuration (Inter-band)							
1	CP-OFDM QPSK	NOTE 1	NOTE 1			DFT-s-OFDM QPSK	NOTE 1
Default Test Settings for a CA_nXC-nYA-ZA and CA_nXB-nYA-ZA Configurations (Intra-band contiguous + Inter-band)							
1	CP-OFDM QPSK	NOTE 1	NOTE 1			DFT-s-OFDM QPSK	NOTE 1
Default Test Settings for a CA_nX(2A)-nYA-ZA Configurations (Intra-band non-contiguous + Inter-band)							
1	CP-OFDM QPSK	NOTE 1	NOTE 1			DFT-s-OFDM QPSK	NOTE 1
Default Test Settings for a CA_nX(2A)-nY(2A) Configurations (Intra-band non-contiguous + Intra-band non-contiguous)							
1	CP-OFDM QPSK	NOTE 1	NOTE 1			DFT-s-OFDM QPSK	NOTE 1
NOTE 1: The specific configuration of uplink and downlink are defined in Table 7.3A.3.4.1-1. Only test points verifying non-exceptional REFSENS requirements are used for in-band blocking testing.							
NOTE 2: CA Configuration Test CC Combination test settings are checked separately for each CA Configuration.							
NOTE 3: Inter-band: X,Y,Z correspond to the different bands in the CA Configuration. E.g. for CA_n1A-n3A-n8A, X=1, Y=3, Z=8; Intra-band contiguous + Inter-band: X,Y correspond to the different bands in the CA Configuration, e.g. for CA_1C-3A, X=1,Y=3; Intra-band non-contiguous + Inter-band: X and Y correspond to the different bands in the CA Configuration. E.g. for CA_n1A-n1A-n8A, X=1, Y =8							
NOTE 4: In a band where UE supports 4Rx, the test shall be performed only with 4Rx antennas ports connected and 4Rx REFSENS requirement (Table 7.3.2.5-2) is used in the test requirements.							
NOTE 5: If the UE supports multiple CC Combinations in the CA Configuration with the same N_{RB_agg} , only the combination with the highest N_{RB_PCC} is tested.							

1. Connect the SS to the UE antenna connectors as shown in TS 38.508-1 [5] Annex A, Figure A.3.1.4.7 for TE diagram and section A.3.2 for UE diagram.
2. The parameter settings for the cell are set up according to TS 38.508-1 [5] subclause 4.4.3.
3. Downlink signals for PCC are initially set up according to Annex C.0, C.1, C.2, and C.3.1, and uplink signals according to Annex G.0, G.1, G.2, and G.3.1.

4. The UL and Reference Measurement Channel is set according to Tables 7.6A.2.3.4.1-1.
5. Propagation conditions are set according to Annex B.0.
6. Ensure the UE is in State RRC_CONNECTED with generic procedure parameters Connectivity *NR*, Connected without release *On*, Test Mode *On* and Test Loop Function *On* according to TS 38.508-1 [5] clause 4.5. Message contents are defined in clause 7.6A.2.2.4.3.

7.6A.2.3.4.2 Test procedure

1. Configure SCC according to Annex C.0, C.1, C.2 for all downlink physical channels.
2. The SS shall configure SCC as per TS 38.508-1 [5] clause 5.5.1. Message contents are defined in clause 7.6A.2.3.4.3.
3. SS activates SCC by sending the activation MAC CE (Refer TS 38.321 [18], clauses 5.9, 6.1.3.10). Wait for at least 2 seconds (Refer TS 38.133[19], clause 9.3).
4. SS transmits PDSCH via PDCCH DCI format [1_1] for C_RNTI to transmit the DL RMC according to Table 7.6A.2.3.4.1-1 on both SCC and PCC. The SS sends downlink MAC padding bits on the DL RMC.
5. SS sends uplink scheduling information for each UL HARQ process via PDCCH DCI format [0_1] for C_RNTI to schedule the UL RMC according to Table 7.6A.2.3.4.1-1 on PCC. Since the UL has no payload and no loopback data to send the UE sends uplink MAC padding bits on the UL RMC.
6. Set the parameters of the signal generator for an interfering signal below the aggregated component carriers in Case 1 according to Table 7.6A.2.3.4.2-1.
7. Set the downlink signal level according to the Table 7.6A.2.3.4.2-1. Send uplink power control commands to the UE using 1dB power step size to ensure that the UE output power measured by the test system is within the Uplink power control window, defined as $-(\text{MU})$ to $-(\text{MU} + \text{Uplink power control window size})$ dB of the target power level in table 7.6A.2.2.4.2-1 for at least the duration of the Throughput measurement, where:
 - MU is the test system uplink power measurement uncertainty and is specified in Table F.1.3-1 for the carrier frequency f and the channel bandwidth BW
 - Uplink power control window size = 1dB (UE power step size) + 0.7dB (UE power step tolerance) + (Test system relative power measurement uncertainty), where, the UE power step tolerance is specified in TS 38.101-1 [2], Table 6.3.4.3-1 and is 0.7dB for 1dB power step size, and the Test system relative power measurement uncertainty is specified for test case 6.3.4.3 in Table F.1.2-1.
8. Measure the average throughput for the carrier(s) indicated in Table 7.6A.2.3.4.2-1 for duration sufficient to achieve statistical significance according to Annex H.2A.
9. Repeat steps from 6 to 8, using an interfering signal above the measured carrier(s) according to Table 7.6A.2.3.4.2-1 in Case 1 at step 6.
10. Repeat steps from 6 to 9, using interfering signals in Case 2 at step 6 and 9. The ranges of case 2 are covered in steps equal to the interferer bandwidth.
11. Repeat steps 1 to 10 for all component carriers listed in Table 7.6A.2.3.4.2-1.

NOTE: The purpose of the Uplink power control window is to ensure that the actual UE output power is no greater than the target power level, and as close as possible to the target power level. The relationship between the Uplink power control window, the target power level and the corresponding possible actual UE Uplink power window is illustrated in Annex F.4.3.

Table 7.6A.2.3.4.2-1: Test repetition and measurement configuration

CA configuration	CA configuration ID in REFSENS	Throughput measured on	Table with test parameters to select
Intra-band contiguous	1	PCC, SCC1, SCC2, SCC3	7.6A.2.3.5-3 7.6A.2.3.5-3a 7.6A.2.3.5-4 7.6A.2.3.5-4a
Inter-band	1 ¹	SCC1, SCC2, SCC3	7.6A.2.3.5-1 7.6A.2.3.5-1a 7.6A.2.3.5-1b 7.6A.2.3.5-2 7.6A.2.3.5-2a
	2 ¹		
	3 ¹		
Intra-band contiguous + Inter-band	1 ²	SCC2, SCC3	7.6A.2.3.5-1 7.6A.2.3.5-1a 7.6A.2.3.5-1b 7.6A.2.3.5-2 7.6A.2.3.5-2a
	2 ²	SCC1, SCC2, SCC3	7.6A.2.3.5-3 7.6A.2.3.5-3a 7.6A.2.3.5-4 7.6A.2.3.5-4a
	3 ²	SCC1, SCC2, SCC3	7.6A.2.3.5-3 7.6A.2.3.5-3a 7.6A.2.3.5-4 7.6A.2.3.5-4a
Intra-band non-contiguous + Inter-band	1 ³	SCC2, SCC3	7.6A.2.3.5-1 7.6A.2.3.5-1a 7.6A.2.3.5-1b 7.6A.2.3.5-2 7.6A.2.3.5-2a
	2 ³	SCC1, SCC2, SCC3	7.6A.2.3.5-1 7.6A.2.3.5-1a 7.6A.2.3.5-1b 7.6A.2.3.5-2 7.6A.2.3.5-2a
	3 ³	SCC1, SCC2, SCC3	7.6A.2.3.5-1 7.6A.2.3.5-1a 7.6A.2.3.5-2 7.6A.2.3.5-2a
Intra-band non-contiguous + Intra-band non-contiguous	1 ⁴	SCC2, SCC3	7.6A.2.3.5-1 7.6A.2.3.5-1a 7.6A.2.3.5-2 7.6A.2.3.5-2a
	2 ⁴	SCC2, SCC3	7.6A.2.3.5-1 7.6A.2.3.5-1a 7.6A.2.3.5-2 7.6A.2.3.5-2a
NOTE 1: CA configuration ID as defined in “Default Test Settings for a CA_nXA-nYA-nZA-VA Configuration (Inter-band)” in table 7.3A.3.4.1-1. NOTE 2: CA configuration ID as defined in “Default Test Settings for a CA_XC-YA-ZA and CA_XB-YA-ZA Configurations (Intra-band contiguous + Inter-band)” in table 7.3A.3.4.1-1. NOTE 3: CA configuration ID as defined in “Default Test Settings for a CA_nX(2A)-nYA-nZA Configuration (Intra-band non-contiguous + Inter-band)” in table 7.3A.3.4.1-1. NOTE 4: CA configuration ID as defined in “Default Test Settings for a CA_nX(2A)-nY(2A) Configuration (Intra-band non-contiguous + Intra-band non-contiguous)” in table 7.3A.2.4.1-1.			

7.6A.2.3.4.3 Message Contents

Message contents are according to TS 38.508-1 [5] subclause 4.6 with TRANSFORM_PRECODER_ENABLED condition in Table 4.6.3-118 PUSCH-Config.

7.6A.2.3.5 Test requirement

The throughput measurement of each carrier derived in test procedure shall be $\geq 95\%$ of the maximum throughput of the reference measurement channels as specified in Annex A.2.2, A.2.3, A.3.2, and A.3.3 (with one sided dynamic OCNG Pattern OP.1 FDD/TDD for the DL-signal as described in Annex A.5.1.1/A.5.2.1) with parameters specified in Tables below, according to the type of CA.

Table 7.6A.2.3.5-1: In-band blocking parameters for NR bands with $F_{DL_high} < 2700$ MHz and $F_{UL_high} < 2700$ MHz (inter-band, intra-band non-contiguous)

RX parameter	Units	Channel bandwidth				
		5 MHz	10 MHz	15 MHz	20 MHz	25 MHz
Power in transmission bandwidth configuration	dBm	REFSENS + channel bandwidth specific value below				
	dB	6	6	7	9	10
BW _{interferer}	MHz	5				
F _{offset, case 1}	MHz	7.5				
F _{offset, case 2}	MHz	12.5				
RX parameter	Units	Channel bandwidth				
		30 MHz	40 MHz	50 MHz	60 MHz	80 MHz
Power in transmission bandwidth configuration	dBm	REFSENS + channel bandwidth specific value below				
	dB	11	12	13	14	15
BW _{interferer}	MHz	5				
F _{offset, case 1}	MHz	7.5				
F _{offset, case 2}	MHz	12.5				
RX parameter	Units	Channel bandwidth				
		90 MHz	100 MHz			
Power in transmission bandwidth configuration	dBm	REFSENS + channel bandwidth specific value below				
	dB	15.5	16			
BW _{interferer}	MHz	5				
F _{offset, case 1}	MHz	7.5				
F _{offset, case 2}	MHz	12.5				
NOTE 1: The transmitter shall be set to 4 dB below P _{CMAX_L,f,c} at the minimum UL configuration specified in Table 7.3.2.3-3 with P _{CMAX_L,f,c} defined in clause 6.2.4.						
NOTE 2: The interferer consists of the RMC specified in Annexes A.3.2.2 and A.3.3.2 with one sided dynamic OCNG Pattern OP.1 FDD/TDD for the DL-signal as described in Annex A.5.1.1/A.5.2.1 and 15 kHz SCS.						

Table 7.6A.2.3.5-1a: In-band blocking for NR bands with $F_{DL_high} < 2700$ MHz and $F_{UL_high} < 2700$ MHz (inter-band, intra-band non-contiguous)

NR band	Parameter	Unit	Case 1	Case 2	Case 3	Case 4
		$P_{interferer}$	dBm	-56	-44	-15
	$F_{interferer}$ (offset)	MHz	-CBW/2 – $F_{offset, case 1}$ and CBW/2 + $F_{offset, case 1}$	\leq -CBW/2 – $F_{offset, case 2}$ and \geq CBW/2 + $F_{offset, case 2}$		-CBW/2-11
n1, n2, n3, n5, n7, n8, n12, n14, n18, n20, n25, n26, n28, n34, n38, n39, n40, n41, n48 ³ , n50, n51, n53, n65, n66, n70, n74, n75, n76	$F_{interferer}$	MHz	NOTE 2	$F_{DL_low} - 15$ to $F_{DL_high} + 15$		
n30	$F_{interferer}$	MHz	NOTE 2	$F_{DL_low} - 15$ to $F_{DL_high} + 15$		$F_{DL_low} - 11$
n71	$F_{interferer}$	MHz	NOTE 2	$F_{DL_low} - 12$ to $F_{DL_high} + 15$	$F_{DL_low} - 12$	
<p>NOTE 1: The absolute value of the interferer offset $F_{interferer}$ (offset) shall be further adjusted to $(\lceil F_{interferer} / SCS \rceil + 0.5) SCS$ MHz with SCS the sub-carrier spacing of the wanted signal in MHz. The interferer is an NR signal with 15 kHz SCS.</p> <p>NOTE 2: For each carrier frequency, the requirement applies for two interferer carrier frequencies: a: -CBW/2 – $F_{offset, case 1}$; b: CBW/2 + $F_{offset, case 1}$</p> <p>NOTE 3: n48 follows the requirement in this frequency range according to the general requirement defined in Clause 7.1.</p>						

7.6A.2.3.5-1b: In-band blocking for additional NR operating bands for carrier aggregation with $F_{DL_high} < 2700$ MHz and $F_{UL_high} < 2700$ MHz (inter-band)

NR band	Parameter	Unit	Case 1	Case 2
		$P_{interferer}$	dBm	-56
	$F_{interferer}$ (offset)	MHz	-CBW/2 – $F_{offset, case 1}$ and CBW/2 + $F_{offset, case 1}$	\leq -CBW/2 – $F_{offset, case 2}$ and \geq CBW/2 + $F_{offset, case 2}$
n29	$F_{interferer}$	MHz	NOTE 2	$F_{DL_low} - 15$ to $F_{DL_high} + 15$
<p>NOTE 1: For certain bands, the unwanted modulated interfering signal may not fall inside the UE receive band, but within the first 15 MHz below or above the UE receive band</p> <p>NOTE 2: For each carrier frequency, the requirement applies for two interferer carrier frequencies: a: -CBW/2 – $F_{offset, case 1}$; b: CBW/2 + $F_{offset, case 1}$</p> <p>NOTE 3: The absolute value of the interferer offset $F_{interferer}$ (offset) shall be further adjusted to $(\lceil F_{interferer} / SCS \rceil + 0.5) SCS$ MHz with SCS the sub-carrier spacing of the wanted signal in MHz. The interferer is an NR signal with an SCS equal to that of the wanted signal</p> <p>NOTE 4: CBW denotes the channel bandwidth of the wanted signal</p>				

Table 7.6A.2.3.5-2: In-band blocking parameters for NR bands with $F_{DL_low} \geq 3300$ MHz and $F_{UL_low} \geq 3300$ MHz (inter-band, intra-band non-contiguous)

RX parameter	Units	Channel bandwidth				
		10 MHz	15 MHz	20 MHz	25 MHz	30 MHz
Power in transmission bandwidth configuration	dBm	REFSENS + channel bandwidth specific value below				
	dB	6				
$BW_{interferer}$	MHz	10	15	20	25	30
$F_{offset, case 1}$	MHz	15	22.5	30	37.5	45
$F_{offset, case 2}$	MHz	25	37.5	50	62.5	75
RX parameter	Units	Channel bandwidth				
		40 MHz	50 MHz	60 MHz	70 MHz	80 MHz
Power in transmission bandwidth configuration	dBm	REFSENS + channel bandwidth specific value below				
	dB	6				
$BW_{interferer}$	MHz	40	50	60	70	80
$F_{offset, case 1}$	MHz	60	75	90	105	120
$F_{offset, case 2}$	MHz	100	125	150	175	200
RX parameter	Units	Channel bandwidth				
		90 MHz	100 MHz			
Power in transmission bandwidth configuration	dBm	REFSENS + channel bandwidth specific value below				
	dB	6				
$BW_{interferer}$	MHz	90	100			
$F_{offset, case 1}$	MHz	135	150			
$F_{offset, case 2}$	MHz	225	250			
NOTE 1: The transmitter shall be set to 4 dB below $P_{CMAX_L,f,c}$ at the minimum UL configuration specified in Table 7.3.2.3-3 with $P_{CMAX_L,f,c}$ defined in clause 6.2.4.						
NOTE 2: The interferer consists of the RMC specified in Annexes A.3.2.2 and A.3.3.2 with one sided dynamic OCN Pattern OP.1 FDD/TDD for the DL-signal as described in Annex A.5.1.1/A.5.2.1						

Table 7.6A.2.3.5-2a: In-band blocking for NR bands with $F_{DL_low} \geq 3300$ MHz and $F_{UL_low} \geq 3300$ MHz (inter-band, intra-band non-contiguous)

NR band	Parameter	Unit	Case 1	Case 2
	$P_{interferer}$	dBm	-56	-44
n77, n78, n79	$F_{interferer}$ (offset)	MHz	$-CBW/2 - F_{offset, case 1}$ and $BW/2 + F_{offset, case 1}$	$\leq -CBW/2 - F_{offset, case 2}$ and $\geq CBW/2 + F_{offset, case 2}$
	$F_{interferer}$		NOTE 2	$F_{DL_low} - 3CBW$ to $F_{DL_high} + 3CBW$
NOTE 1: The absolute value of the interferer offset $F_{interferer}$ (offset) shall be further adjusted to $(\lceil F_{interferer} / SCS \rceil + 0.5) \cdot SCS$ MHz with SCS the sub-carrier spacing of the wanted signal in MHz. The interferer is an NR signal with an SCS equal to that of the wanted signal.				
NOTE 2: For each carrier frequency, the requirement applies for two interferer carrier frequencies: a: $-CBW/2 - F_{offset, case 1}$; b: $CBW/2 + F_{offset, case 1}$				
NOTE 3: CBW denotes the channel bandwidth of the wanted signal				

Table 7.6A.2.3.5-3: In-band blocking parameters with $F_{DL_low} \geq 3300$ MHz and $F_{UL_low} \geq 3300$ MHz (intra-band contiguous CA)

Rx Parameter	Units	NR CA bandwidth class		
		B	C	D
Pw in Transmission Bandwidth Configuration, per CC	dB	REFSENS + CA bandwidth class specific value below		
		10.0	6	13.8
BW _{interferer}	MHz	20	BW _{channel CA}	50
F _{offset, case 1}	MHz	30	BW _{channel CA} + BW _{channel CA/2}	75
F _{offset, case 2}	MHz	50	BW _{interferer} + F _{offset, case 1}	125

NOTE 1: The transmitter shall be set to 4dB below P_{CMAX_L,f,c} at the minimum UL configuration specified in Table 7.3.2.3-3 with P_{CMAX_L,f,c} defined in clause 6.2.4.

NOTE 2: The interferer consists of the Reference measurement channel specified in Annexes A.3.2 and A.3.3 with one sided dynamic OCNG Pattern OP.1 FDD/TDD as described in Annex A.5.1.1/A.5.2.1 and set-up according to Annex C.3.1

Table 7.6A.2.3.5-3a: In-band blocking parameters with $F_{DL_low} < 2700$ MHz and $F_{UL_low} < 2700$ MHz (intra-band contiguous CA)

Rx Parameter	Units	NR CA bandwidth class	
		B	C
Pw in Transmission Bandwidth Configuration, per CC	dBm	REFSENS + NR CA bandwidth class specific value below	
		16.0	19.0
BW _{interferer}	MHz	5	5
F _{offset, case 1}	MHz	7.5	7.5
F _{offset, case 2}	MHz	12.5	12.5

NOTE 1: The transmitter shall be set to 4 dB below P_{CMAX_L,f,c} at the minimum UL configuration specified in Table 7.3.2.3-3 with P_{CMAX_L,f,c} defined in clause 6.2.4.

NOTE 2: The interferer consists of the Reference measurement channel specified in Annexes A.3.2 and A.3.3 with one sided dynamic OCNG Pattern OP.1 FDD/TDD as described in Annex A.5.1.1/A.5.2.1 and set-up according to Annex C.3.1

Table 7.6A.2.3.5-4: In-band blocking with $F_{DL_low} \geq 3300$ MHz and $F_{UL_low} \geq 3300$ MHz (intra-band contiguous CA)

NR band	Parameter	Unit	Case 1	Case 2
	P _{interferer}	dBm	-56	-44
n77, n78, n79	F _{interferer (offset)}	MHz	-BW _{channel CA/2} - F _{offset, case 1} and BW _{channel CA/2} + F _{offset, case 1}	≤ -BW _{channel CA/2} - F _{offset, case 2} and ≥ BW _{channel CA/2} + F _{offset, case 2}
	F _{interferer}	MHz	NOTE 2	F _{DL_low} - 3BW _{channel CA} to F _{DL_high} + 3BW _{channel CA}

NOTE 1: The absolute value of the interferer offset F_{interferer (offset)} shall be further adjusted to $(\lceil |F_{interferer}| / SCS \rceil + 0.5) SCS$ MHz with SCS the sub-carrier spacing of the carrier closest to the interferer in MHz. The interferer is an NR signal with an SCS equal to that of the closest carrier.

NOTE 2: For each carrier frequency, the requirement applies for two interferer carrier frequencies: a: -BW_{channel CA/2} - F_{offset, case 1}; b: BW_{channel CA/2} + F_{offset, case 1}

NOTE 3: BW_{channel CA} denotes the aggregated channel bandwidth of the wanted signal

Table 7.6A.2.3.5-4a: In-band blocking with $F_{DL_low} < 2700$ MHz and $F_{UL_low} < 2700$ MHz (intra-band contiguous CA)

NR band	Parameter	Unit	Case 1	Case 2	Case 3
			-56	-44	
n41, n66, n48 ⁴ , n40	$F_{interferer}$ (offset)	MHz	$-BW_{channel\ CA/2} - F_{offset, case\ 1}$ and $BW_{channel\ CA/2} + F_{offset, case\ 1}$	$\leq -BW_{channel\ CA/2} - F_{offset, case\ 2}$ and $\geq BW_{channel\ CA/2} + F_{offset, case\ 2}$	
	$F_{interferer}$	MHz	NOTE 2	$F_{DL_low} - 15$ to $F_{DL_high} + 15$	
n71	$F_{interferer}$	MHz	NOTE 2	$F_{DL_low} - 12$ to $F_{DL_high} + 15$	$F_{DL_low} - 12$
<p>NOTE 1: The absolute value of the interferer offset $F_{interferer}$ (offset) shall be further adjusted to $(\lceil F_{interferer} / SCS \rceil + 0.5) SCS$ MHz with SCS the sub-carrier spacing of the carrier closest to the interferer in MHz. The interferer is an NR signal with 15 kHz SCS.</p> <p>NOTE 2: For each carrier frequency, the requirement applies for two interferer carrier frequencies: a: $-BW_{channel\ CA/2} - F_{offset, case\ 1}$; b: $BW_{channel\ CA/2} + F_{offset, case\ 1}$</p> <p>NOTE 3: $BW_{channel\ CA}$ denotes the aggregated channel bandwidth of the wanted signal</p> <p>NOTE 4: n48 follows the requirement in this frequency range according to the general requirement defined in Clause 7.1A.</p>					

For the UE which supports inter-band CA configuration in Table 7.3A.3.2.3-1, $P_{interferer}$ power defined in Table 7.6A.2.3.5-1a and Table 7.6A.2.3.5-2a is increased by the amount given by $\Delta R_{IB,c}$ in Table 7.3A.3.2.3-1.

7.6A.3 Out-of-band blocking for CA

7.6A.3.0 Minimum conformance requirements

7.6A.3.0.1 Out-of-band blocking for Intra-band contiguous CA

For intra-band contiguous carrier aggregation the downlink SCC(s) shall be configured at nominal channel spacing to the PCC. For FDD, the PCC shall be configured closest to the uplink band. All downlink carriers shall be active throughout the test.

The UE shall fulfil the minimum requirement in presence of an interfering signal specified in Tables 7.6A.3.0.1-1 and Tables 7.6A.3.0.1-2 being on either side of the aggregated signal. The throughput of each carrier shall be $\geq 95\%$ of the maximum throughput of the reference measurement channels as specified in Annexes A.2.2, A.2.3, A.3.2, and A.3.3 (with one sided dynamic OCN Pattern OP.1 FDD/TDD for the DL-signal as described in Annex A.5.1.1/A.5.2.1).

Table 7.6A.3.0.1-1: Out-of-band blocking parameters for intra-band contiguous CA

RX parameter	Units	CA bandwidth class			
		B	C	D	
Power in transmission bandwidth configuration	dBm	REFSENS + CA bandwidth class specific value below			
	dB	9	9	9	
NOTE 1: The transmitter shall be set to 4 dB below $P_{CMAX_L,f,c}$ at the minimum UL configuration specified in Table 7.3.2.3-3 with $P_{CMAX_L,f,c}$ defined in clause 6.2.4.					

Table 7.6A.3.0.1-2: Out of-band blocking for intra-band contiguous CA

NR band	Parameter	Unit	Range1	Range 2	Range 3
	$P_{\text{interferer}}$	dBm	-45	-30	-15
n41, n48 ⁵ , n66, n71	$F_{\text{interferer}}$ (CW)	MHz	$-60 < f - F_{\text{DL_low}} < -15$ or $15 < f - F_{\text{DL_high}} < 60$	$-85 < f - F_{\text{DL_low}} \leq -60$ or $60 \leq f - F_{\text{DL_high}} < 85$	$1 \leq f \leq F_{\text{DL_low}} - 85$ or $F_{\text{DL_high}} + 85 \leq f \leq 12750$
n77, n78 (NOTE 3)	$F_{\text{interferer}}$ (CW)	MHz	N/A	N/A	$1 \leq f \leq F_{\text{DL_low}} - \text{MAX}(200, 3 \cdot \text{BW}_{\text{Channel_CA}})$ or $F_{\text{DL_high}} + \text{MAX}(200, 3 \cdot \text{BW}_{\text{Channel_CA}}) \leq f \leq 12750$
n79 (NOTE 4)	$F_{\text{interferer}}$ (CW)	MHz	N/A	N/A	$1 \leq f \leq F_{\text{DL_low}} - \text{MAX}(150, 3 \cdot \text{BW}_{\text{Channel_CA}})$ or $F_{\text{DL_high}} + \text{MAX}(150, 3 \cdot \text{BW}_{\text{Channel_CA}}) \leq f \leq 12750$
NOTE 1: The power level of the interferer ($P_{\text{interferer}}$) for Range 3 shall be modified to -20 dBm for $F_{\text{interferer}} > 6000$ MHz.					
NOTE 2: $\text{BW}_{\text{Channel_CA}}$ denotes the aggregated channel bandwidth of the wanted signal					
NOTE 3: The power level of the interferer ($P_{\text{interferer}}$) for Range 3 shall be modified to -20 dBm, for $F_{\text{interferer}} > 2700$ MHz and $F_{\text{interferer}} < 4800$ MHz. For $\text{BW}_{\text{Channel_CA}} > 15$ MHz, the requirement for Range 1 is not applicable and Range 2 applies from the frequency offset of $3 \cdot \text{BW}_{\text{Channel_CA}}$ from the band edge. For $\text{BW}_{\text{Channel_CA}}$ larger than 60 MHz, the requirement for Range 2 is not applicable and Range 3 applies from the frequency offset of $3 \cdot \text{BW}_{\text{Channel_CA}}$ from the band edge.					
NOTE 4: The power level of the interferer ($P_{\text{interferer}}$) for Range 3 shall be modified to -20 dBm, for $F_{\text{interferer}} > 3650$ MHz and $F_{\text{interferer}} < 5750$ MHz. For $\text{BW}_{\text{Channel_CA}} \geq 40$ MHz, the requirement for Range 2 is not applicable and Range 3 applies from the frequency offset of $3 \cdot \text{BW}_{\text{Channel_CA}}$ from the band edge.					
NOTE 5: The power level of the interferer ($P_{\text{interferer}}$) for Range 3 shall be modified to -20 dBm for $F_{\text{interferer}} > 2700$ MHz and $F_{\text{interferer}} < 4800$ MHz					

For interferer frequencies across ranges 1, 2 and 3 in Table 7.6A.3-2, a maximum of

$$\lfloor \max \{ 24, 6 \cdot \lceil n \cdot N_{\text{RB}} / 6 \rceil \} / \min \{ \lfloor n \cdot N_{\text{RB}} / 10 \rfloor, 5 \} \rfloor$$

exceptions are allowed for spurious response frequencies in each assigned frequency channel when measured using a step size of $\min \{ \lfloor \text{BW}_{\text{channel}} / 2 \rfloor, 5 \}$ MHz with N_{RB} the number of resource blocks in the downlink transmission bandwidth configuration, $\text{BW}_{\text{Channel}}$ is the bandwidth of the frequency channel in MHz and $n = 1, 2, 3$ for SCS = 15, 30, 60 kHz, respectively. For these exceptions, the requirements in subclause 7.7A.1 apply.

7.6A.3.0.2 Out-of-band blocking for Intra-band non-contiguous CA

For intra-band non-contiguous carrier aggregation with one uplink carrier and two or more downlink sub-blocks, the out-of-band blocking requirements are defined with the uplink configuration in accordance with table 7.3A.0.2.3-1. For this uplink configuration, the UE shall meet the requirements for each sub-block as specified in subclauses 7.6.3 and 7.6A.3.0.1 for one component carrier and two component carriers per sub-block, respectively. The requirements apply with all downlink carriers active.

The throughput of each carrier shall be $\geq 95\%$ of the maximum throughput of the reference measurement channels as specified in Annexes A.2.2, A.2.3, A.3.2, and A.3.3 (with one sided dynamic OCNG Pattern OP.1 FDD/TDD for the DL-signal as described in Annex A.5.1.1/A.5.2.1).

7.6A.3.0.3 Out-of-band blocking for Inter-band CA

For inter-band carrier aggregation with one component carrier per operating band and the uplink assigned to one NR band, the out-of-band blocking requirements are defined with the uplink active on the band(s) other than the band whose downlink is being tested. The UE shall meet the requirements specified in subclause 7.6.3 for each component carrier while all downlink carriers are active.

For inter-band carrier aggregation with component carriers in operating bands < 2.7 GHz including n48, and for $F_{\text{DL_Low}(j)} - 15 \text{ MHz} \leq f \leq F_{\text{DL_High}(j)} + 15 \text{ MHz}$, the appropriate adjacent channel selectivity and in-band blocking requirements in the respective subclauses 7.5 and 7.6.2 shall be applied for carrier j . For inter-band carrier aggregation

with component carriers in operating bands > 2.7GHz excluding n48, and for $F_{DL_Low(j)} - 3 * BW_{Channel} \leq f \leq F_{DL_High(j)} + 3 * BW_{Channel}$, the appropriate adjacent channel selectivity and in-band blocking requirements in the respective subclauses 7.5 and 7.6.2 shall be applied for carrier j . $F_{DL_Low(j)}$ and $F_{DL_High(j)}$ denote the respective lower and upper frequency limits of the operating band containing carrier j , $j = 1, \dots, X$, with carriers numbered in increasing order of carrier frequency and X the number of component carriers in the band combination. $BW_{Channel}$ denotes the channel bandwidth of the wanted signal component carrier j . If CW interferer falls in a gap between $F_{DL_High(j)}$ and $F_{DL_Low(j+1)}$ where the corresponding OOB ranges 1 and 2 overlap, then the lower level interferer limit of the overlapping OOB ranges applies.

For inter-band carrier aggregation with uplink assigned to two NR bands, the out-of-band blocking requirements specified in subclause 7.6.3 shall be met with the transmitter power for the uplink set to 7 dB below $P_{CMAX_L,f,c}$ for each serving cell c .

For the UE which supports inter-band CA configuration in Table 7.3A.0.3.2.1-1, $P_{interferer}$ power defined in Table 7.6.3.3-2 and 7.6.3.3-4 is increased by the amount given by $\Delta R_{IB,c}$ in Table 7.3A.0.3.2.1-1.

For inter-band CA combination listed in Table 7.6A.3.0.3-1, exceptions to the requirement specified in Table 7.6A.3.0.3-2 are allowed when the second order intermodulation product of the lower frequency band UL carrier and the CW interfering signal fully or partially overlaps with the higher frequency band DL carrier.

Table 7.6A.3.0.3-1: CA band combination with exceptions allowed

CA band combination
CA_n8-n78
CA_n8-n79
CA_n28-n78

Table 7.6A.3.0.3-2: Requirement for out-of-band blocking exceptions

Parameter	Unit	Level
$P_{interferer}$ (CW)	dBm	-44 ¹
NOTE 1: The requirement applies when $ f_{interferer} \pm f_{UL}^{LB} - f_{DL}^{HB} \leq (BW_{UL}^{LB} + BW_{DL}^{HB})/2$, where f_{UL}^{LB} and f_{DL}^{HB} are the carrier frequencies for lower frequency band UL and higher frequency band DL, respectively. BW_{UL}^{LB} and BW_{DL}^{HB} are the channel bandwidths configured for lower frequency band UL carrier and higher frequency band DL carrier in MHz, respectively.		

For all interferer frequency ranges specified in subclause 7.6.3 a maximum of

$$\lfloor \max \{24,6 \cdot \lceil n \cdot N_{RB} / 6 \rceil \} / \min \{ n \cdot N_{RB} / 10, 5 \} \rfloor$$

exceptions are allowed for spurious response frequencies in each assigned frequency channel when measured using a step size of $\min(\lfloor BW_{channel} / 2 \rfloor, 5)$ MHz with N_{RB} the number of resource blocks in the downlink transmission bandwidth configuration, $BW_{Channel}$ the bandwidth of the frequency channel in MHz and $n = 1, 2, 3$ for SCS = 15, 30, 60 kHz, respectively. For these exceptions, the requirements in subclause 7.7 apply.

The throughput of each carrier shall be $\geq 95\%$ of the maximum throughput of the reference measurement channels as specified in Annexes A.2.2, A.2.3, A.3.2, and A.3.3 (with one sided dynamic OCNG Pattern OP.1 FDD/TDD for the DL-signal as described in Annex A.5.1.1/A.5.2.1).

The normative reference for this requirement is TS 38.101-1 [2] clause 7.6A.3.

7.6A.3.1 Out-of-band blocking for CA (2DL CA)

7.6A.3.1.1 Test purpose

Out-of-band band blocking for CA is defined for an unwanted CW interfering signal falling more than 15 MHz or $3 * BW_{Channel_CA}$ below or above the UE receive band, at which a given average throughput shall meet or exceed the requirement for the specified measurement channels.

For the first 15 MHz or $3 * BW_{Channel_CA}$ below or above the UE receive band the appropriate in-band blocking or adjacent channel selectivity in sub-clause 7.5A and sub-clause 7.6A.2 shall be applied.

The lack of out-of-band blocking ability will decrease the coverage area when other e-NodeB transmitters exist (except in the adjacent channels and spurious response).

7.6A.3.1.2 Test applicability

This test case applies to all types of NR UE release 15 and forward that supports 2DL CA.

7.6A.3.1.3 Minimum conformance requirements

The minimum conformance requirements are defined in clause 7.6A.3.0.

7.6A.3.1.4 Test description

7.6A.3.1.4.1 Initial conditions

Initial conditions are a set of test configurations the UE needs to be tested in and the steps for the SS to take with the UE to reach the correct measurement state.

The initial test configurations consist of environmental conditions, test frequencies, test channel bandwidths and sub-carrier spacing based on NR CA configurations specified in clause 5.5A. All of these configurations shall be tested with applicable test parameters for each CA configuration, are shown in table 7.6A.3.1.4.1-1, 7.6A.3.1.4.1-2 or 7.6A.3.1.4.1-3. The details of the uplink and downlink reference measurement channels (RMC) are specified in Annexes A.2 and A.3 respectively. The details of the OCNG patterns used are specified in Annex A.5. Configurations of PDSCH and PDCCH before measurement are specified in Annex C.2.

Table 7.6A.3.1.4.1-1: Test configuration table for Intra-band contiguous CA

Default Conditions					
Test Environment as specified in TS 38.508-1 [5] subclause 4.1			Normal		
Test Frequencies as specified in TS 38.508-1 [5] subclause 4.3.1			Mid range		
Test CC Combination setting (N_{RB_agg}) as specified in Table 5.5A.1-1 for the CA Configuration across bandwidth combination sets supported by the UE.			Highest N_{RB_agg} NOTE 3		
Test SCS as specified in Table 5.3.5-1			Lowest		
Test Parameters					
Test ID	Downlink Configuration			Uplink Configuration	
	CC Mod'n	PCC RB allocation	SCC RB allocation	CC Mod'n	PCC RB allocation
1	CP-OFDM QPSK	Full RB ¹	Full RB ¹	DFT-s-OFDM QPSK	REFSENS ²
NOTE 1: Full RB allocation shall be used per each SCS and channel BW as specified in Table 7.3.2.4.1-2.					
NOTE 2: REFSENS refers to the single carrier Uplink RB allocation for reference sensitivity according to table 7.3.2.4.1-3.					
NOTE 3: If the UE supports multiple CC Combinations in the CA Configuration with the same N_{RB_agg} , only the combination with the highest N_{RB_PCC} is tested.					
NOTE 4: In a band where UE supports 4Rx, the test shall be performed only with 4Rx antennas ports connected and 4Rx REFSENS requirement (Table 7.3.2.5-2) is used in the test requirements.					

Table 7.6A.3.1.4.1-2: Test configuration table for Inter-band CA

Default Conditions					
Test Environment as specified in TS 38.508-1 [5] subclause 4.1			Normal		
Test Frequencies as specified in TS 38.508-1 [5] subclause 4.3.1			NOTE 4		
Test CC Combination setting (N_{RB_agg}) as specified in Table 5.5A.3.1-1 for the CA Configuration across bandwidth combination sets supported by the UE.			Highest N_{RB_agg} NOTE 5		
Test SCS as specified in Table 5.3.5-1			Lowest		
Test Parameters					
Test ID	Downlink Configuration			Uplink Configuration	
	CC Mod'n	PCC RB allocation	SCC RB allocation	CC Mod'n	PCC RB allocation
1	CP-OFDM QPSK	Full RB ¹	Full RB ¹	DFT-s-OFDM QPSK	REFSENS ²
NOTE 1: Full RB allocation shall be used per each SCS and channel BW as specified in Table 7.3.2.4.1-2.					
NOTE 2: REFSENS refers to the single carrier Uplink RB allocation for reference sensitivity according to table 7.3.2.4.1-3.					
NOTE 3: In a band where UE supports 4Rx, the test shall be performed only with 4Rx antennas ports connected and 4Rx REFSENS requirement (Table 7.3.2.5-2) is used in the test requirements.					
NOTE 4: Test frequency is set to Mid Range PCC and SCC with exceptions defined in Table 7.3A.2.4.1-1 For NR band n28, 30MHz test channel bandwidth is tested with Low range test frequencies.					
NOTE 5: If the UE supports multiple CC Combinations in the CA Configuration with the same N_{RB_agg} , only the combination with the highest N_{RB_PCC} is tested.					

Table 7.6A.3.1.4.1-3: Test configuration table for Intra-band non-contiguous CA

Default Conditions					
Test Environment as specified in TS 38.508-1 [5] subclause 4.1			Normal		
Test CC Combination setting (N_{RB_agg}) as specified in Table 5.5A.2-1 for the CA Configuration across bandwidth combination sets supported by the UE.			NOTE 1, NOTE 3		
Test Channel Bandwidths as specified in TS 38.508-1 [5] subclause 4.3.1			Highest N_{RB_agg} for PCC and SCC, NOTE 1		
Test SCS as specified in Table 5.3.5-1			Lowest		
Test Parameters					
Test ID	Downlink Configuration			Uplink Configuration	
	CC Mod'n	PCC RB allocation	SCC RB allocation	CC Mod'n	PCC RB allocation
1	CP-OFDM QPSK	NOTE 1	NOTE 1	DFT-s-OFDM QPSK	NOTE 1
NOTE 1: The specific configuration of uplink and downlink are defined in Table 7.3A.1.4.1-3.					
NOTE 2: In a band where UE supports 4Rx, the test shall be performed only with 4Rx antennas ports connected and 4Rx REFSENS requirement (Table 7.3.2.5-2) is used in the test requirements.					
NOTE 3: If the UE supports multiple CC Combinations in the CA Configuration with the same N_{RB_agg} , only the combination with the highest N_{RB_PCC} is tested.					

1. Connect the SS to the UE antenna connectors as shown in TS 38.508-1 [5] Annex A, Figure A.3.1.4.7 for TE diagram and section A.3.2 for UE diagram.
2. The parameter settings for the cell are set up according to TS 38.508-1 [5] subclause 4.4.3.
3. Downlink signals are initially set up according to Annex C.0, C.1, C.2, and C.3.1, and uplink signals according to Annex G.0, G.1, G.2, and G.3.1.
4. The DL and UL Reference Measurement Channels are set according to Table 7.6A.3.1.4.1-1, Table 7.6A.3.1.4.1-2 or Table 7.6A.3.1.4.1-3.
5. Propagation conditions are set according to Annex B.0.

6. Ensure the UE is in State RRC_CONNECTED with generic procedure parameters Connectivity NR, Connected without release On, Test Mode On and Test Loop Function On according to TS 38.508-1 [5] clause 4.5. Message contents are defined in clause 7.6A.3.1.4.3.

7.6A.3.1.4.2 Test procedure

1. Configure SCC according to Annex C.0, C.1, C.2 for all downlink physical channels.
2. The SS shall configure SCC as per TS 38.508-1 [5] clause 5.5.1. Message contents are defined in clause 7.6A.3.1.4.3.
3. SS activates SCC by sending the activation MAC CE (Refer TS 38.321 [18], clauses 5.9, 6.1.3.10). Wait for at least 2 seconds (Refer TS 38.133[19], clause 9.3).
4. SS transmits PDSCH via PDCCH DCI format 1_1 for C_RNTI to transmit the DL RMC according to Table 7.6A.3.1.4.1-1, 7.6A.3.1.4.1-2 or 7.6A.3.1.4.1-3 on both PCC and SCC. The SS sends downlink MAC padding bits on the DL RMC.
5. SS sends uplink scheduling information for each UL HARQ process via PDCCH DCI format 0_1 for C_RNTI to schedule the UL RMC according to Table 7.6A.3.1.4.1-1, 7.6A.3.1.4.1-2 or 7.6A.3.1.4.1-3 on PCC. Since the UE has no payload data to send, the UE transmits uplink MAC padding bits on the UL RMC.
6. Set the parameters of the CW signal generator for an interfering signal below the CA Band for intra-band CA, or below the SCC's operating band for inter-band CA according to table 7.6A.3.1.5.1-2, 7.6A.3.1.5.3-2 or 7.6A.3.1.5.3-4. The frequency step size is $\min(\lfloor BW_{channel} / 2 \rfloor, 5)$ MHz.

If CW interferer falls in a gap between $F_{DL_High(j)}$ and $F_{DL_Low(j+1)}$ where the corresponding OOB ranges 1 and 2 overlap, then the lower level interferer limit of the overlapping OOB ranges applies.

For the UE which supports inter-band CA configuration in Table 7.3A.0.3.2.1-1, $P_{interferer}$ power defined in Table 7.6A.3.1.5.3-2 and 7.6A.3.1.5.3-4 is increased by the amount given by $\Delta R_{IB,c}$ in Table 7.3A.0.3.2.1-1.

For inter-band CA combination listed in Table 7.6A.3.1.5.3-5, exceptions to the requirement specified in Table 7.6A.3.1.5.3-6 are allowed when the second order intermodulation product of the lower frequency band UL carrier and the CW interfering signal fully or partially overlaps with the higher frequency band DL carrier.

7. Set the downlink signal level according to the table 7.6A.3.1.5.1-1, 7.6A.3.1.5.3-1 or 7.6A.3.1.5.3-3 for both carriers. Send uplink power control commands to the UE using 1dB power step size to ensure that the UE output power measured by the test system is within the Uplink power control window, defined as $-MU$ to $-(MU + \text{Uplink power control window size})$ dB of the target power level in Table 7.6A.3.1.5.1-1, 7.6A.3.1.5.3-1 or 7.6A.3.1.5.3-3 for at least the duration of the Throughput measurement, where:
 - MU is the test system uplink power measurement uncertainty and is specified in Table F.1.3-1 for the carrier frequency f and the channel bandwidth BW
 - Uplink power control window size = 1dB (UE power step size) + 0.7dB (UE power step tolerance) + (Test system relative power measurement uncertainty), where, the UE power step tolerance is specified in TS 38.101-1 [2], Table 6.3.4.3-1 and is 0.7dB for 1dB power step size, and the Test system relative power measurement uncertainty is specified for test case 6.3.4.3 in Table F.1.2-1.
8. Measure the average throughput of SCC for a duration sufficient to achieve statistical significance according to Annex H.2A for inter-band CA. Measure the average throughput of both carriers for a duration sufficient to achieve statistical significance according to Annex H.2A for intra-band CA.
9. Record the frequencies for which the throughput doesn't meet the requirements.
10. Repeat steps from 6 to 9, using an interfering signal above the CA Band for intra-band CA, or above the SCC's operating band for inter-band CA at step 6.
11. For Inter-band CA: Switch the SCell into PCell and repeat steps 1 to 10, except for operating bands without uplink band.

NOTE: The purpose of the Uplink power control window is to ensure that the actual UE output power is no greater than the target power level, and as close as possible to the target power level. The relationship between the Uplink power control window, the target power level and the corresponding possible actual UE Uplink power window is illustrated in Annex F.4.3.

7.6A.3.1.4.3 Message contents

Message contents are according to TS 38.508-1 [5] subclause 4.6 Table 4.6.3-118 with condition TRANSFORM_PRECODER_ENABLED.

7.6A.3.1.5 Test requirement

7.6A.3.1.5.1 Out-of-band blocking for Intra-band contiguous CA

Except for the spurious response frequencies recorded in step 9 of test procedure, the throughput measurement derived in the test procedure of each carrier shall be $\geq 95\%$ of the maximum throughput of the reference measurement channels as specified in Annexes A.2.2, A.2.3, A.3.2, and A.3.3 (with one sided dynamic OCNG Pattern OP.1 FDD/TDD for the DL-signal as described in Annex A.5.1.1/A.5.2.1) with parameters specified in Tables 7.6A.3.1.5.1-1 and 7.6A.3.1.5.1-2.

The number of spurious response frequencies recorded in step 9 of test procedure shall not exceed $\lfloor \max\{24,6 \cdot \lceil n \cdot N_{RB} / 6 \rceil\} / \min\{\lfloor n \cdot N_{RB} / 10 \rfloor, 5\} \rfloor$ in each assigned frequency channel when measured using a $\min(\lfloor BW_{channel} / 2 \rfloor, 5)$ MHz step size. For these exceptions the requirements of clause 7.7A Spurious Response are applicable.

Table 7.6A.3.1.5.1-1: Out-of-band blocking parameters for intra-band contiguous CA

RX parameter	Units	CA bandwidth class	
		B	C
Power in transmission bandwidth configuration	dBm	REFSENS + CA bandwidth class specific value below	
	dB	9	9
NOTE 1: The transmitter shall be set to 4 dB below $P_{CMAX_L,f,c}$ at the minimum UL configuration specified in Table 7.3.2.3-3 with $P_{CMAX_L,f,c}$ defined in clause 6.2.4.			

7.6A.3.1.5.1-2: Out of-band blocking for intra-band contiguous CA

NR band	Parameter	Unit	Range1	Range 2	Range 3
	$P_{\text{interferer}}$	dBm	-45	-30	-15
n41, n48 ⁵ , n66, n71	$F_{\text{interferer}}$ (CW)	MHz	$-60 < f - F_{\text{DL_low}} < -15$ or $15 < f - F_{\text{DL_high}} < 60$	$-85 < f - F_{\text{DL_low}} \leq -60$ or $60 \leq f - F_{\text{DL_high}} < 85$	$1 \leq f \leq F_{\text{DL_low}} - 85$ or $F_{\text{DL_high}} + 85 \leq f \leq 12750$
n77, n78 (NOTE 3)	$F_{\text{interferer}}$ (CW)	MHz	N/A	N/A	$1 \leq f \leq F_{\text{DL_low}} - \text{MAX}(200, 3 \cdot \text{BW}_{\text{Channel_CA}})$ or $F_{\text{DL_high}} + \text{MAX}(200, 3 \cdot \text{BW}_{\text{Channel_CA}}) \leq f \leq 12750$
n79 (NOTE 4)	$F_{\text{interferer}}$ (CW)	MHz	N/A	N/A	$1 \leq f \leq F_{\text{DL_low}} - \text{MAX}(150, 3 \cdot \text{BW}_{\text{Channel_CA}})$ or $F_{\text{DL_high}} + \text{MAX}(150, 3 \cdot \text{BW}_{\text{Channel_CA}}) \leq f \leq 12750$

NOTE 1: The power level of the interferer ($P_{\text{interferer}}$) for Range 3 shall be modified to -20 dBm for $F_{\text{interferer}} > 6000$ MHz.

NOTE 2: $\text{BW}_{\text{Channel_CA}}$ denotes the aggregated channel bandwidth of the wanted signal

NOTE 3: The power level of the interferer ($P_{\text{interferer}}$) for Range 3 shall be modified to -20 dBm, for $F_{\text{interferer}} > 2700$ MHz and $F_{\text{interferer}} < 4800$ MHz. For $\text{BW}_{\text{Channel_CA}} > 15$ MHz, the requirement for Range 1 is not applicable and Range 2 applies from the frequency offset of $3 \cdot \text{BW}_{\text{Channel_CA}}$ from the band edge. For $\text{BW}_{\text{Channel_CA}}$ larger than 60 MHz, the requirement for Range 2 is not applicable and Range 3 applies from the frequency offset of $3 \cdot \text{BW}_{\text{Channel_CA}}$ from the band edge.

NOTE 4: The power level of the interferer ($P_{\text{interferer}}$) for Range 3 shall be modified to -20 dBm, for $F_{\text{interferer}} > 3650$ MHz and $F_{\text{interferer}} < 5750$ MHz. For $\text{BW}_{\text{Channel_CA}} \geq 40$ MHz, the requirement for Range 2 is not applicable and Range 3 applies from the frequency offset of $3 \cdot \text{BW}_{\text{Channel_CA}}$ from the band edge.

NOTE 5: The power level of the interferer ($P_{\text{interferer}}$) for Range 3 shall be modified to -20 dBm for $F_{\text{interferer}} > 2700$ MHz and $F_{\text{interferer}} < 4800$ MHz

NOTE 6: The test requirement of configurations for CA operating band including Band n41 also apply for the corresponding CA operating bands with Band n90 replacing Band n41.

7.6A.3.1.5.2 Out-of-band blocking for Intra-band non-contiguous CA

Except for the spurious response frequencies recorded in step 9 of test procedure, the throughput measurement derived in the test procedure of each carrier shall be $\geq 95\%$ of the maximum throughput of the reference measurement channels as specified in Annexes A.2.2, A.2.3, A.3.2, and A.3.3 (with one sided dynamic OCNG Pattern OP.1 FDD/TDD for the DL-signal as described in Annex A.5.1.1/A.5.2.1) with parameters specified in Tables 7.6A.3.1.5.3-1 and 7.6A.3.1.5.3-2 for NR bands with $F_{\text{DL_high}} < 2700$ MHz and $F_{\text{UL_high}} < 2700$ MHz and Tables 7.6A.3.1.5.3-3 and 7.6A.3.1.5.3-4 for NR bands with $F_{\text{DL_low}} \geq 3300$ MHz and $F_{\text{UL_low}} \geq 3300$ MHz. The test requirement of configurations for CA operating band including Band n41 also apply for the corresponding CA operating bands with Band n90 replacing Band n41.

The number of spurious response frequencies recorded in step 9 of test procedure shall not exceed $\lfloor \max\{24, 6 \cdot \lceil n \cdot N_{\text{RB}} / 6 \rceil\} / \min\{\lfloor n \cdot N_{\text{RB}} / 10 \rfloor, 5\} \rfloor$ in each assigned frequency channel when measured using a $\min(\lfloor \text{BW}_{\text{channel}} / 2 \rfloor, 5)$ MHz step size. For these exceptions the requirements of clause 7.7A Spurious Response are applicable.

The throughput of each carrier shall be $\geq 95\%$ of the maximum throughput of the reference measurement channels as specified in Annexes A.2.2, A.2.3, A.3.2, and A.3.3 (with one sided dynamic OCNG Pattern OP.1 FDD/TDD for the DL-signal as described in Annex A.5.1.1/A.5.2.1).

7.6A.3.1.5.3 Out-of-band blocking for Inter-band CA

Except for the spurious response frequencies recorded in step 9 of test procedure, the throughput measurement derived in the test procedure of SCC shall be $\geq 95\%$ of the maximum throughput of the reference measurement channels as specified in Annexes A.2.2, A.2.3, A.3.2, and A.3.3 (with one sided dynamic OCNG Pattern OP.1 FDD/TDD for the DL-signal as described in Annex A.5.1.1/A.5.2.1) with parameters specified in Tables 7.6A.3.1.5.3-1 and 7.6A.3.1.5.3-2 for NR bands with $F_{\text{DL_high}} < 2700$ MHz and $F_{\text{UL_high}} < 2700$ MHz and Tables 7.6A.3.1.5.3-3 and 7.6A.3.1.5.3-4 for NR bands with $F_{\text{DL_low}} \geq 3300$ MHz and $F_{\text{UL_low}} \geq 3300$ MHz. The test requirement of configurations for CA operating band including Band n41 also apply for the corresponding CA operating bands with Band n90 replacing Band n41.

The number of spurious response frequencies recorded in step 9 of test procedure shall not exceed $\lfloor \max\{24,6 \cdot \lceil n \cdot N_{RB} / 6 \rceil / \min\{\lfloor n \cdot N_{RB} / 10 \rfloor, 5\} \rfloor$ in each assigned frequency channel when measured using a $\min(\lfloor BW_{channel} / 2 \rfloor, 5)$ MHz step size. For these exceptions the requirements of clause 7.7A Spurious Response are applicable.

Table 7.6A.3.1.5.3-1: Out-of-band blocking parameters for NR bands with $F_{DL_high} < 2700$ MHz and $F_{UL_high} < 2700$ MHz

RX parameter	Units	Channel bandwidth				
		5 MHz	10 MHz	15 MHz	20 MHz	25 MHz
Power in transmission bandwidth configuration	dBm	REFSENS + channel bandwidth specific value below				
	dB	6	6	7	9	10
RX parameter	Units	Channel bandwidth				
		30 MHz	40 MHz	50 MHz	60 MHz	80 MHz
Power in transmission bandwidth configuration	dBm	REFSENS + channel bandwidth specific value below				
	dB	11	12	13	14	15
RX parameter	Units	Channel bandwidth				
		90 MHz	100 MHz			
Power in transmission bandwidth configuration	dBm	REFSENS + channel bandwidth specific value below				
	dB	15.5	16			
NOTE: The transmitter shall be set to 4dB below $P_{CMAX_L,f,c}$ at the minimum UL configuration specified in Table 7.3.2.3-3 with $P_{CMAX_L,f,c}$ defined in clause 6.2.4.						

Table 7.6A.3.1.5.3-2: Out of-band blocking for NR bands with $F_{DL_high} < 2700$ MHz and $F_{UL_high} < 2700$ MHz

NR band	Parameter	Unit	Range 1	Range 2	Range 3
n1, n2, n3, n5, n7, n8, n12, n20, n25, n28, n34, n38, n39, n40, n41, n48 ⁵ , n50, n51, n66, n70, n71, n74, n75, n76	$P_{interferer}$	dBm	-44	-30	-15
	$F_{interferer}$ (CW)	MHz	$-60 < f - F_{DL_low} < -15$ or $15 < f - F_{DL_high} < 60$	$-85 < f - F_{DL_low} \leq -60$ or $60 \leq f - F_{DL_high} < 85$	$1 \leq f \leq F_{DL_low} - 85$ or $F_{DL_high} + 85 \leq f \leq 12750$
NOTE 1: The power level of the interferer ($P_{interferer}$) for Range 3 shall be modified to -20 dBm for $F_{interferer} > 6000$ MHz.					
NOTE 2: For band 51 the F_{DL_high} of band 50 is applied as F_{DL_high} for band 51. For band 50, the F_{DL_low} of band 51 is applied as F_{DL_low} for band 50.					
NOTE 3: For band 76 the F_{DL_high} of band 75 is applied as F_{DL_high} for band 76. For band 75, the F_{DL_low} of band 76 is applied as F_{DL_low} for band 75.					
NOTE 4: For UEs supporting both bands 38 and 41, the F_{DL_high} and F_{DL_low} of band 41 is applied as F_{DL_high} and F_{DL_low} for band 38.					
NOTE 5: n48 follows the requirement in this frequency range according to the general requirement defined in Clause 7.1. The power level of the interferer ($P_{interferer}$) for Range 3 shall be modified to -20 dBm for $F_{interferer} > 2700$ MHz and $F_{interferer} < 4800$ MHz.					
NOTE 6: Void.					
NOTE 7: For UE supporting both bands 25 and 70, the F_{DL_high} of band 70 is applied as F_{DL_high} for band 25, and the F_{DL_low} of band 25 is applied as F_{DL_low} for band 70.					

Table 7.6A.3.1.5.3-3: Out-of-band blocking parameters for NR bands with $F_{DL_low} \geq 3300$ MHz and $F_{UL_low} \geq 3300$ MHz

RX parameter	Units	Channel bandwidth				
		10 MHz	15 MHz	20 MHz	40 MHz	50 MHz
Power in transmission bandwidth configuration	dBm	REFSENS + channel bandwidth specific value below				
	dB	6	7	9	9	9
RX parameter	Units	Channel bandwidth				
		60 MHz	80 MHz	90 MHz	100 MHz	
Power in transmission bandwidth configuration	dBm	REFSENS + channel bandwidth specific value below				
	dB	9	9	9	9	
NOTE: The transmitter shall be set to 4dB below $P_{CMAX_L,f,c}$ at the minimum UL configuration specified in Table 7.3.2.3-3 with $P_{CMAX_L,f,c}$ defined in clause 6.2.4.						

Table 7.6A.3.1.5.3-4: Out of-band blocking for NR bands with $F_{DL_low} \geq 3300$ MHz and $F_{UL_low} \geq 3300$ MHz

NR band	Parameter	Unit	Range1	Range 2	Range 3
n77, n78 (NOTE 3)	$P_{interferer}$	dBm	-44	-30	-15
	$F_{interferer}$ (CW)	MHz	$-60 < f - F_{DL_low} \leq -3 \cdot BW_{Channel}$ or $3 \cdot BW_{Channel} \leq f - F_{DL_high} < 60$	$-200 < f - F_{DL_low} \leq -$ $MAX(60, 3 \cdot BW_{Channel})$ or $MAX(60, 3 \cdot BW_{Channel}) \leq f - F_{DL_high} < 200$	$1 \leq f \leq F_{DL_low} -$ $MAX(200, 3 \cdot BW_{Channel})$) or $F_{DL_high} +$ $MAX(200, 3 \cdot BW_{Channel})$) $\leq f \leq 12750$
n79 (NOTE 4)	$F_{interferer}$ (CW)	MHz	N/A	$-150 < f - F_{DL_low} \leq -$ $MAX(60, 3 \cdot BW_{Channel})$ or $MAX(60, 3 \cdot BW_{Channel}) \leq f - F_{DL_high} < 150$	$1 \leq f \leq F_{DL_low} -$ $MAX(150, 3 \cdot BW_{Channel})$) or $F_{DL_high} +$ $MAX(150, 3 \cdot BW_{Channel})$) $\leq f \leq 12750$
NOTE 1: The power level of the interferer ($P_{interferer}$) for Range 3 shall be modified to -20 dBm for $F_{interferer} > 6000$ MHz.					
NOTE 2: $BW_{Channel}$ denotes the channel bandwidth of the wanted signal					
NOTE 3: The power level of the interferer ($P_{interferer}$) for Range 3 shall be modified to -20 dBm, for $F_{interferer} > 2700$ MHz and $F_{interferer} < 4800$ MHz. For $BW_{Channel} > 15$ MHz, the requirement for Range 1 is not applicable and Range 2 applies from the frequency offset of $3 \cdot BW_{Channel}$ from the band edge. For $BW_{Channel}$ larger than 60 MHz, the requirement for Range 2 is not applicable and Range 3 applies from the frequency offset of $3 \cdot BW_{Channel}$ from the band edge.					
NOTE 4: The power level of the interferer ($P_{interferer}$) for Range 3 shall be modified to -20 dBm, for $F_{interferer} > 3650$ MHz and $F_{interferer} < 5750$ MHz. For $BW_{Channel} \geq 40$ MHz, the requirement for Range 2 is not applicable and Range 3 applies from the frequency offset of $3 \cdot BW_{Channel}$ from the band edge.					

If CW interferer falls in a gap between $F_{DL_High(j)}$ and $F_{DL_Low(j+1)}$ where the corresponding OOB ranges 1 and 2 overlap, then the lower level interferer limit of the overlapping OOB ranges applies.

For the UE which supports inter-band CA configuration in Table 7.3A.0.3.2.1-1, $P_{interferer}$ power defined in Table 7.6A.3.1.5.3-2 and 7.6A.3.1.5.3-4 is increased by the amount given by $\Delta R_{IB,c}$ in Table 7.3A.0.3.2.1-1.

For inter-band CA combination listed in Table 7.6A.3.1.5.3-5, exceptions to the requirement specified in Table 7.6A.3.1.5.3-6 are allowed when the second order intermodulation product of the lower frequency band UL carrier and the CW interfering signal fully or partially overlaps with the higher frequency band DL carrier.

Table 7.6A.3.1.5.3-5: CA band combination with exceptions allowed

CA band combination
CA_n8-n78
CA_n8-n79
CA_n28-n78

Table 7.6A.3.1.5.3-6: Requirement for out-of-band blocking exceptions

Parameter	Unit	Level
$P_{\text{Interferer}} \text{ (CW)}$	dBm	-44 ¹
NOTE 1: The requirement applies when $ f_{\text{interferer}} \pm f_{\text{UL}}^{\text{LB}} - f_{\text{DL}}^{\text{HB}} \leq (BW_{\text{UL}}^{\text{LB}} + BW_{\text{DL}}^{\text{HB}})/2$, where $f_{\text{UL}}^{\text{LB}}$ and $f_{\text{DL}}^{\text{HB}}$ are the carrier frequencies for lower frequency band UL and higher frequency band DL, respectively. $BW_{\text{UL}}^{\text{LB}}$ and $BW_{\text{DL}}^{\text{HB}}$ are the channel bandwidths configured for lower frequency band UL carrier and higher frequency band DL carrier in MHz, respectively.		

7.6A.3.2 Out-of-band blocking for CA (3DL CA)

7.6A.3.2.1 Test purpose

Out-of-band band blocking for CA is defined for an unwanted CW interfering signal falling more than 15 MHz or $3 \cdot BW_{\text{Channel_CA}}$ below or above the UE receive band, at which a given average throughput shall meet or exceed the requirement for the specified measurement channels.

For the first 15 MHz or $3 \cdot BW_{\text{Channel_CA}}$ below or above the UE receive band the appropriate in-band blocking or adjacent channel selectivity in sub-clause 7.5A and sub-clause 7.6A.2 shall be applied.

The lack of out-of-band blocking ability will decrease the coverage area when other e-NodeB transmitters exist (except in the adjacent channels and spurious response).

7.6A.3.2.2 Test applicability

This test case applies to all types of NR UE release 15 and forward that supports 3DL CA.

7.6A.3.2.3 Minimum conformance requirements

The minimum conformance requirements are defined in clause 7.6A.3.0.

7.6A.3.2.4 Test description

7.6A.3.2.4.1 Initial conditions

Initial conditions are a set of test configurations the UE needs to be tested in and the steps for the SS to take with the UE to reach the correct measurement state.

The initial test configurations consist of environmental conditions, test frequencies, test channel bandwidths and sub-carrier spacing based on NR CA configurations specified in clause 5.5A. All of these configurations shall be tested with applicable test parameters for each CA configuration, are shown in Table 7.6A.3.2.4.1-1 or 7.6A.3.2.4.1-2. The details of the uplink and downlink reference measurement channels (RMC) are specified in Annexes A.2 and A.3 respectively. The details of the OCN patterns used are specified in Annex A.5. Configurations of PDSCH and PDCCH before measurement are specified in Annex C.2.

Table 7.6A.3.2.4.1-1: Test configuration table for Intra-band contiguous CA

Default Conditions					
Test Environment as specified in TS 38.508-1 [5] subclause 4.1			Normal		
Test Frequencies as specified in TS 38.508-1 [5] subclause 4.3.1			Mid range		
Test CC Combination setting (N_{RB_agg}) as specified in Table 5.5A.3.1-1 for the CA Configuration across bandwidth combination sets supported by the UE.			Highest N_{RB_agg} NOTE 3		
Test SCS as specified in Table 5.3.5-1			Lowest		
Test Parameters					
Downlink Configuration				Uplink Configuration	
Test ID	CC Mod'n	PCC RB allocation	SCCs RB allocation	CC Mod'n	PCC RB allocation
1	CP-OFDM QPSK	Full RB ¹	Full RB ¹	DFT-s-OFDM QPSK	REFSENS ²
NOTE 1: Full RB allocation shall be used per each SCS and channel BW as specified in Table 7.3.2.4.1-2.					
NOTE 2: REFSENS refers to the single carrier Uplink RB allocation for reference sensitivity according to Table 7.3.2.4.1-3.					
NOTE 3: If the UE supports multiple CC Combinations in the CA Configuration with the same N_{RB_agg} , only the combination with the highest N_{RB_PCC} is tested.					
NOTE 4: In a band where UE supports 4Rx, the test shall be performed only with 4Rx antennas ports connected and 4Rx REFSENS requirement (Table 7.3.2.5-2) is used in the test requirements.					

Table 7.6A.3.2.4.1-2: Test configuration table for Inter-band CA

Default Conditions					
Test Environment as specified in TS 38.508-1 [5] subclause 4.1			Normal		
Test Frequencies as specified in TS 38.508-1 [5] subclause 4.3.1			Inter-band : NOTE 5 Intra-band contiguous + Inter-band: NOTE 5 Intra-band non-contiguous + Inter-band: Max WGap for Intra-band non-contiguous NOTE 5		
Test CC Combination setting (N_{RB_agg}) as specified in Tables 5.5A.1-1, 5.5A.2-1, or tables in clauses 5.5A.3.x for the CA Configuration across bandwidth combination sets supported by the UE.			Highest N_{RB_agg} NOTE 3		
Test SCS as specified in Table 5.3.5-1			Lowest		
Test Parameters					
Downlink Configuration				Uplink Configuration	
Test ID	CC Mod'n	PCC RB allocation	SCCs RB allocation	CC Mod'n	PCC RB allocation
1	CP-OFDM QPSK	Full RB ¹	Full RB ¹	DFT-s-OFDM QPSK	REFSENS ²
NOTE 1: Full RB allocation shall be used per each SCS and channel BW as specified in Table 7.3.2.4.1-2.					
NOTE 2: REFSENS refers to the single carrier Uplink RB allocation for reference sensitivity according to Table 7.3.2.4.1-3.					
NOTE 3: If the UE supports multiple CC Combinations in the CA Configuration with the same N_{RB_agg} , only the combination with the highest N_{RB_PCC} is tested.					
NOTE 4: In a band where UE supports 4Rx, the test shall be performed only with 4Rx antennas ports connected and 4Rx REFSENS requirement (Table 7.3.2.5-2) is used in the test requirements.					
NOTE 5: Test frequency is set to Mid Range PCC and SCC with exceptions defined in Table 7.3A.2.4.1-1. For NR band n28, 30MHz test channel bandwidth is tested with Low range test frequencies.					

1. Connect the SS to the UE antenna connectors as shown in TS 38.508-1 [5] Annex A, Figure A.3.1.4.7 for TE diagram and section A.3.2 for UE diagram.
2. The parameter settings for the cell are set up according to TS 38.508-1 [5] subclause 4.4.3.
3. Downlink signals are initially set up according to Annex C.0, C.1, C.2, and C.3.1, and uplink signals according to Annex G.0, G.1, G.2, and G.3.1.
4. The DL and UL Reference Measurement Channels are set according to Table 7.6A.3.2.4.1-1 or Table 7.6A.3.2.4.1-2.

5. Propagation conditions are set according to Annex B.0.
6. Ensure the UE is in State RRC_CONNECTED with generic procedure parameters Connectivity NR, Connected without release On, Test Mode On and Test Loop Function On according to TS 38.508-1 [5] clause 4.5. Message contents are defined in clause 7.6A.3.2.4.3.

7.6A.3.2.4.2 Test procedure

1. Configure SCCs according to Annex C.0, C.1, C.2 for all downlink physical channels.
2. The SS shall configure SCCs as per TS 38.508-1 [5] clause 5.5.1. Message contents are defined in clause 7.6A.3.2.4.3.
3. SS activates SCCs by sending the activation MAC CE (Refer TS 38.321 [18], clauses 5.9, 6.1.3.10). Wait for at least 2 seconds (Refer TS 38.133[19], clause 9.3).
4. SS transmits PDSCH via PDCCH DCI format 1_1 for C_RNTI to transmit the DL RMC according to Table 7.6A.3.2.4.1-1 or 7.6A.3.2.4.1-2 on both PCC and SCCs. The SS sends downlink MAC padding bits on the DL RMC.
5. SS sends uplink scheduling information for each UL HARQ process via PDCCH DCI format 0_1 for C_RNTI to schedule the UL RMC according to Table 7.6A.3.2.4.1-1 or 7.6A.3.2.4.1-2 on PCC. Since the UE has no payload data to send, the UE transmits uplink MAC padding bits on the UL RMC.
6. Set the parameters of the CW signal generator for an interfering signal below the CA Band for intra-band CA, or below each SCC's operating band for inter-band CA according to Table 7.6A.3.2.5.1-2, 7.6A.3.2.5.2-2 or 7.6A.3.2.5.2-4. The frequency step size is $\min(\lfloor BW_{channel} / 2 \rfloor, 5)$ MHz.

If CW interferer falls in a gap between $F_{DL_High(j)}$ and $F_{DL_Low(j+1)}$ where the corresponding OOB ranges 1 and 2 overlap, then the lower level interferer limit of the overlapping OOB ranges applies.

For the UE which supports inter-band CA configuration in Table 7.3A.0.3.2.1-1, $P_{interferer}$ power defined in Table 7.6A.3.2.5.2-2 and 7.6A.3.2.5.2-4 is increased by the amount given by $\Delta R_{IB,c}$ in Table 7.3A.0.3.2.1-1. Use the highest $\Delta R_{IB,c}$ among CA bands for $P_{interferer}$ calculation.

For inter-band CA combination listed in Table 7.6A.3.2.5.2-5, exceptions to the requirement specified in Table 7.6A.3.2.5.2-6 are allowed when the second order intermodulation product of the lower frequency band UL carrier and the CW interfering signal fully or partially overlaps with the higher frequency band DL carrier.

7. Set the downlink signal level according to Table 7.6A.3.2.5.1-1, 7.6A.3.2.5.2-1 or 7.6A.3.2.5.2-3 for all carriers. Send uplink power control commands to the UE using 1dB power step size to ensure that the UE output power measured by the test system is within the Uplink power control window, defined as $-(MU)$ to $-(MU + \text{Uplink power control window size})$ dB of the target power level in Table 7.6A.3.2.5.1-1, 7.6A.3.2.5.2-1 or 7.6A.3.2.5.2-3 for at least the duration of the Throughput measurement, where:
 - MU is the test system uplink power measurement uncertainty and is specified in Table F.1.3-1 for the carrier frequency f and the channel bandwidth BW
 - Uplink power control window size = 1dB (UE power step size) + 0.7dB (UE power step tolerance) + (Test system relative power measurement uncertainty), where, the UE power step tolerance is specified in TS 38.101-1 [2], Table 6.3.4.3-1 and is 0.7dB for 1dB power step size, and the Test system relative power measurement uncertainty is specified for test case 6.3.4.3 in Table F.1.2-1.
8. Measure the average throughput of SCCs simultaneously for a duration sufficient to achieve statistical significance according to Annex H.2A for inter-band CA. Measure the average throughput of all carriers simultaneously for a duration sufficient to achieve statistical significance according to Annex H.2A for intra-band CA.
9. Record the frequencies for which the throughput doesn't meet the requirements and for each frequency, the carriers for which the throughput was not met.
10. Repeat steps 6 to 8 for each recorded frequency-carrier pair, with exception of pairs for which $\Delta R_{IB,c}$ is the same as ΔR_{IB} used in Step 6. In Step 6 use only recorded frequencies for interferer placement and use $\Delta R_{IB,c}$ relevant to recorded carrier for $P_{interferer}$ calculation. Remove the frequency-carrier pairs that meet the throughput requirements from the record.

11. Repeat steps from 6 to 10, using an interfering signal above the CA Band for intra-band CA, or above each SCC's operating band for inter-band CA at step 6.
12. For Inter-band CA: Switch the SCell into PCell and repeat steps 1 to 11, except for operating bands without uplink band.

NOTE: The purpose of the Uplink power control window is to ensure that the actual UE output power is no greater than the target power level, and as close as possible to the target power level. The relationship between the Uplink power control window, the target power level and the corresponding possible actual UE Uplink power window is illustrated in Annex F.4.3.

7.6A.3.2.4.3 Message contents

Message contents are according to TS 38.508-1 [5] subclause 4.6 Table 4.6.3-118 with condition TRANSFORM_PRECODER_ENABLED.

7.6A.3.2.5 Test requirement

7.6A.3.2.5.1 Out-of-band blocking for Intra-band contiguous CA

Except for the spurious response frequencies recorded in step 9 of test procedure, the throughput measurement derived in the test procedure of each carrier shall be $\geq 95\%$ of the maximum throughput of the reference measurement channels as specified in Annexes A.2.2, A.2.3, A.3.2, and A.3.3 (with one sided dynamic OCNG Pattern OP.1 FDD/TDD for the DL-signal as described in Annex A.5.1.1/A.5.2.1) with parameters specified in Tables 7.6A.3.2.5.1-1 and 7.6A.3.2.5.1-2.

The number of spurious response frequencies recorded in step 9 of test procedure shall not exceed $\lfloor \max\{24,6 \cdot \lceil n \cdot N_{RB} / 6 \rceil / \min\{\lfloor n \cdot N_{RB} / 10 \rfloor, 5\} \rfloor$ in each assigned frequency channel when measured using a $\min(\lfloor BW_{channel} / 2 \rfloor, 5)$ MHz step size. For these exceptions the requirements of clause 7.7A Spurious Response are applicable.

Table 7.6A.3.2.5.1-1: Out-of-band blocking parameters for intra-band contiguous CA

RX parameter	Units	CA bandwidth class	
		D	
Power in transmission bandwidth configuration	dBm	REFSENS + CA bandwidth class specific value below	
	dB	9	
NOTE 1: The transmitter shall be set to 4 dB below $P_{CMAX_L,f,c}$ at the minimum UL configuration specified in Table 7.3.2.3-3 with $P_{CMAX_L,f,c}$ defined in clause 6.2.4.			

7.6A.3.2.5.1-2: Out of-band blocking for intra-band contiguous CA

NR band	Parameter	Unit	Range1	Range 2	Range 3
	$P_{\text{interferer}}$	dBm	-45	-30	-15
n41, n48 ⁵ , n66, n71	$F_{\text{interferer}}$ (CW)	MHz	$-60 < f - F_{\text{DL_low}} < -15$ or $15 < f - F_{\text{DL_high}} < 60$	$-85 < f - F_{\text{DL_low}} \leq -60$ or $60 \leq f - F_{\text{DL_high}} < 85$	$1 \leq f \leq F_{\text{DL_low}} - 85$ or $F_{\text{DL_high}} + 85 \leq f \leq 12750$
n77, n78 (NOTE 3)	$F_{\text{interferer}}$ (CW)	MHz	N/A	N/A	$1 \leq f \leq F_{\text{DL_low}} - \text{MAX}(200, 3 \cdot \text{BW}_{\text{Channel_CA}})$ or $F_{\text{DL_high}} + \text{MAX}(200, 3 \cdot \text{BW}_{\text{Channel_CA}}) \leq f \leq 12750$
n79 (NOTE 4)	$F_{\text{interferer}}$ (CW)	MHz	N/A	N/A	$1 \leq f \leq F_{\text{DL_low}} - \text{MAX}(150, 3 \cdot \text{BW}_{\text{Channel_CA}})$ or $F_{\text{DL_high}} + \text{MAX}(150, 3 \cdot \text{BW}_{\text{Channel_CA}}) \leq f \leq 12750$

NOTE 1: The power level of the interferer ($P_{\text{interferer}}$) for Range 3 shall be modified to -20 dBm for $F_{\text{interferer}} > 6000$ MHz.

NOTE 2: $\text{BW}_{\text{Channel_CA}}$ denotes the aggregated channel bandwidth of the wanted signal

NOTE 3: The power level of the interferer ($P_{\text{interferer}}$) for Range 3 shall be modified to -20 dBm, for $F_{\text{interferer}} > 2700$ MHz and $F_{\text{interferer}} < 4800$ MHz. For $\text{BW}_{\text{Channel_CA}} > 15$ MHz, the requirement for Range 1 is not applicable and Range 2 applies from the frequency offset of $3 \cdot \text{BW}_{\text{Channel_CA}}$ from the band edge. For $\text{BW}_{\text{Channel_CA}}$ larger than 60 MHz, the requirement for Range 2 is not applicable and Range 3 applies from the frequency offset of $3 \cdot \text{BW}_{\text{Channel_CA}}$ from the band edge.

NOTE 4: The power level of the interferer ($P_{\text{interferer}}$) for Range 3 shall be modified to -20 dBm, for $F_{\text{interferer}} > 3650$ MHz and $F_{\text{interferer}} < 5750$ MHz. For $\text{BW}_{\text{Channel_CA}} \geq 40$ MHz, the requirement for Range 2 is not applicable and Range 3 applies from the frequency offset of $3 \cdot \text{BW}_{\text{Channel_CA}}$ from the band edge.

NOTE 5: The power level of the interferer ($P_{\text{interferer}}$) for Range 3 shall be modified to -20 dBm for $F_{\text{interferer}} > 2700$ MHz and $F_{\text{interferer}} < 4800$ MHz.

NOTE 6: The test requirement of configurations for CA operating band including Band n41 also apply for the corresponding CA operating bands with Band n90 replacing Band n41.

7.6A.3.2.5.2 Out-of-band blocking for Inter-band CA

Except for the spurious response frequencies recorded in step 9 and step 10 of test procedure, the throughput measurement derived in the test procedure of SCCs shall be $\geq 95\%$ of the maximum throughput of the reference measurement channels as specified in Annexes A.2.2, A.2.3, A.3.2, and A.3.3 (with one sided dynamic OCNG Pattern OP.1 FDD/TDD for the DL-signal as described in Annex A.5.1.1/A.5.2.1) with parameters specified in Tables 7.6A.3.2.5.2-1 and 7.6A.3.2.5.2-2 for NR bands with $F_{\text{DL_high}} < 2700$ MHz and $F_{\text{UL_high}} < 2700$ MHz and Tables 7.6A.3.2.5.2-3 and 7.6A.3.2.5.2-4 for NR bands with $F_{\text{DL_low}} \geq 3300$ MHz and $F_{\text{UL_low}} \geq 3300$ MHz. The test requirement of configurations for CA operating band including Band n41 also apply for the corresponding CA operating bands with Band n90 replacing Band n41.

The number of spurious response frequencies recorded in step 9 and step 10 of test procedure shall not exceed $\lfloor \max\{24, 6 \cdot \lceil n \cdot N_{\text{RB}} / 6 \rceil\} / \min\{\lfloor n \cdot N_{\text{RB}} / 10 \rfloor, 5\} \rfloor$ in each assigned frequency channel when measured using a $\min(\lfloor \text{BW}_{\text{channel}} / 2 \rfloor, 5)$ MHz step size. For these exceptions the requirements of clause 7.7A Spurious Response are applicable.

Table 7.6A.3.2.5.2-1: Out-of-band blocking parameters for NR bands with $F_{DL_high} < 2700$ MHz and $F_{UL_high} < 2700$ MHz

RX parameter	Units	Channel bandwidth				
		5 MHz	10 MHz	15 MHz	20 MHz	25 MHz
Power in transmission bandwidth configuration	dBm	REFSENS + channel bandwidth specific value below				
	dB	6	6	7	9	10
RX parameter	Units	Channel bandwidth				
		30 MHz	40 MHz	50 MHz	60 MHz	80 MHz
Power in transmission bandwidth configuration	dBm	REFSENS + channel bandwidth specific value below				
	dB	11	12	13	14	15
RX parameter	Units	Channel bandwidth				
		90 MHz	100 MHz			
Power in transmission bandwidth configuration	dBm	REFSENS + channel bandwidth specific value below				
	dB	15.5	16			
NOTE: The transmitter shall be set to 4dB below $P_{CMAX_L,f,c}$ at the minimum UL configuration specified in Table 7.3.2.3-3 with $P_{CMAX_L,f,c}$ defined in clause 6.2.4.						

Table 7.6A.3.2.5.2-2: Out of-band blocking for NR bands with $F_{DL_high} < 2700$ MHz and $F_{UL_high} < 2700$ MHz

NR band	Parameter	Unit	Range 1	Range 2	Range 3
n1, n2, n3, n5, n7, n8, n12, n20, n25, n28, n34, n38, n39, n40, n41, n48 ⁵ , n50, n51, n66, n70, n71, n74, n75, n76	$P_{interferer}$	dBm	-44	-30	-15
	$F_{interferer}$ (CW)	MHz	$-60 < f - F_{DL_low} < -15$ or $15 < f - F_{DL_high} < 60$	$-85 < f - F_{DL_low} \leq -60$ or $60 \leq f - F_{DL_high} < 85$	$1 \leq f \leq F_{DL_low} - 85$ or $F_{DL_high} + 85 \leq f \leq 12750$
NOTE 1: The power level of the interferer ($P_{interferer}$) for Range 3 shall be modified to -20 dBm for $F_{interferer} > 6000$ MHz.					
NOTE 2: For band 51 the F_{DL_high} of band 50 is applied as F_{DL_high} for band 51. For band 50, the F_{DL_low} of band 51 is applied as F_{DL_low} for band 50.					
NOTE 3: For band 76 the F_{DL_high} of band 75 is applied as F_{DL_high} for band 76. For band 75, the F_{DL_low} of band 76 is applied as F_{DL_low} for band 75.					
NOTE 4: For UEs supporting both bands 38 and 41, the F_{DL_high} and F_{DL_low} of band 41 is applied as F_{DL_high} and F_{DL_low} for band 38.					
NOTE 5: n48 follows the requirement in this frequency range according to the general requirement defined in Clause 7.1. The power level of the interferer ($P_{interferer}$) for Range 3 shall be modified to -20 dBm for $F_{interferer} > 2700$ MHz and $F_{interferer} < 4800$ MHz.					
NOTE 6: Void.					
NOTE 7: For UE supporting both bands 25 and 70, the F_{DL_high} of band 70 is applied as F_{DL_high} for band 25, and the F_{DL_low} of band 25 is applied as F_{DL_low} for band 70.					

Table 7.6A.3.2.5.2-3: Out-of-band blocking parameters for NR bands with $F_{DL_low} \geq 3300$ MHz and $F_{UL_low} \geq 3300$ MHz

RX parameter	Units	Channel bandwidth				
		10 MHz	15 MHz	20 MHz	40 MHz	50 MHz
Power in transmission bandwidth configuration	dBm	REFSENS + channel bandwidth specific value below				
	dB	6	7	9	9	9
RX parameter	Units	Channel bandwidth				
		60 MHz	80 MHz	90 MHz	100 MHz	
Power in transmission bandwidth configuration	dBm	REFSENS + channel bandwidth specific value below				
	dB	9	9	9	9	
NOTE: The transmitter shall be set to 4dB below $P_{C_{MAX_L,f,c}}$ at the minimum UL configuration specified in Table 7.3.2.3-3 with $P_{C_{MAX_L,f,c}}$ defined in clause 6.2.4.						

Table 7.6A.3.2.5.2-4: Out of-band blocking for NR bands with $F_{DL_low} \geq 3300$ MHz and $F_{UL_low} \geq 3300$ MHz

NR band	Parameter	Unit	Range1	Range 2	Range 3
n77, n78 (NOTE 3)	$P_{interferer}$	dBm	-44	-30	-15
	$F_{interferer}$ (CW)	MHz	$-60 < f - F_{DL_low} \leq -3 \cdot BW_{Channel}$ or $3 \cdot BW_{Channel} \leq f - F_{DL_high} < 60$	$-200 < f - F_{DL_low} \leq -$ $MAX(60, 3 \cdot BW_{Channel})$ or $MAX(60, 3 \cdot BW_{Channel}) \leq f - F_{DL_high} < 200$	$1 \leq f \leq F_{DL_low} -$ $MAX(200, 3 \cdot BW_{Channel})$) or $F_{DL_high} +$ $MAX(200, 3 \cdot BW_{Channel})$) $\leq f \leq 12750$
n79 (NOTE 4)	$F_{interferer}$ (CW)	MHz	N/A	$-150 < f - F_{DL_low} \leq -$ $MAX(60, 3 \cdot BW_{Channel})$ or $MAX(60, 3 \cdot BW_{Channel}) \leq f - F_{DL_high} < 150$	$1 \leq f \leq F_{DL_low} -$ $MAX(150, 3 \cdot BW_{Channel})$) or $F_{DL_high} +$ $MAX(150, 3 \cdot BW_{Channel})$) $\leq f \leq 12750$
NOTE 1: The power level of the interferer ($P_{interferer}$) for Range 3 shall be modified to -20 dBm for $F_{interferer} > 6000$ MHz.					
NOTE 2: $BW_{Channel}$ denotes the channel bandwidth of the wanted signal					
NOTE 3: The power level of the interferer ($P_{interferer}$) for Range 3 shall be modified to -20 dBm, for $F_{interferer} > 2700$ MHz and $F_{interferer} < 4800$ MHz. For $BW_{Channel} > 15$ MHz, the requirement for Range 1 is not applicable and Range 2 applies from the frequency offset of $3 \cdot BW_{Channel}$ from the band edge. For $BW_{Channel}$ larger than 60 MHz, the requirement for Range 2 is not applicable and Range 3 applies from the frequency offset of $3 \cdot BW_{Channel}$ from the band edge.					
NOTE 4: The power level of the interferer ($P_{interferer}$) for Range 3 shall be modified to -20 dBm, for $F_{interferer} > 3650$ MHz and $F_{interferer} < 5750$ MHz. For $BW_{Channel} \geq 40$ MHz, the requirement for Range 2 is not applicable and Range 3 applies from the frequency offset of $3 \cdot BW_{Channel}$ from the band edge.					

If CW interferer falls in a gap between $F_{DL_High(j)}$ and $F_{DL_Low(j+1)}$ where the corresponding OOB ranges 1 and 2 overlap, then the lower level interferer limit of the overlapping OOB ranges applies.

For the UE which supports inter-band CA configuration in Table 7.3A.3.5.1.3-5, $P_{interferer}$ power defined in Table 7.6A.3.2.5.2-2 and 7.6A.3.2.5.2-4 is increased by the amount given by $\Delta R_{IB,c}$ in Table 7.3A.3.5.1.3-1.

For inter-band CA combination listed in Table 7.6A.3.2.5.2-5, exceptions to the requirement specified in Table 7.6A.3.2.5.2-6 are allowed when the second order intermodulation product of the lower frequency band UL carrier and the CW interfering signal fully or partially overlaps with the higher frequency band DL carrier.

Table 7.6A.3.2.5.2-5: CA band combination with exceptions allowed

CA band combination
CA_n8-n78
CA_n8-n79
CA_n28-n78

Table 7.6A.3.2.5.2-6: Requirement for out-of-band blocking exceptions

Parameter	Unit	Level
$P_{\text{Interferer}} \text{ (CW)}$	dBm	-44 ¹
NOTE 1: The requirement applies when $ f_{\text{interferer}} \pm f_{\text{UL}}^{\text{LB}} - f_{\text{DL}}^{\text{HB}} \leq (BW_{\text{UL}}^{\text{LB}} + BW_{\text{DL}}^{\text{HB}})/2$, where $f_{\text{UL}}^{\text{LB}}$ and $f_{\text{DL}}^{\text{HB}}$ are the carrier frequencies for lower frequency band UL and higher frequency band DL, respectively. $BW_{\text{UL}}^{\text{LB}}$ and $BW_{\text{DL}}^{\text{HB}}$ are the channel bandwidths configured for lower frequency band UL carrier and higher frequency band DL carrier in MHz, respectively.		

7.6A.3.3 Out-of-band blocking for CA (4DL CA)

7.6A.3.3.1 Test purpose

Out-of-band band blocking for CA is defined for an unwanted CW interfering signal falling more than 15 MHz or $3 \cdot BW_{\text{Channel_CA}}$ below or above the UE receive band, at which a given average throughput shall meet or exceed the requirement for the specified measurement channels.

For the first 15 MHz or $3 \cdot BW_{\text{Channel_CA}}$ below or above the UE receive band the appropriate in-band blocking or adjacent channel selectivity in sub-clause 7.5A and sub-clause 7.6A.2 shall be applied.

The lack of out-of-band blocking ability will decrease the coverage area when other e-NodeB transmitters exist (except in the adjacent channels and spurious response).

7.6A.3.3.2 Test applicability

This test case applies to all types of NR UE release 15 and forward that supports 4DL CA.

7.6A.3.3.3 Minimum conformance requirements

The minimum conformance requirements are defined in clause 7.6A.3.0.

7.6A.3.3.4 Test description

7.6A.3.3.4.1 Initial conditions

Initial conditions are a set of test configurations the UE needs to be tested in and the steps for the SS to take with the UE to reach the correct measurement state.

The initial test configurations consist of environmental conditions, test frequencies, test channel bandwidths and sub-carrier spacing based on NR CA configurations specified in clause 5.5A. All of these configurations shall be tested with applicable test parameters for each CA configuration, are shown in Table 7.6A.3.3.4.1-1. The details of the uplink and downlink reference measurement channels (RMC) are specified in Annexes A.2 and A.3 respectively. The details of the OCNG patterns used are specified in Annex A.5. Configurations of PDSCH and PDCCH before measurement are specified in Annex C.2.

Table 7.6A.3.3.4.1-1: Test configuration table for Inter-band CA

Default Conditions					
Test Environment as specified in TS 38.508-1 [5] subclause 4.1		Normal			
Test Frequencies as specified in TS 38.508-1 [5] subclause 4.3.1		Inter-band : NOTE 5 Intra-band contiguous + Inter-band: NOTE 5 Intra-band non-contiguous + Inter-band: MaxWGap for Intra-band non-contiguous (NOTE 5) Intra-band non-contiguous + Intra-band non-contiguous: MaxWGap for Intra-band non-contiguous (NOTE 5)			
Test CC Combination setting (N_{RB_agg}) as specified in Tables 5.5A.1-1, 5.5A.2-1, or tables in clauses 5.5A.3.x for the CA Configuration across bandwidth combination sets supported by the UE.		Highest N_{RB_agg} NOTE 3			
Test SCS as specified in Table 5.3.5-1		Lowest			
Test Parameters					
Test ID	Downlink Configuration			Uplink Configuration	
	CC Mod'n	PCC RB allocation	SCCs RB allocation	CC Mod'n	PCC RB allocation
1	CP-OFDM QPSK	Full RB ¹	Full RB ¹	DFT-s-OFDM QPSK	REFSENS ²
NOTE 1: Full RB allocation shall be used per each SCS and channel BW as specified in Table 7.3.2.4.1-2.					
NOTE 2: REFSENS refers to the single carrier Uplink RB allocation for reference sensitivity according to Table 7.3.2.4.1-3.					
NOTE 3: If the UE supports multiple CC Combinations in the CA Configuration with the same N_{RB_agg} , only the combination with the highest N_{RB_PCC} is tested.					
NOTE 4: In a band where UE supports 4Rx, the test shall be performed only with 4Rx antennas ports connected and 4Rx REFSENS requirement (Table 7.3.2.5-2) is used in the test requirements.					
NOTE 5: Test frequency is set to Mid Range PCC and SCC with exceptions defined in Table 7.3A.2.4.1-1. For NR band n28, 30MHz test channel bandwidth is tested with Low range test frequencies.					

1. Connect the SS to the UE antenna connectors as shown in TS 38.508-1 [5] Annex A, Figure A.3.1.4.7 for TE diagram and section A.3.2 for UE diagram.
2. The parameter settings for the cell are set up according to TS 38.508-1 [5] subclause 4.4.3.
3. Downlink signals are initially set up according to Annex C.0, C.1, C.2, and C.3.1, and uplink signals according to Annex G.0, G.1, G.2, and G.3.1.
4. The DL and UL Reference Measurement Channels are set according to Table 7.6A.3.3.4.1-1.
5. Propagation conditions are set according to Annex B.0.
6. Ensure the UE is in State RRC_CONNECTED with generic procedure parameters Connectivity NR, Connected without release On, Test Mode On and Test Loop Function On according to TS 38.508-1 [5] clause 4.5. Message contents are defined in clause 7.6A.3.3.4.3.

7.6A.3.3.4.2 Test procedure

1. Configure SCCs according to Annex C.0, C.1, C.2 for all downlink physical channels.
2. The SS shall configure SCCs as per TS 38.508-1 [5] clause 5.5.1. Message contents are defined in clause 7.6A.3.3.4.3.
3. SS activates SCCs by sending the activation MAC CE (Refer TS 38.321 [18], clauses 5.9, 6.1.3.10). Wait for at least 2 seconds (Refer TS 38.133[19], clause 9.3).
4. SS transmits PDSCH via PDCCH DCI format 1_1 for C_RNTI to transmit the DL RMC according to Table 7.6A.3.3.4.1-1 on both PCC and SCCs. The SS sends downlink MAC padding bits on the DL RMC.
5. SS sends uplink scheduling information for each UL HARQ process via PDCCH DCI format 0_1 for C_RNTI to schedule the UL RMC according to Table 7.6A.3.3.4.1-1 on PCC. Since the UE has no payload data to send, the UE transmits uplink MAC padding bits on the UL RMC.

6. Set the parameters of the CW signal generator for an interfering signal below each SCC's operating band for inter-band CA according to Table 7.6A.3.3.5.1-2 or 7.6A.3.3.5.1-4. The frequency step size is $\min(\lfloor BW_{channel} / 2 \rfloor, 5)$ MHz.

If CW interferer falls in a gap between $F_{DL_High(j)}$ and $F_{DL_Low(j+1)}$ where the corresponding OOB ranges 1 and 2 overlap, then the lower level interferer limit of the overlapping OOB ranges applies.

For the UE which supports inter-band CA configuration in Table 7.3A.0.3.2.1-1, $P_{interferer}$ power defined in Table 7.6A.3.3.5.1-2 and 7.6A.3.3.5.1-4 is increased by the amount given by $\Delta R_{IB,c}$ in Table 7.3A.0.3.2.1-1. Use the highest $\Delta R_{IB,c}$ among CA bands for $P_{interferer}$ calculation.

For inter-band CA combination listed in Table 7.6A.3.3.5.1-5, exceptions to the requirement specified in Table 7.6A.3.3.5.1-6 are allowed when the second order intermodulation product of the lower frequency band UL carrier and the CW interfering signal fully or partially overlaps with the higher frequency band DL carrier.

7. Set the downlink signal level according to the Table 7.6A.3.3.5.1-1, or 7.6A.3.3.5.1-3 for all carriers. Send uplink power control commands to the UE using 1dB power step size to ensure that the UE output power measured by the test system is within the Uplink power control window, defined as $-\text{MU}$ to $-(\text{MU} + \text{Uplink power control window size})$ dB of the target power level in Table 7.6A.3.3.5.1-1, or 7.6A.3.3.5.1-3 for at least the duration of the Throughput measurement, where:
- MU is the test system uplink power measurement uncertainty and is specified in Table F.1.3-1 for the carrier frequency f and the channel bandwidth BW
 - Uplink power control window size = 1dB (UE power step size) + 0.7dB (UE power step tolerance) + (Test system relative power measurement uncertainty), where, the UE power step tolerance is specified in TS 38.101-1 [2], Table 6.3.4.3-1 and is 0.7dB for 1dB power step size, and the Test system relative power measurement uncertainty is specified for test case 6.3.4.3 in Table F.1.2-1.
8. Measure the average throughput of SCCs simultaneously for a duration sufficient to achieve statistical significance according to Annex H.2A for inter-band CA.
9. Record the frequencies for which the throughput doesn't meet the requirements and for each frequency, the carriers for which the throughput was not met.
10. Repeat steps 6 to 8 for each recorded frequency-carrier pair, with exception of pairs for which $\Delta R_{IB,c}$ is the same as ΔR_{IB} used in Step 6. In Step 6 use only recorded frequencies for interferer placement and use $\Delta R_{IB,c}$ relevant to recorded carrier for $P_{interferer}$ calculation. Remove the frequency-carrier pairs that meet the throughput requirements from the record.
11. Repeat steps from 6 to 10, using an interfering signal above each SCC's operating band for inter-band CA at step 6.
12. For Inter-band CA: Switch the SCell into PCell and repeat steps 1 to 11, except for operating bands without uplink band.

NOTE: The purpose of the Uplink power control window is to ensure that the actual UE output power is no greater than the target power level, and as close as possible to the target power level. The relationship between the Uplink power control window, the target power level and the corresponding possible actual UE Uplink power window is illustrated in Annex F.4.3.

7.6A.3.3.4.3 Message contents

Message contents are according to TS 38.508-1 [5] subclause 4.6 Table 4.6.3-118 with condition TRANSFORM_PRECODER_ENABLED.

7.6A.3.3.5 Test requirement

7.6A.3.3.5.1 Out-of-band blocking for Inter-band CA

Except for the spurious response frequencies recorded in step 9 and step 10 of test procedure, the throughput measurement derived in the test procedure of SCCs shall be $\geq 95\%$ of the maximum throughput of the reference measurement channels as specified in Annexes A.2.2, A.2.3, A.3.2, and A.3.3 (with one sided dynamic OCNG Pattern OP.1 FDD/TDD for the DL-signal as described in Annex A.5.1.1/A.5.2.1) with parameters specified in Tables 7.6A.3.3.5.1-1 and 7.6A.3.3.5.1-2 for NR bands with $F_{DL_high} < 2700$ MHz and $F_{UL_high} < 2700$ MHz and Tables

7.6A.3.3.5.1-3 and 7.6A.3.3.5.1-4 for NR bands with $F_{DL_low} \geq 3300$ MHz and $F_{UL_low} \geq 3300$ MHz. The test requirement of configurations for CA operating band including Band n41 also apply for the corresponding CA operating bands with Band n90 replacing Band n41.

The number of spurious response frequencies recorded in step 9 and step 10 of test procedure shall not exceed $\lfloor \max\{24, 6 \cdot \lceil n \cdot N_{RB} / 6 \rceil\} / \min\{\lfloor n \cdot N_{RB} / 10 \rfloor, 5\} \rfloor$ in each assigned frequency channel when measured using a $\min(\lfloor BW_{channel} / 2 \rfloor, 5)$ MHz step size. For these exceptions the requirements of clause 7.7A Spurious Response are applicable.

Table 7.6A.3.3.5.1-1: Out-of-band blocking parameters for NR bands with $F_{DL_high} < 2700$ MHz and $F_{UL_high} < 2700$ MHz

RX parameter	Units	Channel bandwidth				
		5 MHz	10 MHz	15 MHz	20 MHz	25 MHz
Power in transmission bandwidth configuration	dBm	REFSENS + channel bandwidth specific value below				
	dB	6	6	7	9	10
RX parameter	Units	Channel bandwidth				
		30 MHz	40 MHz	50 MHz	60 MHz	80 MHz
Power in transmission bandwidth configuration	dBm	REFSENS + channel bandwidth specific value below				
	dB	11	12	13	14	15
RX parameter	Units	Channel bandwidth				
		90 MHz	100 MHz			
Power in transmission bandwidth configuration	dBm	REFSENS + channel bandwidth specific value below				
	dB	15.5	16			
NOTE: The transmitter shall be set to 4dB below $P_{CMAX_L,f,c}$ at the minimum UL configuration specified in Table 7.3.2.3-3 with $P_{CMAX_L,f,c}$ defined in clause 6.2.4.						

Table 7.6A.3.3.5.1-2: Out of-band blocking for NR bands with $F_{DL_high} < 2700$ MHz and $F_{UL_high} < 2700$ MHz

NR band	Parameter	Unit	Range 1	Range 2	Range 3
n1, n2, n3, n5, n7, n8, n12, n20, n25, n28, n34, n38, n39, n40, n41, n50, n51, n66, n70, n71, n74, n75, n76	$P_{interferer}$	dBm	-44	-30	-15
	$F_{interferer}$ (CW)	MHz	$-60 < f - F_{DL_low} < -15$ or $15 < f - F_{DL_high} < 60$	$-85 < f - F_{DL_low} \leq -60$ or $60 \leq f - F_{DL_high} < 85$	$1 \leq f \leq F_{DL_low} - 85$ or $F_{DL_high} + 85 \leq f \leq 12750$
NOTE1: The power level of the interferer ($P_{interferer}$) for Range 3 shall be modified to -20 dBm for $F_{interferer} > 6000$ MHz.					
NOTE 2: For band 51 the F_{DL_high} of band 50 is applied as F_{DL_high} for band 51. For band 50, the F_{DL_low} of band 51 is applied as F_{DL_low} for band 50.					
NOTE 3: For band 76 the F_{DL_high} of band 75 is applied as F_{DL_high} for band 76. For band 75, the F_{DL_low} of band 76 is applied as F_{DL_low} for band 75.					
NOTE 4: For UEs supporting both bands 38 and 41, the F_{DL_high} and F_{DL_low} of band 41 is applied as F_{DL_high} and F_{DL_low} for band 38.					
NOTE 6: Void.					
NOTE 7: For UE supporting both bands 25 and 70, the F_{DL_high} of band 70 is applied as F_{DL_high} for band 25, and the F_{DL_low} of band 25 is applied as F_{DL_low} for band 70.					

Table 7.6A.3.3.5.1-3: Out-of-band blocking parameters for NR bands with $F_{DL_low} \geq 3300$ MHz and $F_{UL_low} \geq 3300$ MHz

RX parameter	Units	Channel bandwidth				
		10 MHz	15 MHz	20 MHz	40 MHz	50 MHz
Power in transmission bandwidth configuration	dBm	REFSENS + channel bandwidth specific value below				
	dB	6	7	9	9	9
RX parameter	Units	Channel bandwidth				
		60 MHz	80 MHz	90 MHz	100 MHz	
Power in transmission bandwidth configuration	dBm	REFSENS + channel bandwidth specific value below				
	dB	9	9	9	9	
NOTE: The transmitter shall be set to 4dB below $P_{CMAX_L,f,c}$ at the minimum UL configuration specified in Table 7.3.2.3-3 with $P_{CMAX_L,f,c}$ defined in clause 6.2.4.						

Table 7.6A.3.3.5.1-4: Out of-band blocking for NR bands with $F_{DL_low} \geq 3300$ MHz and $F_{UL_low} \geq 3300$ MHz

NR band	Parameter	Unit	Range1	Range 2	Range 3
n77, n78 (NOTE 3)	$P_{interferer}$	dBm	-44	-30	-15
	$F_{interferer}$ (CW)	MHz	$-60 < f - F_{DL_low} \leq -3 \cdot BW_{Channel}$ or $3 \cdot BW_{Channel} \leq f - F_{DL_high} < 60$	$-200 < f - F_{DL_low} \leq -$ $MAX(60, 3 \cdot BW_{Channel})$ or $MAX(60, 3 \cdot BW_{Channel}) \leq f - F_{DL_high} < 200$	$1 \leq f \leq F_{DL_low} -$ $MAX(200, 3 \cdot BW_{Channel})$) or $F_{DL_high} +$ $MAX(200, 3 \cdot BW_{Channel})$) $\leq f \leq 12750$
n79 (NOTE 4)	$F_{interferer}$ (CW)	MHz	N/A	$-150 < f - F_{DL_low} \leq -$ $MAX(60, 3 \cdot BW_{Channel})$ or $MAX(60, 3 \cdot BW_{Channel}) \leq f - F_{DL_high} < 150$	$1 \leq f \leq F_{DL_low} -$ $MAX(150, 3 \cdot BW_{Channel})$) or $F_{DL_high} +$ $MAX(150, 3 \cdot BW_{Channel})$) $\leq f \leq 12750$
NOTE 1: The power level of the interferer ($P_{interferer}$) for Range 3 shall be modified to -20 dBm for $F_{interferer} > 6000$ MHz.					
NOTE 2: $BW_{Channel}$ denotes the channel bandwidth of the wanted signal					
NOTE 3: The power level of the interferer ($P_{interferer}$) for Range 3 shall be modified to -20 dBm, for $F_{interferer} > 2700$ MHz and $F_{interferer} < 4800$ MHz. For $BW_{Channel} > 15$ MHz, the requirement for Range 1 is not applicable and Range 2 applies from the frequency offset of $3 \cdot BW_{Channel}$ from the band edge. For $BW_{Channel}$ larger than 60 MHz, the requirement for Range 2 is not applicable and Range 3 applies from the frequency offset of $3 \cdot BW_{Channel}$ from the band edge.					
NOTE 4: The power level of the interferer ($P_{interferer}$) for Range 3 shall be modified to -20 dBm, for $F_{interferer} > 3650$ MHz and $F_{interferer} < 5750$ MHz. For $BW_{Channel} \geq 40$ MHz, the requirement for Range 2 is not applicable and Range 3 applies from the frequency offset of $3 \cdot BW_{Channel}$ from the band edge.					

If CW interferer falls in a gap between $F_{DL_High(j)}$ and $F_{DL_Low(j+1)}$ where the corresponding OOB ranges 1 and 2 overlap, then the lower level interferer limit of the overlapping OOB ranges applies.

For the UE which supports inter-band CA configuration in Table 7.3A.3.5.1.3-5, $P_{interferer}$ power defined in Table 7.6A.3.3.5.1-2 and 7.6A.3.3.5.1-4 is increased by the amount given by $\Delta R_{IB,c}$ in Table 7.3A.3.5.1.3-1.

For inter-band CA combination listed in Table 7.6A.3.3.5.1-5, exceptions to the requirement specified in Table 7.6A.3.3.5.1-6 are allowed when the second order intermodulation product of the lower frequency band UL carrier and the CW interfering signal fully or partially overlaps with the higher frequency band DL carrier.

Table 7.6A.3.3.5.1-5: CA band combination with exceptions allowed

CA band combination
CA_n8-n78
CA_n8-n79
CA_n28-n78

Table 7.6A.3.3.5.1-6: Requirement for out-of-band blocking exceptions

Parameter	Unit	Level
$P_{\text{Interferer}} \text{ (CW)}$	dBm	-44 ¹
NOTE 1: The requirement applies when $ f_{\text{interferer}} \pm f_{\text{UL}}^{\text{LB}} - f_{\text{DL}}^{\text{HB}} \leq (BW_{\text{UL}}^{\text{LB}} + BW_{\text{DL}}^{\text{HB}})/2$, where $f_{\text{UL}}^{\text{LB}}$ and $f_{\text{DL}}^{\text{HB}}$ are the carrier frequencies for lower frequency band UL and higher frequency band DL, respectively. $BW_{\text{UL}}^{\text{LB}}$ and $BW_{\text{DL}}^{\text{HB}}$ are the channel bandwidths configured for lower frequency band UL carrier and higher frequency band DL carrier in MHz, respectively.		

7.6A.4 Narrow band blocking for CA

7.6A.4.0 Minimum conformance requirements

7.6A.4.0.1 Narrow band blocking for Intra-band contiguous CA

For intra-band contiguous carrier aggregation, the downlink SCC(s) shall be configured at nominal channel spacing to the PCC. For FDD, the PCC shall be configured closest to the uplink band. All downlink carriers shall be active throughout the test. The uplink output power shall be set as specified in Table 7.6A.4.0.1-1 with the uplink configuration. For UE(s) supporting one uplink, the uplink configuration of the PCC shall be in accordance with Table 7.3.2.3-3. The UE shall fulfil the minimum requirement in presence of an interfering signal specified in Table 7.6A.4.0.1-1 being on either side of the aggregated signal. The throughput of each carrier shall be $\geq 95\%$ of the maximum throughput of the reference measurement channels as specified in Annexes A.2.2, A.2.3, A3.2 and A.3.3 (with one sided dynamic OCNG Pattern OP.1 FDD/TDD for the DL-signal as described in Annex A.5.1.1/A.5.2.1) with parameters specified in Table 7.6A.4.0.1-1.

Table 7.6A.4.0.1-1: Narrow-band blocking for intra-band contiguous CA

NR band	Parameter	Unit	NR CA bandwidth class	
			B	C
n41, n66, n48, n71	P_w in Transmission Bandwidth Configuration, per CC	dBm	REFSENS + NA CA Bandwidth Class specific value below	REFSENS + NA CA Bandwidth Class specific value below
			16	16
	$P_{\text{uw}} \text{ (CW)}$	dBm	-55	-55
	F_{uw} (offset for $\Delta f = 15$ kHz, 30 kHz)	MHz	- $F_{\text{offset}} - 0.2$ / + $F_{\text{offset}} + 0.2$	- $F_{\text{offset}} - 0.2$ / + $F_{\text{offset}} + 0.2$
NOTE 1: The transmitter shall be set a 4 dB below $P_{\text{CMAX_L,f,c}}$ at the minimum UL configuration specified in Table 7.3.2.3-3 with $P_{\text{CMAX_L,f,c}}$ defined in clause 6.2.4.				
NOTE 2: Reference measurement channel is specified in Annexes A.3.2 and A3.2 with one sided dynamic OCNG Pattern OP.1 FDD/TDD as described in Annex A.5.1.1/A.5.2.1.				
NOTE 3: The PREFSENS power level is specified in Table 7.3.2.3-1 and Table 7.3.2.3-2 for two and four antenna ports, respectively.				
NOTE 4: The F_{uw} (offset) is the frequency separation of the centre frequency of the carrier closest to the interferer and the centre frequency of the interferer and shall be further adjusted to $\lfloor F_{\text{interferer}} / 0.015 + 0.5 \rfloor 0.015 + 0.0075$ MHz to be offset from the sub-carrier raster.				

7.6A.4.0.2 Narrow band blocking for Intra-band non-contiguous CA

For intra-band non-contiguous carrier aggregation with $F_{\text{DL_low}} < 2700$ MHz and $F_{\text{UL_low}} < 2700$ MHz with one uplink carrier and two or more downlink sub-blocks, the narrow band blocking requirements are defined with the uplink configuration in accordance with Table 7.3A.0.2.2-1. For this uplink configuration, the UE shall meet the requirements for each sub-block as specified in subclauses 7.6.4 and 7.6A.4.0.1 for one component carrier and two component

carriers per sub-block, respectively. The requirements apply for in-gap and out-of-gap interferers while all downlink carriers are active.

The throughput of each carrier shall be $\geq 95\%$ of the maximum throughput of the reference measurement channels as specified in Annexes A.2.2, A.2.3, A.3.2, and A.3.3 (with one sided dynamic OCNG Pattern OP.1 FDD/TDD for the DL-signal as described in Annex A.5.1.1/A.5.2.1).

7.6A.4.0.3 Narrow band blocking for Inter-band CA

For inter-band carrier aggregation with one component carrier per operating band and the uplink assigned to one NR band, the narrow band blocking requirements are defined with the uplink active on the band(s) other than the band whose downlink is being tested. The UE shall meet the requirements specified in subclause 7.6.4 for each component carrier while all downlink carriers are active.

For the UE which supports inter-band CA configuration in Table 7.3A.0.3.2.1-1, P_{UW} power defined in Table 7.6.4.3-1 is increased by the amount given by $\Delta R_{\text{IB,c}}$ in Table 7.3A.0.3.2.1-1.

The throughput of each carrier shall be $\geq 95\%$ of the maximum throughput of the reference measurement channels as specified in Annexes A.2.2, A.2.3, A.3.2, and A.3.3 (with one sided dynamic OCNG Pattern OP.1 FDD/TDD for the DL-signal as described in Annex A.5.1.1/A.5.2.1).

The normative reference for this requirement is TS 38.101-1 [2] clause 7.6A.4.

7.6A.4.1 Narrow band blocking for CA (2DL CA)

7.6A.4.1.1 Test purpose

Verifies a receiver's ability to receive an NR signal at its assigned CA channel frequencies in the presence of an unwanted narrow band CW interferer at a frequency, which is less than the nominal channel spacing.

The lack of narrow-band blocking ability will decrease the coverage area when other e-NodeB transmitters exist (except in the adjacent channels and spurious response).

7.6A.4.1.2 Test applicability

This test case applies to all types of NR UE release 15 and forward that supports 2DL CA.

7.6A.4.1.3 Minimum conformance requirements

The minimum conformance requirements are defined in clause 7.6A.4.0.

7.6A.4.1.4 Test description

7.6A.4.1.4.1 Initial conditions

Initial conditions are a set of test configurations the UE needs to be tested in and the steps for the SS to take with the UE to reach the correct measurement state.

The initial test configurations consist of environmental conditions, test frequencies, test channel bandwidths and sub-carrier spacing based on NR CA configurations specified in clause 5.5A. All of these configurations shall be tested with applicable test parameters for each CA configuration, are shown in Table 7.6A.4.1.4.1-1, 7.6A.4.1.4.1-2 or 7.6A.4.1.4.1-3. The details of the uplink and downlink reference measurement channels (RMC) are specified in Annexes A.2 and A.3 respectively. The details of the OCNG patterns used are specified in Annex A.5. Configurations of PDSCH and PDCCH before measurement are specified in Annex C.2.

Table 7.6A.4.1.4.1-1: Test configuration table for Intra-band contiguous CA

Default Conditions					
Test Environment as specified in TS 38.508-1 [5] subclause 4.1			Normal		
Test Frequencies as specified in TS 38.508-1 [5] subclause 4.3.1			Mid range		
Test CC Combination setting (N_{RB_agg}) as specified in Table 5.5A.1-1 for the CA Configuration across bandwidth combination sets supported by the UE.			Highest N_{RB_agg} NOTE 3		
Test SCS as specified in Table 5.3.5-1			Lowest		
Test Parameters					
Test ID	Downlink Configuration			Uplink Configuration	
	CC Mod'n	PCC RB allocation	SCC RB allocation	CC Mod'n	PCC RB allocation
1	CP-OFDM QPSK	Full RB ¹	Full RB ¹	DFT-s-OFDM QPSK	REFSENS ²
NOTE 1: Full RB allocation shall be used per each SCS and channel BW as specified in Table 7.3.2.4.1-2.					
NOTE 2: REFSENS refers to the single carrier Uplink RB allocation for reference sensitivity according to Table 7.3.2.4.1-3.					
NOTE 3: If the UE supports multiple CC Combinations in the CA Configuration with the same N_{RB_agg} , only the combination with the highest N_{RB_PCC} is tested.					
NOTE 4: In a band where UE supports 4Rx, the test shall be performed only with 4Rx antennas ports connected and 4Rx REFSENS requirement (Table 7.3.2.5-2) is used in the test requirements.					

Table 7.6A.4.1.4.1-2: Test configuration table for Inter-band CA

Default Conditions					
Test Environment as specified in TS 38.508-1 [5] subclause 4.1			Normal		
Test Frequencies as specified in TS 38.508-1 [5] subclause 4.3.1			NOTE 4		
Test CC Combination setting (N_{RB_agg}) as specified in Table 5.5A.3.1-1 for the CA Configuration across bandwidth combination sets supported by the UE.			Highest N_{RB_agg} NOTE 5		
Test SCS as specified in Table 5.3.5-1			Lowest		
Test Parameters					
Test ID	Downlink Configuration			Uplink Configuration	
	CC Mod'n	PCC RB allocation	SCC RB allocation	CC Mod'n	PCC RB allocation
1	CP-OFDM QPSK	Full RB ¹	Full RB ¹	DFT-s-OFDM QPSK	REFSENS ²
NOTE 1: Full RB allocation shall be used per each SCS and channel BW as specified in Table 7.3.2.4.1-2.					
NOTE 2: REFSENS refers to the single carrier Uplink RB allocation for reference sensitivity according to Table 7.3.2.4.1-3.					
NOTE 3: In a band where UE supports 4Rx, the test shall be performed only with 4Rx antennas ports connected and 4Rx REFSENS requirement (Table 7.3.2.5-2) is used in the test requirements.					
NOTE 4: Test frequency is set to Mid Range PCC and SCC with exceptions defined in Table 7.3A.2.4.1-1. For NR band n28, 30MHz test channel bandwidth is tested with Low range test frequencies.					
NOTE 5: If the UE supports multiple CC Combinations in the CA Configuration with the same N_{RB_agg} , only the combination with the highest N_{RB_PCC} is tested.					

Table 7.6A.4.1.4.1-3: Test configuration table for Intra-band non-contiguous CA

Default Conditions					
Test Environment as specified in TS 38.508-1 [5] subclause 4.1			Normal		
Test Frequencies as specified in TS 38.508-1 [5] subclause 4.3.1			NOTE 1		
Test CC Combination setting (N_{RB_agg}) as specified in Table 5.5A.2-1 for the CA Configuration across bandwidth combination sets supported by the UE.			Highest N_{RB_agg} NOTE 1, NOTE 3		
Test SCS as specified in Table 5.3.5-1			Lowest		
Test Parameters					
Test ID	Downlink Configuration			Uplink Configuration	
	CC Mod'n	PCC RB allocation	SCC RB allocation	CC Mod'n	PCC RB allocation
1	CP-OFDM QPSK	NOTE 1	NOTE 1	DFT-s-OFDM QPSK	NOTE 1
NOTE 1: The specific configuration of uplink and downlink are defined in Table 7.3A.1.4.1-3.					
NOTE 2: In a band where UE supports 4Rx, the test shall be performed only with 4Rx antennas ports connected and 4Rx REFSENS requirement (Table 7.3.2.5-2) is used in the test requirements.					
NOTE 3: If the UE supports multiple CC Combinations in the CA Configuration with the same N_{RB_agg} , only the combination with the highest N_{RB_PCC} is tested.					

1. Connect the SS to the UE antenna connectors as shown in TS 38.508-1 [5] Annex A, Figure A.3.1.4.7 for TE diagram and section A.3.2 for UE diagram.
2. The parameter settings for the cell are set up according to TS 38.508-1 [5] subclause 4.4.3.
3. Downlink signals are initially set up according to Annex C.0, C.1, C.2, and C.3.1, and uplink signals according to Annex G.0, G.1, G.2, and G.3.1.
4. The DL and UL Reference Measurement Channels are set according to Table 7.6A.4.1.4.1-1, Table 7.6A.4.1.4.1-2 or Table 7.6A.4.1.4.1-3.
5. Propagation conditions are set according to Annex B.0.
6. Ensure the UE is in State RRC_CONNECTED with generic procedure parameters Connectivity *NR*, Connected without release *On*, Test Mode *On* and Test Loop Function *On* according to TS 38.508-1 [5] clause 4.5. Message contents are defined in clause 7.6A.4.1.4.3.

7.6A.4.1.4.2 Test procedure

1. Configure SCC according to Annex C.0, C.1, C.2 for all downlink physical channels.
2. The SS shall configure SCC as per TS 38.508-1 [5] clause 5.5.1. Message contents are defined in clause 7.6A.4.1.4.3.
3. SS activates SCC by sending the activation MAC CE (Refer TS 38.321 [18], clauses 5.9, 6.1.3.10). Wait for at least 2 seconds (Refer TS 38.133[19], clause 9.3).
4. SS transmits PDSCH via PDCCH DCI format 1_1 for C_RNTI to transmit the DL RMC according to Table 7.6A.4.1.4.1-1, 7.6A.4.1.4.1-2 or 7.6A.4.1.4.1-3 on both PCC and SCC. The SS sends downlink MAC padding bits on the DL RMC.
5. SS sends uplink scheduling information for each UL HARQ process via PDCCH DCI format 0_1 for C_RNTI to schedule the UL RMC according to Table 7.6A.4.1.4.1-1, 7.6A.4.1.4.1-2 or 7.6A.4.1.4.1-3 on PCC. Since the UE has no payload and no loopback data to send, the UE transmits uplink MAC padding bits on the UL RMC.
6. Set the parameters of the CW signal generator for an interfering signal below the CA Band for intra-band CA, or below the SCC's operating band for inter-band CA according to Table 7.6A.4.1.5.1-1 or 7.6A.4.1.5.3-1. For the UE which supports inter-band CA configuration in Table 7.3A.0.3.2.1-1, P_{UW} power defined in Table 7.6A.4.1.5.3-1 is increased by the amount given by $\Delta R_{IB,c}$ in Table 7.3A.0.3.2.1-1.
7. Set the downlink signal level for both carriers according to 7.6A.4.1.5.1-1 or 7.6A.1.4.5.3-1. Send uplink power control commands to the UE using 1dB power step size to ensure that the UE output power measured by the test

system is within the Uplink power control window, defined as $-(\text{MU} + \text{Uplink power control window size})$ dB of the target power level in Table 7.6A.4.1.5.1-1 or 7.6A.1.4.5.3-1 for at least the duration of the Throughput measurement, where:

- MU is the test system uplink power measurement uncertainty and is specified in Table F.1.3-1 for the carrier frequency f and the channel bandwidth BW
 - Uplink power control window size = 1dB (UE power step size) + 0.7dB (UE power step tolerance) + (Test system relative power measurement uncertainty), where, the UE power step tolerance is specified in TS 38.101-1 [2], Table 6.3.4.3-1 and is 0.7dB for 1dB power step size, and the Test system relative power measurement uncertainty is specified for test case 6.3.4.3 in Table F.1.2-1.
8. Measure the average throughput of SCC for a duration sufficient to achieve statistical significance according to Annex H.2A for inter-band CA. Measure the average throughput of both carriers for a duration sufficient to achieve statistical significance according to Annex H.2A for intra-band CA.
 9. Repeat steps from 6 to 8, using an interfering signal above the CA Band for intra-band CA, and between PCC's and SCC's wanted signal for intra-band non-contiguous CA, or above the SCC's operating band for inter-band CA at step 6.
 10. For Inter-band CA: Switch the SCell into PCell and repeat steps 1 to 9, except for operating bands without uplink band.

NOTE: The purpose of the Uplink power control window is to ensure that the actual UE output power is no greater than the target power level, and as close as possible to the target power level. The relationship between the Uplink power control window, the target power level and the corresponding possible actual UE Uplink power window is illustrated in Annex F.4.3.

7.6A.4.1.4.3 Message contents

Message contents are according to TS 38.508-1 [5] subclause 4.6 Table 4.6.3-118 with condition TRANSFORM_PRECODER_ENABLED.

7.6A.4.1.5 Test requirement

7.6A.4.1.5.1 Narrow band blocking for Intra-band contiguous CA

The throughput of each carrier shall be $\geq 95\%$ of the maximum throughput of the reference measurement channels as specified in Annexes A.2.2, A.2.3, A3.2 and A.3.3 (with one sided dynamic OCNB Pattern OP.1 FDD/TDD for the DL-signal as described in Annex A.5.1.1/A.5.2.1) with parameters specified in Table 7.6A.4.1.5.1-1.

Table 7.6A.4.1.5.1-1: Narrow-band blocking for intra-band contiguous CA

NR band	Parameter	Unit	NR CA bandwidth class	
			B	C
n41, n48, n66, n71	P_w in Transmission Bandwidth Configuration, per CC	dBm	REFSENS + NA CA Bandwidth Class specific value below	REFSENS + NA CA Bandwidth Class specific value below
	P_{uw} (CW)	dBm	-55	-55
	F_{uw} (offset for $\Delta f = 15$ kHz, 30 kHz)	MHz	- $F_{offset} - 0.2$ / + $F_{offset} + 0.2$	- $F_{offset} - 0.2$ / + $F_{offset} + 0.2$
NOTE 1: The transmitter shall be set a 4 dB below $P_{CMAX_L,f,c}$ at the minimum UL configuration specified in Table 7.3.2.3-3 with $P_{CMAX_L,f,c}$ defined in clause 6.2.4.				
NOTE 2: Reference measurement channel is specified in Annexes A.3.2 and A3.2 with one sided dynamic OCNB Pattern OP.1 FDD/TDD as described in Annex A.5.1.1/A.5.2.1.				
NOTE 3: The PREFSENS power level is specified in Table 7.3.2.3-1 and Table 7.3.2.3-2 for two and four antenna ports, respectively.				
NOTE 4: The F_{uw} (offset) is the frequency separation of the centre frequency of the carrier closest to the interferer and the centre frequency of the interferer and shall be further adjusted to $\lfloor F_{interferer} / 0.015 + 0.5 \rfloor 0.015 + 0.0075$ MHz to be offset from the sub-carrier raster.				
NOTE 5: The test requirement of configurations for CA operating band including Band n41 also apply for the corresponding CA operating bands with Band n90 replacing Band n41.				

7.6A.4.1.5.2 Narrow band blocking for Intra-band non-contiguous CA

For intra-band non-contiguous carrier aggregation with $F_{DL_low} < 2700$ MHz and $F_{UL_low} < 2700$ MHz with one uplink carrier and two downlink carriers, the narrow band blocking requirements are defined with the uplink configuration in accordance with Table 7.3A.0.2.2-1. The UE shall meet the requirements for each carrier as specified in subclause 7.6.4 for each component carrier respectively. The requirements apply for in-gap and out-of-gap interferers while all downlink carriers are active.

The throughput of each carrier shall be $\geq 95\%$ of the maximum throughput of the reference measurement channels as specified in Annexes A.2.2, A.2.3, A.3.2, and A.3.3 (with one sided dynamic OCNG Pattern OP.1 FDD/TDD for the DL-signal as described in Annex A.5.1.1/A.5.2.1) with parameters specified in Table 7.6A.4.1.5.3-1. The test requirement of configurations for CA operating band including Band n41 also apply for the corresponding CA operating bands with Band n90 replacing Band n41.

7.6A.4.1.5.3 Narrow band blocking for Inter-band CA

For inter-band carrier aggregation with one component carrier per operating band and the uplink assigned to one NR band, the narrow band blocking requirements are defined with the uplink active on the band(s) other than the band whose downlink is being tested, i.e. the requirements are tested only for the SCell downlink.

The throughput of each carrier, when operated as SCC, shall be $\geq 95\%$ of the maximum throughput of the reference measurement channels as specified in Annexes A.2.2, A.2.3, A.3.2, and A.3.3 (with one sided dynamic OCNG Pattern OP.1 FDD/TDD for the DL-signal as described in Annex A.5.1.1/A.5.2.1) with parameters specified in Table 7.6A.4.1.5.3-1. The test requirement of configurations for CA operating band including Band n41 also apply for the corresponding CA operating bands with Band n90 replacing Band n41.

Table 7.6A.4.1.5.3-1: Narrow-band blocking

NR band	Parameter	Unit	Channel Bandwidth											
			5 MHz	10 MHz	15 MHz	20 MHz	25 MHz	30 MHz	40 MHz	50 MHz	60 MHz	80 MHz	90 MHz	100 MHz
n1, n2, n3, n5, n7, n8, n12, n20, n25	P_w	dBm	P _{REFSENS} + channel-bandwidth specific value below											
			16	13	14	16	16	16	16	16	16	16	16	16
n1, n2, n3, n5, n7, n8, n12, n20, n25	P_{UW} (CW)	dBm	-55	-55	-55	-55	-55	-55	-55	-55	-55	-55	-55	-55
			2.707	5.212	7.702	10.20	13.02	15.60	20.55	25.70	NA	NA	NA	NA
n28, n34, n38, n39, n40, n41, n48, n50, n51, n66, n70, n71, n74, n75, n76	F_{UW} (offset SCS= 30 kHz)	MHz	NA	NA	NA	NA	NA	NA	NA	NA	30.85	40.93	45.91	50.86
											5	5	5	5

NOTE 1: The transmitter shall be set a 4 dB below $P_{CMAX_L,f,c}$ at the minimum UL configuration specified in Table 7.3.2.3-3 with $P_{CMAX_L,f,c}$ defined in clause 6.2.4

NOTE 2: Reference measurement channel is specified in Annexes A.3.2 and A.3.3 with one sided dynamic OCNG Pattern OP.1 FDD/TDD as described in Annex A.5.1.1/A.5.2.1.

For the UE which supports inter-band CA configuration in Table 7.3A.0.3.2.1-1, P_{UW} power defined in Table 7.6A.4.1.5.3-1 is increased by the amount given by $\Delta R_{IB,c}$ in Table 7.3A.0.3.2.1-1.

7.6A.4.2 Narrow band blocking for CA (3DL CA)

7.6A.4.2.1 Test purpose

Verifies a receiver's ability to receive an NR signal at its assigned CA channel frequencies in the presence of an unwanted narrow band CW interferer at a frequency, which is less than the nominal channel spacing.

The lack of narrow-band blocking ability will decrease the coverage area when other e-NodeB transmitters exist (except in the adjacent channels and spurious response).

7.6A.4.2.2 Test applicability

This test case applies to all types of NR UE release 15 and forward that supports 3DL CA.

7.6A.4.2.3 Minimum conformance requirements

The minimum conformance requirements are defined in clause 7.6A.4.0.

7.6A.4.2.4 Test description

7.6A.4.2.4.1 Initial conditions

Initial conditions are a set of test configurations the UE needs to be tested in and the steps for the SS to take with the UE to reach the correct measurement state.

The initial test configurations consist of environmental conditions, test frequencies, test channel bandwidths and sub-carrier spacing based on NR CA configurations specified in clause 5.5A. All of these configurations shall be tested with applicable test parameters for each CA configuration, are shown in Table 7.6A.4.2.4.1-1. The details of the uplink and downlink reference measurement channels (RMC) are specified in Annexes A.2 and A.3 respectively. The details of the OCNG patterns used are specified in Annex A.5. Configurations of PDSCH and PDCCH before measurement are specified in Annex C.2.

Table 7.6A.4.2.4.1-1: Test configuration table for 3DL CA

Default Conditions					
Test Environment as specified in TS 38.508-1 [5] subclause 4.1			Normal		
Test Frequencies as specified in TS 38.508-1 [5] subclause 4.3.1			Inter-band : NOTE 5 Intra-band contiguous + Inter-band: NOTE 5 Intra-band non-contiguous + Inter-band: MaxWGap for Intra-band non-contiguous (NOTE 5)		
Test CC Combination setting (N_{RB_agg}) as specified in Tables 5.5A.1-1, 5.5A.2-1, or tables in clauses 5.5A.3.x for the CA Configuration across bandwidth combination sets supported by the UE.			Highest N_{RB_agg} NOTE 3		
Test SCS as specified in Table 5.3.5-1			Lowest		
Test Parameters					
Test ID	Downlink Configuration			Uplink Configuration	
	CC Mod'n	PCC RB allocation	SCCs RB allocation	CC Mod'n	PCC RB allocation
1	CP-OFDM QPSK	NOTE 1	NOTE 1	DFT-s-OFDM QPSK	NOTE 1
NOTE 1: The specific configuration of uplink and downlink are defined in Table 7.3A.2.4.1-1.					
NOTE 2: Void.					
NOTE 3: If the UE supports multiple CC Combinations in the CA Configuration with the same N_{RB_agg} , only the combination with the highest N_{RB_PCC} is tested.					
NOTE 4: In a band where UE supports 4Rx, the test shall be performed only with 4Rx antennas ports connected and 4Rx REFSSENS requirement (Table 7.3.2.5-2) is used in the test requirements.					
NOTE 5: Test frequency is set to Mid Range PCC and SCC with exceptions defined in Table 7.3A.2.4.1-1. For NR band n28, 30MHz test channel bandwidth is tested with Low range test frequencies.					

1. Connect the SS to the UE antenna connectors as shown in TS 38.508-1 [5] Annex A, Figure A.3.1.4.7 for TE diagram and section A.3.2 for UE diagram.
2. The parameter settings for the cell are set up according to TS 38.508-1 [5] subclause 4.4.3.

3. Downlink signals are initially set up according to Annex C.0, C.1, C.2, and C.3.1, and uplink signals according to Annex G.0, G.1, G.2, and G.3.1.
4. The DL and UL Reference Measurement Channels are set according to Table 7.6A.4.2.4.1-1 or Table 7.6A.4.2.4.1-2.
5. Propagation conditions are set according to Annex B.0.
6. Ensure the UE is in State RRC_CONNECTED with generic procedure parameters Connectivity *NR*, Connected without release *On*, Test Mode *On* and Test Loop Function *On* according to TS 38.508-1 [5] clause 4.5. Message contents are defined in clause 7.6A.4.2.4.3.

7.6A.4.2.4.2 Test procedure

1. Configure SCCs according to Annex C.0, C.1, C.2 for all downlink physical channels.
2. The SS shall configure SCCs as per TS 38.508-1 [5] clause 5.5.1. Message contents are defined in clause 7.6A.4.2.4.3.
3. SS activates SCCs by sending the activation MAC CE (Refer TS 38.321 [18], clauses 5.9, 6.1.3.10). Wait for at least 2 seconds (Refer TS 38.133[19], clause 9.3).
4. SS transmits PDSCH via PDCCH DCI format 1_1 for C_RNTI to transmit the DL RMC according to Table 7.6A.4.2.4.1-1 on both PCC and SCCs. The SS sends downlink MAC padding bits on the DL RMC.
5. SS sends uplink scheduling information for each UL HARQ process via PDCCH DCI format 0_1 for C_RNTI to schedule the UL RMC according to Table 7.6A.4.2.4.1-1 on PCC. Since the UE has no payload and no loopback data to send, the UE transmits uplink MAC padding bits on the UL RMC.
6. Set the parameters of the CW signal generator for an interfering signal below each SCC's operating band for inter-band CA according to Table 7.6A.4.2.5.1-1. For the UE which supports inter-band CA configuration in Table 7.3A.0.3.2.1-1, P_{UW} power defined in Table 7.6A.4.2.5.1-1 is increased by the amount given by $\Delta R_{IB,c}$ in Table 7.3A.0.3.2.1-1.
7. Set the downlink signal level for all carriers according to Table 7.6A.4.2.5.1-1. Send uplink power control commands to the UE using 1dB power step size to ensure that the UE output power measured by the test system is within the Uplink power control window, defined as $-(MU)$ to $-(MU + \text{Uplink power control window size})$ dB of the target power level in Table 7.6A.4.2.5.1-1 for at least the duration of the Throughput measurement, where:
 - MU is the test system uplink power measurement uncertainty and is specified in Table F.1.3-1 for the carrier frequency f and the channel bandwidth BW
 - Uplink power control window size = 1dB (UE power step size) + 0.7dB (UE power step tolerance) + (Test system relative power measurement uncertainty), where, the UE power step tolerance is specified in TS 38.101-1 [2], Table 6.3.4.3-1 and is 0.7dB for 1dB power step size, and the Test system relative power measurement uncertainty is specified for test case 6.3.4.3 in Table F.1.2-1.
8. Measure the average throughput of SCCs for a duration sufficient to achieve statistical significance according to Annex H.2A for inter-band CA.
9. Repeat steps from 6 to 8, using an interfering signal above each SCC's operating band for inter-band CA at step 6.
10. For Inter-band CA: Switch the SCell into PCell as per corresponding test IDs defined in Table 7.3A.2.4.1-1 and repeat steps 1 to 9, except for operating bands without uplink band.

NOTE: The purpose of the Uplink power control window is to ensure that the actual UE output power is no greater than the target power level, and as close as possible to the target power level. The relationship between the Uplink power control window, the target power level and the corresponding possible actual UE Uplink power window is illustrated in Annex F.4.3.

7.6A.4.2.4.3 Message contents

Message contents are according to TS 38.508-1 [5] subclause 4.6 Table 4.6.3-118 with condition TRANSFORM_PRECODER_ENABLED.

7.6A.4.2.5 Test requirement

7.6A.4.2.5.1 Narrow band blocking for Inter-band CA

For inter-band carrier aggregation with one component carrier per operating band and the uplink assigned to one NR band, the narrow band blocking requirements are defined with the uplink active on the band(s) other than the band whose downlink is being tested, i.e. the requirements are tested only for the SCell downlink.

The throughput of each carrier, when operated as SCC, shall be $\geq 95\%$ of the maximum throughput of the reference measurement channels as specified in Annexes A.2.2, A.2.3, A.3.2, and A.3.3 (with one sided dynamic OCNG Pattern OP.1 FDD/TDD for the DL-signal as described in Annex A.5.1.1/A.5.2.1) with parameters specified in Table 7.6A.4.2.5.1-1. The test requirement of configurations for CA operating band including Band n41 also apply for the corresponding CA operating bands with Band n90 replacing Band n41.

Table 7.6A.4.2.5.1-1: Narrow-band blocking

NR band	Parameter	Unit	Channel Bandwidth											
			5 MHz	10 MHz	15 MHz	20 MHz	25 MHz	30 MHz	40 MHz	50 MHz	60 MHz	80 MHz	90 MHz	100 MHz
n1, n2, n3, n5, n7, n8, n12, n20, n25	P _w	dBm	P _{REFSENS} + channel-bandwidth specific value below											
			16	13	14	16	16	16	16	16	16	16	16	16
n5, n7, n8, n12, n20, n25	P _{uw} (CW)	dBm	-55	-55	-55	-55	-55	-55	-55	-55	-55	-55	-55	-55
			2.7075	5.2125	7.7025	10.2075	13.0275	15.6075	20.5575	25.7025	NA	NA	NA	NA
n28, n34, n38, n39, n40, n41, n48, n50, n51, n66, n70, n71, n74, n75, n76	F _{uw} (offset SCS= 30 kHz)	MHz	NA	NA	NA	NA	NA	NA	NA	NA	30.855	40.935	45.915	50.865

NOTE 1: The transmitter shall be set a 4 dB below P_{CMAX_L,f,c} at the minimum UL configuration specified in Table 7.3.2.3-3 with P_{CMAX_L,f,c} defined in clause 6.2.4

NOTE 2: Reference measurement channel is specified in Annexes A.3.2 and A.3.3 with one sided dynamic OCNG Pattern OP.1 FDD/TDD as described in Annex A.5.1.1/A.5.2.1.

For the UE which supports inter-band CA configuration in Table 7.3A.0.3.2.1-1, P_{uw} power defined in Table 7.6A.4.2.5.1-1 is increased by the amount given by ΔR_{IB,c} in Table 7.3A.0.3.2.1-1.

7.6A.4.3 Narrow band blocking for CA (4DL CA)

7.6A.4.3.1 Test purpose

Verifies a receiver's ability to receive an NR signal at its assigned CA channel frequencies in the presence of an unwanted narrow band CW interferer at a frequency, which is less than the nominal channel spacing.

The lack of narrow-band blocking ability will decrease the coverage area when other e-NodeB transmitters exist (except in the adjacent channels and spurious response).

7.6A.4.3.2 Test applicability

This test case applies to all types of NR UE release 15 and forward that supports 4DL CA.

7.6A.4.3.3 Minimum conformance requirements

The minimum conformance requirements are defined in clause 7.6A.4.0.

7.6A.4.3.4 Test description

7.6A.4.3.4.1 Initial conditions

Initial conditions are a set of test configurations the UE needs to be tested in and the steps for the SS to take with the UE to reach the correct measurement state.

The initial test configurations consist of environmental conditions, test frequencies, test channel bandwidths and sub-carrier spacing based on NR CA configurations specified in clause 5.5A. All of these configurations shall be tested with applicable test parameters for each CA configuration, are shown in Table 7.6A.4.3.4.1-1. The details of the uplink and downlink reference measurement channels (RMC) are specified in Annexes A.2 and A.3 respectively. The details of the OCNG patterns used are specified in Annex A.5. Configurations of PDSCH and PDCCH before measurement are specified in Annex C.2.

Table 7.6A.4.3.4.1-1: Test configuration table for 4DL CA

Default Conditions					
Test Environment as specified in TS 38.508-1 [5] subclause 4.1		Normal			
Test Frequencies as specified in TS 38.508-1 [5] subclause 4.3.1		Inter-band : NOTE 5 Intra-band contiguous + Inter-band: NOTE 5 Intra-band non-contiguous + Inter-band: MaxWGap for Intra-band non-contiguous (NOTE 5) Intra-band non-contiguous + Intra-band non-contiguous: MaxWGap for Intra-band non-contiguous (NOTE 5)			
Test CC Combination setting (N_{RB_agg}) as specified in Tables 5.5A.1-1, 5.5A.2-1, or tables in clauses 5.5A.3.x for the CA Configuration across bandwidth combination sets supported by the UE.		Highest N_{RB_agg} NOTE 3			
Test SCS as specified in Table 5.3.5-1		Lowest			
Test Parameters					
Test ID	Downlink Configuration			Uplink Configuration	
	CC Mod'n	PCC RB allocation	SCCs RB allocation	CC Mod'n	PCC RB allocation
1	CP-OFDM QPSK	NOTE 1	NOTE 1	DFT-s-OFDM QPSK	NOTE 1
NOTE 1: The specific configuration of uplink and downlink are defined in Table 7.3A.3.4.1-1. NOTE 2: Void. NOTE 3: If the UE supports multiple CC Combinations in the CA Configuration with the same N_{RB_agg} , only the combination with the highest N_{RB_PCC} is tested. NOTE 4: In a band where UE supports 4Rx, the test shall be performed only with 4Rx antennas ports connected and 4Rx REFSSENS requirement (Table 7.3.2.5-2) is used in the test requirements. NOTE 5: Test frequency is set to Mid Range PCC and SCC with exceptions defined in Table 7.3A.2.4.1-1. For NR band n28, 30MHz test channel bandwidth is tested with Low range test frequencies.					

1. Connect the SS to the UE antenna connectors as shown in TS 38.508-1 [5] Annex A, Figure A.3.1.4.7 for TE diagram and section A.3.2 for UE diagram.
2. The parameter settings for the cell are set up according to TS 38.508-1 [5] subclause 4.4.3.
3. Downlink signals are initially set up according to Annex C.0, C.1, C.2, and C.3.1, and uplink signals according to Annex G.0, G.1, G.2, and G.3.1.
4. The DL and UL Reference Measurement Channels are set according to Table 7.6A.4.3.4.1-1 or Table 7.6A.4.3.4.1-2.
5. Propagation conditions are set according to Annex B.0.
6. Ensure the UE is in State RRC_CONNECTED with generic procedure parameters Connectivity NR, Connected without release On, Test Mode On and Test Loop Function On according to TS 38.508-1 [5] clause 4.5. Message contents are defined in clause 7.6A.4.3.4.3.

7.6A.4.3.4.2 Test procedure

1. Configure SCCs according to Annex C.0, C.1, C.2 for all downlink physical channels.
2. The SS shall configure SCCs as per TS 38.508-1 [5] clause 5.5.1. Message contents are defined in clause 7.6A.4.3.4.3.
3. SS activates SCCs by sending the activation MAC CE (Refer TS 38.321 [18], clauses 5.9, 6.1.3.10). Wait for at least 2 seconds (Refer TS 38.133[19], clause 9.3).
4. SS transmits PDSCH via PDCCH DCI format 1_1 for C_RNTI to transmit the DL RMC according to Table 7.6A.4.3.4.1-1 on both PCC and SCCs. The SS sends downlink MAC padding bits on the DL RMC.
5. SS sends uplink scheduling information for each UL HARQ process via PDCCH DCI format 0_1 for C_RNTI to schedule the UL RMC according to Table 7.6A.4.3.4.1-1 on PCC. Since the UE has no payload and no loopback data to send, the UE transmits uplink MAC padding bits on the UL RMC.
6. Set the parameters of the CW signal generator for an interfering signal below each SCC's operating band for inter-band CA according to Table 7.6A.4.3.5.1-1. For the UE which supports inter-band CA configuration in Table 7.3A.0.3.2.1-1, P_{UW} power defined in Table 7.6A.4.3.5.1-1 is increased by the amount given by $\Delta R_{IB,c}$ in Table 7.3A.0.3.2.1-1.
7. Set the downlink signal level for all carriers according to Table 7.6A.4.3.5.1-1. Send uplink power control commands to the UE using 1dB power step size to ensure that the UE output power measured by the test system is within the Uplink power control window, defined as $-MU$ to $-(MU + \text{Uplink power control window size})$ dB of the target power level in Table 7.6A.4.3.5.1-1 for at least the duration of the Throughput measurement, where:
 - MU is the test system uplink power measurement uncertainty and is specified in Table F.1.3-1 for the carrier frequency f and the channel bandwidth BW
 - Uplink power control window size = 1dB (UE power step size) + 0.7dB (UE power step tolerance) + (Test system relative power measurement uncertainty), where, the UE power step tolerance is specified in TS 38.101-1 [2], Table 6.3.4.3-1 and is 0.7dB for 1dB power step size, and the Test system relative power measurement uncertainty is specified for test case 6.3.4.3 in Table F.1.2-1.
8. Measure the average throughput of SCCs for a duration sufficient to achieve statistical significance according to Annex H.2A for inter-band CA.
9. Repeat steps from 6 to 8, using an interfering signal above each SCC's operating band for inter-band CA at step 6.
10. For Inter-band CA: Switch the SCell into PCell as per corresponding test IDs defined in Table 7.3A.3.4.1-1 and repeat steps 1 to 9, except for operating bands without uplink band.

NOTE: The purpose of the Uplink power control window is to ensure that the actual UE output power is no greater than the target power level, and as close as possible to the target power level. The relationship between the Uplink power control window, the target power level and the corresponding possible actual UE Uplink power window is illustrated in Annex F.4.3.

7.6A.4.3.4.3 Message contents

Message contents are according to TS 38.508-1 [5] subclause 4.6 Table 4.6.3-118 with condition TRANSFORM_PRECODER_ENABLED.

7.6A.4.3.5 Test requirement

7.6A.4.3.5.1 Narrow band blocking for Inter-band CA

For inter-band carrier aggregation with one component carrier per operating band and the uplink assigned to one NR band, the narrow band blocking requirements are defined with the uplink active on the band(s) other than the band whose downlink is being tested, i.e. the requirements are tested only for the SCell downlink.

The throughput of each carrier, when operated as SCC, shall be $\geq 95\%$ of the maximum throughput of the reference measurement channels as specified in Annexes A.2.2, A.2.3, A.3.2, and A.3.3 (with one sided dynamic OCNG Pattern OP.1 FDD/TDD for the DL-signal as described in Annex A.5.1.1/A.5.2.1) with parameters specified in Table

7.6A.4.3.5.1-1. The test requirement of configurations for CA operating band including Band n41 also apply for the corresponding CA operating bands with Band n90 replacing Band n41.

Table 7.6A.4.3.5.1-1: Narrow-band blocking

NR band	Parameter	Unit	Channel Bandwidth											
			5 MHz	10 MHz	15 MHz	20 MHz	25 MHz	30 MHz	40 MHz	50 MHz	60 MHz	80 MHz	90 MHz	100 MHz
n1, n2, n3, n5, n7, n8, n12, n20, n25	P_w	dBm	P _{REFSENS} + channel-bandwidth specific value below											
			16	13	14	16	16	16	16	16	16	16	16	16
n7, n8, n12, n20, n25	P_{UW} (CW)	dBm	-55	-55	-55	-55	-55	-55	-55	-55	-55	-55	-55	-55
			2.707 5	5.212 5	7.702 5	10.20 75	13.02 75	15.60 75	20.55 75	NA	NA	NA	NA	NA
n28, n34, n38, n39, n40, n41, n50, n51, n66, n70, n71, n74, n75, n76	F_{UW} (offset SCS= 30 kHz)	MHz	NA	NA	NA	NA	NA	NA	NA	25.70 25	30.85 5	40.93 5	45.91 5	50.86 5

NOTE 1: The transmitter shall be set a 4 dB below P_{C_{MAX}_L,f,c} at the minimum UL configuration specified in Table 7.3.2.3-3 with P_{C_{MAX}_L,f,c} defined in clause 6.2.4

NOTE 2: Reference measurement channel is specified in Annexes A.3.2 and A.3.3 with one sided dynamic OCNG Pattern OP.1 FDD/TDD as described in Annex A.5.1.1/A.5.2.1.

For the UE which supports inter-band CA configuration in Table 7.3A.0.3.2.1-1, P_{UW} power defined in Table 7.6A.4.3.5.1-1 is increased by the amount given by $\Delta R_{IB,c}$ in Table 7.3A.0.3.2.1-1.

7.6C Blocking characteristics for SUL

7.6C.1 General

7.6C.2 In-band blocking for SUL

7.6C.2.1 Test purpose

Same test purpose as in clause 7.6.2.1.

7.6C.2.2 Test applicability

This test applies to all types of NR UE release 15 and forward that support SUL operating on the SUL bands.

7.6C.2.3 Minimum conformance requirements

For SUL operation, the in-band blocking requirement for downlink bands specified in clause 7.6.2.3 shall be met.

The normative reference for this requirement is TS 38.101-1 [2] clauses 7.6C.2.

7.6C.2.4 Test description

Same test description as specified in clause 7.6.2.4 with following exceptions:

Instead of table 5.3.5-1 → use Table 5.5C-1

Instead of table 7.6.2.4.1-1 → use Table 7.6C.2.4-1.

Table 7.6C.2.4-1: Test Configuration Table

Default Conditions					
Test Environment as specified in TS 38.508-1 [5] subclause 4.1			Normal		
Test Frequencies as specified in TS 38.508-1 [5] subclause 4.3.1			Mid range for both SUL carrier and Non-SUL carrier		
Test Channel Bandwidths as specified in TS 38.508-1 [5] subclause 4.3.1			Lowest, Mid, Highest for Non-SUL carrier For SUL band: n80: 30 MHz n81: 20 MHz n82: 20 MHz n83: 20 MHz n84: 20 MHz n86: 40 MHz n95: 15 MHz		
Test SCS as specified in Table 5.3.5-1			15kHz for SUL carrier and lowest SCS for Non-SUL carrier		
Test Parameters					
Test ID	DL Configuration		UL Configuration	SUL Configuration	
	Mod'n	RB allocation		Mod'n	RB allocation
1	CP-OFDM QPSK	Full RB (NOTE 1)	N/A	DFT-s-OFDM QPSK	REFSENS (NOTE 1)
NOTE 1: The specific configuration of SUL and DL are defined in Table 7.3C.2.4.1-1. NOTE 2: Test Channel Bandwidths are checked separately for each SUL band combination, the applicable channel bandwidths are specified in Table 5.5C-1. NOTE 3: DFT-s-OFDM PI/2 BPSK test applies only for UEs which supports half Pi BPSK in FR1. NOTE 4: In a band where UE supports 4Rx, the test shall be performed only with 4Rx antennas ports connected and 4Rx REFSENS requirement (Table 7.3.2.5-2) is used in the test requirements.					

- Connect the SS to the UE antenna connectors as shown in TS 38.508-1 [5] Annex A, Figure A.3.1.4.8 for TE diagram and section A.3.2 for UE diagram.
- The parameter setting for the cell are set up according to the TS 38.508-1 [5] subclause 4.4.3.
- Downlink signals are initially setup according to Annex C.0, C.1, C.2 and uplink signals according to Annex G.0, G.1, G.2, and G.3.0 with consideration of supplementary uplink physical channels.

Message contents in initial conditions are according to TS 38.508-1 [5] subclause 4.3.6.1.1.2 ensuring UL/SUL indicator in Table 4.3.6.1.1.2-1 with condition SUL, subclause 4.6 ensuring Tables 4.6.1-28 with condition SUL AND (RF OR RRM), 4.6.3-14 with condition SUL_SUL for SUL carrier, and Table 4.6.3-167 with condition PUSCH_PUCCH_ON_SUL, additionally the following exception shown in Table 7.6C.2.4-2 is considered.

Table 7.6C.2.4-2: PUSCH-Config

Derivation Path: TS 38.508-1 [5], Table 4.6.3-118 with condition TRANSFORM_PRECODER_ENABLED

Table 7.6C.2.4-3: Void

7.6C.2.5 Test requirement

Same test requirement specified in clause 7.6.2.5 for downlink bands shall be met for in-band blocking testing for SUL.

7.6C.2_1 Inband Blocking for SUL with DL CA

7.6C.2_1.1 Inband Blocking for SUL with 2 DL CA

Editor’s Note: No test points defined for Inband Blocking for SUL with inter-band 2 DL CA testing. The testing is covered by 7.6.2 and 7.6C.2.

7.6C.2_1.1.1 Test purpose

Same test purpose as in clause 7.6A.2.1.

7.6C.2_1.1.2 Test applicability

This test applies to all types of NR UE release 15 and forward that support SUL operating on the SUL bands and intra-band contiguous 2DL CA.

7.6C.2_1.1.3 Minimum conformance requirements

For SUL operation with downlink CA, the in-band blocking requirement for downlink bands specified in clause 7.6A.2.0 shall be met.

The normative reference for this requirement is TS 38.101-1 [2] clauses 7.6C.2.

7.6C.2_1.1.4 Test description

7.6C.2_1.1.4.1 Initial conditions

Initial conditions are a set of test configurations the UE needs to be tested in and the steps for the SS to take with the UE to reach the correct measurement state.

The initial test configurations consist of environmental conditions, test frequencies, test channel bandwidths and sub-carrier spacing based on NR CA configuration specified in clause 5.5A. All of these configurations shall be tested with applicable test parameters for each SUL configuration, are shown in Table 7.6C.2_1.1.4.1-1 for SUL with intra-band contiguous DL CA or Table 7.6C.2_1.1.4.1-2 for SUL with inter-band DL CA. The details of the uplink and downlink reference measurement channels (RMC) are specified in Annexes A.2 and A.3. Configuration of PDSCH and PDCCH before measurement are specified in Annex C.2.

Table 7.6C.2_1.1.4.1-1: Test configuration table for SUL configuration with Intra-band contiguous CA

Default Conditions						
Test Environment as specified in TS 38.508-1 [5] subclause 4.1			Normal			
Test Frequencies as specified in TS 38.508-1 [5] subclause 4.3.1			Mid range for both SUL carrier and Non-SUL carrier			
Test Channel Bandwidths as specified in TS 38.508-1 [5] subclause 4.3.1			Highest N_{RB_agg} for downlink bands For SUL band: n80: 30 MHz n81: 20 MHz n82: 20 MHz n83: 20 MHz n84: 20 MHz n86: 40 MHz n95: 15 MHz			
Test SCS as specified in Table 5.3.5-1			15kHz for SUL carrier and lowest for Non-SUL carrier			
Test Parameters						
Test ID	Downlink Configuration			Uplink Configuration	SUL Configuration	
	CC Mod'n	PCC RB allocation	SCC RB allocation		CC Mod'n	PCC RB allocation
1	CP-OFDM QPSK	NOTE 1	NOTE 1	N/A	DFT-s-OFDM QPSK	NOTE 2
NOTE 1: The specific downlink configuration is defined in Table 7.3A.1.4.1-1.						
NOTE 2: The specific SUL configuration is defined in Table 7.3C.2.4.1-1a.						
NOTE 3: In a band where UE supports 4Rx, the test shall be performed only with 4Rx antennas ports connected and 4Rx REFSSENS requirement (Table 7.3.2.5-2) is used in the test requirements.						

For SUL configuration with inter-band DL CA: No testing need to be performed since the testing has been covered in test case 7.6.2 and 7.6C.2. For band combination CA_nX_SUL_nY-nZ, test the inband blocking of SUL configuration or NR band as listed in Table 7.6C.2_1.1.4.1-2.

Table 7.6C.2_1.1.4.1-2: Test band combinations and configuration

Band configuration	Verifying in-band blocking of SUL configurations/ NR band	Subtest case	Table with test parameters to select
CA_n1A_SUL_n78A-n80A	SUL_n78-n80	7.6C.2	Table 7.6C.2.4-1
	n1	7.6.2	Table 7.6.2.4.1-1
CA_n1A_SUL_n78A-n84A	SUL_n78-n84	7.6C.2	Table 7.6C.2.4-1
	n1	7.6.2	Table 7.6.2.4.1-1
CA_n3A_SUL_n78A-n80A	SUL_n78-n80	7.6C.2	Table 7.6C.2.4-1
	n3	7.6.2	Table 7.6.2.4.1-1
CA_n28A_SUL_n41A-n83A	SUL_n41-n83	7.6C.2	Table 7.6C.2.4-1
	n28	7.6.2	Table 7.6.2.4.1-1
CA_n28A_SUL_n79A-n83A	SUL_n79A-n83A	7.6C.2	Table 7.6C.2.4-1
	n28	7.6.2	Table 7.6.2.4.1-1

- Connect the SS to the UE antenna connectors as shown in TS 38.508-1 [5] Annex A, Figure A.3.1.4.10 for TE diagram and section A.3.2 for UE diagram.
- The parameter setting for the cell are set up according to the TS 38.508-1 [5] subclause 4.4.3.
- Downlink signals are initially setup according to Annex C.0, C.1, C.2 and uplink signals according to Annex G.0, G.1, G.2, and G.3.0 with consideration of supplementary uplink physical channels.

Message contents in initial conditions are according to TS 38.508-1 [5] subclause 4.3.6.1.1.2 ensuring UL/SUL indicator in Table 4.3.6.1.1.2-1 with condition SUL, subclause 4.6 ensuring Tables 4.6.1-28 with condition SUL AND (RF OR RRM), 4.6.3-14 with condition SUL_SUL for SUL carrier, and Table 4.6.3-167 with condition PUSCH_PUCCH_ON_SUL, additionally the following exception shown in Table 7.6C.2_1.1.4.1-3 is considered.

Table 7.6C.2_1.1.4.1-3: PUSCH-Config

Derivation Path: TS 38.508-1 [5], Table 4.6.3-118 with condition TRANSFORM_PRECODER_ENABLED

7.6C.2_1.1.4.2 Test procedure

For SUL configuration with intra-band contiguous DL CA:

1. Configure SCC according to Annex C.0, C.1, C.2 for all downlink physical channels.
2. The SS shall configure SCC as per TS 38.508-1 [5] clause 5.5.1. Message contents are defined in clause 7.6C.2_1.1.4.1.
3. SS activates SCC by sending the activation MAC CE (Refer TS 38.321 [18], clauses 5.9, 6.1.3.10). Wait for at least 2 seconds (Refer TS 38.133[19], clause 9.3).
4. SS transmits PDSCH via PDCCH DCI format 1_1 for C_RNTI to transmit the DL RMC according to Table 7.6C.2_1.1.4.1-1 on both SCC and PCC. The SS sends downlink MAC padding bits on the DL RMC.
5. SS sends uplink scheduling information for each UL HARQ process via PDCCH DCI format 0_1 for C_RNTI to schedule the UL RMC according to Table 7.6C.2_1.1.4.1-1 on SUL. Since the UL has no payload and no loopback data to send the UE sends uplink MAC padding bits on the UL RMC.
6. Set the parameters of the signal generator for an interfering signal below the aggregated component carriers in Case 1 according to Tables 7.6A.2.1.5.1-1 and 7.6A.2.1.5.1-2 or Tables 7.6A.2.1.5.1-1a and 7.6A.2.1.5.1-2a as appropriate depending on NR band.
7. Set the downlink signal level on both carriers according to the Table 7.6A.2.1.5.1-1, 7.6A.2.1.5.1-1a or 7.6A.2.1.5.3-1, 7.6A.2.1.5.3-1a as appropriate. Send uplink power control commands to the UE using 1dB power step size to ensure that the UE output power measured by the test system is within the Uplink power control window, defined as $-MU$ to $-(MU + \text{Uplink power control window size})$ dB of the target power level in Table 7.6A.2.1.5.1-1, 7.6A.2.1.5.1-1a or 7.6A.2.1.5.3-1, 7.6A.2.1.5.3-1a for at least the duration of the Throughput measurement, where:
 - MU is the test system uplink power measurement uncertainty and is specified in Table F.1.3-1 for the carrier frequency f and the channel bandwidth BW

- Uplink power control window size = 1dB (UE power step size) + 0.7dB (UE power step tolerance) + (Test system relative power measurement uncertainty), where, the UE power step tolerance is specified in TS 38.101-1 [2], Table 6.3.4.3-1 and is 0.7dB for 1dB power step size, and the Test system relative power measurement uncertainty is specified for test case 6.3.4.3 in Table F.1.2-1.
8. Measure the average throughput of both carriers for a duration sufficient to achieve statistical significance according to Annex H.2A.
 9. Repeat steps from 6 to 8, using an interfering signal above the wanted signal in Case 1 at step 6.
 10. Repeat steps from 6 to 9, using interfering signals in Case 2 at step 6 and 9. The ranges of case 2 are covered in steps equal to the interferer bandwidth.
 12. Repeat steps from 6 to 10, using interfering signals in Case 3 as applicable at step 6 and 9. The ranges of case 3 are covered in steps equal to the interferer bandwidth.

NOTE: The purpose of the Uplink power control window is to ensure that the actual UE output power is no greater than the target power level, and as close as possible to the target power level. The relationship between the Uplink power control window, the target power level and the corresponding possible actual UE Uplink power window is illustrated in Annex F.4.3.

7.6C.2_1.1.5 Test requirement

Same test requirement specified in 7.6A.2.1.5.1 shall be met for downlink bands for SUL configuration with intra-band contiguous DL CA.

Same test requirement specified in clause 7.6C.2.5 or 7.6.2.5 for each band or band combinations listed in Table 7.6C.2_1.1.4.1-2 shall be met for inband blocking testing for SUL configuration with inter-band DL CA.

7.6C.3 Out-of-band blocking for SUL

7.6C.3.1 Test Purpose

Same test purpose as in clause 7.6.3.1.

7.6C.3.2 Test applicability

This test applies to all types of NR UE release 15 and forward that support SUL operating on the SUL bands.

7.6C.3.3 Minimum conformance requirements

For SUL operation, the out-of-band blocking requirement for downlink bands specified in clause 7.6.3 shall be met. For operation band combination listed in Table 7.6C.3.3-1, exceptions to the requirement specified in Table 7.6C.3.3-2 are allowed when the second order intermodulation product of the SUL carrier and the CW interfering signal fully or partially overlaps with the DL carrier.

Table 7.6C.3.3-1: SUL operating band combination with exceptions allowed

NR Band combination for SUL
SUL_n78-n81
SUL_n78-n82
SUL_n78-n83
SUL_n79-n81
SUL_n79-n83

Table 7.6C.3.3-2: Requirement for out-of-band blocking exceptions

Parameter	Unit	Level
$P_{\text{Interferer}} \text{ (CW)}$	dBm	-44 ¹
NOTE 1: The requirement applies when $ f_{\text{Interferer}} \pm f_{\text{SUL}} - f_{\text{DL}} \leq (BW_{\text{SUL}} + BW_{\text{DL}})/2$, where BW_{SUL} and BW_{DL} are the channel bandwidths configured for SUL and DL (victim) bands in MHz, respectively.		

For all interferer frequency ranges specified in clause 7.6.3 a maximum of

$$\lfloor \max\{24,6 \cdot \lceil n \cdot N_{\text{RB}} / 6 \rceil \} / \min\{\lfloor n \cdot N_{\text{RB}} / 10 \rfloor, 5\} \rfloor$$

exceptions are allowed for spurious response frequencies in each assigned frequency channel when measured using a step size of $\min(\lfloor CBW / 2 \rfloor, 5)$ MHz with N_{RB} the number of resource blocks in the downlink transmission bandwidth configuration, CBW the bandwidth of the frequency channel in MHz and $n = 1, 2, 3$ for SCS = 15, 30, 60 kHz, respectively. For these exceptions, the requirements in clause 7.7 apply.

The normative reference for this requirement is TS 38.101-1 [2] clauses 7.6C.3.

7.6C.3.4 Test description

Same test description as specified in clause 7.6.3.4 with following exceptions:

Instead of table 5.3.5-1 → use Table 5.5C-1

Instead of table 7.6.3.4.1-1 → use Table 7.6C.3.4-1.

Table 7.6C.3.4-1: Test Configuration Table

Default Conditions					
Test Environment as specified in TS 38.508-1 [5] subclause 4.1			Normal		
Test Frequencies as specified in TS 38.508-1 [5] subclause 4.3.1			Mid range for SUL carrier One frequency chosen arbitrarily from low or high range for Non-SUL carrier		
Test Channel Bandwidths as specified in TS 38.508-1 [5] subclause 4.3.1			Lowest, Mid, Highest for Non-SUL carrier For SUL band: n80: 30 MHz n81: 20 MHz n82: 20 MHz n83: 20 MHz n84: 20 MHz n86: 40 MHz n95: 15 MHz		
Test SCS as specified in Table 5.3.5-1			15kHz for SUL carrier and lowest for Non-SUL carrier		
Test Parameters					
Test ID	DL Configuration		UL Configuration	SUL Configuration	
	Mod'n	RB allocation		Mod'n	RB allocation
1	CP-OFDM QPSK	Full RB (NOTE 1)	N/A	DFT-s-OFDM QPSK	REFSENS (NOTE 1)
NOTE 1: The specific configuration of SUL and DL are defined in Table 7.3C.2.4.1-1. NOTE 2: Test Channel Bandwidths are checked separately for each SUL band combination, the applicable channel bandwidths are specified in Table 5.5C-1. NOTE 3: DFT-s-OFDM PI/2 BPSK test applies only for UEs which supports half Pi BPSK in FR1. NOTE 4: In a band where UE supports 4Rx, the test shall be performed only with 4Rx antennas ports connected and 4Rx REFSENS requirement (Table 7.3.2.5-2) is used in the test requirements.					

- Connect the SS to the UE antenna connectors as shown in TS 38.508-1 [5] Annex A, Figure A.3.1.4.9 for TE diagram and section A.3.2 for UE diagram.
- The parameter setting for the cell are set up according to the TS 38.508-1 [5] subclause 4.4.3.

- Downlink signals are initially setup according to Annex C.0, C.1, C.2 and uplink signals according to Annex G.0, G.1, G.2, and G.3.0 with consideration of supplementary uplink physical channels.

Message contents in initial conditions are according to TS 38.508-1 [5] subclause 4.3.6.1.1.2 ensuring UL/SUL indicator in Table 4.3.6.1.1.2-1 with condition SUL, subclause 4.6 ensuring Tables 4.6.1-28 with condition SUL AND (RF OR RRM), 4.6.3-14 with condition SUL_SUL for SUL carrier, and Table 4.6.3-167 with condition PUSCH_PUCCH_ON_SUL, additionally the following exception shown in Table 7.6C.3.4-2 is considered.

Table 7.6C.3.4-2: PUSCH-Config

Derivation Path: TS 38.508-1 [5], Table 4.6.3-118 with condition TRANSFORM_PRECODER_ENABLED

Table 7.6C.3.4-3: Void

7.6C.3.5 Test Requirement

For SUL operation, the out-of-band blocking requirement for downlink bands specified in clause 7.6.3.5 shall be met. For operation band combination listed in Table 7.6C.3.5-1, exceptions to the requirement specified in Table 7.6C.3.5-2 are allowed when the second order intermodulation product of the SUL carrier and the CW interfering signal fully or partially overlaps with the DL carrier.

Table 7.6C.3.5-1: SUL operating band combination with exceptions allowed

NR Band combination for SUL
SUL_n78-n81
SUL_n78-n82
SUL_n78-n83
SUL_n79-n81
SUL_n79-n83

Table 7.6C.3.5-2: Requirement for out-of-band blocking exceptions

Parameter	Unit	Level
$P_{\text{Interferer (CW)}}$	dBm	-44 ¹
NOTE 1: The requirement applies when $ f_{\text{Interferer}} \pm f_{\text{SUL}} - f_{\text{DL}} \leq (BW_{\text{SUL}} + BW_{\text{DL}})/2$, where BW_{SUL} and BW_{DL} are the channel bandwidths configured for SUL and DL (victim) bands in MHz, respectively.		

For all interferer frequency ranges, a maximum of

$$\lfloor \max\{24, 6 \cdot \lceil n \cdot N_{RB} / 6 \rceil\} / \min\{\lfloor n \cdot N_{RB} / 10 \rfloor, 5\} \rfloor$$

exceptions are allowed for the spurious response frequencies recorded in the final step of test procedure in each assigned frequency channel when measured using a step size of $\min(\lfloor CBW / 2 \rfloor, 5)$ MHz with N_{RB} the number of resource blocks in the downlink transmission bandwidth configuration, CBW the bandwidth of the frequency channel in MHz and $n = 1, 2, 3$ for SCS = 15, 30, 60 kHz, respectively. For these exceptions, the requirements in clause 7.7 apply.

7.6C.3_1 Out-of-band blocking for SUL with DL CA

7.6C.3_1.1 Out-of-band Blocking for SUL with 2 DL CA

Editor's Note: No test points defined for Out-of-band Blocking for SUL with inter-band 2 DL CA testing. The testing is covered by 7.6.3 and 7.6C.3

7.6C.3_1.1.1 Test purpose

Same test purpose as in clause 7.6.3.1.

7.6C.3_1.1.2 Test applicability

This test applies to all types of NR UE release 15 and forward that support SUL operating on the SUL bands and intra-band contiguous 2DL CA.

7.6C.3_1.1.3 Minimum conformance requirements

For SUL operation with downlink CA, the out-of-band blocking requirement for downlink bands specified in clause 7.6A.3 shall be met. For operation band combination listed in Table 7.6C.3_1.1.3-1, exceptions to the requirement specified in Table 7.6C.3_1.1.3-2 are allowed when the second order intermodulation product of the SUL carrier and the CW interfering signal fully or partially overlaps with the DL carrier.

Table 7.6C.3_1.1.3-1: SUL operating band combination with exceptions allowed

NR Band combination for SUL
SUL_n78-n81
SUL_n78-n82
SUL_n78-n83
SUL_n79-n81
SUL_n79-n83

Table 7.6C.3_1.1.3-2: Requirement for out-of-band blocking exceptions

Parameter	Unit	Level
$P_{\text{Interferer (CW)}}$	dBm	-44 ¹
NOTE 1: The requirement applies when $ f_{\text{Interferer}} \pm f_{\text{SUL}} - f_{\text{DL}} \leq (BW_{\text{SUL}} + BW_{\text{DL}})/2$, where BW_{SUL} and BW_{DL} are the channel bandwidths configured for SUL and DL (victim) bands in MHz, respectively.		

For all interferer frequency ranges specified in clause 7.6.3 a maximum of

$$\lfloor \max \{24,6 \cdot \lceil n \cdot N_{RB} / 6 \rceil \} / \min \{ \lfloor n \cdot N_{RB} / 10 \rfloor, 5 \} \rfloor$$

exceptions are allowed for spurious response frequencies in each assigned frequency channel when measured using a step size of $\min \{ BW_{\text{channel}} / 2, 5 \}$ MHz with N_{RB} the number of resource blocks in the downlink transmission bandwidth configuration, BW_{channel} the bandwidth of the frequency channel in MHz and $n = 1, 2, 3$ for SCS = 15, 30, 60 kHz, respectively. For these exceptions, the requirements in clause 7.7 apply.

The normative reference for this requirement is TS 38.101-1 [2] clauses 7.6C.3.

7.6C.3_1.1.4 Test description

7.6C.3_1.1.4.1 Initial conditions

Initial conditions are a set of test configurations the UE needs to be tested in and the steps for the SS to take with the UE to reach the correct measurement state.

The initial test configurations consist of environmental conditions, test frequencies, test channel bandwidths and sub-carrier spacing based on NR CA configurations specified in clause 5.5A. All of these configurations shall be tested with applicable test parameters for each CA configuration, are shown in Table 7.6C.3_1.1.4.1-1 for SUL with intra-band contiguous DL CA or Table 7.6C.3_1.1.4.1-2 for SUL with inter-band DL CA. The details of the uplink and downlink reference measurement channels (RMC) are specified in Annexes A.2 and A.3 respectively. The details of the OCNG patterns used are specified in Annex A.5. Configurations of PDSCH and PDCCH before measurement are specified in Annex C.2.

Table 7.6C.3_1.1.4.1-1: Test configuration table for SUL configuration with Intra-band contiguous CA

Default Conditions						
Test Environment as specified in TS 38.508-1 [5] subclause 4.1		Normal				
Test Frequencies as specified in TS 38.508-1 [5] subclause 4.3.1		Mid range for SUL carrier One frequency chosen arbitrarily from low or high range for Non-SUL carrier				
Test Channel Bandwidths as specified in TS 38.508-1 [5] subclause 4.3.1		Highest N_{RB_agg} for downlink bands For SUL band: n80: 30 MHz n81: 20 MHz n82: 20 MHz n83: 20 MHz n84: 20 MHz n86: 40 MHz n95: 15 MHz				
Test SCS as specified in Table 5.3.5-1		15kHz				
Test Parameters						
Downlink Configuration				Uplink Configuration	SUL Configuration	
Test ID	CC Mod'n	PCC RB allocation	SCC RB allocation	N/A	CC Mod'n	PCC RB allocation
1	CP-OFDM QPSK	NOTE 1	NOTE 1		DFT-s-OFDM QPSK	NOTE 2
NOTE 1: The specific downlink configuration is defined in Table 7.3A.1.4.1-1.						
NOTE 2: The specific SUL configuration is defined in Table 7.3C.2.4.1-1a.						
NOTE 3: In a band where UE supports 4Rx, the test shall be performed only with 4Rx antennas ports connected and 4Rx REFSSENS requirement (Table 7.3.2.5-2) is used in the test requirements.						

For SUL configuration with inter-band DL CA: No testing need to be performed since the testing has been covered in test case 7.6.3 and 7.6C.3. For band combination CA_nX_SUL_nY-nZ, test the out-of-band blocking of SUL configuration or NR band as listed in Table 7.6C.3_1.1.4.1-2.

Table 7.6C.3_1.1.4.1-2: Test band combinations and configuration

Band configuration	Verifying out-of-band blocking of SUL configurations/ NR band	Subtest case	Table with test parameters to select
CA_n1A_SUL_n78A-n80A	SUL_n78-n80	7.6C.3	Table 7.6C.3.4-1
	n1	7.6.3	Table 7.6.3.4.1-1
CA_n1A_SUL_n78A-n84A	SUL_n78-n84	7.6C.3	Table 7.6C.3.4-1
	n1	7.6.3	Table 7.6.3.4.1-1
CA_n3A_SUL_n78A-n80A	SUL_n78-n80	7.6C.3	Table 7.6C.3.4-1
	n3	7.6.3	Table 7.6.3.4.1-1
CA_n28A_SUL_n41A-n83A	SUL_n41-n83	7.6C.3	Table 7.6C.3.4-1
	n28	7.6.3	Table 7.6.3.4.1-1
CA_n28A_SUL_n79A-n83A	SUL_n79A-n83A	7.6C.3	Table 7.6C.3.4-1
	n28	7.6.3	Table 7.6.3.4.1-1

- Connect the SS to the UE antenna connectors as shown in TS 38.508-1 [5] Annex A, Figure A.3.1.4.10 for TE diagram and section A.3.2 for UE diagram.
- The parameter setting for the cell are set up according to the TS 38.508-1 [5] subclause 4.4.3.
- Downlink signals are initially setup according to Annex C.0, C.1, C.2 and uplink signals according to Annex G.0, G.1, G.2, and G.3.0 with consideration of supplementary uplink physical channels.

Message contents in initial conditions are according to TS 38.508-1 [5] subclause 4.3.6.1.1.2 ensuring UL/SUL indicator in Table 4.3.6.1.1.2-1 with condition SUL, subclause 4.6 ensuring Tables 4.6.1-28 with condition SUL AND (RF OR RRM), 4.6.3-14 with condition SUL_SUL for SUL carrier, and Table 4.6.3-167 with condition PUSCH_PUCCH_ON_SUL, additionally the following exception shown in Table 7.6C.3_1.1.4.1-3 is considered.

Table 7.6C.3_1.1.4.1-3: PUSCH-Config

Derivation Path: TS 38.508-1 [5], Table 4.6.3-118 with condition TRANSFORM_PRECODER_ENABLED

7.6C.3_1.1.4.2 Test procedure

For SUL configuration with intra-band contiguous DL CA:

1. Configure SCC according to Annex C.0, C.1, C.2 for all downlink physical channels.
2. The SS shall configure SCC as per TS 38.508-1 [5] clause 5.5.1. Message contents are defined in clause 7.6A.3.1.4.3.
3. SS activates SCC by sending the activation MAC CE (Refer TS 38.321 [18], clauses 5.9, 6.1.3.10). Wait for at least 2 seconds (Refer TS 38.133[19], clause 9.3).
4. SS transmits PDSCH via PDCCH DCI format 1_1 for C_RNTI to transmit the DL RMC according to Table 7.6C.3_1.1.4.1-1 on both PCC and SCC. The SS sends downlink MAC padding bits on the DL RMC.
5. SS sends uplink scheduling information for each UL HARQ process via PDCCH DCI format 0_1 for C_RNTI to schedule the UL RMC according to Table 7.6C.3_1.1.4.1-1 on SUL. Since the UE has no payload data to send, the UE transmits uplink MAC padding bits on the UL RMC.
6. Set the parameters of the CW signal generator for an interfering signal below the CA Band for intra-band CA, or below the SCC's operating band for inter-band CA according to Table 7.6A.3.1.5.1-2, 7.6A.3.1.5.3-2 or 7.6A.3.1.5.3-4. The frequency step size is $\min(\lfloor BW_{channel} / 2 \rfloor, 5)$ MHz.

If CW interferer falls in a gap between $F_{DL_High(j)}$ and $F_{DL_Low(j+1)}$ where the corresponding OOB ranges 1 and 2 overlap, then the lower level interferer limit of the overlapping OOB ranges applies.

7. Set the downlink signal level according to the Table 7.6A.3.1.5.1-1, 7.6A.3.1.5.3-1 or 7.6A.3.1.5.3-3 for both carriers. Send uplink power control commands to the UE using 1dB power step size to ensure that the UE output power measured by the test system is within the Uplink power control window, defined as $-MU$ to $-(MU + \text{Uplink power control window size})$ dB of the target power level in Table 7.6A.3.1.5.1-1, 7.6A.3.1.5.3-1 or 7.6A.3.1.5.3-3 for at least the duration of the Throughput measurement, where:
 - MU is the test system uplink power measurement uncertainty and is specified in Table F.1.3-1 for the carrier frequency f and the channel bandwidth BW
 - Uplink power control window size = 1dB (UE power step size) + 0.7dB (UE power step tolerance) + (Test system relative power measurement uncertainty), where, the UE power step tolerance is specified in TS 38.101-1 [2], Table 6.3.4.3-1 and is 0.7dB for 1dB power step size, and the Test system relative power measurement uncertainty is specified for test case 6.3.4.3 in Table F.1.2-1.
8. Measure the average throughput of both carriers for a duration sufficient to achieve statistical significance according to Annex H.2A for intra-band CA.
9. Record the frequencies for which the throughput doesn't meet the requirements.
10. Repeat steps from 6 to 9, using an interfering signal above the CA Band for intra-band CA at step 6.

NOTE: The purpose of the Uplink power control window is to ensure that the actual UE output power is no greater than the target power level, and as close as possible to the target power level. The relationship between the Uplink power control window, the target power level and the corresponding possible actual UE Uplink power window is illustrated in Annex F.4.3.

7.6C.3_1.1.5 Test requirement

Same test requirement specified in 7.6A.3.1.5.1 shall be met for downlink bands for SUL configuration with intra-band contiguous DL CA with following exception:

Table 7.6C.3_1.1.5-1: SUL operating band combination with exceptions allowed

NR Band combination for SUL
SUL_n78-n81
SUL_n78-n82
SUL_n78-n83
SUL_n79-n81
SUL_n79-n83

Table 7.6C.3_1.1.5-2: Requirement for out-of-band blocking exceptions

Parameter	Unit	Level
$P_{\text{Interferer}} \text{ (CW)}$	dBm	-44 ¹
NOTE 1: The requirement applies when $ f_{\text{Interferer}} \pm f_{\text{SUL}} - f_{\text{DL}} \leq (BW_{\text{SUL}} + BW_{\text{DL}})/2$, where BW_{SUL} and BW_{DL} are the channel bandwidths configured for SUL and DL (victim) bands in MHz, respectively.		

Same test requirement specified in clause 7.6C.3.5 or 7.6.3.5 for each band or band combinations listed in Table 7.6C.3_1.1.4-1 shall be met for out-of-band blocking testing for SUL configuration with inter-band 2DL CA.

7.6D Blocking characteristics for UL MIMO

7.6D.1 General

The blocking characteristic for UL MIMO is a measure of the receiver's ability of an UE that support UL MIMO to receive a wanted signal at its assigned channel frequency in the presence of an unwanted interferer on frequencies other than those of the spurious response or the adjacent channels, without this unwanted input signal causing a degradation of the performance of the receiver beyond a specified limit. The blocking performance shall apply at all frequencies except those at which a spurious response occur.

For UE with two transmitter antenna connectors in closed-loop spatial multiplexing scheme, the minimum requirements specified in subclause 7.6 shall be met with the UL MIMO configurations described in sub-clause 6.2D.1. For UL MIMO, the parameter $P_{\text{CMAX,L}}$ is defined as the total transmitter power over the two transmit antenna connectors.

7.6D.2 In-band blocking for UL MIMO

7.6D.2.1 Test purpose

In-band blocking for UL MIMO is defined for an unwanted interfering signal falling into the range from 15MHz below to 15MHz above the receive band of an UE that support UL MIMO, with $F_{\text{DL,high}} < 2700$ MHz and $F_{\text{UL,high}} < 2700$ MHz, or into the range from 3CBW below to 3CBW above the receive band of an UE that support UL MIMO, with $F_{\text{DL,high}} < 3300$ MHz and $F_{\text{UL,high}} < 3300$ MHz, at which the relative throughput shall meet or exceed the requirement for the specified measurement channels.

The lack of in-band blocking ability will decrease the coverage area when other g-NodeB transmitters exist (except in the adjacent channels and spurious response).

7.6D.2.2 Test applicability

This test case applies to all types of NR UE release 15 and forward that support UL MIMO on FDD bands.

7.6D.2.3 Minimum conformance requirements

For UE with two transmitter antenna connectors in closed-loop spatial multiplexing scheme, the minimum requirements specified in subclause 7.6 shall be met with the UL MIMO configurations described in sub-clause 6.2D.1. For UL MIMO, the parameter $P_{\text{CMAX,L}}$ is defined as the total transmitter power over the two transmit antenna connectors.

The normative reference for this requirement is TS 38.101-1 [2] clause 7.6D.

7.6D.2.4 Test description

7.6D.2.4.1 Initial conditions

Initial conditions are a set of test configurations the UE needs to be tested in and the steps for the SS to take with the UE to reach the correct measurement state.

The initial test configurations consist of environmental conditions, test frequencies, test channel bandwidths and sub-carrier spacing based on NR operating bands specified in table 5.3.5-1. All of these configurations shall be tested with applicable test parameters for each combination of channel bandwidth and sub-carrier spacing, are shown in table 7.6D.2.4.1-1. The details of the uplink and downlink reference measurement channels (RMC) are specified in Annexes A.2 and A.3. The details of the OCN patterns used are specified in Annex A.5. Configurations of PDSCH and PDCCH before measurement are specified in Annex C.2.

Table 7.6D.2.4.1-1: Test Configuration Table

Default Conditions				
Test Environment as specified in TS 38.508-1 [5] subclause 4.1			Normal	
Test Frequencies as specified in TS 38.508-1 [5] subclause 4.3.1			Mid range	
Test Channel Bandwidths as specified in TS 38.508-1 [5] subclause 4.3.1			Lowest, Mid, Highest	
Test SCS as specified in Table 5.3.5-1			Lowest	
Test Parameters				
Test ID	Downlink Configuration		Uplink Configuration	
	Mod'n	RB allocation	Mod'n	RB allocation
1	CP-OFDM QPSK	NOTE 1	CP-OFDM QPSK	NOTE 1
NOTE 1: The specific configuration of uplink and downlink are defined in Table 7.3D.2.4.1-1. NOTE 2: In a band where UE supports 4Rx, the test shall be performed only with 4Rx antennas ports connected and 4Rx REFSENS requirement (Table 7.3.2.5-2) is used in the test requirements.				

1. Connect the SS and interfering source to the UE antenna connectors as shown in TS 38.508-1 [5] Annex A, in Figure A.3.1.4.4 for TE diagram and section A.3.2 for UE diagram.
2. The parameter settings for the cell are set up according to TS 38.508-1 [5] subclause 4.4.3.
3. Downlink signals are initially set up according to Annex C.0, C.1, C.2, C.3.1, and uplink signals according to Annex G.0, G.1, G.2, G.3.1.
4. The DL and UL Reference Measurement channels are set according to Table 7.6D.2.4.1-1.
5. Propagation conditions are set according to Annex B.0.
6. Ensure the UE is in state RRC_CONNECTED with generic procedure parameters Connectivity NR, Connected without release *On*, Test Mode *On* and Test Loop Function *On* according to TS 38.508-1 [5] clause 4.5. Message content are defined in clause 7.6D.2.4.3.

7.6D.2.4.2 Test procedure

Same test procedure as specified in 7.6.2.4.2.

7.6D.2.4.3 Message contents

Message contents are according to TS 38.508-1 [5] subclause 4.6 ensuring Table 4.6.3-182 with condition 2TX_UL_MIMO.

7.6D.2.5 Test requirement

Same test requirement as specified in 7.6.2.5.

Table 7.6D.2.5-1: Void

7.6D.3 Out-of-band blocking for UL MIMO

7.6D.3.1 Test purpose

Out-of-band blocking for UL MIMO is defined for an unwanted CW interfering signal falling more than 15 MHz below or above the receive band of an UE that support UL MIMO, with $F_{DL_high} < 2700$ MHz and $F_{UL_high} < 2700$ MHz, or falling more than 3CBW below or above the receive band of an UE that support UL MIMO, with $F_{DL_low} \geq 3300$ MHz and $F_{UL_low} \geq 3300$ MHz, at which a given average throughput shall meet or exceed the requirement for the specified measurement channels.

The lack of out-of-band blocking ability will decrease the coverage area when other g-NodeB transmitters exist (except in the adjacent channels and spurious response).

7.6D.3.2 Test applicability

This test case applies to all types of NR UE release 15 and forward that support UL MIMO on FDD bands.

7.6D.3.3 Minimum conformance requirements

For UE with two transmitter antenna connectors in closed-loop spatial multiplexing scheme, the minimum requirements specified in subclause 7.6 shall be met with the UL MIMO configurations described in sub-clause 6.2D.1. For UL MIMO, the parameter $P_{C_{MAX_L}}$ is defined as the total transmitter power over the two transmit antenna connectors.

The normative reference for this requirement is TS 38.101-1 [2] clause 7.6D.

7.6D.3.4 Test description

7.6D.3.4.1 Initial conditions

Initial conditions are a set of test configurations the UE needs to be tested in and the steps for the SS to take with the UE to reach the correct measurement state.

The initial test configurations consist of environmental conditions, test frequencies, test channel bandwidths and sub-carrier spacing based on NR operating bands specified in table 5.3.5-1. All of these configurations shall be tested with applicable test parameters for each combination of channel bandwidth and sub-carrier spacing, are shown in table 7.6D.3.4.1-1. The details of the uplink and downlink reference measurement channels (RMC) are specified in Annexes A.2 and A.3. The details of the OCN patterns used are specified in Annex A.5. Configurations of PDSCH and PDCCH before measurement are specified in Annex C.2.

Table 7.6D.3.4.1-1: Test Configuration Table

Default Conditions				
Test Environment as specified in TS 38.508-1 [5] subclause 4.1		Normal		
Test Frequencies as specified in TS 38.508-1 [5] subclause 4.3.1		One frequency chosen arbitrarily from low or high range		
Test Channel Bandwidths as specified in TS 38.508-1 [5] subclause 4.3.1		Lowest, Mid, Highest		
Test SCS as specified in Table 5.3.5-1		Lowest		
Test Parameters				
Test ID	Downlink Configuration		Uplink Configuration	
	Mod'n	RB allocation	Mod'n	RB allocation
1	CP-OFDM QPSK	NOTE 1	CP-OFDM QPSK	NOTE 1
NOTE 1: The specific configuration of uplink and downlink are defined in Table 7.3D.2.4.1-1.				
NOTE 2: In a band where UE supports 4Rx, the test shall be performed only with 4Rx antennas ports connected and 4Rx REFSSENS requirement (Table 7.3.2.5-2) is used in the test requirements.				

1. Connect the SS and interfering source to the UE antenna connectors as shown in TS 38.508-1 [5] Annex A, in Figure A.3.1.4.5 for TE diagram and section A.3.2 for UE diagram.
2. The parameter settings for the cell are set up according to TS 38.508-1 [5] subclause 4.4.3.
3. Downlink signals are initially set up according to Annex C.0, C.1, C.2, C.3.1, and uplink signals according to Annex G.0, G.1, G.2, G.3.1.

4. The DL and UL Reference Measurement channels are set according to Table 7.6D.3.4.1-1.

5. Propagation conditions are set according to Annex B.0.

6. Ensure the UE is in state RRC_CONNECTED with generic procedure parameters Connectivity *NR*, Connected without release *On*, Test Mode *On* and Test Loop Function *On* according to TS 38.508-1 [5] clause 4.5. Message content are defined in clause 7.6D.3.4.3.

7.6D.3.4.2 Test procedure

Same test procedure as specified in 7.6.3.4.2.

7.6D.3.4.3 Message contents

Message contents are according to TS 38.508-1 [5] subclause 4.6 ensuring Table 4.6.3-182 with condition 2TX_UL_MIMO.

7.6D.3.5 Test requirement

Same test requirement as specified in 7.6.3.5.

Table 7.6D.3.5-1: Void

7.6D.4 Narrow band blocking for UL MIMO

7.6D.4.1 Test purpose

Narrow band blocking for UL MIMO is defined for a receiver's ability of an UE that supports UL MIMO to receive a NR signal at its assigned channel frequency in the presence of an unwanted narrow band CW interferer at a frequency, which is less than the nominal channel spacing, at which a given average throughput shall meet or exceed the requirement for the specified measurement channels.

The lack of narrow-band blocking ability will decrease the coverage area when other g-NodeB transmitters exist (except in the adjacent channels and spurious response).

7.6D.4.2 Test applicability

This test case applies to all types of NR UE release 15 and forward that support UL MIMO on FDD bands.

7.6D.4.3 Minimum conformance requirements

For UE with two transmitter antenna connectors in closed-loop spatial multiplexing scheme, the minimum requirements specified in subclause 7.6 shall be met with the UL MIMO configurations described in sub-clause 6.2D.1. For UL MIMO, the parameter P_{CMAX_L} is defined as the total transmitter power over the two transmit antenna connectors.

The normative reference for this requirement is TS 38.101-1 [2] clause 7.6D.

7.6D.4.4 Test description

7.6D.4.4.1 Initial conditions

Initial conditions are a set of test configurations the UE needs to be tested in and the steps for the SS to take with the UE to reach the correct measurement state.

The initial test configurations consist of environmental conditions, test frequencies, test channel bandwidths and sub-carrier spacing based on NR operating bands specified in table 5.3.5-1. All of these configurations shall be tested with applicable test parameters for each combination of channel bandwidth and sub-carrier spacing, are shown in table 7.6D.4.4.1-1. The details of the uplink and downlink reference measurement channels (RMC) are specified in Annexes A.2 and A.3. The details of the OCNG patterns used are specified in Annex A.5. Configurations of PDSCH and PDCCH before measurement are specified in Annex C.2.

Table 7.6D.4.4.1-1: Test Configuration Table

Default Conditions				
Test Environment as specified in TS 38.508-1 [5] subclause 4.1		Normal		
Test Frequencies as specified in TS 38.508-1 [5] subclause 4.3.1		Mid range		
Test Channel Bandwidths as specified in TS 38.508-1 [5] subclause 4.3.1		Lowest, Mid, Highest		
Test SCS as specified in Table 5.3.5-1		Lowest		
Test Parameters				
Test ID	Downlink Configuration		Uplink Configuration	
	Mod'n	RB allocation	Mod'n	RB allocation
1	CP-OFDM QPSK	NOTE 1	CP-OFDM QPSK	NOTE 1
NOTE 1: The specific configuration of uplink and downlink are defined in Table 7.3D.2.4.1-1. NOTE 2: In a band where UE supports 4Rx, the test shall be performed only with 4Rx antennas ports connected and 4Rx REFSENS requirement (Table 7.3.2.5-2) is used in the test requirements.				

1. Connect the SS and interfering source to the UE antenna connectors as shown in TS 38.508-1 [5] Annex A, in Figure A.3.1.4.5 for TE diagram and section A.3.2 for UE diagram.
2. The parameter settings for the cell are set up according to TS 38.508-1 [5] subclause 4.4.3.
3. Downlink signals are initially set up according to Annex C.0, C.1, C.2, C.3.1, and uplink signals according to Annex G.0, G.1, G.2, G.3.1.
4. The DL and UL Reference Measurement channels are set according to Table 7.6D.4.4.1-1.
5. Propagation conditions are set according to Annex B.0.
6. Ensure the UE is in state RRC_CONNECTED with generic procedure parameters Connectivity *NR*, Connected without release *On*, Test Mode *On* and Test Loop Function *On* according to TS 38.508-1 [5] clause 4.5. Message content are defined in clause 7.6D.4.4.3.

7.6D.4.4.2 Test procedure

Same test procedure as specified in 7.6.4.4.2.

7.6D.4.4.3 Message contents

Message contents are according to TS 38.508-1 [5] subclause 4.6 ensuring Table 4.6.3-182 with condition 2TX_UL_MIMO.

7.6D.4.5 Test requirement

Same test requirement as specified in 7.6.4.5.

Table 7.6D.4.5-1: Void

7.6E Blocking characteristics for V2X

7.6E.1 General

The blocking characteristic is a measure of the receiver's ability to receive a wanted signal at its assigned channel frequency in the presence of an unwanted interferer on frequencies other than those of the spurious response or the adjacent channels, without this unwanted input signal causing a degradation of the performance of the receiver beyond a specified limit. The blocking performance shall apply at all frequencies except those at which a spurious response occurs.

7.6E.2 In-band blocking for V2X

7.6E.2.0 Minimum conformance requirements

7.6E.2.0.1 General

The throughput of the wanted signal shall be $\geq 95\%$ of the maximum throughput of the reference measurement channels as specified in Annex A.7.2 with parameters specified in Table 7.6E.2.0.1-1 and Table 7.6E.2.0.1-2. The relative throughput requirement shall be met for any SCS specified for the channel bandwidth of the wanted signal.

Table 7.6E.2.0.1-1: In-band blocking parameters for NR V2X

RX parameter	Units	Channel bandwidth			
		10 MHz	20 MHz	30 MHz	40 MHz
Power in transmission bandwidth configuration	dBm	PREFSENS_V2X + channel bandwidth specific value below			
	dB	6	9	11	12
$BW_{\text{interferer}}$	MHz	10			
$F_{\text{offset, case 1}}$	MHz	15			
$F_{\text{offset, case 2}}$	MHz	25			
NOTE 1: The interferer is QPSK modulated PUSCH containing data and reference symbols. Normal cyclic prefix is used.					

Table 7.6E.2.0.1-2: In-band blocking for NR V2X

NR band	Parameter	Unit	Case 1	Case 2
n38, n47	$P_{\text{interferer}}$	dBm	-44	-44
	$F_{\text{interferer (offset)}}$	MHz	$-BW/2 - F_{\text{offset, case 1}}$ and $BW/2 + F_{\text{offset, case 1}}$	$\leq -BW/2 - F_{\text{offset, case 2}}$ and $\geq BW/2 + F_{\text{offset, case 2}}$
	$F_{\text{interferer}}$	MHz	NOTE 2	$F_{\text{DL_low}} - 30$ to $F_{\text{DL_high}} + 30$
NOTE 1: For certain bands, the unwanted modulated interfering signal may not fall inside the UE receive band, but within the first 15 MHz below or above the UE receive band.				
NOTE 2: For each carrier frequency the requirement is valid for two frequencies: a. the carrier frequency $-BW/2 - F_{\text{offset, case 1}}$ and b. the carrier frequency $+BW/2 + F_{\text{offset, case 1}}$				
NOTE 3: $F_{\text{interferer}}$ range values for unwanted modulated interfering signal are interferer centre frequencies				
NOTE 4: The absolute value of the interferer offset $F_{\text{interferer (offset)}}$ shall be further adjusted to $(\lceil F_{\text{interferer}} / SCS \rceil + 0.5) SCS$ MHz with SCS the sub-carrier spacing of the wanted signal in MHz. The interferer is an NR signal with 15 kHz SCS.				

7.6E.2.0.2 In-band blocking for V2X con-current operation

For the inter-band con-current NR V2X operation, the requirements specified in clause 7.6E.2.0.1 shall apply for the NR sidelink reception in the operating Bands in Table 5.2E.1-1 and the requirements specified in clause 7.6.2 shall apply for the NR downlink reception in licensed band while all downlink carriers are active.

The normative reference for this requirement is TS 38.101-1 [2] clause 7.6E.2.

7.6E.2.1 In-band blocking for V2X / non-concurrent operation

FFS

7.6E.2.2 In-band blocking for V2X / con-current operation

FFS

7.6E.3 Out-of-band blocking for V2X

7.6E.3.0 Minimum conformance requirements

7.6E.3.0.1 General

For NR V2X bands out-of-band band blocking is defined for an unwanted CW interfering signal falling outside a frequency range 30 MHz below or above the UE receive band. The throughput of the wanted signal shall be $\geq 95\%$ of the maximum throughput of the reference measurement channels as specified in Annexes A.7.2 with parameters specified in Table 7.6E.3.0.1-1 and Table 7.6E.3.0.1-2. The relative throughput requirement shall be met for any SCS specified for the channel bandwidth of the wanted signal.

Table 7.6E.3.0.1-1: Out-of-band blocking parameters for NR V2X

RX parameter	Units	Channel bandwidth			
		10 MHz	20 MHz	30 MHz	40 MHz
Power in transmission bandwidth configuration	dBm	$P_{\text{REFSENS_V2X}}$ + channel bandwidth specific value below			
	dB	6	9	11	12
NOTE: Reference measurement channel is A.7.2.					

Table 7.6E.3.0.1-2: Out of-band blocking for NR V2X

NR band	Parameter	Units	Range 1	Range 2	Range 3
n47	$P_{\text{interferer}}$	dBm	-44	-30	-15
	$F_{\text{interferer}}$ (CW)	MHz	$F_{\text{DL_low}} - 30$ to $F_{\text{DL_low}} - 60$	$F_{\text{DL_low}} - 60$ to $F_{\text{DL_low}} - 85$	$F_{\text{DL_low}} - 85$ to 1 MHz
n38	$P_{\text{interferer}}$	dBm	-44	-30	-15
	$F_{\text{interferer}}$ (CW)	MHz	$F_{\text{DL_high}} + 30$ to $F_{\text{DL_high}} + 60$	$F_{\text{DL_high}} + 60$ to $F_{\text{DL_high}} + 85$	$F_{\text{DL_high}} + 85$ to +12750 MHz
NOTE 1: The power level of the interferer ($P_{\text{interferer}}$) for Range 3 shall be modified to -20 dBm for $F_{\text{interferer}} > 4400$ MHz.					

7.6E.3.0.2 Out-of-band blocking for V2X con-current operation

For the inter-band con-current NR V2X operation, the requirements specified in clause 7.6E.3.0.1 shall apply for the NR sidelink reception in Band n47 and the requirements specified in clause 7.6.3 shall apply for the NR downlink reception in licensed band while all downlink carriers are active.

The normative reference for this requirement is TS 38.101-1 [2] clause 7.6E.3.

7.6E.3.1 Out-of-band blocking for V2X / non-concurrent operation

FFS

7.6E.3.2 Out-of-band blocking for V2X / con-current operation

FFS

7.6F Blocking characteristics for shared spectrum channel access

7.6F.1 General

The blocking characteristic is a measure of the receiver's ability to receive a wanted signal at its assigned channel frequency in the presence of an unwanted interferer on frequencies other than those of the spurious response or the adjacent channels, without this unwanted input signal causing a degradation of the performance of the receiver beyond a specified limit. The blocking performance shall apply at all frequencies except those at which a spurious response occurs.

7.6F.2 In-band blocking for shared spectrum channel access

7.6F.2.1 Test purpose

In-band blocking (IBB) is defined for an unwanted interfering signal falling into the UE receive band or into the first 60 MHz below or above the UE receive band, at which the relative throughput shall meet or exceed the requirement for the specified measurement channel.

7.6F.2.2 Test applicability

This test case applies to all types of NR UE release 16 and forward that support NR standalone shared spectrum channel access..

7.6F.2.3 Minimum conformance requirements

In-band blocking (IBB) is defined for an unwanted interfering signal falling into the UE receive band or into the first 60 MHz below or above the UE receive band. The throughput of the wanted signal shall be $\geq 95\%$ of the maximum throughput of the reference measurement channels as specified in Annexes A.2.2, A.3.2 and A.3.3 (with one sided dynamic OCNG Pattern OP.1 FDD/TDD for the DL-signal as described in Annex A.5.1.1/A.5.2.1) with parameters specified in Table 7.6F.2.3-1 and Table 7.6F.2.3-2. The relative throughput requirement shall be met for any SCS specified for the channel bandwidth of the wanted signal.

Table 7.6F.2.3-1: In-band blocking parameters for shared access bands

RX parameter	Units	Channel bandwidth			
		20 MHz	40 MHz	60 MHz	80 MHz
Power in transmission bandwidth configuration	dBm	REFSENS + channel bandwidth specific value below			
	dB	9	12	13.8	15
$BW_{\text{interferer}}$	MHz	20			
$F_{\text{offset, case 1}}$	MHz	30			
$F_{\text{offset, case 2}}$	MHz	≥ 50			

Table 7.6F.2.3-2: In-band blocking for shared access bands

Operating band	Parameter	Unit	Case 1	Case 2
	$P_{\text{interferer}}$	dBm	-56	-44
	$F_{\text{interferer (offset)}}$	MHz	$-\text{CBW}/2 - F_{\text{offset, case 1}}$ and $\text{CBW}/2 + F_{\text{offset, case 1}}$	$\leq -\text{CBW}/2 - F_{\text{offset, case 2}}$ and $\geq \text{CBW}/2 + F_{\text{offset, case 2}}$
n46, n96	$F_{\text{interferer}}$		NOTE 2	$F_{\text{DL, low}} - 3 \cdot \text{CBW}$ to $F_{\text{DL, high}} + 3 \cdot \text{CBW}$, NOTE 4
NOTE 1: The absolute value of the interferer offset $F_{\text{interferer (offset)}}$ shall be further adjusted to $(\lceil F_{\text{interferer (offset)} / \text{SCS} \rceil + 0.5) \cdot \text{SCS}$ MHz with SCS the sub-carrier spacing of the wanted signal in MHz. The interferer is an NR signal with an SCS equal to that of the wanted signal.				
NOTE 2: For each carrier frequency, the requirement applies for two interferer carrier frequencies: a: $-\text{CBW}/2 - F_{\text{offset, case 1}}$; b: $\text{CBW}/2 + F_{\text{offset, case 1}}$				
NOTE 3: CBW denotes the channel bandwidth of the wanted signal				
NOTE 4: Interferer carrier frequencies in the frequency range for Case 2 shall be located at discrete frequencies in integer multiples of 20 MHz offset from $-\text{CBW}/2 - F_{\text{offset, case 2}}$ and $\text{CBW}/2 + F_{\text{offset, case 2}}$				

The normative reference for this requirement is TS 38.101-1 [2] clause 7.6F.2.

7.6F.2.4 Test description

7.6F.2.4.1 Initial conditions

Initial conditions are a set of test configurations the UE needs to be tested in and the steps for the SS to take with the UE to reach the correct measurement state.

The initial test configurations consist of environmental conditions, test frequencies, test channel bandwidths and sub-carrier spacing based on NR operating bands specified in Table 5.3.5-1. All of these configurations shall be tested with applicable test parameters for each combination of channel bandwidth and sub-carrier spacing, are shown in table 7.6F.2.4.1-1. The details of the uplink and downlink reference measurement channels (RMC) are specified in Annexes A.2 and A.3. Configuration of PDSCH and PDCCH before measurement are specified in Annex C.2.

Table 7.6F.2.4.1-1: Test Configuration Table

FFS

1. Connect the SS to the UE antenna connectors as shown in TS 38.508-1 [5] Annex A, in Figure A.3.1.4.1 for TE diagram and section A.3.2 for UE diagram.
2. The parameter settings for the cell are set up according to TS 38.508-1 [5] subclause 4.4.3.
3. Downlink signals are initially set up according to Annex C.0, C.1, C.2, C.3.1, and uplink signals according to Annex G.0, G.1, G.2, G.3.1.
4. The DL and UL Reference Measurement channels are set according to Table 7.6F.2.4.1-1.
5. Propagation conditions are set according to Annex B.0.
6. Ensure the UE is in state RRC_CONNECTED with generic procedure parameters Connectivity *NR*, Connected without release *On*, Test Mode *On* and Test Loop Function *On* according to TS 38.508-1 [5] clause 4.5. Message content are defined in clause 7.6.2.4.3.

7.6F.2.4.2 Test procedure

1. SS transmits PDSCH via PDCCH DCI format 1_1 for C_RNTI to transmit the DL RMC according to Table 7.6F.2.4.1-1. The SS sends downlink MAC padding bits on the DL RMC.
2. SS sends uplink scheduling information for each UL HARQ process via PDCCH DCI format 0_1 for C_RNTI to schedule the UL RMC according to Table 7.6F.2.4.1-1. Since the UL has no payload and no loopback data to send the UE sends uplink MAC padding bits on the UL RMC.
3. Set the parameters of the signal generator for an interfering signal below the wanted signal in according to Tables 7.6F.2.5-1 and 7.6F.2.5-2.
4. Set the downlink signal level according to the table 7.6F.2.5-1. Send uplink power control commands to the UE using 1dB power step size to ensure that the UE output power measured by the test system is within the Uplink power control window, defined as $-(\text{MU})$ to $-(\text{MU} + \text{Uplink power control window size})$ dB of the target power level in Table 7.6F.2.5-1 for at least the duration of the Throughput measurement, where:
 - MU is the test system uplink power measurement uncertainty and is specified in Table F.1.3-1 for the carrier frequency f and the channel bandwidth BW.
 - Uplink power control window size = 1dB (UE power step size) + 0.7dB (UE power step tolerance) + (Test system relative power measurement uncertainty), where, the UE power step tolerance is specified in TS 38.101-1 [2], Table 6.3.4.3-1 and is 0.7dB for 1dB power step size, and the Test system relative power measurement uncertainty is specified for test case 6.3.4.3 in Table F.1.2-1.
5. Measure the average throughput for a duration sufficient to achieve statistical significance according to Annex H.

NOTE: The purpose of the Uplink power control window is to ensure that the actual UE output power is no greater than the target power level, and as close as possible to the target power level. The relationship between the Uplink power control window, the target power level and the corresponding possible actual UE Uplink power window is illustrated in Annex F.4.3.

7.6.2.4.3 Message contents

Message contents are according to TS 38.508-1 [5] subclause 4.6 with TRANSFORM_PRECODER_ENABLED condition in Table 4.6.3-118 PUSCH-Config.

7.6F.2.5 Test requirement

For shared spectrum channel access band, the throughput measurement derived in test procedure shall be $\geq 95\%$ of the maximum throughput of the reference measurement channels as specified in Annex in Annexes A.2.2, A.2.3 and A.3.2 with parameters specified in Tables 7.6F.2.5-1 and Tables 7.6F.2.5-2.

Table 7.6F.2.5-1: In-band blocking parameters for shared access bands

RX parameter	Units	Channel bandwidth			
		20 MHz	40 MHz	60 MHz	80 MHz
Power in transmission bandwidth configuration	dBm	REFSENS + channel bandwidth specific value below			
	dB	9	12	13.8	15
$BW_{interferer}$	MHz	20			
$F_{offset, case 1}$	MHz	30			
$F_{offset, case 2}$	MHz	≥ 50			
NOTE 1: The transmitter shall be set to 4 dB below $P_{CMAX_L,f,c}$ at the minimum UL configuration specified in Table 7.3.2-3 with $P_{CMAX_L,f,c}$ defined in clause [6.2F.4].					
NOTE 2: The interferer consists of the RMC specified in Annexes A.3.2.2 and A.3.3.2 with one sided dynamic OCNB Pattern OP.1 FDD/TDD for the DL-signal as described in Annex A.5.1.1/A.5.2.1					

Table 7.6F.2.5-2: In-band blocking for shared access bands

Operating band	Parameter	Unit	Case 1	Case 2
	$P_{interferer}$	dBm	-56	-44
	$F_{interferer}$ (offset)	MHz	$-CBW/2 - F_{offset, case 1}$ and $CBW/2 + F_{offset, case 1}$	$\leq -CBW/2 - F_{offset, case 2}$ and $\geq CBW/2 + F_{offset, case 2}$
n46, n96	$F_{interferer}$		NOTE 2	$F_{DL_low} - 3*CBW$ to $F_{DL_high} + 3*CBW$, NOTE 4
NOTE 1: The absolute value of the interferer offset $F_{interferer}$ (offset) shall be further adjusted to $(\lceil F_{interferer} / SCS \rceil + 0.5) SCS$ MHz with SCS the sub-carrier spacing of the wanted signal in MHz. The interferer is an NR signal with an SCS equal to that of the wanted signal.				
NOTE 2: For each carrier frequency, the requirement applies for two interferer carrier frequencies: a: $-CBW/2 - F_{offset, case 1}$; b: $CBW/2 + F_{offset, case 1}$				
NOTE 3: CBW denotes the channel bandwidth of the wanted signal				
NOTE 4: Interferer carrier frequencies in the frequency range for Case 2 shall be located at discrete frequencies in integer multiples of 20 MHz offset from $-CBW/2 - F_{offset, case 2}$ and $CBW/2 + F_{offset, case 2}$				

7.7 Spurious response

7.7.1 Test Purpose

Spurious response is a measure of the ability of the receiver to receive a wanted signal on its assigned channel frequency without exceeding a given degradation due to the presence of an unwanted CW interfering signal at any other frequency for which a response is obtained, i.e. for which the out-of-band blocking limit as specified in subclause 7.6.3 is not met.

The lack of the spurious response ability decreases the coverage area when other unwanted interfering signal exists at any other frequency.

7.7.2 Test Applicability

This test applies to all types of NR UE release 15 and forward.

7.7.3 Minimum Conformance Requirements

The throughput shall be $\geq 95\%$ of the maximum throughput of the reference measurement channels as specified in Annexes A.2.2, A.2.3, A.3.2 and A.3.3 (with one sided dynamic OCN Pattern OP.1 FDD/TDD for the DL-signal as described in Annex A.5.1.1/A.5.2.1) with parameters for the wanted signal as specified in Table 7.7.3-1 for NR bands with $F_{DL_high} < 2700$ MHz and $F_{UL_high} < 2700$ MHz and in Table 7.7.3-1a for NR bands with $F_{DL_high} \geq 3300$ MHz and $F_{UL_high} \geq 3300$ MHz and for the interferer as specified in Table 7.7.3-2. The relative throughput requirement shall be met for any SCS specified for the channel bandwidth of the wanted signal. For operating bands with an unpaired DL part (as noted in Table 5.2-1), the requirements only apply for carriers assigned in the paired part.

Table 7.7.3-1: Spurious response parameters for NR bands with $F_{DL_high} < 2700$ MHz and $F_{UL_high} < 2700$ MHz

RX parameter	Units	Channel bandwidth (MHz)		
		5, 10	15	20, 25, 30, 35, 40, 45, 50, 60, 70, 80, 90, 100
Power in transmission bandwidth configuration ²	dBm	REFSENS + 6 dB	REFSENS + 7 dB	REFSENS + (9 + 10log ₁₀ (BW _{Channel} / 20)) dB
NOTE 1: The transmitter shall be set to 4 dB below P _{CMAX_L,f,c} at the minimum UL configuration specified in Table 7.3.2.3-3 with P _{CMAX_L,f,c} defined in clause 6.2.4.				
NOTE 2: Power in transmission bandwidth configuration value is rounded to the next higher 0.5dB value.				

Table 7.7.3-1a: Spurious response parameters for NR bands with $F_{DL_low} \geq 3300$ MHz and $F_{UL_low} \geq 3300$ MHz

RX parameter	Units	Channel bandwidth (MHz)		
		10	15	20, 25, 30, 35, 40, 45, 50, 60, 70, 80, 90, 100
Power in transmission bandwidth configuration	dBm	REFSENS + 6 dB	REFSENS + 7 dB	REFSENS + 9 dB
NOTE 1: The transmitter shall be set to 4 dB below P _{CMAX_L,f,c} at the minimum UL configuration specified in Table 7.3.2.3-3 with P _{CMAX_L,f,c} defined in clause 6.2.4.				

Table 7.7.3-2: Spurious response

Parameter	Unit	Level
P _{Interferer} (CW)	dBm	-44
F _{Interferer}	MHz	Spurious response frequencies

The normative reference for this requirement is TS 38.101-1 [2] clause 7.7.

7.7.4 Test Description

7.7.4.1 Initial Conditions

The initial conditions shall be the same as in clause 7.6.3.4.1 in order to test spurious responses obtained in clause 7.6.3 under the same conditions.

7.7.4.2 Test Procedure

1. SS transmits PDSCH via PDCCH DCI format 1_1 for C_RNTI to transmit the DL RMC according to Table 7.6.3.4.1-1. The SS sends downlink MAC padding bits on the DL RMC.
2. SS sends uplink scheduling information for each UL HARQ process via PDCCH DCI format 0_1 for C_RNTI to schedule the UL RMC according to Table 7.6.3.4.1-1. Since the UE has no payload and no loopback data to send, the UE transmits uplink MAC padding bits on the UL RMC.
3. Set the parameters of the CW signal generator for an interfering signal according to Table 7.7.5-2. The spurious frequencies are taken from records in the final step of test procedures in clause 7.6.3.4.2.
4. Set the downlink signal level according to the table 7.7.5-1 or 7.7.5-1a. Send uplink power control commands to the UE using 1dB power step size to ensure that the UE output power measured by the test system is within the Uplink power control window, defined as $-(\text{MU})$ to $-(\text{MU} + \text{Uplink power control window size})$ dB of the target power level in Table 7.7.5-1 or 7.7.5-1a for at least the duration of the Throughput measurement, where:
 - MU is the test system uplink power measurement uncertainty and is specified in Table F.1.3-1 for the carrier frequency f and the channel bandwidth BW
 - Uplink power control window size = 1dB (UE power step size) + 0.7dB (UE power step tolerance) + (Test system relative power measurement uncertainty), where, the UE power step tolerance is specified in TS 38.101-1 [2], Table 6.3.4.3-1 and is 0.7dB for 1dB power step size, and the Test system relative power measurement uncertainty is specified for test case 6.3.4.3 in Table F.1.2-1.
5. For the spurious frequency, measure the average throughput for a duration sufficient to achieve statistical significance according to Annex H.2.

NOTE: The purpose of the Uplink power control window is to ensure that the actual UE output power is no greater than the target power level, and as close as possible to the target power level. The relationship between the Uplink power control window, the target power level and the corresponding possible actual UE Uplink power window is illustrated in Annex F.4.3.

7.7.4.3 Message Contents

Message contents are according to TS 38.508-1 [5] subclause 4.6.

7.7.5 Test Requirement

The throughput measurement derived in test procedure shall be $\geq 95\%$ of the maximum throughput of the reference measurement channels as specified in Annex A.3.2 and A.3.3 with parameters for the wanted signal as specified in Table 7.7.5-1 for NR bands with $F_{\text{DL_high}} < 2700$ MHz and $F_{\text{UL_high}} < 2700$ MHz and in Table 7.7.5-1a for NR bands with $F_{\text{DL_high}} \geq 3300$ MHz and $F_{\text{UL_high}} \geq 3300$ MHz and for the interferer as specified in Table 7.7.5-2.

Table 7.7.5-1: Spurious response parameters for NR bands with $F_{\text{DL_high}} < 2700$ MHz and $F_{\text{UL_high}} < 2700$ MHz

RX parameter	Units	Channel bandwidth (MHz)		
		5, 10	15	20, 25, 30, 35, 40, 45, 50, 60, 70, 80, 90, 100
Power in transmission bandwidth configuration ²	dBm	REFSENS + 6 dB	REFSENS + 7 dB	REFSENS + (9 + 10log ₁₀ (BW _{Channel} /20)) dB
NOTE 1: The transmitter shall be set to 4 dB below P _{C_{MAX}L,f,c} at the minimum UL configuration specified in Table 7.3.2.3-3 with P _{C_{MAX}L,f,c} defined in clause 6.2.4.				
NOTE 2: Power in transmission bandwidth configuration value is rounded to the next higher 0.5dB value.				

Table 7.7.5-1a: Spurious response parameters for NR bands with $F_{DL_low} \geq 3300$ MHz and $F_{UL_low} \geq 3300$ MHz

RX parameter	Units	Channel bandwidth (MHz)		
		10	15	20, 25, 30, 35, 40, 45, 50, 60, 70, 80, 90, 100
Power in transmission bandwidth configuration	dBm	REFSENS + 6 dB	REFSENS + 7 dB	REFSENS + 9 dB
NOTE 1: The transmitter shall be set to 4 dB below $P_{C_{MAX_L,f,c}}$ at the minimum UL configuration specified in Table 7.3.2.3-3 with $P_{C_{MAX_L,f,c}}$ defined in clause 6.2.4.				

Table 7.7.5-2: Spurious response

Parameter	Unit	Level
$P_{Interferer}$ (CW)	dBm	-44
$F_{Interferer}$	MHz	Spurious response frequencies

Table 7.7.5-3: Void

7.7A Spurious response for CA

7.7A.0 Minimum conformance requirements

7.7A.0.1 Minimum conformance requirements for intra-band contiguous CA

The normative reference for this requirement is TS 38.101-1 [2] clause 7.7A.1.

Table 7.7A.0.1-1: Spurious response parameters for intra-band contiguous CA

RX parameter	Units	BW Class		
		B	C	D
Power in transmission bandwidth configuration	dBm	REFSENS + channel specific value below		
	dB	9	9	9
NOTE 1: The transmitter shall be set to 4 dB below $P_{C_{MAX_L,f,c}}$ at the minimum UL configuration specified in Table 7.3.2.3-3 with $P_{C_{MAX_L,f,c}}$ defined in clause 6.2.4.				

Table 7.7A.0.1-2: Spurious response for CA

Parameter	Unit	Level
$P_{Interferer}$ (CW)	dBm	-44
$F_{Interferer}$	MHz	Spurious response frequencies

7.7A.0.2 Void

7.7A.0.3 Minimum conformance requirements for inter-band CA

For inter-band carrier aggregation with one component carrier per operating band and the uplink assigned to one NR band, the spurious response are defined with the uplink active on the band(s) other than the band whose downlink is being tested. The UE shall meet the requirements specified in subclause 7.7 for each component carrier while all downlink carriers are active.

For the UE which supports inter-band CA configuration in Table 7.3A.0.3.2.1-1, $P_{interferer}$ power defined in Table 7.7.3-2 is increased by the amount given by $\Delta R_{IB,c}$ defined in Table 7.3A.0.3.2.1-1.

The throughput of each carrier shall be $\geq 95\%$ of the maximum throughput of the reference measurement channels as specified in Annexes A.2.2, A.2.3, A.3.2 and A.3.3 (with one sided dynamic OCNG Pattern OP.1 FDD/TDD for the DL-signal as described in Annex A.5.1.1/A.5.2.1).

The normative reference for this requirement is TS 38.101-1 [2] clause 7.7A.3.

7.7A.0.4 Minimum conformance requirements for intra-band non-contiguous CA

For intra-band non-contiguous carrier aggregation with one uplink carrier and two or more downlink sub-blocks, the spurious response requirements are defined with the uplink configuration in accordance with Table 7.3A.0.2.2-1. For this uplink configuration, the UE shall meet the requirements for each sub-block as specified in clauses 7.7 and 7.7A.1 for one component carrier and two component carriers per sub-block, respectively. The requirements apply with all downlink carriers active.

The throughput of each carrier shall be $\geq 95\%$ of the maximum throughput of the reference measurement channels as specified in Annexes A.2.2, A.2.3, A.3.2, and A.3.3 (with one sided dynamic OCNG Pattern OP.1 FDD/TDD for the DL-signal as described in Annex A.5.1.1/A.5.2.1).

7.7A.1 Spurious response for CA (2DL CA)

7.7A.1.1 Test Purpose

Spurious response for 2DL CA verifies the receiver's ability to receive a wanted 2DL carrier aggregated signal on its assigned channel frequency without exceeding a given degradation due to the presence of an unwanted CW interfering signal at any other frequency at which a response is obtained i.e. for which the out of band blocking limit as specified in sub-clause 7.6A.3 is not met.

The lack of the spurious response ability decreases the coverage area when other unwanted interfering signal exists at any other frequency.

7.7A.1.2 Test Applicability

This test case applies to all types of NR UE release 15 and forward that support 2DL CA.

7.7A.1.3 Minimum Conformance Requirements

The minimum conformance requirements are defined in clause 7.7A.0.

7.7A.1.4 Test Description

7.7A.1.4.1 Initial Conditions

The initial conditions shall be the same as in clause 7.6A.3.1.4.1 in order to test spurious responses obtained in clause 7.6A.3.1 under the same conditions.

7.7A.1.4.2 Test Procedure

1. Configure SCC according to Annex C.0, C.1, C.2 for all downlink physical channels.
2. The SS shall configure SCC as per TS 38.508-1 [5] clause 5.5.1. Message contents are defined in clause 7.7A.1.4.3.
3. SS activates SCC by sending the activation MAC CE (Refer TS 38.321 [18], clauses 5.9, 6.1.3.10). Wait for at least 2 seconds (Refer TS 38.133[19], clause 9.3).
4. SS transmits PDSCH via PDCCH DCI format 1_1 for C_RNTI to transmit the DL RMC according to Test Configuration Table 7.6A.3.1.4.1-1, 7.6A.3.1.4.1-2 or 7.6A.3.1.4.1-3 in Clause 7.6A.3 on both PCC and SCC. The SS sends downlink MAC padding bits on the DL RMC.
5. SS sends uplink scheduling information for each UL HARQ process via PDCCH DCI format 0_1 for C_RNTI to schedule the UL RMC according to Test Configuration Table 7.6A.3.1.4.1-1, 7.6A.3.1.4.1-2 or 7.6A.3.1.4.1-3 in Clause 7.6A.3 on both PCC and SCC. Since the UE has no payload data to send, the UE sends uplink MAC padding bits on the UL RMC.

6. Set the parameters of the CW signal generator for an interfering signal according to Table 7.7A.0.1-2. The spurious frequencies are taken from records in the final step of test procedures in clause 7.6A.3 Out-of-band blocking for CA.
7. Set the downlink signal level according to Table 7.7A.0.1-1 for both carriers. Send uplink power control commands to the UE using 1dB power step size to ensure that the UE output power measured by the test system is within the Uplink power control window, defined as $-(\text{MU} + \text{Uplink power control window size})$ dB of the target power level in Table 7.7A.0.1-1 + $(10\log(P_{\text{LCRB}}/N_{\text{RB_alloc}})$ for PCC, $10\log(S_{\text{LCRB}}/N_{\text{RB_alloc}})$ for SCC) for at least the duration of the Throughput measurement, where:
 - MU is the test system uplink power measurement uncertainty and is specified in Table F.1.3-1 for the carrier frequency f and the channel bandwidth BW
 - Uplink power control window size = 1dB (UE power step size) + 0.7dB (UE power step tolerance) + (Test system relative power measurement uncertainty), where, the UE power step tolerance is specified in TS 38.101-1 [2], Table 6.3.4.3-1 and is 0.7dB for 1dB power step size, and the Test system relative power measurement uncertainty is specified for test case 6.3.4.3 in Table F.1.2-1.
8. For each spurious frequency, measure the average throughput for each component carrier for duration sufficient to achieve statistical significance according to Annex H.2A.

NOTE: The purpose of the Uplink power control window is to ensure that the actual UE output power is no greater than the target power level, and as close as possible to the target power level. The relationship between the Uplink power control window, the target power level and the corresponding possible actual UE Uplink power window is illustrated in Annex F.4.3.

Table 7.7A.1.4.2-1: Void

7.7A.1.4.3 Message Contents

Message contents are according to TS 38.508-1 [5] subclause 4.6.

7.7A.1.5 Test Requirement

The throughput measurement of each carrier derived in test procedure shall be $\geq 95\%$ of the maximum throughput of the reference measurement channels as specified in Annex A.2.2, A.2.3, A.3.2 and A.3.3 (with one sided dynamic OCNG Pattern OP.1 FDD/TDD for the DL-signal as described in Annex A.5.1.1/A.5.2.1) with parameters specified in Table 7.7A.0.1-1 and 7.7A.0.1-2. For the UE which supports inter-band 2DL CA configuration in Table 7.3A.0.3.2.1-1, $P_{\text{Interferer}}$ power defined in Table 7.7A.0.1-2 is increased by the amount given by $\Delta R_{\text{IB},c}$ in Table 7.3A.0.3.2.1-1.

7.7A.2 Spurious response for 3DL CA

7.7A.2.1 Test Purpose

Spurious response for 3DL CA verifies the receiver's ability to receive a wanted 3DL carrier aggregated signal on its assigned channel frequency without exceeding a given degradation due to the presence of an unwanted CW interfering signal at any other frequency at which a response is obtained i.e. for which the out of band blocking limit as specified in sub-clause 7.6A.3 is not met.

The lack of the spurious response ability decreases the coverage area when other unwanted interfering signal exists at any other frequency.

7.7A.2.2 Test Applicability

This test case applies to all types of NR UE release 15 and forward that support 3DL CA.

7.7A.2.3 Minimum Conformance Requirements

The minimum conformance requirements are defined in clause 7.7A.0.

7.7A.2.4 Test Description

7.7A.2.4.1 Initial Conditions

The initial conditions shall be the same as in clause 7.6A.3.2.4.1 in order to test spurious responses obtained in clause 7.6A.3.2 under the same conditions.

7.7A.2.4.2 Test Procedure

Same test procedure as sub-clause 7.7A.1.4.2 with the following exceptions:

Step 1, 2 and 4 of Test Procedure as in clause 7.7A.1.4.2 is replaced by:

1. SS transmits PDSCH via PDCCH DCI format 1_1 for C_RNTI to transmit the DL RMC according to Test Configuration Table 7.6A.3.1.4.1-1, 7.6A.3.1.4.1-2 or 7.6A.3.1.4.1-3 in Clause 7.6A.3 on both PCC and SCCs. The SS sends downlink MAC padding bits on the DL RMC.
2. SS sends uplink scheduling information for each UL HARQ process via PDCCH DCI format 0_1 for C_RNTI to schedule the UL RMC according to Test Configuration Table 7.6A.3.1.4.1-1, 7.6A.3.1.4.1-2 or 7.6A.3.1.4.1-3 in Clause 7.6A.3 on both PCC and SCCs. Since the UE has no payload data to send, the UE sends uplink MAC padding bits on the UL RMC.
4. Set the downlink signal level according to Table 7.7A.0.1-1 for both carriers. Send uplink power control commands to the UE using 1dB power step size to ensure that the UE output power measured by the test system is within the Uplink power control window, defined as $-(\text{MU} + \text{Uplink power control window size})$ dB of the target power level in Table 7.7A.0.1-1 + $(10\log(P_{L_CRB}/N_{RB_alloc})$ for PCC, $10\log(S_{L_CRB}/N_{RB_alloc})$ for SCC) for at least the duration of the Throughput measurement, where:
 - MU is the test system uplink power measurement uncertainty and is specified in Table F.1.3-1 for the carrier frequency f and the channel bandwidth BW
 - Uplink power control window size = 1dB (UE power step size) + 0.7dB (UE power step tolerance) + (Test system relative power measurement uncertainty), where, the UE power step tolerance is specified in TS 38.101-1 [2], Table 6.3.4.3-1 and is 0.7dB for 1dB power step size, and the Test system relative power measurement uncertainty is specified for test case 6.3.4.3 in Table F.1.2-1.

7.7A.2.4.3 Message Contents

Same message contents as sub-clause 7.7A.1.4.3.

7.7A.2.5 Test Requirement

The throughput measurement of each carrier derived in test procedure shall be $\geq 95\%$ of the maximum throughput of the reference measurement channels as specified in Annex A.2.2, A.2.3, A.3.2 and A.3.3 (with one sided dynamic OCNG Pattern OP.1 FDD/TDD for the DL-signal as described in Annex A.5.1.1/A.5.2.1) with parameters specified in Table 7.7A.0.1-1 and 7.7A.0.1-2. For the UE which supports inter-band 3DL CA configuration in Table 7.3A.0.3.2.3-1, $P_{\text{Interferer}}$ power defined in Table 7.7A.0.1-2 is increased by the amount given by $\Delta R_{\text{IB},c}$ in Table 7.3A.0.3.2.3-1.

7.7A.3 Spurious response for 4DL CA

7.7A.3.1 Test Purpose

Spurious response for 4DL CA verifies the receiver's ability to receive a wanted 4DL carrier aggregated signal on its assigned channel frequency without exceeding a given degradation due to the presence of an unwanted CW interfering signal at any other frequency at which a response is obtained i.e. for which the out of band blocking limit as specified in sub-clause 7.6A.3 is not met.

The lack of the spurious response ability decreases the coverage area when other unwanted interfering signal exists at any other frequency.

7.7A.3.2 Test Applicability

This test case applies to all types of NR UE release 15 and forward that support 4DL CA.

7.7A.3.3 Minimum Conformance Requirements

The minimum conformance requirements are defined in clause 7.7A.0.

7.7A.3.4 Test Description

7.7A.3.4.1 Initial Conditions

The initial conditions shall be the same as in clause 7.6A.3.3.4.1 in order to test spurious responses obtained in clause 7.6A.3.3 under the same conditions.

7.7A.3.4.2 Test Procedure

Same test procedure as sub-clause 7.7A.2.4.2.

7.7A.3.4.3 Message Contents

Same message contents as sub-clause 7.7A.1.4.3.

7.7A.3.5 Test Requirement

The throughput measurement of each carrier derived in test procedure shall be $\geq 95\%$ of the maximum throughput of the reference measurement channels as specified in Annex A.2.2, A.2.3, A.3.2 and A.3.3 (with one sided dynamic OCNG Pattern OP.1 FDD/TDD for the DL-signal as described in Annex A.5.1.1/A.5.2.1) with parameters specified in Table 7.7A.0.1-1 and 7.7A.0.1-2. For the UE which supports inter-band 4DL CA configuration in Table 7.3.2_1.3-1 and Table 7.3A.0.3.2.4-1, $P_{\text{Interferer}}$ power defined in Table 7.7A.0.1-2 is increased by the amount given by $\Delta R_{\text{IB,c}}$ in Table 7.3.2_1.3-1 and Table 7.3A.0.3.2.4-1.

7.7D Spurious response for UL MIMO

7.7D.1 Test Purpose

Spurious response verifies the ability of the UE that support UL MIMO to receive a wanted signal on its assigned channel frequency without exceeding a given degradation due to the presence of an unwanted CW interfering signal at any other frequency at which a response is obtained i.e. for which the out of band blocking for UL MIMO limit as specified in sub-clause 7.6D.3 is not met.

The lack of the spurious response ability decreases the coverage area when other unwanted interfering signal exists at any other frequency.

7.7D.2 Test Applicability

This test applies to all types of NR UE release 15 and forward that support UL MIMO on FDD bands.

7.7D.3 Minimum Conformance Requirements

For UE with two transmitter antenna connectors in closed-loop spatial multiplexing scheme, the minimum requirements in Clause 7.7.3 shall be met with the UL MIMO configurations specified in Table 6.2D.1.4.1-1 in Clause 6.2 D.1 UE maximum output power for UL MIMO. For UL MIMO, the parameter P_{CMAX_L} is defined as the total transmitter power over the two transmitter antenna connectors.

The normative reference for this requirement is TS 38.101-1 [2] clause 7.7D.

7.7D.4 Test Description

7.7D.4.1 Initial Conditions

The initial conditions shall be the same as in clause 7.6D.3.4.1 in order to test spurious responses obtained in clause 7.6D.3 under the same conditions.

7.7D.4.2 Test Procedure

1. SS transmits PDSCH via PDCCH DCI format 1_1 for C_RNTI to transmit the DL RMC according to Test Configuration Table 7.6D.3.4.1-1 in Clause 7.6D.3. The SS sends downlink MAC padding bits on the DL RMC.
2. SS sends uplink scheduling information for each UL HARQ process via PDCCH DCI format 0_1 for C_RNTI to schedule the UL RMC according to Test Configuration Table 7.6D.3.4.1-1 in Clause 7.6D.3. Since the UE has no payload data to send, the UE transmits uplink MAC padding bits on the UL RMC. The PDCCH DCI format 0_1 is specified with condition 2TX_UL_MIMO in 38.508-1 [5] subclause 4.3.6.1.1.2.

3. Set the parameters of the CW signal generator for an interfering signal according to Table 7.7.5-2. The spurious frequencies are taken from records in the final step of test procedures in clause 7.6D.3.4.2.
4. Set the downlink signal level according to the Table 7.7.5-1 or 7.7.5-1a. Send uplink power control commands to the UE (less or equal to 1dB step size should be used), to ensure that the UE output power is within +0, - 3.4 dB of the target level in table 7.7.5-1a in table 7.7.5-1 for carrier frequency $f \leq 3.0\text{GHz}$ or within +0, -4.0 dB of the target level for carrier frequency $3.0\text{GHz} < f \leq 4.2\text{GHz}$, for at least the duration of the throughput measurement.
5. For the spurious frequency, measure the average throughput for a duration sufficient to achieve statistical significance according to Annex H.2.

7.7D.4.3 Message Contents

Message contents are according to TS 38.508-1 [5] clause 4.6 ensuring Table 4.6.3-182 with condition 2TX_UL_MIMO.

7.7D.5 Test Requirement

Same test requirement as specified in 7.7.5.

7.7E Spurious response for V2X

7.7E.0 Minimum conformance requirements

7.7E.0.1 General

Spurious response is a measure of the receiver's ability to receive a wanted signal on its assigned channel frequency without exceeding a given degradation due to the presence of an unwanted CW interfering signal at any other frequency for which a response is obtained, i.e. for which the out-of-band blocking limit as specified in clause 7.6E.3 is not met.

The throughput shall be $\geq 95\%$ of the maximum throughput of the reference measurement channels as specified in Annexes A.7.2 with parameters for the wanted signal as specified in Table 7.7E.0.1-1 and Table 7.7E.0.1-2 for NR V2X bands. The relative throughput requirement shall be met for any SCS specified for the channel bandwidth of the wanted signal.

Table 7.7E.0.1-1: Spurious response parameters for NR V2X

RX parameter	Units	Channel bandwidth			
		10 MHz	20 MHz	30 MHz	40 MHz
Power in transmission bandwidth configuration	dBm	$P_{\text{REFSENS_V2X}}$ + channel bandwidth specific value below			
	dB	6	9	11	12

NOTE 1: Reference measurement channel is A.7.2

Table 7.7E.0.1-2: Spurious response for NR V2X

Parameter	Unit	Level
$P_{\text{Interferer (CW)}}$	dBm	-44
$F_{\text{Interferer}}$	MHz	Spurious response frequencies

7.7E.0.2 Spurious response for V2X con-current operation

For the inter-band con-current NR V2X operation, the requirements specified in clause 7.7E.0.1 shall apply for the NR sidelink reception in the operating Bands in Table 5.2E.1-1 and the requirements specified in clause 7.7 shall apply for the NR downlink reception in licensed band while all downlink carriers are active.

The normative reference for this requirement is TS 38.101-1 [2] clause 7.7E.

7.7E.1 Spurious response for V2X / non-concurrent operation

7.7E.2 Spurious response for V2X / con-current operation

7.8 Intermodulation characteristics

7.8.1 General

Intermodulation response rejection is a measure of the capability of the receiver to receive a wanted signal on its assigned channel frequency in the presence of two or more interfering signals which have a specific frequency relationship to the wanted signal

7.8.2 Wide band Intermodulation

7.8.2.1 Test purpose

Intermodulation response tests the UE's ability to receive data with a given average throughput for a specified reference measurement channel, in the presence of two or more interfering signals which have a specific frequency relationship to the wanted signal, under conditions of ideal propagation and no added noise.

A UE unable to meet the throughput requirement under these conditions will decrease the coverage area when two or more interfering signals exist which have a specific frequency relationship to the wanted signal.

7.8.2.2 Test applicability

This test applies to all types of NR UE release 15 and forward.

7.8.2.3 Minimum conformance requirements

The wide band intermodulation requirement is defined using a CW carrier and modulated NR signal as interferer 1 and interferer 2 respectively.

The throughput shall be $\geq 95\%$ of the maximum throughput of the reference measurement channels as specified in Annexes A.2.2, A.2.3, A.3.2 and A.3.3 (with one sided dynamic OCNNG Pattern OP.1 FDD/TDD for the DL-signal as described in Annex A.5.1.1/A.5.2.1) with parameters specified in Table 7.8.2.3-1 for NR bands with $F_{DL_high} < 2700$ MHz and $F_{UL_high} < 2700$ MHz and Table 7.8.2.3-2 for NR bands with $F_{DL_low} \geq 3300$ MHz and $F_{UL_low} \geq 3300$ MHz. The relative throughput requirement shall be met for any SCS specified for the channel bandwidth of the wanted signal. For operating bands with an unpaired DL part (as noted in Table 5.2-1), the requirements only apply for carriers assigned in the paired part.

Table 7.8.2.3-1: Wide band intermodulation parameters for NR bands with $F_{DL_high} < 2700$ MHz and $F_{UL_high} < 2700$ MHz

Rx parameter	Units	Channel bandwidth (MHz)		
		5, 10	15	20, 25, 30, 35, 40, 45, 50, 60, 70, 80, 90, 100
P_w in Transmission Bandwidth Configuration, per CC ⁵	dBm	REFSENS + 6 dB	REFSENS + 7 dB	REFSENS + (9 + 10log ₁₀ (BW _{Channel} /20)) dB
$P_{Interferer\ 1}$ (CW)	dBm	-46		
$P_{Interferer\ 2}$ (Modulated)	dBm	-46		
$BW_{Interferer\ 2}$	MHz	5		
$F_{Interferer\ 1}$ (Offset)	MHz	-BW/2 – 7.5 / +BW/2 + 7.5		
$F_{Interferer\ 2}$ (Offset)	MHz	2* $F_{Interferer\ 1}$		
NOTE 1: The transmitter shall be set to 4 dB below $P_{C_{MAX_L,f,c}}$ at the minimum UL configuration specified in Table 7.3.2.3-3 with $P_{C_{MAX_L,f,c}}$ defined in clause 6.2.4.				
NOTE 2: Reference measurement channel is specified in Annexes A.2.2, A.3.2, and A.3.3 (with one sided dynamic OCNG Pattern OP.1 FDD/TDD for the DL-signal as described in Annex A.5.1.1/A.5.2.1).				
NOTE 3: The modulated interferer consists of the Reference measurement channel specified in Annexes A.3.2.2 and A.3.3.2 with one sided dynamic OCNG Pattern OP.1 FDD/TDD for the DL-signal as described in Annex A.5.1.1/A.5.2.1 and 15 kHz SCS.				
NOTE 4: The $F_{Interferer\ 1}$ (offset) is the frequency separation of the centre frequency of the carrier closest to the interferer and the centre frequency of the CW interferer and $F_{Interferer\ 2}$ (offset) is the frequency separation of the centre frequency of the carrier closest to the interferer and the centre frequency of the modulated interferer.				
NOTE 5: P_w in Transmission Bandwidth Configuration per CC shall be rounded to the next higher 0.5dB value.				

Table 7.8.2.3-2: Wide band intermodulation parameters for NR bands with $F_{DL_low} \geq 3300$ MHz and $F_{UL_low} \geq 3300$ MHz

Rx parameter	Units	Channel bandwidth (MHz)		
		10, 15, 20, 25, 30, 35, 40, 45, 50, 60, 70, 80, 90, 100		
P_w in Transmission Bandwidth Configuration, per CC	dBm	REFSENS + 6dB		
$P_{Interferer\ 1}$ (CW)	dBm	-46		
$P_{Interferer\ 2}$ (Modulated)	dBm	-46		
$BW_{Interferer\ 2}$	MHz	BW		
$F_{Interferer\ 1}$ (Offset)	MHz	-2BW / +2BW		
$F_{Interferer\ 2}$ (Offset)	MHz	2* $F_{Interferer\ 1}$		
NOTE 1: The transmitter shall be set to 4dB below $P_{C_{MAX_L,f,c}}$ at the minimum UL configuration specified in Table 7.3.2.3-3 with $P_{C_{MAX_L,f,c}}$ defined in clause 6.2.4.				
NOTE 2: Reference measurement channel is specified in Annexes A.2.2, A.2.3, A.3.2, and A.3.3 (with one sided dynamic OCNG Pattern OP.1 FDD/TDD for the DL-signal as described in Annex A.5.1.1/A.5.2.1).				
NOTE 3: The modulated interferer consists of the Reference measurement channel specified in Annexes A.3.2.2 and A.3.3.2 with one sided dynamic OCNG Pattern OP.1 FDD/TDD for the DL-signal as described in Annex A.5.1.1/A.5.2.1 and the same SCS as the wanted signal.				
NOTE 4: The $F_{Interferer\ 1}$ (offset) is the frequency separation of the centre frequency of the carrier closest to the interferer and the centre frequency of the CW interferer and $F_{Interferer\ 2}$ (offset) is the frequency separation of the centre frequency of the carrier closest to the interferer and the centre frequency of the modulated interferer.				

The normative reference for this requirement is TS 38.101-1 [2] clause 7.8.2.

7.8.2.4 Test description

7.8.2.4.1 Initial conditions

Initial conditions are a set of test configurations the UE needs to be tested in and the steps for the SS to take with the UE to reach the correct measurement state.

The initial test configurations consist of environmental conditions, test frequencies, test channel bandwidths and sub-carrier spacing based on NR operating bands specified in Table 5.3.5-1. All of these configurations shall be tested with applicable test parameters for each combination of channel bandwidth and sub-carrier spacing, are shown in table 7.8.2.4.1-1. The details of the uplink and downlink reference measurement channels (RMC) are specified in Annexes A.2 and A.3. Configuration of PDSCH and PDCCH before measurement are specified in Annex C.2.

Table 7.8.2.4.1-1: Test Configuration Table

Default Conditions				
Test Environment as specified in TS 38.508-1 [5] subclause 4.1			Normal	
Test Frequencies as specified in TS 38.508-1 [5] subclause 4.3.1			Mid range (NOTE 4)	
Test Channel Bandwidths as specified in TS 38.508-1 [5] subclause 4.3.1			Lowest, Mid, Highest (NOTE 3)	
Test SCS as specified in Table 5.3.5-1			Highest	
Test Parameters				
Test ID	Downlink Configuration		Uplink Configuration	
	Mod'n	RB allocation	Mod'n	RB allocation
1	CP-OFDM QPSK	NOTE 1	DFT-s-OFDM QPSK	NOTE 1
NOTE 1: The specific configuration of uplink and downlink are defined in Table 7.3.2.4.1-1.				
NOTE 2: In a band where UE supports 4Rx, the test shall be performed only with 4Rx antennas ports connected and 4Rx REFSENS requirement (Table 7.3.2.5-2) is used in the test requirements.				
NOTE 3: For n70, highest test channel bandwidth shall be Highest UL / Highest DL according to asymmetric channel bandwidths specified in clause 5.3.6.				
NOTE 4: For NR band n28, 30MHz test channel bandwidth is tested with Low range test frequencies.				

1. Connect the SS to the UE antenna connectors as shown in TS 38.508-1 [5] Annex A, in Figure A.3.1.4.3 for TE diagram and section A.3.2 for UE diagram.
2. The parameter settings for the cell are set up according to TS 38.508-1 [5] subclause 4.4.3.
3. Downlink signals are initially set up according to Annex C.0, C.1, C.2, C.3.1, and uplink signals according to Annex G.0, G.1, G.2, G.3.1.
4. The DL and UL Reference Measurement channels are set according to Table 7.5.4.1-1.
5. Propagation conditions are set according to Annex B.0.
6. Ensure the UE is in state RRC_CONNECTED with generic procedure parameters Connectivity NR, Connected without release *On*, Test Mode *On* and Test Loop Function *On* according to TS 38.508-1 [5] clause 4.5. Message content are defined in clause 7.5.4.3.

7.8.2.4.2 Test procedure

1. SS transmits PDSCH via PDCCH DCI format 1_1 for C_RNTI to transmit the DL RMC according to Table 7.8.2.4.1-1. The SS sends downlink MAC padding bits on the DL RMC.
2. SS sends uplink scheduling information for each UL HARQ process via PDCCH DCI format 0_1 for C_RNTI to schedule the UL RMC according to Table 7.8.2.4.1-1. Since the UE has no payload data to send, the UE transmits uplink MAC padding bits on the UL RMC.
3. Set the Downlink signal level to the value as defined in Table 7.8.2.5-1. Send uplink power control commands to the UE using 1dB power step size to ensure that the UE output power measured by the test system is within the Uplink power control window, defined as -MU to -(MU + Uplink power control window size) dB of the target power level in Table 7.8.2.5-1 for at least the duration of the Throughput measurement, where:

- MU is the test system uplink power measurement uncertainty and is specified in Table F.1.3-1 for the carrier frequency f and the channel bandwidth BW
 - Uplink power control window size = 1dB (UE power step size) + 0.7dB (UE power step tolerance) + (Test system relative power measurement uncertainty), where, the UE power step tolerance is specified in TS 38.101-1 [2], Table 6.3.4.3-1 and is 0.7dB for 1dB power step size, and the Test system relative power measurement uncertainty is specified for test case 6.3.4.3 in Table F.1.2-1.
4. Set the Interfering signal levels to the values as defined in Table 7.8.2.5-1 and frequency below the wanted signal.
 5. Measure the average throughput for a duration sufficient to achieve statistical significance according to Annex G.2.
 6. Repeat steps from 3 to 5, using an interfering signal above the wanted signal at step 4.

NOTE: The purpose of the Uplink power control window is to ensure that the actual UE output power is no greater than the target power level, and as close as possible to the target power level. The relationship between the Uplink power control window, the target power level and the corresponding possible actual UE Uplink power window is illustrated in Annex F.4.3.

7.8.2.4.3 Message contents

Message contents are according to TS 38.508-1 [5] subclause 4.6 with DFT-s-OFDM condition in Table 4.6.3-118 PUSCH-Config.

7.8.2.5 Test requirement

The throughput shall be $\geq 95\%$ of the maximum throughput of the reference measurement channels as specified in Annex A.3.2 with parameters specified in Table 7.8.2.5-1 for the specified wanted signal mean power in the presence of two interfering signals.

Table 7.8.2.5-1: Wide band intermodulation parameters for NR bands with $F_{DL_high} < 2700$ MHz and $F_{UL_high} < 2700$ MHz

Rx parameter	Units	Channel bandwidth (MHz)		
		5, 10	15	20, 25, 30, 35, 40, 45, 50, 60, 70, 80, 90, 100
P_w in Transmission Bandwidth Configuration, per CC ⁵	dBm	REFSENS + 6 dB	REFSENS + 7 dB	REFSENS + (9 + 10log ₁₀ (BW _{Channel} / 20)) dB
$P_{Interferer\ 1}$ (CW)	dBm	-46		
$P_{Interferer\ 2}$ (Modulated)	dBm	-46		
BW _{Interferer\ 2}	MHz	5		
$F_{Interferer\ 1}$ (Offset)	MHz	-BW/2 - 7.5 / +BW/2 + 7.5		
$F_{Interferer\ 2}$ (Offset)	MHz	2* $F_{Interferer\ 1}$		

- NOTE 1: The transmitter shall be set to 4 dB below $P_{CMAX_L,f,c}$ at the minimum UL configuration specified in Table 7.3.2.3-3 with $P_{CMAX_L,f,c}$ defined in clause 6.2.4.
- NOTE 2: Reference measurement channel is specified in Annexes A.2.2, A.3.2, and A.3.3 (with one sided dynamic OCNG Pattern OP.1 FDD/TDD for the DL-signal as described in Annex A.5.1.1/A.5.2.1).
- NOTE 3: The modulated interferer consists of the Reference measurement channel specified in Annexes A.3.2.2 and A.3.3.2 with one sided dynamic OCNG Pattern OP.1 FDD/TDD for the DL-signal as described in Annex A.5.1.1/A.5.2.1 and 15 kHz SCS.
- NOTE 4: The $F_{Interferer\ 1}$ (offset) is the frequency separation of the centre frequency of the carrier closest to the interferer and the centre frequency of the CW interferer and $F_{Interferer\ 2}$ (offset) is the frequency separation of the centre frequency of the carrier closest to the interferer and the centre frequency of the modulated interferer.
- NOTE 5: P_w in Transmission Bandwidth Configuration per CC shall be rounded to the next higher 0.5dB value.

Table 7.8.2.5-2: Wide band intermodulation parameters for NR bands with $F_{DL_low} \geq 3300$ MHz and $F_{UL_low} \geq 3300$ MHz

Rx parameter	Units	Channel bandwidth (MHz)
		10, 15, 20, 25, 30, 35, 40, 45, 50, 60, 70, 80, 90, 100
P_w in Transmission Bandwidth Configuration, per CC	dBm	REFSENS + 6dB
$P_{Interferer\ 1}$ (CW)	dBm	-46
$P_{Interferer\ 2}$ (Modulated)	dBm	-46
$BW_{Interferer\ 2}$	MHz	BW
$F_{Interferer\ 1}$ (Offset)	MHz	-2BW / +2BW
$F_{Interferer\ 2}$ (Offset)	MHz	$2 * F_{Interferer\ 1}$
<p>NOTE 1: The transmitter shall be set to 4dB below $P_{CMAX_L,f,c}$ at the minimum UL configuration specified in Table 7.3.2.3-3 with $P_{CMAX_L,f,c}$ defined in clause 6.2.4.</p> <p>NOTE 2: Reference measurement channel is specified in Annexes A.2.2, A.2.3, A.3.2, and A.3.3 (with one sided dynamic OCNG Pattern OP.1 FDD/TDD for the DL-signal as described in Annex A.5.1.1/A.5.2.1).</p> <p>NOTE 3: The modulated interferer consists of the Reference measurement channel specified in Annexes A.3.2.2 and A.3.3.2 with one sided dynamic OCNG Pattern OP.1 FDD/TDD for the DL-signal as described in Annex A.5.1.1/A.5.2.1 and the same SCS as the wanted signal.</p> <p>NOTE 4: The $F_{Interferer\ 1}$ (offset) is the frequency separation of the centre frequency of the carrier closest to the interferer and the centre frequency of the CW interferer and $F_{Interferer\ 2}$ (offset) is the frequency separation of the centre frequency of the carrier closest to the interferer and the centre frequency of the modulated interferer.</p>		

Table 7.8.2.5-3: Void

7.8A Intermodulation characteristics for CA

7.8A.1 General

7.8A.2 Wide band Intermodulation for CA

7.8A.2.0 Minimum conformance requirements

7.8A.2.0.1 Wide band Intermodulation for Intra-band contiguous CA

Table 7.8A.2.0.1-1: Wide band intermodulation parameters for intra-band contiguous CA with $F_{DL_low} \geq 3300$ MHz and $F_{UL_low} \geq 3300$ MHz

Rx parameter	Units	NR CA bandwidth class		
		BC	C	D
P_w in Transmission Bandwidth Configuration, per CC	dBm	REFSENS + 10	REFSENS + 6	REFSENS + 13.8
$P_{\text{Interferer 1 (CW)}}$	dBm	-46		
$P_{\text{Interferer 2 (Modulated)}}$	dBm	-46		
$BW_{\text{Interferer 2}}$	MHz	$BW_{\text{Channel_CA}20}$	$BW_{\text{Channel_CA}}$	50
$F_{\text{Interferer 1 (Offset)}}$	MHz	$-F_{\text{offset}}-30$ / $F_{\text{offset}}+30$	$-2BW_{\text{Channel_CA}}$ / $+2BW_{\text{Channel_CA}}$	$-F_{\text{offset}}-75$ / $F_{\text{offset}}+75$
$F_{\text{Interferer 2 (Offset)}}$	MHz	$2 * F_{\text{Interferer 1}}$		
<p>NOTE 1: The transmitter shall be set to 4 dB below $P_{\text{CMAX_L,f,c}}$ at the minimum UL configuration specified in Table 7.3.2.3-3 with $P_{\text{CMAX_L,f,c}}$ defined in clause 6.2.4.</p> <p>NOTE 2: Reference measurement channel is specified in Annexes A.2.2, A.2.3, A.3.2, and A.3.3 (with one sided dynamic OCNG Pattern OP.1 FDD/TDD for the DL-signal as described in Annex A.5.1.1/A.5.2.1).</p> <p>NOTE 3: The modulated interferer consists of the Reference measurement channel specified in Annexes A.3.2.2 and A.3.3.2 with one sided dynamic OCNG Pattern OP.1 FDD/TDD for the DL-signal as described in Annex A.5.1.1/A.5.2.1 and the same SCS as the closest carrier.</p> <p>NOTE 4: The $F_{\text{interferer 1 (offset)}}$ is the frequency separation of the centre frequency of the carrier closest to the interferer and the centre frequency of the CW interferer and $F_{\text{interferer 2 (offset)}}$ is the frequency separation of the centre frequency of the carrier closest to the interferer and the centre frequency of the modulated interferer.</p>				

Table 7.8A.2.0.1-2: Wide band intermodulation parameters for intra-band contiguous CA with $F_{DL_low} < 2700$ MHz and $F_{UL_low} < 2700$ MHz

Rx parameter	Units	NR CA bandwidth class	
		B	C
P_w in Transmission Bandwidth Configuration, per CC	dBm	REFSENS + 16	REFSENS + 19
$P_{Interferer\ 1}$ (CW)	dBm	-46	-46
$P_{Interferer\ 2}$ (Modulated)	dBm	-46	-46
$BW_{Interferer\ 2}$	MHz	5	5
$F_{Interferer\ 1}$ (Offset)	MHz	$-F_{offset}-7.5$ / $F_{offset}+7.5$	$-F_{offset}-7.5$ / $F_{offset}+7.5$
$F_{Interferer\ 2}$ (Offset)	MHz	$2 \cdot F_{Interferer\ 1}$	$2 \cdot F_{Interferer\ 1}$
NOTE 1: The transmitter shall be set to 4 dB below $P_{CMAX_L,f,c}$ at the minimum UL configuration specified in Table 7.3.2.3-3 with $P_{CMAX_L,f,c}$ defined in clause 6.2.4.			
NOTE 2: Reference measurement channel is specified in Annexes A.2.2, A.2.3, A.3.2, and A.3.3 (with one sided dynamic OCNG Pattern OP.1 FDD/TDD for the DL-signal as described in Annex A.5.1.1/A.5.2.1).			
NOTE 3: The modulated interferer consists of the Reference measurement channel specified in Annexes A.3.2.2 and A.3.3.2 with one sided dynamic OCNG Pattern OP.1 FDD/TDD for the DL-signal as described in Annex A.5.1.1/A.5.2.1 and the same SCS as the 15 kHz SCS.			
NOTE 4: The $F_{interferer\ 1}$ (offset) is the frequency separation of the centre frequency of the carrier closest to the interferer and the centre frequency of the CW interferer and $F_{interferer\ 2}$ (offset) is the frequency separation of the centre frequency of the carrier closest to the interferer and the centre frequency of the modulated interferer.			

7.8A.2.0.2 Wide band intermodulation for Intra-band non-contiguous CA

For intra-band non-contiguous carrier aggregation with one uplink carrier and two or more downlink sub-blocks, the wide band intermodulation requirements are defined with the uplink configuration in accordance with Table 7.3A.0.2.3-1. For this uplink configuration, the UE shall meet the requirements for each sub-block as specified in subclause 7.8.2 and 7.8A.2.0.1 for one component carrier and two component carriers per sub-block, respectively. The requirements apply for out-of-gap interferers while all downlink carriers are active.

The throughput of each carrier shall be ≥ 95 % of the maximum throughput of the reference measurement channels as specified in Annexes A.2.2, A.2.3, A.3.2, and A.3.3 (with one sided dynamic OCNG Pattern OP.1 FDD/TDD for the DL-signal as described in Annex A.5.1.1/A.5.2.1).

7.8A.2.0.3 Wide band Intermodulation for Inter-band CA

For inter-band carrier aggregation with one component carrier per operating band and the uplink assigned to one NR band, the wide band intermodulation requirements are defined with the uplink active on the band(s) other than the band whose downlink is being tested. The UE shall meet the requirements specified in subclause 7.8 for each component carrier while all downlink carriers are active.

For the UE which supports inter-band CA configuration in Table 7.3A.0.3.2.1-1, $P_{interferer}$ power defined in Table 7.8.2.3-1 and 7.8.2.3-2 is increased by the amount given by $\Delta R_{IB,c}$ in Table 7.3A.0.3.2.1-1.

The throughput of each carrier shall be ≥ 95 % of the maximum throughput of the reference measurement channels as specified in Annexes A.2.2, A.2.3, A.3.2, and A.3.3 (with one sided dynamic OCNG Pattern OP.1 FDD/TDD for the DL-signal as described in Annex A.5.1.1/A.5.2.1).

The normative reference for this requirement is TS 38.101-1 [2] clause 7.8A.2.

7.8A.2.1 Wide band Intermodulation for CA (2DL CA)

7.8A.2.1.1 Test purpose

Intermodulation response tests the UE's ability to receive data with a given average throughput for a specified reference measurement channel, in the presence of two or more interfering signals which have a specific frequency relationship to the wanted signal, under conditions of ideal propagation and no added noise.

A UE unable to meet the throughput requirement under these conditions will decrease the coverage area when two or more interfering signals exist which have a specific frequency relationship to the wanted signal.

7.8A.2.1.2 Test applicability

This test case applies to all types of NR UE release 15 and forward that supports 2DL CA.

7.8A.2.1.3 Minimum conformance requirements

The minimum conformance requirements are defined in clause 7.8A.2.0.

7.8A.2.1.4 Test description

7.8A.2.1.4.1 Initial conditions

Initial conditions are a set of test configurations the UE needs to be tested in and the steps for the SS to take with the UE to reach the correct measurement state.

The initial test configurations consist of environmental conditions, test frequencies, test channel bandwidths and sub-carrier spacing based on NR CA configurations specified in clause 5.5A. All of these configurations shall be tested with applicable test parameters for each CA configuration, are shown in Table 7.8A.2.1.4.1-1, 7.8A.2.1.4.1-2 or 7.8A.2.1.4.1-3. The details of the uplink and downlink reference measurement channels (RMC) are specified in Annexes A.2 and A.3 respectively. The details of the OCNG patterns used are specified in Annex A.5. Configurations of PDSCH and PDCCH before measurement are specified in Annex C.2.

Table 7.8A.2.1.4.1-1: Test configuration table for Intra-band contiguous CA

Default Conditions					
Test Environment as specified in TS 38.508-1 [5] subclause 4.1			Normal		
Test Frequencies as specified in TS 38.508-1 [5] subclause 4.3.1			Mid range		
Test CC Combination setting (N_{RB_agg}) as specified in Table 5.5A.1-1 for the CA Configuration across bandwidth combination sets supported by the UE.			Highest N_{RB_agg} NOTE 3		
Test SCS as specified in Table 5.3.5-1			Highest		
Test Parameters					
Test ID	Downlink Configuration			Uplink Configuration	
	CC Mod'n	PCC RB allocation	SCC RB allocation	CC Mod'n	PCC RB allocation
1	CP-OFDM QPSK	Full RB ¹	Full RB ¹	DFT-s-OFDM QPSK	REFSENS ²
NOTE 1: Full RB allocation shall be used per each SCS and channel BW as specified in Table 7.3.2.4.1-2.					
NOTE 2: REFSENS refers to the single carrier Uplink RB allocation for reference sensitivity according to Table 7.3.2.4.1-3.					
NOTE 3: If the UE supports multiple CC Combinations in the CA Configuration with the same N_{RB_agg} , only the combination with the highest N_{RB_PCC} is tested.					
NOTE 4: In a band where UE supports 4Rx, the test shall be performed only with 4Rx antennas ports connected and 4Rx REFSENS requirement (Table 7.3.2.5-2) is used in the test requirements.					

Table 7.8A.2.1.4.1-2: Test configuration table for Inter-band CA

Default Conditions					
Test Environment as specified in TS 38.508-1 [5] subclause 4.1			Normal		
Test Frequencies as specified in TS 38.508-1 [5] subclause 4.3.1			NOTE 4		
Test CC Combination setting (N_{RB_agg}) as specified in Table 5.5A.3.1-1 for the CA Configuration across bandwidth combination sets supported by the UE.			Highest N_{RB_agg} NOTE 5		
Test SCS as specified in Table 5.3.5-1			Highest		
Test Parameters					
Test ID	Downlink Configuration			Uplink Configuration	
	CC Mod'n	PCC RB allocation	SCC RB allocation	CC Mod'n	PCC RB allocation
1	CP-OFDM QPSK	Full RB ¹	Full RB ¹	DFT-s-OFDM QPSK	REFSENS ²
NOTE 1: Full RB allocation shall be used per each SCS and channel BW as specified in Table 7.3.2.4.1-2.					
NOTE 2: REFSENS refers to the single carrier Uplink RB allocation for reference sensitivity according to Table 7.3.2.4.1-3.					
NOTE 3: In a band where UE supports 4Rx, the test shall be performed only with 4Rx antennas ports connected and 4Rx REFSENS requirement (Table 7.3.2.5-2) is used in the test requirements.					
NOTE 4: Test frequency is set to Mid Range PCC and SCC with exceptions defined in Table 7.3A.2.4.1-1. For NR band n28, 30MHz test channel bandwidth is tested with Low range test frequencies.					
NOTE 5: If the UE supports multiple CC Combinations in the CA Configuration with the same N_{RB_agg} , only the combination with the highest N_{RB_PCC} is tested.					

Table 7.8A.1.4.1-3: Test configuration table for Intra-band non-contiguous CA

Default Conditions					
Test Environment as specified in TS 38.508-1 [5] subclause 4.1			Normal		
Test Frequencies as specified in TS 38.508-1 [5] subclause 4.3.1			NOTE 1		
Test CC Combination setting (N_{RB_agg}) as specified in Table 5.5A.2-1 for the CA Configuration across bandwidth combination sets supported by the UE.			Highest N_{RB_agg} , NOTE 1, NOTE 3		
Test SCS as specified in Table 5.3.5-1			Highest		
Test Parameters					
Test ID	Downlink Configuration			Uplink Configuration	
	CC Mod'n	PCC RB allocation	SCC RB allocation	CC Mod'n	PCC RB allocation
1	CP-OFDM QPSK	NOTE 1	NOTE 1	DFT-s-OFDM QPSK	NOTE 1
NOTE 1: The specific configuration of uplink and downlink are defined in Table 7.3A.1.4.1-3.					
NOTE 2: In a band where UE supports 4Rx, the test shall be performed only with 4Rx antennas ports connected and 4Rx REFSENS requirement (Table 7.3.2.5-2) is used in the test requirements.					
NOTE 3: If the UE supports multiple CC Combinations in the CA Configuration with the same N_{RB_agg} , only the combination with the highest N_{RB_PCC} is tested.					

1. Connect the SS to the UE antenna connectors as shown in TS 38.508-1 [5] Annex A, Figure A.3.1.4.7 for TE diagram and section A.3.2 for UE diagram.
2. The parameter settings for the cell are set up according to TS 38.508-1 [5] subclause 4.4.3.
3. Downlink signals are initially set up according to Annex C.0, C.1, C.2, and C.3.1, and uplink signals according to Annex G.0, G.1, G.2, and G.3.1.
4. The DL and UL Reference Measurement Channels are set according to Table 7.8A.2.1.4.1-1, Table 7.8A.2.1.4.1-2 or Table 7.8A.2.1.4.1-3.
5. Propagation conditions are set according to Annex B.0.

6. Ensure the UE is in State RRC_CONNECTED with generic procedure parameters Connectivity NR, Connected without release On, Test Mode On and Test Loop Function On according to TS 38.508-1 [5] clause 4.5. Message contents are defined in clause 7.8A.2.1.4.3.

7.8A.2.1.4.2 Test procedure

1. Configure SCC according to Annex C.0, C.1, C.2 for all downlink physical channels.
2. The SS shall configure SCC as per TS 38.508-1 [5] clause 5.5.1. Message contents are defined in clause 7.8A.2.1.4.3.
3. SS activates SCC by sending the activation MAC CE (Refer TS 38.321 [18], clauses 5.9, 6.1.3.10). Wait for at least 2 seconds (Refer TS 38.133[19], clause 9.3).
4. SS transmits PDSCH via PDCCH DCI format 1_1 for C_RNTI to transmit the DL RMC according to Table 7.8A.2.1.4.1-1, 7.8A.2.1.4.1-2 or 7.8A.2.1.4.1-3 on both PCC and SCC. The SS sends downlink MAC padding bits on the DL RMC.
5. SS sends uplink scheduling information for each UL HARQ process via PDCCH DCI format 0_1 for C_RNTI to schedule the UL RMC according to Table 7.8A.2.1.4.1-1, 7.8A.2.1.4.1-2 or 7.8A.2.1.4.1-3 on PCC. Since the UE has no payload data to send, the UE transmits uplink MAC padding bits on the UL RMC.
6. Set the Interfering signal levels to the values as defined in Table 7.8A.2.1.5.1-1, 7.8A.2.1.5.1-2, 7.8A.2.1.5.3-1 or 7.8A.2.1.5.3-2 and frequency below the CA Band for intra-band CA, or below the SCC's operating band for inter-band CA according to Table 7.8A.2.1.5.1-1, 7.8A.2.1.5.1-2, 7.8A.2.1.5.3-1 or 7.8A.2.1.5.3-2, using a modulated interferer bandwidth as defined in Annex D of the present document. For the UE which supports inter-band CA configuration in Table 7.3A.0.3.2.1-1, $P_{\text{interferer}}$ power defined in Table 7.8A.2.1.5.3-1 and 7.8A.2.1.5.3-2 is increased by the amount given by $\Delta R_{\text{IB,c}}$ in Table 7.3A.0.3.2.1-1.
7. Set the Downlink signal level for PCC and SCC to the value as defined in Table 7.8A.2.1.5.1-1, 7.8A.2.1.5.1-2, 7.8A.2.1.5.3-1 or 7.8A.2.1.5.3-2. Send uplink power control commands to the UE using 1dB power step size to ensure that the UE output power measured by the test system is within the Uplink power control window, defined as $-\text{MU}$ to $-(\text{MU} + \text{Uplink power control window size})$ dB of the target power level in Table 7.8A.2.1.5.1-1, 7.8A.2.1.5.1-2, 7.8A.2.1.5.3-1 or 7.8A.2.1.5.3-2 for at least the duration of the Throughput measurement, where:
 - MU is the test system uplink power measurement uncertainty and is specified in Table F.1.3-1 for the carrier frequency f and the channel bandwidth BW
 - Uplink power control window size = 1dB (UE power step size) + 0.7dB (UE power step tolerance) + (Test system relative power measurement uncertainty), where, the UE power step tolerance is specified in TS 38.101-1 [2], Table 6.3.4.3-1 and is 0.7dB for 1dB power step size, and the Test system relative power measurement uncertainty is specified for test case 6.3.4.3 in Table F.1.2-1.
8. Measure the average throughput of SCC for a duration sufficient to achieve statistical significance according to Annex H.2A for inter-band CA. Measure the average throughput of both carriers for a duration sufficient to achieve statistical significance according to Annex H.2A for intra-band CA.
9. Repeat steps from 6 to 8, using an interfering signal above the CA Band for intra-band CA, or above the SCC's operating band for inter-band CA at step 6.
10. For Inter-band CA: Switch the SCell into PCell and repeat steps 1 to 9, except for operating bands without uplink band.

NOTE: The purpose of the Uplink power control window is to ensure that the actual UE output power is no greater than the target power level, and as close as possible to the target power level. The relationship between the Uplink power control window, the target power level and the corresponding possible actual UE Uplink power window is illustrated in Annex F.4.3.

7.8A.2.1.4.3 Message contents

Message contents are according to TS 38.508-1 [5] subclause 4.6 Table 4.6.3-118 with condition TRANSFORM_PRECODER_ENABLED.

7.8A.2.1.5 Test requirement

7.8A.2.1.5.1 Wide band intermodulation for Intra-band contiguous CA

The throughput shall be $\geq 95\%$ of the maximum throughput of the reference measurement channels as specified in Annex A.3.2 with parameters specified in Table 7.8A.2.1.5.1-1 or 7.8A.2.1.5.1-2 for the specified wanted signal mean power in the presence of two interfering signals.

Table 7.8A.2.1.5.1-1: Wide band intermodulation parameters for intra-band contiguous CA with $F_{DL_low} \geq 3300$ MHz and $F_{UL_low} \geq 3300$ MHz

Rx parameter	Units	NR CA bandwidth class	
		B	C
P_w in Transmission Bandwidth Configuration, per CC	dBm	REFSENS + 10	REFSENS + 6
$P_{Interferer\ 1}$ (CW)	dBm	-46	
$P_{Interferer\ 2}$ (Modulated)	dBm	-46	
$BW_{Interferer\ 2}$	MHz	20	$BW_{Channel_CA}$
$F_{Interferer\ 1}$ (Offset)	MHz	$-F_{offset} - 30$ / $F_{offset} + 30$	$-2BW_{Channel_CA}$ / $+2BW_{Channel_CA}$
$F_{Interferer\ 2}$ (Offset)	MHz	$2 * F_{Interferer\ 1}$	
NOTE 1: The transmitter shall be set to 4 dB below $P_{CMAX_L,f,c}$ at the minimum UL configuration specified in Table 7.3.2.3-3 with $P_{CMAX_L,f,c}$ defined in clause 6.2.4.			
NOTE 2: Reference measurement channel is specified in Annexes A.2.2, A.2.3, A.3.2, and A.3.3 (with one sided dynamic OCNG Pattern OP.1 FDD/TDD for the DL-signal as described in Annex A.5.1.1/A.5.2.1).			
NOTE 3: The modulated interferer consists of the Reference measurement channel specified in Annexes A.3.2.2 and A.3.3.2 with one sided dynamic OCNG Pattern OP.1 FDD/TDD for the DL-signal as described in Annex A.5.1.1/A.5.2.1 and the same SCS as the closest carrier.			
NOTE 4: The $F_{Interferer\ 1}$ (offset) is the frequency separation of the centre frequency of the carrier closest to the interferer and the centre frequency of the CW interferer and $F_{Interferer\ 2}$ (offset) is the frequency separation of the centre frequency of the carrier closest to the interferer and the centre frequency of the modulated interferer.			

Table 7.8A.2.1.5.1-2: Wide band intermodulation parameters for intra-band contiguous CA with $F_{DL_low} < 2700$ MHz and $F_{UL_low} < 2700$ MHz

Rx parameter	Units	NR CA bandwidth class	
		B	C
P_w in Transmission Bandwidth Configuration, per CC	dBm	REFSENS + 16	REFSENS + 19
$P_{Interferer\ 1}$ (CW)	dBm	-46	-46
$P_{Interferer\ 2}$ (Modulated)	dBm	-46	-46
$BW_{Interferer\ 2}$	MHz	5	5
$F_{Interferer\ 1}$ (Offset)	MHz	$-F_{offset}-7.5$ / $F_{offset}+7.5$	$-F_{offset}-7.5$ / $F_{offset}+7.5$
$F_{Interferer\ 2}$ (Offset)	MHz	$2 \cdot F_{Interferer\ 1}$	$2 \cdot F_{Interferer\ 1}$
<p>NOTE 1: The transmitter shall be set to 4 dB below $P_{C_{MAX_L,f,c}}$ at the minimum UL configuration specified in Table 7.3.2.3-3 with $P_{C_{MAX_L,f,c}}$ defined in clause 6.2.4.</p> <p>NOTE 2: Reference measurement channel is specified in Annexes A.2.2, A.2.3, A.3.2, and A.3.3 (with one sided dynamic OCNG Pattern OP.1 FDD/TDD for the DL-signal as described in Annex A.5.1.1/A.5.2.1).</p> <p>NOTE 3: The modulated interferer consists of the Reference measurement channel specified in Annexes A.3.2.2 and A.3.3.2 with one sided dynamic OCNG Pattern OP.1 FDD/TDD for the DL-signal as described in Annex A.5.1.1/A.5.2.1 and the same SCS as the 15 kHz SCS.</p> <p>NOTE 4: The $F_{interferer\ 1}$ (offset) is the frequency separation of the centre frequency of the carrier closest to the interferer and the centre frequency of the CW interferer and $F_{interferer\ 2}$ (offset) is the frequency separation of the centre frequency of the carrier closest to the interferer and the centre frequency of the modulated interferer.</p>			

7.8A.2.1.5.2 Wide band intermodulation for Intra-band non-contiguous CA

For intra-band non-contiguous carrier aggregation with one uplink carrier and two downlink carriers, the wide band intermodulation requirements are defined with the uplink configuration in accordance with Table 7.3A.0.2.3-1. For this uplink configuration, the UE shall meet the requirements for each carrier as specified in subclause 7.8.2 for each component carrier respectively. The requirements apply for out-of-gap interferers while all downlink carriers are active.

The throughput of each carrier shall be ≥ 95 % of the maximum throughput of the reference measurement channels as specified in Annexes A.2.2, A.2.3, A.3.2, and A.3.3 (with one sided dynamic OCNG Pattern OP.1 FDD/TDD for the DL-signal as described in Annex A.5.1.1/A.5.2.1) with parameters defined in Table 7.8A.2.1.5.3-1 or 7.8A.2.1.5.3-2.

7.8A.2.1.5.3 Wide band intermodulation for Inter-band CA

For inter-band carrier aggregation with one component carrier per operating band and the uplink assigned to one NR band, the wide band intermodulation requirements are defined with the uplink active on the band(s) other than the band whose downlink is being tested.

The throughput of each carrier shall be ≥ 95 % of the maximum throughput of the reference measurement channels as specified in Annexes A.2.2, A.2.3, A.3.2, and A.3.3 (with one sided dynamic OCNG Pattern OP.1 FDD/TDD for the DL-signal as described in Annex A.5.1.1/A.5.2.1) with parameters defined in Table 7.8A.2.1.5.3-1 or 7.8A.2.1.5.3-2.

Table 7.8A.2.1.5.3-1: Wide band intermodulation parameters for NR bands with $F_{DL_high} < 2700$ MHz and $F_{UL_high} < 2700$ MHz

Rx parameter	Units	Channel bandwidth											
		5 MHz	10 MHz	15 MHz	20 MHz	25 MHz	30 MHz	40 MHz	50 MHz	60 MHz	80 MHz	90 MHz	100 MHz
P _w in Transmission Bandwidth Configuration, per CC	dBm	REFSENS + channel bandwidth specific value below											
		6	6	7	9	10	11	12	13	14	15	15	16
P _{Interferer 1 (CW)}	dBm	-46											
P _{Interferer 2 (Modulated)}	dBm	-46											
BW _{Interferer 2}	MHz	5											
F _{Interferer 1 (Offset)}	MHz	-BW/2 – 7.5 / +BW/2 + 7.5											
F _{Interferer 2 (Offset)}	MHz	2*F _{Interferer 1}											
<p>NOTE 1: The transmitter shall be set to 4dB below P_{C_{MAX}_L,f,c} at the minimum UL configuration specified in Table 7.3.2.3-3 with P_{C_{MAX}_L,f,c} defined in clause 6.2.4.</p> <p>NOTE 2: Reference measurement channel is specified in Annexes A.2.2, A.2.3, A.3.2, and A.3.3 (with one sided dynamic OCNG Pattern OP.1 FDD/TDD for the DL-signal as described in Annex A.5.1.1/A.5.2.1).</p> <p>NOTE 3: The modulated interferer consists of the Reference measurement channel specified in Annexes A.3.2.2 and A.3.3.2 with one sided dynamic OCNG Pattern OP.1 FDD/TDD for the DL-signal as described in Annex A.5.1.1/A.5.2.1 and 15 kHz SCS.</p> <p>NOTE 4: The F_{Interferer 1 (offset)} is the frequency separation of the centre frequency of the carrier closest to the interferer and the centre frequency of the CW interferer and F_{Interferer 2 (offset)} is the frequency separation of the centre frequency of the carrier closest to the interferer and the centre frequency of the modulated interferer.</p>													

For the UE which supports inter-band CA configuration in Table 7.3A.0.3.2.1-1, P_{interferer} power defined in Table 7.8A.2.1.5.3-1 and 7.8A.2.1.5.3-2 is increased by the amount given by $\Delta R_{IB,c}$ in Table 7.3A.0.3.2.1-1.

Table 7.8A.2.1.5.3-2: Wide band intermodulation parameters for NR bands with $F_{DL_low} \geq 3300$ MHz and $F_{UL_low} \geq 3300$ MHz

Rx parameter	Units	Channel bandwidth							
		10 MHz	20 MHz	40 MHz	50 MHz	60 MHz	80 MHz	90 MHz	100 MHz
P_w in Transmission Bandwidth Configuration, per CC	dBm	REFSENS + 6							
$P_{Interferer\ 1}$ (CW)	dBm	-46							
$P_{Interferer\ 2}$ (Modulated)	dBm	-46							
$BW_{Interferer\ 2}$	MHz	BW							
$F_{Interferer\ 1}$ (Offset)	MHz	-2BW / +2BW							
$F_{Interferer\ 2}$ (Offset)	MHz	$2 * F_{Interferer\ 1}$							
<p>NOTE 1: The transmitter shall be set to 4dB below $P_{CMAX_L,f,c}$ at the minimum UL configuration specified in Table 7.3.2.3-3 with $P_{CMAX_L,f,c}$ defined in clause 6.2.4.</p> <p>NOTE 2: Reference measurement channel is specified in Annexes A.2.2, A.2.3, A.3.2, and A.3.3 (with one sided dynamic OCNG Pattern OP.1 FDD/TDD for the DL-signal as described in Annex A.5.1.1/A.5.2.1).</p> <p>NOTE 3: The modulated interferer consists of the Reference measurement channel specified in Annexes A.3.2.2 and A.3.3.2 with one sided dynamic OCNG Pattern OP.1 FDD/TDD for the DL-signal as described in Annex A.5.1.1/A.5.2.1 and the same SCS as the wanted signal.</p> <p>NOTE 4: The $F_{interferer\ 1}$ (offset) is the frequency separation of the centre frequency of the carrier closest to the interferer and the centre frequency of the CW interferer and $F_{interferer\ 2}$ (offset) is the frequency separation of the centre frequency of the carrier closest to the interferer and the centre frequency of the modulated interferer.</p>									

7.8A.2.2 Wide band Intermodulation for CA (3DL CA)

7.8A.2.2.1 Test purpose

Intermodulation response tests the UE's ability to receive data with a given average throughput for a specified reference measurement channel, in the presence of two or more interfering signals which have a specific frequency relationship to the wanted signal, under conditions of ideal propagation and no added noise.

A UE unable to meet the throughput requirement under these conditions will decrease the coverage area when two or more interfering signals exist which have a specific frequency relationship to the wanted signal.

7.8A.2.2.2 Test applicability

This test case applies to all types of NR UE release 15 and forward that supports 3DL CA.

7.8A.2.2.3 Minimum conformance requirements

The minimum conformance requirements are defined in clause 7.8A.2.0.

7.8A.2.2.4 Test description

7.8A.2.2.4.1 Initial conditions

Initial conditions are a set of test configurations the UE needs to be tested in and the steps for the SS to take with the UE to reach the correct measurement state.

The initial test configurations consist of environmental conditions, test frequencies, test channel bandwidths and sub-carrier spacing based on NR CA configurations specified in clause 5.5A. All of these configurations shall be tested with applicable test parameters for each CA configuration, are shown in Table 7.8A.2.2.4.1-1. The details of the uplink and downlink reference measurement channels (RMC) are specified in Annexes A.2 and A.3 respectively. The details of the OCNG patterns used are specified in Annex A.5. Configurations of PDSCH and PDCCH before measurement are specified in Annex C.2.

Table 7.8A.2.2.4.1-1: Test configuration table for CA

Default Conditions					
Test Environment as specified in TS 38.508-1 [5] subclause 4.1			Normal		
Test Frequencies as specified in TS 38.508-1 [5] subclause 4.3.1			Intra-band contiguous: Mid range Inter-band: NOTE 3 Intra-band contiguous + Inter-band: NOTE 3 Intra-band non-contiguous + Inter-band: NOTE 3		
Test CC Combination setting (N_{RB_agg}) as specified in Tables 5.5A.1-1, 5.5A.2-1, or tables in clauses 5.5A.3.x for the CA Configuration across bandwidth combination sets supported by the UE.			Highest N_{RB_agg} (NOTE 4)		
Test SCS as specified in Table 5.3.5-1			Highest		
Test Parameters					
Test ID	Downlink Configuration			Uplink Configuration	
	CC Mod'n	PCC RB allocation	SCCs RB allocation	CC Mod'n	PCC RB allocation
Default Test Settings for a CA_nXD Configuration (Intra-band contiguous)					
1	CP-OFDM QPSK	Full RB ¹	Full RB ¹	DFT-s-OFDM QPSK	REFSENS ²
Default Test Settings for a CA_nXA-nYA-nZA Configuration (Inter-band)					
1	CP-OFDM QPSK	Full RB ¹	Full RB ¹	DFT-s-OFDM QPSK	REFSENS ²
Default Test Settings for a CA_nXC-nYA, CA_nYA-nXC, CA_nYA-nXB and CA_nXB-nYA Configurations (Intra-band contiguous + Inter-band)					
1	CP-OFDM QPSK	Full RB ¹	Full RB ¹	DFT-s-OFDM QPSK	REFSENS ²
Default Test Settings for a CA_nX(2A)-nYA Configuration (Intra-band non-contiguous + Inter-band)					
1	CP-OFDM QPSK	Full RB ¹	Full RB ¹	DFT-s-OFDM QPSK	REFSENS ²
NOTE 1: Full RB allocation shall be used per each SCS and channel BW as specified in Table 7.3.2.4.1-2.					
NOTE 2: REFSENS refers to the single carrier Uplink RB allocation for reference sensitivity according to Table 7.3.2.4.1-3.					
NOTE 3: The specific test frequencies for PCC and SCCs and Wgap for intra-band non-contiguous are defined in Table 7.3A.2.4.1-1. Only test points verifying non-exceptional REFSENS requirements are used for wide band blocking testing.					
NOTE 4: If the UE supports multiple CC Combinations in the CA Configuration with the same N_{RB_agg} , only the combination with the highest N_{RB_PCC} is tested.					
NOTE 5: In a band where UE supports 4Rx, the test shall be performed only with 4Rx antennas ports connected and 4Rx REFSENS requirement (Table 7.3.2.5-2) is used in the test requirements.					

Table 7.8A.2.2.4.1-2: Void

1. Connect the SS to the UE antenna connectors as shown in TS 38.508-1 [5] Annex A, Figure A.3.1.4.7 for TE diagram and section A.3.2 for UE diagram.
2. The parameter settings for the cell are set up according to TS 38.508-1 [5] subclause 4.4.3.
3. Downlink signals are initially set up according to Annex C.0, C.1, C.2, and C.3.1, and uplink signals according to Annex G.0, G.1, G.2, and G.3.1.
4. The DL and UL Reference Measurement Channels are set according to Table 7.8A.2.2.4.1-1.
5. Propagation conditions are set according to Annex B.0.
6. Ensure the UE is in State RRC_CONNECTED with generic procedure parameters Connectivity *NR*, Connected without release *On*, Test Mode *On* and Test Loop Function *On* according to TS 38.508-1 [5] clause 4.5. Message contents are defined in clause 7.8A.2.2.4.3.

7.8A.2.2.4.2 Test procedure

1. Configure SCCs according to Annex C.0, C.1, C.2 for all downlink physical channels.
2. The SS shall configure SCCs as per TS 38.508-1 [5] clause 5.5.1. Message contents are defined in clause 7.8A.2.2.4.3.

3. SS activates SCCs by sending the activation MAC CE (Refer TS 38.321 [18], clauses 5.9, 6.1.3.10). Wait for at least 2 seconds (Refer TS 38.133[19], clause 9.3).
4. SS transmits PDSCH via PDCCH DCI format 1_1 for C_RNTI to transmit the DL RMC according to Table 7.8A.2.2.4.1-1 on both PCC and SCCs. The SS sends downlink MAC padding bits on the DL RMC.
5. SS sends uplink scheduling information for each UL HARQ process via PDCCH DCI format 0_1 for C_RNTI to schedule the UL RMC according to Table 7.8A.2.2.4.1-1 on PCC. Since the UE has no payload data to send, the UE transmits uplink MAC padding bits on the UL RMC.
6. Set the Interfering signal levels to the values as defined in Table 7.8A.2.2.5.1-1, 7.8A.2.2.5.1-2, 7.8A.2.2.5.2-1 or 7.8A.2.2.5.2-2 and frequency below the CA Band for intra-band CA, or below each SCC's operating band for inter-band CA according to Table 7.8A.2.2.5.1-1, 7.8A.2.2.5.1-2, 7.8A.2.2.5.2-1 or 7.8A.2.2.5.2-2, using a modulated interferer bandwidth as defined in Annex D of the present document. For the UE which supports inter-band CA configuration in Table 7.3A.0.3.2.1-1, $P_{\text{interferer}}$ power defined in Table 7.8A.2.2.5.2-1 and 7.8A.2.2.5.2-2 is increased by the amount given by $\Delta R_{\text{IB,c}}$ in Table 7.3A.0.3.2.1-1.
7. Set the Downlink signal level for PCC and SCCs to the value as defined in Table 7.8A.2.2.5.1-1, 7.8A.2.2.5.1-2, 7.8A.2.2.5.2-1 or 7.8A.2.2.5.2-2. Send uplink power control commands to the UE using 1dB power step size to ensure that the UE output power measured by the test system is within the Uplink power control window, defined as $-(\text{MU} + \text{Uplink power control window size})$ dB of the target power level in Table 7.8A.2.2.5.1-1, 7.8A.2.2.5.1-2, 7.8A.2.2.5.2-1 or 7.8A.2.2.5.2-2 for at least the duration of the Throughput measurement, where:
 - MU is the test system uplink power measurement uncertainty and is specified in Table F.1.3-1 for the carrier frequency f and the channel bandwidth BW
 - Uplink power control window size = 1dB (UE power step size) + 0.7dB (UE power step tolerance) + (Test system relative power measurement uncertainty), where, the UE power step tolerance is specified in TS 38.101-1 [2], Table 6.3.4.3-1 and is 0.7dB for 1dB power step size, and the Test system relative power measurement uncertainty is specified for test case 6.3.4.3 in Table F.1.2-1.
8. Measure the average throughput of SCCs for a duration sufficient to achieve statistical significance according to Annex H.2A for inter-band CA. Measure the average throughput of all carriers for a duration sufficient to achieve statistical significance according to Annex H.2A for intra-band CA.
9. Repeat steps from 6 to 8, using an interfering signal above the CA Band for intra-band CA, or above the each SCC's operating band for inter-band CA at step 6.
10. For Inter-band CA: Switch the SCell into PCell and repeat steps 1 to 9, except for operating bands without uplink band.

NOTE: The purpose of the Uplink power control window is to ensure that the actual UE output power is no greater than the target power level, and as close as possible to the target power level. The relationship between the Uplink power control window, the target power level and the corresponding possible actual UE Uplink power window is illustrated in Annex F.4.3.

7.8A.2.2.4.3 Message contents

Message contents are according to TS 38.508-1 [5] subclause 4.6 Table 4.6.3-118 with condition TRANSFORM_PRECODER_ENABLED.

7.8A.2.2.5 Test requirement

7.8A.2.2.5.1 Wide band intermodulation for Intra-band contiguous CA

The throughput shall be $\geq 95\%$ of the maximum throughput of the reference measurement channels as specified in Annex A.3.2 with parameters specified in Table 7.8A.2.2.5.1-1 or 7.8A.2.2.5.1-2 for the specified wanted signal mean power in the presence of two interfering signals.

Table 7.8A.2.2.5.1-1: Wide band intermodulation parameters for intra-band contiguous CA with $F_{DL_low} \geq 3300$ MHz and $F_{UL_low} \geq 3300$ MHz

Rx parameter	Units	NR CA bandwidth class		
		B	C	D
P_w in Transmission Bandwidth Configuration, per CC	dBm	REFSENS + 10	REFSENS + 6	REFSENS + 13.8
$P_{Interferer\ 1}$ (CW)	dBm	-46		
$P_{Interferer\ 2}$ (Modulated)	dBm	-46		
$BW_{Interferer\ 2}$	MHz	20	$BW_{Channel_CA}$	50
$F_{Interferer\ 1}$ (Offset)	MHz	$-F_{offset}-30$ / $F_{offset}+30$	$-2BW_{Channel_CA}$ / $+2BW_{Channel_CA}$	$-F_{offset}-75$ / $F_{offset}+75$
$F_{Interferer\ 2}$ (Offset)	MHz	$2 * F_{Interferer\ 1}$		
NOTE 1: The transmitter shall be set to 4 dB below $P_{CMAX_L,f,c}$ at the minimum UL configuration specified in Table 7.3.2.3-3 with $P_{CMAX_L,f,c}$ defined in clause 6.2.4.				
NOTE 2: Reference measurement channel is specified in Annexes A.2.2, A.2.3, A.3.2, and A.3.3 (with one sided dynamic OCNG Pattern OP.1 FDD/TDD for the DL-signal as described in Annex A.5.1.1/A.5.2.1).				
NOTE 3: The modulated interferer consists of the Reference measurement channel specified in Annexes A.3.2.2 and A.3.3.2 with one sided dynamic OCNG Pattern OP.1 FDD/TDD for the DL-signal as described in Annex A.5.1.1/A.5.2.1 and the same SCS as the closest carrier.				
NOTE 4: The $F_{Interferer\ 1}$ (offset) is the frequency separation of the centre frequency of the carrier closest to the interferer and the centre frequency of the CW interferer and $F_{Interferer\ 2}$ (offset) is the frequency separation of the centre frequency of the carrier closest to the interferer and the centre frequency of the modulated interferer.				

Table 7.8A.2.2.5.1-2: Wide band intermodulation parameters for intra-band contiguous CA with $F_{DL_low} < 2700$ MHz and $F_{UL_low} < 2700$ MHz

Rx parameter	Units	NR CA bandwidth class	
		B	C
P_w in Transmission Bandwidth Configuration, per CC	dBm	REFSENS + 16	REFSENS + 22
$P_{Interferer\ 1}$ (CW)	dBm	-46	-46
$P_{Interferer\ 2}$ (Modulated)	dBm	-46	-46
$BW_{Interferer\ 2}$	MHz	5	5
$F_{Interferer\ 1}$ (Offset)	MHz	$-F_{offset}-7.5$ / $F_{offset}+7.5$	$-F_{offset}-7.5$ / $F_{offset}+7.5$
$F_{Interferer\ 2}$ (Offset)	MHz	$2 * F_{Interferer\ 1}$	$2 * F_{Interferer\ 1}$
NOTE 1: The transmitter shall be set to 4 dB below $P_{CMAX_L,f,c}$ at the minimum UL configuration specified in Table 7.3.2.3-3 with $P_{CMAX_L,f,c}$ defined in clause 6.2.4.			
NOTE 2: Reference measurement channel is specified in Annexes A.2.2, A.2.3, A.3.2, and A.3.3 (with one sided dynamic OCNG Pattern OP.1 FDD/TDD for the DL-signal as described in Annex A.5.1.1/A.5.2.1).			
NOTE 3: The modulated interferer consists of the Reference measurement channel specified in Annexes A.3.2.2 and A.3.3.2 with one sided dynamic OCNG Pattern OP.1 FDD/TDD for the DL-signal as described in Annex A.5.1.1/A.5.2.1 and the same SCS as the 15 kHz SCS.			
NOTE 4: The $F_{Interferer\ 1}$ (offset) is the frequency separation of the centre frequency of the carrier closest to the interferer and the centre frequency of the CW interferer and $F_{Interferer\ 2}$ (offset) is the frequency separation of the centre frequency of the carrier closest to the interferer and the centre frequency of the modulated interferer.			

7.8A.2.2.5.2 Wide band intermodulation for Inter-band CA

For inter-band carrier aggregation with one component carrier per operating band and the uplink assigned to one NR band, the wide band intermodulation requirements are defined with the uplink active on the band(s) other than the band whose downlink is being tested.

The throughput of each carrier shall be ≥ 95 % of the maximum throughput of the reference measurement channels as specified in Annexes A.2.2, A.2.3, A.3.2, and A.3.3 (with one sided dynamic OCNG Pattern OP.1 FDD/TDD for the DL-signal as described in Annex A.5.1.1/A.5.2.1) with parameters defined in Table 7.8A.2.2.5.2-1 or 7.8A.2.2.5.2-2.

Table 7.8A.2.2.5.2-1: Wide band intermodulation parameters for NR bands with $F_{DL_high} < 2700$ MHz and $F_{UL_high} < 2700$ MHz

Rx parameter	Units	Channel bandwidth											
		5 MHz	10 MHz	15 MHz	20 MHz	25 MHz	30 MHz	40 MHz	50 MHz	60 MHz	80 MHz	90 MHz	100 MHz
P _w in Transmission Bandwidth Configuration, per CC	dBm	REFSENS + channel bandwidth specific value below											
		6	6	7	9	10	11	12	13	14	15	15	16
P _{Interferer 1} (CW)	dBm	-46											
P _{Interferer 2} (Modulated)	dBm	-46											
BW _{Interferer 2}	MHz	5											
F _{Interferer 1} (Offset)	MHz	-BW/2 – 7.5 / +BW/2 + 7.5											
F _{Interferer 2} (Offset)	MHz	2*F _{Interferer 1}											
NOTE 1: The transmitter shall be set to 4dB below P _{C_{MAX}_L,f,c} at the minimum UL configuration specified in Table 7.3.2.3-3 with P _{C_{MAX}_L,f,c} defined in clause 6.2.4.													
NOTE 2: Reference measurement channel is specified in Annexes A.2.2, A.2.3, A.3.2, and A.3.3 (with one sided dynamic OCNG Pattern OP.1 FDD/TDD for the DL-signal as described in Annex A.5.1.1/A.5.2.1).													
NOTE 3: The modulated interferer consists of the Reference measurement channel specified in Annexes A.3.2.2 and A.3.3.2 with one sided dynamic OCNG Pattern OP.1 FDD/TDD for the DL-signal as described in Annex A.5.1.1/A.5.2.1 and 15 kHz SCS.													
NOTE 4: The F _{Interferer 1} (offset) is the frequency separation of the centre frequency of the carrier closest to the interferer and the centre frequency of the CW interferer and F _{Interferer 2} (offset) is the frequency separation of the centre frequency of the carrier closest to the interferer and the centre frequency of the modulated interferer.													

For the UE which supports inter-band CA configuration in Table 7.3A.0.3.2.1-1, P_{interferer} power defined in Table 7.8A.2.2.5.2-1 and 7.8A.2.2.5.2-2 is increased by the amount given by $\Delta R_{IB,c}$ in Table 7.3A.0.3.2.1-1.

Table 7.8A.2.2.5.2-2: Wide band intermodulation parameters for NR bands with $F_{DL_low} \geq 3300$ MHz and $F_{UL_low} \geq 3300$ MHz

Rx parameter	Units	Channel bandwidth							
		10 MHz	20 MHz	40 MHz	50 MHz	60 MHz	80 MHz	90 MHz	100 MHz
P_w in Transmission Bandwidth Configuration, per CC	dBm	REFSENS + 6							
$P_{Interferer\ 1}$ (CW)	dBm	-46							
$P_{Interferer\ 2}$ (Modulated)	dBm	-46							
$BW_{Interferer\ 2}$	MHz	BW							
$F_{Interferer\ 1}$ (Offset)	MHz	-2BW / +2BW							
$F_{Interferer\ 2}$ (Offset)	MHz	$2 * F_{Interferer\ 1}$							
<p>NOTE 1: The transmitter shall be set to 4dB below $P_{CMAX_L,f,c}$ at the minimum UL configuration specified in Table 7.3.2.3-3 with $P_{CMAX_L,f,c}$ defined in clause 6.2.4.</p> <p>NOTE 2: Reference measurement channel is specified in Annexes A.2.2, A.2.3, A.3.2, and A.3.3 (with one sided dynamic OCNG Pattern OP.1 FDD/TDD for the DL-signal as described in Annex A.5.1.1/A.5.2.1).</p> <p>NOTE 3: The modulated interferer consists of the Reference measurement channel specified in Annexes A.3.2.2 and A.3.3.2 with one sided dynamic OCNG Pattern OP.1 FDD/TDD for the DL-signal as described in Annex A.5.1.1/A.5.2.1 and the same SCS as the wanted signal.</p> <p>NOTE 4: The $F_{interferer\ 1}$ (offset) is the frequency separation of the centre frequency of the carrier closest to the interferer and the centre frequency of the CW interferer and $F_{interferer\ 2}$ (offset) is the frequency separation of the centre frequency of the carrier closest to the interferer and the centre frequency of the modulated interferer.</p>									

7.8A.2.3 Wide band Intermodulation for CA (4DL CA)

7.8A.2.3.1 Test purpose

Intermodulation response tests the UE's ability to receive data with a given average throughput for a specified reference measurement channel, in the presence of two or more interfering signals which have a specific frequency relationship to the wanted signal, under conditions of ideal propagation and no added noise.

A UE unable to meet the throughput requirement under these conditions will decrease the coverage area when two or more interfering signals exist which have a specific frequency relationship to the wanted signal.

7.8A.2.3.2 Test applicability

This test case applies to all types of NR UE release 15 and forward that supports 4DL CA.

7.8A.2.3.3 Minimum conformance requirements

The minimum conformance requirements are defined in clause 7.8A.2.0.

7.8A.2.3.4 Test description

7.8A.2.3.4.1 Initial conditions

Initial conditions are a set of test configurations the UE needs to be tested in and the steps for the SS to take with the UE to reach the correct measurement state.

The initial test configurations consist of environmental conditions, test frequencies, test channel bandwidths and sub-carrier spacing based on NR CA configurations specified in clause 5.5A. All of these configurations shall be tested with applicable test parameters for each CA configuration, are shown in Table 7.8A.2.3.4.1-1. The details of the uplink and downlink reference measurement channels (RMC) are specified in Annexes A.2 and A.3 respectively. The details of the OCNG patterns used are specified in Annex A.5. Configurations of PDSCH and PDCCH before measurement are specified in Annex C.2.

Table 7.8A.2.3.4.1-1: Test configuration table for Inter-band CA

Default Conditions					
Test Environment as specified in TS 38.508-1 [5] subclause 4.1			Normal		
Test Frequencies as specified in TS 38.508-1 [5] subclause 4.3.1			Inter-band : Mid range for PCC and SCCs (NOTE 5) Intra-band contiguous + Inter-band: Mid range for PCC and SCCs (NOTE 5) Intra-band non-contiguous + Inter-band: Mid range for PCC and SCCs with maxWGap for Intra-band non-contiguous (NOTE 5)		
Test CC Combination setting (NRB_agg) as specified in Tables 5.5A.1-1, 5.5A.2-1, or tables in clauses 5.5A.3.x for the CA Configuration across bandwidth combination sets supported by the UE.			Highest N _{RB_agg} NOTE 3		
Test SCS as specified in Table 5.3.5-1			Highest		
Test Parameters					
Test ID	Downlink Configuration			Uplink Configuration	
	CC Mod'n	PCC RB allocation	SCCs RB allocation	CC Mod'n	PCC RB allocation
1	CP-OFDM QPSK	Full RB ¹	Full RB ¹	DFT-s-OFDM QPSK	REFSENS ²
NOTE 1: Full RB allocation shall be used per each SCS and channel BW as specified in Table 7.3.2.4.1-2.					
NOTE 2: REFSENS refers to the single carrier Uplink RB allocation for reference sensitivity according to Table 7.3.2.4.1-3.					
NOTE 3: If the UE supports multiple CC Combinations in the CA Configuration with the same NRB_agg, only the combination with the highest NRB_PCC is tested.					
NOTE 4: In a band where UE supports 4Rx, the test shall be performed only with 4Rx antennas ports connected and 4Rx REFSENS requirement (Table 7.3.2.5-2) is used in the test requirements.					
NOTE 5: For NR band n28, 30MHz test channel bandwidth is tested with Low range test frequencies.					

1. Connect the SS to the UE antenna connectors as shown in TS 38.508-1 [5] Annex A, Figure A.3.1.4.7 for TE diagram and section A.3.2 for UE diagram.
 2. The parameter settings for the cell are set up according to TS 38.508-1 [5] subclause 4.4.3.
 3. Downlink signals are initially set up according to Annex C.0, C.1, C.2, and C.3.1, and uplink signals according to Annex G.0, G.1, G.2, and G.3.1.
 4. The DL and UL Reference Measurement Channels are set according to Table 7.8A.2.3.4.1-1.
 5. Propagation conditions are set according to Annex B.0.
 6. Ensure the UE is in State RRC_CONNECTED with generic procedure parameters Connectivity *NR*, Connected without release *On*, Test Mode *On* and Test Loop Function *On* according to TS 38.508-1 [5] clause 4.5. Message contents are defined in clause 7.8A.2.3.4.3.7.8A.2.3.4.2 Test procedure
1. Configure SCCs according to Annex C.0, C.1, C.2 for all downlink physical channels.
 2. The SS shall configure SCCs as per TS 38.508-1 [5] clause 5.5.1. Message contents are defined in clause 7.8A.2.3.4.3.
 3. SS activates SCCs by sending the activation MAC CE (Refer TS 38.321 [18], clauses 5.9, 6.1.3.10). Wait for at least 2 seconds (Refer TS 38.133[19], clause 9.3).
 4. SS transmits PDSCH via PDCCH DCI format 1_1 for C_RNTI to transmit the DL RMC according to Table 7.8A.2.3.4.1-1 on both PCC and SCCs. The SS sends downlink MAC padding bits on the DL RMC.
 5. SS sends uplink scheduling information for each UL HARQ process via PDCCH DCI format 0_1 for C_RNTI to schedule the UL RMC according to Table 7.8A.2.3.4.1-1 on PCC. Since the UE has no payload data to send, the UE transmits uplink MAC padding bits on the UL RMC.
 6. Set the Interfering signal levels to the values as defined in Table 7.8A.2.3.5.2-1 or Table 7.8A.2.3.5.1-2 and frequency below each SCC's operating band for inter-band CA according to Table 7.8A.2.3.5.2-1 or Table 7.8A.2.3.5.1-2, using a modulated interferer bandwidth as defined in Annex D of the present document. For the

UE which supports inter-band CA configuration in Table 7.3A.0.3.2.1-1, $P_{\text{interferer}}$ power defined in Table 7.8A.2.3.5.1-1 and 7.8A.2.3.5.1-2 is increased by the amount given by $\Delta R_{\text{IB,c}}$ in Table 7.3A.0.3.2.1-1.

7. Set the Downlink signal level for PCC and SCCs to the value as defined in Table 7.8A.2.3.5.2-1 or Table 7.8A.2.3.5.1-2. Send uplink power control commands to the UE using 1dB power step size to ensure that the UE output power measured by the test system is within the Uplink power control window, defined as $-(\text{MU} + \text{Uplink power control window size})$ dB of the target power level in Table 7.8A.2.3.5.2-1 or Table 7.8A.2.3.5.1-2 for at least the duration of the Throughput measurement, where:
 - MU is the test system uplink power measurement uncertainty and is specified in Table F.1.3-1 for the carrier frequency f and the channel bandwidth BW
 - Uplink power control window size = 1dB (UE power step size) + 0.7dB (UE power step tolerance) + (Test system relative power measurement uncertainty), where, the UE power step tolerance is specified in TS 38.101-1 [2], Table 6.3.4.3-1 and is 0.7dB for 1dB power step size, and the Test system relative power measurement uncertainty is specified for test case 6.3.4.3 in Table F.1.2-1.
8. Measure the average throughput of SCCs for a duration sufficient to achieve statistical significance according to Annex H.2A for inter-band CA.
9. Repeat steps from 6 to 8, using an interfering signal above the each SCC's operating band for inter-band CA at step 6.
10. For Inter-band CA: Switch the SCell into PCell and repeat steps 1 to 9, except for operating bands without uplink band.

NOTE: The purpose of the Uplink power control window is to ensure that the actual UE output power is no greater than the target power level, and as close as possible to the target power level. The relationship between the Uplink power control window, the target power level and the corresponding possible actual UE Uplink power window is illustrated in Annex F.4.3.

7.8A.2.3.4.3 Message contents

Message contents are according to TS 38.508-1 [5] subclause 4.6 Table 4.6.3-118 with condition TRANSFORM_PRECODER_ENABLED.

7.8A.2.3.5 Test requirement

7.8A.2.3.5.1 Wide band intermodulation for Inter-band CA

For inter-band carrier aggregation with one component carrier per operating band and the uplink assigned to one NR band, the wide band intermodulation requirements are defined with the uplink active on the band(s) other than the band whose downlink is being tested.

The throughput of each carrier shall be ≥ 95 % of the maximum throughput of the reference measurement channels as specified in Annexes A.2.2, A.2.3, A.3.2, and A.3.3 (with one sided dynamic OCNG Pattern OP.1 FDD/TDD for the DL-signal as described in Annex A.5.1.1/A.5.2.1) with parameters defined in Table 7.8A.2.3.5.1-1 or 7.8A.2.3.5.1-2.

Table 7.8A.2.3.5.1-1: Wide band intermodulation parameters for NR bands with $F_{DL_high} < 2700$ MHz and $F_{UL_high} < 2700$ MHz

Rx parameter	Units	Channel bandwidth											
		5 MHz	10 MHz	15 MHz	20 MHz	25 MHz	30 MHz	40 MHz	50 MHz	60 MHz	80 MHz	90 MHz	100 MHz
P _w in Transmission Bandwidth Configuration, per CC	dBm	REFSENS + channel bandwidth specific value below											
		6	6	7	9	10	11	12	13	14	15	15	16
P _{Interferer 1 (CW)}	dBm	-46											
P _{Interferer 2 (Modulated)}	dBm	-46											
BW _{Interferer 2}	MHz	5											
F _{Interferer 1 (Offset)}	MHz	-BW/2 – 7.5 / +BW/2 + 7.5											
F _{Interferer 2 (Offset)}	MHz	2*F _{Interferer 1}											
<p>NOTE 1: The transmitter shall be set to 4dB below P_{C_{MAX}_L,f,c} at the minimum UL configuration specified in Table 7.3.2.3-3 with P_{C_{MAX}_L,f,c} defined in clause 6.2.4.</p> <p>NOTE 2: Reference measurement channel is specified in Annexes A.2.2, A.2.3, A.3.2, and A.3.3 (with one sided dynamic OCNG Pattern OP.1 FDD/TDD for the DL-signal as described in Annex A.5.1.1/A.5.2.1).</p> <p>NOTE 3: The modulated interferer consists of the Reference measurement channel specified in Annexes A.3.2.2 and A.3.3.2 with one sided dynamic OCNG Pattern OP.1 FDD/TDD for the DL-signal as described in Annex A.5.1.1/A.5.2.1 and 15 kHz SCS.</p> <p>NOTE 4: The F_{Interferer 1 (offset)} is the frequency separation of the centre frequency of the carrier closest to the interferer and the centre frequency of the CW interferer and F_{Interferer 2 (offset)} is the frequency separation of the centre frequency of the carrier closest to the interferer and the centre frequency of the modulated interferer.</p>													

For the UE which supports inter-band CA configuration in Table 7.3A.0.3.2.1-1, P_{interferer} power defined in Table 7.8A.2.3.5.1-1 and 7.8A.2.3.5.1-2 is increased by the amount given by ΔR_{IB,c} in Table 7.3A.0.3.2.1-1.

Table 7.8A.2.3.5.1-2: Wide band intermodulation parameters for NR bands with $F_{DL_low} \geq 3300$ MHz and $F_{UL_low} \geq 3300$ MHz

Rx parameter	Units	Channel bandwidth							
		10 MHz	20 MHz	40 MHz	50 MHz	60 MHz	80 MHz	90 MHz	100 MHz
P_w in Transmission Bandwidth Configuration, per CC	dBm	REFSENS + 6							
$P_{Interferer\ 1}$ (CW)	dBm	-46							
$P_{Interferer\ 2}$ (Modulated)	dBm	-46							
$BW_{Interferer\ 2}$	MHz	BW							
$F_{Interferer\ 1}$ (Offset)	MHz	-2BW / +2BW							
$F_{Interferer\ 2}$ (Offset)	MHz	$2 \cdot F_{Interferer\ 1}$							
<p>NOTE 1: The transmitter shall be set to 4dB below $P_{CMAX_L,f,c}$ at the minimum UL configuration specified in Table 7.3.2.3-3 with $P_{CMAX_L,f,c}$ defined in clause 6.2.4.</p> <p>NOTE 2: Reference measurement channel is specified in Annexes A.2.2, A.2.3, A.3.2, and A.3.3 (with one sided dynamic OCNG Pattern OP.1 FDD/TDD for the DL-signal as described in Annex A.5.1.1/A.5.2.1).</p> <p>NOTE 3: The modulated interferer consists of the Reference measurement channel specified in Annexes A.3.2.2 and A.3.3.2 with one sided dynamic OCNG Pattern OP.1 FDD/TDD for the DL-signal as described in Annex A.5.1.1/A.5.2.1 and the same SCS as the wanted signal.</p> <p>NOTE 4: The $F_{interferer\ 1}$ (offset) is the frequency separation of the centre frequency of the carrier closest to the interferer and the centre frequency of the CW interferer and $F_{interferer\ 2}$ (offset) is the frequency separation of the centre frequency of the carrier closest to the interferer and the centre frequency of the modulated interferer.</p>									

7.8D Intermodulation characteristics for UL MIMO

7.8D.1 General

Intermodulation response rejection for UL MIMO is a measure of the capability of the receiver of an UE that support UL MIMO to receive a wanted signal on its assigned channel frequency in the presence of two or more interfering signals which have a specific frequency relationship to the wanted signal.

7.8D.2 Wide band Intermodulation for UL MIMO

7.8D.2.1 Test purpose

Wide band Intermodulation for UL MIMO tests the ability of UE that support UL MIMO to receive data with a given average throughput for a specified reference measurement channel, in the presence of two or more interfering signals which have a specific frequency relationship to the wanted signal, under conditions of ideal propagation and no added noise.

An UE unable to meet the throughput requirement under these conditions will decrease the coverage area when two or more interfering signals exist which have a specific frequency relationship to the wanted signal.

7.8D.2.2 Test applicability

This test case applies to all types of NR UE release 15 and forward that support UL MIMO on FDD bands.

7.8D.2.3 Minimum conformance requirements

For UE(s) with two transmitter antenna connectors in closed-loop spatial multiplexing scheme, the minimum requirements in subclause 7.8 shall be met with the UL MIMO configurations described in sub-clause 6.2D.1. For UL MIMO, the parameter P_{CMAX_L} is defined as the total transmitter power over the two transmit antenna connectors.

The normative reference for this requirement is TS 38.101-1 [2] clause 7.8D.

7.8D.2.4 Test description

7.8D.2.4.1 Initial conditions

Initial conditions are a set of test configurations the UE needs to be tested in and the steps for the SS to take with the UE to reach the correct measurement state.

The initial test configurations consist of environmental conditions, test frequencies, test channel bandwidths and sub-carrier spacing based on NR operating bands specified in table 5.3.5-1. All of these configurations shall be tested with applicable test parameters for each combination of channel bandwidth and sub-carrier spacing, are shown in table 7.8D.2.4.1-1. The details of the uplink and downlink reference measurement channels (RMC) are specified in Annexes A.2 and A.3. The details of the OCN patterns used are specified in Annex A.5. Configurations of PDSCH and PDCCH before measurement are specified in Annex C.2.

Table 7.8D.2.4.1-1: Test Configuration Table

Default Conditions				
Test Environment as specified in TS 38.508-1 [5] subclause 4.1			Normal	
Test Frequencies as specified in TS 38.508-1 [5] subclause 4.3.1			Mid range	
Test Channel Bandwidths as specified in TS 38.508-1 [5] subclause 4.3.1			Lowest, Mid, Highest	
Test SCS as specified in Table 5.3.5-1			Highest	
Test Parameters				
Test ID	Downlink Configuration		Uplink Configuration	
	Mod'n	RB allocation	Mod'n	RB allocation
1	CP-OFDM QPSK	NOTE 1	CP-OFDM QPSK	NOTE 1
NOTE 1: The specific configuration of uplink and downlink are defined in Table 7.3D.2.4.1-1. NOTE 2: In a band where UE supports 4Rx, the test shall be performed only with 4Rx antennas ports connected and 4Rx REFSENS requirement (Table 7.3.2.5-2) is used in the test requirements.				

1. Connect the SS and interfering sources to the UE antenna connectors as shown in TS 38.508-1 [5] Annex A, in Figure A.3.1.4.6 for TE diagram and section A.3.2 for UE diagram.
2. The parameter settings for the cell are set up according to TS 38.508-1 [5] subclause 4.4.3.
3. Downlink signals are initially set up according to Annex C.0, C.1, C.2, C.3.1, and uplink signals according to Annex G.0, G.1, G.2, G.3.1.
4. The DL and UL Reference Measurement channels are set according to Table 7.8D.2.4.1-1.
5. Propagation conditions are set according to Annex B.0.
6. Ensure the UE is in state RRC_CONNECTED with generic procedure parameters Connectivity NR, Connected without release *On*, Test Mode *On* and Test Loop Function *On* according to TS 38.508-1 [5] clause 4.5. Message content are defined in clause 7.8D.2.4.3.

7.8D.2.4.2 Test procedure

Same test procedure as specified in 7.8.2.4.2.

7.8D.2.4.3 Message contents

Message contents are according to TS 38.508-1 [5] subclause 4.6 ensuring Table 4.6.3-182 with condition 2TX_UL_MIMO.

7.8D.2.5 Test requirement

Same test requirement as specified in 7.8.2.5.

Table 7.8D.2.5-1: Void

7.8E Intermodulation characteristics for V2X

7.8E.1 General

Intermodulation response rejection is a measure of the capability of the receiver to receive a wanted signal on its assigned channel frequency in the presence of two or more interfering signals which have a specific frequency relationship to the wanted signal.

7.8E.2 Wide band Intermodulation for V2X

7.8E.2.0 Minimum conformance requirements

7.8E.2.0.1 Wide band Intermodulation

The wide band intermodulation requirement is defined using modulated NR carrier and a CW signal as interferer 1 and interferer 2 respectively. The throughput shall be $\geq 95\%$ of the maximum throughput of the reference measurement channels as specified in Annexes A.7.2 with parameters specified in Table 7.8E.2.0.1-1 for NR V2X bands. The relative throughput requirement shall be met for any SCS specified for the channel bandwidth of the wanted signal.

Table 7.8E.2.0.1-1: Wide band intermodulation parameters for NR V2X

NR band	Rx parameter	Units	Channel bandwidth			
			10 MHz	20 MHz	30 MHz	40 MHz
n38, n47	Power in Transmission Bandwidth Configuration	dBm	P _{PREFSENS_V2X} + channel bandwidth specific value below			
			6	9	11	12
	P _{Interferer 1 (CW)}	dBm	-46			
	P _{Interferer 2 (Modulated)}		-46			
	BW _{Interferer 2}	MHz	10MHz			
	F _{Interferer 1 (Offset)}		-BW/2 – 15 / +BW/2 + 15			
F _{Interferer 2 (Offset)}	MHz	2 * F _{Interferer 1}				
NOTE 1: Reference measurement channel is A.7.2						
NOTE 2: The interferer is QPSK modulated PUSCH containing data and reference symbols. Normal cyclic prefix is used.						

7.8E.2.0.2 Intermodulation for V2X con-current operation

For the inter-band con-current NR V2X operation, the requirements specified in clause 7.8E.2.0.1 shall apply for the NR sidelink reception in the operating Bands in in Table 5.2E.1-1 and the requirements specified in clause 7.8 shall apply for the NR downlink reception in licensed band while all downlink carriers are active.

The normative reference for this requirement is TS 38.101-1 [2] clause 7.8E.

7.8E.2.1 Wide band Intermodulation for V2X / non-concurrent operation

FFS

7.8E.2.2 Wide band Intermodulation for V2X / con-current operation

FFS

7.9 Spurious emissions

The spurious emissions power is the power of emissions generated or amplified in a receiver that appear at the UE antenna connector.

7.9.1 Test purpose

Test verifies the UE's spurious emissions meet the requirements described in clause 7.9.3.

Excess spurious emissions increase the interference to other systems.

7.9.2 Test applicability

This test applies to all types of NR UE release 15 and forward.

7.9.3 Minimum conformance requirements

The spurious emissions power is the power of emissions generated or amplified in a receiver that appear at the UE antenna connector.

The power of any narrow band CW spurious emission shall not exceed the maximum level specified in Table 7.9.3-1

Table 7.9.3-1: General receiver spurious emission requirements

Frequency range	Measurement bandwidth	Maximum level	NOTE
30 MHz ≤ f < 1 GHz	100 kHz	-57 dBm	
1 GHz ≤ f ≤ 12.75 GHz	1 MHz	-47 dBm	
12.75 GHz ≤ f ≤ 5 th harmonic of the upper frequency edge of the DL operating band in GHz	1 MHz	-47 dBm	2
12.75 GHz – 26 GHz	1 MHz	-47 dBm	3
NOTE 1: Unused PDCCH resources are padded with resource element groups with power level given by PDCCH as defined in Annex C.3.1.			
NOTE 2: Applies for Band that the upper frequency edge of the DL Band more than 2.69 GHz.			
NOTE 3: Applies for Band that the upper frequency edge of the DL Band more than 5.2 GHz.			

The normative reference for this requirement is TS 38.101-1 [2] clause 7.9.

7.9.4 Test description

7.9.4.1 Initial conditions

Initial conditions are a set of test configurations the UE needs to be tested in and the steps for the SS to take with the UE to reach the correct measurement state.

The initial test configurations consist of environmental conditions, test frequencies, test channel bandwidths and sub-carrier spacing based on NR operating bands specified in Table 5.3.5-1. All of these configurations shall be tested with applicable test parameters for each combination of channel bandwidth and sub-carrier spacing, are shown in table 7.9.4.1-1. The details of the uplink and downlink reference measurement channels (RMC) are specified in Annexes A.2 and A.3. Configuration of PDSCH and PDCCH before measurement are specified in Annex C.2.

Table 7.9.4.1-1: Test Configuration Table

Default Conditions				
Test Environment as specified in TS 38.508-1 [5] subclause 4.1		Normal		
Test Frequencies as specified in TS 38.508-1 [5] subclause 4.3.1		Low range, Mid range, High range (NOTE 4)		
Test Channel Bandwidths as specified in TS 38.508-1 [5] subclause 4.3.1		Highest (NOTE 3)		
Test SCS as specified in Table 5.3.5-1		Highest		
Test Parameters				
Test ID	Downlink Configuration		Uplink Configuration	
	Mod'n	RB allocation	Mod'n	RB allocation
1	N/A	0	N/A	0
NOTE 1: The specific configuration of uplink and downlink are defined in Table 7.3.2.4.1-1.				
NOTE 2: In a band where UE supports 4Rx, the test shall be performed only with 4Rx antennas ports connected and 4Rx REFSSENS requirement (Table 7.3.2.5-2) is used in the test requirements.				
NOTE 3: For n70, highest test channel bandwidth shall be Highest UL / Highest DL according to asymmetric channel bandwidths specified in clause 5.3.6.				
NOTE 4: For NR band n28, 30MHz test channel bandwidth is tested with Low range and High range test frequencies.				

1. Connect the SS to the UE antenna connectors as shown in TS 38.508-1 [5] Annex A, in Figure A.3.1.5.1 for TE diagram and section A.3.2 for UE diagram.
2. The parameter settings for the cell are set up according to TS 38.508-1 [5] subclause 4.4.3.
3. Downlink signals are initially set up according to Annex C.0, C.1, C.2 , C.3.1 , and uplink signals according to Annex G.0, G.1, G.2, G.3.1.
4. The DL and UL Reference Measurement channels are set according to Table 7.9.4.1-1.
5. Propagation conditions are set according to Annex B.0.
6. Ensure the UE is in state RRC_CONNECTED with generic procedure parameters Connectivity NR, Connected without release *On*, Test Mode *On* and Test Loop Function *On* according to TS 38.508-1 [5] clause 4.5. Message content are defined in clause 7.5.4.3.

7.9.4.2 Test procedure

1. Sweep the spectrum analyzer (or equivalent equipment) over a frequency range and measure the average power of spurious emission.
2. Repeat step 1 for all NR Rx antennas of the UE.

7.9.4.3 Message contents

Message contents are according to TS 38.508-1 [5] subclause 4.6.

7.9.5 Test requirement

The measured spurious emissions derived in step 1), shall not exceed the maximum level specified in Table 7.9.5-1.

Table 7.9.5-1: General receiver spurious emission requirements

Frequency range	Measurement bandwidth	Maximum level	NOTE
$30 \text{ MHz} \leq f < 1 \text{ GHz}$	100 kHz	-57 dBm	
$1 \text{ GHz} \leq f \leq 12.75 \text{ GHz}$	1 MHz	-47 dBm	
$12.75 \text{ GHz} \leq f \leq 5^{\text{th}}$ harmonic of the upper frequency edge of the DL operating band in GHz	1 MHz	-47 dBm	2
$12.75 \text{ GHz} - 26 \text{ GHz}$	1 MHz	-47 dBm	3
NOTE 1: Unused PDCCH resources are padded with resource element groups with power level given by PDCCH as defined in Annex C.3.1.			
NOTE 2: Applies for Band that the upper frequency edge of the DL Band more than 2.69 GHz.			
NOTE 3: Applies for Band that the upper frequency edge of the DL Band more than 5.2 GHz.			

7.9A Spurious emissions for CA

7.9A.0 Minimum conformance requirements

For inter-band carrier aggregation including an operating band without uplink band, the UE shall meet the Rx spurious emissions requirements specified in subclause 7.9 for each component carrier while all downlink carriers are active.

The normative reference for this requirement is TS 38.101-1 [2] clause 7.9A.3.

7.9A.1 Spurious emissions for CA (2DL CA)

7.9A.1.1 Test Purpose

Test verifies the UE's spurious emissions meet the requirements described in clause 7.9A.1.3.

Excess spurious emissions increase the interference to other systems.

7.9A.1.2 Test Applicability

This test case applies to all types of NR UE release 15 and forward that support inter-band 2DL CA with a DL-only band.

7.9A.1.3 Minimum Conformance Requirements

The minimum conformance requirements are defined in clause 7.9A.0.

7.9A.1.4 Test Description

7.9A.1.4.1 Initial Conditions

Initial conditions are a set of test configurations the UE needs to be tested in and the steps for the SS to take with the UE to reach the correct measurement state.

The initial test configurations consist of environmental conditions, test frequencies, and channel bandwidths based on NR CA bands specified in Table 5.5A.3-1. All of these configurations shall be tested with applicable test parameters for each CA Configuration, and are shown in Table 7.9A.1.4.1-1. The details of the uplink reference measurement channels (RMCs) are specified in Annex A.2. Configurations of PDSCH and PDCCH before measurement are specified in Annex C.2.

Table 7.9A.1.4.1-1: Test Configuration Table

Initial Conditions						
Test Environment as specified in TS 38.508-1 [5] subclause 4.1		Normal				
Test Frequencies as specified in TS 38.508-1 [5] subclause 4.3.1		Low range, Mid range, High range (NOTE 3)				
Test CC Combination setting (N_{RB_agg}) as specified in Table 5.5A.1-1 for the CA Configuration across bandwidth combination sets supported by the UE.		Highest N_{RB_agg} NOTE 4				
Test SCS as specified in Table 5.3.5-1		Highest				
Test Parameters for CA Configurations						
Ch Configuration / N_{RB_agg}		Downlink Configuration			Uplink Configuration	
PCC N_{RB}	SCCs N_{RB}	Mod'n	PCC & SCC RB allocation		Mod'n	PCC RB allocation
100	100	N/A	0	0	N/A	0
NOTE 1: The specific configuration of uplink and downlink are defined in Table 7.3.2.4.1-1.						
NOTE 2: In a band where UE supports 4Rx, the test shall be performed only with 4Rx antennas ports connected and 4Rx REFSSENS requirement (Table 7.3.2.5-2) is used in the test requirements.						
NOTE 3: For NR band n28, 30MHz test channel bandwidth is tested with Low range and High range test frequencies.						
NOTE 4: If the UE supports multiple CC Combinations in the CA Configuration with the same N_{RB_agg} , only the combination with the highest N_{RB_PCC} is tested						

1. Connect the SS to the UE antenna connectors as shown in TS 38.508-1 [5] Annex A, in Figure A.3.1.5.2 for TE diagram and section A.3.2 for UE diagram.
2. The parameter settings for the cell are set up according to TS 38.508-1 [5] subclause 4.4.3.
3. Downlink signals for PCC are initially set up according to Annex C.0, C.1, C.2.
4. Propagation conditions are set according to Annex B.0.
5. Ensure the UE is in state RRC_CONNECTED with generic procedure parameters Connectivity NR according to TS 38.508-1 [5] clause 4.5. Message contents are defined in clause 7.9A.1.4.3.

7.9A.1.4.2 Test Procedure

1. Configure SCC according to Annex C.0, C.1, C.2 for all downlink physical channels.

2. The SS shall configure SCC as per TS 38.508-1 [5] clause 5.5.1. Message contents are defined in clause 6.5A.2.2.1.4.3.
3. SS activates SCC by sending the activation MAC CE (Refer TS 38.321 [18], clauses 5.9, 6.1.3.10). Wait for at least 2 seconds (Refer TS 38.133 [19], clause 9.3).
4. Sweep the spectrum analyzer (or equivalent equipment) over a frequency range and measure the average power of spurious emission. During measurement SS sends no uplink scheduling information to the UE.
5. Repeat step 1 for all NR Rx antennas of the UE.

7.9A.1.4.3 Message Contents

Message contents are according to TS 38.508-1 [5] subclause 4.6.

7.9A.1.5 Test Requirement

The measured spurious emissions derived in step 1), shall not exceed the maximum level specified in Table 7.9.5-1.

Annex A (normative): Measurement channels

A.1 General

The throughput values defined in the measurement channels specified in Annex A, are calculated and are valid per datastream (codeword). For multi-stream (more than one codeword) transmissions, the throughput referenced in the minimum requirements is the sum of throughputs of all datastreams (codewords).

The UE category entry in the definition of the reference measurement channel in Annex A is only informative and reveals the UE categories, which can support the corresponding measurement channel. Whether the measurement channel is used for testing a certain UE category or not is specified in the individual minimum requirements.

A.2 UL reference measurement channels

A.2.1 General

The measurement channels in the following subclauses are defined to derive the requirements in clause 6 (Transmitter Characteristics) and clause 7 (Receiver Characteristics). The measurement channels represent example configurations of physical channels for different data rates.

The measurement channels in the following clauses are applicable to both FDD and TDD.

The active uplink slots for TDD configurations are specified in table A.2.1-1. TDD slot patterns defined for reference sensitivity tests will be used for TDD UL RMCs.

Table A.2.1-1: TDD active uplink slots

SCS	Active Uplink slots
15 kHz	4, 9
30 kHz	8, 9, 18, 19
60 kHz	16, 17, 18, 19, 36, 37, 38, 39

A.2.2 Reference measurement channels for FDD

A.2.2.1 DFT-s-OFDM Pi/2-BPSK

Table A.2.2.1-1: Reference Channels for DFT-s-OFDM Pi/2-BPSK

Parameter	Allocated resource blocks (L _{CRB})	DFT-s-OFDM Symbols per slot (Note 1)	Modulation	MCS Index (Note 2)	Payload size	Transport block CRC	LDPC Base Graph	Number of code blocks per slot (Note 3)	Total number of bits per slot	Total modulated symbols per slot
Unit					Bits	Bits			Bits	
	1	11	pi/2 BPSK	0	24	16	2	1	132	132
	5	11	pi/2 BPSK	0	160	16	2	1	660	660
	9	11	pi/2 BPSK	0	288	16	2	1	1188	1188
	10	11	pi/2 BPSK	0	320	16	2	1	1320	1320
	12	11	pi/2 BPSK	0	384	16	2	1	1584	1584
	15	11	pi/2 BPSK	0	480	16	2	1	1980	1980
	18	11	pi/2 BPSK	0	576	16	2	1	2376	2376
	24	11	pi/2 BPSK	0	768	16	2	1	3168	3168
	25	11	pi/2 BPSK	0	808	16	2	1	3300	3300
	30	11	pi/2 BPSK	0	984	16	2	1	3960	3960
	32	11	pi/2 BPSK	0	1032	16	2	1	4224	4224
	36	11	pi/2 BPSK	0	1128	16	2	1	4752	4752
	45	11	pi/2 BPSK	0	1416	16	2	1	5940	5940
	50	11	pi/2 BPSK	0	1544	16	2	1	6600	6600
	60	11	pi/2 BPSK	0	1864	16	2	1	7920	7920
	64	11	pi/2 BPSK	0	2024	16	2	1	8448	8448
	75	11	pi/2 BPSK	0	2408	16	2	1	9900	9900
	80	11	pi/2 BPSK	0	2472	16	2	1	10560	10560
	81	11	pi/2 BPSK	0	2536	16	2	1	10692	10692
	90	11	pi/2 BPSK	0	2792	16	2	1	11880	11880
	100	11	pi/2 BPSK	0	3104	16	2	1	13200	13200
	108	11	pi/2 BPSK	0	3368	16	2	1	14256	14256
	120	11	pi/2 BPSK	0	3752	16	2	1	15840	15840
	128	11	pi/2 BPSK	0	3976	24	2	2	16896	16896
	135	11	pi/2 BPSK	0	4104	24	2	2	17820	17820
	160	11	pi/2 BPSK	0	4872	24	2	2	21120	21120
	162	11	pi/2 BPSK	0	5000	24	2	2	21384	21384
	180	11	pi/2 BPSK	0	5512	24	2	2	23760	23760
	216	11	pi/2 BPSK	0	6664	24	2	2	28512	28512
	243	11	pi/2 BPSK	0	7560	24	2	2	32076	32076
	270	11	pi/2 BPSK	0	8448	24	2	3	35640	35640

NOTE 1: PUSCH mapping Type-A and single-symbol DM-RS configuration Type-1 with 2 additional DM-RS symbols, such that the DM-RS positions are set to symbols 2, 7, 11. DMRS is [TDM'ed] with PUSCH data. DM-RS symbols are not counted.

NOTE 2: MCS Index is based on MCS table 6.1.4.1-1 defined in TS 38.214 [10].

NOTE 3: If more than one Code Block is present, an additional CRC sequence of L = 24 Bits is attached to each Code Block (otherwise L = 0 Bit)

NOTE 4: The RMCs apply to all channel bandwidth where $L_{CRB} \leq N_{RB}$.

Table A.2.2.1-2: Void

Table A.2.2.1-3: Void

A.2.2.2 DFT-s-OFDM QPSK

Table A.2.2.2-1: Reference Channels for DFT-s-OFDM QPSK

Parameter	Allocated resource blocks (L_{CRB})	DFT-s-OFDM Symbols per slot (Note 1)	Modulation	MCS Index (Note 2)	Payload size	Transport block CRC	LDPC Base Graph	Number of code blocks per slot (Note 3)	Total number of bits per slot	Total modulated symbols per slot
Unit					Bits	Bits			Bits	
	1	11	QPSK	2	48	16	2	1	264	132
	5	11	QPSK	2	256	16	2	1	1320	660
	9	11	QPSK	2	456	16	2	1	2376	1188
	10	11	QPSK	2	504	16	2	1	2640	1320
	12	11	QPSK	2	608	16	2	1	3168	1584
	15	11	QPSK	2	768	16	2	1	3960	1980
	18	11	QPSK	2	928	16	2	1	4752	2376
	20	11	QPSK	2	1032	16	2	1	5280	2640
	24	11	QPSK	2	1192	16	2	1	6336	3168
	25	11	QPSK	2	1256	16	2	1	6600	3300
	30	11	QPSK	2	1544	16	2	1	7920	3960
	32	11	QPSK	2	1608	16	2	1	8448	4224
	36	11	QPSK	2	1800	16	2	1	9504	4752
	45	11	QPKS	2	2208	16	2	1	11880	5940
	50	11	QPSK	2	2472	16	2	1	13200	6600
	60	11	QPSK	2	3104	16	2	1	15840	7920

	64	11	QPSK	2	3240	16	2	1	16896	8448
	75	11	QPSK	2	3752	16	2	1	19800	9900
	80	11	QPSK	2	3976	24	2	2	21120	10560
	81	11	QPSK	2	4040	24	2	2	21384	10692
	90	11	QPSK	2	4488	24	2	2	23760	11880
	100	11	QPSK	2	5000	24	2	2	26400	13200
	108	11	QPSK	2	5384	24	2	2	28512	14256
	120	11	QPSK	2	5896	24	2	2	31680	15840
	128	11	QPSK	2	6408	24	2	2	33792	16896
	135	11	QPSK	2	6664	24	2	2	35640	17820
	160	11	QPSK	2	7944	24	2	3	42240	21120
	162	11	QPSK	2	8064	24	2	3	42768	21384
	180	11	QPSK	2	8976	24	2	3	47520	23760
	216	11	QPSK	2	10752	24	2	3	57024	28512
	243	11	QPSK	2	12040	24	2	4	64152	32076
	270	11	QPSK	2	13320	24	2	4	71280	35640

NOTE 1: PUSCH mapping Type-A and single-symbol DM-RS configuration Type-1 with 2 additional DM-RS symbols, such that the DM-RS positions are set to symbols 2, 7, 11. DMRS is [TDM'ed] with PUSCH data. DM-RS symbols are not counted.

NOTE 2: MCS Index is based on MCS table 6.1.4.1-1 defined in TS 38.214 [10].

NOTE 3: If more than one Code Block is present, an additional CRC sequence of L = 24 Bits is attached to each Code Block (otherwise L = 0 Bit)

NOTE 4: The RMCs apply to all channel bandwidth where $L_{CRB} \leq N_{RB}$.

Table A.2.2.2-2: Void

Table A.2.2.2-3: Void

A.2.2.3 DFT-s-OFDM 16QAM

Table A.2.2.3-1: Reference Channels for DFT-s-OFDM 16QAM

Parameter	Allocated resource blocks (L_{CRB})	DFT-s-OFDM Symbols per slot (Note 1)	Modulation	MCS Index (Note 2)	Payload size	Transport block CRC	LDPC Base Graph	Number of code blocks per slot (Note 3)	Total number of bits per slot	Total modulated symbols per slot
Unit					Bits	Bits			Bits	
	1	11	16QAM	10	176	16	2	1	528	132

	5	11	16QAM	10	888	16	2	1	2640	660
	9	11	16QAM	10	1608	16	2	1	4752	1188
	10	11	16QAM	10	1800	16	2	1	5280	1320
	12	11	16QAM	10	2088	16	2	1	6336	1584
	15	11	16QAM	10	2664	16	2	1	7920	1980
	18	11	16QAM	10	3240	16	2	1	9504	2376
	24	11	16QAM	10	4224	24	1	1	12672	3168
	25	11	16QAM	10	4352	24	1	1	13200	3300
	30	11	16QAM	10	5248	24	1	1	15840	3960
	32	11	16QAM	10	5632	24	1	1	16896	4224
	36	11	16QAM	10	6272	24	1	1	19008	4752
	45	11	16QAM	10	7808	24	1	1	23760	5940
	50	11	16QAM	10	8712	24	1	2	26400	6600
	60	11	16QAM	10	10504	24	1	2	31680	7920
	64	11	16QAM	10	11272	24	1	2	33792	8448
	75	11	16QAM	10	13064	24	1	2	39600	9900
	80	11	16QAM	10	14088	24	1	2	42240	10560
	81	11	16QAM	10	14088	24	1	2	42768	10692
	90	11	16QAM	10	15880	24	1	2	47520	11880
	100	11	16QAM	10	17424	24	1	3	52800	13200
	108	11	16QAM	10	18960	24	1	3	57024	14256
	120	11	16QAM	10	21000	24	1	3	63360	15840
	128	11	16QAM	10	22536	24	1	3	67584	16896
	135	11	16QAM	10	23568	24	1	3	71280	17820
	160	11	16QAM	10	28168	24	1	4	84480	21120
	162	11	16QAM	10	28168	24	1	4	85536	21384
	180	11	16QAM	10	31752	24	1	4	95040	23760
	216	11	16QAM	10	37896	24	1	5	114048	28512
	243	11	16QAM	10	43032	24	1	6	128304	32076
	270	11	16QAM	10	47112	24	1	6	142560	35640

NOTE 1: PUSCH mapping Type-A and single-symbol DM-RS configuration Type-1 with 2 additional DM-RS symbols, such that the DM-RS positions are set to symbols 2, 7, 11. DMRS is [TDM'ed] with PUSCH data. DM-RS symbols are not counted.

NOTE 2: MCS Index is based on MCS table 6.1.4.1-1 defined in TS 38.214 [10].

NOTE 3: If more than one Code Block is present, an additional CRC sequence of L = 24 Bits is attached to each Code Block (otherwise L = 0 Bit)

NOTE 4: The RMCs apply to all channel bandwidth where $L_{CRB} \leq N_{RB}$.

Table A.2.2.3-2: Void

Table A.2.2.3-3: Void

A.2.2.4 DFT-s-OFDM 64QAM

Table A.2.2.4-1: Reference Channels for DFT-s-OFDM 64QAM

Parameter	Allocated resource blocks (L _{CRB})	DFT-s-OFDM Symbols per slot (Note 1)	Modulation	MCS Index (Note 2)	Payload size	Transport block CRC	LDPC Base Graph	Number of code blocks per slot (Note 3)	Total number of bits per slot	Total modulated symbols per slot
Unit					Bits	Bits			Bits	
	1	11	64QAM	18	408	16	2	1	792	132
	5	11	64QAM	18	2024	16	2	1	3960	660
	9	11	64QAM	18	3624	16	2	1	7128	1188
	10	11	64QAM	18	3968	24	1	1	7920	1320
	12	11	64QAM	18	4736	24	1	1	9504	1584
	15	11	64QAM	18	6016	24	1	1	11880	1980
	18	11	64QAM	18	7168	24	1	1	14256	2376
	24	11	64QAM	18	9480	24	1	2	19008	3168
	25	11	64QAM	18	9992	24	1	2	19800	3300
	30	11	64QAM	18	12040	24	1	2	23760	3960
	32	11	64QAM	18	12808	24	1	2	25344	4224
	36	11	64QAM	18	14344	24	1	2	28512	4752
	45	11	64QAM	18	17928	24	1	3	35640	5940
	50	11	64QAM	18	19968	24	1	3	39600	6600
	60	11	64QAM	18	24072	24	1	3	47520	7920
	64	11	64QAM	18	25608	24	1	4	50688	8448
	75	11	64QAM	18	30216	24	1	4	59400	9900
	80	11	64QAM	18	31752	24	1	4	63360	10560
	81	11	64QAM	18	32264	24	1	4	64152	10692
	90	11	64QAM	18	35856	24	1	5	71280	11880
	108	11	64QAM	18	43032	24	1	6	85536	14256
	100	11	64QAM	18	39936	24	1	5	79200	13200
	120	11	64QAM	18	48168	24	1	6	95040	15840
	128	11	64QAM	18	51216	24	1	7	101376	16896
	135	11	64QAM	18	54296	24	1	7	106920	17820
	160	11	64QAM	18	63528	24	1	8	126720	21120
	162	11	64QAM	18	64552	24	1	8	128304	21384
	180	11	64QAM	18	71688	24	1	9	142560	23760

	216	11	64QAM	18	86040	24	1	11	171072	28512
	243	11	64QAM	18	96264	24	1	12	192456	32076
	270	11	64QAM	18	108552	24	1	13	213840	35640

NOTE 1: PUSCH mapping Type-A and single-symbol DM-RS configuration Type-1 with 2 additional DM-RS symbols, such that the DM-RS positions are set to symbols 2, 7, 11. DMRS is [TDM'ed] with PUSCH data. DM-RS symbols are not counted.

NOTE 2: MCS Index is based on MCS table 6.1.4.1-1 defined in TS 38.214 [10].

NOTE 3: If more than one Code Block is present, an additional CRC sequence of L = 24 Bits is attached to each Code Block (otherwise L = 0 Bit)

NOTE 4: The RMCs apply to all channel bandwidth where $L_{CRB} \leq N_{RB}$.

Table A.2.2.4-2: Void

Table A.2.2.4-3: Void

A.2.2.5 DFT-s-OFDM 256QAM

Table A.2.2.5-1: Reference Channels for DFT-s-OFDM 256QAM

Parameter	Allocated resource blocks (L_{CRB})	DFT-s-OFDM Symbols per slot (Note 1)	Modulation	MCS Index (Note 2)	Payload size	Transport block CRC	LDPC Base Graph	Number of code blocks per slot (Note 3)	Total number of bits per slot	Total modulated symbols per slot
Unit					Bits	Bits			Bits	
	1	11	256QAM	20	704	16	2	1	1056	132
	5	11	256QAM	20	3496	16	2	1	5280	660
	9	11	256QAM	20	6272	24	1	1	9504	1188
	10	11	256QAM	20	7040	24	1	1	10560	1320
	12	11	256QAM	20	8456	24	1	2	12672	1584
	15	11	256QAM	20	10504	24	1	2	15840	1980
	18	11	256QAM	20	12552	24	1	2	19008	2376
	24	11	256QAM	20	16896	24	1	3	25344	3168
	25	11	256QAM	20	17424	24	1	3	26400	3300
	30	11	256QAM	20	21000	24	1	3	31680	3960
	32	11	256QAM	20	22536	24	1	3	33792	4224

	36	11	256QAM	20	25104	24	1	3	38016	4752
	45	11	256QAM	20	31752	24	1	4	47520	5940
	50	11	256QAM	20	34816	24	1	5	52800	6600
	60	11	256QAM	20	42016	24	1	5	63360	7920
	64	11	256QAM	20	45096	24	1	6	67584	8448
	75	11	256QAM	20	53288	24	1	7	79200	9900
	80	11	256QAM	20	56368	24	1	7	84480	10560
	81	11	256QAM	20	57376	24	1	7	85536	10692
	90	11	256QAM	20	63528	24	1	8	95040	11880
	108	11	256QAM	20	75792	24	1	9	114048	14256
	100	11	256QAM	20	69672	24	1	9	105600	13200
	120	11	256QAM	20	83976	24	1	10	126720	15840
	128	11	256QAM	20	90176	24	1	11	135168	16896
	135	11	256QAM	20	94248	24	1	12	142560	17820
	160	11	256QAM	20	112648	24	1	14	168960	21120
	162	11	256QAM	20	114776	24	1	14	171072	21384
	180	11	256QAM	20	127080	24	1	16	190080	23760
	216	11	256QAM	20	151608	24	1	18	228096	28512
	243	11	256QAM	20	172176	24	1	21	256608	32076
	270	11	256QAM	20	188576	24	1	23	285120	35640
NOTE 1: PUSCH mapping Type-A and single-symbol DM-RS configuration Type-1 with 2 additional DM-RS symbols, such that the DM-RS positions are set to symbols 2, 7, 11. DMRS is [TDM'ed] with PUSCH data. DM-RS symbols are not counted.										
NOTE 2: MCS Index is based on MCS table 5.1.3.1-2 defined in TS 38.214 [10].										
NOTE 3: If more than one Code Block is present, an additional CRC sequence of L = 24 Bits is attached to each Code Block (otherwise L = 0 Bit)										
NOTE 4: The RMCs apply to all channel bandwidth where $L_{CRB} \leq N_{RB}$.										

Table A.2.2.5-2: Void

Table A.2.2.5-3: Void

A.2.2.6 CP-OFDM QPSK

Table A.2.2.6-1: Reference Channels for CP-OFDM QPSK

Parameter	Allocated resource blocks (L _{CRB})	CP-OFDM Symbols per slot (Note 1)	Modulation	MCS Index (Note 2)	Payload size	Transport block CRC	LDPC Base Graph	Number of code blocks per slot (Note 3)	Total number of bits per slot	Total modulated symbols per slot
Unit					Bits	Bits			Bits	
	1	11	QPSK	2	48	16	2	1	264	132
	5	11	QPSK	2	256	16	2	1	1320	660
	6	11	QPSK	2	304	16	2	1	1584	792
	9	11	QPSK	2	456	16	2	1	2376	1188
	10	11	QPSK	2	504	16	2	1	2640	1320
	11	11	QPSK	2	552	16	2	1	2904	1452
	12	11	QPSK	2	608	16	2	1	3168	1584
	13	11	QPSK	2	672	16	2	1	3432	1716
	15	11	QPSK	2	768	16	2	1	3960	1980
	16	11	QPSK	2	808	16	2	1	4224	2112
	18	11	QPSK	2	928	16	2	1	4752	2376
	19	11	QPSK	2	984	16	2	1	5016	2508
	24	11	QPSK	2	1192	16	2	1	6336	3168
	25	11	QPSK	2	1256	16	2	1	6600	3300
	26	11	QPSK	2	1288	16	2	1	6864	3432
	31	11	QPSK	2	1544	16	2	1	8184	4092
	33	11	QPSK	2	1672	16	2	1	8712	4356
	38	11	QPSK	2	1928	16	2	1	10032	5016
	39	11	QPSK	2	2024	16	2	1	10296	5148
	40	11	QPSK	2	2024	16	2	1	10560	5280
	47	11	QPSK	2	2408	16	2	1	12408	6204
	51	11	QPSK	2	2536	16	2	1	13464	6732
	52	11	QPSK	2	2600	16	2	1	13728	6864
	53	11	QPSK	2	2664	16	2	1	13992	6996
	54	11	QPSK	2	2664	16	2	1	14256	7128
	61	11	QPSK	2	3104	16	2	1	16104	8052
	65	11	QPSK	2	3240	16	2	1	17160	8580
	67	11	QPSK	2	3368	16	2	1	17688	8844
	68	11	QPSK	2	3368	16	2	1	17952	8976
	78	11	QPSK	2	3848	24	2	2	20592	10296
	79	11	QPSK	2	3912	24	2	2	20856	10428
	80	11	QPSK	2	3976	24	2	2	21120	10560
	81	11	QPSK	2	4040	24	2	2	21384	10692

	93	11	QPSK	2	4616	24	2	2	24552	12276
	95	11	QPSK	2	4744	24	2	2	25080	12540
	106	11	QPSK	2	5256	24	2	2	27984	13992
	107	11	QPSK	2	5256	24	2	2	28248	14124
	108	11	QPSK	2	5384	24	2	2	28512	14256
	109	11	QPSK	2	5384	24	2	2	28776	14388
	121	11	QPSK	2	6024	24	2	2	31944	15972
	123	11	QPSK	2	6152	24	2	2	32472	16236
	133	11	QPSK	2	6664	24	2	2	35112	17556
	135	11	QPSK	2	6664	24	2	2	35640	17820
	137	11	QPSK	2	6792	24	2	2	36168	18084
	160	11	QPSK	2	7944	24	2	3	42240	21120
	162	11	QPSK	2	8064	24	2	3	42768	21384
	189	11	QPSK	2	9480	24	2	3	49896	24948
	216	11	QPSK	2	10752	24	2	3	57024	28512
	217	11	QPSK	2	10752	24	2	3	57288	28644
	245	11	QPSK	2	12296	24	2	4	64680	32340
	270	11	QPSK	2	13320	24	2	4	71280	35640
	273	11	QPSK	2	13576	24	2	4	72072	36036

NOTE 1: PUSCH mapping Type-A and single-symbol DM-RS configuration Type-1 with 2 additional DM-RS symbols, such that the DM-RS positions are set to symbols 2, 7, 11. DMRS is [TDM'ed] with PUSCH data. DM-RS symbols are not counted.

NOTE 2: MCS Index is based on MCS table 5.1.3.1-1 defined in TS 38.214 [10].

NOTE 3: If more than one Code Block is present, an additional CRC sequence of L = 24 Bits is attached to each Code Block (otherwise L = 0 Bit)

NOTE 4: The RMCs apply to all channel bandwidth where $L_{CRB} \leq N_{RB}$.

Table A.2.2.6-2: Void

Table A.2.2.6-3: Void

A.2.2.7 CP-OFDM 16QAM

Table A.2.2.7-1: Reference Channels for CP-OFDM 16QAM

Parameter	Allocated resource	CP-OFDM Symbols	Modulation	MCS Index (Note 2)	Payload size	Transport block CRC	LDPC Base Graph	Number of code blocks	Total number	Total modulated
-----------	--------------------	-----------------	------------	--------------------	--------------	---------------------	-----------------	-----------------------	--------------	-----------------

	blocks (L _{CRB})	per slot (Note 1)						per slot (Note 3)	of bits per slot	symbols per slot
Unit					Bits	Bits			Bits	
	1	11	16QAM	10	176	16	2	1	528	132
	5	11	16QAM	10	888	16	2	1	2640	660
	6	11	16QAM	10	1064	16	2	1	3168	792
	9	11	16QAM	10	1608	16	2	1	4752	1188
	10	11	16QAM	10	1800	16	2	1	5280	1320
	11	11	16QAM	10	1928	16	2	1	5808	1452
	12	11	16QAM	10	2088	16	2	1	6336	1584
	13	11	16QAM	10	2280	16	2	1	6864	1716
	15	11	16QAM	10	2664	16	2	1	7920	1980
	16	11	16QAM	10	2792	16	2	1	8448	2112
	18	11	16QAM	10	3240	16	2	1	9504	2376
	19	11	16QAM	10	3368	16	2	1	10032	2508
	24	11	16QAM	10	4224	24	1	1	12672	3168
	25	11	16QAM	10	4352	24	1	1	13200	3300
	26	11	16QAM	10	4480	24	1	1	13728	3432
	31	11	16QAM	10	5376	24	1	1	16368	4092
	33	11	16QAM	10	5760	24	1	1	17424	4356
	38	11	16QAM	10	6656	24	1	1	20064	5016
	39	11	16QAM	10	6784	24	1	1	20592	5148
	40	11	16QAM	10	7040	24	1	1	21120	5280
	47	11	16QAM	10	8192	24	1	1	24816	6204
	51	11	16QAM	10	8968	24	1	2	26928	6732
	52	11	16QAM	10	9224	24	1	2	27456	6864
	53	11	16QAM	10	9224	24	1	2	27984	6996
	54	11	16QAM	10	9480	24	1	2	28512	7128
	61	11	16QAM	10	10760	24	1	2	32208	8052
	65	11	16QAM	10	11272	24	1	2	34320	8580
	67	11	16QAM	10	11784	24	1	2	35376	8844
	68	11	16QAM	10	11784	24	1	2	35904	8976
	78	11	16QAM	10	13576	24	1	2	41184	10296
	79	11	16QAM	10	13832	24	1	2	41712	10428
	80	11	16QAM	10	14088	24	1	2	42240	10560
	81	11	16QAM	10	14088	24	1	2	42768	10692
	93	11	16QAM	10	16392	24	1	2	49404	12276
	95	11	16QMA	10	16392	24	1	2	50160	12540
	106	11	16QAM	10	18432	24	1	3	55968	13992
	107	11	16QAM	10	18960	24	1	3	56496	14124
	108	11	16QAM	10	18960	24	1	3	57024	14256
	109	11	16QAM	10	18960	24	1	3	57552	14388
	121	11	16QAM	10	21000	24	1	3	63888	15972
	123	11	16QAM	10	21504	24	1	3	64944	16236

	133	11	16QAM	10	23040	24	1	3	70224	17556
	135	11	16QAM	10	23568	24	1	3	71280	17820
	137	11	16QAM	10	24072	24	1	3	72336	18084
	160	11	16QAM	10	28168	24	1	4	84480	21120
	162	11	16QAM	10	28168	24	1	4	85536	21384
	189	11	16QAM	10	32776	24	1	4	99792	24948
	216	11	16QAM	10	37896	24	1	5	114048	28512
	217	11	16QAM	10	37896	24	1	5	114576	28644
	245	11	16QAM	10	43032	24	1	6	129360	32340
	270	11	16QAM	10	47112	24	1	6	142560	35640
	273	11	16QAM	10	48168	24	1	6	144144	36036

NOTE 1: PUSCH mapping Type-A and single-symbol DM-RS configuration Type-1 with 2 additional DM-RS symbols, such that the DM-RS positions are set to symbols 2, 7, 11. DMRS is [TDM'ed] with PUSCH data. DM-RS symbols are not counted.

NOTE 2: MCS Index is based on MCS table 5.1.3.1-1 defined in TS 38.214 [10].

NOTE 3: If more than one Code Block is present, an additional CRC sequence of L = 24 Bits is attached to each Code Block (otherwise L = 0 Bit)

NOTE 4: The RMCs apply to all channel bandwidth where $L_{CRB} \leq N_{RB}$.

Table A.2.2.7-2: Void

Table A.2.2.7-3: Void

A.2.2.8 CP-OFDM 64QAM

Table A.2.2.8-1: Reference Channels for CP-OFDM 64QAM

Parameter	Allocated resource blocks (L_{CRB})	CP-OFDM Symbols per slot (Note 1)	Modulation	MCS Index (Note 2)	Payload size	Transport block CRC	LDPC Base Graph	Number of code blocks per slot (Note 3)	Total number of bits per slot	Total modulated symbols per slot

Unit					Bits	Bits			Bits	
	1	11	64QAM	19	408	16	2	1	792	132
	5	11	64QAM	19	2024	16	2	1	3960	660
	9	11	64QAM	19	3624	16	2	1	7128	1188
	10	11	64QAM	19	3968	24	1	1	7920	1320
	11	11	64QAM	19	4352	24	1	1	8712	1452
	12	11	64QAM	19	4736	24	1	1	9504	1584
	13	11	64QAM	19	5120	24	1	1	10296	1716
	15	11	64QAM	19	6016	24	1	1	11880	1980
	18	11	64QAM	19	7168	24	1	1	14256	2376
	19	11	64QAM	19	7552	24	1		15048	2508
	24	11	64QAM	19	9480	24	1	2	19008	3168
	25	11	64QAM	19	9992	24	1	2	19800	3300
	26	11	64QAM	19	10504	24	1	2	20592	3432
	31	11	64QAM	19	12296	24	1	2	24552	4092
	33	11	64QAM	19	13064	24	1	2	26136	4356
	38	11	64QAM	19	15112	24	1	2	30096	5016
	39	11	64QAM	19	15624	24	1	2	30888	5148
	47	11	64QAM	19	18960	24	1	3	37224	6204
	51	11	64QAM	19	20496	24	1	3	40392	6732
	52	11	64QAM	19	21000	24	1	3	41184	6864
	53	11	64QAM	19	21000	24	1	3	41976	6996
	61	11	64QAM	19	24567	24	1	3	48312	8052
	65	11	64QAM	19	26120	24	1	4	51480	8580
	67	11	64QAM	19	26632	24	1	4	53064	8844
	78	11	64QAM	19	31240	24	1	4	61776	10296
	79	11	64QAM	19	31752	24	1	4	62568	10428
	80	11	64QAM	19	31752	24	1	4	63360	10560
	81	11	64QAM	19	32264	24	1	4	64152	10692
	93	11	64QAM	19	36896	24	1	5	73656	12276
	95	11	64QAM	19	37896	24	1	5	75240	12540
	106	11	64QAM	19	42016	24	1	5	83952	13992
	107	11	64QAM	19	43032	24	1	6	84744	14124
	108	11	64QAM	19	43032	24	1	6	85536	14256
	109	11	64QAM	19	44040	24	1	6	86328	14388
	121	11	64QAM	19	48168	24	1	6	95832	15972
	123	11	64QAM	19	49176	24	1	6	97416	16236
	133	11	64QAM	19	53288	24	1	7	105336	17556
	135	11	64QAM	19	54296	24	1	7	106920	17820
	137	11	64QAM	19	54296	24	1	7	108504	18084
	160	11	64QAM	19	63528	24	1	8	126720	21120
	162	11	64QAM	19	64552	24	1	8	128304	21384
	189	11	64QAM	19	75792	24	1	9	149688	24948
	216	11	64QAM	19	86040	24	1	11	171072	28512

	217	11	64QAM	19	86040	24	1	11	171864	28644
	245	11	64QAM	19	98376	24	1	12	194040	32340
	270	11	64QAM	19	108552	24	1	13	213840	35640
	273	11	64QAM	19	108552	24	1	13	216216	36036

NOTE 1: PUSCH mapping Type-A and single-symbol DM-RS configuration Type-1 with 2 additional DM-RS symbols, such that the DM-RS positions are set to symbols 2, 7, 11. DMRS is [TDM'ed] with PUSCH data. DM-RS symbols are not counted.

NOTE 2: MCS Index is based on MCS table 5.1.3.1-1 defined in TS 38.214 [10].

NOTE 3: If more than one Code Block is present, an additional CRC sequence of L = 24 Bits is attached to each Code Block (otherwise L = 0 Bit)

NOTE 4: The RMCs apply to all channel bandwidth where $L_{CRB} \leq N_{RB}$.

Table A.2.2.8-2: Void

Table A.2.2.8-3: Void

A.2.2.9 CP-OFDM 256QAM

Table A.2.2.9-1: Reference Channels for CP-OFDM 256QAM

Parameter	Allocated resource blocks (L_{CRB})	DFT-s-OFDM Symbols per slot (Note 1)	Modulation	MCS Index (Note 2)	Payload size	Transport block CRC	LDPC Base Graph	Number of code blocks per slot (Note 3)	Total number of bits per slot	Total modulated symbols per slot
Unit					Bits	Bits			Bits	
	1	11	256QAM	20	704	16	2	1	1056	132
	5	11	256QAM	20	3496	16	2	1	5280	660
	9	11	256QAM	20	6272	24	1	1	9504	1188

	10	11	256QAM	20	7040	24	1	1	10560	1320
	11	11	256QAM	20	7680	24	1	1	11616	1452
	12	11	256QAM	20	8456	24	1	2	12672	1584
	13	11	256QAM	20	9224	24	1	2	13728	1716
	15	11	256QAM	20	10504	24	1	2	15840	1980
	18	11	256QAM	20	12552	24	1	2	19008	2376
	19	11	256QAM	20	13320	24	1	2	20064	2508
	24	11	256QAM	20	16896	24	1	3	25344	3168
	25	11	256QAM	20	17424	24	1	3	26400	3300
	26	11	256QAM	20	18432	24	1	3	27456	3432
	31	11	256QAM	20	22032	24	1	3	32736	4092
	33	11	256QAM	20	23040	24	1	3	34848	4356
	38	11	256QAM	20	26632	24	1	4	40128	5016
	39	11	256QAM	20	27656	24	1	4	41184	5148
	47	11	256QAM	20	32776	24	1	4	49632	6204
	51	11	256QAM	20	35856	24	1	5	53856	6732
	52	11	256QAM	20	36896	24	1	5	54912	6864
	53	11	256QAM	20	36896	24	1	5	55968	6996
	61	11	256QAM	20	43032	24	1	6	64416	8052
	65	11	256QAM	20	46104	24	1	6	68640	8580
	67	11	256QAM	20	47112	24	1	6	70752	8844
	78	11	256QAM	20	55304	24	1	7	82368	10296
	79	11	256QAM	20	55304	24	1	7	83424	10428
	80	11	256QAM	20	56368	24	1	7	84480	10560
	81	11	256QAM	20	57376	24	1	7	85536	10692
	93	11	256QAM	20	65576	24	1	8	98208	12276
	95	11	256QAM	20	67584	24	1	8	100320	12540
	106	11	256QAM	20	73776	24	1	9	111936	13992
	107	11	256QAM	20	75792	24	1	9	112992	14124
	108	11	256QAM	20	75792	24	1	9	114048	14256
	109	11	256QAM	20	75792	24	1	9	115104	14388
	121	11	256QAM	20	86040	24	1	11	127776	15972
	123	11	256QAM	20	86040	24	1	11	129888	16236
	133	11	256QAM	20	94248	24	1	12	140448	17556
	135	11	256QAM	20	94248	24	1	12	142560	17820
	137	11	256QAM	20	96264	24	1	12	144672	18084
	160	11	256QAM	20	112648	24	1	14	168960	21120
	162	11	256QAM	20	114776	24	1	14	171072	21384
	189	11	256QAM	20	131176	24	1	16	199584	24948
	216	11	256QAM	20	151608	24	1	18	228096	28512
	217	11	256QAM	20	151608	24	1	18	229152	28644
	245	11	256QAM	20	172176	24	1	21	258720	32340
	270	11	256QAM	20	188576	24	1	23	285120	35640
	273	11	256QAM	20	192624	24	1	23	288288	36036

NOTE 1: PUSCH mapping Type-A and single-symbol DM-RS configuration Type-1 with 2 additional DM-RS symbols, such that the DM-RS positions are set to symbols 2, 7, 11. DMRS is [TDM'ed] with PUSCH data. DM-RS symbols are not counted.

NOTE 2: MCS Index is based on MCS table 5.1.3.1-2 defined in TS 38.214 [10].

NOTE 3: If more than one Code Block is present, an additional CRC sequence of $L = 24$ Bits is attached to each Code Block (otherwise $L = 0$ Bit)

NOTE 4: The RMCs apply to all channel bandwidth where $L_{CRB} \leq N_{RB}$.

Table A.2.2.9-2: Void

Table A.2.2.9-3: Void

A.2.3 Reference measurement channels for TDD

The TDD UL RMCs are defined in clause A.2.2 with the active UL slots specified in table A.2.1-1 and TDD slot patterns as defined for reference sensitivity tests.

A.2.3.1 DFT-s-OFDM Pi/2-BPSK

Void

A.2.3.2 DFT-s-OFDM QPSK

Void

A.2.3.3 DFT-s-OFDM 16QAM

Void

A.2.3.4 DFT-s-OFDM 64QAM

Void

A.2.3.5 DFT-s-OFDM 256QAM

Void

A.2.3.6 CP-OFDM QPSK

Void

A.2.3.7 CP-OFDM 16QAM

Void

A.2.3.8 CP-OFDM 64QAM

Void

A.2.3.9 CP-OFDM 256QAM

Void

A.3 DL reference measurement channels

A.3.1 General

Unless otherwise stated, Tables A.3.2.2-1, A.3.2.2-2, A.3.2.2-3, A.3.3.2-1, A.3.3.2-2 and A.3.3.2-3 are applicable for measurements of the Receiver Characteristics (clause 7) with the exception of subclauses 7.4 (Maximum input level).

Unless otherwise stated, Tables A.3.2.3-1, A.3.2.3-2, A.3.2.3-3, A.3.3.3-1, A.3.3.3-2 and A.3.3.3-3 are applicable for subclauses 7.4 (Maximum input level) and for UE not supporting PDSCH 256QAM,

Unless otherwise stated, Tables A.3.2.4-1, A.3.2.4-2, A.3.2.4-3, A.3.3.4-1, A.3.3.4-2 and A.3.3.4-3 are applicable for subclauses 7.4 (Maximum input level) and for UE supporting PDSCH 256QAM,

Unless otherwise stated, Tables A.3.2.2-1, A.3.2.2-2, A.3.2.2-3, A.3.3.2-1, A.3.3.2-2 and A.3.3.2-3 also apply for the modulated interferer used in Clauses 7.5, 7.6 and 7.8 with test specific bandwidths.

Table A.3.1-1: Common reference channel parameters

Parameter		Unit	Value
CORESET frequency domain allocation			Full BW
CORESET time domain allocation			2 OFDM symbols at the begin of each slot
PDSCH mapping type			Type A
PDSCH start symbol index (S)			2
Number of consecutive PDSCH symbols (L)			12
PDSCH PRB bundling		PRBs	2
Dynamic PRB bundling			false
Overhead value for TBS determination			0
First DMRS position for Type A PDSCH mapping			2
DMRS type			Type 1
Number of additional DMRS			2
FDM between DMRS and PDSCH			Disable
CSI-RS for tracking	First subcarrier index in the PRB used for CSI-RS (k_0)		0 for CSI-RS resource 1,2,3,4
	OFDM symbols in the PRB used for CSI-RS		$l_0 = 6$ for CSI-RS resource 1 and 3 $l_0 = 10$ for CSI-RS resource 2 and 4
	Number of CSI-RS ports		1 for CSI-RS resource 1,2,3,4
	CDM Type		'No CDM' for CSI-RS resource 1,2,3,4
	Density (ρ)		3 for CSI-RS resource 1,2,3,4
	CSI-RS periodicity	Slots	15 kHz SCS: 20 for CSI-RS resource 1,2,3,4 30 kHz SCS: 40 for CSI-RS resource 1,2,3,4 60 kHz SCS: 80 for CSI-RS resource 1,2,3,4
	CSI-RS offset	Slots	15 kHz SCS: 0 for CSI-RS resource 1 and 2 1 for CSI-RS resource 3 and 4 30 kHz SCS: 1 for CSI-RS resource 1 and 2 2 for CSI-RS resource 3 and 4 60 kHz SCS: 2 for CSI-RS resource 1 and 2 3 for CSI-RS resource 3 and 4
	Frequency Occupation		Start PRB 0 Number of PRB = BWP size
QCL info			TCI state #0
PTRS configuration			PTRS is not configured

A.3.2 DL reference measurement channels for FDD

A.3.2.1 General

Table A.3.2.1-1: Additional reference channels parameters for FDD

Parameter	Unit	Value
Number of HARQ Processes		4
K1 value		2 for all slots

A.3.2.2 FRC for receiver requirements for QPSK

Table A.3.2.2-1: Fixed reference channel for receiver requirements (SCS 15 kHz, FDD, QPSK 1/3)

Parameter	Unit	Value							
		5	10	15	20	25	30	40	50
Channel bandwidth	MHz	5	10	15	20	25	30	40	50
Subcarrier spacing	kHz	15	15	15	15	15	15	15	15
Subcarrier spacing configuration μ		0	0	0	0	0	0	0	0
Allocated resource blocks		25	52	79	106	133	160	216	270
Subcarriers per resource block		12	12	12	12	12	12	12	12
Allocated slots per Frame		8	8	8	8	8	8	8	8
MCS Index		4	4	4	4	4	4	4	4
MCS Table for TBS determination		64QAM							
Modulation		QPSK	QPSK	QPSK	QPSK	QPSK	QPSK	QPSK	QPSK
Target Coding Rate		1/3	1/3	1/3	1/3	1/3	1/3	1/3	1/3
Maximum number of HARQ transmissions		1	1	1	1	1	1	1	1
Information Bit Payload per Slot									
For Slots 0,1	Bits	N/A	N/A	N/A	N/A	N/A	N/A	N/A	N/A
For Slots 2,3,4,5,6,7,8,9	Bits	1672	3368	5120	6912	8712	10504	14088	17424
Transport block CRC	Bits	16	16	24	24	24	24	24	24
LDPC base graph		2	2	1	1	1	1	1	1
Number of Code Blocks per Slot									
For Slots 0,1	CBs	N/A	N/A	N/A	N/A	N/A	N/A	N/A	N/A
For Slots 2,3,4,5,6,7,8,9	CBs	1	1	1	1	2	2	2	3
Binary Channel Bits per Slot									
For Slots 0,1	Bits	N/A	N/A	N/A	N/A	N/A	N/A	N/A	N/A
For Slots 2,3,4,5,6,7,8,9	Bits	5400	11232	17064	22896	28728	34560	46656	58320
Max. Throughput averaged over 1 frame	Mbps	1.338	2.694	4.096	5.530	6.970	8.403	11.27 0	13.93 92
Note 1:	Additional parameters are specified in Table A.3.1-1 and Table A.3.2.1-1.								
Note 2:	If more than one Code Block is present, an additional CRC sequence of L = 24 Bits is attached to each Code Block (otherwise L = 0 Bit).								
Note 3:	SS/PBCH block is transmitted in slot #0 of each frame.								
Note 4:	Slot i is slot index per frame.								

Table A.3.2.2-2: Fixed reference channel for receiver requirements (SCS 30 kHz, FDD, QPSK 1/3)

Parameter	Unit	Value											
		5	10	15	20	25	30	40	50	60	80	90	100
Channel bandwidth	MHz	5	10	15	20	25	30	40	50	60	80	90	100
Subcarrier spacing configuration μ		1	1	1	1	1	1	1	1	1	1	1	1
Allocated resource blocks		11	24	38	51	65	78	106	133	162	217	245	273
Subcarriers per resource block		12	12	12	12	12	12	12	12	12	12	12	12
Allocated slots per Frame		17	17	17	17	17	17	17	17	17	17	17	17
MCS Index		4	4	4	4	4	4	4	4	4	4	4	4
MCS Table for TBS determination		64QAM											
Modulation		QPSK	QPSK	QPSK	QPSK	QPSK	QPSK	QPSK	QPSK	QPSK	QPSK	QPSK	QPSK
Target Coding Rate		1/3	1/3	1/3	1/3	1/3	1/3	1/3	1/3	1/3	1/3	1/3	1/3
Maximum number of HARQ transmissions		1	1	1	1	1	1	1	1	1	1	1	1
Information Bit Payload per Slot													
For Slots 0,1,2	Bits	N/A	N/A	N/A	N/A	N/A	N/A	N/A	N/A	N/A	N/A	N/A	N/A
For Slots 3,...,19	Bits	736	1608	2472	3368	4224	4992	6912	8712	10504	14088	15880	17928
Transport block CRC	Bits	16	16	16	16	24	24	24	24	24	24	24	24
LDPC base graph		2	2	2	2	1	1	1	1	1	1	1	1
Number of Code Blocks per Slot													
For Slots 0,1,2	CBs	N/A	N/A	N/A	N/A	N/A	N/A	N/A	N/A	N/A	N/A	N/A	N/A
For Slots 3,...,19	CBs	1	1	1	1	1	1	1	2	2	2	2	3
Binary Channel Bits per Slot													
For Slots 0,1,2	Bits	N/A	N/A	N/A	N/A	N/A	N/A	N/A	N/A	N/A	N/A	N/A	N/A
For Slots 3,...,19	Bits	2376	5184	8208	11016	14040	16848	22896	28728	34992	46872	52920	58968
Max. Throughput averaged over 1 frame	Mbps	1.251	2.734	4.202	5.726	7.181	8.486	11.750	14.810	17.857	23.950	26.996	30.478
<p>Note 1: Additional parameters are specified in Table A.3.1-1 and Table A.3.2.1-1.</p> <p>Note 2: If more than one Code Block is present, an additional CRC sequence of L = 24 Bits is attached to each Code Block (otherwise L = 0 Bit).</p> <p>Note 3: SS/PBCH block is transmitted in slot #0 of each frame.</p> <p>Note 4: Slot i is slot index per frame.</p>													

Table A.3.2.2-3: Fixed reference channel for receiver requirements (SCS 60 kHz, FDD, QPSK 1/3)

Parameter	Unit	Value										
		10	15	20	25	30	40	50	60	80	90	100
Channel bandwidth	MHz	10	15	20	25	30	40	50	60	80	90	100
Subcarrier spacing configuration μ		2	2	2	2	2	2	2	2	2	2	2
Allocated resource blocks		11	18	24	31	38	51	65	79	107	121	135
Subcarriers per resource block		12	12	12	12	12	12	12	12	12	12	12
Allocated slots per Frame		36	36	36	36	36	36	36	36	36	36	36
MCS Index		4	4	4	4	4	4	4	4	4	4	4
MCS Table for TBS Determination		64QAM										
Modulation		QPSK	QPSK	QPSK	QPSK	QPSK	QPSK	QPSK	QPSK	QPSK	QPSK	QPSK
Target Coding Rate		1/3	1/3	1/3	1/3	1/3	1/3	1/3	1/3	1/3	1/3	1/3
Maximum number of HARQ transmissions		1	1	1	1	1	1	1	1	1	1	1
Information Bit Payload per Slot												
For Slots 0,1,2,3	Bits	N/A	N/A	N/A	N/A	N/A	N/A	N/A	N/A	N/A	N/A	N/A
For Slots 4,...,39	Bits	736	1192	1608	2024	2472	3368	4224	5120	6912	7808	8712
Transport block CRC	Bits	16	16	16	16	16	16	24	24	24	24	24
LDPC base graph		2	2	2	2	2	2	1	1	1	1	1
Number of Code Blocks per Slot												
For Slots 0,1,2,3	CBs	N/A	N/A	N/A	N/A	N/A	N/A	N/A	N/A	N/A	N/A	N/A
For Slots 4,...,39	CBs	1	1	1	1	1	1	1	1	1	1	2
Binary Channel Bits per Slot												
For Slots 0,1,2,3	Bits	N/A	N/A	N/A	N/A	N/A	N/A	N/A	N/A	N/A	N/A	N/A
For Slots 4,...,39	Bits	2376	3888	5184	6696	8208	11016	14040	17064	23112	26136	29160
Max. Throughput averaged over 1 frame	Mbps	2.650	4.291	5.789	7.286	8.899	12.125	15.206	18.432	24.883	28.109	31.363

NOTE 1: Additional parameters are specified in Table A.3.1-1 and Table A.3.2.1-1.

NOTE 2: If more than one Code Block is present, an additional CRC sequence of L = 24 Bits is attached to each Code Block (otherwise L = 0 Bit).

NOTE 3: SS/PBCH block is transmitted in slot #0 of each frame.

NOTE 4: Slot i is slot index per frame.

A.3.2.3 FRC for maximum input level for 64QAM

Table A.3.2.3-1: Fixed reference channel for maximum input level receiver requirements (SCS 15 kHz, FDD, 64QAM)

Parameter	Unit	Value							
		5	10	15	20	25	30	40	50
Channel bandwidth	MHz	5	10	15	20	25	30	40	50
Subcarrier spacing	kHz	15	15	15	15	15	15	15	15
Subcarrier spacing configuration μ		0	0	0	0	0	0	0	0
Allocated resource blocks		25	52	79	106	133	160	216	270
Subcarriers per resource block		12	12	12	12	12	12	12	12
Allocated slots per Frame		8	8	8	8	8	8	8	8
MCS Index		24	24	24	24	24	24	24	24
MCS Table for TBS determination		64QAM							
Modulation		64 QAM	64 QAM	64 QAM	64 QAM	64 QAM	64 QAM	64 QAM	64 QAM
Target Coding Rate		3/4	3/4	3/4	3/4	3/4	3/4	3/4	3/4
Maximum number of HARQ transmissions		1	1	1	1	1	1	1	1
Information Bit Payload per Slot									
For Slots 0,1	Bits	N/A	N/A	N/A	N/A	N/A	N/A	N/A	N/A
For Slots 2,3,4,5,6,7,8,9	Bits	12296	25608	38936	52224	64552	77896	106576	131176
Transport block CRC	Bits	24	24	24	24	24	24	24	24
LDPC base graph		1	1	1	1	1	1	1	1
Number of Code Blocks per Slot									
For Slots 0,1	CBs	N/A	N/A	N/A	N/A	N/A	N/A	N/A	N/A
For Slots 2,3,4,5,6,7,8,9	CBs	2	4	5	7	8	10	13	16
Binary Channel Bits per Slot									
For Slots 0,1	Bits	N/A	N/A	N/A	N/A	N/A	N/A	N/A	N/A
For Slots 2,3,4,5,6,7,8,9	Bits	16200	33696	51192	68688	86184	103680	139968	174960
Max. Throughput averaged over 1 frame	Mbps	9.837	20.486	31.149	41.779	51.642	62.317	85.261	104.941
NOTE 1: Additional parameters are specified in Table A.3.1-1 and Table A.3.2.1-1.									
NOTE 2: If more than one Code Block is present, an additional CRC sequence of L = 24 Bits is attached to each Code Block (otherwise L = 0 Bit).									
NOTE 3: SS/PBCH block is transmitted in slot 0 of each frame									
NOTE 4: Slot i is slot index per frame									

Table A.3.2.3-2: Fixed reference channel for maximum input level receiver requirements (SCS 30 kHz, FDD, 64QAM)

Parameter	Unit	Value										
		5	10	15	20	25	30	40	50	60	80	100
Channel bandwidth	MHz	5	10	15	20	25	30	40	50	60	80	100
Subcarrier spacing configuration ^μ		1	1	1	1	1	1	1	1	1	1	1
Allocated resource blocks		11	24	38	51	65	78	106	133	162	217	273
Subcarriers per resource block		12	12	12	12	12	12	12	12	12	12	12
Allocated slots per Frame		17	17	17	17	17	17	17	17	17	17	17
MCS Index		24	24	24	24	24	24	24	24	24	24	24
MCS Table for TBS determination		64QAM										
Modulation		64 QAM	64 QAM	64 QAM	64 QAM	64 QAM	64 QAM	64 QAM	64 QAM	64 QAM	64 QAM	64 QAM
Target Coding Rate		3/4	3/4	3/4	3/4	3/4	3/4	3/4	3/4	3/4	3/4	3/4
Maximum number of HARQ transmissions		1	1	1	1	1	1	1	1	1	1	1
Information Bit Payload per Slot												
For Slots 0,1,2	Bits	N/A	N/A	N/A	N/A	N/A	N/A	N/A	N/A	N/A	N/A	N/A
For Slots 3,...,19	Bits	5376	11784	18432	25104	31752	37896	52224	64552	79896	106576	135296
Transport block CRC	Bits	24	24	24	24	24	24	24	24	24	24	24
LDPC base graph		1	1	1	1	1	1	1	1	1	1	1
Number of Code Blocks per Slot												
For Slots 0,1,2	CBs	N/A	N/A	N/A	N/A	N/A	N/A	N/A	N/A	N/A	N/A	N/A
For Slots 3,...,19	CBs	1	2	3	3	4	5	7	8	10	13	17
Binary Channel Bits per Slot												
For Slots 0,1,2	Bits	N/A	N/A	N/A	N/A	N/A	N/A	N/A	N/A	N/A	N/A	N/A
For Slots 3,...,19	Bits	7128	15552	24624	33048	42120	50544	68688	86184	104976	140616	176904
Max. Throughput averaged over 1 frame	Mbps	9.139	20.033	31.334	42.677	53.978	64.423	88.781	109.73 8	135.82 3	181.17 9	230.00 3
Note 1:	Additional parameters are specified in Table A.3.1-1 and Table A.3.2.1-1											
Note 2:	If more than one Code Block is present, an additional CRC sequence of L = 24 Bits is attached to each Code Block (otherwise L = 0 Bit)											
Note 3:	SS/PBCH block is transmitted in slot 0 of each frame.											
Note 4:	Slot i is slot index per frame.											

Table A.3.2.3-3: Fixed Reference Channel for Maximum input level receiver requirements (SCS 60 kHz, FDD, 64QAM)

Parameter	Unit	Value									
		10	15	20	25	30	40	50	60	80	100
Channel bandwidth	MHz	10	15	20	25	30	40	50	60	80	100
Subcarrier spacing configuration μ		2	2	2	2	2	2	2	2	2	2
Allocated resource blocks		11	18	24	31	38	51	65	79	107	135
Subcarriers per resource block		12	12	12	12	12	12	12	12	12	12
Allocated slots per Frame		36	36	36	36	36	36	36	36	36	36
MCS Index		24	24	24	24	24	24	24	24	24	24
MCS Table for TBS determination		64QAM									
Modulation		64 QAM	64 QAM	64 QAM	64 QAM	64 QAM	64 QAM	64 QAM	64 QAM	64 QAM	64 QAM
Target Coding Rate		3/4	3/4	3/4	3/4	3/4	3/4	3/4	3/4	3/4	3/4
Maximum number of HARQ transmissions		1	1	1	1	1	1	1	1	1	1
Information Bit Payload per Slot											
For Slots 0,1,2,3	Bits	N/A	N/A	N/A	N/A	N/A	N/A	N/A	N/A	N/A	N/A
For Slots 4,...,39	Bits	5376	8712	11784	15112	18432	25104	31752	38936	52224	65576
Transport block CRC	Bits	24	24	24	24	24	24	24	24	24	24
LDPC base graph		1	1	1	1	1	1	1	1	1	1
Number of Code Blocks per Slot											
For Slots 0,1,2,3	CBs	N/A	N/A	N/A	N/A	N/A	N/A	N/A	N/A	N/A	N/A
For Slots 4,...,39	CBs	1	2	2	2	3	3	4	5	7	8
Binary Channel Bits per Slot											
For Slots 0,1,2,3	Bits	N/A	N/A	N/A	N/A	N/A	N/A	N/A	N/A	N/A	N/A
For Slots 4,...,39	Bits	7128	11664	15552	20088	24624	33048	42120	51192	69336	87480
Max. Throughput averaged over 1 frame	Mbps	19.354	31.363	42.422	54.403	66.355	90.374	114.30 7	140.17 0	188.00 6	236.07 4
Note 1:	Additional parameters are specified in Table A.3.1-1 and Table A.3.2.1-1.										
Note 2:	If more than one Code Block is present, an additional CRC sequence of L = 24 Bits is attached to each Code Block (otherwise L = 0 Bit)										
Note 3:	SS/PBCH block is transmitted in slot #0 of each frame.										
Note 4:	Slot i is slot index per frame.										

A.3.2.4 FRC for maximum input level for 256 QAM

Table A.3.2.4-1: Fixed reference channel for maximum input level receiver requirements (SCS 15 kHz, FDD, 256QAM)

Parameter	Unit	Value							
		5	10	15	20	25	30	40	50
Channel bandwidth	MHz	5	10	15	20	25	30	40	50
Subcarrier spacing	kHz	15	15	15	15	15	15	15	15
Subcarrier spacing configuration μ		0	0	0	0	0	0	0	0
Allocated resource blocks		25	52	79	106	133	160	216	270
Subcarriers per resource block		12	12	12	12	12	12	12	12
Allocated slots per Frame		8	8	8	8	8	8	8	8
MCS Index		23	23	23	23	23	23	23	23
MCS Table for TBS determination		256QAM							
Modulation		256 QAM	256 QAM	256 QAM	256 QAM	256 QAM	256 QAM	256 QAM	256 QAM
Target Coding Rate		4/5	4/5	4/5	4/5	4/5	4/5	4/5	4/5
Maximum number of HARQ transmissions		1	1	1	1	1	1	1	1
Information Bit Payload per Slot									
For Slots 0,1	Bits	N/A	N/A	N/A	N/A	N/A	N/A	N/A	N/A
For Slots 2,3,4,5,6,7,8,9	Bits	16896	34816	53288	71688	90176	108552	143400	180376
Transport block CRC	Bits	24	24	24	24	24	24	24	24
LDPC base graph		1	1	1	1	1	1	1	1
Number of Code Blocks per Slot									
For Slots 0,1	CBs	N/A	N/A	N/A	N/A	N/A	N/A	N/A	N/A
For Slots 2,3,4,5,6,7,8,9	CBs	3	5	7	9	12	14	18	23
Binary Channel Bits per Slot									
For Slots 0,1	Bits	N/A	N/A	N/A	N/A	N/A	N/A	N/A	N/A
For Slots 2,3,4,5,6,7,8,9	Bits	21600	44928	68256	91584	114912	138240	186624	233280
Max. Throughput averaged over 1 frame	Mbps	13.517	27.853	42.630	57.350	72.141	86.842	114.720	144.310
Note 1:	Additional parameters are specified in Table A.3.1-1 and Table A.3.2.1-1.								
Note 2:	If more than one Code Block is present, an additional CRC sequence of L = 24 Bits is attached to each Code Block (otherwise L = 0 Bit)								
Note 3:	SS/PBCH block is transmitted in slot 0 of each frame.								
Note 4:	Slot i is slot index per frame.								

Table A.3.2.4-2: Fixed reference channel for maximum input level receiver requirements (SCS 30 kHz, FDD, 256QAM)

Parameter	Unit	Value										
		5	10	15	20	25	30	40	50	60	80	100
Channel bandwidth	MHz	5	10	15	20	25	30	40	50	60	80	100
Subcarrier spacing configuration μ		1	1	1	1	1	1	1	1	1	1	1
Allocated resource blocks		11	24	38	51	65	78	106	133	162	217	273
Subcarriers per resource block		12	12	12	12	12	12	12	12	12	12	12
Allocated slots per Frame		17	17	17	17	17	17	17	17	17	17	17
MCS Index		23	23	23	23	23	23	23	23	23	23	23
MCS Table for TBS determination		256QAM										
Modulation		256 QAM	256 QAM	256 QAM	256 QAM	256 QAM	256 QAM	256 QAM	256 QAM	256 QAM	256 QAM	256 QAM
Target Coding Rate		4/5	4/5	4/5	4/5	4/5	4/5	4/5	4/5	4/5	4/5	4/5
Maximum number of HARQ transmissions		1	1	1	1	1	1	1	1	1	1	1
Information Bit Payload per Slot												
For Slots 0,1,2	Bits	N/A	N/A	N/A	N/A	N/A	N/A	N/A	N/A	N/A	N/A	N/A
For Slots 3,...,19	Bits	7424	16136	25608	33816	44040	52224	71688	90176	108552	147576	184424
Transport block CRC	Bits	24	24	24	24	24	24	24	24	24	24	24
LDPC base graph		1	1	1	1	1	1	1	1	1	1	1
Number of Code Blocks per Slot												
For Slots 0,1,2	CBs	N/A	N/A	N/A	N/A	N/A	N/A	N/A	N/A	N/A	N/A	N/A
For Slots 3,...,19	CBs	1	3	4	5	6	7	9	12	14	19	23
Binary Channel Bits per Slot												
For Slots 0,1,2	Bits	N/A	N/A	N/A	N/A	N/A	N/A	N/A	N/A	N/A	N/A	N/A
For Slots 3,...,19	Bits	9504	20736	32832	44064	56160	67392	91584	114912	139968	187488	235872
Max. Throughput averaged over 1 frame	Mbps	12.621	27.431	43.534	57.487	74.868	88.781	121.87 0	153.29 9	184.53 8	250.87 9	313.52 1
Note 1:	Additional parameters are specified in Table A.3.1-1 and Table A.3.2.1-1.											
Note 2:	If more than one Code Block is present, an additional CRC sequence of L = 24 Bits is attached to each Code Block (otherwise L = 0 Bit)											
Note 3:	SS/PBCH block is transmitted in slot 0 of each frame.											
Note 4:	Slot i is slot index per frame.											

Table A.3.2.4-3: Fixed reference channel for maximum input level receiver requirements (SCS 60 kHz, FDD, 256QAM)

Parameter	Unit	Value									
		10	15	20	25	30	40	50	60	80	100
Channel bandwidth	MHz	10	15	20	25	30	40	50	60	80	100
Subcarrier spacing configuration μ		2	2	2	2	2	2	2	2	2	2
Allocated resource blocks		11	18	24	31	38	51	65	79	107	135
Subcarriers per resource block		12	12	12	12	12	12	12	12	12	12
Allocated slots per Frame		36	36	36	36	36	36	36	36	36	36
MCS Index		23	23	23	23	23	23	23	23	23	23
MCS Table for TBS determination		256QAM									
Modulation		256 QAM	256 QAM	256 QAM	256 QAM	256 QAM	256 QAM	256 QAM	256 QAM	256 QAM	256 QAM
Target Coding Rate		4/5	4/5	4/5	4/5	4/5	4/5	4/5	4/5	4/5	4/5
Maximum number of HARQ transmissions		1	1	1	1	1	1	1	1	1	1
Information Bit Payload per Slot											
For Slots 0,1,2,3	Bits	N/A	N/A	N/A	N/A	N/A	N/A	N/A	N/A	N/A	N/A
For Slots 4,...,39	Bits	7424	12040	16136	21000	25608	33816	44040	53288	71688	90176
Transport block CRC	Bits	24	24	24	24	24	24	24	24	24	24
LDPC base graph		1	1	1	1	1	1	1	1	1	1
Number of Code Blocks per Slot											
For Slots 0,1,2,3	CBs	N/A	N/A	N/A	N/A	N/A	N/A	N/A	N/A	N/A	N/A
For Slots 4,...,39	CBs	1	2	3	3	4	5	6	7	9	12
Binary Channel Bits per Slot											
For Slots 0,1,2,3	Bits	N/A	N/A	N/A	N/A	N/A	N/A	N/A	N/A	N/A	N/A
For Slots 4,...,39	Bits	9504	15552	20736	26784	32832	44064	56160	68256	92448	116640
Max. Throughput averaged over 1 frame	Mbps	26.726	43.344	58.090	75.600	92.189	121.73 8	158.54 4	191.83 7	258.07 7	324.63 4
Note 1:	Additional parameters are specified in Table A.3.1-1 and Table A.3.2.1-1.										
Note 2:	If more than one Code Block is present, an additional CRC sequence of L = 24 Bits is attached to each Code Block (otherwise L = 0 Bit)										
Note 3:	SS/PBCH block is transmitted in slot #0 of each frame.										
Note 4:	Slot i is slot index per frame.										

A.3.3 DL reference measurement channels for TDD

A.3.3.1 General

Table A.3.3.1-1: Additional reference channels parameters for TDD

Parameter		Value		
		SCS 15 kHz ($\mu=0$)	SCS 30 kHz ($\mu=1$)	SCS 60 kHz ($\mu=2$)
TDD Slot Configuration pattern (Note 1)		DDDSU	7DS2U	14DS ₁ S ₂ 4U
Special Slot Configuration (Note 2)		10D+2G+2U	6D+4G+4U	S ₁ =12D+2G, S ₂ =6G+8U
referenceSubcarrierSpacing		15 kHz	30 kHz	60 kHz
UL-DL configuration	<i>dl-UL-TransmissionPeriodicity</i>	5 ms	5 ms	5 ms
	<i>nrofDownlinkSlots</i>	3	7	14
	<i>nrofDownlinkSymbols</i>	10	6	12
	<i>nrofUplinkSlot</i>	1	2	4
	<i>nrofUplinkSymbols</i>	2	4	8
Number of HARQ Processes		8	8	16
The number of slots between PDSCH and corresponding HARQ-ACK information (Note 3)		K1 = 4 if mod(i,5) = 0 K1 = 3 if mod(i,5) = 1 K1 = 2 if mod(i,5) = 2 where i is slot index per frame; i = {0,...,9}	K1 = 8 if mod(i,10) = 0 K1 = 7 if mod(i,10) = 1 K1 = 6 if mod(i,10) = 2 K1 = 5 if mod(i,10) = 3 K1 = 4 if mod(i,10) = 4 K1 = 3 if mod(i,10) = 5 K1 = 2 if mod(i,10) = 6 where i is slot index per frame; i = {0,...,19}	K1 = 13 if mod(i,20) = 2 K1 = 12 if mod(i,20) = 3 K1 = 11 if mod(i,20) = 4 K1 = 10 if mod(i,20) = 5 K1 = 9 if mod(i,20) = 6 K1 = 8 if mod(i,20) = 7 K1 = 7 if mod(i,20) = 8 K1 = 6 if mod(i,20) = 9 K1 = 6 if mod(i,20) = 10 K1 = 6 if mod(i,20) = 11 K1 = 6 if mod(i,20) = 12 K1 = 6 if mod(i,20) = 13 where i is slot index per frame; i = {0,...,39}
NOTE 1: D denotes a slot with all DL symbols; S denotes a slot with a mix of DL, UL and guard symbols; U denotes a slot with all UL symbols. The field is for information.				
NOTE 2: D, G, U denote DL, guard and UL symbols, respectively. The field is for information.				
NOTE 3: i is the slot index per frame.				

A.3.3.2 FRC for receiver requirements for QPSK

Table A.3.3.2-1: Fixed reference channel for receiver requirements (SCS 15 kHz, TDD, QPSK 1/3)

Parameter	Unit	Value							
		5	10	15	20	25	30	40	50
Channel bandwidth	MHz	5	10	15	20	25	30	40	50
Subcarrier spacing	kHz	15	15	15	15	15	15	15	15
Subcarrier spacing configuration μ		0	0	0	0	0	0	0	0
Allocated resource blocks		25	52	79	106	133	160	216	270
Subcarriers per resource block		12	12	12	12	12	12	12	12
Allocated slots per Frame		4	4	4	4	4	4	4	4
MCS Index		4	4	4	4	4	4	4	4
MCS Table for TBS determination		64QAM							
Modulation		QPSK	QPSK	QPSK	QPSK	QPSK	QPSK	QPSK	QPSK
Target Coding Rate		1/3	1/3	1/3	1/3	1/3	1/3	1/3	1/3
Maximum number of HARQ transmissions		1	1	1	1	1	1	1	1
Information Bit Payload per Slot									
For Slots 0,1,3,4,8,9	Bits	N/A	N/A	N/A	N/A	N/A	N/A	N/A	N/A
For Slots 2,5,6,7	Bits	1672	3368	5120	6912	8712	10504	14088	17424
Transport block CRC	Bits	16	16	24	24	24	24	24	24
LDPC base graph		2	2	1	1	1	1	1	1
Number of Code Blocks per Slot									
For Slots 0,1,3,4,8,9	CBs	N/A	N/A	N/A	N/A	N/A	N/A	N/A	N/A
For Slots 2,5,6,7	CBs	1	1	1	1	2	2	2	3
Binary Channel Bits per Slot									
For Slots 0,1,3,4,8,9	Bits	N/A	N/A	N/A	N/A	N/A	N/A	N/A	N/A
For Slots 2,5,6,7	Bits	5400	11232	17064	22896	28728	34560	46656	58320
Max. Throughput averaged over 1 frame	Mbps	0.669	1.347	2.048	2.765	3.485	4.202	5.635	6.970
Note 1:	Additional parameters are specified in Table A.3.1-1 and Table A.3.3.1-1.								
Note 2:	If more than one Code Block is present, an additional CRC sequence of L = 24 Bits is attached to each Code Block (otherwise L = 0 Bit)								
Note 3:	SS/PBCH block is transmitted in slot 0 of each frame.								
Note 4:	Slot i is slot index per frame.								

Table A.3.3.2-2: Fixed reference channel for receiver requirements (SCS 30 kHz, TDD, QPSK 1/3)

Parameter	Unit	Value										
		5	10	15	20	25	30	40	50	60	80	100
Channel bandwidth	MHz	5	10	15	20	25	30	40	50	60	80	100
Subcarrier spacing configuration μ		1	1	1	1	1	1	1	1	1	1	1
Allocated resource blocks		11	24	38	51	65	78	106	133	162	217	273
Subcarriers per resource block		12	12	12	12	12	12	12	12	12	12	12
Allocated slots per Frame		11	11	11	11	11	11	11	11	11	11	11
MCS Index		4	4	4	4	4	4	4	4	4	4	4
MCS Table for TBS determination		64QAM										
Modulation		QPSK	QPSK	QPSK	QPSK	QPSK	QPSK	QPSK	QPSK	QPSK	QPSK	QPSK
Target Coding Rate		1/3	1/3	1/3	1/3	1/3	1/3	1/3	1/3	1/3	1/3	1/3
Maximum number of HARQ transmissions		1	1	1	1	1	1	1	1	1	1	1
Information Bit Payload per Slot												
For Slots 0,1,2 and Slot i, if $\text{mod}(i, 10) = \{7,8,9\}$ for i from $\{0, \dots, 19\}$	Bits	N/A	N/A	N/A	N/A	N/A	N/A	N/A	N/A	N/A	N/A	N/A
For Slot i, if $\text{mod}(i, 10) = \{0,1,2,3,4,5,6\}$ for i from $\{3, \dots, 19\}$	Bits	736	1608	2472	3368	4224	4992	6912	8712	10504	14088	17928
Transport block CRC	Bits	16	16	16	16	24	24	24	24	24	24	24
LDPC base graph		2	2	2	2	1	1	1	1	1	1	1
Number of Code Blocks per Slot												
For Slots 0,1,2 and Slot i, if $\text{mod}(i, 10) = \{7,8,9\}$ for i from $\{0, \dots, 19\}$	CBs	N/A	N/A	N/A	N/A	N/A	N/A	N/A	N/A	N/A	N/A	N/A
For Slot i, if $\text{mod}(i, 10) = \{0,1,2,3,4,5,6\}$ for i from $\{3, \dots, 19\}$	CBs	1	1	1	1	1	1	1	2	2	2	3
Binary Channel Bits per Slot												
For Slots 0,1,2 and Slot i, if $\text{mod}(i, 10) = \{7,8,9\}$ for i from $\{0, \dots, 19\}$	Bits	N/A	N/A	N/A	N/A	N/A	N/A	N/A	N/A	N/A	N/A	N/A
For Slot i, if $\text{mod}(i, 10) = \{0,1,2,3,4,5,6\}$ for i from $\{3, \dots, 19\}$	Bits	2376	5184	8208	11016	14040	16848	22896	28728	34992	46872	58968
Max. Throughput averaged over 1 frame	Mbps	0.810	2.1.769	2.719	3.705	4.646	5.491	7.603	9.583	11.554	15.497	19.721
Note 1:	Additional parameters are specified in Table A.3.1-1 and Table A.3.3.1-1.											
Note 2:	If more than one Code Block is present, an additional CRC sequence of L = 24 Bits is attached to each Code Block (otherwise L = 0 Bit)											
Note 3:	SS/PBCH block is transmitted in slot #0 of each frame.											
Note 4:	Slot i is slot index per frame.											

Table A.3.3.2-3: Fixed reference channel for receiver requirements (SCS 60 kHz, TDD, QPSK 1/3)

Parameter	Unit	Value									
		10	15	20	25	30	40	50	60	80	100
Channel bandwidth	MHz	10	15	20	25	30	40	50	60	80	100
Subcarrier spacing configuration μ		2	2	2	2	2	2	2	2	2	2
Allocated resource blocks		11	18	24	31	38	51	65	79	107	135
Subcarriers per resource block		12	12	12	12	12	12	12	12	12	12
Allocated slots per Frame		24	24	24	24	24	24	24	24	24	24
MCS Index		4	4	4	4	4	4	4	4	4	4
MCS Table for TBS determination		64QAM									
Modulation		QPSK	QPSK	QPSK	QPSK	QPSK	QPSK	QPSK	QPSK	QPSK	QPSK
Target Coding Rate		1/3	1/3	1/3	1/3	1/3	1/3	1/3	1/3	1/3	1/3
Maximum number of HARQ transmissions		1	1	1	1	1	1	1	1	1	1
Information Bit Payload per Slot											
For Slots 0,1,2,3 and Slot i, if $\text{mod}(i, 20) = \{14, 15, 16, 17, 18, 19\}$ for i from $\{0, \dots, 39\}$	Bits	N/A	N/A	N/A	N/A	N/A	N/A	N/A	N/A	N/A	N/A
For Slot i, if $\text{mod}(i, 20) = \{0, \dots, 13\}$ for i from $\{4, \dots, 39\}$	Bits	736	1192	1608	2024	2472	3368	4224	5120	6912	8712
Transport block CRC	Bits	16	16	16	16	16	16	24	24	24	24
LDPC base graph		2	2	2	2	2	2	1	1	1	1
Number of Code Blocks per Slot											
For Slots 0,1,2,3 and Slot i, if $\text{mod}(i, 20) = \{14, 15, 16, 17, 18, 19\}$ for i from $\{0, \dots, 39\}$	CBs	N/A	N/A	N/A	N/A	N/A	N/A	N/A	N/A	N/A	N/A
For Slot i, if $\text{mod}(i, 20) = \{0, \dots, 13\}$ for i from $\{4, \dots, 39\}$	CBs	1	1	1	1	1	1	1	1	1	2
Binary Channel Bits per Slot											
For Slots 0,1,2,3 and Slot i, if $\text{mod}(i, 20) = \{14, 15, 16, 17, 18, 19\}$ for i from $\{0, \dots, 39\}$	Bits	N/A	N/A	N/A	N/A	N/A	N/A	N/A	N/A	N/A	N/A
For Slot i, if $\text{mod}(i, 20) = \{0, \dots, 13\}$ for i from $\{4, \dots, 39\}$	Bits	2376	3888	5184	6696	8208	11016	14040	17064	23112	29160
Max. Throughput averaged over 1 frame	Mbps	1.766	3.2.861	3.859	4.858	5.933	8.083	10.138	12.288	16.589	20.909
Note 1:	Additional parameters are specified in Table A.3.1-1 and Table A.3.3.1-1.										
Note 2:	If more than one Code Block is present, an additional CRC sequence of L = 24 Bits is attached to each Code Block (otherwise L = 0 Bit)										
Note 3:	SS/PBCH block is transmitted in slot #0 of each frame.										
Note 4:	Slot i is slot index per frame.										

A.3.3.3 FRC for maximum input level for 64QAM

Table A.3.3.3-1: Fixed reference channel for maximum input level receiver requirements (SCS 15 kHz, TDD, 64QAM)

Parameter	Unit	Value							
		5	10	15	20	25	30	40	50
Channel bandwidth	MHz	5	10	15	20	25	30	40	50
Subcarrier spacing	kHz	15	15	15	15	15	15	15	15
Subcarrier spacing configuration μ		0	0	0	0	0	0	0	0
Allocated resource blocks		25	52	79	106	133	160	216	270
Subcarriers per resource block		12	12	12	12	12	12	12	12
Allocated slots per Frame		4	4	4	4	4	4	4	4
MCS Index		24	24	24	24	24	24	24	24
MCS Table for TBS determination		64QAM							
Modulation		64 QAM	64 QAM	64 QAM	64 QAM	64 QAM	64 QAM	64 QAM	64 QAM
Target Coding Rate		3/4	3/4	3/4	3/4	3/4	3/4	3/4	3/4
Maximum number of HARQ transmissions		1	1	1	1	1	1	1	1
Information Bit Payload per Slot									
For Slots 0,1,3,4,8,9	Bits	N/A	N/A	N/A	N/A	N/A	N/A	N/A	N/A
For Slots 2,5,6,7	Bits	12296	25608	38936	52224	64552	77896	106576	131176
Transport block CRC	Bits	24	24	24	24	24	24	24	24
LDPC base graph		1	1	1	1	1	1	1	1
Number of Code Blocks per Slot									
For Slots 0,1,3,4,8,9	CBs	N/A	N/A	N/A	N/A	N/A	N/A	N/A	N/A
For Slots 2,5,6,7	CBs	2	4	5	7	8	10	13	16
Binary Channel Bits per Slot									
For Slots 0,1,3,4,8,9	Bits	N/A	N/A	N/A	N/A	N/A	N/A	N/A	N/A
For Slots 2,5,6,7	Bits	16200	33696	51192	68688	86184	103680	139968	174960
Max. Throughput averaged over 1 frame	Mbps	4.918	10.243	15.574	20.890	20.890	31.158	42.630	52.470
Note 1:	Additional parameters are specified in Table A.3.1-1 and Table A.3.3.1-1.								
Note 2:	If more than one Code Block is present, an additional CRC sequence of L = 24 Bits is attached to each Code Block (otherwise L = 0 Bit)								
Note 3:	SS/PBCH block is transmitted in slot 0 of each frame.								
Note 4:	Slot i is slot index per frame.								

Table A.3.3.3-2: Fixed reference channel for maximum input level receiver requirements (SCS 30 kHz, TDD, 64QAM)

Parameter	Unit	Value										
		5	10	15	20	25	30	40	50	60	80	100
Channel bandwidth	MHz	5	10	15	20	25	30	40	50	60	80	100
Subcarrier spacing configuration μ		1	1	1	1	1	1	1	1	1	1	1
Allocated resource blocks		11	24	38	51	65	78	106	133	162	217	273
Subcarriers per resource block		12	12	12	12	12	12	12	12	12	12	12
Allocated slots per Frame		11	11	11	11	11	11	11	11	11	11	11
MCS Index		24	24	24	24	24	24	24	24	24	24	24
MCS Table for TBS determination		64QAM										
Modulation		64 QAM	64 QAM	64 QAM	64 QAM	64 QAM	64 QAM	64 QAM	64 QAM	64 QAM	64 QAM	64 QAM
Target Coding Rate		3/4	3/4	3/4	3/4	3/4	3/4	3/4	3/4	3/4	3/4	3/4
Maximum number of HARQ transmissions		1	1	1	1	1	1	1	1	1	1	1
Information Bit Payload per Slot												
For Slots 0,1,2 and Slot i, if mod(i, 10) = {7,8,9} for i from {0,...,19}	Bits	N/A	N/A	N/A	N/A	N/A	N/A	N/A	N/A	N/A	N/A	N/A
For Slot i, if mod(i, 10) = {0,1,2,3,4,5,6} for i from {3,...,19}	Bits	5376	11784	18432	25104	31752	37896	52224	64552	79896	106576	135296
Transport block CRC	Bits	24	24	24	24	24	24	24	24	24	24	24
LDPC base graph		1	1	1	1	1	1	1	1	1	1	1
Number of Code Blocks per Slot												
For Slots 0,1,2 and Slot i, if mod(i, 10) = {7,8,9} for i from {0,...,19}	CBs	N/A	N/A	N/A	N/A	N/A	N/A	N/A	N/A	N/A	N/A	N/A
For Slot i, if mod(i, 10) = {0,1,2,3,4,5,6} for i from {3,...,19}	CBs	1	2	3	3	4	5	7	8	10	13	17
Binary Channel Bits per Slot												
For Slots 0,1,2 and Slot i, if mod(i, 10) = {7,8,9} for i from {0,...,19}	Bits	N/A	N/A	N/A	N/A	N/A	N/A	N/A	N/A	N/A	N/A	N/A
For Slot i, if mod(i, 10) = {0,1,2,3,4,5,6} for i from {3,...,19}	Bits	7128	15552	24624	33048	42120	50544	68688	86184	104976	140616	176904
Max. Throughput averaged over 1 frame	Mbps	5.914	12.962	20.275	27.614	34.927	41.686	57.446	71.007	87.886	117.23 4	148.82 6
Note 1:	Additional parameters are specified in Table A.3.1-1 and Table A.3.3.1-1.											
Note 2:	If more than one Code Block is present, an additional CRC sequence of L = 24 Bits is attached to each Code Block (otherwise L = 0 Bit)											
Note 3:	SS/PBCH block is transmitted in slot #0 of each frame.											
Note 4:	Slot i is slot index per frame.											

Table A.3.3.3-3: Fixed reference channel for maximum input level receiver requirements (SCS 60 kHz, TDD, 64QAM)

Parameter	Unit	Value									
		10	15	20	25	30	40	50	60	80	100
Channel bandwidth	MHz	10	15	20	25	30	40	50	60	80	100
Subcarrier spacing configuration μ		2	2	2	2	2	2	2	2	2	2
Allocated resource blocks		11	18	24	31	38	51	65	79	107	135
Subcarriers per resource block		12	12	12	12	12	12	12	12	12	12
Allocated slots per Frame		24	24	24	24	24	24	24	24	24	24
MCS Index		24	24	24	24	24	24	24	24	24	24
MCS Table for TBS determination		64QAM									
Modulation		64 QAM	64 QAM	64 QAM	64 QAM	64 QAM	64 QAM	64 QAM	64 QAM	64 QAM	64 QAM
Target Coding Rate		3/4	3/4	3/4	3/4	3/4	3/4	3/4	3/4	3/4	3/4
Maximum number of HARQ transmissions		1	1	1	1	1	1	1	1	1	1
Information Bit Payload per Slot											
For Slots 0,1,2,3 and Slot i, if $\text{mod}(i, 20) = \{14, 15, 16, 17, 18, 19\}$ for i from $\{0, \dots, 39\}$	Bits	N/A	N/A	N/A	N/A	N/A	N/A	N/A	N/A	N/A	N/A
For Slot i, if $\text{mod}(i, 5) = \{0, \dots, 13\}$ for i from $\{4, \dots, 39\}$	Bits	5376	8712	11784	15112	18432	25104	31752	38936	52224	65576
Transport block CRC	Bits	24	24	24	24	24	24	24	24	24	24
LDPC base graph		1	1	1	1	1	1	1	1	1	1
Number of Code Blocks per Slot											
For Slots 0,1,2,3 and Slot i, if $\text{mod}(i, 20) = \{14, 15, 16, 17, 18, 19\}$ for i from $\{0, \dots, 39\}$	CBs	N/A	N/A	N/A	N/A	N/A	N/A	N/A	N/A	N/A	N/A
For Slot i, if $\text{mod}(i, 5) = \{0, \dots, 13\}$ for i from $\{4, \dots, 39\}$	CBs	1	2	2	2	3	3	4	5	7	8
Binary Channel Bits per Slot											
For Slots 0,1,2,3 and Slot i, if $\text{mod}(i, 20) = \{14, 15, 16, 17, 18, 19\}$ for i from $\{0, \dots, 39\}$	Bits	N/A	N/A	N/A	N/A	N/A	N/A	N/A	N/A	N/A	N/A
For Slot i, if $\text{mod}(i, 20) = \{0, \dots, 13\}$ for i from $\{4, \dots, 39\}$	Bits	7128	11664	15552	20088	24624	33048	42120	51192	69336	87480
Max. Throughput averaged over 1 frame	Mbps	12.902	20.909	28.282	36.269	44.237	60.250	76.205	93.446	125.33 8	157.38 2
Note 1:	Additional parameters are specified in Table A.3.1-1 and Table A.3.3.1-1.										
Note 2:	If more than one Code Block is present, an additional CRC sequence of L = 24 Bits is attached to each Code Block (otherwise L = 0 Bit)										
Note 3:	SS/PBCH block is transmitted in slot #0 of each frame.										
Note 4:	Slot i is slot index per frame.										

A.3.3.4 FRC for maximum input level for 256 QAM

Table A.3.3.4-1: Fixed reference channel for maximum input level receiver requirements (SCS 15 kHz, TDD, 256QAM)

Parameter	Unit	Value							
		5	10	15	20	25	30	40	50
Channel bandwidth	MHz	5	10	15	20	25	30	40	50
Subcarrier spacing	kHz	15	15	15	15	15	15	15	15
Subcarrier spacing configuration μ		0	0	0	0	0	0	0	0
Allocated resource blocks		25	52	79	106	133	160	216	270
Subcarriers per resource block		12	12	12	12	12	12	12	12
Allocated slots per Frame		4	4	4	4	4	4	4	4
MCS Index		23	23	23	23	23	23	23	23
MCS Table for TBS determination		256QAM							
Modulation		256 QAM	256 QAM	256 QAM	256 QAM	256 QAM	256 QAM	256 QAM	256 QAM
Target Coding Rate		4/5	4/5	4/5	4/5	4/5	4/5	4/5	4/5
Maximum number of HARQ transmissions		1	1	1	1	1	1	1	1
Information Bit Payload per Slot									
For Slots 0,1,3,4,8,9	Bits	N/A	N/A	N/A	N/A	N/A	N/A	N/A	N/A
For Slots 2,5,6,7	Bits	16896	34816	53288	71688	90176	108552	143400	180376
Transport block CRC	Bits	24	24	24	24	24	24	24	24
LDPC base graph		1	1	1	1	1	1	1	1
Number of Code Blocks per Slot									
For Slots 0,1,3,4,8,9	CBs	N/A	N/A	N/A	N/A	N/A	N/A	N/A	N/A
For Slots 2,5,6,7	CBs	3	5	7	9	12	14	18	23
Binary Channel Bits per Slot									
For Slots 0,1,3,4,8,9	Bits	N/A	N/A	N/A	N/A	N/A	N/A	N/A	N/A
For Slots 2,5,6,7	Bits	21600	44928	68256	91584	114912	138240	186624	233280
Max. Throughput averaged over 1 frame	Mbps	6.758	13.926	21.315	28.675	36.070	43.421	57.360	72.150
Note 1:	Additional parameters are specified in Table A.3.1-1 and Table A.3.3.1-1.								
Note 2:	If more than one Code Block is present, an additional CRC sequence of L = 24 Bits is attached to each Code Block (otherwise L = 0 Bit)								
Note 3:	SS/PBCH block is transmitted in slot 0 of each frame.								
Note 4:	Slot i is slot index per frame.								

Table A.3.3.4-2: Fixed Reference channel for maximum input level receiver requirements (SCS 30 kHz, TDD, 256QAM)

Parameter	Unit	Value										
		5	10	15	20	25	30	40	50	60	80	100
Channel bandwidth	MHz	5	10	15	20	25	30	40	50	60	80	100
Subcarrier spacing configuration μ		1	1	1	1	1	1	1	1	1	1	1
Allocated resource blocks		11	24	38	51	65	78	106	133	162	217	273
Subcarriers per resource block		12	12	12	12	12	12	12	12	12	12	12
Allocated slots per Frame		11	11	11	11	11	11	11	11	11	11	11
MCS Index		23	23	23	23	23	23	23	23	23	23	23
MCS Table for TBS determination		256QAM										
Modulation		256 QAM	256 QAM	256 QAM	256 QAM	256 QAM	256 QAM	256 QAM	256 QAM	256 QAM	256 QAM	256 QAM
Target Coding Rate		4/5	4/5	4/5	4/5	4/5	4/5	4/5	4/5	4/5	4/5	4/5
Maximum number of HARQ transmissions		1	1	1	1	1	1	1	1	1	1	1
Information Bit Payload per Slot												
For Slots 0,1,2 and Slot i, if mod(i, 10) = {7,8,9} for i from {0,...,19}	Bits	N/A	N/A	N/A	N/A	N/A	N/A	N/A	N/A	N/A	N/A	N/A
For Slot i, if mod(i, 10) = {0,1,2,3,4,5,6} for i from {3,...,19}	Bits	7424	16136	25608	33816	44040	52224	71688	90176	108552	147576	184424
Transport block CRC	Bits	24	24	24	24	24	24	24	24	24	24	24
LDPC base graph		1	1	1	1	1	1	1	1	1	1	1
Number of Code Blocks per Slot												
For Slots 0,1,2 and Slot i, if mod(i, 10) = {7,8,9} for i from {0,...,19}	CBs	N/A	N/A	N/A	N/A	N/A	N/A	N/A	N/A	N/A	N/A	N/A
For Slot i, if mod(i, 10) = {0,1,2,3,4,5,6} for i from {3,...,19}	CBs	1	1	1	1	1	1	1	2	2	2	3
Binary Channel Bits per Slot												
For Slots 0,1,2 and Slot i, if mod(i, 10) = {7,8,9} for i from {0,...,19}	Bits	N/A	N/A	N/A	N/A	N/A	N/A	N/A	N/A	N/A	N/A	N/A
For Slot i, if mod(i, 10) = {0,1,2,3,4,5,6} for i from {3,...,19}	Bits	9504	20736	32832	44064	56160	67392	91584	114912	139968	187488	235872
Max. Throughput averaged over 1 frame	Mbps	8.166	17.750	28.169	37.198	48.444	57.446	78.857	99.194	119.40 7	162.33 4	202.86 6
Note 1:	Additional parameters are specified in Table A.3.1-1 and Table A.3.3.1-1.											
Note 2:	If more than one Code Block is present, an additional CRC sequence of L = 24 Bits is attached to each Code Block (otherwise L = 0 Bit)											
Note 3:	SS/PBCH block is transmitted in slot #0 of each frame.											
Note 4:	Slot i is slot index per frame.											

Table A.3.3.4-3: Fixed reference channel for maximum input level receiver requirements (SCS 60 kHz, TDD, 256QAM)

Parameter	Unit	Value									
		10	15	20	25	30	40	50	60	80	100
Channel bandwidth	MHz	10	15	20	25	30	40	50	60	80	100
Subcarrier spacing configuration μ		2	2	2	2	2	2	2	2	2	2
Allocated resource blocks		11	18	24	31	38	51	65	79	107	135
Subcarriers per resource block		12	12	12	12	12	12	12	12	12	12
Allocated slots per Frame		24	24	24	24	24	24	24	24	24	24
MCS Index		23	23	23	23	23	23	23	23	23	23
MCS Table for TBS determination		256QAM									
Modulation		256 QAM	256 QAM	256 QAM	256 QAM	256 QAM	256 QAM	256 QAM	256 QAM	256 QAM	256 QAM
Target Coding Rate		4/5	4/5	4/5	4/5	4/5	4/5	4/5	4/5	4/5	4/5
Maximum number of HARQ transmissions		1	1	1	1	1	1	1	1	1	1
Information Bit Payload per Slot											
For Slots 0,1,2,3 and Slot i, if $\text{mod}(i, 20) = \{14, 15, 16, 17, 18, 19\}$ for i from $\{0, \dots, 39\}$	Bits	N/A	N/A	N/A	N/A	N/A	N/A	N/A	N/A	N/A	N/A
For Slot i, if $\text{mod}(i, 20) = \{0, \dots, 13\}$ for i from $\{4, \dots, 39\}$	Bits	7424	12040	16136	21000	25608	33816	44040	53288	71688	90176
Transport block CRC	Bits	24	24	24	24	24	24	24	24	24	24
LDPC base graph		1	1	1	1	1	1	1	1	1	1
Number of Code Blocks per Slot											
For Slots 0,1,2,3 and Slot i, if $\text{mod}(i, 20) = \{14, 15, 16, 17, 18, 19\}$ for i from $\{0, \dots, 39\}$	CBs	N/A	N/A	N/A	N/A	N/A	N/A	N/A	N/A	N/A	N/A
For Slot i, if $\text{mod}(i, 5) = \{0, \dots, 13\}$ for i from $\{4, \dots, 39\}$	CBs	1	2	3	3	4	5	6	7	9	12
Binary Channel Bits per Slot											
For Slots 0,1,2,3 and Slot i, if $\text{mod}(i, 20) = \{14, 15, 16, 17, 18, 19\}$ for i from $\{0, \dots, 39\}$	Bits	N/A	N/A	N/A	N/A	N/A	N/A	N/A	N/A	N/A	N/A
For Slot i, if $\text{mod}(i, 20) = \{0, \dots, 13\}$ for i from $\{4, \dots, 39\}$	Bits	9504	15552	20736	26784	32832	44064	56160	68256	92448	116640
Max. Throughput averaged over 1 frame	Mbps	17.818	28.896	38.726	50.400	61.459	81.158	105.69 6	127.89 1	172.05 1	216.42 2
<p>Note 1: Additional parameters are specified in Table A.3.1-1 and Table A.3.3.1-1.</p> <p>Note 2: If more than one Code Block is present, an additional CRC sequence of L = 24 Bits is attached to each Code Block (otherwise L = 0 Bit)</p> <p>Note 3: SS/PBCH block is transmitted in slot #0 of each frame.</p> <p>Note 4: Slot i is slot index per frame.</p>											

A.4 CSI reference measurement channels

TBD

A.5 OFDMA Channel Noise Generator (OCNG)

A.5.1 OCNG Patterns for FDD

A.5.1.1 OCNG FDD pattern 1: Generic OCNG FDD Pattern for all unused REs

Table A.5.1.1-1: OP.1 FDD: Generic OCNG FDD Pattern for all unused REs

OCNG Distribution OCNG Parameters	Control Region (Core Set)	Data Region
Resources allocated	All unused REs (Note 1)	All unused REs (Note 2)
Structure	PDCCH	PDSCH
Content	Uncorrelated pseudo random QPSK modulated data	Uncorrelated pseudo random QPSK modulated data
Transmission scheme for multiple antennas ports transmission	Single Tx port transmission	Spatial multiplexing using any precoding matrix with dimensions same as the precoding matrix for PDSCH
Subcarrier Spacing	Same as for RMC PDCCH in the active BWP	Same as for RMC PDSCH in the active BWP
Power Level	Same as for RMC PDCCH	Same as for RMC PDSCH
Note 1: All unused REs in the active CORESETS appointed by the search spaces in use.		
Note 2: Unused available REs refer to REs in PRBs not allocated for any physical channels, CORESETS, synchronization signals or reference signals in channel bandwidth.		

A.5.2 OCNG Patterns for TDD

A.5.2.1 OCNG TDD pattern 1: Generic OCNG TDD Pattern for all unused REs

Table A.5.2.1-1: OP.1 TDD: Generic OCNG TDD Pattern for all unused REs

OCNG Distribution OCNG Parameters	Control Region (Core Set)	Data Region
Resources allocated	All unused REs (Note 1)	All unused REs (Note 2)
Structure	PDCCH	PDSCH
Content	Uncorrelated pseudo random QPSK modulated data	Uncorrelated pseudo random QPSK modulated data
Transmission scheme for multiple antennas ports transmission	Single Tx port transmission	Spatial multiplexing using any precoding matrix with dimensions same as the precoding matrix for PDSCH
Subcarrier Spacing	Same as for RMC PDCCH in the active BWP	Same as for RMC PDSCH in the active BWP
Power Level	Same as for RMC PDCCH	Same as for RMC PDSCH
Note 1: All unused REs in the active CORESETS appointed by the search spaces in use.		
Note 2: Unused available REs refer to REs in PRBs not allocated for any physical channels, CORESETS, synchronization signals or reference signals in channel bandwidth.		

A.6

A.7 V2X reference measurement channels

A.7.1 General

The algorithm for determining the payload size A is as follows; given a desired coding rate R and radio block allocation NRB

1. Calculate the RE number of 2nd stage SCI Q_{SCI2^A} that can be transmitted in a given sub-frame, where in order to make sure that the code-rate of 2-A is approximate to SCI 1-A, a beta offset is selected based on MCS, and vacant resource elements γ value is determined based on NRB and DMRS frequency density.
2. Transport Block Size is determined according to clause 8.1.3.2 of TS 38.214 [12] based on Table A.7.1-1.
3. Calculate Binary Channel Bits per Slot for PSSCH as below.

Binary Channel Bits per Slot = $(NRB * \text{Subcarriers per resource block} * \text{CP-OFDM symbols per slot} - \text{DMRS resource REs} - \text{PSCCH resource Res} - Q_{SCI2^A}) * Q_m$

Where Q_m is the modulation order corresponding to MCS.

In Table A.7.1-1 Common reference channel parameters are listed the Sidelink reference measurement channels specified in annexes A.7.2 to A.7.4.

Table A.7.1-1: Common reference channel parameters

Parameter	Value	remark
Number of HARQ Processes	1	
Channel state	AWGN	
Subcarriers per resource block	12	
sl-PSSCH-DMRS-TimePatternList	2	symbol4 and symbol 10 in each slot FDMed with PSSCH within DMRS symbol Frequency density is $\frac{1}{2}$
CP-OFDM symbols per slot (Note1)	12 for all slots	Excluding the first OFDM symbol in one SL slot used for AGC
PSCCH resource	10 PRBs, 3 symbols in time domain	
Slot number in 10ms	$10 * 2^\mu$	$\mu = 0,1,2$ for 15kHz, 30kHz, 60kHz
PT-RS	disable	
CSI-RS	disable	
x-overhead	0	
PSFCH period	0	
2 nd stage SCI payload size	59	35bits SCI-2A + 24bits CRC
Redundancy Version	RV0	For channel coding
Alpha value for SCI-2	1	

A.7.2 FRC for V2X receiver requirements for QPSK

For V2X transmission over PC5, Table A.7.2-1, Table A.7.2-2 and Table A.7.2-3 are applicable for measurements on the Receiver Characteristics with the exception of Maximum input level.

Table A.7.2-1: Fixed reference channel for V2X receiver requirements (SCS 15 kHz, QPSK)

Parameter	Unit	Value			
		10	20	30	40
Channel bandwidth	MHz	10	20	30	40
Subcarrier spacing	kHz	15	15	15	15
Subchannel size		10	15	10	12
Allocated resource blocks		50	105	160	216
MCS Index		4	4	4	4
MCS Table for TBS determination		64QAM			
Modulation		QPSK	QPSK	QPSK	QPSK
Transport Block Size		3624	7936	12296	16896
Transport block CRC	Bits	16	24	24	24
LDPC base graph		2	1	1	1
Number of Code Blocks per Slot		1	1	2	3
Beta offset for 2nd stage SCI		2.25	2.25	2.25	2.25
γ value when 2nd stage SCI rate match		1	1	1	1
Binary Channel Bits per Slot		12036	26556	41076	55860
Max. Throughput averaged over 100ms	Mbps	0.3624	0.7936	1.2296	1.6896
NOTE 1: If more than one Code Block is present, an additional CRC sequence of L = 24 Bits is attached to each Code Block (otherwise L = 0 Bit).					
NOTE 2: γ is the number of vacant resource elements in the resource block to which the last coded symbol of the 2 nd -stage SCI belongs.					

Table A.7.2-2: Fixed reference channel for V2X receiver requirements (SCS 30 kHz, QPSK)

Parameter	Unit	Value			
		10	20	30	40
Channel bandwidth	MHz	10	20	30	40
Subcarrier spacing	kHz	30	30	30	30
Subchannel size		12	10	15	15
Allocated resource blocks		24	50	75	105
MCS Index		4	4	4	4
MCS Table for TBS determination		64QAM			
Modulation		QPSK	QPSK	QPSK	QPSK
Transport Block Size		1608	3624	5632	7936
Transport block CRC	Bits	16	16	24	24
LDPC base graph		2	2	1	1
Number of Code Blocks per Slot		1	1	1	1
Beta offset for 2nd stage SCI		2.25	2.25	2.25	2.25
γ value when 2nd stage SCI rate match		7	1	1	1
Binary Channel Bits per Slot		5160	12036	18636	26556
Max. Throughput averaged over 100ms	Mbps	0.3216	0.7248	1.1264	1.5872
NOTE 1: If more than one Code Block is present, an additional CRC sequence of L = 24 Bits is attached to each Code Block (otherwise L = 0 Bit).					
NOTE 2: γ is the number of vacant resource elements in the resource block to which the last coded symbol of the 2 nd -stage SCI belongs.					

Table A.7.2-3: Fixed reference channel for V2X receiver requirements (SCS 60 kHz, QPSK)

Parameter	Unit	Value			
		10	20	30	40
Channel bandwidth	MHz	10	20	30	40
Subcarrier spacing	kHz	60	60	60	60
Subchannel size		10	12	12	10
Allocated resource blocks		10	24	36	50
MCS Index		4	4	4	4
MCS Table for TBS determination		64QAM			
Modulation		QPSK	QPSK	QPSK	QPSK
Transport Block Size		456	1608	2536	3624
Transport block CRC	Bits	16	16	16	16
LDPC base graph		2	2	2	2
Number of Code Blocks per Slot		1	1	1	1
Beta offset for 2nd stage SCI		2.25	2.25	2.25	2.25
γ value when 2nd stage SCI rate match		7	7	7	1
Binary Channel Bits per Slot		1464	5160	8328	12036
Max. Throughput averaged over 100ms	Mbps	0.1824	0.6432	1.0144	1.4496
NOTE 1: If more than one Code Block is present, an additional CRC sequence of L = 24 Bits is attached to each Code Block (otherwise L = 0 Bit).					
NOTE 2: γ is the number of vacant resource elements in the resource block to which the last coded symbol of the 2 nd -stage SCI belongs.					

A.7.3 FRC for maximum input level for 64QAM

For V2X transmission over PC5, Table A.7.3-1, Table A.7.3-2 and Table A.7.3-3 are applicable for Maximum input level when the maximum modulation order is 64QAM.

Table A.7.3-1: Fixed reference channel for V2X receiver requirements (SCS 15 kHz, 64QAM)

Parameter	Unit	Value			
		10	20	30	40
Channel bandwidth	MHz	10	20	30	40
Subcarrier spacing	kHz	15	15	15	15
Subchannel size		10	15	10	12
Allocated resource blocks		50	105	160	216
MCS Index		24	24	24	24
MCS Table for TBS determination		64QAM			
Modulation		64QAM	64QAM	64QAM	64QAM
Transport Block Size		27144	60456	92200	127080
Transport block CRC	Bits	24	24	24	24
LDPC base graph		1	1	1	1
Number of Code Blocks per Slot		4	8	11	16
Beta offset for 2nd stage SCI		6.25	6.25	6.25	6.25
γ value when 2nd stage SCI rate match		1	1	1	1
Binary Channel Bits per Slot		35964	79524	123084	167436
Max. Throughput averaged over 100ms	Mbps	2.7144	6.0456	9.22	12.708
NOTE 1: If more than one Code Block is present, an additional CRC sequence of L = 24 Bits is attached to each Code Block (otherwise L = 0 Bit).					
NOTE 2: γ is the number of vacant resource elements in the resource block to which the last coded symbol of the 2 nd -stage SCI belongs.					

Table A.7.3-2: Fixed reference channel for V2X receiver requirements (SCS 30 kHz, 64QAM)

Parameter	Unit	Value			
		10	20	30	40
Channel bandwidth	MHz	10	20	30	40
Subcarrier spacing	kHz	30	30	30	30
Subchannel size		12	10	15	15
Allocated resource blocks		24	50	75	105
MCS Index		24	24	24	24
MCS Table for TBS determination		64QAM			
Modulation		64QAM	64QAM	64QAM	64QAM
Transport Block Size		11528	27144	42016	60456
Transport block CRC	Bits	24	24	24	24
LDPC base graph		1	1	1	1
Number of Code Blocks per Slot		2	4	5	8
Beta offset for 2nd stage SCI		6.25	6.25	6.25	6.25
γ value when 2nd stage SCI rate match		7	1	1	1
Binary Channel Bits per Slot		15336	35964	55764	79524
Max. Throughput averaged over 100ms	Mbps	2.3056	5.4288	8.4032	12.091
NOTE 1: If more than one Code Block is present, an additional CRC sequence of L = 24 Bits is attached to each Code Block (otherwise L = 0 Bit).					
NOTE 2: γ is the number of vacant resource elements in the resource block to which the last coded symbol of the 2 nd -stage SCI belongs.					

Table A.7.3-3: Fixed reference channel for V2X receiver requirements (SCS 60 kHz, 64QAM)

Parameter	Unit	Value			
		10	20	30	40
Channel bandwidth	MHz	10	20	30	40
Subcarrier spacing	kHz	60	60	60	60
Subchannel size		10	12	12	10
Allocated resource blocks		10	24	36	50
MCS Index		24	24	24	24
MCS Table for TBS determination		64QAM			
Modulation		64QAM	64QAM	64QAM	64QAM
Transport Block Size		3240	11528	18960	27144
Transport block CRC	Bits	16	24	24	24
LDPC base graph		2	1	1	1
Number of Code Blocks per Slot		1	2	3	4
Beta offset for 2nd stage SCI		6.25	6.25	6.25	6.25
γ value when 2nd stage SCI rate match		7	7	7	1
Binary Channel Bits per Slot		4248	15336	24840	35964
Max. Throughput averaged over 100ms	Mbps	1.296	4.6112	7.584	10.858
NOTE 1: If more than one Code Block is present, an additional CRC sequence of L = 24 Bits is attached to each Code Block (otherwise L = 0 Bit).					
NOTE 2: γ is the number of vacant resource elements in the resource block to which the last coded symbol of the 2 nd -stage SCI belongs.					

A.7.4 FRC for maximum input level for 256QAM

For V2X transmission over PC5, Table A.7.4-1, Table A.7.4-2 and Table A.7.4-3 are applicable for Maximum input level when the 256QAM is supported.

Table A.7.4-1: Fixed reference channel for V2X receiver requirements (SCS 15 kHz, 256QAM)

Parameter	Unit	Value			
		10	20	30	40
Channel bandwidth	MHz	10	20	30	40
Subcarrier spacing	kHz	15	15	15	15
Subchannel size		10	15	10	12
Allocated resource blocks		50	105	160	216
MCS Index		23	23	23	23
MCS Table for TBS determination		256QAM			
Modulation		256QAM	256QAM	256QAM	256QAM
Transport Block Size		36896	81976	127080	172176
Transport block CRC	Bits	24	24	24	24
LDPC base graph		1	1	1	1
Number of Code Blocks per Slot		5	10	16	21
Beta offset for 2nd stage SCI		6.25	6.25	6.25	6.25
γ value when 2nd stage SCI rate match		3	3	3	3
Binary Channel Bits per Slot		48000	106080	164160	223296
Max. Throughput averaged over 100ms	Mbps	3.6896	8.1976	12.708	17.218
NOTE 1: If more than one Code Block is present, an additional CRC sequence of L = 24 Bits is attached to each Code Block (otherwise L = 0 Bit).					
NOTE 2: γ is the number of vacant resource elements in the resource block to which the last coded symbol of the 2 nd -stage SCI belongs.					

Table A.7.4-2: Fixed reference channel for V2X receiver requirements (SCS 30 kHz, 256QAM)

Parameter	Unit	Value			
		10	20	30	40
Channel bandwidth	MHz	10	20	30	40
Subcarrier spacing	kHz	30	30	30	30
Subchannel size		12	10	15	15
Allocated resource blocks		24	50	75	105
MCS Index		23	23	23	23
MCS Table for TBS determination		256QAM			
Modulation		256QAM	256QAM	256QAM	256QAM
Transport Block Size		15880	36896	58384	81976
Transport block CRC	Bits	24	24	24	24
LDPC base graph		1	1	1	1
Number of Code Blocks per Slot		2	5	7	10
Beta offset for 2nd stage SCI		6.25	6.25	6.25	6.25
γ value when 2nd stage SCI rate match		3	3	3	3
Binary Channel Bits per Slot		20544	48000	74400	106080
Max. Throughput averaged over 100ms	Mbps	3.176	7.3792	11.677	16.395
NOTE 1: If more than one Code Block is present, an additional CRC sequence of L = 24 Bits is attached to each Code Block (otherwise L = 0 Bit).					
NOTE 2: γ is the number of vacant resource elements in the resource block to which the last coded symbol of the 2 nd -stage SCI belongs.					

Table A.7.4-3: Fixed reference channel for V2X receiver requirements (SCS 60kHz, 256QAM)

Parameter	Unit	Value			
		10	20	30	40
Channel bandwidth	MHz	10	20	30	40
Subcarrier spacing	kHz	60	60	60	60
Subchannel size		10	12	12	10
Allocated resource blocks		10	24	36	50
MCS Index		23	23	23	23
MCS Table for TBS determination		256QAM			
Modulation		256QAM	256QAM	256QAM	256QAM
Transport Block Size		4480	15880	25608	36896
Transport block CRC	Bits	24	24	24	24
LDPC base graph		1	1	1	1
Number of Code Blocks per Slot		1	2	4	5
Beta offset for 2nd stage SCI		6.25	6.25	6.25	6.25
γ value when 2nd stage SCI rate match		3	3	3	3
Binary Channel Bits per Slot		5760	20544	33216	48000
Max. Throughput averaged over 100ms	Mbps	1.792	6.352	10.243	14.758
NOTE 1: If more than one Code Block is present, an additional CRC sequence of L = 24 Bits is attached to each Code Block (otherwise L = 0 Bit).					
NOTE 2: γ is the number of vacant resource elements in the resource block to which the last coded symbol of the 2 nd -stage SCI belongs.					

A.7.5 FRC for transmitter requirements

For V2X transmission over PC5, FRC specified in clause A.7.5-1, A.7.5-2, A.7.5-3 and A.7.5-4 are applicable for measurements on the Transmitter Characteristics.

Table A.7.5-1: Fixed reference channel for V2X transmitter requirements (QPSK)

Parameter	Unit	Value											
		10	12	15	24	25	36	50	75	80	105	160	216
Allocated resource blocks		10	12	15	24	25	36	50	75	80	105	160	216
MCS Index		4											
MCS Table for TBS determination		64QAM											
Modulation		QPSK											
Transport Block Size		456	608	848	1608	1672	2536	3624	5632	6016	7936	12296	16896
Transport block CRC	Bits	16	16	16	16	16	16	16	24	24	24	24	24
LDPC base graph		2	2	2	2	2	2	2	1	1	1	1	1
Number of Code Blocks per Slot		1	1	1	1	1	1	1	1	1	1	2	3
Beta offset for 2nd stage SCI		2.25											
γ value when 2nd stage SCI rate match		7	7	1	7	1	7	1	1	1	1	1	1
Binary Channel Bits per Slot		1464	1992	2796	5160	5436	8328	12036	18636	19956	26556	41076	55860
NOTE 1: If more than one Code Block is present, an additional CRC sequence of L = 24 Bits is attached to each Code Block (otherwise L = 0 Bit).													
NOTE 2: γ is the number of vacant resource elements in the resource block to which the last coded symbol of the 2nd-stage SCI belongs.													

Table A.7.5-2: Fixed reference channel for V2X transmitter requirements (16QAM)

Parameter	Unit	Value											
		Allocated resource blocks	10	12	15	24	25	36	50	75	80	105	160
MCS Index		13											
MCS Table for TBS determination		64QAM											
Modulation		16QAM											
Transport Block Size		1480	1928	2664	4992	5248	7936	11528	17928	18960	25608	38936	53288
Transport block CRC	Bits	16	16	16	24	24	24	24	24	24	24	24	24
LDPC base graph		2	2	2	1	1	1	1	1	1	1	1	1
Number of Code Blocks per Slot		1	1	1	1	1	1	2	3	3	4	5	7
Beta offset for 2nd stage SCI		3.5											
γ value when 2nd stage SCI rate match		0	0	6	0	6	0	0	0	0	0	0	0
Binary Channel Bits per Slot		2976	4032	5592	10368	10872	16704	24096	37296	39936	53136	82176	111744
NOTE 1: If more than one Code Block is present, an additional CRC sequence of L = 24 Bits is attached to each Code Block (otherwise L = 0 Bit).													
NOTE 2: γ is the number of vacant resource elements in the resource block to which the last coded symbol of the 2nd-stage SCI belongs.													

Table A.7.5-3: Fixed reference channel for V2X transmitter requirements (64QAM)

Parameter	Unit	Value											
Allocated resource blocks		10	12	15	24	25	36	50	75	80	105	160	216
MCS Index		24											
MCS Table for TBS determination		64QAM											
Modulation		64QAM											
Transport Block Size		3240	4352	6144	11528	12296	18960	27144	42016	45096	60456	92200	127080
Transport block CRC	Bits	16	24	24	24	24	24	24	24	24	24	24	24
LDPC base graph		2	1	1	1	1	1	1	1	1	1	1	1
Number of Code Blocks per Slot		1	1	1	2	2	3	4	5	6	8	11	16
Beta offset for 2nd stage SCI		6.25											
γ value when 2nd stage SCI rate match		7	7	1	7	1	7	1	1	1	1	1	1
Binary Channel Bits per Slot		4248	5832	8244	15336	16164	24840	35964	55764	59724	79524	123084	167436
NOTE 1: If more than one Code Block is present, an additional CRC sequence of L = 24 Bits is attached to each Code Block (otherwise L = 0 Bit).													
NOTE 2: γ is the number of vacant resource elements in the resource block to which the last coded symbol of the 2nd-stage SCI belongs.													

Table A.7.5-4: Fixed reference channel for V2X transmitter requirements (256QAM)

Parameter	Unit	Value											
Allocated resource blocks		10	12	15	24	25	36	50	75	80	105	160	216
MCS Index		23											
MCS Table for TBS determination		256QAM											
Modulation		256QAM											
Transport Block Size		4480	6144	8712	15880	16896	25608	36896	58384	62504	81976	127080	172176
Transport block CRC	Bits	24	24	24	24	24	24	24	24	24	24	24	24
LDPC base graph		1	1	1	1	1	1	1	1	1	1	1	1
Number of Code Blocks per Slot		1	1	2	2	3	4	5	7	8	10	16	21
Beta offset for 2nd stage SCI		6.25											
γ value when 2nd stage SCI rate match		3	3	9	3	9	3	3	3	3	3	3	3
Binary Channel Bits per Slot		5760	7872	10992	20544	21552	33216	48000	74400	79680	106080	164160	223296
NOTE 1: If more than one Code Block is present, an additional CRC sequence of L = 24 Bits is attached to each Code Block (otherwise L = 0 Bit).													
NOTE 2: γ is the number of vacant resource elements in the resource block to which the last coded symbol of the 2nd-stage SCI belongs.													

Annex B (normative): Propagation Conditions

The propagation conditions and channel models for various environments are specified. For each environment a propagation model is used to evaluate the propagation pathloss due to the distance. Channel models are formed by combining delay profiles with a Doppler spectrum, with the addition of correlation properties in the case of a multi-antenna scenario.

B.0 No interference

The downlink connection between the System Simulator and the UE is without Additive White Gaussian Noise, and has no fading or multipath effects.

Annex C (normative): Downlink physical channels

This annex specifies the downlink physical channels that are needed for setting a connection and channels that are needed during a connection.

C.0 Downlink signal levels

The downlink power settings in Table C.0-1 is used unless otherwise specified in a test case.

If the UE has more than one Rx antenna, the downlink signal is applied to each one. All UE Rx antennas shall be connected.

If the UE has one Rx antenna, the downlink signal is applied to it.

Table C.0-1: Default Downlink power levels for NR

SCS (kHz)	Unit	Channel bandwidth													
		5 MHz	10 MHz	15 MHz	20 MHz	25 MHz	30 MHz	40 MHz	50 MHz	60 MHz	70 MHz	80 MHz	90 MHz	100 MHz	
15	Number of RBs	25	52	79	106	133	160	216	270	N/A	N/A	N/A	N/A	N/A	
	Channel BW power	dBm	-60	-57	-55	-54	-53	-52	-51	-50	N/A	N/A	N/A	N/A	N/A
30	Number of RBs	11	24	38	51	65	78	106	133	162	189	217	245	273	
	Channel BW power	dBm	-61	-57	-55	-54	-53	-52	-51	-50	-49	-48	-48	-47	-47
60	Number of RBs	N/A	11	18	24	31	38	51	65	79	93	107	121	135	
	Channel BW power	dBm	N/A	-58	-56	-54	-53	-52	-51	-50	-49	-48	-48	-47	-47
	RS EPRE	dBm/15kHz	-85	-85	-85	-85	-85	-85	-85	-85	-85	-85	-85	-85	-85
Note 1:		The channel bandwidth powers are informative, based on -85dBm/15kHz SS/PBCH SSS EPRE, then scaled according to the number of RBs and rounded to the nearest integer dBm value. Full RE allocation with no boost or deboost is assumed.													
Note 2:		The power level is specified at each UE Rx antenna.													
Note 3:		DL level is applied for any of the Subcarrier Spacing configuration () with the same power spectrum density of -85dBm/15kHz.													

The default signal level uncertainty is +/-3dB at each test port, for any level specified. If the uncertainty value is critical for the test purpose, a tighter uncertainty is specified for the related test case in Annex F

C.1 General

The following clauses, describes the downlink Physical Channels that are transmitted during a connection i.e., when measurements are done.

C.2 Setup

Table C.2-1 describes the downlink Physical Channels that are required for connection set up.

Table C.2-1: Downlink Physical Channels required for connection set-up

Physical Channel
PBCH
SSS
PSS
PDCCH
PDSCH
PBCH DMRS
PDCCH DMRS
PDSCH DMRS
CSI-RS

As common PDSCH and PDCCH configuration parameters the parameters in Table A.3.1-1, A.3.2.1-1, C.2-2, C.2-3, and C.2-4 shall be used to bring up the connection setup for FR1 NR cell.

Table C.2-2: PDSCH and PDCCH configuration

Parameter	Unit	Value
Number of HARQ processes		8 (TDD)
		4 (FDD)
Aggregation level	CCE	4

Table C.2-3: TDD UL-DL pattern for SCS 15 KHz

Parameter	Unit	UL-DL pattern	
TDD Slot Configuration pattern (Note 1)		DDDSU	
Special Slot Configuration (Note 2)		10D+2G+2U	
UL-DL configuration (<i>tdd-UL-DL-ConfigurationCommon</i>)	<i>referenceSubcarrierSpacing</i>	kHz	15
	<i>dl-UL-TransmissionPeriodicity</i>	ms	5
	<i>nrofDownlinkSlots</i>		3
	<i>nrofDownlinkSymbols</i>		10
	<i>nrofUplinkSlot</i>		1
			2
K1 value (PDSCH-to-HARQ-timing-indicator)		[4] if mod(i,5) = 0 [3] if mod(i,5) = 1 [2] if mod(i,5) = 2 [6] if mod(i,5) = 3	
Note 1: D denotes a slot with all DL symbols; S denotes a slot with a mix of DL, UL and guard symbols; U denotes a slot with all UL symbols. The field is for information.			
Note 2: D, G, U denote DL, guard and UL symbols, respectively. The field is for information.			
Note 3: i is the slot index per frame; i = {0,...,9}			

Table C.2-4: TDD UL-DL pattern for SCS 30 KHz

Parameter	Unit	UL-DL Pattern	
TDD Slot Configuration pattern (Note 1)		7DS2U	
Special Slot Configuration (Note 2)		6D+4G+4U	
UL-DL configuration (<i>tdd-UL-DL-ConfigurationCommon</i>)	<i>referenceSubcarrierSpacing</i>	30	kHz
	<i>dl-UL-TransmissionPeriodicity</i>	5	
	<i>nrofDownlinkSlots</i>	7	
	<i>nrofDownlinkSymbols</i>	6	
	<i>nrofUplinkSlot</i>	2	
		4	
UL-DL configuration2 (<i>tdd-UL-DL-ConfigurationCommon2</i>)	<i>referenceSubcarrierSpacing</i>	N/A	
	<i>dl-UL-TransmissionPeriodicity</i>	N/A	
	<i>nrofDownlinkSlots</i>	N/A	
	<i>nrofDownlinkSymbols</i>	N/A	
	<i>nrofUplinkSlot</i>	N/A	

	<i>nrofUplinkSymbols</i>	N/A	
K1 value (PDSCH-to-HARQ-timing-indicator)			8 if $\text{mod}(i, 10) = 0$ 7 if $\text{mod}(i, 10) = 1$ 6 if $\text{mod}(i, 10) = 2$ 5 if $\text{mod}(i, 10) = 3$ 5 if $\text{mod}(i, 10) = 4$ 4 if $\text{mod}(i, 10) = 5$ 3 if $\text{mod}(i, 10) = 6$ 2 if $\text{mod}(i, 10) = 7$
Note 1: D denotes a slot with all DL symbols; S denotes a slot with a mix of DL, UL and guard symbols; U denotes a slot with all UL symbols. The field is for information. Note 2: D, G, U denote DL, guard and UL symbols, respectively. The field is for information. Note 3: i is the slot index per frame; $i = \{0, \dots, 19\}$			

C.3 Connection

C.3.0 Measurement of Transmitter Characteristics

Unless otherwise stated, Table C.3.0-1 is applicable for measurements on the Transmitter Characteristics (clause 6).

Table C.3.0-1: Downlink Physical Channels transmitted during a connection (FDD and TDD)

Parameter	Unit	Value
SSS transmit power	W	Test specific
EPRE ratio of PSS to SSS	dB	0
EPRE ratio of PBCH to SSS	dB	0
EPRE ratio of PBCH to PBCH DMRS	dB	0
EPRE ratio of PDCCH to SSS	dB	0
EPRE ratio of PDCCH to PDCCH DMRS	dB	0
EPRE ratio of PDSCH to SSS	dB	0
EPRE ratio of PDSCH to PDSCH DMRS (Note 1)	dB	-3
EPRE ratio of CSI-RS to SSS	dB	0
EPRE ratio of PTRS to PDSCH	dB	Test specific
EPRE ratio of OCNG DMRS to SSS	dB	0
EPRE ratio of OCNG to OCNG DMRS (Note 1)	dB	0
Note 1: No boosting is applied to any of the channels except PDSCH DMRS. For PDSCH DMRS, 3 dB power boosting is applied assuming DMRS Type 1 configuration when DMRS and PDSCH are TDM'ed and only half of the DMRS REs are occupied.		
Note 2: Number of DMRS CDM groups without data for PDSCH DMRS configuration for OCNG is set to 1.		

C.3.1 Measurement of Receiver Characteristics

Unless otherwise stated, Table C.3.1-1 is applicable for measurements on the Receiver Characteristics (clause 7). For Adjacent channel selectivity testing, Table C.3.1-2 is applied.

Table C.3.1-1: Downlink Physical Channels transmitted during a connection (FDD and TDD)

Parameter	Unit	Value
SSS transmit power	W	Test specific
EPRE ratio of PSS to SSS	dB	0
EPRE ratio of PBCH to SSS	dB	0
EPRE ratio of PBCH to PBCH DMRS	dB	0
EPRE ratio of PDCCH to SSS	dB	0
EPRE ratio of PDCCH to PDCCH DMRS	dB	0
EPRE ratio of PDSCH to SSS	dB	0
EPRE ratio of PDSCH to PDSCH DMRS (Note 1)	dB	-3
EPRE ratio of CSI-RS to SSS	dB	0
EPRE ratio of PTRS to PDSCH	dB	Test specific
EPRE ratio of OCNG DMRS to SSS	dB	0
EPRE ratio of OCNG to OCNG DMRS (Note 1)	dB	0
Note 1: No boosting is applied to any of the channels except PDSCH DMRS. For PDSCH DMRS, 3 dB power boosting is applied assuming DMRS Type 1 configuration when DMRS and PDSCH are TDM'ed and only half of the DMRS REs are occupied.		
Note 2: Number of DMRS CDM groups without data for PDSCH DMRS configuration for OCNG is set to 1.		

Table C.3.1-2: PDCCH Aggregation Level for ACS testing

Parameter	Unit	Value	Comment
Aggregation level	CCE	1	CBW=10MHz when SCS=60kHz
		2	CBW=15MHz when SCS=60kHz
		4	CBW=5MHz when SCS=15kHz CBW=10,15MHz when SCS=30kHz CBW=20,25,30MHz when SCS=60kHz
		8	CBW=10,15MHz when SCS=15kHz CBW=20,25,30MHz when SCS=30kHz CBW=40,50,60,70MHz when SCS=60kHz
		16	CBW>15 MHz when SCS=15kHz CBW>30 MHz when SCS=30kHz CBW>70 MHz when SCS=60kHz

Annex D (normative): Characteristics of the Interfering Signal

D.1 General

Some RF performance requirements for the NR UE receiver are defined with interfering signals present in addition to the wanted signal.

For NR bands with $F_{DL_high} < 2700$ MHz and $F_{UL_high} < 2700$ MHz, a modulated 5MHz full bandwidth NR down link signal, and in some cases an additional CW signal, are used as interfering signal.

For NR bands with $F_{DL_low} \geq 3300$ MHz and $F_{UL_low} \geq 3300$ MHz, a modulated NR downlink signal which equals to channel bandwidth of the wanted signal for Single Carrier case and Inter-band CA case is used as interfering. For intra-band contiguous CA Bandwidth Class C case, a modulated NR downlink signal which equals to the aggregated channel bandwidth of the wanted signal is used. For intra-band contiguous CA Bandwidth Class D and E case, a modulated 50MHz NR downlink signal is used. And in some cases, an additional CW signal is used.

D.2 Interference signals

Table D.2-1 describes the modulated interferer for different channel bandwidth options for NR band lower than 2700MHz.

Table D.2-1: Description of modulated NR interferer for NR bands with $F_{DL_high} < 2700$ MHz and $F_{UL_high} < 2700$ MHz

	Channel bandwidth						
	5 MHz	10MHz	15 MHz	20 MHz	25 MHz	30 MHz	40 MHz
RB	NOTE1						
BW _{Interferer}	5 MHz						
	Channel bandwidth						
	50 MHz	60 MHz	70 MHz	80 MHz	90 MHz	100 MHz	
RB	NOTE1						
BW _{Interferer}	5 MHz						
NOTE 1: The RB configured for interfering signal is the same as maximum RB number defined in Table 5.3.2-1 for each sub-carrier spacing.							

Table D.2-2 and Table D.2-3 describe the modulated interferer for different channel bandwidth options for NR band higher than 3300MHz.

Table D.2-2: Description of modulated NR interferer for NR bands with $F_{DL_low} \geq 3300$ MHz and $F_{UL_low} \geq 3300$ MHz

	Channel bandwidth										
	10 MHz	15 MHz	20 MHz	30 MHz	40 MHz	50 MHz	60 MHz	70 MHz	80 MHz	90 MHz	100 MHz
RB	NOTE1										
BW _{Interferer}	10 MHz	15 MHz	20 MHz	30 MHz	40 MHz	50 MHz	60 MHz	70 MHz	80 MHz	90 MHz	100 MHz
NOTE 1: The RB configured for interfering signal is the same as maximum RB number defined in Table 5.3.2-1 for each sub-carrier spacing.											

Table D.2-3: Description of modulated NR interferer for NR bands with $F_{DL_low} \geq 3300$ MHz and $F_{UL_low} \geq 3300$ MHz for Intra-band contiguous CA

	Aggregated Channel bandwidth of Bandwidth Class C								Bandwidth Class D/E
	110 MHz	120 MHz	130 MHz	140 MHz	150 MHz	160 MHz	180 MHz	200 MHz	
RB(SCS=30 kHz)	Note 1								133
RB(SCS=60 kHz)	Note 1								65
$BW_{Interferer}$	110 MHz	120 MHz	130 MHz	140 MHz	150 MHz	160 MHz	180 MHz	200 MHz	50MHz
NOTE 1: The interfering signal shall be configured in the same way as the aggregated bandwidth of the wanted signal. The RB configurations for each component carrier are defined in Table 5.3.2-1 for each sub-carrier spacing.									

Annex E (normative): Global In-Channel TX-Test

NOTE: Clauses E.2.2 to E.5.9.3 are descriptions, which assume no power ramping adjacent to the measurement period.

E.1 General

The global in-channel TX test enables the measurement of all relevant parameters that describe the in-channel quality of the output signal of the TX under test in a single measurement process.

The parameters describing the in-channel quality of a transmitter, however, are not necessarily independent. The algorithm chosen for description inside this annex places particular emphasis on the exclusion of all interdependencies among the parameters.

E.2 Signals and results

E.2.1 Basic principle

The process is based on the comparison of the actual **output signal of the TX under test**, received by an ideal receiver, with a **reference signal**, that is generated by the measuring equipment and represents an ideal error free received signal. All signals are represented as equivalent (generally complex) baseband signals.

The description below uses numbers as examples. These numbers are taken from FDD with normal CP length and 100 MHz bandwidth with 30 kHz SCS. The application of the text below, however, is not restricted to this frame structure and bandwidth.

E.2.2 Output signal of the TX under test

The output signal of the TX under test is acquired by the measuring equipment and stored for further processing. It is sampled at a sampling rate of 122.88 Mbps. In the time domain it comprises at least 10 uplink subframes. The measurement period is derived by concatenating the correct number of individual uplink slots until the correct measurement period is reached. The output signal is named $z(v)$. Each slot is modelled as a signal with the following parameters: demodulated data content, carrier frequency, amplitude and phase for each subcarrier, timing, carrier leakage.

NOTE 1: TDD

Since the uplink subframes are not continuous, n slots should be extracted from more than 1 continuous radio frame where

$$n = \begin{cases} 10, & \text{for 15 kHz SCS} \\ 20, & \text{for 30 kHz SCS} \\ 40, & \text{for 60 kHz SCS} \end{cases}$$

For Error Vector Magnitude including symbols with transient periods

$$n = \begin{cases} [108] & \text{for 15 kHz SCS} \\ [216] & \text{for 30 kHz SCS} \end{cases}$$

E.2.3 Reference signal

Two types of reference signal are defined:

The reference signal $i_1(v)$ is constructed by the measuring equipment according to the relevant TX specifications, using the following parameters: demodulated data content, nominal carrier frequency, nominal amplitude and phase for each

subcarrier, nominal timing, no carrier leakage. It is represented as a sequence of samples at a sampling rate of 122.88 Msps in the time domain.

The reference signal $i_2(v)$ is constructed by the measuring equipment according to the relevant TX specifications, using the following parameters: restricted data content: nominal reference symbols, (all modulation symbols for user data symbols are set to 0V), nominal carrier frequency, nominal amplitude and phase for each applicable subcarrier, nominal timing, no carrier leakage. It is represented as a sequence of samples at a sampling rate of 122.88 Msps in the time domain.

NOTE: The PUCCH is off during the time under test.

E.2.4 Measurement results

The measurement results, achieved by the global in channel TX test are the following:

- Carrier Frequency error
- EVM (Error Vector Magnitude)
- Carrier leakage
- Unwanted emissions, falling into non allocated resource blocks.
- EVM equalizer spectrum flatness

E.2.5 Measurement points

The unwanted emission falling into non-allocated RB(s) is calculated directly after the FFT as described below. In contrast to this, the EVM for the allocated RB(s) is calculated after the IDFT for DFT-s-OFDM or after the Tx-Rx chain equalizer for CP-OFDM. The samples after the TX-RX chain equalizer are used to calculate EVM equalizer spectrum flatness. Carrier frequency error and carrier leakage is calculated in the block “RF correction”.

In case the parameter 3300 or 3301 is reported from UE via *txDirectCurrentLocation* IE (as defined in TS 38.331 [6]), carrier leakage measurement in RF correction block shall be omitted. All statements from Annex E.3 onwards shall be read assuming that no carrier leakage has been measured.

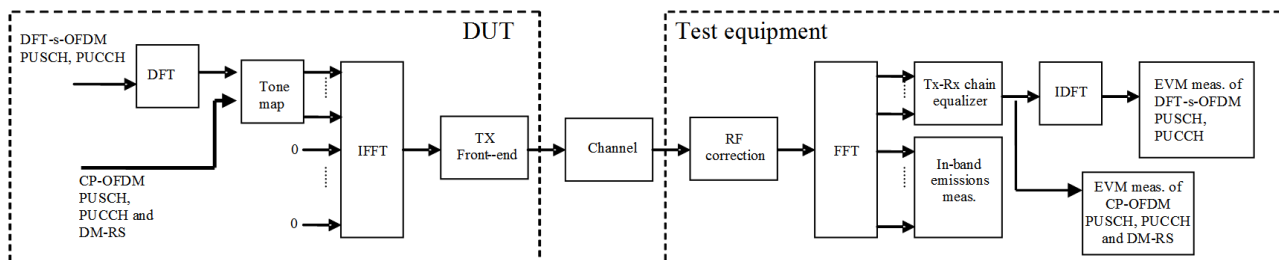

Figure E.2.5-1: EVM measurement points

E.3 Signal processing

E.3.1 Pre FFT minimization process

Before applying the pre-FFT minimization process, $z(v)$ and $i(v)$ are portioned into n pieces, comprising one slot each, where n is as defined in Annex E.2.2.

Each slot is processed separately. Sample timing, Carrier frequency and carrier leakage in $z(v)$ are jointly varied in order to minimise the difference between $z(v)$ and $i(v)$. Best fit (minimum difference) is achieved when the RMS difference value between $z(v)$ and $i(v)$ is an absolute minimum.

The carrier frequency variation and the IQ variation are the measurement results: Carrier Frequency Error and Carrier leakage.

From the acquired samples 10 carrier frequencies can be derived by averaging frequency errors for every 1, 2 or 4 slots for 15, 30 and 60 kHz SCS.

From the acquired samples n carrier frequencies and n carrier leakages can be derived.

NOTE 1: The minimisation process, to derive carrier leakage and RF error can be supported by Post FFT operations. However the minimisation process defined in the pre FFT domain comprises all acquired samples (i.e. it does not exclude the samples in between the FFT widths and it does not exclude the bandwidth outside the transmission bandwidth configuration)

NOTE 2: The algorithm would allow deriving Carrier Frequency error and Sample Frequency error of the TX under test separately. However there are no requirements for Sample Frequency error. Hence the algorithm models the RF and the sample frequency commonly (not independently). It returns one error and does not distinguish between both.

After this process the samples $z(v)$ are called $z^0(v)$.

E.3.2 Timing of the FFT window

The FFT window length is 4096 samples per OFDM symbol. 14 FFTs (57344 samples) cover less than the acquired number of samples (61440 samples). The position in time for FFT must be determined.

In an ideal signal, the FFT may start at any instant within the cyclic prefix without causing an error. The TX filter, however, reduces the window. The EVM requirements shall be met within a window $W < CP$. There are three different instants for FFT:

Centre of the reduced window, called $\Delta\tilde{c}$, $\Delta\tilde{c} - W/2$ and $\Delta\tilde{c} + W/2$.

The timing of the measured signal is determined in the pre FFT domain as follows, using $z^0(v)$ and $i_2(v)$:

1. The measured signal is delay spread by the TX filter. Hence the distinct borders between the OFDM symbols and between Data and CP are also spread and the timing is not obvious.
2. In the Reference Signal $i_2(v)$ the timing is known.
3. Correlation between (1.) and (2.) will result in a correlation peak. The meaning of the correlation peak is approx. the “impulse response” of the TX filter. The meaning of “impulse response” assumes that the autocorrelation of the reference signal $i_2(v)$ is a Dirac peak and that the correlation between the reference signal $i_2(v)$ and the data in the measured signal is 0. The correlation peak, (the highest, or in case of more than one, the earliest) indicates the timing in the measured signal.

From the acquired samples, n timings can be derived, where n is as defined in Annex E.2.2.

For all calculations, except EVM, the number of samples in $z^0(v)$ is reduced to 14 blocks of samples, comprising 4096 samples (FFT width) and starting with $\Delta\tilde{c}$ in each OFDM symbol including the demodulation reference signal.

For the EVM calculation the output signal under test is reduced to 28 blocks of samples, comprising 4096 samples (FFT width) and starting with $\Delta\tilde{c} - W/2$ and $\Delta\tilde{c} + W/2$ in each OFDM symbol including the demodulation reference signal.

The number of samples, used for FFT is reduced compared to $z^0(v)$. This subset of samples is called $z'(v)$.

The timing of the centre $\Delta\tilde{c}$ with respect to the different CP length in a slot is as follows: (FDD, normal CP length)

$\Delta\tilde{c}$ is on $T_f=144$ (=CP/2) within the CP of length 288 FFT samples (in OFDM symbols except 0 and 14 (=7 · 2^μ), where symbol 0 is the first symbol of each subframe) for 100 MHz channel bandwidth and SCS = 30 kHz.

$\Delta\tilde{c}$ is on $T_f=208$ (=352-144) within the CP of length 352 FFT samples (in OFDM symbol 0 and 14 (=7 · 2^μ), where symbol 0 is the first symbol of each subframe) for 100 MHz channel bandwidth and SCS = 30 kHz.

E.3.3 Post FFT equalisation

Perform 14 FFTs on $z'(v)$, one for each OFDM symbol in a slot using the timing $\Delta\tilde{c}$, including the demodulation reference symbol. The result is an array of samples, 14 in the time axis t times 4096 in the frequency axis f . The samples represent the data symbols (in OFDM-symbol 0,1,3,4,5,6,8,9,10,12,13 in each slot) and demodulation reference symbols (OFDM symbol 2, 7, 11 in each slot) in the allocated RBs and inband emissions in the non-allocated RBs within the transmission BW.

Only the allocated resource blocks in the frequency domain are used for equalisation.

The nominal demodulation reference symbols and nominal data symbols are used to equalize the measured data symbols. (Location for equalization see Figure E.2.5-1)

NOTE: The nomenclature inside this note is local and not valid outside.

The nominal data symbols are created by a demodulation process. The location to gain the demodulated data symbols is “EVM” in Figure E.2.5-1. For CP-OFDM, the process described in Annex E.5 can be applied. A demodulation process as follows is recommended for DFT-s-OFDM:

1. Equalize the measured data symbols using the reference symbols for equalisation. Result: Equalized data symbols
2. Only for DFT-s-OFDM, iDFT transform the equalized data symbols: Result: Equalized data symbols
3. Decide for the nearest constellation point: Result: Nominal data symbols
4. Only for DFT-s-OFDM, DFT transform the nominal data symbols: Result: Nominal data symbols

At this stage we have an array of Measured data-Symbols and reference-Symbols ($MS(f,t)$)

versus an array of Nominal data-Symbols and reference Symbols ($NS(f,t)$)

(complex, the arrays comprise 11 data symbols and 3 demodulation reference symbol in the time axis and the number of allocated subcarriers in the frequency axis.)

$MS(f,t)$ and $NS(f,t)$ are processed with a least square (LS) estimator, to derive one equalizer coefficient per time slot and per allocated subcarrier. $EC(f)$ is defined as

$$EC(f) = \frac{\sum_{t=0}^{13} NS(f,t)^* NS(f,t)}{\sum_{t=0}^{13} NS(f,t)^* MS(f,t)}$$

With $*$ denoting complex conjugation.

$EC(f)$ are used to equalize the DFT-coded data symbols. The measured DFT-coded data and the references symbols are equalized by:

$$Z'(f,t) = MS(f,t) \cdot EC(f)$$

With \cdot denoting multiplication.

$Z'(f,t)$, restricted to the data symbol (excluding $t=2,7,11$) is used to calculate EVM, as described in E.4.1.

$EC(f)$ is used in E.4.4.1 to calculate EVM equalizer spectral flatness.

NOTE: The post FFT minimisation process is done over 14 symbols (11 DFT-coded data symbols and 3 reference symbols).

The samples of the non-allocated resource blocks within the transmission bandwidth configuration in the post FFT domain are called $Y(f,t)$ (f covering the non-allocated subcarriers within the transmission bandwidth configuration, t covering the OFDM symbols during 1 slot).

E.4 Derivation of the results

E.4.1 EVM

For EVM create two sets of $Z'(f,t)$, according to the timing " $\Delta\tilde{c} -W/2$ and $\Delta\tilde{c} +W/2$ " using the equalizer coefficients from E.3.3.

Perform the iDFTs on $Z'(f,t)$ in the case of DFT-s-OFDM waveform. The IDFT-decoding preserves the meaning of t but transforms the variable f (representing the allocated sub carriers) into another variable g , covering the same count and representing the demodulated symbols. The samples in the post IDFT domain are called $iZ'(g, t)$. The equivalent ideal samples are called $iI(g,t)$. Those samples of $Z'(f,t)$, carrying the reference symbols (=symbol 2,7,11) are not iDFT processed.

The EVM is the difference between the ideal waveform and the measured and equalized waveform for the allocated RB(s)

$$EVM = \sqrt{\frac{\sum_{t \in T} \sum_{g \in G} |iZ'(g, t) - iI(g, t)|^2}{|G| \cdot |T| \cdot P_0}},$$

where

t covers the count of demodulated symbols with the considered modulation scheme being active within the measurement period, (i.e. symbol 0,1,3,4,5,6,8,9,10,12,13 in each slot, $\rightarrow |T|=11$)

g covers the count of demodulated symbols with the considered modulation scheme being active within the allocated bandwidth. ($|G|=12 * L_{CRBs}$ (with L_{CRBs} : number of allocated resource blocks)).

$iZ'(g, t)$ are the samples of the signal evaluated for the EVM.

$iI(g, t)$ is the ideal signal reconstructed by the measurement equipment, and

P_0 is the average power of the ideal signal. For normalized modulation symbols P_0 is equal to 1.

From the acquired samples $2n$ EVM values can be derived, n values for the timing $\Delta\tilde{c} -W/2$ and n values for the timing $\Delta\tilde{c} +W/2$ where n is as defined in Annex E.2.2.

E.4.2 Averaged EVM

EVM is averaged over all basic EVM measurements.

The averaging comprises n UL slots

$$\overline{EVM} = \sqrt{\frac{1}{n} \sum_{i=1}^n EVM_i^2}$$

where n is as defined in Annex E.2.2 for PUCCH, PUSCH.

The averaging is done separately for timing $\Delta\tilde{c} -W/2$ and $\Delta\tilde{c} +W/2$ leading to \overline{EVM}_l and \overline{EVM}_h

$EVM_{final} = \max(\overline{EVM}_l, \overline{EVM}_h)$ is compared against the test requirements.

E.4.3 In-band emissions measurement

The in-band emissions are a measure of the interference falling into the non-allocated resources blocks.

Explanatory Note:

The inband emission measurement is only meaningful with allocated RB(s) next to non-allocated RB. The allocated RB(s) are necessary but not under test. The non-allocated RBs are under test. The RB allocation for this test is as follows: The allocated RB(s) are at one end of the channel BW, leaving the other end unallocated. The number of allocated RB(s) is smaller than half of the number of RBs, available in the channel BW. This means that the vicinity of the carrier in the centre is unallocated.

There are 3 types of inband emissions:

1. General
2. IQ image
3. Carrier leakage

Carrier leakage are inband emissions next to the carrier.

IQ image are inband emissions symmetrically (with respect to the carrier) on the other side of the allocated RBs.

General are applied to all unallocated RBs.

For each evaluated RB, the minimum requirement is calculated as the higher of $P_{RB} - 30$ dB and the power sum of all limit values (General, IQ Image or Carrier leakage) that apply.

In specific the following combinations:

- Power (General)
- Power (General + Carrier leakage)
- Power (General + IQ Image)

1 and 2 is expressed in terms of power in one non allocated RB under test, normalized to the average power of an allocated RB (unit dB).

3 is expressed in terms of power in one non allocated RB, normalized to the power of all allocated RBs. (unit dBc).

This is the reason for two formulas *Emissions relative*.

Create one set of $Y(t,f)$ per slot according to the timing “ $\Delta\tilde{c}$ ”

For the non-allocated RBs below the in-band emissions are calculated as follows

$$Emissions_{absolute}(\Delta_{RB}) = \begin{cases} \frac{1}{|T_s|} \sum_{t \in T_s} \sum_{\substack{c_l + (12 \cdot \Delta_{RB} + 11) \cdot \Delta f \\ \max(f_{\min}, (c_l + 12 \cdot \Delta_{RB} \cdot \Delta f))}} |Y(t, f)|^2, \Delta_{RB} < 0 \\ \frac{1}{|T_s|} \sum_{t \in T_s} \sum_{\substack{\min(f_{\max}, (c_h + 12 \cdot \Delta_{RB} \cdot \Delta f)) \\ c_h + (12 \cdot \Delta_{RB} - 11) \cdot \Delta f}} |Y(t, f)|^2, \Delta_{RB} > 0 \end{cases}$$

where

the upper formula represents the in band emissions below the allocated frequency block and the lower one the in band emissions above the allocated frequency block.

T_s is a set of $|T_s|$ DFT-s-OFDM symbols with the considered modulation scheme being active within the measurement period,

Δ_{RB} is the starting frequency offset between the allocated RB and the measured non-allocated RB (e.g. $\Delta_{RB} = 1$ for the first upper or $\Delta_{RB} = -1$ for the first lower adjacent RB),

f_{\min} and f_{\max} are the lower and upper edge of the UL transmission BW configuration,

c_l and c_h are the lower and upper edge of the allocated BW,

Δf is the SCS, and

$Y(t, f)$ is the frequency domain signal evaluated for in-band emissions as defined in the clause E.3.3

The allocated RB power per RB and the total allocated RB power are given by:

$$P_{RB} = \frac{1}{|T_s| \cdot L_{CRBS}} \sum_{t \in T_s} \sum_{c_1}^{c_1 + (12 \cdot L_{CRBS} - 1) \cdot \Delta f} |\text{MS}(t, f)|^2 [\text{dBm}/(12\Delta f)]$$

$$P_{All-RBs} = \frac{1}{|T_s|} \sum_{t \in T_s} \sum_{c_1}^{c_1 + (12 \cdot L_{CRBS} - 1) \cdot \Delta f} |\text{MS}(t, f)|^2 [\text{dBm}]$$

The relative in-band emissions, applicable for General and IQ image, are given by:

$$\begin{aligned} Emissions_{relative}(\Delta_{RB}) &= 10 \cdot \log_{10} \left(\frac{Emissions_{absolute}(\Delta_{RB})}{\frac{1}{|T_s| \cdot L_{CRBS}} \sum_{t \in T_s} \sum_{c_1}^{c_1 + (12 \cdot L_{CRBS} - 1) \cdot \Delta f} |\text{MS}(t, f)|^2} \right) [\text{dB}] = \\ &= Emissions_{absolute}(\Delta_{RB}) [\text{dBm}/12\Delta f] - P_{RB} [\text{dBm}/12\Delta f] \end{aligned}$$

where

L_{CRBS} is the number of allocated resource blocks,

and

$\text{MS}(t, f)$ is the frequency domain samples for the allocated bandwidth, as defined in the clause E.3.3.

The relative in-band emissions, applicable for carrier leakage, is given by:

$$\begin{aligned} Emissions_{relative} &= 10 \cdot \log_{10} \left(\frac{Emissions_{absolute}(DCRB)}{\frac{1}{|T_s|} \sum_{t \in T_s} \sum_{c_1}^{c_1 + (12 \cdot L_{CRBS} - 1) \cdot \Delta f} |\text{MS}(t, f)|^2} \right) [\text{dBc}] \\ &= Emissions_{absolute}(DCRB) [\text{dBm}/12\Delta f] - P_{All-RBs} [\text{dBm}] \end{aligned}$$

where DCRB is one RB or one pair of RBs, depending whether the DC carrier is inside an RB or in-between two RBs.

Although an exclusion period may be applicable in the time domain, when evaluating EVM, the inband emissions measurement interval is defined over one complete slot in the time domain.

From the acquired samples n functions for general in band emissions and IQ image inband emissions can be derived, where n is as defined in Annex E.2.2. n values or n pairs of carrier leakage inband emissions can be derived. They are compared against different limits after the final averaging:

The in-band emissions are averaged over the n samples (equivalent to 10 UL subframes):

$$\overline{Emissions}_{absolute}(\Delta_{RB}) = \frac{1}{n} \sum_{i=1}^n Emissions_{absolute,i}(\Delta_{RB})$$

$$\overline{Emissions}_{relative}(\Delta_{RB}) = 10 * \log_{10} \left(\frac{1}{n} \sum_{i=1}^n 10^{Emissions_{relative,i}(\Delta_{RB})/10} \right) [dB]$$

$$\overline{Emissions}_{relative} = 10 * \log_{10} \left(\frac{1}{n} \sum_{i=1}^n 10^{Emissions_{relative,i}/10} \right) [dBc]$$

E.4.4 EVM equalizer

E.4.4.1 EVM equalizer spectrum flatness

For EVM equalizer spectrum flatness use EC(f) as defined in E.3.3. Note, EC(f) represents equalizer coefficient $f \in F$, f is the allocated subcarriers within the transmission bandwidth ($|F|=12 * L_{CRBS}$)

From the acquired samples n functions EC(f) can be derived, where n is as defined in Annex E.2.2.

EC(f) is broken down to 2 functions:

$$EC_1(f), f \in Range \ 1$$

$$EC_2(f), f \in Range \ 2$$

Where Range 1 and Range 2 are as defined for Clause 6.4.2.4 in Table 6.4.2.4.5-1 for normal condition and Table 6.4.2.4.5-2 for extreme condition and for Clause 6.4.2.5 as in Table 6.4.2.5.5-1.

The following peak to peak ripple is calculated:

$$RP_1 = 20 * \log(\max(|EC_1(f)|) / \min(|EC_1(f)|)) , \text{which denote the maximum ripple in Range 1}$$

$$RP_2 = 20 * \log(\max(|EC_2(f)|) / \min(|EC_2(f)|)) , \text{which denote the maximum ripple in Range 2}$$

$RP_{12} = 20 * \log(\max(|EC_1(f)|) / \min(|EC_2(f)|))$, which denote the maximum ripple between the upper side of Range 1 and lower side of Range 2

$RP_{21} = 20 * \log(\max(|EC_2(f)|) / \min(|EC_1(f)|))$, which denote the maximum ripple between the upper side of Range 2 and lower side of Range 1

E.4.4.2 EVM equalizer spectral shaping filter

The calculation of the impulse response of the spectral shaping filter is based on $EC(f)$ as defined in E.3.3. Note that $EC(f)$ represents complex valued equalizer coefficient with $f \in F$, where f is the allocated subcarriers within the transmission bandwidth ($|F|=12 \cdot L_{CRBS}$).

$EC'(f)$ is the corrected version of $EC(f)$ by shifting by T_f . T_f is as defined in Clause E.3.2.

The impulse responses are the IDFT transformed equalizer coefficients:

$$a(\tau) = IDFT \left\{ \frac{1}{EC'(f)} \right\}, \text{ where } f \text{ is the frequency of the } M \text{ allocated subcarriers.}$$

The impulse response is normalized to its first value.

$$\tilde{a}(\tau) = \frac{a(\tau)}{a(0)}$$

This is equivalent to defining the 0dB as $20 \log_{10} |\tilde{a}_i(0)|$.

From the acquired samples, n functions $\tilde{a}(\tau)$ can be derived, where n is as defined in Annex E.2.2.

Note, that this method provides reasonable results only in the case of full allocations.

E.4.5 Frequency error and Carrier leakage

See E.3.1.

E.4.6 EVM of Demodulation reference symbols (EVM_{DMRS})

For the purpose of EVM_{DMRS}, the steps E.2.2 to E.4.2 are repeated 6 times, constituting 6 EVM_{DMRS} sub-periods. The only purpose of the repetition is to cover the longer gross measurement period of EVM_{DMRS} ($6 \cdot n$ time slots) and to derive the FFT window timing per sub-period.

The bigger of the EVM results in one n TS period corresponding to the timing! $\Delta\tilde{c} -W/2$ or $\Delta\tilde{c} +W/2$ is compared against the limit, where n is as defined in Annex E.2.2. (Clause E.4.2) This timing is re-used for EVM_{DMRS} in the equivalent EVM_{DMRS} sub-period.

For EVM the demodulation reference symbols are excluded, while the data symbols are used. For EVM_{DMRS} the data symbols are excluded, while the demodulation references symbols are used. This is illustrated in figure E.4.6-1

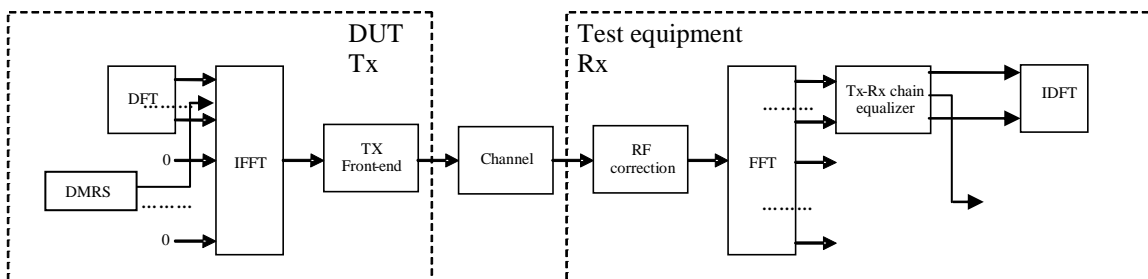

Figure E.4.6-1: EVM_{DMRS} measurement points

Re-use the following formula from E.3.3:

$$Z'(f,t) = MS(f,t) \cdot EC(f)$$

To calculate EVM_{DMRS} , the data symbol ($t=0,1,3,4,5,6,8,9,10,12,13$) in $Z'(f,t)$ are excluded and only the reference symbols ($t=2,7,11$) is used.

The EVM_{DMRS} is the difference between the ideal waveform and the measured and equalized waveform for the allocated RB(s)

$$EVM_{DMRS} = \sqrt{\frac{\sum_{t \in T} \sum_{f \in F} |Z'(f,t) - I(f,t)|^2}{|T| \cdot P_0 \cdot |F|}},$$

where

t covers the count of demodulation reference symbols (i.e. symbols 2,7,11 in each slot, so count=3)

f covers the count of demodulation reference symbols within the allocated bandwidth. ($|F|=12 * L_{CRBs}$ (with L_{CRBs} : number of allocated resource blocks)).

$Z'(f,t)$ are the samples of the signal evaluated for the EVM_{DMRS}

$I(f,t)$ is the ideal signal reconstructed by the measurement equipment, and

P_0 is the average power of the ideal signal. For normalized modulation symbols P_0 is equal to 1.

n such results are generated per measurement sub-period, where n is as defined in Annex E.2.2.

E.4.6.1 1st average for EVM_{DMRS}

EVM_{DMRS} is averaged over all basic EVM_{DMRS} measurements in one sub-period

The averaging comprises n UL slots

$$1stEVM_{DMRS} = \sqrt{\frac{1}{n} \sum_{i=1}^n (EVM_{DMRS,i})^2},$$

where n is as defined in Annex E.2.2.

The timing is taken from the EVM for the data. 6 of those results are achieved from the samples. In general the timing is not the same for each result.

E.4.6.2 Final average for EVM_{DMRS}

$$finalEVM_{DMRS} = \sqrt{\frac{1}{6} \sum_{i=1}^6 (1stEVM_{DMRS,i})^2}$$

E.4.7 Modified signal under test

Implicit in the definition of EVM is an assumption that the receiver is able to compensate a number of transmitter impairments.

The DFT-s-OFDM modulated signals or PRACH signal under test is modified and, in the case of DFT-s-OFDM modulated signals, decoded according to:

$$Z'(t, f) = IDFT \left\{ \frac{FFT \left\{ z(v - \Delta\tilde{t}) \cdot e^{-j2\pi\Delta\tilde{f}v} \right\} e^{j2\pi f \Delta\tilde{t}}}{\tilde{a}(t, f) \cdot e^{j\tilde{\varphi}(t, f)}} \right\}$$

where

$z(v)$ is the time domain samples of the signal under test.

The CP-OFDM modulated signals or PUSCH demodulation reference signal or PUCCH data signal under test is equalised and, in the case of CP-OFDM modulated signals decoded according to:

$$Z'(t, f) = \frac{FFT \left\{ z(v - \Delta\tilde{t}) \cdot e^{-j2\pi\Delta\tilde{f}v} \right\} e^{j2\pi f \Delta\tilde{t}}}{\tilde{a}(t, f) \cdot e^{j\tilde{\varphi}(t, f)}}$$

where

$z(v)$ is the time domain samples of the signal under test.

To minimize the error, the signal under test should be modified with respect to a set of parameters following the procedure explained below.

Notation:

$\Delta\tilde{t}$ is the sample timing difference between the FFT processing window in relation to nominal timing of the ideal signal.

$\Delta\tilde{f}$ is the RF frequency offset.

$\tilde{\varphi}(t, f)$ is the phase response of the TX chain.

$\tilde{a}(t, f)$ is the amplitude response of the TX chain.

In the following $\Delta\tilde{c}$ represents the middle sample of the EVM window of length W (defined in the next clauses) or the last sample of the first window half if W is even.

The EVM analyser shall

- detect the start of each slot and estimate $\Delta\tilde{t}$ and $\Delta\tilde{f}$,
- determine $\Delta\tilde{c}$ so that the EVM window of length W is centred
 - on the time interval determined by the measured cyclic prefix minus 16κ samples of the considered OFDM symbol for symbol l for subcarrier spacing configuration μ in a subframe, with $l = 0$ or $l = 7 \cdot 2^\mu$ for normal CP, i.e. the first 16κ samples of the CP should not be taken into account for this step. In the determination of the number of excluded samples, a sampling rate of $1/T_c$ is assumed. If a different sampling rate is used, the number of excluded samples is scaled linearly.
 - on the measured cyclic prefix of the considered OFDM symbol for all other symbols for normal CP and for symbol 0 to 11 for extended CP.
 - on the measured preamble cyclic prefix for the PRACH

To determine the other parameters a sample timing offset equal to $\Delta\tilde{c}$ is corrected from the signal under test. The EVM analyser shall then

- correct the RF frequency offset $\Delta\tilde{f}$ for each time slot, and

- apply an FFT of appropriate size. The chosen FFT size shall ensure that in the case of an ideal signal under test, there is no measured inter-subcarrier interference.

The carrier leakage shall be removed from the evaluated signal before calculating the EVM and the in-band emissions; however, the removed relative carrier leakage power also has to satisfy the applicable requirement.

At this stage the allocated RBs shall be separated from the non-allocated RBs. In the case of PUCCH and PUSCH EVM, the signal on the non-allocated RB(s), $Y(t, f)$, is used to evaluate the in-band emissions.

Moreover, the following procedure applies only to the signal on the allocated RB(s).

- In the case of PUCCH and PUSCH, the UL EVM analyzer shall estimate the TX chain equalizer coefficients $\tilde{a}(t, f)$ and $\tilde{\varphi}(t, f)$ used by the ZF equalizer for all subcarriers by time averaging at each signal subcarrier of the amplitude and phase of the reference and data symbols. The time-averaging length is 1 slot. This process creates an average amplitude and phase for each signal subcarrier used by the ZF equalizer. The knowledge of data modulation symbols may be required in this step because the determination of symbols by demodulation is not reliable before signal equalization.
- In the case of PRACH, the UL EVM analyzer shall estimate the TX chain coefficients $\tilde{a}(t)$ and $\tilde{\varphi}(t)$ used for phase and amplitude correction and are selected so as to minimize the resulting EVM. The TX chain coefficients are not dependent on frequency, i.e. $\tilde{a}(t, f) = \tilde{a}(t)$ and $\tilde{\varphi}(t, f) = \tilde{\varphi}(t)$. The TX chain coefficient are chosen independently for each preamble transmission and for each $\Delta\tilde{f}$.

At this stage estimates of $\Delta\tilde{f}$, $\tilde{a}(t, f)$, $\tilde{\varphi}(t, f)$ and $\Delta\tilde{c}$ are available. $\Delta\tilde{f}$ is one of the extremities of the window

W , i.e. $\Delta\tilde{f}$ can be $\Delta\tilde{c} + \alpha - \left\lfloor \frac{W}{2} \right\rfloor$ or $\Delta\tilde{c} + \left\lfloor \frac{W}{2} \right\rfloor$, where $\alpha = 0$ if W is odd and $\alpha = 1$ if W is even. The EVM analyser shall then

- calculate EVM_l with $\Delta\tilde{f}$ set to $\Delta\tilde{c} + \alpha - \left\lfloor \frac{W}{2} \right\rfloor$,
- calculate EVM_h with $\Delta\tilde{f}$ set to $\Delta\tilde{c} + \left\lfloor \frac{W}{2} \right\rfloor$.

For the EVM calculation on the symbols with a transient period when the UE signals a transient period capability (tp) of 2, 4 or 7usec, $\Delta\tilde{t}$ is given below.

- calculate $EVM_{l,tp}$ with $\Delta\tilde{t}$ set to $\left\lfloor \frac{tp+tp_{start}}{T_c} \right\rfloor + 1$, where $1/T_c$ is the sampling rate
- calculate $EVM_{h,tp}$ with $\Delta\tilde{t}$ set to $\left\lfloor \frac{CP+tp_{start}}{T_c} \right\rfloor - 1$, where $1/T_c$ is the sampling rate and the CP is the cyclic prefix of the symbol on which EVM is calculated (e.g. long CP for the first symbol of the slot) in seconds

A pictorial representation of the EVM measurement windows is given in Figure F.4-1.

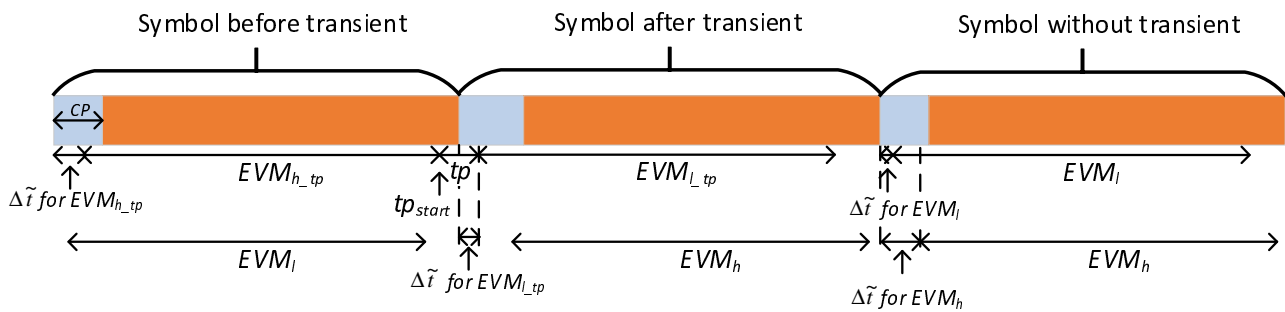

Figure E.4.7-1: EVM measurement window

E.5 EVM and inband emissions for PUCCH

For the purpose of worst case testing, the PUCCH shall be located on the edges of the Transmission Bandwidth Configuration.

The EVM for PUCCH (EVM_{PUCCH}) is averaged over n slots, where n is as defined in Annex E.2.2.

At least n TSs shall be transmitted by the UE without power change. SRS multiplexing shall be avoided during this period. The following transition periods are applicable: One OFDM symbol on each side of the slot border (instant of band edge alternation).

The description below is generic in the sense that all 5 PUCCH formats are covered. Although the number of OFDM symbols in one slot can be different from 14 (depending on the format, configuration and cyclic prefix length), the text below uses 14 without excluding the others.

E.5.1 Basic principle

The basic principle is the same as described in E.2.1

E.5.2 Output signal of the TX under test

The output signal of the TX under test is processed same as described in E.2.2

E.5.3 Reference signal

The reference signal is defined same as in E.2.3. Same as in E.2.3, $i_1(v)$ is the ideal reference for EVM_{PUCCH} and $i_2(v)$ is used to estimate the FFT window timing.

Note PUSCH is off during the PUCCH measurement period.

E.5.4 Measurement results

The measurement results are:

- EVM_{PUCCH}
- Inband emissions with the sub-results: General in-band emission, IQ image (according to: 38.101. Annex F.4, Clause starting with: "At this stage the")

E.5.5 Measurement points

The measurement points are illustrated in Figure E.2.5-1.

E.5.6 Pre FFT minimization process

The pre FFT minimisation process is the same as describes in clause E.3.1.

NOTE: although an exclusion period for EVM_{PUCCH} is applicable in E.5.9.1, the pre FFT minimisation process is done over the complete slot.

RF error, and carrier leakage are necessary for best fit of the measured signal towards the ideal signal in the pre FFT domain. However they are not used to compare them against the limits.

E.5.7 Timing of the FFT window

Timing of the FFT window is estimated with the same method as described in E.3.2.

E.5.8 Post FFT equalisation

The post FFT equalisation is described separately without reference to E.3.3:

Perform 14 FFTs on $z'(v)$, one for each OFDM symbol in a slot using the timing $\Delta\tilde{C}$, including the demodulation reference symbol. The result is an array of samples, 14 in the time axis t times 4096 in the frequency axis f . The samples represent the OFDM symbols (data and reference symbols) in the allocated RBs and inband emissions in the non-allocated RBs within the transmission BW.

Only the allocated resource blocks in the frequency domain are used for equalisation.

The nominal reference symbols and **nominal** OFDM data symbols are used to equalize the measured data symbols.

Note: (The nomenclature inside this note is local and not valid outside)

The nominal OFDM data symbols are created by a demodulation process. A demodulation process as follows is recommended:

1. Equalize the measured OFDM data symbols using the reference symbols for equalisation. Result: Equalized OFDM data symbols
2. Decide for the nearest constellation point, however not independent for each subcarrier in the RB. 12 constellation points are decided dependent, using the applicable CAZAC sequence. Result: Nominal OFDM data symbols

At this stage we have an array of Measured data-Symbols and reference-Symbols ($MS(f,t)$)

versus an array of Nominal data-Symbols and reference Symbols ($NS(f,t)$)

The arrays comprise in sum 14 data and reference symbols, depending on the PUCCH format, in the time axis and the number of allocated sub-carriers in the frequency axis.

$MS(f,t)$ and $NS(f,t)$ are processed with a least square (LS) estimator, to derive one equalizer coefficient per time slot and per allocated subcarrier. $EC(f)$

$$EC(f) = \frac{\sum_{t=0}^{13} NS(f,t) * NS(f,t)}{\sum_{t=0}^{13} MS(f,t) * NS(f,t)}$$

With * denoting complex conjugation.

$EC(f)$ are used to equalize the OFDM data together with the demodulation reference symbols by:

$$Z'(f,t) = MS(f,t) \cdot EC(f)$$

With \cdot denoting multiplication.

$Z'(f,t)$ is used to calculate EVM_{PUCCH} , as described in E.5.9 1

NOTE: although an exclusion period for EVM_{PUCCH} is applicable in E.5.9.1, the post FFT minimisation process is done over 14 OFDM symbols.

The samples of the non-allocated resource blocks within the transmission bandwidth configuration in the post FFT domain are called $Y(f,t)$ (f covering the non-allocated subcarriers within the transmission bandwidth configuration, t covering the OFDM symbols during 1 slot).

E.5.9 Derivation of the results

E.5.9.1 EVM_{PUCCH}

For EVM_{PUCCH} create two sets of $Z'(f,t)$, according to the timing " $\Delta\tilde{c} - W/2$ and $\Delta\tilde{c} + W/2$ " using the equalizer coefficients from E.5.8

The EVM_{PUCCH} is the difference between the ideal waveform and the measured and equalized waveform for the allocated RB(s)

$$EVM_{PUCCH} = \sqrt{\frac{\sum_{t \in T} \sum_{f \in F} |Z'(f,t) - I(f,t)|^2}{|T| \cdot P_0 \cdot |F|}},$$

where

the OFDM symbols next to transition borders (instant of PUCCH frequency hopping) are excluded:

t covers less than the count of demodulated symbols in the slot ($|T|=12$)

f covers the count of subcarriers within the allocated bandwidth. ($|F|=12$)

$Z'(f,t)$ are the samples of the signal evaluated for the EVM_{PUCCH}

$I(f,t)$ is the ideal signal reconstructed by the measurement equipment, and

P_0 is the average power of the ideal signal. For normalized modulation symbols P_0 is equal to 1.

From the acquired samples $2n$ EVM_{PUCCH} value can be derived, n values for the timing $\Delta\tilde{c} - W/2$ and n values for the timing $\Delta\tilde{c} + W/2$, where n is as defined in Annex E.2.2.

E.5.9.2 Averaged EVM_{PUCCH}

EVM_{PUCCH} is averaged over all basic EVM_{PUCCH} measurements

The averaging comprises n UL slots

$$\overline{EVM}_{PUCCH} = \sqrt{\frac{1}{n} \sum_{i=1}^n (EVM_{PUCCH,i})^2},$$

where n is as defined in Annex E.2.2.

The averaging is done separately for timing! $\Delta\tilde{c} - W/2$ and $\Delta\tilde{c} + W/2$ leading to $\overline{EVM}_{PUCCH,low}$ and $\overline{EVM}_{PUCCH,high}$

$\overline{EVM}_{PUCCH,final} = \max(\overline{EVM}_{PUCCH,low}, \overline{EVM}_{PUCCH,high})$ is compared against the test requirements.

E.5.9.3 In-band emissions measurement

The in-band emissions are a measure of the interference falling into the non-allocated resources blocks

Create one set of $Y(t,f)$ per slot according to the timing “ $\Delta\tilde{C}$ ”

For the non-allocated RBs the in-band emissions are calculated as follows

$$Emissions_{absolute}(\Delta_{RB}) = \begin{cases} \frac{1}{|T_s|} \sum_{t \in T_s} \sum_{\substack{c_l + (12 \cdot \Delta_{RB} + 1) \cdot \Delta f \\ \max(f_{\min}, (c_l + 12 \cdot \Delta_{RB} \cdot \Delta f))}}^{\substack{c_l + (12 \cdot \Delta_{RB} + 1) \cdot \Delta f \\ \min(f_{\max}, (c_l + 12 \cdot \Delta_{RB} \cdot \Delta f))}} |Y(t, f)|^2, \Delta_{RB} < 0 \\ \frac{1}{|T_s|} \sum_{t \in T_s} \sum_{\substack{c_h + (12 \cdot \Delta_{RB} - 1) \cdot \Delta f \\ \min(f_{\max}, (c_h + 12 \cdot \Delta_{RB} \cdot \Delta f))}}^{\substack{c_h + (12 \cdot \Delta_{RB} - 1) \cdot \Delta f \\ \max(f_{\min}, (c_h + 12 \cdot \Delta_{RB} \cdot \Delta f))}} |Y(t, f)|^2, \Delta_{RB} > 0 \end{cases},$$

where

the upper formula represents the inband emissions below the allocated frequency block and the lower one the inband emissions above the allocated frequency block.

T_s is a set of $|T_s|$ OFDM symbols in the measurement period,

Δ_{RB} is the starting frequency offset between the allocated RB and the measured non-allocated RB (e.g. $\Delta_{RB} = 1$ for the first upper or $\Delta_{RB} = -1$ for the first lower adjacent RB),

f_{\min} and f_{\max} are the lower and upper edge of the UL UE channel bandwidth

c_l and c_h are the lower and upper edge of the allocated BW,

Δf is the SCS, and

$Y(t, f)$ is the frequency domain signal evaluated for in-band emissions as defined in the clause E.5.8.

The relative in-band emissions are, given by

$$Emissions_{relative}(\Delta_{RB}) = 10 * \log_{10} \frac{Emissions_{absolute}(\Delta_{RB})}{\frac{1}{|T_s|} \cdot L_{CRBs} \sum_{t \in T_s} \sum_{c_1}^{c_1 + (12 \cdot L_{CRBs} - 1) \cdot \Delta f} |MS(t, f)|^2} [dB]$$

where

L_{CRBs} is the number of allocated RBs,

and $MS(t, f)$ is the frequency domain samples for the allocated bandwidth, as defined in the subsection E.5.8

Although an exclusion period for EVM is applicable in E.5.9.1, the inband emissions measurement interval is defined over one complete slot in the time domain.

From the acquired samples n functions for inband emissions can be derived, where n is as defined in Annex E.2.2.

The in-band emissions are averaged over the n samples (equivalent to 10 UL subframes) with the same PUCCH position to prevent averaging of allocated and non-allocated RBs due to PUCCH frequency hopping:

$$\overline{Emissions_{absolute}}(\Delta_{RB}) = \frac{1}{n} \sum_{i=1}^n Emissions_{absolute,i}(\Delta_{RB})$$

$$\overline{Emissions_{relative}}(\Delta_{RB}) = 10 * \log_{10} \left(\frac{1}{n} \sum_{i=1}^n 10^{Emissions_{relative,i}(\Delta_{RB})/10} \right) [dB]$$

Since the PUCCH allocation is always on the upper or lower band-edge, the opposite of the allocated one represents the IQ image, and the remaining inner RBs represent the general inband emissions. They are compared against different limits.

E.6 EVM for PRACH

The description below is generic in the sense that all PRACH formats are covered. The numbers, used in the text below are taken from PRACH format#0 without excluding the other formats. The sampling rate for PRACH is assumed as , 30.72 Msps in the time domain.

E.6.1 Basic principle

The basic principle is the same as described in E.2.1

E.6.2 Output signal of the TX under test

The output signal of the TX under test is processed same as described in E.2.2

The measurement period is different since 2 PRACH preambles are recorded for long preamble formats as defined in Table 6.3.3.1-1 in [8] and 10 preambles are recorded for short preamble formats as defined in Table 6.3.3.1-2 in [8].

E.6.3 Reference signal

The test description in 6.4.2.1.4.1 is based on non-contention based access:

- PRACH configuration index (responsible for Preamble format, System frame number and subframe number)
- Preamble ID
- Preamble power

signalled to the UE, defines the reference signal unambiguously, such that no demodulation process is necessary to gain the reference signal.

The reference signal $i(v)$ is constructed by the measuring equipment according to the relevant TX specifications, using the following parameters: the applicable Zadoff Chu sequence, nominal carrier frequency, nominal amplitude and phase for each subcarrier, nominal timing, no carrier leakage. It is represented as a sequence of samples at a sampling rate of 122.88 Msps in the time domain.

E.6.4 Measurement results

The measurement result is:

- EVM_{PRACH}

E.6.5 Measurement points

The measurement points are illustrated in the figure below:

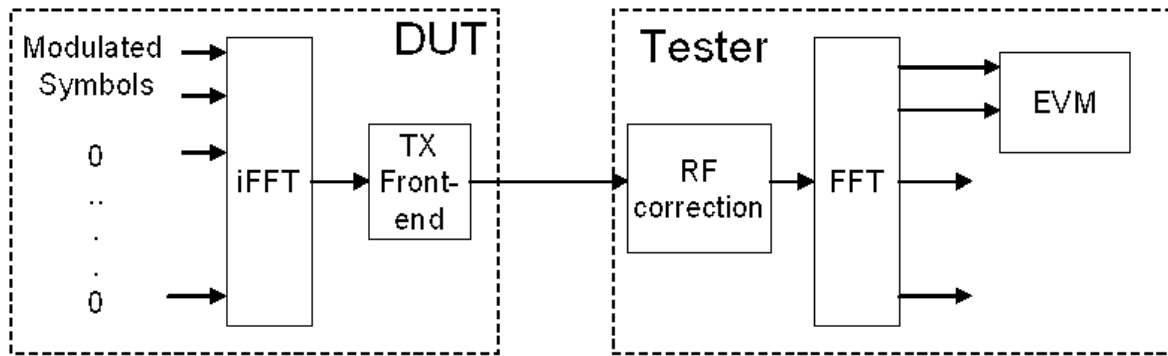

Figure E.6.5-1: Measurement points

E.6.6 Pre FFT minimization process

The pre-FFT minimization process is applied to each PRACH preamble separately. The time period for the pre-FFT minimisation process includes the complete CP and Zadoff-Chu sequence (in other words, the power transition period is per definition outside of this time period). Sample timing, Carrier frequency and carrier leakage in $z(v)$ are jointly varied in order to minimise the difference between $z(v)$ and $i(v)$. Best fit (minimum difference) is achieved when the RMS difference value between $z(v)$ and $i(v)$ is an absolute minimum.

After this process the samples $z(v)$ are called $z^0(v)$.

RF error, and carrier leakage are necessary for best fit of the measured signal towards the ideal signal in the pre-FFT domain. However they are not used to compare them against the limits.

E.6.7 Timing of the FFT window

The FFT window length is 24576 samples for preamble format 0, however in the measurement period at least 27744 samples are taken. The position in time for FFT must be determined.

In an ideal signal, the FFT may start at any instant within the cyclic prefix without causing an error. The TX filter, however, reduces the window. The EVM requirements shall be met within a window $W < CP$.

The reference instant for the FFT start is the centre of the reduced window, called $\Delta\tilde{c}$,

EVM is measured at the following two instants: $\Delta\tilde{c} - W/2$ and $\Delta\tilde{c} + W/2$.

The timing of the measured signal $z^0(v)$ with respect to the ideal signal $i(v)$ is determined in the pre-FFT domain as follows:

Correlation between $z^0(v)$ and $i(v)$ will result in a correlation peak. The meaning of the correlation peak is approx. the “impulse response” of the TX filter. The correlation peak, (the highest, or in case of more than one, the earliest) indicates the timing in the measured signal with respect to the ideal signal.

W is different for different preamble formats and shown in Table E.6.7-1 for $L_{RA} = 839$ and $\Delta f^{RA} \in \{1.25, 5\}$ kHz in Table E.6.7-2 for $L_{RA} = 139$ and $\Delta f^{RA} = 15 \cdot 2^\mu$ kHz where $\mu \in \{0, 1, 2\}$.

Table E.6.7-1: EVM window length for PRACH formats for $L_{RA} = 839$

Preamble format	Cyclic prefix length N_{cp}	Nominal FFT size ¹	EVM window length W in FFT samples	Ratio of W to CP*
0	3168	24576	2307	72.8%
1	21024	24576	20163	95.9%
2	4688	24576	3827	81.6%
3	3168	6144	2952	93.2%
Note 1: The use of other FFT sizes is possible as long as appropriate scaling of the window length is applied				
Note 2: These percentages are informative				

Table E.6.7-2: EVM window length for PRACH formats for $L_{RA} = 139$

Preamble format	Cyclic prefix length N_{cp}	Nominal FFT size ¹	EVM window length W in FFT samples	Ratio of W to CP*
A1	288 \llcorner 2 \circ	2048 \llcorner 2 \circ	144 \llcorner 2 \circ	50.0%
A2	576 \llcorner 2 \circ	2048 \llcorner 2 \circ	432 \llcorner 2 \circ	75.0%
A3	864 \llcorner 2 \circ	2048 \llcorner 2 \circ	720 \llcorner 2 \circ	83.3%
B1	216 \llcorner 2 \circ	2048 \llcorner 2 \circ	72 \llcorner 2 \circ	33.3%
B2	360 \llcorner 2 \circ	2048 \llcorner 2 \circ	216 \llcorner 2 \circ	60.0%
B3	504 \llcorner 2 \circ	2048 \llcorner 2 \circ	360 \llcorner 2 \circ	71.4%
B4	936 \llcorner 2 \circ	2048 \llcorner 2 \circ	792 \llcorner 2 \circ	84.6%
C0	1240 \llcorner 2 \circ	2048 \llcorner 2 \circ	1096 \llcorner 2 \circ	88.4%
C2	2048 \llcorner 2 \circ	2048 \llcorner 2 \circ	1904 \llcorner 2 \circ	93.0%
Note 1: The use of other FFT sizes is possible as long as appropriate scaling of the window length is applied				
Note 2: These percentages are informative				

The number of samples, used for FFT is reduced compared to $z^0(v)$. This subset of samples is called $z'(v)$.

EVM is based on Nominal FFT size samples per PRACH preamble and demodulated symbol.

E.6.8 Post FFT equalisation

Equalisation is not applicable for the PRACH.

E.6.9 Derivation of the results

E.6.9.1 EVM_{PRACH}

Perform FFT on $z'(v)$ and $i(v)$ using the FFT timing $\Delta\tilde{c} - W/2$ and $\Delta\tilde{c} + W/2$.

For format 2 and 3 the first and the repeated preamble sequence are FFT-converted separately, using the standard FFT length of 2048.

The EVM_{PRACH} is the difference between the ideal waveform and the measured and equalized waveform for the allocated RB(s).

$$EVM_{PRACH} = \sqrt{\frac{\sum_{t \in T} \sum_{f \in F} |Z'(f, t) - I(f, t)|^2}{|T| \cdot P_0 \cdot |F|}}$$

where

t covers the count of demodulated symbols in the slot.

f covers the count of demodulated symbols within the allocated bandwidth.

$Z'(f, t)$ are the samples of the signal evaluated for the EVM_{PRACH}

$I(f, t)$ is the ideal signal reconstructed by the measurement equipment, and

P_0 is the average power of the ideal signal. For normalized modulation symbols P_0 is equal to 1.

From the acquired samples $2m$ EVM_{PRACH} values can be derived, m values for the timing $\Delta\tilde{c} - W/2$ and m values for the timing $\Delta\tilde{c} + W/2$, where m is the number of recorded preambles as defined in Annex E.6.2.

E.6.9.2 Averaged EVM_{PRACH}

The PRACH EVM, EVM_{PRACH} , is averaged over m preamble sequence measurements.

$$\overline{EVM}_{PRACH} = \sqrt{\frac{1}{m} \sum_{i=1}^m (EVM_{PRACH,i})^2},$$

where m is the number of recorded preambles as defined in Annex E.6.2. The averaging is done separately for timing $\Delta\tilde{c} - W/2$ and $\Delta\tilde{c} + W/2$ leading to $\overline{EVM}_{PRACH,low}$ and $\overline{EVM}_{PRACH,high}$

$EVM_{PRACH,final} = \max(\overline{EVM}_{PRACH,low}, \overline{EVM}_{PRACH,high})$ is compared against the test requirements.

Annex F (normative): Measurement uncertainties and Test Tolerances

F.1 Acceptable uncertainty of Test System (normative)

The maximum acceptable uncertainty of the Test System is specified below for each test, where appropriate. The Test System shall enable the stimulus signals in the test case to be adjusted to within the specified range, and the equipment under test to be measured with an uncertainty not exceeding the specified values. All ranges and uncertainties are absolute values, and are valid for a confidence level of 95 %, unless otherwise stated.

A confidence level of 95 % is the measurement uncertainty tolerance interval for a specific measurement that contains 95 % of the performance of a population of test equipment.

For RF tests it should be noted that the uncertainties in clause F.1 apply to the Test System operating into a nominal 50 ohm load and do not include system effects due to mismatch between the DUT and the Test System.

The downlink signal uncertainties apply at each receiver antenna connector.

F.1.1 Measurement of test environments

The measurement accuracy of the UE test environments defined in TS 38.508-1 [5] subclause 4.1, Test environments shall be

- Pressure ± 5 kPa.
- Temperature ± 2 degrees.
- Relative Humidity ± 5 %.
- DC Voltage $\pm 1,0$ %.
- AC Voltage $\pm 1,5$ %.
- Vibration 10 %.
- Vibration frequency 0,1 Hz.

The above values shall apply unless the test environment is otherwise controlled and the specification for the control of the test environment specifies the uncertainty for the parameter.

F.1.2 Measurement of transmitter

Table F.1.2-1: Maximum Test System Uncertainty for transmitter tests

Subclause	Maximum Test System Uncertainty	Derivation of Test System Uncertainty
6.2.1 UE maximum output power	$f \leq 3.0\text{GHz}$ $\pm 0.7\text{ dB}$, $\text{BW} \leq 40\text{MHz}$ $\pm 1.4\text{ dB}$, $40\text{MHz} < \text{BW} \leq 100\text{MHz}$ $3.0\text{GHz} < f \leq 4.2\text{GHz}$ $\pm 1.0\text{ dB}$, $\text{BW} \leq 40\text{MHz}$ $\pm 1.6\text{ dB}$, $40\text{MHz} < \text{BW} \leq 100\text{MHz}$ $4.2\text{GHz} < f \leq 6.0\text{GHz}$ $\pm 1.3\text{ dB}$, $\text{BW} \leq 20\text{MHz}$ $\pm 1.5\text{ dB}$, $20\text{MHz} < \text{BW} \leq 40\text{MHz}$ $\pm 1.6\text{ dB}$, $40\text{MHz} < \text{BW} \leq 100\text{MHz}$	
6.2.2 Maximum Power Reduction (MPR)	$f \leq 3.0\text{GHz}$ $\pm 0.7\text{ dB}$, $\text{BW} \leq 40\text{MHz}$ $\pm 1.4\text{ dB}$, $40\text{MHz} < \text{BW} \leq 100\text{MHz}$ $3.0\text{GHz} < f \leq 4.2\text{GHz}$ $\pm 1.0\text{ dB}$, $\text{BW} \leq 40\text{MHz}$ $\pm 1.6\text{ dB}$, $40\text{MHz} < \text{BW} \leq 100\text{MHz}$ $4.2\text{GHz} < f \leq 6.0\text{GHz}$ $\pm 1.3\text{ dB}$, $\text{BW} \leq 20\text{MHz}$ $\pm 1.5\text{ dB}$, $20\text{MHz} < \text{BW} \leq 40\text{MHz}$ $\pm 1.6\text{ dB}$, $40\text{MHz} < \text{BW} \leq 100\text{MHz}$	
6.2.3 UE additional maximum output power reduction	$f \leq 3.0\text{GHz}$ $\pm 0.7\text{ dB}$, $\text{BW} \leq 40\text{MHz}$ $\pm 1.4\text{ dB}$, $40\text{MHz} < \text{BW} \leq 100\text{MHz}$ $3.0\text{GHz} < f \leq 4.2\text{GHz}$ $\pm 1.0\text{ dB}$, $\text{BW} \leq 40\text{MHz}$ $\pm 1.6\text{ dB}$, $40\text{MHz} < \text{BW} \leq 100\text{MHz}$ $4.2\text{GHz} < f \leq 6.0\text{GHz}$ $\pm 1.3\text{ dB}$, $\text{BW} \leq 20\text{MHz}$ $\pm 1.5\text{ dB}$, $20\text{MHz} < \text{BW} \leq 40\text{MHz}$ $\pm 1.6\text{ dB}$, $40\text{MHz} < \text{BW} \leq 100\text{MHz}$	
6.2.4 Configured transmitted power	$f \leq 3.0\text{GHz}$ $\pm 0.7\text{ dB}$, $\text{BW} \leq 40\text{MHz}$ $\pm 1.4\text{ dB}$, $40\text{MHz} < \text{BW} \leq 100\text{MHz}$ $3.0\text{GHz} < f \leq 4.2\text{GHz}$ $\pm 1.0\text{ dB}$, $\text{BW} \leq 40\text{MHz}$ $\pm 1.6\text{ dB}$, $40\text{MHz} < \text{BW} \leq 100\text{MHz}$ $4.2\text{GHz} < f \leq 6.0\text{GHz}$ $\pm 1.3\text{ dB}$, $\text{BW} \leq 20\text{MHz}$ $\pm 1.5\text{ dB}$, $20\text{MHz} < \text{BW} \leq 40\text{MHz}$ $\pm 1.6\text{ dB}$, $40\text{MHz} < \text{BW} \leq 100\text{MHz}$	
6.2A.1.1 UE maximum output power for CA (2UL CA)	For Inter-band CA MAX (MU_{CC1} , MU_{CC2})	MU_{CCX} is MU of each UL CC specified in single UL case 6.2.1.
6.2A.2.1 UE maximum output power reduction for CA (2UL CA)	For Inter-band CA MAX (MU_{CC1} , MU_{CC2}) For intra-band contiguous CA Aggregated BW $\leq 100\text{M}$: same as 6.2.2 for sum of powers of all CCs Aggregated BW $> 100\text{M}$: TBD	MU_{CCX} is MU of each UL CC specified in single UL case 6.2.2.
6.2A.3.1 UE additional maximum output power reduction CA (2UL CA)	For Inter-band CA MAX (MU_{CC1} , MU_{CC2})	MU_{CCX} is MU of each UL CC specified in single UL case 6.2.3.
6.2A.4.1 Configured transmitted power for CA (2UL CA)	For Inter-band CA MAX (MU_{CC1} , MU_{CC2}) For intra-band contiguous CA Aggregated BW $\leq 100\text{M}$: same as 6.2.2 for sum of powers of all CCs Aggregated BW $> 100\text{M}$: TBD	MU_{CCX} is MU of each UL CC specified in single UL case 6.2.4.

6.2C.1 Configured transmitted power for SUL	Same as 6.2.4	
6.2C.3 UE maximum output power for SUL	Same as 6.2.1	
6.2C.4 UE maximum output power reduction for SUL	Same as 6.2.2	
6.2C.5 UE additional maximum output power reduction for SUL	Same as 6.2.3	
6.2D.1 UE maximum output power for UL MIMO	Same as 6.2.1 for the sum of power at each of UE antenna connector	MU is for the sum of power at each of UE antenna connector, and is the same as the MU of single antenna port in 6.2.1 with SNR assumption reduced by 3dB compared to the single antenna case.
6.2D.2 UE maximum output power reduction for UL MIMO	Same as 6.2.2 for the sum of power at each of UE antenna connector	MU is for the sum of power at each of UE antenna connector, and is the same as the MU of single antenna port in 6.2.2 with SNR assumption reduced by 3dB compared to the single antenna case.
6.2D.3 UE additional maximum output power reduction for UL MIMO	Same as 6.2.3 for the sum of power at each of UE antenna connector	MU is for the sum of power at each of UE antenna connector, and is the same as the MU of single antenna port in 6.2.3 with SNR assumption reduced by 3dB compared to the single antenna case.
6.2D.4 Configured transmitted power for UL MIMO	Same as 6.2.4 for the sum of power at each of UE antenna connector	MU is for the sum of power at each of UE antenna connector, and is the same as the MU of single antenna port in 6.2.4 with SNR assumption reduced by 3dB compared to the single antenna case.
6.2F.1 UE maximum output power for shared spectrum channel access	4.2GHz < f ≤ 5.925GHz ±1.3 dB, BW ≤ 20MHz ±1.5 dB, 20MHz < BW ≤ 40MHz ±1.6 dB, 40MHz < BW ≤ 100MHz 5.925GHz < f ≤ 7.125GHz TBD	
6.2F.3 UE additional maximum output power reduction for shared spectrum access	Same as 6.2F.1	
6.2G.1 UE maximum output power for Tx Diversity	Same as 6.2.1 for the sum of power at each of UE antenna connector	MU is for the sum of power at each of UE antenna connector, and is the same as the MU of single antenna connector in 6.2.1 with SNR assumption reduced by 3dB compared to the single antenna case.
6.2G.2 UE maximum output power reduction for Tx Diversity	Same as 6.2.2 for the sum of power at each of UE antenna connector	MU is for the sum of power at each of UE antenna connector, and is the same as the MU of single antenna connector in 6.2.2 with SNR assumption reduced by 3dB compared to the single antenna case.

6.2G.3 UE additional maximum output power reduction for Tx Diversity	Same as 6.2.3 for the sum of power at each of UE antenna connector	MU is for the sum of power at each of UE antenna connector, and is the same as the MU of single antenna connector in 6.2.3 with SNR assumption reduced by 3dB compared to the single antenna case.
6.3.1 Minimum output power	<p>$f \leq 3.0\text{GHz}$ $\pm 1.0\text{ dB}$, $\text{BW} \leq 40\text{MHz}$ $\pm 1.4\text{ dB}$, $40\text{MHz} < \text{BW} \leq 100\text{MHz}$</p> <p>$3.0\text{GHz} < f \leq 4.2\text{GHz}$ $\pm 1.3\text{ dB}$, $\text{BW} \leq 40\text{MHz}$ $\pm 1.6\text{ dB}$, $40\text{MHz} < \text{BW} \leq 100\text{MHz}$</p> <p>$4.2\text{GHz} < f \leq 6.0\text{GHz}$ $\pm 1.5\text{ dB}$, $\text{BW} \leq 40\text{MHz}$ $\pm 1.8\text{ dB}$, $40\text{MHz} < \text{BW} \leq 100\text{MHz}$</p>	
6.3.2 Transmit OFF power	<p>$f \leq 3.0\text{GHz}$ $\pm 1.5\text{ dB}$, $\text{BW} \leq 40\text{MHz}$ $\pm 1.7\text{ dB}$, $40\text{MHz} < \text{BW} \leq 100\text{MHz}$</p> <p>$3.0\text{GHz} < f \leq 4.2\text{GHz}$ $\pm 1.8\text{ dB}$, $\text{BW} \leq 40\text{MHz}$ $\pm 1.9\text{ dB}$, $40\text{MHz} < \text{BW} \leq 80\text{MHz}$ $\pm 2.2\text{ dB}$, $80\text{MHz} < \text{BW} \leq 100\text{MHz}$</p> <p>$4.2\text{GHz} < f \leq 6.0\text{GHz}$ $\pm 2.0\text{ dB}$, $\text{BW} \leq 20\text{MHz}$ $\pm 2.1\text{ dB}$, $20\text{MHz} < \text{BW} \leq 80\text{MHz}$ $\pm 2.2\text{ dB}$, $80\text{MHz} < \text{BW} \leq 100\text{MHz}$</p>	
6.3.3.2 General ON/OFF time mask	<p>$f \leq 3.0\text{GHz}$ $\pm 1.5\text{ dB}$, $\text{BW} \leq 40\text{MHz}$ $\pm 1.7\text{ dB}$, $40\text{MHz} < \text{BW} \leq 100\text{MHz}$</p> <p>$3.0\text{GHz} < f \leq 4.2\text{GHz}$ $\pm 1.8\text{ dB}$, $\text{BW} \leq 40\text{MHz}$ $\pm 1.9\text{ dB}$, $40\text{MHz} < \text{BW} \leq 80\text{MHz}$ $\pm 2.2\text{ dB}$, $80\text{MHz} < \text{BW} \leq 100\text{MHz}$</p> <p>$4.2\text{GHz} < f \leq 6.0\text{GHz}$ $\pm 2.0\text{ dB}$, $\text{BW} \leq 20\text{MHz}$ $\pm 2.1\text{ dB}$, $20\text{MHz} < \text{BW} \leq 80\text{MHz}$ $\pm 2.2\text{ dB}$, $80\text{MHz} < \text{BW} \leq 100\text{MHz}$</p>	
6.3.3.4 PRACH time mask	<p>$f \leq 3.0\text{GHz}$ $\pm 1.5\text{ dB}$, $\text{BW} \leq 40\text{MHz}$ $\pm 1.7\text{ dB}$, $40\text{MHz} < \text{BW} \leq 100\text{MHz}$</p> <p>$3.0\text{GHz} < f \leq 4.2\text{GHz}$ $\pm 1.8\text{ dB}$, $\text{BW} \leq 40\text{MHz}$ $\pm 1.9\text{ dB}$, $40\text{MHz} < \text{BW} \leq 80\text{MHz}$ $\pm 2.2\text{ dB}$, $80\text{MHz} < \text{BW} \leq 100\text{MHz}$</p> <p>$4.2\text{GHz} < f \leq 6.0\text{GHz}$ $\pm 2.0\text{ dB}$, $\text{BW} \leq 20\text{MHz}$ $\pm 2.1\text{ dB}$, $20\text{MHz} < \text{BW} \leq 80\text{MHz}$ $\pm 2.2\text{ dB}$, $80\text{MHz} < \text{BW} \leq 100\text{MHz}$</p>	

6.3.3.6 SRS time mask	$f \leq 3.0\text{GHz}$ $\pm 1.5\text{ dB}$, $\text{BW} \leq 40\text{MHz}$ $\pm 1.7\text{ dB}$, $40\text{MHz} < \text{BW} \leq 100\text{MHz}$ $3.0\text{GHz} < f \leq 4.2\text{GHz}$ $\pm 1.8\text{ dB}$, $\text{BW} \leq 40\text{MHz}$ $\pm 1.9\text{ dB}$, $40\text{MHz} < \text{BW} \leq 80\text{MHz}$ $\pm 2.2\text{ dB}$, $80\text{MHz} < \text{BW} \leq 100\text{MHz}$ $4.2\text{GHz} < f \leq 6.0\text{GHz}$ $\pm 2.0\text{ dB}$, $\text{BW} \leq 20\text{MHz}$ $\pm 2.1\text{ dB}$, $20\text{MHz} < \text{BW} \leq 80\text{MHz}$ $\pm 2.2\text{ dB}$, $80\text{MHz} < \text{BW} \leq 100\text{MHz}$	
6.3.4.2 Absolute power tolerance	$f \leq 3.0\text{GHz}$ $\pm 1.0\text{ dB}$, $\text{BW} \leq 40\text{MHz}$ $\pm 1.6\text{ dB}$, $40\text{MHz} < \text{BW} \leq 100\text{MHz}$ $3.0\text{GHz} < f \leq 4.2\text{GHz}$ $\pm 1.4\text{ dB}$, $\text{BW} \leq 40\text{MHz}$ $\pm 1.9\text{ dB}$, $40\text{MHz} < \text{BW} \leq 100\text{MHz}$ $4.2\text{GHz} < f \leq 6.0\text{GHz}$ $\pm 2.0\text{ dB}$, $\text{BW} \leq 20\text{MHz}$ $\pm 2.1\text{ dB}$, $20\text{MHz} < \text{BW} \leq 40\text{MHz}$ $\pm 2.2\text{ dB}$, $80\text{MHz} < \text{BW} \leq 100\text{MHz}$	Test System uncertainty = $\text{SQRT}(\text{UL Meas Uncer}^2 + \text{DL Meas Uncer}^2)$
6.3.4.3 Power Control Relative power tolerance	$\pm 0.7\text{ dB}$, $\text{BW} \leq 40\text{MHz}$ $\pm 1.0\text{ dB}$, $40\text{MHz} < \text{BW} \leq 100\text{MHz}$ Absolute Uplink power measurement for step 2.1 same as 6.2.1. Absolute Uplink power measurement for step 1.1 same as 6.3.1.	
6.3.4.4 Aggregate power tolerance	$\pm 0.7\text{ dB}$, $\text{BW} \leq 40\text{MHz}$ $\pm 1.0\text{ dB}$, $40\text{MHz} < f \leq 100\text{MHz}$	
6.3A.1.1 Minimum output power for CA (2UL CA)	Same as 6.3.1 for each CC	
6.3A.3.1 Transmit ON/OFF time mask for CA (2UL CA)	Same as 6.3.3.2 for each CC	
6.3A.3.1_1 Time mask for switching between two uplink carriers	FFS	
6.3A.4.1.1 Absolute power tolerance for CA (2UL CA)	Same as 6.3.4.2 for each CC	
6.3A.4.2.1 Power Control Relative power tolerance for CA (2UL CA)	Same as 6.3.4.3 for each CC	
6.3A.4.3.1 Aggregate power tolerance for CA (2UL CA)	Same as 6.3.4.4 for each CC	
6.3D.1 Minimum output power for UL MIMO	Same as 6.3.1 for the sum of power at each of UE antenna connector	MU is for the sum of power at each of UE antenna connector, and is the same as the MU of single antenna port in 6.3.1 with SNR assumption reduced by 3dB compared to the single antenna case.
6.3D.2 Transmit OFF power for UL MIMO	Same as 6.3.2 for each antenna	
6.3D.3 Transmit ON/OFF time mask for UL MIMO	ON power: Same as 6.2D.1 OFF power: Same as 6.3D.2	

6.3D.4.1 Absolute Power tolerance	Same as 6.3.4.2 for the sum of power at each of UE antenna connector	MU is for the sum of power at each of UE antenna connector, and is the same as the MU of single antenna port in 6.3.4.2 with SNR assumption reduced by 3dB compared to the single antenna case.
6.3D.4.2 Relative Power tolerance	± 0.9 dB, $BW \leq 40$ MHz ± 1.4 dB, $40\text{MHz} < f \leq 100$ MHz	MU is for the sum of power at each of UE antenna connector
6.3D.4.3 Aggregate Power tolerance	Same as 6.3.4.4 for the sum of power at each of UE antenna connector	MU is for the sum of power at each of UE antenna connector, and is the same as the MU of single antenna port in 6.3.4.4 with SNR assumption reduced by 3dB compared to the single antenna case.
6.3F.2 Transmit OFF power for shared spectrum channel access	$4.2\text{GHz} < f \leq 5.925\text{GHz}$ ± 2.0 dB, $BW \leq 20$ MHz ± 2.1 dB, $20\text{MHz} < BW \leq 80$ MHz ± 2.2 dB, $80\text{MHz} < BW \leq 100$ MHz $5.925\text{GHz} < f \leq 7.125\text{GHz}$ TBD	
6.3F.3.2 General ON/OFF time mask for shared spectrum channel access	$4.2\text{GHz} < f \leq 5.925\text{GHz}$ ± 2.0 dB, $BW \leq 20$ MHz ± 2.1 dB, $20\text{MHz} < BW \leq 80$ MHz ± 2.2 dB, $80\text{MHz} < BW \leq 100$ MHz $5.925\text{GHz} < f \leq 7.125\text{GHz}$ TBD	
6.4.1 Frequency Error	± 15 Hz, $f \leq 3.0$ GHz ± 36 Hz, $f > 3.0$ GHz DL Signal level: ± 0.7 dB, $f \leq 3.0$ GHz ± 1.0 dB, $3.0\text{GHz} < f \leq 4.2$ GHz ± 1.5 dB, $4.2\text{GHz} < f \leq 6.0$ GHz	
6.4.2.1 Error Vector Magnitude	For up to 256QAM: $f \leq 6.0$ GHz, $BW \leq 100$ MHz 15 dBm $< P_{UL}$ PUSCH, PUCCH, PRACH: ± 1.5 % -25 dBm $< P_{UL} \leq 15$ dBm PUSCH, PUCCH, PRACH: ± 2.5 % -40 dBm $\leq P_{UL} \leq -25$ dBm PUSCH, PUCCH, PRACH: ± 3.0 % Absolute Uplink power measurement same as 6.3.1. Relative Uplink power measurement same as 6.3.4.3.	
6.4.2.1a Error Vector Magnitude including symbols with transient period	Same as 6.4.2.1	

6.4.2.2 Carrier Leakage	<p>$f \leq 3.0\text{GHz}$ $\pm 0.8\text{ dB}$, $\text{BW} \leq 40\text{MHz}$ $\pm 1.5\text{ dB}$, $40\text{MHz} < \text{BW} \leq 100\text{MHz}$</p> <p>$3.0\text{GHz} < f \leq 4.2\text{GHz}$ $\pm 0.8\text{ dB}$, $\text{BW} \leq 40\text{MHz}$ $\pm 1.6\text{ dB}$, $40\text{MHz} < \text{BW} \leq 100\text{MHz}$</p> <p>$4.2\text{GHz} < f \leq 6.0\text{GHz}$ $\pm 1.0\text{ dB}$, $\text{BW} \leq 40\text{MHz}$ $\pm 1.6\text{ dB}$, $40\text{MHz} < \text{BW} \leq 100\text{MHz}$</p> <p>Absolute Uplink power measurement for step 2 and step 4 same as 6.2.1. Absolute Uplink power measurement for step 6 and step 8 same as 6.3.1. Relative Uplink power measurement same as 6.3.4.3.</p>	
6.4.2.3 In-band emissions	<p>$f \leq 3.0\text{GHz}$ $\pm 0.8\text{ dB}$, $\text{BW} \leq 40\text{MHz}$ $\pm 1.5\text{ dB}$, $40\text{MHz} < \text{BW} \leq 100\text{MHz}$</p> <p>$3.0\text{GHz} < f \leq 4.2\text{GHz}$ $\pm 0.8\text{ dB}$, $\text{BW} \leq 40\text{MHz}$ $\pm 1.6\text{ dB}$, $40\text{MHz} < \text{BW} \leq 100\text{MHz}$</p> <p>$4.2\text{GHz} < f \leq 6.0\text{GHz}$ $\pm 1.0\text{ dB}$, $\text{BW} \leq 40\text{MHz}$ $\pm 1.6\text{ dB}$, $40\text{MHz} < \text{BW} \leq 100\text{MHz}$</p> <p>Absolute Uplink power measurement for steps 1.2, 1.4, 2.2, and 2.4 same as 6.2.1. Absolute Uplink power measurement for steps 1.6, 1.8, 2.6, and 2.8 same as 6.3.1. Relative Uplink power measurement same as 6.3.4.3.</p>	
6.4.2.4 EVM equalizer spectrum flatness	<p>$\pm 1.4\text{ dB}$, $\text{BW} \leq 40\text{MHz}$ $\pm 1.6\text{ dB}$, $40\text{MHz} < \text{BW} \leq 100\text{MHz}$</p>	
6.4.2.5 EVM equalizer spectrum flatness for Pi/2 BPSK	Same as 6.4.2.4	
6.4A.1 Frequency error for CA	For inter-band CA: same as 6.4.1 for each CC	
6.4A.2.1 Error Vector Magnitude for CA	For inter-band CA: same as 6.4.2.1 for each CC Absolute Uplink power measurement same as 6.3A.1.1. Relative Uplink power measurement same as 6.3.4.3.	
6.4A.2.2 Carrier leakage for CA	For inter-band CA: same as 6.4.2.2 for each CC Uplink power measurement for step 5 and step 7 same as 6.2A.1.1. Absolute Uplink power measurement for step 9 and step 11 same as 6.3A.1.1] Relative Uplink power measurement same as 6.3.4.3.	
6.4A.2.3 In-band emission for CA	For inter-band CA: same as 6.4.2.3 for each CC Absolute Uplink power measurement for step 5 and step 7 same as 6.2A.1.1. Absolute Uplink power measurement for step 9 and step 11 same as 6.3A.1.1. Relative Uplink power measurement same as 6.3.4.3.	
6.4C.1 Frequency error for SUL	Same as 6.4.1	
6.4C.2.1 Error Vector Magnitude for SUL	Same as 6.4.2.1	
6.4C.2.2 Carrier leakage for SUL	Same as 6.4.2.2	
6.4C.2.3 In-band emissions for SUL	Same as 6.4.2.3	
6.4C.2.4 EVM equalizer spectrum flatness for SUL	Same as 6.4.2.4	

6.4D.1 Frequency error for UL MIMO	Same as 6.4.1 for each antenna	
6.4D.2.1 Error Vector Magnitude for UL MIMO	Same as 6.4.2.1 for each antenna Absolute Uplink power measurement same as 6.3D.1. Relative Uplink power measurement same as 6.3.4.3.	
6.4D.2.2 Carrier leakage for UL MIMO	Same as 6.4.2.2 for each antenna Absolute Uplink power measurement for step 2 and step 4 same as 6.2D.1. Absolute Uplink power measurement for step 6 and step 8 same as 6.3D.1. Relative Uplink power measurement same as 6.3.4.3.	
6.4D.2.3 In-band emissions for UL MIMO	Same as 6.4.2.3 for each antenna Absolute Uplink power measurement for steps 1.2 and 1.4 same as 6.2D.1. Absolute Uplink power measurement for steps 1.6 and 1.8 same as 6.3D.1. Relative Uplink power measurement same as 6.3.4.3.	
6.4D.2.4 EVM equalizer spectrum flatness for UL MIMO	Same as 6.4.2.4 for each antenna	
6.4D.3 Time alignment error for UL MIMO	$\pm 25\text{ns}$	
6.4D.4 Requirements for Coherent UL MIMO	FFS	
6.5.1 Occupied bandwidth	1.5% of channel bandwidth	
6.5.2.2 Spectrum Emission Mask	$\pm 1.5\text{ dB}$, $f \leq 3.0\text{GHz}$ $\pm 1.8\text{ dB}$, $3.0\text{GHz} < f \leq 4.2\text{GHz}$ $\pm 2.0\text{ dB}$, $4.2\text{GHz} < f \leq 6.0\text{GHz}$	
6.5.2.3 Additional spectrum emission mask	$\pm 1.5\text{ dB}$, $f \leq 3.0\text{GHz}$ $\pm 1.8\text{ dB}$, $3.0\text{GHz} < f \leq 4.2\text{GHz}$ $\pm 2.0\text{ dB}$, $4.2\text{GHz} < f \leq 6.0\text{GHz}$	
6.5.2.4.1 NR ACLR	$\pm 0.8\text{ dB}$, $f \leq 4.0\text{GHz}$ $\pm 1.0\text{ dB}$, $4.0\text{GHz} < f \leq 6.0\text{GHz}$	
6.5.2.4.2 UTRA ACLR	$\pm 0.8\text{ dB}$, $f \leq 4.0\text{GHz}$ $\pm 1.0\text{ dB}$, $4.0\text{GHz} < f \leq 6.0\text{GHz}$	
6.5.3.1 General spurious emissions	for results $> -60\text{ dBm}$: $\pm 2.0\text{ dB}$, $9\text{kHz} < f \leq 3\text{GHz}$ $\pm 2.5\text{ dB}$, $3\text{GHz} < f \leq 4\text{GHz}$ $\pm 4.0\text{ dB}$, $4\text{GHz} < f \leq 19\text{GHz}$ $\pm 6.0\text{ dB}$, $19\text{GHz} < f \leq 26\text{GHz}$	
6.5.3.2 Spurious emission for UE co-existence	for results $> -60\text{ dBm}$: $\pm 2.0\text{ dB}$, $9\text{kHz} < f \leq 3\text{GHz}$ $\pm 2.5\text{ dB}$, $3\text{GHz} < f \leq 4\text{GHz}$ $\pm 4.0\text{ dB}$, $4\text{GHz} < f \leq 19\text{GHz}$ $\pm 6.0\text{ dB}$, $19\text{GHz} < f \leq 26\text{GHz}$	
6.5.3.3 Additional spurious emissions	for results $> -60\text{ dBm}$: $\pm 2.0\text{ dB}$, $9\text{kHz} < f \leq 3\text{GHz}$ $\pm 2.5\text{ dB}$, $3\text{GHz} < f \leq 4\text{GHz}$ $\pm 4.0\text{ dB}$, $4\text{GHz} < f \leq 19\text{GHz}$ $\pm 6.0\text{ dB}$, $19\text{GHz} < f \leq 26\text{GHz}$	

6.5.4 Transmit intermodulation	<p>$f \leq 3.0\text{GHz}$ $\pm 2.7\text{ dB, BW} \leq 40\text{MHz}$ $\pm 3.1\text{ dB, } 40\text{MHz} < \text{BW} \leq 100\text{MHz}$</p> <p>$3.0\text{GHz} < f \leq 4.2\text{GHz}$ $\pm 3.7\text{ dB, BW} \leq 40\text{MHz}$ $\pm 4.0\text{ dB, } 40\text{MHz} < \text{BW} \leq 100\text{MHz}$</p> <p>$4.2\text{GHz} < f \leq 6.0\text{GHz}$ $\pm 5.1\text{ dB, BW} \leq 40\text{MHz}$ $\pm 5.3\text{ dB, } 40\text{MHz} < \text{BW} \leq 100\text{MHz}$</p>	<p>Overall system uncertainty comprises four quantities:</p> <ol style="list-style-type: none"> 1. Wanted signal setting error 2. CW Interferer level error 3. Wanted signal meas. error 4. Intermodulation product measurement error <p>The relative level of the wanted signal and the CW interferer has 2 x effect on the intermodulation product.</p> <p>Items 1, 2, 3 and 4 are assumed to be uncorrelated so can be root sum squared to provide the combined effect.</p> <p>Test System uncertainty = $\text{SQRT} [(2 \times \text{SQRT} (\text{Wanted_setting_error}^2 + \text{CW_level_error}^2))^2 + \text{Wanted_level_meas error}^2 + \text{Intermodulation product measurement error}^2]$</p>
6.5A.1 Occupied bandwidth for CA	For inter-band CA: same as 6.5.1 for each CC	
6.5A.2.2 Spectrum emission mask	For inter-band CA: same as 6.5.2.2 for each CC	
6.5A.2.4.1 NR ACLR	For inter-band CA: same as 6.5.2.4.1 for each CC	
6.5A.2.4.2 URTA ACLR	For inter-band CA: same as 6.5.2.4.2 for each CC	
6.5A.3.1 General spurious emissions for CA	For inter-band CA: same as 6.5.3.1 for each CC	
6.5A.3.2 Spurious emission for UE co-existence	For inter-band CA: same as 6.5.3.2 for each CC	
6.5A.4 Transmit intermodulation for CA	For inter-band CA: same as 6.5.2.4.2, at each antenna used for transmission	
6.5C.1 Occupied bandwidth for SUL	Same as 6.5.1	
6.5C.2.2 Spectrum Emission Mask for SUL	Same as 6.5.2.2	
6.5C.2.3 Additional spectrum emission mask for SUL	Same as 6.5.2.3	
6.5C.2.4.1 NR ACLR for SUL	Same 6.5.2.4.1	
6.5C.2.4.2 UTRA ACLR for SUL	Same as 6.5.2.4.2	
6.5C.3.1 General spurious emissions for SUL	Same as 6.5.3.1	
6.5C.3.2 Spurious emission for UE co-existence for SUL	Same as 6.5.3.2	
6.5C.3.3 Additional spurious emissions for SUL	Same as 6.5.3.3	
6.5C.4 Transmit intermodulation for SUL	Same as 6.5.4	
6.5D.1 Occupied bandwidth for UL MIMO	Same as 6.5.1 for the sum of power at each of UE antenna connector	MU is for the sum of power at each of UE antenna connector, and is the same as the MU of single antenna port in 6.5.1 with SNR assumption reduced by 3dB compared to the single antenna case.

6.5D.2.2 Spectrum emission mask for UL MIMO	Same as 6.5.2.2 for the sum of power at each of UE antenna connector	MU is for the sum of power at each of UE antenna connector, and is the same as the MU of single antenna port in 6.5.2.2 with SNR assumption reduced by 3dB compared to the single antenna case.
6.5D.2.3 Additional spectrum emission mask for UL MIMO	Same as 6.5.2.3 for each antenna	
6.5D.2.4.1 NR ACLR for UL MIMO	Same as 6.5.2.4.1 for the sum of power at each of UE antenna connector	MU is for the sum of power at each of UE antenna connector, and is the same as the MU of single antenna port in 6.5.2.4.1 with SNR assumption reduced by 3dB compared to the single antenna case.
6.5D.2.4.2 UTRA ACLR for UL MIMO	Same as 6.5.2.4.2 for the sum of power at each of UE antenna connector	MU is for the sum of power at each of UE antenna connector, and is the same as the MU of single antenna port in 6.5.2.4.2 with SNR assumption reduced by 3dB compared to the single antenna case.
6.5D.3.1 General spurious emissions for UL MIMO	Same as 6.5.3.1 for each antenna	
6.5D.3.2 Spurious emissions for UE co-existence for UL MIMO	Same as 6.5.3.2 for each antenna	
6.5D.3.3 Additional spurious emissions for UL MIMO	Same as 6.5.3.3 for each antenna	
6.5D.3_1.1 General spurious emissions for UL MIMO(Rel-16 onward)	Same as 6.5.3.1 for the sum of power at each of UE antenna connector	MU is for the sum of power at each of UE antenna connector, and is the same as the MU of single antenna port in 6.5.3.1 with SNR assumption reduced by 3dB compared to the single antenna case.
6.5D.3_1.2 Spurious emissions for UE co-existence for UL MIMO (Rel-16 onward)	Same as 6.5.3.2 for the sum of power at each of UE antenna connector	MU is for the sum of power at each of UE antenna connector, and is the same as the MU of single antenna port in 6.5.3.2 with SNR assumption reduced by 3dB compared to the single antenna case.
6.5D.3_1.3 Additional spurious emissions for UL MIMO (Rel-16 onward)	Same as 6.5.3.3 for the sum of power at each of UE antenna connector	MU is for the sum of power at each of UE antenna connector, and is the same as the MU of single antenna port in 6.5.3.3 with SNR assumption reduced by 3dB compared to the single antenna case.
6.5D.4 Transmit intermodulation for UL MIMO	Same as 6.5.4 for each antenna	
6.5G.2.3.1 NR ACLR for Tx Diversity	Same as 6.5.2.4.1 for the sum of power at each of UE antenna connector	MU is for the sum of power at each of UE antenna connector, and is the same as the MU of single antenna connector in 6.5.2.4.2 with SNR assumption reduced by 3dB compared to the single antenna case.

F.1.3 Measurement of receiver

Table F.1.3-1: Maximum Test System Uncertainty for receiver tests

Subclause	Maximum Test System Uncertainty	Derivation of Test System Uncertainty
7.3.2 Reference sensitivity power level	± 0.7 dB, $f \leq 3.0$ GHz ± 1.0 dB, 3.0 GHz $< f \leq 4.2$ GHz ± 1.5 dB, 4.2 GHz $< f \leq 6$ GHz	
7.3A Reference sensitivity for CA (Same MU apply to all subsections including 7.3A.1, 7.3A.2, 7.3A.3, 7.3A.4, etc.)	Same as 7.3.2 for each component carrier	
7.3C.2 Reference sensitivity power level	Same as 7.3.2	
7.3D Reference sensitivity for MIMO	Same as 7.3.2	
7.4 Maximum input level	Downlink power ± 0.7 dB, $f \leq 3.0$ GHz ± 1.0 dB, 3.0 GHz $< f \leq 4.2$ GHz ± 1.5 dB, 4.2 GHz $< f \leq 6$ GHz Uplink power measurement same as 6.2.1	
7.4A Maximum input level for CA (Same MU apply to all subsections including 7.4A.1, 7.4A.2, 7.4A.3, 7.4A.4, etc.)	Same as 7.4 for each component carrier	
7.4D Maximum input level for UL MIMO	Downlink power same as 7.4 Uplink power measurement same as 6.2D.1	The overall UL power is the linear sum of the output powers over all Tx antenna connectors
7.5 Adjacent channel selectivity	ACS value ± 1.6 dB, $f \leq 3.0$ GHz ± 2.3 dB, 3.0 GHz $< f \leq 4.2$ GHz ± 3.0 dB, 4.2 GHz $< f \leq 6.0$ GHz Uplink power measurement same as 6.2.1	Overall ACS uncertainty comprises three quantities: 1. Wanted signal level error 2. Interferer signal level error 3. Additional impact of interferer ACLR Items 1 and 2 are assumed to be uncorrelated so can be root sum squared to provide the ratio error of the two signals. The interferer ACLR effect is systematic, and is added arithmetically. Test System uncertainty = [$\text{SQRT}(\text{wanted_level_error}^2 + \text{interferer_level_error}^2)$] + ACLR effect.
7.5A Adjacent channel selectivity for CA (Same MU apply to all subsections including 7.5A.1, 7.5A.2, 7.5A.3, 7.5A.4, etc.)	Same as 7.5 for each component carrier	Same as 7.5 The wanted signal level uncertainty applies for each CC. Overall ACS uncertainty calculation includes the uncertainty for wanted level error only once, as the uncertainty of other CCs is not expected to have any significant effect.
7.5D Adjacent channel selectivity for UL MIMO	ACS value same as 7.5 Uplink power measurement same as 6.2D.1	The overall UL power is the linear sum of the output powers over all Tx antenna connectors

7.5F.1 Adjacent channel selectivity for shared spectrum channel access	ACS value ±3.0 dB, 4.2GHz < f ≤ 5.925 GHz TBD, 5.925 GHz – 7.125 GHz Uplink power measurement same as 6.2F.1	Same as 7.5
7.6.2 Inband Blocking	Blocking ±1.6 dB, f ≤ 3.0GHz ±2.3 dB, 3.0GHz < f ≤ 4.2GHz ±3.0 dB, 4.2GHz < f ≤ 6.0GHz Uplink power measurement same as 6.2.1	Overall blocking uncertainty can have these contributions: 1. Wanted signal level error 2. Interferer signal level error 3. Interferer ACLR 4. Interferer broadband noise Items 1 and 2 are assumed to be uncorrelated so can be root sum squared to provide the ratio error of the two signals. The Interferer ACLR or Broadband noise effect is systematic, and is added arithmetically. Test System uncertainty = [SQRT (wanted_level_error ² + interferer_level_error ²)] + ACLR effect + Broadband noise effect. <u>In-band blocking, using modulated interferer:</u> Broadband noise not applicable
7.6.3 Out-of-band blocking	Wanted signal, f ≤ 3.0GHz ±2.0 dB, Blocking, 1MHz < f _{interferer} ≤ 3GHz ±3.9 dB, Blocking, 3GHz < f _{interferer} ≤ 12.75GHz Wanted signal, 3.0GHz < f ≤ 4.2GHz ±2.2 dB, Blocking, 1MHz < f _{interferer} ≤ 3GHz ±4.0 dB, Blocking, 3GHz < f _{interferer} ≤ 12.75GHz Wanted signal, 4.2GHz < f ≤ 6GHz ±2.6 dB, Blocking, 1MHz < f _{interferer} ≤ 3GHz ±4.2 dB, Blocking, 3GHz < f _{interferer} ≤ 12.75GHz Uplink power measurement same as 6.2.1	Out of band blocking, using CW interferer: Interferer ACLR not applicable Impact of interferer Broadband noise 0.8dB Figures are combined to give Test System uncertainty, using formula given for 7.6.2
7.6.4 Narrow band blocking	Blocking ± 2.0dB, f ≤ 3.0GHz ± 2.4dB, 3.0GHz < f ≤ 4.2GHz ± 3.1dB, 4.2GHz < f ≤ 6.0GHz Uplink power measurement same as 6.2.1	Narrow band blocking, using CW interferer: Interferer ACLR not applicable Impact of interferer Broadband noise 0.8dB Figures are combined to give Test System uncertainty, using formula given for 7.6.2
7.6A.2 Inband Blocking for CA (Same MU apply to all subsections including 7.6A.2.1, 7.6A.2.2, 7.6A.2.3, 7.6A.2.4, etc.)	Same as 7.6.2 for each component carrier	Same as 7.6.2 The wanted signal level uncertainty applies for each CC. Overall blocking uncertainty calculation includes the uncertainty for wanted level error only once, as the uncertainty of other CCs is not expected to have any significant effect.

7.6A.3 Out-of-band Blocking for CA (Same MU apply to all subsections including 7.6A.3.1, 7.6A.3.2, 7.6A.3.3, 7.6A.3.4, etc.)	Same as 7.6.3 for each component carrier	Same as 7.6.3 The wanted signal level uncertainty applies for each CC. Overall blocking uncertainty calculation includes the uncertainty for wanted level error only once, as the uncertainty of other CCs is not expected to have any significant effect.
7.6A.4 Narrow band Blocking for CA (Same MU apply to all subsections including 7.6A.4.1, 7.6A.4.2, 7.6A.4.3, 7.6A.4.4, etc.)	Same as 7.6.4 for each component carrier	Same as 7.6.4 The wanted signal level uncertainty applies for each CC. Overall blocking uncertainty calculation includes the uncertainty for wanted level error only once, as the uncertainty of other CCs is not expected to have any significant effect.
7.6C.2_1.1 Inband Blocking for SUL with 2 DL CA	Same as 7.6A.2	Same as 7.6A.2
7.6D.2 Inband blocking for UL MIMO	Blocking same as 7.6.2 Uplink power measurement same as 6.2D.1	The overall UL power is the linear sum of the output powers over all Tx antenna connectors
7.6D.3 Out-of-band blocking for UL MIMO	Wanted signal same as 7.6.3 Uplink power measurement same as 6.2D.1	The overall UL power is the linear sum of the output powers over all Tx antenna connectors
7.6D.4 Narrow-band blocking for UL MIMO	Blocking same as 7.6.4 Uplink power measurement same as 6.2D.1	The overall UL power is the linear sum of the output powers over all Tx antenna connectors
7.6F.2 In-band blocking for shared spectrum channel access	Blocking ± 3.0 dB, 4.2GHz < f \leq 5.925 GHz TBD, 5.925 GHz – 7.125 GHz Uplink power measurement same as 6.2F.1	Same as 7.6.2
7.7 Spurious response	Same as 7.6.3	Same as 7.6.3
7.7A Spurious response for CA (Same MU apply to all subsections including 7.7A.1, 7.7A.2, 7.7A.3, etc.)	Same as 7.6A.3	Same as 7.6A.3
7.7D Spurious response for UL MIMO	Same as 7.7 Uplink power measurement same as 6.2D.1	The overall UL power is the linear sum of the output powers over all Tx antenna connectors

7.8.2 Wide band Intermodulation	Intermodulation $\pm 2.3\text{dB}$, $f \leq 3.0\text{GHz}$ $\pm 3.1\text{dB}$, $3.0\text{GHz} < f \leq 4.2\text{GHz}$ $\pm 4.3\text{dB}$, $4.2\text{GHz} < f \leq 6.0\text{GHz}$ Uplink power measurement same as 6.2.1	Overall intermodulation uncertainty comprises three quantities: 1. Wanted signal level error 2. CW Interferer level error 3. Modulated Interferer level error Effect of interferer ACLR has not been included as modulated interferer has larger frequency offset The effect of the closer CW signal has twice the effect. Items 1, 2 and 3 are assumed to be uncorrelated so can be root sum squared to provide the combined effect of the three signals. Test System uncertainty = $\text{SQRT} [(2 \times \text{CW_level_error})^2 + (\text{mod interferer_level_error})^2 + (\text{wanted signal_level_error})^2]$
7.8A.2 Wide band Intermodulation for CA (Same MU apply to all subsections including 7.8A.1, 7.8A.2, 7.8A.3, etc.)	Same as 7.8.2 for each component carrier	Same as 7.8.2 The wanted signal level uncertainty applies for each CC. Overall intermodulation uncertainty calculation includes the uncertainty for wanted level error only once, as the uncertainty of other CCs is not expected to have any significant effect.
7.8D Intermodulation characteristics for UL MIMO	Intermodulation same as 7.8.2 Uplink power measurement same as 6.2D.1	The overall UL power is the linear sum of the output powers over all Tx antenna connectors
7.9 Spurious emissions	for results $> -60\text{ dBm}$: $\pm 2.0\text{ dB}$, $9\text{kHz} < f \leq 3\text{GHz}$ $\pm 2.5\text{ dB}$, $3\text{GHz} < f \leq 4\text{GHz}$ $\pm 4.0\text{ dB}$, $4\text{GHz} < f \leq 19\text{GHz}$ $\pm 6.0\text{ dB}$, $19\text{GHz} < f \leq 26\text{GHz}$	
7.9A.1 Spurious emissions for CA (2DL CA)	Same as 7.9	

F.2 Interpretation of measurement results (normative)

The measurement results returned by the Test System are compared – without any modification – against the Test Requirements. The Test Requirement is defined as a threshold considered in a test to assess compliance of the device; it might be either equal (“Shared Risk” principle) or relaxed (“Never fail a good DUT” principle) compared to the corresponding core specification value by an amount defined in Annex F.3 as Test Tolerance.

The “Shared Risk” and the “Never fail a good DUT” principles are defined in Rec. ITU-R M.1545.

The actual measurement uncertainty of the Test System for the measurement of each parameter shall be included in the test report.

The recorded value for the Test System uncertainty shall be, for each measurement, equal to or lower than the appropriate figure in clause F.1 of the present document.

If the Test System for a test is known to have a measurement uncertainty greater than that specified in clause F.1, it is still permitted to use this apparatus provided that an adjustment is made value as follows:

Any additional uncertainty in the Test System over and above that specified in clause F.1 shall be used to tighten the Test Requirement, making the test harder to pass. For some tests, for example receiver tests, this may require modification of stimulus signals. This procedure will ensure that a Test System not compliant with clause F.1 does not

increase the chance of passing a device under test where that device would otherwise have failed the test if a Test System compliant with clause F.1 had been used.

F.3 Test Tolerance and Derivation of Test Requirements (informative)

The Test Requirements in the present document have been calculated by relaxing the Minimum Requirements of the core specification using the Test Tolerances defined in this clause. When the Test Tolerance is zero, the Test Requirement will be the same as the Minimum Requirement. When the Test Tolerance is non-zero, the Test Requirements will differ from the Minimum Requirements, and the formula used for the relaxation is given in this clause.

The Test Tolerances are derived from Test System uncertainties, regulatory requirements and criticality to system performance. As a result, the Test Tolerances may sometimes be set to zero.

The test tolerances should not be modified for any reason e.g. to take account of commonly known test system errors (such as mismatch, cable loss, etc.).

The downlink Test Tolerances apply at each receiver antenna connector.

F.3.1 Measurement of test environments

The UE test environments are set to the values defined in TS 38.508-1 subclause 4.1, without any relaxation. The applied Test Tolerance is therefore zero.

F.3.2 Measurement of transmitter

Table F.3.2-1: Derivation of Test Requirements (Transmitter tests)

Sub clause	Test Tolerance (TT)	Formula for test requirement
6.2.1 UE maximum output power	$f \leq 3.0\text{GHz}$ 0.7 dB, $\text{BW} \leq 40\text{MHz}$ 1.0 dB, $40\text{MHz} < \text{BW} \leq 100\text{MHz}$ $3.0\text{GHz} < f \leq 6.0\text{GHz}$ 1.0 dB, $\text{BW} \leq 100\text{MHz}$	Upper limit + TT, Lower limit - TT
6.2.2 Maximum Power Reduction (MPR)	$f \leq 3.0\text{GHz}$ 0.7 dB, $\text{BW} \leq 40\text{MHz}$ 1.0 dB, $40\text{MHz} < \text{BW} \leq 100\text{MHz}$ $3.0\text{GHz} < f \leq 6.0\text{GHz}$ 1.0 dB, $\text{BW} \leq 100\text{MHz}$	Upper limit + TT, Lower limit - TT
6.2.3 UE additional maximum output power reduction	$f \leq 3.0\text{GHz}$ 0.7 dB, $\text{BW} \leq 40\text{MHz}$ 1.0 dB, $40\text{MHz} < \text{BW} \leq 100\text{MHz}$ $3.0\text{GHz} < f \leq 6.0\text{GHz}$ 1.0 dB, $\text{BW} \leq 100\text{MHz}$	Upper limit + TT, Lower limit - TT
6.2.4 Configured transmitted power	$f \leq 3.0\text{GHz}$ 0.7 dB, $\text{BW} \leq 40\text{MHz}$ 1.0 dB, $40\text{MHz} < \text{BW} \leq 100\text{MHz}$ $3.0\text{GHz} < f \leq 6.0\text{GHz}$ 1.0 dB, $\text{BW} \leq 100\text{MHz}$	Upper limit + TT, Lower limit - TT
6.2A.1.1 UE maximum output power for CA (2UL CA)	For Inter-band CA MAX (TT_{CC1} , TT_{CC2})	TT_{CCX} is TT of each UL CC specified in single UL case 6.2.1.
6.2A.2.1 UE maximum output power reduction for CA (2UL CA)	For Inter-band CA MAX (TT_{CC1} , TT_{CC2}) For intra-band contiguous CA Aggregated BW $\leq 100\text{M}$: same as 6.2.2 for sum of powers of all CCs Aggregated BW $> 100\text{M}$: TBD	TT_{CCX} is TT of each UL CC specified in single UL case 6.2.2.
6.2A.3.1 UE additional maximum output power reduction CA (2UL CA)	For Inter-band CA MAX (TT_{CC1} , TT_{CC2})	TT_{CCX} is TT of each UL CC specified in single UL case 6.2.3.
6.2A.4.1 Configured transmitted power for CA (2UL CA)	For Inter-band CA MAX (TT_{CC1} , TT_{CC2}) For intra-band contiguous CA Aggregated BW $\leq 100\text{M}$: same as 6.2.4 for sum of powers of all CCs Aggregated BW $> 100\text{M}$: TBD	TT_{CCX} is TT of each UL CC specified in single UL case 6.2.4.
6.2C.1 Configured transmitted power for SUL	Same as 6.2.4	Same as 6.2.4
6.2C.3 UE maximum output power for SUL	Same as 6.2.1	Same as 6.2.1
6.2C.4 UE maximum output power reduction for SUL	Same as 6.2.2	Same as 6.2.2
6.2C.5 UE additional maximum output power reduction for SUL	Same as 6.2.3	Same as 6.2.3
6.2D.1 UE maximum output power for UL MIMO	Same as 6.2.1 for the sum of power at each of UE antenna connector	Same as 6.2.1 Uplink power measurement applies to overall UL power, which is the linear sum of the output powers over all Tx antenna connectors
6.2D.2 UE maximum output power reduction for UL MIMO	Same as 6.2.2 for the sum of power at each of UE antenna connector	Same as 6.2.2 Uplink power measurement applies to overall UL power, which is the linear sum of the output powers over all Tx antenna connectors

6.2D.3 UE additional maximum output power reduction for UL MIMO	Same as 6.2.3 for the sum of power at each of UE antenna connector	Same as 6.2.3 Uplink power measurement applies to overall UL power, which is the linear sum of the output powers over all Tx antenna connectors
6.2D.4 Configured transmitted power for UL MIMO	Same as 6.2.4 for the sum of power at each of UE antenna connector	Same as 6.2.4 Uplink power measurement applies to overall UL power, which is the linear sum of the output powers over all Tx antenna connectors
6.2F.1 UE maximum output power for shared spectrum channel access	3.0GHz < f ≤ 5.925GHz 1.0 dB, BW ≤ 100MHz 5.925GHz < f ≤ 7.125GHz TBD	Upper limit + TT, Lower limit - TT
6.2F.3 UE additional maximum output power reduction for shared spectrum access	<u>Same as 6.2F.1</u>	<u>Same as 6.2F.</u>

6.2G.1 UE maximum output power for Tx Diversity	Same as 6.2.1 for the sum of power at each of UE antenna connector	Same as 6.2.1 Uplink power measurement applies to overall UL power, which is the linear sum of the output powers over both Tx antenna connectors
6.2G.2 UE maximum output power reduction for Tx Diversity	Same as 6.2.2 for the sum of power at each of UE antenna connector	Same as 6.2.2 Uplink power measurement applies to overall UL power, which is the linear sum of the output powers over both Tx antenna connectors
6.2G.3 UE additional maximum output power reduction for Tx Diversity	Same as 6.2.3 for the sum of power at each of UE antenna connector	Same as 6.2.3 Uplink power measurement applies to overall UL power, which is the linear sum of the output powers over both Tx antenna connectors
6.3.1 Minimum output power	$f \leq 3.0\text{GHz}$ 1.0 dB, $\text{BW} \leq 40\text{MHz}$ 1.3 dB, $40\text{MHz} < \text{BW} \leq 100\text{MHz}$ $3.0\text{GHz} < f \leq 6.0\text{GHz}$ 1.3 dB, $\text{BW} \leq 100\text{MHz}$	Minimum requirement + TT
6.3.2 Transmit OFF power	$f \leq 3.0\text{GHz}$ 1.5 dB, $\text{BW} \leq 40\text{MHz}$ 1.7 dB, $40\text{MHz} < \text{BW} \leq 100\text{MHz}$ $3.0\text{GHz} < f \leq 6.0\text{GHz}$ 1.8 dB, $\text{BW} \leq 100\text{MHz}$	Minimum requirement + TT
6.3.3.2 General ON/OFF time mask	$f \leq 3.0\text{GHz}$ 1.5 dB, $\text{BW} \leq 40\text{MHz}$ 1.7 dB, $40\text{MHz} < \text{BW} \leq 100\text{MHz}$ $3.0\text{GHz} < f \leq 6.0\text{GHz}$ 1.8 dB, $\text{BW} \leq 100\text{MHz}$	<u>OFF Power:</u> Minimum requirement + TT <u>ON Power:</u> Upper limit + TT, Lower limit - TT
6.3.3.4 PRACH time mask	$f \leq 3.0\text{GHz}$ 1.5 dB, $\text{BW} \leq 40\text{MHz}$ 1.7 dB, $40\text{MHz} < \text{BW} \leq 100\text{MHz}$ $3.0\text{GHz} < f \leq 6.0\text{GHz}$ 1.8 dB, $\text{BW} \leq 100\text{MHz}$	<u>OFF Power:</u> Minimum requirement + TT <u>ON Power:</u> Upper limit + TT, Lower limit - TT
6.3.3.6 SRS time mask	$f \leq 3.0\text{GHz}$ 1.5 dB, $\text{BW} \leq 40\text{MHz}$ 1.7 dB, $40\text{MHz} < \text{BW} \leq 100\text{MHz}$ $3.0\text{GHz} < f \leq 6.0\text{GHz}$ 1.8 dB, $\text{BW} \leq 100\text{MHz}$	<u>OFF Power:</u> Minimum requirement + TT <u>ON Power:</u> Upper limit + TT, Lower limit - TT
6.3.4.2 Absolute power tolerance	<u>UL Power $\geq 0\text{dBm}$</u> $f \leq 3.0\text{GHz}$ 1.0 dB, $\text{BW} \leq 40\text{MHz}$ 1.4 dB, $40\text{MHz} < \text{BW} \leq 100\text{MHz}$ $3.0\text{GHz} < f \leq 6.0\text{GHz}$ 1.4 dB, $\text{BW} \leq 100\text{MHz}$	Upper limit + TT, Lower limit – TT
6.3.4.3 Power Control Relative power tolerance	0.7 dB, $\text{BW} \leq 100\text{MHz}$	Upper limit + TT, Lower limit – TT
6.3.4.4 Aggregate power tolerance	0.7 dB, $\text{BW} \leq 100\text{MHz}$	Upper limit + TT, Lower limit – TT
6.3A.1.1 Minimum output power for CA (2UL CA)	Same as 6.3.1	Minimum requirement + TT
6.3A.3.1 Transmit ON/OFF time mask for CA (2UL CA)	Same as 6.3.3.2	Minimum requirement + TT
6.3A.3.1_1 Time mask for switching between two uplink carriers	FFS	

6.3A.4.1.1 Absolute power tolerance for CA (2UL CA)	Same as 6.3.4.2 for each CC	Upper limit + TT, Lower limit – TT
6.3A.4.2.1 Power Control Relative power tolerance for CA (2UL CA)	Same as 6.3.4.3 for each CC	Upper limit + TT, Lower limit – TT
6.3A.4.3.1 Aggregate power tolerance for CA (2UL CA)	Same as 6.3.4.4 for each CC	Upper limit + TT, Lower limit – TT
6.3C.1 Minimum output power for SUL	Same as 6.3.1	Same as 6.3.1
6.3C.2 Transmit OFF power for SUL	Same as 6.3.2	Same as 6.3.2
6.3C.3 Transmit ON/OFF time mask for SUL	Same as 6.3.3.2	Same as 6.3.3.2
6.3C.4.1 Absolute power tolerance for SUL	Same as 6.3.4.2	Same as 6.3.4.2
6.3C.4.2 Power Control Relative power tolerance for SUL	Same as 6.3.4.3	Same as 6.3.4.3
6.3C.4.3 Aggregate power tolerance for SUL	Same as 6.3.4.4	Same as 6.3.4.4
6.3D.1 Minimum output power for UL MIMO	Same as 6.3.1 for the sum of power at each of UE antenna connector	Same as 6.3.1 Uplink power measurement applies to overall UL power, which is the linear sum of the output powers over all Tx antenna connectors
6.3D.2 Transmit OFF power for UL MIMO	Same as 6.3.2 for each antenna	Same as 6.3.2 Uplink power measurement applies to each Tx antenna connector
6.3D.3 Transmit ON/OFF time mask for UL MIMO	ON power: Same as 6.2D.1 OFF power: Same as 6.3D.2	ON power: Same as 6.2D.1 OFF power: Same as 6.3D.2
6.3D.4.1 Absolute Power tolerance	Same as 6.3.4.2 for the sum of power at each of UE antenna connector	Same as 6.3.4.2 Uplink power measurement applies to overall UL power, which is the linear sum of the output powers over all Tx antenna connectors
6.3D.4.2 Relative Power tolerance	Same as 6.3.4.3 for the sum of power at each of UE antenna connector	Same as 6.3.4.3 Uplink power measurement applies to overall UL power, which is the linear sum of the output powers over all Tx antenna connectors
6.3D.4.3 Aggregate Power tolerance	Same as 6.3.4.4 for the sum of power at each of UE antenna connector	Same as 6.3.4.4 Uplink power measurement applies to overall UL power, which is the linear sum of the output powers over all Tx antenna connectors
6.3F.2 Transmit OFF power	$3.0\text{GHz} < f \leq 6.0\text{GHz}$ 1.8 dB, BW \leq 100MHz $5.925\text{GHz} < f \leq 7.125\text{GHz}$ TBD	Minimum requirement + TT
6.3F.3.2 General ON/OFF time mask	$3.0\text{GHz} < f \leq 6.0\text{GHz}$ 1.8 dB, BW \leq 100MHz $5.925\text{GHz} < f \leq 7.125\text{GHz}$ TBD	<u>OFF Power:</u> Minimum requirement + TT <u>ON Power:</u> Upper limit + TT, Lower limit - TT

6.4.1 Frequency Error	15 Hz	<u>Modulated carrier frequency:</u> Upper limit + TT, Lower limit – TT <u>DL power:</u> REFSENS + TT
6.4.2.1 Error Vector Magnitude	For up to 64QAM 0% For 256QAM $f \leq 6.0\text{GHz}$, $\text{BW} \leq 100\text{MHz}$ 0.3%, $15\text{dBm} < P_{\text{UL}}$ 0.8%, $-25\text{dBm} < P_{\text{UL}} \leq 15\text{dBm}$, 1.1%, $-40\text{dBm} \leq P_{\text{UL}} \leq -25\text{dBm}$	Minimum requirement + TT
6.4.2.1a Error Vector Magnitude including symbols with transient period	Same as 6.4.2.1	Same as 6.4.2.1
6.4.2.2 Carrier Leakage	0.8 dB, $\text{BW} \leq 100\text{MHz}$	Minimum requirement + TT
6.4.2.3 In-band emissions	0.8 dB, $\text{BW} \leq 100\text{MHz}$	Minimum requirement + TT
6.4.2.4 EVM equalizer spectrum flatness	1.4 dB, $\text{BW} \leq 100\text{MHz}$	Minimum requirement + TT
6.4.2.5 EVM equalizer spectrum flatness for Pi/2 BPSK	Same as 6.4.2.4	Minimum requirement + TT
6.4A.1.1 Frequency error for CA (2UL CA)	For inter-band CA: same as 6.4.1 for each CC	<u>Modulated carrier frequency:</u> Upper limit + TT, Lower limit – TT
6.4A.2.1.1 Error Vector Magnitude for CA (2UL CA)	For up to 64QAM 0% For 256QAM For inter-band CA: same as 6.4.2.1 for each CC	Minimum requirement + TT
6.4A.2.2.1 Carrier leakage for CA (2UL CA)	For inter-band CA: same as 6.4.2.2 for each CC	Minimum requirement + TT
6.4A.2.3.1 In-band emissions for CA (2UL CA)	For inter-band CA: same as 6.4.2.3 for each CC	Minimum requirement + TT
6.4C.1 Frequency error for SUL	Same as 6.4.1	Minimum requirement + TT
6.4C.2.1 Error Vector Magnitude for SUL	Same as 6.4.2.1	Minimum requirement + TT
6.4C.2.2 Carrier leakage for SUL	Same as 6.4.2.2	Minimum requirement + TT
6.4C.2.3 In-band emissions for SUL	Same as 6.4.2.3	Minimum requirement + TT
6.4C.2.4 EVM equalizer spectrum flatness for SUL	Same as 6.4.2.4	Minimum requirement + TT
6.4D.1 Frequency error for UL MIMO	Same as 6.4.1 for each antenna	Same as 6.4.1
6.4D.2.1 Error Vector Magnitude for UL MIMO	Same as 6.4.2.1 for each antenna	Same as 6.4.2.1 Uplink power measurement window applies to overall UL power, which is the linear sum of the output powers over all Tx antenna connectors
6.4D.2.2 Carrier leakage for UL MIMO	Same as 6.4.2.2 for each antenna	Same as 6.4.2.2 Uplink power measurement window applies to overall UL power, which is the linear sum of the output powers over all Tx antenna connectors
6.4D.2.3 In-band emissions for UL MIMO	Same as 6.4.2.3 for each antenna	Same as 6.4.2.3 Uplink power measurement window applies to overall UL power, which is the linear sum of the output powers over all Tx antenna connectors

6.4D.2.4 EVM equalizer spectrum flatness for UL MIMO	Same as 6.4.2.4 for each antenna	Same as 6.4.2.4
6.4D.3 Time alignment error for UL MIMO	25ns	Minimum Requirement + TT
6.4D.4 Requirements for Ccoherent UL MIMO	FFS	FFS
6.5.1 Occupied bandwidth	0 kHz	Minimum requirement + TT
6.5.2.2 Spectrum Emission Mask	1.5 dB, $f \leq 3.0\text{GHz}$ 1.8 dB, $3.0\text{GHz} < f \leq 6.0\text{GHz}$	Minimum requirement + TT
6.5.2.3 Additional spectrum emission mask	1.5 dB, $f \leq 3.0\text{GHz}$ 1.8 dB, $3.0\text{GHz} < f \leq 6.0\text{GHz}$	Minimum requirement + TT
6.5.2.4.1 NR ACLR	<u>Absolute requirement</u> 0 dB <u>Relative requirement</u> 0.8 dB	<u>Absolute requirement</u> ACLR Minimum Requirement + TT <u>Relative requirement</u> ACLR Minimum Requirement - TT
6.5.2.4.2 UTRA ACLR	Same as 6.5.2.4.1	Same as 6.5.2.4.1
6.5.3.1 General spurious emissions	0 dB	Minimum requirement + TT
6.5.3.2 Spurious emission for UE co-existence	0 dB	Minimum requirement + TT
6.5.3.3 Additional spurious emissions	0 dB	Minimum requirement + TT
6.5.4 Transmit intermodulation	0 dB	CW interferer Minimum Requirement - TT
6.5A.1 Occupied bandwidth for CA	For inter-band CA: same as 6.5.1 for each CC	
6.5A.2.2.1 Spectrum emission mask for CA (2UL CA)	For inter-band CA: same as 6.5.2.2 for each CC	Minimum requirement + TT
6.5A.2.4.1.1 NR ACLR for CA (2UL CA)	For inter-band CA: same as 6.5.2.4.1 for each CC	Same as 6.5.2.4.1
6.5A.2.4.2.1 UTRA ACLR for CA (2UL CA)	For inter-band CA: same as 6.5.2.4.2 for each CC	Same as 6.5.2.4.2
6.5A.3.1.1 General spurious emissions for CA (2UL CA)	0 dB	Minimum requirement + TT
6.5A.3.2.1 Spurious emissions for UE co-existence for CA (2UL CA)	0 dB	Minimum requirement + TT
6.5A.4.1 Transmit intermodulation for CA (2UL CA)	0 dB	CW interferer Minimum Requirement - TT
6.5C.1 Occupied bandwidth for SUL	Same as 6.5.1	Same as 6.5.1
6.5C.2.2 Spectrum Emission Mask for SUL	Same as 6.5.2.2	Same as 6.5.2.2
6.5C.2.3 Additional spectrum emission mask for SUL	Same as 6.5.2.3	Same as 6.5.2.3
6.5C.2.4.1 NR ACLR for SUL	Same as 6.5.2.4.1	Same as 6.5.2.4.1
6.5C.2.4.2 UTRA ACLR for SUL	Same as 6.5.2.4.2	Same as 6.5.2.4.2
6.5C.3.1 General spurious emissions for SUL	Same as 6.5.3.1	Same as 6.5.3.1
6.5C.3.2 Spurious emission for UE co-existence for SUL	Same as 6.5.3.2	Same as 6.5.3.2
6.5C.3.3 Additional spurious emissions for SUL	Same as 6.5.3.3	Same as 6.5.3.3
6.5C.4 Transmit intermodulation for SUL	Same as 6.5.4	Same as 6.5.4

6.5D.1 Occupied bandwidth for UL MIMO	Same as 6.5.1 for the sum of power at each of UE antenna connector	Same as 6.5.1 Uplink power measurement applies to overall UL power, which is the linear sum of the output powers over all Tx antenna connectors
6.5D.2.2 Spectrum emission mask for UL MIMO	Same as 6.5.2.2 for the sum of power at each of UE antenna connector	Same as 6.5.2.2 Uplink power measurement applies to overall UL power, which is the linear sum of the output powers over all Tx antenna connectors
6.5D.2.3 Additional spectrum emission mask for UL MIMO	Same as 6.5.2.3 for each antenna	Same as 6.5.2.3
6.5D.2.4.1 NR ACLR for UL MIMO	Same as 6.5.2.4.1 for the sum of power at each of UE antenna connector	Same as 6.5.2.4.1 Uplink power measurement applies to overall UL power, which is the linear sum of the output powers over all Tx antenna connectors
6.5D.2.4.2 UTRA ACLR for UL MIMO	Same as 6.5.2.4.2 for the sum of power at each of UE antenna connector	Same as 6.5.2.4.2 Uplink power measurement applies to overall UL power, which is the linear sum of the output powers over all Tx antenna connectors
6.5D.3.1 General spurious emissions for UL MIMO	Same as 6.5.3.1 for each antenna	Same as 6.5.3.1
6.5D.3.2 Spurious emissions for UE co-existence for UL MIMO	Same as 6.5.3.2 for each antenna	Same as 6.5.3.2
6.5D.3.3 Additional spurious emissions for UL MIMO	Same as 6.5.3.3 for each antenna	Same as 6.5.3.3
6.5D.3_1.1 General spurious emissions for UL MIMO (Rel-16 onward)	Same as 6.5.3.1 for the sum of power at each of UE antenna connector	Same as 6.5.3.1 Uplink power measurement applies to overall UL power, which is the linear sum of the output powers over all Tx antenna connectors
6.5D.3_1.2 Spurious emissions for UE co-existence for UL MIMO (Rel-16 onward)	Same as 6.5.3.2 for the sum of power at each of UE antenna connector	Same as 6.5.3.2 Uplink power measurement applies to overall UL power, which is the linear sum of the output powers over all Tx antenna connectors
6.5D.3_1.3 Additional spurious emissions for UL MIMO (Rel-16 onward)	Same as 6.5.3.3 for the sum of power at each of UE antenna connector	Same as 6.5.3.3 Uplink power measurement applies to overall UL power, which is the linear sum of the output powers over all Tx antenna connectors
6.5D.4 Transmit intermodulation for UL MIMO	Same as 6.5.4 for each antenna	Same as 6.5.4
6.5G.2.3.1 NR ACLR for Tx Diversity	Same as 6.5.2.4.1 for the sum of power at each of UE antenna connector	Same as 6.5.2.4.1 Uplink power measurement applies to overall UL power, which is the linear sum of the output powers over both Tx antenna connectors

F.3.3 Measurement of receiver

Table F.3.3-1: Derivation of Test Requirements (Receiver tests)

Sub clause	Test Tolerance (TT)	Formula for test requirement
7.3.2 Reference sensitivity power level	0.7 dB, $f \leq 3.0\text{GHz}$ 1.0 dB, $3.0\text{GHz} < f \leq 6.0\text{GHz}$	Reference sensitivity power level + TT T-put limit unchanged
7.3A Reference sensitivity for CA (Same TT apply to all subsections including 7.3A.1, 7.3A.2, 7.3A.3, 7.3A.4, etc.)	Same as 7.3.2 for each component carrier	Same as 7.3.2 for each component carrier
7.3C.2 Reference sensitivity power level	Same as 7.3.2	Same as 7.3.2
7.3D Reference sensitivity for MIMO	Same as 7.3.2	Same as 7.3.2
7.4 Maximum input level	0.7 dB, $f \leq 3.0\text{GHz}$ 1.0 dB, $3.0\text{GHz} < f \leq 6.0\text{GHz}$	Maximum input level - TT
7.4A Maximum input level for CA (Same TT apply to all subsections including 7.4A.1, 7.4A.2, 7.4A.3, 7.4A.4, etc.)	Same as 7.4 for each component carrier	Same as 7.4 for each component carrier
7.4D Maximum input level for UL MIMO	Same as 7.4	Same as 7.4 Uplink power measurement window applies to overall UL power, which is the linear sum of the output powers over all Tx antenna connectors
7.5 Adjacent channel selectivity	0 dB	Wanted signal power + TT Interferer signal power unchanged T-put limit unchanged
7.5A Adjacent channel selectivity for CA (Same TT apply to all subsections including 7.4A.1, 7.4A.2, 7.4A.3, 7.4A.4, etc.)	Same as 7.5 for each component carrier	Same as 7.5 for each component carrier
7.5D Adjacent channel selectivity for UL MIMO	Same as 7.5	Same as 7.5 Uplink power measurement window applies to overall UL power, which is the linear sum of the output powers over all Tx antenna connectors
7.5F.1 Adjacent channel selectivity for shared spectrum channel access	Same as 7.5	Same as 7.5
7.6.2 Inband Blocking	0 dB	Wanted signal power + TT Interferer signal power unchanged T-put limit unchanged
7.6.3 Out-of-band blocking	0 dB	Wanted signal power + TT Interferer signal power unchanged T-put limit unchanged
7.6.4 Narrow band blocking	0 dB	Wanted signal power + TT Interferer signal power unchanged T-put limit unchanged
7.6A.2 Inband Blocking for CA (Same TT apply to all subsections including 7.6A.2.1, 7.6A.2.2, 7.6A.2.3, 7.6A.2.4, etc.)	Same as 7.6.2 for each component carrier	Same as 7.6.2 for each component carrier

7.6A.3 Out-of-band Blocking for CA (Same TT apply to all subsections including 7.6A.3.1, 7.6A.3.2, 7.6A.3.3, 7.6A.3.4, etc.)	Same as 7.6.3 for each component carrier	Same as 7.6.3 for each component carrier
7.6A.4 Narrow band Blocking for CA (Same TT apply to all subsections including 7.6A.4.1, 7.6A.4.2, 7.6A.4.3, 7.6A.4.4, etc.)	Same as 7.6.4 for each component carrier	Same as 7.6.4 for each component carrier
7.6C.2 Inband Blocking for SUL	Same as 7.6.2	Same as 7.6.2
7.6C.2_1.1 Inband Blocking for SUL with 2 DL CA	Same as 7.6A.2	Same as 7.6A.2
7.6C.3 Out-of-band blocking for SUL	Same as 7.6.3	Same as 7.6.3
7.6D.2 Inband blocking for UL MIMO	Same as 7.6.2	Same as 7.6.2 Uplink power measurement window applies to overall UL power, which is the linear sum of the output powers over all Tx antenna connectors
7.6D.3 Out-of-band blocking for UL MIMO	Same as 7.6.3	Same as 7.6.3 Uplink power measurement window applies to overall UL power, which is the linear sum of the output powers over all Tx antenna connectors
7.6D.4 Narrow-band blocking for UL MIMO	Same as 7.6.4	Same as 7.6.4 Uplink power measurement window applies to overall UL power, which is the linear sum of the output powers over all Tx antenna connectors
7.6F.2 In-band blocking for shared spectrum channel access	Same as 7.6.2	Same as 7.6.2
7.7 Spurious response	0 dB	Wanted signal power + TT Interferer signal power unchanged T-put limit unchanged
7.7A Spurious response for CA (Same TT apply to all subsections including 7.7A.1, 7.7A.2, 7.7A.3, etc.)	Same as 7.7 for each component carrier	Same as 7.7 for each component carrier
7.7D Spurious response for UL MIMO	Same as 7.7	Same as 7.7 Uplink power measurement window applies to overall UL power, which is the linear sum of the output powers over all Tx antenna connectors
7.8.2 Wide band Intermodulation	0 dB	Wanted signal power +TT CW Interferer signal power unchanged Modulated Interferer signal power unchanged T-put limit unchanged
7.8A.2 Wide band Intermodulation for CA (Same TT apply to all subsections including 7.8A.1, 7.8A.2, 7.8A.3, etc.)	Same as 7.8.2 for each component carrier	Same as 7.8.2 for each component carrier

7.8D Intermodulation characteristics for UL MIMO	Same as 7.8.2	Same as 7.8.2 Uplink power measurement window applies to overall UL power, which is the linear sum of the output powers over all Tx antenna connectors
7.9 Spurious emissions	0 dB	Minimum requirement + TT
7.9A.1 Spurious emissions for CA (2DL CA)	Same as 7.9	Same as 7.9

F.4 Uplink power window

F.4.1 Introduction

A number of Tx and Rx Test cases set the UE uplink power to be within a defined window to ensure the test is carried out in the intended conditions. This clause gives the method for calculating the uplink power window used in Tx test cases and Rx Test cases.

F.4.2 Setting the power window above a requirement

F.4.2.1 NR FR1

The method used to derive the uplink power window is defined in TS 38.521-3 [14] clause F.4.2.1.

F.4.3 Setting the power window below a requirement

F.4.3.1 NR FR1

The method used to derive the uplink power window is defined in TS 38.521-3 [14] clause F.4.3.1.

F.4.4 Setting the power window centred on a target value

F.4.4.1 NR FR1

The method used to derive the uplink power window is defined in TS 38.521-3 [14] clause F.4.4.1.

Annex G (normative): Uplink Physical Channels

G.0 Uplink Signal Levels

Uplink signal power is a UE figure, which is configured by the Test System by means of:

RRC messages (IE-s), such as:

- PUSCH-PowerControl
- PUCCH-PowerControl
- RACH-ConfigGeneric
- SRS-Config

and L1/2 Power control commands (TPC).

The uplink power settings are specified in the test case.

Otherwise, the uplink power settings result from the default RRC messages described in TS 38.508 [5], and appropriate TPC-s, which are sent to the UE to transmit with an UL power level necessary for maintaining the call during the test.

G.1 General

This annex specifies the uplink physical channels that are needed for setting a connection and channels that are needed during a connection. Table G.1-1 describes the mapping of uplink physical channels and signals to physical resources

Table G.1-1: Mapping of uplink physical channels and signals to physical resources

Physical channel	Time Domain Location	Frequency Domain Location	Note
PRACH	Allowed by the parameter prach-ConfigurationIndex provided by higher layers	Allowed by the parameter msg1-FrequencyStart provided by higher layers	Mapping rule is specified in TS 38.211 [8] Section 6.3.3
DMRS	For DMRS on PUCCH format 1: Every other symbols i.e., 0, 2, 4... For DMRS on PUCCH format 2: All the PUCCH symbols For DMRS on PUCCH format 3,4: PUCCH length dependent For One symbol DMRS on PUSCH: Symbol 2,7 and 11 of each slot	DMRS on CP-OFDM PUSCH: Specified by the parameters <i>dmrs-Type</i> provided by higher layers. DMRS on DFT-OFDM PUSCH: Allowed for DMRS configuration type1 DMRS on PUCCH: PUCCH bandwidth dependent.	Mapping rule of DMRS for PUCCH is specified in TS 38.211 [8] Section 6.4.1.3 Mapping rule of DMRS for PUSCH is specified in TS 38.211 [8] Sections 6.4.1.1, 6.4.1.2
PUCCH	For PUCCH Format 0: 1 ~ 2 symbols each slot, specified by the parameters of <i>nrofSymbols</i> and <i>startingSymbolIndex</i> in PUCCH-format0 provided by the higher layer. For PUCCH Format 1: 4 ~ 14 symbols each slot, specified by the parameters of <i>nrofSymbols</i> and those of <i>startingSymbolIndex</i> of PUCCH-format1 provided by the higher layer. For PUCCH Format 2, 1 ~ 2 symbols each slot, specified by the parameters of <i>nrofSymbols</i> and <i>startingSymbolIndex</i> in PUCCH-format2 provided by the higher layer. For PUCCH Format 3: 4 ~ 14 symbols each slot, allowed by the parameters of <i>nrofSymbols</i> and <i>startingSymbolIndex</i> in PUCCH-format3, provided by the higher layer. For PUCCH Format 4: 4 ~ 14 symbols each slot, specified by the parameters of <i>nrofSymbols</i> and <i>startingSymbolIndex</i> in PUCCH-format4, provided by higher layer.	For PUCCH Format 0, 1 1 RB, the position specified by the parameters of <i>startingPRB</i> and <i>intraSlotFrequencyHopping</i> in the corresponding PUCCH-Resource provided by the higher layer. For PUCCH Format 2, 3: 1~16 RBs, specified by the parameter of <i>nrofPRBs</i> in PUCCH-format2 and PUCCH-format3 respectively; additionally the position specified by the parameters of <i>startingPRB</i> and <i>intraSlotFrequencyHopping</i> in the corresponding PUCCH-Resource provided by the higher layer. For PUCCH Format 4 1 RB, the position specified by the parameters of <i>startingPRB</i> and <i>intraSlotFrequencyHopping</i> in the corresponding PUCCH-Resource provided by the higher layer	Mapping rule is specified in TS 38.211 [8] Section 6.3.2 and 38.213 [9] Section 9.2
PUSCH	All remaining uplink symbols of each slot not allocated to DMRS	RBs allocated according to Reference Measurement channel in Annex A.2	Mapping rule is specified in TS 38.211 [8] Section 6.3 and 38.214 [12] Section 6.1
SRS	1, 2, or 4 symbols among the last 6 symbols in each SRS transmission slot specified by the parameters of <i>resourceMapping</i> , and <i>resourceType</i> in SRS-Config provided by the higher layer.	RBs specified by the ue-specific parameters of <i>freqDomainPosition</i> , <i>freqDomainShift</i> and <i>freqHopping</i> in SRS-Config provided by the higher layer.	Mapping rule is specified in TS 38.211 [8] Section 6.4.1.4.3

G.2 Set-up

Table G.2-1 describes the uplink physical channels that are required for connection set up.

Table G.2-1: Uplink Physical Channels required for connection set-up

Physical Channel
PRACH
PUCCH
PUSCH
PUCCH DMRS
PUSCH DMRS
SRS

In case of supplementary test, Table G.2-2 describes the supplementary uplink physical channels that are required for connection set-up, and unless stated otherwise, there is no other uplink physical channels configured on the NON-SUL carrier except PRACH.

Table G.2-2: Supplementary Uplink Physical Channels required for connection set-up

Physical Channel
PRACH
DMRS
PUCCH
PUSCH

G.3 Connection

The following clauses describes the uplink physical channels that are transmitted during a connection i.e., when measurements are done.

G.3.0 Measurement of Transmitter Characteristics

As specified in the test case. Otherwise:

- PUSCH + DMRS for PUSCH (and DMRS) measurements.
- PUCCH + DMRS for PUCCH (and DMRS) measurements.
- PRACH for PRACH measurements.

SRS for SRS measurements.

G.3.1 Measurement of Receiver Characteristics

As specified in the test case. Otherwise:

- PUSCH + DMRS for measurements with uplink interference configured.
- PUCCH + DMRS for measurements without uplink interference configured.

G.3.2 Measurement of Performance Requirements

As specified in the test case. Otherwise:

PUCCH + DMRS for measurements without CSI feedback, or with CSI feedback in PUCCH mode.

PUSCH + DMRS for measurements with CSI feedback in PUSCH mode.

Annex H (normative): Statistical Testing

H.1 General

This annex specifies mapping throughput to error ratio, pass fail limits and pass fail decision rules that are needed for measuring average throughput for a duration sufficient to achieve statistical significance for testing receiver characteristics.

H.2 Statistical testing of receiver characteristics

H.2.1 General

The test of receiver characteristics is twofold.

1. A signal or a combination of signals is offered to the RX port(s) of the receiver.
2. The ability of the receiver to demodulate /decode this signal is verified by measuring the throughput.

In (2) is the statistical aspect of the test and is treated here.

The minimum requirement for all receiver tests is >95% of the maximum throughput.

All receiver tests are performed in static propagation conditions. No fading conditions are applied.

H.2.2 Mapping throughput to error ratio

- a) The measured information bit throughput R is defined as the sum (in kilobits) of the information bit payloads successfully received during the test interval, divided by the duration of the test interval (in seconds).
- b) In measurement practice the UE indicates successfully received information bit payload by signalling an ACK to the SS.
If payload is received, but damaged and cannot be decoded, the UE signals a NACK.
- c) Only the ACK and NACK signals, not the data bits received, are accessible to the SS.
The number of bits is known in the SS from knowledge of what payload was sent.
- d) For the reference measurement channel, applied for testing, the number of bits is different in different slots, however in a radio frame it is fixed during one test.
- e) The time in the measurement interval is composed of successfully received slots (ACK), unsuccessfully received slots (NACK) and no reception at all (DTX-slots).
- f) DTX-slots may occur regularly according the applicable reference measurement channel (regDTX).
In real live networks this is the time when other UEs are served. In TDD these are the UL and special slots. regDTX vary from test to test but are fixed within the test.
- g) Additional DTX-slots occur statistically when the UE is not responding ACK or NACK where it should. (statDTX)
This may happen when the UE was not expecting data or decided that the data were not intended for it.

The pass / fail decision is done by observing the:

- number of NACKs
- number of ACKs and
- number of statDTXs (regDTX is implicitly known to the SS)

The ratio $(NACK + statDTX)/(NACK + statDTX + ACK)$ is the Error Ratio (ER). Taking into account the time consumed by the ACK, NACK, and DTX-TTIs (regular and statistical), ER can be mapped unambiguously to throughput for any single reference measurement channel test.

H.2.3 Design of the test

The test is defined by the following design principles (see clause H.2.6, Theory....):

1. The early decision concept is applied.
2. A second limit is introduced: Bad DUT factor $M > 1$
3. To decide the test pass:

Supplier risk is applied based on the Bad DUT quality

To decide the test fail

Customer Risk is applied based on the specified DUT quality

The test is defined by the following parameters:

1. Limit ER = 0.05 (Throughput limit = 95%)
2. Bad DUT factor $M = 1.5$ (selectivity)
3. Confidence level CL = 95% (for specified DUT and Bad DUT-quality)

H.2.4 Numerical definition of the pass fail limits

Table H.2.4-1: pass fail limits

ne	ns _p	ns _f	ne	ns _p	ns _f	ne	ns _p	ns _f	ne	ns _p	ns _f
0	67	NA	37	715	477	74	1290	1093	111	1847	1739
1	67	NA	38	731	493	75	1306	1110	112	1862	1756
2	95	NA	39	747	509	76	1321	1128	113	1877	1774
3	119	NA	40	763	525	77	1336	1145	114	1891	1792
4	141	NA	41	779	541	78	1351	1162	115	1906	1809
5	162	NA	42	795	557	79	1366	1179	116	1921	1827
6	183	NA	43	810	573	80	1382	1197	117	1936	1845
7	203	NA	44	826	590	81	1397	1214	118	1951	1863
8	222	NA	45	842	606	82	1412	1231	119	1966	1880
9	241	67	46	858	622	83	1427	1248	120	1981	1898
10	259	80	47	873	639	84	1442	1266	121	1995	1916
11	278	92	48	889	655	85	1457	1283	122	2010	1934
12	296	105	49	905	672	86	1472	1300	123	2025	1951
13	314	118	50	920	688	87	1487	1318	124	2040	1969
14	332	131	51	936	705	88	1503	1335	125	2055	1987
15	349	145	52	952	721	89	1518	1353	126	2069	2005
16	367	159	53	967	738	90	1533	1370	127	2084	2023
17	384	173	54	983	755	91	1548	1387	128	2099	2041
18	401	187	55	998	771	92	1563	1405	129	2114	2058
19	419	201	56	1014	788	93	1578	1422	130	2128	2076
20	436	216	57	1029	805	94	1593	1440	131	2143	2094
21	453	230	58	1045	822	95	1608	1457	132	2158	2112
22	469	245	59	1060	838	96	1623	1475	133	2173	2130
23	486	260	60	1076	855	97	1638	1492	134	2187	2148
24	503	275	61	1091	872	98	1653	1510	135	2202	2166
25	520	290	62	1107	889	99	1668	1527	136	2217	2183
26	536	305	63	1122	906	100	1683	1545	137	2232	2201
27	553	320	64	1137	923	101	1698	1562	138	2246	2219
28	569	335	65	1153	940	102	1713	1580	139	2261	2237
29	585	351	66	1168	957	103	1728	1598	140	2276	2255
30	602	366	67	1184	974	104	1742	1615	141	2291	2273
31	618	382	68	1199	991	105	1757	1633	142	2305	2291
32	634	398	69	1214	1008	106	1772	1650	143	2320	2309
33	651	413	70	1229	1025	107	1787	1668	144	2335	2327
34	667	429	71	1245	1042	108	1802	1686	145	2349	2345
35	683	445	72	1260	1059	109	1817	1703	146	2364	2363
36	699	461	73	1275	1076	110	1832	1721	*) note 2 in H.2.5		

NOTE 1: The first column is the number of errors (ne = number of NACK + statDTX)

NOTE 2: The second column is the number of samples for the pass limit (ns_p, ns=Number of Samples= number of NACK + statDTX + ACK)

NOTE 3: The third column is the number of samples for the fail limit (ns_f)

NOTE 4: The UE could be decided as early pass/fail when at least 67 samples are received. The ns_f is set to NA for ne less than 9.

H.2.5 Pass fail decision rules

The pass fail decision rules apply for a single measurement. A test case is passed only when all the measurements in the test case are passed.

Having observed 0 errors, pass the test at 67+ samples, otherwise continue

Having observed 1 error, pass the test at 95+ otherwise continue

Having observed 2 errors, pass the test at 119+ samples, otherwise continue

Etc. etc.

Having observed 14645 errors, pass the test at 23642349+ samples, fail the test at 2345- samples, otherwise continue

Having observed 152 errors, pass the test at + samples, fail the test at 2363- samples.

Where x+ means: x or more, x- means x or less

NOTE 1: an ideal DUT passes after 67 samples. The maximum test time is 2364 samples.

NOTE 2: It is allowed to deviate from the early decision concept by postponing the decision (pass/fail or continue). Postponing the decision to or beyond the end of Table H.2.4-1 requires a pass fail decision against the test limit: pass the DUT for $ER < 0.0618$, otherwise fail.

H.2.6 Theory to derive the pass fail limits (Informative)

Editor's note: This clause of the Annex H is for information only and it describes the background theory and information for statistical testing.

H.2.6.1 Numerical definition of the pass-fail limits

A statistical test is characterized by test time, selectivity and confidence level. The outcome of the statistical test is a decision. This decision may be correct, i.e., DUTs whose throughput is less than 95% maximum throughput being declared to fail, and DUTs whose throughput is higher or equal to 95% being declared to pass, or in-correct with opposite decision. The Confidence Level (CL) describes the probability that the decision is a correct one. The complement is the wrong decision probability (risk) $D = 1 - CL$.

As described in H.2.2, the measurement of throughput could be mapped to ER (Error Ratio). When testing ER, transport blocks or "samples" are observed and the number of correctly and erroneously received blocks are recorded. For a "standard" test, a pre-defined number of samples are observed, and a pass/fail decision is made based on the number of observed errors being above/below a threshold. This threshold is based on the targeted throughput or BLER and the design target CL. There is always some risk of a statistical variation leading to an incorrect pass/fail decision. The greater the number of samples that are recorded, the lower is the risk of such an error. The number of samples that are observed in a standard test is dimensioned to achieve an acceptable low risk of error (i.e., an acceptable high confidence level) for DUTs that just meet the specified limit.

The standard test works well where the target ER level is relatively high and confidence level relatively low (both are chosen to be on a comparable order of magnitude). However, for relatively low ER testing the length of time required for observing sufficient samples to achieve a 95% confidence level is excessive. In many cases, the DUTs will in fact have a much lower true ER level than the target ER level, (in which case, the number of samples needed to achieve high confidence that the true ER level is lower than the limit is much smaller). On the other hand, a bad DUT which is expected to fail the requirement might have a much higher true ER level (in which case, errors occur more frequently and it can be demonstrated that the DUT is above the target ER limit with fewer samples).

To avoid long test time, an alternative test method called early pass/fail is adopted. With the early pass/fail, each time a block error is encountered, a decision is made on whether the DUT can be passed/failed with 95% CL or the test needs to continue until another error is encountered. In the case of very good DUTs, the test can also be passed, when the number of samples permissible for one error event is reached and no error event is recorded. Pass/Fail is decided based on the total number of observed samples and errors, and a statistical calculation based on an inverse binomial cumulative distribution. The calculation involves one parameter, one variable and the result:

- Parameter: d (per step decision probability).

- Variable: ne (number of observed errors).
- Result: ns (number of expected samples for pass/fail, depending on which one is calculated).

The per step decision probability risk, d , expresses the probability of making an incorrect pass/fail decision in the current step (i.e., for the current decision coordinate). d is determined by simulation such that the overall risk of making a wrong decision over all steps of each test of a large number of tests on a large number of DUTs that exactly meet the target ER limit is $D=5\%$ (and hence the CL 95%).

It should be noted that d is determined separately considering early pass and early fail testing.

For a marginal DUT (i.e., a DUT almost exactly meeting the target ER level), the unmodified early pass/early fail approach is unable to distinguish whether the DUT has just passed or just failed the BLER ($\epsilon \rightarrow 0$), and can thus terminate with an "undecided" result. To avoid this undecided result and provide selectivity, a so-called "bad device factor" (M) is introduced into the early pass calculation. This factor biases the decision towards avoiding failing good DUT.

H.2.6.2 Simulation to derive the pass-fail limits for testing 95% throughput

As per the description in H.2.2, the 95% throughput measurement is mapped to $ER=0.05$, where ER is $(NACK + statDTX)/(NACK + statDTX + ACK)$.

The binomial distribution and its inverse are used to design the pass and fail limits. Note that this method is not unique and that other methods exist.

$$\text{fail}(ne, d_f) := \frac{ne}{ns_f} = \frac{ne}{(ne + qnbinom(d_f, ne, ER))}$$

$$\text{pass}(ne, cl_p, M) := \frac{ne}{ns_p} = \frac{ne}{(ne + qnbinom(cl_p, ne, ER \cdot M))}$$

Where

- $\text{fail}(\cdot)$ is the error ratio for the fail limit.
- $\text{pass}(\cdot)$ is the error ratio for the pass limit.
- ER is the specified error ratio 5%.
- ne is the number of bad results. This is the variable in both equations.
- M is the Bad DUT factor $M=1.5$.
- d_f is the wrong decision probability of a single (ne, ns) co-ordinate for the fail limit. It is found by simulation to be $d_f = 0.006$.
- cl_p is the confidence level of a single (ne, ns) co-ordinate for the pass limit. It is found by simulation to be $cl_p = 0.9945$.
- $qnbinom(\cdot)$: The inverse cumulative function of the negative binomial distribution.

The simulation works as follows:

- A large population of limit DUTs with true $ER = 0.05$ is decided against the pass and fail limits.
- cl_p and d_f are tuned such that CL (95 %) of the population passes and D (5 %) of the population fails.
- A population of Bad DUTs with true $ER = M \cdot 0.05$ is decided against the same pass and fail limits.
- cl_p and d_f are tuned such that CL (95 %) of the population fails and D (5 %) of the population passes.

- The number of DUTs decrease during the simulation, as the decided DUTs leave the population. That number decreases with an approximately exponential characteristics. After 146 bad results all DUTs of the population are decided.

NOTE: The exponential decrease of the population is an optimal design goal for the decision co-ordinates (n_e , n_s), which can be achieved with other formulas or methods as well.

H.2A Statistical testing of receiver characteristics with CA

H.2A.1 General

H.2A.1 applies.

H.2A.2 Mapping throughput to error ratio

H.2A.2 applies for each component carrier.

H.2A.3 Design of the test

The test is defined by the following design principles (see clause H.2.6, Theory....):

1. The standard concept is applied. (not the early decision concept).
2. A second limit is introduced, defining the Bad DUT.
3. To decide the test pass:
 - Supplier risk is applied based on the Bad DUT quality.
 - To decide the test fail.
 - Customer Risk is applied based on the specified DUT quality.

The test is defined by the following parameters:

- 1) Limit Error Ratio = 0.05 (95% throughput is tested).
- 2) Bad DUT factor $M=1.5$ (selectivity).
- 3) Confidence level $CL = 95\%$ (for specified DUT and Bad DUT-quality).

H.2A.4 Pass fail decision rules

Apply 1003 samples to the DUT per CC.

Decide pass per CC in case of ≤ 62 errors, otherwise fail.

NOTE 1: The pass fail decision is done individually for each CC. The pass fail decision for one measurement is as follows: pass if all CCs or SCC only according to the test cases pass, otherwise fail. A test case is passed only when all the measurements in the test case are passed.

NOTE 2: It is allowed to apply more samples to the DUT, common for all CCs, (e.g. up to an integer number of frames). Use the ratio (62/1003) for the pass fail decision.

NOTE 3: $62/1003 = 0.0618$, the same test limit is used at the end of Table H.2.4-1

Annex I (informative): Change history

Change history							
Date	Meeting	TDoc	CR	R ev	Cat	Subject/Comment	New versio n
2017-08	RAN5#76	R5-175705	-	-	-	Draft skeleton	0.0.1
2018-01	RAN5#1- 5G-NR Adhoc	R5-180068 R5-180069 R5-180070 R5-180071 R5-180072 R5-180073 R5-180075 R5-180076 R5-180077 R5-180078 R5-180079	-	-	-	Implementation of pCRs to TS 38.521-1 V0.1.0	0.1.0
2018-01	RAN5#78	R5-181506 R5-181507 R5-181670 R5-181671 R5-181672 R5-181676 R5-181677 R5-181678 R5-181679 R5-181685 R5-181686 R5-181698 R5-181699 R5-181700	-	-	-	Implementation of pCRs to TS 38.521-1 V0.2.0	0.2.0
2018-03	RAN5#2- 5G-NR Adhoc	R5-181759	-	-	-	Update TS 38.521-1 to align with new structure of TS 38.101-1 based on endorsed CR R4-1802403	0.3.0
2018-04	RAN5#2- 5G-NR Adhoc	R5-81976	-	-	-	3GU mismatch	0.3.1
2018-04	RAN5#2- 5G-NR Adhoc	R5-181771 R5-181833 R5-181842 R5-182000 R5-182002 R5-182003 R5-182004 R5-182005 R5-182020 R5-182021 R5-182026	-	-	-	Implementation of pCRs to TS 38.521-1 V0.4.0 Add clause 4.4 Test point analysis	0.4.0
2018-07	RAN5#79	R5-182768 R5-182973 R5-183702 R5-183703 R5-183704 R5-183705 R5-183906 R5-183936 R5-183280 R5-183923 R5-183953 R5-183954 R5-183955 R5-183956 R5-183957 R5-183958 R5-183959 R5-183960	-	-	-	Implementation of pCRs to TS 38.521-1 V0.5.0	0.5.0
2018-07	RAN5#79	R5-183960 R5-183279	-	-	-	Corrected Table numbering issues in subclause 6.5.2.4.1.4.2 Test procedure to capture R5-183960 changes into draft TS 38.521-1 v0.5.1	0.5.1
2018-07	RAN5#79	R5-182363	-	-	-	withdrawn	1.0.0

2018-08	RAN#80	R5-185321 R5-184298 R5-185305 R5-185322 R5-185323 R5-185495 R5-185444 R5-185565 R5-185445 R5-185524 R5-184572 R5-185390 R5-184574 R5-185521 R5-185408 R5-184822 R5-185446 R5-185324 R5-185447 R5-185411 R5-185413 R5-185496 R5-185414 R5-185415 R5-185325 R5-185500 R5-185501 R5-185312 R5-185326 R5-185315 R5-185317 R5-185320	-	-	-	Implementation of pCRs to TS 38.521-1 V1.0.1	1.0.1
2018-09	RAN#81	-	-	-	-	raised to v15.0.0 with editorial changes only	15.0.0
2018-12	RAN#82	R5-186604	0072	-	F	5G_FR1 Text update for 7.3 Reference sensitivity	15.1.0
2018-12	RAN#82	R5-186605	0073	-	F	5R_FR1 Text Update for 6.5.3.1_General spurious emissions	15.1.0
2018-12	RAN#82	R5-186606	0074	-	F	5R FR1 Text Update for 6.5.3.2 Spurious emission for UE co-existence	15.1.0
2018-12	RAN#82	R5-186670	0078	-	F	Updating test case 6.2.3 UE additional maximum output power reduction	15.1.0
2018-12	RAN#82	R5-186671	0079	-	F	Updating test case 6.5.2.3 Additional spectrum emission mask	15.1.0
2018-12	RAN#82	R5-186680	0080	-	F	Update of test case 6.5.2.4.2, UTRA ACLR in 38.521-1	15.1.0
2018-12	RAN#82	R5-186736	0084	-	F	Update of FR1 Transmit OFF power	15.1.0
2018-12	RAN#82	R5-186774	0088	-	F	Addition of 6.3D.1 Minimum output power for UL-MIMO	15.1.0
2018-12	RAN#82	R5-186776	0089	-	F	Addition of 6.3D.2 Transmit OFF power for UL-MIMO	15.1.0
2018-12	RAN#82	R5-186781	0090	-	F	Addition of 6.3D.3 Transmit ON/OFF time mask for UL-MIMO	15.1.0
2018-12	RAN#82	R5-186901	0091	-	F	Update SEM requirements to TS 38.101-1 v15.3.0	15.1.0
2018-12	RAN#82	R5-186902	0092	-	F	Update ACS and inband blocking test cases in TS 38.521-1	15.1.0
2018-12	RAN#82	R5-187034	0107	-	F	Adding edge allocation into common uplink configuration in 6.1	15.1.0
2018-12	RAN#82	R5-187038	0109	-	F	Update test points for multiple FR1 test cases	15.1.0
2018-12	RAN#82	R5-187149	0111	-	F	Updated to Annexes for FR1 tests	15.1.0
2018-12	RAN#82	R5-187150	0112	-	F	General clauses updated for TS38.521-1	15.1.0
2018-12	RAN#82	R5-187376	0120	-	F	Update of 6.2.1 MOP	15.1.0
2018-12	RAN#82	R5-187378	0122	-	F	Update of 6.3.1 Minimum Output Power	15.1.0
2018-12	RAN#82	R5-187379	0123	-	F	Update of 6.3.3.2 General ON/OFF time mask	15.1.0
2018-12	RAN#82	R5-187380	0124	-	F	Addition of 6.2D.1 MOP for MIMO	15.1.0
2018-12	RAN#82	R5-187381	0125	-	F	Addition of 6.2D.2 MPR for MIMO	15.1.0
2018-12	RAN#82	R5-187382	0126	-	F	Addition of 6.2D.4 Configured Output Power for MIMO	15.1.0
2018-12	RAN#82	R5-187383	0127	-	F	Addition of 6.4D.1 Frequency error for MIMO	15.1.0
2018-12	RAN#82	R5-187384	0128	-	F	Addition of 6.4D.2.1 EVM for MIMO	15.1.0
2018-12	RAN#82	R5-187385	0129	-	F	Addition of 6.4D.2.2 Carrier Leakage for MIMO	15.1.0
2018-12	RAN#82	R5-187386	0130	-	F	Addition of 6.4D.2.3 In-band emissions for MIMO	15.1.0
2018-12	RAN#82	R5-187387	0131	-	F	Addition of 6.4D.2.4 EVM equalizer spectrum flatness for MIMO	15.1.0
2018-12	RAN#82	R5-187395	0132	-	F	Update of test case 6.2.3 UE A-MPR, general	15.1.0
2018-12	RAN#82	R5-187397	0133	-	F	Update of test case 6.2.3 UE A-MPR, NS_04	15.1.0
2018-12	RAN#82	R5-187399	0134	-	F	Update of test case test case 6.5.2.3 Additional spectrum emission mask, NS_04	15.1.0
2018-12	RAN#82	R5-187421	0136	-	F	Introduction of TC 6.5D.1 Occupied bandwidth for UL MIMO	15.1.0
2018-12	RAN#82	R5-187422	0137	-	F	Introduction of TC 6.5D.2.2 Spectrum Emission Mask for UL MIMO	15.1.0
2018-12	RAN#82	R5-187423	0138	-	F	Introduction of TC 6.5D.2.3 Additional Spectrum Emission Mask for UL MIMO	15.1.0
2018-12	RAN#82	R5-187424	0139	-	F	Introduction of TC 6.5D.2.4.1 NR ACLR for UL MIMO	15.1.0
2018-12	RAN#82	R5-187425	0140	-	F	Introduction of TC 6.5D.2.4.2 UTRA ACLR for UL MIMO	15.1.0
2018-12	RAN#82	R5-187429	0144	-	F	Introduction of TC 6.5D.4 Transmit intermodulation for UL MIMO	15.1.0

2018-12	RAN#82	R5-187431	0146	-	F	Introduction of TC 7.4D Maximum input level for UL-MIMO	15.1.0
2018-12	RAN#82	R5-187432	0147	-	F	Updating of 6.2C.1 Configured transmitted power for SUL	15.1.0
2018-12	RAN#82	R5-187433	0148	-	F	Introduction of TC 6.5C.1 Occupied bandwidth for SUL	15.1.0
2018-12	RAN#82	R5-187434	0149	-	F	Introduction of TC 6.5C.2 Spectrum Emission Mask for SUL	15.1.0
2018-12	RAN#82	R5-187435	0150	-	F	Introduction of TC 6.5C.2.3 Additional Spectrum Emission Mask for SUL	15.1.0
2018-12	RAN#82	R5-187436	0151	-	F	Introduction of TC 6.5C.2.4.1 NR ACLR for SUL	15.1.0
2018-12	RAN#82	R5-187437	0152	-	F	Introduction of TC 6.5C.2.4.2 UTRA ACLR for SUL	15.1.0
2018-12	RAN#82	R5-187438	0153	-	F	Introduction of TC 6.5C.3.2 General spurious emissions for SUL	15.1.0
2018-12	RAN#82	R5-187439	0154	-	F	Introduction of TC 6.5C.3.3 Spurious Emission for UE co-existence for SUL	15.1.0
2018-12	RAN#82	R5-187440	0155	-	F	Introduction of TC 6.5C.3.4 Additional Spurious Emission for SUL	15.1.0
2018-12	RAN#82	R5-187455	0158	-	F	Updating test case 6.3.4.2 Absolute Power Tolerance	15.1.0
2018-12	RAN#82	R5-187456	0159	-	F	Updating test case 6.3.4.4 Aggregate Power Tolerance	15.1.0
2018-12	RAN#82	R5-187560	0162	-	F	Update to Table 5.3.5-1 in TS 38.521-1	15.1.0
2018-12	RAN#82	R5-187585	0164	-	F	Update of transmit signal quality test cases in 38.521-1	15.1.0
2018-12	RAN#82	R5-187615	0167	-	F	Introduction of TC 6.5D.3.1 General spurious emissions for UL MIMO	15.1.0
2018-12	RAN#82	R5-187616	0168	-	F	Introduction of TC 6.5D.3.2 Spurious Emission for UE co-existence for UL MIMO	15.1.0
2018-12	RAN#82	R5-187617	0169	-	F	Introduction of TC 6.5D.3.3 Additional Spurious Emission for UL MIMO	15.1.0
2018-12	RAN#82	R5-187618	0170	-	F	Updating of Uplink channel for SUL in Annex G	15.1.0
2018-12	RAN#82	R5-187804	0069	1	F	Editorial Cleaning up for description of test requirement in clause 6	15.1.0
2018-12	RAN#82	R5-187805	0063	1	F	Introduction of TC 7.7D Spurious response for UL-MIMO	15.1.0
2018-12	RAN#82	R5-187807	0113	1	F	Introduction of receiver spurious emission tests for FR1 SA	15.1.0
2018-12	RAN#82	R5-187810	0114	1	F	Introduction of wideband intermodulation tests for FR1 SA	15.1.0
2018-12	RAN#82	R5-187811	0145	1	F	Introduction of TC 7.3D Reference sensitivity for UL-MIMO	15.1.0
2018-12	RAN#82	R5-187812	0085	1	F	Update of operating bands and channel arrangement to TS 38.521-1	15.1.0
2018-12	RAN#82	R5-187888	0121	1	F	Update of 6.2.4 Configured Output Power	15.1.0
2018-12	RAN#82	R5-187890	0156	1	F	Introduction of TC 6.5C.4 Transmit intermodulation for SUL	15.1.0
2018-12	RAN#82	R5-187892	0108	1	F	Removing the Editor's notes of SA messages and procedures for all FR1 test cases	15.1.0
2018-12	RAN#82	R5-187893	0083	1	F	Update of FR1 6.2.2 MPR	15.1.0
2018-12	RAN#82	R5-187894	0086	1	F	Addition of Time alignment error for UL-MIMO to TS38.521-1	15.1.0
2018-12	RAN#82	R5-187895	0115	1	F	Introduction of New FR1 test case 6.3.3.6 SRS time mask	15.1.0
2018-12	RAN#82	R5-187896	0116	1	F	5G_FR1 Text update for 6.5.3.3 Additional Spurious emission	15.1.0
2018-12	RAN#82	R5-187897	0161	1	F	Update of test case 6.3.4.3, Power Control Relative power tolerance in 38.521-1	15.1.0
2018-12	RAN#82	R5-187898	0165	1	F	Addition of EVM equalizer spectral flatness test case 6.4.2.5 to TS 38.521-1	15.1.0
2018-12	RAN#82	R5-187899	0099	1	F	Introduction of test case for Frequency error for CA	15.1.0
2018-12	RAN#82	R5-187900	0100	1	F	Introduction of test cases for Transmit modulation quality for CA	15.1.0
2018-12	RAN#82	R5-187901	0101	1	F	Introduction of test case for Spectrum emission mask for Inter-band CA	15.1.0
2018-12	RAN#82	R5-187902	0102	1	F	Introduction of test case for NR ACLR for Inter-band CA	15.1.0
2018-12	RAN#82	R5-187903	0103	1	F	Introduction of test case for UTRA ACLR for Inter-band CA	15.1.0
2018-12	RAN#82	R5-187904	0104	1	F	Introduction of test case for General spurious emissions for Inter-band CA	15.1.0
2018-12	RAN#82	R5-187905	0105	1	F	Introduction of test case for Spurious emission for UE co-existence for CA	15.1.0
2018-12	RAN#82	R5-187906	0106	1	F	Introduction of test case for Transmit intermodulation for Inter-band CA	15.1.0
2018-12	RAN#82	R5-187911	0118	1	F	Addition of notes to clarify test point selection into general section of TS 38.521-1	15.1.0
2018-12	RAN#82	R5-187914	0163	1	F	Update of Global In-channel Tx Test Annex in 38.521-1	15.1.0
2018-12	RAN#82	R5-187915	0082	1	F	Introduction of FR1 7.4 Maximum input level	15.1.0
2018-12	RAN#82	R5-188032	0075	1	F	Addition of 6.3D.4.1 Absolute Power tolerance for UL-MIMO	15.1.0
2018-12	RAN#82	R5-188033	0076	1	F	Addition of 6.3D.4.2 Relative Power Tolerance for UL-MIMO	15.1.0
2018-12	RAN#82	R5-188034	0077	1	F	Addition of 6.3D.4.3 Aggregate Power tolerance for UL-MIMO	15.1.0
2018-12	RAN#82	R5-188035	0110	1	F	Update to FR1 test case 6.3.3.4 PRACH time mask	15.1.0
2018-12	RAN#82	R5-188206	0117	1	F	Introduction of New FR1 test case 6.3.3.7 PUSCH-PUCCH and PUSCH-SRS time masks	15.1.0
2018-12	RAN#82	R5-188207	0071	1	F	5G_FR1 Text update for 7.3A Reference sensitivity for CA	15.1.0
2018-12	RAN#82	R5-188208	0067	2	F	Updates of MU in TS 38.521-1 Annex F during RAN5#81	15.1.0
2018-12	RAN#82	R5-188209	0068	2	F	Updates of TT in TS 38.521-1 Annex F during RAN5#81	15.1.0
2018-12	RAN#82	R5-188210	0097	1	F	TDD configuration for UE Tx test in FR1	15.1.0
2018-12	RAN#82	R5-188211	0119	1	F	Core alignment CR to capture TS 38.101-1 updates during RAN4#89	15.1.0
2019-03	RAN#83	R5-191034	0228	-	F	Update Clause 2 of TS 38.521-1	15.2.0
2019-03	RAN#83	R5-191035	0229	-	F	Update Clause 3.2 of TS 38.521-1	15.2.0
2019-03	RAN#83	R5-191039	0232	-	F	Correction to TC 6.4A.2.1.1 Error Vector Magnitude for CA (2UL CA)	15.2.0

2019-03	RAN#83	R5-191088	0244	-	F	Editorial cleaning up of test configuration tables in TS 38.521-1	15.2.0
2019-03	RAN#83	R5-191089	0245	-	F	Editorial correction of core alignment in TS 38.521-1	15.2.0
2019-03	RAN#83	R5-191090	0246	-	F	Updates of TT in TS38.521-1 Annex F during RAN5#NR4	15.2.0
2019-03	RAN#83	R5-191156	0247	-	F	General clauses updated for TS38.521-1	15.2.0
2019-03	RAN#83	R5-191244	0249	-	F	Editorial change in 6.5.2.1 general section	15.2.0
2019-03	RAN#83	R5-191245	0250	-	F	Update ACS and Inband Blocking test cases in TS38.521-1	15.2.0
2019-03	RAN#83	R5-191258	0251	-	F	Update to FR1 test case 6.5.4 Transmit intermodulation	15.2.0
2019-03	RAN#83	R5-191262	0252	-	F	Update of TC 7.6.3 Out-of-band blocking	15.2.0
2019-03	RAN#83	R5-191264	0253	-	F	Introduction of TC 7.6.4 Narrow-band blocking	15.2.0
2019-03	RAN#83	R5-191265	0254	-	F	Introduction of TC 7.7 Spurious response	15.2.0
2019-03	RAN#83	R5-191338	0256	-	F	Update of test case 6.3.4.3, Power Control Relative power tolerance in 38.521-1	15.2.0
2019-03	RAN#83	R5-191465	0257	-	F	Correction of FR1 6.2.2 Maximum Power Reduction (MPR)	15.2.0
2019-03	RAN#83	R5-191506	0262	-	F	Shared Risk clarification in TS 38.521-1	15.2.0
2019-03	RAN#83	R5-191526	0263	-	F	Update to FR1 test case 6.3.3.6 SRS time mask	15.2.0
2019-03	RAN#83	R5-191675	0267	-	F	Addition of MU and TT for NR FR1 UL-MIMO test cases	15.2.0
2019-03	RAN#83	R5-191815	0272	-	F	OBW test procedure update for 38.521-1	15.2.0
2019-03	RAN#83	R5-191846	0277	-	F	FR1 Text update for 6.5.3.1 General spurious emission	15.2.0
2019-03	RAN#83	R5-191848	0278	-	F	Correction of errors in Table 6.1-1 of 38.521-1	15.2.0
2019-03	RAN#83	R5-191849	0279	-	F	FR1 Text update for 7.3C Reference sensitivity power level for SUL	15.2.0
2019-03	RAN#83	R5-191852	0280	-	F	FR1 Text update for 6.5.3.2 Spurious emission for UE co-existence	15.2.0
2019-03	RAN#83	R5-191854	0281	-	F	FR1 Text update for 7.3.2 Reference sensitivity power level	15.2.0
2019-03	RAN#83	R5-192088	0317	-	F	Test mode and test loop function activation in SA Tx RF test cases in TS 38.521-1	15.2.0
2019-03	RAN#83	R5-192089	0318	-	F	Test mode and test loop function activation in SA Rx RF test cases in TS 38.521-1	15.2.0
2019-03	RAN#83	R5-192121	0320	-	F	Update of Global In-channel Tx Test Annex for FR1	15.2.0
2019-03	RAN#83	R5-192402	0266	1	F	Update of FR1 6.2.4 Configured transmitted power	15.2.0
2019-03	RAN#83	R5-192407	0294	1	F	Update of time alignment error for UL MIMO FR1 6.4D.3	15.2.0
2019-03	RAN#83	R5-192408	0295	1	F	Introduction of TC 6.4D.4	15.2.0
2019-03	RAN#83	R5-192409	0309	1	F	Update of FR1 6.2.1 MOP	15.2.0
2019-03	RAN#83	R5-192411	0310	1	F	Update of FR1 6.3.1 Minimum Output Power	15.2.0
2019-03	RAN#83	R5-192412	0311	1	F	Addition of FR1 6.3A.1 minimum output power for CA	15.2.0
2019-03	RAN#83	R5-192413	0321	1	F	Update of transmit signal quality test cases for FR1	15.2.0
2019-03	RAN#83	R5-192414	0231	1	F	Introduction of TC 7.7A.0 Minimum conformance requirements	15.2.0
2019-03	RAN#83	R5-192416	0240	1	F	Update to Wideband Intermodulation for SA FR1	15.2.0
2019-03	RAN#83	R5-192417	0241	1	F	Updates to 7.9 spurious emission for SA in FR1	15.2.0
2019-03	RAN#83	R5-192418	0259	1	F	Introduction of FR1 7.6D.3 Out-of-band blocking for UL-MIMO	15.2.0
2019-03	RAN#83	R5-192419	0260	1	F	Introduction of FR1 7.6D.4 Narrow band blocking for UL-MIMO	15.2.0
2019-03	RAN#83	R5-192420	0261	1	F	Introduction of FR1 7.8D.2 Wide band Intermodulation for UL-MIMO	15.2.0
2019-03	RAN#83	R5-192421	0276	1	F	Correction of FR1 7.4 Maximum input level	15.2.0
2019-03	RAN#83	R5-192510	0322	1	F	Asymmetric CH BWs test configuration for Reference Sensitivity	15.2.0
2019-03	RAN#83	R5-192544	0230	1	F	Correction to TC 6.4A.2.2 Carrier leakage for CA	15.2.0
2019-03	RAN#83	R5-192545	0248	1	F	Update of test case 6.5.2.4.2, UTRA ACLR in 38.521-1	15.2.0
2019-03	RAN#83	R5-192547	0273	1	F	Update of FR1 6.2D.1 MOP for MIMO	15.2.0
2019-03	RAN#83	R5-192548	0275	1	F	Update of 6.2D.4 Configured Output Power for MIMO	15.2.0
2019-03	RAN#83	R5-192549	0284	1	F	Update of FR1 test case 6.3D.1 Minimum output power for UL-MIMO	15.2.0
2019-03	RAN#83	R5-192550	0296	1	F	Update of TC 6.5D.1	15.2.0
2019-03	RAN#83	R5-192551	0297	1	F	Update of TC 6.5D.2.2	15.2.0
2019-03	RAN#83	R5-192553	0298	1	F	Introduction of TC 6.5D.2.3	15.2.0
2019-03	RAN#83	R5-192554	0299	1	F	Update of TC 6.5D.2.4.1	15.2.0
2019-03	RAN#83	R5-192555	0300	1	F	Update of TC 6.5D.2.4.2	15.2.0
2019-03	RAN#83	R5-192556	0301	1	F	Update of 6.5D.3.1	15.2.0
2019-03	RAN#83	R5-192557	0302	1	F	Update of 6.5D.3.2	15.2.0
2019-03	RAN#83	R5-192558	0303	1	F	Update of 6.5D.3.3	15.2.0
2019-03	RAN#83	R5-192559	0304	1	F	Update of 6.5D.4	15.2.0
2019-03	RAN#83	R5-192561	0313	1	F	Addition of FR1 6.3A.3 Transmit ON/OFF time mask for CA	15.2.0
2019-03	RAN#83	R5-192562	0325	1	F	Update of FR1 6.2D.2 MPR for MIMO	15.2.0
2019-03	RAN#83	R5-192563	0233	1	F	Introduction of TC 7.7A.1 Spurious response for 2DL CA	15.2.0
2019-03	RAN#83	R5-192564	0234	1	F	Introduction of TC 7.7A.2 Spurious response for 3DL CA	15.2.0
2019-03	RAN#83	R5-192565	0235	1	F	Introduction of TC 7.7A.3 Spurious response for 4DL CA	15.2.0
2019-03	RAN#83	R5-192566	0258	1	F	Introduction of FR1 7.6D.2 Inband blocking for UL-MIMO	15.2.0
2019-03	RAN#83	R5-192567	0285	1	F	Update on TC 6.4A.1.1 Frequency error for CA	15.2.0
2019-03	RAN#83	R5-192570	0286	1	F	Update on TCs in section 6.4A.2 Transmit modulation quality for CA	15.2.0
2019-03	RAN#83	R5-192576	0287	1	F	Update on TC 6.5A.2.2.1 Spectrum emission mask for CA	15.2.0
2019-03	RAN#83	R5-192577	0288	1	F	Update on TC 6.5A.2.4.1.1 NR ACLR for CA	15.2.0
2019-03	RAN#83	R5-192578	0289	1	F	Update on TC 6.5A.2.4.2.1 UTRA ACLR for CA	15.2.0
2019-03	RAN#83	R5-192579	0290	1	F	Update on TC 6.5A.3.1.1 General spurious emissions for CA	15.2.0
2019-03	RAN#83	R5-192580	0291	1	F	Update on TC 6.5A.3.2.1 Spurious emissions for UE co-existence for CA	15.2.0
2019-03	RAN#83	R5-192581	0292	1	F	Update on TC 6.5A.4.1 TX IM for CA	15.2.0
2019-03	RAN#83	R5-192583	0268	1	F	Addition of 7.5A.0 Minimum conformance requirements	15.2.0

2019-03	RAN#83	R5-192584	0269	1	F	Addition of 7.5A.1 Adjacent channel selectivity for 2DL CA	15.2.0
2019-03	RAN#83	R5-192585	0270	1	F	Addition of 7.5A.2 Adjacent channel selectivity for 3DL CA	15.2.0
2019-03	RAN#83	R5-192586	0271	1	F	Addition of 7.5A.3 Adjacent channel selectivity for 4DL CA	15.2.0
2019-03	RAN#83	R5-192587	0282	1	F	FR1 Text update for 7.3A.2 Reference sensitivity power level for CA	15.2.0
2019-03	RAN#83	R5-192588	0283	1	F	FR1 Text update for 7.3.2_1 Reference sensitivity level with 4 Rx antenna ports	15.2.0
2019-03	RAN#83	R5-192589	0305	1	F	Update of 7.3D.2	15.2.0
2019-03	RAN#83	R5-192590	0306	1	F	Update of TC 7.4D	15.2.0
2019-03	RAN#83	R5-192591	0307	1	F	Introduction of TC 7.5D	15.2.0
2019-03	RAN#83	R5-192592	0324	1	F	Update of TC 7.7D Spurious response for UL-MIMO	15.2.0
2019-03	RAN#83	R5-192593	0243	1	F	Updates of TT in TS38.521-1 Annex F during RAN5#82	15.2.0
2019-03	RAN#83	R5-192594	0265	1	F	Correction of HARQ-ACK transmission timing for DL RMC for FR1 TDD SCS=60kHz	15.2.0
2019-03	RAN#83	R5-192597	0319	1	F	Updating test case 7.3.2 Reference sensitivity power level Table 7.3.2.4.1-3	15.2.0
2019-03	RAN#83	R5-192598	0323	1	F	Update OBW, SEM and ACLR in TS 38.521-1	15.2.0
2019-03	RAN#83	R5-192682	0236	1	F	Introduction of TC 7.9A.0 Minimum conformance requirements	15.2.0
2019-03	RAN#83	R5-192683	0237	1	F	Introduction of TC 7.9A.1 Spurious emission for 2DL CA	15.2.0
2019-03	RAN#83	R5-192685	0312	2	F	Addition of FR1 6.3A.2 Transmit OFF power for CA	15.2.0
2019-03	RAN#83	R5-192693	0293	1	F	Introduction of Annex on Characteristics of the Interfering Signal FR1	15.2.0
2019-03	RAN#83	R5-192837	0326	1	F	Update of operating bands and channel arrangement to TS 38.521-1	15.2.0
2019-03	RAN#83	-	-	-	-	Editorial correction of references to TS 38.508-1 clause 4.6 tables	15.2.0
2019-06	RAN#84	R5-193535	0389	-	F	Update of test case 6.5.2.4.2, UTRA ACLR in 38.521-1	15.3.0
2019-06	RAN#84	R5-193536	0390	-	F	Update of test case 6.3.4.3, Power Control Relative power tolerance	15.3.0
2019-06	RAN#84	R5-193567	0394	-	F	Correction of 38.521-1 7.6D.2	15.3.0
2019-06	RAN#84	R5-193569	0395	-	F	Correction of 38.521-1 7.6D.3	15.3.0
2019-06	RAN#84	R5-193571	0396	-	F	Correction of 38.521-1 7.6D.4	15.3.0
2019-06	RAN#84	R5-193573	0397	-	F	Correction of 38.521-1 7.8D.2	15.3.0
2019-06	RAN#84	R5-193574	0398	-	F	Correction of 38.521-1 6.2.2	15.3.0
2019-06	RAN#84	R5-193585	0400	-	F	Update of TC 7.7A.0 Spurious response for CA	15.3.0
2019-06	RAN#84	R5-193586	0401	-	F	Correction of section number for UE diagram in Initial conditions of 38.521-1 Clause 6	15.3.0
2019-06	RAN#84	R5-193589	0404	-	F	Correction of section number for UE diagram in Initial conditions of 38.521-1 Clause 7	15.3.0
2019-06	RAN#84	R5-193593	0405	-	F	Unify Outer_1RB and Edge_1RB in Test Configuration Table of 38.521-1	15.3.0
2019-06	RAN#84	R5-193753	0413	-	F	Update of 6.3D Output power dynamics for UL-MIMO	15.3.0
2019-06	RAN#84	R5-193915	0417	-	F	Update of NR FR1 6.2.3 A-MPR NS_04	15.3.0
2019-06	RAN#84	R5-193917	0418	-	F	Update of SA FR1 RF 6.5D.2.3	15.3.0
2019-06	RAN#84	R5-193918	0419	-	F	Update of SA FR1 RF 6.5D.2.4.2	15.3.0
2019-06	RAN#84	R5-193920	0420	-	F	Update of SA FR1 RF 6.5D.3.3	15.3.0
2019-06	RAN#84	R5-193930	0421	-	F	Addition of NR FR1 6.2D.3 A-MPR for UL-MIMO	15.3.0
2019-06	RAN#84	R5-193955	0423	-	F	Update of clause 5 to TS 38.521-1	15.3.0
2019-06	RAN#84	R5-194125	0425	-	F	Update Out of band emission test cases in TS 38.521-1	15.3.0
2019-06	RAN#84	R5-194126	0426	-	F	Update ACS and Inband blocking interferer definition in TS 38.521-1	15.3.0
2019-06	RAN#84	R5-194161	0428	-	F	Update of test case 6.2.3 UE A-MPR, NS_35	15.3.0
2019-06	RAN#84	R5-194162	0429	-	F	Update of test case 6.5.2.3; Additional spectrum emission mask	15.3.0
2019-06	RAN#84	R5-194226	0435	-	F	Correction to In-band emission test case	15.3.0
2019-06	RAN#84	R5-194228	0437	-	F	Correction to PRACH configurations	15.3.0
2019-06	RAN#84	R5-194256	0439	-	F	Correction to FR1 Reference Sensitivity	15.3.0
2019-06	RAN#84	R5-194268	0440	-	F	Update of 7.5A.0 Minimum conformance requirements	15.3.0
2019-06	RAN#84	R5-194304	0442	-	F	Correction to time domain allocation of DMRS	15.3.0
2019-06	RAN#84	R5-194305	0443	-	F	Updating 7.8.2 Wide band Intermodulation	15.3.0
2019-06	RAN#84	R5-194307	0445	-	F	Correction to ON/OFF time mask test	15.3.0
2019-06	RAN#84	R5-194308	0446	-	F	Correction to carrier leakage and in-band emission tests	15.3.0
2019-06	RAN#84	R5-194312	0447	-	F	FR1 Update for 7.3A Reference sensitivity for CA	15.3.0
2019-06	RAN#84	R5-194313	0448	-	F	FR1 Update for 7.3.2 Reference sensitivity power level	15.3.0
2019-06	RAN#84	R5-194314	0449	-	F	FR1 Update for 7.3.3 Ref sensitivity ?RIB,c	15.3.0
2019-06	RAN#84	R5-194315	0450	-	F	FR1 Update for 7.3C Reference sensitivity for SUL	15.3.0
2019-06	RAN#84	R5-194316	0451	-	F	FR1 Update for 6.5.3.2 Spurious emission for UE co-existence	15.3.0
2019-06	RAN#84	R5-194377	0454	-	F	FR1 Update for 6.5.3.3 Additional spurious emissions	15.3.0
2019-06	RAN#84	R5-194383	0455	-	F	Update of 7.5A.2 Adjacent channel selectivity for 3DL CA	15.3.0
2019-06	RAN#84	R5-194905	0414	1	F	Update of 6.3D.4.1 Absolute Power tolerance for UL-MIMO	15.3.0
2019-06	RAN#84	R5-194906	0415	1	F	Update of 6.3D.4.2 Relative Power Tolerance for UL-MIMO	15.3.0
2019-06	RAN#84	R5-194908	0465	1	F	Update of TC 6.3A.3 Transmit ON/OFF time mask for CA	15.3.0
2019-06	RAN#84	R5-194910	0463	1	F	Update of TC 6.3A.1 Minimum output power for CA FR1	15.3.0
2019-06	RAN#84	R5-194911	0434	1	F	Update of 6.2.3 for UE additional maximum output power reduction	15.3.0
2019-06	RAN#84	R5-194912	0430	1	F	Update of test case 6.2.3 UE A-MPR FR1, general part and minimum requirements	15.3.0
2019-06	RAN#84	R5-194915	0438	1	F	Correction to SRS time mask test	15.3.0

2019-06	RAN#84	R5-194916	0444	1	F	Correction to transmit signal quality test cases	15.3.0
2019-06	RAN#84	R5-194917	0461	1	F	Introduction of 6.2A.4.0.2 TIB for CA into Rel-15	15.3.0
2019-06	RAN#84	R5-194918	0468	1	F	Update of transmit signal quality test cases for FR1	15.3.0
2019-06	RAN#84	R5-194919	0407	1	F	Update of TC 7.9A.1 Spurious emissions for 2DL CA	15.3.0
2019-06	RAN#84	R5-194920	0456	1	F	Update of 7.5A.3 Adjacent channel selectivity for 4DL CA	15.3.0
2019-06	RAN#84	R5-194921	0469	1	F	Correction to FR1 Reference Sensitivity test configurations with n70	15.3.0
2019-06	RAN#84	R5-194922	0431	1	F	Update of clause 3 to TS 38.521-1	15.3.0
2019-06	RAN#84	R5-194923	0432	1	F	Update of clause 4 to TS 38.521-1	15.3.0
2019-06	RAN#84	R5-194924	0433	1	F	Update of clause 5 for operating bands and channel arrangement	15.3.0
2019-06	RAN#84	R5-194925	0452	1	F	General clause updated for FR1 spec	15.3.0
2019-06	RAN#84	R5-194926	0467	1	F	Update of Global In-channel Tx Test Annex for FR1	15.3.0
2019-06	RAN#84	R5-194957	0392	1	F	Updates of MU and TT in TS 38.521-1 Annex F during RAN5#NR5	15.3.0
2019-06	RAN#84	R5-194973	0402	1	F	Update of TC 7.9A.0 Spurious emissions for CA	15.3.0
2019-06	RAN#84	R5-194974	0403	1	F	Update of TC 7.7D Spurious response for UL-MIMO	15.3.0
2019-06	RAN#84	R5-195090	0470	1	F	Update of FR1 ON_ON time mask test cases	15.3.0
2019-06	RAN#84	R5-195092	0441	1	F	Update of 7.5A.1 Adjacent channel selectivity for 2DL CA	15.3.0
2019-06	RAN#84	R5-195140	0416	1	F	Update of 6.3D.4.3 Aggregate Power tolerance for UL-MIMO	15.3.0
2019-06	RAN#84	R5-195142	0422	1	F	Addition of TT values for NR FR1 UL-MIMO test cases	15.3.0
2019-06	RAN#84	R5-195143	0457	1	F	Introduction of Occupied bandwidth for Inter-band CA in NR SA FR1	15.3.0
2019-06	RAN#84	R5-195144	0458	1	F	Update of 6.4D.3 Time alignment error for UL-MIMO FR1	15.3.0
2019-06	RAN#84	R5-195145	0464	1	F	Update of TC 6.3A.2 Transmit OFF power for CA FR1	15.3.0
2019-06	RAN#84	R5-195198	0436	1	F	Correction to power control test cases	15.3.0
2019-06	RAN#84	R5-195403	0459	1	F	Addition of 6.2A.1.3 FR1 MOP for inter-band CA	15.3.0
2019-06	RAN#84	R5-195430	0393	1	F	Updates of MU and TT in TS 38.521-1	15.3.0
2019-06	RAN#84	R5-195431	0424	1	F	Core alignment with TS 38.101-1	15.3.0
2019-06	RAN#84	R5-193550	0391	-	F	Introduction of CA_n41A-n79A into Rel-16	16.0.0
2019-06	RAN#84	R5-195053	0462	1	F	Introduction of 6.2A.4.0.2 TIB for CA into Rel-16	16.0.0
2019-06	RAN#84	R5-195056	0399	1	F	Introduction of CA_n41 into Rel-16 TS 38.521-1	16.0.0
2019-06	RAN#84	R5-195405	0460	1	F	Introduction of 6.2A.1.3 FR1 MOP for inter-band CA into Rel-16	16.0.0
2019-09	RAN#85	R5-195732	0472	-	F	Update Clause 6.2A.4.0.2 TIB for CA	16.1.0
2019-09	RAN#85	R5-195804	0474	-	F	Update of UE A_MPR test case in 6.2.3	16.1.0
2019-09	RAN#85	R5-196191	0477	-	F	Update of Minimum conformance requirements and addition of test points in TC 6.2.2	16.1.0
2019-09	RAN#85	R5-196231	0483	-	F	Correction to 6.5.2.3 Additional spectrum emission mask	16.1.0
2019-09	RAN#85	R5-196233	0485	-	F	Correction to 6.3.4.3 Power Control Relative power tolerance	16.1.0
2019-09	RAN#85	R5-196234	0486	-	F	Correction to PUCCH format in EVM and In-band emissions test	16.1.0
2019-09	RAN#85	R5-196291	0488	-	F	Add Annex F.4 Uplink Power window explanation for SA test cases	16.1.0
2019-09	RAN#85	R5-196396	0489	-	F	Update of Minimum output power for CA FR1	16.1.0
2019-09	RAN#85	R5-196402	0492	-	F	Update of NR test case 6.2A.1-UE maximum output power for CA	16.1.0
2019-09	RAN#85	R5-196413	0498	-	F	Update of FR1 6.4D.1 Frequency error for UL MIMO	16.1.0
2019-09	RAN#85	R5-196421	0502	-	F	Update of FR1 6.4D.2.4 EVM equalizer spectrum flatness for UL MIMO	16.1.0
2019-09	RAN#85	R5-196425	0504	-	F	Update of DL RB allocation in Annex C	16.1.0
2019-09	RAN#85	R5-196481	0514	-	F	Remove references to 4Rx Reference Sensitivity test case 7.3.2_1 from Annex F	16.1.0
2019-09	RAN#85	R5-196499	0517	-	F	Updated to Annex A for RF FR1 tests	16.1.0
2019-09	RAN#85	R5-196500	0518	-	F	General clause updated for FR1 spec	16.1.0
2019-09	RAN#85	R5-196653	0521	-	F	Update TT for 6.3D.4.1	16.1.0
2019-09	RAN#85	R5-196696	0523	-	F	Update of Minimum conformance requirements and Test requirement in TC 7.4	16.1.0
2019-09	RAN#85	R5-196699	0524	-	F	Update of Minimum conformance requirements in TC 6.3.2	16.1.0
2019-09	RAN#85	R5-196711	0525	-	F	Addition of TT for 6.3D.4.2	16.1.0
2019-09	RAN#85	R5-196726	0526	-	F	Addition of TT for 6.3D.4.3	16.1.0

2019-09	RAN#85	R5-197307	0476	1	F	Update UL-MIMO to UL MIMO to align with RAN4 terminology in FR1	16.1.0
2019-09	RAN#85	R5-197308	0506	1	F	Update for 6.5.3.1 General spurious emissions	16.1.0
2019-09	RAN#85	R5-197309	0508	1	F	Update for 6.5.3.3 Additional spurious emissions	16.1.0
2019-09	RAN#85	R5-197312	0473	1	F	Update of Additional spectrum emission mask test case 6.5.2.3	16.1.0
2019-09	RAN#85	R5-197313	0480	1	F	Add TT to 6.3D.1 Minimum output power for UL-MIMO	16.1.0
2019-09	RAN#85	R5-197314	0484	1	F	Correction to PRACH configurations	16.1.0
2019-09	RAN#85	R5-197316	0494	1	F	Addition of NR test case 6.2A.3-UE additional maximum output power reduction for CA	16.1.0
2019-09	RAN#85	R5-197318	0495	1	F	Addition of NR test case 6.2A.4-Configured output power for CA	16.1.0
2019-09	RAN#85	R5-197319	0499	1	F	Update of FR1 6.4D.2.1 EVM for UL MIMO	16.1.0
2019-09	RAN#85	R5-197321	0500	1	F	Update of FR1 6.4D.2.2 Carrier leakage for UL MIMO	16.1.0
2019-09	RAN#85	R5-197324	0501	1	F	Update of FR1 6.4D.2.3 Inband emission for UL MIMO	16.1.0
2019-09	RAN#85	R5-197327	0511	1	F	Update for 7.3C.0 Minimum conformance requirements for SUL	16.1.0
2019-09	RAN#85	R5-197328	0512	1	F	Update for 7.3A.0 Minimum conformance requirements for CA	16.1.0
2019-09	RAN#85	R5-197329	0522	1	F	Update of Minimum conformance requirements and Test requirement in TCs 7.6.3 7.6.4 and 7.7	16.1.0
2019-09	RAN#85	R5-197330	0527	1	F	Update of 7.5A.0	16.1.0
2019-09	RAN#85	R5-197492	0503	1	F	Update of UL power configuration for ON/OFF and Absolute power tolerance	16.1.0
2019-09	RAN#85	R5-197514	0478	1	F	Correction of uplink power setting for SA FR1 transmitter test cases	16.1.0
2019-09	RAN#85	R5-197515	0479	1	F	Correction of uplink power setting for SA FR1 receiver test cases	16.1.0
2019-09	RAN#85	R5-197519	0493	1	F	Addition of NR test case 6.2A.2-UE maximum output power reduction for CA	16.1.0
2019-09	RAN#85	R5-197520	0497	1	F	Update of FR1 6.2D.1 MOP for UL MIMO	16.1.0
2019-09	RAN#85	R5-197521	0507	1	F	Update for 6.5.3.2 Spurious emission for UE co-existence	16.1.0
2019-09	RAN#85	R5-197522	0515	1	F	Update to Occupied bandwidth for CA in NR SA FR1	16.1.0
2019-09	RAN#85	R5-197523	0496	1	F	Addition of FR1 7.4A Maximum input level for CA	16.1.0
2019-09	RAN#85	R5-197608	0510	1	F	Update for 7.3C.2 Reference sensitivity power level for SUL	16.1.0
2019-09	RAN#85	R5-197609	0513	1	F	Update for 7.3.2 Reference sensitivity power level	16.1.0
2019-09	RAN#85	R5-197610	0471	1	F	Updates of MU and TT in TS 38.521-1	16.1.0
2019-09	RAN#85	R5-197634	0475	2	F	Update of operating bands and channel arrangement to TS38.521-1 g00	16.1.0
2019-09	RAN#85	R5-197635	0491	2	F	Update of Transmit ON/OFF time mask for CA FR1	16.1.0
2019-09	RAN#85	R5-197639	0482	2	F	Correction to power control TC 6.3.4.2 and 6.3.4.4	16.1.0
2019-09	RAN#85	R5-197640	0509	2	F	Update for 7.3A Reference sensitivity for CA	16.1.0
2019-09	RAN#85	R5-197641	0528	2	F	Addition of the connection setup in TS 38.521-1	16.1.0
2019-10	RAN#85	-	-	-	-	Deletion of R5-197560 which was added by mistake but was withdrawn and belonged to another spec	16.1.1
2019-12	RAN#86	R5-197917	0705	-	F	Addition of FR1 SUL test case 6.2C.5	16.2.0
2019-12	RAN#86	R5-197923	0711	-	F	Editorial update of test case 6.4D.2.1	16.2.0

2019-12	RAN#86	R5-198044	0714	-	F	Update of Clause 7.9A.1 Spurious emission for 2DL CA	16.2.0
2019-12	RAN#86	R5-198103	0715	-	F	Correction of Clause 7.9 Spurious emissions	16.2.0
2019-12	RAN#86	R5-198134	0716	-	F	Updating incorrect note in test procedure	16.2.0
2019-12	RAN#86	R5-198237	0723	-	F	Alignment with core specification for test case 6.3.4.3	16.2.0
2019-12	RAN#86	R5-198397	0739	-	F	Correction to Test Configuration for In-band emissions	16.2.0
2019-12	RAN#86	R5-198398	0740	-	F	Editorial correction to test configuration table in MPR test	16.2.0
2019-12	RAN#86	R5-198399	0741	-	F	Correction to the test procedure for frequency error	16.2.0
2019-12	RAN#86	R5-198401	0743	-	F	Correction to Common Uplink Configuration	16.2.0
2019-12	RAN#86	R5-198479	0747	-	F	Correction of UL RMCs	16.2.0
2019-12	RAN#86	R5-198526	0753	-	F	Update of test case 6.2.3 UE A_MPR NS_43	16.2.0
2019-12	RAN#86	R5-198546	0760	-	F	Message Contents Update for TC 6.2.4 and 6.2D.4 of TS 38.521-1	16.2.0
2019-12	RAN#86	R5-198547	0761	-	F	Addition of NR FR1 intraband non-contiguous 2CA tests to 7.4A.1 and 7.5A.1 and updating 7.5A.1 to 38.521-1 to enable testing of CA combinations involving bands n66, n70 and n71	16.2.0
2019-12	RAN#86	R5-198635	0764	-	F	Updated to Annex A for RF FR1 tests	16.2.0
2019-12	RAN#86	R5-198747	0774	-	F	Update for 7.3.3	16.2.0
2019-12	RAN#86	R5-198755	0777	-	F	Introduction of n65 to 38.521-1 Chapter 7	16.2.0
2019-12	RAN#86	R5-199085	0701	1	F	Updates of MU and TT in TS 38.521-1	16.2.0
2019-12	RAN#86	R5-199308	0724	1	F	Correction of 6.3D.3 Transmit ONOFF time mask for UL-MIMO	16.2.0
2019-12	RAN#86	R5-199309	0725	1	F	Correction of 6.3D.4.1	16.2.0
2019-12	RAN#86	R5-199310	0727	1	F	Correction of 6.3D.4.2 Relative power tolerance for UL-MIMO	16.2.0
2019-12	RAN#86	R5-199311	0731	1	F	Corrections to 6.3A.1.1 Minimum output power for CA 2UL CA FR1	16.2.0
2019-12	RAN#86	R5-199313	0702	1	F	Update of FR1 SUL test case 6.2C.1	16.2.0
2019-12	RAN#86	R5-199314	0703	1	F	Addition of FR1 SUL test case 6.2C.3	16.2.0
2019-12	RAN#86	R5-199315	0704	1	F	Addition of FR1 SUL test case 6.2C.4	16.2.0
2019-12	RAN#86	R5-199316	0706	1	F	Addition of FR1 SUL test case 6.4C.1	16.2.0
2019-12	RAN#86	R5-199317	0707	1	F	Addition of FR1 SUL test case 6.4C.2.1	16.2.0
2019-12	RAN#86	R5-199318	0708	1	F	Addition of FR1 SUL test case 6.4C.2.2	16.2.0
2019-12	RAN#86	R5-199319	0709	1	F	Addition of FR1 SUL test case 6.4C.2.3	16.2.0
2019-12	RAN#86	R5-199320	0710	1	F	Addition of FR1 SUL test case 6.4C.2.4	16.2.0
2019-12	RAN#86	R5-199321	0712	1	F	Update test points in transmit quality to replace -40dBm by minimum output power	16.2.0
2019-12	RAN#86	R5-199322	0746	1	F	Correction to UL Power Control Window in FR1	16.2.0
2019-12	RAN#86	R5-199323	0749	1	F	Corrections on A-MPR requirements in 38.521-1	16.2.0
2019-12	RAN#86	R5-199324	0750	1	F	Update of UE A_MPR Minimum Conformance requirements in 6.2.3	16.2.0
2019-12	RAN#86	R5-199325	0751	1	F	Update of test case 6.2.3 for UE A_MPR, NS_03 and NS_03U	16.2.0
2019-12	RAN#86	R5-199329	0752	1	F	Update of test case 6.2.3 UE A_MPR, NS_05 and NS_05U	16.2.0
2019-12	RAN#86	R5-199330	0754	1	F	Update of test case 6.2.3 UE A_MPR NS_43U	16.2.0
2019-12	RAN#86	R5-199331	0755	1	F	Adding of test requirements for UE A_MPR NS_100	16.2.0

2019-12	RAN#86	R5-199332	0756	1	F	Adding of test requirements for UE A_MPR NS_18	16.2.0
2019-12	RAN#86	R5-199333	0758	1	F	Update of Additional spectrum emission mask test case in 6.5.2.3	16.2.0
2019-12	RAN#86	R5-199334	0775	1	F	Update for 6.5.3.3 Additional spurious emissions	16.2.0
2019-12	RAN#86	R5-199335	0718	1	F	Correction of test applicability and minimum conformance requirements for SA FR1 7.6.4	16.2.0
2019-12	RAN#86	R5-199336	0719	1	F	Correction of minimum conformance requirements for SA FR1 7.6.3 7.7 and 7.9	16.2.0
2019-12	RAN#86	R5-199337	0717	1	F	Correction and addition of uplink power measurement MUs for SA FR1 TCs	16.2.0
2019-12	RAN#86	R5-199338	0728	1	F	Update of Operating bands and Channel arrangement to TS 38.521-1 R15	16.2.0
2019-12	RAN#86	R5-199339	0766	1	F	Update of Annex C.3.1	16.2.0
2019-12	RAN#86	R5-199412	0765	1	F	Update of clause 5 for R16 CA configurations in 38.521-1	16.2.0
2019-12	RAN#86	R5-199433	0736	1	F	Addition of reference sensitivity test for NR CA combination n29-n66	16.2.0
2019-12	RAN#86	R5-199434	0729	1	F	Update of Operating bands and Channel arrangement to TS 38.521-1 R16	16.2.0
2019-12	RAN#86	R5-199435	0767	1	F	Introduction of n29 and n65 to 38.521-1 Chapter 5 and 6.2.1	16.2.0
2019-12	RAN#86	R5-199484	0720	1	F	Correction of test procedure of SA FR1 6.5.3.1	16.2.0
2019-12	RAN#86	R5-199485	0768	1	F	Update to ACLR test case	16.2.0
2019-12	RAN#86	R5-199486	0776	1	F	Update for 6.5.3.2 Spurious emission for UE co-existence	16.2.0
2019-12	RAN#86	R5-199490	0748	1	F	update of 7.5A.2	16.2.0
2019-12	RAN#86	R5-199491	0773	1	F	Update for 7.3C.0 Minimum conformance requirements for SUL	16.2.0
2019-12	RAN#86	R5-199493	0770	1	F	Add section 4.5 Applicability and test coverage rules	16.2.0
2019-12	RAN#86	R5-199502	0721	1	F	Correction of test description for SA FR1 6.5.2.4.2	16.2.0
2019-12	RAN#86	R5-199503	0730	1	F	Addition of almost contiguous allocation test points and update of minimum conformance requirements for SA FR1 6.2.2	16.2.0
2019-12	RAN#86	R5-199556	0735	1	F	Introduction of 3CA reference sensitivity case 7.3A.2 for NR and addition of reference sensitivity test for many combinations involving bands n66, n70 and n71 to 38.521-1	16.2.0
2019-12	RAN#86	R5-199557	0762	1	F	Introduction of CA blocking case 7.6A to 38.521-1	16.2.0
2019-12	RAN#86	R5-199563	0732	1	F	Addition of 7.6A.3.1 Out-of-band blocking for CA (2DL CA) for SA FR1	16.2.0
2019-12	RAN#86	R5-199564	0733	1	F	Addition of 7.6A.4.1 Narrow band blocking for CA (2DL CA) for SA FR1	16.2.0
2019-12	RAN#86	R5-199565	0734	1	F	Addition of 7.8A.2.1 Wide band Intermodulation for CA (2DL CA) for SA FR1	16.2.0
2020-03	RAN#87	R5-200393	0789		F	Adding MU and TT for FR1 Rx CA test cases	16.3.0
2020-03	RAN#87	R5-200397	0791		F	Updating power configuration for PRACH time mask	16.3.0
2020-03	RAN#87	R5-200438	0792		F	Clarification of measurement interval of frequency error in FR1	16.3.0
2020-03	RAN#87	R5-200440	0794		F	Correction to 6.3.4.3 Power Control Relative power tolerance	16.3.0
2020-03	RAN#87	R5-200441	0795		F	Correction to SEM and ACLR test cases	16.3.0
2020-03	RAN#87	R5-200443	0797		F	Correction to UL power window description for 6.3.4.4	16.3.0
2020-03	RAN#87	R5-200461	0798		F	Update of 7.6A.3.1 Out-of-band blocking for 2DL CA	16.3.0

2020-03	RAN#87	R5-200462	0799		F	Update of 7.6A.4.1 Narrow band blocking for 2DL CA	16.3.0
2020-03	RAN#87	R5-200463	0800		F	Update of 7.8A.2.1 Wide band Intermodulation for 2DL CA	16.3.0
2020-03	RAN#87	R5-200570	0804		F	Update of NR test case 6.5.3.2-Spurious emission for UE co-existence	16.3.0
2020-03	RAN#87	R5-200640	0808		F	Update of Minimum requirements of 6.2.2 UE maximum output power reduction	16.3.0
2020-03	RAN#87	R5-200658	0810		F	Update of 6.1 common part of Tx in TS38.521-1	16.3.0
2020-03	RAN#87	R5-200659	0811		F	Core spec alignment for test case 6.3.4.3 Relative power tolerance	16.3.0
2020-03	RAN#87	R5-200664	0812		F	Correction of UL configuration for almost contiguous allocation in 6.2.2	16.3.0
2020-03	RAN#87	R5-200666	0813		F	Update measurement bandwidth references in 6.5.4	16.3.0
2020-03	RAN#87	R5-200693	0814		F	Update for 6.5.3.2 Spurious emission for UE co-existence	16.3.0
2020-03	RAN#87	R5-200700	0817		F	Removal of square brackets for DCI format for test cases in 7.6 and 7.7 of SA FR1	16.3.0
2020-03	RAN#87	R5-200721	0818		F	Addition of new Rel-16 70MHz CBW for 6.3.2 and 7.4 of SA FR1	16.3.0
2020-03	RAN#87	R5-200725	0819		F	Correction of A-SE for NS_04	16.3.0
2020-03	RAN#87	R5-200755	0823		F	Removing text from a Void clause	16.3.0
2020-03	RAN#87	R5-200757	0825		F	Correction of A_MPR test for NS_05 and NS_05U	16.3.0
2020-03	RAN#87	R5-200759	0826		F	Update of test case 6.2.3 UE A_MPR, NS_37	16.3.0
2020-03	RAN#87	R5-200761	0827		F	Update of test case 6.2.3 UE A_MPR, NS_38	16.3.0
2020-03	RAN#87	R5-200763	0828		F	Update of test case 6.2.3 UE A_MPR, NS_39	16.3.0
2020-03	RAN#87	R5-200765	0829		F	Corrections of NS_43 in 38.521-1 section 6	16.3.0
2020-03	RAN#87	R5-200767	0830		F	Corrections of NS_43U in 38.521-1 section 6	16.3.0
2020-03	RAN#87	R5-200892	0815	1	F	Update for 6.5.3.3 Additional spurious emissions	16.3.0
2020-03	RAN#87	R5-200893	0809	1	F	Core spec alignment for 7.6.3 and 7.8	16.3.0
2020-03	RAN#87	R5-200895	0787	1	F	Introduction of n95 SUL band test cases	16.3.0
2020-03	RAN#87	R5-200906	0824	1	F	Aligning A-MPR clause with TS 38.101-1 Rel-15	16.3.0
2020-03	RAN#87	R5-200907	0781	1	F	Update of TC 7.7A.1	16.3.0
2020-03	RAN#87	R5-200908	0782	1	F	Update of Clause 4 in TS 38.521-1	16.3.0
2020-03	RAN#87	R5-200909	0783	1	F	Update of clause 5 to TS 38.521-1 in R15	16.3.0
2020-03	RAN#87	R5-200922	0822	1	F	Introduction of Rel-16 spurious emissions co-existence requirements for bands n48, n65 and n95	16.3.0
2020-03	RAN#87	R5-200924	0788	1	F	Adding statistical testing condition in Annex H for CA testing	16.3.0
2020-03	RAN#87	R5-200962	0786	1	F	Corrections to TC 6.3A.3 transmit On OFF time mask for CA FR1	16.3.0
2020-03	RAN#87	R5-200971	0780	1	F	Correction of reference numbers in TS 38.521-1	16.3.0
2020-03	RAN#87	R5-200972	0793	1	F	Correction to 6.2.3 A-MPR test case	16.3.0
2020-03	RAN#87	R5-200974	0802	1	F	Update of test requirements for NR test case 6.5D.2.2 and 6.5D.2.4	16.3.0
2020-03	RAN#87	R5-200975	0803	1	F	Update of NR SUL test cases	16.3.0
2020-03	RAN#87	R5-200976	0820	1	F	Update of NR test case 6.2.4-ConfigTP	16.3.0
2020-03	RAN#87	R5-200977	0805	1	F	Update of NR test case 7.4A Maximum input level for CA	16.3.0

2020-03	RAN#87	R5-200978	0806	1	F	Update of NR test case 7.6A.2 Inband Blocking for CA	16.3.0
2020-03	RAN#87	R5-200979	0821	1	F	Cleaning up of Rx 2DL CA test cases in FR1	16.3.0
2020-03	RAN#87	R5-201054	0785	1	F	Update of R16 new bands and CBWs to TS 38.521-1 clause 5	16.3.0
2020-03	RAN#87	R5-201069	0832	1	F	Adding n65 A-MPR and Emission Requirements	16.3.0
2020-03	RAN#87	R5-201247	0790	2	F	Cleaning up of power class 2 test cases in FR1	16.3.0
2020-03	RAN#87	R5-201238	0831	1	F	Corrections of NS_18 in 38.521-1 section 6	16.3.0
2020-06	RAN#88	R5-201597	0835	-	F	Correction of 4RX Reference requirement for n77 high range in 7.3.2	16.4.0
2020-06	RAN#88	R5-201598	0836	-	F	Correction of lower limit for test ID 55 in test 6.2.3	16.4.0
2020-06	RAN#88	R5-201734	0841	-	F	Addition of NR test case 6.3C.1 Minimum output power for SUL	16.4.0
2020-06	RAN#88	R5-201735	0842	-	F	Addition of NR test case 6.3C.2 Transmit OFF power for SUL	16.4.0
2020-06	RAN#88	R5-201736	0843	-	F	Addition of NR test case 6.3C.3 Transmit ON/OFF time mask for SUL	16.4.0
2020-06	RAN#88	R5-201739	0846	-	F	Addition of NR test case 6.3C.4.3 Aggregate power tolerance for SUL	16.4.0
2020-06	RAN#88	R5-201741	0848	-	F	Update of NR test case 6.5C.3.3-Additional spurious emissions for SUL	16.4.0
2020-06	RAN#88	R5-201742	0849	-	F	Update test description of NR test case 7.6.3-Out-of-band blocking	16.4.0
2020-06	RAN#88	R5-201744	0851	-	F	Addition of NR test case 7.6C.3 Out-of-band blocking for SUL	16.4.0
2020-06	RAN#88	R5-201745	0852	-	F	Update of Annex F.3.2 and F.3.3	16.4.0
2020-06	RAN#88	R5-201749	0854	-	F	Update of NR test case 7.4A.1 Maximum input level for 2DL CA	16.4.0
2020-06	RAN#88	R5-201750	0855	-	F	Addition of NR test case 7.4A.2 Maximum input level for 3DL CA	16.4.0
2020-06	RAN#88	R5-201752	0857	-	F	Addition of NR test case 7.6A.2.2 IBB for 3DL CA	16.4.0
2020-06	RAN#88	R5-201764	0861	-	F	Adding NS_27 A_MPR and Emission Requirements for band n48	16.4.0
2020-06	RAN#88	R5-201772	0865	-	F	Adding NS_47 A_MPR and Emission Requirements for band n41	16.4.0
2020-06	RAN#88	R5-201801	0866	-	F	Update of clause 5 to TS 38.521-1 in R15	16.4.0
2020-06	RAN#88	R5-201833	0867	-	F	Update of Refsense requirements for n79	16.4.0
2020-06	RAN#88	R5-201834	0868	-	F	Correction of FR1 PUCCH EVM definition	16.4.0
2020-06	RAN#88	R5-201845	0871	-	F	Editorial correction of 6.2.1 test requirements	16.4.0
2020-06	RAN#88	R5-201847	0873	-	F	Updating 6.3.4.3 alternating sub-test	16.4.0
2020-06	RAN#88	R5-201861	0875	-	F	Addition of asymmetric BW combination set 1 of n66	16.4.0
2020-06	RAN#88	R5-201934	0877	-	F	Update of Operating bands and Channel arrangement to TS 38.521-1 for R16 CADC configurations	16.4.0
2020-06	RAN#88	R5-202034	0883	-	F	Addition of new test case 7.6A.3.2 Out-of-band blocking for CA 3DL CA R16	16.4.0
2020-06	RAN#88	R5-202035	0884	-	F	Addition of new test case 7.6A.3.3 Out-of-band blocking for CA 4DL CA R16	16.4.0
2020-06	RAN#88	R5-202036	0885	-	F	Addition of new test case 7.6A.4.2 Narrow band blocking for CA 3DL CA R16	16.4.0
2020-06	RAN#88	R5-202037	0886	-	F	Addition of new test case 7.6A.4.3 Narrow band blocking for CA 4DL CA R16	16.4.0
2020-06	RAN#88	R5-202039	0888	-	F	Addition of new test case 7.8A.2.3 Wide band Intermodulation for CA 4DL CA R16	16.4.0

2020-06	RAN#88	R5-202041	0890	-	F	Correction of test procedure and some typos in 7.6A.4.1 Narrow band blocking for CA 2DL CA R16	16.4.0
2020-06	RAN#88	R5-202042	0891	-	F	Correction of test procedure and test requirement in 7.8A.2.1 R16	16.4.0
2020-06	RAN#88	R5-202109	0893	-	F	Correction to n70 asymmetric test points in Rx tests	16.4.0
2020-06	RAN#88	R5-202217	0899	-	F	Corrections on transmitter power for CA in 38.521-1	16.4.0
2020-06	RAN#88	R5-202422	0906	-	F	Update F.1.2 with Relative Uplink power measurement uncertainty as 6.3.4.3	16.4.0
2020-06	RAN#88	R5-202430	0909	-	F	Add Reference sensitivity requirement for n48	16.4.0
2020-06	RAN#88	R5-202484	0913	-	F	Update of Reference sensitivity power level for R16 new CBW of n1	16.4.0
2020-06	RAN#88	R5-202503	0914	-	F	CR on EVM Window Centre Timing Definition in FR1	16.4.0
2020-06	RAN#88	R5-202710	0840	1	F	Update of NR test case 6.2A.3 AMPR for CA	16.4.0
2020-06	RAN#88	R5-202711	0844	1	F	Addition of NR test case 6.3C.4.1-Absolute power tolerance for SUL	16.4.0
2020-06	RAN#88	R5-202712	0845	1	F	Addition of NR test case 6.3C.4.2 Power Control Relative power tolerance for SUL	16.4.0
2020-06	RAN#88	R5-202713	0847	1	F	Update of NR test case 6.5.2.4 ACLR	16.4.0
2020-06	RAN#88	R5-202714	0864	1	F	Update of test case 6.2.3 UE A_MPR, NS_42	16.4.0
2020-06	RAN#88	R5-202715	0905	1	F	Update Uplink power control window size for SA TX TCs	16.4.0
2020-06	RAN#88	R5-202716	0910	1	F	Update for 6.5.3.1 General spurious emissions	16.4.0
2020-06	RAN#88	R5-202717	0850	1	F	Addition of NR test case 7.6C.2-Inband Blocking for SUL	16.4.0
2020-06	RAN#88	R5-202718	0902	1	F	Update of UL configuration in REFSSENS	16.4.0
2020-06	RAN#88	R5-202719	0903	1	F	Diversity Characteristics requirements alignment	16.4.0
2020-06	RAN#88	R5-202765	0880	1	F	Updates to test case 6.5.2.2, Spectrum Emission Mask	16.4.0
2020-06	RAN#88	R5-202781	0859	1	F	Adding several new 2CA and 3CA combinations to 7.3A and corrections to 7.3A.1	16.4.0
2020-06	RAN#88	R5-202783	0881	1	F	Adding REFSSENS requirements for 30 MHz channel bandwidth in band n41	16.4.0
2020-06	RAN#88	R5-202791	0869	1	F	Update of general clause 7.1	16.4.0
2020-06	RAN#88	R5-202807	0904	1	F	Receiver characteristics testing update to 38.521-1	16.4.0
2020-06	RAN#88	R5-202821	0862	1	F	Update of test case 6.2.3 UE A_MPR, NS_40	16.4.0
2020-06	RAN#88	R5-202822	0863	1	F	Update of test case 6.2.3 UE A_MPR, NS_41	16.4.0
2020-06	RAN#88	R5-202823	0908	1	F	Update for 6.5.3.3 Additional spurious emissions	16.4.0
2020-06	RAN#88	R5-202860	0912	1	F	Update of Spurious emission for UE co-existence for CA_n1-n78	16.4.0
2020-06	RAN#88	R5-202886	0860	1	F	Aligning A-MPR clause with TS 38.101-1 Rel-15	16.4.0
2020-06	RAN#88	R5-202887	0894	1	F	NS_05 corrections related to n65	16.4.0
2020-06	RAN#88	R5-202888	0896	1	F	Corrections on network signalling value abbreviation in 38.521-1	16.4.0
2020-06	RAN#88	R5-202889	0897	1	F	Corrections on NS signalling label for band n39 in 38.521-1	16.4.0
2020-06	RAN#88	R5-202890	0900	1	F	Correction on txDirectCurrentLocation in FR1 SA tests	16.4.0
2020-06	RAN#88	R5-202891	0911	1	F	Updated MOP UL MIMO test case to include steps for per port testing	16.4.0
2020-06	RAN#88	R5-202892	0834	1	F	Correction and clarifications of default DL physical channels power in annex C	16.4.0

2020-06	RAN#88	R5-202927	0876	1	F	Update of Operating bands and Channel arrangement to TS 38.521-1 for R16 new bands and CBWs	16.4.0
2020-06	RAN#88	R5-202928	0856	1	F	Update for NR test case 7.6A.2.1 Inband Blocking for 2DL CA	16.4.0
2020-06	RAN#88	R5-202929	0887	1	F	Addition of new test case 7.8A.2.2 Wide band Intermodulation for CA 3DL CA R16	16.4.0
2020-06	RAN#88	R5-202930	0889	1	F	Correction of CW interference setting for OOB Inter-band 2DL CA in TC 7.6A.3.1 R16	16.4.0
2020-06	RAN#88	R5-202931	0892	1	F	Alignment of minimum conformance requirements in 7.6A.3.0 and 7.8A.2.0 with core spec R16	16.4.0
2020-06	RAN#88	R5-202940	0879	1	F	Updates to test case 6.5.2.4.1, NR ACLR	16.4.0
2020-06	RAN#88	R5-202941	0870	1	F	Skipping 2Rx testing on bands where UE support 4Rx for SA test cases	16.4.0
2020-06	RAN#88	R5-202942	0901	1	F	Re-organization of CA refsens test cases	16.4.0
2020-06	RAN#88	R5-202957	0853	1	F	Update of NR test case 6.2.2 UE maximum output power reduction	16.4.0
2020-09	RAN#89	R5-203260	0917	-	F	Adding NS_47 to Additional spurious emissions test case	16.5.0
2020-09	RAN#89	R5-203261	0918	-	F	Adding UL MIMO additional spurious emissions test for NS_47	16.5.0
2020-09	RAN#89	R5-203290	0926	-	F	Clarification of Interferer frequency selection in FR1 IBB test case 7.6.2	16.5.0
2020-09	RAN#89	R5-203291	0927	-	F	Correction of K1 to achieve PUCCH Format 3 in FDD in EVM and in-band emission	16.5.0
2020-09	RAN#89	R5-203572	0932	-	F	Corrected test config for NS_24 in additional spurious emission test 6.5.3.3	16.5.0
2020-09	RAN#89	R5-203678	0935	-	F	Adding MU and TTs for Inter-band UL CA test cases	16.5.0
2020-09	RAN#89	R5-203679	0936	-	F	Updating message content in SUL test cases	16.5.0
2020-09	RAN#89	R5-203682	0937	-	F	Updating test case 6.5A.2.4.1-NR ACLR for CA	16.5.0
2020-09	RAN#89	R5-203687	0939	-	F	Updating channel configurations for Intra-band UL contiguous CA	16.5.0
2020-09	RAN#89	R5-203688	0940	-	F	Updating intra-band CA UL and DL configurations	16.5.0
2020-09	RAN#89	R5-203689	0941	-	F	Adding MU and TTs for Intra-band UL CA test cases	16.5.0
2020-09	RAN#89	R5-203690	0942	-	F	Introduce general requirement for UL CA test cases	16.5.0
2020-09	RAN#89	R5-203691	0943	-	F	Updating NR test case 6.2A.1- MOP for CA	16.5.0
2020-09	RAN#89	R5-203696	0946	-	F	Addition of general clause 7.1A	16.5.0
2020-09	RAN#89	R5-203697	0947	-	F	Updating REFSENS minimum requirements for Intra-band non-contiguous CA	16.5.0
2020-09	RAN#89	R5-203698	0948	-	F	Update of 7.4A.2-Maximum input level for 3DL CA	16.5.0
2020-09	RAN#89	R5-203700	0950	-	F	Update of test case 7.6A.2-Inband blocking for CA	16.5.0
2020-09	RAN#89	R5-203701	0951	-	F	Update of test case 7.6A.2.2 Inband blocking for 3DL CA	16.5.0
2020-09	RAN#89	R5-203735	0956	-	F	Add intra-band contiguous CA to 6.3A.2	16.5.0
2020-09	RAN#89	R5-203748	0958	-	F	Change of RB allocation start for test case 6.3.4.3	16.5.0
2020-09	RAN#89	R5-203777	0960	-	F	Update of NR test case 6.2.1 UE MOP for n30	16.5.0
2020-09	RAN#89	R5-203778	0961	-	F	Update of NR test case 6.2.2 UE MPR for n30	16.5.0
2020-09	RAN#89	R5-203780	0962	-	F	Update of NR test case 6.2D.1 UE MOP for UL MIMO for n30	16.5.0

2020-09	RAN#89	R5-203783	0964	-	F	Update of NR test case 6.5.3.2 Spurious Emissions for UE Co-Ex for n30	16.5.0
2020-09	RAN#89	R5-203786	0965	-	F	Update of NR test case 7.3 UE Ref Sens for n30	16.5.0
2020-09	RAN#89	R5-203788	0967	-	F	Update of NR test case 7.6.3 UE OBB for n30	16.5.0
2020-09	RAN#89	R5-203789	0968	-	F	Update of NR test case 7.6.4 UE NBB for n30	16.5.0
2020-09	RAN#89	R5-203879	0972	-	F	Correction of diversity characteristics requirement in section 7.2	16.5.0
2020-09	RAN#89	R5-203880	0973	-	F	Correction of UE mean power requirements Table numbers in SEM and ACLR test cases for SA FR1	16.5.0
2020-09	RAN#89	R5-203881	0974	-	F	Adding NOTEs to the test requirement tables in 6.2D.2	16.5.0
2020-09	RAN#89	R5-203885	0978	-	F	Correction of test requirement for 6.2.1	16.5.0
2020-09	RAN#89	R5-203967	0983	-	F	Editorial correction of 6.2.4	16.5.0
2020-09	RAN#89	R5-204010	0986	-	F	Correction to target power level Pmin for SA UL MIMO TCs	16.5.0
2020-09	RAN#89	R5-204035	0987	-	F	Updating NR test case 7.6A.3 for n48	16.5.0
2020-09	RAN#89	R5-204040	0989	-	F	Update of NR test case 7.7A Spurious response for CA	16.5.0
2020-09	RAN#89	R5-204054	0990	-	F	Correction to test Configuration of flatness for Pi/2 BPSK	16.5.0
2020-09	RAN#89	R5-204103	0991	-	F	Correction of QPSK UL RMC	16.5.0
2020-09	RAN#89	R5-204195	0996	-	F	Update 6.5.3.2 Spurious emission for UE co-existence	16.5.0
2020-09	RAN#89	R5-204202	0997	-	F	Update for 7.3A.0 Minimum conformance requirements for CA	16.5.0
2020-09	RAN#89	R5-204263	1001	-	F	Update of CSI-RS definition for DL RMCs in TS 38.521-1	16.5.0
2020-09	RAN#89	R5-204711	0933	1	F	Updating 6.2A.3-AMPR for CA for NS_43 and NS_01,NS_43U and NS_01	16.5.0
2020-09	RAN#89	R5-204760	0934	1	F	Cleaning up of Tx inter-band CA test cases	16.5.0
2020-09	RAN#89	R5-204761	1000	1	F	Editorial correction to FR1 co-existence requirements	16.5.0
2020-09	RAN#89	R5-204762	0923	1	F	Update of clause5 into TS 38.521-1 R15	16.5.0
2020-09	RAN#89	R5-204807	0993	1	F	Update of UE co-existence for CA_n1-n78	16.5.0
2020-09	RAN#89	R5-204808	0925	1	F	Update of R16 CADC combos in TS 38.521-1	16.5.0
2020-09	RAN#89	R5-204823	0916	1	F	Correction of test frequencies for NS_47	16.5.0
2020-09	RAN#89	R5-204824	0919	1	F	Adding band n48 to maximum output power and maximum output power reduction tests	16.5.0
2020-09	RAN#89	R5-204825	0984	1	F	Addition of 25MHz for NR band n1	16.5.0
2020-09	RAN#89	R5-204826	0985	1	F	Addition of AMPR NS_48 for NR band n1	16.5.0
2020-09	RAN#89	R5-204827	0992	1	F	Addition of n1 R16 new CBW into 38.521-1 Refsense test	16.5.0
2020-09	RAN#89	R5-204828	0924	1	F	Update of R16 new bands and CBWs in 38.521-1	16.5.0
2020-09	RAN#89	R5-204832	0952	1	F	Introduce of new TC 6.3A.4.1	16.5.0
2020-09	RAN#89	R5-204833	0953	1	F	Introduce of new TC 6.3A.4.2	16.5.0
2020-09	RAN#89	R5-204834	0954	1	F	Introduce of new TC 6.3A.4.3	16.5.0
2020-09	RAN#89	R5-204835	0955	1	F	Add intra-band contiguous CA to 6.3A.1	16.5.0
2020-09	RAN#89	R5-204836	0957	1	F	Add intra-band contiguous CA to 6.3A.3	16.5.0
2020-09	RAN#89	R5-204837	0949	1	F	Adding band n48 for Blocking characteristics testing	16.5.0

2020-09	RAN#89	R5-204839	0995	1	F	Updated to FR1 general clauses for NRSL eV2X	16.5.0
2020-09	RAN#89	R5-204854	0959	1	F	Correct UE output power configuration to some UL MIMO cases	16.5.0
2020-09	RAN#89	R5-204855	0969	1	F	Removal of editor's note about missing of Rel-15 In-gap OOB blocking requirement in RAN4 spec	16.5.0
2020-09	RAN#89	R5-204897	0929	1	F	Update to 7.5A.2 ACS for 3DL CA	16.5.0
2020-09	RAN#89	R5-204898	0988	1	F	Update of NR test case 7.5A Adjacent Channel selectivity for CA	16.5.0
2020-09	RAN#89	R5-204905	0975	1	F	Correction of 6.2D.1 and Test applicability of 6.5.2.4.2	16.5.0
2020-09	RAN#89	R5-204906	0976	1	F	Correction of test requirement for 6.2.4	16.5.0
2020-09	RAN#89	R5-204907	0977	1	F	Addition of test procedure and test requirement for PC2 fallback to PC3 for network signalling value NS_04	16.5.0
2020-09	RAN#89	R5-204908	0979	1	F	Adding additional tolerance to test requirement of 6.2.1, 6.2.2, 6.2.3 and 6.2.4	16.5.0
2020-09	RAN#89	R5-204909	0980	1	F	Update of 6.2.3 for minimum conformance requirements for A-MPR	16.5.0
2020-09	RAN#89	R5-204910	0970	1	F	Alignment of requirements in 7.6.3 and 7.6A.3 with the core spec	16.5.0
2020-09	RAN#89	R5-204911	0971	1	F	Removal of SDL bands from single carrier Rx TCs 7.6.2, 7.6.3 and 7.6.4	16.5.0
2020-09	RAN#89	R5-204912	0981	1	F	Update of SA Rx test cases for 4Rx UEs	16.5.0
2020-09	RAN#89	R5-204913	0998	1	F	Update Uplink power control window size for SA RX TCs	16.5.0
2020-09	RAN#89	R5-204960	0928	1	F	Addition of test cases for n28 with CBW of 30MHz	16.5.0
2020-09	RAN#89	R5-204961	0922	1	F	n26 Rx requirements in 38.521-1	16.5.0
2020-09	RAN#89	R5-204962	0966	1	F	Update of NR test case 7.6.2 UE IBB for n30	16.5.0
2020-09	RAN#89	R5-204974	0945	1	F	Updating of NR test case 6.2A.4-Configured output power for CA	16.5.0
2020-09	RAN#89	R5-204980	0930	2	F	Corrections and additions to 7.3A	16.5.0
2020-09	RAN#89	R5-204981	0931	2	F	Completing 3CA Rx cases 7.5A.2 and 7.7A.2	16.5.0
2020-09	RAN#89	R5-204984	0944	1	F	Update of NR test case 6.2A.2-MPR for CA	16.5.0
2020-09	RAN#89	RP-201670	1002	-	F	Adding FR1 PDCCH Aggregation Level in Annex C.3	16.5.0
2020-12	RAN#90	R5-205252	1005	-	F	Adding NR Band n53 to UE maximum output power and MPR test cases	16.6.0
2020-12	RAN#90	R5-205254	1007	-	F	Adding NR Band n53 into Spurious emission for UE co-existence	16.6.0
2020-12	RAN#90	R5-205299	1011	-	F	Update of clause 5 in TS 38.521-1 R15	16.6.0
2020-12	RAN#90	R5-205490	1014	-	F	Update of Reference sensitivity power level for R16 new CBW of n3	16.6.0
2020-12	RAN#90	R5-205493	1015	-	F	Correction of diversity characteristics requirement in section 7.2	16.6.0
2020-12	RAN#90	R5-205494	1016	-	F	Correction of minimum conformance requirements and test requirement for narrow band blocking for Intra-band contiguous CA	16.6.0
2020-12	RAN#90	R5-205495	1017	-	F	Correction of Allocated slots per Frame for DL reference measurement channels	16.6.0
2020-12	RAN#90	R5-205535	1018	-	F	Correcting RB start for test case 6.3C.4.2	16.6.0
2020-12	RAN#90	R5-205537	1019	-	F	Update of NR test case 6.2.1 UE MOP for n14	16.6.0
2020-12	RAN#90	R5-205550	1023	-	F	Update of NR test case 7.3 UE Ref Sens for n14	16.6.0
2020-12	RAN#90	R5-205551	1024	-	F	Update of NR test case 7.6.2 UE IBB for n14	16.6.0
2020-12	RAN#90	R5-205552	1025	-	F	Update of NR test case 7.6.3 UE OBB for n14	16.6.0

2020-12	RAN#90	R5-205553	1026	-	F	Update of NR test case 7.6.4 UE NBB for n14	16.6.0
2020-12	RAN#90	R5-205557	1028	-	F	Updating abbreviation list	16.6.0
2020-12	RAN#90	R5-205569	1031	-	F	Adding 30 MHz channel bandwidth to test requirements for UL MIMO Spurious	16.6.0
2020-12	RAN#90	R5-205574	1032	-	F	Co-existence Table corrections related to n65	16.6.0
2020-12	RAN#90	R5-205700	1043	-	F	Addition of V2X reference measurement channels	16.6.0
2020-12	RAN#90	R5-205731	1045	-	F	Introduce General requirement for CA configurations	16.6.0
2020-12	RAN#90	R5-205732	1046	-	F	Adding RB allocation for channel BW 70MHz	16.6.0
2020-12	RAN#90	R5-205733	1047	-	F	Updating test configuration tables for intra-band UL CA test cases	16.6.0
2020-12	RAN#90	R5-205734	1048	-	F	Updating NR test case MOP for MIMO for several NR bands	16.6.0
2020-12	RAN#90	R5-205735	1049	-	F	Updating NR test case MPR for MIMO for several NR bands	16.6.0
2020-12	RAN#90	R5-205736	1050	-	F	Updating minimum requirement for OBW for inter-band CA	16.6.0
2020-12	RAN#90	R5-205737	1051	-	F	Update OBW testing for intra-band UL CA	16.6.0
2020-12	RAN#90	R5-205743	1055	-	F	Updating NR test case 7.4A.2-Maximum input level for 3 DL CA	16.6.0
2020-12	RAN#90	R5-205745	1056	-	F	Updating NR test case 7.5A.2- Adjacent channel selectivity for 3DL CA	16.6.0
2020-12	RAN#90	R5-205746	1057	-	F	Updating NR test case 7.6A.2.2- In-band Blocking for 3DL CA	16.6.0
2020-12	RAN#90	R5-205748	1058	-	F	Updating Narrow band blocking for CA for band n48	16.6.0
2020-12	RAN#90	R5-205790	1061	-	F	Removing the highest SCS from test configuration for Tx spurious emissions for UL MIMO	16.6.0
2020-12	RAN#90	R5-205791	1062	-	F	Update of MPR for PC3 half Pi BPSK DMRS in 6.2.2	16.6.0
2020-12	RAN#90	R5-205796	1066	-	F	Update of MOP for UL MIMO with ULFPTx in 6.2D.1	16.6.0
2020-12	RAN#90	R5-205799	1068	-	F	Addition of new test case 6.5D.3_1.2 UE co-existence spurious emissions for Rel-16 UL MIMO	16.6.0
2020-12	RAN#90	R5-205800	1069	-	F	Addition of new test case 6.5D.3_1.3 additional spurious emissions for Rel-16 UL MIMO	16.6.0
2020-12	RAN#90	R5-205852	1070	-	F	Correction of RAR timing for PRACH TC 6.3.3.4 and EVM TC 6.4.2.1	16.6.0
2020-12	RAN#90	R5-205872	1073	-	F	Editorial correction to minimum requirements of REFSENS for CA	16.6.0
2020-12	RAN#90	R5-205879	1075	-	F	Update of Rx test cases to add 40MHz for NR band n38	16.6.0
2020-12	RAN#90	R5-205882	1076	-	F	Update of A-MPR for NS_18	16.6.0
2020-12	RAN#90	R5-206022	1082	-	F	Update of 6.3.1 for UE minimum output power test	16.6.0
2020-12	RAN#90	R5-206088	1088	-	F	Correction to ASEM for NS_27	16.6.0
2020-12	RAN#90	R5-206160	1102	-	F	Correction of Test Message Table 6.3.3.4.4.3-2 in section 6.3.3.4	16.6.0
2020-12	RAN#90	R5-206638	1071	1	F	Handling of delta Tib for UE supporting multiple band combinations	16.6.0
2020-12	RAN#90	R5-206639	1077	1	F	Update of A-MPR for NS_46	16.6.0
2020-12	RAN#90	R5-206640	1090	1	F	Update for 6.5.3.2 Spurious emission for UE co-existence	16.6.0
2020-12	RAN#90	R5-206641	1092	1	F	Correction for 6.3.3.6 SRS time mask	16.6.0
2020-12	RAN#90	R5-206642	1098	1	F	Correction to spurious co-existence requirements for n28 and n83	16.6.0
2020-12	RAN#90	R5-206643	1044	1	F	CR to update DMRS position in UL RMC for FR1	16.6.0

2020-12	RAN#90	R5-206718	1037	1	F	Addition of UL CA combinations to maximum output power for Inter-band CA	16.6.0
2020-12	RAN#90	R5-206719	1035	1	F	Update of 7.5A.3 Adjacent channel selectivity for 4DL CA	16.6.0
2020-12	RAN#90	R5-206740	1006	1	F	Adding NR Band n53 to UE additional maximum output power reduction test cases	16.6.0
2020-12	RAN#90	R5-206741	1008	1	F	Adding NS_45 to Additional spurious emissions test case for NR Band n53	16.6.0
2020-12	RAN#90	R5-206742	1020	1	F	Update of NR test case 6.2.2 UE MPR for n14	16.6.0
2020-12	RAN#90	R5-206743	1021	1	F	Update of NR test case 6.2.3 UE A-MPR for n14	16.6.0
2020-12	RAN#90	R5-206744	1022	1	F	Update of NR test case 6.5.3.2 Spurious Emissions for UE Co-Ex for n14	16.6.0
2020-12	RAN#90	R5-206745	1029	1	F	Adding A-MPR test for band n30 with NS_21	16.6.0
2020-12	RAN#90	R5-206746	1030	1	F	Adding additional Spectrum emission test for band n30 with NS_21	16.6.0
2020-12	RAN#90	R5-206747	1041	1	F	Update of NR test case 6.5.2.3 Additional Spectrum Emission Mask for n30	16.6.0
2020-12	RAN#90	R5-206748	1074	1	F	Update of Tx test cases to add 40MHz for NR band n38	16.6.0
2020-12	RAN#90	R5-206749	1080	1	F	Correction of 6.3.2 for UE transmit OFF power test	16.6.0
2020-12	RAN#90	R5-206750	1096	1	F	Adding n26 Tx requirements	16.6.0
2020-12	RAN#90	R5-206751	1009	1	F	Adding NR Band n53 Receiver requirements	16.6.0
2020-12	RAN#90	R5-206761	1010	1	F	Update of Test case 6.3A.4.1	16.6.0
2020-12	RAN#90	R5-206762	1034	1	F	Update of Test case 6.3A.4.3	16.6.0
2020-12	RAN#90	R5-206763	1059	1	F	Updating NR test case 7.8A.2.2-Wide band Intermodulation for 3DL CA	16.6.0
2020-12	RAN#90	R5-206764	1078	1	F	Addition of 6.2E.1.1 V2X MOP for non-concurrent	16.6.0
2020-12	RAN#90	R5-206765	1079	1	F	Addition of 7.3E.2 V2X REFSSENS for non-concurrent	16.6.0
2020-12	RAN#90	R5-206766	1063	1	F	Update of SEM for PC3 half Pi BPSK DMRS in 6.5.2.2	16.6.0
2020-12	RAN#90	R5-206767	1064	1	F	Update of NR ACLR for PC3 half Pi BPSK DMRS in 6.5.2.4.1	16.6.0
2020-12	RAN#90	R5-206768	1067	1	F	Addition of new test case 6.5D.3_1.1 general spurious emissions for Rel-16 UL MIMO	16.6.0
2020-12	RAN#90	R5-206863	1060	1	F	Update of signalling configuration for almost contiguous allocation across clause 6	16.6.0
2020-12	RAN#90	R5-206864	1053	1	F	Updating NR test case REFSSENS for 2DL CA	16.6.0
2020-12	RAN#90	R5-206879	1036	1	F	Addition of 2UL CA exception to reference sensitivity test case	16.6.0
2020-12	RAN#90	R5-206880	1039	1	F	Update of Refsense test case for CA_n1A-n78A into 38.521-1	16.6.0
2020-12	RAN#90	R5-206881	1040	1	F	Update of Refsense test case for CA_n1A-n77A into 38.521-1	16.6.0
2020-12	RAN#90	R5-206882	1042	1	F	Update of R16 CADC configurations into 38.521-1 clause 5	16.6.0
2020-12	RAN#90	R5-206888	1089	1	F	Update for 6.5D.3.3 Additional spurious emissions for UL MIMO	16.6.0
2020-12	RAN#90	R5-206889	1094	1	F	Update for 6.5.3.3 Additional spurious emission	16.6.0
2020-12	RAN#90	R5-206890	1012	1	F	Update of R16 new band and CBWs into TS 38.521-1 clause 5	16.6.0
2020-12	RAN#90	R5-206891	1033	1	F	Update of Test case 6.3A.4.2	16.6.0
2020-12	RAN#90	R5-206892	1054	1	F	Updating NR test case REFSSENS for 3DL CA	16.6.0

2020-12	RAN#90	R5-206894	1027	1	F	Addition of test case 6.5D.1_1, Occupied bandwidth for UL MIMO (Rel-16 onward)	16.6.0
2020-12	RAN#90	R5-206901	1093	1	F	Update for 6.5A.3.2 Spurious emission for UE co-existence	16.6.0
2020-12	RAN#90	R5-206912	1091	1	F	Update for 6.5A.3.1 General spurious emissions for CA	16.6.0
2021-03	RAN#91	R5-210169	1106	-	F	Addition of TC 7.3A.0.3.2.4 RIB,c for four bands	16.7.0
2021-03	RAN#91	R5-210170	1107	-	F	Update of TC 7.7A.3	16.7.0
2021-03	RAN#91	R5-210290	1108	-	F	Clarification of uplink power measurement uncertainty in test case 6.3.4.3	16.7.0
2021-03	RAN#91	R5-210291	1109	-	F	Message exceptions definition in test case 6.2.2	16.7.0
2021-03	RAN#91	R5-210384	1114	-	F	Add TT to power control for UL CA	16.7.0
2021-03	RAN#91	R5-210385	1115	-	F	Update MU/TT on power control for UL CA	16.7.0
2021-03	RAN#91	R5-210419	1116	-	F	Addition of new test case 6.4E.2.2.1 Error Vector Magnitude for V2X for non-concurrent operation	16.7.0
2021-03	RAN#91	R5-210423	1118	-	F	Addition of 6.5E.2.2.1D	16.7.0
2021-03	RAN#91	R5-210424	1119	-	F	Addition of 6.5E.2.3.1	16.7.0
2021-03	RAN#91	R5-210425	1120	-	F	Addition of 6.5E.2.3.1D	16.7.0
2021-03	RAN#91	R5-210426	1121	-	F	Addition of 6.5E.2.4.1	16.7.0
2021-03	RAN#91	R5-210427	1122	-	F	Addition of 6.5E.2.4.1D	16.7.0
2021-03	RAN#91	R5-210428	1123	-	F	Addition of 6.5E.3.2.1	16.7.0
2021-03	RAN#91	R5-210429	1124	-	F	Addition of 6.5E.3.2.1D	16.7.0
2021-03	RAN#91	R5-210485	1125	-	F	Correction of test purpose for 6.3.2 and 6.3D.2	16.7.0
2021-03	RAN#91	R5-210487	1127	-	F	Editorial correction for error in Table 7.6.4.4.1-1	16.7.0
2021-03	RAN#91	R5-210539	1129	-	F	Introduction 4CA Reference Sensitivity test 7.3A.3	16.7.0
2021-03	RAN#91	R5-210540	1130	-	F	Introduction 4CA Maximum Input Level test 7.4A.3	16.7.0
2021-03	RAN#91	R5-210541	1131	-	F	Introduction 4CA In-Band Blocking test 7.6A.2.3	16.7.0
2021-03	RAN#91	R5-210723	1133	-	F	Omitting of FR1 Rx cases with UL-MIMO on TDD bands	16.7.0
2021-03	RAN#91	R5-210782	1136	-	F	Update of A-MPR minimum requirements for Rel-16 DMRS	16.7.0
2021-03	RAN#91	R5-210787	1139	-	F	Adding additional TP for half Pi BPSK DMRS to SEM test case for SUL	16.7.0
2021-03	RAN#91	R5-210788	1140	-	F	Adding additional TP for half Pi BPSK DMRS to NR ACLR test case for SUL	16.7.0
2021-03	RAN#91	R5-210793	1142	-	F	Update of the test configuration for carrier leakage for SUL	16.7.0
2021-03	RAN#91	R5-210899	1146	-	F	Removal of the highest SCS from test configuration for Tx spurious emissions for CA	16.7.0
2021-03	RAN#91	R5-210902	1147	-	F	Updating test case 7.3A.1_1 for 4Rx test requirements	16.7.0
2021-03	RAN#91	R5-210903	1148	-	F	Editorial correction to clause 7.3.1	16.7.0
2021-03	RAN#91	R5-210906	1150	-	F	Updating A-SEM for MIMO testing for NS_04	16.7.0
2021-03	RAN#91	R5-210908	1152	-	F	Updating test applicability of test case 6.5D.2.4.2-UTRA ACLR for UL MIMO	16.7.0
2021-03	RAN#91	R5-210911	1154	-	F	Correction to test configuration table Test IDs for test case 6.5D.3.3	16.7.0
2021-03	RAN#91	R5-210912	1155	-	F	Correction to test case 6.2.3 AMPR for NS_24	16.7.0

2021-03	RAN#91	R5-210918	1160	-	F	Updating MOP and MPR for MIMO testing for several NR bands	16.7.0
2021-03	RAN#91	R5-210919	1161	-	F	Updating 6.5A.3.1.0 for intra-band CA	16.7.0
2021-03	RAN#91	R5-210920	1162	-	F	Updating test requirement of CA test cases for CA configurations including n90	16.7.0
2021-03	RAN#91	R5-210922	1164	-	F	Updating test case 7.6A.4 for band n48	16.7.0
2021-03	RAN#91	R5-210991	1174	-	F	Update for 7.3.2 Reference sensitivity power level	16.7.0
2021-03	RAN#91	R5-210995	1175	-	F	Update for 6.5.3.2 Spurious emission for UE co-existence_R15	16.7.0
2021-03	RAN#91	R5-210996	1176	-	F	Addition of test case 6.5D.2_1.4.2, UTRA ACLR for UL MIMO (Rel-16 onward)	16.7.0
2021-03	RAN#91	R5-211008	1178	-	F	Update of CA_n1A-n78C into 3DL CA Refsense TC 7.3A.2	16.7.0
2021-03	RAN#91	R5-211026	1180	-	F	Update of CA_n1A-n78C into 3DL CA maximum input level TC 7.4A.2	16.7.0
2021-03	RAN#91	R5-211037	1181	-	F	Addition of minimum requirement for intra-band UL CA in the test case 6.4A.2	16.7.0
2021-03	RAN#91	R5-211040	1182	-	F	Addition of 70M into 38.521-1 TC6.3A.1	16.7.0
2021-03	RAN#91	R5-211041	1183	-	F	Addition of 70M into 38.521-1 TC6.3D	16.7.0
2021-03	RAN#91	R5-211048	1185	-	F	Correction to test tolerance for FR1 blocking tests	16.7.0
2021-03	RAN#91	R5-211092	1186	-	F	Test ID separation to powerBoostPiBPSK 1 and 0 in Table 6.5.2.2.4.1-1	16.7.0
2021-03	RAN#91	R5-211109	1187	-	F	Corrections to subclauses in 38.521-1 with appropriate subclause level and heading styles	16.7.0
2021-03	RAN#91	R5-211113	1188	-	F	Corrections to reference figures for transmission bandwidth in FR1	16.7.0
2021-03	RAN#91	R5-211133	1189	-	F	Addition of ULFTx in MPR test case	16.7.0
2021-03	RAN#91	R5-211176	1191	-	F	Reference to measurement BW corrected in 6.5D.4 TX intermodulation test case	16.7.0
2021-03	RAN#91	R5-211274	1195	-	F	Updating 6.5A.3.2 for CA_n1A-n79A	16.7.0
2021-03	RAN#91	R5-211613	1184	1	F	Spurious emissions for UE co-existence update to core specs	16.7.0
2021-03	RAN#91	R5-211657	1192	1	F	PC1 and PC3 Updates for Band n14	16.7.0
2021-03	RAN#91	R5-211676	1110	1	F	Clarifications for ON/OFF time mask for UL MIMO test case	16.7.0
2021-03	RAN#91	R5-211677	1126	1	F	Correction of test frequencies for NR band n28 30MHz test channel bandwidth of CA SUL and UL MIMO test cases in section 6	16.7.0
2021-03	RAN#91	R5-211678	1151	1	F	Updating AMPR for MIMO test case for NS_35	16.7.0
2021-03	RAN#91	R5-211679	1153	1	F	Correction to RB allocation start for test case 6.3D.4.2	16.7.0
2021-03	RAN#91	R5-211680	1128	1	F	Correction of test frequencies for NR band n28 30MHz test channel bandwidth of CA SUL and UL MIMO test cases in section 7	16.7.0
2021-03	RAN#91	R5-211681	1149	1	F	Updating test case 7.3C.2-Reference sensitivity power level for SUL	16.7.0
2021-03	RAN#91	R5-211682	1143	1	F	Update of clause 5 to R15 TS 38.521-1	16.7.0
2021-03	RAN#91	R5-211764	1113	1	F	Update of 7.5A.3 Adjacent channel selectivity for 4DL CA	16.7.0
2021-03	RAN#91	R5-211765	1144	1	F	Update of R16 CADC configurations into TS38.521-1 clause 5	16.7.0
2021-03	RAN#91	R5-211786	1134	1	F	Correction of test points for NS_48	16.7.0
2021-03	RAN#91	R5-211787	1135	1	F	Addition of A-MPR test for NS_49	16.7.0
2021-03	RAN#91	R5-211788	1177	1	F	Update for 6.5.3.2 Spurious emission for UE co-existence_R16	16.7.0

2021-03	RAN#91	R5-211804	1172	1	F	Updating Editors Note in 6.2A.2 and 6.2A.4 for intra-band UL CA	16.7.0
2021-03	RAN#91	R5-211805	1159	1	F	Updating general requirements for intra-band non-contiguous CA	16.7.0
2021-03	RAN#91	R5-211806	1117	1	F	Addition of 6.5E.2.2.1	16.7.0
2021-03	RAN#91	R5-211807	1137	1	F	Adding test point for Rel-16 DMRS in EVM equalizer spectrum flatness test case	16.7.0
2021-03	RAN#91	R5-211808	1141	1	F	Addition of new test case 6.4C.2.5 EVM equalizer spectrum flatness for half Pi BPSK DMRS for SUL	16.7.0
2021-03	RAN#91	R5-211911	1165	1	F	Adding NR test case-Time mask for Uplink carriers switching	16.7.0
2021-03	RAN#91	R5-211912	1166	1	F	Adding MU and TT for Uplink carriers switching testing	16.7.0
2021-03	RAN#91	R5-211915	1138	1	F	Adding additional TP for half Pi BPSK DMRS to MPR test case for SUL	16.7.0
2021-03	RAN#91	R5-210804	1145	-	F	Update of R17 CADC configurations into TS38.521-1 clause 5	17.0.0
2021-03	RAN#91	R5-210932	1169	-	F	Updating Additional spurious emissions testing for SUL band n83 and n84	17.0.0
2021-03	RAN#91	R5-210933	1170	-	F	Updating clause 6.2C.2 for Rel-17 SUL combinations	17.0.0
2021-03	RAN#91	R5-210934	1171	-	F	Updating REFSENS for SUL for new R17 configurations	17.0.0
2021-03	RAN#91	R5-211174	1190	-	F	Addition of R17 new CBWs into 38.521-1 clause 5	17.0.0
2021-03	RAN#91	R5-211837	1167	1	F	Updating MPR testing for SUL band n83	17.0.0
2021-03	RAN#91	R5-211838	1168	1	F	Updating AMPR testing for SUL band n83 and n84	17.0.0
2021-06	RAN#92	R5-212029	1198	-	F	Updating clause 6.2C.2 for Rel-17 SUL combinations	17.1.0
2021-06	RAN#92	R5-212168	1201	-	F	Removal of technical content in 38.521-1 v16.7.0 and substitution with pointer to the next Release	17.1.0
2021-06	RAN#92	R5-212340	1216	-	F	Typos in references of clause 6.5.3.2	17.1.0
2021-06	RAN#92	R5-212619	1218	-	F	Correction to A-MPR test ID for NS_24 in TC6.2.3	17.1.0
2021-06	RAN#92	R5-212668	1220	-	F	Correction of A-MPR test requirements for NS_04 band n41	17.1.0
2021-06	RAN#92	R5-212671	1222	-	F	Addition of A-MPR test requirements for NS_03 band n70	17.1.0
2021-06	RAN#92	R5-212682	1227	-	F	Update of 70M CBW into TC 6.3D.3	17.1.0
2021-06	RAN#92	R5-212704	1228	-	F	Update of 70M CBW into TC 6.3.3.2	17.1.0
2021-06	RAN#92	R5-212739	1229	-	F	Update of V2X in Section 5	17.1.0
2021-06	RAN#92	R5-212740	1230	-	F	Update to FR1 test case title in clause 6	17.1.0
2021-06	RAN#92	R5-212741	1231	-	F	Update to FR1 test case title in clause 7	17.1.0
2021-06	RAN#92	R5-212839	1235	-	F	Update of clause 3 for symbols and abbreviations	17.1.0
2021-06	RAN#92	R5-212856	1240	-	F	Correction of the test step number in the test requirement section	17.1.0
2021-06	RAN#92	R5-212914	1241	-	F	Editorial correction of 6.2.1	17.1.0
2021-06	RAN#92	R5-212926	1243	-	F	Addition of 6.1E General section	17.1.0
2021-06	RAN#92	R5-212927	1244	-	F	Addition of 6.2E.2.1 V2X MPR non-concurrent	17.1.0
2021-06	RAN#92	R5-212928	1245	-	F	Addition of 6.3E.1.1 V2X minimum output power non-concurrent	17.1.0
2021-06	RAN#92	R5-212969	1246	-	F	Updating AMPR for SUL test case for n84	17.1.0
2021-06	RAN#92	R5-212970	1247	-	F	Updating UTRA ACLR for SUL testing for n84	17.1.0
2021-06	RAN#92	R5-212971	1248	-	F	Updating test case 7.6C.2 Inband Blocking for SUL	17.1.0

2021-06	RAN#92	R5-212972	1249	-	F	Updating test case 7.6C.3 Out-of-band blocking for SUL	17.1.0
2021-06	RAN#92	R5-212974	1251	-	F	Updating H.2.2 for NR SA FR1 testing	17.1.0
2021-06	RAN#92	R5-212979	1252	-	F	Correction to RB allocations for test case 6.2.3 A-MPR for NS_46	17.1.0
2021-06	RAN#92	R5-212980	1253	-	F	Updating test case general spurious emission for CA_n28A-n41A	17.1.0
2021-06	RAN#92	R5-212981	1254	-	F	Updating Spurious emission for UE co-existence for CA_n28A-n41A	17.1.0
2021-06	RAN#92	R5-212983	1255	-	F	Updating Transmitter power for CA requirements for CA_n28A-n41A	17.1.0
2021-06	RAN#92	R5-212988	1257	-	F	Updating 6.2D.3 A-MPR for UL MIMO for band n1	17.1.0
2021-06	RAN#92	R5-212989	1258	-	F	Updating UTRA ACLR for MIMO testing for NR band n1	17.1.0
2021-06	RAN#92	R5-212992	1260	-	F	Updating 6.2C.2 for new R17 SUL configurations	17.1.0
2021-06	RAN#92	R5-212993	1261	-	F	Updating test case 6.2A.1 MOP for CA for R17 configuration CA_n28A-n79A	17.1.0
2021-06	RAN#92	R5-212994	1262	-	F	Correction to wrong RB allocations in NR test case 6.5C.3.3	17.1.0
2021-06	RAN#92	R5-212998	1265	-	F	Updating test case 7.3C.2 REFSSENS for SUL for new R17 SUL configurations	17.1.0
2021-06	RAN#92	R5-212999	1266	-	F	Updating REFSSENS for SUL 3CC testing for new R17 SUL configurations	17.1.0
2021-06	RAN#92	R5-213000	1267	-	F	Updating 7.6C.3 Out-of-band blocking for SUL_n79A-n83A	17.1.0
2021-06	RAN#92	R5-213015	1270	-	F	Updating test description to enable DFT-s-OFDM modulation across clause 6	17.1.0
2021-06	RAN#92	R5-213016	1271	-	F	Updating message contents to enable DFT-s-OFDM modulation in 7.3 refsens	17.1.0
2021-06	RAN#92	R5-213058	1275	-	F	Update of test configuration for UTRA ACLR for Rel-16 UL MIMO	17.1.0
2021-06	RAN#92	R5-213100	1278	-	F	Updating 6.5D.3_1.3 Additional spurious emissions for UL MIMO Rel-16 onward for NR band n1	17.1.0
2021-06	RAN#92	R5-213101	1279	-	F	Correction to Reference sensitivity test requirements in DL CA	17.1.0
2021-06	RAN#92	R5-213102	1280	-	F	Corrections to band n70 reference sensitivity testing	17.1.0
2021-06	RAN#92	R5-213160	1285	-	F	Correction to Message Contents Condition for NR ACLR	17.1.0
2021-06	RAN#92	R5-213882	1202	1	F	Change Editors note in 6.2D.2	17.1.0
2021-06	RAN#92	R5-213883	1208	1	F	Update p-Max of PCC to 6.2A.1.1	17.1.0
2021-06	RAN#92	R5-213884	1209	1	F	Update p-Max of PCC to 6.2A.2.1	17.1.0
2021-06	RAN#92	R5-213885	1210	1	F	Update p-Max of PCC to 6.5A.1.1	17.1.0
2021-06	RAN#92	R5-213886	1211	1	F	Update p-Max of PCC to out of band emission for CA	17.1.0
2021-06	RAN#92	R5-213887	1212	1	F	Update p-Max of PCC to spurious emission for CA	17.1.0
2021-06	RAN#92	R5-213888	1213	1	F	Correct message content to 6.2A.4.1	17.1.0
2021-06	RAN#92	R5-213889	1214	1	F	Cleanup for TS 38.521-1 spurious emission for UE co-existence table (non CA)	17.1.0
2021-06	RAN#92	R5-213890	1215	1	F	Cleanup for TS 38.521-1 spurious emission for UE co-existence table (CA Bands)	17.1.0
2021-06	RAN#92	R5-213891	1221	1	F	Correction of A-MPR and A-SEM test requirements for NS_06 band n12	17.1.0
2021-06	RAN#92	R5-213892	1242	1	F	Addition of A-MPR NS_10 test	17.1.0
2021-06	RAN#92	R5-213893	1250	1	F	Updating NR SA test frequency selection for NR band n28	17.1.0

2021-06	RAN#92	R5-213894	1224	1	F	Update of R15 38.521-1 clause 5	17.1.0
2021-06	RAN#92	R5-213970	1256	1	F	Updating test case REFSENS for CA for CA_n28A-n41A	17.1.0
2021-06	RAN#92	R5-213971	1272	1	F	Corrections to NR Rx CA cases	17.1.0
2021-06	RAN#92	R5-213972	1284	1	F	Update of CA_n1A-n78C into 3DL CA TCs in 38.521-1	17.1.0
2021-06	RAN#92	R5-213978	1232	1	F	Correction of 6.5.1 for test of channel occupied bandwidth	17.1.0
2021-06	RAN#92	R5-213979	1233	1	F	Correction of 6.5.2.2 for test of spectrum emission mask	17.1.0
2021-06	RAN#92	R5-213980	1234	1	F	Correction of 6.5.2.4 for test of adjacent channel leakage ratio	17.1.0
2021-06	RAN#92	R5-213981	1282	1	F	Update of 70M CBW into TC 6.3.3.4 PRACH time mask	17.1.0
2021-06	RAN#92	R5-213982	1283	1	F	Update of 70M CBW into 38.521-1 TC 6.3A.4.1	17.1.0
2021-06	RAN#92	R5-213983	1223	1	F	Update of R16 new CBW configurations into TS38.521-1 clause 5	17.1.0
2021-06	RAN#92	R5-213995	1239	1	F	Update of minimum conformance requirements for Occupied bandwidth for CA in TC 6.5A.1	17.1.0
2021-06	RAN#92	R5-213998	1203	1	F	Update of 6.5E.2.2.1	17.1.0
2021-06	RAN#92	R5-213999	1204	1	F	Update of 6.5E.2.3.1	17.1.0
2021-06	RAN#92	R5-214000	1205	1	F	Update of 6.5E.2.4.1	17.1.0
2021-06	RAN#92	R5-214001	1206	1	F	Update of 6.5E.3.2.1	17.1.0
2021-06	RAN#92	R5-214002	1207	1	F	Addition of 6.5E.3.3.1	17.1.0
2021-06	RAN#92	R5-214003	1236	1	F	Addition of new test case 6.4E.2.2.1D Error Vector Magnitude for V2X for non-concurrent operation SL-MIMO	17.1.0
2021-06	RAN#92	R5-214004	1237	1	F	Addition of new test case 6.4E.2.4.1 In band emissions for V2X for non-concurrent operation	17.1.0
2021-06	RAN#92	R5-214005	1238	1	F	Addition of new test case 6.4E.2.4.1D In band emissions for V2X for non-concurrent operation SL-MIMO	17.1.0
2021-06	RAN#92	R5-214007	1274	1	F	Test case 6.2D.4 updated for ULFPtx	17.1.0
2021-06	RAN#92	R5-214021	1199	1	F	Updating clause 7.3C for Rel-17 SUL combinations	17.1.0
2021-06	RAN#92	R5-214022	1263	1	F	Updating REFSENS for CA test case for CA_n28A-n79A	17.1.0
2021-06	RAN#92	R5-214023	1268	1	F	Adding new test case 7.6C.2_1 Inband Blocking for SUL and DL CA	17.1.0
2021-06	RAN#92	R5-214024	1269	1	F	Adding new test case 7.6C.3_1 Out-of-band blocking for SUL and DL CA	17.1.0
2021-06	RAN#92	R5-214025	1226	1	F	Update of R17 CADC configurations into TS38.521-1 clause 5	17.1.0
2021-06	RAN#92	R5-214110	1225	1	F	Update of R16 new CADC configurations into TS38.521-1 clause 5	17.1.0
2021-09	RAN#93	R5-214221	1288	-	F	Updating clause 6.2C.2 for Rel-17 SUL combinations in TS 38.521-1	17.2.0
2021-09	RAN#93	R5-214224	1289	-	F	Update clause 7 for R17 CA and SUL RX characteristics in TS 38.521-1	17.2.0
2021-09	RAN#93	R5-214476	1294	-	F	Addition of Configured Tx Power Minimum Conformance Requirements for n41 Power Class 1.5	17.2.0
2021-09	RAN#93	R5-214477	1295	-	F	Addition of MOP for UL MIMO Minimum Conformance Requirements for n41 Power Class 1.5	17.2.0
2021-09	RAN#93	R5-214479	1297	-	F	Update of NR ACLR Test Requirement for n41 Power Class 1.5	17.2.0
2021-09	RAN#93	R5-214598	1305	-	F	Addition of reference section for TDD DL reference measurement channels in 7.1	17.2.0
2021-09	RAN#93	R5-214599	1306	-	F	Correction of test SCS in the test configuration table	17.2.0

2021-09	RAN#93	R5-214600	1307	-	F	Correction of Test Frequencies in the test configuration table	17.2.0
2021-09	RAN#93	R5-214601	1308	-	F	Correction of Test Frequencies for NR band n28 and 30MHz test channel bandwidth in the test configuration table	17.2.0
2021-09	RAN#93	R5-214603	1310	-	F	Unify the Terminology of normal condition in the test configuration tables	17.2.0
2021-09	RAN#93	R5-214604	1311	-	F	Correction of subclause titles with appropriate styles	17.2.0
2021-09	RAN#93	R5-215043	1313	-	F	Correcting test frequencies in test case 6.2D.4	17.2.0
2021-09	RAN#93	R5-215073	1316	-	F	Addition of 6.2E.1.1D MOP for non-concurrent with SL-MIMO	17.2.0
2021-09	RAN#93	R5-215074	1317	-	F	Addition of 6.2E.2.1D MPR for non-concurrent with SL-MIMO	17.2.0
2021-09	RAN#93	R5-215075	1318	-	F	Addition of 6.3E.1.1D Minimum output power for non-concurrent with SL-MIMO	17.2.0
2021-09	RAN#93	R5-215080	1319	-	F	Addition of NR ACLR for intra-band CA	17.2.0
2021-09	RAN#93	R5-215165	1321	-	F	Correction of test frequencies for A-MPR NS_47	17.2.0
2021-09	RAN#93	R5-215185	1323	-	F	Update of 6.2D.2 MPR for UL MIMO with supporting ULFPTx	17.2.0
2021-09	RAN#93	R5-215214	1331	-	F	Corrections on power tolerance for intra-band contiguous CA	17.2.0
2021-09	RAN#93	R5-215282	1334	-	F	Introduction of CA_n71(2A) to Rx cases	17.2.0
2021-09	RAN#93	R5-215284	1335	-	F	Updating message contents for SUL test cases	17.2.0
2021-09	RAN#93	R5-215285	1336	-	F	Removal of SUL band in NR single-carrier test cases	17.2.0
2021-09	RAN#93	R5-215286	1337	-	F	Editorial correction to test case 6.2A.1 and 6.2A.2	17.2.0
2021-09	RAN#93	R5-215287	1338	-	F	Correction to test procedure of test case 6.5.2.3 Additional SEM	17.2.0
2021-09	RAN#93	R5-215297	1339	-	F	Updating the test requirement of NR test case MPR for MIMO	17.2.0
2021-09	RAN#93	R5-215298	1340	-	F	Updating NR test case 6.2A.1 MOP for intra-band non-contiguous UL CA	17.2.0
2021-09	RAN#93	R5-215305	1344	-	F	Updating test case 6.5A.1.1 occupied bandwidth for intra-band CA	17.2.0
2021-09	RAN#93	R5-215307	1345	-	F	Updating test case 6.3A.2 Transmit OFF power for intra-band non-contiguous UL CA	17.2.0
2021-09	RAN#93	R5-215311	1346	-	F	Updating MOP testing for SUL band n97	17.2.0
2021-09	RAN#93	R5-215312	1347	-	F	Updating MPR testing for SUL band n97	17.2.0
2021-09	RAN#93	R5-215332	1350	-	F	Update of requirement for spurious emission test case in 6.5A.3.2.1	17.2.0
2021-09	RAN#93	R5-215334	1352	-	F	Correction of A-MPR test configuration for NS_27 in 6.2.3	17.2.0
2021-09	RAN#93	R5-215335	1353	-	F	Correction of A-SPR test configuration for NS_17 in 6.5.3.3	17.2.0
2021-09	RAN#93	R5-215373	1354	-	F	Update Test applicability to FR1 TC 6.3C.2	17.2.0
2021-09	RAN#93	R5-215406	1359	-	F	Update of CBW 70MHz into TC 6.3.4.2 absolute power tolerance	17.2.0
2021-09	RAN#93	R5-215438	1360	-	F	Update of CBW 70MHz into TC 6.3.4.3 relative power tolerance	17.2.0
2021-09	RAN#93	R5-215439	1361	-	F	Update of CBW 70MHz into TC 6.3A.3.1	17.2.0
2021-09	RAN#93	R5-215463	1366	-	F	Correct the abbreviations for network signalling value in 38.521-1	17.2.0
2021-09	RAN#93	R5-215472	1368	-	F	Correction of test configuration in test case 6.5.2.2.2	17.2.0
2021-09	RAN#93	R5-215513	1372	-	F	Update of CBW 70MHz into TC 6.3A.3.1_1	17.2.0
2021-09	RAN#93	R5-215562	1374	-	F	Introduction of Reference sensitivity for NR-U	17.2.0
2021-09	RAN#93	R5-215564	1376	-	F	Introduction of Spectrum emission mask for NR-U	17.2.0

2021-09	RAN#93	R5-215573	1378	-	F	Update for 6.5.4 Transmit intermodulation	17.2.0
2021-09	RAN#93	R5-215845	1315	1	F	Correction of UTRA ACLR for inter-band CA	17.2.0
2021-09	RAN#93	R5-215846	1320	1	F	Adding A-MPR NS_06 test case for band 14 power class 1	17.2.0
2021-09	RAN#93	R5-215847	1312	1	F	Update of FR1 UL RMCs	17.2.0
2021-09	RAN#93	R5-215929	1356	1	F	Update of R16 new CBW configurations into TS38.521-1 clause 5	17.2.0
2021-09	RAN#93	R5-215962	1325	1	B	Introduction of MOP, MPR and configured Tx power test cases for n24 and n99	17.2.0
2021-09	RAN#93	R5-215963	1327	1	B	Introduction of n24 and n99 to spurious emissions and addition spurious emission test cases	17.2.0
2021-09	RAN#93	R5-215964	1348	1	F	Updating Spurious emissions for UE co-existence test cases for R17 requirements	17.2.0
2021-09	RAN#93	R5-215965	1328	1	B	Introduction of n24 to receiver sensitivity test cases	17.2.0
2021-09	RAN#93	R5-215966	1329	1	B	Introduction of n24 - blocking test cases	17.2.0
2021-09	RAN#93	R5-215967	1358	1	F	Update of R17 new band and CBWs into TS38.521-1 clause 5	17.2.0
2021-09	RAN#93	R5-215983	1292	1	F	Introduction of NR-U MOP test case	17.2.0
2021-09	RAN#93	R5-215984	1293	1	F	Introduction of NR-U in general clauses	17.2.0
2021-09	RAN#93	R5-215985	1375	1	F	Introduction of general spurious emission for NR-U	17.2.0
2021-09	RAN#93	R5-215986	1298	1	F	Update of Tx test cases for PC2 CA_n3A-n41A with UL CA_n3A-n41A	17.2.0
2021-09	RAN#93	R5-215987	1299	1	F	Update of Tx test cases for PC2 CA_n28A-n79A with UL CA_n28A-n79A	17.2.0
2021-09	RAN#93	R5-215988	1300	1	F	Update of Tx test cases for PC2 CA_n28A-n41A with UL CA_n28A-n41A	17.2.0
2021-09	RAN#93	R5-215989	1301	1	F	Update of Tx test cases for PC2 CA_n40A-n41A with UL CA_n40A-n41A	17.2.0
2021-09	RAN#93	R5-215990	1302	1	F	Update of Tx test cases for PC2 CA_n3A-n41A with UL PC2 n41A	17.2.0
2021-09	RAN#93	R5-215991	1303	1	F	Update of Tx test cases for PC2 CA_n28A-n79A with UL PC2 n79A	17.2.0
2021-09	RAN#93	R5-215992	1304	1	F	Update of Tx test cases for PC2 CA_n28A-n41A with UL PC2 n41A	17.2.0
2021-09	RAN#93	R5-215999	1296	1	F	Addition of MOP for UL MIMO Test Requirements for n41 Power Class 1.5	17.2.0
2021-09	RAN#93	R5-216000	1369	1	F	Adding Power Class 1.5 for LTE Band 41and NR Band n41 MOP	17.2.0
2021-09	RAN#93	R5-216001	1370	1	F	Adding Power Class 1.5 for LTE Band 41and NR Band n41 MPR	17.2.0
2021-09	RAN#93	R5-216002	1371	1	F	Adding Power Class 1.5 for LTE Band 41and NR Band n41 A-MPR	17.2.0
2021-09	RAN#93	R5-216029	1290	1	F	Update of NR FR1 General ON-OFF time mask test case	17.2.0
2021-09	RAN#93	R5-216030	1291	1	F	Update of NR FR1 SRS time mask test case	17.2.0
2021-09	RAN#93	R5-216031	1330	1	F	Cleanup for spurious emission for UE co-existence table	17.2.0
2021-09	RAN#93	R5-216032	1332	1	F	Update intra-band CA to 6.2A.2.1	17.2.0
2021-09	RAN#93	R5-216033	1373	1	F	Update to the coherent UL-MIMO test case	17.2.0
2021-09	RAN#93	R5-216034	1377	1	F	Correction to test applicability for different NS value	17.2.0
2021-09	RAN#93	R5-216035	1351	1	F	Correction to test configuration in 7.3A.1	17.2.0
2021-09	RAN#93	R5-216065	1341	1	F	Updating test case 6.3A.4.1 Absolute power tolerance for intra-band non-contiguous UL CA	17.2.0

2021-09	RAN#93	R5-216066	1342	1	F	Updating test case 6.3A.4.2 Relative power tolerance for intra-band non-contiguous UL CA	17.2.0
2021-09	RAN#93	R5-216067	1343	1	F	Updating test case 6.3A.4.3 Aggregate power tolerance for intra-band non-contiguous UL CA	17.2.0
2021-09	RAN#93	R5-216080	1357	1	F	Update of R17 CADC configurations into TS38.521-1 clause 5	17.2.0
2021-09	RAN#93	R5-216084	1333	1	F	Update p-Max of PCC of intra-band CA to 6.5A.1.1	17.2.0
2021-09	RAN#93	R5-216085	1364	1	F	Correction of 6.2.3 for UE additional maximum output power reduction	17.2.0
2021-09	RAN#93	R5-216086	1365	1	F	Correction of 6.2.1 for UE capability IE for maximum output power	17.2.0
2021-09	RAN#93	R5-216107	1363	1	F	Update of 6.2A.1 for UE maximum output power for CA	17.2.0
2021-09	RAN#93	R5-216110	1362	1	F	Update of 6.3.3.6 for SRS time mask test for BW 70MHz	17.2.0
2021-09	RAN#93	R5-216114	1326	1	B	Introduction of A-MPR test cases for n24 and n99	17.2.0
2021-09	RAN#93	R5-216141	1322	1	F	Correction to IE and UE capability for low PAPR DMRS across Tx cases	17.2.0
2021-12	RAN#94	R5-216512	1391	-	F	Updates on FR1 On-Off time mask for UL MIMO test 6.3D.3 upon RAN4 clarifications	17.3.0
2021-12	RAN#94	R5-216514	1392	-	F	Editorial corrections for NS_47 in A-MPR FR1 test 6.2.3	17.3.0
2021-12	RAN#94	R5-216515	1393	-	F	Corrections for NS_27 in A-MPR FR1 test 6.2.3	17.3.0
2021-12	RAN#94	R5-216533	1399	-	F	Addition of asymmetric channel bandwidths for n24	17.3.0
2021-12	RAN#94	R5-217111	1410	-	F	Clarifications for inter-band testing in 7.4.A.1 2DL CA MIL test	17.3.0
2021-12	RAN#94	R5-217112	1411	-	F	Clarifications for inter-band testing in 7.5.A.1 2DL CA ACS test	17.3.0
2021-12	RAN#94	R5-217199	1412	-	F	Update for 6.3.3.1 Transmit ON/OFF time mask general	17.3.0
2021-12	RAN#94	R5-217200	1413	-	F	Update for 6.3.3.6 SRS time mask	17.3.0
2021-12	RAN#94	R5-217202	1415	-	F	Addition of Annex E.4.7 Modified signal under test	17.3.0
2021-12	RAN#94	R5-217215	1416	-	F	Correction to IE and UE capability for low PAPR DMRS	17.3.0
2021-12	RAN#94	R5-217216	1417	-	F	Removal of low PAPR test points from 6.2.3 A-MPR	17.3.0
2021-12	RAN#94	R5-217234	1418	-	F	Introduction of ACLR for NR-U	17.3.0
2021-12	RAN#94	R5-217235	1419	-	F	Introduction of 7.3F.3 for NR-U	17.3.0
2021-12	RAN#94	R5-217261	1421	-	F	Addition of CA_n26A-66A, CA_n26A-70A, CA_n48A-66A, CA_n48A-70A and CA_n48A-n71A to the UL CA Maximum output power and Tx Spurious emissions	17.3.0
2021-12	RAN#94	R5-217262	1422	-	F	Addition of Reference Sensitivity test for CA combinations CA_n26A-66A, CA_n26A-70A, CA_n48A-66A and CA_n48A-70A	17.3.0
2021-12	RAN#94	R5-217263	1423	-	F	Addition of intra-band non-contiguous + intra-band non-contiguous to 4CA Reference sensitivity, Maximum input level and blocking cases	17.3.0
2021-12	RAN#94	R5-217427	1431	-	F	Correction to test configuration of NS_49 in 6.2.3	17.3.0
2021-12	RAN#94	R5-217476	1437	-	F	Cleaning up General sections of NR SA test cases	17.3.0
2021-12	RAN#94	R5-217479	1440	-	F	Correction to PDCCH DCI format for test case 6.4A.2.3.1	17.3.0
2021-12	RAN#94	R5-217482	1443	-	F	Update to test case Transmit ON/OFF time mask for SUL	17.3.0
2021-12	RAN#94	R5-217485	1446	-	F	Updating title of clause 6.4D	17.3.0
2021-12	RAN#94	R5-217487	1448	-	F	Adding intra-band contiguous CA non-contiguous RB allocations in 6.1A	17.3.0

2021-12	RAN#94	R5-217492	1453	-	F	Updating 6.3A.4.3 Aggregate power tolerance for intra-band CA	17.3.0
2021-12	RAN#94	R5-217552	1455	-	F	Addition of n3 CBW 50MHz into TC 7.3.2 Reference sensitivity power level	17.3.0
2021-12	RAN#94	R5-217553	1456	-	F	Editorial cleanup of message exceptions in PRACH time mask	17.3.0
2021-12	RAN#94	R5-217608	1463	-	F	Update to 5G V2X RMCs	17.3.0
2021-12	RAN#94	R5-217609	1464	-	F	Correction to 5G V2X RF tests	17.3.0
2021-12	RAN#94	R5-217631	1466	-	F	Update of R16 new band and CBWs into TS38.521-1 clause 5	17.3.0
2021-12	RAN#94	R5-217660	1469	-	F	Update of R17 new band and CBWs into TS38.521-1 clause 5	17.3.0
2021-12	RAN#94	R5-217665	1471	-	F	Update of CBW 70MHz into TC 6.3D.4.2	17.3.0
2021-12	RAN#94	R5-217686	1477	-	F	Update of R16 CADC configurations into TS38.521-1 clause 5	17.3.0
2021-12	RAN#94	R5-217746	1478	-	F	Update 7.5A.3 Adjacent channel selectivity for 4DL CA within RF1	17.3.0
2021-12	RAN#94	R5-218223	1379	1	F	Update of 6.3.3.4 PRACH time mask	17.3.0
2021-12	RAN#94	R5-218224	1408	1	F	Corrections for CA MPR table reference	17.3.0
2021-12	RAN#94	R5-218225	1420	1	F	6.5.3 Spurious emissions-Editorial correction	17.3.0
2021-12	RAN#94	R5-218226	1433	1	F	Correction to the number of HARQ process for PUCCH format 3 with FDD condition	17.3.0
2021-12	RAN#94	R5-218227	1438	1	F	Updating SRS time mask test case	17.3.0
2021-12	RAN#94	R5-218228	1439	1	F	Correction to PDCCH DCI format for test case 6.4.2.3	17.3.0
2021-12	RAN#94	R5-218229	1441	1	F	Correction to NR test case 6.4A.1.1 - Frequency error for CA	17.3.0
2021-12	RAN#94	R5-218230	1442	1	F	Update to NR FR1 ON-OFF time mask for CA (2UL CA)	17.3.0
2021-12	RAN#94	R5-218232	1475	1	F	Update of NR FR1 TC 6.3A.3 Transmit ON/OFF time mask for CA	17.3.0
2021-12	RAN#94	R5-218233	1432	1	F	Correction to the periodicity of CSI-RS for tracking	17.3.0
2021-12	RAN#94	R5-218280	1470	1	F	Update of CBW 70MHz into TC 6.3D.4.1	17.3.0
2021-12	RAN#94	R5-218281	1473	1	F	Update of CBW 70MHz into 6.5A of 38.521-1	17.3.0
2021-12	RAN#94	R5-218282	1474	1	F	Update of CBW 70MHz into 6.5C of 38.521-1	17.3.0
2021-12	RAN#94	R5-218292	1450	1	F	Updating 6.2A.4 Configured output power for intra-band UL CA	17.3.0
2021-12	RAN#94	R5-218300	1401	1	F	Update to test case 6.4E.2.4.1 In-band emissions for V2X / non-concurrent operation	17.3.0
2021-12	RAN#94	R5-218301	1402	1	F	Update to test case 6.4E.2.4.1D In-band emissions for V2X / non-concurrent operation / SL-MIMO	17.3.0
2021-12	RAN#94	R5-218302	1403	1	F	Addition of new test case 6.4E.2.4.2 In-band emissions for V2X / con-current operation	17.3.0
2021-12	RAN#94	R5-218303	1404	1	F	Addition of new test case 6.4E.2.5.1 EVM equalizer spectrum flatness for V2X / non-concurrent operation	17.3.0
2021-12	RAN#94	R5-218304	1405	1	F	Addition of new test case 6.4E.2.5.1D EVM equalizer spectrum flatness for V2X / non-concurrent operation / SL-MIMO	17.3.0
2021-12	RAN#94	R5-218305	1406	1	F	Addition of new test case 6.4E.2.5.2 EVM equalizer spectrum flatness for V2X / con-current operation	17.3.0
2021-12	RAN#94	R5-218362	1397	1	F	Updates to A-MPR test case for n24 and n99	17.3.0
2021-12	RAN#94	R5-218363	1398	1	F	Updates to additional spurious emission test case for n24 and n99	17.3.0
2021-12	RAN#94	R5-218365	1467	1	F	Update of R17 CADC configurations into TS38.521-1 clause 5	17.3.0

2021-12	RAN#94	R5-218373	1425	1	F	Update of MOP test cases for PC2 CA_n3A-n78A with UL CA_n3A-n78A	17.3.0
2021-12	RAN#94	R5-218379	1380	1	F	Update of PC1.5 n41 MOP test requirement	17.3.0
2021-12	RAN#94	R5-218380	1381	1	F	Adding Power Class 1.5 for NR Band n79 MOP	17.3.0
2021-12	RAN#94	R5-218381	1382	1	F	Introduction of PC1.5 n79 MOP for UL MIMO	17.3.0
2021-12	RAN#94	R5-218382	1383	1	F	Introduction of PC1.5 n79 MPR	17.3.0
2021-12	RAN#94	R5-218383	1384	1	F	Introduction of PC2 n34 MOP	17.3.0
2021-12	RAN#94	R5-218384	1385	1	F	Introduction of PC2 n34 MOP for UL MIMO	17.3.0
2021-12	RAN#94	R5-218385	1386	1	F	Introduction of PC2 n34 MPR	17.3.0
2021-12	RAN#94	R5-218386	1387	1	F	Introduction of PC2 n39 MOP	17.3.0
2021-12	RAN#94	R5-218387	1388	1	F	Introduction of PC2 n39 MOP for UL MIMO	17.3.0
2021-12	RAN#94	R5-218388	1389	1	F	Introduction of PC2 n39 MPR	17.3.0
2021-12	RAN#94	R5-218389	1390	1	F	Introduction of PC2 n39 A-MPR for NS_50	17.3.0
2021-12	RAN#94	R5-218411	1468	1	F	Introduction of NR-U A-MPR test case	17.3.0
2021-12	RAN#94	R5-218416	1409	1	F	Clarifications on additional UE co-ex requirements for 2 Band UL CA	17.3.0
2021-12	RAN#94	R5-218417	1429	1	F	Update of 6.2.2 for UE maximum output power reduction	17.3.0
2021-12	RAN#94	R5-218418	1430	1	F	Update of 6.2.3.3.28 for alignment of NS_56 with RAN4 specification	17.3.0
2021-12	RAN#94	R5-218419	1444	1	F	Update to test case Transmit ON/OFF time mask for UL MIMO	17.3.0
2021-12	RAN#94	R5-218420	1445	1	F	Updating test applicability to FR1 test cases	17.3.0
2021-12	RAN#94	R5-218421	1465	1	F	Update of A-MPR NS_04 for band n41	17.3.0
2021-12	RAN#94	R5-218422	1476	1	F	38.521-1_Corrections of test cases having impact on ETSI EN 301 908 25	17.3.0
2021-12	RAN#94	R5-218423	1435	1	F	Updating 7.3A.2 Reference sensitivity for CA_n1A-n78A-n79A	17.3.0
2021-12	RAN#94	R5-218456	1434	1	F	Addition of UE co-existence requirements for band n40 to TS 38.521-1	17.3.0
2021-12	RAN#94	R5-218457	1449	1	F	Updating 6.2A.2 MPR for CA test case for intra-band UL CA	17.3.0
2021-12	RAN#94	R5-218458	1451	1	F	Updating 6.3A.4.1 Absolute power tolerance for intra-band CA	17.3.0
2021-12	RAN#94	R5-218459	1454	1	F	Updating 6.5A.1.1 Occupied bandwidth for CA	17.3.0
2021-12	RAN#94	R5-218471	1462	1	F	Addition of CA_n1A-n3A into TC 7.3A Reference sensitivity for CA	17.3.0
2021-12	RAN#94	R5-218476	1424	1	F	Update of MOP test cases for PC2 CA_n1A-n78A with UL CA_n1A-n78A	17.3.0
2021-12	RAN#94	R5-218477	1394	1	F	PC1.5 MPR n77 n78	17.3.0
2021-12	RAN#94	R5-218478	1395	1	F	PC1.5 MOP n77 n78	17.3.0
2021-12	RAN#94	R5-218481	1414	1	F	Introduction of new test case 6.4.2.1a	17.3.0
2022-03	RAN#95	R5-220071	1481	-	F	Addition of Test description and Test requirement for 6.3A.2.1 Transmit OFF power for 2UL CA	17.4.0
2022-03	RAN#95	R5-220072	1482	-	F	Correction of Table number in step 4 of 6.3A.4.2.1.4.1	17.4.0
2022-03	RAN#95	R5-220073	1483	-	F	Correction of Test SCS in Table 6.2D.2.4.1-1	17.4.0
2022-03	RAN#95	R5-220074	1484	-	F	Addition of missing clause titles for 6.5B, 6.5D.2_1.4 and 6.5D.2_1.4.1	17.4.0

2022-03	RAN#95	R5-220075	1485	-	F	Correction of clause title styles	17.4.0
2022-03	RAN#95	R5-220076	1486	-	F	Correction of Test SCS in Table 7.3C.2.4.1-1	17.4.0
2022-03	RAN#95	R5-220077	1487	-	F	Correction of style in Table 7.4D.4.1-1	17.4.0
2022-03	RAN#95	R5-220078	1488	-	F	Correction of Test frequency in Table 7.6C.3_1.1.4.1-1	17.4.0
2022-03	RAN#95	R5-220080	1489	-	F	Adding additional tolerance to test requirement of Transmitter power test cases	17.4.0
2022-03	RAN#95	R5-220081	1490	-	F	Removal of Editor note about PC1 requirements in Rel-15 and Rel-16	17.4.0
2022-03	RAN#95	R5-220082	1491	-	F	Correction of table numbers in 7.6C.2_1.1 and 7.6C.3_1.1	17.4.0
2022-03	RAN#95	R5-220084	1493	-	F	Introduction of new V2X test cases in 7.6E	17.4.0
2022-03	RAN#95	R5-220086	1495	-	F	Introduction of new V2X test cases in 7.8E	17.4.0
2022-03	RAN#95	R5-220138	1497	-	F	Update test requirements of PC2 n34 MOP for UL MIMO	17.4.0
2022-03	RAN#95	R5-220139	1498	-	F	Update test requirements of PC2 n39 MOP for UL MIMO	17.4.0
2022-03	RAN#95	R5-220249	1510	-	F	Corrected REFSENS reference in SUL Frequency error test	17.4.0
2022-03	RAN#95	R5-220250	1511	-	F	Correction of test requirements in spurious test 7.7D	17.4.0
2022-03	RAN#95	R5-220251	1512	-	F	DL RMC correction for TDD SCS 60kHz	17.4.0
2022-03	RAN#95	R5-220252	1513	-	F	Editorial correction to minimum requirements in test 6.2D.2	17.4.0
2022-03	RAN#95	R5-220253	1514	-	F	General corrections in FR1 6.3A.3.1 ONOFF time mask CA	17.4.0
2022-03	RAN#95	R5-220254	1515	-	F	Frequency correction for NS_27 in A-MPR test	17.4.0
2022-03	RAN#95	R5-220255	1516	-	F	n71 IBNC - UL allocation correction for testing REFSENS without exceptions	17.4.0
2022-03	RAN#95	R5-220273	1518	-	F	Clarifications on 5G NR connectivity options for RF FR1	17.4.0
2022-03	RAN#95	R5-220280	1520	-	F	Update CA configurations for CA_n41A-n79A BCS1	17.4.0
2022-03	RAN#95	R5-220349	1522	-	F	Adding NR bands for UL MIMO in FR1	17.4.0
2022-03	RAN#95	R5-220362	1527	-	F	Introduction of CA_n7A-n78A reference sensitivity test requirements	17.4.0
2022-03	RAN#95	R5-220537	1531	-	F	Correction on test procedure and initial condition for power tolerance test cases	17.4.0
2022-03	RAN#95	R5-220639	1532	-	F	Editorial, correction of clause numbering in test case 6.5D.2.4.1	17.4.0
2022-03	RAN#95	R5-220752	1536	-	F	Updating on additional UE co-ex requirements for 2 Band UL CA	17.4.0
2022-03	RAN#95	R5-220753	1537	-	F	Updating on n74 co-existence for TS 38.521-1	17.4.0
2022-03	RAN#95	R5-220870	1547	-	F	Updating MOP and Configured Tx Power TCs for CA_n24A-n41A	17.4.0
2022-03	RAN#95	R5-220871	1548	-	F	Updating MOP and Configured Tx Power TCs for CA_n24A-n48A	17.4.0
2022-03	RAN#95	R5-220872	1549	-	F	Updating MOP and Configured Tx Power TCs for CA_n24A-n77A	17.4.0
2022-03	RAN#95	R5-220873	1550	-	F	Updating reference sensitivity test requirement for CA combination of n24 and n41	17.4.0
2022-03	RAN#95	R5-220874	1551	-	F	Updating Delta_RIB_c and reference sensitivity test requirement for CA combination of n24 and n48	17.4.0
2022-03	RAN#95	R5-220893	1558	-	F	Correction to test procedure of SRS time mask	17.4.0
2022-03	RAN#95	R5-220899	1560	-	F	Correction to test requirement of NS_27 in 6.2.3	17.4.0
2022-03	RAN#95	R5-220900	1561	-	F	Correction to test requirement of NS_47 in 6.2.3	17.4.0

2022-03	RAN#95	R5-220905	1563	-	F	Correction to test CBW for Non-SUL carrier in 6.4C.2.2	17.4.0
2022-03	RAN#95	R5-220906	1564	-	F	Correction to test requirement of 6.5C.3.2	17.4.0
2022-03	RAN#95	R5-220914	1566	-	F	Correction to RMC for PUCCH format 1 test cases	17.4.0
2022-03	RAN#95	R5-220915	1567	-	F	Correction to connection diagram and test configuration for Tx SUL test cases	17.4.0
2022-03	RAN#95	R5-220919	1568	-	F	Correction to transmission slot in SRS time mask test case	17.4.0
2022-03	RAN#95	R5-221046	1570	-	F	Addition of 6.5.2.3 on new CBW to A-SEM for NS_04	17.4.0
2022-03	RAN#95	R5-221051	1571	-	F	Correction of 6.2A.1 for UE maximum output power for CA	17.4.0
2022-03	RAN#95	R5-221052	1572	-	F	Correction of 6.2A.2 on UE MPR for CA	17.4.0
2022-03	RAN#95	R5-221106	1573	-	F	Correcting test applicabilities for MIMO test cases	17.4.0
2022-03	RAN#95	R5-221107	1574	-	F	Correcting to NR test case 6.2A.1 MOP for CA	17.4.0
2022-03	RAN#95	R5-221109	1576	-	F	Updating test case 6.2.3 AMPR for NS_03 and NS_03U	17.4.0
2022-03	RAN#95	R5-221113	1577	-	F	Updating General Spurious testing for CA_n41A-n79A	17.4.0
2022-03	RAN#95	R5-221114	1578	-	F	Updating A-MPR for CA testing for CA_n41A-n79A	17.4.0
2022-03	RAN#95	R5-221116	1579	-	F	Updating minimum requirements for test case 6.2.3 AMPR	17.4.0
2022-03	RAN#95	R5-221117	1580	-	F	Updating test case Additional spurious emissions for NS_46	17.4.0
2022-03	RAN#95	R5-221119	1582	-	F	Updating UTRA ACLR for UL MIMO Rel-16 onward for NS_100	17.4.0
2022-03	RAN#95	R5-221120	1583	-	F	Updating Additional spurious emissions for UL MIMO Rel-16 onward for several bands	17.4.0
2022-03	RAN#95	R5-221121	1584	-	F	Updating 6.1A for intra-band contiguous CA Outer1 RB allocation	17.4.0
2022-03	RAN#95	R5-221122	1585	-	F	Updating test case 6.2A.2 MPR for intra-band non-contiguous CA	17.4.0
2022-03	RAN#95	R5-221128	1588	-	F	Updating FR1 Spectrum emission mask for intra-band CA test case	17.4.0
2022-03	RAN#95	R5-221130	1589	-	F	Updating Relative power control tolerance testing for intra-band CA	17.4.0
2022-03	RAN#95	R5-221198	1591	-	F	Addition of CBW 70MHz into TC 6.5D	17.4.0
2022-03	RAN#95	R5-221200	1592	-	F	Addition of CBW 70MHz into Rx TCs	17.4.0
2022-03	RAN#95	R5-221209	1593	-	F	Updating MPR minimum requirement for NR band n97	17.4.0
2022-03	RAN#95	R5-221244	1596	-	F	Addition of CA_n1A-n3A into TC 6.2A	17.4.0
2022-03	RAN#95	R5-221266	1604	-	F	Correction of in-band emissions test cases	17.4.0
2022-03	RAN#95	R5-221267	1605	-	F	Correction of SRS time mask test case	17.4.0
2022-03	RAN#95	R5-221322	1606	-	F	Update for 6.5C.3.3 Additional spurious emissions for SUL	17.4.0
2022-03	RAN#95	R5-221339	1610	-	F	A-MPR updates for n77	17.4.0
2022-03	RAN#95	R5-221361	1613	-	F	Editorial update within channel raster section	17.4.0
2022-03	RAN#95	R5-221675	1480	1	F	Correction of test applicability of A-MPR	17.4.0
2022-03	RAN#95	R5-221676	1528	1	F	Alignment of test points of ACLR with MPR	17.4.0
2022-03	RAN#95	R5-221677	1539	1	F	Corrections of Tx TCs having impact on ETSI EN 301 908-25	17.4.0
2022-03	RAN#95	R5-221678	1557	1	F	Correction to note of general spurious emissions	17.4.0
2022-03	RAN#95	R5-221679	1559	1	F	Correction to test requirement of 6.2.4	17.4.0
2022-03	RAN#95	R5-221680	1562	1	F	Correction to measurement timing for inter-band CA with FDD and TDD	17.4.0

2022-03	RAN#95	R5-221681	1565	1	F	Editorial correction to SUL test cases	17.4.0
2022-03	RAN#95	R5-221682	1607	1	F	Editorial correction to clause 6.5.3.2 and 6.5.3.3	17.4.0
2022-03	RAN#95	R5-221683	1541	1	F	Update to statistical testing	17.4.0
2022-03	RAN#95	R5-221684	1603	1	F	Correction to FR1 UL RMCs	17.4.0
2022-03	RAN#95	R5-221758	1509	1	F	Update Spurious emissions for UE co-existence for CA_n3A-n41A	17.4.0
2022-03	RAN#95	R5-221759	1517	1	F	Update Spurious emissions for UE co-existence for CA_n41A-n79A	17.4.0
2022-03	RAN#95	R5-221760	1508	1	F	Update Reference sensitivity test case for CA_n3A-n41A	17.4.0
2022-03	RAN#95	R5-221761	1526	1	F	Introduction of CA_n5A-n78A reference sensitivity test requirements	17.4.0
2022-03	RAN#95	R5-221762	1538	1	F	Introduction of CA_n5A-n7A and CA_n7A_n78A maximum output power test requirements	17.4.0
2022-03	RAN#95	R5-221763	1611	1	F	MSD test configurations modification for US inter-band CA combinations with n77	17.4.0
2022-03	RAN#95	R5-221764	1507	1	F	Update operating bands and CA configurations for CA_n3A-n41A	17.4.0
2022-03	RAN#95	R5-221765	1553	1	F	General updates of clause 5 for R16 CADC configurations	17.4.0
2022-03	RAN#95	R5-221788	1597	1	F	New channel bandwidth for n25. UL-MIMO.	17.4.0
2022-03	RAN#95	R5-221789	1602	1	F	Addition of CBHWs 25 MHz, 30 MHz, 40 MHz for n25	17.4.0
2022-03	RAN#95	R5-221790	1598	1	F	New channel bandwidth for n25. refsens and UL-MIMO	17.4.0
2022-03	RAN#95	R5-221791	1540	1	F	General updates of clause 5 for R16 new CBW configurations	17.4.0
2022-03	RAN#95	R5-221794	1581	1	F	Updating test case AMPR for MIMO	17.4.0
2022-03	RAN#95	R5-221795	1586	1	F	Updating Absolute power tolerance for intra-band non-contiguous CA	17.4.0
2022-03	RAN#95	R5-221796	1587	1	F	Updating FR1 ACLR for intra-band CA test case	17.4.0
2022-03	RAN#95	R5-221817	1492	1	F	Introduction of new V2X test cases in 6.3E.2	17.4.0
2022-03	RAN#95	R5-221818	1542	1	F	Update to NR V2X test cases with non-concurrent operation	17.4.0
2022-03	RAN#95	R5-221819	1543	1	F	Addition of 6.2E.2.2 MPR for concurrent operation	17.4.0
2022-03	RAN#95	R5-221820	1494	1	F	Introduction of new V2X test cases in 7.7E	17.4.0
2022-03	RAN#95	R5-221870	1601	1	F	Update of R17 new CBW 45M into refsense TC	17.4.0
2022-03	RAN#95	R5-221877	1519	1	F	Update of R17 NR inter-band CA Tx requirements within FR1	17.4.0
2022-03	RAN#95	R5-221878	1521	1	F	Update of R17 NR inter-band CA Rx requirements within FR1	17.4.0
2022-03	RAN#95	R5-221879	1552	1	F	Updating Delta_RIB_c and reference sensitivity test requirement for CA combination of n24 and n77	17.4.0
2022-03	RAN#95	R5-221880	1569	1	F	Addition of several CA combinations to Reference Sensitivity test case	17.4.0
2022-03	RAN#95	R5-221881	1554	1	F	General updates of clause 5 for R17 CADC configurations	17.4.0
2022-03	RAN#95	R5-221882	1590	1	F	Updating clause 5.2C for R17 SUL configurations	17.4.0
2022-03	RAN#95	R5-221894	1599	1	F	Introduction of NR-U OFF power test case	17.4.0
2022-03	RAN#95	R5-221895	1600	1	F	Introduction of NR-U General ON/OFF time mask test case	17.4.0
2022-03	RAN#95	R5-221896	1529	1	F	Update of MOP test cases for PC2 CA_n1A-n78A with UL CA_n1A-n78A	17.4.0
2022-03	RAN#95	R5-221897	1530	1	F	Update of MOP test cases for PC2 CA_n3A-n78A with UL CA_n3A-n78A	17.4.0

2022-03	RAN#95	R5-221898	1534	1	F	Update superscripts of power class for inter-band CA	17.4.0
2022-03	RAN#95	R5-221899	1535	1	F	Update MOP for 2 bands DL and 1 band UL CA	17.4.0
2022-03	RAN#95	R5-221900	1594	1	F	Update MOP for Intra-band contiguous CA	17.4.0
2022-03	RAN#95	R5-221901	1595	1	F	Update MOP for Intra-band non-contiguous CA	17.4.0
2022-03	RAN#95	R5-221902	1505	1	F	Update UL CA configurations for PC2 and PC1.5 CA_n41C	17.4.0
2022-03	RAN#95	R5-221903	1506	1	F	Update configuration for PC2 CA_n3A-n41A	17.4.0
2022-03	RAN#95	R5-221904	1502	1	F	Update NR ACLR test case for PC1.5	17.4.0
2022-03	RAN#95	R5-221905	1496	1	F	Update TC Frequency Error for DSS	17.4.0
2022-03	RAN#95	R5-221906	1499	1	F	Update TC Frequency Error for UL MIMO for DSS	17.4.0
2022-03	RAN#95	R5-221907	1500	1	F	Update TC Frequency Error for CA for DSS	17.4.0
2022-03	RAN#95	R5-221912	1609	1	F	Update for 6.4.2.1a EVM including symbols with transient period	17.4.0
2022-03	RAN#95	R5-221930	1575	1	F	Updating message contents for REFSSENS for 2DL CA exceptions testing	17.4.0
2022-06	RAN#96	R5-222174	1616	-	F	Correction to n46 ARFCN	17.5.0
2022-06	RAN#96	R5-222200	1617	-	F	Removing the empty space in the table number of Table 7.3.2.3-1a and correct the style of table title of Table 7.3.2.3-1b	17.5.0
2022-06	RAN#96	R5-222201	1618	-	F	Correction of test metric of out of band emission for UL MIMO	17.5.0
2022-06	RAN#96	R5-222202	1619	-	F	Correction of Test Environment in Table 6.5A.2.2.1.4.1-2	17.5.0
2022-06	RAN#96	R5-222203	1620	-	F	Correction of test applicability of 6.4.2.5	17.5.0
2022-06	RAN#96	R5-222204	1621	-	F	Moving test requirement of 6.3E.1.1D to the correct section and correction of style of some table notes	17.5.0
2022-06	RAN#96	R5-222205	1622	-	F	Correction of clause style in 6.2E.2.2	17.5.0
2022-06	RAN#96	R5-222206	1623	-	F	Removing FFS for the test configuration table in 6.2E.1.1.4.1	17.5.0
2022-06	RAN#96	R5-222241	1629	-	F	Update Spurious emissions for UE co-existence for CA_n41C	17.5.0
2022-06	RAN#96	R5-222310	1631	-	F	Introduction of Transmitter power for NR-DC	17.5.0
2022-06	RAN#96	R5-222311	1632	-	F	Introduction of UE maximum output power reduction for NR-DC	17.5.0
2022-06	RAN#96	R5-222312	1633	-	F	Introduction of UE additional maximum output power reduction for NR-DC	17.5.0
2022-06	RAN#96	R5-222313	1634	-	F	Introduction of Configured output power for inter-band NR-DC in FR1	17.5.0
2022-06	RAN#96	R5-222327	1648	-	F	Editorial correction for references to Table 5.5A.3-1	17.5.0
2022-06	RAN#96	R5-222331	1649	-	F	FR1 - 6.5A.3.2 - Spurious for co-existence - correction for CA_n41-n79	17.5.0
2022-06	RAN#96	R5-222334	1652	-	F	Reference correction in test case 6.5C.4	17.5.0
2022-06	RAN#96	R5-222335	1653	-	F	Correction of min value for A-MPR - FR1 - NS_44 - Test ID 17	17.5.0
2022-06	RAN#96	R5-222336	1654	-	F	Replace n79C by n77C in test case 6.2A.2.1	17.5.0
2022-06	RAN#96	R5-222337	1655	-	F	Editorial correction in Test IDs in FR1 test case 7.5A.2	17.5.0
2022-06	RAN#96	R5-222338	1656	-	F	Corrections for n50 and n79 in FR1 test case 7.3.2	17.5.0
2022-06	RAN#96	R5-222339	1657	-	F	Editorial corrections for FR1 in annex F.1.2	17.5.0
2022-06	RAN#96	R5-222351	1659	-	F	Update of reference sense test case 7.3.2 for n48 and CWBs 30 and 70 MHz	17.5.0

2022-06	RAN#96	R5-222352	1660	-	F	Update of reference sense test case 7.3.2 for n2 and CWBs 25 30 and 40 MHz	17.5.0
2022-06	RAN#96	R5-222353	1661	-	F	Update of reference sense test case 7.3.2 for n5 and CWB 25 MHz	17.5.0
2022-06	RAN#96	R5-222354	1662	-	F	Introducing CBW 70 MHz for Default Downlink Power levels in Annex C	17.5.0
2022-06	RAN#96	R5-222355	1663	-	F	Introducing CBW 30 MHz for Characteristics of the Interfering Signalling in Annex D	17.5.0
2022-06	RAN#96	R5-222356	1664	-	F	Introducing CBW 70 MHz for Characteristics of the Interfering Signalling in Annex D	17.5.0
2022-06	RAN#96	R5-222448	1667	-	F	Editorial correction of REFSENS test case 7.3.2	17.5.0
2022-06	RAN#96	R5-222450	1669	-	F	Correction of REFSENS test case for n66 and CBW 25 and 30 MHz	17.5.0
2022-06	RAN#96	R5-222481	1671	-	F	Correction to EVM measurement point for DFTs-OFDM DM-RS Type 2	17.5.0
2022-06	RAN#96	R5-222540	1674	-	F	Correction of REFSENS test case for n66 and CBW 40 MHz	17.5.0
2022-06	RAN#96	R5-222571	1676	-	F	Addition of reference sensitivity test for several CA combinations	17.5.0
2022-06	RAN#96	R5-222655	1678	-	F	Addition of UE co-existence requirements for band n18 to TS 38.521-1	17.5.0
2022-06	RAN#96	R5-222664	1682	-	F	General updates of clause 5 for R17 new CBW configurations	17.5.0
2022-06	RAN#96	R5-222683	1693	-	F	Update of R17 CADC configurations into refsense TC	17.5.0
2022-06	RAN#96	R5-222738	1696	-	F	Update 7.3F.2 Ref sensitivity power level	17.5.0
2022-06	RAN#96	R5-222739	1697	-	F	Introduction of 7.6F.2 IBB for NR_U	17.5.0
2022-06	RAN#96	R5-222745	1700	-	F	Update 6.5.3.2 Spurious emissions for UE co-existence	17.5.0
2022-06	RAN#96	R5-222746	1701	-	F	Introduction of ACS for NR_U	17.5.0
2022-06	RAN#96	R5-222808	1703	-	F	Correction of A-MPR regions for NS_46	17.5.0
2022-06	RAN#96	R5-222857	1706	-	F	Updates of clause 5 for R15 bands and CBW configurations	17.5.0
2022-06	RAN#96	R5-222873	1707	-	F	Aligning test case Occupied bandwidth for UL MIMO with the latest work plan version	17.5.0
2022-06	RAN#96	R5-222930	1719	-	F	Update of the definition of uplink RB allocation for power class 1.5 UE	17.5.0
2022-06	RAN#96	R5-222939	1720	-	F	Aligning test case 6.5D.2.4.1 NR ACLR for UL MIMO with the latest work plan version	17.5.0
2022-06	RAN#96	R5-222955	1722	-	F	Aligning test case 6.5D.2.4.2 UTRA ACLR for UL MIMO with the latest work plan version	17.5.0
2022-06	RAN#96	R5-222975	1723	-	F	Addition of CA_n1A-n8A into MOP TC	17.5.0
2022-06	RAN#96	R5-222993	1724	-	F	Corrections of DCI format for Tx TCs having impact on ETSI EN 301 908-25	17.5.0
2022-06	RAN#96	R5-222997	1725	-	F	Removal of brackets for DCI for Rx test cases	17.5.0
2022-06	RAN#96	R5-223018	1727	-	F	Update of Annex F for UL MIMO test cases	17.5.0
2022-06	RAN#96	R5-223022	1728	-	F	Addition of CA_n1A-n8A into Refsens TC	17.5.0
2022-06	RAN#96	R5-223124	1731	-	F	Updating minimum requirement for 7.6A.3 OOB for CA testing	17.5.0
2022-06	RAN#96	R5-223130	1734	-	F	Updating almost contiguous RB allocation for 45MHz CBW	17.5.0
2022-06	RAN#96	R5-223133	1736	-	F	Updating Additional spurious emissions for NS_48 for 45MHz CBW	17.5.0
2022-06	RAN#96	R5-223134	1737	-	F	Updating test case 6.3.1 Minimum output power for CBW 45MHz	17.5.0

2022-06	RAN#96	R5-223135	1738	-	F	Updating transmit ON_OFF time mask test case for 45MHz CBW	17.5.0
2022-06	RAN#96	R5-223136	1739	-	F	Updating test case 7.4 Maximum input level for new Rel-17 CBWs	17.5.0
2022-06	RAN#96	R5-223137	1740	-	F	Updating 6.3D.1 Minimum output power for UL MIMO for 45MHz CBW	17.5.0
2022-06	RAN#96	R5-223138	1741	-	F	Updating transmit ON_OFF time mask for MIMO test case for 45MHz CBW	17.5.0
2022-06	RAN#96	R5-223159	1746	-	F	Update TC 6.5.3.3 Additional spurious emissions for PC2 n39	17.5.0
2022-06	RAN#96	R5-223198	1748	-	F	Addition of redcap requirement into sub-clause 7.1 and 7.2	17.5.0
2022-06	RAN#96	R5-223655	1753	1	F	Introduction of test specifications for additional Rel-16 CA combos to Clause 6	17.5.0
2022-06	RAN#96	R5-223656	1650	1	F	Test procedure correction in FR1 CA test case 7.6A.4.3	17.5.0
2022-06	RAN#96	R5-223657	1721	1	F	General updates of clause 5 for R16 CADC configurations	17.5.0
2022-06	RAN#96	R5-223693	1750	1	F	Update test configuration table for NS_27 of A-MPR	17.5.0
2022-06	RAN#96	R5-223694	1694	1	F	Update of CBW 70MHz into refsens TC	17.5.0
2022-06	RAN#96	R5-223695	1692	1	F	General updates of clause 5 for R16 new CBW configurations	17.5.0
2022-06	RAN#96	R5-223697	1666	1	F	Corrections in message exceptions and test points for FR1 test case 6.3A.4.1.1	17.5.0
2022-06	RAN#96	R5-223698	1702	1	F	Update 6.5.3.2 Spur-emiss R16_17 for UE co-exist	17.5.0
2022-06	RAN#96	R5-223699	1732	1	F	Correction to NS_27 in test case AMPR for MIMO	17.5.0
2022-06	RAN#96	R5-223700	1651	1	F	Test procedure correction in FR1 CA test case 7.6A.4.2	17.5.0
2022-06	RAN#96	R5-223705	1726	1	F	Addition of spectrum emission mask testing for UL MIMO with ULFPTx	17.5.0
2022-06	RAN#96	R5-223729	1733	1	F	Updating RB allocation for CBW 45MHz	17.5.0
2022-06	RAN#96	R5-223730	1735	1	F	Updating AMPR test case for NS_48 for CBW 45MHz	17.5.0
2022-06	RAN#96	R5-223731	1658	1	F	Update of reference sense test case 7.3.2 for n41 and CWB 70 MHz	17.5.0
2022-06	RAN#96	R5-223734	1679	1	F	Updating General Spurious Emissions TC for CA_n24-n41	17.5.0
2022-06	RAN#96	R5-223735	1680	1	F	Updating General Spurious Emissions TCs for CA_n24-n48	17.5.0
2022-06	RAN#96	R5-223736	1681	1	F	Updating General Spurious Emissions TCs for CA_n24-n77	17.5.0
2022-06	RAN#96	R5-223737	1683	1	F	Updating Spurious emission for UE co-existence TC for CA_n24-n41	17.5.0
2022-06	RAN#96	R5-223738	1684	1	F	Updating Spurious emission for UE co-existence TC for CA_n24-n48	17.5.0
2022-06	RAN#96	R5-223739	1685	1	F	Updating Spurious emission for UE co-existence TC for CA_n24-n77	17.5.0
2022-06	RAN#96	R5-223740	1686	1	F	Updating AMPR TC for Rel-17 CA_n24-n41	17.5.0
2022-06	RAN#96	R5-223741	1687	1	F	Updating AMPR TC for Rel-17 CA_n24-n48	17.5.0
2022-06	RAN#96	R5-223742	1689	1	F	Updating AMPR TC for Rel-17 CA_n24-n77	17.5.0
2022-06	RAN#96	R5-223743	1690	1	F	General updates of clause 5 for R17 CADC configurations	17.5.0
2022-06	RAN#96	R5-223754	1695	1	F	Add MU and TT for 7.5F.1 and 7.6F.2	17.5.0
2022-06	RAN#96	R5-223756	1635	1	F	Introduction of Output power dynamics and Minimum output power for NR-DC in FR1	17.5.0
2022-06	RAN#96	R5-223757	1636	1	F	Introduction of Transmit OFF power for NR-DC in FR1	17.5.0
2022-06	RAN#96	R5-223758	1637	1	F	Introduction of Transmit ON/OFF time mask for NR-DC in FR1	17.5.0

2022-06	RAN#96	R5-223759	1638	1	F	Introduction of Transmit signal quality and Frequency error for NR-DC in FR1	17.5.0
2022-06	RAN#96	R5-223760	1639	1	F	Introduction of Error Vector Magnitude for NR-DC in FR1	17.5.0
2022-06	RAN#96	R5-223761	1640	1	F	Introduction of Carrier leakage for NR-DC in FR1	17.5.0
2022-06	RAN#96	R5-223762	1641	1	F	Introduction of In-band emissions for NR-DC in FR1	17.5.0
2022-06	RAN#96	R5-223763	1642	1	F	Introduction of Output RF spectrum emissions and Occupied bandwidth for NR-DC in FR1	17.5.0
2022-06	RAN#96	R5-223764	1643	1	F	Introduction of Out of band emission Spectrum emission mask for NR-DC in FR1	17.5.0
2022-06	RAN#96	R5-223765	1644	1	F	Introduction of Adjacent channel leakage ratio for NR-DC in FR1	17.5.0
2022-06	RAN#96	R5-223766	1645	1	F	Introduction of Spurious emission for NR-DC in FR1	17.5.0
2022-06	RAN#96	R5-223767	1646	1	F	Introduction of Transmit intermodulation for NR-DC in FR1	17.5.0
2022-06	RAN#96	R5-223768	1647	1	F	Introduction of NR-DC references to transmitter test requirements	17.5.0
2022-06	RAN#96	R5-223769	1630	1	F	Introduction of configuration DC_n48A-n70A for NR-DC in FR1	17.5.0
2022-06	RAN#96	R5-223770	1665	1	F	UL MIMO MOP requirements for PC1.5 in n77 and n78	17.5.0
2022-06	RAN#96	R5-223773	1625	1	F	Removal of PC1.5 from TC 6.2.1 MOP	17.5.0
2022-06	RAN#96	R5-223774	1626	1	F	Removal of PC1.5 from TC 6.2.2 MPR	17.5.0
2022-06	RAN#96	R5-223775	1627	1	F	Removal of PC1.5 from TC 6.2.3 A-MPR	17.5.0
2022-06	RAN#96	R5-223776	1628	1	F	Removal of PC1.5 from TC 6.5.2.4.1 ACLR	17.5.0
2022-06	RAN#96	R5-223777	1713	1	F	Addition of new test case 6.2G.1 maximum output power for Tx Diversity	17.5.0
2022-06	RAN#96	R5-223778	1714	1	F	Addition of new test case 6.2G.2 maximum output power reduction for Tx Diversity	17.5.0
2022-06	RAN#96	R5-223779	1715	1	F	Addition of new test case 6.2G.3 additional maximum output power reduction for Tx Diversity	17.5.0
2022-06	RAN#96	R5-223780	1716	1	F	Addition of new test case 6.5G.2.3 Adjacent channel leakage ratio for Tx Diversity	17.5.0
2022-06	RAN#96	R5-223781	1729	1	F	Introduce SRS IL for UE with NR TxD	17.5.0
2022-06	RAN#96	R5-223782	1718	1	F	Addition of Annex F for Tx Diversity test cases	17.5.0
2022-06	RAN#96	R5-223785	1709	1	F	Addition of Redcap MOP 6.2I.1	17.5.0
2022-06	RAN#96	R5-223786	1710	1	F	Addition of Redcap MPR 6.2I.2	17.5.0
2022-06	RAN#96	R5-223787	1711	1	F	Addition of Redcap AMPR 6.2I.3	17.5.0
2022-06	RAN#96	R5-223788	1712	1	F	Addition of Redcap configured output power 6.2I.4	17.5.0
2022-06	RAN#96	R5-223789	1704	1	F	Addition of Reference sensitivity TC for RedCap	17.5.0
2022-06	RAN#96	R5-223790	1705	1	F	Addition of redcap general requirement into clause 3-5	17.5.0
2022-06	RAN#96	R5-223804	1624	1	F	Moving additional tolerance in 6.2A.3.1.5 and 6.2D.3.5 to end of the section	17.5.0
2022-06	RAN#96	R5-223805	1670	1	F	Correction to time mask test cases	17.5.0
2022-06	RAN#96	R5-223806	1672	1	F	Correction to RB allocation and test requirement in 6.2.3	17.5.0
2022-06	RAN#96	R5-223807	1673	1	F	Correction to DCI format in 6.4.2.1	17.5.0
2022-06	RAN#96	R5-223809	1708	1	F	Update to MPR test requirements to remove ambiguity of T_LC	17.5.0

2022-06	RAN#96	R5-223810	1743	1	F	Correction to Test Channel Bandwidths for FR1 CA	17.5.0
2022-06	RAN#96	R5-223811	1744	1	F	Editorial correction to test requirement of Aggregate power tolerance for UL MIMO	17.5.0
2022-06	RAN#96	R5-223812	1752	1	F	Update 6.2.3 for additional maximum power reduction	17.5.0
2022-06	RAN#96	R5-223813	1675	1	F	Clarification of BCS in test configuration of CA test cases	17.5.0
2022-06	RAN#96	R5-223872	1698	1	F	Update 6.4.2.1a EVM including symbols with transient period	17.5.0
2022-06	RAN#96	R5-223873	1755	1	F	Update for 6.3.3.1 General clause of Tx ON-OFF time mask	17.5.0
2022-06	RAN#96	R5-223875	1699	2	F	Update AMPR for NS_04	17.5.0

History

Document history		
V17.4.1	July 2022	Publication
V17.5.0	September 2022	Publication