

# ETSI TS 138 533 V17.3.1 (2022-09)



**5G;  
NR;  
User Equipment (UE) conformance specification;  
Radio Resource Management (RRM)  
(3GPP TS 38.533 version 17.3.1 Release 17)**



---

Reference

RTS/TSGR-0538533vh31

---

Keywords

5G

**ETSI**

650 Route des Lucioles  
F-06921 Sophia Antipolis Cedex - FRANCE

Tel.: +33 4 92 94 42 00 Fax: +33 4 93 65 47 16

Siret N° 348 623 562 00017 - APE 7112B  
Association à but non lucratif enregistrée à la  
Sous-Préfecture de Grasse (06) N° w061004871

---

**Important notice**

The present document can be downloaded from:

<http://www.etsi.org/standards-search>

The present document may be made available in electronic versions and/or in print. The content of any electronic and/or print versions of the present document shall not be modified without the prior written authorization of ETSI. In case of any existing or perceived difference in contents between such versions and/or in print, the prevailing version of an ETSI deliverable is the one made publicly available in PDF format at [www.etsi.org/deliver](http://www.etsi.org/deliver).

Users of the present document should be aware that the document may be subject to revision or change of status.

Information on the current status of this and other ETSI documents is available at

<https://portal.etsi.org/TB/ETSIDeliverableStatus.aspx>

If you find errors in the present document, please send your comment to one of the following services:

<https://portal.etsi.org/People/CommitteeSupportStaff.aspx>

If you find a security vulnerability in the present document, please report it through our  
Coordinated Vulnerability Disclosure Program:

<https://www.etsi.org/standards/coordinated-vulnerability-disclosure>

---

**Notice of disclaimer & limitation of liability**

The information provided in the present deliverable is directed solely to professionals who have the appropriate degree of experience to understand and interpret its content in accordance with generally accepted engineering or other professional standard and applicable regulations.

No recommendation as to products and services or vendors is made or should be implied.

No representation or warranty is made that this deliverable is technically accurate or sufficient or conforms to any law and/or governmental rule and/or regulation and further, no representation or warranty is made of merchantability or fitness for any particular purpose or against infringement of intellectual property rights.

In no event shall ETSI be held liable for loss of profits or any other incidental or consequential damages.

Any software contained in this deliverable is provided "AS IS" with no warranties, express or implied, including but not limited to, the warranties of merchantability, fitness for a particular purpose and non-infringement of intellectual property rights and ETSI shall not be held liable in any event for any damages whatsoever (including, without limitation, damages for loss of profits, business interruption, loss of information, or any other pecuniary loss) arising out of or related to the use of or inability to use the software.

---

**Copyright Notification**

No part may be reproduced or utilized in any form or by any means, electronic or mechanical, including photocopying and microfilm except as authorized by written permission of ETSI.

The content of the PDF version shall not be modified without the written authorization of ETSI.

The copyright and the foregoing restriction extend to reproduction in all media.

© ETSI 2022.  
All rights reserved.

---

# Intellectual Property Rights

## Essential patents

IPRs essential or potentially essential to normative deliverables may have been declared to ETSI. The declarations pertaining to these essential IPRs, if any, are publicly available for **ETSI members and non-members**, and can be found in ETSI SR 000 314: "*Intellectual Property Rights (IPRs); Essential, or potentially Essential, IPRs notified to ETSI in respect of ETSI standards*", which is available from the ETSI Secretariat. Latest updates are available on the ETSI Web server (<https://ipr.etsi.org/>).

Pursuant to the ETSI Directives including the ETSI IPR Policy, no investigation regarding the essentiality of IPRs, including IPR searches, has been carried out by ETSI. No guarantee can be given as to the existence of other IPRs not referenced in ETSI SR 000 314 (or the updates on the ETSI Web server) which are, or may be, or may become, essential to the present document.

## Trademarks

The present document may include trademarks and/or tradenames which are asserted and/or registered by their owners. ETSI claims no ownership of these except for any which are indicated as being the property of ETSI, and conveys no right to use or reproduce any trademark and/or tradename. Mention of those trademarks in the present document does not constitute an endorsement by ETSI of products, services or organizations associated with those trademarks.

**DECT™**, **PLUGTESTS™**, **UMTS™** and the ETSI logo are trademarks of ETSI registered for the benefit of its Members. **3GPP™** and **LTE™** are trademarks of ETSI registered for the benefit of its Members and of the 3GPP Organizational Partners. **oneM2M™** logo is a trademark of ETSI registered for the benefit of its Members and of the oneM2M Partners. **GSM®** and the GSM logo are trademarks registered and owned by the GSM Association.

---

# Legal Notice

This Technical Specification (TS) has been produced by the ETSI 3rd Generation Partnership Project (3GPP).

The present document may refer to technical specifications or reports using their 3GPP identities. These shall be interpreted as being references to the corresponding ETSI deliverables.

The cross reference between 3GPP and ETSI identities can be found under <http://webapp.etsi.org/key/queryform.asp>.

---

# Modal verbs terminology

In the present document "**shall**", "**shall not**", "**should**", "**should not**", "**may**", "**need not**", "**will**", "**will not**", "**can**" and "**cannot**" are to be interpreted as described in clause 3.2 of the [ETSI Drafting Rules](#) (Verbal forms for the expression of provisions).

"**must**" and "**must not**" are **NOT** allowed in ETSI deliverables except when used in direct citation.

# Contents

Intellectual Property Rights .....	2
Legal Notice .....	2
Modal verbs terminology.....	2
Foreword.....	24
1 Scope .....	25
2 References .....	25
3 Definitions, symbols and abbreviations .....	26
3.1 Definitions .....	26
3.2 Symbols.....	27
3.3 Abbreviations .....	28
3A Requirements for the support of RRM .....	30
3A.1 General .....	30
3A.1.0 Overview of RRM requirements.....	30
3A.1.1 Test coverage across 5G NR connectivity options .....	31
3A.2 Requirements Classification for Statistical Testing.....	31
3A.3 Antenna Configuration .....	31
3A.4 NR band groups.....	31
3A.4.0 General.....	31
3A.4.1 NR operating bands in FR1 .....	32
3A.4.2 NR operating bands in FR2 .....	32
3A.5 NR operating band configuration .....	33
3A.6 UE with Multiband Capability .....	34
4 EN-DC with all NR cells in FR1 .....	34
4.0 General .....	34
4.1 Void.....	35
4.2 Void.....	35
4.3 RRC_CONNECTED state mobility .....	35
4.3.1 Void .....	35
4.3.2 RRC connection mobility control .....	35
4.3.2.1 Void.....	35
4.3.2.2 Random access.....	35
4.3.2.2.1 EN-DC FR1 contention based random access.....	35
4.3.2.2.2 EN-DC FR1 non-contention based random access.....	41
4.3.2.2.3 EN-DC FR1 2-step contention based random access .....	48
4.3.2.2.4 EN-DC FR1 2-step non-contention based random access.....	53
4.3.2.3 Void.....	58
4.4 Timing .....	58
4.4.1 UE transmit timing .....	58
4.4.1.0 Minimum conformance requirements .....	58
4.4.1.0.1 Minimum conformance requirements for UE transmit timing accuracy .....	58
4.4.1.1 EN-DC FR1 UE transmit timing accuracy.....	60
4.4.2 UE timer accuracy .....	66
4.4.3 Timing advance .....	66
4.4.3.0 Minimum conformance requirements .....	66
4.4.3.0.1 Minimum conformance requirements for timing advance adjustment accuracy .....	66
4.4.3.0.2 Minimum conformance requirements for timing advance adjustment delay.....	66
4.4.3.1 EN-DC FR1 timing advance adjustment accuracy.....	67
4.5 Signaling characteristics.....	72
4.5.1 Radio link monitoring.....	72
4.5.1.00 General .....	72
4.5.1.0 Minimum conformance requirements .....	72
4.5.1.0.1 Minimum conformance requirements for out-of-sync SSB-based RLM.....	72
4.5.1.0.2 Void.....	73

4.5.1.0.3	Minimum conformance requirements for out-of-sync CSI-RS based RLM.....	73
4.5.1.0.4	Minimum conformance requirements for in-sync CSI-RS based RLM .....	74
4.5.1.1	EN-DC FR1 radio link monitoring out-of-sync test for PSCell configured with SSB-based RLM RS in non-DRX mode .....	76
4.5.1.2	EN-DC FR1 radio link monitoring in-sync test for PSCell configured with SSB-based RLM RS in non-DRX mode .....	81
4.5.1.3	EN-DC FR1 radio link monitoring out-of-sync test for PSCell configured with SSB-based RLM RS in DRX mode .....	86
4.5.1.4	EN-DC FR1 radio link monitoring in-sync test for PSCell configured with SSB-based RLM RS in DRX mode .....	91
4.5.1.5	EN-DC FR1 radio link monitoring out-of-sync test for PSCell configured with CSI-RS-based RLM RS in non-DRX mode .....	96
4.5.1.6	EN-DC FR1 radio link monitoring in-sync test for PSCell configured with CSI-RS-based RLM RS in non-DRX mode .....	101
4.5.1.7	EN-DC FR1 radio link monitoring out-of-sync test for PSCell configured with CSI-RS-based RLM RS in DRX mode.....	106
4.5.2	Interruption .....	117
4.5.2.0	Minimum conformance requirements .....	117
4.5.2.0.1	Minimum conformance requirements for interruptions at transitions between active and non- active during DRX.....	117
4.5.2.0.2	Minimum conformance requirements for interruptions during measurements on deactivated NR SCC.....	117
4.5.2.0.3	Minimum conformance requirements for interruptions during measurements on deactivated E-UTRAN SCC .....	118
4.5.2.1	EN-DC FR1 interruptions at transitions between active and non-active during DRX in synchronous EN-DC .....	119
4.5.2.2	EN-DC FR1 interruptions at transitions between active and non-active during DRX in asynchronous EN-DC.....	122
4.5.2.3	EN-DC FR1 interruptions during measurements on deactivated NR SCC in synchronous EN-DC ...	126
4.5.2.4	EN-DC FR1 interruptions during measurements on deactivated NR SCC in asynchronous EN- DC .....	132
4.5.2.5	EN-DC FR1 interruptions during measurements on deactivated E-UTRAN SCC in synchronous EN-DC .....	137
4.5.2.5.3	Minimum conformance requirements.....	137
4.5.2.6	EN-DC FR1 interruptions during measurements on deactivated E-UTRAN SCC in asynchronous EN-DC .....	141
4.5.3	SCell activation and deactivation delay .....	146
4.5.3.0	Minimum conformance requirements .....	146
4.5.3.1	EN-DC FR1 SCell activation and deactivation of known SCell in non-DRX for 160ms SCell measurement cycle .....	150
4.5.3.2	EN-DC FR1 SCell activation and deactivation of known SCell in non-DRX for 640ms SCell measurement cycle .....	158
4.5.3.3	EN-DC FR1 SCell activation and deactivation of unknown SCell in non-DRX .....	160
4.5.4	UE UL carrier RRC reconfiguration delay .....	162
4.5.4.1	EN-DC FR1 UE UL carrier RRC reconfiguration delay.....	162
4.5.5	Link recovery procedures .....	170
4.5.5.0	Minimum conformance requirements .....	170
4.5.5.0.3	Scheduling availability of UE during beam failure detection and candidate beam detection.....	172
4.5.5.0.4	Requirements for Beam Failure Recovery in SCell.....	172
4.5.5.1	EN-DC FR1 SSB-based beam failure detection and link recovery in non-DRX .....	172
4.5.5.2	EN-DC FR1 SSB-based beam failure detection and link recovery in DRX .....	179
4.5.5.3	EN-DC FR1 CSI-RS-based beam failure detection and link recovery in non-DRX .....	185
4.5.5.4	EN-DC FR1 CSI-RS-based beam failure detection and link recovery in DRX .....	192
4.5.5.5	EN-DC FR1 SCell CSI-RS-based beam failure detection and SSB-based link recovery in non- DRX .....	195
4.5.5.6	EN-DC FR1 SCell CSI-RS-based beam failure detection and SSB-based link recovery in DRX.....	201
4.5.6	Active BWP switch delay .....	210
4.5.6.1	DCI-based and time-based active BWP switch.....	210
4.5.6.1.0	Minimum conformance requirements.....	210
4.5.6.1.1	EN-DC FR1 DCI-based DL active BWP switch in non-DRX in synchronous EN-DC .....	212
4.5.6.1.2	EN-DC FR1 DCI-based DL active BWP switch with SCell in non-DRX in synchronous EN- DC .....	220

4.5.6.2	RRC-based active BWP switch.....	227
4.5.6.2.0	Minimum conformance requirements.....	227
4.5.6.2.1	EN-DC FR1 RRC-based DL active BWP switch in non-DRX in synchronous EN-DC.....	228
4.5.7	PSCell addition and release delay.....	234
4.5.7.0	Minimum conformance requirements.....	234
4.5.7.0.1	NR PSCell Addition Delay Requirement.....	234
4.5.7.0.2	NR PSCell Release Delay Requirement.....	234
4.5.7.1	EN-DC FR1 addition and release delay of known PSCell.....	235
4.5.8	UL switching.....	240
4.5.8.0	Minimum conformance requirements.....	240
4.5.8.1	EN-DC FR1 interruptions at switching between two uplink carriers.....	241
4.6	Measurement procedures.....	251
4.6.1	Intra-frequency measurements.....	251
4.6.1.0	Minimum conformance requirements.....	251
4.6.1.0.1	Minimum conformance requirements for event-triggered reporting without gap.....	251
4.6.1.0.2	Minimum conformance requirements for event-triggered measurements with gap.....	255
4.6.1.1	EN-DC FR1 event-triggered reporting without gap in non-DRX.....	258
4.6.1.2	EN-DC FR1 event-triggered reporting without gap in DRX.....	262
4.6.1.3	EN-DC FR1 event-triggered reporting with gap in non-DRX.....	265
4.6.1.4	EN-DC FR1 event-triggered reporting with gap in DRX.....	271
4.6.1.5	EN-DC FR1 event-triggered reporting without gap in non-DRX with SSB time index detection.....	276
4.6.1.6	EN-DC FR1 event-triggered reporting with gap in non-DRX with SSB time index detection.....	280
4.6.1.7	EN-DC FR1 event-triggered reporting without gap in DRX for UE configured with highSpeedMeasFlag-r16.....	284
4.6.2	Inter-frequency measurements.....	289
4.6.2.0	Minimum conformance requirements for Inter-frequency measurements.....	289
4.6.2.1	EN-DC FR1-FR1 event-triggered reporting in non-DRX.....	290
4.6.2.2	EN-DC FR1-FR1 event-triggered reporting in DRX.....	295
4.6.2.3	Void.....	301
4.6.2.4	Void.....	301
4.6.2.5	EN-DC FR1-FR1 event-triggered reporting in non-DRX with SSB time index detection.....	301
4.6.2.6	EN-DC FR1-FR1 event-triggered reporting in DRX with SSB time index detection.....	306
4.6.2.7	Void.....	311
4.6.2.8	Void.....	311
4.6.3	Void.....	311
4.6.4	L1-RSRP measurement for beam reporting.....	311
4.6.4.0	Minimum conformance requirements.....	311
4.6.4.0.1	Minimum conformance requirements for SSB-based L1-RSRP measurement for beam reporting.....	312
4.6.4.1	EN-DC FR1 SSB-based L1-RSRP measurement in non-DRX.....	315
4.6.4.1.5	Test requirement.....	319
4.6.4.2	EN-DC FR1 SSB-based L1-RSRP measurement in DRX.....	319
4.6.4.2.3	Minimum conformance requirements.....	320
4.6.4.3	EN-DC FR1 CSI-RS-based L1-RSRP measurement in non-DRX.....	323
4.6.4.4	EN-DC FR1 CSI-RS-based L1-RSRP measurement in DRX.....	327
4.6.4.5	EN-DC FR1 SSB-based L1-RSRP measurement in DRX for UE configured with highSpeedMeasFlag-r16.....	330
4.6.5	CLI measurements.....	334
4.6.5.0	Minimum conformance requirements.....	334
4.6.5.0.2	Minimum conformance requirements for CLI-RSSI measurement with non-DRX.....	335
4.6.5.1	EN-DC FR1 SRS-RSRP measurement with non-DRX.....	335
4.6.5.1.3	Minimum conformance requirements.....	336
4.6.5.2	EN-DC FR1 CLI-RSSI measurement with non-DRX.....	339
4.6.6	342	
4.6.7	L1-SINR measurement for beam reporting.....	342
4.6.7.0	Minimum conformance requirements.....	342
4.6.7.1	EN-DC FR1 CSI-RS based CMR and no dedicated IMR L1-SINR measurement in non-DRX.....	347
4.6.7.2	EN-DC FR1 SSB based CMR and dedicated IMR L1-SINR measurement in DRX.....	352
4.6.7.3	EN-DC FR1 CSI-RS based CMR and dedicated IMR L1-SINR measurement in DRX.....	358
4.7	Measurement performance requirements.....	363
4.7.1	SS-RSRP.....	363
4.7.1.0	Minimum conformance requirements.....	363

4.7.1.1	Intra-frequency measurements .....	368
4.7.1.2	Inter-frequency measurements .....	377
4.7.2	SS-RSRQ .....	384
4.7.2.0	Minimum conformance requirements .....	384
4.7.2.1	EN-DC FR1 SS-RSRQ measurement accuracy .....	386
4.7.2.2	Inter-Frequency SS-RSRQ measurement accuracy .....	390
4.7.2.2.1	EN-DC FR1-FR1 SS-RSRQ absolute measurement accuracy .....	390
4.7.2.2.2	EN-DC FR1-FR1 SS-RSRQ relative measurement accuracy .....	394
4.7.3	SS-SINR .....	396
4.7.3.0	Minimum conformance requirements .....	396
4.7.3.0.1	Intra-frequency SS-SINR measurement accuracy requirements .....	396
4.7.3.0.2	Inter-frequency absolute SS-SINR measurement accuracy requirements .....	397
4.7.3.0.3	Inter-frequency relative SS-SINR measurement accuracy requirements .....	398
4.7.3.1	EN-DC FR1 SS-SINR measurement accuracy .....	399
4.7.3.2	Inter-Frequency SS-SINR measurement accuracy .....	403
4.7.3.2.1	EN-DC FR1-FR1 SS-SINR absolute measurement accuracy .....	403
4.7.3.2.2	EN-DC FR1-FR1 SS-SINR relative measurement accuracy .....	406
4.7.4	L1-RSRP .....	408
4.7.4.0	Minimum conformance requirements .....	408
4.7.4.0.1	SSB based absolute L1-RSRP measurement accuracy requirements .....	408
4.7.4.0.3	CSI-RS based absolute L1-RSRP measurement accuracy requirements .....	411
4.7.4.0.4	CSI-RS based relative L1-RSRP measurement accuracy requirements .....	412
4.7.4.1	SSB based L1-RSRP measurements .....	413
4.7.4.1.1	EN-DC FR1 SSB-based L1-RSRP absolute measurement accuracy .....	413
4.7.4.1.2	EN-DC FR1 SSB-based L1-RSRP relative measurement accuracy .....	418
4.7.4.2	CSI-RS based L1-RSRP measurements .....	420
4.7.4.2.1	EN-DC FR1 CSI-RS-based L1-RSRP absolute measurement accuracy .....	420
4.7.4.2.2	EN-DC FR1 CSI-RS-based L1-RSRP relative measurement accuracy .....	424
4.7.5	SFTD .....	426
4.7.5.0	Minimum conformance requirements .....	426
4.7.5.0.1	SFTD Accuracy Requirement .....	426
4.7.5.1	EN-DC FR1 SFTD measurement accuracy .....	427
4.7.6	CLI measurements .....	431
4.7.6.0	Minimum conformance requirements .....	431
4.7.6.0.1	Minimum conformance requirements for SRS-RSRP accuracy .....	431
4.7.6.0.1.1	SRS-RSRP report mapping .....	432
4.7.6.0.2	Minimum conformance requirements for CLI-RSSI measurement accuracy with FR1 serving cell .....	433
4.7.6.1	EN-DC SRS-RSRP measurement accuracy with FR1 serving cell .....	434
4.7.6.2	EN-DC CLI-RSSI measurement accuracy with FR1 serving cell .....	439
4.7.7	L1-SINR measurement for beam reporting .....	443
4.7.7.0	Minimum conformance requirements .....	443
4.7.7.0.1	Minimum conformance requirements for CSI-RS based CMR and no dedicated IMR configured and CSI-RS resource set with repetition off .....	443
4.7.7.0.2	Minimum conformance requirements for SSB based CMR and dedicated IMR .....	446
4.7.7.0.3	Minimum conformance requirements for CSI-RS based CMR and dedicated IMR .....	448
4.7.7.1	EN-DC FR1 CSI-RS based CMR and no dedicated IMR configured and CSI-RS resource set with repetition off L1-SINR measurement accuracy .....	452
4.7.7.2	EN-DC FR1 SSB based CMR and dedicated IMR L1-SINR absolute measurement accuracy .....	457
4.7.7.3	EN-DC FR1 CSI-RS based CMR and dedicated IMR L1-SINR measurement accuracy .....	462
4A	NE-DC with all NR cells in FR1 .....	467
4A.0	General .....	467
4A.1	Signalling characteristics .....	467
4A.1.1	E-UTRAN PSCell addition .....	467
4A.1.1.0	Minimum conformance requirements .....	467
4A.1.1.0.1	E-UTRA PSCell Addition Delay Requirement .....	467
4A.1.1.0.2	E-UTRA PSCell Release Delay Requirement .....	468
4A.1.1.1	NE-DC FR1 addition and release delay of known PSCell .....	468
4A.1.1.1	Test purpose .....	468
4A.1.1.2	Test applicability .....	469
4A.1.1.3	Minimum conformance requirements .....	469

4A.1.1.4	Test description .....	469
4A.1.1.5	Test Requirements .....	469
4A.1.2	Active BWP switch delay .....	470
4A.2	Measurement performance requirements .....	470
4A.2.1	SFTD accuracy .....	470
5	EN-DC with at least one NR cell in FR2 .....	471
5.0	General .....	471
5.1	Void.....	471
5.2	Void.....	471
5.3	RRC_CONNECTED state mobility .....	471
5.3.1	Void .....	471
5.3.2	RRC connection mobility control .....	471
5.3.2.1	Void.....	471
5.3.2.2	Random access .....	471
5.3.2.2.1	EN-DC FR2 contention based random access .....	471
5.3.2.2.2	EN-DC FR2 non-contention based random access.....	479
5.3.2.2.3	EN-DC FR2 2-step contention based random access .....	487
5.3.2.2.4	EN-DC FR2 2-step non-contention based random access .....	491
5.3.2.3	Void.....	495
5.4	Timing .....	495
5.4.1	UE transmit timing .....	495
5.4.1.0	Minimum Conformance Requirements .....	495
5.4.1.0.1	Minimum conformance requirements for UE transmit timing accuracy .....	495
5.4.1.1	EN-DC FR2 UE transmit timing accuracy .....	497
5.4.2	UE timer accuracy .....	503
5.4.3	Timing advance .....	503
5.4.3.0	Minimum conformance requirements .....	503
5.4.3.0.1	Minimum conformance requirements for timing advance adjustment accuracy .....	503
5.4.3.1	EN-DC FR2 timing advance adjustment accuracy.....	503
5.5	Signaling characteristics .....	508
5.5.1	Radio link monitoring .....	508
5.5.1.0	Minimum conformance requirements .....	508
5.5.1.0.1	Minimum conformance requirements for out-of-sync SSB-based RLM.....	508
5.5.1.0.2	Minimum conformance requirements for in-sync SSB-based RLM .....	509
5.5.1.0.3	Minimum conformance requirements for out-of-sync CSI-RS based RLM.....	510
5.5.1.0.4	Minimum conformance requirements for in-sync CSI-RS based RLM .....	513
5.5.1.0.5	Minimum conformance requirements for UE scheduling restrictions during radio link monitoring .....	516
5.5.1.1	EN-DC FR2 radio link monitoring out-of-sync test for PSCell configured with SSB-based RLM RS in non-DRX mode .....	517
5.5.1.2	EN-DC FR2 radio link monitoring in-sync test for PSCell configured with SSB-based RLM RS in non-DRX mode .....	523
5.5.1.3	EN-DC FR2 radio link monitoring out-of-sync test for PSCell configured with SSB-based RLM RS in DRX mode .....	529
5.5.1.4	EN-DC FR2 radio link monitoring in-sync test for PSCell configured with SSB-based RLM RS in DRX mode .....	535
5.5.1.5	EN-DC FR2 radio link monitoring out-of-sync test for PSCell configured with CSI-RS-based RLM RS in non-DRX mode .....	540
5.5.1.6	EN-DC FR2 radio link monitoring in-sync test for PSCell configured with CSI-RS-based RLM RS in non-DRX mode .....	545
5.5.1.7	EN-DC FR2 radio link monitoring out-of-sync test for PSCell configured with CSI-RS-based RLM RS in DRX mode.....	550
5.5.1.9	EN-DC FR2 radio link monitoring UE scheduling restrictions .....	561
5.5.2	Interruption .....	566
5.5.2.0	Minimum conformance requirements .....	566
5.5.2.0.1	Minimum conformance requirements for interruptions at transitions between active and non-active during DRX.....	566
5.5.2.0.2	Minimum conformance requirements for interruptions during measurements on deactivated NR SCC.....	566
5.5.2.0.3	Minimum conformance requirements for interruptions during measurements on deactivated E-UTRAN SCC .....	567



5.5.2.1	EN-DC FR2 interruptions at transitions between active and non-active during DRX in synchronous EN-DC .....	568
5.5.2.2	EN-DC FR2 interruptions at transitions between active and non-active during DRX in asynchronous EN-DC.....	572
5.5.2.3	EN-DC FR2 interruptions during measurements on deactivated NR SCC in synchronous EN-DC...	576
5.5.2.4	EN-DC FR2 interruptions during measurements on deactivated NR SCC in asynchronous EN-DC .....	581
5.5.2.5	EN-DC FR2 interruptions during measurements on deactivated E-UTRAN SCC in synchronous EN-DC .....	585
5.5.2.6	EN-DC FR2 interruptions during measurements on deactivated E-UTRAN SCC in asynchronous EN-DC .....	590
5.5.3	SCell activation and deactivation delay .....	594
5.5.3.1	EN-DC FR2 SCell activation and deactivation intra-band in non-DRX .....	594
5.5.4	UE UL carrier RRC reconfiguration delay .....	598
5.5.5	Link recovery procedures .....	598
5.5.5.0	Minimum conformance requirements .....	598
5.5.5.0.1	Minimum conformance requirements for SSB-based BFD and link recovery procedures.....	598
5.5.5.0.2	Minimum conformance requirements for CSI-RS-based BFD and link recovery procedures .....	602
5.5.5.0.3	Scheduling availability of UE during beam failure detection and candidate beam detection.....	608
5.5.5.0.4	Requirements for Beam Failure Recovery in SCell.....	609
5.5.5.1	EN-DC FR2 SSB-based beam failure detection and link recovery in non-DRX .....	609
5.5.5.2	EN-DC FR2 SSB-based beam failure detection and link recovery in DRX .....	615
5.5.5.3	EN-DC FR2 CSI-RS-based beam failure detection and link recovery in non-DRX .....	620
5.5.5.4	EN-DC FR2 CSI-RS-based beam failure detection and link recovery in DRX .....	625
5.5.5.5	EN-DC FR2 scheduling available restriction during SSB-based beam failure detection and link recovery in non-DRX.....	631
5.5.5.6	EN-DC FR2 CSI-RS-based BFD and LR for SCell in non-DRX .....	636
5.5.5.7	EN-DC FR2 SCell CSI-RS-based beam failure detection and link recovery in DRX .....	642
5.5.6	Active BWP switch delay .....	648
5.5.6.1	DCI-based and time-based active BWP switch.....	648
5.5.6.1.0	Minimum conformance requirements.....	648
5.5.6.1.1	EN-DC FR2 DCI-based DL active BWP switch in non-DRX in synchronous EN-DC .....	648
5.5.6.1.2	EN-DC FR2 DCI-based DL active BWP switch with SCell in non-DRX in synchronous EN-DC .....	649
5.5.6.2	RRC-based active BWP switch.....	649
5.5.6.2.0	Minimum conformance requirements.....	649
5.5.6.2.1	EN-DC FR2 RRC-based DL active BWP switch in non-DRX in synchronous EN-DC .....	650
5.5.7	Void .....	654
5.5.8	Active TCI state switch delay .....	654
5.5.8.0	Minimum conformance requirements .....	654
5.5.8.0.1	Minimum conformance requirements for MAC-CE based active TCI state switch .....	654
5.5.8.0.2	Minimum conformance requirements for RRC based active TCI state switch.....	655
5.5.8.1	EN-DC FR2 MAC-CE based active TCI state switch.....	656
5.5.8.2	EN-DC FR2 RRC based active TCI state switch .....	660
5.6	Measurement procedures.....	664
5.6.1	Intra-frequency measurements.....	664
5.6.1.0	Minimum conformance requirements .....	664
5.6.1.0.1	Minimum conformance requirements for event-triggered measurement without gap.....	664
5.6.1.0.2	Minimum conformance requirements for event-triggered measurement with gap.....	666
5.6.1.1	EN-DC FR2 event-triggered reporting without gap in non-DRX .....	668
5.6.1.2	EN-DC FR2 event-triggered reporting without gap in DRX .....	673
5.6.1.3	EN-DC FR2 event-triggered reporting with gap in non-DRX .....	677
5.6.1.4	EN-DC FR2 event-triggered reporting with gap in DRX.....	682
5.6.2	Inter-frequency measurements.....	687
5.6.2.0	Minimum conformance requirements for Inter-frequency measurements .....	687
5.6.2.1	EN-DC FR2-FR2 event-triggered reporting in non-DRX .....	689
5.6.2.2	EN-DC FR2-FR2 event-triggered reporting in DRX .....	693
5.6.2.3	EN-DC FR2-FR2 event-triggered reporting in non-DRX with SSB time index detection .....	698
5.6.2.4	EN-DC FR2-FR2 event-triggered reporting in DRX with SSB time index detection.....	702
5.6.2.5	EN-DC FR1-FR2 event-triggered reporting in non-DRX .....	707
5.6.2.6	EN-DC FR1-FR2 event-triggered reporting in DRX .....	712
5.6.2.7	EN-DC FR1-FR2 event-triggered reporting in non-DRX with SSB time index detection .....	718

5.6.2.8	EN-DC FR1-FR2 event-triggered reporting in DRX with SSB time index detection.....	723
5.6.3	L1-RSRP measurement for beam reporting.....	729
5.6.3.0	Minimum conformance requirements .....	729
5.6.3.0.1	Minimum conformance requirements for SSB-based L1-RSRP measurement for beam reporting .....	729
5.6.3.0.2	Minimum conformance requirements for CSI-RS-based L1-RSRP measurement for beam reporting .....	730
5.6.3.1	EN-DC FR2 SSB-based L1-RSRP measurement in non-DRX.....	733
5.6.3.2	EN-DC FR2 SSB-based L1-RSRP measurement in DRX .....	737
5.6.3.3	EN-DC FR2 CSI-RS-based L1-RSRP measurement in non-DRX .....	741
5.6.3.4	EN-DC FR2 CSI-RS-based L1-RSRP measurement in DRX.....	745
5.6.4	CLI measurements .....	748
5.6.4.0	Minimum conformance requirements .....	748
5.6.4.0.1	Minimum conformance requirements for SRS-RSRP measurement period.....	748
5.6.4.1	EN-DC FR2 SRS-RSRP measurement in non-DRX.....	749
5.6.5	753	
5.6.6	L1-SINR measurement for beam reporting .....	753
5.6.6.0	Minimum conformance requirements .....	753
5.6.6.0.1	L1-SINR reporting with CSI-RS based CMR and no dedicated IMR configured.....	753
5.6.6.0.2	L1-SINR reporting with SSB based CMR and dedicated IMR configured .....	756
5.6.6.0.3	L1-SINR reporting with CSI-RS based CMR and dedicated IMR configured.....	758
5.6.6.1	EN-DC FR2 CSI-RS based CMR and no dedicated IMR L1-SINR measurement in DRX.....	760
5.6.6.2	EN-DC FR2 SSB based CMR and dedicated IMR L1-SINR measurement in non-DRX.....	765
5.6.6.3	EN-DC FR2 CSI-RS based CMR and dedicated IMR L1-SINR measurement in non-DRX .....	770
5.7	Measurement performance requirements .....	775
5.7.1	SS-RSRP.....	775
5.7.1.0	Minimum conformance requirements .....	775
5.7.1.0.1	Intra-frequency SS-RSRP measurement accuracy requirements.....	775
5.7.1.0.2	Inter-frequency SS-RSRP measurement accuracy requirements.....	776
5.7.1.1	EN-DC FR2 SS-RSRP measurement accuracy.....	778
5.7.1.2	EN-DC FR2-FR2 SS-RSRP measurement accuracy.....	784
5.7.1.3	EN-DC FR1-FR2 SS-RSRP measurement accuracy.....	791
5.7.2	SS-RSRQ.....	792
5.7.2.0	Minimum conformance requirements .....	792
5.7.2.0.1	Intra-frequency SS-RSRQ measurement accuracy requirements .....	792
5.7.2.0.2	Inter-frequency SS-RSRQ measurement accuracy requirements .....	793
5.7.2.1	EN-DC FR2 SS-RSRQ measurement accuracy .....	794
5.7.2.2	EN-DC FR2-FR2 SS-RSRQ measurement accuracy .....	798
5.7.3	SS-SINR .....	803
5.7.3.0	Minimum conformance requirements .....	803
5.7.3.0.1	Intra-frequency SS-SINR measurement accuracy requirements .....	803
5.7.3.0.2	Inter-frequency SS-SINR measurement accuracy requirements .....	804
5.7.3.1	EN-DC FR2 SS-SINR measurement accuracy .....	805
5.7.3.2	EN-DC FR2-FR2 SS-SINR measurement accuracy .....	809
5.7.4	L1-RSRP.....	815
5.7.4.0	Minimum conformance requirements .....	815
5.7.4.0.1	SSB-based L1-RSRP absolute measurement accuracy requirements.....	815
5.7.4.0.2	SSB-based L1-RSRP relative measurement accuracy requirements .....	815
5.7.4.0.3	CSI-RS-based L1-RSRP absolute measurement accuracy requirements.....	816
5.7.4.0.4	CSI-RS-based L1-RSRP relative measurement accuracy requirements.....	817
5.7.4.1	EN-DC FR2 SSB based L1-RSRP measurement accuracy.....	818
5.7.4.2	EN-DC FR2 CSI-RS based L1-RSRP measurement accuracy .....	824
5.7.5	SRS-RSRP.....	830
5.7.5.0	Minimum conformance requirements .....	830
5.7.5.0.1	Minimum conformance requirements for SRS-RSRP measurement accuracy.....	830
5.7.5.1	EN-DC FR2 SRS-RSRP measurement accuracy .....	832
6	NR standalone in FR1 .....	837
6.0	General .....	837
6.1	RRC_IDLE state mobility .....	837
6.1.1	NR cell re-selection .....	837
6.1.1.0	Minimum conformance requirements .....	837

6.1.1.0.1	Minimum conformance requirements for intra-frequency cell re-selection .....	837
6.1.1.0.2	Minimum conformance requirements for inter-frequency cell re-selection .....	837
6.1.1.0.3	Minimum conformance requirements for intra-frequency cell re-selection for UE configured with highSpeedMeasFlag-r16.....	839
6.1.1.0.4	Minimum conformance requirements for intra-frequency cell re-selection when UE configured with relaxed measurement criterion .....	839
6.1.1.0.5	Minimum conformance requirements for inter-frequency cell re-selection when UE configured with relaxed measurement criterion .....	841
6.1.1.1	NR SA FR1 cell re-selection.....	843
6.1.1.2	NR SA FR1-FR1 cell re-selection.....	849
6.1.1.3	NR SA FR1 cell re-selection for UE fulfilling low mobility relaxed measurement criterion .....	853
6.1.1.4	NR SA FR1 cell re-selection for UE fulfilling not-at-cell edge relaxed measurement criterion.....	860
6.1.1.5	NR SA FR1-FR1 cell re-selection for UE fulfilling low mobility relaxed measurement criterion.....	866
6.1.1.6	NR SA FR1-FR1 cell re-selection for UE fulfilling not-at-cell edge relaxed measurement criterion .....	872
6.1.1.7	NR SA FR1 cell re-selection for UE configured with highSpeedMeasFlag-r16.....	878
6.1.2	NR – E-UTRA cell re-selection.....	883
6.1.2.0	Minimum conformance requirements .....	883
6.1.2.0.1	Minimum conformance requirements for NR – E-UTRA cell re-selection.....	883
6.1.2.0.2	Minimum conformance requirement for inter-RAT E-UTRAN cells for UE configured with relaxed measurement criterion.....	885
6.1.2.1	NR SA FR1 – E-UTRA cell re-selection to higher priority E-UTRA.....	887
6.1.2.2	NR SA FR1 – E-UTRA cell re-selection to lower priority E-UTRA.....	892
6.1.2.3	NR SA FR1 – E-UTRA cell re-selection to lower priority E-UTRAN for UE fulfilling low mobility relaxed measurement criterion.....	898
6.1.2.4	NR SA FR1 – E-UTRA cell re-selection to lower priority E-UTRAN for UE fulfilling not-at-cell edge relaxed measurement criterion.....	904
6.1.2.5	NR SA FR1 – E-UTRA cell re-selection to lower priority E-UTRA for UE configured with highSpeedMeasFlag-r16 .....	909
6.2	RRC_INACTIVE state mobility .....	915
6.3	RRC_CONNECTED state mobility .....	915
6.3.1	Handover .....	915
6.3.1.0	Minimum conformance requirements .....	915
6.3.1.0.1	Minimum conformance requirements for NR – E-UTRAN handover .....	915
6.3.1.0.2	Minimum conformance requirements for NR FR1 – NR FR1 handover.....	915
6.3.1.0.3	Minimum conformance requirements for NR – UTRAN handover .....	916
6.3.1.0.4	Minimum conformance requirements for NR FR1- NR FR1 DAPS handover .....	917
6.3.1.1	NR SA FR1 handover with known target cell.....	919
6.3.1.2	NR SA FR1 handover with unknown target cell.....	923
6.3.1.3	NR SA FR1-FR1 handover with unknown target cell.....	926
6.3.1.4	NR SA FR1 – E-UTRA handover with known target cell .....	929
6.3.1.5	NR SA FR1 – E-UTRA handover with unknown target cell .....	936
6.3.1.6	NR SA FR1 – UTRAN FDD handover with known target cell .....	941
6.3.1.7	NR SA FR1 synchronous DAPS handover .....	947
6.3.1.8	NR SA FR1 asynchronous DAPS handover .....	955
6.3.1.9	NR SA FR1 Intra-band inter-frequency synchronous DAPS handover .....	960
6.3.1.10	NR SA FR1 Intra-band inter-frequency asynchronous DAPS handover .....	968
6.3.1.11	NR SA FR1 Inter-band inter-frequency synchronous DAPS handover .....	975
6.3.1.12	NR SA FR1 Inter-band inter-frequency asynchronous DAPS handover .....	984
6.3.2	RRC connection mobility control .....	992
6.3.2.1	RRC re-establishment .....	992
6.3.2.1.0	Minimum conformance requirements.....	992
6.3.2.1.1	NR SA FR1 RRC re-establishment .....	994
6.3.2.1.2	NR SA FR1 - FR1 RRC re-establishment .....	998
6.3.2.1.3	NR SA FR1 RRC re-establishment without serving cell timing .....	1002
6.3.2.2	Random access.....	1006
6.3.2.2.0	Minimum conformance requirements.....	1006
6.3.2.2.1	NR SA FR1 contention based random access .....	1008
6.3.2.2.2	NR SA FR1 non-contention based random access .....	1014
6.3.2.2.3	NR SA FR2 2-step contention based random access.....	1021
6.3.2.2.4	NR SA FR2 2-step non-contention based random access .....	1024
6.3.2.3	RRC connection release with redirection.....	1028

6.3.2.3.0	Minimum conformance requirements.....	1028
6.3.2.3.1	NR SA FR1 RRC connection release with redirection.....	1030
6.3.2.3.2	NR SA FR1 – E-UTRA RRC connection release with redirection .....	1033
6.3.3	Conditional handover.....	1038
6.3.3.0	Minimum conformance requirements .....	1038
6.3.3.0.1	Minimum conformance requirements for NR FR1 intra-frequency conditional handover.....	1038
6.3.3.0.2	Minimum conformance requirements for NR FR1 inter-frequency conditional handover.....	1041
6.3.3.1	NR SA FR1 conditional handover .....	1044
6.3.3.2	NR SA FR1-FR1 conditional handover .....	1051
6.4	Timing .....	1059
6.4.1	UE transmit timing .....	1059
6.4.1.0	Minimum conformance requirements .....	1059
6.4.1.1	NR SA FR1 UE transmit timing accuracy .....	1060
6.4.2	UE timer accuracy .....	1066
6.4.3	Timing advance .....	1066
6.4.3.0	Minimum conformance requirement.....	1066
6.4.3.0.1	Minimum conformance requirement for timing advance adjustment.....	1066
6.4.3.1	NR SA FR1 timing advance adjustment accuracy .....	1066
6.5	Signaling characteristics .....	1071
6.5.1	Radio link monitoring.....	1071
6.5.1.00	General .....	1071
6.5.1.0	Minimum conformance requirements .....	1072
6.5.1.0.1	Minimum conformance requirements for out-of-sync SSB-based RLM.....	1072
6.5.1.0.2	Minimum conformance requirements for in-sync SSB-based RLM .....	1074
6.5.1.0.3	Minimum conformance requirements for out-of-sync and in-sync CSI-RS based RLM .....	1075
6.5.1.1	NR SA FR1 radio link monitoring out-of-sync test for PCell configured with SSB-based RLM RS in non-DRX mode .....	1076
6.5.1.2	NR SA FR1 radio link monitoring in-sync test for PCell configured with SSB-based RLM RS in non-DRX mode .....	1081
6.5.1.3	NR SA FR1 radio link monitoring out-of-sync test for PCell configured with SSB-based RLM RS in DRX mode .....	1088
6.5.1.4	NR SA FR1 radio link monitoring in-sync test for PCell configured with SSB-based RLM RS in DRX mode .....	1093
6.5.1.5	NR SA FR1 radio link monitoring out-of-sync test for PCell configured with CSI-RS-based RLM RS in non-DRX mode .....	1100
6.5.1.6	NR SA FR1 radio link monitoring in-sync test for PCell configured with CSI-RS-based RLM RS in non-DRX mode.....	1107
6.5.1.7	NR SA FR1 radio link monitoring out-of-sync test for PCell configured with CSI-RS-based RLM RS in DRX mode.....	1113
6.5.1.8	NR SA FR1 radio link monitoring in-sync test for PCell configured with CSI-RS-based RLM RS in DRX mode .....	1120
6.5.2	Interruption .....	1126
6.5.2.0	Minimum conformance requirements .....	1126
6.5.2.0.1	Minimum conformance requirements for interruptions during measurements on deactivated NR SCC.....	1126
6.5.2.1	NR SA FR1 interruptions during measurements on deactivated NR SCC.....	1127
6.5.3	SCell activation and deactivation delay .....	1133
6.5.3.0	Minimum conformance requirements .....	1133
6.5.3.0.1	Minimum conformance requirements for SCell activation and deactivation delay.....	1133
6.5.3.1	NR SA FR1 SCell activation and deactivation of known SCell in non-DRX for 160ms SCell measurement cycle.....	1134
6.5.3.2	NR SA FR1 SCell activation and deactivation of known SCell in non-DRX for 640ms SCell measurement cycle.....	1143
6.5.3.3	NR SA FR1 SCell activation and deactivation of unknown SCell in non-DRX.....	1145
6.5.4	UE UL carrier RRC reconfiguration delay .....	1147
6.5.4.0	Minimum conformance requirements .....	1147
6.5.4.0.1	Minimum conformance requirements for UL carrier RRC reconfiguration delay .....	1147
6.5.4.1	NR SA FR1 UE UL carrier RRC reconfiguration delay .....	1147
6.5.5	Link recovery procedures .....	1155
6.5.5.0	Minimum conformance requirements .....	1155
6.5.5.0.1	Minimum conformance requirements for SSB-based BFD and link recovery procedures.....	1155
6.5.5.0.3	Scheduling availability of UE during beam failure detection and candidate beam detection.....	1155

6.5.5.0.4	Requirements for Beam Failure Recovery in SCell.....	1155
6.5.5.0.2	Minimum conformance requirements for CSI-RS-based BFD and link recovery procedures ....	1155
6.5.5.1	NR SA FR1 SSB-based beam failure detection and link recovery in non-DRX.....	1157
6.5.5.2	NR SA FR1 SSB-based beam failure detection and link recovery in DRX.....	1165
6.5.5.3	NR SA FR1 CSI-RS-based beam failure detection and link recovery in non-DRX .....	1172
6.5.5.4	NR SA FR1 CSI-RS-based beam failure detection and link recovery in DRX.....	1180
6.5.5.5	NR SA FR1 SCell CSI-RS-based beam failure detection and SSB-based link recovery in non-DRX .....	1187
6.5.5.6	NR SA FR1 SCell CSI-RS-based beam failure detection and SSB-based link recovery in DRX .....	1193
6.5.6	Active BWP switch delay .....	1200
6.5.6.1	DCI-based and time-based active BWP switch.....	1200
6.5.6.1.0	Minimum conformance requirements.....	1200
6.5.6.1.1	NR SA FR1-FR1 DCI-based DL active BWP switch in non-DRX.....	1202
6.5.6.1.2	NR SA FR1 DCI-based DL active BWP switch in non-DRX .....	1210
6.5.6.2	RRC-based active BWP switch.....	1219
6.5.6.2.0	Minimum conformance requirements.....	1219
6.5.6.2.1	NR SA FR1 RRC-based DL active BWP switch in non-DRX.....	1219
6.5.7	DL interruptions at switching between two uplink carriers .....	1227
6.5.7.0	Minimum conformance requirements .....	1227
6.5.7.1	NR SA FR1 DL Interruptions at switching between two uplink carriers in FDD-TDD CA .....	1228
6.5.7.2	NR SA FR1 DL Interruptions at switching between two uplink carriers in TDD-TDD CA .....	1240
6.6	Measurement procedures.....	1249
6.6.1	Intra-frequency measurements.....	1249
6.6.1.0	Minimum conformance requirements .....	1249
6.6.1.0.1	Minimum conformance requirements for event-triggered measurement without gap.....	1249
6.6.1.0.2	Minimum conformance requirements for event-triggered measurement with gap.....	1250
6.6.1.0.3	Minimum conformance requirements for event-triggered measurement without gap with SSB index reading .....	1251
6.6.1.0.4	Minimum conformance requirements for event-triggered measurement with gap with SSB index reading .....	1253
6.6.1.0.5	Minimum conformance requirements for event-triggered measurement without gap for UE configured with highSpeedMeasFlag-r16.....	1254
6.6.1.1	NR SA FR1 event-triggered reporting without gap in non-DRX.....	1256
6.6.1.2	NR SA FR1 event-triggered reporting without gap in DRX .....	1260
6.6.1.3	NR SA FR1 event-triggered reporting with gap in non-DRX.....	1265
6.6.1.4	NR SA FR1 event-triggered reporting with gap in DRX .....	1271
6.6.1.5	NR SA FR1 event-triggered reporting without gap in non-DRX with SSB index reading.....	1276
6.6.1.6	NR SA FR1 event-triggered reporting with gap in non-DRX with SSB index reading.....	1280
6.6.1.7	NR SA FR1 event-triggered reporting without gap in DRX for UE configured with highSpeedMeasFlag-r16 .....	1284
6.6.2	Inter-frequency measurements.....	1289
6.6.2.0	Minimum conformance requirements for Inter-frequency measurements .....	1289
6.6.2.1	NR SA FR1-FR1 event-triggered reporting in non-DRX .....	1289
6.6.2.2	NR SA FR1-FR1 event-triggered reporting in DRX.....	1295
6.6.2.3	Void.....	1301
6.6.2.4	Void.....	1301
6.6.2.5	NR SA FR1-FR1 event-triggered reporting in non-DRX with SSB time index detection .....	1301
6.6.2.6	NR SA FR1-FR1 event-triggered reporting in DRX with SSB time index detection .....	1308
6.6.2.7	Void.....	1314
6.6.2.8	Void.....	1314
6.6.3	Inter-RAT Measurements .....	1314
6.6.3.0	Minimum conformance requirements .....	1314
6.6.3.0.1	Minimum conformance requirements for inter-RAT event triggered reporting to E-UTRAN FDD .....	1314
6.6.3.0.2	Minimum conformance requirements for inter-RAT event triggered reporting to E-UTRAN TDD.....	1317
6.6.3.1	NR SA FR1 – E-UTRAN event-triggered reporting in non-DRX .....	1319
6.6.3.2	NR SA FR1 – E-UTRAN event-triggered reporting in DRX .....	1327
6.6.3.3	NR SA FR1 – E-UTRAN event-triggered reporting in DRX for UE configured with highSpeedMeasFlag-r16 .....	1333
6.6.4	L1-RSRP measurement for beam reporting.....	1338
6.6.4.0	Minimum conformance requirements .....	1338

6.6.4.0.1	Minimum conformance requirements for SSB-based L1-RSRP measurement for beam reporting .....	1338
6.6.4.0.2	Minimum conformance requirements for CSI-RS-based L1-RSRP measurement for beam reporting .....	1338
6.6.4.1	NR SA FR1 SSB-based L1-RSRP measurement in non-DRX .....	1338
6.6.4.2	NR SA FR1 SSB-based L1-RSRP measurement in DRX.....	1342
6.6.4.3	NR SA FR1 CSI-RS-based L1-RSRP measurement in non-DRX .....	1346
6.6.4.4	NR SA FR1 CSI-RS-based L1-RSRP measurement in DRX .....	1350
6.6.4.5	NR SA FR1 SSB-based L1-RSRP measurement in DRX for UE configured with highSpeedMeasFlag-r16 .....	1353
6.6.5	UTRAN inter-RAT measurement.....	1358
6.6.5.1	NR SA FR1 – UTRAN event-triggered reporting in non-DRX .....	1358
6.6.6 to 6.6.7	1365	
6.6.8	L1-SINR measurement for beam reporting .....	1365
6.6.8.0	Minimum conformance requirements .....	1365
6.6.8.0.1	L1-SINR reporting with CSI-RS based CMR and no dedicated IMR configured.....	1365
6.6.8.0.2	L1-SINR reporting with SSB based CMR and dedicated IMR configured .....	1365
6.6.8.0.3	L1-SINR reporting with CSI-RS based CMR and dedicated IMR configured.....	1365
6.6.8.1	NR SA FR1 CSI-RS based CMR and no dedicated IMR L1-SINR measurement in DRX .....	1365
6.6.8.2	NR SA FR1 SSB based CMR and dedicated IMR L1-SINR measurement in non-DRX .....	1371
6.6.8.3	NR SA FR1 CSI-RS based CMR and dedicated IMR L1-SINR measurement in non-DRX.....	1377
6.6.9	Idle Mode CA/DC Measurements .....	1383
6.6.9.0	Minimum conformance requirements.....	1383
6.6.9.1	NR SA FR1 SA Idle mode CA/DC measurement for FR1 .....	1383
6.6.10 to 6.6.14.....		1390
6.6.15	Idle Mode inter-RAT CA/DC Measurements .....	1390
6.6.15.0	Minimum conformance requirements.....	1390
6.6.15.1	NR SA FR1 Idle Mode measurements of inter-RAT CA candidate cells for early reporting .....	1390
6.7	Measurement performance requirements .....	1397
6.7.1	SS-RSRP.....	1397
6.7.1.0	Minimum conformance requirements .....	1397
6.7.1.0.1	Intra-frequency absolute SS-RSRP measurement accuracy requirements.....	1397
6.7.1.0.2	Intra-frequency relative SS-RSRP measurement accuracy requirements .....	1397
6.7.1.0.3	Inter-frequency absolute SS-RSRP measurement accuracy requirements.....	1397
6.7.1.0.4	Inter-frequency relative SS-RSRP measurement accuracy requirements.....	1397
6.7.1.1	Intra-frequency measurements .....	1397
6.7.1.1.1	NR SA FR1 SS-RSRP absolute measurement accuracy.....	1397
6.7.1.1.2	NR SA FR1 SS-RSRP relative measurement accuracy .....	1404
6.7.1.2	Inter-frequency measurements .....	1406
6.7.1.2.1	NR SA FR1-FR1 SS-RSRP absolute measurement accuracy .....	1406
6.7.1.2.2	NR SA FR1-FR1 SS-RSRP relative measurement accuracy.....	1413
6.7.2	SS-RSRQ .....	1415
6.7.2.0	Minimum conformance requirements .....	1415
6.7.2.0.1	Intra-frequency SS-RSRQ measurement accuracy requirements .....	1415
6.7.2.0.2	Inter-frequency SS-RSRQ absolute measurement accuracy requirements .....	1415
6.7.2.0.3	Inter-frequency SS-RSRQ relative measurement accuracy requirements .....	1415
6.7.2.1	NR SA FR1 SS-RSRQ measurement accuracy.....	1415
6.7.2.2	Inter-Frequency SS-RSRQ measurement accuracy.....	1419
6.7.2.2.1	NR SA FR1-FR1 SS-RSRQ absolute measurement accuracy.....	1419
6.7.2.2.2	NR SA FR1-FR1 SS-RSRQ relative measurement accuracy .....	1424
6.7.3	SS-SINR .....	1426
6.7.3.0	Minimum conformance requirements .....	1426
6.7.3.0.1	Intra-frequency SS-SINR measurement accuracy requirements .....	1426
6.7.3.0.2	Inter-frequency absolute SS-SINR measurement accuracy requirements .....	1426
6.7.3.0.3	Inter-frequency relative SS-SINR measurement accuracy requirements.....	1426
6.7.3.1	NR SA FR1 SS-SINR measurement accuracy .....	1426
6.7.3.2	Inter-Frequency SS-SINR measurement accuracy .....	1430
6.7.3.2.1	NR SA FR1-FR1 SS-SINR absolute measurement accuracy .....	1430
6.7.3.2.2	NR SA FR1-FR1 SS-SINR relative measurement accuracy .....	1434
6.7.4	L1-RSRP.....	1436
6.7.4.0	Minimum conformance requirements .....	1436
6.7.4.0.1	SSB based absolute L1-RSRP measurement accuracy requirements .....	1436

6.7.4.0.2	SSB based relative L1-RSRP measurement accuracy requirements.....	1436
6.7.4.0.3	CSI-RS based absolute L1-RSRP measurement accuracy requirements.....	1436
6.7.4.0.4	CSI-RS based relative L1-RSRP measurement accuracy requirements.....	1436
6.7.4.1	SSB based L1-RSRP measurements.....	1436
6.7.4.1.1	NR SA FR1 SSB based L1-RSRP absolute measurement accuracy.....	1436
6.7.4.1.2	NR SA FR1 SSB based L1-RSRP relative measurement accuracy.....	1441
6.7.4.2	CSI-RS based L1-RSRP measurements.....	1443
6.7.4.2.1	NR SA FR1 CSI-RS based L1-RSRP absolute measurement accuracy.....	1443
6.7.4.2.2	NR SA FR1 CSI-RS based L1-RSRP relative measurement accuracy.....	1447
6.7.5	E-UTRAN RSRP.....	1449
6.7.5.0	Minimum conformance requirements.....	1449
6.7.5.0.1	E-UTRAN RSRP absolute accuracy.....	1449
6.7.5.1	NR SA FR1 – E-UTRAN RSRP absolute measurement accuracy.....	1450
6.7.6	E-UTRAN RSRQ.....	1457
6.7.6.0	Minimum conformance requirements.....	1457
6.7.6.0.1	E-UTRAN RSRQ absolute accuracy.....	1457
6.7.6.1	NR SA FR1 – E-UTRAN RSRQ absolute measurement accuracy.....	1458
6.7.7	E-UTRAN RS-SINR.....	1464
6.7.7.0	Minimum conformance requirements.....	1464
6.7.7.0.1	E-UTRAN RS-SINR absolute accuracy.....	1464
6.7.7.1	NR SA FR1 – E-UTRAN RS-SINR absolute measurement accuracy.....	1465
6.7.8	1472	
6.7.9	L1-SINR measurement for beam reporting.....	1472
6.7.9.0	Minimum conformance requirements.....	1472
6.7.9.0.1	Minimum conformance requirements for CSI-RS based CMR and no dedicated IMR configured and CSI-RS resource set with repetition off.....	1472
6.7.9.0.2	Minimum conformance requirements for SSB based CMR and dedicated IMR.....	1475
6.7.9.0.3	Minimum conformance requirements for CSI-RS based CMR and dedicated IMR.....	1477
6.7.9.1	NR SA FR1 CSI-RS based CMR and no dedicated IMR configured and CSI-RS resource set with repetition off L1-SINR measurement accuracy.....	1481
6.7.9.2	NR SA FR1 SSB based CMR and dedicated IMR L1-SINR absolute measurement accuracy.....	1485
6.7.9.3	NR SA FR1 CSI-RS based CMR and dedicated IMR L1-SINR measurement accuracy.....	1490
7	NR standalone with at least one NR cell in FR2.....	1496
7.0	General.....	1496
7.1	RRC_IDLE state mobility.....	1496
7.1.1	NR cell re-selection.....	1496
7.1.1.0	Minimum conformance requirements.....	1496
7.1.1.0.1	Minimum conformance requirements for intra-frequency cell re-selection.....	1496
7.1.1.0.2	Minimum conformance requirements for inter-frequency cell re-selection.....	1496
7.1.1.0.3	Minimum conformance requirements for intra-frequency cell re-selection for UE configured with relaxed measurement criterion.....	1498
7.1.1.0.4	Minimum conformance requirements for inter-frequency cell re-selection for UE configured with relaxed measurement criterion.....	1499
7.1.1.1	NR SA FR2 cell re-selection.....	1500
7.1.1.2	NR SA FR2-FR2 cell re-selection.....	1505
7.1.1.3	NR SA FR2 cell re-selection for UE fulfilling low mobility relaxed measurement criterion.....	1510
7.1.1.4	NR SA FR2 cell re-selection for UE fulfilling not-at-cell edge relaxed measurement criterion.....	1515
7.1.1.5	NR SA FR2-FR2 cell re-selection for UE fulfilling low mobility relaxed measurement criterion... 1520	
7.1.1.6	NR SA FR2-FR2 cell re-selection for UE fulfilling not-at-cell edge relaxed measurement criterion.....	1525
7.2	RRC_INACTIVE state mobility.....	1530
7.3	RRC_CONNECTED state mobility.....	1530
7.3.1	Handover.....	1530
7.3.1.4	NR SA FR1-FR2 synchronous DAPS handover.....	1530
7.3.1.5	NR SA FR1-FR2 asynchronous DAPS handover.....	1541
7.3.2	RRC connection mobility control.....	1548
7.3.2.1	RRC re-establishment.....	1548
7.3.2.1.0	Minimum conformance requirements.....	1548
7.3.2.1.1	NR SA FR2 RRC re-establishment.....	1549
7.3.2.1.2	NR SA FR2 - FR2 RRC re-establishment.....	1553
7.3.2.1.3	NR SA FR2 RRC re-establishment without serving cell timing.....	1556

7.3.2.2	Random access .....	1561
7.3.2.2.0	Minimum conformance requirements .....	1561
7.3.2.2.1	NR SA FR2 contention based random access .....	1562
7.3.2.2.2	NR SA FR2 non-contention based random access .....	1570
7.3.2.2.3	NR SA FR2 2-step contention based random access .....	1577
7.3.2.2.4	NR SA FR2 2-step non-contention based random access .....	1584
7.3.2.3	RRC connection release with redirection .....	1587
7.3.3	Conditional handover .....	1587
7.3.3.0	Minimum conformance requirements .....	1587
7.3.3.0.1	Minimum conformance requirements for NR FR2 intra-frequency conditional handover .....	1587
7.3.3.0.2	Minimum conformance requirements for NR FR2 inter-frequency conditional handover .....	1591
7.3.3.1	NR SA FR2 conditional handover .....	1595
7.3.3.2	NR SA FR2-FR2 conditional handover .....	1602
7.4	Timing .....	1609
7.4.1	UE transmit timing .....	1609
7.4.2	UE timer accuracy .....	1609
7.4.3	Timing advance .....	1609
7.5	Signalling characteristics .....	1609
7.5.1	Radio link monitoring .....	1609
7.5.1.0	Minimum conformance requirements .....	1609
7.5.1.0.1	1609	
7.5.1.0.2	1609	
7.5.1.0.3	1609	
7.5.1.0.4	1609	
7.5.1.0.5	Minimum conformance requirements for UE scheduling restrictions during radio link monitoring .....	1609
7.5.1.9	NR SA FR2 radio link monitoring UE scheduling restrictions .....	1610
7.5.2	Interruption .....	1614
7.5.3	SCell activation and deactivation delay .....	1614
7.5.3.0	Minimum conformance requirements .....	1614
7.5.3.0.1	Minimum conformance requirements for SCell activation delay for deactivated SCell .....	1614
7.5.3.0.2	Minimum conformance requirements for SCell deactivation delay for activated SCell .....	1617
7.5.3.1	NR SA FR2-FR2 intra-band SCell activation and deactivation delay .....	1617
7.5.3.2	NR SA FR1-FR2 inter-band SCell activation and deactivation delay .....	1619
7.5.4	UE UL carrier RRC reconfiguration delay .....	1622
7.5.5	Link recovery procedures .....	1622
7.5.5.0	Minimum conformance requirements .....	1622
7.5.5.0.1	Minimum conformance requirements for SSB-based BFD and link recovery procedures .....	1622
7.5.5.0.2	Minimum conformance requirements for CSI-RS-based BFD and link recovery procedures .....	1622
7.5.5.0.3	Scheduling availability of UE during beam failure detection and candidate beam detection .....	1622
7.5.5.0.4	Requirements for Beam Failure Recovery in SCell .....	1622
7.5.5.1	NR SA FR2 SSB-based beam failure detection and link recovery in non-DRX .....	1622
7.5.5.2	NR SA FR2 SSB-based beam failure detection and link recovery in DRX .....	1627
7.5.5.3	NR SA FR2 CSI-RS-based beam failure detection and link recovery in non-DRX .....	1633
7.5.5.4	NR SA FR2 CSI-RS-based beam failure detection and link recovery in DRX .....	1638
7.5.5.5	NR SA FR2 scheduling availability restriction during SSB-based beam failure detection and link recovery in non-DRX .....	1645
7.5.5.6	NR SA FR2 SCell CSI-RS-based beam failure detection and link recovery in non-DRX .....	1649
7.5.5.7	NR SA FR2 SCell CSI-RS-based beam failure detection and link recovery in DRX .....	1656
7.5.6	Active BWP switch delay .....	1662
7.5.6.1	DCI-based and time-based active BWP switch .....	1662
7.5.6.1.0	Minimum conformance requirements .....	1662
7.5.6.1.1	NR SA FR2 DCI-based DL active BWP switch in non-DRX .....	1662
7.5.6.1.2	NR SA FR1-FR2 DCI-based DL active BWP switch in non-DRX .....	1663
7.5.6.1.3	NR SA FR2 DCI-based DL active BWP switch in non-DRX .....	1664
7.5.6.2	RRC-based active BWP switch .....	1665
7.5.6.2.0	Minimum conformance requirements .....	1665
7.5.6.2.1	NR SA FR2 RRC-based DL active BWP switch in non-DRX .....	1666
7.5.7	PSCell addition and release delay .....	1666
7.5.7.0	Minimum conformance requirements .....	1666
7.5.7.0.1	Minimum conformance requirements for PSCell addition delay .....	1666
7.5.7.0.2	Minimum conformance requirements for PSCell release delay .....	1667



7.5.7.1	NR SA FR2 addition and release delay of known PSCell.....	1667
7.5.7.2	NR SA FR2 addition and release delay of unknown PSCell.....	1669
7.6	Measurement procedures.....	1671
7.6.1	Intra-frequency measurements.....	1671
7.6.1.0	Minimum conformance requirements .....	1671
7.6.1.0.1	Minimum conformance requirements for event-triggered measurement without gap.....	1671
7.6.1.0.2	Minimum conformance requirements for event-triggered measurement with gap.....	1673
7.6.1.1	NR SA FR2 event-triggered reporting without gap in non-DRX.....	1674
7.6.1.2	NR SA FR2 event-triggered reporting without gap in DRX .....	1679
7.6.1.3	NR SA FR2 event-triggered reporting with gap in non-DRX.....	1684
7.6.1.4	NR SA FR2 event-triggered reporting with gap in DRX .....	1691
7.6.2	Inter-frequency measurements.....	1697
7.6.2.0	Minimum conformance requirements for Inter-frequency measurements .....	1697
7.6.2.1	NR SA FR2-FR2 event-triggered reporting in non-DRX .....	1697
7.6.2.2	NR SA FR2-FR2 event-triggered reporting in DRX.....	1702
7.6.2.3	NR SA FR2-FR2 event-triggered reporting in non-DRX with SSB time index detection.....	1708
7.6.2.4	NR SA FR2-FR2 event-triggered reporting in DRX with SSB time index detection .....	1713
7.6.2.5	NR SA FR1-FR2 event-triggered reporting in non-DRX .....	1719
7.6.2.6	NR SA FR1-FR2 event-triggered reporting in DRX.....	1725
7.6.2.7	NR SA FR1-FR2 event-triggered reporting in non-DRX with SSB time index detection.....	1731
7.6.2.8	NR SA FR1-FR2 event-triggered reporting in DRX with SSB time index detection .....	1737
7.6.3	L1-RSRP measurement for beam reporting.....	1743
7.6.3.0	Minimum conformance requirements for L1-RSRP measurement for beam reporting .....	1743
7.6.3.0.1	Minimum conformance requirements for SSB-based L1-RSRP measurement for beam reporting .....	1743
7.6.3.0.2	Minimum conformance requirements for CSI-RS-based L1-RSRP measurement for beam reporting .....	1743
7.6.3.1	NR SA FR2 SSB-based L1-RSRP measurement in non-DRX .....	1743
7.6.3.2	NR SA FR2 SSB-based L1-RSRP measurement in DRX.....	1749
7.6.3.3	NR SA FR2 CSI-RS-based L1-RSRP measurement in non-DRX.....	1753
7.6.3.4	NR SA FR2 CSI-RS-based L1-RSRP measurement in DRX .....	1757
7.6.4	CLI measurements .....	1760
7.6.4.0	Minimum conformance requirements .....	1760
7.6.4.0.1	Minimum conformance requirements for SRS-RSRP measurement period.....	1760
7.6.4.1	NR SA FR2 SRS-RSRP measurement in non-DRX .....	1761
7.6.5	1765	
7.6.6	L1-SINR measurement for beam reporting .....	1765
7.6.6.0	Minimum conformance requirements .....	1765
7.6.6.0.1	L1-SINR reporting with CSI-RS based CMR and no dedicated IMR configured.....	1765
7.6.6.0.2	L1-SINR reporting with SSB based CMR and dedicated IMR configured .....	1765
7.6.6.0.3	L1-SINR reporting with CSI-RS based CMR and dedicated IMR configured.....	1765
7.6.6.1	NR SA FR2 CSI-RS based CMR and no dedicated IMR L1-SINR measurement in non-DRX.....	1766
7.6.6.2	NR SA FR2 SSB based CMR and dedicated IMR L1-SINR measurement in DRX .....	1770
7.6.6.3	NR SA FR2 CSI-RS based CMR and dedicated IMR L1-SINR measurement in DRX .....	1775
7.7	Measurement performance requirements .....	1781
7.7.1	SS-RSRP.....	1781
7.7.1.0	Minimum conformance requirements .....	1781
7.7.1.0.1	Intra-frequency SS-RSRP measurement accuracy requirements.....	1781
7.7.1.0.2	Inter-frequency SS-RSRP measurement accuracy requirements.....	1781
7.7.1.1	NR SA FR2 SS-RSRP measurement accuracy .....	1781
7.7.1.2	NR SA FR2-FR2 SS-RSRP measurement accuracy .....	1788
7.7.1.3	Inter-frequency measurements between FR1 and FR2 .....	1796
7.7.1.3.1	NR SA FR1-FR2 SS-RSRP measurement accuracy.....	1796
7.7.1.3.2	Void.....	1801
7.7.2	SS-RSRQ.....	1801
7.7.2.0	Minimum conformance requirements .....	1801
7.7.2.0.1	Intra-frequency SS-RSRQ measurement accuracy requirements .....	1801
7.7.2.0.2	Inter-frequency SS-RSRQ measurement accuracy requirements .....	1801
7.7.2.1	NR SA FR2 SS-RSRQ measurement accuracy.....	1802
7.7.2.2	NR SA FR2-FR2 SS-RSRQ measurement accuracy.....	1806
7.7.3	SS-SINR .....	1812
7.7.3.0	Minimum conformance requirements .....	1812

7.7.3.0.1	Intra-frequency SS-SINR measurement accuracy requirements .....	1812
7.7.3.0.2	Inter-frequency SS-SINR measurement accuracy requirements .....	1812
7.7.3.1	NR SA FR2 SS-SINR measurement accuracy .....	1812
7.7.3.2	NR SA FR2-FR2 SS-SINR measurement accuracy .....	1817
7.7.4	L1-RSRP .....	1824
7.7.4.0	Minimum conformance requirements .....	1824
7.7.4.0.1	SSB-based L1-RSRP absolute measurement accuracy requirements .....	1824
7.7.4.0.2	SSB-based L1-RSRP relative measurement accuracy requirements .....	1824
7.7.4.0.3	CSI-RS-based L1-RSRP absolute measurement accuracy requirements .....	1824
7.7.4.0.4	CSI-RS-based L1-RSRP relative measurement accuracy requirements .....	1824
7.7.4.1	NR SA FR2 SSB based L1-RSRP measurement accuracy .....	1824
7.7.4.2	NR SA FR2 CSI-RS based L1-RSRP measurement accuracy .....	1829
7.7.5	SRS-RSRP .....	1835
7.7.5.0	Minimum conformance requirements .....	1835
7.7.5.0.1	Minimum conformance requirements for SRS-RSRP measurement accuracy .....	1835
7.7.5.1	NR SA FR2 SRS-RSRP measurement accuracy .....	1837
7.7.6	L1-SINR .....	1842
7.7.6.0	Minimum conformance requirements .....	1842
7.7.6.0.1	Minimum conformance requirements for CSI-RS based CMR and no dedicated IMR configured and CSI-RS resource set with repetition off .....	1842
7.7.6.0.2	Minimum conformance requirements for SSB based CMR and dedicated IMR L1-SINR measurement accuracy .....	1844
7.7.6.0.3	Minimum conformance requirements for CSI-RS based CMR and dedicated IMR L1-SINR measurement accuracy .....	1846
7.7.6.1	NR SA FR2 CSI-RS based CMR and no dedicated IMR configured and CSI-RS resource set with repetition off L1-SINR measurement accuracy .....	1849
7.7.6.2	NR SA FR2 SSB based CMR and dedicated IMR L1-SINR measurement accuracy .....	1852
7.7.6.3	NR SA FR2 CSI-RS based CMR and dedicated IMR L1-SINR measurement accuracy .....	1856
8.0	General .....	1861
8.1	Void .....	1861
8.2.1.0	Minimum conformance requirements .....	1861
8.2.1.0.1	Minimum conformance requirements for E-UTRA-NR FR1 inter-RAT cell reselection .....	1861
8.2.1.1	E-UTRA - NR FR1 cell re-selection to higher priority NR target cell .....	1863
8.2.1.2	E-UTRA - NR FR1 Cell reselection to lower priority NR target Cell in FR1 for UE configured with highSpeedInterRAT-NR-r16 .....	1870
8.3.1.0	Minimum conformance requirements .....	1875
8.3.1.0.1	Minimum conformance requirements for E-UTRA - NR FR1 handover .....	1875
8.3.1.1	E-UTRA - NR FR1 handover with known target cell .....	1876
8.3.1.1.3	Minimum conformance requirements .....	1876
8.4.1.0	Minimum conformance requirements .....	1881
8.4.1.0.1	Minimum conformance requirements for E-UTRA - NR FR1 SFTD measurement delay .....	1881
8.4.1.1	E-UTRA - NR FR1 SFTD measurement delay in non-DRX .....	1882
8.4.1.2	E-UTRA - NR FR1 SFTD measurement delay in DRX .....	1888
8.4.2.0	Minimum conformance requirements .....	1893
8.4.2.0.1	Minimum conformance requirements for E-UTRA - NR event-triggered measurement .....	1893
8.4.2.0.2	Void .....	1897
8.4.2.1	E-UTRA event-triggered reporting of a NR FR1 neighbour cell without SSB time index detection in non-DRX .....	1897
8.4.2.2	E-UTRA event-triggered reporting of a NR FR1 neighbour cell without SSB time index detection in DRX .....	1903
8.4.2.3	E-UTRA event-triggered reporting of a NR FR1 neighbour cell with SSB time index detection in non-DRX .....	1909
8.4.2.4	E-UTRA event-triggered reporting of a NR FR1 neighbour cell with SSB time index detection in DRX .....	1915
8.4.2.5	E-UTRA event-triggered reporting of a NR FR2 neighbour cell without SSB time index detection in non-DRX .....	1921
8.4.2.6	E-UTRA event-triggered reporting of a NR FR2 neighbour cell without SSB time index detection in DRX .....	1925
8.4.2.7	E-UTRA event-triggered reporting of a NR FR2 neighbour cell with SSB time index detection in non-DRX .....	1930
8.4.2.8	E-UTRA event-triggered reporting of a NR FR2 neighbour cell with SSB time index detection in DRX .....	1934

8.4.2.9	E-UTRA event triggered reporting of a NR FR1 neighbour cell with SSB time index detection in DRX for UE configured with highSpeedInterRAT-NR-r16 .....	1939
8.5.1	SFTD measurement accuracy .....	1945
8.5.1.0	Minimum conformance requirements .....	1945
8.5.1.0.1	Intra-frequency absolute SS-RSRP measurement accuracy requirements.....	1945
8.5.1.1	E-UTRA - NR FR1 SFTD measurement accuracy .....	1946
8.5.2	Inter-RAT measurement accuracy .....	1952
8.5.2.1	SS-RSRP .....	1952
8.5.2.1.0	Minimum conformance requirements.....	1952
8.5.2.1.1	SS-RSRP with NR FR1 target cell .....	1953
8.5.2.1.2	E-UTRA SS-RSRP absolute measurement accuracy of a NR FR2 neighbour cell .....	1958
8.5.2.2	SS-RSRQ .....	1963
8.5.2.2.0	Minimum conformance requirements.....	1963
8.5.2.2.1	E-UTRA SS-RSRQ absolute measurement accuracy of a NR FR1 neighbour cell.....	1963
8.5.2.2.2	E-UTRA SS-RSRQ absolute measurement accuracy of a NR FR2 neighbour cell.....	1966
8.5.2.3	SS-SINR.....	1971
8.5.2.3.0	Minimum conformance requirements.....	1971
8.5.2.3.1	E-UTRA SS-SINR absolute measurement accuracy of a NR FR1 neighbour cell.....	1971
8.5.2.3.2	E-UTRA SS-SINR absolute measurement accuracy of a NR FR2 neighbour cell.....	1974
9	NR sidelink.....	1979
9.1	NR sidelink in FR1 .....	1979
9.1.1	UE transmit timing .....	1979
9.1.1.0	Minimum conformance requirements .....	1979
9.1.1.0.1	Minimum conformance requirements for GNSS as synchronization reference source .....	1979
9.1.1.0.2	Minimum conformance requirements for SyncRef UE as synchronization reference source .....	1979
9.1.1.0.3	Minimum conformance requirements for FR1 NR Cell as synchronization reference source .....	1979
9.1.1.1	NR SA FR1 UE transmit timing accuracy for GNSS as synchronization reference source .....	1980
9.1.1.2	NR SA FR1 UE transmit timing accuracy for SyncRef UE as synchronization reference source .....	1982
9.1.1.3	NR SA FR1 UE transmit timing accuracy for FR1 NR cell as synchronization reference source .....	1984
9.1.2	Initiation/Cease of S-SSB transmission .....	1988
9.1.2.0	Minimum conformance requirements .....	1988
9.1.2.0.1	Minimum conformance requirements for FR1 NR cell as synchronization reference source .....	1988
9.1.2.0.2	Minimum conformance requirements for SyncRef UE as synchronization reference source .....	1989
9.1.2.1	NR SA FR1 initiation/cease of S-SSB transmission for FR1 NR cell as synchronization reference source .....	1990
9.1.2.2	NR SA FR1 initiation/cease of S-SSB transmission for SyncRef UE as synchronization reference source .....	1994
9.1.3	Synchronization reference selection/reselection .....	1997
9.1.3.0	Minimum conformance requirements .....	1997
9.1.3.0.1	Minimum conformance requirements for GNSS configured as the highest priority synchronization reference source .....	1997
9.1.3.0.2	Minimum conformance requirements for eNB/gNB configured as the highest priority synchronization reference source .....	1999
9.1.3.1	NR SA FR1 synchronization reference selection/reselection for GNSS configured as the highest priority synchronization reference source .....	2000
9.1.3.2	NR SA FR1 synchronization reference selection/reselection for FR1 NR Cell configured as the highest priority synchronization reference source.....	2004
9.1.4	L1 SL-RSRP measurements .....	2008
9.1.4.0	Minimum conformance requirements .....	2008
9.1.4.0.1	Minimum conformance requirements for resource selection/reselection, re-evaluation and pre-emption .....	2008
9.1.4.1	NR SA FR1 L1 SL-RSRP measurement for autonomous resource selection/reselection .....	2009
9.1.4.2	NR SA FR1 L1 SL-RSRP measurement for resource pre-emption .....	2014
9.1.4.3	NR SA FR1 L1 SL-RSRP measurement for resource re-evaluation .....	2018
9.1.5	Congestion control measurement.....	2024
9.1.5.0	Minimum conformance requirements .....	2024
9.1.5.0.1	Minimum conformance requirements for congestion control measurements .....	2024
9.1.5.1	NR SA FR1 congestion control measurement for concurrent operation.....	2025
9.1.5.2	NR SA FR1 congestion control measurement for PC5-only operation.....	2030
9.1.6	Congestion control measurement.....	2033
9.1.6.0	Minimum conformance requirements .....	2033

9.1.6.0.1	Minimum conformance requirements for interruption to WAN due to NR sidelink communication .....	2033
9.1.6.1	NR SA FR1 interruption to WAN due to NR sidelink communication .....	2033
<b>Annex A (normative): RRM test configurations .....</b>		<b>2038</b>
A.1	Reference measurement channels .....	2038
A.1.0	General .....	2038
A.1.1	PDSCH .....	2038
A.1.1.1	FDD .....	2038
A.1.1.2	TDD .....	2039
A.1.2	CORESET for RMSI scheduling .....	2042
A.1.2.1	FDD .....	2042
A.1.2.2	TDD .....	2043
A.1.3	CORESET for RMC scheduling .....	2046
A.1.3.1	FDD .....	2046
A.1.3.2	TDD .....	2046
A.1.4	CSI-RS .....	2048
A.1.4.1	FDD .....	2048
A.1.4.2	TDD .....	2049
A.1.4A	CSI-RS for tracking .....	2053
A.1.4A.1	FR1 .....	2053
A.1.4A.1.1	FDD .....	2053
A.1.4A.1.2	TDD .....	2054
A.1.4A.2	FR2 .....	2054
A.1.4A.2.1	TDD .....	2054
A.1.4B	CSI-IM configurations .....	2054
A.1.4B.1	FDD .....	2054
A.1.4B.2	TDD .....	2055
A.1.5	TDD UL/DL configuration .....	2057
A.1.6	PUSCH .....	2058
A.2	Reference OCGN configuration .....	2058
A.2.1	Generic OFDMA channel noise generator (OCNG) .....	2058
A.3	Reference SSB configuration .....	2061
A.3.1	SSB configuration for FR1 .....	2061
A.3.2	SSB configuration for FR2 .....	2061
A.4	Reference SMTC configuration .....	2062
A.5	Reference DRX configurations .....	2062
A.6	EN-DC test setup .....	2062
A.6.1	E-UTRA serving cell parameters .....	2062
A.6.1.1	E-UTRA serving cell parameters for EN-DC tests with NR FR1 .....	2062
A.6.1.2	E-UTRA serving cell parameters for EN-DC tests with NR FR2 .....	2064
A.6A	NR FR1-FR2 test setup .....	2066
A.7	Reference PRACH configurations .....	2066
A.7.1	PRACH configurations for FR1 .....	2066
A.7.2	PRACH configurations for FR2 .....	2067
A.7A	Reference MsgA configurations .....	2068
A.7A.1	MsgA configurations for FR1 .....	2068
A.7A.2	MsgA configurations for FR2 .....	2071
A.8	Reference BWP configurations .....	2073
A.8.1	Downlink BWP configurations .....	2073
A.8.2	Uplink BWP configurations .....	2073
A.9	Angle of Arrival (AoA) for FR2 RRM test cases .....	2074
A.9.1	Setup 1: Single AoA in Rx beam peak direction .....	2074
A.9.2	Setup 2: Single AoA in non Rx beam peak direction .....	2074
A.9.2.1	Setup 2a: Single AoA in non Rx beam peak direction without change in direction .....	2074

A.9.2.2	Setup 2b: Single AoA in non Rx beam peak direction with change in direction.....	2074
A.9.3	Setup 3: 2 AoAs .....	2074
A.9.4	Setup 4: 2 AoAs, 1 AoA in Rx beam peak direction, 1 in non Rx beam peak .....	2075
A.9.4.1	Setup 4a: 2 AoAs, 1 AoA in Rx beam peak direction, 1 in non Rx beam peak without change in direction .....	2075
A.9.4.2	Setup 4b: 2 AoAs, 1 AoA in Rx beam peak direction, 1 in non Rx beam peak with change in direction .....	2075
A.10	TCI State Configuration .....	2075
A.10.1	Introduction .....	2075
A.10.2	TCI states.....	2076
A.11	NR sidelink communication .....	2076
A.11.1	Introduction .....	2076
A.11.2	Reference resource pool configurations for NR Sidelink Communication .....	2076
A.11.3	Reference measurement channels for NR Sidelink Communication.....	2079
<b>Annex B (normative):        Conditions for RRM requirements applicability for operating bands .2080</b>		
B.1	Conditions for NR RRC_IDLE state mobility .....	2080
B.1.1	Introduction .....	2080
B.1.2	Conditions for measurements on NR intra-frequency cells for cell re-selection .....	2080
B.1.3	Conditions for measurements on NR inter-frequency cells for cell re-selection .....	2081
B.2	Conditions for NR RRC_CONNECTED state.....	2081
B.2.1	Introduction .....	2081
B.2.2	Conditions for NR intra-frequency measurements .....	2082
B.2.3	Conditions for NR inter-frequency measurements .....	2083
B.2.4	Conditions for NR L1-RSRP reporting .....	2083
B.2.4.1	Conditions for SSB based L1-RSRP reporting .....	2083
B.2.4.2	Conditions for CSI-RS based L1-RSRP reporting.....	2084
B.2.5	Conditions for RRC connection release with redirection to NR.....	2085
B.2.6	Conditions for UE transmit timing .....	2086
B.2.6.1	Conditions for SSB based UE transmit timing .....	2086
B.3	RRM requirement exceptions.....	2087
B.3.1	Introduction .....	2087
B.3.2	Receiver sensitivity relaxation for CA .....	2087
B.3.2.1	Receiver sensitivity relaxation for UE supporting CA in FR1.....	2087
B.3.2.2	Receiver sensitivity relaxation for UE configured with CA in FR1 .....	2088
B.3.2.2.1	Inter-band carrier aggregation.....	2088
B.3.2.2.2	Reference sensitivity exceptions due to UL harmonic interference for CA.....	2088
B.3.2.2.3	Reference sensitivity exceptions due to intermodulation interference due to 2UL CA .....	2088
B.3.2.3	Receiver sensitivity relaxation for UE supporting CA in FR2.....	2088
B.3.2.4	Receiver sensitivity relaxation for UE configured with CA in FR2 .....	2088
B.3.2.4.1	Intra-band contiguous carrier aggregation .....	2088
B.3.2.4.2	Intra-band non-contiguous carrier aggregation .....	2089
B.3.3	Receiver sensitivity relaxation for DC .....	2089
B.3.4	Receiver sensitivity relaxation for SUL .....	2089
B.3.4.1	Receiver sensitivity relaxation for UE supporting SUL in FR1.....	2089
B.3.4.2	Receiver sensitivity relaxation for UE configured with SUL in FR1 .....	2089
B.3.4.2.1	Reference sensitivity exceptions due to UL harmonic interference for SUL .....	2089
B.4	Conditions for NR sidelink.....	2089
B.4.1	Test parameters for GNSS signals.....	2089
B.4.2	Conditions for PSBCH-RSRP Accuracy Requirements.....	2090
B.4.3	Conditions for Selection/Reselection to Intra-frequency SyncRef UE.....	2090
B.4.4	Conditions for L1 SL-RSRP Accuracy Requirements .....	2090
<b>Annex C (normative):        Downlink physical channels and propagation conditions .....2091</b>		
C.1	Downlink physical channels.....	2091
C.1.1	General .....	2091
C.1.2	Default downlink signal levels .....	2091
C.1.3	Default connection setup.....	2092

C.2	Propagation conditions .....	2092
C.2.0	General .....	2092
C.2.1	No interference .....	2093
C.2.2	Static propagation conditions .....	2093
C.2.2.0	General.....	2093
C.2.2.1	UE receiver with 2Rx antenna connectors .....	2093
C.2.2.2	UE receiver with 4Rx antenna connectors .....	2093
C.2.3	Multi-path fading propagation conditions .....	2094
<b>Annex D (normative): Deviations from standard test configuration.....</b>		<b>2095</b>
D.1	Test cases with different numerologies .....	2095
D.2	EN-DC test cases with different EN-DC configurations.....	2095
D.2.0	General .....	2095
D.2.1	Principle of testing.....	2095
D.3	Carrier aggregation test cases with different CA configurations .....	2095
D.3.0	General .....	2095
D.3.1	Principle of testing.....	2095
D.4	Antenna connection for 4Rx capable UEs.....	2095
D.4.0	General .....	2095
D.4.1	Principle of testing.....	2096
D.4.1.1	Single carrier tests.....	2096
D.4.1.2	Carrier aggregation tests .....	2097
D.4.1.3	EN-DC tests.....	2097
D.4.2	Antenna connection .....	2097
D.4.2.1	Antenna connection for NR bands where 2Rx is supported .....	2097
D.4.2.2	Antenna connection for NR bands where only 4Rx is supported .....	2097
D.4.2.3	Antenna connection for E-UTRA bands where 2Rx is supported .....	2097
D.4.2.4	Antenna connection for E-UTRA bands where only 4Rx is supported .....	2098
D.5	Test Cases with Different Channel Bandwidths.....	2098
D.5.1	Test Cases with Different E-UTRA Channel Bandwidths .....	2098
D.5.1.1	Introduction.....	2098
D.5.1.2	Principle of testing.....	2098
D.6	Test Cases for Synchronous and Asynchronous DC Operations .....	2098
D.6.1	EN-DC Test Cases for Synchronous and Asynchronous EN-DC Operations .....	2098
D.6.1.1	Introduction.....	2098
D.6.1.2	Principle of Testing.....	2098
<b>Annex E (normative): Cell configuration mapping .....</b>		<b>2099</b>
E.0	General .....	2099
E.1	Test frequency selection.....	2099
E.1.0	General .....	2099
E.1.1	E-UTRA PCell for EN-DC test cases.....	2099
E.1.2	Test cases with one NR cell.....	2099
E.1.3	Test cases with more than one NR cell.....	2099
E.1.3.1	Intra-frequency test cases.....	2099
E.1.3.2	Inter-frequency test cases.....	2099
E.1.4	Carrier aggregation test cases.....	2100
E.1.4.1	Inter-band carrier aggregation.....	2100
E.1.4.2	Intra-band contiguous carrier aggregation .....	2100
E.1.4.3	Intra-band non-contiguous carrier aggregation.....	2100
E.1.5	E-UTRA – NR inter RAT test cases.....	2100
E.1.6	Intra-band EN-DC test cases .....	2100
E.1.6.1	Intra-band non-contiguous EN-DC.....	2100
E.1.6.1.1	Inter frequency neighbour cell .....	2100
E.1.6.2	Intra-band contiguous EN-DC .....	2100
E.1.6.1.1	E-UTRA PCell .....	2100
E.1.7	NR sidelink test cases.....	2101

E.2	Cell configuration mapping for EN-DC FR1 test cases in Chapter 4 .....	2101
E.3	Cell configuration mapping for EN-DC FR2 test cases in Chapter 5 .....	2104
E.4	Cell configuration mapping for SA FR1 test cases in Chapter 6.....	2107
E.5	Cell configuration mapping for SA FR2 test cases in Chapter 7.....	2111
E.6	Cell configuration mapping for E-UTRAN – SA test cases in Chapter 8.....	2113
E.7	Cell configuration mapping for NR sidelink test cases in Chapter 9 .....	2114
<b>Annex F (normative): Measurement uncertainties and test tolerances .....</b>		<b>2115</b>
F.1	Measurement uncertainties and test tolerances for FR1 and FR2 .....	2115
F.1.1	Acceptable uncertainty of test system (normative) .....	2115
F.1.1.1	Measurement of test environments .....	2115
F.1.1.2	Measurement of RRM requirements.....	2115
F.1.2	Interpretation of measurement results (normative).....	2146
F.1.3	Test Tolerance and Derivation of Test Requirements (informative).....	2146
F.1.3.1	Measurement of test environments .....	2146
F.1.3.2	Measurement of RRM requirements.....	2146
<b>Annex G (normative): Statistical testing .....</b>		<b>2217</b>
G.1	General .....	2217
G.2	Statistical testing of delay and UE measurement performance in RRM tests .....	2217
G.2.1	General .....	2217
G.2.2	Design of the test.....	2217
G.2.3	Numerical definition of the pass fail limits .....	2217
G.2.4	Pass fail decision rules .....	2218
G.2.5	Void.....	2219
G.2.6	Test conditions for delay tests and UE measurement performance.....	2219
G.3	Statistical testing of NR sidelink CBR measurement tests.....	2219
G.3.1	General .....	2219
G.3.2	Design of the test.....	2219
G.3.3	Numerical definition of the pass fail limits .....	2220
G.3.4	Pass fail decision rules .....	2220
G.X	Theory to derive the numbers in Table G.2.3-1 (informative) .....	2220
<b>Annex H (normative): Default message contents for RRM.....</b>		<b>2221</b>
H.1	Void.....	2221
H.2	System information blocks message content exceptions.....	2221
H.2.1	System information blocks message contents exceptions for NR intra frequency cell re-selection.....	2221
H.2.2	System information blocks message contents exceptions for NR inter frequency cell re-selection.....	2223
H.2.3	System information blocks message contents exceptions for NR inter-RAT cell re-selection .....	2224
H.3	RRC message content exceptions.....	2225
H.3.1	RRC messages and information elements contents exceptions for NR measurement configuration .....	2225
H.3.2	RRC messages and information elements contents exceptions for and handover.....	2241
H.3.3	RRC messages and information elements contents exceptions for NR inter-RAT handover.....	2242
H.3.4	E-UTRA RRC messages and information elements contents exceptions for NR measurement configuration .....	2243
H.3.6	RRC messages and IE content exceptions for L1-RSRP measurement for beam reporting.....	2252
H.3.6A	RRC messages and IE content exceptions for L1-SINR measurement for beam reporting .....	2255
H.3.7	RRC messages and information elements contents exceptions for NR cell search when DRX is used .....	2261
H.3.8	RRC messages and information elements contents exceptions for NR RRC reconfiguration delay .....	2264
H.3.9	RRC messages and information elements contents exceptions for UL timing.....	2265
<b>Annex I (normative): RRM OTA procedures .....</b>		<b>2266</b>
I.0	Test applicability per permitted test method .....	2266

I.1	Direct far field (DFF) .....	2266
I.1.1	RX beam peak direction search .....	2266
I.1.2	Search for directions corresponding to the EIS spherical coverage percentile .....	2266
I.2	Direct far field (DFF) simplification .....	2266
I.2.1	RX beam peak direction search .....	2266
I.2.2	Search for directions corresponding to the EIS spherical coverage percentile .....	2267
I.3	Indirect far field (IFF) .....	2267
I.3.1	RX beam peak direction search .....	2267
I.3.2	Search for directions corresponding to the EIS spherical coverage percentile .....	2267
I.3A	Enhanced indirect far field (Enhanced IFF) .....	2267
I.3A.1	RX beam peak direction search .....	2267
I.3A.2	Search for directions corresponding to the EIS spherical coverage percentile .....	2267
I.4	Procedures to search test directions for RRM FR2 .....	2267
I.4.1	RSRPB-based scan with fallback option to R <sub>x</sub> beam peak direction search .....	2267
<b>Annex J (informative):</b>	<b>Change history .....</b>	<b>2269</b>
History .....		2324



---

# Foreword

This Technical Specification has been produced by the 3<sup>rd</sup> Generation Partnership Project (3GPP).

The contents of the present document are subject to continuing work within the TSG and may change following formal TSG approval. Should the TSG modify the contents of the present document, it will be re-released by the TSG with an identifying change of release date and an increase in version number as follows:

Version x.y.z

where:

- x the first digit:
  - 1 presented to TSG for information;
  - 2 presented to TSG for approval;
  - 3 or greater indicates TSG approved document under change control.
- y the second digit is incremented for all changes of substance, i.e. technical enhancements, corrections, updates, etc.
- z the third digit is incremented when editorial only changes have been incorporated in the document.

---

# 1 Scope

The present document specifies the measurement procedures for the conformance test of the user equipment (UE) that contain requirements for support of RRM (Radio Resource Management) as part of the 5G New Radio (5G-NR). The present document covers NR Range 1, NR Range 2 and Interworking.

The requirements are listed in different clauses only if the corresponding parameters deviate. More generally, tests are only applicable to those mobiles that are intended to support the appropriate functionality. To indicate the circumstances in which tests apply, this is noted in the "*test applicability*" part of the test.

For example, only Release 15 and later UE declared to support NR shall be tested for this functionality. In the event that for some tests different conditions apply for different releases, this is indicated within the text of the test itself.

---

# 2 References

The following documents contain provisions, which, through reference in this text, constitute provisions of the present document.

- References are either specific (identified by date of publication, edition number, version number, etc.) or non-specific.
- For a specific reference, subsequent revisions do not apply.
- For a non-specific reference, the latest version applies. In the case of a reference to a 3GPP document (including a GSM document), a non-specific reference implicitly refers to the latest version of that document *in the same Release as the present document*.

- [1] 3GPP TR 21.905: "Vocabulary for 3GPP Specifications".
- [2] 3GPP TS 38.101-1: "NR; User Equipment (UE) radio transmission and reception; Part 1: Range 1 Standalone".
- [3] 3GPP TS 38.101-2: "NR; User Equipment (UE) radio transmission and reception; Part 2: Range 2 Standalone".
- [4] 3GPP TS 38.101-3: "NR; User Equipment (UE) radio transmission and reception; Part 3: Range 1 and Range 2 Interworking operation with other radios".
- [5] 3GPP TS 38.101-4: "NR; User Equipment (UE) radio transmission and reception; Part 4: Performance requirements".
- [6] 3GPP TS 38.133: "NR; Requirements for support of radio resource management".
- [7] 3GPP TS 38.211: "NR; Physical channels and modulation".
- [8] 3GPP TS 38.213: "NR; Physical layer procedures for control".
- [9] 3GPP TS 38.214: "NR; Physical layer procedures for data".
- [10] 3GPP TS 38.215: "NR; Physical layer measurements".
- [11] 3GPP TS 38.306: "NR; User Equipment (UE) radio access capabilities".
- [12] 3GPP TS 38.321: "NR; Medium Access Control (MAC) protocol specification".
- [13] 3GPP TS 38.331: "NR; Radio Resource Control (RRC); Protocol specification".
- [14] 3GPP TS 38.508-1: "5GS; User Equipment (UE) conformance specification; Part 1: Common test environment".
- [15] 3GPP TS 38.508-2: "5GS; User Equipment (UE) conformance specification; Part 2: Common Implementation Conformance Statement (ICS) proforma".

- [16] 3GPP TS 38.509: "5GS; Special Conformance Testing Functions for UE".
- [17] 3GPP TS 38.521-1: "NR; User Equipment (UE) conformance specification; Radio transmission and reception; Part 1: Range 1 Standalone".
- [18] 3GPP TS 38.521-2: " NR; User Equipment (UE) conformance specification; Radio transmission and reception; Part 2: Range 2 Standalone".
- [19] 3GPP TS 38.521-3: " NR; User Equipment (UE) conformance specification; Radio transmission and reception; Part 3: Range 1 and Range 2 Interworking operation with other radios".
- [20] 3GPP TS 38.521-4: "NR; User Equipment (UE) conformance specification; Part 4: Performance".
- [21] 3GPP TS 38.522: "NR; User Equipment (UE) conformance specification; Applicability of radio transmission, radio reception and radio resource management test cases".
- [22] 3GPP TS 38.903: "NR; Derivation of test tolerances and measurement uncertainty for User Equipment (UE) conformance test cases".
- [23] 3GPP TS 36.133: "E-UTRA requirements for support of radio resource management".
- [24] 3GPP TS 36.211: "E-UTRA Physical Channels and Modulation".
- [25] 3GPP TS 36.508: "Common test environments for User Equipment (UE)".
- [26] 3GPP TS 36.521-3: "E-UTRA; UE conformance specification; Radio transmission and reception; Part 3: Radio Resource Management (RRM) conformance testing"
- [27] 3GPP TS 36.101: "E-UTRA UE radio transmission and reception".
- [28] 3GPP TS 38.104: "NR; Base Station (BS) radio transmission and reception".
- [29] 3GPP TS 36.331: "Evolved Universal Terrestrial Radio Access (E-UTRA) Radio Resource Control (RRC) Protocol Specification".
- [30] 3GPP TS 38.304: "NR; User Equipment (UE) procedures in idle mode".
- [31] 3GPP TS 38.212 "NR; Multiplexing and channel coding".
- [32] 3GPP TR 38.810: "Study on test methods for New Radio".
- [33] 3GPP TR 36.213: "E-UTRA; Physical layer procedures".
- [34] 3GPP TS 37.340: "NR; Multi-connectivity; Overall description; Stage-2".
- [35] 3GPP TS 38.300: "NR; NR and NG-RAN Overall description; Stage-2".

---

## 3 Definitions, symbols and abbreviations

### 3.1 Definitions

For the purposes of the present document, the terms and definitions given in 3GPP TR 21.905 [1] and the following apply. A term defined in the present document takes precedence over the definition of the same term, if any, in 3GPP TR 21.905 [1].

**Active DL BWP:** Active DL bandwidth part as defined in 3GPP TS 38.213 [8].

**Blackbox Approach:** Testing methodology, in which the UE internal implementation of certain specific UE functionality involved in the test, is unknown.

**Control Resource Set:** As defined in 3GPP TS 38.213 [8].

**DL BWP:** DL bandwidth part as defined in 3GPP TS 38.213 [8].

**EN-DC:** E-UTRA-NR Dual Connectivity as defined in clause 4.1.2 of 3GPP TS 37.340 [34].

**en-gNB:** As defined in 3GPP TS 37.340 [34].

**FR1:** Frequency range 1 as defined in clause 5.1 of 3GPP TS 38.104 [28].

**FR2:** Frequency range 2 as defined in clause 5.1 of 3GPP TS 38.104 [28].

**gNB:** as defined in 3GPP TS 38.300 [TBD].

**Master Cell Group:** As defined in 3GPP TS 38.331 [13].

**Multi-Radio Dual Connectivity:** Dual Connectivity between E-UTRA and NR nodes, or between two NR nodes, as defined in 3GPP TS 37.340 [34].

**ng-eNB:** As defined in 3GPP TS 38.300 [35].

**NE-DC:** NR-E-UTRA Dual Connectivity as defined in clause 4.1.3.2 of 3GPP TS 37.340 [34].

**NGEN-DC:** NG-RAN E-UTRA-NR Dual Connectivity as defined in clause 4.1.3.1 of 3GPP TS 37.340 [34].

**NR-DC:** NR-NR Dual Connectivity as defined in clause 4.1.3.3 of 3GPP TS 37.340 [34].

**Primary Cell:** As defined in 3GPP TS 38.331 [13].

**Quasi Co-Location:** As defined in 3GPP TS 38.214 [9].

**RLM-RS resource:** A resource out of the set of resources configured for RLM by higher layer parameter RLM-RS-List [2] as defined in 3GPP TS 38.213 [8].

**SA operation mode:** Operation mode when the UE is configured with at least PCell and not any MR-DC.

**Secondary Cell:** As defined in 3GPP TS 38.331 [13].

**Secondary Cell Group:** As defined in 3GPP TS 38.331 [13].

**Serving Cell:** As defined in 3GPP TS 38.331 [13].

**SMTC:** An SSB-based measurement timing configuration configured by *SSB-MeasurementTimingConfiguration* as specified in 3GPP TS 38.331 [13].

**Special Cell:** As defined in 3GPP TS 38.331 [13].

**SSB:** SS/PBCH block as defined in clause 7.8.3 of 3GPP TS 38.211 [7].

**Timing Advance Group:** As defined in 3GPP TS 38.331 [13].

## 3.2 Symbols

For the purposes of the present document, the following symbols apply:

[...]	Values included in square bracket shall be considered for further studies, because it means that a decision about that value was not taken.
$BW_{\text{Channel}}$	Channel bandwidth, defined in TS 38.101-1 [2], 38.101-2 [3] and 38.101-3 [4] subclause 3.2
$\hat{E}_s$	Received energy per RE (power normalized to the subcarrier spacing) during the useful part of the symbol, i.e. excluding the cyclic prefix, at the UE antenna connector or at the gNB reference point as defined in TS 38.215 [10], subclause 5.2 for the respective measurement type
$I_o$	The total received power density, including signal and interference, as measured at the UE antenna connector.
$I_{oc}$	The power spectral density (integrated in a noise bandwidth equal to the chip rate and normalized to the chip rate) of a band limited noise source (simulating interference from cells, which are not defined in a test procedure) as measured at the UE antenna connector.

I <sub>ot</sub>	The received power spectral density of the total noise and interference for a certain RE (power integrated over the RE and normalized to the subcarrier spacing) as measured at the UE antenna connector or at the gNB reference point as defined in TS 38.215 [10], subclause 5.2 for the respective measurement type
N <sub>oc</sub>	The power spectral density of a white noise source (average power per RE normalised to the subcarrier spacing), simulating interference from cells that are not defined in a test procedure, as measured at the UE antenna connector
S	Cell Selection Criterion defined in TS 38.304, subclause 5.2.3.2 for NR
SSB_RP	Received (linear) average power of the resource elements that carry NR synchronisation burst, measured at the UE antenna connector
S <sub>rxlev</sub>	Cell selection RX level, defined in TS 38.304, subclause 5.2.3.2
S <sub>qual</sub>	Cell selection quality, defined in TS 38.304, subclause 5.2.3.2
S <sub>intrasearch</sub>	Defined in TS 38.304 [30], subclause 5.2.4.7 for E-UTRAN and 38.304 subclause 5.2.4.7 for NR
S <sub>nonintrasearch</sub>	Defined in TS 38.304 [30], subclause 5.2.4.7
Thresh <sub>x, high</sub>	Defined in TS 38.304 [30], subclause 5.2.4.7
Thresh <sub>x, low</sub>	Defined in TS 38.304 [30], subclause 5.2.4.7
Thresh <sub>serv, low</sub>	Defined in TS 38.304 [30], subclause 5.2.4.7
T <sub>RE-ESTABLISH-REQ</sub>	The RRC Re-establishment delay requirement, the time between the moment when erroneous CRCs are applied, to when the UE starts to send preambles on the PRACH. T <sub>c</sub> Basic time unit, defined in clause 4.1 of 3GPP TS 38.211 [7].
T <sub>s</sub>	Reference time unit, defined in clause 4.1 of 3GPP TS 38.211 [7].
T <sub>UE_re-establish_delay</sub>	Time between the moments when any of the conditions requiring RRC re-establishment as defined in clause 5.3.7 in TS 38.331 [13] is detected by the UE and when the UE sends PRACH to the target PCell.

### 3.3 Abbreviations

For the purposes of the present document, the abbreviations given in 3GPP TR 21.905 [1] and the following apply. An abbreviation defined in the present document takes precedence over the definition of the same abbreviation, if any, in 3GPP TR 21.905 [1].

AoA	Angle of Arrival
AoD	Angle of Departure
BFD	Beam Failure Detection
BFD-RS	BFD Reference Signal
BS	Base Station
BWP	Bandwidth Part
CBD	Candidate Beam Detection
CDF	Cumulative Distribution Function
CC	Component Carrier
CLI	Cross Link Interference
CMR	Channel Measurement Resource
CORESET	Control Resource Set
CP	Cyclic Prefix
CSI	Channel-State Information
CSI-RS	CSI Reference Signal
CSI-RSRP	CSI Reference Signal based Reference Signal Received Power
CSI-RSRQ	CSI Reference Signal based Reference Signal Received Quality
CSI-SINR	CSI Reference Signal based Signal to Noise and Interference Ratio
DC	Dual Connectivity
DCI	Downlink Control Information
DL	Downlink
DMRS	Demodulation Reference Signal
DRX	Discontinuous Reception
E-CID	Enhanced Cell ID
E-UTRA	Evolved UTRA
E-UTRA/5GC	E-UTRA connected to 5GC
E-UTRAN	Evolved UTRAN
EN-DC	E-UTRA – NR Dual Connectivity
FR	Frequency Range
FR1	Frequency Range 1
FR2	Frequency Range 2

HARQ	Hybrid Automatic Repeat Request
HO	Handover
IMR	Interference Measurement Resource
L1-RSRP	Layer 1 RSRP
MAC	Medium Access Control
MCG	Master Cell Group
MG	Measurement Gap
MGL	Measurement Gap Length
MGRP	Measurement Gap Repetition Period
MIB	Master Information Block
MN	Master Node
MR-DC	Multi-Radio Dual Connectivity
NE-DC	NR-E-UTRA Dual Connectivity
NGEN-DC	NG-RAN E-UTRA-NR Dual Connectivity
NR	New Radio
NR/5GC	NR connected to 5GC
NR-DC	NR-NR Dual Connectivity
NSA	Non-Standalone
OCNG	OFDMA Channel Noise Generator
OFDM	Orthogonal Frequency Division Multiplexing
OFDMA	Orthogonal Frequency Division Multiple Access
PCC	Primary Component Carrier
PCell	Primary Cell
PDCCH	Physical Downlink Control Channel
PDSCH	Physical Downlink Shared Channel
PLMN	Public Land Mobile Network
PRACH	Physical RACH
PSCell	Primary Secondary Cell
PSS	Primary Synchronization Signal
pTAG	Primary Timing Advance Group
PUCCH	Physical Uplink Control Channel
PUSCH	Physical Uplink Shared Channel
QCL	Quasi Co-Location
RACH	Random Access Channel
RAT	Radio Access Technology
RLM	Radio Link Monitoring
RLM-RS	Reference Signal for RLM
RMC	Reference Measurement Channel
RMSI	Remaining Minimum System Information
RRC	Radio Resource Control
RRM	Radio Resource Management
RSRP	Reference Signal Received Power
RSRQ	Reference Signal Received Quality
RSSI	Received Signal Strength Indicator
RSTD	Reference Signal Time Difference
RTT	Round Trip Time
SA	Standalone
SCC	Secondary Component Carrier
SCell	Secondary Cell
SCG	Secondary Cell Group
SCS	Subcarrier Spacing
SCS <sub>SSB</sub>	SSB subcarrier spacing
SDL	Supplementary Downlink
SFN	System Frame Number
SFTD	SFN and Frame Timing DifferenceSI System Information
SIB	System Information Block
SMTC	SSB-based Measurement Timing configuration
SpCell	Special Cell
SRS	Sounding Reference Signal
SRS-RSRP	Sounding Reference Signal based Reference Signal Received Power
SS	System Simulator

SS-RSRP	Synchronization Signal based Reference Signal Received Power
SS-RSRQ	Synchronization Signal based Reference Signal Received Quality
SS-SINR	Synchronization Signal based Signal to Noise and Interference Ratio
SSB	Synchronization Signal Block
SSB_RP	Received (linear) average power of the resource elements that carry NR SSB signals and channels, measured at the UE antenna connector.
SSS	Secondary Synchronization Signal
sTAG	Secondary Timing Advance Group
SUL	Supplementary Uplink
TA	Timing Advance
TAG	Timing Advance Group
TCI	Transmission Configuration Indicator
TTI	Transmission Time Interval
UL	Uplink

---

## 3A Requirements for the support of RRM

### 3A.1 General

#### 3A.1.0 Overview of RRM requirements

Radio Resource Management (RRM) ensures the efficient use of the available radio resources and also provides mechanisms that enable NR to meet radio resource related requirements. The requirements are divided in four main clauses according to the network deployment and the frequency range:

- Clause 4 for EN-DC test cases where all NR cells are in FR1.
- Clause 5 for EN-DC test cases where at least one NR cell is in FR2.
- Clause 6 for NR/5GC test cases where all NR cells are in FR1.
- Clause 7 for NR/5GC test cases where at least one NR cell is in FR2.

The requirements that are tested include:

- Idle mode, the cell re-selection algorithms that are controlled by the setting of parameters (thresholds and hysteresis values) that define the best cell and/or determine when the UE should select a new cell.  
Inactive mode, the cell re-selection algorithms that are controlled by the setting of parameters (thresholds and hysteresis values) that define the best cell and/or determine when the UE should select a new cell.
- The configuration of the UE measurement and reporting procedures that are transmitted via dedicated signalling in connected mode and the reporting accuracy of the required measurements.
- Connected mode, the mobility of radio connections that has to be supported.
- Handover decisions that may be based on UE or gNB measurements.
- Inter-RAT RRM, the management of radio resources in connection with inter-RAT mobility, e.g. Inter-RAT handover.

Inter frequency and inter-RAT test cases are performed without frequency overlapping between cells required in the test:

- For bands with bandwidth not accommodating all the NR cells required in the test without frequency overlapping, inter band testing shall be done according to clause 3A.5. If the UE does not support the combination given in clause 3A.5, the relevant tests are applicable only to the bands with the necessary bandwidth.

- In case when frequency overlapping occurs due to the frequency channel selection defined for the test (i.e. Cell number as per Annex D), other frequency channels which avoid the frequency overlapping shall be selected. If no suitable selection is found the test is not applicable for the affected band.

### 3A.1.1 Test coverage across 5G NR connectivity options

The test cases in this specification cover both NR/5GC (including FR1+ FR2 CA or FR1+FR2 NR-DC) as well as EN-DC and NGEN-DC testing. Below shall be the understanding with respect to coverage across 5G NR connectivity options:

1. Unless otherwise stated within the test case, it shall be understood that test requirements are agnostic of the EN-DC and NGEN-DC connectivity option configured within the test. The test coverage across the EN-DC and NGEN-DC connectivity options shall be considered fulfilled by executing the test case in one of these connectivity options.
2. EN-DC is the default connectivity option used for EN-DC and NGEN-DC test cases.
3. If a UE does not support EN-DC, NGEN-DC can be configured to execute the test. The leverage rule detailed in (1) would apply.

**Table 3A.1.1-1: Void**

**Table 3A.1.1-2: Void**

**Editor's Note:** Any additional test config details needed for NE-DC and NGEN-DC are FFS.

## 3A.2 Requirements Classification for Statistical Testing

The test requirements are expressed as absolute requirements with a single value stating the requirement or expressed as a success rate. The statistical nature depends on the type of test requirement. Some have large statistical variations, while others are not statistical in nature at all. When testing a parameter with a statistical nature, a confidence level is set. This establishes the probability that a Device Under Test (DUT) passing the test actually meets the test requirement and determines how many times a test have to be repeated and what the pass and fail criteria is. The statistical significance shall be set according to Annex G.

## 3A.3 Antenna Configuration

Unless otherwise specified, NR FDD or NR TDD cells in all RRM test cases in AWGN propagation condition are configured with antenna configuration 1x2.

## 3A.4 NR band groups

### 3A.4.0 General

The intention of the band grouping defined in this clause is to increase the readability of the test specification.

The frequency bands grouping is derived based on UE REFSENS requirements specified in 3GPP TS 38.101-1 [2], TS 38.101-2 [3] and TS 38.101-3 [4] and assuming 0.5 dB step between the neighbour groups. The groups are defined in the order of increasing REFSENS, i.e., the group A has the smallest REFSENS among the groups. For the same SCS and a given bandwidth, the bands within the same group have the same Io conditions in a corresponding requirement in this specification, provided the bands support this SCS. For different SCSs supported by a frequency band and the same bandwidth, different Io conditions may apply for the frequency band in the requirements, while the band group is the same, based on the lowest REFSENS requirement normalized by the number of subcarriers among its supported SCSs for this bandwidth. For the same SCS but different supported bandwidths, the group for a band is determined based on the lowest REFSENS requirement normalized by the number of subcarriers among its supported bandwidths.



### 3A.4.1 NR operating bands in FR1

NR frequency bands grouping for FR1 is specified in Table 3A.4.1-1.

**Table 3A.4.1-1: NR frequency band groups for FR1**

Group	NR FDD		NR TDD		NR SDL <sup>5</sup>	
	Band group notation	Operating bands	Band group notation	Operating bands	Band group notation	Operating bands
A	NR_FDD_FR1_A	n1, n18, n24, n70, n74 <sup>4</sup>	NR_TDD_FR1_A	n34, n38 <sup>9</sup> , n39, n40, n50, n51, n53	NR_SDL_FR1_A	n75, n76
B	NR_FDD_FR1_B	n65, n66, n74 <sup>3</sup>	NR_TDD_FR1_B	n38 <sup>7</sup>	NR_SDL_FR1_B	-
C	NR_FDD_FR1_C	n30	NR_TDD_FR1_C	n48, n77 <sup>1</sup> , n78, n79	NR_SDL_FR1_C	-
D	NR_FDD_FR1_D	n28	NR_TDD_FR1_D	n77 <sup>2</sup>	NR_SDL_FR1_D	-
E	NR_FDD_FR1_E	n2, n5, n7	NR_TDD_FR1_E	n41	NR_SDL_FR1_E	-
F	NR_FDD_FR1_F	n26 <sup>6</sup>	NR_TDD_FR1_F	-	NR_SDL_FR1_F	-
G	NR_FDD_FR1_G	n3, n8, n12, n14, n20, n71	NR_TDD_FR1_G	-	NR_SDL_FR1_G	n29
H	NR_FDD_FR1_H	n25	NR_TDD_FR1_H	-	NR_SDL_FR1_H	-
J	NR_FDD_FR1_J	-	NR_TDD_FR1_J	n47 <sup>8</sup>	NR_SDL_FR1_J	-

NOTE 1: Except 3.8 GHz to 4.2 GHz.  
NOTE 2: Only 3.8 GHz to 4.2 GHz.  
NOTE 3: Except 1475.9 MHz to 1510.9 MHz.  
NOTE 4: Only when the band is confined in 1475.9 MHz to 1510.9 MHz.  
NOTE 5: These bands are used only in NR carrier aggregation with other NR bands according to NR CA band combinations specified in 3GPP TS 38.101-1 [18] and TS 38.101-3 [20].  
NOTE 6: The minimum Io condition is reduced by 0.5 dB when the carrier frequency of the assigned NR channel bandwidth is within 865-894 MHz.  
NOTE 7: When this band is only used for V2X SL service, the band is exclusively used for NR V2X in particular regions.  
NOTE 8: This band is unlicensed band used for V2X service. There is no expected network deployment in this band.  
NOTE 9: When this band is only used for WAN service.

**Table 3A.4.1-2: Power offsets for the test configuration between NR frequency band groups for FR1 with respect to NR\_FDD\_FR1\_A**

Group	NR FDD		NR TDD		NR SDL	
	Band group notation	Power Offset [dB], $\Delta_{BG\_offset}$	Band group notation	Power Offset [dB], $\Delta_{BG\_offset}$	Band group notation	Operating bands
A	NR_FDD_FR1_A	-	NR_TDD_FR1_A	0.0	NR_SDL_FR1_A	0.0
B	NR_FDD_FR1_B	0.5	NR_TDD_FR1_B	0.5	NR_SDL_FR1_B	-
C	NR_FDD_FR1_C	1.0	NR_TDD_FR1_C	1.0	NR_SDL_FR1_C	-
D	NR_FDD_FR1_D	1.5	NR_TDD_FR1_D	1.5	NR_SDL_FR1_D	-
E	NR_FDD_FR1_E	2.0	NR_TDD_FR1_E	2.0	NR_SDL_FR1_E	-
F	NR_FDD_FR1_F	2.5	NR_TDD_FR1_F	2.5	NR_SDL_FR1_F	-
G	NR_FDD_FR1_G	3.0	NR_TDD_FR1_G	3.0	NR_SDL_FR1_G	-
H	NR_FDD_FR1_H	3.5	NR_TDD_FR1_H	3.5	NR_SDL_FR1_H	-
J	NR_FDD_FR1_J	4.5	NR_TDD_FR1_J	4.5	NR_SDL_FR1_J	-

NOTE: In the test parameters table, only the power configuration for NR\_FDD\_FR1\_A or NR\_TDD\_FR1\_A will be given.

### 3A.4.2 NR operating bands in FR2

NR frequency bands grouping for FR2 is specified in Table 3A.4.2-1.

**Table 3A.4.2-1: NR frequency band groups for FR2**

Group	Band group notation	Operating bands
A	NR_TDD_FR2_A	n257 <sup>1</sup> , n258 <sup>1</sup> , n261 <sup>1</sup>
B	NR_TDD_FR2_B	n257 <sup>4</sup> , n258 <sup>4</sup> , n261 <sup>4</sup>
C	NR_TDD_FR2_C	
D	NR_TDD_FR2_D	
E	NR_TDD_FR2_E	
F	NR_TDD_FR2_F	n260 <sup>4</sup>
G	NR_TDD_FR2_G	n260 <sup>1</sup>
H	NR_TDD_FR2_H	
I	NR_TDD_FR2_I	
J	NR_TDD_FR2_J	
K	NR_TDD_FR2_K	
L	NR_TDD_FR2_L	n257 <sup>2</sup> , n258 <sup>2</sup> , n261 <sup>2</sup>
M	NR_TDD_FR2_M	
N	NR_TDD_FR2_N	
O	NR_TDD_FR2_O	
P	NR_TDD_FR2_P	
Q	NR_TDD_FR2_Q	
R	NR_TDD_FR2_R	
S	NR_TDD_FR2_S	
T	NR_TDD_FR2_T	n257 <sup>3</sup> , n258 <sup>3</sup> , n261 <sup>3</sup>
U	NR_TDD_FR2_U	
V	NR_TDD_FR2_V	
W	NR_TDD_FR2_W	
X	NR_TDD_FR2_X	
Y	NR_TDD_FR2_Y	n260 <sup>3</sup>
Z	NR_TDD_FR2_Y	
AA	NR_TDD_FR2_AA	n259 <sup>3</sup>
NOTE 1: UE power class 1.		
NOTE 2: UE power class 2.		
NOTE 3: UE power class 3.		
NOTE 4: UE power class 4.		

**Table 3A.4.2-2: FFS**

## 3A.5 NR operating band configuration

The additional band defined in Table 3A.5-1 shall be used for RRM inter-frequency tests where the band under test cannot accommodate two (or more) non-overlapping inter-frequency cells. The usage of the additional band is conditioned to the UE supporting this band, the corresponding channel bandwidth and other band-dependent parameters. If the UE does not support the additional band or associated parameters, the inter-frequency test shall be considered Not Applicable for the band under test.

Inter-band configuration is not affecting the Test purpose since the minimum requirements are valid regardless of band. Band combinations defined in table 3A.5-1 shall be used for testing.

**Table 3A.5-1: Inter-band configuration**

Band under test	Additional band (s)
n12	n66
n14	n66
n18	n1
n30	n66
n34	n41
n38	n41
n39	n41
n53	n41
n70	n66
NOTE 1: The band under test should contain the inter-frequency (neighbour) cell.	
NOTE 2: The additional band should contain the serving cell of the test. If more than one inter-frequency cell is needed, that cell should be on the additional band.	
NOTE 3: The bands and cells referred in this table are NR bands and cells only. For instructions on how to configure the E-UTRA operating band please refer to 3GPP TS 36.521-3 [26].	
NOTE 4: The additional bands in this table are to be used in NR SA test cases only. EN-DC test cases cannot make use of additional bands.	

## 3A.6 UE with Multiband Capability

The Radio Resource Management performance of a UE in all sections except 4.7, 5.7, 6.7, 7.7 and 8.5.2 is independent from all bands. Therefore, the required performance in the respective test cases can be verified in one of the bands supported by the UE, except for inter-band testing requirements in clause 3A.1.

The NR standalone test cases in sections 6.7 and 7.7 are dependent on the NR band of the target cell, and is required to be verified in all UE supported NR bands.

The EN-DC test cases in sections 4.7, 5.7 and inter-RAT test cases in clause 8.5.2 are dependent on the NR band of the target cell, and is required to be verified in all UE supported NR bands. It is not necessary to repeat the tests for different LTE bands. For EN-DC configurations with the same NR band, it is sufficient to configure any one of them to execute the tests.

---

# 4 EN-DC with all NR cells in FR1

## 4.0 General

This clause contains test scenarios for E-UTRA and NR dual connectivity with E-UTRA as PCell and NR and PSCell. All NR cells are in Frequency Range 1.

## 4.1 Void

## 4.2 Void

## 4.3 RRC\_CONNECTED state mobility

### 4.3.1 Void

### 4.3.2 RRC connection mobility control

#### 4.3.2.1 Void

#### 4.3.2.2 Random access

##### 4.3.2.2.1 EN-DC FR1 contention based random access

###### 4.3.2.2.1.1 Test purpose

The purpose of this test is to verify that the behaviour of the random access procedure is according to the requirements and that the PRACH power settings and timing are within specified limits.

###### 4.3.2.2.1.2 Test applicability

This test applies to all types of E-UTRA UE release 15 and forward, supporting EN-DC.

###### 4.3.2.2.1.3 Minimum conformance requirement

The random access procedure is used when establishing the layer 1 communication between the UE and NG-RAN. The random access is as defined in TS 38.213 [8] clause 7.4 and the control of the RACH transmission is as defined in TS 38.321 [12] clause 5.1.

The UE shall have capability to calculate PRACH transmission power according to the PRACH power formula as defined in TS 38.213 [8] clause 7.4 and apply this power level at the first preamble or additional preambles. The absolute power applied to the first preamble shall have an accuracy as defined in TS 38.101-1 [2] Table 6.3.4.2-1. The relative power applied to additional preambles shall have an accuracy as specified in TS 38.101-1 [2] Table 6.3.4.3-1.

The UE shall indicate a Random Access problem to upper layers if the maximum number of preamble transmission counter has been reached for the random access procedure on PCell or PSCell as specified in TS 38.321 [12] clause 5.1.4.

With the UE selected SSB with SS-RSRP above  $rsrp-ThresholdSSB$ , UE shall have the capability to select a Random Access Preamble randomly with equal probability from the Random Access Preambles associated with the selected SSB if the association between Random Access Preambles and SS blocks is configured, as specified in clause 5.1.2 in TS 38.321 [12].

With the UE selected SSB with SS-RSRP above  $rsrp-ThresholdSSB$ , UE shall have the capability to transmit Random Access Preamble on the next available PRACH occasion from the PRACH occasions corresponding to the selected SSB permitted by the restrictions given by the  $ra-ssb-OccasionMaskIndex$  if configured, if the association between PRACH occasions and SSBs is configured, and PRACH occasion shall be randomly selected with equal probability amongst the selected SSB associated PRACH occasions occurring simultaneously but on different subcarriers, as specified in clause 5.1.2 in TS 38.321 [12].

The UE may stop monitoring for Random Access Response(s) and shall transmit the msg3 if the Random Access Response contains a Random Access Preamble identifier corresponding to the transmitted Random Access Preamble.

The UE shall again perform the Random Access Resource selection procedure defined in clause 5.1.2 in TS 38.321 [12], and transmit with the calculated PRACH transmission power when the backoff time expires if all

received Random Access Responses contain Random Access Preamble identifiers that do not match the transmitted Random Access Preamble.

The UE shall again perform the Random Access Resource selection procedure defined in clause 5.1.2 in TS 38.321 [12], and transmit with the calculated PRACH transmission power when the backoff time expires if no Random Access Response is received within the RA Response window defined in clause 5.1.4 in TS 38.321 [12].

The UE shall re-transmit the msg3 upon the reception of an UL grant for msg3 retransmission.

The UE shall re-select a preamble and transmit with the calculated PRACH transmission power when the backoff time expires if the Contention Resolution Timer expires.

The normative reference for this requirement is TS 38.133 [6] clauses 6.2.2 and A.4.3.2.2.1.

#### 4.3.2.2.1.4 Test description

##### 4.3.2.2.1.4.1 Initial conditions

This test can be run in the configurations defined in Table 4.3.2.2.1.4.1-1.

**Table 4.3.2.2.1.4.1-1: Contention based random access test in FR1 for PSCell in EN-DC supported test configurations**

Test Case ID	Test Config Index	Description
4.3.2.2.1-1	1	LTE FDD, NR 15 kHz SSB SCS, 10MHz bandwidth, FDD
4.3.2.2.1-2	2	LTE TDD, NR 15 kHz SSB SCS, 10MHz bandwidth, FDD
4.3.2.2.1-3	3	LTE FDD, NR 30 kHz SSB SCS, 40MHz bandwidth, TDD
4.3.2.2.1-4	4	LTE TDD, NR 30 kHz SSB SCS, 40MHz bandwidth, TDD
NOTE: The UE is only required to be tested in one of the supported test configurations.		

Configure the test equipment and the DUT according to the parameters in Table 4.3.2.2.1.4.1-2.

**Table 4.3.2.2.1.4.1-2: Initial conditions for Contention based random access test in FR1 for EN-DC**

Parameter	Value		Comment
Test environment	NC		As specified in TS 38.508-1 [14] clause 4.1.
Test frequencies	As specified in Annex E, Table E.1-1 and TS 38.508-1 [14] clause 4.3.1.		
Channel bandwidth	As specified by the test configuration selected from Table 4.3.2.2.1.4.1-1.		
Propagation conditions	AWGN		As specified in Clause C.2.2.
Connection Diagram	TE Part	A.3.1.7.1	As specified in TS 38.508-1 [14] Annex A.
	DUT Part	A.3.2.3.4	
Exceptions to connection diagram	N/A		

1. Message contents are defined in clause 4.3.2.2.1.4.3.
2. Cell 1 is the E-UTRA serving cell (PCell) for the EN-DC setup. The E-UTRAN PCell power levels and settings are specified in Table A.6.1.1-1. Cell 2 is the NR FR1 PSCell. The connection setup is done according to the settings in clause C.1.3, with downlink signal levels as per clause C.1.2. General Test parameters are defined in Table 4.3.2.2.1.5-1.
3. Downlink signals for NR cell are initially set up according to clause C.2.1.

## 4.3.2.2.1.4.2 Test procedure

For this test two cells are used, an E-UTRA serving cell (PCell) and an NR FR1 PSCell. For the NR PSCell, the System Simulator shall not explicitly assign a random access preamble via dedicated signalling in the downlink.

1. Ensure the UE is in state E-UTRA RRC\_CONNECTED with generic procedure parameters *Connectivity E-UTRA/EPC* with Test Mode *On* according to TS 38.508-1 [14] clause 4.5.
2. Set the parameters according to Table 4.3.2.2.1.5-1.
3. The test system shall send a RRCReconfiguration message to the UE to add NR PSCell, then the UE shall trigger a random access procedure.
4. Test 1: Correct behaviour when transmitting Random Access Preamble:
  - 4.1. The UE shall send a preamble to the System Simulator. The System Simulator shall check that the Random Access Preamble belongs to one of the Random Access Preambles associated with the SSB with index 0, which has SS-RSRP above the configured *rsrp-ThresholdSSB*.
5. Test 2: Correct behaviour when receiving Random Access Response:
  - 5.1. Repeat steps 1-3.
  - 5.2. The UE shall send preambles to the System Simulator. In response to the first 4 preambles, the System Simulator shall transmit a Random Access Response containing Random Access Preamble identifiers that do not match the transmitted Random Access Preamble.
  - 5.3. As the received Random Access Responses contain Random Access Preamble identifiers that do not match the transmitted Random Access Preamble, the UE shall perform the Random Access Resource selection procedure specified in clause 5.1.2 in TS 38.321 [12], and transmit with the calculated PRACH transmission power when the backoff time expires.
  - 5.4. The System Simulator shall transmit a Random Access Response containing a Random Access Preamble identifier matching the transmitted Random Access Preamble after 5 preambles have been received by the System Simulator.
  - 5.5. As the received Random Access Response contains a Random Access Preamble identifier that matches the transmitted Random Access Preamble, the UE shall transmit the *msg3*.
  - 5.6. Measure the power and timing of the first preamble and it shall not exceed the values specified in clause 4.3.2.2.1.5. Measure the relative power and timing applied to additional preambles (last 4 preambles) and it shall not exceed the values specified in clause 4.3.2.2.1.5.
6. Test 3: Correct behaviour when not receiving Random Access Response:
  - 6.1. Repeat steps 1-3.
  - 6.2. The UE shall send preambles to the System Simulator. The System Simulator shall not respond to the first 4 preambles.
  - 6.3. As no Random Access Response was received within the RA Response window, the UE shall perform the Random Access Resource selection procedure specified in clause 5.1.2 in TS 38.321 [12], and transmit with the calculated PRACH transmission power when the backoff time expires.
  - 6.4. The System Simulator shall transmit a Random Access Response containing a Random Access Preamble identifier matching the transmitted Random Access Preamble after 5 preambles have been received by the System Simulator.
  - 6.5. As the received Random Access Response contains a Random Access Preamble identifier that matches the transmitted Random Access Preamble, the UE shall transmit the *msg3*.
  - 6.6. Measure the power and timing of the first preamble and it shall not exceed the values specified in clause 4.3.2.2.1.5. Measure the relative power and timing applied to additional preambles (last 4 preambles) and it shall not exceed the values specified in clause 4.3.2.2.1.5.

7. Test 4: Correct behaviour when receiving an UL grant for msg3 retransmission:
  - 7.1. Repeat steps 1-3.
  - 7.2. The UE shall send a preamble to the System Simulator. The System Simulator shall transmit a Random Access Response containing a Random Access Preamble identifier matching the transmitted Random Access Preamble.
  - 7.3. As the received Random Access Response contains a Random Access Preamble identifier that matches the transmitted Random Access Preamble, the UE shall transmit the msg3 including C-RNTI MAC control element.
  - 7.4. The System Simulator shall send PDCCH addressed to the Temporary C-RNTI after receiving the msg3.
  - 7.5. The UE shall re-transmit the msg3 including C-RNTI MAC control element.
  - 7.6. The System Simulator shall check if UE re-transmit the msg3.
8. Test 5: Correct behaviour when receiving a successful UE Contention Resolution:
  - 8.1. Repeat steps 1-3.
  - 8.2. The UE shall send a preamble to the System Simulator. The System Simulator shall transmit a Random Access Response containing a Random Access Preamble identifier matching the transmitted Random Access Preamble.
  - 8.3. As the received Random Access Response contains a Random Access Preamble identifier that matches the transmitted Random Access Preamble, the UE shall transmit the msg3 including C-RNTI MAC control element.
  - 8.4. The System Simulator shall send a PDCCH addressed to the C-RNTI.
  - 8.5. The UE shall send PUSCH according to the received PDCCH addressed to the C-RNTI.
9. Test 7: Correct behaviour when contention Resolution timer expires:
  - 9.1. Repeat steps 1-3.
  - 9.2. The UE shall send a preamble to the System Simulator. The System Simulator shall transmit a Random Access Response containing a Random Access Preamble identifier matching the transmitted Random Access Preamble.
  - 9.3. As the received Random Access Response contains a Random Access Preamble identifier that matches the transmitted Random Access Preamble, the UE shall transmit the msg3 including C-RNTI MAC control element.
  - 9.4. The System Simulator shall not send a PDCCH addressing the C-RNTI.
  - 9.5. As there was no PDCCH addressing the C-RNTI, the UE shall perform the Random Access Resource selection procedure specified in clause 5.1.2 in TS 38.321 [12], and transmit with the calculated PRACH transmission power when the Contention Resolution Timer expires and then after the backoff timer expires.
  - 9.6. Measure the power and timing of the first preamble after the Contention Resolution Timer and backoff timer expire and it shall not exceed the values specified in clause 4.3.2.2.1.5.

## 4.3.2.2.1.4.3 Message contents

Message contents are according to TS 38.508-1 [14] clause 7.3 with the following exceptions:

**Table 4.3.2.2.1.4.3-0: Common Exception messages**

Default Message Contents	
Common contents of system information blocks exceptions	
Default RRC messages and information elements contents exceptions	
Common exceptions to the contents of TS 38.508-1 [14]	Table 4.6.3-115 with SSB-Index 0 Table 4.6.3-120 with SSB-Index 0

**Table 4.3.2.2.1.4.3-1: RACH-ConfigCommon for Contention Based Random Access**

Derivation Path: TS 38.508-1 [14], table 4.6.3-128			
Information Element	Value/remark	Comment	Condition
RACH-ConfigCommon ::= SEQUENCE {			
rach-ConfigGeneric	RACH-ConfigGeneric		
totalNumberOfRA-Preambles	48		
ssb-perRACH-OccasionAndCB-PreamblesPerSSB CHOICE {			
oneFourth	n48		FR1
}			
groupBconfigured SEQUENCE {			
numberOfRA-PreamblesGroupA	48		
}			
ra-ContentionResolutionTimer	sf48		
rsrp-ThresholdSSB	RSRP_51		
prach-RootSequenceIndex CHOICE {			
l139	0		
}			
msg1-SubcarrierSpacing	kHz 15 kHz 30		15 kHz 30 kHz
}			

**Table 4.3.2.2.1.4.3-2: RACH-ConfigGeneric for Contention Based Random Access**

Derivation Path: TS 38.508-1 [14], table 4.6.3-130			
Information Element	Value/remark	Comment	Condition
RACH-ConfigGeneric ::= SEQUENCE {			
prach-ConfigurationIndex	102		FR1
msg1-FDM	one		FR1
zeroCorrelationZoneConfig	11		
preambleReceivedTargetPower	-120		
preambleTransMax	n6		
powerRampingStep	dB2		
ra-ResponseWindow	sl10		
}			

**Table 4.3.2.2.1.4.3-3: ServingCellConfigCommon for Contention Based Random Access**

Derivation Path: TS 38.508-1 [14], table 7.3.1-4			
Information Element	Value/remark	Comment	Condition
ServingCellConfigCommon ::= SEQUENCE {			
ss-PBCH-BlockPower	-5		
}			



## 4.3.2.2.1.5 Test requirement

Table 4.3.2.2.1.5-1 defines the primary level settings for contention based random access test in FR1 for PSCell in EN-DC. Tables 4.3.2.2.1.5-2, 4.3.2.2.1.5-3 and 4.3.2.2.1.5-4 define the Absolute power limits, Relative power limits and uplink timing error limits respectively, and all include test tolerances.

**Table 4.3.2.2.1.5-1: General test parameters for contention based random access test in FR1 for PSCell in EN-DC**

Parameter		Unit	Test-1	Comments	
SSB Configuration	Config 1,2		SSB.3 FR1	As defined in clause A.3.1	
	Config 3,4		SSB.4 FR1		
Duplex Mode for Cell 2	Config 1,2		FDD		
	Config 3,4		TDD		
TDD Configuration	Config 3,4		TDDConf.2.1		
OCNG Pattern <sup>Note 1</sup>			OCNG pattern 1	As defined in clause A.2.1.	
PDSCH parameters <sup>Note 4</sup>	Config 1,2		SR1.1 FDD	As defined in clause A.1.1.	
	Config 3,4		SR.2.1 TDD		
RMSI CORESET reference channel	Config 1,2		CR.1.1 FDD		
	Config 3,4		CR.2.1 TDD		
Dedicated CORESET reference channel	Config 1,2		CCR.1.1 FDD		
	Config 3,4		CCR.2.1 TDD		
NR RF Channel Number			1		
EPRE ratio of PSS to SSS		dB	0		
EPRE ratio of PBCH_DMRS to SSS		dB			
EPRE ratio of PBCH to PBCH_DMRS		dB			
EPRE ratio of PDCCH_DMRS to SSS		dB			
EPRE ratio of PDCCH to PDCCH_DMRS		dB			
EPRE ratio of PDSCH_DMRS to SSS		dB			
EPRE ratio of PDSCH to PDSCH_DMRS		dB			
SSB with index 0	$\hat{E}_s / I_{ot}$	dB	3	Power of SSB with index 0 is set to be above configured <i>rsrp-ThresholdSSB</i>	
	$N_{oc}$	Config 1,2	dBm/15kHz		-98
		Config 3,4			-101
	$\hat{E}_s / N_{oc}$	dB	3		
	SS-RSRP	Config 1,2	dBm / 15kHz		-95
		Config 3,4			-98
SS-RSRP		dBm/ SCS	-95		
SSB with index 1	$\hat{E}_s / I_{ot}$	dB	-17	Power of SSB with index 1 is set to be below configured <i>rsrp-ThresholdSSB</i>	
	$N_{oc}$	Config 1,2	dBm/15kHz		-98
		Config 3,4			-101
	$\hat{E}_s / N_{oc}$	dB	-17		
	SS-RSRP	Config 1,2	dBm / 15kHz		-115
		Config 3,4			-118
SS-RSRP		dBm/ SCS	-115		
$I_o$ <sup>Note 2</sup>	Config 1,2	dBm	-65.3/9.36MHz	For symbols without SSB index 1	
	Config 3,4		-62.2/38.16MHz		
ss-PBCH-BlockPower		dBm/ SCS	-5	As defined in clause 6.3.2 in TS 38.331 [13].	
Configured UE transmitted power ( $P_{CMAX, f, c}$ )		dBm	23	As defined in clause 6.2.4 in TS 38.101-1 [2].	
PRACH Configuration			PRACH.1 FR1	As defined in clause A.7.1.	
Propagation Condition		-	AWGN		
NOTE 1: OCNG shall be used such that the cell is fully allocated and a constant total transmitted power spectral density is achieved for all OFDM symbols. The OCNG pattern is chosen during the test according to the presence of a DL reference measurement channel.					
NOTE 2: $E_s/I_{ot}$ , SS-RSRP and $I_o$ level have been derived from other parameters for information purpose. They are not settable parameters.					
NOTE 3: Void.					
NOTE 4: The DL PDSCH reference measurement channel is used in the test only when a downlink transmission dedicated to the UE under test is required.					

Test 1: Correct behaviour when transmitting Random Access Preamble:

- The Random Access Preamble shall be one of the Random Access Preambles associated with SSB index 0.

Test 2: Correct behaviour when receiving Random Access Response:

- The power of the first preamble shall be -22 dBm within the accuracy specified in Table 4.3.2.2.1.5-2.
- The relative power for preamble ramping step shall be 2 dB within the accuracy specified in Table 4.3.2.2.1.5-3.
- The transmit timing of all PRACH transmissions shall be within the accuracy specified in Table 4.3.2.2.1.5-4.

Test 3: Correct behaviour when not receiving Random Access Response:

- The power of the first preamble shall be -22 dBm within the accuracy specified in Table 4.3.2.2.1.5-2.
- The relative power for preamble ramping step shall be 2 dB within the accuracy specified in Table 4.3.2.2.1.5-3.
- The transmit timing of all PRACH transmissions shall be within the accuracy specified in Table 4.3.2.2.1.5-4.

Test 4: Correct behaviour when receiving an UL grant for msg3 retransmission:

- The UE shall re-transmit the msg3 upon the reception of an UL grant for msg3 retransmission.

Test 5: Correct behaviour when receiving a successful UE Contention Resolution:

- The UE shall send PUSCH according to the PDCCH addressed to the C-RNTI.

Test 7: Correct behaviour when contention resolution timer expires:

- The UE shall re-select a preamble and transmit with the calculated PRACH transmission power when the back off time expires if the contention resolution timer expires.
- The power of the first preamble shall be -22 dBm within the accuracy specified in Table 4.3.2.2.1.5-2.
- The transmit timing of the PRACH transmission shall be within the accuracy specified in Table 4.3.2.2.1.5-4.

**Table 4.3.2.2.1.5-2: Absolute power tolerance Test requirements**

Conditions	Tolerance
Normal	$\pm 11.1$ dB

**Table 4.3.2.2.1.5-3: Relative power tolerance Test requirements**

Power step $\Delta P$ (Up or down) (dB)	PRACH (dB)
$2 \leq \Delta P < 3$	$\pm 3.2$

**Table 4.3.2.2.1.5-4:  $T_e$  Timing error Test requirements**

Frequency Range	SCS of SSB signals (kHz)	SCS of uplink signals s(KHz)	$T_e$
1	15	15	$880 * T_c$
	30	30	$624 * T_c$
NOTE: $T_c$ is the basic timing unit defined in TS 38.211 [7]			

#### 4.3.2.2.2 EN-DC FR1 non-contention based random access

##### 4.3.2.2.2.1 Test purpose

The purpose of this test is to verify that the behaviour of the random access procedure is according to the requirements and that the PRACH power settings and timing are within specified limits.

#### 4.3.2.2.2.2 Test applicability

This test applies to all types of E-UTRA UE release 15 and forward, supporting EN-DC. Additionally Test 2 is applicable to UE that supports CSI-RS based Random Access Preamble which requires UE to support *csi-RSRP-AndRSRQ-MeasWithSSB* or *csi-RSRP-AndRSRQ-MeasWithoutSSB*.

#### 4.3.2.2.2.3 Minimum conformance requirement

The random access procedure is used when establishing the layer 1 communication between the UE and NG-RAN. The random access is as defined in TS 38.213 [8] clause 7.4 and the control of the RACH transmission is as defined in TS 38.321 [12] clause 5.1.

The UE shall have capability to calculate PRACH transmission power according to the PRACH power formula as defined in TS 38.213 [8] clause 7.4 and apply this power level at the first preamble or additional preambles. The absolute power applied to the first preamble shall have an accuracy as defined in TS 38.101-1 [2] Table 6.3.4.2-1. The relative power applied to additional preambles shall have an accuracy as specified in TS 38.101-1 [2] Table 6.3.4.3-1.

The UE shall indicate a Random Access problem to upper layers if the maximum number of preamble transmission counter has been reached for the random access procedure on PCell or PSCell as specified in TS 38.321 [12] clause 5.1.4.

If the contention-free Random Access Resources and the contention-free PRACH occasions associated with SSBs is configured, with the UE selected SSB with *SS-RSRP* above *rsrp-ThresholdSSB* amongst the associated SSBs, UE shall have the capability to select the Random Access Preamble corresponding to the selected SSB, and to transmit Random Access Preamble on the next available PRACH occasion from the PRACH occasions corresponding to the selected SSB permitted by the restrictions given by the *ra-ssb-OccasionMaskIndex* if configured, and PRACH occasion shall be randomly selected with equal probability amongst the selected SSB associated PRACH occasions occurring simultaneously but on different subcarriers, as specified in clause 5.1.2 in TS 38.321 [12].

If the contention-free Random Access Resources and the contention-free PRACH occasions associated with CSI-RSs is configured, with the UE selected CSI-RS with *CSI-RSRP* above *cfra-csirs-DedicatedRACH-Threshold* amongst the associated CSI-RSs, UE shall have the capability to select the Random Access Preamble corresponding to the selected CSI-RS, and to transmit Random Access Preamble on the next available PRACH occasion from the PRACH occasions in *ra-OccasionList* corresponding to the selected CSI-RS, and PRACH occasion shall be randomly selected with equal probability amongst the selected CSI-RS associated PRACH occasions occurring simultaneously but on different subcarriers, as specified in clause 5.1.2 in TS 38.321 [12].

The UE may stop monitoring for Random Access Response(s), if the Random Access Response contains a Random Access Preamble identifier corresponding to the transmitted Random Access Preamble, unless the random access procedure is initialized for Other SI request from UE.

The UE shall again perform the Random Access Resource selection procedure defined in clause 5.1.2 in TS 38.321 [12] for the next available PRACH occasion, and transmit the preamble with the calculated PRACH transmission power if all received Random Access Responses contain Random Access Preamble identifiers that do not match the transmitted Random Access Preamble.

The UE shall again perform the Random Access Resource selection procedure defined in clause 5.1.2 in TS 38.321 [12] for the next available PRACH occasion, and transmit the preamble with the calculated PRACH transmission power, if no Random Access Response is received within the RA Response window configured in *RACH-ConfigCommon* or if no PDCCH addressed to UE's C-RNTI is received within the RA Response window configured in *BeamFailureRecoveryConfig*, as defined in clause 5.1.4 in TS 38.321 [12].

The normative reference for this requirement is TS 38.133 [6] clauses 6.2.2 and A.4.3.2.2.2. Non-contention based random access procedure is not initialized for Other SI requested from UE or for beam failure recovery, so the requirements related to those features are omitted.

#### 4.3.2.2.2.4 Test description

##### 4.3.2.2.2.4.1 Initial conditions

This test can be run in the configurations defined in Table 4.3.2.2.2.4.1-1.

**Table 4.3.2.2.4.1-1: Non-contention based random access test in FR1 for PSCell in EN-DC supported test configurations**

Test Case ID	Test Config Index	Description
4.3.2.2.2-1	1	LTE FDD, NR 15 kHz SSB SCS, 10MHz bandwidth, FDD
4.3.2.2.2-2	2	LTE TDD, NR 15 kHz SSB SCS, 10MHz bandwidth, FDD
4.3.2.2.2-3	3	LTE FDD, NR 30 kHz SSB SCS, 40MHz bandwidth, TDD
4.3.2.2.2-4	4	LTE TDD, NR 30 kHz SSB SCS, 40MHz bandwidth, TDD
NOTE: The UE is only required to be tested in one of the supported test configurations.		

Configure the test equipment and the DUT according to the parameters in Table 4.3.2.2.4.1-2.

**Table 4.3.2.2.4.1-2: Initial conditions for Non-contention based random access test in FR1 for EN-DC**

Parameter	Value		Comment
Test environment	NC		As specified in TS 38.508-1 [14] clause 4.1.
Test frequencies	As specified in Annex E, Table E.1-1 and TS 38.508-1 [14] subclause 4.3.1.		
Channel bandwidth	As specified by the test configuration selected from Table 4.3.2.2.4.1-1.		
Propagation conditions	AWGN		As specified in clause C.2.2.
Connection Diagram	TE Part	A.3.1.7.1	As specified in TS 38.508-1 [14] Annex A.
	DUT Part	A.3.2.3.4	
Exceptions to connection diagram	N/A		

1. Message contents are defined in clause 4.3.2.2.4.3.
2. Cell 1 is the E-UTRA serving cell (PCell) for the EN-DC setup. The E-UTRAN PCell power levels and settings are specified in Table A.6.1.1-1. Cell 2 is the NR FR1 PSCell. The connection setup is done according to the settings in clause C.1.3, with downlink signal levels as per clause C.1.2. General Test parameters are defined in Table 4.3.2.2.5-1.
3. Downlink signals for NR cell are initially set up according to clause C.2.1.

#### 4.3.2.2.4.2 Test procedure

For this test two cells are used, an E-UTRA serving cell (PCell) and an NR FR1 PSCell. For the NR PSCell, the System Simulator shall explicitly assign a random access preamble via dedicated signalling in the downlink. There are two subtests, to test both SSB-based non-contention based random access (subtest 1) and CSI-RS-based non-contention based random access (subtest 2).

1. Ensure the UE is in state RRC\_CONNECTED with generic procedure parameters *Connectivity* EN-DC , DC bearer MCG and SCG, Connected without release *On* and Test Mode *On* according to TS 38.508-1 [6] clause 4.5.
2. Set the parameters according to Table 4.3.2.2.5-1.
3. SS sends a RRCReconfiguration to trigger a contention-free random access procedure according to the Tables for Non-Contention Random Access in clause 4.3.2.2.4.3.
4. Test 1: Correct behaviour when transmitting SSB-based Random Access Preamble:
  - 4.1. The UE shall send a preamble to the System Simulator. The System Simulator shall check that the Random Access Preamble has the Preamble Index associated with the SSB with index 0, that it arrives on a PRACH occasion which belongs to the PRACH occasions corresponding to the SSB with index 0, and that the selected PRACH occasion belongs to the PRACH occasions permitted by the restrictions given by the *ra-ssb-OccasionMaskIndex*.

5. Test 2: Correct behaviour when transmitting CSI-RS-based Random Access Preamble:
  - 5.1. Set the parameters according to Table 4.3.2.2.2.5-1 Subtest 2.
  - 5.2. Repeat steps 1-3.
  - 5.3. The UE shall send a preamble to the System Simulator. The System Simulator shall check that the Random Access Preamble has the Preamble Index associated with the CSI-RS configured, that it arrives on a PRACH occasion which belongs to the PRACH occasions corresponding to the CSI-RS configured, and that the selected PRACH occasion belongs to the PRACH occasions permitted by the restrictions given by the *ra-OccasionList*.
6. Test 3: Correct behaviour when receiving Random Access Response:
  - 6.1. Repeat steps 1-3.
  - 6.2. The UE shall send preambles to the System Simulator. In response to the first 4 preambles, the System Simulator shall transmit a Random Access Response containing Random Access Preamble identifiers that do not match the transmitted Random Access Preamble.
  - 6.3. As the received Random Access Responses contain Random Access Preamble identifiers that do not match the transmitted Random Access Preamble, the UE shall perform the Random Access Resource selection procedure specified in clause 5.1.2 in TS 38.321 [12], and transmit with the calculated PRACH transmission power.
  - 6.4. The System Simulator shall transmit a Random Access Response containing a Random Access Preamble identifier matching the transmitted Random Access Preamble after 5 preambles have been received by the System Simulator.
  - 6.5. As the received Random Access Response contains a Random Access Preamble identifier that matches the transmitted Random Access Preamble, the UE may stop monitoring for Random Access Response(s).
  - 6.6. Measure the power and timing of the first preamble and it shall not exceed the values specified in clause 4.3.2.2.2.5. Measure the relative power and timing applied to additional preambles (last 4 preambles) and it shall not exceed the values specified in clause 4.3.2.2.2.5.
7. Test 4: Correct behaviour when not receiving Random Access Response:
  - 7.1. Repeat steps 1-3.
  - 7.2. The UE shall send preambles to the System Simulator. The System Simulator shall not respond to the first 4 preambles.
  - 7.3. As no Random Access Response was received within the RA Response window configured in *RACH-ConfigCommon*, the UE shall perform the Random Access Resource selection procedure specified in clause 5.1.2 in TS 38.321 [12], and transmit with the calculated PRACH transmission power.
  - 7.4. The System Simulator shall transmit a Random Access Response containing a Random Access Preamble identifier matching the transmitted Random Access Preamble after 5 preambles have been received by the System Simulator.
  - 7.5. As the received Random Access Response contains a Random Access Preamble identifier that matches the transmitted Random Access Preamble, the UE may stop monitoring for Random Access Response(s).
  - 7.6. Measure the power and timing of the first preamble and it shall not exceed the values specified in clause 4.3.2.2.2.5. Measure the relative power and timing applied to additional preambles (last 4 preambles) and it shall not exceed the values specified in clause 4.3.2.2.2.5.

#### 4.3.2.2.2.4.3 Message contents

Message contents are according to TS 38.508-1 [14] clause 4.6.1 with the following exceptions.

**Table 4.3.2.2.4.3-0: Common Exception messages**

Default Message Contents	
Common contents of system information blocks exceptions	
Default RRC messages and information elements contents exceptions	
Common exceptions to the contents of TS 38.508-1 [14]	Table 4.6.3-115 with SSB-Index 0 Table 4.6.3-120 with SSB-Index 0

**Table 4.3.2.2.4.3-1: RACH-ConfigCommon for Non-Contention Based Random Access**

Derivation Path: TS 38.508-1 [14], table 4.6.3-128			
Information Element	Value/remark	Comment	Condition
RACH-ConfigCommon ::= SEQUENCE {			
rach-ConfigGeneric	RACH-ConfigGeneric		
totalNumberOfRA-Preambles	48		
groupBconfigured SEQUENCE {			
numberOfRA-PreamblesGroupA	48		
}			
rsrp-ThresholdSSB	RSRP_51		Subtest 1
prach-RootSequenceIndex CHOICE {			
l139	0		
}			
msg1-SubcarrierSpacing	kHz 15 kHz 30		15kHz 30kHz
}			

**Table 4.3.2.2.4.3-2: RACH-ConfigDedicated for Non-Contention Based Random Access**

Derivation Path: TS 38.508-1 [14], table 4.6.3-129			
Information Element	Value/remark	Comment	Condition
RACH-ConfigDedicated ::= SEQUENCE {			
cfra SEQUENCE {			
occasions SEQUENCE {			
ssb-perRACH-Occasion	oneFourth		
}			
resources CHOICE {			
ssb SEQUENCE {			
ssb-ResourceList SEQUENCE (SIZE(1..maxRA-SSB-Resources)) OF {	1 entry		
ssb[1]	0		
ra-PreambleIndex[1]	50		Subtest 1
}			
ra-ssb-OccasionMaskIndex	1		Subtest 1
}			
csirs SEQUENCE {			
csirs-ResourceList SEQUENCE (SIZE(1..maxRA-CSIRS-Resources)) OF {			
ra-OccasionList	1		Subtest 2
ra-PreambleIndex[1]	50		Subtest 2
}			
rsrp-ThresholdCSI-RS	RSRP_51		Subtest 2
}			
}			

**Table 4.3.2.2.2.4.3-3: RACH-ConfigGeneric for Non-Contention Based Random Access**

Derivation Path: TS 38.508-1 [14], table 4.6.3-130			
Information Element	Value/remark	Comment	Condition
RACH-ConfigGeneric ::= SEQUENCE {			
prach-ConfigurationIndex	102		
msg1-FDM	one		
zeroCorrelationZoneConfig	11		
preambleReceivedTargetPower	-120		
preambleTransMax	n6		
powerRampingStep	dB2		
ra-ResponseWindow	sl10		
}			

**Table 4.3.2.2.2.4.3-4: ServingCellConfigCommon for Non-Contention Based Random Access**

Derivation Path: TS 38.508-1 [14], table 4.6.3-168			
Information Element	Value/remark	Comment	Condition
ServingCellConfigCommon ::= SEQUENCE {			
ss-PBCH-BlockPower	-5		
}			

**Table 4.3.2.2.2.4.3-5: CellGroupConfig for Non-Contention Based Random Access**

Derivation Path: TS 38.508-1 [14], table 4.6.3-19 with Condition CFRA			
Information Element	Value/remark	Comment	Condition
CellGroupConfig ::= SEQUENCE {			
spCellConfig SEQUENCE {			
servCellIndex	ServCellIndex		
reconfigurationWithSync SEQUENCE {			
newUE-Identity	1		
}			
spCellConfigDedicated SEQUENCE {			
uplinkConfig SEQUENCE {			
initialUplinkBWP SEQUENCE {			
srs-Config	SRS-Config		
}			
}			
}			
}			

#### 4.3.2.2.2.5 Test requirement

Table 4.3.2.2.2.5-1 defines the primary level settings for non-contention based random access test in FR1 for PSCell in EN-DC. Tables 4.3.2.2.2.5-2, 4.3.2.2.2.5-3 and 4.3.2.2.2.5-4 define the Absolute power limits, Relative power limits and uplink timing error limits respectively, and all include test tolerances.

**Table 4.3.2.2.2.5-1: General test parameters for non-contention based random access test in FR1 for PSCell in EN-DC**

Parameter	Unit	Test-1	Test-2	Comments
SSB Configuration	Config 1,2	SSB.3 FR1	SSB.3 FR1	As defined in clause A.3.1
	Config 3,4	SSB.4 FR1	SSB.4 FR1	
CSI-RS Configuration	Config 1,2	N/A	CSI-RS.1.1 FDD	As defined in clause A.1.4
	Config 3,4		CSI-RS.2.1 TDD	
Duplex Mode for Cell 2	Config 1,2	FDD	FDD	
	Config 3,4	TDD	TDD	
TDD Configuration	Config 3,4	TDDConf.2.1	TDDConf.2.1	
OCNG Pattern <sup>Note 1</sup>		OCNG pattern 1	OCNG pattern 1	As defined in clause A.2.1
	Config 1,2	SR1.1 FDD	SR1.1 FDD	

Parameter		Unit	Test-1	Test-2	Comments	
PDSCH parameters Note 4	Config 3,4		SR2.1 TDD	SR2.1 TDD	As defined in clause A.1.1	
RMSI CORESET reference channel	Config 1,2		CR.1.1 FDD	CR.1.1 FDD		
	Config 3,4		CR.2.1 TDD	CR.2.1 TDD		
Dedicated CORESET reference channel	Config 1,2		CCR.1.1 FDD	CCR.1.1 FDD		
	Config 3,4		CCR.2.1 TDD	CCR.2.1 TDD		
NR RF Channel Number			1	1		
EPRE ratio of PSS to SSS		dB	0	0		
EPRE ratio of PBCH_DMRS to SSS		dB				
EPRE ratio of PBCH to PBCH_DMRS		dB				
EPRE ratio of PDCCH_DMRS to SSS		dB				
EPRE ratio of PDCCH to PDCCH_DMRS		dB				
EPRE ratio of PDSCH_DMRS to SSS		dB				
EPRE ratio of PDSCH to PDSCH_DMRS		dB				
SSB with index 0	$\hat{E}_s / I_{ot}$	dB	3	3	Power of SSB with index 0 is set to be above configured <i>rsrp-ThresholdSSB</i>	
	$N_{oc}$	Config 1,2	dBm/15kHz	-98		-98
		Config 3,4		-101		-101
	$\hat{E}_s / N_{oc}$	dB	3	3		
	SS-RSRP Note 3	Config 1,2	dBm/15kHz	-95		-95
Config 3,4			-98	-98		
SS-RSRP Note 3		dBm/ SCS	-95	-95		
SSB with index 1	$\hat{E}_s / I_{ot}$	dB	-17	-17	Power of SSB with index 1 is set to be below configured <i>rsrp-ThresholdSSB</i>	
	$N_{oc}$	Config 1,2	dBm/15kHz	-98		-98
		Config 3,4		-101		-101
	$\hat{E}_s / N_{oc}$	dB	-17	-17		
	SS-RSRP Note 3	Config 1,2	dBm/15kHz	-115		-115
Config 3,4			-118	-118		
SS-RSRP Note 3		dBm/ SCS	-115	-115		
$I_o$ Note 2	Config 1,2	dBm	-65.3/9.36MHz	-65.3/9.36MHz	For symbols without SSB index 1	
	Config 3,4		-62.2/38.16MHz	-62.2/38.16MHz		
ss-PBCH-BlockPower		dBm/ SCS	-5	-5	As defined in clause 6.3.2 in TS 38.331 [13]	
Configured UE transmitted power ( $P_{CMAX, f, c}$ )		dBm	23	23	As defined in clause 6.2.4 in TS 38.101-1 [2]	
PRACH Configuration			PRACH.2 FR1	PRACH.3 FR1	As defined in clause A.7.1	
Propagation Condition		-	AWGN	AWGN		
NOTE 1: OCNG shall be used such that the cell is fully allocated and a constant total transmitted power spectral density is achieved for all OFDM symbols. The OCNG pattern is chosen during the test according to the presence of a DL reference measurement channel.						
NOTE 2: Es/Iot, SS-RSRP and Io levels have been derived from other parameters for information purpose. They are not settable parameters.						
NOTE 3: Void.						
NOTE 4: The DL PDSCH reference measurement channel is used in the test only when a downlink transmission dedicated to the UE under test is required.						

Test 1: Correct behaviour when transmitting SSB-based Random Access Preamble:

- The Random Access Preamble shall be one of the Random Access Preambles associated with SSB index 0.
- The Random Access Preamble shall arrive on a PRACH occasion which belongs to the PRACH occasions corresponding to the SSB with index 0.
- The selected PRACH occasion shall belong to the PRACH occasions permitted by the restrictions given by the *ra-ssb-OccasionMaskIndex*.



Test 2: Correct behaviour when transmitting CSI-RS-based Random Access Preamble:

- The Random Access Preamble shall have the Preamble Index associated with the CSI-RS configured.
- The Random Access Preamble shall arrive on a PRACH occasion which belongs to the PRACH occasions corresponding to the CSI-RS configured.
- the selected PRACH occasion belongs to the PRACH occasions permitted by the restrictions given by the *ra-OccasionList*.

Test 3: Correct behaviour when receiving Random Access Response:

- The power of the first preamble shall be -22 dBm within the accuracy specified in Table 4.3.2.2.2.5-2.
- The relative power for preamble ramping step shall be 2 dB within the accuracy specified in Table 4.3.2.2.2.5-3.
- The transmit timing of all PRACH transmissions shall be within the accuracy specified in Table 4.3.2.2.2.5-4.

Test 4: Correct behaviour when not receiving Random Access Response:

- The power of the first preamble shall be -22 dBm within the accuracy specified in Table 4.3.2.2.2.5-2.
- The relative power for preamble ramping step shall be 2 dB within the accuracy specified in Table 4.3.2.2.2.5-3.
- The transmit timing of all PRACH transmissions shall be within the accuracy specified in Table 4.3.2.2.2.5-4.

**Table 4.3.2.2.2.5-2: Absolute power tolerance Test requirements**

Conditions	Tolerance
Normal	$\pm 11.1$ dB

**Table 4.3.2.2.2.5-3: Relative power tolerance Test requirements**

Power step $\Delta P$ (Up or down) (dB)	PRACH (dB)
$2 \leq \Delta P < 3$	$\pm 3.2$

**Table 4.3.2.2.2.5-4:  $T_e$  Timing error Test requirements**

Frequency Range	SCS of SSB signals (kHz)	SCS of uplink signals s(KHz)	$T_e$
1	15	15	$880 * T_c$
	30	30	$624 * T_c$
NOTE: $T_c$ is the basic timing unit defined in TS 38.211 [7].			

#### 4.3.2.2.3 EN-DC FR1 2-step contention based random access

**Editor's note: This test case is incomplete. The following aspects are either missing or TBD**

- **TT analysis and test requirement for MsgA PRACH power needs further work.**

##### 4.3.2.2.3.1 Test purpose

The purpose of this test is to verify that the behaviour of the 2-step random access procedure is according to the requirements and that the MsgA PRACH and MsgA PUSCH power settings and timing are within specified limits.

##### 4.3.2.2.3.2 Test applicability

This test applies to all types of E-UTRA UE release 16 and forward, supporting EN-DC.

#### 4.3.2.2.3.3 Minimum conformance requirement

The UE shall select the type of random access at initiation of the random access procedure based on network configuration, as specified in clause 5.1.1 in TS 38.321 [12].

The UE shall have capability to calculate MsgA PRACH transmission power according to the PRACH power formula defined in clause 7.4 of TS 38.213 [3] and the MsgA PUSCH power formula of clause 7.1.1 of TS 38.213 [8] and apply this power level at the first MsgA or additional MsgA repetitions. The absolute power applied to the first preamble shall have an accuracy as specified in Table 6.3.4.2-1 of TS 38.101-1 [2] for frequency range 1 and in Table 6.3.4.2-1 of TS 38.101-2 [3] for frequency range 2. The relative power applied to additional preambles shall have an accuracy as specified in Table 6.3.4.3-1 of TS 38.101-1 [2] for frequency range 1 and clause 6.3.4.3 of TS 38.101-2 [3] for frequency range 2.

The UE shall switch to 4-step RA type procedure if the MsgA transmission counter has exceeded *msgA-TransMax*, if configured, as specified in clause 5.1.4a of TS 38.321 [12]. The UE shall indicate a Random Access problem to upper layers if the maximum number of preamble transmission counter has been reached for the random access procedure on PCell or PSCell as specified in clause 5.1.4a in TS 38.321 [12].

The requirements in this clause apply for UE in SA operation mode or any MR-DC operation mode.

##### 4.3.2.2.3.3.1 Correct behaviour when transmitting MsgA

With the UE selected SSB with SS-RSRP above *msgA-RSRP-ThresholdSSB*, the UE shall have the capability to select a Random Access Preamble randomly with equal probability from the Random Access Preambles associated with the selected SSB if the association between Random Access Preambles and SS blocks is configured, as specified in clause 5.1.2a in TS 38.321 [7].

With the UE selected SSB with SS-RSRP above *msgA-RSRP-ThresholdSSB*, UE shall have the capability to transmit MsgA PRACH on the next available PRACH occasion from the PRACH occasions corresponding to the selected SSB permitted by the restrictions given first by the *msgA-SSB-SharedRO-MaskIndex* if configured, or next by the *ra-ssb-OccasionMaskIndex* if configured, if the association between PRACH occasions and SSBs is configured.

The PRACH preamble and PRACH occasion shall be randomly selected with equal probability amongst the selected SSB associated PRACH occasions occurring simultaneously but on different subcarriers, as specified in clause 5.1.2a in TS 38.321 [7].

In association with the MsgA PRACH, the UE should have the capability to transmit MsgA PUSCH on the corresponding PUSCH occasion associated with a DMRS resource, which is mapped from the MsgA PRACH occasion, and preamble index as defined in clause 8.1A in TS 38.213 [3].

##### 4.3.2.2.3.3.2 Correct behaviour when receiving MsgB

The UE shall stop monitoring for MsgB, when the UE has successfully received the PDCCH addressed to UE as specified in clause 8.2A in TS 38.213 [8] containing a successRAR MAC subPDU or a fallbackRAR MAC subPDU as described in clause 5.1.4a in TS 38.321 [12].

The UE shall send ACK if Success RAR is received in MsgB and the Contention Resolution is successful, as defined in clause 5.1.4a in TS 38.321 [12].

If MsgB contains a fallbackRAR MAC subPDU the UE shall fallback to the 4-step RA type by transmitting the msg3 containing the payload of MsgA PUSCH and monitor contention resolution as described in clause 8.2A in TS 38.213 [8].

The UE shall again perform the Random Access Resource selection procedure defined in clause 5.1.2a in TS 38.321 [12], and transmit with the calculated MsgA PRACH and MsgA PUSCH transmission power when the backoff time expires unless the Random Access Response reception is considered as successful, as defined in clause 5.1.4a in TS 38.321 [12].

##### 4.3.2.2.3.3.3 Correct behaviour when not receiving MsgB

The UE shall again perform the Random Access Resource selection procedure defined in clause 5.1.2a in TS 38.321 [12], and transmit with the calculated MsgA PRACH and MsgA PUSCH transmission power when the backoff time expires unless the Random Access Response reception is considered as successful, as defined in clause 5.1.4a in TS 38.321 [12].

The normative reference for this requirement is TS 38.133 [6] clauses 6.2.2.3 and A.4.3.2.2.3.

#### 4.3.2.2.3.4 Test description

##### 4.3.2.2.3.4.1 Initial conditions

This test can be run in the configurations defined in Table 4.3.2.2.3.4.1-1.

**Table 4.3.2.2.3.4.1-1: Contention based random access test in FR1 for PSCell in EN-DC supported test configurations**

Test Case ID	Test Config Index	Description
4.3.2.2.3-1	1	LTE FDD, NR 15 kHz SSB SCS, 10MHz bandwidth, FDD
4.3.2.2.3-2	2	LTE TDD, NR 15 kHz SSB SCS, 10MHz bandwidth, FDD
4.3.2.2.3-3	3	LTE FDD, NR 30 kHz SSB SCS, 40MHz bandwidth, TDD
4.3.2.2.3-4	4	LTE TDD, NR 30 kHz SSB SCS, 40MHz bandwidth, TDD
NOTE: The UE is only required to be tested in one of the supported test configurations.		

Configure the test equipment and the DUT according to the parameters in Table 4.3.2.2.3.4.1-2.

**Table 4.3.2.2.3.4.1-2: Initial conditions for Contention based random access test in FR1 for EN-DC**

Parameter	Value		Comment
Test environment	NC		As specified in TS 38.508-1 [14] clause 4.1.
Test frequencies	As specified in Annex E, Table E.1-1 and TS 38.508-1 [14] clause 4.3.1.		
Channel bandwidth	As specified by the test configuration selected from Table 4.3.2.2.3.4.1-1.		
Propagation conditions	AWGN		As specified in clause C.2.2.
Connection Diagram	TE Part	A.3.1.7.1	As specified in TS 38.508-1 [14] Annex A.
	DUT Part	A.3.2.3.4	
Exceptions to connection diagram	N/A		

1. Message contents are defined in clause 4.3.2.2.3.4.3.
2. Cell 1 is the E-UTRA serving cell (PCell) for the EN-DC setup. The E-UTRAN PCell power levels and settings are specified in Table A.6.1.1-1. Cell 2 is the NR FR1 PSCell. The connection setup is done according to the settings in clause C.1.3, with downlink signal levels as per clause C.1.2. General Test parameters are defined in Table 4.3.2.2.3.5-1.
3. Downlink signals for NR cell are initially set up according to clause C.2.1.

##### 4.3.2.2.3.4.2 Test procedure

For this test two cells are used, an E-UTRA serving cell (PCell) and an NR FR1 PSCell. For the NR PSCell, the System Simulator shall not explicitly assign a random access preamble via dedicated signalling in the downlink:

1. Ensure the UE is in state E-UTRA RRC\_CONNECTED with generic procedure parameters *Connectivity E-UTRA/EPC* with Test Mode *On* according to TS 38.508-1 [14] clause 4.5.
2. Set the parameters according to Table 4.3.2.2.3.5-1.
3. The test system shall send a RRCReconfiguration message to the UE to add NR PSCell, then the UE shall trigger a random access procedure.
4. Test 1: Correct behaviour when transmitting MsgA:
  - 4.1. The UE shall send a MsgA to the System Simulator. The System Simulator shall check that the MsgA preamble belongs to one of the Random Access Preambles associated with the SSB with index 0, which has SSB\_RP above the configured *rsrp-ThresholdSSB*.

5. Test 2: Correct behaviour when receiving MsgB:
  - 5.1. Repeat steps 1-3.
  - 5.2. The UE shall send preambles to the System Simulator. In response to the first 4 preambles, the System Simulator shall transmit a MsgB containing identifiers that do not match the transmitted Random Access Preamble.
  - 5.3. As the received MsgB contain Random Access Preamble identifiers that do not match the transmitted Random Access Preamble, the UE shall perform the Random Access Resource selection procedure specified in clause 5.1.2a in TS 38.321 [12], and transmit with the calculated MsgA PRACH transmission power when the backoff time expires.
  - 5.4. The System Simulator shall transmit a MsgB containing a Random Access Preamble identifier matching the transmitted Random Access Preamble after 5 preambles have been received by the System Simulator.
  - 5.5. As the received MsgB contains a Random Access Preamble identifier that matches the transmitted Random Access Preamble, the UE shall transmit an ACK and stop monitoring for MsgB.
  - 5.6. Measure the power and timing of the first preamble and it shall not exceed the values specified in clause 4.3.2.2.3.5. Measure the relative power and timing applied to additional preambles (last 4 preambles) and it shall not exceed the values specified in clause 4.3.2.2.3.5.
6. Test 3: Correct behaviour when not receiving MsgB:
  - 6.1. Repeat steps 1-3.
  - 6.2. The UE shall send preambles to the System Simulator. The System Simulator shall not respond to the first 4 preambles.
  - 6.3. As no MsgB was received within the RA Response window, the UE shall perform the Random Access Resource selection procedure specified in clause 5.1.2a in TS 38.321 [12], and transmit with the calculated MsgA PRACH transmission power when the backoff time expires.
  - 6.4. The System Simulator shall transmit a MsgB containing a Random Access Preamble identifier matching the transmitted Random Access Preamble after 5 preambles have been received by the System Simulator.
  - 6.5. As the received MsgB contains a Random Access Preamble identifier that matches the transmitted Random Access Preamble, the UE shall transmit an ACK and stop monitoring for MsgB.
  - 6.6. Measure the power and timing of the first preamble and it shall not exceed the values specified in clause 4.3.2.2.3.5. Measure the relative power and timing applied to additional preambles (last 4 preambles) and it shall not exceed the values specified in clause 4.3.2.2.3.5.

#### 4.3.2.2.3.4.3 Message contents

Message contents are according to TS 38.508-1 [14] clause 7.3 with the following exceptions:

**Table 4.3.2.2.3.4.3-0: Common Exception messages**

Default Message Contents	
Common contents of system information blocks exceptions	
Default RRC messages and information elements contents exceptions	
Common exceptions to the contents of TS 38.508-1 [14]	Table 4.6.3-115 with SSB-Index 0 Table 4.6.3-120 with SSB-Index 0

#### 4.3.2.2.3.5 Test requirement

Table 4.3.2.2.3.5-1 defines the primary level settings for contention based random access test in FR1 for PSCell in EN-DC. The test requirements are FFS.

Table 4.3.2.2.3.5-1: General test parameters

Parameter		Unit	Test-1	Comments	
SSB Configuration	Config 1,2		SSB.3 FR1	As defined in clause A.3.1	
	Config 3,4		SSB.4 FR1		
Duplex Mode for Cell 2	Config 1,2		FDD		
	Config 3,4		TDD		
TDD Configuration	Config 3,4		TDDConf.2.1		
OCNG Pattern <sup>Note 1</sup>			OCNG pattern 1	As defined in clause A.2.1.	
PDSCH parameters <sup>Note 4</sup>	Config 1,2		SR1.1 FDD	As defined in clause A.1.1.	
	Config 3,4		SR.2.1 TDD		
NR RF Channel Number			1		
EPRE ratio of PSS to SSS		dB	0		
EPRE ratio of PBCH_DMRS to SSS		dB			
EPRE ratio of PBCH to PBCH_DMRS		dB			
EPRE ratio of PDCCH_DMRS to SSS		dB			
EPRE ratio of PDCCH to PDCCH_DMRS		dB			
EPRE ratio of PDSCH_DMRS to SSS		dB			
EPRE ratio of PDSCH to PDSCH_DMRS		dB			
SSB with index 0	$\hat{E}_s / I_{ot}$		dB	3	Power of SSB with index 0 is set to be above configured <i>rsrp-ThresholdSSB</i>
	$N_{oc}$	Config 1,2	dBm/15kHz	-98	
		Config 3,4		-101	
	$\hat{E}_s / N_{oc}$		dB	3	
	SS-RSRP	Config 1,2	dBm / 15kHz	-95	
Config 3,4			-98		
SS-RSRP		dBm/ SCS	-95		
SSB with index 1	$\hat{E}_s / I_{ot}$		dB	-17	Power of SSB with index 1 is set to be below configured <i>rsrp-ThresholdSSB</i>
	$N_{oc}$	Config 1,2	dBm/15kHz	-98	
		Config 3,4		-101	
	$\hat{E}_s / N_{oc}$		dB	-17	
	SS-RSRP	Config 1,2	dBm / 15kHz	-115	
Config 3,4			-118		
SS-RSRP		dBm/ SCS	-115		
$I_o$ <sup>Note 2</sup>	Config 1,2	dBm	-65.3/9.36 MHz	For symbols without SSB index 1	
	Config 3,4		-62.2/38.16 MHz		
ss-PBCH-BlockPower		dBm/ SCS	-5	As defined in clause 6.3.2 in TS 38.331 [13].	
Configured UE transmitted power ( $P_{CMAX, f, c}$ )		dBm	23	As defined in clause 6.2.4 in TS 38.101-1 [2].	
MsgA Configuration			FR1 MsgA configuration 1		
<i>msgA-RSRP-ThresholdSSB</i>		dBm	RSRP_51	The actual value of the threshold is -105dBm, as defined in TS 38.331 [13].	
Propagation Condition		-	AWGN		
NOTE 1: OCNG shall be used such that the cell is fully allocated and a constant total transmitted power spectral density is achieved for all OFDM symbols. The OCNG pattern is chosen during the test according to the presence of a DL reference measurement channel.					
NOTE 2: SS-RSRP, $E_s/I_{ot}$ and $I_o$ levels have been derived from other parameters for information purpose. They are not settable parameters.					
NOTE 3: The DL PDSCH reference measurement channel is used in the test only when a downlink transmission dedicated to the UE under test is required.					

Test 1: Correct behaviour when transmitting MsgA:

- The MsgA shall be one of the Random Access Preambles associated with SSB index 0.

Test 2: Correct behaviour when receiving MsgB:

- The power of the first preamble shall be -22 dBm within the accuracy specified in Table 4.3.2.2.3.5-2.
- The relative power for preamble ramping step shall be FFS within the accuracy specified in Table 4.3.2.2.3.5-3.

- The transmit timing of all MsgA PRACH transmissions shall be within the accuracy specified in Table 4.3.2.2.3.5-4.

Test 3: Correct behaviour when not receiving MsgB:

- The power of the first preamble shall be -22 dBm within the accuracy specified in Table 4.3.2.2.3.5-2.
- The relative power for preamble ramping step shall be FFS within the accuracy specified in Table 4.3.2.2.3.5-3.
- The transmit timing of all MsgA PRACH transmissions shall be within the accuracy specified in Table 4.3.2.2.3.5-4.

**Table 4.3.2.2.3.5-2: Absolute power tolerance Test requirements**

Conditions	Tolerance
Normal	$\pm 11.1$ dB

**Table 4.3.2.2.3.5-3: Relative power tolerance Test requirements**

Power step $\Delta P$ (Up or down) (dB)	MsgA PRACH (dB)
FFS	FFS

**Table 4.3.2.2.3.5-4:  $T_e$  Timing error Test requirements**

Frequency Range	SCS of SSB signals (kHz)	SCS of uplink signals s(KHz)	$T_e$
1	15	15	$880 * T_c$
	30	30	$624 * T_c$

NOTE:  $T_c$  is the basic timing unit defined in TS 38.211 [7]

#### 4.3.2.2.4 EN-DC FR1 2-step non-contention based random access

**Editor's note: This test case is incomplete. The following aspects are either missing or TBD**

- TT analysis and test requirements are missing.

##### 4.3.2.2.4.1 Test purpose

The purpose of this test is to verify that the behaviour of the 2-step non-contention based random access procedure is according to the requirements and that the MsgA PRACH and MsgA PUSCH power settings and timing are within specified limits.

##### 4.3.2.2.4.2 Test applicability

This test applies to all types of E-UTRA UE release 16 and forward, supporting EN-DC.

##### 4.3.2.2.4.3 Minimum conformance requirement

The UE shall select the type of random access at initiation of the random access procedure based on network configuration, as specified in clause 5.1.1 in TS 38.321 [12].

The UE shall have capability to calculate MsgA PRACH transmission power according to the PRACH power formula defined in clause 7.4 of TS 38.213 [3] and the MsgA PUSCH power formula of clause 7.1.1 of TS 38.213 [8] and apply this power level at the first MsgA or additional MsgA repetitions. The absolute power applied to the first preamble shall have an accuracy as specified in Table 6.3.4.2-1 of TS 38.101-1 [2] for frequency range 1 and in Table 6.3.4.2-1 of TS 38.101-2 [3] for frequency range 2. The relative power applied to additional preambles shall have an accuracy as specified in Table 6.3.4.3-1 of TS 38.101-1 [2] for frequency range 1 and clause 6.3.4.3 of TS38.101-2 [3] for frequency range 2.

The UE shall switch to 4-step RA type procedure if the MsgA transmission counter has exceeded *msgA-TransMax*, if configured, as specified in clause 5.1.4a of TS 38.321 [12]. The UE shall indicate a Random Access problem to upper layers if the maximum number of preamble transmission counter has been reached for the random access procedure on PCell or PSCell as specified in clause 5.1.4a in TS 38.321 [12].

The requirements in this clause apply for UE in SA operation mode or any MR-DC operation mode.

#### 4.3.2.2.4.3.1 Correct behaviour when transmitting MsgA

If the contention-free Random Access Resources and the contention-free PRACH occasions associated with SSBs is configured, with the UE selected SSB with SS-RSRP above *msgA-RSRP-ThresholdSSB* amongst the associated SSBs, UE shall have the capability to select the Random Access Preamble corresponding to the selected SSB, and to transmit Random Access Preamble on the next available PRACH occasion from the PRACH occasions corresponding to the selected SSB permitted by the restrictions given first by the *msgA-SSB-SharedRO-MaskIndex* if configured, or next by the *ra-ssb-OccasionMaskIndex* if configured, and PRACH occasion shall be randomly selected with equal probability amongst the selected SSB associated PRACH occasions occurring simultaneously but on different subcarriers, as specified in clause 5.1.2a in TS 38.321 [12].

In association with the MsgA PRACH, the UE should have the capability to transmit MsgA PUSCH on the corresponding PUSCH occasion associated with a DMRS resource, which is mapped from the MsgA PRACH occasion, and preamble index as defined in clause 8.1A in TS 38.213 [8].

#### 4.3.2.2.4.3.2 Correct behaviour when receiving MsgB

The UE may stop monitoring for MsgB, when the UE has successfully received the PDCCH addressed to UE as specified in clause 8.2A in TS 38.213 [8] containing a successRAR MAC subPDU or a fallbackRAR MAC subPDU as described in clause 5.1.4a in TS 38.321 [12].

If MsgB contains a fallbackRAR MAC subPDU the UE shall fallback to the 4-step RA type by transmitting the msg3 containing the payload of MsgA PUSCH as described in clause 8.2A in TS 38.213 [8].

The UE shall again perform the Random Access Resource selection procedure defined in clause 5.1.2a in TS 38.321 [12] for the next available PRACH occasion, and transmit the preamble with the calculated MsgA PRACH and MsgA PUSCH transmission power if all received MsgBs contain Random Access Preamble identifiers that do not match the transmitted Random Access Preamble.

#### 4.3.2.2.4.3.3 Correct behaviour when not receiving MsgB

The UE shall again perform the Random Access Resource selection procedure defined in clause 5.1.2a in TS 38.321 [12] for the next available PRACH occasion, and transmit MsgA with the calculated MsgA PRACH and MsgA PUSCH transmission power, if no MsgB is received within the MsgB Response window configured in *RACH-ConfigGenericTwoStepRA* and the Random Access Response Reception has not been considered as successful as defined in clause 5.1.4a in TS 38.321 [12].

The normative reference for this requirement is TS 38.133 [6] clauses 6.2.2.3 and A.4.3.2.2.4.

#### 4.3.2.2.4.4 Test description

##### 4.3.2.2.4.4.1 Initial conditions

This test can be run in the configurations defined in Table 4.3.2.2.4.4.1-1.

**Table 4.3.2.2.4.4.1-1: Non-contention based random access test in FR1 for PSCell in EN-DC supported test configurations**

Test Case ID	Test Config Index	Description
4.3.2.2.4-1	1	LTE FDD, NR 15 kHz SSB SCS, 10MHz bandwidth, FDD
4.3.2.2.4-2	2	LTE TDD, NR 15 kHz SSB SCS, 10MHz bandwidth, FDD
4.3.2.2.4-3	3	LTE FDD, NR 30 kHz SSB SCS, 40MHz bandwidth, TDD
4.3.2.2.4-4	4	LTE TDD, NR 30 kHz SSB SCS, 40MHz bandwidth, TDD

NOTE: The UE is only required to be tested in one of the supported test configurations.

Configure the test equipment and the DUT according to the parameters in Table 4.3.2.2.4.4.1-2.

**Table 4.3.2.2.4.4.1-2: Initial conditions for non-contention based random access test in FR1 for EN-DC**

Parameter	Value		Comment
Test environment	NC		As specified in TS 38.508-1 [14] clause 4.1.
Test frequencies	As specified in Annex E, Table E.1-1 and TS 38.508-1 [14] clause 4.3.1.		
Channel bandwidth	As specified by the test configuration selected from Table 4.3.2.2.4.4.1-1.		
Propagation conditions	AWGN		As specified in clause C.2.2.
Connection Diagram	TE Part	A.3.1.7.1	As specified in TS 38.508-1 [14] Annex A.
	DUT Part	A.3.2.3.4	
Exceptions to connection diagram	N/A		

1. Message contents are defined in clause 4.3.2.2.4.4.3.
2. Cell 1 is the E-UTRA serving cell (PCell) for the EN-DC setup. The E-UTRAN PCell power levels and settings are specified in Table A.6.1.1-1. Cell 2 is the NR FR1 PSCell. The connection setup is done according to the settings in clause C.1.3, with downlink signal levels as per clause C.1.2. General Test parameters are defined in Table 4.3.2.2.4.5-1.
3. Downlink signals for NR cell are initially set up according to clause C.2.1.

#### 4.3.2.2.4.4.2 Test procedure

For this test two cells are used, an E-UTRA serving cell (PCell) and an NR FR1 PSCell. For the NR PSCell, the System Simulator shall not explicitly assign a random access preamble via dedicated signalling in the downlink.

1. Ensure the UE is in state E-UTRA RRC\_CONNECTED with generic procedure parameters *Connectivity E-UTRA/EPC* with Test Mode *On* according to TS 38.508-1 [14] clause 4.5.
2. Set the parameters according to Table 4.3.2.2.4.5-1.
3. The test system shall send a RRCReconfiguration message to the UE to add NR PSCell, then the UE shall trigger a random access procedure.
4. Test 1: Correct behaviour when transmitting MsgA:
  - 4.1. The UE shall send a MsgA to the System Simulator. The System Simulator shall check that the MsgA preamble belongs to one of the Random Access Preambles associated with the SSB with index 0, that it arrives on a PRACH occasion which belongs to the PRACH occasions corresponding to the SSB with index 0, and that the selected PRACH occasion belongs to the PRACH occasions permitted by the restrictions given by the *msgA-SSB-SharedRO-MaskIndex*.
5. Test 2: Correct behaviour when receiving MsgB:
  - 5.1. Repeat steps 1-3.
  - 5.2. The UE shall send preambles to the System Simulator. In response to the first 4 preambles, the System Simulator shall transmit a MsgB containing identifiers that do not match the transmitted Random Access Preamble.
  - 5.3. As the received MsgB contain Random Access Preamble identifiers that do not match the transmitted Random Access Preamble, the UE shall perform the Random Access Resource selection procedure specified in clause 5.1.2a in TS 38.321 [12], and transmit with the calculated MsgA PRACH transmission power when the backoff time expires.
  - 5.4. The System Simulator shall transmit a MsgB containing a Random Access Preamble identifier matching the transmitted Random Access Preamble after 5 preambles have been received by the System Simulator.



- 5.5. As the received MsgB contains a Random Access Preamble identifier that matches the transmitted Random Access Preamble, the UE shall transmit an ACK and stop monitoring for MsgB.
- 5.6. Measure the power and timing of the first preamble and it shall not exceed the values specified in clause 4.3.2.2.4.5. Measure the relative power and timing applied to additional preambles (last 4 preambles) and it shall not exceed the values specified in clause 4.3.2.2.4.5.
- 6. Test 3: Correct behaviour when not receiving MsgB:
  - 6.1. Repeat steps 1-3.
  - 6.2. The UE shall send preambles to the System Simulator. The System Simulator shall not respond to the first 4 preambles.
  - 6.3. As no MsgB was received within the MsgB Response window configured in *RACH-ConfigGenericTwoStepRA*, the UE shall perform the Random Access Resource selection procedure specified in clause 5.1.2a in TS 38.321 [12], and transmit with the calculated MsgA PRACH transmission power when the backoff time expires.
  - 6.4. The System Simulator shall transmit a MsgB containing a Random Access Preamble identifier matching the transmitted Random Access Preamble after 5 preambles have been received by the System Simulator.
  - 6.5. As the received MsgB contains a Random Access Preamble identifier that matches the transmitted Random Access Preamble, the UE shall transmit an ACK and stop monitoring for MsgB.
  - 6.6. Measure the power and timing of the first preamble and it shall not exceed the values specified in clause 4.3.2.2.3.5. Measure the relative power and timing applied to additional preambles (last 4 preambles) and it shall not exceed the values specified in clause 4.3.2.2.3.5.

4.3.2.2.4.4.3 Message contents

Message contents are according to TS 38.508-1 [14] clause 7.3 with the following exceptions:

**Table 4.3.2.2.4.4.3-0: Common Exception messages**

Default Message Contents	
Common contents of system information blocks exceptions	
Default RRC messages and information elements contents exceptions	
Common exceptions to the contents of TS 38.508-1 [14]	Table 4.6.3-115 with SSB-Index 0 Table 4.6.3-120 with SSB-Index 0

4.3.2.2.4.5 Test requirement

Table 4.3.2.2.4.5-1 defines the primary level settings for non-contention based random access test in FR1 for PSCell in EN-DC. The test requirements are FFS.

**Table 4.3.2.2.4.5-1: General test parameters**

Parameter	Unit	Test-1	Comments
SSB Configuration	Config 1,2	SSB.3 FR1	As defined in clause A.3.1
	Config 3,4	SSB.4 FR1	
Duplex Mode for Cell 2	Config 1,2	FDD	
	Config 3,4	TDD	
TDD Configuration	Config 3,4	TDDConf.2.1	
OCNG Pattern <sup>Note 1</sup>		OCNG pattern 1	As defined in clause A.2.1.
PDSCH parameters <sup>Note 4</sup>	Config 1,2	SR1.1 FDD	As defined in clause A.1.1.
	Config 3,4	SR.2.1 TDD	
NR RF Channel Number		1	
EPRE ratio of PSS to SSS	dB	0	
EPRE ratio of PBCH_DMRS to SSS	dB		
EPRE ratio of PBCH to PBCH_DMRS	dB		
EPRE ratio of PDCCH_DMRS to SSS	dB		
EPRE ratio of PDCCH to PDCCH_DMRS	dB		

Parameter		Unit	Test-1	Comments	
EPRE ratio of PDSCH_DMRS to SSS		dB			
EPRE ratio of PDSCH to PDSCH_DMRS		dB			
SSB with index 0	$\hat{E}_s / I_{ot}$	dB	3	Power of SSB with index 0 is set to be above configured <i>rsrp-ThresholdSSB</i>	
	$N_{oc}$	Config 1,2	dBm/15kHz		-98
		Config 3,4			-101
	$\hat{E}_s / N_{oc}$	dB	3		
	SS-RSRP	Config 1,2	dBm / 15kHz		-95
Config 3,4			-98		
SS-RSRP	dBm/ SCS	-95			
SSB with index 1	$\hat{E}_s / I_{ot}$	dB	-17	Power of SSB with index 1 is set to be below configured <i>rsrp-ThresholdSSB</i>	
	$N_{oc}$	Config 1,2	dBm/15kHz		-98
		Config 3,4			-101
	$\hat{E}_s / N_{oc}$	dB	-17		
	SS-RSRP	Config 1,2	dBm / 15kHz		-115
Config 3,4			-118		
SS-RSRP	dBm/ SCS	-115			
I <sub>o</sub> Note 2	Config 1,2	dBm	-65.3/9.36MHz	For symbols without SSB index 1	
	Config 3,4		-62.2/38.16MHz		
ss-PBCH-BlockPower		dBm/ SCS	-5	As defined in clause 6.3.2 in TS 38.331 [13].	
Configured UE transmitted power ( $P_{CMAX, f, c}$ )		dBm	23	As defined in clause 6.2.4 in TS 38.101-1 [2].	
MsgA Configuration			FR1 MsgA configuration 2		
<i>msgA-RSRP-ThresholdSSB</i>		dBm	RSRP_51	The actual value of the threshold is -105dBm, as defined in TS 38.331 [13].	
Propagation Condition		-	AWGN		
NOTE 1: OCNG shall be used such that the cell is fully allocated and a constant total transmitted power spectral density is achieved for all OFDM symbols. The OCNG pattern is chosen during the test according to the presence of a DL reference measurement channel.					
NOTE 2: SS-RSRP, Es/I <sub>ot</sub> and I <sub>o</sub> levels have been derived from other parameters for information purpose. They are not settable parameters.					
NOTE 3: The DL PDSCH reference measurement channel is used in the test only when a downlink transmission dedicated to the UE under test is required.					

Test 1: Correct behaviour when transmitting MsgA:

- The MsgA shall be one of the Random Access Preambles associated with SSB index 0.
- The MsgA shall arrive on a PRACH occasion which belongs to the PRACH occasions corresponding to the SSB with index 0.
- The selected PRACH occasion shall belong to the PRACH occasions permitted by the restrictions given by the *msgA-SSB-SharedRO-MaskIndex*.

Test 2: Correct behaviour when receiving MsgB:

- The power of the first preamble shall be -22 dBm within the accuracy specified in Table 4.3.2.2.4.5-2.
- The relative power for preamble ramping step shall be FFS within the accuracy specified in Table 4.3.2.2.4.5-3.
- The transmit timing of all PRACH transmissions shall be within the accuracy specified in Table 4.3.2.2.4.5-4.

Test 3: Correct behaviour when not receiving MsgB:

- The power of the first preamble shall be -22 dBm within the accuracy specified in Table 4.3.2.2.4.5-2.
- The relative power for preamble ramping step shall be FFS within the accuracy specified in Table 4.3.2.2.4.5-3.
- The transmit timing of all PRACH transmissions shall be within the accuracy specified in Table 4.3.2.2.4.5-4.

**Table 4.3.2.2.4.5-2: Absolute power tolerance Test requirements**

Conditions	Tolerance
Normal	$\pm 11.1$ dB

**Table 4.3.2.2.4.5-3: Relative power tolerance Test requirements**

Power step $\Delta P$ (Up or down) (dB)	MsgA PRACH (dB)
FFS	FFS

**Table 4.3.2.2.4.5-4:  $T_e$  Timing error Test requirements**

Frequency Range	SCS of SSB signals (kHz)	SCS of uplink signals s(KHz)	$T_e$
1	15	15	$880 * T_c$
	30	30	$624 * T_c$
NOTE: $T_c$ is the basic timing unit defined in TS 38.211 [7]			

4.3.2.3 Void

## 4.4 Timing

### 4.4.1 UE transmit timing

#### 4.4.1.0 Minimum conformance requirements

##### 4.4.1.0.1 Minimum conformance requirements for UE transmit timing accuracy

The UE initial transmission timing error shall be less than or equal to  $\pm T_e$  where the timing error limit value  $T_e$  is specified in Table 4.4.1.0.1-1. This requirement applies:

- when it is the first transmission in a DRX cycle for PUCCH, PUSCH and SRS or it is the PRACH transmission.

The UE shall meet the  $T_e$  requirement for an initial transmission provided that at least one SSB is available at the UE during the last 160 ms. The reference point for the UE initial transmit timing control requirement shall be the downlink timing of the reference cell minus  $(N_{TA} + N_{TA\text{ offset}}) \times T_c$ . The downlink timing is defined as the time when the first detected path (in time) of the corresponding downlink frame is received from the reference cell.  $N_{TA}$  for PRACH is defined as 0.

$(N_{TA} + N_{TA\text{ offset}}) \times T_c$  (in  $T_c$  units) for other channels is the difference between UE transmission timing and the downlink timing immediately after when the last timing advance in TS 38.133 [6] clause 7.3 was applied.  $N_{TA}$  for other channels is not changed until next timing advance is received. The value of  $N_{TA\text{ offset}}$  depends on the duplex mode of the cell in which the uplink transmission takes place and the frequency range (FR).  $N_{TA\text{ offset}}$  is defined in Table 4.4.1.0.1-2.

**Table 4.4.1.0.1-1:  $T_e$  Timing Error Limit**

Frequency Range	SCS of SSB signals (KHz)	SCS of uplink signals s(KHz)	$T_e$
1	15	15	$12 \cdot 64 \cdot T_c$
		30	$10 \cdot 64 \cdot T_c$
		60	$10 \cdot 64 \cdot T_c$
	30	15	$8 \cdot 64 \cdot T_c$
		30	$8 \cdot 64 \cdot T_c$
		60	$7 \cdot 64 \cdot T_c$
2	120	60	$3.5 \cdot 64 \cdot T_c$
		120	$3.5 \cdot 64 \cdot T_c$
	240	60	$3 \cdot 64 \cdot T_c$
		120	$3 \cdot 64 \cdot T_c$

NOTE:  $T_c$  is the basic timing unit defined in TS 38.211 [6].

**Table 4.4.1.0.1-2: The Value of  $N_{TA\text{ offset}}$**

Frequency range and band of cell used for uplink transmission	$N_{TA\text{ offset}}$ (Unit: $T_c$ )
FR1 FDD band without LTE-NR coexistence case or FR1 TDD band without LTE-NR coexistence case	25600 (Note 1)
FR1 FDD band with LTE-NR coexistence case	0 (Note 1)
FR1 TDD band with LTE-NR coexistence case	39936 (Note 1)
FR2	13792

NOTE 1: The UE identifies  $N_{TA\text{ offset}}$  based on the information n-TimingAdvanceOffset according to TS 38.101-1 [2]. If UE is not provided with the information n-TimingAdvanceOffset, the default value of  $N_{TA\text{ offset}}$  is set as 25600 for FR1 band. In case of multiple UL carriers in the same TAG, UE expects that the same value of n-TimingAdvanceOffset is provided for all the UL carriers according to clause 4.2 in TS 38.101-2 [3] and the value 39936 of  $N_{TA\text{ offset}}$  can also be provided for a FDD serving cell.

NOTE 2: Void

When it is not the first transmission in a DRX cycle or there is no DRX cycle, and when it is the transmission for PUCCH, PUSCH and SRS transmission, the UE shall be capable of changing the transmission timing according to the received downlink frame of the reference cell except when the timing advance in TS 38.133 [6] clause 7.3 is applied.

When the transmission timing error between the UE and the reference timing exceeds  $\pm T_e$ , the UE is required to adjust its timing to within  $\pm T_e$ . The reference timing shall be  $(N_{TA} + N_{TA\text{ offset}}) \times T_c$  before the downlink timing of the reference cell. All adjustments made to the UE uplink timing shall follow these rules:

- 1) The maximum amount of the magnitude of the timing change in one adjustment shall be  $T_q$ .
- 2) The minimum aggregate adjustment rate shall be  $T_p$  per second.
- 3) The maximum aggregate adjustment rate shall be  $T_q$  per 200ms.

where the maximum autonomous time adjustment step  $T_q$  and the aggregate adjustment rate  $T_p$  are specified in Table 4.4.1.0.1-3.

**Table 4.4.1.0.1-3:  $T_q$  Maximum Autonomous Time Adjustment Step and  $T_p$  Minimum Aggregate Adjustment rate**

Frequency Range	SCS of uplink signals (KHz)	$T_q$	$T_p$
1	15	$5.5 \cdot 64 \cdot T_c$	$5.5 \cdot 64 \cdot T_c$
	30	$5.5 \cdot 64 \cdot T_c$	$5.5 \cdot 64 \cdot T_c$
	60	$5.5 \cdot 64 \cdot T_c$	$5.5 \cdot 64 \cdot T_c$
2	60	$2.5 \cdot 64 \cdot T_c$	$2.5 \cdot 64 \cdot T_c$
	120	$2.5 \cdot 64 \cdot T_c$	$2.5 \cdot 64 \cdot T_c$

NOTE:  $T_c$  is the basic timing unit defined in TS 38.211 [6].

The normative reference for this requirement is TS.38.133 [6] clause 7.1.2.

#### 4.4.1.1 EN-DC FR1 UE transmit timing accuracy

##### 4.4.1.1.1 Test purpose

The purpose of this test is to verify that the UE can follow frame timing change of the connected gNB and that the UE initial transmit timing accuracy, maximum amount of timing change in one adjustment, minimum and maximum adjustment rate are within the specified limits.

##### 4.4.1.1.2 Test applicability

This test applies to all types of E-UTRA UE release 15 and forward supporting EN-DC.

##### 4.4.1.1.3 Minimum conformance requirements

The minimum conformance requirements are specified in clause 4.4.1.0.1.

The normative reference for this requirement is TS.38.133 [6] clause A.4.4.1.1.

##### 4.4.1.1.4 Test Description

###### 4.4.1.1.4.1 Initial Conditions

This test can be run in one of the configurations defined in Table 4.4.1.1.4.1-1.

**Table 4.4.1.1.4.1-1: Supported test configurations for FR1 PSCell**

Configuration	Description
4.4.1.1-1	LTE FDD, NR FDD, SSB SCS 15 KHz, data SCS 15 KHz, BW 10 MHz
4.4.1.1-2	LTE FDD, NR TDD, SSB SCS 15 KHz, data SCS 15 KHz, BW 10 MHz
4.4.1.1-3	LTE FDD, NR TDD, SSB SCS 30 KHz, data SCS 30 KHz, BW 40 MHz
4.4.1.1-4	LTE TDD, NR FDD, SSB SCS 15 KHz, data SCS 15 KHz, BW 10 MHz
4.4.1.1-5	LTE TDD, NR TDD, SSB SCS 15 KHz, data SCS 15 KHz, BW 10 MHz
4.4.1.1-6	LTE TDD, NR TDD, SSB SCS 30 KHz, data SCS 30 KHz, BW 40 MHz

NOTE: The UE is only required to be tested in one of the supported test configurations in FR1 depending on UE capability.

Configure the test equipment and the DUT according to the parameters in Table 4.4.1.1.4.1-2

**Table 4.4.1.1.4.1-2: Initial conditions for EN-DC FR1 transmit timing accuracy**

Parameter	Value		Comment
Test environment	NC		As specified in TS 38.508-1 [14] clause 4.1.
Test frequencies	As specified in Annex E.1.1, Table E.2-1 and TS 38.508-1 [14] clause 4.3.1.		
Channel bandwidth	As specified by the test configuration selected from Table 4.4.1.1.4.1-1		
Propagation conditions	AWGN		As specified in clause C.2.2.
Connection Diagram	TE Part	A.3.1.7.1	As specified in TS 38.508-1 [14] Annex A.
	DUT Part	A.3.2.3.4	
Exceptions to connection diagram	N/A		

1. Message contents are defined in clause 6 4.4.1.1.4.3.
2. There are two cells, Cell 1 is the E-UTRAN PCell, and Cell 2 is the PSCell, in the test. The E-UTRAN PCell setting refers to Table A.6.1.1-1. The power levels and settings for Cell 1 are set according to clause A.6, Table A.6.1.1-1. Cell 2 is NR FR1 PSCell. The connection setup is done according to the settings in clause C.1.3, and the downlink signal levels as per clause C.1.2.
3. Downlink signals for NR cell are initially set up according to clause C.1.

#### 4.4.1.1.4.2 Test procedure

The test consists of two cells, a single E-UTRA cell (Pcell), and a single NR cell (PSCell). The downlink timing of the PSCell is changed and the changes in UE transmit timing are observed. The transmit timing is verified by the UE transmitting SRS used as a measurement reference facilitating the SS timing estimation.

The test sequence shall be carried out in RRC\_CONNECTED for every test case.

Following will be the test sequence for this test:

1. Ensure the UE is in state RRC\_CONNECTED with generic procedure parameters *Connectivity* EN-DC, DC bearer MCG and SCG, Connected without release *On* and Test Mode *On* according to TS 38.508-1 [6] clause 4.5.
2. Set up E-UTRA PCell according to parameters given in Table A.6.1.1-1 and setup NR PSCell according to parameters given in Table 4.4.1.1.5-1.
3. The SS shall transmit an RRCConnectionReconfiguration message configuring the UE with the message content defined in clause 4.4.1.1.4.3.
4. The UE shall transmit RRCConnectionReconfigurationComplete message.
5. After connection set up with the cell and during 2 seconds before DL timing adjustment, the test equipment shall monitor all SRS transmissions and verify that, for each received SRS, the timing of the NR cell is within  $(N_{TA} + N_{TA\_offset}) \times T_c \pm T_e$  of the first detected path of DL SSB:
  - a. The  $N_{TA}$  offset value (in  $T_c$  units) is 25600 for FR1.
  - b. The  $T_e$  values depend on the DL and UL SCS for which the test is being run and are given in Table 4.4.1.1.5-4.
6. The test system shall adjust the timing of the DL path by values given in Table 4.4.1.1.4.2-1. For Test 2, the DL timing change shall be applied within the first half of the DRX cycle upon expiration of the preceding DRX ON duration.

**Table 4.4.1.1.4.2-1: Adjustment Value for DL Timing**

SCS of SSB signals (KHz)	Adjustment Value	
	Test1	Test2
15	+64*64Tc	+32*64Tc
30	+32*64Tc	+16*64Tc

7. The test system shall verify that the adjustment step size and the adjustment rate shall be according to requirements specified in Table 4.4.1.1.5-5. This will only be done for Test1. The test system samples the UE Transmit Timing once per SRS transmission (as per configured SRS periodicity). To check Rule 1, the SS shall check that the maximum time adjustment step size  $T_q$  between one SRS transmission to next consecutive SRS transmission of a valid UL slot is within Rule 1 as specified in clause 4.4.1.0.1 and Table 4.4.1.0.1-3. To check that the minimum adjustment rate is within Rule 2 as specified in clause 4.4.1.0.1 and Table 4.4.1.0.1-3, the SS shall measure the change in SRS transmission timing over a  $1 + \text{offset}$  seconds sliding window (offset in ms to the next consecutive SRS transmission), with step size  $p$  (where  $p$  is the periodicity of SRS) , as long as the resulting slot is a valid UL slot. To check that the maximum adjustment rate is within Rule 3 as specified in clause 4.4.1.0.1 and Table 4.4.1.0.1-3, the SS shall measure the change in SRS transmission timing over a  $200\text{ms} - \text{offset}$  sliding window of previous SRS transmission, with step size  $p$  (where  $p$  is the periodicity of SRS) , as long as the resulting slot is a valid UL slot. The three rules apply until the UE transmit timing offset is within the limits specified in 4.4.1.0.1 and Table 4.4.1.0.1-3 with respect to the first detected path (in time) of the corresponding downlink frame of Cell 1. The test system will wait till evaluation interval of  $T$  seconds is met to ensure UE transmit timing is stable at the end of the step, where  $T = \text{DL\_timing\_change}[Ts]/5.5Ts$  and  $\text{DL\_timing\_change}$  is specified in Table 4.4.1.1.4.2-1.
8. After the UE transmit timing is within the limits specified in step 7, and during 2 seconds, the test system shall monitor all SRS transmissions and verify that, for each received SRS, the UE transmit timing offset stays within  $(N_{TA} + N_{TA\_offset}) \times T_c \pm T_e$  of the first detected path of DL SSB. For Test 2 the UE transmit timing offset shall be verified for the first transmission in the DRX cycle immediately after DL timing adjustment.

#### 4.4.1.1.4.3 Message contents

Message contents are according to TS 38.508-1 [14] clause 7.3 with the following exceptions:

**Table 4.4.1.1.4.3-0: Common Exception messages**

Default Message Contents	
Common contents of system information blocks exceptions	
Default RRC messages and information elements contents exceptions	Table H.3.9-1

**Table 4.4.1.1.4.3-1: SRS-Config : Additional test requirement for UE transmit timing accuracy for EN-DC FR1 UE**

Derivation Path: TS 38.331 [6], clause 6.3.2			
Information Element	Value/remark	Comment	Condition
SRS-Config ::= SEQUENCE {			
srs-ResourceSetToAddModList SEQUENCE (SIZE(0..maxNrofSRS-ResourceSets)) OF SEQUENCE {			
SRS-ResourceSet[1] SEQUENCE {		entry 1	
resourceType CHOICE {			
periodic SEQUENCE {			
}			
}			
}			
srs-ResourceToAddModList SEQUENCE (SIZE(1..maxNrofSRS-Resources)) OF SEQUENCE {			
SRS-Resource[1] SEQUENCE {		entry 1	
freqHopping SEQUENCE {			
c-SRS	14		SCS15
	25		SCS30
}			
groupOrSequenceHopping	neither		
resourceType CHOICE {			
periodic SEQUENCE {			
periodicityAndOffset-p CHOICE {			
sl1	0		Test 1
sl320	3		Test 2 and SCS15
sl640	5		Test 2 and SCS30
}			
}			
}			
}			
}			

**Table 4.4.1.1.4.3-2: DRX-Config : Additional test requirement for UE transmit timing accuracy Test 2 for EN-DC FR1**

Derivation Path: TS 38.331 [6], clause 6.3.2			
Information Element	Value/remark	Comment	Condition
DRX-Config ::= CHOICE {			
drx-onDurationTimer CHOICE {			
milliSeconds	ms6		
}			
drx-InactivityTimer	ms1		
drx-HARQ-RTT-TimerDL	56		
drx-HARQ-RTT-TimerUL	56		
drx-RetransmissionTimerDL	sl1		
drx-RetransmissionTimerUL	sl1		
drx-LongCycleStartOffset CHOICE {			
ms320	0		
}			
shortDRX		NOT PRESENT	
}			



4.4.1.1.5 Test Requirements

Table 4.4.1.1.5-1: Cell Specific Test Parameters for UL Transmit Timing test

Parameter	Unit	Config	Test1	Test2	Band Group
SSB ARFCN		1,2,3,4,5,6	Freq1	Freq1	
Duplex Mode		1,4	FDD		
		2,3,5,6	TDD		
TDD configuration		1,4	Not Applicable		
		2,5	TDDConf.1.1		
		3,6	TDDConf.2.1		
BW <sub>channel</sub>	MHz	1,4	10: N <sub>RB,c</sub> = 52		
		2,5	10: N <sub>RB,c</sub> = 52		
		3,6	40: N <sub>RB,c</sub> = 106		
Initial BWP Configuration		1,2,3,4,5,6	DLBWP.0.1 ULBWP.0.1		
Dedicated BWP Configuration		1,2,3,4,5,6	DLBWP.1.1 ULBWP.1.1		
DRx Cycle	ms	1,2,3,4,5,6	N/A	DRX.8 <sup>Note5</sup>	
PDSCH Reference measurement channel		1,4	SR.1.1 FDD		
		2,5	SR.1.1 TDD		
		3,6	SR.2.1 TDD		
RMSI CORESET Reference Channel		1,4	CR.1.1 FDD		
		2,5	CR.1.1 TDD		
		3,6	CR.2.1 TDD		
Dedicated CORESET Reference Channel		1,4	CCR.1.1 FDD		
		2,5	CCR.1.1 TDD		
		3,6	CCR.2.1 TDD		
OCNG Patterns		1,2,3,4,5,6	OP.1		
SSB configuration		1,4	SSB.1 FR1		
		2,5	SSB.1 FR1		
		3,6	SSB.2 FR1		
SMTC configuration		1,2,3,4,5,6	SMTC.2		
TRS configuration		1,4	TRS.1.1 FDD		
		2,5	TRS.1.1 TDD		
		3,6	TRS.1.2 TDD		
PDSCH/PDCCH subcarrier spacing	kHz	1,2,4,5	15		
		3,6	30		
EPRE ratio of PSS to SSS	dB	1,2,3,4,5,6	0	0	
EPRE ratio of PBCH DMRS to SSS					
EPRE ratio of PBCH to PBCH DMRS					
EPRE ratio of PDCCH DMRS to SSS					
EPRE ratio of PDCCH to PDCCH DMRS					
EPRE ratio of PDSCH DMRS to SSS					
EPRE ratio of PDSCH to PDSCH					
EPRE ratio of OCNG DMRS to SSS(Note 1)					
EPRE ratio of OCNG to OCNG DMRS (Note 1)					
$N_{oc}^{Note2}$					
$N_{oc}^{Note2}$	dBm/SCS	1,2,4,5	-98	-98	
		3,6	-95	-95	
$\hat{E}_s / I_{ot}$		1,2,3,4,5,6	3.3	3.3	
$\hat{E}_s / N_{oc}$		1,2,3,4,5,6	3.3	3.3	
SS-RSRP <sup>Note3</sup>	dBm/SCS	1,2,4,5	-95	-95	
		3,6	-92	-92	
I <sub>o</sub> <sup>Note3</sup>	dBm/9.36MHz	1,2,4,5	-65.08	-65.08	
	dBm/38.1MHz	3,6	-61.99	-61.99	

Parameter	Unit	Config	Test1	Test2	Band Group
Propagation condition		1,2,3,4,5,6	AWGN		
SRS Config		1,2,4,5	SRSConf.1 <sup>Note6</sup>	SRSConf.3 <sup>Note6</sup>	
		3, 6	SRSConf.1 <sup>Note6</sup>	SRSConf.2 <sup>Note6</sup>	
<p>NOTE 1: OCNG shall be used such that both cells are fully allocated and a constant total transmitted power spectral density is achieved for all OFDM symbols.</p> <p>NOTE 2: Interference from other cells and noise sources not specified in the test is assumed to be constant over subcarriers and time and shall be modelled as AWGN of appropriate power for <math>N_{oc}</math> to be fulfilled.</p> <p>NOTE 3: SS-RSRP and Io levels have been derived from other parameters for information purposes. They are not settable parameters themselves.</p> <p>NOTE 4: SS-RSRP minimum requirements are specified assuming independent interference and noise at each receiver antenna port.</p> <p>NOTE 5: DRx related parameters are given in Table 4.4.1.1.5-3.</p> <p>NOTE 6: SRS configs are given in Table 4.4.1.1.5-2.</p>					

**Table 4.4.1.1.5-2: SRS Configuration for Timing Accuracy Test**

	Field	SRSConf.1	SRSConf.2	SRSConf.3	Comments
SRS-ResourceSet	srS-ResourceSetId	0	0	0	
	srS-ResourceSetList	0	0	0	
	resourceType	Periodic	Periodic	Periodic	
	Usage	Codebook	Codebook	Codebook	
	SRS-ResourceSetId	0	0	0	
SRS-Resource	nrofSRS-Ports	Port1	Port1	Port1	
	transmissionComb	n2	n2	n2	
	combOffset-n2	0	0	0	
	cyclicShift-n2	0	0	0	
	resourceMapping startPosition	0	0	0	
	resourceMapping nrofSymbols	n1	n1	n1	
	resourceMapping repetitionFactor	n1	n1	n1	
	freqDomainPosition	0	0	0	
	freqDomainShift	0	0	0	
	freqHopping c-SRS	14 for test configuration 1,2,4,5 25 for test configuration 3,6	25	14	Matches $N_{RB,c}$
	freqHopping b-SRS	0	0	0	
	freqHopping b-hop	0	0	0	
	groupOrSequenceHopping	Neither	Neither	Neither	
	resourceType	Periodic	Periodic	Periodic	
	periodicityAndOffset-p	sl1	sl640,5	sl320, 3	Offset to align with DRx periodicity
sequenceId	0	0	0	Any 10 bit number	

**Table 4.4.1.1.5-3: DRX-Configuration for UL Timing Tests**

Field	Test 2 Value

drx-onDurationTimer	6 ms
drx-InactivityTimer	1 ms
drx-RetransmissionTimerDL	1 slot
drx-RetransmissionTimerUL	1 slot
longDRX-CycleStartOffset	320 ms
shortDRX	disable
TimeAlignmentTimer	Infinity
NOTE: The DRX cycle and time alignment timer parameters are specified in clause 6.3.2 in TS 38.331 [13].	

Table 4.4.1.1.5-4:  $T_e$  Timing Error Limit

Frequency Range	SCS of SSB signals (KHz)	SCS of uplink signals s(KHz)	$T_e$
1	15	15	$13.75 \cdot 64 \cdot T_c$
		30	$11.75 \cdot 64 \cdot T_c$
		60	$11.75 \cdot 64 \cdot T_c$
	30	15	$9.75 \cdot 64 \cdot T_c$
		30	$9.75 \cdot 64 \cdot T_c$
		60	$8.75 \cdot 64 \cdot T_c$
NOTE: $T_c$ is the basic timing unit defined in TS 38.211 [6].			

Table 4.4.1.1.5-5:  $T_q$  Maximum Autonomous Time Adjustment Step and  $T_p$  Minimum Aggregate Adjustment rate

Frequency Range	SCS of uplink signals (KHz)	$T_q$	$T_p$	Maximum Adjustment Rate
1	15	$6.0 \cdot 64 \cdot T_c$	$1.9 \cdot 64 \cdot T_c$	$6.6 \cdot 64 \cdot T_c$
	30	$6.0 \cdot 64 \cdot T_c$	$1.9 \cdot 64 \cdot T_c$	$6.6 \cdot 64 \cdot T_c$
	60	$6.0 \cdot 64 \cdot T_c$	$1.9 \cdot 64 \cdot T_c$	$6.6 \cdot 64 \cdot T_c$
NOTE: $T_c$ is the basic timing unit defined in TS 38.211 [6].				

## 4.4.2 UE timer accuracy

## 4.4.3 Timing advance

### 4.4.3.0 Minimum conformance requirements

The timing advance is initiated from PSCell in EN-DC operation mode with MAC message that implies and adjustment of the timing advance, as defined in clause 5.2 of TS 38.321 [12].

#### 4.4.3.0.1 Minimum conformance requirements for timing advance adjustment accuracy

The UE shall adjust the timing of its transmissions with a relative accuracy better than or equal to the UE Timing Advance adjustment accuracy requirement in Table 4.4.3.0.1-1, to the signalled timing advance value compared to the timing of preceding uplink transmission. The timing advance command step is defined in TS38.213 [8].

Table 4.4.3.0.1-1: UE Timing Advance adjustment accuracy

Sub Carrier Spacing, SCS kHz	15	30	60	120
UE Timing Advance adjustment accuracy	$\pm 256 T_c$	$\pm 256 T_c$	$\pm 128 T_c$	$\pm 32 T_c$

#### 4.4.3.0.2 Minimum conformance requirements for timing advance adjustment delay

UE shall adjust the timing of its uplink transmission timing at time slot  $n+k$  for a timing advance command received in time slot  $n$ , and the value of  $k$  is defined in clause 4.2 in TS 38.213 [8]. The same requirement applies also when the UE is not able to transmit a configured uplink transmission due to the channel assessment procedure.

The normative reference for this requirement is TS.38.133 [6] clause A.4.4.3.1.

#### 4.4.3.1 EN-DC FR1 timing advance adjustment accuracy

##### 4.4.3.1.1 Test purpose

The purpose of the test is to verify UE timing advance adjustment delay and accuracy requirement defined in clause 7.3 of TS 38.133 [6].

##### 4.4.3.1.2 Test applicability

This test applies to all types of E-UTRA UE release 15 and forward, supporting EN-DC.

##### 4.4.3.1.3 Minimum conformance requirement

The minimum conformance requirements are specified in clause 4.4.3.0.1 and clause 4.4.3.0.2.

The normative reference for this requirement is TS.38.133 [6] clause A.4.4.3.1.

##### 4.4.3.1.4 Test description

###### 4.4.3.1.4.1 Initial conditions

This test shall be tested using any of the test configurations in Table 4.4.3.1.4.1-1.

**Table 4.4.3.1.4.1-1: EN-DC FR1 timing advance adjustment accuracy supported test configurations**

Test Case ID	Description
4.4.3.1.4.1-1	LTE FDD, NR: 15 kHz SSB SCS, 10MHz bandwidth, FDD
4.4.3.1.4.1-2	LTE FDD, NR: 15 kHz SSB SCS, 10MHz bandwidth, TDD
4.4.3.1.4.1-3	LTE FDD, NR: 30 kHz SSB SCS, 40MHz bandwidth, TDD
4.4.3.1.4.1-4	LTE TDD, NR: 15 kHz SSB SCS, 10MHz bandwidth, FDD
4.4.3.1.4.1-5	LTE TDD, NR: 15 kHz SSB SCS, 10MHz bandwidth, TDD
4.4.3.1.4.1-6	LTE TDD, NR: 30 kHz SSB SCS, 40MHz bandwidth, TDD
NOTE: The UE is only required to be tested in one of the supported test configurations.	

Configure the test equipment and the DUT according to the parameters in Table 4.4.3.1.4.1-2

**Table 4.4.3.1.4.1-2: Initial conditions for EN-DC FR1 timing advance adjustment accuracy**

Parameter	Value		Comment
Test environment	NC		As specified in TS 38.508-1 [14] clause 4.1.
Test frequencies	As specified in Annex E.1.1, E.1.2, and Table E.2-1 and TS 38.508-1 [14] clause 4.3.1.		
Channel bandwidth	As specified by the test configuration selected from Table 4.4.3.1.4.1-1		
Propagation conditions	AWGN		As specified in clause C.2.2.
Connection Diagram	TE Part	A.3.1.7.1	As specified in TS 38.508-1 [14] Annex A.
	DUT Part	A.3.2.3.4	
Exceptions to connection diagram	N/A		

Table 4.4.3.1.4.1-3: General test parameters for timing advance

Parameter	Unit	Value	Comment
RF channel number		Cell 1: 1 Cell 2: 2	1 for E-UTRAN Pcell 2 for NR PSCell
DL BWP		DLBWP.1.1	As specified in Table A.8.1-2
UL BWP		ULBWP.1.1	As specified in Table A.8.2-2
Timing Advance Command ( $T_A$ ) value during T1		31	$N_{TA\_new} = N_{TA\_old}$ for the purpose of establishing a reference value from which the timing advance adjustment accuracy can be measured during T2
Timing Advance Command ( $T_A$ ) value during T2		39	For SCS = 15kHz, $N_{TA\_new} = N_{TA\_old} + 8192 * T_c$ (based on equation in TS 38.213 [8] clause 4.2) For SCS = 30kHz, $N_{TA\_new} = N_{TA\_old} + 4096 * T_c$ (based on equation in TS 38.213 [8] clause 4.2)
T1	S	5	
T2	S	5	

1. Cell 1 is the E-UTRA serving cell (PCell) for the EN-DC setup. The power levels and settings for Cell 1 are set according to Annex A.6. Cell 2 is NR FR1 PSCell. The connection setup is done according to the settings in clause C.1.1.
2. Downlink signals for NR cell are initially set up according to clauses C.1.2 and C.1.3.

#### 4.4.3.1.4.2 Test Procedure

The test consists of two cells, a single E-UTRA cell (PCell), and a single NR cell (PSCell). Cell 1 is the PCell in the primary Timing Advance Group (pTAG) and cell 2 is the PSCell in the secondary Timing Advance Group (sTAG). The test consists of two successive time periods, with time durations of T1 and T2 respectively. In each time period, timing advance commands for sTAG are sent to the UE and Sounding Reference Signals (SRS), as specified in Table 4.4.3.1.4.1-3 and Table 4.4.3.1.5-2, are sent from the UE and received by the test equipment. By measuring the reception of the SRS, the transmit timing, and hence the timing advance adjustment accuracy, can be measured for PSCell in sTAG. The UE Time Alignment Timer (timeAlignmentTimer IE), described in Clause 5.2 in TS 38.321 [12], shall be configured so that it does not expire in the duration of the test.

1. Ensure the UE is in state RRC\_CONNECTED with generic procedure parameters *Connectivity* EN-DC, DC bearer MCG and SCG, Connected without release *On* and Test Mode *On* according to TS 38.508-1 [14] clause 4.5. Message content are defined in clause 4.4.3.1.4.3.
2. Set the parameters according to values in Tables 4.4.3.1.4.1-3 and Table 4.4.3.1.5-1 as appropriate. Propagation conditions are set according to clause C.2.2.
3. SS shall transmit an RRCConnectionReconfiguration message.
4. The UE shall transmit RRCConnectionReconfigurationComplete message.
5. During time period T1, the test equipment shall send one message with a Timing Advance Command MAC Control Element for sTAG, as specified in clause 6.1.3.4 in TS 38.321 [12]. The Timing Advance Command value shall be set to 31, which according to clause 4.2 in TS 38.213 [8] results in zero adjustment of the Timing Advance. In this way, a reference value for the timing advance for sTAG used by the UE is established.
6. During time period T2, the test equipment shall send a sequence of messages with Timing Advance Command MAC Control Elements for sTAG, with Timing Advance Command value of 39 as specified in Table 4.4.3.1.4.1-3.
7. This value shall result in changes of the timing advance for sTAG used by the UE, and the accuracy of the change shall then be measured, using the SRS sent from the UE.
8. As specified in clause 7.3.2.1 of TS 38.133 [6], the UE adjusts its uplink timing at slot n+k+1 for a timing advance command received in slot n. This delay should be taken into account when measuring the timing advance adjustment accuracy, via the SRS sent from the UE.

9. The UE Time Alignment Timer, described in clause 5.2 in TS 38.321 [12], shall be configured so that it does not expire in the duration of the test.
10. The result from the SRS and adjustment of the timing advance in step 7) is used to measure that the UE adjusts the timing of its transmission with a relative accuracy better than or equal to value specified in Table 4.4.3.0.1-1 to the signalled timing advance value compared to the timing of preceding uplink transmission.
11. If the UE adjust the timing of its transmission within a relative accuracy greater than or equal to value specified in Table 4.4.3.0.1-1 to the signalled timing advance value compared to the timing of preceding uplink transmission then the number of successful tests is increased by one. Otherwise, the number of failure tests is increased by one.
12. The SS shall transmit RRCConnectionReconfiguration message with condition EN-DC\_PSCell\_Rel according to TS 36.508 [25] Table 4.6.1-8 to release NR cell (PSCell). The UE shall transmit RRCConnectionReconfigurationComplete message.
13. The SS then shall transmit RRCConnectionReconfiguration message with condition MCG\_and\_SCG according to TS 36.508 [25] Table 4.6.1-8 to add NR cell (PSCell). The UE shall transmit RRCConnectionReconfigurationComplete message.
14. If any of the above Reconfiguration in Step 12 or 13 fails, switch off and on the UE and ensure the UE is in RRC\_CONNECTED with generic procedure parameters *Connectivity* EN-DC, DC bearer MCG and SCG, Connected without release *On* according to TS 38.508-1 [14] clause 4.5.
15. Repeat steps 3-14 until the confidence level according to Tables G.2.3-1 in Annex G clause G.2 is achieved.

4.4.3.1.4.3 Message Contents

Message contents are according to TS 38.508-1 [14] clause 7.3, with the following exceptions:

**Table 4.4.3.1.4.3-0: Common Exception messages**

Default Message Contents	
Common contents of system information blocks exceptions	
Default RRC messages and information elements contents exceptions	Table H.3.9-1

**Table 4.4.3.1.4.3-1: srs-Config setup**

Derivation Path: TS 38.508-1, Table 4.6.3-182			
Information Element	Value/remark	Comment	Condition
SRS-Config ::= SEQUENCE {			
srs-ResourceSetToAddModList SEQUENCE (SIZE(0..maxNrofSRS-ResourceSets)) OF SEQUENCE {	1 entry		
SRS-ResourceSet[1] SEQUENCE {		entry 1	
resourceType CHOICE {			
periodic SEQUENCE {			
}			
}			
}			
srs-ResourceToAddModList SEQUENCE (SIZE(1..maxNrofSRS-Resources)) OF SEQUENCE {	1 entry		
SRS-Resource[1] SEQUENCE {		entry 1	
freqHopping SEQUENCE {			
c-SRS	12		Config 1,2,4,5
	24		Config 3,6
}			
groupOrSequenceHopping	neither		
resourceType CHOICE {			

Derivation Path: TS 38.508-1, Table 4.6.3-182

Information Element	Value/remark	Comment	Condition
periodic SEQUENCE {			
periodicityAndOffset-p CHOICE {			
sl5	2	Once every 5 Slots	SCS15
sl5	4	Once every 5 Slots	SCS30
}			
}			
}			
}			
}			
}			

4.4.3.1.5 Test Requirement

The UE shall apply the signalled Timing Advance value for PSCell in sTAG to the transmission timing at the designated activation time i.e.  $k+1$  slots after the reception of the timing advance command, where:

$$k = 5 \text{ for Config 1, 2, 3, 4, 5, 6}$$

The Timing Advance adjustment accuracy for PSCell in sTAG shall be within the limits specified in Table 4.4.3.1.5-3.

The rate of correct Timing Advance adjustments observed during repeated tests shall be at least 90 %.

Table 4.4.3.1.5-1 and Table 4.4.3.1.5-2 define the primary level settings.

**Table 4.4.3.1.5-1: Cell specific test parameters for timing advance**

Parameter		Unit	Test1	
			T1	T2
Duplex mode	Config 1,4		FDD	
	Config 2,3,5,6		TDD	
TDD configuration	Config 1,4		Not Applicable	
	Config 2,5		TDDConf.1.1	
	Config 3,6		TDDConf.2.1	
BW <sub>channel</sub>	Config 1,4	MHz	10: N <sub>RB,c</sub> = 52	
	Config 2,5		10: N <sub>RB,c</sub> = 52	
	Config 3,6		40: N <sub>RB,c</sub> = 106	
BWP BW	Config 1,4	MHz	10: N <sub>RB,c</sub> = 52	
	Config 2,5		10: N <sub>RB,c</sub> = 52	
	Config 3,6		40: N <sub>RB,c</sub> = 106	
DRx Cycle		ms	Not Applicable	
PDSCH Reference measurement channel	Config 1,4		SR.1.1 FDD	
	Config 2,5		SR.1.1 TDD	
	Config 3,6		SR2.1 TDD	
RMSI CORESET Reference Channel	Config 1,4		CR.1.1 FDD	
	Config 2,5		CR.1.1 TDD	
	Config 3,6		CR2.1 TDD	
Dedicated CORESET Reference Channel	Config 1,4		CCR.1.1 FDD	
	Config 2,5		CCR.1.1 TDD	
	Config 3,6		CCR2.1 TDD	
OCNG Patterns			OCNG pattern 1	
TRS configuration	Config 1,4		TRS.1.1 FDD	
	Config 2,5		TRS.1.1 TDD	
	Config 3,6		TRS.1.2 TDD	
SMTc configuration	Config 1,2,4,5		SMTc.1 FR1	
	Config 3,6		SMTc.2 FR1	
PDSCH/PDCCH subcarrier spacing	Config 1,2,4,5	kHz	15 kHz	
	Config 3,6		30 kHz	
PUCCH/PUSCH subcarrier spacing	Config 1,2,4,5	kHz	15 kHz	
	Config 3,6		30 kHz	

Parameter	Unit	Test1		
		T1	T2	
EPRE ratio of PSS to SSS	dB	0		
EPRE ratio of PBCH DMRS to SSS				
EPRE ratio of PBCH to PBCH DMRS				
EPRE ratio of PDCCH DMRS to SSS				
EPRE ratio of PDCCH to PDCCH DMRS				
EPRE ratio of PDSCH DMRS to SSS				
EPRE ratio of PDSCH to PDSCH				
EPRE ratio of OCNG DMRS to SSS(Note 1)				
EPRE ratio of OCNG to OCNG DMRS (Note 1)				
$N_{oc}^{Note2}$	dBm/15kHz	-98		
$N_{oc}^{Note2}$	Config 1,2,4,5	-98		
	Config 3,6	-95		
$\hat{E}_s / I_{ot}$	dB	3		
$\hat{E}_s / N_{oc}$	dB	3		
$I_o^{Note3}$	Config 1,2,4,5	dBm/ 9.36MHz	-67.57	
	Config 3,6	dBm/ 38.16MHz	-62.58	
Propagation condition		-	AWGN	

NOTE 1: OCNG shall be used such that both cells are fully allocated and a constant total transmitted power spectral density is achieved for all OFDM symbols.

NOTE 2: Interference from other cells and noise sources not specified in the test is assumed to be constant over subcarriers and time and shall be modelled as AWGN of appropriate power for  $N_{oc}$  to be fulfilled.

NOTE 3:  $I_o$  levels have been derived from other parameters for information purposes. They are not settable parameters themselves.

**Table 4.4.3.1.5-2: Sounding Reference Symbol Configuration for timing advance**

Field	Value	Comment
c-SRS	Config 1,2,4,5	12
	Config 3,6	
b-SRS	0	Frequency hopping is disabled
b-hop	0	
freqDomainPosition	0	Frequency domain position of SRS
freqDomainShift	0	
groupOrSequenceHopping	neither	No group or sequence hopping
SRS-PeriodicityAndOffset	sl5@2 for SCS 15kHz sl5@4 for SCS 30kHz	Once every 5 slots
pathlossReferenceRS	ssb-Index=0	SSB #0 is used for SRS path loss estimation
Usage	Codebook	Codebook based UL transmission resourceMapping setting. SRS on last symbol of slot, and 1symbols for SRS without repetition.
startPosition	0	
nrofSymbols	n1	
repetitionFactor	n1	
combOffset-n2	0	transmissionComb setting
cyclicShift-n2	0	
nrofSRS-Ports	port1	Number of antenna ports used for SRS transmission

NOTE: For further information see clause 6.3.2 in TS 38.331.

**Table 4.4.3.1.5-3: UE Timing Advance adjustment accuracy**

Sub Carrier Spacing, SCS kHz	15	30	60
UE Timing Advance adjustment accuracy	$\pm 344 T_c$	$\pm 344 T_c$	$\pm 216 T_c$



For the test to pass, the total number of successful tests shall be more than 90% of the cases with a confidence level of 95 %.

## 4.5 Signaling characteristics

### 4.5.1 Radio link monitoring

#### 4.5.1.00 General

The requirements in this section apply for radio link monitoring on PSCell in EN-DC operation mode.

The UE shall monitor the downlink link quality based on the reference signal in the configured RLM-RS resource(s) in order to detect the downlink radio link quality of the PCell and PSCell as specified in TS 38.213 [8]. The configured RLM-RS resources can be all SSBs, or all CSI-RSs, or a mix of SSBs and CSI-RSs. UE is not required to perform RLM outside the active DL BWP.

On each RLM-RS resource, the UE shall estimate the downlink radio link quality and compare it to the thresholds  $Q_{out}$  and  $Q_{in}$  for the purpose of monitoring downlink radio link quality of the cell.

#### 4.5.1.0 Minimum conformance requirements

##### 4.5.1.0.1 Minimum conformance requirements for out-of-sync SSB-based RLM

UE shall be able to evaluate whether the downlink radio link quality on the configured RLM-RS resource estimated over the last  $T_{Evaluate\_out\_SSB}$  [ms] period becomes worse than the threshold  $Q_{out\_SSB}$  within  $T_{Evaluate\_out\_SSB}$  [ms] evaluation period. The requirements in this section apply for each SSB based RLM-RS resource configured for PSCell, provided that the SSB configured for RLM is transmitted within UE active DL BWP during the entire evaluation period defined in Table 4.5.1.0.1-1.

$T_{Evaluate\_out\_SSB}$  is defined in Table 4.5.1.0.1-1 for FR1.

**Table 4.5.1.0.1-1: Evaluation period  $T_{Evaluate\_out}$  for FR1**

Configuration	$T_{Evaluate\_out\_SSB}$ (ms)
no DRX	$\max(200, \text{ceil}(10 \cdot P) \cdot T_{SSB})$
DRX cycle $\leq 320$	$\max(200, \text{ceil}(15 \cdot P) \cdot \max(T_{DRX}, T_{SSB}))$
DRX cycle $> 320$	$\text{ceil}(10 \cdot P) \cdot T_{DRX}$
NOTE: $T_{SSB}$ is the periodicity of SSB configured for RLM. $T_{DRX}$ is the DRX cycle length	

For FR1,

- $P=1/(1 - T_{SSB}/MGRP)$ , when in the monitored cell there are measurement gaps configured for intra-frequency, inter-frequency or inter-RAT measurements, which are overlapping with some but not all occasions of the SSB; and
- $P=1$  when in the monitored cell there are no measurement gaps overlapping with any occasion of the SSB.

If the high layer in TS 38.331 [13] signaling of *smtc2* is present,  $T_{SMTcperiod}$  follows *smtc2*; otherwise  $T_{SMTcperiod}$  follows *smtc1*.

The normative reference for this requirement is TS 38.133 [6] clause 8.1.2.

4.5.1.0.2 Void

#### 4.5.1.0.3 Minimum conformance requirements for out-of-sync CSI-RS based RLM

[TS 38.133, clause 8.1.3.1]

The requirements apply for each CSI-RS based RLM-RS resource configured for PSCell, provided that the CSI-RS configured for RLM are actually transmitted within UE active DL BWP during the entire evaluation period specified in TS 38.133, clause 8.1.3.2. UE is not expected to perform radio link monitoring measurements on the CSI-RS configured as RLM-RS if the CSI-RS is not in the active TCI state of any CORESET configured in the UE active BWP.

[TS 38.133, clause 8.1.3.2]

UE shall be able to evaluate whether the downlink radio link quality on the configured RLM-RS resource estimated over the last  $T_{\text{Evaluate\_out\_CSI-RS}}$  [ms] period becomes worse than the threshold  $Q_{\text{out\_CSI-RS}}$  within  $T_{\text{Evaluate\_out\_CSI-RS}}$  [ms] evaluation period.

- $T_{\text{Evaluate\_out\_CSI-RS}}$  is defined in Table 4.5.1.0.3-1 for FR1.

For FR1,

- $P=1/(1 - T_{\text{CSI-RS}}/\text{MGRP})$ , when in the monitored cell there are measurement gaps configured for intra-frequency, inter-frequency or inter-RAT measurements, which are overlapping with some but not all occasions of the CSI-RS; and
- $P=1$  when in the monitored cell there are no measurement gaps overlapping with any occasion of the CSI-RS.

The value of  $M_{\text{out}}$  used in Table 4.5.1.0.3-1 is defined as:

- $M_{\text{out}} = 20$  if the CSI-RS resource configured for RLM is transmitted with higher layer CSI-RS parameter *density* set to 3 and over the bandwidth  $\geq 24$  PRBs.

**Table 4.5.1.0.3-1: Evaluation period  $T_{\text{Evaluate\_out\_CSI-RS}}$  for FR1**

Configuration	$T_{\text{Evaluate\_out\_CSI-RS}}$ (ms)
no DRX	$\max(200, \text{ceil}(M_{\text{out}} \times P) \times T_{\text{CSI-RS}})$
$\text{DRX} \leq 320\text{ms}$	$\max(200, \text{ceil}(1.5 \times M_{\text{out}} \times P) \times \max(T_{\text{DRX}}, T_{\text{CSI-RS}}))$
$\text{DRX} > 320\text{ms}$	$\text{ceil}(M_{\text{out}} \times P) \times T_{\text{DRX}}$
NOTE: $T_{\text{CSI-RS}}$ is the periodicity of CSI-RS resource configured for RLM. The requirements in this table apply for $T_{\text{CSI-RS}}$ equal to 5 ms, 10ms, 20 ms or 40 ms. $T_{\text{DRX}}$ is the DRX cycle length.	

[TS 38.133, clause 8.1.3.3]

The UE is required to be capable of measuring CSI-RS for RLM without measurement gaps. The UE is required to perform the CSI-RS measurements with measurement restrictions as described in the following clauses.

For FR1, when the CSI-RS for RLM is in the same OFDM symbol as SSB for RLM/BFD/CBD/L1-RSRP measurement, UE is not required to receive CSI-RS for RLM in the PRBs that overlap with an SSB.

For FR1, when the SSB for RLM/BFD/CBD/L1-RSRP measurement is within the active BWP and has same SCS than CSI-RS for RLM, the UE shall be able to perform CSI-RS measurement without restrictions.

For FR1, when the SSB for RLM/BFD/CBD/L1-RSRP measurement is within the active BWP and has different SCS than CSI-RS for RLM, the UE shall be able to perform CSI-RS measurement with restrictions according to its capabilities:

- If the UE supports *simultaneousRxDataSSB-DiffNumerology* the UE shall be able to perform CSI-RS measurement without restrictions.
- If the UE does not support *simultaneousRxDataSSB-DiffNumerology*, UE is required to measure one of but not both CSI-RS for RLM and SSB. Longer measurement period for CSI-RS based RLM is expected, and no requirements are defined.

For FR1, when the CSI-RS for RLM is in the same OFDM symbol as another CSI-RS for RLM/BFD/CBD/L1-RSRP measurement, UE shall be able to measure the CSI-RS for RLM without any restriction.

[TS 38.133, clauses 8.1.4 and 8.1.5]

When the UE transitions between DRX and no DRX or when DRX cycle periodicity changes, for each RLM-RS resource, for a duration of time equal to the evaluation period corresponding to the second mode after the transition occurs, the UE shall use an evaluation period that is no less than the minimum of evaluation period corresponding to the first mode and the second mode. Subsequent to this duration, the UE shall use an evaluation period corresponding to the second mode for each RLM-RS resource. This requirement shall be applied to both out-of-sync evaluation and in-sync evaluation of the monitored cell.

When the UE transitions from a first configuration of RLM-RS resources to a second configuration of RLM-RS resources that is different from the first configuration, for each RLM-RS resource present in the second configuration, for a duration of time equal to the evaluation period corresponding to the second configuration after the transition occurs, the UE shall use an evaluation period that is no less than the minimum of evaluation periods corresponding to the first configuration and the second configuration. Subsequent to this duration, the UE shall use an evaluation period corresponding to the second configuration for each RLM-RS resource present in the second configuration. This requirement shall be applied to both out-of-sync evaluation and in-sync evaluation of the monitored cell.

When the UE transitions from a first configuration of active TCI state of the CORESET to a second configuration of active TCI state of the CORESET, for each CSI-RS for RLM present in the second configuration, the UE shall use an evaluation period corresponding to the second configuration from the time of transition. This requirement shall be applied to both out-of-sync evaluation and in-sync evaluation of the monitored cell.

The transmitter power of the UE in the monitored cell shall be turned off within 40ms after expiry of T310 timer as specified in TS 38.331.

[TS 38.133, clause 8.1.6]

When the downlink radio link quality on all the configured RLM-RS resources is worse than  $Q_{out}$ , Layer 1 of the UE shall send an out-of-sync indication for the cell to the higher layers. A Layer 3 filter shall be applied to the out-of-sync indications as specified in TS 38.331.

The out-of-sync evaluations for the configured RLM-RS resources shall be performed as specified in clause 5 in TS 38.213. Two successive indications from Layer 1 shall be separated by at least  $T_{Indication\_interval}$ .

When DRX is not used  $T_{Indication\_interval}$  is  $\max(10\text{ms}, T_{RLM-RS,M})$ , where  $T_{RLM-RS,M}$  is the shortest periodicity of all configured RLM-RS resources for the monitored cell, which corresponds to  $T_{SSB}$  specified in clause 8.1.2 if the RLM-RS resource is SSB, or  $T_{CSI-RS}$  specified in clause 8.1.3 if the RLM-RS resource is CSI-RS.

In case DRX is used,  $T_{Indication\_interval}$  is  $\max(10\text{ms}, 1.5 \cdot \text{DRX\_cycle\_length}, 1.5 \cdot T_{RLM-RS,M})$  if DRX cycle\_length is less than or equal to 320ms, and  $T_{Indication\_interval}$  is DRX\_cycle\_length if DRX cycle\_length is greater than 320ms. Upon start of T310 timer as specified in TS 38.331 [2], the UE shall monitor the configured RLM-RS resources for recovery using the evaluation period and Layer 1 indication interval corresponding to the no DRX mode until the expiry or stop of T310 timer.

References: The conformance requirements covered in the current TC are specified in: TS 38.133 [6], clauses 8.1.3, 8.1.4, 8.1.5 and 8.1.6.

#### 4.5.1.0.4 Minimum conformance requirements for in-sync CSI-RS based RLM

[TS 38.133, clause 8.1.3.1]

The requirements apply for each CSI-RS based RLM-RS resource configured for PSCell, provided that the CSI-RS configured for RLM are actually transmitted within UE active DL BWP during the entire evaluation period specified in TS 38.133 clause 8.1.3.2. UE is not expected to perform radio link monitoring measurements on the CSI-RS configured as RLM-RS if the CSI-RS is not in the active TCI state of any CORESET configured in the UE active BWP.

[TS 38.133, clause 8.1.3.2]

UE shall be able to evaluate whether the downlink radio link quality on the configured RLM-RS resource estimated over the last  $T_{Evaluate\_in\_CSI-RS}$  [ms] period becomes better than the threshold  $Q_{in\_CSI-RS}$  within  $T_{Evaluate\_in\_CSI-RS}$  [ms] evaluation period.

- $T_{\text{Evaluate\_in\_CSI-RS}}$  is defined in Table 8.1.3.2-1 for FR1.

For FR1,

- $P=1/(1 - T_{\text{CSI-RS}}/M_{\text{GRP}})$ , when in the monitored cell there are measurement gaps configured for intra-frequency, inter-frequency or inter-RAT measurements, which are overlapping with some but not all occasions of the CSI-RS; and
- $P=1$  when in the monitored cell there are no measurement gaps overlapping with any occasion of the CSI-RS.

The value of  $M_{\text{in}}$  used in Table 8.1.3.2-1 is defined as:

- $M_{\text{in}} = 10$ , if the CSI-RS resource configured for RLM is transmitted with higher layer CSI-RS parameter *density* set to 3 and over the bandwidth  $\geq 24$  PRBs.

**Table 8.1.3.2-1: Evaluation period  $T_{\text{Evaluate\_in\_CSI-RS}}$  for FR1**

Configuration	$T_{\text{Evaluate\_in\_CSI-RS}}$ (ms)
no DRX	$\max(100, \text{ceil}(M_{\text{in}} \times P) \times T_{\text{CSI-RS}})$
$\text{DRX} \leq 320\text{ms}$	$\max(100, \text{ceil}(1.5 \times M_{\text{in}} \times P) \times \max(T_{\text{DRX}}, T_{\text{CSI-RS}}))$
$\text{DRX} > 320\text{ms}$	$\text{ceil}(M_{\text{in}} \times P) \times T_{\text{DRX}}$
NOTE: $T_{\text{CSI-RS}}$ is the periodicity of CSI-RS resource configured for RLM. The requirements in this table apply for $T_{\text{CSI-RS}}$ equal to 5 ms, 10ms, 20 ms or 40 ms. $T_{\text{DRX}}$ is the DRX cycle length.	

[TS 38.133, clause 8.1.3.3]

The UE is required to be capable of measuring CSI-RS for RLM without measurement gaps. The UE is required to perform the CSI-RS measurements with measurement restrictions as described in the following clauses.

For FR1, when the CSI-RS for RLM is in the same OFDM symbol as SSB for RLM/BFD/CBD/L1-RSRP measurement, UE is not required to receive CSI-RS for RLM in the PRBs that overlap with an SSB.

For FR1, when the SSB for RLM/BFD/CBD/L1-RSRP measurement is within the active BWP and has same SCS than CSI-RS for RLM, the UE shall be able to perform CSI-RS measurement without restrictions.

For FR1, when the SSB for RLM/BFD/CBD/L1-RSRP measurement is within the active BWP and has different SCS than CSI-RS for RLM, the UE shall be able to perform CSI-RS measurement with restrictions according to its capabilities:

- If the UE supports *simultaneousRxDataSSB-DiffNumerology* the UE shall be able to perform CSI-RS measurement without restrictions.
- If the UE does not support *simultaneousRxDataSSB-DiffNumerology*, UE is required to measure one of but not both CSI-RS for RLM and SSB. Longer measurement period for CSI-RS based RLM is expected, and no requirements are defined.

For FR1, when the CSI-RS for RLM is in the same OFDM symbol as another CSI-RS for RLM/BFD/CBD/L1-RSRP measurement, UE shall be able to measure the CSI-RS for RLM without any restriction.

[TS 38.133, clauses 8.1.4 and 8.1.5]

When the UE transitions between DRX and no DRX or when DRX cycle periodicity changes, for each RLM-RS resource, for a duration of time equal to the evaluation period corresponding to the second mode after the transition occurs, the UE shall use an evaluation period that is no less than the minimum of evaluation period corresponding to the first mode and the second mode. Subsequent to this duration, the UE shall use an evaluation period corresponding to the second mode for each RLM-RS resource. This requirement shall be applied to both out-of-sync evaluation and in-sync evaluation of the monitored cell.

When the UE transitions from a first configuration of RLM-RS resources to a second configuration of RLM-RS resources that is different from the first configuration, for each RLM-RS resource present in the second configuration, for a duration of time equal to the evaluation period corresponding to the second configuration after the transition occurs, the UE shall use an evaluation period that is no less than the minimum of evaluation periods corresponding to the first configuration and the second configuration. Subsequent to this duration, the UE shall use an evaluation period

corresponding to the second configuration for each RLM-RS resource present in the second configuration. This requirement shall be applied to both out-of-sync evaluation and in-sync evaluation of the monitored cell.

When the UE transitions from a first configuration of active TCI state of the CORESET to a second configuration of active TCI state of the CORESET, for each CSI-RS for RLM present in the second configuration, the UE shall use an evaluation period corresponding to the second configuration from the time of transition. This requirement shall be applied to both out-of-sync evaluation and in-sync evaluation of the monitored cell.

The transmitter power of the UE in the monitored cell shall be turned off within 40ms after expiry of T310 timer as specified in TS 38.331 [2].

[TS 38.133, clause 8.1.6]

When the downlink radio link quality on at least one of the configured RLM-RS resources is better than  $Q_{in}$ , Layer 1 of the UE shall send an in-sync indication for the cell to the higher layers. A Layer 3 filter shall be applied to the in-sync indications as specified in TS 38.331 [2].

The in-sync evaluations for the configured RLM-RS resources shall be performed as specified in clause 5 in TS 38.213 [3]. Two successive indications from Layer 1 shall be separated by at least  $T_{\text{Indication\_interval}}$ .

When DRX is not used  $T_{\text{Indication\_interval}}$  is  $\max(10\text{ms}, T_{\text{RLM-RS,M}})$ , where  $T_{\text{RLM-RS,M}}$  is the shortest periodicity of all configured RLM-RS resources for the monitored cell, which corresponds to  $T_{\text{SSB}}$  specified in clause 8.1.2 if the RLM-RS resource is SSB, or  $T_{\text{CSI-RS}}$  specified in clause 8.1.3 if the RLM-RS resource is CSI-RS.

In case DRX is used,  $T_{\text{Indication\_interval}}$  is  $\max(10\text{ms}, 1.5 \cdot \text{DRX\_cycle\_length}, 1.5 \cdot T_{\text{RLM-RS,M}})$  if DRX cycle\_length is less than or equal to 320ms, and  $T_{\text{Indication\_interval}}$  is DRX\_cycle\_length if DRX cycle\_length is greater than 320ms. Upon start of T310 timer as specified in TS 38.331 [2], the UE shall monitor the configured RLM-RS resources for recovery using the evaluation period and Layer 1 indication interval corresponding to the no DRX mode until the expiry or stop of T310 timer.

References: The conformance requirements covered in the current TC are specified in: TS 38.133 [6], clauses 8.1.3, 8.1.4, 8.1.5 and 8.1.6.

#### 4.5.1.1 EN-DC FR1 radio link monitoring out-of-sync test for PSCell configured with SSB-based RLM RS in non-DRX mode

##### 4.5.1.1.1 Test purpose

The purpose of this test is to verify that the UE properly detects the out of sync for the purpose of monitoring downlink radio link quality of the PSCell configured with SSB-based RLM RS in non-DRX mode. This test will partly verify the FR1 PSCell radio link monitoring requirements in TS 38.133 [6], clause 8.1.2.

##### 4.5.1.1.2 Test applicability

This test applies to all types of E-UTRA UE release 15 and forward, supporting EN-DC.

##### 4.5.1.1.3 Minimum conformance requirement

The minimum requirements are specified in clause 4.5.1.0.1. DRX configuration is not used for this test.

The normative reference for this requirement is TS 38.133 [6] clause A.4.5.1.1.

##### 4.5.1.1.4 Test description

There are two cells, Cell 1 is the E-UTRAN PCell, and Cell 2 is the PSCell, in the test. The E-UTRAN PCell setting refers to Table A.3.7.2.1-1 as defined in TS 38.133 [6]. The test consists of three successive time periods, with time duration of T1, T2 and T3 respectively. Figure 4.5.1.1.4-1 shows the variation of the downlink SNR in the active Cell 2 to emulate out-of-sync and in-sync states. Prior to the start of the time duration T1, the UE shall be fully synchronized to Cell 1 and Cell 2. The UE shall be configured for periodic CSI reporting with a reporting periodicity of 5 ms. The UE is configured to perform inter-frequency measurements using Gap Pattern ID #0 (40ms) in test 1.

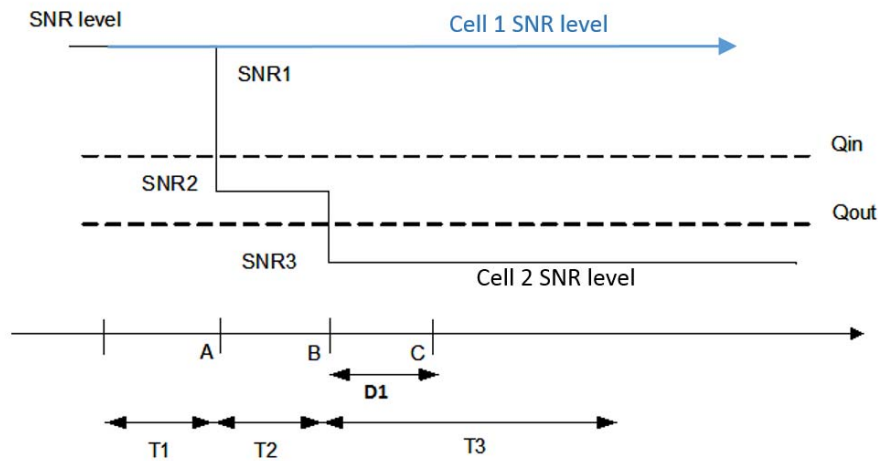

Figure 4.5.1.1.4-1: SNR variation for out-of-sync testing

4.5.1.1.4.1 Initial conditions

This test shall be tested using any of the test configurations in Table 4.5.1.1.4.1-1.

Table 4.5.1.1.4.1-1: EN-DC FR1 radio link monitoring out-of-sync test for PSCell configured with SSB-based RLM RS in non-DRX mode supported test configurations

Test Case ID	Description
4.5.1.1-1	LTE FDD, NR 15 KHz SSB SCS, 10MHz bandwidth, FDD duplex mode
4.5.1.1-2	LTE FDD, NR 15 KHz SSB SCS, 10MHz bandwidth, TDD duplex mode
4.5.1.1-3	LTE FDD, NR 30 KHz SSB SCS, 40MHz bandwidth, TDD duplex mode
4.5.1.1-4	LTE TDD, NR 15 KHz SSB SCS, 10MHz bandwidth, FDD duplex mode
4.5.1.1-5	LTE TDD, NR 15 KHz SSB SCS, 10MHz bandwidth, TDD duplex mode
4.5.1.1-6	LTE TDD, NR 30 KHz SSB SCS, 40MHz bandwidth, TDD duplex mode

NOTE: The UE is only required to pass in one of the supported test configurations in FR1.

Configure the test equipment and the DUT according to the parameters in Table 4.5.1.1.4.1-2.

Table 4.5.1.1.4.1-2: Initial conditions for EN-DC FR1 radio link monitoring out-of-sync test for PSCell configured with SSB-based RLM RS in non-DRX mode

Parameter	Value	Comment
Test environment	NC	As specified in TS 38.508-1 [14] clause 4.1.
Test frequencies	As specified in Annex E.1.1, Table E.2-1 and TS 38.508-1 [14] clause 4.3.1.	
Channel bandwidth	As specified by the test configuration selected from Table 4.5.1.1.4.1-1	
Propagation conditions	AWGN	As specified in clause C.2.2.
Connection Diagram	TE Part	A.3.1.7.1
	DUT Part	A.3.2.3.4
Exceptions to connection diagram	For 4Rx capable UEs without any 2 Rx RF bands use A.3.2.5.2 for DUT part and A.3.1.7.4 for TE Part	

Table 4.5.1.1.4.1-3: Void

1. Message contents are defined in clause 4.5.1.1.4.3.
2. The power levels and settings for Cell 1 are set according to Annex A.6, Table A.6.1.1-1. Cell 2 is NR FR1 PSCell. The connection setup is done according to the settings in clause C.1.3, and the downlink signal levels as per clause C.1.2.

3. The test parameters are given in Table 4.5.1.1.4.1-4 below.
4. Downlink signals for NR cell are initially set up according to clauses C.1.2 and C.1.3.

**Table 4.5.1.1.4.1-4: General test parameters for FR1 out-of-sync testing in non-DRX mode**

Parameter		Unit	Value
			Test 1
Active E-UTRA PCell			Cell 1
E-UTRA RF Channel Number			1
Active PSCell			Cell 2
RF Channel Number			2
Duplex mode	Config 1, 4		FDD
	Config 2, 3, 5, 6		TDD
BW <sub>channel</sub>	Config 1, 4	MHz	10: N <sub>RB,c</sub> = 52
	Config 2, 5		10: N <sub>RB,c</sub> = 52
	Config 3, 6		40: N <sub>RB,c</sub> = 106
DL initial BWP configuration	Config 1, 2, 3, 4, 5, 6		DLBWP.0.1
DL dedicated BWP configuration	Config 1, 2, 3, 4, 5, 6		DLBWP.1.1
UL initial BWP configuration	Config 1, 2, 3, 4, 5, 6		ULBWP.0.1
UL dedicated BWP configuration	Config 1, 2, 3, 4, 5, 6		ULBWP.1.1
TDD Configuration	Config 1, 4		Not Applicable
	Config 2, 5		TDDConf.1.1
	Config 3, 6		TDDConf.2.1
RMSI CORESET Reference Channel	Config 1, 4		CR.1.1 FDD
	Config 2, 5		CR.1.1 TDD
	Config 3, 6		CR.2.1 TDD
Dedicated CORESET Reference Channel	Config 1, 4		CCR.1.3 FDD
	Config 2, 5		CCR.1.3 TDD
	Config 3, 6		CCR.2.2 TDD
SSB Configuration	Config 1, 4		SSB.1 FR1
	Config 2, 5		SSB.1 FR1
	Config 3, 6		SSB.2 FR1
SMTC Configuration	Config 1, 2, 4, 5		SMTC.1
	Config 3, 6		SMTC.1
PDSCH/PDCCH subcarrier spacing	Config 1, 2, 4, 5		15 KHz
	Config 3, 6		30 KHz
PRACH Configuration	Config 1, 2, 4, 5		Table A.7.1-1, PRACH.1 FR1
	Config 3, 6		Table A.7.1-1, PRACH.1 FR1
SSB index assigned as RLM RS			0
OCNG parameters			OP.1
CP length			Normal
Correlation Matrix and Antenna Configuration			2x2 Low
Out of sync transmission parameters	DCI format		1-0
	Number of Control OFDM symbols		2
	Aggregation level	CCE	8
	Ratio of hypothetical PDCCH RE energy to average SSS RE energy	dB	4
	Ratio of hypothetical PDCCH DMRS energy to average SSS RE energy	dB	4
	DMRS precoder granularity		REG bundle size
	REG bundle size		6
DRX			OFF
Gap pattern ID			gp0
Layer 3 filtering			Enabled
T310 timer		ms	0
T311 timer		ms	1000
N310			1
N311			1
CSI-RS configuration	Config 1, 4		CSI-RS.1.1 FDD
	Config 2, 5		CSI-RS.1.1 TDD
	Config 3, 6		CSI-RS.2.1 TDD
CSI-RS for tracking	Config 1, 4		TRS.1.1 FDD
	Config 2, 5		TRS.1.1 TDD

Parameter	Unit	Value
		Test 1
Config 3, 6		TRS.1.2 TDD
T1	s	0.2
T2	s	0.48
T3	s	0.48
D1	s	0.44
NOTE 1: All configurations are assigned to the UE prior to the start of time period T1.		
NOTE 2: UE-specific PDCCH is not transmitted after T1 starts.		
NOTE 3: E-UTRAN is in non-DRX mode under test.		

#### 4.5.1.1.4.2 Test Procedure

The test consists of two cells, a single E-UTRA cell (Pcell), and a single NR cell (PSCell). Prior to the start of the time duration T1, the UE shall be fully synchronized to PSCell. The UE shall be configured for periodic CSI reporting in PUCCH format 2 with a reporting periodicity as mentioned in the above table 4.5.1.1.4.1-4.

1. Ensure the UE is in state `RRC_CONNECTED` with generic procedure parameters *Connectivity* EN-DC, DC bearer MCG and SCG, Connected without release *On* and Test Mode *On* according to TS 38.508-1 [6] clause 4.5.
2. The SS shall transmit an *RRCConnectionReconfiguration* message configuring the UE for inter-frequency measurements.
3. The UE shall transmit *RRCReconfigurationComplete* message.
4. Set the parameters according to T1 in Table 4.5.1.1.5-1 for subtest 1 and 2. Propagation conditions are set according to clause C.2.3. T1 starts.
5. When T1 expires the SS shall change the SNR value to T2 as specified in Table 4.5.1.1.5-1 for subtests 1 and 2. T2 starts.
6. When T2 expires the SS shall change the SNR value to T3 as specified in Table 4.5.1.1.5-1 for subtests 1 and 2. T3 starts.
7. If the SS:
  - a) detects uplink power equal to or higher than minimum output power defined in TS 38.521-1 [17] clause 6.3.1.5 in each subframe configured for CSI transmission (according to configured CSI periodicity on PUCCH format 2) during the period from time point A to time point B; and
  - b) does not detect any uplink power higher than OFF power defined in TS 38.521-1 [17] clause 6.3.2.5 from time point C (D1 after the start of T3) until T3 expires, the number of successful tests is increased by one.
8. Otherwise the number of failed tests is increased by one and proceed to Step 12.
9. When T3 expires the SS shall change the SNR value to T1 as specified in Table 4.5.1.1.5-1.
10. If the UE has not re-established the connection in at least 1s, the SS shall ensure PSCell is released.
11. The SS then shall transmit *RRCConnectionReconfiguration* message with condition MCG\_and\_SCG according to TS 36.508 [25] Table 4.6.1-8 to add NR cell (PSCell). The UE shall transmit *RRCConnectionReconfigurationComplete* message.
12. If the Reconfiguration fails, switch off and on the UE and ensure the UE is in `RRC_CONNECTED` with generic procedure parameters *Connectivity* EN-DC, DC bearer MCG and SCG, Connected without release *On* according to TS 38.508-1 [14] clause 4.5.
13. Repeat steps 4-12 until the confidence level according to Tables G.2.3-1 in Annex G clause G.2 is achieved.



4.5.1.1.4.3 Message Contents

Message contents are according to TS 38.508-1 [14] clause 4.6.1 and 7.3.1 with condition "Short\_DCI" and with the following exceptions.

**Table 4.5.1.1.4.3-1: Common Exception messages for EN-DC FR1 radio link monitoring out-of-sync test for PSCell configured with SSB-based RLM RS in non-DRX mode test requirement**

Default Message Contents	
Common contents of system information blocks exceptions	
Default RRC messages and information elements contents exceptions	Table H.3.1-1 Table H.3.1-2 with Condition INTER-FREQ, L3 FILTERING NEEDED Table H.3.1-3 with Condition INTER-FREQ MO (where ssbFrequency is set to the ARFCN value of carrier center of High range) Table H.3.1-4 with A3-offset = 0 Table H.3.4-1 Table H.3.4-1a Table H.3.4-4 with condition gapUE Table H.3.4-5 with condition BFD Table H.3.5-4 Table H.3.5-9 with Condition SSB RLM

**Table 4.5.1.1.4.3-2: Void**

**Table 4.5.1.1.4.3-3: RLF-TimersAndConstant**

Derivation Path: TS 38.508-1 [14], Table 4.6.3-150			
Information Element	Value/remark	Comment	Condition
RLF-TimersAndConstants ::= SEQUENCE {			
t310	ms0		
n310	n1		
n311	n1		
t311-v1530	ms1000		
}			

4.5.1.1.5 Test Requirement

Table 4.5.1.1.5-1 defines the cell specific primary level settings.

The UE behavior in each test during time durations T1, T2 and T3 shall be as follows.

During the period from time point A to time point B the UE shall transmit uplink signal at least in all uplink slots configured for CSI transmission according to the configured periodic CSI reporting.

The UE shall stop transmitting uplink signal no later than time point C (D1 second after the start of the time duration T3).

The rate of correct events observed during repeated tests shall be at least 90 %.

**Table 4.5.1.1.5-1: Cell specific test parameters for FR1 (Cell 2) for out-of-sync radio link monitoring tests in non-DRX mode**

Parameter	Unit	Test 1		
		T1	T2	T3

EPRE ratio of PDCCH DMRS to SSS		dB	4		
EPRE ratio of PDCCH to PDCCH DMRS		dB	0		
EPRE ratio of PBCH DMRS to SSS		dB	0		
EPRE ratio of PBCH to PBCH DMRS		dB			
EPRE ratio of PSS to SSS		dB			
EPRE ratio of PDSCH DMRS to SSS		dB			
EPRE ratio of PDSCH to PDSCH DMRS		dB			
EPRE ratio of OCNB DMRS to SSS		dB			
EPRE ratio of OCNB to OCNB DMRS		dB			
SNR on RLM-RS	Config 1, 4	dB	1.8	-6.2	-15.8
	Config 2, 5		1.8	-6.2	-15.8
	Config 3, 6		1.8	-6.2	-15.8
$N_{oc}$	Config 1, 4	dBm/15 KHz	-98		
	Config 2, 5		-98		
	Config 3, 6		-98		
Propagation condition			TDL-C 300ns 100Hz		
NOTE 1: OCNB shall be used such that the resources in Cell 2 are fully allocated and a constant total transmitted power spectral density is achieved for all OFDM symbols.					
NOTE 2: The signal contains PDCCH for UEs other than the device under test as part of OCNB.					
NOTE 3: SNR levels correspond to the signal to noise ratio over the SSS REs.					
NOTE 4: The SNR values are specified for a UE with 2RX antennas connected under test. For a UE with 4RX antennas connected under test, the SNR during T3 from D.4.1.1 is -18 -TT, which is -18.9dB (including test tolerances)					

**Table 4.5.1.1.5-2: Measurement gap configuration for out-of-sync tests in non-DRX mode**

Field	Test 1
	Value
gapOffset	0
NOTE: E-UTRAN PCell and PSCell are SFN-synchronous and frame boundary aligned. (Ensure that RLM RS is partially overlapped with measurement gap).	

For the test to pass, the total number of successful tests shall be more than 90% of the cases with a confidence level of 95 %.

#### 4.5.1.2 EN-DC FR1 radio link monitoring in-sync test for PSCell configured with SSB-based RLM RS in non-DRX mode

##### 4.5.1.2.1 Test purpose

The purpose of this test is to verify that the UE properly detects in sync, for the purpose of monitoring downlink radio link quality of the PSCell, when DRX is not used. This test will partly verify the FR1 PSCell radio link monitoring requirements in clause 8.1.2.

##### 4.5.1.2.2 Test applicability

This test applies to all types of E-UTRA UEs Release 15 and forward supporting EN-DC.

##### 4.5.1.2.3 Minimum conformance requirements

The minimum requirements are specified in clause 4.5.1.0.2. DRX configuration is not used for this test.

The normative reference for this requirement is TS 38.133 [6] clause A.4.5.1.2.

##### 4.5.1.2.4 Test description

There are two cells, Cell 1 is the E-UTRAN PCell, and Cell 2 is the PSCell, in the test. The E-UTRAN PCell setting refers to Table A.3.7.2.1-1. The test consists of five successive time periods, with time duration of T1, T2, T3, T4 and T5 respectively. Figure 4.5.1.2.4-1 shows the variation of the downlink SNR in the active Cell 2 to emulate out-of-sync and in-sync states. Prior to the start of the time duration T1, the UE shall be fully synchronized to Cell 1 and Cell 2. The UE shall be configured for periodic CSI reporting with a reporting periodicity of 5 ms. In the test, DRX configuration is

enabled and DRX inactivity timer has already been expired, i.e. UE tries to decode PDCCH and to send periodic CSI during the period when On-duration timer is running. Time alignment timers shall be set to "infinity" so that UL timing alignment is maintained during the test.

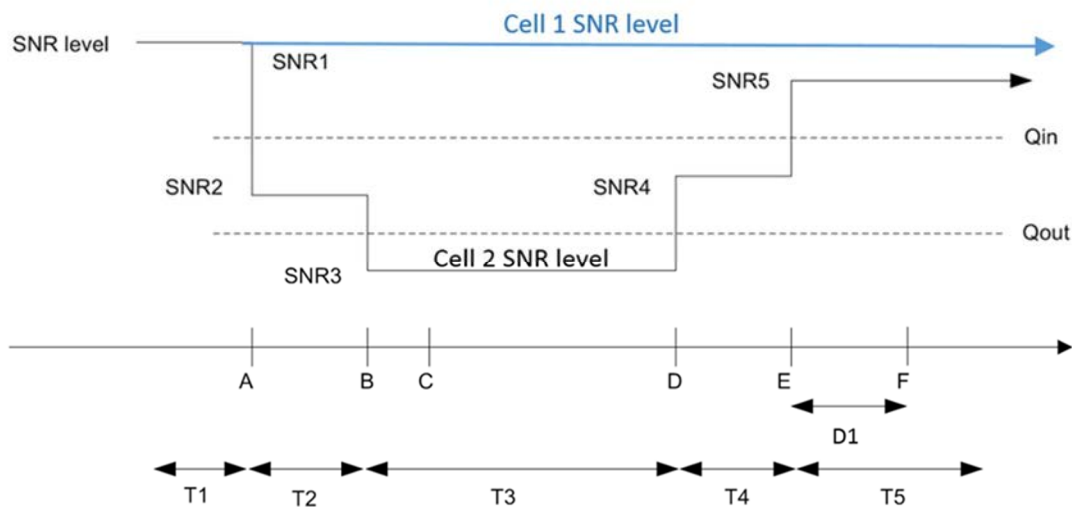

Figure 4.5.1.2.4-1: SNR variation for in-sync testing

4.5.1.2.4.1 Initial conditions

This test shall be tested using any of the test configurations in Table 4.5.1.2.4.1-1.

Table 4.5.1.2.4.1-1: Supported test configurations for FR1 PSCell

Configuration	Description
4.5.1.2-1	LTE FDD, NR 15 KHz SSB SCS, 10MHz bandwidth, FDD duplex mode
4.5.1.2-2	LTE FDD, NR 15 KHz SSB SCS, 10MHz bandwidth, TDD duplex mode
4.5.1.2-3	LTE FDD, NR 30 KHz SSB SCS, 40MHz bandwidth, TDD duplex mode
4.5.1.2-4	LTE TDD, NR 15 KHz SSB SCS, 10MHz bandwidth, FDD duplex mode
4.5.1.2-5	LTE TDD, NR 15 KHz SSB SCS, 10MHz bandwidth, TDD duplex mode
4.5.1.2-6	LTE TDD, NR 30 KHz SSB SCS, 40MHz bandwidth, TDD duplex mode

NOTE: The UE is only required to pass in one of the supported test configurations in FR1.

Configure the test equipment and the DUT according to the parameters in Table 4.5.1.2.4.1-2.

Table 4.5.1.2.4.1-2: Initial conditions for EN-DC FR1 radio link monitoring in-sync test for PSCell configured with SSB-based RLM RS in non-DRX mode

Parameter	Value	Comment
Test environment	NC	As specified in TS 38.508-1 [14] clause 4.1.
Test frequencies	As specified in Annex E.1.1, Table E.2-1 and TS 38.508-1 [14] clause 4.3.1.	
Channel bandwidth	As specified by the test configuration selected from Table 4.5.1.2.5-1	
Propagation conditions	AWGN	As specified in clause C.2.2.
Connection Diagram	TE Part	A.3.1.7.1
	DUT Part	A.3.2.3.4
Exceptions to connection diagram	For 4Rx capable UEs without any 2 Rx RF bands use A.3.2.5.2 for DUT part and A.3.1.7.4 for TE Part	

Table 4.5.1.2.4.1-3: Void

1. Message contents are defined in clause 4.5.1.2.4.3.
2. The power levels and settings for Cell 1 are set according to Annex A.6, Table A.6.1.1-1. Cell 2 is NR FR1 PSCell. The connection setup is done according to the settings in clause C.1.3, and the downlink signal levels as per clause C.1.2
3. The general test parameters are given in Table 4.5.1.2.4.1-4.
4. Downlink signals for NR cell are initially set up according to clause C.1.

**Table 4.5.1.2.4.1-4: General test parameters for FR1 in-sync testing in non-DRX mode**

Parameter		Unit	Value
			Test 1
Active E-UTRA PCell			Cell 1
E-UTRA RF Channel Number			1
Active PSCell			Cell 2
RF Channel Number			2
Duplex mode	Config 1, 4		FDD
	Config 2, 3, 5, 6		TDD
BW <sub>channel</sub>	Config 1, 4	MHz	10: N <sub>RB,c</sub> = 52
	Config 2, 5		10: N <sub>RB,c</sub> = 52
	Config 3, 6		40: N <sub>RB,c</sub> = 106
DL initial BWP configuration	Config 1, 2, 3, 4, 5, 6		DLBWP.0.1
DL dedicated BWP configuration	Config 1, 2, 3, 4, 5, 6		DLBWP.1.1
UL initial BWP configuration	Config 1, 2, 3, 4, 5, 6		ULBWP.0.1
UL dedicated BWP configuration	Config 1, 2, 3, 4, 5, 6		ULBWP.1.1
TDD Configuration	Config 1, 4		Not Applicable
	Config 2, 5		TDDConf.1.1
	Config 3, 6		TDDConf.2.1
RMSI CORESET Reference Channel	Config 1, 4		CR.1.1 FDD
	Config 2, 5		CR.1.1 TDD
	Config 3, 6		CR.2.1 TDD
Dedicated CORESET Reference Channel	Config 1, 4		CCR.1.1 FDD
	Config 2, 5		CCR.1.1 TDD
	Config 3, 6		CCR.2.1 TDD
SSB Configuration	Config 1, 4		SSB.1 FR1
	Config 2, 5		SSB.1 FR1
	Config 3, 6		SSB.2 FR1
SMTC Configuration	Config 1, 2, 4, 5		SMTC.1
	Config 3, 6		SMTC.1
PDSCH/PDCCH subcarrier spacing	Config 1, 2, 4, 5		15 KHz
	Config 3, 6		30 KHz
PRACH Configuration	Config 1, 2, 4, 5		Table A.7.1-1, PRACH.1 FR1
	Config 3, 6		Table A.7.1-1, PRACH.1 FR1
SSB index assigned as RLM RS			0
OCNG parameters			OP.1
CP length			Normal
Correlation Matrix and Antenna Configuration			2x2 Low
In sync transmission parameters	DCI format		1-0
	Number of Control OFDM symbols		2
	Aggregation level	CCE	4
	Ratio of hypothetical PDCCH RE energy to average SSS RE energy	dB	0

Parameter	Unit	Value	
		Test 1	
Ratio of hypothetical PDCCH DMRS energy to average SSS RE energy	dB	0	
DMRS precoder granularity		REG bundle size	
REG bundle size		6	
Out of sync transmission parameters	DCI format	1-0	
	Number of Control OFDM symbols	2	
	Aggregation level	CCE	8
	Ratio of hypothetical PDCCH RE energy to average SSS RE energy	dB	4
	Ratio of hypothetical PDCCH DMRS energy to average SSS RE energy	dB	4
	DMRS precoder granularity		REG bundle size
	REG bundle size		6
	DRX		OFF
Gap pattern ID		N.A.	
Layer 3 filtering		Enabled	
T310 timer	ms	1000	
T311 timer	ms	1000	
N310		1	
N311		1	
CSI-RS for CSI reporting	Config 1, 4	CSI-RS.1.1 FDD	
	Config 2, 5	CSI-RS.1.1 TDD	
	Config 3, 6	CSI-RS.2.1 TDD	
CSI-RS for tracking	Config 1, 4	TRS.1.1 FDD	
	Config 2, 5	TRS.1.1 TDD	
	Config 3, 6	TRS.1.2 TDD	
T1	s	0.2	
T2	s	0.2	
T3	s	0.24	
T4	s	0.2	
T5	s	0.88	
D1	s	0.84	
NOTE 1: All configurations are assigned to the UE prior to the start of time period T1.			
NOTE 2: UE-specific PDCCH is not transmitted after T1 starts.			
NOTE 3: E-UTRAN is in non-DRX mode under test.			

#### 4.5.1.2.4.2 Test procedure

The test consists of two cells, a single E-UTRA cell (Pcell), and a single NR cell (PSCell). Prior to the start of the time duration T1, the UE shall be fully synchronized to PSCell. The UE shall be configured for periodic CSI reporting in PUCCH format 2 with a reporting periodicity as mentioned in the above table 4.5.1.2.4.1-4.

1. Ensure the UE is in state RRC\_CONNECTED with generic procedure parameters *Connectivity* EN-DC, DC bearer MCG and SCG, Connected without release *On* and Test Mode *On* according to TS 38.508-1 [6] clause 4.5.
2. Set the parameters according to T1 in Table 4.5.1.2.5-1 for subtest 1 and 2. Propagation conditions are set according to clause C.2.3. T1 starts.
3. When T1 expires, the SS shall change the SNR value to T2 as specified in Table 4.5.1.2.5-1. T2 starts.
4. When T2 expires, the SS shall change the SNR value to T3 as specified in Table 4.5.1.2.5-1. T3 starts.
5. When T3 expires, the SS shall change the SNR value to T4 as specified in Table 4.5.1.2.5-1. T4 starts.
6. When T4 expires, the SS shall change the SNR value to T5 as specified in Table 4.5.1.2.5-1. T5 starts.

7. If the SS detects uplink power equal to or higher than the minimum output power defined in TS 38.521-1 [17] clause 6.3.1.5 in the subframe according the configured CSI reporting during the period from time point A to time point F (D1 after the start of time duration T5) the number of successful tests is increased by one.

Otherwise the number of failed tests is increased by one.

8. If the iteration fails, the SS shall first attempt to release and add the PSCell, by ensuring the UE is in state RRC\_CONNECTED with generic procedure parameters *Connectivity* EN-DC, DC bearer MCG and SCG, Connected without release *On* and Test Mode *On* according to TS 38.508-1 [6] clause 4.5. If that also fails, then the UE is switched OFF/ON to proceed with the next iteration.

9. Repeat steps 2-7 for all subtests until the confidence level according to Tables G.2.3-1 in Annex G clause G.2 is achieved.

4.5.1.2.4.3 Message Contents

Message contents are according to TS 38.508-1 [14] clause 4.6.1 and clause 7.3.1 with condition "Short\_DCI" with the following exceptions.

**Table 4.5.1.2.4.3-1: Common Exception messages for EN-DC FR1 radio link monitoring out-of-sync test for PSCell configured with SSB-based RLM RS in non-DRX mode test requirement**

Default Message Contents	
Common contents of system information blocks exceptions	
Default RRC messages and information elements contents exceptions	Table H.3.4-1 Table H.3.5-4 Table H.3.5-9 with Condition SSB RLM

**Table 4.5.1.2.4.3-2: Void**

**Table 4.5.1.2.4.3-3: RLF-TimersAndConstant**

Derivation Path: TS 38.508-1 [14], Table 4.6.3-150			
Information Element	Value/remark	Comment	Condition
RLF-TimersAndConstants ::= SEQUENCE {			
t310	ms1000		
n310	n1		
n311	n1		
t311-v1530	ms1000		
}			

4.5.1.2.5 Test Requirement

The requirements in this section apply for each SSB based RLM-RS resource configured for PCell or PSCell, provided that the SSB configured for RLM are actually transmitted within UE active DL BWP during the entire evaluation period specified in clause 4.5.1.2.3.

Table 4.5.1.2.5-1 defines the cell specific primary level settings.

The UE behaviour in each test during time durations T1, T2, T3, T4 and T5 shall be as follows.

During the period from time point A to time point F (D1 second after the start of time duration T5) the UE shall transmit uplink signal at least in all uplink slots configured for CSI transmission according to the configured periodic CSI reporting.

The rate of correct events observed during repeated tests shall be at least 90% with a confidence interval of 95 %.

**Table 4.5.1.2.5-1: Cell specific test parameters for FR1 (Cell 2) for in-sync radio link monitoring tests in non-DRX mode**

Parameter		Unit	Test 1				
			T1	T2	T3	T4	T5
EPRE ratio of PDCCH DMRS to SSS		dB	0				
EPRE ratio of PDCCH to PDCCH DMRS		dB	0				
EPRE ratio of PBCH DMRS to SSS		dB	0				
EPRE ratio of PBCH to PBCH DMRS		dB					
EPRE ratio of PSS to SSS		dB					
EPRE ratio of PDSCH DMRS to SSS		dB					
EPRE ratio of PDSCH to PDSCH DMRS		dB					
EPRE ratio of OCNG DMRS to SSS		dB					
EPRE ratio of OCNG to OCNG DMRS		dB					
SNR on RLM-RS	Config 1, 4	dB					
	Config 2, 5		1.8	-6.2	-15.8	-5.3	1.8
	Config 3, 6		1.8	-6.2	-15.8	-5.3	1.8
$N_{oc}$	Config 1, 4	dBm/1	-98				
	Config 2, 5	5 KHz	-98				
	Config 3, 6		-98				
Propagation condition			TDL-C 300ns 100Hz				
NOTE 1: OCNG shall be used such that the resources in Cell 2 are fully allocated and a constant total transmitted power spectral density is achieved for all OFDM symbols.							
NOTE 2: The signal contains PDCCH for UEs other than the device under test as part of OCNG.							
NOTE 3: SNR levels correspond to the signal to noise ratio over the SSS REs.							
NOTE 4: The SNR in time periods T1, T2, T3, T4 and T5 is denoted as SNR1, SNR2, SNR3, SNR4 and SNR5 respectively in Figure 4.5.1.2.4-1.							
NOTE 5: The SNR values are specified for a UE with 2RX antennas connected under test. For a UE with 4RX antennas connected under test, the SNR during T3 and T4 from D.4.1.1 are -18.0-TT and -8.0-TT, which are -18.8 dB and -8.8 dB(including test tolerances).							

### 4.5.1.3 EN-DC FR1 radio link monitoring out-of-sync test for PSCell configured with SSB-based RLM RS in DRX mode

#### 4.5.1.3.1 Test purpose

The purpose of this test is to verify that the UE properly detects the out of sync for the purpose of monitoring downlink radio link quality of the PSCell configured with SSB-based RLM RS when DRX is used. This test will partly verify the NR cell radio link monitoring requirements in TS 38.133 [6] clause 8.1.

#### 4.5.1.3.2 Test applicability

This test applies to all types of E-UTRA UE release 15 and forward, supporting EN-DC FR1 and long DRX cycle.

#### 4.5.1.3.3 Minimum conformance requirement

The minimum requirements are specified in clause 4.5.1.0.1. DRX configuration is used for this test.

The normative reference for this requirement is TS 38.133 [6] clause A.4.5.1.3.

#### 4.5.1.3.4 Test description

There are two cells, Cell 1 is the E-UTRAN PCell, and Cell 2 is the PSCell, in the test. The E-UTRAN PCell setting refers to Table A.3.7.2.1-1 as defined in TS 38.133 [6]. The test consists of three successive time periods, with time duration of T1, T2 and T3 respectively. Figure 4.5.1.3.4-1 shows the variation of the downlink SNR in the active Cell 2 to emulate out-of-sync and in-sync states. Prior to the start of the time duration T1, the UE shall be fully synchronized to Cell 1 and Cell 2. The UE shall be configured for periodic CSI reporting with a reporting periodicity of 5 ms. In the test, DRX configuration is enabled and DRX inactivity timer has already been expired, i.e. UE tries to decode PDCCH and to send periodic CSI during the period when On-duration timer is running. Time alignment timers shall be set to "infinity" so that UL timing alignment is maintained during the test.

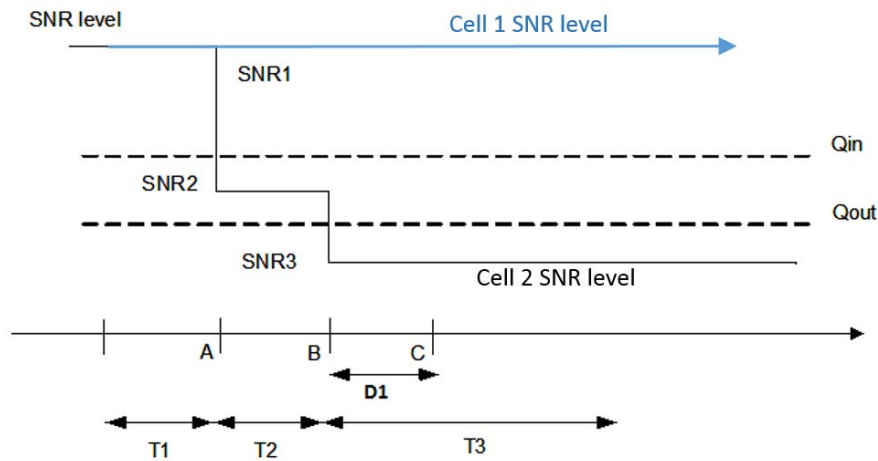

Figure 4.5.1.3.4-1: SNR variation for out-of-sync testing

4.5.1.3.4.1 Initial conditions

This test shall be tested using any of the test configurations in Table 4.5.1.3.4.1-1.

Table 4.5.1.3.4.1-1: EN-DC FR1 radio link monitoring out-of-sync test for PSCell configured with SSB-based RLM RS in DRX mode supported test configurations

Test Case ID	Description
4.5.1.3-1	LTE FDD, NR 15 KHz SSB SCS, 10MHz bandwidth, FDD duplex mode
4.5.1.3-2	LTE FDD, NR 15 KHz SSB SCS, 10MHz bandwidth, TDD duplex mode
4.5.1.3-3	LTE FDD, NR 30 KHz SSB SCS, 40MHz bandwidth, TDD duplex mode
4.5.1.3-4	LTE TDD, NR 15 KHz SSB SCS, 10MHz bandwidth, FDD duplex mode
4.5.1.3-5	LTE TDD, NR 15 KHz SSB SCS, 10MHz bandwidth, TDD duplex mode
4.5.1.3-6	LTE TDD, NR 30 KHz SSB SCS, 40MHz bandwidth, TDD duplex mode

NOTE: The UE is only required to pass in one of the supported test configurations in FR1.

Configure the test equipment and the DUT according to the parameters in Table 4.5.1.3.4.1-2.

Table 4.5.1.3.4.1-2: Initial conditions for EN-DC FR1 radio link monitoring out-of-sync test for PSCell configured with SSB-based RLM RS in DRX mode

Parameter	Value	Comment
Test environment	NC	As specified in TS 38.508-1 [14] clause 4.1.
Test frequencies	As specified in Annex E.1.1, Table E.2-1 and TS 38.508-1 [14] clause 4.3.1.	
Channel bandwidth	As specified by the test configuration selected from Table 4.5.1.3.4.1-1	
Propagation conditions	AWGN	As specified in clause C.2.2.
Connection Diagram	TE Part	A.3.1.7.1
	DUT Part	A.3.2.3.4
Exceptions to connection diagram	For 4Rx capable UEs without any 2 Rx RF bands use A.3.2.5.2 for DUT part and A.3.1.7.4 for TE Part	

Table 4.5.1.3.4.1-3: Void

1. Message contents are defined in clause 4.5.1.3.4.3.



2. The power levels and settings for Cell 1 are set according to Annex A.6, Table A.6.1.1-1. Cell 2 is NR FR1 PSCell. The connection setup is done according to the settings in clause C.1.3, and the downlink signal levels as per clause C.1.2.
3. The test parameters are given in Table 4.5.1.3.4.1-4.
4. Downlink signals for NR cell are initially set up according to clauses C.1.2 and C.1.3.

**Table 4.5.1.3.4.1-4: General test parameters for FR1 out-of-sync testing in DRX mode**

Parameter		Unit	Value
			Test 1
Active E-UTRA PCell			Cell 1
E-UTRA RF Channel Number			1
Active PSCell			Cell 2
RF Channel Number			2
Duplex mode	Config 1, 4		FDD
	Config 2, 3, 5, 6		TDD
BW <sub>channel</sub>	Config 1, 4	MHz	10: N <sub>RB,c</sub> = 52
	Config 2, 5		10: N <sub>RB,c</sub> = 52
	Config 3, 6		40: N <sub>RB,c</sub> = 106
DL initial BWP configuration	Config 1, 2, 3, 4, 5, 6		DLBWP.0.1
DL dedicated BWP configuration	Config 1, 2, 3, 4, 5, 6		DLBWP.1.1
UL initial BWP configuration	Config 1, 2, 3, 4, 5, 6		ULBWP.0.1
UL dedicated BWP configuration	Config 1, 2, 3, 4, 5, 6		ULBWP.1.1
TDD Configuration	Config 1, 4		Not Applicable
	Config 2, 5		TDDConf.1.1
	Config 3, 6		TDDConf.2.1
RMSI CORESET Reference Channel	Config 1, 4		CR.1.1 FDD
	Config 2, 5		CR.1.1 TDD
	Config 3, 6		CR.2.1 TDD
Dedicated CORESET Reference Channel	Config 1, 4		CCR.1.3 FDD
	Config 2, 5		CCR.1.3 TDD
	Config 3, 6		CCR.2.2 TDD
SSB Configuration	Config 1, 4		SSB.1 FR1
	Config 2, 5		SSB.1 FR1
	Config 3, 6		SSB.2 FR1
SMTC Configuration	Config 1, 2, 4, 5		SMTC.1
	Config 3, 6		SMTC.1
PDSCH/PDCCH subcarrier spacing	Config 1, 2, 4, 5		15 KHz
	Config 3, 6		30 KHz
PRACH Configuration	Config 1, 2, 4, 5		Table A.7.1-1, PRACH.1 FR1
	Config 3, 6		Table A.7.1-1, PRACH.1 FR1
SSB index assigned as RLM RS			0
OCNG parameters			OP.1
CP length			Normal
Correlation Matrix and Antenna Configuration			2x2 Low
Out of sync transmission parameters	DCI format		1-0
	Number of Control OFDM symbols		2
	Aggregation level	CCE	8
	Ratio of hypothetical PDCCH RE energy to average SSS RE energy	dB	4
	Ratio of hypothetical PDCCH DMRS energy to average SSS RE energy	dB	4
	DMRS precoder granularity		REG bundle size
	REG bundle size		6
DRX Configuration			DRX.3
Gap pattern ID			N.A.

Parameter		Unit	Value
			Test 1
Layer 3 filtering			<i>Enabled</i>
T310 timer		ms	0
T311 timer		ms	1000
N310			1
N311			1
CSI-RS configuration for CSI reporting	Config 1, 4		CSI-RS.1.1 FDD
	Config 2, 5		CSI-RS.1.1 TDD
	Config 3, 6		CSI-RS.2.1 TDD
CSI-RS for tracking	Config 1, 4		TRS.1.1 FDD
	Config 2, 5		TRS.1.1 TDD
	Config 3, 6		TRS.1.2 TDD
T1		s	0.2
T2		s	0.68
T3		s	0.68
D1		s	0.64
NOTE 1: All configurations are assigned to the UE prior to the start of time period T1.			
NOTE 2: UE-specific PDCCH is not transmitted after T1 starts.			
NOTE 3: E-UTRAN is in non-DRX mode under test.			

#### 4.5.1.3.4.2 Test Procedure

The test consists of two cells, a single E-UTRA cell (Pcell), and a single NR cell (PSCell). Prior to the start of the time duration T1, the UE shall be fully synchronized to PSCell. The UE shall be configured for periodic CSI reporting in PUCCH format 2 with a reporting periodicity as mentioned in the above table 4.5.1.3.4.1-4.

1. Ensure the UE is in state RRC\_CONNECTED with generic procedure parameters *Connectivity* EN-DC, DC bearer MCG and SCG, Connected without release *On* and Test Mode *On* according to TS 38.508-1 [6] clause 4.5.
2. Set the parameters according to T1 in Table 4.5.1.3.5-1 for subtest 1 and 2. Propagation conditions are set according to clause C.2.3. T1 starts.
3. When T1 expires the SS shall change the SNR value to T2 as specified in Table 4.5.1.3.5-1 for subtests 1 and 2. T2 starts.
4. When T2 expires the SS shall change the SNR value to T3 as specified in Table 4.5.1.3.5-1 for subtests 1 and 2. T3 starts.
5. If the SS:
  - a) detects uplink power equal to or higher than minimum output power defined in TS 38.521-1 [17] clause 6.3.1.5 in each subframe configured for CSI transmission (according to configured CSI periodicity on PUCCH format 2) during the period from time point A to time point B; and
  - b) does not detect any uplink power higher than OFF power defined in TS 38.521-1 [17] clause 6.3.2.5 from time point C (D1 after the start of T3) until T3 expires, the number of successful tests is increased by one.
6. Otherwise the number of failed tests is increased by one, and proceed to Step 10.
7. When T3 expires the SS shall change the SNR value to T1 as specified in Table 4.5.1.3.5-1.
8. If the UE has not re-established the connection in at least 1s, the SS shall ensure that PSCell is released.
9. The SS then shall transmit RRCConnectionReconfiguration message with condition MCG\_and\_SCG according to TS 36.508 [25] Table 4.6.1-8 to add NR cell (PSCell). The UE shall transmit RRCConnectionReconfigurationComplete message.
10. If the Reconfiguration fails, switch off and on the UE and ensure the UE is in RRC\_CONNECTED with generic procedure parameters *Connectivity* EN-DC, DC bearer MCG and SCG, Connected without release *On* according to TS 38.508-1 [14] clause 4.5.
11. Repeat steps 2-10 until the confidence level according to Tables G.2.3-1 in Annex G clause G.2 is achieved.

4.5.1.3.4.3 Message Contents

Message contents are according to TS 38.508-1 [14] clause 4.6.1 and 7.3.1 with condition "Short\_DCI" and with the following exceptions:

**Table 4.5.1.3.4.3-0: Common Exception messages for EN-DC FR1 radio link monitoring out-of-sync test for PSCell configured with SSB-based RLM RS in DRX mode test requirement**

Default Message Contents	
Common contents of system information blocks exceptions	
Default RRC messages and information elements contents exceptions	Table H.3.4-1 Table H.3.5-4 Table H.3.5-9 with Condition SSB RLM Table H.3.7-1 with condition DRX.3

**Table 4.5.1.3.4.3-1: Void**

**Table 4.5.1.3.4.3-2: RLF-TimersAndConstant**

Derivation Path: TS 38.508-1 [14], Table 4.6.3-150			
Information Element	Value/remark	Comment	Condition
RLF-TimersAndConstants ::= SEQUENCE {			
t310	ms0		
n310	n1		
n311	n1		
t311-v1530	ms1000		
}			

4.5.1.3.5 Test Requirement

Table 4.5.1.3.5-1 defines the cell specific primary level settings.

The UE behavior in each test during time durations T1, T2 and T3 shall be as follows:

During the period from time point A to time point B the UE shall transmit uplink signal at least in all uplink slots configured for CSI transmission according to the configured periodic CSI reporting.

The UE shall stop transmitting uplink signal in Cell 2 no later than time point C (D1 second after the start of the time duration T3).

The rate of correct events observed during repeated tests shall be at least 90 %.

**Table 4.5.1.3.5-1: Cell specific test parameters for FR1 (Cell 2) for out-of-sync radio link monitoring tests in DRX mode**

Parameter		Unit	Test 1		
			T1	T2	T3
EPRE ratio of PDCCH DMRS to SSS		dB	4		
EPRE ratio of PDCCH to PDCCH DMRS			0		
EPRE ratio of PBCH DMRS to SSS			0		
EPRE ratio of PBCH to PBCH DMRS					
EPRE ratio of PSS to SSS					
EPRE ratio of PDSCH DMRS to SSS					
EPRE ratio of PDSCH to PDSCH DMRS					
EPRE ratio of OCNG DMRS to SSS					
EPRE ratio of OCNG to OCNG DMRS					
SNR on RLM-RS	Config 1, 4		1.8	-6.2	-15.8
	Config 2, 5		1.8	-6.2	-15.8
	Config 3, 6		1.8	-6.2	-15.8
	Config 1, 4		-98		

	Parameter	Unit	Test 1		
			T1	T2	T3
$N_{oc}$	Config 2, 5	dBm/15 KHz	-98		
	Config 3, 6				
Propagation condition		TDL-C 300ns 100Hz			
NOTE 1: OCNG shall be used such that the resources in Cell 2 are fully allocated and a constant total transmitted power spectral density is achieved for all OFDM symbols.					
NOTE 2: The signal contains PDCCH for UEs other than the device under test as part of OCNG.					
NOTE 3: SNR levels correspond to the signal to noise ratio over the SSS REs.					
NOTE 4: The SNR in time periods T1, T2 and T3 is denoted as SNR1, SNR2 and SNR3 respectively in Figure 4.5.1.3.4-1.					
NOTE 5: The SNR values are specified for a UE with 2RX antennas connected under test. For a UE with 4RX antennas connected under test, the SNR during T3 from D.4.1.1, is -18dB-TT = -18.9dB (including test tolerances).					

For the test to pass, the total number of successful tests shall be more than 90 % of the cases with a confidence level of 95 %.

#### 4.5.1.4 EN-DC FR1 radio link monitoring in-sync test for PSCell configured with SSB-based RLM RS in DRX mode

##### 4.5.1.4.1 Test purpose

The purpose of this test is to verify that the UE properly detects in sync for the purpose of monitoring downlink radio link quality of the PSCell when DRX is used. This test will partly verify the FR1 radio link monitoring requirements in TS 38.133 [6] clause 8.1.

##### 4.5.1.4.2 Test applicability

This test applies to all types of E-UTRA UE Release 15 and forward supporting EN-DC FR1 and long DRX cycle.

##### 4.5.1.4.3 Minimum conformance requirements

The minimum requirements are specified in clause 4.5.1.0.2. DRX configuration is used for this test.

The normative reference for this requirement is TS 38.133 [6] clause A.4.5.1.4.

##### 4.5.1.4.4 Test Description

There are two cells, Cell 1 is the E-UTRAN PCell, and Cell 2 is the PSCell, in the test. The E-UTRAN PCell setting refers to Table A.3.7.2.1-1. The test consists of five successive time periods, with time duration of T1, T2, T3, T4 and T5 respectively. Figure 4.5.1.4.4-1 shows the variation of the downlink SNR in the active Cell 2 to emulate out-of-sync and in-sync states. Prior to the start of the time duration T1, the UE shall be fully synchronized to Cell 1 and Cell 2. The UE shall be configured for periodic CSI reporting with a reporting periodicity of 5 ms. In the test, DRX configuration is enabled and DRX inactivity timer has already been expired, i.e. UE tries to decode PDCCH and to send periodic CSI during the period when On-duration timer is running. Time alignment timers shall be set to "infinity" so that UL timing alignment is maintained during the test.

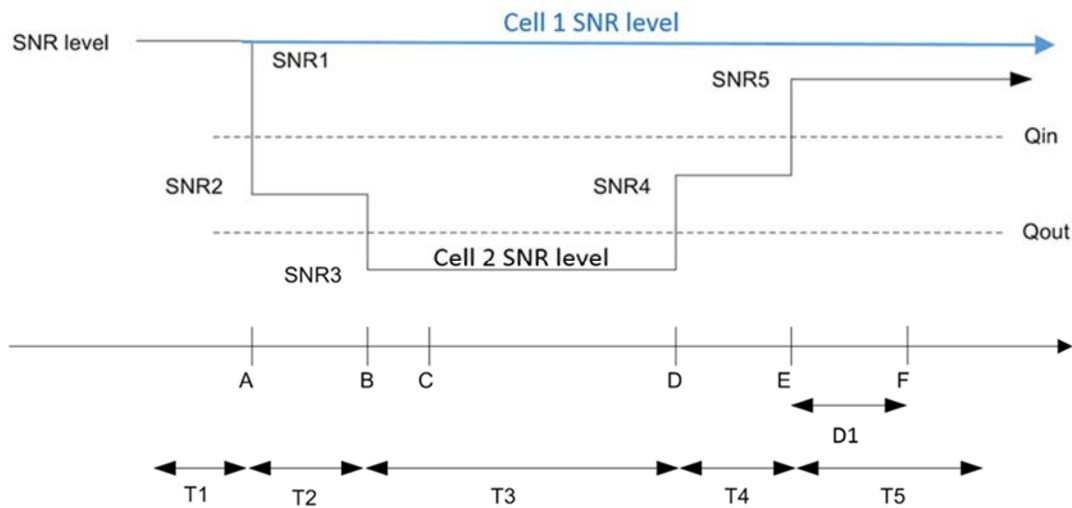

Figure 4.5.1.4.4-1 - SNR variation for in-sync testing

4.5.1.4.4.1 Initial Conditions

This test shall be tested using any of the test configurations in Table 4.5.1.4.4.1-1.

Table 4.5.1.4.4.1-1: Supported test configurations for FR1 PSCell

Configuration	Description
4.5.1.4-1	LTE FDD, NR 15 KHz SSB SCS, 10MHz bandwidth, FDD duplex mode
4.5.1.4-2	LTE FDD, NR 15 KHz SSB SCS, 10MHz bandwidth, TDD duplex mode
4.5.1.4-3	LTE FDD, NR 30 KHz SSB SCS, 40MHz bandwidth, TDD duplex mode
4.5.1.4-4	LTE TDD, NR 15 KHz SSB SCS, 10MHz bandwidth, FDD duplex mode
4.5.1.4-5	LTE TDD, NR 15 KHz SSB SCS, 10MHz bandwidth, TDD duplex mode
4.5.1.4-6	LTE TDD, NR 30 KHz SSB SCS, 40MHz bandwidth, TDD duplex mode

NOTE: The UE is only required to pass in one of the supported test configurations in FR1.

Configure the test equipment and the DUT according to the parameters in Table 4.5.1.4.4.1-2.

Table 4.5.1.4.4.1-2: Initial conditions for EN-DC FR1 radio link monitoring in-sync test for PSCell configured with SSB-based RLM RS in DRX mode

Parameter	Value	Comment
Test environment	NC	As specified in TS 38.508-1 [14] clause 4.1.
Test frequencies	As specified in Annex E.1.1, Table E.2-1 and TS 38.508-1 [14] clause 4.3.1.	
Channel bandwidth	As specified by the test configuration selected from Table 4.5.1.4.4.1-1	
Propagation conditions	AWGN	As specified in clause C.2.2.
Connection Diagram	TE Part	A.3.1.7.1
	DUT Part	A.3.2.3.4
Exceptions to connection diagram	For 4Rx capable UEs without any 2 Rx RF bands use A.3.2.5.2 for DUT part and A.3.1.7.4 for TE Part	

Table 4.5.1.4.4.1-3: Void

1. Message contents are defined in clause 4.5.1.4.4.3.

2. The power levels and settings for Cell 1 are set according to clause A.6, Table A.6.1.1-1. Cell 2 is NR FR1 PSCell. The connection setup is done according to the settings in clause C.1.3, and the downlink signal levels as per clause C.1.2.
3. The general test parameters are given in Table 4.5.1.4.4.1-4 below.
4. Downlink signals for NR cell are initially set up according to clause C.1.

**Table 4.5.1.4.4.1-4: General test parameters for FR1 in-sync testing in DRX mode**

Parameter		Unit	Value
			Test 1
Active E-UTRA PCell			Cell 1
E-UTRA RF Channel Number			1
Active PSCell			Cell 2
RF Channel Number			2
Duplex mode	Config 1, 4		FDD
	Config 2, 3, 5, 6		TDD
BW <sub>channel</sub>	Config 1, 4	MHz	10: N <sub>RB,c</sub> = 52
	Config 2, 5		10: N <sub>RB,c</sub> = 52
	Config 3, 6		40: N <sub>RB,c</sub> = 106
DL initial BWP configuration	Config 1, 2, 3, 4, 5, 6		DLBWP.0.1
DL dedicated BWP configuration	Config 1, 2, 3, 4, 5, 6		DLBWP.1.1
UL initial BWP configuration	Config 1, 2, 3, 4, 5, 6		ULBWP.0.1
UL dedicated BWP configuration	Config 1, 2, 3, 4, 5, 6		ULBWP.1.1
TDD Configuration	Config 1, 4		Not Applicable
	Config 2, 5		TDDConf.1.1
	Config 3, 6		TDDConf.2.1
RMSI CORESET Reference Channel	Config 1, 4		CR.1.1 FDD
	Config 2, 5		CR.1.1 TDD
	Config 3, 6		CR.2.1 TDD
Dedicated CORESET Reference Channel	Config 1, 4		CCR.1.1 FDD
	Config 2, 5		CCR.1.1 TDD
	Config 3, 6		CCR.2.1 TDD
SSB Configuration	Config 1, 4		SSB.1 FR1
	Config 2, 5		SSB.1 FR1
	Config 3, 6		SSB.2 FR1
SMTTC Configuration	Config 1, 2, 4, 5		SMTTC.1
	Config 3, 6		SMTTC.1
PDSCH/PDCCH subcarrier spacing	Config 1, 2, 4, 5		15 KHz
	Config 3, 6		30 KHz
PRACH Configuration	Config 1, 2, 4, 5		Table A.7.1-1, PRACH.1 FR1
	Config 3, 6		Table A.7.1-1, PRACH.1 FR1
SSB index assigned as RLM RS			0
OCNG parameters			OP.1
CP length			Normal
Correlation Matrix and Antenna Configuration			2x2 Low
In sync transmission parameters	DCI format		1-0
	Number of Control OFDM symbols		2
	Aggregation level	CCE	4
	Ratio of hypothetical PDCCH RE energy to average SSS RE energy	dB	0
	Ratio of hypothetical PDCCH DMRS energy to average SSS RE energy	dB	0
	DMRS precoder granularity		REG bundle size
	REG bundle size		6
Out of sync transmission parameters	DCI format		1-0
	Number of Control OFDM symbols		2
	Aggregation level	CCE	8

Parameter		Unit	Value
			Test 1
	Ratio of hypothetical PDCCH RE energy to average SSS RE energy	dB	4
	Ratio of hypothetical PDCCH DMRS energy to average SSS RE energy	dB	4
	DMRS precoder granularity		REG bundle size
REG bundle size			6
DRX Configuration			DRX.3
Gap pattern ID			N.A.
Layer 3 filtering			<i>Enabled</i>
T310 timer		ms	1000
T311 timer		ms	1000
N310			1
N311			1
CSI-RS for CSI reporting	Config 1, 4		CSI-RS.1.1 FDD
	Config 2, 5		CSI-RS.1.1 TDD
	Config 3, 6		CSI-RS.2.1 TDD
CSI-RS tracking	Config 1, 4		TRS.1.1 FDD
	Config 2, 5		TRS.1.1 TDD
	Config 3, 6		TRS.1.2 TDD
T1		s	0.2
T2		s	0.2
T3		s	0.64
T4		s	0.2
T5		s	0.88
D1		s	0.84
NOTE 1: All configurations are assigned to the UE prior to the start of time period T1.			
NOTE 2: UE-specific PDCCH is not transmitted after T1 starts.			
NOTE 3: E-UTRAN is in non-DRX mode under test.			

#### 4.5.1.4.4.2 Test Procedure

The test consists of two cells, a single E-UTRA cell (Pcell), and a single NR cell (PSCell). Prior to the start of the time duration T1, the UE shall be fully synchronized to PSCell. The UE shall be configured for periodic CSI reporting in PUCCH format 2 with a reporting periodicity as mentioned in the above table 4.5.1.4.4.1-4.

1. Ensure the UE is in state RRC\_CONNECTED with generic procedure parameters *Connectivity* EN-DC, DC bearer MCG and SCG, Connected without release *On* and Test Mode *On* according to TS 38.508-1 [6] clause 4.5.
2. Set the parameters according to T1 in Table 4.5.1.4.5-1 for subtest 1 and 2. Propagation conditions are set according to clause C.2.3. T1 starts.
3. When T1 expires the SS shall change the SNR value to T2 as specified in Table 4.5.1.4.5-1. T2 starts.
4. When T2 expires the SS shall change the SNR value to T3 as specified in Table 4.5.1.4.5-1. T3 starts.
5. When T3 expires the SS shall change the SNR value to T4 as specified in Table 4.5.1.4.5-1. T4 starts.
6. When T4 expires the SS shall change the SNR value to T5 as specified in Table 4.5.1.4.5-1. T5 starts.
7. If the SS detects uplink power equal to or higher than the minimum output power defined in TS 38.521-1 [17] clause 6.3.1.5 in the On-duration part of every DRX cycle in the subframe according the configured CSI reporting mode (PUCCH 1-0) during the period from time point A to time point F (D1 after the start of time duration T5) the number of successful tests is increased by one.

Otherwise the number of failed tests is increased by one.

8. If the iteration fails, the SS shall first attempt to release and add the PSCell, by ensuring the UE is in state RRC\_CONNECTED with generic procedure parameters *Connectivity* EN-DC, DC bearer MCG and SCG, Connected without release *On* and Test Mode *On* according to TS 38.508-1 [6] clause 4.5. If that also fails, then the UE is switched OFF/ON to proceed with the next iteration.

9. Repeat steps 2-7 for all subtests until the confidence level according to Tables G.2.3-1 in Annex G clause G.2 is achieved.

4.5.1.4.4.3 Message Contents

Message contents are according to TS 38.508-1 [14] clause 4.6.1 and 7.3.1 with condition "Short\_DCI" and with the following exceptions.

**Table 4.5.1.4.4.3-0: Common Exception messages for EN-DC FR1 radio link monitoring in-sync test for PCell configured with SSB-based RLM RS in DRX mode test requirement**

Default Message Contents	
Common contents of system information blocks exceptions	
Default RRC messages and information elements contents exceptions	Table H.3.4-1 Table H.3.5-4 Table H.3.5-9 with Condition SSB RLM Table H.3.7-1 with condition DRX.3

**Table 4.5.1.4.4.3-1: Void**

**Table 4.5.1.4.4.3-2: RLF-TimersAndConstant**

Derivation Path: TS 38.508-1 [14], Table 4.6.3-150			
Information Element	Value/remark	Comment	Condition
RLF-TimersAndConstants ::= SEQUENCE {			
t310	ms1000		
n310	n1		
n311	n1		
t311-v1530	ms1000		
}			

4.5.1.4.5 Test Requirement

The requirements in this section apply for each SSB based RLM-RS resource configured for PCell or PSCell, provided that the SSB configured for RLM are actually transmitted within UE active DL BWP during the entire evaluation period specified in section 4.5.1.4.3.

Table 4.5.1.4.5-1 defines the cell specific primary level settings.

The UE behaviour in each test during time durations T1, T2, T3, T4 and T5 shall be as follows:

During the period from time point A to time point F (D1 second after the start of time duration T5) the UE shall transmit uplink signal at least in all uplink slots configured for CSI transmission according to the configured periodic CSI reporting.

The rate of correct events observed during repeated tests shall be at least 90 % with a confidence interval of 95 %.

**Table 4.5.1.4.5-1: Cell specific test parameters for FR1 (Cell 2) for in-sync radio link monitoring tests in DRX mode**

Parameter	Unit	Test 1				
		T1	T2	T3	T4	T5
EPRE ratio of PDCCH DMRS to SSS	dB	0				
EPRE ratio of PDCCH to PDCCH DMRS	dB	0				
EPRE ratio of PBCH DMRS to SSS	dB	0				
EPRE ratio of PBCH to PBCH DMRS	dB					
EPRE ratio of PSS to SSS	dB					
EPRE ratio of PDSCH DMRS to SSS	dB					
EPRE ratio of PDSCH to PDSCH DMRS	dB					
EPRE ratio of OCNG DMRS to SSS	dB					



EPRE ratio of OCNG to OCNG DMRS		dB					
SNR on RLM-RS	Config 1, 4	dB	1.8	-6.2	-15.8	-5.3	1.8
	Config 2, 5		1.8	-6.2	-15.8	-5.3	1.8
	Config 3, 6		1.8	-6.2	-15.8	-5.3	1.8
$N_{oc}$	Config 1, 4	dBm/15 KHz	-98				
	Config 2, 5		-98				
	Config 3, 6		-98				
Propagation condition			TDL-C 300ns 100Hz				
<p>NOTE 1: OCNG shall be used such that the resources in Cell 2 are fully allocated and a constant total transmitted power spectral density is achieved for all OFDM symbols.</p> <p>NOTE 2: The signal contains PDCCH for UEs other than the device under test as part of OCNG.</p> <p>NOTE 3: SNR levels correspond to the signal to noise ratio over the SSS REs.</p> <p>NOTE 4: The SNR in time periods T1, T2, T3, T4 and T5 is denoted as SNR1, SNR2, SNR3, SNR4 and SNR5 respectively in Figure 4.5.1.4.4-1.</p> <p>NOTE 5: The SNR values are specified for a UE with 2RX antennas connected under test. For a UE with 4RX antennas connected under test, the SNR during T3 and T4 from D.4.1.1 are -18.0-TT and -8.0-TT, which are -18.8dB and -8.8dB(including test tolerances).</p>							

### 4.5.1.5 EN-DC FR1 radio link monitoring out-of-sync test for PSCell configured with CSI-RS-based RLM RS in non-DRX mode

#### 4.5.1.5.1 Test purpose

The purpose of this test is to verify that the UE properly detects the out of sync for the purpose of monitoring downlink CSI-RS based radio link quality of the PSCell when no DRX is used. This test will partly verify the FR1 PSCell CSI-RS Out-of-sync radio link monitoring requirements in TS 38.133 clause 8.1.

#### 4.5.1.5.2 Test applicability

This test applies to all types of E-UTRA UE release 15 and forward supporting EN-DC and CSI-RS based RLM.

#### 4.5.1.5.3 Minimum conformance requirements

The minimum requirements are specified in clause 4.5.1.0.3. DRX configuration is not used for this test.

The normative reference for this requirement is TS 38.133 [6] clause A.4.5.1.5.

#### 4.5.1.5.4 Test description

There are two cells configured in this test, the E-UTRA PCell and NR PSCell. This test consists of three successive time periods, with time duration of T1, T2 and T3 respectively. Figure 4.5.1.5.4-1 shows the three different time durations and the corresponding variation of the downlink SNR in the active cell to emulate out-of-sync states.

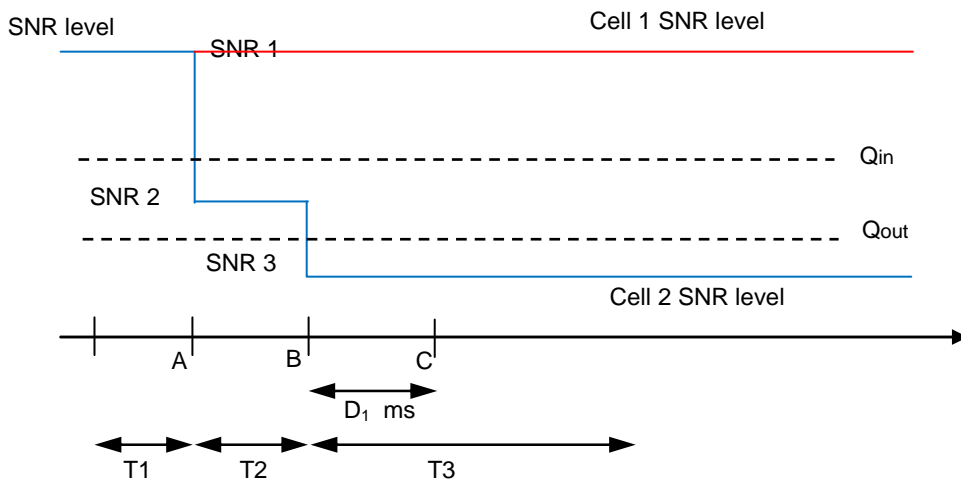

Figure 4.5.1.5.4-1: SNR variation for out-of-sync testing

## 4.5.1.5.4.1 Initial conditions

Test 4.5.1.5 can be run in one of the configurations defined in Table 4.5.1.5.4.1-1.

**Table 4.5.1.5.4.1-1: Supported test configurations for FR1 PSCell**

Configuration	Description
4.5.1.5-1	LTE FDD, NR 15 kHz SSB SCS, 10MHz bandwidth, FDD duplex mode
4.5.1.5-2	LTE FDD, NR 15 kHz SSB SCS, 10MHz bandwidth, TDD duplex mode
4.5.1.5-3	LTE FDD, NR 30 kHz SSB SCS, 40MHz bandwidth, TDD duplex mode
4.5.1.5-4	LTE TDD, NR 15 kHz SSB SCS, 10MHz bandwidth, FDD duplex mode
4.5.1.5-5	LTE TDD, NR 15 kHz SSB SCS, 10MHz bandwidth, TDD duplex mode
4.5.1.5-6	LTE TDD, NR 30 kHz SSB SCS, 40MHz bandwidth, TDD duplex mode
NOTE: The UE is only required to pass in one of the supported test configurations in FR1.	

Configure the test equipment and the DUT according to the parameters in Table 4.5.1.5.4.1-2.

**Table 4.5.1.5.4.1-2: Initial conditions for CSI-RS In-sync radio link monitoring in non-DRX mode**

Parameter	Value	Comment
Test environment	NC	As specified in TS 38.508-1 [14] clause 4.1.
Test frequencies	As specified in Annex E, table E.2-1 and TS 38.508-1 [14] clause 4.3.1.	
Channel bandwidth	As specified by the test configuration selected from Table 4.5.1.6.4.1-1.	
Propagation conditions	AWGN	As specified in clause C.2.2.
Connection Diagram	TE Part DUT Part	A.3.1.7.1 A.3.2.3.4
Exceptions to connection diagram	For 4Rx capable UEs without any 2 Rx RF bands use A.3.2.5.2 for DUT part and A.3.1.7.4 for TE Part	

1. The test parameters are given in Table 4.5.1.5.4.1-3 below.
2. Message contents are defined in clause 4.5.1.5.4.3.
3. There are two cells in the test, where Cell 1 is the E-UTRAN PCell on the E-UTRA carrier, and Cell 2 is the NR PSCell on the NR carrier. Cell 1 is the cell used for connection setup with the power level set according to TS 38.133 [6] Table A.6.1.1-1 for this test. Cell 2 is configured according to clauses C.1.2 and C.1.3.

**Table 4.5.1.5.4.1-3: General test parameters for FR1 PSCell for CSI-RS out-of-sync testing in non-DRX mode**

Parameter	Unit	Value
		Test 1
Active E-UTRA PCell		Cell 1
E-UTRA RF Channel Number		1
Active PSCell		Cell 2
RF Channel Number		2
Duplex mode	Config 1, 4	FDD
	Config 2, 3, 5, 6	
TDD Configuration	Config 1, 4	Not Applicable
	Config 2, 5	TDDConf.1.1
	Config 3, 6	TDDConf.2.1
DL initial BWP configuration	Config 1, 2, 3, 4, 5, 6	DLBWP.0.1
DL dedicated BWP configuration	Config 1, 2, 3, 4, 5, 6	DLBWP.1.1
UL initial BWP configuration	Config 1, 2, 3, 4, 5, 6	ULBWP.0.1
UL dedicated BWP configuration	Config 1, 2, 3, 4, 5, 6	ULBWP.1.1
RMSI	Config 1, 4	CR.1.1 FDD

Parameter		Unit	Value
CORESET Reference Channel	Config 2, 5		Test 1 CR.1.1 TDD
	Config 3, 6		CR.2.1 TDD
Dedicated CORESET Reference Channel	Config 1, 4		CCR.1.3 FDD
	Config 2, 5		CCR.1.3 TDD
	Config 3, 6		CCR.2.2 TDD
SSB Configuration	Config 1, 4		SSB.1 FR1
	Config 2, 5		SSB.1 FR1
	Config 3, 6		SSB.2 FR1
SMTC Configuration	Config 1, 2, 4, 5		SMTC.1
	Config 3, 6		SMTC.1
PDSCH/PDCCH subcarrier spacing	Config 1, 2, 4, 5		15 KHz
	Config 3, 6		30 KHz
TRS configuration	Config 1, 4		TRS.1.1 FDD
	Config 2, 5		TRS.1.1 TDD
	Config 3, 6		TRS.1.2 TDD
CSI-RS for RLM	Config 1, 4		Resource #4 in TRS.1.1 FDD
	Config 2, 5		Resource #4 in TRS.1.1 TDD
	Config 3, 6		Resource #4 in TRS.1.2 TDD
TCI configuration for PDCCH/PDSCH			TCI.State.2
OCNG parameters			OP.1
CP length			Normal
Correlation Matrix and Antenna Configuration			2x2 Low
Out of sync transmission parameters	DCI format		1-0
	Number of Control OFDM symbols		2
	Aggregation level	CCE	8
	Ratio of hypothetical PDCCH RE energy to average CSI-RS RE energy	dB	4
	Ratio of hypothetical PDCCH DMRS energy to average CSI-RS RE energy	dB	4
	DMRS precoder granularity		REG bundle size
REG bundle size			6
DRX			OFF
Gap pattern ID			gp0
Layer 3 filtering			Enabled
T310 timer		ms	0
T311 timer		ms	1000
N310			1
N311			1
CSI-RS configuration	Config 1, 4		CSI-RS 1.1 FDD
	Config 2, 5		CSI-RS.1.1 TDD
	Config 3, 6		CSI-RS.2.1 TDD
T1		s	0.2
T2		s	0.48
T3		s	0.48
D1		s	0.44
NOTE 1: UE-specific PDCCH is not transmitted after T1 starts.			
NOTE 2: E-UTRAN is in non-DRX mode under test.			

**Table 4.5.1.5.4.1-4: Measurement gap configuration for FR1 CSI-RS out-of-sync radio link monitoring in non-DRX mode**

Field	Test 1 Value
gapOffset	0
NOTE: E-UTRAN PCell and PSCell are SFN-synchronous and frame boundary aligned.	

4.5.1.5.4.2 Test procedure

Prior to the start of the time duration T1, the UE shall be fully synchronized to Cell 1 and Cell 2. The UE shall be configured for periodic CSI reporting with a reporting periodicity of 5ms. In the test, DRX configuration is not enabled. The UE is configured to perform inter-frequency measurements using GP ID #0 (40ms).

1. Ensure the UE is in state RRC\_CONNECTED with generic procedure parameters Connectivity *EN-DC*, DC bearer *MCG\_and\_SCG*, Connected without release *On* and Test Mode *On* according to TS 38.508-1 [14] clause 4.5.
2. The SS shall transmit an *RRCConnectionReconfiguration* message configuring the UE for inter-frequency measurements.
3. The UE shall transmit *RRCReconfigurationComplete* message.
4. Set the parameters of Cell 2 according to T1 in Table 4.5.1.5.5-1. Propagation conditions are set according to clause C.2.3. T1 starts.
5. When T1 expires the SS shall change the SNR value to T2 as specified in Table 4.5.1.5.5-1. T2 starts.
6. When T2 expires the SS shall change the SNR value to T3 as specified in Table 4.5.1.5.5-1. T3 starts.
7. If the SS:
  - a) detects uplink power on NR carrier equal to or higher than minimum output power defined in TS 38.521-1 [17] clause 6.3.1.5 in each slot configured for CSI transmission (according CSI reporting on PUCCH) during the period from time point A to time point B; and
  - b) does not detect any uplink power on NR carrier higher than OFF power defined in TS 38.521-1 [17] clause 6.3.2.5 from time point C (D1 after the start of T3) until T3 expires, the number of successful tests is increased by one.

Otherwise the number of failed tests is increased by one.
8. When T3 expires the SS shall change the SNR value to T1 as specified in Table 4.5.1.5.5-1.
9. If the UE has not re-established the connection in at least 1s, the SS shall ensure PSCell is released.
10. The SS then shall transmit *RRCConnectionReconfiguration* message with condition *MCG\_and\_SCG* according to TS 36.508 [25] Table 4.6.1-8 to add NR cell (PSCell). The UE shall transmit *RRCConnectionReconfigurationComplete* message.
11. If the Reconfiguration fails, switch off and on the UE and ensure the UE is in RRC\_CONNECTED with generic procedure parameters Connectivity *EN-DC*, DC bearer *MCG\_and\_SCG*, Connected without release *On* according to TS 38.508-1 [14] clause 4.5.
12. Repeat steps 4-11 until the confidence level according to Tables G.2.3-1 in Annex G clause G.2 is achieved.

4.5.1.5.4.3 Message contents

Message contents are according to TS 38.508-1 [14] clause 4.6 and 7.3.1 with the following exceptions.

**Table 4.5.1.5.4.3-1: Common Exception messages**

Default Message Contents	
Common contents of system information blocks exceptions	

Default RRC messages and information elements contents exceptions	Table H.3.1-1 Table H.3.1-2 with Condition INTER-FREQ, L3 FILTERING NEEDED Table H.3.1-3 with Condition INTER-FREQ MO (where ssbFrequency is set to the ARFCN value of carrier center of High range) Table H.3.1-4 with A3-offset = 0 Table H.3.1-9 Table H.3.4-1 Table H.3.4-1a Table H.3.4-4 with condition gapUE Table H.3.4-5 with condition BFD Table H.3.5-4 Table H.3.5-9 with Condition CSI-RS RLM
---	--

**Table 4.5.1.5.4.3-2: Void**

4.5.1.5.5 Test requirement

Tables 4.5.1.5.4.1-2 and 4.5.1.5.5-1 define the primary level settings including test tolerances for Radio Link Monitoring Out-of-sync Test for FR1 PSCell configured with CSI-RS-based RLM in non-DRX mode.

**Table 4.5.1.5.5-1: Cell specific test parameters for FR1 for CSI-RS out-of-sync radio link monitoring in non-DRX mode**

Parameter		Unit	Test 1		
			T1	T2	T3
EPRE ratio of PDCCH DMRS to SSS		dB	4		
EPRE ratio of PDCCH to PDCCH DMRS			0		
EPRE ratio of PBCH to PBCH DMRS					
EPRE ratio of PSS to SSS					
EPRE ratio of PBCH DMRS to SSS					
EPRE ratio of PDSCH to PDSCH DMRS					
EPRE ratio of PDSCH DMRS to SSS					
EPRE ratio of OCNG DMRS to SSS					
EPRE ratio of OCNG to OCNG DMRS					
SNR on RLM-RS	Config 1, 4	dB	1.8	-6.2	-15.8
	Config 2, 5		1.8	-6.2	-15.8
	Config 3, 6		1.8	-6.2	-15.8
$N_{oc}$	Config 1, 4	dBm/15K	-98		
	Config 2, 5		-98		
	Config 3, 6		-98		
Propagation condition			TDL-C 300ns 100Hz		
NOTE 1: OCNG shall be used such that the resources in Cell 2 are fully allocated and a constant total transmitted power spectral density is achieved for all OFDM symbols.					
NOTE 2: The uplink resources for CSI reporting are assigned to the UE prior to the start of time period T1.					
NOTE 3: NZP CSI-RS resource set configuration for CSI reporting are assigned to the UE prior to the start of time period T1.					
NOTE 4: Measurement gap configuration is assigned to the UE prior to the start of time period T1.					
NOTE 5: The timers and layer 3 filtering related parameters are configured prior to the start of time period T1.					
NOTE 6: The signal contains PDCCH for UEs other than the device under test as part of OCNG.					
NOTE 7: SNR levels correspond to the signal to noise ratio over the SSS REs.					
NOTE 8: The SNR in time periods T1, T2 and T3 is denoted as SNR1, SNR2 and SNR3 respectively in Figure 4.5.1.5.4-1.					
NOTE 9: The SNR values are specified for testing a UE which supports 2RX on at least one band. For testing of a UE which supports 4RX on all bands, the SNR during T3 from D.4.1.1 is -18 -TT, which is -18.8dB (including test tolerances).					

The UE behaviour in each test during time durations T1, T2 and T3 shall be as follows:

During the period from time point A to time point B the UE shall transmit uplink signal at least in all slots configured for CSI transmission according the configured CSI reporting mode on PUCCH.

The UE shall stop transmitting uplink signal no later than time point C (D1 after the start of time duration T3).

The uplink signal is verified on the basis of the UE output power:

- UE output power equal to or higher than Transmit minimum power (as defined in TS 38.521-1 [17] clause 6.3.1.5) means uplink signal
- UE output power equal to or less than Transmit OFF power (as defined in TS 38.521-1 [17] clause 6.3.2.5) means no uplink signal.

The rate of correct events observed during repeated tests shall be at least 90% with a confidence level of 95%.

#### 4.5.1.6 EN-DC FR1 radio link monitoring in-sync test for PSCell configured with CSI-RS-based RLM RS in non-DRX mode

##### 4.5.1.6.1 Test purpose

The purpose of this test is to verify that the UE properly detects the in sync for the purpose of monitoring downlink CSI-RS based radio link quality of the PSCell when no DRX is used. This test will partly verify the FR1 PSCell CSI-RS in-sync radio link monitoring requirements in TS 38.133 clause 8.1.

##### 4.5.1.6.2 Test applicability

This test applies to all types of E-UTRA UE release 15 and forward supporting EN-DC and CSI-RS based RLM.

##### 4.5.1.6.3 Minimum conformance requirements

The minimum requirements are specified in clause 4.5.1.0.4. DRX configuration is not used for this test.

The normative reference for this requirement is TS 38.133 [6] clause A.4.5.1.6.

##### 4.5.1.6.4 Test description

There are two cells configured in this test, the E-UTRA PCell and NR PSCell. This test consists of five successive time periods, with time duration of T1, T2, T3, T4 and T5 respectively. Figure 4.5.1.6.4-1 shows the five different time durations and the corresponding variation of the downlink SNR in the active cell to emulate in-sync states.

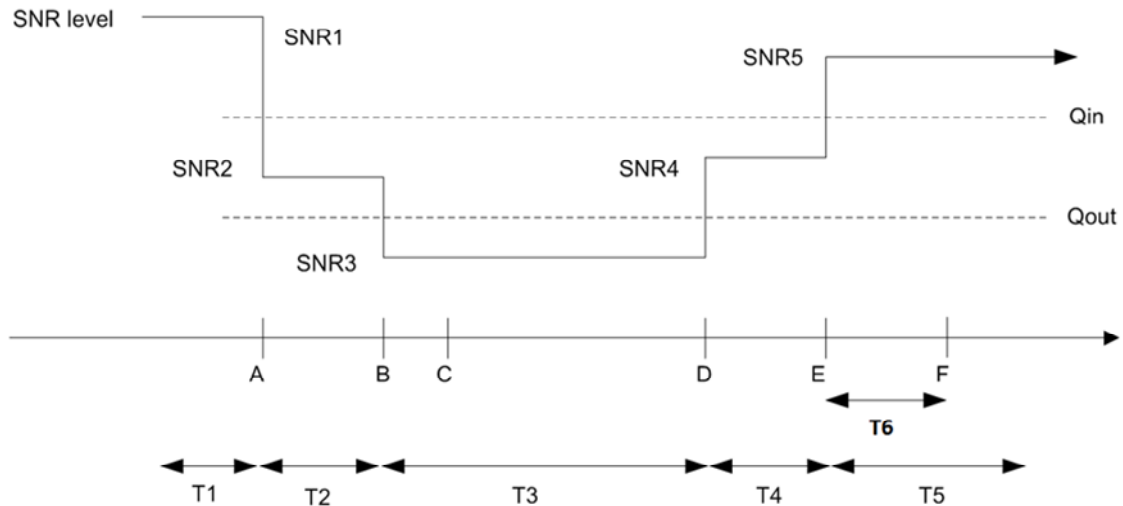

Figure 4.5.1.6.4-1: SNR variation for In-sync testing

4.5.1.6.4.1 Initial conditions

Test 4.5.1.6 can be run in one of the configurations defined in Table 4.5.1.6.4.1-1.

Table 4.5.1.6.4.1-1: Supported test configurations for FR1 PSCell

Configuration	Description
4.5.1.6-1	LTE FDD, NR 15 kHz SSB SCS, 10MHz bandwidth, FDD duplex mode
4.5.1.6-2	LTE FDD, NR 15 kHz SSB SCS, 10MHz bandwidth, TDD duplex mode
4.5.1.6-3	LTE FDD, NR 30 kHz SSB SCS, 40MHz bandwidth, TDD duplex mode
4.5.1.6-4	LTE TDD, NR 15 kHz SSB SCS, 10MHz bandwidth, FDD duplex mode
4.5.1.6-5	LTE TDD, NR 15 kHz SSB SCS, 10MHz bandwidth, TDD duplex mode
4.5.1.6-6	LTE TDD, NR 30 kHz SSB SCS, 40MHz bandwidth, TDD duplex mode

NOTE: The UE is only required to pass in one of the supported test configurations in FR1.

Configure the test equipment and the DUT according to the parameters in Table 4.5.1.6.4.1-2.

Table 4.5.1.6.4.1-2: Initial conditions for CSI-RS In-sync radio link monitoring in non-DRX mode

Parameter	Value	Comment
Test environment	NC	As specified in TS 38.508-1 [14] clause 4.1.
Test frequencies	As specified in Annex E, table E.2-1 and TS 38.508-1 [14] clause 4.3.1.	
Channel bandwidth	As specified by the test configuration selected from Table 4.5.1.6.4.1-1.	
Propagation conditions	AWGN	As specified in clause C.2.2.
Connection Diagram	TE Part: A.3.1.7.1 DUT Part: A.3.2.3.4	As specified in TS 38.508-1 [14] Annex A.
Exceptions to connection diagram	For 4Rx capable UEs without any 2 Rx RF bands use A.3.2.5.2 for DUT part and A.3.1.7.4 for TE Part	

1. The test parameters are given in Table 4.5.1.6.4.1-3 below.
2. Message contents are defined in clause 4.5.1.6.4.3.
3. There are two cells in the test, where Cell 1 is the E-UTRAN PCell on the E-UTRA carrier, and Cell 2 is the NR PSCell on the NR carrier. Cell 1 is the cell used for connection setup with the power level set according to Table A.6.1.1-1 for this test. Cell 2 is configured according to clause C.1.2 and C.1.3.

**Table 4.5.1.6.4.1-3: General test parameters for FR1 PSCell for CSI-RS In-sync testing in non-DRX mode**

Parameter		Unit	Value Test 1
Active E-UTRA PCell			Cell 1
E-UTRA RF Channel Number			1
Active PSCell			Cell 2
RF Channel Number			2
Duplex mode	Config 1, 4		FDD
	Config 2, 3, 5, 6		TDD
TDD Configuration	Config 1, 4		Not Applicable
	Config 2, 5		TDDConf.1.1
	Config 3, 6		TDDConf. 2.1
DL initial BWP configuration	Config 1, 2, 3, 4, 5, 6		DLBWP.0.1
DL dedicated BWP configuration	Config 1, 2, 3, 4, 5, 6		DLBWP.1.1
UL initial BWP configuration	Config 1, 2, 3, 4, 5, 6		ULBWP.0.1
UL dedicated BWP configuration	Config 1, 2, 3, 4, 5, 6		ULBWP.1.1
RMSI CORESET Reference Channel	Config 1, 4		CR.1.1 FDD
	Config 2, 5		CR.1.1 TDD
	Config 3, 6		CR.2.1 TDD
Dedicated CORESET Reference Channel	Config 1, 4		CCR.1.1 FDD
	Config 2, 5		CCR.1.1 TDD
	Config 3, 6		CCR.2.1 TDD
SSB Configuration	Config 1, 4		SSB.1 FR1
	Config 2, 5		SSB.1 FR1
	Config 3, 6		SSB.2 FR1
SMTTC Configuration	Config 1, 2, 4, 5		SMTTC.1
	Config 3, 6		SMTTC.1
PDSCH/PDCCH subcarrier spacing	Config 1, 2, 4, 5		15 KHz
	Config 3, 6		30 KHz
TRS configuration	Config 1, 4		TRS.1.1 FDD
	Config 2, 5		TRS.1.1 TDD
	Config 3, 6		TRS.1.2 TDD
CSI-RS for RLM	Config 1, 4		Resource #4 in TRS.1.1 FDD
	Config 2, 5		Resource #4 in TRS.1.1 TDD
	Config 3, 6		Resource #4 in TRS.1.2 TDD
TCI configuration for PDCCH/PDSCH			TCI.State.2
OCNG parameters			OP.1
CP length			Normal
Correlation Matrix and Antenna Configuration			2x2 Low
Out of sync transmission parameters	DCI format		1-0
	Number of Control OFDM symbols		2
	Aggregation level	CCE	8
	Ratio of hypothetical PDCCH RE energy to average CSI-RS RE energy	dB	4
	Ratio of hypothetical PDCCH DMRS energy to average CSI-RS RE energy	dB	4
	DMRS precoder granularity		REG bundle size
	REG bundle size		6



Parameter		Unit	Value
			Test 1
In sync transmission parameters	DCI format		1-0
	Number of Control OFDM symbols		2
	Aggregation level	CCE	4
	Ratio of hypothetical PDCCH RE energy to average CSI-RS RE energy	dB	0
	Ratio of hypothetical PDCCH DMRS energy to average CSI-RS RE energy	dB	0
	DMRS precoder granularity		REG bundle size
	REG bundle size		6
DRX			OFF
Gap pattern ID			N.A.
Layer 3 filtering			Enabled
T310 timer		ms	1000
T311 timer		ms	1000
N310			1
N311			1
CSI-RS for reporting	Config 1, 4		CSI-RS.1.1 FDD
	Config 2, 5		CSI-RS.1.1 TDD
	Config 3, 6		CSI-RS.2.1 TDD
T1		s	0.2
T2		s	0.2
T3		s	0.44
T4		s	0.2
T5		s	0.88
T6		s	0.84
NOTE 1: UE-specific PDCCH is not transmitted after T1 starts.			
NOTE 2: E-UTRAN is in non-DRX mode under test.			

#### 4.5.1.6.4.2 Test procedure and Test Mode *On*

Prior to the start of the time duration T1, the UE shall be fully synchronized to Cell 1 and Cell 2. The UE shall be configured for periodic CSI reporting with a reporting periodicity of 5ms. In the test, DRX configuration is not enabled.

1. Ensure the UE is in state RRC\_CONNECTED with generic procedure parameters Connectivity *EN-DC*, DC bearer *MCG\_and\_SCG*, Connected without release *On* according to TS 38.508-1 [14] clause 4.5.
2. Set the parameters of Cell 2 according to T1 in Table 4.5.1.6.5-1. Propagation conditions are set according to clause C.2.3. T1 starts.
3. When T1 expires the SS shall change the SNR value to T2 as specified in Table 4.5.1.6.5-1. T2 starts.
4. When T2 expires the SS shall change the SNR value to T3 as specified in Table 4.5.1.6.5-1. T3 starts.
5. When T3 expires the SS shall change the SNR value to T4 as specified in Table 4.5.1.6.5-1. T4 starts.
6. When T4 expires the SS shall change the SNR value to T5 as specified in Table 4.5.1.6.5-1. T5 starts.
7. If the SS detects uplink power on NR carrier equal to or higher than minimum output power defined in TS 38.521-1 [17] clause 6.3.1.5 in each slot configured for CSI transmission (according CSI reporting on PUCCH) during the period from time point A to time point F (T6 after the start of time duration T5) the number of successful tests is increased by one.

Otherwise the number of failed tests is increased by one.

8. If the iteration fails, the SS shall first attempt to release and add the PSCell, by ensuring the UE is in state RRC\_CONNECTED with generic procedure parameters *Connectivity* EN-DC, DC bearer MCG and SCG, Connected without release *On* and Test Mode *On* according to TS 38.508-1 [6] clause 4.5. If that also fails, then the UE is switched OFF/ON to proceed with the next iteration.
9. Repeat steps 2-10 until the confidence level according to Tables G.2.3-1 in Annex G clause G.2 is achieved.

4.5.1.6.4.3 Message contents

Message contents are according to TS 38.508-1 [14] clause 4.6 and 7.3.1 with the following exceptions:

**Table 4.5.1.6.4.3-1: Common Exception messages**

Default Message Contents	
Common contents of system information blocks exceptions	
Default RRC messages and information elements contents exceptions	Table H.3.4-1 Table H.3.5-4 Table H.3.5-9 with Condition CSI-RS RLM

4.5.1.6.5 Test requirement

Tables 4.5.1.6.4.1-2 and 4.5.1.6.5-1 define the primary level settings including test tolerances for Radio Link Monitoring In-sync Test for FR1 PSCell configured with CSI-RS-based RLM in non-DRX mode.

**Table 4.5.1.6.5-1: Cell specific test parameters for FR1 for CSI-RS In-sync radio link monitoring in non-DRX mode**

Parameter	Unit	Test 1									
		T1	T2	T3	T4	T5					
EPRE ratio of PDCCH DMRS to SSS	dB	0									
EPRE ratio of PDCCH to PDCCH DMRS	dB										
EPRE ratio of PBCH DMRS to SSS	dB										
EPRE ratio of PSS to SSS	dB										
EPRE ratio of PBCH to PBCH DMRS	dB										
EPRE ratio of PDSCH to PDSCH DMRS	dB						0				
EPRE ratio of PDSCH DMRS to SSS	dB										
EPRE ratio of OCNG DMRS to SSS	dB										
EPRE ratio of OCNG to OCNG DMRS	dB										
SNR on RLM-RS	Config 1, 4						1.8	-6.2	-15.8	-5.3	1.8
	Config 2, 5	1.8	-6.2	-15.8	-5.3	1.8					
	Config 3, 6	1.8	-6.2	-15.8	-5.3	1.8					
$N_{oc}$	Config 1, 4	-98									
	Config 2, 5	-98									
	Config 3, 6	-98									

Parameter	Unit	Test 1				
		T1	T2	T3	T4	T5
Propagation condition		TDL-C 300ns 100Hz				
NOTE 1: OCNG shall be used such that the resources in Cell 2 are fully allocated and a constant total transmitted power spectral density is achieved for all OFDM symbols.						
NOTE 2: The uplink resources for CSI reporting are assigned to the UE prior to the start of time period T1.						
NOTE 3: NZP CSI-RS resource set configuration for CSI reporting are assigned to the UE prior to the start of time period T1.						
NOTE 4: Measurement gap configuration is assigned to the UE prior to the start of time period T1.						
NOTE 5: The timers and layer 3 filtering related parameters are configured prior to the start of time period T1.						
NOTE 6: The signal contains PDCCH for UEs other than the device under test as part of OCNG.						
NOTE 7: SNR levels correspond to the signal to noise ratio over the SSS REs.						
NOTE 8: The SNR in time periods T1, T2, T3, T4 and T5 is denoted as SNR1, SNR2, SNR3, SNR4 and SNR5 respectively in figure 4.5.1.6.4-1.						
NOTE 9: The SNR values are specified for testing a UE which supports 2RX on at least one band. For testing of a UE which supports 4RX on all bands, the SNR during T3 and T4 from D.4.1.1 are -18.0-TT and -8.0-TT, which are -18.8dB and -8.8dB (including test tolerances).						

The UE behaviour in each test during time durations T1, T2, T3, T4 and T5 shall be as follows:

During the period from time point A to time point F (T6 after the start of time duration T5) the UE shall transmit uplink signal at least in all slots configured for CSI transmission according to the configured CSI reporting mode on PUCCH.

The uplink signal is verified on the basis of the UE output power:

- UE output power equal to or higher than Transmit minimum power (as defined in TS 38.521-1 [17] clause 6.3.1.5) means uplink signal

The rate of correct events observed during repeated tests shall be at least 90% with a confidence level of 95%.

#### 4.5.1.7 EN-DC FR1 radio link monitoring out-of-sync test for PSCell configured with CSI-RS-based RLM RS in DRX mode

##### 4.5.1.7.1 Test purpose

The purpose of this test is to verify that the UE properly detects the out of sync for the purpose of monitoring downlink CSI-RS based radio link quality of the PSCell when DRX is used. This test will partly verify the FR1 PSCell CSI-RS Out-of-sync radio link monitoring requirements in TS 38.133 clause 8.1.

##### 4.5.1.7.2 Test applicability

This test applies to all types of E-UTRA UE release 15 and forward supporting EN-DC FR1, CSI-RS based RLM and long DRX cycle.

##### 4.5.1.7.3 Minimum conformance requirements

The minimum requirements are specified in clause 4.5.1.0.3. DRX configuration is used for this test.

The normative reference for this requirement is TS 38.133 [6] clause A.4.5.1.7.

##### 4.5.1.7.4 Test description

There are two cells configured in this test, the E-UTRA PCell and NR PSCell. This test consists of three successive time periods, with time duration of T1, T2 and T3 respectively. Figure 4.5.1.7.4-1 shows the three different time durations and the corresponding variation of the downlink SNR in the active cell to emulate out-of-sync states.

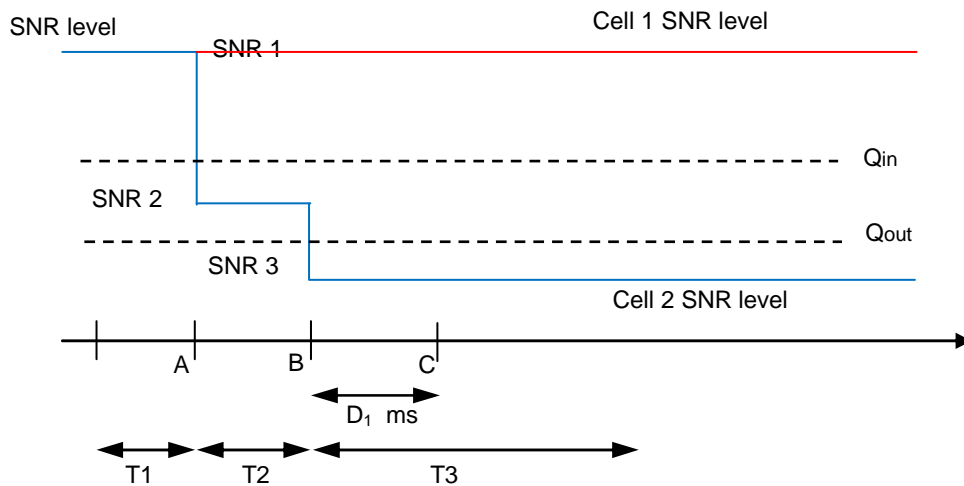

Figure 4.5.1.7.4-1: SNR variation for out-of-sync testing

4.5.1.7.4.1 Initial conditions

Test 4.5.1.7 can be run in one of the configurations defined in Table 4.5.1.7.4.1-1.

Table 4.5.1.7.4.1-1: Supported test configurations for FR1 PSCell

Configuration	Description
4.5.1.7-1	LTE FDD, NR 15 kHz SSB SCS, 10MHz bandwidth, FDD duplex mode
4.5.1.7-2	LTE FDD, NR 15 kHz SSB SCS, 10MHz bandwidth, TDD duplex mode
4.5.1.7-3	LTE FDD, NR 30 kHz SSB SCS, 40MHz bandwidth, TDD duplex mode
4.5.1.7-4	LTE TDD, NR 15 kHz SSB SCS, 10MHz bandwidth, FDD duplex mode
4.5.1.7-5	LTE TDD, NR 15 kHz SSB SCS, 10MHz bandwidth, TDD duplex mode
4.5.1.7-6	LTE TDD, NR 30 kHz SSB SCS, 40MHz bandwidth, TDD duplex mode

NOTE: The UE is only required to pass in one of the supported test configurations in FR1.

Configure the test equipment and the DUT according to the parameters in Table 4.5.1.7.4.1-2.

Table 4.5.1.7.4.1-2: Initial conditions for CSI-RS out-of-sync radio link monitoring in DRX mode

Parameter	Value	Comment
Test environment	NC	As specified in TS 38.508-1 [14] clause 4.1.
Test frequencies	As specified in Annex E, table E.2-1 and TS 38.508-1 [14] clause 4.3.1.	
Channel bandwidth	As specified by the test configuration selected from Table 4.5.1.7.4.1-1.	
Propagation conditions	AWGN	As specified in clause C.2.2.
Connection Diagram	TE Part	A.3.1.7.1
	DUT Part	A.3.2.3.4
Exceptions to connection diagram	For 4Rx capable UEs without any 2 Rx RF bands use A.3.2.5.2 for DUT part and A.3.1.7.4 for TE Part	

1. The test parameters are given in Table 4.5.1.7.4.1-3 below.
2. Message contents are defined in clause 4.5.1.7.4.3.
3. There are two cells in the test, where Cell 1 is the E-UTRAN PCell on the E-UTRA carrier, and Cell 2 is the NR PSCell on the NR carrier. Cell 1 is the cell used for connection setup with the power level set according to Table A.6.1.1-1 for this test. Cell 2 is configured according to clauses C.1.2 and C.1.3.

**Table 4.5.1.7.4.1-3: General test parameters for FR1 PSCell for CSI-RS out-of-sync testing in DRX mode**

Parameter		Unit	Value
			Test 1
Active E-UTRA PCell			Cell 1
E-UTRA RF Channel Number			1
Active PSCell			Cell 2
RF Channel Number			2
Duplex mode	Config 1, 4		FDD
	Config 2, 3, 5, 6		TDD
TDD Configuration	Config 1, 4		Not Applicable
	Config 2, 5		TDDConf.1.1
	Config 3, 6		TDDConf.2.1
DL initial BWP configuration	Config 1, 2, 3, 4, 5, 6		DLBWP.0.1
DL dedicated BWP configuration	Config 1, 2, 3, 4, 5, 6		DLBWP.1.1
UL initial BWP configuration	Config 1, 2, 3, 4, 5, 6		ULBWP.0.1
UL dedicated BWP configuration	Config 1, 2, 3, 4, 5, 6		ULBWP.1.1
RMSI CORESET Reference Channel	Config 1, 4		CR.1.1 FDD
	Config 2, 5		CR.1.1 TDD
	Config 3, 6		CR.2.1 TDD
Dedicated CORESET Reference Channel	Config 1, 4		CCR.1.3 FDD
	Config 2, 5		CCR.1.3 TDD
	Config 3, 6		CCR.2.2 TDD
SSB Configuration	Config 1, 4		SSB.1 FR1
	Config 2, 5		SSB.1 FR1
	Config 3, 6		SSB.2 FR1
SMTTC Configuration	Config 1, 2, 4, 5		SMTTC.1
	Config 3, 6		SMTTC.1
PDSCH/PDCCH subcarrier spacing	Config 1, 2, 4, 5		15 KHz
	Config 3, 6		30 KHz
TRS configuration	Config 1, 4		TRS.1.1 FDD
	Config 2, 5		TRS.1.1 TDD
	Config 3, 6		TRS.1.2 TDD
CSI-RS for RLM	Config 1, 4		Resource #4 in TRS.1.1 FDD
	Config 2, 5		Resource #4 in TRS.1.1 TDD
	Config 3, 6		Resource #4 in TRS.1.2 TDD
TCI configuration for PDCCH/PDSCH			TCI.State.2
OCNG parameters			OP.1
CP length			Normal
Correlation Matrix and Antenna Configuration			2x2 Low
Out of sync transmission parameters	DCI format		1-0
	Number of Control OFDM symbols		2
	Aggregation level	CCE	8
	Ratio of hypothetical PDCCH RE energy to average CSI-RS RE energy	dB	4
	Ratio of hypothetical PDCCH DMRS energy to average CSI-RS RE energy	dB	4
	DMRS precoder granularity		REG bundle size
	REG bundle size		6
DRX			DRX.3
Gap pattern ID			N.A.
Layer 3 filtering			Enabled

Parameter		Unit	Value
			Test 1
T310 timer		ms	0
T311 timer		ms	1000
N310			1
N311			1
CSI-RS for reporting	Config 1, 4		CSI-RS.1.1 FDD
	Config 2, 5		CSI-RS.1.1 TDD
	Config 3, 6		CSI-RS.2.1 TDD
T1		s	0.2
T2		s	1.28
T3		s	1.28
D1		s	1.24
NOTE 1: UE-specific PDCCH is not transmitted after T1 starts.			
NOTE 2: E-UTRAN is in non-DRX mode under test.			

#### 4.5.1.7.4.2 Test procedure

Prior to the start of the time duration T1, the UE shall be fully synchronized to Cell 1 and Cell 2. The UE shall be configured for periodic CSI reporting with a reporting periodicity of 5ms. In the test, DRX configuration is enabled in PSCell and DRX inactivity timer has already been expired, i.e. UE tries to decode PDCCH and to send periodic CQI during the period when On-duration timer is running. Time alignment timers shall be set to "infinity" so that UL timing alignment is maintained during the test.

1. Ensure the UE is in state RRC\_CONNECTED with generic procedure parameters Connectivity *EN-DC*, DC bearer *MCG\_and\_SCG*, Connected without release *On* and Test Mode *On* according to TS 38.508-1 [14] clause 4.5.
2. Set the parameters of Cell 2 according to T1 in Table 4.5.1.7.5-1. Propagation conditions are set according to clause C.2.3. T1 starts.
3. When T1 expires the SS shall change the SNR value to T2 as specified in Table 4.5.1.7.5-1. T2 starts.
4. When T2 expires the SS shall change the SNR value to T3 as specified in Table 4.5.1.7.5-1. T3 starts.
5. If the SS:
  - a) detects uplink power on NR carrier equal to or higher than minimum output power defined in TS 38.521-1 [17] clause 6.3.1.5 in the On-duration part of every DRX cycle in the slots configured for CSI transmission (according CSI reporting on PUCCH) during the period from time point A to time point B; and
  - b) does not detect any uplink power on NR carrier higher than OFF power defined in TS 38.521-1 [17] clause 6.3.2.5 from time point C (D1 after the start of T3) until T3 expires, the number of successful tests is increased by one.

Otherwise the number of failed tests is increased by one.
6. When T3 expires the SS shall change the SNR value to T1 as specified in Table 4.5.1.7.5-1.
7. If the UE has not re-established the connection in at least 1s, the UE is switched off and then on. Ensure the UE is in RRC\_CONNECTED with generic procedure parameters Connectivity *EN-DC*, DC bearer *MCG\_and\_SCG*, Connected without release *On* according to TS 38.508-1 [14] clause 4.5.
8. Repeat steps 2-7 until the confidence level according to Tables G.2.3-1 in Annex G clause G.2 is achieved.

4.5.1.7.4.3 Message contents

Message contents are according to TS 38.508-1 [14] clause 4.6 and 7.3.1 with the following exceptions.

**Table 4.5.1.7.4.3-1: Common Exception messages**

Default Message Contents	
Common contents of system information blocks exceptions	
Default RRC messages and information elements contents exceptions	Table H.3.4-1 Table H.3.5-4 Table H.3.5-9 with Condition CSI-RS RLM Table H.3.7-1 with condition DRX.3

**Table 4.5.1.7.4.3-2: RLF-TimersAndConstant**

Derivation Path: TS 38.508-1 [14], Table 4.6.3-150			
Information Element	Value/remark	Comment	Condition
RLF-TimersAndConstants ::= SEQUENCE {			
t310	ms0		
}			

4.5.1.7.5 Test requirement

Tables 4.5.1.7.4.1-2 and 4.5.1.7.5-1 define the primary level settings including test tolerances for Radio Link Monitoring Out-of-sync Test for FR1 PSCell configured with CSI-RS-based RLM in DRX mode.

**Table 4.5.1.7.5-1: Cell specific test parameters for FR1 for CSI-RS out-of-sync radio link monitoring in DRX mode**

Parameter		Unit	Test 1		
			T1	T2	T3
EPRE ratio of PDCCH DMRS to SSS		dB	4		
EPRE ratio of PDCCH to PDCCH DMRS		dB	0		
EPRE ratio of PBCH DMRS to SSS		dB			
EPRE ratio of PBCH to PBCH DMRS		dB			
EPRE ratio of PBCH to PBCH DMRS		dB			
EPRE ratio of PDSCH DMRS to SSS		dB			
EPRE ratio of PDSCH to PDSCH DMRS		dB			
EPRE ratio of OCNG DMRS to SSS		dB			
EPRE ratio of OCNG to OCNG DMRS		dB			
SNR on RLM-RS	Config 1, 4	dB	1.8	-6.2	-15.8
	Config 2, 5		1.8	-6.2	-15.8
	Config 3, 6		1.8	-6.2	-15.8
$N_{oc}$	Config 1, 4	dBm/15KHz	-98		
	Config 2, 5		-98		
	Config 3, 6		-98		

Parameter	Unit	Test 1		
		T1	T2	T3
Propagation condition		TDL-C 300ns 100Hz		
NOTE 1: OCNG shall be used such that the resources in Cell 2 are fully allocated and a constant total transmitted power spectral density is achieved for all OFDM symbols.				
NOTE 2: The uplink resources for CSI reporting are assigned to the UE prior to the start of time period T1.				
NOTE 3: NZP CSI-RS resource set configuration for CSI reporting are assigned to the UE prior to the start of time period T1.				
NOTE 4: Measurement gap configuration is assigned to the UE prior to the start of time period T1.				
NOTE 5: The timers and layer 3 filtering related parameters are configured prior to the start of time period T1.				
NOTE 6: The signal contains PDCCH for UEs other than the device under test as part of OCNG.				
NOTE 7: SNR levels correspond to the signal to noise ratio over the SSS REs.				
NOTE 8: The SNR in time periods T1, T2 and T3 is denoted as SNR1, SNR2 and SNR3 respectively in figure 4.5.1.7.4-1.				
NOTE 9: The SNR values are specified for testing a UE which supports 2RX on at least one band. For testing of a UE which supports 4RX on all bands, the SNR during T3 from D.4.1.1 is -18 -TT, which is -18.8dB (including test tolerances).				

The UE behaviour in each test during time durations T1, T2 and T3 shall be as follows:

During the period from time point A to time point B the UE shall transmit uplink signal at least once every DRX cycle, in the On-duration part of the cycle in the slots configured for CSI transmission according the configured CSI reporting mode on PUCCH.

The UE shall stop transmitting uplink signal no later than time point C (D1 after the start of time duration T3).

The uplink signal is verified on the basis of the UE output power:

- UE output power equal to or higher than Transmit minimum power (as defined in TS 38.521-1 [17] clause 6.3.1.5) means uplink signal
- UE output power equal to or less than Transmit OFF power (as defined in TS 38.521-1 [17] clause 6.3.2.5) means no uplink signal.

The rate of correct events observed during repeated tests shall be at least 90 % with a confidence level of 95 %.

#### 4.5.1.8 EN-DC FR1 radio link monitoring in-sync test for PSCell configured with CSI-RS-based RLM RS in DRX mode

##### 4.5.1.8.1 Test purpose

The purpose of this test is to verify that the UE properly detects the in sync for the purpose of monitoring downlink CSI-RS based radio link quality of the PSCell when DRX is used. This test will partly verify the FR1 PSCell CSI-RS in-sync radio link monitoring requirements in TS 38.133 clause 8.1.

##### 4.5.1.8.2 Test applicability

This test applies to all types of E-UTRA UE release 15 and forward supporting EN-DC FR1, CSI-RS based RLM and long DRX cycle.

##### 4.5.1.8.3 Minimum conformance requirements

The minimum requirements are specified in clause 4.5.1.0.4. DRX configuration is used for this test.

The normative reference for this requirement is TS 38.133 [6] clause A.4.5.1.8.

##### 4.5.1.8.4 Test description

There are two cells configured in this test, the E-UTRA PCell and NR PSCell. This test consists of five successive time periods, with time duration of T1, T2, T3, T4 and T5 respectively. Figure 4.5.1.8.4-1 shows the five different time durations and the corresponding variation of the downlink SNR in the active cell to emulate in-sync states.



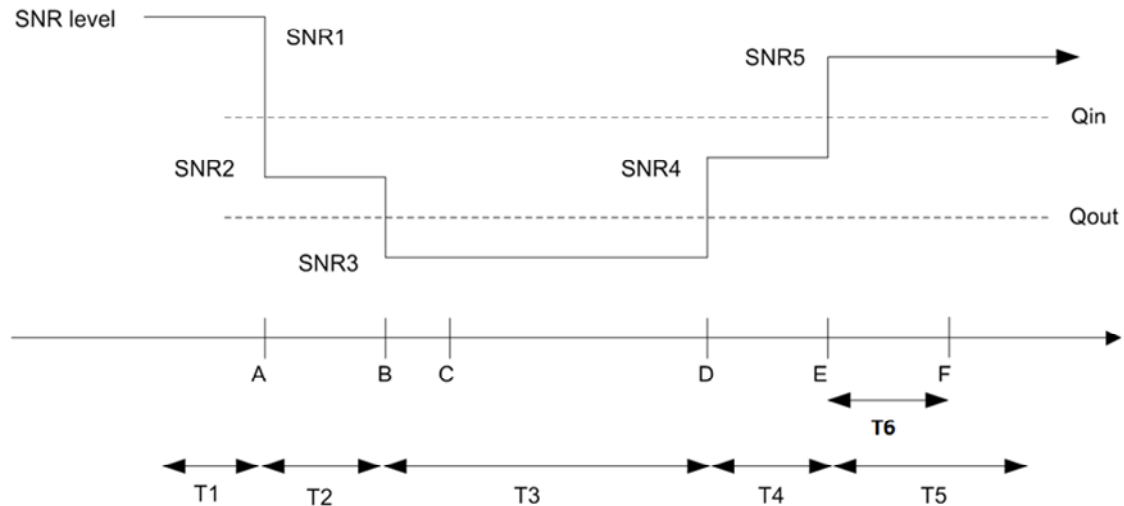

Figure 4.5.1.8.4-1: SNR variation for In-sync testing

4.5.1.8.4.1 Initial conditions

Test 4.5.1.8 can be run in one of the configurations defined in Table 4.5.1.8.4.1-1.

Table 4.5.1.8.4.1-1: Supported test configurations for FR1 PSCell

Configuration	Description
4.5.1.8-1	LTE FDD, NR 15 kHz SSB SCS, 10MHz bandwidth, FDD duplex mode
4.5.1.8-2	LTE FDD, NR 15 kHz SSB SCS, 10MHz bandwidth, TDD duplex mode
4.5.1.8-3	LTE FDD, NR 30 kHz SSB SCS, 40MHz bandwidth, TDD duplex mode
4.5.1.8-4	LTE TDD, NR 15 kHz SSB SCS, 10MHz bandwidth, FDD duplex mode
4.5.1.8-5	LTE TDD, NR 15 kHz SSB SCS, 10MHz bandwidth, TDD duplex mode
4.5.1.8-6	LTE TDD, NR 30 kHz SSB SCS, 40MHz bandwidth, TDD duplex mode

NOTE: The UE is only required to pass in one of the supported test configurations in FR1.

Configure the test equipment and the DUT according to the parameters in Table 4.5.1.8.4.1-2.

Table 4.5.1.8.4.1-2: Initial conditions for CSI-RS In-sync radio link monitoring in DRX mode

Parameter	Value	Comment
Test environment	NC	As specified in TS 38.508-1 [14] clause 4.1.
Test frequencies	As specified in Annex E, table E.2-1 and TS 38.508-1 [14] clause 4.3.1.	
Channel bandwidth	As specified by the test configuration selected from Table 4.5.1.8.4.1-1.	
Propagation conditions	AWGN	As specified in clause C.2.2.
Connection Diagram	TE Part	A.3.1.7.1
	DUT Part	A.3.2.3.4
Exceptions to connection diagram	For 4Rx capable UEs without any 2 Rx RF bands use A.3.2.5.2 for DUT part and A.3.1.7.4 for TE Part	

1. The test parameters are given in Table 4.5.1.8.4.1-3 below.
2. Message contents are defined in clause 4.5.1.8.4.3.
3. There are two cells in the test, where Cell 1 is the E-UTRAN PCell on the E-UTRA carrier, and Cell 2 is the NR PSCell on the NR carrier. Cell 1 is the cell used for connection setup with the power level set according to Table A.6.1.1-1 for this test. Cell 2 is configured according to clauses C.1.2 and C.1.3.

**Table 4.5.1.8.4.1-3: General test parameters for FR1 PSCell for CSI-RS In-sync testing in DRX mode**

Parameter		Unit	Value
			Test 1
Active E-UTRA PCell			Cell 1
E-UTRA RF Channel Number			1
Active PSCell			Cell 2
RF Channel Number			2
Duplex mode	Config 1, 4		FDD
	Config 2, 3, 5, 6		TDD
TDD Configuration	Config 1, 4		Not Applicable
	Config 2, 5		TDDConf.1.1
	Config 3, 6		TDDConf.2.1
DL initial BWP configuration	Config 1, 2, 3, 4, 5, 6		DLBWP.0.1
DL dedicated BWP configuration	Config 1, 2, 3, 4, 5, 6		DLBWP.1.1
UL initial BWP configuration	Config 1, 2, 3, 4, 5, 6		ULBWP.0.1
UL dedicated BWP configuration	Config 1, 2, 3, 4, 5, 6		ULBWP.1.1
RMSI CORESET Reference Channel	Config 1, 4		CR.1.1 FDD
	Config 2, 5		CR.1.1 TDD
	Config 3, 6		CR.2.1 TDD
Dedicated CORESET Reference Channel	Config 1, 4		CCR.1.1 FDD
	Config 2, 5		CCR.1.1 TDD
	Config 3, 6		CCR.2.1 TDD
SSB Configuration	Config 1, 4		SSB.1 FR1
	Config 2, 5		SSB.1 FR1
	Config 3, 6		SSB.2 FR1
SMTTC Configuration	Config 1, 2, 4, 5		SMTTC.1
	Config 3, 6		SMTTC.1
PDSCH/PDCCH subcarrier spacing	Config 1, 2, 4, 5		15 KHz
	Config 3, 6		30 KHz
TRS configuration	Config 1, 4		TRS.1.1 FDD
	Config 2, 5		TRS.1.1 TDD
	Config 3, 6		TRS.1.2 TDD
CSI-RS for RLM	Config 1, 4		Resource #4 in TRS.1.1 FDD
	Config 2, 5		Resource #4 in TRS.1.1 TDD
	Config 3, 6		Resource #4 in TRS.1.2 TDD
TCI configuration for PDCCH/PDSCH			TCI.State.2
OCNG parameters			OP.1
CP length			Normal
Correlation Matrix and Antenna Configuration			2x2 Low
Out of sync transmission parameters	DCI format		1-0
	Number of Control OFDM symbols		2
	Aggregation level	CCE	8
	Ratio of hypothetical PDCCH RE energy to average CSI-RS RE energy	dB	4
	Ratio of hypothetical PDCCH DMRS energy to average CSI-RS RE energy	dB	4
	DMRS precoder granularity		REG bundle size
	REG bundle size		6

Parameter		Unit	Value
			Test 1
In sync transmission parameters	DCI format		1-0
	Number of Control OFDM symbols		2
	Aggregation level	CCE	4
	Ratio of hypothetical PDCCH RE energy to average CSI-RS RE energy	dB	0
	Ratio of hypothetical PDCCH DMRS energy to average CSI-RS RE energy	dB	0
	DMRS precoder granularity		REG bundle size
	REG bundle size		6
DRX			DRX.3
Gap pattern ID			<i>gp0</i>
Layer 3 filtering			<i>Enabled</i>
T310 timer		ms	2000
T311 timer		ms	1000
N310			1
N311			1
CSI for reporting	Config 1, 4		CSI-RS.1.1 FDD
	Config 2, 5		CSI-RS.1.1 TDD
	Config 3, 6		CSI-RS.2.1 TDD
T1		s	0.2
T2		s	0.2
T3		s	1.24
T4		s	0.2
T5		s	1.88
T6		s	1.84
NOTE 1: UE-specific PDCCH is not transmitted after T1 starts.			
NOTE 2: E-UTRAN is in non-DRX mode under test.			

**Table 4.5.1.8.4.1-4: Measurement gap configuration for FR1 CSI-RS In-sync radio link monitoring in DRX mode**

Field	Test 1
	Value
gapOffset	0
NOTE: E-UTRAN PCell and PSCell are SFN-synchronous and frame boundary aligned.	

4.5.1.8.4.2 Test procedure

Prior to the start of the time duration T1, the UE shall be fully synchronized to Cell 1 and Cell 2. The UE shall be configured for periodic CSI reporting with a reporting periodicity of 5ms. In the test, DRX configuration is enabled in PSCell and DRX inactivity timer has already been expired, i.e. UE tries to decode PDCCH and to send periodic CQI during the period when On-duration timer is running. Time alignment timers shall be set to "infinity" so that UL timing alignment is maintained during the test. The UE is configured to perform inter-frequency measurements using GP ID #0 (40ms).

1. Ensure the UE is in state RRC\_CONNECTED with generic procedure parameters Connectivity *EN-DC*, DC bearer *MCG\_and\_SCG*, Connected without release *On* and Test Mode *On* according to TS 38.508-1 [14] clause 4.5.
2. The SS shall transmit an *RRCConnectionReconfiguration* message configuring the UE for inter-frequency measurements.
3. The UE shall transmit *RRCReconfigurationComplete* message.

4. Set the parameters of Cell 2 according to T1 in Table 4.5.1.8.5-1. Propagation conditions are set according to clause C.2.3. T1 starts.
5. When T1 expires the SS shall change the SNR value to T2 as specified in Table 4.5.1.8.5-1. T2 starts.
6. When T2 expires the SS shall change the SNR value to T3 as specified in Table 4.5.1.8.5-1. T3 starts.
7. When T3 expires the SS shall change the SNR value to T4 as specified in Table 4.5.1.8.5-1. T4 starts.
8. When T4 expires the SS shall change the SNR value to T5 as specified in Table 4.5.1.8.5-1. T5 starts.
9. If the SS detects uplink power on NR carrier equal to or higher than minimum output power defined in TS 38.521-1 [17] clause 6.3.1.5 in the On-duration part of every DRX cycle in the configured slots for CSI transmission (according CSI reporting on PUCCH) during the period from time point A to time point F (T6 after the start of time duration T5) the number of successful tests is increased by one.

Otherwise the number of failed tests is increased by one.

10. If the iteration fails, the SS shall first attempt to release and add the PSCell, by ensuring the UE is in state RRC\_CONNECTED with generic procedure parameters *Connectivity* EN-DC, DC bearer MCG and SCG, Connected without release *On* and Test Mode *On* according to TS 38.508-1 [6] clause 4.5. If that also fails, then the UE is switched OFF/ON to proceed with the next iteration.
11. Repeat steps 4-10 for both subtests until the confidence level according to Tables G.2.3-1 in Annex G clause G.2 is achieved.

4.5.1.8.4.3 Message contents

Message contents are according to TS 38.508-1 [14] clause 4.6 and 7.3.1 with the following exceptions:

**Table 4.5.1.8.4.3-1: Common Exception messages**

Default Message Contents	
Common contents of system information blocks exceptions	
Default RRC messages and information elements contents exceptions	Table H.3.1-1 Table H.3.1-2 with Condition INTER-FREQ, L3 FILTERING NEEDED Table H.3.1-3 with Condition INTER-FREQ MO (where ssbFrequency is set to the ARFCN value of carrier center of High range) Table H.3.1-4 with A3-offset = 0 Table H.3.4-1 Table H.3.4-1a Table H.3.4-4 with condition gapUE Table H.3.4-5 with condition BFD Table H.3.5-4 Table H.3.5-9 with Condition CSI-RS RLM Table H.3.7-1 with condition DRX.3 and Gap

**Table 4.5.1.8.4.3-2: Void**

**Table 4.5.1.8.4.3-3: RLF-TimersAndConstant**

Derivation Path: TS 38.508-1 [14], Table 4.6.3-150			
Information Element	Value/remark	Comment	Condition
RLF-TimersAndConstants ::= SEQUENCE {			
t310	ms2000		
}			

4.5.1.8.5 Test requirement

Tables 4.5.1.8.4.1-2 and 4.5.1.8.5-1 define the primary level settings including test tolerances for Radio Link Monitoring In-sync Test for FR1 PSCell configured with CSI-RS-based RLM in DRX mode.

**Table 4.5.1.8.5-1: Cell specific test parameters for FR1 for CSI-RS In-sync radio link monitoring in DRX mode**

Parameter		Unit	Test 1									
			T1	T2	T3	T4	T5					
EPRE ratio of PDCCH DMRS to SSS		dB	0									
EPRE ratio of PDCCH to PDCCH DMRS		dB	0									
EPRE ratio of PBCH DMRS to SSS		dB										
EPRE ratio of PBCH to PBCH DMRS		dB										
EPRE ratio of PBCH to PBCH DMRS		dB										
EPRE ratio of PDSCH DMRS to SSS		dB										
EPRE ratio of PDSCH to PDSCH DMRS		dB										
EPRE ratio of OCNG DMRS to SSS		dB										
EPRE ratio of OCNG to OCNG DMRS		dB										
SNR on RLM-RS	Config 1, 4	dB						1.8	-6.2	-15.8	-5.3	1.8
	Config 2, 5							1.8	-6.2	-15.8	-5.3	1.8
	Config 3, 6		1.8	-6.2	-15.8	-5.3	1.8					
$N_{oc}$	Config 1, 4	dBm/15KHz	-98									
	Config 2, 5		-98									
	Config 3, 6		-98									
Propagation condition			TDL-C 300ns 100Hz									
NOTE 1: OCNG shall be used such that the resources in Cell 2 are fully allocated and a constant total transmitted power spectral density is achieved for all OFDM symbols.												
NOTE 2: The uplink resources for CSI reporting are assigned to the UE prior to the start of time period T1.												
NOTE 3: NZP CSI-RS resource set configuration for CSI reporting are assigned to the UE prior to the start of time period T1.												
NOTE 4: Measurement gap configuration is assigned to the UE prior to the start of time period T1.												
NOTE 5: The timers and layer 3 filtering related parameters are configured prior to the start of time period T1.												
NOTE 6: The signal contains PDCCH for UEs other than the device under test as part of OCNG.												
NOTE 7: SNR levels correspond to the signal to noise ratio over the SSS REs.												
NOTE 8: The SNR in time periods T1, T2, T3, T4 and T5 is denoted as SNR1, SNR2, SNR3, SNR4 and SNR5 respectively in figure 4.5.1.8.4-1.												
NOTE 9: The SNR values are specified for testing a UE which supports 2RX on at least one band. For testing of a UE which supports 4RX on all bands, the SNR during T3 and T4 from D.4.1.1 are -18.0-TT and -8.0-TT, which are -18.8dB and -8.8dB(including test tolerances).												

The UE behaviour in each test during time durations T1, T2, T3, T4 and T5 shall be as follows:

During the period from time point A to time point F (T6 after the start of time duration T5) the UE shall transmit uplink signal at least once every DRX cycle, in the ON-duration part of the cycle in the slots configured for CSI transmission according to the configured CSI reporting mode on PUCCH.

The uplink signal is verified on the basis of the UE output power:

- UE output power equal to or higher than Transmit minimum power (as defined in TS 38.521-1 [17] clause 6.3.1.5) means uplink signal

The rate of correct events observed during repeated tests shall be at least 90% with a confidence level of 95%.

## 4.5.2 Interruption

### 4.5.2.0 Minimum conformance requirements

#### 4.5.2.0.1 Minimum conformance requirements for interruptions at transitions between active and non-active during DRX.

[TS 38.133, clause 8.2.1.2.1]

Interruption on PSCell and the activated SCell if configured due to E-UTRA PCell transitions between active and non-active during DRX when PSCell or SCell is in non-DRX are allowed with up to 1% probability of missed ACK/NACK when the configured E-UTRA PCell DRX cycle is less than 640 ms, and 0.625% probability of missed ACK/NACK is allowed when the configured E-UTRA PCell DRX cycle is 640 ms or longer. Each interruption shall not exceed X slot as defined in table 8.2.1.2.1-1.

Each interruption shall not exceed X slot as defined in table 8.2.1.2.1-1.

**Table 8.2.1.2.1-1: Interruption length X at transition between active and non-active during DRX**

$\mu$	NR Slot length (ms)	Interruption length X	
		Sync	Async
0	1	1	2
1	0.5	1	2
2	0.25	3	
3	0.125	5	

When both E-UTRA PCell and PSCell are in DRX, no interruption is allowed.

The normative reference for this requirement is TS 38.133 [6] clause 8.2.1.2.1.

#### 4.5.2.0.2 Minimum conformance requirements for interruptions during measurements on deactivated NR SCC

[TS 38.133, clause 8.2.1.2.5.1]

Interruption on PSCell and other active NR SCell(s) during measurement on the deactivated NR SCC shall meet requirements in clause 8.2.2.2.3, where the term PCell in clause 8.2.2.2.3 shall be deemed to be replaced with PSCell.

[TS 38.133, clause 8.2.2.2.3]

Interruptions on PCell due to measurements when an SCell is deactivated are allowed with up to 0.5% probability of missed ACK/NACK when the configured *measCycleSCell* [2] is 640 ms or longer. The UE is only allowed to cause interruptions immediately before and immediately after an SMTC. Each interruption shall not exceed requirement in Table 8.2.2.2.2-1 if the PCell is not in the same band as the deactivated SCell. Each interruption shall not exceed requirement in Table 8.2.2.2.2-2 if the PCell is in the same band as the deactivated SCell.

Interruptions on active SCell due to measurements when an SCell is deactivated are allowed with up to 0.5% probability of missed ACK/NACK when the configured *measCycleSCell* [2] is 640 ms or longer. The UE is only allowed to cause interruptions immediately before and immediately after an SMTC. Each interruption shall not exceed requirement in Table 8.2.2.2.2-1 if the active SCell is not in the same band as the deactivated SCell. Each interruption shall not exceed requirement in Table 8.2.2.2.2-2 if the active SCell is in the same band as the deactivated SCell.

[TS 38.133, clause 8.2.2.2.2]

**Table 8.2.2.2-1: Interruption duration for SCell activation/deactivation for inter-band CA**

$\mu$	NR Slot length (ms)	Interruption length
0	1	1
1	0.5	1
2	0.25	2
3	0.125	4

**Table 8.2.2.2-2: Interruption duration for SCell activation/deactivation for intra-band CA**

$\mu$	NR Slot length (ms)	Interruption length
0	1	1 + $T_{\text{SMTC\_duration}}$
1	0.5	1 + $T_{\text{SMTC\_duration}}$
2	0.25	2 + $T_{\text{SMTC\_duration}}$
3	0.125	4 + $T_{\text{SMTC\_duration}}$
NOTE: $T_{\text{SMTC\_duration}}$ is - the longest SMTC duration among all above activated serving cells and the SCell being activated when one SCell is activated; - the longest SMTC duration among all activated serving cells in the same band when one SCell is deactivated.		

The normative reference for this requirement is TS 38.133 [6] clause 8.2.1.2.5.1.

#### 4.5.2.0.3 Minimum conformance requirements for interruptions during measurements on deactivated E-UTRAN SCC

[TS 38.133 clause 8.2.1.2.5.2]

When one E-UTRA SCell in MCG is deactivated, the UE is allowed due to measurements on the E-UTRA SCC with the deactivated E-UTRA SCell:

- an interruption on PSCell or any activated SCell with up to 0.5% probability of missed ACK/NACK when any of the configured *measCycleSCell* [2] for the deactivated E-UTRA SCells is 640 ms or longer.
- an interruption on PSCell or any activated SCell with up to 0.5% probability of missed ACK/NACK regardless of the configured *measCycleSCell* [2] for the deactivated E-UTRA SCells if indicated by the network using IE *allowInterruptions* [2].

Each interruption shall not exceed:

- X3 slot, if the PSCell or activated SCell is not in the same band as the E-UTRA deactivated SCC being measured, or
- Y3 slot + SMTC duration, if the PSCell or activated SCell is in the same band as the E-UTRA deactivated SCC being measured, provided the cell specific reference signals from the PSCell or activated SCell and the E-UTRA deactivated SCC being measured are available in the same slot.

**Table 8.2.1.2.5-1: Interruption length X3 and Y3 at measurements on deactivated E-UTRA SCC**

$\mu$	NR Slot length (ms)	Interruption length X3 slot	Interruption length Y3 slot
0	1	1	1
1	0.5	1	1
2	0.25	2	2
3	0.125	4	4

The normative reference for this requirement is TS 38.133 [6] clause 8.2.1.2.5.1.

#### 4.5.2.1 EN-DC FR1 interruptions at transitions between active and non-active during DRX in synchronous EN-DC

##### 4.5.2.1.1 Test purpose

The purpose of this test is to verify that when LTE PCell is in DRX and NR PSCell is in non-DRX, NR PSCell interruptions due to transitions from active to non-active and from non-active to active during LTE PCell DRX the UE missed ACK/NACK does not exceed the limits This test will verify the missed ACK/NACK rate for NR PSCell in EN-DC.

##### 4.5.2.1.2 Test applicability

This test applies to all types of E-UTRA UE release 15 and forward supporting EN-DC FR1 and long DRX cycle.

##### 4.5.2.1.3 Minimum conformance requirements

The minimum conformance requirements are defined in clause 4.5.2.0.1.

The normative reference for this requirement is TS 38.133 [6] clause A.4.5.2.1.

##### 4.5.2.1.4 Test description

###### 4.5.2.1.4.1 Initial conditions

This test shall be tested using any of the test configurations in Table 4.5.2.1.4.1-1.

**Table 4.5.2.1.4.1-1: Supported test configurations**

Configuration	Description
4.5.2.1-1	LTE FDD, NR 15 kHz SSB SCS, 10MHz bandwidth, FDD duplex mode
4.5.2.1-2	LTE FDD, NR 15 kHz SSB SCS, 10MHz bandwidth, TDD duplex mode
4.5.2.1-3	LTE FDD, NR 30 kHz SSB SCS, 40MHz bandwidth, TDD duplex mode
4.5.2.1-4	LTE TDD, NR 15 kHz SSB SCS, 10MHz bandwidth, FDD duplex mode
4.5.2.1-5	LTE TDD, NR 15 kHz SSB SCS, 10MHz bandwidth, TDD duplex mode
4.5.2.1-6	LTE TDD, NR 30 kHz SSB SCS, 40MHz bandwidth, TDD duplex mode

NOTE: The UE is only required to be tested in one of the supported test configurations.

Configure the test equipment and the DUT according to the parameters in Table 4.5.2.1.4.1-2.

**Table 4.5.2.1.4.1-2: Initial conditions for EN-DC FR1 interruptions at transitions between active and non-active during DRX in synchronous EN-DC**

Parameter	Value	Comment
Test environment	NC	As specified in TS 38.508-1 [14] clause 4.1.
Test frequencies	As specified in Annex E, Table E.1-1 and TS 38.508-1 [14] clause 4.3.1.	
Channel bandwidth	As specified by the test configuration selected from Table 4.7.1.1.2-1.	
Propagation conditions	AWGN	As specified in clause C.2.2.
Connection Diagram	TE Part DUT Part	A.3.1.8.2 A.3.2.3.4
Exceptions to connection diagram	N/A	

1. The general test parameter settings are set up according to Table 4.5.2.1.4.1-3.
2. Message contents are defined in clause 4.5.2.1.4.3.



3. There are one E-UTRAN carrier and one NR carrier and two cells in the test. Cell 1 is PCell on the E-UTRAN carrier, Cell 2 is PSCell on the NR carrier, Cell 1 is the cell used for connection setup with the power levels set according to Table A.6.1.1-1 for this test. Cell 2 is configured according to clauses C.1.1 and C.1.2.

**Table 4.5.2.1.4.1-3: General test parameters for E-UTRAN - NR FR1 interruptions at transitions between active and non-active during DRX in synchronous EN-DC**

Parameter	Unit	Value	Comment
RF Channel Number		1, 2	One is E-UTRAN RF channel and the other is NR RF channel
Active PCell		Cell1	PCell on E-UTRAN RF channel number 1.
Configured PSCell		Cell2	PSCell on NR RF channel number 2.
CP length		Normal	Applicable to Cell1 and Cell 2
DRX		DRX.4	DRX related parameters are defined in TS 38.133 Table A.3.3.4-1
Measurement gap pattern Id		OFF	
T1	s	10	

#### 4.5.2.1.4.2 Test procedure

The test consists of two cells: Cell1 and Cell2. Cell1 is LTE PCell and Cell2 is NR PSCell. The test consists of one time period, with duration of T1. During T1, NR PSCell is continuously scheduled in DL while LTE PCell is not scheduled and has DRX configured. Prior to the start of the time duration T1, the UE shall be fully synchronized to Cell1 and Cell2. Cell1 shall be configured as LTE PCell and Cell2 shall be configured as NR PSCell. Prior to start of T1 the DRX inactivity timer for the LTE PCell has already expired.

1. Ensure the UE is in state RRC\_CONNECTED with generic procedure parameters Connectivity *EN-DC*, DC bearer *MCG\_and\_SCG*, Connected without release *On* and Test Mode *On* according to TS 38.508-1 [14] clause 4.5.
2. Configure MCG according to TS 36.521-3 [26] clause C.0, C.1 and SCG according to clause C.1.1 and C.1.2 for all downlink physical channels.
3. The SS shall transmit an RRCConnectionReconfiguration message to configure PCell (Cell1) and PSCell (Cell2) on the MCG and SCG as per TS 36.508 [7] clause 4.6 with the message content exceptions defined in clause 4.5.2.1.4.3.
4. The UE shall transmit *RRCConnectionReconfigurationComplete* message.
5. The SS would ensure continuous transmission on PSCell, while not scheduling on PCell at least for 200 ms to ensure inactivity timer is expired on the UE for LTE PCell.
5. Set the parameters according to T1 in Table 4.5.2.1.5-1. Propagation conditions are set according to clause C.2.1. T1 starts.
6. SS schedules on PSCell continuously and UE shall start sending ACK/NACK reports. The SS shall monitor ACK/NACK/DTX on PSCell.
7. If more than 99% of uplink transmissions are received by SS then count a success for the event "ACK/NACK". Otherwise count a fail for the event "ACK/NACK".
8. If no two consecutive DTX is observed by the SS, then count a success for the event "DTX". Otherwise count a fail for the event "DTX".
9. The SS shall transmit *RRCConnectionReconfiguration* message with condition EN-DC\_PSCell\_Rel according to TS 36.508 [25] Table 4.6.1-8 to release NR cell (PSCell). The UE shall transmit *RRCConnectionReconfigurationComplete* message.
10. The SS then shall transmit *RRCConnectionReconfiguration* message with condition MCG\_and\_SCG according to TS 36.508 [25] Table 4.6.1-8 to add NR cell (PSCell). The UE shall transmit *RRCConnectionReconfigurationComplete* message.

11. If any the reconfiguration fails, switch off and on the UE and ensure the UE is in RRC\_CONNECTED with generic procedure parameters Connectivity EN-DC, DC bearer MCG and SCG, Connected without release On according to TS 38.508-1 [14] clause 4.5

12. Repeat step 3-9 until a test verdict has been achieved

Each of the events "ACK/NACK" and "DTX" is evaluated independently for the statistic, resulting in an event verdict: pass or fail. Each event is evaluated only until the confidence level according to Table G.2.3-1 in Annex G.2 is achieved. Different events may require different times for a verdict. If all events pass, the test passes. If one event fails, the test fails.

4.5.2.1.4.3 Message contents

Message contents are according to TS 38.508-1 [14] clause 4.6 with the following exceptions:

**Table 4.5.2.1.4.3-1: Common Exception messages**

Default Message Contents	
Common contents of system information blocks exceptions	
Default RRC messages and information elements contents exceptions	Table H.3.7-2 with Condition DRX.4

4.5.2.1.5 Test requirement

Table 4.5.2.1.5-1 defines the NR cell specific primary level settings including test tolerances for E-UTRAN - NR FR1 interruptions at transitions between active and non-active during DRX in synchronous EN-DC test.

**Table 4.5.2.1.5-1: NR Cell specific test parameters for E-UTRAN - NR FR1 interruptions at transitions between active and non-active during DRX in synchronous EN-DC**

Parameter		Unit	Cell 2
Frequency Range			FR1
Duplex mode	Config 1,4		FDD
	Config 2,3,5,6		TDD
TDD configuration	Config 1,4		Not Applicable
	Config 2,5		TDDConf.1.1
	Config 3,6		TDDConf.2.1
BW <sub>channel</sub>	Config 1,4		10: N <sub>RB,c</sub> = 52
	Config 2,5		10: N <sub>RB,c</sub> = 52
	Config 3,6		40: N <sub>RB,c</sub> = 106
Initial DL BWP Configuration	Config 1,4		DLBWP.0.1
	Config 2,5		DLBWP.0.1
	Config 3,6		DLBWP.0.1
Dedicated DL BWP Configuration	Config 1,4		DLBWP.1.1
	Config 2,5		DLBWP.1.1
	Config 3,6		DLBWP.1.1
Initial UL BWP Configuration	Config 1,4		ULBWP.0.1
	Config 2,5		ULBWP.0.1
	Config 3,6		ULBWP.0.1
Dedicated UL BWP Configuration	Config 1,4		ULBWP.1.1
	Config 2,5		ULBWP.1.1
	Config 3,6		ULBWP.1.1
PDSCH Reference measurement channel	Config 1,4		SR.1.1 FDD
	Config 2,5		SR.1.1 TDD
	Config 3,6		SR.2.1 TDD
RMSI CORESET parameters	Config 1,4		CR.1.1 FDD
	Config 2,5		CR.1.1 TDD
	Config 3,6		CR.2.1 TDD
PDCCH CORESET parameters	Config 1,4		CCR.1.1 FDD
	Config 2,5		CCR.1.1 TDD
	Config 3,6		CCR.2.1 TDD
OCNG Patterns			OP.1

Parameter		Unit	Cell 2
SMTC Configuration			SMTC.1
TRS configuration	Config 1,4		TRS.1.1 FDD
	Config 2,5		TRS.1.1 TDD
	Config 3,6		TRS.1.2 TDD
SSB Configuration	Config 1,2,4,5		SSB.1 FR1
	Config 3,6		SSB.2 FR1
Correlation Matrix and Antenna Configuration			1x2 Low
EPRE ratio of PSS to SSS		dB	0
EPRE ratio of PBCH DMRS to SSS			
EPRE ratio of PBCH to PBCH DMRS			
EPRE ratio of PDCCH DMRS to SSS			
EPRE ratio of PDCCH to PDCCH DMRS			
EPRE ratio of PDSCH DMRS to SSS			
EPRE ratio of PDSCH to PDSCH			
EPRE ratio of OCNG DMRS to SSS(Note 1)			
EPRE ratio of OCNG to OCNG DMRS (Note 1)			
$N_{oc}$ <sup>Note 2</sup>		dBm/15 kHz	-104
SS-RSRP <sup>Note 3</sup>		dBm/15 kHz	-87
$\bar{E}_s/I_{ot}$		dB	17
$\bar{E}_s/N_{oc}$		dB	17
$I_o$ <sup>Note3</sup>	Config 1,2,4,5	dBm/ 9.36MHz	-58.96
	Config 3,6	dBm/ 38.16MHz	-52.86
Time offset to cell1 <sup>Note 4</sup>		$\mu$ s	3 for intra-band EN-DC, 33 for inter-band EN-DC
Propagation Condition			AWGN
NOTE 1: OCNG shall be used such that both cells are fully allocated and a constant total transmitted power spectral density is achieved for all OFDM symbols.			
NOTE 2: Interference from other cells and noise sources not specified in the test is assumed to be constant over subcarriers and time and shall be modeled as AWGN of appropriate power for $N_{oc}$ to be fulfilled.			
NOTE 3: SS-RSRP and $I_o$ levels have been derived from other parameters for information purposes. They are not settable parameters themselves.			
NOTE 4: Receive time difference of signals received between subframe timing boundary of E-UTRA PCell and slot timing boundary of PCell at the UE antenna connector including time alignment error between the two cells.			

The UE shall be continuously scheduled in NR PSCell during the entire length of T1. UE shall not be scheduled in LTE PCell during T1. During the time duration T1 the UE shall transmit at least 99% of ACK/NACK on NR PSCell.

Interruption on NR PSCell shall not exceed X slots as defined in Table 4.5.2.1.5-2.

**Table 4.5.2.1.5-2: Interruption length X at transition between active and non-active during DRX**

$\mu$	NR Slot length (ms)	Interruption length X
0	1	1
1	0.5	1

The rate of correct events observed during repeated tests shall be at least 90%.

#### 4.5.2.2 EN-DC FR1 interruptions at transitions between active and non-active during DRX in asynchronous EN-DC

##### 4.5.2.2.1 Test purpose

The purpose of this test is to verify that when LTE PCell is in DRX and NR PSCell is in non-DRX, NR PSCell interruptions due to transitions from active to non-active and from non-active to active during LTE PCell DRX the UE missed ACK/NACK does not exceed the limits. This test will verify the missed ACK/NACK rate for NR PSCell in EN-DC.

## 4.5.2.2.2 Test applicability

This test applies to all types of E-UTRA UE release 15 and forward supporting EN-DC FR1 and long DRX cycle.

## 4.5.2.2.3 Minimum conformance requirements

The minimum conformance requirements are defined in clause 4.5.2.0.1.

The normative reference for this requirement is TS 38.133 [6] clause A.4.5.2.2.

## 4.5.2.2.4 Test description

## 4.5.2.2.4.1 Initial conditions

This test shall be tested using any of the test configurations in Table 4.5.2.2.4.1-1.

**Table 4.5.2.2.4.1-1: Supported test configurations**

Configuration	Description
4.5.2.2-1	LTE FDD, NR 15 kHz SSB SCS, 10MHz bandwidth, FDD duplex mode
4.5.2.2-2	LTE FDD, NR 15 kHz SSB SCS, 10MHz bandwidth, TDD duplex mode
4.5.2.2-3	LTE FDD, NR 30 kHz SSB SCS, 40MHz bandwidth, TDD duplex mode
4.5.2.2-4	LTE TDD, NR 15 kHz SSB SCS, 10MHz bandwidth, FDD duplex mode
4.5.2.2-5	LTE TDD, NR 15 kHz SSB SCS, 10MHz bandwidth, TDD duplex mode
4.5.2.2-6	LTE TDD, NR 30 kHz SSB SCS, 40MHz bandwidth, TDD duplex mode

NOTE: The UE is only required to be tested in one of the supported test configurations.

Configure the test equipment and the DUT according to the parameters in Table 4.5.2.2.4.1-2.

**Table 4.5.2.2.4.1-2: Initial conditions for EN-DC FR1 interruptions at transitions between active and non-active during DRX in asynchronous EN-DC**

Parameter	Value		Comment
Test environment	NC		As specified in TS 38.508-1 [14] clause 4.1.
Test frequencies	As specified in Annex E, Table E.1-1 and TS 38.508-1 [14] clause 4.3.1.		
Channel bandwidth	As specified by the test configuration selected from Table 4.7.1.1.2-1.		
Propagation conditions	AWGN		As specified in clause C.2.2.
Connection Diagram	TE Part	A.3.1.8.2	As specified in TS 38.508-1 [14] Annex A.
	DUT Part	A.3.2.3.4	
Exceptions to connection diagram	N/A		

1. The general test parameter settings are set up according to Table 4.5.2.2.4.1-3.
2. Message contents are defined in clause 4.5.2.2.4.3.
3. There are one E-UTRAN carrier and one NR carrier and two cells in the test. Cell 1 is PCell on the E-UTRAN carrier, Cell 2 is PSCell on the NR carrier. Cell 1 is the cell used for connection setup with the power levels set according to Table A.6.1.1-1 for this test. Cell 2 is configured according to clauses C.1.1 and C.1.2.

**Table 4.5.2.2.4.1-3: General test parameters for E-UTRAN - NR FR1 interruptions at transitions between active and non-active during DRX in asynchronous EN-DC**

Parameter	Unit	Value	Comment
RF Channel Number		1, 2	One is E-UTRAN RF channel and the other is NR RF channel
Active PCell		Cell1	PCell on E-UTRAN RF channel number 1.
Configured PSCell		Cell2	PSCell on NR RF channel number 2.
CP length		Normal	Applicable to Cell1 and Cell 2
DRX		DRX.4	DRX related parameters are defined in TS 38.133 table A.3.3.4-1

Measurement gap pattern Id		OFF	
T1	s	10	

#### 4.5.2.2.4.2 Test procedure

The test consists of two cells: Cell1 and Cell2. Cell1 is LTE PCell and Cell2 is NR PSCell. The test consists of one time period, with duration of T1. During T1, NR PSCell is continuously scheduled in DL while LTE PCell is not scheduled and has DRX configured. Prior to the start of the time duration T1, the UE shall be fully synchronized to Cell1 and Cell2. Cell1 shall be configured as LTE PCell and Cell2 shall be configured as NR PSCell. Prior to start of T1 the DRX inactivity timer for the LTE PCell has already expired.

1. Ensure the UE is in state RRC\_CONNECTED with generic procedure parameters Connectivity *EN-DC*, DC bearer *MCG\_and\_SCG*, Connected without release *On* and Test Mode *On* according to TS 38.508-1 [14] clause 4.5.
2. Configure MCG according to TS 36.521-3 [26] clause C.0, C.1 and SCG according to clause C.1.1 and C.1.2 for all downlink physical channels.
3. The SS shall transmit an RRCConnectionReconfiguration message to configure PCell (Cell1) and PSCell (Cell2) on the MCG and SCG as per TS 36.508 [7] clause 4.6 with the message content exceptions defined in clause 4.5.2.2.4.3.
4. The UE shall transmit *RRCConnectionReconfigurationComplete* message.
5. The SS would ensure continuous transmission on PSCell, while not scheduling on PCell at least for 200 ms to ensure inactivity timer is expired on the UE for LTE PCell.
5. Set the parameters according to T1 in Table 4.5.2.2.5-1. Propagation conditions are set according to clause C.2.1. T1 starts.
6. SS schedules on PSCell continuously and UE shall start sending ACK/NACK reports. The SS shall monitor ACK/NACK/DTX on PSCell.
7. If more than 99% of uplink transmissions are received by SS then count a success for the event "ACK/NACK". Otherwise count a fail for the event "ACK/NACK".
8. If no longer than X consecutive DTX is observed by the SS, then count a success for the event "DTX". Otherwise count a fail for the event "DTX". Where
  - For test configuration 4.5.2.2-1 and 4.5.2.2-4:
    - $X = \text{interruption length} + k1$  if  $k1 \leq \text{interruption length}$ , otherwise  $X = \text{interruption length}$ .
  - For test configuration other than 4.5.2.2-1 and 4.5.2.2-4:
    - $X = \text{interruption length}$ .
  - Interruption length is given in Table 4.5.2.2.5-2.
9. The SS shall transmit *RRCConnectionReconfiguration* message with condition EN-DC\_PSCell\_Rel according to TS 36.508 [25] Table 4.6.1-8 to release NR cell (PSCell). The UE shall transmit *RRCConnectionReconfigurationComplete* message.
10. The SS then shall transmit *RRCConnectionReconfiguration* message with condition MCG\_and\_SCG according to TS 36.508 [25] Table 4.6.1-8 to add NR cell (PSCell). The UE shall transmit *RRCConnectionReconfigurationComplete* message.
11. If any the reconfiguration fails, switch off and on the UE and ensure the UE is in RRC\_CONNECTED with generic procedure parameters Connectivity EN-DC, DC bearer MCG and SCG, Connected without release On according to TS 38.508-1 [14] clause 4.5
12. Repeat step 3-9 until a test verdict has been achieved

Each of the events "ACK/NACK" and "DTX" is evaluated independently for the statistic, resulting in an event verdict: pass or fail. Each event is evaluated only until the confidence level according to Table G.2.3-1 in Annex G.2 is

achieved. Different events may require different times for a verdict. If all events pass, the test passes. If one event fails, the test fails.

4.5.2.2.4.3 Message contents

Message contents are according to TS 38.508-1 [14] clause 4.6 with the following exceptions:

**Table 4.5.2.2.4.3-1: Common Exception messages**

Default Message Contents	
Common contents of system information blocks exceptions	
Default RRC messages and information elements contents exceptions	Table H.3.7-2 with Condition DRX.4

4.5.2.2.5 Test requirement

Table 4.5.2.2.5-1 define the NR cell specific primary level settings including test tolerances for E-UTRAN - NR FR1 interruptions at transitions between active and non-active during DRX in asynchronous EN-DC test.

**Table 4.5.2.2.5-1: NR Cell specific test parameters for E-UTRAN - NR FR1 interruptions at transitions between active and non-active during DRX in asynchronous EN-DC**

Parameter		Unit	Cell 2
Frequency Range			FR1
Duplex mode	Config 1,4		FDD
	Config 2,3,5,6		TDD
TDD configuration	Config 1,4		Not Applicable
	Config 2,5		TDDConf.1.1
	Config 3,6		TDDConf.2.1
BW <sub>channel</sub>	Config 1,4		10: N <sub>RB,c</sub> = 52
	Config 2,5		10: N <sub>RB,c</sub> = 52
	Config 3,6		40: N <sub>RB,c</sub> = 106
Initial DL BWP Configuration	Config 1,4		DLBWP.0.1
	Config 2,5		DLBWP.0.1
	Config 3,6		DLBWP.0.1
Dedicated DL BWP Configuration	Config 1,4		DLBWP.1.1
	Config 2,5		DLBWP.1.1
	Config 3,6		DLBWP.1.1
Initial UL BWP Configuration	Config 1,4		ULBWP.0.1
	Config 2,5		ULBWP.0.1
	Config 3,6		ULBWP.0.1
Dedicated UL BWP Configuration	Config 1,4		ULBWP.1.1
	Config 2,5		ULBWP.1.1
	Config 3,6		ULBWP.1.1
PDSCH Reference measurement channel	Config 1,4		SR.1.1 FDD
	Config 2,5		SR.1.1 TDD
	Config 3,6		SR2.1 TDD
RMSI CORESET parameters	Config 1,4		CR.1.1 FDD
	Config 2,5		CR.1.1 TDD
	Config 3,6		CR2.1 TDD
PDCCH CORESET parameters	Config 1,4		CCR.1.1 FDD
	Config 2,5		CCR.1.1 TDD
	Config 3,6		CCR.2.1 TDD
OCNG Patterns			OP.1
SMTTC Configuration			SMTTC.1
TRS configuration	Config 1,4		TRS.1.1 FDD
	Config 2,5		TRS.1.1 TDD
	Config 3,6		TRS.1.2 TDD
SSB Configuration	Config 1,2,4,5		SSB.1 FR1
	Config 3,6		SSB.2 FR1
Correlation Matrix and Antenna Configuration			1x2 Low
EPRE ratio of PSS to SSS		dB	0
EPRE ratio of PBCH DMRS to SSS			
EPRE ratio of PBCH to PBCH DMRS			

Parameter		Unit	Cell 2
EPRE ratio of PDCCH DMRS to SSS			
EPRE ratio of PDCCH to PDCCH DMRS			
EPRE ratio of PDSCH DMRS to SSS			
EPRE ratio of PDSCH to PDSCH			
EPRE ratio of OCNG DMRS to SSS(Note 1)			
EPRE ratio of OCNG to OCNG DMRS (Note 1)			
$N_{oc}$ <sup>Note 2</sup>		dBm/15 kHz	-104
SS-RSRP <sup>Note 3</sup>		dBm/15 kHz	-87
$\bar{E}_s/I_{ot}$		dB	17
$\bar{E}_s/N_{oc}$		dB	17
$N_{oc}$ <sup>Note 2</sup>	Config 1,2,4,5	-104	-104
	Config 3,6		-101
$I_o$ <sup>Note 3</sup>	Config 1,2,4,5	dBm/ 9.36MHz	-58.96
	Config 3,6	dBm/ 38.16MHz	-52.86
Time offset to Cell1 <sup>Note 4</sup>	Config 1,2,4,5	$\mu$ s	500
	Config 3,6		250
Propagation Condition			AWGN
NOTE 1: OCNG shall be used such that both cells are fully allocated and a constant total transmitted power spectral density is achieved for all OFDM symbols.			
NOTE 2: Interference from other cells and noise sources not specified in the test is assumed to be constant over subcarriers and time and shall be modeled as AWGN of appropriate power for $N_{oc}$ to be fulfilled.			
NOTE 3: SS-RSRP and $I_o$ levels have been derived from other parameters for information purposes. They are not settable parameters themselves.			
NOTE 4: Receive time difference of signals received between subframe timing boundary of E-UTRA PCell and slot timing boundary of PCell at the UE antenna connector including time alignment error between the two cells.			

The UE shall be continuously scheduled in NR PSCell during the entire length of T1. UE shall not be scheduled in LTE PCell during T1. During the time duration T1 the UE shall transmit at least 99% of ACK/NACK on NR PSCell.

Interruption on NR PSCell shall not exceed X slots as defined in Table 4.5.2.2.5-2.

**Table 4.5.2.2.5-2: Interruption length X at transition between active and non-active during DRX**

$\mu$	NR Slot length (ms)	Interruption length X
0	1	2
1	0.5	2

The rate of correct events observed during repeated tests shall be at least 90%.

### 4.5.2.3 EN-DC FR1 interruptions during measurements on deactivated NR SCC in synchronous EN-DC

#### 4.5.2.3.1 Test purpose

The purpose of this test is to verify E-UTRAN PCell and NR PSCell interruptions during the measurement on the deactivated NR SCC, the UE missed ACK/NACK does not exceed the limits. This test will verify the missed ACK/NACK rate for E-UTRAN PCell and NR PSCell in EN-DC.

#### 4.5.2.3.2 Test applicability

This test applies to all types of E-UTRA UE release 15 and forward supporting EN-DC and 2 DL CA in NR.

#### 4.5.2.3.3 Minimum conformance requirements

The minimum conformance requirements are defined in clause 4.5.2.0.2.

The normative reference for this requirement is TS 38.133 [6] clause A.4.5.2.3.

## 4.5.2.3.4 Test description

## 4.5.2.3.4.1 Initial conditions

This test shall be tested using any of the test configurations in Table 4.5.2.3.4.1-1.

**Table 4.5.2.3.4.1-1: Supported test configurations**

Configuration	Description
4.5.2.3-1	LTE FDD, NR 15 kHz SSB SCS, $\geq 10$ MHz bandwidth, FDD duplex mode
4.5.2.3-2	LTE FDD, NR 15 kHz SSB SCS, $\geq 10$ MHz bandwidth, TDD duplex mode
4.5.2.3-3	LTE FDD, NR 30 kHz SSB SCS, $\geq 40$ MHz bandwidth, TDD duplex mode
4.5.2.3-4	LTE TDD, NR 15 kHz SSB SCS, $\geq 10$ MHz bandwidth, FDD duplex mode
4.5.2.3-5	LTE TDD, NR 15 kHz SSB SCS, $\geq 10$ MHz bandwidth, TDD duplex mode
4.5.2.3-6	LTE TDD, NR 30 kHz SSB SCS, $\geq 40$ MHz bandwidth, TDD duplex mode

Note 1: The UE is only required to be tested in one of the supported test configurations  
Note 2: The UE is only required to be tested in one with smallest aggregated channel bandwidth from supported band combinations which is composed of CCs  $\geq$  the bandwidth ( $BW_{\text{channel}}$ ) defined in each test configuration.

Configure the test equipment and the DUT according to the parameters in Table 4.5.2.3.4.1-2.

**Table 4.5.2.3.4.1-2: Initial conditions for EN-DC FR1 interruptions during measurements on deactivated NR SCC in synchronous EN-DC**

Parameter	Value		Comment
Test environment	NC		As specified in TS 38.508-1 [14] clause 4.1.
Test frequencies	As specified in Annex E, Table E.1-1 and TS 38.508-1 [14] clause 4.3.1.		
Channel bandwidth	As specified by the test configuration selected from Table 4.7.1.1.2-1.		
Propagation conditions	AWGN		As specified in clause C.2.2.
Connection Diagram	TE Part	A.3.1.8.2	As specified in TS 38.508-1 [14] Annex A.
	DUT Part	A.3.2.3.4	
Exceptions to connection diagram	N/A		

1. The general test parameter settings are set up according to Table 4.5.2.3.4.1-3.
2. Message contents are defined in clause 4.5.2.3.4.3.
3. There are one E-UTRAN carrier and two NR carriers and three cells specified in the test. Cell 1 is the PCell on E-UTRAN carrier, Cell 2 is the PSCell on one NR carrier and Cell 3 is the NR SCell on the other NR carrier. Cell 1 is the cell used for connection setup with the power level set according to Table A.6.1.1-1. Cell 2 and Cell 3 shall be configured according to clauses C.1.1 and C.1.2.

**Table 4.5.2.3.4.1-3: General test parameters for E-UTRAN - NR interruptions during measurements on deactivated NR SCC in synchronous EN-DC**

Parameter	Unit	Value	Comment
RF Channel Number		1, 2, 3	One is E-UTRAN RF channel and the other two are NR RF channels
Active PCell		Cell1	PCell on E-UTRAN RF channel number 1.
Active PSCell		Cell2	PSCell on NR RF channel number 2.
Configured deactivated SCell		Cell3	Deactivated SCell on NR RF channel number 3.
CP length		Normal	Applicable to Cell1, Cell 2 and Cell3
DRX		OFF	
Measurement gap pattern Id		OFF	
SCell measurement cycle (measCycleSCell)	ms	640	
T1	s	10	

## 4.5.2.3.4.2 Test procedure



The test consists of three cells: Cell1, Cell2 and Cell3. Cell1 is E-UTRAN PCell, Cell2 is NR PSCell and Cell3 is deactivated NR SCell. The test consists of one time period, with duration of T1. Prior to the start of the time duration T1, the UE shall be connected to Cell1 and Cell2 and the RRC message including *measCycleSCell* or *allowInterruptions* for the deactivated NR SCells is received at the UE antenna connector. Cell1 shall be configured as E-UTRAN PCell, Cell2 shall be configured as NR PSCell and Cell3 shall be configured as NR deactivated SCell.. During T1 the UE shall be continuously scheduled on E-UTRAN PCell and NR PSCell.

1. Ensure the UE is in state RRC\_CONNECTED with generic procedure parameters Connectivity *EN-DC*, DC bearer *MCG\_and\_SCG*, Connected without release *On* and Test Mode *On* according to TS 38.508-1 [14] clause 4.5.
  2. Configure MCG according to TS 36.521-3 [26] clause C.0, C.1 and SCG according to clause C.1.1 and C.1.2 for all downlink physical channels.
  3. The SS shall configure SCell (Cell 3) on the SCC as per TS 38.508-1 [14] clause 7.5.2, with the message content exceptions defined in clause 4.5.2.3.4.3. NR RRCReconfiguration message is contained in RRCConnectionReconfiguration and NR RRCReconfigurationComplete message is contained in RRCConnectionReconfigurationComplete.
  4. Set the parameters according to T1 in Table 4.5.2.3.5-1. Propagation conditions are set according to clause C.2.1. T1 starts.
  5. SS schedules on PCell and PSCell continuously and UE shall start sending ACK/NACK reports. The SS shall monitor DTX on PCell and ACK/NACK/DTX on PSCell.
  6. If more than 99.5% of uplink transmissions on PSCell are received by SS then count a success for the event "ACK/NACK". Otherwise count a fail for the event "ACK/NACK".
  - 6a. If no longer than X consecutive DTX on PCell is observed by the SS, then count a success for the event "PCell DTX". Otherwise count a fail for the event "PCell DTX". Where,
    - X = 1 for inter-band EN-DC, and X = 3 for intra-band EN-DC.7.If no longer than X consecutive DTX on PSCell is observed by the SS, then count a success for the event "PSCell DTX". Otherwise count a fail for the event "PSCell DTX". Where,
      - For test configuration 4.5.2.3-1 and 4.5.2.3-4,
        - X = interruption length+k1 if  $k1 \leq$  interruption length, otherwise X = interruption length.
- Note: UE expects that the SS won't use k1 = 3 for test configuration 4.5.2.3-1 and 4.5.2.3-4.
- For test configuration other than 4.5.2.3-1 and 4.5.2.3-4,
    - X = interruption length.
    - interruption length is given in Table 4.5.2.3.5-2 for inter-band case and in Table 4.5.2.3.5-3 for intra-band case.
8. After the RRC connection release, the SS:
    - transmits in Cell 1 a Paging message (including PagingRecord with UE-Identity) for the UE and ensures the UE is in state RRC\_CONNECTED with generic procedure parameters Connectivity *EN-DC*, DC bearer *MCG\_and\_SCG*, Connected without release *On* according to TS 38.508-1 [14] clause 4.5. (if the paging fails, switches off and on the UE and ensures the UE is in state RRC\_CONNECTED with generic procedure parameters Connectivity *EN-DC*, DC bearer *MCG\_and\_SCG*, Connected without release *On* according to TS 38.508-1 [14] clause 4.5); or
    - switches off and on the UE and ensures the UE is in state RRC\_CONNECTED with generic procedure parameters Connectivity *EN-DC*, DC bearer *MCG\_and\_SCG*, Connected without release *On* according to TS 38.508-1 [14] clause 4.5.
  9. Repeat step 2-8 until a test verdict has been achieved.

Each of the events "ACK/NACK", "PCell DTX" and "PSCell DTX" is evaluated independently for the statistic, resulting in an event verdict: pass or fail. Each event is evaluated only until the confidence level according to Table G.2.3-1 in Annex G.2 is achieved. Different events may require different times for a verdict.

If all events pass, the test passes. If one event fails, the test fails.

4.5.2.3.4.3 Message contents

Message contents are according to TS 38.508-1 [14] clause 7.3 with the following exceptions:

**Table 4.5.2.3.4.3-1: Common Exception messages**

Default Message Contents	
Common contents of system information blocks exceptions	
Default RRC messages and information elements contents exceptions	Table H.3.1-2 with Condition Deactivated SCell; Table H.3.1-4 with A3-offset = 15
Specific message contents exceptions for Test Configuration 4.5.2.3-1, 4.5.2.3-2, 4.5.2.3-4 and 4.5.2.3-5	Table H.3.1-3 with Condition Deactivated SCell and SSB.1 FR1 Table 7.3.1-3 in TS 38.508-1 [14] with condition SMTC.1
Specific message contents exceptions for Test Configuration 4.5.2.3-3 and 4.5.2.3-6	Table H.3.1-3 with Condition Deactivated SCell and SSB.2 FR1 Table 7.3.1-3 in TS 38.508-1 [14] with condition SMTC.1

**Table 4.5.2.3.4.3-2: RRCReconfiguration in step 3: SCell addition**

Derivation Path: TS 38.508-1 [14], Table 4.6.1-13 with condition NR_MEAS and SCell_add			
Information Element	Value/remark	Comment	Condition
RRCReconfiguration ::= SEQUENCE { criticalExtensions CHOICE { rrcReconfiguration ::= SEQUENCE { measConfig	MeasConfig-DEFAULT	Measurements configuration	NR_MEAS
nonCriticalExtension SEQUENCE { masterCellGroup	CellGroupConfig-SCell(n)	n is number of SCC to be added	SCell_add
}			
}			
}			
}			

**Table 4.5.2.3.4.3-3: ServingCellConfig (Cell 3)**

Derivation Path: TS 38.508-1 [14], Table 4.6.3-167 with condition MEAS			
Information Element	Value/remark	Comment	Condition
ServingCellConfig ::= SEQUENCE { servingCellMO	2	MeasObjectId for SCell in Table H.3.1-2	
}			

4.5.2.3.5 Test requirement

Table 4.5.2.3.5-1 defines the primary level settings including test tolerances for E-UTRAN - NR FR1 interruptions during measurements on deactivated NR SCC in synchronous EN-DC test configurations.

**Table 4.5.2.3.5-1: NR cell specific test parameters for E-UTRAN - NR interruptions during measurements on deactivated NR SCC in synchronous EN-DC**

Parameter	Unit	Cell 2	Cell 3
Frequency Range		FR1	FR1
Duplex mode	Config 1,4	FDD	FDD
	Config 2,3,5,6	TDD	TDD
TDD configuration	Config 1,4	Not Applicable	Not Applicable
	Config 2,5	TDDConf.1.1	TDDConf.1.1
	Config 3,6	TDDConf.2.1	TDDConf.2.1
BW <sub>channel</sub>	Config 1,4	Note 8	Note 8
	Config 2,5	Note 8	Note 8

Parameter		Unit	Cell 2	Cell 3
BW <sub>occupied</sub>	Config 3,6		Note 8	Note 8
	Config 1,4	RB	52 <sup>Note 6</sup>	52 <sup>Note 6</sup>
	Config 2,5		52 <sup>Note 6</sup>	52 <sup>Note 6</sup>
	Config 3,6		106 <sup>Note 7</sup>	106 <sup>Note 7</sup>
Initial DL BWP Configuration	Config 1,4		DLBWP.0.1	DLBWP.0.1
	Config 2,5		DLBWP.0.1	DLBWP.0.1
	Config 3,6		DLBWP.0.1	DLBWP.0.1
Dedicated DL BWP Configuration	Config 1,4		DLBWP.1.1	DLBWP.1.1
	Config 2,5		DLBWP.1.1	DLBWP.1.1
	Config 3,6		DLBWP.1.1	DLBWP.1.1
Initial UL BWP Configuration	Config 1,4		ULBWP.0.1	ULBWP.0.1
	Config 2,5		ULBWP.0.1	ULBWP.0.1
	Config 3,6		ULBWP.0.1	ULBWP.0.1
Dedicated UL BWP Configuration	Config 1,4		ULBWP.1.1	ULBWP.1.1
	Config 2,5		ULBWP.1.1	ULBWP.1.1
	Config 3,6		ULBWP.1.1	ULBWP.1.1
PDSCH Reference measurement channel	Config 1,4		SR.1.1 FDD	-
	Config 2,5		SR.1.1 TDD	-
	Config 3,6		SR.2.1 TDD	-
RMSI CORESET parameters	Config 1,4		CR.1.1 FDD	CR.1.1 FDD
	Config 2,5		CR.1.1 TDD	CR.1.1 TDD
	Config 3,6		CR.2.1 TDD	CR.2.1 TDD
PDCCH CORESET parameters	Config 1,4		CCR.1.1 FDD	CCR.1.1 FDD
	Config 2,5		CCR.1.1 TDD	CCR.1.1 TDD
	Config 3,6		CCR.2.1 TDD	CCR.2.1 TDD
TRS configuration	Config 1,4		TRS.1.1 FDD	TRS.1.1 FDD
	Config 2,5		TRS.1.1 TDD	TRS.1.1 TDD
	Config 3,6		TRS.1.2 TDD	TRS.1.2 TDD
OCNG Patterns	Config 1,2,4,5		OP.1 <sup>Note 6</sup>	OP.1 <sup>Note 6</sup>
	Config 3,6		OP.1 <sup>Note 7</sup>	OP.1 <sup>Note 7</sup>
SMTc Configuration			SMTc.1	SMTc.1
TCI state			TCI.State.0	TCI.State.0
SSB Configuration	Config 1,2,4,5		SSB.1 FR1	SSB.1 FR1
	Config 3,6		SSB.2 FR1	SSB.2 FR1
Correlation Matrix and Antenna Configuration			1x2 Low	1x2 Low
EPRE ratio of PSS to SSS		dB	0	0
EPRE ratio of PBCH DMRS to SSS				
EPRE ratio of PBCH to PBCH DMRS				
EPRE ratio of PDCCH DMRS to SSS				
EPRE ratio of PDCCH to PDCCH DMRS				
EPRE ratio of PDSCH DMRS to SSS				
EPRE ratio of PDSCH to PDSCH				
EPRE ratio of OCNG DMRS to SSS(Note 1) (Note 1)				
N <sub>oc</sub> <sup>Note 2</sup>		dBm/15 kHz	-104	-104
SS-RSRP <sup>Note 3</sup>		dBm/15 kHz	-87	-87
E <sub>s</sub> /I <sub>ot</sub>		dB	17	17
E <sub>s</sub> /N <sub>oc</sub>		dB	17	17
I <sub>o</sub> <sup>Note 3</sup>	Config 1,2,4,5	dBm/ 9.36MHz	-58.96	-58.96
	Config 3,6	dBm/ 38.16MHz	-52.86	-52.86
Time offset to Cell1 <sup>Note 4</sup>		μs	3 for intra-band EN-DC, 33 for inter-band EN-DC	3 + Time offset to Cell2 for intra-band EN-DC, 33 + Time offset to Cell2 for inter-band EN-DC
Time offset to Cell2 <sup>Note 5</sup>		μs	-	3
Propagation Condition			AWGN	AWGN

Parameter	Unit	Cell 2	Cell 3
NOTE 1:	OCNG shall be used such that both cells are fully allocated and a constant total transmitted power spectral density is achieved for all OFDM symbols.		
NOTE 2:	Interference from other cells and noise sources not specified in the test is assumed to be constant over subcarriers and time and shall be modeled as AWGN of appropriate power for $N_{oc}$ to be fulfilled within $BW_{occupied}$ .		
NOTE 3:	SS-RSRP and $I_0$ levels have been derived from other parameters for information purposes. They are not settable parameters themselves.		
NOTE 4:	Receive time difference of signals received between subframe timing boundary of E-UTRA PCell and slot timing boundary of PSCell at the UE antenna connector including time alignment error between the two cells.		
NOTE 5:	Receive time difference between slot boundaries of signals received from the two cells at the UE antenna connector including time alignment error between the two cells.		
Note 6:	All UL/DL transmission shall be confined within $BW_{occupied}$ (i.e. 10 MHz, 52 RBs) from $F_{C,low}$ , and $I_0$ is independent of the $BW_{channel}$ configured.		
Note 7:	All UL/DL transmission shall be confined within $BW_{occupied}$ (i.e. 40 MHz, 106 RBs) from $F_{C,low}$ , and $I_0$ is independent of the $BW_{channel}$ configured.		
Note 8:	$N_{RB,c}$ is derived from Table 5.3.2-1 in TS38.101-1[2] with configured $BW_{channel}$ .		

The UE shall be continuously scheduled in LTE PCell and NR PSCell during the entire length of T1. During the time duration T1 the UE shall transmit at least 99.5% of ACK/NACK on NR PSCell..

If the NR PSCell is not in the same band as the deactivated SCell, the UE is only allowed to cause interruptions on NR PSCell immediately before and immediately after an SMTC. Each interruption on NR PSCell shall not exceed the value defined in Table 4.5.2.3.5-2.

If the NR PSCell is in the same band as the deactivated SCell, the UE is only allowed to cause an interruption on PSCell no earlier than 1 slot before an SMTC and no later than 1 slot after the SMTC. the interruption on NR PSCell shall not exceed the value defined in Table 4.5.2.3.5-3.

**Table 4.5.2.3.5-2: Interruption duration if the NR PSCell is not in the same band as the deactivated SCell**

$\mu$	NR Slot length (ms)	Interruption length (slot)
0	1	1
1	0.5	1

**Table 4.5.2.3.5-3: Interruption duration if the NR PSCell is in the same band as the deactivated SCell**

$\mu$	NR Slot length (ms)	Interruption length (slot)
0	1	2+SMTC duration
1	0.5	2+SMTC duration

For synchronous inter-band EN-DC, the UE is only allowed to cause interruptions on E-UTRA PCell immediately before and immediately after an SMTC. Each interruption on E-UTRA PCell shall not exceed 1 subframe.

For synchronous intra-band EN-DC, the UE is only allowed to cause an interruption on E-UTRA PCell no earlier than 1 subframe before an SMTC and no later than 1 subframe after the SMTC. The interruption on E-UTRA PCell shall not exceed SMTC duration + 2 subframes.

The rate of correct events observed during repeated tests shall be at least 90 %.

#### 4.5.2.4 EN-DC FR1 interruptions during measurements on deactivated NR SCC in asynchronous EN-DC

##### 4.5.2.4.1 Test purpose

The purpose of this test is to verify E-UTRAN PCell and NR PSCell interruptions during the measurement on the deactivated NR SCC, the UE missed ACK/NACK does not exceed the limits. This test will verify the missed ACK/NACK rate for E-UTRAN PCell and NR PSCell in EN-DC

##### 4.5.2.4.2 Test applicability

This test applies to all types of E-UTRA UE release 15 and forward supporting EN-DC and 2 DL CA in NR.

##### 4.5.2.4.3 Minimum conformance requirements

The minimum conformance requirements are defined in clause 4.5.2.0.2.

The normative reference for this requirement is TS 38.133 [6] clause A.4.5.2.4.

##### 4.5.2.4.4 Test description

###### 4.5.2.4.4.1 Initial conditions

This test shall be tested using any of the test configurations in Table 4.5.2.4.4.1-1.

**Table 4.5.2.4.4.1-1: Supported test configurations**

Configuration	Description
4.5.2.4-1	LTE FDD, NR 15 kHz SSB SCS, $\geq 10$ MHz bandwidth, FDD duplex mode
4.5.2.4-2	LTE FDD, NR 15 kHz SSB SCS, $\geq 10$ MHz bandwidth, TDD duplex mode
4.5.2.4-3	LTE FDD, NR 30 kHz SSB SCS, $\geq 40$ MHz bandwidth, TDD duplex mode
4.5.2.4-4	LTE TDD, NR 15 kHz SSB SCS, $\geq 10$ MHz bandwidth, FDD duplex mode
4.5.2.4-5	LTE TDD, NR 15 kHz SSB SCS, $\geq 10$ MHz bandwidth, TDD duplex mode
4.5.2.4-6	LTE TDD, NR 30 kHz SSB SCS, $\geq 40$ MHz bandwidth, TDD duplex mode
Note 1: The UE is only required to be tested in one of the supported test configurations.	
Note 2: The UE is only required to be tested in one with smallest aggregated channel bandwidth from supported band combinations which is composed of CCs $\geq$ the bandwidth ( $BW_{\text{channel}}$ ) defined in each test configuration	

Configure the test equipment and the DUT according to the parameters in Table 4.5.2.4.4.1-2.

**Table 4.5.2.4.4.1-2: Initial conditions for EN-DC FR1 interruptions during measurements on deactivated NR SCC in asynchronous EN-DC**

Parameter	Value	Comment
Test environment	NC	As specified in TS 38.508-1 [14] clause 4.1.
Test frequencies	As specified in Annex E, Table E.1-1 and TS 38.508-1 [14] clause 4.3.1.	
Channel bandwidth	As specified by the test configuration selected from Table 4.7.1.1.2-1.	
Propagation conditions	AWGN	As specified in clause C.2.2.
Connection Diagram	TE Part	A.3.1.8.2
	DUT Part	A.3.2.3.4
Exceptions to connection diagram	N/A	

1. The general test parameter settings are set up according to Table 4.5.2.4.4.1-3.
2. Message contents are defined in clause 4.5.2.4.4.3.

3. There are one E-UTRAN carrier and two NR carriers and three cells specified in the test. Cell 1 is the PCell on E-UTRAN carrier, Cell 2 is the PSCell on one NR carrier and Cell 3 is the SCell on the other NR carrier. Cell 1 is the cell used for connection setup with the power level set according to Table A.6.1.1-1. Cell 2 and Cell 3 shall be configured according to clauses C.1.1 and C.1.2.

**Table 4.5.2.4.4.1-3: General test parameters for E-UTRAN - NR interruptions during measurements on deactivated NR SCC in asynchronous EN-DC**

Parameter	Unit	Value	Comment
RF Channel Number		1, 2, 3	One is E-UTRAN RF channel and the other two are NR RF channel
Active PCell		Cell1	PCell on E-UTRAN RF channel number 1.
Active PSCell		Cell2	PSCell on NR RF channel number 2.
Configured deactivated SCell		Cell3	Deactivated SCell on NR RF channel number 3.
CP length		Normal	Applicable to Cell1, Cell 2 and Cell3
DRX		OFF	
Measurement gap pattern Id		OFF	
SCell measurement cycle (measCycleSCell)	ms	640	
T1	s	10	

#### 4.5.2.4.4.2 Test procedure

The test consists of three cells: Cell1, Cell2 and Cell3. Cell1 is E-UTRAN PCell, Cell2 is NR PSCell and Cell3 is deactivated NR SCell. The test consists of one time period, with duration of T1. Prior to the start of the time duration T1, the UE shall be connected to Cell1 and Cell2 and the RRC message including *measCycleSCell* or *allowInterruptions* for the deactivated NR SCells is received at the UE antenna connector. Cell1 shall be configured as E-UTRAN PCell, Cell2 shall be configured as NR PSCell and Cell3 shall be configured as NR deactivated SCell.. During T1 the UE shall be continuously scheduled on E-UTRAN PCell and NR PSCell.

1. Ensure the UE is in state RRC\_CONNECTED with generic procedure parameters Connectivity *EN-DC*, DC bearer *MCG\_and\_SCG*, Connected without release *On* and Test Mode *On* according to TS 38.508-1 [14] clause 4.5.
2. Configure MCG according to TS 36.521-3 [26] clause C.0, C.1 and SCG according to clause C.1.1 and C.1.2 for all downlink physical channels.
3. The SS shall configure SCell (Cell 3) on the SCC as per TS 38.508-1 [14] clause 7.5.2, with the message content exceptions defined in clause 4.5.2.4.4.3. NR RRCReconfiguration message is contained in RRCConnectionReconfiguration and NR RRCReconfigurationComplete message is contained in RRCConnectionReconfigurationComplete.
4. Set the parameters according to T1 in Table 4.5.2.4.5-1. Propagation conditions are set according to clause C.2.1. T1 starts.
5. SS schedules on PCell and PSCell continuously and UE shall start sending ACK/NACK reports. The SS shall monitor DTX on PCell and ACK/NACK/DTX on PSCell.
6. If more than 99.5% of uplink transmissions are received by SS then count a success for the event "ACK/NACK". Otherwise count a fail for the event "ACK/NACK".
- 6a. If no longer than X consecutive DTX on PCell is observed by the SS, then count a success for the event "PCell DTX". Otherwise count a fail for the event "PCell DTX". Where,
  - For test configuration 4.5.2.4-1, 4.5.2.4-2 and 4.5.2.4-3, X = 3;
  - For test configuration 4.5.2.4-4, 4.5.2.4-5 and 4.5.2.4-6, X = 2;
7. If no longer than X consecutive DTX on PSCell is observed by the SS, then count a success for the event "PSCell DTX". Otherwise count a fail for the event "PSCell DTX". Where,
  - For test configuration 4.5.2.4-1 and 4.5.2.4-4,
    - X = interruption length+k1 if  $k1 \leq \text{interruption length}$ , otherwise X = interruption length

Note: UE expects that the SS won't use  $k1 = 3$  for test configuration 4.5.2.4-1 and 4.5.2.4-4.

- For test configuration other than 4.5.2.4-1 and 4.5.2.4-4,
    - $X$  = interruption length.
  - Interruption length is given in Table 4.5.2.4.5-2 for inter-band case and in Table 4.5.2.4.5-3 for intra-band case.8. After the RRC connection release, the SS:
    - transmits in Cell 1 a Paging message (including PagingRecord with UE-Identity) for the UE and ensures the UE is in state RRC\_CONNECTED with generic procedure parameters Connectivity *EN-DC*, DC bearer *MCG\_and\_SCG*, Connected without release *On* according to TS 38.508-1 [14] clause 4.5. (if the paging fails, switches off and on the UE and ensures the UE is in state RRC\_CONNECTED with generic procedure parameters Connectivity *EN-DC*, DC bearer *MCG\_and\_SCG*, Connected without release *On* according to TS 38.508-1 [14] clause 4.5); or
    - switches off and on the UE and ensures the UE is in state RRC\_CONNECTED with generic procedure parameters Connectivity *EN-DC*, DC bearer *MCG\_and\_SCG*, Connected without release *On* according to TS 38.508-1 [14] clause 4.5.
9. Repeat step 2-8 until a test verdict has been achieved.

Each of the events "ACK/NACK" "PCell DTX" and "PSCell DTX" is evaluated independently for the statistic, resulting in an event verdict: pass or fail. Each event is evaluated only until the confidence level according to Table G.2.3-1 in Annex G.2 is achieved. Different events may require different times for a verdict.

If all events pass, the test passes. If one event fails, the test fails.

#### 4.5.2.4.4.3 Message contents

Message contents are according to TS 38.508-1 [14] clause 7.3 with the following exceptions.

**Table 4.5.2.4.4.3-1: Common Exception messages**

Default Message Contents	
Common contents of system information blocks exceptions	
Default RRC messages and information elements contents exceptions	Table H.3.1-2 with Condition Deactivated SCell; Table H.3.1-4 with A3-offset = 15
Specific message contents exceptions for Test Configuration 4.5.2.4-1, 4.5.2.4-2, 4.5.2.4 -4 and 4.5.2.4-5	Table H.3.1-3 with Condition Deactivated SCell and SSB.1 FR1 Table 7.3.1-3 in TS 38.508-1 [14] with condition SMTC.1
Specific message contents exceptions for Test Configuration 4.5.2.4-3 and 4.5.2.4-6	Table H.3.1-3 with Condition Deactivated SCell and SSB.2 FR1 Table 7.3.1-3 in TS 38.508-1 [14] with condition SMTC.1

**Table 4.5.2.4.4.3-2: RRCReconfiguration in step 3: SCell addition**

Derivation Path: TS 38.508-1 [14], Table 4.6.1-13 with condition NR_MEAS and SCell_add			
Information Element	Value/remark	Comment	Condition
RRCReconfiguration ::= SEQUENCE {			
criticalExtensions CHOICE {			
rrcReconfiguration ::= SEQUENCE {			
measConfig	MeasConfig-DEFAULT	Measurements configuration	NR_MEAS
nonCriticalExtension SEQUENCE {			
masterCellGroup	CellGroupConfig-SCell(n)	n is number of SCC to be added	SCell_add
}			
}			
}			
}			

Table 4.5.2.4.4.3-3: ServingCellConfig (Cell 3)

Derivation Path: TS 38.508-1 [14], Table 4.6.3-167 with condition MEAS			
Information Element	Value/remark	Comment	Condition
ServingCellConfig ::= SEQUENCE {			
servingCellMO	2	MeasObjectId for SCell in Table H.3.1-2	
}			

## 4.5.2.4.5 Test requirement

Table 4.5.2.4.5-1 defines the primary level settings including test tolerances for E-UTRAN - NR FR1 interruptions during measurements on deactivated NR SCC in asynchronous EN-DC test configurations.

Table 4.5.2.4.5-1: NR cell specific test parameters for E-UTRAN - NR interruptions during measurements on deactivated NR SCC in asynchronous EN-DC

Parameter	Unit	Cell 2	Cell 3
Frequency Range		FR1	FR1
Duplex mode	Config 1,4	FDD	FDD
	Config 2,3,5,6	TDD	TDD
TDD configuration	Config 1,4	Not Applicable	Not Applicable
	Config 2,5	TDDConf.1.1	TDDConf.1.1
	Config 3,6	TDDConf.2.1	TDDConf.2.1
BW <sub>channel</sub>	Config 1,4	Note 8	Note 8
	Config 2,5	Note 8	Note 8
	Config 3,6	Note 8	Note 8
BW <sub>occupied</sub>	Config 1,4	52 <sup>Note 6</sup>	52 <sup>Note 6</sup>
	Config 2,5	52 <sup>Note 6</sup>	52 <sup>Note 6</sup>
	Config 3,6	106 <sup>Note 7</sup>	106 <sup>Note 7</sup>
Initial DL BWP Configuration	Config 1,4	DLBWP.0.1	DLBWP.0.1
	Config 2,5	DLBWP.0.1	DLBWP.0.1
	Config 3,6	DLBWP.0.1	DLBWP.0.1
Dedicated DL BWP Configuration	Config 1,4	DLBWP.1.1	DLBWP.1.1
	Config 2,5	DLBWP.1.1	DLBWP.1.1
	Config 3,6	DLBWP.1.1	DLBWP.1.1
Initial UL BWP Configuration	Config 1,4	ULBWP.0.1	ULBWP.0.1
	Config 2,5	ULBWP.0.1	ULBWP.0.1
	Config 3,6	ULBWP.0.1	ULBWP.0.1
Dedicated UL BWP Configuration	Config 1,4	ULBWP.1.1	ULBWP.1.1
	Config 2,5	ULBWP.1.1	ULBWP.1.1
	Config 3,6	ULBWP.1.1	ULBWP.1.1
PDSCH Reference measurement channel	Config 1,4	SR.1.1 FDD	-
	Config 2,5	SR.1.1 TDD	-
	Config 3,6	SR.2.1 TDD	-
RMSI CORESET parameters	Config 1,4	CR.1.1 FDD	CR.1.1 FDD
	Config 2,5	CR.1.1 TDD	CR.1.1 TDD
	Config 3,6	CR.2.1 TDD	CR.2.1 TDD
PDCCH CORESET parameters	Config 1,4	CCR.1.1 FDD	CCR.1.1 FDD
	Config 2,5	CCR.1.1 TDD	CCR.1.1 TDD
	Config 3,6	CCR.2.1 TDD	CCR.2.1 TDD
TRS configuration	Config 1,4	TRS.1.1 FDD	TRS.1.1 FDD
	Config 2,5	TRS.1.1 TDD	TRS.1.1 TDD
	Config 3,6	TRS.1.2 TDD	TRS.1.2 TDD
OCNG Patterns	Config 1,2,4,5	OP.1 <sup>Note 6</sup>	OP.1 <sup>Note 6</sup>
	Config 3,6	OP.1 <sup>Note 7</sup>	OP.1 <sup>Note 7</sup>
SMTTC Configuration		SMTTC.1	SMTTC.1
SSB Configuration	Config 1,2,4,5	SSB.1 FR1	SSB.1 FR1
	Config 3,6	SSB.2 FR1	SSB.2 FR1
TCI state		TCI.State.0	TCI.State.0
Correlation Matrix and Antenna Configuration		1x2 Low	1x2 Low
EPRE ratio of PSS to SSS	dB	0	0



Parameter	Unit	Cell 2	Cell 3
EPRE ratio of PBCH DMRS to SSS			
EPRE ratio of PBCH to PBCH DMRS			
EPRE ratio of PDCCH DMRS to SSS			
EPRE ratio of PDCCH to PDCCH DMRS			
EPRE ratio of PDSCH DMRS to SSS			
EPRE ratio of PDSCH to PDSCH			
EPRE ratio of OCNG DMRS to SSS(Note 1)			
EPRE ratio of OCNG to OCNG DMRS (Note 1)			
$N_{oc}$ <sup>Note 2</sup>	dBm/15 kHz	-104	-104
SS-RSRP <sup>Note 3</sup>	dBm/15 kHz	-87	-87
$\hat{E}_s/I_{ot}$	dB	17	17
$\hat{E}_s/N_{oc}$	dB	17	17
$I_o$ <sup>Note3</sup>	Config 1,2,4,5	dBm/9.36MHz	-58.96
	Config 3,6	dBm/38.16MHz	-52.86
Time offset to Cell1 <sup>Note 4</sup>	Config 1,2,4,5	$\mu s$	500 + Time offset to Cell2
	Config 3,6	$\mu s$	250 + Time offset to Cell2
Time offset to Cell2 <sup>Note 5</sup>	$\mu s$	-	3
Propagation Condition		AWGN	AWGN
<p>Note 1: OCNG shall be used such that both cells are fully allocated and a constant total transmitted power spectral density is achieved for all OFDM symbols.</p> <p>Note 2: Interference from other cells and noise sources not specified in the test is assumed to be constant over subcarriers and time and shall be modeled as AWGN of appropriate power for <math>N_{oc}</math> to be fulfilled within <math>BW_{occupied}</math>.</p> <p>Note 3: SS-RSRP and <math>I_o</math> levels have been derived from other parameters for information purposes. They are not settable parameters themselves.</p> <p>Note 4: Receive time difference of signals received between subframe timing boundary of E-UTRA PCell and slot timing boundary of PSCell at the UE antenna connector including time alignment error between the two cells.</p> <p>Note 5: Receive time difference between slot boundaries of signals received from the two cells at the UE antenna connector including time alignment error between the two cells.</p> <p>Note 6: All UL/DL transmission shall be confined within <math>BW_{occupied}</math> (i.e. 10 MHz, 52 RBs) from <math>F_{c,low}</math>, and <math>I_o</math> is independent of the <math>BW_{channel}</math> configured.</p> <p>Note 7: All UL/DL transmission shall be confined within <math>BW_{occupied}</math> (i.e. 40 MHz, 106 RBs) from <math>F_{c,low}</math>, and <math>I_o</math> is independent of the <math>BW_{channel}</math> configured.</p> <p>Note 8: <math>N_{RB,c}</math> is derived from Table 5.3.2-1 in TS38.101-1[2] with configured <math>BW_{channel}</math>.</p>			

The UE shall be continuously scheduled in LTE PCell and NR PSCell during the entire length of T1. During the time duration T1 the UE shall transmit at least 99.5% of ACK/NACK on NR PSCell.

If the NR PSCell is not in the same band as the deactivated SCell, the UE is only allowed to cause interruptions on NR PSCell immediately before and immediately after an SMTC. Each interruption on NR PSCell shall not exceed the value defined in Table 4.5.2.4.5-2.

If the NR PSCell is in the same band as the deactivated SCell, the UE is only allowed to cause an interruption on PSCell no earlier than 1 slot before an SMTC and no later than 1 slot after the SMTC. the interruption on NR PSCell shall not exceed the value defined in Table 4.5.2.4.5-3.

**Table 4.5.2.4.5-2: Interruption duration if the NR PSCell is not in the same band as the deactivated SCell**

$\mu$	NR Slot length (ms)	Interruption length (slot)
0	1	1
1	0.5	1

**Table 4.5.2.4.5-3: Interruption duration if the NR PSCell is in the same band as the deactivated SCell**

$\mu$	NR Slot length (ms)	Interruption length (slot)
0	1	2+SMTC duration
1	0.5	2+SMTC duration

For asynchronous inter-band EN-DC, the UE is only allowed to cause interruptions on E-UTRA PCell immediately before and immediately after an SMTC. Each interruption on E-UTRA PCell shall not exceed 2 subframe.

The rate of correct events observed during repeated tests shall be at least 90%.

#### 4.5.2.5 EN-DC FR1 interruptions during measurements on deactivated E-UTRAN SCC in synchronous EN-DC

##### 4.5.2.5.1 Test purpose

The purpose of this test is to verify E-UTRAN PCell and NR PSCell interruptions during the measurement on the deactivated E-UTRAN SCC, the UE missed ACK/NACK does not exceed the limits. This test will verify the missed ACK/NACK rate for E-UTRAN PCell and NR PSCell in EN-DC.

##### 4.5.2.5.2 Test applicability

This test applies to all types of E-UTRA UE release 15 and forward supporting EN-DC and 2 DL CA in E-UTRA.

##### 4.5.2.5.3 Minimum conformance requirements

The minimum conformance requirements are defined in clause 4.5.2.0.3.

The normative reference for this requirement is TS 38.133 [6] clause A.4.5.2.5.

##### 4.5.2.5.4 Test description

###### 4.5.2.5.4.1 Initial conditions

This test shall be tested using any of the test configurations in Table 4.5.2.5.4.1-1.

**Table 4.5.2.5.4.1-1: Supported test configurations**

Configuration	Description
4.5.2.5-1	LTE FDD, NR 15 kHz SSB SCS, 10MHz bandwidth, FDD duplex mode
4.5.2.5-2	LTE FDD, NR 15 kHz SSB SCS, 10MHz bandwidth, TDD duplex mode
4.5.2.5-3	LTE FDD, NR 30 kHz SSB SCS, 40MHz bandwidth, TDD duplex mode
4.5.2.5-4	LTE TDD, NR 15 kHz SSB SCS, 10MHz bandwidth, FDD duplex mode
4.5.2.5-5	LTE TDD, NR 15 kHz SSB SCS, 10MHz bandwidth, TDD duplex mode
4.5.2.5-6	LTE TDD, NR 30 kHz SSB SCS, 40MHz bandwidth, TDD duplex mode

NOTE: The UE is only required to be tested in one of the supported test configurations.

Configure the test equipment and the DUT according to the parameters in Table 4.5.2.5.4.1-2 and Table 4.5.2.5.4.1-3.

**Table 4.5.2.5.4.1-2: Initial conditions for EN-DC FR1 interruptions during measurements on deactivated E-UTRAN SCC in synchronous EN-DC**

Parameter	Value	Comment
Test environment	NC	As specified in TS 38.508-1 [14] clause 4.1.
Test frequencies	As specified in Annex E, Table E.1-1 and TS 38.508-1 [14] clause 4.3.1.	
Channel bandwidth	As specified by the test configuration selected from Table 4.7.1.1.2-1.	
Propagation conditions	AWGN	As specified in clause C.2.2.

Connection Diagram	TE Part	A.3.1.8.2	As specified in TS 38.508-1 [14] Annex A.
	DUT Part	A.3.2.3.4	
Exceptions to connection diagram	N/A		

1. The general test parameter settings are set up according to Table 4.5.2.5.4.1-3.
2. Message contents are defined in clause 4.5.2.5.4.3.
3. There are two E-UTRAN carriers and one NR carrier and three cells specified in the test. Cell1 and Cell3 is E-UTRAN PCell and E-UTRAN deactivated SCell, Cell2 is NR FR1 PSCell. Cell 1 is the cell used for connection setup with the power level set according to Table A.6.1.1-1. Cell 3 shall be configured according to Table A.6.1.1-1 except for the RF channel number 3. Cell 2 shall be configured according to clause C.1.1 and C.1.2.

**Table 4.5.2.5.4.1-3: General test parameters for E-UTRAN - NR FR1 interruptions during measurements on deactivated E-UTRAN SCC in synchronous EN-DC**

Parameter	Unit	Value	Comment
RF Channel Number		1, 2, 3	Two E-UTRAN RF channels and one NR RF channel
Active PCell		Cell1	PCell on E-UTRAN RF channel number 1.
Active PSCell		Cell2	PSCell on NR RF channel number 2.
Configured deactivated SCell		Cell3	Deactivated SCell on E-UTRAN RF channel number 3.
CP length		Normal	Applicable to Cell1, Cell2 and Cell3
DRX		OFF	
Measurement gap pattern Id		OFF	
SCell measurement cycle (measCycleSCell)	ms	640	
T1	s	10	

#### 4.5.2.5.4.2 Test procedure

The test consists of three cells: Cell1, Cell2 and Cell3. Cell1 and Cell3 is E-UTRAN PCell and E-UTRAN deactivated SCell, Cell2 is NR FR1 PSCell. The test consists of one time period, with duration of T1. Prior to the start of the time duration T1, the UE shall be connected to Cell1 and Cell2 and the RRC message including *measCycleSCell* or *allowInterruptions* for the deactivated NR SCells is received at the UE antenna connector. Cell1 shall be configured as E-UTRAN PCell, Cell2 shall be configured as NR PSCell and Cell3 shall be configured as E-UTRAN deactivated SCell. During T1 the UE shall be continuously scheduled on E-UTRAN PCell and NR PSCell.

1. Ensure the UE is in state RRC\_CONNECTED with generic procedure parameters Connectivity *EN-DC*, DC bearer *MCG\_and\_SCG*, Connected without release *On* and Test Mode *On* according to TS 38.508-1 [14] clause 4.5.
2. Configure MCG according to TS 36.521-3 [26] clause C.0, C.1 and SCG according to clause C.1.1 and C.1.2 for all downlink physical channels.
3. The SS shall configure SCell (Cell 3) on the SCC as per TS 36.508 [25] clause 5.2A.
4. Set the parameters according to T1 in Tables 4.5.2.5.5-1. Propagation conditions are set according to clause C.2.1. T1 starts.
5. SS schedules on PCell and PSCell continuously and UE shall start sending ACK/NACK reports. The SS shall monitor DTX on PCell and ACK/NACK/DTX on PSCell.
6. If more than 99.5% of uplink transmissions on PSCell are received by SS then count a success for the event "ACK/NACK". Otherwise count a fail for the event "ACK/NACK".
- 6a. If no longer than X consecutive DTX on PCell is observed by the SS, then count a success for the event "PCell DTX". Otherwise count a fail for the event "PCell DTX". Where,
  - For test configuration 4.5.2.5-1, 4.5.2.5-2 and 4.5.2.5-3,

- $X = 1$  if the PCell is not in the same band as the deactivated SCell, otherwise  $X = 9$ .
- For test configuration 4.5.2.5-4, 4.5.2.5-5 and 4.5.2.5-6,
  - $X = 1$  if the PCell is not in the same band as the deactivated SCell, otherwise  $X = 5$ .
- 7. If no longer than  $Z$  consecutive DTX on PSCell is observed by the SS, then count a success for the event "PSCell DTX". Otherwise count a fail for the event "PSCell DTX".
  - For test configuration 4.5.2.5-1 and 4.5.2.1-4,
    - $Z = \text{interruption length} + k1$  if  $k1 \leq \text{interruption length}$ , otherwise  $Z = \text{interruption length}$
  - For test configuration other than 4.5.2.5-1 and 4.5.2.5-4,
    - $Z = \text{interruption length}$ .
  - Interruption length is given by "Interruption length X" column in Table 4.5.2.5.5-2 for inter-band case and by "Interruption length Y" column in Table 4.5.2.5.5-2 for intra-band case.
- 8. After the RRC connection release, the SS:
  - transmits in Cell 1 a Paging message (including PagingRecord with UE-Identity) for the UE and ensures the UE is in state RRC\_CONNECTED with generic procedure parameters Connectivity *EN-DC*, DC bearer *MCG\_and\_SCG*, Connected without release *On* TS 38.508-1 [14] clause 4.5. (if the paging fails, switches off and on the UE and ensures the UE is in state RRC\_CONNECTED with generic procedure parameters Connectivity *EN-DC*, DC bearer *MCG\_and\_SCG*, Connected without release *On* TS 38.508-1 [14] clause 4.5); or
  - switches off and on the UE and ensures the UE is in state RRC\_CONNECTED with generic procedure parameters Connectivity *EN-DC*, DC bearer *MCG\_and\_SCG*, Connected without release *On* TS 38.508-1 [14] clause 4.5.
- 9. Repeat step 2-8 until a test verdict has been achieved.

Each of the events "ACK/NACK" "PCell DTX" and "PSCell DTX" is evaluated independently for the statistic, resulting in an event verdict: pass or fail. Each event is evaluated only until the confidence level according to Table G.2.3-1 in Annex G.2 is achieved. Different events may require different times for a verdict.

If all events pass, the test passes. If one event fails, the test fails.

#### 4.5.2.5.4.3 Message contents

Message contents are according to TS 38.508-1 [14] clause 7.3 with the following exceptions:

**Table 4.5.2.5.4.3-1: Common Exception messages**

Default Message Contents	
Common contents of system information blocks exceptions	
Default RRC messages and information elements contents exceptions	
Specific message contents exceptions for Test Configuration 4.5.2.5-1, 4.5.2.5-2, 4.5.2.5-4 and 4.5.2.5-5	Table H.3.1-3 with Condition INTRA-FREQ MO and SSB.1 FR1 Table 7.3.1-3 in TS 38.508-1 [14] with condition SMTC.1
Specific message contents exceptions for Test Configuration 4.5.2.5-3 and 4.5.2.5-6	Table H.3.1-3 with Condition INTRA-FREQ MO and SSB.2 FR1 Table 7.3.1-3 in TS 38.508-1 [14] with condition SMTC.1

**Table 4.5.2.5.4.3-2: MeasObjectEUTRA for E-UTRA deactivated SCell**

Derivation Path: 36.508 Table 4.6.6-2			
Information Element	Value/remark	Comment	Condition
MeasObjectEUTRA ::= SEQUENCE {			
carrierFreq	Downlink EARFCN for E-UTRAN SCell		

measCycleSCell-r10	sf640		
}			

**Table 4.5.2.5.4.3-3: RRCConnectionReconfiguration in step 3: SCell addition**

Derivation Path: 36.508 Table 4.6.1-8, condition SCell\_AddMod

4.5.2.5.5 Test requirement

Table 4.5.2.5.5-1 defines the primary level settings including test tolerances for E-UTRAN - NR FR1 interruptions during measurements on deactivated E-UTRAN SCC in synchronous EN-DC test configurations.

**Table 4.5.2.5.5-1: NR cell specific test parameters for E-UTRAN - NR FR1 interruptions during measurements on deactivated E-UTRAN SCC in synchronous EN-DC**

Parameter		Unit	Cell 2
Frequency Range			FR1
Duplex mode	Config 1,4		FDD
	Config 2,3,5,6		TDD
TDD configuration	Config 1,4		Not Applicable
	Config 2,5		TDDConf.1.1
	Config 3,6		TDDConf.2.1
BW <sub>channel</sub>	Config 1,4	MHz	10: N <sub>RB,c</sub> = 52
	Config 2,5		10: N <sub>RB,c</sub> = 52
	Config 3,6		40: N <sub>RB,c</sub> = 106
Initial DL BWP Configuration	Config 1,4		DLBWP.0.1
	Config 2,5		DLBWP.0.1
	Config 3,6		DLBWP.0.1
Dedicated DL BWP Configuration	Config 1,4		DLBWP.1.1
	Config 2,5		DLBWP.1.1
	Config 3,6		DLBWP.1.1
Initial UL BWP Configuration	Config 1,4		ULBWP.0.1
	Config 2,5		ULBWP.0.1
	Config 3,6		ULBWP.0.1
Dedicated UL BWP Configuration	Config 1,4		ULBWP.1.1
	Config 2,5		ULBWP.1.1
	Config 3,6		ULBWP.1.1
PDSCH Reference measurement channel	Config 1,4		SR.1.1 FDD
	Config 2,5		SR.1.1 TDD
	Config 3,6		SR.2.1 TDD
RMSI CORESET parameters	Config 1,4		CR.1.1 FDD
	Config 2,5		CR.1.1 TDD
	Config 3,6		CR.2.1 TDD
PDCCH CORESET parameters	Config 1,4		CCR.1.1 FDD
	Config 2,5		CCR.1.1 TDD
	Config 3,6		CCR.2.1 TDD
TRS configuration	Config 1,4		TRS.1.1 FDD
	Config 2,5		TRS.1.1 TDD
	Config 3,6		TRS.1.2 TDD
OCNG Patterns			OP.1
SMTTC Configuration			SMTTC.1
TCI state			TCI.State.0
SSB Configuration	Config 1,2,4,5		SSB.1 FR1
	Config 3,6		SSB.2 FR1
Correlation Matrix and Antenna Configuration			1x2 Low
EPRE ratio of PSS to SSS		dB	0
EPRE ratio of PBCH DMRS to SSS			
EPRE ratio of PBCH to PBCH DMRS			
EPRE ratio of PDCCH DMRS to SSS			
EPRE ratio of PDCCH to PDCCH DMRS			
EPRE ratio of PDSCH DMRS to SSS			
EPRE ratio of PDSCH to PDSCH			

Parameter		Unit	Cell 2
EPRE ratio of OCNG DMRS to SSS(Note 1)			
EPRE ratio of OCNG to OCNG DMRS (Note 1)			
$N_{oc}$ <sup>Note 2</sup>		dBm/15 kHz	-104
SS-RSRP <sup>Note 3</sup>		dBm/15 kHz	-87
$\bar{E}_s/I_{ot}$		dB	17
$\bar{E}_s/N_{oc}$		dB	17
$I_o$ <sup>Note 3</sup>	Config 1,2,4,5	dBm/ 9.36MHz	-58.96
	Config 3,6	dBm/ 38.16MHz	-52.86
Time offset to Cell1 <sup>Note 4</sup>		$\mu$ s	3 for intra-band EN-DC, 33 for inter-band EN-DC
Propagation Condition			AWGN
NOTE 1: OCNG shall be used such that both cells are fully allocated and a constant total transmitted power spectral density is achieved for all OFDM symbols.			
NOTE 2: Interference from other cells and noise sources not specified in the test is assumed to be constant over subcarriers and time and shall be modeled as AWGN of appropriate power for $N_{oc}$ to be fulfilled.			
NOTE 3: SS-RSRP and $I_o$ levels have been derived from other parameters for information purposes. They are not settable parameters themselves.			
NOTE 4: Receive time difference of signals received between subframe timing boundary of E-UTRA PCell and slot timing boundary of PSCell at the UE antenna connector including time alignment error between the two cells.			
NOTE 5: For unpaired spectrum, a DL BWP is linked with an UL BWP. DLBWP.0.2 is linked with ULBWP.0.2 defined in TS 38.213 [3] section 12.			

The UE shall be continuously scheduled in LTE PCell and NR PSCell during the entire length of T1. During the time duration T1 the UE shall transmit at least 99.5% of ACK/NACK on NR PSCell. The UE is only allowed to cause one interruption on PCell and one interruption on PSCell. Each interruption on NR PSCell shall not exceed X defined in Table 4.5.2.5.5-2 if the NR PSCell is not in the same band as the E-UTRAN deactivated SCell or Y in Table 4.5.2.5.5-2 if the NR PSCell is in the same band as the E-UTRAN deactivated SCell.

**Table 4.5.2.5.5-2: Interruption length X and Y at measurements on deactivated E-UTRA SCC**

$\mu$	NR Slot length (ms)	Interruption length X (slot)	Interruption length Y (slot)
0	1	1	1+SMTC duration
1	0.5	1	1+SMTC duration

Each interruption on E-UTRAN PCell shall not exceed 1 subframe if the PCell is not in the same band as the deactivated SCell, or 5 subframes if the PCell is in the same band as the deactivated SCell.

The rate of correct events observed during repeated tests shall be at least 90 %.

#### 4.5.2.6 EN-DC FR1 interruptions during measurements on deactivated E-UTRAN SCC in asynchronous EN-DC

##### 4.5.2.6.1 Test purpose

The purpose of this test is to verify E-UTRAN PCell and NR PSCell interruptions during the measurement on the deactivated NR SCC, the UE missed ACK/NACK does not exceed the limits. This test will verify the missed ACK/NACK rate for E-UTRAN PCell and NR PSCell in EN-DC.

##### 4.5.2.6.2 Test applicability

This test applies to all types of E-UTRA UE release 15 and forward supporting EN-DC and 2 DL CA in E-UTRA.

## 4.5.2.6.3 Minimum conformance requirements

The minimum conformance requirements are defined in clause 4.5.2.0.3.

The normative reference for this requirement is TS 38.133 [6] clause A.4.5.2.6.

## 4.5.2.6.4 Test description

## 4.5.2.6.4.1 Initial conditions

This test shall be tested using any of the test configurations in Table 4.5.2.6.4.1-1.

**Table 4.5.2.6.4.1-1: Supported test configurations for EN-DC FR1 interruptions during measurements on deactivated E-UTRAN SCC in asynchronous EN-DC**

Configuration	Description
4.5.2.6-1	LTE FDD, NR 15 kHz SSB SCS, 10MHz bandwidth, FDD duplex mode
4.5.2.6-2	LTE FDD, NR 15 kHz SSB SCS, 10MHz bandwidth, TDD duplex mode
4.5.2.6-3	LTE FDD, NR 30 kHz SSB SCS, 40MHz bandwidth, TDD duplex mode
4.5.2.6-4	LTE TDD, NR 15 kHz SSB SCS, 10MHz bandwidth, FDD duplex mode
4.5.2.6-5	LTE TDD, NR 15 kHz SSB SCS, 10MHz bandwidth, TDD duplex mode
4.5.2.6-6	LTE TDD, NR 30 kHz SSB SCS, 40MHz bandwidth, TDD duplex mode

NOTE: The UE is only required to be tested in one of the supported test configurations.

Configure the test equipment and the DUT according to the parameters in Table 4.5.2.6.4.1-2.

**Table 4.5.2.6.4.1-2: Initial conditions for EN-DC FR1 interruptions during measurements on deactivated E-UTRAN SCC in asynchronous EN-DC**

Parameter	Value		Comment
Test environment	NC		As specified in TS 38.508-1 [14] clause 4.1.
Test frequencies	As specified in Annex E, table E.2-1 and TS 38.508-1 [14] clause 4.3.1.		
Channel bandwidth	As specified by the test configuration selected from Table 4.5.2.6.4.1-1.		
Propagation conditions	AWGN		As specified in clause C.2.1.
Connection Diagram	TE Part	A.3.1.8.2	As specified in TS 38.508-1 [14] Annex A.
	DUT Part	A.3.2.3.4	
Exceptions to connection diagram	N/A		

1. The general test parameter settings are set up according to Table 4.5.2.6.4.1-3.
2. Message contents are defined in clause 4.5.2.6.4.3.
3. There are two E-UTRAN carriers and one NR carrier and three cells specified in the test. Cell1 and Cell3 is E-UTRAN PCell and E-UTRAN deactivated SCell, Cell2 is NR FR1 PSCell. Cell 1 is the cell used for connection setup with the power level set according to Table A.6.1.1-1. Cell 3 shall be configured according to Table A.6.1.1-1 except for the RF channel number 3. Cell 2 shall be configured according to clauses C.1.1 and C.1.2.

**Table 4.5.2.6.4.1-3: General test parameters for EN-DC FR1 interruptions during measurements on deactivated E-UTRAN SCC in asynchronous EN-DC**

Parameter	Unit	Value	Comment
RF Channel Number		1, 2, 3	Two E-UTRAN RF channels and one NR RF channel
Active PCell		Cell1	PCell on E-UTRAN RF channel number 1.
Active PSCell		Cell2	PSCell on NR RF channel number 2.
Configured deactivated SCell		Cell3	Deactivated SCell on E-UTRAN RF channel number 3.
CP length		Normal	Applicable to Cell1, Cell 2 and Cell3
DRX		OFF	
Measurement gap pattern Id		OFF	
SCell measurement cycle (measCycleSCell)	ms	640	

T1	s	10	
----	---	----	--

#### 4.5.2.6.4.2 Test procedure

The test consists of three cells: Cell1, Cell2 and Cell3. Cell1 and Cell3 is E-UTRAN PCell and E-UTRAN deactivated SCell, Cell2 is NR FR1 PSCell. The test consists of one time period, with duration of T1. Prior to the start of the time duration T1, the UE shall be connected to Cell1 and Cell2 and the RRC message including *measCycleSCell* or *allowInterruptions* for the deactivated NR SCells is received at the UE antenna connector. Cell1 shall be configured as E-UTRAN PCell, Cell2 shall be configured as NR PSCell and Cell3 shall be configured as E-UTRAN deactivated SCell. During T1 the UE shall be continuously scheduled on E-UTRAN PCell and NR PSCell.

1. Ensure the UE is in state RRC\_CONNECTED with generic procedure parameters Connectivity *EN-DC*, DC bearer *MCG\_and\_SCG*, Connected without release *On* and Test Mode *On* according to TS 38.508-1 [14] clause 4.5.
2. Configure MCG according to TS 36.521-3 [26] clause C.0, C.1 and SCG according to clause C.1.1 and C.1.2 for all downlink physical channels.
3. The SS shall configure SCell (Cell 3) on the SCC as per TS 36.508 [25] clause 5.2A.
4. Set the parameters according to T1 in Table 4.5.2.6.5-1. Propagation conditions are set according to clause C.2.1. T1 starts.
5. SS schedules on PCell and PSCell continuously and UE shall start sending ACK/NACK reports. The SS shall monitor DTX on PCell and ACK/NACK/DTX on PSCell.
6. If more than 99.5% of uplink transmissions on PSCell are received by SS then count a success for the event "ACK/NACK". Otherwise count a fail for the event "ACK/NACK".
- 6a. If no longer than X consecutive DTX on PCell is observed by the SS, then count a success for the event "PCell DTX". Otherwise count a fail for the event "PCell DTX". Where,
  - For test configuration 4.5.2.6-1, 4.5.2.6-2 and 4.5.2.6-3,
    - X = 1 if the PCell is not in the same band as the deactivated SCell, otherwise X = 9.
  - For test configuration 4.5.2.6-4, 4.5.2.6-5 and 4.5.2.6-6,
    - X = 1 if the PCell is not in the same band as the deactivated SCell, otherwise X = 5.
7. If no longer than Xconsecutive DTX on PSCell is observed by the SS, then count a success for the event "PSCell DTX". Otherwise count a fail for the event "PSCell DTX". Where,
  - For test configuration 4.5.2.6-1 and 4.5.2.6-4,
    - Z = interruption length+k1 if  $k1 \leq$  interruption length, otherwise Z = interruption length
  - For test configuration other than 4.5.2.6-1 and 4.5.2.6-4,
    - Z = interruption length.
  - Interruption length is given by Table 4.5.2.6.5-2 for inter-band case and Table 4.5.2.6.5-3 for intra-band case.
8. After the RRC connection release, the SS:
  - transmits in Cell 1 a Paging message (including PagingRecord with UE-Identity) for the UE and ensures the UE is in state RRC\_CONNECTED with generic procedure parameters Connectivity *EN-DC*, DC bearer *MCG\_and\_SCG*, Connected without release *On* according to TS 38.508-1 [14] clause 4.5. (if the paging fails, switches off and on the UE and ensures the UE is in state RRC\_CONNECTED with generic procedure parameters Connectivity *EN-DC*, DC bearer *MCG\_and\_SCG*, Connected without release *On* according to TS 38.508-1 [14] clause 4.5); or
  - switches off and on the UE and ensures the UE is in state RRC\_CONNECTED with generic procedure parameters Connectivity *EN-DC*, DC bearer *MCG\_and\_SCG*, Connected without release *On* TS 38.508-1 [14] clause 4.5.



9. Repeat step 2-8 until a test verdict has been achieved.

Each of the events "ACK/NACK" "PCell DTX" and "PSCell DTX" is evaluated independently for the statistic, resulting in an event verdict: pass or fail. Each event is evaluated only until the confidence level according to Table G.2.3-1 in Annex G.2 is achieved. Different events may require different times for a verdict.

If all events pass, the test passes. If one event fails, the test fails.

4.5.2.6.4.3 Message contents

Message contents are according to TS 38.508-1 [14] clause 7.3 with the following exceptions.

**Table 4.5.2.6.4.3-1: Common Exception messages**

Default Message Contents	
Common contents of system information blocks exceptions	
Default RRC messages and information elements contents exceptions	
Specific message contents exceptions for Test Configuration 4.5.2.6-1, 4.5.2.6-2, 4.5.2.6-4 and 4.5.2.6-5	Table H.3.1-3 with Condition INTRA-FREQ MO and SSB.1 FR1 Table 7.3.1-3 in TS 38.508-1 [14] with condition SMTC.1
Specific message contents exceptions for Test Configuration 4.5.2.6-3 and 4.5.2.6-6	Table H.3.1-3 with Condition INTRA-FREQ MO and SSB.2 FR1 Table 7.3.1-3 in TS 38.508-1 [14] with condition SMTC.1

**Table 4.5.2.6.4.3-2: MeasObjectEUTRA for E-UTRAN deactivated SCell**

Derivation Path: 36.508 Table 4.6.6-2			
Information Element	Value/remark	Comment	Condition
MeasObjectEUTRA ::= SEQUENCE {			
carrierFreq	Downlink EARFCN for E-UTRAN SCell		
measCycleSCell-r10	sf640		
}			

**Table 4.5.2.6.4.3-3: RRCConnectionReconfiguration in step 3: SCell addition**

Derivation Path: 36.508 Table 4.6.1-8, condition SCell_AddMod
---

4.5.2.6.5 Test requirement

Table 4.5.2.6.5-1 defines the primary level settings including test tolerances for EN-DC FR1 interruptions during measurements on deactivated E-UTRAN SCC in asynchronous EN-DC test configurations.

**Table 4.5.2.6.5-1: NR cell specific test parameters for EN-DC FR1 interruptions during measurements on deactivated E-UTRAN SCC in asynchronous EN-DC**

Parameter		Unit	Cell 2
Frequency Range			FR1
Duplex mode	Config 1,4		FDD
	Config 2,3,5,6		TDD
TDD configuration	Config 1,4		Not Applicable
	Config 2,5		TDDConf.1.1
	Config 3,6		TDDConf.2.1
BW <sub>channel</sub>	Config 1,4	MHz	10: N <sub>RB,c</sub> = 52
	Config 2,5		10: N <sub>RB,c</sub> = 52
	Config 3,6		40: N <sub>RB,c</sub> = 106
Initial DL BWP Configuration	Config 1,4		DLBWP.0.1
	Config 2,5		DLBWP.0.1
	Config 3,6		DLBWP.0.1
Dedicated DL BWP Configuration	Config 1,4		DLBWP.1.1
	Config 2,5		DLBWP.1.1

Parameter		Unit	Cell 2
	Config 3,6		DLBWP.1.1
Initial UL BWP Configuration	Config 1,4		ULBWP.0.1
	Config 2,5		ULBWP.0.1
	Config 3,6		ULBWP.0.1
Dedicated UL BWP Configuration	Config 1,4		ULBWP.1.1
	Config 2,5		ULBWP.1.1
	Config 3,6		ULBWP.1.1
PDSCH Reference measurement channel	Config 1,4		SR.1.1 FDD
	Config 2,5		SR.1.1 TDD
	Config 3,6		SR.2.1 TDD
RMSI CORESET parameters	Config 1,4		CR.1.1 FDD
	Config 2,5		CR.1.1 TDD
	Config 3,6		CR.2.1 TDD
PDCCH CORESET parameters	Config 1,4		CCR.1.1 FDD
	Config 2,5		CCR.1.1 TDD
	Config 3,6		CCR.2.1 TDD
TRS configuration	Config 1,4		TRS.1.1 FDD
	Config 2,5		TRS.1.1 TDD
	Config 3,6		TRS.1.2 TDD
OCNG Patterns			OP.1
SMTC Configuration			SMTC.1
TCI state			TCI.State.0
SSB Configuration	Config 1,2,4,5		SSB.1 FR1
	Config 3,6		SSB.2 FR1
Correlation Matrix and Antenna Configuration			1x2 Low
EPRE ratio of PSS to SSS		dB	0
EPRE ratio of PBCH DMRS to SSS			
EPRE ratio of PBCH to PBCH DMRS			
EPRE ratio of PDCCH DMRS to SSS			
EPRE ratio of PDCCH to PDCCH DMRS			
EPRE ratio of PDSCH DMRS to SSS			
EPRE ratio of PDSCH to PDSCH			
EPRE ratio of OCNG DMRS to SSS <sup>Note 1</sup>			
EPRE ratio of OCNG to OCNG DMRS <sup>Note 1</sup>			
N <sub>oc</sub> <sup>Note 2</sup>		dBm/15 kHz	-104
SS-RSRP <sup>Note 3</sup>		dBm/15 kHz	-87
$\bar{E}_s/I_{ot}$		dB	17
$\bar{E}_s/N_{oc}$		dB	17
I <sub>o</sub> <sup>Note 3</sup>	Config 1,2,4,5	dBm/ 9.36MHz	-58.96
	Config 3,6	dBm/ 38.16MHz	-52.86
Time offset to Cell1 <sup>Note 4</sup>	Config 1,2,4,5	$\mu$ s	500
	Config 3,6		250
Propagation Condition			AWGN
NOTE 1: OCNG shall be used such that both cells are fully allocated and a constant total transmitted power spectral density is achieved for all OFDM symbols.			
NOTE 2: Interference from other cells and noise sources not specified in the test is assumed to be constant over subcarriers and time and shall be modeled as AWGN of appropriate power for N <sub>oc</sub> to be fulfilled.			
NOTE 3: SS-RSRP and I <sub>o</sub> levels have been derived from other parameters for information purposes. They are not settable parameters themselves.			
NOTE 4: Receive time difference of signals received between subframe timing boundary of E-UTRA PCell and slot timing boundary of PSCell at the UE antenna connector including time alignment error between the two cells.			

The UE shall be continuously scheduled in LTE PCell and NR PSCell during the entire length of T1. During the time duration T1 the UE shall transmit at least 99.5% of ACK/NACK on E-UTRAN PCell and NR PSCell. The UE is only allowed to cause one interruption on PCell and one interruption on PSCell. Each interruption on E-UTRAN PCell and NR PSCell shall not exceed the value defined in Table 4.5.2.6.5-2 and Table 4.5.2.6.5-3.

**Table 4.5.2.6.5-2: Interruption duration if the NR PSCell is not in the same band as the E-UTRAN deactivated SCell**

$\mu$	NR Slot length (ms)	Interruption length (slot)
0	1	2
1	0.5	2

**Table 4.5.2.6.5-3: Interruption duration if the NR PSCell is in the same band as the E-UTRAN deactivated SCell**

$\mu$	NR Slot length (ms)	Interruption length (slot)
0	1	2 + SMTC duration
1	0.5	2 + SMTC duration

Each interruption on E-UTRAN PCell shall not exceed 1 subframe if the PCell is not in the same band as the deactivated SCell, or 5 subframes if the PCell is in the same band as the deactivated SCell.

The rate of correct events observed during repeated tests shall be at least 90%.

### 4.5.3 SCell activation and deactivation delay

#### 4.5.3.0 Minimum conformance requirements

##### 4.5.3.0.1 Minimum conformance requirements for SCell activation and deactivation delay

The requirements in this clause shall apply for the UE configured with one downlink SCell in EN-DC, or in standalone NR carrier aggregation or in NE-DC or in NR-DC and when one SCell is being activated.

The delay within which the UE shall be able to activate the deactivated SCell depends upon the specified conditions.

Upon receiving SCell activation command in slot  $n$ , the UE shall be capable to transmit valid CSI report and apply actions related to the activation command for the SCell being activated no later than in slot  $n +$

$\frac{T_{\text{HARQ}} + T_{\text{activation\_time}} + T_{\text{CSI\_Reporting}}}{\text{NR slot length}}$ , where:

$T_{\text{HARQ}}$  (in ms) is the timing between DL data transmission and acknowledgement as specified in 38.213 [8].

$T_{\text{activation\_time}}$  is the SCell activation delay in millisecond.

If the SCell is known and belongs to FR1,  $T_{\text{activation\_time}}$  is:

- $T_{\text{FirstSSB}} + 5\text{ms}$ , if the SCell measurement cycle is equal to or smaller than 160ms.
- $T_{\text{FirstSSB\_MAX}} + T_{\text{rs}} + 5\text{ms}$ , if the SCell measurement cycle is larger than 160ms.

If the SCell is unknown and belongs to FR1, provided that the side condition  $\hat{E}_s/\text{Iot} \geq -2\text{dB}$  is fulfilled,

$T_{\text{activation\_time}}$  is:

- $T_{\text{FirstSSB\_MAX}} + T_{\text{SMTC\_MAX}} + 2 * T_{\text{rs}} + 5\text{ms}$ .

If the SCell being activated belongs to FR2, and if there is at least one active serving cell on that FR2 band, then  $T_{\text{activation\_time}}$  is  $T_{\text{FirstSSB}} + 5\text{ms}$  provided:

- The UE is provided with SMTC for the target SCell, and
- The SSBs in the serving cell(s) and the SSBs in the SCell fulfil the condition defined in TS 38.133 [6] clause 3.6.3.
- The parameter *ssb-PositionsInBurst* is same for the serving cell(s) and the SCell.

If the SCell being activated belongs to FR2 and if there is at least one active serving cell on that FR2 band, if the UE is not provided with any SMTC for the target SCell,  $T_{\text{activation\_time}}$  is 3ms, provided

- the RS (s) of SCell being activated is (are) QCL-TypeD with RS (s) of one active serving cell on that FR2 band.

If the SCell being activated belongs to FR2 and if there is no active serving cell on that FR2 band provided that PCell or PSCell is FR1:

If the target SCell is known to UE and semi-persistent CSI-RS is used for CSI reporting, then  $T_{\text{activation\_time}}$  is:

- $3 \text{ ms} + \max(T_{\text{uncertainty\_MAC}} + T_{\text{FineTiming}} + 2\text{ms}, T_{\text{uncertainty\_SP}})$ , where  $T_{\text{uncertainty\_MAC}}=0$  and  $T_{\text{uncertainty\_SP}}=0$ , if UE receives the SCell activation command, semi-persistent CSI-RS activation command and TCI state activation command at the same time.

If the target SCell is known to UE and periodic CSI-RS is used for CSI reporting, then  $T_{\text{activation\_time}}$  is:

- $\max(T_{\text{uncertainty\_MAC}} + 5\text{ms} + T_{\text{FineTiming}}, T_{\text{uncertainty\_RRC}} + T_{\text{RRC\_delay-THARQ}})$ , where  $T_{\text{uncertainty\_MAC}}=0$  if UE receives the SCell activation command and TCI state activation commands at the same time.

If the PCell/PSCell and the target SCell are configured as FR1-FR2 CA or if the PCell/PSCell and the target SCell are in a FR2 band pair with independent beam management, and the target SCell is unknown to UE and semi-persistent CSI-RS is used for CSI reporting, provided that the side condition  $\hat{E}_s/I_{ot} \geq -2\text{dB}$  is fulfilled, then  $T_{\text{activation\_time}}$  is:

- $6\text{ms} + T_{\text{FirstSSB\_MAX}} + 15 * T_{\text{SMTC\_MAX}} + 8 * T_{\text{rs}} + T_{\text{L1-RSRP, measure}} + T_{\text{L1-RSRP, report}} + T_{\text{HARQ}} + \max(T_{\text{uncertainty\_MAC}} + T_{\text{FineTiming}} + 2\text{ms}, T_{\text{uncertainty\_SP}})$

If the PCell/PSCell and the target SCell are configured as FR1-FR2 CA or if the PCell/PSCell and the target SCell are in a FR2 band pair with independent beam management, and the target SCell is unknown to UE and periodic CSI-RS is used for CSI reporting, provided that the side condition  $\hat{E}_s/I_{ot} \geq -2\text{dB}$  is fulfilled, then  $T_{\text{activation\_time}}$  is:

- $3\text{ms} + T_{\text{FirstSSB\_MAX}} + 15 * T_{\text{SMTC\_MAX}} + 8 * T_{\text{rs}} + T_{\text{L1-RSRP, measure}} + T_{\text{L1-RSRP, report}} + \max((T_{\text{HARQ}} + T_{\text{uncertainty\_MAC}} + 5\text{ms} + T_{\text{FineTiming}}), (T_{\text{uncertainty\_RRC}} + T_{\text{RRC\_delay}}))$ .

Where,

$T_{\text{SMTC\_MAX}}$ :

- In FR1, in case of intra-band SCell activation,  $T_{\text{SMTC\_MAX}}$  is the longer SMTC periodicity between active serving cells and SCell being activated provided the cell specific reference signals from the active serving cells and the SCells being activated or released are available in the same slot; in case of inter-band SCell activation,  $T_{\text{SMTC\_MAX}}$  is the SMTC periodicity of SCell being activated.
- In FR2,  $T_{\text{SMTC\_MAX}}$  is the longer SMTC periodicity between active serving cells and SCell being activated provided that in Rel-15 only support FR2 intra-band CA.
- $T_{\text{SMTC\_MAX}}$  is bounded to a minimum value of 10ms.

$T_{\text{rs}}$  is the SMTC periodicity of the SCell being activated if the UE has been provided with an SMTC configuration for the SCell in SCell addition message, otherwise  $T_{\text{rs}}$  is the SMTC configured in the measObjectNR having the same SSB frequency and subcarrier spacing. If the UE is not provided SMTC configuration or measurement object on this frequency, the requirement which involves  $T_{\text{rs}}$  is applied with  $T_{\text{rs}} = 5\text{ms}$  assuming the SSB transmission periodicity is 5ms. There is no requirements if the SSB transmission periodicity is not 5ms.

$T_{\text{FirstSSB}}$ : Is the time to the end of the first complete SSB burst indicated by the SMTC, or within 5ms if

SMTC is not configured, after  $n + \frac{T_{\text{HARQ}} + 3\text{ms}}{\text{NR slot length}}$ .

$T_{\text{FirstSSB\_MAX}}$ : Is the time to the end of the first complete SSB burst indicated by the SMTC, or within 5ms if

SMTC is not configured, after slot  $n + \frac{T_{\text{HARQ}} + 3\text{ms}}{\text{NR slot length}}$ , further fulfilling:

- In FR1, in case of intra-band SCell activation, the occasion when all active serving cells and SCells being activated or released are transmitting SSB bursts in the same slot; in case of inter-band SCell activation, the first occasion when the SCell being activated is transmitting SSB burst.

- In FR2, the occasion when all active serving cells and SCells being activated or released are transmitting SSB bursts in the same slot.

$T_{\text{FineTiming}}$  is the time period between UE finish processing the last activation command for PDCCH TCI, PDSCH TCI (when applicable) and the timing of first complete available SSB corresponding to the TCI state

$T_{\text{L1-RSRP, measure}}$  is L1-RSRP measurement delay  $T_{\text{L1-RSRP, Measurement\_Period\_SSB}}$  ms or  $T_{\text{L1-RSRP, Measurement\_Period\_CSI-RS}}$  based on applicability as defined in TS 38.133 [6] clause 9.5 assuming  $M=1$ .

$T_{\text{L1-RSRP, report}}$  is delay of acquiring CSI reporting resources.

$T_{\text{uncertainty\_MAC}}$  is the time period between reception of the last activation command for PDCCH TCI, PDSCH TCI (when applicable) relative to

- SCell activation command for known case;
- First valid L1-RSRP reporting for unknown case.

$T_{\text{uncertainty\_SP}}$  is the time period between reception of the activation command for semi-persistent CSI-RS resource set for CQI reporting relative to

- SCell activation command for known case;
- First valid L1-RSRP reporting for unknown case.

$T_{\text{uncertainty\_RRC}}$  is the time period between reception of the RRC configuration message for TCI of periodic CSI-RS for CQI reporting (when applicable) relative to

- SCell activation command for known case;
- First valid L1-RSRP reporting for unknown case.

$T_{\text{RRC\_delay}}$  is the RRC procedure delay as specified in [13].

Longer delays for RRM measurement requirements, and in case of FR2 also SSB based RLM/BFD/CBD/L1-RSRP measurement requirements, can be expected during the cell detection time for unknown SCell activation.

When *absoluteFrequencySSB* is not configured in *DownlinkConfigCommon* for target SCell but *SMTc* for target SCell is configured, no requirement would be applied.  $T_{\text{CSI\_reporting}}$  is the delay (in ms) including uncertainty in acquiring the first available downlink CSI reference resource, UE processing time for CSI reporting and uncertainty in acquiring the first available CSI reporting resources as specified in TS 38.331 [13].

SCell in FR1 is known if it has been meeting the following conditions:

- During the period equal to  $\max(5 \text{ measCycleSCell}, 5 \text{ DRX cycles})$  for FR1 before the reception of the SCell activation command:
  - the UE has sent a valid measurement report for the SCell being activated and
  - the SSB measured remains detectable according to the cell identification conditions specified in TS 38.133 [6] section 9.2 and 9.3.
- the SSB measured during the period equal to  $\max(5 \text{ measCycleSCell}, 5 \text{ DRX cycles})$  also remains detectable during the SCell activation delay according to the cell identification conditions specified in TS 38.133 [6] section 9.2 and 9.3.

Otherwise SCell in FR1 is unknown.

The requirements for FR1 unknown SCell activation specified in this clause apply when one of the following conditions is met

- 'ssb-PositionInBurst' indicates only one SSB is being actually transmitted, or

- 'ssb-PositionInBurst' indicates multiple SSBs and TCI indication is provided in same MAC PDU with SCell activation.

For the first SCell activation in FR2 bands, the SCell is known if it has been meeting the following conditions:

- During the period equal to 4s for UE supporting power class1 and 3s for UE supporting power class 2/3/4 before UE receives the last activation command for PDCCH TCI, PDSCH TCI (when applicable) and semi-persistent CSI-RS for CQI reporting (when applicable):
  - the UE has sent a valid L3-RSRP measurement report with SSB index
  - SCell activation command is received after L3-RSRP reporting and no later than the time when UE receives MAC-CE command for TCI activation
- During the period from L3-RSRP reporting to the valid CQI reporting, the reported SSBs with indexes remain detectable according to the cell identification conditions specified in TS 38.133 [6] clause 9.2 and 9.3, and the TCI state is selected based on one of the latest reported SSB indexes.

Otherwise, the first SCell in FR2 band is unknown. The requirement for unknown SCell applies provided that the activation commands for PDCCH TCI, PDSCH TCI (when applicable), semi-persistent CSI-RS for CQI reporting (when applicable), and configuration message for TCI of periodic CSI-RS for CQI reporting (when applicable) are based on the latest valid L1-RSRP reporting.

If the UE has been provided with higher layer in TS 38.331 [13] signalling of *smtc2* prior to the activation command,  $T_{\text{SMTC\_Scell}}$  follows *smtc1* or *smtc2* according to the physical cell ID of the target cell being activated.  $T_{\text{SMTC\_MAX}}$  follows *smtc1* or *smtc2* according to the physical cell IDs of the target cells being activated and the active serving cells.

In addition to CSI reporting defined above, UE shall also apply other actions related to the activation command specified in [13] for a SCell at the first opportunities for the corresponding actions once the SCell is activated.

The starting point of an interruption window on spCell or any activated SCell, as specified in TS 38.133[6] clause 8.2, shall not occur before slot  $n+1 + \frac{T_{\text{HARQ}}}{\text{NR slot length}}$  and not occur after slot  $n+1 + \frac{T_{\text{HARQ}} + 3\text{ms} + T_X}{\text{NR slot length}}$ , where NR slot length is with respect to the numerology used in the SCell being activated, and  $T_X$  is:

- $T_{\text{FirstSSB}}$ , for any scenario where  $T_{\text{activation\_time}}$  includes  $T_{\text{FirstSSB}}$ ;
- $T_{\text{FirstSSB\_MAX}}$ , for any scenario where  $T_{\text{activation\_time}}$  includes  $T_{\text{FirstSSB\_MAX}}$ ;
- $T_{\text{uncertainty\_MAC}} + T_{\text{FineTiming}}$ , for any scenario where  $T_{\text{activation\_time}}$  includes  $T_{\text{FineTiming}}$ .

The length of the interruption window may be different for different victim cells, and depends on the applicable scenario and on the frequency band relation between the aggressor cell and the victim cell.

The requirements in this clause and requirements on interruption due to SCell activation in clause 8.2 apply provided that the SSB of the to-be-activated SCell is within the first active DL BWP of the SCell. Starting from the slot specified in clause 4.3 of TS 38.213 [8] (timing for secondary Cell activation/deactivation) and until the UE has completed the SCell activation, the UE shall report out of range if the UE has available uplink resources to report CQI for the SCell.

Starting from the slot specified in clause 4.3 of TS 38.213 [8] (timing for secondary Cell activation/deactivation) and until the UE has completed a first L1-RSRP measurement, the UE shall report lowest valid L1 SS-RSRP range if the UE has available uplink resources to report L1-RSRP for the SCell.

Upon receiving SCell deactivation command or upon expiry of the *sCellDeactivationTimer* in slot  $n$ , the UE shall accomplish the deactivation actions for the SCell being deactivated no later than in slot  $n + \frac{T_{\text{HARQ}} + 3\text{ms}}{\text{NR slot length}}$ .

The starting point of an interruption on SpCell or any activated SCell in the same cell group as SCell being deactivated for NR standalone, EN-DC, NE-DC or NR-DC mode specified in clause 8.2 shall not occur before slot  $n+1 + \frac{T_{\text{HARQ}}}{\text{NR slot length}}$  and not occur after slot  $n+1 + \frac{T_{\text{HARQ}} + 3\text{ms}}{\text{NR slot length}}$ , where NR slot length is with respect to the numerology used in the SCell being deactivated.

Upon expiry of the *sCellDeactivationTimer* in slot  $n$ , the UE shall accomplish the deactivation actions for the SCell being deactivated no later than in slot  $n + \frac{3\text{ms}}{\text{NR slot length}}$ . The starting point of an interruption window on spCell or any

activated SCell, as specified in TS 38.133 [6] clause 8.2, shall not occur before slot  $n+1$  and not occur after slot  $n+1 + \frac{3ms}{NR\ slot\ length}$ , where NR slot length is with respect to the numerology used in the SCell being deactivated.

The length of the interruption window may be different for different victim cells, and depends on the applicable scenario and on the frequency band relation between the aggressor cell and the victim cell.

The normative reference for this requirement is TS 38.133 [6] clause 8.3.

#### 4.5.3.1 EN-DC FR1 SCell activation and deactivation of known SCell in non-DRX for 160ms SCell measurement cycle

##### 4.5.3.1.1 Test purpose

This test is to verify that the SCell activation and deactivation times are within the requirements, when the SCell in FR1 is known by the UE at the time of activation.

##### 4.5.3.1.2 Test applicability

This test applies to all types of NR UE supporting E-UTRA and EN-DC from Release 15 onwards and supporting 2DL CA in NR.

##### 4.5.3.1.3 Minimum conformance requirements

The minimum conformance requirements are defined in clause 4.5.3.0.1.

The normative reference for this requirement is TS 38.133 [6] clause A.4.5.3.1.

##### 4.5.3.1.4 Test description

###### 4.5.3.1.4.1 Initial conditions

This test shall be tested using any of the test configurations in Table 4.5.3.1.4.1-1.

**Table 4.5.3.1.4.1-1: supported test configurations**

Test Case ID	Description
4.5.3.1-1	LTE FDD, NR 15 kHz SSB SCS, $\geq 10$ MHz bandwidth, FDD duplex mode
4.5.3.1-2	LTE FDD, NR 15 kHz SSB SCS, $\geq 10$ MHz bandwidth, TDD duplex mode
4.5.3.1-3	LTE FDD, NR 30 kHz SSB SCS, $\geq 40$ MHz bandwidth, TDD duplex mode
4.5.3.1-4	LTE TDD, NR 15 kHz SSB SCS, $\geq 10$ MHz bandwidth, FDD duplex mode
4.5.3.1-5	LTE TDD, NR 15 kHz SSB SCS, $\geq 10$ MHz bandwidth, TDD duplex mode
4.5.3.1-6	LTE TDD, NR 30 kHz SSB SCS, $\geq 40$ MHz bandwidth, TDD duplex mode
Note 1::	The UE is only required to be tested in one of the supported test configurations
Note 2::	The UE is only required to be tested in one with smallest aggregated channel bandwidth from supported band combinations which is composed of CCs $\geq$ the bandwidth ( $BW_{channel}$ ) defined in each test configuration.

Configure the test equipment and the DUT according to the parameters in Table 4.5.3.1.4.1-2 and Table 4.5.3.1.4.1-3.

**Table 4.5.3.1.4.1-2: Initial conditions for known FR1 SCell activation case**

Parameter	Value	Comment
Test environment	NC	As specified in TS 38.508-1 [14] clause 4.1.
Test frequencies	As specified in Annex E, Table E.1-1 and TS 38.508-1 [14] clause 4.3.1.	
Channel bandwidth	As specified by the test configuration selected from Table 4.5.3.1.5-1	
Propagation conditions	AWGN	As specified in clause C.2.2.
Connection Diagram	TE Part	A.3.1.7.1
	DUT Part	A.3.2.3.1
	As specified in TS 38.508-1 [14] Annex A.	

Exceptions to connection diagram	N/A	
----------------------------------	-----	--

**Table 4.5.3.1.4.1-3: General test parameters for known FR1 SCell activation case, 160ms SCell measurement cycle**

Parameter	Unit	Value	Comment
RF Channel Number		1,2,3	One E-UTRAN radio channel (1) and two NR radio channel (2,3) are used for this test
Active PCell		Cell 1	Primary cell on E-UTRAN RF channel number 1. As specified in section A.3.7.2.1 of TS38.133 [6]
Active PSCell		Cell 2	Primary secondary cell on NR RF channel number 2.
Configured deactivated SCell		Cell 3	Configured deactivated secondary cell on NR RF channel number 3
CP length		Normal	
DRX		OFF	Continuous monitoring of primary cell
Cell-individual offset for cells on E-UTRA RF channel number	dB	0	Individual offset for cells on primary component carrier.
Cell-individual offset for cells on NR channel number	dB	0	Individual offset for cells on secondary component carrier.
SCell measurement cycle (measCycleSCell)	ms	160	
Cell3 timing offset to cell2	μs	0	
Time alignment error between cell3 and cell2	μs	≤ Time alignment error as specified in TS 38.104 [28] clause 6.5.3.1.	The value of time alignment error depends upon the type of carrier aggregation.
T1	s	7	During this time the PSCell shall be known and the SCell configured and detected.
T2	s	1	During this time the UE shall activate the SCell.
T3	s	1	During this time the UE shall deactivate the SCell.
T <sub>HARQ</sub>	ms	$k_1 \cdot \text{NR slot length}$	$k_1$ is a number of slots and is indicated by the PDSCH-to-HARQ-timing-indicator field in the DCI format, if present, or provided by dl-DataToUL-ACK, the value of $k$ should be the minimum value defined in TS 38.213 [8]
T <sub>CSI_Reporting</sub>	ms	15	the delay (in ms) including uncertainty in acquiring the first available downlink CSI reference resource, UE processing time for CSI reporting (clause 5.2.2.5 in TS 38.214) and uncertainty in acquiring the first available CSI reporting resources as specified in TS 38.331 [13]
K	slot	$k_1 + 3 \cdot N_{\text{slot}}^{\text{subframe}} + 1$	As specified in section 4.3 of TS 38.213 [8]

1. Message contents are defined in clause 4.5.3.1.4.3.
2. Cell 1 is the E-UTRA serving cell (PCell) for the EN-DC setup. The power levels and settings for Cell 1 are set according to Annex A.6. Cell 2 and Cell 3 are NR FR1 cells. Cell 2 is the PSCell and Cell 3 is the deactivated SCell.

#### 4.5.3.1.4.2 Test procedure

The test consists of three successive time periods, with duration of T1, T2 and T3, respectively. There are three carriers, E-UTRA has one cell, NR has two cells. All cells have constant signal levels throughout the test. Before the test starts the UE is connected to Cell 1 (PCell) on E-UTRA and Cell 2 (PSCell) on NR, but is not aware of Cell 3 (SCell) on NR. The UE is monitoring the PCell and PSCell. The UE shall be continuously scheduled in the PCell and PSCell throughout the whole test.



The point in time at which the MAC message is received at the UE antenna connector, in a slot # denoted  $m$ , defines the start of time period T2. The UE shall be able to report valid CSI in PSCell for the activated SCell at latest in slot  $m + \frac{T_{\text{HARQ}} + T_{\text{activation\_time}} + T_{\text{CSI\_Reporting}}}{\text{NR slot length}}$ . The UE shall start reporting CSI in PSCell after at least one CSI-RS transmission occasion for channel measurement and reporting after slot  $(m+k)$  and shall report CQI index 0 (out-of-range) until the SCell activation has been completed. Any PCell or PSCell interruption due to activation of SCell shall occur in the slot  $m + 1 + \frac{T_{\text{HARQ}}}{\text{NR slot length}}$  to  $m + 1 + \frac{T_{\text{HARQ}} + 3\text{ms} + T_X}{\text{NR slot length}} + N_{\text{interruption}}$ . Any E-UTRA PCell interruption due to activation of SCell shall occur in the subframe  $m_1 + 1 + \frac{T_{\text{HARQ}}}{\text{EUTRA slot length}}$  to subframe  $m_2 + 1 + \frac{T_{\text{HARQ}} + 3\text{ms} + T_X}{\text{EUTRA slot length}} + N_{\text{interruption}}$ , where  $m_1$  and  $m_2$  are the index of the first and last subframe of E-UTRA PCell which overlaps with slot  $m$ , and  $N_{\text{interruption}}$  is the interruption length given in TS 36.133 [23] section 7.32.

Time period T3 starts when a MAC message for deactivation of SCell, sent from the test equipment to the UE in a slot # denoted  $n$ , is received at the UE antenna connector. The UE shall carry out deactivation of the SCell in a slot  $n + \frac{T_{\text{HARQ}} + 3\text{ms}}{\text{NR slot length}}$ . The starting point of any PSCell interruption due to the deactivation shall occur in the slot  $n + 1 + \frac{T_{\text{HARQ}}}{\text{NR slot length}}$  to  $n + 1 + \frac{T_{\text{HARQ}} + 3\text{ms}}{\text{NR slot length}}$ . The starting point of any E-UTRA PCell interruption due to the deactivation shall occur in the subframe  $n_1 + 1 + \frac{T_{\text{HARQ}}}{\text{EUTRA subframe length}}$  to subframe  $n_2 + 1 + \frac{T_{\text{HARQ}} + 3\text{ms}}{\text{EUTRA subframe length}}$ , where  $n_1$  and  $n_2$  are the index of the first and last subframe of E-UTRA PCell which overlaps with slot  $n$ .

1. Ensure the UE is in state RRC\_CONNECTED with generic procedure parameters Connectivity EN-DC, DC bearer MCG and SCG, Connected without release *On* and Test Mode *On* according to TS 38.508-1 [14] clause 4.5.
2. Set the parameters according to T1 in Tables 4.5.3.1.5-1 and A.6.1.1-1. Propagation conditions are set according to Annex C clauses C.2.2.
3. T1 starts. Immediately after, the SS shall configure SCell (Cell 3) on the SCC as per TS 38.508-1 [14] clause 7.5.2, with the message content exceptions defined in clause 4.5.3.1.4.3. NR RRCReconfiguration message is contained in RRCConnectionReconfiguration and NR RRCReconfigurationComplete message is contained in RRCConnectionReconfigurationComplete.
- 3a. The UE send a *MeasurementReport* message embedded in *ULInformationTransferMRDC*.
4. The SS shall configure transmission of PDSCH with a maximum number of 1 HARQ transmission.
5. The SS activates SCC by sending the activation MAC-CE (Refer TS 38.321 [12], clauses 5.9, 6.1.3.10) in a slot # denoted  $m$  and T2 starts in slot  $m$ . If the SS receives ACK for MAC-CE sent by the UE, the test proceeds to step 6, otherwise go to step 9.
6. After at least one CSI-RS transmission occasion for channel measurement, the UE shall start sending CSI reports for SCell and the SS shall monitor CSI reports for SCell sent from the UE and ACK/NACK sent in PSCell according to the following criteria:
  - If the first CSI report for SCell is received by the SS no later than slot  $m + 1 + \frac{T_{\text{HARQ}} + 3\text{ms} + T_{\text{CSI\_Reporting}}}{\text{NR slot length}}$ ,
  - or slot  $m + 1 + \frac{T_{\text{HARQ}} + 3\text{ms} + T_{\text{CSI\_Reporting}} + T_X}{\text{NR slot length}} + N_{\text{interruption}} + 1$  if the slot  $m + 1 + \frac{T_{\text{HARQ}} + 3\text{ms} + T_{\text{CSI\_Reporting}}}{\text{NR slot length}}$  was subject to interruption,
  - and CSI report with non-zero CQI index is received by the SS earlier than or equal to slot  $m + \frac{T_{\text{HARQ}} + T_{\text{activation\_time}} + T_{\text{CSI\_Reporting}}}{\text{NR slot length}}$ ,
  - or the next available uplink resource if there are no uplink resources for reporting the valid CSI in a slot  $m + \frac{T_{\text{HARQ}} + T_{\text{activation\_time}} + T_{\text{CSI\_Reporting}}}{\text{NR slot length}}$
  - and DTX is not observed by the SS outside the slot  $m + 1 + \frac{T_{\text{HARQ}}}{\text{NR slot length}}$  to  $m + 1 + \frac{T_{\text{HARQ}} + 3\text{ms} + T_X}{\text{NR slot length}} + N_{\text{interruption}} + \frac{T_{\text{HARQ}}}{\text{NR slot length}}$  up to the end of T2

- Then the number of successes for the event "Activation" is increased by one. Otherwise, count a fail for the event "Activation" and go to step 9.
- 7. When T2 expires, the SS deactivate SCC by sending the deactivation MAC-CE (Refer TS 38.321 [12], clauses 5.9, 6.1.3.10) in a slot # denoted n and T3 starts in slot n. If the SS receives ACK for MAC-CE sent by the UE, the test proceeds to step 8, otherwise go to step 9.
- 8. The UE shall stop sending CSI reports for SCell and the SS shall monitor CSI reports for SCell sent from the UE and ACK/NACK sent in PSCell during SCell deactivation.
  - If the last CSI report is received by the SS earlier than or equal to slot  $n + \frac{T_{HARQ}+3ms}{NR\ slot\ length}$
  - and DTX is not observed by the SS outside the slot  $n + 1 + \frac{T_{HARQ}}{NR\ slot\ length}$  to  $n + 1 + \frac{T_{HARQ}+3ms}{NR\ slot\ length} + N_{interruption} + \frac{T_{HARQ}}{NR\ slot\ length}$  up to the end of T3,
  - Then the number of successes for the event "Deactivation" is increased by one. Otherwise, count a fail for the event "Deactivation".
- 9. When T3 expires, or Activation in step 5 was not acknowledged, or a fail was counted for the event "Activation" in step 6, or Deactivation in step 7 was not acknowledged, the SS shall transmit an *RRCCONNECTIONRECONFIGURATION* message with condition EN-DC\_PSCell\_Rel according to TS 36.508[25] Table 4.6.1-8 to release NR PSCell. The UE shall transmit an *RRCCONNECTIONRECONFIGURATIONCOMPLETE* message.
- 10. Set Cell 3 physical cell identity = ((current cell 3 physical cell identity + 1) mod 1008) for next iteration of the test procedure loop.
- 11. The SS shall transmit an *RRCCONNECTIONRECONFIGURATION* message with condition MCG and SCG according to TS 36.508 [25] Table 4.6.1-8 to ensure the UE is in state RRC\_CONNECTED with generic procedure parameters Connectivity EN-DC, DC bearer MCG and SCG, Connected without release *On* and Test Mode *On* according to TS 38.508-1 [14] clause 4.5. The UE shall transmit an *RRCCONNECTIONRECONFIGURATIONCOMPLETE* message.
- 12. Repeat steps 2-11 until a test verdict has been achieved.

Each of the events "Activation" and "Deactivation" is evaluated independently for the statistic, resulting in an event verdict: pass or fail. Each event is evaluated only until the confidence level according to Table G.2.3-1 in Annex G.2 is achieved. Different events may require different times for a verdict. If all events pass, the test passes. If one event fails, the test fails.

4.5.3.1.4.3 Message contents

Message contents are according to TS 38.508-1 [14] clause 7.3 with the following exceptions:

**Table 4.5.3.1.4.3-1: Common Exception messages**

Default Message Contents	
Common contents of system information blocks exceptions	
Default RRC messages and information elements contents exceptions	Table H.3.1-7 with Condition Deactivated SCell

**Table 4.5.3.1.4.3-2: RRCReconfiguration in step 3: SCell addition**

Derivation Path: TS 38.508-1 [14], Table 4.6.1-13 with condition EN-DC_MEAS and EN-DC_SCell_add			
Information Element	Value/remark	Comment	Condition

RRCReconfiguration ::= SEQUENCE {			
criticalExtensions CHOICE {			
rrcReconfiguration ::= SEQUENCE {			
secondaryCellGroup	CellGroupConfig-SCell	Table 4.5.3.1.4.3-5	
measConfig	MeasConfig	Table 4.5.3.1.4.3-2A	
}			
}			
}			

**Table 4.5.3.1.4.3-2A: MeasConfig (Table 4.5.3.1.4.3-2)**

Derivation path: Table H.3.1-2 with condition Deactivated SCell			
Information Element	Value/Remark	Comment	Condition
measConfig ::= SEQUENCE {			
measObjectToAddModList SEQUENCE (SIZE (1..maxNrofMeasId)) OF SEQUENCE {	2 entries		
measObject[2] CHOICE {			
measObjectNR	MeasObjectNR for SCell	entry 2 Table 4.5.3.1.4.3-3	
}			
}			
reportConfigToAddModList SEQUENCE (SIZE (1..maxReportConfigId)) OF ReportConfigToAddMod {	1 entry		
ReportConfigToAddMod[1] SEQUENCE {		entry 1	
reportConfigId	ReportConfigId		
reportConfig CHOICE {			
reportConfigNR	ReportConfigNR	Table 4.5.3.1.4.3-4	
}			
}			
}			
}			

**Table 4.5.3.1.4.3-3: MeasObjectNR for SCell**

Derivation Path: Table H.3.1-3 with condition Deactivated SCell and Synchronous cells			
Information Element	Value/remark	Comment	Condition
MeasObjectNR ::= SEQUENCE {			
smc1	SSB-MTC specified in TS 38.508-1 [14] Table 7.3.1-3 with condition SMTC.1		
measCycleSCell-v1530	sf160		
}			

**Table 4.5.3.1.4.3-4: ReportConfigNR**

Derivation Path: Table H.3.1-4			
Information Element	Value/remark	Comment	Condition
ReportConfigNR ::= SEQUENCE {			
reportType CHOICE {			
eventTriggered SEQUENCE {			
eventId CHOICE {			
eventA3 SEQUENCE {			
a3-Offset CHOICE {			
rsrp	-30	To ensure reporting can always be triggered	
}			
}			
}			
}			

}		
}		

**Table 4.5.3.1.4.3-5: CellGroupConfig-SCell (Table 4.5.3.1.4.3-2)**

Derivation Path: TS 38.508-1 [14], Table 4.6.3-19 with condition MEAS and SCell_add			
Information Element	Value/remark	Comment	Condition
CellGroupConfig ::= SEQUENCE {			
spCellConfig SEQUENCE {			
servCellIndex	ServCellIndex of NR SpCell		
reconfigurationWithSync	Not present		
rf-TimersAndConstants	Not present		
rlmInSyncOutOfSyncThreshold	Not present		
spCellConfigDedicated	ServingCellConfig-SpCell	Table 4.5.3.1.4.3-6	
}			
sCellToAddModList SEQUENCE (SIZE (1..maxNrofSCells)) OF SCellConfig {	1 entry		
SCellConfig[1] SEQUENCE {		entry 1	
sCellConfigDedicated	ServingCellConfig-SCell	Table 4.5.3.1.4.3-7	
smtc	SSB-MTC specified in TS 38.508-1 [14] Table 7.3.1-3 with condition SMTC.1		
}			
}			
}			

**Table 4.5.3.1.4.3-6: ServingCellConfig-SpCell (Table 4.5.3.1.4.3-5)**

Derivation Path: TS 38.508-1 [14], Table 4.6.3-167 with condition MEAS			
Information Element	Value/remark	Comment	Condition
ServingCellConfig ::= SEQUENCE {			
csi-MeasConfig	CSI-MeasConfig for RRM specified in TS 38.508-1 [14] Table 7.3.1-6		
servingCellMO	1		
}			

**Table 4.5.3.1.4.3-7: ServingCellConfig-SCell (Table 4.5.3.1.4.3-5)**

Derivation Path: TS 38.508-1 [14], Table 4.6.3-167 with condition No_UL			
Information Element	Value/remark	Comment	Condition
ServingCellConfig ::= SEQUENCE {			
csi-MeasConfig	CSI-MeasConfig for RRM specified in TS 38.508-1 [14] Table 7.3.1-6		
servingCellMO	2		
}			

4.5.3.1.5 Test requirement

Table 4.5.3.1.5-1 defines the primary level settings including test tolerances for all tests.

**Table 4.5.3.1.5-1: Cell specific test parameters for known FR1 SCell activation case, 160ms SCell measurement cycle**

Parameter		Unit	Cell 2			Cell 3		
			T1	T2	T3	T1	T2	T3
SSB ARFCN			freq1			freq2		
Duplex mode	Config 1,4		FDD					
	Config 2,3,5,6		TDD					
TDD configuration	Config 1,4		Not Applicable					
	Config 2,5		TDDConf.1.1					
	Config 3,6		TDDConf.2.1					
BW <sub>channel</sub>	Config 1,4	MHz	Note 7					
	Config 2,5		Note 7					
	Config 3,6		Note 7					
BW <sub>occupied</sub>	Config 1,4	RB	52 <sup>Note 5</sup>					
	Config 2,5		52 <sup>Note 5</sup>					
	Config 3,6		106 <sup>Note 6</sup>					
DL initial BWP configuration	Config 1, 2, 3, 4, 5, 6		DLBWP.0.1					
DL dedicated BWP configuration	Config 1, 2, 3, 4, 5, 6		DLBWP.1.1					
UL initial BWP configuration	Config 1, 2, 3, 4, 5, 6		ULBWP.0.1					
UL dedicated BWP configuration	Config 1, 2, 3, 4, 5, 6		ULBWP.1.1					
DRX Cycle		ms	Not Applicable					
PDSCH Reference measurement channel	Config 1,4		SR.1.1 FDD			SR.1.1 FDD		
	Config 2,5		SR.1.1 TDD			SR.1.1 TDD		
	Config 3,6		SR.2.1 TDD			SR.2.1 TDD		
RMSI CORESET Reference Channel	Config 1,4		CR.1.1 FDD			CR.1.1 FDD		
	Config 2,5		CR.1.1 TDD			CR.1.1 TDD		
	Config 3,6		CR.2.1 TDD			CR.2.1 TDD		
RMC CORESET Reference Channel	Config 1,4		CCR.1.1 FDD			CCR.1.1 FDD		
	Config 2,5		CCR.1.1 TDD			CCR.1.1 TDD		
	Config 3,6		CCR.2.1 TDD			CCR.2.1 TDD		
TRS configuration	Config 1,4		TRS.1.1 FDD			TRS.1.1 FDD		
	Config 2,5		TRS.1.1 TDD			TRS.1.1 TDD		
	Config 3,6		TRS.1.2 TDD			TRS.1.2 TDD		
OCNG Patterns	Config 1,2,4,5		OP.1 <sup>Note 5</sup>					
	Config 3,6		OP.1 <sup>Note 6</sup>					
SMTC configuration			SMTC.1					
SSB configuration	Config 1,2,4,5		SSB.1 FR1					
	Config 3,6		SSB.2 FR1					
CSI-RS configuration for CSI reporting	Config 1,4		CSI-RS.1.1 FDD					
	Config 2,5		CSI-RS.1.1 TDD					
	Config 3,6		CSI-RS.2.1 TDD					
PDSCH/PDCCH subcarrier spacing	Config 1,2,4,5	kHz	15					
	Config 3,6		30					
reportConfigType	Config 1-6		periodic			N/A		
reportQuantity	Config 1-6		cri-RI-PMI-CQI			N/A		
CSI reporting periodicity	Config 1,2,4,5	slot	5			N/A		
	Config 3,6		10			N/A		
CSI reporting offset	Config 1,2,4,5	slot	2			N/A		
	Config 3,6		4			N/A		
EPRE ratio of PSS to SSS		dB	0					
EPRE ratio of PBCH DMRS to SSS								
EPRE ratio of PBCH to PBCH DMRS								
EPRE ratio of PDCCH DMRS to SSS								
EPRE ratio of PDCCH to PDCCH DMRS								
EPRE ratio of PDSCH DMRS to SSS								
EPRE ratio of PDSCH to PDSCH								
EPRE ratio of OCNG DMRS to SSS (note 1)								
EPRE ratio of OCNG to OCNG DMRS (note 1)								
$N_{oc}$ note 2		dBm/15kHz	-104					

Parameter		Unit	Cell 2			Cell 3		
			T1	T2	T3	T1	T2	T3
$N_{oc}$ note 2	Config 1,2,4,5	dBm/SCS	-104					
	Config 3,6							
$\hat{E}_s / I_{ot}$		dB	17					
$\hat{E}_s / N_{oc}$		dB	17					
SS-RSRP note 3	Config 1,2,4,5	dBm/SCS	-87					
	Config 3,6							
SCH_RP note 3		dBm/15 kHz	-87					
$I_o$ Note3	Config 1,2,4,5	dBm/9.36MHz	-58.96					
	Config 3,6							
Propagation condition		-	AWGN					

NOTE 1: OCNG shall be used such that both cells are fully allocated and a constant total transmitted power spectral density is achieved for all OFDM symbols.

NOTE 2: Interference from other cells and noise sources not specified in the test is assumed to be constant over subcarriers and time and shall be modelled as AWGN of appropriate power for  $N_{oc}$  to be fulfilled within  $BW_{occupied}$ .

NOTE 3: SS-RSRP,  $I_o$  and SCH\_RP levels have been derived from other parameters for information purposes. They are not settable parameters themselves.

NOTE 4: The uplink resources for CSI reporting are assigned to the UE prior to the start of time period T2.]

NOTE 5: All UL/DL transmission shall be confined within  $BW_{occupied}$  (i.e. 10 MHz, 52 RBs) from  $F_{C,low}$ , and  $I_o$  is independent of the  $BW_{channel}$  configured.

NOTE 6: All UL/DL transmission shall be confined within  $BW_{occupied}$  (i.e. 40 MHz, 106 RBs) from  $F_{C,low}$ , and  $I_o$  is independent of the  $BW_{channel}$  configured.

NOTE 7:  $N_{RB,c}$  is derived from Table 5.3.2-1 in TS38.101-1[2] with configured  $BW_{channel}$ .

During T2 the UE shall send the first CSI report for SCell no later than the first available uplink resource after at least one CSI-RS transmission occasion for channel measurement and reporting after slot  $m + \frac{T_{HARQ} + 3ms}{NR \text{ slot length}}$ . UE is allowed to postpone CSI report to next available UL resource if an available uplink resource is subject to interruption. Whether CSI report in slot  $m + 1 + \frac{T_{HARQ} + 3ms + T_{CSI\_Reporting}}{NR \text{ slot length}}$  was interrupted or not is checked by monitoring ACK/NACK sent in PCell in slot  $m + 1 + \frac{T_{HARQ} + 3ms + T_{CSI\_Reporting}}{NR \text{ slot length}}$ .

During T2 the UE shall start sending CSI reports for SCell with non-zero CQI index at latest in a slot  $m + \frac{T_{HARQ} + T_{activation\_time} + T_{CSI\_Reporting}}{NR \text{ slot length}}$ ,  $T_{activation\_time} = T_{FirstSSB} + 5ms$ , as defined in TS 38.133 [6] section 8.3.

Figures 4.5.3.1.5-1 shows the derivation of the Test procedure requirement for DTX during T2, based on the core requirements for interruption.

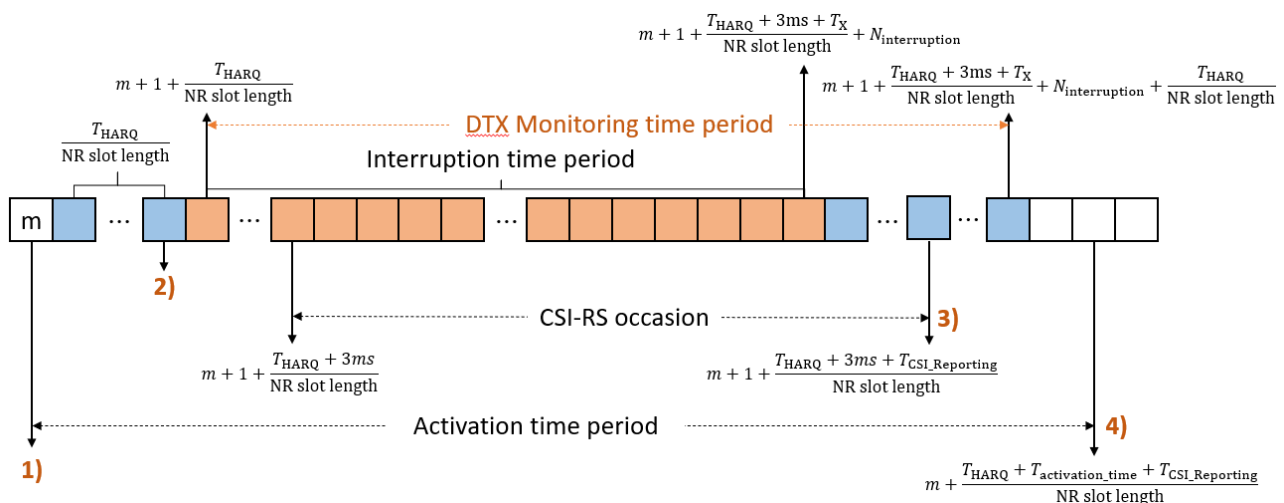

Figure 4.5.3.1.5-1: Procedure derivation for Activation

- 1) Activation command for SCell
- 2) ACK for MAC-CE for SCell1 activation
- 3) First CSI report timing (could be invalid CQI)
- 4) First non-zero CSI report transmission

During T3 the UE shall stop sending CSI reports for SCell at latest in a slot  $n + \frac{T_{HARQ}+3ms}{NR\ slot\ length}$ , as defined in TS 38.133 [6] section 8.3.

During T2 interruption of PSCell during SCell activation shall not happen outside the slot  $m + 1 + \frac{T_{HARQ}}{NR\ slot\ length}$  to  $m + 1 + \frac{T_{HARQ}+3ms+T_X}{NR\ slot\ length} + N_{interruption}$ , and interruption of E-UTRA PCell during SCell activation shall not happen outside the subframe  $m_1 + 1 + \frac{T_{HARQ}}{EUTRA\ slot\ length}$  to subframe  $m_2 + 1 + \frac{T_{HARQ}+3ms+T_X}{EUTRA\ slot\ length} + N_{interruption}$ , as defined in TS 38.133 [6] section 8.3.

During T3 the starting point of interruption of PSCell during SCell deactivation shall not happen outside the slot  $n + 1 + \frac{T_{HARQ}}{NR\ slot\ length}$  to  $n + 1 + \frac{T_{HARQ}+3ms}{NR\ slot\ length}$ , as defined in TS 38.133 [6] section 8.3, and the starting point of interruption of E-UTRA PCell during SCell deactivation shall not happen outside the subframe  $n_1 + 1 + \frac{T_{HARQ}}{EUTRA\ subframe\ length}$  to subframe  $n_2 + 1 + \frac{T_{HARQ}+3ms}{EUTRA\ subframe\ length}$ .

Figures 4.5.3.1.5-2 shows the derivation of the Test procedure requirement for NR PSCell DTX during T3, based on the core requirements for interruption.

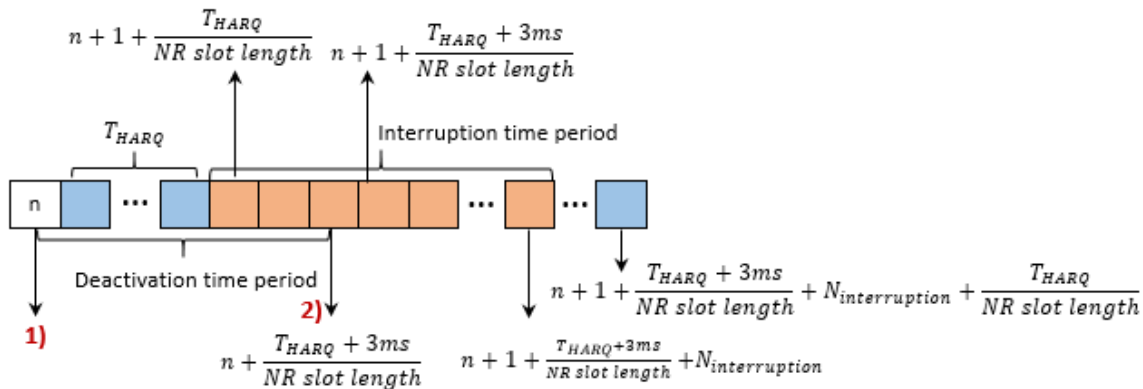

Figure 4.5.3.1.5-2: Procedure derivation for Deactivation

- 1) Deactivation command for SCell
- 2) Latest slot stop sending CSI reports for SCell

The interruption of PSCell shall not be more than the values specified for EN-DC in TS 38.133 [6] clause 8.2.1.2.4.

All of the above test requirements shall be fulfilled in order for the observed SCell activation delay and SCell deactivation delay to be counted as correct. The rate of correct observed SCell activation delay and SCell deactivation delay during repeated tests shall be at least 90 %.

NOTE: During T2 if there are no uplink resources for reporting the valid CSI in a slot  $m + \frac{T_{HARQ}+T_{activation\_time}+T_{CSI\_Reporting}}{NR\ slot\ length}$  as defined in TS 38.133 [6] section 8.3 then the UE shall use the next available uplink resource for reporting the corresponding valid CSI.

#### 4.5.3.2 EN-DC FR1 SCell activation and deactivation of known SCell in non-DRX for 640ms SCell measurement cycle

## 4.5.3.2.1 Test purpose

This test is to verify that the SCell activation and deactivation times are within the requirements, when the SCell in FR1 is known by the UE at the time of activation.

## 4.5.3.2.2 Test applicability

This test applies to all types of NR UE supporting E-UTRA and EN-DC from Release 15 onwards and supporting 2DL CA in NR.

## 4.5.3.2.3 Minimum conformance requirements

The minimum conformance requirements are defined in clause 4.5.3.0.1.

The normative reference for this requirement is TS 38.133 [6] clause A.4.5.3.2.

## 4.5.3.2.4 Test description

## 4.5.3.2.4.1 Initial conditions

Same initial conditions as described in section 4.5.3.1.4.1 with following exception:

- The supported test configurations is replaced by Table 4.5.3.2.4.1-1.
- The listed parameter values in Tables 4.5.3.2.4.1-2 will replace the values of corresponding parameters in Tables 4.5.3.1.4.1-3.

**Table 4.5.3.2.4.1-1: supported test configurations**

Test Case ID	Description
4.5.3.2-1	LTE FDD, NR 15 kHz SSB SCS, $\geq 10$ MHz bandwidth, FDD duplex mode
4.5.3.2-2	LTE FDD, NR 15 kHz SSB SCS, $\geq 10$ MHz bandwidth, TDD duplex mode
4.5.3.2-3	LTE FDD, NR 30 kHz SSB SCS, $\geq 40$ MHz bandwidth, TDD duplex mode
4.5.3.2-4	LTE TDD, NR 15 kHz SSB SCS, $\geq 10$ MHz bandwidth, FDD duplex mode
4.5.3.2-5	LTE TDD, NR 15 kHz SSB SCS, $\geq 10$ MHz bandwidth, TDD duplex mode
4.5.3.2-6	LTE TDD, NR 30 kHz SSB SCS, $\geq 40$ MHz bandwidth, TDD duplex mode
Note 1:	The UE is only required to be tested in one of the supported test configurations
Note 2:	The UE is only required to be tested in one with smallest aggregated channel bandwidth from supported band combinations which is composed of CCs $\geq$ the bandwidth ( $BW_{\text{channel}}$ ) defined in each test configuration.

**Table 4.5.3.2.4.1-2: General test parameters for known FR1 SCell activation case, 640ms SCell measurement cycle**

Parameter	Unit	Value	Comment
SCell measurement cycle (measCycleSCell)	ms	640	

## 4.5.3.2.4.2 Test procedure

Same test procedure as described in section 4.5.3.1.4.2:

## 4.5.3.2.4.3 Message contents

Same message contents as described in section 4.5.3.1.4.3 with following exception:

- Table 4.5.3.1.4.3-3 is replaced by Table 4.5.3.2.4.3-1.

**Table 4.5.3.2.4.3-1: MeasObjectNR for SCell**

Derivation Path: Table H.3.1-3 with condition Deactivated SCell and Synchronous cells



Information Element	Value/remark	Comment	Condition
MeasObjectNR ::= SEQUENCE {			
smc1	SSB-MTC specified in TS 38.508-1 [14] Table 7.3.1-3 with condition SMTC.1		
}			

#### 4.5.3.2.5 Test requirement

Same test requirement as described in section 4.5.3.1.5, except  $T_{\text{activation\_time}}$  will be replaced with the value  $T_{\text{FirstSSB\_MAX}} + T_{\text{rs}} + 5\text{ms}$ .

### 4.5.3.3 EN-DC FR1 SCell activation and deactivation of unknown SCell in non-DRX

#### 4.5.3.3.1 Test purpose

This test is to verify that the SCell activation and deactivation times are within the requirements, when the SCell in FR1 is unknown by the UE at the time of activation.

#### 4.5.3.3.2 Test applicability

This test applies to all types of NR UE supporting E-UTRA and EN-DC from Release 15 onwards and supporting 2DL CA in NR.

#### 4.5.3.3.3 Minimum conformance requirements

The minimum conformance requirements are defined in clause 4.5.3.0.1.

The normative reference for this requirement is TS 38.133 [6] clause A.4.5.3.3.

#### 4.5.3.3.4 Test description

##### 4.5.3.3.4.1 Initial conditions

Same initial conditions as described in section 4.5.3.1.4.1 with following exception:

- The supported test configurations is replaced by Table 4.5.3.3.4.1-1.
- The listed parameter values in Tables 4.5.3.3.4.1-2 will replace the values of corresponding parameters in Tables 4.5.3.1.4.1-3.

**Table 4.5.3.3.4.1-1: supported test configurations**

Test Case ID	Description
4.5.3.3-1	LTE FDD, NR 15 kHz SSB SCS, $\geq 10\text{MHz}$ bandwidth, FDD duplex mode
4.5.3.3-2	LTE FDD, NR 15 kHz SSB SCS, $\geq 10\text{MHz}$ bandwidth, TDD duplex mode
4.5.3.3-3	LTE FDD, NR 30 kHz SSB SCS, $\geq 40\text{MHz}$ bandwidth, TDD duplex mode
4.5.3.3-4	LTE TDD, NR 15 kHz SSB SCS, $\geq 10\text{MHz}$ bandwidth, FDD duplex mode
4.5.3.3-5	LTE TDD, NR 15 kHz SSB SCS, $\geq 10\text{MHz}$ bandwidth, TDD duplex mode
4.5.3.3-6	LTE TDD, NR 30 kHz SSB SCS, $\geq 40\text{MHz}$ bandwidth, TDD duplex mode
Note 1:	The UE is only required to be tested in one of the supported test configurations
Note 2:	The UE is only required to be tested in one with smallest aggregated channel bandwidth from supported band combinations which is composed of CCs $\geq$ the bandwidth ( $BW_{\text{channel}}$ ) defined in each test configuration.

**Table 4.5.3.3.4.1-2: General test parameters for unknown FR1 SCell activation case, 160ms SCell measurement cycle**

Parameter	Unit	Value	Comment
-----------	------	-------	---------

T1	ms	100	During this time the PSCell shall be known and the SCell configured, but not detected.
----	----	-----	--

4.5.3.3.4.2 Test procedure

Same test procedure as described in section 4.5.3.1.4.2, except step 3 and step 5 are replaced by following steps:

3. T1 starts. Immediately after, the SS shall configure SCell (Cell 3) on the SCC as per TS 38.508-1 [14] clause 7.5.2, with the message content exceptions defined in clause 4.5.3.1.4.3. NR RRCReconfiguration message is contained in RRCConnectionReconfiguration and NR RRCReconfigurationComplete message is contained in RRCConnectionReconfigurationComplete. The SCell (Cell 3) shall be powered OFF till T2 starts.
5. The SS activates SCC by sending the activation MAC-CE (Refer TS 38.321 [12], clauses 5.9, 6.1.3.10) in a slot # denoted m, power ON the SCell (Cell3), T2 starts in slot m. If the SS receives ACK for MAC-CE sent by the UE, the test proceeds to step 6, otherwise go to step 9.

and:

- Step 3a is removed.

4.5.3.3.4.3 Message contents

Message contents are according to TS 38.508-1 [14] clause 7.3 with the following exceptions:

**Table 4.5.3.3.4.3-1: RRCReconfiguration in step 3: SCell addition**

Derivation Path: TS 38.508-1 [14], Table 4.6.1-13 with condition EN-DC_SCell_add			
Information Element	Value/remark	Comment	Condition
RRCReconfiguration ::= SEQUENCE {			
criticalExtensions CHOICE {			
rrcReconfiguration ::= SEQUENCE {			
secondaryCellGroup	CellGroupConfig	Table 4.5.3.3.4.3-2	
}			
}			
}			

**Table 4.5.3.3.4.3-2: CellGroupConfig (Table 4.5.3.3.4.3-1)**

Derivation Path: TS 38.508-1 [14], Table 4.6.3-19 with condition SCell_add			
Information Element	Value/remark	Comment	Condition
CellGroupConfig ::= SEQUENCE {			
spCellConfig SEQUENCE {			
servCellIndex	ServCellIndex of NR SpCell		
spCellConfigDedicated	ServingCellConfig-SpCell	Table 4.5.3.3.4.3-3	
}			
sCellToAddModList SEQUENCE (SIZE (1..maxNrofSCells)) OF SCellConfig {	1 entry		
SCellConfig[1] SEQUENCE {		entry 1	
sCellConfigDedicated	ServingCellConfig-SCell	Table 4.5.3.3.4.3-4	
smtc	SSB-MTC specified in TS 38.508-1 [14] Table 7.3.1-3 with condition SMTC.1		
}			
}			
}			

**Table 4.5.3.3.4.3-3: ServingCellConfig-SpCell (Table 4.5.3.3.4.3-2)**

Derivation Path: TS 38.508-1 [14], Table 4.6.3-167			
Information Element	Value/remark	Comment	Condition

ServingCellConfig ::= SEQUENCE {			
csi-MeasConfig	CSI-MeasConfig for RRM specified in TS 38.508-1 [14] Table 7.3.1-6		
}			

Table 4.5.3.3.4.3-4: ServingCellConfig-SCell (Table 4.5.3.3.4.3-2)

Derivation Path: TS 38.508-1 [14], Table 4.6.3-167 with condition No_UL			
Information Element	Value/remark	Comment	Condition
ServingCellConfig ::= SEQUENCE {			
csi-MeasConfig	CSI-MeasConfig for RRM specified in TS 38.508-1 [14] Table 7.3.1-6		
}			

#### 4.5.3.3.5 Test requirement

Same test requirement as described in section 4.5.3.1.5, except  $T_{\text{activation\_time}}$  will be replaced with the value  $T_{\text{FirstSSB\_MAX}} + T_{\text{SMTC\_MAX}} + 2 * T_{\text{Ts}} + 5\text{ms}$

### 4.5.4 UE UL carrier RRC reconfiguration delay

#### 4.5.4.1 EN-DC FR1 UE UL carrier RRC reconfiguration delay

##### 4.5.4.1.1 Test purpose

This test is to verify that when the UE receives a RRC message implying NR UL or Supplementary UL (SUL) carrier configuration, the UE is ready to start transmission on the newly configured carrier within the time limits specified for configuring and deconfiguring carrier. This test will verify the UE being configured or deconfigured with a SUL carrier or NR UL carrier RRC reconfiguration delay requirements in TS 38.133 clause 8.4.

##### 4.5.4.1.2 Test applicability

This test applies to all types of NR UE supporting E-UTRA and EN-DC from Release 15 onwards. This test is applicable to UE that supports SUL.

##### 4.5.4.1.3 Minimum conformance requirements

When the UE receives a RRC message implying NR UL or supplementary UL (SUL) carrier configuration, the UE shall be ready to start transmission on the newly configured carrier within  $T_{\text{UL\_carrier\_config}}$  from the end of the slot  $n$ .

Where

- Slot  $n$  is the last slot overlapping with the PDSCH containing the RRC command.
- $T_{\text{UL\_carrier\_deconfig}}$  equals the maximum RRC procedure delay defined in clause 11.2 in TS 36.331 [16] if the corresponding RRC message is embedded in E-UTRA RRC message, otherwise it equals the maximum RRC procedure delay defined in clause 12 in TS 38.331 [2].

When the UE receives a RRC message implying NR UL or supplementary UL (SUL) carrier deconfiguration RRC signalling, the UE shall stop UL signalling on the deconfigured UL carrier within  $T_{\text{UL\_carrier\_config}}$  from the end of slot  $n$ .

Where

- Slot  $n$  is the last slot overlapping with the PDSCH containing the RRC command.
- $T_{\text{UL\_carrier\_deconfig}}$  equals the maximum RRC procedure delay defined in clause 11.2 in TS 36.331 [16] if the corresponding RRC message is embedded in E-UTRA RRC message, otherwise it equals the maximum RRC procedure delay defined in clause 12 in TS 38.331 [2].

The normative reference for this requirement is TS 38.133 [6] clause A.4.5.4.1.

#### 4.5.4.1.4 Test description

##### 4.5.4.1.4.1 Initial conditions

This test can be run in one of the configurations defined in Table 4.5.4.1.4.1-1.

**Table 4.5.4.1.4.1-1: Supported test configurations for FR1 PSCell (Cell2) and SCell (Cell3)**

Configuration	PSCell (Cell2)	SCell (Cell3)
4.5.4.1-1	15 kHz SSB SCS, $\geq 10$ MHz bandwidth, FDD duplex mode	DL and UL: 15kHz SSB SCS, $\geq 10$ MHz bandwidth, FDD duplex mode; SUL: 15kHz SCS, $\geq 10$ MHz bandwidth, SUL duplex mode
4.5.4.1-2	15 kHz SSB SCS, $\geq 10$ MHz bandwidth, FDD duplex mode	DL and UL: 15kHz SSB SCS, $\geq 10$ MHz bandwidth, TDD duplex mode; SUL: 15kHz SCS, $\geq 10$ MHz bandwidth, SUL duplex mode
4.5.4.1-3	15 kHz SSB SCS, $\geq 10$ MHz bandwidth, FDD duplex mode	DL and UL: 30kHz SSB SCS, $\geq 40$ MHz bandwidth, TDD duplex mode; SUL: 30kHz SCS, $\geq 40$ MHz bandwidth, SUL duplex mode
4.5.4.1-4	15 kHz SSB SCS, $\geq 10$ MHz bandwidth, TDD duplex mode	DL and UL: 15kHz SSB SCS, $\geq 10$ MHz bandwidth, FDD duplex mode; SUL: 15kHz SCS, $\geq 10$ MHz bandwidth, SUL duplex mode
4.5.4.1-5	15 kHz SSB SCS, $\geq 10$ MHz bandwidth, TDD duplex mode	DL and UL: 15kHz SSB SCS, $\geq 10$ MHz bandwidth, TDD duplex mode; SUL: 15kHz SCS, $\geq 10$ MHz bandwidth, SUL duplex mode
4.5.4.1-6	15 kHz SSB SCS, $\geq 10$ MHz bandwidth, TDD duplex mode	DL and UL: 30kHz SSB SCS, $\geq 40$ MHz bandwidth, TDD duplex mode; SUL: 30kHz SCS, $\geq 40$ MHz bandwidth, SUL duplex mode
4.5.4.1-7	30 kHz SSB SCS, $\geq 40$ MHz bandwidth, TDD duplex mode	DL and UL: 15kHz SSB SCS, $\geq 10$ MHz bandwidth, FDD duplex mode; SUL: 15kHz SCS, $\geq 10$ MHz bandwidth, SUL duplex mode
4.5.4.1-8	30 kHz SSB SCS, $\geq 40$ MHz bandwidth, TDD duplex mode	DL and UL: 15kHz SSB SCS, $\geq 10$ MHz bandwidth, TDD duplex mode; SUL: 15kHz SCS, $\geq 10$ MHz bandwidth, SUL duplex mode
4.5.4.1-9	30 kHz SSB SCS, $\geq 40$ MHz bandwidth, TDD duplex mode	DL and UL: 30kHz SSB SCS, $\geq 40$ MHz bandwidth, TDD duplex mode; SUL: 30kHz SCS, $\geq 40$ MHz bandwidth, SUL duplex mode
Note 1:	The UE is only required to be tested in one of the supported test configurations	
Note 2:	The UE is only required to be tested in one with smallest aggregated channel bandwidth from supported band combinations which is composed of CCs $\geq$ the bandwidth ( $BW_{channel}$ ) defined in each test configuration.	

Configure the test equipment and the DUT according to the parameters in Table 4.5.4.1.4.1-2.

**Table 4.5.4.1.4.1-2: Initial conditions for EN-DC FR1 UE UL carrier RRC reconfiguration delay**

Parameter	Value		Comment
Test environment	NC		As specified in TS 38.508-1 [14] clause 4.1.
Test frequencies	As specified in Annex E, Table E.2-1 and TS 38.508-1 [14] clause 4.3.1.		
Channel bandwidth	As specified by the test configuration selected from Table 4.5.4.1.4.1-1.		
Propagation conditions	AWGN		As specified in clause C.2.2.
Connection Diagram	TE Part	A.3.1.8.2	As specified in TS 38.508-1 [14] Annex A.
	DUT Part	A.3.2.3.4	

Exceptions to connection diagram	N/A	
----------------------------------	-----	--

1. Message contents are defined in clause 4.5.4.1.4.3.
2. The power levels and settings for Cell 1 are set according to Annex A.6, Table A.6.1.1-1. Cell 2 is NR FR1 PSCell. Cell 3 is NR FR1 SCell. The connection setup is done according to the settings in clause C.1.3, and the downlink signal levels as per clause C.1.2
3. The test parameters are given in Table 4.5.4.1.4.1-3 below.
4. Downlink signals for NR cell are initially set up according to clauses C.1.2 and C.1.3.

**Table 4.5.4.1.4.1-3: General test parameters for EN-DC FR1 UE UL carrier RRC reconfiguration delay**

Parameter	Unit	Test configuration	Value	Comment
RF Channel Number		Config 1, 2, 3, 4, 5, 6, 7, 8, 9	1, 2, 3	Three radio channels are used for these two tests.
Active cell		Config 1,2, 3, 4, 5, 6, 7, 8, 9	Cell 1: E-UTRAN PCell Cell 2: FR1 PSCell Cell 3: FR1 SCell	E-UTRAN PCell on RF channel number 1 FR1 PSCell on RF channel number 2 FR1 SCell on RF channel number 3
CP length		Config 1,2, 3, 4, 5, 6, 7, 8, 9	Normal	
DRX		Config 1,2, 3, 4, 5, 6, 7, 8, 9	OFF	
Measurement gap pattern Id		Config 1,2, 3, 4, 5, 6, 7, 8, 9	OFF	
Filter coefficient		Config 1,2, 3, 4, 5, 6, 7, 8, 9	0	L3 filtering is not used
T1	s	Config 1,2, 3, 4, 5, 6, 7, 8, 9	5	
T2	s	Config 1,2, 3, 4, 5, 6, 7, 8, 9	5	
T3	s	Config 1,2, 3, 4, 5, 6, 7, 8, 9	5	

#### 4.5.4.1.4.2 Test procedure

There are three cells: E-UTRAN PCell (Cell 1), FR1 PSCell (Cell 2) and FR1 SCell (Cell 3). For SCell, both NR uplink and supplementary uplink are broadcast by *ServingCellConfigCommonSIB*. The test case consists of two tests: Test 1 and Test 2.

In Test 1, the test consists of three time periods, with duration of T1, T2 and T3 respectively. During time duration T1, NR uplink of Cell 3 is configured to UE. At the start of T2, a supplementary uplink of Cell 3 is configured to UE through *RRCReconfiguration*, then UE shall start transmission on both the NR uplink and supplementary uplink. At the start of T3, the supplementary uplink is released through *RRCReconfiguration*.

In Test 2, the test consists of three time periods, with duration of T1, T2 and T3 respectively. During time duration T1, supplementary uplink on Cell 3 is configured to UE. At the start of T2, a NR uplink is configured to UE through *RRCReconfiguration*, then UE shall start transmission on both the NR uplink and supplementary uplink. At the start of T3, the NR uplink is released through *RRCReconfiguration*.

1. Ensure the UE is in state RRC\_CONNECTED with generic procedure parameters *Connectivity* EN-DC, DC bearer MCG and SCG, Connected without release *On* and Test Mode *On* according to TS 38.508-1 [14] clause 4.5.
2. Setup E-UTRAN PCell (Cell 1) according to parameters given in Table A.6.1.1-1 and setup FR1 PSCell (Cell 2) according to parameters given in Table 4.5.4.1.5-1.
3. For SCell (Cell 3), both NR uplink and supplementary uplink are broadcast by *ServingCellConfigCommonSIB*.
4. For Test 1: NR uplink of Cell 3 is configured to UE during T1

- 4.1. During time duration T1, NR uplink of Cell 3 is configured to UE. Setup FR1 SCell (Cell 3) according to parameters given in Table 4.5.4.1.5-2.
- 4.2 T2 starts when a supplementary uplink of SCell (Cell 3) is configured to UE through *RRCCONNECTIONRECONFIGURATION*, then UE shall start transmission on both the NR uplink and supplementary uplink on SCell (Cell 3) within 20ms. If UE transmits data on both the NR uplink and supplementary uplink on SCell (Cell 3) within 20ms from the start of T2, then count a success for the event "reconfiguration" otherwise count a failure for event "reconfiguration".
- 4.3 T3 starts when the supplementary uplink is released through *RRCCONNECTIONRECONFIGURATION*, then UE shall transmit data only on the NR uplink carrier on SCell (Cell 3) within 20ms. If UE stop transmitting data on supplementary uplink carrier on SCell (Cell 3) within 20ms from the start of T3, then count a success for the event "deconfiguration" otherwise count a failure for event "deconfiguration".
5. For Test 2: Supplementary uplink on Cell 3 is configured to UE during T1
  - 5.1. Repeat steps 1-3.
  - 5.2. During time duration T1, Supplementary uplink of Cell 3 is configured to UE. Setup FR1 SCell (Cell 3) according to parameters given in Table 4.5.4.1.5-2.
  - 5.3. T2 starts when a NR uplink of SCell (Cell 3) is configured to UE through *RRCCONNECTIONRECONFIGURATION*, then UE shall start transmission on both the NR uplink and supplementary uplink on SCell (Cell 3) within 20ms. If UE transmits data on both the NR uplink and supplementary uplink on SCell (Cell 3) within 20ms from the start of T2, then count a success for the event "reconfiguration" otherwise count a failure for event "reconfiguration".
  - 5.4 T3 starts when the NR uplink is released through *RRCCONNECTIONRECONFIGURATION*, then UE shall transmit data only on the supplementary uplink carrier on SCell (Cell 3) within 20ms. If UE stop transmitting data on NR uplink carrier on SCell (Cell 3) within 20ms from the start of T3, then count a success for the event "deconfiguration" otherwise count a failure for event "deconfiguration".
6. Repeat steps 1-5 until a test verdict has been achieved.

Each of the events "reconfiguration" and "deconfiguration" is evaluated independently for the statistic, resulting in an event verdict: pass or fail. Each event is evaluated only until the confidence level according to Table G.2.3-1 in Annex G.2 is achieved. Different events may require different times for a verdict.

If all events pass, the test passes. If one event fails, the test fails.

4.5.4.1.4.3 Message contents

Message contents are according to TS 38.508-1 [14] clause 4.6 with the following exceptions:

**Table 4.5.4.1.4.3-1: Common Exception messages**

Default Message Contents	
Common contents of system information blocks exceptions	
Default RRC messages and information elements contents exceptions	Table H.3.8-1 Table H.3.8-2

4.5.4.1.5 Test requirements

Table 4.5.4.1.5-1 and 4.5.4.1.5-2 defines the primary level settings including test tolerances for the EN-DC FR1 UE UL carrier RRC reconfiguration delay test with all NR cells in FR1.

**Table 4.5.4.1.5-1: NR Cell specific test parameters for EN-DC FR1 UE UL carrier RRC reconfiguration delay on PSCell (Cell 2)**

Parameter	Unit	Test Configuration	Test 1			Test 2		
			T1	T2	T3	T1	T2	T3
Channel number		Conf 1, 2, 3, 4, 5, 6, 7, 8, 9	2			2		

Parameter	Unit	Test Configuration	Test 1			Test 2		
			T1	T2	T3	T1	T2	T3
TDD configuration		Conf 1, 2, 3	N/A			N/A		
		Conf 4, 5, 6	TDD Conf.1.1			TDD Conf.1.1		
		Conf 7, 8, 9	TDD Conf.2.1			TDD Conf.2.1		
BW <sub>channel</sub>	MHz	Conf 1, 2, 3	Note 6			Note 6		
		Conf 4, 5, 6	Note 6			Note 6		
		Conf 7, 8, 9	Note 6			Note 6		
BW <sub>occupied</sub>	RB	Conf 1, 2, 3	52 <sup>Note 4</sup>			52 <sup>Note 4</sup>		
		Conf 4, 5, 6	52 <sup>Note 4</sup>			52 <sup>Note 4</sup>		
		Conf 7, 8, 9	106 <sup>Note 5</sup>			106 <sup>Note 5</sup>		
PDSCH reference measurement channel as defined in A.3.1.1		Conf 1, 2, 3	SR.1.1 FDD			SR.1.1 FDD		
		Conf 4, 5, 6	SR.1.1 TDD			SR.1.1 TDD		
		Conf 7, 8, 9	SR 2.1 TDD			SR 2.1 TDD		
RMSI CORESET reference measurement channel as defined in A.3.1.2		Conf 1, 2, 3	CR.1.1 FDD			CR.1.1 FDD		
		Conf 4, 5, 6	CR.1.1 TDD			CR.1.1 TDD		
		Conf 7, 8, 9	CR.2.1 TDD			CR.2.1 TDD		
RMC CORESET reference measurement channel as defined in A.3.1.3		Conf 1, 2, 3	CCR.1.1 FDD			CCR.1.1 FDD		
		Conf 4, 5, 6	CCR.1.1 TDD			CCR.1.1 TDD		
		Conf 7, 8, 9	CCR.2.1 TDD			CCR.2.1 TDD		
OCNG Pattern <sup>Note 1</sup>		Conf 1, 2, 3, 4, 5, 6	OP.1 <sup>Note 4</sup>			OP.1 <sup>Note 4</sup>		
		Conf 7, 8, 9	OP.1 <sup>Note 5</sup>			OP.1 <sup>Note 5</sup>		
SSB configuration		Conf 1, 2, 3, 4, 5, 6	SSB.1 FR1			SSB.1 FR1		
		Conf 7, 8, 9	SSB.2 FR1			SSB.2 FR1		
SMTc configuration		Conf 1, 2, 3, 4, 5, 6, 7, 8, 9	SMTc.1			SMTc.1		
CSI-RS for tracking		Conf 1	TRS.1.1 FDD			TRS.1.1 FDD		
		Conf 2	TRS.1.1 TDD			TRS.1.1 TDD		
		Conf 3	TRS.1.2 TDD			TRS.1.2 TDD		
		Conf 4	TRS.1.1 FDD			TRS.1.1 FDD		
		Conf 5	TRS.1.1 TDD			TRS.1.1 TDD		
		Conf 6	TRS.1.2 TDD			TRS.1.2 TDD		
		Conf 7	TRS.1.1 FDD			TRS.1.1 FDD		
		Conf 8	TRS.1.1 TDD			TRS.1.1 TDD		
Conf 9	TRS.1.2 TDD			TRS.1.2 TDD				
DL initial BWP configuration		Conf 1, 2, 3, 4, 5, 6, 7, 8, 9	DLBWP.0.1			DLBWP.0.1		
DL dedicated BWP configuration		Conf 1, 2, 3, 4, 5, 6, 7, 8, 9	DLBWP.1.1			DLBWP.1.1		
UL dedicated BWP configuration		Conf 1, 2, 3, 4, 5, 6, 7, 8, 9	ULBWP.1.1			ULBWP.1.1		
EPRE ratio of PSS to SSS	dB	Conf 1, 2, 3, 4, 5, 6, 7, 8, 9	0	0	0	0	0	
EPRE ratio of PBCH_DMRS to SSS								
EPRE ratio of PBCH to PBCH_DMRS								
EPRE ratio of PDCCH_DMRS to SSS								
EPRE ratio of PDCCH to PDCCH_DMRS								
EPRE ratio of PDSCH_DMRS to SSS								
EPRE ratio of PDSCH to PDSCH_DMRS								

Parameter	Unit	Test Configuration	Test 1			Test 2		
			T1	T2	T3	T1	T2	T3
EPRE ratio of OCNG DMRS to SSS								
EPRE ratio of OCNG to OCNG DMRS								
$N_{oc}$ Note 2	dBm / 15kHz	Conf 1, 2, 3, 4, 5, 6, 7, 8, 9	-102			-102		
	dBm/SCS	Conf 1,2,3,4,5,6 Conf 7,8,9	-102 -99			-102 -99		
$\hat{E}_s / N_{oc}$	dB	Conf 1, 2, 3, 4, 5, 6, 7, 8, 9	16	16	16	16	16	16
$\hat{E}_s / I_{ot}$ Note 3	dB	Conf 1, 2, 3, 4, 5, 6, 7, 8, 9	16	16	16	16	16	16
SS-RSRP Note 3	dBm/SCS	Conf 1,2,3,4,5,6	-86	-86	-86	-86	-86	-86
		Conf 7,8,9	-83	-83	-83	-83	-83	-83
$I_o$ Note 3	dBm/9.36 MHz	Conf 1,2,3,4,5,6	-57.94	-57.94	-57.94	-57.94	-57.94	-57.94
	dBm/38.16M Hz	Conf 7,8,9	-51.84	-51.84	-51.84	-51.84	-51.84	-51.84
Propagation Condition		Conf 1, 2, 3, 4, 5, 6, 7, 8, 9	AWGN			AWGN		
Antenna configuration		Conf 1, 2, 3, 4, 5, 6, 7, 8, 9	1 x 2			1 x 2		
<p>NOTE 1: OCNG shall be used such that both cells are fully allocated, and a constant total transmitted power spectral density is achieved for all OFDM symbols.</p> <p>NOTE 2: Interference from other cells and noise sources not specified in the test is assumed to be constant over subcarriers and time and shall be modelled as AWGN of appropriate power for <math>N_{oc}</math> to be fulfilled within <math>BW_{occupied}</math>.</p> <p>NOTE 3: <math>\hat{E}_s / I_{ot}</math>, <math>I_o</math>, and SS-RSRP levels have been derived from other parameters for information purposes. They are not settable parameters themselves.</p> <p>NOTE 4: All UL/DL transmission shall be confined within <math>BW_{occupied}</math> (i.e. 10 MHz, 52 RBs) from <math>F_{C,low}</math>, and <math>I_o</math> is independent of the <math>BW_{channel}</math> configured.</p> <p>NOTE 5: All UL/DL transmission shall be confined within <math>BW_{occupied}</math> (i.e. 40 MHz, 106 RBs) from <math>F_{C,low}</math>, and <math>I_o</math> is independent of the <math>BW_{channel}</math> configured.</p> <p>NOTE 6: <math>N_{RB,c}</math> is derived from Table 5.3.2-1 in TS38.101-1[2] with configured <math>BW_{channel}</math>.</p>								

**Table 4.5.4.1.5-2: NR Cell specific test parameters for EN-DC FR1 UE UL carrier RRC reconfiguration delay on SCell (Cell 3)**

Parameter	Unit	Test Configuration	Test 1			Test 2		
			T1	T2	T3	T1	T2	T3
Channel number		Conf 1, 2, 3, 4, 5, 6, 7, 8, 9	3			3		
TDD configuration		Conf 1, 4, 7	N/A			N/A		
		Conf 2, 5, 8	TDDConf.1.1			TDDConf.1.1		
		Conf 3, 6, 9	TDDConf.2.1			TDDConf.2.1		
$BW_{channel}$	MHz	Conf 1, 4, 7	Note 6			Note 6		
		Conf 2, 5, 8	Note 6			Note 6		
		Conf 3, 6, 9	Note 6			Note 6		
$BW_{occupied}$	RB	Conf 1, 4, 7	52 Note 4			52 Note 4		
		Conf 2, 5, 8	52 Note 4			52 Note 4		
		Conf 3, 6, 9	106 Note 5			106 Note 5		
PUSCH parameters for NR UL carrier		Conf 1, 4, 7	G-FR1-A3-10 in [28]	G-FR1-A3-10 in [28]	G-FR1-A3-10 in [28]	N/A	G-FR1-A3-10 in [28]	N/A
		Conf 2, 5, 8	G-FR1-A3-10 in [28]	G-FR1-A3-10 in [28]	G-FR1-A3-10 in [28]	N/A	G-FR1-A3-10 in [28]	N/A
		Conf 3, 6, 9	G-FR1-A3-14 in [28]	G-FR1-A3-14 in [28]	G-FR1-A3-14 in [28]	N/A	G-FR1-A3-14 in [28]	N/A



Parameter	Unit	Test Configuration	Test 1			Test 2		
			T1	T2	T3	T1	T2	T3
PUCCH parameters For NR UL carrier		Conf 1, 4, 7	Table 8.3.3.1.2-1 in [28]	Table 8.3.3.1.2-1 in [28]	Table 8.3.3.1.2-1 in [28]	N/A	N/A	N/A
		Conf 2, 5, 8	Table 8.3.3.1.2-1 in [28]	Table 8.3.3.1.2-1 in [28]	Table 8.3.3.1.2-1 in [28]	N/A	N/A	N/A
		Conf 3, 6, 9	Table 8.3.3.1.2-2 in [28]	Table 8.3.3.1.2-2 in [28]	Table 8.3.3.1.2-2 in [28]	N/A	N/A	N/A
PUSCH parameters for supplementary UL		Conf 1, 4, 7	N/A	G-FR1-A3-10 in [28]	N/A	G-FR1-A3-10 in [28]	G-FR1-A3-10 in [28]	G-FR1-A3-10 in [28]
		Conf 2, 5, 8	N/A	G-FR1-A3-10 in [28]	N/A	G-FR1-A3-10 in [28]	G-FR1-A3-10 in [28]	G-FR1-A3-10 in [28]
		Conf 3, 6, 9	N/A	G-FR1-A3-14 in [28]	N/A	G-FR1-A3-14 in [28]	G-FR1-A3-14 in [28]	G-FR1-A3-14 in [28]
PUCCH parameters for supplementary UL		Conf 1, 4, 7	N/A	N/A	N/A	Table 8.3.3.1.2-1 in [28]	Table 8.3.3.1.2-1 in [28]	Table 8.3.3.1.2-1 in [28]
		Conf 2, 5, 8	N/A	N/A	N/A	Table 8.3.3.1.2-1 in [28]	Table 8.3.3.1.2-1 in [28]	Table 8.3.3.1.2-1 in [28]
		Conf 3, 6, 9	N/A	N/A	N/A	Table 8.3.3.1.2-2 in [28]	Table 8.3.3.1.2-2 in [28]	Table 8.3.3.1.2-2 in [28]
PDSCH reference measurement channel as defined in A.3.1.1		Conf 1, 4, 7	SR.1.1 FDD			SR.1.1 FDD		
		Conf 2, 5, 8	SR.1.1 TDD			SR.1.1 TDD		
		Conf 3, 6, 9	SR 2.1 TDD			SR 2.1 TDD		
RMSI CORESET reference measurement channel as defined in A.3.1.2		Conf 1, 4, 7	CR.1.1 FDD			CR.1.1 FDD		
		Conf 2, 5, 8	CR.1.1 TDD			CR.1.1 TDD		
		Conf 3, 6, 9	CR.2.1 TDD			CR.2.1 TDD		
RMC CORESET reference measurement channel as defined in A.3.1.3		Conf 1, 4, 7	CCR.1.1 FDD			CCR.1.1 FDD		
		Conf 2, 5, 8	CCR.1.1 TDD			CCR.1.1 TDD		
		Conf 3, 6, 9	CCR.2.1 TDD			CCR.2.1 TDD		
OCNG Pattern <sup>Note 1</sup>		Conf 1, 2, 4, 5, 7, 8	OP.1 <sup>Note 4</sup>			OP.1 <sup>Note 4</sup>		
		Conf 3, 6, 9	OP.1 <sup>Note 5</sup>			OP.1 <sup>Note 5</sup>		
SSB configuration		Conf 1, 2, 4, 5, 7, 8	SSB.1 FR1			SSB.1 FR1		
		Conf 3, 6, 9	SSB.2 FR1			SSB.2 FR1		
SMTc configuration		Conf 1, 2, 3, 4, 5, 6, 7, 8, 9	SMTc.1			SMTc.1		
CSI-RS for tracking		Conf 1	TRS.1.1 FDD			TRS.1.1 FDD		
		Conf 2	TRS.1.1 TDD			TRS.1.1 TDD		
		Conf 3	TRS.1.2 TDD			TRS.1.2 TDD		
		Conf 4	TRS.1.1 FDD			TRS.1.1 FDD		
		Conf 5	TRS.1.1 TDD			TRS.1.1 TDD		
		Conf 6	TRS.1.2 TDD			TRS.1.2 TDD		
		Conf 7	TRS.1.1 FDD			TRS.1.1 FDD		
		Conf 8	TRS.1.1 TDD			TRS.1.1 TDD		
	Conf 9	TRS.1.2 TDD			TRS.1.2 TDD			
DL initial BWP configuration		Conf 1, 2, 3, 4, 5, 6, 7, 8, 9	DLBWP.0.1			DLBWP.0.1		
DL dedicated BWP configuration		Conf 1, 2, 3, 4, 5, 6, 7, 8, 9	DLBWP.1.1			DLBWP.1.1		

Parameter	Unit	Test Configuration	Test 1			Test 2		
			T1	T2	T3	T1	T2	T3
UL dedicated BWP configuration		Conf 1, 2, 3, 4, 5, 6, 7, 8, 9	ULBWP.1.1			ULBWP.1.1		
EPRE ratio of PSS to SSS	dB	Conf 1, 2, 3, 4, 5, 6, 7, 8, 9	0			0		
EPRE ratio of PBCH_DMRS to SSS								
EPRE ratio of PBCH to PBCH_DMRS								
EPRE ratio of PDCCH_DMRS to SSS								
EPRE ratio of PDCCH to PDCCH_DMRS								
EPRE ratio of PDSCH_DMRS to SSS								
EPRE ratio of PDSCH to PDSCH_DMRS								
EPRE ratio of OCNG DMRS to SSS								
EPRE ratio of OCNG to OCNG DMRS								
$N_{oc}$ <small>Note 2</small>								
	dBm/SCS	Conf 1, 2, 4, 5, 7, 8	-102			-102		
		Conf 3, 6, 9	-99			-99		
$\hat{E}_s / N_{oc}$	dB	Conf 1, 2, 3, 4, 5, 6, 7, 8, 9	16	16	16	16	16	16
$\hat{E}_s / I_{ot}$ <small>Note 3</small>	dB	Conf 1, 2, 3, 4, 5, 6, 7, 8, 9	16	16	16	16	16	16
SS-RSRP <small>Note 3</small>	dBm/SCS	Conf 1, 2, 4, 5, 7, 8	-86	-86	-86	-86	-86	-86
		Conf 3, 6, 9	-83	-83	-83	-83	-83	-83
$I_o$ <small>Note 3</small>	dBm/9.36 MHz	Conf 1, 2, 4, 5, 7, 8	-57.94	-57.94	-57.94	-57.94	-57.94	-57.94
	dBm/38.16M Hz	Conf 3, 6, 9	-51.84	-51.84	-51.84	-51.84	-51.84	-51.84
Propagation Condition		Conf 1, 2, 3, 4, 5, 6, 7, 8, 9	AWGN			AWGN		
Antenna configuration		Conf 1, 2, 3, 4, 5, 6, 7, 8, 9	1 x 2			1 x 2		
<p>NOTE 1: OCNG shall be used such that both cells are fully allocated, and a constant total transmitted power spectral density is achieved for all OFDM symbols.</p> <p>NOTE 2: Interference from other cells and noise sources not specified in the test is assumed to be constant over subcarriers and time and shall be modelled as AWGN of appropriate power for <math>N_{oc}</math> to be fulfilled within <math>BW_{occupied}</math>.</p> <p>NOTE 3: <math>\hat{E}_s / I_{ot}</math>, <math>I_o</math>, and SS-RSRP levels have been derived from other parameters for information purposes. They are not settable parameters themselves.</p> <p>NOTE 4: All UL/DL transmission shall be confined within <math>BW_{occupied}</math> (i.e. 10 MHz, 52 RBs) from <math>F_{C,low}</math>, and <math>I_o</math> is independent of the <math>BW_{channel}</math> configured.</p> <p>NOTE 5: All UL/DL transmission shall be confined within <math>BW_{occupied}</math> (i.e. 40 MHz, 106 RBs) from <math>F_{C,low}</math>, and <math>I_o</math> is independent of the <math>BW_{channel}</math> configured.</p> <p>NOTE 6: <math>N_{RB,c}</math> is derived from Table 5.3.2-1 in TS38.101-1[2] with configured <math>BW_{channel}</math>.</p>								

In test 1 the UE shall be ready to start transmission on the supplementary uplink carrier on SCell within 20ms from the start of T2.

In test 1 the UE shall stop the transmission on the supplementary uplink carrier on SCell within 20ms from the start of T3.

In test 2 the UE shall be ready to start transmission on the NR uplink carrier on SCell within 20ms from the start of T2.

In test 2 the UE shall stop the transmission on the NR uplink carrier on SCell within 20ms from the start of T3.

All of the above test requirements shall be fulfilled in order for the observed UE UL carrier configuration delay and UE UL carrier release delay to be counted as correct. The rate of correct observed UE UL carrier configuration delay and UE UL carrier release delay during repeated tests shall be at least 90 %.

## 4.5.5 Link recovery procedures

### 4.5.5.0 Minimum conformance requirements

#### 4.5.5.0.1 Minimum conformance requirements for SSB-based beam failure detection

UE shall be able to evaluate whether the downlink radio link quality on the configured SSB resource in set  $\bar{q}_0$  estimated over the last  $T_{\text{Evaluate\_BFD\_SSB}}$  ms period becomes worse than the threshold  $Q_{\text{out\_LR\_SSB}}$  within  $T_{\text{Evaluate\_BFD\_SSB}}$  ms period.

The value of  $T_{\text{Evaluate\_BFD\_SSB}}$  is defined in Table 4.5.5.0.1-1 for FR1.

For FR1,

- $P = \frac{1}{1 - \frac{T_{\text{SSB}}}{MRGP}}$ , when in the monitored cell there are measurement gaps configured for intra-frequency, inter-frequency or inter-RAT measurements, which are overlapping with some but not all occasions of the SSB.
- $P=1$  when in the monitored cell there are no measurement gaps overlapping with any occasion of the SSB.

Longer evaluation period would be expected if the combination of BFD-RS resource, SMTC occasion and measurement gap configurations does not meet previous conditions.

For either an FR1 or FR2 serving cell, longer evaluation period would be expected during the period  $T_{\text{identify\_CGI}}$  when the UE is requested to decode an NR CGI.

For either an FR1 or FR2 serving cell, longer BFD evaluation period would be expected during the period  $T_{\text{identify\_CGLE-UTRAN}}$  when the UE is requested to decode an LTE CGI.

**Table 4.5.5.0.1-1: Evaluation period  $T_{\text{Evaluate\_BFD\_SSB}}$  for FR1**

Configuration	$T_{\text{Evaluate\_BFD\_SSB}}$ (ms)
no DRX	$\text{Max}(50, \text{Ceil}(5 \times P) \times T_{\text{SSB}})$
DRX cycle $\leq 320$ ms	$\text{Max}(50, \text{Ceil}(7.5 \times P) \times \text{Max}(T_{\text{DRX}}, T_{\text{SSB}}))$
DRX cycle $> 320$ ms	$\text{Ceil}(5 \times P) \times T_{\text{DRX}}$
NOTE: $T_{\text{SSB}}$ is the periodicity of SSB in the set $\bar{q}_0$ . $T_{\text{DRX}}$ is the DRX cycle length.	

The UE is required to be capable of measuring SSB for BFD without measurement gaps. The UE is required to perform the SSB measurements with measurement restrictions as described in the following clauses.

For FR1, when the SSB for BFD measurement is in the same OFDM symbol as CSI-RS for RLM, BFD, CBD or L1-RSRP measurement:

- If SSB and CSI-RS have same SCS, UE shall be able to measure the SSB for BFD measurement without any restriction;
- If SSB and CSI-RS have different SCS:
  - If UE supports *simultaneousRxDataSSB-DiffNumerology*, UE shall be able to measure the SSB for BFD measurement without any restriction;

- If UE does not support *simultaneousRxDataSSB-DiffNumerology*, UE is required to measure one of but not both SSB for BFD measurement and CSI-RS. Longer measurement period for SSB based BFD measurement is expected, and no requirements are defined.

The normative reference for this requirement is TS 38.133 [6] clauses 8.5.2.2 and 8.5.2.3.

#### 4.5.5.0.2 Minimum conformance requirements for CSI-RS-based beam failure detection

UE shall be able to evaluate whether the downlink radio link quality on the CSI-RS resource in set  $\bar{q}_0$  estimated over the last  $T_{\text{Evaluate\_BFD\_CSI-RS}}$  ms period becomes worse than the threshold  $Q_{\text{out\_LR\_CSI-RS}}$  within  $T_{\text{Evaluate\_BFD\_CSI-RS}}$  ms period.

The value of  $T_{\text{Evaluate\_BFD\_CSI-RS}}$  is defined in Table 4.5.5.0.2-1 for FR1.

For FR1:

- $P = \frac{1}{1 - \frac{T_{\text{CSI-RS}}}{MRGP}}$ , when in the monitored cell there are measurement gaps configured for intra-frequency, inter-frequency or inter-RAT measurements, which are overlapping with some but not all occasions of the CSI-RS.
- $P = 1$  when in the monitored cell there are no measurement gaps overlapping with any occasion of the CSI-RS.

Longer evaluation period would be expected if the combination of the BFD-RS resource, SMTC occasion and measurement gap configurations does not meet previous conditions.

For either an FR1 or FR2 serving cell, longer evaluation period would be expected during the period  $T_{\text{identify\_CGI}}$  when the UE is requested to decode an NR CGI.

For either an FR1 or FR2 serving cell, longer BFD evaluation period would be expected during the period  $T_{\text{identify\_CGI\_LTE-UTRAN}}$  when the UE is requested to decode an LTE CGI.

The values of  $M_{\text{BFD}}$  used in Table 4.5.5.0.2-1 is defined as:

- $M_{\text{BFD}} = 10$ , if the CSI-RS resource(s) in set  $\bar{q}_0$  used for BFD is transmitted with Density = 3 and over the bandwidth  $\geq 24$  PRBs.

The values of  $P_{\text{BFD}}$  used in Table 4.5.5.0.2-1 is defined as:

For each CSI-RS resource in the set  $\bar{q}_0$  configured for PCell or PSCell in EN-DC or NE-DC or SA; or PCell in NR-DC

- $P_{\text{BFD}} = 1$ ,

For each CSI-RS resource in the set  $\bar{q}_0$  configured for PSCell in NR-DC

$P_{\text{BFD}} = 2$  if UE is configured for beam failure detection on SCell, 1 otherwise.

For each CSI-RS resource in the set  $\bar{q}_0$  configured for a SCell

- $P_{\text{BFD}} = Z$  in EN-DC or NE-DC or SA.
- $P_{\text{BFD}} = 2 * Z$  in NR-DC.

Where Z is the number of band(s) on which UE is performing beam failure detection only for SCell

**Table 4.5.5.0.2-1: Evaluation period  $T_{\text{Evaluate\_BFD\_CSI-RS}}$  for FR1**

Configuration	$T_{\text{Evaluate\_BFD\_CSI-RS}}$ (ms)
no DRX	$\text{Max}(50, \text{Ceil}(M_{\text{BFD}} \times P \times P_{\text{BFD}}) \times T_{\text{CSI-RS}})$
DRX cycle $\leq 320$ ms	$\text{Max}(50, \text{Ceil}(1.5 \times M_{\text{BFD}} \times P \times P_{\text{BFD}}) \times \text{Max}(T_{\text{DRX}}, T_{\text{CSI-RS}}))$
DRX cycle $> 320$ ms	$\text{Ceil}(M_{\text{BFD}} \times P \times P_{\text{BFD}}) \times T_{\text{DRX}}$
NOTE:	$T_{\text{CSI-RS}}$ is the periodicity of CSI-RS resource in the set $\bar{q}_0$ . $T_{\text{DRX}}$ is the DRX cycle length.

The UE is required to be capable of measuring CSI-RS for BFD without measurement gaps. The UE is required to perform the CSI-RS measurements with measurement restrictions as described in the following clauses.

For both FR1 and FR2, when the CSI-RS for BFD measurement is in the same OFDM symbol as SSB for RLM, BFD, CBD or L1-RSRP measurement, UE is not required to receive CSI-RS for BFD measurement in the PRBs that overlap with an SSB.

For FR1, when the SSB for RLM, BFD, CBD or L1-RSRP measurement is within the active BWP and has same SCS than CSI-RS for BFD measurement, the UE shall be able to perform CSI-RS measurement without restrictions.

For FR1, when the SSB for RLM, BFD, CBD or L1-RSRP measurement is within the active BWP and has different SCS than CSI-RS for BFD measurement, the UE shall be able to perform CSI-RS measurement with restrictions according to its capabilities:

- If the UE supports *simultaneousRxDataSSB-DiffNumerology* the UE shall be able to perform CSI-RS measurement without restrictions.
- If the UE does not support *simultaneousRxDataSSB-DiffNumerology*, UE is required to measure one of but not both CSI-RS for BFD measurement and SSB. Longer measurement period for CSI-RS based BFD measurement is expected, and no requirements are defined.

For FR1, when the CSI-RS for BFD measurement is in the same OFDM symbol as another CSI-RS for RLM, BFD, CBD or L1-RSRP measurement, UE shall be able to measure the CSI-RS for BFD measurement without any restriction.

The normative reference for this requirement is TS 38.133 [6] clauses 8.5.3.2 and 8.5.3.3.

#### 4.5.5.0.3 Scheduling availability of UE during beam failure detection and candidate beam detection

[TS 38.133, clause 8.5.7.1]

There are no scheduling restrictions due to beam failure detection performed on SSB and CSI-RS configured for BFD with the same SCS as PDSCH or PDCCH in FR1.

[TS 38.133, clause 8.5.8.1]

There are no scheduling restrictions due to L1-RSRP measurement performed on SSB and CSI-RS configured as link recovery detection resource with the same SCS as PDSCH or PDCCH in FR1.

The normative reference for this requirement is TS 38.133 [6] clauses 8.5.7.1 and 8.5.8.1.

#### 4.5.5.0.4 Requirements for Beam Failure Recovery in SCell

For the UE not provided with a configuration of PUCCH transmission with a link recovery request (LRR) as described in clause 9.2.4 in TS 38.213 [3], if beam recovery procedure is triggered for any of SCells, the UE shall transmit preamble for UL-SCH resource application, followed by MAC CE providing one index for at least one corresponding SCell with radio link quality is worse than  $Q_{out,LR}$ , and the index  $q_{new}$  for a periodic CSI-RS configuration or for a SSB provided by higher layer, as described in clause 5.17 of TS38.321 [7], if any, for a corresponding SCell.

The normative reference for this requirement is TS 38.133 [6] clauses 8.5.9.

### 4.5.5.1 EN-DC FR1 SSB-based beam failure detection and link recovery in non-DRX

#### 4.5.5.1.1 Test purpose

The purpose of this test is to verify that the UE properly detects SSB-based beam failure in the set  $q_0$  configured for a serving PSCell and that the UE performs correct SSB-based link recovery based on beam candidate set  $q_1$ . The purpose is to test the downlink monitoring for beam failure detection within the UEs active DL BWP of the PSCell, during the evaluation period, and link recovery, when no DRX is used. This test will partly verify the SSB based beam failure detection and link recovery for an FR1 serving cell requirements in TS 38.133 [6] clause 8.5.

4.5.5.1.2 Test applicability

This test applies to all types of E-UTRA UE release 15 and forward, supporting EN-DC and link recovery.

4.5.5.1.3 Minimum conformance requirements

The minimum conformance requirements are specified in clause 4.5.5.0.1.

The normative reference for this requirement is TS 38.133 [6] clause A.4.5.5.1.

4.5.5.1.4 Test description

The test consists of five successive time periods, with time duration of T1, T2, T3, T4 and T5 respectively. Figure 4.5.5.1.4-1 shows the variation of the downlink SNR of the PCell and the SNR of the SSB in set  $q_0$  in the active PCell to emulate SSB based beam failure. Figure 4.5.5.1.4-1 additionally shows the variation of the downlink L1-RSRP of the SSB in set  $q_1$  of the candidate beam used for link recovery.

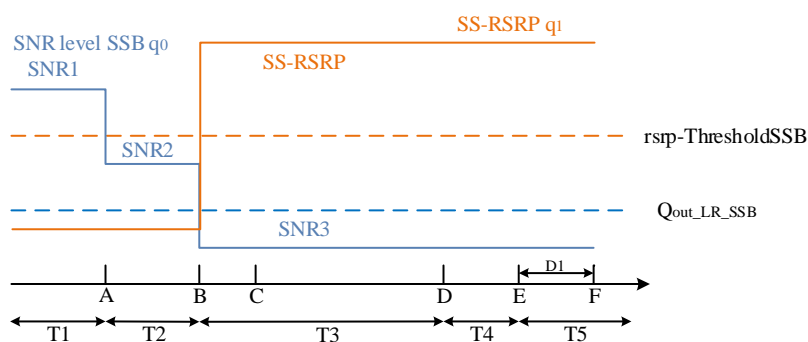

**Figure 4.5.5.1.4-1: SNR and L1-RSRP variation for SSB-based beam failure detection and link recovery testing in non-DRX mode**

4.5.5.1.4.1 Initial conditions

This test shall be tested using any of the test configurations in Table 4.5.5.1.4.1-1.

**Table 4.5.5.1.4.1-1: Supported test configurations for EN-DC FR1 SSB-based beam failure detection and link recovery in non-DRX**

Configuration	Description
4.5.5.1-1	LTE FDD, NR 15 kHz SSB SCS, 10 MHz bandwidth, FDD duplex mode
4.5.5.1-2	LTE FDD, NR 15 kHz SSB SCS, 10 MHz bandwidth, TDD duplex mode
4.5.5.1-3	LTE FDD, NR 30 kHz SSB SCS, 40 MHz bandwidth, TDD duplex mode
4.5.5.1-4	LTE TDD, NR 15 kHz SSB SCS, 10 MHz bandwidth, FDD duplex mode
4.5.5.1-5	LTE TDD, NR 15 kHz SSB SCS, 10 MHz bandwidth, TDD duplex mode
4.5.5.1-6	LTE TDD, NR 30 kHz SSB SCS, 40 MHz bandwidth, TDD duplex mode

NOTE: The UE is only required to pass in one of the supported test configurations in FR1.

Configure the test equipment and the DUT according to the parameters in Table 4.5.5.1.4.1-2.

**Table 4.5.5.1.4.1-2: Initial conditions for EN-DC FR1 SSB-based beam failure detection and link recovery in non-DRX**

Parameter	Value	Comment
Test environment	NC	As specified in TS 38.508-1 [14] clause 4.1.
Test frequencies	As specified in Annex E, table E.2-1 and TS 38.508-1 [14] clause 4.3.1 and 4.4.2.	
Channel bandwidth	As specified by the test configuration selected from Table 4.5.5.1.4.1-1.	
Propagation conditions	AWGN	
	TE Part	A.3.1.7.1
		As specified in TS 38.508-1 [14] Annex A.

Connection Diagram	DUT Part	A.3.2.3.4	
Exceptions to connection diagram	For 4Rx capable UEs without any 2 Rx RF bands use A.3.2.5.2 for DUT part and A.3.1.8.4 for TE Part		

1. The general test parameter settings are set up according to Table 4.5.5.1.4.1-3.
2. Message contents are defined in clause 4.5.5.1.4.3.
3. Cell 1 is the E-UTRA serving cell (PCell) for the EN-DC setup. The power levels and settings for Cell 1 are set according to Annex A.6. Cell 2 is the NR cell (PSCell) with the power level set according to clauses C.1.2 and C.1.3 for this test

**Table 4.5.5.1.4.1-3: General test parameters for FR1 PSCell for SSB-based beam failure detection and link recovery testing in non-DRX mode**

Parameter	Unit	Value	Comment
Active E-UTRA PCell		Cell 1	
E-UTRA RF Channel Number		1	
Active PSCell		Cell 2	
RF Channel Number		2	
Duplex mode	Config 1, 4	FDD	
	Config 2, 3, 5, 6	TDD	
BWchannel	Config 1, 4	10: NRB,c = 52	
	Config 2, 5	10: NRB,c = 52	
	Config 3, 6	40: NRB,c = 106	
DL initial BWP configuration	Config 1, 2, 3, 4, 5, 6	DLBWP.0.1	
DL dedicated BWP configuration	Config 1, 2, 3, 4, 5, 6	DLBWP.1.1	
UL initial BWP configuration	Config 1, 2, 3, 4, 5, 6	ULBWP.0.1	
UL dedicated BWP configuration	Config 1, 2, 3, 4, 5, 6	ULBWP.1.1	
TDD Configuration	Config 1, 4	Not Applicable	
	Config 2, 5	TDDConf.1.1	
	Config 3, 6	TDDConf.2.1	
CORESET Reference Channel	Config 1, 4	CR.1.1 FDD	
	Config 2, 5	CR.1.1 TDD	
	Config 3, 6	CR.2.1 TDD	
SSB Configuration	Config 1, 4	SSB.3 FR1	
	Config 2, 5	SSB.3 FR1	
	Config 3, 6	SSB.4 FR1	
SMTC Configuration	Config 1, 2, 4, 5	SMTC.1	
	Config 3, 6	SMTC.1	
PDSCH/PDCCH subcarrier spacing	Config 1, 2, 4, 5	15 KHz	
	Config 3, 6	30 KHz	
PRACH Configuration	Config 1, 2, 4, 5	PRACH.2 FR1	CFRA for BFR
	Config 3, 6	PRACH.2 FR1	CFRA for BFR
SSB Index assigned as BFD RS ( $q_0$ )		0	
SSB Index assigned as CBD RS ( $q_1$ )		1	
OCNG parameters		OP.1	
CP length		Normal	
Correlation Matrix and Antenna Configuration		2x2 Low	
Beam failure detection	DCI format	1-0	
	Number of Control	2	

Parameter		Unit	Value	Comment
transmission parameters	OFDM symbols			
	Aggregation level	CCE	8	
	Ratio of hypothetical PDCCH RE energy to average CSI-RS RE energy	dB	0	
	Ratio of hypothetical PDCCH DMRS energy to average CSI-RS RE energy	dB	0	
	DMRS precoder granularity		REG bundle size	
	REG bundle size		6	
DRX			OFF	
Gap pattern ID			gp0	
gapOffset			0	
rlmInSyncOutOfSyncThreshold			absent	When the field is absent, the UE applies the value 0.
rsrp-ThresholdSSB	Config 1, 2, 4, 5	dBm/SCS kHz	-98	Threshold used for $Q_{in\_LR\_SSB}$
	Config 3, 6	dBm/SCS kHz	-95	Threshold used for $Q_{in\_LR\_SSB}$
powerControlOffsetSS			db0	Used for deriving rsrp-ThresholdCSI-RS
beamFailureInstanceMaxCount			n1	see TS 38.321 [12], clause 5.17
beamFailureDetectionTimer			pbfd4	see TS 38.321 [12], clause 5.17
CSI-RS configuration for CSI reporting	Config 1, 4		CSI-RS.1.1 FDD	
	Config 2, 5		CSI-RS.1.1 TDD	
	Config 3, 6		CSI-RS.2.1 TDD	
CSI-RS for tracking	Config 1, 4		TRS.1.1 FDD	
	Config 2, 5		TRS.1.1 TDD	
	Config 3, 6		TRS.1.2 TDD	
SSB Index assigned as RLM RS			0,1	
T310 timer		ms	1000	
N310			2	
T1		s	0.2	During this time the UE shall be fully synchronized to cell 1
T2		s	0.37	
T3		s	0.24	
T4		s	0	
T5		s	0.17	
D1		s	0.13	
NOTE 1: All configurations are assigned to the UE prior to the start of time period T1.				
NOTE 2: UE-specific PDCCH is not transmitted after T1 starts.				
NOTE 3: E-UTRAN is in non-DRX mode under test.				



4.5.5.1.4.2 Test procedure

Prior to the start of the time duration T1, the UE shall be fully synchronized to cell 1 and cell 2. The UE shall be configured for periodic CSI reporting with a reporting periodicity of 5 ms. In the test, DRX configuration is not enabled. The UE is configured to perform inter-frequency measurements using GP ID #0 (40ms).

1. Ensure the UE is in state RRC\_CONNECTED with generic procedure parameters Connectivity EN-DC, DC bearer MCG and SCG, Connected without release *On* and Test Mode *On* according to TS 38.508-1 [14] clause 4.5.
2. The SS sends an *RRCReconfiguration* (embedded in *RRCConnectionReconfiguration* message) message to the UE to configure inter-frequency measurement.
3. The UE sends an *RRCReconfigurationComplete* (embedded in *RRCConnectionReconfigurationComplete* message) message.
4. Set the parameters of NR Cell according to T1 in Table 4.5.5.1.5-1. Propagation conditions are set according to clause C.2.3. T1 starts.
5. When T1 expires the SS shall change the SNR value to T2 as specified in Table 4.5.5.1.5-1. T2 starts.
6. When T2 expires the SS shall change the SNR value to T3 as specified in Table 4.5.5.1.5-1. T3 starts.
7. When T3 expires the SS shall change the SNR value to T4 as specified in Table 4.5.5.1.5-1. T4 starts.
8. When T4 expires the SS shall change the SNR value to T5 as specified in Table 4.5.5.1.5-1. T5 starts.
9. If the SS:
  - a) detects uplink power on NR carrier equal to or higher than minimum output power defined in TS 38.521-1 [17] clause 6.3.1.5 in each slot configured for CSI transmission (according CSI reporting on PUCCH) during the period from time point A to time point B; and
  - b) does not detect preamble on a beam associated with the candidate beam set  $q_1$  before time point B; and
  - c) detects preamble on a beam associated with the candidate beam set  $q_1$  before time point F (D1 after the star of T5), the number of successful tests is increased by one.

Otherwise the number of failed tests is increased by one.
10. If the iteration or random access procedure for BFD fails, the SS shall first attempt to release and add the PSCell, by ensuring the UE is in state RRC\_CONNECTED with generic procedure parameters *Connectivity* EN-DC, DC bearer MCG and SCG, Connected without release *On* and Test Mode *On* according to TS 38.508-1 [6] clause 4.5. If that also fails, then the UE is switched OFF/ON to proceed with the next iteration.
11. Repeat steps 2-10 for all subtests until the confidence level according to Tables G.2.3-1 in Annex G clause G.2 is achieved.

4.5.5.1.4.3 Message contents

Message contents are according to TS 38.508-1 [14] clause 7.3 with the following exceptions:

**Table 4.5.5.1.4.3-1: Common Exception messages for EN-DC FR1 SSB-based beam failure detection and link recovery in non-DRX**

Default Message Contents	
Common contents of system information blocks exceptions	

Default RRC messages and information elements contents exceptions	Table H.3.1-1 Table H.3.1-2 with Condition INTER-FREQ, L3 FILTERING NEEDED, Table H.3.1-3 with Condition INTER-FREQ MO (where ssbFrequency is set to the ARFCN value of carrier center of High range) Table H.3.1-4 with A3-offset = 0  Table H.3.1-8 with Condition SSB BFD  Table H.3.1-10 with Condition SSB Table H.3.1-10A Table H.3.4-4 with Condition gapUE Table H.3.4-5 with Condition BFD Table H.3.5-4 Table 7.3.1-3 in TS 38.508-1 [14] with condition SMTC.1
---	---

**Table 4.5.5.1.4.3-2: PDCCH Search Space for BFR**

Derivation Path: TS 38.508-1 [14], Table 4.6.3-162			
Information Element	Value/remark	Comment	Condition
SearchSpace ::= SEQUENCE {			
searchSpaceId	3	BFR	
controlResourceSetId	2	BFR	
monitoringSlotPeriodicityAndOffset CHOICE {			
sl1	NULL		
}			
monitoringSymbolsWithinSlot	10000000000000	Symbols 0 and 1	
nrofCandidates SEQUENCE {			
aggregationLevel1	n0		
aggregationLevel2	n0		
aggregationLevel4	n0		
aggregationLevel8	n1	AL8	
aggregationLevel16	n0		
}			
searchSpaceType CHOICE {			
ue-Specific SEQUENCE {			USS
dci-Formats	formats0-0-And-1-0	DCI Format 1_0	
}			
}			
}			

**Table 4.5.5.1.4.3-3: RLF-TimersAndConstants**

Derivation Path: TS 38.508-1 [14], Table 4.6.3-150			
Information Element	Value/remark	Comment	Condition
RLF-TimersAndConstants ::= SEQUENCE {			
n310	n2		
}			

**Table 4.5.5.1.4.3-4: PDCCH-Config**

Derivation Path: TS 38.501-1 [14], Table 4.6.3-95			
Information Element	Value/remark	Comment	Condition
PDCCH-Config ::= SEQUENCE {			
controlResourceSetToAddModList SEQUENCE(SIZE (1..3)) OF ControlResourceSet {	2 entries		
ControlResourceSet[2]	ControlResourceSet	entry 2, BFR	
}			
controlResourceSetToReleaseList	Not present		
searchSpacesToAddModList SEQUENCE(SIZE (1..10)) OF SearchSpace {	2 entries		
SearchSpace[2]	SearchSpace	entry 2, BFR	
}			
searchSpacesToReleaseList	Not present		

downlinkPreemption	Not present		
tpc-PUSCH	Not present		
tpc-PUCCH	Not present		
tpc-SRS	Not present		
}			

**Table 4.5.5.1.4.3-5: ControlResourceSet for BFR**

Derivation Path: TS 38.501-1 [14], Table 7.3.1-15			
Information Element	Value/remark	Comment	Condition
ControlResourceSet ::= SEQUENCE {			
controlResourceSetId	2		
duration	2		
cce-REG-MappingType CHOICE {			
interleaved ::= SEQUENCE {			
reg-BundleSize	n6		
interleaverSize	n2		
shiftIndex	0		
}			
tci-StatesPDCCH-ToAddList	Not present		
}			

4.5.5.1.5 Test requirements

Tables 4.5.5.1.4.1-3 and 4.5.5.1.5-1 define the primary level settings including test tolerances for EN-DC FR1 SSB-based beam failure detection and link recovery in non-DRX.

**Table 4.5.5.1.5-1: Cell specific test parameters for FR1 PSCell for SSB-based beam failure detection and link recovery testing in non-DRX mode**

Parameter	Unit	Test 1				
		T1	T2	T3	T4	T5
EPRE ratio of PDCCH DMRS to SSS	dB	0				
EPRE ratio of PDCCH to PDCCH DMRS						
EPRE ratio of PBCH DMRS to SSS						
EPRE ratio of PBCH to PBCH DMRS						
EPRE ratio of PSS to SSS						
EPRE ratio of PDSCH DMRS to SSS						
EPRE ratio of PDSCH to PDSCH DMRS						
EPRE ratio of OCNG DMRS to SSS						
EPRE ratio of OCNG to OCNG DMRS						
SNR_SSB of set q <sub>0</sub>	Config 1, 4	5.8	-2.2	-12.8	-12.8	-12.8
	Config 2, 5	5.8	-2.2	-12.8	-12.8	-12.8
	Config 3, 6	5.8	-2.2	-12.8	-12.8	-12.8
SNR_SSB of set q <sub>1</sub>	Config 1, 4	-10.2	-10.2	10.2	10.2	10.2
	Config 2, 5	-10.2	-10.2	10.2	10.2	10.2
	Config 3, 6	-10.2	-10.2	10.2	10.2	10.2
SSB_RP of set q <sub>1</sub>	Config 1, 4	-108.2	-108.2	-87.8	-87.8	-87.8
	Config 2, 5	-108.2	-108.2	-87.8	-87.8	-87.8
	Config 3, 6	-105.2	-105.2	-84.8	-84.8	-84.8
N <sub>oc</sub>	Config 1, 4	-98				
	Config 2, 5					
	Config 3, 6					
Propagation condition		TDL-C 300ns 100Hz				

Parameter	Unit	Test 1				
		T1	T2	T3	T4	T5
NOTE 1: OCNB shall be used such that the resources in Cell 1 are fully allocated and a constant total transmitted power spectral density is achieved for all OFDM symbols.						
NOTE 2: The uplink resources for CSI reporting are assigned to the UE prior to the start of time period T1.						
NOTE 3: NZP CSI-RS resource set configuration for CSI reporting are assigned to the UE prior to the start of time period T1.						
NOTE 4: Measurement gap configuration is assigned to the UE prior to the start of time period T1.						
NOTE 5: The timers and layer 3 filtering related parameters are configured prior to the start of time period T1.						
NOTE 6: The signal contains PDCCH for UEs other than the device under test as part of OCNB.						
NOTE 7: SNR levels correspond to the signal to noise ratio over the SSS REs.						
NOTE 8: The SNR in time periods T1, T2, T3, T4 and T5 is denoted as SNR1, SNR2 and SNR3 respectively in figure 4.5.5.1.4-1.						
NOTE 9: The SNR values are specified for a UE with 2RX antennas connected under test. For a UE with 4RX antennas connected under test, the SNR for RS in set q0 during T3, T4, and T5 from D.4.1.1, is -15dB-TT = -15.8dB (including test tolerances).						

The UE behaviour during time durations T1, T2, T3, T4 and T5 shall be as follows:

During the time duration T1 and T2, the UE shall transmit uplink signal at least in all subframes configured for CSI transmission on Cell 1.

During the period from time point A to time point B the UE shall transmit uplink signal in Cell 1 in all uplink slots configured for CSI transmission according to the configured periodic CSI reporting for Cell 1.

During T3 the UE shall detect beam failure and initiate link recovery. During T4 and T5 the UE measures and evaluate beam candidate from beam candidate set  $q_1$ .

No later than time point F occurring no later than  $D1 = 130$  ms after the start of T5, the UE shall transmit preamble on a beam associated with the candidate beam set  $q_1$ . The UE shall not transmit preamble on a beam associated with the candidate beam set  $q_1$  earlier than time point B.

Test is concluded once the test equipment has received the initial preamble transmission from the UE. The rate of correct events observed during repeated tests shall be at least 90%.

## 4.5.5.2 EN-DC FR1 SSB-based beam failure detection and link recovery in DRX

### 4.5.5.2.1 Test purpose

The purpose of this test is to verify that the UE properly detects SSB-based beam failure in the set  $q_0$  configured for a serving PSCell and that the UE performs correct SSB-based link recovery based on beam candidate set  $q_1$ . The purpose is to test the downlink monitoring for beam failure detection within the UEs active DL BWP of the PSCell, during the evaluation period, and link recovery, when DRX is used. This test will partly verify the SSB based beam failure detection and link recovery for an FR1 serving cell requirements in TS 38.133 [6] clause 8.5.

### 4.5.5.2.2 Test applicability

This test applies to all types of E-UTRA UE release 15 and forward, supporting EN-DC FR1, link recovery and long DRX cycle.

### 4.5.5.2.3 Minimum conformance requirements

The minimum conformance requirements are specified in clause 4.5.5.0.1.

The normative reference for this requirement is TS 38.133 [6] clause A.4.5.5.2.

### 4.5.5.2.4 Test description

The test consists of five successive time periods, with time duration of T1, T2, T3, T4 and T5 respectively.

Figure 4.5.5.2.4-1 shows the variation of the downlink SNR of the PCell and the SNR of the SSB in set  $q_0$  in the active PSCell to emulate SSB based beam failure. Figure 4.5.5.2.4-1 additionally shows the variation of the downlink L1-RSRP of the SSB in set  $q_1$  of the candidate beam used for link recovery.

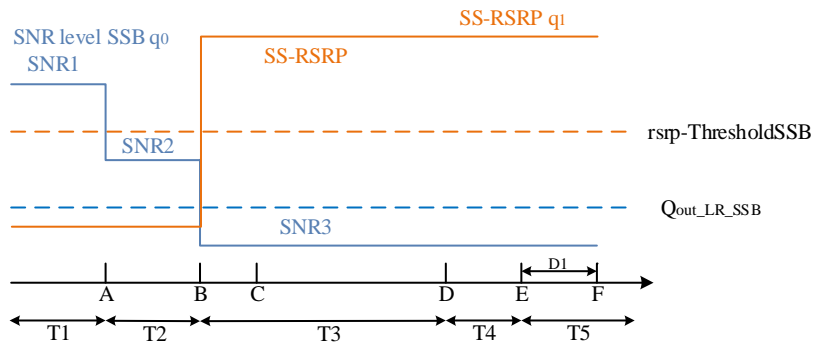

**Figure 4.5.5.2.4-1: SNR and L1-RSRP variation for SSB-based beam failure detection and link recovery testing in DRX mode**

4.5.5.2.4.1 Initial conditions

This test shall be tested using any of the test configurations in Table 4.5.5.2.4.1-1.

**Table 4.5.5.2.4.1-1: Supported test configurations for SSB-based beam failure detection and link recovery testing in DRX mode**

Configuration	Description
4.5.5.2-1	LTE FDD, NR 15 kHz SSB SCS, 10 MHz bandwidth, FDD duplex mode
4.5.5.2-2	LTE FDD, NR 15 kHz SSB SCS, 10 MHz bandwidth, TDD duplex mode
4.5.5.2-3	LTE FDD, NR 30 kHz SSB SCS, 40 MHz bandwidth, TDD duplex mode
4.5.5.2-4	LTE TDD, NR 15 kHz SSB SCS, 10 MHz bandwidth, FDD duplex mode
4.5.5.2-5	LTE TDD, NR 15 kHz SSB SCS, 10 MHz bandwidth, TDD duplex mode
4.5.5.2-6	LTE TDD, NR 30 kHz SSB SCS, 40 MHz bandwidth, TDD duplex mode

NOTE: The UE is only required to pass in one of the supported test configurations in FR1.

Configure the test equipment and the DUT according to the parameters in Table 4.5.5.2.4.1-2.

**Table 4.5.5.2.4.1-2: Initial conditions for EN-DC FR1 SSB-based beam failure detection and link recovery in DRX**

Parameter	Value	Comment
Test environment	NC	As specified in TS 38.508-1 [14] clause 4.1.
Test frequencies	As specified in Annex E, table E.2-1 and TS 38.508-1 [14] clause 4.3.1 and 4.4.2.	
Channel bandwidth	As specified by the test configuration selected from Table 4.5.5.2.4.1-1.	
Propagation conditions	AWGN	As specified in clause C.2.2.
Connection Diagram	TE Part: A.3.1.7.1 DUT Part: A.3.2.3.4	As specified in TS 38.508-1 [14] Annex A.
Exceptions to connection diagram	For 4Rx capable UEs without any 2 Rx RF bands use A.3.2.5.2 for DUT part and A.3.1.8.4 for TE Part	

1. The general test parameter settings are set up according to Table 4.5.5.2.4.1-3.
2. Message contents are defined in clause 4.5.5.2.4.3.
3. Cell 1 is the E-UTRA serving cell (PCell) for the EN-DC setup. The power levels and settings for Cell 1 are set according to Annex A.6. Cell 2 is the NR cell (PSCell) with the power level set according to clauses C.1.2 and C.1.3 for this test

**Table 4.5.5.2.4.1-3: General test parameters for FR1 PCell for SSB-based beam failure detection and link recovery testing in DRX mode**

Parameter		Unit	Value	Comment
			Test 1	
Active E-UTRA PCell			Cell 1	
E-UTRA RF Channel Number			1	
Active PSCell			Cell 2	
RF Channel Number			2	
Duplex mode	Config 1, 4		FDD	
	Config 2, 3, 5, 6		TDD	
BWchannel	Config 1, 4	MHz	10: NRB,c = 52	
	Config 2, 5		10: NRB,c = 52	
	Config 3, 6		40: NRB,c = 106	
DL initial BWP configuration	Config 1, 2, 3, 4, 5, 6		DLBWP.0.1	
DL dedicated BWP configuration	Config 1, 2, 3, 4, 5, 6		DLBWP.1.1	
UL initial BWP configuration	Config 1, 2, 3, 4, 5, 6		ULBWP.0.1	
UL dedicated BWP configuration	Config 1, 2, 3, 4, 5, 6		ULBWP.1.1	
TDD Configuration	Config 1, 4		Not Applicable	
	Config 2, 5		TDDConf.1.1	
	Config 3, 6		TDDConf.2.1	
CORESET Reference Channel	Config 1, 4		CR. 1.1 FDD	
	Config 2, 5		CR. 1.1 TDD	
	Config 3, 6		CR. 2.1 TDD	
SSB Configuration	Config 1, 4		SSB.3 FR1	
	Config 2, 5		SSB.3 FR1	
	Config 3, 6		SSB.4 FR1	
SMTTC Configuration	Config 1, 2, 4, 5		SMTTC.1	
	Config 3, 6		SMTTC.1	
PDSCH/PDCCH subcarrier spacing	Config 1, 2, 4, 5		15 KHz	
	Config 3, 6		30 KHz	
PRACH Configuration	Config 1, 2, 4, 5		PRACH.2 FR1	CFRA for BFR
	Config 3, 6		PRACH.2 FR1	CFRA for BFR
SSB Index assigned as BFD RS (q <sub>0</sub> )			0	
SSB Index assigned as CBD RS (q <sub>1</sub> )			1	
OCNG parameters			OP.1	
CP length			Normal	
Correlation Matrix and Antenna Configuration			2x2 Low	
Beam failure detection transmission parameters	DCI format		1-0	
	Number of Control OFDM symbols		2	
	Aggregation level	CCE	8	
	Ratio of hypothetical PDCCH RE energy to average CSI-RS RE energy	dB	0	
	Ratio of hypothetical PDCCH DMRS energy to average CSI-	dB	0	

Parameter		Unit	Value	Comment
			Test 1	
	RS RE energy			
	DMRS precoder granularity		REG bundle size	
	REG bundle size		6	
DRX			DRX.7	
Gap pattern ID			N.A.	
rimInSyncOutOfSyncThreshold			absent	When the field is absent, the UE applies the value 0.
rsrp-ThresholdSSB	Config 1, 2, 4, 5	dBm/SCS kHz	-98	Threshold used for $Q_{in\_LR\_SSB}$
	Config 3, 6	dBm/SCS kHz	-95	Threshold used for $Q_{in\_LR\_SSB}$
powerControlOffsetSS			db0	Used for deriving rsrp-ThresholdCSI-RS
beamFailureInstanceMaxCount			n1	see TS 38.321 [12], clause 5.17
beamFailureDetectionTimer			pbfd4	see TS 38.321 [12], clause 5.17
CSI-RS configuration for CSI reporting	Config 1, 4		CSI-RS.1.1 FDD	
	Config 2, 5		CSI-RS.1.1 TDD	
	Config 3, 6		CSI-RS.2.1 TDD	
CSI-RS for tracking	Config 1, 4		TRS.1.1 FDD	
	Config 2, 5		TRS.1.1 TDD	
	Config 3, 6		TRS.1.2 TDD	
SSB Index assigned as RLM RS			0,1	
T310 Timer		ms	1000	
N310			2	
T1		s	1	During this time the UE shall be fully synchronized to cell 1
T2		s	5.17	
T3		s	3.24	
T4		s	0	
T5		s	1.97	
D1		s	1.93	
NOTE 1: All configurations are assigned to the UE prior to the start of time period T1.				
NOTE 2: UE-specific PDCCH is not transmitted after T1 starts.				
NOTE 3: E-UTRAN is in non-DRX mode under test.				

#### 4.5.5.2.4.2 Test procedure

Prior to the start of the time duration T1, the UE shall be fully synchronized to cell 1 and cell 2. The UE shall be configured for periodic CSI reporting with a reporting periodicity of 5 ms. In the test, DRX configuration is enabled in PSCell and DRX inactivity timer has already been expired, i.e. UE tries to decode PDCCH and to send periodic CQI during the period when On-duration timer is running. Time alignment timers shall be set to "infinity" so that UL timing alignment is maintained during the test.

1. Ensure the UE is in state RRC\_CONNECTED with generic procedure parameters Connectivity *EN-DC*, DC bearer MCG and SCG, Connected without release *On* and Test Mode *On* according to TS 38.508-1 [14] clause 4.5.
2. Set the parameters of NR Cell 1 according to T1 in Table 4.5.5.2.5-1. Propagation conditions are set according to clause C.2.3. T1 starts.

3. When T1 expires the SS shall change the SNR value to T2 as specified in Table 4.5.5.2.5-1. T2 starts.
4. When T2 expires the SS shall change the SNR value to T3 as specified in Table 4.5.5.2.5-1. T3 starts.
5. When T3 expires the SS shall change the SNR value to T4 as specified in Table 4.5.5.2.5-1. T4 starts.
6. When T4 expires the SS shall change the SNR value to T5 as specified in Table 4.5.5.2.5-1. T5 starts.
7. If the SS:
  - a) detects uplink power on NR carrier equal to or higher than minimum output power defined in TS 38.521-1 [17] clause 6.3.1.5 in each slot configured for CSI transmission (according CSI reporting on PUCCH) during the period from time point A to time point B; and
  - b) does not detect preamble on a beam associated with the candidate beam set  $q_1$  before time point B; and
  - c) detects preamble on a beam associated with the candidate beam set  $q_1$  before time point F (D1 after the start of T5), the number of successful tests is increased by one.

Otherwise the number of failed tests is increased by one.
8. If the iteration or random access procedure for BFD fails, the SS shall first attempt to release and add the PSCell, by ensuring the UE is in state RRC\_CONNECTED with generic procedure parameters *Connectivity* EN-DC, DC bearer MCG and SCG, Connected without release *On* and Test Mode *On* according to TS 38.508-1 [6] clause 4.5. If that also fails, then the UE is switched OFF/ON to proceed with the next iteration.
9. Repeat steps 2-8 for all subtests until the confidence level according to Tables G.2.3-1 in Annex G clause G.2 is achieved.

4.5.5.2.4.3 Message contents

Message contents are according to TS 38.508-1 [14] clause 7.3 with the following exceptions:

**Table 4.5.5.2.4.3-1: Common Exception messages for EN-DC FR1 SSB-based beam failure detection and link recovery in DRX**

Default Message Contents	
Common contents of system information blocks exceptions	
Default RRC messages and information elements contents exceptions	Table H.3.1-8 with Condition SSB BFD Table H.3.1-10 with Condition SSB Table H.3.1-10A Table H.3.5-4 Table H.3.7-1 with Condition DRX.7 Table 7.3.1-3 in TS 38.508-1 [14] with condition SMTC.1

**Table 4.5.5.2.4.3-2: PDCCH Search Space for BFR**

Derivation Path: TS 38.508-1 [14], Table 4.6.3-162			
Information Element	Value/remark	Comment	Condition
SearchSpace ::= SEQUENCE {			
searchSpaceId	3	BFR	
controlResourceSetId	2	BFR	
monitoringSlotPeriodicityAndOffset CHOICE {			
s1	NULL		
}			
monitoringSymbolsWithinSlot	10000000000000	Symbols 0 and 1	
nrofCandidates SEQUENCE {			
aggregationLevel1	n0		
aggregationLevel2	n0		
aggregationLevel4	n0		
aggregationLevel8	n1	AL8	
aggregationLevel16	n0		
}			
searchSpaceType CHOICE {			



ue-Specific SEQUENCE {			USS
dci-Formats	formats0-0-And-1-0	DCI Format 1_0	
}			
}			
}			

**Table 4.5.5.2.4.3-3: RLF-TimersAndConstants**

Derivation Path: TS 38.508-1 [14], Table 4.6.3-150			
Information Element	Value/remark	Comment	Condition
RLF-TimersAndConstants ::= SEQUENCE {			
n310	n2		
}			

**Table 4.5.5.2.4.3-4: PDCCH-Config**

Derivation Path: TS 38.501-1 [14], Table 4.6.3-95			
Information Element	Value/remark	Comment	Condition
PDCCH-Config ::= SEQUENCE {			
controlResourceSetToAddModList SEQUENCE(SIZE (1..3)) OF ControlResourceSet {	2 entries		
ControlResourceSet[2]	ControlResourceSet	entry 2, BFR	
}			
controlResourceSetToReleaseList	Not present		
searchSpacesToAddModList SEQUENCE(SIZE (1..10)) OF SearchSpace {	2 entries		
SearchSpace[2]	SearchSpace	entry 2, BFR	
}			
searchSpacesToReleaseList	Not present		
downlinkPreemption	Not present		
tpc-PUSCH	Not present		
tpc-PUCCH	Not present		
tpc-SRS	Not present		
}			

**Table 4.5.5.2.4.3-5: ControlResourceSet for BFR**

Derivation Path: TS 38.501-1 [14], Table 7.3.1-15			
Information Element	Value/remark	Comment	Condition
ControlResourceSet ::= SEQUENCE {			
controlResourceSetId	2		
duration	2		
cce-REG-MappingType CHOICE {			
interleaved ::= SEQUENCE {			
reg-BundleSize	n6		
interleaverSize	n2		
shiftIndex	0		
}			
tci-StatesPDCCH-ToAddList	Not present		
}			

#### 4.5.5.2.5 Test requirements

Tables 4.5.5.2.4.1-3 and 4.5.5.2.5-1 define the primary level settings including test tolerances for EN-DC FR1 SSB-based beam failure detection and link recovery in DRX.

**Table 4.5.5.2.5-1: Cell specific test parameters for FR1 PSCell for SSB-based beam failure detection and link recovery testing in DRX mode**

Parameter		Unit	Test 1				
			T1	T2	T3	T4	T5
EPRE ratio of PDCCH DMRS to SSS		dB	0				
EPRE ratio of PDCCH to PDCCH DMRS		dB					
EPRE ratio of PBCH DMRS to SSS		dB					
EPRE ratio of PBCH to PBCH DMRS		dB					
EPRE ratio of PSS to SSS		dB					
EPRE ratio of PDSCH DMRS to SSS		dB					
EPRE ratio of PDSCH to PDSCH DMRS		dB					
EPRE ratio of OCNG DMRS to SSS		dB					
EPRE ratio of OCNG to OCNG DMRS		dB					
SNR_SSB of set $q_0$	Config 1, 4	dB	5.8	-2.2	-12.8	-12.8	-12.8
	Config 2, 5		5.8	-2.2	-12.8	-12.8	-12.8
	Config 3, 6		5.8	-2.2	-12.8	-12.8	-12.8
SNR_SSB of set $q_1$	Config 1, 4	dB	-10.2	-10.2	10.2	10.2	10.2
	Config 2, 5		-10.2	-10.2	10.2	10.2	10.2
	Config 3, 6		-10.2	-10.2	10.2	10.2	10.2
SSB_RP of set $q_1$	Config 1, 4	dBm/SC S kHz	-108.2	-108.2	-87.8	-87.8	-87.8
	Config 2, 5		-108.2	-108.2	-87.8	-87.8	-87.8
	Config 3, 6		-105.2	-105.2	-84.8	-84.8	-84.8
$N_{oc}$	Config 1, 4	dBm/15 kHz	-98				
	Config 2, 5		-98				
	Config 3, 6		-98				
Propagation condition			TDL-C 300ns 100Hz				
<p>NOTE 1: OCNG shall be used such that the resources in Cell 1 are fully allocated and a constant total transmitted power spectral density is achieved for all OFDM symbols.</p> <p>NOTE 2: The uplink resources for CSI reporting are assigned to the UE prior to the start of time period T1.</p> <p>NOTE 3: NZP CSI-RS resource set configuration for CSI reporting are assigned to the UE prior to the start of time period T1.</p> <p>NOTE 4: Void</p> <p>NOTE 5: The timers and layer 3 filtering related parameters are configured prior to the start of time period T1.</p> <p>NOTE 6: The signal contains PDCCH for UEs other than the device under test as part of OCNG.</p> <p>NOTE 7: SNR levels correspond to the signal to noise ratio over the SSS REs.</p> <p>NOTE 8: The SNR in time periods T1, T2, T3, T4 and T5 is denoted as SNR1, SNR2 and SNR3 respectively in figure 4.5.5.2.4-1.</p> <p>NOTE 9: The SNR values are specified for a UE with 2RX antennas connected under test. For a UE with 4RX antennas connected under test, the SNR for RS in set <math>q_0</math> during T3, T4, and T5 from D.4.1.1, is <math>-15\text{dB-TT} = -15.8\text{dB}</math> (including test tolerances).</p>							

The UE behaviour during time durations T1, T2, T3, T4 and T5 shall be as follows:

During the time duration T1 and T2, the UE shall transmit uplink signal at least in all subframes configured for CSI transmission on Cell 1.

During the period from time point A to time point B the UE shall transmit uplink signal in Cell 1 in all uplink slots configured for CSI transmission according to the configured periodic CSI reporting for Cell 1.

During T3 the UE shall detect beam failure and initiate link recovery. During T4 and T5 the UE measures and evaluate beam candidate from beam candidate set  $q_1$ .

No later than time point F occurring no later than  $D1 = 1930$  ms after the start of T5, the UE shall transmit preamble on a beam associated with the candidate beam set  $q_1$ . The UE shall not transmit preamble on a beam associated with the candidate beam set  $q_1$  earlier than time point B.

Test is concluded once the test equipment has received the initial preamble transmission from the UE. The rate of correct events observed during repeated tests shall be at least 90%.

#### 4.5.5.3 EN-DC FR1 CSI-RS-based beam failure detection and link recovery in non-DRX

4.5.5.3.1 Test purpose

The purpose of this test is to verify that the UE properly detects CSI-RS-based beam failure in the set  $q_0$  configured for a serving PSCell and that the UE performs correct CSI-RS-based link recovery based on beam candidate set  $q_1$ . The purpose is to test the downlink monitoring for beam failure detection within the UEs active DL BWP of the PSCell, during the evaluation period, and link recovery, when no DRX is used. This test will partly verify the CSI-RS based beam failure detection and link recovery for an FR1 serving cell requirements in TS 38.133 [6] clause 8.5.

4.5.5.3.2 Test applicability

This test applies to all types of E-UTRA UE release 15 and forward, supporting EN-DC, CSI-RS based RLM and link recovery.

4.5.5.3.3 Minimum conformance requirements

The minimum conformance requirements are specified in clause 4.5.5.0.2.

The normative reference for this requirement is TS 38.133 [6] clause A.4.5.5.3.

4.5.5.3.4 Test description

The test consists of five successive time periods, with time duration of T1, T2, T3, T4 and T5 respectively. Figure 4.5.5.3.4-1 shows the variation of the downlink SNR of the PSCell and the SNR of the CSI-RS in set  $q_0$  in the active PSCell to emulate CSI-RS based beam failure. Figure 4.5.5.3.4-1 additionally shows the variation of the downlink L1-RSRP of the CSI-RS in set  $q_1$  of the candidate beam used for link recovery.

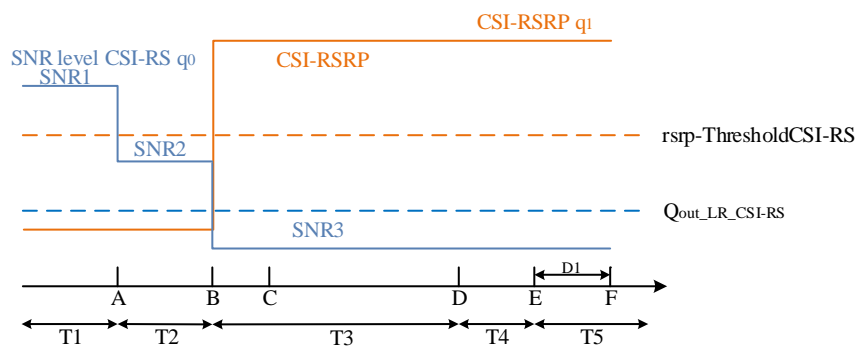

Figure 4.5.5.3.4-1: SNR and L1-RSRP variation for CSI-RS-based beam failure detection and link recovery testing in non-DRX mode

4.5.5.3.4.1 Initial conditions

This test shall be tested using any of the test configurations in Table 4.5.5.3.4.1-1.

Table 4.5.5.3.4.1-1: Supported test configurations for EN-DC FR1 CSI-RS-based beam failure detection and link recovery in non-DRX

Configuration	Description
4.5.5.3-1	LTE FDD, NR 15 kHz SSB SCS, 10 MHz bandwidth, FDD duplex mode
4.5.5.3-2	LTE FDD, NR 15 kHz SSB SCS, 10 MHz bandwidth, TDD duplex mode
4.5.5.3-3	LTE FDD, NR 30 kHz SSB SCS, 40 MHz bandwidth, TDD duplex mode
4.5.5.3-4	LTE TDD, NR 15 kHz SSB SCS, 10 MHz bandwidth, FDD duplex mode
4.5.5.3-5	LTE TDD, NR 15 kHz SSB SCS, 10 MHz bandwidth, TDD duplex mode
4.5.5.3-6	LTE TDD, NR 30 kHz SSB SCS, 40 MHz bandwidth, TDD duplex mode

NOTE: The UE is only required to pass in one of the supported test configurations in FR1.

Configure the test equipment and the DUT according to the parameters in Table 4.5.5.3.4.1-2.

**Table 4.5.5.3.4.1-2: Initial conditions for EN-DC FR1 CSI-RS-based beam failure detection and link recovery in non-DRX**

Parameter	Value		Comment
Test environment	NC		As specified in TS 38.508-1 [14] clause 4.1.
Test frequencies	As specified in Annex E, table E.2-1 and TS 38.508-1 [14] clause 4.3.1 and 4.4.2.		
Channel bandwidth	As specified by the test configuration selected from Table 4.5.5.3.4.1-1.		
Propagation conditions	AWGN		As specified in clause C.2.2.
Connection Diagram	TE Part	A.3.1.7.1	As specified in TS 38.508-1 [14] Annex A.
	DUT Part	A.3.2.3.4	
Exceptions to connection diagram	For 4Rx capable UEs without any 2Rx RF bands use A.3.2.5.2 for DUT part and A.3.1.8.4 for TE Part		

1. The general test parameter settings are set up according to Table 4.5.5.3.4.1-3.
2. Message contents are defined in clause 4.5.5.3.4.3.
3. Cell 1 is the E-UTRA serving cell (PCell) for the EN-DC setup. The power levels and settings for Cell 1 are set according to Annex A.6. Cell 2 is the NR cell (PSCell) with the power level set according to clauses C.1.2 and C.1.3 for this test

**Table 4.5.5.3.4.1-3: General test parameters for FR1 PSCell for CSI-RS-based beam failure detection and link recovery testing in non-DRX mode**

Parameter	Unit	Value		Comment
		Test 1		
Active PCell		Cell 1		
RF Channel Number		1		
Active PSCell		Cell 2		
RF Channel Number		2		
Duplex mode	Config 1, 4	FDD		
	Config 2, 3, 5, 6	TDD		
BWchannel	Config 1, 4	MHz	10: NRB,c = 52	
	Config 2, 5		10: NRB,c = 52	
	Config 3, 6		40: NRB,c = 106	
DL initial BWP configuration	Config 1, 2, 3, 4, 5, 6		DLBWP.0.1	
DL dedicated BWP configuration	Config 1, 2, 3, 4, 5, 6		DLBWP.1.1	
UL initial BWP configuration	Config 1, 2, 3, 4, 5, 6		ULBWP.0.1	
UL dedicated BWP configuration	Config 1, 2, 3, 4, 5, 6		ULBWP.1.1	
TDD Configuration	Config 1, 4		Not Applicable	
	Config 2, 5		TDDConf.1.1	
	Config 3, 6		TDDConf.2.1	
CORESET Reference Channel	Config 1, 4		CR.1.1 FDD	
	Config 2, 5		CR.1.1 TDD	
	Config 3, 6		CR.2.1 TDD	
SSB Configuration	Config 1, 4		SSB.3 FR1	
	Config 2, 5		SSB.3 FR1	
	Config 3, 6		SSB.4 FR1	
SMTc Configuration	Config 1, 2, 4, 5		SMTc.1	
	Config 3, 6		SMTc.1	
PDSCH/PDCCH subcarrier spacing	Config 1, 2, 4, 5		15 KHz	
	Config 3, 6		30 KHz	
PRACH Configuration	Config 1, 2, 4, 5		PRACH.4 FR1	
	Config 3, 6		PRACH.4 FR1	
csi-RS-Index assigned as beam failure detection RS in set $q_0$			0	
OCNG parameters			OP.1	
CP length			Normal	

Parameter		Unit	Value	Comment
			Test 1	
Correlation Matrix and Antenna Configuration			2x2 Low	
Beam failure detection transmission parameters	DCI format		1-0	
	Number of Control OFDM symbols		2	
	Aggregation level	CCE	8	
	Ratio of hypothetical PDCCH RE energy to average CSI-RS RE energy	dB	0	
	Ratio of hypothetical PDCCH DMRS energy to average CSI-RS RE energy	dB	0	
	DMRS precoder granularity		REG bundle size	
	REG bundle size		6	
DRX			OFF	
Gap pattern ID			N.A.	
csi-RS-Index assigned as candidate beam detection RS in set $q_1$			1	
rimInSyncOutOfSyncThreshold			absent	When the field is absent, the UE applies the value 0.
rsrp-ThresholdSSB	Config 1, 2, 4, 5	dBm/SCS kHz	-98	Threshold used for $Q_{in\_LR\_SSB}$
	Config 3, 6	dBm/SCS kHz	-95	Threshold used for $Q_{in\_LR\_SSB}$
powerControlOffsetSS			db0	Used for deriving rsrp-ThresholdCSI-RS
beamFailureInstanceMaxCount			n1	see TS 38.321 [12], clause 5.17
beamFailureDetectionTimer			pbfd4	see TS 38.321 [12], clause 5.17
CSI-RS configuration for $q_0$ and $q_1$	Config 1, 4		CSI-RS.1.2 FDD	
	Config 2, 5		CSI-RS.1.2 TDD	
	Config 3, 6		CSI-RS.2.2 TDD	
CSI-RS configuration for CSI reporting	Config 1, 4		CSI-RS.1.1 FDD	
	Config 2, 5		CSI-RS.1.1 TDD	
	Config 3, 6		CSI-RS.2.1 TDD	
TRS configuration	Config 1, 4		TRS.1.1 FDD	
	Config 2, 5		TRS.1.1 TDD	
	Config 3, 6		TRS.1.2 TDD	
csi-RS-Index assigned as RLM RS	Config 1, 4		CSI-RS.1.2 FDD	
	Config 2, 5		CSI-RS.1.2 TDD	
	Config 3, 6		CSI-RS.2.2 TDD	
T310 Timer		ms	1000	
N310			2	
T1		s	1	During this time the UE shall be fully synchronized to cell 1
T2		s	0.18	
T3		s	0.14	
T4		s	0	
T5		s	0.08	
D1		s	0.04	

Parameter	Unit	Value	Comment
		Test 1	
NOTE: UE-specific PDCCH is not transmitted after T1 starts.			

4.5.5.3.4.2 Test procedure

Prior to the start of the time duration T1, the UE shall be fully synchronized to cell 1 and cell 2. The UE shall be configured for periodic CSI reporting with a reporting periodicity of 5 ms. In the test, DRX configuration is not enabled.

1. Ensure the UE is in state RRC\_CONNECTED with generic procedure parameters Connectivity *EN-DC*, DC bearer MCG and SCG, Connected without release *On* and Test Mode *On* according to TS 38.508-1 [14] clause 4.5.
2. Set the parameters of NR Cell according to T1 in Table 4.5.5.3.5-1. Propagation conditions are set according to clause C.2.3. T1 starts.
3. When T1 expires the SS shall change the SNR value to T2 as specified in Table 4.5.5.3.5-1. T2 starts.
4. When T2 expires the SS shall change the SNR value to T3 as specified in Table 4.5.5.3.5-1. T3 starts.
5. When T3 expires the SS shall change the SNR value to T4 as specified in Table 4.5.5.3.5-1. T4 starts.
6. When T4 expires the SS shall change the SNR value to T5 as specified in Table 4.5.5.3.5-1. T5 starts.
7. If the SS:
  - a) detects uplink power on NR carrier equal to or higher than minimum output power defined in TS 38.521-1 [17] clause 6.3.1.5 in each slot configured for CSI transmission (according CSI reporting on PUCCH) during the period from time point A to time point B; and
  - b) does not detect preamble on a beam associated with the candidate beam set  $q_1$  before time point B, and
  - c) detects preamble on a beam associated with the candidate beam set  $q_1$  before time point F (D1 after the start of T5), the number of successful tests is increased by one.

Otherwise the number of failed tests is increased by one.

8. If the iteration or random access procedure for BFD fails, the SS shall first attempt to release and add the PSCell, by ensuring the UE is in state RRC\_CONNECTED with generic procedure parameters Connectivity *EN-DC*, DC bearer MCG and SCG, Connected without release *On* and Test Mode *On* according to TS 38.508-1 [6] clause 4.5. If that also fails, then the UE is switched OFF/ON to proceed with the next iteration.
9. Repeat steps 2-8 for all subtests until the confidence level according to Tables G.2.3-1 in Annex G clause G.2 is achieved.

4.5.5.3.4.3 Message contents

Message contents are according to TS 38.508-1 [14] clause 7.3 with the following exceptions.

**Table 4.5.5.3.4.3-1: Common Exception messages for EN-DC FR1 CSI-RS-based beam failure detection and link recovery in non-DRX**

Default Message Contents	
Common contents of system information blocks exceptions	
Default RRC messages and information elements contents exceptions	Table H.3.1-8 with Condition CSI-RS BFD Table H.3.1-10 with Condition CSI-RS Table H.3.1-10A Table H.3.1-11 with Condition CSI-RS Table H.3.5-4 Table 7.3.1-3 in TS 38.508-1 [14] with condition SMTC.1

**Table 4.5.5.3.4.3-2: PDCCH Search Space for BFR**

Derivation Path: TS 38.508-1 [14], Table 4.6.3-162			
Information Element	Value/remark	Comment	Condition
SearchSpace ::= SEQUENCE {			
searchSpaceId	4	BFR	
controlResourceSetId	2	BFR	
monitoringSlotPeriodicityAndOffset CHOICE {			
sl1	NULL		
}			
monitoringSymbolsWithinSlot	10000000000000	Symbols 0 and 1	
nrofCandidates SEQUENCE {			
aggregationLevel1	n0		
aggregationLevel2	n0		
aggregationLevel4	n0		
aggregationLevel8	n1	AL8	
aggregationLevel16	n0		
}			
searchSpaceType CHOICE {			
ue-Specific SEQUENCE {			USS
dci-Formats	formats0-0-And-1-0	DCI Format 1_0	
}			
}			
}			

**Table 4.5.5.3.4.3-3: RLF-TimersAndConstants**

Derivation Path: TS 38.508-1 [14], Table 4.6.3-150			
Information Element	Value/remark	Comment	Condition
RLF-TimersAndConstants ::= SEQUENCE {			
n310	n2		
}			

**Table 4.5.5.3.4.3-4: NZP-CSI-RS-Resource**

Derivation Path: TS 38.508-1 [14], Table 4.6.3-85			
Information Element	Value/remark	Comment	Condition
NZP-CSI-RS-Resource ::= SEQUENCE {			
powerControlOffsetSS	db0		
}			

**Table 4.5.5.3.4.3-4: PDCCH-Config**

Derivation Path: TS 38.501-1 [14], Table 4.6.3-95			
Information Element	Value/remark	Comment	Condition
PDCCH-Config ::= SEQUENCE {			
controlResourceSetToAddModList SEQUENCE(SIZE (1..3)) OF ControlResourceSet {	2 entries		
ControlResourceSet[2]	ControlResourceSet	entry 2, BFR	
}			
controlResourceSetToReleaseList	Not present		
searchSpacesToAddModList SEQUENCE(SIZE (1..10)) OF SearchSpace {	2 entries		
SearchSpace[2]	SearchSpace	entry 2, BFR	
}			
searchSpacesToReleaseList	Not present		
downlinkPreemption	Not present		
tpc-PUSCH	Not present		
tpc-PUCCH	Not present		
tpc-SRS	Not present		
}			

**Table 4.5.5.3.4.3-5: ControlResourceSet for BFR**

Derivation Path: TS 38.501-1 [14], Table 7.3.1-15

Information Element	Value/remark	Comment	Condition
ControlResourceSet ::= SEQUENCE {			
controlResourceSetId	2		
duration	2		
cce-REG-MappingType CHOICE {			
interleaved ::= SEQUENCE {			
reg-BundleSize	n6		
interleaverSize	n2		
shiftIndex	0		
}			
tci-StatesPDCCH-ToAddList	Not present		
}			

4.5.5.3.5 Test requirements

Tables 4.5.5.3.4.1-3 and 4.5.5.3.5-1 define the primary level settings including test tolerances for EN-DC FR1 CSI-RS-based beam failure detection and link recovery in non-DRX.

**Table 4.5.5.3.5-1: Cell specific test parameters for FR1 PSCell for CSI-RS-based beam failure detection and link recovery testing in non-DRX mode**

Parameter	Unit	Test 1					
		T1	T2	T3	T4	T5	
EPRE ratio of PDCCH DMRS to SSS	dB	0					
EPRE ratio of PDCCH to PDCCH DMRS	dB						
EPRE ratio of PBCH DMRS to SSS	dB						
EPRE ratio of PBCH to PBCH DMRS	dB						
EPRE ratio of PSS to SSS	dB						
EPRE ratio of PDSCH DMRS to SSS	dB						
EPRE ratio of PDSCH to PDSCH DMRS	dB						
EPRE ratio of OCNG DMRS to SSS	dB						
EPRE ratio of OCNG to OCNG DMRS	dB						
SNR_CSI-RS of set q0	Config 1, 4	dB	5.8	-2.2	-12.8	-12.8	-12.8
	Config 2, 5		5.8	-2.2	-12.8	-12.8	-12.8
	Config 3, 6		5.8	-2.2	-12.8	-12.8	-12.8
SNR_CSI-RS of set q1	Config 1, 4	dB	-10.2	-10.2	10.2	10.2	10.2
	Config 2, 5		-10.2	-10.2	10.2	10.2	10.2
	Config 3, 6		-10.2	-10.2	10.2	10.2	10.2
CSI-RS_RP of set q1	Config 1, 4	dBm/SC S kHz	-108.2	-108.2	-87.8	-87.8	-87.8
	Config 2, 5		-108.2	-108.2	-87.8	-87.8	-87.8
	Config 3, 6		-105.2	-105.2	-84.8	-84.8	-84.8
$N_{oc}$	Config 1, 4	dBm/15 kHz	-98				
	Config 2, 5		-98				
	Config 3, 6		-98				
Propagation condition		TDL-C 300ns 100Hz					
NOTE 1: OCNG shall be used such that the resources in Cell 1 are fully allocated and a constant total transmitted power spectral density is achieved for all OFDM symbols.							
NOTE 2: The uplink resources for CSI reporting are assigned to the UE prior to the start of time period T1.							
NOTE 3: NZP CSI-RS resource set configuration for CSI reporting are assigned to the UE prior to the start of time period T1.							
NOTE 4: Void.							
NOTE 5: The timers and layer 3 filtering related parameters are configured prior to the start of time period T1.							
NOTE 6: The signal contains PDCCH for UEs other than the device under test as part of OCNG.							
NOTE 7: SNR levels correspond to the signal to noise ratio over the REs carrying CSI-RS.							
NOTE 8: The SNR in time periods T1, T2, T3, T4 and T5 is denoted as SNR1, SNR2 and SNR3 respectively in figure 4.5.5.3.4-1.							
NOTE 9: The SNR values are specified for a UE with 2RX antennas connected under test. For a UE with 4RX antennas connected under test, the SNR for RS in set q0 during T3, T4, and T5 from D.4.1.1, is -15dB-TT = -15.8dB (including test tolerances).							

The UE behaviour during time durations T1, T2, T3, T4 and T5 shall be as follows:



During the time duration T1 and T2, the UE shall transmit uplink signal at least in all subframes configured for CSI transmission on Cell 1.

During the period from time point A to time point B the UE shall transmit uplink signal in Cell 1 in all uplink slots configured for CSI transmission according to the configured periodic CSI reporting for Cell 1.

During T3 the UE shall detect beam failure and initiate link recovery. During T4 and T5 the UE measures and evaluate beam candidate from beam candidate set  $q_1$ .

No later than time point F occurring no later than  $D1 = 40$  ms after the start of T5, the UE shall transmit preamble on a beam associated with the candidate beam set  $q_1$ . The UE shall not transmit preamble on a beam associated with the candidate beam set  $q_1$  earlier than time point B.

Test is concluded once the test equipment has received the initial preamble transmission from the UE. The rate of correct events observed during repeated tests shall be at least 90%.

#### 4.5.5.4 EN-DC FR1 CSI-RS-based beam failure detection and link recovery in DRX

##### 4.5.5.4.1 Test purpose

The purpose of this test is to verify that the UE properly detects CSI-RS-based beam failure in the set  $q_0$  configured for a serving PCell and that the UE performs correct CSI-RS-based link recovery based on beam candidate set  $q_1$ . The purpose is to test the downlink monitoring for beam failure detection within the UEs active DL BWP of the PCell, during the evaluation period, and link recovery, when DRX is used. This test will partly verify the CSI-RS based beam failure detection and link recovery for an FR1 serving cell requirements in TS 38.133 [6] clause 8.5.

##### 4.5.5.4.2 Test applicability

This test applies to all types of E-UTRA UE release 15 and forward supporting EN-DC FR1, CSI-RS based RLM, link recovery and long DRX cycle.

##### 4.5.5.4.3 Minimum conformance requirements

The minimum conformance requirements are specified in clause 4.5.5.0.2.

The normative reference for this requirement is TS 38.133 [6] clause A.4.5.5.4.

##### 4.5.5.4.4 Test description

The test consists of five successive time periods, with time duration of T1, T2, T3, T4 and T5 respectively. Figure 4.5.5.4.4-1 shows the variation of the downlink SNR of the PCell and the SNR of the CSI-RS in set  $q_0$  in the active PCell to emulate CSI-RS based beam failure. Figure 4.5.5.4.4-1 additionally shows the variation of the downlink L1-RSRP of the CSI-RS in set  $q_1$  of the candidate beam used for link recovery.

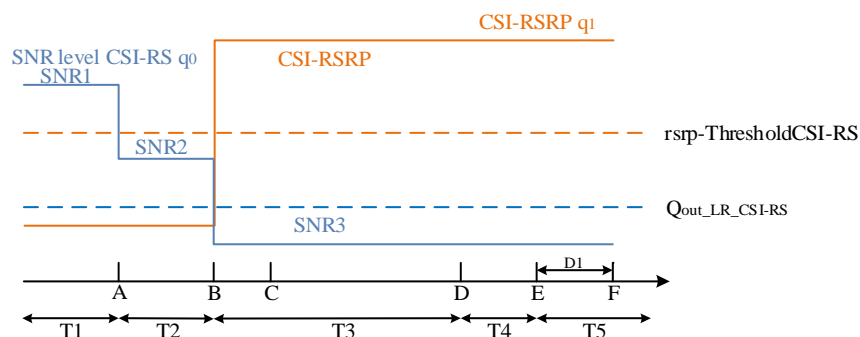

**Figure 4.5.5.4.4-1: SNR and L1-RSRP variation for EN-DC FR1 CSI-RS-based beam failure detection and link recovery in DRX**

## 4.5.5.4.4.1 Initial conditions

This test shall be tested using any of the test configurations in Table 4.5.5.4.4.1-1.

**Table 4.5.5.4.4.1-1: Supported test configurations for EN-DC FR1 CSI-RS-based beam failure detection and link recovery in DRX**

Configuration	Description
4.5.5.4-1	LTE FDD, NR 15 kHz SSB SCS, 10MHz bandwidth, FDD duplex mode
4.5.5.4-2	LTE FDD, NR 15 kHz SSB SCS, 10MHz bandwidth, TDD duplex mode
4.5.5.4-3	LTE FDD, NR 30 kHz SSB SCS, 40MHz bandwidth, TDD duplex mode
4.5.5.4-4	LTE TDD, NR 15 kHz SSB SCS, 10MHz bandwidth, FDD duplex mode
4.5.5.4-5	LTE TDD, NR 15 kHz SSB SCS, 10MHz bandwidth, TDD duplex mode
4.5.5.4-6	LTE TDD, NR 30kHz SSB SCS, 40MHz bandwidth, TDD duplex mode
NOTE: The UE is only required to pass in one of the supported test configurations in FR1	

Configure the test equipment and the DUT according to the parameters in Table 4.5.5.4.4.1-2.

**Table 4.5.5.4.4.1-2: Initial conditions for EN-DC FR1 CSI-RS-based beam failure detection and link recovery in DRX**

Parameter	Value		Comment
Test environment	NC		As specified in TS 38.508-1 [14] clause 4.1.
Test frequencies	As specified in Annex E, table E.2-1 and TS 38.508-1 [14] clause 4.3.1 and 4.4.2.		
Channel bandwidth	As specified by the test configuration selected from Table 4.5.5.4.4.1-1.		
Propagation conditions	AWGN		As specified in clause C.2.2.
Connection Diagram	TE Part	A.3.1.7.1	As specified in TS 38.508-1 [14] Annex A.
	DUT Part	A.3.2.3.4	
Exceptions to connection diagram	For 4Rx capable UEs without any 2Rx RF bands use A.3.2.5.2 for DUT part and A.3.1.8.4 for TE Part		

1. The general test parameter settings are set up according to Table 4.5.5.4.4.1-3.
2. Message contents are defined in clause 4.5.5.4.4.3.
3. There are two cells in the test, where Cell 1 is the E-UTRAN PCell on the E-UTRA carrier, and Cell 2 is the NR PSCell on the NR carrier. Cell 1 is the cell used for connection setup with the power level set according to Table A.6.1.1-1, Cell 2 is configured according to clauses C.1.2 and C.1.3.

**Table 4.5.5.4.4.1-3: General test parameters for EN-DC FR1 CSI-RS-based beam failure detection and link recovery in DRX**

Parameter	Unit	Value	Comment
		Test 1	
Active PCell		Cell 1	
RF Channel Number		1	
Active PSCell		Cell 2	
RF Channel Number		2	
Duplex mode	Config 1, 4	FDD	
	Config 2, 3, 5, 6	TDD	

Parameter		Unit	Value	Comment
			Test 1	
BWchannel	Config 1, 4	MHz	10: NRB,c = 52	
	Config 2, 5		10: NRB,c = 52	
	Config 3, 6		40: NRB,c = 106	
DL initial BWP configuration	Config 1, 2, 3, 4, 5, 6		DLBWP.0.1	
DL dedicated BWP configuration	Config 1, 2, 3, 4, 5, 6		DLBWP.1.1	
UL initial BWP configuration	Config 1, 2, 3, 4, 5, 6		ULBWP.0.1	
UL dedicated BWP configuration	Config 1, 2, 3, 4, 5, 6		ULBWP.1.1	
TDD Configuration	Config 1, 4		Not Applicable	
	Config 2, 5		TDDConf.1.1	
	Config 3, 6		TDDConf.2.1	
CORESET Reference Channel	Config 1, 4		CR.1.1 FDD	
	Config 2, 5		CR.1.1 TDD	
	Config 3, 6		CR.2.1 TDD	
SSB Configuration	Config 1, 4		SSB.3 FR1	
	Config 2, 5		SSB.3 FR1	
	Config 3, 6		SSB.4 FR1	
SMTc Configuration	Config 1, 2, 4, 5		SMTc.1	
	Config 3, 6		SMTc.1	
PDSCH/PDCCH subcarrier spacing	Config 1, 2, 4, 5		15 KHz	
	Config 3, 6		30 KHz	
PRACH Configuration	Config 1, 2, 4, 5		PRACH.4 FR1	
	Config 3, 6		PRACH.4 FR1	
csi-RS-Index assigned as beam failure detection RS in set $q_0$			0	
OCNG parameters			OP.1	
CP length			Normal	
Correlation Matrix and Antenna Configuration			2x2 Low	
Beam failure detection transmission parameters	DCI format		1-0	
	Number of Control OFDM symbols		2	
	Aggregation level	CCE	8	
	Ratio of hypothetical PDCCH RE energy to average CSI-RS RE energy	dB	0	
	Ratio of hypothetical PDCCH DMRS energy to average CSI-RS RE energy	dB	0	
	DMRS precoder granularity		REG bundle size	
	REG bundle size		6	
DRX			DRX.7	
Gap pattern ID			N.A.	
csi-RS-Index assigned as candidate beam detection RS in set $q_1$			1	
rimInSyncOutOfSyncThreshold			absent	When the field is absent, the UE applies the value 0.
rsrp-ThresholdSSB	Config 1, 2, 4, 5	dBm/SC S kHz	-98	Threshold used for $Q_{in\_LR\_SSB}$

Parameter		Unit	Value	Comment
			Test 1	
	Config 3, 6	dBm/SC S kHz	-95	Threshold used for $Q_{in\_LR\_SSB}$
powerControlOffsetSS			db0	Used for deriving $rsrp$ -ThresholdCSI-RS
beamFailureInstanceMaxCount			n1	see TS 38.321 [12], clause 5.17
beamFailureDetectionTimer			pbfd4	see TS 38.321 [12], clause 5.17
CSI-RS configuration for $q_0$ and $q_1$	Config 1, 4		CSI-RS.1.2 FDD	
	Config 2, 5		CSI-RS.1.2 TDD	
	Config 3, 6		CSI-RS.2.2 TDD	
CSI-RS configuration for CSI reporting	Config 1, 4		CSI-RS.1.1 FDD	
	Config 2, 5		CSI-RS.1.1 TDD	
	Config 3, 6		CSI-RS.2.1 TDD	
TRS configuration	Config 1, 4		TRS.1.1 FDD	
	Config 2, 5		TRS.1.1 TDD	
	Config 3, 6		TRS.1.2 TDD	
csi-RS-Index assigned as RLM RS	Config 1, 4		CSI-RS.1.2 FDD	
	Config 2, 5		CSI-RS.1.2 TDD	
	Config 3, 6		CSI-RS.2.2 TDD	
T310 Timer		ms	1000	
N310			2	
T1		s	1	During this time the UE shall be fully synchronized to cell 1
T2		s	8.37	
T3		s	6.44	
T4		s	0	
T5		s	1.97	
D1		s	1.93	
NOTE: UE-specific PDCCH is not transmitted after T1 starts.				

**Table 4.5.5.4.4.1-4: Void**

**Table 4.5.5.4.4.1-5: Void**

**Table 4.5.5.4.4.1-6: Void**

#### 4.5.5.5 EN-DC FR1 SCell CSI-RS-based beam failure detection and SSB-based link recovery in non-DRX

##### 4.5.5.5.1 Test purpose

The purpose of this test is to verify that the UE properly detects CSI-RS-based beam failure in the set  $q_0$  configured for a serving SCell and that the UE performs correct SSB-based link recovery based on beam candidate set  $q_1$ . The purpose is to test the downlink monitoring for beam failure detection within the UEs active DL BWP of the SCell without *schedulingRequestID-BFR-SCell-r16* configuration, during the evaluation period, and link recovery, when no DRX is used. This test will partly verify the beam failure detection and link recovery for an FR1 serving cell requirements in TS 38.133 [6] clause 8.5.

4.5.5.5.2 Test applicability

This test applies to all types of E-UTRA UE release 16 and forward supporting EN-DC FR1, CSI-RS based RLM, and SSB link recovery.

4.5.5.5.3 Minimum conformance requirements

The minimum conformance requirements are specified in clause 4.5.5.0.2.

The normative reference for this requirement is TS 38.133 [6] clause A.4.5.5.4.

4.5.5.5.4 Test description

The test consists of five successive time periods, with time duration of T1, T2, T3, T4 and T5 respectively. Figure 4.5.5.5.4-1 shows the SNR of the CSI-RS in set  $q_0$  in the active SCell to emulate beam failure. Figure 4.5.5.5.4-1 additionally shows the variation of the downlink L1-RSRP of the SSB in set  $q_1$  of the candidate beam used for link recovery.

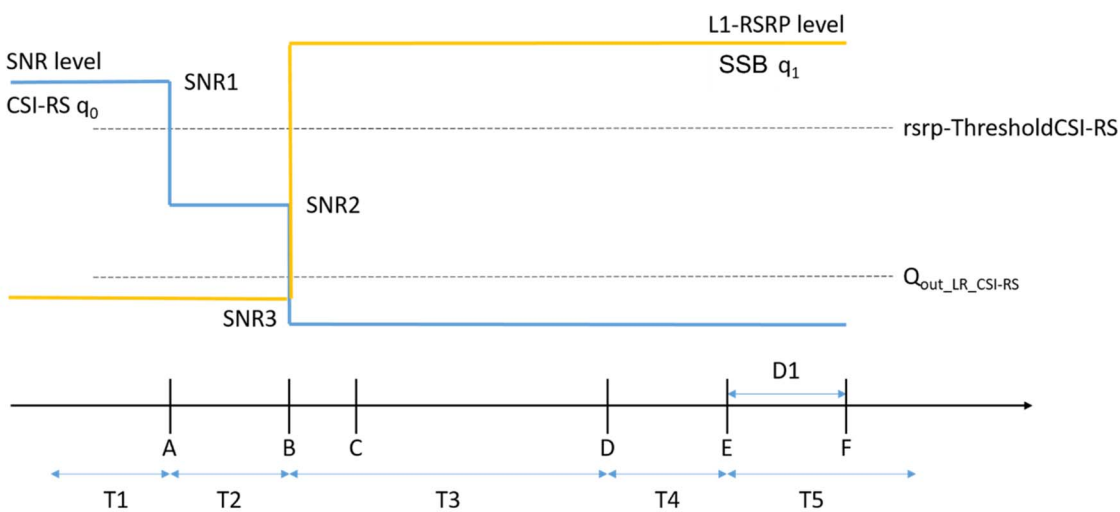

Figure 4.5.5.5.4-1: SNR and L1-RSRP variation for EN-DC FR1 CSI-RS-based beam failure detection and link recovery in DRX

4.5.5.5.4.1 Initial conditions

This test shall be tested using any of the test configurations in Table 4.5.5.4.1-1.

Table 4.5.5.5.4.1-1: Supported test configurations for EN-DC FR1 SCell CSI-RS-based beam failure detection and link recovery in DRX

Configuration	Description
4.5.5.5-1	LTE FDD, NR 15 kHz SSB SCS, 10 MHz bandwidth, FDD duplex mode
4.5.5.5-2	LTE FDD, NR 15 kHz SSB SCS, 10 MHz bandwidth, TDD duplex mode
4.5.5.5-3	LTE FDD, NR 30 kHz SSB SCS, 40 MHz bandwidth, TDD duplex mode
4.5.5.5-4	LTE TDD, NR 15 kHz SSB SCS, 10 MHz bandwidth, FDD duplex mode
4.5.5.5-5	LTE TDD, NR 15 kHz SSB SCS, 10 MHz bandwidth, TDD duplex mode
4.5.5.5-6	LTE TDD, NR 30 kHz SSB SCS, 40 MHz bandwidth, TDD duplex mode
Note:	The UE is only required to pass in one of the supported test configurations in FR1

Configure the test equipment and the DUT according to the parameters in Table 4.5.5.5.4.1-2.

**Table 4.5.5.4.1-2: Initial conditions for EN-DC FR1 Scell CSI-RS-based beam failure detection and link recovery in DRX**

Parameter	Value		Comment
Test environment	NC		As specified in TS 38.508-1 [14] clause 4.1.
Test frequencies	As specified in Annex E, table E.2-1 and TS 38.508-1 [14] clause 4.3.1 and 4.4.2.		
Channel bandwidth	As specified by the test configuration selected from Table 4.5.5.4.1-1.		
Propagation conditions	AWGN		As specified in Annex C.2.2.
Connection Diagram	TE Part	A.3.1.7.1	As specified in TS 38.508-1 [14] Annex A.
	DUT Part	A.3.2.3.4	
Exceptions to connection diagram	For 4Rx capable UEs without any 2Rx RF bands use A.3.2.5.2 for DUT part and A.3.1.8.4 for TE Part		

1. The general test parameter settings are set up according to Table 4.5.5.4.1-3.
2. Message contents are defined in clause 4.5.5.4.3.
3. Cell 1 is the E-UTRA serving cell (PCell) for the EN-DC setup. The power levels and settings for Cell 1 are set according to Annex A.6. Cell 2 is the NR cell (PSCell) and Cell 3 is the NR cell (SCell) with the power level set according to Annex C.1.2 and C.1.3 for this test

**Table 4.5.5.4.1-3: General test parameters for EN-DC FR1 CSI-RS-based beam failure detection and link recovery in DRX**

Parameter	Unit	Value		Comment
		Test 1		
Active PCell		Cell 1		
E-UTRA RF Channel Number		1		
Active PSCell		Cell 2		
RF Channel Number for PSCell		2		
Active SCell		Cell 3		
RF Channel Number for SCell		3		
Duplex mode	Config 1, 4	FDD		
	Config 2, 3, 5, 6	TDD		
BW channel	Config 1, 4	MHz	10: NRB,c = 52	
	Config 2, 5		10: NRB,c = 52	
	Config 3, 6		40: NRB,c = 106	
DL initial BWP configuration	Config 1, 2, 3, 4, 5, 6		DLBWP.0.1	
DL dedicated BWP configuration	Config 1, 2, 3, 4, 5, 6		DLBWP.1.1	
UL initial BWP configuration	Config 1, 2, 3, 4, 5, 6		ULBWP.0.1	
UL dedicated BWP configuration	Config 1, 2, 3, 4, 5, 6		ULBWP.1.1	
TDD Configuration	Config 1, 4	Not Applicable		
	Config 2, 5	TDDConf.1.1		
	Config 3, 6	TDDConf.2.1		
CORESET Reference Channel	Config 1, 4	CR.1.1 FDD		A. 1.2
	Config 2, 5	CR.1.1 TDD		
	Config 3, 6	CR.2.1 TDD		
SSB Configuration	Config 1, 4	SSB.1 FR1		A.3
	Config 2, 5	SSB.1 FR1		
	Config 3, 6	SSB.2 FR1		
SMTC Configuration	Config 1, 2, 3, 4, 5, 6		SMTC.1	A.4

PDSCH/PDCCH subcarrier spacing	Config 1, 2, 4, 5	kHz	15	
	Config 3, 6		30	
PRACH Configuration	Config 1, 2, 4, 5		PRACH.2 FR1	Table A.7.1-1
	Config 3, 6		PRACH.2 FR1	Table A.7.1-1
csi-RS-Index assigned as beam failure detection RS in set $q_0$ in activated SCell			0	
OCNG parameters			OP.1	A.2.1
CP length			Normal	
Correlation Matrix and Antenna Configuration			2x2 Low	
Beam failure detection transmission parameters	DCI format		1-0	
	Number of Control OFDM symbols		2	
	Aggregation level	CCE	8	
	Ratio of hypothetical PDCCH RE energy to average CSI-RS RE energy	dB	0	
	Ratio of hypothetical PDCCH DMRS energy to average CSI-RS RE energy	dB	0	
	DMRS precoder granularity		REG bundle size	
REG bundle size			6	
DRX			OFF	
Gap pattern ID			N.A.	
schedulingRequestID-BFR-SCell-r16			absent	When the field is absent, the random access procedure will be triggered for SCell BFR
SSB Index assigned as CBD RS ( $q_1$ ) in activated SCell			0	
rlmInSyncOutOfSyncThreshold			absent	When the field is absent, the UE applies the value 0. (TS 38.133 [6] Table 8.1.1-1).
rsrp-ThresholdBFRSSB	Config 1, 2, 4, 5	dBm/SCS kHz	-98	Threshold used for $Q_{in\_LR\_SSB}$
	Config 3, 6		-95	
powerControlOffsetSS			db0	Used for deriving rsrp-ThresholdCSI-RS
beamFailureInstanceMaxCount			n1	see TS 38.321 [7], clause 5.17
beamFailureDetectionTimer			pbfd4	see TS 38.321 [7], clause 5.17
CSI-RS configuration for $q_0$ in activated SCell	Config 1, 4		CSI-RS.1.2 FDD	A.1.4
	Config 2, 5		CSI-RS.1.2 TDD	
	Config 3, 6		CSI-RS.2.2 TDD	
CSI-RS configuration for CSI reporting	Config 1, 4		CSI-RS.1.1 FDD	A.1.4
	Config 2, 5		CSI-RS.1.1 TDD	
	Config 3, 6		CSI-RS.2.1 TDD	
TRS configuration	Config 1, 4		TRS.1.1 FDD	
	Config 2, 5		TRS.1.1 TDD	
	Config 3, 6		TRS.1.2 TDD	

csi-RS-Index assigned as RLM RS in PSCell	Config 1, 4		CSI-RS.1.2 FDD	A.1.4
	Config 2, 5		CSI-RS.1.2 TDD	
	Config 3, 6		CSI-RS.2.2 TDD	
T310 Timer		ms	1000	
N310			2	
T1		s	1	During this time the UE shall be fully synchronized to cell 1
T2		s	0.18	
T3		s	0.14	
T4		s	0	
T5		s	0.17	
D1		s	0.13	
Note 1: UE-specific PDCCH is not transmitted after T1 starts.				

#### 4.5.5.5.4.2 Test procedure

Same test procedure as described in section 4.5.5.3.4.2, except following exception and steps 7 and 8:

Prior to the start of the time duration T1, the UE shall be fully synchronized to cell 1, cell 2 and cell 3. The UE shall be configured for periodic CSI reporting with a reporting periodicity of 5 ms. In the test, DRX configuration is not enabled.

##### 7. If the SS:

- a) detects uplink power on the PCell equal to or higher than minimum output power defined in TS 38.521-1 [17] clause 6.3.1.5 in each slot configured for CSI transmission (according CSI reporting on PUCCH) during the period from time point A to time point B

and

- b) does not detect preamble on the PCell before time point B

and

- c) detects preamble on the preconfigured PRACH resource before time point F (D1 after the start of T5).

And

- d) SS transmits a RAR to UE after receiving the preamble transmitted by the UE. SS detects the MAC-CE on the PCell transmitted by the UE providing the index for the activated SCell, and the index for the SSB provided by higher layer.

the number of successful tests is increased by one.

Otherwise the number of failed tests is increased by one.

8. If the iteration or random access procedure for BFD fails, the SS shall first attempt to release and add the FR1 SCell, by ensuring the UE is in state RRC\_CONNECTED with generic procedure parameters *Connectivity* EN-DC, DC bearer MCG and SCG, Connected without release *On* and Test Mode *On* according to TS 38.508-1 [6] clause 4.5. If that also fails, then the UE is switched OFF/ON to proceed with the next iteration.

#### 4.5.5.5.4.3 Message contents

Same message contents as described in section 4.5.5.3.4.3 with following exceptions:



**Table 4.5.5.4.3-1: Common Exception messages for EN-DC FR1 CSI-RS-based beam failure detection and link recovery in non-DRX**

Default Message Contents	
Common contents of system information blocks exceptions	
Default RRC messages and information elements contents exceptions	Table H.3.1-10 with Condition SSB CBD

4.5.5.5.5 Test requirements

**Table 4.5.5.5.5-1: Cell specific test parameters for FR1 PSCell and SCell for beam failure detection and link recovery testing in non-DRX mode**

Parameter	Unit	Cell2	Test 1 Cell3					
		T1 to T5	T1	T2	T3	T4	T5	
EPRE ratio of PDCCH DMRS to SSS	dB	0	0	0	0	0	0	
EPRE ratio of PDCCH to PDCCH DMRS	dB							
EPRE ratio of PBCH DMRS to SSS	dB							
EPRE ratio of PBCH to PBCH DMRS	dB							
EPRE ratio of PSS to SSS	dB							
EPRE ratio of PDSCH DMRS to SSS	dB							
EPRE ratio of PDSCH to PDSCH DMRS	dB							
EPRE ratio of OCNG DMRS to SSS	dB							
EPRE ratio of OCNG to OCNG DMRS	dB							
SNR_SSB of set q <sub>0</sub>	Config 1, 4	dB	5.8	5.8	-2.2	-12.8	-12.8	-12.8
	Config 2, 5	dB	5.8	5.8	-2.2	-12.8	-12.8	-12.8
	Config 3, 6	dB	5.8	5.8	-2.2	-12.8	-12.8	-12.8
SNR_CSI-RS of set q <sub>1</sub>	Config 1, 4	dB	-10.2	-10.2	-10.2	10.2	10.2	10.2
	Config 2, 5	dB	-10.2	-10.2	-10.2	10.2	10.2	10.2
	Config 3, 6	dB	-10.2	-10.2	-10.2	10.2	10.2	10.2
SSB_RP of set q <sub>1</sub>	Config 1, 4	dBm/SCS kHz	-108.2	-	-108.2	-87.8	-87.8	-87.8
	Config 2, 5	dBm/SCS kHz	-108.2	-	-108.2	-87.8	-87.8	-87.8
	Config 3, 6	dBm/SCS kHz	-105.2	-	-105.2	-84.8	-84.8	-84.8
$N_{oc}$	Config 1, 4	dBm/15 kHz	-98	-	-98	-98	-98	-98
	Config 2, 5	dBm/15 kHz	-98	-	-98	-98	-98	-98
	Config 3, 6	dBm/15 kHz	-98	-	-98	-98	-98	-98
Propagation condition		TDL-C 300ns 100Hz	TDL-C 300ns 100Hz					

- Note 1: OCNG shall be used such that the resources in Cell 1 are fully allocated and a constant total transmitted power spectral density is achieved for all OFDM symbols.
- Note 2: The uplink resources for CSI reporting are assigned to the UE prior to the start of time period T1.
- Note 3: NZP CSI-RS resource set configuration for CSI reporting are assigned to the UE prior to the start of time period T1.
- Note 4: Void
- Note 5: The timers and layer 3 filtering related parameters are configured prior to the start of time period T1.
- Note 6: The signal contains PDCCH for UEs other than the device under test as part of OCNG.
- Note 7: SNR levels correspond to the signal to noise ratio over the REs carrying CSI-RS.
- Note 8: The SNR in time periods T1, T2, T3, T4 and T5 is denoted as SNR1, SNR2 and SNR3 respectively in figure A.4.5.5.1.1-1.
- Note 9: The SNR values are specified for testing a UE which supports 2RX on at least one band. For testing of a UE which supports 4RX on all bands, the SNR during T3 is modified as specified in clause [A.3.6].

The UE behaviour during time durations T1, T2, T3, T4 and T5 shall be as follows:

During the time duration T1 and T2, the UE shall transmit uplink signal at least in all subframes configured for CSI transmission on Cell 2.

During the period from time point A to time point B the UE shall transmit uplink signal in Cell 2 in all uplink slots configured for CSI transmission according to the configured periodic CSI reporting for Cell 2.

During T3 the UE shall detect beam failure and initiate link recovery. During T4 and T5 the UE measures and evaluate beam candidate from beam candidate set  $q_1$ .

No later than time point F occurring no later than  $D1 = 120+10$  ms after the start of T5, the UE shall transmit preamble for UL-SCH resource application, followed by MAC-CE on the assigned uplink resources containing a beam associated with the candidate beam set  $q_1$ . The UE shall not transmit preamble earlier than time point B.

During T5, the System Simulator shall transmit a Random Access Response to UE after the System Simulator receives the preamble from UE. The UE shall transmit the msg.3 containing candidate beam set  $q_1$  for SCell BFR if UE receives the Random Access Response.

Test is concluded once the test equipment has received the initial preamble transmission from the UE. The rate of correct events observed during repeated tests shall be at least 90%.

#### 4.5.5.6 EN-DC FR1 Scell CSI-RS-based beam failure detection and SSB-based link recovery in DRX

##### 4.5.5.6.1 Test purpose

The purpose of this test is to verify that the UE properly detects CSI-RS based beam failure in the set  $q_0$  configured for a serving SCell and that the UE performs correct SSB-based link recovery based on beam candidate set  $q_1$ . The purpose is to test the downlink monitoring for beam failure detection within the UEs active DL BWP of the SCell without *schedulingRequestID-BFR-SCell-r16* configuration, during the evaluation period, and link recovery, when DRX is used. This test will partly verify the beam failure detection and link recovery for an FR1 serving cell requirements in TS 38.133 [6] clause 8.5.

##### 4.5.5.6.2 Test applicability

This test applies to all types of E-UTRA UE release 16 and forward supporting EN-DC FR1, CSI-RS based RLM, and SSB link recovery and long DRX cycle.

##### 4.5.5.6.3 Minimum conformance requirements

The minimum conformance requirements are specified in clause 4.5.5.0.2.

The normative reference for this requirement is TS 38.133 [6] clause A.4.5.5.4.

##### 4.5.5.6.4 Test description

The test consists of five successive time periods, with time duration of T1, T2, T3, T4 and T5 respectively. Figure 4.5.5.6.4.1-1 shows the SNR of the CSI-RS in set  $q_0$  in the active SCell to emulate beam failure. Figure 4.5.5.6.4.1-1 additionally shows the variation of the downlink L1-RSRP of the CSI-RS in set  $q_1$  of the candidate beam used for link recovery.

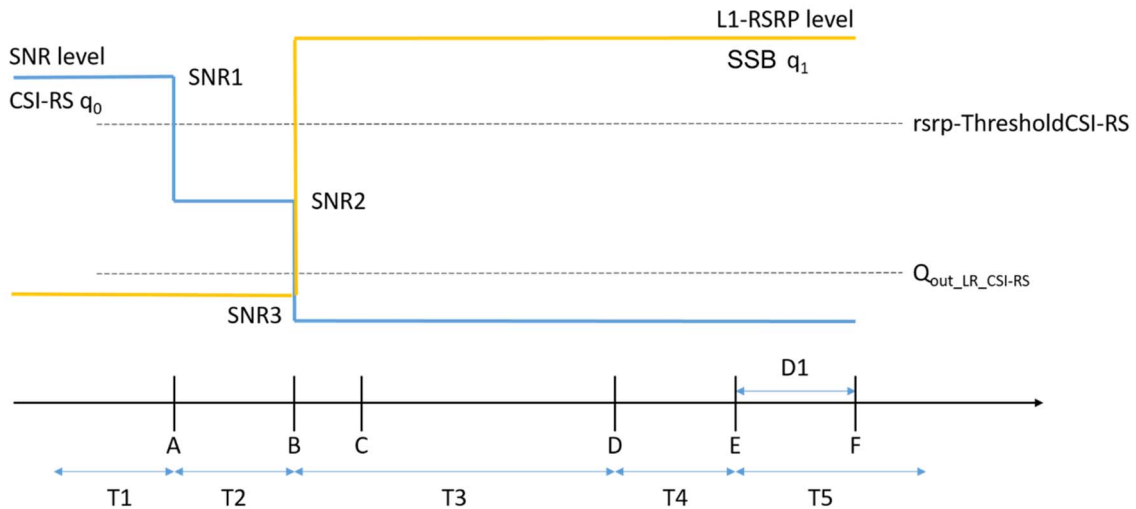

**Figure 4.5.5.6.4.1-1: SNR and L1-RSRP variation for beam failure detection and LR testing for SCell in DRX mode**

4.5.5.6.4.1 Initial conditions

This test shall be tested using any of the test configurations in Table 4.5.5.6.4.1-1.

**Table 4.5.5.6.4.1-1: Supported test configurations for FR1 PCell and SCell**

Configuration	Description
4.5.5.6-1	LTE FDD, NR 15 kHz SSB SCS, 10 MHz bandwidth, FDD duplex mode
4.5.5.6-2	LTE FDD, NR 15 kHz SSB SCS, 10 MHz bandwidth, TDD duplex mode
4.5.5.6-3	LTE FDD, NR 30 kHz SSB SCS, 40 MHz bandwidth, TDD duplex mode
4.5.5.6-4	LTE TDD, NR 15 kHz SSB SCS, 10 MHz bandwidth, FDD duplex mode
4.5.5.6-5	LTE TDD, NR 15 kHz SSB SCS, 10 MHz bandwidth, TDD duplex mode
4.5.5.6-6	LTE TDD, NR 30 kHz SSB SCS, 40 MHz bandwidth, TDD duplex mode
Note: The UE is only required to pass in one of the supported test configurations in FR1	

Configure the test equipment and the DUT according to the parameters in Table 4.5.5.6.4.1-2.

**Table 4.5.5.6.4.1-2: Initial conditions for EN-DC FR1 SCell CSI-RS-based beam failure detection and link recovery in DRX**

Parameter	Value		Comment
Test environment	NC		As specified in TS 38.508-1 [14] clause 4.1.
Test frequencies	As specified in Annex E, table E.2-1 and TS 38.508-1 [14] clause 4.3.1 and 4.4.2.		
Channel bandwidth	As specified by the test configuration selected from Table 4.5.5.4.4.1-1.		
Propagation conditions	AWGN		As specified in Annex C.2.2.
Connection Diagram	TE Part	A.3.1.7.1	As specified in TS 38.508-1 [14] Annex A.
	DUT Part	A.3.2.3.4	
Exceptions to connection diagram	For 4Rx capable UEs without any 2Rx RF bands use A.3.2.5.2 for DUT part and A.3.1.8.4 for TE Part		

1. The general test parameter settings are set up according to Table 4.5.5.6.4.1-3.
2. Message contents are defined in clause 4.5.5.6.4.3.

3. Cell 1 is the E-UTRA serving cell (PCell) for the EN-DC setup. The power levels and settings for Cell 1 are set according to Annex A.6. Cell 2 is the NR cell (PSCell) and Cell 3 is the NR cell (SCell) with the power level set according to Annex C.1.2 and C.1.3 for this test

**Table 4.5.5.6.4.1-3: General test parameters for FR1 SCell for beam failure detection and link recovery testing in DRX mode**

Parameter		Unit	Value	Comment
			Test 1	
Active PCell			Cell 1	
E-UTRA RF Channel Number			1	
Active PSCell			Cell 2	
RF Channel Number for PSCell			2	
Active SCell			Cell 3	
RF Channel Number for SCell			3	
Duplex mode	Config 1, 4		FDD	
	Config 2, 3, 5, 6		TDD	
BWchannel	Config 1, 4	MHz	10: NRB,c = 52	
	Config 2, 5		10: NRB,c = 52	
	Config 3, 6		40: NRB,c = 106	
DL initial BWP configuration	Config 1, 2, 3, 4, 5, 6		DLBWP.0.1	
DL dedicated BWP configuration	Config 1, 2, 3, 4, 5, 6		DLBWP.1.1	
UL initial BWP configuration	Config 1, 2, 3, 4, 5, 6		ULBWP.0.1	
UL dedicated BWP configuration	Config 1, 2, 3, 4, 5, 6		ULBWP.1.1	
TDD Configuration	Config 1, 4		Not Applicable	
	Config 2, 5		TDDConf.1.1	
	Config 3, 6		TDDConf.2.1	
CORESET Reference Channel	Config 1, 4		CR.1.1 FDD	A.1.2
	Config 2, 5		CR.1.1 TDD	
	Config 3, 6		CR.2.1 TDD	
SSB Configuration	Config 1, 4		SSB.1 FR1	A.3
	Config 2, 5		SSB.1 FR1	
	Config 3, 6		SSB.2 FR1	
SMTC Configuration	Config 1, 2, 3, 4, 5, 6		SMTC.1	A.4
PDSCH/PDCCH subcarrier spacing	Config 1, 2, 4, 5	kHz	15	
	Config 3, 6		30	
PRACH Configuration	Config 1, 2, 4, 5		PRACH.2 FR1	
	Config 3, 6		PRACH.2 FR1	
csi-RS-Index assigned as beam failure detection RS in set $q_0$ in activated SCell			0	
OCNG parameters			OP.1	A.2.1
CP length			Normal	
Correlation Matrix and Antenna Configuration			2x2 Low	
Beam failure detection transmission parameters	DCI format		1-0	
	Number of Control OFDM symbols		2	
	Aggregation level	CCE	8	
	Ratio of hypothetical PDCCH RE energy to average CSI-RS RE energy	dB	0	

	Ratio of hypothetical PDCCH DMRS energy to average CSI-RS RE energy	dB	0	
	DMRS precoder granularity		REG bundle size	
	REG bundle size		6	
DRX			DRX.7	A.5
Gap pattern ID			N.A.	
schedulingRequestID-BFR-SCell-r16			absent	When the field is absent, the random access procedure will be triggered for SCell BFR
SSB Index assigned as CBD RS (q1) in activated SCell			1	
rlmInSyncOutOfSyncThreshold			absent	When the field is absent, the UE applies the value 0. ((TS 38.133 [6] Table 8.1.1-1).
rsrp-ThresholdBFR	Config 1, 2, 4, 5	dBm/SCS	-98	Threshold used for $Q_{in\_LR\_SSB}$
	Config 3, 6		-95	
powerControlOffsetSS			db0	Used for deriving rsrp-ThresholdCSI-RS
beamFailureInstanceMaxCount			n1	see TS 38.321 [7], clause 5.17
beamFailureDetectionTimer			pbfd4	see TS 38.321 [7], clause 5.17
CSI-RS configuration for $q_0$ in activated SCell	Config 1, 4		CSI-RS.1.2 FDD	A.1.4
	Config 2, 5		CSI-RS.1.2 TDD	
	Config 3, 6		CSI-RS.2.2 TDD	
CSI-RS configuration for CSI reporting	Config 1, 4		CSI-RS.1.1 FDD	A.1.4
	Config 2, 5		CSI-RS.1.1 TDD	
	Config 3, 6		CSI-RS.2.1 TDD	
TRS configuration	Config 1, 4		TRS.1.1 FDD	
	Config 2, 5		TRS.1.1 TDD	
	Config 3, 6		TRS.1.2 TDD	
csi-RS-Index assigned as RLM RS in PSCell	Config 1, 4		CSI-RS.1.2 FDD	A.1.4
	Config 2, 5		CSI-RS.1.2 TDD	
	Config 3, 6		CSI-RS.2.2 TDD	
T310 Timer		ms	1000	
N310			2	

T1	s	1	During this time the UE shall be fully synchronized to cell 1
T2	s	8.37	
T3	s	6.44	
T4	s	0	
T5	s	1.97	
D1	s	1.93	
Note 1: UE-specific PDCCH is not transmitted after T1 starts.			

#### 4.5.5.6.4.2 Test procedure

Same test procedure as described in section 4.5.5.4.4.2, except following exception and steps 7 and 8:

Prior to the start of the time duration T1, the UE shall be fully synchronized to Cell 1, Cell 2 and Cell 3. The UE shall be configured for periodic CSI reporting with a reporting periodicity of 5 ms. In the test, DRX configuration is enabled in PCell and DRX inactivity timer has already been expired, i.e. UE tries to decode PDCCH and to send periodic CQI during the period when On-duration timer is running. Time alignment timers shall be set to “infinity” so that UL timing alignment is maintained during the test.

##### 7. If the SS:

- a) detects uplink power on the PCell equal to or higher than minimum output power defined in TS 38.521-1 [17] clause 6.3.1.5 in each slot configured for CSI transmission (according CSI reporting on PUCCH) during the period from time point A to time point B

and

- b) does not detect preamble on the PCell before time point B

and

- c) detects preamble on the preconfigured PRACH resource before time point F (D1 after the start of T5).

And

- d) SS transmits a RAR to UE after receiving the preamble transmitted by the UE. SS detects the MAC-CE on the PCell transmitted by the UE providing the index for the activated SCell, and the index for the SSB provided by higher layer.

the number of successful tests is increased by one.

Otherwise the number of failed tests is increased by one.

- 8. If the iteration or random access procedure for BFD fails, the SS shall first attempt to release and add the FR1 SCell, by ensuring the UE is in state RRC\_CONNECTED with generic procedure parameters *Connectivity* EN-DC, DC bearer MCG and SCG, Connected without release *On* and Test Mode *On* according to TS 38.508-1 [6] clause 4.5. If that also fails, then the UE is switched OFF/ON to proceed with the next iteration.

#### 4.5.5.6.4.3 Message contents

Same message contents as described in section 4.5.5.4.4.3 with following exceptions:



**Table 4.5.5.6.4.3-1: Common Exception messages for EN-DC FR1 CSI-RS-based beam failure detection and link recovery in DRX**

<b>Default Message Contents</b>	
Common contents of system information blocks exceptions	
Default RRC messages and information elements contents exceptions	Table H.3.1-10 with Condition SSB CBD

#### 4.5.5.6.5 Test requirement

Tables 4.5.5.6.4.1-3 and 4.5.5.6.5-1 define the primary level settings including test tolerances for EN-DC FR1 CSI-RS-based beam failure detection and link recovery in DRX.

**Table 4.5.5.6.5-1: Cell specific test parameters for FR1 SCell for beam failure detection and link recovery testing in DRX mode**

Parameter		Unit	Cell2	Test 1 Cell3				
			T1 to T5	T1	T2	T3	T4	T5
EPRE ratio of PDCCH DMRS to SSS		dB	0	0				
EPRE ratio of PDCCH to PDCCH DMRS								
EPRE ratio of PBCH DMRS to SSS								
EPRE ratio of PBCH to PBCH DMRS								
EPRE ratio of PSS to SSS								
EPRE ratio of PDSCH DMRS to SSS								
EPRE ratio of PDSCH to PDSCH DMRS								
EPRE ratio of OCNG DMRS to SSS								
EPRE ratio of OCNG to OCNG DMRS								
SNR_SSB of set $q_0$	Config 1, 4	dB	5.8	5.8	-2.2	-12.8	-12.8	-12.8
	Config 2, 5		5.8	5.8	-2.2	-12.8	-12.8	-12.8
	Config 3, 6		5.8	5.8	-2.2	-12.8	-12.8	-12.8
SNR_CSI-RS of set $q_1$	Config 1, 4	dB	-10.2	-10.2	-10.2	10.2	10.2	10.2
	Config 2, 5		-10.2	-10.2	-10.2	10.2	10.2	10.2
	Config 3, 6		-10.2	-10.2	-10.2	10.2	10.2	10.2
SSB_RP of set $q_1$	Config 1, 4	dBm/SCS kHz	-108.2	-108.2	-108.2	-87.8	-87.8	-87.8
	Config 2, 5		-108.2	-108.2	-108.2	-87.8	-87.8	-87.8
	Config 3, 6		-105.2	-105.2	-105.2	-84.8	-84.8	-84.8
$N_{oc}$	Config 1, 4	dBm/ 15 kHz	-98	-98				
	Config 2, 5		-98	-98				
	Config 3, 6		-98	-98				
Propagation condition			TDL-C 300ns 100Hz	TDL-C 300ns 100Hz				
<p>Note 1: OCNG shall be used such that the resources in Cell 1 are fully allocated and a constant total transmitted power spectral density is achieved for all OFDM symbols.</p> <p>Note 2: The uplink resources for CSI reporting are assigned to the UE prior to the start of time period T1.</p> <p>Note 3: NZP CSI-RS resource set configuration for CSI reporting are assigned to the UE prior to the start of time period T1.</p> <p>Note 4: Void</p> <p>Note 5: The timers and layer 3 filtering related parameters are configured prior to the start of time period T1.</p> <p>Note 6: The signal contains PDCCH for UEs other than the device under test as part of OCNG.</p> <p>Note 7: SNR levels correspond to the signal to noise ratio over the REs carrying CSI-RS.</p> <p>Note 8: The SNR in time periods T1, T2, T3, T4 and T5 is denoted as SNR1, SNR2 and SNR3 respectively in figure A.4.5.5.1.1-1.</p> <p>Note 9: The SNR values are specified for testing a UE which supports 2RX on at least one band. For testing of a UE which supports 4RX on all bands, the SNR during T3 is modified as specified in clause A.3.6.</p>								

The UE behaviour during time durations T1, T2, T3, T4 and T5 shall be as follows:

During the time duration T1 and T2, the UE shall transmit uplink signal at least in all subframes configured for CSI transmission on Cell 2.

During the period from time point A to time point B the UE shall transmit uplink signal in Cell 2 in all uplink slots configured for CSI transmission according to the configured periodic CSI reporting for Cell 2.

During T3 the UE shall detect beam failure and initiate link recovery. During T4 and T5 the UE measures and evaluate beam candidate from beam candidate set  $q_1$ .

No later than time point F occurring no later than  $D1 = 120 + 10$  ms after the start of T5, the UE shall transmit preamble for UL-SCH resource application, followed by MAC-CE on the assigned uplink resources containing a beam associated with the candidate beam set  $q_1$ . The UE shall not transmit preamble earlier than time point B.

During T5, the System Simulator shall transmit a Random Access Response to UE after the System Simulator receives the preamble from UE. The UE shall transmit the msg.3 containing candidate beam set  $q_1$  for SCell BFR if UE receives the Random Access Response.

Test is concluded once the test equipment has received the initial preamble transmission from the UE. The rate of correct events observed during repeated tests shall be at least 90%.

## 4.5.6 Active BWP switch delay

### 4.5.6.1 DCI-based and time-based active BWP switch

#### 4.5.6.1.0 Minimum conformance requirements

##### 4.5.6.1.0.1 Minimum conformance requirements for DCI-based and time-based active BWP switch

For DCI-based BWP switch, after the UE receives BWP switching request at DL slot  $n$  on a serving cell, UE shall be able to receive PDSCH (for DL active BWP switch) or transmit PUSCH (for UL active BWP switch) on the new BWP on the serving cell on which BWP switch on the first DL or UL slot occurs right after a time duration of  $T_{\text{BWPswitchDelay}}$  which starts from the beginning of DL slot  $n$ .

The UE is not required to transmit UL signals or receive DL signals until the first DL or UL slot occurs right after a time duration of  $T_{\text{BWPswitchDelay}}$  which starts from the beginning of DL slot  $n$  except DCI triggering BWP switch on the cell where DCI-based BWP switch occurs. The UE is not required to follow the requirements defined in this clause when performing a DCI-based BWP switch between the BWPs in disjoint channel bandwidths or in partially overlapping channel bandwidths.

For timer-based BWP switch, the UE shall start BWP switch at DL slot  $n$ , where slot  $n$  is the first slot of a DL subframe (FR1) or DL half-subframe (FR2) immediately after a BWP-inactivity timer *bwp-InactivityTimer* [13] expires on a serving cell, and the UE shall be able to receive PDSCH (for DL active BWP switch) or transmit PUSCH (for UL active BWP switch) on the new BWP on the serving cell on which BWP switch on the first DL or UL slot occurs right after a time duration of  $T_{\text{BWPswitchDelay}}$  which starts from the beginning of DL slot  $n$ .

The UE is not required to transmit UL signals or receive DL signals during time duration  $T_{\text{BWPswitchDelay}}$  after *bwp-InactivityTimer* [13] expires on the cell where timer-based BWP switch occurs.

Depending on UE capability *bwp-SwitchingDelay* [13], UE shall finish BWP switch within the time duration  $T_{\text{BWPswitchDelay}}$  defined in Table 4.5.6.1.0.1-1.

**Table 4.5.6.1.0.1-1: BWP switch delay**

$\mu$	NR Slot length (ms)	BWP switch delay $T_{\text{BWPswitchDelay}}$ (slots)	
		Type 1 <sup>Note 1</sup>	Type 2 <sup>Note 1</sup>
0	1	1	3
1	0.5	2	5
2	0.25	3	9
3	0.125	6	18

NOTE 1: Depends on UE capability.  
NOTE 2: If the BWP switch involves changing of SCS, the BWP switch delay is determined by the smaller SCS between the SCS before BWP switch and the SCS after BWP switch.

Provided the UE does not have the required TCI-state information to receive PDCCH and PDSCH in the new BWP, the UE shall use old TCI-states before the BWP switch until a new MAC CE updating the required TCI-state information for PDCCH and PDSCH is received after the BWP switch.

If UE has the information on the required TCI-state information to receive PDCCH and PDSCH in the new BWP:

- UE shall be able to receive PDCCH and PDSCH with old TCI-states before the delay as specified in TS 38.133 [6] Clause 8.10 in the new BWP.
- UE shall be able to receive PDCCH and PDSCH with new TCI-states after the delay as specified in TS 38.133 [6] Clause 8.10 in the new BWP.

If the BWP switch is triggered within DRX active time, and one of the two BWPs in a BWP switching is a dormant BWP [TS 38.321, 12], UE shall be able to complete active BWP switching within:

- $T_{\text{BWPswitchDelay}}$ , provided that the BWP switching request is received in any of the first 3 OFDM symbols of a slot corresponding to the serving cell where BWP switching occurs, or
- $T_{\text{BWPswitchDelay}} + 1$ , provided that the BWP switching request is received after the first 3 OFDM symbols of a slot corresponding to the serving cell where BWP switching occurs

When either of the DCI-based, timer-based or RRC-based downlink BWP switch and/or uplink BWP switch occur on multiple CCs simultaneously or over partially overlapping period, the interruption requirements described in this section apply for each BWP switch.

When UE receives a DCI indicating UE to switch its active BWP involving changes in any of the parameters listed in Table 4.5.6.1.0.1-3, the UE is allowed to cause interruption of up to X slot to other active serving cells if the UE is not capable of per-FR gap, or if the BWP switching involves SCS changing. When the BWP switch imposes changes in any of the parameters listed in Table 4.5.6.1.0.1-3 and the UE is capable of per-FR gap, the UE is allowed to cause interruption of up to X slot to other active serving cells in the same frequency range wherein the UE is performing BWP switching. X is defined in Table 4.5.6.1.0.1-2. The starting time of interruption is only allowed within the BWP switching delay  $T_{\text{BWPswitchDelay}}$  as defined in TS 38.133 [6] clause 8.6.2. Interruptions are not allowed during BWP switch involving any other parameter change.

When a BWP timer *bwp-InactivityTimer* defined in TS 38.331 [13] expires, UE is allowed to cause interruption of up to X slot to other active serving cells due to switching its active BWP involving changes in any of the parameters listed in Table 4.5.6.1.0.1-3 if the UE is not capable of per-FR gap, or if the BWP switching involves SCS changing. When the BWP switch imposes changes in any of the parameters listed in Table 4.5.6.1.0.1-3 and the UE is capable of per-FR gap, the UE is allowed to cause interruption of up to X slot to other active serving cells in the same frequency range wherein the UE is performing BWP switching. X is defined in Table 4.5.6.1.0.1-2. The starting time of interruption is only allowed within the BWP switching delay  $T_{\text{BWPswitchDelay}}$  as defined in TS 38.133 [6] clause 8.6.2. Interruptions are not allowed during BWP switch involving any other parameter change.

**Table 4.5.6.1.0.1-2: interruption length X**

$\mu$	NR Slot length (ms)	Interruption length X (slots)
0	1	1
1	0.5	1
2	0.25	3
3	0.125	5
NOTE: Void.		

**Table 4.5.6.1.0.1-3: Parameters which cause interruption other than SCS**

Parameters	Comment
<i>locationAndBandwidth</i>	From TS 38.331 [13]
<i>nrofSRS-Ports</i>	
<i>maxMIMO-Layers-r16</i>	

When either of the DCI-based, timer-based or RRC-based downlink BWP switch and/or uplink BWP switch occur on multiple CCs simultaneously or over partially overlapping period, the interruption requirements described in this section apply for each BWP switch.

DCI-based or timer-based downlink BWP and/or uplink BWP switching due to change in any of the parameters listed in Table 8.2.1.2.7-2 of TS 38.133 [6] or SCS in NR PCell or in any NR SCell may cause an interruption on PCell or on activated SCell(s) in the MCG. Interruptions are not allowed during BWP switch involving other parameter change.

Uplink BWP switching on a NR PSCell triggered by consistent uplink LBT failures on the NR PSCell may cause an interruption on PCell or on activated SCell(s) in the MCG.

The starting time of interruption due to DCI-based or timer-based downlink BWP and/or uplink BWP switching or due to uplink BWP switching on a NR PSCell triggered by consistent uplink LBT failures on the NR PSCell is only allowed within the BWP switching delay  $T_{\text{BWPswitchDelay}}$  as defined in clause 8.6.2 of TS 38.133 [6].

RRC-based downlink BWP and/or uplink BWP switching due to change in any of the parameters listed in Table 8.2.1.2.7-2 of TS 38.133 [6] or SCS in NR PSCell or in any NR SCell may cause an interruption on PCell or on activated SCell(s) in the MCG. Interruptions are not allowed during BWP switch involving other parameter change.

The interruption due to RRC-based downlink BWP and/or uplink BWP switching is allowed anywhere within the BWP switching delay ( $T_{\text{RRCprocessingDelay}} + T_{\text{BWPswitchDelayRRC}}$ ) defined in clause 8.6.3 of TS 38.133 [6]. The interruption due to RRC-based downlink BWP and/or uplink BWP switching defined in this clause is applicable provided that:

- the RRC reconfiguration requires the UE to only switch its active BWP; and
- the BWP switching occurs on only one NR serving cell.

When BWP switch involves SCS changes:

- the UE is allowed to cause interruption on PCell or on any activated SCell(s) regardless of the frequency range of the NR PCell or NR SCell on which the BWP switching occurs.

Otherwise:

- the UE capable of per UE measurement gap [29] is allowed to cause interruption on PCell or on any activated SCell(s) regardless of the frequency range of the NR PSCell or NR SCell on which the BWP switching occurs;
- the UE capable of per FR measurement gap [29] is allowed to cause interruption on PCell or on any activated SCell(s) provided that the NR PSCell or NR SCell on which the BWP switching occurs belongs to FR1.

The interruption on PCell or on any activated SCell(s) shall not exceed:

- 1 subframe in synchronous EN-DC;
- 2 subframes in asynchronous EN-DC.

The normative reference for this requirement is TS 38.133 [6] clauses 8.6.2, 8.2.1.2.7 and TS 36.133 [23] clause 7.32.2.7.

#### 4.5.6.1.1 EN-DC FR1 DCI-based DL active BWP switch in non-DRX in synchronous EN-DC

##### 4.5.6.1.1.1 Test purpose

The purpose of this test is to verify the DL BWP switch delay requirement defined in TS 38.133 [6] clause 8.6, and interruption requirement for E-UTRA victim cell defined in TS 36.133 [23] clause 7.32.2.7.

##### 4.5.6.1.1.2 Test applicability

This test applies to all types of E-UTRA UE release 15 onwards, supporting EN-DC, BWP adaptation of at least 2BWPs, DCI and timer-based active BWP switching delay Type1 or Type2.

##### 4.5.6.1.1.3 Minimum conformance requirements

The minimum conformance requirements are specified in clause 4.5.6.1.0.1.

The normative reference for this requirement is TS 38.133 [6] clause A.4.5.6.1.1.

##### 4.5.6.1.1.4 Test description

##### 4.5.6.1.1.4.1 Initial conditions

This test shall be tested using any of the test configurations in Table 4.5.6.1.1.4.1-1.

**Table 4.5.6.1.1.4.1-1: Supported test configurations for FR1 DCI-based DL active BWP switch in non-DRX in synchronous EN-DC**

Config	Description
4.5.6.1.1-1	LTE FDD, NR 15 kHz SSB SCS, 10 MHz bandwidth, FDD duplex mode
4.5.6.1.1-2	LTE FDD, NR 15 kHz SSB SCS, 10 MHz bandwidth, TDD duplex mode
4.5.6.1.1-3	LTE FDD, NR 30 kHz SSB SCS, 40 MHz bandwidth, TDD duplex mode
4.5.6.1.1-4	LTE TDD, NR 15 kHz SSB SCS, 10 MHz bandwidth, FDD duplex mode
4.5.6.1.1-5	LTE TDD, NR 15 kHz SSB SCS, 10 MHz bandwidth, TDD duplex mode
4.5.6.1.1-6	LTE TDD, NR 30 kHz SSB SCS, 40 MHz bandwidth, TDD duplex mode

NOTE 1: The UE is only required to be tested in one of the supported test configurations.  
NOTE 2: A UE which fulfils the requirements in test case 4.5.6.1.2 can skip the test cases in clause 4.5.6.1.1.

Configure the test equipment and the DUT according to the parameters in Table 4.5.6.1.1.4.1-2.

**Table 4.5.6.1.1.4.1-2: Initial conditions for FR1 DCI-based DL active BWP switch in non-DRX in synchronous EN-DC**

Parameter	Value	Comment
Test environment	NC	As specified in TS 38.508-1 [14] clause 4.1.
Test frequencies	As specified in Annex E, Table E.4-1 and TS 38.508-1 [14] clause 4.3.1.	
Channel bandwidth	As specified by the test configuration selected from Table 4.5.6.1.1.4.1-1.	
Propagation conditions	AWGN	As specified in clause C.2.2
Connection Diagram	TE Part DUT Part	A.3.1.8.2 A.3.2.3.4
Exceptions to connection diagram	- For 4Rx capable UEs without any 2Rx RF bands use A.3.2.5.2 for DUT part and A.3.1.8.4 for TE part.	

1. The general test parameter settings are set up according to Table 4.5.6.1.1.4.1-3.
2. Message contents are defined in clause 4.5.6.1.1.4.3.
3. The test scenario comprises of one E-UTRA PCell (Cell 1), and one NR PSCell (Cell 2). The power levels and settings for Cell 1 are set according to Annex A.6. Cell 2 are configured according to clause C.1.2 and C.1.3.

**Table 4.5.6.1.1.4.1-3: General test parameters for DL BWP switch in synchronous EN-DC**

Parameter	Unit	Value	Comment
E-UTRA RF Channel Number		1	One E-UTRA radio channel is used for this test
NR RF Channel Number		2	One NR radio channel is used for this test
Active PCell		Cell 1	PCell on RF channel number 1.
Active PSCell		Cell 2	PSCell on RF channel number 2.
CP length		Normal	
DRX		OFF	For both PCell and PSCell
<i>bwp-InactivityTimer</i>	ms	200	
Cell-individual offset for cells on RF channel number 1	dB	0	Individual offset for cells on PCC.
Cell-individual offset for cells on RF channel number 2	dB	0	Individual offset for cells on PSCC.
Cell2 timing offset to cell1	µs	3	Synchronous EN-DC
T1	s	0.2	
T2	s	0.2	
T3	s	0.2	

#### 4.5.6.1.1.4.2 Test procedure

The test consists of 3 successive time periods, with durations of T1, T2, and T3, respectively.

PDCCHs indicating new transmissions shall be sent continuously on E-UTRA PCell (Cell 1) to ensure that the UE will have ACK/NACK sending.

PDCCHs indicating new transmissions shall be sent continuously on PSCell (Cell 2) to ensure that the UE would have ACK/NACK sending except for the time duration when BWP is switching on Cell 2 and the time duration of T2.

Before the test starts,

- UE is connected to Cell 1 (E-UTRA PCell) on radio channel 1 (PCC), and Cell 2 (PSCell) on radio channel 2 (PSCC).
- UE is configured with 2 different UE-specific downlink bandwidth parts for PSCell, BWP-1 and BWP-2, in Cell 2 before starting the test. BWP-1 and BWP-2 always include bandwidth of the initial DL BWP and SSB.
- UE is indicated in *firstActiveDownlinkBWP-Id* that the active DL BWP is BWP-1 in PSCell.
- UE is configured with a *bwp-InactivityTimer* timer value for PSCell.

All cells have constant signal levels throughout the test.

1. Ensure the UE is in state RRC\_CONNECTED with generic procedure parameters Connectivity *EN-DC*, DC bearer *MCG\_and\_SCG*, Connected without release *On* and Test Mode *On* according to TS 38.508-1 [14] clause 4.5.
2. Set the parameters according to Tables 4.5.6.1.1.4.1-3 and 4.5.6.1.1.5-1. Propagation conditions are set according to Annex C clauses C.2.2.
3. The SS shall transmit an *RRCConnectionReconfiguration* message releasing the dedicated configuration of the *initialDownlinkBWP* and the *initialUplinkBWP*. This message also configures 2 different UE-specific bandwidth parts, BWP-1 and BWP-2, and indicates BWP-1 as the active DL BWP using *firstActiveDownlinkBWP-Id*, according to Table 4.5.6.1.1.4.3-2.
4. The UE shall transmit an *RRCConnectionReconfigurationComplete* message.
5. The SS shall send a DCI format 1\_1 command for PSCell DL BWP switch.
6. The UE shall receive the DCI format 1\_1 command in PSCell's slot # denoted *i*, then T1 starts and the UE switch its bandwidth part from BWP-1 to BWP-2:
  - a) If the UE starts to report valid ACK/NACK for PSCell from the first UL slot that occurs after the beginning of the DL slot ( $i + T_{\text{BWPswitchDelay}} + k_1$ ); and
  - b) If the UE starts to report valid ACK/NACK for PCell from the first UL slot that occurs after the beginning of the DL slot ( $i + T_{\text{BWPswitchDelay}} + 1 \text{ subframe} + k$ ); and
  - c) If the number of consecutive missing ACK/NACK for PCell is no more than 1.  
Then, the number of successful subtests is increased by one. Otherwise, count a fail for the test, switch off/on the UE and go to step 1.
7. If the UE sends valid ACK/NACK for the PSCell on BWP-2, T2 starts. During T2, the SS shall not transmit DCI format for PDSCH reception on PSCell.
8. T3 starts from the first slot #*j* of the DL subframe immediately after the slot wherein *bwp-InactivityTimer* timer expires and the SS restarts to send DCI format for PDSCH reception on PSCell. Then, the UE shall switch its bandwidth part from BWP-2 back to the default bandwidth part - BWP-1 on PSCell:
  - a) If the UE starts to report valid ACK/NACK for PSCell from the first UL slot that occurs after the beginning of the DL slot ( $j + T_{\text{BWPswitchDelay}} + k_1$ ); and
  - b) If the UE starts to report valid ACK/NACK for PCell from the first UL slot that occurs after the beginning of the DL slot ( $j + T_{\text{BWPswitchDelay}} + 1 \text{ subframe} + k$ ); and
  - c) If the number of consecutive missing ACK/NACK for PCell is no more than 1  
Then, the number of successful subtests is increased by one. Otherwise, count a fail for the test, switch off/on the UE and go to step 1.

9. Repeat steps 5-8 until the confidence level according to Tables G.2.3-1 in Annex G clause G.2 is achieved.

The SS verifies the DL BWP switch time in PSCell by counting the slots from the time when the BWP switch command is received or *bwp-InactivityTimer* timer expires till an ACK/NACK is received.

The SS verifies that potential interruption to E-UTRA PCell is carried out in the correct time span by monitoring ACK/NACK sent in PCell during BWP switch of PSCell, respectively.

"k" is the length (slot) between E-UTRA PCell PDSCH and its corresponding ACK/NACK as specified in TS 36.213 [33].

If all subtests pass, the test passes. If one subtest fails, the test fails.

4.5.6.1.1.4.3 Message contents

Message contents are according to TS 38.508-1 [14] clause 7.3 with the following exceptions:

**Table 4.5.6.1.1.4.3-1: Common Exception messages for FR1 DCI-based DL active BWP switch in non-DRX in synchronous EN-DC**

Default Message Contents	
Common contents of system information blocks exceptions	
Default RRC messages and information elements contents exceptions	Table H.3.4-1

**Table 4.5.6.1.1.4.3-1A: RRCReconfiguration (Step3)**

Derivation Path: TS 38.508-1 [14], Table 4.6.1-13 with condition EN-DC			
Information Element	Value/remark	Comment	Condition
RRCReconfiguration ::= SEQUENCE {			
criticalExtensions CHOICE {			
rrcReconfiguration SEQUENCE {			
secondaryCellGroup	CellGroupConfig	Table 4.5.6.1.1.4.3-1B	
}			
}			
}			

**Table 4.5.6.1.1.4.3-1B: CellGroupConfig (Table 4.5.6.1.1.4.3-1A)**

Derivation Path: TS 38.508-1 [14], Table 4.6.3-19			
Information Element	Value/remark	Comment	Condition
CellGroupConfig ::= SEQUENCE {			
cellGroupId	1		
spCellConfig SEQUENCE {			
servCellIndex	ServCellIndex of NR PSCell		
spCellConfigDedicated	ServingCellConfig	Table 4.5.6.1.1.4.3-2	
}			
}			



Table 4.5.6.1.1.4.3-2: *ServingCellConfig* (Table 4.5.6.1.1.4.3-1B)

Derivation Path: TS 38.508-1 [14], Table 4.6.3-167			
Information Element	Value/remark	Comment	Condition
ServingCellConfig ::= SEQUENCE {			
initialDownlinkBWP SEQUENCE {			
pdccch-Config CHOICE {			
release	NULL		
}			
pdsch-Config CHOICE {			
release	NULL		
}			
radioLinkMonitoringConfig CHOICE {			
release	NULL		
}			
}			
downlinkBWP-ToAddModList SEQUENCE (SIZE (1..maxNrofBWPs)) OF SEQUENCE {	2 entries		
BWP-Downlink[1]	BWP-Downlink with condition BWP1	entry 1 Table 4.5.6.1.1.4.3-3	
BWP-Downlink[2]	BWP-Downlink with condition BWP2	entry 2 Table 4.5.6.1.1.4.3-3	
}			
firstActiveDownlinkBWP-Id	1	According to BWP-1	
bwp-InactivityTimer	ms200		
defaultDownlinkBWP-Id	1	According to BWP-1	
uplinkConfig SEQUENCE {			
initialUplinkBWP SEQUENCE {			
pucch-Config CHOICE {			
release	NULL		
}			
pusch-Config CHOICE {			
release	NULL		
}			
srs-Config CHOICE {			
release	NULL		
}			
uplinkBWP-ToAddModList SEQUENCE (SIZE (1..maxNrofBWPs)) OF SEQUENCE {	2 entries		
BWP-Uplink[1]	BWP-Uplink with condition BWP1	entry 1 Table 4.5.6.1.1.4.3-4	
BWP-Uplink[2]	BWP-Uplink with condition BWP2	entry 2 Table 4.5.6.1.1.4.3-4	
firstActiveUplinkBWP-Id	1	According to BWP-1	
}			
}			
}			

Table 4.5.6.1.1.4.3-3: *BWP-Downlink* (Table 4.5.6.1.1.4.3-2)

Derivation Path: TS 38.508-1 [14], Table 4.6.3-9			
Information Element	Value/remark	Comment	Condition
BWP-Downlink ::= SEQUENCE {			
bwp-Id	1	BWP-1	BWP1
	2	BWP-2	BWP2
bwp-Common SEQUENCE {			
genericParameters	RIV defined in TS 38.214 [9] that corresponds to DLBWP.1.1		BWP1
	RIV defined in TS 38.214 [9] that corresponds to DLBWP.1.3		BWP2
}			
}			

Table 4.5.6.1.1.4.3-4: *BWP-Uplink* (Table 4.5.6.1.1.4.3-2)

Derivation Path: TS 38.508-1 [14], Table 4.6.3-13			
Information Element	Value/remark	Comment	Condition
BWP-Uplink ::= SEQUENCE {			
bwp-Id	1	BWP-1	BWP1
	2	BWP-2	BWP2
bwp-Common SEQUENCE {			
genericParameters	RIV defined in TS 38.214 [9] that corresponds to ULBWP.1.1	BWP-1	BWP1
	RIV defined in TS 38.214 [9] that corresponds to ULBWP.1.3	BWP-2	BWP2
}			
}			

Table 4.5.6.1.1.4.3-5: *Void*Table 4.5.6.1.1.4.3-6: *PDSCH-TimeDomainResourceAllocationList*

Derivation Path: TS 38.508-1 [14], Table 4.6.3-103			
Information Element	Value/remark	Comment	Condition
PDSCH-TimeDomainResourceAllocationList ::= SEQUENCE(SIZE(1..maxNrofDL-Allocations)) OF PDSCH-TimeDomainResourceAllocation {	4 entries		
PDSCH-TimeDomainResourceAllocation[1] SEQUENCE {		entry 1	
k0	Not present		
mappingType	typeA		
startSymbolAndLength	53	Start symbol(S)=2, Length(L)=12	
}			
PDSCH-TimeDomainResourceAllocation[2] SEQUENCE {		entry 2	
k0	Not present		
mappingType	typeA		
startSymbolAndLength	72	S=2, L=6	
}			
PDSCH-TimeDomainResourceAllocation[3] SEQUENCE {		entry 3	
k0	T <sub>BWPswitchDelay</sub>	Defined in Table 4.5.6.1.0.1-1	The DCI indicating BWP switch
mappingType	typeA		
startSymbolAndLength	53	Start symbol(S)=2, Length(L)=12	

Derivation Path: TS 38.508-1 [14], Table 4.6.3-103

Information Element	Value/remark	Comment	Condition
}			
PDSCH-TimeDomainResourceAllocation[4] SEQUENCE {		entry 4	
k0	1		First DCI right after DCI-based BWP switch
mappingType	typeA		
startSymbolAndLength	53	Start symbol(S)=2, Length(L)=12	
}			
}			

4.5.6.1.1.5 Test requirements

Tables 4.5.6.1.1.4.1-3 and 4.5.6.1.1.5-1 define the primary level settings including test tolerances.

**Table 4.5.6.1.1.5-1: NR Cell specific test parameters for DL BWP switch in synchronous EN-DC**

Parameter		Unit	Cell 2
Frequency Range			FR1
Duplex mode	Config 1,4		FDD
	Config 2,3,5,6		TDD
TDD configuration	Config 1,4		Not Applicable
	Config 2,5		TDDConf.1.1
	Config 3,6		TDDConf.2.1
BW <sub>channel</sub>	Config 1,4		10 MHz: N <sub>RB,c</sub> = 52
	Config 2,5		10 MHz: N <sub>RB,c</sub> = 52
	Config 3,6		40 MHz: N <sub>RB,c</sub> = 106
Active BWP ID			1, 2
Initial DL BWP Configuration	Config 1,4		DLBWP.0.2 <sup>Note 4</sup>
	Config 2,5		
	Config 3,6		
Active DL BWP-1 Configuration	Config 1,4		DLBWP.1.1 <sup>Note 4</sup>
	Config 2,5		
	Config 3,6		
Active DL BWP-2 Configuration	Config 1,4		DLBWP.1.3 <sup>Note 4</sup>
	Config 2,5		
	Config 3,6		
Initial UL BWP Configuration	Config 1,4		ULBWP.0.2 <sup>Note 4</sup>
	Config 2,5		
	Config 3,6		
Active UL BWP-1 Configuration	Config 1,4		ULBWP.1.1 <sup>Note 4</sup>
	Config 2,5		
	Config 3,6		
Active UL BWP-2 Configuration	Config 1,4		N/A
	Config 2,5		ULBWP.1.3 <sup>Note 4</sup>
	Config 3,6		ULBWP.1.3 <sup>Note 4</sup>
PDSCH Reference measurement channel	Config 1,4		SR.1.1 FDD
	Config 2,5		SR.1.1 TDD
	Config 3,6		SR.2.1 TDD
RMSI CORESET parameters	Config 1,4		CR.1.1 FDD
	Config 2,5		CR.1.1 TDD
	Config 3,6		CR.2.1 TDD
Dedicated CORESET parameters	Config 1,4		CCR.1.2 FDD
	Config 2,5		CCR.1.2 TDD
	Config 3,6		CCR.2.4 TDD
OCNG Patterns			OP.1
SSB Configuration	Config 1,2,4,5		SSB.1 FR1
	Config 3,6		SSB.2 FR1
SMTc Configuration			SMTc.1

Parameter		Unit	Cell 2
Correlation Matrix and Antenna Configuration			1x2 Low
TRS Configuration	Config 1,4		TRS.1.1 FDD
	Config 2,5		TRS.1.1 TDD
	Config 3,6		TRS.1.2 TDD
EPRE ratio of PSS to SSS		dB	0
EPRE ratio of PBCH DMRS to SSS			
EPRE ratio of PBCH to PBCH DMRS			
EPRE ratio of PDCCH DMRS to SSS			
EPRE ratio of PDCCH to PDCCH DMRS			
EPRE ratio of PDSCH DMRS to SSS			
EPRE ratio of PDSCH to PDSCH			
EPRE ratio of OCNB DMRS to SSS(Note 1)			
EPRE ratio of OCNB to OCNB DMRS (Note 1)			
$N_{oc}$ Note 2	Config 1,2,4,5	dBm/SCS	-104
	Config 3,6		-101
$N_{oc}$ Note 2		dBm/15kHz	-104
SS-RSRP Note 3	Config 1,2,4,5	dBm/SCS	-87
	Config 3,6		-84
$\bar{E}_s/I_{ot}$		dB	17
$\bar{E}_s/N_{oc}$		dB	17
$I_o$ Note 3	Config 1,2,4,5	dBm/ 9.36MHz	-58.96
	Config 3,6	dBm/ 38.16MHz	-52.86
Propagation Condition			AWGN
NOTE 1: OCNB shall be used such that both cells are fully allocated and a constant total transmitted power spectral density is achieved for all OFDM symbols.			
NOTE 2: Interference from other cells and noise sources not specified in the test is assumed to be constant over subcarriers and time and shall be modelled as AWGN of appropriate power for $N_{oc}$ to be fulfilled.			
NOTE 3: SS-RSRP and $I_o$ levels have been derived from other parameters for information purposes. They are not settable parameters themselves.			
NOTE 4: For unpaired spectrum, a DL BWP is linked with an UL BWP. DLBWP.0.2 is linked with ULBWP.0.2; DLBWP.1.1 is linked with ULBWP.1.1; DLBWP.1.3 is linked with ULBWP.1.3 defined in clause 12 of TS 38.213 [8].			

During T1, the UE shall start to send the ACK/NACK for PSCell from the first UL slot that occurs after the beginning of DL slot ( $i+T_{BWPswitchDelay}+k_1$ ).

During T3, the UE shall start to send the ACK/NACK for PSCell from the first UL slot that occurs after the beginning of DL slot ( $j+T_{BWPswitchDelay}+k_1$ ).

Where,  $k_1$  is the timing between DL data receiving and acknowledgement as specified in 38.214 [9].

Depending on UE capability *bwp-SwitchingDelay* [13], UE shall finish BWP switch within the time duration  $T_{BWPswitchDelay}$  defined in TS 38.133 [6] Table 8.6.2-1.

All of the above test requirements shall be fulfilled in order for the observed PCell active BWP switch delay to be counted as correct.

The rate of correct events observed during repeated tests shall be at least 90%.

During T1, the start time of E-UTRA PCell interruption during PSCell active BWP switch shall not happen outside the BWP switch delay.

During T3, the start time of E-UTRA PCell interruption of during PSCell active BWP switch shall not happen outside the BWP switch delay.

The interruption of E-UTRA PCell shall not be longer than the interruption duration specified for active BWP switch in TS 36.133 [23] clause 7.32.2.7.

All of the above test requirements shall be fulfilled in order for the observed E-UTRA PCell active BWP switch interruption to be counted as correct.

The rate of correct events observed during repeated tests shall be at least 90%.

NOTE: During T1, T3 if there are no uplink resources for reporting the ACK/NACK in the first UL slot that occurs after the beginning of DL slot ( $i + T_{\text{BWPswitchDelay}+k_1}$ ), ( $j + T_{\text{BWPswitchDelay}+k_1}$ ), then the UE shall use the next available uplink resource for reporting the corresponding ACK/NACK.

#### 4.5.6.1.2 EN-DC FR1 DCI-based DL active BWP switch with SCell in non-DRX in synchronous EN-DC

##### 4.5.6.1.2.1 Test purpose

The purpose of this test is to verify the DL BWP switch delay requirement defined in TS 38.133 [6] clause 8.6, and interruption requirements for NR victim cell defined in TS 38.133 [6] clause 8.2.1.2.7 and interruption requirement for E-UTRA victim cell defined in clause 7.32.2.7 of TS 36.133 [23].

##### 4.5.6.1.2.2 Test applicability

This test applies to all types of E-UTRA UE release 15 onwards, supporting EN-DC, BWP adaptation of at least 2BWPs, DCI and timer-based active BWP switching delay Type1 or Type2 and 2DL CA.

##### 4.5.6.1.2.3 Minimum conformance requirements

The minimum conformance requirements are specified in clause 4.5.6.1.0.1.

The normative reference for this requirement is TS 38.133 [6] clause A.4.5.6.1.2.

##### 4.5.6.1.2.4 Test description

###### 4.5.6.1.2.4.1 Initial conditions

This test shall be tested using any of the test configurations in Table 4.5.6.1.2.4.1-1.

**Table 4.5.6.1.2.4.1-1: Supported test configurations for FR1 DCI-based DL active BWP switch with SCell in non-DRX in synchronous EN-DC**

Config	Description
4.5.6.1.2-1	LTE FDD, NR 15 kHz SSB SCS, $\geq 10$ MHz bandwidth, FDD duplex mode
4.5.6.1.2-2	LTE FDD, NR 15 kHz SSB SCS, $\geq 10$ MHz bandwidth, TDD duplex mode
4.5.6.1.2-3	LTE FDD, NR 30 kHz SSB SCS, $\geq 40$ MHz bandwidth, TDD duplex mode
4.5.6.1.2-4	LTE TDD, NR 15 kHz SSB SCS, $\geq 10$ MHz bandwidth, FDD duplex mode
4.5.6.1.2-5	LTE TDD, NR 15 kHz SSB SCS, $\geq 10$ MHz bandwidth, TDD duplex mode
4.5.6.1.2-6	LTE TDD, NR 30 kHz SSB SCS, $\geq 40$ MHz bandwidth, TDD duplex mode
Note 1:	The UE is only required to be tested in one of the supported test configurations.
Note 2:	A UE which fulfils the requirements in test case A.4.5.6.1.2 can skip the test cases in clause A.4.5.6.1.1.
Note 3:	NR configuration is the same for PSCell and SCells
Note 4:	The UE is only required to be tested in one with smallest aggregated channel bandwidth from supported band combinations which is composed of CCs $\geq$ the bandwidth ( $BW_{\text{channel}}$ ) defined in each test configuration.

Configure the test equipment and the DUT according to the parameters in Table 4.5.6.1.2.4.1-2.

**Table 4.5.6.1.2.4.1-2: Initial conditions for FR1 DCI-based DL active BWP switch with SCell in non-DRX in synchronous EN-DC**

Parameter	Value	Comment
Test environment	NC	As specified in TS 38.508-1 [14] clause 4.1.
Test frequencies	As specified in Annex E, Table E.4-1 and TS 38.508-1 [14] clause 4.3.1.	
Channel bandwidth	As specified by the test configuration selected from Table 4.5.6.1.2.4.1-1.	
Propagation conditions	AWGN	As specified in clause C.2.2

Connection Diagram	TE Part	A.3.1.8.2	As specified in TS 38.508-1 [14] Annex A.
	DUT Part	A.3.2.3.4	
Exceptions to connection diagram	- For 4Rx capable UEs without any 2Rx RF bands use A.3.2.5.2 for DUT part and A.3.1.8.4 for TE part.		

1. The general test parameter settings are set up according to Table 4.5.6.1.2.4.1-3.
2. Message contents are defined in clause 4.5.6.1.2.4.3.
3. There are one E-UTRAN carrier and two NR carriers and three cells specified in the test. Cell 1 is the PCell on E-UTRAN carrier, Cell 2 is the PSCell on one NR carrier and Cell 3 is the NR SCell on the other NR carrier. Cell 1 is the cell used for connection setup with the power level set according to Annex A.6. Cell 2 and Cell 3 are configured according to clauses C.1.2 and C.1.3.

**Table 4.5.6.1.2.4.1-3: General test parameters for DL BWP switch in synchronous EN-DC**

Parameter	Unit	Value	Comment
E-UTRA RF Channel Number		1	One E-UTRA radio channel is used for this test
NR RF Channel Number		2, 3	Two NR radio channel are used for this test
Active PCell		Cell 1	PCell on RF channel number 1.
Active PSCell		Cell 2	PSCell on RF channel number 2.
Active SCell		Cell 3	SCell on RF channel number 3.
CP length		Normal	
DRX		OFF	
<i>bwp-InactivityTimer</i>	ms	200	
Cell-individual offset for cells on RF channel number 1	dB	0	Individual offset for cells on PCC.
Cell-individual offset for cells on RF channel number 2	dB	0	Individual offset for cells on PSCC.
Cell-individual offset for cells on RF channel number 3	dB	0	Individual offset for cells on SCC.
Cell2 timing offset to cell1	μs	3	Synchronous EN-DC
Cell3 timing offset to cell2	μs	3	Synchronous cells
T1	s	0.2	
T2	s	0.2	
T3	s	0.2	

#### 4.5.6.1.2.4.2 Test procedure

The test consists of 3 successive time periods, with durations of T1, T2, and T3, respectively.

PDCCHs indicating new transmissions shall be sent continuously on E-UTRA PCell (Cell 1) and PSCell (Cell 2) to ensure that the UE will have ACK/NACK sending.

PDCCHs indicating new transmissions shall be sent continuously on SCell (Cell 3) to ensure that the UE would have ACK/NACK sending except for the time duration when BWP is switching on Cell 3 and the time duration of T2.

Before the test starts:

- UE is connected to Cell 1 (E-UTRA PCell) on radio channel 1 (PCC), Cell 2 (PSCell) on radio channel 2 (PSCC) and Cell 3 (SCell) on radio channel 3 (SCC).
- UE is configured with 2 different UE-specific downlink bandwidth parts for SCell, BWP-1 and BWP-2, in Cell 3 before starting the test. BWP-1 and BWP-2 always include bandwidth of the initial DL BWP and SSB.
- UE is configured with 1 UE-specific downlink bandwidth parts the same as initial BWP for PSCell, BWP-0 in Cell 2 before starting the test.
- UE is indicated in *firstActiveDownlinkBWP-Id* that the active DL BWP is BWP-1 in SCell.
- UE is indicated in *firstActiveDownlinkBWP-Id* that the active DL BWP is BWP-0 in PSCell.

- UE is configured with a *bwp-InactivityTimer* timer value for SCell.

All cells have constant signal levels throughout the test:

1. Ensure the UE is in state RRC\_CONNECTED with generic procedure parameters Connectivity *EN-DC*, DC bearer *MCG\_and\_SCG*, Connected without release *On* and Test Mode *On* according to TS 38.508-1 [14] clause 4.5.
2. The SS shall configure SCell (Cell 3) on the SCC as per TS 38.508-1 [14] clause 7.5.1. Set the parameters according to Tables 4.5.6.1.2.4.1-3 and 4.5.6.1.2.5-1. Propagation conditions are set according to Annex C clauses C.2.2.
3. The SS shall transmit an *RRCConnectionReconfiguration* message releasing the dedicated configuration of the *initialDownlinkBWP* and the *initialUplinkBWP* of Cell 3. This message also configures 2 different UE-specific bandwidth parts for Cell 3, BWP-1 and BWP-2, and indicates BWP-1 as the active DL BWP using *firstActiveDownlinkBWP-Id*, according to Table 4.5.6.1.2.4.3-2.
4. The UE shall transmit an *RRCConnectionReconfigurationComplete* message.
5. The SS shall send a DCI format 1\_1 command for SCell DL BWP switch.
6. The UE shall receive the DCI format 1\_1 command in SCell's slot # denoted *i*, then T1 starts and the UE switch its bandwidth part from BWP-1 to BWP-2:
  - a) If the UE starts to report valid ACK/NACK for SCell on PSCell from the first UL slot that occurs after the beginning of the DL slot ( $i + T_{\text{BWPswitchDelay}} + k_1$ ); and
  - b) If the UE starts to report valid ACK/NACK for PCell from the first UL slot that occurs after the beginning of the DL slot ( $i + T_{\text{BWPswitchDelay}} + 1 \text{ subframe} + k$ ); and
  - c) If the UE starts to report valid ACK/NACK for PSCell from the first UL slot that occurs after the beginning of DL slot ( $i + T_{\text{BWPswitchDelay}} + \text{Interruption length} + k_1$ ); and
  - d) If the number of consecutive missing ACK/NACK for PCell is no more than 1; and
  - e) If the number of consecutive missing ACK/NACK for PSCell is no more than 1.

Then, the number of successful subtests is increased by one. Otherwise, count a fail for the test, switch off/on the UE and go to step 1.

7. If the UE sends valid ACK/NACK for the SCell on PSCell on BWP-2, T2 starts. During T2, the SS shall not transmit DCI format for PDSCH reception on SCell.
8. T3 starts from the first slot #*j* of the DL subframe immediately after the slot wherein *bwp-InactivityTimer* timer expires and the SS restarts to send DCI format for PDSCH reception on SCell. Then, the UE shall switch its bandwidth part from BWP-2 back to the default bandwidth part, BWP-1, on SCell:
  - a) If the UE starts to report valid ACK/NACK for PCell from the first UL slot that occurs after the beginning of the DL slot ( $j + T_{\text{BWPswitchDelay}} + 1 \text{ subframe} + k$ ); and
  - b) If the UE starts to report valid ACK/NACK for SCell on PSCell from the first UL slot that occurs after the beginning of the DL slot ( $j + T_{\text{BWPswitchDelay}} + k_1$ ); and
  - c) If the UE starts to report valid ACK/NACK for PSCell from the first UL slot that occurs after the beginning of DL slot ( $i + T_{\text{BWPswitchDelay}} + \text{Interruption length} + k_1$ ); and
  - d) If the number of consecutive missing ACK/NACK for PCell is no more than 2 for configuration 4.5.6.1.2-1/2/3 and no more than 1 for configuration 4.5.6.1.2-4/5/6; and
  - e) If the number of consecutive missing ACK/NACK for PSCell is no more than 2 for configuration 4.5.6.1.2-1/4 and no more than 1 for configuration 4.5.6.1.2-2/3/5/6. Then, the number of successful subtests is increased by one. Otherwise, count a fail for the test, switch off/on the UE and go to step 1.
9. Repeat steps 5-8 until the confidence level according to Tables G.2.3-1 in Annex G clause G.2 is achieved.

The SS verifies the DL BWP switch time in SCell by counting the slots from the time when the BWP switch command is received or *bwp-InactivityTimer* timer expires till an ACK/NACK is received.

The SS verifies that potential interruption to E-UTRA PCell and NR PSCell is carried out in the correct time span by monitoring ACK/NACK sent in E-UTRA PCell and PSCell during BWP switch of SCell, respectively.

Interruption length is defined in TS 38.133 [6] Table 8.2.2.2.5-1-1.

$k$  is the length (slot) between E-UTRA PCell PDSCH and its corresponding ACK/NACK as specified in TS 36.213 [33].

$k_1$  is the timing between NR DL data receiving and acknowledgement as specified in TS 38.214 [9].

If all subtests pass, the test passes. If one subtest fails, the test fails.

4.5.6.1.2.4.3 Message contents

Message contents are according to TS 38.508-1 [14] clause 7.3 with the following exceptions:

**Table 4.5.6.1.2.4.3-1: Common Exception messages for FR1 DCI-based DL active BWP switch with SCell in non-DRX in synchronous EN-DC**

Default Message Contents	
Common contents of system information blocks exceptions	
Default RRC messages and information elements contents exceptions	Table H.3.4-1

**Table 4.5.6.1.2.4.3-1A: RRCReconfiguration (Step 3)**

Derivation Path: TS 38.508-1 [14], Table 4.6.1-13 with condition EN-DC_SCell_add			
Information Element	Value/remark	Comment	Condition
RRCReconfiguration ::= SEQUENCE {			
criticalExtensions CHOICE {			
rrcReconfiguration SEQUENCE {			
secondaryCellGroup	CellGroupConfig	Table 4.5.6.1.2.4.3-1B	
}			
}			
}			

**Table 4.5.6.1.2.4.3-1B: CellGroupConfig (Table 4.5.6.1.2.4.3-1A)**

Derivation Path: TS 38.508-1 [14], Table 4.6.3-19 with condition SCell_add			
Information Element	Value/remark	Comment	Condition
CellGroupConfig ::= SEQUENCE {			
cellGroupId	1		
sCellToAddModList SEQUENCE (SIZE (1..maxNrofSCells)) OF SCellConfig {	1 entry		
SCellConfig[1] SEQUENCE {		entry 1	
sCellConfigDedicated	ServingCellConfig	Table 4.5.6.1.2.4.3-2	
}			
}			
}			

**Table 4.5.6.1.2.4.3-2: ServingCellConfig (Table 4.5.6.1.2.4.3-1B)**

Derivation Path: TS 38.508-1 [14], Table 4.6.3-167			
Information Element	Value/remark	Comment	Condition
ServingCellConfig ::= SEQUENCE {			
initialDownlinkBWP SEQUENCE {			



pdccch-Config CHOICE {			
release	NULL		
}			
pdsch-Config CHOICE {			
release	NULL		
}			
radioLinkMonitoringConfig CHOICE {			
release	NULL		
}			
downlinkBWP-ToAddModList SEQUENCE (SIZE (1..maxNrofBWPs)) OF SEQUENCE {	2 entries		
BWP-Downlink[1]	BWP-Downlink with condition BWP1	entry 1 Table 4.5.6.1.2.4.3-3	
BWP-Downlink[2]	BWP-Downlink with condition BWP2	entry 2 Table 4.5.6.1.2.4.3-3	
}			
firstActiveDownlinkBWP-Id	1	According to BWP-1	
bwp-InactivityTimer	ms200		
defaultDownlinkBWP-Id	1	According to BWP-1	
}			

**Table 4.5.6.1.2.4.3-3: BWP-Downlink (Table 4.5.6.1.2.4.3-2)**

Derivation Path: TS 38.508-1 [14], Table 4.6.3-9			
Information Element	Value/remark	Comment	Condition
BWP-Downlink ::= SEQUENCE {			
bwp-Id	1	BWP-1	BWP1
	2	BWP-2	BWP2
bwp-Common SEQUENCE {			
genericParameters	RIV defined in TS 38.214 [9] that corresponds to DLBWP.1.3		BWP1
	RIV defined in TS 38.214 [9] that corresponds to DLBWP.1.1		BWP2
}			
}			

**Table 4.5.6.1.2.4.3-4: Void**

**Table 4.5.6.1.2.4.3-5: Void**

**Table 4.5.6.1.2.4.3-6: PDSCH-TimeDomainResourceAllocationList**

Derivation Path: TS 38.508-1 [14], Table 4.6.3-103			
Information Element	Value/remark	Comment	Condition
PDSCH-TimeDomainResourceAllocationList ::= SEQUENCE(SIZE(1..maxNrofDL-Allocations)) OF PDSCH-TimeDomainResourceAllocation {	4 entries		
PDSCH-TimeDomainResourceAllocation[1]		entry 1	
SEQUENCE {			
k0	Not present		
mappingType	typeA		
startSymbolAndLength	53	Start symbol(S)=2, Length(L)=12	
}			

PDSCH-TimeDomainResourceAllocation[2] SEQUENCE {		entry 2	
k0	Not present		
mappingType	typeA		
startSymbolAndLength	72	S=2, L=6	
}			
PDSCH-TimeDomainResourceAllocation[3] SEQUENCE {		entry 3	
k0	T <sub>BWPswitchDelay</sub>	Defined in Table 4.5.6.1.0.1-1	The DCI indicating BWP switch
mappingType	typeA		
startSymbolAndLength	53	Start symbol(S)=2, Length(L)=12	
}			
PDSCH-TimeDomainResourceAllocation[4] SEQUENCE {		entry 4	
k0	1		First DCI right after DCI-based BWP switch
mappingType	typeA		
startSymbolAndLength	53	Start symbol(S)=2, Length(L)=12	
}			
}			

**Table 4.5.6.1.2.4.3-7: Void**

4.5.6.1.2.5 Test requirements

Tables 4.5.6.1.2.4.1-3 and 4.5.6.1.2.5-1 define the primary level settings including test tolerances.

**Table 4.5.6.1.2.5-1: NR Cell specific test parameters for DL BWP switch in synchronous EN-DC**

Parameter		Unit	Cell 2	Cell 3
Frequency Range			FR1	
Duplex mode	Config 1,4		FDD	
	Config 2,3,5,6		TDD	
TDD configuration	Config 1,4		Not Applicable	
	Config 2,5		TDDConf.1.1	
	Config 3,6		TDDConf.2.1	
BW <sub>channel</sub>	Config 1,4		Note 7	
	Config 2,5		Note 7	
	Config 3,6		Note 7	
BW <sub>occupied</sub>	Config 1,4	RB	52 <sup>Note 5</sup>	
	Config 2,5		52 <sup>Note 5</sup>	
	Config 3,6		106 <sup>Note 6</sup>	
Active BWP ID			0	1,2
Initial DL BWP Configuration	Config 1,4		DLBWP.0.2 <sup>Note4</sup>	DLBWP.0.2 <sup>Note4</sup>
	Config 2,5			
	Config 3,6			
Active DL BWP-0 Configuration	Config 1,4		DLBWP.0.2 <sup>Note4</sup>	N/A
	Config 2,5			
	Config 3,6			
Active DL BWP-1 Configuration	Config 1,4		N/A	DLBWP.1.3 <sup>Note4</sup>
	Config 2,5			
	Config 3,6			
Active DL BWP-2 Configuration	Config 1,4		N/A	DLBWP.1.1 <sup>Note4</sup>
	Config 2,5			
	Config 3,6			

Parameter		Unit	Cell 2	Cell 3
Initial UL BWP Configuration	Config 1,4		ULBWP.0.2 <sup>Note4</sup>	N/A
	Config 2,5			
	Config 3,6			
Active UL BWP-0 Configuration	Config 1,4		ULBWP.0.2 <sup>Note4</sup>	N/A
	Config 2,5			
	Config 3,6			
Active UL BWP-1 Configuration	Config 1,4		N/A	N/A
	Config 2,5			
	Config 3,6			
Active UL BWP-2 Configuration	Config 1,4		N/A	N/A
	Config 2,5			
	Config 3,6			
PDSCH Reference measurement channel	Config 1,4		SR.1.1 FDD	
	Config 2,5		SR.1.1 TDD	
	Config 3,6		SR2.1 TDD	
RMSI CORESET parameters	Config 1,4		CR.1.1 FDD	
	Config 2,5		CR.1.1 TDD	
	Config 3,6		CR2.1 TDD	
Dedicated CORESET parameters	Config 1,4		CCR.1.2 FDD	
	Config 2,5		CCR.1.2 TDD	
	Config 3,6		CCR.2.4 TDD	
OCNG Patterns	Config 1,2,4,5		OP.1 <sup>Note 5</sup>	
	Config 3,6		OP.1 <sup>Note 6</sup>	
SSB Configuration	Config 1,2,4,5		SSB.1 FR1	
	Config 3,6		SSB.2 FR1	
SMTC Configuration			SMTC.1	
TRS Configuration	Config 1,4		TRS.1.1 FDD	
	Config 2,5		TRS.1.1 TDD	
	Config 3,6		TRS.1.2 TDD	
Antenna Configuration			1x2	
Propagation Condition			AWGN	
EPRE ratio of PSS to SSS		dB	0	0
EPRE ratio of PBCH DMRS to SSS				
EPRE ratio of PBCH to PBCH DMRS				
EPRE ratio of PDCCH DMRS to SSS				
EPRE ratio of PDCCH to PDCCH DMRS				
EPRE ratio of PDSCH DMRS to SSS				
EPRE ratio of PDSCH to PDSCH				
EPRE ratio of OCNG DMRS to SSS <sup>Note 1</sup>				
EPRE ratio of OCNG to OCNG DMRS <sup>Note 1</sup>				
$N_{oc}$ <sup>Note 2</sup>				
SS-RSRP <sup>Note 3</sup>		dBm/15 kHz	-87	-87
$\bar{E}_s/I_{ot}$		dB	17	17
$\bar{E}_s/N_{oc}$		dB	17	17
$I_o$ <sup>Note3</sup>	Config 1,2,4,5	dBm/ 9.36MHz	-58.96	-58.96
	Config 3,6	dBm/ 38.16MHz	-52.86	-52.86

Note 1: OCNG shall be used such that both cells are fully allocated and a constant total transmitted power spectral density is achieved for all OFDM symbols.

Note 2: Interference from other cells and noise sources not specified in the test is assumed to be constant over subcarriers and time and shall be modelled as AWGN of appropriate power for  $N_{oc}$  to be fulfilled within  $BW_{occupied}$ .

Note 3: SS-RSRP and  $I_o$  levels have been derived from other parameters for information purposes. They are not settable parameters themselves.

Note 4: For unpaired spectrum, a DL BWP is linked with an UL BWP. DLBWP.0.2 is linked with ULBWP.0.2; DLBWP.1.1 is linked with ULBWP.1.1; DLBWP.1.3 is linked with ULBWP.1.3 defined in clause 12 of TS 38.213 [8].

Note 5: All UL/DL transmission shall be confined within  $BW_{occupied}$  (i.e. 10 MHz, 52 RBs) from  $F_{c,low}$ , and  $I_o$  is independent of the  $BW_{channel}$  configured.

Note 6: All UL/DL transmission shall be confined within  $BW_{occupied}$  (i.e. 40 MHz, 106 RBs) from  $F_{c,low}$ , and  $I_o$  is independent of the  $BW_{channel}$  configured.

Note 7:  $N_{RB,c}$  is derived from Table 5.3.2-1 in TS38.101-1[2] with configured  $BW_{channel}$ .

During T1, the UE shall start to send the ACK/NACK for PCell from the first UL slot that occurs after the beginning of DL slot  $(i+T_{\text{BWPswitchDelay}}+k_1)$ .

During T3, the UE shall start to send the ACK/NACK for SCell from the first UL slot that occurs after the beginning of DL slot  $(j+T_{\text{BWPswitchDelay}}+k_1)$ .

Where,  $k_1$  is the timing between DL data receiving and acknowledgement as specified in [9].

Depending on UE capability *bwp-SwitchingDelay* [13], UE shall finish BWP switch within the time duration  $T_{\text{BWPswitchDelay}}$  defined in TS 38.133 [6] Table 8.6.2-1.

All of the above test requirements shall be fulfilled in order for the observed SCell active BWP switch delay to be counted as correct.

The rate of correct events observed during repeated tests shall be at least 90%.

During T1, the start of the interruption of E-UTRA PCell during SCell active BWP switch shall not happen outside the BWP switch delay.

During T3, the start of the interruption of E-UTRA PCell during SCell active BWP switch shall not happen outside the BWP switch delay.

The interruption of E-UTRA PCell shall not be longer than the interruption duration specified for active BWP switch in clause 7.32.2.7 of TS 36.133 [23].

During T1, the start of the interruption of PSCell during SCell active BWP switch shall not happen outside the BWP switch delay.

During T3, the start of the interruption of PSCell during SCell active BWP switch shall not happen outside the BWP switch delay.

The interruption of PSCell shall not be longer than the interruption duration specified for active BWP switch in TS 38.133 [6] clause 8.6.2.

All of the above test requirements shall be fulfilled in order for the observed E-UTRA PCell and PSCell active BWP switch interruption to be counted as correct.

The rate of correct events observed during repeated tests shall be at least 90%.

NOTE: During T1, T3 if there are no uplink resources for reporting the ACK/NACK in the first UL slot that occurs after the beginning of DL slot  $(i+T_{\text{BWPswitchDelay}}+k_1)$ ,  $(j+T_{\text{BWPswitchDelay}}+k_1)$ , then the UE shall use the next available uplink resource for reporting the corresponding ACK/NACK.

## 4.5.6.2 RRC-based active BWP switch

### 4.5.6.2.0 Minimum conformance requirements

#### 4.5.6.2.0.1 Minimum conformance requirements for RRC-based active BWP switch

For RRC-based BWP switch, after the UE receives RRC reconfiguration involving active BWP switching or parameter change of its active BWP, UE shall be able to receive PDSCH/PDCCH (for DL active BWP switch) or transmit PUSCH (for UL active BWP switch) on the new BWP on the serving cell on which BWP switch occurs on the first DL or UL slot right after a time duration of  $\frac{T_{\text{RRCprocessingDelay}}+T_{\text{BWPswitchDelay}}}{NR \text{ Slot length}}$  slots which begins from the beginning of DL slot  $n$ , where

DL slot  $n$  is the last slot overlapping with the PDSCH containing the RRC command, and

NR Slot length is determined by the smaller SCS between the SCS before BWP switch and the SCS after BWP switch if the BWP switch involves changing of SCS.

$T_{\text{RRCprocessingDelay}}$  is the length of the RRC procedure delay in ms as defined in clause 11.2 in TS 36.331 [29] if the corresponding RRC message is embedded in E-UTRA RRC message, otherwise it is the length of the RRC procedure delay in ms as defined in clause 12 in TS 38.331 [13], and

$T_{BWPswitchDelayRRC} = 6ms$  is the time used by the UE to perform BWP switch.

The UE is not required to transmit UL signals or receive DL signals during the time defined by  $T_{RRCprocessingDelay} + T_{BWPswitchDelayRRC}$  on the cell where RRC-based BWP switch occurs. When  $T_{HARQ} > T_{RRCprocessingDelay}$  a longer switching delay is allowed. Where  $T_{HARQ}$  is the time between DL data transmission and acknowledgement as specified in TS 38.213 [8].

The normative reference for this requirement is TS 38.133 [6] clauses 8.6.3.

#### 4.5.6.2.1 EN-DC FR1 RRC-based DL active BWP switch in non-DRX in synchronous EN-DC

##### 4.5.6.2.1.1 Test purpose

The purpose of this test is to verify the DL BWP switch delay requirement for RRC-based BWP switch defined in TS 38.133 [6] clause 8.6.3.

##### 4.5.6.2.1.2 Test applicability

This test applies to all types of E-UTRA UE release 15 onwards supporting EN-DC, BWP adaptation of at least 2BWPs.

##### 4.5.6.2.1.3 Minimum conformance requirements

The minimum conformance requirements are specified in clause 4.5.6.2.0.1.

The normative reference for this requirement is TS 38.133 [6] clause A.4.5.6.2.1.

##### 4.5.6.2.1.4 Test description

##### 4.5.6.2.1.4.1 Initial conditions

This test shall be tested using any of the test configurations in Table 4.5.6.2.1.4.1-1.

**Table 4.5.6.2.1.4.1-1: Supported test configurations for FR1 RRC-based DL active BWP switch in non-DRX in synchronous EN-DC**

Config	Description
4.5.6.2.1-1	LTE FDD, NR 15 kHz SSB SCS, 10 MHz bandwidth, FDD duplex mode
4.5.6.2.1-2	LTE FDD, NR 15 kHz SSB SCS, 10 MHz bandwidth, TDD duplex mode
4.5.6.2.1-3	LTE FDD, NR 30 kHz SSB SCS, 40 MHz bandwidth, TDD duplex mode
4.5.6.2.1-4	LTE TDD, NR 15 kHz SSB SCS, 10 MHz bandwidth, FDD duplex mode
4.5.6.2.1-5	LTE TDD, NR 15 kHz SSB SCS, 10 MHz bandwidth, TDD duplex mode
4.5.6.2.1-6	LTE TDD, NR 30 kHz SSB SCS, 40 MHz bandwidth, TDD duplex mode

NOTE: The UE is only required to be tested in one of the supported test configurations.

Configure the test equipment and the DUT according to the parameters in Table 4.5.6.2.1.4.1-2.

**Table 4.5.6.2.1.4.1-2: Initial conditions for FR1 RRC-based DL active BWP switch in non-DRX in synchronous EN-DC**

Parameter	Value		Comment
Test environment	NC		As specified in TS 38.508-1 [14] clause 4.1.
Test frequencies	As specified in Annex E, Table E.4-1 and TS 38.508-1 [14] clause 4.3.1.		
Channel bandwidth	As specified by the test configuration selected from Table 4.5.6.2.1.4.1-1.		
Propagation conditions	AWGN		As specified in clause C.2.2
Connection Diagram	TE Part	A.3.1.8.2	As specified in TS 38.508-1 [14] Annex A.
	DUT Part	A.3.2.3.4	

Exceptions to connection diagram	- For 4Rx capable UEs without any 2Rx RF bands use A.3.2.5.2 for DUT part and A.3.1.8.4 for TE part.	
----------------------------------	--	--

1. The general test parameter settings are set up according to Table 4.5.6.2.1.4.1-3.
2. Message contents are defined in clause 4.5.6.2.1.4.3.
3. The test scenario comprises of one E-UTRA PCell (Cell 1) and one NR PSCell (Cell 2). The power levels and settings for Cell 1 are set according to Annex A.6. Cell 2 are configured according to clause C.1.2 and C.1.3.

**Table 4.5.6.2.1.4.1-3: General test parameters for DL BWP switch in synchronous EN-DC**

Parameter	Unit	Value	Comment
E-UTRA RF Channel Number		1	One E-UTRA radio channel is used for this test
NR RF Channel Number		2	One NR radio channel is used for this test
Active PCell		Cell 1	PCell on RF channel number 1.
Active PSCell		Cell 2	PSCell on RF channel number 2.
CP length		Normal	
DRX		OFF	
Cell-individual offset for cells on RF channel number 1	dB	0	Individual offset for cells on PCC.
Cell-individual offset for cells on RF channel number 2	dB	0	Individual offset for cells on PSCC.
Cell2 timing offset to cell1	μs	3	Synchronous EN-DC
T1	s	0.2	

#### 4.5.6.2.1.4.2 Test procedure

The test consists of 1 time period, with duration of T1.

PDCCHs indicating new transmissions shall be sent continuously on PSCell (Cell 2) to ensure that the UE will have ACK/NACK sending.

Before the test starts:

- UE is connected to Cell 1 (E-UTRA PCell) on radio channel 1 (PCC) and to Cell 2 (PSCell) on radio channel 2 (PSCC).
- UE has bandwidth part BWP-1 in its RRC-configuration for Cell 2 (PSCell).
- UE is indicated in *firstActiveDownlinkBWP-Id* that the active DL BWP is BWP-1 in PSCell.

All cells have constant signal levels throughout the test:

1. Ensure the UE is in state *RRC\_CONNECTED* with generic procedure parameters *Connectivity EN-DC*, DC bearer *MCG\_and\_SCG*, Connected without release *On* and Test Mode *On* according to TS 38.508-1 [14] clause 4.5.
2. Set the parameters according to Tables 4.5.6.2.1.4.1-3 and 4.5.6.2.1.5-1. Propagation conditions are set according to Annex C clauses C.2.2.
3. The SS shall send an *RRCCONNECTIONRECONFIGURATION* message releasing the dedicated configuration of the *initialDownlinkBWP* and the *initialUplinkBWP*. This message also configures another UE-specific bandwidth part, BWP-1, and indicates BWP-1 as the active DL BWP using *firstActiveDownlinkBWP-Id*, according to the initial condition of Active BWP-1 in Table 4.5.6.2.1.5-1.
4. The UE shall transmit an *RRCCONNECTIONRECONFIGURATIONCOMPLETE* message.
5. The SS shall send an *RRCCONNECTIONRECONFIGURATION* message with updated bandwidth part configuration for PSCell DL BWP switch, changing the BWP according to the final condition of Active BWP-1 in Table 4.5.6.2.1.5-1. T1 starts.

6. The UE shall receive the *RRCCONNECTIONRECONFIGURATION* in PSCell's slot # denoted i and reconfigure its bandwidth part with the updated bandwidth part configuration:
7. If the UE starts to report valid ACK/NACK for PSCell from the first UL slot that occurs after the beginning of DL slot  $i+X+k_1$  then the number of successful tests is increased by one. Otherwise, the number of failure tests is increased by one. Where,
  - $X = 26$  for test configuration 4.5.6.2-1, 4.5.6.2-2, 4.5.6.2-4 and 4.5.6.2-5;
  - $X = 52$  for test configuration 4.5.6.2-3 and 4.5.6.2-6.
8. After the SS receives the ACK/NACK in step 5) or when T1 expires, the SS shall transmit *RRCCONNECTIONRECONFIGURATION* message with condition EN-DC\_PSCell\_Rel according to TS 36.508 [25] Table 4.6.1-8 to release NR cell (PSCell). The UE shall transmit *RRCCONNECTIONRECONFIGURATIONCOMPLETE* message.
9. The SS shall transmit *RRCCONNECTIONRECONFIGURATION* message with condition MCG\_and\_SCG according to TS 36.508 [25] Table 4.6.1-8 to add NR cell (PSCell). The UE shall transmit *RRCCONNECTIONRECONFIGURATIONCOMPLETE* message. If either of the reconfiguration in step 6 or step 7 fails, switch off and on the UE and go to step 1.
10. Repeat steps 2-9 until the confidence level according to Tables G.2.3-1 in Annex G clause G.2 is achieved.

The SS verifies the DL BWP switch time in PSCell by counting the slots from the time when the *RRCCONNECTIONRECONFIGURATION* message including updated BWP configuration is sent till the time when a valid ACK/NACK is received.

4.5.6.2.1.4.3 Message contents

Message contents are according to TS 38.508-1 [14] clause 7.3 with the following exceptions:

**Table 4.5.6.2.1.4.3-1: Common Exception messages for FR1 RRC-based DL active BWP switch in non-DRX in synchronous EN-DC**

Default Message Contents	
Common contents of system information blocks exceptions	
Default RRC messages and information elements contents exceptions	Table H.3.4-1

**Table 4.5.6.2.1.4.3-1A: RRCReconfiguration (Step 3, Step 5)**

Derivation Path: TS 38.508-1 [14], Table 4.6.1-13 with condition EN-DC			
Information Element	Value/remark	Comment	Condition
<i>RRCReconfiguration</i> ::= SEQUENCE {			
criticalExtensions CHOICE {			
rrcReconfiguration SEQUENCE {			
secondaryCellGroup	CellGroupConfig	Table 4.5.6.2.1.4.3-1B	
}			
}			
}			

**Table 4.5.6.2.1.4.3-1B: CellGroupConfig (Table 4.5.6.2.1.4.3-1A)**

Derivation Path: TS 38.508-1 [14], Table 4.6.3-19			
Information Element	Value/remark	Comment	Condition
<i>CellGroupConfig</i> ::= SEQUENCE {			
cellGroupld	1		
spCellConfig SEQUENCE {			
servCellIndex	ServCellIndex of NR PSCell		
spCellConfigDedicated	ServingCellConfig	Table 4.5.6.2.1.4.3-1C	

--	--	--

**Table 4.5.6.2.1.4.3-1C: *ServingCellConfig* (Table 4.5.6.2.1.4.3-1B)**

Derivation Path: TS 38.508-1 [14], Table 4.6.3-167			
Information Element	Value/remark	Comment	Condition
ServingCellConfig ::= SEQUENCE {			
initialDownlinkBWP SEQUENCE {			
pdcch-Config CHOICE {			
release	NULL		
}			
pdsch-Config CHOICE {			
release	NULL		
}			
radioLinkMonitoringConfig CHOICE {			
release	NULL		
}			
}			
downlinkBWP-ToAddModList SEQUENCE (SIZE (1..maxNrofBWPs)) OF BWP-Downlink {	1 entry		
BWP-Downlink[1] SEQUENCE {	BWP-Downlink	entry 1 Table 4.5.6.2.1.4.3-1D	
}			
firstActiveDownlinkBWP-Id	1	BWP-1	
defaultDownlinkBWP-Id	1	BWP-1	
uplinkConfig SEQUENCE {			
initialUplinkBWP SEQUENCE {			
pucch-Config CHOICE {			
release	NULL		
}			
pusch-Config CHOICE {			
release	NULL		
}			
srs-Config CHOICE {			
release	NULL		
}			
}			
uplinkBWP-ToAddModList SEQUENCE (SIZE (1..maxNrofBWPs)) OF BWP-Uplink {	1 entry		
BWP-Uplink[1]	BWP-Uplink	entry 1 4.5.6.2.1.4.3-1E	
}			
firstActiveUplinkBWP-Id	1	BWP-1	
}			
}			

**Table 4.5.6.2.1.4.3-1D: *BWP-Downlink* (Table 4.5.6.2.1.4.3-1C)**

Derivation Path: TS 38.508-1 [14], Table 4.6.3-9			
Information Element	Value/remark	Comment	Condition
BWP-Downlink ::= SEQUENCE {			
bwp-Id	1		
bwp-Common SEQUENCE {			
genericParameters	RIV defined in TS 38.214 [9] that corresponds to DLBWP.1.3		Step 3
}	RIV defined in TS 38.214 [9] that corresponds to DLBWP.1.1		Step 5
}			



**Table 4.5.6.2.1.4.3-1E: BWP-Uplink (Table 4.5.6.2.1.4.3-1C)**

Derivation Path: TS 38.508-1 [14], Table 4.6.3-13			
Information Element	Value/remark	Comment	Condition
BWP-Uplink ::= SEQUENCE {			
bwp-Id	1		
bwp-Common SEQUENCE {			
genericParameters	RIV defined in TS 38.214 [9] that corresponds to ULBWP.1.3		Step 3
	RIV defined in TS 38.214 [9] that corresponds to ULBWP.1.1		Step 5
}			
}			

**Table 4.5.6.2.1.4.3-2: Void**

4.5.6.2.1.5 Test requirements

Tables 4.5.6.2.1.4.1-3 and 4.5.6.2.1.5-1 define the primary level settings including test tolerances.

**Table 4.5.6.2.1.5-1: NR Cell specific test parameters for DL BWP switch in synchronous EN-DC**

Parameter		Unit	Cell 2
Frequency Range			FR1
Duplex mode	Config 1,4		FDD
	Config 2,3,5,6		TDD
TDD configuration	Config 1,4		Not Applicable
	Config 2,5		TDDConf.1.1
	Config 3,6		TDDConf.2.1
BW <sub>channel</sub>	Config 1,4		10 MHz: N <sub>RB,c</sub> = 52
	Config 2,5		10 MHz: N <sub>RB,c</sub> = 52
	Config 3,6		40 MHz: N <sub>RB,c</sub> = 106
Active DL BWP ID			1
Initial DL BWP Configuration	Config 1,4		DLBWP.0.2 <sup>Note4</sup>
	Config 2,5		
	Config 3,6		
Initial UL BWP Configuration	Config 1,4		ULBWP.0.2 <sup>Note4</sup>
	Config 2,5		
	Config 3,6		
Initial Condition	Active DL BWP-1 Configuration	Config 1,4	DLBWP.1.3 <sup>Note4</sup>
		Config 2,5	
		Config 3,6	
Initial Condition	Active UL BWP-1 Configuration	Config 1,4	ULBWP.1.3 <sup>Note4</sup>
		Config 2,5	
		Config 3,6	
Final Condition	Active DL BWP-1 Configuration	Config 1,4	DLBWP.1.1 <sup>Note4</sup>
		Config 2,5	
		Config 3,6	
Final Condition	Active UL BWP-1 Configuration	Config 1,4	ULBWP.1.1 <sup>Note4</sup>
		Config 2,5	
		Config 3,6	
PDSCH Reference measurement channel	Config 1,4		SR.1.1 FDD
	Config 2,5		SR.1.1 TDD
	Config 3,6		SR.2.1 TDD
RMSI CORESET parameters	Config 1,4		CR.1.1 FDD
	Config 2,5		CR.1.1 TDD

Parameter	Unit	Cell 2	
	Config 3,6	CR.2.1 TDD	
Dedicated CORESET parameters	Config 1,4	CCR.1.2 FDD	
	Config 2,5	CCR.1.2 TDD	
	Config 3,6	CCR.2.4 TDD	
OCNG Patterns		OP.1	
SSB Configuration	Config 1,2,4,5	SSB.1 FR1	
	Config 3,6	SSB.2 FR1	
SMTTC Configuration		SMTTC.1	
TRS Configuration	Config 1,4	TRS.1.1 FDD	
	Config 2,5	TRS.1.1 TDD	
	Config 3,6	TRS.1.2 TDD	
Antenna Configuration		1x2	
Propagation Condition		AWGN	
EPRE ratio of PSS to SSS	dB	0	
EPRE ratio of PBCH DMRS to SSS			
EPRE ratio of PBCH to PBCH DMRS			
EPRE ratio of PDCCH DMRS to SSS			
EPRE ratio of PDCCH to PDCCH DMRS			
EPRE ratio of PDSCH DMRS to SSS			
EPRE ratio of PDSCH to PDSCH			
EPRE ratio of OCNG DMRS to SSS(Note 1)			
EPRE ratio of OCNG to OCNG DMRS (Note 1)			
$N_{oc}$ <sup>Note 2</sup>			dBm/15 kHz
SS-RSRP <sup>Note 3</sup>	dBm/15 kHz	-87	
$\bar{E}_s/I_{ot}$	dB	17	
$\bar{E}_s/N_{oc}$	dB	17	
$I_o$ <sup>Note3</sup>	Config 1,2,4,5	dBm/ 9.36MHz	-58.96
	Config 3,6	dBm/ 38.16MHz	-52.86
NOTE 1: OCNG shall be used such that both cells are fully allocated and a constant total transmitted power spectral density is achieved for all OFDM symbols.			
NOTE 2: Interference from other cells and noise sources not specified in the test is assumed to be constant over subcarriers and time and shall be modelled as AWGN of appropriate power for $N_{oc}$ to be fulfilled.			
NOTE 3: SS-RSRP and $I_o$ levels have been derived from other parameters for information purposes. They are not settable parameters themselves.			
NOTE 4: For unpaired spectrum, a DL BWP is linked with an UL BWP. DLBWP.0.2 is linked with ULBWP.0.2; DLBWP.1.1 is linked with ULBWP.1.1; DLBWP.1.3 is linked with ULBWP.1.3 defined in clause 12 of TS 38.213 [8].			

During T1, the UE shall be ready for the reception of uplink grant on PSCell from the first DL slot occurs after the beginning of DL slot  $i + \frac{T_{RRCprocessingDelay} + T_{BWPswitchDelayRRC}}{NR\ Slot\ length}$ , and starts to report valid ACK/NACK for the PSCell from the first UL slot that occurs after the beginning of DL slot  $i + \frac{T_{RRCprocessingDelay} + T_{BWPswitchDelayRRC}}{NR\ Slot\ length} + k_1$

Where,

$T_{RRCprocessingDelay} = 20$  ms, is the RRC procedure delay in ms as defined in clause 11.2 in TS 36.331 [29];

$T_{BWPswitchDelayRRC} = 6$  ms, is the time used by the UE to perform BWP switch;

NR slot length = 1ms for SCS = 15kHz, and NR slot length = 0.5 ms for SCS = 30kHz.

$k_1$  is the timing between DL data receiving and acknowledgement as specified in [12].

Which gives  $\frac{T_{RRCprocessingDelay} + T_{BWPswitchDelayRRC}}{NR\ Slot\ length} =$

26 slots, for SCS = 15kHz,

52 slots, for SCS = 30kHz.

All of the above test requirements shall be fulfilled in order for the observed PSCell active BWP switch delay to be counted as correct.

The rate of correct events observed during repeated tests shall be at least 90%.

## 4.5.7 PSCell addition and release delay

### 4.5.7.0 Minimum conformance requirements

#### 4.5.7.0.1 NR PSCell Addition Delay Requirement

The requirements in this section shall apply for the UE which is configured with PCell, and may also be configured with one or more SCells.

Upon receiving NR PSCell addition in subframe  $n$ , the UE shall be capable to transmit PRACH preamble towards NR PSCell no later than in subframe  $n + T_{\text{config PSCell}}$ :

Where:

$$T_{\text{config PSCell}} = T_{\text{RRC\_delay}} + T_{\text{processing}} + T_{\text{search}} + T_{\Delta} + T_{\text{PSCell\_DU}} + 2 \text{ ms}$$

$T_{\text{RRC\_delay}}$  is the RRC procedure delay as specified in TS 36.331 [29].

$T_{\text{processing}}$  is the SW processing time needed by UE, including RF warm up period.  $T_{\text{processing}} = 20 \text{ ms}$  if NR PSCell is in FR1,  $T_{\text{processing}} = 40 \text{ ms}$  if NR PSCell is in FR2.

$T_{\text{search}}$  is the time for AGC settling and PSS/SSS detection.

- For NR PSCell in FR1: if the target cell is a known cell,  $T_{\text{search}} = 0 \text{ ms}$ . If the target cell is an unknown cell and the target cell  $E_s/I_{ot} \geq -2 \text{ dB}$ , then  $T_{\text{search}} = 3 * Tr_s \text{ ms}$ ;
- For NR PSCell in FR2: if the target cell is a known cell,  $T_{\text{search}} = 0 \text{ ms}$ . If the target cell is an unknown cell and the target cell  $E_s/I_{ot} \geq -2 \text{ dB}$ , then  $T_{\text{search}} = 24 * Tr_s \text{ ms}$ .

$T_{\Delta}$  is time for fine time tracking and acquiring full timing information of the target cell.  $T_{\Delta} = 1 * Tr_s \text{ ms}$  for a known or unknown PSCell.

$T_{\text{PSCell\_DU}}$  is the delay uncertainty in acquiring the first available PRACH occasion in the NR PSCell.  $T_{\text{PSCell\_DU}}$  is up to the summation of SSB to PRACH occasion association period and 10 ms. SSB to PRACH occasion associated period is defined in the table 8.1-1 of TS 38.213 [8].

$Tr_s$  is the SMTC periodicity of the target NR cell if the UE has been provided with an SMTC configuration for the target cell in PSCell addition message, otherwise  $Tr_s$  is the SMTC configured in the measObjectNR having the same SSB frequency and subcarrier spacing. If the UE is not provided SMTC configuration or measurement object on this frequency, the requirement in this section is applied with  $Tr_s = 5 \text{ ms}$  assuming the SSB transmission periodicity is 5 ms. There is no requirement if the SSB transmission periodicity is not 5 ms.

In FR1 and FR2, the NR PSCell is known if it has been meeting the following conditions:

During the last 5 seconds before the reception of the NR PSCell configuration command:

- the UE has sent a valid measurement report for the NR PSCell being configured and
- One of the SSBs measured from the NR PSCell being configured remains detectable according to the cell identification conditions specified in section 9.3 of TS 38.133 [6],
- One of the SSBs measured from NR PSCell being configured also remains detectable during the NR PSCell configuration delay according to the cell identification conditions specified in section 9.3 of TS 38.133 [6].

otherwise it is unknown.

The PCell interruption specified in section 7.32 is allowed only during the RRC reconfiguration procedure TS 36.331 [29].

#### 4.5.7.0.2 NR PSCell Release Delay Requirement

The requirements in this section shall apply for a UE which is configured with PCell and NR PSCell, and may also be configured with one or more SCells and/or NR SCells.

Upon receiving NR PSCell release in subframe  $n$ , the UE shall accomplish the release actions specified in TS 36.331 [29] no later than in subframe  $n + T_{\text{RRC\_delay}}$ :

Where

$T_{\text{RRC\_delay}}$  is the RRC procedure delay as specified in TS 36.331 [29].

The PCell interruption specified in section 7.32 is allowed only during the RRC reconfiguration procedure TS 36.331 [29].

#### 4.5.7.1 EN-DC FR1 addition and release delay of known PSCell

##### 4.5.7.1.1 Test purpose

The purpose of this test is to verify that the PSCell addition and release delay for an NR PSCell is within the specified limits and the CSI transmissions are according to the requirements.

##### 4.5.7.1.2 Test applicability

This test applies to all types of NR UE supporting E-UTRA and EN-DC from Release 15 onwards.

##### 4.5.7.1.3 Minimum conformance requirements

The minimum conformance requirements are specified in clause 4.5.7.0.1 and 4.5.7.0.2.

The normative reference for this requirement is TS 38.133 [6] clause A.4.5.7.1.

##### 4.5.7.1.4 Test description

###### 4.5.7.1.4.1 Initial conditions

This test shall be tested using any of the test configurations in Table 4.5.7.1.4.1-1.

**Table 4.5.7.1.4.1-1: Test configurations**

Test Case ID	Description
4.5.7.1-1	LTE FDD, NR: 15 kHz SSB SCS, 10MHz bandwidth, FDD
4.5.7.1-2	LTE FDD, NR: 15 kHz SSB SCS, 10MHz bandwidth, TDD
4.5.7.1-3	LTE FDD, NR: 30 kHz SSB SCS, 40MHz bandwidth, TDD
4.5.7.1-4	LTE TDD, NR: 15 kHz SSB SCS, 10MHz bandwidth, FDD
4.5.7.1-5	LTE TDD, NR: 15 kHz SSB SCS, 10MHz bandwidth, TDD
4.5.7.1-6	LTE TDD, NR: 30 kHz SSB SCS, 40MHz bandwidth, TDD

NOTE: The UE is only required to be tested in one of the supported test configurations.

Configure the test equipment and the DUT according to the parameters in Table 4.5.7.1.4.1-2.

**Table 4.5.7.1.4.1-2: Initial conditions**

Parameter	Value	Comment
Test environment	NC, TL/VL, TL/VH, TH/VL, TH/VH	As specified in TS 38.508-1 [14] clause 4.1.
Test frequencies	As specified in Annex E, Table E.2-1 and TS 38.508-1 [14] clause 4.3.1.	
Channel bandwidth	As specified by the test configuration selected from Table 4.5.7.1.4.1-1.	
Propagation conditions	AWGN	As specified in clause C.2.2.
Connection Diagram	TE Part 2Rx	A.3.1.8.2 with $n = 1$
	TE Part 4Rx	A.3.1.8.5 with $n = 1$
	DUT Part 2Rx	A.3.2.3.4

	DUT Part 4Rx	A.3.2.5.2	
Exceptions to connection diagram	N/A		

1. Message contents are defined in clause 4.5.7.1.4.3.
2. Cell 1 is the E-UTRA serving cell (PCell) for the EN-DC setup. The power levels and settings for Cell 1 are set according to Annex A.6. Cell 2 is the NR FR1 cell. Cell 2 is the PSCell. The connection setup is done according to the settings in clause C.1.1.
3. Common test parameters are defined in Table 4.5.7.1.4.1-3.

**Table 4.5.7.1.4.1-3: General Test Parameters for PSCell Addition and Release**

Parameter		Unit	Value	Comment
RF Channel Number			1, 2	Two radio channels are used for this test. One for E-UTRA cell and second for NR Cell
Initial Condition	Active PCell		Cell1	PCell on RF channel number 1.
	Neighbour cell		Cell2	Neighbour cell on RF channel number 2.
Final Condition	Active PCell		Cell1	PCell on RF channel number 1.
	Neighbour Cell		Cell2	PSCell released on RF channel number 2.
B1	Hysteresis	dB	0	Hysteresis for evaluation of event B1.
	Threshold RSRP (Config 1,2,4,5)	dBm	-99	Actual RSRP threshold for event B1. Needs to take absolute accuracy tolerance in clause 9.11.1 of TS 36.133 [23] into account plus margin.
	Threshold RSRP (Config 3,6)	dBm	-96	Actual RSRP threshold for event B1. Needs to take absolute accuracy tolerance in clause 9.11.1 of TS 36.133 [23] into account plus margin.
	Time to Trigger	S	0	
DRX			OFF	Continuous monitoring of primary cell
Measurement gap pattern Id			0	Gaps are configured before T2 and released before T3.
PRACH configuration on cell2			PRACH.1 FR1	See A.7.1
Cell-individual offset for cells on RF channel number 1		dB	0	Individual offset for cells on primary component carrier.
Cell-individual offset for cells on RF channel number 2		dB	0	Individual offset for cells on carrier frequency of cell2.
T1		s	1	During this time the PCell shall be known and cell2 shall be unknown.
T2		s	1.5	During this time the UE shall identify neighbour cell (cell2) and report event B1.
T3		s	0.5	During this time the UE adds the PSCell.
T4		s	0.5	During this time the UE sends CSI reports for PSCell.
T5		s	0.5	During this time the UE releases the PSCell.

#### 4.5.7.1.4.2 Test procedure

1. Ensure the UE is in state E-UTRA RRC\_CONNECTED with generic procedure parameters *Connectivity E-UTRA/EPC* with Test Mode *On* according to TS 38.508-1 [14] clause 4.5.
2. The SS shall set the parameters according to Table 4.5.7.1.5-1 as appropriate. T1 starts
3. The SS shall transmit an *RRCCONNECTIONRECONFIGURATION* message with event B1 configured.
4. The UE shall transmit an *RRCCONNECTIONRECONFIGURATIONCOMPLETE* message.
5. When T1 expires, the SS shall set T2 parameters according to Table 4.5.7.1.5-1 as appropriate. T2 starts.

6. The UE shall transmit a *MeasurementReport* message triggered by Event B1 for Cell 2 no later than 1.5s from the start of T2.
7. The SS shall transmit an *RRCConnectionReconfiguration* message to release measurement gap.
8. The UE shall transmit an *RRCConnectionReconfigurationComplete* message.
9. The SS then shall transmit *RRCConnectionReconfiguration* message with condition *MCG\_and\_SCG* according to TS 36.508 [25] Table 4.6.1-8 to add NR cell (PSCell). T3 starts when the UE receives the RRC message.
10. The UE shall transmit an *RRCConnectionReconfigurationComplete* message.
11. The UE shall send a PRACH to PSCell during T3. The UE shall send PRACH no later than 82ms from the start of T3, otherwise increase the number of failed iterations by one, switch off the UE and continue with step 17.
12. T4 starts.
13. During T4 the UE shall send at least one CSI report for PSCell with non-zero CQI index, otherwise increase the number of failed iterations by one, switch off the UE and continue to step 17.
14. The SS shall transmit *RRCConnectionReconfiguration* message with condition *EN-DC\_PSCell\_Rel* according to TS 36.508 [25] Table 4.6.1-8 to release NR cell (PSCell) after the UE has send at least one CQI report with non-zero CQI index for PSCell (Cell 2). T5 starts when the UE receives the RRC message.
15. The UE shall transmit an *RRCConnectionReconfigurationComplete* message.
16. The UE shall stop sending CSI reports for PSCell no later than 20ms from the start of T5, if so increase the number of passed iterations by one otherwise increase the number of failed iterations by one and switch off the UE.
17. Set Cell 2 physical cell identity =  $[(\text{current cell 2 physical cell identity} + 1) \bmod 1008]$  for next iteration of the test procedure loop.
18. If the UE is not switched off, the SS shall transmit an *RRCConnectionRelease* message to release the RRC connection then, the SS transmits in Cell 1 a Paging message (including *PagingRecord* with UE-Identity) for the UE and ensures the UE is in State E-UTRA RRC\_CONNECTED with generic parameter *Connectivity E-UTRA/EPC*. If paging succeeds, go to step 20, otherwise switches off the UE.
19. Switches on the UE and ensures the UE is in state E-UTRA RRC\_CONNECTED with generic procedure parameters *Connectivity E-UTRA/EPC* with Test Mode *On* according to TS 38.508-1 [14] clause 4.5.
20. Repeat step 2-19 until a test verdict has been achieved.

4.5.7.1.4.3 Message contents

Message contents are according to TS 38.508-1 [14] clause 7.3 with the following exceptions:

**Table 4.5.7.1.4.3-1: Common exception messages**

Default Message Contents	
Common contents of system information blocks exceptions	
Default RRC messages and information elements contents exceptions	Table H.3.4-7 for step 3 Table H.3.4-1 for step 6. Table H.3.4-4 with condition INTER-RAT NR and EVENT B1 Table H.3.4-5 with condition Pattern#0
Specific message contents exceptions for Test Configuration 4.5.7.1-1, 4.5.7.1-2, 4.5.7.1-4, 4.5.7.1-5	Table H.3.4-6 with condition SMTC.1 and SSB.1 FR1
Specific message contents exceptions for Test Configuration 4.5.7.1-3, 4.5.7.1-6	Table H.3.4-6 with condition SMTC.1 and SSB.2 FR1

**Table 4.5.7.1.4.3-2: Void**

**Table 4.5.7.1.4.3-3: CSI-ReportConfig**

Derivation Path: TS 38.508-1 [14], Table 7.3.1-12F			
Information Element	Value/remark	Comment	Condition
CSI-ReportConfig ::= SEQUENCE {			
csi-IM-ResourcesForInterference	Not present		
nzp-CSI-RS-ResourcesForInterference	Not present		
reportConfigType CHOICE {			
periodic SEQUENCE {			
reportSlotConfig CHOICE {			
slots5	2		SCS15
slots10	4		SCS30
}			
pucch-CSI-ResourceList SEQUENCE (SIZE (1..maxNrofBWPs)) OF PUCCH-CSI-Resource {	1 entry		
PUCCH-CSI-Resource [1] SEQUENCE {			
uplinkBandwidthPartId	BWP-Id of active BWP		
pucch-Resource	8	PUCCH-format2 as configured in TS 38.508-1 [14], Table 4.6.3-112	
}			
}			
}			
}			

4.5.7.1.5 Test requirements

Table 4.5.7.1.5-1 defines the primary level settings including test tolerances.

**Table 4.5.7.1.5-1: Cell Specific Parameters for PSCell Addition and Release**

Parameter	Unit	Config	Test				
			T1	T2	T3	T4	T5
E-UTRA RF Channel Number		1,2,3,4,5,6	1				
NR RF Channel Number		1,2,3,4,5,6	2				
TDD configuration		1,4	Not Applicable				
		2,5	TDDConf.1.1				
		3,6	TDDConf.2.1				
BW <sub>channel</sub>	MHz	1,4	10: N <sub>RB,c</sub> = 52				
		2,5	10: N <sub>RB,c</sub> = 52				
		3,6	40: N <sub>RB,c</sub> = 106				
Initial BWP Configuration		1,2,3	DLBWP.0.1 ULBWP.0.1				
Dedicated BWP Configuration		1,2,3	DLBWP.1.1 ULBWP.1.1				
PDSCH Reference measurement channel		1,4	SR.1.1 FDD				
		2,5	SR.1.1 TDD				
		3,6	SR.2.1 TDD				
RMSI CORESET Reference Channel		1,4	CR.1.1 FDD				
		2,5	CR.1.1 TDD				
		3,6	CR.2.1 TDD				
Dedicated CORESET Reference Channel		1,4	CCR.1.1 FDD				
		2,5	CCR.1.1 TDD				
		3,6	CCR.2.1 TDD				
OCNG Patterns		1,2,3,4,5,6	OP.1				
SSB configuration		1,2,4,5	SSB.1 FR1				

Parameter	Unit	Config	Test				
			T1	T2	T3	T4	T5
SMTC configuration		3,6	SSB.2 FR1				
		1,2,4,5	SMTC.1				
		3,6	SMTC.1				
TRS Configuration		1,4	TRS.1.1 FDD				
		2,5	TRS.1.1 TDD				
		3,6	TRS.1.2 TDD				
CSI-RS configuration for CSI reporting		1,4	CSI-RS.1.1 FDD				
		2,5	CSI-RS.1.1 TDD				
		3,6	CSI-RS.2.1 TDD				
reportConfigType		1,2,3,4,5,6	periodic				
reportQuantity		1,2,3,4,5,6	cri-RI-PMI-CQI				
CSI reporting periodicity	slot	1,2,4,5	5				
		3,6	10				
CSI reporting offset	slot	1,2,4,5	2				
		3,6	4				
EPRE ratio of PSS to SSS	dB	1,2,3,4,5,6	0				
EPRE ratio of PBCH DMRS to SSS							
EPRE ratio of PBCH to PBCH DMRS							
EPRE ratio of PDCCH DMRS to SSS							
EPRE ratio of PDCCH to PDCCH DMRS							
EPRE ratio of PDSCH DMRS to SSS							
EPRE ratio of PDSCH to PDSCH							
EPRE ratio of OCNG DMRS to SSS(Note 1)							
EPRE ratio of OCNG to OCNG DMRS (Note 1)							
$N_{oc}^{Note2}$							
	3,6	N/A	-88.6				
$N_{oc}^{Note2}$	dBm/SCS	1,2,4,5	N/A	-88.6			
		3,6	N/A	-85.6			
$\hat{E}_s/I_{ot}$		1,2,3,4,5,6	-infinity	0			
$\hat{E}_s/N_{oc}$		1,2,3,4,5,6	-infinity	0			
SS-RSRP <sup>Note3</sup>	dBm/SCS	1,2,4,5	-infinity	-88.6			
		3,6	-infinity	-85.6			
$I_o^{Note3}$	dBm/9.36MHz	1,2,4,5	N/A	-57.6			
	dBm/38.1MHz	3,6	N/A	-51.5			
Propagation condition		1,2,3,4,5,6	AWGN				
<p>NOTE 1: OCNG shall be used such that both cells are fully allocated and a constant total transmitted power spectral density is achieved for all OFDM symbols.</p> <p>NOTE 2: Interference from other cells and noise sources not specified in the test is assumed to be constant over subcarriers and time and shall be modelled as AWGN of appropriate power for <math>N_{oc}</math> to be fulfilled.</p>							



Parameter	Unit	Config	Test				
			T1	T2	T3	T4	T5
NOTE 3: SS-RSRP and $I_0$ levels have been derived from other parameters for information purposes. They are not settable parameters themselves.							
NOTE 4: SS-RSRP minimum requirements are specified assuming independent interference and noise at each receiver antenna port.							

The UE shall transmit the PRACH to PSCell no later than 82 ms<sup>Note1</sup> from the start of T3.

The UE shall send at least one CSI report for PSCell with non-zero CQI index during T4.

The UE shall periodically send CSI reports for PSCell after the UE has sent first CQI report with non-zero CQI index during T4.

The UE shall stop sending CSI reports for PSCell no later than 20ms from the start of T5.

All the above test requirements shall be fulfilled in order for the observed PSCell addition delay and PSCell release delay to be counted as correct. The rate of correct observed PSCell addition delay and PSCell release delay during repeated tests shall be at least 90%.

NOTE: The PSCell addition delay can be expressed as follows as specified in clause 4.7.5.0.1:

$$T_{\text{config\_PSCell}} = T_{\text{RRC\_delay}} + T_{\text{processing}} + T_{\text{search}} + T_{\Delta} + T_{\text{PSCell\_DU}} + 2\text{ms}$$

Where:

$$T_{\text{RRC\_delay}} = 20\text{ms}$$

$$T_{\text{processing}} = 20\text{ms}$$

$$T_{\text{search}} = 0$$

$$T_{\Delta} = 20\text{ms}$$

$$T_{\text{PSCell\_DU}} = 1 \cdot 10 + 10 = 20\text{ms}$$

## 4.5.8 UL switching

### 4.5.8.0 Minimum conformance requirements

[TS 38.133, clause 8.2.1.2.14]

The DL interruption requirements at dynamic switching between two uplink carriers specified in this clause are applicable for an uplink band pair of an inter-band EN-DC configuration when the capability *uplinkTxSwitchingPeriod* is present, and is only applicable for uplink switching mechanism specified in clause 6.1.6 of TS 38.214 [9], where E-UTRA UL carrier is capable of one transmit antenna connector and NR UL carrier is capable of two transmit antenna connectors, and the two uplink carriers are in different bands with different carrier frequencies.

When dynamic switching between two uplink carriers is conducted, UE is allowed to cause DL interruption of X OFDM symbols in NR downlink carrier(s) as indicated by *uplinkTxSwitching-DL-Interruption* [13]. The DL interruption starts from the first OFDM symbol which fully or partially overlaps with the UL switching period located in NR carrier. The DL interruption lengths of X for NR carrier(s) are defined in Table 4.5.8.0-1.

No DL interruption is allowed in the NR downlink carrier(s) which is not indicated by *uplinkTxSwitching-DL-Interruption*. No DL interruption is allowed for some inter-band EN-DC configurations as specified in clause 5.5B.4 of TS 38.101-3 [4].

**Table 4.5.8.0-1: DL interruption length on NR carrier(s) in the unit of OFDM symbols (X) for switching between two uplink carriers**

$\mu$	NR Slot length (ms)	Uplink Tx switching period Note1	
		35us	140us
0	1	2	3
1	0.5	3	6
2	0.25	4	10
Note 1: Uplink Tx switching period depends on UE capability <i>uplinkTxSwitchingPeriod</i> .			

#### 4.5.8.1 EN-DC FR1 interruptions at switching between two uplink carriers

##### 4.5.8.1.1 Test purpose

The purpose of this test is to verify DL interruption requirements during UE dynamic switching between two uplink carriers. The test case is applicable for an uplink band pair of an inter-band EN-DC configuration when the capability *uplinkTxSwitchingPeriod* is present.

##### 4.5.8.1.2 Test applicability

This test applies to all types of NR UE supporting E-UTRA and EN-DC from Release 16 onwards supporting dynamic UL Tx switching in case of inter-band EN-DC.

##### 4.5.8.1.3 Minimum conformance requirements

The minimum conformance requirements are specified in clause 4.5.8.0.

The normative reference for this requirement is TS 38.133 [6] clause A.4.5.8.

##### 4.5.8.1.4 Test description

###### 4.5.8.1.4.1 Initial conditions

This test shall be tested using any of the test configurations in Table 4.5.8.1.4.1-1.

**Table 4.5.8.1.4.1-1: Test configurations**

Test Case ID	PSCell (Cell2)
4.5.8.1-1	30 kHz SSB SCS, 40 MHz bandwidth, TDD duplex mode

Configure the test equipment and the DUT according to the parameters in Table 4.5.8.1.4.1-2.

**Table 4.5.8.1.4.1-2: Initial conditions**

Parameter	Value		Comment
Test environment	NC		As specified in TS 38.508-1 [14] clause 4.1.
Test frequencies	As specified in Annex E, Table E.2-1 and TS 38.508-1 [14] clause 4.3.1.		
Channel bandwidth	As specified by the test configuration selected from Table 4.5.8.1.4.1-1.		
Propagation conditions	AWGN		As specified in Annex C.2.2.
Connection Diagram	TE Part	A.3.1.8.2	As specified in TS 38.508-1 [14] Annex A.
	DUT Part	A.3.2.3.4	
Exceptions to connection diagram	N/A		

1. The general test parameter settings are set up according to Table 4.5.8.1.4.1-3

2. Message contents are defined in clause 4.5.8.1.4.3.
3. Cell 1 is the E-UTRA serving cell (PCell) for the EN-DC setup. The power levels and settings for Cell 1 are set according to Annex A.6. Cell 2 is the NR FR1 cell. Cell 2 is the PSCell. The connection setup is done according to the settings in Annex C.1.1.

**Table 4.5.8.1.4.1-3: General Test Parameters for DL Interruptions at switching between two uplink carriers in EN-DC**

Parameter	Unit	Test configuration	Value	Comment
RF Channel Number		Config 1	1, 2	Two radio channels are used for the test.
Active cell		Config 1	Cell 1: E-UTRAN FDD PCell Cell 2: FR1 PSCell	E-UTRAN FDD PCell on RF channel number 1 FR1 PSCell on RF channel number 2
CP length		Config 1	Normal	
DRX		Config 1	OFF	
Measurement gap pattern Id		Config 1	OFF	
Filter coefficient		Config 1	0	L3 filtering is not used
CSI-RS configuration for L1-RSRP reporting		Config 1	CSI-RS.2.5 TDD	
T1	s	Config 1	5	

#### 4.5.8.1.4.2 Test procedure

The test consists of two cells: Cell1 and Cell2. Cell1 is E-UTRAN PCell, Cell2 is NR FR1 PSCell. The test consists of one time period, with duration of T1. Prior to the start of the time duration T1, the UE shall be connected to Cell1 and Cell2 and *uplinkTxSwitching* is indicated to the UE.

UE is configured to transmit SRS on PSCell on the last 2 symbols of special slot. DL interruption is expected to take place prior of the SRS symbols.

1. Ensure the UE is in state RRC\_CONNECTED with generic procedure parameters Connectivity EN-DC, DC bearer MCG\_and\_SCG, Connected without release On and Test Mode On according to TS 38.508-1 [14] clause 4.5.
2. Configure MCG according to TS 36.521-3 [26] Annex C.0, C.1 and SCG according to Annex C.1.1 and C.1.2 for all downlink physical channels.
3. The SS shall transmit an RRCConnectionReconfiguration message to configure PCell (Cell1) and PSCell (Cell2) on the MCG and SCG as per TS 36.508 [7] clause 4.6 with the message content exceptions defined in clause 4.5.8.1.4.3. *UplinkTxSwitching* is configured to the UE.
4. The UE shall transmit *RRCConnectionReconfigurationComplete* message.
5. Set the parameters according to T1 in Tables 4.5.8.1.5-1. T1 starts.
6. SS schedules UL transmission on PCell continuously on the DL slots of PSCell.
7. SS triggers aperiodic CSI-RS for L1-RSRP reporting with power boosting (6dB) on following symbol on the special slot on PSCell.
  - symbol#10 if UE does not report *uplinkTxSwitching-DL-Interruption-r16*;
  - otherwise,
    - symbol#5 if UE capability *uplinkTxSwitchingPeriod* is 140us or
    - symbol #8 if UE capability *uplinkTxSwitchingPeriod* is 35us.

8. After 80ms from the aperiodic CSI-RS transmission, the SS transmits the DCI trigger. The UE shall send L1-RSRP report containing L1-RSRP of CSI-RS#0 at slot 5 from the reception of DCI trigger, if so increase the number of passed iterations by one otherwise increase the number of failed iterations by one and switch off the UE.
9. The SS shall transmit *RRCConnectionReconfiguration* message with condition EN-DC\_PSCell\_Rel according to TS 36.508 [25] Table 4.6.1-8 to release NR cell (PSCell). The UE shall transmit *RRCConnectionReconfigurationComplete* message.
10. The SS then shall transmit *RRCConnectionReconfiguration* message with condition MCG\_and\_SCG according to TS 36.508 [25] Table 4.6.1-8 to add NR cell (PSCell). The UE shall transmit *RRCConnectionReconfigurationComplete* message.
11. If any of the reconfigurations fails, switch off and on the UE and ensure the UE is in RRC\_CONNECTED with generic procedure parameters Connectivity EN-DC, DC bearer MCG and SCG, Connected without release On according to TS 38.508-1 [14] clause 4.5
12. Repeat step 3-11 until a test verdict has been achieved.

4.5.8.1.4.3 Message contents

Message contents are according to TS 38.508-1 [14] clause 7.3 with the following exceptions:

**Table 4.5.8.1.4.3-1: Common exception messages**

Default Message Contents	
Common contents of system information blocks exceptions	
Default RRC messages and information elements contents exceptions	Table H.3.1-5

**Table 4.5.8.1.4.3-2: CellGroupConfig**

Derivation Path: TS 38.508-1 [14], Table 4.6.3-19			
Information Element	Value/remark	Comment	Condition
CellGroupConfig ::= SEQUENCE {			
uplinkTxSwitchingOption-r16	switchedUL		UE reports 'switchedUL' or 'both' for capability IE <i>uplinkTxSwitchingOptionSupport-r16</i>
	dualUL		UE reports 'dualUL' for capability IE <i>uplinkTxSwitchingOptionSupport-r16</i>
}			

Table 4.5.8.1.4.3-3: ServingCellConfig

Derivation Path: TS 38.508-1 [14], Table 4.6.3-167			
Information Element	Value/remark	Comment	Condition
ServingCellConfig ::= SEQUENCE {			
uplinkConfig SEQUENCE {			
uplinkTxSwitching-r16 CHOICE {			
setup SEQUENCE {			
uplinkTxSwitchingPeriodLocation-r1	1		
uplinkTxSwitchingCarrier-r16	carrier2		
}			
}			
}			
}			

Table 4.5.8.1.4.3-4: TDD-UL-DL-ConfigCommon

Derivation Path: Table 7.3.1-1 with condition TDDConf.2.1			
Information Element	Value/remark	Comment	Condition
TDD-UL-DL-ConfigCommon ::= SEQUENCE {			
pattern1 SEQUENCE {			
nrofDownlinkSymbols	11		
nrofUplinkSymbols	2		
}			
}			

Table 4.5.8.1.4.3-5: SRS-Config

Derivation Path: TS 38.508-1 [14], Table 4.6.3-182			
Information Element	Value/remark	Comment	Condition
SRS-Config ::= SEQUENCE {			
srs-ResourceSetToAddModList SEQUENCE (SIZE(0..maxNrofSRS-ResourceSets)) OF SEQUENCE {			
SRS-ResourceSet[1] SEQUENCE {		entry 1	
resourceType CHOICE {			
periodic SEQUENCE {			
}			
}			
}			
srs-ResourceToAddModList SEQUENCE (SIZE(1..maxNrofSRS-Resources)) OF SEQUENCE {			
SRS-Resource[1] SEQUENCE {		entry 1	
nrofSRS-Ports	ports2		
resourceMapping SEQUENCE {			
startPosition	1		
nrofSymbols	n2		
}			
freqHopping SEQUENCE {			
c-SRS	0		
}			
groupOrSequenceHopping	neither		
resourceType CHOICE {			
periodic SEQUENCE {			
periodicityAndOffset-p CHOICE {			
sl8	3		
}			
}			
}			
}			
}			
}			

**Table 4.5.8.1.4.3-6: *CSI-MeasConfig***

Derivation Path: TS 38.508-1 [14], Table 4.6.3-38			
Information Element	Value/remark	Comment	Condition
CSI-MeasConfig ::= SEQUENCE {			
nzp-CSI-RS-ResourceToAddModList SEQUENCE (SIZE (1..maxNrofNzp-Csi-Rs-Resources)) OF NZP-CSI-RS-Resource {	1 entry		
NZP-CSI-RS-Resource[1] SEQUENCE {		entry 1	
nzp-CSI-RS-ResourceId	0		
resourceMapping SEQUENCE {			
frequencyDomainAllocation CHOICE {			
other	000001		
}			
nrofPorts	p1		
firstOFDMSymbolInTimeDomain	10		UE does not report uplinkTxSwitching-DL- Interruption-r16
	5		UE capability uplinkTxSwitchingPeriod is 140us
	8		UE capability uplinkTxSwitchingPeriod is 35us
firstOFDMSymbolInTimeDomain2	Not present		
cdm-Type	noCDM		
density CHOICE {			
three			
}			
freqBand SEQUENCE {			
startingRB	0		
nrofRBs	106		
}			
powerControlOffset	0		
powerControlOffsetSS	db0		
scramblingID	0		
periodicityAndOffset	Not Present		
qcl-InfoPeriodicCSI-RS	Not Present		
}			
}			
nzp-CSI-RS-ResourceSetToAddModList SEQUENCE (SIZE (1..maxNrofNzp-Csi-Rs-ResourceSets)) OF NZP-CSI-RS-ResourceSetId {	1 entry		
NZP-CSI-RS-ResourceSet[1]	NZP-CSI-RS-ResourceSet	entry 1 Table 4.5.8.1.4.3-7	
}			
csi-ResourceConfigToAddModList SEQUENCE (SIZE (1..maxNrofCsi-ResourceConfigurations)) OF CSI-ResourceConfig {	1 entry		
CSI-ResourceConfig[1]		entry 1 Table 4.5.8.1.4.3-8	
}			
csi-ReportConfigToAddModList SEQUENCE (SIZE (1..maxNrofCsi-ReportConfigurations)) OF CSI-ReportConfig {	1 entry		
CSI-ReportConfig[1]	CSI-ReportConfig	entry 1 Table 4.5.8.1.4.3-9	
}			



}		
---	--	--

**Table 4.5.8.1.4.3-7: NZP-CSI-RS-ResourceSet**

Derivation Path: TS 38.508-1 [14], Table 4.6.3-87			
Information Element	Value/remark	Comment	Condition
NZP-CSI-RS-ResourceSet ::= SEQUENCE {			
nzp-CSI-ResourceSetId	0		
nzp-CSI-RS-Resources SEQUENCE (SIZE (1..maxNrofNZP-CSI-RS-ResourcesPerSet)) OF NZP-CSI-RS-ResourceId {	1 entry		
NZP-CSI-RS-ResourceId [1]	0	entry 1	
}			
repetition	off		
aperiodicTriggeringOffset	6		
trs-Info	Not present		
}			

**Table 4.5.8.1.4.3-8: CSI-ResourceConfig**

Derivation Path: TS 38.508-1 [14], Table 4.6.3-41			
Information Element	Value/remark	Comment	Condition
CSI-ResourceConfig ::= SEQUENCE {			
csi-ResourceConfigId	0		
csi-RS-ResourceSetList CHOICE {			
nzp-CSI-RS-SSB SEQUENCE {			
nzp-CSI-RS-ResourceSetList SEQUENCE (SIZE (1..maxNrofNZP-CSI-RS-ResourceSetsPerConfig)) OF NZP-CSI-RS-ResourceSetId {			
NZP-CSI-RS-ResourceSetId [1]	0		
}			
csi-SSB-ResourceSetList	Not present		
}			
bwp-Id	0		
resourceType	aperiodic		
}			

Table 4.5.8.1.4.3-9: CSI-ReportConfig

Derivation Path: TS 38.508-1 [14], Table 4.6.3-39			
Information Element	Value/remark	Comment	Condition
CSI-ReportConfig ::= SEQUENCE {			
reportConfigId	0		
carrier	ServCellIndex		
resourcesForChannelMeasurement	0		
csi-IM-ResourcesForInterference	Not present		
nzp-CSI-RS-ResourcesForInterference	Not present		
reportConfigType CHOICE {			
Aperiodic SEQUENCE {			
reportSlotOffsetList SEQUENCE (SIZE (1..maxNrofUL-Allocations)) OF INTEGER {			
INTEGER	5		
INTEGER	5		
}			
}			
}			
reportQuantity CHOICE {			
cri-RSRP	NULL		
}			
reportFreqConfiguration	Not present		
timeRestrictionForChannelMeasurements	Not present		
timeRestrictionForInterferenceMeasurements	Not present		
codebookConfig	Not present		
dummy	Not present		
groupBasedBeamReporting	Not present		
cqi-Table	Not present		
subbandSize	Not present		
non-PMI-PortIndication	Not present		
semiPersistentOnPUSCH-v1530	Not present		
semiPersistentOnPUSCH-v1610	Not present		
aperiodic-v1610 SEQUENCE {			
reportSlotOffsetListDCI-0-2-r16	Not present		
reportSlotOffsetListDCI-0-1-r16 SEQUENCE (SIZE (1..maxNrofUL-Allocations-r16)) OF INTEGER {			
INTEGER	5		
INTEGER	5		
}			
}			
reportQuantity-r16	Not present		
codebookConfig-r16	Not present		
}			

## 4.5.8.1.5 Test requirements

Table 4.5.8.1.5-1 defines the NR cell specific primary level settings including test tolerances for E-UTRAN – NR FR1 interruptions at switching between two uplink carriers.

**Table 4.5.8.1.5-1: NR Cell specific test parameters for DL Interruptions at switching between two uplink carriers in EN-DC (Cell 2)**

Parameter		Unit	Cell2
Frequency Range			FR1
Duplex mode	Config 1		TDD
TDD configuration	Config 1		TDDConf.2.1 except that: S='11DL: 1GP:2UL'; nrofDownlinkSymbols: 11 nrofUplinkSymbols: 2
BW <sub>channel</sub>	Config 1		40 MHz: N <sub>RB,c</sub> = 106
Initial BWP Configuration	Config 1		DLBWP.0.1
DL dedicated BWP configuration	Config 1		DLBWP.1.1
UL dedicated BWP configuration			ULBWP.1.1
SRS configuration			SRSConf.4 in Table 4.5.8.1.5-2
PDSCH Reference measurement channel	Config 1		SR.2.1 TDD
RMSI CORESET parameters	Config 1		CR.2.1 TDD
Dedicated CORESET parameters	Config 1		CCR.2.1 TDD
OCNG Patterns			OP.1
SMTTC Configuration			SMTTC.1
SSB Configuration	Config 1		SSB.2 FR1
Correlation Matrix and Antenna Configuration			2x2 low
EPRE ratio of PSS to SSS		dB	0
EPRE ratio of PBCH DMRS to SSS			
EPRE ratio of PBCH to PBCH DMRS			
EPRE ratio of PDCCH DMRS to SSS			
EPRE ratio of PDCCH to PDCCH DMRS			
EPRE ratio of PDSCH DMRS to SSS			
EPRE ratio of PDSCH to PDSCH			
EPRE ratio of OCNG DMRS to SSS(Note 1)			
EPRE ratio of OCNG to OCNG DMRS (Note 1)			
N <sub>oc</sub> <sup>Note 2</sup>		dBm/15 kHz	-104
SS-RSRP <sup>Note 3</sup>		dBm/SCS	84
$\bar{E}_s/I_{ot}$		dB	17
$\bar{E}_s/N_{oc}$		dB	17
N <sub>oc</sub> <sup>Note 2</sup>	Config 1	dBm/SCS	-101
I <sub>o</sub> <sup>Note3</sup>	Config 1	dBm/ 38.16MHz	-52.86
Time offset to Cell1 <sup>Note 5</sup>		μs	0
Propagation Condition			AWGN
<p>Note 1: OCNG shall be used such that both cells are fully allocated and a constant total transmitted power spectral density is achieved for all OFDM symbols.</p> <p>Note 2: Interference from other cells and noise sources not specified in the test is assumed to be constant over subcarriers and time and shall be modelled as AWGN of appropriate power for N<sub>oc</sub> to be fulfilled.</p> <p>Note 3: SS-RSRP and I<sub>o</sub> levels have been derived from other parameters for information purposes. They are not settable parameters themselves.</p> <p>Note 4: Void</p> <p>Note 5: Receive time difference between slot boundaries of signals received from the two cells at the UE antenna connector including time alignment error between the two cells.</p>			

**Table 4.5.8.1.5-2: SRS Configuration for DL Interruptions at switching between two uplink carriers**

	Field	SRSCnf.4	Comments
SRS-ResourceSet	srs-ResourceSetId	0	
	srs-ResourceIdList	0	
	resourceType	Periodic	
	Usage	Codebook	
SRS-Resource	SRS-ResourceId	0	
	nrofSRS-Ports	Port2	
	transmissionComb	n2	
	combOffset-n2	0	
	cyclicShift-n2	0	
	resourceMapping startPosition	1	
	resourceMapping nrofSymbols	n2	
	resourceMapping repetitionFactor	n1	
	freqDomainPosition	0	
	freqDomainShift	0	
	freqHopping c-SRS	0	Matches $N_{RB,c}$
	freqHopping b-SRS	0	
	freqHopping b-hop	0	
	groupOrSequenceHopping	Neither	
	resourceType	Periodic	
	periodicityAndOffset-p	sl8, 3	Offset to align with DRx periodicity
sequenceId	0	Any 10 bit number	

The UE shall send L1-RSRP report at slot 5 from the reception of DCI trigger. The L1-RSRP report shall include the results of CSI-RS#0. Each L1-RSRP measurement report shall meet the corresponding absolute accuracy requirements in Table 4.5.8.1.5-3.

**Table 4.5.8.1.5-3: L1-RSRP absolute accuracy requirements for the reported values**

Normal Conditions	T1
Lowest reported value (CSI-RS#0)	62
Highest reported value (CSI-RS#0)	83

The rate of correct events observed during repeated tests shall be at least 90%.

## 4.6 Measurement procedures

### 4.6.1 Intra-frequency measurements

#### 4.6.1.0 Minimum conformance requirements

##### 4.6.1.0.1 Minimum conformance requirements for event-triggered reporting without gap

The UE shall be able to identify a new detectable intra frequency cell within  $T_{\text{identify\_intra\_without\_index}}$  if UE is not indicated to report SSB based RRM measurement result with the associated SSB index (*reportQuantityRSIndexes* or *maxNrofRSIndexesToReport* is not configured), or the UE is indicated that the neighbour cell is synchronous with the serving cell (*deriveSSB-IndexFromCell* is enabled). Otherwise UE shall be able to identify a new detectable intra

frequency cell within  $T_{\text{identify\_intra\_with\_index}}$ . The UE shall be able to identify a new detectable intra frequency SS block of an already detected cell within  $T_{\text{identify\_intra\_without\_index}}$ . It is assumed that *deriveSSB-IndexFromCell* is always enabled for FR1 TDD and FR2.

$$T_{\text{identify\_intra\_without\_index}} = (T_{\text{PSS/SSS\_sync\_intra}} + T_{\text{SSB\_measurement\_period\_intra}}) \text{ ms}$$

$$T_{\text{identify\_intra\_with\_index}} = (T_{\text{PSS/SSS\_sync\_intra}} + T_{\text{SSB\_measurement\_period\_intra}} + T_{\text{SSB\_time\_index\_intra}}) \text{ ms}$$

Where:

$T_{\text{PSS/SSS\_sync\_intra}}$ : it is the time period used in PSS/SSS detection given in table 4.6.1.0.1-1, 4.6.1.0.1-2, 4.6.1.0.1-4 (deactivated SCell) or 4.6.1.0.1-5 (deactivated SCell)

$T_{\text{SSB\_time\_index\_intra}}$ : it is the time period used to acquire the index of the SSB being measured given in table 4.6.1.0.1-3 or 4.6.1.0.1-6 (deactivated SCell)

$T_{\text{SSB\_measurement\_period\_intra}}$ : equal to a measurement period of SSB based measurement given in table 4.6.1.0.1-7, table 4.6.1.0.1-8, table 4.6.1.0.1-9 (deactivated SCell), 4.6.1.0.1-10 (deactivated SCell), or 4.6.1.0.1-11 ()

$\text{CSSF}_{\text{intra}}$ : it is a carrier specific scaling factor and is determined

- according to  $\text{CSSF}_{\text{outside\_gap},i}$  in TS 38.133 [6] section 9.1.5.1 for measurement conducted outside measurement gaps, i.e. when intrafrequency SMTC is fully non overlapping or partially overlapping with measurement gaps, or according to  $\text{CSSF}_{\text{within\_gap},i}$  in TS 38.133 [6] section 9.1.5.2 for measurement conducted within measurement gaps, i.e. when intrafrequency SMTC is fully overlapping with measurement gaps.
- if the high layer in TS 38.331 [13] signalling of *smtc2* is configured, the assumed periodicity of intrafrequency SMTC occasions corresponds to the value of higher layer parameter *smtc2*; Otherwise the assumed periodicity of intrafrequency SMTC occasions corresponds to the value of higher layer parameter *smtc1*.

$M_{\text{pss/sss\_sync\_w/o\_gaps}}$ : For a UE supporting FR2 power class 1,  $M_{\text{pss/sss\_sync}}=40$ . For a UE supporting power class 2,  $M_{\text{pss/sss\_sync\_w/o\_gaps}}=24$ . For a UE supporting FR2 power class 3,  $M_{\text{pss/sss\_sync\_w/o\_gaps}}=24$ . For a UE supporting FR2 power class 4,  $M_{\text{pss/sss\_sync\_w/o\_gaps}}=24$

$M_{\text{meas\_period\_w/o\_gaps}}$ : For a UE supporting power class 1,  $M_{\text{meas\_period\_w/o\_gaps}}=40$ . For a UE supporting FR2 power class 2,  $M_{\text{meas\_period\_w/o\_gaps}}=24$ . For a UE supporting power class 3,  $M_{\text{meas\_period\_w/o\_gaps}}=24$ . For a UE supporting power class 4,  $M_{\text{meas\_period\_w/o\_gaps}}=24$ .

When intra-frequency SMTC is fully non overlapping with measurement gaps or intra-frequency SMTC is fully overlapping with MGs,  $K_p=1$

When intra-frequency SMTC is partially overlapping with measurement gaps,  $K_p = 1/(1 - (\text{SMTC period} / \text{MGRP}))$ , where  $\text{SMTC period} < \text{MGRP}$

If the higher layer signalling in TS 38.331 [13] signalling of *smtc2* is present and *smtc1* is fully overlapping with measurement gaps and *smtc2* is partially overlapping with measurement gaps, requirements are not specified for  $T_{\text{identify\_intra\_without\_index}}$  or  $T_{\text{identify\_intra\_with\_index}}$

For FR2,

$$K_{\text{layer1\_measurement}}=1,$$

- if all of the reference signals configured for RLM, BFD, CBD or L1-RSRP for beam reporting on any FR2 serving frequency in the same band outside measurement gap are not fully overlapped by intra-frequency SMTC occasions, or
- if all of the reference signal configured for RLM, BFD, CBD or L1-RSRP for beam reporting on any FR2 serving frequency in the same band outside measurement gap and fully-overlapped by intra-frequency SMTC occasions are not overlapped with any of the SSB symbols and the RSSI symbols, and 1 symbol before each consecutive SSB symbols and the RSSI symbols, and 1 symbol after each consecutive SSB symbols and the RSSI symbols, given that *SSB-ToMeasure* and *SS-RSSI-Measurement* are configured, where SSB symbols are indicated by the union set of *SSB-ToMeasure* from all the configured

measurement objects on the same serving carrier which can be merged. and RSSI symbols are indicated by *SS-RSSI-Measurement*;

$K_{layer1\_measurement}=1.5$ , otherwise.

If the above-mentioned reference signal configured for L1-RSRP measurement is aperiodic CSI-RS resource, longer cell identification delay would be expected.

If SCG DRX is in use, intrafrequency cell identification requirements specified in Table 4.6.1.0.1-1, Table 4.6.1.0.1-2, Table 4.6.1.0.1-3, Table 4.6.1.0.1-4, Table 4.6.1.0.1-5 and Table 4.6.1.0.1-6 shall depend on the SCG DRX cycle. Otherwise, the requirements for when DRX is not in use shall apply.

**Table 4.6.1.0.1-1: Time period for PSS/SSS detection, (Frequency range FR1)**

DRX cycle	$T_{PSS/SSS\_sync\_intra}$
No DRX	$\max(600\text{ms}, \text{ceil}(5 \times K_p) \times \text{SMTC period})^{\text{Note 1}} \times \text{CSSF}_{intra}$
DRX cycle $\leq 320\text{ms}$	$\max(600\text{ms}, \text{ceil}(M2^{\text{Note 2}} \times 5 \times K_p) \times \max(\text{SMTC period}, \text{DRX cycle})) \times \text{CSSF}_{intra}$
DRX cycle $> 320\text{ms}$	$\text{ceil}(5 \times K_p) \times \text{DRX cycle} \times \text{CSSF}_{intra}$
NOTE 1: If different SMTC periodicities are configured for different cells, the SMTC period in the requirement is the one used by the cell being identified	
NOTE 2: When <i>highSpeedMeasFlag-r16</i> is not configured, $M2 = 1.5$ ; When <i>highSpeedMeasFlag-r16</i> is configured, $M2 = 1.5$ if SMTC periodicity $> 40$ ms; otherwise $M2=1$ .	
NOTE 3: When <i>highSpeedMeasFlag-r16</i> is configured, the requirements apply only to UE supporting either <i>measurementEnhancement-r16</i> or <i>intraRAT-MeasurementEnhancement-r16</i> on measurements of the primary component carrier and do not apply to measurements of a secondary component carrier with active SCell.	

**Table 4.6.1.0.1-2: Time period for PSS/SSS detection, (Frequency range FR2)**

DRX cycle	$T_{PSS/SSS\_sync\_intra}$
No DRX	$\max(600\text{ms}, \text{ceil}(M_{pss/sss\_sync\_w/o\_gaps} \times K_p \times K_{layer1\_measurement}) \times \text{SMTC period})^{\text{note 1}} \times \text{CSSF}_{intra}$
DRX cycle $\leq 320\text{ms}$	$\max(600\text{ms}, \text{ceil}(1.5 \times M_{pss/sss\_sync\_w/o\_gaps} \times K_p \times K_{layer1\_measurement}) \times \max(\text{SMTC period}, \text{DRX cycle})) \times \text{CSSF}_{intra}$
DRX cycle $> 320\text{ms}$	$\text{ceil}(M_{pss/sss\_sync\_w/o\_gaps} \times K_p \times K_{layer1\_measurement}) \times \text{DRX cycle} \times \text{CSSF}_{intra}$
NOTE: If different SMTC periodicities are configured for different cells, the SMTC period in the requirement is the one used by the cell being identified.	

**Table 4.6.1.0.1-3: Time period for time index detection (Frequency range FR1)**

DRX cycle	$T_{SSB\_time\_index\_intra}$
No DRX	$\max(120\text{ms}, \text{ceil}(3 \times K_p) \times \text{SMTC period})^{\text{Note 1}} \times \text{CSSF}_{intra}$
DRX cycle $\leq 320\text{ms}$	$\max(120\text{ms}, \text{ceil}(M2^{\text{Note 2}} \times 3 \times K_p) \times \max(\text{SMTC period}, \text{DRX cycle})) \times \text{CSSF}_{intra}$
DRX cycle $> 320\text{ms}$	$\text{Ceil}(3 \times K_p) \times \text{DRX cycle} \times \text{CSSF}_{intra}$
NOTE 1: If different SMTC periodicities are configured for different cells, the SMTC period in the requirement is the one used by the cell being identified.	
NOTE 2: When <i>highSpeedMeasFlag-r16</i> is not configured, $M2 = 1.5$ ; When <i>highSpeedMeasFlag-r16</i> is configured, $M2 = 1.5$ if SMTC periodicity $> 40$ ms; otherwise $M2=1$ .	
NOTE 3: When <i>highSpeedMeasFlag-r16</i> is configured, the requirements apply only to UE supporting either <i>measurementEnhancement-r16</i> or [ <i>intraRAT-MeasurementEnhancement-r16</i> ] on measurements of the primary component carrier and do not apply to measurements of a secondary component carrier with active SCell.	

**Table 4.6.1.0.1-4: Time period for PSS/SSS detection, deactivated SCell (Frequency range FR1)**

DRX cycle	$T_{PSS/SSS\_sync\_intra}$
No DRX	$5 \times \text{measCycleSCell} \times \text{CSSF}_{intra}$

DRX cycle $\leq$ 320ms	$5 \times \max(\text{measCycleSCell}, 1.5 \times \text{DRX cycle}) \times \text{CSSF}_{\text{intra}}$
DRX cycle $>$ 320ms	$5 \times \max(\text{measCycleSCell}, \text{DRX cycle}) \times \text{CSSF}_{\text{intra}}$

**Table 4.6.1.0.1-5: Time period for PSS/SSS detection, deactivated SCell (Frequency range FR2)**

DRX cycle	$T_{\text{PSS/SSS\_sync\_intra}}$
No DRX	$M_{\text{pss/sss\_sync\_w/o\_gaps}} \times \text{measCycleSCell} \times \text{CSSF}_{\text{intra}}$
DRX cycle $\leq$ 320ms	$M_{\text{pss/sss\_sync\_w/o\_gaps}} \times \max(\text{measCycleSCell}, 1.5 \times \text{DRX cycle}) \times \text{CSSF}_{\text{intra}}$
DRX cycle $>$ 320ms	$M_{\text{pss/sss\_sync\_w/o\_gaps}} \times \max(\text{measCycleSCell}, \text{DRX cycle}) \times \text{CSSF}_{\text{intra}}$

**Table 4.6.1.0.1-6: Time period for time index detection, deactivated SCell (Frequency range FR1)**

DRX cycle	$T_{\text{SSB\_time\_index\_intra}}$
No DRX	$3 \times \text{measCycleSCell} \times \text{CSSF}_{\text{intra}}$
DRX cycle $\leq$ 320ms	$3 \times \max(\text{measCycleSCell}, 1.5 \times \text{DRX cycle}) \times \text{CSSF}_{\text{intra}}$
DRX cycle $>$ 320ms	$3 \times \max(\text{measCycleSCell}, \text{DRX cycle}) \times \text{CSSF}_{\text{intra}}$

The measurement period for intra-frequency measurements without gaps is as shown in table 4.6.1.0.1-7, 4.6.1.0.1-8, 4.6.1.0.1-9 (deactivated SCell) or 4.6.1.0.1-10 (deactivated SCell). When *highSpeedMeasFlag-r16* is configured,  $T_{\text{SSB\_measurement\_period\_intra}}$  is specified in Table 4.6.1.0.1-11.

If the higher layer signalling in TS38.331 [13] signalling of *smtc2* is present and *smtc1* is fully overlapping with measurement and *smtc2* is partially overlapping with measurement gaps, requirements are not specified for  $T_{\text{SSB\_measurement\_period\_intra}}$ .

If SCG DRX is in use, intrafrequency measurement period requirements specified in Table 4.6.1.0.1-7, Table 4.6.1.0.1-8, Table 4.6.1.0.1-9 and Table 4.6.1.0.1-10 shall depend on the SCG DRX cycle. Otherwise, the requirements for when DRX is not in use shall apply.

For FR2, a longer measurement period is allowed, if aperiodic CSI-RS resource is measured for L1-RSRP measurement on any FR2 serving frequency in the same band, and the CSI-RS resource is outside measurement gap and overlapped with any of the SSB symbols and the RSSI symbols, and 1 symbol before each consecutive SSB symbols and the RSSI symbols, and 1 symbol after each consecutive SSB symbols and the RSSI symbols. If *SSB-ToMeasure* or *SS-RSSI-Measurement* is configured, the SSB symbols are indicated by the union set of *SSB-ToMeasure* from all the configured measurement objects on the same band which can be merged and the RSSI symbols are indicated by *SS-RSSI-Measurement*.

**Table 4.6.1.0.1-7: Measurement period for intrafrequency measurements without gaps (Frequency FR1)**

DRX cycle	$T_{\text{SSB\_measurement\_period\_intra}}$
No DRX	$\max(200\text{ms}, \text{ceil}(5 \times K_p) \times \text{SMTC period})^{\text{Note 1}} \times \text{CSSF}_{\text{intra}}$
DRX cycle $\leq$ 320ms	$\max(200\text{ms}, \text{ceil}(1.5 \times 5 \times K_p) \times \max(\text{SMTC period}, \text{DRX cycle})) \times \text{CSSF}_{\text{intra}}$
DRX cycle $>$ 320ms	$\text{ceil}(5 \times K_p) \times \text{DRX cycle} \times \text{CSSF}_{\text{intra}}$

NOTE: If different SMTC periodicities are configured for different cells, the SMTC period in the requirement is the one used by the cell being identified.

**Table 4.6.1.0.1-8: Measurement period for intrafrequency measurements without gaps (Frequency FR2)**

DRX cycle	$T_{\text{SSB\_measurement\_period\_intra}}$
No DRX	$\max(400\text{ms}, \text{ceil}(M_{\text{meas\_period\_w/o\_gaps}} \times K_p \times K_{\text{layer1\_measurement}}) \times \text{SMTC period})^{\text{Note 1}} \times \text{CSSF}_{\text{intra}}$
DRX cycle $\leq$ 320ms	$\max(400\text{ms}, \text{ceil}(1.5 \times M_{\text{meas\_period\_w/o\_gaps}} \times K_p \times K_{\text{layer1\_measurement}}) \times \max(\text{SMTC period}, \text{DRX cycle})) \times \text{CSSF}_{\text{intra}}$

DRX cycle > 320ms	$\text{ceil}(M_{\text{meas\_period\_w/o\_gaps}} \times K_p \times K_{\text{layer1\_measurement}}) \times \text{DRX cycle} \times \text{CSSF}_{\text{intra}}$
NOTE: If different SMTC periodicities are configured for different cells, the SMTC period in the requirement is the one used by the cell being identified.	

**Table 4.6.1.0.1-9: Measurement period for intrafrequency measurements without gaps (deactivated SCell) (Frequency range FR1)**

DRX cycle	$T_{\text{SSB\_measurement\_period\_intra}}$
No DRX	$5 \times \text{measCycleSCell} \times \text{CSSF}_{\text{intra}}$
DRX cycle $\leq$ 320ms	$5 \times \max(\text{measCycleSCell}, 1.5 \times \text{DRX cycle}) \times \text{CSSF}_{\text{intra}}$
DRX cycle > 320ms	$5 \times \max(\text{measCycleSCell}, \text{DRX cycle}) \times \text{CSSF}_{\text{intra}}$

**Table 4.6.1.0.1-10: Measurement period for intrafrequency measurements without gaps (deactivated SCell) (Frequency range FR2)**

DRX cycle	$T_{\text{SSB\_measurement\_period\_intra}}$
No DRX	$M_{\text{meas\_period\_with\_gaps}} \times \text{measCycleSCell} \times \text{CSSF}_{\text{intra}}$
DRX cycle $\leq$ 320ms	$M_{\text{meas\_period\_with\_gaps}} \times \max(\text{measCycleSCell}, 1.5 \times \text{DRX cycle}) \times \text{CSSF}_{\text{intra}}$
DRX cycle > 320ms	$M_{\text{meas\_period\_with\_gaps}} \times \max(\text{measCycleSCell}, \text{DRX cycle}) \times \text{CSSF}_{\text{intra}}$

**Table 4.6.1.0.1-11:  $T_{\text{SSB\_measurement\_period\_intra}}$  When *highSpeedMeasFlag-r16* is configured (Frequency range FR1)**

DRX cycle	$T_{\text{SSB\_measurement\_period\_intra}}$
No DRX <sup>Note 2</sup>	$\max(200\text{ms}, \text{ceil}(5 \times K_p) \times \text{SMTC period})^{\text{Note 1}} \times \text{CSSF}_{\text{intra}}$
DRX cycle $\leq$ 160ms	$\max(200\text{ms}, \text{ceil}(5 \times M2^{\text{Note 2}} \times K_p) \times \max(\text{SMTC period}, \text{DRX cycle})) \times \text{CSSF}_{\text{intra}}$
160ms < DRX cycle $\leq$ 320ms	$\text{ceil}(4 \times M2^{\text{Note 2}} \times K_p) \times \max(\text{SMTC period}, \text{DRX cycle}) \times \text{CSSF}_{\text{intra}}$
DRX cycle > 320ms	$\text{ceil}(Y^{\text{Note 3}} \times K_p) \times \text{DRX cycle} \times \text{CSSF}_{\text{intra}}$
NOTE 1: If different SMTC periodicities are configured for different cells, the SMTC period in the requirement is the one used by the cell being identified.	
NOTE 2: $M2 = 1.5$ if SMTC periodicity > 40 ms, otherwise $M2 = 1$ .	
NOTE 3: $Y = 3$ when SMTC $\leq$ 40ms, $Y = 5$ when SMTC > 40ms.	
NOTE 4: When <i>highSpeedMeasFlag-r16</i> is configured, the requirements apply only to UE supporting either <i>measurementEnhancement-r16</i> or [ <i>intraRAT-MeasurementEnhancement-r16</i> ] on measurements of the primary component carrier and do not apply to measurements of a secondary component carrier with active SCell.	

The normative reference for this requirement is TS 38.133 [6] clause 9.2.5.1 and 9.2.5.2.

#### 4.6.1.0.2 Minimum conformance requirements for event-triggered measurements with gap TS 38.133, clause 9.2.2]

The requirements in TS 38.133 [6] Section 9.2 apply, provided:

- The cell being identified or measured is detectable.

An intra-frequency cell shall be considered detectable when for each relevant SSB:

- SS-RSRP related side conditions given in TS 38.133 [6] Sections 10.1.2 and 10.1.3 for FR1 and FR2, respectively, for a corresponding Band,
- SS-RSRQ related side conditions given in TS 38.133 [6] Sections 10.1.7 and 10.1.8 for FR1 and FR2, respectively, for a corresponding Band,



- SS-SINR related side conditions given in TS 38.133 [6] Sections 10.1.12 and 10.1.13 for FR1 and FR2, respectively, for a corresponding Band,
- SSB<sub>RP</sub> and SSB Ês/Iot according to Annex B.2.2 for a corresponding Band.

[TS 38.133, clause 9.2.6.2]

The UE shall be able to identify a new detectable intra frequency cell within  $T_{\text{identify\_intra\_without\_index}}$  if UE is not indicated to report SSB based RRM measurement result with the associated SSB index (*reportQuantityRsIndexes* or *maxNrofRSIndexesToReport* is not configured), or the UE has been indicated that the neighbour cell is synchronous with the serving cell (*deriveSSB-IndexFromCell* is enabled). Otherwise UE shall be able to identify a new detectable intra frequency cell within  $T_{\text{identify\_intra\_with\_index}}$ . The UE shall be able to identify a new detectable intra frequency SS block of an already detected cell within  $T_{\text{identify\_intra\_without\_index}}$ . It is assumed that *deriveSSB-IndexFromCell* is always enabled for FR1 TDD and FR2.

$$T_{\text{identify\_intra\_without\_index}} = T_{\text{PSS/SSS\_sync\_intra}} + T_{\text{SSB\_measurement\_period\_intra}} \text{ ms}$$

$$T_{\text{identify\_intra\_with\_index}} = T_{\text{PSS/SSS\_sync\_intra}} + T_{\text{SSB\_measurement\_period\_intra}} + T_{\text{SSB\_time\_index\_intra}}$$

Where:

$T_{\text{PSS/SSS\_sync\_intra}}$ : it is the time period used in PSS/SSS detection given in table 4.6.1.0.2 or 4.6.1.0.2.

$T_{\text{SSB\_time\_index\_intra}}$ : it is the time period used to acquire the index of the SSB being measured given in table 4.6.1.0.2.

$T_{\text{SSB\_measurement\_period\_intra}}$ : equal to a measurement period of SSB based measurement given in table 4.6.1.0.2 or 4.6.1.0.2.

$\text{CSSF}_{\text{intra}}$ : it is a carrier specific scaling factor and is determined according to  $\text{CSSF}_{\text{within\_gap},i}$  in TS 38.133 [6] section 9.1.5.2 for measurement conducted within measurement gaps.

$M_{\text{pss/sss\_sync\_with\_gaps}}$ : For a UE supporting FR2 power class 1,  $M_{\text{pss/sss\_sync\_with\_gaps}}=40$ . For a UE supporting FR2 power class 2,  $M_{\text{pss/sss\_sync\_with\_gaps}}=24$ . For a UE supporting FR2 power class 3,  $M_{\text{pss/sss\_sync\_with\_gaps}}=24$ . For a UE supporting power class 4,  $M_{\text{pss/sss\_sync\_with\_gaps}}=24$

$M_{\text{meas\_period\_with\_gaps}}$ : For a UE supporting power class 1,  $M_{\text{meas\_period\_with\_gaps}}=40$ . For a UE supporting power class 2,  $M_{\text{meas\_period\_with\_gaps}}=24$ . For a UE supporting power class 3,  $M_{\text{meas\_period\_with\_gaps}}=24$ . For a UE supporting power class 4,  $M_{\text{meas\_period\_with\_gaps}}=24$ .

If the higher layer signalling in TS 38.331 [13] signalling of *smtc2* is present and *smtc1* is fully overlapping with measurement gaps and *smtc2* is partially overlapping with measurement gaps, requirements are not specified for  $T_{\text{identify\_intra\_without\_index}}$  Or  $T_{\text{identify\_intra\_with\_index}}$ .

If SCG DRX is in use, intrafrequency cell identification requirements specified in TS 38.133 [6] Table 9.2.6.1-1, Table 9.2.6.1-2, and Table 9.2.5.1-3 shall depend on the SCG DRX cycle. Otherwise, the requirements for when DRX is not in use shall apply.

**Table 4.6.1.0.2: Time period for PSS/SSS detection (Frequency range FR1)**

DRX cycle	$T_{\text{PSS/SSS\_sync\_intra}}$
No DRX	$\max(600\text{ms}, 5 \times \max(\text{MGRP}, \text{SMTC period})) \times \text{CSSF}_{\text{intra}}$
DRX cycle ≤ 320ms	$\max(600\text{ms}, \text{ceil}(1.5 \times 5) \times \max(\text{MGRP}, \text{SMTC period}, \text{DRX cycle})) \times \text{CSSF}_{\text{intra}}$
DRX cycle > 320ms	$5 \times \max(\text{MGRP}, \text{DRX cycle}) \times \text{CSSF}_{\text{intra}}$

**Table 4.6.1.0.2-2: Time period for PSS/SSS detection (Frequency range FR2)**

DRX cycle	$T_{\text{PSS/SSS\_sync\_intra}}$
No DRX	$\max(600\text{ms}, M_{\text{pss/sss\_sync\_with\_gaps}} \times \max(\text{MGRP}, \text{SMTC period})) \times \text{CSSF}_{\text{intra}}$
DRX cycle ≤ 320ms	$\max(600\text{ms}, \text{ceil}(1.5 \times M_{\text{pss/sss\_sync\_with\_gaps}}) \times \max(\text{MGRP}, \text{SMTC period}, \text{DRX cycle})) \times \text{CSSF}_{\text{intra}}$
DRX cycle > 320ms	$M_{\text{pss/sss\_sync\_with\_gaps}} \times \max(\text{MGRP}, \text{DRX cycle}) \times \text{CSSF}_{\text{intra}}$

**Table 4.6.1.0.2: Time period for time index detection (Frequency range FR1)**

DRX cycle	$T_{SSB\_time\_index\_intra}$
No DRX	$\max(120\text{ms}, 3 \times \max(\text{MGRP}, \text{SMTC period})) \times \text{CSSF}_{intra}$
DRX cycle $\leq 320\text{ms}$	$\max(120\text{ms}, \text{ceil}(1.5 \times 3) \times \max(\text{MGRP}, \text{SMTC period}, \text{DRX cycle})) \times \text{CSSF}_{intra}$
DRX cycle $> 320\text{ms}$	$3 \times \max(\text{MGRP}, \text{DRX cycle}) \times \text{CSSF}_{intra}$

[TS 38.133, clause 9.2.6.3]

The measurement period for FR1 intrafrequency measurements with gaps is as shown in Table 4.6.1.0.2-4.

The measurement period for FR2 intrafrequency measurements with gaps is as shown in Table 4.6.1.0.2-5.

If SCG DRX is in use, intrafrequency measurement period requirements specified in Table 4.6.1.0.2-4 and Table 4.6.1.0.2-5, shall depend on the SCG DRX cycle. Otherwise, the requirements for when DRX is not in use shall apply.

**Table 4.6.1.0.2-4: Measurement period for intrafrequency measurements with gaps (Frequency Range FR1)**

DRX cycle	$T_{SSB\_measurement\_period\_intra}$
No DRX	$\text{Max}(200\text{ms}, 5 \times \max(\text{MGRP}, \text{SMTC period})) \times \text{CSSF}_{intra}$
DRX cycle $\leq 320\text{ms}$	$\max(200\text{ms}, \text{ceil}(1.5 \times 5) \times \max(\text{MGRP}, \text{SMTC period}, \text{DRX cycle})) \times \text{CSSF}_{intra}$
DRX cycle $> 320\text{ms}$	$5 \times \max(\text{MGRP}, \text{DRX cycle}) \times \text{CSSF}_{intra}$

**Table 4.6.1.0.2-5: Measurement period for intrafrequency measurements with gaps (Frequency Range FR2)**

DRX cycle	$T_{SSB\_measurement\_period\_intra}$
No DRX	$\max(400\text{ms}, M_{\text{meas\_period with\_gaps}} \times \max(\text{MGRP}, \text{SMTC period})) \times \text{CSSF}_{intra}$
DRX cycle $\leq 320\text{ms}$	$\max(400\text{ms}, \text{ceil}(1.5 \times M_{\text{meas\_period with\_gaps}}) \times \max(\text{MGRP}, \text{SMTC period}, \text{DRX cycle})) \times \text{CSSF}_{intra}$ <sup>Note 1</sup>
DRX cycle $> 320\text{ms}$	$M_{\text{meas\_period with\_gaps}} \times \max(\text{MGRP}, \text{DRX cycle}) \times \text{CSSF}_{intra}$

[TS 38.133, clause 9.2.4.3]

Reported RSRP, RSRQ, and RS-SINR measurements contained in periodically triggered measurement reports shall meet the requirements in TS 38.133 [6] sections 10.1.2.1, 10.1.3.1, 10.1.7.1, 10.1.8.1, 10.1.12.1 and 10.1.13.1, respectively.

The UE shall not send any event triggered measurement reports, as long as no reporting criteria are fulfilled.

The measurement reporting delay is defined as the time between an event that will trigger a measurement report and the point when the UE starts to transmit the measurement report over the air interface. This requirement assumes that the measurement report is not delayed by other RRC signalling on the DCCH. This measurement reporting delay excludes a delay uncertainty resulted when inserting the measurement report to the TTI of the uplink DCCH. The delay uncertainty is:  $2 \times TTI_{DCCH}$ . This measurement reporting delay excludes a delay which caused by no UL resources for UE to send the measurement report.

The event triggered measurement reporting delay, measured without L3 filtering shall be less than  $T_{\text{identify intra with index}}$  Or  $T_{\text{identify intra without index}}$  defined in TS 38.133 [6] clause 9.2.5.1 or clause 9.2.6.2. When L3 filtering is used an additional delay can be expected.

If a cell which has been detectable at least for the time period  $T_{\text{identify intra without index}}$  Or  $T_{\text{identify intra with index}}$  defined in TS 38.133 [6] clause 9.2.5.1 or clause 9.2.6.2 becomes undetectable for a period and then the cell becomes detectable again

and triggers an event, the event triggered measurement reporting delay shall be less than  $T_{\text{Measurement\_Period, Intra}}$  provided the timing to that cell has not changed more than  $\pm 3200 T_c$  while the measurement gap has not been available and the L3 filter has not been used. When L3 filtering is used, an additional delay can be expected.

The normative reference for this requirement is TS 38.133 [6] clause 9.2.2, 9.2.6.2, 9.2.6.3 and 9.2.4.3.

#### 4.6.1.1 EN-DC FR1 event-triggered reporting without gap in non-DRX

##### 4.6.1.1.1 Test purpose

This test is to verify the UE makes correct reporting of an event without gap within the intra-frequency cell search requirements.

##### 4.6.1.1.2 Test applicability

This test applies to all types of E-UTRA UE release 15 and forward, supporting EN-DC.

##### 4.6.1.1.3 Minimum conformance requirements

The minimum conformance requirements are defined in clause 4.6.1.0.1.

The normative reference for this requirement is TS 38.133 [6] clause A.4.6.1.1.

##### 4.6.1.1.4 Test description

###### 4.6.1.1.4.1 Initial conditions

This test shall be tested using any of the test configurations in Table 4.6.1.1.4.1-1.

**Table 4.6.1.1.4.1-1: supported test configurations**

Test Case ID	Description
4.6.1.1-1	15 kHz SSB SCS, 10MHz bandwidth, FDD duplex mode
4.6.1.1-2	15 kHz SSB SCS, 10MHz bandwidth, TDD duplex mode
4.6.1.1-3	30 kHz SSB SCS, 40MHz bandwidth, TDD duplex mode
NOTE: The UE is only required to be tested in one of the supported test configurations.	

Configure the test equipment and the DUT according to the parameters in Table 4.6.1.1.4.1-2 and Table 4.6.1.1.4.1-3.

**Table 4.6.1.1.4.1-2: Initial conditions for EN-DC intra-frequency event triggered reporting without gap for PSCell in FR1**

Parameter	Value	Comment
Test environment	NC	As specified in TS 38.508-1 [14] clause 4.1.
Test frequencies	As specified in Annex E, Table E.1-1 and TS 38.508-1 [14] clause 4.3.1.	
Channel bandwidth	As specified by the test configuration selected from Table 4.7.1.1.2-1.	
Propagation conditions	AWGN	As specified in clause C.2.2.
Connection Diagram	TE Part	A.3.1.8.2
	DUT Part	A.3.2.3.4
Exceptions to connection diagram	N/A	

**Table 4.6.1.1.4.1-3: General test parameters for EN-DC intra-frequency event triggered reporting without gap for PSCell in FR1**

Parameter	Unit	Test configuration	Value	Comment
Active cell		1, 2, 3	E-UTRAN Cell 1 and NR Cell 2	
Neighbour cell		1, 2, 3	NR Cell 3	Cell to be identified.
RF Channel Number		1, 2, 3	1: Cell 1 2: Cell 2 and Cell 3	
SSB configuration		1	SSB.1 FR1	
		2	SSB.1 FR1	
		3	SSB.2 FR1	
SMTC configuration		1	SMTC.2	
		2	SMTC.1	
		3	SMTC.1	
A3-Offset	dB	1, 2, 3	-4.5	
CP length		1, 2, 3	Normal	
Hysteresis	dB	1, 2, 3	0	
Time To Trigger	s	1, 2, 3	0	
Filter coefficient		1, 2, 3	0	L3 filtering is not used
DRX		1, 2, 3	N/A	OFF
Time offset between PCell and PSCell		1, 2, 3	3 $\mu$ s	Synchronous EN-DC
Time offset between serving and neighbour cells		1	3 ms	Asynchronous cells. The timing of Cell 3 is 3ms later than the timing of Cell 2.
		2	3 $\mu$ s	Synchronous cells
		3	3 $\mu$ s	Synchronous cells
T1	s	1, 2, 3	5	
T2	s	1, 2, 3	5	

1. Message contents are defined in clause 4.6.1.1.4.3.

2. Cell 1 is the E-UTRA serving cell (PCell) for the EN-DC setup. The power levels and settings for Cell 1 are set according to Annex A.6. Cell 2 and Cell 3 are NR FR1 cells in the same frequency. Cell 2 is the PSCell and Cell 3 is the neighbour NR Cell.

#### 4.6.1.1.4.2 Test procedure

The test consists of two successive time periods, with time duration of T1, and T2 respectively. During time duration T1, the UE shall not have any timing information of cell 3.

1. Ensure the UE is in state RRC\_CONNECTED with generic procedure parameters Connectivity EN-DC, DC bearer MCG and SCG, Connected without release *On* and Test Mode *On* according to TS 38.508-1 [14] clause 4.5.
2. Configure MCG and SCG according to clause C.1 for all downlink physical channels.
3. The SS shall configure the PCell (Cell 1) and PSCell (Cell 2) on the MCG and SCG as per TS 38.508-1 [14] clause 4.5 with the message content exceptions defined in clause 4.6.1.1.4.3.
4. Set the parameters according to T1 in Table 4.6.1.1.4.1-2. Propagation conditions are set according to Annex C clauses C.2.2
5. The SS shall transmit an RRCConnectionReconfiguration message with event A3 configured.
6. The UE shall transmit an RRCConnectionReconfigurationComplete message. T1 starts.
7. When T1 expires, the SS shall switch the power setting from T1 to T2 as specified in Table 4.6.1.1.4.1-2.
8. UE shall transmit a MeasurementReport message triggered by Event A3 for Cell 3 on PCell (Cell 1). If the measurement reporting delay from the beginning of time period T2 is less than 802 the number of successful tests is increased by one. If the UE fails to report the event within the measurement reporting delay requirement then the number of failure tests is increased by one.
9. The SS waits until the MeasurementReport message is received or when T2 expires.

10. The SS shall transmit *RRCConnectionReconfiguration* message with condition EN-DC\_PSCell\_Rel according to TS 36.508 [25] Table 4.6.1-8 to release NR cell (PSCell). The UE shall transmit *RRCConnectionReconfigurationComplete* message.
11. Set Cell 3 physical cell identity =  $[(\text{current cell 3 physical cell identity} + 1) \bmod 14 + 2]$  for next iteration of the test procedure loop.
12. The SS then shall transmit *RRCConnectionReconfiguration* message with condition MCG\_and\_SCG according to TS 36.508 [25] Table 4.6.1-8 to add NR cell (PSCell). The UE shall transmit *RRCConnectionReconfigurationComplete* message.
13. If any the reconfiguration fails, switch off and on the UE and ensure the UE is in RRC\_CONNECTED with generic procedure parameters Connectivity EN-DC, DC bearer MCG and SCG, Connected without release On according to TS 38.508-1 [14] clause 4.5].
14. Repeat steps 3-13 until the confidence level according to Tables G.2.3-1 in Annex G clause G.2 is achieved.

4.6.1.1.4.3 Message contents

Message contents are according to TS 38.508-1 [14] clause 7.3 with the following exceptions:

**Table 4.6.1.1.4.3-1: Common Exception messages for Additional EN-DC FR1 event-triggered reporting without gap in non-DRX test requirement**

Default Message Contents	
Common contents of system information blocks exceptions	
Default RRC messages and information elements contents exceptions	Table H.3.1-1 Table H.3.1-2 Table H.3.1-4 with A3-offset = -4.5dB Table H.3.1-5 Table H.3.1-7 Table H.3.4-1 Table H.3.4-1a Table H.3.4-4
Specific message contents exceptions for Test Configuration 4.6.1.1-1 and 4.6.1.1-4	Table H.3.1-3 with Condition SSB.1 FR1 Table 7.3.1-3 in TS 38.508-1 [14] with condition SMTC.2
Specific message contents exceptions for Test Configuration 4.6.1.1-2 and 4.6.1.1-5	Table H.3.1-3 with Condition SSB.1 FR1 and Synchronous cells Table 7.3.1-3 in TS 38.508-1 [14] with condition SMTC.1
Specific message contents exceptions for Test Configuration 4.6.1.1-3 and 4.6.1.1-6	Table H.3.1-3 with Condition SSB.2 FR1 and Synchronous cells Table 7.3.1-3 in TS 38.508-1 [14] with condition SMTC.1

4.6.1.1.5 Test requirement

Table 4.6.1.1.5-1 defines the primary level settings including test tolerances for all tests.

**Table 4.6.1.1.5-1: NR Cell specific test parameters for EN-DC intra-frequency event triggered reporting without gap for PSCell in FR1**

Parameter	Unit	Test configuration	Cell 2		Cell 3	
			T1	T2	T1	T2
TDD configuration		1	N/A		N/A	
		2	TDDConf.1.1		TDDConf.1.1	
		3	TDDConf.2.1		TDDConf.2.1	
PDSCH RMC configuration		1	SR.1.1 FDD		N/A	
		2	SR.1.1 TDD			
		3	SR.2.1 TDD			
RMSI CORESET RMC configuration		1	CR.1.1 FDD		CR.1.1 FDD	
		2	CR.1.1 TDD		CR.1.1 TDD	
		3	CR.2.1 TDD		CR.2.1 TDD	
Dedicated CORESET RMC configuration		1	CCR.1.1 FDD		CCR.1.1 FDD	
		2	CCR.1.1 TDD		CCR.1.1 TDD	
		3	CCR.2.1 TDD		CCR.2.1 TDD	
OCNG Patterns		1, 2, 3	OP.1		OP.1	

Parameter	Unit	Test configuration	Cell 2		Cell 3	
			T1	T2	T1	T2
TRS configuration		1	TRS.1.1 FDD		N/A	
		2	TRS.1.1 TDD		N/A	
		3	TRS.1.2 TDD		N/A	
Initial BWP configuration		1, 2, 3	DLBWP.0.1 ULBWP.0.1		DLBWP.0.1 ULBWP.0.1	
Active DL BWP configuration		1, 2, 3	DLBWP.1.1		DLBWP.1.1	
Active UL BWP configuration		1, 2, 3	ULBWP.1.1		ULBWP.1.1	
RLM-RS		1, 2, 3	SSB		SSB	
$N_{oc}^{note\ 2}$	dBm/SCS	1	-98			
		2	-98			
		3	-95			
$N_{oc}^{note\ 2}$	dBm/15 kHz	1	-98			
		2				
		3				
$\hat{E}_s/I_{ot}$	dB	1	4	-1.46	-Infinity	-1.46
		2				
		3				
$\hat{E}_s/N_{oc}$	dB	1	4	4	-Infinity	4
		2				
		3				
SS-RSRP <sup>note 3</sup>	dBm/SCS kHz	1	-94	-94	-Infinity	-94
		2	-94	-94	-Infinity	-94
		3	-91	-91	-Infinity	-91
I <sub>o</sub>	dBm/9.36 MHz	1	-64.60	-62.25	-Infinity	-62.25
	dBm/9.36 MHz	2	-64.60	-62.25	-Infinity	-62.25
	dBm/38.16 MHz	3	-58.50	-56.16	-Infinity	-56.16
Propagation Condition		1, 2, 3	AWGN			
NOTE 1: The resources for uplink transmission are assigned to the UE prior to the start of time period T2.						
NOTE 2: Interference from other cells and noise sources not specified in the test is assumed to be constant over subcarriers and time and shall be modelled as AWGN of appropriate power for $N_{oc}$ to be fulfilled.						
NOTE 3: SS-RSRP levels have been derived from other parameters for information purposes. They are not settable parameters themselves.						

The UE shall send one Event A3 triggered measurement report, with a measurement reporting delay less than 800 ms from the beginning of time period T2. The UE is not required to read the neighbour cell SSB index in this test.

The UE shall not send event triggered measurement reports, as long as the reporting criteria are not fulfilled.

The overall delays measured test requirement is expressed as:

$$T_{\text{identify\_intra\_without\_index}} = (T_{\text{PSS/SSS\_sync\_intra}} + T_{\text{SSB\_measurement\_period\_intra}}) \text{ ms}$$

$$T_{\text{PSS/SSS\_sync\_intra}} = \max[600\text{ms}, \text{ceil}(5 \times K_p) \times \text{SMTC period}] \times \text{CSSF}_{\text{intra}} = 600\text{ms}$$

$$T_{\text{SSB\_measurement\_period\_intra}} = \max[200\text{ms}, \text{ceil}(5 \times K_p) \times \text{SMTC period}] \times \text{CSSF}_{\text{intra}} = 200 \text{ ms}$$

Which:

$$K_p = 1;$$

SMTC period as defined in Table 4.6.1.1.4.1-3;

$$\text{CSSF}_{\text{intra}} = 1$$

$$\text{TTI insertion uncertainty} = \text{TTI}_{\text{DCCH}} = 1 \text{ ms}; 2 \times \text{TTI}_{\text{DCCH}} = 2 \text{ ms}$$

The overall delays measured shall be less than a total of 802 ms in this test case (note: this gives a total of 800 ms for measurement reporting delay plus 2 ms for TTI insertion uncertainty).

The rate of correct events observed during repeated tests shall be at least 90% with confidence level of 95%.

NOTE: The actual overall delays measured in the test may be up to  $2 \times TTI_{DCCH}$  higher than the measurement reporting delays above because of TTI insertion uncertainty of the measurement report in DCCH.

#### 4.6.1.2 EN-DC FR1 event-triggered reporting without gap in DRX

##### 4.6.1.2.1 Test purpose

This test is to verify the UE makes correct reporting of an event without gap in DRX within the intra-frequency cell search requirements.

##### 4.6.1.2.2 Test applicability

This test applies to all types of E-UTRA UE release 15 and forward, supporting EN-DC FR1 and long DRX cycle.

##### 4.6.1.2.3 Minimum conformance requirements

The minimum conformance requirements are defined in clause 4.6.1.0.1.

The normative reference for this requirement is TS 38.133 [6] clause A.4.6.1.2.

##### 4.6.1.2.4 Test description

###### 4.6.1.2.4.1 Initial conditions

This test shall be tested using any of the test configurations in Table 4.6.1.2.4.1-1.

**Table 4.6.1.2.4.1-1: supported test configurations**

Test Case ID	Description
4.6.1.2-1	15 kHz SSB SCS, 10MHz bandwidth, FDD duplex mode
4.6.1.2-2	15 kHz SSB SCS, 10MHz bandwidth, TDD duplex mode
4.6.1.2-3	30 kHz SSB SCS, 40MHz bandwidth, TDD duplex mode
NOTE: The UE is only required to be tested in one of the supported test configurations.	

Configure the test equipment and the DUT according to the parameters in Table 4.6.1.2.4.1-2 and Table 4.6.1.2.4.1-3.

**Table 4.6.1.2.4.1-2: Initial conditions for EN-DC intra-frequency event triggered reporting without gap for PSCell in FR1 with DRX**

Parameter	Value		Comment
Test environment	NC		As specified in TS 38.508-1 [14] clause 4.1.
Test frequencies	As specified in Annex E, Table E.1-1 and TS 38.508-1 [14] clause 4.3.1.		
Channel bandwidth	As specified by the test configuration selected from Table 4.7.1.1.2-1.		
Propagation conditions	AWGN		As specified in clause C.2.2.
Connection Diagram	TE Part	A.3.1.8.2	As specified in TS 38.508-1 [14] Annex A.
	DUT Part	A.3.2.3.4	
Exceptions to connection diagram	N/A		

**Table 4.6.1.2.4.1-3: General test parameters for EN-DC intra-frequency event triggered reporting without gap for PSCell in FR1 with DRX**

Parameter	Unit	Test configuration	Value		Comment
			Test 1	Test 2	
Active cell		1, 2, 3	E-UTRAN Cell 1 and NR Cell 2		

Parameter	Unit	Test configuration	Value		Comment
			Test 1	Test 2	
Neighbour cell		1, 2, 3	NR Cell 3		Cell to be identified.
RF Channel Number		1, 2, 3	1: Cell 1 2: Cell 2 and Cell 3		
SSB configuration		1	SSB.1 FR1		
		2	SSB.1 FR1		
		3	SSB.2 FR1		
SMTC configuration		1	SMTC.2		
		2	SMTC.1		
		3	SMTC.1		
A3-Offset	dB	1, 2, 3	-4.5		
CP length		1, 2, 3	Normal		
Hysteresis	dB	1, 2, 3	0		
Time To Trigger	s	1, 2, 3	0		
Filter coefficient		1, 2, 3	0		L3 filtering is not used
DRX		1, 2, 3	DRX.1	DRX.7	Annex A.5 Table A.5-1
Time offset between PCell and PSCell		1, 2, 3	3 μs		Synchronous EN-DC
Time offset between serving and neighbour cells		1	3 ms		Asynchronous cells. The timing of Cell 3 is 3ms later than the timing of Cell 2.
		2	3 μs		Synchronous cells
		3	3 μs		Synchronous cells
T1	s	1, 2, 3	5		
T2	s	1, 2, 3	5	10	

1. Message contents are defined in clause 4.6.1.2.4.3.

2. Cell 1 is the E-UTRA serving cell (PCell) for the EN-DC setup. The power levels and settings for Cell 1 are set according to Annex A.6. Cell 2 and Cell 3 are NR FR1 cells in the same frequency. Cell 2 is the PSCell and Cell 3 is the neighbour NR Cell.

4.6.1.2.4.2 Test procedure

Same test procedure as in subclause 4.6.1.1.4.2 with Step 8 is replaced by following:

8. UE shall transmit a MeasurementReport message triggered by Event A3 for Cell 3 on PCell (Cell 1). If the overall delays measured from the beginning of time period T2 is less than 922 ms for Test 1 or less than 6402 ms for Test 2 then the number of successful tests is increased by one. If the UE fails to report the event within the overall delays measured requirement then the number of failure tests is increased by one.

4.6.1.2.4.3 Message contents

Message contents are according to TS 38.508-1 [14] clause 7.3 with the following exceptions:

**Table 4.6.1.2.4.3-1: Common Exception messages for Additional EN-DC FR1 event-triggered reporting without gap in DRX test requirement**

Default Message Contents	
Common contents of system information blocks exceptions	
Default RRC messages and information elements contents exceptions	Table H.3.1-1 Table H.3.1-2 Table H.3.1-4 with A3-offset = -4.5dB Table H.3.1-5 Table H.3.1-7 Table H.3.7-1 with Condition DRX.1 for Test 1 Table H.3.7-1 with Condition DRX.7 for Test 2 Table H.3.4-1 Table H.3.4-1a Table H.3.4-2



Specific message contents exceptions for Test Configuration 4.6.1.2-1 and 4.6.1.2-4	Table H.3.1-3 with Condition SSB.1 FR1 Table 7.3.1-3 in TS 38.508-1 [14] with condition SMTC.2
Specific message contents exceptions for Test Configuration 4.6.1.2-2 and 4.6.1.2-5	Table H.3.1-3 with Condition SSB.1 FR1 and Synchronous cells Table 7.3.1-3 in TS 38.508-1 [14] with condition SMTC.1
Specific message contents exceptions for Test Configuration 4.6.1.2-3 and 4.6.1.2-6	Table H.3.1-3 with Condition SSB.2 FR1 and Synchronous cells Table 7.3.1-3 in TS 38.508-1 [14] with condition SMTC.1

4.6.1.2.5 Test requirement

Table 4.6.1.2.4.1-2 and Table 4.6.1.2.5-1 defines the primary level settings including test tolerances for all tests.

**Table 4.6.1.2.5-1: NR Cell specific test parameters for EN-DC intra-frequency event triggered reporting without gap for PSCell in FR1 with DRX**

Parameter	Unit	Test configuration	Cell 2		Cell 3	
			T1	T2	T1	T2
TDD configuration		1	N/A		N/A	
		2	TDDConf.1.1		TDDConf.1.1	
		3	TDDConf.2.1		TDDConf.2.1	
PDSCH RMC configuration		1	SR.1.1 FDD		N/A	
		2	SR.1.1 TDD			
		3	SR.2.1 TDD			
RMSI CORESET RMC configuration		1	CR.1.1 FDD		CR.1.1 FDD	
		2	CR.1.1 TDD		CR.1.1 TDD	
		3	CR.2.1 TDD		CR.2.1 TDD	
Dedicated CORESET RMC configuration		1	CCR.1.1 FDD		CCR.1.1 FDD	
		2	CCR.1.1 TDD		CCR.1.1 TDD	
		3	CCR.2.1 TDD		CCR.2.1 TDD	
OCNG Patterns		1, 2, 3	OP.1		OP.1	
TRS configuration		1	TRS.1.1 FDD		N/A	
		2	TRS.1.1 TDD		N/A	
		3	TRS.1.2 TDD		N/A	
Initial BWP configuration		1, 2, 3	DLBWP. 0.1 ULBWP.0.1		DLBWP. 0.1 ULBWP.0.1	
Active DL BWP configuration		1, 2, 3	DLBWP.1.1		DLBWP.1.1	
Active UL BWP configuration		1, 2, 3	ULBWP.1.1		ULBWP.1.1	
RLM-RS		1, 2, 3	SSB		SSB	
$N_{oc}$ <sup>note 2</sup>	dBm/SCS	1	-98			
		2	-98			
		3	-95			
$N_{oc}$ <sup>note 2</sup>	dBm/15 KHz	1	-98			
		2				
		3				
$\hat{E}_s/I_{ot}$	dB	1	4	-1.46	-Infinity	-1.46
		2				
		3				
$\hat{E}_s/N_{oc}$	dB	1	4	4	-Infinity	4
		2				
		3				
SS-RSRP <sup>note 3</sup>	dBm/SCS KHz	1	-94	-94	-Infinity	-94
		2	-94	-94	-Infinity	-94
		3	-91	-91	-Infinity	-91
I <sub>o</sub>	dBm/9.36 MHz	1	-64.60	-62.25	-Infinity	-62.25
	dBm/9.36 MHz	2	-64.60	-62.25	-Infinity	-62.25
	dBm/38.16 MHz	3	-58.50	-56.16	-Infinity	-56.16
Propagation Condition		1, 2, 3	AWGN			

NOTE 1: The resources for uplink transmission are assigned to the UE prior to the start of time period T2.
NOTE 2: Interference from other cells and noise sources not specified in the test is assumed to be constant over subcarriers and time and shall be modelled as AWGN of appropriate power for $N_{oc}$ to be fulfilled.
NOTE 3: SS-RSRP levels have been derived from other parameters for information purposes. They are not settable parameters themselves.

In test 1, the UE shall send one Event A3 triggered measurement report, with a measurement reporting delay less than 922 ms from the beginning of time period T2. The UE is not required to read the neighbour cell SSB index in this test.

The overall delays measured test requirement is expressed in test 1 with DRX 40ms as:

$$T_{\text{identify\_intra\_without\_index}} = (T_{\text{PSS/SSS\_sync\_intra}} + T_{\text{SSB\_measurement\_period\_intra}}) \text{ ms}$$

$$T_{\text{PSS/SSS\_sync\_intra}} = \max[600\text{ms}, \text{ceil}(1.5 \times 5 \times K_p) \times \max(\text{SMTC period}, \text{DRX cycle})] \times \text{CSSF}_{\text{intra}} = 600\text{ms}$$

$$T_{\text{SSB\_measurement\_period\_intra}} = \max[200\text{ms}, \text{ceil}(1.5 \times 5 \times K_p) \times \max(\text{SMTC period}, \text{DRX cycle})] \times \text{CSSF}_{\text{intra}} = 320 \text{ ms}$$

Which:

$$K_p = 1;$$

SMTC period as defined in Table 4.6.1.2.4.1-3;

$$\text{DRX cycle} = 40;$$

$$\text{CSSF}_{\text{intra}} = 1$$

$$\text{TTI insertion uncertainty} = \text{TTI}_{\text{DCCH}} = 1 \text{ ms}; 2 \times \text{TTI}_{\text{DCCH}} = 2 \text{ ms}$$

The overall delays measured shall be less than a total of 922 ms in test 1 (note: this gives a total of 920 ms for measurement reporting delay plus 2 ms for TTI insertion uncertainty).

In test 2, the UE shall send one Event A3 triggered measurement report, with a measurement reporting delay less than 6402 ms from the beginning of time period T2. The UE is not required to read the neighbour cell SSB index in this test.

The overall delays measured test requirement is expressed in test 2 with DRX 640ms as:

$$T_{\text{identify\_intra\_without\_index}} = (T_{\text{PSS/SSS\_sync\_intra}} + T_{\text{SSB\_measurement\_period\_intra}}) \text{ ms}$$

$$T_{\text{PSS/SSS\_sync\_intra}} = \text{ceil}(5 \times K_p) \times \text{DRX cycle} \times \text{CSSF}_{\text{intra}} = 3200\text{ms}$$

$$T_{\text{SSB\_measurement\_period\_intra}} = \text{ceil}(5 \times K_p) \times \text{DRX cycle} \times \text{CSSF}_{\text{intra}} = 3200 \text{ ms}$$

Which:

$$K_p = 1;$$

$$\text{DRX cycle} = 640;$$

$$\text{CSSF}_{\text{intra}} = 1$$

$$\text{TTI insertion uncertainty} = \text{TTI}_{\text{DCCH}} = 1 \text{ ms}; 2 \times \text{TTI}_{\text{DCCH}} = 2 \text{ ms}$$

The overall delays measured shall be less than a total of 6402 ms in test 2 (note: this gives a total of 6400 ms for measurement reporting delay plus 2 ms for TTI insertion uncertainty).

The UE shall not send event triggered measurement reports, as long as the reporting criteria are not fulfilled.

The rate of correct events observed during repeated tests shall be at least 90% with confidence level of 95%.

NOTE: The actual overall delays measured in the test may be up to  $2 \times \text{TTI}_{\text{DCCH}}$  higher than the measurement reporting delays above because of TTI insertion uncertainty of the measurement report in DCCH.

#### 4.6.1.3 EN-DC FR1 event-triggered reporting with gap in non-DRX

## 4.6.1.3.1 Test purpose

To verify that the UE makes correct reporting of an event in non-DRX within EN-DC intra-frequency NR cell search requirements in TS 38.133 [6] clause 9.2. This test will partly verify the TDD intra-frequency cell search requirements.

## 4.6.1.3.2 Test applicability

This test applies to all types of E-UTRA UE release 15 and forward supporting EN-DC, CSI-RS-based RLM and BWP operation without bandwidth restriction.

## 4.6.1.3.3 Minimum conformance requirements

The minimum conformance requirements are defined in clause 4.6.1.0.2.

The normative reference for this requirement is TS 38.133 [6] clause A.4.6.1.3.

## 4.6.1.3.4 Test description

## 4.6.1.3.4.1 Initial conditions

Test 4.6.1.3 can be run in one of the configurations defined in Table 4.6.1.3.4.1-1.

**Table 4.6.1.3.4.1-1: Supported test configurations for NR FR1 Cell**

Configuration	Description
4.6.1.3-1	LTE FDD, NR: 15 kHz SSB SCS, 10MHz bandwidth, FDD
4.6.1.3-2	LTE FDD, NR: 15 kHz SSB SCS, 10MHz bandwidth, TDD
4.6.1.3-3	LTE FDD, NR: 30 kHz SSB SCS, 40MHz bandwidth, TDD
4.6.1.3-4	LTE TDD, NR: 15 kHz SSB SCS, 10MHz bandwidth, FDD
4.6.1.3-5	LTE TDD, NR: 15 kHz SSB SCS, 10MHz bandwidth, TDD
4.6.1.3-6	LTE TDD, NR: 30 kHz SSB SCS, 40MHz bandwidth, TDD
NOTE: The UE is only required to be tested in one of the supported test configurations.	

Configure the test equipment and the DUT according to the parameters in Table 4.6.1.5.4.1-2.

**Table 4.6.1.3.4.1-2: Initial conditions for EN-DC event-triggered reporting in FR1**

Parameter	Value		Comment
Test environment	NC		As specified in TS 38.508-1 [14] clause 4.1.
Test frequencies	As specified in Annex E, Table E.2-1 and TS 38.508-1 [14] clause 4.4.2 and 4.3.1.		
Channel bandwidth	As specified by the test configuration selected from Table 4.6.1.3.4.1-1.		
Propagation conditions	AWGN		As specified in clause C.2.2.
Connection Diagram	TE Part	A.3.1.8.2	As specified in TS 38.508-1 [14] Annex A.
	DUT Part	A.3.2.3.4	
Exceptions to connection diagram	N/A		

1. Message contents are defined in clause 4.6.1.3.4.3.
2. The general test parameter settings are set up according to Table 4.6.1.3.4.1-3.
3. Three cells are deployed in the test, which are E-UTRAN PCell (Cell 1), FR1 PSCell (Cell 2) and a FR1 neighbour cell (Cell 3) on the same frequency as the PSCell. Cell 1 is the cell used for connection setup with the power level set according to Table A.6.1.1-1 for this test. Cell 2 is configured according to clauses C.1.1 and C.1.2. Cell 3 is powered OFF.

**Table 4.6.1.3.4.1-3: General test parameters for EN-DC intra-frequency event triggered reporting with per-UE gaps for PSCell in FR1**

Parameter	Unit	Test configuration	Value	Comment
Active cell		1-6	E-UTRAN Cell 1 and NR Cell 2	
Neighbour cell		1-6	NR Cell 3	Cell to be identified.
RF Channel Number		1-6	1: Cell 1 2: Cell 2 and Cell 3	
Measurement gap type		1-6	Per-UE gaps	
Measurement gap repetition periodicity	ms	1-6	40	
Measurement gap length	ms	1-6	6	
Measurement gap offset	ms	1-6	39	
SSB configuration		1,4	SSB.1 FR1	
		2,5	SSB.1 FR1	
		3,6	SSB.2 FR1	
SMTC configuration		1,4	SMTC.2	
		2,5	SMTC.1	
		3,6	SMTC.1	
CSI-RS parameters		1,4	CSI-RS.1.2 FDD resource #0	
		2,5	CSI-RS.1.2 TDD resource #0	
		3,6	CSI-RS.2.2 TDD resource #0	
A3-Offset	dB	1-6	-4.5	
CP length		1-6	Normal	
Hysteresis	dB	1-6	0	
Time To Trigger	s	1-6	0	
Filter coefficient		1-6	0	L3 filtering is not used
DRX		1-6	N/A	OFF
Time offset between PCell and PSCell		1-6	3 $\mu$ s	Synchronous EN-DC
Time offset between serving and neighbour cells		1,4	3 ms	Asynchronous cells. The timing of Cell 3 is 3ms later than the timing of Cell 2.
		2,5	3 $\mu$ s	Synchronous cells
		3,6	3 $\mu$ s	Synchronous cells
T1	s	1-6	5	
T2	s	1-6	5	

#### 4.6.1.3.4.2 Test procedure

Three cells are deployed in the test, which are E-UTRAN PCell (Cell 1), FR1 PSCell (Cell 2) and a FR1 neighbour cell (Cell 3) on the same frequency as the PSCell.

In the measurement control information, a measurement object is configured for the frequency of the PSCell, and it is indicated to the UE that event-triggered reporting with Event A3 is used.

The test consists of two successive time periods, with time duration of T1, and T2 respectively. During time duration T1, the UE shall not have any timing information of cell 3.

There are two BWPs configured in Cell 2, BWP1 which contains the cell defining SSB, and BWP2 which does not contain any SSB of Cell 2. During the whole test, BWP2 is always scheduled as the active BWP for the UE.

1. Ensure the UE is in state RRC\_CONNECTED with generic procedure parameters Connectivity EN-DC, DC bearer *MCG* and *SCG*, Connected without release *On* and Test Mode *On* according to TS 38.508-1 [14] clause 4.5.
2. Set the parameters of NR cells according to T1 in Table 4.6.1.3.5-1.
3. SS shall transmit an RRCConnectionReconfiguration message with event A3 configured.
4. The UE shall transmit RRCConnectionReconfigurationComplete message. T1 starts.

5. When T1 expires, the SS shall switch the power setting from T1 to T2 as specified in Table 4.6.1.3.5-1. T2 starts.
6. UE shall transmit a MeasurementReport message embedded in E-UTRA RRC message *ULInformationTransferMRDC* triggered by Event A3. If the overall delays measured from the beginning of time period T2 is less than 802 ms then the number of successful tests is increased by one. If the UE fails to report the event within the overall delays measured requirement then the number of failure tests is increased by one.
7. After the SS receive the MeasurementReport message in step 6 or when T2 expires, the SS shall transmit RRCConnectionReconfiguration message with condition EN-DC\_PSCell\_Rel according to TS 36.508 [25] Table 4.6.1-8 to release NR cell (PSCell). The UE shall transmit RRCConnectionReconfigurationComplete message.
8. Set Cell 3 physical cell identity = ((current cell 3 physical cell identity + 1) mod 14 + 2) for next iteration of the test procedure loop.
9. The SS shall transmit RRCConnectionReconfiguration message with condition MCG\_and\_SCG according to TS 36.508 [25] Table 4.6.1-8 to add NR cell (PSCell). The UE shall transmit RRCConnectionReconfigurationComplete message. If either of the reconfiguration in step 7 or step 9 fails, the SS switches off and on the UE and ensures the UE is in state RRC\_CONNECTED with generic procedure parameters Connectivity EN-DC, DC bearer *MCG* and *SCG*, Connected without release *On* according to TS 38.508-1 [14] clause 4.5.
10. Repeat step 2-9 until the confidence level according to Tables G.2.3-1 in Annex G clause G.2 is achieved.

4.6.1.3.4.3 Message contents

Message contents are according to TS 38.508-1 [14] clause 7.3 with the following exceptions.

**Table 4.6.1.3.4.3-1: Common Exception messages for Additional EN-DC FR1 event-triggered reporting with gap in non-DRX test requirement**

Default Message Contents	
Common contents of system information blocks exceptions	
Default RRC messages and information elements contents exceptions	Table H.3.1-1 Table H.3.1-2 Table H.3.1-4 with A3-offset = -4.5dB Table H.3.1-5 Table H.3.1-7 with Condition INTRA-FREQ Table H.3.1-8 with Condition CSI-RS RLM Table H.3.4-1 Table H.3.4-1a Table H.3.4-2 Table H.3.4-4 with Condition gapUE Table H.3.4-5 with Condition Pattern #0 Table H.3.5-8
Specific message contents exceptions for Test Configuration 4.6.1.3-1 and 4.6.1.3-4	Table H.3.1-3 with Condition SSB.1 FR1 and Table 7.3.1-3 in TS 38.508-1 [14] with condition SMTC.2
Specific message contents exceptions for Test Configuration 4.6.1.3-2 and 4.6.1.3-5	Table H.3.1-3 with Condition SSB.1 FR1 and Synchronous cells Table 7.3.1-3 in TS 38.508-1 [14] with condition SMTC.1
Specific message contents exceptions for Test Configuration 4.6.1.3-3 and 4.6.1.3-6	Table H.3.1-3 with Condition SSB.2 FR1 and Synchronous cells Table 7.3.1-3 in TS 38.508-1 [14] with condition SMTC.1

**Table 4.6.1.3.4.3-2: ServingCellConfig**

Derivation Path: TS 38.508-1 [14], Table 4.6.3-167			
Information Element	Value/remark	Comment	Condition
ServingCellConfig ::= SEQUENCE {			
downlinkBWP-ToAddModList SEQUENCE (SIZE (1..maxNrofBWPs)) OF SEQUENCE {			
BWP-Downlink[1]	BWP-Downlink with condition BWP-Id1	DLBWP.1.2 configuration	
}			
firstActiveDownlinkBWP-Id	1	Active DL BWP-ID (BWP2)	BWP-Id1
defaultDownlinkBWP-Id	0	Initial BWP (BWP1)	
uplinkConfig SEQUENCE {			
uplinkBWP-ToAddModList SEQUENCE (SIZE (1..maxNrofBWPs)) OF SEQUENCE {			
BWP-Uplink[1]	BWP-Uplink with condition BWP-Id1	ULBWP.1.2 configuration	
}			
firstActiveUplinkBWP-Id	1	Active UL BWP-ID (BWP2)	BWP-Id1
}			
}			
}			

**Table 4.6.1.3.4.3-3**

Condition	Explanation
BWP-Id1	Active BWP (BWP2)

4.6.1.3.5 Test requirement

Tables 4.6.1.3.4.1-3 and 4.6.1.3.5-1 define the primary level settings including test tolerances for EN-DC intra-frequency event triggered reporting with per-UE gaps for PSCell in FR1.

**Table 4.6.1.3.5-1: NR Cell specific test parameters for EN-DC intra-frequency event triggered reporting with per-UE gaps for PSCell in FR1**

Parameter	Unit	Test configuration	Cell 2		Cell 3	
			T1	T2	T1	T2
TDD configuration		1,4	N/A		N/A	
		2,5	TDDConf.1.1		TDDConf.1.1	
		3,6	TDDConf.2.1		TDDConf.2.1	
PDSCH RMC configuration		1,4	SR.1.1 FDD		N/A	
		2,5	SR.1.1 TDD			
		3,6	SR.2.1 TDD			
RMSI CORESET RMC configuration		1,4	CR.1.1 FDD		CR.1.1 FDD	
		2,5	CR.1.1 TDD		CR.1.1 TDD	
		3,6	CR.2.1 TDD		CR.2.1 TDD	
Dedicated CORESET RMC configuration		1,4	CCR.1.2 FDD		CCR.1.1 FDD	
		2,5	CCR.1.2 TDD		CCR.1.1 TDD	
		3,6	CCR.2.1 TDD		CCR.2.1 TDD	
OCNG Patterns		1-6	OP.1		OP.1	
TRS configuration		1,4	TRS.1.1 FDD		N/A	
		2,5	TRS.1.1 TDD		N/A	
		3,6	TRS.1.2 TDD		N/A	
Initial BWP configuration		1-6	DLBWP.0.1	ULBWP.0.1	DLBWP.0.1	ULBWP.0.1
Active DL BWP configuration		1-6	DLBWP.1.2		DLBWP.1.1	
Active UL BWP configuration		1-6	ULBWP.1.2		ULBWP.1.1	

Parameter	Unit	Test configuration	Cell 2		Cell 3	
			T1	T2	T1	T2
RLM-RS		1-6	CSI-RS		SSB	
$N_{oc}$ <sup>Note 2</sup>	dBm/SCS	1,4	-98			
		2,5	-98			
		3,6	-95			
$N_{oc}$ <sup>Note 2</sup>	dBm/15 kHz	1,4	-98			
		2,5				
		3,6				
$\hat{E}_s/I_{ot}$	dB	1,4	4	-1.46	-Infinity	-1.46
		2,5				
		3,6				
$\hat{E}_s/N_{oc}$	dB	1,4	4	4	-Infinity	4
		2,5				
		3,6				
SS-RSRP <sup>Note 3</sup>	dBm/SCS kHz	1,4	-94	-94	-Infinity	-94
		2,5	-94	-94	-Infinity	-94
		3,6	-91	-91	-Infinity	-91
Io	dBm/9.36 MHz	1,4	-64.60	-62.25	-64.60	-62.25
		2,5	-64.60	-62.25	-64.60	-62.25
		3,6	-58.50	-56.16	-58.50	-56.16
Propagation Condition		1-6	AWGN			
NOTE 1: The resources for uplink transmission are assigned to the UE prior to the start of time period T2.						
NOTE 2: Interference from other cells and noise sources not specified in the test is assumed to be constant over subcarriers and time and shall be modelled as AWGN of appropriate power for $N_{oc}$ to be fulfilled.						
NOTE 3: SS-RSRP levels have been derived from other parameters for information purposes. They are not settable parameters themselves.						

The overall delays measured is defined as the time from the beginning of time period T2, to the moment the UE send one Event A3 triggered measurement report to Cell 1.

The overall delays measured in the test may be up to  $2xTTI_{DCCH}$  higher than the measurement reporting delays because of TTI insertion uncertainty of the measurement report in DCCH.

The overall delays measured test requirement is expressed as:

Overall delays measured = measurement reporting delay + TTI insertion uncertainty

Measurement reporting delay =  $T_{\text{identify\_intra\_with\_index}}$

where,

$T_{\text{identify\_intra\_with\_index}} = (T_{\text{PSS/SSS\_sync\_intra}} + T_{\text{SSB\_measurement\_period\_intra}})$  ms

$T_{\text{PSS/SSS\_sync\_intra}} = \max(600\text{ms}, \text{ceil}(5 \times K_p) \times \text{SMTC period})^{\text{Note 1}} \times \text{CSSF}_{\text{intra}} = \max(600\text{ms}, \text{ceil}(5 \times 1) \times 20\text{ms}) \times 1 = 600\text{ms}$

$T_{\text{SSB\_measurement\_period\_intra}} = \max(200\text{ms}, \text{ceil}(5 \times K_p) \times \text{SMTC period})^{\text{Note 1}} \times \text{CSSF}_{\text{intra}} = \max(200\text{ms}, \text{ceil}(5 \times 1) \times 20\text{ms}) \times 1 = 200\text{ms}$

TTI insertion uncertainty = 2 ms

The overall delays measured shall be less than a total of 802 ms in this test case (note: this gives a total of 800 ms for measurement reporting delay plus 2 ms for TTI insertion uncertainty).

For the test to pass, the total number of successful tests shall be more than 90% of the cases with a confidence level of 95%.

#### 4.6.1.4 EN-DC FR1 event-triggered reporting with gap in DRX

##### 4.6.1.4.1 Test purpose

To verify that the UE makes correct reporting of an event in DRX within EN-DC intra-frequency NR cell search requirements in TS 38.133 [6] clause 9.2. This test will partly verify the intra-frequency cell search requirements.

##### 4.6.1.4.2 Test applicability

This test applies to all types of E-UTRA UE release 15 and forward supporting EN-DC, CSI-RS-based RLM, BWP operation without bandwidth restriction and long DRX cycle.

##### 4.6.1.4.3 Minimum conformance requirements

The minimum conformance requirements are defined in clause 4.6.1.0.2.

The normative reference for this requirement is TS 38.133 [6] clause A.4.6.1.4.

##### 4.6.1.4.4 Test description

###### 4.6.1.4.4.1 Initial conditions

Test 4.6.1.4 can be run in one of the configurations defined in Table 4.6.1.4.4.1-1.

**Table 4.6.1.4.4.1-1: Supported test configurations for NR FR1 Cell**

Configuration	Description
4.6.1.4-1	LTE FDD, NR: 15 kHz SSB SCS, 10MHz bandwidth, FDD
4.6.1.4-2	LTE FDD, NR: 15 kHz SSB SCS, 10MHz bandwidth, TDD
4.6.1.4-3	LTE FDD, NR: 30 kHz SSB SCS, 40MHz bandwidth, TDD
4.6.1.4-4	LTE TDD, NR: 15 kHz SSB SCS, 10MHz bandwidth, FDD
4.6.1.4-5	LTE TDD, NR: 15 kHz SSB SCS, 10MHz bandwidth, TDD
4.6.1.4-6	LTE TDD, NR: 30 kHz SSB SCS, 40MHz bandwidth, TDD
NOTE: The UE is only required to be tested in one of the supported test configurations.	

Configure the test equipment and the DUT according to the parameters in Table 4.6.1.4.4.1-2.

**Table 4.6.1.4.4.1-2: Initial conditions for EN-DC event-triggered reporting in FR1**

Parameter	Value		Comment
Test environment	NC		As specified in TS 38.508-1 [14] clause 4.1.
Test frequencies	As specified in Annex E, Table E.2-1 and TS 38.508-1 [14] clause 4.4.2 and 4.3.1.		
Channel bandwidth	As specified by the test configuration selected from Table 4.6.1.4.4.1-1.		
Propagation conditions	AWGN		As specified in clause C.2.2.
Connection Diagram	TE Part	A.3.1.8.2	As specified in TS 38.508-1 [14] Annex A.
	DUT Part	A.3.2.3.4	
Exceptions to connection diagram	N/A		

1. Message contents are defined in clause 4.6.1.4.4.3.
2. The general test parameter settings are set up according to Table 4.6.1.4.4.1-3.
3. Three cells are deployed in the test, which are E-UTRAN PCell (Cell 1), FR1 PSCell (Cell 2) and a FR1 neighbour cell (Cell 3) on the same frequency as the PSCell. Cell 1 is the cell used for connection setup with the power level set according to Table A.6.1.1-1 for this test. Cell 2 is configured according to clauses C.1.1 and C.1.2. Cell 3 is powered OFF.



**Table 4.6.1.4.4.1-3: General test parameters for EN-DC intra-frequency event triggered reporting with per-UE gaps for PSCell in FR1 with DRX**

Parameter	Unit	Test configuration	Value		Comment
			Test 1	Test 2	
Active cell		1-6	E-UTRAN Cell 1 and NR Cell 2		
Neighbour cell		1-6	NR Cell 3		Cell to be identified.
RF Channel Number		1-6	1: Cell 1 2: Cell 2 and Cell 3		
Measurement gap type		1-6	Per-UE gaps		
Measurement gap repetition periodicity	ms	1-6	40		
Measurement gap length	ms	1-6	6		
Measurement gap offset	ms	1-6	39		
SSB configuration		1,4	SSB.1 FR1		
		2,5	SSB.1 FR1		
		3,6	SSB.2 FR1		
SMTC configuration		1,4	SMTC.2		
		2,5	SMTC.1		
		3,6	SMTC.1		
CSI-RS parameters		1,4	CSI-RS.1.2 FDD resource #0		
		2,5	CSI-RS.1.2 TDD resource #0		
		3,6	CSI-RS.2.2 TDD resource #0		
A3-Offset	dB	1-6	-4.5		
CP length		1-6	Normal		
Hysteresis	dB	1-6	0		
Time To Trigger	s	1-6	0		
Filter coefficient		1-6	0		L3 filtering is not used
DRX		1-6	DRX.1	DRX.7	
Time offset between PCell and PSCell		1-6	3 $\mu$ s		Synchronous EN-DC
Time offset between serving and neighbour cells		1,4	3 ms		Asynchronous cells. The timing of Cell 3 is 3ms later than the timing of Cell 2.
		2,5	3 $\mu$ s		Synchronous cells
		3,6	3 $\mu$ s		Synchronous cells
T1	s	1-6	5		
T2	s	1-6	5	10	

#### 4.6.1.4.4.2 Test procedure

Three cells are deployed in the test, which are E-UTRAN PCell (Cell 1), FR1 PSCell (Cell 2) and a FR1 neighbour cell (Cell 3) on the same frequency as the PSCell.

In the measurement control information a measurement object is configured for the frequency of the PSCell, and it is indicated to the UE that event-triggered reporting with Event A3 is used.

The test consists of two successive time periods, with time duration of T1, and T2 respectively. During time duration T1, the UE shall not have any timing information of cell 3.

There are two BWPs configured in Cell 2, BWP1 which contains the cell defining SSB, and BWP2 which does not contain any SSB of Cell 2. During the whole test, BWP2 is always scheduled as the active BWP for the UE.

1. Ensure the UE is in state RRC\_CONNECTED with generic procedure parameters Connectivity EN-DC, DC bearer *MCG* and *SCG*, Connected without release *On* and Test Mode *On* according to TS 38.508-1 [14] clause 4.5.
2. Set the parameters of NR cells according to T1 in Table 4.6.1.4.5-1.
3. SS shall transmit an RRCConnectionReconfiguration message with event A3 configured.

4. The UE shall transmit RRCConnectionReconfigurationComplete message. T1 starts.
5. When T1 expires, the SS shall switch the power setting from T1 to T2 as specified in Table 4.6.1.4.5-1. T2 starts.
6. UE shall transmit a MeasurementReport message embedded in E-UTRA RRC message *ULInformationTransferMRDC* triggered by Event A3. If the overall delays measured from the beginning of time period T2 is less than 922 ms for Test 1 or less than 6402 ms for Test 2 then the number of successful tests is increased by one. If the UE fails to report the event within the overall delays measured requirement then the number of failure tests is increased by one.
7. After the SS receive the MeasurementReport message in step 6 or when T2 expires, the SS shall transmit RRCConnectionReconfiguration message with condition EN-DC\_PSCell\_Rel according to TS 36.508 [25] Table 4.6.1-8 to release NR cell (PSCell). The UE shall transmit RRCConnectionReconfigurationComplete message.
8. Set Cell 3 physical cell identity = ((current cell 3 physical cell identity + 1) mod 14 + 2) for next iteration of the test procedure loop.
9. The SS shall transmit RRCConnectionReconfiguration message with condition MCG\_and\_SCG according to TS 36.508 [25] Table 4.6.1-8 to add NR cell (PSCell). The UE shall transmit RRCConnectionReconfigurationComplete message. If either of the reconfiguration in step 7 or step 9 fails, the SS switches off and on the UE and ensures the UE is in state RRC\_CONNECTED with generic procedure parameters Connectivity EN-DC, DC bearer MCG and SCG, Connected without release *On* according to TS 38.508-1 [14] clause 4.5.
10. Repeat step 2-9 until the confidence level according to Tables G.2.3-1 in Annex G clause G.2 is achieved.
11. Repeat step 1-10 for each sub-test in Table 4.6.1.4.4.1-3 as appropriate.

4.6.1.4.4.3 Message contents

Message contents are according to TS 38.508-1 [14] clause 7.3 with the following exceptions:

**Table 4.6.1.4.4.3-1: Common Exception messages**

Default Message Contents	
Common contents of system information blocks exceptions	
Default RRC messages and information elements contents exceptions	Table H.3.1-1 Table H.3.1-2 Table H.3.1-4 with A3-offset = -4.5dB Table H.3.1-5 Table H.3.1-7 with Condition INTRA-FREQ Table H.3.1-8 with Condition CSI-RS RLM Table H.3.4-1 Table H.3.4-1a Table H.3.4-2 Table H.3.7-1 with Condition DRX.1 and Gap for test 1 Table H.3.7-1 with Condition DRX.7 and Gap for test 2 Table H.3.4-4 with Condition gapUE Table H.3.4-5 with Condition Pattern #0 Table H.3.5-8
Specific message contents exceptions for Test Configuration 4.6.1.3-1 and 4.6.1.3-4	Table H.3.1-3 with Condition SSB.1 FR1 and Table 7.3.1-3 in TS 38.508-1 [14] with condition SMTC.2
Specific message contents exceptions for Test Configuration 4.6.1.3-2 and 4.6.1.3-5	Table H.3.1-3 with Condition SSB.1 FR1 and Synchronous cells Table 7.3.1-3 in TS 38.508-1 [14] with condition SMTC.1
Specific message contents exceptions for Test Configuration 4.6.1.3-3 and 4.6.1.3-6	Table H.3.1-3 with Condition SSB.2 FR1 and Synchronous cells Table 7.3.1-3 in TS 38.508-1 [14] with condition SMTC.1

Table 4.6.1.4.4.3-2: *ServingCellConfig*

Derivation Path: TS 38.508-1 [14], Table 4.6.3-167			
Information Element	Value/remark	Comment	Condition
ServingCellConfig ::= SEQUENCE {			
downlinkBWP-ToAddModList SEQUENCE (SIZE (1..maxNrofBWPs)) OF SEQUENCE {			
BWP-Downlink[1]	BWP-Downlink with condition BWP-Id1	DLBWP.1.2 configuration	
}			
firstActiveDownlinkBWP-Id	1	Active DL BWP-ID (BWP2)	BWP-Id1
defaultDownlinkBWP-Id	0	Initial BWP (BWP1)	
uplinkConfig SEQUENCE {			
uplinkBWP-ToAddModList SEQUENCE (SIZE (1..maxNrofBWPs)) OF SEQUENCE {			
BWP-Uplink[1]	BWP-Uplink with condition BWP-Id1	ULBWP.1.2 configuration	
}			
firstActiveUplinkBWP-Id	1	Active UL BWP-ID (BWP2)	BWP-Id1
}			
}			
}			
}			

Table 4.6.1.4.4.3-3

Condition	Explanation
BWP-Id1	Active BWP (BWP2)

## 4.6.1.4.5 Test requirement

Tables 4.6.1.4.4.1-3 and 4.6.1.4.5-1 define the primary level settings including test tolerances for EN-DC intra-frequency event triggered reporting with per-UE gaps for PSCell in FR1.

Table 4.6.1.4.5-1: NR Cell specific test parameters for EN-DC intra-frequency event triggered reporting with per-UE gaps for PSCell in FR1 with DRX

Parameter	Unit	Test configuration	Cell 2		Cell 3	
			T1	T2	T1	T2
TDD configuration		1,4	N/A		N/A	
		2,5	TDDConf.1.1		TDDConf.1.1	
		3,6	TDDConf.2.1		TDDConf.2.1	
PDSCH RMC configuration		1,4	SR.1.1 FDD		N/A	
		2,5	SR.1.1 TDD			
		3,6	SR.2.1 TDD			
RMSI CORESET RMC configuration		1,4	CR.1.1 FDD		CR.1.1 FDD	
		2,5	CR.1.1 TDD		CR.1.1 TDD	
		3,6	CR.2.1 TDD		CR.2.1 TDD	
Dedicated CORESET RMC configuration		1,4	CCR.1.2 FDD		CCR.1.1 FDD	
		2,5	CCR.1.2 TDD		CCR.1.1 TDD	
		3,6	CCR.2.1 TDD		CCR.2.1 TDD	
OCNG Patterns		1-6	OP.1		OP.1	
TRS configuration		1,4	TRS.1.1 FDD		N/A	
		2,5	TRS.1.1 TDD		N/A	
		3,6	TRS.1.2 TDD		N/A	
Initial BWP configuration		1-6	DLBWP.0.1 ULBWP.0.1		DLBWP.0.1 ULBWP.0.1	
Active DL BWP configuration		1-6	DLBWP.1.2		DLBWP.1.1	
Active UL BWP configuration		1-6	ULBWP.1.2		ULBWP.1.1	

Parameter	Unit	Test configuration	Cell 2		Cell 3	
			T1	T2	T1	T2
RLM-RS		1-6	CSI-RS		SSB	
$N_{oc}$ <sup>Note 2</sup>	dBm/SCS	1,4	-98			
		2,5	-98			
		3,6	-95			
$N_{oc}$ <sup>Note 2</sup>	dBm/15 KHz	1,4	-98			
		2,5				
		3,6				
$\hat{E}_s/I_{ot}$	dB	1,4	4	-1.46	-Infinity	-1.46
		2,5				
		3,6				
$\hat{E}_s/N_{oc}$	dB	1,4	4	4	-Infinity	4
		2,5				
		3,6				
SS-RSRP <sup>Note 3</sup>	dBm/SCS KHz	1,4	-94	-94	-Infinity	-94
		2,5	-94	-94	-Infinity	-94
		3,6	-91	-91	-Infinity	-91
Io	dBm/9.36 MHz	1,4	-64.60	-62.25	-64.60	-62.25
	dBm/9.36 MHz	2,5	-64.60	-62.25	-64.60	-62.25
	dBm/38.16 MHz	3,6	-58.50	-56.16	-58.50	-56.16
Propagation Condition		1-6	AWGN			
NOTE 1: The resources for uplink transmission are assigned to the UE prior to the start of time period T2.						
NOTE 2: Interference from other cells and noise sources not specified in the test is assumed to be constant over subcarriers and time and shall be modelled as AWGN of appropriate power for $N_{oc}$ to be fulfilled.						
NOTE 3: SS-RSRP levels have been derived from other parameters for information purposes. They are not settable parameters themselves.						

The overall delays measured is defined as the time from the beginning of time period T2, to the moment the UE send one Event A3 triggered measurement report to Cell 1.

The overall delays measured in the test may be up to  $2xTTI_{DCCH}$  higher than the measurement reporting delays because of TTI insertion uncertainty of the measurement report in DCCH.

The overall delays measured test requirement is expressed as:

Overall delays measured = measurement reporting delay + TTI insertion uncertainty

Measurement reporting delay =  $T_{\text{identify\_intra\_with\_index}}$

where,

For Test 1:

$$T_{\text{identify\_intra\_with\_index}} = (T_{\text{PSS/SSS\_sync\_ntra}} + T_{\text{SSB\_measurement\_period\_intra}}) \text{ ms}$$

$$T_{\text{PSS/SSS\_sync\_ntra}} = \max(600\text{ms}, \text{ceil}(1.5 \times 5 \times K_p)) \times \max(\text{SMTC period, DRX cycle}) \times \text{CSSF}_{\text{intra}} = \max(600\text{ms}, \text{ceil}(1.5 \times 5 \times 1)) \times \max(20\text{ms}, 40\text{ms}) \times 1 = 600\text{ms}$$

$$T_{\text{SSB\_measurement\_period\_intra}} = \max(200\text{ms}, \text{ceil}(1.5 \times 5 \times K_p)) \times \max(\text{SMTC period, DRX cycle}) \times \text{CSSF}_{\text{intra}} = \max(200\text{ms}, \text{ceil}(1.5 \times 5 \times 1)) \times \max(20\text{ms}, 40\text{ms}) \times 1 = 320\text{ms}$$

TTI insertion uncertainty = 2 ms

The overall delays measured shall be less than a total of 922 ms in this test case (note: this gives a total of 920 ms for measurement reporting delay plus 2 ms for TTI insertion uncertainty).

For Test 2:

$$T_{\text{identify\_intra\_with\_index}} = (T_{\text{PSS/SSS\_sync\_ntra}} + T_{\text{SSB\_measurement\_period\_intra}}) \text{ ms}$$

$$T_{\text{PSS/SSS\_sync\_ntra}} = \text{ceil}(5 \times K_p) \times \text{DRX cycle} \times \text{CSSF}_{\text{intra}} = \text{ceil}(5 \times 1) \times 640\text{ms} \times 1 = 3200\text{ms}$$

$$T_{\text{SSB\_measurement\_period\_intra}} = \text{ceil}(5 \times K_p) \times \text{DRX cycle} \times \text{CSSF}_{\text{intra}} = \text{ceil}(5 \times 1) \times 640\text{ms} \times 1 = 3200\text{ms}$$

TTI insertion uncertainty = 2 ms

The overall delays measured shall be less than a total of 6402 ms in this test case (note: this gives a total of 6400 ms for measurement reporting delay plus 2 ms for TTI insertion uncertainty).

For the test to pass, the total number of successful tests shall be more than 90% of the cases with a confidence level of 95%.

#### 4.6.1.5 EN-DC FR1 event-triggered reporting without gap in non-DRX with SSB time index detection

##### 4.6.1.5.1 Test purpose

To verify that the UE makes correct reporting of an event in non-DRX within EN-DC intra-frequency NR cell search requirements in TS 38.133 [6] clause 9.2. This test will partly verify the FDD intra-frequency cell search requirements. UE is required to report SSB time index.

##### 4.6.1.5.2 Test applicability

This test applies to all types of E-UTRA UE release 15 and forward supporting EN-DC.

##### 4.6.1.5.3 Minimum conformance requirements

The minimum conformance requirements are defined in clause 4.6.1.0.1.

The normative reference for this requirement is TS 38.133 [6] clause A.4.6.1.5.

##### 4.6.1.5.4 Test description

###### 4.6.1.5.4.1 Initial conditions

Test 4.6.1.5 can be run in one of the configurations defined in Table 4.6.1.5.4.1-1.

**Table 4.6.1.5.4.1-1: Supported test configurations for FR1 PSCell**

Configuration	Description
4.6.1.5-1	LTE FDD, 15 kHz SSB SCS, 10MHz bandwidth, FDD duplex mode
4.6.1.5-2	LTE TDD, 15 kHz SSB SCS, 10MHz bandwidth, FDD duplex mode
NOTE: The UE is only required to be tested in one of the supported test configurations.	

Configure the test equipment and the DUT according to the parameters in Table 4.6.1.5.4.1-2.

**Table 4.6.1.5.4.1-2: Initial conditions for EN-DC event-triggered reporting in FR1**

Parameter	Value		Comment
Test environment	NC		As specified in TS 38.508-1 [14] clause 4.1.
Test frequencies	As specified in Annex E, Table E.2-1 and TS 38.508-1 [14] clause 4.4.2 and 4.3.1.		
Channel bandwidth	As specified by the test configuration selected from Table 4.6.1.5.4.1-1.		
Propagation conditions	AWGN		As specified in clause C.2.2.
Connection Diagram	TE Part	A.3.1.8.2	As specified in TS 38.508-1 [14] Annex A.
	DUT Part	A.3.2.3.4	
Exceptions to connection diagram	N/A		

1. Message contents are defined in clause 4.6.1.5.4.3.
2. The general test parameter settings are set up according to Table 4.6.1.5.4.1-3.
3. Three cells are deployed in the test, which are E-UTRAN PCell (Cell 1), FR1 PSCell (Cell 2) and a FR1 neighbour cell (Cell 3) on the same frequency as the PSCell. Cell 1 is the cell used for connection setup with the power level set according to Table A.6.1.1-1 for this test. Cell 2 is configured according to clauses C.1.1 and C.1.2. Cell 3 is powered OFF.

**Table 4.6.1.5.4.1-3: General test parameters for EN-DC intra-frequency event triggered reporting without gap for FDD PSCell in FR1 with SSB index reading**

Parameter	Unit	Test configuration	Value	Comment
Active cell		1,2	E-UTRAN Cell 1 and NR Cell 2	
Neighbour cell		1,2	NR Cell 3	Cell to be identified.
RF Channel Number		1,2	1: Cell 1 2: Cell 2 and Cell 3	
SSB configuration		1,2	SSB.1 FR1	
SMTC configuration		1,2	SMTC.2	
A3-Offset	dB	1,2	-4.5	
CP length		1,2	Normal	
Hysteresis	dB	1,2	0	
Time To Trigger	s	1,2	0	
Filter coefficient		1,2	0	L3 filtering is not used
DRX		1,2	N/A	OFF
Time offset between PCell and PSCell		1,2	3 $\mu$ s	Synchronous EN-DC
Time offset between serving and neighbour cells		1,2	3 ms	Asynchronous cells. The timing of Cell 3 is 3ms later than the timing of Cell 2.
T1	s	1,2	5	
T2	s	1,2	5	

#### 4.6.1.5.4.2 Test procedure

Three cells are deployed in the test, which are E-UTRAN PCell (Cell 1), FR1 PSCell (Cell 2) and a FR1 neighbour cell (Cell 3) on the same frequency as the PSCell.

In the measurement control information, a measurement object is configured for the frequency of the PSCell, and it is indicated to the UE that event-triggered reporting with Event A3 is used.

The test consists of two successive time periods, with time duration of T1, and T2 respectively. During time duration T1, the UE shall not have any timing information of cell 3.

1. Ensure the UE is in state RRC\_CONNECTED with generic procedure parameters Connectivity EN-DC, DC bearer MCG and SCG, Connected without release On and Test Mode On according to TS 38.508-1 [14] clause 4.5.
2. Set the parameters of NR cells according to T1 in Table 4.6.1.5.5-1.
3. SS shall transmit an RRCConnectionReconfiguration message with event A3 configured.
4. The UE shall transmit RRCConnectionReconfigurationComplete message. T1 starts.
5. When T1 expires, the SS shall switch the power setting from T1 to T2 as specified in Table 4.6.1.5.5-1. T2 starts.
6. UE shall transmit a MeasurementReport message embedded in E-UTRA RRC message *ULInformationTransferMRDC* triggered by Event A3. If the overall delays measured from the beginning of time period T2 is less than 922 ms then the number of successful tests is increased by one. If the UE fails to report the event within the overall delays measured requirement then the number of failure tests is increased by one.
7. After the SS receive the MeasurementReport message in step 6 or when T2 expires, the SS shall transmit RRCConnectionReconfiguration message with condition EN-DC\_PSCell\_Rel according to TS 36.508 [25] Table 4.6.1-8 to release NR cell (PSCell). The UE shall transmit RRCConnectionReconfigurationComplete message.
8. Set Cell 3 physical cell identity = ((current cell 3 physical cell identity + 1) mod 14 + 2) for next iteration of the test procedure loop.
9. The SS shall transmit RRCConnectionReconfiguration message with condition MCG\_and\_SCG according to TS 36.508 [25] Table 4.6.1-8 to add NR cell (PSCell). The UE shall transmit RRCConnectionReconfigurationComplete message. If either of the reconfiguration in step 7 or step 9 fails, the SS switches off and on the UE and ensures the UE is in state RRC\_CONNECTED with generic procedure parameters Connectivity EN-DC, DC bearer MCG and SCG, Connected without release On according to TS 38.508-1 [14] clause 4.5.
10. Repeat step 2-9 until the confidence level according to Tables G.2.3-1 in Annex G clause G.2 is achieved.

4.6.1.5.4.3 Message contents

Message contents are according to TS 38.508-1 [14] clause 7.3 with the following exceptions:

**Table 4.6.1.5.4.3-1: Common Exception messages for Additional EN-DC FR1 event-triggered reporting without gap in non-DRX with SSB time index detection test requirement**

Default Message Contents	
Common contents of system information blocks exceptions	
Default RRC messages and information elements contents exceptions	Table H.3.1-1 Table H.3.1-2 Table H.3.1-3 with Condition SSB.1 FR1 and Table 7.3.1-3 in TS 38.508-1 [14] with condition SMTC.2 Table H.3.1-4 with Condition SSB Index and A3-offset = -4.5dB Table H.3.1-5 Table H.3.1-7 with Condition INTRA-FREQ and SSB Index Table H.3.4-1 Table H.3.4-1a Table H.3.4-2

4.6.1.5.5 Test requirement

Tables 4.6.1.5.4.1-3 and 4.6.1.5.5-1 define the primary level settings including test tolerances for EN-DC FR1 event-triggered reporting without gap in non-DRX with SSB time index detection.

**Table 4.6.1.5.5-1: NR Cell specific test parameters for EN-DC intra-frequency event triggered reporting without gap for FDD PSCell in FR1 with SSB index reading**

Parameter	Unit	Test configuration	Cell 2		Cell 3	
			T1	T2	T1	T2
TDD configuration		1,2	N/A		N/A	
PDSCH RMC configuration		1,2	SR.1.1 FDD		N/A	
RMSI CORESET RMC configuration		1,2	CR.1.1 FDD		CR.1.1 FDD	
Dedicated CORESET RMC configuration		1,2	CCR.1.1 FDD		CCR.1.1 FDD	
OCNG Patterns		1,2	OP.1		OP.1	
TRS configuration		1,2	TRS.1.1 FDD		N/A	
Initial BWP configuration		1,2	DLBWP.0.1 ULBWP.0.1		DLBWP.0.1 ULBWP.0.1	
Active DL BWP configuration		1,2	DLBWP.1.1		DLBWP.1.1	
Active UL BWP configuration		1,2	ULBWP.1.1		ULBWP.1.1	
RLM-RS		1,2	SSB		SSB	
$N_{oc}$ <sup>Note 2</sup>	dBm/SCS	1,2	-98			
$N_{oc}$ <sup>Note 2</sup>	dBm/15 kHz	1,2	-98			
$\hat{E}_s/I_{ot}$	dB	1,2	4	-1.46	-Infinity	-1.46
$\hat{E}_s/N_{oc}$	dB	1,2	4	4	-Infinity	4
SS-RSRP <sup>Note 3</sup>	dBm/SCS kHz	1,2	-94	-94	-Infinity	-94
Io	dBm/9.36 MHz	1,2	-64.60	-62.25	-64.60	-62.25
Propagation Condition		1,2	AWGN			
NOTE 1: The resources for uplink transmission are assigned to the UE prior to the start of time period T2.						
NOTE 2: Interference from other cells and noise sources not specified in the test is assumed to be constant over subcarriers and time and shall be modelled as AWGN of appropriate power for $N_{oc}$ to be fulfilled.						
NOTE 3: SS-RSRP levels have been derived from other parameters for information purposes. They are not settable parameters themselves.						

The overall delays measured is defined as the time from the beginning of time period T2, to the moment the UE send one Event A3 triggered measurement report to Cell 1. The UE is required to read the neighbour cell SSB index and report the acquired SSB index in this test.

The overall delays measured in the test may be up to  $2xTTI_{DCCH}$  higher than the measurement reporting delays because of TTI insertion uncertainty of the measurement report in DCCH.

The overall delays measured test requirement is expressed as:

Overall delays measured = measurement reporting delay + TTI insertion uncertainty

Measurement reporting delay =  $T_{\text{identify\_intra\_with\_index}}$

where,

$T_{\text{identify\_intra\_with\_index}} = (T_{\text{PSS/SSS\_sync\_intra}} + T_{\text{SSB\_measurement\_period\_intra}} + T_{\text{SSB\_time\_index\_intra}})$  ms

- $T_{\text{PSS/SSS\_sync\_intra}} = \max(600\text{ms}, \text{ceil}(5 \times K_p) \times \text{SMTC period})^{\text{Note 1}} \times \text{CSSF}_{\text{intra}} = \max(600\text{ms}, \text{Ceil}(5 \times 1) \times 20\text{ms}) \times 1 = 600\text{ms}$
- $T_{\text{SSB\_measurement\_period\_intra}} = \max(200\text{ms}, \text{ceil}(5 \times K_p) \times \text{SMTC period})^{\text{Note 1}} \times \text{CSSF}_{\text{intra}} = \max(200\text{ms}, \text{ceil}(5 \times 1) \times 20\text{ms}) \times 1 = 200\text{ms}$



- $T_{SSB\_time\_index\_intra} = \max(120ms, \text{ceil}(3 \times K_p) \times \text{SMTC period})^{\text{Note 1}} \times CSSF_{intra} = \max(120ms, \text{ceil}(3 \times 1) \times 20ms) \times 1 = 120ms$

TTI insertion uncertainty = 2 ms

The overall delays measured shall be less than a total of 922 ms in this test case (note: this gives a total of 920 ms for measurement reporting delay plus 2 ms for TTI insertion uncertainty).

For the test to pass, the total number of successful tests shall be more than 90% of the cases with a confidence level of 95%.

#### 4.6.1.6 EN-DC FR1 event-triggered reporting with gap in non-DRX with SSB time index detection

##### 4.6.1.6.1 Test purpose

To verify that the UE makes correct reporting of an event in non-DRX within EN-DC intra-frequency NR cell search requirements in TS 38.133 [6] clause 9.2. This test will partly verify the FDD intra-frequency cell search requirements. UE is required to report SSB time index.

##### 4.6.1.6.2 Test applicability

This test applies to all types of E-UTRA UE release 15 and forward supporting EN-DC, CSI-RS-based RLM and BWP operation without bandwidth restriction.

##### 4.6.1.6.3 Minimum conformance requirements

The minimum conformance requirements are defined in clause 4.6.1.0.2.

The normative reference for this requirement is TS 38.133 [6] clause A.4.6.1.6.

##### 4.6.1.6.4 Test description

###### 4.6.1.6.4.1 Initial conditions

Test 4.6.1.6 can be run in one of the configurations defined in Table 4.6.1.6.4.1-1.

**Table 4.6.1.6.4.1-1: Supported test configurations for NR FR1 Cell**

Configuration	Description
4.6.1.6-1	LTE FDD, 15 kHz SSB SCS, 10MHz bandwidth, FDD duplex mode
4.6.1.6-2	LTE TDD, 15 kHz SSB SCS, 10MHz bandwidth, FDD duplex mode
NOTE: The UE is only required to be tested in one of the supported test configurations.	

Configure the test equipment and the DUT according to the parameters in Table 4.6.1.6.4.1-2.

**Table 4.6.1.6.4.1-2: Initial conditions for EN-DC event-triggered reporting in FR1**

Parameter	Value	Comment
Test environment	NC	As specified in TS 38.508-1 [14] clause 4.1.
Test frequencies	As specified in Annex E, Table E.2-1 and TS 38.508-1 [14] clause 4.4.2 and 4.3.1.	
Channel bandwidth	As specified by the test configuration selected from Table 4.6.1.6.4.1-1.	
Propagation conditions	AWGN	
Connection Diagram	TE Part	A.3.1.8.2
	DUT Part	A.3.2.3.4
Exceptions to connection diagram	N/A	

1. Message contents are defined in clause 4.6.1.6.4.3.

2. The general test parameter settings are set up according to Table 4.6.1.6.4.1-3.
3. Three cells are deployed in the test, which are E-UTRAN PCell (Cell 1), FR1 PSCell (Cell 2) and a FR1 neighbour cell (Cell 3) on the same frequency as the PSCell. Cell 1 is the cell used for connection setup with the power level set according to Table A.6.1.1-1 for this test. Cell 2 is configured according to clauses C.1.1 and C.1.2. Cell 3 is powered OFF.

**Table 4.6.1.6.4.1-3: General test parameters for EN-DC intra-frequency event triggered reporting with gap for PSCell in FR1 with SSB index reading**

Parameter	Unit	Test configuration	Value	Comment
Active cell		1,2	E-UTRAN Cell 1 and NR Cell 2	
Neighbour cell		1,2	NR Cell 3	Cell to be identified.
RF Channel Number		1,2	1: Cell 1 2: Cell 2 and Cell 3	
Measurement gap type		1,2	Per-UE gaps	
Measurement gap repetition periodicity	ms	1,2	40	
Measurement gap length	ms	1,2	6	
Measurement gap offset	ms	1,2	39	
SSB configuration		1,2	SSB.1 FR1	
SMTC configuration		1,2	SMTC.2	
CSI-RS parameters		1,2	CSI-RS.1.2 FDD resource #0	
A3-Offset	dB	1,2	-4.5	
CP length		1,2	Normal	
Hysteresis	dB	1,2	0	
Time To Trigger	s	1,2	0	
Filter coefficient		1,2	0	L3 filtering is not used
DRX		1,2	N/A	OFF
Time offset between PCell and PSCell		1,2	3 $\mu$ s	Synchronous EN-DC
Time offset between serving and neighbour cells		1,2	3 ms	Asynchronous cells. The timing of Cell 3 is 3ms later than the timing of Cell 2.
T1	s	1,2	5	
T2	s	1,2	5	

#### 4.6.1.6.4.2 Test procedure

Three cells are deployed in the test, which are E-UTRAN PCell (Cell 1), FR1 PSCell (Cell 2) and a FR1 neighbour cell (Cell 3) on the same frequency as the PSCell.

In the measurement control information, a measurement object is configured for the frequency of the PSCell, and it is indicated to the UE that event-triggered reporting with Event A3 is used.

The test consists of two successive time periods, with time duration of T1, and T2 respectively. During time duration T1, the UE shall not have any timing information of cell 3.

There are two BWPs configured in Cell 2, BWP1 which contains the cell defining SSB, and BWP2 which does not contain any SSB of Cell 2. During the whole test, BWP2 is always scheduled as the active BWP for the UE.

1. Ensure the UE is in state RRC\_CONNECTED with generic procedure parameters Connectivity EN-DC, DC bearer *MCG* and *SCG*, Connected without release *On* and Test Mode *On* according to TS 38.508-1 [14] clause 4.5.
2. Set the parameters of NR cells according to T1 in Table 4.6.1.6.5-1.
3. SS shall transmit an RRCConnectionReconfiguration message with event A3 configured.
4. The UE shall transmit RRCConnectionReconfigurationComplete message. T1 starts.

5. When T1 expires, the SS shall switch the power setting from T1 to T2 as specified in Table 4.6.1.6.5-1. T2 starts.
6. UE shall transmit a MeasurementReport message embedded in E-UTRA RRC message *ULInformationTransferMRDC* triggered by Event A3. If the overall delays measured from the beginning of time period T2 is less than 922 ms then the number of successful tests is increased by one. If the UE fails to report the event within the overall delays measured requirement then the number of failure tests is increased by one.
7. After the SS receive the MeasurementReport message in step 6 or when T2 expires, the SS shall transmit RRCConnectionReconfiguration message with condition EN-DC\_PSCell\_Rel according to TS 36.508 [25] Table 4.6.1-8 to release NR cell (PSCell). The UE shall transmit RRCConnectionReconfigurationComplete message.
8. Set Cell 3 physical cell identity = ((current cell 3 physical cell identity + 1) mod 14 + 2) for next iteration of the test procedure loop.
9. The SS shall transmit RRCConnectionReconfiguration message with condition MCG\_and\_SCG according to TS 36.508 [25] Table 4.6.1-8 to add NR cell (PSCell). The UE shall transmit RRCConnectionReconfigurationComplete message. If either of the reconfiguration in step 7 or step 9 fails, the SS switches off and on the UE and ensures the UE is in state RRC\_CONNECTED with generic procedure parameters Connectivity EN-DC, DC bearer MCG and SCG, Connected without release *On* according to TS 38.508-1 [14] clause 4.5.
10. Repeat step 2-9 until the confidence level according to Tables G.2.3-1 in Annex G clause G.2 is achieved.

4.6.1.6.4.3 Message contents

Message contents are according to TS 38.508-1 [14] clause 7.3 with the following exceptions:

**Table 4.6.1.6.4.3-1: Common Exception messages for Additional EN-DC FR1 event-triggered reporting with gap in non-DRX with SSB time index detection test requirement**

Default Message Contents	
Common contents of system information blocks exceptions	
Default RRC messages and information elements contents exceptions	Table H.3.1-1 Table H.3.1-2 Table H.3.1-3 with Condition SSB.1 FR1 Table 7.3.1-3 in TS 38.508-1 [14] with condition SMTC.2 Table H.3.1-3 with Condition INTRA-FREQ MO, SSB.1 FR1, SMTC.2 for Configuration 4.6.1.6-1 Table H.3.1-4 with Condition SSB Index and A3-offset = -4.5dB Table H.3.1-5 Table H.3.1-7 with Condition INTRA-FREQ and SSB Index Table H.3.1-8 with Condition CSI-RS RLM Table H.3.4-1 Table H.3.4-1a Table H.3.4-2 Table H.3.4-4 with Condition gapUE Table H.3.4-5 with Condition Pattern #0 Table H.3.5-8

**Table 4.6.1.6.4.3-2: ServingCellConfig**

Derivation Path: TS 38.508-1 [14], Table 4.6.3-167			
Information Element	Value/remark	Comment	Condition
ServingCellConfig ::= SEQUENCE {			
downlinkBWP-ToAddModList SEQUENCE (SIZE (1..maxNrofBWPs)) OF SEQUENCE {			
BWP-Downlink[1]	BWP-Downlink with condition BWP-Id1	DLBWP.1.2 configuration	
}			

firstActiveDownlinkBWP-Id	1	Active DL BWP-ID (BWP2)	BWP-Id1
defaultDownlinkBWP-Id	0	Initial BWP (BWP1)	
uplinkConfig SEQUENCE {			
uplinkBWP-ToAddModList SEQUENCE (SIZE (1..maxNrofBWPs)) OF SEQUENCE {			
BWP-Uplink[1]	BWP-Uplink with condition BWP-Id1	ULBWP.1.2 configuration	
}			
firstActiveUplinkBWP-Id	1	Active UL BWP-ID (BWP2)	BWP-Id1
}			
}			

Condition	Explanation
BWP-Id1	Active BWP (BWP2)

#### 4.6.1.6.5 Test requirement

Tables 4.6.1.6.4.1-3 and 4.6.1.6.5-1 define the primary level settings including test tolerances for EN-DC intra-frequency event triggered reporting with gap for PSCell in FR1 with SSB index reading.

**Table 4.6.1.6.5-1: NR Cell specific test parameters for EN-DC intra-frequency event triggered reporting with gap for PSCell in FR1 with SSB index reading**

Parameter	Unit	Test configuration	Cell 2		Cell 3	
			T1	T2	T1	T2
TDD configuration		1,2	N/A		N/A	
PDSCH RMC configuration		1,2	SR.1.1 FDD		N/A	
RMSI CORESET RMC configuration		1,2	CR.1.1 FDD		CR.1.1 FDD	
Dedicated CORESET RMC configuration		1,2	CCR.1.2 FDD		CCR.1.1 FDD	
OCNG Patterns		1,2	OP.1		OP.1	
TRS configuration		1,2	TRS.1.1 FDD		N/A	
Initial BWP configuration		1,2	DLBWP.0.1 ULBWP.0.1		DLBWP.0.1 ULBWP.0.1	
Active DL BWP configuration		1,2	DLBWP.1.2		DLBWP.1.1	
Active UL BWP configuration		1,2	ULBWP.1.2		ULBWP.1.1	
RLM-RS		1,2	CSI-RS		SSB	
$N_{oc}$ <sup>Note 2</sup>	dBm/SCS	1,2	-98			
$N_{oc}$ <sup>Note 2</sup>	dBm/15 kHz	1,2	-98			
$\hat{E}_s/I_{ot}$	dB	1,2	4	-1.46	-Infinity	-1.46
$\hat{E}_s/N_{oc}$	dB	1,2	4	4	-Infinity	4
SS-RSRP <sup>Note 3</sup>	dBm/SCS kHz	1,2	-94	-94	-Infinity	-94
Io	dBm/9.36 MHz	1,2	-64.60	-62.25	-64.60	-62.25
Propagation Condition		1,2	AWGN			
NOTE 1: The resources for uplink transmission are assigned to the UE prior to the start of time period T2.						
NOTE 2: Interference from other cells and noise sources not specified in the test is assumed to be constant over subcarriers and time and shall be modelled as AWGN of appropriate power for $N_{oc}$ to be fulfilled.						
NOTE 3: SS-RSRP levels have been derived from other parameters for information purposes. They are not settable parameters themselves.						

The overall delays measured is defined as the time from the beginning of time period T2, to the moment the UE send one Event A3 triggered measurement report to Cell 1. The UE is required to read the neighbour cell SSB index and report the acquired SSB index in this test.

The overall delays measured in the test may be up to  $2 \times TTI_{DCCH}$  higher than the measurement reporting delays because of TTI insertion uncertainty of the measurement report in DCCH.

The overall delays measured test requirement is expressed as:

Overall delays measured = measurement reporting delay + TTI insertion uncertainty

Measurement reporting delay =  $T_{\text{identify\_intra\_with\_index}}$

where,

$T_{\text{identify\_intra\_with\_index}} = (T_{\text{PSS/SSS\_sync\_ntra}} + T_{\text{SSB\_measurement\_period\_intra}} + T_{\text{SSB\_time\_index\_intra}})$  ms

$T_{\text{PSS/SSS\_sync\_ntra}} = \max(600\text{ms}, \text{ceil}(5 \times K_p) \times \text{SMTC period})^{\text{Note 1}} \times \text{CSSF}_{\text{intra}} = \max(600\text{ms}, \text{Ceil}(5 \times 1) \times 20\text{ms}) \times 1 = 600\text{ms}$

$T_{\text{SSB\_measurement\_period\_intra}} = \max(200\text{ms}, \text{ceil}(5 \times K_p) \times \text{SMTC period})^{\text{Note 1}} \times \text{CSSF}_{\text{intra}} = \max(200\text{ms}, \text{ceil}(5 \times 1) \times 20\text{ms}) \times 1 = 200\text{ms}$

$T_{\text{SSB\_time\_index\_intra}} = \max(120\text{ms}, \text{ceil}(3 \times K_p) \times \text{SMTC period})^{\text{Note 1}} \times \text{CSSF}_{\text{intra}} = \max(120\text{ms}, \text{ceil}(3 \times 1) \times 20\text{ms}) \times 1 = 120\text{ms}$

TTI insertion uncertainty = 2 ms

The overall delays measured shall be less than a total of 922 ms in this test case (note: this gives a total of 920 ms for measurement reporting delay plus 2 ms for TTI insertion uncertainty).

For the test to pass, the total number of successful tests shall be more than 90% of the cases with a confidence level of 95%.

#### 4.6.1.7 EN-DC FR1 event-triggered reporting without gap in DRX for UE configured with highSpeedMeasFlag-r16

##### 4.6.1.7.1 Test purpose

This test is to verify that the UE makes correct reporting of an event for UE configured with *highSpeedMeasFlag-r16*. This test will partly verify the intra-frequency cell search requirements in TS 38.133 [6] clause 9.2.5.1 and 9.2.5.2.

##### 4.6.1.7.2 Test applicability

This test applies to all types of E-UTRA UE release 16 and forward, supporting EN-DC FR1 and long DRX cycle.

##### 4.6.1.7.3 Minimum conformance requirements

The minimum conformance requirements are defined in clause 4.6.1.0.1.

The normative reference for this requirement is TS 38.133 [6] clause A.4.6.1.7.

##### 4.6.1.7.4 Test description

###### 4.6.1.7.4.1 Initial conditions

This test shall be tested using any of the test configurations in Table 4.6.1.7.4.1-1.

**Table 4.6.1.7.4.1-1: supported test configurations for EN-DC FR1 event-triggered reporting without gap in DRX for UE configured with highSpeedMeasFlag-r16**

Configuration	Description
4.6.1.7-1	LTE FDD, NR 15 kHz SSB SCS, 10 MHz bandwidth, FDD duplex mode
4.6.1.7-2	LTE FDD, NR 15 kHz SSB SCS, 10 MHz bandwidth, TDD duplex mode
4.6.1.7-3	LTE FDD, NR 30 kHz SSB SCS, 40 MHz bandwidth, TDD duplex mode
4.6.1.7-4	LTE TDD, NR 15 kHz SSB SCS, 10 MHz bandwidth, FDD duplex mode
4.6.1.7-5	LTE TDD, NR 15 kHz SSB SCS, 10 MHz bandwidth, TDD duplex mode
4.6.1.7-6	LTE TDD, NR 30 kHz SSB SCS, 40 MHz bandwidth, TDD duplex mode
NOTE 1: The UE is only required to be tested in one of the supported test configurations.	
NOTE 2: Target NR Cell 3 has the same SCS, BW and duplex mode as NR serving Cell 2	

Configure the test equipment and the DUT according to the parameters in Table 4.6.1.7.4.1-2 and Table 4.6.1.7.4.1-3.

**Table 4.6.1.7.4.1-2: Initial conditions for EN-DC FR1 event-triggered reporting without gap in DRX for UE configured with highSpeedMeasFlag-r16**

Parameter	Value		Comment
Test environment	NC		As specified in TS 38.508-1 [14] clause 4.1.
Test frequencies	As specified in Annex E, Table E.1-1 and TS 38.508-1 [14] clause 4.3.1.		
Channel bandwidth	As specified by the test configuration selected from Table 4.7.1.1.2-1.		
Propagation conditions	AWGN		As specified in clause C.2.2.
Connection Diagram	TE Part	A.3.1.8.2	As specified in TS 38.508-1 [14] Annex A.
	DUT Part	A.3.2.3.4	
Exceptions to connection diagram	N/A		

**Table 4.6.1.7.4.1-3: General test parameters for EN-DC FR1 event-triggered reporting without gap in DRX for UE configured with highSpeedMeasFlag-r16**

Parameter	Unit	Test configuration	Value	Comment
<i>highSpeedMeasFlag-r16</i>		1,2,3,4,5,6	Present	To enable high speed measurement enhancements
Active cell		1, 2, 3,4,5,6	E-UTRAN Cell 1 and NR Cell 2	
Neighbour cell		1, 2, 3,4,5,6	NR Cell 3	Cell to be identified.
RF Channel Number		1, 2, 3,4,5,6	1: Cell 1 2: Cell 2 and Cell 3	
SSB configuration		1,4	SSB.1 FR1	
		2,5	SSB.1 FR1	
		3,6	SSB.2 FR1	
SMTC configuration		1,4	SMTC.2	
		2,5	SMTC.1	
		3,6	SMTC.1	
A3-Offset	dB	1, 2, 3,4,5,6	-4.5	
CP length		1, 2, 3,4,5,6	Normal	
Hysteresis	dB	1, 2, 3,4,5,6	0	
Time To Trigger	s	1, 2, 3,4,5,6	0	
Filter coefficient		1, 2, 3,4,5,6	0	L3 filtering is not used
DRX		1, 2, 3,4,5,6	DRX.7.	640ms DRX cycle
Time offset between PCell and PSCell		1, 2, 3,4,5,6	3 $\mu$ s	Synchronous EN-DC
Time offset between serving and neighbour cells		1,4	3 ms	Asynchronous cells. The timing of Cell 3 is 3ms later than the timing of Cell 2.

Parameter	Unit	Test configuration	Value	Comment
		2,5	3 μs	Synchronous cells
		3,6	3 μs	Synchronous cells
T1	s	1, 2, 3,4,5,6	5	
T2	s	1, 2, 3,4,5,6	6	

1. Message contents are defined in clause 4.6.1.7.4.3.
2. Cell 1 is the E-UTRA serving cell (PCell) for the EN-DC setup. The power levels and settings for Cell 1 are set according to Annex A.6. Cell 2 and Cell 3 are NR FR1 cells in the same frequency. Cell 2 is the PSCell and Cell 3 is the neighbour NR Cell.

4.6.1.7.4.2 Test procedure

Same test procedure as in subclause 4.6.1.1.4.2 with Step 1 and 8 are replaced by following:

1. Ensure the UE is in state RRC\_CONNECTED with generic procedure parameters Connectivity EN-DC, DC bearer MCG and SCG, Connected without release *On* and Test Mode *On* according to TS 38.508-1 [14] clause 4.5. UE is configured with *highSpeedMeasFlag-r16*.
8. UE shall transmit a *MeasurementReport* message triggered by Event A3 for Cell 3 on PCell (Cell 1). If the overall delays measured from the beginning of time period T2 is less than 5122 ms then the number of successful tests is increased by one. If the UE fails to report the event within the overall delays measured requirement then the number of failure tests is increased by one.

4.6.1.7.4.3 Message contents

Message contents are according to TS 38.508-1 [14] clause 7.3 with the following exceptions:

**Table 4.6.1.7.4.3-0: Common Exception messages for Additional EN-DC FR1 event-triggered reporting without gap in DRX for UE configured with highSpeedMeasFlag-r16 test requirement**

Default Message Contents	
Common contents of system information blocks exceptions	
Default RRC messages and information elements contents exceptions	Table H.3.1-1 Table H.3.1-2 Table H.3.1-4 with A3-offset = -4.5dB Table H.3.1-5 Table H.3.1-7 Table H.3.7-1 with Condition DRX.7 Table H.3.4-1 Table H.3.4-1a Table H.3.4-2
Specific message contents exceptions for Test Configuration 4.6.1.2-1 and 4.6.1.2-4	Table H.3.1-3 with Condition SSB.1 FR1 and Table 7.3.1-3 in TS 38.508-1 [14] with condition SMTC.2
Specific message contents exceptions for Test Configuration 4.6.1.2-2 and 4.6.1.2-5	Table H.3.1-3 with Condition SSB.1 FR1 and Synchronous cells Table 7.3.1-3 in TS 38.508-1 [14] with condition SMTC.1
Specific message contents exceptions for Test Configuration 4.6.1.2-3 and 4.6.1.2-6	Table H.3.1-3 with Condition SSB.2 FR1 and Synchronous cells Table 7.3.1-3 in TS 38.508-1 [14] with condition SMTC.1

**Table 4.6.1.7.4.3-1: Void**

**Table 4.6.1.7.4.3-2: Void**

**Table 4.6.1.7.4.3-3: CellGroupConfig (Step 1)**

Derivation Path: TS 38.508-1 [14], Table 4.6.3-19 with condition EN-DC			
Information Element	Value/remark	Comment	Condition
CellGroupConfig ::= SEQUENCE {			
spCellConfig SEQUENCE {			
servCellIndex	ServCellIndex for Cell 2		
reconfigurationWithSync SEQUENCE {			
spCellConfigCommon	ServingCellConfigCommon	Table 4.6.1.7.4.3-4	
}			
}			
}			

**Table 4.6.1.7.4.3-4: ServingCellConfigCommon (Table 4.6.1.7.4.3-3)**

Derivation Path: TS 38.508-1[14], Table 4.6.3-168 with condition HST			
Information Element	Value/remark	Comment	Condition
ServingCellConfigCommon ::= SEQUENCE {			
highSpeedConfig-r16 SEQUENCE {			
highSpeedMeasFlag-r16	true		
}			
}			

4.6.1.7.5 Test requirement

Table 4.6.1.7.4.1-2 and Table 4.6.1.7.5-1 defines the primary level settings including test tolerances for all tests.

**Table 4.6.1.7.5-1: NR Cell specific test parameters for EN-DC FR1 event-triggered reporting without gap in DRX for UE configured with highSpeedMeasFlag-r16**

Parameter	Unit	Test configuration	Cell 2		Cell 3	
			T1	T2	T1	T2
TDD configuration		1,4	N/A		N/A	
		2,5	TDDConf.1.1		TDDConf.1.1	
		3,6	TDDConf.2.1		TDDConf.2.1	
PDSCH RMC configuration		1,4	SR.1.1 FDD		N/A	
		2,5	SR.1.1 TDD			
		3,6	SR.2.1 TDD			
RMSI CORESET RMC configuration		1,4	CR.1.1 FDD		CR.1.1 FDD	
		2,5	CR.1.1 TDD		CR.1.1 TDD	
		3,6	CR.2.1 TDD		CR.2.1 TDD	
Dedicated CORESET RMC configuration		1,4	CCR.1.1 FDD		CCR.1.1 FDD	
		2,5	CCR.1.1 TDD		CCR.1.1 TDD	
		3,6	CCR.2.1 TDD		CCR.2.1 TDD	
OCNG Patterns		1, 2, 3,4,5,6	OP.1		OP.1	
TRS configuration		1,4	TRS.1.1 FDD		N/A	
		2,5	TRS.1.1 TDD		N/A	
		3,6	TRS.1.2 TDD		N/A	
Initial BWP configuration		1, 2, 3,4,5,6	DLBWP.0.1 ULBWP.0.1		DLBWP.0.1 ULBWP.0.1	
Active DL BWP configuration		1, 2, 3,4,5,6	DLBWP.1.1		DLBWP.1.1	
Active UL BWP configuration		1, 2, 3,4,5,6	ULBWP.1.1		ULBWP.1.1	
RLM-RS		1, 2, 3,4,5,6	SSB		SSB	
$N_{oc}$ <small>Note 2</small>	dBm/SCS	1,4	-98			



Parameter	Unit	Test configuration	Cell 2		Cell 3	
			T1	T2	T1	T2
$N_{oc}$ <sup>Note 2</sup>	dBm/15 kHz	2,5	-98			
		3,6	-95			
		1,4	-98			
		2,5				
		3,6				
$\hat{E}_s/I_{ot}$	dB	1,4	4	-1.46	-Infinity	-1.46
		2,5				
		3,6				
$\hat{E}_s/N_{oc}$	dB	1,4	4	4	-Infinity	4
		2,5				
		3,6				
SS-RSRP <sup>Note 3</sup>	dBm/SCS kHz	1,4	-94	-94	-Infinity	-94
		2,5	-94	-94	-Infinity	-94
		3,6	-91	-91	-Infinity	-91
I <sub>o</sub>	dBm/9.36 MHz	1,4	-64.60	-62.25	-64.60	-62.25
		2,5	-64.60	-62.25	-64.60	-62.25
		3,6	-58.50	-56.16	-58.50	-56.16
Propagation Condition		1, 2,4,5	AWGN		AWGN 1944 Hz <sup>Note 4</sup>	
		3,6	AWGN		AWGN 3334 Hz <sup>Note 5</sup>	

NOTE 1: The resources for uplink transmission are assigned to the UE prior to the start of time period T2.  
NOTE 2: Interference from other cells and noise sources not specified in the test is assumed to be constant over subcarriers and time and shall be modelled as AWGN of appropriate power for  $N_{oc}$  to be fulfilled.  
NOTE 3: SS-RSRP levels have been derived from other parameters for information purposes. They are not settable parameters themselves.  
NOTE 4: The AWGN 1944 Hz condition is a non-fading propagation channel with one tap. Doppler shift is a constant 1944Hz.  
NOTE 5: The AWGN 3334 Hz condition is a non-fading propagation channel with one tap. Doppler shift is a constant 3334Hz.

The UE shall send one Event A3 triggered measurement report, with a measurement reporting delay less than  $T_{\text{identify\_intra\_without\_index}} + 2 \times TTI_{\text{DCC}} \text{ ms}$  from the beginning of time period T2. The UE is not required to read the neighbour cell SSB index in this test.

NOTE: The actual overall delays measured in the test may be up to  $2 \times TTI_{\text{DCC}}$  higher than the measurement reporting delays because of TTI insertion uncertainty of the measurement report in DCC.

The overall delays measured test requirement is expressed as:

$T_{\text{identify\_intra\_without\_index}} = T_{\text{PSS/SSS\_sync\_intra}} + T_{\text{SSB\_measurement\_period\_intra}}$ , is the measurement reporting delay.

$T_{\text{PSS/SSS\_sync\_intra}} = \text{ceil}(5 \times K_p) \times \text{DRX cycle} \times \text{CSSF}_{\text{intra}} = 3200 \text{ ms}$ , is the time period used in PSS/SSS detection defined in 38.133 [6] clause 9.2.5.1

$T_{\text{SSB\_measurement\_period\_intra}} = \text{ceil}(Y \times K_p) \times \text{DRX cycle} \times \text{CSSF}_{\text{intra}} = 1920 \text{ ms}$ , equal to a measurement period of SSB based measurement defined in 38.133 [6] clause 9.2.5.2.

Where:

$K_p = 1$  for intra-frequency SMTC which is fully non-overlapping with measurement gaps;

DRX cycle = 640 as given in Table 4.6.1.7.4.1-3;

$\text{CSSF}_{\text{intra}} = 1$  when only 1 intra-frequency layer is configured.

$Y = 3$  for DRX cycle = 640 ms and SMTC period = 20 ms as given in Table 4.6.1.7.4.1-3.

$TTI_{\text{DCC}} = 1 \text{ ms}$ , is the TTI insertion uncertainty.

That gives a total of 5122 ms.

The UE shall not send event triggered measurement reports, as long as the reporting criteria are not fulfilled.

The rate of correct events observed during repeated tests shall be at least 90% with confidence level of 95%.

## 4.6.2 Inter-frequency measurements

### 4.6.2.0 Minimum conformance requirements for Inter-frequency measurements

The requirements in clause 9.3 apply, provided:

- The cell being identified or measured is detectable.

An inter-frequency cell shall be considered detectable when for each relevant SSB:

- SS-RSRP related side conditions given in clauses 10.1.4 and 10.1.5 for FR1 and FR2, respectively, for a corresponding Band,
- SS-RSRQ related side conditions given in clauses 10.1.9 and 10.1.10 for FR1 and FR2, respectively, for a corresponding Band,
- SS-SINR related side conditions given in clauses 10.1.14 and 10.1.15 for FR1 and FR2, respectively, for a corresponding Band,
- SSB<sub>RP</sub> and SSB Ês/Iot according to clause B.2.3 for a corresponding Band.

[TS 38.133-f50, clause 9.3.4]

When measurement gaps are provided, or the UE supports capability of conducting such measurements without gaps, the UE shall be able to identify a new detectable inter frequency cell within  $T_{\text{identify\_inter\_without\_index}}$  if UE is not indicated to report SSB based RRM measurement result with the associated SSB index (*reportQuantityRsIndexes* or *maxNrofRSIndexesToReport* is not configured). Otherwise UE shall be able to identify a new detectable inter frequency cell within  $T_{\text{identify\_inter\_with\_index}}$ . The UE shall be able to identify a new detectable inter frequency SS block of an already detected cell within  $T_{\text{identify\_inter\_without\_index}}$ .

$$T_{\text{identify\_inter\_without\_index}} = (T_{\text{PSS/SSS\_sync\_inter}} + T_{\text{SSB\_measurement\_period\_inter}}) \text{ ms}$$

$$T_{\text{identify\_inter\_with\_index}} = (T_{\text{PSS/SSS\_sync\_inter}} + T_{\text{SSB\_measurement\_period\_inter}} + T_{\text{SSB\_time\_index\_inter}}) \text{ ms}$$

Where:

$T_{\text{PSS/SSS\_sync\_inter}}$ : it is the time period used in PSS/SSS detection given in table 9.3.4-1 and table 9.3.4-2.

$T_{\text{SSB\_time\_index\_inter}}$ : it is the time period used to acquire the index of the SSB being measured given in table 9.3.4-3 and table 9.3.4-4.

$T_{\text{SSB\_measurement\_period\_inter}}$ : equal to a measurement period of SSB based measurement given in table 9.3.5-1 and table 9.3.5-2.

$\text{CSSF}_{\text{inter}}$ : it is a carrier specific scaling factor and is determined according to  $\text{CSSF}_{\text{within\_gap},i}$  in section 9.1.5.2 for measurement conducted within measurement gaps.

**Table 9.3.4-1: Time period for PSS/SSS detection, (Frequency range FR1)**

Condition <sup>NOTE1,2</sup>	$T_{\text{PSS/SSS\_sync\_inter}}$
No DRX	$\text{Max}(600\text{ms}, 8 \times \text{Max}(\text{MGRP}, \text{SMTC period})) \times \text{CSSF}_{\text{inter}}$
DRX cycle $\leq$ 320ms	$\text{Max}(600\text{ms}, \text{Ceil}(8 \times 1.5) \times \text{Max}(\text{MGRP}, \text{SMTC period}, \text{DRX cycle})) \times \text{CSSF}_{\text{inter}}$
DRX cycle $>$ 320ms	$8 \times \text{DRX cycle} \times \text{CSSF}_{\text{inter}}$
NOTE 1: DRX or non DRX requirements apply according to the conditions described in clause 3.6.1.	
NOTE 2: In EN-DC operation, the parameters, timers and scheduling requests referred to in clause 3.6.1 are for the secondary cell group. The DRX cycle is the DRX cycle of the secondary cell group.	

**Table 9.3.4-3: Time period for time index detection (Frequency range FR1)**

Condition <sup>NOTE1,2</sup>	$T_{\text{SSB\_time\_index\_inter}}$
------------------------------	--------------------------------------

No DRX	$\text{Max}(120\text{ms}, 3 \times \text{Max}(\text{MGRP}, \text{SMTC period})) \times \text{CSSF}_{\text{inter}}$
DRX cycle $\leq$ 320ms	$\text{Max}(120\text{ms}, \text{Ceil}(3 \times 1.5) \times \text{Max}(\text{MGRP}, \text{SMTC period}, \text{DRX cycle})) \times \text{CSSF}_{\text{inter}}$
DRX cycle $>$ 320ms	$3 \times \text{DRX cycle} \times \text{CSSF}_{\text{inter}}$
NOTE 1: DRX or non DRX requirements apply according to the conditions described in clause 3.6.1	
NOTE 2: In EN-DC operation, the parameters, timers and scheduling requests referred to in clause 3.6.1 are for the secondary cell group. The DRX cycle is the DRX cycle of the secondary cell group.	

[TS 38.133-f50, clause 9.3.5]

When measurement gaps are provided for inter frequency measurements, or the UE supports capability of conducting such measurements without gaps, the UE physical layer shall be capable of reporting SS-RSRP, SS-RSRQ and SS-SINR measurements to higher layers with measurement accuracy as specified in subclauses 10.1.4, 10.1.5, 10.1.9, 10.1.10, 10.1.14 and 10.1.15, respectively, as shown in table 9.3.5-1 and 9.3.5-2:

**Table 9.3.5-1: Measurement period for inter-frequency measurements with gaps (Frequency FR1)**

Condition <sup>NOTE1,2</sup>	$T_{\text{SSB\_measurement\_period\_inter}}$
No DRX	$\text{Max}(200\text{ms}, 8 \times \text{Max}(\text{MGRP}, \text{SMTC period})) \times \text{CSSF}_{\text{inter}}$
DRX cycle $\leq$ 320ms	$\text{Max}(200\text{ms}, \text{Ceil}(8 \times 1.5) \times \text{Max}(\text{MGRP}, \text{SMTC period}, \text{DRX cycle})) \times \text{CSSF}_{\text{inter}}$
DRX cycle $>$ 320ms	$8 \times \text{DRX cycle} \times \text{CSSF}_{\text{inter}}$
NOTE 1: DRX or non DRX requirements apply according to the conditions described in clause 3.6.1	
NOTE 2: In EN-DC operation, the parameters, timers and scheduling requests referred to in clause 3.6.1 are for the secondary cell group. The DRX cycle is the DRX cycle of the secondary cell group.	

[TS 38.133, clause 9.3.6.3]

Reported SS-RSRP, SS-RSRQ, and SS-SINR measurements contained in event triggered measurement reports shall meet the requirements in sections 10.1.4.1, 10.1.5.1, 10.1.9.1, 10.1.10.1, 10.1.14.1 and 10.1.15.1, respectively.

The UE shall not send any event triggered measurement reports, as long as no reporting criteria are fulfilled.

The measurement reporting delay is defined as the time between an event that will trigger a measurement report and the point when the UE starts to transmit the measurement report over the air interface. This requirement assumes that the measurement report is not delayed by other RRC signalling on the DCCH. This measurement reporting delay excludes a delay uncertainty resulted when inserting the measurement report to the TTI of the uplink DCCH. The delay uncertainty is:  $2 \times T_{\text{TTI}_{\text{DCCH}}}$ . This measurement reporting delay excludes a delay which caused by no UL resources for UE to send the measurement report.

The event triggered measurement reporting delay, measured without L3 filtering shall be within  $T_{\text{identify\_inter\_without\_index}}$  if UE is not indicated to report SSB based RRM measurement result with the associated SSB index. Otherwise UE shall be able to identify a new detectable inter frequency cell within  $T_{\text{identify\_inter\_with\_index}}$ . Both  $T_{\text{identify\_inter\_without\_index}}$  and  $T_{\text{identify\_inter\_with\_index}}$  are defined in clause 9.3.4. When L3 filtering is used an additional delay can be expected.

If a cell which has been detectable at least for the time period  $T_{\text{identify\_inter\_without\_index}}$  or  $T_{\text{identify\_inter\_with\_index}}$  defined in clause 9.3.4 and then triggers the measurement report as per TS 38.331 [2], the event triggered measurement reporting delay shall be less than  $T_{\text{SSB\_measurement\_period\_inter}}$  defined in clause 9.3.5 provided the timing to that cell has not changed more than  $\pm 3200 T_c$  while measurement gap has not been available and the L3 filter has not been used. When L3 filtering is used an additional delay can be expected.

The normative reference for this requirement is TS 38.133 [6] clause 9.3.2, 9.3.4, 9.3.5, 9.3.6.3.

## 4.6.2.1 EN-DC FR1-FR1 event-triggered reporting in non-DRX

### 4.6.2.1.1 Test purpose

To verify that the UE makes correct reporting of an event in non-DRX within EN-DC inter-frequency NR cell search requirements without SSB time index detection in TS 38.133 [6] clause 9.3.4.

## 4.6.2.1.2 Test applicability

This test applies to all types of E-UTRA UE release 15 and forward, supporting EN-DC. Test 1 is applicable to UEs not supporting per-FR gap (IndependentGapConfig, as defined in TS 38.306 [11]) and Test 2 is applicable only to UEs supporting per-FR gap and Gap Pattern Id 4.

## 4.6.2.1.3 Minimum conformance requirements

The minimum conformance requirements are specified in clause 4.6.2.0.

The normative reference for this requirement is TS 38.133 [6] clause A.4.6.2.1.

## 4.6.2.1.4 Test description

## 4.6.2.1.4.1 Initial conditions

This test shall be tested using any of the test configurations in Table 4.6.2.1.4.1-1. Configure the test equipment and the DUT according to the parameters in Table 4.6.2.1.4.1-2. Test environment parameters are given in Table 4.6.2.1.4.1-3.

**Table 4.6.2.1.4.1-1: EN-DC FR1-FR1 event triggered reporting tests in non-DRX supported test configurations**

Test Case ID	Description
4.6.2.1-1	LTE FDD, NR 15 kHz SSB SCS, 10MHz bandwidth, FDD duplex mode
4.6.2.1-2	LTE FDD, NR 15 kHz SSB SCS, 10MHz bandwidth, TDD duplex mode
4.6.2.1-3	LTE FDD, NR 30 kHz SSB SCS, 40MHz bandwidth, TDD duplex mode
4.6.2.1-4	LTE TDD, NR 15 kHz SSB SCS, 10MHz bandwidth, FDD duplex mode
4.6.2.1-5	LTE TDD, NR 15 kHz SSB SCS, 10MHz bandwidth, TDD duplex mode
4.6.2.1-6	LTE TDD, NR 30 kHz SSB SCS, 40MHz bandwidth, TDD duplex mode
NOTE 1: The UE is only required to be tested in one of the supported test configurations	
NOTE 2: The target NR cell3 has the same SCS, BW and duplex mode as NR serving cell2	

**Table 4.6.2.1.4.1-2: General test parameters for EN-DC inter-frequency event triggered reporting without SSB time index detection in non-DRX**

Parameter	Unit	Test configuration	Value		Comment
			Test 1	Test 2	
E-UTRA RF Channel Number		Config 1,2,3,4,5,6	1		One E-UTRAN TDD carrier frequencies is used.
NR RF Channel Number		Config 1,2,3,4,5,6	1, 2		Two FR1 NR carrier frequencies are used.
Active cell		Config 1,2,3,4,5,6	LTE Cell 1 (PCell) and NR cell 2 (PScell)		LTE Cell 1 is on E-UTRA RF channel number 1. NR Cell 2 is on NR RF channel number 1.
Neighbour cell		Config 1,2,3,4,5,6	NR cell 3		NR cell 3 is on NR RF channel number 2.
Gap Pattern Id		Config 1,2,3,4,5,6	0	4	As specified in TS 38.133 clause 9.1.2-1.
Measurement gap offset		Config 1,2,3,4,5,6	9	9	
A3-Offset	dB	Config 1,2,3,4,5,6	-6		
Hysteresis	dB	Config 1,2,3,4,5,6	0		
CP length		Config 1,2,3,4,5,6	Normal		
TimeToTrigger	s	Config 1,2,3,4,5,6	0		
Filter coefficient		Config 1,2,3,4,5,6	0		L3 filtering is not used

Parameter	Unit	Test configuration	Value		Comment
			Test 1	Test 2	
DRX		Config 1,2,3,4,5,6	OFF		DRX is not used
Time offset between PCell and PSCell		Config 1,2,3,4,5,6	3 $\mu$ s		Synchronous EN-DC
Time offset between serving and neighbour cells		Config 1,4	3 ms		Asynchronous cells. The timing of Cell 3 is 3ms later than the timing of Cell 2.
		Config 2,3,5,6	3 $\mu$ s		Synchronous cells.
T1	s	Config 1,2,3,4,5,6	5		
T2	s	Config 1,2,3,4,5,6	1	1	

**Table 4.6.2.1.4.1-3: Test Environment test parameters for EN-DC inter-frequency event triggered reporting without SSB time index detection in non-DRX**

Parameter	Value		Comment
Test environment	NC		As specified in TS 38.508-1 [14] clause 4.1.
Test frequencies	As specified in Annex E, Table E.2-1 and TS 38.508-1 [14] clause 4.3.1 and 4.4.2.		
Channel bandwidth	As specified by the test configuration selected from Table 4.6.2.1.4.1-1.		
Propagation conditions	AWGN		As specified in clause C.2.2.
Connection Diagram	TE Part	A.3.1.8.2	As specified in TS 38.508-1 [14] Annex A.
	DUT Part	A.3.2.3.4	
Exceptions to connection diagram	For 4Rx capable UEs without any 2Rx RF bands use A.3.2.5.2 for DUT Part. and A.3.1.8.4 for TE Part		

1. Message contents are defined in clause 4.6.2.1.4.3.
2. Cell 1 is the E-UTRA serving cell (PCell) for the EN-DC setup. The power levels and settings for Cell 1 are set according to Annex A.6. Cell 2 and Cell 3 are NR FR1 cells in different frequencies. Cell 2 is the PSCell and Cell 3 is the target cell. The power levels and settings for Cell 2 are set according to clause C.1.2 and clause C.1.3. Cell 3 is switched off during the initial connection setup.

#### 4.6.2.1.4.2 Test procedure

In this test, there are three cells: LTE cell 1 as PCell on E-UTRA RF channel 1, NR cell 2 as PSCell in FR1 on NR RF channel 1 and NR cell 3 as neighbour cell in FR1 on NR RF channel 2.

In test 1 measurement gap pattern configuration # 0 as defined in Table 4.6.2.1.4.1-2 is provided for a UE that does not support per-FR gap and in test 2 measurement gap pattern configuration #4 as defined in Table 4.6.2.1.4.1-2 is provided for UE that support per-FR gap. In the measurement control information, it is indicated to the UE that event-triggered reporting with Event A3 is used. The test consists of two successive time periods, with time duration of T1, and T2 respectively. During time duration T1, the UE shall not have any timing information of NR cell 3.

1. Ensure the UE is in state RRC\_CONNECTED with generic procedure parameters Connectivity EN-DC, DC bearer MCG and SCG, Connected without release *On* and Test Mode *On* according to TS 38.508-1 [14] clause 4.5.
2. Set the parameters according to T1 in Table 4.6.2.1.4.1-2.
3. The SS shall transmit an RRCConnectionReconfiguration message on Cell 1.
4. The UE shall transmit RRCConnectionReconfigurationComplete message. T1 starts.
5. When T1 expires, the SS shall switch the power setting from T1 to T2 as specified in Table 4.6.2.1.4.1-2. T2 starts.

6. UE shall transmit a MeasurementReport message triggered by Event A3 embedded in E-UTRA RRC message *ULInformationTransferMRDC*. If the overall delay measured from the beginning of time period T2 is less than 920 ms for Test 1 and 760 ms for Test 2 then the number of successful tests is increased by one. If the UE fails to report the event within the overall delays measured requirement then the number of failure tests is increased by one.
7. After the SS receives the MeasurementReport message in step 6 or when T2 expires, the SS shall transmit RRCConnectionReconfiguration message with condition EN-DC\_PSCell\_Rel according to TS 36.508 [25] Table 4.6.1-8 to release NR cell (PSCell). The UE shall transmit RRCConnectionReconfigurationComplete message.
8. Set Cell 3 physical cell identity = ((current cell 3 physical cell identity + 1) mod 14 + 2) for next iteration of the test procedure loop.
9. The SS shall transmit RRCConnectionReconfiguration message with condition MCG\_and\_SCG according to TS 36.508 [25] Table 4.6.1-8 to add NR cell (PSCell). The UE shall transmit RRCConnectionReconfigurationComplete message. If either of the reconfiguration in step 7 or step 9 fails, SS switches off and on the UE and ensures the UE is in state RRC\_CONNECTED with generic procedure parameters Connectivity EN-DC, DC bearer MCG and SCG, Connected without release *On* according to TS 38.508-1 [14] clause 4.5.
10. Repeat step 2-9 until the confidence level according to Tables G.2.3-1 in Annex G clause G.2 is achieved.
11. Repeat step 1-10 for each sub-test in Table 4.6.2.1.4.1-2 as appropriate.

4.6.2.1.4.3 Message contents

Message contents are according to TS 38.508-1 [14] clause 7.3 with the following exceptions:

**Table 4.6.2.1.4.3-1: Common Exception messages for Additional EN-DC FR1-FR1 event triggered reporting tests in non-DRX test requirement**

Default Message Contents	
Common contents of system information blocks exceptions	
Default RRC messages and information elements contents exceptions	Table H.3.1-1 Table H.3.1-2 with Condition INTER-FREQ Table H.3.1-4 with A3-offset = -6dB Table H.3.1-5 Table H.3.1-7 with Condition INTER-FREQ  Table H.3.4-1a Table H.3.4-2 Table H.3.4-3 Table H.3.4-4 with Condition gapUE for Test 1 Table H.3.4-4 with Condition gapFR1 for Test 2 Table H.3.4-5 with Condition Pattern #0 and gap offset = 9 for Test 1 Table H.3.4-5 with Condition Pattern #4 and gap offset = 9 for Test 2
Specific message contents exceptions for Test Configuration 4.6.2.1-1 and 4.6.2.1-4	Table H.3.1-3 with Conditions INTER-FREQ MO Table 7.3.1-3 in TS 38.508-1 [14] with condition SMTC.5
Specific message contents exceptions for Test Configuration 4.6.2.1-2 and 4.6.2.1-5	Table H.3.1-3 with Conditions INTER-FREQ MO and Synchronous cells Table 7.3.1-3 in TS 38.508-1 [14] with condition SMTC.4
Specific message contents exceptions for Test Configuration 4.6.2.1-3 and 4.6.2.1-6	Table H.3.1-3 with Conditions INTER-FREQ MO and Synchronous cells Table 7.3.1-3 in TS 38.508-1 [14] with condition SMTC.4

**Table 4.6.2.1.4.3-2: SchedulingRequest-Config for E-UTRAN PCell**

Derivation Path: 36.508 [25], Table 4.6.3-20			
Information Element	Value/remark	Comment	Condition
SchedulingRequest-Config-DEFAULT ::= CHOICE { setup SEQUENCE { sr-ConfigIndex	23		TDD
} }			

4.6.2.1.5 Test requirement

Table 4.6.2.1.5-1 defines the primary level settings including test tolerances for all tests.

**Table 4.6.2.1.5-1: Cell specific test parameters for EN-DC inter-frequency event triggered reporting without SSB time index detection in non-DRX**

Parameter	Unit	Test configuration	Cell 2		Cell 3	
			T1	T2	T1	T2
NR RF Channel Number		Config 1,2,3,4,5,6	1		2	
Duplex mode		Config 1,4	FDD			
		Config 2,3,5,6	TDD			
BW <sub>channel</sub>	MHz	Config 1,4	10: N <sub>RB,c</sub> = 52			
		Config 2,5	10: N <sub>RB,c</sub> = 52			
		Config 3,6	40: N <sub>RB,c</sub> = 106			
BWP BW	MHz	Config 1,4	10: N <sub>RB,c</sub> = 52			
		Config 2,5	10: N <sub>RB,c</sub> = 52			
		Config 3,6	40: N <sub>RB,c</sub> = 106			
TDD configuration		Config 2,5	TDDConf.1.1		TDDConf.1.1	
		Config 3,6	TDDConf.2.1		TDDConf.2.1	
Initial DL BWP		Config 1,2,3,4,5,6	DLBWP.0.1		NA	
Initial UL BWP		Config 1,2,3,4,5,6	ULBWP.0.1		NA	
Dedicated DL BWP		Config 1,2,3,4,5,6	DLBWP.1.1		NA	
Dedicated UL BWP		Config 1,2,3,4,5,6	ULBWP.1.1		NA	
OCNG Patterns		Config 1,2,3,4,5,6	OP.1		OP.1	
TRS configuration		Config 1,4	TRS.1.1 FDD		NA	
		Config 2,5	TRS.1.1 TDD		NA	
		Config 3,6	TRS.1.2 TDD		NA	
PDSCH Reference measurement channel		Config 1,4	SR.1.1 FDD		-	
		Config 2,5	SR.1.1 TDD			
		Config 3,6	SR 2.1 TDD			
RMSI CORESET Reference Channel		Config 1,4	CR.1.1 FDD		-	
		Config 2,5	CR.1.1 TDD			
		Config 3,6	CR 2.1 TDD			
Dedicated CORESET Reference Channel		Config 1,4	CCR.1.1 FDD		-	
		Config 2,5	CCR.1.1 TDD			
		Config 3,6	CCR 2.1 TDD			
SSB parameters		Config 1,4	SSB.1 FR1		SSB.5 FR1	
		Config 2,5	SSB.1 FR1		SSB.5 FR1	
		Config 3,6	SSB.2 FR1		SSB.6 FR1	
SMTC configuration		Config 1,4	SMTC.2		SMTC.5	
		Config 2,3,5,6	SMTC.1		SMTC.4	
PDSCH/PDCCH subcarrier spacing	kHz	Config 1,2,4,5	15			
		Config 3,6	30			
EPRE ratio of PSS to SSS		Config 1,2,3,4,5,6	0		0	
EPRE ratio of PBCH DMRS to SSS						
EPRE ratio of PBCH to PBCH DMRS						
EPRE ratio of PDCCH DMRS to SSS						
EPRE ratio of PDCCH to PDCCH DMRS						
EPRE ratio of PDSCH DMRS to SSS						

Parameter	Unit	Test configuration	Cell 2		Cell 3	
			T1	T2	T1	T2
EPRE ratio of PDSCH to PDSCH						
EPRE ratio of OCNG DMRS to SSS(Note 1)						
EPRE ratio of OCNG to OCNG DMRS (Note 1)						
$N_{oc}$ <sup>Note2</sup>	dBm/15kHz		-98		-98	
$N_{oc}$ <sup>Note2</sup>	dBm/SCS	Config 1,2,4,5	-98		-98	
		Config 3,6	-95		-95	
SS-RSRP <sup>Note 3</sup>	dBm/SCS	Config 1,2,4,5	-94	-94	-Infinity	-91
		Config 3,6	-91	-91	-Infinity	-88
$\hat{E}_s / I_{oc}$	dB	Config 1,2,3,4,5,6	4	4	-Infinity	7
$\hat{E}_s / N_{oc}$	dB	Config 1,2,3,4,5,6	4	4	-Infinity	7
$I_o$ <sup>Note3</sup>	dBm/9.36MHz	Config 1,2,4,5	-64.59	-64.59	-70.05	-62.26
	dBm/38.16MHz	Config 3,6	-58.49	-58.49	-63.94	-56.15
Propagation Condition		Config 1,2,3,4,5,6	AWGN		AWGN	
<p>NOTE 1: OCNG shall be used such that both cells are fully allocated and a constant total transmitted power spectral density is achieved for all OFDM symbols.</p> <p>NOTE 2: Interference from other cells and noise sources not specified in the test is assumed to be constant over subcarriers and time and shall be modelled as AWGN of appropriate power for <math>N_{oc}</math> to be fulfilled.</p> <p>NOTE 3: SS-RSRP and <math>I_o</math> levels have been derived from other parameters for information purposes. They are not settable parameters themselves.</p> <p>NOTE 4: SS-RSRP minimum requirements are specified assuming independent interference and noise at each receiver antenna port.</p>						

In test 1 with per-UE gap, the UE shall send one Event A3 triggered measurement report, with a measurement reporting delay less than 920 ms from the beginning of time period T2. The UE shall not send event triggered measurement reports, as long as the reporting criteria are not fulfilled. The rate of correct events observed during repeated tests shall be at least 90% with a confidence level of 95%.

In test 2 with per-FR gap, the UE shall send one Event A3 triggered measurement report, with a measurement reporting delay less than 760 ms from the beginning of time period T2. The UE shall not send event triggered measurement reports, as long as the reporting criteria are not fulfilled. The rate of correct events observed during repeated tests shall be at least 90% with a confidence level of 95%.

In test 1 and 2 UE is not required to report SSB time index.

NOTE: The actual overall delays measured in the test may be up to  $2 \times TTI_{DCCH}$  higher than the measurement reporting delays above because of TTI insertion uncertainty of the measurement report in DCCH.

## 4.6.2.2 EN-DC FR1-FR1 event-triggered reporting in DRX

### 4.6.2.2.1 Test purpose

The purpose of this test is to verify that the UE makes correct reporting of an event in DRX within EN-DC inter-frequency NR cell search requirements without SSB time index detection in TS 38.133 [6] clause 9.3.4.



## 4.6.2.2.2 Test applicability

This test applies to all types of E-UTRA UE release 15 and forward, supporting EN-DC FR1 and long DRX cycle. Test 1 and Test 2 are applicable to UEs not supporting per-FR gap (IndependentGapConfig, as defined in TS 38.306 [11]) and Test 3 and Test 4 are applicable only to UEs supporting per-FR gap and Gap Pattern Id 4.

## 4.6.2.2.3 Minimum conformance requirements

The minimum conformance requirements are specified in clause 4.6.2.0.

The normative reference for this requirement is TS 38.133 [6] clause A.4.6.2.2.

## 4.6.2.2.4 Test description

## 4.6.2.2.4.1 Initial conditions

This test shall be tested using any of the test configurations in Table 4.6.2.2.4.1-1. Configure the test equipment and the DUT according to the parameters in Table 4.6.2.2.4.1-2. Test environment parameters are given in Table 4.6.2.2.4.1-3.

**Table 4.6.2.2.4.1-1: EN-DC FR1-FR1 event triggered reporting tests in DRX supported test configurations**

Test Case ID	Description
4.6.2.2-1	LTE FDD, NR 15 kHz SSB SCS, 10MHz bandwidth, FDD duplex mode
4.6.2.2-2	LTE FDD, NR 15 kHz SSB SCS, 10MHz bandwidth, TDD duplex mode
4.6.2.2-3	LTE FDD, NR 30 kHz SSB SCS, 40MHz bandwidth, TDD duplex mode
4.6.2.2-4	LTE TDD, NR 15 kHz SSB SCS, 10MHz bandwidth, FDD duplex mode
4.6.2.2-5	LTE TDD, NR 15 kHz SSB SCS, 10MHz bandwidth, TDD duplex mode
4.6.2.2-6	LTE TDD, NR 30 kHz SSB SCS, 40MHz bandwidth, TDD duplex mode
NOTE 1: The UE is only required to be tested in one of the supported test configurations.	
NOTE 2: The target NR cell3 has the same SCS, BW and duplex mode as NR serving cell2.	

**Table 4.6.2.2.4.1-2: General test parameters for EN-DC inter-frequency event triggered reporting without SSB time index detection in DRX**

Parameter	Unit	Test configuration	Value				Comment
			Test 1	Test 2	Test 3	Test 4	
E-UTRA RF Channel Number		Config 1,2,3,4,5,6	1				One E-UTRAN TDD carrier frequencies is used.
NR RF Channel Number		Config 1,2,3,4,5,6	1, 2				Two FR1 NR carrier frequencies are used.
Active cell		Config 1,2,3,4,5,6	LTE Cell 1 (PCell) and NR cell 2 (PScell)				LTE Cell 1 is on E-UTRA RF channel number 1. NR Cell 2 is on NR RF channel number 1.
Neighbour cell		Config 1,2,3,4,5,6	NR cell 3				NR cell 3 is on NR RF channel number 2.
Gap Pattern Id		Config 1,2,3,4,5,6	0		4		As specified in TS 38.133 clause 9.1.2-1.
Measurement gap offset		Config 1,2,3,4,5,6	9		9		
A3-Offset	dB	Config 1,2,3,4,5,6	-6				
Hysteresis	dB	Config 1,2,3,4,5,6	0				
CP length		Config 1,2,3,4,5,6	Normal				
TimeToTrigger	s	Config 1,2,3,4,5,6	0				
Filter coefficient		Config 1,2,3,4,5,6	0				L3 filtering is not used

Parameter	Unit	Test configuration	Value				Comment
			Test 1	Test 2	Test 3	Test 4	
DRX	ms	Config 1,2,3,4,5,6	DRX. 1	DRX. 7	DRX. 1	DRX. 7	As specified in A.5
Time offset between PCell and PSCell		Config 1,2,3,4,5,6	3 μs				Synchronous EN-DC
Time offset between serving and neighbour cells		Config 1,4	3ms				Asynchronous cells. The timing of Cell 3 is 3ms later than the timing of Cell 2.
		Config 2,3,5,6	3μs				Synchronous cells.
T1	s	Config 1,2,3,4,5,6	5				
T2	s	Config 1,2,3,4,5,6	1.1	11	1.1	11	

**Table 4.6.2.2.4.1-3: Test Environment parameters for EN-DC inter-frequency event triggered reporting without SSB time index detection in DRX**

Parameter	Value	Comment
Test environment	NC	As specified in TS 38.508-1 [14] clause 4.1.
Test frequencies	As specified in Annex E, Table E.2-1 and TS 38.508-1 [14] clause 4.3.1 and 4.4.2.	
Channel bandwidth	As specified by the test configuration selected from Table 4.6.2.2.4.1-1.	
Propagation conditions	AWGN	As specified in clause C.2.2.
Connection Diagram	TE Part	A.3.1.8.2
	DUT Part	A.3.2.3.4
Exceptions to connection diagram	For 4Rx capable UEs without any 2Rx RF bands use A.3.2.5.1 for DUT Part. and A.3.1.8.4 for TE Part	

1. Message contents are defined in clause 4.6.2.2.4.3.
2. Cell 1 is the E-UTRA serving cell (PCell) for the EN-DC setup. The power levels and settings for Cell 1 are set according to Annex A.6. Cell 2 and Cell 3 are NR FR1 cells in different frequencies. Cell 2 is the PSCell and Cell 3 is the target cell. The power levels and settings for Cell 2 and are set according to clause C.1.2 and clause C.1.3. Cell 3 is switched off during the initial connection setup.

#### 4.6.2.2.4.2 Test procedure

In this test, there are three cells: LTE cell 1 as PCell on E-UTRA RF channel 1, NR cell 2 as PSCell in FR1 on NR RF channel 1 and NR cell 3 as neighbour cell in FR1 on NR RF channel 2.

In test 1&2 measurement gap pattern configuration # 0 as defined in Table 4.6.2.2.4.1-2 is provided for a UE that does not support per-FR gap and in test 3&4 measurement gap pattern configuration #4 as defined in Table 4.6.2.2.4.1-2 is provided for UE that support per-FR gap.

In the measurement control information, it is indicated to the UE that event-triggered reporting with Event A3 is used. The test consists of two successive time periods, with time duration of T1, and T2 respectively. During time duration T1, the UE shall not have any timing information of NR cell 3.

UE needs to be provided at least once every 500ms with new Timing Advance Command MAC control element to restart the Time alignment timer to keep UE uplink time alignment. Furthermore UE is allocated with PUSCH resource at every DRX cycle.

1. Ensure the UE is in state RRC\_CONNECTED with generic procedure parameters Connectivity EN-DC, DC bearer MCG and SCG, Connected without release *On* and Test Mode *On* according to TS 38.508-1 [14] clause 4.5.
2. Set the parameters according to T1 in Table 4.6.2.2.4.1-2 and Table 4.6.2.2.5-1.
3. The SS shall transmit an RRCConnectionReconfiguration message on Cell 1.

4. The UE shall transmit RRCConnectionReconfigurationComplete message. T1 starts.
5. When T1 expires, the SS shall switch the power setting from T1 to T2 as specified in Table 4.6.2.2.5-1. T2 starts.
6. UE shall transmit a MeasurementReport message triggered by Event A3 embedded in E-UTRA RRC message *ULInformationTransferMRDC*. If the overall delays measured from the beginning of time period T2 is less than 1080 ms for Test 1, 10240 ms for Test 2, 1080 ms for Test 3 and 10240 ms for Test 4 then the number of successful tests is increased by one. If the UE fails to report the event within the overall delays measured requirement then the number of failure tests is increased by one.
7. After the SS receives the MeasurementReport message in step 6 or when T2 expires, the SS shall transmit RRCConnectionReconfiguration message with condition EN-DC\_PSCell\_Rel according to TS 36.508 [25] Table 4.6.1-8 to release NR cell (PSCell). The UE shall transmit RRCConnectionReconfigurationComplete message.
8. Set Cell 3 physical cell identity = ((current cell 3 physical cell identity + 1) mod 14 + 2) for next iteration of the test procedure loop.
9. The SS shall transmit RRCConnectionReconfiguration message with condition MCG\_and\_SCG according to TS 36.508 [25] Table 4.6.1-8 to add NR cell (PSCell). The UE shall transmit RRCConnectionReconfigurationComplete message. If either of the reconfiguration in step 7 or step 9 fails, SS switches off and on the UE and ensures the UE is in state RRC\_CONNECTED with generic procedure parameters Connectivity EN-DC, DC bearer MCG and SCG, Connected without release *On* according to TS 38.508-1 [14] clause 4.5.
10. Repeat step 2-9 until the confidence level according to Tables G.2.3-1 in Annex G clause G.2 is achieved.
11. Repeat step 1-10 for each sub-test in Table 4.6.2.2.4.1-2 as appropriate.

4.6.2.2.4.3 Message contents

Message contents are according to TS 38.508-1 [14] clause 7.3 with the following exceptions:

**Table 4.6.2.2.4.3-1: Common Exception messages for Additional EN-DC FR1-FR1 event triggered reporting with SSB test requirement**

Default Message Contents	
Common contents of system information blocks exceptions	
Default RRC messages and information elements contents exceptions	Table H.3.1-1 Table H.3.1-2 with Condition INTER-FREQ Table H.3.1-4 with A3-offset = -6dB Table H.3.1-5 Table H.3.1-7 with Condition INTER-FREQ Table H.3.7-1 with Condition DRX.1 and Gap and INTER-FREQ for Test 1 and Test 3 Table H.3.7-1 with Condition DRX.7 and Gap and INTER-FREQ for Test 2 and Test 4  Table H.3.4-1a Table H.3.4-2 Table H.3.4-3 Table H.3.4-4 with Condition gapUE for Test 1 and Test 2 Table H.3.4-4 with Condition gapFR1 for Test 3 and Test 4 Table H.3.4-5 with Condition Pattern #0 and gap offset = 9 for Test 1 and Test 2 Table H.3.4-5 with Condition Pattern #4 and gap offset = 9 for Test 3 and Test 4
Specific message contents exceptions for Test Configuration 4.6.2.2-1 and 4.6.2.2-4	Table H.3.1-3 with Conditions INTER-FREQ MO Table 7.3.1-3 in TS 38.508-1 [14] with condition SMTC.5
Specific message contents exceptions for Test Configuration 4.6.2.2-2 and 4.6.2.2-5	Table H.3.1-3 with Conditions INTER-FREQ MO and Synchronous cells Table 7.3.1-3 in TS 38.508-1 [14] with condition SMTC.4
Specific message contents exceptions for Test Configuration 4.6.2.2-3 and 4.6.2.2-6	Table H.3.1-3 with Conditions INTER-FREQ MO and Synchronous cells Table 7.3.1-3 in TS 38.508-1 [14] with condition SMTC.4

**Table 4.6.2.2.4.3-2: SchedulingRequest-Config for E-UTRAN PCell**

Derivation Path: 36.508 [25], Table 4.6.3-20			
Information Element	Value/remark	Comment	Condition
SchedulingRequest-Config-DEFAULT ::= CHOICE {			
setup SEQUENCE {			
sr-ConfigIndex	23		TDD
}			
}			

4.6.2.2.5 Test requirement

Table 4.6.2.2.5-1 defines the primary level settings including test tolerances for all tests.

**Table 4.6.2.2.5-1: Cell specific test parameters for EN-DC inter-frequency event triggered reporting without SSB time index detection**

Parameter	Unit	Test configuration	Cell 2		Cell 3	
			T1	T2	T1	T2
NR RF Channel Number		Config 1,2,3,4,5,6	1		2	
Duplex mode		Config 1,4	FDD			
		Config 2,3,5,6	TDD			
BW <sub>channel</sub>	MHz	Config 1,4	10: N <sub>RB,c</sub> = 52			
		Config 2,5	10: N <sub>RB,c</sub> = 52			
		Config 3,6	40: N <sub>RB,c</sub> = 106			
BWP BW	MHz	Config 1,4	10: N <sub>RB,c</sub> = 52			
		Config 2,5	10: N <sub>RB,c</sub> = 52			
		Config 3,6	40: N <sub>RB,c</sub> = 106			
TDD configuration		Config 2,5	TDDConf.1.1		TDDConf.1.1	
		Config 3,6	TDDConf.2.1		TDDConf.2.1	
Initial DL BWP		Config 1,2,3,4,5,6	DLBWP.0.1		NA	
Initial UL BWP		Config 1,2,3,4,5,6	ULBWP.0.1		NA	
Dedicated DL BWP		Config 1,2,3,4,5,6	DLBWP.1.1		NA	
Dedicated UL BWP		Config 1,2,3,4,5,6	ULBWP.1.1		NA	
TRS configuration		Config 1,4	TRS.1.1 FDD		NA	
		Config 2,5	TRS.1.1 TDD		NA	
		Config 3,6	TRS.1.2 TDD		NA	
OCNG Patterns		Config 1,2,3,4,5,6	OP.1		OP.1	
PDSCH Reference measurement channel		Config 1,4	SR.1.1 FDD		-	
		Config 2,5	SR.1.1 TDD			
		Config 3,6	SR.2.1 TDD			
RMSI CORESET Reference Channel		Config 1,4	CR.1.1 FDD		-	
		Config 2,5	CR.1.1 TDD			
		Config 3,6	CR.2.1 TDD			
Dedicated CORESET Reference Channel		Config 1,4	CCR.1.1 FDD		-	
		Config 2,5	CCR.1.1 TDD			
		Config 3,6	CCR.2.1 TDD			
SSB parameters		Config 1,4	SSB.1 FR1		SSB.5 FR1	
		Config 2,5	SSB.1 FR1		SSB.5 FR1	
		Config 3,6	SSB.2 FR1		SSB.6 FR1	
SMTC configuration		Config 1,4	SMTC.2		SMTC.5	
		Config 2,3,5,6	SMTC.1		SMTC.4	
PDSCH/PDCCH subcarrier spacing	kHz	Config 1,2,4,5	15			
		Config 3,6	30			
EPRE ratio of PSS to SSS		Config 1,2,3,4,5,6	0		0	
EPRE ratio of PBCH DMRS to SSS						

Parameter	Unit	Test configuration	Cell 2		Cell 3	
			T1	T2	T1	T2
EPRE ratio of PBCH to PBCH DMRS						
EPRE ratio of PDCCH DMRS to SSS						
EPRE ratio of PDCCH to PDCCH DMRS						
EPRE ratio of PDSCH DMRS to SSS						
EPRE ratio of PDSCH to PDSCH						
EPRE ratio of OCNG DMRS to SSS(Note 1)						
EPRE ratio of OCNG to OCNG DMRS (Note 1)						
$N_{oc}$ <sup>Note2</sup>	dBm/15k Hz		-98		-98	
$N_{oc}$ <sup>Note2</sup>	dBm/SC S	Config 1,2,4,5	-98		-98	
		Config 3,6	-95		-95	
SS-RSRP <sup>Note 3</sup>	dBm/SC S	Config 1,2,4,5	-94	-94	-Infinity	-91
		Config 3,6	-91	-91	-Infinity	-88
$\hat{E}_s / I_{ot}$	dB	Config 1,2,3,4,5,6	4	4	-Infinity	7
$\hat{E}_s / N_{oc}$	dB	Config 1,2,3,4,5,6	4	4	-Infinity	7
$I_o$ <sup>Note3</sup>	dBm/9.3 6MHz	Config 1,2,4,5	-64.59	-64.59	-70.05	-62.26
	dBm/38. 16MHz	Config 3,6	-58.49	-58.49	-63.94	-56.15
Propagation Condition		Config 1,2,3,4,5,6	AWGN		AWGN	
<p>NOTE 1: OCNG shall be used such that both cells are fully allocated and a constant total transmitted power spectral density is achieved for all OFDM symbols.</p> <p>NOTE 2: Interference from other cells and noise sources not specified in the test is assumed to be constant over subcarriers and time and shall be modelled as AWGN of appropriate power for <math>N_{oc}</math> to be fulfilled.</p> <p>NOTE 3: SS-RSRP and <math>I_o</math> levels have been derived from other parameters for information purposes. They are not settable parameters themselves.</p> <p>NOTE 4: SS-RSRP minimum requirements are specified assuming independent interference and noise at each receiver antenna port.</p>						

In test 1 with per-UE gap, the UE shall send one Event A3 triggered measurement report, with a measurement reporting delay less than 1080 ms from the beginning of time period T2. The UE shall not send event triggered measurement reports, as long as the reporting criteria are not fulfilled. The rate of correct events observed during repeated tests shall be at least 90% with a confidence level of 95%.

In test 2 with per-UE gap, the UE shall send one Event A3 triggered measurement report, with a measurement reporting delay less than 10240 ms from the beginning of time period T2. The UE shall not send event triggered measurement reports, as long as the reporting criteria are not fulfilled. The rate of correct events observed during repeated tests shall be at least 90% with a confidence level of 95%.

In test 3 with per-FR gap, the UE shall send one Event A3 triggered measurement report, with a measurement reporting delay less than 1080 ms from the beginning of time period T2. The UE shall not send event triggered measurement reports, as long as the reporting criteria are not fulfilled. The rate of correct events observed during repeated tests shall be at least 90% with a confidence level of 95%.

In test 4 with per-FR gap, the UE shall send one Event A3 triggered measurement report, with a measurement reporting delay less than 10240 ms from the beginning of time period T2. The UE shall not send event triggered measurement reports, as long as the reporting criteria are not fulfilled. The rate of correct events observed during repeated tests shall be at least 90% with a confidence level of 95%.

In test 1, 2, 3 and 4 UE is not required to report SSB time index.

NOTE: The actual overall delays measured in the test may be up to  $2 \times TTI_{DCCH}$  higher than the measurement reporting delays above because of TTI insertion uncertainty of the measurement report in DCCH.

4.6.2.3 Void

4.6.2.4 Void

4.6.2.5 EN-DC FR1-FR1 event-triggered reporting in non-DRX with SSB time index detection

4.6.2.5.1 Test purpose

The purpose of this test is to verify that the UE makes correct reporting of an event in non-DRX within EN-DC inter-frequency NR cell search requirements with SSB time index detection in TS 38.133 [6] clause 9.3.4.

4.6.2.5.2 Test applicability

This test applies to all types of E-UTRA UE release 15 and forward, supporting EN-DC. Test 1 is applicable to UEs not supporting per-FR gap (IndependentGapConfig, as defined in TS 38.306 [11]) and Test 2 is applicable only to UEs supporting per-FR gap and Gap Pattern Id 4.

4.6.2.5.3 Minimum conformance requirements

The minimum conformance requirements are specified in clause 4.6.2.0.

The normative reference for this requirement is TS 38.133 [6] clause A.4.6.2.3.

4.6.2.5.4 Test description

4.6.2.5.4.1 Initial conditions

This test shall be tested using any of the test configurations in Table 4.6.2.5.4.1-1. Configure the test equipment and the DUT according to the parameters in Table 4.6.2.5.4.1-2. Test environment parameters are given in Table 4.6.2.5.4.1-3.

**Table 4.6.2.5.4.1-1: EN-DC FR1-FR1 event triggered reporting tests in non-DRX with SSB time index detection supported test configurations**

Test Case ID	Description
4.6.2.5 -1	LTE FDD, NR 15 kHz SSB SCS, 10MHz bandwidth, FDD duplex mode
4.6.2.5 -2	LTE FDD, NR 15 kHz SSB SCS, 10MHz bandwidth, TDD duplex mode
4.6.2.5 -3	LTE FDD, NR 30 kHz SSB SCS, 40MHz bandwidth, TDD duplex mode
4.6.2.5 -4	LTE TDD, NR 15 kHz SSB SCS, 10MHz bandwidth, FDD duplex mode
4.6.2.5 -5	LTE TDD, NR 15 kHz SSB SCS, 10MHz bandwidth, TDD duplex mode
4.6.2.5 -6	LTE TDD, NR 30 kHz SSB SCS, 40MHz bandwidth, TDD duplex mode
NOTE 1: The UE is only required to be tested in one of the supported test configurations.	
NOTE 2: The target NR cell3 has the same SCS, BW and duplex mode as NR serving cell2.	

**Table 4.6.2.5.4.1-2: General test parameters for EN-DC inter-frequency event triggered reporting with SSB time index detection in non-DRX**

Parameter	Unit	Test configuration	Value		Comment
			Test 1	Test 2	
E-UTRA RF Channel Number		Config 1,2,3,4,5,6	1		One E-UTRAN TDD carrier frequencies is used.
NR RF Channel Number		Config 1,2,3,4,5,6	1, 2		Two FR1 NR carrier frequencies are used.

Parameter	Unit	Test configuration	Value		Comment
			Test 1	Test 2	
Active cell		Config 1,2,3,4,5,6	LTE Cell 1 (PCell) and NR cell 2 (PScell)		LTE Cell 1 is on E-UTRA RF channel number 1. NR Cell 2 is on NR RF channel number 1.
Neighbour cell		Config 1,2,3,4,5,6	NR cell 3		NR cell 3 is on NR RF channel number 2.
Gap Pattern Id		Config 1,2,3,4,5,6	0	4	As specified in TS 38.133 clause 9.1.2-1.
Measurement gap offset		Config 1,2,3,4,5,6	9	9	
A3-Offset	dB	Config 1,2,3,4,5,6	-6		
Hysteresis	dB	Config 1,2,3,4,5,6	0		
CP length		Config 1,2,3,4,5,6	Normal		
TimeToTrigger	s	Config 1,2,3,4,5,6	0		
Filter coefficient		Config 1,2,3,4,5,6	0		L3 filtering is not used
DRX		Config 1,2,3,4,5,6	OFF		DRX is not used
Time offset between PCell and PScell		Config 1,2,3,4,5,6	3 $\mu$ s		Synchronous EN-DC
Time offset between serving and neighbour cells		Config 1,4	3ms		Asynchronous cells. The timing of Cell 3 is 3ms later than the timing of Cell 2.
		Config 2,3,5,6	3 $\mu$ s		Synchronous cells.
T1	s	Config 1,2,3,4,5,6	5		
T2	s	Config 1,2,3,4,5,6	1.1	1	

**Table 4.6.2.5.4.1-3: Test Environment parameters for EN-DC inter-frequency event triggered reporting with SSB time index detection in non-DRX**

Parameter	Value	Comment
Test environment	NC	As specified in TS 38.508-1 [14] clause 4.1.
Test frequencies	As specified in Annex E, Table E.2-1 and TS 38.508-1 [14] clause 4.3.1 and 4.4.2.	
Channel bandwidth	As specified by the test configuration selected from Table 4.6.2.5.4.1-1.	
Propagation conditions	AWGN	As specified in clause C.2.2.
Connection Diagram	TE Part	A.3.1.8.2
	DUT Part	A.3.2.3.4
Exceptions to connection diagram	- For 4Rx capable UEs without any 2Rx RF bands use A.3.2.5.1 for DUT Part. and A.3.1.8.4 for TE Part	

1. Message contents are defined in clause 4.6.2.5.4.3.
2. Cell 1 is the E-UTRA serving cell (PCell) for the EN-DC setup. The power levels and settings for Cell 1 are set according to Annex A.6. Cell 2 and Cell 3 are NR FR1 cells in different frequencies. Cell 2 is the PScell and Cell 3 is the target cell. The power levels and settings for Cell 2 and are set according to clause C.1.2 and clause C.1.3. Cell 3 is switched off during the initial connection setup.

#### 4.6.2.5.4.2 Test procedure

In this test, there are three cells: LTE cell 1 as PCell on E-UTRA RF channel 1, NR cell 2 as PScell in FR1 on NR RF channel 1 and NR cell 3 as neighbour cell in FR1 on NR RF channel 2.

In test 1 measurement gap pattern configuration # 0 as defined in Table 4.6.2.5.4.1-2 is provided for a UE that does not support per-FR gap and in test 2 measurement gap pattern configuration #4 as defined in Table 4.6.2.5.4.1-2 is provided for UE that support per-FR gap.

In the measurement control information, it is indicated to the UE that event-triggered reporting with Event A3 is used. The test consists of two successive time periods, with time duration of T1, and T2 respectively. During time duration T1, the UE shall not have any timing information of NR cell 3.

1. Ensure the UE is in state RRC\_CONNECTED with generic procedure parameters Connectivity EN-DC, DC bearer MCG and SCG, Connected without release *On* and Test Mode *On* according to TS 38.508-1 [14] clause 4.5.
2. Set the parameters according to T1 in Table 4.6.2.5.4.1-2.
3. The SS shall transmit an RRCConnectionReconfiguration message on Cell 1.
4. The UE shall transmit RRCConnectionReconfigurationComplete message. T1 starts.
5. When T1 expires, the SS shall switch the power setting from T1 to T2 as specified in Table 4.6.2.5.4.1-2. T2 starts.
6. UE shall transmit a MeasurementReport message triggered by Event A3 embedded in E-UTRA RRC message *ULInformationTransferMRDC*. If the overall delays measured from the beginning of time period T2 is less than 1040 ms for Test 1 and 880 ms for Test 2 then the number of successful tests is increased by one. If the UE fails to report the event within the overall delays measured requirement then the number of failure tests is increased by one.
7. After the SS receives the MeasurementReport message in step 6 or when T2 expires, the SS shall transmit RRCConnectionReconfiguration message with condition EN-DC\_PSCell\_Rel according to TS 36.508 [25] Table 4.6.1-8 to release NR cell (PSCell). The UE shall transmit RRCConnectionReconfigurationComplete message.
8. Set Cell 3 physical cell identity = ((current cell 3 physical cell identity + 1) mod 14 + 2) for next iteration of the test procedure loop.
9. The SS shall transmit RRCConnectionReconfiguration message with condition MCG\_and\_SCG according to TS 36.508 [25] Table 4.6.1-8 to add NR cell (PSCell). The UE shall transmit RRCConnectionReconfigurationComplete message. If either of the reconfiguration in step 7 or step 9 fails, switches off and on the UE and ensures the UE is in state RRC\_CONNECTED with generic procedure parameters Connectivity EN-DC, DC bearer MCG and SCG, Connected without release *On* according to TS 38.508-1 [14] clause 4.5.)
10. Repeat step 2-9 until the confidence level according to Tables G.2.3-1 in Annex G clause G.2 is achieved.
11. Repeat step 1-10 for each sub-test in Table 4.6.2.5.4.1-2 as appropriate.

#### 4.6.2.5.4.3 Message contents

Message contents are according to TS 38.508-1 [14] clause 7.3 with the following exceptions:



**Table 4.6.2.5.4.3-1: Common Exception messages for Additional EN-DC FR1-FR1 event triggered reporting tests in non-DRX with SSB test requirement**

Default Message Contents	
Common contents of system information blocks exceptions	
Default RRC messages and information elements contents exceptions	Table H.3.1-1 Table H.3.1-2 with Condition INTER-FREQ Table H.3.1-4 with A3-offset = -6dB and with Condition SSB Index Table H.3.1-5 Table H.3.1-7 with Condition INTER-FREQ and SSB Index Table H.3.4-1a Table H.3.4-2 Table H.3.4-3 Table H.3.4-4 with Condition gapUE for Test 1 Table H.3.4-4 with Condition gapFR1 for Test 2 Table H.3.4-5 with Condition Pattern #0 and gap offset = 9 for Test 1 Table H.3.4-5 with Condition Pattern #4 and gap offset = 9 for Test 2
Specific message contents exceptions for Test Configuration 4.6.2.5-1 and 4.6.2.5-4	Table H.3.1-3 with Conditions INTER-FREQ MO Table 7.3.1-3 in TS 38.508-1 [14] with condition SMTC.5
Specific message contents exceptions for Test Configuration 4.6.2.5-2 and 4.6.2.5-5	Table H.3.1-3 with Conditions INTER-FREQ MO and Synchronous cells Table 7.3.1-3 in TS 38.508-1 [14] with condition SMTC.4
Specific message contents exceptions for Test Configuration 4.6.2.5-3 and 4.6.2.5-6	Table H.3.1-3 with Conditions INTER-FREQ MO and Synchronous cells Table 7.3.1-3 in TS 38.508-1 [14] with condition SMTC.4

**Table 4.6.2.5.4.3-2: SchedulingRequest-Config for E-UTRAN PCell**

Derivation Path: 36.508 [25], Table 4.6.3-20			
Information Element	Value/remark	Comment	Condition
SchedulingRequest-Config-DEFAULT ::= CHOICE { setup SEQUENCE { sr-ConfigIndex	23		TDD
}			
}			

4.6.2.5.5 Test requirement

Table 4.6.2.5.5-1 defines the primary level settings including test tolerances for all tests.

**Table 4.6.2.5.5-1: Cell specific test parameters for EN-DC inter-frequency event triggered reporting with SSB time index detection**

Parameter	Unit	Test configuration	Cell 2		Cell 3	
			T1	T2	T1	T2
NR RF Channel Number		Config 1,2,3,4,5,6	1		2	
Duplex mode		Config 1,4	FDD			
		Config 2,3,5,6	TDD			
BW <sub>channel</sub>	MHz	Config 1,4	10: N <sub>RB,c</sub> = 52			
		Config 2,5	10: N <sub>RB,c</sub> = 52			
		Config 3,6	40: N <sub>RB,c</sub> = 106			
BWP BW	MHz	Config 1,4	10: N <sub>RB,c</sub> = 52			
		Config 2,5	10: N <sub>RB,c</sub> = 52			
		Config 3,6	40: N <sub>RB,c</sub> = 106			
TDD configuration		Config 2,5	TDDConf.1.1		TDDConf.1.1	
		Config 3,6	TDDConf.2.1		TDDConf.2.1	
Initial DL BWP		Config 1,2,3,4,5,6	DLBWP.0.1		NA	
Initial UL BWP		Config 1,2,3,4,5,6	ULBWP.0.1		NA	
Dedicated DL BWP		Config 1,2,3,4,5,6	DLBWP.1.1		NA	

Parameter	Unit	Test configuration	Cell 2		Cell 3	
			T1	T2	T1	T2
Dedicated UL BWP		Config 1,2,3,4,5,6	ULBWP.1.1		NA	
TRS configuration		Config 1,4	TRS.1.1 FDD		NA	
		Config 2,5	TRS.1.1 TDD		NA	
		Config 3,6	TRS.1.2 TDD		NA	
OCNG Patterns		Config 1,2,3,4,5,6	OP.1		OP.1	
PDSCH Reference measurement channel		Config 1,4	SR.1.1 FDD		-	
		Config 2,5	SR.1.1 TDD			
		Config 3,6	SR 2.1 TDD			
RMSI CORESET Reference Channel		Config 1,4	CR.1.1 FDD		-	
		Config 2,5	CR.1.1 TDD			
		Config 3,6	CR 2.1 TDD			
Dedicated CORESET Reference Channel		Config 1,4	CCR.1.1 FDD		-	
		Config 2,5	CCR.1.1 TDD			
		Config 3,6	CCR 2.1 TDD			
SSB parameters		Config 1,4	SSB.1 FR1		SSB.5 FR1	
		Config 2,5	SSB.1 FR1		SSB.5 FR1	
		Config 3,6	SSB.2 FR1		SSB.6 FR1	
SMTC configuration		Config 1,4	SMTC.2		SMTC.5	
		Config 2,3,5,6	SMTC.1		SMTC.4	
PDSCH/PDCCH subcarrier spacing	kHz	Config 1,2,4,5			15	
		Config 3,6			30	
EPRE ratio of PSS to SSS		Config 1,2,3,4,5,6	0		0	
EPRE ratio of PBCH DMRS to SSS						
EPRE ratio of PBCH to PBCH DMRS						
EPRE ratio of PDCCH DMRS to SSS						
EPRE ratio of PDCCH to PDCCH DMRS						
EPRE ratio of PDSCH DMRS to SSS						
EPRE ratio of PDSCH to PDSCH						
EPRE ratio of OCNG DMRS to SSS(Note 1)						
EPRE ratio of OCNG to OCNG DMRS (Note 1)						
$N_{oc}$ <sup>Note2</sup>	dBm/15kHz		-98		-98	
$N_{oc}$ <sup>Note2</sup>	dBm/SCS	Config 1,2,4,5	-98		-98	
		Config 3,6	-95		-95	
SS-RSRP <sup>Note 3</sup>	dBm/SCS	Config 1,2,4,5	-94	-94	-Infinity	-91
		Config 3,6	-91	-91	-Infinity	-88
$\hat{E}_s / I_{\alpha}$	dB	Config 1,2,3,4,5,6	4	4	-Infinity	7
$\hat{E}_s / N_{oc}$	dB	Config 1,2,3,4,5,6	4	4	-Infinity	7
$I_0$ <sup>Note3</sup>	dBm/9.36MHz	Config 1,2,4,5	-64.59	-64.59	-70.05	-62.26
	dBm/38.16MHz	Config 3,6	-58.49	-58.49	-63.94	-56.15

Parameter	Unit	Test configuration	Cell 2		Cell 3	
			T1	T2	T1	T2
Propagation Condition		Config 1,2,3,4,5,6	AWGN		AWGN	
NOTE 1: OCNG shall be used such that both cells are fully allocated and a constant total transmitted power spectral density is achieved for all OFDM symbols.						
NOTE 2: Interference from other cells and noise sources not specified in the test is assumed to be constant over subcarriers and time and shall be modelled as AWGN of appropriate power for $N_{oc}$ to be fulfilled.						
NOTE 3: SS-RSRP and $I_o$ levels have been derived from other parameters for information purposes. They are not settable parameters themselves.						
NOTE 4: SS-RSRP minimum requirements are specified assuming independent interference and noise at each receiver antenna port.						

In test 1 with per-UE gap, the UE shall send one Event A3 triggered measurement report, with a measurement reporting delay less than 1040 ms from the beginning of time period T2. The UE shall not send event triggered measurement reports, as long as the reporting criteria are not fulfilled. The rate of correct events observed during repeated tests shall be at least 90% with a confidence level of 95%.

In test 2 with per-FR gap, the UE shall send one Event A3 triggered measurement report, with a measurement reporting delay less than 880 ms from the beginning of time period T2. The UE shall not send event triggered measurement reports, as long as the reporting criteria are not fulfilled. The rate of correct events observed during repeated tests shall be at least 90% with a confidence level of 95%.

In test 1 and 2 UE is required to report SSB time index.

NOTE: The actual overall delays measured in the test may be up to  $2 \times TTI_{DCCH}$  higher than the measurement reporting delays above because of TTI insertion uncertainty of the measurement report in DCCH.

#### 4.6.2.6 EN-DC FR1-FR1 event-triggered reporting in DRX with SSB time index detection

##### 4.6.2.6.1 Test purpose

The purpose of this test is to verify that the UE makes correct reporting of an event in DRX within EN-DC inter-frequency NR cell search requirements with SSB time index detection in TS 38.133 [6] clause 9.3.4.

##### 4.6.2.6.2 Test applicability

This test applies to all types of E-UTRA UE release 15 and forward, supporting EN-DC FR1 and long DRX cycle. Test 1 and Test 2 are applicable to UEs not supporting per-FR gap (IndependentGapConfig, as defined in TS 38.306 [11]) and Test 3 and Test 4 are applicable only to UEs supporting per-FR gap and Gap Pattern Id 4.

##### 4.6.2.6.3 Minimum conformance requirements

The minimum conformance requirements are specified in clause 4.6.2.0.

The normative reference for this requirement is TS 38.133 [6] clause A. 4.6.2.6.

##### 4.6.2.6.4 Test description

###### 4.6.2.6.4.1 Initial conditions

This test shall be tested using any of the test configurations in Table 4.6.2.6.4.1-1. Configure the test equipment and the DUT according to the parameters in Table 4.6.2.6.4.1-2. Test environment parameters are given in Table 4.6.2.6.4.1-3.

**Table 4.6.2.6.4.1-1: EN-DC FR1-FR1 event triggered reporting tests in DRX with SSB time index detection supported test configurations**

Test Case ID	Description
4.6.2.6-1	LTE FDD, NR 15 kHz SSB SCS, 10MHz bandwidth, FDD duplex mode
4.6.2.6-2	LTE FDD, NR 15 kHz SSB SCS, 10MHz bandwidth, TDD duplex mode
4.6.2.6-3	LTE FDD, NR 30 kHz SSB SCS, 40MHz bandwidth, TDD duplex mode
4.6.2.6-4	LTE TDD, NR 15 kHz SSB SCS, 10MHz bandwidth, FDD duplex mode
4.6.2.6-5	LTE TDD, NR 15 kHz SSB SCS, 10MHz bandwidth, TDD duplex mode
4.6.2.6-6	LTE TDD, NR 30 kHz SSB SCS, 40MHz bandwidth, TDD duplex mode
NOTE 1: The UE is only required to be tested in one of the supported test configurations.	
NOTE 2: The target NR cell3 has the same SCS, BW and duplex mode as NR serving cell2.	

**Table 4.6.2.6.4.1-2: General test parameters for EN-DC inter-frequency event triggered reporting with SSB time index detection in DRX**

Parameter	Unit	Test configuration	Value				Comment
			Test 1	Test 2	Test 3	Test 4	
E-UTRA RF Channel Number		Config 1,2,3,4,5,6	1				One E-UTRAN TDD carrier frequencies is used.
NR RF Channel Number		Config 1,2,3,4,5,6	1, 2				Two FR1 NR carrier frequencies are used.
Active cell		Config 1,2,3,4,5,6	LTE Cell 1 (PCell) and NR cell 2 (PScell)				LTE Cell 1 is on E-UTRA RF channel number 1. NR Cell 2 is on NR RF channel number 1.
Neighbour cell		Config 1,2,3,4,5,6	NR cell 3				NR cell 3 is on NR RF channel number 2.
Gap Pattern Id		Config 1,2,3,4,5,6	0	4			As specified in TS 38.133 clause 9.1.2-1.
Measurement gap offset		Config 1,2,3,4,5,6	9	9			
A3-Offset	dB	Config 1,2,3,4,5,6	-6				
Hysteresis	dB	Config 1,2,3,4,5,6	0				
CP length		Config 1,2,3,4,5,6	Normal				
TimeToTrigger	s	Config 1,2,3,4,5,6	0				
Filter coefficient		Config 1,2,3,4,5,6	0				L3 filtering is not used
DRX	ms	Config 1,2,3,4,5,6	DRX. 1	DRX. 7	DRX. 1	DRX. 7	As specified in clause A.5
Time offset between PCell and PScell		Config 1,2,3,4,5,6	3 μs				Synchronous EN-DC
Time offset between serving and neighbour cells		Config 1,4	3ms				Asynchronous cells. The timing of Cell 3 is 3ms later than the timing of Cell 2.
		Config 2,3,5,6	3μs				Synchronous cells.
T1	s	Config 1,2,3,4,5,6	5				
T2	s	Config 1,2,3,4,5,6	1.3	13.5	1.3	13.5	

**Table 4.6.2.6.4.1-3: Test Environment parameters for EN-DC inter-frequency event triggered reporting with SSB time index detection in DRX**

Parameter	Value	Comment
Test environment	NC	As specified in TS 38.508-1 [14] clause 4.1.
Test frequencies	As specified in Annex E, Table E.2-1 and TS 38.508-1 [14] clause 4.3.1 and 4.4.2.	
Channel bandwidth	As specified by the test configuration selected from Table 4.6.2.6.4.1-1.	

Propagation conditions	AWGN		As specified in clause C.2.2.
Connection Diagram	TE Part	A.3.1.8.2	As specified in TS 38.508-1 [14] Annex A.
	DUT Part	A.3.2.3.4	
Exceptions to connection diagram	For 4Rx capable UEs without any 2Rx RF bands use A.3.2.5.1 for DUT Part. and A.3.1.8.4 for TE Part		

1. Message contents are defined in clause 4.6.2.6.4.3.
2. Cell 1 is the E-UTRA serving cell (PCell) for the EN-DC setup. The power levels and settings for Cell 1 are set according to Annex A.6. Cell 2 and Cell 3 are NR FR1 cells in different frequencies. Cell 2 is the PSCell and Cell 3 is the target cell. The power levels and settings for Cell 2 and are set according to clause C.1.2 and clause C.1.3. Cell 3 is switched off during the initial connection setup.

#### 4.6.2.6.4.2 Test procedure

In this test, there are three cells: LTE cell 1 as PCell on E-UTRA RF channel 1, NR cell 2 as PSCell in FR1 on NR RF channel 1 and NR cell 3 as neighbour cell in FR1 on NR RF channel 2.

In test 1&2 measurement gap pattern configuration # 0 as defined in Table 4.6.2.6.4.1-2 is provided for a UE that does not support per-FR gap and in test 3&4 measurement gap pattern configuration #4 as defined in Table 4.6.2.6.4.1-2 is provided for UE that support per-FR gap.

In the measurement control information, it is indicated to the UE that event-triggered reporting with Event A3 is used. The test consists of two successive time periods, with time duration of T1, and T2 respectively. During time duration T1, the UE shall not have any timing information of NR cell 3.

UE needs to be provided at least once every 500ms with new Timing Advance Command MAC control element to restart the Time alignment timer to keep UE uplink time alignment. Furthermore UE is allocated with PUSCH resource at every DRX cycle.

1. Ensure the UE is in state RRC\_CONNECTED with generic procedure parameters Connectivity EN-DC, DC bearer MCG and SCG, Connected without release *On* and Test Mode *On* according to TS 38.508-1 [14] clause 4.5.
2. Set the parameters according to T1 in Table 4.6.2.6.4.1-2 and Table 4.6.2.6.5-1.
3. The SS shall transmit an RRCConnectionReconfiguration message on Cell 1.
4. The UE shall transmit RRCConnectionReconfigurationComplete message. T1 starts.
5. When T1 expires, the SS shall switch the power setting from T1 to T2 as specified in Table 4.6.2.6.5-1. T2 starts.
6. UE shall transmit a MeasurementReport message triggered by Event A3 embedded in E-UTRA RRC message *ULInformationTransferMRDC*. If the overall delays measured from the beginning of time period T2 is less than 1280 ms for Test 1, 13440 ms for Test 2, 1280 ms for Test 3 and 13440 ms for Test 4 then the number of successful tests is increased by one. If the UE fails to report the event within the overall delays measured requirement then the number of failure tests is increased by one.
7. After the SS receives the MeasurementReport message in step 6 or when T2 expires, the SS shall transmit RRCConnectionReconfiguration message with condition EN-DC\_PSCell\_Rel according to TS 36.508 [25] Table 4.6.1-8 to release NR cell (PSCell). The UE shall transmit RRCConnectionReconfigurationComplete message.
8. Set Cell 3 physical cell identity = ((current cell 3 physical cell identity + 1) mod 14 + 2) for next iteration of the test procedure loop.]
9. The SS shall transmit RRCConnectionReconfiguration message with condition MCG\_and\_SCG according to TS 36.508 [25] Table 4.6.1-8 to add NR cell (PSCell). The UE shall transmit RRCConnectionReconfigurationComplete message. If either of the reconfiguration in step 7 or step 9 fails, SS switches off and on the UE and ensures the UE is in state RRC\_CONNECTED with generic procedure

parameters Connectivity EN-DC, DC bearer MCG and SCG, Connected without release *On* according to TS 38.508-1 [14] clause 4.5.

- 10. Repeat step 2-9 until the confidence level according to Tables G.2.3-1 in Annex G clause G.2 is achieved.
- 11. Repeat step 1-10 for each sub-test in Table 4.6.2.6.4.1-2 as appropriate.

4.6.2.6.4.3 Message contents

Message contents are according to TS 38.508-1 [14] clause 7.3 with the following exceptions:

**Table 4.6.2.6.4.3-1: Common Exception messages for Additional EN-DC FR1-FR1 event triggered reporting in DRX with SSB test requirement**

Default Message Contents	
Common contents of system information blocks exceptions	
Default RRC messages and information elements contents exceptions	Table H.3.1-1 Table H.3.1-2 with Condition INTER-FREQ Table H.3.1-4 with A3-offset = -6dB and with Condition SSB Index Table H.3.1-5 Table H.3.1-7 with Condition INTER-FREQ and SSB Index Table H.3.7-1 with Condition DRX.1 and Gap and INTER-FREQ for Test 1 and Test 3 Table H.3.7-1 with Condition DRX.7 and Gap and INTER-FREQ for Test 2 and Test 4  Table H.3.4-1a Table H.3.4-2 Table H.3.4-3 Table H.3.4-4 with Condition gapUE for Test 1 and Test 2 Table H.3.4-4 with Condition gapFR1 for Test 3 and Test 4 Table H.3.4-5 with Condition Pattern #0 and gap offset = 9 for Test 1 and Test 2 Table H.3.4-5 with Condition Pattern #4 and gap offset = 9 for Test 3 and Test 4
Specific message contents exceptions for Test Configuration 4.6.2.6-1 and 4.6.2.6-4	Table H.3.1-3 with Conditions INTER-FREQ MO Table 7.3.1-3 in TS 38.508-1 [14] with condition SMTC.5
Specific message contents exceptions for Test Configuration 4.6.2.6-2 and 4.6.2.6-5	Table H.3.1-3 with Conditions INTER-FREQ MO and Synchronous cells Table 7.3.1-3 in TS 38.508-1 [14] with condition SMTC.4
Specific message contents exceptions for Test Configuration 4.6.2.6-3 and 4.6.2.6-6	Table H.3.1-3 with Conditions INTER-FREQ MO and Synchronous cells Table 7.3.1-3 in TS 38.508-1 [14] with condition SMTC.4

**Table 4.6.2.6.4.3-2: SchedulingRequest-Config for E-UTRAN PCell**

Derivation Path: 36.508 [25], Table 4.6.3-20			
Information Element	Value/remark	Comment	Condition
SchedulingRequest-Config-DEFAULT ::= CHOICE {			
setup SEQUENCE {			
sr-ConfigIndex	23		TDD
}			
}			

4.6.2.6.5 Test requirement

Table 4.6.2.6.5-1 defines the primary level settings including test tolerances for all tests.

**Table 4.6.2.6.5-1: Cell specific test parameters for EN-DC inter-frequency event triggered reporting with SSB time index detection**

Parameter	Unit	Test configuration	Cell 2		Cell 3	
			T1	T2	T1	T2
NR RF Channel Number		Config 1,2,3,4,5,6	1		2	
Duplex mode		Config 1,4	FDD			
		Config 2,3,5,6	TDD			
BW <sub>channel</sub>	MHz	Config 1,4	10: N <sub>RB,c</sub> = 52			
		Config 2,5	10: N <sub>RB,c</sub> = 52			
		Config 3,6	40: N <sub>RB,c</sub> = 106			
BWP BW	MHz	Config 1,4	10: N <sub>RB,c</sub> = 52			
		Config 2,5	10: N <sub>RB,c</sub> = 52			
		Config 3,6	40: N <sub>RB,c</sub> = 106			
OCNG Patterns		Config 1,2,3,4,5,6	OP.1		OP.1	
PDSCH Reference measurement channel		Config 1,4	SR.1.1 FDD		-	
		Config 2,5	SR.1.1 TDD			
		Config 3,6	SR 2.1 TDD			
RMSI CORESET Reference Channel		Config 1,4	CR.1.1 FDD		-	
		Config 2,5	CR.1.1 TDD			
		Config 3,6	CR 2.1 TDD			
Dedicated CORESET Reference Channel		Config 1,4	CCR.1.1 FDD		-	
		Config 2,5	CCR.1.1 TDD			
		Config 3,6	CCR 2.1 TDD			
TDD configuration		Config 2,5	TDDConf.1.1			
		Config 3,6	TDDConf.2.1			
Initial DL BWP		Config 1,2,3,4,5,6	DLBWP.0.1			
Initial UL BWP		Config 1,2,3,4,5,6	ULBWP.0.1			
Dedicated DL BWP		Config 1,2,3,4,5,6	DLBWP.1.1			
Dedicated UL BWP		Config 1,2,3,4,5,6	ULBWP.1.1			
TRS configuration		Config 1,4	TRS.1.1 FDD		N/A	
		Config 2,5	TRS.1.1 TDD		N/A	
		Config 3,6	TRS.1.2 TDD		N/A	
SSB parameters		Config 1,4	SSB.1 FR1		SSB.5 FR1	
		Config 2,5	SSB.1 FR1		SSB.5 FR1	
		Config 3,6	SSB.2 FR1		SSB.6 FR1	
SMTC configuration		Config 1,4	SMTC.2		SMTC.5	
		Config 2,3,5,6	SMTC.1		SMTC.4	
PDSCH/PDCCH subcarrier spacing	kHz	Config 1,2,4,5	15			
		Config 3,6	30			
EPRE ratio of PSS to SSS		Config 1,2,3,4,5,6	0		0	
EPRE ratio of PBCH DMRS to SSS						
EPRE ratio of PBCH to PBCH DMRS						
EPRE ratio of PDCCH DMRS to SSS						
EPRE ratio of PDCCH to PDCCH DMRS						
EPRE ratio of PDSCH DMRS to SSS						
EPRE ratio of PDSCH to PDSCH						
EPRE ratio of OCNG DMRS to SSS(Note 1)						
EPRE ratio of OCNG to OCNG DMRS (Note 1)						
$N_{oc}$ <sup>Note2</sup>	dBm/15kHz		-98		-98	
$N_{oc}$ <sup>Note2</sup>	dBm/SCS	Config 1,2,4,5	-98		-98	
		Config 3,6	-95		-95	
SS-RSRP <sup>Note 3</sup>		Config 1,2,4,5	-94	-94	-Infinity	-91

Parameter	Unit	Test configuration	Cell 2		Cell 3	
			T1	T2	T1	T2
	dBm/SCS	Config 3,6	-91	-91	-Infinity	-88
$\hat{E}_s / I_{ot}$	dB	Config 1,2,3,4,5,6	4	4	-Infinity	7
$\hat{E}_s / N_{oc}$	dB	Config 1,2,3,4,5,6	4	4	-Infinity	7
$I_o$ <sup>Note3</sup>	dBm/9.36MHz	Config 1,2,4,5	-64.59	-64.59	-70.05	-62.26
	dBm/38.16MHz	Config 3,6	-58.49	-58.49	-63.94	-56.15
Propagation Condition		Config 1,2,3,4,5,6	AWGN		AWGN	
<p>NOTE 1: OCNG shall be used such that both cells are fully allocated and a constant total transmitted power spectral density is achieved for all OFDM symbols.</p> <p>NOTE 2: Interference from other cells and noise sources not specified in the test is assumed to be constant over subcarriers and time and shall be modelled as AWGN of appropriate power for <math>N_{oc}</math> to be fulfilled.</p> <p>NOTE 3: SS-RSRP and <math>I_o</math> levels have been derived from other parameters for information purposes. They are not settable parameters themselves.</p> <p>NOTE 4: SS-RSRP minimum requirements are specified assuming independent interference and noise at each receiver antenna port.</p>						

In test 1 with per-UE gap, the UE shall send one Event A3 triggered measurement report, with a measurement reporting delay less than 1280 ms from the beginning of time period T2. The UE shall not send event triggered measurement reports, as long as the reporting criteria are not fulfilled. The rate of correct events observed during repeated tests shall be at least 90% with a confidence level of 95%.

In test 2 with per-UE gap, the UE shall send one Event A3 triggered measurement report, with a measurement reporting delay less than 13440 ms from the beginning of time period T2. The UE shall not send event triggered measurement reports, as long as the reporting criteria are not fulfilled. The rate of correct events observed during repeated tests shall be at least 90%. with a confidence level of 95%.

In test 3 with per-FR gap, the UE shall send one Event A3 triggered measurement report, with a measurement reporting delay less than 1280 ms from the beginning of time period T2. The UE shall not send event triggered measurement reports, as long as the reporting criteria are not fulfilled. The rate of correct events observed during repeated tests shall be at least 90% with a confidence level of 95%.

In test 4 with per-FR gap, the UE shall send one Event A3 triggered measurement report, with a measurement reporting delay less than 13440 ms from the beginning of time period T2. The UE shall not send event triggered measurement reports, as long as the reporting criteria are not fulfilled. The rate of correct events observed during repeated tests shall be at least 90% with a confidence level of 95%.

In test 1, 2, 3 and 4 UE is required to report SSB time index.

NOTE: The actual overall delays measured in the test may be up to  $2 \times TTI_{DCCCH}$  higher than the measurement reporting delays above because of TTI insertion uncertainty of the measurement report in DCCCH.

4.6.2.7 Void

4.6.2.8 Void

4.6.3 Void

4.6.4 L1-RSRP measurement for beam reporting

4.6.4.0 Minimum conformance requirements



#### 4.6.4.0.1 Minimum conformance requirements for SSB-based L1-RSRP measurement for beam reporting

The UE shall be capable of performing L1-RSRP measurements based on the configured SSB resource for L1-RSRP computation, and the UE physical layer shall be capable of reporting L1-RSRP measured over the measurement period of  $T_{L1-RSRP\_Measurement\_Period\_SSB}$ .

The value of  $T_{L1-RSRP\_Measurement\_Period\_SSB}$  is defined in Table 9.5.4.1-1 for FR1,

where

- $M=1$  if higher layer parameter *timeRestrictionForChannelMeasurement* is configured, and  $M=3$  otherwise

For FR1,

- $P = \frac{1}{1 - \frac{T_{SSB}}{MRGP}}$ , when in the monitored cell there are measurement gaps configured for intra-frequency, inter-frequency or inter-RAT measurements, which are overlapping with some but not all occasions of the SSB; and
- $P=1$  when in the monitored cell there are no measurement gaps overlapping with any occasion of the SSB.

Where:

$T_{SSB} = \text{ssb-periodicityServingCell}$

$T_{SMTCperiod} = \text{the configured SMTC period}$

If the high layer in TS 38.331 [13] signalling of *smtc2* is configured,  $T_{SMTCperiod}$  corresponds to the value of higher layer parameter *smtc2*; Otherwise  $T_{SMTCperiod}$  corresponds to the value of higher layer parameter *smtc1*.  $T_{SMTCperiod}$  is the shortest SMTC period among all CCs in the same FR2 band, provided the SMTC offset of all CCs in FR2 have the same offset.

Longer evaluation period would be expected if the combination of SSB, SMTC occasion and measurement gap configurations does not meet previous conditions.

For either an FR1 or FR2 serving cell, longer evaluation period would be expected during the period  $T_{identify\_CGI}$  when the UE is requested to decode an NR CGI.

For either an FR1 or FR2 serving cell, longer L1 RSRP measurement period would be expected during the period  $T_{identify\_CGI,E-UTRAN}$  when the UE is requested to decode an LTE CGI.

**Table 9.5.4.1-1: Measurement period  $T_{L1-RSRP\_Measurement\_Period\_SSB}$  for FR1**

Configuration	$T_{L1-RSRP\_Measurement\_Period\_SSB}$ (ms)
non-DRX	$\max(T_{Report}, \text{ceil}(M \cdot P) \cdot T_{SSB})$
DRX cycle $\leq 320$ ms	$\max(T_{Report}, \text{ceil}(1.5 \cdot M \cdot P) \cdot \max(T_{DRX}, T_{SSB}))$
DRX cycle $> 320$ ms	$\text{ceil}(M \cdot P) \cdot T_{DRX}$
NOTE 1: $T_{SSB} = \text{ssb-periodicityServingCell}$ is the periodicity of the SSB-Index configured for L1-RSRP measurement. $T_{DRX}$ is the DRX cycle length. $T_{Report}$ is configured periodicity for reporting.	
NOTE 2: $K = 1$ when $T_{SSB} \leq 40$ ms and <i>highSpeedMeasFlag-r16</i> are configured; otherwise $K = 1.5$ .	

The UE shall send L1-RSRP reports only for report configurations configured for the active BWP.

The UE shall report the L1-RSRP value as a 7-bit value in the range [-140, -44] dBm with 1dB step size according to clause 10.1.19 for FR1 and 10.1.20 for FR2 if *nrofReportedRS* is configured to one. If *nrofReportedRS* is configured to be larger than one, or if *groupBasedBeamReporting* is enabled, the UE shall use differential L1-RSRP based reporting as defined in clause 10.1.19 for FR1 and 10.1.20 for FR2. The differential L1-RSRP is quantized to a 4-bit value with 2dB step size. The mapping between the reported L1-RSRP value and the measured quantity is described in 10.1.6.

In EN-DC and NE-DC operation, when the UE is configured to perform E-UTRA SRS carrier-based switching an additional delay can be expected in FR1 if the UE is capable of per-FR gap, or an additional delay can be expected in both FR1 and FR2 if the UE is not capable of per-FR gap.

Reported L1-RSRP measurements contained in periodic L1-RSRP measurement reports shall meet the requirements in clauses 10.1.19 for FR1 and 10.1.20 for FR2, respectively.

The UE shall only send periodic L1-RSRP measurement reports for an active BWP.

The UE shall transmit the periodic L1-RSRP reporting on PUCCH over the air interface according to the periodicity defined in clause 5.2.1.4 in TS 36.214 [24].

The UE is required to be capable of measuring SSB and CSI-RS for L1-RSRP without measurement gaps. The UE is required to perform the SSB and CSI-RS measurements with measurement restrictions as described in the following clauses.

For FR1, when the SSB for L1-RSRP measurement is in the same OFDM symbol as CSI-RS for RLM/BFD/CBD/L1-RSRP measurement,

- If SSB and CSI-RS have same SCS, UE shall be able to measure the SSB for L1-RSRP measurement without any restriction;
- If SSB and CSI-RS have different SCS,
  - If UE supports `simultaneousRxDataSSB-DiffNumerology`, UE shall be able to measure the SSB for L1-RSRP measurement without any restriction;
  - If UE does not support `simultaneousRxDataSSB-DiffNumerology`, UE is required to measure one of but not both SSB for L1-RSRP measurement and CSI-RS. Longer measurement period for SSB based L1-RSRP measurement is expected, and no requirements are defined.

The normative reference for this requirement is TS 38.133 [6] clause 9.5.3.1, 9.5.4.1 and 9.5.5.1.

#### 4.6.4.0.2 Minimum conformance requirements for CSI-RS-based L1-RSRP measurement for beam reporting

The UE shall be capable of performing L1-RSRP measurements based on the configured CSI-RS resource for L1-RSRP computation, and the UE physical layer shall be capable of reporting L1-RSRP measured over the measurement period of  $T_{L1-RSRP\_Measurement\_Period\_CSI-RS}$ .

The value of  $T_{L1-RSRP\_Measurement\_Period\_CSI-RS}$  is defined in Table 9.5.4.2-1 for FR1, where

- For periodic and semi-persistent CSI-RS resources,  $M=1$  if higher layer parameter `timeRestrictionForChannelMeasurement` is configured, and  $M=3$  otherwise
- For aperiodic CSI-RS resources  $M=1$
- For periodic CSI-RS resources in a resource set configured with higher layer parameter `repetition` set to OFF,  $N=1$ . The requirements apply if `qcl-InfoPeriodicCSI-RS` is configured for all the resources in the resource set and for each resource one RS has QCL-TypeD with
  - SSB for L1-RSRP measurement, or
  - another CSI-RS in resource set configured with repetition ON.
- For periodic CSI-RS resources in a resource set configured with higher layer parameter `repetition` set to ON,  $N=\text{ceil}(\text{maxNumberRxBeam} / N_{\text{res\_per\_set}})$ , where  $N_{\text{res\_per\_set}}$  is number of resources in the resource set. The requirements apply provided `qcl-InfoPeriodicCSI-RS` is configured with QCL-TypeD for all resources in the resource set.
- For semi-persistent CSI-RS resources in a resource set configured with higher layer parameter `repetition` set to OFF,  $N=1$ . The requirements apply provided TCI state is provided for all resources in the resource set in the MAC CE activating the resource set and for each resource one RS has QCL-TypeD with
  - SSB for L1-RSRP measurement, or
  - another CSI-RS in resource set configured with repetition ON.
- For semi-persistent CSI-RS resources in a resource set configured with higher layer parameter `repetition` set to ON,  $N=\text{ceil}(\text{maxNumberRxBeam} / N_{\text{res\_per\_set}})$ , where  $N_{\text{res\_per\_set}}$  is number of resources in the resource set. The

requirements apply provided TCI state is provided with QCL-TypeD for all resources in the resource set in the MAC CE activating the resource set.

- For aperiodic CSI-RS resources in a resource set configured with higher layer parameter *repetition* set to OFF,  $N=1$ . The requirements apply provided *qcl-info* is configured for all resources in the resource set and for each resource one RS has QCL-TypeD with
  - SSB for L1-RSRP measurement, or
  - another CSI-RS in resource set configured with repetition ON.
- For aperiodic CSI-RS resources in a resource set configured with higher layer parameter *repetition* set to ON,  $N=1$ . UE is not required to meet the accuracy requirements in clause 10.1.19.2 and 10.1.20.2 if number of resources in the resource set is smaller than *maxNumberRxBeam*. The requirements apply provided *qcl-info* is configured with QCL-TypeD for all resources in the resource set.

For FR1,

- $P = \frac{1}{1 - \frac{T_{\text{CSI-RS}}}{M_{\text{GRP}}}}$ , when in the monitored cell there are measurement gaps configured for intra-frequency, inter-frequency or inter-RAT measurements, which are overlapping with some but not all occasions of the CSI-RS; and
- $P=1$  when in the monitored cell there are no measurement gaps overlapping with any occasion of the CSI-RS.

Where:

$T_{\text{CSI-RS}}$  = the periodicity of CSI-RS configured for L1-RSRP measurement

Longer evaluation period would be expected if the combination of CSI-RS, SMTC occasion and measurement gap configurations does not meet previous conditions.

For either an FR1 or FR2 serving cell, longer evaluation period would be expected during the period  $T_{\text{identify\_CGI}}$  when the UE is requested to decode an NR CGI.

For either an FR1 or FR2 serving cell, longer L1 RSRP measurement period would be expected during the period  $T_{\text{identify\_CGI,E-UTRAN}}$  when the UE is requested to decode an LTE CGI.

**Table 9.5.4.2-1: Measurement period  $T_{\text{L1-RSRP\_Measurement\_Period\_CSI-RS}}$  for FR1**

Configuration	$T_{\text{L1-RSRP\_Measurement\_Period\_CSI-RS}}$ (ms)
non-DRX	$\max(T_{\text{Report}}, \text{ceil}(M \cdot P) \cdot T_{\text{CSI-RS}})$
DRX cycle $\leq 320$ ms	$\max(T_{\text{Report}}, \text{ceil}(1.5 \cdot M \cdot P) \cdot \max(T_{\text{DRX}}, T_{\text{CSI-RS}}))$
DRX cycle $> 320$ ms	$\text{ceil}(M \cdot P) \cdot T_{\text{DRX}}$
NOTE 1: $T_{\text{CSI-RS}}$ is the periodicity of CSI-RS configured for L1-RSRP measurement. $T_{\text{DRX}}$ is the DRX cycle length. $T_{\text{Report}}$ is configured periodicity for reporting.	
NOTE 2: the requirements are applicable provided that the CSI-RS resource configured for L1-RSRP measurement is transmitted with Density = 3.	
NOTE 3: $K = 1$ when $T_{\text{CSI-RS}} \leq 40$ ms and <i>highSpeedMeasFlag-r16</i> are configured; otherwise $K = 1.5$ .	

The UE shall send L1-RSRP reports only for report configurations configured for the active BWP.

The UE shall report the L1-RSRP value as a 7-bit value in the range [-140, -44] dBm with 1dB step size according to clause 10.1.19 for FR1 and 10.1.20 for FR2 if *nrofReportedRS* is configured to one. If *nrofReportedRS* is configured to be larger than one, or if *groupBasedBeamReporting* is enabled, the UE shall use differential L1-RSRP based reporting as defined in clause 10.1.19 for FR1 and 10.1.20 for FR2. The differential L1-RSRP is quantized to a 4-bit value with 2dB step size. The mapping between the reported L1-RSRP value and the measured quantity is described in 10.1.6.

In EN-DC and NE-DC operation, when the UE is configured to perform E-UTRA SRS carrier-based switching an additional delay can be expected in FR1 if the UE is capable of per-FR gap, or an additional delay can be expected in both FR1 and FR2 if the UE is not capable of per-FR gap.

Reported L1-RSRP measurements contained in aperiodic triggered, aperiodic triggered periodic and aperiodic triggered semi-persistent L1-RSRP reports shall meet the requirements in clauses 10.1.19 for FR1 and 10.1.20 for FR2, respectively.

The UE shall only send aperiodic L1-RSRP measurement reports, if a DCI trigger has been received.

After the UE receives CSI request in DCI, the UE shall transmit the aperiodic L1-RSRP reporting on PUSCH over the air interface at the time specified according to clause 6.2.1.2 in TS 36.300 [24].

For both FR1 and FR2, when the CSI-RS for L1-RSRP measurement is in the same OFDM symbol as SSB for RLM/BFD/CBD/L1-RSRP measurement, UE is not required to receive CSI-RS for L1-RSRP measurement in the PRBs that overlap with an SSB.

For FR1, when the SSB for RLM/BFD/CBD/L1-RSRP measurement is within the active BWP and has same SCS than CSI-RS for L1-RSRP measurement, the UE shall be able to perform CSI-RS measurement without restrictions.

For FR1, when the SSB for RLM/BFD/CBD/L1-RSRP measurement is within the active BWP and has different SCS than CSI-RS for L1-RSRP measurement, the UE shall be able to perform CSI-RS measurement with restrictions according to its capabilities:

- If the UE supports *simultaneousRxDataSSB-DiffNumerology* the UE shall be able to perform CSI-RS measurement without restrictions.
- If the UE does not support *simultaneousRxDataSSB-DiffNumerology*, UE is required to measure one of but not both CSI-RS for L1-RSRP measurement and SSB. Longer measurement period for CSI-RS based L1-RSRP measurement is expected, and no requirements are defined.

For FR1, when the CSI-RS for L1-RSRP measurement is in the same OFDM symbol as another CSI-RS for RLM/BFD/CBD/L1-RSRP measurement, UE shall be able to measure the CSI-RS for L1-RSRP measurement without any restriction.

The normative reference for this requirement is TS 38.133 [6] clauses 9.5.3.1, 9.5.4.2 and 9.5.5.2.

#### 4.6.4.1 EN-DC FR1 SSB-based L1-RSRP measurement in non-DRX

##### 4.6.4.1.1 Test purpose

To verify that the UE makes correct reporting of L1-RSRP measurement in non-DRX within L1-RSRP measurement requirements in TS 38.133 [6] clause 9.5.4.1.

##### 4.6.4.1.2 Test applicability

This test applies to all types of E-UTRA UE release 15 and forward, supporting EN-DC.

##### 4.6.4.1.3 Minimum conformance requirements

The minimum conformance requirements are specified in clause 4.6.4.0.1.

The normative reference for this requirement is TS 38.133 [6] clause A.4.6.4.1.

4.6.4.1.4 Test description

4.6.4.1.4.1 Initial conditions

This test shall be tested using any of the test configurations in Table 4.6.4.1.4.1-1. Configure the test equipment and the DUT according to the parameters in Table 4.6.4.1.4.1-2. Test environment parameters are given in Table 4.6.4.1.4.1-3.

**Table 4.6.4.1.4.1-1: EN-DC SSB based L1-RSRP measurement supported test configurations**

Test Case ID	Description
4.6.4.1-1	LTE FDD, NR 15 kHz SSB SCS, 10MHz bandwidth, FDD duplex mode
4.6.4.1-2	LTE FDD, NR 15 kHz SSB SCS, 10MHz bandwidth, TDD duplex mode
4.6.4.1-3	LTE FDD, NR 30kHz SSB SCS, 40MHz bandwidth, TDD duplex mode
4.6.4.1-4	LTE TDD, NR 15 kHz SSB SCS, 10MHz bandwidth, FDD duplex mode
4.6.4.1-5	LTE TDD, NR 15 kHz SSB SCS, 10MHz bandwidth, TDD duplex mode
4.6.4.1-6	LTE TDD, NR 30kHz SSB SCS, 40MHz bandwidth, TDD duplex mode

NOTE: The UE is only required to be tested in one of the supported test configurations.

**Table 4.6.4.1.4.1-2: General test parameters for EN-DC SSB based L1-RSRP measurement**

Parameter	Config	Unit	Value
SSB GSCN	1~6		freq1
Duplex mode	1,4		FDD
	2,5		TDD
	3,6		TDD
TDD Configuration	1,4		N/A
	2,5		TDDConf.1.1
	3,6		TDDConf.2.1
BW <sub>channel</sub>	1,4	MHz	10: N <sub>RB,c</sub> = 52
	2,5		10: N <sub>RB,c</sub> = 52
	3,6		40: N <sub>RB,c</sub> = 106
PDSCH Reference measurement channel	1,4		SR.1.1 FDD
	2,5		SR.1.1 TDD
	3,6		SR.2.1 TDD
RMSI CORESET Reference Channel	1,4		CR.1.1 FDD
	2,5		CR.1.1 TDD
	3,6		CR.2.1 TDD
Dedicated CORESET Reference Channel	1,4		CCR.1.1 FDD
	2,5		CCR.1.1 TDD
	3,6		CCR.2.1 TDD
SSB configuration	1,4		SSB.3 FR1
	2,5		SSB.3 FR1
	3,6		SSB.4 FR1
OCNG Patterns	1~6		OP.1
Initial BWP Configuration	1~6		DLBWP.0.1 ULBWP.0.1
Dedicated BWP configuration	1~6		DLBWP.1.1 ULBWP.1.1
SMTc configuration	1~6		SMTc.1
TRS Configuration	1,4		TRS.1.1 FDD
	2,5		TRS.1.1 TDD
	3,6		TRS.1.2 TDD
DRX configuration	1~6		Off
reportConfigType	1~6		periodic
reportQuantity	1~6		ssb-Index-RSRP
Number of reported RS	1~6		2
L1-RSRP reporting period	1~6	slot	80
T1	1~6	s	5
T2	1~6	s	1
EPRE ratio of PSS to SSS	1~6	dB	0
EPRE ratio of PBCH DMRS to SSS			
EPRE ratio of PBCH to PBCH DMRS			
EPRE ratio of PDCCH DMRS to SSS			

Parameter	Config	Unit	Value
EPRE ratio of PDCCH to PDCCH DMRS			
EPRE ratio of PDSCH DMRS to SSS			
EPRE ratio of PDSCH to PDSCH DMRS			
EPRE ratio of OCNG DMRS to SSS <sup>Note 1</sup>			
EPRE ratio of OCNG to OCNG DMRS <sup>Note 1</sup>			
Propagation condition	1~6		AWGN
NOTE: OCNG shall be used such that both cells are fully allocated and a constant total transmitted power spectral density is achieved for all OFDM symbols.			

**Table 4.6.4.1.4.1-3: Test Environment parameters for EN-DC SSB based L1-RSRP measurement**

Parameter	Value	Comment
Test environment	NC	As specified in TS 38.508-1 [14] clause 4.1.
Test frequencies	As specified in Annex E, Table E.2-1 and TS 38.508-1 [14] clause 4.3.1 and 4.4.2.	
Channel bandwidth	As specified by the test configuration selected from Table 4.6.4.1.4.1-1.	
Propagation conditions	AWGN	As specified in clause C.2.2.
Connection Diagram	TE Part A.3.1.7.1 DUT Part A.3.2.3.4	As specified in TS 38.508-1 [14] Annex A.
Exceptions to connection diagram	For 4Rx capable UEs without any 2 Rx RF bands use A.3.2.5.2 for DUT part and A.3.1.8.4 for TE Part	

1. Message contents are defined in clause 4.6.4.1.4.3.
2. Cell 1 is the E-UTRA serving cell (PCell) for the EN-DC setup. The power levels and settings for Cell 1 are set according to Annex A.6. Cell 2 is NR FR1 cell (PSCell). Cell 2 is the target for SSB based L1-RSRP measurements. UE is configured to perform RLM, BFD and L1-RSRP measurement based on the SSBs.

#### 4.6.4.1.4.2 Test procedure

Prior to the start of the time duration T1, the UE shall be fully synchronized to PSCell. The UE shall be configured for periodic CSI reporting in PUCCH [format 2] with a reporting periodicity as mentioned in the above table 4.6.4.1.4.1-2. Before the test, UE is configured to perform RLM, BFD and L1-RSRP measurement based on the SSBs.

1. Ensure the UE is in state RRC\_CONNECTED with generic procedure parameters Connectivity EN-DC, DC bearer MCG and SCG, Connected without release *On* and Test Mode *On*, according to TS 38.508-1 [14] clause 4.5 and general test parameters set according to Table 4.6.4.1.4.1-2.
2. Set the parameters according to T1 in Table 4.6.4.1.5-1. T1 starts.
5. The UE shall be transmitting CSI on PUCCH with a periodicity of 80 slots.
6. When T1 expires, the SS shall set the parameters according to T2 in 4.6.4.1.5-1. T2 starts.
7. The UE shall start sending L1-RSRP reports. The SS shall check following requirements:
  - R1: the UE shall start to transmit valid reports no later than 720 ms for configuration 1, 2, 4 and 5 and no later than 680 ms for configuration 3 and 6 from the beginning of time period T2. A valid report shall meet the absolute L1-RSRP requirement for SSB#1 (Table 4.6.4.1.5-2 for test configurations 1, 2, 4 and 5 and Table 4.6.4.1.5-3 for test configurations 3 and 6) and the relative L1-RSRP requirement for SSB#0 in Table 4.6.4.1.5-4. If the first valid report is received earlier than the specified time, the number of passed iterations for R1 is increased by one. Otherwise, the number of failed iterations for R1 is increased by one.
  - R2: the UE shall transmit reports every 80 slots until the end of time period T2. If the reports are received accordingly, the number of passed iterations for R2 is increased by one. Otherwise, the number of failed iterations for R2 is increased by one.

- R3: The L1-RSRP value of SSB#1 reported by the UE is compared to the expected L1-RSRP value for SSB#1. In all consecutive reports after the first valid value is received, if the resulting value is outside the limits in Table 4.6.4.1.5-2 for test configurations 1, 2, 4 and 5 and in Table 4.6.4.1.5-3 for test configurations 3 and 6 or the UE fails to report the measurement value for SSB#1, the number of failed iterations for R3 is increased by one. Otherwise, the number of passed iterations for R3 is increased by one.
- R4: The DIFF RSRP value of SSB#0 reported by the UE is compared to the expected DIFF RSRP value. In all consecutive reports after the first valid value is received, if the resulting value is outside the limits in Table 4.6.4.1.5-4 or the UE fails to report the measurement value for SSB#0, the number of failed iterations for R4 is increased by one. Otherwise, the number of passed iterations for R4 is increased by one.
- 8. The SS waits until T2 expires.
- 9. The SS shall transmit *RRCCONNECTIONRECONFIGURATION* message with condition EN-DC\_PSCell\_Rel according to TS 36.508 [25] Table 4.6.1-8 to release NR cell (PSCell). The UE shall transmit *RRCCONNECTIONRECONFIGURATIONCOMPLETE* message.
- 10. The SS then shall transmit *RRCCONNECTIONRECONFIGURATION* message with condition MCG\_and\_SCG according to TS 36.508 [25] Table 4.6.1-8 to add NR cell (PSCell). The UE shall transmit *RRCCONNECTIONRECONFIGURATIONCOMPLETE* message.
- 11. If any the reconfiguration fails, switch off and on the UE and ensure the UE is in RRC\_CONNECTED with generic procedure parameters Connectivity EN-DC, DC bearer MCG and SCG, Connected without release On and Test Mode On according to TS 38.508-1 [14] clause 4.5.
- 12. Repeat steps 2-11 until the confidence level according to Tables G.2.3-1 in Annex G clause G.2 is achieved.

4.6.4.1.4.3 Message contents

Message contents are according to TS 38.508-1 [14] clause 7.3 with the following exceptions:

**Table 4.6.4.1.4.3-1: Common Exception messages EN-DC SSB based L1-RSRP measurement**

Default Message Contents	
Common contents of system information blocks exceptions	
Default RRC messages and information elements contents exceptions	Table H.3.6-2 with conditions PERIODIC and SS-RSRP Table H.3.6-3 with conditions SSB and PERIODIC Table H.3.4-1

**Table 4.6.4.1.4.3-2: RadioLinkMonitoringConfig**

Derivation Path: TS 38.508-1 [14], Table 4.6.3-133			
Information Element	Value/remark	Comment	Condition
RadioLinkMonitoringConfig ::= SEQUENCE {			
failureDetectionResourcesToAddModList	1 entry		
SEQUENCE (SIZE(1..maxNrofFailureDetectionResources)) OF SEQUENCE {			
purpose	both	UE is configured to perform RLM and BFD based on the SSBs.	
detectionResource CHOICE {			
ssb-Index	0		
}			
}			
}			

## 4.6.4.1.5 Test requirement

Table 4.6.4.1.5-1 defines the primary level settings including test tolerances for all tests.

**Table 4.6.4.1.5-1: SSB specific test parameters for EN-DC SSB based L1-RSRP measurement**

Parameter	Config	Unit	SSB#0		SSB#1	
			T1	T2	T1	T2
$N_{oc}$ Note2	1~6	dBm/15kHz	-94.65			
$N_{oc}$ Note2	1,2,4,5	dBm/SSB SCS	-94.65			
	3,6		-91.65			
$\hat{E}_s/I_{ot}$	1~6	dB	0	0	-Infinity	3.5
SSB RSRP Note3	1,2,4,5	dBm/SSB SCS	-94.65	-94.65	-Infinity	-91.15
	3,6		-91.65	-91.65	-Infinity	-88.14
$I_o$ Note3	1,2,4,5	dBm/9.36 MHz	-63.69	-63.69	-66.70	-61.59
	3,6	dBm/38.16 MHz	-57.59	-57.59	-60.61	-55.49
$\hat{E}_s/N_{oc}$	1~6	dB	0	0	-Infinity	3.5

The UE shall send L1-RSRP report every 80 slots. After 640 ms plus 80 slots from the beginning of time period T2, UE shall send L1-RSRP report including the results for both SSB#0 and SSB#1. Each L1-RSRP measurement report shall meet the corresponding absolute accuracy requirements in Table 4.6.4.1.5-2 for for test configurations 1, 2, 4 and 5, the corresponding absolute accuracy requirements in Table 4.6.4.1.5-3 for test configurations 3 and 6 and the corresponding relative accuracy requirements in Table 4.6.4.1.5-4 for all test configurations.

**Table 4.6.4.1.5-2: L1-RSRP absolute accuracy requirements for the reported values for test configurations 1, 2, 4 and 5**

Normal Conditions	T1	T2
Lowest reported value (SSB#1)	-	55
Highest reported value (SSB#1)	-	75

**Table 4.6.4.1.5-3: L1-RSRP absolute accuracy requirements for the reported values for test configurations 3 and 6**

Normal Conditions	T1	T2
Lowest reported value (SSB#1)	-	58
Highest reported value (SSB#1)	-	78

**Table 4.6.4.1.5-4: L1-RSRP relative accuracy requirements for the reported values for all test configurations**

Normal Conditions	T1	T2
Lowest DIFF RSRP reported (SSB#0)	-	0
Highest DIFF RSRP reported (SSB#0)	-	3

For the test to pass, the ratio of successful reported values for each requirement (R1 to R4) shall be more than 90% with a confidence level of 95%. Each requirement is evaluated independently of the others.

NOTE: The actual overall delays measured in the test may be up to  $2xTTI_{DCCH}$  higher than the measurement reporting delays above because of TTI insertion uncertainty of the measurement report in DCCH.

## 4.6.4.2 EN-DC FR1 SSB-based L1-RSRP measurement in DRX

## 4.6.4.2.1 Test purpose

To verify that the UE makes correct reporting of SSB-based L1-RSRP measurement in DRX within L1-RSRP measurement requirements in TS 38.133 [6] clause 9.5.4.1.



## 4.6.4.2.2 Test applicability

This test applies to all types of E-UTRA UE release 15 and forward, supporting EN-DC FR1 and long DRX cycle.

## 4.6.4.2.3 Minimum conformance requirements

The minimum conformance requirements are specified in clause 4.6.4.0.1.

The normative reference for this requirement is TS 38.133 [6] clause A.4.6.4.2.

## 4.6.4.2.4 Test description

## 4.6.4.2.4.1 Initial conditions

This test shall be tested using any of the test configurations in Table 4.6.4.2.4.1-1. Configure the test equipment and the DUT according to the parameters in Table 4.6.4.2.4.1-2. Test environment parameters are given in Table 4.6.4.2.4.1-3.

**Table 4.6.4.2.4.1-1: EN-DC SSB based L1-RSRP measurement in DRX supported test configurations**

Config	Description
1	LTE FDD, NR 15 kHz SSB SCS, 10 MHz bandwidth, FDD duplex mode
2	LTE FDD, NR 15 kHz SSB SCS, 10 MHz bandwidth, TDD duplex mode
3	LTE FDD, NR 30 kHz SSB SCS, 40 MHz bandwidth, TDD duplex mode
4	LTE TDD, NR 15 kHz SSB SCS, 10 MHz bandwidth, FDD duplex mode
5	LTE TDD, NR 15 kHz SSB SCS, 10 MHz bandwidth, TDD duplex mode
6	LTE TDD, NR 30 kHz SSB SCS, 40 MHz bandwidth, TDD duplex mode

NOTE: The UE is only required to be tested in one of the supported test configurations.

**Table 4.6.4.2.4.1-2: General test parameters for EN-DC SSB based L1-RSRP measurement in DRX**

Parameter	Config	Unit	Value
SSB GSCN	1~6		freq1
Duplex mode	1,4		FDD
	2,5		TDD
	3,6		TDD
TDD Configuration	1,4		N/A
	2,5		TDDConf.1.1
	3,6		TDDConf.2.1
BW <sub>channel</sub>	1,4	MHz	10: N <sub>RB,c</sub> = 52
	2,5		10: N <sub>RB,c</sub> = 52
	3,6		40: N <sub>RB,c</sub> = 106
PDSCH Reference measurement channel	1,4		SR.1.1 FDD
	2,5		SR.1.1 TDD
	3,6		SR.2.1 TDD
RMSI CORESET Reference Channel	1,4		CR.1.1 FDD
	2,5		CR.1.1 TDD
	3,6		CR.2.1 TDD
Dedicated CORESET Reference Channel	1,4		CCR.1.1 FDD
	2,5		CCR.1.1 TDD
	3,6		CCR.2.1 TDD
SSB configuration	1,4		SSB.3 FR1
	2,5		SSB.3 FR1
	3,6		SSB.4 FR1
OCNG Patterns	1~6		OP.1
Initial BWP Configuration	1~6		DLBWP.0.1 ULBWP.0.1
Dedicated BWP configuration	1~6		DLBWP.1.1 ULBWP.1.1
SMTTC configuration	1~6		SMTTC.1

Parameter	Config	Unit	Value
TRS Configuration	1,4		TRS.1.1 FDD
	2,5		TRS.1.1 TDD
	3,6		TRS.1.2 TDD
DRX configuration	1~6		DRX.3
reportConfigType	1~6		periodic
reportQuantity	1~6		ssb-Index-RSRP
Number of reported RS	1~6		2
L1-RSRP reporting period	1~6	slot	80
T1	1~6	s	5
T2	1~6	s	1
EPRE ratio of PSS to SSS	1~6	dB	0
EPRE ratio of PBCH DMRS to SSS			
EPRE ratio of PBCH to PBCH DMRS			
EPRE ratio of PDCCH DMRS to SSS			
EPRE ratio of PDCCH to PDCCH DMRS			
EPRE ratio of PDSCH DMRS to SSS			
EPRE ratio of PDSCH to PDSCH DMRS			
EPRE ratio of OCNG DMRS to SSS <sup>Note 1</sup>			
EPRE ratio of OCNG to OCNG DMRS <sup>Note 1</sup>			
Propagation condition	1~6		AWGN
NOTE: OCNG shall be used such that both cells are fully allocated and a constant total transmitted power spectral density is achieved for all OFDM symbols.			

**Table 4.6.4.2.4.1-3: Test Environment parameters for EN-DC SSB based L1-RSRP measurement in DRX**

Parameter	Value	Comment
Test environment	NC	As specified in TS 38.508-1 [14] clause 4.1.
Test frequencies	As specified in Annex E, Table E.2-1 and TS 38.508-1 [14] clause 4.3.1 and 4.4.2.	
Channel bandwidth	As specified by the test configuration selected from Table 4.6.4.2.4.1-1.	
Propagation conditions	AWGN	As specified in clause C.2.2.
Connection Diagram	TE Part	A.3.1.7.1
	DUT Part	A.3.2.3.4
Exceptions to connection diagram	For 4Rx capable UEs without any 2 Rx RF bands use A.3.2.5.2 for DUT part and A.3.1.8.4 for TE Part	

1. Message contents are defined in clause 4.6.4.2.4.3.
2. Cell 1 is the E-UTRA serving cell (PCell) for the EN-DC setup. The power levels and settings for Cell 1 are set according to Annex A.6. Cell 2 is NR FR1 cell (PSCell). Cell 2 is the target for SSB based L1-RSRP measurements. Before the test, UE is configured to perform RLM, BFD and L1-RSRP measurement based on the SSBs. DRX is configured as specified in Table 4.6.4.2.4.1-2.

**4.6.4.2.4.2 Test procedure**

Same test procedure as in subclause 4.6.4.1.4.2 with tables 4.6.4.1.4.1-2 and 4.6.4.1.5-1 replaced by tables 4.6.4.2.4.1-2 and 4.6.4.2.5-1.

**4.6.4.2.4.3 Message contents**

Same message content as in subclause 4.6.4.1.4.3 with the following exception:

**Table 4.6.4.2.4.3-1: Common Exception messages EN-DC SSB based L1-RSRP measurement in DRX**

<b>Default Message Contents</b>
---------------------------------

Common contents of system information blocks exceptions	
Default RRC messages and information elements contents exceptions	Table H.3.7-1 with condition DRX.3

4.6.4.2.5 Test requirement

Table 4.6.4.2.5-1 defines the primary level settings including test tolerances for all tests.

**Table 4.6.4.2.5-1: SSB specific test parameters for EN-DC SSB based L1-RSRP measurement in DRX**

Parameter	Config	Unit	SSB#0		SSB#1	
			T1	T2	T1	T2
$N_{oc}$ <sup>Note2</sup>	1~6	dBm/15kHz	-94.65			
$N_{oc}$ <sup>Note2</sup>	1,2,4,5	dBm/SSB SCS	-94.65			
	3,6		-91.65			
$\hat{E}_s / I_{ot}$	1~6	dB	0	0	-Infinity	3.5
SSB RSRP <sup>Note3</sup>	1,2,4,5	dBm/SSB SCS	-94.65	-94.65	-Infinity	-91.15
	3,6		-91.65	-91.65	-Infinity	-88.14
$I_o$ <sup>Note3</sup>	1,2,4,5	dBm/9.36 MHz	-63.69	-63.69	-66.70	-61.59
	3,6	dBm/38.16 MHz	-57.59	-57.59	-60.61	-55.49
$\hat{E}_s / N_{oc}$	1~6	dB	0	0	-Infinity	3.5
<p>NOTE 1: The resources for uplink transmission are assigned to the UE prior to the start of time period T2.</p> <p>NOTE 2: Interference from other cells and noise sources not specified in the test is assumed to be constant over subcarriers and time and shall be modelled as AWGN of appropriate power for <math>N_{oc}</math> to be fulfilled.</p> <p>NOTE 3: SS-RSRP and <math>I_o</math> levels have been derived from other parameters for information purposes. They are not settable parameters themselves.</p>						

The UE shall send L1-RSRP report every 80 slots. No later than 640ms plus 80 slots from the beginning of time period T2, UE shall send L1-RSRP report including results of both SSB0 and SSB1. Each L1-RSRP measurement report shall meet the corresponding absolute accuracy requirements in Table 4.6.4.2.5-2 for for test configurations 1, 2, 4 and 5, the corresponding absolute accuracy requirements in Table 4.6.4.2.5-3 for test configurations 3 and 6 and the corresponding relative accuracy requirements in Table 4.6.4.2.5-4 for all test configurations.

**Table 4.6.4.2.5-2: L1-RSRP absolute accuracy requirements for the reported values for test configurations 1, 2, 4 and 5**

Normal Conditions	T1	T2
Lowest reported value (SSB#1)	-	55
Highest reported value (SSB#1)	-	75

**Table 4.6.4.2.5-3: L1-RSRP absolute accuracy requirements for the reported values for test configurations 3 and 6**

Normal Conditions	T1	T2
Lowest reported value (SSB#1)	-	58
Highest reported value (SSB#1)	-	78

**Table 4.6.4.2.5-4: L1-RSRP relative accuracy requirements for the reported values for all test configurations**

Normal Conditions	T1	T2
Lowest DIFF RSRP reported (SSB#0)	-	0
Highest DIFF RSRP reported (SSB#0)	-	3

The rate of correct events observed during repeated tests shall be at least 90% with a confidence level of 95%.

NOTE: The actual overall delays measured in the test may be up to  $2 \times TTI_{DCCH}$  higher than the measurement reporting delays above because of TTI insertion uncertainty of the measurement report in DCCH.

#### 4.6.4.3 EN-DC FR1 CSI-RS-based L1-RSRP measurement in non-DRX

##### 4.6.4.3.1 Test purpose

To verify that the UE makes correct reporting of CSI-RS-based L1-RSRP measurement in non-DRX within L1-RSRP measurement requirements in TS 38.133 [6] clause 9.5.4.2.

##### 4.6.4.3.2 Test applicability

This test applies to all types of E-UTRA UE release 15 and forward, supporting EN-DC.

##### 4.6.4.3.3 Minimum conformance requirements

The minimum conformance requirements are specified in clause 4.6.4.0.2.

The normative reference for this requirement is TS 38.133 [6] clause A.4.6.4.3.

##### 4.6.4.3.4 Test description

###### 4.6.4.3.4.1 Initial conditions

This test shall be tested using any of the test configurations in Table 4.6.4.3.4.1-1. Configure the test equipment and the DUT according to the parameters in Table 4.6.4.3.4.1-2. Test environment parameters are given in Table 4.6.4.3.4.1-3.

**Table 4.6.4.3.4.1-1: EN-DC CSI-RS based L1-RSRP measurement supported test configurations**

Test Case ID	Description
4.6.4.3-1	LTE FDD, NR 15 kHz SSB SCS, 10MHz bandwidth, FDD duplex mode
4.6.4.3-2	LTE FDD, NR 15 kHz SSB SCS, 10MHz bandwidth, TDD duplex mode
4.6.4.3-3	LTE FDD, NR 30kHz SSB SCS, 40MHz bandwidth, TDD duplex mode
4.6.4.3-4	LTE TDD, NR 15 kHz SSB SCS, 10MHz bandwidth, FDD duplex mode
4.6.4.3-5	LTE TDD, NR 15 kHz SSB SCS, 10MHz bandwidth, TDD duplex mode
4.6.4.3-6	LTE TDD, NR 30kHz SSB SCS, 40MHz bandwidth, TDD duplex mode
NOTE: The UE is only required to be tested in one of the supported test configurations.	

**Table 4.6.4.3.4.1-2: General test parameters for EN-DC CSI-RS based L1-RSRP measurement**

Parameter	Config	Unit	Value
SSB GSCN	1~6		freq1
Duplex mode	1,4		FDD
	2,5		TDD
	3,6		TDD
TDD Configuration	1,4		N/A
	2,5		TDDConf.1.1
	3,6		TDDConf.2.1
BW <sub>channel</sub>	1,4	MHz	10: N <sub>RB,c</sub> = 52
	2,5		10: N <sub>RB,c</sub> = 52
	3,6		40: N <sub>RB,c</sub> = 106
PDSCH Reference measurement channel	1,4		SR.1.1 FDD
	2,5		SR.1.1 TDD
	3,6		SR.2.1 TDD
RMSI CORESET Reference Channel	1,4		CR.1.1 FDD
	2,5		CR.1.1 TDD
	3,6		CR.2.1 TDD
Dedicated CORESET Reference Channel	1,4		CCR.1.1 FDD
	2,5		CCR.1.1 TDD

Parameter	Config	Unit	Value
SSB configuration	3,6		CCR.2.1 TDD
	1,4		SSB.3 FR1
	2,5		SSB.3 FR1
	3,6		SSB.4 FR1
CSI-RS configuration	1,4		CSI-RS 1.3 FDD
	2,5		CSI-RS 1.3 TDD
	3,6		CSI-RS 2.3 TDD
OCNG Patterns	1~6		OP.1
TRS Configuration	1,4		TRS.1.1 FDD
	2,5		TRS.1.1 TDD
	3,6		TRS.1.2 TDD
Initial BWP Configuration	1~6		DLBWP.0.1 ULBWP.0.1
Dedicated BWP configuration	1~6		DLBWP.1.1 ULBWP.1.1
SMTC configuration	1~6		SMTC.1
DRX configuration	1~6		Off
reportConfigType	1~6		aperiodic
reportQuantity	1~6		cri-RSRP
Number of reported RS	1~6		2
qcl-Info	1~6		SSB#0 for resource#0
			SSB#1 for resource#1
reportSlotOffsetList	1~6	slots	8
T1	1~6	s	5
EPRE ratio of PSS to SSS	1~6	dB	0
EPRE ratio of PBCH DMRS to SSS			
EPRE ratio of PBCH to PBCH DMRS			
EPRE ratio of PDCCH DMRS to SSS			
EPRE ratio of PDCCH to PDCCH DMRS			
EPRE ratio of PDSCH DMRS to SSS			
EPRE ratio of PDSCH to PDSCH DMRS			
EPRE ratio of OCNG DMRS to SSS <sup>Note 1</sup>			
EPRE ratio of OCNG to OCNG DMRS <sup>Note 1</sup>			
Propagation condition	1~6		AWGN
NOTE: OCNG shall be used such that both cells are fully allocated and a constant total transmitted power spectral density is achieved for all OFDM symbols.			

Table 4.6.4.3.4.1-3: Test Environment parameters for EN-DC CSI-RS L1-RSRP measurement

Parameter	Value	Comment
Test environment	NC	As specified in TS 38.508-1 [14] clause 4.1.
Test frequencies	As specified in Annex E, Table E.2-1 and TS 38.508-1 [14] clause 4.3.1 and 4.4.2.	
Channel bandwidth	As specified by the test configuration selected from Table 4.6.4.3.4.1-1.	
Propagation conditions	AWGN	As specified in clause C.2.2.
Connection Diagram	TE Part	A.3.1.7.1
	DUT Part	A.3.2.3.4
Exceptions to connection diagram	For 4Rx capable UEs without any 2 Rx RF bands use A.3.2.5.2 for DUT part and A.3.1.8.4 for TE Part	

1. Message contents are defined in clause 4.6.4.3.4.3.
2. Cell 1 is the E-UTRA serving cell (PCell) for the EN-DC setup. The power levels and settings for Cell 1 are set according to Annex A.6. Cell 2 is NR FR1 cell (PSCell). Cell 2 is the target for CSI-RS based L1-RSRP measurements. Before the test, UE is configured to perform RLM and BFD measurement based on the SSBs.

## 4.6.4.3.4.2 Test procedure

The test consists of a single time period T1, during which the UE is triggered via DCI to report L1-RSRP on aperiodic CSI-RS resources. Prior to the start of the time duration T1, the UE shall be fully synchronized to PSCell. UE is also configured to measure L1-RSRP based on SSB. Upon receiving the DCI trigger, UE provides the report back based on the reporting configuration as defined in table 4.6.4.3.4.1-2.

1. Ensure the UE is in state RRC\_CONNECTED with generic procedure parameters Connectivity EN-DC, DC bearer MCG and SCG, Connected without release *On* and Test Mode *On*, according to TS 38.508-1 [14] clause 4.5.
2. Set the parameters according to T1 in Table 4.6.4.3.5-1. T1 starts.
3. After 80ms from the start of the test the SS transmits the DCI trigger in slot 0 for configuration 1,2,4,5 and slot 8 for configuration 3,6. The corresponding CSI-RS set is transmitted with the offset of 4 slots after the DCI trigger.
4. The SS shall check following requirements:
  - R1: the UE shall send L1-RSRP report at slot 8 from the reception of DCI trigger. If the report is received at slot 8 from the reception of DCI trigger, the number of passed iterations for R1 is increased by one. Otherwise, the number of failed iterations for R1 is increased by one.
  - R2: The L1-RSRP value of CSI-RS#1 reported by the UE is compared to the expected L1-RSRP value for CSI-RS #1. If the resulting value is outside the limits in Table 4.6.4.3.5-2 for test configurations 1, 2, 4 and 5 and in Table 4.6.4.3.5-3 for test configurations 3 and 6 or the UE fails to report the measurement value for CSI-RS #1, the number of failed iterations for R2 is increased by one. Otherwise, the number of passed iterations for R2 is increased by one.
  - R3: The DIFF RSRP value of CSI-RS #0 reported by the UE is compared to the expected DIFF RSRP value. If the resulting value is outside the limits in Table 4.6.4.3.5-4 or the UE fails to report the measurement value for CSI-RS #0, the number of failed iterations for R3 is increased by one. Otherwise, the number of passed iterations for R3 is increased by one.
5. Void
6. The SS shall transmit *RRCConnectionReconfiguration* message with condition EN-DC\_PSCell\_Rel according to TS 36.508 [25] Table 4.6.1-8 to release NR cell (PSCell). The UE shall transmit *RRCConnectionReconfigurationComplete* message.
7. The SS then shall transmit *RRCConnectionReconfiguration* message with condition MCG\_and\_SCG according to TS 36.508 [25] Table 4.6.1-8 to add NR cell (PSCell). The UE shall transmit *RRCConnectionReconfigurationComplete* message.
8. If any the reconfiguration fails, switch off and on the UE and ensure the UE is in RRC\_CONNECTED with generic procedure parameters Connectivity EN-DC, DC bearer MCG and SCG, Connected without release *On* and Test Mode *On* according to TS 38.508-1 [14] clause 4.5.
9. Repeat steps 2-8 until the confidence level according to Tables G.2.3-1 in Annex G clause G.2 is achieved.

## 4.6.4.3.4.3 Message contents

Message contents are according to TS 38.508-1 [14] clause 7.3 with the following exceptions:

**Table 4.6.4.3.4.3-1: Common Exception messages EN-DC CSI-RS based L1-RSRP measurement**

Default Message Contents	
Common contents of system information blocks exceptions	TBD
Default RRC messages and information elements contents exceptions	Table H.3.6-2 with conditions APERIODIC and CSI-RSRP Table H.3.6-3 with conditions CSI-RS and APERIODIC Table H.3.4-1

**Table 4.6.4.3.4.3-2: RadioLinkMonitoringConfig**

Derivation Path: TS 38.508-1 [14], Table 4.6.3-133			
Information Element	Value/remark	Comment	Condition
RadioLinkMonitoringConfig ::= SEQUENCE {			
failureDetectionResourcesToAddModList	1 entry		
SEQUENCE			
(SIZE(1..maxNrofFailureDetectionResources)) OF			
SEQUENCE {			
purpose	both	UE is configured to perform RLM and BFD based on the SSBs.	
}			
}			

#### 4.6.4.3.5 Test requirement

Table 4.6.4.3.5-1 defines the primary level settings including test tolerances for all tests.

**Table 4.6.4.3.5-1: CSI-RS specific test parameters for EN-DC CSI-RS L1-RSRP measurement**

Parameter	Config	Unit	CSI-RS#0	CSI-RS#1
$N_{oc}$ <sup>Note1</sup>	1~6	dBm/15kHz	-94.65	
$N_{oc}$ <sup>Note1</sup>	1,2,4,5	dBm/SSB SCS	-94.65	
	3,6		-91.65	
$\hat{E}_s / I_{ot}$	1~6	dB	0	3.5
CSI-RS RSRP <sup>Note2</sup>	1,2,4,5	dBm/SSB SCS	-94.65	-91.15
	3,6		-91.65	-88.14
$I_o$ <sup>Note2</sup>	1,2,4,5	dBm/9.36 MHz	-63.69	-61.59
	3,6	dBm/38.16 MHz	-57.59	-55.49
$\hat{E}_s / N_{oc}$	1~6	dB	0	3.5
NOTE 1: Void.				
NOTE 2: Interference from other cells and noise sources not specified in the test is assumed to be constant over subcarriers and time and shall be modelled as AWGN of appropriate power for $N_{oc}$ to be fulfilled.				
NOTE 3: CSI-RS RSRP and $I_o$ levels have been derived from other parameters for information purposes. They are not settable parameters themselves.				

After 80ms from the beginning of the test, the UE shall send L1-RSRP report at slot 8 from the beginning of T2. The L1-RSRP report shall include the results for both CSI-RS#0 and CSI-RS#1. Each L1-RSRP measurement report shall meet the corresponding absolute accuracy requirements in Table 4.6.4.3.5-2 for for test configurations 1, 2, 4 and 5 and the corresponding absolute accuracy requirements in Table 4.6.4.3.5-3 for test configurations 3 and 6 and the corresponding relative accuracy requirements in Table 4.6.4.3.5-4 for all test configurations.

**Table 4.6.4.3.5-2: L1-RSRP absolute accuracy requirements for the reported values for test configurations 1, 2, 4 and 5**

Normal Conditions	T1
Lowest reported value (CSI-RS#1)	55
Highest reported value (CSI-RS#1)	75

**Table 4.6.4.3.5-3: L1-RSRP absolute accuracy requirements for the reported values for test configurations 3 and 6**

Normal Conditions	T1
Lowest reported value (CSI-RS#1)	58
Highest reported value (CSI-RS#1)	78

**Table 4.6.4.3.5-4: L1-RSRP relative accuracy requirements for the reported values for all test configurations**

Normal Conditions	T1
Lowest DIFF RSRP reported (CSI-RS#0)	0
Highest DIFF RSRP reported (CSI-RS#0)	3

For the test to pass, the ratio of successful reported values for each requirement (R1 to R3) shall be more than 90% with a confidence level of 95%. Each requirement is evaluated independently of the others.

NOTE: The actual overall delays measured in the test may be up to  $2 \times TTI_{DCCH}$  higher than the measurement reporting delays above because of TTI insertion uncertainty of the measurement report in DCCH.

#### 4.6.4.4 EN-DC FR1 CSI-RS-based L1-RSRP measurement in DRX

##### 4.6.4.4.1 Test purpose

To verify that the UE makes correct reporting of CSI-RS-based L1-RSRP measurement in DRX within L1-RSRP measurement requirements in TS 38.133 [6] clause 9.5.4.2.

##### 4.6.4.4.2 Test applicability

This test applies to all types of E-UTRA UE release 15 and forward, supporting EN-DC FR1 and long DRX cycle.

##### 4.6.4.4.3 Minimum conformance requirements

The minimum conformance requirements are specified in clause 4.6.4.0.2.

The normative reference for this requirement is TS 38.133 [6] clause A.4.6.4.4.

##### 4.6.4.4.4 Test description

###### 4.6.4.4.4.1 Initial conditions

This test shall be tested using any of the test configurations in Table 4.6.4.4.1-1. Configure the test equipment and the DUT according to the parameters in Table 4.4.1-2. Test environment parameters are given in Table 4.4.1-3.

**Table 4.6.4.4.1-1: EN-DC CSI-RS based L1-RSRP measurement in DRX supported test configurations**

Config	Description
1	LTE FDD, NR 15 kHz SSB SCS, 10 MHz bandwidth, FDD duplex mode
2	LTE FDD, NR 15 kHz SSB SCS, 10 MHz bandwidth, TDD duplex mode
3	LTE FDD, NR 30 kHz SSB SCS, 40 MHz bandwidth, TDD duplex mode
4	LTE TDD, NR 15 kHz SSB SCS, 10 MHz bandwidth, FDD duplex mode
5	LTE TDD, NR 15 kHz SSB SCS, 10 MHz bandwidth, TDD duplex mode
6	LTE TDD, NR 30 kHz SSB SCS, 40 MHz bandwidth, TDD duplex mode

NOTE: The UE is only required to be tested in one of the supported test configurations.

**Table 4.6.4.4.1-2: General test parameters for EN-DC CSI-RS based L1-RSRP measurement in DRX**

Parameter	Config	Unit	Value
SSB GSCN	1~6		freq1
Duplex mode	1,4		FDD
	2,5		TDD
	3,6		TDD
TDD Configuration	1,4		N/A
	2,5		TDDConf.1.1



Parameter	Config	Unit	Value
	3,6		TDDConf.2.1
BW <sub>channel</sub>	1,4	MHz	10: N <sub>RB,c</sub> = 52
	2,5		10: N <sub>RB,c</sub> = 52
	3,6		40: N <sub>RB,c</sub> = 106
PDSCH Reference measurement channel	1,4		SR.1.1 FDD
	2,5		SR.1.1 TDD
	3,6		SR.2.1 TDD
RMSI CORESET Reference Channel	1,4		CR.1.1 FDD
	2,5		CR.1.1 TDD
	3,6		CR.2.1 TDD
Dedicated CORESET Reference Channel	1,4		CCR.1.1 FDD
	2,5		CCR.1.1 TDD
	3,6		CCR.2.1 TDD
SSB configuration	1,4		SSB.3 FR1
	2,5		SSB.3 FR1
	3,6		SSB.4 FR1
CSI-RS configuration	1,4		CSI-RS 1.3 FDD
	2,5		CSI-RS 1.3 TDD
	3,6		CSI-RS 2.3 TDD
OCNG Patterns	1~6		OP.1
TRS Configuration	1,4		TRS.1.1 FDD
	2,5		TRS.1.1 TDD
	3,6		TRS.1.2 TDD
Initial BWP Configuration	1~6		DLBWP.0.1 ULBWP.0.1
Dedicated BWP configuration	1~6		DLBWP.1.1 ULBWP.1.1
SMTC configuration	1~6		SMTC.1
DRX configuration	1~6		DRX.3
reportConfigType	1~6		aperiodic
reportQuantity	1~6		cri-RSRP
Number of reported RS	1~6		2
qcl-Info	1~6		SSB#0 for resource#0
			SSB#1 for resource#1
reportSlotOffsetList	1~6	slots	8
T1	1~6	s	5
EPRE ratio of PSS to SSS	1~6	dB	0
EPRE ratio of PBCH DMRS to SSS			
EPRE ratio of PBCH to PBCH DMRS			
EPRE ratio of PDCCH DMRS to SSS			
EPRE ratio of PDCCH to PDCCH DMRS			
EPRE ratio of PDSCH DMRS to SSS			
EPRE ratio of PDSCH to PDSCH DMRS			
EPRE ratio of OCNG DMRS to SSS <sup>Note 1</sup>			
EPRE ratio of OCNG to OCNG DMRS <sup>Note 1</sup>			
Propagation condition	1~6		AWGN
NOTE: OCNG shall be used such that both cells are fully allocated and a constant total transmitted power spectral density is achieved for all OFDM symbols.			

**Table 4.6.4.4.1-3: Test Environment parameters for EN-DC CSI-RS based L1-RSRP measurement in DRX**

Parameter	Value		Comment
Test environment	NC		As specified in TS 38.508-1 [14] clause 4.1.
Test frequencies	As specified in Annex E, Table E.2-1 and TS 38.508-1 [14] clause 4.3.1 and 4.4.2.		
Channel bandwidth	As specified by the test configuration selected from Table 4.6.4.4.1-1.		
Propagation conditions	AWGN		As specified in clause C.2.2.
Connection Diagram	TE Part	A.3.1.7.1	As specified in TS 38.508-1 [14] Annex A.
	DUT Part	A.3.2.3.4	
Exceptions to connection diagram	For 4Rx capable UEs without any 2 Rx RF bands use A.3.2.5.2 for DUT part and A.3.1.8.4 for TE Part		

1. Message contents are defined in clause 4.6.4.4.3.
2. Cell 1 is the E-UTRA serving cell (PCell) for the EN-DC setup. The power levels and settings for Cell 1 are set according to Annex A.6. Cell 2 is NR FR1 cell (PSCell). Cell 2 is the target for CSI-RS based L1-RSRP measurements. Before the test, UE is configured to perform RLM, BFD and L1-RSRP measurement based on the SSBs. DRX is configured as specified in Table 4.6.4.4.1-2.

#### 4.6.4.4.2 Test procedure

Same test procedure as in subclause 4.6.4.3.4.2 with tables 4.6.4.3.4.1-2 and 4.6.4.3.5-1 replaced by tables 4.6.4.4.1-2 and 4.6.4.4.5-1.

#### 4.6.4.4.3 Message contents

Same message content as in subclause 4.6.4.3.4.3 with the following exception:

**Table 4.6.4.4.3-1: Common Exception messages EN-DC CSI-RS based L1-RSRP measurement in DRX**

Default Message Contents	
Common contents of system information blocks exceptions	
Default RRC messages and information elements contents exceptions	Table H.3.7-1 with condition DRX.3

#### 4.6.4.4.5 Test requirement

Table 4.6.4.4.5-1 defines the primary level settings including test tolerances for all tests.

**Table 4.6.4.4.5-1: CSI-RS specific test parameters for EN-DC SSB based L1-RSRP measurement in DRX**

Parameter	Config	Unit	CSI-RS#0	CSI-RS#1
$N_{oc}$ <sup>Note1</sup>	1~6	dBm/15kHz	-94.65	
$N_{oc}$ <sup>Note1</sup>	1,2,4,5 3,6			
$\hat{E}_s / I_{ot}$	1~6	dB	0	3.5
CSI-RS RSRP <sup>Note2</sup>	1,2,4,5 3,6			
$I_o$ <sup>Note2</sup>	1,2,4,5	dBm/9.36 MHz	-63.69	-61.59
	3,6			

Parameter	Config	Unit	CSI-RS#0	CSI-RS#1
$\hat{E}_s / N_{oc}$	1~6	dB	0	3.5
NOTE 1: Void.				
NOTE 2: Interference from other cells and noise sources not specified in the test is assumed to be constant over subcarriers and time and shall be modelled as AWGN of appropriate power for $N_{oc}$ to be fulfilled.				
NOTE 3: CSI-RS RSRP and Io levels have been derived from other parameters for information purposes. They are not settable parameters themselves.				

After 80ms from the beginning of the test, the UE shall send L1-RSRP report at slot 8 from the reception of DCI triggering the L1-RSRP measurement. The L1-RSRP report shall include the results for both CSI-RS#0 and CSI-RS#1.

Each L1-RSRP measurement report shall meet the corresponding absolute accuracy requirements in Table 4.6.4.4.5-2 for test configurations 1, 2, 4 and 5, the corresponding absolute accuracy requirements in Table 4.6.4.4.5-3 for test configurations 3 and 6 and the corresponding relative accuracy requirements in Table 4.6.4.4.5-4 for all test configurations.

**Table 4.6.4.4.5-2: L1-RSRP absolute accuracy requirements for the reported values for test configurations 1, 2, 4 and 5**

Normal Conditions	T1
Lowest reported value (CSI-RS#1)	55
Highest reported value (CSI-RS#1)	75

**Table 4.6.4.4.5-3: L1-RSRP absolute accuracy requirements for the reported values for test configurations 3 and 6**

Normal Conditions	T1
Lowest reported value (CSI-RS#1)	58
Highest reported value (CSI-RS#1)	78

**Table 4.6.4.4.5-4: L1-RSRP relative accuracy requirements for the reported values for all test configurations**

Normal Conditions	T1
Lowest DIFF RSRP reported (CSI-RS#0)	0
Highest DIFF RSRP reported (CSI-RS#0)	3

The rate of correct events observed during repeated tests shall be at least 90% with a confidence level of 95%.

NOTE: The actual overall delays measured in the test may be up to  $2 \times TTI_{DCCH}$  higher than the measurement reporting delays above because of TTI insertion uncertainty of the measurement report in DCCH.

#### 4.6.4.5 EN-DC FR1 SSB-based L1-RSRP measurement in DRX for UE configured with *highSpeedMeasFlag-r16*

##### 4.6.4.5.1 Test purpose

To verify that the UE makes correct reporting of L1-RSRP measurement when UE is configured with *highSpeedMeasFlag-r16*.

To verify the L1-RSRP measurement requirements for UE configured with *highSpeedMeasFlag-r16* in TS 38.133 [6] clause 9.5.4.1.

##### 4.6.4.5.2 Test applicability

This test applies to all types of E-UTRA UE release 16 and forward, supporting EN-DC FR1, HST enhancement and long DRX cycle.

## 4.6.4.5.3 Minimum conformance requirements

The minimum conformance requirements are specified in clause 4.6.4.0.1.

The normative reference for this requirement is TS 38.133 [6] clause A.4.6.4.5.

## 4.6.4.5.4 Test description

## 4.6.4.5.4.1 Initial conditions

This test shall be tested using any of the test configurations in Table 4.6.4.5.4.1-1. Configure the test equipment and the DUT according to the parameters in Table 4.6.4.5.4.1-2. Test environment parameters are given in Table 4.6.4.5.4.1-3.

**Table 4.6.4.5.4.1-1: Supported test configurations for EN-DC FR1 SSB-based L1-RSRP measurement in DRX for UE configured with highSpeedMeasFlag-r16**

Config	Description
4.6.4.5-1	LTE FDD, NR 15 kHz SSB SCS, 10 MHz bandwidth, FDD duplex mode
4.6.4.5-2	LTE FDD, NR 15 kHz SSB SCS, 10 MHz bandwidth, TDD duplex mode
4.6.4.5-3	LTE FDD, NR 30 kHz SSB SCS, 40 MHz bandwidth, TDD duplex mode
4.6.4.5-4	LTE TDD, NR 15 kHz SSB SCS, 10 MHz bandwidth, FDD duplex mode
4.6.4.5-5	LTE TDD, NR 15 kHz SSB SCS, 10 MHz bandwidth, TDD duplex mode
4.6.4.5-6	LTE TDD, NR 30 kHz SSB SCS, 40 MHz bandwidth, TDD duplex mode

NOTE: The UE is only required to be tested in one of the supported test configurations.

**Table 4.6.4.5.4.1-2: General test parameters for EN-DC FR1 SSB-based L1-RSRP measurement in DRX for UE configured with highSpeedMeasFlag-r16**

Parameter	Config	Unit	Value
SSB GSCN	1~6		freq1
Duplex mode	1,4		FDD
	2,5		TDD
	3,6		TDD
TDD Configuration	1,4		N/A
	2,5		TDDConf.1.1
	3,6		TDDConf.2.1
BW <sub>channel</sub>	1,4	MHz	10: N <sub>RB,c</sub> = 52
	2,5		10: N <sub>RB,c</sub> = 52
	3,6		40: N <sub>RB,c</sub> = 106
PDSCH Reference measurement channel	1,4		SR.1.1 FDD
	2,5		SR.1.1 TDD
	3,6		SR.2.1 TDD
RMSI CORESET Reference Channel	1,4		CR.1.1 FDD
	2,5		CR.1.1 TDD
	3,6		CR.2.1 TDD
Dedicated CORESET Reference Channel	1,4		CCR.1.1 FDD
	2,5		CCR.1.1 TDD
	3,6		CCR.2.1 TDD
SSB configuration	1,4		SSB.3 FR1
	2,5		SSB.3 FR1
	3,6		SSB.4 FR1
OCNG Patterns	1~6		OP.1
Initial BWP Configuration	1~6		DLBWP.0.1
			ULBWP.0.1
Dedicated BWP configuration	1~6		DLBWP.1.1
			ULBWP.1.1
SMTc configuration	1~6		SMTc.1
TRS Configuration	1,4		TRS.1.1 FDD
	2,5		TRS.1.1 TDD
	3,6		TRS.1.2 TDD
DRX configuration	1~6		DRX.3

Parameter	Config	Unit	Value
reportConfigType	1~6		periodic
reportQuantity	1~6		ssb-Index-RSRP
Number of reported RS	1~6		2
L1-RSRP reporting period	1~6	slot	80
T1	1~6	s	5
T2	1~6	s	2
EPRE ratio of PSS to SSS	1~6	dB	0
EPRE ratio of PBCH DMRS to SSS			
EPRE ratio of PBCH to PBCH DMRS			
EPRE ratio of PDCCH DMRS to SSS			
EPRE ratio of PDCCH to PDCCH DMRS			
EPRE ratio of PDSCH DMRS to SSS			
EPRE ratio of PDSCH to PDSCH DMRS			
EPRE ratio of OCNG DMRS to SSS <sup>Note 1</sup>			
EPRE ratio of OCNG to OCNG DMRS <sup>Note 1</sup>			
Propagation condition			
	3,6		AWGN 3334 Hz
NOTE: OCNG shall be used such that both cells are fully allocated and a constant total transmitted power spectral density is achieved for all OFDM symbols.			

**Table 4.6.4.5.4.1-3: Test Environment parameters for EN-DC FR1 SSB-based L1-RSRP measurement in DRX for UE configured with highSpeedMeasFlag-r16**

Parameter	Value	Comment
Test environment	NC	As specified in TS 38.508-1 [14] clause 4.1.
Test frequencies	As specified in Annex E, Table E.2-1 and TS 38.508-1 [14] clause 4.3.1 and 4.4.2.	
Channel bandwidth	As specified by the test configuration selected from Table 4.6.4.5.4.1-1.	
Propagation conditions	AWGN	As specified in clause C.2.2.
Connection Diagram	TE Part	A.3.1.7.1
	DUT Part	A.3.2.3.4
Exceptions to connection diagram	For 4Rx capable UEs without any 2 Rx RF bands use A.3.2.5.2 for DUT part and A.3.1.8.4 for TE Part	

1. Message contents are defined in clause 4.6.4.5.4.3.

2. Cell 1 is the E-UTRA serving cell (PCell) for the EN-DC setup. The power levels and settings for Cell 1 are set according to Annex A.6. Cell 2 is NR FR1 cell (PSCell). Cell 2 is the target for SSB based L1-RSRP measurements. Before the test, UE is configured to perform RLM, BFD and L1-RSRP measurement based on the SSBs. DRX is configured as specified in Table 4.6.4.5.4.1-2.

#### 4.6.4.5.4.2 Test procedure

Same test procedure as in subclause 4.6.4.1.4.2 with tables 4.6.4.1.4.1-2 and 4.6.4.1.5-1 replaced by tables 4.6.4.5.4.1-2 and 4.6.4.5.5-1.

#### 4.6.4.5.4.3 Message contents

In addition to the same message contents as clause 4.6.4.2.4.3, the following exceptions are also needed:

**Table 4.6.4.5.4.3-1: Void**

**Table 4.6.4.5.4.3-2: Void**

**Table 4.6.4.5.4.3-3: CellGroupConfig (Step 1)**

Derivation Path: TS 38.508-1 [14], Table 4.6.3-19 with condition EN-DC			
Information Element	Value/remark	Comment	Condition
CellGroupConfig ::= SEQUENCE {			
spCellConfig SEQUENCE {			
servCellIndex	ServCellIndex for Cell 2		
reconfigurationWithSync SEQUENCE {			
spCellConfigCommon	ServingCellConfigCommon	Table 4.6.4.5.4.3-4	
}			
}			
}			

**Table 4.6.4.5.4.3-4: ServingCellConfigCommon (Table 4.6.4.5.4.3-3)**

Derivation Path: TS 38.508-1[14], Table 4.6.3-168 with condition HST			
Information Element	Value/remark	Comment	Condition
ServingCellConfigCommon ::= SEQUENCE {			
highSpeedConfig-r16 SEQUENCE {			
highSpeedMeasFlag-r16	true		
}			
}			

4.6.4.5.5 Test requirement

Table 4.6.4.5.5-1 defines the primary level settings including test tolerances for all tests.

**Table 4.6.4.5.5-1: SSB specific test parameters for EN-DC FR1 SSB-based L1-RSRP measurement in DRX for UE configured with highSpeedMeasFlag-r16**

Parameter	Config	Unit	SSB#0		SSB#1	
			T1	T2	T1	T2
$N_{oc}$ <sup>Note2</sup>	1~6	dBm/15kHz	-94.65			
$N_{oc}$ <sup>Note2</sup>	1,2,4,5	dBm/SSB SCS	-94.65			
	3,6		-91.65			
$\hat{E}_s / I_{ot}$	1~6	dB	0	0	-Infinity	3.5
SSB RSRP <sup>Note3</sup>	1,2,4,5	dBm/SSB SCS	-94.65	-94.65	-Infinity	-91.15
	3,6		-91.65	-91.65	-Infinity	-88.15
$I_o$ <sup>Note3</sup>	1,2,4,5	dBm/9.36 MHz	-63.69	-63.69	-66.70	-61.59
	3,6	dBm/38.16 MHz	-57.59	-57.59	-60.61	-55.49
$\hat{E}_s / N_{oc}$	1~6	dB	0	0	-Infinity	3.5

NOTE 1 The resources for uplink transmission are assigned to the UE prior to the start of time period T2.

NOTE 2: Interference from other cells and noise sources not specified in the test is assumed to be constant over subcarriers and time and shall be modelled as AWGN of appropriate power for  $N_{oc}$  to be fulfilled.

NOTE 3: SS-RSRP and  $I_o$  levels have been derived from other parameters for information purposes. They are not settable parameters themselves.

The UE shall send L1-RSRP report every 80 slots. No later than [1920ms] plus 80 slots from the beginning of time period T2, UE shall send L1-RSRP report including results of both SSB0 and SSB1. Each L1-RSRP measurement report shall meet the corresponding absolute accuracy requirements in Table 4.6.4.5.5-2 for test configurations 1, 2, 4 and 5, the corresponding absolute accuracy requirements in Table 4.6.4.5.5-3 for test configurations 3 and 6 and the corresponding relative accuracy requirements in Table 4.6.4.5.5-4 for all test configurations.

**Table 4.6.4.5.5-2: L1-RSRP absolute accuracy requirements for the reported values for test configurations 1, 2, 4 and 5**

Normal Conditions	T1	T2
Lowest reported value (SSB#1)	-	55
Highest reported value (SSB#1)	-	75

**Table 4.6.4.5.5-3: L1-RSRP absolute accuracy requirements for the reported values for test configurations 3 and 6**

Normal Conditions	T1	T2
Lowest reported value (SSB#1)	-	58
Highest reported value (SSB#1)	-	78

**Table 4.6.4.5.5-4: L1-RSRP relative accuracy requirements for the reported values for all test configurations**

Normal Conditions	T1	T2
Lowest DIFF RSRP reported (SSB#0)	-	0
Highest DIFF RSRP reported (SSB#0)	-	3

The rate of correct events observed during repeated tests shall be at least 90% with a confidence level of 95%.

NOTE: The actual overall delays measured in the test may be up to  $2 \times TTI_{DCCH}$  higher than the measurement reporting delays above because of TTI insertion uncertainty of the measurement report in DCCH.

## 4.6.5 CLI measurements

### 4.6.5.0 Minimum conformance requirements

#### 4.6.5.0.1 Minimum conformance requirements for SRS-RSRP measurement

The UE shall be capable of performing SRS-RSRP measurement based on the configured SRS resource, and the UE shall be capable of reporting SRS-RSRP measured over measurement period of  $T_{SRS\_RSRP\_measurement\_period}$  for FR1 and FR2.

**Table 4.6.5.0.1-1 Measurement period  $T_{SRS\_RSRP\_measurement\_period}$**

Configuration	$T_{SRS\_measurement\_period}$ (ms)
No DRX	$\text{Max}(60, 3 \times T_{SRS})$
DRX cycle $\leq 320$ ms	$\text{Max}(60, \text{Ceil}(1.5 \times 3) \times \text{max}(T_{SRS}, T_{DRX}))$
DRX cycle $> 320$ ms	$3 \times T_{DRX}$
NOTE:	$T_{SRS}$ is SRS measurement periodicity configured <i>SRS-PeriodicityAndOffset</i> , and $T_{DRX}$ is the DRX cycle length.

If the SRS resources configured for measurement are partially or fully overlapping with SMTC window, SSB or CSI-RS configured for RLM, BFD, CBD or L1-RSRP measurement or measurement gaps, requirements are not specified for  $T_{SRS\_RSRP\_measurement\_period}$ .

When configured by the network, the UE shall be able to perform SRS-RSRP measurements of configured *srs-ResourceConfigCLI*. The requirements apply when the subcarrier spacing for SRS-RSRP measurement resource configuration is the same as the subcarrier spacing of the active DL BWP of serving cell. The UE is not required to measure SRS using different SCS compared to the downlink active BWP SCS of the same carrier.

The requirements apply, provided:

- SRS resources configured for SRS-RSRP measurements are measurable.

An SRS resource configured for SRS-RSRP shall be considered measurable when for each relevant SRS the following conditions are met:

- SRS-RSRP related side conditions given in clauses 10.1.22.1 of TS 38.133 [6] for FR1 and FR2 for a corresponding band,

- SRS<sub>RP</sub> and SRS  $\hat{E}_s/I_{ot}$  according to Annex B.2.7 of TS 38.133 [6] for a corresponding band.

The UE shall send SRS-RSRP reports only for report configurations according to *reportType* which is *cliPeriodical* or *cliEventTriggered* when SRS-RSRP report is configured.

The UE shall report the SRS-RSRP value as a 7-bit value in the range [-140, -44] dBm with 1dB step size according to clause 10.1.22.1 of TS 38.133[6] for FR1 and FR2.

The UE shall not send any event triggered measurement reports as long as no reporting criteria is fulfilled.

The measurement reporting delay is defined as the time between an event that will trigger a measurement report and the point when the UE starts to transmit the measurement report over the air interface. This requirement assumes that the measurement report is not delayed by other RRC signalling on the DCCH. This measurement reporting delay excludes a delay uncertainty resulted when inserting the measurement report to the TTI of the uplink DCCH. The delay uncertainty is:  $2 \times TTI_{DCCH}$ . This measurement reporting delay excludes a delay which caused by no UL resources for UE to send the measurement report on.

The normative reference for this requirement is TS 38.133 [6] clause 9.7.2.5, 9.7.2.1, 9.7.2.2 and 9.7.2.3.3.

#### 4.6.5.0.2 Minimum conformance requirements for CLI-RSSI measurement with non-DRX

The UE shall be capable of performing CLI-RSSI measurement based on the configured measurement resource within *TCLI\_RSSI\_measurement\_period*. The UE shall be able to provide a single RSSI sample for each measurement resource configured for CLI-RSSI measurement occurring with a configured periodicity. The CLI-RSSI measurement period *TCLI\_RSSI\_measurement\_period* corresponds to the CLI-RSSI measurement resource periodicity, which is configured for by higher layers via *RSSI-PeriodicityAndOffset*.

If the CLI-RSSI measurement resources configured for measurement are partially or fully overlapping with SMTC window, SSB or CSI-RS configured for RLM, BFD, CBD or L1-RSRP measurement or measurement gaps, requirements are not specified for *TCLI\_RSSI\_measurement\_period*.

The UE shall send CLI-RSSI reports only for report configurations according to *reportType* which is *cliPeriodical* or *cliEventTriggered* when CLI-RSSI report is configured.

The requirements apply, provided:

- The measurement resources configured for CLI-RSSI measurements are measurable.

A measurement resource configured for CLI-RSSI shall be considered measurable when for each relevant CLI-RSSI resource the following conditions are met:

- CLI-RSSI related side conditions given in clauses 10.1.22.2 for FR1 and FR2 for a corresponding band.

The UE shall report the CLI-RSSI value as a 7-bit value in the range [-100, -25] dBm with 1dB step size according to clause 10.1.22.2 of TS 38.133[6] for FR1 and FR2.

The UE shall not send any event triggered measurement reports as long as no reporting criteria is fulfilled.

The measurement reporting delay is defined as the time between an event that will trigger a measurement report and the point when the UE starts to transmit the measurement report over the air interface. This requirement assumes that the measurement report is not delayed by other RRC signalling on the DCCH. This measurement reporting delay excludes a delay uncertainty resulted when inserting the measurement report to the TTI of the uplink DCCH. The delay uncertainty is:  $2 \times TTI_{DCCH}$ . This measurement reporting delay excludes a delay which caused by no UL resources for UE to send the measurement report on.

The normative reference for this requirement is TS 38.133 [6] clauses 9.7.3.5, 9.7.3.1 and 9.7.3.3.2.

#### 4.6.5.1 EN-DC FR1 SRS-RSRP measurement with non-DRX

**Editor's NOTE: This test case is incomplete in following aspects:**

- Message contents are missing.
- TT analysis is missing.



- Test Procedure might need update.
- Test applicability needs to be updated

#### 4.6.5.1.1 Test purpose

To verify that the UE makes correct reporting of SRS-RSRP measurement within SRS-RSRP measurement requirements in TS 38.133 [6] clause 9.7.2.5.

#### 4.6.5.1.2 Test applicability

FFS.

#### 4.6.5.1.3 Minimum conformance requirements

The minimum conformance requirements are specified in clause 4.6.5.0.1.

The normative reference for this requirement is TS 38.133 [6] clause A.4.6.5.1.

#### 4.6.5.1.4 Test description

##### 4.6.5.1.4.1 Initial conditions

This test shall be tested using any of the test configurations in Table 4.6.5.1.4.1-1. Configure the test equipment and the DUT according to the parameters in Table 4.6.5.1.4.1-2. Test environment parameters are given in Table 4.6.5.1.4.1-3.

**Table 4.6.5.1.4.1-1: EN-DC FR1 SRS-RSRP measurement supported test configurations**

Configuration	Description
1	NR 15 kHz SRS SCS, 10 MHz bandwidth, TDD duplex mode
2	NR 30 kHz SRS SCS, 40 MHz bandwidth, TDD duplex mode
NOTE: The UE is only required to be tested in one of the supported test configurations.	

**Table 4.6.5.1.4.1-2: General test parameters for EN-DC SRS-RSRP event triggered reporting for PSCell in FR1**

Parameter	Unit	Test configuration	Value	Comment
Active cell		1, 2	E-UTRAN Cell 1 and NR Cell 2	
RF Channel Number		1, 2	1: Cell 1 2: Cell 2	
SSB configuration		1	SSB.1 FR1	
		2	SSB.2 FR1	
SMTC configuration		1	SMTC.1	
		2	SMTC.1	
SRS configuration		1	SRSCConf.1	Table 4.6.5.1.5-3
		2	SRSCConf.2	
CP length		1, 2	Normal	
i1-Threshold	dBm	1	-97	
		2	-95	
Hysteresis	dB	1, 2	0	
Time To Trigger	s	1, 2	0	
Filter coefficient		1, 2	0	L3 filtering is not used
DRX		1, 2	OFF	Non-DRX
Time offset between DL from serving cell and SRS from test system	μs	1, 2	17.67	
T1	s	1, 2	5	
T2	s	1, 2	1	

**Table 4.6.5.1.4.1-3: Test Environment parameters for EN-DC SRS-RSRP event triggered reporting for PSCell in FR1**

Parameter	Value		Comment
Test environment	NC		As specified in TS 38.508-1 [14] clause 4.1.
Test frequencies	As specified in Annex E, Table E.2-1 and TS 38.508-1 [14] clause 4.3.1 and 4.4.2.		
Channel bandwidth	As specified by the test configuration selected from Table 4.6.5.2.4.1-1.		
Propagation conditions	AWGN		As specified in clause C.2.2.
Connection Diagram	TE Part	A.3.1.7.1	As specified in TS 38.508-1 [14] Annex A.
	DUT Part	A.3.2.3.4	
Exceptions to connection diagram	For 4Rx capable UEs without any 2 Rx RF bands use A.3.2.5.2 for DUT part and A.3.1.8.4 for TE Part		

1. Message contents are defined in clause 4.6.5.1.4.3.
2. Cell 1 is the E-UTRA serving cell (PCell) for the EN-DC setup. The power levels and settings for Cell 1 are set according to Annex A.6. Cell 2 is NR FR1 cell (PSCell). Cell 2 is the target for SRS-RSRP measurements. In the measurement control information, a measurement object is configured for the frequency of the PSCell, and it is indicated to the UE that event-triggered reporting with Event I1 is used. The test consists of two successive time periods, with time duration of T1 and T2, respectively.

#### 4.6.5.1.4.2 Test procedure

FFS

#### 4.6.5.1.4.3 Message contents

Message contents are according to TS 38.508-1 [14] clause 7.3 with the following exceptions:

FFS

#### 4.6.5.1.5 Test requirement

Table 4.6.5.1.5-1 defines the primary level settings including test tolerances for all tests.

**Table 4.6.5.1.5-1: NR Cell specific test parameters for EN-DC SRS-RSRP event triggered reporting for PSCell in FR1**

Parameter	Unit	Test configuration	Cell 2	
			T1	T2
TDD configuration		1	TDDConf.1.1	
		2	TDDConf.2.1	
PDSCH RMC configuration		1	SR.1.1 TDD	
		2	SR.2.1 TDD	
RMSI CORESET RMC configuration		1	CR.1.1 TDD	
		2	CR.2.1 TDD	
Dedicated CORESET RMC configuration		1	CCR.1.1 TDD	
		2	CCR.2.1 TDD	
OCNG Patterns		1, 2	OP.1	
TRS Configuration		1	TRS.1.1 TDD	
		2	TRS.1.2 TDD	
Initial BWP configuration		1, 2	DLBWP.0.1 ULBWP.0.1	
Active DL BWP configuration		1, 2	DLBWP.1.1	
Active UL BWP configuration		1, 2	ULBWP.1.1	
$N_{oc}$ <small>Note 2</small>	dBm/15 kHz	1	-98+TT	

Parameter	Unit	Test	Cell 2
		2	
$N_{oc}$ Note 2	dBm/SCS	1	-98+TT
		2	-95+TT
Propagation Condition		1, 2	AWGN
NOTE 1: The resources for uplink transmission are assigned to the UE prior to the start of time period T2.			
NOTE 2: Interference from other cells and noise sources not specified in the test is assumed to be constant over subcarriers and time and shall be modelled as AWGN of appropriate power for $N_{oc}$ to be fulfilled.			

**Table 4.6.5.1.5-2: NR Cell specific test parameters for EN-DC FR1 SRS-RSRP event triggered reporting for neighbour cell UE**

Parameter	Unit	Test configuration	Neighbour cell UE	
			T1	T2
$N_{oc}$ Note 2	dBm/15 kHz	1	-98+TT	
		2		
$N_{oc}$ Note 2	dBm/SCS	1	-98+TT	
		2	-95+TT	
$\hat{E}_s/I_{ot}$	dB	1	-infinity	4+TT
		2		
$\hat{E}_s/N_{oc}$	dB	1	-infinity	4+TT
		2		
SRS-RSRP Note 3	dBm/SCS kHz	1	-infinity	-94+TT
		2	-infinity	-91+TT
Io	dBm/9.36 MHz	1	-70.05+TT	-64.59+TT
	dBm/38.16 MHz	2	-63.96+TT	-58.50+TT
Propagation Condition		1, 2	AWGN	
NOTE 1: The resources for uplink transmission are assigned to the UE prior to the start of time period T2.				
NOTE 2: Interference from other cells and noise sources not specified in the test is assumed to be constant over subcarriers and time and shall be modelled as AWGN of appropriate power for $N_{oc}$ to be fulfilled.				
NOTE 3: SRS-RSRP levels have been derived from other parameters for information purposes. They are not settable parameters themselves.				

**Table 4.6.5.1.5-3: SRS configuration for measurement reporting**

	Field	SRSCnf.1	SRSCnf.2	Comments
SRS-ResourceSet	srs-ResourceSetId	0	0	
	srs-ResourceSetList	0	0	
	resourceType	Periodic	Periodic	
	Usage	Codebook	Codebook	
SRS-Resource	SRS-ResourceId	0	0	
	nrofSRS-Ports	Port1	Port1	
	transmissionComb	n2	n2	
	combOffset-n2	0	0	
	cyclicShift-n2	0	0	
	resourceMapping startPosition	0	0	
	resourceMapping nrofSymbols	n1	n1	
	resourceMapping repetitionFactor	n1	n1	
	freqDomainPosition	0	0	
	freqDomainShift	0	0	
	freqHopping c-SRS	12	12	
	freqHopping b-SRS	0	0	
	freqHopping b-hop	0	0	
	groupOrSequenceHopping	Neither	Neither	
	resourceType	Periodic	Periodic	
	periodicityAndOffset	sl20, 9	sl40, 19	
	sequenceId	0	0	Any 10 bit number

The UE shall send one Event I1 triggered measurement report, with a measurement reporting delay less than 60 ms from the beginning of time period T2.

The UE shall not send event triggered measurement reports, as long as the reporting criteria are not fulfilled.

The rate of correct events observed during repeated tests shall be at least 90%.

NOTE: The actual overall delays measured in the test may be up to  $2 \times TTI_{DCCH}$  higher than the measurement reporting delays above because of TTI insertion uncertainty of the measurement report in DCCH.

#### 4.6.5.2 EN-DC FR1 CLI-RSSI measurement with non-DRX

Editor's NOTE: This test case is incomplete in following aspects:

- Message contents are missing.
- Test Procedure might need update.
- Test applicability needs to be updated

##### 4.6.5.2.1 Test purpose

To verify that the UE makes correct reporting of CLI-RSSI measurement in non-DRX within CLI-RSSI measurement requirements in TS 38.133 [6] clause 9.7.3.5.

##### 4.6.5.2.2 Test applicability

FFS.

##### 4.6.5.2.3 Minimum conformance requirements

The minimum conformance requirements are specified in clause 4.6.5.0.2.

The normative reference for this requirement is TS 38.133 [6] clause A.4.6.5.2.

#### 4.6.5.2.4 Test description

##### 4.6.5.2.4.1 Initial conditions

This test shall be tested using any of the test configurations in Table 4.6.5.2.4.1-1. Configure the test equipment and the DUT according to the parameters in Table 4.6.5.2.4.1-2. Test environment parameters are given in Table 4.6.5.2.4.1-3.

**Table 4.6.5.2.4.1-1: EN-DC FR1 CLI-RSSI measurement in non-DRX test configurations**

Configuration	Description
1	NR 15 kHz SCS, 10 MHz bandwidth, TDD duplex mode
2	NR 30 kHz SCS, 40 MHz bandwidth, TDD duplex mode
NOTE: The UE is only required to be tested in one of the supported test configurations.	

**Table 4.6.5.2.4.1-2: General test parameters for CLI-RSSI event triggered reporting for PSCell in FR1**

Parameter	Unit	Test configuration	Value	Comment
Active cell		1, 2	E-UTRAN Cell 1 and NR Cell 2	
RF Channel Number		1, 2	1: Cell 1 2: Cell 2	
SSB configuration		1	SSB.1 FR1	
		2	SSB.2 FR1	
SMTC configuration		1	SMTC.1	
		2	SMTC.1	
CLI-RSSI configuration		1	CLI-RSSICConf.1	Table 4.6.5.2.5-2
		2	CLI-RSSICConf.2	
CP length		1, 2	Normal	
i1-Threshold	dBm	1	-93	
		2	-93	
Hysteresis	dB	1, 2	0	
Time To Trigger	s	1, 2	0	
Filter coefficient		1, 2	0	L3 filtering is not used
DRX		1, 2	OFF	Non-DRX
Time offset between DL from serving cell and OCNG from test system	µs	1,2	17.67	
T1	s	1, 2	5	
T2	s	1, 2	1	

**Table 4.6.5.2.4.1-3: Test Environment parameters for EN-DC SSB based L1-RSRP measurement in DRX**

Parameter	Value		Comment
Test environment	NC		As specified in TS 38.508-1 [14] clause 4.1.
Test frequencies	As specified in Annex E, Table E.2-1 and TS 38.508-1 [14] clause 4.3.1 and 4.4.2.		
Channel bandwidth	As specified by the test configuration selected from Table 4.6.5.2.4.1-1.		
Propagation conditions	AWGN		As specified in clause C.2.2.
Connection Diagram	TE Part	A.3.1.7.1	As specified in TS 38.508-1 [14] Annex A.
	DUT Part	A.3.2.3.4	
Exceptions to connection diagram	For 4Rx capable UEs without any 2 Rx RF bands use A.3.2.5.2 for DUT part and A.3.1.8.4 for TE Part		

1. Message contents are defined in clause 4.6.5.2.4.3.
2. Cell 1 is the E-UTRA serving cell (PCell) for the EN-DC setup. The power levels and settings for Cell 1 are set according to Annex A.6. Cell 2 is NR FR1 cell (PSCell). Cell 2 is the target for CLI-RSSI measurements. In the

measurement control information, a measurement object is configured for the frequency of the PSCell, and it is indicated to the UE that event-triggered reporting with Event I1 is used.

4.6.5.2.4.2 Test procedure

FFS

4.6.5.2.4.3 Message contents

FFS

4.6.5.2.5 Test requirement

Table 4.6.5.2.5-1 defines the primary level settings including test tolerances for all tests.

**Table 4.6.5.2.5-1: NR Cell specific test parameters for CLI-RSSI event triggered reporting for PSCell in FR1**

Parameter	Unit	Test configuration	Cell 2	
			T1	T2
TDD configuration		1	TDDConf.1.1	
		2	TDDConf.2.1	
PDSCH RMC configuration		1	SR.1.1 TDD	
		2	SR.2.1 TDD	
RMSI CORESET RMC configuration		1	CR.1.1 TDD	
		2	CR.2.1 TDD	
Dedicated CORESET RMC configuration		1	CCR.1.1 TDD	
		2	CCR.2.1 TDD	
OCNG Patterns <sup>Note 3</sup>		1, 2	OP.1	
TRS Configuration		1	TRS.1.1 TDD	
		2	TRS.1.2 TDD	
Initial BWP configuration		1, 2	DLBWP.0.1 ULBWP.0.1	
Active DL BWP configuration		1, 2	DLBWP.1.1	
Active UL BWP configuration		1, 2	ULBWP.1.1	
$N_{oc}$ on CLI-RSSI measurement resource <sup>Note 2</sup>	dBm/15 kHz	1	-116	-108
		2		
$N_{oc}$ on CLI-RSSI measurement resource <sup>Note 2</sup>	dBm/SCS	1	-116	-108
		2	-113	-105
Io on CLI-RSSI measurement resource	dBm/9.36 MHz	1	-88.05	79.55
	dBm/38.16 MHz	2	-81.96	73.5
Io on CLI-RSSI measurement resource	dBm/1.08 MHz	1	-97.43	88.93
	dBm/1.08 MHz	2	-97.44	88.94
Propagation Condition		1, 2	AWGN	
NOTE 1: The resources for uplink transmission are assigned to the UE prior to the start of time period T2.				
NOTE 2: Interference from other cells and noise sources not specified in the test is assumed to be constant over subcarriers and time and shall be modelled as AWGN of appropriate power for $N_{oc}$ to be fulfilled.				
NOTE 3: OCNG is not transmitted in the CLI-RSSI measurement resources.				

**Table 4.6.5.2.5-2: CLI-RSSI measurement resource configuration for measurement reporting**

	Field	CLI-RSSICnf.1	CLI-RSSICnf.2
RSSI-Resource	rsi-ResourceId	0	0
	rsi-SCS	15	30
	startPRB	0	0
	nrofPRBs	52	106
	startPosition	3	3
	nrofSymbols	11	11
	rsi-PeriodicityAndOffset	sl20, 9	sl40, 19

The UE shall send one Event I1 triggered measurement report, with a measurement reporting delay less than 20 ms from the beginning of time period T2. The nominal RSSI used to evaluate the requirement shall be based on  $I_0$ .

The UE shall not send event triggered measurement reports, as long as the reporting criteria are not fulfilled.

The rate of correct events observed during repeated tests shall be at least 90%.

NOTE: The actual overall delays measured in the test may be up to  $2 \times TTI_{DCCH}$  higher than the measurement reporting delays above because of TTI insertion uncertainty of the measurement report in DCCH.

## 4.6.6

## 4.6.7 L1-SINR measurement for beam reporting

### 4.6.7.0 Minimum conformance requirements

#### 4.6.7.0.1 L1-SINR reporting with CSI-RS based CMR and no dedicated IMR configured

The UE shall be capable of performing L1-SINR measurements with the CSI-RS resource configured as CMR and no dedicated resource configured as IMR for L1-SINR computation, and the UE physical layer shall be capable of reporting L1-SINR measured over the measurement period of  $T_{L1-SINR\_Measurement\_Period\_CSI-RS\_CMR\_Only}$ .

The value of  $T_{L1-SINR\_Measurement\_Period\_CSI-RS\_CMR\_Only}$  is defined in Table 9.8.4.1-1 for FR1, where

For the value of M,

- For periodic and semi-persistent CSI-RS resources as CMR,  $M=1$  if higher layer parameter *timeRestrictionForChannelMeasurement* is configured, and  $M=3$  otherwise;
- For aperiodic CSI-RS resources as CMR,  $M=1$ .

For the value of P in FR1,

- $P = \frac{1}{1 - \frac{T_{CSI-RS}}{MRGP}}$ , when in the monitored cell there are measurement gaps configured for intra-frequency, inter-frequency or inter-RAT measurements, which are overlapping with some but not all occasions of the CSI-RS; and
- $P=1$  when in the monitored cell there are no measurement gaps overlapping with any occasion of the CSI-RS.

Where:

$T_{SMTCperiod}$  = the configured SMTC1 period or SMTC2 period if configured.

$T_{CSI-RS}$  = the periodicity of CSI-RS configured for L1-SINR measurement

If the high layer in TS 38.331 [2] signaling of *smtc2* is configured,  $T_{SMTCperiod}$  corresponds to the value of higher layer parameter *smtc2*; Otherwise  $T_{SMTCperiod}$  corresponds to the value of higher layer parameter *smtc1*.

Note: The overlap between CSI-RS for L1-SINR measurement and SMTC means that CSI-RS for L1-SINR measurement is within the SMTC window duration.

Longer evaluation period would be expected if the combination of CSI-RS, SMTC occasion and measurement gap configurations does not meet previous conditions.

**Table 9.8.4.1-1: Measurement period  $T_{L1-SINR\_Measurement\_Period\_CSI-RS\_CMR\_Only}$  for FR1**

Configuration	$T_{L1-SINR\_Measurement\_Period\_CSI-RS\_CMR\_Only}$ (ms)
non-DRX	$\max(T_{Report}, \text{ceil}(M \cdot P) \cdot T_{CSI-RS})$
DRX cycle $\leq 320$ ms	$\max(T_{Report}, \text{ceil}(1.5 \cdot M \cdot P) \cdot \max(T_{DRX}, T_{CSI-RS}))$
DRX cycle $> 320$ ms	$\text{ceil}(M \cdot P) \cdot T_{DRX}$
Note 1:	$T_{CSI-RS}$ is the periodicity of CSI-RS configured for L1-SINR measurement. $T_{DRX}$ is the DRX cycle length. $T_{Report}$ is configured periodicity for reporting.
Note 2:	the requirements are applicable provided that the CSI-RS resource configured for L1-SINR measurement is transmitted with Density = 3.

The UE shall send L1-SINR reports only for report configurations configured for the active BWP.

The UE shall report the L1-SINR value as a 7-bit value in the range [-23, 40] dB with 0.5dB step size if *nrofReportedRS* is configured to one. If *nrofReportedRS* is configured to be larger than one, or if *groupBasedBeamReporting* is enabled, the UE shall use differential L1-SINR based reporting. The differential L1-SINR is quantized to a 4-bit value with 1dB step size. The mapping between the reported L1-SINR value and the measured quantity is described in 10.1.16.

Reported L1-SINR measurements contained in aperiodic triggered, aperiodic triggered periodic and aperiodic triggered semi-persistent L1-SINR reports shall meet the requirements in clauses 10.1.27 for FR1 and 10.1.28 for FR2, respectively.

The UE shall only send aperiodic L1-SINR measurement reports, if a DCI for triggering report has been received.

After the UE receives CSI request in DCI, the UE shall transmit the aperiodic L1-SINR reporting on PUSCH over the air interface at the time specified according to clause 5.2.1.4 in TS 38.214 [26].

The UE is required to be capable of measuring L1-SINR without measurement gaps. The UE is required to perform the SSB and CSI-RS/CSI-IM measurements with measurement restrictions as described in the following clauses.

For both FR1 and FR2, when the CSI-RS configured for L1-SINR measurement is in the same OFDM symbol as SSB for RLM, BFD, CBD, L1-RSRP or L1-SINR measurement, UE is not required to receive CSI-RS for L1-SINR measurement in the PRBs that overlap with an SSB.

For FR1, when the SSB for RLM, BFD, CBD, L1-RSRP or L1-SINR measurement is within the active BWP and has same SCS than CSI-RS configured for L1-SINR measurement, the UE shall be able to perform CSI-RS measurement without restrictions.

For FR1, when the SSB for RLM, BFD, CBD, L1-RSRP or L1-SINR measurement is within the active BWP and has different SCS than CSI-RS configured for L1-SINR measurement, the UE shall be able to perform CSI-RS measurement with restrictions according to its capabilities:

- If the UE supports *simultaneousRxDataSSB-DiffNumerology*, UE shall be able to perform CSI-RS measurement without restrictions.
- If the UE does not support *simultaneousRxDataSSB-DiffNumerology*, UE is required to measure one of but not both CSI-RS for L1-SINR measurement and SSB. Longer measurement period for CSI-RS based L1-SINR measurement is expected, and no requirements are defined.

For FR1, when the CSI-RS configured for L1-SINR measurement is in the same OFDM symbol as another CSI-RS for RLM, BFD, CBD, L1-RSRP or L1-SINR measurement, UE shall be able to measure the CSI-RS for L1-SINR measurement without any restriction.

The normative reference for this requirement is TS 38.133 [6] clause 9.8.3, 9.8.4.1 and 9.8.5.2.

#### 4.6.7.0.2 L1-SINR reporting with SSB based CMR and dedicated IMR configured

The UE shall be capable of performing L1-SINR measurements with the SSB configured as CMR and dedicated resource configured as IMR for L1-SINR computation, in which the NZP-CSI-RS or CSI-IM resource configured as dedicated IMR shall be 1-to-1 mapped to SSB configured as CMR, with the same periodicity. The UE physical layer shall be capable of reporting L1-SINR measured over the measurement period of  $T_{L1-SINR\_Measurement\_Period\_SSB\_CMR\_IMR}$ .



The requirements in this clause are not applicable if NZP-CSI-RS or CSI-IM resource configured as dedicated IMR is scheduled with different periodicity as SSB configured as CMR.

The value of  $T_{L1-SINR\_Measurement\_Period\_SSB\_CMR\_IMR}$  is defined in Table 9.8.4.2-1 for FR1, where

For the value of M

- For periodic or semi-persistent NZP CSI-RS or CSI-IM resource as dedicated IMR, M=1 if the higher layer parameters *timeRestrictionForChannelMeasurements* and/or *timeRestrictionForInterferenceMeasurements* are configured, and M=3 otherwise;

P is defined as the maximum value between  $P_{CMR}$  and  $P_{IMR}$ , i.e.,  $P = \max(P_{CMR}, P_{IMR})$ , where

- the value of  $P_{CMR}$  shall be derived in the same way as the value of P used for SSB based L1-RSRP measurement in clause 9.5.4.1, in which the occasions and period of the SSB for CMR shall be used instead.
- the value of  $P_{IMR}$  shall be derived in the same way as the value of P used for CSI-RS based L1-RSRP measurement in clause 9.5.4.2, in which the occasions and period of the NZP CSI-RS for NZP-IMR or CSI-IM for ZP-IMR shall be used instead.

Longer evaluation period would be expected if the combination of SSB, SMTC occasion and measurement gap configurations does not meet pervious conditions.

For L1-SINR measurement with SSB as CMR and CSI-RS or CSI-IM as IMR, the requirement shall apply if the CSI-RS is configured as IMR with repetition field as “repetition = OFF” or CSI-IM is configured as IMR.

For L1-SINR measurement with SSB as CMR and CSI-RS/CSI-IM as IMR, no requirement shall apply if SSB occasions for CMR or CSI-RS/CSI-IM occasions for IMR are fully overlapped with the configured measurement gap.

**Table 9.8.4.2-1: Measurement period  $T_{L1-SINR\_Measurement\_Period\_SSB\_CMR\_IMR}$  for FR1**

Configuration	$T_{L1-SINR\_Measurement\_Period\_SSB\_CMR\_IMR}$ (ms)
non-DRX	$\max(T_{Report}, \text{ceil}(M \cdot P) \cdot T_{SSB})$
DRX cycle $\leq$ 320ms	$\max(T_{Report}, \text{ceil}(1.5 \cdot M \cdot P) \cdot \max(T_{DRX}, T_{SSB}))$
DRX cycle $>$ 320ms	$\text{ceil}(M \cdot P) \cdot T_{DRX}$
Note 1:	$T_{SSB}$ = <i>ssb-periodicityServingCell</i> is the periodicity of the SSB-Index configured for L1-SINR channel measurement. $T_{DRX}$ is the DRX cycle length. $T_{Report}$ is configured periodicity for reporting.
Note 2:	The requirements are applicable provided that the CSI-RS resource configured for interference measurement shall be 1-to-1 mapped to SSB configured for channel measurement, with the same periodicity.

The UE shall send L1-SINR reports only for report configurations configured for the active BWP.

The UE shall report the L1-SINR value as a 7-bit value in the range [-23, 40] dB with 0.5dB step size if *nrofReportedRS* is configured to one. If *nrofReportedRS* is configured to be larger than one, or if *groupBasedBeamReporting* is enabled, the UE shall use differential L1-SINR based reporting. The differential L1-SINR is quantized to a 4-bit value with 1dB step size. The mapping between the reported L1-SINR value and the measured quantity is described in 10.1.16.

The UE shall transmit the periodic L1-SINR reporting on PUCCH over the air interface according to the periodicity defined in clause 5.2.1.4 in TS 38.214 [26].

Reported L1-SINR measurements contained in periodic L1-SINR measurement reports shall meet the requirements in clauses 10.1.27 for FR1 and 10.1.28 for FR2, respectively.

For FR1, when the SSB configured as CMR for L1-SINR measurement is in the same OFDM symbol as CSI-RS for RLM, BFD, CBD, L1-RSRP or L1-SINR measurement,

- If SSB and CSI-RS have same SCS, UE shall be able to measure the SSB for L1-SINR measurement without any restriction;
- If SSB and CSI-RS have different SCS,
  - If UE supports *simultaneousRxDataSSB-DiffNumerology*, UE shall be able to measure the SSB for L1-SINR measurement without any restriction;

- If UE does not support *simultaneousRxDataSSB-DiffNumerology*, UE is required to measure one of but not both SSB for L1-SINR measurement and CSI-RS. Longer measurement period for SSB based L1-SINR measurement is expected, and no requirements are defined.

For both FR1 and FR2, when the CSI-RS configured for L1-SINR measurement is in the same OFDM symbol as SSB for RLM, BFD, CBD, L1-RSRP or L1-SINR measurement, UE is not required to receive CSI-RS for L1-SINR measurement in the PRBs that overlap with an SSB.

For FR1, when the SSB for RLM, BFD, CBD, L1-RSRP or L1-SINR measurement is within the active BWP and has same SCS than CSI-RS configured for L1-SINR measurement, the UE shall be able to perform CSI-RS measurement without restrictions.

For FR1, when the SSB for RLM, BFD, CBD, L1-RSRP or L1-SINR measurement is within the active BWP and has different SCS than CSI-RS configured for L1-SINR measurement, the UE shall be able to perform CSI-RS measurement with restrictions according to its capabilities:

- If the UE supports *simultaneousRxDataSSB-DiffNumerology*, UE shall be able to perform CSI-RS measurement without restrictions.
- If the UE does not support *simultaneousRxDataSSB-DiffNumerology*, UE is required to measure one of but not both CSI-RS for L1-SINR measurement and SSB. Longer measurement period for CSI-RS based L1-SINR measurement is expected, and no requirements are defined.

For FR1, when the CSI-RS configured for L1-SINR measurement is in the same OFDM symbol as another CSI-RS for RLM, BFD, CBD, L1-RSRP or L1-SINR measurement, UE shall be able to measure the CSI-RS for L1-SINR measurement without any restriction.

For both FR1 and FR2, when the CSI-IM configured for L1-SINR measurement is in the same OFDM symbol as SSB for RLM, BFD, CBD, L1-RSRP or L1-SINR measurement, UE is not required to measure CSI-IM for L1-SINR measurement in the PRBs that overlap with an SSB.

For FR1, UE shall be able to measure the CSI-IM configured for L1-SINR measurement without any restriction.

The normative reference for this requirement is TS 38.133 [6] clause 9.8.3, 9.8.4.2 and 9.8.5.

#### 4.6.7.0.3 L1-SINR reporting with CSI-RS based CMR and dedicated IMR configured

The UE shall be capable of performing L1-SINR measurements with the CSI-RS resource configured as CMR and dedicated resource configured as IMR for L1-SINR computation, in which the NZP-CSI-RS or CSI-IM resource configured as dedicated IMR shall be 1-to-1 mapped to CSI-RS resource configured as CMR, with the same periodicity. The UE physical layer shall be capable of reporting L1-SINR measured over the measurement period of  $T_{L1}$ .

$T_{L1}$  = SINR\_Measurement\_Period\_CSI-RS\_CMR\_IMR

The requirements in this clause are not applicable if NZP-CSI-RS or CSI-IM resource configured as dedicated IMR is scheduled with different periodicity as CSI-RS resource configured as CMR.

The value of  $T_{L1}$  = SINR\_Measurement\_Period\_CSI-RS\_CMR\_IMR is defined in Table 9.8.4.3-1 for FR1, where

For the value of M,

- M=1 shall be applied if
  - aperiodic NZP-CSI-RS as CMR or dedicated IMR, or
  - aperiodic CSI-IMR as dedicated IMR, or
  - periodic and semi-persistent NZP-CSI-RS as CMR or dedicated IMR and the higher layer parameters *timeRestrictionForChannelMeasurement* and/or *timeRestrictionForInterferenceMeasurements* are configured, or
  - periodic and semi-persistent CSI-IM as dedicated IMR and the higher layer parameters *timeRestrictionForChannelMeasurement* and/or *timeRestrictionForInterferenceMeasurements* are configured;
- M=3 otherwise.

P is defined as the maximum value between  $P_{\text{CMR}}$  and  $P_{\text{IMR}}$ , i.e.,  $P = \max(P_{\text{CMR}}, P_{\text{IMR}})$ , where

- The value of  $P_{\text{CMR}}$  and  $P_{\text{IMR}}$  shall be derived in the same way as the value of P used for CSI-RS based L1-RSRP measurement in clause 9.5.4.2, in which the occasions and period of the CSI-RS for CMR and NZP CSI-RS for NZP-IMR or CSI-IM for ZP-IMR shall be used instead respectively.

Longer evaluation period would be expected if the combination of CSI-RS, SMTTC occasion and measurement gap configurations does not meet pervious conditions.

For L1-SINR measurement with CSI-RS as CMR and CSI-RS as IMR, the requirement shall apply only if CSI-RS resources as CMR and IMR are configured with the same repetition field and the number of CSI-RS resources in the resource sets for CMR and IMR are same.

For L1-SINR measurement with CSI-RS as CMR and CSI-IM as IMR, the requirement shall apply only if the number of CSI-RS resources in the resource set for CMR and the number of CSI-IM resources in the resource set for IMR are same.

For L1-SINR measurement with CSI-RS as CMR and CSI-RS/CSI-IM as IMR, no requirement shall apply if CSI-RS occasions for CMR or CSI-RS/CSI-IM occasions for IMR are fully overlapped with the configured measurement gap.

**Table 9.8.4.3-1: Measurement period  $T_{\text{L1-SINR\_Measurement\_Period\_CSI-RS\_CMR\_IMR}}$  for FR1**

Configuration	$T_{\text{L1-SINR\_Measurement\_Period\_CSI-RS\_CMR\_IMR}}$ (ms)
non-DRX	$\max(T_{\text{Report}}, \text{ceil}(M \cdot P) \cdot T_{\text{CSI-RS}})$
DRX cycle $\leq 320\text{ms}$	$\max(T_{\text{Report}}, \text{ceil}(1.5 \cdot M \cdot P) \cdot \max(T_{\text{DRX}}, T_{\text{CSI-RS}}))$
DRX cycle $> 320\text{ms}$	$\text{ceil}(M \cdot P) \cdot T_{\text{DRX}}$
Note 1:	$T_{\text{CSI-RS}}$ is the periodicity of CSI-RS configured for L1-SINR measurement. $T_{\text{DRX}}$ is the DRX cycle length. $T_{\text{Report}}$ is configured periodicity for reporting.
Note 2:	the requirements are applicable provided that the CSI-RS resource configured for L1-SINR measurement is transmitted with Density = 3.
Note 3:	The requirements are applicable provided that the CSI-RS resource configured for interference measurement shall be 1-to-1 mapped to CSI-RS configured for channel measurement, with the same periodicity.

The UE shall send L1-SINR reports only for report configurations configured for the active BWP.

The UE shall report the L1-SINR value as a 7-bit value in the range [-23, 40] dB with 0.5dB step size if *nrofReportedRS* is configured to one. If *nrofReportedRS* is configured to be larger than one, or if *groupBasedBeamReporting* is enabled, the UE shall use differential L1-SINR based reporting. The differential L1-SINR is quantized to a 4-bit value with 1dB step size. The mapping between the reported L1-SINR value and the measured quantity is described in 10.1.16.

Reported L1-SINR measurements contained in aperiodic triggered, aperiodic triggered periodic and aperiodic triggered semi-persistent L1-SINR reports shall meet the requirements in clauses 10.1.27 for FR1 and 10.1.28 for FR2, respectively.

The UE shall only send aperiodic L1-SINR measurement reports, if a DCI for triggering report has been received.

After the UE receives CSI request in DCI, the UE shall transmit the aperiodic L1-SINR reporting on PUSCH over the air interface at the time specified according to clause 5.2.1.4 in TS 38.214 [26].

For both FR1 and FR2, when the CSI-RS configured for L1-SINR measurement is in the same OFDM symbol as SSB for RLM, BFD, CBD, L1-RSRP or L1-SINR measurement, UE is not required to receive CSI-RS for L1-SINR measurement in the PRBs that overlap with an SSB.

For FR1, when the SSB for RLM, BFD, CBD, L1-RSRP or L1-SINR measurement is within the active BWP and has same SCS than CSI-RS configured for L1-SINR measurement, the UE shall be able to perform CSI-RS measurement without restrictions.

For FR1, when the SSB for RLM, BFD, CBD, L1-RSRP or L1-SINR measurement is within the active BWP and has different SCS than CSI-RS configured for L1-SINR measurement, the UE shall be able to perform CSI-RS measurement with restrictions according to its capabilities:

- If the UE supports *simultaneousRxDataSSB-DiffNumerology*, UE shall be able to perform CSI-RS measurement without restrictions.
- If the UE does not support *simultaneousRxDataSSB-DiffNumerology*, UE is required to measure one of but not both CSI-RS for L1-SINR measurement and SSB. Longer measurement period for CSI-RS based L1-SINR measurement is expected, and no requirements are defined.

For FR1, when the CSI-RS configured for L1-SINR measurement is in the same OFDM symbol as another CSI-RS for RLM, BFD, CBD, L1-RSRP or L1-SINR measurement, UE shall be able to measure the CSI-RS for L1-SINR measurement without any restriction.

For both FR1 and FR2, when the CSI-IM configured for L1-SINR measurement is in the same OFDM symbol as SSB for RLM, BFD, CBD, L1-RSRP or L1-SINR measurement, UE is not required to measure CSI-IM for L1-SINR measurement in the PRBs that overlap with an SSB.

For FR1, UE shall be able to measure the CSI-IM configured for L1-SINR measurement without any restriction.

The normative reference for this requirement is TS 38.133 [6] clause 9.8.3, 9.8.4.3 and 9.8.5.

#### 4.6.7.1 EN-DC FR1 CSI-RS based CMR and no dedicated IMR L1-SINR measurement in non-DRX

##### 4.6.7.1.1 Test purpose

To verify that the UE makes correct reporting of L1-SINR measurement based on CSI-RS CMR without dedicated IMR in non-DRX within L1-SINR measurement requirements in TS 38.133 [6] clause 9.8.4.1.

##### 4.6.7.1.2 Test applicability

This test applies to all types of E-UTRA UE release 16 and forward, supporting EN-DC and L1-SINR measurement.

##### 4.6.7.1.3 Minimum conformance requirements

The minimum conformance requirements are specified in clause 4.6.7.0.1.

The normative reference for this requirement is TS 38.133 [6] clause A.4.6.7.1.

##### 4.6.7.1.4 Test description

###### 4.6.7.1.4.1 Initial conditions

This test shall be tested using any of the test configurations in Table 4.6.7.1.4.1-1. Configure the test equipment and the DUT according to the parameters in Table 4.6.7.1.4.1-2. Test environment parameters are given in Table 4.6.7.1.4.1-3.

**Table 4.6.7.1.4.1-1: EN-DC CSI-RS based CMR without dedicated IMR L1-SINR measurement supported test configurations**

Config	Description
1	LTE FDD, NR 15 kHz SSB SCS, 10 MHz bandwidth, FDD duplex mode
2	LTE FDD, NR 15 kHz SSB SCS, 10 MHz bandwidth, TDD duplex mode
3	LTE FDD, NR 30 kHz SSB SCS, 40 MHz bandwidth, TDD duplex mode
4	LTE TDD, NR 15 kHz SSB SCS, 10 MHz bandwidth, FDD duplex mode
5	LTE TDD, NR 15 kHz SSB SCS, 10 MHz bandwidth, TDD duplex mode
6	LTE TDD, NR 30 kHz SSB SCS, 40 MHz bandwidth, TDD duplex mode
Note:	The UE is only required to be tested in one of the supported test configurations

**Table 4.6.7.1.4.1-2: General test parameters for EN-DC CSI-RS based CMR without dedicated IMR L1-SINR measurement**

Parameter	Config	Unit	Value
SSB GSCN	1~6		freq1
Duplex mode	1,4		FDD
	2,5		TDD
	3,6		TDD
TDD Configuration	1,4		N/A
	2,5		TDDConf.1.1
	3,6		TDDConf.2.1
BW <sub>channel</sub>	1,4	MHz	10: N <sub>RB,c</sub> = 52
	2,5		10: N <sub>RB,c</sub> = 52
	3,6		40: N <sub>RB,c</sub> = 106
PDSCH Reference measurement channel	1,4		SR.1.1 FDD
	2,5		SR.1.1 TDD
	3,6		SR.2.1 TDD
RMSI CORESET Reference Channel	1,4		CR.1.1 FDD
	2,5		CR.1.1 TDD
	3,6		CR.2.1 TDD
Dedicated CORESET Reference Channel	1,4		CCR.1.1 FDD
	2,5		CCR.1.1 TDD
	3,6		CCR.2.1 TDD
SSB configuration	1,4		SSB.3 FR1
	2,5		SSB.3 FR1
	3,6		SSB.4 FR1
CSI-RS configuration	1,4		CSI-RS.1.3 FDD
	2,5		CSI-RS.1.3 TDD
	3,6		CSI-RS.2.3 TDD
OCNG Patterns	1~6		OP.1
TRS Configuration	1,4		TRS.1.1 FDD
	2,5		TRS.1.1 TDD
	3,6		TRS.1.2 TDD
Initial BWP Configuration	1~6		DLBWP.0.1 ULBWP.0.1
Dedicated BWP configuration	1~6		DLBWP.1.1 ULBWP.1.1
SMTC configuration	1~6		SMTC.1
DRX configuration	1~6		Off
reportConfigType	1~6		aperiodic
reportQuantity-r16	1~6		cri-SINR-r16
Number of reported RS	1~6		2
qcl-Info	1~6		SSB#0 for resource#0
			SSB#1 for resource#1
reportSlotOffsetList	1~6	slots	26
T1	1~6	s	5
EPRE ratio of PSS to SSS	1~6	dB	0
EPRE ratio of PBCH DMRS to SSS			
EPRE ratio of PBCH to PBCH DMRS			
EPRE ratio of PDCCH DMRS to SSS			
EPRE ratio of PDCCH to PDCCH DMRS			
EPRE ratio of PDSCH DMRS to SSS			
EPRE ratio of PDSCH to PDSCH DMRS			
EPRE ratio of OCNG DMRS to SSS <sup>Note 1</sup>			
EPRE ratio of OCNG to OCNG DMRS <sup>Note 1</sup>			
Propagation condition	1~6		AWGN
Note 1: OCNG shall be used such that both cells are fully allocated and a constant total transmitted power spectral density is achieved for all OFDM symbols.			

**Table 4.6.7.1.4.1-3: Test Environment parameters for EN-DC CSI-RS based CMR without dedicated IMR L1-SINR measurement**

Parameter	Value		Comment
Test environment	NC		As specified in TS 38.508-1 [14] clause 4.1.
Test frequencies	As specified in Annex E, Table E.2-1 and TS 38.508-1 [14] clause 4.3.1 and 4.4.2.		
Channel bandwidth	As specified by the test configuration selected from Table 4.6.7.1.4.1-1.		
Propagation conditions	AWGN		As specified in Annex C.2.2.
Connection Diagram	TE Part	A.3.1.8.2 with $n = 1$	As specified in TS 38.508-1 [14] Annex A.
	DUT Part	A.3.2.3.4	
Exceptions to connection diagram	For 4Rx capable UEs without any 2 Rx RF bands use A.3.2.5.2 for DUT part and A.3.1.8.5 for TE Part		

1. Message contents are defined in clause 4.6.7.1.4.3.
2. Cell 1 is the E-UTRA serving cell (PCell) for the EN-DC setup. The power levels and settings for Cell 1 are set according to Annex A.6. Cell 2 is NR FR1 cell (PSCell). Cell 2 is the target for CSI-RS based L1-SINR measurements. Before the test, UE is configured to perform RLM and BFD measurement based on the SSBs.

#### 4.6.7.1.4.2 Test procedure

The test consists of a single time period T1, during which the UE is triggered via DCI to report L1-SINR on aperiodic CSI-RS resources. Prior to the start of the time duration T1, the UE shall be fully synchronized to PSCell. UE is also configured to measure L1-SINR based on SSB. Upon receiving the DCI trigger, UE provides the report back based on the reporting configuration as defined in Table 4.6.7.1.4.1-2.

1. Ensure the UE is in state RRC\_CONNECTED with generic procedure parameters Connectivity EN-DC, DC bearer MCG and SCG, Connected without release  $On$  and Test Mode  $On$ , according to TS 38.508-1 [14] clause 4.5.
2. Set the parameters according to T1 in Table 4.6.7.1.5-1. T1 starts.
3. After 80ms from the start of the test the SS transmits the DCI trigger in slot 1 for configuration 1,2,4,5 and slot 8 for configuration 3, 6. The corresponding CSI-RS set is transmitted with the offset of 4 slots after the DCI trigger.
4. The UE shall send L1-SINR report at slot 26 from the reception of DCI trigger. The report shall contain L1-SINR of both CSI-RS#0 and CSI-RS#1.
5. The SS shall check following requirements:
  - R1: the UE shall send L1-SINR report at slot 26 from the reception of DCI trigger. If the report is received at slot 26 from the reception of DCI trigger, the number of passed iterations for R1 is increased by one. Otherwise, the number of failed iterations for R1 is increased by one.
  - R2: The L1-SINR value of CSI-RS#1 reported by the UE is compared to the expected L1-SINR value for CSI-RS #1. If the resulting value is outside the limits in Table 4.6.7.1.5-2 for all test configurations or the UE fails to report the measurement value for CSI-RS #1, the number of failed iterations for R2 is increased by one. Otherwise, the number of passed iterations for R2 is increased by one.
  - R3: The DIFF SINR value of CSI-RS#0 reported by the UE is compared to the expected DIFF SINR value. If the resulting value is outside the limits in Table 4.6.7.1.5-4 for all test configurations or the UE fails to report the measurement value for CSI-RS #0, the number of failed iterations for R3 is increased by one. Otherwise, the number of passed iterations for R3 is increased by one.
6. The SS shall transmit *RRCConnectionReconfiguration* message with condition EN-DC\_PSCell\_Rel according to TS 36.508 [25] Table 4.6.1-8 to release NR cell (PSCell). The UE shall transmit *RRCConnectionReconfigurationComplete* message.

7. The SS then shall transmit *RRCConnectionReconfiguration* message with condition MCG\_and\_SCG according to TS 36.508 [25] Table 4.6.1-8 to add NR cell (PSCell). The UE shall transmit *RRCConnectionReconfigurationComplete* message.
8. If any the reconfiguration fails, switch off and on the UE and ensure the UE is in RRC\_CONNECTED with generic procedure parameters Connectivity EN-DC, DC bearer MCG and SCG, Connected without release On and Test Mode *On* according to TS 38.508-1 [14] clause 4.5.
9. Repeat steps 2-8 until the confidence level according to Tables G.2.3-1 in Annex G clause G.2 is achieved.

4.6.7.1.4.3 Message contents

Message contents are according to TS 38.508-1 [14] clause 7.3 with the following exceptions:

**Table 4.6.7.1.4.3-1: Common Exception messages EN-DC CSI-RS based CMR without dedicated IMR L1-SINR measurement**

Default Message Contents	
Common contents of system information blocks exceptions	
Default RRC messages and information elements contents exceptions	Table H.3.6A-1 with conditions APERIODIC and CSI-SINR Table H.3.6A-2 with conditions CSI-RS and APERIODIC

**Table 4.6.7.1.4.3-2: RadioLinkMonitoringConfig**

Derivation Path: TS 38.508-1 [14], Table 4.6.3-133			
Information Element	Value/remark	Comment	Condition
RadioLinkMonitoringConfig ::= SEQUENCE {			
failureDetectionResourcesToAddModList	1 entry		
SEQUENCE (SIZE(1..maxNrofFailureDetectionResources)) OF			
SEQUENCE {			
purpose	both	UE is configured to perform RLM and BFD based on the SSBs.	
}			
}			

4.6.7.1.5 Test requirement

Table 4.6.7.1.5-1 defines the primary level settings including test tolerances for all tests.

**Table 4.6.7.1.5-1: CSI-RS specific test parameters for EN-DC CSI-RS based CMR without dedicated IMR L1-SINR measurement**

Parameter	Config	Unit	CSI-RS#0	CSI-RS#1
$N_{oc}$ <sup>Note1</sup>	1~6	dBm/15kHz	-94.65	
$N_{oc}$ <sup>Note1</sup>	1,2,4,5	dBm/SSB SCS	-94.65	
	3,6		-91.65	
$\hat{E}_s / I_{ot}$	1~6	dB	0	3
CSI-RS RSRP <sup>Note3</sup>	1,2,4,5	dBm/SSB SCS	-94.65	-91.65
	3,6		-91.65	-88.65
$I_o$ <sup>Note2</sup>	1,2,4,5	dBm/9.36 MHz	-63.69	-61.93
	3,6	dBm/38.16 MHz	-57.59	-55.84
$\hat{E}_s / N_{oc}$	1~6	dB	0	3
Note 1: xxx? Note 2: Interference from other cells and noise sources not specified in the test is assumed to be constant over subcarriers and time and shall be modelled as AWGN of appropriate power for $N_{oc}$ to be fulfilled. Note 3: CSI-RS RSRP and $I_o$ levels have been derived from other parameters for information purposes. They are not settable parameters themselves.				

After 80ms from the beginning of the test, the UE shall send L1-SINR report at slot 26 from the reception of DCI triggering the L1-SINR measurement. The L1-SINR report shall include the results for both CSI-RS#0 and CSI-RS#1.

Each L1-SINR measurement report shall meet the corresponding absolute accuracy requirements in Table 4.6.7.1.5-2 for all test configurations and the corresponding relative accuracy requirements in Table 4.6.7.1.5-4 for all test configurations.

**Table 4.6.7.1.5-2: L1-SINR absolute accuracy requirements for the reported values for all test configurations**

Normal Conditions	T1
Lowest reported value (CSI-RS#1)	41
Highest reported value (CSI-RS#1)	64

**Table 4.6.7.1.5-3: Void**

**Table 4.6.7.1.5-4: L1-SINR relative accuracy requirements for the reported values for all test configurations**

Normal Conditions	T1
Lowest DIFF SINR reported (CSI-RS#0)	0
Highest DIFF SINR reported (CSI-RS#0)	7

For the test to pass, the ratio of successful reported values for each requirement (R1 to R3) shall be more than 90% with a confidence level of 95%. Each requirement is evaluated independently of the others..

NOTE: The actual overall delays measured in the test may be up to  $2 \times TTI_{DCCH}$  higher than the measurement reporting delays above because of TTI insertion uncertainty of the measurement report in DCCH.



#### 4.6.7.2 EN-DC FR1 SSB based CMR and dedicated IMR L1-SINR measurement in DRX

##### 4.6.7.2.1 Test purpose

To verify that the UE makes correct reporting of SSB-based CMR and CSI-IM based IMR L1-SINR measurement in DRX within L1-SINR measurement requirements based in TS 38.133 [6] clause 9.8.4.2.

##### 4.6.7.2.2 Test applicability

This test applies to all types of E-UTRA UE release 16 and forward, supporting EN-DC FR1 and long DRX cycle and L1-SINR measurement.

##### 4.6.7.2.3 Minimum conformance requirements

The minimum conformance requirements are specified in clause 4.6.7.0.2.

The normative reference for this requirement is TS 38.133 [6] clause A.4.6.7.2.

##### 4.6.7.2.4 Test description

###### 4.6.7.2.4.1 Initial conditions

This test shall be tested using any of the test configurations in Table 4.6.7.2.4.1-1. Configure the test equipment and the DUT according to the parameters in Table 4.6.7.2.4.1-2. Test environment parameters are given in Table 4.6.7.2.4.1-3.

**Table 4.6.7.2.4.1-1: EN-DC SSB based CMR and CSI-IM based IMR L1-SINR measurement in DRX supported test configurations**

Config	Description
1	LTE FDD, NR 15 kHz SSB SCS, 10 MHz bandwidth, FDD duplex mode
2	LTE FDD, NR 15 kHz SSB SCS, 10 MHz bandwidth, TDD duplex mode
3	LTE FDD, NR 30 kHz SSB SCS, 40 MHz bandwidth, TDD duplex mode
4	LTE TDD, NR 15 kHz SSB SCS, 10 MHz bandwidth, FDD duplex mode
5	LTE TDD, NR 15 kHz SSB SCS, 10 MHz bandwidth, TDD duplex mode
6	LTE TDD, NR 30 kHz SSB SCS, 40 MHz bandwidth, TDD duplex mode
Note:	The UE is only required to be tested in one of the supported test configurations

**Table 4.6.7.2.4.1-2: General test parameters for EN-DC SSB based CMR and CSI-IM based IMR L1-SINR measurement in DRX**

Parameter	Config	Unit	Value
SSB GSCN	1~6		freq1
Duplex mode	1,4		FDD
	2,5		TDD
	3,6		TDD
TDD Configuration	1,4		N/A
	2,5		TDDConf.1.1
	3,6		TDDConf.2.1
BW <sub>channel</sub>	1,4	MHz	10: N <sub>RB,c</sub> = 52
	2,5		10: N <sub>RB,c</sub> = 52
	3,6		40: N <sub>RB,c</sub> = 106
PDSCH Reference measurement channel	1,4		SR.1.1 FDD
	2,5		SR.1.1 TDD
	3,6		SR.2.1 TDD
RMSI CORESET Reference Channel	1,4		CR.1.1 FDD
	2,5		CR.1.1 TDD
	3,6		CR.2.1 TDD
Dedicated CORESET Reference Channel	1,4		CCR.1.1 FDD
	2,5		CCR.1.1 TDD
	3,6		CCR.2.1 TDD
SSB configuration	1,4		SSB.3 FR1
	2,5		SSB.3 FR1
	3,6		SSB.4 FR1
CSI-IM configuration	1,4		CSI-IM.1.1 FDD
	2,5		CSI-IM.1.1 TDD
	3,6		CSI-IM.2.1 TDD
OCNG Patterns	1~6		OP.1
Initial BWP Configuration	1~6		DLBWP.0.1 ULBWP.0.1
Dedicated BWP configuration	1~6		DLBWP.1.1 ULBWP.1.1
SMTc configuration	1~6		SMTc.1
TRS Configuration	1,4		TRS.1.1 FDD
	2,5		TRS.1.1 TDD
	3,6		TRS.1.2 TDD
DRX configuration	1~6		DRX.3
reportConfigType	1~6		periodic
reportQuantity-r16	1~6		ssb-Index-SINR-r16
Number of reported RS	1~6		2
L1-SINR reporting period	1~6	slot	80
T1	1~6	s	5
T2	1~6	s	1
EPRE ratio of PSS to SSS	1~6	dB	0
EPRE ratio of PBCH DMRS to SSS			
EPRE ratio of PBCH to PBCH DMRS			
EPRE ratio of PDCCH DMRS to SSS			
EPRE ratio of PDCCH to PDCCH DMRS			
EPRE ratio of PDSCH DMRS to SSS			
EPRE ratio of PDSCH to PDSCH DMRS			
EPRE ratio of OCNG DMRS to SSS <sup>Note 1</sup>			
EPRE ratio of OCNG to OCNG DMRS <sup>Note 1</sup>			
Propagation condition			
Note 1: OCNG shall be used such that both cells are fully allocated and a constant total transmitted power spectral density is achieved for all OFDM symbols.			

**Table 4.6.7.2.4.1-3: Test Environment parameters for EN-DC SSB based CMR and CSI-IM based IMR L1-SINR measurement in DRX**

Parameter	Value		Comment
Test environment	NC		As specified in TS 38.508-1 [14] clause 4.1.
Test frequencies	As specified in Annex E, Table E.2-1 and TS 38.508-1 [14] clause 4.3.1 and 4.4.2.		
Channel bandwidth	As specified by the test configuration selected from Table 4.6.7.2.4.1-1.		
Propagation conditions	AWGN		As specified in Annex C.2.2.
Connection Diagram	TE Part	A.3.1.8.2 with $n = 1$ TBD	As specified in TS 38.508-1 [14] Annex A.
	DUT Part	A.3.2.3.4TBD	
Exceptions to connection diagram	For 4Rx capable UEs without any 2 Rx RF bands use A.3.2.5.2 for DUT part and A.3.1.8.5 for TE Part		

1. Message contents are defined in clause 4.6.7.2.4.3.
2. Cell 1 is the E-UTRA serving cell (PCell) for the EN-DC setup. The power levels and settings for Cell 1 are set according to Annex A.6. Cell 2 is NR FR1 cell (PSCell). Cell 2 is the target for SSB based CMR and CSI-IM based IMR L1-SINR measurements. Before the test, UE is configured to perform RLM and BFD based on the SSBs. DRX is configured as specified in Table 4.6.7.2.4.1-2.

#### 4.6.7.2.4.2 Test procedure

Prior to the start of the time duration T1, the UE shall be fully synchronized to PSCell. The UE shall be configured for periodic CSI reporting in PUCCH [format 2] with a reporting periodicity as mentioned in the above Table 4.6.7.2.4.1-2. Before the test, UE is configured to perform RLM, BFD and L1-SINR measurement based on the SSBs.

1. Ensure the UE is in state RRC\_CONNECTED with generic procedure parameters Connectivity EN-DC, DC bearer MCG and SCG, Connected without release  $On$  and Test Mode  $On$ , according to TS 38.508-1 [14] clause 4.5 and general test parameters set according to Table 4.6.7.2.4.1-2.
2. Set the parameters according to T1 in Table 4.6.7.2.5-1. T1 starts.
5. The UE shall be transmitting CSI on PUCCH with a periodicity of 80 slots.
6. When T1 expires, the SS shall set the parameters according to T2 in 4.6.7.2.5-1. T2 starts.
7. The UE shall start sending L1-SINR reports. The SS shall check following requirements:
  - R1: the UE shall start to transmit valid reports no later than 720 ms for configuration 1, 2, 4 and 5 and no later than 680 ms for configuration 3 and 6 from the beginning of time period T2. A valid report shall meet the absolute L1-SINR requirement for SSB#1 in Table 4.6.7.2.5-2 for all test configurations and the relative L1-SINR requirement for SSB#0 in Table 4.6.7.2.5-4 for all test configurations. If the first valid report is received earlier than the specified time, the number of passed iterations for R1 is increased by one. Otherwise, the number of failed iterations for R1 is increased by one.
  - R2: the UE shall transmit reports every 80 slots until the end of time period T2. If the reports are received accordingly, the number of passed iterations for R2 is increased by one. Otherwise, the number of failed iterations for R2 is increased by one.
  - R3: The L1-SINR value of SSB#1 reported by the UE is compared to the expected L1-SINR value for SSB#1. In all consecutive reports after the first valid value is received, if the resulting value is outside the limits in Table 4.6.7.2.5-2 for all test configurations or the UE fails to report the measurement value for SSB#1, the number of failed iterations for R3 is increased by one. Otherwise, the number of passed iterations for R3 is increased by one.
  - R4: The DIFF SINR value of SSB#0 reported by the UE is compared to the expected DIFF SINR value. In all consecutive reports after the first valid value is received, if the resulting value is outside the limits in Table 4.6.7.2.5-2 for all test configurations or the UE fails to report the measurement value for SSB#0, the number of failed iterations for R4 is increased by one. Otherwise, the number of passed iterations for R4 is increased by one..

8. The SS waits until T2 expires.
9. The SS shall transmit *RRCCONNECTIONRECONFIGURATION* message with condition EN-DC\_PSCell\_Rel according to TS 36.508 [25] Table 4.6.1-8 to release NR cell (PSCell). The UE shall transmit *RRCCONNECTIONRECONFIGURATIONCOMPLETE* message.
10. The SS then shall transmit *RRCCONNECTIONRECONFIGURATION* message with condition MCG\_and\_SCG according to TS 36.508 [25] Table 4.6.1-8 to add NR cell (PSCell). The UE shall transmit *RRCCONNECTIONRECONFIGURATIONCOMPLETE* message.
11. If any the reconfiguration fails, switch off and on the UE and ensure the UE is in RRC\_CONNECTED with generic procedure parameters Connectivity EN-DC, DC bearer MCG and SCG, Connected without release On and Test Mode On according to TS 38.508-1 [14] clause 4.5.
12. Repeat steps 2-11 until the confidence level according to Tables G.2.3-1 in Annex G clause G.2 is achieved.

4.6.7.2.4.3 Message contents

Message contents are according to TS 38.508-1 [14] clause 7.3 with the following exceptions:

**Table 4.6.7.2.4.3-1: Common Exception messages EN-DC SSB based CMR and CSI-IM based IMR L1-SINR measurement**

Default Message Contents	
Common contents of system information blocks exceptions	
Default RRC messages and information elements contents exceptions	Table H.3.6A-1 with conditions PERIODIC and SS-SINR and CSI-IM_IMR Table H.3.6A-2 with conditions SSB and PERIODIC Table H.3.6A-4 with condition PERIODIC Table H.3.7-1 with condition DRX.3

**Table 4.6.7.2.4.3-2: RadioLinkMonitoringConfig**

Derivation Path: TS 38.508-1 [14], Table 4.6.3-133			
Information Element	Value/remark	Comment	Condition
RadioLinkMonitoringConfig ::= SEQUENCE {			
failureDetectionResourcesToAddModList	1 entry		
SEQUENCE			
(SIZE(1..maxNrofFailureDetectionResources)) OF			
SEQUENCE {			
purpose	both	UE is configured to perform RLM and BFD based on the SSBs.	
detectionResource CHOICE {			
ssb-Index	0		
}			
}			
}			

4.6.7.2.5 Test requirement

Table 4.6.7.2.5-1 defines the primary level settings including test tolerances for all tests.

**Table 4.6.7.2.5-1: SSB specific test parameters for EN-DC SSB based CMR and CSI-IM based IMR L1-SINR measurement in DRX**

Parameter	Config	Unit	SSB#0		SSB#1	
			T1	T2	T1	T2

$N_{oc}$ <sup>Note2</sup>	1~6	dBm/15kHz	-94.65+TT			
$N_{oc}$ <sup>Note2</sup>	1,2,4,5	dBm/SSB SCS	-94.65+TT			
	3,6		-91.65+TT			
$\hat{E}_s / I_{ot}$	1~6	dB	0+TT	0+TT	0+TT	0+TT
SS-RSRP <sup>Note3</sup>	1,2,4,5	dBm/SSB SCS	- 94.65+ TT	- 94.65+ TT	- 94.65+ TT	- 94.65+ TT
	3,6		- 91.65+ TT	- 91.65+ TT	- 91.65+ TT	- 91.65+ TT
$I_o$ <sup>Note3</sup>	1,2,4,5	dBm/9.36 MHz	- 63.69+ TT	- 63.69+ TT	- 63.69+ TT	- 63.69+ TT
	3,6	dBm/38.16 MHz	- 57.59+ TT	- 57.59+ TT	- 57.59+ TT	- 57.59+ TT
$\hat{E}_s / N_{oc}$	1~6	dB	0+TT	0+TT	0+TT	0+TT
<p>Note 1: The resources for uplink transmission are assigned to the UE prior to the start of time period T2.</p> <p>Note 2: Interference from other cells and noise sources not specified in the test is assumed to be constant over subcarriers and time and shall be modelled as AWGN of appropriate power for <math>N_{oc}</math> to be fulfilled.</p> <p>Note 3: SS-RSRP and <math>I_o</math> levels have been derived from other parameters for information purposes. They are not settable parameters themselves.</p>						

The UE shall send L1-SINR report every 80 slots. No later than 640ms plus 80 slots from the beginning of time period T2, UE shall send L1-SINR report including results of both SSB#0+CSI-IM#0 and SSB#1+CSI-IM#1. Each L1-SINR measurement report shall meet the corresponding absolute accuracy requirements in Table 4.6.7.2.5-2 for all test configurations and the corresponding relative accuracy requirements in Table 4.6.7.2.5-4 for all test configurations.

**Table 4.6.7.2.5-2: L1-SINR absolute accuracy requirements for the reported values for all test configurations**

Normal Conditions	T1	T2
Lowest reported value (SSB#1)	-	TBD43
Highest reported value (SSB#1)	-	TBD62

**Table 4.6.7.2.5-3: Void**

**Table 4.6.7.2.5-4: L1-SINR relative accuracy requirements for the reported values for all test configurations**

Normal Conditions	T1	T2
Lowest DIFF SINR reported (SSB#0)	-	TBD0
Highest DIFF SINR reported (SSB#0)	-	TBD6

For the test to pass, the ratio of successful reported values for each requirement (R1 to R4) shall be more than 90% with a confidence level of 95%. Each requirement is evaluated independently of the others..

NOTE: The actual overall delays measured in the test may be up to  $2xTTI_{DCCH}$  higher than the measurement reporting delays above because of TTI insertion uncertainty of the measurement report in DCCH.

### 4.6.7.3 EN-DC FR1 CSI-RS based CMR and dedicated IMR L1-SINR measurement in DRX

#### 4.6.7.3.1 Test purpose

To verify that the UE makes correct reporting of CSI-RS-based CMR and dedicated IMR L1-SINR measurement in DRX within L1-SINR measurement requirements in TS 38.133 [6] clause 9.8.4.3.

#### 4.6.7.3.2 Test applicability

This test applies to all types of E-UTRA UE release 16 and forward, supporting EN-DC FR1 and L1-SINR measurement and long DRX cycle.

#### 4.6.7.3.3 Minimum conformance requirements

The minimum conformance requirements are specified in clause 4.6.7.0.3.

The normative reference for this requirement is TS 38.133 [6] clause A.4.6.7.3.

#### 4.6.7.3.4 Test description

##### 4.6.7.3.4.1 Initial conditions

This test shall be tested using any of the test configurations in Table 4.6.7.3.4.1-1. Configure the test equipment and the DUT according to the parameters in Table 4.6.7.3.4.1-2. Test environment parameters are given in Table 4.6.7.3.4.1-3.

**Table 4.6.7.3.4.1-1: EN-DC CSI-RS based CMR and dedicated IMR L1-SINR measurement in DRX supported test configurations**

Config	Description
1	LTE FDD, NR 15 kHz SSB SCS, 10 MHz bandwidth, FDD duplex mode
2	LTE FDD, NR 15 kHz SSB SCS, 10 MHz bandwidth, TDD duplex mode
3	LTE FDD, NR 30 kHz SSB SCS, 40 MHz bandwidth, TDD duplex mode
4	LTE TDD, NR 15 kHz SSB SCS, 10 MHz bandwidth, FDD duplex mode
5	LTE TDD, NR 15 kHz SSB SCS, 10 MHz bandwidth, TDD duplex mode
6	LTE TDD, NR 30 kHz SSB SCS, 40 MHz bandwidth, TDD duplex mode
Note:	The UE is only required to be tested in one of the supported test configurations

**Table 4.6.7.3.4.1-2: General test parameters for EN-DC CSI-RS based CMR and dedicated IMR L1-SINR measurement in DRX**



Parameter	Config	Unit	Value
SSB GSCN	1~6		freq1
Duplex mode	1,4		FDD
	2,5		TDD
	3,6		TDD
TDD Configuration	1,4		N/A
	2,5		TDDConf.1.1
	3,6		TDDConf.2.1
BW <sub>channel</sub>	1,4	MHz	10: N <sub>RB,c</sub> = 52
	2,5		10: N <sub>RB,c</sub> = 52
	3,6		40: N <sub>RB,c</sub> = 106
PDSCH Reference measurement channel	1,4		SR.1.1 FDD
	2,5		SR.1.1 TDD
	3,6		SR.2.1 TDD
RMSI CORESET Reference Channel	1,4		CR.1.1 FDD
	2,5		CR.1.1 TDD
	3,6		CR.2.1 TDD
Dedicated CORESET Reference Channel	1,4		CCR.1.1 FDD
	2,5		CCR.1.1 TDD
	3,6		CCR.2.1 TDD
SSB configuration	1,4		SSB.3 FR1
	2,5		SSB.3 FR1
	3,6		SSB.4 FR1
CSI-RS configuration as CMR	1,4		CSI-RS.1.3 FDD
	2,5		CSI-RS.1.3 TDD
	3,6		CSI-RS.2.3 TDD
CSI-RS configuration as IMR	1,4		CSI-RS.1.2A FDD
	2,5		CSI-RS.1.2A TDD
	3,6		CSI-RS.2.2A TDD
OCNG Patterns	1~6		OP.1
TRS Configuration	1,4		TRS.1.1 FDD
	2,5		TRS.1.1 TDD
	3,6		TRS.1.2 TDD
Initial BWP Configuration	1~6		DLBWP.0.1 ULBWP.0.1
Dedicated BWP configuration	1~6		DLBWP.1.1 ULBWP.1.1
SMTc configuration	1~6		SMTc.1
DRX configuration	1~6		DRX.3
reportConfigType	1~6		aperiodic
reportQuantity-r16	1~6		cri-SINR-r16
Number of reported RS	1~6		2
qcl-Info	1~6		SSB#0 for resource#0
			SSB#1 for resource#1
reportSlotOffsetList	1~6	slots	26
T1	1~6	s	5
EPRE ratio of PSS to SSS	1~6	dB	0
EPRE ratio of PBCH DMRS to SSS			
EPRE ratio of PBCH to PBCH DMRS			
EPRE ratio of PDCCH DMRS to SSS			
EPRE ratio of PDCCH to PDCCH DMRS			
EPRE ratio of PDSCH DMRS to SSS			
EPRE ratio of PDSCH to PDSCH DMRS			
EPRE ratio of OCNG DMRS to SSS <sup>Note 1</sup>			
EPRE ratio of OCNG to OCNG DMRS <sup>Note 1</sup>			
Propagation condition			
Note 1: OCNG shall be used such that both cells are fully allocated and a constant total transmitted power spectral density is achieved for all OFDM symbols.			

**Table 4.6.7.3.4.1-3: Test Environment parameters for EN-DC CSI-RS based CMR and dedicated IMR L1-SINR measurement in DRX**

Parameter	Value		Comment
Test environment	NC		As specified in TS 38.508-1 [14] clause 4.1.
Test frequencies	As specified in Annex E, Table E.2-1 and TS 38.508-1 [14] clause 4.3.1 and 4.4.2.		
Channel bandwidth	As specified by the test configuration selected from Table 4.6.7.3.4.1-1.		
Propagation conditions	AWGN		As specified in Annex C.2.2.
Connection Diagram	TE Part	A.3.1.8.2 with $n = 1$	As specified in TS 38.508-1 [14] Annex A.
	DUT Part	A.3.2.3.4	
Exceptions to connection diagram	For 4Rx capable UEs without any 2 Rx RF bands use A.3.2.5.2 for DUT part and A.3.1.8.5 for TE Part		

1. Message contents are defined in clause 4.6.7.3.4.3.
2. Cell 1 is the E-UTRA serving cell (PCell) for the EN-DC setup. The power levels and settings for Cell 1 are set according to Annex A.6. Cell 2 is NR FR1 cell (PSCell). Cell 2 is the target for CSI-RS based CMR and dedicated IMR L1-SINR measurements. Before the test, UE is configured to perform RLM and BFD measurement based on the SSBs. DRX is configured as specified in Table 4.6.7.3.4.1-2.

#### 4.6.7.3.4.2 Test procedure

The test consists of a single time period T1, during which the UE is triggered via DCI to report L1-SINR on aperiodic CSI-RS resources. Prior to the start of the time duration T1, the UE shall be fully synchronized to PSCell. UE is also configured to measure L1-SINR based on SSB. Upon receiving the DCI trigger, UE provides the report back based on the reporting configuration as defined in table 4.6.7.3.4.1-2.

1. Ensure the UE is in state RRC\_CONNECTED with generic procedure parameters Connectivity EN-DC, DC bearer MCG and SCG, Connected without release  $O_n$  and Test Mode  $O_n$ , according to TS 38.508-1 [14] clause 4.5.
2. Set the parameters according to T1 in Table 4.6.7.3.5-1. T1 starts.
3. After 80ms from the start of the test the SS transmits the DCI trigger in slot 1 for configuration 1,2,4,5 and slot 8 for configuration 3, 6. The corresponding CSI-RS as CMR and the associated CSI-RS as IMR are transmitted with the offset of 4 slots and 6 slots after the DCI trigger, respectively.
4. The UE shall send L1-SINR report at slot 26 from the reception of DCI trigger. The report shall contain L1-SINR of both CSI-RS#0 and CSI-RS#1.
5. The SS shall check following requirements:
  - R1: the UE shall send L1-SINR report at slot 26 from the reception of DCI trigger. If the report is received at slot 26 from the reception of DCI trigger, the number of passed iterations for R1 is increased by one. Otherwise, the number of failed iterations for R1 is increased by one.
  - R2: The L1-SINR value of CSI-RS#1 reported by the UE is compared to the expected L1-SINR value for CSI-RS #1. If the resulting value is outside the limits in Table 4.6.7.3.5-2 for all test configurations or the UE fails to report the measurement value for CSI-RS #1, the number of failed iterations for R2 is increased by one. Otherwise, the number of passed iterations for R2 is increased by one.
  - R3: The DIFF SINR value of CSI-RS#0 reported by the UE is compared to the expected DIFF SINR value. If the resulting value is outside the limits in Table 4.6.7.3.5-4 for all test configurations or the UE fails to report the measurement value for CSI-RS #0, the number of failed iterations for R3 is increased by one. Otherwise, the number of passed iterations for R3 is increased by one.
6. The SS shall transmit *RRCConnectionReconfiguration* message with condition EN-DC\_PSCell\_Rel according to TS 36.508 [25] Table 4.6.1-8 to release NR cell (PSCell). The UE shall transmit *RRCConnectionReconfigurationComplete* message.

7. The SS then shall transmit *RRCConnectionReconfiguration* message with condition MCG\_and\_SCG according to TS 36.508 [25] Table 4.6.1-8 to add NR cell (PSCell). The UE shall transmit *RRCConnectionReconfigurationComplete* message.
8. If any the reconfiguration fails, switch off and on the UE and ensure the UE is in RRC\_CONNECTED with generic procedure parameters Connectivity EN-DC, DC bearer MCG and SCG, Connected without release On and Test Mode On according to TS 38.508-1 [14] clause 4.5.
9. Repeat steps 2-8 until the confidence level according to Tables G.2.3-1 in Annex G clause G.2 is achieved.

4.6.7.3.4.3 Message contents

Message contents are according to TS 38.508-1 [14] clause 7.3 with the following exceptions:

**Table 4.6.7.3.4.3-1: Common Exception messages EN-DC CSI-RS based CMR and dedicated IMR L1-SINR measurement in DRX**

Default Message Contents	
Common contents of system information blocks exceptions	
Default RRC messages and information elements contents exceptions	Table H.3.6A-1 with conditions APERIODIC and CSI-SINR and CSI-RS_IMR Table H.3.6A-2 with conditions CSI-RS and APERIODIC Table H.3.6A-3 with conditions APERIODIC Table H.3.7-1 with condition DRX.3

4.6.7.3.5 Test requirement

Table 4.6.7.3.5-1 defines the primary level settings including test tolerances for all tests.

**Table 4.6.7.3.5-1: CSI-RS specific test parameters for EN-DC CSI-RS based CMR and dedicated IMR L1-SINR measurement in DRX**

Parameter	Config	Unit	CSI-RS#0	CSI-RS#1
$N_{oc}$ <sup>Note1</sup>	1~6	dBm/15kHz	-94.65	
$N_{oc}$ <sup>Note1</sup>	1,2,4,5	dBm/SSB SCS	-94.65	
	3,6		-91.65	
$\hat{E}_s / I_{ot}$	1~6	dB	0.5	3
$\hat{E}_s / N_{oc}$	1~6	dB	0.5	3
CSI-RS RSRP <sup>Note2</sup>	1,2,4,5	dBm/SSB SCS	-94.15	-91.65
	3,6		-91.14	-88.65
$I_o$ <sup>Note2</sup>	1,2,4,5	dBm/9.36 MHz	-63.43	-61.93
	3,6	dBm/38.16 MHz	-57.33	-55.84
<p>Note 1: Interference from other cells and noise sources not specified in the test is assumed to be constant over subcarriers and time and shall be modelled as AWGN of appropriate power for <math>N_{oc}</math> to be fulfilled.</p> <p>Note 2: CSI-RS RSRP and <math>I_o</math> levels have been derived from other parameters for information purposes. They are not settable parameters themselves.</p>				

After 80ms from the beginning of the test, the UE shall send L1-RSRP report at slot 26 from the reception of DCI triggering the L1-SINR measurement. The L1-SINR report shall include the results for both CSI-RS#0 as CMR + CSI-RS#0 as IMR and CSI-RS#1 as CMR + CSI-RS#1 as IMR.

Each L1-SINR measurement report shall meet the corresponding absolute accuracy requirements in Table 4.6.7.3.5-2 for all configurations and the corresponding relative accuracy requirements in Table 4.6.7.3.5-4 for all test configurations.

**Table 4.6.7.3.5-2: L1-SINR absolute accuracy requirements for the reported values for test configurations 1, 2, 4 and 5**

Normal Conditions	T1
Lowest reported value (CSI-RS#1)	44
Highest reported value (CSI-RS#1)	61

**Table 4.6.7.3.5-3: Void**

**Table 4.6.7.3.5-4: L1-RSRP relative accuracy requirements for the reported values for all test configurations**

Normal Conditions	T1
Lowest DIFF RSRP reported (CSI-RS#0)	0
Highest DIFF RSRP reported (CSI-RS#0)	5

For the test to pass, the ratio of successful reported values for each requirement (R1 to R3) shall be more than 90% with a confidence level of 95%. Each requirement is evaluated independently of the others..

NOTE: The actual overall delays measured in the test may be up to  $2 \times TTI_{DCCH}$  higher than the measurement reporting delays above because of TTI insertion uncertainty of the measurement report in DCCH.

## 4.7 Measurement performance requirements

### 4.7.1 SS-RSRP

#### 4.7.1.0 Minimum conformance requirements

##### 4.7.1.0.1 Intra-frequency absolute SS-RSRP measurement accuracy requirements

The intra-frequency SS-RSRP absolute accuracy requirements are defined for the SS-RSRP measured from a cell on the same frequency as that of the PCell or PSCell in FR1.

The accuracy requirements in Table 4.7.1.0.1-1 are valid under the following conditions:

- Conditions defined in 38.101-1 [2] Clause 7.3 for reference sensitivity are fulfilled.
- Conditions for intra-frequency measurements are fulfilled according to Annex B.2.2 for a corresponding Band for each relevant SSB.

Table 4.7.1.0.1-1: SS-RSRP intra frequency absolute accuracy in FR1

Accuracy		Conditions					
Normal condition	Extreme condition	SSB $\hat{E}_s/\text{lot}$	NR operating band groups <small>Note 2</small>	$I_o$ <small>Note 1</small> range			
				Minimum $I_o$		Maximum $I_o$	
dB	dB	dB		dBm / $SCS_{SSB}$		dBm/ $BW_{\text{Channel}}$	dBm/ $BW_{\text{Channel}}$
				$SCS_{SSB} = 15 \text{ kHz}$	$SCS_{SSB} = 30 \text{ kHz}$		
$\pm 4.5$	$\pm 9$	$\geq -6$	NR_FDD_FR1_A, NR_TDD_FR1_A, NR_SDL_FR1_A	-121	-118	N/A	-70
			NR_FDD_FR1_B	-120.5	-117.5	N/A	-70
			NR_TDD_FR1_C	-120	-117	N/A	-70
			NR_FDD_FR1_D, NR_TDD_FR1_D	-119.5	-116.5	N/A	-70
			NR_FDD_FR1_E, NR_TDD_FR1_E	-119	-116	N/A	-70
			NR_FDD_FR1_G	-118	-115	N/A	-70
			NR_FDD_FR1_H	-117.5	-114.5	N/A	-70
$\pm 8$	$\pm 11$	$\geq -6$	NR_FDD_FR1_A, NR_TDD_FR1_A, NR_SDL_FR1_A, NR_FDD_FR1_B, NR_TDD_FR1_C, NR_FDD_FR1_D, NR_TDD_FR1_D, NR_FDD_FR1_E, NR_TDD_FR1_E, NR_FDD_FR1_G, NR_FDD_FR1_H,	N/A	N/A	-70	-50

NOTE 1:  $I_o$  is assumed to have constant EPRE across the bandwidth.  
 NOTE 2: NR operating band groups in FR1 are as defined in Section 3A.4.1

The reporting range for SS-RSRP is defined from -156dBm to -31dBm with 1dB resolution. The mapping of the measured quantity to the reported value is defined by Table 4.7.1.0.1-2.

**Table 4.7.1.0.1-2: SS-RSRP and CSI-RSRP measurement report mapping**

Reported value	Measured quantity value(L3 SS-RSRP)	Measured quantity value(L1 SS-RSRP and CSI-RSRP)	Unit
RSRP_0	SS-RSRP<-156	Not valid	dBm
RSRP_1	-156≤ SS-RSRP<-155	Not valid	dBm
RSRP_2	-155≤ SS-RSRP<-154	Not valid	dBm
RSRP_3	-154≤ SS-RSRP<-153	Not valid	dBm
RSRP_4	-153≤ SS-RSRP<-152	Not valid	dBm
RSRP_5	-152≤ SS-RSRP<-151	Not valid	dBm
RSRP_6	-151≤ SS-RSRP<-150	Not valid	dBm
RSRP_7	-150≤ SS-RSRP<-149	Not valid	dBm
RSRP_8	-149≤ SS-RSRP<-148	Not valid	dBm
RSRP_9	-148≤ SS-RSRP<-147	Not valid	dBm
RSRP_10	-147≤ SS-RSRP<-146	Not valid	dBm
RSRP_11	-146≤ SS-RSRP<-145	Not valid	dBm
RSRP_12	-145≤ SS-RSRP<-144	Not valid	dBm
RSRP_13	-144≤ SS-RSRP<-143	Not valid	dBm
RSRP_14	-143≤ SS-RSRP<-142	Not valid	dBm
RSRP_15	-142≤ SS-RSRP<-141	Not valid	dBm
RSRP_16	-141≤ SS-RSRP<-140	RSRP<-140	dBm
RSRP_17	-140≤ SS-RSRP<-139	-140≤ RSRP<-139	dBm
RSRP_18	-139≤ SS-RSRP<-138	-139≤ RSRP<-138	dBm
...	...	...	...
RSRP_111	-46≤ SS-RSRP<-45	-46≤ RSRP<-45	dBm
RSRP_112	-45≤ SS-RSRP<-44	-45≤ RSRP<-44	dBm
RSRP_113	-44≤ SS-RSRP<-43	-44≤ RSRP	dBm
RSRP_114	-43≤ SS-RSRP<-42	Not valid	dBm
RSRP_115	-42≤ SS-RSRP<-41	Not valid	dBm
RSRP_116	-41≤ SS-RSRP<-40	Not valid	dBm
RSRP_117	-40≤ SS-RSRP<-39	Not valid	dBm
RSRP_118	-39≤ SS-RSRP<-38	Not valid	dBm
RSRP_119	-38≤ SS-RSRP<-37	Not valid	dBm
RSRP_120	-37≤ SS-RSRP<-36	Not valid	dBm
RSRP_121	-36≤ SS-RSRP<-35	Not valid	dBm
RSRP_122	-35≤ SS-RSRP<-34	Not valid	dBm
RSRP_123	-34≤ SS-RSRP<-33	Not valid	dBm
RSRP_124	-33≤ SS-RSRP<-32	Not valid	dBm
RSRP_125	-32≤ SS-RSRP<-31	Not valid	dBm
RSRP_126	-31≤ SS-RSRP	Not valid	dBm
RSRP_127 <sup>1</sup>	Infinity	Infinity	dBm
NOTE: The value of RSRP_127 is applicable for RSRP threshold configured by the network as defined in TS 38.331 [13], but not for the purpose of measurement reporting.			

The normative reference for this requirement is TS 38.133 [6] clauses 10.1.2.1.1 and 10.1.6.

#### 4.7.1.0.2 Intra-frequency relative SS-RSRP measurement accuracy requirements

The intra-frequency relative accuracy of SS-RSRP is defined as the SS-RSRP measured from one cell compared to the SS-RSRP measured from another cell on the same frequency in FR1.

The accuracy requirements in Table 4.7.1.0.2-1 are valid under the following conditions:

- Conditions defined in 38.101-1 [2] Clause 7.3 for reference sensitivity are fulfilled.
- Conditions for intra-frequency measurements are fulfilled according to Annex B.2.2 for a corresponding Band for each relevant SSB.

**Table 4.7.1.0.2-1: SS-RSRP Intra frequency relative accuracy in FR1**

Accuracy		Conditions					
Normal condition	Extreme condition	SSB $\hat{E}_s/\text{lot}$ Note 2	$I_o$ Note 1 range				
			NR operating band groups Note 4	Minimum $I_o$		Maximum $I_o$	
dB	dB	dB		dBm / $SCS_{SSB}$		dBm/BW <sub>Channel</sub>	dBm/BW <sub>Channel</sub>
				$SCS_{SSB} = 15 \text{ kHz}$	$SCS_{SSB} = 30 \text{ kHz}$		
$\pm 2$	$\pm 3$	$\geq -3$	NR_FDD_FR1_A, NR_TDD_FR1_A, NR_SDL_FR1_A	-121	-118	N/A	-50
			NR_FDD_FR1_B	-120.5	-117.5	N/A	-50
			NR_TDD_FR1_C	-120	-117	N/A	-50
			NR_FDD_FR1_D, NR_TDD_FR1_D	-119.5	-116.5	N/A	-50
			NR_FDD_FR1_E, NR_TDD_FR1_E	-119	-116	N/A	-50
			NR_FDD_FR1_G	-118	-115	N/A	-50
			NR_FDD_FR1_H	-117.5	-114.5	N/A	-50
$\pm 3$	$\pm 3$	$\geq -6$	Note 3	Note 3	Note 3	N/A	Note 3

NOTE 1:  $I_o$  is assumed to have constant EPRE across the bandwidth.  
 NOTE 2: The parameter SSB  $\hat{E}_s/\text{lot}$  is the minimum SSB  $\hat{E}_s/\text{lot}$  of the pair of cells to which the requirement applies.  
 NOTE 3: The same bands and the same  $I_o$  conditions for each band apply for this requirement as for the corresponding highest accuracy requirement.  
 NOTE 4: NR operating band groups in FR1 are as defined in Section 3A.4.1.

The reporting range for SS-RSRP is defined from -156dBm to -31dBm with 1dB resolution. The mapping of the measured quantity to the reported value is defined by Table 4.7.1.0.1-2.

The normative reference for this requirement is TS 38.133 [6] clauses 10.1.2.1.2 and 10.1.6.

**4.7.1.0.3 Inter-frequency absolute SS-RSRP measurement accuracy requirements**

The inter-frequency SS-RSRP absolute accuracy requirements in this clause are defined for the SS-RSRP measured from a cell on a different frequency as that of the PCell or PSCell in FR1.

The accuracy requirements in Table 4.7.1.0.3-1 are valid under the following conditions:

- Conditions defined in TS 38.101-1 [2] Clause 7.3 for reference sensitivity are fulfilled.
- Conditions for intra-frequency measurements are fulfilled according to clause B.2.3 for a corresponding Band for each relevant SSB.

Table 4.7.1.0.3-1: SS-RSRP inter frequency absolute accuracy in FR1

Accuracy		Conditions					
Normal condition	Extreme condition	SSB Es/lot Note 2	NR operating band groups Note 3	Io <sup>Note 1</sup> range			
				Minimum Io		Maximum Io	
dB	dB	dB		dBm / SCS <sub>SSB</sub>		dBm/BW <sub>Channel</sub>	dBm/BW <sub>Channel</sub>
				SCS <sub>SSB</sub> = 15 kHz	SCS <sub>SSB</sub> = 30 kHz		
±4.5	±9	≥6	NR_FDD_FR1_A, NR_TDD_FR1_A, NR_SDL_FR1_A	-121	-118	N/A	-70
			NR_FDD_FR1_B	-120.5	-117.5	N/A	-70
			NR_TDD_FR1_C	-120	-117	N/A	-70
			NR_FDD_FR1_D, NR_TDD_FR1_D	-119.5	-116.5	N/A	-70
			NR_FDD_FR1_E, NR_TDD_FR1_E	-119	-116	N/A	-70
			NR_FDD_FR1_G	-118	-115	N/A	-70
			NR_FDD_FR1_H	-117.5	-114.5	N/A	-70
±8	±11	≥6	NR_FDD_FR1_A, NR_TDD_FR1_A, NR_SDL_FR1_A, NR_FDD_FR1_B, NR_TDD_FR1_C, NR_FDD_FR1_D, NR_TDD_FR1_D, NR_FDD_FR1_E, NR_TDD_FR1_E, NR_FDD_FR1_G, NR_FDD_FR1_H,	N/A	N/A	-70	-50

NOTE 1: Io is assumed to have constant EPRE across the bandwidth.  
NOTE 2: Void.  
NOTE 3: NR operating band groups in FR1 are as defined in Section 3A.4.1.

The reporting range for SS-RSRP is defined from -156dBm to -31dBm with 1dB resolution. The mapping of the measured quantity to the reported value is defined by Table 4.7.1.0.1-2.

The normative reference for this requirement is TS 38.133 [6] clauses 10.1.4.1.1 and 10.1.6.

#### 4.7.1.0.4 Inter-frequency relative SS-RSRP measurement accuracy requirements

The inter-frequency SS-RSRP relative accuracy requirements in this clause are defined for the SS-RSRP measured from one cell on a frequency in FR1 compared to the SS-RSRP measured from another cell on a different frequency in FR1.

The accuracy requirements in Table 4.7.1.0.4-1 are valid under the following conditions:

- Conditions defined in 38.101-1 [2] Clause 7.3 for reference sensitivity are fulfilled.
- Conditions for inter-frequency measurements are fulfilled according to Annex B.2.3 for a corresponding Band for each relevant SSB,

$$\left| RSRP1 \Big|_{dBm} - RSRP2 \Big|_{dBm} \right| \leq 27dB$$

- $| \text{Channel 1}_{Io} - \text{Channel 2}_{Io} | \leq 20 \text{ dB}$



Table 4.7.1.0.4-1: SS-RSRP inter frequency relative accuracy in FR1

Accuracy		Conditions					
Normal condition	Extreme condition	SSB $\hat{E}_s/\text{lot}$ Note 2	$I_o$ Note 1 range				
			NR operating band groups Note 3	Minimum $I_o$		Maximum $I_o$	
dB	dB	dB		dBm / $SCS_{SSB}$			dBm/ $BW_{\text{Channel}}$
			$SCS_{SSB} = 15$ kHz	$SCS_{SSB} = 30$ kHz			
$\pm 4.5$	$\pm 6$	$\geq 6$	NR_FDD_FR1_A, NR_TDD_FR1_A, NR_SDL_FR1_A	-121	-118	N/A	-50
			NR_FDD_FR1_B	-120.5	-117.5	N/A	-50
			NR_TDD_FR1_C	-120	-117	N/A	-50
			NR_FDD_FR1_D, NR_TDD_FR1_D	-119.5	-116.5	N/A	-50
			NR_FDD_FR1_E, NR_TDD_FR1_E	-119	-116	N/A	-50
			NR_FDD_FR1_G	-118	-115	N/A	-50
			NR_FDD_FR1_H	-117.5	-114.5	N/A	-50

NOTE 1:  $I_o$  is assumed to have constant EPRE across the bandwidth.

NOTE 2: The parameter SSB  $\hat{E}_s/\text{lot}$  is the minimum SSB  $\hat{E}_s/\text{lot}$  of the pair of cells to which the requirement applies.

NOTE 3: NR operating band groups in FR1 are as defined in Section 3A.4.1.

The reporting range for SS-RSRP is defined from -156dBm to -31dBm with 1dB resolution. The mapping of the measured quantity to the reported value is defined by Table 4.7.1.0.1-2.

The normative reference for this requirement is TS 38.133 [6] clauses 10.1.4.1.2 and 10.1.6.

#### 4.7.1.1 Intra-frequency measurements

##### 4.7.1.1.1 EN-DC FR1 SS-RSRP absolute measurement accuracy

###### 4.7.1.1.1.1 Test purpose

The purpose of this test is to verify that the intra-frequency SS-RSRP absolute measurement accuracy is within the specified limits for all bands.

###### 4.7.1.1.1.2 Test applicability

This test applies to all types of NR UE supporting E-UTRA and EN-DC from Release 15 onwards.

###### 4.7.1.1.1.3 Minimum conformance requirements

The minimum conformance requirements are specified in clause 4.7.1.0.1.

The normative reference for this requirement is TS 38.133 [6] clause A.4.7.1.1.

###### 4.7.1.1.1.4 Test description

###### 4.7.1.1.1.4.1 Initial conditions

This test shall be tested using any of the test configurations in Table 4.7.1.1.4.1-1.

**Table 4.7.1.1.1.4.1-1: EN-DC FR1 SS-RSRP measurement accuracy supported test configurations**

Test Case ID	Description
4.7.1.1.1-1	LTE FDD, NR: 15 kHz SSB SCS, 10MHz bandwidth, FDD
4.7.1.1.1-2	LTE FDD, NR: 15 kHz SSB SCS, 10MHz bandwidth, TDD
4.7.1.1.1-3	LTE FDD, NR: 30 kHz SSB SCS, 40MHz bandwidth, TDD
4.7.1.1.1-4	LTE TDD, NR: 15 kHz SSB SCS, 10MHz bandwidth, FDD
4.7.1.1.1-5	LTE TDD, NR: 15 kHz SSB SCS, 10MHz bandwidth, TDD
4.7.1.1.1-6	LTE TDD, NR: 30 kHz SSB SCS, 40MHz bandwidth, TDD

NOTE: The UE is only required to be tested in one of the supported test configurations.

Configure the test equipment and the DUT according to the parameters in Table 4.7.1.1.1.4.1-2.

**Table 4.7.1.1.1.4.1-2: Initial conditions for SS-RSRP intra frequency absolute accuracy in FR1**

Parameter	Value	Comment
Test environment	NC, TL/VL, TL/VH, TH/VL, TH/VH	As specified in TS 38.508-1 [14] clause 4.1.
Test frequencies	As specified in Annex E, Table E.2-1 and TS 38.508-1 [14] clause 4.3.1.	
Channel bandwidth	As specified by the test configuration selected from Table 4.7.1.1.1.4.1-1.	
Propagation conditions	AWGN	As specified in clause C.2.2.
Connection Diagram	TE Part 2Rx	A.3.1.8.2 with $n = 2$ and $\varphi_1 = 5$ Hz
	TE Part 4Rx	A.3.1.8.5 with $n = 2$ and $\varphi_{1,1} = 5$ Hz, $\varphi_{1,2} = 10$ Hz, $\varphi_{1,3} = 15$ Hz
	DUT Part 2Rx	A.3.2.3.4
	DUT Part 4Rx	A.3.2.5.2
Exceptions to connection diagram	N/A	

1. Message contents are defined in clause 4.7.1.1.1.4.3.
2. Cell 1 is the E-UTRA serving cell (PCell) for the EN-DC setup. The power levels and settings for Cell 1 are set according to Annex A.6. Cell 2 and Cell 3 are NR FR1 cells in the same frequency. Cell 2 is the PSCell and Cell 3 is the target cell for SS-RSRP measurements. The connection setup is done according to the settings in clause C.1.1.

#### 4.7.1.1.1.4.2 Test procedure

1. Ensure the UE is in state RRC\_CONNECTED with generic procedure parameters Connectivity EN-DC, DC bearer MCG and SCG, Connected without release  $On$  and Test Mode  $On$ , according to TS 38.508-1 [14] clause 4.5.
2. Set the parameters according to Table 4.7.1.1.1.5-1 as appropriate.
3. The SS shall transmit an RRCConnectionReconfiguration message on Cell 1.
4. The UE shall transmit an RRCConnectionReconfigurationComplete message.
5. The UE shall transmit periodically MeasurementReport messages.
6. After 10s wait from Step 3, the SS shall check the SS-RSRP reported values in the periodic MeasurementReport. The SS-RSRP value of Cell 3 reported by the UE is compared to the expected SS-RSRP. If the value is outside the limits in Table 4.7.1.1.1.5-2 or the UE fails to report the measurement value for Cell 3, the number of failed iterations is increased by one. Otherwise, the number of passed iterations is increased by one.
7. The SS shall continue checking the MeasurementReport messages transmitted by the UE until the confidence level according to Table G.2.3-1 in Annex G is achieved.

8. Set the parameters according to each sub-test in Table 4.7.1.1.1.5-1 as appropriate and repeat steps 5-7.

#### 4.7.1.1.1.4.3 Message contents

Message contents are according to TS 38.508-1 [14] clause 7.3 with the following exceptions:

**Table 4.7.1.1.1.4.3-1: Common Exception messages for EN-DC FR1 SS-RSRP absolute measurement accuracy**

Default Message Contents	
Common contents of system information blocks exceptions	
Default RRC messages and information elements contents exceptions	Table H.3.1-1 Table H.3.1-2 Table H.3.1-5 Table H.3.1-7 Table H.3.4-1 Table H.3.4-1a Table H.3.4-2
Specific message contents exceptions for Test Configuration 4.7.1.1.1.-1 and 4.7.1.1.1-4	Table H.3.1-3 with Condition SSB.1 FR1 and Table 7.3.1-3 in TS 38.508-1 [14] with condition SMTC.2
Specific message contents exceptions for Test Configuration 4.7.1.1.1-2 and 4.7.1.1.1-5	Table H.3.1-3 with Condition SSB.1 FR1 and Synchronous cells Table 7.3.1-3 in TS 38.508-1 [14] with condition SMTC.1
Specific message contents exceptions for Test Configuration 4.7.1.1.1-3 and 4.7.1.1.1-6	Table H.3.1-3 with Condition SSB.2 FR1 and Synchronous cells Table 7.3.1-3 in TS 38.508-1 [14] with condition SMTC.1

**Table 4.7.1.1.1.4.3-2: ReportConfigNR-DEFAULT(Periodical) for EN-DC FR1 SS-RSRP Accuracy**

Derivation Path: 38.508-1 [14] Table 4.6.3-142 with condition PERIODICAL			
Information Element	Value/remark	Comment	Condition
ReportConfigNR ::= SEQUENCE {			
reportType CHOICE {			
periodical SEQUENCE {			PERIODICAL
reportQuantityCell SEQUENCE {			
rsrq	false		
sinr	false		
}			
maxReportCells	2		
}			
}			
}			

#### 4.7.1.1.1.5 Test requirement

Table 4.7.1.1.1.5-1 defines the primary level settings including test tolerances for all tests.

Each SS-RSRP measurement report for each of the tests in Table 4.7.1.1.1.5-1 shall meet the corresponding absolute accuracy requirements in Table 4.7.1.1.1.5-2 for test configurations 1, 2, 4 and 5, and the corresponding absolute accuracy requirements in Table 4.7.1.1.1.5-3 for test configurations 3 and 6.

Table 4.7.1.1.1.5-1: EN-DC FR1 SS-RSRP measurement accuracy test parameters

Parameter		Unit	Test 1		Test 2		Test 3	
			Cell 2	Cell 3	Cell 2	Cell 3	Cell 2	Cell 3
Physical cell ID			489	0	489	0	489	0
SSB ARFCN			freq1		freq1		freq1	
Duplex mode	Config 1,4		FDD					
	Config 2,3,5,6		TDD					
TDD configuration	Config 1,4		Not Applicable					
	Config 2,5		TDDConf.1.1					
	Config 3,6		TDDConf.2.1					
BW <sub>channel</sub>	Config 1,4	MHz	10: N <sub>RB,c</sub> = 52					
	Config 2,5		10: N <sub>RB,c</sub> = 52					
	Config 3,6		40: N <sub>RB,c</sub> = 106					
BWP BW	Config 1,4		10: N <sub>RB,c</sub> = 52					
	Config 2,5		10: N <sub>RB,c</sub> = 52					
	Config 3,6		40: N <sub>RB,c</sub> = 106					
Downlink initial BWP configuration			DLBWP.0					
Downlink dedicated BWP configuration			DLBWP.1					
Uplink dedicated BWP configuration			ULBWP.1					
DRx Cycle		ms	Not Applicable					
TRS Configuration	Config 1,4		TRS.1.1 FDD	-	TRS.1.1 FDD	-	TRS.1.1 FDD	-
	Config 2,5		TRS.1.1 TDD	-	TRS.1.1 TDD	-	TRS.1.1 TDD	-
	Config 3,6		TRS.2.1 TDD	-	TRS.2.1 TDD	-	TRS.2.1 TDD	-
PDSCH Reference measurement channel	Config 1,4		SR.1.1 FDD	-	SR.1.1 FDD	-	SR.1.1 FDD	-
	Config 2,5		SR.1.1 TDD	-	SR.1.1 TDD	-	SR.1.1 TDD	-
	Config 3,6		SR.2.1 TDD	-	SR.2.1 TDD	-	SR.2.1 TDD	-
RMSI CORESET Reference Channel	Config 1,4		CR.1.1 FDD	-	CR.1.1 FDD	-	CR.1.1 FDD	-
	Config 2,5		CR.1.1 TDD	-	CR.1.1 TDD	-	CR.1.1 TDD	-
	Config 3,6		CR2.1 TDD	-	CR2.1 TDD	-	CR2.1 TDD	-
Control Channel RMC	Config 1,4		CCR.1.1 FDD	-	CCR.1.1 FDD	-	CCR.1.1 FDD	-
	Config 2,5		CCR.1.1 TDD	-	CCR.1.1 TDD	-	CCR.1.1 TDD	-
	Config 3,6		CCR2.1 TDD	-	CCR2.1 TDD	-	CCR2.1 TDD	-
SSB configuration	Config 1,4		SSB 1.FR1	SSB.1 FR1	SSB 1.FR1	SSB.1 FR1	SSB 1.FR1	SSB.1 FR1
	Config 2,5		SSB 1.FR1	SSB.1 FR1	SSB 1.FR1	SSB.1 FR1	SSB 1.FR1	SSB.1 FR1
	Config 3,6		SSB 2.FR1	SSB.2 FR1	SSB 2.FR1	SSB.2 FR1	SSB 2.FR1	SSB.2 FR1
Time offset with Cell 2	Config 1,4	ms	-	3	-	3	-	3
	Config 2,3,5,6	µs	-	3	-	3	-	3
SMTC Configuration	Config 1,4		SMTC.2					
	Config 2,3,5,6		SMTC.1					
OCNG Patterns			OP.1					
PDSCH/PDCCH subcarrier spacing	Config 1,2,4,5	kHz	15 kHz					
	Config 3,6		30kHz					

Parameter			Unit	Test 1		Test 2		Test 3	
				Cell 2	Cell 3	Cell 2	Cell 3	Cell 2	Cell 3
EPRE ratio of PSS to SSS			dB	0	0	0	0	0	0
EPRE ratio of PBCH DMRS to SSS									
EPRE ratio of PBCH to PBCH DMRS									
EPRE ratio of PDCCH DMRS to SSS									
EPRE ratio of PDCCH to PDCCH DMRS									
EPRE ratio of PDSCH DMRS to SSS									
EPRE ratio of PDSCH to PDSCH									
EPRE ratio of OCNG DMRS to SSS(Note 1)									
EPRE ratio of OCNG to OCNG DMRS (Note 1)									
$N_{oc}$ Note2	Config 1,2,4,5	Depending on band group	dBm/15KHz	-107.5		-88		$-116 + \Delta_{BG\_offset}$	
	Config 3,6	Depending on band group		-113.8		-94		$-116 + \Delta_{BG\_offset}$	
$N_{oc}$ Note2	Config 1,2,4,5		dBm/SCS	-107.4		-88		Same as $N_{oc}/15kHz$	
	Config 3,6	Depending on band group		-110.8		-91		$-113 + \Delta_{BG\_offset}$	
$\hat{E}_s/I_{ot}$			dB	1.88	-5.57	1.88	-5.57	0.09	-5.56
$\hat{E}_s/N_{oc}$			dB	6	1.4	6	1.4	3	-0.8
SS-RSRP Note3	Config 1,2,4,5	Depending on band group	dBm/SCS	-101.5	-106.1	-82	-86.6	$-113 + \Delta_{BG\_offset}$	$-116.8 + \Delta_{BG\_offset}$
	Config 3,6	Depending on band group		-104.8	-109.4	-85	-89.6	$-110 + \Delta_{BG\_offset}$	$-113.8 + \Delta_{BG\_offset}$
$I_o$ Note3	Config 1,2,4,5	Depending on band group	dBm/9.36MHz	-71.68		-52.18		$-82.39 + \Delta_{BG\_offset}$	
	Config 3,6	Depending on band group	dBm/38.16MHz	-71.71		-51.91		$-76.12 + \Delta_{BG\_offset}$	
Propagation condition			-	AWGN					
Antenna configuration			-	1x2					
NOTE 1: OCNG shall be used such that both cells are fully allocated and a constant total transmitted power spectral density is achieved for all OFDM symbols.									
NOTE 2: Interference from other cells and noise sources not specified in the test is assumed to be constant over subcarriers and time and shall be modelled as AWGN of appropriate power for $N_{oc}$ to be fulfilled.									
NOTE 3: SS-RSRP and $I_o$ levels have been derived from other parameters for information purposes. They are not settable parameters themselves.									
NOTE 4: SS-RSRP minimum requirements are specified assuming independent interference and noise at each receiver antenna port.									
NOTE 5: $\Delta_{BG\_offset}$ is defined in clause 3A.4, Table 3A.4.1-2.									

**Table 4.7.1.1.5-2: SS-RSRP Intra frequency absolute accuracy requirements for the reported values for test configurations 1, 2, 4 and 5**

Normal Conditions	Test 1 All bands	Test 2 All bands	Test 3	
Lowest reported value (Cell 3)	44	60	Bands NR_FDD_FR1_A, NR_TDD_FR1_A	34
			Bands NR_FDD_FR1_B	34
			Bands NR_TDD_FR1_C	35
			Bands NR_FDD_FR1_D, NR_TDD_FR1_D	35
			Bands NR_FDD_FR1_E, NR_TDD_FR1_E	36
			Bands NR_FDD_FR1_G	37
			Bands NR_FDD_FR1_H	37

Normal Conditions	Test 1 All bands	Test 2 All bands	Test 3	
Highest reported value (Cell 3)	56	79	Bands NR_FDD_FR1_A, NR_TDD_FR1_A	46
			Bands NR_FDD_FR1_B	46
			Bands NR_TDD_FR1_C	47
			Bands NR_FDD_FR1_D, NR_TDD_FR1_D	47
			Bands NR_FDD_FR1_E, NR_TDD_FR1_E	48
			Bands NR_FDD_FR1_G	49
			Bands NR_FDD_FR1_H	49
Extreme Conditions	Test 1 All bands	Test 2 All bands	Test 3	
Lowest reported value (Cell 3)	40	57	Bands NR_FDD_FR1_A, NR_TDD_FR1_A	29
			Bands NR_FDD_FR1_B	30
			Bands NR_TDD_FR1_C	30
			Bands NR_FDD_FR1_D, NR_TDD_FR1_D	31
			Bands NR_FDD_FR1_E, NR_TDD_FR1_E	31
			Bands NR_FDD_FR1_G	33
			Bands NR_FDD_FR1_H	34
Highest reported value (Cell 3)	61	82	Bands NR_FDD_FR1_A, NR_TDD_FR1_A	50
			Bands NR_FDD_FR1_B	51
			Bands NR_TDD_FR1_C	51
			Bands NR_FDD_FR1_D, NR_TDD_FR1_D	52
			Bands NR_FDD_FR1_E, NR_TDD_FR1_E	52
			Bands NR_FDD_FR1_G	53
Bands NR_FDD_FR1_H	54			
NOTE: NR operating band groups are defined in clause 3A.4, Table 3A.4.1-2.				

**Table 4.7.1.1.1.5-3: SS-RSRP Intra frequency absolute accuracy requirements for the reported values for test configurations 3 and 6**

Normal Conditions	Test 1 All bands	Test 2 All bands	Test 3	
Lowest reported value (Cell 3)	41	57	Bands NR_FDD_FR1_A, NR_TDD_FR1_A	37
			Bands NR_FDD_FR1_B	37
			Bands NR_TDD_FR1_C	38
			Bands NR_FDD_FR1_D, NR_TDD_FR1_D	38
			Bands NR_FDD_FR1_E, NR_TDD_FR1_E	39
			Bands NR_FDD_FR1_G	40
			Bands NR_FDD_FR1_H	40
Highest reported value (Cell 3)	53	76	Bands NR_FDD_FR1_A, NR_TDD_FR1_A	49
			Bands NR_FDD_FR1_B	49
			Bands NR_TDD_FR1_C	50
			Bands NR_FDD_FR1_D, NR_TDD_FR1_D	50
			Bands NR_FDD_FR1_E, NR_TDD_FR1_E	51
			Bands NR_FDD_FR1_G	52
Bands NR_FDD_FR1_H	52			

Extreme Conditions	Test 1 All bands	Test 2 All bands	Test 3	
Lowest reported value (Cell 3)	37	54	Bands NR_FDD_FR1_A, NR_TDD_FR1_A	32
			Bands NR_FDD_FR1_B	33
			Bands NR_TDD_FR1_C	33
			Bands NR_FDD_FR1_D, NR_TDD_FR1_D	34
			Bands NR_FDD_FR1_E, NR_TDD_FR1_E	34
			Bands NR_FDD_FR1_G	35
			Bands NR_FDD_FR1_H	36
Highest reported value (Cell 3)	58	79	Bands NR_FDD_FR1_A, NR_TDD_FR1_A	53
			Bands NR_FDD_FR1_B	54
			Bands NR_TDD_FR1_C	54
			Bands NR_FDD_FR1_D, NR_TDD_FR1_D	55
			Bands NR_FDD_FR1_E, NR_TDD_FR1_E	55
			Bands NR_FDD_FR1_G	56
			Bands NR_FDD_FR1_H	57
NOTE: NR operating band groups are defined in clause 3A.4, Table 3A.4.1-2.				

For the test to pass, the ratio of successful reported values in each test shall be more than 90% with a confidence level of 95%.

#### 4.7.1.1.2 EN-DC FR1 SS-RSRP relative measurement accuracy

##### 4.7.1.1.2.1 Test purpose

The purpose of this test is to verify that the intra-frequency SS-RSRP relative measurement accuracy is within the specified limits for all bands.

##### 4.7.1.1.2.2 Test applicability

This test applies to all types of NR UE supporting E-UTRA and EN-DC from Release 15 onwards.

##### 4.7.1.1.2.3 Minimum conformance requirements

The minimum conformance requirements are specified in clause 4.7.1.0.2.

The normative reference for this requirement is TS 38.133 [6] clause A.4.7.1.1.

## 4.7.1.1.2.4 Test description

## 4.7.1.1.2.4.1 Initial conditions

This test shall be tested using any of the test configurations in Table 4.7.1.1.2.4.1-1.

**Table 4.7.1.1.2.4.1-1: EN-DC FR1 SS-RSRP measurement accuracy supported test configurations**

Test Case ID	Description
4.7.1.1.2-1	LTE FDD, NR: 15 kHz SSB SCS, 10MHz bandwidth, FDD
4.7.1.1.2-2	LTE FDD, NR: 15 kHz SSB SCS, 10MHz bandwidth, TDD
4.7.1.1.2-3	LTE FDD, NR: 30 kHz SSB SCS, 40MHz bandwidth, TDD
4.7.1.1.2-4	LTE TDD, NR: 15 kHz SSB SCS, 10MHz bandwidth, FDD
4.7.1.1.2-5	LTE TDD, NR: 15 kHz SSB SCS, 10MHz bandwidth, TDD
4.7.1.1.2-6	LTE TDD, NR: 30 kHz SSB SCS, 40MHz bandwidth, TDD
NOTE: The UE is only required to be tested in one of the supported test configurations.	

Configure the test equipment and the DUT according to the parameters in Table 4.7.1.1.2.4.1-2.

**Table 4.7.1.1.2.4.1-2: Initial conditions for SS-RSRP intra frequency relative accuracy in FR1**

Parameter	Value		Comment
Test environment	NC, TL/VL, TL/VH, TH/VL, TH/VH		As specified in TS 38.508-1 [14] clause 4.1.
Test frequencies	As specified in Annex E, Table E.2-1 and TS 38.508-1 [14] clause 4.3.1.		
Channel bandwidth	As specified by the test configuration selected from Table 4.7.1.1.2.4.1-1.		
Propagation conditions	AWGN		As specified in clause C.2.2.
Connection Diagram	TE Part 2Rx	A.3.1.8.2 with $n = 2$ and $\varphi_1 = 5$ Hz	As specified in TS 38.508-1 [14] Annex A.
	TE Part 4Rx	A.3.1.8.5 with $n = 2$ and $\varphi_{1,1} = 5$ Hz, $\varphi_{1,2} = 10$ Hz, $\varphi_{1,3} = 15$ Hz	
	DUT Part 2Rx	A.3.2.3.4	
	DUT Part 4Rx	A.3.2.5.2	
Exceptions to connection diagram	N/A		

1. Message contents are defined in clause 4.7.1.1.2.4.3.
2. Cell 1 is the E-UTRA serving cell (PCell) for the EN-DC setup. The power levels and settings for Cell 1 are set according to Annex A.6. Cell 2 and Cell 3 are NR FR1 cells in the same frequency. Cell 2 is the PSCell and Cell 3 is the target cell for SS-RSRP measurements. The connection setup is done according to the settings in clause C.1.1.

## 4.7.1.1.2.4.2 Test procedure

1. Ensure the UE is in state RRC\_CONNECTED with generic procedure parameters Connectivity EN-DC, DC bearer MCG and SCG, Connected without release *On* and Test Mode *On* according to TS 38.508-1 [14] clause 4.5.
2. Set the parameters according to Table 4.7.1.1.2.5-1 as appropriate.
3. The SS shall transmit an RRCConnectionReconfiguration message on Cell 1.
4. The UE shall transmit an RRCConnectionReconfigurationComplete message.
5. The UE shall transmit periodically MeasurementReport messages.
6. After 10s wait from Step 3, the SS shall check the SS-RSRP reported values of Cell 2 and Cell 3 in the periodic MeasurementReport. The SS-RSRP value of Cell 3 reported by the UE is compared to the reported SS-RSRP of



Cell 2. If the resulting value is outside the limits in Table 4.7.1.1.2.5-2 or the UE fails to report the measurement value for Cell 2 or Cell 3, the number of failed iterations is increased by one. Otherwise, the number of passed iterations is increased by one.

7. The SS shall continue checking the MeasurementReport messages transmitted by the UE until the confidence level according to Table G.2.3-1 in Annex G is achieved.
8. Set the parameters according to each sub-test in Table 4.7.1.1.2.5-1 as appropriate and repeat steps 5-7.

4.7.1.1.2.4.3 Message contents

Message contents are same as in clause 4.7.1.1.1.4.3.

4.7.1.1.2.5 Test requirement

Table 4.7.1.1.2.5-1 defines the primary level settings including test tolerances for all tests.

Each SS-RSRP measurement report for each of the tests in Table 4.7.1.1.2.5-1 shall meet the corresponding absolute accuracy requirements in Table 4.7.1.1.2.5-2.

**Table 4.7.1.1.2.5-1: Same as Table 4.7.1.1.1.5-1 with the following exceptions:**

Parameter			Unit	Test 1		Test 2		Test 3	
				Cell 2	Cell 3	Cell 2	Cell 3	Cell 2	Cell 3
$N_{oc}$ <sup>Note2</sup>	Config 1,2,4,5	Depending on band group	dBm/15kHz	-106		-88		$-116 + \Delta_{BG\_offset}$	
	Config 3,6	Depending on band group		-113		-94		$-116 + \Delta_{BG\_offset}$	
$N_{oc}$ <sup>Note2</sup>	Config 1,2,4,5		dBm/SCS	Same as Noc/15kHz		Same as Noc/15kHz		Same as Noc/15kHz	
	Config 3,6	Depending on band group		-110		-91		$-113 + \Delta_{BG\_offset}$	
$\hat{E}_s / I_{ot}$			dB	1.88	-4.97	1.88	-4.97	-0.01	-4.76
$\hat{E}_s / N_{oc}$			dB	6	2	6	2	3	0
SS-RSRP <sup>Note3</sup>	Config 1,2,4,5	Depending on band group	dBm/SCS	-100	-104	-82	-86	$-113 + \Delta_{BG\_offse}$ <sub>t</sub>	$-116 + \Delta_{BG\_offse}$ <sub>t</sub>
	Config 3,6	Depending on band group		-104	-108	-85	-89	$-110 + \Delta_{BG\_offse}$ <sub>t</sub>	$-113 + \Delta_{BG\_offse}$ <sub>t</sub>
$I_0$ <sup>Note3</sup>	Config 1,2,4,5	Depending on band group	dBm/9.36MHz	-70.05		-52.05		$-82.20 + \Delta_{BG\_offset}$	
	Config 3,6	Depending on band group	dBm/38.16MHz	-70.77		-51.77		$-75.93 + \Delta_{BG\_offset}$	

**Table 4.7.1.1.2.5-2: SS-RSRP Intra frequency relative accuracy requirements for the reported values**

	Test 1	Test 2	Test 3
	All bands	All bands	All bands
Normal Conditions			
Lowest reported value (Cell 3)	RSRP_x - 8	RSRP_x - 8	RSRP_x - 7
Highest reported value (Cell 3)	RSRP_x - 1	RSRP_x - 1	RSRP_x + 1
Extreme Conditions			
Lowest reported value (Cell 3)	RSRP_x - 8	RSRP_x - 8	RSRP_x - 7
Highest reported value (Cell 3)	RSRP_x - 1	RSRP_x - 1	RSRP_x + 1
RSRP_x is the reported value of Cell 2			

For the test to pass, the ratio of successful reported values in each test shall be more than 90% with a confidence level of 95%.

## 4.7.1.2 Inter-frequency measurements

### 4.7.1.2.1 EN-DC FR1-FR1 SS-RSRP absolute measurement accuracy

#### 4.7.1.2.1.1 Test purpose

The purpose of this test is to verify that the inter-frequency SS-RSRP absolute measurement accuracy is within the specified limits for all bands.

#### 4.7.1.2.1.2 Test applicability

This test applies to all types of NR UE supporting E-UTRA and EN-DC from Release 15 onwards.

#### 4.7.1.2.1.3 Minimum conformance requirements

The minimum conformance requirements are specified in clause 4.7.1.0.3.

The normative reference for this requirement is TS 38.133 [6] clause A.4.7.1.2.

#### 4.7.1.2.1.4 Test description

##### 4.7.1.2.1.4.1 Initial conditions

This test shall be tested using any of the test configurations in Table 4.7.1.2.1.4.1-1.

**Table 4.7.1.2.1.4.1-1: EN-DC FR1-FR1 SS-RSRP measurement accuracy supported test configurations**

Test Case ID	Description
4.7.1.2.1-1	LTE FDD, NR: 15 kHz SSB SCS, 10MHz bandwidth, FDD
4.7.1.2.1-2	LTE FDD, NR: 15 kHz SSB SCS, 10MHz bandwidth, TDD
4.7.1.2.1-3	LTE FDD, NR: 30 kHz SSB SCS, 40MHz bandwidth, TDD
4.7.1.2.1-4	LTE TDD, NR: 15 kHz SSB SCS, 10MHz bandwidth, FDD
4.7.1.2.1-5	LTE TDD, NR: 15 kHz SSB SCS, 10MHz bandwidth, TDD
4.7.1.2.1-6	LTE TDD, NR: 30 kHz SSB SCS, 40MHz bandwidth, TDD
NOTE: The UE is only required to be tested in one of the supported test configurations.	

Configure the test equipment and the DUT according to the parameters in Table 4.7.1.2.1.4.1-2.

**Table 4.7.1.2.1.4.1-2: Initial conditions for SS-RSRP inter frequency absolute accuracy in FR1**

Parameter	Value		Comment
Test environment	NC, TL/VL, TL/VH, TH/VL, TH/VH		As specified in TS 38.508-1 [14] clause 4.1.
Test frequencies	As specified in Annex E, Table E.2-1 and TS 38.508-1 [14] clause 4.3.1.		
Channel bandwidth	As specified by the test configuration selected from Table 4.7.1.2.1.4.1-1.		
Propagation conditions	AWGN		As specified in clause C.2.2.
Connection Diagram	TE Part 2Rx	A.3.1.8.2 with $n = 2$ and $\phi_1 = 5$ Hz	As specified in TS 38.508-1 [14] Annex A.
	TE Part 4Rx	A.3.1.8.5 with $n = 2$ and $\phi_{1,1} = 5$ Hz, $\phi_{1,2} = 10$ Hz, $\phi_{1,3} = 15$ Hz	
	DUT Part 2Rx	A.3.2.3.4	
	DUT Part 4Rx	A.3.2.5.2	
Exceptions to connection diagram	N/A		

1. Message contents are defined in clause 4.7.1.2.1.4.3.

- 2. Cell 1 is the E-UTRA serving cell (PCell) for the EN-DC setup. The power levels and settings for Cell 1 are set according to Annex A.6. Cell 2 and Cell 3 are NR FR1 cells in two different FR1 frequencies. Cell 2 is the PSCell and Cell 3 is the target cell for SS-RSRP measurements. The connection setup is done according to the settings in clause C.1.1.

4.7.1.2.1.4.2 Test procedure

Same as in clause 4.7.1.1.1.4.2 but replacing Table 4.7.1.1.1.5-1 and 4.7.1.1.1.5-2 with 4.7.1.2.1.5-1 and 4.7.1.2.1.5-2, respectively.

4.7.1.2.1.4.3 Message contents

Message contents are according to TS 38.508-1 [14] clause 7.3 with the following exceptions:

**Table 4.7.1.2.1.4.3-1: Common Exception messages for EN-DC FR1-FR1 SS-RSRP absolute measurement accuracy**

Default Message Contents	
Common contents of system information blocks exceptions	
Default RRC messages and information elements contents exceptions	Table H.3.1-1 Table H.3.1-2 with condition INTER-FREQ and GAP NEEDED Table H.3.1-5 Table H.3.1-7 with condition INTER-FREQ Table H.3.4-1 Table H.3.4-1a Table H.3.4-2 Table H.3.4-4 with Condition gapUE Table H.3.4-5 with Condition Pattern#0
Specific message contents exceptions for Test Configuration 4.7.1.1.1.-1 and 4.7.1.1.1.-4	Table H.3.1-3 with Conditions INTER-FREQ MO, SSB.1 FR1 Table 7.3.1-3 in TS 38.508-1 [14] with condition SMTC.2
Specific message contents exceptions for Test Configuration 4.7.1.1.1.-2 and 4.7.1.1.1.-5	Table H.3.1-3 with Conditions INTER-FREQ MO, SSB.1 FR1 and Synchronous cells Table 7.3.1-3 in TS 38.508-1 [14] with condition SMTC.1
Specific message contents exceptions for Test Configuration 4.7.1.1.1.-3 and 4.7.1.1.1.-6	Table H.3.1-3 with Conditions INTER-FREQ MO, SSB.2 FR1 and Synchronous cells Table 7.3.1-3 in TS 38.508-1 [14] with condition SMTC.1

**Table 4.7.1.2.1.4.3-2: ReportConfigNR-DEFAULT(Periodical) for EN-DC FR1-FR1 SS-RSRP Accuracy**

Derivation Path: 38.508-1 [14] Table 4.6.3-142 with condition PERIODICAL			
Information Element	Value/remark	Comment	Condition
ReportConfigNR ::= SEQUENCE {			
reportType CHOICE {			
periodical SEQUENCE {			PERIODICAL
reportQuantityCell SEQUENCE {			
rsrq	false		
sinr	false		
}			
maxReportCells	2		
}			
}			
}			

4.7.1.2.1.5 Test requirement

Table 4.7.1.2.1.5-1 defines the primary level settings including test tolerances for all tests.

Each SS-RSRP measurement report for each of the tests in Table 4.7.1.2.1.5-1 shall meet the corresponding absolute accuracy requirements in Table 4.7.1.2.1.5-2 for test configurations 1, 2, 4 and 5, and the corresponding absolute accuracy requirements in Table 4.7.1.2.1.5-3 for test configurations 3 and 6.

**Table 4.7.1.2.1.5-1: SS-RSRP inter-frequency test parameters**

Parameter	Config	Unit	Test 1		Test 2		
			Cell 2	Cell 3	Cell 2	Cell 3	
SSB ARFCN	1~6		freq1	freq2	freq1	freq2	
BW <sub>channel</sub>	1,4	MHz	10: N <sub>RB,c</sub> = 52		10: N <sub>RB,c</sub> = 52		
	2,5		10: N <sub>RB,c</sub> = 52		10: N <sub>RB,c</sub> = 52		
	3,6		40: N <sub>RB,c</sub> = 106		40: N <sub>RB,c</sub> = 106		
Gap pattern ID			0		0		
Duplex mode	1,4		FDD		FDD		
	2,5		TDD		TDD		
	3,6		TDD		TDD		
TDD configuration	1,4		N/A		N/A		
	2,5		TDDConf.1.1		TDDConf.1.1		
	3,6		TDDConf.2.1		TDDConf.2.1		
PDSCH Reference measurement channel	1,4		SR.1.1 FDD	-	SR.1.1 FDD	-	
	2,5		SR.1.1 TDD		SR.1.1 TDD		
	3,6		SR.2.1 FDD		SR.2.1 FDD		
RMSI CORESET Reference Channel	1,4		CR.1.1 FDD	-	CR.1.1 FDD	-	
	2,5		CR.1.1 TDD		CR.1.1 TDD		
	3,6		CR.2.1 FDD		CR.2.1 FDD		
Dedicated CORESET Reference Channel	1,4		CCR.1.1 FDD	-	CCR.1.1 FDD	-	
	2,5		CCR.1.1 TDD		CCR.1.1 TDD		
	3,6		CCR.2.1 TDD		CCR.2.1 TDD		
SSB configuration	1,4		SSB.1 FR1		SSB.1 FR1		
	2,5		SSB.1 FR1		SSB.1 FR1		
	3,6		SSB.2 FR1		SSB.2 FR1		
OCNG Patterns	1~6		OP.1		OP.1		
TRS configuration	1,4		TRS.1.1 FDD	-	TRS.1.1 FDD	-	
	2,5		TRS.1.1 TDD		TRS.1.1 TDD		
	3,6		TRS.1.2 TDD		TRS.1.2 TDD		
Initial BWP Configuration	1~6		DLBWP.0.1 ULBWP.0.1		DLBWP.0.1 ULBWP.0.1		
Dedicated BWP configuration	1~6		DLBWP.1.1 ULBWP.1.1		DLBWP.1.1 ULBWP.1.1		
SMTC configuration	1,4		SMTC.2		SMTC.2		
	2,3,5,6		SMTC.1		SMTC.1		
Time offset between Cell 2 and Cell 3	1,4	ms	3		3		
	2,3,5,6	µs	3		3		
EPRE ratio of PSS to SSS	1~6	dB	0	0	0	0	
EPRE ratio of PBCH DMRS to SSS							
EPRE ratio of PBCH to PBCH DMRS							
EPRE ratio of PDCCH DMRS to SSS							
EPRE ratio of PDCCH to PDCCH DMRS							
EPRE ratio of PDSCH DMRS to SSS							
EPRE ratio of PDSCH to PDSCH DMRS							
EPRE ratio of OCNG DMRS to SSS <sup>Note 1</sup>							
EPRE ratio of OCNG to OCNG DMRS <sup>Note 1</sup>							
$N_{oc}$ <sup>Note 2</sup>	Depending on band group	1,2,4,5	dBm/15k Hz	-94.65	-94.65	( $N_{oc}$ for Cell 3 +8dB)	-115+ ΔBG <sub>offset</sub>

Parameter		Config	Unit	Test 1		Test 2	
				Cell 2	Cell 3	Cell 2	Cell 3
$N_{oc}$ <sup>Note2</sup>	Depending on band group	3,6	dBm/15k Hz	-96	-96	( $N_{oc}$ for Cell 3 +8dB)	-115+ $\Delta_{BG\_offset}$
$N_{oc}$ <sup>Note2</sup>	Depending on band group	1,2,4,5	dBm/SS B SCS	-94.65	-94.65	( $N_{oc}$ for Cell 3 +8dB)	-115+ $\Delta_{BG\_offset}$
	Depending on band group	3,6		-93	-93	( $N_{oc}$ for C 3 +8dB)	-112.00+ $\Delta_{BG\_offset}$
$\hat{E}_s/I_{ot}$		1-6	dB	10	10	13	-3
SS-RSRP <sup>Note3</sup>	Depending on band group	1,2,4,5	dBm/SC S	-84.65	84.65	(RSRP for Cell 3 +25dB)	-118.00+ $\Delta_{BG\_offset}$
	Depending on band group	3,6		-83	-83	(RSRP for Cell 3 +25dB)	-115.00+ $\Delta_{BG\_offset}$
$I_o$ <sup>Note3</sup>	Depending on band group	1,2,4,5	dBm/9.36MHz	56.28	56.28	( $I_o$ for Channel 3 +19.75dB)	-85.28+ $\Delta_{BG\_offset}$
	Depending on band group	3,6	dBm/38.16MHz	-51.53	-51.53	( $I_o$ for Channel 3 +19.75dB)	-79.19+ $\Delta_{BG\_offset}$
$\hat{E}_s/N_{oc}$		1-6	dB	10	10	13	-3
Propagation condition		1-6	-	AWGN		AWGN	
Antenna configuration				1x2		1x2	
<p>NOTE 1: OCNB shall be used such that both cells are fully allocated and a constant total transmitted power spectral density is achieved for all OFDM symbols.</p> <p>NOTE 2: Interference from other cells and noise sources not specified in the test is assumed to be constant over subcarriers and time and shall be modelled as AWGN of appropriate power for <math>N_{oc}</math> to be fulfilled.</p> <p>NOTE 3: RSRP and <math>I_o</math> levels have been derived from other parameters for information purposes. They are not settable parameters themselves.</p> <p>NOTE 4: RSRP minimum requirements are specified assuming independent interference and noise at each receiver antenna port.</p> <p>Note 5 The test configuration excludes support for band n51 and it is not required to run this test on band n51 in this release of the specification</p> <p>NOTE 6: <math>\Delta_{BG\_offset}</math> is defined in clause 3A.4, Table 3A.4.1-2.</p>							

**Table 4.7.1.2.1.5-2: SS-RSRP Inter frequency absolute accuracy requirements for the reported values for test configurations 1, 2, 4 and 5**

Normal Conditions	Test 1 All bands	Test 2	
Lowest reported value (Cell 3)	62	Bands NR_FDD_FR1_A, NR_TDD_FR1_A	32
		Bands NR_FDD_FR1_B	33
		Bands NR_TDD_FR1_C	33
		Bands NR_FDD_FR1_D, NR_TDD_FR1_D	34
		Bands NR_FDD_FR1_E, NR_TDD_FR1_E	34
		Bands NR_FDD_FR1_G	35
		Bands NR_FDD_FR1_H	36
Highest reported value (Cell 3)	81	Bands NR_FDD_FR1_A, NR_TDD_FR1_A	45
		Bands NR_FDD_FR1_B	45
		Bands NR_TDD_FR1_C	46

		Bands NR_FDD_FR1_D, NR_TDD_FR1_D	46
		Bands NR_FDD_FR1_E, NR_TDD_FR1_E	47
		Bands NR_FDD_FR1_G	48
		Bands NR_FDD_FR1_H	48
<b>Extreme Conditions</b>	<b>Test 1 All bands</b>	<b>Test 2</b>	
Lowest reported value (Cell 3)	59	Bands NR_FDD_FR1_A, NR_TDD_FR1_A	28
		Bands NR_FDD_FR1_B	28
		Bands NR_TDD_FR1_C	29
		Bands NR_FDD_FR1_D, NR_TDD_FR1_D	29
		Bands NR_FDD_FR1_E, NR_TDD_FR1_E	30
		Bands NR_FDD_FR1_G	31
		Bands NR_FDD_FR1_H	31
Highest reported value (Cell 3)	84	Bands NR_FDD_FR1_A, NR_TDD_FR1_A	49
		Bands NR_FDD_FR1_B	50
		Bands NR_TDD_FR1_C	50
		Bands NR_FDD_FR1_D, NR_TDD_FR1_D	51
		Bands NR_FDD_FR1_E, NR_TDD_FR1_E	51
		Bands NR_FDD_FR1_G	52
		Bands NR_FDD_FR1_H	53
NOTE: NR operating band groups are defined in clause 3A.4, Table 3A.4.1-2.			

**Table 4.7.1.2.1.5-3: SS-RSRP Inter frequency absolute accuracy requirements for the reported values for test configurations 3 and 6**

<b>Normal Conditions</b>	<b>Test 1 All bands</b>	<b>Test 2</b>	
Lowest reported value (Cell 3)	64	Bands NR_FDD_FR1_A, NR_TDD_FR1_A	35
		Bands NR_FDD_FR1_B	36
		Bands NR_TDD_FR1_C	36
		Bands NR_FDD_FR1_D, NR_TDD_FR1_D	37
		Bands NR_FDD_FR1_E, NR_TDD_FR1_E	37
		Bands NR_FDD_FR1_G	38
		Bands NR_FDD_FR1_H	39
Highest reported value (Cell 3)	83	Bands NR_FDD_FR1_A, NR_TDD_FR1_A	48
		Bands NR_FDD_FR1_B	48
		Bands NR_TDD_FR1_C	49
		Bands NR_FDD_FR1_D, NR_TDD_FR1_D	49
		Bands NR_FDD_FR1_E, NR_TDD_FR1_E	50
		Bands NR_FDD_FR1_G	51
		Bands NR_FDD_FR1_H	51
<b>Extreme Conditions</b>	<b>Test 1 All bands</b>	<b>Test 2</b>	
Lowest reported value (Cell 3)	61	Bands NR_FDD_FR1_A, NR_TDD_FR1_A	31
		Bands NR_FDD_FR1_B	31
		Bands NR_TDD_FR1_C	32

		Bands NR_FDD_FR1_D, NR_TDD_FR1_D	32
		Bands NR_FDD_FR1_E, NR_TDD_FR1_E	33
		Bands NR_FDD_FR1_G	34
		Bands NR_FDD_FR1_H	34
Highest reported value (Cell 3)	86	Bands NR_FDD_FR1_A, NR_TDD_FR1_A	52
		Bands NR_FDD_FR1_B	53
		Bands NR_TDD_FR1_C	53
		Bands NR_FDD_FR1_D, NR_TDD_FR1_D	54
		Bands NR_FDD_FR1_E, NR_TDD_FR1_E	54
		Bands NR_FDD_FR1_G	55
		Bands NR_FDD_FR1_H	56
NOTE: NR operating band groups are defined in clause 3A.4, Table 3A.4.1-2			

For the test to pass, the ratio of successful reported values in each test shall be more than 90% with a confidence level of 95%.

#### 4.7.1.2.2 EN-DC FR1-FR1 SS-RSRP relative measurement accuracy

##### 4.7.1.2.2.1 Test purpose

The purpose of this test is to verify that the inter-frequency SS-RSRP absolute measurement accuracy is within the specified limits for all bands.

##### 4.7.1.2.2.2 Test applicability

This test applies to all types of NR UE supporting E-UTRA and EN-DC from Release 15 onwards.

##### 4.7.1.2.2.3 Minimum conformance requirements

The minimum conformance requirements are specified in clause 4.7.1.0.4.

The normative reference for this requirement is TS 38.133 [6] clause A.4.7.1.2.

##### 4.7.1.2.2.4 Test description

###### 4.7.1.2.2.4.1 Initial conditions

This test shall be tested using any of the test configurations in Table 4.7.1.2.2.4.1-1.

**Table 4.7.1.2.2.4.1-1: EN-DC FR1-FR1 SS-RSRP measurement accuracy supported test configurations**

Test Case ID	Description
4.7.1.2.2-1	LTE FDD, NR: 15 kHz SSB SCS, 10MHz bandwidth, FDD
4.7.1.2.2-2	LTE FDD, NR: 15 kHz SSB SCS, 10MHz bandwidth, TDD
4.7.1.2.2-3	LTE FDD, NR: 30 kHz SSB SCS, 40MHz bandwidth, TDD
4.7.1.2.2-4	LTE TDD, NR: 15 kHz SSB SCS, 10MHz bandwidth, FDD
4.7.1.2.2-5	LTE TDD, NR: 15 kHz SSB SCS, 10MHz bandwidth, TDD
4.7.1.2.2-6	LTE TDD, NR: 30 kHz SSB SCS, 40MHz bandwidth, TDD
NOTE: The UE is only required to be tested in one of the supported test configurations.	

Configure the test equipment and the DUT according to the parameters in Table 4.7.1.2.2.4.1-2.

**Table 4.7.1.2.2.4.1-2: Initial conditions for SS-RSRP inter frequency relative accuracy in FR1**

Parameter	Value		Comment
Test environment	NC, TL/VL, TL/VH, TH/VL, TH/VH		As specified in TS 38.508-1 [14] clause 4.1.
Test frequencies	As specified in Annex E, Table E.2-1 and TS 38.508-1 [14] clause 4.3.1.		
Channel bandwidth	As specified by the test configuration selected from Table 4.7.1.2.2.4.1-1.		
Propagation conditions	AWGN		As specified in clause C.2.2.
Connection Diagram	TE Part 2Rx	A.3.1.8.2 with $n = 2$ and $\varphi_1 = 5$ Hz	As specified in TS 38.508-1 [14] Annex A.
	TE Part 4Rx	A.3.1.8.5 with $n = 2$ and $\varphi_{1,1} = 5$ Hz, $\varphi_{1,2} = 10$ Hz, $\varphi_{1,3} = 15$ Hz	
	DUT Part 2Rx	A.3.2.3.4	
	DUT Part 4Rx	A.3.2.5.2	
Exceptions to connection diagram	N/A		

1. Message contents are defined in clause 4.7.1.2.2.4.3.
2. Cell 1 is the E-UTRA serving cell (PCell) for the EN-DC setup. The power levels and settings for Cell 1 are set according to Annex A.6. Cell 2 and Cell 3 are NR FR1 cells in two different FR1 frequencies. Cell 2 is the PSCell and Cell 3 is the target cell for SS-RSRP measurements. The connection setup is done according to the settings in clause C.1.1.

#### 4.7.1.2.2.4.2 Test procedure

Same as in clause 4.7.1.1.2.4.2 but replacing Table 4.7.1.1.2.5-1 and 4.7.1.1.2.5-2 with 4.7.1.2.2.5-1 and 4.7.1.2.2.5-2, respectively.

#### 4.7.1.2.2.4.3 Message contents

Message contents are same as in clause 4.7.1.2.1.4.3.

#### 4.7.1.2.2.5 Test requirement

Table 4.7.1.2.2.5-1 defines the primary level settings including test tolerances for all tests.

Each SS-RSRP measurement report for each of the tests in Table 4.7.1.2.2.5-1 shall meet the corresponding absolute accuracy requirements in Table 4.7.1.2.2.5-2.

**Table 4.7.1.2.2.5-1: same as Table 4.7.1.2.1.5-1**

**Table 4.7.1.2.2.5-2: SS-RSRP Intra frequency relative accuracy requirements for the reported values**

	Test 1	Test 2
	All bands	All bands
Normal Conditions		
Lowest reported value (Cell 3)	SS-RSRP <sub>x</sub> - 7	SS-RSRP <sub>x</sub> - 31
Highest reported value (Cell 3)	SS-RSRP <sub>x</sub> + 7	SS-RSRP <sub>x</sub> - 18
Extreme Conditions		
Lowest reported value (Cell 3)	SS-RSRP <sub>x</sub> - 9	SS-RSRP <sub>x</sub> - 33
Highest reported value (Cell 3)	SS-RSRP <sub>x</sub> + 9	SS-RSRP <sub>x</sub> - 17
SS-RSRP <sub>x</sub> is the reported value of Cell 2		

For the test to pass, the ratio of successful reported values in each test shall be more than 90% with a confidence level of 95%.



## 4.7.2 SS-RSRQ

### 4.7.2.0 Minimum conformance requirements

#### 4.7.2.0.1 Intra-frequency SS-RSRQ measurement accuracy requirements

The intra-frequency SS-RSRQ accuracy requirements are defined for the SS-RSRQ measured from a cell on the same frequency as that of the PCell or PSCell in FR1.

The accuracy requirements in Table 4.7.2.0.1-1 are valid under the following conditions:

- Conditions defined in clause 7.3 of TS 38.101-1 [2] for reference sensitivity are fulfilled.
- Conditions for intra-frequency measurements are fulfilled according to Annex B.2.2 for a corresponding Band for each relevant SSB.

**Table 4.7.2.0.1-1: SS-RSRQ Intra frequency absolute accuracy in FR1**

Accuracy		Conditions					
Normal condition	Extreme condition	SSB $\hat{E}_s/\text{lot}$	$I_0$ <sup>Note 1</sup> range				
			NR operating band groups <sup>Note 3</sup>	Minimum $I_0$			Maximum $I_0$
dB	dB	dB		dBm / $SCS_{SSB}$		dBm/BW <sub>Channel</sub>	dBm/BW <sub>Channel</sub>
				$SCS_{SSB} = 15$ kHz	$SCS_{SSB} = 30$ kHz		
$\pm 2.5$	$\pm 4$	$\geq -3$ dB	NR_FDD_FR1_A, NR_TDD_FR1_A, NR_SDL_FR1_A	-121	-118	N/A	-50
			NR_FDD_FR1_B	-120.5	-117.5	N/A	-50
			NR_TDD_FR1_C	-120	-117	N/A	-50
			NR_FDD_FR1_D, NR_TDD_FR1_D	-119.5	-116.5	N/A	-50
			NR_FDD_FR1_E, NR_TDD_FR1_E	-119	-116	N/A	-50
			NR_FDD_FR1_G	-118	-115	N/A	-50
			NR_FDD_FR1_H	-117.5	-114.5	N/A	-50
$\pm 3.5$	$\pm 4$	$\geq -6$ dB	Note 2	Note 2	Note 2	Note 2	Note 2

NOTE 1:  $I_0$  is assumed to have constant EPRE across the bandwidth.  
NOTE 2: The same bands and the same  $I_0$  conditions for each band apply for this requirement as for the corresponding highest accuracy requirement.  
NOTE 3: NR operating band groups in FR1 are as defined in Section 3A.4.1.

The reporting range of SS-RSRQ is defined from -43 dB to 20 dB with 0.5 dB resolution. The mapping of measured quantity is defined in Table 4.7.2.0.1-2. The range in the signalling may be larger than the guaranteed accuracy range.

**Table 4.7.2.0.1-2: SS-RSRQ measurement report mapping**

Reported value	Measured quantity value	Unit
SS-RSRQ_0	$SS-RSRQ < -43$	dB
SS-RSRQ_1	$-43 \leq SS-RSRQ < -42.5$	dB
SS-RSRQ_2	$-42.5 \leq SS-RSRQ < -42$	dB
SS-RSRQ_3	$-42 \leq SS-RSRQ < -41.5$	dB
SS-RSRQ_4	$-41.5 \leq SS-RSRQ < -41$	dB
..	..	...
SS-RSRQ_122	$17.5 \leq SS-RSRQ < 18$	dB
SS-RSRQ_123	$18 \leq SS-RSRQ < 18.5$	dB
SS-RSRQ_124	$18.5 \leq SS-RSRQ < 19$	dB
SS-RSRQ_125	$19 \leq SS-RSRQ < 19.5$	dB
SS-RSRQ_126	$19.5 \leq SS-RSRQ < 20$	dB
SS-RSRQ_127	$20 \leq SS-RSRQ$	dB

The normative reference for this requirement is TS 38.133 [6] clauses 10.1.7.1.1 and 10.1.11.

#### 4.7.2.0.2 Inter-frequency absolute SS-RSRQ measurement accuracy requirements

The inter-frequency SS-RSRQ absolute accuracy requirements in this clause are defined for the SS-RSRQ measured from a cell on a different frequency as that of the PCell or PSCell in FR1.

The accuracy requirements in Table 4.7.2.0.2-1 are valid under the following conditions:

- Conditions defined in 38.101-1 [2] Clause 7.3 for reference sensitivity are fulfilled.
- Conditions for intra-frequency measurements are fulfilled according to Annex B.2.3 for a corresponding Band for each relevant SSB.

**Table 4.7.2.0.2-1: SS-RSRQ Inter frequency absolute accuracy in FR1**

Accuracy		Conditions					
Normal condition	Extreme condition	SSB $\hat{E}_s/\text{lot}$	$I_o$ <sup>Note 1</sup> range				
			NR operating band groups <sup>Note 3</sup>	Minimum $I_o$		Maximum $I_o$	
dB	dB	dB		dBm / $SCS_{SSB}$		dBm/ $BW_{\text{Channel}}$	dBm/ $BW_{\text{Channel}}$
				$SCS_{SSB} = 15 \text{ kHz}$	$SCS_{SSB} = 30 \text{ kHz}$		
$\pm 2.5$	$\pm 4$	$\geq -3 \text{ dB}$	NR_FDD_FR1_A, NR_TDD_FR1_A, NR_SDL_FR1_A	-121	-118	N/A	-50
			NR_FDD_FR1_B	-120.5	-117.5	N/A	-50
			NR_TDD_FR1_C	-120	-117	N/A	-50
			NR_FDD_FR1_D, NR_TDD_FR1_D	-119.5	-116.5	N/A	-50
			NR_FDD_FR1_E, NR_TDD_FR1_E	-119	-116	N/A	-50
			NR_FDD_FR1_G	-118	-115	N/A	-50
			NR_FDD_FR1_H	-117.5	-114.5	N/A	-50
$\pm 3.5$	$\pm 4$	$\geq -6 \text{ dB}$	Note 2	Note 2	Note 2	Note 2	Note 2

NOTE 1:  $I_o$  is assumed to have constant EPRE across the bandwidth.  
NOTE 2: The same bands and the same  $I_o$  conditions for each band apply for this requirement as for the corresponding highest accuracy requirement.  
NOTE 3: NR operating band groups in FR1 are as defined in Section 3A.4.1.

The normative reference for this requirement is TS 38.133 [6] clauses 10.1.9.1.1 and 10.1.11.

#### 4.7.2.0.3 Inter-frequency relative SS-RSRQ measurement accuracy requirements

The inter-frequency SS-RSRQ relative accuracy requirements in this clause are defined for the SS-RSRQ measured from one cell on a frequency in FR1 compared to the SS-RSRQ measured from another cell on a different frequency in FR1.

The accuracy requirements in Table 4.7.2.0.3-1 are valid under the following conditions:

- Conditions defined in clause 7.3 of TS 38.101-1 [2] for reference sensitivity are fulfilled.
- Conditions for inter-frequency measurements are fulfilled according to Annex B.2.3 for a corresponding Band for each relevant SSB.
- $|\text{SSB\_RP1}_{\text{dBm}} - \text{SSB\_RP2}_{\text{dBm}}| \leq 27 \text{ dB}$
- $|\text{Channel 1}_{I_o} - \text{Channel 2}_{I_o}| \leq 20 \text{ dB}$

Table 4.7.2.0.3-1: SS-RSRQ Inter frequency relative accuracy in FR1

Accuracy		Conditions					
Normal condition	Extreme condition	SSB $\hat{E}_s/\text{lot}$ Note 2	$I_o$ Note 1 range				
			NR operating band groups Note 4	Minimum $I_o$		Maximum $I_o$	
dB	dB	dB		dBm / $SCS_{SSB}$			dBm/BW <sub>Channel</sub>
			$SCS_{SSB} =$ 15 kHz	$SCS_{SSB} =$ 30 kHz			
$\pm 3$	$\pm 4$	$\geq -3$ dB	NR_FDD_FR1_A, NR_TDD_FR1_A, NR_SDL_FR1_A	-121	-118	N/A	-50
			NR_FDD_FR1_B	-120.5	-117.5	N/A	-50
			NR_TDD_FR1_C	-120	-117	N/A	-50
			NR_FDD_FR1_D, NR_TDD_FR1_D	-119.5	-116.5	N/A	-50
			NR_FDD_FR1_E, NR_TDD_FR1_E	-119	-116	N/A	-50
			NR_FDD_FR1_G	-118	-115	N/A	-50
			NR_FDD_FR1_H	-117.5	-114.5	N/A	-50
$\pm 4$	$\pm 4$	$\geq -6$ dB	Note 3	Note 3	Note 3	Note 3	Note 3

NOTE 1:  $I_o$  is assumed to have constant EPRE across the bandwidth.  
NOTE 2: The parameter SSB  $\hat{E}_s/\text{lot}$  is the minimum SSB  $\hat{E}_s/\text{lot}$  of the pair of cells to which the requirement applies.  
NOTE 3: The same bands and the same  $I_o$  conditions for each band apply for this requirement as for the corresponding highest accuracy requirement.  
NOTE 4: NR operating band groups in FR1 are as defined in Section 3A.4.1.

The normative reference for this requirement is TS 38.133 [6] clauses 10.1.9.1.2 and 10.1.11.

#### 4.7.2.1 EN-DC FR1 SS-RSRQ measurement accuracy

##### 4.7.2.1.1 Test purpose

The purpose of this test is to verify that the intra-frequency SS-RSRQ measurement accuracy is within the specified limits for all bands.

##### 4.7.2.1.2 Test applicability

This test applies to all types of NR UE supporting E-UTRA and EN-DC from Release 15 onwards.

##### 4.7.2.1.3 Minimum conformance requirements

The minimum conformance requirements are specified in clause 4.7.2.0.1.

The normative reference for this requirement is TS 38.133 [6] clause A.4.7.2.1.

##### 4.7.2.1.4 Test description

###### 4.7.2.1.4.1 Initial conditions

This test shall be tested using any of the test configurations in Table 4.7.2.1.4.1-1.

**Table 4.7.2.1.4.1-1: EN-DC FR1 SS-RSRQ measurement accuracy supported test configurations**

Test Case ID	Description
4.7.2.1-1	LTE FDD, NR: 15 kHz SSB SCS, 10MHz bandwidth, FDD
4.7.2.1-2	LTE FDD, NR: 15 kHz SSB SCS, 10MHz bandwidth, TDD
4.7.2.1-3	LTE FDD, NR: 30 kHz SSB SCS, 40MHz bandwidth, TDD
4.7.2.1-4	LTE TDD, NR: 15 kHz SSB SCS, 10MHz bandwidth, FDD
4.7.2.1-5	LTE TDD, NR: 15 kHz SSB SCS, 10MHz bandwidth, TDD
4.7.2.1-6	LTE TDD, NR: 30 kHz SSB SCS, 40MHz bandwidth, TDD

NOTE: The UE is only required to be tested in one of the supported test configurations.

Configure the test equipment and the DUT according to the parameters in Table 4.7.2.1.4.1-2.

**Table 4.7.2.1.4.1-2: Initial conditions for SS-RSRQ intra frequency accuracy in FR1**

Parameter	Value	Comment
Test environment	NC, TL/VL, TL/VH, TH/VL, TH/VH	As specified in TS 38.508-1 [14] clause 4.1.
Test frequencies	As specified in Annex E, Table E.2-1 and TS 38.508-1 [14] clause 4.3.1.	
Channel bandwidth	As specified by the test configuration selected from Table 4.7.2.1.4.1-1.	
Propagation conditions	AWGN As specified in clause C.2.2.	
Connection Diagram	TE Part 2Rx	A.3.1.8.2 with $n = 2$ and $\varphi_1 = 5$ Hz
	TE Part 4Rx	A.3.1.8.5 with $n = 2$ and $\varphi_{1,1} = 5$ Hz, $\varphi_{1,2} = 10$ Hz, $\varphi_{1,3} = 15$ Hz
	DUT Part 2Rx	A.3.2.3.4
	DUT Part 4Rx	A.3.2.5.2
Exceptions to connection diagram	N/A	

1. Message contents are defined in clause 4.7.2.1.4.3.
2. Cell 1 is the E-UTRA serving cell (PCell) for the EN-DC setup. The power levels and settings for Cell 1 are set according to Annex A.6. Cell 2 and Cell 3 are NR FR1 cells in the same frequency. Cell 2 is the PSCell and Cell 3 is the target cell for SS-RSRQ measurements. The connection setup is done according to the settings in clause C.1.3.

#### 4.7.2.1.4.2 Test procedure

1. Ensure the UE is in state RRC\_CONNECTED with generic procedure parameters Connectivity EN-DC, DC bearer MCG and SCG, Connected without release  $On$  and Test Mode  $On$ , according to TS 38.508-1 [14] clause 4.5.
2. Set the parameters according to Table 4.7.2.1.5-1 as appropriate.
3. The SS shall transmit an RRCConnectionReconfiguration message on Cell 1.
4. The UE shall transmit an RRCConnectionReconfigurationComplete message.
5. The UE shall transmit periodically MeasurementReport messages.
6. After 10s wait from Step 3, the SS shall check the SS-RSRQ reported values in the periodic MeasurementReport. The SS-RSRQ value of Cell 3 reported by the UE is compared to the expected SS-RSRQ. If the value is outside the limits in Table 4.7.2.1.5-2 or the UE fails to report the measurement value for Cell 3, the number of failed iterations is increased by one. Otherwise, the number of passed iterations is increased by one.
7. The SS shall continue checking the MeasurementReport messages transmitted by the UE until the confidence level according to Table G.2.3-1 in Annex G is achieved.

8. Set the parameters according to each sub-test in Table 4.7.2.1.5-1 as appropriate and repeat steps 5-7.

4.7.2.1.4.3 Message contents

Message contents are according to TS 38.508-1 [14] clause 7.3 with the following exceptions:

**Table 4.7.2.1.4.3-1: Common Exception messages for EN-DC FR1 SS-RSRQ measurement accuracy**

Default Message Contents	
Common contents of system information blocks exceptions	
Default RRC messages and information elements contents exceptions	Table H.3.1-1 Table H.3.1-2 Table H.3.1-5 Table H.3.1-7 Table H.3.4-1 Table H.3.4-1a Table H.3.4-2
Specific message contents exceptions for Test Configuration 4.7.2.1-1 and 4.7.2.1-4	Table H.3.1-3 with Condition SSB.1 FR1 Table 7.3.1-3 in TS 38.508-1 [14] with condition SMTC.2
Specific message contents exceptions for Test Configuration 4.7.2.1-2 and 4.7.2.1-5	Table H.3.1-3 with Condition SSB.1 FR1 and Synchronous cells Table 7.3.1-3 in TS 38.508-1 [14] with condition SMTC.1
Specific message contents exceptions for Test Configuration 4.7.2.1-3 and 4.7.2.1-6	Table H.3.1-3 with Condition SSB.2 FR1 and Synchronous cells Table 7.3.1-3 in TS 38.508-1 [14] with condition SMTC.1

**Table 4.7.2.1.4.3-2: ReportConfigNR-DEFAULT(Periodical) for EN-DC FR1 SS-RSRQ Accuracy**

Derivation Path: 38.508-1 [14] Table 4.6.3-142 with condition PERIODICAL			
Information Element	Value/remark	Comment	Condition
ReportConfigNR ::= SEQUENCE {			
reportType CHOICE {			
periodical SEQUENCE {			PERIODICAL
reportQuantityCell SEQUENCE {			
rsrp	false		
sinr	false		
}			
maxReportCells	2		
}			
}			
}			

4.7.2.1.5 Test requirement

Table 4.7.2.1.5-1 defines the primary level settings including test tolerances for all tests.

Each SS-RSRQ measurement report for each of the tests in Table 4.7.2.1.5-1 shall meet the corresponding absolute accuracy requirements in Table 4.7.2.1.5-2.

**Table 4.7.2.1.5-1: SS-RSRQ Intra frequency test parameters**

Parameter	Unit	Test 1		Test 2		Test 3	
		Cell 2	Cell 3	Cell 2	Cell 3	Cell 2	Cell 3
SSB ARFCN		freq1		freq1		freq1	
Duplex mode	Config 1,4	FDD					
	Config 2,3,5,6	TDD					
TDD configuration	Config 1,4	Not Applicable					
	Config 2,5	TDDConf.1.1					
	Config 3,6	TDDConf.2.1					
BW <sub>channel</sub>	Config 1,4	10: N <sub>RB,c</sub> = 52					
	Config 2,5	10: N <sub>RB,c</sub> = 52					
	Config 3,6	40: N <sub>RB,c</sub> = 106					

Parameter			Unit	Test 1		Test 2		Test 3	
				Cell 2	Cell 3	Cell 2	Cell 3	Cell 2	Cell 3
BWP configuration	Initial DL BWP		DLBWP.0.1						
	Dedicated DL BWP		DLBWP.1.1						
	Initial UL BWP		ULBWP.0.1						
	Dedicated UL BWP		ULBWP.1.1						
DRX Cycle			ms						
PDSCH Reference measurement channel	Config 1,4		Not Applicable						
	Config 2,5		SR.1.1 FDD	-	SR.1.1 FDD	-	SR.1.1 FDD	-	
	Config 3,6		SR.1.1 TDD	-	SR.1.1 TDD	-	SR.1.1 TDD	-	
RMSI CORESET Reference Channel	Config 1,4		SR2.1 TDD	-	SR2.1 TDD	-	SR2.1 TDD	-	
	Config 2,5		CR.1.1 FDD	-	CR.1.1 FDD	-	CR.1.1 FDD	-	
	Config 3,6		CR.1.1 TDD	-	CR.1.1 TDD	-	CR.1.1 TDD	-	
Control Channel RMC	Config 1,4		CR.2.1 TDD	-	CR.2.1 TDD	-	CR.2.1 TDD	-	
	Config 2,5		CCR.1.1 FDD	-	CCR.1.1 FDD	-	CCR.1.1 FDD	-	
	Config 3,6		CCR.1.1 TDD	-	CCR.1.1 TDD	-	CCR.1.1 TDD	-	
TRS configuration	Config 1,4		CCR.2.1 TDD	-	CCR.2.1 TDD	-	CCR.2.1 TDD	-	
	Config 2,5		TRS.1.1 FDD	-	TRS.1.1 FDD	-	TRS.1.1 FDD	-	
	Config 3,6		TRS.1.1 TDD	-	TRS.1.1 TDD	-	TRS.1.1 TDD	-	
OCNG Patterns			OP. 1						
SS-RSSI-Measurement			Not Applicable						
Time offset with Cell 2	Config 2,3,5,6		-	3	-	3	-	3	
	Config 1,4		-	3	-	3	-	3	
STMC configuration	Config 2,3,5,6		SMTC.1						
	Config 1,4		SMTC.2						
SSB configuration	Config 1,2,4,5		SSB.1 FR1						
	Config 3,6		SSB.2 FR1						
PDSCH/PDCCH subcarrier spacing	Config 1,2,4,5		15 kHz						
	Config 3,6		30kHz						
EPRE ratio of PSS to SSS			dB	0	0	0	0	0	
EPRE ratio of PBCH DMRS to SSS									
EPRE ratio of PBCH to PBCH DMRS									
EPRE ratio of PDCCH DMRS to SSS									
EPRE ratio of PDCCH to PDCCH DMRS									
EPRE ratio of PDSCH DMRS to SSS									
EPRE ratio of PDSCH to PDSCH									
EPRE ratio of OCNG DMRS to SSS(Note 1)									
EPRE ratio of OCNG to OCNG DMRS (Note 1)									
$N_{oc}$ Note2	Config 1,2,4,5	Depending on band group	-86.5	-86.5	-101	-101	-114+ $\Delta_{BG\_offset}$	-114+ $\Delta_{BG\_offset}$	
	Config 3,6	Depending on band group	-92.6	-92.6	-	-	-114+ $\Delta_{BG\_offset}$	-114+ $\Delta_{BG\_offset}$	
$N_{oc}$ Note2	Config 1,2,4,5	Depending on band group	-86.5	-86.5	-101	-101	-114+ $\Delta_{BG\_offset}$	-114+ $\Delta_{BG\_offset}$	
	Config 3,6	Depending on band group	-89.6	-89.6	-	-	-111+ $\Delta_{BG\_offset}$	-111+ $\Delta_{BG\_offset}$	
$\hat{E}_s/I_{ot}$			dB		-1.76	-4.7	-5.46	-5.46	
$\hat{E}_s/N_{oc}$			dB		3	3	-2.9	-2.9	
SS-RSRP <sub>No</sub> te3	Config 1,2,4,5	Depending on band group	-83.5	-83.5	-103.9	-103.9	-	-118+ $\Delta_{BG\_offset}$	
	Config 3,6	Depending on band group	-86.6	-86.6	-	-	118+ $\Delta_{BG\_offset}$	-115+ $\Delta_{BG\_offset}$	

Parameter			Unit	Test 1		Test 2		Test 3	
				Cell 2	Cell 3	Cell 2	Cell 3	Cell 2	Cell 3
SS-RSRQ <sup>Note3</sup>			dB	-14.77	-14.77	-16.76	-16.76	-17.34	-17.34
I <sub>o</sub> <sup>Note3</sup>	Config 1,2,4,5	Depending on band group	dBm/9.36MHz	-51.57		-70		-83.50+ Δ <sub>BG_offset</sub>	
	Config 3,6	Depending on band group	dBm/38.16MHz	-51.56		-		-77.40+ Δ <sub>BG_offset</sub>	
Propagation condition			-	AWGN	AWGN	AWGN	AWGN	AWGN	AWGN
Antenna configuration				1x2	1x2	1x2	1x2	1x2	1x2
<p>NOTE 1: OCNG shall be used such that both cells are fully allocated and a constant total transmitted power spectral density is achieved for all OFDM symbols.</p> <p>NOTE 2: Interference from other cells and noise sources not specified in the test is assumed to be constant over subcarriers and time and shall be modelled as AWGN of appropriate power for <math>N_{oc}</math> to be fulfilled.</p> <p>NOTE 3: SS-RSRQ, SS-RSRP, and I<sub>o</sub> levels have been derived from other parameters for information purposes. They are not settable parameters themselves.</p> <p>NOTE 4: SS-RSRQ, SS-RSRP minimum requirements are specified assuming independent interference and noise at each receiver antenna port.</p> <p>NOTE 5: Δ<sub>BG_offset</sub> is defined in clause 3A.4, Table 3A.4.1-2.</p> <p>NOTE 6: Subtest 2 is not used when testing with 30kHz SSB SCS.</p> <p>NOTE 7: The test configuration excludes support for band n51 and it is not required to run this test on band n51 in this release of the specification.</p>									

**Table 4.7.2.1.5-2: SS-RSRQ Intra frequency absolute accuracy requirements for the reported values**

	Test 1	Test 2	Test 3
	All bands	All bands	All bands
Normal Conditions			
Lowest reported value (Cell 3)	SS-RSRQ_52	SS-RSRQ_46	SS-RSRQ_44
Highest reported value (Cell 3)	SS-RSRQ_62	SS-RSRQ_60	SS-RSRQ_59
Extreme Conditions			
Lowest reported value (Cell 3)	SS-RSRQ_49	SS-RSRQ_45	SS-RSRQ_43
Highest reported value (Cell 3)	SS-RSRQ_65	SS-RSRQ_61	SS-RSRQ_60

For the test to pass, the ratio of successful reported values in each test shall be more than 90% with a confidence level of 95%.

### 4.7.2.2 Inter-Frequency SS-RSRQ measurement accuracy

#### 4.7.2.2.1 EN-DC FR1-FR1 SS-RSRQ absolute measurement accuracy

##### 4.7.2.2.1.1 Test purpose

The purpose of this test is to verify that the inter-frequency SS-RSRQ absolute measurement accuracy is within the specified limits for all bands.

##### 4.7.2.2.1.2 Test applicability

This test applies to all types of NR UE supporting E-UTRA and EN-DC from Release 15 onwards.

##### 4.7.2.2.1.3 Minimum conformance requirements

The minimum conformance requirements are specified in clause 4.7.2.0.2.

The normative reference for this requirement is TS 38.133 [6] clause A.4.7.2.2.1.

4.7.2.2.1.4 Test description

4.7.2.2.1.4.1 Initial conditions

This test shall be tested using any of the test configurations in Table 4.7.2.2.1.4.1-1.

**Table 4.7.2.2.1.4.1-1: EN-DC FR1-FR1 SS-RSRQ measurement accuracy supported test configurations**

Test Case ID	Description
4.7.2.2.1-1	LTE FDD, NR: 15 kHz SSB SCS, 10MHz bandwidth, FDD
4.7.2.2.1-2	LTE FDD, NR: 15 kHz SSB SCS, 10MHz bandwidth, TDD
4.7.2.2.1-3	LTE FDD, NR: 30 kHz SSB SCS, 40MHz bandwidth, TDD
4.7.2.2.1-4	LTE TDD, NR: 15 kHz SSB SCS, 10MHz bandwidth, FDD
4.7.2.2.1-5	LTE TDD, NR: 15 kHz SSB SCS, 10MHz bandwidth, TDD
4.7.2.2.1-6	LTE TDD, NR: 30 kHz SSB SCS, 40MHz bandwidth, TDD
NOTE:	The UE is only required to be tested in one of the supported test configurations.

Configure the test equipment and the DUT according to the parameters in Table 4.7.2.2.1.4.1-2.

**Table 4.7.2.2.1.4.1-2: Initial conditions for SS-RSRQ inter frequency accuracy in FR1**

Parameter	Value	Comment
Test environment	NC, TL/VL, TL/VH, TH/VL, TH/VH	As specified in TS 38.508-1 [14] clause 4.1.
Test frequencies	As specified in Annex E, Table E.2-1 and TS 38.508-1 [14] clause 4.3.1.	
Channel bandwidth	As specified by the test configuration selected from Table 4.7.2.2.1.4.1-1.	
Propagation conditions	AWGN	As specified in clause C.2.2.
Connection Diagram	TE Part 2Rx	A.3.1.8.2 with $n = 2$ and $\varphi_1 = 5$ Hz
	TE Part 4Rx	A.3.1.8.5 with $n = 2$ and $\varphi_{1,1} = 5$ Hz, $\varphi_{1,2} = 10$ Hz, $\varphi_{1,3} = 15$ Hz
	DUT Part 2Rx	A.3.2.3.4
	DUT Part 4Rx	A.3.2.5.2
Exceptions to connection diagram	N/A	

1. Message contents are defined in clause 4.7.2.2.1.4.3.
2. Cell 1 is the E-UTRA serving cell (PCell) for the EN-DC setup. The power levels and settings for Cell 1 are set according to Annex A.6. Cell 2 and Cell 3 are NR FR1 cells in two different FR1 frequencies. Cell 2 is the PSCell and Cell 3 is the target cell for SS-RSRQ measurements. The connection setup is done according to the settings in clause C.1.1.

4.7.2.2.1.4.2 Test procedure

Same as in clause 4.7.2.1.4.2 but replacing Table 4.7.2.1.5-1 and 4.7.2.1.5-2 with 4.7.2.2.1.5-1 and 4.7.2.2.1.5-2, respectively.

4.7.2.2.1.4.3 Message contents

Message contents are according to TS 38.508-1 [14] clause 7.3 with the following exceptions:

**Table 4.7.2.2.1.4.3-1: Common Exception messages for EN-DC FR1-FR1 SS-RSRQ absolute measurement accuracy**



Default Message Contents	
Common contents of system information blocks exceptions	
Default RRC messages and information elements contents exceptions	Table H.3.1-1 Table H.3.1-2 with condition INTER-FREQ and GAP NEEDED Table H.3.1-5 Table H.3.1-7 with condition INTER-FREQ Table H.3.4-1 Table H.3.4-1a Table H.3.4-2 Table H.3.4-4 with Condition gapUE Table H.3.4-5 with Condition Pattern#0
Specific message contents exceptions for Test Configuration 4.7.2.1.1-1 and 4.7.2.1.1-4	Table H.3.1-3 with Conditions INTER-FREQ MO, SSB.1 FR1 Table 7.3.1-3 in TS 38.508-1 [14] with condition SMTC.2
Specific message contents exceptions for Test Configuration 4.7.2.1.1-2 and 4.7.2.1.1-5	Table H.3.1-3 with Conditions INTER-FREQ MO, SSB.1 FR1 and Synchronous cells Table 7.3.1-3 in TS 38.508-1 [14] with condition SMTC.1
Specific message contents exceptions for Test Configuration 4.7.2.1.1-3 and 4.7.2.1.1-6	Table H.3.1-3 with Conditions INTER-FREQ MO, SSB.2 FR1 and Synchronous cells Table 7.3.1-3 in TS 38.508-1 [14] with condition SMTC.1

**Table 4.7.2.2.1.4.3-2: ReportConfigNR-DEFAULT(Periodical) for EN-DC FR1-FR1 SS-RSRQ Accuracy**

Derivation Path: 38.508-1 [14] Table 4.6.3-142 with condition PERIODICAL			
Information Element	Value/remark	Comment	Condition
ReportConfigNR ::= SEQUENCE {			
reportType CHOICE {			
periodical SEQUENCE {			PERIODICAL
reportQuantityCell SEQUENCE {			
rsrp	false		
sinr	false		
}			
maxReportCells	2		
}			
}			
}			

4.7.2.2.1.5 Test requirement

Table 4.7.2.2.1.5-1 defines the primary level settings including test tolerances for all tests.

Each SS-RSRP measurement report for each of the tests in Table 4.7.2.2.1.5-1 shall meet the corresponding absolute accuracy requirements in Table 4.7.2.2.1.5-2

**Table 4.7.2.2.1.5-1: SS-RSRQ Inter frequency test parameters**

Parameter		Unit	Test 1		Test 2		Test 3	
			Cell 2	Cell 3	Cell 2	Cell 3	Cell 2	Cell 3
SSB ARFCN			freq1	freq2	freq1	freq2	freq1	freq2
Duplex mode	Config 1,4		FDD					
	Config 2,3,5,6		TDD					
TDD configuration	Config 1,4		Not Applicable					
	Config 2,5		TDDConf.1.1					
	Config 3,6		TDDConf.2.1					
BW <sub>channel</sub>	Config 1,4	MHz	10: N <sub>RB,c</sub> = 52					
	Config 2,5		10: N <sub>RB,c</sub> = 52					
	Config 3,6		40: N <sub>RB,c</sub> = 106					
Gap pattern ID	Config 1-6		0					
BWP configuration	Initial DL BWP		DLBWP.0.1					

Parameter		Unit	Test 1		Test 2		Test 3			
			Cell 2	Cell 3	Cell 2	Cell 3	Cell 2	Cell 3		
	Dedicated DL BWP		DLBWP.1.1							
	Initial UL BWP		ULBWP.0.1							
	Dedicated UL BWP		ULBWP.1.1							
DRX Cycle		ms	Not Applicable							
PDSCH Reference measurement channel	Config 1,4		SR.1.1 FDD	-	SR.1.1 FDD	-	SR.1.1 FDD	-		
	Config 2,5		SR.1.1 TDD		SR.1.1 TDD		SR.1.1 TDD			
	Config 3,6		SR2.1 TDD		SR2.1 TDD		SR2.1 TDD			
RMSI CORESET Reference Channel	Config 1,4		CR.1.1 FDD	-	R.1.1 FDD	-	CR.1.1 FDD			
	Config 2,5		CR.1.1 TDD		CR.1.1 TDD		CR.1.1 TDD			
	Config 3,6		CR2.1 TDD		CR2.1 TDD		CR2.1 TDD			
Dedicated CORESET Reference Channel	Config 1,4		CCR.1.1 FDD	-	CCR.1.1 FDD	-	CCR.1.1 FDD	-		
	Config 2,5		CCR.1.1 TDD		CCR.1.1 TDD		CCR.1.1 TDD			
	Config 3,6		CCR2.1 TDD		CCR2.1 TDD		CCR2.1 TDD			
TRS configuration	Config 1,4		TRS.1.1 FDD	-	TRS.1.1 FDD	-	TRS.1.1 FDD	-		
	Config 2,5		TRS.1.1 TDD		TRS.1.1 TDD		TRS.1.1 TDD			
	Config 3,6		TRS.1.2 TDD		TRS.1.2 TDD		TRS.1.2 TDD			
OCNG Patterns			OP.1							
SMTC configuration	Config 2,3,5,6		SMTC.1							
	Config 1,4		SMTC.2							
Time offset between Cell 2 and Cell 3	Config 2,3,5,6	µs	3							
	Config 1,4	ms	3							
SSB configuration	Config 1,2,4,5		SSB.1 in FR1							
	Config 3,6		SSB.2 in FR1							
PDSCH/PDCCH subcarrier spacing	Config 1,2,4,5	kHz	15 kHz							
	Config 3,6		30 kHz							
EPRE ratio of PSS to SSS		dB	0	0	0	0	0	0		
EPRE ratio of PBCH DMRS to SSS										
EPRE ratio of PBCH to PBCH DMRS										
EPRE ratio of PDCCH DMRS to SSS										
EPRE ratio of PDCCH to PDCCH DMRS										
EPRE ratio of PDSCH DMRS to SSS										
EPRE ratio of PDSCH to PDSCH										
EPRE ratio of OCNG DMRS to SSS(Note 1)										
EPRE ratio of OCNG to OCNG DMRS (Note 1)										
$N_{oc}$ <sup>Note2</sup>	Config 1,2,4,5	Depending on band group	dBm/15kHz	-81.68	-81.68	-106	-106	-116 + $\Delta_{BG\_offse}$ <sub>t</sub>	-116 + $\Delta_{BG\_offs}$ <sub>et</sub>	
$N_{oc}$ <sup>Note2</sup>	Config 3,6	Depending on band group	dBm/15kHz	-87.80	-87.80	-113	-113	-116+ $\Delta_{BG\_offse}$ <sub>t</sub>	-116+ $\Delta_{BG\_offs}$ <sub>et</sub>	
$N_{oc}$ <sup>Note2</sup>	Config 1,2,4,5	Depending on band group	dBm/SCS	-81.68	-81.68	-106	-106	-116 + $\Delta_{BG\_offse}$ <sub>t</sub>	-116 + $\Delta_{BG\_offs}$ <sub>et</sub>	
	Config 3,6	Depending on band group		-84.8	-84.8	-110	-110	-113+ $\Delta_{BG\_offse}$ <sub>t</sub>	-113+ $\Delta_{BG\_offs}$ <sub>et</sub>	
$\hat{E}_s / I_{ot}$			dB	-1.75	-1.75	-1.75	-1.75	3	-1.75	
$\hat{E}_s / N_{oc}$			dB	-1.75	-1.75	-1.75	-1.75	3	-1.75	

Parameter			Unit	Test 1		Test 2		Test 3	
				Cell 2	Cell 3	Cell 2	Cell 3	Cell 2	Cell 3
SS-RSRP <sup>Note 3</sup>	Config 1,2,4,5	Depending on band group	dBm/SCS	-83.43	-83.43	-107.75	-107.75	-113+ $\Delta_{BG\_offset}$	- 117.75 +
	Config 3,6	Depending on band group		-86.54	-86.54	-111.75	-111.75	-110+ $\Delta_{BG\_offset}$	- 114.75 +
SS-RSRQ <sup>Note 3</sup>			dB	-14.76	-14.76	-14.76	-14.76	-12.56	-14.76
I <sub>o</sub> <sup>Note 3</sup>	Config 1,2,4,5	Depending on band group	dBm/Ch BW	-51.51	-51.51	-75.83	-75.83	-83.28+ $\Delta_{BG\_offset}$	- 85.83+ $\Delta_{BG\_offset}$
	Config 3,6	Depending on band group		-51.52	-51.52	-76.73	-76.73	-77.19+ $\Delta_{BG\_offset}$	- 79.73+ $\Delta_{BG\_offset}$
Propagation condition			-	AWGN	AWGN	AWGN	AWGN	AWGN	AWGN
Antenna configuration				1x2	1x2	1x2	1x2	1x2	1x2
<p>NOTE 1: OCNG shall be used such that both cells are fully allocated and a constant total transmitted power spectral density is achieved for all OFDM symbols.</p> <p>NOTE 2: Interference from other cells and noise sources not specified in the test is assumed to be constant over subcarriers and time and shall be modelled as AWGN of appropriate power for <math>N_{oc}</math> to be fulfilled.</p> <p>NOTE 3: SS-RSRQ, SS-RSRP, and I<sub>o</sub> levels have been derived from other parameters for information purposes. They are not settable parameters themselves.</p> <p>NOTE 4: SS-RSRQ, SS-RSRP minimum requirements are specified assuming independent interference and noise at each receiver antenna port.</p> <p>NOTE 5: <math>\Delta_{BG\_offset}</math> is defined in clause 3A.4, Table 3A.4.1-2.</p> <p>NOTE 6: The test configuration excludes support for band n51 and it is not required to run this test on band n51 in this release of the specification.</p>									

**Table 4.7.2.2.1.5-2: SS-RSRQ Intra frequency absolute accuracy requirements for the reported values**

	Test 1	Test 2	Test 3
	All bands	All bands	All bands
Normal Conditions			
Lowest reported value (Cell 3)	SS-RSRQ_52	SS-RSRQ_52	SS-RSRQ_52
Highest reported value (Cell 3)	SS-RSRQ_62	SS-RSRQ_62	SS-RSRQ_62
Extreme Conditions			
Lowest reported value (Cell 3)	SS-RSRQ_49	SS-RSRQ_49	SS-RSRQ_49
Highest reported value (Cell 3)	SS-RSRQ_65	SS-RSRQ_65	SS-RSRQ_65

For the test to pass, the ratio of successful reported values in each test shall be more than 90% with a confidence level of 95%.

**4.7.2.2.2 EN-DC FR1-FR1 SS-RSRQ relative measurement accuracy**

**4.7.2.2.2.1 Test purpose**

The purpose of this test is to verify that the inter-frequency SS-RSRQ relative measurement accuracy is within the specified limits for all bands.

**4.7.2.2.2.2 Test applicability**

This test applies to all types of NR UE supporting E-UTRA and EN-DC from Release 15 onwards.

## 4.7.2.2.2.3 Minimum conformance requirements

The minimum conformance requirements are specified in clause 4.7.2.0.2.

The normative reference for this requirement is TS 38.133 [6] clause A.4.7.2.2.2.

## 4.7.2.2.2.4 Test description

## 4.7.2.2.2.4.1 Initial conditions

This test shall be tested using any of the test configurations in Table 4.7.2.2.2.4.1-1.

**Table 4.7.2.2.2.4.1-1: EN-DC FR1-FR1 SS-RSRQ measurement accuracy supported test configurations**

Test Case ID	Description
4.7.2.2.2-1	LTE FDD, NR: 15 kHz SSB SCS, 10MHz bandwidth, FDD
4.7.2.2.2-2	LTE FDD, NR: 15 kHz SSB SCS, 10MHz bandwidth, TDD
4.7.2.2.2-3	LTE FDD, NR: 30 kHz SSB SCS, 40MHz bandwidth, TDD
4.7.2.2.2-4	LTE TDD, NR: 15 kHz SSB SCS, 10MHz bandwidth, FDD
4.7.2.2.2-5	LTE TDD, NR: 15 kHz SSB SCS, 10MHz bandwidth, TDD
4.7.2.2.2-6	LTE TDD, NR: 30 kHz SSB SCS, 40MHz bandwidth, TDD

NOTE: The UE is only required to be tested in one of the supported test configurations.

Configure the test equipment and the DUT according to the parameters in Table 4.7.2.2.2.4.1-2.

**Table 4.7.2.2.2.4.1-2: Initial conditions for SS-RSRQ inter frequency accuracy in FR1**

Parameter	Value	Comment
Test environment	NC, TL/VL, TL/VH, TH/VL, TH/VH	As specified in TS 38.508-1 [14] clause 4.1.
Test frequencies	As specified in Annex E, Table E.2-1 and TS 38.508-1 [14] clause 4.3.1.	
Channel bandwidth	As specified by the test configuration selected from Table 4.7.2.2.2.4.1-1.	
Propagation conditions	AWGN	As specified in clause C.2.2.
Connection Diagram	TE Part 2Rx	A.3.1.8.2 with $n = 2$ and $\varphi_1 = 5$ Hz
	TE Part 4Rx	A.3.1.8.5 with $n = 2$ and $\varphi_{1,1} = 5$ Hz, $\varphi_{1,2} = 10$ Hz, $\varphi_{1,3} = 15$ Hz
	DUT Part 2Rx	A.3.2.3.4
	DUT Part 4Rx	A.3.2.5.2
Exceptions to connection diagram	N/A	

1. Message contents are defined in clause 4.7.2.2.2.4.3.
2. Cell 1 is the E-UTRA serving cell (PCell) for the EN-DC setup. The power levels and settings for Cell 1 are set according to Annex A.6. Cell 2 and Cell 3 are NR FR1 cells in two different FR1 frequencies. Cell 2 is the PSCell and Cell 3 is the target cell for SS-RSRQ measurements. The connection setup is done according to the settings in clause C.1.1.

## 4.7.2.2.2.4.2 Test procedure

1. Ensure the UE is in state RRC\_CONNECTED with generic procedure parameters Connectivity EN-DC, DC bearer MCG and SCG, Connected without release *On* and Test Mode *On*, according to TS 38.508-1 [14] clause 4.5.
2. Set the parameters according to Table 4.7.2.2.2.5-1 as appropriate.

3. The SS shall transmit an RRCConnectionReconfiguration message on Cell 1.
4. The UE shall transmit an RRCConnectionReconfigurationComplete message.
5. The UE shall transmit periodically MeasurementReport messages.
6. After 10s wait from Step 3, the SS shall check the SS-RSRQ reported values in the periodic MeasurementReport. The SS-RSRQ value of Cell 3 reported by the UE is compared to the SS-RSRQ value of Cell 2 reported by the UE. If the difference between both values is outside the limits in Table 4.7.2.2.5-2 or the UE fails to report the measurement value for Cell 3 or Cell 2, the number of failed iterations is increased by one. Otherwise, the number of passed iterations is increased by one.
7. The SS shall continue checking the MeasurementReport messages transmitted by the UE until the confidence level according to Table G.2.3-1 in Annex G is achieved.
8. Set the parameters according to each sub-test in Table 4.7.2.2.5-1 as appropriate and repeat steps 5-7.

#### 4.7.2.2.4.3 Message contents

Message contents are same as in clause 4.7.2.2.1.4.3.

#### 4.7.2.2.5 Test requirement

Table 4.7.2.2.5-1 defines the primary level settings including test tolerances for all tests.

Each SS-RSRQ measurement report for each of the tests in Table 4.7.2.2.5-1 shall meet the corresponding absolute accuracy requirements in Table 4.7.2.2.5-2.

**Table 4.7.2.2.5-1: same as Table 4.7.2.2.1.5-1**

**Table 4.7.2.2.5-2: SS-RSRQ Inter frequency relative accuracy requirements for the reported values**

	<b>Test 1</b>	<b>Test 2</b>	<b>Test 3</b>
	All bands	All bands	All bands
Normal Conditions			
Lowest reported value (Cell 3)	SS-RSRQ <sub>x</sub> - 7	SS-RSRQ <sub>x</sub> - 7	SS-RSRQ <sub>x</sub> - 11
Highest reported value (Cell 3)	SS-RSRQ <sub>x</sub> + 7	SS-RSRQ <sub>x</sub> + 7	SS-RSRQ <sub>x</sub> + 2
Extreme Conditions			
Lowest reported value (Cell 3)	SS-RSRQ <sub>x</sub> - 9	SS-RSRQ <sub>x</sub> - 9	SS-RSRQ <sub>x</sub> - 13
Highest reported value (Cell 3)	SS-RSRQ <sub>x</sub> + 9	SS-RSRQ <sub>x</sub> + 9	SS-RSRQ <sub>x</sub> + 4
RSRQ <sub>x</sub> is the reported value of Cell 2			

For the test to pass, the ratio of successful reported values in each test shall be more than 90% with a confidence level of 95%.

## 4.7.3 SS-SINR

### 4.7.3.0 Minimum conformance requirements

#### 4.7.3.0.1 Intra-frequency SS-SINR measurement accuracy requirements

The intra-frequency SS-SINR accuracy requirements are defined for the SS-SINR measured from a cell on the same frequency as that of the PCell or PSCell in FR1.

The accuracy requirements in Table 4.7.3.0.1-1 are valid under the following conditions:

- Conditions defined in clause 7.3 of TS 38.101-1 [2] for reference sensitivity are fulfilled.
- Conditions for intra-frequency measurements are fulfilled according to clause B.2.2 for a corresponding Band.

**Table 4.7.3.0.1-1: SS-SINR Intra frequency absolute accuracy in FR1**

Accuracy		Conditions					
Normal condition	Extreme condition	SSB $\hat{E}_s/\text{lot}$ Note 3	$I_o$ <sup>Note 1</sup> range				
			NR operating band groups Note 4	Minimum $I_o$		Maximum $I_o$	
dB	dB	dB		dBm / $SCS_{SSB}$			dBm/BW <sub>Channel</sub>
			$SCS_{SSB} = 15 \text{ kHz}$	$SCS_{SSB} = 30 \text{ kHz}$			
$\pm 3.0$	$\pm 4$	$\geq -3 \text{ dB}$	NR_FDD_FR1_A, NR_TDD_FR1_A, NR_SDL_FR1_A	-121	-118	N/A	-50
			NR_FDD_FR1_B	-120.5	-117.5	N/A	-50
			NR_TDD_FR1_C	-120	-117	N/A	-50
			NR_FDD_FR1_D, NR_TDD_FR1_D	-119.5	-116.5	N/A	-50
			NR_FDD_FR1_E, NR_TDD_FR1_E	-119	-116	N/A	-50
			NR_FDD_FR1_G	-118	-115	N/A	-50
			NR_FDD_FR1_H	-117.5	-114.5	N/A	-50
$\pm 3.5$	$\pm 4$	$\geq -6 \text{ dB}$	Note 2	Note 2	Note 2	Note 2	Note 2

NOTE 1:  $I_o$  is assumed to have constant EPRE across the bandwidth.  
 NOTE 2: The same bands and the same  $I_o$  conditions for each band apply for this requirement as for the corresponding highest accuracy requirement.  
 NOTE 3: The requirements apply for SSB  $\hat{E}_s/\text{lot} \leq 25 \text{ dB}$ .  
 NOTE 4: NR operating band groups in FR1 are as defined in Section 3A.4.1.

The reporting range of SS-SINR and CSI-SINR is defined from -23 dB to 40 dB with 0.5 dB resolution. The mapping of measured quantity is defined in Table 4.7.3.0.1-2. The range in the signalling may be larger than the guaranteed accuracy range.

**Table 4.7.3.0.1-2: SS-SINR and CSI-RSRP measurement report mapping**

Reported value	Measured quantity value (L3 SS-SINR)	Measured quantity value (L1 SS-SINR and L1 CSI-SINR)	Unit
SINR_0	$SS-SINR < -23$	$SINR < -23$	dB
SINR_1	$-23 \leq SS-SINR < -22.5$	$-23 \leq SINR < -22.5$	dB
SINR_2	$-22.5 \leq SS-SINR < -22$	$-22.5 \leq SINR < -22$	dB
SINR_3	$-22 \leq SS-SINR < -21.5$	$-22 \leq SINR < -21.5$	dB
SINR_4	$-21.5 \leq SS-SINR < -21$	$-21.5 \leq SINR < -21$	dB
..	..	..	...
SINR_123	$38 \leq SS-SINR < 38.5$	$38 \leq SINR < 38.5$	dB
SINR_124	$38.5 \leq SS-SINR < 39$	$38.5 \leq SINR < 39$	dB
SINR_125	$39 \leq SS-SINR < 39.5$	$39 \leq SINR < 39.5$	dB
SINR_126	$39.5 \leq SS-SINR < 40$	$39.5 \leq SINR < 40$	dB
SINR_127	$40 \leq SS-SINR$	$40 \leq SINR$	dB

The normative reference for this requirement is TS 38.133 [6] clauses 10.1.12.1.1 and 10.1.16.

**4.7.3.0.2 Inter-frequency absolute SS-SINR measurement accuracy requirements**

The intra-frequency SS-SINR accuracy requirements are defined for the SS-SINR measured from a cell on a different carrier frequency than that of the PCell or PSCell in FR1.

The accuracy requirements in Table 4.7.3.0.2-1 are valid under the following conditions:

- Conditions defined in clause 7.3 of TS 38.101-1 [2] for reference sensitivity are fulfilled.
- Conditions for inter-frequency measurements are fulfilled according to Annex B.2.3 for a corresponding Band.

**Table 4.7.3.0.2-1: SS-SINR Inter frequency absolute accuracy in FR1**

Accuracy		Conditions					
Normal condition	Extreme condition	SSB $\hat{E}_s/\text{lot}$ Note 3	$I_o$ Note 1 range				
			NR operating band groups Note 4	Minimum $I_o$		Maximum $I_o$	
dB	dB	dB		dBm / $SCS_{SSB}$			dBm/ $BW_{Channel}$
			$SCS_{SSB} = 15 \text{ kHz}$	$SCS_{SSB} = 30 \text{ kHz}$			
$\pm 3.0$	$\pm 4$	$\geq -3 \text{ dB}$	NR_FDD_FR1_A, NR_TDD_FR1_A, NR_SDL_FR1_A	-121	-118	N/A	-50
			NR_FDD_FR1_B	-120.5	-117.5	N/A	-50
			NR_TDD_FR1_C	-120	-117	N/A	-50
			NR_FDD_FR1_D, NR_TDD_FR1_D	-119.5	-116.5	N/A	-50
			NR_FDD_FR1_E, NR_TDD_FR1_E	-119	-116	N/A	-50
			NR_FDD_FR1_G	-118	-115	N/A	-50
			NR_FDD_FR1_H	-117.5	-114.5	N/A	-50
$\pm 3.5$	$\pm 4$	$\geq -6 \text{ dB}$	Note 2	Note 2	Note 2	Note 2	Note 2

NOTE 1:  $I_o$  is assumed to have constant EPRE across the bandwidth.  
 NOTE 2: The same bands and the same  $I_o$  conditions for each band apply for this requirement as for the corresponding highest accuracy requirement.  
 NOTE 3: The requirements apply for SSB  $\hat{E}_s/\text{lot} \leq 25 \text{ dB}$ .  
 NOTE 4: NR operating band groups in FR1 are as defined in clause 3A.4.1.

The normative reference for this requirement is TS 38.133 [6] clauses 10.1.13.1.1 and 10.1.16.

#### 4.7.3.0.3 Inter-frequency relative SS-SINR measurement accuracy requirements

The inter-frequency SS-SINR relative accuracy requirements in this clause are defined for the SS-SINR measured from one cell on a frequency in FR1 compared to the SS-SINR measured from another cell on a different frequency in FR1.

The accuracy requirements in Table 4.7.3.0.3-1 are valid under the following conditions:

- Conditions defined in clause 7.3 of TS 38.101-1 [2] for reference sensitivity are fulfilled.
- Conditions for inter-frequency measurements are fulfilled according to Annex B.2.3 for a corresponding Band.
- $|\text{SSB\_RP1}_{\text{dBm}} - \text{SSB\_RP2}_{\text{dBm}}| \leq 27 \text{ dB}$
- $|\text{Channel 1\_}I_o - \text{Channel 2\_}I_o| \leq 20 \text{ dB}$

**Table 4.7.3.0.3-1: SS-SINR Inter frequency relative accuracy in FR1**

Accuracy		Conditions					
Normal condition	Extreme condition	SSB $\hat{E}_s/\text{lot}$ Note 2,4	$I_o$ Note 1 range				
			NR operating band groups Note 5	Minimum $I_o$		Maximum $I_o$	
dB	dB	dB		dBm / $SCS_{SSB}$			dBm/ $BW_{Channel}$
			$SCS_{SSB} = 120 \text{ kHz}$	$SCS_{SSB} = 240 \text{ kHz}$			
$\pm 3.5$	$\pm 4$	$\geq -3 \text{ dB}$	NR_FDD_FR1_A, NR_TDD_FR1_A, NR_SDL_FR1_A	-121	-118	N/A	-50
			NR_FDD_FR1_B	-120.5	-117.5	N/A	-50
			NR_TDD_FR1_C	-120	-117	N/A	-50
			NR_FDD_FR1_D, NR_TDD_FR1_D	-119.5	-116.5	N/A	-50
			NR_FDD_FR1_E, NR_TDD_FR1_E	-119	-116	N/A	-50
			NR_FDD_FR1_G	-118	-115	N/A	-50
			NR_FDD_FR1_H	-117.5	-114.5	N/A	-50

$\pm 4$	$\pm 4$	$\geq -6$ dB	Note 3	Note 3	Note 3	Note 3	Note 3
<p>NOTE 1: <math>I_0</math> is assumed to have constant EPRE across the bandwidth.</p> <p>NOTE 2: The parameter SSB <math>\hat{E}_s/I_0</math> is the minimum SSB <math>\hat{E}_s/I_0</math> of the pair of cells to which the requirement applies.</p> <p>NOTE 3: The same bands and the same <math>I_0</math> conditions for each band apply for this requirement as for the corresponding highest accuracy requirement.</p> <p>NOTE 4: The requirements apply for SSB <math>\hat{E}_s/I_0 \leq [25]</math> dB.</p> <p>NOTE 5: NR operating band groups in FR1 are as defined in clause 3.5.2.</p>							

The normative reference for this requirement is TS 38.133 [6] clauses 10.1.13.1.2 and 10.1.16.

### 4.7.3.1 EN-DC FR1 SS-SINR measurement accuracy

#### 4.7.3.1.1 Test purpose

The purpose of this test is to verify that the intra-frequency SS-SINR measurement accuracy is within the specified limits for all bands.

#### 4.7.3.1.2 Test applicability

This test applies to all types of NR UE supporting E-UTRA and EN-DC from Release 15 onwards, which support ss-SINR-Meas.

#### 4.7.3.1.3 Minimum conformance requirements

The minimum conformance requirements are specified in clause 4.7.3.0.1.

The normative reference for this requirement is TS 38.133 [6] clause A.4.7.3.1.

#### 4.7.3.1.4 Test description

##### 4.7.3.1.4.1 Initial conditions

This test shall be tested using any of the test configurations in Table 4.7.3.1.4.1-1.

**Table 4.7.3.1.4.1-1: EN-DC FR1 SS-SINR measurement accuracy supported test configurations**

Test Case ID	Description
4.7.3.1-1	LTE FDD, NR: 15 kHz SSB SCS, 10MHz bandwidth, FDD
4.7.3.1-2	LTE FDD, NR: 15 kHz SSB SCS, 10MHz bandwidth, TDD
4.7.3.1-3	LTE FDD, NR: 30 kHz SSB SCS, 40MHz bandwidth, TDD
4.7.3.1-4	LTE TDD, NR: 15 kHz SSB SCS, 10MHz bandwidth, FDD
4.7.3.1-5	LTE TDD, NR: 15 kHz SSB SCS, 10MHz bandwidth, TDD
4.7.3.1-6	LTE TDD, NR: 30 kHz SSB SCS, 40MHz bandwidth, TDD
NOTE: The UE is only required to be tested in one of the supported test configurations.	

Configure the test equipment and the DUT according to the parameters in Table 4.7.3.1.4.1-2.

**Table 4.7.3.1.4.1-2: Initial conditions for SS-SINR intra frequency accuracy in FR1**

Parameter	Value	Comment
Test environment	NC, TL/VL, TL/VH, TH/VL, TH/VH	As specified in TS 38.508-1 [14] clause 4.1.
Test frequencies	As specified in Annex E, Table E.2-1 and TS 38.508-1 [14] clause 4.3.1.	
Channel bandwidth	As specified by the test configuration selected from Table 4.7.3.1.4.1-1.	
Propagation conditions	AWGN	As specified in clause C.2.2.
Connection Diagram	TE Part 2Rx	A.3.1.8.2 with $n = 2$ and $\varphi_1 = 5$ Hz
	TE Part 4Rx	A.3.1.8.5 with $n = 2$ and $\varphi_{1,1} = 5$ Hz, $\varphi_{1,2} = 10$ Hz, $\varphi_{1,3} = 15$ Hz



	DUT Part 2Rx	A.3.2.3.4	
	DUT Part 4Rx	A.3.2.5.2	
Exceptions to connection diagram	N/A		

1. Message contents are defined in clause 4.7.3.1.4.3.
2. Cell 1 is the E-UTRA serving cell (PCell) for the EN-DC setup. The power levels and settings for Cell 1 are set according to Annex A.6. Cell 2 and Cell 3 are NR FR1 cells in the same frequency. Cell 2 is the PSCell and Cell 3 is the target cell for SS-SINR measurements. The connection setup is done according to the settings in clause C.1.1.

4.7.3.1.4.2 Test procedure

1. Ensure the UE is in state RRC\_CONNECTED with generic procedure parameters Connectivity EN-DC, DC bearer MCG and SCG, Connected without release *On* and Test Mode *On*, according to TS 38.508-1 [14] clause 4.5.
2. Set the parameters according to Table 4.7.3.1.5-1 as appropriate.
3. The SS shall transmit an RRCConnectionReconfiguration message on Cell 1.
4. The UE shall transmit an RRCConnectionReconfigurationComplete message.
5. The UE shall transmit periodically MeasurementReport messages.
6. After 10s wait from Step 3, the SS shall check the SS-SINR reported values in the periodic MeasurementReport. The SS-SINR value of Cell 3 reported by the UE is compared to the expected SS-SINR. If the value is outside the limits in Table 4.7.3.1.5-2 or the UE fails to report the measurement value for Cell 3, the number of failed iterations is increased by one. Otherwise, the number of passed iterations is increased by one.
7. The SS shall continue checking the MeasurementReport messages transmitted by the UE until the confidence level according to Table G.2.3-1 in Annex G is achieved.
8. Set the parameters according to each sub-test in Table 4.7.3.1.5-1 as appropriate and repeat steps 5-7.

4.7.3.1.4.3 Message contents

Message contents are according to TS 38.508-1 [14] clause 7.3 with the following exceptions:

**Table 4.7.3.1.4.3-1: Common Exception messages for EN-DC FR1 SS-SINR measurement accuracy**

Default Message Contents	
Common contents of system information blocks exceptions	
Default RRC messages and information elements contents exceptions	Table H.3.1-1 Table H.3.1-2 Table H.3.1-5 Table H.3.1-7 Table H.3.4-1 Table H.3.4-1a Table H.3.4-2
Specific message contents exceptions for Test Configuration 4.7.3.1-1 and 4.7.3.1-4	Table H.3.1-3 with Condition and SS-SINR Table 7.3.1-3 in TS 38.508-1 [14] with condition SMTC.2
Specific message contents exceptions for Test Configuration 4.7.3.1-2 and 4.7.3.1-5	Table H.3.1-3 with Condition Synchronous cells and SS-SINR Table 7.3.1-3 in TS 38.508-1 [14] with condition SMTC.1
Specific message contents exceptions for Test Configuration 4.7.3.1-3 and 4.7.3.1-6	Table H.3.1-3 with Condition Synchronous cells and SS-SINR Table 7.3.1-3 in TS 38.508-1 [14] with condition SMTC.1

**Table 4.7.3.1.4.3-2: ReportConfigNR-DEFAULT(Periodical) for EN-DC FR1 SS-SINR Accuracy**

Derivation Path: 38.508-1 [14] Table 4.6.3-142 with condition PERIODICAL			
Information Element	Value/remark	Comment	Condition
ReportConfigNR::= SEQUENCE {			
reportType CHOICE {			
periodical SEQUENCE {			PERIODICAL
reportQuantityCell SEQUENCE {			
rsrp	false		
rsrq	false		
sinr	true		
}			
maxReportCells	2		
}			
}			

4.7.3.1.5 Test requirements

Table 4.7.3.1.5-1 defines the primary level settings including test tolerances for all tests.

Each SS-SINR measurement report for each of the tests in Table 4.7.3.1.5-1 shall meet the corresponding absolute accuracy requirements in Table 4.7.3.1.5-2

**Table 4.7.3.1.5-1: SS-SINR Intra frequency test parameters**

Parameter		Unit	Test 1		Test 2	
			Cell 2	Cell 3	Cell 2	Cell 3
SSB ARFCN			freq1		freq1	
Duplex mode	Config 1,4		FDD			
	Config 2,3,5,6		TDD			
TDD configuration	Config 1,4		Not Applicable			
	Config 2,5		TDDConf.1.1			
	Config 3,6		TDDConf.2.1			
Downlink initial BWP configuration			DLBWP.0.1			
Downlink dedicated BWP configuration			DLBWP.1.1			
Uplink initial BWP configuration			ULBWP.0.1			
Uplink dedicated BWP configuration			ULBWP.1.1			
DRX Cycle configuration		ms	Not Applicable			
TRS configuration	Config 1,4		TRS.1.1 FDD		TRS.1.1 FDD	
	Config 2,5		TRS.1.1 TDD	-	TRS.1.1 TDD	-
	Config 3,6		TRS.1.2 TDD		TRS.1.2 TDD	
PDSCH Reference measurement channel	Config 1,4		SR.1.1 FDD		SR.1.1 FDD	
	Config 2,5		SR.1.1 TDD	-	SR.1.1 TDD	-
	Config 3,6		SR.2.1 TDD		SR2.1 TDD	
RMSI CORESET Reference Channel	Config 1,4		CR.1.1 FDD		CR.1.1 FDD	
	Config 2,5		CR.1.1 TDD	-	CR.1.1 TDD	
	Config 3,6		CR.2.1 TDD		CR.2.1 TDD	
Dedicated CORESET Reference Channel	Config 1,4		CCR.1.1 FDD		CCR.1.1 FDD	
	Config 2,5		CCR.1.1 TDD	-	CCR.1.1 TDD	-
	Config 3,6		CCR.2.1 TDD		CCR.2.1 TDD	
OCNG Patterns			OP.1			

Parameter		Unit	Test 1		Test 2	
			Cell 2	Cell 3	Cell 2	Cell 3
SS-RSSI-Measurement			Not Applicable			
Time offset with Cell 2	Config 2,3,5,6	µs	-	3	-	3
	Config 1,4	ms	-	3	-	3
SMTC configuration	Config 1,4		SMTC.2			
	Config 2,3,5,6		SMTC.1			
SSB configuration	Config 1,2,4,5		SSB.1 FR1			
	Config 3,6		SSB.2 FR1			
PDSCH/PDCCH subcarrier spacing	Config 1,2,4,5	kHz	15			
	Config 3,6		30			
EPRE ratio of PSS to SSS		dB	0	0	0	0
EPRE ratio of PBCH DMRS to SSS						
EPRE ratio of PBCH to PBCH DMRS						
EPRE ratio of PDCCH DMRS to SSS						
EPRE ratio of PDCCH to PDCCH DMRS						
EPRE ratio of PDSCH DMRS to SSS						
EPRE ratio of PDSCH to PDSCH						
EPRE ratio of OCNG DMRS to SSS(Note 1)						
EPRE ratio of OCNG to OCNG DMRS (Note 1)						
$N_{oc}$ Note2	Depending on band group	dBm/15kHz	-93		-116+ $\Delta_{BG\_offset}$	
$N_{oc}$ Note2	Config 1,2,4,5	dBm/SCS	-93.2		Same as $N_{oc}$ for 15kHz	
	Config 3,6		-90.2		-113+ $\Delta_{BG\_offset}$	
$\hat{E}_s / I_{ot}$		dB	0	-3.19	-5.46	-5.46
$\hat{E}_s / N_{oc}$		dB	4.54	2.66	-3.5	-3.5
SS-RSRP <sup>Note3</sup>	Config 1,2,4,5	dBm/SCS	-88.46	-90.34	-119.5+ $\Delta_{BG\_offset}$	-119.5+ $\Delta_{BG\_offset}$
	Config 3,6		-85.65	-87.53	-116.5+ $\Delta_{BG\_offset}$	-116.5+ $\Delta_{BG\_offset}$
SS-SINR <sup>Note3</sup>		dB	0	-3.19	-5.1	-5.1
$I_o$ <sup>Note3</sup>	Config 1,2,4,5	dBm/ 9.36MHz	-57.5		-85.28+ $\Delta_{BG\_offset}$	
	Config 3,6		dBm/ 38.16MHz	-51.59		-79.17+ $\Delta_{BG\_offset}$
Propagation condition		-		AWGN		
Antenna configuration		-	1x2			
NOTE 1: OCNG shall be used such that both cells are fully allocated and a constant total transmitted power spectral density is achieved for all OFDM symbols.						
NOTE 2: Interference from other cells and noise sources not specified in the test is assumed to be constant over subcarriers and time and shall be modelled as AWGN of appropriate power for $N_{oc}$ to be fulfilled.						
NOTE 3: SS-SINR, SS-RSRP, and $I_o$ levels have been derived from other parameters for information purposes. They are not settable parameters themselves.						
NOTE 4: SS-SINR, SS-RSRP minimum requirements are specified assuming independent interference and noise at each receiver antenna port.						
NOTE 5: $\Delta_{BG\_offset}$ is defined in clause 3A.4, Table 3A.4.1-2						
NOTE 6: The test configuration excludes support for band n51 and it is not required to run this test on band n51 in this release of the specification						

Table 4.7.3.1.5-2: SS-SINR Intra frequency absolute accuracy requirements for the reported values

	Test 1	Test 2
	All bands	All bands
Normal Conditions		
Lowest reported value (Cell 3)	SS-SINR_31	SS-SINR_28
Highest reported value (Cell 3)	SS-SINR_49	SS-SINR_45
Extreme Conditions		
Lowest reported value (Cell 3)	SS-SINR_30	SS-SINR_27

Highest reported value (Cell 3)	SS-SINR_50	SS-SINR_46
---------------------------------	------------	------------

For the test to pass, the ratio of successful reported values in each test shall be more than 90% with a confidence level of 95%.

#### 4.7.3.2 Inter-Frequency SS-SINR measurement accuracy

##### 4.7.3.2.1 EN-DC FR1-FR1 SS-SINR absolute measurement accuracy

###### 4.7.3.2.1.1 Test purpose

The purpose of this test is to verify that the inter-frequency SS-SINR absolute measurement accuracy is within the specified limits for all bands.

###### 4.7.3.2.1.2 Test applicability

This test applies to all types of NR UE supporting E-UTRA and EN-DC from Release 15 onwards, which support ss-SINR-Meas.

###### 4.7.3.2.1.3 Minimum conformance requirements

The minimum conformance requirements are specified in clause 4.7.3.0.2.

The normative reference for this requirement is TS 38.133 [6] clause A.4.7.3.2.1.

###### 4.7.3.2.1.4 Test description

###### 4.7.3.2.1.4.1 Initial conditions

This test shall be tested using any of the test configurations in Table 4.7.3.2.1.4.1-1.

**Table 4.7.3.2.1.4.1-1: EN-DC FR1-FR1 SS-SINR measurement accuracy supported test configurations**

Test Case ID	Description
4.7.3.2.1-1	LTE FDD, NR: 15 kHz SSB SCS, 10MHz bandwidth, FDD
4.7.3.2.1-2	LTE FDD, NR: 15 kHz SSB SCS, 10MHz bandwidth, TDD
4.7.3.2.1-3	LTE FDD, NR: 30 kHz SSB SCS, 40MHz bandwidth, TDD
4.7.3.2.1-4	LTE TDD, NR: 15 kHz SSB SCS, 10MHz bandwidth, FDD
4.7.3.2.1-5	LTE TDD, NR: 15 kHz SSB SCS, 10MHz bandwidth, TDD
4.7.3.2.1-6	LTE TDD, NR: 30 kHz SSB SCS, 40MHz bandwidth, TDD
NOTE: The UE is only required to be tested in one of the supported test configurations.	

Configure the test equipment and the DUT according to the parameters in Table 4.7.3.2.1.4.1-2.

**Table 4.7.3.2.1.4.1-2: Initial conditions for SS-SINR inter frequency accuracy in FR1**

Parameter	Value		Comment
Test environment	NC, TL/VL, TL/VH, TH/VL, TH/VH		As specified in TS 38.508-1 [14] clause 4.1.
Test frequencies	As specified in Annex E, Table E.2-1 and TS 38.508-1 [14] clause 4.3.1.		
Channel bandwidth	As specified by the test configuration selected from Table 4.7.3.2.1.4.1-1.		
Propagation conditions	AWGN		As specified in clause C.2.2.
Connection Diagram	TE Part 2Rx	A.3.1.8.2 with $n = 2$ and $\phi_1 = 5$ Hz	As specified in TS 38.508-1 [14] Annex A.
	TE Part 4Rx	A.3.1.8.5 with $n = 2$ and $\phi_{1,1} = 5$ Hz, $\phi_{1,2} = 10$ Hz, $\phi_{1,3} = 15$ Hz	
	DUT Part 2Rx	A.3.2.3.4	

	DUT Part 4Rx	A.3.2.5.2	
Exceptions to connection diagram	N/A		

1. Message contents are defined in clause 4.7.3.2.1.4.3.
2. Cell 1 is the E-UTRA serving cell (PCell) for the EN-DC setup. The power levels and settings for Cell 1 are set according to Annex A.6. Cell 2 and Cell 3 are NR FR1 cells in two different FR1 frequencies. Cell 2 is the PSCell and Cell 3 is the target cell for SS-SINR measurements. The connection setup is done according to the settings in clause C.1.1.

4.7.3.2.1.4.2 Test procedure

Same as in clause 4.7.3.1.4.2 but replacing Table 4.7.3.1.5-1 and 4.7.3.1.5-2 with 4.7.3.2.1.5-1 and 4.7.3.2.1.5-2, respectively.

4.7.3.2.1.4.3 Message contents

Message contents are according to TS 38.508-1 [14] clause 7.3 with the following exceptions:

**Table 4.7.3.2.1.4.3-1: Common Exception messages for EN-DC FR1-FR1 SS-SINR absolute measurement accuracy**

Default Message Contents	
Common contents of system information blocks exceptions	
Default RRC messages and information elements contents exceptions	Table H.3.1-1 Table H.3.1-2 with condition INTER-FREQ Table H.3.1-5 Table H.3.1-7 with condition INTER-FREQ Table H.3.4-1 Table H.3.4-1a Table H.3.4-2 Table H.3.4-4 with Condition gapUE Table H.3.4-5 with Condition Pattern#0
Specific message contents exceptions for Test Configuration 4.7.3.1.1.-1 and 4.7.3.1.1-4	Table H.3.1-3 with Conditions INTER-FREQ MO and SS-SINR Table 7.3.1-3 in TS 38.508-1 [14] with condition SMTC.2
Specific message contents exceptions for Test Configuration 4.7.3.1.1-2 and 4.7.3.1.1-5	Table H.3.1-3 with Conditions INTER-FREQ MO and Synchronous cells and SS-SINR Table 7.3.1-3 in TS 38.508-1 [14] with condition SMTC.1
Specific message contents exceptions for Test Configuration 4.7.3.1.1-3 and 4.7.3.1.1-6	Table H.3.1-3 with Conditions INTER-FREQ MO and Synchronous cells and SS-SINR Table 7.3.1-3 in TS 38.508-1 [14] with condition SMTC.1

**Table 4.7.3.2.1.4.3-2: ReportConfigNR-DEFAULT(Periodical) for EN-DC FR1-FR1 SS-SINR Accuracy**

Derivation Path: 38.508-1 [14] Table 4.6.3-142 with condition PERIODICAL			
Information Element	Value/remark	Comment	Condition
ReportConfigNR ::= SEQUENCE {			
reportType CHOICE {			
periodical SEQUENCE {			PERIODICAL
reportQuantityCell SEQUENCE {			
rsrp	false		
rsrq	false		
sinr	true		
}			
maxReportCells	2		
}			

}			
}			

4.7.3.2.1.5 Test requirements

Table 4.7.3.2.1.5-1 defines the primary level settings including test tolerances for all tests.

Each SS-SINR measurement report for each of the tests in Table 4.7.3.2.1.5-1 shall meet the corresponding absolute accuracy requirements in Table 4.7.3.2.1.5-2.

**Table 4.7.3.2.1.5-1: SS-SINR Inter frequency test parameters**

Parameter		Unit	Test 1		Test 2		Test 3	
			Cell 2	Cell 3	Cell 2	Cell 3	Cell 2	Cell 3
SSB ARFCN			freq1	freq2	freq1	freq2	freq1	freq2
Duplex mode	Config 1,4		FDD					
	Config 2,3,5,6		TDD					
TDD configuration	Config 1,4		Not Applicable					
	Config 2,5		TDDConf.1.1					
	Config 3,6		TDDConf.2.1					
Downlink initial BWP configuration			DLBWP.0.1					
Downlink dedicated BWP configuration			DLBWP.1.1					
Uplink initial BWP configuration			ULBWP.0.1					
Uplink dedicated BWP configuration			ULBWP.1.1					
DRX Cycle configuration		ms	Not Applicable					
Gap pattern ID			0	-	0	-	0	-
TRS configuration	Config 1, 4		TRS.1.1 FDD		TRS.1.1 FDD		TRS.1.1 FDD	
	Config 2, 5		TRS.1.1 TDD	-	TRS.1.1 TDD	-	TRS.1.1 TDD	-
	Config 3, 6		TRS.1.2 TDD		TRS.1.2 TDD		TRS.1.2 TDD	
PDSCH Reference measurement channel	Config 1,4		SR.1.1 FDD	-	SR.1.1 FDD	-	SR.1.1 FDD	-
	Config 2,5		SR.1.1 TDD		SR.1.1 TDD		SR.1.1 TDD	
	Config 3,6		SR.2.1 TDD		SR.2.1 TDD		SR.2.1 TDD	
RMSI CORESET Reference Channel	Config 1,4		CR.1.1 FDD	-	CR.1.1 FDD	-	CR.1.1 FDD	-
	Config 2,5		CR.1.1 TDD		CR.1.1 TDD		CR.1.1 TDD	
	Config 3,6		CR.2.1 TDD		CR.2.1 TDD		CR.2.1 TDD	
Dedicated CORESET Reference Channel	Config 1,4		CCR.1.1 FDD	-	CCR.1.1 FDD	-	CCR.1.1 FDD	-
	Config 2,5		CCR.1.1 TDD		CCR.1.1 TDD		CCR.1.1 TDD	
	Config 3,6		CCR.2.1 TDD		CCR.2.1 TDD		CCR.2.1 TDD	
OCNG Patterns			OP.1					
SS-RSSI-Measurement			Not Applicable					
Time offset with Cell 2	Config 2,3,5,6	μs	-	3	-	3	-	3
	Config 1,4	ms	-	3	-	3	-	3
STMC configuration	Config 2,3,5,6		SMTc.1					
	Config 1,4		SMTc.2					
SSB configuration	Config 1,2,4,5		SSB.1 FR1					
	Config 3,6		SSB.2 FR1					
PDSCH/PDCCH subcarrier spacing	Config 1,2,4,5	kHz	15					
	Config 3,6		30					
EPRE ratio of PSS to SSS		dB	0	0	0	0	0	0
EPRE ratio of PBCH DMRS to SSS								
EPRE ratio of PBCH to PBCH DMRS								
EPRE ratio of PDCCH DMRS to SSS								

Parameter			Unit	Test 1		Test 2		Test 3	
				Cell 2	Cell 3	Cell 2	Cell 3	Cell 2	Cell 3
EPRE ratio of PDCCH to PDCCH DMRS									
EPRE ratio of PDSCH DMRS to SSS									
EPRE ratio of PDSCH to PDSCH									
EPRE ratio of OCNG DMRS to SSS(Note 1)									
EPRE ratio of OCNG to OCNG DMRS (Note 1)									
$N_{oc}$ <sup>Note2</sup>	Config 1,2,4,5	Depending on band group	dBm/15k Hz	-88	-88	-108.5	-108.5	-119.5+ $\Delta_{BG\_offset}$	-119.5+ $\Delta_{BG\_offset}$
$N_{oc}$ <sup>Note2</sup>	Config 1,2,4,5		dBm/SCS	-88	-88	-108.5	-108.5	Same as Noc for 15kHz	Same as Noc for 15kHz
	Config 3,6	Depending on band group		-85	-85	-105.5	-105.5	-116.5+ $\Delta_{BG\_offset}$	116.5+ $\Delta_{BG\_offset}$
$\hat{E}_s / I_{ot}$			dB	-1.75	-1.75	20	20	-3.2	-3.2
$\hat{E}_s / N_{oc}$			dB	-1.75	-1.75	20	20	-3.2	-3.2
SS-RSRP <sup>Note3</sup>	Config 1,2,4,5	Depending on band group	dBm/SCS	-89.75	-89.75	-88.5	-88.5	-122.7+ $\Delta_{BG\_offset}$	-122.7+ $\Delta_{BG\_offset}$
	Config 3,6	Depending on band group		-86.75	-86.75	-85.5	-85.5	-119.7+ $\Delta_{BG\_offset}$	-119.7+ $\Delta_{BG\_offset}$
SS-SINR <sup>Note3</sup>			dB	-1.75	-1.75	20	20	-3.2	-3.2
$I_o$ <sup>Note3</sup>	Config 1,2,4,5	Depending on band group	dBm/ 9.36MHz	-57.83	-57.83	-60.5	-60.5	-89.85+ $\Delta_{BG\_offset}$	-89.85+ $\Delta_{BG\_offset}$
	Config 3,6	Depending on band group	dBm/ 38.16MHz	-51.73	-51.73	-54.41	-54.41	-83.75+ $\Delta_{BG\_offset}$	-83.75+ $\Delta_{BG\_offset}$
Propagation condition			-	AWGN					
Antenna configuration			-	1x2					
NOTE 1: OCNG shall be used such that both cells are fully allocated and a constant total transmitted power spectral density is achieved for all OFDM symbols.									
NOTE 2: Interference from other cells and noise sources not specified in the test is assumed to be constant over subcarriers and time and shall be modelled as AWGN of appropriate power for $N_{oc}$ to be fulfilled.									
NOTE 3: SS-SINR, SS-RSRP, and $I_o$ levels have been derived from other parameters for information purposes. They are not settable parameters themselves.									
NOTE 4: SS-SINR, SS-RSRP minimum requirements are specified assuming independent interference and noise at each receiver antenna port.									
NOTE 5: $\Delta_{BG\_offset}$ is defined in clause 3A.4, Table 3A.4.1-2.									
NOTE 6: The test configuration excludes support for band n51 and it is not required to run this test on band n51 in this release of the specification.									

**Table 4.7.3.2.1.5-2: SS-SINR Inter frequency absolute accuracy requirements for the reported values**

	Test 1	Test 2	Test 3
	All bands	All bands	All bands
Normal Conditions			
Lowest reported value (Cell 3)	SS-SINR_35	SS-SINR_79	SS-SINR_32
Highest reported value (Cell 3)	SS-SINR_51	SS-SINR_94	SS-SINR_49
Extreme Conditions			
Lowest reported value (Cell 3)	SS-SINR_33	SS-SINR_77	SS-SINR_31
Highest reported value (Cell 3)	SS-SINR_53	SS-SINR_96	SS-SINR_50

For the test to pass, the ratio of successful reported values in each test shall be more than 90% with a confidence level of 95%.

4.7.3.2.2 EN-DC FR1-FR1 SS-SINR relative measurement accuracy

4.7.3.2.2.1 Test purpose

The purpose of this test is to verify that the inter-frequency SS-SINR relative measurement accuracy is within the specified limits for all bands.

## 4.7.3.2.2.2 Test applicability

This test applies to all types of NR UE supporting E-UTRA and EN-DC from Release 15 onwards, which support ss-SINR-Meas.

## 4.7.3.2.2.3 Minimum conformance requirements

The minimum conformance requirements are specified in clause 4.7.3.0.3.

The normative reference for this requirement is TS 38.133 [6] clause A.4.7.3.2.2.

## 4.7.3.2.2.4 Test description

## 4.7.3.2.2.4.1 Initial conditions

This test shall be tested using any of the test configurations in Table 4.7.3.2.2.4.1-1.

**Table 4.7.3.2.2.4.1-1: EN-DC FR1-FR1 SS-SINR measurement accuracy supported test configurations**

Test Case ID	Description
4.7.3.2.2-1	LTE FDD, NR: 15 kHz SSB SCS, 10MHz bandwidth, FDD
4.7.3.2.2-2	LTE FDD, NR: 15 kHz SSB SCS, 10MHz bandwidth, TDD
4.7.3.2.2-3	LTE FDD, NR: 30 kHz SSB SCS, 40MHz bandwidth, TDD
4.7.3.2.2-4	LTE TDD, NR: 15 kHz SSB SCS, 10MHz bandwidth, FDD
4.7.3.2.2-5	LTE TDD, NR: 15 kHz SSB SCS, 10MHz bandwidth, TDD
4.7.3.2.2-6	LTE TDD, NR: 30 kHz SSB SCS, 40MHz bandwidth, TDD
NOTE: The UE is only required to be tested in one of the supported test configurations.	

Configure the test equipment and the DUT according to the parameters in Table 4.7.3.2.2.4.1-2.

**Table 4.7.3.2.2.4.1-2: Initial conditions for SS-SINR inter frequency accuracy in FR1**

Parameter	Value		Comment
Test environment	NC, TL/VL, TL/VH, TH/VL, TH/VH		As specified in TS 38.508-1 [14] clause 4.1.
Test frequencies	As specified in Annex E, Table E.2-1 and TS 38.508-1 [14] clause 4.3.1.		
Channel bandwidth	As specified by the test configuration selected from Table 4.7.3.2.2.4.1-1.		
Propagation conditions	AWGN		As specified in clause C.2.2.
Connection Diagram	TE Part 2Rx	A.3.1.8.2 with $n = 2$ and $\varphi_1 = 5$ Hz	As specified in TS 38.508-1 [14] Annex A.
	TE Part 4Rx	A.3.1.8.5 with $n = 2$ and $\varphi_{1,1} = 5$ Hz, $\varphi_{1,2} = 10$ Hz, $\varphi_{1,3} = 15$ Hz	
	DUT Part 2Rx	A.3.2.3.4	
	DUT Part 4Rx	A.3.2.5.2	
Exceptions to connection diagram	N/A		

1. Message contents are defined in clause 4.7.3.2.2.4.3.
2. Cell 1 is the E-UTRA serving cell (PCell) for the EN-DC setup. The power levels and settings for Cell 1 are set according to Annex A.6. Cell 2 and Cell 3 are NR FR1 cells in two different FR1 frequencies. Cell 2 is the PSCell and Cell 3 is the target cell for SS-SINR measurements. The connection setup is done according to the settings in clause C.1.1.

## 4.7.3.2.2.4.2 Test procedure



1. Ensure the UE is in state RRC\_CONNECTED with generic procedure parameters Connectivity EN-DC, DC bearer MCG and SCG, Connected without release *On* and Test Mode *On*, according to TS 38.508-1 [14] clause 4.5.
2. Set the parameters according to Table 4.7.3.2.2.5-1 as appropriate.
3. The SS shall transmit an RRCConnectionReconfiguration message on Cell 1.
4. The UE shall transmit an RRCConnectionReconfigurationComplete message.
5. The UE shall transmit periodically MeasurementReport messages.
6. After 10s wait from Step 3, the SS shall check the SS-SINR reported values in the periodic MeasurementReport. The SS-SINR value of Cell 3 reported by the UE is compared to the SS-SINR value of Cell 2 reported by the UE. If the difference between both values is outside the limits in Table 4.7.3.2.2.5-2 or the UE fails to report the measurement value for Cell 3 or Cell 2, the number of failed iterations is increased by one. Otherwise, the number of passed iterations is increased by one.
7. The SS shall continue checking the MeasurementReport messages transmitted by the UE until the confidence level according to Table G.2.3-1 in Annex G is achieved.
8. Set the parameters according to each sub-test in Table 4.7.3.2.2.5-1 as appropriate and repeat steps 5-7.

#### 4.7.3.2.2.4.3 Message contents

Message contents are same as in clause 4.7.3.2.1.4.3.

#### 4.7.3.2.2.5 Test requirements

Table 4.7.3.2.2.5-1 defines the primary level settings including test tolerances for all tests.

Each SS-SINR measurement report for each of the tests in Table 4.7.3.2.2.5-1 shall meet the corresponding relative accuracy requirements in Table 4.7.3.2.2.5-2

**Table 4.7.3.2.2.5-1: same as Table 4.7.3.2.2.1.5-1**

**Table 4.7.3.2.2.5-2: SS-SINR Inter frequency relative accuracy requirements for the reported values**

	Test 1	Test 2	Test 3
	All bands	All bands	All bands
Normal Conditions			
Lowest reported value (Cell 3)	SS-SINR <sub>x</sub> - 10	SS-SINR <sub>x</sub> - 10	SS-SINR <sub>x</sub> - 11
Highest reported value (Cell 3)	SS-SINR <sub>x</sub> + 10	SS-SINR <sub>x</sub> + 10	SS-SINR <sub>x</sub> + 11
Extreme Conditions			
Lowest reported value (Cell 3)	SS-SINR <sub>x</sub> - 12	SS-SINR <sub>x</sub> - 12	SS-SINR <sub>x</sub> - 12
Highest reported value (Cell 3)	SS-SINR <sub>x</sub> + 12	SS-SINR <sub>x</sub> + 12	SS-SINR <sub>x</sub> + 12
RSRQ <sub>x</sub> is the reported value of Cell 2			

For the test to pass, the ratio of successful reported values in each test shall be more than 90% with a confidence level of 95%.

## 4.7.4 L1-RSRP

### 4.7.4.0 Minimum conformance requirements

#### 4.7.4.0.1 SSB based absolute L1-RSRP measurement accuracy requirements

Unless otherwise specified, the requirements for absolute accuracy of SSB based L1-RSRP in this clause apply to all SSBs of the serving cell configured for L1-RSRP measurement.

The accuracy requirements in Table 4.7.4.0.1-1 are valid under the following conditions:

- Conditions defined in clause 7.3 of TS 38.101-1 [2] for reference sensitivity are fulfilled.
- Conditions for L1-RSRP measurements are fulfilled according to Annex B.2.4.1 of TS 38.133 [6] for a corresponding Band for each relevant SSB.

**Table 4.7.4.0.1-1: SSB based L1-RSRP absolute accuracy in FR1**

Accuracy		Conditions					
Normal condition	Extreme condition	SSB $\hat{E}_s/\text{lot}$	$I_o$ <sup>Note 1</sup> range				
			NR operating band groups <sup>Note 2</sup>	Minimum $I_o$		Maximum $I_o$	
dB	dB	dB		dBm / $SCS_{SSB}$		dBm/ $BW_{Channel}$	dBm/ $BW_{Channel}$
				$SCS_{SSB} = 15$ kHz	$SCS_{SSB} = 30$ kHz		
±5.0	±9.5	≥-3	NR_FDD_FR1_A, NR_TDD_FR1_A, NR_SDL_FR1_A	-121	-118	N/A	-70
			NR_FDD_FR1_B	-120.5	-117.5	N/A	-70
			NR_TDD_FR1_C	-120	-117	N/A	-70
			NR_FDD_FR1_D, NR_TDD_FR1_D	-119.5	-116.5	N/A	-70
			NR_FDD_FR1_E, NR_TDD_FR1_E	-119	-116	N/A	-70
			NR_FDD_FR1_F	-118.5	-115.5	N/A	-70
			NR_FDD_FR1_G	-118	-115	N/A	-70
			NR_FDD_FR1_H	-117.5	-114.5	N/A	-70
±8.5	±11.5	≥-3	NR_FDD_FR1_A, NR_TDD_FR1_A, NR_SDL_FR1_A, NR_FDD_FR1_B, NR_TDD_FR1_C, NR_FDD_FR1_D, NR_TDD_FR1_D, NR_FDD_FR1_E, NR_TDD_FR1_E, NR_FDD_FR1_F, NR_FDD_FR1_G, NR_FDD_FR1_H,	N/A	N/A	-70	-50

NOTE 1:  $I_o$  is assumed to have constant EPRE across the bandwidth.  
 NOTE 2: NR operating band groups in FR1 are as defined in clause 3A.4.

The reporting range of SS-RSRP and CSI-RSRP for L1 reporting is defined from -140 to -44 dBm with 1 dB resolution. The mapping of the measured quantity to the reported value is defined by Table 4.7.4.0.1-2. The range in the signalling may be larger than the guaranteed accuracy range.

Table 4.7.4.0.1-2: SS-RSRP and CSI-RSRP measurement report mapping

Reported value	Measured quantity value (L3 SS-RSRP and CSI-RSRP)	Measured quantity value (L1 SS-RSRP and CSI-RSRP)	Unit
RSRP_0	RSRP<-156	Not valid	dBm
RSRP_1	-156≤RSRP<-155	Not valid	dBm
RSRP_2	-155≤RSRP<-154	Not valid	dBm
RSRP_3	-154≤RSRP<-153	Not valid	dBm
RSRP_4	-153≤RSRP<-152	Not valid	dBm
RSRP_5	-152≤RSRP<-151	Not valid	dBm
RSRP_6	-151≤RSRP<-150	Not valid	dBm
RSRP_7	-150≤RSRP<-149	Not valid	dBm
RSRP_8	-149≤RSRP<-148	Not valid	dBm
RSRP_9	-148≤RSRP<-147	Not valid	dBm
RSRP_10	-147≤RSRP<-146	Not valid	dBm
RSRP_11	-146≤RSRP<-145	Not valid	dBm
RSRP_12	-145≤RSRP<-144	Not valid	dBm
RSRP_13	-144≤RSRP<-143	Not valid	dBm
RSRP_14	-143≤RSRP<-142	Not valid	dBm
RSRP_15	-142≤RSRP<-141	Not valid	dBm
RSRP_16	-141≤RSRP<-140	RSRP<-140	dBm
RSRP_17	-140≤RSRP<-139	-140≤RSRP<-139	dBm
RSRP_18	-139≤RSRP<-138	-139≤RSRP<-138	dBm
...	...		...
RSRP_111	-46≤RSRP<-45	-46≤RSRP<-45	dBm
RSRP_112	-45≤RSRP<-44	-45≤RSRP<-44	dBm
RSRP_113	-44≤RSRP<-43	-44≤RSRP	dBm
RSRP_114	-43≤RSRP<-42	Not valid	dBm
RSRP_115	-42≤RSRP<-41	Not valid	dBm
RSRP_116	-41≤RSRP<-40	Not valid	dBm
RSRP_117	-40≤RSRP<-39	Not valid	dBm
RSRP_118	-39≤RSRP<-38	Not valid	dBm
RSRP_119	-38≤RSRP<-37	Not valid	dBm
RSRP_120	-37≤RSRP<-36	Not valid	dBm
RSRP_121	-36≤RSRP<-35	Not valid	dBm
RSRP_122	-35≤RSRP<-34	Not valid	dBm
RSRP_123	-34≤RSRP<-33	Not valid	dBm
RSRP_124	-33≤RSRP<-32	Not valid	dBm
RSRP_125	-32≤RSRP<-31	Not valid	dBm
RSRP_126	-31≤RSRP	Not valid	dBm
RSRP_127 (Note)	Infinity	Infinity	dBm
Note:	The value of RSRP_127 is applicable for RSRP threshold configured by the network as defined in TS 38.331 [13], but not for the purpose of measurement reporting.		

The normative reference for this requirement is TS 38.133 [6] clauses 10.1.19.1.1 and 10.1.6.

## 4.7.4.0.2 SSB based relative L1-RSRP measurement accuracy requirements

The relative accuracy of SSB based L1-RSRP is defined as the L1-RSRP measured from one SSB compared to the largest measured value of L1-RSRP among all SSBs of the serving cell.

The accuracy requirements in Table 4.7.4.0.2-1 are valid under the following conditions:

- Conditions defined in clause 7.3 of TS 38.101-1 [2] for reference sensitivity are fulfilled.
- Conditions for L1-RSRP measurements are fulfilled according to Annex B.2.4.1 of TS 38.133 [6] for a corresponding Band for each relevant SSB.

**Table 4.7.4.0.2-1: SSB based L1-RSRP relative accuracy in FR1**

Accuracy		Conditions					
Normal condition	Extreme condition	SSB $\hat{E}_s/\text{lot}$ Note 2	$I_0$ Note 1 range				
			NR operating band groups Note 4	Minimum $I_0$		Maximum $I_0$	
dB	dB	dB		dBm / $SCS_{SSB}$		dBm/ $BW_{Channel}$	dBm/ $BW_{Channel}$
				$SCS_{SSB} = 15$ kHz	$SCS_{SSB} = 30$ kHz		
$\pm 3$	$\pm 4$	$\geq 3$	NR_FDD_FR1_A, NR_TDD_FR1_A, NR_SDL_FR1_A	-121	-118	N/A	-50
			NR_FDD_FR1_B	-120.5	-117.5	N/A	-50
			NR_TDD_FR1_C	-120	-117	N/A	-50
			NR_FDD_FR1_D, NR_TDD_FR1_D	-119.5	-116.5	N/A	-50
			NR_FDD_FR1_E, NR_TDD_FR1_E	-119	-116	N/A	-50
			NR_FDD_FR1_F	-118.5	-115.5	N/A	-50
			NR_FDD_FR1_G	-118	-115	N/A	-50
			NR_FDD_FR1_H	-117.5	-114.5	N/A	-50

NOTE 1:  $I_0$  is assumed to have constant EPRE across the bandwidth.  
NOTE 2: The parameter SSB  $\hat{E}_s/\text{lot}$  is the minimum SSB  $\hat{E}_s/\text{lot}$  of the pair of SSBs to which the requirement applies.  
NOTE 3: Void  
NOTE 4: NR operating band groups in FR1 are as defined in clause 3A.4.

The reporting range of SS-RSRP and CSI-RSRP for L1 reporting is defined from -140 to -44 dBm with 1 dB resolution. The mapping of the measured quantity to the reported value is defined by Table 4.7.4.0.1-2. The range in the signalling may be larger than the guaranteed accuracy range.

The normative reference for this requirement is TS 38.133 [6] clauses 10.1.19.1.2 and 10.1.6.

## 4.7.4.0.3 CSI-RS based absolute L1-RSRP measurement accuracy requirements

Unless otherwise specified, the requirements for absolute accuracy of CSI-RS based L1-RSRP in this clause apply to all CSI-RS resources of the serving cell configured for L1-RSRP measurement.

The accuracy requirements in Table 4.7.4.0.3-1 are valid under the following conditions:

- Conditions defined in clause 7.3 of TS 38.101-1 [2] for reference sensitivity are fulfilled.
- Conditions for L1-RSRP measurements are fulfilled according to Annex B.2.4.2 of TS 38.133 [6] for a corresponding Band for each relevant CSI-RS.
- The bandwidth of CSI-RS is 48 PRBs and the density is 3.

The performance with larger bandwidth of CSI-RS is equal to or better than the accuracy requirements in Table 4.7.4.0.3-1.

Table 4.7.4.0.3-1: CSI-RS based L1-RSRP absolute accuracy in FR1

Accuracy		Conditions						
Normal condition	Extreme condition	CSI-RS $\hat{\epsilon}$ s/lot	$Io$ <sup>Note 1</sup> range					
			NR operating band groups <sup>Note 2</sup>	Minimum $Io$			Maximum $Io$	
dB	dB	dB		dBm / SCS <sub>CSI-RS</sub>			dBm/BW <sub>Channel</sub>	dBm/BW <sub>Channel</sub>
				SCS <sub>CSI-RS</sub> = 15 kHz	SCS <sub>CSI-RS</sub> = 30 kHz	SCS <sub>CSI-RS</sub> = 60 kHz		
±5.0	±9.5	≥3	NR_FDD_FR1_A, NR_TDD_FR1_A, NR_SDL_FR1_A	-121	-118	-115	N/A	-70
			NR_FDD_FR1_B	-120.5	-117.5	-114.5	N/A	-70
			NR_TDD_FR1_C	-120	-117	-114	N/A	-70
			NR_FDD_FR1_D, NR_TDD_FR1_D	-119.5	-116.5	-113.5	N/A	-70
			NR_FDD_FR1_E, NR_TDD_FR1_E	-119	-116	-113	N/A	-70
			NR_FDD_FR1_F	-118.5	-115.5	-112.5	N/A	-70
			NR_FDD_FR1_G	-118	-115	-112	N/A	-70
			NR_FDD_FR1_H	-117.5	-114.5	-111.5	N/A	-70
±8.5	±11.5	≥3	NR_FDD_FR1_A, NR_TDD_FR1_A, NR_SDL_FR1_A, NR_FDD_FR1_B, NR_TDD_FR1_C, NR_FDD_FR1_D, NR_TDD_FR1_D, NR_FDD_FR1_E, NR_TDD_FR1_E, NR_FDD_FR1_F, NR_FDD_FR1_G, NR_FDD_FR1_H	N/A	N/A	N/A	-70	-50

NOTE 1:  $Io$  is assumed to have constant EPRE across the bandwidth.  
 NOTE 2: NR operating band groups in FR1 are as defined in clause 3A.4.

The reporting range of SS-RSRP and CSI-RSRP for L1 reporting is defined from -140 to -44 dBm with 1 dB resolution. The mapping of the measured quantity to the reported value is defined by Table 4.7.4.0.1-2. The range in the signalling may be larger than the guaranteed accuracy range.

The normative reference for this requirement is TS 38.133 [6] clauses 10.1.19.2.1 and 10.1.6.

#### 4.7.4.0.4 CSI-RS based relative L1-RSRP measurement accuracy requirements

The relative accuracy of CSI-RS based L1-RSRP is defined as the L1-RSRP measured from one CSI-RS compared to the largest measured value of L1-RSRP among all CSI-RS resources of the serving cell.

The accuracy requirements in Table 4.7.4.0.4-1 are valid under the following conditions:

- Conditions defined in clause 7.3 of TS 38.101-1 [2] for reference sensitivity are fulfilled.
- Conditions for L1-RSRP measurements are fulfilled according to Annex B.2.4.2 of TS 38.133 [6] for a corresponding Band for each relevant CSI-RS.
- The bandwidth of CSI-RS is 48 PRBs and the density is 3.

The performance with larger bandwidth of CSI-RS is equal to or better than the accuracy requirements in Table 4.7.4.0.4-1.

Table 4.7.4.0.4-1: CSI-RS based L1-RSRP relative accuracy in FR1

Accuracy		Conditions						
Normal condition	Extreme condition	CSI-RS $\hat{E}_s/\text{lot}$ Note 2	$I_o$ <sup>Note 1</sup> range					
			NR operating band groups <sup>Note 4</sup>	Minimum $I_o$			Maximum $I_o$	
dB	dB	dB		dBm / $SCS_{\text{CSI-RS}}$			dBm/ $BW_{\text{Channel}}$	dBm/ $BW_{\text{Channel}}$
				$SCS_{\text{CSI-RS}} = 15$ kHz	$SCS_{\text{CSI-RS}} = 30$ kHz	$SCS_{\text{CSI-RS}} = 60$ kHz		
±3	±4	≥-3	NR_FDD_FR1_A, NR_TDD_FR1_A, NR_SDL_FR1_A	-121	-118	-115	N/A	-50
			NR_FDD_FR1_B	-120.5	-117.5	-114.5	N/A	-50
			NR_TDD_FR1_C	-120	-117	-114	N/A	-50
			NR_FDD_FR1_D, NR_TDD_FR1_D	-119.5	-116.5	-113.5	N/A	-50
			NR_FDD_FR1_E, NR_TDD_FR1_E	-119	-116	-113	N/A	-50
			NR_FDD_FR1_F	-118.5	-115.5	-112.5	N/A	-50
			NR_FDD_FR1_G	-118	-115	-112	N/A	-50
			NR_FDD_FR1_H	-117.5	-114.5	-111.5	N/A	-50
NOTE 1: $I_o$ is assumed to have constant EPRE across the bandwidth. NOTE 2: The parameter CSI-RS $\hat{E}_s/\text{lot}$ is the minimum CSI-RS $\hat{E}_s/\text{lot}$ of the pair of CSI-RS resources to which the requirement applies. NOTE 3: Void NOTE 4: NR operating band groups in FR1 are as defined in clause 3.5.2.								

The reporting range of SS-RSRP and CSI-RSRP for L1 reporting is defined from -140 to -44 dBm with 1 dB resolution. The mapping of the measured quantity to the reported value is defined by Table 4.7.4.0.1-2. The range in the signalling may be larger than the guaranteed accuracy range.

The normative reference for this requirement is TS 38.133 [6] clauses 10.1.19.2.2 and 10.1.6.

#### 4.7.4.1 SSB based L1-RSRP measurements

##### 4.7.4.1.1 EN-DC FR1 SSB-based L1-RSRP absolute measurement accuracy

###### 4.7.4.1.1.1 Test purpose

The purpose of this test is to verify that the SSB based L1-RSRP absolute measurement accuracy is within the specified limits for all bands.

###### 4.7.4.1.1.2 Test applicability

This test applies to all types of NR UE supporting E-UTRA and EN-DC from Release 15 onwards.

###### 4.7.4.1.1.3 Minimum conformance requirements

The minimum conformance requirements are specified in clause 4.7.4.0.1.

The normative reference for this requirement is TS 38.133 [6] clause A.4.7.4.1.

###### 4.7.4.1.1.4 Test description

###### 4.7.4.1.1.4.1 Initial conditions

This test shall be tested using any of the test configurations in Table 4.7.4.1.1.4.1-1.

**Table 4.7.4.1.1.4.1-1: EN-DC FR1 SSB based L1-RSRP absolute measurement accuracy supported test configurations**

Test Case ID	Description
4.7.4.1.1-1	LTE FDD, NR: 15 kHz SSB SCS, 10MHz bandwidth, FDD
4.7.4.1.1-2	LTE FDD, NR: 15 kHz SSB SCS, 10MHz bandwidth, TDD
4.7.4.1.1-3	LTE FDD, NR: 30 kHz SSB SCS, 40MHz bandwidth, TDD
4.7.4.1.1-4	LTE TDD, NR: 15 kHz SSB SCS, 10MHz bandwidth, FDD
4.7.4.1.1-5	LTE TDD, NR: 15 kHz SSB SCS, 10MHz bandwidth, TDD
4.7.4.1.1-6	LTE TDD, NR: 30 kHz SSB SCS, 40MHz bandwidth, TDD

NOTE: The UE is only required to be tested in one of the supported test configurations.

Configure the test equipment and the DUT according to the parameters in Table 4.7.4.1.1.4.1-2.

**Table 4.7.4.1.1.4.1-2: Initial conditions for SSB based L1-RSRP absolute accuracy in FR1**

Parameter	Value	Comment
Test environment	NC, TL/VL, TL/VH, TH/VL, TH/VH	As specified in TS 38.508-1 [14] clause 4.1.
Test frequencies	As specified in Annex E, Table E.2-1 and TS 38.508-1 [14] clause 4.3.1.	
Channel bandwidth	As specified by the test configuration selected from Table 4.7.4.1.1.4.1-1.	
Propagation conditions	AWGN	As specified in clause C.2.2.
Connection Diagram	TE Part 2Rx	A.3.1.8.2 with n = 1
	TE Part 4Rx	A.3.1.8.5 with n = 1
	DUT Part 2Rx	A.3.2.3.4
	DUT Part 4Rx	A.3.2.5.2
Exceptions to connection diagram	N/A	

1. Message contents are defined in clause 4.7.4.1.1.4.3.
2. Cell 1 is the E-UTRA serving cell (PCell) for the EN-DC setup. The power levels and settings for Cell 1 are set according to Annex A.6. Cell 2 is the NR FR1 cell. Cell 2 is the PSCell and the target for SSB-based L1-RSRP measurements. The UE is configured to perform RLM, BFD and L1-RSRP measurement based on the SSBs. The connection setup is done according to the settings in clause C.1.1.

#### 4.7.4.1.1.4.2 Test procedure

Prior to the start of the time duration T1, the UE shall be fully synchronized to PSCell. The UE shall be configured for periodic CSI reporting in PUCCH [format 2] with a reporting periodicity as mentioned in the above table 4.7.4.1.1.4.1-2.

1. Ensure the UE is in state RRC\_CONNECTED with generic procedure parameters Connectivity EN-DC, DC bearer MCG and SCG, Connected without release *On* and Test Mode *On*, according to TS 38.508-1 [14] clause 4.5 and general test parameters set according to Table 4.7.4.1.1.4.1-2.
2. Set the parameters according to T1 in Table 4.7.4.1.1.5-1.
3. The UE shall start sending L1-RSRP report including results of both SSB#0 and SSB#1 every 80 slots.
4. The SS shall check the L1-RSRP reported values of SSB#0 and SSB#1 in the periodic L1-RSRP reports. If the value for both SSBs is within the limits in Table 4.7.4.1.1.5-2 or Table 4.7.4.1.1.5-3 (depending on the test configuration), the number of passed iterations is increased by one, otherwise the number of failed iterations is increased by one.
5. The SS shall continue checking the L1-RSRP report messages transmitted by the UE until the confidence level according to Table G.2.3-1 in Annex G is achieved.
6. Set the parameters according to each sub-test in Table 4.7.4.1.1.5-1 as appropriate and repeat steps 3-5.

## 4.7.4.1.1.4.3 Message contents

Message contents are according to TS 38.508-1 [14] clause 7.3 with the following exceptions:

**Table 4.7.4.1.1.4.3-1: Common Exception messages EN-DC SSB based L1-RSRP measurement**

Default Message Contents	
Common contents of system information blocks exceptions	
Default RRC messages and information elements contents exceptions	Table H.3.6-2 with conditions PERIODIC and SS-RSRP Table H.3.6-3 with conditions SSB and PERIODIC Table H.3.4-1 Table 7.3.1-3 in TS 38.508-1 [14] with condition SMTC.1 Table H.3.5-8

**Table 4.7.4.1.1.4.3-2: RadioLinkMonitoringConfig**

Derivation Path: TS 38.508-1 [14], Table 4.6.3-133			
Information Element	Value/remark	Comment	Condition
RadioLinkMonitoringConfig ::= SEQUENCE {			
failureDetectionResourcesToAddModList SEQUENCE (SIZE(1..maxNrofFailureDetectionResources)) OF SEQUENCE {	1 entry		
purpose	both	UE is configured to perform RLM and BFD based on the SSBs.	
detectionResource CHOICE {			
ssb-Index	0		
}			
}			
}			

## 4.7.4.1.1.5 Test requirement

Table 4.7.4.1.1.5-1 defines the primary level settings including test tolerances for all tests.

Each L1-RSRP measurement report for each of the tests in Table 4.7.4.1.1.5-1 shall meet the corresponding absolute accuracy requirements in Table 4.7.4.1.1.5-2 for test configurations 1, 2, 4 and 5, and the corresponding absolute accuracy requirements in Table 4.7.4.1.1.5-3 for test configurations 3 and 6.

**Table 4.7.4.1.1.5-1: L1-RSRP test parameters**

Parameter	Config	Unit	Test 1	Test 2
SSB GSCN	1~6		freq1	freq1
Duplex mode	1,4		FDD	FDD
	2,5		TDD	TDD
	3,6		TDD	TDD
TDD Configuration	1,4		N/A	N/A
	2,5		TDDConf.1.1	TDDConf.1.1
	3,6		TDDConf.2.1	TDDConf.2.1
BW <sub>channel</sub>	1,4	MHz	10: N <sub>RB,c</sub> = 52	10: N <sub>RB,c</sub> = 52
	2,5		10: N <sub>RB,c</sub> = 52	10: N <sub>RB,c</sub> = 52
	3,6		40: N <sub>RB,c</sub> = 106	40: N <sub>RB,c</sub> = 106
PDSCH Reference measurement channel	1,4		SR.1.1 FDD	SR.1.1 FDD
	2,5		SR.1.1 TDD	SR.1.1 TDD
	3,6		SR.2.1 TDD	SR.2.1 TDD
RMSI CORESET Reference Channel	1,4		CR.1.1 FDD	CR.1.1 FDD
	2,5		CR.1.1 TDD	CR.1.1 TDD
	3,6		CR.2.1 TDD	CR.2.1 TDD



Parameter	Config	Unit	Test 1	Test 2	
Dedicated CORESET Reference Channel	1,4		CCR.1.1 FDD	CCR.1.1 FDD	
	2,5		CCR.1.1 TDD	CCR.1.1 TDD	
	3,6		CCR.2.1 TDD	CCR.2.1 TDD	
SSB configuration	1,4		SSB.3 FR1	SSB.3 FR1	
	2,5		SSB.3 FR1	SSB.3 FR1	
	3,6		SSB.4 FR1	SSB.4 FR1	
OCNG Patterns	1~6		OP.1	OP.1	
TRS configuration	1,4		TRS.1.1 FDD	TRS.1.1 FDD	
	2,5		TRS.1.1 TDD	TRS.1.1 TDD	
	3,6		TRS.1.2 TDD	TRS.1.2 TDD	
Initial BWP Configuration	1~6		DLBWP.0.1 ULBWP.0.1	DLBWP.0.1 ULBWP.0.1	
Dedicated BWP configuration	1~6		DLBWP.1.1 ULBWP.1.1	DLBWP.1.1 ULBWP.1.1	
SMTc configuration	1~6		SMTc.1	SMTc.1	
reportConfigType	1~6		periodic	periodic	
reportQuantity	1~6		ssb-Index-RSRP	ssb-Index-RSRP	
Number of reported RS	1~6		2	2	
L1-RSRP reporting period	1~6		slot80	slot80	
EPRE ratio of PSS to SSS	1~6	dB	0	0	
EPRE ratio of PBCH DMRS to SSS					
EPRE ratio of PBCH to PBCH DMRS					
EPRE ratio of PDCCH DMRS to SSS					
EPRE ratio of PDCCH to PDCCH DMRS					
EPRE ratio of PDSCH DMRS to SSS					
EPRE ratio of PDSCH to PDSCH DMRS					
EPRE ratio of OCNG DMRS to SSS <sup>Note 1</sup>					
EPRE ratio of OCNG to OCNG DMRS <sup>Note 1</sup>					
$N_{oc}$ <sup>Note2</sup>					Depending on band group
	3,6	-96.00	$117 + \Delta_{BG\_offset}$		
$N_{oc}$ <sup>Note2</sup>	group	1,2,4,5	dBm/SSB SCS	-94.65	$-117 + \Delta_{BG\_offset}$
		3,6		-93.00	$-114 + \Delta_{BG\_offset}$
$\hat{E}_s / I_{ot}$	1~6	dB	10	-2.2	
SSB RSRP <sup>Note3</sup>	Depending on band group	1,2,4,5	dBm/SSB SCS	-84.65	$-119.2 + \Delta_{BG\_offset}$
		3,6		-83.00	$-116.2 + \Delta_{BG\_offset}$
$I_o$ <sup>Note3</sup>	Depending on band group	1,2,4,5	dBm/9.36 MHz	-56.28	$-87.00 + \Delta_{BG\_offset}$
		3,6	dBm/38.16 MHz	-51.53	$-80.90 + \Delta_{BG\_offset}$
$\hat{E}_s / N_{oc}$	1~6	dB	10	-2.2	
Propagation condition	1~6		AWGN	AWGN	
Antenna configuration	1~6		1x2	1x2	
NOTE 1: OCNG shall be used such that both cells are fully allocated and a constant total transmitted power spectral density is achieved for all OFDM symbols.					
NOTE 2: Interference from other cells and noise sources not specified in the test is assumed to be constant over subcarriers and time and shall be modelled as AWGN of appropriate power for $N_{oc}$ to be fulfilled.					
NOTE 3: RSRP and $I_o$ levels have been derived from other parameters for information purposes. They are not settable parameters themselves.					
NOTE 4: RSRP minimum requirements are specified assuming independent interference and noise at each receiver antenna port.					
NOTE 5: The test configuration excludes support for band n51 and it is not required to run this test on band n51 in this release of the specification.					

**Table 4.7.4.1.1.5-2: L1-RSRP absolute accuracy requirements for the reported values for test configurations 1, 2, 4 and 5**

Normal Conditions	Test 1 All bands	Test 2	
Lowest reported value (Cell 2)	62	Bands NR_FDD_FR1_A, NR_TDD_FR1_A	31
		Bands NR_FDD_FR1_B	31
		Bands NR_TDD_FR1_C	32
		Bands NR_FDD_FR1_D, NR_TDD_FR1_D	32
		Bands NR_FDD_FR1_E, NR_TDD_FR1_E	33
		Bands NR_FDD_FR1_G	34
		Bands NR_FDD_FR1_H	34
Highest reported value (Cell 2)	82	Bands NR_FDD_FR1_A, NR_TDD_FR1_A	44
		Bands NR_FDD_FR1_B	45
		Bands NR_TDD_FR1_C	45
		Bands NR_FDD_FR1_D, NR_TDD_FR1_D	46
		Bands NR_FDD_FR1_E, NR_TDD_FR1_E	46
		Bands NR_FDD_FR1_G	47
		Bands NR_FDD_FR1_H	48
Extreme Conditions	Test 1 All bands	Test 2	
Lowest reported value (Cell 2)	61	Bands NR_FDD_FR1_A, NR_TDD_FR1_A	30
		Bands NR_FDD_FR1_B	30
		Bands NR_TDD_FR1_C	31
		Bands NR_FDD_FR1_D, NR_TDD_FR1_D	31
		Bands NR_FDD_FR1_E, NR_TDD_FR1_E	32
		Bands NR_FDD_FR1_G	33
		Bands NR_FDD_FR1_H	33
Highest reported value (Cell 2)	83	Bands NR_FDD_FR1_A, NR_TDD_FR1_A	45
		Bands NR_FDD_FR1_B	46
		Bands NR_TDD_FR1_C	46
		Bands NR_FDD_FR1_D, NR_TDD_FR1_D	47
		Bands NR_FDD_FR1_E, NR_TDD_FR1_E	47
		Bands NR_FDD_FR1_G	48
		Bands NR_FDD_FR1_H	49
NOTE: NR operating band groups are defined in clause 3A.4, Table 3A.4.1-2.			

**Table 4.7.4.1.1.5-3: L1-RSRP absolute accuracy requirements for the reported values for test configurations 3 and 6**

Normal Conditions	Test 1 All bands	Test 2	
Lowest reported value (Cell 2)	63	Bands NR_FDD_FR1_A, NR_TDD_FR1_A	34
		Bands NR_FDD_FR1_B	34
		Bands NR_TDD_FR1_C	35

		Bands NR_FDD_FR1_D, NR_TDD_FR1_D	35
		Bands NR_FDD_FR1_E, NR_TDD_FR1_E	36
		Bands NR_FDD_FR1_G	37
		Bands NR_FDD_FR1_H	37
Highest reported value (Cell 2)	84	Bands NR_FDD_FR1_A, NR_TDD_FR1_A	47
		Bands NR_FDD_FR1_B	48
		Bands NR_TDD_FR1_C	48
		Bands NR_FDD_FR1_D, NR_TDD_FR1_D	49
		Bands NR_FDD_FR1_E, NR_TDD_FR1_E	49
		Bands NR_FDD_FR1_G	50
		Bands NR_FDD_FR1_H	51
<b>Extreme Conditions</b>	<b>Test 1 All bands</b>	<b>Test 2</b>	
Lowest reported value (Cell 2)	62	Bands NR_FDD_FR1_A, NR_TDD_FR1_A	33
		Bands NR_FDD_FR1_B	33
		Bands NR_TDD_FR1_C	34
		Bands NR_FDD_FR1_D, NR_TDD_FR1_D	34
		Bands NR_FDD_FR1_E, NR_TDD_FR1_E	35
		Bands NR_FDD_FR1_G	36
		Bands NR_FDD_FR1_H	36
Highest reported value (Cell 2)	85	Bands NR_FDD_FR1_A, NR_TDD_FR1_A	48
		Bands NR_FDD_FR1_B	49
		Bands NR_TDD_FR1_C	49
		Bands NR_FDD_FR1_D, NR_TDD_FR1_D	50
		Bands NR_FDD_FR1_E, NR_TDD_FR1_E	50
		Bands NR_FDD_FR1_G	51
		Bands NR_FDD_FR1_H	52
NOTE: NR operating band groups are defined in clause 3A.4, Table 3A.4.1-2			

For the test to pass, the ratio of successful reported values in each test shall be more than 90% with a confidence level of 95%.

#### 4.7.4.1.2 EN-DC FR1 SSB-based L1-RSRP relative measurement accuracy

##### 4.7.4.1.2.1 Test purpose

The purpose of this test is to verify that the SSB based L1-RSRP relative measurement accuracy is within the specified limits for all bands.

##### 4.7.4.1.2.2 Test applicability

This test applies to all types of NR UE supporting E-UTRA and EN-DC from Release 15 onwards.

##### 4.7.4.1.2.3 Minimum conformance requirements

The minimum conformance requirements are specified in clause 4.7.4.0.2.

The normative reference for this requirement is TS 38.133 [6] clause A.4.7.4.1.

## 4.7.4.1.2.4 Test description

## 4.7.4.1.2.4.1 Initial conditions

This test shall be tested using any of the test configurations in Table 4.7.4.1.2.4.1-1.

**Table 4.7.4.1.2.4.1-1: EN-DC FR1 SSB based L1-RSRP relative measurement accuracy supported test configurations**

Test Case ID	Description
4.7.4.1.2-1	LTE FDD, NR: 15 kHz SSB SCS, 10MHz bandwidth, FDD
4.7.4.1.2-2	LTE FDD, NR: 15 kHz SSB SCS, 10MHz bandwidth, TDD
4.7.4.1.2-3	LTE FDD, NR: 30 kHz SSB SCS, 40MHz bandwidth, TDD
4.7.4.1.2-4	LTE TDD, NR: 15 kHz SSB SCS, 10MHz bandwidth, FDD
4.7.4.1.2-5	LTE TDD, NR: 15 kHz SSB SCS, 10MHz bandwidth, TDD
4.7.4.1.2-6	LTE TDD, NR: 30 kHz SSB SCS, 40MHz bandwidth, TDD
NOTE: The UE is only required to be tested in one of the supported test configurations	

Configure the test equipment and the DUT according to the parameters in Table 4.7.4.1.2.4.1-2.

**Table 4.7.4.1.2.4.1-2: Initial conditions for SSB based L1-RSRP relative accuracy in FR1**

Parameter	Value	Comment
Test environment	NC, TL/VL, TL/VH, TH/VL, TH/VH	As specified in TS 38.508-1 [14] clause 4.1.
Test frequencies	As specified in Annex E, Table E.2-1 and TS 38.508-1 [14] clause 4.3.1.	
Channel bandwidth	As specified by the test configuration selected from Table 4.7.4.1.2.4.1-1.	
Propagation conditions	AWGN	As specified in clause C.2.2.
Connection Diagram	TE Part 2Rx	A.3.1.8.2 with $n = 1$
	TE Part 4Rx	A.3.1.8.5 with $n = 1$
	DUT Part 2Rx	A.3.2.3.4
	DUT Part 4Rx	A.3.2.5.2
Exceptions to connection diagram	N/A	

1. Message contents are defined in clause 4.7.4.1.2.4.3.
2. Cell 1 is the E-UTRA serving cell (PCell) for the EN-DC setup. The power levels and settings for Cell 1 are set according to Annex A.6. Cell 2 is the NR FR1 cell. Cell 2 is the PSCell and the target for SSB-based L1-RSRP measurements. The UE is configured to perform RLM, BFD and L1-RSRP measurement based on the SSBs. The connection setup is done according to the settings in clause C.1.1.

## 4.7.4.1.2.4.2 Test procedure

Prior to the start of the time duration T1, the UE shall be fully synchronized to PSCell. The UE shall be configured for periodic CSI reporting in PUCCH [format 2] with a reporting periodicity as mentioned in the above table 4.7.4.1.2.4.1-2.

1. Ensure the UE is in state RRC\_CONNECTED with generic procedure parameters Connectivity EN-DC, DC bearer MCG and SCG, Connected without release  $On$  and Test Mode  $On$ , according to TS 38.508-1 [14] clause 4.5 and general test parameters set according to Table 4.7.4.1.2.4.1-2.
2. Set the parameters according to T1 in Table 4.7.4.1.2.5-1.
3. The UE shall start sending L1-RSRP report including results of both SSB#0 and SSB#1 every 80 slots.
4. The SS shall check the L1-RSRP reported values of SSB#0 and SSB#1 in the periodic L1-RSRP reports. The L1-RSRP value for SSB#1 is compared to the L1-RSRP value for SSB#0. If the difference is within the limits in

Table 4.7.4.1.2.5-2, the number of passed iterations is increased by one, otherwise the number of failed iterations is increased by one.

5. The SS shall continue checking the L1-RSRP report messages transmitted by the UE until the confidence level according to Table G.2.3-1 in Annex G is achieved.
6. Set the parameters according to each sub-test in Table 4.7.4.1.2.5-1 as appropriate and repeat steps 3-5.

#### 4.7.4.1.2.4.3 Message contents

Message contents are same as in Clause 4.7.4.1.1.4.3.

#### 4.7.4.1.2.5 Test requirement

Table 4.7.4.1.2.5-1 defines the primary level settings including test tolerances for all tests.

Each L1-RSRP measurement report for each of the tests in Table 4.7.4.1.2.5-1 shall meet the corresponding relative accuracy requirements in Table 4.7.4.1.2.5-2.

**Table 4.7.4.1.2.5-1: Same as Table 4.7.4.1.1.5-1**

**Table 4.7.4.1.2.5-2: L1-RSRP relative accuracy requirements for the reported values**

	Test 1	Test 2
	All bands	All bands
Normal Conditions		
Lowest reported value (Cell 2 SSB resource 1)	RSRP <sub>x</sub> - 3	RSRP <sub>x</sub> - 3
Highest reported value (Cell 2 SSB resource 1)	RSRP <sub>x</sub> + 3	RSRP <sub>x</sub> + 3
Extreme Conditions		
Lowest reported value (Cell 2 SSB resource 1))	RSRP <sub>x</sub> - 4	RSRP <sub>x</sub> - 4
Highest reported value (Cell 2 SSB resource 1)	RSRP <sub>x</sub> + 4	RSRP <sub>x</sub> + 4
RSRP <sub>x</sub> is the reported value of Cell 2 SSB resource 0		

For the test to pass, the ratio of successful reported values in each test shall be more than 90% with a confidence level of 95%.

### 4.7.4.2 CSI-RS based L1-RSRP measurements

#### 4.7.4.2.1 EN-DC FR1 CSI-RS-based L1-RSRP absolute measurement accuracy

##### 4.7.4.2.1.1 Test purpose

The purpose of this test is to verify that the CSI-RS based L1-RSRP absolute measurement accuracy is within the specified limits for all bands.

##### 4.7.4.2.1.2 Test applicability

This test applies to all types of NR UE supporting E-UTRA and EN-DC from Release 15 onwards.

##### 4.7.4.2.1.3 Minimum conformance requirements

The minimum conformance requirements are specified in clause 4.7.4.0.3.

The normative reference for this requirement is TS 38.133 [6] clause A.4.7.4.2.

##### 4.7.4.2.1.4 Test description

## 4.7.4.2.1.4.1 Initial conditions

This test shall be tested using any of the test configurations in Table 4.7.4.2.1.4.1-1.

**Table 4.7.4.2.1.4.1-1: EN-DC FR1 CSI-RS based L1-RSRP absolute measurement accuracy supported test configurations**

Test Case ID	Description
4.7.4.2.1-1	LTE FDD, NR: 15 kHz SSB SCS, 10MHz bandwidth, FDD
4.7.4.2.1-2	LTE FDD, NR: 15 kHz SSB SCS, 10MHz bandwidth, TDD
4.7.4.2.1-3	LTE FDD, NR: 30 kHz SSB SCS, 40MHz bandwidth, TDD
4.7.4.2.1-4	LTE TDD, NR: 15 kHz SSB SCS, 10MHz bandwidth, FDD
4.7.4.2.1-5	LTE TDD, NR: 15 kHz SSB SCS, 10MHz bandwidth, TDD
4.7.4.2.1-6	LTE TDD, NR: 30 kHz SSB SCS, 40MHz bandwidth, TDD
NOTE: The UE is only required to be tested in one of the supported test configurations.	

Configure the test equipment and the DUT according to the parameters in Table 4.7.4.2.1.4.1-2.

**Table 4.7.4.2.1.4.1-2: Initial conditions for CSI-RS based L1-RSRP absolute accuracy in FR1**

Parameter	Value	Comment
Test environment	NC, TL/VL, TL/VH, TH/VL, TH/VH	As specified in TS 38.508-1 [14] clause 4.1.
Test frequencies	As specified in Annex E, Table E.2-1 and TS 38.508-1 [14] clause 4.3.1.	
Channel bandwidth	As specified by the test configuration selected from Table 4.7.4.2.1.4.1-1.	
Propagation conditions	AWGN	As specified in clause C.2.2.
Connection Diagram	TE Part 2Rx	A.3.1.8.2 with $n = 1$
	TE Part 4Rx	A.3.1.8.5 with $n = 1$
	DUT Part 2Rx	A.3.2.3.4
	DUT Part 4Rx	A.3.2.5.2
Exceptions to connection diagram	N/A	

1. Message contents are defined in clause 4.7.4.2.1.4.3.
2. Cell 1 is the E-UTRA serving cell (PCell) for the EN-DC setup. The power levels and settings for Cell 1 are set according to Annex A.6. Cell 2 is the NR FR1 cell. Cell 2 is the PSCell and the target for CSI-RS-based L1-RSRP measurements. Before the test, UE is configured to perform RLM and BFD measurement based on the SSBs. The connection setup is done according to the settings in clause C.1.1.

## 4.7.4.2.1.4.2 Test procedure

Prior to the start of the time duration T1, the UE shall be fully synchronized to PSCell. The UE shall be configured for periodic CSI reporting in PUCCH [format 2] with a reporting periodicity as mentioned in the above table 4.7.4.2.1.4.1-2.

1. Ensure the UE is in state RRC\_CONNECTED with generic procedure parameters Connectivity EN-DC, DC bearer MCG and SCG, Connected without release  $On$  and Test Mode  $On$ , according to TS 38.508-1 [14] clause 4.5 and general test parameters set according to Table 4.7.4.2.1.4.1-2.
2. Set the parameters according to T1 in Table 4.7.4.2.1.5-1.
3. The UE shall start sending L1-RSRP report including results of both CSI-RS#0 and CSI-RS #1 every 80 slots.
4. The SS shall check the L1-RSRP reported values of CSI-RS #0 and CSI-RS #1 in the periodic L1-RSRP reports. If the value for both CSI-RSs is within the limits in Table 4.7.4.2.1.5-2 or Table 4.7.4.2.1.5-3 (depending on the test configuration), the number of passed iterations is increased by one, otherwise the number of failed iterations is increased by one.

5. The SS shall continue checking the L1-RSRP report messages transmitted by the UE until the confidence level according to Table G.2.3-1 in Annex G is achieved.
6. Set the parameters according to each sub-test in Table 4.7.4.2.1.5-1 as appropriate and repeat steps 3-5.

4.7.4.2.1.4.3 Message contents

Message contents are according to TS 38.508-1 [14] clause 7.3 with the following exceptions:

**Table 4.7.4.2.1.4.3-1: Common Exception messages EN-DC CSI-RS-based L1-RSRP measurement**

Default Message Contents	
Common contents of system information blocks exceptions	
Default RRC messages and information elements contents exceptions	Table H.3.6-2 with conditions PERIODIC and CSI-RSRP Table H.3.6-3 with conditions CSI-RS and PERIODIC Table H.3.4-1 Table H.3.5-8 Table 7.3.1-3 in TS 38.508-1 [14] with condition SMTC.1

**Table 4.7.4.2.1.4.3-2: RadioLinkMonitoringConfig**

Derivation Path: TS 38.508-1 [14], Table 4.6.3-133

Information Element	Value/remark	Comment	Condition
RadioLinkMonitoringConfig ::= SEQUENCE {			
failureDetectionResourcesToAddModList SEQUENCE (SIZE(1..maxNrofFailureDetectionResources)) OF SEQUENCE {	1 entry		
purpose	both	UE is configured to perform RLM and BFD based on the SSB.	
detectionResource CHOICE {			
ssb-Index	0		
}			
}			
}			

4.7.4.2.1.5 Test requirement

Table 4.7.4.2.1.5-1 defines the primary level settings including test tolerances for all tests.

Each L1-RSRP measurement report for each of the tests in Table 4.7.4.2.1.5-1 shall meet the corresponding absolute accuracy requirements in Table 4.7.4.2.1.5-2 for test configurations 1, 2, 4 and 5, and the corresponding absolute accuracy requirements in Table 4.7.4.2.1.5-3 for test configurations 3 and 6.

**Table 4.7.4.2.1.5-1: L1-RSRP test parameters**

Parameter	Config	Unit	Test 1	Test 2
SSB GSCN	1~6		freq1	freq1
Duplex mode	1,4		FDD	FDD
	2,5		TDD	TDD
	3,6		TDD	TDD
TDD Configuration	1,4		N/A	N/A
	2,5		TDDConf.1.1	TDDConf.1.1
	3,6		TDDConf.2.1	TDDConf.2.1
BW <sub>channel</sub>	1,4	MHz	10: N <sub>RB,c</sub> = 52	10: N <sub>RB,c</sub> = 52
	2,5		10: N <sub>RB,c</sub> = 52	10: N <sub>RB,c</sub> = 52
	3,6		40: N <sub>RB,c</sub> = 106	40: N <sub>RB,c</sub> = 106
	1,4		SR.1.1 FDD	SR.1.1 FDD

Parameter	Config	Unit	Test 1	Test 2	
PDSCH Reference measurement channel	2,5		SR.1.1 TDD	SR.1.1 TDD	
	3,6		SR.2.1 TDD	SR.2.1 TDD	
RMSI CORESET Reference Channel	1,4		CR.1.1 FDD	CR.1.1 FDD	
	2,5		CR.1.1 TDD	CR.1.1 TDD	
	3,6		CR.2.1 TDD	CR.2.1 TDD	
Dedicated CORESET Reference Channel	1,4		CCR.1.1 FDD	CCR.1.1 FDD	
	2,5		CCR.1.1 TDD	CCR.1.1 TDD	
	3,6		CCR.2.1 TDD	CCR.2.1 TDD	
SSB configuration	1,4		SSB.3 FR1	SSB.3 FR1	
	2,5		SSB.3 FR1	SSB.3 FR1	
	3,6		SSB.4 FR1	SSB.4 FR1	
OCNG Patterns	1~6		OP.1	OP.1	
TRS configuration	1,4		TRS.1.1 FDD	TRS.1.1 FDD	
	2,5		TRS.1.1 TDD	TRS.1.1 TDD	
	3,6		TRS.1.2 TDD	TRS.1.2 TDD	
Initial BWP Configuration	1~6		DLBWP.0.1 ULBWP.0.1	DLBWP.0.1 ULBWP.0.1	
Dedicated BWP configuration	1~6		DLBWP.1.1 ULBWP.1.1	DLBWP.1.1 ULBWP.1.1	
SMTc configuration	1~6		SMTc.1	SMTc.1	
CSI-RS	1,4		CSI-RS 1.2 FDD	CSI-RS 1.2 FDD	
	2,5		CSI-RS 1.2 TDD	CSI-RS 1.2 TDD	
	3,6		CSI-RS 2.2 TDD	CSI-RS 2.2 FDD	
reportConfigType	1~6		periodic	periodic	
reportQuantity	1~6		cri-RSRP	cri-RSRP	
Number of reported RS	1~6		2	2	
L1-RSRP reporting period	1~6		slot80	slot80	
EPRE ratio of PSS to SSS	1~6	dB	0	0	
EPRE ratio of PBCH DMRS to SSS					
EPRE ratio of PBCH to PBCH DMRS					
EPRE ratio of PDCCH DMRS to SSS					
EPRE ratio of PDCCH to PDCCH DMRS					
EPRE ratio of PDSCH DMRS to SSS					
EPRE ratio of PDSCH to PDSCH DMRS					
EPRE ratio of OCNG DMRS to SSS <sup>Note 1</sup>					
EPRE ratio of OCNG to OCNG DMRS <sup>Note 1</sup>					
$N_{oc}$ <small>Note2</small>	Depending on band group	1,2,4,5	dBm/15kHz	-94.65	$-117 + \Delta_{BG\_offset}$
		3,6		-96.00	$117 + \Delta_{BG\_offset}$
$N_{oc}$ <small>Note2</small>		1,2,4,5	dBm/CSI-RS SCS	-94.65	$-117 + \Delta_{BG\_offset}$
		3,6		-93.00	$-114 + \Delta_{BG\_offset}$
$\hat{E}_s / I_{ot}$	1~6	dB	10	-2.2	
CSI-RSRP <small>Note3</small>	Depending on band group	1,2,4,5	dBm/CSI-RS SCS	-84.65	$-119.2 + \Delta_{BG\_offset}$
		3,6		-83.00	$-116.2 + \Delta_{BG\_offset}$
$I_o$ <small>Note3</small>	Depending on band group	1,2,4,5	dBm/9.36 MHz	-56.28	$-87.00 + \Delta_{BG\_offset}$
		3,6		dBm/38.16 MHz	-51.53
$\hat{E}_s / N_{oc}$	1~6	dB	10	-2.2	
Propagation condition	1~6		AWGN	AWGN	
Antenna configuration	1~6		1x2	1x2	

NOTE 1: OCNG shall be used such that both cells are fully allocated and a constant total transmitted power spectral density is achieved for all OFDM symbols.



Parameter	Config	Unit	Test 1	Test 2
NOTE 2: Interference from other cells and noise sources not specified in the test is assumed to be constant over subcarriers and time and shall be modelled as AWGN of appropriate power for $N_{oc}$ to be fulfilled.				
NOTE 3: RSRP and $I_o$ levels have been derived from other parameters for information purposes. They are not settable parameters themselves.				
NOTE 4: RSRP minimum requirements are specified assuming independent interference and noise at each receiver antenna port.				
NOTE 5: The test configuration excludes support for band n51 and it is not required to run this test on band n51 in this release of the specification.				

**Table 4.7.4.2.1.5-2: Same as Table 4.7.4.1.1.5-2****Table 4.7.4.2.1.5-3: Same as Table 4.7.4.1.1.5-3**

For the test to pass, the ratio of successful reported values in each test shall be more than 90% with a confidence level of 95%.

#### 4.7.4.2.2 EN-DC FR1 CSI-RS-based L1-RSRP relative measurement accuracy

##### 4.7.4.2.2.1 Test purpose

The purpose of this test is to verify that the CSI-RS based L1-RSRP relative measurement accuracy is within the specified limits for all bands.

##### 4.7.4.2.2.2 Test applicability

This test applies to all types of NR UE supporting E-UTRA and EN-DC from Release 15 onwards.

##### 4.7.4.2.2.3 Minimum conformance requirements

The minimum conformance requirements are specified in clause 4.7.4.0.4.

The normative reference for this requirement is TS 38.133 [6] clause A.4.7.4.2.

##### 4.7.4.2.2.4 Test description

###### 4.7.4.2.2.4.1 Initial conditions

This test shall be tested using any of the test configurations in Table 4.7.4.2.2.4.1-1.

**Table 4.7.4.2.2.4.1-1: EN-DC FR1 CSI-RS based L1-RSRP relative measurement accuracy supported test configurations**

Test Case ID	Description
4.7.4.2.2-1	LTE FDD, NR: 15 kHz SSB SCS, 10MHz bandwidth, FDD
4.7.4.2.2-2	LTE FDD, NR: 15 kHz SSB SCS, 10MHz bandwidth, TDD
4.7.4.2.2-3	LTE FDD, NR: 30 kHz SSB SCS, 40MHz bandwidth, TDD
4.7.4.2.2-4	LTE TDD, NR: 15 kHz SSB SCS, 10MHz bandwidth, FDD
4.7.4.2.2-5	LTE TDD, NR: 15 kHz SSB SCS, 10MHz bandwidth, TDD
4.7.4.2.2-6	LTE TDD, NR: 30 kHz SSB SCS, 40MHz bandwidth, TDD

NOTE: The UE is only required to be tested in one of the supported test configurations.

Configure the test equipment and the DUT according to the parameters in Table 4.7.4.2.2.4.1-2.

**Table 4.7.4.2.2.4.1-2: Initial conditions for CSI-RS based L1-RSRP relative accuracy in FR1**

Parameter	Value	Comment
Test environment	NC, TL/VL, TL/VH, TH/VL, TH/VH	As specified in TS 38.508-1 [14] clause 4.1.
Test frequencies	As specified in Annex E, Table E.2-1 and TS 38.508-1 [14] clause 4.3.1.	
Channel bandwidth	As specified by the test configuration selected from Table 4.7.4.2.2.4.1-1.	
Propagation conditions	AWGN	As specified in clause C.2.2.
Connection Diagram	TE Part 2Rx	A.3.1.8.2 with $n = 1$
	TE Part 4Rx	A.3.1.8.5 with $n = 1$
	DUT Part 2Rx	A.3.2.3.4
	DUT Part 4Rx	A.3.2.5.2
Exceptions to connection diagram	N/A	

1. Message contents are defined in clause 4.7.4.2.2.4.3.
2. Cell 1 is the E-UTRA serving cell (PCell) for the EN-DC setup. The power levels and settings for Cell 1 are set according to Annex A.6. Cell 2 is the NR FR1 cell. Cell 2 is the PSCell and the target for CSI-RS-based L1-RSRP measurements. Before the test, UE is configured to perform RLM and BFD measurement based on the SSBs. The connection setup is done according to the settings in clause C.1.1.

#### 4.7.4.2.2.4.2 Test procedure

Prior to the start of the time duration T1, the UE shall be fully synchronized to PSCell. The UE shall be configured for periodic CSI reporting in PUCCH [format 2] with a reporting periodicity as mentioned in the above table 4.7.4.2.2.4.1-2.

1. Ensure the UE is in state RRC\_CONNECTED with generic procedure parameters Connectivity EN-DC, DC bearer MCG and SCG, Connected without release  $On$  and Test Mode  $On$ , according to TS 38.508-1 [14] clause 4.5 and general test parameters set according to Table 4.7.4.2.2.4.1-2.
2. Set the parameters according to T1 in Table 4.7.4.2.2.5-1.
3. The UE shall start sending L1-RSRP report including results of both CSI-RS#0 and CSI-RS #1 every 80 slots.
4. The SS shall check the L1-RSRP reported values of CSI-RS #0 and CSI-RS #1 in the periodic L1-RSRP reports. The L1-RSRP value for CSI-RS #1 is compared to the L1-RSRP value for CSI-RS #0. If the difference is within the limits in Table 4.7.4.2.2.5-2, the number of passed iterations is increased by one, otherwise the number of failed iterations is increased by one.
5. The SS shall continue checking the L1-RSRP report messages transmitted by the UE until the confidence level according to Table G.2.3-1 in Annex G is achieved.
6. Set the parameters according to each sub-test in Table 4.7.4.2.2.5-1 as appropriate and repeat steps 3-5.

#### 4.7.4.2.2.4.3 Message contents

Message contents are same as in Clause 4.7.4.2.1.4.3.

#### 4.7.4.2.2.5 Test requirement

Table 4.7.4.2.2.5-1 defines the primary level settings including test tolerances for all tests.

Each L1-RSRP measurement report for each of the tests in Table 4.7.4.2.2.5-1 shall meet the corresponding absolute accuracy requirements in Table 4.7.4.2.2.5-2.

**Table 4.7.4.2.2.5-1: Same as Table 4.7.4.2.1.5-1**

**Table 4.7.4.2.2.5-2: Same as Table 4.7.4.1.2.5-2**

For the test to pass, the ratio of successful reported values in each test shall be more than 90% with a confidence level of 95%.

## 4.7.5 SFTD

### 4.7.5.0 Minimum conformance requirements

#### 4.7.5.0.1 SFTD Accuracy Requirement

The SFN and frame timing difference (SFTD) is measured between PCell and NR PSCell under EN-DC, or between PCell and NR cell for inter-RAT SFTD. The inter-RAT SFTD measurement can only be configured for E-UTRA - NR band combinations that are supported by the UE.

The accuracy requirements in Table 4.7.5.0.1-3 are applicable under the following conditions:

For PCell SFN and frame timing measurement:

- Cell specific reference signals are transmitted either from one, two or four antenna ports.
- Conditions defined in TS 36.101 [27] clause 7.3 for reference sensitivity are fulfilled.
- No changes to the uplink transmission timing are applied during the measurement period.
- $RSRP_{dBm}$  according to Annex B.3.5 of TS 36.133 [23] for a corresponding Band.
- $I_o$  range defined in Table 4.7.5.0.1-1.

**Table 4.7.5.0.1-1: PCell  $I_o$  range conditions for SFTD measurement accuracy**

Parameter	$I_o$ <sup>Note 1</sup> range		
	E-UTRA operating band groups <sup>Note 4, 5</sup>	Minimum $I_o$ dBm/15kHz <sup>Note 2, 3</sup>	Maximum $I_o$ dBm/BW <sub>Channel</sub>
Conditions	FDD_A, TDD_A	-121	-50
	FDD_C, TDD_C	-120	-50
	FDD_D	-119.5	-50
	FDD_E, TDD_E	-119	-50
	FDD_F	-118.5	-50
	FDD_G	-118	-50
	FDD_H	-117.5	-50
	FDD_N	-114.5	-50

NOTE 1: When in dBm/15kHz, the minimum  $I_o$  condition is expressed as the average  $I_o$  per RE over all REs in that symbol.  $I_o$  may be different in different symbols within a subframe.

NOTE 2: The condition level is increased by  $\Delta > 0$ , when applicable, as described in clause B.4.2 and B.4.3 of TS 36.133 [23].

NOTE 3: The condition level is increased by MSD as defined in clause 7.3B in TS 38.101-3 [4], if applicable depending on E-UTRA - NR band combination.

NOTE 4: E-UTRA operating band groups are as defined in clause 3.5 of TS 36.133 [23].

NOTE 5: Only E-UTRA bands within EN-DC band combinations as specified in clause 5.5B in TS 38.101-3 [4] are applicable.

For NR PSCell, or NR cell SFN and frame timing measurement in FR1:

- Conditions defined in TS 38.101-1 [2] clause 7.3 for reference sensitivity are fulfilled.
- $I_o$  range defined in Table 4.7.5.0.1-2.

**Table 4.7.5.0.1-2: NR PSCell, or NR cell lo range conditions for SFTD measurement accuracy in FR1**

Parameter	Io <sup>Note 1</sup> range			
	NR operating band groups <sup>Note 4, 5</sup>	Minimum Io <sup>Note 2, 3</sup>		Maximum Io
		dBm/ SCS <sub>SSB</sub>		
		SCS <sub>SSB</sub> = 15 kHz	SCS <sub>SSB</sub> = 30 kHz	dBm/BW <sub>Channel</sub>
Conditions	NR_FDD_FR1_A, NR_TDD_FR1_A	-121	-118	-50
	NR_FDD_FR1_B	-120.5	-117.5	-50
	NR_TDD_FR1_C	-120	-117	-50
	NR_FDD_FR1_D, NR_TDD_FR1_D	-119.5	-116.5	-50
	NR_FDD_FR1_E, NR_TDD_FR1_E	-119	-116	-50
	NR_FDD_FR1_G	-118	-115	-50
	NR_FDD_FR1_H	-117.5	-114.5	-50

NOTE 1: Io is assumed to have constant EPRE across the bandwidth.  
 NOTE 2: The condition level is increased by ΔR<sub>B,c</sub> as defined in clause 7.3B in TS 38.101-3 [4], depending on E-UTRA - NR band combination.  
 NOTE 3: The condition level is increased by MSD as defined in clause 7.3B in TS 38.101-3 [4], if applicable depending on E-UTRA - NR band combination.  
 NOTE 4: NR operating band groups are as defined in clause 3.5 of TS 36.133 [23].  
 NOTE 5: Only NR bands within EN-DC band combinations as specified in clause 5.5B in TS 38.101-3 [4] are applicable.

**Table 4.7.5.0.1-3: SFTD measurement accuracy**

Accuracy	Conditions	
	Ês/lot	Frequency range
Ts <sup>Note 1</sup>	dB	
40	≥ -3 dB	FR1
40		FR2

NOTE 1: Ts is the basic timing unit defined in TS 36.211 [24].  
 NOTE 2: The parameter Ês/lot is the minimum Ês/lot of the pair of cells to which the requirement applies.

**4.7.5.1 EN-DC FR1 SFTD measurement accuracy**

**4.7.5.1.1 Test purpose**

The purpose of this test is to verify that SFTD measurement accuracy is within the specified limits for all bands.

**4.7.5.1.2 Test applicability**

This test applies to all types of NR UE supporting E-UTRA and EN-DC from Release 15 onwards. Applicability requires support of SFTD measurements between an E-UTRA PCell and an NR PSCell.

**4.7.5.1.3 Minimum conformance requirements**

The minimum conformance requirements are specified in clause 4.7.5.0.1.

The normative reference for this requirement is TS 38.133 [6] clause A.4.7.5.1.

**4.7.5.1.4 Test description**

**4.7.5.1.4.1 Initial conditions**

This test shall be tested using any of the test configurations in Table 4.7.5.1.4.1-1.

**Table 4.7.5.1.4.1-1: Test configurations**

Test Case ID	Description
--------------	-------------

4.7.5.1-1	LTE FDD, NR: 15 kHz SSB SCS, 10MHz bandwidth, FDD
4.7.5.1-2	LTE FDD, NR: 15 kHz SSB SCS, 10MHz bandwidth, TDD
4.7.5.1-3	LTE FDD, NR: 30 kHz SSB SCS, 40MHz bandwidth, TDD
4.7.5.1-4	LTE TDD, NR: 15 kHz SSB SCS, 10MHz bandwidth, FDD
4.7.5.1-5	LTE TDD, NR: 15 kHz SSB SCS, 10MHz bandwidth, TDD
4.7.5.1-6	LTE TDD, NR: 30 kHz SSB SCS, 40MHz bandwidth, TDD
NOTE: The UE is only required to be tested in one of the supported test configurations.	

Configure the test equipment and the DUT according to the parameters in Table 4.7.5.1.4.1-2.

**Table 4.7.5.1.4.1-2: Initial conditions**

Parameter	Value	Comment
Test environment	NC, TL/VL, TL/VH, TH/VL, TH/VH	As specified in TS 38.508-1 [14] clause 4.1.
Test frequencies	As specified in Annex E, Table E.2-1 and TS 38.508-1 [14] clause 4.3.1.	
Channel bandwidth	As specified by the test configuration selected from Table 4.7.5.1.4.1-1.	
Propagation conditions	AWGN	As specified in clause C.2.2.
Connection Diagram	TE Part 2Rx	A.3.1.8.2 with $n = 1$
	TE Part 4Rx	A.3.1.8.5 with $n = 1$
	DUT Part 2Rx	A.3.2.3.4
	DUT Part 4Rx	A.3.2.5.2
Exceptions to connection diagram	N/A	

1. Message contents are defined in clause 4.7.5.1.4.3.
2. Cell 1 is the E-UTRA serving cell (PCell) for the EN-DC setup. The power levels and settings for Cell 1 are set according to Annex A.6. Cell 2 is the NR FR1 cell. Cell 2 is the PSCell. The connection setup is done according to the settings in clause C.1.1.
3. The SFTD between PCell and PSCell shall be set to one of the differences in Table 4.7.5.1.5-2.

#### 4.7.5.1.4.2 Test procedure

1. Ensure the UE is in state RRC\_CONNECTED with generic procedure parameters Connectivity EN-DC, DC bearer MCG and SCG, Connected without release *On* and Test Mode *On*, according to TS 38.508-1 [14] clause 4.5.
2. Set the parameters according to Table 4.7.5.1.5-1 and Table 4.7.5.1.5-2 as appropriate. (Condition = 3)
3. The SS shall transmit an RRCConnectionReconfiguration message on Cell 1.
4. The UE shall transmit an RRCConnectionReconfigurationComplete message.
5. The UE shall transmit a MeasurementReport containing the MeasResultCellListSFTD-r15 for the PSCell with SFTD measurements.
6. The SS shall check the reported SFN offset and frame boundary offset between the E-UTRA PCell and the NR PSCell. The number of failed iterations is increased by one if
  - The value of *sfn-OffsetResult* is different with the expected SFN offset value, or
  - The value of *frameBoundaryOffsetResult* is outside the range given in Table 4.7.5.1.5-3, or
  - The UE fails to report the measurement value for Cell 2.

Otherwise the number of successful iterations is increased by one.

7. Switch off and on the UE and ensure the UE is in RRC\_CONNECTED with generic procedure parameters Connectivity EN-DC, DC bearer MCG and SCG, Connected without release *On* and Test Mode *On*, according to TS 38.508-1 [14] clause 4.5.
8. Repeat steps 2-7 until the confidence level according to Tables G.2.3-1 in Annex G clause G.2 is achieved.

#### 4.7.5.1.4.3 Message contents

Message contents are according to TS 38.508-1 [14] clause 7.3 with the following exceptions:

**Table 4.7.5.1.4.3-1: Common exception messages**

Default Message Contents	
Common contents of system information blocks exceptions	
Default RRC messages and information elements contents exceptions	Table H.3.4-4 with Condition INTER_RAT, GAPLESS and SFTD Table H.3.4-7 with Condition Inter-RAT and SFTD
Specific message contents exceptions for Test Configuration 4.7.5.1.-1, 4.7.5.1-2, 4.7.5.1-4 and 4.7.5.1-54	Table H.3.4-6 with Condition SSB.1 FR1 and SMTC.1
Specific message contents exceptions for Test Configuration 4.7.5.1-3 and 4.7.5.1-6	Table H.3.4-6 with Condition S SB.2 FR1 and SMTC.1

**Table 4.7.5.1.4.3-2: ReportConfigInterRAT-SFTD**

Derivation Path: TS 36.508 [25], Table 4.6.6-8B			
Information Element	Value/remark	Comment	Condition
ReportConfigInterRAT ::= SEQUENCE {			
reportQuantityCellNR-r15 ::= SEQUENCE {			
ss-rsrp	true		
}			
reportSFTD-Meas-r15	pSCell		
}			

#### 4.7.5.1.5 Test requirement

Table 4.7.5.1.5-1 defines the primary level settings including test tolerances.

**Table 4.7.5.1.5-1: Test parameters for SFTD accuracy**

Parameter	Config	Unit	Test 1
SSB GSCN	1~6		freq1
Duplex mode	1,4		FDD
	2,5		TDD
	3,6		TDD
TDD Configuration	1,4		N/A
	2,5		TDDConf.1.1
	3,6		TDDConf.2.1
BW <sub>channel</sub>	1,4	MHz	10: N <sub>RB,c</sub> = 52
	2,5		10: N <sub>RB,c</sub> = 52
	3,6		40: N <sub>RB,c</sub> = 106
PDSCH Reference measurement channel	1,4		SR.1.1 FDD
	2,5		SR.1.1 TDD
	3,6		SR.2.1 TDD
RMSI CORESET Reference Channel	1,4		CR.1.1 FDD
	2,5		CR.1.1 TDD
	3,6		CR.2.1 TDD
RMC CORESET Reference Channel	1,4		CCR.1.1 FDD
	2,5		CCR.1.1 TDD

Parameter	Config	Unit	Test 1
	3,6		CCR.2.1 TDD
SSB configuration	1,4		SSB.1 FR1
	2,5		SSB.1 FR1
	3,6		SSB.2 FR1
SMTC configuration	1~6		SMTC.1
DL BWP configuration	1~6		DLBWP.1.1
UL BWP configuration	1~6		ULBWP.1.1
CSI-RS for tracking	1,4		TRS.1.1 FDD
	2,5		TRS.1.1 TDD
	3,6		TRS.1.2 TDD
OCNG Patterns	1~6		OP.1
EPRE ratio of PSS to SSS	1~6	dB	0
EPRE ratio of PBCH DMRS to SSS			
EPRE ratio of PBCH to PBCH DMRS			
EPRE ratio of PDCCH DMRS to SSS			
EPRE ratio of PDCCH to PDCCH DMRS			
EPRE ratio of PDSCH DMRS to SSS			
EPRE ratio of PDSCH to PDSCH DMRS			
EPRE ratio of OCNG DMRS to SSS <sup>Note 1</sup>			
EPRE ratio of OCNG to OCNG DMRS <sup>Note 1</sup>			
$N_{oc}$ <sup>Note2</sup>			
$N_{oc}$ <sup>Note2</sup>	1,2,4,5	dBm/SSB SCS	-104
	3,6		-101
$\hat{E}_s/I_{ot}$	1~6	dB	-2.7
$\hat{E}_s/N_{oc}$	1~6	dB	-2.7
SS-RSRP <sup>Note3</sup>	1,2,4,5	dBm/SCS	-106.7
	3,6		-103.7
$I_o$ <sup>Note3</sup>	1,2,4,5	dBm/9.36 MHz	-74.18
	3,6	dBm/38.16 MHz	-68.08
Propagation condition	1~6		AWGN
Antenna configuration	1~6		1x2
<p>NOTE 1: OCNG shall be used such that both cells are fully allocated and a constant total transmitted power spectral density is achieved for all OFDM symbols.</p> <p>NOTE 2: Interference from other cells and noise sources not specified in the test is assumed to be constant over subcarriers and time and shall be modelled as AWGN of appropriate power for <math>N_{oc}</math> to be fulfilled.</p> <p>NOTE 3: SS-RSRP and <math>I_o</math> levels have been derived from other parameters for information purposes. They are not settable parameters themselves.</p> <p>NOTE 4: SS-RSRP minimum requirements are specified assuming independent interference and noise at each receiver antenna port.</p> <p>NOTE 5: The test configuration excludes support for band n51 and it is not required to run this test on band n51 in this release of the specification</p>			

The SFTD reported by the UE consists of two elements, the SFN offset and the frame boundary offset between PCell and PSCell. Table 4.7.5.1.5-2 defines the timing offsets for the SFTD accuracy test. The SFN offset in reported SFTD shall match the values in Table 4.7.5.1.5-2 and the frame boundary offset in reported SFTD shall be within the range given in Table 4.7.5.1.5-3.

**Table 4.7.5.1.5-2: Timing offsets for SFTD accuracy test**

Condition	SFN offset between PCell and PSCell	Frame boundary offset between PCell and PSCell (Ts)
1	100	-122000
2	300	-60540

3	500	1000
4	700	62540
5	900	124000

**Table 4.7.5.1.5-3: EN-DC FR1 SFTD measurement accuracy requirements for the value of frameBoundaryOffsetResult in reported SFTD**

Normal and Extreme Conditions	frameBoundaryOffsetResult				
	Condition 1	Condition 2	Condition 3	Condition 4	Condition 5
Lowest reported value	-24408	-12116	192	12100	24392
Highest reported value	-24392	-12100	208	12116	24408

For the test to pass, the ratio of successful reported values in each test shall be more than 90% with a confidence level of 95%.

## 4.7.6 CLI measurements

### 4.7.6.0 Minimum conformance requirements

#### 4.7.6.0.1 Minimum conformance requirements for SRS-RSRP accuracy

The SRS-RSRP measurement reported by the UE shall fulfil the accuracy requirements defined in Table 4.7.6.0.1-1 for FR1 and Table 4.7.6.0.1-2 for FR2, provided that the following conditions are met. The accuracy requirements in this clause are derived based on AWGN radio propagation conditions.

- Conditions defined in clause 7.3 of TS 38.101-1 [18] for reference sensitivity are fulfilled.
- Conditions for SRS-RSRP measurements are fulfilled according to Annex B.2.z for a corresponding Band for each relevant SRS resource configured for measurement.
- The time difference between UE's DL reference timing in the serving cell and SRS arrival time is no larger than  $T_{\text{error\_SRS\_RSRP}}$ , where
  - $T_{\text{error\_SRS\_RSRP}} = T_C \times N_{\text{TA\_offset}} + 4.67\mu\text{s}$  for FR1
  - $T_{\text{error\_SRS\_RSRP}} = T_C \times N_{\text{TA\_offset}} + 3.67\mu\text{s}$  for FR2
  - $N_{\text{TA\_offset}}$  is defined in Table 7.1.2-2
  - $T_C$  is 0.509ns
- The number of SRS ports in the SRS resource configured for measurement is 1,
- The number of symbols in the SRS resource configured for measurement is 1,
- The number of repetitions in the SRS resource configured for measurement is 1,
- Frequency hopping, sequence group hopping or sequence hopping is disabled in the SRS resource configured for measurement,
- The bandwidth of the SRS resource is 48 PRBs.
- One of the following conditions is met
  - There is no other SRS resource with the same root sequence and on the same symbol and with same comb as the relevant SRS resource.
  - If multiple SRS resources are on the same symbol and with same comb, the distance between cyclic shifts of any two resources is no less than 6 if  $\text{transmissionComb} = n4$ , and no less than 4 if  $\text{transmissionComb} = n2$ .



Table 4.7.6.0.1-1: SRS-RSRP absolute accuracy in FR1

Accuracy						Conditions						
Normal condition			Extreme condition			SRS Es/lot	Io <sup>Note 1</sup> range					
dB							dB	Minimum Io			Maximum Io	
SCS <sub>SRS</sub> (kHz)			SCS <sub>SRS</sub> (kHz)			NR operating band groups <sup>Note 2</sup>		dBm / SCS <sub>SRS</sub>			dBm/BW Channel	dBm/BW Channel
15	30	60	15	30	60		SCS <sub>SRS</sub> = 15 kHz	SCS <sub>SRS</sub> = 30 kHz	SCS <sub>SRS</sub> = 60 kHz			
±3	±3.5	±5	±7.5	±8	±9.5	≥1	NR_TDD_FR1_A	-120	-117	-114	N/A	-70
							NR_TDD_FR1_C	-119	-116	-113	N/A	-70
							NR_TDD_FR1_D	-118.5	-115.5	-112.5	N/A	-70
							NR_TDD_FR1_E	-118	-115	-112	N/A	-70
±6.5	±7	±8.5	±9.5	±10	±11.5	≥1	NR_TDD_FR1_A	N/A	N/A	N/A	-70	-50
							NR_TDD_FR1_C					
							NR_TDD_FR1_D					
							NR_TDD_FR1_E					

NOTE 1: Io is assumed to have constant EPRE across the bandwidth.

NOTE 2: NR operating band groups in FR1 are as defined in clause 3.5.2.

Table 4.7.6.0.1-2: SRS-RSRP absolute accuracy in FR2

Accuracy				Conditions			
Normal condition		Extreme condition		SRS Es/lot	Io <sup>Note 1</sup> range		
dB					dB	Minimum Io	
SCS <sub>SRS</sub> (kHz)		SCS <sub>SRS</sub> (kHz)		SCS <sub>SRS</sub> = 60kHz		SCS <sub>SRS</sub> = 120kHz	dBm/BW <sub>Channel</sub>
60	120	60	120				
±6	±8.5	±9	±11.5	≥1	Same value as SRS_RP in Table B.2.7-2, according to UE Power class, operating band and angle of arrival	N/A	-
±9	±11.5	±11	±13.5	≥1	N/A	-70	-

NOTE 1: Io specified at the Reference point, and assumed to have constant EPRE across the bandwidth.

NOTE 2: Values based on Refsens and EIS spherical coverage as defined in clauses 7.3.2 and 7.3.4 of TS 38.101-2 [19]. Application condition selected depending on angle of arrival.

NOTE 3: In the test cases, the SSB Es/lot and related parameters may need to be adjusted to ensure Es/lot at UE baseband is at value defined in this table.

4.7.6.0.1.1 SRS-RSRP report mapping

The reporting range of SRS-RSRP is defined from -140 dBm to -44 dBm with 1 dB resolution. The mapping of measured quantity is defined in Table 4.7.6.0.1.2-1. The range in the signalling may be larger than the guaranteed accuracy range.

**Table 4.7.6.0.1.2-1: SRS-RSRP measurement report mapping**

Reported value	Measured quantity value	Unit
SRS-RSRP_0	SRS-RSRP < -140	dBm
SRS-RSRP_1	-140 ≤ SRS-RSRP < -139	dBm
SRS-RSRP_2	-139 ≤ SRS-RSRP < -138	dBm
SRS-RSRP_3	-138 ≤ SRS-RSRP < -137	dBm
SRS-RSRP_4	-137 ≤ SRS-RSRP < -136	dBm
..	..	...
SRS-RSRP_95	-46 ≤ SRS-RSRP < -45	dBm
SRS-RSRP_96	-45 ≤ SRS-RSRP < -44	dBm
SRS-RSRP_97	-44 ≤ SRS-RSRP	dBm
SRS-RSRP_98	Infinity	
Note: 'Infinity' means that UE cannot detect SRS due to too strong signal to measure.		

The normative reference for this requirement is TS 38.133 [6] clause 10.1.22.1.

**4.7.6.0.2 Minimum conformance requirements for CLI-RSSI measurement accuracy with FR1 serving cell**

The CLI-RSSI measurement reported by the UE shall fulfil the accuracy requirements defined in Table 4.7.6.0.2-1 for FR1 and Table 4.7.6.0.2-2 for FR2, provided that the following conditions are met.

- Conditions defined in clause 7.3 of TS 38.101-1 [18] for reference sensitivity are fulfilled.

**Table 4.7.6.0.2-1: CLI-RSSI absolute accuracy in FR1**

Accuracy		Conditions					
Normal condition	Extreme condition	Io <sup>Note 1</sup> range					
		NR operating band groups <sup>Note 2</sup>	Minimum Io			Maximum Io	
dB	dB			dBm / SCS <sub>SRS</sub>			dBm/BW <sub>Channel</sub>
		SCS <sub>SRS</sub> = 15 kHz		SCS <sub>SRS</sub> = 30 kHz	SCS <sub>SRS</sub> = 60 kHz		
±3.5	±6.5	NR_TDD_FR1_A,	-120	-117	-114	N/A	-70
		NR_TDD_FR1_C	-119	-116	-113	N/A	-70
		NR_TDD_FR1_D	-118.5	-115.5	-112.5	N/A	-70
		NR_TDD_FR1_E	-118	-115	-112	N/A	-70
±5.5	±8.5	Note 3	Note 3	Note 3	Note 3	-70	-50

NOTE 1: Io is assumed to have constant EPRE across the bandwidth.  
 NOTE 2: NR operating band groups in FR1 are as defined in clause 3.5.2.  
 NOTE 3: The same bands and the same Io conditions for each band apply for this requirement as for the corresponding highest accuracy requirement.

**Table 4.7.6.0.2-2: CLI-RSSI absolute accuracy in FR2**

Accuracy		Conditions		
Normal condition	Extreme condition	I <sub>o</sub> <sup>Note 1</sup> range		
		Minimum I <sub>o</sub>		Maximum I <sub>o</sub>
dB	dB	dBm / SCS <sub>SRS</sub> <sup>Note 2</sup>		dBm/BW <sub>Channel</sub>
		SCS <sub>SRS</sub> = 60kHz	SCS <sub>SRS</sub> = 120kHz	
±5	±8	Same value as SRS_RP in Table B.2.7-2, according to UE Power class, operating band and angle of arrival		N/A
±7	±10	Note 4		-70
				-50

NOTE 1: I<sub>o</sub> specified at the Reference point, and assumed to have constant EPRE across the bandwidth.  
 NOTE 2: Values based on Refsens and EIS spherical coverage as defined in clauses 7.3.2 and 7.3.4 of TS 38.101-2 [19]. Applicable side condition selected depending on angle of arrival.  
 NOTE 3: In the test cases, the SSB Ês/lot and related parameters may need to be adjusted to ensure Ês/lot at UE baseband is above the value defined in this table.  
 NOTE 4: The same bands and the same I<sub>o</sub> conditions for each band apply for this requirement as for the corresponding highest accuracy requirement.

4.7.6.0.2.1 CLI-RSSI report mapping

The reporting range of CLI-RSSI is defined from -100 dBm to -25 dBm with 1 dB resolution. The mapping of measured quantity is defined in Table 4.7.6.0.2.1-1. The range in the signalling may be larger than the guaranteed accuracy range. UE shall scale the measured CLI-RSSI to report a nominal RSSI equivalent to 6RB measurement with 15kHz SCS.

**Table 4.7.6.0.2.1-1: CLI-RSSI measurement report mapping**

Reported value	Measured quantity value	Unit
CLI-RSSI_00	CLI-RSSI < -100	dBm
CLI-RSSI_01	-100 ≤ CLI-RSSI < -99	dBm
CLI-RSSI_02	-99 ≤ CLI-RSSI < -98	dBm
...	...	...
CLI-RSSI_74	-27 ≤ CLI-RSSI < -26	dBm
CLI-RSSI_75	-26 ≤ CLI-RSSI < -25	dBm
CLI-RSSI_76	-25 ≤ CLI-RSSI	dBm

The normative reference for this requirement is TS 38.133 [6] clauses 10.1.22.2.

4.7.6.1 EN-DC SRS-RSRP measurement accuracy with FR1 serving cell

**Editor's Note: This test case is incomplete in following aspects:**

- Message contents are missing.
- TT analysis is missing.
- Test Procedure is FFS.
- Test applicability needs to be updated

4.7.6.1.1 Test purpose

The purpose of this test is to verify that the SRS-RSRP measurement accuracy is within the specified limits with SRS-RSRP measurement requirements in TS 38.133 [6] clause 10.1.22.1.1.

4.7.6.1.2 Test applicability

FFS

### 4.7.6.1.3 Minimum conformance requirements

The minimum conformance requirements are specified in clause 4.7.6.0.1.

The normative reference for this requirement is TS 38.133 [6] clause A.4.7.6.1.

### 4.7.6.1.4 Test description

#### 4.7.6.1.4.1 Initial conditions

This test shall be tested using any of the test configurations in Table 4.7.6.1.4.1-1. Test environment parameters are given in Table 4.7.6.2.4.1-2.

**Table 4.7.6.1.4.1-1: EN-DC FR1 SRS-RSRP accuracy supported test configurations**

Config	Description
1	LTE FDD, NR 15 kHz SRS SCS, 10 MHz bandwidth, TDD duplex mode
2	LTE FDD, NR 30kHz SRS SCS, 40 MHz bandwidth, TDD duplex mode
3	LTE TDD, NR 15 kHz SRS SCS, 10 MHz bandwidth, TDD duplex mode
4	LTE TDD, NR 30kHz SRS SCS, 40 MHz bandwidth, TDD duplex mode
Note:	The UE is only required to be tested in one of the supported test configurations in each supported band

**Table 4.7.6.1.4.1-2: SRS Configuration parameters for EN-DC SRS-RSRP accuracy**

Parameter	Value	Comment
Test environment	NC	As specified in TS 38.508-1 [14] clause 4.1.
Test frequencies	As specified in Annex E, Table E.2-1 and TS 38.508-1 [14] clause 4.3.1 and 4.4.2.	
Channel bandwidth	As specified by the test configuration selected from Table 4.7.6.2.4.1-1.	
Propagation conditions	AWGN	As specified in Annex C.2.2.
Connection Diagram	TE Part	A.3.1.7.1
	DUT Part	A.3.2.3.4
Exceptions to connection diagram	For 4Rx capable UEs without any 2 Rx RF bands use A.3.2.5.2 for DUT part and A.3.1.8.4 for TE Part	

1. Message contents are defined in clause 4.7.6.1.4.3.
2. Cell 1 is the E-UTRA serving cell (PCell) for the EN-DC setup. The power levels and settings for Cell 1 are set according to Annex A.6. Cell 2 is NR FR1 cell (PSCell). Cell 2 is the target for SRS-RSRP measurements. Before the test UE is configured to perform SRS-RSRP measurement. During the test, the test system transmits SRS resources for measurement in the DL slots according to the SRS configuration in Table 4.7.6.1.5-3. There is no measurement gap configured in the test. During the test, the test system does not transmit PDCCH/PDSCH/OCNG on SRS symbol to be transmitted and on 1 data symbol before SRS to be transmitted.

#### 4.7.6.1.4.2 Test procedure

FFS

#### 4.7.6.1.4.3 Message contents

Message contents are according to TS 38.508-1 [14] clause 7.3 with the following exceptions:

FFS

#### 4.7.6.1.5 Test requirement

Table 4.7.6.1.5-1 defines the primary level settings including test tolerances for all tests.

**Table 4.7.6.1.5-1: NR Cell specific test parameters for EN-DC SRS-RSRP accuracy for PSCell**

Parameter		Config	Unit	Test 1	Test 2	Test 3	
SSB GSCN		1~4		freq1	freq1	freq1	
Duplex mode		1~4		TDD	TDD	TDD	
TDD configuration		1,3		TDDConf.1.1	TDDConf.1.1	TDDConf.1.1	
		2,4		TDDConf.2.1	TDDConf.2.1	TDDConf.2.1	
BW <sub>channel</sub>		1,3	MHz	10: N <sub>RB,c</sub> = 52	10: N <sub>RB,c</sub> = 52	10: N <sub>RB,c</sub> = 52	
		2,4		40: N <sub>RB,c</sub> = 106	40: N <sub>RB,c</sub> = 106	40: N <sub>RB,c</sub> = 106	
PDSCH Reference measurement channel		1,3		SR.1.1 TDD	SR.1.1 TDD	SR.1.1 TDD	
		2,4		SR.2.1 TDD	SR.2.1 TDD	SR.2.1 TDD	
RMSI CORESET Reference Channel		1,3		CR.1.1 TDD	CR.1.1 TDD	CR.1.1 TDD	
		2,4		CR.2.1 TDD	CR.2.1 TDD	CR.2.1 TDD	
Dedicated CORESET Reference Channel		1,3		CCR.1.1 TDD	CCR.1.1 TDD	CCR.1.1 TDD	
		2,4		CCR.2.1 TDD	CCR.2.1 TDD	CCR.2.1 TDD	
SSB configuration		1,3		SSB.1 FR1	SSB.1 FR1	SSB.1 FR1	
		2,4		SSB.2 FR1	SSB.2 FR1	SSB.2 FR1	
OCNG Patterns		1~4		OP.1	OP.1	OP.1	
TRS configuration		1,3		TRS.1.1 TDD	TRS.1.1 TDD	TRS.1.1 TDD	
		2,4		TRS.1.2 TDD	TRS.1.2 TDD	TRS.1.2 TDD	
Initial BWP Configuration		1~4		DLBWP.0.1 ULBWP.0.1	DLBWP.0.1 ULBWP.0.1	DLBWP.0.1 ULBWP.0.1	
Dedicated BWP configuration		1~4		DLBWP.1.1 ULBWP.1.1	DLBWP.1.1 ULBWP.1.1	DLBWP.1.1 ULBWP.1.1	
SMTc configuration		1~4		SMTc.1	SMTc.1	SMTc.1	
Time offset between DL from serving cell and SRS from test system		1~4	µs	17.67	17.67	17.67	
EPRE ratio of PSS to SSS		1~4	dB	0	0	0	
EPRE ratio of PBCH DMRS to SSS							
EPRE ratio of PBCH to PBCH DMRS							
EPRE ratio of PDCCH DMRS to SSS							
EPRE ratio of PDCCH to PDCCH DMRS							
EPRE ratio of PDSCH DMRS to SSS							
EPRE ratio of PDSCH to PDSCH DMRS							
EPRE ratio of OCNG DMRS to SSS <sup>Note 1</sup>							
EPRE ratio of OCNG to OCNG DMRS <sup>Note 1</sup>							
N <sub>oc</sub> Note2	NR_TDD_FR1_A <sup>Note3</sup>						1,3
	NR_TDD_FR1_C	-113					
	NR_TDD_FR1_D	-112.5					
	NR_TDD_FR1_E		-112				
	NR_TDD_FR1_A <sup>Note3</sup>	2,4	Not applicable <sup>Note4</sup>	-91	-114		
	NR_TDD_FR1_C				-113		
	NR_TDD_FR1_D				-112.5		
NR_TDD_FR1_E	-112						
N <sub>oc</sub> Note2	NR_TDD_FR1_A <sup>Note3</sup>	1,3		dBm/SRS SCS	-106	-88	-114
	NR_TDD_FR1_C						-113
	NR_TDD_FR1_D						-112.5
	NR_TDD_FR1_E		-112				
	NR_TDD_FR1_A <sup>Note3</sup>	2,4	Not applicable <sup>Note4</sup>		-88	-111	
	NR_TDD_FR1_C					-110	
	NR_TDD_FR1_D					-109.5	
NR_TDD_FR1_E	-109						

Note 1: OCNB shall be used such that a constant total transmitted power spectral density is achieved for all OFDM symbols.

Note 2: Interference from other cells and noise sources not specified in the test is assumed to be constant over subcarriers and time and shall be modelled as AWGN of appropriate power for  $N_{oc}$  to be fulfilled.

Note 3: The test configuration excludes support for band n51 and it is not required to run this test on band n51 in this release of the specification

Note 4: Test 1 is not used when testing with 30kHz SSB SCS

**Table 4.7.6.1.5-2: NR Cell specific test parameters for EN-DC FR1 SRS-RSRP accuracy for neighbour cell UE**

Parameter		Config	Unit	Test 1	Test 2	Test 3	
$N_{oc}$ Note2	NR_TDD_FR1_A NOTE 3	1,3	dBm/15kHz	-106	-88	-114	
	NR_TDD_FR1_C					-113	
	NR_TDD_FR1_D					-112.5	
	NR_TDD_FR1_E	2,4		Not applicable <sup>Note 6</sup>	-91	-112	
	NR_TDD_FR1_A NOTE 5					-114	
	NR_TDD_FR1_C					-113	
	NR_TDD_FR1_D					-112.5	
NR_TDD_FR1_E	-112						
$N_{oc}$ Note2	NR_TDD_FR1_A NOTE 5	1,3	dBm/SRS SCS	-106	-88	-114	
	NR_TDD_FR1_C					-113	
	NR_TDD_FR1_D					-112.5	
	NR_TDD_FR1_E	2,4		Not applicable <sup>Note 6</sup>	-88	-112	
	NR_TDD_FR1_A NOTE 5					-111	
	NR_TDD_FR1_C					-110	
	NR_TDD_FR1_D					-109.5	
NR_TDD_FR1_E	-109						
$\hat{E}_s / I_{ot}$ on SRS		1~4	dB	1	1	1	
SRS RSRP Note3	NR_TDD_FR1_A NOTE 5	1,3	dBm/SRS SCS	-105 +TT	-87 +TT	-113+TT	
	NR_TDD_FR1_C					-112+TT	
	NR_TDD_FR1_D					-111.5+TT	
	NR_TDD_FR1_E	2,4		Not applicable <sup>Note 6</sup>	-87+TT	-111+TT	
	NR_TDD_FR1_A NOTE 5					-110+TT	
	NR_TDD_FR1_C					-109+TT	
	NR_TDD_FR1_D					-108.5+TT	
NR_TDD_FR1_E	-108+TT						
$I_o$ Note3	NR_TDD_FR1_A NOTE 5	1,3	dBm/9.36 MHz	-74.51	-56.51	-82.51	
	NR_TDD_FR1_C					-81.51	
	NR_TDD_FR1_D					-81.01	
	NR_TDD_FR1_E	2,4		dBm/38.16 MHz	Not applicable <sup>Note 6</sup>	-53.42	-79.51
	NR_TDD_FR1_A NOTE 5						-76.42
	NR_TDD_FR1_C						-75.42
	NR_TDD_FR1_D						-74.92
NR_TDD_FR1_E	-74.42						
$\hat{E}_s / N_{oc}$ on SRS		1~4	dB	1	1	1	
Propagation condition		1~4		AWGN	AWGN	AWGN	
Antenna configuration		1~4		1x2	1x2	1x2	
SRS configuration		1,3		SRSCConf.1	SRSCConf.1	SRSCConf.1	
		2,4		SRSCConf.2	SRSCConf.2	SRSCConf.2	

Note 1:	The resources for uplink transmission are assigned to the UE prior to the start of the test.
Note 2:	Interference from other cells and noise sources not specified in the test is assumed to be constant over subcarriers and time and shall be modelled as AWGN of appropriate power for $N_{oc}$ to be fulfilled.
Note 3:	RSRP and $I_0$ levels have been derived from other parameters for information purposes. They are not settable parameters themselves.
Note 4:	RSRP minimum requirements are specified assuming independent interference and noise at each receiver antenna port.
Note 5:	The test configuration excludes support for band n51 and it is not required to run this test on band n51 in this release of the specification
Note 6:	Test 1 is not used when testing with 30kHz SSB SCS

**Table 4.7.6.1.5-3: SRS configuration for FR1 SRS-RSRP accuracy**

	Field	SRSCnf.1	SRSCnf.2
SRS-ResourceSet	srs-ResourceSetId	0	0
	srs-ResourceIdList	0	0
	resourceType	Periodic	Periodic
	Usage	Codebook	Codebook
SRS-Resource	SRS-ResourceId	0	0
	nrofSRS-Ports	Port1	Port1
	transmissionComb	n2	n2
	combOffset-n2	0	0
	cyclicShift-n2	0	0
	resourceMapping startPosition	0	0
	resourceMapping nrofSymbols	n1	n1
	resourceMapping repetitionFactor	n1	n1
	freqDomainPosition	0	0
	freqDomainShift	0	0
	freqHopping c-SRS	12	12
	freqHopping b-SRS	0	0
	freqHopping b-hop	0	0
	groupOrSequenceHopping	Neither	Neither
	resourceType	Periodic	Periodic
	periodicityAndOffset-p	sl20, 9	sl40, 19
sequenceId	0	0	

For the test to pass, the ratio of successful reported values in each test shall be more than 90% with a confidence level of 95%.

#### 4.7.6.2 EN-DC CLI-RSSI measurement accuracy with FR1 serving cell

**Editor's Note:** This test case is incomplete in following aspects:

- Message contents are missing.
- TT analysis is missing.
- Test Procedure is FFS.
- Test applicability needs to be updated

##### 4.7.6.2.1 Test purpose

To verify that the UE makes correct reporting of CLI-RSSI measurement accuracy in TS 38.133 [6] clause 10.1.22.2.1.



## 4.7.6.2.2 Test applicability

FFS.

## 4.7.6.2.3 Minimum conformance requirements

The minimum conformance requirements are specified in clause 4.7.6.0.2.

The normative reference for this requirement is TS 38.133 [6] clause A.4.7.6.2.

## 4.7.6.2.4 Test description

## 4.7.6.2.4.1 Initial conditions

This test shall be tested using any of the test configurations in Table 4.7.6.2.4.1-1. Test environment parameters are given in Table 4.7.6.2.4.1-2.

**Table 4.7.6.2.4.1-1: Applicable NR configurations for FR1 CLI-RSSI accuracy test**

Config	Description
1	LTE FDD, NR 15 kHz SRS SCS, 10 MHz bandwidth, TDD duplex mode
2	LTE FDD, NR 30kHz SRS SCS, 40 MHz bandwidth, TDD duplex mode
3	LTE TDD, NR 15 kHz SRS SCS, 10 MHz bandwidth, TDD duplex mode
4	LTE TDD, NR 30kHz SRS SCS, 40 MHz bandwidth, TDD duplex mode
Note:	The UE is only required to be tested in one of the supported test configurations in each supported band

**Table 4.7.6.2.4.1-2: Test Environment parameters for EN-DC SSB based L1-RSRP measurement in DRX**

Parameter	Value		Comment
Test environment	NC		As specified in TS 38.508-1 [14] clause 4.1.
Test frequencies	As specified in Annex E, Table E.2-1 and TS 38.508-1 [14] clause 4.3.1 and 4.4.2.		
Channel bandwidth	As specified by the test configuration selected from Table 4.7.6.2.4.1-1.		
Propagation conditions	AWGN		As specified in Annex C.2.2.
Connection Diagram	TE Part	A.3.1.7.1	As specified in TS 38.508-1 [14] Annex A.
	DUT Part	A.3.2.3.4	
Exceptions to connection diagram	For 4Rx capable UEs without any 2 Rx RF bands use A.3.2.5.2 for DUT part and A.3.1.8.4 for TE Part		

1. Message contents are defined in clause 4.7.6.2.4.3.
2. Cell 1 is the E-UTRA serving cell (PCell) for the EN-DC setup. The power levels and settings for Cell 1 are set according to Annex A.6. Cell 2 is NR FR1 cell (PSCell). Cell 2 is the target for CLI-RSSI measurements. Before the test UE is configured to perform CLI-RSSI measurement. There is no measurement gap configured in the test. During the test, the test system does not transmit PDCCH/PDSCH/OCNG on symbols for CLI-RSSI resource and on 1 data symbol before.

## 4.7.6.2.4.2 Test procedure

FFS

## 4.7.6.2.4.3 Message contents

FFS

## 4.7.6.2.5 Test requirement

Table 4.7.6.2.5-1 defines the primary level settings including test tolerances for all tests.

**Table 4.7.6.2.5-1: NR Cell specific test parameters for CLI-RSSI accuracy**

Parameter	Config	Unit	Value
SSB GSCN	1~4		freq1
Duplex mode	1~4		TDD
TDD configuration	1,3		TDDConf.1.1
	2,4		TDDConf.2.1
$BW_{\text{channel}}$	1,3	MHz	10: $N_{\text{RB,c}} = 52$
	2,4		40: $N_{\text{RB,c}} = 106$
PDSCH Reference measurement channel	1,3		SR.1.1 TDD
	2,4		SR.2.1 TDD
RMSI CORESET Reference Channel	1,3		CR.1.1 TDD
	2,4		CR.2.1 TDD
Dedicated CORESET Reference Channel	1,3		CCR.1.1 TDD
	2,4		CCR.2.1 TDD
SSB configuration	1,3		SSB.1 FR1
	2,4		SSB.2 FR1
OCNG Patterns <sup>Note6</sup>	1~4		OP.1
TRS configuration	1,3		TRS.1.1 TDD
	2,4		TRS.1.2 TDD
Initial BWP Configuration	1~4		DLBWP.0.1 ULBWP.0.1
Dedicated BWP configuration	1~4		DLBWP.1.1 ULBWP.1.1
SMTC configuration	1~4		SMTC.1
Time offset between DL from serving cell and OCNG from test system	1~4	$\mu\text{s}$	17.67
EPRE ratio of PSS to SSS	1~4	dB	0
EPRE ratio of PBCH DMRS to SSS			
EPRE ratio of PBCH to PBCH DMRS			
EPRE ratio of PDCCH DMRS to SSS			
EPRE ratio of PDCCH to PDCCH DMRS			
EPRE ratio of PDSCH DMRS to SSS			
EPRE ratio of PDSCH to PDSCH DMRS			
EPRE ratio of OCNG DMRS to SSS <sup>Note 1</sup>			
EPRE ratio of OCNG to OCNG DMRS <sup>Note 1</sup>			
$N_{oc}$ on CLI-RSSI measurement resource <sup>Note2</sup>	1,3	dBm/15kHz	-106
	2,4		-106
$N_{oc}$ on CLI-RSSI measurement resource <sup>Note2</sup>	1,3	dBm/ BWP SCS	-106
	2,4		-103
$\hat{E}_s/I_{ot}$ on CLI-RSSI measurement resource	1~4	dB	-Infinity
RSRP on CLI-RSSI measurement resource <sup>Note3</sup>	1~4	dBm/ BWP SCS	-Infinity
Io on CLI-RSSI measurement resource <sup>Note3</sup>	1,3	dBm/9.36 MHz	-78.05+TT
	2,4	dBm/38.16 MHz	-71.96+TT
Io on CLI-RSSI measurement resource <sup>Note3</sup>	1,3	dBm/1.08 MHz	-87.43+TT
	2,4		-87.44+TT

$\hat{E}_s / N_{oc}$ on CLI-RSSI measurement resource	1~4	dB	-Infinity
Propagation condition	1~4		AWGN
Antenna configuration	1~4		1x2
Note 1:	OCNG shall be used such that a constant total transmitted power spectral density is achieved for all OFDM symbols.		
Note 2:	Interference from other cells and noise sources not specified in the test is assumed to be constant over subcarriers and time and shall be modelled as AWGN of appropriate power for $N_{oc}$ to be fulfilled.		
Note 3:	RSRP and $I_o$ levels have been derived from other parameters for information purposes. They are not settable parameters themselves.		
Note 4:	RSRP minimum requirements are specified assuming independent interference and noise at each receiver antenna port.		
Note 5:	The test configuration excludes support for band n51 and it is not required to run this test on band n51 in this release of the specification		
Note 6:	OCNG is not transmitted in the CLI-RSSI measurement resources.		

**Table 4.7.6.2.5-2: CLI-RSSI measurement resource configuration for FR1 CLI-RSSI accuracy**

	Field	Config	SRSSConf.1
CLI-RSSI measurement resource	rssi-ResourceId	1~4	0
	rssi-SCS	1,3	15kHz
		2,4	30kHz
	startPRB	1~4	0
	nrofPRBs	1,3	52
		2,4	106
	startPosition	1~4	3
	nrofSymbols	1~4	11
	rssi-PeriodicityAndOffset	1,3	sl20, 9
2,4		sl40, 19	

For the test to pass, the ratio of successful reported values in each test shall be more than 90% with a confidence level of 95%.

## 4.7.7 L1-SINR measurement for beam reporting

### 4.7.7.0 Minimum conformance requirements

#### 4.7.7.0.1 Minimum conformance requirements for CSI-RS based CMR and no dedicated IMR configured and CSI-RS resource set with repetition off

The UE shall be capable of performing L1-SINR measurements with the CSI-RS configured as CMR and no dedicated resource configured as IMR for L1-SINR computation, and the UE physical layer shall be capable of reporting L1-SINR measured over the measurement period of  $T_{L1-SINR\_Measurement\_Period\_CSI-RS\_CMR\_Only}$ .

The value of  $T_{L1-SINR\_Measurement\_Period\_CSI-RS\_CMR\_Only}$  is defined in Table 4.7.7.0.1-1 for FR1 and in Table 4.7.7.0.1-2 for FR2, where

For the value of M,

- For periodic and semi-persistent CSI-RS resources as CMR, M=1 if higher layer parameter *timeRestrictionForChannelMeasurement* is configured, and M=3 otherwise;
- For aperiodic CSI-RS resources as CMR, M=1.

For the value of N in FR2

- For periodic CSI-RS resources as CMR in a resource set configured with higher layer parameter *repetition* set to OFF, N=1. The requirements apply if *qcl-InfoPeriodicCSI-RS* is configured for all the resources in the resource set and for each resource one RS has QCL-TypeD with

- SSB for L1-RSRP or L1-SINR measurement, or
- another CSI-RS in resource set configured with repetition ON.
- For periodic CSI-RS resources as CMR in a resource set configured with higher layer parameter *repetition* set to ON,  $N = \text{ceil}(\text{maxNumberRxBeam} / N_{\text{res\_per\_set}})$ , where  $N_{\text{res\_per\_set}}$  is number of resources in the resource set. The requirements apply provided *qcl-InfoPeriodicCSI-RS* is configured for all resources in the resource set.
- For semi-persistent CSI-RS resources as CMR in a resource set configured with higher layer parameter *repetition* set to OFF,  $N=1$ . The requirements apply provided TCI state is provided for all resources in the resource set in the MAC CE activating the resource set and for each resource has QCL-TypeD with
  - SSB for L1-RSRP or L1-SINR measurement, or
  - another CSI-RS in resource set configured with repetition ON.
- For semi-persistent CSI-RS resources as CMR in a resource set configured with higher layer parameter *repetition* set to ON,  $N = \text{ceil}(\text{maxNumberRxBeam} / N_{\text{res\_per\_set}})$ , where  $N_{\text{res\_per\_set}}$  is number of resources in the resource set. The requirements apply provided TCI state is provided for all resources in the resource set in the MAC CE activating the resource set.
- For aperiodic CSI-RS resources as CMR in a resource set configured with higher layer parameter *repetition* set to OFF,  $N=1$ . The requirements apply provided *qcl-info* is configured for all resources in the resource set and for each resource has QCL-TypeD with
  - SSB for L1-RSRP or L1-SINR measurement, or
  - another CSI-RS in resource set configured with repetition ON.
- For aperiodic CSI-RS resources as CMR in a resource set configured with higher layer parameter *repetition* set to ON,  $N=1$ . UE is not required to meet the accuracy requirements in clause 10.1.28.1 and 10.1.28.3 of TS 38.133 [6] if number of resources in the resource set is smaller than *maxNumberRxBeam*. The requirements apply provided *qcl-info* is configured for all resources in the resource set.

For the value of P in FR1,

- $P = \frac{1}{1 - \frac{T_{\text{CSI-RS}}}{\text{MGRP}}}$ , when in the monitored cell there are measurement gaps configured for intra-frequency, inter-frequency or inter-RAT measurements, which are overlapping with some but not all occasions of the CSI-RS; and
- $P=1$  when in the monitored cell there are no measurement gaps overlapping with any occasion of the CSI-RS.

For the value of P in FR2,

- $P=1$ , when CSI-RS is not overlapped with measurement gap and also not overlapped with SMTC occasion.
- $P = \frac{1}{1 - \frac{T_{\text{CSI-RS}}}{\text{MGRP}}}$ , when CSI-RS is partially overlapped with measurement gap and CSI-RS is not overlapped with SMTC occasion ( $T_{\text{CSI-RS}} < \text{MGRP}$ )
- $P = \frac{1}{1 - \frac{T_{\text{CSI-RS}}}{T_{\text{SMTCperiod}}}}$ , when CSI-RS is not overlapped with measurement gap and CSI-RS is partially overlapped with SMTC occasion ( $T_{\text{CSI-RS}} < T_{\text{SMTCperiod}}$ ).
- $P=3$ , when CSI-RS is not overlapped with measurement gap and CSI-RS is fully overlapped with SMTC occasion ( $T_{\text{CSI-RS}} = T_{\text{SMTCperiod}}$ ).
- $P = \frac{1}{1 - \frac{T_{\text{CSI-RS}}}{\text{MGRP}} - \frac{T_{\text{CSI-RS}}}{T_{\text{SMTCperiod}}}}$ , when CSI-RS is partially overlapped with measurement gap and CSI-RS is partially overlapped with SMTC occasion ( $T_{\text{CSI-RS}} < T_{\text{SMTCperiod}}$ ) and SMTC occasion is not overlapped with measurement gap and
  - $T_{\text{SMTCperiod}} \neq \text{MGRP}$  or
  - $T_{\text{SMTCperiod}} = \text{MGRP}$  and  $T_{\text{CSI-RS}} < 0.5 * T_{\text{SMTCperiod}}$

- $P = \frac{3}{1 - \frac{T_{\text{CSI-RS}}}{\text{MGRP}}}$ , when CSI-RS is partially overlapped with measurement gap and CSI-RS is partially overlapped with SMTC occasion ( $T_{\text{CSI-RS}} < T_{\text{SMTCperiod}}$ ) and SMTC occasion is not overlapped with measurement gap and  $T_{\text{SMTCperiod}} = \text{MGRP}$  and  $T_{\text{CSI-RS}} = 0.5 * T_{\text{SMTCperiod}}$
- $P = \frac{1}{1 - \frac{T_{\text{CSI-RS}}}{\min(T_{\text{SMTCperiod}}, \text{MGRP})}}$ , when CSI-RS is partially overlapped with measurement gap ( $T_{\text{CSI-RS}} < \text{MGRP}$ ) and CSI-RS is partially overlapped with SMTC occasion ( $T_{\text{CSI-RS}} < T_{\text{SMTCperiod}}$ ) and SMTC occasion is partially or fully overlapped with measurement gap.
- $P = \frac{3}{1 - \frac{T_{\text{CSI-RS}}}{\text{MGRP}}}$ , when CSI-RS is partially overlapped with measurement gap and CSI-RS is fully overlapped with SMTC occasion ( $T_{\text{CSI-RS}} = T_{\text{SMTCperiod}}$ ) and SMTC occasion is partially overlapped with measurement gap ( $T_{\text{SMTCperiod}} < \text{MGRP}$ )

Where:

$T_{\text{SMTCperiod}}$  = the configured SMTC1 period or SMTC2 period if configured.

$T_{\text{CSI-RS}}$  = the periodicity of CSI-RS configured for L1-SINR measurement

If the high layer in TS 38.331 [2] signalling of *smtc2* is configured,  $T_{\text{SMTCperiod}}$  corresponds to the value of higher layer parameter *smtc2*; Otherwise  $T_{\text{SMTCperiod}}$  corresponds to the value of higher layer parameter *smtc1*.

Note: The overlap between CSI-RS for L1-SINR measurement and SMTC means that CSI-RS for L1-SINR measurement is within the SMTC window duration.

Longer evaluation period would be expected if the combination of CSI-RS, SMTC occasion and measurement gap configurations does not meet pervious conditions.

**Table 4.7.7.0.1-1: Measurement period  $T_{\text{L1-SINR\_Measurement\_Period\_CSI-RS\_CMR\_Only}}$  for FR1**

Configuration	$T_{\text{L1-SINR\_Measurement\_Period\_CSI-RS\_CMR\_Only}}$ (ms)
non-DRX	$\max(T_{\text{Report}}, \text{ceil}(M * P) * T_{\text{CSI-RS}})$
DRX cycle $\leq$ 320ms	$\max(T_{\text{Report}}, \text{ceil}(1.5 * M * P) * \max(T_{\text{DRX}}, T_{\text{CSI-RS}}))$
DRX cycle $>$ 320ms	$\text{ceil}(M * P) * T_{\text{DRX}}$
Note 1:	$T_{\text{CSI-RS}}$ is the periodicity of CSI-RS configured for L1-SINR measurement. $T_{\text{DRX}}$ is the DRX cycle length. $T_{\text{Report}}$ is configured periodicity for reporting.
Note 2:	the requirements are applicable provided that the CSI-RS resource configured for L1-SINR measurement is transmitted with Density = 3.

**Table 4.7.7.0.1-2: Measurement period  $T_{\text{L1-SINR\_Measurement\_Period\_CSI-RS\_CMR\_Only}}$  for FR2**

Configuration	$T_{\text{L1-SINR\_Measurement\_Period\_CSI-RS\_CMR\_Only}}$ (ms)
non-DRX	$\max(T_{\text{Report}}, \text{ceil}(M * P * N) * T_{\text{CSI-RS}})$
DRX cycle $\leq$ 320ms	$\max(T_{\text{Report}}, \text{ceil}(1.5 * M * P * N) * \max(T_{\text{DRX}}, T_{\text{CSI-RS}}))$
DRX cycle $>$ 320ms	$\text{ceil}(M * P * N) * T_{\text{DRX}}$
Note 1:	$T_{\text{CSI-RS}}$ is the periodicity of CSI-RS configured for L1-SINR measurement. $T_{\text{DRX}}$ is the DRX cycle length. $T_{\text{Report}}$ is configured periodicity for reporting.
Note 2:	the requirements are applicable provided that the CSI-RS resource configured for L1-SINR measurement is transmitted with Density = 3.

The accuracy requirements in Table 4.7.7.0.1-3 are valid under the following conditions:

- Conditions defined in clause 7.3 of TS 38.101-1 [18] for reference sensitivity are fulfilled.
- Conditions for L1-SINR measurements are fulfilled according to Annex B.2.8.1 for a corresponding Band for each relevant CSI-RS based CMR.
- The bandwidth of CSI-RS as CMR is 48 PRBs and the density is 3.
- AWGN radio propagation conditions.

The performance with larger bandwidth of CSI-RS as CMR is equal to or better than the accuracy requirements in Table 4.7.7.0.1-3.

**Table 4.7.7.0.1-3: L1-SINR absolute accuracy for CSI-RS based CMR only in FR1**

Accuracy		Conditions						
Normal condition	Extreme condition	CSI-RS CMR $\hat{E}_s/\hat{I}_t$	$I_0$ <sup>Note 1</sup> range					
			NR operating band groups <sup>Note 2</sup>	Minimum $I_0$			Maximum $I_0$	
dB	dB	dB		dBm / $SCS_{CSI-RS}$			dBm/BW Channel	dBm/BW Channel
				$SCS_{CSI-RS} = 15$ kHz	$SCS_{CSI-RS} = 30$ kHz	$SCS_{CSI-RS} = 60$ kHz		
$\pm 5.5$	$\pm 6.5$	$\geq 3$	NR_FDD_FR1_A, NR_TDD_FR1_A, NR_SDL_FR1_A	-121	-118	-115	N/A	-50
			NR_FDD_FR1_B	-120.5	-117.5	-114.5	N/A	-50
			NR_TDD_FR1_C	-120	-117	-114	N/A	-50
			NR_FDD_FR1_D, NR_TDD_FR1_D	-119.5	-116.5	-113.5	N/A	-50
			NR_FDD_FR1_E, NR_TDD_FR1_E	-119	-116	-113	N/A	-50
			NR_FDD_FR1_F	-118.5	-115.5	-112.5	N/A	-50
			NR_FDD_FR1_G	-118	-115	-112	N/A	-50
			NR_FDD_FR1_H	-117.5	-114.5	-111.5	N/A	-50

NOTE 1:  $I_0$  is assumed to have constant EPRE across the bandwidth.  
NOTE 2: NR operating band groups in FR1 are as defined in clause 3.5.2.

The normative reference for this requirement is TS 38.133 [6] clauses 9.8.4.1 and 10.1.27.1.

#### 4.7.7.0.2 Minimum conformance requirements for SSB based CMR and dedicated IMR

The UE shall be capable of performing L1-SINR measurements with the SSB configured as CMR and dedicated resource configured as IMR for L1-SINR computation, in which the NZP-CSI-RS or CSI-IM resource configured as dedicated IMR shall be 1-to-1 mapped to SSB configured as CMR, with the same periodicity. The UE physical layer shall be capable of reporting L1-SINR measured over the measurement period of  $T_{L1-SINR\_Measurement\_Period\_SSB\_CMR\_IMR}$ .

The requirements in this clause are not applicable if NZP-CSI-RS or CSI-IM resource configured as dedicated IMR is scheduled with different periodicity as SSB configured as CMR.

The value of  $T_{L1-SINR\_Measurement\_Period\_SSB\_CMR\_IMR}$  is defined in Table 4.7.7.0.2-1 for FR1 and in Table 4.7.7.0.2-2 for FR2, where

For the value of M

- For periodic or semi-persistent NZP CSI-RS or CSI-IM resource as dedicated IMR,  $M=1$  if the higher layer parameters *timeRestrictionForChannelMeasurements* and/or *timeRestrictionForInterferenceMeasurements* are configured, and  $M=3$  otherwise;

For the value of N in FR2

- $N = 8$ .

P is defined as the maximum value between  $P_{CMR}$  and  $P_{IMR}$ , i.e.,  $P = \max(P_{CMR}, P_{IMR})$ , where

- the value of  $P_{CMR}$  shall be derived in the same way as the value of P used for SSB based L1-RSRP measurement in clause 9.5.4.1 of TS 38.133 [6], in which the occasions and period of the SSB for CMR shall be used instead.

- the value of  $P_{IMR}$  shall be derived in the same way as the value of  $P$  used for CSI-RS based L1-RSRP measurement in clause 9.5.4.2 of TS 38.133 [6], in which the occasions and period of the NZP CSI-RS for NZP-IMR or CSI-IM for ZP-IMR shall be used instead.

Longer evaluation period would be expected if the combination of SSB, SMTC occasion and measurement gap configurations does not meet previous conditions.

For L1-SINR measurement with SSB as CMR and CSI-RS or CSI-IM as IMR, the requirement shall apply if the CSI-RS is configured as IMR with repetition field as “repetition = OFF” or CSI-IM is configured as IMR.

For L1-SINR measurement with SSB as CMR and CSI-RS/CSI-IM as IMR, no requirement shall apply if SSB occasions for CMR or CSI-RS/CSI-IM occasions for IMR are fully overlapped with the configured measurement gap

**Table 4.7.7.0.2-1: Measurement period  $T_{L1-SINR\_Measurement\_Period\_SSB\_CMR\_IMR}$  for FR1**

Configuration	$T_{L1-SINR\_Measurement\_Period\_SSB\_CMR\_IMR}$ (ms)
non-DRX	$\max(T_{Report}, \text{ceil}(M \cdot P) \cdot T_{SSB})$
DRX cycle $\leq 320$ ms	$\max(T_{Report}, \text{ceil}(1.5 \cdot M \cdot P) \cdot \max(T_{DRX}, T_{SSB}))$
DRX cycle $> 320$ ms	$\text{ceil}(M \cdot P) \cdot T_{DRX}$
Note 1:	$T_{SSB} = \text{ssb-periodicityServingCell}$ is the periodicity of the SSB-Index configured for L1-SINR channel measurement. $T_{DRX}$ is the DRX cycle length. $T_{Report}$ is configured periodicity for reporting.
Note 2:	The requirements are applicable provided that the CSI-RS resource configured for interference measurement shall be 1-to-1 mapped to SSB configured for channel measurement, with the same periodicity.

**Table 4.7.7.0.2-2: Measurement period  $T_{L1-SINR\_Measurement\_Period\_SSB\_CMR\_IMR}$  for FR2**

Configuration	$T_{L1-SINR\_Measurement\_Period\_SSB\_CMR\_IMR}$ (ms)
non-DRX	$\max(T_{Report}, \text{ceil}(M \cdot P \cdot N) \cdot T_{SSB})$
DRX cycle $\leq 320$ ms	$\max(T_{Report}, \text{ceil}(1.5 \cdot M \cdot P \cdot N) \cdot \max(T_{DRX}, T_{SSB}))$
DRX cycle $> 320$ ms	$\text{ceil}(1.5 \cdot M \cdot P \cdot N) \cdot T_{DRX}$
Note 1:	$T_{SSB} = \text{ssb-periodicityServingCell}$ is the periodicity of the SSB-Index configured for L1-SINR measurement. $T_{DRX}$ is the DRX cycle length. $T_{Report}$ is configured periodicity for reporting.
Note 2:	The requirements are applicable provided that the CSI-RS resource configured for interference measurement shall be 1-to-1 mapped to SSB configured for channel measurement, with the same periodicity.

The accuracy requirements in Tables 4.7.7.0.2-3 and 4.7.7.0.2-4 are valid under the following conditions:

- Conditions defined in clause 7.3 of TS 38.101-1 [18] for reference sensitivity are fulfilled.
- Conditions for L1-SINR measurements are fulfilled according to Annex B.2.8.2 for a corresponding Band for each relevant SSB based CMR and IMR.
- The bandwidth of NZP-IMR and ZP-IMR is 48 PRBs and the density is 3.
- AWGN radio propagation conditions.

The performance with larger bandwidth of NZP-IMR and ZP-IMR is equal to or better than the accuracy requirements in Tables 4.7.7.0.2-3 and 4.7.7.0.2-4.



Table 4.7.7.0.2-3: L1-SINR absolute accuracy for SSB based CMR and NZZ-IMR in FR1

Accuracy		Conditions						
Normal condition	Extreme condition	SSB-CMR Ês/lot	NZZ-IMR Ês/lot	Io <sup>Note 1</sup> range				
				NR operating band groups <sup>Note 2</sup>	Minimum Io		Maximum Io	
dB	dB	dB	dB		dBm / SCS <sub>SSB</sub>		dBm/BW <sub>Channel</sub>	dBm/BW <sub>Channel</sub>
				SCS <sub>SSB</sub> = 15 kHz	SCS <sub>SSB</sub> = 30 kHz			
±4.0	±5.0	≥0	≥0	NR_FDD_FR1_A, NR_TDD_FR1_A, NR_SDL_FR1_A	-121	-118	N/A	-50
				NR_FDD_FR1_B	-120.5	-117.5	N/A	-50
				NR_TDD_FR1_C	-120	-117	N/A	-50
				NR_FDD_FR1_D, NR_TDD_FR1_D	-119.5	-116.5	N/A	-50
				NR_FDD_FR1_E, NR_TDD_FR1_E	-119	-116	N/A	-50
				NR_FDD_FR1_F	-118.5	-115.5	N/A	-50
				NR_FDD_FR1_G	-118	-115	N/A	-50
				NR_FDD_FR1_H	-117.5	-114.5	N/A	-50

NOTE 1: Io is assumed to have constant EPRE across the bandwidth.  
 NOTE 2: NR operating band groups in FR1 are as defined in clause 3.5.2.

Table 4.7.7.0.2-4: L1-SINR absolute accuracy for SSB based CMR and ZP-IMR in FR1

Accuracy		Conditions					
Normal condition	Extreme condition	SSB-CMR Ês/lot	Io <sup>Note 1</sup> range				
			NR operating band groups <sup>Note 2</sup>	Minimum Io		Maximum Io	
dB	dB	dB		dB	dBm / SCS <sub>SSB</sub>		dBm/BW <sub>Channel</sub>
			SCS <sub>SSB</sub> = 15 kHz		SCS <sub>SSB</sub> = 30 kHz		
±4.5	±5.5	≥-3	NR_FDD_FR1_A, NR_TDD_FR1_A, NR_SDL_FR1_A	-121	-118	N/A	-50
			NR_FDD_FR1_B	-120.5	-117.5	N/A	-50
			NR_TDD_FR1_C	-120	-117	N/A	-50
			NR_FDD_FR1_D, NR_TDD_FR1_D	-119.5	-116.5	N/A	-50
			NR_FDD_FR1_E, NR_TDD_FR1_E	-119	-116	N/A	-50
			NR_FDD_FR1_F	-118.5	-115.5	N/A	-50
			NR_FDD_FR1_G	-118	-115	N/A	-50
			NR_FDD_FR1_H	-117.5	-114.5	N/A	-50

NOTE 1: Io is assumed to have constant EPRE across the bandwidth.  
 NOTE 2: NR operating band groups in FR1 are as defined in clause 3.5.2.

The normative reference for this requirement is TS 38.133 [6] clauses 9.8.4.2 and 10.1.27.2.

4.7.7.0.3 Minimum conformance requirements for CSI-RS based CMR and dedicated IMR

The UE shall be capable of performing L1-SINR measurements with the CSI-RS resource configured as CMR and dedicated resource configured as IMR for L1-SINR computation, in which the NZZ-CSI-RS or CSI-IM resource configured as dedicated IMR shall be 1-to-1 mapped to CSI-RS resource configured as CMR, with the same periodicity.

The UE physical layer shall be capable of reporting L1-SINR measured over the measurement period of  $T_{L1-SINR\_Measurement\_Period\_CSI-RS\_CMR\_IMR}$ .

The requirements in this clause are not applicable if NZP-CSI-RS or CSI-IM resource configured as dedicated IMR is scheduled with different periodicity as CSI-RS resource configured as CMR.

The value of  $T_{L1-SINR\_Measurement\_Period\_CSI-RS\_CMR\_IMR}$  is defined in Table 4.7.7.0.3-1 for FR1 and in Table 4.7.7.0.2-2 for FR2, where

For the value of M,

- M=1 shall be applied if
  - aperiodic NZP-CSI-RS as CMR or dedicated IMR, or
  - aperiodic CSI-IMR as dedicated IMR, or
  - periodic and semi-persistent NZP-CSI-RS as CMR or dedicated IMR and the higher layer parameters *timeRestrictionForChannelMeasurement* and/or *timeRestrictionForInterferenceMeasurements* are configured, or
  - periodic and semi-persistent CSI-IM as dedicated IMR and the higher layer parameters *timeRestrictionForChannelMeasurement* and/or *timeRestrictionForInterferenceMeasurements* are configured;
- M=3 otherwise.

For the value of N in FR2

- For periodic CSI-RS resources as CMR in a resource set configured with higher layer parameter *repetition* set to OFF, N=1. The requirements apply if *qcl-InfoPeriodicCSI-RS* is configured for all the resources in the resource set and for each resource one RS has QCL-TypeD with
  - SSB for L1-RSRP or L1-SINR measurement, or
  - another CSI-RS in resource set configured with repetition ON.
- For periodic CSI-RS resources as CMR in a resource set configured with higher layer parameter *repetition* set to ON,  $N = \text{ceil}(\text{maxNumberRxBeam} / N_{\text{res\_per\_set}})$ , where  $N_{\text{res\_per\_set}}$  is number of resources in the resource set. The requirements apply provided *qcl-InfoPeriodicCSI-RS* is configured for all resources in the resource set.
- For semi-persistent CSI-RS resources as CMR in a resource set configured with higher layer parameter *repetition* set to OFF, N=1. The requirements apply provided TCI state is provided for all resources in the resource set in the MAC CE activating the resource set and for each resource has QCL-TypeD with
  - SSB for L1-RSRP or L1-SINR measurement, or
  - another CSI-RS in resource set configured with repetition ON.
- For semi-persistent CSI-RS resources as CMR in a resource set configured with higher layer parameter *repetition* set to ON,  $N = \text{ceil}(\text{maxNumberRxBeam} / N_{\text{res\_per\_set}})$ , where  $N_{\text{res\_per\_set}}$  is number of resources in the resource set. The requirements apply provided TCI state is provided for all resources in the resource set in the MAC CE activating the resource set.
- For aperiodic CSI-RS resources as CMR in a resource set configured with higher layer parameter *repetition* set to OFF, N=1. The requirements apply provided *qcl-info* is configured for all resources in the resource set and for each resource has QCL-TypeD with
  - SSB for L1-RSRP or L1-SINR measurement, or
  - another CSI-RS in resource set configured with repetition ON.
- For aperiodic CSI-RS resources as CMR in a resource set configured with higher layer parameter *repetition* set to ON, N=1. UE is not required to meet the accuracy requirements in clause 10.1.28.1 and 10.1.28.3 of TS 38.133 [6] if number of resources in the resource set is smaller than *maxNumberRxBeam*. The requirements apply provided *qcl-info* is configured for all resources in the resource set.

P is defined as the maximum value between  $P_{\text{CMR}}$  and  $P_{\text{IMR}}$ , i.e.,  $P = \max(P_{\text{CMR}}, P_{\text{IMR}})$ , where

- The value of  $P_{\text{CMR}}$  and  $P_{\text{IMR}}$  shall be derived in the same way as the value of P used for CSI-RS based L1-RSRP measurement in clause 9.5.4.2 of TS 38.133 [6], in which the occasions and period of the CSI-RS for CMR and NZP CSI-RS for NZP-IMR or CSI-IM for ZP-IMR shall be used instead respectively.

Longer evaluation period would be expected if the combination of CSI-RS, SMTTC occasion and measurement gap configurations does not meet previous conditions.

For L1-SINR measurement with CSI-RS as CMR and CSI-RS as IMR, the requirement shall apply only if CSI-RS resources as CMR and IMR are configured with the same repetition field and the number of CSI-RS resources in the resource sets for CMR and IMR are same.

For L1-SINR measurement with CSI-RS as CMR and CSI-IM as IMR, the requirement shall apply only if the number of CSI-RS resources in the resource set for CMR and the number of CSI-IM resources in the resource set for IMR are same.

For L1-SINR measurement with CSI-RS as CMR and CSI-RS/CSI-IM as IMR, no requirement shall apply if CSI-RS occasions for CMR or CSI-RS/CSI-IM occasions for IMR are fully overlapped with the configured measurement gap.

**Table 4.7.7.0.3-1: Measurement period  $T_{\text{L1-SINR\_Measurement\_Period\_CSI-RS\_CMR\_IMR}}$  for FR1**

Configuration	$T_{\text{L1-SINR\_Measurement\_Period\_CSI-RS\_CMR\_IMR}}$ (ms)
non-DRX	$\max(T_{\text{Report}}, \text{ceil}(M \cdot P) \cdot T_{\text{CSI-RS}})$
DRX cycle $\leq 320\text{ms}$	$\max(T_{\text{Report}}, \text{ceil}(1.5 \cdot M \cdot P) \cdot \max(T_{\text{DRX}}, T_{\text{CSI-RS}}))$
DRX cycle $> 320\text{ms}$	$\text{ceil}(M \cdot P) \cdot T_{\text{DRX}}$
Note 1:	$T_{\text{CSI-RS}}$ is the periodicity of CSI-RS configured for L1-SINR measurement. $T_{\text{DRX}}$ is the DRX cycle length. $T_{\text{Report}}$ is configured periodicity for reporting.
Note 2:	the requirements are applicable provided that the CSI-RS resource configured for L1-SINR measurement is transmitted with Density = 3.
Note 3:	The requirements are applicable provided that the CSI-RS resource configured for interference measurement shall be 1-to-1 mapped to CSI-RS configured for channel measurement, with the same periodicity.

**Table 4.7.7.0.3-2: Measurement period  $T_{\text{L1-SINR\_Measurement\_Period\_CSI-RS\_CMR\_IMR}}$  for FR2**

Configuration	$T_{\text{L1-SINR\_Measurement\_Period\_CSI-RS\_CMR\_IMR}}$ (ms)
non-DRX	$\max(T_{\text{Report}}, \text{ceil}(M \cdot P \cdot N) \cdot T_{\text{CSI-RS}})$
DRX cycle $\leq 320\text{ms}$	$\max(T_{\text{Report}}, \text{ceil}(1.5 \cdot M \cdot P \cdot N) \cdot \max(T_{\text{DRX}}, T_{\text{CSI-RS}}))$
DRX cycle $> 320\text{ms}$	$\text{ceil}(M \cdot P \cdot N) \cdot T_{\text{DRX}}$
Note 1:	$T_{\text{CSI-RS}}$ is the periodicity of CSI-RS configured for L1-SINR measurement. $T_{\text{DRX}}$ is the DRX cycle length. $T_{\text{Report}}$ is configured periodicity for reporting.
Note 2:	the requirements are applicable provided that the CSI-RS resource configured for L1-SINR measurement is transmitted with Density = 3.
Note 3:	The requirements are applicable provided that the CSI-RS resource configured for interference measurement shall be 1-to-1 mapped to CSI-RS configured for channel measurement, with the same periodicity.

The accuracy requirements in Tables 4.7.7.0.3-3 and 4.7.7.0.3-4 are valid under the following conditions:

- Conditions defined in clause 7.3 of TS 38.101-1 [18] for reference sensitivity are fulfilled.
- Conditions for L1-SINR measurements are fulfilled according to Annex B.2.8.3 for a corresponding Band for each relevant CSI-RS based CMR and IMR.
- The bandwidth of CSI-RS as CMR, NZP-IMR and ZP-IMR is 48 PRBs and the density is 3.
- AWGN radio propagation conditions.

The performance with larger bandwidth of CSI-RS as CMR, NZP-IMR and ZP-IMR is equal to or better than the accuracy requirements in Tables 4.7.7.0.3-3 and 4.7.7.0.3-4.

**Table 4.7.7.0.3-3: L1-SINR absolute accuracy for CSI-RS based CMR and NZP-IMR in FR1**

Accuracy		Conditions							
Normal condition	Extreme condition	CSI-RS CMR Ês/lot	NZP-IMR Ês/lot	I <sub>o</sub> <sup>Note 1</sup> range					
				NR operating band groups <sup>Note 2</sup>	Minimum I <sub>o</sub>			Maximum I <sub>o</sub>	
dB	dB	dB	dB		dBm / SCS <sub>CSI-RS</sub>			dBm/BW <sub>Channel</sub>	dBm/BW <sub>Channel</sub>
					SCS <sub>CSI-RS</sub> = 15 kHz	SCS <sub>CSI-RS</sub> = 30 kHz	SCS <sub>CSI-RS</sub> = 60 kHz		
±4.0	±5.0	≥0	≥0	NR_FDD_FR1_A, NR_TDD_FR1_A, NR_SDL_FR1_A	-121	-118	-115	N/A	-50
				NR_FDD_FR1_B	-120.5	-117.5	-114.5	N/A	-50
				NR_TDD_FR1_C	-120	-117	-114	N/A	-50
				NR_FDD_FR1_D, NR_TDD_FR1_D	-119.5	-116.5	-113.5	N/A	-50
				NR_FDD_FR1_E, NR_TDD_FR1_E	-119	-116	-113	N/A	-50
				NR_FDD_FR1_F	-118.5	-115.5	-112.5	N/A	-50
				NR_FDD_FR1_G	-118	-115	-112	N/A	-50
				NR_FDD_FR1_H	-117.5	-114.5	-111.5	N/A	-50

NOTE 1: I<sub>o</sub> is assumed to have constant EPRE across the bandwidth.  
 NOTE 2: NR operating band groups in FR1 are as defined in clause 3.5.2.

**Table 4.7.7.0.3-4: L1-SINR absolute accuracy for CSI-RS based CMR and ZP-IMR in FR1**

Accuracy		Conditions						
Normal condition	Extreme condition	CSI-RS CMR Ês/lot	I <sub>o</sub> <sup>Note 1</sup> range					
			NR operating band groups <sup>Note 2</sup>	Minimum I <sub>o</sub>			Maximum I <sub>o</sub>	
dB	dB	dB		dBm / SCS <sub>CSI-RS</sub>			dBm/BW <sub>Channel</sub>	dBm/BW <sub>Channel</sub>
				SCS <sub>CSI-RS</sub> = 15 kHz	SCS <sub>CSI-RS</sub> = 30 kHz	SCS <sub>CSI-RS</sub> = 60 kHz		
±4.5	±5.5	≥-3	NR_FDD_FR1_A, NR_TDD_FR1_A, NR_SDL_FR1_A	-121	-118	-115	N/A	-50
			NR_FDD_FR1_B	-120.5	-117.5	-114.5	N/A	-50
			NR_TDD_FR1_C	-120	-117	-114	N/A	-50
			NR_FDD_FR1_D, NR_TDD_FR1_D	-119.5	-116.5	-113.5	N/A	-50
			NR_FDD_FR1_E, NR_TDD_FR1_E	-119	-116	-113	N/A	-50
			NR_FDD_FR1_F	-118.5	-115.5	-112.5	N/A	-50
			NR_FDD_FR1_G	-118	-115	-112	N/A	-50
			NR_FDD_FR1_H	-117.5	-114.5	-111.5	N/A	-50

NOTE 1: I<sub>o</sub> is assumed to have constant EPRE across the bandwidth.  
 NOTE 2: NR operating band groups in FR1 are as defined in clause 3.5.2.

The normative reference for this requirement is TS 38.133 [6] clauses 9.8.4.3 and 10.1.27.3.

#### 4.7.7.1 EN-DC FR1 CSI-RS based CMR and no dedicated IMR configured and CSI-RS resource set with repetition off L1-SINR measurement accuracy

**Editor's note: This test case is incomplete. The following aspects are either missing or not yet determined:**

- The test requirement is FFS.
- MU/TT is FFS.

##### 4.7.7.1.1 Test purpose

The purpose of this test is to verify that the L1-SINR measurement accuracy is within the specified limits.

##### 4.7.7.1.2 Test applicability

This test applies to all types of NR UE supporting E-UTRA and EN-DC from Release 16 onwards.

##### 4.7.7.1.3 Minimum conformance requirements

The minimum conformance requirements are specified in clause 4.7.7.0.1.

The normative reference for this requirement is TS 38.133 [6] clause A.4.7.7.1.

##### 4.7.7.1.4 Test description

###### 4.7.7.1.4.1 Initial conditions

This test shall be tested using any of the test configurations in Table 4.7.7.1.4.1-1. Configure the test equipment and the DUT according to the parameters in Table 4.7.7.1.4.1-2.

**Table 4.7.7.1.4.1-1: EN-DC CSI-RS based CMR without dedicated IMR L1-SINR measurement supported test configurations**

Config	Description
1	LTE FDD, NR 15 kHz CSI-RS SCS, 10 MHz bandwidth, FDD duplex mode
2	LTE FDD, NR 15 kHz CSI-RS SCS, 10 MHz bandwidth, TDD duplex mode
3	LTE FDD, NR 30kHz CSI-RS SCS, 40 MHz bandwidth, TDD duplex mode
4	LTE TDD, NR 15 kHz CSI-RS SCS, 10 MHz bandwidth, FDD duplex mode
5	LTE TDD, NR 15 kHz CSI-RS SCS, 10 MHz bandwidth, TDD duplex mode
6	LTE TDD, NR 30kHz CSI-RS SCS, 40 MHz bandwidth, TDD duplex mode
Note:	The UE is only required to be tested in one of the supported test configurations in each supported band

**Table 4.7.7.1.4.1-2: Test Environment parameters for EN-DC CSI-RS based CMR without dedicated IMR L1-SINR measurement**

Parameter	Value		Comment
Test environment	NC, TL/VL, TL/VH, TH/VL, TH/VH		As specified in TS 38.508-1 [14] clause 4.1.
Test frequencies	As specified in Annex E, Table E.2-1 and TS 38.508-1 [14] clause 4.3.1.		
Channel bandwidth	As specified by the test configuration selected from Table 4.7.7.1.4.1-1.		
Propagation conditions	AWGN		As specified in Annex C.2.2.
Connection Diagram	TE Part 2Rx	A.3.1.8.2 with n = 1	As specified in TS 38.508-1 [14] Annex A.
	TE Part 4Rx	A.3.1.8.5 with n = 1	
	DUT Part 2Rx	A.3.2.3.4	
	DUT Part 4Rx	A.3.2.5.2	
Exceptions to connection diagram	N/A		

1. Message contents are defined in clause 4.7.7.1.4.3.
2. Cell 1 is the E-UTRA serving cell (PCell) for the EN-DC setup. The power levels and settings for Cell 1 are set according to Annex A.6. Cell 2 is the NR FR1 cell (PSCell). Cell 2 is the target for CSI-RS-based L1-SINR measurements. Before the test, UE is configured to perform RLM and BFD measurement based on the SSBs. The connection setup is done according to the settings in Annex C.1.1.

#### 4.7.7.1.4.2 Test procedure

Prior to the start of the time duration T1, the UE shall be fully synchronized to PSCell. The UE shall be configured for periodic CSI reporting in PUCCH [format 2] with a reporting periodicity as mentioned in the above table 4.7.7.1.4.1-2.

1. Ensure the UE is in state RRC\_CONNECTED with generic procedure parameters Connectivity EN-DC, DC bearer MCG and SCG, Connected without release *On* and Test Mode *On*, according to TS 38.508-1 [14] clause 4.5 and general test parameters set according to Table 4.7.7.1.4.1-2.
2. Set the parameters according to T1 in Table 4.7.7.2.1.5-1.
3. The UE shall start sending L1-SINR report including results of both CSI-RS#0 and CSI-RS #1 every 80 slots.
4. The SS shall check the L1-SINR reported values of CSI-RS #0 and CSI-RS #1 in the periodic L1-SINR reports. If the value for both CSI-RSs is within the limits in Table 4.7.4.2.1.5-2 or Table 4.7.4.2.1.5-3 (depending on the test configuration), the number of passed iterations is increased by one, otherwise the number of failed iterations is increased by one.
5. The SS shall continue checking the L1-SINR report messages transmitted by the UE until the confidence level according to Table G.2.3-1 in Annex G is achieved.
6. Set the parameters according to each sub-test in Table 4.7.4.2.1.5-1 as appropriate and repeat steps 3-5.

#### 4.7.7.1.4.3 Message contents

Message contents are according to TS 38.508-1 [14] clause 7.3 with the following exceptions:

**Table 4.7.7.1.4.3-1: Common Exception messages EN-DC CSI-RS based CMR without dedicated IMR L1-SINR measurement**

Default Message Contents	
Common contents of system information blocks exceptions	
Default RRC messages and information elements contents exceptions	Table H.3.6A-1 with conditions PERIODIC and CSI-SINR Table H.3.6A-2 with conditions CSI-RS and PERIODIC Table H.3.6A-3 with condition PERIODIC Table 7.3.1-3 in TS 38.508-1 [14] with condition SMTC.1

**Table 4.7.7.1.4.3-2: RadioLinkMonitoringConfig**

Derivation Path: TS 38.508-1 [14], Table 4.6.3-133			
Information Element	Value/remark	Comment	Condition
RadioLinkMonitoringConfig ::= SEQUENCE {			
failureDetectionResourcesToAddModList SEQUENCE (SIZE(1..maxNrofFailureDetectionResources)) OF SEQUENCE {	1 entry		
purpose	both	UE is configured to perform RLM and BFD based on the SSBs.	
}			
}			

4.7.7.1.5 Test requirement

**Table 4.7.7.1.5-1: FR1 CSI-RS based L1-SINR test parameters**

Parameter	Config	Unit	Test 1	Test 2
SSB GSCN	1~6		freq1	freq1
Duplex mode	1,4		FDD	FDD
	2,5		TDD	TDD
	3,6		TDD	TDD
TDD Configuration	1,4		N/A	N/A
	2,5		TDDConf.1.1	TDDConf.1.1
	3,6		TDDConf.2.1	TDDConf.2.1
BW <sub>channel</sub>	1,4	MHz	10: N <sub>RB,c</sub> = 52	10: N <sub>RB,c</sub> = 52
	2,5		10: N <sub>RB,c</sub> = 52	10: N <sub>RB,c</sub> = 52
	3,6		40: N <sub>RB,c</sub> = 106	40: N <sub>RB,c</sub> = 106
PDSCH Reference measurement channel	1,4		SR.1.1 FDD	SR.1.1 FDD
	2,5		SR.1.1 TDD	SR.1.1 TDD
	3,6		SR.2.1 TDD	SR.2.1 TDD
RMSI CORESET Reference Channel	1,4		CR.1.1 FDD	CR.1.1 FDD
	2,5		CR.1.1 TDD	CR.1.1 TDD
	3,6		CR.2.1 TDD	CR.2.1 TDD
Dedicated CORESET Reference Channel	1,4		CCR.1.1 FDD	CCR.1.1 FDD
	2,5		CCR.1.1 TDD	CCR.1.1 TDD
	3,6		CCR.2.1 TDD	CCR.2.1 TDD
SSB configuration	1,4		SSB.1 FR1	SSB.1 FR1
	2,5		SSB.1 FR1	SSB.1 FR1
	3,6		SSB.2 FR1	SSB.2 FR1
OCNG Patterns	1~6		OP.1	OP.1
TRS configuration	1,4		TRS.1.1 FDD	TRS.1.1 FDD
	2,5		TRS.1.1 TDD	TRS.1.1 TDD
	3,6		TRS.1.2 TDD	TRS.1.2 TDD
Initial BWP Configuration	1~6		DLBWP.0.1	DLBWP.0.1
			ULBWP.0.1	ULBWP.0.1

Dedicated BWP configuration	1~6		DLBWP.1.1 ULBWP.1.1	DLBWP.1.1 ULBWP.1.1	
SMTC configuration	1~6		SMTC.1	SMTC.1	
CSI-RS	1,4		CSI-RS 1.2 FDD	CSI-RS 1.2 FDD	
	2,5		CSI-RS 1.2 TDD	CSI-RS 1.2 TDD	
	3,6		CSI-RS 2.2 TDD	CSI-RS 2.2 FDD	
reportConfigType	1~6		periodic	periodic	
reportQuantity-r16	1~6		cri-SINR-r16	cri-SINR-r16	
nrofReportedRS	1~6		2	2	
L1-RSRP reporting period	1~6		slot80	slot80	
EPRE ratio of PSS to SSS	1~6	dB	0	0	
EPRE ratio of PBCH DMRS to SSS					
EPRE ratio of PBCH to PBCH DMRS					
EPRE ratio of PDCCH DMRS to SSS					
EPRE ratio of PDCCH to PDCCH DMRS					
EPRE ratio of PDSCH DMRS to SSS					
EPRE ratio of PDSCH to PDSCH DMRS					
EPRE ratio of OCNG DMRS to SSS <sup>Note 1</sup>					
EPRE ratio of OCNG to OCNG DMRS <sup>Note 1</sup>					
$N_{oc}$ <sup>Note2</sup>					NR_FDD_FR1_A, NR_TDD_FR1_A <sup>NOTE 5</sup>
	NR_FDD_FR1_B	-116.5+TT			
	NR_TDD_FR1_C	-116+TT			
	NR_FDD_FR1_D, NR_TDD_FR1_D	-115.5+TT			
	NR_FDD_FR1_E, NR_TDD_FR1_E	-115+TT			
	NR_FDD_FR1_F	-114.5+TT			
	NR_FDD_FR1_G	-114+TT			
	NR_FDD_FR1_H	-113.5+TT			
$N_{oc}$ <sup>Note2</sup>	NR_FDD_FR1_A, NR_TDD_FR1_A <sup>NOTE 5</sup>	1,2,4,5	dBm/CSI-RS SCS	-94.65+TT	-117+TT
	NR_FDD_FR1_B				-116.5+TT
	NR_TDD_FR1_C				-116+TT
	NR_FDD_FR1_D, NR_TDD_FR1_D				-115.5+TT
	NR_FDD_FR1_E, NR_TDD_FR1_E				-115+TT
	NR_FDD_FR1_F				-114.5+TT
	NR_FDD_FR1_G				-114+TT
	NR_FDD_FR1_H				-113.5+TT
	NR_FDD_FR1_A, NR_TDD_FR1_A <sup>NOTE 5</sup>	3,6		-91.65+TT	-114+TT
	NR_FDD_FR1_B				-113.5+TT
	NR_TDD_FR1_C				-114+TT
	NR_FDD_FR1_D, NR_TDD_FR1_D				-112.5+TT
	NR_FDD_FR1_E, NR_TDD_FR1_E				-112+TT
	NR_FDD_FR1_F				-111.5+TT
NR_FDD_FR1_G	-111+TT				



	NR_FDD_FR1_H				-110.5+TT		
$\hat{E}_s/I_{ot}$		1~6	dB	10+TT	-3+TT		
CSI-RS RSRP Note3	NR_FDD_FR1_A, NR_TDD_FR1_A NOTE 5	1,2,4,5	dBm/CSI-RS SCS	-84.65+TT	-120+TT		
	NR_FDD_FR1_B				-119.5+TT		
	NR_TDD_FR1_C				-119+TT		
	NR_FDD_FR1_D, NR_TDD_FR1_D				-118.5+TT		
	NR_FDD_FR1_E, NR_TDD_FR1_E				-118+TT		
	NR_FDD_FR1_F				-117.5+TT		
	NR_FDD_FR1_G				-117+TT		
	NR_FDD_FR1_H				-116.5+TT		
	NR_FDD_FR1_A, NR_TDD_FR1_A NOTE 5	3,6		-81.65+TT	-117+TT		
	NR_FDD_FR1_B				-116.5+TT		
	NR_TDD_FR1_C				-116+TT		
	NR_FDD_FR1_D, NR_TDD_FR1_D				-115.5+TT		
	NR_FDD_FR1_E, NR_TDD_FR1_E				-115+TT		
	NR_FDD_FR1_F				-114.5+TT		
	NR_FDD_FR1_G				-114+TT		
	NR_FDD_FR1_H				-113.5+TT		
	$I_o$ Note3	NR_FDD_FR1_A, NR_TDD_FR1_A NOTE 5		1,2,4,5	dBm/9.36 MHz	-56.28+TT	-87.28+TT
		NR_FDD_FR1_B					-86.78+TT
NR_TDD_FR1_C		-86.28+TT					
NR_FDD_FR1_D, NR_TDD_FR1_D		-85.78+TT					
NR_FDD_FR1_E, NR_TDD_FR1_E		-85.28+TT					
NR_FDD_FR1_F		-84.78+TT					
NR_FDD_FR1_G		-84.28+TT					
NR_FDD_FR1_H		-83.78+TT					
NR_FDD_FR1_A, NR_TDD_FR1_A NOTE 5		3,6	dBm/38.16 MHz	-50.19+TT		-81.19+TT	
NR_FDD_FR1_B						-80.69+TT	
NR_TDD_FR1_C						-80.19+TT	
NR_FDD_FR1_D, NR_TDD_FR1_D						-79.69+TT	
NR_FDD_FR1_E, NR_TDD_FR1_E						-79.19+TT	
NR_FDD_FR1_F						-78.69+TT	
NR_FDD_FR1_G						-78.19+TT	
NR_FDD_FR1_H						-77.69+TT	
$\hat{E}_s/N_{oc}$			1~6	dB		10+TT	-3+TT
Propagation condition			1~6			AWGN	AWGN
Antenna configuration		1~6		1x2	1x2		

Note 1:	OCNG shall be used such that both cells are fully allocated and a constant total transmitted power spectral density is achieved for all OFDM symbols.
Note 2:	Interference from other cells and noise sources not specified in the test is assumed to be constant over subcarriers and time and shall be modelled as AWGN of appropriate power for $N_{oc}$ to be fulfilled.
Note 3:	RSRP and $I_o$ levels have been derived from other parameters for information purposes. They are not settable parameters themselves.
Note 4:	RSRP minimum requirements are specified assuming independent interference and noise at each receiver antenna port.
Note 5:	The test configuration excludes support for band n51 and it is not required to run this test on band n51 in this release of the specification.

**Table 4.7.7.1.5-2: L1-SINR absolute accuracy requirements for the reported values for test configurations 1, 2, 4 and 5**

FFS

**Table 4.7.7.1.5-3: L1-SINR absolute accuracy requirements for the reported values for test configurations 3 and 6**

FFS

For the test to pass, the ratio of successful reported values in each test shall be more than 90% with a confidence level of 95%.

#### 4.7.7.2 EN-DC FR1 SSB based CMR and dedicated IMR L1-SINR absolute measurement accuracy

**Editor's note:** This test case is incomplete. The following aspects are either missing or not yet determined:

- The test requirement is FFS.
- MU/TT is FFS.

##### 4.7.7.2.1 Test purpose

The purpose of this test is to verify that the L1-SINR measurement accuracy is within the specified limits.

##### 4.7.7.2.2 Test applicability

This test applies to all types of NR UE supporting E-UTRA and EN-DC from Release 16 onwards. Applicability requires support of L1-SINR measurements between an E-UTRA PCell and an NR PSCell.

##### 4.7.7.2.3 Minimum conformance requirements

The minimum conformance requirements are specified in clause 4.7.7.0.2.

The normative reference for this requirement is TS 38.133 [6] clause A.4.7.7.2.

##### 4.7.7.2.4 Test description

###### 4.7.7.2.4.1 Initial conditions

This test shall be tested using any of the test configurations in Table 4.7.7.2.4.1-1.

**Table 4.7.7.2.4.1-1: Applicable NR configurations for FR1 L1-SINR measurement test with SSB based CMR and CSI-IM based IMR**

Config	Description
1	LTE FDD, NR 15 kHz SSB SCS, 10 MHz bandwidth, FDD duplex mode
2	LTE FDD, NR 15 kHz SSB SCS, 10 MHz bandwidth, TDD duplex mode
3	LTE FDD, NR 30kHz SSB SCS, 40 MHz bandwidth, TDD duplex mode
4	LTE TDD, NR 15 kHz SSB SCS, 10 MHz bandwidth, FDD duplex mode
5	LTE TDD, NR 15 kHz SSB SCS, 10 MHz bandwidth, TDD duplex mode
6	LTE TDD, NR 30kHz SSB SCS, 40 MHz bandwidth, TDD duplex mode
Note:	The UE is only required to be tested in one of the supported test configurations in each supported band

Configure the test equipment and the DUT according to the parameters in Table 4.7.7.2.4.1-2.

**Table 4.7.7.2.4.1-2: Initial conditions**

Parameter	Value		Comment
Test environment	NC, TL/VL, TL/VH, TH/VL, TH/VH		As specified in TS 38.508-1 [14] clause 4.1.
Test frequencies	As specified in Annex E, Table E.2-1 and TS 38.508-1 [14] clause 4.3.1.		
Channel bandwidth	As specified by the test configuration selected from Table 4.7.7.2.4.1-1.		
Propagation conditions	AWGN		As specified in Annex C.2.2.
Connection Diagram	TE Part 2Rx	A.3.1.8.2 with n = 1	As specified in TS 38.508-1 [14] Annex A.
	TE Part 4Rx	A.3.1.8.5 with n = 1	
	DUT Part 2Rx	A.3.2.3.4	
	DUT Part 4Rx	A.3.2.5.2	
Exceptions to connection diagram	N/A		

1. Message contents are defined in clause 4.7.7.2.4.3.
2. Cell 1 is the E-UTRA serving cell (PCell) for the EN-DC setup. The power levels and settings for Cell 1 are set according to Annex A.6. Cell 2 is the NR FR1 cell. Cell 2 is the PSCell and the target for SSB-based L1-SINR measurements. Before the test, UE is configured to perform RLM and BFD and L1-SINR measurement based on the SSBs and CSI-IMs. The connection setup is done according to the settings in Annex C.1.1.

#### 4.7.7.2.4.2 Test procedure

Prior to the start of the time duration T1, the UE shall be fully synchronized to PSCell. The UE shall be configured for periodic CSI reporting in PUCCH [format 2] with a reporting periodicity as mentioned in the above table 4.7.4.1.2.4.1-2.

1. Ensure the UE is in state RRC\_CONNECTED with generic procedure parameters Connectivity EN-DC, DC bearer MCG and SCG, Connected without release *On* and Test Mode *On*, according to TS 38.508-1 [14] clause 4.5 and general test parameters set according to Table 4.7.7.2.4.1-2.
2. Set the parameters according to T1 in Table 4.7.7.2.5-1.
3. The UE shall start sending L1-SINR report including results of both SSB#0 and SSB#1 every 80 slots.
4. The SS shall check the L1-SINR reported values of SSB#0+CSI-IM#0 and SSB#1+CSI-IM#1 in the periodic L1-SINR reports. If the value for both SSB#0+CSI-IM#0 and SSB#1+CSI-IM#1 is within the limits in Table 4.7.7.2.5-2 or Table 4.7.7.2.5-3 (depending on the test configuration), the number of passed iterations is increased by one, otherwise the number of failed iterations is increased by one.
5. The SS shall continue checking the L1-SINR report messages transmitted by the UE until the confidence level according to Table G.2.3-1 in Annex G is achieved.

6. Set the parameters according to each sub-test in Table 4.7.7.2.5-1 as appropriate and repeat steps 3-5.

4.7.7.2.4.3 Message contents

Message contents are according to TS 38.508-1 [14] clause 7.3 with the following exceptions:

**Table 4.7.7.2.4.3-1: Common Exception messages EN-DC SSB based L1-SINR measurement**

Default Message Contents	
Common contents of system information blocks exceptions	
Default RRC messages and information elements contents exceptions	Table H.3.6A-1 with conditions PERIODIC and SS-SINR and CSI-RS_IMR Table H.3.6A-2 with conditions SSB and PERIODIC Table H.3.6A-4 with condition PERIODIC Table 7.3.1-3 in TS 38.508-1 [14] with condition SMTC.1

**Table 4.7.7.2.4.3-2: RadioLinkMonitoringConfig**

Derivation Path: TS 38.508-1 [14], Table 4.6.3-133			
Information Element	Value/remark	Comment	Condition
RadioLinkMonitoringConfig ::= SEQUENCE {			
failureDetectionResourcesToAddModList	1 entry		
SEQUENCE			
(SIZE(1..maxNrofFailureDetectionResources)) OF			
SEQUENCE {			
purpose	both	UE is configured to perform RLM and BFD based on the SSBs.	
}			
}			
}			

4.7.7.2.5 Test requirement

**Table 4.7.7.2.5-1: FR1 L1-SINR measurement test with SSB based CMR and CSI-IM based IMR**

Parameter	Config	Unit	Test 1	Test 2
SSB GSCN	1-6		freq1	freq1
Duplex mode	1,4		FDD	FDD
	2,5		TDD	TDD
	3,6		TDD	TDD
TDD Configuration	1,4		N/A	N/A
	2,5		TDDConf.1.1	TDDConf.1.1
	3,6		TDDConf.2.1	TDDConf.2.1
BW <sub>channel</sub>	1,4	MHz	10: N <sub>RB,c</sub> = 52	10: N <sub>RB,c</sub> = 52
	2,5		10: N <sub>RB,c</sub> = 52	10: N <sub>RB,c</sub> = 52
	3,6		40: N <sub>RB,c</sub> = 106	40: N <sub>RB,c</sub> = 106
PDSCH Reference measurement channel	1,4		SR.1.1 FDD	SR.1.1 FDD
	2,5		SR.1.1 TDD	SR.1.1 TDD
	3,6		SR.2.1 TDD	SR.2.1 TDD
RMSI CORESET Reference Channel	1,4		CR.1.1 FDD	CR.1.1 FDD
	2,5		CR.1.1 TDD	CR.1.1 TDD
	3,6		CR.2.1 TDD	CR.2.1 TDD
Dedicated CORESET Reference Channel	1,4		CCR.1.1 FDD	CCR.1.1 FDD
	2,5		CCR.1.1 TDD	CCR.1.1 TDD
	3,6		CCR.2.1 TDD	CCR.2.1 TDD
SSB configuration	1,4		SSB.3 FR1	SSB.3 FR1
	2,5		SSB.3 FR1	SSB.3 FR1
	3,6		SSB.4 FR1	SSB.4 FR1

CSI-IM configuration	1,4		CSI-IM 1.1 FDD	CSI-IM 1.1 FDD	
	2,5		CSI-IM 1.1 TDD	CSI-IM 1.1 TDD	
	3,6		CSI-IM 2.1 TDD	CSI-IM 2.1 TDD	
OCNG Patterns	1~6		OP.1	OP.1	
TRS configuration	1,4		TRS.1.1 FDD	TRS.1.1 FDD	
	2,5		TRS.1.1 TDD	TRS.1.1 TDD	
	3,6		TRS.1.2 TDD	TRS.1.2 TDD	
Initial BWP Configuration	1~6		DLBWP.0.1 ULBWP.0.1	DLBWP.0.1 ULBWP.0.1	
Dedicated BWP configuration	1~6		DLBWP.1.1 ULBWP.1.1	DLBWP.1.1 ULBWP.1.1	
SMTc configuration	1~6		SMTc.1	SMTc.1	
reportConfigType	1~6		periodic	periodic	
reportQuantity-r16	1~6		ssb-Index-SINR-r16	ssb-Index-SINR-r16	
Number of reported RS	1~6		2	2	
L1-SINR reporting period	1~6		slot80	slot80	
EPRE ratio of PSS to SSS	1~6	dB	0	0	
EPRE ratio of PBCH DMRS to SSS					
EPRE ratio of PBCH to PBCH DMRS					
EPRE ratio of PDCCH DMRS to SSS					
EPRE ratio of PDCCH to PDCCH DMRS					
EPRE ratio of PDSCH DMRS to SSS					
EPRE ratio of PDSCH to PDSCH DMRS					
EPRE ratio of OCNG DMRS to SSS <sup>Note 1</sup>					
EPRE ratio of OCNG to OCNG DMRS <sup>Note 1</sup>					
$N_{oc}$ <sup>Note2</sup>	NR_FDD_FR1_A, NR_TDD_FR1_A <sup>NOTE 5</sup>	1~6	dBm/15kHz	-94.65	-117
	NR_FDD_FR1_B				-116.5
	NR_TDD_FR1_C				-116
	NR_FDD_FR1_D, NR_TDD_FR1_D				-115.5
	NR_FDD_FR1_E, NR_TDD_FR1_E				-115
	NR_FDD_FR1_F				-114.5
	NR_FDD_FR1_G				-114
	NR_FDD_FR1_H				-113.5
$N_{oc}$ <sup>Note2</sup>	NR_FDD_FR1_A, NR_TDD_FR1_A <sup>NOTE 5</sup>	1,2,4,5	dBm/SSB SCS	-94.65	-117
	NR_FDD_FR1_B				-116.5
	NR_TDD_FR1_C				-116
	NR_FDD_FR1_D, NR_TDD_FR1_D				-115.5
	NR_FDD_FR1_E, NR_TDD_FR1_E				-115
	NR_FDD_FR1_F				-114.5
	NR_FDD_FR1_G				-114
	NR_FDD_FR1_H				-113.5
	NR_FDD_FR1_A, NR_TDD_FR1_A <sup>NOTE 5</sup>	3,6		-91.65	-114
	NR_FDD_FR1_B				-113.5
NR_TDD_FR1_C	-114				

	NR_FDD_FR1_D, NR_TDD_FR1_D				-112.5			
	NR_FDD_FR1_E, NR_TDD_FR1_E				-112			
	NR_FDD_FR1_F				-111.5			
	NR_FDD_FR1_G				-111			
	NR_FDD_FR1_H				-110.5			
	$\hat{E}_s / I_{ot}$	1~6	dB	10	-3			
SSB RSRP Note3	NR_FDD_FR1_A, NR_TDD_FR1_A NOTE 5	1,2,4,5	dBm/SSB SCS		-120			
	NR_FDD_FR1_B				-119.5			
	NR_TDD_FR1_C				-119			
	NR_FDD_FR1_D, NR_TDD_FR1_D				-118.5			
	NR_FDD_FR1_E, NR_TDD_FR1_E				-118			
	NR_FDD_FR1_F				-117.5			
	NR_FDD_FR1_G				-117			
	NR_FDD_FR1_H				-116.5			
	NR_FDD_FR1_A, NR_TDD_FR1_A NOTE 5	3,6			-117			
	NR_FDD_FR1_B				-116.5			
	NR_TDD_FR1_C				-116			
	NR_FDD_FR1_D, NR_TDD_FR1_D				-115.5			
	NR_FDD_FR1_E, NR_TDD_FR1_E				-115			
	NR_FDD_FR1_F				-114.5			
	NR_FDD_FR1_G				-114			
	NR_FDD_FR1_H				-113.5			
	I <sub>o</sub> Note3	NR_FDD_FR1_A, NR_TDD_FR1_A NOTE 5			1,2,4,5	dBm/9.36 MHz		-87.28
		NR_FDD_FR1_B						-86.78
		NR_TDD_FR1_C						-86.28
		NR_FDD_FR1_D, NR_TDD_FR1_D						-85.78
NR_FDD_FR1_E, NR_TDD_FR1_E		-85.28						
NR_FDD_FR1_F		-84.78						
NR_FDD_FR1_G		-84.28						
NR_FDD_FR1_H		-83.78						
NR_FDD_FR1_A, NR_TDD_FR1_A NOTE 5		3,6	dBm/38.16 MHz	-81.19				
NR_FDD_FR1_B				-80.69				
NR_TDD_FR1_C				-80.19				
NR_FDD_FR1_D, NR_TDD_FR1_D				-79.69				
NR_FDD_FR1_E, NR_TDD_FR1_E				-79.19				
NR_FDD_FR1_F				-78.69				
NR_FDD_FR1_G				-78.19				
NR_FDD_FR1_H				-77.69				
$\hat{E}_s / N_{oc}$	1~6	dB		10	-3			
Propagation condition	1~6			AWGN	AWGN			
antenna configuration	1~6			1x2	1x2			

Note 1:	OCNG shall be used such that both cells are fully allocated and a constant total transmitted power spectral density is achieved for all OFDM symbols.
Note 2:	Interference from other cells and noise sources not specified in the test is assumed to be constant over subcarriers and time and shall be modelled as AWGN of appropriate power for $N_{oc}$ to be fulfilled.
Note 3:	RSRP and lo levels have been derived from other parameters for information purposes. They are not settable parameters themselves.
Note 4:	RSRP minimum requirements are specified assuming independent interference and noise at each receiver antenna port.
Note 5:	The test configuration excludes support for band n51 and it is not required to run this test on band n51 in this release of the specification.

**Table 4.7.7.2.5-2: Same as Table 4.7.7.1.5-2**

**Table 4.7.7.2.5-3: Same as Table 4.7.7.1.5-3**

For the test to pass, the ratio of successful reported values in each test shall be more than 90% with a confidence level of 95%.

#### 4.7.7.3 EN-DC FR1 CSI-RS based CMR and dedicated IMR L1-SINR measurement accuracy

**Editor's note:** This clause is incomplete. The following aspects are either missing or not yet determined:

- MU & TT needs further study
- Test applicability is incomplete

##### 4.7.7.3.1 Test purpose

The purpose of this test is to verify that the L1-SINR measurement accuracy is within the specified limits.

##### 4.7.7.3.2 Test applicability

This test applies to all types of NR UE supporting E-UTRA and EN-DC from Release 16 onwards. Applicability requires support of L1-SINR measurements between an E-UTRA PCell and an NR PSCell.

##### 4.7.7.3.3 Minimum conformance requirements

The minimum conformance requirements are specified in clause 4.7.7.0.3.

The normative reference for this requirement is TS 38.133 [6] clause A.4.7.7.3.

##### 4.7.7.3.4 Test description

###### 4.7.7.3.4.1 Initial conditions

This test shall be tested using any of the test configurations in Table 4.7.7.3.4.1-1.

**Table 4.7.7.3.4.1-1: Applicable NR configurations for FR1 L1-SINR measurement test with CSI-RS based both CMR based IMR**

Config	Description
1	LTE FDD, NR 15 kHz CSI-RS SCS, 10 MHz bandwidth, FDD duplex mode
2	LTE FDD, NR 15 kHz CSI-RS SCS, 10 MHz bandwidth, TDD duplex mode
3	LTE FDD, NR 30kHz CSI-RS SCS, 40 MHz bandwidth, TDD duplex mode
4	LTE TDD, NR 15 kHz CSI-RS SCS, 10 MHz bandwidth, FDD duplex mode
5	LTE TDD, NR 15 kHz CSI-RS SCS, 10 MHz bandwidth, TDD duplex mode
6	LTE TDD, NR 30kHz CSI-RS SCS, 40 MHz bandwidth, TDD duplex mode

Note: The UE is only required to be tested in one of the supported test configurations in each supported band.

Configure the test equipment and the DUT according to the parameters in Table 4.7.7.3.4.1-2.

**Table 4.7.7.3.4.1-2: Initial conditions**

Parameter	Value	Comment
Test environment	NC, TL/VL, TL/VH, TH/VL, TH/VH	As specified in TS 38.508-1 [14] clause 4.1.
Test frequencies	As specified in Annex E, Table E.2-1 and TS 38.508-1 [14] clause 4.3.1.	
Channel bandwidth	As specified by the test configuration selected from Table 4.7.7.3.4.1-1.	
Propagation conditions	AWGN	
Connection Diagram	TE Part 2Rx	A.3.1.8.2 with n = 1
	TE Part 4Rx	A.3.1.8.5 with n = 1
	DUT Part 2Rx	A.3.2.3.4
	DUT Part 4Rx	A.3.2.5.2
Exceptions to connection diagram	N/A	

1. Message contents are defined in clause 4.7.7.3.4.3.
2. Cell 1 is the E-UTRA serving cell (PCell) for the EN-DC setup. The power levels and settings for Cell 1 are set according to Annex A.6. Cell 2 is the NR FR1 cell. Cell 2 is the PSCell and the target for CSI-RS based L1-SINR measurements. Before the test, UE is configured to perform RLM and BFD and L1-SINR measurement based on the SSBs. The connection setup is done according to the settings in Annex C.1.1.

#### 4.7.7.3.4.2 Test procedure

Prior to the start of the time duration T1, the UE shall be fully synchronized to PSCell. The UE shall be configured for periodic CSI reporting in PUCCH [format 2] with a reporting periodicity as mentioned in the above table 4.7.4.1.2.4.1-2.

1. Ensure the UE is in state RRC\_CONNECTED with generic procedure parameters Connectivity EN-DC, DC bearer MCG and SCG, Connected without release *On* and Test Mode *On*, according to TS 38.508-1 [14] clause 4.5 and general test parameters set according to Table 4.7.7.3.4.1-2.
2. Set the parameters according to T1 in Table 4.7.7.3.5-1.
3. The UE shall start sending L1-SINR report including results of both CSI-RS#0 and CSI-RS #1 every 80 slots.
4. The SS shall check the L1-SINR reported values of CSI-RS #0 and CSI-RS #1 in the periodic L1-SINR reports. If the value for both CSI-RSs is within the limits in Table 4.7.7.3.5-2 or Table 4.7.7.3.5-3 (depending on the test configuration), the number of passed iterations is increased by one, otherwise the number of failed iterations is increased by one.
5. The SS shall continue checking the L1-SINR report messages transmitted by the UE until the confidence level according to Table G.2.3-1 in Annex G is achieved.



6. Set the parameters according to each sub-test in Table 4.7.7.3.5-1 as appropriate and repeat steps 3-5.

4.7.7.3.4.3 Message contents

Message contents are according to TS 38.508-1 [14] clause 7.3 with the following exceptions:

**Table 4.7.7.3.4.3-1: Common Exception messages EN-DC CSI-RS based CMR without dedicated IMR L1-SINR measurement**

Default Message Contents	
Common contents of system information blocks exceptions	
Default RRC messages and information elements contents exceptions	Table H.3.6A-1 with conditions PERIODIC and CSI-SINR and CSI-IM_IMR Table H.3.6A-2 with conditions CSI-RS and PERIODIC Table H.3.6A-3 with condition PERIODIC Table 7.3.1-3 in TS 38.508-1 [14] with condition SMTC.1

**Table 4.7.7.3.4.3-2: RadioLinkMonitoringConfig**

Derivation Path: TS 38.508-1 [14], Table 4.6.3-133			
Information Element	Value/remark	Comment	Condition
RadioLinkMonitoringConfig ::= SEQUENCE {			
failureDetectionResourcesToAddModList	1 entry		
SEQUENCE			
(SIZE(1..maxNrofFailureDetectionResources)) OF			
SEQUENCE {			
purpose	both	UE is configured to perform RLM and BFD based on the SSBs.	
}			
}			
}			

4.7.7.3.5 Test requirement

Table 4.7.7.3.5-1 defines the primary level settings not including test tolerances for all tests.

Each L1-RSRP measurement report for each of the tests in Table 4.7.7.3.5-1 shall meet the corresponding absolute accuracy requirements in Table 4.7.7.3.5-2 for test configurations 1, 2, 4 and 5, and the corresponding absolute accuracy requirements in Table 4.7.7.3.5-3 for test configurations 3 and 6.

**Table 4.7.7.3.5-1: FR1 L1-SINR measurement test with CSI-RS based both CMR and IMR**

Parameter	Config	Unit	Test 1	Test 2
-----------	--------	------	--------	--------

SSB GSCN	1~6		freq1	freq1	
Duplex mode	1,4		FDD	FDD	
	2,5		TDD	TDD	
	3,6		TDD	TDD	
TDD Configuration	1,4		N/A	N/A	
	2,5		TDDConf.1.1	TDDConf.1.1	
	3,6		TDDConf.2.1	TDDConf.2.1	
BW <sub>channel</sub>	1,4	MHz	10: N <sub>RB,c</sub> = 52	10: N <sub>RB,c</sub> = 52	
	2,5		10: N <sub>RB,c</sub> = 52	10: N <sub>RB,c</sub> = 52	
	3,6		40: N <sub>RB,c</sub> = 106	40: N <sub>RB,c</sub> = 106	
PDSCH Reference measurement channel	1,4		SR.1.1 FDD	SR.1.1 FDD	
	2,5		SR.1.1 TDD	SR.1.1 TDD	
	3,6		SR.2.1 TDD	SR.2.1 TDD	
RMSI CORESET Reference Channel	1,4		CR.1.1 FDD	CR.1.1 FDD	
	2,5		CR.1.1 TDD	CR.1.1 TDD	
	3,6		CR.2.1 TDD	CR.2.1 TDD	
Dedicated CORESET Reference Channel	1,4		CCR.1.1 FDD	CCR.1.1 FDD	
	2,5		CCR.1.1 TDD	CCR.1.1 TDD	
	3,6		CCR.2.1 TDD	CCR.2.1 TDD	
SSB configuration	1,4		SSB.1 FR1	SSB.1 FR1	
	2,5		SSB.1 FR1	SSB.1 FR1	
	3,6		SSB.2 FR1	SSB.2 FR1	
OCNG Patterns	1~6		OP.1	OP.1	
TRS configuration	1,4		TRS.1.1 FDD	TRS.1.1 FDD	
	2,5		TRS.1.1 TDD	TRS.1.1 TDD	
	3,6		TRS.1.2 TDD	TRS.1.2 TDD	
Initial BWP Configuration	1~6		DLBWP.0.1 ULBWP.0.1	DLBWP.0.1 ULBWP.0.1	
Dedicated BWP configuration	1~6		DLBWP.1.1 ULBWP.1.1	DLBWP.1.1 ULBWP.1.1	
SMTc configuration	1~6		SMTc.1	SMTc.1	
CSI-RS configuration as CMR	1,4		CSI-RS 1.2 FDD	CSI-RS 1.2 FDD	
	2,5		CSI-RS 1.2 TDD	CSI-RS 1.2 TDD	
	3,6		CSI-RS 2.2 TDD	CSI-RS 2.2 FDD	
CSI-RS configuration as IMR	1,4		CSI-RS 1.3A FDD	CSI-RS 1.3A FDD	
	2,5		CSI-RS 1.3A TDD	CSI-RS 1.3A TDD	
	3,6		CSI-RS 2.3A TDD	CSI-RS 2.3A TDD	
reportConfigType	1~6		periodic	periodic	
reportQuantity-r16	1~6		cri-SINR-r16	cri-SINR-r16	
nrofReportedRS	1~6		2	2	
L1-RSRP reporting period	1~6		slot80	slot80	
EPRE ratio of PSS to SSS	1~6	dB	0	0	
EPRE ratio of PBCH DMRS to SSS					
EPRE ratio of PBCH to PBCH DMRS					
EPRE ratio of PDCCH DMRS to SSS					
EPRE ratio of PDCCH to PDCCH DMRS					
EPRE ratio of PDSCH DMRS to SSS					
EPRE ratio of PDSCH to PDSCH DMRS					
EPRE ratio of OCNG DMRS to SSS <sup>Note 1</sup>					
EPRE ratio of OCNG to OCNG DMRS <sup>Note 1</sup>					
$N_{oc}$ Note2					1~6
	NR_FDD_FR1_A, NR_TDD_FR1_A NOTE 5				
	NR_FDD_FR1_B NR_TDD_FR1_C				
				-116.5+TT	
				-116+TT	

	NR_FDD_FR1_D, NR_TDD_FR1_D				-115.5+TT
	NR_FDD_FR1_E, NR_TDD_FR1_E				-115+TT
	NR_FDD_FR1_F				-114.5+TT
	NR_FDD_FR1_G				-114+TT
	NR_FDD_FR1_H				-113.5+TT
$N_{oc}$ Note2	NR_FDD_FR1_A, NR_TDD_FR1_A NOTE 5	1,2,4,5	dBm/CSI-RS SCS	-94.65+TT	-117+TT
	NR_FDD_FR1_B				-116.5+TT
	NR_TDD_FR1_C				-116+TT
	NR_FDD_FR1_D, NR_TDD_FR1_D				-115.5+TT
	NR_FDD_FR1_E, NR_TDD_FR1_E				-115+TT
	NR_FDD_FR1_F				-114.5+TT
	NR_FDD_FR1_G				-114+TT
	NR_FDD_FR1_H				-113.5+TT
	NR_FDD_FR1_A, NR_TDD_FR1_A NOTE 5	3,6		-91.65+TT	-114+TT
	NR_FDD_FR1_B				-113.5+TT
	NR_TDD_FR1_C				-114+TT
	NR_FDD_FR1_D, NR_TDD_FR1_D				-112.5+TT
	NR_FDD_FR1_E, NR_TDD_FR1_E				-112+TT
	NR_FDD_FR1_F				-111.5+TT
	NR_FDD_FR1_G				-111+TT
	NR_FDD_FR1_H				-110.5+TT
$\hat{E}_s/I_{ot}$		1-6	dB	10+TT	0+TT
CSI-RS RSRP Note3	NR_FDD_FR1_A, NR_TDD_FR1_A NOTE 5	1,2,4,5	dBm/CSI-RS SCS	-84.65+TT	-117+TT
	NR_FDD_FR1_B				-116.5+TT
	NR_TDD_FR1_C				-116+TT
	NR_FDD_FR1_D, NR_TDD_FR1_D				-115.5+TT
	NR_FDD_FR1_E, NR_TDD_FR1_E				-115+TT
	NR_FDD_FR1_F				-114.5+TT
	NR_FDD_FR1_G				-114+TT
	NR_FDD_FR1_H				-113.5+TT
	NR_FDD_FR1_A, NR_TDD_FR1_A NOTE 5	3,6		-81.65+TT	-114+TT
	NR_FDD_FR1_B				-113.5+TT
	NR_TDD_FR1_C				-114+TT
	NR_FDD_FR1_D, NR_TDD_FR1_D				-112.5+TT
	NR_FDD_FR1_E, NR_TDD_FR1_E				-112+TT
	NR_FDD_FR1_F				-111.5+TT
	NR_FDD_FR1_G				-111+TT
	NR_FDD_FR1_H				-110.5+TT
$I_o$ Note3	NR_FDD_FR1_A, NR_TDD_FR1_A NOTE 5	1,2,4,5	dBm/9.36 MHz	-56.28+TT	-87.28+TT
	NR_FDD_FR1_B				-86.78+TT
	NR_TDD_FR1_C				-86.28+TT
	NR_FDD_FR1_D, NR_TDD_FR1_D				-85.78+TT
	NR_FDD_FR1_E, NR_TDD_FR1_E				-85.28+TT
	NR_FDD_FR1_F				-84.78+TT

NR_FDD_FR1_G				-84.28+TT
NR_FDD_FR1_H				-83.78+TT
NR_FDD_FR1_A, NR_TDD_FR1_A NOTE 5	3,6	dBm/38.16 MHz	-50.19+TT	-81.19+TT
NR_FDD_FR1_B				-80.69+TT
NR_TDD_FR1_C				-80.19+TT
NR_FDD_FR1_D, NR_TDD_FR1_D				-79.69+TT
NR_FDD_FR1_E, NR_TDD_FR1_E				-79.19+TT
NR_FDD_FR1_F				-78.69+TT
NR_FDD_FR1_G				-78.19+TT
NR_FDD_FR1_H				-77.69+TT
$\hat{E}_s / N_{oc}$	1~6	dB	10+TT	0+TT
Propagation condition	1~6		AWGN	AWGN
Antenna configuration	1~6		1x2	1x2
<p>Note 1: OCNG shall be used such that both cells are fully allocated and a constant total transmitted power spectral density is achieved for all OFDM symbols.</p> <p>Note 2: Interference from other cells and noise sources not specified in the test is assumed to be constant over subcarriers and time and shall be modelled as AWGN of appropriate power for <math>N_{oc}</math> to be fulfilled.</p> <p>Note 3: RSRP and <math>I_o</math> levels have been derived from other parameters for information purposes. They are not settable parameters themselves.</p> <p>Note 4: RSRP minimum requirements are specified assuming independent interference and noise at each receiver antenna port.</p> <p>Note 5: The test configuration excludes support for band n51 and it is not required to run this test on band n51 in this release of the specification</p>				

**Table 4.7.7.3.5-2: Same as Table 4.7.7.1.5-2**

**Table 4.7.7.3.5-3: Same as Table 4.7.7.1.5-3**

For the test to pass, the ratio of successful reported values in each test shall be more than 90% with a confidence level of 95%.

## 4A NE-DC with all NR cells in FR1

### 4A.0 General

This clause contains test scenarios for NR and E-UTRA dual connectivity with NR as PCell and E-UTRA and PSCell. This configuration is also known as NE-DC. All NR cells are in Frequency Range 1.

### 4A.1 Signalling characteristics

#### 4A.1.1 E-UTRAN PSCell addition

##### 4A.1.1.0 Minimum conformance requirements

##### 4A.1.1.0.1 E-UTRA PSCell Addition Delay Requirement

This clause defines requirements for the delay within which the UE shall be able to configure an E-UTRAN PSCell in NR - E-UTRA dual connectivity. The requirements are applicable to an NR - E-UTRA dual connectivity capable UE.

Upon receiving E-UTRAN PSCell addition in subframe  $n$ , the UE shall be capable to transmit PRACH preamble towards E-UTRAN PSCell no later than in subframe  $n + T_{\text{config\_E-UTRAN-PSCell}}$ :

Where:

$$T_{\text{config\_E-UTRAN-PSCell}} = T_{\text{RRC\_delay}} + T_{\text{activation\_time}} + 50\text{ms} + T_{\text{E-UTRAN-PSCell\_DU}}$$

$T_{\text{RRC\_delay}}$  is the RRC procedure delay as specified in TS 38.331 [13].

$T_{\text{activation\_time}}$  is the E-UTRAN PSCell activation delay. If the E-UTRAN PSCell is known, then  $T_{\text{activation\_time}}$  is 20ms. If the E-UTRAN PSCell is unknown, then  $T_{\text{activation\_time}}$  is 30ms provided the E-UTRAN PSCell can be successfully detected on the first attempt.

$T_{\text{E-UTRAN-PSCell\_DU}}$  is the delay uncertainty in acquiring the first available PRACH occasion in the E-UTRAN PSCell.  $T_{\text{E-UTRAN-PSCell\_DU}}$  is up to 30ms.

E-UTRAN PSCell is known if it has been meeting the following conditions:

- During the last 5 seconds before the reception of the E-UTRAN PSCell configuration command:
  - the UE has sent a valid measurement report for the E-UTRAN PSCell being configured and
  - the E-UTRAN PSCell being configured remains detectable according to the cell identification conditions specified in clause 8.8 of TS 36.133 [23],
- E-UTRAN PSCell being configured also remains detectable during the E-UTRAN PSCell configuration delay  $T_{\text{config\_E-UTRAN-PSCell}}$  according to the cell identification conditions specified in clause 8.8 of TS 36.133 [23].

otherwise it is unknown.

The PCell interruption specified in clause 8.2 of TS 38.133 [6] is allowed only during the RRC reconfiguration procedure [14].

#### 4A.1.1.0.2 E-UTRA PSCell Release Delay Requirement

The requirements in this clause shall apply for a UE which is configured with PCell and E-UTRAN PSCell and may also be configured with one or more SCells and/or E-UTRAN SCells.

Upon receiving E-UTRAN PSCell release in subframe  $n$ , the UE shall accomplish the release actions specified in TS 38.331 [14] no later than in subframe  $n + T_{\text{RRC\_delay}}$ :

Where

$T_{\text{RRC\_delay}}$  is the RRC procedure delay as specified in TS 38.331 [13].

The PCell interruption specified in clause 8.2 of TS 38.133 [6] is allowed only during the RRC reconfiguration procedure [14].

#### 4A.1.1.1 NE-DC FR1 addition and release delay of known PSCell

**Editor's note: This test case is incomplete. The following aspects are either missing or TBD**

- TT analysis and test requirements are missing
- Test procedure is FFS
- Message contents are not added

##### 4A.1.1.1 Test purpose

The purpose of this test is to verify that the LTE PSCell addition/release delay and interruption under NE-DC are within the specified requirements for the case when the PSCell is known by the UE at the time of addition.

## 4A.1.1.2 Test applicability

This test applies to all types of NR UE supporting E-UTRA and NE-DC from Release 15 onwards.

## 4A.1.1.3 Minimum conformance requirements

The minimum conformance requirements are specified in clause 4A.1.1.0.

The normative reference for this requirement is TS 38.133 [6] clause A.4A.1.1.

## 4A.1.1.4 Test description

## 4A.1.1.4.1 Initial conditions

This test shall be tested using any of the test configurations in Table 4A.1.1.4.1-1.

**Table 4A.1.1.4.1-1: Test configurations for NE-DC PSCell addition and Release test**

Config	Description
1	LTE FDD, NR 15 kHz SSB SCS, 10 MHz bandwidth, FDD duplex mode
2	LTE FDD, NR 15 kHz SSB SCS, 10 MHz bandwidth, TDD duplex mode
3	LTE FDD, NR 30 kHz SSB SCS, 40 MHz bandwidth, TDD duplex mode
4	LTE TDD, NR 15 kHz SSB SCS, 10 MHz bandwidth, FDD duplex mode
5	LTE TDD, NR 15 kHz SSB SCS, 10 MHz bandwidth, TDD duplex mode
6	LTE TDD, NR 30 kHz SSB SCS, 40 MHz bandwidth, TDD duplex mode
Note:	The UE is only required to be tested in one of the supported test configurations

Configure the test equipment and the DUT according to the parameters in Table 4A.1.1.4.1-2.

**Table 4A.1.1.4.1-2: Initial conditions**

Parameter	Value	Comment
Test environment	NC	As specified in TS 38.508-1 [14] clause 4.1.
Test frequencies		FFS
Channel bandwidth		FFS
Propagation conditions	AWGN	FFS
Connection Diagram	TE Part 2Rx	FFS
	TE Part 4Rx	FFS
	DUT Part 2Rx	FFS
	DUT Part 4Rx	FFS
Exceptions to connection diagram	N/A	

## 4A.1.1.4.2 Test Procedure

FFS

## 4A.1.1.4.3 Message Contents

FFS

## 4A.1.1.5 Test Requirements

FFS

## 4A.1.2 Active BWP switch delay

FFS

## 4A.2 Measurement performance requirements

### 4A.2.1 SFTD accuracy

FFS

---

## 5 EN-DC with at least one NR cell in FR2

### 5.0 General

This clause contains test scenarios for E-UTRA and NR dual connectivity with E-UTRA as PCell and NR as PSCell. At least one NR cell is in Frequency Range 2.

For conformance testing involving FR2 test cases in this specification, the UE under test shall be pre-configured with UL Tx diversity schemes disabled to account for single polarization System Simulator (SS) in the test environment. The UE under test may transmit with dual polarization.

#### 5.1 Void

#### 5.2 Void

### 5.3 RRC\_CONNECTED state mobility

#### 5.3.1 Void

#### 5.3.2 RRC connection mobility control

##### 5.3.2.1 Void

##### 5.3.2.2 Random access

###### 5.3.2.2.1 EN-DC FR2 contention based random access

*Editor's note: This test case is incomplete for Test 2, 3 and 7. The following aspects are either missing or not yet determined:*

- *The settable window for first preamble uplink power and the uplink calibration process are FFS.*
- *The test requirement for absolute uplink power is FFS.*
- *The test requirement for relative uplink power is FFS.*
- *The uncertainty value and test requirement for PRACH timing are in [ ]*
- *The results of the TT analysis are provisional until the corresponding MU values are agreed*

###### 5.3.2.2.1.1 Test purpose

The purpose of this test is to verify that the behaviour of the random access procedure is according to the requirements and that the PRACH power settings and timing are within specified limits.

###### 5.3.2.2.1.2 Test applicability

This test applies to all types of E-UTRA UE release 15 and forward, supporting EN-DC with FR2.



### 5.3.2.2.1.3 Minimum conformance requirement

The random access procedure is used when establishing the layer 1 communication between the UE and NG-RAN. The random access is as defined in TS 38.213 [8] clause 7.4 and the control of the RACH transmission is as defined in TS 38.321 [12] clause 5.1.

The UE shall have capability to calculate PRACH transmission power according to the PRACH power formula as defined in TS 38.213 [8] clause 7.4 and apply this power level at the first preamble or additional preambles. The absolute power applied to the first preamble shall have an accuracy as defined in TS 38.101-2 [3] Table 6.3.4.2-1. The relative power applied to additional preambles shall have an accuracy as specified in TS 38.101-2 [3] Tables 6.3.4.3-1 and 6.3.4.3-2.

The UE shall indicate a Random Access problem to upper layers if the maximum number of preamble transmission counter has been reached for the random access procedure on PCell or PSCell as specified in TS 38.321 [12] clause 5.1.4.

With the UE selected SSB with SS-RSRP above  $rsrp-ThresholdSSB$ , UE shall have the capability to select a Random Access Preamble randomly with equal probability from the Random Access Preambles associated with the selected SSB if the association between Random Access Preambles and SS blocks is configured, as specified in clause 5.1.2 in TS 38.321 [12].

With the UE selected SSB with SS-RSRP above  $rsrp-ThresholdSSB$ , UE shall have the capability to transmit Random Access Preamble on the next available PRACH occasion from the PRACH occasions corresponding to the selected SSB permitted by the restrictions given by the  $ra-ssb-OccasionMaskIndex$  if configured, if the association between PRACH occasions and SSBs is configured, and PRACH occasion shall be randomly selected with equal probability amongst the selected SSB associated PRACH occasions occurring simultaneously but on different subcarriers, as specified in clause 5.1.2 in TS 38.321 [12].

The UE may stop monitoring for Random Access Response(s) and shall transmit the msg3 if the Random Access Response contains a Random Access Preamble identifier corresponding to the transmitted Random Access Preamble.

The UE shall again perform the Random Access Resource selection procedure defined in clause 5.1.2 in TS 38.321 [12], and transmit with the calculated PRACH transmission power when the backoff time expires if all received Random Access Responses contain Random Access Preamble identifiers that do not match the transmitted Random Access Preamble.

The UE shall again perform the Random Access Resource selection procedure defined in clause 5.1.2 in TS 38.321 [12], and transmit with the calculated PRACH transmission power when the backoff time expires if no Random Access Response is received within the RA Response window defined in clause 5.1.4 in TS 38.321 [12].

The UE shall re-transmit the msg3 upon the reception of an UL grant for msg3 retransmission.

The UE shall send ACK if the Contention Resolution is successful.

The UE shall again perform the Random Access Resource selection procedure defined in clause 5.1.2 in TS 38.321 [12], and transmit with the calculated PRACH transmission power when the backoff time expires unless the received message includes a UE Contention Resolution Identity MAC control element and the UE Contention Resolution Identity included in the MAC control element matches the CCCH SDU transmitted in the uplink message.

The UE shall re-select a preamble and transmit with the calculated PRACH transmission power when the backoff time expires if the Contention Resolution Timer expires.

The normative reference for this requirement is TS 38.133 [6] clause 6.2.2.

### 5.3.2.2.1.4 Test description

#### 5.3.2.2.1.4.1 Initial conditions

This test can be run in the configurations defined in Table 5.3.2.2.1.4.1-1.

**Table 5.3.2.2.1.4.1-1: Supported test configurations**

Test Case ID	Test Config Index	Description
5.3.2.2.1-1	1	LTE FDD, NR 120 kHz SSB SCS, 10MHz bandwidth, TDD
5.3.2.2.1-2	2	LTE TDD, NR 120 kHz SSB SCS, 10MHz bandwidth, TDD
NOTE: The UE is only required to be tested in one of the supported test configurations.		

Before the test procedure, Downlink and Uplink calibrations are carried out to derive signalled parameter values. This is necessary to ensure that the test case operates within the specified ranges. The detail of the calibration process is implementation dependent, but shall derive the values of  $\Delta_{DL}$  and  $\Delta_{UL}$  according to the following principles:

With the UE configured to report SS-RSRP, the  $\Delta_{DL}$  value is calculated as  $(RSRP_{REP} - RSRP_{76})$ , where  $RSRP_{REP}$  is the SS-RSRP Reported value according to TS 38.133 [6] Table 10.1.6.1-1 with -80.6dBm/SCS applied at the Reference point. For a Reported value  $RSRP_x$ , x is treated as a positive integer value.

With the UE configured to send a first PRACH preamble,  $\Delta_{UL}$  value is calculated as  $-\text{ROUND}(\text{PPRACH0} - 1)$ , where PPRACH0 is the measured first PRACH power with -80.6dBm/SCS applied at the Reference point, and with signalled values  $preambleReceivedTargetPower = -100\text{dBm}$  and  $ss-PBCH-BlockPower = 20\text{dBm}$ .

Configure the test equipment and the DUT according to the parameters in Table 5.3.2.2.1.4.1-2.

**Table 5.3.2.2.1.4.1-2: Initial conditions**

Parameter	Value		Comment
Test environment	NC		As specified in TS 38.508-1 [14] clause 4.1.
Test frequencies	As specified in Annex E, E.1.1, E.1.3.1 and Table E.3-1 and TS 38.508-1 [14] clause 4.3.1 for E-UTRA and 7.2.3 for NR		
Channel bandwidth	As specified by the test configuration selected from Table 4.3.2.2.1.4.1-1.		
Propagation conditions	AWGN		As specified in clause C.2.2.
Connection Diagram	TE Part	A.3.3.1.1	As specified in TS 38.508-1 [14] Annex A.
	DUT Part	A.3.4.1.1	
Exceptions to connection diagram	N/A		

1. Message contents are defined in clause 5.3.2.2.1.4.3.
2. Cell 1 is the E-UTRA serving cell (PCell) for the EN-DC setup. The E-UTRAN PCell power levels and settings are specified in Table A.6.1.1-1. Cell 2 is the NR FR2 PSCell. The connection setup is done according to the settings in clause C.1.3, with downlink signal levels as per clause C.1.2. General Test parameters are defined in Table 5.3.2.2.1.5-1.
3. Downlink signals for NR cell are initially set up according to clause C.2.1.
4. The UE Rx beam peak direction has been obtained previously using one of the Rx Beam Peak Search procedures as described in Annex I.

#### 5.3.2.2.1.4.2 Test procedure

For this test two cells are used, an E-UTRA serving cell (PCell) and an NR FR2 PSCell. For the NR PSCell, the System Simulator shall not explicitly assign a random access preamble via dedicated signalling in the downlink.

1. Ensure the UE is in state E-UTRA RRC\_CONNECTED with generic procedure parameters *Connectivity E-UTRA/EPC* with Test Mode *On* according to TS 38.508-1 [14] clause 4.5.
2. Set the parameters according to Table 5.3.2.2.1.5-1.
3. The test system shall send a RRCReconfiguration message to the UE to add NR PSCell, then the UE shall trigger a random access procedure.
4. Test 1: Correct behaviour when transmitting Random Access Preamble

- 4.1. The UE shall send a preamble to the System Simulator. The System Simulator shall check that the Random Access Preamble belongs to one of the Random Access Preambles associated with the SSB with index 0, which has SS-RSRP above the configured  $\text{rsrp-ThresholdSSB}$ .
5. Test 2: Correct behaviour when receiving Random Access Response
  - 5.1. Repeat steps 1-3.
  - 5.2. The UE shall send preambles to the System Simulator. In response to the first 4 preambles, the System Simulator shall transmit a Random Access Response containing Random Access Preamble identifiers that do not match the transmitted Random Access Preamble.
  - 5.3. As the received Random Access Responses contain Random Access Preamble identifiers that do not match the transmitted Random Access Preamble, the UE shall perform the Random Access Resource selection procedure specified in clause 5.1.2 in TS 38.321 [12], and transmit with the calculated PRACH transmission power when the backoff time expires.
  - 5.4. The System Simulator shall transmit a Random Access Response containing a Random Access Preamble identifier matching the transmitted Random Access Preamble after 5 preambles have been received by the System Simulator.
  - 5.5. As the received Random Access Response contains a Random Access Preamble identifier that matches the transmitted Random Access Preamble, the UE shall transmit the msg3.
  - 5.6. Measure the power and timing of the first preamble and it shall not exceed the values specified in 5.3.2.2.1.5. Measure the relative power and timing applied to additional preambles (last 4 preambles) and it shall not exceed the values specified in 5.3.2.2.1.5.
6. Test 3: Correct behaviour when not receiving Random Access Response
  - 6.1. Repeat steps 1-3.
  - 6.2. The UE shall send preambles to the System Simulator. The System Simulator shall not respond to the first 4 preambles.
  - 6.3. As no Random Access Response was received within the RA Response window, the UE shall perform the Random Access Resource selection procedure specified in clause 5.1.2 in TS 38.321 [12], and transmit with the calculated PRACH transmission power when the backoff time expires.
  - 6.4. The System Simulator shall transmit a Random Access Response containing a Random Access Preamble identifier matching the transmitted Random Access Preamble after 5 preambles have been received by the System Simulator.
  - 6.5. As the received Random Access Response contains a Random Access Preamble identifier that matches the transmitted Random Access Preamble, the UE shall transmit the msg3.
  - 6.6. Measure the power and timing of the first preamble and it shall not exceed the values specified in 5.3.2.2.1.5. Measure the relative power and timing applied to additional preambles (last 4 preambles) and it shall not exceed the values specified in 5.3.2.2.1.5.
7. Test 4: Correct behaviour when receiving an UL grant for msg3 retransmission
  - 7.1. Repeat steps 1-3.
  - 7.2. The UE shall send a preamble to the System Simulator. The System Simulator shall transmit a Random Access Response containing a Random Access Preamble identifier matching the transmitted Random Access Preamble.
  - 7.3. As the received Random Access Response contains a Random Access Preamble identifier that matches the transmitted Random Access Preamble, the UE shall transmit the msg3 including C-RNTI MAC control element.
  - 7.4. The System Simulator shall send PDCCH addressed to the Temporary C-RNTI after receiving the msg3.
  - 7.5. The UE shall re-transmit the msg3 including C-RNTI MAC control element.

- 7.6. The System Simulator shall check if UE re-transmit the msg3.
- 8. Test 5: Correct behaviour when receiving a successful UE Contention Resolution
  - 8.1. Repeat steps 1-3.
  - 8.2. The UE shall send a preamble to the System Simulator. The System Simulator shall transmit a Random Access Response containing a Random Access Preamble identifier matching the transmitted Random Access Preamble.
  - 9.3. As the received Random Access Response contains a Random Access Preamble identifier that matches the transmitted Random Access Preamble, the UE shall transmit the msg3 including C-RNTI MAC control element.
  - 9.4. The System Simulator shall send a PDCCH addressed to the C-RNTI.
  - 9.5. The UE shall send PUSCH according to the received PDCCH addressed to the C-RNTI.
- 10. Test 7: Correct behaviour when contention Resolution timer expires
  - 10.1. Repeat steps 1-3.
  - 10.2. The UE shall send a preamble to the System Simulator. The System Simulator shall transmit a Random Access Response containing a Random Access Preamble identifier matching the transmitted Random Access Preamble.
  - 10.3. As the received Random Access Response contains a Random Access Preamble identifier that matches the transmitted Random Access Preamble, the UE shall transmit the msg3.
  - 10.4. The System Simulator shall not send a response.
  - 10.5. As there was no response, the UE shall perform the Random Access Resource selection procedure specified in clause 5.1.2 in TS 38.321 [12], and transmit with the calculated PRACH transmission power when the Contention Resolution Timer expires and then after the backoff timer expires.
  - 10.6. Measure the power and timing of the first preamble after the Contention Resolution Timer and backoff timer expire and it shall not exceed the values specified in 5.3.2.2.1.5.

5.3.2.2.1.4.3 Message contents

Message contents are according to TS 38.508-1 [14] clause 7.3.1 with the following exceptions:

**Table 5.3.2.2.1.4.3-0: Common Exception messages**

Default Message Contents	
Common contents of system information blocks exceptions	
Default RRC messages and information elements contents exceptions	
Common exceptions to the contents of TS 38.508-1 [14]	Table 4.6.3-115 with SSB-Index 0 Table 4.6.3-120 with SSB-Index 0

**Table 5.3.2.2.1.4.3-1: FrequencyInfoUL-SIB for Contention Based Random Access**

Derivation Path: TS 38.508-1 [14], table 4.6.3-62			
Information Element	Value/remark	Comment	Condition
FrequencyInfoUL-SIB SEQUENCE {			
p-Max	23	23 dBm	
}			

**Table 5.3.2.2.1.4.3-2: RACH-ConfigCommon for Contention Based Random Access**

Derivation Path: TS 38.508-1 [14], table 4.6.3-128			
Information Element	Value/remark	Comment	Condition
RACH-ConfigCommon ::= SEQUENCE {			
rach-ConfigGeneric	RACH-ConfigGeneric		
totalNumberOfRA-Preambles	48		
ssb-perRACH-OccasionAndCB-PreamblesPerSSB CHOICE {			
oneFourth	n48		FR2
}			
groupBconfigured SEQUENCE {			
numberOfRA-PreamblesGroupA	48		
}			
ra-ContentionResolutionTimer	sf48		
rsrp-ThresholdSSB	RSRP_69 + $\Delta_{DL}$	$\Delta_{DL}$ is derived from the downlink calibration process	
prach-RootSequenceIndex CHOICE {			
l139	0		
}			
msg1-SubcarrierSpacing	kHz 120		
}			

**Table 5.3.2.2.1.4.3-3: RACH-ConfigGeneric for Contention Based Random Access**

Derivation Path: TS 38.508-1 [14], table 4.6.3-130			
Information Element	Value/remark	Comment	Condition
RACH-ConfigGeneric ::= SEQUENCE {			
prach-ConfigurationIndex	190		FR2
msg1-FDM	one		FR2
zeroCorrelationZoneConfig	11		
preambleReceivedTargetPower	-100		
preambleTransMax	n6		
powerRampingStep	dB2		
ra-ResponseWindow	sl10		
}			

**Table 5.3.2.2.1.4.3-4: ServingCellConfigCommonSIB for Contention Based Random Access**

Derivation Path: TS 38.508-1 [14], table 4.6.3-169			
Information Element	Value/remark	Comment	Condition
ServingCellConfigCommonSIB ::= SEQUENCE {			
ssb-PositionsInBurst SEQUENCE {			
inOneGroup	'1100 0000'B		
}			
ss-PBCH-BlockPower	20 + $\Delta_{UL}$	$\Delta_{UL}$ is derived from the uplink calibration process	
}			

#### 5.3.2.2.1.5 Test requirement

Table 5.3.2.2.1.5-2 defines the primary level settings for contention based random access test in FR2 for NR Standalone. Tables 5.3.2.2.1.5-3, 5.3.2.2.1.5-4 and 5.3.2.2.1.5-5 define the Absolute power limits, Relative power limits and uplink timing error limits respectively, and all include test tolerances.

Table 5.3.2.2.1.5-1: General test parameters

Parameter		Unit	Test-1	Comments
SSB Configuration	Config 1,2		SSB.1 FR2	As defined in A.3.2
CSI-RS for tracking	Config 1,2		TRS.2.1 TDD	
Duplex Mode for Cell 2	Config 1,2		TDD	
TDD Configuration	Config 1,2		TDDConf.3.1	As defined in A.1.5
$BW_{channel}$	Config 1,2	MHz	100: $N_{RB,c} = 24$	
OCNG Pattern <sup>Note 1</sup>			OP.3	As defined in A.2.1
PDSCH Reference Channel <sup>Note 2</sup>	Config 1,2		SR.3.1 TDD	As defined in A.1.1
RMSI CORESET Reference Channel	Config 1,2		CR.3.1 TDD	As defined in A.1.2
RMC CORESET Reference Channel	Config 1,2		CCR.3.1 TDD	As defined in A.1.3
NR RF Channel Number			1	
EPRE ratio of PSS to SSS		dB	0	
EPRE ratio of PBCH_DMRS to SSS		dB		
EPRE ratio of PBCH to PBCH_DMRS		dB		
EPRE ratio of PDCCH_DMRS to SSS		dB		
EPRE ratio of PDCCH to PDCCH_DMRS		dB		
EPRE ratio of PDSCH_DMRS to SSS		dB		
EPRE ratio of PDSCH to PDSCH_DMRS		dB		
$ss\text{-}PBCH\text{-}BlockPower$		dBm/ SCS	+20 + $\Delta_{UL}$	As defined in TS 38.331 [13]. $\Delta_{UL}$ is derived from the uplink calibration process <sup>Note 3</sup>
Configured UE transmitted power ( $P_{CMAX, f, c}$ )		dBm	maximum value configurable for certain power class	As defined in clause 6.2.4 of TS 38.101-2 [3]
PRACH Configuration			PRACH.1 FR2	As defined in A.7.2, with exceptions as defined below
$rsrp\text{-}ThresholdSSB$		dBm	RSRP_69 + $\Delta_{DL}$	RSRP_69 corresponds to -88dBm. $\Delta_{DL}$ is derived from the downlink calibration process <sup>Note 4</sup>
$preambleReceivedTargetPower$		dBm	-100	As defined in TS 38.331 [13]
<p>NOTE 1: OCNG shall be used such that a constant total transmitted power spectral density is achieved for all OFDM symbols. The OCNG pattern is chosen during the test according to the presence of a DL reference measurement channel.</p> <p>NOTE 2: The DL PDSCH reference measurement channel is used in the test only when a downlink transmission dedicated to the UE under test is required.</p> <p>NOTE 3: The <math>\Delta_{UL}</math> value is calculated as <math>-\text{ROUND}(\text{PPRACH0} - 1)</math>, where PPRACH0 is the measured first PRACH power with -80.6dBm/SCS applied, <math>preambleReceivedTargetPower = -100\text{dBm}</math> and <math>ss\text{-}PBCH\text{-}BlockPower = 20\text{dBm}</math>. These values are used during the uplink calibration process carried out before the test case is run, with the UE configured to send PRACH.</p> <p>NOTE 4: The <math>\Delta_{DL}</math> value is calculated as <math>(RSRP_{REP} - RSRP_{76})</math>, where RSRP_REP is the SS-RSRP Reported value in Table 10.1.6.1-1 with -80.6dBm/SCS applied. These values are used during the downlink calibration process carried out before the test case is run, with the UE configured to report SS-RSRP. For a Reported value RSRP_x, x is treated as a positive integer value.</p>				

Table 5.3.2.2.1.5-2: OTA-related test parameters

Parameter	Unit	Test-1	Comments	
AoA setup		Setup 1	As defined in A.9.1	
Assumption for UE beams <sup>Note 2</sup>		Rough		
SSB with index 0	Es <sup>Note 1</sup>	dBm/SCS	-80.6	Power of SSB with index 0 is set to be above configured <i>rsrp-ThresholdSSB</i>
	SSB_RP	dBm/SCS	-80.6	
	Es/Iot <sub>BB</sub>	dB	21.09	
	Io	dBm/95.04 MHz	-56.01	Io in symbols containing SSB index 0
SSB with index 1	Es <sup>Note 1</sup>	dBm/SCS	-95.0	Power of SSB with index 1 is set to be below configured <i>rsrp-ThresholdSSB</i>
	SSB_RP	dBm/SCS	-95.0	
	Es/Iot <sub>BB</sub>	dB	6.69	
	Io	dBm/95.04 MHz	-70.41	Io in symbols containing SSB index 1
Propagation Condition	-	AWGN		
NOTE 1: No artificial noise is applied in this test.				
NOTE 2: Information about types of UE beam is given in TS 38.133 [6] clause B.2.1.3, and does not limit UE implementation or test system implementation				

Test 1: Correct behaviour when transmitting Random Access Preamble

- The Random Access Preamble shall be one of the Random Access Preambles associated with SSB index 0.

Test 2: Correct behaviour when receiving Random Access Response

- The power of the first preamble shall be 0.6 dBm within the accuracy specified in Table 5.3.2.2.1.5-3.
- The relative power for preamble ramping step shall be 2 dB within the accuracy specified in Table 5.3.2.2.1.5-4.
- The transmit timing of all PRACH transmissions shall be within the accuracy specified in Table 5.3.2.2.1.5-5.

Test 3: Correct behaviour when not receiving Random Access Response

- The power of the first preamble shall be 0.6 dBm within the accuracy specified in Table 5.3.2.2.1.5-3.
- The relative power for preamble ramping step shall be 2 dB within the accuracy specified in Table 5.3.2.2.1.5-4.
- The transmit timing of all PRACH transmissions shall be within the accuracy specified in Table 5.3.2.2.1.5-5.

Test 4: Correct behaviour when receiving an UL grant for msg3 retransmission

- The UE shall re-transmit the msg3 upon the reception of an UL grant for msg3 retransmission.

Test 5: Correct behaviour when receiving a successful UE Contention Resolution

- The UE shall send PUSCH according to the PDCCH addressed to the C-RNTI.

Test 7: Correct behaviour when contention resolution timer expires

- The UE shall re-select a preamble and transmit with the calculated PRACH transmission power when the back off time expires if the contention resolution timer expires.
- The power of the first preamble shall be 0.6 dBm within the accuracy specified in Table 5.3.2.2.1.5-3.
- The transmit timing of the PRACH transmission shall be within the accuracy specified in Table 5.3.2.2.1.5-5.

Table 5.3.2.2.1.5-3 Absolute power tolerance Test requirements

Conditions	Tolerance
Normal	± FFS dB

**Table 5.3.2.2.1.5-4 Relative power tolerance Test requirements**

Measured power	Power step $\Delta P$ (dB)	PRACH (dB)
Measured power of both PRACHs being compared > $(P_{\max}^{\text{Note1}} - 6\text{dB})$	$2 \leq \Delta P < 3$	$\pm (4+\text{FFS})$ .
Measured power of either PRACHs being compared $\leq (P_{\max}^{\text{Note1}} - 6\text{dB})$		$\pm (6+\text{FFS})$
NOTE 1: $P_{\max}$ is the Min peak EIRP defined in clause 6.2.1 of TS 38.101-2 [3], selected according to power class and operating band.		

**Table 5.3.2.2.1.5-5:  $T_e$  Timing error Test requirements**

Frequency Range	SCS of SSB signals (kHz)	SCS of uplink signals s(KHz)	$T_e$
2	120	120	$224+[48]*T_c$
NOTE 1: $T_c$ is the basic timing unit defined in TS 38.211 [7]			

### 5.3.2.2.2 EN-DC FR2 non-contention based random access

Editor's note: This test case is incomplete for Test 3 and 4. The following aspects are either missing or not yet determined:

- The settable window for first preamble uplink power and the uplink calibration process are FFS.
- The test requirement for absolute uplink power is FFS.
- The test requirement for relative uplink power is FFS.
- The uncertainty value and test requirement for PRACH timing are in [ ]
- The results of the TT analysis are provisional until the corresponding MU values are agreed

#### 5.3.2.2.2.1 Test purpose

The purpose of this test is to verify that the behaviour of the random access procedure is according to the requirements and that the PRACH power settings and timing are within specified limits.

#### 5.3.2.2.2.2 Test applicability

This test applies to all types of E-UTRA UE release 15 and forward, supporting EN-DC with FR2. Additionally Test 2 is applicable to UE that supports CSI-RS based Random Access Preamble which requires UE to support csi-RSRP-AndRSRQ-MeasWithSSB or csi-RSRP-AndRSRQ-MeasWithoutSSB.

#### 5.3.2.2.2.3 Minimum conformance requirement

The random access procedure is used when establishing the layer 1 communication between the UE and NG-RAN. The random access is as defined in TS 38.213 [8] clause 7.4 and the control of the RACH transmission is as defined in TS 38.321 [12] clause 5.1.

The UE shall have capability to calculate PRACH transmission power according to the PRACH power formula as defined in TS 38.213 [8] clause 7.4 and apply this power level at the first preamble or additional preambles. The absolute power applied to the first preamble shall have an accuracy as defined in TS 38.101-2 [3] Table 6.3.4.2-1. The relative power applied to additional preambles shall have an accuracy as specified in TS 38.101-2 [3] Tables 6.3.4.3-1 and 6.3.4.3-2.

The UE shall indicate a Random Access problem to upper layers if the maximum number of preamble transmission counter has been reached for the random access procedure on PCell or PSCell as specified in TS 38.321 [12] clause 5.1.4.



If the contention-free Random Access Resources and the contention-free PRACH occasions associated with SSBs is configured, with the UE selected SSB with SS-RSRP above  $rsrp\text{-}ThresholdSSB$  amongst the associated SSBs, UE shall have the capability to select the Random Access Preamble corresponding to the selected SSB, and to transmit Random Access Preamble on the next available PRACH occasion from the PRACH occasions corresponding to the selected SSB permitted by the restrictions given by the  $ra\text{-}ssb\text{-}OccasionMaskIndex$  if configured, and PRACH occasion shall be randomly selected with equal probability amongst the selected SSB associated PRACH occasions occurring simultaneously but on different subcarriers, as specified in clause 5.1.2 in TS 38.321 [12].

If the contention-free Random Access Resources and the contention-free PRACH occasions associated with CSI-RSs is configured, with the UE selected CSI-RS with CSI-RSRP above  $cfra\text{-}csirs\text{-}DedicatedRACH\text{-}Threshold$  amongst the associated CSI-RSs, UE shall have the capability to select the Random Access Preamble corresponding to the selected CSI-RS, and to transmit Random Access Preamble on the next available PRACH occasion from the PRACH occasions in  $ra\text{-}OccasionList$  corresponding to the selected CSI-RS, and PRACH occasion shall be randomly selected with equal probability amongst the selected CSI-RS associated PRACH occasions occurring simultaneously but on different subcarriers, as specified in clause 5.1.2 in TS 38.321 [12].

The UE may stop monitoring for Random Access Response(s), if the Random Access Response contains a Random Access Preamble identifier corresponding to the transmitted Random Access Preamble, unless the random access procedure is initialized for Other SI request from UE.

The UE shall again perform the Random Access Resource selection procedure defined in clause 5.1.2 in TS 38.321 [12] for the next available PRACH occasion, and transmit the preamble with the calculated PRACH transmission power if all received Random Access Responses contain Random Access Preamble identifiers that do not match the transmitted Random Access Preamble.

The UE shall again perform the Random Access Resource selection procedure defined in clause 5.1.2 in TS 38.321 [12] for the next available PRACH occasion, and transmit the preamble with the calculated PRACH transmission power, if no Random Access Response is received within the RA Response window configured in  $RACH\text{-}ConfigCommon$  or if no PDCCH addressed to UE's C-RNTI is received within the RA Response window configured in  $BeamFailureRecoveryConfig$ , as defined in clause 5.1.4 in TS 38.321 [12].

The normative reference for this requirement is TS 38.133 [6] clause 6.2.2.

Non-contention based random access procedure is not initialized for Other SI requested from UE or for beam failure recovery, so the requirements related to those features are omitted.

#### 5.3.2.2.2.4 Test description

##### 5.3.2.2.2.4.1 Initial conditions

This test can be run in the configurations defined in Table 5.3.2.2.2.4.1-1.

**Table 5.3.2.2.2.4.1-1: Supported test configurations**

Test Case ID	Test Config Index	Description
5.3.2.2.2-1	1	LTE FDD, NR 120 kHz SSB SCS, 10MHz bandwidth, TDD
5.3.2.2.2-2	2	LTE TDD, NR 120 kHz SSB SCS, 10MHz bandwidth, TDD
NOTE: The UE is only required to be tested in one of the supported test configurations		

Before the test procedure, Downlink and Uplink calibrations are carried out to derive signalled parameter values. This is necessary to ensure that the test case operates within the specified ranges. The detail of the calibration process is implementation dependent, but shall derive the values of  $\Delta_{DL}$  and  $\Delta_{UL}$  according to the following principles:

With the UE configured to report SS-RSRP, the  $\Delta_{DL}$  value is calculated as  $(RSRP_{REP} - RSRP_{76})$ , where  $RSRP_{REP}$  is the SS-RSRP Reported value according to TS 38.133 [6] Table 10.1.6.1-1 with -80.6dBm/SCS applied at the Reference point. For a Reported value  $RSRP_x$ , x is treated as a positive integer value.

With the UE configured to send a first PRACH preamble,  $\Delta_{UL}$  value is calculated as  $-\text{ROUND}(\text{PPRACH0} - 1)$ , where PPRACH0 is the measured first PRACH power with -80.6dBm/SCS applied at the Reference point, and with signalled values  $preambleReceivedTargetPower = -100\text{dBm}$  and  $ss\text{-}PBCH\text{-}BlockPower = 20\text{dBm}$ .

Configure the test equipment and the DUT according to the parameters in Table 5.3.2.2.4.1-2.

**Table 5.3.2.2.4.1-2: Initial conditions**

Parameter	Value		Comment
Test environment	NC		As specified in TS 38.508-1 [14] clause 4.1.
Test frequencies	As specified in Annex E, E.1.1, E.1.3.1 and Table E.3-1 and TS 38.508-1 [14] clause 4.3.1 for E-UTRA and 7.2.3 for NR		
Channel bandwidth	As specified by the test configuration selected from Table 4.3.2.2.1.4.1-1.		
Propagation conditions	AWGN		As specified in clause C.2.2.
Connection Diagram	TE Part	A.3.3.1.1	As specified in TS 38.508-1 [14] Annex A.
	DUT Part	A.3.4.1.1	
Exceptions to connection diagram	N/A		

1. Message contents are defined in clause 5.3.2.2.4.3.
2. Cell 1 is the E-UTRA serving cell (PCell) for the EN-DC setup. The E-UTRAN PCell power levels and settings are specified in Table A.6.1.1-1. Cell 2 is the NR FR2 PSCell. The connection setup is done according to the settings in clause C.1.3, with downlink signal levels as per clause C.1.2. General Test parameters are defined in Table 5.3.2.2.5-1.
3. Downlink signals for NR cell are initially set up according to clause C.2.1.
4. The UE Rx beam peak direction has been obtained previously using one of the Rx Beam Peak Search procedures as described in Annex I.

#### 5.3.2.2.4.2 Test procedure

For this test two cells are used, an E-UTRA serving cell (PCell) and an NR FR2 PSCell. For the NR PSCell, the System Simulator shall not explicitly assign a random access preamble via dedicated signalling in the downlink.

1. Ensure the UE is in state E-UTRA RRC\_CONNECTED with generic procedure parameters *Connectivity E-UTRA/EPC* with Test Mode *On* according to TS 38.508-1 [14] clause 4.5.
2. Set the parameters according to Table 5.3.2.2.5-1.
3. SS sends a RRCReconfiguration to trigger a contention-free random access procedure according to Table 5.3.2.2.4.3-2.
4. Test 1: Correct behaviour when transmitting SSB-based Random Access Preamble
  - 4.1. The UE shall send a preamble to the System Simulator. The System Simulator shall check that the Random Access Preamble has the Preamble Index associated with the SSB with index 0, that it arrives on a PRACH occasion which belongs to the PRACH occasions corresponding to the SSB with index 0, and that the selected PRACH occasion belongs to the PRACH occasions permitted by the restrictions given by the *ra-ssb-OccasionMaskIndex*.
5. Test 2: Correct behaviour when transmitting CSI-RS-based Random Access Preamble
  - 5.1. Set the parameters according to Table 5.3.2.2.5-1 Subtest 2.
  - 5.2. Repeat steps 1-3
  - 5.3. The UE shall send a preamble to the System Simulator. The System Simulator shall check that the Random Access Preamble has the Preamble Index associated with the CSI-RS configured, that it arrives on a PRACH occasion which belongs to the PRACH occasions corresponding to the CSI-RS configured, and that the selected PRACH occasion belongs to the PRACH occasions permitted by the restrictions given by the *ra-OccasionList*.
6. Test 3: Correct behaviour when receiving Random Access Response
  - 6.1. Repeat steps 1-3

- 6.2. The UE shall send preambles to the System Simulator. In response to the first 2 preambles, the System Simulator shall transmit a Random Access Response containing Random Access Preamble identifiers that do not match the transmitted Random Access Preamble.
- 6.3. As the received Random Access Responses contain Random Access Preamble identifiers that do not match the transmitted Random Access Preamble, the UE shall perform the Random Access Resource selection procedure specified in clause 5.1.2 in TS 38.321 [12], and transmit with the calculated PRACH transmission power.
- 6.4. The System Simulator shall transmit a Random Access Response containing a Random Access Preamble identifier matching the transmitted Random Access Preamble after 3 preambles have been received by the System Simulator.
- 6.5. As the received Random Access Response contains a Random Access Preamble identifier that matches the transmitted Random Access Preamble, the UE may stop monitoring for Random Access Response(s).
- 6.6. Measure the power and timing of the first preamble and it shall not exceed the values specified in 5.3.2.2.2.5. Measure the relative power and timing applied to additional preambles (last 2 preambles) and it shall not exceed the values specified in 5.3.2.2.2.5.
- 7. Test 4: Correct behaviour when not receiving Random Access Response
  - 7.1. Repeat steps 1-3.
  - 7.2. The UE shall send preambles to the System Simulator. The System Simulator shall not respond to the first 2 preambles.
  - 7.3. As no Random Access Response was received within the RA Response window configured in *RACH-ConfigCommon*, the UE shall perform the Random Access Resource selection procedure specified in clause 5.1.2 in TS 38.321 [12], and transmit with the calculated PRACH transmission power.
  - 7.4. The System Simulator shall transmit a Random Access Response containing a Random Access Preamble identifier matching the transmitted Random Access Preamble after 3 preambles have been received by the System Simulator.
  - 7.5. As the received Random Access Response contains a Random Access Preamble identifier that matches the transmitted Random Access Preamble, the UE may stop monitoring for Random Access Response(s).
  - 7.6. Measure the power and timing of the first preamble and it shall not exceed the values specified in 5.3.2.2.2.5. Measure the relative power and timing applied to additional preambles (last 2 preambles) and it shall not exceed the values specified in 5.3.2.2.2.5.

5.3.2.2.2.4.3 Message contents

Message contents are according to TS 38.508-1 [14] clause 7.3.1 with the following exceptions:

**Table 5.3.2.2.2.4.3-0: Common Exception messages**

Default Message Contents	
Common contents of system information blocks exceptions	
Default RRC messages and information elements contents exceptions	
Common exceptions to the contents of TS 38.508-1 [14]	Table 4.6.3-115 with SSB-Index 0 Table 4.6.3-120 with SSB-Index 0

**Table 5.3.2.2.4.3-1: RACH-ConfigCommon for Non-Contention Based Random Access**

Derivation Path: TS 38.508-1 [14], table 4.6.3-128			
Information Element	Value/remark	Comment	Condition
RACH-ConfigCommon ::= SEQUENCE {			
rach-ConfigGeneric	RACH-ConfigGeneric		
totalNumberOfRA-Preambles	48		
groupBconfigured SEQUENCE {			
numberOfRA-PreamblesGroupA	48		
}			
rsrp-ThresholdSSB	RSRP <sub>69</sub> + $\Delta_{DL}$	$\Delta_{DL}$ is derived from the downlink calibration process	Subtest 1
prach-RootSequenceIndex CHOICE {			
1139	0		
}			
msg1-SubcarrierSpacing	kHz 120		
}			
}			

**Table 5.3.2.2.4.3-2: RACH-ConfigDedicated for Non-Contention Based Random Access**

Derivation Path: TS 38.508-1 [14], table 4.6.3-129			
Information Element	Value/remark	Comment	Condition
RACH-ConfigDedicated ::= SEQUENCE {			
cfra SEQUENCE {			
occasions SEQUENCE {			
ssb-perRACH-Occasion	oneFourth		
}			
resources CHOICE {			
ssb SEQUENCE {			
ssb-ResourceList SEQUENCE (SIZE(1..maxRA-SSB-Resources)) OF {	1 entry		
ssb[1]	0		
ra-PreambleIndex[1]	50		Subtest 1
}			
ra-ssb-OccasionMaskIndex	1		Subtest 1
}			
csirs SEQUENCE {			
csirs-ResourceList SEQUENCE (SIZE(1..maxRA-CSIRS-Resources)) OF {			
ra-OccasionList	1		Subtest 2
ra-PreambleIndex[1]	50		Subtest 2
}			
rsrp-ThresholdCSI-RS	RSRP <sub>69</sub> + $\Delta_{DL}$	$\Delta_{DL}$ is derived from the downlink calibration process	Subtest 2
}			
}			
}			
}			

**Table 5.3.2.2.2.4.3-3: RACH-ConfigGeneric for Non-Contention Based Random Access**

Derivation Path: TS 38.508-1 [14], table 4.6.3-130			
Information Element	Value/remark	Comment	Condition
RACH-ConfigGeneric ::= SEQUENCE {			
prach-ConfigurationIndex	190		FR2
msg1-FDM	one		FR2
zeroCorrelationZoneConfig	11		
preambleReceivedTargetPower	-100		
preambleTransMax	n6		
powerRampingStep	dB2		
ra-ResponseWindow	sl10		
}			

**Table 5.3.2.2.2.4.3-4: ServingCellConfigCommon for Non-Contention Based Random Access**

Derivation Path: TS 38.508-1 [14], table 4.6.3-168			
Information Element	Value/remark	Comment	Condition
ServingCellConfigCommon ::= SEQUENCE {			
ssb-PositionsInBurst SEQUENCE {			
inOneGroup	'1100 0000'B		
}			
ss-PBCH-BlockPower	20 + $\Delta_{UL}$	$\Delta_{UL}$ is derived from the uplink calibration process	
}			

**Table 5.3.2.2.2.4.3-5: CellGroupConfig for Non-Contention Based Random Access**

Derivation Path: TS 38.508-1 [14], table 4.6.3-19			
Information Element	Value/remark	Comment	Condition
CellGroupConfig ::= SEQUENCE {			
spCellConfig SEQUENCE {			
servCellIndex	ServCellIndex		
reconfigurationWithSync SEQUENCE {			
newUE-Identity	1		
rach-ConfigDedicated CHOICE {			
uplink	RACH-ConfigDedicated		
}			
}			
}			

#### 5.3.2.2.2.5 Test requirement

Table 5.3.2.2.2.5-2 defines the primary level settings for non-contention based random access test in FR2 for NR Standalone. Tables 5.3.2.2.2.5-3, 5.3.2.2.2.5-4 and 5.3.2.2.2.5-5 define the Absolute power limits, Relative power limits and uplink timing error limits respectively, and all include test tolerances.

Table 5.3.2.2.5-1: General test parameters

Parameter	Unit	Test-1	Test-2	Comments
SSB Configuration	Config 1,2	SSB.1 FR2	SSB.1 FR2	As defined in A.3.2
CSI-RS Configuration	Config 1,2	N/A	CSI-RS.3.1 TDD	As defined in A.1.4
Duplex Mode for Cell 2	Config 1,2	TDD	TDD	
TDD Configuration	Config 1,2	TDDConf.3.1	TDDConf.3.1	As defined in A.1.5
BW <sub>channel</sub>	Config 1,2	MHz	100: N <sub>RB,c</sub> = 24	100: N <sub>RB,c</sub> = 24
OCNG Pattern <sup>Note 1</sup>		OP.3	OP.3	As defined in A.2.1.
PDSCH Reference Channel <sup>Note 2</sup>	Config 1,2	SR3.1 TDD	SR3.1 TDD	As defined in A.1.1.
RMSI CORESET Reference Channel	Config 1,2	CR.3.1 TDD	CR.3.1 TDD	As defined in A.1.2
RMC CORESET Reference Channel	Config 1,2	CCR.3.1 TDD	CCR.3.1 TDD	As defined in A.1.3
NR RF Channel Number		1	1	
EPRE ratio of PSS to SSS	dB	0	0	
EPRE ratio of PBCH_DMRS to SSS	dB			
EPRE ratio of PBCH to PBCH_DMRS	dB			
EPRE ratio of PDCCH_DMRS to SSS	dB			
EPRE ratio of PDCCH to PDCCH_DMRS	dB			
EPRE ratio of PDSCH_DMRS to SSS	dB			
EPRE ratio of PDSCH to PDSCH_DMRS	dB			
ss-PBCH-BlockPower	dBm/ SCS	+20 + $\Delta_{UL}$	+20 + $\Delta_{UL}$	As defined in TS 38.331 [13]. $\Delta_{UL}$ is derived from the uplink calibration process <sup>Note 3</sup>
Configured UE transmitted power ( $P_{CMAX, f, c}$ )	dBm	maximum value configurable for certain power class	maximum value configurable for certain power class	As defined in clause 6.2.4 in TS 38.101-2 [3]
PRACH Configuration		PRACH.2 FR2	PRACH.3 FR2	As defined in A.7.2, with exceptions as defined below.
rsrp-ThresholdSSB	dBm	RSRP <sub>69</sub> + $\Delta_{DL}$	RSRP <sub>69</sub> + $\Delta_{DL}$	RSRP <sub>69</sub> corresponds to -88dBm. $\Delta_{DL}$ is derived from the downlink calibration process <sup>Note 4</sup>
preambleReceivedTargetPower	dBm	-100	-100	As defined in TS 38.331 [13]
NOTE 1: OCNG shall be used such that a constant total transmitted power spectral density is achieved for all OFDM symbols. The OCNG pattern is chosen during the test according to the presence of a DL reference measurement channel.				
NOTE 2: The DL PDSCH reference measurement channel is used in the test only when a downlink transmission dedicated to the UE under test is required.				
NOTE 3: The $\Delta_{UL}$ value is calculated as $-\text{ROUND}(\text{PPRACH0} - 1)$ , where PPRACH0 is the measured first PRACH power with -80.6dBm/SCS applied, $\text{preambleReceivedTargetPower} = -100\text{dBm}$ and $\text{ss-PBCH-BlockPower} = 20\text{dBm}$ . These values are used during the uplink calibration process carried out before the test case is run, with the UE configured to send PRACH.				
NOTE 4: The $\Delta_{DL}$ value is calculated as $(\text{RSRP}_{\text{REP}} - \text{RSRP}_{76})$ , where RSRP <sub>REP</sub> is the SS-RSRP Reported value in Table 10.1.6.1-1 with -80.6dBm/SCS applied. These values are used during the downlink calibration process carried out before the test case is run, with the UE configured to report SS-RSRP. For a Reported value RSRP <sub>x</sub> , x is treated as a positive integer value.				

Table 5.3.2.2.5-2: OTA-related test parameters

Parameter	Unit	Test-1	Test-2	Comments
AoA setup		Setup 1	Setup 1	As defined in A.9.1
Assumption for UE beams <sup>Note 2</sup>		Rough	Rough	
SSB with index 0	Es <sup>Note 1</sup>	dBm/SCS	-80.6	Power of SSB with index 0 is set to be above configured <i>rsrp-ThresholdSSB</i>
	SSB_RP	dBm/SCS	-80.6	
	Es/lot <sub>BB</sub>	dB	21.09	
	lo	dBm/95.0 4 MHz	-56.01	lo in symbols containing SSB index 0
SSB with index 1	Es <sup>Note 1</sup>	dBm/SCS	-95.0	Power of SSB with index 1 is set to be below configured <i>rsrp-ThresholdSSB</i>
	SSB_RP	dBm/SCS	-95.0	
	Es/lot <sub>BB</sub>	dB	6.69	
	lo	dBm/95.0 4 MHz	-70.41	lo in symbols containing SSB index 1
Propagation Condition	-	AWGN	AWGN	
NOTE 1: No artificial noise is applied in this test.				
NOTE 2: Information about types of UE beam is given in TS 38.133 [6] clause B.2.1.3, and does not limit UE implementation or test system implementation				

Test 1: Correct behaviour when transmitting SSB-based Random Access Preamble

- The Random Access Preamble shall be one of the Random Access Preambles associated with SSB index 0.
- The Random Access Preamble shall arrive on a PRACH occasion which belongs to the PRACH occasions corresponding to the SSB with index 0.
- The selected PRACH occasion shall belong to the PRACH occasions permitted by the restrictions given by the *ra-ssb-OccasionMaskIndex*.

Test 2: Correct behaviour when transmitting CSI-RS-based Random Access Preamble

- The Random Access Preamble shall have the Preamble Index associated with the CSI-RS configured.
- The Random Access Preamble shall arrive on a PRACH occasion which belongs to the PRACH occasions corresponding to the CSI-RS configured.
- The selected PRACH occasion belongs to the PRACH occasions permitted by the restrictions given by the *ra-OccasionList*.

Test 3: Correct behaviour when receiving Random Access Response

- The power of the first preamble shall be 0.6 dBm within the accuracy specified in Table 5.3.2.2.5-3.
- The relative power for preamble ramping step shall be 2 dB within the accuracy specified in Table 5.3.2.2.5-4.
- The transmit timing of all PRACH transmissions shall be within the accuracy specified in Table 5.3.2.2.5-5.

Test 4: Correct behaviour when not receiving Random Access Response

- The power of the first preamble shall be 0.6 dBm within the accuracy specified in Table 5.3.2.2.5-3.
- The relative power for preamble ramping step shall be 2 dB within the accuracy specified in Table 5.3.2.2.5-4.
- The transmit timing of all PRACH transmissions shall be within the accuracy specified in Table 5.3.2.2.5-5.

Table 5.3.2.2.5-3 Absolute power tolerance Test requirements

Conditions	Tolerance
Normal	± FFS dB

**Table 5.3.2.2.5-4 Relative power tolerance Test requirements**

Measured power	Power step $\Delta P$ (dB)	PRACH (dB)
Measured power of both PRACHs being compared > $(P_{\max}^{\text{Note1}} - 6\text{dB})$	$2 \leq \Delta P < 3$	$\pm (4+\text{FFS})$ .
Measured power of either PRACHs being compared $\leq (P_{\max}^{\text{Note1}} - 6\text{dB})$		$\pm (6+\text{FFS})$
NOTE 1: $P_{\max}$ is the Min peak EIRP defined in clause 6.2.1 of TS 38.101-2 [3], selected according to power class and operating band.		

**Table 5.3.2.2.5-5:  $T_e$  Timing error Test requirements**

Frequency Range	SCS of SSB signals (kHz)	SCS of uplink signals s(KHz)	$T_e$
2	120	120	$224+[48]*T_c$
NOTE 1: $T_c$ is the basic timing unit defined in TS 38.211 [7]			

### 5.3.2.2.3 EN-DC FR2 2-step contention based random access

Editor's note: This test case is incomplete. The following aspects are either missing or TBD

- Message contents are not complete.
- TT analysis and test requirements are missing.
- Test procedure is FFS

#### 5.3.2.2.3.1 Test purpose

The purpose of this test is to verify that the behaviour of the random access procedure is according to the requirements and that the MsgA PRACH and MsgA PUSCH power settings and timing are within specified limits.

#### 5.3.2.2.3.2 Test applicability

This test applies to all types of E-UTRA UE release 16 and forward, supporting EN-DC with FR2.

#### 5.3.2.2.3.3 Minimum conformance requirement

Same as in clause 4.3.2.2.3.3

The normative reference for this requirement is TS 38.133 [6] clause 6.2.2 and A.5.3.2.2.3.

#### 5.3.2.2.3.4 Test description

##### 5.3.2.2.3.4.1 Initial conditions

This test can be run in the configurations defined in Table 5.3.2.2.3.4.1-1.

**Table 5.3.2.2.3.4.1-1: Supported test configurations**

Test Case ID	Test Config Index	Description
5.3.2.2.3-1	1	LTE FDD, NR 120 kHz SSB SCS, 10MHz bandwidth, TDD
5.3.2.2.3-2	2	LTE TDD, NR 120 kHz SSB SCS, 10MHz bandwidth, TDD
NOTE: The UE is only required to be tested in one of the supported test configurations		



Before the test procedure, Downlink and Uplink calibrations are carried out to derive signalled parameter values. This is necessary to ensure that the test case operates within the specified ranges. The detail of the calibration process is implementation dependent, but shall derive the values of  $\Delta_{DL}$  and  $\Delta_{UL}$  according to the following principles:

With the UE configured to report SS-RSRP, the  $\Delta_{DL}$  value is calculated as  $(RSRP_{REP} - RSRP_{76})$ , where  $RSRP_{REP}$  is the SS-RSRP Reported value according to TS 38.133 [6] Table 10.1.6.1-1 with -80.6dBm/SCS applied at the Reference point. For a Reported value  $RSRP_x$ , x is treated as a positive integer value.

With the UE configured to send a first PRACH preamble,  $\Delta_{UL}$  value is calculated as  $-\text{ROUND}(\text{PPRACH0} - 1)$ , where PPRACH0 is the measured first PRACH power with -80.6dBm/SCS applied at the Reference point, and with signalled values  $preambleReceivedTargetPower = -100\text{dBm}$  and  $ss-PBCH-BlockPower = 20\text{dBm}$ .

Configure the test equipment and the DUT according to the parameters in Table 5.3.2.2.3.4.1-2.

**Table 5.3.2.2.3.4.1-2: Initial conditions**

Parameter	Value		Comment
Test environment	NC		As specified in TS 38.508-1 [14] clause 4.1.
Test frequencies	As specified in Annex E, E.1.1, E.1.3.1 and Table E.3-1 and TS 38.508-1 [14] clause 4.3.1 for E-UTRA and 7.2.3 for NR		
Channel bandwidth	As specified by the test configuration selected from Table 4.3.2.2.1.4.1-1.		
Propagation conditions	AWGN		As specified in clause C.2.2.
Connection Diagram	TE Part	A.3.3.1.1	As specified in TS 38.508-1 [14] Annex A.
	DUT Part	A.3.4.1.1	
Exceptions to connection diagram	N/A		

1. Message contents are defined in clause 5.3.2.2.3.4.3.
2. Cell 1 is the E-UTRA serving cell (PCell) for the EN-DC setup. The E-UTRAN PCell power levels and settings are specified in Table A.6.1.1-1. Cell 2 is the NR FR2 PSCell. The connection setup is done according to the settings in clause C.1.3, with downlink signal levels as per clause C.1.2. General Test parameters are defined in Table 5.3.2.2.3.5-1.
3. Downlink signals for NR cell are initially set up according to clause C.2.1.
4. The UE Rx beam peak direction has been obtained previously using one of the Rx Beam Peak Search procedures as described in Annex I.

#### 5.3.2.2.3.4.2 Test procedure

For this test two cells are used, an E-UTRA serving cell (PCell) and an NR FR2 PSCell. For the NR PSCell, the System Simulator shall not explicitly assign a random access preamble via dedicated signalling in the downlink.

1. Ensure the UE is in state E-UTRA RRC\_CONNECTED with generic procedure parameters *Connectivity E-UTRA/EPC* with Test Mode *On* according to TS 38.508-1 [14] clause 4.5.
2. Set the parameters according to Table 5.3.2.2.3.5-1.
3. The test system shall send a RRCReconfiguration message to the UE to add NR PSCell, then the UE shall trigger a random access procedure.

FFS

#### 5.3.2.2.3.4.3 Message contents

Message contents are according to TS 38.508-1 [14] clause 7.3.1 with the following exceptions:

**Table 5.3.2.2.3.4.3-0: Common Exception messages**

Default Message Contents	
Common contents of system information blocks exceptions	
Default RRC messages and information elements contents exceptions	FFS
Common exceptions to the contents of TS 38.508-1 [14]	FFS

#### 5.3.2.2.3.5 Test requirement

Table 5.3.2.2.3.5-2 defines the primary level settings for contention based random access test in FR2 for NR Standalone. The test requirements are FFS.

Table 5.3.2.2.3.5-1: General test parameters

Parameter		Unit	Test-1	Comments
SSB Configuration	Config 1,2		SSB.1 FR2	As defined in A.3.2
Duplex Mode for Cell 2	Config 1,2		TDD	
TDD Configuration	Config 1,2		TDDConf.3.1	As defined in A.1.5
$BW_{channel}$	Config 1,2	MHz	100: $N_{RB,c} = 24$	
OCNG Pattern <sup>Note 1</sup>			OP.3	As defined in A.2.1
PDSCH Reference Channel <sup>Note 2</sup>	Config 1,2		SR.3.1 TDD	As defined in A.1.1
RMSI CORESET Reference Channel	Config 1,2		CR.3.1 TDD	As defined in A.1.2
RMC CORESET Reference Channel	Config 1,2		CCR.3.1 TDD	As defined in A.1.3
NR RF Channel Number			1	
EPRE ratio of PSS to SSS		dB	0	
EPRE ratio of PBCH_DMRS to SSS		dB		
EPRE ratio of PBCH to PBCH_DMRS		dB		
EPRE ratio of PDCCH_DMRS to SSS		dB		
EPRE ratio of PDCCH to PDCCH_DMRS		dB		
EPRE ratio of PDSCH_DMRS to SSS		dB		
EPRE ratio of PDSCH to PDSCH_DMRS		dB		
<i>ss-PBCH-BlockPower</i>		dBm/ SCS	+20 + $\Delta_{UL}$	As defined in TS 38.331 [13]. $\Delta_{UL}$ is derived from the uplink calibration process <sup>Note 3</sup>
Configured UE transmitted power ( $P_{C_{MAX, f, c}}$ )		dBm	maximum value configurable for certain power class	As defined in clause 6.2.4 of TS 38.101-2 [3]
MsgA Configuration			FR2 MsgA configuration 1	As defined in FFS, with exceptions as defined below
<i>msgA-RSRP-ThresholdSSB</i>		dBm	RSRP_69 + $\Delta_{DL}$	RSRP_69 corresponds to -88dBm. $\Delta_{DL}$ is derived from the downlink calibration process <sup>Note 4</sup>
<i>msgA-PreambleReceivedTargetPower</i>		dBm	-100	As defined in TS 38.331 [13]
<p>NOTE 1: OCNG shall be used such that a constant total transmitted power spectral density is achieved for all OFDM symbols. The OCNG pattern is chosen during the test according to the presence of a DL reference measurement channel.</p> <p>NOTE 2: The DL PDSCH reference measurement channel is used in the test only when a downlink transmission dedicated to the UE under test is required.</p> <p>NOTE 3: The <math>\Delta_{UL}</math> value is calculated as <math>-\text{ROUND}(\text{PPRACH0} - 1)</math>, where PPRACH0 is the measured first PRACH power with -80.6dBm/SCS applied, <i>preambleReceivedTargetPower</i> = -100dBm and <i>ss-PBCH-BlockPower</i> = 20dBm. These values are used during the uplink calibration process carried out before the test case is run, with the UE configured to send PRACH.</p> <p>NOTE 4: The <math>\Delta_{DL}</math> value is calculated as <math>(\text{RSRP}_{\text{REP}} - \text{RSRP}_{76})</math>, where RSRP_REP is the SS-RSRP Reported value in Table 10.1.6.1-1 with -80.6dBm/SCS applied. These values are used during the downlink calibration process carried out before the test case is run, with the UE configured to report SS-RSRP. For a Reported value RSRP_x, x is treated as a positive integer value.</p>				

Table 5.3.2.2.3.5-2: OTA-related test parameters

Parameter	Unit	Test-1	Comments	
AoA setup		Setup 1	As defined in A.9.1	
Assumption for UE beams <sup>Note 2</sup>		Rough		
SSB with index 0	Es <sup>Note1</sup>	dBm/SCS	-80.6	Power of SSB with index 0 is set to be above configured <i>rsrp-ThresholdSSB</i>
	SSB_RP	dBm/SCS	-80.6	
	Es/Iot <sub>BB</sub>	dB	21.09	
	Io	dBm/95.04 MHz	-56.01	Io in symbols containing SSB index 0
SSB with index 1	Es <sup>Note1</sup>	dBm/SCS	-95.0	Power of SSB with index 1 is set to be below configured <i>rsrp-ThresholdSSB</i>
	SSB_RP	dBm/SCS	-95.0	
	Es/Iot <sub>BB</sub>	dB	6.69	
	Io	dBm/95.04 MHz	-70.41	Io in symbols containing SSB index 1
Propagation Condition	-	AWGN		
NOTE 1: No artificial noise is applied in this test.				
NOTE 2: Information about types of UE beam is given in TS 38.133 [6] clause B.2.1.3, and does not limit UE implementation or test system implementation				

#### 5.3.2.2.4 EN-DC FR2 2-step non-contention based random access

**Editor's note: This test case is incomplete. The following aspects are either missing or TBD**

- Message contents are not complete.
- TT analysis and test requirements are missing.
- Test procedure is FFS

##### 5.3.2.2.4.1 Test purpose

The purpose of this test is to verify that the behaviour of the random access procedure is according to the requirements and that the MsgA PRACH and MsgA PUSCH power settings and timing are within specified limits.

##### 5.3.2.2.4.2 Test applicability

This test applies to all types of E-UTRA UE release 16 and forward, supporting EN-DC with FR2.

##### 5.3.2.2.4.3 Minimum conformance requirement

Same as in clause 4.3.2.2.4.3

The normative reference for this requirement is TS 38.133 [6] clause 6.2.2 and A.5.3.2.2.4.

##### 5.3.2.2.4.4 Test description

###### 5.3.2.2.4.4.1 Initial conditions

This test can be run in the configurations defined in Table 5.3.2.2.4.4.1-1.

Table 5.3.2.2.4.4.1-1: Supported test configurations

Test Case ID	Test Config Index	Description
5.3.2.2.4-1	1	LTE FDD, NR 120 kHz SSB SCS, 10MHz bandwidth, TDD
5.3.2.2.4-2	2	LTE TDD, NR 120 kHz SSB SCS, 10MHz bandwidth, TDD
NOTE: The UE is only required to be tested in one of the supported test configurations		

Before the test procedure, Downlink and Uplink calibrations are carried out to derive signalled parameter values. This is necessary to ensure that the test case operates within the specified ranges. The detail of the calibration process is implementation dependent, but shall derive the values of  $\Delta_{DL}$  and  $\Delta_{UL}$  according to the following principles:

With the UE configured to report SS-RSRP, the  $\Delta_{DL}$  value is calculated as  $(RSRP_{REP} - RSRP_{76})$ , where  $RSRP_{REP}$  is the SS-RSRP Reported value according to TS 38.133 [6] Table 10.1.6.1-1 with -80.6dBm/SCS applied at the Reference point. For a Reported value  $RSRP_x$ , x is treated as a positive integer value.

With the UE configured to send a first PRACH preamble,  $\Delta_{UL}$  value is calculated as  $-\text{ROUND}(\text{PPRACH0} - 1)$ , where PPRACH0 is the measured first PRACH power with -80.6dBm/SCS applied at the Reference point, and with signalled values  $preambleReceivedTargetPower = -100\text{dBm}$  and  $ss\text{-PBCH-BlockPower} = 20\text{dBm}$ .

Configure the test equipment and the DUT according to the parameters in Table 5.3.2.2.4.4.1-2.

**Table 5.3.2.2.4.4.1-2: Initial conditions**

Parameter	Value		Comment
Test environment	NC		As specified in TS 38.508-1 [14] clause 4.1.
Test frequencies	As specified in Annex E, E.1.1, E.1.3.1 and Table E.3-1 and TS 38.508-1 [14] clause 4.3.1 for E-UTRA and 7.2.3 for NR.		
Channel bandwidth	As specified by the test configuration selected from Table 4.3.2.2.1.4.1-1.		
Propagation conditions	AWGN		As specified in clause C.2.2.
Connection Diagram	TE Part	A.3.3.1.1	As specified in TS 38.508-1 [14] Annex A.
	DUT Part	A.3.4.1.1	
Exceptions to connection diagram	N/A		

1. Message contents are defined in clause 5.3.2.2.4.4.3.
2. Cell 1 is the E-UTRA serving cell (PCell) for the EN-DC setup. The E-UTRAN PCell power levels and settings are specified in Table A.6.1.1-1. Cell 2 is the NR FR2 PSCell. The connection setup is done according to the settings in clause C.1.3, with downlink signal levels as per clause C.1.2. General Test parameters are defined in Table 5.3.2.2.4.5-1.
3. Downlink signals for NR cell are initially set up according to clause C.2.1.
4. The UE Rx beam peak direction has been obtained previously using one of the Rx Beam Peak Search procedures as described in Annex I.

#### 5.3.2.2.4.4.2 Test procedure

For this test two cells are used, an E-UTRA serving cell (PCell) and an NR FR2 PSCell. For the NR PSCell, the System Simulator shall not explicitly assign a random access preamble via dedicated signalling in the downlink.

1. Ensure the UE is in state E-UTRA RRC\_CONNECTED with generic procedure parameters *Connectivity E-UTRA/EPC* with Test Mode *On* according to TS 38.508-1 [14] clause 4.5.
2. Set the parameters according to Table 5.3.2.2.4.5-1.
3. The test system shall send a RRCReconfiguration message to the UE to add NR PSCell, then the UE shall trigger a random access procedure.

FFS

#### 5.3.2.2.4.4.3 Message contents

Message contents are according to TS 38.508-1 [14] clause 7.3.1 with the following exceptions:

**Table 5.3.2.2.4.3-0: Common Exception messages**

Default Message Contents	
Common contents of system information blocks exceptions	
Default RRC messages and information elements contents exceptions	FFS
Common exceptions to the contents of TS 38.508-1 [14]	FFS

#### 5.3.2.2.4.5 Test requirement

Table 5.3.2.2.4.5-2 defines the primary level settings for non-contention based random access test in FR2 for NR Standalone. The test requirements are FFS.

Table 5.3.2.2.4.5-1: General test parameters

Parameter		Unit	Test-1	Comments
SSB Configuration	Config 1,2		SSB.1 FR2	As defined in A.3.2
Duplex Mode for Cell 2	Config 1,2		TDD	
TDD Configuration	Config 1,2		TDDConf.3.1	As defined in A.1.5
$BW_{channel}$	Config 1,2	MHz	100: $N_{RB,c} = 24$	
OCNG Pattern <sup>Note 1</sup>			OP.3	As defined in A.2.1
PDSCH Reference Channel <sup>Note 2</sup>	Config 1,2		SR.3.1 TDD	As defined in A.1.1
RMSI CORESET Reference Channel	Config 1,2		CR.3.1 TDD	As defined in A.1.2
RMC CORESET Reference Channel	Config 1,2		CCR.3.1 TDD	As defined in A.1.3
NR RF Channel Number			1	
EPRE ratio of PSS to SSS		dB	0	
EPRE ratio of PBCH_DMRS to SSS		dB		
EPRE ratio of PBCH to PBCH_DMRS		dB		
EPRE ratio of PDCCH_DMRS to SSS		dB		
EPRE ratio of PDCCH to PDCCH_DMRS		dB		
EPRE ratio of PDSCH_DMRS to SSS		dB		
EPRE ratio of PDSCH to PDSCH_DMRS		dB		
<i>ss-PBCH-BlockPower</i>		dBm/ SCS	+20 + $\Delta_{UL}$	As defined in TS 38.331 [13]. $\Delta_{UL}$ is derived from the uplink calibration process <sup>Note 3</sup>
Configured UE transmitted power ( $P_{C_{MAX, f, c}}$ )		dBm	maximum value configurable for certain power class	As defined in clause 6.2.4 of TS 38.101-2 [3]
MsgA Configuration			FR2 MsgA configuration 2	As defined in FFS, with exceptions as defined below
<i>msgA-RSRP-ThresholdSSB</i>		dBm	RSRP_69 + $\Delta_{DL}$	RSRP_69 corresponds to -88dBm. $\Delta_{DL}$ is derived from the downlink calibration process <sup>Note 4</sup>
<i>msgA-PreambleReceivedTargetPower</i>		dBm	-100	As defined in TS 38.331 [13]
<p>NOTE 1: OCNG shall be used such that a constant total transmitted power spectral density is achieved for all OFDM symbols. The OCNG pattern is chosen during the test according to the presence of a DL reference measurement channel.</p> <p>NOTE 2: The DL PDSCH reference measurement channel is used in the test only when a downlink transmission dedicated to the UE under test is required.</p> <p>NOTE 3: The <math>\Delta_{UL}</math> value is calculated as <math>-\text{ROUND}(\text{PPRACH0} - 1)</math>, where PPRACH0 is the measured first PRACH power with -80.6dBm/SCS applied, <i>preambleReceivedTargetPower</i> = -100dBm and <i>ss-PBCH-BlockPower</i> = 20dBm. These values are used during the uplink calibration process carried out before the test case is run, with the UE configured to send PRACH.</p> <p>NOTE 4: The <math>\Delta_{DL}</math> value is calculated as <math>(\text{RSRP}_{\text{REP}} - \text{RSRP}_{76})</math>, where RSRP_REP is the SS-RSRP Reported value in Table 10.1.6.1-1 with -80.6dBm/SCS applied. These values are used during the downlink calibration process carried out before the test case is run, with the UE configured to report SS-RSRP. For a Reported value RSRP_x, x is treated as a positive integer value.</p>				

Table 5.3.2.2.4.5-2: OTA-related test parameters

Parameter	Unit	Test-1	Comments	
AoA setup		Setup 1	As defined in A.9.1	
Assumption for UE beams <sup>Note 2</sup>		Rough		
SSB with index 0	Es <sup>Note1</sup>	dBm/SCS	-80.6	Power of SSB with index 0 is set to be above configured <i>rsrp-ThresholdSSB</i>
	SSB_RP	dBm/SCS	-80.6	
	Es/Iot <sub>BB</sub>	dB	21.09	
	Io	dBm/95.04 MHz	-56.01	Io in symbols containing SSB index 0
SSB with index 1	Es <sup>Note1</sup>	dBm/SCS	-95.0	Power of SSB with index 1 is set to be below configured <i>rsrp-ThresholdSSB</i>
	SSB_RP	dBm/SCS	-95.0	
	Es/Iot <sub>BB</sub>	dB	6.69	
	Io	dBm/95.04 MHz	-70.41	Io in symbols containing SSB index 1
Propagation Condition	-	AWGN		
NOTE 1: No artificial noise is applied in this test.				
NOTE 2: Information about types of UE beam is given in TS 38.133 [6] clause B.2.1.3, and does not limit UE implementation or test system implementation				

### 5.3.2.3 Void

## 5.4 Timing

### 5.4.1 UE transmit timing

#### 5.4.1.0 Minimum Conformance Requirements

##### 5.4.1.0.1 Minimum conformance requirements for UE transmit timing accuracy

The UE initial transmission timing error shall be less than or equal to  $\pm T_e$  where the timing error limit value  $T_e$  is specified in Table 5.4.1.0.1-1. This requirement applies:

- when it is the first transmission in a DRX cycle for PUCCH, PUSCH and SRS or it is the PRACH transmission.

The UE shall meet the  $T_e$  requirement for an initial transmission provided that at least one SSB is available at the UE during the last 160 ms. The reference point for the UE initial transmit timing control requirement shall be the downlink timing of the reference cell minus  $(N_{TA} + N_{TA\ offset}) \times T_c$ . The downlink timing is defined as the time when the first detected path (in time) of the corresponding downlink frame is received from the reference cell.  $N_{TA}$  for PRACH is defined as 0.

$(N_{TA} + N_{TA\ offset}) \times T_c$  (in  $T_c$  units) for other channels is the difference between UE transmission timing and the downlink timing immediately after when the last timing advance in TS 38.133 [6] clause 7.3 was applied.  $N_{TA}$  for other channels is not changed until next timing advance is received. The value of  $N_{TA\ offset}$  depends on the duplex mode of the cell in which the uplink transmission takes place and the frequency range (FR).  $N_{TA\ offset}$  is defined in Table 5.4.1.0.1-2.



**Table 5.4.1.0.1-1:  $T_e$  Timing Error Limit**

Frequency Range	SCS of SSB signals (KHz)	SCS of uplink signals (KHz)	$T_e$
1	15	15	$12 \cdot 64 \cdot T_c$
		30	$10 \cdot 64 \cdot T_c$
		60	$10 \cdot 64 \cdot T_c$
	30	15	$8 \cdot 64 \cdot T_c$
		30	$8 \cdot 64 \cdot T_c$
		60	$7 \cdot 64 \cdot T_c$
2	120	60	$3.5 \cdot 64 \cdot T_c$
		120	$3.5 \cdot 64 \cdot T_c$
	240	60	$3 \cdot 64 \cdot T_c$
		120	$3 \cdot 64 \cdot T_c$

NOTE 1:  $T_c$  is the basic timing unit defined in TS 38.211 [6]

**Table 5.4.1.0.1-2: The Value of  $N_{TA\ offset}$** 

Frequency range and band of cell used for uplink transmission	$N_{TA\ offset}$ (Unit: $T_c$ )
FR1 FDD band without LTE-NR coexistence case or FR1 TDD band without LTE-NR coexistence case	25600 (Note 1)
FR1 FDD band with LTE-NR coexistence case	0 (Note 1)
FR1 TDD band with LTE-NR coexistence case	39936 (Note 1)
FR2	13792
NOTE: The UE identifies $N_{TA\ offset}$ based on the information n-TimingAdvanceOffset according to [2]. If UE is not provided with the information n-TimingAdvanceOffset, the default value of $N_{TA\ offset}$ is set as 25600 for FR1 band. In case of multiple UL carriers in the same TAG, UE expects that the same value of n-TimingAdvanceOffset is provided for all the UL carriers according to clause 4.2 in [3] and the value 39936 of $N_{TA\ offset}$ can also be provided for a FDD serving cell. NOTE 2: Void	

When it is not the first transmission in a DRX cycle or there is no DRX cycle, and when it is the transmission for PUCCH, PUSCH and SRS transmission, the UE shall be capable of changing the transmission timing according to the received downlink frame of the reference cell except when the timing advance in TS 38.133 [6] clause 7.3 is applied.

When the transmission timing error between the UE and the reference timing exceeds  $\pm T_e$ , the UE is required to adjust its timing to within  $\pm T_e$ . The reference timing shall be  $(N_{TA} + N_{TA\ offset}) \times T_c$  before the downlink timing of the reference cell. All adjustments made to the UE uplink timing shall follow these rules:

- 1) The maximum amount of the magnitude of the timing change in one adjustment shall be  $T_q$ .
- 2) The minimum aggregate adjustment rate shall be  $T_p$  per second.
- 3) The maximum aggregate adjustment rate shall be  $T_q$  per 200ms.

where the maximum autonomous time adjustment step  $T_q$  and the aggregate adjustment rate  $T_p$  are specified in Table 5.4.1.0.1-3.

**Table 5.4.1.0.1-3:  $T_q$  Maximum Autonomous Time Adjustment Step and  $T_p$  Minimum Aggregate Adjustment rate**

Frequency Range	SCS of uplink signals (KHz)	$T_q$	$T_p$
1	15	$5.5 \cdot 64 \cdot T_c$	$5.5 \cdot 64 \cdot T_c$
	30	$5.5 \cdot 64 \cdot T_c$	$5.5 \cdot 64 \cdot T_c$
	60	$5.5 \cdot 64 \cdot T_c$	$5.5 \cdot 64 \cdot T_c$
2	60	$2.5 \cdot 64 \cdot T_c$	$2.5 \cdot 64 \cdot T_c$
	120	$2.5 \cdot 64 \cdot T_c$	$2.5 \cdot 64 \cdot T_c$

NOTE:  $T_c$  is the basic timing unit defined in TS 38.211 [6]

The normative reference for this requirement is TS.38.133 [6] clause 7.1.2.

#### 5.4.1.1 EN-DC FR2 UE transmit timing accuracy

**Editor's Note:** This test case has been completed for the following configurations:

- Test frequency  $f \leq 40.8$  GHz
- UE PC3
- The test is incomplete for UE power classes other than PC3
- The test is incomplete for test frequencies  $> 40.8$  GHz

##### 5.4.1.1.1 Test purpose

The purpose of this test is to verify that the UE can follow frame timing change of the connected gNB and that the UE initial transmit timing accuracy, maximum amount of timing change in one adjustment, minimum and maximum adjustment rate are within the specified limits. This test will verify the requirements in clause 7.1.2

##### 5.4.1.1.2 Test applicability

This test applies to all types of E-UTRA UE release 15 and forward supporting EN-DC FR2.

##### 5.4.1.1.3 Minimum conformance requirements

The minimum conformance requirements are specified in clause 5.4.1.0.1.

The normative reference for this requirement is TS.38.133 [6] clause A.5.4.1.1

##### 5.4.1.1.4 Test Description

###### 5.4.1.1.4.1 Initial Conditions

This test can be run in one of the configurations defined in Table 5.4.1.1.4.1-1.

**Table 5.4.1.1.4.1-1: Supported test configurations for FR2 PSCell**

Configuration	Description
1	LTE FDD, NR TDD, SSB SCS 240 kHz, data SCS 120 kHz, BW 100 MHz
2	LTE TDD, NR TDD, SSB SCS 240 kHz, data SCS 120 kHz, BW 100 MHz
NOTE: The UE is only required to be tested in one of the supported test configurations in FR2 depending on UE capability.	

Configure the test equipment and the DUT according to the parameters in Table 5.4.1.1.4.1-2

**Table 5.4.1.1.4.1-2: Initial conditions for EN-DC FR2 transmit timing accuracy**

Parameter	Value	Comment
Test environment	NC	As specified in TS 38.508-1 [14] clause 4.1.
Test frequencies	As specified in Annex E.1.1, Table E.3-1 and TS 38.508-1 [14] clause 4.3.1 for E-UTRA and 7.2.3 for NR.	
Channel bandwidth	As specified by the test configuration selected from Table 5.5.1.4.4.1-1	
Propagation conditions	AWGN	As specified in clause C.2.2.
Connection Diagram	TE Part	A.3.3.3.1-1
	DUT Part	A.3.4.1.1
Exceptions to connection diagram	N/A	

1. Message contents are defined in clause 5.4.1.1.4.3.

2. There are two cells, Cell 1 is the E-UTRAN PCell, and Cell 2 is the PSCell, in the test. The E-UTRAN PCell setting refers to Table A.6.1.1-1. The power levels and settings for Cell 1 are set according to Annex A.6, Table A.6.1.1-1. Cell 2 is NR FR2 PSCell. The connection setup is done according to the settings in clause C.1.3, and the downlink signal levels as per clause C.1.2.
3. Downlink signals for NR cell are initially set up according to clause C.1.2 and C.1.3.
4. The UE Rx beam peak direction has been obtained previously using one of the Rx Beam Peak Search procedures as described in Annex I.

#### 5.4.1.1.4.2 Test procedure

The test consists of two cells, a single E-UTRA cell (Pcell), and a single NR FR2 cell (PSCell). The downlink timing of the PSCell is changed and the changes in UE transmit timing are observed. The transmit timing is verified by the UE transmitting SRS used as a measurement reference facilitating the SS timing estimation.

The test sequence shall be carried out in RRC\_CONNECTED for every test case. Unless otherwise stated, the downlink signal and noise are aligned to arrive in the UE Rx beam peak direction.

Following will be the test sequence for this test

1. Ensure the UE is in state RRC\_CONNECTED with generic procedure parameters *Connectivity* EN-DC, DC bearer MCG and SCG, Connected without release *On* and Test Mode *On* according to TS 38.508-1 [6] clause 4.5.
2. Set up E-UTRA PCell according to parameters given in Table A.6.1.1-1 and setup NR PSCell according to parameters given in Table 5.4.1.1.4.1-1.
3. The SS shall transmit an RRCConnectionReconfiguration message configuring the UE with the message content defined in clause 5.4.1.1.4.3.
4. The UE shall transmit RRCConnectionReconfigurationComplete message.
5. Set the UE in the Rx beam peak direction found with a 3D EIS scan as performed in Annex I.1 - I.3. Allow at least BEAM\_SELECT\_WAIT\_TIME (NOTE 1) for the UE Rx beam selection to complete.
6. After connection set up with the cell and during 2 seconds before DL timing adjustment, the test equipment shall monitor all SRS transmissions and verify that, for each received SRS, the timing of the NR cell is within  $(N_{TA} + N_{TA\_offset}) \times T_c \pm T_e$  of the first detected path of DL SSB.
  - a. The  $N_{TA}$  offset value (in  $T_c$  units) is 13792 for FR2
  - b. The  $T_e$  values depend on the DL and UL SCS for which the test is being run and are given in Table 5.4.1.1.5-4.
7. The test system shall adjust the timing of the DL path by values given in Table 5.4.1.1.4.2-1

**Table 5.4.1.1.4.2-1: Adjustment Value for DL Timing**

SCS of SSB signals (KHz)	Adjustment Value	
	Test1	Test2
240	+8*64Tc	+4*64Tc

8. The test system shall verify that the adjustment step size and the adjustment rate shall be according to requirements specified in Table 5.4.1.1.5-5. This will only be done for Test1. The test system samples the UE Transmit Timing once per SRS transmission (as per configured SRS periodicity). To check Rule 1, the SS shall check that the maximum time adjustment step size  $T_q$  between one SRS transmission to next consecutive SRS transmission of a valid UL slot is within Rule 1 as specified in clause 5.4.1.0.1 and Table 5.4.1.0.1-3. To check that the minimum adjustment rate is within Rule 2 as specified in clause 5.4.1.0.1 and Table 5.4.1.0.1-3, the SS shall measure the change in SRS transmission timing over a  $1 + \text{offset}$  seconds sliding window (offset in ms to the next consecutive SRS transmission), with step size  $p$  (where  $p$  is the periodicity of SRS), as long as the resulting slot is a valid UL slot. To check that the maximum adjustment rate is within Rule 3 as specified in clause 5.4.1.0.1 and Table 5.4.1.0.1-3, the SS shall measure the change in SRS transmission timing over a 200ms – offset sliding window of previous SRS transmission, with step size  $p$  (where  $p$  is the periodicity of SRS), as

long as the resulting slot is a valid UL slot. The three rules apply until the UE transmit timing offset is within the limits specified in 5.4.1.0.1 and Table 5.4.1.0.1-3 with respect to the first detected path (in time) of the corresponding downlink frame of Cell 1. The test system will wait till evaluation interval of T seconds is met to ensure UE transmit timing is stable at the end of the step, where  $T = \text{DL\_timing\_change}[Ts]/5.5Ts$  and DL\_timing\_change is specified in Table 5.4.1.1.4.2-1.

9. After the UE transmit timing is within the limits specified in step 7, and during 2 seconds, the test system shall monitor all SRS transmissions and verify that, for each received SRS, the UE transmit timing offset stays within  $(N_{TA} + N_{TA\_offset}) \times T_c \pm T_e$  of the first detected path of DL SSB. For Test 2 the UE transmit timing offset shall be verified for the first transmission in the DRX cycle immediately after DL timing adjustment.

NOTE: The BEAM\_SELECT\_WAIT\_TIME default value is defined in Annex K.1.1 in TS 38.521-2 [3].

5.4.1.1.4.3 Message contents

Message contents are according to TS 38.508-1 [14] clause 7.3 with the following exceptions:

**Table 5.4.1.1.4.3-0: Common Exception messages**

Default Message Contents	
Common contents of system information blocks exceptions	
Default RRC messages and information elements contents exceptions	Table H.3.9-1

**Table 5.4.1.1.4.3-1: SRS-Config : Additional test requirement for UE transmit timing accuracy for EN-DC FR2 UE**

Derivation Path: TS 38.331 [6], clause 6.3.2			
Information Element	Value/remark	Comment	Condition
SRS-Config ::= SEQUENCE {			
srs-ResourceSetToAddModList SEQUENCE (SIZE(0..maxNrofSRS-ResourceSets)) OF SEQUENCE {			
SRS-ResourceSet[1] SEQUENCE {		entry 1	
resourceType CHOICE {			
periodic SEQUENCE {			
}			
}			
}			
srs-ResourceToAddModList SEQUENCE (SIZE(1..maxNrofSRS-Resources)) OF SEQUENCE {			
SRS-Resource[1] SEQUENCE {		entry 1	
freqHopping SEQUENCE {			
c-SRS	17		
}			
groupOrSequenceHopping	Neither		
resourceType CHOICE {			
periodic SEQUENCE {			
periodicityAndOffset-p CHOICE {			
sl1	0		Test 1
sl2560	4		Test 2
}			
}			
}			
}			
}			
}			

**Table 5.4.1.1.4.3-2: DRX-Config : Additional test requirement for UE transmit timing accuracy Test 2 for EN-DC FR2**

Derivation Path: TS 38.331 [6], clause 6.3.2			
Information Element	Value/remark	Comment	Condition
DRX-Config ::= CHOICE {			
drx-onDurationTimer CHOICE {			
milliSeconds	ms6		
}			
drx-InactivityTimer	ms1		
drx-HARQ-RTT-TimerDL	56		
drx-HARQ-RTT-TimerUL	56		
drx-RetransmissionTimerDL	sl1		
drx-RetransmissionTimerUL	sl1		
drx-LongCycleStartOffset CHOICE {			
ms320	0		
}			
shortDRX		NOT PRESENT	
}			

#### 5.4.1.1.5 Test Requirements

The UE initial transmission timing error shall be less than or equal to  $\pm T_e$  where the timing error limit value  $T_e$  is specified in Table 5.4.1.1.5-4.

The UE shall meet the  $T_e$  requirement for an initial transmission provided that at least one SSB is available at the UE during the last 160 ms. The reference point for the UE initial transmit timing control requirement shall be the downlink timing of the reference cell minus  $(N_{TA} + N_{TA\text{ offset}}) \times T_c$ . The downlink timing is defined as the time when the first detected path (in time) of the corresponding downlink frame is received from the reference cell.  $N_{TA}$  for PRACH is defined as 0.

$(N_{TA} + N_{TA\text{ offset}}) \times T_c$  (in  $T_c$  units) for other channels is the difference between UE transmission timing and the downlink timing immediately after when the last timing advance was applied.  $N_{TA}$  for other channels is not changed until next timing advance is received. The value of  $N_{TA\text{ offset}}$  depends on the duplex mode of the cell in which the uplink transmission takes place and the frequency range (FR).  $N_{TA\text{ offset}}$  is defined in Table 5.4.1.1.5-5.

**Table 5.4.1.1.5-1: Cell Specific Test Parameters for UL Transmit Timing test**

Parameter	Unit	Config	Test1	Test2	Band Group
SSB ARFCN		1,2	Freq1	Freq1	
Duplex Mode		1,2	TDD		
TDD configuration		1,2	TDDConf.3.1		
BW <sub>channel</sub>	MHz	1,2	100: NRB,c = 66		
Initial BWP Configuration		1,2	DLBWP.0.1 ULBWP.0.1		
Dedicated BWP Configuration		1,2	DLBWP.1.1 ULBWP.1.1		
TRS Configuration		1,2	TRS.2.1 TDD		
PDSCH/PDCCH TCI State		1,2	TCI.State.2		
DRx Cycle	ms	1,2	N/A	DRX.8 <sup>Note5</sup>	
PDSCH Reference measurement channel		1,2	SR.3.3 TDD		
RMSI CORESET Reference Channel		1,2	CR.3.2 TDD		
Dedicated CORESET Reference Channel		1,2	CCR.3.7 TDD		
OCNG Patterns		1,2	OP.1		
SSB Configuration		1,2	SSB.4 FR2		
SMTC Configuration		1,2	SMTC.1		
PDSCH/PDCCH subcarrier spacing	kHz	1,2	120		
EPRE ratio of PSS to SSS	dB	1,2	0	0	

EPRE ratio of PBCH DMRS to SSS					
EPRE ratio of PBCH to PBCH DMRS					
EPRE ratio of PDCCH DMRS to SSS					
EPRE ratio of PDCCH to PDCCH DMRS					
EPRE ratio of PDSCH DMRS to SSS					
EPRE ratio of PDSCH to PDSCH DMRS					
EPRE ratio of OCNG DMRS to SSS(Note 1)					
EPRE ratio of OCNG to OCNG DMRS (Note 1)					
Propagation condition		1,2	AWGN		
SRS Config		1,2	Config1 <sup>Note6</sup>	Config2 <sup>Note6</sup>	
NOTE 1: OCNG shall be used such that both cells are fully allocated and a constant total transmitted power spectral density is achieved for all OFDM symbols.					
NOTE 2: Void					
NOTE 3: Void					
NOTE 4: Void					
NOTE 5: DRx related parameters are given in Table A.3.3.5-1 or Table A.5-1					
NOTE 6: SRS configs are given in Table A. 5.4.1.1.5-2					

**Table 5.4.1.1.5-2: SRS Configuration for Timing Accuracy Test**

	Field	Config1	Config 2	Comments
SRS-ResourceSet	srs-ResourceSetId	0	0	
	srs-ResourceIdList	0	0	
	resourceType	Periodic	Periodic	
	Usage	Codebook	Codebook	
SRS-Resource	SRS-ResourceId	0	0	
	nrofSRS-Ports	Port1	Port1	
	transmissionComb	n2	n2	
	combOffset-n2	0	0	
	cyclicShift-n2	0	0	
	resourceMapping startPosition	0	0	
	resourceMapping nrofSymbols	n1	n1	
	resourceMapping repetitionFactor	n1	n1	
	freqDomainPosition	0	0	
	freqDomainShift	0	0	
	freqHopping c-SRS	17	17	Matches N <sub>RB,c</sub>
	freqHopping b-SRS	0	0	
	freqHopping b-hop	0	0	
	groupOrSequenceHopping	Neither	Neither	
	resourceType	Periodic	Periodic	
	periodicityAndOffset-p	sl1,0	sl2560,4	Offset to align with DRx periodicity
	sequenceId	0	0	Any 10 bit number

**Table 5.4.1.1.5-3: OTA related test parameters**

Parameter	Unit	Test 1	Test 2
Angle of arrival configuration		Setup 1 defined in A.9.1	
Assumption for UE beams <sup>Note 6</sup>		Fine	
$N_{oc}$ <sup>Note1</sup>	dBm/15kHz <sup>Note4</sup>	-112	
$N_{oc}$ <sup>Note1</sup>	dBm/SCS <sup>Note3</sup>	-100	
$\hat{E}_s/N_{oc}$	dB	4	
SS-RSRP <sup>Note2</sup>	dBm/SCS <sup>Note4</sup>	-96	
$\hat{E}_s/I_{ot}$	dB	4	
$I_o$ <sup>Note2</sup>	dBm/95.04 MHz <sup>Note4</sup>	-68.5	
<p>NOTE 1: Interference from other cells and noise sources not specified in the test is assumed to be constant over subcarriers and time and shall be modelled as AWGN of appropriate power for <math>N_{oc}</math> to be fulfilled.</p> <p>NOTE 2: SSB_RP and <math>I_o</math> levels have been derived from other parameters for information purposes. They are not settable parameters themselves.</p> <p>NOTE 3: Void</p> <p>NOTE 4: Equivalent power received by an antenna with 0dBi gain at the centre of the quiet zone</p> <p>NOTE 5: As observed with 0dBi gain antenna at the centre of the quiet zone</p> <p>NOTE 6: Information about types of UE beam is given in B.2.1.3, and does not limit UE implementation or test system implementation</p>			

**Table 5.4.1.1.5-4:  $T_e$  Timing Error Limit**

Frequency Range	SCS of SSB signals ( kHz)	SCS of uplink signals ( kHz)	$T_e$
2	120	60	N/A
		120	N/A
	240	60	N/A
		120	$3.75*64*T_c$
NOTE 1: $T_c$ is the basic timing unit defined in TS 38.211 [6]			

**Table 5.4.1.1.5-5:  $T_q$  Maximum Autonomous Time Adjustment Step and  $T_p$  Minimum Aggregate Adjustment rate**

Frequency Range	SCS of uplink signals (KHz)	The Maximum timing change in one adjustment $T_q$	The Minimum aggregate adjustment rate $T_p$	The Maximum aggregate adjustment rate $T_q$
2	120	$3.125*64*T_c$	$-1.225*64*T_c$	$+3.725*64*T_c$
NOTE: $T_c$ is the basic timing unit defined in TS 38.211 [6]				

**Table 5.4.1.1.5-6: The Value of  $N_{TA\ offset}$**

Frequency range and band of cell used for uplink transmission	$N_{TA\ offset}$ (Unit: $T_c$ )
FR2	13792
<p>NOTE 1: The UE identifies <math>N_{TA\ offset}</math> based on the information n-TimingAdvanceOffset as specified in TS 38.331 [2]. If UE is not provided with the information n-TimingAdvanceOffset, the default value of <math>N_{TA\ offset}</math> is set as 25600 for FR1 band. In case of multiple UL carriers in the same TAG, UE expects that the same value of n-TimingAdvanceOffset is provided for all the UL carriers according to clause 4.2 in TS 38.213 [3] and the value 39936 of <math>N_{TA\ offset}</math> can also be provided for a FDD serving cell.</p> <p>NOTE 2: Void</p>	

## 5.4.2 UE timer accuracy

FFS.

## 5.4.3 Timing advance

### 5.4.3.0 Minimum conformance requirements

#### 5.4.3.0.1 Minimum conformance requirements for timing advance adjustment accuracy

The timing advance is initiated from gNB with MAC message that implies an adjustment of the timing advance, as defined in clause 5.2 of TS 38.321 [12].

The UE shall adjust the timing of its transmissions with a relative accuracy better than or equal to the UE Timing Advance adjustment accuracy requirement in Table 5.4.3.0.3-1, to the signalled timing advance value compared to the timing of preceding uplink transmission. The timing advance command step is defined in TS38.213 [8].

**Table 5.4.3.0.3-1: UE Timing Advance adjustment accuracy**

Sub Carrier Spacing, SCS kHz	15	30	60	120
UE Timing Advance adjustment accuracy	$\pm 256 T_c$	$\pm 256 T_c$	$\pm 128 T_c$	$\pm 32 T_c$

The normative reference for this requirement is TS.38.133 [6] clause A.5.4.3.

#### 5.4.3.1 EN-DC FR2 timing advance adjustment accuracy

**Editor's Note: This test case has been completed for the following configurations:**

- Test frequency  $f \leq 40.8$  GHz
- UE PC3
- The test is incomplete for UE power classes other than PC3
- The test is incomplete for test frequencies  $> 40.8$  GHz

##### 5.4.3.1.1 Test purpose

The purpose of the test is to verify UE timing advance adjustment delay and accuracy requirement defined in clause 7.3 of TS 38.133 [6].

##### 5.4.3.1.2 Test applicability

This test applies to all types of E-UTRA UE release 15 and forward, supporting EN-DC.

##### 5.4.3.1.3 Minimum conformance requirement

The minimum conformance requirements are specified in clause 5.4.3.0.1.

The normative reference for this requirement is TS.38.133 [6] clause A.5.4.3.1.

##### 5.4.3.1.4 Test description

###### 5.4.3.1.4.1 Initial conditions

Initial conditions are a set of test configurations the UE needs to be tested in and the steps for the SS to take with the UE to reach the correct measurement state.



The initial test configurations consist of environmental conditions, test frequencies, test channel bandwidths and sub-carrier spacing based on NR operating bands specified in Table 5.3.5-1 of 38.521-2 [17].

This test shall be tested using any of the test configurations in Table 5.4.3.1.4.1-1.

**Table 5.4.3.1.4.1-1: EN-DC FR2 timing advance adjustment accuracy supported test configurations**

Config	Description
1	LTE FDD, NR 120 kHz SSB SCS, 100MHz bandwidth, TDD duplex mode
2	LTE TDD, NR 120 kHz SSB SCS, 100MHz bandwidth, TDD duplex mode

NOTE: The UE is only required to be tested in one of the supported test configurations

Configure the test equipment and the DUT according to the parameters in Table 5.4.3.1.4.1-2

**Table 5.4.3.1.4.1-2: Initial conditions for EN-DC FR2 timing advance adjustment accuracy**

Parameter	Value	Comment
Test environment	NC	As specified in TS 38.508-1 [14] clause 4.1.
Test frequencies	As specified in Annex E.1.1, E.1.2, and Table E.3-1 and TS 38.508-1 [14] clause 4.3.1 for E-UTRA and clause 7.2.3 for NR.	
Channel bandwidth	As specified by the test configuration selected from Table 5.4.3.1.4.1-1	
Propagation conditions	AWGN	As specified in clause C.2.2.
Connection Diagram	TE Part DUT Part	A.3.3.3.1-1 A.3.4.1.1
Exceptions to connection diagram	N/A	

**Table 5.4.3.1.4.1-3: General test parameters for timing advance**

Parameter	Unit	Value	Comment
RF channel number		Cell 1: 1 Cell 2: 2	1 for E-UTRAN PCell 2 for NR PSCell
Initial DL BWP		DLBWP.0.1	As specified in Table A.3.9.2.1-1 of TS 38.133 [6]
Dedicated DL BWP		DLBWP.1.1	As specified in Table A.3.9.2.2-1 of TS 38.133 [6]
Initial UL BWP		ULBWP.0.1	As specified in Table A.3.9.3.1-1 of TS 38.133 [6]
Dedicated UL BWP		ULBWP.1.1	As specified in Table A.3.9.3.2-1 of TS 38.133 [6]
Timing Advance Command ( $T_A$ ) value during T1		31	$N_{TA\_new} = N_{TA\_old}$ for the purpose of establishing a reference value from which the timing advance adjustment accuracy can be measured during T2
Timing Advance Command ( $T_A$ ) value during T2		39	$N_{TA\_new} = N_{TA\_old} + 1024 * T_c$ (based on equation in TS 38.213 [3] clause 4.2)
T1	s	5	
T2	s	5	

1. Cell 1 is the E-UTRA serving cell (PCell) for the EN-DC setup. The power levels and settings for Cell 1 are set according to Annex A.6. Cell 2 is NR FR2 PSCell. The connection setup is done according to the settings in clause C.1.1.
2. Downlink signals for NR cell are initially set up according to clause C.1.2, C.1.3.
3. The UE Rx beam peak direction has been obtained previously using one of the Rx Beam Peak Search procedures as described in Annex I.

## 5.4.3.1.4.2 Test Procedure

The test consists of two cells, a single E-UTRA cell (PCell), and a single NR cell (PSCell). Cell 1 is the PCell in the primary Timing Advance Group (pTAG) and cell 2 is the PSCell in the secondary Timing Advance Group (sTAG). The test consists of two successive time periods, with time durations of T1 and T2 respectively. In each time period, timing advance commands for sTAG are sent to the UE and Sounding Reference Signals (SRS), as specified in Table 5.4.3.1.5-1 and Table 5.4.3.1.5-2, are sent from the UE and received by the test equipment. By measuring the reception of the SRS, the transmit timing, and hence the timing advance adjustment accuracy, can be measured for PSCell in sTAG. The UE Time Alignment Timer (timeAlignmentTimer IE), described in Clause 5.2 in TS 38.321, shall be configured so that it does not expire in the duration of the test.

Unless otherwise stated, the downlink signal and noise are aligned to arrive in the UE Rx beam peak direction.

1. Ensure the UE is in state RRC\_CONNECTED with generic procedure parameters *Connectivity* EN-DC, DC bearer MCG and SCG, Connected without release *On* and Test Mode *On* according to TS 38.508-1 [14] clause 4.5. Message content are defined in clause 5.4.3.1.2.3.
2. Set the parameters according to values in Tables 5.4.3.1.4.1-3 and Table 5.4.3.1.5-1 as appropriate. Propagation conditions are set according to clause C.2.2.
3. SS shall transmit an RRCConnectionReconfiguration message.
4. The UE shall transmit RRCConnectionReconfigurationComplete message.
5. During time period T1, the test equipment shall send one message with a Timing Advance Command MAC Control Element for sTAG, as specified in Clause 6.1.3.4 in TS 38.321. The Timing Advance Command value shall be set to 31, which according to Clause 4.2 in TS 38.213 results in zero adjustment of the Timing Advance. In this way, a reference value for the timing advance for sTAG used by the UE is established.
6. During time period T2, the test equipment shall send a sequence of messages with Timing Advance Command MAC Control Elements for sTAG, with Timing Advance Command value of 39 as specified in table 5.4.3.1.4.1-3.
7. This value shall result in changes of the timing advance for sTAG used by the UE, and the accuracy of the change shall then be measured, using the SRS sent from the UE.
8. As specified in Clause 7.3.2.1 of TS 38.133 [6], the UE adjusts its uplink timing at slot  $n+k+1$  for a timing advance command received in slot  $n$ . This delay shall be taken into account when measuring the timing advance adjustment accuracy, via the SRS sent from the UE.
9. The UE Time Alignment Timer, described in Clause 5.2 in TS 38.321, shall be configured so that it does not expire in the duration of the test.
10. The result from the SRS and adjustment of the timing advance in step 7) is used to measure that the UE adjusts the timing of its transmission with a relative accuracy better than or equal to value specified in Table 5.4.3.0.3-1 to the signalled timing advance value compared to the timing of preceding uplink transmission.
11. If the UE adjust the timing of its transmission within a relative accuracy greater than or equal to value specified in Table 5.4.3.0.3-1 to the signalled timing advance value compared to the timing of preceding uplink transmission then the number of successful tests is increased by one. Otherwise, the number of failure tests is increased by one.
12. The SS shall transmit RRCConnectionReconfiguration message with condition EN-DC\_PSCell\_Rel according to TS 36.508 [25] Table 4.6.1-8 to release NR cell (PSCell). The UE shall transmit RRCConnectionReconfigurationComplete message.
13. The SS then shall transmit RRCConnectionReconfiguration message with condition MCG\_and\_SCG according to TS 36.508 [25] Table 4.6.1-8 to add NR cell (PSCell). The UE shall transmit RRCConnectionReconfigurationComplete message.
14. If any of the above Reconfiguration in Step 12 or 13 fails, switch off and on the UE and ensure the UE is in RRC\_CONNECTED with generic procedure parameters *Connectivity* EN-DC, DC bearer MCG and SCG, Connected without release *On* according to TS 38.508-1 [14] clause 4.5.
15. Repeat steps 3-14 until the confidence level according to Tables G.2.3-1 in Annex G clause G.2 is achieved.

5.4.3.1.4.3 Message Contents

Message contents are according to TS 38.508-1 [14] clause 7.3, with the following exceptions:

**Table 5.4.3.1.4.3-0: Common Exception messages**

Default Message Contents	
Common contents of system information blocks exceptions	
Default RRC messages and information elements contents exceptions	Table H.3.9-1

**Table 5.4.3.1.4.3-1: srs-Config setup**

Derivation Path: TS 38.508-1, Table 4.6.3-182			
Information Element	Value/remark	Comment	Condition
SRS-Config ::= SEQUENCE {			
srs-ResourceSetToAddModList SEQUENCE (SIZE(0..maxNrofSRS-ResourceSets)) OF SEQUENCE {	1 entry		
SRS-ResourceSet[1] SEQUENCE {		entry 1	
resourceType CHOICE {			
periodic SEQUENCE {			
}			
}			
}			
srs-ResourceToAddModList SEQUENCE (SIZE(1..maxNrofSRS-Resources)) OF SEQUENCE {	1 entry		
SRS-Resource[1] SEQUENCE {		entry 1	
freqHopping SEQUENCE {			
c-SRS	16		
}			
groupOrSequenceHopping	Neither		
resourceType CHOICE {			
periodic SEQUENCE {	Periodic		
periodicityAndOffset-p CHOICE {			
sl5	4		
}			
}			
}			
}			
}			
}			

5.4.3.1.5 Test Requirement

The UE shall apply the signalled Timing Advance value for PSCell in sTAG to the transmission timing at the designated activation time i.e.  $k+1$  slots after the reception of the timing advance command, where  $k = 11$ .

The Timing Advance adjustment accuracy for PSCell in sTAG shall be within the limits specified in Table 5.4.3.1.5-3.

The rate of correct Timing Advance adjustments observed during repeated tests shall be at least 90% with a confidence level of 95%.

Table 5.4.3.1.5-1, Table 5.4.3.1.5-1a and Table 5.4.3.1.5-2 define the primary level settings.

**Table 5.4.3.1.5-1: Cell specific test parameters for timing advance**

Parameter	Unit	Test1	
		T1	T2
Duplex mode		TDD	
TDD configuration		TDDConf.3.1	
BW <sub>channel</sub>	MHz	100: N <sub>RB,c</sub> = 66	
BWP BW	MHz	100: N <sub>RB,c</sub> = 66	
DRx Cycle	ms	Not Applicable	
PDSCH Reference measurement channel		SR.3.1 TDD	
CORESET Reference Channel		CR.3.1 TDD	
TRS configuration		TRS.2.1 TDD	
PDSCH/PDCCH TCI state		TCI.State.2	
OCNG Patterns		OCNG pattern 1	
SMTc configuration		SMTc.1 FR2	
SSB configuration		SSB.3 FR2	
PDSCH/PDCCH subcarrier spacing	kHz	120 kHz	
PUCCH/PUSCH subcarrier spacing	kHz	120 kHz	
EPRE ratio of PSS to SSS	dB	0	
EPRE ratio of PBCH DMRS to SSS			
EPRE ratio of PBCH to PBCH DMRS			
EPRE ratio of PDCCH DMRS to SSS			
EPRE ratio of PDCCH to PDCCH DMRS			
EPRE ratio of PDSCH DMRS to SSS			
EPRE ratio of PDSCH to PDSCH			
EPRE ratio of OCNG DMRS to SSS(Note 1)			
EPRE ratio of OCNG to OCNG DMRS (Note 1)			
Propagation condition	-	AWGN	

NOTE 1: OCNG shall be used such that both cells are fully allocated and a constant total transmitted power spectral density is achieved for all OFDM symbols.

**Table 5.4.3.1.5-1a: OTA specific test parameters for timing advance**

Parameter	Unit	Test 1	
		T1	T2
Angle of arrival configuration		Setup 1	
Assumption for UE beams <sup>Note 6</sup>		Fine	
$N_{oc}$ <sup>Note1</sup>	dBm/15kHz <sup>Note4</sup>	-112	
$N_{oc}$ <sup>Note1</sup>	dBm/SCS <sup>Note3</sup>	-103	
$\hat{E}_s / N_{oc}$	dB	4	
SS-RSRP <sup>Note2</sup>	dBm/SCS <sup>Note4</sup>	-99	
$\hat{E}_s / I_{ot}$	dB	4	
$I_o$ <sup>Note2</sup>	dBm/95.04 MHz <sup>Note4</sup>	-68.53	

NOTE 1: Interference from other cells and noise sources not specified in the test is assumed to be constant over subcarriers and time and shall be modelled as AWGN of appropriate power for  $N_{oc}$  to be fulfilled.

NOTE 2: SS-RSRP and  $I_o$  levels have been derived from other parameters for information purposes. They are not settable parameters themselves.

NOTE 3: SS-RSRP minimum requirements are specified assuming independent interference and noise at each receiver antenna port.

NOTE 4: Equivalent power received by an antenna with 0dBi gain at the centre of the quiet zone

NOTE 5: As observed with 0dBi gain antenna at the centre of the quiet zone

NOTE 6: Information about types of UE beam is given in B.2.1.3 of TS 38.133 [6], and does not limit UE implementation or test system implementation

**Table 5.4.3.1.5-2: Sounding Reference Symbol Configuration for timing advance**

Field	Value	Comment
c-SRS	16	Frequency hopping is disabled
b-SRS	0	
b-hop	0	
freqDomainPosition	0	Frequency domain position of SRS
freqDomainShift	0	
groupOrSequenceHopping	neither	No group or sequence hopping
SRS-PeriodicityAndOffset	sl5=4	Once every 5 slots
pathlossReferenceRS	ssb-Index=0	SSB #0 is used for SRS path loss estimation
usage	Codebook	Codebook based UL transmission
startPosition	0	resourceMapping setting. SRS on last
nrofSymbols	n1	symbol of slot, and 1symbols for SRS
repetitionFactor	n1	without repetition.
combOffset-n2	0	transmissionComb setting
cyclicShift-n2	0	
nrofSRS-Ports	port1	Number of antenna ports used for SRS transmission

NOTE: For further information see clause 6.3.2 in TS 38.331 [13].

**Table 5.4.3.1.5-3: UE Timing Advance adjustment accuracy**

UL Sub Carrier Spacing(kHz)	60	120
UE Timing Advance adjustment accuracy	$\pm 128 T_c$	$\pm 72 T_c$

For the test to pass, the total number of successful tests shall be more than 90% of the cases with a confidence level of 95%.

## 5.5 Signaling characteristics

### 5.5.1 Radio link monitoring

The requirements in this clause apply for radio link monitoring on PSCell in EN-DC operation mode. The UE shall monitor the downlink link quality based on the reference signal in the configured RLM-RS resource(s) in order to detect the downlink radio link quality of the PCell and PSCell as specified in TS 38.213 [8]. The configured RLM-RS resources can be all SSBs, or all CSI-RSs, or a mix of SSBs and CSI-RSs. UE is not required to perform RLM outside the active DL BWP.

On each RLM-RS resource, the UE shall estimate the downlink radio link quality and compare it to the thresholds  $Q_{out}$  and  $Q_{in}$  for the purpose of monitoring downlink radio link quality of the cell.

#### 5.5.1.0 Minimum conformance requirements

##### 5.5.1.0.1 Minimum conformance requirements for out-of-sync SSB-based RLM

UE shall be able to evaluate whether the downlink radio link quality on the configured RLM-RS resource estimated over the last  $T_{Evaluate\_out\_SSB}$  [ms] period becomes worse than the threshold  $Q_{out\_SSB}$  within  $T_{Evaluate\_out\_SSB}$  [ms] evaluation period. The requirements in this clause apply for each SSB based RLM-RS resource configured for PSCell, provided that the SSB configured for RLM is transmitted within UE active DL BWP during the entire evaluation period defined in Table 5.5.1.0.1-1.

$T_{Evaluate\_out\_SSB}$  is defined in Table 5.5.1.0.1-1 for FR2.

**Table 5.5.1.0.1-1: Evaluation period  $T_{\text{Evaluate\_out}}$  for FR2**

Configuration	$T_{\text{Evaluate\_out\_SSB}}$ (ms)
no DRX	$\max(200, \text{ceil}(10 \cdot P \cdot N) \cdot T_{\text{SSB}})$
DRX cycle $\leq 320$	$\max(200, \text{ceil}(15 \cdot P \cdot N) \cdot \max(T_{\text{DRX}}, T_{\text{SSB}}))$
DRX cycle $> 320$	$\text{ceil}(10 \cdot P \cdot N) \cdot T_{\text{DRX}}$
NOTE: $T_{\text{SSB}}$ is the periodicity of SSB configured for RLM. $T_{\text{DRX}}$ is the DRX cycle length.	

For FR2,

- $P = 1 / (1 - T_{\text{SSB}} / T_{\text{SMTCperiod}})$ , when RLM-RS is not overlapped with measurement gap and RLM-RS is partially overlapped with SMTC occasion ( $T_{\text{SSB}} < T_{\text{SMTCperiod}}$ ).
- $P$  is 3, when RLM-RS is not overlapped with measurement gap and RLM-RS is fully overlapped with SMTC period ( $T_{\text{SSB}} = T_{\text{SMTCperiod}}$ ).
- $P$  is  $1 / (1 - T_{\text{SSB}} / \text{MGRP} - T_{\text{SSB}} / T_{\text{SMTCperiod}})$ , when RLM-RS is partially overlapped with measurement gap and RLM-RS is partially overlapped with SMTC occasion ( $T_{\text{SSB}} < T_{\text{SMTCperiod}}$ ) and SMTC occasion is not overlapped with measurement gap and
- $T_{\text{SMTCperiod}} \neq \text{MGRP}$  or
- $T_{\text{SMTCperiod}} = \text{MGRP}$  and  $T_{\text{SSB}} < 0.5 \cdot T_{\text{SMTCperiod}}$
- $P$  is  $1 / (1 - T_{\text{SSB}} / \text{MGRP}) \cdot 3$ , when RLM-RS is partially overlapped with measurement gap and RLM-RS is partially overlapped with SMTC occasion ( $T_{\text{SSB}} < T_{\text{SMTCperiod}}$ ) and SMTC occasion is not overlapped with measurement gap and  $T_{\text{SMTCperiod}} = \text{MGRP}$  and  $T_{\text{SSB}} = 0.5 \cdot T_{\text{SMTCperiod}}$
- $P$  is  $1 / \{1 - T_{\text{SSB}} / \min(T_{\text{SMTCperiod}}, \text{MGRP})\}$ , when RLM-RS is partially overlapped with measurement gap and RLM-RS is partially overlapped with SMTC occasion ( $T_{\text{SSB}} < T_{\text{SMTCperiod}}$ ) and SMTC occasion is partially or fully overlapped with measurement gap
- $P$  is  $1 / (1 - T_{\text{SSB}} / \text{MGRP}) \cdot 3$ , when RLM-RS is partially overlapped with measurement gap and RLM-RS is fully overlapped with SMTC occasion ( $T_{\text{SSB}} = T_{\text{SMTCperiod}}$ ) and SMTC occasion is partially overlapped with measurement gap ( $T_{\text{SMTCperiod}} < \text{MGRP}$ )

The normative reference for this requirement is TS 38.133 [6] clauses 8.1.2.

### 5.5.1.0.2 Minimum conformance requirements for in-sync SSB-based RLM

UE shall be able to evaluate whether the downlink radio link quality on the configured RLM-RS resource estimated over the last  $T_{\text{Evaluate\_out\_SSB}}$  [ms] period becomes worse than the threshold  $Q_{\text{out\_SSB}}$  within  $T_{\text{Evaluate\_out\_SSB}}$  [ms] evaluation period.

UE shall be able to evaluate whether the downlink radio link quality on the configured RLM-RS resource estimated over the last  $T_{\text{Evaluate\_in\_SSB}}$  [ms] period becomes better than the threshold  $Q_{\text{in\_SSB}}$  within  $T_{\text{Evaluate\_in\_SSB}}$  [ms] evaluation period.

$T_{\text{Evaluate\_out\_SSB}}$  and  $T_{\text{Evaluate\_in\_SSB}}$  are defined in Table 8.1.2.2-1 for FR1.

$T_{\text{Evaluate\_out\_SSB}}$  and  $T_{\text{Evaluate\_in\_SSB}}$  are defined in Table 8.1.2.2-2 for FR2 with scaling factor  $N=8$ .

For FR2,

- $P = \frac{1}{1 - \frac{T_{\text{SSB}}}{T_{\text{SMTCperiod}}}}$ , when RLM-RS is not overlapped with measurement gap and the RLM-RS is partially overlapped with SMTC occasion ( $T_{\text{SSB}} < T_{\text{SMTCperiod}}$ ).
- $P$  is  $P_{\text{sharing}}$  factor, when the RLM-RS is not overlapped with measurement gap and RLM-RS is fully overlapped with SMTC period ( $T_{\text{SSB}} = T_{\text{SMTCperiod}}$ ).

- $P = \frac{1}{1 - \frac{T_{SSB}}{MGRP} - \frac{T_{SSB}}{T_{SMTCperiod}}}$ , when the RLM-RS is partially overlapped with measurement gap and the RLM-RS is partially overlapped with SMTC occasion ( $T_{SSB} < T_{SMTCperiod}$ ) and SMTC occasion is not overlapped with measurement gap and
  - $T_{SMTCperiod} \neq MGRP$  or
  - $T_{SMTCperiod} = MGRP$  and  $T_{SSB} < 0.5 * T_{SMTCperiod}$
- $P = \frac{P_{sharing\ factor}}{1 - \frac{T_{SSB}}{MGRP}}$ , when the RLM-RS is partially overlapped with measurement gap and the RLM-RS is partially overlapped with SMTC occasion ( $T_{SSB} < T_{SMTCperiod}$ ) and SMTC occasion is not overlapped with measurement gap and  $T_{SMTCperiod} = MGRP$  and  $T_{SSB} = 0.5 * T_{SMTCperiod}$
- $P = \frac{1}{1 - \frac{T_{SSB}}{Min(MGRP, T_{SMTCperiod})}}$ , when the RLM-RS is partially overlapped with measurement gap and the RLM-RS is partially overlapped with SMTC occasion ( $T_{SSB} < T_{SMTCperiod}$ ) and SMTC occasion is partially or fully overlapped with measurement gap
- $P = \frac{P_{sharing\ factor}}{1 - \frac{T_{SSB}}{MGRP}}$ , when the RLM-RS is partially overlapped with measurement gap and the RLM-RS is fully overlapped with SMTC occasion ( $T_{SSB} = T_{SMTCperiod}$ ) and SMTC occasion is partially overlapped with measurement gap ( $T_{SMTCperiod} < MGRP$ )
- $P_{sharing\ factor} = 1$ 
  - if all of the reference signals configured for RLM outside measurement gap are not fully overlapped by intra-frequency SMTC occasions, or
  - if all of the reference signal configured for RLM outside measurement gap and fully-overlapped by intra-frequency SMTC occasions are not overlapped by with the SSB symbols indicated by SSB-ToMeasure and 1 symbol before each consecutive SSB symbols indicated by SSB-ToMeasure and 1 symbol after each consecutive SSB symbols indicated by SSB-ToMeasure, given that SSB-ToMeasure is configured;
- $P_{sharing\ factor} = 3$ , otherwise.

If the high layer in TS 38.331 [2] signalling of *smtc2* is present,  $T_{SMTCperiod}$  follows *smtc2*; Otherwise  $T_{SMTCperiod}$  follows *smtc1*.

Longer evaluation period would be expected if the combination of RLM-RS, SMTC occasion and measurement gap configurations does not meet previous conditions.

**Table 5.5.1.0.2-1: Evaluation period  $T_{Evaluate\_out\_SSB}$  and  $T_{Evaluate\_in\_SSB}$  for FR2**

Configuration	$T_{Evaluate\_out\_SSB}$ (ms)	$T_{Evaluate\_in\_SSB}$ (ms)
no DRX	$Max(200, Ceil(10 * P * N) * T_{SSB})$	$Max(100, Ceil(5 * P * N) * T_{SSB})$
DRX cycle ≤ 320	$Max(200, Ceil(15 * P * N) * Max(T_{DRX}, T_{SSB}))$	$Max(100, Ceil(7.5 * P * N) * Max(T_{DRX}, T_{SSB}))$
DRX cycle > 320	$Ceil(10 * P * N) * T_{DRX}$	$Ceil(5 * P * N) * T_{DRX}$

NOTE:  $T_{SSB}$  is the periodicity of the SSB configured for RLM.  $T_{DRX}$  is the DRX cycle length.

Figure 5.5.1.2.4-1 shows the variation of the downlink SNR in the active cell to emulate out-of-sync and in-sync states

The UE behaviour in each test during time durations T1, T2, T3, T4 and T5 shall be as follows:

During the period from time point A to time point F (D1 second after the start of time duration T5) the UE shall transmit uplink signal at least in all uplink slots configured for CSI transmission according to the configured periodic CSI reporting.

The rate of correct events observed during repeated tests shall be at least 90%.

### 5.5.1.0.3 Minimum conformance requirements for out-of-sync CSI-RS based RLM

[TS38.133, clause 8.1.3.1]

The requirements apply for each CSI-RS based RLM-RS resource configured for PSCell, provided that the CSI-RS configured for RLM are actually transmitted within UE active DL BWP during the entire evaluation period specified in TS 38.133, clause 8.1.3.2. UE is not expected to perform radio link monitoring measurements on the CSI-RS configured as RLM-RS if the CSI-RS is not in the active TCI state of any CORESET configured in the UE active BWP.

**Table 5.5.1.0.3-1: PDCCH transmission parameters for out-of-sync**

Attribute	Value for BLER Configuration #0
DCI format	1-0
Number of control OFDM symbols	2
Aggregation level (CCE)	8
Ratio of hypothetical PDCCH RE energy to average CSI-RS RE energy	4dB
Ratio of hypothetical PDCCH DMRS energy to average CSI-RS RE energy	4dB
Bandwidth (MHz)	48
Sub-carrier spacing (kHz)	SCS of the active DL BWP
DMRS precoder granularity	REG bundle size
REG bundle size	6
CP length	Normal
Mapping from REG to CCE	Distributed

[TS38.133, clause 8.1.3.2]

UE shall be able to evaluate whether the downlink radio link quality on the configured RLM-RS resource estimated over the last  $T_{\text{Evaluate\_out\_CSI-RS}}$  [ms] period becomes worse than the threshold  $Q_{\text{out\_CSI-RS}}$  within  $T_{\text{Evaluate\_out\_CSI-RS}}$  [ms] evaluation period.

- $T_{\text{Evaluate\_out\_CSI-RS}}$  is defined in Table 5.5.1.0.3-2 for FR2 with  $N=1$ . The requirements of  $T_{\text{Evaluate\_out\_CSI-RS}}$  applies provided that the CSI-RS for RLM is not in a resource set configured with repetition ON. The requirements doesn't apply when the CSI-RS resource in the active TCI state of CORESET is the same CSI-RS resource for RLM and the TCI state information of the CSI-RS resource is not given, wherein the TCI state information means QCL Type-D to SSB for L1-RSRP or CSI-RS with repetition ON.

For FR2,

- $P=1$ , when RLM-RS is not overlapped with measurement gap and also not overlapped with SMTC occasion.
- $P=1/(1 - T_{\text{CSI-RS}}/\text{MGRP})$ , when RLM-RS is partially overlapped with measurement gap and RLM-RS is not overlapped with SMTC occasion ( $T_{\text{CSI-RS}} < \text{MGRP}$ )
- $P=1/(1 - T_{\text{CSI-RS}}/T_{\text{SMTCperiod}})$ , when RLM-RS is not overlapped with measurement gap and RLM-RS is partially overlapped with SMTC occasion ( $T_{\text{CSI-RS}} < T_{\text{SMTCperiod}}$ ).
- $P$  is 3, when RLM-RS is not overlapped with measurement gap and RLM-RS is fully overlapped with SMTC occasion ( $T_{\text{CSI-RS}} = T_{\text{SMTCperiod}}$ ).
- $P$  is  $1/(1 - T_{\text{CSI-RS}}/\text{MGRP} - T_{\text{CSI-RS}}/T_{\text{SMTCperiod}})$ , when RLM-RS is partially overlapped with measurement gap and RLM-RS is partially overlapped with SMTC occasion ( $T_{\text{CSI-RS}} < T_{\text{SMTCperiod}}$ ) and SMTC occasion is not overlapped with measurement gap and
  - $T_{\text{SMTCperiod}} \neq \text{MGRP}$  or
  - $T_{\text{SMTCperiod}} = \text{MGRP}$  and  $T_{\text{CSI-RS}} < 0.5 * T_{\text{SMTCperiod}}$
- $P$  is  $1/(1 - T_{\text{CSI-RS}}/\text{MGRP}) * 3$ , when RLM-RS is partially overlapped with measurement gap and RLM-RS is partially overlapped with SMTC occasion ( $T_{\text{CSI-RS}} < T_{\text{SMTCperiod}}$ ) and SMTC occasion is not overlapped with measurement gap and  $T_{\text{SMTCperiod}} = \text{MGRP}$  and  $T_{\text{CSI-RS}} = 0.5 * T_{\text{SMTCperiod}}$
- $P$  is  $1/\{1 - T_{\text{CSI-RS}}/\min(T_{\text{SMTCperiod}}, \text{MGRP})\}$ , when RLM-RS is partially overlapped with measurement gap and RLM-RS is partially overlapped with SMTC occasion ( $T_{\text{CSI-RS}} < T_{\text{SMTCperiod}}$ ) and SMTC occasion is partially or fully overlapped with measurement gap



- $P$  is  $1/(1 - T_{\text{CSI-RS}}/\text{MGRP}) * 3$ , when RLM-RS is partially overlapped with measurement gap and RLM-RS is fully overlapped with SMTC occasion ( $T_{\text{CSI-RS}} = T_{\text{SMTCperiod}}$ ) and SMTC occasion is partially overlapped with measurement gap ( $T_{\text{SMTCperiod}} < \text{MGRP}$ )

If the high layer in TS 38.331 [2] signalling of *smtc2* is present,  $T_{\text{SMTCperiod}}$  follows *smtc2*; Otherwise  $T_{\text{SMTCperiod}}$  follows *smtc1*.

NOTE: The overlap between CSI-RS RLM and SMTC means that CSI-RS based RLM is within the SMTC window duration. Longer evaluation period would be expected if the combination of RLM-RS, SMTC occasion and measurement gap configurations does not meet pervious conditions.

The value of  $M_{\text{out}}$  used in Table 5.5.1.0.3-2 is defined as:

- $M_{\text{out}} = 20$  if the CSI-RS resource configured for RLM is transmitted with higher layer CSI-RS parameter *density* set to 3 and over the bandwidth  $\geq 24$  PRBs.

**Table 5.5.1.0.3-2: Evaluation period  $T_{\text{Evaluate\_out\_CSI-RS}}$  for FR2**

Configuration	$T_{\text{Evaluate\_out\_CSI-RS}}$ (ms)
no DRX	$\max(200, \text{ceil}(M_{\text{out}} \times P \times N) \times T_{\text{CSI-RS}})$
$\text{DRX} \leq 320\text{ms}$	$\max(200, \text{ceil}(1.5 \times M_{\text{out}} \times P \times N) \times \max(T_{\text{DRX}}, T_{\text{CSI-RS}}))$
$\text{DRX} > 320\text{ms}$	$\text{ceil}(M_{\text{out}} \times P \times N) \times T_{\text{DRX}}$
NOTE: $T_{\text{CSI-RS}}$ is the periodicity of CSI-RS resource configured for RLM. The requirements in this table apply for $T_{\text{CSI-RS}}$ equal to 5 ms, 10 ms, 20 ms or 40 ms. $T_{\text{DRX}}$ is the DRX cycle length.	

[TS38.133, clause 8.1.3.3]

The UE is required to be capable of measuring CSI-RS for RLM without measurement gaps. The UE is required to perform the CSI-RS measurements with measurement restrictions as described in the following clauses.

For FR2, when the CSI-RS for RLM is in the same OFDM symbol as SSB for RLM/BFD/CBD/L1-RSRP measurement, UE is not required to receive CSI-RS for RLM in the PRBs that overlap with an SSB.

For FR2, when the CSI-RS for RLM is in the same OFDM symbol as SSB for RLM/BFD/L1-RSRP measurement, or in the same symbol as SSB for CBD when beam failure is detected, UE is required to measure one of but not both CSI-RS for RLM and SSB. Longer measurement period for CSI-RS based RLM is expected, and no requirements are defined.

For FR2, when the CSI-RS for RLM is in the same OFDM symbol as another CSI-RS for RLM/BFD/CBD/L1-RSRP measurement,

- In the following cases, UE is required to measure one of but not both CSI-RS for RLM and the other CSI-RS. Longer measurement period for CSI-RS based RLM is expected, and no requirements are defined.
  - The CSI-RS for RLM or the other CSI-RS in a resource set configured with repetition ON, or
  - The other CSI-RS is configured in  $q_1$  and beam failure is detected, or
  - The two CSI-RS-es are not QCL-ed w.r.t. QCL-TypeD, or the QCL information is not known to UE,
- Otherwise, UE shall be able to measure the CSI-RS for RLM without any restriction.

[TS38.133, clause 8.1.4 and 8.1.5]

When the UE transitions between DRX and no DRX or when DRX cycle periodicity changes, for each RLM-RS resource, for a duration of time equal to the evaluation period corresponding to the second mode after the transition occurs, the UE shall use an evaluation period that is no less than the minimum of evaluation period corresponding to the first mode and the second mode. Subsequent to this duration, the UE shall use an evaluation period corresponding to the second mode for each RLM-RS resource. This requirement shall be applied to both out-of-sync evaluation and in-sync evaluation of the monitored cell.

When the UE transitions from a first configuration of RLM-RS resources to a second configuration of RLM-RS resources that is different from the first configuration, for each RLM-RS resource present in the second configuration, for a duration of time equal to the evaluation period corresponding to the second configuration after the transition occurs, the UE shall use an evaluation period that is no less than the minimum of evaluation periods corresponding to the first configuration and the second configuration. Subsequent to this duration, the UE shall use an evaluation period corresponding to the second configuration for each RLM-RS resource present in the second configuration. This requirement shall be applied to both out-of-sync evaluation and in-sync evaluation of the monitored cell.

When the UE transitions from a first configuration of active TCI state of the CORESET to a second configuration of active TCI state of the CORESET, for each CSI-RS for RLM present in the second configuration, the UE shall use an evaluation period corresponding to the second configuration from the time of transition. This requirement shall be applied to both out-of-sync evaluation and in-sync evaluation of the monitored cell.

The transmitter power of the UE in the monitored cell shall be turned off within 40ms after expiry of T310 timer as specified in TS 38.331.

[TS38.133, clause 8.1.6]

When the downlink radio link quality on all the configured RLM-RS resources is worse than  $Q_{out}$ , Layer 1 of the UE shall send an out-of-sync indication for the cell to the higher layers. A Layer 3 filter shall be applied to the out-of-sync indications as specified in TS 38.331.

The out-of-sync evaluations for the configured RLM-RS resources shall be performed as specified in clause 5 in TS 38.213. Two successive indications from Layer 1 shall be separated by at least  $T_{Indication\_interval}$ .

When DRX is not used  $T_{Indication\_interval}$  is  $\max(10\text{ms}, T_{RLM-RS,M})$ , where  $T_{RLM-RS,M}$  is the shortest periodicity of all configured RLM-RS resources for the monitored cell, which corresponds to  $T_{SSB}$  specified in clause 8.1.2 if the RLM-RS resource is SSB, or  $T_{CSI-RS}$  specified in clause 8.1.3 if the RLM-RS resource is CSI-RS.

In case DRX is used,  $T_{Indication\_interval}$  is  $\max(10\text{ms}, 1.5 \cdot \text{DRX\_cycle\_length}, 1.5 \cdot T_{RLM-RS,M})$  if DRX cycle\_length is less than or equal to 320ms, and  $T_{Indication\_interval}$  is DRX\_cycle\_length if DRX cycle\_length is greater than 320ms. Upon start of T310 timer as specified in TS 38.331 [2], the UE shall monitor the configured RLM-RS resources for recovery using the evaluation period and Layer 1 indication interval corresponding to the no DRX mode until the expiry or stop of T310 timer.

References: The conformance requirements covered in the current TC are specified in: TS 38.133 [6], clauses 8.1.3, 8.1.4, 8.1.5 and 8.1.6.

#### 5.5.1.0.4 Minimum conformance requirements for in-sync CSI-RS based RLM

[TS38.133, clause 8.1.3.1]

The requirements apply for each CSI-RS based RLM-RS resource configured for PSCell, provided that the CSI-RS configured for RLM are actually transmitted within UE active DL BWP during the entire evaluation period specified in TS 38.133 clause 8.1.3.2. UE is not expected to perform radio link monitoring measurements on the CSI-RS configured as RLM-RS if the CSI-RS is not in the active TCI state of any CORESET configured in the UE active BWP.

**Table 5.5.1.0.4-1: PDCCH transmission parameters for in-sync**

Attribute	Value for BLER Configuration #0
DCI payload size	1-0
Number of control OFDM symbols	2
Aggregation level (CCE)	4
Ratio of hypothetical PDCCH RE energy to average CSI-RS RE energy	0dB
Ratio of hypothetical PDCCH DMRS energy to average CSI-RS RE energy	[0]dB
Bandwidth (MHz)	48
Sub-carrier spacing (kHz)	SCS of the active DL BWP
DMRS precoder granularity	REG bundle size
REG bundle size	6
CP length	Normal
Mapping from REG to CCE	Distributed

[TS38.133, clause 8.1.3.2]

UE shall be able to evaluate whether the downlink radio link quality on the configured RLM-RS resource estimated over the last  $T_{\text{Evaluate\_in\_CSI-RS}}$  [ms] period becomes better than the threshold  $Q_{\text{in\_CSI-RS}}$  within  $T_{\text{Evaluate\_in\_CSI-RS}}$  [ms] evaluation period.

- $T_{\text{Evaluate\_in\_CSI-RS}}$  is defined in Table 5.5.1.0.4-2 for FR2 with  $N=1$ . The requirements of  $T_{\text{Evaluate\_in\_CSI-RS}}$  applies provided that the CSI-RS for RLM is not in a resource set configured with repetition ON. The requirements doesn't apply when the CSI-RS resource in the active TCI state of CORESET is the same CSI-RS resource for RLM and the TCI state information of the CSI-RS resource is not given, wherein the TCI state information means QCL Type-D to SSB for L1-RSRP or CSI-RS with repetition ON.

For FR2,

- $P=1$ , when RLM-RS is not overlapped with measurement gap and also not overlapped with SMTC occasion.
- $P=1/(1 - T_{\text{CSI-RS}}/\text{MGRP})$ , when RLM-RS is partially overlapped with measurement gap and RLM-RS is not overlapped with SMTC occasion ( $T_{\text{CSI-RS}} < \text{MGRP}$ )
- $P=1/(1 - T_{\text{CSI-RS}}/T_{\text{SMTCperiod}})$ , when RLM-RS is not overlapped with measurement gap and RLM-RS is partially overlapped with SMTC occasion ( $T_{\text{CSI-RS}} < T_{\text{SMTCperiod}}$ ).
- $P$  is 3, when RLM-RS is not overlapped with measurement gap and RLM-RS is fully overlapped with SMTC occasion ( $T_{\text{CSI-RS}} = T_{\text{SMTCperiod}}$ ).
- $P$  is  $1/(1 - T_{\text{CSI-RS}}/\text{MGRP} - T_{\text{CSI-RS}}/T_{\text{SMTCperiod}})$ , when RLM-RS is partially overlapped with measurement gap and RLM-RS is partially overlapped with SMTC occasion ( $T_{\text{CSI-RS}} < T_{\text{SMTCperiod}}$ ) and SMTC occasion is not overlapped with measurement gap and
  - $T_{\text{SMTCperiod}} \neq \text{MGRP}$  or
  - $T_{\text{SMTCperiod}} = \text{MGRP}$  and  $T_{\text{CSI-RS}} < 0.5 * T_{\text{SMTCperiod}}$
- $P$  is  $1/(1 - T_{\text{CSI-RS}}/\text{MGRP}) * 3$ , when RLM-RS is partially overlapped with measurement gap and RLM-RS is partially overlapped with SMTC occasion ( $T_{\text{CSI-RS}} < T_{\text{SMTCperiod}}$ ) and SMTC occasion is not overlapped with measurement gap and  $T_{\text{SMTCperiod}} = \text{MGRP}$  and  $T_{\text{CSI-RS}} = 0.5 * T_{\text{SMTCperiod}}$
- $P$  is  $1/\{1 - T_{\text{CSI-RS}}/\min(T_{\text{SMTCperiod}}, \text{MGRP})\}$ , when RLM-RS is partially overlapped with measurement gap and RLM-RS is partially overlapped with SMTC occasion ( $T_{\text{CSI-RS}} < T_{\text{SMTCperiod}}$ ) and SMTC occasion is partially or fully overlapped with measurement gap
- $P$  is  $1/(1 - T_{\text{CSI-RS}}/\text{MGRP}) * 3$ , when RLM-RS is partially overlapped with measurement gap and RLM-RS is fully overlapped with SMTC occasion ( $T_{\text{CSI-RS}} = T_{\text{SMTCperiod}}$ ) and SMTC occasion is partially overlapped with measurement gap ( $T_{\text{SMTCperiod}} < \text{MGRP}$ )

If the high layer in TS 38.331 [2] signalling of *smtc2* is present,  $T_{\text{SMTCPeiod}}$  follows *smtc2*; Otherwise  $T_{\text{SMTCPeiod}}$  follows *smtc1*.

NOTE: The overlap between CSI-RS RLM and SMTC means that CSI-RS based RLM is within the SMTC window duration. Longer evaluation period would be expected if the combination of RLM-RS, SMTC occasion and measurement gap configurations does not meet previous conditions.

The values of  $M_{\text{in}}$  used in Table 5.5.1.0.4-2 are defined as:

- $M_{\text{in}} = 10$ , if the CSI-RS resource configured for RLM is transmitted with higher layer CSI-RS parameter *density* set to 3 and over the bandwidth  $\geq 24$  PRBs.

**Table 5.5.1.0.4-2: Evaluation period  $T_{\text{Evaluate\_in\_CSI-RS}}$  for FR2**

Configuration	$T_{\text{Evaluate\_in\_CSI-RS}}$ (ms)
no DRX	$\max(100, \text{ceil}(M_{\text{in}} \times P \times N) \times T_{\text{CSI-RS}})$
$\text{DRX} \leq 320\text{ms}$	$\max(100, \text{ceil}(1.5 \times M_{\text{in}} \times P \times N) \times \max(T_{\text{DRX}}, T_{\text{CSI-RS}}))$
$\text{DRX} > 320\text{ms}$	$\text{ceil}(M_{\text{in}} \times P \times N) \times T_{\text{DRX}}$
NOTE:	$T_{\text{CSI-RS}}$ is the periodicity of CSI-RS resource configured for RLM. The requirements in this table apply for $T_{\text{CSI-RS}}$ equal to 5 ms, 10 ms, 20 ms or 40 ms. $T_{\text{DRX}}$ is the DRX cycle length.

[TS38.133, clause 8.1.3.3]

The UE is required to be capable of measuring CSI-RS for RLM without measurement gaps. The UE is required to perform the CSI-RS measurements with measurement restrictions as described in the following clauses.

For FR2, when the CSI-RS for RLM is in the same OFDM symbol as SSB for RLM/BFD/CBD/L1-RSRP measurement, UE is not required to receive CSI-RS for RLM in the PRBs that overlap with an SSB.

For FR2, when the CSI-RS for RLM is in the same OFDM symbol as SSB for RLM/BFD/L1-RSRP measurement, or in the same symbol as SSB for CBD when beam failure is detected, UE is required to measure one of but not both CSI-RS for RLM and SSB. Longer measurement period for CSI-RS based RLM is expected, and no requirements are defined.

For FR2, when the CSI-RS for RLM is in the same OFDM symbol as another CSI-RS for RLM/BFD/CBD/L1-RSRP measurement,

- In the following cases, UE is required to measure one of but not both CSI-RS for RLM and the other CSI-RS. Longer measurement period for CSI-RS based RLM is expected, and no requirements are defined.
  - The CSI-RS for RLM or the other CSI-RS in a resource set configured with repetition ON, or
  - The other CSI-RS is configured in  $q_1$  and beam failure is detected, or
  - The two CSI-RS-es are not QCL-ed w.r.t. QCL-TypeD, or the QCL information is not known to UE,
- Otherwise, UE shall be able to measure the CSI-RS for RLM without any restriction.

[TS38.133, clause 8.1.4 and 8.1.5]

When the UE transitions between DRX and no DRX or when DRX cycle periodicity changes, for each RLM-RS resource, for a duration of time equal to the evaluation period corresponding to the second mode after the transition occurs, the UE shall use an evaluation period that is no less than the minimum of evaluation period corresponding to the first mode and the second mode. Subsequent to this duration, the UE shall use an evaluation period corresponding to the second mode for each RLM-RS resource. This requirement shall be applied to both out-of-sync evaluation and in-sync evaluation of the monitored cell.

When the UE transitions from a first configuration of RLM-RS resources to a second configuration of RLM-RS resources that is different from the first configuration, for each RLM-RS resource present in the second configuration, for a duration of time equal to the evaluation period corresponding to the second configuration after the transition occurs, the UE shall use an evaluation period that is no less than the minimum of evaluation periods corresponding to the first configuration and the second configuration. Subsequent to this duration, the UE shall use an evaluation period corresponding to the second configuration for each RLM-RS resource present in the second configuration. This requirement shall be applied to both out-of-sync evaluation and in-sync evaluation of the monitored cell.

When the UE transitions from a first configuration of active TCI state of the CORESET to a second configuration of active TCI state of the CORESET, for each CSI-RS for RLM present in the second configuration, the UE shall use an evaluation period corresponding to the second configuration from the time of transition. This requirement shall be applied to both out-of-sync evaluation and in-sync evaluation of the monitored cell.

The transmitter power of the UE in the monitored cell shall be turned off within 40ms after expiry of T310 timer as specified in TS 38.331 [2].

[TS38.133, clause 8.1.6]

When the downlink radio link quality on at least one of the configured RLM-RS resources is better than  $Q_{in}$ , Layer 1 of the UE shall send an in-sync indication for the cell to the higher layers. A Layer 3 filter shall be applied to the in-sync indications as specified in TS 38.331 [2].

The in-sync evaluations for the configured RLM-RS resources shall be performed as specified in clause 5 in TS 38.213 [3]. Two successive indications from Layer 1 shall be separated by at least  $T_{Indication\_interval}$ .

When DRX is not used  $T_{Indication\_interval}$  is  $\max(10\text{ms}, T_{RLM-RS,M})$ , where  $T_{RLM-RS,M}$  is the shortest periodicity of all configured RLM-RS resources for the monitored cell, which corresponds to  $T_{SSB}$  specified in clause 8.1.2 if the RLM-RS resource is SSB, or  $T_{CSI-RS}$  specified in clause 8.1.3 if the RLM-RS resource is CSI-RS.

In case DRX is used,  $T_{Indication\_interval}$  is  $\max(10\text{ms}, 1.5 \cdot \text{DRX\_cycle\_length}, 1.5 \cdot T_{RLM-RS,M})$  if DRX cycle\_length is less than or equal to 320ms, and  $T_{Indication\_interval}$  is DRX\_cycle\_length if DRX cycle\_length is greater than 320ms. Upon start of T310 timer as specified in TS 38.331 [2], the UE shall monitor the configured RLM-RS resources for recovery using the evaluation period and Layer 1 indication interval corresponding to the no DRX mode until the expiry or stop of T310 timer.

References: The conformance requirements covered in the current TC are specified in: TS 38.133 [6], clauses 8.1.3, 8.1.4, 8.1.5 and 8.1.6.

#### 5.5.1.0.5 Minimum conformance requirements for UE scheduling restrictions during radio link monitoring

The following scheduling restriction applies due to radio link monitoring on an FR2 serving PCell and/or PSCell.

- If the RLM-RS is CSI-RS which is type-D QCLed with active TCI state for PDCCH or PDSCH, and the CSI-RS is not in a CSI-RS resource set with repetition ON,
  - There are no scheduling restrictions due to radio link monitoring based on the CSI-RS.
- Otherwise
  - The UE is not expected to transmit PUCCH, PUSCH or SRS or receive PDCCH, PDSCH or CSI-RS for tracking or CSI-RS for CQI on RLM-RS symbols to be measured for radio link monitoring.

When intra-band carrier aggregation in FR2 is performed, the scheduling restrictions on FR2 serving PCell or PSCell applies to all serving cells in the same band on the symbols that fully or partially overlap with restricted symbols.

When inter-band carrier aggregation in FR2 is performed, there are no scheduling restrictions on FR2 serving cell(s) in the bands due to radio link monitoring performed on FR2 serving PCell or PSCell in different bands, provided that UE is capable of independent beam management on this FR2 band pair.

For FR2, if following conditions are met,

- UE has been notified about system information update through paging,
- The gap between UE's reception of PDCCH that UE monitors in the Type2-PDCCH CSS set and that notifies system information update, and the PDCCH that UE monitors in the Type0-PDCCH CSS set, is greater than 2 slots,

For the SSB for RLM and CORESET for RMSI scheduling multiplexing patterns 3, UE is expected to receive the PDCCH that UE monitors in the Type0-PDCCH CSS set, and the corresponding PDSCH, on SSB symbols to be measured for RLM; and

For the SSB for RLM and CORESET for RMSI scheduling multiplexing patterns 2, UE is expected to receive PDSCH that corresponds to the PDCCH that UE monitors in the Type0-PDCCH CSS set, on SSB symbols to be measured for RLM.

### 5.5.1.1 EN-DC FR2 radio link monitoring out-of-sync test for PSCell configured with SSB-based RLM RS in non-DRX mode

*Editor's note: This test case is incomplete. The following aspects are either missing or TBD*

*- Test tolerance analysis is missing*

*- Test Procedure will need further editing and review*

#### 5.5.1.1.1 Test purpose

The purpose of this test is to verify that the UE properly detects the out of sync for the purpose of monitoring downlink radio link quality of the PSCell configured with SSB-based RLM RS in non-DRX mode. This test will partly verify the NR cell radio link monitoring requirements in TS 38.133 [6] clause 8.1.2.

#### 5.5.1.1.2 Test applicability

This test applies to all types of E-UTRA UE release 15 and forward, supporting EN-DC.

#### 5.5.1.1.3 Minimum conformance requirement

The minimum requirements are specified in clause 5.5.1.0.1. DRX configuration is not used for this test.

The normative reference for this requirement is TS 38.133 [6] clause A.5.5.1.1.

#### 5.5.1.1.4 Test description

There are two cells, Cell 1 is the E-UTRAN PCell, and Cell 2 is the PSCell, in the test. The E-UTRAN PCell setting refers to Table A.3.7.2.1-1 as defined in 38.133 [6]. The test consists of three successive time periods, with time duration of T1, T2 and T3 respectively. Figure 5.5.1.1.4-1 shows the variation of the downlink SNR in the active Cell 2 to emulate out-of-sync and in-sync states and Figure 5.5.1.1.4-2 shows the Time multiplexed downlink transmissions from each Angle of Arrival. Prior to the start of the time duration T1, the UE shall be fully synchronized to Cell 1 and Cell 2. The UE shall be configured for periodic CSI reporting with a reporting periodicity of 5 ms. The UE is configured to perform inter-frequency measurements using Gap Pattern ID #0 (40ms) in test 2.

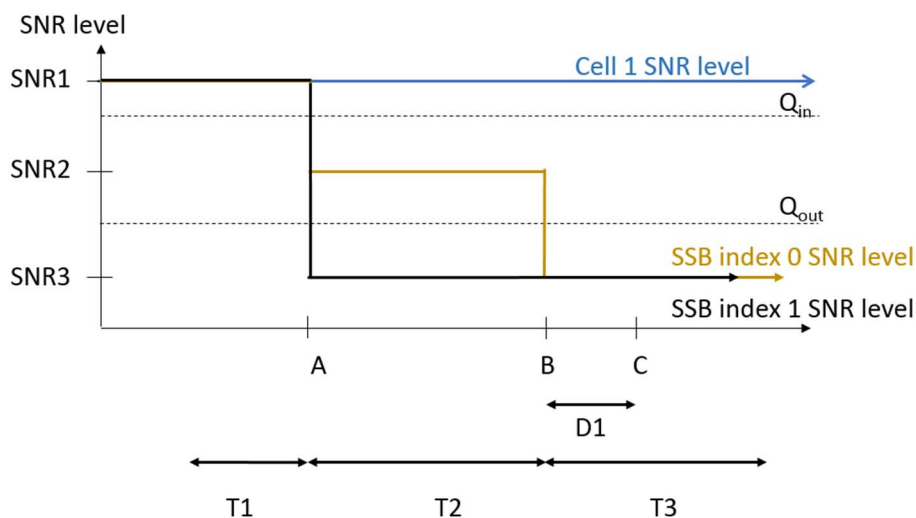
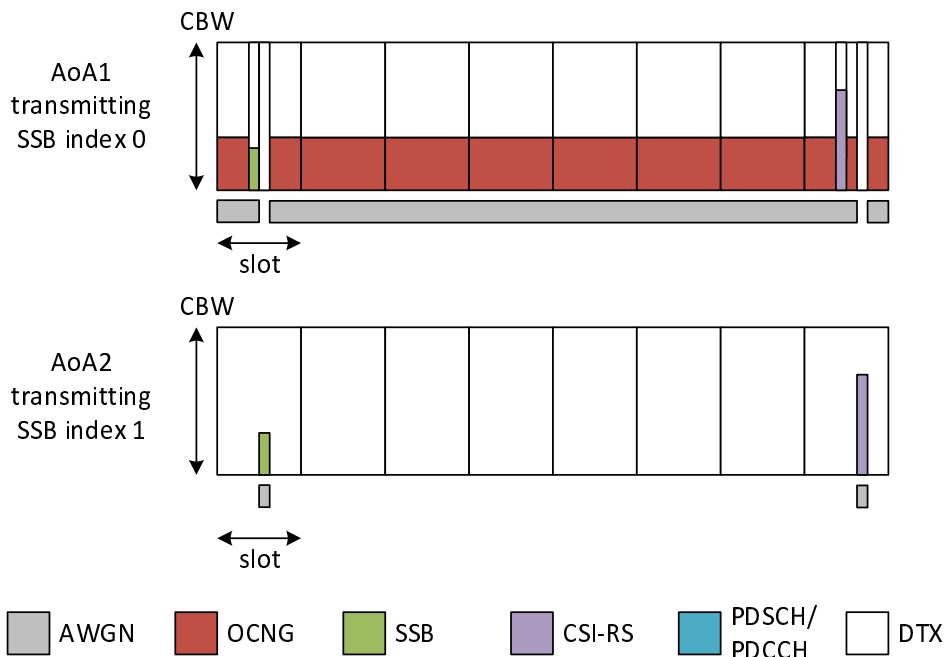

Figure 5.5.1.1.4-1: SNR variation for out-of-sync testing



**Figure 5.5.1.1.4-2: Time multiplexed downlink transmissions**

5.5.1.1.4.1 Initial conditions

Initial conditions are a set of test configurations the UE needs to be tested in and the steps for the SS to take with the UE to reach the correct measurement state.

The initial test configurations consist of environmental conditions, test frequencies, test channel bandwidths and sub-carrier spacing based on NR operating bands specified in Table 5.3.5-1 of 38.521-2 [18].

This test shall be tested using any of the test configurations in Table 5.5.1.1.4.1-1.

**Table 5.5.1.1.4.1-1: EN-DC FR2 radio link monitoring out-of-sync test for PSCell configured with SSB-based RLM RS in non-DRX mode supported test configurations**

Configuration	Description
5.5.1.1-1	FDD LTE PCell, NR 120 KHz SSB SCS, 100MHz bandwidth, TDD duplex mode
5.5.1.1-2	TDD LTE PCell, NR 120 KHz SSB SCS, 100MHz bandwidth, TDD duplex mode
NOTE: The UE is only required to pass in one of the supported test configurations in FR2	

Configure the test equipment and the DUT according to the parameters in Table 5.5.1.1.4.1-2

**Table 5.5.1.1.4.1-2: Initial conditions for EN-DC FR2 radio link monitoring out-of-sync test for PSCell configured with SSB-based RLM RS in non-DRX mode**

Parameter	Value	Comment
Test environment	NC	As specified in TS 38.508-1 [14] clause 4.1.
Test frequencies	As specified in Annex E.1.1, Table E.2-1 and TS 38.508-1 [14] clause 4.3.1 for E-UTRA and 7.2.3 for NR.	
Channel bandwidth	As specified by the test configuration selected from Table 5.5.1.1.4.1-1	
Propagation conditions	AWGN	As specified in clause C.2.2.
Connection Diagram	TE Part	A.3.3.1.1
	DUT Part	A.3.4.1.1
Exceptions to connection diagram	N/A	

PDCCH transmission parameters are given in Table 5.5.1.1.4.1-4

**Table 5.5.1.1.4.1-3: Void**

1. Message contents are defined in clause 5.5.1.1.4.3.
2. The power levels and settings for Cell 1 are set according to Annex A.6, Table A.6.1.1-1. Cell 2 is NR FR2 PSCell. The connection setup is done according to the settings in clause C.1.3, and the downlink signal levels as per clause C.1.2
3. The test parameters are given in Table 5.5.1.1.4.1-4 below.
4. Downlink signals for NR cell are initially set up according to Annex [C.x].



Table 5.5.1.1.4.1-4: General test parameters for FR2 out-of-sync testing in non-DRX mode

Parameter		Unit	Value Test 1
Active E-UTRA PCell			Cell 1
E-UTRA RF Channel Number			1
Active PSCell			Cell 2
RF Channel Number			2
Duplex mode	Config 1, 2		TDD
BW <sub>channel</sub>	Config 1, 2		100: N <sub>RB,c</sub> = 66
Data RBs allocated	Config 1, 2		24
DL initial BWP configuration	Config 1, 2		DLBWP.0.1
DL dedicated BWP configuration	Config 1, 2		DLBWP.1.1
UL initial BWP configuration	Config 1, 2		ULBWP.0.1
UL dedicated BWP configuration	Config 1, 2		ULBWP.1.1
TDD Configuration	Config 1, 2		TDDConf.3.1
RMSI CORESET Reference Channel	Config 1, 2		CR.3.1 TDD
Dedicated CORESET Reference Channel	Config 1, 2		CCR.3.4 TDD
SSB Configuration	Config 1, 2		SSB.1 FR2
SMTC Configuration	Config 1, 2		SMTC.1
PDSCH/PDCCH subcarrier spacing	Config 1, 2		120 KHz
PRACH Configuration	Config 1, 2		PRACH.4 FR2
SSB index assigned as RLM RS	Config 1, 2		0,1
OCNG parameters			OP.5
CP length			Normal
Out of sync transmission parameters	DCI format		1-0
	Number of Control OFDM symbols		2
	Aggregation level	CCE	8
	Ratio of hypothetical PDCCH RE energy to average SSS RE energy	dB	4
	Ratio of hypothetical PDCCH DMRS energy to average SSS RE energy	dB	4
	DMRS precoder granularity		REG bundle size
REG bundle size			6
DRX			OFF
Gap pattern ID			gp0
Layer 3 filtering			Enabled
T310 timer		ms	0
T311 timer		ms	1000
N310			1
N311			1
CSI-RS for CSI reporting	Config 1, 2		CSI-RS.3.1 TDD
reportConfigType			periodic
reportQuantity			cri-RI-PMI-CQI
CSI reporting periodicity		slot	40
CSI reporting offset		slot	4
TCI states for PDCCH/PDSCH			TCI.State.2
CSI-RS for tracking	Config 1, 2		TRS.2.1 TDD
T1		s	0.2
T2		s	9.68
T3		s	9.68
D1		s	9.64
Note 1: All configurations are assigned to the UE prior to the start of time period T1.			
Note 2: UE-specific PDCCH is not transmitted after T1 starts.			
Note 3: E-UTRAN is in non-DRX mode under test.			

5.5.1.1.4.2 Test Procedure

The test consists of two cells, a single E-UTRA cell (Pcell), and a single NR cell (PSCell). Prior to the start of the time duration T1, the UE shall be fully synchronized to PSCell. The UE shall be configured for periodic CQI reporting in PUCCH [format 1] with a reporting periodicity as mentioned in the above table 5.5.1.1.4.1-4.

1. Ensure the UE is in state RRC\_CONNECTED with generic procedure parameters *Connectivity* EN-DC, DC bearer MCG and SCG, Connected without release *On* according to TS 38.508-1 [6] clause 5.5.
2. Set the parameters according to T1 in Table 5.5.1.1.4.4-1 for subtest 1 and 2. Propagation conditions are set according to Annex TBD. T1 starts.
3. When T1 expires the SS shall change the SNR value to T2 as specified in Table 5.5.1.1.4.4-1 for subtests 1 and 2. T2 starts.
4. When T2 expires the SS shall change the SNR value to T3 as specified in Table 5.5.1.1.4.4-1 for subtests 1 and 2. T3 starts.
5. If the SS:
  - a) detects uplink power in each subframe configured for CQI transmission (according to configured CQI periodicity on PUCCH [format 1]) during the period from time point A to time point B
 and
  - b) does not detect any uplink power from time point C (240 ms after the start of T3) until T3 expires, the number of successful tests is increased by one.
6. Otherwise the number of failed tests is increased by one and proceed to Step 10.
7. When T3 expires the SS shall change the SNR value to T1 as specified in Table 5.5.1.1.4.4-1.
8. If the UE has not re-established the connection in at least 1s, the SS shall ensure PSCell is released.
9. The SS then shall transmit RRCConnectionReconfiguration message with condition MCG\_and\_SCG according to TS 36.508 [25] Table 4.6.1-8 to add NR cell (PSCell). The UE shall transmit RRCConnectionReconfigurationComplete message.
10. If the Reconfiguration fails, switch off and on the UE and ensure the UE is in RRC\_CONNECTED with generic procedure parameters *Connectivity* EN-DC, DC bearer MCG and SCG, Connected without release *On* according to TS 38.508-1 [14] clause 4.5].
11. Repeat steps 2-10 until the confidence level according to Tables G.2.3-1 in Annex G clause G.2 is achieved.

5.5.1.1.4.3 Message Contents

Message contents are according to TS 38.508-1 [14] clause 7.3 with the following exceptions:

**Table 5.5.1.1.4.3-0: Common Exception messages**

Default Message Contents	
Common contents of system information blocks exceptions	
Default RRC messages and information elements contents exceptions	Table H.3.1-1 Table H.3.1-2 with Condition INTER-FREQ, L3 FILTERING NEEDED Table H.3.1-3 with Condition INTER-FREQ MO (where <i>ssbFrequency</i> is set to the ARFCN value of carrier center of Adjacent range) Table H.3.1-4 with <i>A3</i> -offset = 0 Table H.3.4-1 Table H.3.4-1a Table H.3.4-4 with condition <i>gapUE</i> Table H.3.4-5 with condition BFD Table H.3.5-4 Table H.3.5-9 with Condition SSB RLM

Table 5.5.1.1.4.3-1: PDCCH Search Space

Derivation Path: TS 38.508-1 [14], Table 4.6.3-162			
Information Element	Value/remark	Comment	Condition
SearchSpace ::= SEQUENCE {			
monitoringSlotPeriodicityAndOffset CHOICE {			
sl1	NULL		
}			
Duration	2		
monitoringSymbolsWithinSlot	11000000000000	Symbols 0 and 1	
nrofCandidates SEQUENCE {			
aggregationLevel1	n0		
aggregationLevel2	n0		
aggregationLevel4	n0		
aggregationLevel8	n1	AL8	
aggregationLevel16	n0		
}			
searchSpaceType CHOICE {			
common SEQUENCE {			CSS, SISS
ue-Specific SEQUENCE {			USS
dci-Formats	formats0-0-And-1-0	DCI Format 1_0	
}			
}			
}			

Table 5.5.1.1.4.3-2: UE-TimersAndConstants

Derivation Path: TS 38.508-1 [14], Table 4.6.3-200			
Information Element	Value/remark	Comment	Condition
UE-TimersAndConstants ::= SEQUENCE {			
t310	ms0		
n310	n1		
t311	ms1000		
n311	n1		
}			

Table 5.5.1.1.4.3-3: CSI-FrequencyOccupation

Derivation Path: TS 38.508-1 [14], Table 4.6.3-33			
Information Element	Value/remark	Comment	Condition
CSI-FrequencyOccupation ::= SEQUENCE {			
startingRB	0		
nrofRBs	66	100 MHz (120 KHz SCS)	
}			

#### 5.5.1.1.5 Test Requirement

Table 5.5.1.1.5-1 defines the cell specific primary level settings.

The UE behavior in each test during time durations T1, T2 and T3 shall be as follows:

During the period from time point A to time point B the UE shall transmit uplink signal at least in all uplink slots configured for CSI transmission according to the configured periodic CSI reporting.

The UE shall stop transmitting uplink signal no later than time point C (D1 second after the start of the time duration T3).

The rate of correct events observed during repeated tests shall be at least 90%.

**Table 5.5.1.1.5-1: OTA related cell specific test parameters for FR2 (Cell 2) for out-of-sync radio link monitoring tests in non-DRX mode**

Parameter		Unit	Test 1								
			T1	T2	T3	T1	T2	T3			
AoA setup			Setup 3 defined in A.9.3								
			AoA1			AoA2					
Assumption for UE beams <sup>Note 5</sup>			Rough			Rough					
EPRE ratio of PDCCH DMRS to SSS		dB	4			Not sent					
EPRE ratio of PDCCH to PDCCH DMRS		dB	0								
EPRE ratio of PBCH DMRS to SSS		dB									
EPRE ratio of PBCH to PBCH DMRS		dB									
EPRE ratio of PSS to SSS		dB									
EPRE ratio of PDSCH DMRS to SSS		dB									
EPRE ratio of PDSCH to PDSCH DMRS		dB									
EPRE ratio of OCNG DMRS to SSS		dB									
EPRE ratio of OCNG to OCNG DMRS		dB									
ssb-Index 0 SNR	Config 1, 2	dB							2 <sup>Note 6</sup>	-6 <sup>Note 6</sup>	-15
ssb-Index 1 SNR	Config 1, 2					Not sent			2 <sup>Note 6</sup>	-15	-15
$N_{oc}$	Config 1, 2	dBm/ 15kHz	-92.1			-92.1					
Time multiplexing of the downlink transmissions from each AoA			Defined in Figure 5.5.1.1.4-2								
Propagation condition			TDL-A 30ns 75Hz			TDL-A 30ns 75Hz					
Note 1: OCNG shall be used such that a constant total transmitted power spectral density is achieved for all OFDM symbols.											
Note 2: The signal contains PDCCH for UEs other than the device under test as part of OCNG.											
Note 3: SNR levels correspond to the signal to noise ratio over the SSS REs.											
Note 4: The SNR values are specified for testing a UE which supports 2RX on at least one band. For testing of a UE which supports 4RX on all bands, the SNR during T3 is 38.133 [6] A.3.6.											
Note 5: Information about types of UE beam is given in 38.133 [6] B.2.1.3, and does not limit UE implementation or test system implementation											
Note 6: This value allows up to 1dB degradation from applied SNR to UE baseband											

### 5.5.1.2 EN-DC FR2 radio link monitoring in-sync test for PSCell configured with SSB-based RLM RS in non-DRX mode

**Editor's Notes:** This test case is incomplete. The following aspects are either missing or not yet determined

- Test procedure is needs further updates specific to OTA aspect
- MU/TT is FFS

#### 5.5.1.2.1 Test Purpose

The purpose of this test is to verify that the UE properly detects the out of sync and in sync for the purpose of monitoring downlink radio link quality of the PSCell. This test will partly verify the FR2 PSCell radio link monitoring requirements in clause 8.1 of TS 38.133 [3].

#### 5.5.1.2.2 Test Applicability

This test applies to all types of E-UTRA UEs Release 15 and forward supporting EN-DC FR2.

#### 5.5.1.2.3 Minimum Conformance Requirements

The minimum requirements are specified in clause 5.5.1.0.2. DRX configuration is not used for this test.

The normative reference for this requirement is TS 38.133 [6] clause A.5.5.1.2.

5.5.1.2.4 Test Description

There are two cells, Cell 1 is the E-UTRAN PCell, and Cell 2 is the PSCell, in the test. The E-UTRAN PCell setting refers to Table A.3.7.2.1-2. The test consists of five successive time periods, with time duration of T1, T2, T3, T4 and T5 respectively. Figure 5.5.1.2.4-1 shows the variation of the downlink SNR in the active cell to emulate out-of-sync and in-sync states and Figure 5.5.1.2.4-2 shows the Time multiplexed downlink transmissions from each Angle of Arrival. Prior to the start of the time duration T1, the UE shall be fully synchronized to Cell 1 and Cell 2. The UE shall be configured for periodic CSI reporting with a reporting periodicity of 5ms.

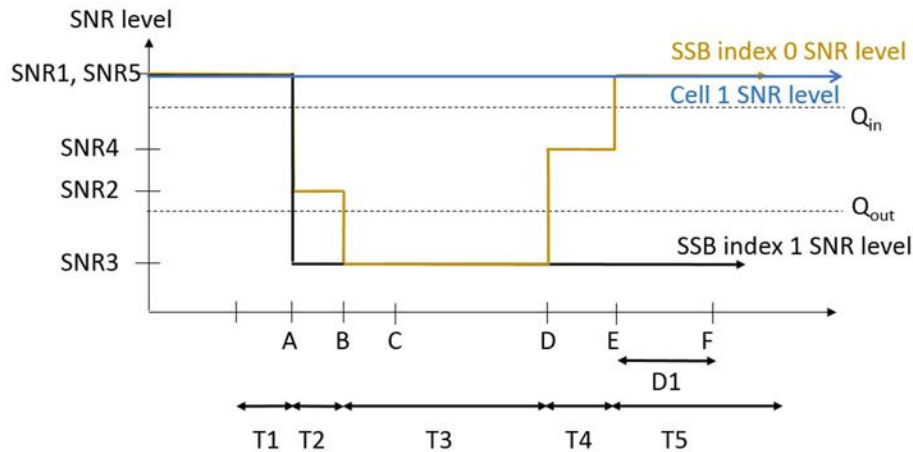

Figure 5.5.1.2.4-1: SNR variation for in-sync testing

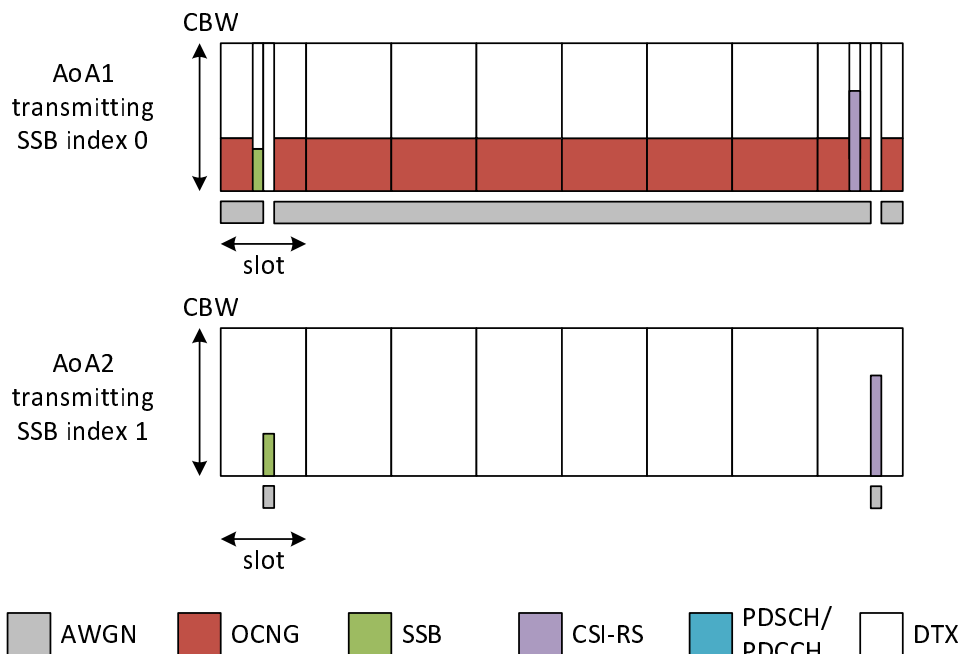

Figure 5.5.1.2.4-2: Time multiplexed downlink transmissions

5.5.1.2.4.1 Initial conditions

Initial conditions are a set of test configurations the UE needs to be tested in and the steps for the SS to take with the UE to reach the correct measurement state.

The initial test configurations consist of environmental conditions, test frequencies, test channel bandwidths and sub-carrier spacing based on NR operating bands specified in Table [5.3.5-1] and Table 5.3.5-1 of 38.521-2 [18].

This test shall be tested using any of the test configurations in Table 5.5.1.2.4.1-1.

**Table 5.5.1.2.4.1-1: Supported test configurations for FR2 PSCell**

Configuration	Description
5.5.1.2-1	FDD LTE PCell, NR 120 KHz SSB SCS, 100MHz bandwidth, TDD duplex mode
5.5.1.2-2	TDD LTE PCell, NR 120 KHz SSB SCS, 100MHz bandwidth, TDD duplex mode
NOTE: The UE is only required to pass in one of the supported test configurations in FR2	

Configure the test equipment and the DUT according to the parameters in Table 5.5.1.2.4.1-2.

**Table 5.5.1.2.4.1-2: Initial conditions for EN-DC FR2 radio link monitoring in-sync test for PSCell configured with SSB-based RLM RS in non-DRX mode**

Parameter	Value	Comment
Test environment	NC	As specified in TS 38.508-1 [14] clause 4.1.
Test frequencies	As specified in Annex E.1.1, Table E.2-1 and TS 38.508-1 [14] clause 4.3.1 for E-UTRA and 7.2.3 for NR.	
Channel bandwidth	As specified by the test configuration selected from Table 5.5.1.3.4.1-1	
Propagation conditions	AWGN	As specified in clause C.2.2.
Connection Diagram	TE Part	A.3.3.1.1
	DUT Part	A.3.4.1.1
Exceptions to connection diagram	N/A	

PDCCH transmission parameters are given in Table 5.5.1.2.4.1-4.

**Table 5.5.1.2.4.1-3: Void**

1. Message contents are defined in clause 5.5.1.2.4.3.
2. The power levels and settings for Cell 1 are set according to Annex A.6, Table A.6.1.1-1. Cell 2 is NR FR2 PSCell. The connection setup is done according to the settings in clause C.1.3, and the downlink signal levels as per clause C.1.2
3. The general test parameters are given in Table 5.5.1.2.5-4 below.
4. Downlink signals for NR cell are initially set up according to clause C.1.

**Table 5.5.1.2.4.1-4: General test parameters for FR2 in-sync testing in non-DRX mode**

Parameter	Unit	Value
		Test 1
Active E-UTRA PCell		Cell 1
E-UTRA RF Channel Number		1
Active PSCell		Cell 2
RF Channel Number		2
Duplex mode	Config 1, 2	TDD
BW <sub>channel</sub>	Config 1, 2	100: N <sub>RB,c</sub> = 66
DL initial BWP configuration	Config 1, 2	DLBWP.0.1
DL dedicated BWP configuration	Config 1, 2	DLBWP.1.1
UL initial BWP configuration	Config 1, 2	ULBWP.0.1
UL dedicated BWP configuration	Config 1, 2	ULBWP.1.1
TDD Configuration	Config 1, 2	TDDConf.3.1
CORESET Reference Channel	Config 1, 2	CR.3.1 TDD
Dedicated CORESET Reference Channel	Config 1, 2	CCR.3.1 TDD

Parameter		Unit	Value
			Test 1
SSB Configuration	Config 1, 2		SSB.1 FR2
SMTC Configuration	Config 1, 2		SMTC.3
PDSCH/PDCCH subcarrier spacing	Config 1, 2		120 KHz
PRACH Configuration	Config 1, 2		PRACH.4 FR2
SSB index assigned as RLM RS	Config 1, 2		0,1
OCNG parameters			OP.2
CP length			Normal
In sync transmission parameters	DCI format		1-0
	Number of Control OFDM symbols		2
	Aggregation level	CCE	4
	Ratio of hypothetical PDCCH RE energy to average SSS RE energy	dB	0
	Ratio of hypothetical PDCCH DMRS energy to average SSS RE energy	dB	0
	DMRS precoder granularity		REG bundle size
	REG bundle size		6
Out of sync transmission parameters	DCI format		1-0
	Number of Control OFDM symbols		2
	Aggregation level	CCE	8
	Ratio of hypothetical PDCCH RE energy to average SSS RE energy	dB	4
	Ratio of hypothetical PDCCH DMRS energy to average SSS RE energy	dB	4
	DMRS precoder granularity		REG bundle size
	REG bundle size		6
DRX			OFF
Gap pattern ID			N.A.
Layer 3 filtering			Enabled
T310 timer		ms	4000
T311 timer		ms	1000
N310			1
N311			1
CSI-RS for CSI reporting	Config 1, 2		CSI-RS.3.1 TDD
TCI states for PDCCH/PDSCH			TCI.State.2
CSI-RS for tracking	Config 1, 2		TRS.2.1 TDD
reportConfigType			periodic
reportQuantity			cri-RI-PMI-CQI
CSI reporting periodicity		slot	40
CSI reporting offset		slot	4
T1		s	0.2
T2		s	0.2
T3		s	1.88
T4		s	0.2
T5		s	3.84
D1		s	3.8
NOTE 1: All configurations are assigned to the UE prior to the start of time period T1.			
NOTE 2: UE-specific PDCCH is not transmitted after T1 starts.			
NOTE 3: E-UTRAN is in non-DRX mode under test.			

#### 5.5.1.2.4.2 Test procedure

**Editor's Note: Test procedure updates to ensure accurate FR2 test measurement state is TBD**

The test consists of two cells, a single E-UTRA cell (Pcell), and a single NR cell (PSCell). Prior to the start of the time duration T1, the UE shall be fully synchronized to PSCell. The UE shall be configured for periodic CQI reporting in PUCCH [format 1] with a reporting periodicity as mentioned in the above table 5.5.1.2.4.1-4.

1. Ensure the UE is in state RRC\_CONNECTED with generic procedure parameters *Connectivity* EN-DC, DC bearer MCG and SCG, Connected without release *On* according to TS 38.508-1 [6] clause 4.5.

2. Set the parameters according to T1 in Table 5.5.1.2.4-1 for subtest 1 and 2. Propagation conditions are set according to Annex TBD. T1 starts.
3. When T1 expires, the SS shall change the SNR value to T2 as specified in Table 5.5.1.2.5-1. T2 starts.
4. When T2 expires, the SS shall change the SNR value to T3 as specified in Table 5.5.1.2.5-1. T3 starts.
5. When T3 expires, the SS shall change the SNR value to T3 as specified in Table 5.5.1.2.5-1. T4 starts.
6. When T4 expires, the SS shall change the SNR value to T3 as specified in Table 5.5.1.2.5-1. T5 starts.
7. If the SS detects uplink power in the On-duration part of every DRX cycle in the subframe according the configured CQI reporting mode (PUCCH 1-0) during the period from time point A to time point F (1120 ms after the start of time duration T5) the number of successful tests is increased by one.

Otherwise the number of failed tests is increased by one.

8. Repeat steps 2-7 for all subtests until the confidence level according to Tables G.2.3-1 in Annex G clause G.2 is achieved.

5.5.1.2.4.3 Message Contents

Message contents are according to TS 38.508-1 [14] clause 7.3 with the following exceptions.

**Table 5.5.1.2.4.3-1: Common Exception messages**

Default Message Contents	
Common contents of system information blocks exceptions	
Default RRC messages and information elements contents exceptions	Table H.3.4-1 Table H.3.5-4 Table H.3.5-9 with Condition SSB RLM

**Table 5.5.1.2.4.3-2: PDCCH Search Space**

Derivation Path: TS 38.508-1 [14], Table 4.6.3-162			
Information Element	Value/remark	Comment	Condition
SearchSpace ::= SEQUENCE {			
monitoringSlotPeriodicityAndOffset CHOICE {			
s1	NULL		
}			
duration	2		
monitoringSymbolsWithinSlot	11000000000000	Symbols 0 and 1	
nrofCandidates SEQUENCE {			
aggregationLevel1	n0		
aggregationLevel2	n0		
aggregationLevel4	n0		
aggregationLevel8	n1	AL8	
aggregationLevel16	n0		
}			
searchSpaceType CHOICE {			
ue-Specific SEQUENCE {			USS
dci-Formats	formats0-0-And-1-0	DCI Format 1_0	
}			
}			
}			



**Table 5.5.1.2.4.3-3: RLF-TimersAndConstant**

Derivation Path: TS 38.508-1 [14], Table 4.6.3-150			
Information Element	Value/remark	Comment	Condition
RLF-TimersAndConstants ::= SEQUENCE {			
t310	ms4000		
n310	n1		
n311	n1		
t311-v1530	ms1000		
}			

**Table 5.5.1.2.4.3-4: CSI-FrequencyOccupation**

Derivation Path: TS 38.508-1 [14], Table 4.6.3-33			
Information Element	Value/remark	Comment	Condition
CSI-FrequencyOccupation ::= SEQUENCE {			
startingRB	0		
nrofRBs	66	100 MHz (120 KHz SCS)	
}			

#### 5.5.1.2.5 Test Requirements

The UE behaviour in each test during time durations T1, T2, T3, T4 and T5 shall be as follows:

During the period from time point A to time point F (D1 second after the start of time duration T5) the UE shall transmit uplink signal at least in all uplink slots configured for CSI transmission according to the configured periodic CSI reporting.

The rate of correct events observed during repeated tests shall be at least 90% with a 95% confidence interval.

**5.5.1.2.5-1: OTA related cell specific test parameters for FR2 (Cell 2) for in-sync radio link monitoring tests in non-DRX mode**

Parameter		Unit	Test 1														
			T1	T2	T3	T4	T5	T1	T2	T3	T4	T5					
AoA setup			Setup 3 defined in A.9.3														
			AoA1					AoA2									
Assumption for UE beams <sup>Note 5</sup>			Rough					Rough									
EPRE ratio of PDCCH DMRS to SSS		dB	0					Not sent									
EPRE ratio of PDCCH to PDCCH DMRS		dB	0														
EPRE ratio of PBCH DMRS to SSS		dB															
EPRE ratio of PBCH to PBCH DMRS		dB															
EPRE ratio of PSS to SSS		dB															
EPRE ratio of PDSCH DMRS to SSS		dB															
EPRE ratio of PDSCH to PDSCH DMRS		dB															
EPRE ratio of OCNG DMRS to SSS		dB															
EPRE ratio of OCNG to OCNG DMRS		dB															
ssb-Index 0 SNR	Config 1, 2	dB											2 <sup>Note 6</sup>	-6 <sup>Note 6</sup>	-15	-4.5	2 <sup>Note 6</sup>
ssb-Index 1 SNR	Config 1, 2							Not sent					2 <sup>Note 6</sup>	-15	-15	-15	-15
$N_{oc}$	Config 1, 2	dBm/15kHz	-92.1					-92.1									
Time multiplexing of the downlink transmissions from each AoA			Defined in Figure 5.5.1.2.4-2														
Propagation condition			TDL-A 30ns 75Hz					TDL-A 30ns 75Hz									
Note 1: OCNG shall be used such that a constant total transmitted power spectral density is achieved for all OFDM symbols. Note 2: The signal contains PDCCH for UEs other than the device under test as part of OCNG. Note 3: SNR levels correspond to the signal to noise ratio over the SSS REs. Note 4: The SNR values are specified for testing a UE which supports 2RX on at least one band. For testing of a UE which supports 4RX on all bands, the SNR during T3 is 38.133 [6] A.3.6. Note 5: Information about types of UE beam is given in B.2.1.3, and does not limit UE implementation or test system implementation Note 6: This value allows up to 1dB degradation from applied SNR to UE baseband																	

**5.5.1.3 EN-DC FR2 radio link monitoring out-of-sync test for PSCell configured with SSB-based RLM RS in DRX mode**

*Editor's note: This test case is incomplete. The following aspects are either missing or TBD*

*- Test tolerance analysis is missing*

*- Test Procedure needs to be finalized and reviewed.*

**5.5.1.3.1 Test purpose**

The purpose of this test is to verify that the UE properly detects the out of sync for the purpose of monitoring downlink radio link quality of the PSCell configured with SSB-based RLM RS when DRX is used. This test will partly verify the NR cell radio link monitoring requirements in TS 38.133 [6] clause 8.1.2.

**5.5.1.3.2 Test applicability**

This test applies to all types of E-UTRA UE release 15 and forward, supporting EN-DC.

5.5.1.3.3 Minimum conformance requirement

The minimum requirements are specified in clause 5.5.1.0.1. DRX configuration is used for this test.

The normative reference for this requirement is TS 38.133 [6] clause A.5.5.1.3.

5.5.1.3.4 Test description

There are two cells, Cell 1 is the E-UTRAN PCell, and Cell 2 is the PSCell, in the test. The E-UTRAN PCell setting refers to Table A.3.7.2.1-2 as defined in 38.133 [6]. The test consists of three successive time periods, with time duration of T1, T2 and T3 respectively. Figure 5.5.1.3.4-1 shows the variation of the downlink SNR in the active Cell 2 to emulate out-of-sync and in-sync states. Prior to the start of the time duration T1, the UE shall be fully synchronized to Cell 1 and Cell 2. The UE shall be configured for periodic CSI reporting with a reporting periodicity of 5 ms. The UE is configured to perform inter-frequency measurements using Gap Pattern ID #0 (40ms) in test 2.

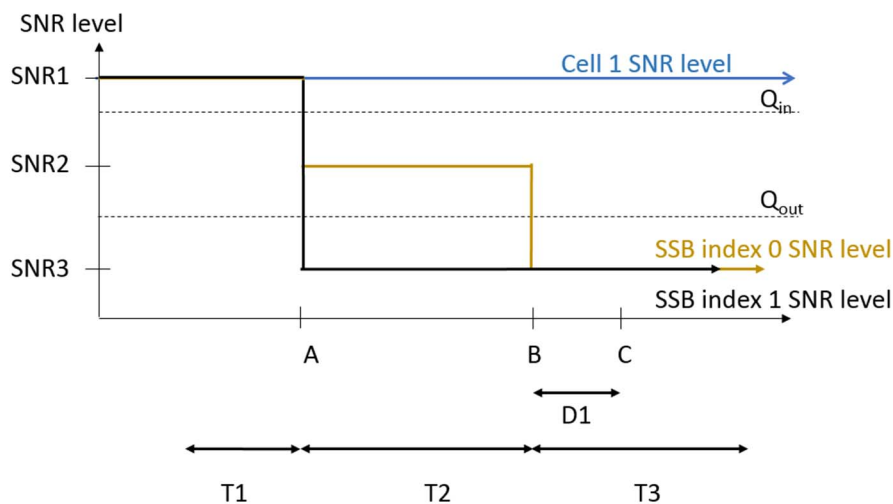

Figure 5.5.1.3.4-1: SNR variation for out-of-sync testing

5.5.1.3.4.1 Initial conditions

Initial conditions are a set of test configurations the UE needs to be tested in and the steps for the SS to take with the UE to reach the correct measurement state.

The initial test configurations consist of environmental conditions, test frequencies, test channel bandwidths and sub-carrier spacing based on NR operating bands specified in Table 5.3.5-1 of 38.521-2 [18].

This test shall be tested using any of the test configurations in Table 5.5.1.3.4.1-1.

Table 5.5.1.3.4.1-1: EN-DC FR2 radio link monitoring out-of-sync test for PSCell configured with SSB-based RLM RS in non-DRX mode supported test configurations

Configuration	Description
5.5.1.3-1	FDD LTE PCell, NR 120 KHz SSB SCS, 100MHz bandwidth, TDD duplex mode
5.5.1.3-2	TDD LTE PCell, NR 120 KHz SSB SCS, 100MHz bandwidth, TDD duplex mode

NOTE: The UE is only required to pass in one of the supported test configurations in FR2

Configure the test equipment and the DUT according to the parameters in Table 5.5.1.3.4.1-2

**Table 5.5.1.3.4.1-2: Initial conditions for EN-DC FR2 radio link monitoring out-of-sync test for PSCell configured with SSB-based RLM RS in non-DRX mode**

Parameter	Value		Comment
Test environment	NC		As specified in TS 38.508-1 [14] clause 4.1.
Test frequencies	As specified in Annex E.1.1, Table E.2-1 and TS 38.508-1 [14] clause 4.3.1 for E-UTRA and 7.2.3 for NR.		
Channel bandwidth	As specified by the test configuration selected from Table 5.5.1.3.4.1-1		
Propagation conditions	AWGN		As specified in clause C.2.2.
Connection Diagram	TE Part	A.3.3.1.1	As specified in TS 38.508-1 [14] Annex A.
	DUT Part	A.3.4.1.1	
Exceptions to connection diagram	N/A		

PDCCH transmission parameters are given in Table 5.5.1.3.4.1-4

**Table 5.5.1.3.4.1-3: Void**

1. Message contents are defined in clause 5.5.1.3.4.3.
2. The power levels and settings for Cell 1 are set according to Annex A.6, Table A.6.1.1-1. Cell 2 is NR FR2 PSCell. The connection setup is done according to the settings in clause C.1.3, and the downlink signal levels as per clause C.1.2
3. The test parameters are given in Table 5.5.1.3.4.1-4 below.
4. Downlink signals for NR cell are initially set up according to Annex [C.x].

Table 5.5.1.3.4.1-4: General test parameters for FR2 out-of-sync testing in DRX mode

Parameter		Unit	Value
			Test 1
Active E-UTRA PCell			Cell 1
E-UTRA RF Channel Number			1
Active PSCell			Cell 2
RF Channel Number			2
Duplex mode	Config 1, 2		TDD
$BW_{channel}$	Config 1, 2		100: $N_{RB,C} = 66$
Data RBs allocated	Config 1, 2		66
DL initial BWP configuration	Config 1, 2		DLBWP.0.1
DL dedicated BWP configuration	Config 1, 2		DLBWP.1.1
UL initial BWP configuration	Config 1, 2		ULBWP.0.1
UL dedicated BWP configuration	Config 1, 2		ULBWP.1.1
TDD Configuration	Config 1, 2		TDDConf.3.1
CORESET Reference Channel	Config 1, 2		CR.3.1 TDD
Dedicated CORESET Reference Channel	Config 1, 2		CCR.3.4 TDD
SSB Configuration	Config 1, 2		SSB.1 FR2
SMTc Configuration	Config 1, 2		SMTc.1
PDSCH/PDCCH subcarrier spacing	Config 1, 2		120 KHz
PRACH Configuration	Config 1, 2		PRACH.4 FR2
SSB index assigned as RLM RS	Config 1, 2		0,1
OCNG parameters			OP.1
CP length			Normal
Out of sync transmission parameters	DCI format		1-0
	Number of Control OFDM symbols		2
	Aggregation level	CCE	8
	Ratio of hypothetical PDCCH RE energy to average SSS RE energy	dB	4
	Ratio of hypothetical PDCCH DMRS energy to average SSS RE energy	dB	4
	DMRS precoder granularity		REG bundle size
	REG bundle size		6
DRX Configuration			DRX.3
Gap pattern ID			N.A.
Layer 3 filtering			Enabled
T310 timer		ms	0
T311 timer		ms	1000
N310			1
N311			1
CSI-RS for CSI reporting	Config 1, 2		CSI-RS.3.1 TDD
reportConfigType			periodic
reportQuantity			cri-RI-PMI-CQI
CSI reporting periodicity		slot	40
CSI reporting offset		slot	4
TCI states for PDCCH/PDSCH			TCI.State.2
CSI-RS for tracking	Config 1, 2		TRS.2.1 TDD
T1		s	0.2
T2		s	14.48
T3		s	14.48
D1		s	14.44
Note 1: All configurations are assigned to the UE prior to the start of time period T1.			
Note 2: UE-specific PDCCH is not transmitted after T1 starts.			
Note 3: E-UTRAN is in non-DRX mode under test.			

5.5.1.3.4.2 Test Procedure

The test consists of two cells, a single E-UTRA cell (Pcell), and a single NR cell (PSCell). Prior to the start of the time duration T1, the UE shall be fully synchronized to PSCell. The UE shall be configured for periodic CQI reporting in PUCCH [format 1] with a reporting periodicity as mentioned in the above table 5.5.1.3.4.1-4.

1. Ensure the UE is in state RRC\_CONNECTED with generic procedure parameters *Connectivity* EN-DC, DC bearer MCG and SCG, Connected without release *On* according to TS 38.508-1 [6] clause 5.5.
2. Set the parameters according to T1 in Table 5.5.1.3.5-1 for subtest 1 and 2. Propagation conditions are set according to Annex TBD. T1 starts.
3. When T1 expires the SS shall change the SNR value to T2 as specified in Table 5.5.1.3.5-1 for subtests 1 and 2. T2 starts.
4. When T2 expires the SS shall change the SNR value to T3 as specified in Table 5.5.1.3.5-1 for subtests 1 and 2. T3 starts.
5. If the SS:
  - a) detects uplink power in each subframe configured for CQI transmission (according to configured CQI periodicity on PUCCH [format 1]) during the period from time point A to time point B
 and
  - b) does not detect any uplink power from time point C (240 ms after the start of T3) until T3 expires, the number of successful tests is increased by one.
6. Otherwise the number of failed tests is increased by one and proceed to Step 10.
7. When T3 expires the SS shall change the SNR value to T1 as specified in Table 5.5.1.3.4.4-1.
8. If the UE has not re-established the connection in at least 1s, the SS shall ensure PSCell is released.
9. The SS then shall transmit RRCConnectionReconfiguration message with condition MCG\_and\_SCG according to TS 36.508 [25] Table 4.6.1-8 to add NR cell (PSCell). The UE shall transmit RRCConnectionReconfigurationComplete message.
10. If the Reconfiguration fails, switch off and on the UE and ensure the UE is in RRC\_CONNECTED with generic procedure parameters *Connectivity* EN-DC, DC bearer MCG and SCG, Connected without release *On* according to TS 38.508-1 [14] clause 4.5].
11. Repeat steps 2-10 until the confidence level according to Tables G.2.3-1 in Annex G clause G.2 is achieved.

5.5.1.3.4.3 Message Contents

Message contents are according to TS 38.508-1 [14] clause 7.3 with the following exceptions:

**Table 5.5.1.3.4.3-0: Common Exception messages**

Default Message Contents	
Common contents of system information blocks exceptions	
Default RRC messages and information elements contents exceptions	Table H.3.4-1 Table H.3.5-4 Table H.3.5-9 with Condition SSB RLM Table H.3.7-1 with condition DRX.3

Table 5.5.1.3.4.3-1: PDCCH Search Space

Derivation Path: TS 38.508-1 [14], Table 4.6.3-162			
Information Element	Value/remark	Comment	Condition
SearchSpace ::= SEQUENCE {			
monitoringSlotPeriodicityAndOffset CHOICE {			
sl1	NULL		
}			
Duration	2		
monitoringSymbolsWithinSlot	11000000000000	Symbols 0 and 1	
nrofCandidates SEQUENCE {			
aggregationLevel1	n0		
aggregationLevel2	n0		
aggregationLevel4	n0		
aggregationLevel8	n1	AL8	
aggregationLevel16	n0		
}			
searchSpaceType CHOICE {			
common SEQUENCE {			CSS, SISS
ue-Specific SEQUENCE {			USS
dci-Formats	formats0-0-And-1-0	DCI Format 1_0	
}			
}			
}			

Table 5.5.1.3.4.3-2: UE-TimersAndConstants

Derivation Path: TS 38.508-1 [14], Table 4.6.3-200			
Information Element	Value/remark	Comment	Condition
UE-TimersAndConstants ::= SEQUENCE {			
t310	ms0		
n310	n1		
t311	ms1000		
n311	n1		
}			

Table 5.5.1.3.4.3-3: CSI-FrequencyOccupation

Derivation Path: TS 38.508-1 [14], Table 4.6.3-33			
Information Element	Value/remark	Comment	Condition
CSI-FrequencyOccupation ::= SEQUENCE {			
startingRB	0		
nrofRBs	66	100 MHz (120 KHz SCS)	
}			

### 5.5.1.3.5 Test Requirement

Table 5.5.1.3.5-1 defines the cell specific primary level settings.

The UE behavior in each test during time durations T1, T2 and T3 shall be as follows:

During the period from time point A to time point B the UE shall transmit uplink signal at least in all uplink slots configured for CSI transmission according to the configured periodic CSI reporting.

The UE shall stop transmitting uplink signal no later than time point C (D1 second after the start of the time duration T3).

The rate of correct events observed during repeated tests shall be at least 90%.

**Table 5.5.1.3.5-1: OTA related cell specific test parameters for FR2 (Cell 2) for out-of-sync radio link monitoring tests in DRX mode**

Parameter		Unit	Test 1		
			T1	T2	T3
AoA setup			Setup 1 defined in A.9.1		
Assumption for UE beams <sup>Note 5</sup>			Rough		
EPRE ratio of PDCCH DMRS to SSS		dB	4		
EPRE ratio of PDCCH to PDCCH DMRS		dB	0		
EPRE ratio of PBCH DMRS to SSS		dB	0		
EPRE ratio of PBCH to PBCH DMRS		dB			
EPRE ratio of PSS to SSS		dB			
EPRE ratio of PDSCH DMRS to SSS		dB			
EPRE ratio of PDSCH to PDSCH DMRS		dB			
EPRE ratio of OCNG DMRS to SSS		dB			
EPRE ratio of OCNG to OCNG DMRS		dB			
ssb-Index 0 SNR	Config 1, 2	dB	2 <sup>Note 6</sup>	-6 <sup>Note 6</sup>	-15
ssb-Index 1 SNR	Config 1, 2		2 <sup>Note 6</sup>	-15	-15
$N_{oc}$	Config 1, 2	dBm/15K Hz	-104.7dBm		
Propagation condition			TDL-A 30ns 75Hz		
<p>Note 1: OCNG shall be used such that the resources in Cell 2 are fully allocated and a constant total transmitted power spectral density is achieved for all OFDM symbols.</p> <p>Note 2: The signal contains PDCCH for UEs other than the device under test as part of OCNG.</p> <p>Note 3: SNR levels correspond to the signal to noise ratio over the SSS REs.</p> <p>Note 4: The SNR values are specified for testing a UE which supports 2RX on at least one band. For testing of a UE which supports 4RX on all bands, the SNR during T3 is TS 38.133 [6] A.3.6.</p> <p>Note 5: Information about types of UE beam is given in TS 38.133 [6] B.2.1.3, and does not limit UE implementation or test system implementation</p> <p>Note 6: This value allows up to 1dB degradation from applied SNR to UE baseband</p>					

#### 5.5.1.4 EN-DC FR2 radio link monitoring in-sync test for PSCell configured with SSB-based RLM RS in DRX mode

**Editor's Notes:** This test case is incomplete. The following aspects are either missing or not yet determined

- Test procedure needs further updates specific to OTA aspect
- MU/TT is FFS

##### 5.5.1.4.1 Test Purpose

The purpose of this test is to verify that the UE properly detects the out of sync and in sync for the purpose of monitoring downlink radio link quality of the PSCell with DRX configured. This test will partly verify the FR2 PSCell radio link monitoring requirements in clause 8.1.

##### 5.5.1.4.2 Test Applicability

This test applies to all types of E-UTRA UEs Release 15 and forward supporting EN-DC

##### 5.5.1.4.3 Minimum Conformance Requirements

The minimum requirements are specified in clause 5.5.1.0.2. DRX configuration is used for this test.

The normative reference for this requirement is TS 38.133 [6] clause A.5.5.1.2.

##### 5.5.1.4.4 Test Description

##### 5.5.1.4.4 Test Description

There are two cells, Cell 1 is the E-UTRAN PCell, and Cell 2 is the PSCell, in the test. The E-UTRAN PCell setting refers to Table A.3.7.2.1-2. The test consists of five successive time periods, with time duration of T1, T2, T3, T4 and



T5 respectively. Figure A.5.5.1.4.1-1 shows the variation of the downlink SNR in the active cell to emulate out-of-sync and in-sync states. Prior to the start of the time duration T1, the UE shall be fully synchronized to Cell 1 and Cell 2. The UE shall be configured for periodic CSI reporting with a reporting periodicity of 5 ms. In the test, DRX configuration is enabled and DRX inactivity timer has already been expired, i.e. UE tries to decode PDCCH and to send periodic CSI during the period when On-duration timer is running. Time alignment timers shall be set to “infinity” so that UL timing alignment is maintained during the test.

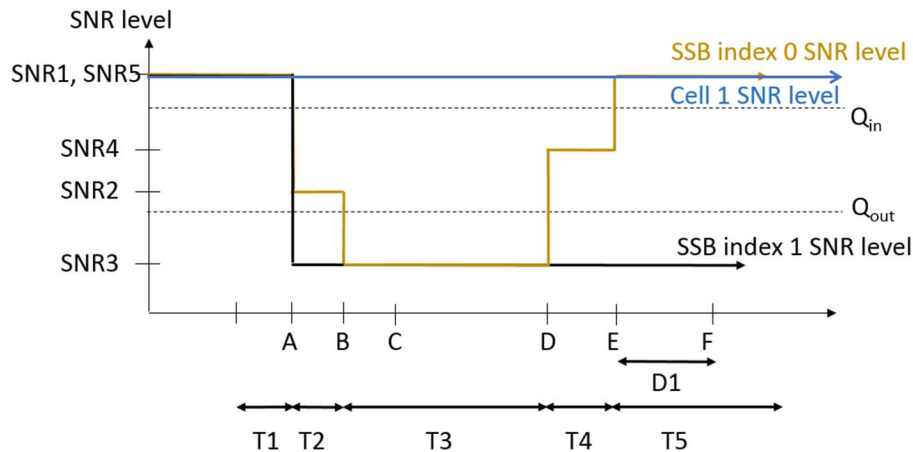

Figure 5.5.1.4.4-1: SNR variation for in-sync testing

5.5.1.4.4.1 Initial conditions

Initial conditions are a set of test configurations the UE needs to be tested in and the steps for the SS to take with the UE to reach the correct measurement state.

The initial test configurations consist of environmental conditions, test frequencies, test channel bandwidths and sub-carrier spacing based on NR operating bands specified in Table [5.3.5-1] and Table 5.3.5-1 of 38.521-2 [18].

This test shall be tested using any of the test configurations in Table 5.5.1.4.4.1-1.

Table 5.5.1.4.4.1-1: Supported test configurations for FR2 PSCell

Configuration	Description
5.5.1.4-1	FDD LTE PCell, NR 120 KHz SSB SCS, 100MHz bandwidth, TDD duplex mode
5.5.1.4-2	TDD LTE PCell, NR 120 KHz SSB SCS, 100MHz bandwidth, TDD duplex mode

NOTE: The UE is only required to pass in one of the supported test configurations in FR2

Configure the test equipment and the DUT according to the parameters in Table 5.5.1.4.4.1-2.

Table 5.5.1.4.4.1-2: Initial conditions for EN-DC FR2 radio link monitoring in-sync test for PSCell configured with SSB-based RLM RS in non-DRX mode

Parameter	Value	Comment
Test environment	NC	As specified in TS 38.508-1 [14] clause 4.1.
Test frequencies	As specified in Annex E.1.1, Table E.2-1 and TS 38.508-1 [14] clause 4.3.1 for E-UTRA and 7.2.3 for NR.	
Channel bandwidth	As specified by the test configuration selected from Table 5.5.1.3.4.1-1	
Propagation conditions	AWGN	As specified in clause C.2.2.
Connection Diagram	TE Part	A.3.3.1.1
	DUT Part	A.3.4.1.1

Exceptions to connection diagram	N/A	
----------------------------------	-----	--

PDCCH transmission parameters are given in Table 5.5.1.4.4.1-4.

**Table 5.5.1.4.4.1-3: Void**

1. Message contents are defined in clause 5.5.1.4.4.3.
2. The power levels and settings for Cell 1 are set according to Annex A.6, Table A.6.1.1-1. Cell 2 is NR FR2 PSCell. The connection setup is done according to the settings in clause C.1.3, and the downlink signal levels as per clause C.1.2
3. The general test parameters are given in Table 5.5.1.4.5-4 below.
4. Downlink signals for NR cell are initially set up according to clause C.1.

**Table 5.5.1.4.4.1-4: General test parameters for FR2 in-sync testing in DRX mode**

Parameter		Unit	Value
			Test 1
Active E-UTRA PCell			Cell 1
E-UTRA RF Channel Number			1
Active PSCell			Cell 2
RF Channel Number			2
Duplex mode	Config 1, 2		TDD
BW <sub>channel</sub>	Config 1, 2		100: N <sub>RB,c</sub> = 66
DL initial BWP configuration	Config 1, 2		DLBWP.0.1
DL dedicated BWP configuration	Config 1, 2		DLBWP.1.1
UL initial BWP configuration	Config 1, 2		ULBWP.0.1
UL dedicated BWP configuration	Config 1, 2		ULBWP.1.1
TDD Configuration	Config 1, 2		TDDConf.3.1
CORESET Reference Channel	Config 1, 2		CR.3.1 TDD
Dedicated CORESET Reference Channel	Config 1, 2		CCR.3.1 TDD
SSB Configuration	Config 1, 2		SSB.1 FR2
SMTC Configuration	Config 1, 2		SMTC.3
PDSCH/PDCCH subcarrier spacing	Config 1, 2		120 KHz
PRACH Configuration	Config 1, 2		PRACH.4 FR2
SSB index assigned as RLM RS	Config 1, 2		0,1
OCNG parameters			OP.1
CP length			Normal
In sync transmission parameters	DCI format		1-0
	Number of Control OFDM symbols		2
	Aggregation level	CCE	4
	Ratio of hypothetical PDCCH RE energy to average SSS RE energy	dB	0
	Ratio of hypothetical PDCCH DMRS energy to average SSS RE energy	dB	0
	DMRS precoder granularity		REG bundle size
Out of sync transmission parameters	DCI format		1-0
	Number of Control OFDM symbols		2
	Aggregation level	CCE	8
	Ratio of hypothetical PDCCH RE energy to average SSS RE energy	dB	4
	Ratio of hypothetical PDCCH DMRS energy to average SSS RE energy	dB	4
	DMRS precoder granularity		REG bundle size

Parameter	Unit	Value
		Test 1
REG bundle size		6
DRX Configuration		DRX.11
Gap pattern ID		N.A.
Layer 3 filtering		Enabled
T310 timer	ms	4000
T311 timer	ms	1000
N310		1
N311		1
CSI-RS for CSI reporting	Config 1, 2	CSI-RS.3.1 TDD
reportConfigType		periodic
reportQuantity		cri-RI-PMI-CQI
CSI reporting periodicity	slot	40
CSI reporting offset	slot	4
TCI states for PDCCH/PDSCH		TCI.State.2
CSI-RS for tracking	Config 1, 2	TRS.2.1 TDD
T1	s	0.2
T2	s	0.2
T3	s	2.8
T4	s	0.2
T5	s	3.88
D1	s	3.84
NOTE 1: All configurations are assigned to the UE prior to the start of time period T1.		
NOTE 2: UE-specific PDCCH is not transmitted after T1 starts.		
NOTE 3: E-UTRAN is in non-DRX mode under test.		

#### 5.5.1.4.4.2 Test procedure

**Editor's Note: Test procedure updates to ensure accurate FR2 measurement state is TBD**

The test consists of two cells, a single E-UTRA cell (Pcell), and a single NR cell (PSCell). Prior to the start of the time duration T1, the UE shall be fully synchronized to PSCell. The UE shall be configured for periodic CQI reporting in PUCCH [format 1] with a reporting periodicity as mentioned in the above table 5.5.1.4.4.1-4.

1. Ensure the UE is in state RRC\_CONNECTED with generic procedure parameters *Connectivity* EN-DC, DC bearer MCG and SCG, Connected without release *On* according to TS 38.508-1 [6] clause 4.5.
2. Set the parameters according to T1 in Table 5.5.1.4.4-1 for subtest 1 and 2. Propagation conditions are set according to Annex TBD. T1 starts.
3. When T1 expires, the SS shall change the SNR value to T2 as specified in Table 5.5.1.4.5-1. T2 starts.
4. When T2 expires, the SS shall change the SNR value to T3 as specified in Table 5.5.1.4.5-1. T3 starts.
5. When T3 expires, the SS shall change the SNR value to T3 as specified in Table 5.5.1.4.5-1. T4 starts.
6. When T4 expires, the SS shall change the SNR value to T3 as specified in Table 5.5.1.4.5-1. T5 starts.
7. If the SS detects uplink power in the On-duration part of every DRX cycle in the subframe according the configured CQI reporting mode (PUCCH 1-0) during the period from time point A to time point F (1120 ms after the start of time duration T5) the number of successful tests is increased by one.  
Otherwise the number of failed tests is increased by one.
8. Repeat steps 2-7 for all subtests until the confidence level according to Tables G.2.3-1 in Annex G clause G.2 is achieved.

#### 5.5.1.4.4.3 Message Contents

Message contents are according to TS 38.508-1 [14] clause 7.3 with the following exceptions.

**Table 5.5.1.4.4.3-1: Common Exception messages**

Default Message Contents	
Common contents of system information blocks exceptions	
Default RRC messages and information elements contents exceptions	Table H.3.4-1 Table H.3.5-4 Table H.3.5-9 with Condition SSB RLM Table H.3.7-1 with condition DRX.3

**Table 5.5.1.4.4.3-2: PDCCH Search Space**

Derivation Path: TS 38.508-1 [14], Table 4.6.3-162

Information Element	Value/remark	Comment	Condition
SearchSpace ::= SEQUENCE {			
monitoringSlotPeriodicityAndOffset CHOICE {			
s1	NULL		
}			
duration	2		
monitoringSymbolsWithinSlot	11000000000000	Symbols 0 and 1	
nrofCandidates SEQUENCE {			
aggregationLevel1	n0		
aggregationLevel2	n0		
aggregationLevel4	n0		
aggregationLevel8	n1	AL8	
aggregationLevel16	n0		
}			
searchSpaceType CHOICE {			
ue-Specific SEQUENCE {			USS
dci-Formats	formats0-0-And-1-0	DCI Format 1_0	
}			
}			
}			

**Table 5.5.1.4.4.3-3: RLF-TimersAndConstant**

Derivation Path: TS 38.508-1 [14], Table 4.6.3-150

Information Element	Value/remark	Comment	Condition
RLF-TimersAndConstants ::= SEQUENCE {			
t310	ms4000		
n310	n1		
n311	n1		
t311-v1530	ms1000		
}			

**Table 5.5.1.4.4.3-4: CSI-FrequencyOccupation**

Derivation Path: TS 38.508-1 [14], Table 4.6.3-33

Information Element	Value/remark	Comment	Condition
CSI-FrequencyOccupation ::= SEQUENCE {			
startingRB	0		
nrofRBs	66	100 MHz (120 KHz SCS)	
}			

5.5.1.4.5 Test Requirements

The UE behaviour in each test during time durations T1, T2, T3, T4 and T5 shall be as follows:

During the period from time point A to time point F (D1 second after the start of time duration T5) the UE shall transmit uplink signal at least in all uplink slots configured for CSI transmission according to the configured periodic CSI reporting.

The rate of correct events observed during repeated tests shall be at least 90% with a 95% confidence interval.

**5.5.1.4.5-1: OTA related cell specific test parameters for FR2 (Cell 2) for in-sync radio link monitoring tests in DRX mode**

Parameter		Unit	Test 1				
			T1	T2	T3	T4	T5
AoA setup			Setup 1 defined in A.9.1				
Assumption for UE beams <sup>Note 5</sup>			Rough				
EPRE ratio of PDCCH DMRS to SSS		dB	0				
EPRE ratio of PDCCH to PDCCH DMRS		dB	0				
EPRE ratio of PBCH DMRS to SSS		dB	0				
EPRE ratio of PBCH to PBCH DMRS		dB					
EPRE ratio of PSS to SSS		dB					
EPRE ratio of PDSCH DMRS to SSS		dB					
EPRE ratio of PDSCH to PDSCH DMRS		dB					
EPRE ratio of OCNG DMRS to SSS		dB					
EPRE ratio of OCNG to OCNG DMRS		dB					
ssb-Index 0 SNR	Config 1, 2	dB	2 <sup>Note 6</sup>	-6 <sup>Note 6</sup>	-15	-4.5	2 <sup>Note 6</sup>
ssb-Index 1 SNR	Config 1, 2		2 <sup>Note 6</sup>	-15	-15	-15	-15
$N_{oc}$	Config 1, 2	dBm/15 KHz	-104.7dBm				
Propagation condition			TDL-A 30ns 75Hz				
NOTE 1: OCNG shall be used such that the resources in Cell 2 are fully allocated and a constant total transmitted power spectral density is achieved for all OFDM symbols.							
NOTE 2: The signal contains PDCCH for UEs other than the device under test as part of OCNG.3							
NOTE 3: SNR levels correspond to the signal to noise ratio over the SSS REs.							
NOTE 4: The SNR values are specified for testing a UE which supports 2RX on at least one band. For testing of a UE which supports 4RX on all bands, the SNR during T3 is TS 38.133 [6] A.3.6.							
Note 5: Information about types of UE beam is given in 38.133 [6] B.2.1.3, and does not limit UE implementation or test system implementation							
Note 6: This value allows up to 1dB degradation from applied SNR to UE baseband							

**5.5.1.5 EN-DC FR2 radio link monitoring out-of-sync test for PSCell configured with CSI-RS-based RLM RS in non-DRX mode**

**Editor's note: This test case is incomplete. The following aspects are either missing or TBD**

- TT analysis is made at Test frequency  $f \leq 40.8$  GHz
- Connection diagram is TBD
- Test Procedure and message contents will need further editing and review

**5.5.1.5.1 Test purpose**

The purpose of this test is to verify that the UE properly detects the out of sync for the purpose of monitoring downlink CSI-RS based radio link quality of the PSCell when no DRX is used. This test will partly verify the FR2 TDD PSCell CSI-RS Out-of-sync radio link monitoring requirements in TS 38.133 clause 8.1.

**5.5.1.5.2 Test applicability**

This test applies to all types of E-UTRA UE release 15 and forward supporting EN-DC and CSI-RS based RLM.

5.5.1.5.3 Minimum conformance requirements

The minimum requirements are specified in clause 5.5.1.0.3. DRX configuration is not used for this test.

The normative reference for this requirement is TS 38.133 [6] clause A.5.5.1.5.

5.5.1.5.4 Test description

There are two cells configured in this test, the E-UTRA PCell and NR PSCell. This test consists of three successive time periods, with time duration of T1, T2 and T3 respectively. Figure 5.5.1.5.4-1 shows the three different time durations and the corresponding variation of the downlink SNR in the active cell to emulate out-of-sync states.

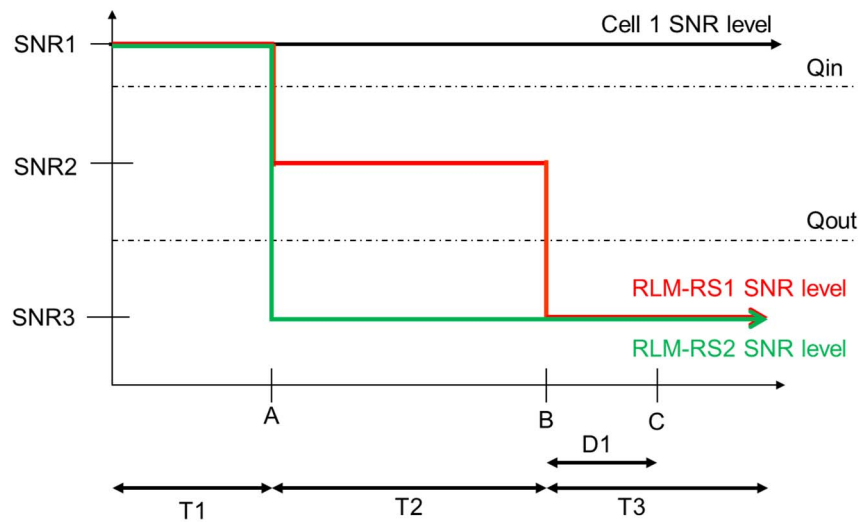

Figure 5.5.1.5.4-1: SNR variation for out-of-sync testing

5.5.1.5.4.1 Initial conditions

Test 5.5.1.5 can be run in one of the configurations defined in Table 5.5.1.5.4.1-1.

Table 5.5.1.5.4.1-1: Supported test configurations for FR2 PSCell

Configuration	Description
5.5.1.5-1	LTE FDD, NR 120 kHz SSB SCS, 100 MHz bandwidth, TDD duplex mode
5.5.1.5-2	LTE TDD, NR 120 kHz SSB SCS, 100 MHz bandwidth, TDD duplex mode

NOTE: The UE is only required to pass in one of the supported test configurations in FR2

Configure the test equipment and the DUT according to the parameters in Table 5.5.1.5.4.1-2

Table 5.5.1.5.4.1-2: Initial conditions for CSI-RS In-sync radio link monitoring in non-DRX mode

Parameter	Value	Comment
Test environment	NC	As specified in TS 38.508-1 [14] clause 4.1.
Test frequencies	As specified in Annex E, table E.2-1 and TS 38.508-1 [14] clause 4.3.1 for E-UTRA and 7.2.3 for NR.	
Channel bandwidth	As specified by the test configuration selected from Table 4.5.1.6.4.1-1.	
Propagation conditions	AWGN As specified in clause C.2.2.	
Connection Diagram	TE Part DUT Part	TBD TBD As specified in TS 38.508-1 [14] Annex A.
Exceptions to connection diagram	N/A	

1. The test parameters are given in Table 5.5.1.5.4.1-3 below.
2. Message contents are defined in clause 5.5.1.5.4.3.
3. There are two cells in the test, where Cell 1 is the E-UTRAN PCell on the E-UTRA carrier, and Cell 2 is the NR PSCell on the NR carrier. Cell 1 is the cell used for connection setup with the power level set according to TS 38.133 [6] Table A.6.1.1-1 for this test. Cell 2 is configured according to clause C.1.1 and C.1.2.

**Table 5.5.1.5.4.1-3: General test parameters for FR2 PSCell for CSI-RS out-of-sync testing in non-DRX mode**

Parameter		Unit	Value
			Test 1
Active E-UTRA PCell			Cell 1
E-UTRA RF Channel Number			1
Active PSCell			Cell 2
RF Channel Number			2
Duplex Mode			TDD
$BW_{channel}$		Config 1, 2	
Data RBs allocated		Config 1, 2	
$BW_{occupied}$		Config 1, 2	
$BW_{channel}$		Config 1, 2	
TDD Configuration	Config 1		TDDConf.3.1
	Config 2		TDDConf.3.1
DL initial BWP configuration	Config 1, 2		DLBWP.0.1
DL dedicated BWP configuration	Config 1, 2		DLBWP.1.4
UL initial BWP configuration	Config 1, 2		ULBWP.0.1
UL dedicated BWP configuration	Config 1, 2		ULBWP.1.4
RMSI CORESET	Config 1		CR.3.1 TDD
Reference Channel	Config 2		CR.3.1 TDD
Dedicated CORESET Reference Channel	Config 1		CCR.3.4 TDD CCR.3.6 TDD
	Config 2		CCR.3.4 TDD CCR.3.6 TDD
SSB Configuration	Config 1		SSB.1 FR2
	Config 2		SSB.1 FR2
SMTC Configuration	Config 1		SMTC.1
	Config 2		SMTC.1
PDSCH/PDCCH subcarrier spacing	Config 1		120 KHz
	Config 2		120 KHz
CSI-RS for RLM	Config 1, 2		Resource #4 in TRS.2.1 TDD Resource #4 in TRS.2.2 TDD
reportConfigType			periodic
reportQuantity			cri-RI-PMI-CQI
CSI reporting periodicity		slot	40
CSI reporting offset		slot	4
TRS configuration			TRS.2.1 TDD TRS.2.2 TDD
TCI configuration for PDCCH#1/PDSCH			TCI.State.2
TCI configuration for PDCCH#2			TCI.State.3
OCNG parameters			OP.5
CP length			Normal
Out of sync transmission parameters	DCI format		1-0
	Number of Control OFDM symbols		2
	Aggregation level	CCE	8
	Ratio of hypothetical PDCCH RE energy to average CSI-RS RE energy	dB	4
	Ratio of hypothetical PDCCH DMRS energy to average CSI-RS RE energy	dB	4

Parameter		Unit	Value
			Test 1
	DMRS precoder granularity		REG bundle size
	REG bundle size		6
DRX			OFF
Gap pattern ID			gp0
Layer 3 filtering			Enabled
T310 timer		ms	0
T311 timer		ms	1000
N310			1
N311			1
CSI-RS for CSI reporting	Config 1		CSI-RS.3.1 TDD
	Config 2		CSI-RS.3.1 TDD
T1		s	0.2
T2		s	0.35
T3		s	0.35
D1		s	0.31
NOTE 1: UE-specific PDCCH is not transmitted after T1 starts.			
NOTE 2: E-UTRAN is in non-DRX mode under test.			

**Table 5.5.1.5.4.1-4: Measurement gap configuration for FR2 CSI-RS out-of-sync radio link monitoring in non-DRX mode**

Field	Test 1 Value
gapOffset	0
NOTE 1: E-UTRAN PCell and PSCell are SFN-synchronous and frame boundary aligned. (Ensure that RLM RS is partially overlapped with measurement gap)	

#### 5.5.1.5.4.2 Test procedure

Prior to the start of the time duration T1, the UE shall be fully synchronized to Cell 1 and Cell 2. The UE shall be configured for periodic CSI reporting with a reporting periodicity defined in CSI-RS configuration. In the test, DRX configuration is not enabled. The UE is configured to perform inter-frequency measurements using GP ID #0 (40ms).

1. Ensure the UE is in state RRC\_CONNECTED with generic procedure parameters Connectivity EN-DC, DC bearer MCG and SCG, Connected without release *On* according to TS 38.508-1 [14] clause 4.5.4.
2. Set the parameters of Cell 2 according to T1 in Table 5.5.1.5.5-1. Propagation conditions are set according to clause C.2.3. T1 starts.
3. When T1 expires the SS shall change the SNR value to T2 as specified in Table 5.5.1.5.5-1. T2 starts.
4. When T2 expires the SS shall change the SNR value to T3 as specified in Table 5.5.1.5.5-1. T3 starts.
5. If the SS:
  - a) detects uplink power on NR carrier in each slot configured for CQI transmission (according CQI reporting on PUCCH) during the period from time point A to time point B

and

  - b) does not detect any uplink power on NR carrier from time point C (D1 after the start of T3) until T3 expires, the number of successful tests is increased by one.

Otherwise the number of failed tests is increased by one.
6. When T3 expires the SS shall change the SNR value to T1 as specified in Table 5.5.1.5.5-1.
7. If the UE has not re-established the connection in at least 1s, the SS shall ensure PSCell is released.



8. The SS then shall transmit *RRCConnectionReconfiguration* message with condition MCG and\_SCG according to TS 36.508 [25] Table 4.6.1-8 to add NR cell (PSCell). The UE shall transmit *RRCConnectionReconfigurationComplete* message.
9. If the Reconfiguration fails, switch off and on the UE and ensure the UE is in RRC\_CONNECTED with generic procedure parameters *Connectivity* EN-DC, DC bearer MCG and SCG, Connected without release *On* according to TS 38.508-1 [14] clause 4.5].
10. Repeat steps 2-10 until the confidence level according to Tables G.2.3-1 in Annex G clause G.2 is achieved.

5.5.1.5.4.3 Message contents

Message contents are according to TS 38.508-1 [14] clause 4.6 with the following exceptions:

**Table 5.5.1.5.4.3-1: Common Exception messages**

Default Message Contents	
Common contents of system information blocks exceptions	
Default RRC messages and information elements contents exceptions	Table H.3.1-2 with Condition INTER-FREQ, L3 FILTERING NEEDED; Table H.3.1-3 with Condition INTER-FREQ MO, SSB.1 FR2, SMTC.1 and RLM Table H.3.1-4 with a3-offset = -6dB; Table H.3.1-8 with Condition CSI RLM Table H.3.1-9

**Table 5.5.1.5.4.3-2: MeasConfig for E-UTRAN PCell**

Derivation Path: TS 36.508 [25], Table 4.6.6-1 with condition RF			
Information Element	Value/remark	Comment	Condition
MeasConfig-DEFAULT ::= SEQUENCE {			
reportConfigToAddModList	Not present		
measIdToAddModList	Not present		
measGapConfig	MeasGapConfig-GP1	TS 36.508, table 4.6.6-1A	
}			

5.5.1.5.5 Test requirement

Tables 5.5.1.5.4.1-2 and 5.5.1.5.5-1 define the primary level settings including test tolerances for Radio Link Monitoring Out-of-sync Test for FR2 PSCell configured with CSI-RS-based RLM in non-DRX mode.

**Table 5.5.1.5.5-1: Cell specific test parameters for FR2 for CSI-RS out-of-sync radio link monitoring in non-DRX mode**

Parameter		Unit	Test 1					
			T1	T2	T3	T1	T2	T3
AoA setup			Setup 3 defined in A.9.3					
			AoA1			AoA2		
Assumption for UE beams <sup>Note 10</sup>			Rough			Rough		
EPRE ratio of PDCCH DMRS to SSS		dB	4			Not sent		
EPRE ratio of PDCCH to PDCCH DMRS		dB	0					
EPRE ratio of PBCH DMRS to SSS		dB						
EPRE ratio of PBCH to PBCH DMRS		dB						
EPRE ratio of PSS to SSS		dB						
EPRE ratio of PDSCH DMRS to SSS		dB						
EPRE ratio of PDSCH to PDSCH DMRS		dB						
EPRE ratio of OCNG DMRS to SSS		dB						
EPRE ratio of OCNG to OCNG DMRS		dB						
SNR on RLM-RS1	Config 1, 2	dB						
SNR on RLM-RS2	Config 1, 2		Not sent			4.1 <sup>Note 11</sup>	-14	-15
$N_{oc}$	Config 1, 2	dBm/ 15kHz	-94.8			-94.8		
Propagation condition			TDL-A 30ns 75Hz			TDL-A 30ns 75Hz		
<p>Note 1: OCNG shall be used such that the resources in Cell 2 are fully allocated and a constant total transmitted power spectral density is achieved for all OFDM symbols.</p> <p>Note 2: The uplink resources for CSI reporting are assigned to the UE prior to the start of time period T1.</p> <p>Note 3: NZP CSI-RS resource set configuration for CSI reporting are assigned to the UE prior to the start of time period T1.</p> <p>Note 4: Measurement gap configuration is assigned to the UE prior to the start of time period T1.</p> <p>Note 5: The timers and layer 3 filtering related parameters are configured prior to the start of time period T1.</p> <p>Note 6: The signal contains PDCCH for UEs other than the device under test as part of OCNG.</p> <p>Note 7: SNR levels correspond to the signal to noise ratio over the SSS REs.</p> <p>Note 8: The SNR in time periods T1, T2 and T3 is denoted as SNR1, SNR2 and SNR3 respectively in figure 5.5.1.5.4-1.</p> <p>Note 9: The SNR values are specified for testing a UE which supports 2RX on at least one band. For testing of a UE which supports 4RX on all bands, the SNR during T3 is TS 38.133 [6] A.3.6.</p> <p>Note 10: Information about types of UE beam is given in TS 38.133 [6] B.2.1.3, and does not limit UE implementation or test system implementation</p> <p>Note 11: This value allows up to 1dB degradation from applied SNR to UE baseband</p>								

The UE behaviour in each test during time durations T1, T2 and T3 shall be as follows:

During the period from time point A to time point B the UE shall transmit uplink signal in Cell 2 (PSCell) at least in all uplink slots configured for CSI transmission according the configured periodic CSI reporting for Cell 2.

The UE shall stop transmitting uplink signal in Cell 2 (PSCell) no later than time point C (D1 after the start of time duration T3) on the PSCell.

The rate of correct events observed during repeated tests shall be at least 90% with a confidence level of 95%.

### 5.5.1.6 EN-DC FR2 radio link monitoring in-sync test for PSCell configured with CSI-RS-based RLM RS in non-DRX mode

**Editor's note: This test case is incomplete. The following aspects are either missing or TBD**

- TT analysis is made at Test frequency  $f \leq 40.8$  GHz- Connection diagram is TBD.

- Test Procedure and message contents will need further editing and review

5.5.1.6.1 Test purpose

The purpose of this test is to verify that the UE properly detects the in-sync for the purpose of monitoring downlink CSI-RS based radio link quality of the PSCell when no DRX is used. This test will partly verify the FR2 TDD PSCell CSI-RS in-sync radio link monitoring requirements in TS 38.133 clause 8.1.

5.5.1.6.2 Test applicability

This test applies to all types of E-UTRA UE release 15 and forward supporting EN-DC and CSI-RS based RLM.

5.5.1.6.3 Minimum conformance requirements

The minimum requirements are specified in clause 4.5.1.0.4. DRX configuration is not used for this test.

The normative reference for this requirement is TS 38.133 [6] clause A.5.5.1.6.

5.5.1.6.4 Test description

There are two cells configured in this test, the E-UTRA PCell and NR PSCell. This test consists of five successive time periods, with time duration of T1, T2, T3, T4 and T5 respectively. Figure 5.5.1.6.4-1 shows the five different time durations and the corresponding variation of the downlink SNR in the active cell to emulate in-sync states.

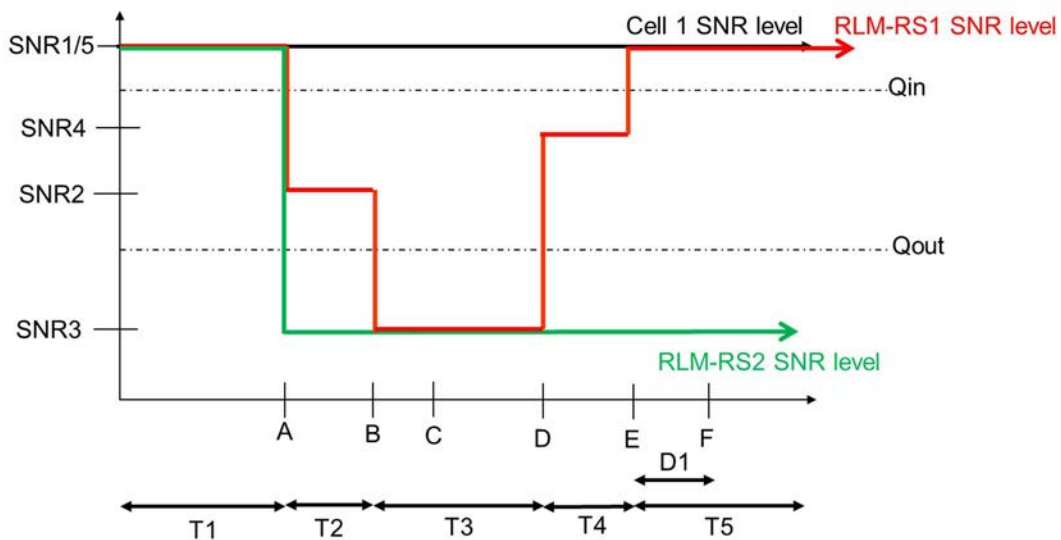

Figure 5.5.1.6.4-1: SNR variation for in-sync testing

5.5.1.6.4.1 Initial conditions

Test 5.5.1.6 can be run in one of the configurations defined in Table 5.5.1.6.4.1-1.

Table 5.5.1.6.4.1-1: Supported test configurations for FR2 PSCell

Configuration	Description
5.5.1.6-1	LTE FDD, NR 120 kHz SSB SCS, 100 MHz bandwidth, TDD duplex mode
5.5.1.6-2	LTE TDD, NR 120 kHz SSB SCS, 100 MHz bandwidth, TDD duplex mode

NOTE: The UE is only required to pass in one of the supported test configurations in FR2

Configure the test equipment and the DUT according to the parameters in Table 5.5.1.6.4.1-2

**Table 5.5.1.6.4.1-2: Initial conditions for CSI-RS in-sync radio link monitoring in non-DRX mode**

Parameter	Value		Comment
Test environment	NC		As specified in TS 38.508-1 [14] clause 4.1.
Test frequencies	As specified in Annex E, table E.2-1 and TS 38.508-1 [14] clause 4.3.1 for E-UTRA and 7.2.3 for NR.		
Channel bandwidth	As specified by the test configuration selected from Table 4.5.1.6.4.1-1.		
Propagation conditions	AWGN		As specified in clause C.2.2.
Connection Diagram	TE Part	TBD	As specified in TS 38.508-1 [14] Annex A.
	DUT Part	TBD	
Exceptions to connection diagram	N/A		

1. The test parameters are given in Table 5.5.1.6.4.1-3 below.
2. Message contents are defined in clause 5.5.1.6.4.3.
3. There are two cells in the test, where Cell 1 is the E-UTRAN PCell on the E-UTRA carrier, and Cell 2 is the NR PSCell on the NR carrier. Cell 1 is the cell used for connection setup with the power level set according to TS 38.133 [6] Table A.6.1.1-1 for this test. Cell 2 is configured according to clause C.1.1 and C.1.2.

**Table 5.5.1.6.4.1-3: General test parameters for FR2 PSCell for CSI-RS in-sync testing in non-DRX mode**

Parameter		Unit	Value
			Test 1
Active E-UTRA PCell			Cell 1
E-UTRA RF Channel Number			1
Active PSCell			Cell 2
RF Channel Number			2
Duplex Mode			TDD
BW <sub>channel</sub>	Config 1, 2		100: N <sub>RB,c</sub> = 66
Data RBs allocated	Config 1, 2		24
BW <sub>occupied</sub>	Config 1, 2		24
TDD Configuration	Config 1		TDDConf.3.1
	Config 2		TDDConf.3.1
DL initial BWP configuration	Config 1, 2		DLBWP.0.1
DL dedicated BWP configuration	Config 1, 2		DLBWP.1.4
UL initial BWP configuration	Config 1, 2		ULBWP.0.1
UL dedicated BWP configuration	Config 1, 2		ULBWP.1.4
RMSI CORESET Reference Channel	Config 1		CR.3.1 TDD
	Config 2		CR.3.1 TDD
Dedicated CORESET Reference Channel	Config 1		CCR.3.1 TDD CCR.3.3 TDD
	Config 2		CCR.3.1 TDD CCR.3.3 TDD
SSB Configuration	Config 1		SSB.1 FR2
	Config 2		SSB.1 FR2
SMTC Configuration	Config 1		SMTC.1
	Config 2		SMTC.1
PDSCH/PDCCH subcarrier spacing	Config 1		120 KHz
	Config 2		120 KHz
CSI-RS for RLM	Config 1, 2		Resource #4 in TRS.2.1 TDD Resource #4 in TRS.2.2 TDD
OCNG parameters			OP.5
TRS configuration			TRS.2.1 TDD TRS.2.2 TDD
TCI configuration for PDCCH#1/PDSCH			TCI.State.2

Parameter		Unit	Value
			Test 1
TCI configuration for PDCCH#2			TCI.State.3
CP length			Normal
Out of sync transmission parameters	DCI format		1-0
	Number of Control OFDM symbols		2
	Aggregation level	CCE	8
	Ratio of hypothetical PDCCH RE energy to average CSI-RS RE energy	dB	4
	Ratio of hypothetical PDCCH DMRS energy to average CSI-RS RE energy	dB	4
	DMRS precoder granularity		REG bundle size
	REG bundle size		6
In sync transmission parameters	DCI format		1-0
	Number of Control OFDM symbols		2
	Aggregation level	CCE	4
	Ratio of hypothetical PDCCH RE energy to average CSI-RS RE energy	dB	0
	Ratio of hypothetical PDCCH DMRS energy to average CSI-RS RE energy	dB	0
	DMRS precoder granularity		REG bundle size
	REG bundle size		6
DRX			OFF
Gap pattern ID			N.A.
Layer 3 filtering			Enabled
T310 timer		ms	1000
T311 timer		ms	1000
N310			1
N311			1
CSI-RS for CSI reporting	Config 1		CSI-RS.3.1 TDD
	Config 2		CSI-RS.3.1 TDD
T1		s	0.2
reportConfigType			periodic
reportQuantity			cri-RI-PMI-CQI
CSI reporting periodicity		slot	40
CSI reporting offset		slot	4
T2		s	0.2
T3		s	0.24
T4		s	0.2
T5		s	0.88
D1		s	0.84
NOTE 1: UE-specific PDCCH is not transmitted after T1 starts.			
NOTE 2: E-UTRAN is in non-DRX mode under test.			

#### 5.5.1.6.4.2 Test procedure

Prior to the start of the time duration T1, the UE shall be fully synchronized to Cell 1 and Cell 2. The UE shall be configured for periodic CSI reporting with a reporting periodicity defined in CSI-RS configuration. In the test, DRX configuration is not enabled.

1. Ensure the UE is in state RRC\_CONNECTED with generic procedure parameters Connectivity EN-DC, DC bearer MCG and SCG, Connected without release *On* according to TS 38.508-1 [14] clause 4.5.4.

2. Set the parameters of Cell 2 according to T1 in Table 5.5.1.6.5-1. Propagation conditions are set according to clause C.2.3. T1 starts.
3. When T1 expires the SS shall change the SNR value to T2 as specified in Table 5.5.1.6.5-1. T2 starts.
4. When T2 expires the SS shall change the SNR value to T3 as specified in Table 5.5.1.6.5-1. T3 starts.
5. When T3 expires the SS shall change the SNR value to T4 as specified in Table 5.5.1.6.5-1. T4 starts.
6. When T4 expires the SS shall change the SNR value to T5 as specified in Table 5.5.1.6.5-1. T5 starts.
7. If the SS detects uplink power on NR carrier in each slot configured for CQI transmission (according CQI reporting on PUCCH) during the period from time point A to time point F (T6 ms after the start of time duration T5) the number of successful tests is increased by one.  
  
Otherwise the number of failed tests is increased by one.
8. If the UE has not re-established the connection in at least 1s, the SS shall ensure PSCell is released.
9. The SS then shall transmit *RRCConnectionReconfiguration* message with condition MCG\_and\_SCG according to TS 36.508 [25] Table 4.6.1-8 to add NR cell (PSCell). The UE shall transmit *RRCConnectionReconfigurationComplete* message.
10. If the Reconfiguration fails, switch off and on the UE and ensure the UE is in RRC\_CONNECTED with generic procedure parameters Connectivity EN-DC, DC bearer MCG and SCG, Connected without release On according to TS 38.508-1 [14] clause 4.5].
11. Repeat steps 2-10 until the confidence level according to Tables G.2.3-1 in Annex G clause G.2 is achieved.

5.5.1.6.4.3 Message contents

Message contents are according to TS 38.508-1 [14] clause 4.6 with the following exceptions:

**Table 5.5.1.6.4.3-1: Common Exception messages**

Default Message Contents	
Common contents of system information blocks exceptions	
Default RRC messages and information elements contents exceptions	Table H.3.1-2 with Condition INTRA-FREQ, L3 FILTERING NEEDED;  Table H.3.1-3 with Condition INTRA-FREQ MO, SSB.1 FR2, SMTc.1 and RLM  Table H.3.1-8 with Condition CSI RLM  Table H.3.1-9

5.5.1.6.5 Test requirement

Tables 5.5.1.6.4.1-2 and 5.5.1.6.5-1 define the primary level settings including test tolerances for Radio Link Monitoring in-sync Test for FR2 PSCell configured with CSI-RS-based RLM in non-DRX mode.

**Table 5.5.1.6.5-1: Cell specific test parameters for FR2 for CSI-RS is-sync radio link monitoring in non-DRX mode**

Parameter		Unit	Test 1														
			T1	T2	T3	T4	T5	T1	T2	T3	T4	T5					
AoA setup			Setup 3 defined in A.9.3														
			AoA1					AoA2									
Assumption for UE beams <sup>Note 10</sup>			Rough					Rough									
EPRE ratio of PDCCH DMRS to SSS		dB	0					Not sent									
EPRE ratio of PDCCH to PDCCH DMRS		dB	0														
EPRE ratio of PBCH DMRS to SSS		dB															
EPRE ratio of PBCH to PBCH DMRS		dB															
EPRE ratio of PSS to SSS		dB															
EPRE ratio of PDSCH DMRS to SSS		dB															
EPRE ratio of PDSCH to PDSCH DMRS		dB															
EPRE ratio of OCNG DMRS to SSS		dB															
EPRE ratio of OCNG to OCNG DMRS		dB															
SNR on RLM-RS1	Config 1, 2	dB											4.1 <sup>Note 11</sup>	3.9 <sup>Note 11</sup>	-15	-4.5	4.1 <sup>Note 11</sup>
SNR on RLM-RS2	Config 1, 2												4.1 <sup>Note 11</sup>	-14	-15	-15	-14
$N_{oc}$	Config 1, 2	dBm/15KHz	-94.8					-94.8									
Propagation condition			TDL-A 30ns 75Hz					TDL-A 30ns 75Hz									
<p>Note 1: OCNG shall be used such that the resources in Cell 2 are fully allocated and a constant total transmitted power spectral density is achieved for all OFDM symbols.</p> <p>Note 2: The uplink resources for CSI reporting are assigned to the UE prior to the start of time period T1.</p> <p>Note 3: NZP CSI-RS resource set configuration for CSI reporting are assigned to the UE prior to the start of time period T1.</p> <p>Note 4: Measurement gap configuration is assigned to the UE prior to the start of time period T1.</p> <p>Note 5: The timers and layer 3 filtering related parameters are configured prior to the start of time period T1.</p> <p>Note 6: The signal contains PDCCH for UEs other than the device under test as part of OCNG.</p> <p>Note 7: SNR levels correspond to the signal to noise ratio over the SSS REs.</p> <p>Note 8: The SNR in time periods T1, T2, T3, T4 and T5 is denoted as SNR1, SNR2, SNR3, SNR4 and SNR5 respectively in figure 5.5.1.6.4-1.</p> <p>Note 9: The SNR values are specified for testing a UE which supports 2RX on at least one band. For testing of a UE which supports 4RX on all bands, the SNR during T3 is TS 38.133 [6] A.3.6.</p> <p>Note 10: Information about types of UE beam is given in TS 38.133 [6] B.2.1.3, and does not limit UE implementation or test system implementation</p> <p>Note 11: This value allows up to 1dB degradation from applied SNR to UE baseband</p>																	

The UE behaviour in each test during time durations T1, T2, T3, T4 and T5 shall be as follows:

During the period from time point A to time point F (T6 after the start of time duration T5) the UE shall transmit uplink signal at least in all slots configured for CSI transmission according to the configured periodic CSI reporting on the PSCell.

The rate of correct events observed during repeated tests shall be at least 90% with a confidence level of 95%.

**5.5.1.7 EN-DC FR2 radio link monitoring out-of-sync test for PSCell configured with CSI-RS-based RLM RS in DRX mode**

**Editor's note: This test case is incomplete. The following aspects are either missing or TBD**

- TT analysis is missing.

- Connection Diagrams are TBD

- Test Procedure and message contents will need further editing and review

5.5.1.7.1 Test purpose

The purpose of this test is to verify that the UE properly detects the out of sync for the purpose of monitoring downlink CSI-RS based radio link quality of the PSCell when DRX is used. This test will partly verify the FR2 TDD PSCell CSI-RS Out-of-sync radio link monitoring requirements in TS 38.133 clause 8.1.

5.5.1.7.2 Test applicability

This test applies to all types of E-UTRA UE release 15 and forward supporting EN-DC, CSI-RS based RLM and long DRX cycle.

5.5.1.7.3 Minimum conformance requirements

The minimum requirements are specified in clause 5.5.1.0.3. DRX configuration is used for this test.

The normative reference for this requirement is TS 38.133 [6] clause A.5.5.1.7.

5.5.1.7.4 Test description

There are two cells configured in this test, the E-UTRA PCell and NR PSCell. This test consists of three successive time periods, with time duration of T1, T2 and T3 respectively. Figure 5.5.1.7.4-1 shows the three different time durations and the corresponding variation of the downlink SNR in the active cell to emulate out-of-sync states.

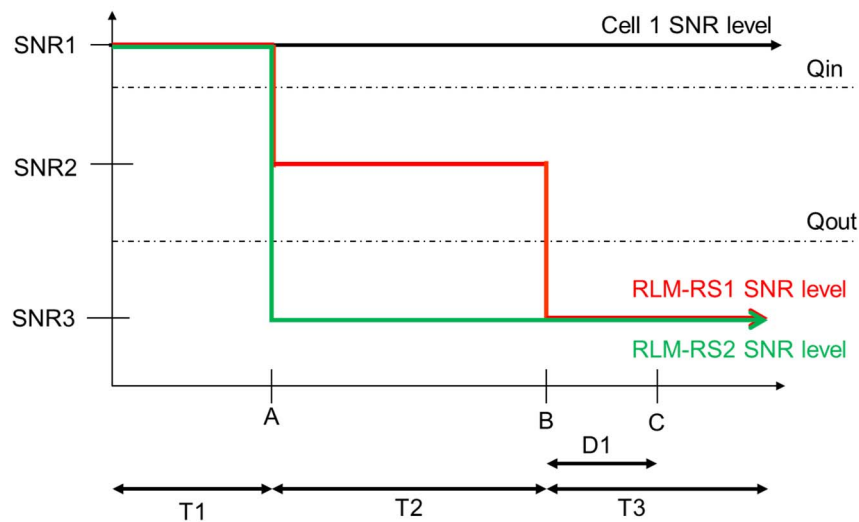

Figure 5.5.1.7.4-1: SNR variation for out-of-sync testing

5.5.1.7.4.1 Initial conditions

Test 5.5.1.7 can be run in one of the configurations defined in Table 5.5.1.7.4.1-1.

Table 5.5.1.7.4.1-1: Supported test configurations for FR2 PSCell

Configuration	Description
5.5.1.7-1	LTE FDD, NR 120 kHz SSB SCS, 100 MHz bandwidth, TDD duplex mode
5.5.1.7-2	LTE TDD, NR 120 kHz SSB SCS, 100 MHz bandwidth, TDD duplex mode
NOTE: The UE is only required to pass in one of the supported test configurations in FR2	

Configure the test equipment and the DUT according to the parameters in Table 5.5.1.7.4.1-2



**Table 5.5.1.7.4.1-2: Initial conditions for CSI-RS out-of-sync radio link monitoring in DRX mode**

Parameter	Value		Comment
Test environment	NC		As specified in TS 38.508-1 [14] clause 4.1.
Test frequencies	As specified in Annex E, table E.2-1 and TS 38.508-1 [14] clause 4.3.1 for E-UTRA and 7.2.3 for NR.		
Channel bandwidth	As specified by the test configuration selected from Table 5.5.1.7.4.1-1.		
Propagation conditions	AWGN		As specified in clause C.2.2.
Connection Diagram	TE Part	TBD	As specified in TS 38.508-1 [14] Annex A.
	DUT Part	TBD	
Exceptions to connection diagram	N/A		

1. The test parameters are given in Table 5.5.1.7.4.1-3 below.
2. Message contents are defined in clause 5.5.1.7.4.3.
3. There are two cells in the test, where Cell 1 is the E-UTRAN PCell on the E-UTRA carrier, and Cell 2 is the NR PSCell on the NR carrier. Cell 1 is the cell used for connection setup with the power level set according to Table A.6.1.1-1 for this test. Cell 2 is configured according to clause C.1.1 and C.1.2.

**Table 5.5.1.7.4.1-3: General test parameters for FR2 PSCell for CSI-RS out-of-sync testing in DRX mode**

Parameter		Unit	Value
			<b>Test 1</b>
Active E-UTRA PCell			Cell 1
E-UTRA RF Channel Number			1
Active PSCell			Cell 2
RF Channel Number			2
Duplex Mode			TDD
TDD Configuration	Config 1		TDDConf.3.1
	Config 2		TDDConf.3.1
DL initial BWP configuration	Config 1, 2		DLBWP.0.1
DL dedicated BWP configuration	Config 1, 2		DLBWP.1.1
UL initial BWP configuration	Config 1, 2		ULBWP.0.1
UL dedicated BWP configuration	Config 1, 2		ULBWP.1.1
RMSI CORESET Reference Channel	Config 1		CR. 3.1 TDD
	Config 2		CR. 3.1 TDD
RMC CORESET Reference Channel	Config 1		CCR. 3.4 TDD CCR.3.6 TDD
	Config 2		CCR. 3.4 TDD CCR.3.6 TDD
SSB Configuration	Config 1		SSB.1 FR2
	Config 2		SSB.1 FR2
SMTC Configuration	Config 1		SMTC.1
	Config 2		SMTC.1
PDSCH/PDCCH subcarrier spacing	Config 1		120 KHz
	Config 2		120 KHz
CSI-RS for RLM	Config 1, 2		Resource #4 in TRS.2.1 TDD Resource #4 in TRS.2.2 TDD
TRS configuration			TRS.2.1 TDD TRS.2.2 TDD
TCI configuration for PDCCH#1/PDSCH			TCI.State.2
TCI configuration for PDCCH#2			TCI.State.3
OCNG parameters			OP.1

Parameter		Unit	Value
			Test 1
Out of sync transmission parameters	DCI format		1-0
	Number of Control OFDM symbols		2
	Aggregation level	CCE	8
	Ratio of hypothetical PDCCH RE energy to average CSI-RS RE energy	dB	4
	Ratio of hypothetical PDCCH DMRS energy to average CSI-RS RE energy	dB	4
	DMRS precoder granularity		REG bundle size
	REG bundle size		6
DRX			DRX.3
Gap pattern ID			N.A.
Layer 3 filtering			<i>Enabled</i>
T310 timer		ms	0
T311 timer		ms	1000
N310			1
N311			1
CSI-RS for CSI reporting	Config 1		CSI-RS.3.1 TDD
	Config 2		CSI-RS.3.1 TDD
reportConfigType			periodic
reportQuantity			cri-RI-PMI-CQI
CSI reporting periodicity		slot	40
CSI reporting offset		slot	4
T1		s	0.2
T2		s	1.28
T3		s	1.28
D1		s	1.24
NOTE 1: UE-specific PDCCH is not transmitted after T1 starts.			
NOTE 2: E-UTRAN is in non-DRX mode under test.			

#### 5.5.1.7.4.2 Test procedure

Prior to the start of the time duration T1, the UE shall be fully synchronized to Cell 1 and Cell 2. The UE shall be configured for periodic CSI reporting with a reporting periodicity defined in CSI-RS configuration. In the test, DRX configuration is enabled in PSCell and DRX inactivity timer has already been expired, i.e. UE tries to decode PDCCH and to send periodic CQI during the period when On-duration timer is running. Time alignment timers shall be set to “infinity” so that UL timing alignment is maintained during the test.

1. Ensure the UE is in state RRC\_CONNECTED with generic procedure parameters Connectivity EN-DC, DC bearer *MCG* and *SCG*, Connected without release *On* according to TS 38.508-1 [14] clause 4.5.4.
2. Set the parameters of Cell 2 according to T1 in Table 5.5.1.7.5-1. Propagation conditions are set according to clause C.2.3. T1 starts.
3. When T1 expires the SS shall change the SNR value to T2 as specified in Table 5.5.1.7.5-1. T2 starts.
4. When T2 expires the SS shall change the SNR value to T3 as specified in Table 5.5.1.7.5-1. T3 starts.
5. If the SS:
  - a) detects uplink power on NR carrier in the On-duration part of every DRX cycle in the slots configured for CQI transmission (according CQI reporting on PUCCH) during the period from time point A to time point B
and

b) does not detect any uplink power on NR carrier from time point C (D1 after the start of T3) until T3 expires, the number of successful tests is increased by one.

Otherwise the number of failed tests is increased by one.

6. When T3 expires the SS shall change the SNR value to T1 as specified in Table 5.5.1.7.5-1.
7. If the UE has not re-established the connection in at least 1s, the UE is switched off and then on. Ensure the UE is in RRC\_CONNECTED with generic procedure parameters Connectivity EN-DC, DC bearer MCG and SCG, Connected without release *On* according to TS 38.508-1 [14] clause 4.5.
8. Repeat steps 2-7 for all subtests until the confidence level according to Tables G.2.3-1 in Annex G clause G.2 is achieved.

5.5.1.7.4.3 Message contents

Message contents are according to TS 38.508-1 [14] clause 4.6 with the following exceptions:

**Table 5.5.1.7.4.3-1: Common Exception messages**

Default Message Contents	
Common contents of system information blocks exceptions	
Default RRC messages and information elements contents exceptions	Table H.3.1-2 with Condition INTRA-FREQ, L3 FILTERING NEEDED; Table H.3.1-3 with Condition INTRA-FREQ MO, SSB.1 FR2, SMTTC.1 and RLM Table H.3.1-8 with Condition CSI RLM Table H.3.1-9 Table H.3.7-1 with condition DRX.7

5.5.1.7.5 Test requirement

Tables 5.5.1.7.4.1-2 and 5.5.1.7.5-1 define the primary level settings including test tolerances for Radio Link Monitoring Out-of-sync Test for FR2 PSCell configured with CSI-RS-based RLM in DRX mode.

**Table 5.5.1.7.5-1: Cell specific test parameters for FR2 for CSI-RS out-of-sync radio link monitoring in DRX mode**

Parameter		Unit	Test 1		
			T1	T2	T3
AoA setup			Setup 1 defined in A.9.3		
Assumption for UE beams <sup>Note 10</sup>			Rough		
EPRE ratio of PDCCH DMRS to SSS		dB	4		
EPRE ratio of PDCCH to PDCCH DMRS		dB	0		
EPRE ratio of PBCH DMRS to SSS		dB			
EPRE ratio of PBCH to PBCH DMRS		dB			
EPRE ratio of PSS to SSS		dB			
EPRE ratio of PDSCH DMRS to SSS		dB			
EPRE ratio of PDSCH to PDSCH DMRS		dB			
EPRE ratio of OCNG DMRS to SSS		dB			
EPRE ratio of OCNG to OCNG DMRS		dB			
SNR on RLM-RS1	Config 1, 2	dB	<sup>2</sup> Note 11	<sup>-6</sup> Note 11	-15
SNR on RLM-RS2	Config 1, 2		<sup>2</sup> Note 11	-14	-15
$N_{oc}$	Config 1	dBm/15KHz	-104.7		
	Config 2		-104.7		
Propagation condition			TDL-A 30ns 75Hz		
<p>Note 1: OCNG shall be used such that the resources in Cell 2 are fully allocated and a constant total transmitted power spectral density is achieved for all OFDM symbols.</p> <p>Note 2: The uplink resources for CSI reporting are assigned to the UE prior to the start of time period T1.</p> <p>Note 3: NZP CSI-RS resource set configuration for CSI reporting are assigned to the UE prior to the start of time period T1.</p> <p>Note 4: Measurement gap configuration is assigned to the UE prior to the start of time period T1.</p> <p>Note 5: The timers and layer 3 filtering related parameters are configured prior to the start of time period T1.</p> <p>Note 6: The signal contains PDCCH for UEs other than the device under test as part of OCNG.</p> <p>Note 7: SNR levels correspond to the signal to noise ratio over the SSS REs.</p> <p>Note 8: The SNR in time periods T1, T2 and T3 is denoted as SNR1, SNR2 and SNR3 respectively in figure 5.5.1.7.4-1.</p> <p>Note 9: The SNR values are specified for testing a UE which supports 2RX on at least one band. For testing of a UE which supports 4RX on all bands, the SNR during T3 is TS 38.133 [6] A.3.6.</p> <p>Note 10: Information about types of UE beam is given in TS 38.133 [6] B.2.1.3, and does not limit UE implementation or test system implementation</p> <p>Note 11: This value allows up to 1dB degradation from applied SNR to UE baseband</p>					

The UE behaviour in each test during time durations T1, T2 and T3 shall be as follows:

During the period from time point A to time point B the UE shall transmit uplink signal at least once every DRX cycle, in the On-duration part of the cycle in the slots configured for CSI transmission according the configured periodic CSI reporting for Cell 2.

The UE shall stop transmitting uplink signal in Cell 2 (PSCell) no later than time point C (D1 after the start of time duration T3) on the PSCell.

The rate of correct events observed during repeated tests shall be at least 90% with a confidence level of 95%.

### 5.5.1.8 EN-DC FR2 radio link monitoring in-sync test for PSCell configured with CSI-RS-based RLM RS in DRX mode

Editor's note: This test case is incomplete. The following aspects are either missing or TBD

- TT analysis is missing.
- Connection Diagram is TBD.
- Test Procedure and message contents will need further editing and review

#### 5.5.1.8.1 Test purpose

The purpose of this test is to verify that the UE properly detects the in sync for the purpose of monitoring downlink CSI-RS based radio link quality of the PSCell when DRX is used. This test will partly verify the FR2 PSCell CSI-RS in-sync radio link monitoring requirements in TS 38.133 clause 8.1.

#### 5.5.1.8.2 Test applicability

This test applies to all types of E-UTRA UE release 15 and forward supporting EN-DC, CSI-RS based RLM and long DRX cycle.

#### 5.5.1.8.3 Minimum conformance requirements

The minimum requirements are specified in clause 5.5.1.0.4. DRX configuration is used for this test.

The normative reference for this requirement is TS 38.133 [6] clause A.5.5.1.8.

#### 5.5.1.8.4 Test description

There are two cells configured in this test, the E-UTRA PCell and NR PSCell. This test consists of five successive time periods, with time duration of T1, T2, T3, T4 and T5 respectively. Figure 5.5.1.8.4-1 shows the five different time durations and the corresponding variation of the downlink SNR in the active cell to emulate in-sync states.

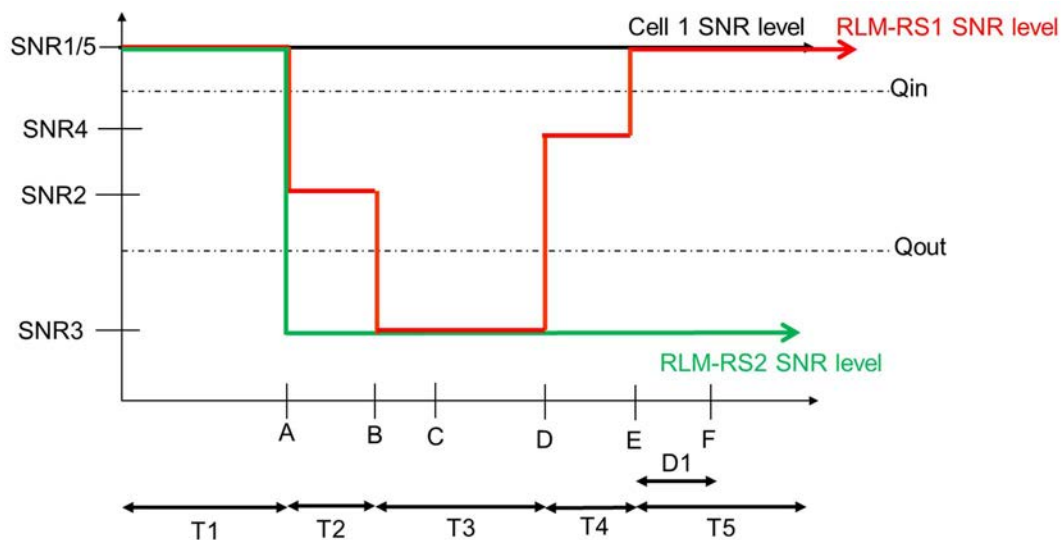

Figure 5.5.1.8.4-1: SNR variation for In-sync testing

#### 5.5.1.8.4.1 Initial conditions

Test 5.5.1.8 can be run in one of the configurations defined in Table 5.5.1.8.4.1-1.

**Table 5.5.1.8.4.1-1: Supported test configurations for FR2 PSCell**

Configuration	Description
5.5.1.8-1	LTE FDD, NR 120 kHz SSB SCS, 100 MHz bandwidth, TDD duplex mode
5.5.1.8-2	LTE TDD, NR 120 kHz SSB SCS, 100 MHz bandwidth, TDD duplex mode
NOTE: The UE is only required to pass in one of the supported test configurations in FR2	

Configure the test equipment and the DUT according to the parameters in Table 5.5.1.8.4.1-2

**Table 5.5.1.8.4.1-2: Initial conditions for CSI-RS In-sync radio link monitoring in DRX mode**

Parameter	Value	Comment
Test environment	NC	As specified in TS 38.508-1 [14] clause 4.1.
Test frequencies	As specified in Annex E, table E.2-1 and TS 38.508-1 [14] clause 4.3.1 for E-UTRA and 7.2.3 for NR.	
Channel bandwidth	As specified by the test configuration selected from Table 5.5.1.8.4.1-1.	
Propagation conditions	AWGN	As specified in clause C.2.2.
Connection Diagram	TE Part	TBD
	DUT Part	TBD
Exceptions to connection diagram	N/A	

1. The test parameters are given in Table 5.5.1.8.4.1-2 below.
2. Message contents are defined in clause 5.5.1.8.4.3.
3. There are two cells in the test, where Cell 1 is the E-UTRAN PCell on the E-UTRA carrier, and Cell 2 is the NR PSCell on the NR carrier. Cell 1 is the cell used for connection setup with the power level set according to Table A.6.1.1-1 for this test. Cell 2 is configured according to clause C.1.1 and C.1.2.

**Table 5.5.1.8.4.1-3: General test parameters for FR2 PSCell for CSI-RS In-sync testing in DRX mode**

Parameter		Unit	Value
			Test 1
Active E-UTRA PCell			Cell 1
E-UTRA RF Channel Number			1
Active PSCell			Cell 2
RF Channel Number			2
Duplex Mode			TDD
TDD Configuration	Config 1		TDDConf.3.1
	Config 2		TDDConf.3.1
DL initial BWP configuration	Config 1, 2		DLBWP.0.1
DL dedicated BWP configuration	Config 1, 2		DLBWP.1.1
UL initial BWP configuration	Config 1, 2		ULBWP.0.1
UL dedicated BWP configuration	Config 1, 2		ULBWP.1.1
RMSI CORESET Reference Channel	Config 1		CR.3.1 TDD
	Config 2		CR.3.1 TDD
Dedicated CORESET Reference Channel	Config 1		CCR.3.1 TDD CCR.3.3 TDD
	Config 2		CCR.3.1 TDD CCR.3.3 TDD
SSB Configuration	Config 1		SSB.1 FR2
	Config 2		SSB.1 FR2
SMTTC Configuration	Config 1		SMTTC.1
	Config 2		SMTTC.1
PDSCH/PDCCH subcarrier spacing	Config 1		120 KHz
	Config 2		120 KHz
CSI-RS for RLM	Config 1, 2		Resource #4 in TRS.2.1 TDD

Parameter		Unit	Value
			Test 1
			Resource #4 in TRS.2.2 TDD
TRS configuration			TRS.2.1 TDD TRS.2.2 TDD
TCI configuration for PDCCH#1/PDSCH			TCI.State.2
TCI configuration for PDCCH#2			TCI.State.3
OCNG parameters			OP.1
CP length			Normal
Out of sync transmission parameters	DCI format		1-0
	Number of Control OFDM symbols		2
	Aggregation level	CCE	8
	Ratio of hypothetical PDCCH RE energy to average CSI-RS RE energy	dB	4
	Ratio of hypothetical PDCCH DMRS energy to average CSI-RS RE energy	dB	4
	DMRS precoder granularity		REG bundle size
	REG bundle size		6
	In sync transmission parameters	DCI format	
Number of Control OFDM symbols			2
Aggregation level		CCE	4
Ratio of hypothetical PDCCH RE energy to average CSI-RS RE energy		dB	0
Ratio of hypothetical PDCCH DMRS energy to average CSI-RS RE energy		dB	0
DMRS precoder granularity			REG bundle size
REG bundle size			6
DRX			DRX.3
Gap pattern ID			<i>gp0</i>
Layer 3 filtering			<i>Enabled</i>
T310 timer		ms	2000
T311 timer		ms	1000
N310			1
N311			1
CSI-RS for CSI reporting	Config 1		CSI-RS.3.1 TDD
	Config 2		CSI-RS.3.1 TDD
reportConfigType			periodic
reportQuantity			cri-RI-PMI-CQI
CSI reporting periodicity		slot	40
CSI reporting offset		slot	4
T1		s	0.2
T2		s	0.2
T3		s	1.64
T4		s	0.2
T5		s	1.88

Parameter	Unit	Value
		Test 1
D1	s	1.84
NOTE 1: UE-specific PDCCH is not transmitted after T1 starts.		
NOTE 2: E-UTRAN is in non-DRX mode under test.		

**Table 5.5.1.8.4.1-4: Measurement gap configuration for FR2 CSI-RS In-sync radio link monitoring in DRX mode**

Field	Test 1
	Value
gapOffset	0
NOTE 1: E-UTRAN PCell and PSCell are SFN-synchronous and frame boundary aligned. (Ensure that RLM RS is partially overlapped with measurement gap)	

#### 5.5.1.8.4.2 Test procedure

Prior to the start of the time duration T1, the UE shall be fully synchronized to Cell 1 and Cell 2. The UE shall be configured for periodic CSI reporting with a reporting periodicity defined in CSI-RS configuration. In the test, DRX configuration is enabled in PSCell and DRX inactivity timer has already been expired, i.e. UE tries to decode PDCCH and to send periodic CSI during the period when On-duration timer is running. Time alignment timers shall be set to “infinity” so that UL timing alignment is maintained during the test. The UE is configured to perform inter-frequency measurements using GP ID #0 (40ms).

1. Ensure the UE is in state RRC\_CONNECTED with generic procedure parameters Connectivity EN-DC, DC bearer *MCG* and *SCG*, Connected without release *On* according to TS 38.508-1 [14] clause 4.5.4.
2. Set the parameters of Cell 2 according to T1 in Table 5.5.1.8.5-1. Propagation conditions are set according to clause C.2.3. T1 starts.
3. When T1 expires the SS shall change the SNR value to T2 as specified in Table 5.5.1.8.5-1. T2 starts.
4. When T2 expires the SS shall change the SNR value to T3 as specified in Table 5.5.1.8.5-1. T3 starts.
5. When T3 expires the SS shall change the SNR value to T4 as specified in Table 5.5.1.8.5-1. T4 starts.
6. When T4 expires the SS shall change the SNR value to T5 as specified in Table 5.5.1.8.5-1. T5 starts.
7. If the SS detects uplink power on NR carrier in the On-duration part of every DRX cycle in the configured slots for CQI transmission (according CQI reporting on PUCCH) during the period from time point A to time point F (T6 after the start of time duration T5) the number of successful tests is increased by one.

Otherwise the number of failed tests is increased by one.

8. If the UE has not re-established the connection in at least 1s, the SS shall ensure PSCell is released.
9. The SS then shall transmit *RRCConnectionReconfiguration* message with condition *MCG\_and\_SCG* according to TS 36.508 [25] Table 4.6.1-8 to add NR cell (PSCell). The UE shall transmit *RRCConnectionReconfigurationComplete* message.
10. If the Reconfiguration fails, switch off and on the UE and ensure the UE is in RRC\_CONNECTED with generic procedure parameters Connectivity EN-DC, DC bearer *MCG and SCG*, Connected without release *On* according to TS 38.508-1 [14] clause 4.5].
11. Repeat steps 2-10 until the confidence level according to Tables G.2.3-1 in Annex G clause G.2 is achieved.

#### 5.5.1.8.4.3 Message contents

Message contents are according to TS 38.508-1 [14] clause 4.6 with the following exceptions:



**Table 5.5.1.8.4.3-1: Common Exception messages**

Default Message Contents	
Common contents of system information blocks exceptions	
Default RRC messages and information elements contents exceptions	Table H.3.1-2 with Condition INTER-FREQ, L3 FILTERING NEEDED; Table H.3.1-3 with Condition INTER-FREQ MO, SSB.1 FR2, SMTC.1 and RLM Table H.3.1-4 with a3-offset = -6dB; Table H.3.1-8 with Condition CSI RLM Table H.3.1-9 Table H.3.7-1 with condition DRX.3 and Gap

**Table 5.5.1.8.4.3-2: MeasConfig for E-UTRAN PCell**

Derivation Path: TS 36.508, Table 4.6.6-1 with condition RF			
Information Element	Value/remark	Comment	Condition
MeasConfig-DEFAULT ::= SEQUENCE {			
reportConfigToAddModList	Not present		
measIdToAddModList	Not present		
measGapConfig	MeasGapConfig-GP1	TS 36.508, table 4.6.6-1A	
}			

5.5.1.8.5 Test requirement

Tables 5.5.1.8.4.1-2 and 5.5.1.8.5-1 define the primary level settings including test tolerances for Radio Link Monitoring In-sync Test for FR2 PCell configured with CSI-RS-based RLM in DRX mode.

**Table 5.5.1.8.5-1: Cell specific test parameters for FR2 for CSI-RS In-sync radio link monitoring in DRX mode**

Parameter		Unit	Test 1				
			T1	T2	T3	T4	T5
AoA setup			Setup 1 defined in A.9.3				
Assumption for UE beams <sup>Note 10</sup>			Rough				
EPRE ratio of PDCCH DMRS to SSS		dB	0				
EPRE ratio of PDCCH to PDCCH DMRS		dB	0				
EPRE ratio of PBCH DMRS to SSS		dB					
EPRE ratio of PBCH to PBCH DMRS		dB					
EPRE ratio of PSS to SSS		dB					
EPRE ratio of PDSCH DMRS to SSS		dB					
EPRE ratio of PDSCH to PDSCH DMRS		dB					
EPRE ratio of OCNB DMRS to SSS		dB					
EPRE ratio of OCNB to OCNB DMRS		dB	-104.7				
SNR on RLM-RS1	Config 1, 2	dB					
SNR on RLM-RS2	Config 1, 2	dB	<sup>2</sup> Note 11	-14	-15	-15	-14
$N_{oc}$	Config 1, 2	dBm/15KHz	-104.7				
Propagation condition			TDL-A 30ns 75Hz				
<p>Note 1: OCNB shall be used such that the resources in Cell 2 are fully allocated and a constant total transmitted power spectral density is achieved for all OFDM symbols.</p> <p>Note 2: The uplink resources for CSI reporting are assigned to the UE prior to the start of time period T1.</p> <p>Note 3: NZP CSI-RS resource set configuration for CSI reporting are assigned to the UE prior to the start of time period T1.</p> <p>Note 4: Measurement gap configuration is assigned to the UE prior to the start of time period T1.</p> <p>Note 5: The timers and layer 3 filtering related parameters are configured prior to the start of time period T1.</p> <p>Note 6: The signal contains PDCCH for UEs other than the device under test as part of OCNB.</p> <p>Note 7: SNR levels correspond to the signal to noise ratio over the SSS REs.</p> <p>Note 8: The SNR in time periods T1, T2, T3, T4 and T5 is denoted as SNR1, SNR2, SNR3, SNR4 and SNR5 respectively in figure 5.5.1.8.4-1.</p> <p>Note 9: The SNR values are specified for testing a UE which supports 2RX on at least one band. For testing of a UE which supports 4RX on all bands, the SNR during T3 is TS 38.133 [6] A.3.6.</p> <p>Note 10: Information about types of UE beam is given in TS 38.133 [6] B.2.1.3, and does not limit UE implementation or test system implementation</p> <p>Note 11: This value allows up to 1dB degradation from applied SNR to UE baseband</p>							

The UE behaviour in each test during time durations T1, T2, T3, T4 and T5 shall be as follows:

During the period from time point A to time point F (T6 after the start of time duration T5) the UE shall transmit uplink signal at least once every DRX cycle, in the ON-duration part of the cycle in the slots configured for CSI transmission according to the configured periodic CSI reporting on the PSCell.

The rate of correct events observed during repeated tests shall be at least 90% with a confidence level of 95%.

### 5.5.1.9 EN-DC FR2 radio link monitoring UE scheduling restrictions

**Editor's note: This test case is incomplete. The following aspects are either missing or not yet determined:**

-The test tolerances and test system uncertainties applicable to this test are undefined.

-Message content is TBD

5.5.1.9.1 Test purpose

The purpose of this test is to verify that the NR UE correctly follows the RLM scheduling restrictions requirements defined in TS 38.133 [6] clause 8.1.7, and to verify that the UE correctly receive the PDCCH scheduled on the symbols right before the RLM SSB symbols without overlap so that it sends ACK/NACK correctly.

5.5.1.9.2 Test applicability

This test applies to all types of NR UE from Release 15 onwards.

This test is only applicable to UE which supports *pdccch-MonitoringAnyOccasions* or *pdccch-MonitoringAnyOccasionsWithSpanGap*.

5.5.1.9.3 Minimum conformance requirement

The minimum conformance requirements are specified in clause 5.5.1.0.5.

The normative reference for this requirement is TS 38.133 [6] clause A.5.5.1.9.

5.5.1.9.4 Test description

Two cells are deployed in the test, which are E-UTRAN PCell (Cell 1) and NR FR2 PSCell (Cell 2). The test parameters for NR PSCell are given in table 5.5.1.9.4.1-1, table 5.5.1.9.4.1-3 and table 5.5.1.9.5-1 below and the parameters and applicability for the E-UTRAN cell are defined in A.6.1.2. The test consists of one time period with time duration of T1. Figure 5.5.1.9.4-1 shows the Time multiplexed downlink transmissions from each Angle of Arrival. The UE is required during time period T1 to transmit ACK/NACK correctly upon scheduling of PDSCH.

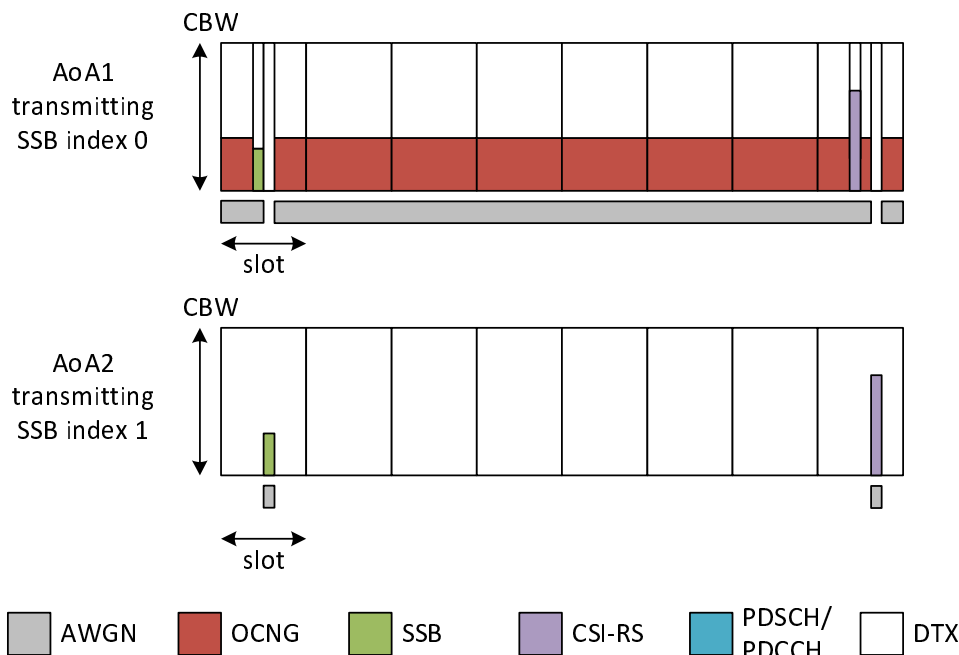

Figure 5.5.1.9.4-1: Time multiplexed downlink transmissions

5.5.1.9.4.1 Initial conditions

This test shall be tested using any of the test configurations in Table 5.5.1.9.4.1-1.

**Table 5.5.1.9.4.1-1: Supported test configurations for EN-DC FR2 radio link monitoring UE scheduling restrictions**

Configuration	Description
5.5.1.9-1	FDD LTE, 120 kHz SSB SCS, 120 kHz RMC SCS, 100 MHz bandwidth, TDD duplex mode
5.5.1.9-2	TDD LTE, 120 kHz SSB SCS, 120 kHz RMC SCS, 100 MHz bandwidth, TDD duplex mode
NOTE: The UE is only required to be tested in one of the supported test configurations.	

Configure the test equipment and the DUT according to the parameters in Table 5.5.1.9.4.1-2

**Table 5.5.1.9.4.1-2: Initial conditions for EN-DC FR2 radio link monitoring UE scheduling restrictions**

Parameter	Value	Comment
Test environment	NC	As specified in TS 38.508-1 [14] clause 4.1.
Test frequencies	As specified in Annex E.1.2, Table E.4-1 and TS 38.508-1 [14] clause 4.3.1 for E-UTRA and 7.2.3 for NR.	
Channel bandwidth	As specified by the test configuration selected from Table 5.5.1.9.4.1-1	
Propagation conditions	AWGN	As specified in clause C.2.2.
Connection Diagram	TE Part	TBD
	DUT Part	TBD
Exceptions to connection diagram	N/A	

1. The test parameters for PSCell are given in Table 5.5.1.9.4.1-3
2. Message contents are defined in clause 5.5.1.9.4.3.
3. The power levels and settings for Cell 1 are set according to Annex A.6, Table A.6.1.1-1. Cell 2 is NR FR2 PSCell. The connection setup is done according to the settings in clause C.1.3, and the downlink signal levels as per clause C.1.2

**Table 5.5.1.9.4.1-3: General test parameters for EN-DC FR2 radio link monitoring UE scheduling restrictions**

Parameter	Unit	Test configuration	Value	Comment
RF Channel Number		1, 2	1 and 2	1 for NR PSCell and 2 for LTE PCell
SSB configuration		1, 2	SSB.1 FR2	
SMTC configuration		1, 2	SMTC pattern 1	
DRX cycle length	s	1, 2	OFF	
T1	s	1, 2	5	During T1 the UE is required to correctly transmit ACK/NACK

#### 5.5.1.9.4.2 Test Procedure

During the test PDCCHs indicating new transmissions shall be sent continuously on PSCell (Cell 2) to ensure that the UE would have ACK/NACK sending.

1. Set the parameters according to T1 in Table 5.5.1.9.4.1. Propagation conditions are set according to clause C.2.2. T1 starts.
2. If the SS receives ACK/NACK from Cell 2 on each UL transmission occasion scheduled by PDCCH which are not overlapped with SSBs configured for radio link monitoring during T1, the number of successful tests is increased by one. otherwise the number of failed tests is increased by one.
3. The UE is switched off and then on. Ensure the UE is in state RRC\_CONNECTED with generic procedure parameters Connectivity NR, Connected without release *On* according to TS 38.508-1 [10] clause 4.5.
4. Repeat steps 1-3 until the confidence level according to Tables G.2.3-1 in Annex G clause G.2 is achieved.

## 5.5.1.9.4.3 Message Contents

Message contents are according to TS 38.508-1 [14] clause 7.3 with the following exceptions:

**Table 5.5.1.9.4.3-1: Common Exception messages for EN-DC FR2 radio link monitoring UE scheduling restrictions**

Default Message Contents	
Common contents of system information blocks exceptions	TBD
Default RRC messages and information elements contents exceptions	TBD

## 5.5.1.9.5 Test Requirement

Table 5.5.1.9.4.1-3 and 5.5.1.9.5-1 define the primary level settings including test tolerances for EN-DC FR2 radio link monitoring UE scheduling restrictions.

**Table 5.5.1.9.5-1: Cell specific test parameters for EN-DC FR2 radio link monitoring UE scheduling restrictions**

Parameter	Unit	Test configuration	Cell 2	
			AoA1	AoA2
AoA setup		1, 2	Setup 3 defined in A.9.3	
Assumption for UE beams <sup>Note 1</sup>			Rough	Rough
TDD configuration		1, 2	TDDConf.3.1	
BW <sub>channel</sub>	MHz	1, 2	100: N <sub>RB,c</sub> = 66	
Data RBs allocated		1, 2	24	
PDSCH Reference measurement channel		1, 2	SR.3.2 TDD	Not sent
RMSI CORESET RMC configuration		1, 2	CR.3.1 TDD	Not sent
Dedicated CORESET RMC configuration		1, 2	CCR.3.2 TDD	Not sent
TRS configuration		1, 2	TRS.2.1 TDD	TRS.2.2 TDD
PDCCH/PDSCH TCI state		1, 2	TCI.State.2	Not sent
OCNG Pattern		1, 2	OP.5	Not sent
Initial DL BWP configuration		1, 2	DLBWP.0.1	
Initial UL BWP configuration		1, 2	ULBWP.0.1	
RLM-RS		1, 2	SSB with index 0	SSB with index 1
$N_{oc}$	dBm/15kHz	1, 2	-92.1	-92.1
$N_{oc}$ <sup>Note2</sup>	dBm/SCS	1, 2	-83.1	-83.1
$\hat{E}_s/N_{oc}$	dB	1, 2	2	2
$\hat{E}_s/I_{ot\_BB}$ <sup>Note 4</sup>	dB	1, 2	1	1
SSB_RP <sup>Note3</sup>	dBm/SCS	1, 2	-81.1	-81.1
Io	dBm/95.04 MHz	1, 2	-54.35	-54.35
Time multiplexing of the downlink transmissions from each AoA		1, 2	Defined in Figure 5.5.1.9.4-1	
Propagation Condition		1, 2	AWGN	AWGN
Note 1:	Information about types of UE beam is given in B.2.1.3, and does not limit UE implementation or test system implementation			
Note 2:	Interference from other cells and noise sources not specified in the test is assumed to be constant over subcarriers and time and shall be modelled as AWGN of appropriate power for N <sub>oc</sub> to be fulfilled.			
Note 3:	Es/I <sub>ot</sub> , SSB_RP and Io levels have been derived from other parameters for information purposes. They are not settable parameters themselves.			
Note 4:	Calculation of Es/I <sub>otBB</sub> includes the effect of UE internal noise up to the value assumed for the associated Refsens requirement in clause 7.3.2 of TS 38.101-2 [3], and an allowance of 1dB for UE multi-band relaxation factor ΔMB <sub>s</sub> from TS 38.101-2 [3] Table 6.2.1.3-4.			

The UE behaviour during time duration T1 follows the requirements defined in TS 38.133 [6] clause 8.1.7.3:

The UE is not expected to transmit PUCCH, PUSCH or SRS or receive PDCCH, PDSCH or CSI-RS for tracking or CSI-RS for CQI on RLM-RS symbols to be measured for radio link monitoring.

For the test to pass, the total number of successful tests shall be more than 90% of the cases with a confidence level of 95%.

## 5.5.2 Interruption

### 5.5.2.0 Minimum conformance requirements

#### 5.5.2.0.1 Minimum conformance requirements for interruptions at transitions between active and non-active during DRX

[TS38.133, clause 8.2.1.2.1]

Interruption on PSCell and the activated SCell if configured due to E-UTRA PCell transitions between active and non-active during DRX when PSCell or SCell is in non-DRX are allowed with up to 1% probability of missed ACK/NACK when the configured E-UTRA PCell DRX cycle is less than 640 ms, and 0.625% probability of missed ACK/NACK is allowed when the configured E-UTRA PCell DRX cycle is 640 ms or longer. Each interruption shall not exceed X slot as defined in table 5.5.2.0.1-1.

Each interruption shall not exceed X slot as defined in table 5.5.2.0.1-1.

**Table 5.5.2.0.1-1: Interruption length X at transition between active and non-active during DRX**

$\mu$	NR Slot length (ms)	Interruption length X	
		Sync	Async
0	1	1	2
1	0.5	1	2
2	0.25	3	
3	0.125	5	

When both E-UTRA PCell and PSCell are in DRX, no interruption is allowed.

The normative reference for this requirement is TS 38.133 [6] clause 8.2.1.2.1.

#### 5.5.2.0.2 Minimum conformance requirements for interruptions during measurements on deactivated NR SCC

[TS38.133, clause 8.2.1.2.5.1]

Interruption on PSCell and other active NR SCell(s) during measurement on the deactivated NR SCC shall meet requirements in clause 8.2.2.2.3, where the term PCell in clause 8.2.2.2.3 shall be deemed to be replaced with PSCell.

[TS38.133, clause 8.2.2.2.3]

Interruptions on PCell due to measurements when an SCell is deactivated are allowed with up to 0.5% probability of missed ACK/NACK when the configured *measCycleSCell* [2] is 640 ms or longer. The UE is only allowed to cause interruptions immediately before and immediately after an SMTC. Each interruption shall not exceed requirement in Table 5.5.2.0.2-1 if the PCell is not in the same band as the deactivated SCell. Each interruption shall not exceed requirement in Table 5.5.2.0.2-2 if the PCell is in the same band as the deactivated SCell.

Interruptions on active SCell due to measurements when an SCell is deactivated are allowed with up to 0.5% probability of missed ACK/NACK when the configured *measCycleSCell* [2] is 640 ms or longer. The UE is only allowed to cause interruptions immediately before and immediately after an SMTC. Each interruption shall not exceed requirement in Table 5.5.2.0.2-1 if the active SCell is not in the same band as the deactivated SCell. Each interruption shall not exceed requirement in Table 5.5.2.0.2-2 if the active SCell is in the same band as the deactivated SCell.

[TS38.133, clause 8.2.2.2.2]

**Table 5.5.2.0.2-1: Interruption duration for SCell activation/deactivation for inter-band CA**

$\mu$	NR Slot length (ms)	Interruption length
0	1	1
1	0.5	1
2	0.25	2
3	0.125	4

**Table 5.5.2.0.2-2: Interruption duration for SCell activation/deactivation for intra-band CA**

$\mu$	NR Slot length (ms)	Interruption length
0	1	1 + $T_{\text{SMTC\_duration}}$
1	0.5	1 + $T_{\text{SMTC\_duration}}$
2	0.25	2 + $T_{\text{SMTC\_duration}}$
3	0.125	4 + $T_{\text{SMTC\_duration}}$
NOTE: $T_{\text{SMTC\_duration}}$ is - the longest SMTC duration among all above activated serving cells and the SCell being activated when one SCell is activated; - the longest SMTC duration among all activated serving cells in the same band when one SCell is deactivated.		

The normative reference for this requirement is TS 38.133 [6] clause 8.2.1.2.5.1.

### 5.5.2.0.3 Minimum conformance requirements for interruptions during measurements on deactivated E-UTRAN SCC

[TS38.133 clause 8.2.1.2.5.2]

When one E-UTRA SCell in MCG is deactivated, the UE is allowed due to measurements on the E-UTRA SCC with the deactivated E-UTRA SCell:

- an interruption on PSCell or any activated SCell with up to 0.5% probability of missed ACK/NACK when any of the configured *measCycleSCell* [2] for the deactivated E-UTRA SCells is 640 ms or longer.
- an interruption on PSCell or any activated SCell with up to 0.5% probability of missed ACK/NACK regardless of the configured *measCycleSCell* [2] for the deactivated E-UTRA SCells if indicated by the network using IE *allowInterruptions* [2].

Each interruption shall not exceed

- X3 slot, if the PSCell or activated SCell is not in the same band as the E-UTRA deactivated SCC being measured, or
- Y3 slot + SMTC duration, if the PSCell or activated SCell is in the same band as the E-UTRA deactivated SCC being measured, provided the cell specific reference signals from the PSCell or activated SCell and the E-UTRA deactivated SCC being measured are available in the same slot.

**Table 5.5.2.0.3-1: Interruption length X3 and Y3 at measurements on deactivated E-UTRA SCC**

$\mu$	NR Slot length (ms)	Interruption length X3 slot	Interruption length Y3 slot
0	1	1	1
1	0.5	1	1
2	0.25	2	2
3	0.125	4	4

The normative reference for this requirement is TS 38.133 [6] clause 8.2.1.2.5.1.



## 5.5.2.1 EN-DC FR2 interruptions at transitions between active and non-active during DRX in synchronous EN-DC

Editor's Note: This test case has been completed for the following configurations:

- Test frequency  $f \leq 40.8$  GHz
- UE PC3
- The test is incomplete for UE power classes other than PC3
- The test is incomplete for test frequencies  $> 40.8$  GHz

### 5.5.2.1.1 Test purpose

The purpose of this test is:

- To verify that when LTE PCell is in DRX and NR PSCell is in non-DRX, NR PSCell interruptions due to transitions from active to non-active and from non-active to active during LTE PCell DRX the UE missed ACK/NACK does not exceed the limits.
- To verify the missed ACK/NACK rate for NR PSCell in EN-DC.

### 5.5.2.1.2 Test applicability

This test applies to all types of E-UTRA UE release 15 and forward supporting EN-DC and long DRX cycle.

### 5.5.2.1.3 Minimum conformance requirements

The minimum conformance requirements are specified in clause 5.5.2.0.1.

The normative reference for this requirement is TS 38.133 [6] clause A.5.5.2.1.

### 5.5.2.1.4 Test description

#### 5.5.2.1.4.1 Initial conditions

This test shall be tested using any of the test configurations in Table 5.5.2.1.4.1-1.

**Table 5.5.2.1.4.1-1: Supported test configurations for EN-DC FR2 interruptions at transitions between active and non-active during DRX in synchronous EN-DC**

Configuration	Description
5.5.2.1-1	LTE FDD, NR 120 kHz SSB SCS, 100MHz bandwidth, TDD duplex mode
5.5.2.1-2	LTE TDD, NR 120 kHz SSB SCS, 100MHz bandwidth, TDD duplex mode

Configure the test equipment and the DUT according to the parameters in Table 5.5.2.1.4.1-2.

**Table 5.5.2.1.4.1-2: Initial conditions for EN-DC FR2 interruptions at transitions between active and non-active during DRX in synchronous EN-DC**

Parameter	Value	Comment
Test environment	NC	As specified in TS 38.508-1 [14] clause 4.1.
Test frequencies	As specified in Annex E, table E.3-1 and TS 38.508-1 [14] clause 4.3.1 for E-UTRA and 7.2.3 for NR.	
Channel bandwidth	As specified by the test configuration selected from Table 5.5.2.1.4.1-1.	
Propagation conditions	AWGN	As specified in clause C.2.1.
Connection Diagram	TE Part	A.3.3.3.1-1
	DUT Part	A.3.4.1.1

Exceptions to connection diagram	N/A	
----------------------------------	-----	--

1. The general test parameter settings are set up according to Table 5.5.2.1.4.1-3.
2. Message contents are defined in clause 5.5.2.1.4.3.
3. There are one E-UTRAN carrier and one NR carrier and two cells in the test. Cell 1 is PCell on the E-UTRAN carrier, Cell 2 is PSCell on the NR carrier, Cell 1 is the cell used for connection setup with the power levels set according to Table A.6.1.1-1 for this test. Cell 2 is configured according to clause C.1.1 and C.1.2.

**Table 5.5.2.1.4.1-3: General test parameters for EN-DC FR2 interruptions at transitions between active and non-active during DRX in synchronous EN-DC**

Parameter	Unit	Value	Comment
RF Channel Number		1, 2	One is E-UTRAN RF channel and the other is NR RF channel
Active PCell		Cell1	PCell on E-UTRAN RF channel number 1.
Configured PSCell		Cell2	PSCell on NR RF channel number 2.
CP length		Normal	Applicable to cell1 and cell 2
DRX		DRX.4	DRX related parameters are defined in TS 38.133 Table A.3.3.4-1
Measurement gap pattern Id		OFF	
T1	s	6.25	

#### 5.5.2.1.4.2 Test procedure

The test consists of two cells: Cell1 and Cell2. Cell1 is LTE PCell and Cell2 is NR PSCell. The test consists of one time period, with duration of T1. During T1, NR PSCell is continuously scheduled in DL while LTE PCell is not scheduled and has DRX configured. Prior to the start of the time duration T1, the UE shall be fully synchronized to Cell1 and Cell2. Cell1 shall be configured as LTE PCell and Cell2 shall be configured as NR PSCell. Prior to start of T1 the DRX inactivity timer for the LTE PCell has already expired. During T1 the UE shall be continuously scheduled on NR PSCell while not scheduled on LTE PCell.

1. Ensure the UE is in state RRC\_CONNECTED with generic procedure parameters Connectivity *EN-DC*, DC bearer *MCG\_and\_SCG*, Connected without release *On* according to TS 38.508-1 [14] clause 4.5.
2. Configure MCG according to TS 36.521-3 [26] clause C.0, C.1 and SCG according to clause C.1.1 and C.1.2 for all downlink physical channels.
3. The SS shall transmit an *RRCConnectionReconfiguration* message to configure PCell (Cell1) and PSCell (Cell2) on the MCG and SCG as per TS 36.508 [7] clause 4.6 with the message content exceptions defined in clause 5.5.2.1.4.3.
4. The UE shall transmit *RRCConnectionReconfigurationComplete* message.
5. The SS would ensure continuous transmission on PSCell, while not scheduling on PCell at least for 200 ms to ensure inactivity timer is expired on the UE for LTE PCell.
6. Set the parameters according to T1 in Table 5.5.2.1.5-1. Propagation conditions are set according to clause C.2.1. T1 starts.
7. SS schedules on PSCell continuously and UE shall start sending ACK/NACK reports. The SS shall monitor ACK/NACK/DTX on PSCell.
8. If more than 99% of uplink transmissions are received by SS then count a success for the event "ACK/NACK". Otherwise count a fail for the event "ACK/NACK".
9. If no two consecutive missing PUCCH transmissions are observed by the SS, then count a success for the event "DTX". Otherwise count a fail for the event "DTX".
10. After the RRC connection release, the SS:

- transmits in Cell 1 a Paging message (including PagingRecord with UE-Identity) for the UE and ensures the UE is in state RRC\_CONNECTED with generic procedure parameters Connectivity EN-DC, DC bearer MCG\_and\_SCG, Connected without release On according to TS 38.508-1 [14] clause 4.5. (if the paging fails, switches off and on the UE and ensures the UE is in state RRC\_CONNECTED with generic procedure parameters Connectivity EN-DC, DC bearer MCG\_and\_SCG, Connected without release On according to TS 38.508-1 [14] clause 4.5),

or

- switches off and on the UE and ensures the UE is in state RRC\_CONNECTED with generic procedure parameters Connectivity EN-DC, DC bearer MCG\_and\_SCG, Connected without release On according to TS 38.508-1 [14] clause 4.5.

11. Repeat step 3-10 until a test verdict has been achieved

Each of the events "ACK/NACK" and "DTX" is evaluated independently for the statistic, resulting in an event verdict: pass or fail. Each event is evaluated only until the confidence level according to Table G.2.3-1 in Annex G.2 is achieved. Different events may require different times for a verdict. If all events pass, the test passes. If one event fails, the test fails.

5.5.2.1.4.3 Message contents

Message contents are according to TS 38.508-1 [14] clause 7.3 with the following exceptions:

**Table 5.5.2.1.4.3-1: Common Exception messages**

Default Message Contents	
Common contents of system information blocks exceptions	
Default RRC messages and information elements contents exceptions	Table H.3.7-2 with Condition DRX.4

5.5.2.1.5 Test requirement

Table 5.5.2.1.4.1-1, 5.5.2.1.5-1 and 5.5.2.1.5-2 define the NR cell specific primary level settings including test tolerances for EN-DC FR2 interruptions at transitions between active and non-active during DRX in synchronous EN-DC test.

**Table 5.5.2.1.5-1: NR cell specific test parameters for EN-DC FR2 interruptions at transitions between active and non-active during DRX in synchronous EN-DC**

Parameter		Unit	Cell 2
Frequency Range			FR2
Duplex mode	Config 1,2		TDD
TDD configuration	Config 1,2		TDDConf.3.1
BW <sub>channel</sub>	Config 1,2	MHz	100: N <sub>RB,c</sub> = 66
Data RBs allocated	Config 1,2		66
Initial DL BWP Configuration	Config 1,2		DLBWP.0.1
Downlink dedicated BWP Configuration	Config 1,2		DLBWP.1.1
Uplink initial BWP configuration	Config 1,2		ULBWP.0.1
Uplink dedicated BWP configuration	Config 1,2		ULBWP.1.1
TRS configuration	Config 1,2		TRS.2.1 TDD
TCI state	Config 1,2		TCI.State.0
PDSCH Reference measurement channel	Config 1,2		SR.3.1 TDD
RMSI CORESET parameters	Config 1,2		CR.3.1 TDD
PDCCH CORESET parameters	Config 1,2		CCR.3.1 TDD
OCNG Patterns			OP.1
SSB Configuration			SSB.3 FR2
SMTTC Configuration	Config 1,2		SMTTC.1
EPRE ratio of PSS to SSS		dB	0
EPRE ratio of PBCH DMRS to SSS			
EPRE ratio of PBCH to PBCH DMRS			
EPRE ratio of PDCCH DMRS to SSS			
EPRE ratio of PDCCH to PDCCH DMRS			
EPRE ratio of PDSCH DMRS to SSS			
EPRE ratio of PDSCH to PDSCH			
EPRE ratio of OCNG DMRS to SSS(Note 1)			
EPRE ratio of OCNG to OCNG DMRS (Note 1)			
$\bar{E}_s/N_{oc}$			
Propagation Condition			AWGN
Time offset to cell1 <sup>Note 2</sup>		$\mu$ s	3
NOTE 1: OCNG shall be used such that both cells are fully allocated and a constant total transmitted power spectral density is achieved for all OFDM symbols.			
NOTE 2: Receive time difference of signals received between subframe timing boundary of E-UTRA PCell and slot timing boundary of PSCell including time alignment error between the two cells			

**Table 5.5.2.1.5-2: NR cell specific OTA related test parameters for EN-DC FR2 interruptions at transitions between active and non-active during DRX in synchronous EN-DC**

Parameter	Unit	Cell2
Angle of arrival configuration		Setup 1 according to clause A.9.1
Assumption for UE beams <sup>Note 6</sup>		Fine
$N_{oc}$ <sup>Note1</sup>	dBm/15kHz <sup>Note4</sup>	-112
$N_{oc}$ <sup>Note1</sup>	dBm/SCS <sup>Note3</sup>	-102.97
$\hat{E}_s / N_{oc}$	dB	17
SSB_RP <sup>Note2</sup>	dBm/SCS <sup>Note4</sup>	-85.97
$\hat{E}_s / I_{ot}$	dB	17
$I_o$ <sup>Note2</sup>	dBm/95.04 MHz <sup>Note4</sup>	-56.90
<p>NOTE 1: Interference from other cells and noise sources not specified in the test is assumed to be constant over subcarriers and time and shall be modelled as AWGN of appropriate power for <math>N_{oc}</math> to be fulfilled.</p> <p>NOTE 2: SSB_RP and <math>I_o</math> levels have been derived from other parameters for information purposes. They are not settable parameters themselves.</p> <p>NOTE 3: SS-RSRP minimum requirements are specified assuming independent interference and noise at each receiver antenna port.</p> <p>NOTE 4: Equivalent power received by an antenna with 0dBi gain at the centre of the quiet zone</p> <p>NOTE 5: As observed with 0dBi gain antenna at the centre of the quiet zone</p> <p>NOTE 6: Information about types of UE beam is given in B.2.1.3 of TS 38.133[6], and does not limit UE implementation or test system implementation</p>		

The UE shall be continuously scheduled in NR PSCell during the entire length of T1. UE shall not be scheduled in LTE PCell during T1. During the time duration T1 the UE shall transmit at least 99% of ACK/NACK on NR PSCell.

Interruption on NR PSCell shall not exceed 0.625ms (5 slots) as defined in clause TS 38.133 clause 8.2.1.

The rate of correct events observed during repeated tests shall be at least 90%.

### 5.5.2.2 EN-DC FR2 interruptions at transitions between active and non-active during DRX in asynchronous EN-DC

**Editor's Note:** This test case has been completed for the following configurations:

- Test frequency  $f \leq 40.8$  GHz
- UE PC3
- The test is incomplete for UE power classes other than PC3
- The test is incomplete for test frequencies  $> 40.8$  GHz

#### 5.5.2.2.1 Test purpose

The purpose of this test is:

- To verify that when LTE PCell is in DRX and NR PSCell is in non-DRX, NR PSCell interruptions due to transitions from active to non-active and from non-active to active during LTE PCell DRX the UE missed ACK/NACK does not exceed the limits.
- To verify the missed ACK/NACK rate for NR PSCell in EN-DC.

#### 5.5.2.2.2 Test applicability

This test applies to all types of E-UTRA UE release 15 and forward supporting EN-DC and long DRX cycle.

### 5.5.2.2.3 Minimum conformance requirements

The minimum conformance requirements are specified in clause 5.5.2.0.1.

The normative reference for this requirement is TS 38.133 [6] clause A.5.5.2.2.

### 5.5.2.2.4 Test description

#### 5.5.2.2.4.1 Initial conditions

This test shall be run in one of the configurations defined in Table 5.5.2.2.4.1-1.

**Table 5.5.2.2.4.1-1: Supported test configurations for EN-DC FR2 interruptions at transitions between active and non-active during DRX in asynchronous EN-DC**

Configuration	Description
5.5.2.2-1	LTE FDD, NR 120 kHz SSB SCS, 100MHz bandwidth, TDD duplex mode
5.5.2.2-2	LTE TDD, NR 120 kHz SSB SCS, 100MHz bandwidth, TDD duplex mode

Configure the test equipment and the DUT according to the parameters in Table 5.5.2.2.4.1-2.

**Table 5.5.2.2.4.1-2: Initial conditions for EN-DC FR2 interruptions at transitions between active and non-active during DRX in asynchronous EN-DC**

Parameter	Value	Comment
Test environment	NC	As specified in TS 38.508-1 [14] clause 4.1.
Test frequencies	As specified in Annex E, Table E.3-1 and TS 38.508-1 [14] clause 4.3.1 for E-UTRA and 7.2.3 for NR.	
Channel bandwidth	As specified by the test configuration selected from Table 5.5.2.2.4.1-1.	
Propagation conditions	AWGN	As specified in clause C.2.1.
Connection Diagram	TE Part DUT Part	A.3.3.3.1-1 A.3.4.1.1
Exceptions to connection diagram	N/A	

1. The general test parameter settings are set up according to Table 5.5.2.2.4.1-3.
2. Message contents are defined in clause 5.5.2.2.4.3.
3. There are one E-UTRAN carrier and one NR carrier and two cells in the test. Cell 1 is PCell on the E-UTRAN carrier, Cell 2 is PSCell on the NR carrier, Cell 1 is the cell used for connection setup with the power levels set according to Table A.6.1.1-1 for this test. Cell 2 is configured according to clause C.1.1 and C.1.2.

**Table 5.5.2.2.4.1-3: General test parameters for EN-DC FR2 interruptions at transitions between active and non-active during DRX in asynchronous EN-DC**

Parameter	Unit	Value	Comment
RF Channel Number		1, 2	One is E-UTRAN RF channel and the other is NR RF channel
Active PCell		Cell1	PCell on E-UTRAN RF channel number 1.
Configured PSCell		Cell2	PSCell on NR RF channel number 2.
CP length		Normal	Applicable to cell1 and cell 2
DRX		DRX.4	DRX related parameters are defined in TS 38.133 Table A.3.3.4-1
Measurement gap pattern Id		OFF	
T1	s	6.25	

#### 5.5.2.2.4.2 Test procedure

The test consists of two cells: Cell1 and Cell2. Cell1 is LTE PCell and Cell2 is NR PSCell. The test consists of one time period, with duration of T1. During T1, NR PSCell is continuously scheduled in DL while LTE PCell is not scheduled and has DRX configured. Prior to the start of the time duration T1, the UE shall be fully synchronized to Cell1 and Cell2. Cell1 shall be configured as LTE PCell and Cell2 shall be configured as NR PSCell. Prior to start of T1 the DRX inactivity timer for the LTE PCell has already expired. During T1 the UE shall be continuously scheduled on NR PSCell while not scheduled on LTE PCell.

1. Ensure the UE is in state `RRC_CONNECTED` with generic procedure parameters Connectivity *EN-DC*, DC bearer *MCG\_and\_SCG*, Connected without release *On* according to TS 38.508-1 [14] clause 4.5.
  2. Configure MCG according to TS 36.521-3 [26] clause C.0, C.1 and SCG according to clause C.1.1 and C.1.2 for all downlink physical channels.
  3. The SS shall transmit an *RRCConnectionReconfiguration* message to configure PCell (Cell1) and PSCell (Cell2) on the MCG and SCG as per TS 36.508 [7] clause 4.6 with the message content exceptions defined in clause 5.5.2.2.4.3.
  4. The UE shall transmit *RRCConnectionReconfigurationComplete* message.
  5. The SS would ensure continuous transmission on PSCell, while not scheduling on PCell at least for 200 ms to ensure inactivity timer is expired on the UE for LTE PCell.
  6. Set the parameters according to T1 in Table 5.5.2.2.5-1. Propagation conditions are set according to clause C.2.1. T1 starts.
  7. SS schedules on PSCell continuously and UE shall start sending ACK/NACK reports. The SS shall monitor ACK/NACK/DTX on PSCell.
  8. If more than 99% of uplink transmissions are received by SS then count a success for the event "ACK/NACK". Otherwise count a fail for the event "ACK/NACK".
  9. If no two consecutive missing PUCCH transmissions are observed by the SS, then count a success for the event "DTX". Otherwise count a fail for the event "DTX".
  10. After the RRC connection release, the SS:
    - transmits in Cell 1 a Paging message (including PagingRecord with UE-Identity) for the UE and ensures the UE is in state `RRC_CONNECTED` with generic procedure parameters Connectivity *EN-DC*, DC bearer *MCG\_and\_SCG*, Connected without release *On* according to TS 38.508-1 [14] clause 4.5. (if the paging fails, switches off and on the UE and ensures the UE is in state `RRC_CONNECTED` with generic procedure parameters Connectivity *EN-DC*, DC bearer *MCG\_and\_SCG*, Connected without release *On* according to TS 38.508-1 [14] clause 4.5),
- or
- switches off and on the UE and ensures the UE is in state `RRC_CONNECTED` with generic procedure parameters Connectivity *EN-DC*, DC bearer *MCG\_and\_SCG*, Connected without release *On* according to TS 38.508-1 [14] clause 4.5.

11. Repeat step 3-10 until a test verdict has been achieved

Each of the events "ACK/NACK" and "DTX" is evaluated independently for the statistic, resulting in an event verdict: pass or fail. Each event is evaluated only until the confidence level according to Table G.2.3-1 in Annex G.2 is achieved. Different events may require different times for a verdict. If all events pass, the test passes. If one event fails, the test fails.

#### 5.5.2.2.4.3 Message contents

Message contents are according to TS 38.508-1 [14] clause 7.3 with the following exceptions:

**Table 5.5.2.2.4.3-1: Common Exception messages**

Default Message Contents	
Common contents of system information blocks exceptions	
Default RRC messages and information elements contents exceptions	Table H.3.7-2 with Condition DRX.4

5.5.2.2.5 Test requirement

Table 5.5.2.2.4.1-1, 5.5.2.2.5-1 and 5.5.2.2.5-2 define the NR cell specific primary level settings including test tolerances for EN-DC FR2 interruptions at transitions between active and non-active during DRX in asynchronous EN-DC test.

**Table 5.5.2.2.5-1: NR cell specific test parameters for EN-DC FR2 interruptions at transitions between active and non-active during DRX in asynchronous EN-DC**

Parameter		Unit	Cell 2
Frequency Range			FR2
Duplex mode	Config 1,2		TDD
TDD configuration	Config 1,2		TDDConf.3.1
BW <sub>channel</sub>	Config 1,2	MHz	100: N <sub>RB,c</sub> = 66
Data RBs allocated	Config 1,2		66
Initial DL BWP Configuration	Config 1,2		DLBWP.0.1
Dedicated DL BWP Configuration	Config 1,2		DLBWP.1.1
Initial UL BWP configuration	Config 1,2		ULBWP.0.1
Dedicated UL BWP configuration	Config 1,2		ULBWP.1.1
TRS configuration	Config 1,2		TRS.2.1 TDD
TCI state	Config 1,2		TCI.State.0
PDSCH Reference measurement channel	Config 1,2		SR.3.1 TDD
RMSI CORESET parameters	Config 1,2		CR.3.1 TDD
PDCCH CORESET parameters	Config 1,2		CCR.3.1 TDD
OCNG Patterns			OP.1
SSB Configuration			SSB.3 FR2
SMTC Configuration	Config 1,2		SMTC.1
EPRE ratio of PSS to SSS		dB	0
EPRE ratio of PBCH DMRS to SSS			
EPRE ratio of PBCH to PBCH DMRS			
EPRE ratio of PDCCH DMRS to SSS			
EPRE ratio of PDCCH to PDCCH DMRS			
EPRE ratio of PDSCH DMRS to SSS			
EPRE ratio of PDSCH to PDSCH			
EPRE ratio of OCNG DMRS to SSS(Note 1)			
EPRE ratio of OCNG to OCNG DMRS (Note 1)			
E <sub>s</sub> /N <sub>oc</sub>		dB	17
Propagation Condition			AWGN
Time offset to cell1 <sup>Note 2</sup>		µs	62.5
NOTE 1: OCNG shall be used such that both cells are fully allocated and a constant total transmitted power spectral density is achieved for all OFDM symbols.			
NOTE 2: Receive time difference of signals received between subframe timing boundary of E-UTRA PCell and slot timing boundary of PSCell including time alignment error between the two cells			



**Table 5.5.2.5-2: NR cell specific OTA related test parameters for EN-DC FR2 interruptions at transitions between active and non-active during DRX in asynchronous EN-DC**

Parameter	Unit	Cell2
Angle of arrival configuration		Setup 1 according to clause A.9.1
Assumption for UE beams <sup>Note 6</sup>		Fine
$N_{oc}$ <sup>Note1</sup>	dBm/15kHz <sup>Note4</sup>	-112
$N_{oc}$ <sup>Note1</sup>	dBm/SCS <sup>Note3</sup>	-102.97
$\hat{E}_s / N_{oc}$	dB	17
SSB_RP <sup>Note2</sup>	dBm/SCS <sup>Note4</sup>	-85.97
$\hat{E}_s / I_{ot}$	dB	17
$I_o$ <sup>Note2</sup>	dBm/95.04 MHz <sup>Note4</sup>	-56.90
<p>NOTE 1: Interference from other cells and noise sources not specified in the test is assumed to be constant over subcarriers and time and shall be modelled as AWGN of appropriate power for <math>N_{oc}</math> to be fulfilled.</p> <p>NOTE 2: SSB_RP and <math>I_o</math> levels have been derived from other parameters for information purposes. They are not settable parameters themselves.</p> <p>NOTE 3: SS-RSRP minimum requirements are specified assuming independent interference and noise at each receiver antenna port.</p> <p>NOTE 4: Equivalent power received by an antenna with 0dBi gain at the centre of the quiet zone</p> <p>NOTE 5: As observed with 0dBi gain antenna at the centre of the quiet zone</p> <p>NOTE 6: Information about types of UE beam is given in B.2.1.3 of TS 38.133[6], and does not limit UE implementation or test system implementation</p>		

The UE shall be continuously scheduled in NR PSCell during the entire length of T1. UE shall not be scheduled in LTE PCell during T1. During the time duration T1 the UE shall transmit at least 99% of ACK/NACK on NR PSCell.

Interruption on NR PSCell shall not exceed 0.625ms (5 slots) as defined in TS 38.133 clause 8.2.1.

The rate of correct events observed during repeated tests shall be at least 90%.

### 5.5.2.3 EN-DC FR2 interruptions during measurements on deactivated NR SCC in synchronous EN-DC

**Editor's note:**

- Connection diagram is TBD.
- Test tolerance is missing.
- Test procedure may be further modified.

#### 5.5.2.3.1 Test purpose

The purpose of this test is:

- To verify NR PSCell interruptions during the measurement on the deactivated NR SCC, the UE missed ACK/NACK does not exceed the limits.
- To verify the missed ACK/NACK rate for NR PSCell in EN-DC.

#### 5.5.2.3.2 Test applicability

This test applies to all types of E-UTRA UE release 15 and forward supporting EN-DC.

#### 5.5.2.3.3 Minimum conformance requirements

The minimum conformance requirements are specified in clause 5.5.2.0.2.

The normative reference for this requirement is TS 38.133 [6] clause A.5.5.2.3.

#### 5.5.2.3.4 Test description

##### 5.5.2.3.4.1 Initial conditions

This test shall be run in one of the configurations defined in Table 5.5.2.3.4.1-1.

**Table 5.5.2.3.4.1-1: Supported test configurations for EN-DC FR2 interruptions during measurements on deactivated NR SCC in synchronous EN-DC**

Configuration	Description
5.5.2.3-1	LTE FDD, NR 120 kHz SSB SCS, 100MHz bandwidth, TDD duplex mode
5.5.2.3-2	LTE TDD, NR 120 kHz SSB SCS, 100MHz bandwidth, TDD duplex mode
NOTE 1: The UE is only required to be tested in one of the supported test configurations	

Configure the test equipment and the DUT according to the parameters in Table 5.5.2.3.4.1-2.

**Table 5.5.2.3.4.1-2: Initial conditions for EN-DC FR2 interruptions during measurements on deactivated NR SCC in synchronous EN-DC**

Parameter	Value	Comment
Test environment	NC	As specified in TS 38.508-1 [14] clause 4.1.
Test frequencies	As specified in Annex E, table E.3-1 and TS 38.508-1 [14] clause 4.3.1 for E-UTRA and 7.2.3 for NR.	
Channel bandwidth	As specified by the test configuration selected from Table 5.5.2.3.4.1-1.	
Propagation conditions	AWGN	As specified in clause C.2.1.
Connection Diagram	TE Part DUT Part	A.3.TBD A.3.TBD
Exceptions to connection diagram	N/A	

1. The general test parameter settings are set up according to Table 5.5.2.3.4.1-3.
2. Message contents are defined in clause 5.5.2.3.4.3.
3. There are one E-UTRAN carrier and two NR carriers and three cells specified in the test. Cell 1 is the PCell on E-UTRAN carrier, Cell 2 is the PSCell on one NR carrier and Cell 3 is the SCell on the other NR carrier. Cell 1 is the cell used for connection setup with the power level set according to Table A.6.1.1-1. Cell 2 and Cell 3 shall be configured according to clause C.1.1 and C.1.2.

**Table 5.5.2.3.4.1-3: General test parameters for EN-DC FR2 interruptions during measurements on deactivated NR SCC in synchronous EN-DC**

Parameter	Unit	Value	Comment
RF Channel Number		1, 2	One is E-UTRAN RF channel and the other two are NR RF channel
Active PCell		Cell1	PCell on E-UTRAN RF channel number 1.
Configured PSCell		Cell2	PSCell on NR RF channel number 2.
Configured deactivated SCell		Cell3	Deactivated SCell on NR RF channel number 2.
CP length		Normal	Applicable to cell1, cell 2 and cell3
DRX		OFF	
Measurement gap pattern Id		OFF	
SCell measurement cycle (measCycleSCell)	ms	640	
T1	s	10	

#### 5.5.2.3.4.2 Test procedure

The test consists of three cells: Cell1, Cell2 and Cell3. Cell1 is E-UTRAN PCell, Cell2 is NR PSCell and Cell3 is deactivated NR SCell. The test consists of one time period, with duration of T1. Prior to the start of the time duration T1, the UE shall be fully synchronized to Cell1, Cell2 and Cell3. Cell1 shall be configured as E-UTRAN PCell, Cell2 shall be configured as NR PSCell and Cell3 shall be configured as NR deactivated SCell. The point in time at which the RRC message including *measCycleSCell* for the deactivated NR SCell is received by the UE, defines the start of time period T1. During T1 the UE shall be continuously scheduled on E-UTRAN PCell and NR PSCell.

1. Ensure the UE is in state RRC\_CONNECTED with generic procedure parameters Connectivity *EN-DC*, DC bearer *MCG\_and\_SCG*, Connected without release *On* according to TS 38.508-1 [14] clause 4.5.
2. Configure MCG according to TS 36.521-3 [26] clause C.0, C.1 and SCG according to clause C.1.1 and C.1.2 for all downlink physical channels.
3. The SS shall transmit an *RRCReconfiguration* message including *measCycleSCell* for the deactivated NR SCell.
4. The UE shall transmit *RRCReconfigurationComplete* message.
5. Set the parameters according to T1 in Table 5.5.2.3.5-1. Propagation conditions are set according to clause C.2.1. T1 starts.
6. SS schedules on PSCell continuously and UE shall start sending ACK/NACK reports. The SS shall monitor ACK/NACK/DTX on PSCell.
7. If more than 99.5% of uplink transmissions are received by SS then count a success for the event "ACK/NACK". Otherwise count a fail for the event "ACK/NACK".
8. If no longer than X consecutive DTXs are observed by the SS, then count a success for the event "DTX". Where,
  - X = 6 if the NR PSCell is not in the same band as the deactivated SCell, otherwise X = 16.
9. After the RRC connection release, the SS:
  - transmits in Cell 1 a Paging message (including PagingRecord with UE-Identity) for the UE and ensures the UE is in state RRC\_CONNECTED with generic procedure parameters Connectivity *EN-DC*, DC bearer *MCG\_and\_SCG*, Connected without release *On* according to TS 38.508-1 [14] clause 4.5. (if the paging fails, switches off and on the UE and ensures the UE is in state RRC\_CONNECTED with generic procedure parameters Connectivity *EN-DC*, DC bearer *MCG\_and\_SCG*, Connected without release *On* according to TS 38.508-1 [14] clause 4.5),

or

  - switches off and on the UE and ensures the UE is in state RRC\_CONNECTED with generic procedure parameters Connectivity *EN-DC*, DC bearer *MCG\_and\_SCG*, Connected without release *On* according to TS 38.508-1 [14] clause 4.5.
10. Repeat step 3-9 until a test verdict has been achieved.

Each of the events "ACK/NACK" and "DTX" is evaluated independently for the statistic, resulting in an event verdict: pass or fail. Each event is evaluated only until the confidence level according to Table G.2.3-1 in Annex G.2 is achieved. Different events may require different times for a verdict.

If all events pass, the test passes. If one event fails, the test fails.

#### 5.5.2.3.4.3 Message contents

Message contents are according to TS 38.508-1 [14] clause 4.6 with the following exceptions:

**Table 5.5.2.3.4.3-1: Common Exception messages**

Default Message Contents	
Common contents of system information blocks exceptions	
Default RRC messages and information elements contents exceptions	Table H.3.1-1; Table H.3.1-2 with Condition Deactivated SCell; Table H.3.1-3 with Condition Deactivated SCell, SSB.1 FR2 and SMTC.1 for configuration 5.5.2.3-1; Table H.3.1-3 with Condition Deactivated SCell, SSB.2 FR2 and SMTC.1 for configuration 5.5.2.3-3; Table H.3.1-4 with A3-offset = -6dB; Table H.3.1-7 with Condition Deactivated SCell;

5.5.2.3.5 Test requirement

Table 5.5.2.3.5-1 and Table 5.5.2.3.5-2 define the primary level settings including test tolerances for FR2 interruptions during measurements on deactivated NR SCC in synchronous EN-DC test configurations.

**Table 5.5.2.3.5-1: NR cell specific test parameters for EN-DC FR2 interruptions during measurements on deactivated NR SCC in synchronous EN-DC**

Parameter		Unit	Cell 2	Cell 3
Frequency Range			FR2	FR2
Duplex mode	Config 1		FDD	FDD
	Config 2		TDD	TDD
TDD configuration	Config 1		N.A	N.A
	Config 2		TBD	TBD
BW <sub>channel</sub>	Config 1,2	MHz	100: N <sub>RB,c</sub> = 66	100: N <sub>RB,c</sub> = 66
Initial BWP Configuration	Config 1,2		TBD	TBD
PDSCH Reference measurement channel	Config 1,2		SR.3.1 TDD	-
RMSI CORESET parameters	Config 1,2		CR.3.1 TDD	CR.3.1 TDD
PDCCH CORESET parameters	Config 1,2		TBD	TBD
OCNG Patterns			OP.1	OP.1
SMTC Configuration	Config 1,2		SMTC.1 FR2	SMTC.1 FR2
EPRE ratio of PSS to SSS		dB	0	0
EPRE ratio of PBCH DMRS to SSS				
EPRE ratio of PBCH to PBCH DMRS				
EPRE ratio of PDCCH DMRS to SSS				
EPRE ratio of PDCCH to PDCCH DMRS				
EPRE ratio of PDSCH DMRS to SSS				
EPRE ratio of PDSCH to PDSCH				
EPRE ratio of OCNG DMRS to SSS(Note 1)				
EPRE ratio of OCNG to OCNG DMRS (Note 1)				
E <sub>s</sub> /N <sub>oc</sub>		dB	TBD	TBD
Propagation Condition			AWGN	AWGN
Time offset to cell1 <sup>Note 2</sup>		μs	3	3+ Time offset to cell2
Time offset to cell2 <sup>Note 3</sup>		μs	-	3
NOTE 1: OCNG shall be used such that both cells are fully allocated and a constant total transmitted power spectral density is achieved for all OFDM symbols. NOTE 2: Receive time difference of signals received between subframe timing boundary of E-UTRA PCell and slot timing boundary of PSCell including time alignment error between the two cells NOTE 3: Receive time difference of signals received between slot timing boundary from two NR Cells including time alignment error between the two cells				

**Table 5.5.2.3.5-2: NR cell specific OTA related test parameters for EN-DC FR2 interruptions during measurements on deactivated NR SCC in synchronous EN-DC**

Parameter		Unit	Cell 2	Cell 3
UE orientation around TBD axis and TBD axis			TBD	
Relative difference in angle of arrival of cell 2 and cell 3 relative to cell 1		degrees	TBD	
$N_{oc}$ <sup>Note1</sup>	NR_TDD_FR2_A	dBm/15kHz <sup>Note4</sup>	TBD+TT	TBD+TT
	NR_TDD_FR2_B			
	NR_TDD_FR2_C			
	NR_TDD_FR2_D			
	NR_TDD_FR2_E			
	NR_TDD_FR2_F			
	NR_TDD_FR2_G			
$N_{oc}$ <sup>Note1</sup>	NR_TDD_FR2_A	dBm/SCS <sup>Note3</sup>	TBD+TT	TBD+TT
	NR_TDD_FR2_B			
	NR_TDD_FR2_C			
	NR_TDD_FR2_D			
	NR_TDD_FR2_E			
	NR_TDD_FR2_F			
	NR_TDD_FR2_G			
SS-RSRP <sup>Note2</sup>	NR_TDD_FR2_A	dBm/SCS <sup>Note4</sup>	TBD+TT	TBD+TT
	NR_TDD_FR2_B			
	NR_TDD_FR2_C			
	NR_TDD_FR2_D			
	NR_TDD_FR2_E			
	NR_TDD_FR2_F			
	NR_TDD_FR2_G			
$\hat{E}_s/I_{ot}$		dB	TBD+TT	TBD+TT
$I_o$ <sup>Note2</sup>	NR_TDD_FR2_A	dBm/95.04 MHz <sup>Note4</sup>	TBD+TT	TBD+TT
NOTE 1: Interference from other cells and noise sources not specified in the test is assumed to be constant over subcarriers and time and shall be modeled as AWGN of appropriate power for $N_{oc}$ to be fulfilled.				
NOTE 2: SS-RSRP and $I_o$ levels have been derived from other parameters for information purposes. They are not settable parameters themselves.				
NOTE 3: SS-RSRP minimum requirements are specified assuming independent interference and noise at each receiver antenna port.				
NOTE 4: Equivalent power received by an antenna with 0dBi gain at the centre of the quiet zone				
NOTE 5: As observed with 0dBi gain antenna at the centre of the quiet zone				

The UE shall be continuously scheduled in LTE PCell and NR PSCell during the entire length of T1. During the time duration T1 the UE shall transmit at least 99.5% of ACK/NACK on NR PSCell.

If the NR PSCell is not in the same band as the deactivated SCell, the UE is only allowed to cause interruptions immediately before and immediately after an SMTC. Each interruption on NR PSCell shall not exceed the value defined in Table 5.5.2.3.5-3.

If the NR PSCell is in the same band as the deactivated SCell, the UE is only allowed to cause an interruption on PSCell no earlier than 4 slot before an SMTC and no later than 4 slot after the SMTC. the interruption on NR PSCell shall not exceed the value defined in Table 5.5.2.3.5-4.

**Table 5.5.2.3.5-3: Interruption duration if the NR PSCell is not in the same band as the deactivated SCell**

$\mu$	NR Slot length (ms)	Interruption length (slot)
3	0.125	4

**Table 5.5.2.3.5-4: Interruption duration if the NR PSCell is in the same band as the deactivated SCell**

$\mu$	NR Slot length (ms)	Interruption length (slot)
3	0.125	8 + SMTC duration

The rate of correct events observed during repeated tests shall be at least 90%.

#### 5.5.2.4 EN-DC FR2 interruptions during measurements on deactivated NR SCC in asynchronous EN-DC

**Editor's note:**

- Connection diagram is TBD.
- Test tolerance is missing.
- Test procedure may be further modified.

##### 5.5.2.4.1 Test purpose

The purpose of this test is:

- To verify NR PSCell interruptions during the measurement on the deactivated NR SCC, the UE missed ACK/NACK does not exceed the limits.
- To verify the missed ACK/NACK rate for NR PSCell in EN-DC.

##### 5.5.2.4.2 Test applicability

This test applies to all types of E-UTRA UE release 15 and forward supporting EN-DC.

##### 5.5.2.4.3 Minimum conformance requirements

The minimum conformance requirements are specified in clause 5.5.2.0.2.

The normative reference for this requirement is TS 38.133 [6] clause A.5.5.2.4.

##### 5.5.2.4.4 Test description

###### 5.5.2.4.4.1 Initial conditions

This test shall be tested using any of the test configurations in Table 5.5.2.4.4.1-1.

**Table 5.5.2.4.4.1-1: Supported test configurations for EN-DC FR2 interruptions during measurements on deactivated NR SCC in asynchronous EN-DC**

Configuration	Description
5.5.2.4-1	LTE FDD, NR 120 kHz SSB SCS, 100MHz bandwidth, TDD duplex mode
5.5.2.4-2	LTE TDD, NR 120 kHz SSB SCS, 100MHz bandwidth, TDD duplex mode
NOTE 1: The UE is only required to be tested in one of the supported test configurations	

Configure the test equipment and the DUT according to the parameters in Table 5.5.2.4.4.1-2.

**Table 5.5.2.4.4.1-2: Initial conditions for EN-DC FR2 interruptions during measurements on deactivated NR SCC in asynchronous EN-DC**

Parameter	Value		Comment
Test environment	NC		As specified in TS 38.508-1 [14] clause 4.1.
Test frequencies	As specified in Annex E, table E.3-1 and TS 38.508-1 [14] clause 4.3.1 for E-UTRA and 7.2.3 for NR.		
Channel bandwidth	As specified by the test configuration selected from Table 5.5.2.4.4.1-1.		
Propagation conditions	AWGN		As specified in clause C.2.1.
Connection Diagram	TE Part	A.3.TBD	As specified in TS 38.508-1 [14] Annex A.
	DUT Part	A.3.TBD	
Exceptions to connection diagram	N/A		

1. The general test parameter settings are set up according to Table 5.5.2.4.4.1-3.
2. Message contents are defined in clause 5.5.2.4.4.3.
3. There are one E-UTRAN carrier and two NR carriers and three cells specified in the test. Cell 1 is the PCell on E-UTRAN carrier, Cell 2 is the PSCell on one NR carrier and Cell 3 is the SCell on the other NR carrier. Cell 1 is the cell used for connection setup with the power level set according to Table A.6.1.1-1. Cell 2 and Cell 3 shall be configured according to clause C.1.1 and C.1.2.

**Table 5.5.2.4.4.1-3: General test parameters for EN-DC FR2 interruptions during measurements on deactivated NR SCC in asynchronous EN-DC**

Parameter	Unit	Value	Comment
RF Channel Number		1, 2	One is E-UTRAN RF channel and the other two are NR RF channel
Active PCell		Cell1	PCell on E-UTRAN RF channel number 1.
Configured PSCell		Cell2	PSCell on NR RF channel number 2.
Configured deactivated SCell		Cell3	Deactivated SCell on NR RF channel number 2.
CP length		Normal	Applicable to cell1, cell 2 and cell3
AoA number		1	Applicable to cell2 and cell3
DRX		OFF	
Measurement gap pattern Id		OFF	
SCell measurement cycle (measCycleSCell)	ms	640	
T1	s	10	

#### 5.5.2.4.4.2 Test procedure

The test consists of three cells: Cell1, Cell2 and Cell3. Cell1 is E-UTRAN PCell, Cell2 is NR PSCell and Cell3 is deactivated NR SCell. The test consists of one time period, with duration of T1. Prior to the start of the time duration T1, the UE shall be fully synchronized to Cell1, Cell2 and Cell3. Cell1 shall be configured as E-UTRAN PCell, Cell2 shall be configured as NR PSCell and Cell3 shall be configured as NR deactivated SCell. The point in time at which the RRC message including *measCycleSCell* for the deactivated NR SCell is received by the UE, defines the start of time period T1. During T1 the UE shall be continuously scheduled on E-UTRAN PCell and NR PSCell.

1. Ensure the UE is in state RRC\_CONNECTED with generic procedure parameters Connectivity *EN-DC*, DC bearer *MCG\_and\_SCG*, Connected without release *On* according to TS 38.508-1 [14] clause 4.5.
2. Configure MCG according to TS 36.521-3 [26] clause C.0, C.1 and SCG according to clause C.1.1 and C.1.2 for all downlink physical channels.
3. The SS shall transmit an *RRCReconfiguration* message including *measCycleSCell* for the deactivated NR SCell.
4. The UE shall transmit *RRCReconfigurationComplete* message.

5. Set the parameters according to T1 in Table 5.5.2.4.5-1. Propagation conditions are set according to clause C.2.1. T1 starts.
6. SS schedules on PSCell continuously and UE shall start sending ACK/NACK reports. The SS shall monitor ACK/NACK/DTX on PSCell.
7. If more than 99.5% of uplink transmissions are received by SS then count a success for the event "ACK/NACK". Otherwise count a fail for the event "ACK/NACK".
8. If no longer than X consecutive DTX is observed by the SS, then count a success for the event "DTX". Otherwise count a fail for the event "DTX". Where,
  - X = 6 if the NR PSCell is not in the same band as the deactivated SCell, otherwise X = 16.
9. After the RRC connection release, the SS:
  - transmits in Cell 1 a Paging message (including PagingRecord with UE-Identity) for the UE and ensures the UE is in state RRC\_CONNECTED with generic procedure parameters Connectivity EN-DC, DC bearer MCG\_and\_SCG, Connected without release On according to TS 38.508-1 [14] clause 4.5. (if the paging fails, switches off and on the UE and ensures the UE is in state RRC\_CONNECTED with generic procedure parameters Connectivity EN-DC, DC bearer MCG\_and\_SCG, Connected without release On according to TS 38.508-1 [14] clause 4.5),

or

  - switches off and on the UE and ensures the UE is in state RRC\_CONNECTED with generic procedure parameters Connectivity EN-DC, DC bearer MCG\_and\_SCG, Connected without release On according to TS 38.508-1 [14] clause 4.5.
10. Repeat step 3-9 until a test verdict has been achieved.

Each of the events "ACK/NACK" and "DTX" is evaluated independently for the statistic, resulting in an event verdict: pass or fail. Each event is evaluated only until the confidence level according to Table G.2.3-1 in Annex G.2 is achieved. Different events may require different times for a verdict.

If all events pass, the test passes. If one event fails, the test fails.

5.5.2.4.4.3 Message contents

Message contents are according to TS 38.508-1 [14] clause 4.6 with the following exceptions:

**Table 5.5.2.4.4.3-1: Common Exception messages**

Default Message Contents	
Common contents of system information blocks exceptions	
Default RRC messages and information elements contents exceptions	Table H.3.1-1; Table H.3.1-2 with Condition Deactivated SCell; Table H.3.1-3 with Condition Deactivated SCell, SSB.1 FR2 and SMTC.1 for configuration 5.5.2.4-1; Table H.3.1-3 with Condition Deactivated SCell, SSB.2 FR2 and SMTC.1 for configuration 5.5.2.4-3; Table H.3.1-4 with A3-offset = -6dB; Table H.3.1-7 with Condition Deactivated SCell;

5.5.2.4.5 Test requirement

Table 5.5.2.4.5-1 and Table 5.5.2.4.5-2 define the primary level settings including test tolerances for FR2 interruptions during measurements on deactivated NR SCC in asynchronous EN-DC test configurations.



**Table 5.5.2.4.5-1: NR cell specific test parameters for EN-DC FR2 interruptions during measurements on deactivated NR SCC in asynchronous EN-DC**

Parameter		Unit	Cell 2	Cell 3
Frequency Range			FR2	FR2
Duplex mode	Config 1		FDD	FDD
	Config 2		TDD	TDD
TDD configuration	Config 1		N.A	N.A
	Config 2		TBD	TBD
BW <sub>channel</sub>	Config 1,2	MHz	100: N <sub>RB,c</sub> = 66	100: N <sub>RB,c</sub> = 66
Initial BWP Configuration	Config 1,2		TBD	TBD
PDSCH Reference measurement channel	Config 1,2		SR.3.1 TDD	-
RMSI CORESET parameters	Config 1,2		CR.3.1 TDD	CR.3.1 TDD
PDCCH CORESET parameters	Config 1,2		TBD	TBD
OCNG Patterns			OP.1	OP.1
SMTC Configuration	Config 1,2		SMTC.1 FR2	SMTC.1 FR2
EPRE ratio of PSS to SSS		dB	0	0
EPRE ratio of PBCH DMRS to SSS				
EPRE ratio of PBCH to PBCH DMRS				
EPRE ratio of PDCCH DMRS to SSS				
EPRE ratio of PDCCH to PDCCH DMRS				
EPRE ratio of PDSCH DMRS to SSS				
EPRE ratio of PDSCH to PDSCH				
EPRE ratio of OCNG DMRS to SSS(Note 1)				
EPRE ratio of OCNG to OCNG DMRS (Note 1)				
E <sub>s</sub> /N <sub>oc</sub>		dB	TBD	TBD
Propagation Condition			AWGN	AWGN
Time offset to cell1 <sup>Note 2</sup>		μs	62.5	62.5+ Time offset to cell2
Time offset to cell2 <sup>Note 3</sup>		μs	-	3
NOTE 1: OCNG shall be used such that both cells are fully allocated and a constant total transmitted power spectral density is achieved for all OFDM symbols.				
NOTE 2: Receive time difference of signals received between subframe timing boundary of E-UTRA PCell and slot timing boundary of PSCell including time alignment error between the two cells.				
NOTE 3: Receive time difference of signals received between slot timing boundary from two NR Cells including time alignment error between the two cells				

**Table 5.5.2.4.5-2: NR cell specific OTA related test parameters for EN-DC FR2 interruptions during measurements on deactivated NR SCC in asynchronous EN-DC**

Parameter		Unit	Cell 2	Cell 3
UE orientation around TBD axis and TBD axis			TBD	
Relative difference in angle of arrival of cell 2 and cell 3 relative to cell 1		degrees	TBD	
N <sub>oc</sub> <sup>Note1</sup>	NR_TDD_FR2_A	dBm/15kHz <sup>Note4</sup>	TBD+TT	TBD+TT
	NR_TDD_FR2_B			
	NR_TDD_FR2_C			
	NR_TDD_FR2_D			
	NR_TDD_FR2_E			
	NR_TDD_FR2_F			
	NR_TDD_FR2_G			
N <sub>oc</sub> <sup>Note1</sup>	NR_TDD_FR2_A	dBm/SCS <sup>Note3</sup>	TBD+TT	TBD+TT
	NR_TDD_FR2_B			
	NR_TDD_FR2_C			
	NR_TDD_FR2_D			
	NR_TDD_FR2_E			
	NR_TDD_FR2_F			
	NR_TDD_FR2_G			

Parameter		Unit	Cell 2	Cell 3
SS-RSRP <sup>Note2</sup>	NR_TDD_FR2_A	dBm/SCS <sup>Note4</sup>	TBD+TT	TBD+TT
	NR_TDD_FR2_B			
	NR_TDD_FR2_C			
	NR_TDD_FR2_D			
	NR_TDD_FR2_E			
	NR_TDD_FR2_F			
	NR_TDD_FR2_G			
$\hat{E}_s / I_{ot}$		dB	TBD+TT	TBD+TT
$I_o$ <sup>Note2</sup>	NR_TDD_FR2_A	dBm/95.04 MHz <sup>Note4</sup>	TBD+TT	TBD+TT
NOTE 1: Interference from other cells and noise sources not specified in the test is assumed to be constant over subcarriers and time and shall be modeled as AWGN of appropriate power for $N_{oc}$ to be fulfilled.				
NOTE 2: SS-RSRP and $I_o$ levels have been derived from other parameters for information purposes. They are not settable parameters themselves.				
NOTE 3: SS-RSRP minimum requirements are specified assuming independent interference and noise at each receiver antenna port.				
NOTE 4: Equivalent power received by an antenna with 0dBi gain at the centre of the quiet zone				
NOTE 5: As observed with 0dBi gain antenna at the centre of the quiet zone				

The UE shall be continuously scheduled in LTE PCell and NR PSCell during the entire length of T1. During the time duration T1 the UE shall transmit at least 99.5% of ACK/NACK on NR PSCell.

If the NR PSCell is not in the same band as the deactivated SCell, the UE is only allowed to cause interruptions on NR PSCell immediately before and immediately after an SMTC. Each interruption on NR PSCell shall not exceed the value defined in Table 5.5.2.4.5-3.

If the NR PSCell is in the same band as the deactivated SCell, the UE is only allowed to cause an interruption on PSCell no earlier than 4 slot before an SMTC and no later than 4 slot after the SMTC. the interruption on NR PSCell shall not exceed the value defined in Table 5.5.2.4.2-4.

**Table 5.5.2.4.5-3: Interruption duration if the NR PSCell is not in the same band as the deactivated SCell**

$\mu$	NR Slot length (ms)	Interruption length (slot)
3	0.125	4

**Table 5.5.2.4.2-4: Interruption duration if the NR PSCell is in the same band as the deactivated SCell**

$\mu$	NR Slot length (ms)	Interruption length (slot)
3	0.125	8 + SMTC duration

The rate of correct events observed during repeated tests shall be at least 90%.

### 5.5.2.5 EN-DC FR2 interruptions during measurements on deactivated E-UTRAN SCC in synchronous EN-DC

Editor's note:

- Connection diagram is TBD.
- Test tolerance is missing.
- Test procedure may be further modified.

#### 5.5.2.5.1 Test purpose

The purpose of this test is:

- To verify NR PSCell interruptions during the measurement on the deactivated E-UTRAN SCC, the UE missed ACK/NACK does not exceed the limits.
- To verify the missed ACK/NACK rate for NR PSCell in EN-DC.

#### 5.5.2.5.2 Test applicability

This test applies to all types of E-UTRA UE release 15 and forward supporting EN-DC.

#### 5.5.2.5.3 Minimum conformance requirements

The minimum conformance requirements are specified in clause 5.5.2.0.3.

The normative reference for this requirement is TS 38.133 [6] clause A.5.5.2.5.

#### 5.5.2.5.4 Test description

##### 5.5.2.5.4.1 Initial conditions

This test shall be run in one of the configurations defined in Table 5.5.2.5.4.1-1.

**Table 5.5.2.5.4.1-1: Supported test configurations for EN-DC FR2 interruptions during measurements on deactivated E-UTRAN SCC in synchronous EN-DC**

Configuration	Description
5.5.2.5-1	LTE FDD, NR 120 kHz SSB SCS, 100MHz bandwidth, TDD duplex mode
5.5.2.5-2	LTE TDD, NR 120 kHz SSB SCS, 100MHz bandwidth, TDD duplex mode

Configure the test equipment and the DUT according to the parameters in Table 5.5.2.5.4.1-2.

**Table 5.5.2.5.4.1-2: Initial conditions for EN-DC FR2 interruptions during measurements on deactivated E-UTRAN SCC in synchronous EN-DC**

Parameter	Value		Comment
Test environment	NC		As specified in TS 38.508-1 [14] clause 4.1.
Test frequencies	As specified in Annex E, table E.3-1 and TS 38.508-1 [14] clause 4.3.1 for E-UTRA and 7.2.3 for NR.		
Channel bandwidth	As specified by the test configuration selected from Table 5.5.2.5.4.1-1.		
Propagation conditions	AWGN		As specified in clause C.2.1.
Connection Diagram	TE Part	A.3.TBD	As specified in TS 38.508-1 [14] Annex A.
	DUT Part	A.3.TBD	
Exceptions to connection diagram	N/A		

1. The general test parameter settings are set up according to Table 5.5.2.5.4.1-3.
2. Message contents are defined in clause 5.5.2.5.4.3.
3. There are two E-UTRAN carriers and one NR carrier and three cells specified in the test. Cell1 and Cell3 is E-UTRAN PCell and E-UTRAN deactivated SCell, Cell2 is NR FR2 PSCell. Cell 1 is the cell used for connection setup with the power level set according to Table A.6.1.1-1. Cell 2 and Cell 3 shall be configured according to clause C.1.1 and C.1.2.

**Table 5.5.2.5.4.1-3: General test parameters for EN-DC FR2 interruptions during measurements on deactivated E-UTRAN SCC in synchronous EN-DC**

Parameter	Unit	Value	Comment
RF Channel Number		1, 2	One is E-UTRAN RF channel and the other two are NR RF channel
Active PCell		Cell1	PCell on E-UTRAN RF channel number 1.
Configured PSCell		Cell2	PSCell on NR RF channel number 2.
Configured deactivated SCell		Cell3	Deactivated SCell on NR RF channel number 2.
CP length		Normal	Applicable to cell1, cell 2 and cell3
DRX		OFF	
Measurement gap pattern Id		OFF	
SCell measurement cycle (measCycleSCell)	ms	640	
T1	s	10	

#### 5.5.2.5.4.2 Test procedure

The test consists of three cells: Cell1, Cell2 and Cell3. Cell1 and Cell3 is E-UTRAN PCell and E-UTRAN deactivated SCell, Cell2 is NR FR2 PSCell. The test consists of one time period, with duration of T1. Prior to the start of the time duration T1, the UE shall be fully synchronized to Cell1, Cell2 and Cell3. Cell1 shall be configured as E-UTRAN PCell, Cell2 shall be configured as NR PSCell and Cell3 shall be configured as E-UTRAN deactivated SCell. The point in time at which the RRC message including *measCycleSCell* or *allowInterruptions* for the E-UTRAN SCell is received by the UE, defines the start of time period T1. During T1 the UE shall be continuously scheduled on E-UTRAN PCell and NR PSCell.

1. Ensure the UE is in state RRC\_CONNECTED with generic procedure parameters Connectivity *EN-DC*, DC bearer *MCG\_and\_SCG*, Connected without release *On* according to TS 38.508-1 [14] clause 4.5.
  2. Configure MCG according to TS 36.521-3 [26] clause C.0, C.1 and SCG according to clause C.1.1 and C.1.2 for all downlink physical channels.
  3. The SS shall transmit an *RRCConnectionReconfiguration* message including *measCycleSCell* or *allowInterruptions* for the deactivated E-UTRAN SCell to perform measurements on the deactivated SCC.
  4. The UE shall transmit *RRCConnectionReconfigurationComplete* message.
  5. Set the parameters according to T1 in Table 5.5.2.5.5-1. Propagation conditions are set according to clause C.2.1. T1 starts.
  6. SS schedules on PSCell continuously and UE shall start sending ACK/NACK reports. The SS shall monitor ACK/NACK/DTX on PSCell.
  7. If more than 99.5% of uplink transmissions are received by SS then count a success for the event "ACK/NACK". Otherwise count a fail for the event "ACK/NACK".
  8. If no longer than 8 consecutive DTX is observed by the SS, then count a success for the event "DTX". Otherwise count a fail for the event "DTX".
  9. After the RRC connection release, the SS:
    - transmits in Cell 1 a Paging message (including PagingRecord with UE-Identity) for the UE and ensures the UE is in state RRC\_CONNECTED with generic procedure parameters Connectivity *EN-DC*, DC bearer *MCG\_and\_SCG*, Connected without release *On* according to TS 38.508-1 [14] clause 4.5. (if the paging fails, switches off and on the UE and ensures the UE is in state RRC\_CONNECTED with generic procedure parameters Connectivity *EN-DC*, DC bearer *MCG\_and\_SCG*, Connected without release *On* according to TS 38.508-1 [14] clause 4.5),
- or
- switches off and on the UE and ensures the UE is in state RRC\_CONNECTED with generic procedure parameters Connectivity *EN-DC*, DC bearer *MCG\_and\_SCG*, Connected without release *On* according to TS 38.508-1 [14] clause 4.5.

10. Repeat step 3-9 until a test verdict has been achieved.

Each of the events "ACK/NACK" and "DTX" is evaluated independently for the statistic, resulting in an event verdict: pass or fail. Each event is evaluated only until the confidence level according to Table G.2.3-1 in Annex G.2 is achieved. Different events may require different times for a verdict.

If all events pass, the test passes. If one event fails, the test fails.

5.5.2.5.4.3 Message contents

Message contents are according to TS 38.508-1 [14] clause 4.6 with the following exceptions:

**Table 5.5.2.5.4.3-1: Common Exception messages**

Default Message Contents	
Common contents of system information blocks exceptions	
Default RRC messages and information elements contents exceptions	

**Table 5.5.2.5.4.3-2: MeasObjectEUTRA for E-UTRAN deactivated SCell**

Derivation Path: 36.508 Table 4.6.6-2			
Information Element	Value/remark	Comment	Condition
MeasObjectEUTRA ::= SEQUENCE {			
carrierFreq	Downlink EARFCN for E-UTRAN SCell		
measCycleSCell-r10	sf640		
}			

5.5.2.5.5 Test requirement

Table 5.5.2.5.5-1 and Table 5.5.2.5.5-2 defines the primary level settings including test tolerances for E-UTRAN – NR FR2 interruptions during measurements on deactivated E-UTRAN SCC in synchronous EN-DC test configurations.

**Table 5.5.2.5.5-1: NR cell specific test parameters for EN-DC FR2 interruptions during measurements on deactivated E-UTRAN SCC in synchronous EN-DC**

Parameter		Unit	Cell 2
Frequency Range			FR2
Duplex mode	Config 1,2		TDD
TDD configuration	Config 1,2		TBD
BW <sub>channel</sub>	Config 1,2	MHz	100: N <sub>RB,c</sub> = 66
Initial BWP Configuration	Config 1,2		TBD
PDSCH Reference measurement channel	Config 1,2		SR.3.1 TDD
RMSI CORESET parameters	Config 1,2		CR.3.1 TDD
PDCCH CORESET parameters	Config 1,2		TBD
OCNG Patterns			OP.1
SMTc Configuration	Config 1,2		SMTc.1 FR2
EPRE ratio of PSS to SSS		dB	0
EPRE ratio of PBCH DMRS to SSS			
EPRE ratio of PBCH to PBCH DMRS			
EPRE ratio of PDCCH DMRS to SSS			
EPRE ratio of PDCCH to PDCCH DMRS			
EPRE ratio of PDSCH DMRS to SSS			
EPRE ratio of PDSCH to PDSCH			
EPRE ratio of OCNG DMRS to SSS(Note 1)			
EPRE ratio of OCNG to OCNG DMRS (Note 1)			
E <sub>s</sub> /N <sub>oc</sub>		dB	TBD+TT
Propagation Condition			AWGN
Time offset to cell1 <sup>Note 2</sup>		μs	3
NOTE 1: OCNG shall be used such that both cells are fully allocated and a constant total transmitted power spectral density is achieved for all OFDM symbols.			
NOTE 2: Receive time difference of signals received between subframe timing boundary of E-UTRA PCell and slot timing boundary of PSCell including time alignment error between the two cells			

**Table 5.5.2.5.5-2: NR cell specific OTA related test parameters for EN-DC FR2 interruptions during measurements on deactivated E-UTRAN SCC in synchronous EN-DC**

Parameter		Unit	Cell 2
UE orientation around TBD axis and TBD axis			TBD
Relative difference in angle of arrival of cell 2 relative to cell 1		degrees	TBD
N <sub>oc</sub> <sup>Note1</sup>	NR_TDD_FR2_A	dBm/15kHz <sup>Note4</sup>	TBD+TT
	NR_TDD_FR2_B		
	NR_TDD_FR2_C		
	NR_TDD_FR2_D		
	NR_TDD_FR2_E		
	NR_TDD_FR2_F		
N <sub>oc</sub> <sup>Note1</sup>	NR_TDD_FR2_G	dBm/SCS <sup>Note3</sup>	TBD+TT
	NR_TDD_FR2_A		
	NR_TDD_FR2_B		
	NR_TDD_FR2_C		
	NR_TDD_FR2_D		
	NR_TDD_FR2_E		
SS-RSRP <sup>Note2</sup>	NR_TDD_FR2_F	dBm/SCS <sup>Note4</sup>	TBD+TT
	NR_TDD_FR2_G		
	NR_TDD_FR2_A		
	NR_TDD_FR2_B		
	NR_TDD_FR2_C		
	NR_TDD_FR2_D		

Parameter	Unit	Cell 2
$\hat{E}_s / I_{ot}$	dB	TBD+TT
$I_{o}^{Note2}$   NR_TDD_FR2_A	dBm/95.04 MHz <sup>Note4</sup>	TBD+TT
NOTE 1: Interference from other cells and noise sources not specified in the test is assumed to be constant over subcarriers and time and shall be modeled as AWGN of appropriate power for $N_{oc}$ to be fulfilled.		
NOTE 2: SS-RSRP and $I_o$ levels have been derived from other parameters for information purposes. They are not settable parameters themselves.		
NOTE 3: SS-RSRP minimum requirements are specified assuming independent interference and noise at each receiver antenna port.		
NOTE 4: Equivalent power received by an antenna with 0dBi gain at the centre of the quiet zone		
NOTE 5: As observed with 0dBi gain antenna at the centre of the quiet zone		

The UE shall be continuously scheduled in LTE PCell and NR PSCell during the entire length of T1. During the time duration T1 the UE shall transmit at least 99.5% of ACK/NACK on NR PSCell. The UE is only allowed to cause interruptions immediately before and immediately after an SMTC. Each interruption on NR PSCell shall not exceed the value defined in Table 5.5.2.5.5-3.

**Table 5.5.2.5.5-3: Interruption duration if the NR PSCell is not in the same band as the deactivated SCell**

$\mu$	NR Slot length (ms)	Interruption length (slot)
3	0.125	5

**Table 5.5.2.5.5-4: Void**

The rate of correct events observed during repeated tests shall be at least 90%.

### 5.5.2.6 EN-DC FR2 interruptions during measurements on deactivated E-UTRAN SCC in asynchronous EN-DC

**Editor's note:**

- Connection diagram is TBD.
- Test tolerance is missing.
- Test procedure may be further modified.

#### 5.5.2.6.1 Test purpose

The purpose of this test is:

- To verify NR PSCell interruptions during the measurement on the deactivated E-UTRAN SCC, the UE missed ACK/NACK does not exceed the limits.
- To verify the missed ACK/NACK rate for NR PSCell in EN-DC.

#### 5.5.2.6.2 Test applicability

This test applies to all types of E-UTRA UE release 15 and forward supporting EN-DC.

#### 5.5.2.6.3 Minimum conformance requirements

The minimum conformance requirements are specified in clause 5.5.2.0.3.

The normative reference for this requirement is TS 38.133 [6] clause A.5.5.2.6.

## 5.5.2.6.4 Test description

## 5.5.2.6.4.1 Initial conditions

Test 5.5.2.6 can be run in one of the configurations defined in Table 5.5.2.6.4.1-1.

**Table 5.5.2.6.4.1-1: Supported test configurations for EN-DC FR2 interruptions during measurements on deactivated E-UTRAN SCC in asynchronous EN-DC**

Configuration	Description
5.5.2.6-1	LTE FDD, NR 120 kHz SSB SCS, 100MHz bandwidth, TDD duplex mode
5.5.2.6-2	LTE TDD, NR 120 kHz SSB SCS, 100MHz bandwidth, TDD duplex mode

Configure the test equipment and the DUT according to the parameters in Table 5.5.2.6.4.1-2.

**Table 5.5.2.6.4.1-2: Initial conditions for EN-DC FR2 interruptions during measurements on deactivated E-UTRAN SCC in asynchronous EN-DC**

Parameter	Value		Comment
Test environment	NC		As specified in TS 38.508-1 [14] clause 4.1.
Test frequencies	As specified in Annex E, table E.3-1 and TS 38.508-1 [14] clause 4.3.1 for E-UTRA and 7.2.3 for NR.		
Channel bandwidth	As specified by the test configuration selected from Table 5.5.2.6.4.1-1.		
Propagation conditions	AWGN		As specified in clause C.2.1.
Connection Diagram	TE Part	A.3.TBD	As specified in TS 38.508-1 [14] Annex A.
	DUT Part	A.3.TBD	
Exceptions to connection diagram	N/A		

- The general test parameter settings are set up according to Table 5.5.2.6.4.1-3.
- Message contents are defined in clause 5.5.2.6.4.3.
- There are two E-UTRAN carriers and one NR carrier and three cells specified in the test. Cell1 and Cell3 is E-UTRAN PCell and E-UTRAN deactivated SCell, Cell2 is NR FR2 PSCell. Cell 1 is the cell used for connection setup with the power level set according to Table A.6.1.1-1. Cell 2 and Cell 3 shall be configured according to clause C.1.1 and C.1.2.

**Table 5.5.2.6.4.1-3: General test parameters for EN-DC FR2 interruptions during measurements on deactivated E-UTRAN SCC in asynchronous EN-DC**

Parameter	Unit	Value	Comment
RF Channel Number		1, 2	One is E-UTRAN RF channel and the other two are NR RF channel
Active PCell		Cell1	PCell on E-UTRAN RF channel number 1.
Configured PSCell		Cell2	PSCell on NR RF channel number 2.
Configured deactivated SCell		Cell3	Deactivated SCell on NR RF channel number 2.
CP length		Normal	Applicable to cell1, cell 2 and cell3
DRX		OFF	
Measurement gap pattern Id		OFF	
SCell measurement cycle (measCycleSCell)	ms	640	
T1	s	10	

## 5.5.2.6.4.2 Test procedure

The test consists of three cells: Cell1, Cell2 and Cell3. Cell1 and Cell3 is E-UTRAN PCell and E-UTRAN deactivated SCell, Cell2 is NR FR2 PSCell. The test consists of one time period, with duration of T1. Prior to the start of the time duration T1, the UE shall be fully synchronized to Cell1, Cell2 and Cell3. Cell1 shall be configured as E-UTRAN



PCell, Cell2 shall be configured as NR PSCell and Cell3 shall be configured as E-UTRAN deactivated SCell. The point in time at which the RRC message including *measCycleSCell* or *allowInterruptions* for the E-UTRAN SCell is received by the UE, defines the start of time period T1. During T1 the UE shall be continuously scheduled on E-UTRAN PCell and NR PSCell.

1. Ensure the UE is in state RRC\_CONNECTED with generic procedure parameters Connectivity *EN-DC*, DC bearer *MCG\_and\_SCG*, Connected without release *On* according to TS 38.508-1 [14] clause 4.5.
2. Configure MCG according to TS 36.521-3 [26] clause C.0, C.1 and SCG according to clause C.1.1 and C.1.2 for all downlink physical channels.
3. The SS shall transmit an *RRCConnectionReconfiguration* message including *measCycleSCell* or *allowInterruptions* for the deactivated E-UTRAN SCell to perform measurements on the deactivated SCC.
4. The UE shall transmit *RRCConnectionReconfigurationComplete* message.
5. Set the parameters according to T1 in Table 5.5.2.6.5-1. Propagation conditions are set according to clause C.2.1. T1 starts.
6. SS schedules on PSCell continuously and UE shall start sending ACK/NACK reports. The SS shall monitor ACK/NACK/DTX on PSCell.
7. If more than 99.5% of uplink transmissions are received by SS then count a success for the event "ACK/NACK". Otherwise count a fail for the event "ACK/NACK".
8. If no longer than 8 consecutive DTX is observed by the SS, then count a success for the event "DTX". Otherwise count a fail for the event "DTX".
9. After the RRC connection release, the SS:
  - transmits in Cell 1 a Paging message (including PagingRecord with UE-Identity) for the UE and ensures the UE is in state RRC\_CONNECTED with generic procedure parameters Connectivity *EN-DC*, DC bearer *MCG\_and\_SCG*, Connected without release *On* according to TS 38.508-1 [14] clause 4.5. (if the paging fails, switches off and on the UE and ensures the UE is in state RRC\_CONNECTED with generic procedure parameters Connectivity *EN-DC*, DC bearer *MCG\_and\_SCG*, Connected without release *On* according to TS 38.508-1 [14] clause 4.5),

or

  - switches off and on the UE and ensures the UE is in state RRC\_CONNECTED with generic procedure parameters Connectivity *EN-DC*, DC bearer *MCG\_and\_SCG*, Connected without release *On* according to TS 38.508-1 [14] clause 4.5.
10. Repeat step 3-9 until a test verdict has been achieved.

Each of the events "ACK/NACK" and "DTX" is evaluated independently for the statistic, resulting in an event verdict: pass or fail. Each event is evaluated only until the confidence level according to Table G.2.3-1 in Annex G.2 is achieved. Different events may require different times for a verdict.

If all events pass, the test passes. If one event fails, the test fails.

5.5.2.6.4.3 Message contents

Message contents are according to TS 38.508-1 [14] clause 4.6 with the following exceptions:

**Table 5.5.2.6.4.3-1: Common Exception messages**

Default Message Contents	
Common contents of system information blocks exceptions	
Default RRC messages and information elements contents exceptions	

**Table 5.5.2.6.4.3-2: MeasObjectEUTRA for EUTRAN deactivated SCell**

Derivation Path: 36.508 Table 4.6.6-2			
Information Element	Value/remark	Comment	Condition
MeasObjectEUTRA ::= SEQUENCE {			
carrierFreq	Downlink EARFCN for E-UTRAN SCell		
measCycleSCell-r10	sf640		
}			

5.5.2.6.5 Test requirement

Table 5.5.2.6.5-1 and Table 5.5.2.6.5-2 defines the primary level settings including test tolerances for E-UTRAN – NR FR2 interruptions during measurements on deactivated E-UTRAN SCC in asynchronous EN-DC test configurations.

**Table 5.5.2.6.5-1: NR cell specific test parameters for EN-DC FR2 interruptions during measurements on deactivated E-UTRAN SCC in asynchronous EN-DC**

Parameter	Unit	Cell 2
Frequency Range		FR2
Duplex mode	Config 1,2	TDD
TDD configuration	Config 1,2	TBD
BW <sub>channel</sub>	Config 1,2	MHz 100: N <sub>RB,c</sub> = 66
Initial BWP Configuration	Config 1,2	TBD
PDSCH Reference measurement channel	Config 1,2	SR.3.1 TDD
RMSI CORESET parameters	Config 1,2	CR.3.1 TDD
PDCCH CORESET parameters	Config 1,2	TBD
OCNG Patterns		OP.1
SMTC Configuration	Config 1,2	SMTC.1 FR2
EPRE ratio of PSS to SSS	dB	0
EPRE ratio of PBCH DMRS to SSS		
EPRE ratio of PBCH to PBCH DMRS		
EPRE ratio of PDCCH DMRS to SSS		
EPRE ratio of PDCCH to PDCCH DMRS		
EPRE ratio of PDSCH DMRS to SSS		
EPRE ratio of PDSCH to PDSCH		
EPRE ratio of OCNG DMRS to SSS(Note 1)		
EPRE ratio of OCNG to OCNG DMRS (Note 1)		
$\bar{E}_s/N_{oc}$	dB	TBD
Propagation Condition		AWGN
Time offset to cell1 <sup>Note 2</sup>	$\mu$ s	62.5
NOTE 1: OCNG shall be used such that both cells are fully allocated and a constant total transmitted power spectral density is achieved for all OFDM symbols.		
NOTE 2: Receive time difference of signals received between subframe timing boundary of E-UTRA PCell and slot timing boundary of PSCell including time alignment error between the two cells		

**Table 5.5.2.6.5-2: NR cell specific OTA related test parameters for EN-DC FR2 interruptions during measurements on deactivated E-UTRAN SCC in asynchronous EN-DC**

Parameter	Unit	Cell 2	
UE orientation around TBD axis and TBD axis		TBD	
Relative difference in angle of arrival of cell 2 relative to cell 1	degrees	TBD	
$N_{oc}$ <sup>Note1</sup>	NR_TDD_FR2_A	dBm/15kHz <sup>Note4</sup>	TBD
	NR_TDD_FR2_B		
	NR_TDD_FR2_C		
	NR_TDD_FR2_D		
	NR_TDD_FR2_E		
	NR_TDD_FR2_G		

$N_{oc}$ <sup>Note1</sup>	NR_TDD_FR2_A	dBm/SCS <sup>Note3</sup>	TBD
	NR_TDD_FR2_B		
	NR_TDD_FR2_C		
	NR_TDD_FR2_D		
	NR_TDD_FR2_E		
	NR_TDD_FR2_F		
	NR_TDD_FR2_G		
SS-RSRP <sup>Note2</sup>	NR_TDD_FR2_A	dBm/SCS <sup>Note4</sup>	TBD
	NR_TDD_FR2_B		
	NR_TDD_FR2_C		
	NR_TDD_FR2_D		
	NR_TDD_FR2_E		
	NR_TDD_FR2_F		
	NR_TDD_FR2_G		
$\hat{E}_s / I_{ot}$		dB	TBD
$I_o$ <sup>Note2</sup>	NR_TDD_FR2_A	dBm/95.04 MHz <sup>Note4</sup>	TBD
<p>NOTE 1: Interference from other cells and noise sources not specified in the test is assumed to be constant over subcarriers and time and shall be modeled as AWGN of appropriate power for <math>N_{oc}</math> to be fulfilled.</p> <p>NOTE 2: SS-RSRP and <math>I_o</math> levels have been derived from other parameters for information purposes. They are not settable parameters themselves.</p> <p>NOTE 3: SS-RSRP minimum requirements are specified assuming independent interference and noise at each receiver antenna port.</p> <p>NOTE 4: Equivalent power received by an antenna with 0dBi gain at the center of the quiet zone</p> <p>NOTE 5: As observed with 0dBi gain antenna at the center of the quiet zone</p>			

The UE shall be continuously scheduled in LTE PCell and NR PSCell during the entire length of T1. During the time duration T1 the UE shall transmit at least 99.5% of ACK/NACK on NR PSCell. The UE is only allowed to cause interruptions immediately before and immediately after an SMTTC. Each interruption on NR PSCell shall not exceed the value defined in Table 5.5.2.6.5-3.

**Table 5.5.2.6.5-3: Interruption duration if the NR PSCell is not in the same band as the deactivated SCell**

$\mu$	NR Slot length (ms)	Interruption length
3	0.125	5

**Table 5.5.2.6.5-4: Void**

The rate of correct events observed during repeated tests shall be at least 90%.

### 5.5.3 SCell activation and deactivation delay

#### 5.5.3.1 EN-DC FR2 SCell activation and deactivation intra-band in non-DRX

*Editor's notes: This clause is incomplete, the following items are TBD*

- *The core requirements in TS 38.133 are between [.] or TBD;*
- *Test tolerance analysis is missing;*
- *Test procedure and Message content are TBD;*
- *Cell mapping and Connection diagram is TBD;*
- *Test applicability Table in TS38.522 need to be updated.*

### 5.5.3.1.1 Test purpose

This test is to verify that the SCell activation and deactivation times are within the requirements, when the SCell in FR2 intra-band is known by the UE at the time of activation.

### 5.5.3.1.2 Test applicability

This test applies to all types of NR UE supporting E-UTRA and EN-DC from Release 15 onwards and supporting 2DL CA.

### 5.5.3.1.3 Minimum conformance requirements

Same minimum conformance requirements as described in clause 4.5.3.1.3.

The normative reference for this requirement is TS 38.133 [6] clause 8.3 and A.5.5.3.1.

### 5.5.3.1.4 Test description

#### 5.5.3.1.4.1 Initial conditions

This test shall be tested using any of the test configurations in Table 5.5.3.1.4.1-1.

**Table 5.5.3.1.4.1-1: Supported test configurations for FR2 SCell activation case with FR2 PSCell**

Test Case ID	Description
5.5.3.1-1	FDD LTE PCell, Cell 2&3 120 kHz SSB SCS, 100MHz bandwidth, TDD duplex mode
5.5.3.1-2	TDD LTE PCell, Cell 2&3 120 kHz SSB SCS, 100MHz bandwidth, TDD duplex mode
NOTE: The UE is only required to pass in one of the supported test configurations.	

Configure the test equipment and the DUT according to the parameters in Table 5.5.3.1.4.1-2 and Table 5.5.3.1.4.1-3.

**Table 5.5.3.1.4.1-2: Initial conditions for known FR2 SCell activation case with FR2 PSCell**

Parameter	Value	Comment
Test environment	NC	As specified in TS 38.508-1 [14] clause 4.1.
Test frequencies	As specified in Annex E, Table E.1-1 and TS 38.508-1 [14] clause 4.3.1 for E-UTRA and 7.2.3 for NR.	
Channel bandwidth	As specified by the test configuration selected from Table 4.7.1.1.2-1.	
Propagation conditions	AWGN	As specified in clause C.2.2.
Connection Diagram	TE Part DUT Part	TBD TBD
Exceptions to connection diagram	N/A	

**Table 5.5.3.1.4.1-3: General test parameters for FR2 SCell activation case with FR2 PSCell**

Parameter	Unit	Value	Comment
RF Channel Number		1,2,3	One E-UTRAN radio channel (1) and two NR radio channel (2,3) are used for this test
Active PCell		Cell 1	Primary cell on E-UTRAN RF channel number 1. As specified in clause A.3.7.2.2 of TS38.133 [6]
Active PSCell		Cell 2	Primary secondary cell on NR RF channel number 2.
Configured deactivated SCell		Cell 3	Configured deactivated secondary cell on NR RF channel number 3
CP length		Normal	
DRX		OFF	Continuous monitoring of primary cell
Cell-individual offset for cells on E-UTRA RF channel number	dB	0	Individual offset for cells on primary component carrier.
Cell-individual offset for cells on NR channel number	dB	0	Individual offset for cells on secondary component carrier.
SCell measurement cycle (measCycleSCell)	ms	160	
Cell3 timing offset to cell2	μs	0	
Time alignment error between cell3 and cell2	μs	≤ Time alignment error as specified in TS 38.104 [28] clause 6.5.3.1.	The value of time alignment error depends upon the type of carrier aggregation.
T1	s	7	During this time the PSCell shall be known and the SCell configured and detected.
T2	s	1	During this time the UE shall activate the SCell.
T3	s	1	During this time the UE shall deactivate the SCell.
T <sub>HARQ</sub>	ms	$k_1 \cdot \text{NR slot length}$	$k_1$ is a number of slots and is indicated by the PDSCH-to-HARQ-timing-indicator field in the DCI format, if present, or provided by dl-DataToUL-ACK, the value of $k$ should be the minimum value defined in TS 38.213 [8]
T <sub>CSI_Reporting</sub>	ms	15	the delay (in ms) including uncertainty in acquiring the first available downlink CSI reference resource, UE processing time for CSI reporting (clause 5.2.2.5 in TS 38.214) and uncertainty in acquiring the first available CSI reporting resources as specified in 38.331 [13].
k	ms	$k_1 + 3 \cdot N_{\text{slot}}^{\text{subframe}, \mu} + 1$	As specified in clause 4.3 of TS38.213 [8]

1. Message contents are defined in clause 5.5.3.1.4.3.
2. Cell 1 is the E-UTRA serving cell (PCell) for the EN-DC setup. The power levels and settings for Cell 1 are set according to Annex A.6. Cell 2 and Cell 3 are NR FR2 cells in the same frequency. Cell 2 is the PSCell and Cell 3 is the deactivated SCell.

#### 5.5.3.1.4.2 Test procedure

The test consists of three successive time periods, with duration of T1, T2 and T3, respectively. There are three carriers, E-UTRA has one cell, NR has two cells. All cells have constant signal levels throughout the test. Before the test starts the UE is connected to Cell 1 (PCell) on E-UTRA and Cell 2 (PSCell) on NR, but is not aware of Cell 3 (SCell) on NR. The UE is monitoring the PCell and PSCell. The UE shall be continuously scheduled in the PCell and PSCell throughout the whole test.

1. Ensure the UE is in state RRC\_CONNECTED with generic procedure parameters Connectivity EN-DC, DC bearer MCG and SCG according to TS 38.508-1 [14] clause 4.5.
2. TBD.

5.5.3.1.4.3 Message contents

Message contents are according to TS 38.508-1 [14] clause 7.3.

5.5.3.1.5 Test requirement

Table 5.5.3.1.5-1 will replace the values of corresponding parameters in Table 4.5.3.1.5-1 and Table 5.5.3.1.5-2 defines OTA related test parameters.

**Table 5.5.3.1.5-1: Cell specific test parameters for FR2 SCell activation case with FR2 PSCell**

Parameter <sup>Note 5</sup>	Unit	Cell 2			Cell 3		
		T1	T2	T3	T1	T2	T3
SSB ARFCN		freq1			freq2		
Duplex mode		TDD			TDD		
TDD configuration		TDDConf.3.1			TDDConf.3.1		
BW <sub>channel</sub>	MHz	100: N <sub>RB,c</sub> = 66			100: N <sub>RB,c</sub> = 66		
PDSCH Reference measurement channel		SR.3.1 TDD			SR.3.1 TDD		
RMSI CORESET Reference Channel		CR.3.1 TDD			CR.3.1 TDD		
RMC CORESET Reference Channel		CCR.3.1 TDD			CCR.3.1 TDD		
DL initial BWP configuration		DLBWP.0.1					
DL dedicated BWP configuration		DLBWP.1.1					
UL initial BWP configuration		ULBWP.0.1					
UL dedicated BWP configuration		ULBWP.1.1					
OCNG Patterns		OP.1					
SMTC configuration		SMTC.1					
SSB configuration		SSB.1 FR2					
CSI-RS configuration for CSI reporting		CSI-RS.3.1 TDD					
reportQuantity		cri-RI-CQI			N/A		
CSI reporting periodicity	slot	40			N/A		
CSI reporting offset	slot	4			N/A		
PDSCH/PDCCH subcarrier spacing	kHz	120					
TCI state		TCI.State.0					
TRS configuration		TRS.2.1 TDD					
EPRE ratio of PSS to SSS	dB	0					
EPRE ratio of PBCH_DMRS to SSS							
EPRE ratio of PBCH to PBCH_DMRS							
EPRE ratio of PDCCH_DMRS to SSS							
EPRE ratio of PDCCH to PDCCH_DMRS							
EPRE ratio of PDSCH_DMRS to SSS							
EPRE ratio of PDSCH to PDSCH_DMRS							
EPRE ratio of OCNG DMRS to SSS <sup>note 1</sup>							
EPRE ratio of OCNG to OCNG DMRS <sup>note 1</sup>							
Propagation conditions		AWGN					
NOTE 1: OCNG shall be used such that both cells are fully allocated and a constant total transmitted power spectral density is achieved for all OFDM symbols.							
NOTE 2: Interference from other cells and noise sources not specified in the test is assumed to be constant over subcarriers and time and shall be modelled as AWGN of appropriate power for $N_{oc}$ to be fulfilled.							
NOTE 3: SS-RSRP and I <sub>o</sub> levels have been derived from other parameters for information purposes. They are not settable parameters themselves.							
NOTE 4: SS-RSRP minimum requirements are specified assuming independent interference and noise at each receiver antenna port.							
NOTE 5: All parameters apply for configuration 1 and 2.							

Table 5.5.3.1.5-2: OTA related test parameters for FR2 SCell activation case with FR2 PSCell

Parameter <sup>Note 6</sup>	Unit	Cell 2			Cell 3		
		T1	T2	T3	T1	T2	T3
Angle of arrival configuration		Setup 1 according to A.9.1					
Assumption for UE beams <sup>Note 7</sup>		Rough			Rough		
$N_{oc}$ <sup>Note1</sup>	dBm/15kHz <sup>Note4</sup>	-112			-112		
$N_{oc}$ <sup>Note1</sup>	dBm/SCS <sup>Note3</sup>	-102.97			-102.97		
$\hat{E}_s / N_{oc}$	dB	14			14		
SS-RSRP <sup>Note2</sup>	dBm/SCS <sup>Note4</sup>	-88.97			-88.97		
$\hat{E}_s / I_{ot}$	dB	14			14		
$I_o$ <sup>Note2</sup>	dBm/95.04 MHz <sup>Note4</sup>	-88.80			-88.80		
<p>NOTE 1: Interference from other cells and noise sources not specified in the test is assumed to be constant over subcarriers and time and shall be modelled as AWGN of appropriate power for <math>N_{oc}</math> to be fulfilled.</p> <p>NOTE 2: SS-RSRP and <math>I_o</math> levels have been derived from other parameters for information purposes. They are not settable parameters themselves.</p> <p>NOTE 3: SS-RSRP minimum requirements are specified assuming independent interference and noise at each receiver antenna port.</p> <p>NOTE 4: Equivalent power received by an antenna with 0dBi gain at the centre of the quiet zone</p> <p>NOTE 5: As observed with 0dBi gain antenna at the centre of the quiet zone</p> <p>NOTE 6: All parameters apply for configuration 1 and 2</p> <p>NOTE 7: Information about types of UE beam is given in TS 38.133 [6] clause B.2.1.3, and does not limit UE implementation or test system implementation</p>							

The test requirements defined in clause 4.5.3.1.5 shall apply to this test case.

## 5.5.4 UE UL carrier RRC reconfiguration delay

## 5.5.5 Link recovery procedures

### 5.5.5.0 Minimum conformance requirements

#### 5.5.5.0.1 Minimum conformance requirements for SSB-based BFD and link recovery procedures

[TS38.133, clause 8.5.2.1]

The requirements in this clause apply for each SSB resource in the set  $\bar{q}_0$  configured for a serving cell, provided that the SSB configured for beam failure detection is actually transmitted within the UE active DL BWP during the entire evaluation period specified in TS 38.133 [6] clause 8.5.2.2. The requirements in this clause could not be applicable if UE is required to perform beam failure detection on more than 1 serving cell per band.

**Table 5.5.5.0.1-1: PDCCH transmission parameters for beam failure instance**

Attribute	Value for BLER
DCI format	1-0
Number of control OFDM symbols	2
Aggregation level (CCE)	8
Ratio of hypothetical PDCCH RE energy to average SSS RE energy	0dB
Ratio of hypothetical PDCCH DMRS energy to average SSS RE energy	0dB
Bandwidth (PRBs)	24
Sub-carrier spacing (kHz)	Same as the SCS of RMSI CORESET
DMRS precoder granularity	REG bundle size
REG bundle size	6
CP length	Normal
Mapping from REG to CCE	Distributed

[TS38.133, clause 8.5.2.2]

UE shall be able to evaluate whether the downlink radio link quality on the configured SSB resource in set  $\bar{q}_0$  estimated over the last  $T_{\text{Evaluate\_BFD\_SSB}}$  ms period becomes worse than the threshold  $Q_{\text{out\_LR\_SSB}}$  within  $T_{\text{Evaluate\_BFD\_SSB}}$  ms period.

The value of  $T_{\text{Evaluate\_BFD\_SSB}}$  is defined in Table 5.5.5.0.1-2 for FR2 with scaling factor  $N=8$ .

For FR2,

- $P=1/(1-T_{\text{SSB}}/T_{\text{SMTCperiod}})$ , when BFD-RS is not overlapped with measurement gap and the BFD-RS resource is partially overlapped with SMTC occasion ( $T_{\text{SSB}} < T_{\text{SMTCperiod}}$ ).
- $P = P_{\text{sharing factor}}$ , when the BFD-RS resource is not overlapped with measurement gap and the BFD-RS resource is fully overlapped with SMTC period ( $T_{\text{SSB}} = T_{\text{SMTCperiod}}$ ).
- $P=1/(1-T_{\text{SSB}}/MGRP-T_{\text{SSB}}/T_{\text{SMTCperiod}})$ , when the BFD-RS resource is partially overlapped with measurement gap and the BFD-RS resource is partially overlapped with SMTC occasion ( $T_{\text{SSB}} < T_{\text{SMTCperiod}}$ ) and SMTC occasion is not overlapped with measurement gap and
  - $T_{\text{SMTCperiod}} \neq MGRP$  or
  - $T_{\text{SMTCperiod}} = MGRP$  and  $T_{\text{SSB}} < 0.5 * T_{\text{SMTCperiod}}$
- $P= P_{\text{sharing factor}} / (1-T_{\text{SSB}}/MGRP)$ , when the BFD-RS resource is partially overlapped with measurement gap and the BFD-RS resource is partially overlapped with SMTC occasion ( $T_{\text{SSB}} < T_{\text{SMTCperiod}}$ ) and SMTC occasion is not overlapped with measurement gap and  $T_{\text{SMTCperiod}} = MGRP$  and  $T_{\text{SSB}} = 0.5 * T_{\text{SMTCperiod}}$
- $P=1/(1-T_{\text{SSB}}/T_{\text{SMTCperiod}})$ , when the BFD-RS resource is partially overlapped with measurement gap ( $T_{\text{SSB}} < MGRP$ ) and the BFD-RS resource is partially overlapped with SMTC occasion ( $T_{\text{SSB}} < T_{\text{SMTCperiod}}$ ) and SMTC occasion is partially or fully overlapped with measurement gap.
- $P= P_{\text{sharing factor}} / (1-T_{\text{SSB}}/MGRP)$ , when the BFD-RS resource is partially overlapped with measurement gap and the BFD-RS resource is fully overlapped with SMTC occasion ( $T_{\text{SSB}} = T_{\text{SMTCperiod}}$ ) and SMTC occasion is partially overlapped with measurement gap ( $T_{\text{SMTCperiod}} < MGRP$ )
- $P_{\text{sharing factor}} = 1$ , if the BFD-RS resource outside measurement gap is
  - not overlapped with the SSB symbols indicated by *SSB-ToMeasure* and 1 data symbol before each consecutive SSB symbols indicated by *SSB-ToMeasure* and 1 data symbol after each consecutive SSB symbols indicated by *SSB-ToMeasure*, given that *SSB-ToMeasure* is configured, where the *SSB-ToMeasure* is the union set of *SSB-ToMeasure* from all the configured measurement objects merged on the same serving carrier, and;-
  - not overlapped with the RSSI symbols indicated by *ss-RSSI-Measurement* and 1 data symbol



before each RSSI symbol indicated by *ss-RSSI-Measurement* and 1 data symbol after each RSSI symbol indicated by *ss-RSSI-Measurement*, given that *ss-RSSI-Measurement* is configured.

- $P_{\text{sharing factor}} = 3$ , otherwise.

where,

If the high layer in TS 38.331 [2] signaling of *smtc2* is configured,  $T_{\text{SMTCperiod}}$  corresponds to the value of higher layer parameter *smtc2*; Otherwise  $T_{\text{SMTCperiod}}$  corresponds to the value of higher layer parameter *smtc1*.  $T_{\text{SMTCperiod}}$  is the shortest SMTC period among all CCs in the same FR2 band, given the SMTC offset of all CCs in FR2 provided the same offset.

Longer evaluation period would be expected if the combination of BFD resource, SMTC occasion and measurement gap configurations does not meet previous conditions.

For either an FR1 or FR2 serving cell, longer evaluation period would be expected during the period  $T_{\text{identify\_CGI}}$  when the UE is requested to decode an NR CGI.

For either an FR1 or FR2 serving cell, longer BFD evaluation period would be expected during the period  $T_{\text{identify\_CGI-LTE-UTRAN}}$  when the UE is requested to decode an LTE CGI.

**Table 5.5.5.0.1-2: Evaluation period  $T_{\text{Evaluate\_BFD\_SSB}}$  for FR2**

Configuration	$T_{\text{Evaluate\_BFD\_SSB}}$ (ms)
no DRX	$\text{Max}([50], \text{Cceil}(5 \cdot P \cdot N) \cdot T_{\text{SSB}})$
DRX cycle $\leq 320\text{ms}$	$\text{Mmax}([50], \text{Cceil}(7.5 \cdot P \cdot N) \cdot \text{Mmax}(T_{\text{DRX}}, T_{\text{SSB}}))$
DRX cycle $> 320\text{ms}$	$\text{Cceil}(5 \cdot P \cdot N) \cdot T_{\text{DRX}}$
NOTE: $T_{\text{SSB}}$ is the periodicity of SSB in the set $\bar{q}_0$ . $T_{\text{DRX}}$ is the DRX cycle length.	

[TS38.133, clause 8.5. 2.3]

The UE is required to be capable of measuring SSB for BFD without measurement gaps. The UE is required to perform the SSB measurements with measurement restrictions as described in the following clauses.

For FR2, when the SSB for BFD measurement on one CC is in the same OFDM symbol as CSI-RS for RLM, BFD, CBD or L1-RSRP measurement on the same CC or different CCs in the same band, UE is required to measure one of but not both SSB for BFD measurement and CSI-RS. Longer measurement period for SSB based BFD measurement is expected, and no requirements are defined.

[TS38.133, clause 8.5.4]

When the radio link quality on all the RS resources in set  $\bar{q}_0$  is worse than  $Q_{\text{out\_LR}}$ , Layer 1 of the UE shall send a beam failure instance indication to the higher layers.

The beam failure instance evaluation for the RS resources in set  $\bar{q}_0$  shall be performed as specified in clause 6 in TS 38.213. Two successive indications from Layer 1 shall be separated by at least  $T_{\text{Indication\_interval\_BFD}}$ .

When DRX is not used,  $T_{\text{Indication\_interval\_BFD}}$  is  $\text{max}(2\text{ms}, T_{\text{SSB-RS,M}})$  or  $\text{max}(2\text{ms}, T_{\text{CSI-RS,M}})$ , where  $T_{\text{SSB-RS,M}}$  and  $T_{\text{CSI-RS,M}}$  is the shortest periodicity of all RS resources in set  $\bar{q}_0$  for the accessed cell, corresponding to either the shortest periodicity of the SSB in the set  $\bar{q}_0$  or CSI-RS resource in the set  $\bar{q}_0$ .

When DRX is used, for SSB based link quality measurement,

- $T_{\text{Indication\_interval\_BFD}} = \text{Max}(1.5 \times \text{DRX\_cycle\_length}, 1.5 \times T_{\text{SSB-RS,M}})$ , if  $\text{DRX\_cycle\_length} \leq 320\text{ms}$ ,
- $T_{\text{Indication\_interval\_BFD}} = \text{DRX\_cycle\_length}$ , if  $\text{DRX\_cycle\_length} > 320\text{ms}$ .

[TS38.133, clause 8.5.5.1]

The requirements in this clause apply for each SSB resource in the set  $\bar{q}_1$  configured for a serving cell, provided that the SSBs configured for candidate beam detection are actually transmitted within UE active DL BWP during the entire evaluation period specified in TS 38.133 [6] clause 8.5.5.2. The requirements in this clause could not be applicable if UE is required to perform candidate beam detection on more than 1 serving cell per band or on more than one band among a set of bands that it can receive with a common beam.

[TS38.133, clause 8.5.5.2]

Upon request the UE shall be able to evaluate whether the L1-RSRP measured on the configured SSB resource in set  $\bar{q}_1$  estimated over the last  $T_{\text{Evaluate\_CBD\_SSB}}$  ms period becomes better than the threshold  $Q_{\text{in\_LR}}$  provided  $\text{SSB\_RP}$  and  $\text{SSB } \hat{E}_s/\text{lot}$  are according to Annex Table B.2.4.1 for a corresponding band.

The UE shall monitor the configured SSB resources using the evaluation period in table 5.5.5.0.1-3 corresponding to the non-DRX mode, if the configured DRX cycle  $\leq 320$ ms.

The value of  $T_{\text{Evaluate\_CBD\_SSB}}$  is defined in Table 5.5.5.0.1-3 for FR2 with scaling factor  $N=8$ .

Where,

For FR2,

- $P=1/(1-T_{\text{SSB}}/T_{\text{SMTCperiod}})$ , when candidate beam detection RS is not overlapped with measurement gap and candidate beam detection RS is partially overlapped with SMTC occasion ( $T_{\text{SSB}} < T_{\text{SMTCperiod}}$ ).
- $P$  is  $P_{\text{sharing factor}}$ , when candidate beam detection RS is not overlapped with measurement gap and candidate beam detection RS is fully overlapped with SMTC period ( $T_{\text{SSB}} = T_{\text{SMTCperiod}}$ ).
- $P=1/(1-T_{\text{SSB}}/\text{MGRP}-T_{\text{SSB}}/T_{\text{SMTCperiod}})$ , when candidate beam detection RS is partially overlapped with measurement gap and candidate beam detection RS is partially overlapped with SMTC occasion ( $T_{\text{SSB}} < T_{\text{SMTCperiod}}$ ) and SMTC occasion is not overlapped with measurement gap and
  - $T_{\text{SMTCperiod}} \neq \text{MGRP}$  or
  - $T_{\text{SMTCperiod}} = \text{MGRP}$  and  $T_{\text{SSB}} < 0.5 * T_{\text{SMTCperiod}}$
- $P= P_{\text{sharing factor}} / (1-T_{\text{SSB}}/\text{MGRP})$ , when candidate beam detection RS is partially overlapped with measurement gap and candidate beam detection RS is partially overlapped with SMTC occasion ( $T_{\text{SSB}} < T_{\text{SMTCperiod}}$ ) and SMTC occasion is not overlapped with measurement gap and  $T_{\text{SMTCperiod}} = \text{MGRP}$  and  $T_{\text{SSB}} = 0.5 * T_{\text{SMTCperiod}}$
- $P=1/(1-T_{\text{SSB}}/T_{\text{SMTCperiod}})$ , when candidate beam detection RS is partially overlapped with measurement gap and candidate beam detection RS is partially overlapped with SMTC occasion ( $T_{\text{SSB}} < T_{\text{SMTCperiod}}$ ) and SMTC occasion is partially or fully overlapped with measurement gap
- $P= P_{\text{sharing factor}} / (1-T_{\text{SSB}}/\text{MGRP})$ , when candidate beam detection RS is partially overlapped with measurement gap and candidate beam detection RS is fully overlapped with SMTC occasion ( $T_{\text{SSB}} = T_{\text{SMTCperiod}}$ ) and SMTC occasion is partially overlapped with measurement gap ( $T_{\text{SMTCperiod}} < \text{MGRP}$ )
- $P_{\text{sharing factor}} = 1$ , if the candidate beam detection RS outside measurement gap is
  - not overlapped with the SSB symbols indicated by *SSB-ToMeasure* and 1 data symbol before each consecutive SSB symbols indicated by *SSB-ToMeasure* and 1 data symbol after each consecutive SSB symbols indicated by *SSB-ToMeasure*, given that *SSB-ToMeasure* is configured, where the *SSB-ToMeasure* is the union set of *SSB-ToMeasure* from all the configured measurement objects merged on the same serving carrier, and;
  - not overlapped with the RSSI symbols indicated by *ss-RSSI-Measurement* and 1 data symbol before each RSSI symbol indicated by *ss-RSSI-Measurement* and 1 data symbol after each RSSI symbol indicated by *ss-RSSI-Measurement*, given that *ss-RSSI-Measurement* is configured -  $P_{\text{sharing factor}} = 3$ , otherwise.

where,

If the high layer in TS 38.331 [2] signaling of *smtc2* is present,  $T_{\text{SMTCperiod}}$  follows *smtc2*; Otherwise  $T_{\text{SMTCperiod}}$  follows *smtc1*.  $T_{\text{SMTCperiod}}$  is the shortest SMTC period among all CCs in the same FR2 band, provided the SMTC offset of all CCs in FR2 have the same offset.

Longer evaluation period would be expected if the combination of the CBD-RS resource, SMTC occasion and measurement gap configurations does not meet previous conditions.

For either an FR1 or FR2 serving cell, longer evaluation period would be expected during the period  $T_{\text{identify\_CGI}}$  when the UE is requested to decode an NR CGI.

For either an FR1 or FR2 serving cell, longer CBD evaluation period would be expected during the period  $T_{\text{identify\_CGI,E-UTRAN}}$  when the UE is requested to decode an LTE CGI.

The values of  $P_{\text{CBD}}$  used in Table 5.5.5.0.1-3 are defined as

For each SSB resource in the set  $\bar{q}_1$  configured for PCell or PSCell in EN-DC or NE-DC or SA; or PCell in NR-DC

- $P_{\text{CBD}} = 1$ .

For each SSB resource in the set  $\bar{q}_1$  configured for PSCell in NR-DC

- $P_{\text{CBD}} = 2$  if UE is configured for candidate beam detection on SCell, 1 otherwise.

For each SSB resource in the set  $\bar{q}_1$  configured for a SCell

- $P_{\text{CBD}} = Z$  in EN-DC or NE-DC or SA.
- $P_{\text{CBD}} = 2 * Z$  in NR-DC.

Where Z is the number of band(s) on which UE is performing beam failure detection only for SCell Table 5.5.5.0.1-3: Evaluation period  $T_{\text{Evaluate\_CBD\_SSB}}$  for FR2

Configuration	$T_{\text{Evaluate\_CBD\_SSB}}$ (ms)
non-DRX, DRX cycle $\leq$ 320ms	$\text{Max}(25, \text{Ceil}(3 \times P \times N \times P_{\text{CBD}}) \times T_{\text{SSB}})$
DRX cycle $>$ 320ms	$\text{Ceil}(3 \times P \times N \times P_{\text{CBD}}) \times T_{\text{DRX}}$
NOTE: $T_{\text{SSB}}$ is the periodicity of SSB in the set $\bar{q}_1$ . $T_{\text{DRX}}$ is the DRX cycle length.	

[TS38.133, clause 8.5.5.3]

For FR2, when the SSB for CBD measurement on one CC is in the same OFDM symbol as CSI-RS for RLM, BFD, CBD or L1-RSRP measurement on the same CC or different CCs in the same band, UE is required to measure one of but not both SSB for CBD measurement and CSI-RS. Longer measurement period for SSB based CBD measurement is expected, and no requirements are defined.

References: The conformance requirements covered in the current TC are specified in: TS 38.133 [6], clauses 8.5.2.1, 8.5.2.2, 8.5.2.3, 8.5.4, 8.5.5.1, 8.5.5.2 and 8.5.5.3.

### 5.5.5.0.2 Minimum conformance requirements for CSI-RS-based BFD and link recovery procedures

[TS38.133, clause 8.5.3.1]

The requirements in this clause apply for each CSI-RS resource in the set  $\bar{q}_0$  of resource configurations for a serving cell, provided that the CSI-RS resource(s) in set  $\bar{q}_0$  for beam failure detection are actually transmitted within the UE active DL BWP during the entire evaluation period specified in TS 38.133 clause 8.5.3.2. UE is not expected to perform beam failure detection measurements on the CSI-RS configured as BFD-RS if the CSI-RS is not QCL-ed, with QCL-TypeD when applicable, with the RS in the active TCI state of any CORESET configured in the UE active BWP. The requirements in this clause could not be applicable if UE is required to perform beam failure detection on more than 1 serving cell per band or on more than one band among a set of bands that it can receive with a common beam.

**Table 5.5.5.0.2-1: PDCCH transmission parameters for beam failure instance**

Attribute	Value for BLER
DCI format	1-0
Number of control OFDM symbols	2
Aggregation level (CCE)	8
Ratio of hypothetical PDCCH RE energy to average CSI-RS RE energy	0dB
Ratio of hypothetical PDCCH DMRS energy to average CSI-RS RE energy	0dB
Bandwidth (PRBs)	48
Sub-carrier spacing (kHz)	SCS of the active DL BWP
DMRS precoder granularity	REG bundle size
REG bundle size	6
CP length	Normal
Mapping from REG to CCE	Distributed

[TS38.133, clause 8.5.3.2]

UE shall be able to evaluate whether the downlink radio link quality on the CSI-RS resource in set  $\bar{q}_0$  estimated over the last  $T_{\text{Evaluate\_BFD\_CSI-RS}}$  ms period becomes worse than the threshold  $Q_{\text{out\_LR\_CSI-RS}}$  within  $T_{\text{Evaluate\_BFD\_CSI-RS}}$  ms period.

The value of  $T_{\text{Evaluate\_BFD\_CSI-RS}}$  is defined in Table 5.5.5.0.2-2 for FR2 with  $N=1$ . The requirements of  $T_{\text{Evaluate\_BFD\_CSI-RS}}$  apply provided that the CSI-RS for BFD is not in a resource set configured with repetition ON. The requirements shall not apply when the CSI-RS resource in the active TCI state of CORESET is the same CSI-RS resource for BFD and the TCI state information of the CSI-RS resource is not given, wherein the TCI state information means QCL Type-D to SSB for L1-RSRP or CSI-RS with repetition ON.

For FR2,

- $P=1$ , when the BFD-RS resource is not overlapped with measurement gap and also not overlapped with SMTC occasion.
- $P=1/(1 - T_{\text{CSI-RS}}/\text{MGRP})$ , when the BFD-RS resource is partially overlapped with measurement gap and the BFD-RS resource is not overlapped with SMTC occasion ( $T_{\text{CSI-RS}} < \text{MGRP}$ )
- $P=1/(1 - T_{\text{CSI-RS}}/T_{\text{SMTCperiod}})$ , when the BFD-RS resource is not overlapped with measurement gap and the BFD-RS resource is partially overlapped with SMTC occasion ( $T_{\text{CSI-RS}} < T_{\text{SMTCperiod}}$ ).
- $P$  is  $P_{\text{sharing factor}}$ , when the BFD-RS resource is not overlapped with measurement gap and the BFD-RS resource is fully overlapped with SMTC occasion ( $T_{\text{CSI-RS}} = T_{\text{SMTCperiod}}$ ).
- $P$  is  $1/(1 - T_{\text{CSI-RS}}/\text{MGRP} - T_{\text{CSI-RS}}/T_{\text{SMTCperiod}})$ , when the BFD-RS resource is partially overlapped with measurement gap and the BFD-RS resource is partially overlapped with SMTC occasion ( $T_{\text{CSI-RS}} < T_{\text{SMTCperiod}}$ ) and SMTC occasion is not overlapped with measurement gap and
  - $T_{\text{SMTCperiod}} \neq \text{MGRP}$  or
  - $T_{\text{SMTCperiod}} = \text{MGRP}$  and  $T_{\text{CSI-RS}} < 0.5 * T_{\text{SMTCperiod}}$
- $P$  is  $1/(1 - T_{\text{CSI-RS}}/\text{MGRP}) * P_{\text{sharing factor}}$ , when the BFD-RS resource is partially overlapped with measurement gap and the BFD-RS resource is partially overlapped with SMTC occasion ( $T_{\text{CSI-RS}} < T_{\text{SMTCperiod}}$ ) and SMTC occasion is not overlapped with measurement gap and  $T_{\text{SMTCperiod}} = \text{MGRP}$  and  $T_{\text{CSI-RS}} = 0.5 * T_{\text{SMTCperiod}}$
- $P$  is  $1/\{1 - T_{\text{CSI-RS}}/T_{\text{SMTCperiod}}\}$ , when the BFD-RS resource is partially overlapped with measurement gap ( $T_{\text{CSI-RS}} < \text{MGRP}$ ) and the BFD-RS resource is partially overlapped with SMTC occasion ( $T_{\text{CSI-RS}} < T_{\text{SMTCperiod}}$ ) and SMTC occasion is partially or fully overlapped with measurement gap.
- $P$  is  $1/(1 - T_{\text{CSI-RS}}/\text{MGRP}) * P_{\text{sharing factor}}$ , when the BFD-RS resource is partially overlapped with measurement gap and the BFD-RS resource is fully overlapped with SMTC occasion ( $T_{\text{CSI-RS}} = T_{\text{SMTCperiod}}$ ) and SMTC occasion is partially overlapped with measurement gap ( $T_{\text{SMTCperiod}} < \text{MGRP}$ )

- $P_{\text{sharing factor}} = 1$ , if the BFD-RS resource outside measurement gap is
  - not overlapped with the SSB symbols indicated by *SSB-ToMeasure* and 1 data symbol before each consecutive SSB symbols indicated by *SSB-ToMeasure* and 1 data symbol after each consecutive SSB symbols indicated by *SSB-ToMeasure*, given that *SSB-ToMeasure* is configured, where the *SSB-ToMeasure* is the union set of *SSB-ToMeasure* from all the configured measurement objects merged on the same serving carrier, and;
  - not overlapped with the RSSI symbols indicated by *ss-RSSI-Measurement* and 1 data symbol before each RSSI symbol indicated by *ss-RSSI-Measurement* and 1 data symbol after each RSSI symbol indicated by *ss-RSSI-Measurement*, given that *ss-RSSI-Measurement* is configured,
- $P_{\text{sharing factor}}$  is 3, otherwise.

where,

If the high layer in TS 38.331 [2] signalling of *smtc2* is configured,  $T_{\text{SMTCperiod}}$  corresponds to the value of higher layer parameter *smtc2*; Otherwise  $T_{\text{SMTCperiod}}$  corresponds to the value of higher layer parameter *smtc1*.  $T_{\text{SMTCperiod}}$  is the shortest SMTC period among all CCs in the same FR2 band, provided the SMTC offset of all CCs in FR2 have the same offset.

NOTE: The overlap between CSI-RS for BFD and SMTC means that CSI-RS for BFD is within the SMTC window duration.

Longer evaluation period would be expected if the combination of BFD-RS, SMTC occasion and measurement gap configurations does not meet previous conditions.

For either an FR1 or FR2 serving cell, longer evaluation period would be expected during the period  $T_{\text{identify\_CGI}}$  when the UE is requested to decode an NR CGI.

For either an FR1 or FR2 serving cell, longer BFD evaluation period would be expected during the period  $T_{\text{identify\_CGI-LTE-UTRAN}}$  when the UE is requested to decode an LTE CGI.

The values of  $M_{\text{BFD}}$  used in Table 5.5.5.0.2-2 are defined as

- $M_{\text{BFD}} = 10$ , if the CSI-RS resource(s) in set  $\bar{q}_0$  used for BFD is transmitted with Density = 3 and over the bandwidth  $\geq 24$  PRBs.

The values of  $P_{\text{BFD}}$  used in Table 5.5.5.0.2-2 are defined as

For each CSI-RS resource in the set  $\bar{q}_0$  configured for PCell or PSCell in EN-DC or NE-DC or SA; or PCell in NR-DC

- $P_{\text{BFD}} = 1$ .

For each CSI-RS resource in the set  $\bar{q}_0$  configured for PSCell in NR-DC

$P_{\text{BFD}} = 2$  if UE is configured for beam failure detection on SCell, 1 otherwise.

For each CSI-RS resource in the set  $\bar{q}_0$  configured for a SCell

- $P_{\text{BFD}} = Z$  in EN-DC or NE-DC or SA.
- $P_{\text{BFD}} = 2 * Z$  in NR-DC.

Where  $Z$  is the number of band(s) on which UE is performing beam failure detection only for SCell

**Table 5.5.5.0.2-2: Evaluation period  $T_{\text{Evaluate\_BFD\_CSI-RS}}$  for FR2**

Configuration	$T_{\text{Evaluate\_BFD\_CSI-RS}}$ (ms)
no DRX	$\text{Max}(50, \text{Ceil}(M_{\text{BFD}} \times P \times N \times P_{\text{BFD}}) \times T_{\text{CSI-RS}})$
DRX cycle $\leq 320\text{ms}$	$\text{Max}(50, \text{Ceil}(1.5 \times M_{\text{BFD}} \times P \times N \times P_{\text{BFD}}) \times \text{Max}(T_{\text{DRX}}, T_{\text{CSI-RS}}))$
DRX cycle $> 320\text{ms}$	$\text{Ceil}(M_{\text{BFD}} \times P \times N \times P_{\text{BFD}}) \times T_{\text{DRX}}$
NOTE: $T_{\text{CSI-RS}}$ is the periodicity of CSI-RS resource in the set $\bar{q}_0$ . $T_{\text{DRX}}$ is the DRX cycle length.	

[TS38.133, clause 8.5.3.3]

The UE is required to be capable of measuring CSI-RS for BFD without measurement gaps. The UE is required to perform the CSI-RS measurements with measurement restrictions as described in the following clauses.

For FR2, when the CSI-RS for BFD measurement is in the same OFDM symbol as SSB for RLM/BFD/CBD/L1-RSRP measurement, UE is not required to receive CSI-RS for BFD measurement in the PRBs that overlap with an SSB.

For FR2, when the CSI-RS for BFD measurement on one CC is in the same OFDM symbol as SSB for RLM, BFD or L1-RSRP measurement on the same CC or different CCs in the same band, or in the same symbol as SSB for CBD measurement on the same CC or different CCs in the same band when beam failure is detected, UE is required to measure one of but not both CSI-RS for BFD measurement and SSB. Longer measurement period for CSI-RS based BFD measurement is expected, and no requirements are defined.

For FR2, when the CSI-RS for BFD measurement on one CC is in the same OFDM symbol as another CSI-RS for RLM, BFD, CBD or L1-RSRP measurement on the same CC or different CCs in the same band,

- In the following cases, UE is required to measure one of but not both CSI-RS for BFD measurement and the other CSI-RS. Longer measurement period for CSI-RS based BFD measurement is expected, and no requirements are defined.
  - The CSI-RS for BFD measurement or the other CSI-RS in a resource set configured with repetition ON, or
  - The other CSI-RS is configured in set  $\bar{q}_1$  and beam failure is detected, or
  - The two CSI-RS-es are not QCL-ed w.r.t. QCL-TypeD, or the QCL information is not known to UE,
- Otherwise, UE shall be able to measure the CSI-RS for BFD measurement without any restriction.

[TS38.133, clause 8.5.4]

When the radio link quality on all the RS resources in set  $\bar{q}_0$  is worse than  $Q_{\text{out\_LR}}$ , Layer 1 of the UE shall send a beam failure instance indication to the higher layers.

The beam failure instance evaluation for the RS resources in set  $\bar{q}_0$  shall be performed as specified in clause 6 in TS 38.213. Two successive indications from Layer 1 shall be separated by at least  $T_{\text{Indication\_interval\_BFD}}$ .

When DRX is not used,  $T_{\text{Indication\_interval\_BFD}}$  is  $\text{max}(2\text{ms}, T_{\text{SSB-RS,M}})$  or  $\text{max}(2\text{ms}, T_{\text{CSI-RS,M}})$ , where  $T_{\text{SSB-RS,M}}$  and  $T_{\text{CSI-RS,M}}$  is the shortest periodicity of all RS resources in set  $\bar{q}_0$  for the accessed cell, corresponding to either the shortest periodicity of the SSB in the set  $\bar{q}_0$  or CSI-RS resource in the set  $\bar{q}_0$ .

When DRX is used, for CSI-RS based link quality measurement,

- $T_{\text{Indication\_interval\_BFD}} = \text{Max}(1.5 \times \text{DRX\_cycle\_length}, 1.5 \times T_{\text{CSI-RS,M}})$ , if  $\text{DRX\_cycle\_length} \leq 320\text{ms}$ ,
- $T_{\text{Indication\_interval\_BFD}} = \text{DRX\_cycle\_length}$ , if  $\text{DRX\_cycle\_length} > 320\text{ms}$ .

[TS38.133, clause 8.5.6.1]

The requirements in this clause apply for each CSI-RS resource in the set  $\bar{q}_1$  configured for a serving cell, provided that the CSI-RS resources configured for candidate beam detection are actually transmitted within UE active DL BWP during the entire evaluation period specified in TS 38.133 clause 8.5.6.2. The requirements in this clause could not be

applicable if UE is required to perform candidate beam detection on more than 1 serving cell per band or on more than one band among a set of bands that it can receive with a common beam.

[TS38.133, clause 8.5.6.2]

Upon request the UE shall be able to evaluate whether the L1-RSRP measured on the configured CSI-RS resource in set  $\bar{q}_1$  estimated over the last  $T_{\text{Evaluate\_CBD\_CSI-RS}}$  [ms] period becomes better than the threshold  $Q_{\text{in\_LR}}$  within  $T_{\text{Evaluate\_CBD\_CSI-RS}}$  [ms] period provided CSI-RS  $\hat{E}_s/I_{\text{ot}}$  is according to TS 38.133 Annex Table B.2.4.2 for a corresponding band.

The UE shall monitor the configured CSI-RS resources using the evaluation period in Table 5.5.5.0.2-3 corresponding to the non-DRX mode, if the configured DRX cycle  $\leq 320$ ms.

The value of  $T_{\text{Evaluate\_CBD\_CSI-RS}}$  is defined in Table 5.5.5.0.2-3 for FR2 with scaling factor  $N=8$ .

For FR2,

- $P=1$ , when candidate beam detection RS is not overlapped with measurement gap and also not overlapped with SMTC occasion.
- $P=1/(1 - T_{\text{CSI-RS}}/MGRP)$ , when candidate beam detection RS is partially overlapped with measurement gap and candidate beam detection RS is not overlapped with SMTC occasion ( $T_{\text{CSI-RS}} < MGRP$ )
- $P=1/(1 - T_{\text{CSI-RS}}/T_{\text{SMTCperiod}})$ , when candidate beam detection RS is not overlapped with measurement gap and candidate beam detection RS is partially overlapped with SMTC occasion ( $T_{\text{CSI-RS}} < T_{\text{SMTCperiod}}$ ).
- $P = P_{\text{sharing factor}}$ , when candidate beam detection RS is not overlapped with measurement gap and candidate beam detection RS is fully overlapped with SMTC occasion ( $T_{\text{CSI-RS}} = T_{\text{SMTCperiod}}$ ).
- $P$  is  $1/(1 - T_{\text{CSI-RS}}/MGRP - T_{\text{CSI-RS}}/T_{\text{SMTCperiod}})$ , when candidate beam detection RS is partially overlapped with measurement gap and candidate beam detection RS is partially overlapped with SMTC occasion ( $T_{\text{CSI-RS}} < T_{\text{SMTCperiod}}$ ) and SMTC occasion is not overlapped with measurement gap and
  - $T_{\text{SMTCperiod}} \neq MGRP$  or
  - $T_{\text{SMTCperiod}} = MGRP$  and  $T_{\text{CSI-RS}} < 0.5 * T_{\text{SMTCperiod}}$
- $P$  is  $1/(1 - T_{\text{CSI-RS}}/MGRP) * P_{\text{sharing factor}}$ , when candidate beam detection RS is partially overlapped with measurement gap and candidate beam detection RS is partially overlapped with SMTC occasion ( $T_{\text{CSI-RS}} < T_{\text{SMTCperiod}}$ ) and SMTC occasion is not overlapped with measurement gap and  $T_{\text{SMTCperiod}} = MGRP$  and  $T_{\text{CSI-RS}} = 0.5 * T_{\text{SMTCperiod}}$
- $P$  is  $1/\{1 - T_{\text{CSI-RS}}/T_{\text{SMTCperiod}}\}$ , when candidate beam detection RS is partially overlapped with measurement gap and candidate beam detection RS is partially overlapped with SMTC occasion ( $T_{\text{CSI-RS}} < T_{\text{SMTCperiod}}$ ) and SMTC occasion is partially or fully overlapped with measurement gap
- $P$  is  $1/(1 - T_{\text{CSI-RS}}/MGRP) * 3$ , when candidate beam detection RS is partially overlapped with measurement gap and candidate beam detection RS is fully overlapped with SMTC occasion ( $T_{\text{CSI-RS}} = T_{\text{SMTCperiod}}$ ) and SMTC occasion is partially overlapped with measurement gap ( $T_{\text{SMTCperiod}} < MGRP$ )-  $P_{\text{sharing factor}} = 1$ , if the candidate beam detection RS outside measurement gap is
  - not overlapped with the SSB symbols indicated by *SSB-ToMeasure* and 1 data symbol before each consecutive SSB symbols indicated by *SSB-ToMeasure* and 1 data symbol after each consecutive SSB symbols indicated by *SSB-ToMeasure*, given that *SSB-ToMeasure* is configured, where the *SSB-ToMeasure* is the union set of *SSB-ToMeasure* from all the configured measurement objects merged on the same serving carrier, and;
  - not overlapped with the RSSI symbols indicated by *ss-RSSI-Measurement* and 1 data symbol before each RSSI symbol indicated by *ss-RSSI-Measurement* and 1 data symbol after each RSSI symbol indicated by *ss-RSSI-Measurement*, given that *ss-RSSI-Measurement* is configured.
- $P_{\text{sharing factor}} = 3$ , otherwise.

where,

If the high layer in TS 38.331 [2] signalling of *smtc2* is present,  $T_{\text{SMTCperiod}}$  follows *smtc2*; Otherwise  $T_{\text{SMTCperiod}}$  follows *smtc1*.  $T_{\text{SMTCperiod}}$  is the shortest SMTC period among all CCs in the same FR2 band, provided the SMTC offset of all CCs in FR2 have the same offset.

Note: The overlap between CSI-RS for CBD and SMTC means that CSI-RS for CBD is within the SMTC window duration.

Longer evaluation period would be expected if the combination of the CBD-RS resource, SMTC occasion and measurement gap configurations does not meet previous conditions.

Longer evaluation period would be expected if the CSI-RS is on the same OFDM symbols with RLM, BFD, BM-RS, or other CBD-RS, according to the measurement restrictions defined in TS 38.133 clause 8.5.6.3.

For either an FR1 or FR2 serving cell, longer evaluation period would be expected during the period  $T_{\text{identify\_CGI}}$  when the UE is requested to decode an NR CGI.

For either an FR1 or FR2 serving cell, longer CBD evaluation period would be expected during the period  $T_{\text{identify\_CGI,E-UTRAN}}$  when the UE is requested to decode an LTE CGI.

The values of  $M_{\text{CBD}}$  used in Table 8.5.6.2-1 and Table 8.5.6.2-2 are defined as

- $M_{\text{CBD}} = 3$ , if the CSI-RS resource configured in the set  $\bar{q}_1$  is transmitted with Density = 3 and over the bandwidth  $\geq 24$  PRBs.

The values of  $P_{\text{CBD}}$  used in Table 8.5.6.2-1 and Table 8.5.6.2-2 are defined as

For each CSI-RS resource in the set  $\bar{q}_1$  configured for PCell or PSCell in EN-DC or NE-DC or SA; or PCell in NR-DC

- $P_{\text{CBD}} = 1$ .

For each CSI-RS resource in the set  $\bar{q}_1$  configured for PSCell in NR-DC

- $P_{\text{CBD}} = 2$  if UE configured for candidate beam detection on SCell, 1 otherwise.

For each CSI-RS resource in the set  $\bar{q}_1$  configured for a SCell

- $P_{\text{CBD}} = Z$  in EN-DC or NE-DC or SA.
- $P_{\text{CBD}} = 2 * Z$  in NR-DC.

Where  $Z$  is the number of band(s) on which UE is performing beam failure detection only for SCell

**Table 5.5.5.0.2-3: Evaluation period  $T_{\text{Evaluate\_CBD\_CSI-RS}}$  for FR2**

Configuration	$T_{\text{Evaluate\_CBD\_CSI-RS}}$ (ms)
non-DRX, DRX cycle $\leq$ 320ms	$\text{Max}(25, \text{Ceil}(M_{\text{CBD}} \times P \times N \times P_{\text{CBD}}) \times T_{\text{CSI-RS}})$
DRX cycle $>$ 320ms	$\text{Ceil}(M_{\text{CBD}} \times P \times N \times P_{\text{CBD}}) \times T_{\text{DRX}}$
NOTE: $T_{\text{CSI-RS}}$ is the periodicity of CSI-RS resource in the set $\bar{q}_1$ . $T_{\text{DRX}}$ is the DRX cycle length.	

[TS38.133, clause 8.5.6.3]

For FR2, when the CSI-RS for CBD measurement is in the same OFDM symbol as SSB for RLM/BFD/CBD/L1-RSRP measurement, UE is not required to receive CSI-RS for CBD measurement in the PRBs that overlap with an SSB.

For FR2, when the CSI-RS for CBD measurement on one CC is in the same OFDM symbol as SSB for RLM, BFD, CBD or L1-RSRP measurement on the same CC or different CCs in the same band, UE is required to measure one of but not both CSI-RS for CBD measurement and SSB. Longer evaluation period for CSI-RS based CBD measurement is expected, and no requirements are defined.



For FR2, when the CSI-RS for CBD measurement on one CC is in the same OFDM symbol as another CSI-RS for RLM, BFD, CBD or L1-RSRP measurement on the same CC or different CCs in the same band, UE is required to measure one of but not both CSI-RS for CBD measurement and the other CSI-RS. Longer evaluation period for CSI-RS based CBD measurement is expected, and no requirements are defined.

References: The conformance requirements covered in the current TC are specified in: TS 38.133 [6], clauses 8.5.3.1, 8.5.3.2, 8.5.3.3, 8.5.4, 8.5.6.1, 8.5.6.2 and 8.5.6.3.

#### 5.5.5.0.3 Scheduling availability of UE during beam failure detection and candidate beam detection

[TS38.133, clause 8.5.7.3]

The following scheduling restriction applies due to beam failure detection.

- For the case where no RSs are provided for BFD, or when CSI-RS is configured for BFD is explicitly configured and is type-D QCLed with active TCI state for PDCCH or PDSCH, and the CSI-RS is not in a CSI-RS resource set with repetition ON
  - There are no scheduling restrictions due to beam failure detection performed based on the CSI-RS.
- Otherwise
  - The UE is not expected to transmit PUCCH, PUSCH or SRS or receive PDCCH, PDSCH or CSI-RS for tracking or CSI-RS for CQI on BFD-RS resource symbols to be measured for beam failure detection.

For FR2, if following conditions are met,

- UE has been notified about system information update through paging,
- The gap between UE's reception of PDCCH that UE monitors in the Type2-PDCCH CSS set and that notifies system information update, and the PDCCH that UE monitors in the Type0-PDCCH CSS set, is greater than 2 slots,

For the SSB and CORESET for RMSI scheduling multiplexing patterns 3, UE is expected to receive the PDCCH that UE monitors in the Type0-PDCCH CSS set, and the corresponding PDSCH, on SSB symbols to be measured for BFD measurement; and

For the SSB and CORESET for RMSI scheduling multiplexing patterns 2, UE is expected to receive PDSCH that corresponds to the PDCCH that UE monitors in the Type0-PDCCH CSS set, on SSB symbols to be measured for BFD measurement.

[TS38.133, clause 8.5.8.3]

The following scheduling restriction applies due to candidate beam detection

- The UE is not expected to transmit PUCCH, PUSCH or SRS or receive PDCCH, PDSCH, CSI-RS for tracking or CSI-RS for CQI on reference symbols to be measured for candidate beam detection.

For FR2, if following conditions are met,

- UE has been notified about system information update through paging,
- The gap between UE's reception of PDCCH that UE monitors in the Type2-PDCCH CSS set and that notifies system information update, and the PDCCH that UE monitors in the Type0-PDCCH CSS set, is greater than 2 slots,

For the SSB and CORESET for RMSI scheduling multiplexing patterns 3, UE is expected to receive the PDCCH that UE monitors in the Type0-PDCCH CSS set, and the corresponding PDSCH, on SSB symbols to be measured for CBD measurement; and

For the SSB and CORESET for RMSI scheduling multiplexing patterns 2, UE is expected to receive PDSCH that corresponds to the PDCCH that UE monitors in the Type0-PDCCH CSS set, on SSB symbols to be measured for CBD measurement.

References: The conformance requirements covered in the current TC are specified in: TS 38.133 [6], clauses 8.5.7.4, 8.5.8.3.

#### 5.5.5.0.4 Requirements for Beam Failure Recovery in SCell

[TS 38.133, clause 8.5.9.1]

For the UE provided with a configuration of PUCCH transmission with a link recovery request (LRR) as described in clause 9.2.4 in TS 38.213 [3], if beam recovery procedure is triggered for any of SCells, the UE shall transmit SR for UL resource, followed by MAC CE providing one index for at least one corresponding SCell with radio link quality is worse than  $Q_{out,LR}$ , and the index  $q_{new}$  for a periodic CSI-RS configuration or for a SSB provided by higher layer, as described in clause 5.17 of TS38.321 [7], if any, for a corresponding SCell.

For the UE not provided with a configuration of PUCCH transmission with a link recovery request (LRR) as described in clause 9.2.4 in TS 38.213 [3], if beam recovery procedure is triggered for any of SCells, the UE shall transmit preamble for UL-SCH resource application, followed by MAC CE providing one index for at least one corresponding SCell with radio link quality is worse than  $Q_{out,LR}$ , and the index  $q_{new}$  for a periodic CSI-RS configuration or for a SSB provided by higher layer, as described in clause 5.17 of TS38.321 [7], if any, for a corresponding SCell.

[TS 38.133, clause 8.5.9.2]

Provided that UE is configured by *schedulingRequestIDForBFR* a configuration for LRR in a PUCCH transmission, after BFR is triggered on any of SCells as described in clause 5.17 of TS38.321 [7], UE shall be capable of transmit PUCCH with a LRR within a period of T, where

- $T = T_1 \times \text{Ceil}((T_2+D) / T_1)$  in which  $T_1$ ,  $T_2$  and D are defined as
  - $T_1$  is equal to the periodicity of PUCCH configured with *schedulingRequestIDForBFR*.
  - $T_2 = T_{\text{Evaluate\_CBD}}$  is the evaluation period specified in TS 38.133 clause 8.5.5 or 8.5.6 for SSB or CSI-RS based candidate beam detection, that is  $T_{\text{Evaluate\_CBD\_SSB}}$  or  $T_{\text{Evaluate\_CBD\_CSI-RS}}$ , depending on the applicable reference signal configured for candidate beam detection.
  - $D = 2\text{ms}$  is the UE Processing time.

References: The conformance requirements covered in the current TC are specified in: TS 38.133 [6], clauses 8.5.9.1, 8.5.9.2.

#### 5.5.5.1 EN-DC FR2 SSB-based beam failure detection and link recovery in non-DRX

**Editor's Note: This test case is complete for the following configurations:**

- Test frequency  $f \leq 40.8$  GHz
- UE PC3

**This test case is incomplete for Test frequency  $f > 40.8$  GHz**

**This test case is incomplete for UE power class other than PC3.**

##### 5.5.5.1.1 Test purpose

The purpose of this test is to verify that the UE properly detects SSB-based beam failure in the set  $q_0$  configured for a serving PSCell and that the UE performs correct SSB-based link recovery based on beam candidate set  $q_1$ . The purpose is to test the downlink monitoring for beam failure detection within the UEs active DL BWP of the PSCell, during the evaluation period, and link recovery, when no DRX is used. This test will partly verify the SSB based beam failure detection and link recovery for an FR2 serving cell requirements in TS 38.133 [6] clause 8.5.

##### 5.5.5.1.2 Test applicability

This test applies to all types of NR UE supporting E-UTRA and EN-DC from release 15 onwards.

5.5.5.1.3 Minimum conformance requirements

The minimum conformance requirements are specified in clause 5.5.5.0.1.

The normative reference for this requirement is TS 38.133 [6] clause A.5.5.5.1.

5.5.5.1.4 Test description

There are two cell configured in this test: E-UTRAN PCell and NR PSCell. This test consists of five successive time periods, with time duration of T1, T2, T3, T4 and T5 respectively. Figure 5.5.5.1.4-1 shows the five different time durations and the corresponding variation of the downlink SNR of the PCell and the SNR of the SSB in set  $q_0$  in the active PCell to emulate SSB based beam failure. Figure 5.5.5.1.4-1 additionally shows the variation of the downlink L1-RSRP of the SSB in set  $q_1$  of the candidate beam used for link recovery.

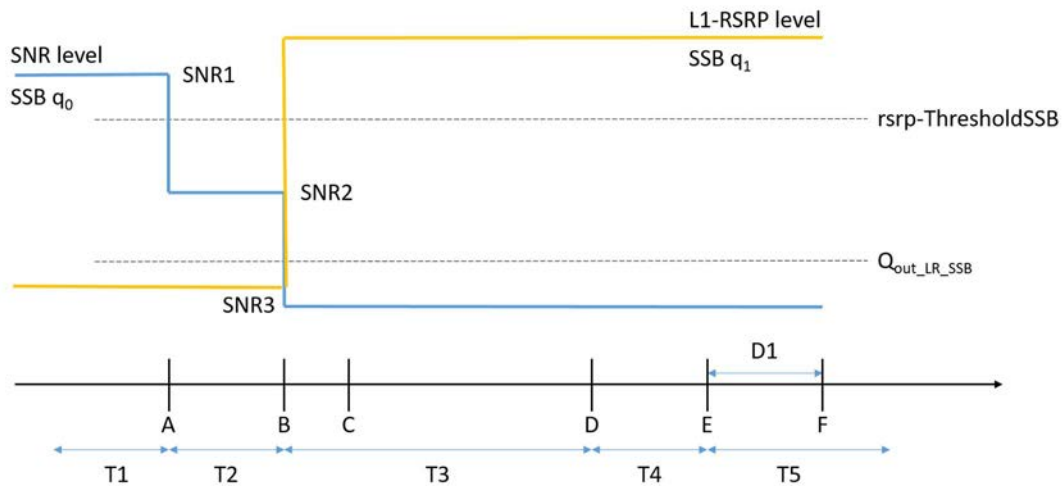

Figure 5.5.5.1.4-1: SNR and L1-RSRP for EN-DC FR2 SSB-based beam failure detection and link recovery in non-DRX

5.5.5.1.4.1 Initial conditions

This test shall be tested using any of the test configurations in Table 5.5.5.1.4.1-1.

Table 5.5.5.1.4.1-1: Supported test configurations for EN-DC FR2 SSB-based beam failure detection and link recovery in non-DRX

Configuration	Description
5.5.5.1-1	LTE FDD, NR TDD duplex mode, 120 kHz SSB SCS, 100 MHz bandwidth
5.5.5.1-2	LTE TDD, NR TDD duplex mode, 120 kHz SSB SCS, 100 MHz bandwidth
5.5.5.1-3	LTE FDD, NR TDD duplex mode, 240 kHz SSB SCS, 100 MHz bandwidth
5.5.5.1-4	LTE TDD, NR TDD duplex mode, 240 kHz SSB SCS, 100 MHz bandwidth
NOTE: The UE is only required to pass in one of the supported test configurations in FR2	

Configure the test equipment and the DUT according to the parameters in Table 5.5.5.1.4.1-2.

**Table 5.5.5.1.4.1-2: Initial conditions for EN-DC FR2 SSB-based beam failure detection and link recovery in non-DRX**

Parameter	Value		Comment
Test environment	NC		As specified in TS 38.508-1 [14] clause 4.1.
Test frequencies	As specified in Annex E, table E.5-1 and TS 38.508-1 [14] clause 4.3.1 for E-UTRA and 7.2.3 for NR.		
Channel bandwidth	As specified by the test configuration selected from Table 5.5.5.1.4.1-1.		
Propagation conditions	AWGN		As specified in clause C.2.2.
Connection Diagram	TE Part	A.3.3.1.1	As specified in TS 38.508-1 [14] Annex A.
	DUT Part	A.3.4.1.1	
Exceptions to connection diagram	N/A		

1. The general test parameter settings are set up according to Table 5.5.5.1.4.1-3.
2. Message contents are defined in clause 5.5.5.1.4.3.
3. There are one E-UTRAN cell and one NR cell specified in the test. E-UTRAN Cell 1 is the cell used for connection setup with the power level set according to clause C.1.1 and C.1.2 for this test.

**Table 5.5.5.1.4.1-3: General test parameters for EN-DC FR2 SSB-based beam failure detection and link recovery in non-DRX**

Parameter	Test Config.	Unit	Value	Comment
			<b>Test 1</b>	
Active E-UTRA PCell	1-4		Cell 1	
E-UTRA RF Channel Number	1-4		1	
Active PCell	1-4		Cell 2	
RF Channel Number	1-4		2	
Duplex mode	1-4		TDD	
TDD Configuration	1-4		TDDConf.3.1	Table A.1.5-3
BW <sub>channel</sub>	1-4	MHz	100: N <sub>RB,c</sub> = 66	
Data RBs allocated	1-4		66	
PDSCH/PDCCH subcarrier spacing	1-4	kHz	120	
DL initial BWP configuration	1-4		DLBWP.0.1	Table A.8.1-1
DL dedicated BWP configuration	1-4		DLBWP.1.1	Table A.8.1-2
UL initial BWP configuration	1-4		ULBWP.0.1	Table A.8.2-1
UL dedicated BWP configuration	1-4		ULBWP.1.1	Table A.8.2-2
PDSCH Reference Channel	1-2		SR.3.2 TDD	Table A.1.1.2-3
	3-4		SR.3.3 TDD	
RMSI CORESET Reference Channel	1-2		CR.3.1 TDD	Table A.1.2.2-3
	3-4		CR.3.2 TDD	
Dedicated CORESET Reference Channel	1-2		CCR.3.1 TDD	Table A.1.3.2-3
	3-4		CCR.3.7 TDD	
OCNG parameters	1-4		OP.1	Table A.2.1-1
CP length	1-4		Normal	
PDSCH/PDCCH TCI state	1-4		TCI.State.0	Table A.10.2-1
CSI-RS for tracking	1-4		TRS.2.1 TDD	Table A.1.4A.2.1-1
SSB Configuration	1-2		SSB.1 FR2	Table A.3.2-1
	3-4		SSB.2 FR2	
SMTc Configuration	1-4		SMTc.3	Table A.4-1
PRACH Configuration	1-4		PRACH.2 FR2	Table A.7.2-1
DRX configuration	1-4		OFF	
SSB index assigned as BFD RS (q <sub>0</sub> )	1-4		0	
SSB index assigned as CBD RS (q <sub>1</sub> )	1-4		1	
SSB index assigned as RLM RS	1-4		0,1	
Beam failure detection transmission parameters	DCI format	1-4	1-0	
	Number of Control OFDM symbols	1-4	2	
	Aggregation level	1-4	CCE	8

	Ratio of hypothetical PDCCH RE energy to average SSS RE energy	1-4	dB	0	
	Ratio of hypothetical PDCCH DMRS energy to average SSS RE energy	1-4	dB	0	
	DMRS precoder granularity	1-4		REG bundle size	
	REG bundle size	1-4		6	
Gap pattern ID		1-4		gp0	
gapOffset		1-4	ms	0	
rInSyncOutOfSyncThreshold		1-4		absent	Value 0 is applied. (38.133 [6] Table 8.1.1-1).
rsrp-ThresholdSSB		1-2	dBm/SCS	-109 <sup>Note 3</sup>	Threshold used for $Q_{in\_LR\_SSB}$
		3-4		-106 <sup>Note 3</sup>	
powerControlOffsetSS		1-4		db0	Used for deriving rsrp-ThresholdCSI-RS
beamFailureInstanceMaxCount		1-4		n1	see TS 38.321 [12], clause 5.17
beamFailureDetectionTimer		1-4		pbfd4	see TS 38.321 [12], clause 5.17
CSI-RS configuration for CSI reporting		1-4		CSI-RS.3.1 TDD	Table A.1.4.2-3
reportConfigType		1-4		periodic	
reportQuantity		1-4		cri-RI-PMI-CQI	
CSI reporting periodicity		1-4	slot	40	
CSI reporting offset		1-4	slot	4	
T310		1-4	ms	1000	
N310		1-4		2	
T1		1-4	s	1	The UE shall be fully synchronized to cell 1 during T1
T2		1-4	s	2.61	
T3		1-4	s	1.64	
T4		1-4	s	0	
T5		1-4	s	1.01	
D1		1-4	s	0.97	
Note 1: All configurations are assigned to the UE prior to the start of time period T1.					
Note 2: UE-specific PDCCH is not transmitted after T1 starts.					
Note 3: Including test tolerance given in Annex F.1.3.2.					

#### 5.5.5.1.4.2 Test procedure

Prior to the start of the time duration T1, the UE shall be fully synchronized to E-UTRA Cell 1 and NR Cell 2. The UE shall be configured for periodic CSI reporting with a reporting periodicity of 5 ms. In the test, DRX configuration is not enabled. The UE is configured to perform inter-frequency measurements using GP ID #0 (40ms) given in table 5.5.5.1.5-2.

1. Ensure the UE is in state RRC\_CONNECTED with generic procedure parameters Connectivity *EN-DC*, DC bearer *MCG* and *SCG*, Connected without release *On* according to TS 38.508-1 [14] clause 4.5.4.
2. Set the parameters of NR Cell 1 according to T1 in Table 5.5.5.1.5-1. Propagation conditions are set according to clause C.2.3. T1 starts.
3. When T1 expires the SS shall change the SNR value to T2 as specified in Table 5.5.5.1.5-1. T2 starts.
4. When T2 expires the SS shall change the SNR value to T3 as specified in Table 5.5.5.1.5-1. T3 starts.
5. When T3 expires the SS shall change the SNR value to T4 as specified in Table 5.5.5.1.5-1. T4 starts.
6. When T4 expires the SS shall change the SNR value to T5 as specified in Table 5.5.5.1.5-1. T5 starts.
7. If the SS:

- a) detects uplink power on NR carrier in each slot configured for CQI transmission (according CQI reporting on PUCCH) during the period from time point A to time point B; and
- b) does not detect preamble on a beam associated with candidate beam set  $q_1$  before time point B; and
- c) detects preamble on a beam associated with candidate beam set  $q_1$  before time point F (D1 after the start of T5),

the number of successful tests is increased by one. Otherwise the number of failed tests is increased by one.

8. When T5 expires the SS shall change the SNR value to T1 as specified in Table 5.5.5.1.5-1.
9. Wait 1s for the UE to re-establish the connection or continue directly to step 10. If the UE re-establishes the connection within 1s continue to step 11. Otherwise continue to step 10.
10. Switch the UE on and off. Ensure the UE is in RRC\_CONNECTED with generic procedure parameters Connectivity *EN-DC*, DC bearer *MCG* and *SCG*, Connected without release *On* according to TS 38.508-1 [14] clause 4.5.4.
11. Repeat steps 2-10 for all subtests until the confidence level according to Tables G.2.3-1 in Annex G clause G.2 is achieved.

5.5.5.1.4.3 Message contents

Message contents are according to TS 38.508-1 [14] clause 7.3 with the following exceptions:

**Table 5.5.5.1.4.3-1: Common Exception messages for EN-DC FR2 SSB-based beam failure detection and link recovery in non-DRX**

Default Message Contents	
Common contents of system information blocks exceptions	
Default RRC messages and information elements contents exceptions	Table H.3.1-1 Table H.3.1-2 with condition INTER-FREQ and GAP_NEEDED Table H.3.1-3 with condition INTER-FREQ MO (where <i>ssbFrequency</i> is set to the ARFCN value of carrier centre of High range) Table H.3.1-4 with <i>A3-offset</i> = 0 Table H.3.1-6 with condition <i>gapUE</i> and BFD Table H.3.1-8 with condition SSB BFD Table H.3.1-10 with condition SSB Table H.3.1-10A

5.5.5.1.5 Test requirement

Tables 5.5.5.1.4.1-3 and 5.5.5.1.5-1 define the primary level settings including test tolerances for EN-DC FR2 SSB-based beam failure detection and link recovery in non-DRX.

**Table 5.5.5.1.5-1: NR Cell specific test parameters for EN-DC FR2 SSB-based beam failure detection and link recovery in non-DRX**

Parameter	Unit	Test 1					
		T1	T2	T3	T4	T5	
AoA setup		Setup 1 defined in A.9					
Assumption for UE beams <sup>Note 10</sup>		Rough					
EPRE ratio of PDCCH DMRS to SSS	dB	0					
EPRE ratio of PDCCH to PDCCH DMRS	dB						
EPRE ratio of PBCH DMRS to SSS	dB						
EPRE ratio of PBCH to PBCH DMRS	dB						
EPRE ratio of PSS to SSS	dB						
EPRE ratio of PDSCH DMRS to SSS	dB						
EPRE ratio of PDSCH to PDSCH DMRS	dB						
EPRE ratio of OCNG DMRS to SSS	dB						
EPRE ratio of OCNG to OCNG DMRS	dB						
SNR_SSB of set $q_0$	Config 1-4						dB
SNR_SSB of set $q_1$	Config 1-4	dB	0.2	0.2	20 <sup>Note 12</sup>	20 <sup>Note 12</sup>	20 <sup>Note 12</sup>
SSB_RP of set $q_1$	Config 1-2	dBm/ SCS	-104.5	-104.5	-84.7	-84.7	-84.7
	Config 3-4		-101.5	-101.5	-101.5	-81.7	-81.7
$N_{oc}$	Config 1-4	dBm/120 KHz	-104.7				
Propagation condition			TDL-A 30ns 75Hz				
NOTE 1: OCNG shall be used such that the resources in Cell 1 are fully allocated and a constant total transmitted power spectral density is achieved for all OFDM symbols.							
NOTE 2: The uplink resources for CSI reporting are assigned to the UE prior to the start of time period T1.							
NOTE 3: NZP CSI-RS resource set configuration for CSI reporting are assigned to the UE prior to the start of time period T1.							
NOTE 4: Measurement gap configuration is assigned to the UE prior to the start of time period T1.							
NOTE 5: The timers and layer 3 filtering related parameters are configured prior to the start of time period T1.							
NOTE 6: The signal contains PDCCH for UEs other than the device under test as part of OCNG.							
NOTE 7: SNR levels correspond to the signal to noise ratio over the SSS REs.							
NOTE 8: The SNR in time periods T1, T2, T3, T4 and T5 is denoted as SNR1, SNR2 and SNR3 respectively in figure 5.5.5.1.4-1.							
NOTE 9: The SNR values are specified for testing a UE which supports 2RX on at least one band. For testing of a UE which supports 4RX on all bands, the SNR during T3 is modified as specified in clause D.4.							
NOTE 10: Information about types of UE beam is given in TS 38.133 clause B.2.1.3, and does not limit UE implementation or test system implementation							
Note 11: This value allows up to 1dB degradation from applied SNR to UE baseband							
Note 12: Including test tolerance given in Annex F.1.3.2							

**Table 5.5.5.1.5-2: Void**

The UE behaviour during time durations T1, T2, T3, T4 and T5 shall be as follows:

During the time duration T1 and T2, the UE shall transmit uplink signal at least in all subframes configured for CSI transmission on Cell 1.

During the period from time point A to time point B the UE shall transmit uplink signal in Cell 1 in all uplink slots configured for CSI transmission according to the configured periodic CSI reporting for Cell 1.

During T3 the shall detect beam failure and initiate link recovery. During T4 and T5 the UE measures and evaluate beam candidate from beam candidate set  $q_1$ .

No later than time point F occurring no later than  $D1 = 960+10$  ms after the start of T5, the UE shall transmit preamble on a beam associated with the candidate beam set  $q_1$ . The UE shall not transmit preamble on a beam associated with the candidate beam set  $q_1$  earlier than time point B.

Test is concluded once the test equipment has received the initial preamble transmission from the UE. The rate of correct events observed during repeated tests shall be at least 90%.

### 5.5.5.2 EN-DC FR2 SSB-based beam failure detection and link recovery in DRX

**Editor's Note:** This test case is complete for the following configurations:

- Test frequency  $f \leq 40.8$  GHz
- UE PC3

This test case is incomplete for Test frequency  $f > 40.8$  GHz

This test case is incomplete for UE power class other than PC3.

#### 5.5.5.2.1 Test purpose

The purpose of this test is to verify that the UE properly detects SSB-based beam failure in the set  $q_0$  configured for a serving PSCell and that the UE performs correct SSB-based link recovery based on beam candidate set  $q_1$ . The purpose is to test the downlink monitoring for beam failure detection within the UEs active DL BWP of the PSCell, during the evaluation period, and link recovery, when DRX is used. This test will partly verify the SSB based beam failure detection and link recovery for an FR2 serving cell requirements in TS 38.133 [6] clause 8.5.

#### 5.5.5.2.2 Test applicability

This test applies to all types of NR UE supporting E-UTRA and EN-DC from release 15 onwards and supporting long DRX cycle.

#### 5.5.5.2.3 Minimum conformance requirements

The minimum conformance requirements are specified in clause 5.5.5.0.1.

The normative reference for this requirement is TS 38.133 [6] clause A.5.5.5.2.

#### 5.5.5.2.4 Test description

There is one E-UTRAN PCell and one NR PSCell configured in this test. This test consists of five successive time periods, with time duration of T1, T2, T3, T4 and T5 respectively. Figure 5.5.5.2.4-1 shows the variation of the downlink SNR of the PCell and the SNR of the SSB in set  $q_0$  in the active PSCell to emulate SSB based beam failure. Figure 5.5.5.2.4-1 additionally shows the variation of the downlink L1-RSRP of the SSB in set  $q_1$  of the candidate beam used for link recovery

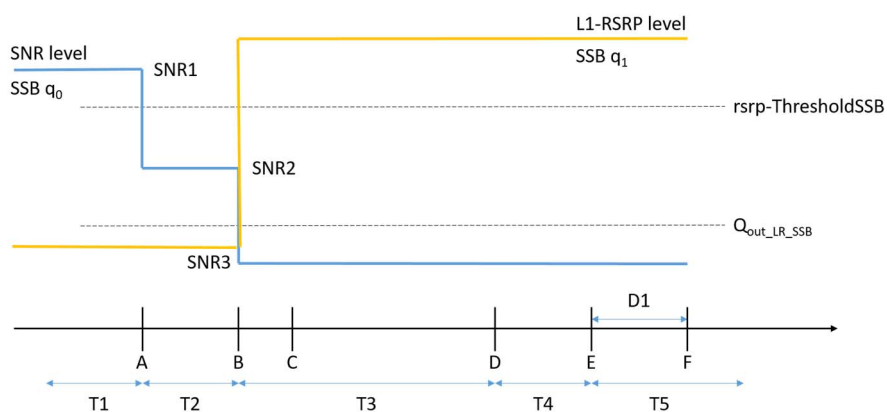

**Figure 5.5.5.2.4-1: SNR and L1-RSRP variation for EN-DC FR2 SSB-based beam failure detection and link recovery in DRX**

##### 5.5.5.2.4.1 Initial conditions

This test shall be tested using any of the test configurations in Table 5.5.5.2.4.1-1.



**Table 5.5.5.2.4.1-1: Supported test configurations for EN-DC FR2 SSB-based beam failure detection and link recovery in DRX**

Configuration	Description
5.5.5.2-1	LTE FDD, NR TDD duplex mode, 120 kHz SSB SCS, 100 MHz bandwidth
5.5.5.2-2	LTE TDD, NR TDD duplex mode, 120 kHz SSB SCS, 100 MHz bandwidth
5.5.5.2-3	LTE FDD, NR TDD duplex mode, 240 kHz SSB SCS, 100 MHz bandwidth
5.5.5.2-4	LTE TDD, NR TDD duplex mode, 240 kHz SSB SCS, 100 MHz bandwidth
NOTE:	The UE is only required to pass in one of the supported test configurations in FR2

Configure the test equipment and the DUT according to the parameters in Table 5.5.5.2.4.1-2.

**Table 5.5.5.2.4.1-2: Initial conditions for EN-DC FR2 SSB-based beam failure detection and link recovery in DRX**

Parameter	Value	Comment
Test environment	NC	As specified in TS 38.508-1 [14] clause 4.1.
Test frequencies	As specified in Annex E, table E.5-1 and TS 38.508-1 [14] clause 4.3.1 for E-UTRA and 7.2.3 for NR.	
Channel bandwidth	As specified by the test configuration selected from Table 6.5.5.3.4.1-1.	
Propagation conditions	AWGN	As specified in clause C.2.2.
Connection Diagram	TE Part DUT Part	A.3.3.1.1 A.3.4.1.1
Exceptions to connection diagram	N/A	

1. The general test parameter settings are set up according to Table 5.5.5.2.4.1-3. The DRX configuration for is according to Table 5.5.5.2.4.1-3. Time alignment timers shall be set to “infinity” so that UL timing alignment is maintained during the test.
2. Message contents are defined in clause 5.5.5.2.4.3.
3. There is one E-UTRAN cell and one NR cell specified in the test. E-UTRAN Cell 1 is the cell used for connection setup with the power level set according to clause C.1.1 and C.1.2 for this test.

**Table 5.5.5.2.4.1-3: General test parameters for EN-DC FR2 SSB-based beam failure detection and link recovery in DRX**

Parameter	Test Config.	Unit	Value	Comment
			<b>Test 1</b>	
Active E-UTRA PCell	1-4		Cell 1	
E-UTRA RF Channel Number	1-4		1	
Active PCell	1-4		Cell 2	
RF Channel Number	1-4		2	
Duplex mode	1-4		TDD	Table A.1.5-3
TDD Configuration	1-4		TDDConf.3.1	
BW <sub>channel</sub>	1-4	MHz	100: N <sub>RB,c</sub> = 66	
Data RBs allocated	1-4		66	
PDSCH/PDCCH subcarrier spacing	1-4	kHz	120	
DL initial BWP configuration	1-4		DLBWP.0.1	Table A.8.1-1
DL dedicated BWP configuration	1-4		DLBWP.1.1	Table A.8.1-2
UL initial BWP configuration	1-4		ULBWP.0.1	Table A.8.2-1
UL dedicated BWP configuration	1-4		ULBWP.1.1	Table A.8.2-2
PDSCH Reference Channel	1-2		SR.3.2 TDD	Table A.1.1.2-3
	3-4		SR.3.3 TDD	
RMSI CORESET Reference Channel	1-2		CR.3.1 TDD	Table A.1.2.2-3
	3-4		CR.3.2 TDD	

Dedicated CORESET Reference Channel	1-2		CCR.3.1 TDD	Table A.1.3.2-3
	3-4		CCR.3.7 TDD	
OCNG parameters	1-4		OP.1	Table A.2.1-1
CP length	1-4		Normal	
PDSCH/PDCCH TCI state	1-4		TCI.State.0	Table A.10.2-1
CSI-RS for tracking	1-4		TRS.2.1 TDD	Table A.1.4A.2.1-1
SSB Configuration	1-2		SSB.1 FR2	Table A.3.2-1
	3-4		SSB.2 FR2	
SMTTC Configuration	1-4		SMTTC.3	Table A.4-1
PRACH Configuration	1-4		PRACH.2 FR2	Table A.7.2-1
DRX configuration	1-4		DRX.3	Table A.5-1
SSB index assigned as BFD RS ( $q_0$ )	1-4		0	
SSB index assigned as CBD RS ( $q_1$ )	1-4		1	
SSB index assigned as RLM RS	1-4		0,1	
Beam failure detection transmission parameters	DCI format	1-4		1-0
	Number of Control OFDM symbols	1-4		2
	Aggregation level	1-4	CCE	8
	Ratio of hypothetical PDCCH RE energy to average SSS RE energy	1-4	dB	0
	Ratio of hypothetical PDCCH DMRS energy to average SSS RE energy	1-4	dB	0
	DMRS precoder granularity	1-4		REG bundle size
	REG bundle size	1-4		6
Gap pattern ID	1-4		N/A	
rimInSyncOutOfSyncThreshold	1-4		absent	Value 0 is applied. (TS 38.133 [6] Table 8.1.1-1).
rsrp-ThresholdSSB	1-2	dBm/SCS	-109 <sup>Note 2</sup>	Threshold used for $Q_{in\_LR\_SSB}$
	3-4		-106 <sup>Note 2</sup>	
powerControlOffsetSS	1-4		db0	Used for deriving rsrp-ThresholdCSI-RS
beamFailureInstanceMaxCount	1-4		n1	see TS 38.321 [12], clause 5.17
beamFailureDetectionTimer	1-4		pbfd4	see TS 38.321 [12], clause 5.17
CSI-RS configuration for CSI reporting	1-4		CSI-RS.3.1 TDD	Table A.1.4.2-3
reportConfigType	1-4		periodic	
reportQuantity	1-4		cri-RI-PMI-CQI	
CSI reporting periodicity	1-4	slot	40	
CSI reporting offset	1-4	slot	4	
T310	1-4	ms	1000	
N310	1-4		2	
T1	1-4	s	1	The UE shall be fully synchronized to cell 1 during T1
T2	1-4	s	3.37	
T3	1-4	s	2.8	
T4	1-4	s	0	
T5	1-4	s	0.61	
D1	1-4	s	0.57	
Note 1: UE-specific PDCCH is not transmitted after T1 starts.				
Note 2: Including test tolerance given in Annex F.1.3.2				

5.5.5.2.4.2 Test procedure

Prior to the start of the time duration T1, the UE shall be fully synchronized to cell 1 and cell 2. The UE shall be configured for periodic CSI reporting with a reporting periodicity of 2 ms. In the test, DRX configuration is enabled in PCSEll and DRX inactivity timer has already been expired, i.e. UE tries to decode PDCCH and to send periodic CQI during the period when On-duration timer is running. Time alignment timers shall be set to “infinity” so that UL timing alignment is maintained during the test.

1. Ensure the UE is in state RRC\_CONNECTED with generic procedure parameters Connectivity *EN-DC*, DC bearer *MCG* and *SCG*, Connected without release *On* according to TS 38.508-1 [14] clause 4.5.4
2. Set the parameters of NR Cell 1 according to T1 in Table 5.5.5.2.5-1. Propagation conditions are set according to clause C.2.3. T1 starts.
3. When T1 expires the SS shall change the SNR value to T2 as specified in Table 5.5.5.2.5-1. T2 starts.
4. When T2 expires the SS shall change the SNR value to T3 as specified in Table 5.5.5.2.5-1. T3 starts.
5. When T3 expires the SS shall change the SNR value to T4 as specified in Table 5.5.5.2.5-1. T4 starts.
6. When T4 expires the SS shall change the SNR value to T5 as specified in Table 5.5.5.2.5-1. T5 starts.
7. If the SS:
  - a) detects uplink power on NR carrier in each slot configured for CQI transmission (according CQI reporting on PUCCH) during the period from time point A to time point B; and
  - b) does not detect preamble on a beam associated with the candidate beam set  $q_1$  before time point B; and
  - c) detects preamble on a beam associated with the candidate beam set  $q_1$  before time point F (D1 after the start of T5),

the number of successful tests is increased by one. Otherwise the number of failed tests is increased by one.
8. When T5 expires the SS shall change the SNR value to T1 as specified in Table 5.5.5.2.5-1.
9. Wait 1s for the UE to re-establish the connection or continue directly to step 10. If the UE re-establishes the connection within 1s continue to step 11. Otherwise continue to step 10.
10. Switch the UE on and off. Ensure the UE is in state RRC\_CONNECTED with generic procedure parameters Connectivity *EN-DC*, DC bearer *MCG* and *SCG*, Connected without release *On* according to TS 38.508-1 [14] clause 4.5.4.
11. Repeat steps 2-10 for all subtests until the confidence level according to Tables G.2.3-1 in Annex G clause G.2 is achieved.

5.5.5.2.4.3 Message contents

Message contents are according to TS 38.508-1 [14] clause 7.3 with the following exceptions:

**Table 5.5.5.2.4.3-1: Common Exception messages for EN-DC FR2 SSB-based beam failure detection and link recovery in DRX**

Default Message Contents	
Common contents of system information blocks exceptions	
Default RRC messages and information elements contents exceptions	Table H.3.1-8 with condition SSB BFD Table H.3.1-10 with condition SSB Table H.3.1-10A Table H.3.7-1 with condition DRX.3

5.5.5.2.5 Test requirement

Tables 5.5.5.2.4.1-3 and 5.5.5.2.5-1 define the primary level settings including test tolerances for EN-DC FR2 SSB-based beam failure detection and link recovery in DRX.

**Table 5.5.5.2.5-1: NR Cell specific test parameters for EN-DC FR2 SSB-based beam failure detection and link recovery in DRX**

Parameter	Unit	Test 1				
		T1	T2	T3	T4	T5
AoA setup		Setup 1 defined in A.9				
Assumption for UE beams <sup>Note 10</sup>		Rough				
EPRE ratio of PDCCH DMRS to SSS	dB	0				
EPRE ratio of PDCCH to PDCCH DMRS	dB					
EPRE ratio of PBCH DMRS to SSS	dB					
EPRE ratio of PBCH to PBCH DMRS	dB					
EPRE ratio of PSS to SSS	dB					
EPRE ratio of PDSCH DMRS to SSS	dB					
EPRE ratio of PDSCH to PDSCH DMRS	dB					
EPRE ratio of OCNG DMRS to SSS	dB					
EPRE ratio of OCNG to OCNG DMRS	dB					
SNR_SSB of set q <sub>0</sub>	Config 1-4 dB					
SNR_SSB of set q <sub>1</sub>	Config 1-4 dB	0.2	0.2	20 <sup>Note 12</sup>	20 <sup>Note 12</sup>	20 <sup>Note 12</sup>
SSB_RP of set q <sub>1</sub>	Config 1-2 dBm/	-104.5	-104.5	-84.7	-84.7	-84.7
	Config 3-4 SCS kHz	-101.5	-101.5	-81.7	-81.7	-81.7
N <sub>oc</sub>	Config 1-4 dBm/12 0 KHz	-104.7				
Propagation condition		TDL-A 30ns 75Hz				
<p>NOTE 1: OCNG shall be used such that the resources in Cell 1 are fully allocated and a constant total transmitted power spectral density is achieved for all OFDM symbols.</p> <p>NOTE 2: The uplink resources for CSI reporting are assigned to the UE prior to the start of time period T1.</p> <p>NOTE 3: NZP CSI-RS resource set configuration for CSI reporting are assigned to the UE prior to the start of time period T1.</p> <p>NOTE 4: Measurement gap configuration is assigned to the UE prior to the start of time period T1.</p> <p>NOTE 5: The timers and layer 3 filtering related parameters are configured prior to the start of time period T1.</p> <p>NOTE 6: The signal contains PDCCH for UEs other than the device under test as part of OCNG.</p> <p>NOTE 7: SNR levels correspond to the signal to noise ratio over the SSS REs.</p> <p>NOTE 8: The SNR in time periods T1, T2, T3, T4 and T5 is denoted as SNR1, SNR2 and SNR3 respectively in figure 5.5.5.2.4-1.</p> <p>NOTE 9: The SNR values are specified for testing a UE which supports 2RX on at least one band. For testing of a UE which supports 4RX on all bands, the SNR during T3 is modified as specified in clause D.4.</p> <p>NOTE 10: Information about types of UE beam is given in TS 38.133 clause B.2.1.3, and does not limit UE implementation or test system implementation</p> <p>Note 11: This value allows up to 1dB degradation from applied SNR to UE baseband</p> <p>Note 12: Including test tolerance given in Annex F.1.3.2</p>						

The UE behaviour during time durations T1, T2, T3, T4 and T5 shall be as follows:

During the time duration T1 and T2, the UE shall transmit uplink signal at least in all subframes configured for CSI transmission on Cell 1.

During the period from time point A to time point B the UE shall transmit uplink signal in Cell 1 in all uplink slots configured for CSI transmission according to the configured periodic CSI reporting for Cell 1.

During T3 the UE shall detect beam failure and initiate link recovery. During T4 and T5 the UE measures and evaluate beam candidate from beam candidate set q<sub>1</sub>.

No later than time point F occurring no later than D1 = 560+10 ms after the start of T5, the UE shall transmit preamble on a beam associated with the candidate beam set q<sub>1</sub>. The UE shall not transmit preamble on a beam associated with the candidate beam set q<sub>1</sub> earlier than time point B.

Test is concluded once the test equipment has received the initial preamble transmission from the UE. The rate of correct events observed during repeated tests shall be at least 90%.

### 5.5.5.3 EN-DC FR2 CSI-RS-based beam failure detection and link recovery in non-DRX

**Editor's Note:** This test case is complete for the following configurations:

- Test frequency  $f \leq 40.8$  GHz
- UE PC3

This test case is incomplete for Test frequency  $f > 40.8$  GHz

This test case is incomplete for UE power class other than PC3.

#### 5.5.5.3.1 Test purpose

The purpose of this test is to verify that the UE properly detects CSI-RS-based beam failure in the set  $q_0$  configured for a serving cell and that the UE performs correct CSI-RS-based link recovery based on beam candidate set  $q_1$ . The purpose is to test the downlink monitoring for beam failure detection within the UEs active DL BWP, during the evaluation period, and link recovery, when no DRX is used. This test will partly verify the CSI-RS based beam failure detection and link recovery for an FR2 serving cell requirements in TS 38.133 [6] clause 8.5.

#### 5.5.5.3.2 Test applicability

This test applies to all types of NR UE supporting E-UTRA and EN-DC from release 15 and forward supporting CSI-RS-based RLM and link recovery.

#### 5.5.5.3.3 Minimum conformance requirements

The minimum conformance requirements are specified in clause 5.5.5.0.2.

The normative reference for this requirement is TS 38.133 [6] clause A.5.5.5.3.

#### 5.5.5.3.4 Test description

There are two cell configured in this test: E-UTRAN PCell and NR PSCell. This test consists of five successive time periods, with time duration of T1, T2, T3, T4 and T5 respectively. Figure 5.5.5.3.4-1 shows the five different time durations and the corresponding variation of the downlink SNR in the active cell to emulate CSI-RS based beam failure. Figure 5.5.5.3.4-1 additionally shows the variation of the downlink L1-RSRP of the CSI-RS in set  $q_1$  of the candidate beam used for link recovery.

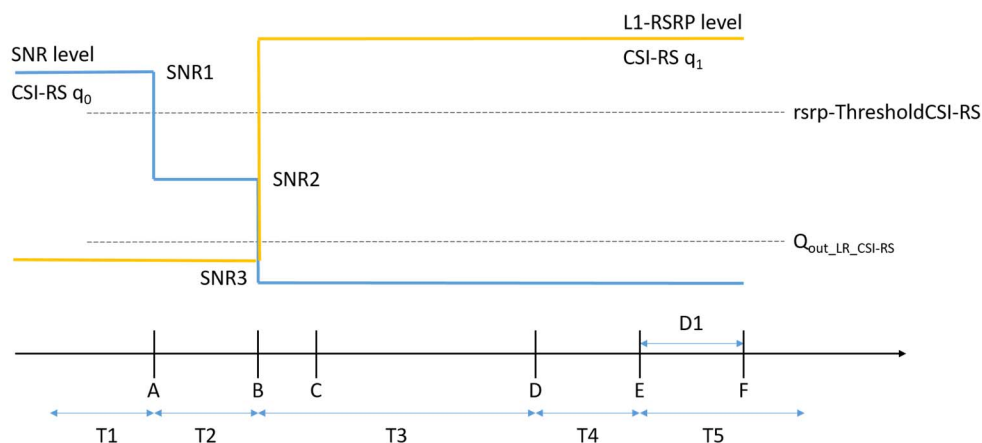

**Figure 5.5.5.3.4-1: SNR and L1-RSRP variation for EN-DC FR2 CSI-RS-based beam failure detection and link recovery in non-DRX**

## 5.5.5.3.4.1 Initial conditions

This test shall be tested using any of the test configurations in Table 5.5.5.3.4.1-1.

**Table 5.5.5.3.4.1-1: Supported test configurations for EN-DC FR2 CSI-RS-based beam failure detection and link recovery in non-DRX**

Configuration	Description
5.5.5.3-1	LTE FDD, NR TDD duplex mode, 120 kHz SSB SCS, 100 MHz bandwidth
5.5.5.3-2	LTE TDD, NR TDD duplex mode, 120 kHz SSB SCS, 100 MHz bandwidth

Configure the test equipment and the DUT according to the parameters in Table 5.5.5.3.4.1-2.

**Table 5.5.5.3.4.1-2: Initial conditions for EN-DC FR2 CSI-RS-based beam failure detection and link recovery in non-DRX**

Parameter	Value	Comment
Test environment	NC	As specified in TS 38.508-1 [14] clause 4.1.
Test frequencies	As specified in Annex E, table E.5-1 and TS 38.508-1 [14] clause 4.3.1 for E-UTRA and 7.2.3 for NR.	
Channel bandwidth	As specified by the test configuration selected from Table 5.5.5.3.4.1-1.	
Propagation conditions	AWGN	As specified in clause C.2.2.
Connection Diagram	TE Part	A.3.3.1.1
	DUT Part	A.3.4.1.1
Exceptions to connection diagram	N/A	

1. The general test parameter settings are set up according to Table 5.5.5.3.4.1-3. The NZP-CSI-RS configuration is according to Table 5.5.5.3.4.1-3.
2. Message contents are defined in clause 5.5.5.3.4.3.
3. There are one E-UTRAN cell and one NR cell specified in the test. E-UTRAN Cell 1 is the cell used for connection setup with the power level set according to clause C.1.1 and C.1.2 for this test.

**Table 5.5.5.3.4.1-3: General test parameters for EN-DC FR2 CSI-RS-based beam failure detection and link recovery in non-DRX**

Parameter	Test Config.	Unit	Value	Comment
			Test 1	

Active E-UTRA PCell	1-2		Cell 1	
E-UTRA RF Channel Number	1-2		1	
Active PCell	1-2		Cell 2	
RF Channel Number	1-2		2	
Duplex mode	1-2		TDD	
TDD Configuration	1-2		TDDConf.3.1	Table A.1.5-3
$BW_{channel}$	1-2	MHz	100: $N_{RB,c} = 66$	
Data RBs allocated	1-2		66	
PDSCH/PDCCH subcarrier spacing	1-2	kHz	120	
DL initial BWP configuration	1-2		DLBWP.0.1	Table A.8.1-1
DL dedicated BWP configuration	1-2		DLBWP.1.1	Table A.8.1-2
UL initial BWP configuration	1-2		ULBWP.0.1	Table A.8.2-1
UL dedicated BWP configuration	1-2		ULBWP.1.1	Table A.8.2-2
PDSCH Reference Channel	1-2		SR.3.2 TDD	Table A.1.1.2-3
RMSI CORESET Reference Channel	1-2		CR.3.1 TDD	Table A.1.2.2-3
Dedicated CORESET Reference Channel	1-2		CCR.3.1 TDD	Table A.1.3.2-3
OCNG parameters	1-2		OP.1	Table A.2.1-1
CP length	1-2		Normal	
PDSCH/PDCCH TCI state	1-2		TCI.State.0	Table A.10.2-1
CSI-RS for tracking	1-2		TRS.2.1 TDD	Table A.1.4A.2.1-1
SSB Configuration	1-2		SSB.1 FR2	Table A.3.2-1
SMTC Configuration	1-2		SMTC.3	Table A.4-1
PRACH Configuration	1-2		PRACH.4 FR2	Table A.7.2-1
DRX configuration	1-2		OFF	
CSI-RS configuration for BFD/CBD/RLM	1-2		CSI-RS.3.2 TDD	Table A.1.4.2-3
CSI-RS index assigned as BFD RS ( $q_0$ )	1-2		0	
CSI-RS index assigned as CBD RS ( $q_1$ )	1-2		1	
CSI-RS index assigned as RLM RS	1-2		0,1	
Beam failure detection transmission parameters	DCI format	1-2		1-0
	Number of Control OFDM symbols	1-2		2
	Aggregation level	1-2	CCE	8
	Ratio of hypothetical PDCCH RE energy to average SSS RE energy	1-2	dB	0
	Ratio of hypothetical PDCCH DMRS energy to average SSS RE energy	1-2	dB	0
	DMRS precoder granularity	1-2		REG bundle size
	REG bundle size	1-2		6

Gap pattern ID	1-2		N/A	
rlmInSyncOutOfSyncThreshold	1-2		absent	Value 0 is applied. (TS 38.133 [6] Table 8.1.1-1).
rsrp-ThresholdSSB	1-2	dBm/SCS	-109 <sup>Note 2</sup>	Threshold used for $Q_{in\_LR\_SSB}$
powerControlOffsetSS	1-2		db0	Used for deriving rsrp-ThresholdCSI-RS
beamFailureInstanceMaxCount	1-2		n1	see TS 38.321 [12], clause 5.17
beamFailureDetectionTimer	1-2		pbfd4	see TS 38.321 [12], clause 5.17
CSI-RS configuration for CSI reporting	1-2		CSI-RS.3.1 TDD	Table A.1.4.2-3
reportConfigType	1-2		periodic	
reportQuantity	1-2		cri-RI-PMI-CQI	
CSI reporting periodicity	1-2	slot	40	
CSI reporting offset	1-2	slot	4	
T310	1-2	ms	1000	
N310	1-2		2	
T1	1-2	s	1	The UE shall be fully synchronized to cell 1 during T1
T2	1-2	s	1.17	
T3	1-2	s	0.9	
T4	1-2	s	0	
T5	1-2	s	0.31	
D1	1-2	s	0.27	
Note 1: UE-specific PDCCH is not transmitted after T1 starts.				
Note 2: Including test tolerance given in Annex F.1.3.2.				

#### 5.5.5.3.4.2 Test procedure

Prior to the start of the time duration T1, the UE shall be fully synchronized to NR Cell 1. The UE shall be configured for periodic CSI reporting with a reporting periodicity of 5 ms. In the test, DRX configuration is not enabled.

1. Ensure the UE is in state RRC\_CONNECTED with generic procedure parameters Connectivity *EN-DC*, DC bearer *MCG* and *SCG*, Connected without release *On* according to TS 38.508-1 [14] clause 4.5.4.
2. Set the parameters of NR Cell 1 according to T1 in Table 5.5.5.3.5-1. Propagation conditions are set according to clause C.2.3. T1 starts.
3. When T1 expires the SS shall change the SNR value to T2 as specified in Table 5.5.5.3.5-1. T2 starts.
4. When T2 expires the SS shall change the SNR value to T3 as specified in Table 5.5.5.3.5-1. T3 starts.
5. When T3 expires the SS shall change the SNR value to T4 as specified in Table 5.5.5.3.5-1. T4 starts.
6. When T4 expires the SS shall change the SNR value to T5 as specified in Table 5.5.5.3.5-1. T5 starts.
7. If the SS:
  - a) detects uplink power on NR carrier in each slot configured for CQI transmission (according CQI reporting on PUCCH) during the period from time point A to time point B;

and

  - b) does not detect preamble on a beam associated with the candidate beam set  $q_1$  before time point B; and
  - c) detects preamble on a beam associated with the candidate beam set  $q_1$  before time point F (D1 after the start of T5),

the number of successful tests is increased by one. Otherwise the number of failed tests is increased by one.
8. When T5 expires the SS shall change the SNR value to T1 as specified in Table 5.5.5.3.5-1.



9. Wait 1s for the UE to re-establish the connection or continue directly to step 10. If the UE re-establishes the connection within 1s continue to step 11. Otherwise continue to step 10.
10. Switch the UE on and off. Ensure the UE is in RRC\_CONNECTED with generic procedure parameters Connectivity *EN-DC*, DC bearer *MCG* and *SCG*, Connected without release *On* according to TS 38.508-1 [14] clause 4.5.4.
11. Repeat steps 2-10 for all subtests until the confidence level according to Tables G.2.3-1 in Annex G clause G.2 is achieved.

5.5.5.3.4.3 Message contents

Message contents are according to TS 38.508-1 [14] clause 7.3 with the following exceptions:

**Table 5.5.5.3.4.3-1: Common Exception messages for EN-DC FR2 CSI-RS-based beam failure detection and link recovery in non-DRX**

Default Message Contents	
Common contents of system information blocks exceptions	
Default RRC messages and information elements contents exceptions	Table H.3.1-8 with condition CSI-RS BFD Table H.3.1-10 with condition CSI-RS Table H.3.1-10A

5.5.5.3.5 Test requirement

Tables 5.5.5.3.4.1-3 and 5.5.5.3.5-1 define the primary level settings including test tolerances for EN-DC FR2 CSI-RS-based beam failure detection and link recovery in non-DRX.

**Table 5.5.5.3.5-1: NR Cell specific test parameters for EN-DC FR2 CSI-RS-based beam failure detection and link recovery in non-DRX**

Parameter		Unit	Test 1				
			T1	T2	T3	T4	T5
AoA setup			Setup 1 defined in A.9				
Assumption for UE beams <sup>Note 10</sup>			Rough				
EPRE ratio of PDCCH DMRS to SSS		dB	0				
EPRE ratio of PDCCH to PDCCH DMRS		dB					
EPRE ratio of PBCH DMRS to SSS		dB					
EPRE ratio of PBCH to PBCH DMRS		dB					
EPRE ratio of PSS to SSS		dB					
EPRE ratio of PDSCH DMRS to SSS		dB					
EPRE ratio of PDSCH to PDSCH DMRS		dB					
EPRE ratio of OCNG DMRS to SSS		dB					
EPRE ratio of OCNG to OCNG DMRS		dB					
SNR_CSI-RS of set $q_0$	Config 1-2	dB					
SNR_CSI-RS of set $q_1$	Config 1-2	dB	0.2	0.2	20 <sup>Note 12</sup>	20 <sup>Note 12</sup>	20 <sup>Note 12</sup>
CSI-RS_RP of set $q_1$	Config 1-2	dBm/SCS	-104.5	-104.5	-84.7	-84.7	-84.7
$N_{oc}$	Config 1-2	dBm/120 KHz	TBD				
Propagation condition			TDL-A 30ns 75Hz				
NOTE 1: OCNG shall be used such that the resources in Cell 1 are fully allocated and a constant total transmitted power spectral density is achieved for all OFDM symbols.							
NOTE 2: The uplink resources for CSI reporting are assigned to the UE prior to the start of time period T1.							
NOTE 3: NZP CSI-RS resource set configuration for CSI reporting are assigned to the UE prior to the start of time period T1.							
NOTE 4: Void							
NOTE 5: The timers and layer 3 filtering related parameters are configured prior to the start of time period T1.							
NOTE 6: The signal contains PDCCH for UEs other than the device under test as part of OCNG.							
NOTE 7: SNR levels correspond to the signal to noise ratio over the REs carrying CSI-RS.							
NOTE 8: The SNR in time periods T1, T2, T3, T4 and T5 is denoted as SNR1, SNR2 and SNR3 respectively in figure 5.5.5.3.4-1.							
NOTE 9: The SNR values are specified for testing a UE which supports 2RX on at least one band. For testing of a UE which supports 4RX on all bands, the SNR during T3 is modified as specified in clause D.4.							
NOTE 10: Information about types of UE beam is given in TS 38.133 clause B.2.1.3, and does not limit UE implementation or test system implementation							
Note 11: This value allows up to 1dB degradation from applied SNR to UE baseband							
Note 12: Including test tolerance given in Annex F.1.3.2							

The UE behaviour during time durations T1, T2, T3, T4 and T5 shall be as follows:

During the time duration T1 and T2, the UE shall transmit uplink signal at least in all subframes configured for CSI transmission on Cell 1.

During the period from time point A to time point B the UE shall transmit uplink signal in Cell 1 in all uplink slots configured for CSI transmission according to the configured periodic CSI reporting for Cell 1.

During T3 the shall detect beam failure and initiate link recovery. During T4 and T5 the UE measures and evaluate beam candidate from beam candidate set  $q_1$ .

No later than time point F occurring no later than  $D1 = 260+10$  ms after the start of T5, the UE shall transmit preamble on a beam associated with the candidate beam set  $q_1$ . The UE shall not transmit preamble on a beam associated with the candidate beam set  $q_1$  earlier than time point B

Test is concluded once the test equipment has received the initial preamble transmission from the UE. The rate of correct events observed during repeated tests shall be at least 90%.

#### 5.5.5.4 EN-DC FR2 CSI-RS-based beam failure detection and link recovery in DRX

**Editor's Note:** This test case is complete for the following configurations:

- Test frequency  $f \leq 40.8$  GHz
- UE PC3

This test case is incomplete for Test frequency  $f > 40.8$  GHz

This test case is incomplete for UE power class other than PC3.

5.5.5.4.1 Test purpose

The purpose of this test is to verify that the UE properly detects CSI-RS-based beam failure in the set  $q_0$  configured for a serving cell and that the UE performs correct CSI-RS-based link recovery based on beam candidate set  $q_1$ . The purpose is to test the downlink monitoring for beam failure detection within the UEs active DL BWP, during the evaluation period, and link recovery, when DRX is used. This test will partly verify the CSI-RS based beam failure detection and link recovery for an FR2 serving cell requirements in TS 38.133 [6] clause 8.5.

5.5.5.4.2 Test applicability

This test applies to all types of NR UE supporting E-UTRA and EN-DC from release 15 and forward supporting CSI-RS-based RLM and long DRX cycle and link recovery.

5.5.5.4.3 Minimum conformance requirements

The minimum conformance requirements are specified in clause 5.5.5.0.2.

The normative reference for this requirement is TS 38.133 [6] clause A.5.5.5.4.

5.5.5.4.4 Test description

There is one E-UTRAN PCell and one NR PSCell configured in this test. This test consists of five successive time periods, with time duration of T1, T2, T3, T4 and T5 respectively. Figure 5.5.5.4.4-1 shows the five different time durations and the corresponding variation of the downlink SNR in the active cell to emulate CSI-RS based beam failure. Figure 5.5.5.4.1-1 additionally shows the variation of the downlink L1-RSRP of the CSI-RS in set  $q_1$  of the candidate beam used for link recovery.

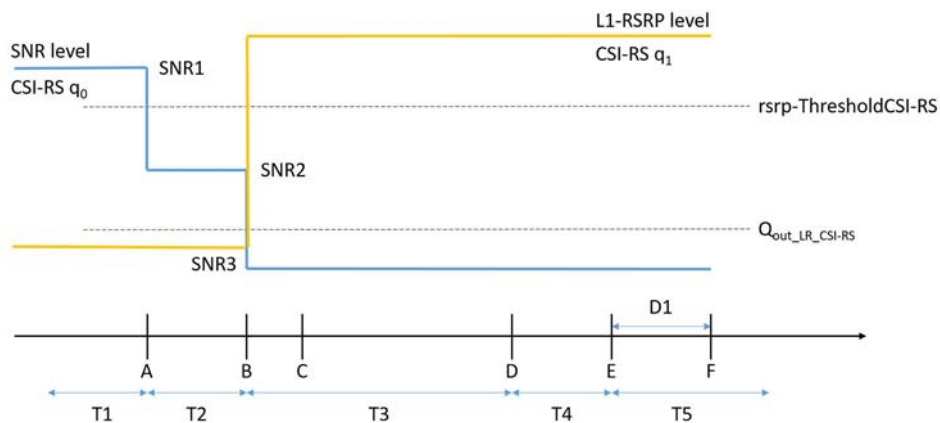

Figure 5.5.5.4.4-1: SNR and L1-RSRP variation for EN-DC FR2 CSI-RS-based beam failure detection and link recovery in DRX

5.5.5.4.4.1 Initial conditions

This test shall be tested using any of the test configurations in Table 5.5.5.4.4.1-1.

**Table 5.5.5.4.4.1-1: Supported test configurations for EN-DC FR2 CSI-RS-based beam failure detection and link recovery in DRX**

Configuration	Description
5.5.5.4-1	LTE FDD, NR TDD duplex mode, 120 kHz SSB SCS, 100MHz bandwidth
5.5.5.4-2	LTE TDD, NR TDD duplex mode, 120 kHz SSB SCS, 100 MHz bandwidth

Configure the test equipment and the DUT according to the parameters in Table 5.5.5.4.4.1-2.

**Table 5.5.5.4.4.1-2: Initial conditions for EN-DC FR2 CSI-RS-based beam failure detection and link recovery in DRX**

Parameter	Value	Comment
Test environment	NC	As specified in TS 38.508-1 [14] clause 4.1.
Test frequencies	As specified in Annex E, table E.5-1 and TS 38.508-1 [14] clause 4.3.1 for E-UTRA and 7.2.3 for NR.	
Channel bandwidth	As specified by the test configuration selected from Table 6.5.5.3.4.1-1.	
Propagation conditions	AWGN	As specified in clause C.2.2.
Connection Diagram	TE Part	A.3.3.1.1
	DUT Part	A.3.4.1.1
Exceptions to connection diagram	N/A	

1. The general test parameter settings are set up according to Table 5.5.5.4.4.1-3. The NZP-CSI-RS configuration is according to Table 5.5.5.4.4.1-3. The DRX configuration for is according to Table 5.5.5.4.4.1-3. Time alignment timers shall be set to “infinity” so that UL timing alignment is maintained during the test.
2. Message contents are defined in clause 5.5.5.4.4.3.
3. There is one E-UTRAN cell and one NR cell specified in the test. E-UTRAN Cell 1 is the cell used for connection setup with the power level set according to clause C.1.1 and C.1.2 for this test.

**Table 5.5.5.4.4.1-3: General test parameters for EN-DC FR2 CSI-RS-based beam failure detection and link recovery in DRX**

Parameter	Test Config.	Unit	Value	Comment
			Test 1	

Active E-UTRA PCell	1-2		Cell 1	
E-UTRA RF Channel Number	1-2		1	
Active PCell	1-2		Cell 2	
RF Channel Number	1-2		2	
Duplex mode	1-2		TDD	
TDD Configuration	1-2		TDDConf.3.1	Table A.1.5-3
$BW_{channel}$	1-2	MHz	100: $N_{RB,c} = 66$	
Data RBs allocated	1-2		66	
PDSCH/PDCCH subcarrier spacing	1-2	kHz	120	
DL initial BWP configuration	1-2		DLBWP.0.1	Table A.8.1-1
DL dedicated BWP configuration	1-2		DLBWP.1.1	Table A.8.1-2
UL initial BWP configuration	1-2		ULBWP.0.1	Table A.8.2-1
UL dedicated BWP configuration	1-2		ULBWP.1.1	Table A.8.2-2
PDSCH Reference Channel	1-2		SR.3.2 TDD	Table A.1.1.2-3
RMSI CORESET Reference Channel	1-2		CR.3.1 TDD	Table A.1.2.2-3
Dedicated CORESET Reference Channel	1-2		CCR.3.1 TDD	Table A.1.3.2-3
OCNG parameters	1-2		OP.1	Table A.2.1-1
CP length	1-2		Normal	
PDSCH/PDCCH TCI state	1-2		TCI.State.0	Table A.10.2-1
CSI-RS for tracking	1-2		TRS.2.1 TDD	Table A.1.4A.2.1-1
SSB Configuration	1-2		SSB.1 FR2	Table A.3.2-1
SMTC Configuration	1-2		SMTC.3	Table A.4-1
PRACH Configuration	1-2		PRACH.4 FR2	Table A.7.2-1
DRX configuration	1-2		DRX.3	Table A.5-1
CSI-RS configuration for BFD/CBD/RLM	1-2		CSI-RS.3.2 TDD	Table A.1.4.2-3
CSI-RS index assigned as BFD RS ( $q_0$ )	1-2		0	
CSI-RS index assigned as CBD RS ( $q_1$ )	1-2		1	
CSI-RS index assigned as RLM RS	1-2		0,1	
Beam failure detection transmission parameters	DCI format	1-2		1-0
	Number of Control OFDM symbols	1-2		2
	Aggregation level	1-2	CCE	8
	Ratio of hypothetical PDCCH RE energy to average SSS RE energy	1-2	dB	0
	Ratio of hypothetical PDCCH DMRS energy to average SSS RE energy	1-2	dB	0
	DMRS precoder granularity	1-2		REG bundle size
	REG bundle size	1-2		6

Gap pattern ID	1-2		N/A	
rlmInSyncOutOfSyncThreshold	1-2		absent	Value 0 is applied. (TS 38.133 [6] Table 8.1.1-1).
rsrp-ThresholdSSB	1-2	dBm/SCS	-109 <sup>Note 2</sup>	Threshold used for $Q_{in\_LR\_SSB}$
powerControlOffsetSS	1-2		db0	Used for deriving rsrp-ThresholdCSI-RS
beamFailureInstanceMaxCount	1-2		n1	see TS 38.321 [12], clause 5.17
beamFailureDetectionTimer	1-2		pbfd4	see TS 38.321 [12], clause 5.17
CSI-RS configuration for CSI reporting	1-2		CSI-RS.3.1 TDD	Table A.1.4.2-3
reportConfigType	1-2		periodic	
reportQuantity	1-2		cri-RI-PMI-CQI	
CSI reporting periodicity	1-2	slot	40	
CSI reporting offset	1-2	slot	4	
T310	1-2	ms	1000	
N310	1-2		2	
T1	1-2	s	1	The UE shall be fully synchronized to cell 1 during T1
T2	1-2	s	5.43	
T3	1-2	s	5.16	
T4	1-2	s	0	
T5	1-2	s	0.31	
D1	1-2	s	0.27	
Note 1: UE-specific PDCCH is not transmitted after T1 starts.				
Note 2: Including test tolerance given in Annex F.1.3.2.				

**Table 5.5.5.4.4.1-4: Void****5.5.5.4.4.2 Test procedure**

Prior to the start of the time duration T1, the UE shall be fully synchronized to NR Cell 1. The UE shall be configured for periodic CSI reporting with a reporting periodicity of 5 ms. In the test, DRX configuration is enabled.

1. Ensure the UE is in state RRC\_CONNECTED with generic procedure parameters Connectivity *EN-DC*, DC bearer *MCG* and *SCG*, Connected without release *On* according to TS 38.508-1 [14] clause 4.5.4
2. Set the parameters of NR Cell 1 according to T1 in Table 5.5.5.4.5-1. Propagation conditions are set according to clause C.2.3. T1 starts.
3. When T1 expires the SS shall change the SNR value to T2 as specified in Table 5.5.5.4.5-1. T2 starts.
4. When T2 expires the SS shall change the SNR value to T3 as specified in Table 5.5.5.4.5-1. T3 starts.
5. When T3 expires the SS shall change the SNR value to T4 as specified in Table 5.5.5.4.5-1. T4 starts.
6. When T4 expires the SS shall change the SNR value to T5 as specified in Table 5.5.5.4.5-1. T5 starts.
7. If the SS:
  - a) detects uplink power on NR carrier in each slot configured for CQI transmission (according CQI reporting on PUCCH) during the period from time point A to time point B; and
  - b) does not detect preamble on a beam associated with the candidate beam set  $q_1$  before time point B; and
  - c) detects preamble on a beam associated with the candidate beam set  $q_1$  before time point F (D1 after the start of T5),

the number of successful tests is increased by one. Otherwise the number of failed tests is increased by one.
8. When T5 expires the SS shall change the SNR value to T1 as specified in Table 5.5.5.4.5-1.

9. Wait 1s for the UE to re-establish the connection or continue directly to step 10. If the UE re-establishes the connection within 1s continue to step 11. Otherwise continue to step 10.

10. Switch the UE on and off. Ensure the UE is in state RRC\_CONNECTED with generic procedure parameters Connectivity EN-DC, DC bearer MCG and SCG, Connected without release On according to TS 38.508-1 [14] clause 4.5.4.

11. Repeat steps 2-10 for all subtests until the confidence level according to Tables G.2.3-1 in Annex G clause G.2 is achieved.

5.5.5.4.4.3 Message contents

Message contents are according to TS 38.508-1 [14] clause 7.3 with the following exceptions:

**Table 5.5.5.4.4.3-1: Common Exception messages for EN-DC FR2 CSI-RS-based beam failure detection and link recovery in DRX**

Default Message Contents	
Common contents of system information blocks exceptions	
Default RRC messages and information elements contents exceptions	Table H.3.1-8 with condition CSI-RS BFD Table H.3.1-10 with condition CSI-RS Table H.3.1-10A Table H.3.7-1 with condition DRX.3

5.5.5.4.5 Test requirement

Tables 5.5.5.4.4.1-3 and 5.5.5.4.5-1 define the primary level settings including test tolerances for EN-DC FR2 CSI-RS-based beam failure detection and link recovery in DRX.

**Table 5.5.5.4.5-1: NR Cell specific test parameters for EN-DC FR2 CSI-RS-based beam failure detection and link recovery in DRX**

Parameter	Unit	Test 1				
		T1	T2	T3	T4	T5
AoA setup		Setup 1 defined in A.9				
Assumption for UE beams <sup>Note 10</sup>		Rough				
EPRE ratio of PDCCH DMRS to SSS	dB	0				
EPRE ratio of PDCCH to PDCCH DMRS	dB					
EPRE ratio of PBCH DMRS to SSS	dB					
EPRE ratio of PBCH to PBCH DMRS	dB					
EPRE ratio of PSS to SSS	dB					
EPRE ratio of PDSCH DMRS to SSS	dB					
EPRE ratio of PDSCH to PDSCH DMRS	dB					
EPRE ratio of OCNG DMRS to SSS	dB					
EPRE ratio of OCNG to OCNG DMRS	dB					
SNR_CSI-RS of set q <sub>0</sub>	Config 1-2 dB	13.7 <sup>Note 11,12</sup>	5.7 <sup>Note 11,12</sup>	-12	-12	-12
SNR_CSI-RS of set q <sub>1</sub>	Config 1-2 dB	0.2	0.2	20 <sup>Note 12</sup>	20 <sup>Note 12</sup>	20 <sup>Note 12</sup>
CSI-RS_RP of set q <sub>1</sub>	Config 1-2 dBm/SCS	-104.5	-104.5	-84.7	-84.7	-84.7
N <sub>oc</sub>	Config 1-2 dBm/120 KHz	-104.7				
Propagation condition		TDL-A 30ns 75Hz				

NOTE 1:	OCNG shall be used such that the resources in Cell 1 are fully allocated and a constant total transmitted power spectral density is achieved for all OFDM symbols.
NOTE 2:	The uplink resources for CSI reporting are assigned to the UE prior to the start of time period T1.
NOTE 3:	NZP CSI-RS resource set configuration for CSI reporting are assigned to the UE prior to the start of time period T1.
NOTE 4:	Void
NOTE 5:	The timers and layer 3 filtering related parameters are configured prior to the start of time period T1.
NOTE 6:	The signal contains PDCCH for UEs other than the device under test as part of OCNG.
NOTE 7:	SNR levels correspond to the signal to noise ratio over the SSS REs.
NOTE 8:	The SNR in time periods T1, T2, T3, T4 and T5 is denoted as SNR1, SNR2 and SNR3 respectively in figure 5.5.5.4.4-1.
NOTE 9:	The SNR values are specified for testing a UE which supports 2RX on at least one band. For testing of a UE which supports 4RX on all bands, the SNR during T3 is modified as specified in clause D.4.
NOTE 10:	Information about types of UE beam is given in TS 38.133 clause B.2.1.3, and does not limit UE implementation or test system implementation
Note 11:	This value allows up to 1dB degradation from applied SNR to UE baseband
Note 12:	Including test tolerance given in Annex F.1.3.2.

The UE behaviour during time durations T1, T2, T3, T4 and T5 shall be as follows:

During the time duration T1 and T2, the UE shall transmit uplink signal at least in all subframes configured for CSI transmission on Cell 1.

During the period from time point A to time point B the UE shall transmit uplink signal in Cell 1 in all uplink slots configured for CSI transmission according to the configured periodic CSI reporting for Cell 1.

During T3 the UE shall detect beam failure and initiate link recovery. During T4 and T5 the UE measures and evaluate beam candidate from beam candidate set  $q_1$ .

No later than time point F occurring no later than  $D1 = 260+10$  ms after the start of T5, the UE shall transmit preamble on a beam associated with the candidate beam set  $q_1$ . The UE shall not transmit preamble on a beam associated with the candidate beam set  $q_1$  earlier than time point B.

Test is concluded once the test equipment has received the initial preamble transmission from the UE. The rate of correct events observed during repeated tests shall be at least 90%.

### 5.5.5.5 EN-DC FR2 scheduling available restriction during SSB-based beam failure detection and link recovery in non-DRX

**Editor's Note:** This test case is complete for the following configurations:

- Test frequency  $f \leq 40.8$  GHz
- UE PC3

This test case is incomplete for Test frequency  $f > 40.8$  GHz

This test case is incomplete for UE power class other than PC3.

#### 5.5.5.5.1 Test purpose

The purpose of this test is to test scheduling availability restrictions when the UE is performing beam failure detection or when the UE is performing L1-RSRP measurement for candidate beam detection, when no DRX is used, and to verify the scheduling availability restriction requirements for SSB based beam failure detection and link recovery for an FR2 serving cell in TS 38.133 [6] clause 8.5.7 and 8.5.8.

#### 5.5.5.5.2 Test applicability

This test applies to all types of NR UE supporting E-UTRA and EN-DC from release 15 onwards.

#### 5.5.5.5.3 Minimum conformance requirements



The minimum conformance requirements are specified in clause 5.5.5.0.3.

The normative reference for this requirement is TS 38.133 [6] clause A.5.5.5.5.

5.5.5.5.4 Test description

There are two cell configured in this test. Cell 1 is the E-UTRAN PCell and Cell 2 is the PSCell. This test consists of five successive time periods, with time duration of T1, T2, T3, T4 and T5 respectively. Figure 5.5.5.5.4-1 shows the variation of the downlink SNR of the PCell and the SNR of the SSB in set  $q_0$  in the active PCell to emulate SSB based beam failure. Figure 5.5.5.5.4-1 additionally shows the variation of the downlink L1-RSRP of the SSB in set  $q_1$  of the candidate beam used for link recovery.

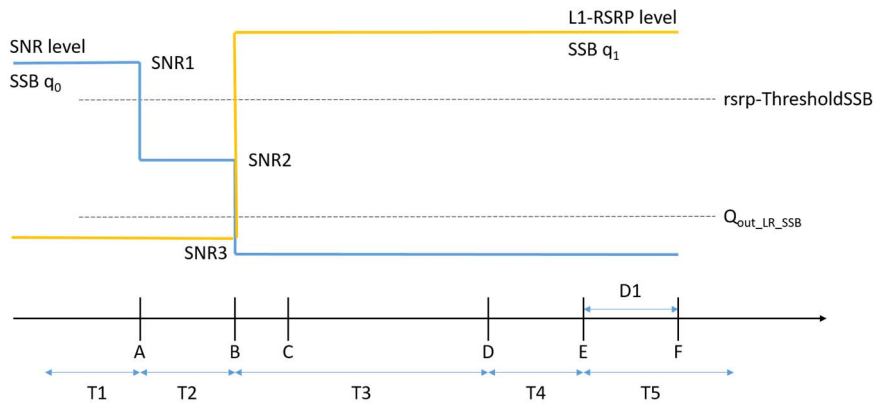

Figure 5.5.5.5.4-1: SNR and L1-RSRP variation for EN-DC FR2 scheduling available restriction during SSB-based beam failure detection and link recovery in non-DRX

5.5.5.5.4.1 Initial conditions

This test shall be tested using any of the test configurations in Table 5.5.5.5.4.1-1.

Table 5.5.5.5.4.1-1: Supported test configurations for EN-DC FR2 scheduling available restriction during SSB-based beam failure detection and link recovery in non-DRX

Configuration	Description
5.5.5.5-1	LTE FDD, NR 120 kHz SSB SCS, 100MHz bandwidth, TDD duplex mode
5.5.5.5-2	LTE TDD, NR 120 kHz SSB SCS, 100MHz bandwidth, TDD duplex mode
5.5.5.5-3	LTE FDD, NR 240 kHz SSB SCS, 100MHz bandwidth, TDD duplex mode
5.5.5.5-4	LTE TDD, NR 240 kHz SSB SCS, 100MHz bandwidth, TDD duplex mode
NOTE: The UE is only required to be tested in one of the supported test configurations	

Configure the test equipment and the DUT according to the parameters in Table 5.5.5.5.4.1-2.

Table 5.5.5.5.4.1-2: Initial conditions for EN-DC FR2 scheduling available restriction during SSB-based beam failure detection and link recovery in non-DRX

Parameter	Value	Comment
Test environment	NC	As specified in TS 38.508-1 [14] clause 4.1.
Test frequencies	As specified in Annex E, table E.5-1 and TS 38.508-1 [14] clause 4.3.1 for E-UTRA and 7.2.3 for NR.	
Channel bandwidth	As specified by the test configuration selected from Table 5.5.5.5.4.1-1.	
Propagation conditions	AWGN As specified in clause C.2.2.	
Connection Diagram	TE Part: A.3.3.1.1 DUT Part: A.3.4.1.1	As specified in TS 38.508-1 [14] Annex A.
Exceptions to connection diagram	N/A	

1. The general test parameter settings are set up according to Table 5.5.5.5.4.1-3.
2. Message contents are defined in clause 5.5.5.5.4.3.
3. There are one E-UTRAN cell and one NR cell specified in the test. E-UTRAN Cell 1 is the cell used for connection setup with the power level set according to clause C.1.1 and C.1.2 for this test.

**Table 5.5.5.5.4.1-3: General test parameters for EN-DC FR2 scheduling available restriction during SSB-based beam failure detection and link recovery in non-DRX**

Parameter	Test Config.	Unit	Value	Comment	
			<b>Test 1</b>		
Active E-UTRA PCell	1-4		Cell 1		
E-UTRA RF Channel Number	1-4		1		
Active PCell	1-4		Cell 2		
RF Channel Number	1-4		2		
Duplex mode	1-4		TDD		
TDD Configuration	1-4		TDDConf.3.1	Table A.1.5-3	
BW <sub>channel</sub>	1-4	MHz	100: N <sub>RB,c</sub> = 66		
Data RBs allocated	1-4		66		
PDSCH/PDCCH subcarrier spacing	1-4	kHz	120		
DL initial BWP configuration	1-4		DLBWP.0.1	Table A.8.1-1	
DL dedicated BWP configuration	1-4		DLBWP.1.1	Table A.8.1-2	
UL initial BWP configuration	1-4		ULBWP.0.1	Table A.8.2-1	
UL dedicated BWP configuration	1-4		ULBWP.1.1	Table A.8.2-2	
PDSCH Reference Channel	1-2		SR.3.2 TDD	Table A.1.1.2-3	
	3-4		SR.3.3 TDD		
RMSI CORESET Reference Channel	1-2		CR.3.1 TDD	Table A.1.2.2-3	
	3-4		CR.3.2 TDD		
Dedicated CORESET Reference Channel	1-2		CCR.3.1 TDD	Table A.1.3.2-3	
	3-4		CCR.3.7 TDD		
OCNG parameters	1-4		OP.1	Table A.2.1-1	
CP length	1-4		Normal		
PDSCH/PDCCH TCI state	1-4		TCI.State.0	Table A.10.2-1	
CSI-RS for tracking	1-4		TRS.2.1 TDD	Table A.1.4A.2.1-1	
SSB Configuration	1-2		SSB.1 FR2	Table A.3.2-1	
	3-4		SSB.2 FR2		
SMTC Configuration	1-4		SMTC.1	Table A.4-1	
PRACH Configuration	1-4		PRACH.2 FR2	Table A.7.2-1	
DRX configuration	1-4		OFF		
SSB index assigned as BFD RS (q <sub>0</sub> )	1-4		0		
SSB index assigned as CBD RS (q <sub>1</sub> )	1-4		1		
Beam failure detection transmission parameters	DCI format	1-4	1-0		
	Number of Control OFDM symbols	1-4	2		
	Aggregation level	1-4	CCE	8	
	Ratio of hypothetical PDCCH RE energy to average SSS RE energy	1-4	dB	0	
	Ratio of hypothetical PDCCH DMRS energy to average SSS RE energy	1-4	dB	0	
	DMRS precoder granularity	1-4		REG bundle size	
	REG bundle size	1-4	6		
Gap pattern ID	1-4		N/A	No measurement gap is configured	
rlmInSyncOutOfSyncThreshold	1-4		absent	Value 0 is applied. (TS 38.133 [6] Table 8.1.1-1).	
rsrp-ThresholdSSB	1-2	dBm/SCS	-109 <sup>Note 3</sup>	Threshold used for Q <sub>in_LR_SSB</sub>	
	3-4		-106 <sup>Note 3</sup>		

powerControlOffsetSS	1-4		db0	Used for deriving rsrp-ThresholdCSI-RS
beamFailureInstanceMaxCount	1-4		n1	see TS 38.321 [12], clause 5.17
beamFailureDetectionTimer	1-4		pbfd4	see TS 38.321 [12], clause 5.17
CSI-RS configuration for CSI reporting	1-4		CSI-RS.3.1 TDD	Table A.1.4.2-3
reportConfigType	1-4		periodic	
reportQuantity	1-4		cri-RI-PMI-CQI	
CSI reporting periodicity	1-4	slot	40	
CSI reporting offset	1-4	slot	4	
T310	1-4	ms	1000	
N310	1-4		2	
T1	1-4	s	1	The UE shall be fully synchronized to cell 1 during T1
T2	1-4	s	2.6	
T3	1-4	s	1.64	
T4	1-4	s	0	
T5	1-4	s	1.01	
D1	1-4	s	0.97	
<p>Note 1: All configurations are assigned to the UE prior to the start of time period T1.</p> <p>Note 2: UE-specific PDCCH is not transmitted after T1 starts.</p> <p>Note 3: Including test tolerance given in Annex F.1.3.2</p>				

#### 5.5.5.5.4.2 Test procedure

Prior to the start of the time duration T1, the UE shall be fully synchronized to Cell 1 and Cell 2. The UE shall be configured for periodic CSI reporting with a reporting periodicity defined in CSI-RS configuration. This test will focus on the scheduling availability during beam failure detection and candidate beam detection. In the test, DRX configuration is not enabled. During the test the UE is scheduled to transmit continuously in UL.

1. Ensure the UE is in state RRC\_CONNECTED with generic procedure parameters Connectivity *EN-DC*, DC bearer *MCG* and *SCG*, Connected without release *On* and Test Mode *On* according to TS 38.508-1 [14] clause 4.5.4.
2. Set the parameters of NR Cell 1 according to T1 in Table 5.5.5.5-1. Propagation conditions are set according to clause C.2.3. T1 starts.
3. When T1 expires the SS shall change the SNR value to T2 as specified in Table 5.5.5.5-1. T2 starts.
4. When T2 expires the SS shall change the SNR value to T3 as specified in Table 5.5.5.5-1. T3 starts.
5. When T3 expires the SS shall change the SNR value to T4 as specified in Table 5.5.5.5-1. T4 starts.
6. When T4 expires the SS shall change the SNR value to T5 as specified in Table 5.5.5.5-1. T5 starts.
7. If the SS:
  - a) detects uplink power on NR carrier in each slot configured for CQI transmission (according CQI reporting on PUCCH) which are not overlapped with SSBs configured for beam failure detection during the period from time point B to time point D; and
  - b) detects uplink power on NR carrier in each slot configured for CQI transmission (according CQI reporting on PUCCH) during the period from time point D until T5 expires,

the number of successful tests is increased by one.

Otherwise the number of failed tests is increased by one.
8. When T5 expires the SS shall change the SNR value to T1 as specified in Table 5.5.5.5-1.
9. Wait 1s for the UE to re-establish the connection or continue directly to step 10. If the UE re-establishes the connection within 1s continue to step 11. Otherwise continue to step 10.

- 10. Switch the UE on and off. Ensure the UE is in RRC\_CONNECTED with generic procedure parameters Connectivity *EN-DC*, DC bearer *MCG* and *SCG*, Connected without release *On* and Test Mode *On* according to TS 38.508-1 [14] clause 4.5.4.
- 11. Repeat steps 2-10 for all subtests until the confidence level according to Tables G.2.3-1 in Annex G clause G.2 is achieved.

5.5.5.4.3 Message contents

Message contents are according to TS 38.508-1 [14] clause 7.3 with the following exceptions:

**Table 5.5.5.4.3-1: Common Exception messages for EN-DC FR2 scheduling available restriction during SSB-based beam failure detection and link recovery in non-DRX**

Default Message Contents	
Common contents of system information blocks exceptions	
Default RRC messages and information elements contents exceptions	Table H.3.1-8 with condition SSB BFD Table H.3.1-10 with condition SSB Table H.3.1-10A

5.5.5.5.5 Test requirement

Tables 5.5.5.4.1-3 and 5.5.5.5-1 define the primary level settings including test tolerances for EN-DC FR2 scheduling available restriction during SSB-based beam failure detection and link recovery in non-DRX.

**Table 5.5.5.5-1: NR Cell specific test parameters for EN-DC FR2 scheduling available restriction during SSB-based beam failure detection and link recovery in non-DRX**

Parameter	Unit	Test 1				
		T1	T2	T3	T4	T5
AoA setup		Setup 1 defined in A. 9.1				
Assumption for UE beams <sup>Note 10</sup>		Rough				
EPRE ratio of PDCCH DMRS to SSS	dB	0				
EPRE ratio of PDCCH to PDCCH DMRS	dB					
EPRE ratio of PBCH DMRS to SSS	dB					
EPRE ratio of PBCH to PBCH DMRS	dB					
EPRE ratio of PSS to SSS	dB					
EPRE ratio of PDSCH DMRS to SSS	dB					
EPRE ratio of PDSCH to PDSCH DMRS	dB					
EPRE ratio of OCNG DMRS to SSS	dB					
EPRE ratio of OCNG to OCNG DMRS	dB					
SNR_SSB of set q <sub>0</sub>	Config 1-4 dB	13.7 <sup>Note 11,12</sup>	5.7 <sup>Note 11,12</sup>	-12	-12	-12
SNR_SSB of set q <sub>1</sub>	Config 1-4 dB	0.2	0.2	20 <sup>Note 12</sup>	20 <sup>Note 12</sup>	20 <sup>Note 12</sup>
SSB_RP of set q <sub>1</sub>	Config 1-2 dBm/	-104.5	-104.5	-84.7	-84.7	-84.7
	Config 3-4 SCS	-101.5	-101.5	-81.7	-81.7	-81.7
$N_{oc}$	Config 1-4 dBm/120K Hz	-104.7				
Propagation condition		TDL-A 30ns 75Hz				

NOTE 1:	OCNG shall be used such that the resources in Cell 1 are fully allocated and a constant total transmitted power spectral density is achieved for all OFDM symbols.
NOTE 2:	The uplink resources for CSI reporting are assigned to the UE prior to the start of time period T1.
NOTE 3:	NZP CSI-RS resource set configuration for CSI reporting are assigned to the UE prior to the start of time period T1.
NOTE 4:	Void
NOTE 5:	The timers and layer 3 filtering related parameters are configured prior to the start of time period T1.
NOTE 6:	The signal contains PDCCH for UEs other than the device under test as part of OCNG.
NOTE 7:	SNR levels correspond to the signal to noise ratio over the SSS REs.
NOTE 8:	The SNR in time periods T1, T2, T3, T4 and T5 is denoted as SNR1, SNR2 and SNR3 respectively in figure 5.5.5.5.4-1.
NOTE 9:	The SNR values are specified for testing a UE which supports 2RX on at least one band. For testing of a UE which supports 4RX on all bands, the SNR during T3 is modified as specified in clause D.4.
NOTE 10:	Information about types of UE beam is given in TS 38.133 clause B.2.1.3, and does not limit UE implementation or test system implementation
Note 11:	This value allows up to 1dB degradation from applied SNR to UE baseband
Note 12:	Including test tolerance given in Annex F.1.3.2.

The UE behaviour during time duration T3 follows the requirements defined in TS 38.133 [6] clause 8.5.7.3:

The UE is not expected to transmit PUCCH/PUSCH/SRS or receive PDCCH/PDSCH/CSI-RS for tracking/CSI-RS for CQI on BFD-RS symbols to be measured for beam failure detection.

The UE behaviour during time durations T4 and T5 follows the requirements defined in TS 38.133 [6] clause 8.5.8.3:

The UE is not expected to transmit PUCCH/PUSCH or receive PDCCH/PDSCH on reference symbols to be measured for candidate beam detection.

## 5.5.5.6 EN-DC FR2 CSI-RS-based BFD and LR for SCell in non-DRX

### Editor's Note:

- This test case is incomplete for Test frequency  $f > 40.8$  GHz
- This test case is incomplete for UE power class other than PC3.

### 5.5.5.6.1 Test purpose

The purpose of this test is to verify that the UE properly detects CSI-RS-based beam failure in the set  $q_0$  configured for an active SCell and that the UE performs correct CSI-RS-based link recovery based on beam candidate set  $q_1$ . The purpose is to test the downlink monitoring for beam failure detection within the UEs active DL BWP of the SCell with *schedulingRequestID-BFR-SCell-r16* configuration, during the evaluation period, and link recovery, when no DRX is used. This test will partly verify the CSI-RS based beam failure detection and link recovery for an FR2 SCell requirements in TS 38.133 [6] clause 8.5.

### 5.5.5.6.2 Test applicability

This test applies to all types of NR UE supporting E-UTRA and EN-DC from release 16 onwards supporting SCell BFR.

### 5.5.5.6.3 Minimum conformance requirements

The minimum conformance requirements are specified in clause 5.5.5.0.2 and 5.5.5.0.4.

The normative reference for this requirement is TS 38.133 [6] clause A.5.5.5.6.

### 5.5.5.6.4 Test description

There are three cells configured in this test. Cell 1 is the E-UTRAN PCell, Cell 2 is the PSCell and Cell 3 is the SCell. This test consists of five successive time periods, with time duration of T1, T2, T3, T4 and T5 respectively. Figure 5.5.5.6.4-1 shows the variation of the downlink SNR of the active SCell and the SNR of the CSI-RS in set  $q_0$  in the

active SCell to emulate CSI-RS based beam failure. Figure 5.5.5.6.4-1 additionally shows the variation of the downlink L1-RSRP of the CSI-RS in set  $q_1$  of the candidate beam used for link recovery.

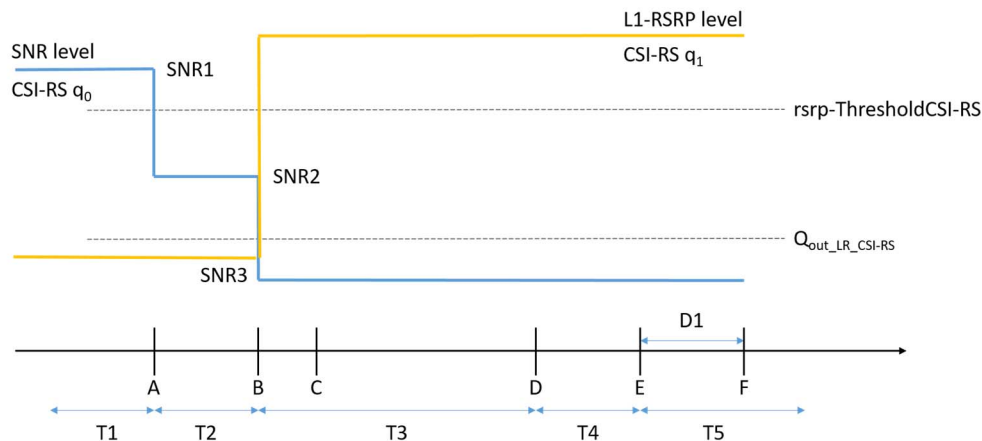

**Figure 5.5.5.6.4-1: SNR and L1-RSRP variation for CSI-RS based beam failure detection and link recovery testing for SCell in non-DRX mode**

5.5.5.6.4.1 Initial conditions

This test shall be tested using any of the test configurations in Table 5.5.5.6.4.1-1.

**Table 5.5.5.6.4.1-1: Supported test configurations for EN-DC FR2 SCell beam failure detection and link recovery testing in non-DRX**

Configuration	Description
5.5.5.6-1	LTE FDD, TDD duplex mode, 120 kHz SSB SCS, 100 MHz bandwidth
5.5.5.6-2	LTE TDD, TDD duplex mode, 120 kHz SSB SCS, 100 MHz bandwidth
Note:	The UE is only required to be tested in one of the supported test configurations

Configure the test equipment and the DUT according to the parameters in Table 5.5.5.6.4.1-2.

**Table 5.5.5.6.4.1-2: Initial conditions for EN-DC FR2 SCell beam failure detection and link recovery testing in non-DRX**

Parameter	Value	Comment
Test environment	NC	As specified in TS 38.508-1 [14] clause 4.1.
Test frequencies	As specified in Annex E, table E.5-1 and TS 38.508-1 [14] clause 4.3.1 for E-UTRA and 7.2.3 for NR.	
Channel bandwidth	As specified by the test configuration selected from Table 5.5.5.6.4.1-1.	
Propagation conditions	AWGN	As specified in Annex C.2.2.
Connection Diagram	TE Part	A.3.3.3.1
	DUT Part	A.3.4.1.1
Exceptions to connection diagram	N/A	

1. The general test parameter settings are set up according to Table 5.5.5.6.4.1-3.
2. Message contents are defined in clause 5.5.5.6.4.3.
3. There are one E-UTRAN cell and two NR cells specified in the test. E-UTRAN Cell 1 is the cell used for connection setup with the power level set according to Annex C.1.1 and C.1.2 for this test.

**Table 5.5.5.6.4.1-3: General test parameters for FR2 SCell for beam failure detection and link recovery testing in non-DRX mode**

Parameter		Test Config.	Unit	Value	Comment
				Test 1	
Active E-UTRA PCell		1-2		Cell 1	
E-UTRA RF Channel Number		1-2		1	
Active PCell		1-2		Cell 2	
RF Channel Number for PSCell		1-2		2	
Active SCell		1-2		Cell 3	
RF Channel Number for SCell		1-2		3	
Duplex mode		1-2		TDD	
TDD Configuration		1-2		TDDConf.3.1	
BW <sub>channel</sub>		1-2	MHz	100: N <sub>RB,c</sub> = 66	
Data RBs allocated		1-2		66	
PDSCH/PDCCH subcarrier spacing		1-2	kHz	120	
DL initial BWP configuration		1-2		DLBWP.0.1	
DL dedicated BWP configuration		1-2		DLBWP.1.1	
UL initial BWP configuration		1-2		ULBWP.0.1	
UL dedicated BWP configuration		1-2		ULBWP.1.1	
PDSCH Reference Channel		1-2		SR.3.2 TDD	
RMSI CORESET Reference Channel		1-2		CR.3.1 TDD	A.1.2.2
Dedicated CORESET Reference Channel		1-2		CCR.3.1 TDD	
OCNG parameters		1-2		OP.1	A.2.1
CP length		1-2		Normal	
PDSCH/PDCCH TCI state		1-2		TCI.State.0	
CSI-RS for tracking		1-2		TRS.2.1 TDD	
SSB Configuration		1-2		SSB.3 FR2	A.3
SMTC Configuration		1-2		SMTC.3	A.4
PRACH Configuration		1-2		FR2 PRACH configuration 4	Table A.7.2-1
DRX configuration		1-2		OFF	
CSI-RS configuration for BFD/CBD in activated SCell		1-2		CSI-RS.3.2 TDD	A.1.4.2
CSI-RS index assigned as BFD RS (q <sub>0</sub> ) in activated SCell		1-2		0	
CSI-RS index assigned as CBD RS (q <sub>1</sub> ) in activated SCell		1-2		1	
CSI-RS configuration for RLM in PSCell		1-2		CSI-RS.3.2 TDD	A.1.4.2
Beam failure detection transmission parameters	DCI format	1-2		1-0	
	Number of Control OFDM symbols	1-2		2	
	Aggregation level	1-2	CCE	8	
	Ratio of hypothetical PDCCH RE energy to average SSS RE energy	1-2	dB	0	
	Ratio of hypothetical PDCCH DMRS energy to average SSS RE energy	1-2	dB	0	
	DMRS precoder granularity	1-2		REG bundle size	
	REG bundle size	1-2		6	

Gap pattern ID	1-2		N/A	
schedulingRequestID-BFR-SCell-r16	1-2		Configured	
Periodicity of PUCCH for SR configuration for BFR on SCell	1-2	slot	40	5ms
Offset of PUCCH for SR configuration for BFR on SCell	1-2	slot	4	
PUCCH parameters for SR configuration for BFR on SCell	1-2		Table 8.3.3.1.2-1 in [28]	
rlmInSyncOutOfSyncThreshold	1-2		absent	Value 0 is applied. (Table 8.1.1-1 in TS 38.133 [6]).
rsrp-ThresholdSSB	1-2	dBm/SCS	-109 <sup>Note 2</sup>	Threshold used for $Q_{in\_LR\_SSB}$
powerControlOffsetSS	1-2		db0	Used for deriving rsrp-ThresholdCSI-RS
beamFailureInstanceMaxCount	1-2		n1	see TS 38.321 [7], clause 5.17
beamFailureDetectionTimer	1-2		pbfd4	see TS 38.321 [7], clause 5.17
CSI-RS configuration for CSI reporting	1-2		CSI-RS.3.1 TDD	A.1.4.2
reportConfigType	1-2		periodic	
reportQuantity	1-2		cri-RI-PMI-CQI	
CSI reporting periodicity	1-2	slot	40	
CSI reporting offset	1-2	slot	4	
T310	1-2	ms	1000	
N310	1-2		2	
T1	1-2	s	1	The UE shall be fully synchronized to cell 1 during T1
T2	1-2	s	1.17	
T3	1-2	s	0.9	
T4	1-2	s	0	
T5	1-2	s	0.31	
D1	1-2	s	0.27	
Note 1: UE-specific PDCCH is not transmitted after T1 starts.				
Note 2: Including test tolerance given in Annex F.1.3.2				

#### 5.5.5.6.4.2 Test procedure

Prior to the start of the time duration T1, the UE shall be fully synchronized to Cell 1, Cell 2 and Cell 3. The UE shall be configured for periodic CSI reporting with a reporting periodicity defined in CSI-RS configuration. In the test, DRX configuration is not enabled. During the test the UE is scheduled to transmit continuously in UL.

1. Ensure the UE is in state RRC\_CONNECTED with generic procedure parameters Connectivity *EN-DC*, DC bearer *MCG* and *SCG*, Connected without release *On* and Test Mode *On* according to TS 38.508-1 [14] clause 4.5.4.
2. The SS shall configure SCell (Cell 3) on the SCC as per TS 38.508-1 [14] clause 7.5.2, with the message content exceptions defined in clause 5.5.5.6.4.3. NR RRCReconfiguration message is contained in RRCConnectionReconfiguration and NR RRCReconfigurationComplete message is contained in RRCConnectionReconfigurationComplete.
3. The SS activates SCC by sending the activation MAC-CE (Refer TS 38.321 [12], clauses 5.9, 6.1.3.10).
4. Set the parameters of NR Cell 2 and Cell 3 according to T1 in Table 5.5.5.6.5-1. Propagation conditions are set according to Annex C.2.3. T1 starts.
5. When T1 expires the SS shall change the SNR value to T2 as specified in Table 5.5.5.6.5-1. T2 starts.
6. When T2 expires the SS shall change the SNR value to T3 as specified in Table 5.5.5.6.5-1. T3 starts.
7. When T3 expires the SS shall change the SNR value to T4 as specified in Table 5.5.5.6.5-1. T4 starts.
8. When T4 expires the SS shall change the SNR value to T5 as specified in Table 5.5.5.6.5-1. T5 starts.



9. If the SS:

- a) detects uplink power on NR in each slot configured for CSI transmission (according CSI reporting on PUCCH) during the period from time point A to time point B; and
- b) does not detect PUCCH with LRR before time point B, and
- c) detects PUCCH with LRR, followed by BFR MAC CE containing a beam associated with the candidate beam set  $q_1$  before time point F (D1 after the start of T5),

the number of successful tests is increased by one.

Otherwise the number of failed tests is increased by one.

10. When T5 expires the SS shall change the SNR value to T1 as specified in Table 5.5.5.6.5-1.

11. If the iteration fails, the SS shall first attempt to release and add the FR2 SCell. If that also fails, then the UE is switched OFF/ON to proceed with the next iteration, and ensure the UE is in state RRC\_CONNECTED with generic procedure parameters Connectivity *EN-DC*, DC bearer *MCG* and *SCG*, Connected without release *On* and Test Mode *On* according to TS 38.508-1 [14] clause 4.5.4.

12. Repeat steps 2-11 for all subtests until the confidence level according to Tables G.2.3-1 in Annex G clause G.2 is achieved.

5.5.5.6.4.3 Message contents

Message contents are according to TS 38.508-1 [14] clause 7.3 with the following exceptions:

**Table 5.5.5.6.4.3-1: Common Exception messages for EN-DC FR2 SCell for beam failure detection and link recovery testing in non-DRX mode**

Default Message Contents	
Common contents of system information blocks exceptions	
Default RRC messages and information elements contents exceptions	Table H.3.1-8 with Condition CSI-RS BFD Table H.3.1-12 on Cell 3 Table H.3.1-13 on Cell 3

**Table 5.5.5.6.4.3-2: MAC-CellGroupConfig**

Derivation Path: TS 38.508-1 [14], Table 4.6.3-68			
Information Element	Value/remark	Comment	Condition
MAC-CellGroupConfig ::= SEQUENCE {			
schedulingRequestID-BFR-SCell-r16	SchedulingRequestId		
}			

**Table 5.5.5.6.4.3-3: SchedulingRequestResourceConfig**

Derivation Path: TS 38.508-1 [14], Table 4.6.3-157			
Information Element	Value/remark	Comment	Condition
SchedulingRequestResourceConfig ::= SEQUENCE {			
periodicityAndOffset CHOICE {			
sl40	4		
}			
}			

5.5.5.6.5 Test requirement

Tables 5.5.5.6.4.1-3 and 5.5.5.6.5-1 define the primary level settings including test tolerances for EN-DC FR2 SCell for beam failure detection and link recovery testing in non-DRX.

**Table 5.5.6.5-1: NR Cell specific test parameters for EN-DC FR2 SCell for beam failure detection and link recovery testing in non-DRX mode**

Parameter		Unit	Cell2 T1 to T5	Cell3 Test 1				
				T1	T2	T3	T4	T5
AoA setup			Setup 1 defined in A.9.1	Setup 1 defined in A.9.1				
Assumption for UE beams <sup>Note 10</sup>			Rough	Rough				
EPRE ratio of PDCCH DMRS to SSS		dB	0	0				
EPRE ratio of PDCCH to PDCCH DMRS		dB						
EPRE ratio of PBCH DMRS to SSS		dB						
EPRE ratio of PBCH to PBCH DMRS		dB						
EPRE ratio of PSS to SSS		dB						
EPRE ratio of PDSCH DMRS to SSS		dB						
EPRE ratio of PDSCH to PDSCH DMRS		dB						
EPRE ratio of OCNG DMRS to SSS		dB						
EPRE ratio of OCNG to OCNG DMRS		dB						
SNR_CSI-RS of set $q_0$	Config 1	dB						
SNR_CSI-RS of set $q_1$	Config 1	dB	0.2	0.2	0.2	20	20	20
CSI-RS_RP of set $q_1$	Config 1	dBm/S CS kHz	-104.5	-104.5	-104.5	-84.7	-84.7	-84.7
$N_{oc}$	Config 1	dBm/12 0kHz	-104.7	-104.7				
Propagation condition			TDL-A 30ns 75Hz	TDL-A 30ns 75Hz				
<p>Note 1: OCNG shall be used such that the resources in Cell 1 are fully allocated and a constant total transmitted power spectral density is achieved for all OFDM symbols.</p> <p>Note 2: The uplink resources for CSI reporting are assigned to the UE prior to the start of time period T1.</p> <p>Note 3: NZP CSI-RS resource set configuration for CSI reporting are assigned to the UE prior to the start of time period T1.</p> <p>Note 4: Void</p> <p>Note 5: The timers and layer 3 filtering related parameters are configured prior to the start of time period T1.</p> <p>Note 6: The signal contains PDCCH for UEs other than the device under test as part of OCNG.</p> <p>Note 7: SNR levels correspond to the signal to noise ratio over the REs carrying CSI-RS.</p> <p>Note 8: The SNR in time periods T1, T2, T3, T4 and T5 is denoted as SNR1, SNR2 and SNR3 respectively in figure 5.5.6.4-1.</p> <p>Note 9: The SNR values are specified for testing a UE which supports 2RX on at least one band. For testing of a UE which supports 4RX on all bands, the SNR during T3 is modified as specified in clause D.4.</p> <p>Note 10: Information about types of UE beam is given in B.2.1.3 in TS 38.133 [6], and does not limit UE implementation or test system implementation</p>								

The UE behaviour during time durations T1, T2, T3, T4 and T5 shall be as follows:

During the time duration T1 and T2, the UE shall transmit uplink signal at least in all subframes configured for CSI transmission on Cell 2.

During the period from time point A to time point B the UE shall transmit uplink signal in Cell 2 in all uplink slots configured for CSI transmission according to the configured periodic CSI reporting for Cell 2.

During T3 the UE shall detect beam failure and initial link recovery. During T4 and T5 the UE measures and evaluates beam candidate from beam candidate set  $q_1$ .

No later than time point F occurring no later than  $D1 = 260 + 10$  ms after the start of T5, the UE shall transmit PUCCH with LRR, followed by BFR MAC CE containing a beam associated with the candidate beam set  $q_1$ . The UE shall not transmit PUCCH with an LRR with the candidate beam set  $q_1$  earlier than time point B.

Test is concluded once the test equipment has received the initial preamble transmission from the UE. The rate of correct events observed during repeated tests shall be at least 90%.

### 5.5.5.7 EN-DC FR2 SCell CSI-RS-based beam failure detection and link recovery in DRX

**Editor's Note:** This test case is incomplete for Test frequency  $f > 40.8$  GHz

- This test case is incomplete for UE power class other than PC3.

#### 5.5.5.7.1 Test purpose

The purpose of this test is to verify that the UE properly detects CSI-RS-based beam failure in the set  $q_0$  configured for an active SCell and that the UE performs correct CSI-RS-based link recovery based on beam candidate set  $q_1$ . The purpose is to test the downlink monitoring for beam failure detection within the UE's active DL BWP of the SCell with *schedulingRequestID-BFR-SCell-r16* configuration, during the evaluation period, and link recovery, when DRX is used. This test will partly verify the CSI-RS based beam failure detection and link recovery for an FR2 SCell requirements in TS 38.133 [6] clause 8.5.

#### 5.5.5.7.2 Test applicability

This test applies to all types of NR UE supporting E-UTRA and EN-DC from release 16 onwards supporting SCell BFR.

#### 5.5.5.7.3 Minimum conformance requirements

The minimum conformance requirements are specified in clause 5.5.5.0.2 and 5.5.5.0.4.

The normative reference for this requirement is TS 38.133 [6] clause A.5.5.7.

#### 5.5.5.7.4 Test description

There are three cells configured in this test. Cell 1 is the E-UTRAN PCell, Cell 2 is the PSCell and Cell 3 is the SCell. This test consists of five successive time periods, with time duration of T1, T2, T3, T4 and T5 respectively. Figure 5.5.5.7.4-1 shows the variation of the downlink SNR of the active SCell and the SNR of the CSI-RS in set  $q_0$  in the active SCell to emulate CSI-RS based beam failure. Figure 5.5.5.7.4-1 additionally shows the variation of the downlink L1-RSRP of the CSI-RS in set  $q_1$  of the candidate beam used for link recovery.

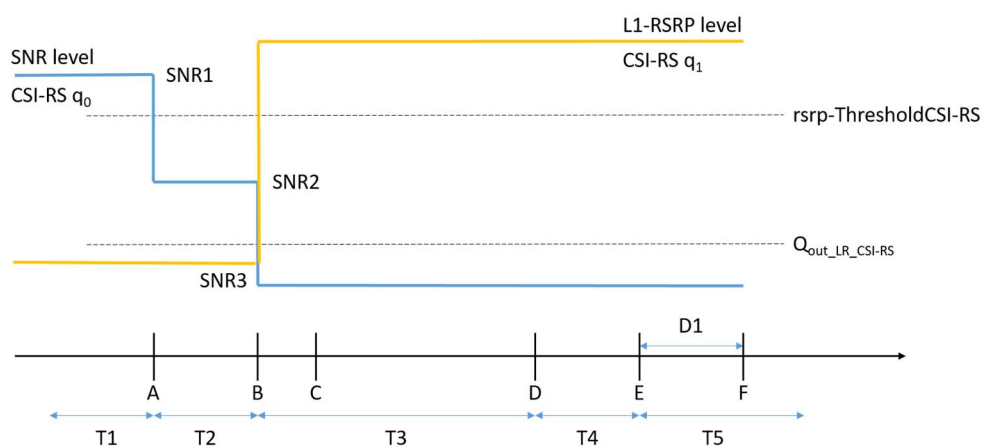

**Figure 5.5.5.7.4-1: SNR and L1-RSRP variation for CSI-RS based beam failure detection and link recovery testing for SCell in DRX mode**

5.5.5.7.4.1 Initial conditions

This test shall be tested using any of the test configurations in Table 5.5.5.7.4.1-1.

**Table 5.5.5.7.4.1-1: Supported test configurations for EN-DC FR2 SCell beam failure detection and link recovery testing in DRX**

Configuration	Description
5.5.5.7-1	LTE FDD, TDD duplex mode, 120 kHz SSB SCS, 100 MHz bandwidth
5.5.5.7-2	LTE TDD, TDD duplex mode, 120 kHz SSB SCS, 100 MHz bandwidth
Note:	The UE is only required to be tested in one of the supported test configurations

Configure the test equipment and the DUT according to the parameters in Table 5.5.5.7.4.1-2.

**Table 5.5.5.7.4.1-2: Initial conditions for EN-DC FR2 SCell beam failure detection and link recovery testing in DRX**

Parameter	Value		Comment
Test environment	NC		As specified in TS 38.508-1 [14] clause 4.1.
Test frequencies	As specified in Annex E, table E.5-1 and TS 38.508-1 [14] clause 4.3.1 for E-UTRA and 7.2.3 for NR.		
Channel bandwidth	As specified by the test configuration selected from Table 5.5.5.7.4.1-1.		
Propagation conditions	AWGN		As specified in Annex C.2.2.
Connection Diagram	TE Part	A.3.3.3.1	As specified in TS 38.508-1 [14] Annex A.
	DUT Part	A.3.4.1.1	
Exceptions to connection diagram	N/A		

1. The general test parameter settings are set up according to Table 5.5.5.7.4.1-3.
2. Message contents are defined in clause 5.5.5.7.4.3.
3. There are one E-UTRAN cell and two NR cells specified in the test. E-UTRAN Cell 1 is the cell used for connection setup with the power level set according to Annex C.1.1 and C.1.2 for this test.

**Table 5.5.5.7.4.1-3: General test parameters for FR2 SCell for beam failure detection and link recovery testing in DRX mode**

Parameter	Test Config.	Unit	Value	Comment
			Test 1	

Active E-UTRA PCell	1-2		Cell 1	
E-UTRA RF Channel Number	1-2		1	
Active PCell	1-2		Cell 2	
RF Channel Number for PSCell	1-2		2	
Active SCell	1-2		Cell 3	
RF Channel Number for SCell	1-2		3	
Duplex mode	1-2		TDD	
TDD Configuration	1-2		TDDConf.3.1	
$BW_{channel}$	1-2	MHz	100: $N_{RB,c} = 66$	
Data RBs allocated	1-2		66	
PDSCH/PDCCH subcarrier spacing	1-2	kHz	120	
DL initial BWP configuration	1-2		DLBWP.0.1	
DL dedicated BWP configuration	1-2		DLBWP.1.1	
UL initial BWP configuration	1-2		ULBWP.0.1	
UL dedicated BWP configuration	1-2		ULBWP.1.1	
PDSCH Reference Channel	1-2		SR.3.2 TDD	
RMSI CORESET Reference Channel	1-2		CR.3.1 TDD	A.1.2.2
Dedicated CORESET Reference Channel	1-2		CCR.3.1 TDD	
OCNG parameters	1-2		OP.1	A.2.1
CP length	1-2		Normal	
PDSCH/PDCCH TCI state	1-2		TCI.State.0	
CSI-RS for tracking	1-2		TRS.2.1 TDD	
SSB Configuration	1-2		SSB.3 FR2	A.3
SMTC Configuration	1-2		SMTC.3	A.4
PRACH Configuration	1-2		FR2 PRACH configuration 4	Table A.7.2-1
DRX configuration	1-2		DRX.3	A.5
CSI-RS configuration for BFD/CBD in activated SCell	1-2		CSI-RS.3.2 TDD	A.1.4.2
CSI-RS index assigned as BFD RS ( $q_0$ ) in activated SCell	1-2		0	
CSI-RS index assigned as CBD RS ( $q_1$ ) in activated SCell	1-2		1	
CSI-RS configuration for RLM in PSCell	1-2		CSI-RS.3.2 TDD	A.1.4.2
Beam failure detection transmission parameters	DCI format	1-2	1-0	
	Number of Control OFDM symbols	1-2	2	
	Aggregation level	1-2	CCE	8
	Ratio of hypothetical PDCCH RE energy to average SSS RE energy	1-2	dB	0
	Ratio of hypothetical PDCCH DMRS energy to average SSS RE energy	1-2	dB	0
	DMRS precoder granularity	1-2		REG bundle size
REG bundle size	1-2		6	

Gap pattern ID	1-2		N/A	
schedulingRequestID-BFR-SCell-r16	1-2		Configured	
Periodicity of PUCCH for SR configuration for BFR on SCell	1-2	slot	40	5ms
Offset of PUCCH for SR configuration for BFR on SCell	1-2	slot	4	
PUCCH parameters for SR configuration for BFR on SCell	1-2		Table 8.3.3.1.2-1 in [28]	
rlmInSyncOutOfSyncThreshold	1-2		absent	Value 0 is applied. (Table 8.1.1-1 in TS 38.133 [6]).
rsrp-ThresholdSSB	1-2	dBm/SCS	-109 <sup>Note 2</sup>	Threshold used for $Q_{in\_LR\_SSB}$
powerControlOffsetSS	1-2		db0	Used for deriving rsrp-ThresholdCSI-RS
beamFailureInstanceMaxCount	1-2		n1	see TS 38.321 [12], clause 5.17
beamFailureDetectionTimer	1-2		pbfd4	see TS 38.321 [12], clause 5.17
CSI-RS configuration for CSI reporting	1-2		CSI-RS.3.1 TDD	A.1.4.2
reportConfigType	1-2		periodic	
reportQuantity	1-2		cri-RI-PMI-CQI	
CSI reporting periodicity	1-2	slot	40	
CSI reporting offset	1-2	slot	4	
T310	1-2	ms	1000	
N310	1-2		2	
T1	1-2	s	1	The UE shall be fully synchronized to cell 1 during T1
T2	1-2	s	5.43	
T3	1-2	s	5.16	
T4	1-2	s	0	
T5	1-2	s	0.31	
D1	1-2	s	0.27	
Note 1: UE-specific PDCCH is not transmitted after T1 starts.				
Note 2: Including test tolerance given in Annex F.1.3.2				

#### 5.5.5.7.4.2 Test procedure

Prior to the start of the time duration T1, the UE shall be fully synchronized to Cell 1, Cell 2 and Cell 3. The UE shall be configured for periodic CSI reporting with a reporting periodicity defined in CSI-RS configuration. In the test, DRX configuration is enabled in PCell and DRX inactivity timer has already been expired, i.e. UE tries to decode PDCCH and to send periodic CQI during the period when On-duration timer is running. Time alignment timers shall be set to “infinity” so that UL timing alignment is maintained during the test. During the test the UE is scheduled to transmit continuously in UL.

1. Ensure the UE is in state RRC\_CONNECTED with generic procedure parameters Connectivity *EN-DC*, DC bearer *MCG* and *SCG*, Connected without release *On* and Test Mode *On* according to TS 38.508-1 [14] clause 4.5.4.
2. The SS shall configure SCell (Cell 3) on the SCC as per TS 38.508-1 [14] clause 7.5.2, with the message content exceptions defined in clause 5.5.5.7.4.3. NR RRCReconfiguration message is contained in RRCConnectionReconfiguration and NR RRCReconfigurationComplete message is contained in RRCConnectionReconfigurationComplete.
3. The SS activates SCC by sending the activation MAC-CE (Refer TS 38.321 [12], clauses 5.9, 6.1.3.10).
4. Set the parameters of NR Cell 2 and Cell 3 according to T1 in Table 5.5.5.7.5-1. Propagation conditions are set according to Annex C.2.3. T1 starts.
5. When T1 expires the SS shall change the SNR value to T2 as specified in Table 5.5.5.7.5-1. T2 starts.
6. When T2 expires the SS shall change the SNR value to T3 as specified in Table 5.5.5.7.5-1. T3 starts.

7. When T3 expires the SS shall change the SNR value to T4 as specified in Table 5.5.5.7.5-1. T4 starts.
8. When T4 expires the SS shall change the SNR value to T5 as specified in Table 5.5.5.7.5-1. T5 starts.
9. If the SS:
  - a) detects uplink power on NR carrier in each slot configured for CSI transmission (according CSI reporting on PUCCH) during the period from time point A to time point B; and
  - b) does not detect PUCCH with LRR before time point B, and
  - c) detects PUCCH with LRR, followed by BFR MAC CE containing a beam associated with the candidate beam set  $q_1$  before time point F (D1 after the start of T5),

the number of successful tests is increased by one.

Otherwise the number of failed tests is increased by one.
10. When T5 expires the SS shall change the SNR value to T1 as specified in Table 5.5.5.7.5-1.
11. If the iteration fails, the SS shall first attempt to release and add the FR2 SCell. If that also fails, then the UE is switched OFF/ON to proceed with the next iteration, and ensure the UE is in state RRC\_CONNECTED with generic procedure parameters Connectivity *EN-DC*, DC bearer *MCG* and *SCG*, Connected without release *On* and Test Mode *On* according to TS 38.508-1 [14] clause 4.5.4.
12. Repeat steps 2-11 for all subtests until the confidence level according to Tables G.2.3-1 in Annex G clause G.2 is achieved.

5.5.5.7.4.3 Message contents

Message contents are according to TS 38.508-1 [14] clause 7.3 with the following exceptions:

**Table 5.5.5.7.4.3-1: Common Exception messages for EN-DC FR2 SCell for beam failure detection and link recovery testing in DRX mode**

Default Message Contents	
Common contents of system information blocks exceptions	
Default RRC messages and information elements contents exceptions	Table H.3.1-8 with Condition CSI-RS BFD Table H.3.1-12 on Cell 3 Table H.3.1-13 on Cell 3 Table H.3.7-1 with condition DRX.3

**Table 5.5.5.7.4.3-2: MAC-CellGroupConfig**

Derivation Path: TS 38.508-1 [14], Table 4.6.3-68			
Information Element	Value/remark	Comment	Condition
MAC-CellGroupConfig ::= SEQUENCE {			
schedulingRequestID-BFR-SCell-r16	SchedulingRequestId		
}			

**Table 5.5.5.7.4.3-3: SchedulingRequestResourceConfig**

Derivation Path: TS 38.508-1 [14], Table 4.6.3-157			
Information Element	Value/remark	Comment	Condition
SchedulingRequestResourceConfig ::= SEQUENCE {			
periodicityAndOffset CHOICE {			
sl40	4		
}			
}			

## 5.5.5.7.5 Test requirement

Tables 5.5.5.7.4.1-3 and 5.5.5.7.5-1 define the primary level settings including test tolerances for EN-DC FR2 SCell for beam failure detection and link recovery testing in DRX.

**Table 5.5.5.7.5-1: NR Cell specific test parameters for EN-DC FR2 SCell for beam failure detection and link recovery testing in DRX mode**

Parameter		Unit	Cell2 T1 to T5	Cell3 Test 1				
				T1	T2	T3	T4	T5
AoA setup			Setup 1 defined in A.9.1	Setup 1 defined in A.9.1				
Assumption for UE beams <sup>Note 10</sup>			Rough	Rough				
EPRE ratio of PDCCH DMRS to SSS		dB	0	0				
EPRE ratio of PDCCH to PDCCH DMRS		dB						
EPRE ratio of PBCH DMRS to SSS		dB						
EPRE ratio of PBCH to PBCH DMRS		dB						
EPRE ratio of PSS to SSS		dB						
EPRE ratio of PDSCH DMRS to SSS		dB						
EPRE ratio of PDSCH to PDSCH DMRS		dB						
EPRE ratio of OCNG DMRS to SSS		dB						
EPRE ratio of OCNG to OCNG DMRS		dB						
SNR_CSI-RS of set $q_0$	Config 1	dB						
SNR_CSI-RS of set $q_1$	Config 1	dB	0.2	0.2	0.2	20	20	20
CSI-RS_RP of set $q_1$	Config 1	dBm/S CS kHz	-104.5	-104.5	-104.5	-84.7	-84.7	-84.7
$N_{oc}$	Config 1	dBm/12 0kHz	-104.7	-104.7				
Propagation condition			TDL-A 30ns 75Hz	TDL-A 30ns 75Hz				
<p>Note 1: OCNG shall be used such that the resources in Cell 1 are fully allocated and a constant total transmitted power spectral density is achieved for all OFDM symbols.</p> <p>Note 2: The uplink resources for CSI reporting are assigned to the UE prior to the start of time period T1.</p> <p>Note 3: NZP CSI-RS resource set configuration for CSI reporting are assigned to the UE prior to the start of time period T1.</p> <p>Note 4: Void</p> <p>Note 5: The timers and layer 3 filtering related parameters are configured prior to the start of time period T1.</p> <p>Note 6: The signal contains PDCCH for UEs other than the device under test as part of OCNG.</p> <p>Note 7: SNR levels correspond to the signal to noise ratio over the REs carrying CSI-RS.</p> <p>Note 8: The SNR in time periods T1, T2, T3, T4 and T5 is denoted as SNR1, SNR2 and SNR3 respectively in figure 5.5.5.7.4-1.</p> <p>Note 9: The SNR values are specified for testing a UE which supports 2RX on at least one band. For testing of a UE which supports 4RX on all bands, the SNR during T3 is modified as specified in clause D.4.</p> <p>Note 10: Information about types of UE beam is given in B.2.1.3 in TS 38.133 [6], and does not limit UE implementation or test system implementation</p>								

The UE behaviour during time durations T1, T2, T3, T4 and T5 shall be as follows:

During the time duration T1 and T2, the UE shall transmit uplink signal at least in all subframes configured for CSI transmission on Cell 2.



During the period from time point A to time point B the UE shall transmit uplink signal in Cell 2 in all uplink slots configured for CSI transmission according to the configured periodic CSI reporting for Cell 2.

During T3 the UE shall detect beam failure and initial link recovery. During T4 and T5 the UE measures and evaluates beam candidate from beam candidate set  $q_1$ .

No later than time point F occurring no later than  $D1 = 260+10$  ms after the start of T5, the UE shall transmit PUCCH with LRR, followed by BFR MAC CE containing a beam associated with the candidate beam set  $q_1$ . The UE shall not transmit PUCCH with an LRR with the candidate beam set  $q_1$  earlier than time point B.

Test is concluded once the test equipment has received the initial preamble transmission from the UE. The rate of correct events observed during repeated tests shall be at least 90%.

## 5.5.6 Active BWP switch delay

### 5.5.6.1 DCI-based and time-based active BWP switch

#### 5.5.6.1.0 Minimum conformance requirements

FFS

#### 5.5.6.1.1 EN-DC FR2 DCI-based DL active BWP switch in non-DRX in synchronous EN-DC

*Editor's note: This test case is incomplete. The following aspects are either missing or TBD*

*- Test tolerance analysis is missing*

*- Message contents are TBD*

*- Cell mapping is TBD*

*- Test procedure is TBD*

*- Test applicability needs to be added to TS 38.522*

##### 5.5.6.1.1.1 Test purpose

FFS

##### 5.5.6.1.1.2 Test applicability

FFS

##### 5.5.6.1.1.3 Minimum conformance requirements

The minimum conformance requirements are specified in clause 5.5.6.1.0.1.

The normative reference for this requirement is TS 38.133 [6] clause A.5.5.6.1.1.

##### 5.5.6.1.1.4 Test description

###### 5.5.6.1.1.4.1 Initial conditions

FFS

###### 5.5.6.1.1.4.2 Test procedure

FFS

###### 5.5.6.1.1.4.3 Message contents

FFS

5.5.6.1.1.5 Test requirements

FFS

5.5.6.1.2 EN-DC FR2 DCI-based DL active BWP switch with SCell in non-DRX in synchronous EN-DC

*Editor's note: This test case is incomplete. The following aspects are either missing or TBD*

*- Test tolerance analysis is missing*

*- Message contents are TBD*

*- Cell mapping is TBD*

*- Test procedure is TBD*

*- Test applicability needs to be added to TS 38.522*

5.5.6.1.2.1 Test purpose

FFS

5.5.6.1.2.2 Test applicability

FFS

5.5.6.1.2.3 Minimum conformance requirements

The minimum conformance requirements are specified in clause 5.5.6.1.0.2.

The normative reference for this requirement is TS 38.133 [6] clause A.5.5.6.1.2.

5.5.6.1.2.4 Test description

5.5.6.1.2.4.1 Initial conditions

FFS

5.5.6.1.2.4.2 Test procedure

FFS

5.5.6.1.2.4.3 Message contents

FFS

5.5.6.1.2.5 Test requirements

FFS

5.5.6.2 RRC-based active BWP switch

The requirements in this clause apply for a UE configured with more than one BWP on PSCell or any activated SCell in SCG in EN-DC. UE shall complete the switch of active DL and/or UL BWP within the delay defined in this clause.

5.5.6.2.0 Minimum conformance requirements

The requirements in this clause only apply to the case that the BWP switch is performed on a single CC with one or more than one BWP configuration(s) configured, with

- Active BWP switch or parameter change of its active BWPs for SpCell
- Parameter change of its active BWPs except parameter *firstActiveDownlinkBWP-Id* and *firstActiveUplinkBWP-Id* for SCell

For RRC-based BWP switch, after the UE receives BWP switching request, UE shall be able to receive PDSCH/PDCCH (for DL active BWP switch) or transmit PUSCH (for UL active BWP switch) on the new BWP on the serving cell on which BWP switch occurs on the first DL or UL slot right after the beginning of DL slot  $n + \frac{T_{RRCprocessingDelay} + T_{BWPswitchDelayRRC}}{NR\ Slot\ length}$ , where

DL slot  $n$  is the last slot overlapping with the PDSCH containing the RRC command, and

*NR Slot length* is determined by the smaller SCS between the SCS before BWP switch and the SCS after BWP switch if the BWP switch involves changing of SCS.

$T_{RRCprocessingDelay}$  is the length of the RRC procedure delay in millisecond as defined in clause 11.2 in TS 36.331 [29] if the corresponding RRC message is embedded in E-UTRA RRC message, otherwise it is the length of the RRC procedure delay in ms as defined in clause 12 in TS 38.331 [2], and

$T_{BWPswitchDelayRRC} = 6ms$  is the time used by the UE to perform BWP switch.

The UE is not required to transmit UL signals or receive DL signals during the time defined by  $T_{RRCprocessingDelay} + T_{BWPswitchDelayRRC}$  on the cell where RRC-based BWP switch occurs. When  $T_{HARQ} > T_{RRCprocessingDelay}$  a longer switching delay is allowed. Where  $T_{HARQ}$  is the time between DL data transmission and acknowledgement as specified in TS 38.213 [8].

#### 5.5.6.2.1 EN-DC FR2 RRC-based DL active BWP switch in non-DRX in synchronous EN-DC

*Editor's note: This test case is incomplete. The following aspects are either missing or TBD*

- *Test tolerance analysis is missing*
- *Message contents are TBD*
- *Cell mapping is TBD*
- *Test applicability needs to be added to TS 38.522*

##### 5.5.6.2.1.1 Test purpose

The purpose of this test is to verify the DL BWP switch delay requirement for RRC-based BWP switch defined in clause 5.5.6.2.0.1. Supported test configurations are shown in Table 5.5.6.2.1.4.1-1.

##### 5.5.6.2.1.2 Test applicability

This test applies to all types of E-UTRA UE release 15 and forward, supporting EN-DC.

##### 5.5.6.2.1.3 Minimum conformance requirements

The minimum conformance requirements are specified in clause 5.5.6.2.0.1.

The normative reference for this requirement is TS 38.133 [6] clause A.5.5.6.2.1.

##### 5.5.6.2.1.4 Test description

##### 5.5.6.2.1.4.1 Initial conditions

Initial conditions are a set of test configurations the UE needs to be tested in and the steps for the SS to take with the UE to reach the correct measurement state.

The initial test configurations consist of environmental conditions, test frequencies, test channel bandwidths and sub-carrier spacing based on NR operating bands specified in Table 5.3.5-1 of 38.521-2 [18].

This test shall be tested using any of the test configurations in Table 5.5.6.2.1.4.1-1.

**Table 5.5.6.2.1.4.1-1: DL BWP switch supported test configurations**

Config	Description
1	LTE FDD, NR 120 kHz SSB SCS, 100 MHz bandwidth, TDD duplex mode
2	LTE TDD, NR 120 kHz SSB SCS, 100 MHz bandwidth, TDD duplex mode
NOTE 1: The UE is only required to be tested in one of the supported test configurations	

Configure the test equipment and the DUT according to the parameters in Table 5.5.6.2.1.4.1-2

**Table 5.5.6.2.1.4.1-2: Initial conditions for EN-DC FR2 RRC-based DL active BWP switch in non-DRX in synchronous EN-DC**

Parameter	Value	Comment
Test environment	NC	As specified in TS 38.508-1 [14] clause 4.1.
Test frequencies	As specified in Annex E.1.1, Table E.2-1 and TS 38.508-1 [14] clause 4.3.1 for E-UTRA and 7.2.3 for NR.	
Channel bandwidth	As specified by the test configuration selected from Table 5.5.1.1.4.1-1	
Propagation conditions	AWGN	As specified in clause C.2.2.
Connection Diagram	TE Part	A.3.3.1.1
	DUT Part	A.3.4.1.1
Exceptions to connection diagram	N/A	

1. Message contents are defined in clause 5.5.6.2.1.4.3.
2. The power levels and settings for Cell 1 are set according to Annex A.6, Table A.6.1.1-1. Cell 2 is NR FR2 PSCell. The connection setup is done according to the settings in Annex [C.x], and the downlink signal levels as per Annex [C.x]
3. The test parameters are given in Table 5.5.6.2.1.4.1-3 below.
4. Downlink signals for NR cell are initially set up according to Annex [C.x].

**Table 5.5.6.2.1.4.1-3: General test parameters for DL BWP switch in synchronous EN-DC**

Parameter	Unit	Value	Comment
E-UTRA RF Channel Number		1	One E-UTRA radio channel is used for this test
NR RF Channel Number		2	One NR radio channel is used for this test
Active PCell		Cell 1	PCell on RF channel number 1.
Active PSCell		Cell 2	PSCell on RF channel number 2.
CP length		Normal	
DRX		OFF	
Cell-individual offset for cells on RF channel number 1	dB	0	Individual offset for cells on PCC.
Cell-individual offset for cells on RF channel number 2	dB	0	Individual offset for cells on PSCC.
Cell2 timing offset to cell1	μs	3	Synchronous EN-DC
T1	s	[0.2]	

#### 5.5.6.2.1.4.2 Test procedure

The test consists of two cells, a single E-UTRA cell (PCell), and a single NR cell (PSCell). Prior to the start of the test, the UE shall be fully synchronized to PSCell. The UE shall be configured for parameters as mentioned in the Table 5.5.6.2.1.4.1-3.

1. Ensure the UE is in state RRC\_CONNECTED with generic procedure parameters *Connectivity* EN-DC, DC bearer MCG and SCG, Connected without release *On* according to TS 38.508-1 [6] clause 5.5.
2. PDCCHs indicating new transmissions shall be sent continuously on PCell (Cell 1) to ensure that the UE will have ACK/NACK sending.
3. The SS shall send an *RRCCONNECTIONRECONFIGURATION* message releasing the dedicated configuration of the *initialDownlinkBWP* and the *initialUplinkBWP*. This message also configures another UE-specific bandwidth part, BWP-1, and indicates BWP-1 as the active DL BWP using *firstActiveDownlinkBWP-Id*, according to the initial condition of Active BWP-1 in Table 5.5.6.2.1.5-1.
4. The UE shall transmit an *RRCCONNECTIONRECONFIGURATIONCOMPLETE* message.
5. Before the test starts UE is connected to Cell 1 (PCell) on radio channel 1 (PCC) and to Cell 2 (PSCell) on radio channel 2 (PSCC).
6. Before the test starts UE has bandwidth part BWP-1 in its RRC-configuration for Cell 2 (PSCell).
7. Before the test starts UE is indicated in *firstActiveDownlinkBWP-Id* that the active DL BWP is BWP-1 in PSCell.
8. Ensure all cells have constant signal levels throughout the test.
9. The test consists of 1 time period, with duration of T1.
10. Time period T1 starts when a *RRCCONNECTIONRECONFIGURATION* with bandwidth part configuration BWP-2, sent from the test equipment to the UE, is received at the UE side in PSCell's slot # denoted *i*. The UE shall switch its bandwidth part from BWP-1 to BWP-2.
11. If the UE starts to report valid ACK/NACK for PSCell from the first UL slot that occurs after the beginning of DL slot  $i+208+k_1$  then the number of successful tests is increased by one. Otherwise, the number of failure tests is increased by one.
12. After the SS receives the ACK/NACK in step 9) or when T1 expires, the SS shall transmit *RRCCONNECTIONRECONFIGURATION* message with condition EN-DC\_PSCell\_Rel according to TS 36.508 [25] Table 4.6.1-8 to release NR cell (PSCell). The UE shall transmit *RRCCONNECTIONRECONFIGURATIONCOMPLETE* message.
13. The SS shall transmit *RRCCONNECTIONRECONFIGURATION* message with condition MCG\_and\_SCG according to TS 36.508 [25] Table 4.6.1-8 to add NR cell (PSCell). The UE shall transmit *RRCCONNECTIONRECONFIGURATIONCOMPLETE* message. If either of the reconfiguration in step 10 or step 11 fails, switch off and on the UE and go to step 1.
14. Repeat steps 2-13 until the confidence level according to Tables G.2.3-1 in Annex G clause G.2 is achieved.

#### 5.5.6.2.1.4.3 Message contents

FFS

#### 5.5.6.2.1.5 Test requirements

During T1, the UE shall be ready for the reception of uplink grant for PSCell in a slot  $i +$

$\frac{T_{\text{RRCprocessingDelay}} + T_{\text{BWPSwitchDelayRRC}}}{\text{NR Slot length}}$ , and starts to report valid ACK/NACK for the PSCell from the first UL slot that occurs after the beginning of DL slot  $i + \frac{T_{\text{RRCprocessingDelay}} + T_{\text{BWPSwitchDelayRRC}}}{\text{NR Slot length}} + k_1$ , where,

$T_{\text{RRCprocessingDelay}} = 20$  ms, is the RRC procedure delay in ms as defined in clause 11.2 in TS 36.331 [29];

$T_{\text{BWPSwitchDelayRRC}} = 6$  ms, is the time used by the UE to perform BWP switch;

NR slot length = 0.125 ms for SCS = 120 kHz.

$k_1$  is the timing between DL data receiving and acknowledgement as specified in [12].

Which gives  $\frac{T_{RRCprocessingDelay} + T_{BWPswitchDelayRRC}}{NR\ Slot\ length} = 208\ slots.$

All of the above test requirements shall be fulfilled in order for the observed PSCell active BWP switch delay to be counted as correct.

The rate of correct events observed during repeated tests shall be at least 90%.

**Table 5.5.6.2.1.5-1: NR Cell specific test parameters for DL BWP switch in synchronous EN-DC**

Parameter	Unit	Cell 2
Frequency Range		FR2
Duplex mode		TDD
TDD configuration		TDDConf.3.1
BW <sub>channel</sub>		100 MHz: N <sub>RB,c</sub> = 66
Active BWP ID		1, 2
Initial DL BWP Configuration		DLBWP.0.2
Active DL BWP-1 Configuration		DLBWP.1.3
Active DL BWP-2 Configuration		DLBWP.1.1
Initial UL BWP Configuration		ULBWP.0.2
Active UL BWP-1 Configuration		ULBWP.1.3
Active UL BWP-2 Configuration		ULBWP.1.1
PDSCH Reference measurement channel		SR.3.1 TDD
RMSI CORESET parameters		CR.3.1 TDD
Dedicated CORESET parameters		CCR.3.1 TDD
OCNG Patterns		OP.1
SSB Configuration		SSB.1 FR2
SMTc Configuration		SMTc.1
TCI State		TCI.State.0
TRS Configuration		TRS.2.1 TDD
Antenna Configuration		1x2
Propagation Condition		AWGN
EPRE ratio of PSS to SSS	dB	0
EPRE ratio of PBCH DMRS to SSS		
EPRE ratio of PBCH to PBCH DMRS		
EPRE ratio of PDCCH DMRS to SSS		
EPRE ratio of PDCCH to PDCCH DMRS		
EPRE ratio of PDSCH DMRS to SSS		
EPRE ratio of PDSCH to PDSCH		
EPRE ratio of OCNG DMRS to SSS(Note 1)		
EPRE ratio of OCNG to OCNG DMRS (Note 1)		
NOTE 1: OCNG shall be used such that both cells are fully allocated and a constant total transmitted power spectral density is achieved for all OFDM symbols.		
NOTE 2: Interference from other cells and noise sources not specified in the test is assumed to be constant over subcarriers and time and shall be modelled as AWGN of appropriate power for N <sub>oc</sub> to be fulfilled.		
NOTE 3: SS-RSRP and I <sub>o</sub> levels have been derived from other parameters for information purposes. They are not settable parameters themselves.		
NOTE 4: For unpaired spectrum, a DL BWP is linked with an UL BWP. DLBWP.0.2 is linked with ULBWP.0.2; DLBWP.1.1 is linked with ULBWP.1.1; DLBWP.1.3 is linked with ULBWP.1.3 defined in clause 12 of TS 38.213 [3].		

**Table 5.5.6.2.1.5-2: OTA related test parameters for BWP switching test case**

Parameter	Unit	Cell 2	
Angle of arrival configuration		According to table A.3.15	
N <sub>oc</sub> Note1	NR_TDD_FR2_A	dBm/15kHz	
	NR_TDD_FR2_B		
	NR_TDD_FR2_F		
	NR_TDD_FR2_G		
	NR_TDD_FR2_T		
	NR_TDD_FR2_Y		
	NR_TDD_FR2_A	dBm/SCS	TBD

Parameter		Unit	Cell 2
$N_{oc}$ <sup>Note1</sup>	NR_TDD_FR2_B		
	NR_TDD_FR2_F		
	NR_TDD_FR2_G		
	NR_TDD_FR2_T		
	NR_TDD_FR2_Y		
SS-RSRP <sup>Note2</sup>	NR_TDD_FR2_A	dBm/SCS <sup>Note3</sup>	TBD
	NR_TDD_FR2_B		
	NR_TDD_FR2_F		
	NR_TDD_FR2_G		
	NR_TDD_FR2_T		
	NR_TDD_FR2_Y		
$\hat{E}_s/I_{ot}$		dB	TBD
$I_o$ <sup>Note2</sup>	NR_TDD_FR2_A	dBm/95.04 MHz <sup>Note4</sup>	TBD
	NR_TDD_FR2_B		
	NR_TDD_FR2_F		
	NR_TDD_FR2_G		
	NR_TDD_FR2_T		
	NR_TDD_FR2_Y		
<p>NOTE 1: Interference from other cells and noise sources not specified in the test is assumed to be constant over subcarriers and time and shall be modelled as AWGN of appropriate power for <math>N_{oc}</math> to be fulfilled.</p> <p>NOTE 2: SS-RSRP and <math>I_o</math> levels have been derived from other parameters for information purposes. They are not settable parameters themselves.</p> <p>NOTE 3: SS-RSRP minimum requirements are specified assuming independent interference and noise at each receiver antenna port.</p> <p>NOTE 4: Equivalent power received by an antenna with 0dBi gain at the centre of the quiet zone</p>			

### 5.5.7 Void

### 5.5.8 Active TCI state switch delay

#### 5.5.8.0 Minimum conformance requirements

##### 5.5.8.0.1 Minimum conformance requirements for MAC-CE based active TCI state switch

[TS38.133, clause 8.10.2]

The TCI state is known if the following conditions are met:

- During the period from the last transmission of the RS resource used for the L1-RSRP measurement reporting for the target TCI state to the completion of active TCI state switch, where the RS resource for L1-RSRP measurement is the RS in target TCI state or QCLed to the target TCI state
  - TCI state switch command is received within 1280 ms upon the last transmission of the RS resource for beam reporting or measurement
  - The UE has sent at least 1 L1-RSRP report for the target TCI state before the TCI state switch command
  - The TCI state remain detectable during the TCI state switching period
  - The SSB associated with the TCI state remain detectable during the TCI switching period
  - SNR of the TCI state  $\geq -3$ dB

Otherwise, the TCI state is unknown.

[TS38.133, clause 8.10.3]

If the target TCI state is known, upon receiving PDSCH carrying MAC-CE activation command in slot  $n$ , UE shall be able to receive PDCCH with target TCI state of the serving cell on which TCI state switch occurs no later than at slot  $n + T_{\text{HARQ}} + (3\text{ms} + T_{\text{O}_k} * (T_{\text{first-SSB}} + T_{\text{SSB-proc}})) / NR \text{ slot length}$ . The UE shall be able to receive PDCCH with the old TCI state until slot  $n + T_{\text{HARQ}} + (3\text{ms} + T_{\text{O}_k} * (T_{\text{first-SSB}})) / NR \text{ slot length}$ .

Where,

$T_{\text{HARQ}}$  is the timing between DL data transmission and acknowledgement as specified in TS 38.321 [7];

$T_{\text{first-SSB}}$  is time to first SSB transmission after MAC CE command is decoded by the UE;

$T_{\text{SSB-proc}} = 2\text{ms}$ ;

$T_{\text{O}_k} = 1$  if target TCI state is not in the active TCI state list for PDSCH, 0 otherwise.

If the target TCI state is unknown, upon receiving PDSCH carrying MAC-CE activation command in slot  $n$ , UE shall be able to receive PDCCH with target TCI state of the serving cell on which TCI state switch occurs no later than at slot  $n + T_{\text{HARQ}} + (3\text{ms} + T_{\text{L1-RSRP}} + T_{\text{O}_{\text{uk}}} * (T_{\text{first-SSB}} + T_{\text{SSB-proc}})) / NR \text{ slot length}$ . The UE shall be able to receive PDCCH with the old TCI state until slot  $n + T_{\text{HARQ}} + (3\text{ms} + T_{\text{L1-RSRP}} + T_{\text{O}_{\text{uk}}} * (T_{\text{first-SSB}})) / NR \text{ slot length}$ .

Where

$T_{\text{L1-RSRP}}$  is the time for L1-RSRP measurement for Rx beam refinement, defined as

- $T_{\text{L1-RSRP\_Measurement\_Period\_SSB}}$  for SSB as specified in clause 9.5.4.1,
  - with the assumption of  $M=1$
  - with  $T_{\text{Report}} = 0$
- $T_{\text{L1-RSRP\_Measurement\_Period\_CSI-RS}}$  for CSI-RS as specified in clause 9.5.4.2
  - with the assumption of  $M=1$  for periodic CSI-RS
  - for aperiodic CSI-RS if number of resources in resource set at least equal to *MaxNumberRxBeam*
  - with  $T_{\text{Report}} = 0$
- $T_{\text{L1-RSRP\_Measurement\_Period\_SSB}} = 0$  for SSB in FR2 and  $T_{\text{L1-RSRP\_Measurement\_Period\_CSI-RS}} = 0$  for CSI-RS in FR2, provided that the TCI state switching involves QCL-TypeA, QCL-TypeB or QCL-TypeC only.

$T_{\text{O}_{\text{uk}}} = 1$  for CSI-RS based L1-RSRP measurement, and 0 for SSB based L1-RSRP measurement when TCI state switching involves QCL-TypeD

$T_{\text{O}_{\text{uk}}} = 1$  when TCI state switching involves other QCL types

$T_{\text{first-SSB}}$  is time to first SSB transmission after L1-RSRP measurement when TCI state switching involves QCL-TypeD;

$T_{\text{first-SSB}}$  is time to first SSB transmission after MAC CE command is decoded by the UE for other QCL types;

The SSB shall be the QCL-TypeA or QCL-TypeC to target TCI state

During MAC-CE based TCI state switch the UE is allowed an interruption due to one shot timing adjustment on the serving or any activated serving cells as defined in clause 8.2.

### 5.5.8.0.2 Minimum conformance requirements for RRC based active TCI state switch

[TS38.133, clause 8.10.2]

The TCI state is known if the following conditions are met:

- During the period from the last transmission of the RS resource used for the L1-RSRP measurement reporting for the target TCI state to the completion of active TCI state switch, where the RS resource for L1-RSRP measurement is the RS in target TCI state or QCLed to the target TCI state



- TCI state switch command is received within 1280 ms upon the last transmission of the RS resource for beam reporting or measurement
- The UE has sent at least 1 L1-RSRP report for the target TCI state before the TCI state switch command
- The TCI state remain detectable during the TCI state switching period
- The SSB associated with the TCI state remain detectable during the TCI switching period
  - SNR of the TCI state  $\geq -3\text{dB}$

Otherwise, the TCI state is unknown.

[TS38.133, clause 8.10.5]

If the target TCI state is known, UE shall be able to receive PDCCH with target TCI state of the serving cell on which TCI state switch occurs no later than at slot  $n + T_{\text{RRC\_processing}} + \text{TO}_k * (T_{\text{first-SSB}} + T_{\text{SSB-proc}}) / \text{NR slot length}$ . The UE is not required to receive PDCCH/PDSCH or transmit PUCCH/PUSCH until the end of switching period.

Where

- Slot  $n$  is the last slot overlapping with the PDSCH carrying RRC activation command.
- $T_{\text{RRC\_processing}}$  is the RRC processing delay defined in Clause 11.2 of TS 36.331 [16] if the corresponding RRC message is embedded in E-UTRA RRC message, otherwise it is the RRC processing delay defined in Clause 12 of TS 38.331 [2].
- $T_{\text{first-SSB}}$  is time to first SSB transmission after RRC processing by the UE; The SSB shall be the QCL-TypeA or QCL-TypeC to target TCI state
- $T_{\text{SSB-proc}}$  and  $\text{TO}_k$  are defined in clause 8.10.3.

If the target TCI state is unknown, UE shall be able to receive PDCCH with target TCI state of the serving cell on which TCI state switch occurs no later than at slot  $n + T_{\text{RRC\_processing}} + T_{\text{L1-RSRP}} + \text{TO}_{\text{uk}} * (T_{\text{first-SSB}} + T_{\text{SSB-proc}}) / \text{NR slot length}$ . The UE is not required to receive PDCCH/PDSCH or transmit PUCCH/PUSCH until the end of switching period.

Where

- Slot  $n$  is the last slot overlapping with the PDSCH carrying RRC activation command.
- $T_{\text{RRC\_processing}}$  is the RRC processing delay defined in Clause 11.2 of TS 36.331 [16] if the corresponding RRC message is embedded in E-UTRA RRC message, otherwise it is the RRC processing delay defined in Clause 12 of TS 38.331 [2].
- $T_{\text{first-SSB}}$  is time to first SSB transmission after L1-RSRP measurement when TCI state switching involves QCL-TypeD;
- $T_{\text{first-SSB}}$  is time to first SSB transmission after RRC processing time at the UE for other QCL types;
  - The SSB shall be the QCL-TypeA or QCL-TypeC to target TCI state
- $T_{\text{L1-RSRP}}$ ,  $\text{TO}_{\text{uk}}$  and  $T_{\text{SSB-proc}}$  are defined in 38.133 clause 8.10.3.

The requirements for RRC based TCI state switch delay apply when only 1 TCI state is configured in RRC TCI state list. When  $T_{\text{HARQ}} > T_{\text{RRC\_processing}}$  a longer switching delay is allowed. Where  $T_{\text{HARQ}}$  is the time between DL data transmission and acknowledgement as specified in TS 38.213 [8].

### 5.5.8.1 EN-DC FR2 MAC-CE based active TCI state switch

**Editor's note: This test case is incomplete. The following aspects are either missing or TBD**

- Message contents are not complete.
- Connection diagram is TBD.

- TT analysis is missing.

- RAN4 dependency: Test parameters have brackets and TBDs.

#### 5.5.8.1.1 Test purpose

The purpose of this test is to verify the active TCI state switch delay requirement defined in TS 38.133 [6] clause 8.10.3.

#### 5.5.8.1.2 Test applicability

This test applies to all types of NR UE release 15 onwards.

#### 5.5.8.1.3 Minimum conformance requirements

The minimum conformance requirements are specified in clause 5.5.8.0.1.

The normative reference for this requirement is TS 38.133 [6] clause A.5.5.8.1.

#### 5.5.8.1.4 Test description

There are two cell configured in this test: E-UTRAN PCell (Cell 1) and NR PSCell (Cell 2). This test consists of two successive time periods, with time duration of T1 and T2 respectively.

##### 5.5.8.1.4.1 Initial conditions

This test shall be tested using any of the test configurations in Table 5.5.8.1.4.1-1.

**Table 5.5.8.1.4.1-1: Supported test configurations for EN-DC FR2 MAC-CE based active TCI state switch**

Config	Description
5.5.8.1-1	LTE FDD, NR 120 kHz SSB SCS, 100 MHz bandwidth, TDD duplex mode
5.5.8.1-2	LTE TDD, NR 120 kHz SSB SCS, 100 MHz bandwidth, TDD duplex mode
NOTE 1: The UE is only required to be tested in one of the supported test configurations	

Configure the test equipment and the DUT according to the parameters in Table 5.5.8.1.4.1-2.

**Table 5.5.8.1.4.1-2: Initial conditions for EN-DC FR2 MAC-CE based active TCI state switch**

Parameter	Value		Comment
Test environment	NC		As specified in TS 38.508-1 [14] clause 4.1.
Test frequencies	As specified in Annex E, table E.5-1 and TS 38.508-1 [14] clause 4.3.1 for E-UTRA and 7.2.3 for NR.		
Channel bandwidth	As specified by the test configuration selected from Table 5.5.8.1.4.1-1.		
Propagation conditions	AWGN		As specified in clause C.2.2.
Connection Diagram	TE Part	A.3.TBD	As specified in TS 38.508-1 [14] Annex A.
	DUT Part	A.3.TBD	
Exceptions to connection diagram	N/A		

1. The general test parameter settings are set up according to Table 5.5.8.1.4.1-3.
2. Message contents are defined in clause 5.5.8.1.4.3.
3. There are one E-UTRAN cell and one NR cell specified in the test. E-UTRAN Cell 1 is the cell used for connection setup with the power level set according to clause C.1.1 and C.1.2 for this test.

**Table 5.5.8.1.4.1-3: General test parameters for EN-DC FR2 MAC-CE based active TCI state switch**

Parameter	Unit	Value	Comment
E-UTRA RF Channel Number		1	One E-UTRA radio channel is used for this test
NR RF Channel Number		2	One NR radio channel is used for this test
Active PCell		Cell 1	PCell on RF channel number 1.
Active PSCell		Cell 2	PSCell on RF channel number 2.
CP length		Normal	
DRX		OFF	For both PCell and PSCell
Cell-individual offset for cells on RF channel number 1	dB	0	Individual offset for cells on PCC.
Cell-individual offset for cells on RF channel number 2	dB	0	Individual offset for cells on PSCC.
Cell2 timing offset to cell1	$\mu$ s	3	Synchronous EN-DC
T1	s	[0.2]	
T2	s	[0.2]	

#### 5.5.8.1.4.2 Test procedure

During the test PDCCHs indicating new transmissions shall be sent continuously on PSCell (Cell 2) to ensure that the UE would have ACK/NACK sending.

Prior to the start of the time duration T1, the UE shall be fully synchronized to E-UTRA PCell and PSCell. The UE shall be configured with 2 different TCI states for PSCell: PDCCH TCI-state 0 (QCL'd to SSB0) and TCI-state 1 (QCL'd to SSB1), in Cell 2 before starting the test. TCI state-0 is indicated as the active PDCCH TCI-state

1. Ensure the UE is in state RRC\_CONNECTED with generic procedure parameters Connectivity *EN-DC*, DC bearer *MCG* and *SCG*, Connected without release *On* according to TS 38.508-1 [14] clause 4.5.4.
2. Set the parameters of NR Cell 1 according to T1 in Table 5.5.8.1.5-1. Propagation conditions are set according to clause C.2.3. T1 starts. During T1 only SSB to which PDCCH TCI-state 0 is QCL'd is transmitted.
3. When T1 expires the SS shall change the SNR value to T2 as specified in Table 5.5.8.1.5-1. T2 starts. At the beginning of T2, the SSB corresponding to TCI state 1 starts transmitting.
4. The SS transmits an *RRCReconfiguration* message to configure periodic L1-RSRP reporting.
5. The UE transmits an *RRCReconfigurationComplete* message.
6. The SS sends a MAC-CE to indicate switch to TCI-state 1 in slot  $n$  which is within 1280ms of UE providing L1-RSRP report with results for both SSB0 and SSB1.
7. If the SS:
  - a) Receives ACK/NACK on each UL transmission occasion scheduled on TCI-state 0 until slot  $n+T_{\text{HARQ}}+24+8 \times T_{\text{first-SSB}}$ , and
  - b) Receives ACK/NACK on each UL transmission occasion scheduled on TCI-state 1 after slot  $n+T_{\text{HARQ}}+40+8 \times T_{\text{first-SSB}}$
 the number of successful tests is increased by one, otherwise the number of failed tests is increased by one.
8. When T2 expires the SS shall sends a MAC-CE to indicate switch to TCI-state 0.
9. Wait 1s for the UE to switch TCI-state 0. If the SS receives ACK/NACK on each UL transmission occasion scheduled on TCI-state 0 continue to step 11. Otherwise continue to step 10.
10. Switch the UE on and off. Ensure the UE is in RRC\_CONNECTED with generic procedure parameters Connectivity *EN-DC*, DC bearer *MCG* and *SCG*, Connected without release *On* according to TS 38.508-1 [14] clause 4.5.4.
11. Repeat steps 2-10 for all subtests until the confidence level according to Tables G.2.3-1 in Annex G clause G.2 is achieved.

#### 5.5.8.1.4.3 Message contents

Message contents are according to TS 38.508-1 [14] clause 7.3 with the following exceptions:

**Table 5.5.8.1.4.3-1: Common Exception messages for EN-DC FR2 MAC-CE based active TCI state switch**

Default Message Contents	
Common contents of system information blocks exceptions	
Default RRC messages and information elements contents exceptions	FFS

5.5.8.1.5 Test requirement

Tables 5.5.8.1.4.1-3, 5.5.8.1.5-1 and 5.5.8.1.5-2 define the primary level settings including test tolerances for EN-DC FR2 MAC-CE based active TCI state switch.

**Table 5.5.8.1.5-1: NR Cell specific test parameters for EN-DC FR2 MAC-CE based active TCI state switch**

Parameter	Unit	Cell 2
Frequency Range		FR2
Duplex mode		TDD
TDD configuration		TDDConf.3.1
BW <sub>channel</sub>		100 MHz: N <sub>RB,c</sub> = 66
Initial DL BWP Configuration		DLBWP.0.2
Dedicated DL BWP Configuration		DLBWP.1.1
Initial UL BWP Configuration		ULBWP.0.2
Dedicated UL BWP Configuration		ULBWP.1.1
PDSCH Reference measurement channel		SR.3.1 TDD
RMSI CORESET parameters		CR.3.1 TDD
Dedicated CORESET parameters		CCR.3.1 TDD
OCNG Patterns		OP.1
SSB Configuration		SSB.1 FR2
SMTc Configuration		SMTc.1
TCI State 0		TC.State.0
TCI State 1		TCI.State.1
TRS Configuration		TRS.2.1 TDD
Correlation Matrix and Antenna Configuration		1x2 Low
EPRE ratio of PSS to SSS	dB	0
EPRE ratio of PBCH DMRS to SSS		
EPRE ratio of PBCH to PBCH DMRS		
EPRE ratio of PDCCH DMRS to SSS		
EPRE ratio of PDCCH to PDCCH DMRS		
EPRE ratio of PDSCH DMRS to SSS		
EPRE ratio of PDSCH to PDSCH		
EPRE ratio of OCNG DMRS to SSS(Note 1)		
EPRE ratio of OCNG to OCNG DMRS (Note 1)		
Propagation Condition		
NOTE 1: OCNG shall be used such that both cells are fully allocated and a constant total transmitted power spectral density is achieved for all OFDM symbols.		

**Table 5.5.8.1.5-2: OTA related test parameter for EN-DC FR2 MAC-CE based active TCI state switch**

Parameter	Unit	Cell 2			
		SSB0		SSB1	
		T1	T2	T1	T2
Angle of arrival configuration		Setup 3			
N <sub>oc</sub> <sup>Note 1</sup>	dBm/15 kHz	[-92.1]			
N <sub>oc</sub> <sup>Note 1</sup>	dBm/SCS	[-83.1]			
$\bar{E}_s/N_{oc}$	dB	1	1	-Infinity	1
SS-RSRP <sup>Note 2</sup>	dBm/120 kHz <sup>Note3</sup>	-82.1	-82.1	-Infinity	-82.1

$I_o$ <sup>Note2, Note6</sup>	dBm/95.04 MHz <sup>Note4</sup>	-54.94	-54.94	-54.94	-54.94
NOTE 1: Interference from other cells and noise sources not specified in the test is assumed to be constant over subcarriers and time and shall be modelled as AWGN of appropriate power for $N_{oc}$ to be fulfilled.					
NOTE 2: SS-RSRP and $I_o$ levels have been derived from other parameters for information purposes. They are not settable parameters themselves.					
NOTE 3: SS-RSRP minimum requirements are specified assuming independent interference and noise at each receiver antenna port.					
NOTE 4: Equivalent power received by an antenna with 0 dBi gain at the centre of the quiet zone					
NOTE 5: As observed with 0dBi gain antenna at the center of the quiet zone.					

During T2, UE shall send L1-RSRP report with results for both SSB0 and SSB1.

After receiving MAC-CE command in slot  $n$ , UE shall be able to continue to receive on TCI state 0 until  $n+T_{HARQ}+(3ms+T_{first-SSB}) / NR$  slot length, where

- $T_{HARQ}$  (in ms) is the timing between DL data transmission and acknowledgement as specified in TS 38.213 [8];
- $T_{first-SSB}$  is time to first SSB transmission after MAC CE command is decoded by the UE;
- NR slot length = 0.125ms for 120kHz SSB SCS;

So UE shall be able to continue to receive PDCCH on TCI state 0 until  $n+T_{HARQ}+24+8 \times T_{first-SSB}$

After receiving MAC-CE command in slot  $n$ , UE shall be able to receive PDCCH with TCI state 1 no later than at slot  $n+T_{HARQ}+(3ms+T_{first-SSB} + T_{SSB-proc}) / NR$  slot length., where

- $T_{HARQ}$  (in ms) is the timing between DL data transmission and acknowledgement as specified in TS 38.213 [8];
- $T_{first-SSB}$  is time to first SSB transmission after MAC CE command is decoded by the UE;
- $T_{SSB-proc} = 2$  ms;
- NR slot length = 0.125ms for 120kHz SSB SCS;

So UE shall be able to continue to receive PDCCH on TCI state 1 no later than  $n+T_{HARQ}+40+8 \times T_{first-SSB}$

### 5.5.8.2 EN-DC FR2 RRC based active TCI state switch

**Editor's note: This test case is incomplete. The following aspects are either missing or TBD**

- Message contents are not complete.
- Connection diagram is TBD.
- TT analysis is missing.
- RAN4 dependency: Test parameters have brackets and TBDs.

#### 5.5.8.2.1 Test purpose

The purpose of this test is to verify the active TCI state switch delay requirement defined in TS 38.133 [6] clause 8.10.3.

#### 5.5.8.2.2 Test applicability

This test applies to all types of NR UE release 15 onwards.

#### 5.5.8.2.3 Minimum conformance requirements

The minimum conformance requirements are specified in clause 5.5.8.0.2.

The normative reference for this requirement is TS 38.133 [6] clause A.5.5.8.2.

#### 5.5.8.2.4 Test description

There are two cell configured in this test: E-UTRAN PCell (Cell 1) and NR PSCell (Cell 2). This test consists of two successive time periods, with time duration of T1 and T2 respectively.

##### 5.5.8.2.4.1 Initial conditions

This test shall be tested using any of the test configurations in Table 5.5.8.2.4.1-1.

**Table 5.5.8.2.4.1-1: Supported test configurations for EN-DC FR2 RRC based active TCI state switch**

Config	Description
5.5.8.2-1	LTE FDD, NR 120 kHz SSB SCS, 100 MHz bandwidth, TDD duplex mode
5.5.8.2-2	LTE TDD, NR 120 kHz SSB SCS, 100 MHz bandwidth, TDD duplex mode

NOTE 1: The UE is only required to be tested in one of the supported test configurations

Configure the test equipment and the DUT according to the parameters in Table 5.5.8.2.4.1-2.

**Table 5.5.8.2.4.1-2: Initial conditions for EN-DC FR2 RRC based active TCI state switch**

Parameter	Value		Comment
Test environment	NC		As specified in TS 38.508-1 [14] clause 4.1.
Test frequencies	As specified in Annex E, table E.5-1 and TS 38.508-1 [14] clause 4.3.1 for E-UTRA and 7.2.3 for NR.		
Channel bandwidth	As specified by the test configuration selected from Table 5.5.8.2.4.1-1.		
Propagation conditions	AWGN		As specified in clause C.2.2.
Connection Diagram	TE Part	A.3.TBD	As specified in TS 38.508-1 [14] Annex A.
	DUT Part	A.3.TBD	
Exceptions to connection diagram	N/A		

1. The general test parameter settings are set up according to Table 5.5.8.2.4.1-3.
2. Message contents are defined in clause 5.5.8.2.4.3.
3. There are one E-UTRAN cell and one NR cell specified in the test. E-UTRAN Cell 1 is the cell used for connection setup with the power level set according to clause C.1.1 and C.1.2 for this test.

**Table 5.5.8.2.4.1-3: General test parameters for EN-DC FR2 RRC based active TCI state switch**

Parameter	Unit	Value	Comment
E-UTRA RF Channel Number		1	One E-UTRA radio channel is used for this test
NR RF Channel Number		2	One NR radio channel is used for this test
Active PCell		Cell 1	PCell on RF channel number 1.
Active PSCell		Cell 2	PSCell on RF channel number 2.
CP length		Normal	
DRX		OFF	For both PCell and PSCell
Cell-individual offset for cells on RF channel number 1	dB	0	Individual offset for cells on PCC.
Cell-individual offset for cells on RF channel number 2	dB	0	Individual offset for cells on PSCC.
Cell2 timing offset to cell1	μs	3	Synchronous EN-DC
T1	s	[0.2]	
T2	s	[0.2]	

##### 5.5.8.2.4.2 Test procedure

During the test PDCCHs indicating new transmissions shall be sent continuously on PSCell (Cell 2) to ensure that the UE would have ACK/NACK sending.

Prior to the start of the time duration T1, the UE shall be fully synchronized to E-UTRA PCell and PSCell. The UE shall be configured with 2 different TCI states for PSCell: PDCCH TCI-state 0 (QCL'd to SSB0) and TCI-state 1 (QCL'd to SSB1), in Cell 2 before starting the test. TCI state-0 is indicated as the active PDCCH TCI-state

1. Ensure the UE is in state RRC\_CONNECTED with generic procedure parameters Connectivity *EN-DC*, DC bearer *MCG* and *SCG*, Connected without release *On* according to TS 38.508-1 [14] clause 4.5.4.
2. Set the parameters of NR Cell 1 according to T1 in Table 5.5.8.2.5-1. Propagation conditions are set according to clause C.2.3. T1 starts. During T1 only SSB to which PDCCH TCI-state 0 is QCL'd is transmitted.
3. When T1 expires the SS shall change the SNR value to T2 as specified in Table 5.5.8.2.5-1. T2 starts. At the beginning of T2, the SSB corresponding to TCI state 1 starts transmitting.
4. The SS transmits an *RRCReconfiguration* message to configure periodic L1-RSRP reporting.
5. The UE transmits an *RRCReconfigurationComplete* message.
6. The SS sends an *RRCReconfiguration* message to indicate switch to TCI-state 1 in slot n which is within 1280ms of UE providing L1-RSRP report with results for both SSB0 and SSB1.
7. The UE transmits an *RRCReconfigurationComplete* message.
8. If the SS receives ACK/NACK on each UL transmission occasion scheduled on TCI-state 1 after slot  $n+176+8 \times T_{\text{first-SSB}}$  the number of successful tests is increased by one, otherwise the number of failed tests is increased by one.
9. When T2 expires the SS sends an *RRCReconfiguration* message to indicate switch to TCI-state 0.
10. The UE transmits an *RRCReconfigurationComplete* message.
11. Wait 1s for the UE to switch TCI-state 0. If the SS receives ACK/NACK on each UL transmission occasion scheduled on TCI-state 0 continue to step 13. Otherwise continue to step 12.
12. Switch the UE on and off. Ensure the UE is in RRC\_CONNECTED with generic procedure parameters Connectivity *EN-DC*, DC bearer *MCG* and *SCG*, Connected without release *On* according to TS 38.508-1 [14] clause 4.5.4.
13. Repeat steps 2-10 for all subtests until the confidence level according to Tables G.2.3-1 in Annex G clause G.2 is achieved.

5.5.8.2.4.3 Message contents

Message contents are according to TS 38.508-1 [14] clause 7.3 with the following exceptions:

**Table 5.5.8.2.4.3-1: Common Exception messages for EN-DC FR2 RRC based active TCI state switch**

Default Message Contents	
Common contents of system information blocks exceptions	
Default RRC messages and information elements contents exceptions	FFS

5.5.8.2.5 Test requirement

Tables 5.5.8.2.4.1-3, 5.5.8.2.5-1 and 5.5.8.2.5-2 define the primary level settings including test tolerances for EN-DC FR2 RRC based active TCI state switch.

**Table 5.5.8.2.5-1: NR Cell specific test parameters for EN-DC FR2 RRC based active TCI state switch**

Parameter	Unit	Cell 2
Frequency Range		FR2
Duplex mode		TDD
TDD configuration		TDDConf.3.1
BW <sub>channel</sub>		100 MHz: N <sub>RB,C</sub> = 66

Parameter	Unit	Cell 2
Initial DL BWP Configuration		DLBWP.0.2
Dedicated DL BWP Configuration		DLBWP.1.1
Initial UL BWP Configuration		ULBWP.0.2
Dedicated UL BWP Configuration		ULBWP.1.1
PDSCH Reference measurement channel		SR.3.1 TDD
RMSI CORESET parameters		CR.3.1 TDD
Dedicated CORESET parameters		CCR.3.1 TDD
OCNG Patterns		OP.1
SSB Configuration		SSB.1 FR2
SMTTC Configuration		SMTTC.1
TCI State 0		TCI.State.0
TCI State 1		TCI.State.1
TRS Configuration		TRS.2.1 TDD
Correlation Matrix and Antenna Configuration		1x2 Low
EPRE ratio of PSS to SSS	dB	0
EPRE ratio of PBCH DMRS to SSS		
EPRE ratio of PBCH to PBCH DMRS		
EPRE ratio of PDCCH DMRS to SSS		
EPRE ratio of PDCCH to PDCCH DMRS		
EPRE ratio of PDSCH DMRS to SSS		
EPRE ratio of PDSCH to PDSCH		
EPRE ratio of OCNG DMRS to SSS(Note 1)		
EPRE ratio of OCNG to OCNG DMRS (Note 1)		
Propagation Condition		

NOTE: OCNG shall be used such that both cells are fully allocated and a constant total transmitted power spectral density is achieved for all OFDM symbols.

Table 5.5.8.2.5-2: OTA related test parameter for EN-DC FR2 RRC based active TCI state switch

Parameter	Unit	Cell 2			
		SSB0		SSB1	
		T1	T2	T1	T2
Angle of arrival configuration		Setup 3			
$N_{oc}$ <sup>Note 1</sup>	dBm/15 kHz	[-92.1]			
$N_{oc}$ <sup>Note 1</sup>	dBm/SCS	[-83.1]			
$\hat{E}_s/N_{oc}$	dB	1	1	-Infinity	1
SS-RSRP <sup>Note 2</sup>	dBm/120 kHz <sup>Note3</sup>	-82.1	-82.1	-Infinity	-82.1
$I_o$ <sup>Note2,Note6</sup>	dBm/95.04 MHz <sup>Note4</sup>	-54.94	-54.94	-54.94	-54.94

NOTE 1: Interference from other cells and noise sources not specified in the test is assumed to be constant over subcarriers and time and shall be modelled as AWGN of appropriate power for  $N_{oc}$  to be fulfilled.

NOTE 2: SS-RSRP and  $I_o$  levels have been derived from other parameters for information purposes. They are not settable parameters themselves.

NOTE 3: SS-RSRP minimum requirements are specified assuming independent interference and noise at each receiver antenna port.

NOTE 4: Equivalent power received by an antenna with 0 dBi gain at the centre of the quiet zone

NOTE 5: As observed with 0dBi gain antenna at the center of the quiet zone.

During T2, UE shall send L1-RSRP report with results for both SSB0 and SSB1.

After receiving RRC command in slot n, UE shall be able to receive PDCCH with TCI state 1 no later than at slot n+ ( $T_{RRC\_processing} + T_{first-SSB} + T_{SSB-proc}$ ) / NR slot length, where

- $T_{RRC\_processing} = 20$  ms is the RRC processing delay as specified in TS 38.331 [13];
- $T_{first-SSB}$  is time to first SSB transmission after RRC processing by the UE; The SSB shall be the QCL-TypeA or QCL-TypeC to TCI state 1;
- $T_{SSB-proc} = 2$  ms;



- NR slot length = 0.125ms for 120kHz SSB SCS;

So UE shall be able to continue to receive PDCCH on TCI state 1 no later than slot  $n+176+8 \times T_{\text{first-SSB}}$ .

## 5.6 Measurement procedures

### 5.6.1 Intra-frequency measurements

#### 5.6.1.0 Minimum conformance requirements

##### 5.6.1.0.1 Minimum conformance requirements for event-triggered measurement without gap

[TS38.133, clause 9.2.2]

The requirements in Section 9.2 apply, provided:

- The cell being identified or measured is detectable.

An intra-frequency cell shall be considered detectable when for each relevant SSB:

- SS-RSRP related side conditions given in Sections 10.1.2 and 10.1.3 for FR1 and FR2, respectively, for a corresponding Band,
- SS-RSRQ related side conditions given in Sections 10.1.7 and 10.1.8 for FR1 and FR2, respectively, for a corresponding Band,
- SS-SINR related side conditions given in Sections 10.1.12 and 10.1.13 for FR1 and FR2, respectively, for a corresponding Band,
- SSB<sub>RP</sub> and SSB  $\hat{E}_s/I_{ot}$  according to Annex B.2.2 for a corresponding Band.

[TS38.133, clause 9.2.4.3]

Reported RSRP, RSRQ, and RS-SINR measurements contained in periodically triggered measurement reports shall meet the requirements in clauses 10.1.2.1, 10.1.3.1, 10.1.7.1, 10.1.8.1, 10.1.12.1 and 10.1.13.1, respectively.

The UE shall not send any event triggered measurement reports as long as no reporting criteria are fulfilled.

The measurement reporting delay is defined as the time between an event that will trigger a measurement report and the point when the UE starts to transmit the measurement report over the air interface. This requirement assumes that the measurement report is not delayed by other RRC signalling on the DCCH. This measurement reporting delay excludes a delay uncertainty resulted when inserting the measurement report to the TTI of the uplink DCCH. The delay uncertainty is:  $2 \times TTI_{DCCH}$ . This measurement reporting delay excludes a delay which caused by no UL resources for UE to send the measurement report.

The event triggered measurement reporting delay, measured without L3 filtering shall be less than  $T_{\text{identify intra with index}}$  Or  $T_{\text{identify intra without index}}$  defined in clause 9.2.5.1 or clause 9.2.6.2. When L3 filtering is used an additional delay can be expected.

A cell is detectable only if at least one SSBs measured from the Cell being configured remains detectable during the time period  $T_{\text{identify intra without index}}$  Or  $T_{\text{identify intra with index}}$  defined in clause 9.2.5.1 or clause 9.2.6.2. If a cell which has been detectable at least for the time period  $T_{\text{identify intra without index}}$  Or  $T_{\text{identify intra with index}}$  defined in clause 9.2.5.1 or clause 9.2.6.2 becomes undetectable for a period and then the cell becomes detectable again and triggers an event, the event triggered measurement reporting delay shall be less than  $T_{SSB\_measurement\_period\_intra}$  provided the timing to that cell has not changed more than  $\pm 3200 T_c$  while the measurement gap has not been available and the L3 filter has not been used. When L3 filtering is used, an additional delay can be expected.

[TS38.133-f60, clause 9.2.5.1]

The UE shall be able to identify a new detectable intra frequency cell within  $T_{\text{identify\_intra\_without\_index}}$  if UE is not indicated to report SSB based RRM measurement result with the associated SSB index (*reportQuantityRsrIndexes* or *maxNrofRSIndexesToReport* is not configured), or the UE is indicated that the neighbour cell is synchronous with the serving cell (*deriveSSB-IndexFromCell* is enabled). Otherwise UE shall be able to identify a new detectable intra frequency cell within  $T_{\text{identify\_intra\_with\_index}}$ . The UE shall be able to identify a new detectable intra frequency SS block of an already detected cell within  $T_{\text{identify\_intra\_without\_index}}$ . It is assumed that *deriveSSB-IndexFromCell* is always enabled for FR1 TDD and FR2.

$$T_{\text{identify\_intra\_without\_index}} = (T_{\text{PSS/SSS\_sync\_intra}} + T_{\text{SSB\_measurement\_period\_intra}}) \text{ ms}$$

Where:

$T_{\text{PSS/SSS\_sync\_intra}}$ : it is the time period used in PSS/SSS detection given in table 5.6.1.0.1-1

$T_{\text{SSB\_measurement\_period\_intra}}$ : equal to a measurement period of SSB based measurement given in table 5.6.1.0.1-2

$\text{CSSF}_{\text{intra}}$ : it is a carrier specific scaling factor and is determined

-according to  $\text{CSSF}_{\text{outside\_gap},i}$  in clause 9.1.5.1 for measurement conducted outside measurement gaps, i.e. when intra frequency SMTC is fully non overlapping or partially overlapping with measurement gaps, or according to  $\text{CSSF}_{\text{within\_gap},i}$  in clause 9.1.5.2 for measurement conducted within measurement gaps, i.e. when intra frequency SMTC is fully overlapping with measurement gaps.

-if the high layer in TS 38.331 [2] signalling of *smtc2* is configured, the assumed periodicity of intra frequency SMTC occasions corresponds to the value of higher layer parameter *smtc2*; Otherwise the assumed periodicity of intra frequency SMTC occasions corresponds to the value of higher layer parameter *smtc1*.

$M_{\text{pss/sss\_sync\_w/o\_gaps}}$  : For a UE supporting FR2 power class 1,  $M_{\text{pss/sss\_sync}}=40$ . For a UE supporting power class 2,  $M_{\text{pss/sss\_sync\_w/o\_gaps}}=24$ . For a UE supporting FR2 power class 3,  $M_{\text{pss/sss\_sync\_w/o\_gaps}}=24$ . For a UE supporting FR2 power class 4,  $M_{\text{pss/sss\_sync\_w/o\_gaps}}=24$

$M_{\text{meas\_period\_w/o\_gaps}}$  : For a UE supporting power class 1,  $M_{\text{meas\_period\_w/o\_gaps}}=40$ . For a UE supporting FR2 power class 2,  $M_{\text{meas\_period\_w/o\_gaps}}=24$ . For a UE supporting power class 3,  $M_{\text{meas\_period\_w/o\_gaps}}=24$ . For a UE supporting power class 4,  $M_{\text{meas\_period\_w/o\_gaps}}=24$ .

When intra frequency SMTC is fully non overlapping with measurement gaps or intra frequency SMTC is fully overlapping with MGs,  $K_p=1$

When intra frequency SMTC is partially overlapping with measurement gaps,  $K_p = 1/(1 - (\text{SMTC period} / \text{MGRP}))$ , where SMTC period < MGRP

If the higher layer signalling in TS38.331 [2] signalling of *smtc2* is present and *smtc1* is fully overlapping with measurement gaps and *smtc2* is partially overlapping with measurement gaps, requirements are not specified for  $T_{\text{identify\_intra\_without\_index}}$  Or  $T_{\text{identify\_intra\_with\_index}}$

For FR2, if *SSB-ToMeasure* is configured, when all of the reference signals configured for RLM, BFD, CBD or L1-RSRP for beam reporting outside measurement gap is fully non-overlapping with the SSB symbols indicated by *SSB-ToMeasure* and 1 symbol before each consecutive SSB symbols indicated by *SSB-ToMeasure* and 1 symbol after each consecutive SSB symbols indicated by *SSB-ToMeasure*,  $K_{\text{layer1\_measurement}}=1$ , otherwise  $K_{\text{layer1\_measurement}}=1.5$ . If *SSB-ToMeasure* is not configured, when any of the reference signals configured for RLM, BFD, CBD or L1-RSRP for beam reporting outside measurement gap is fully overlapping with intra-frequency SMTC,  $K_{\text{layer1\_measurement}}=1.5$ , otherwise  $K_{\text{layer1\_measurement}}=1$ .

If SCG DRX is in use, intra frequency cell identification requirements specified in Table 5.6.1.0.1-1 shall depend on the SCG DRX cycle. Otherwise, the requirements for when DRX is not in use shall apply.

**Table 5.6.1.0.1-1: Time period for PSS/SSS detection, (Frequency range FR2)**

DRX cycle	$T_{\text{PSS/SSS\_sync\_intra}}$
No DRX	$\max(600\text{ms}, \text{ceil}(M_{\text{pss/sss\_sync\_w/o\_gaps}} \times K_p \times K_{\text{layer1\_measurement}}) \times \text{SMTC period})^{\text{Note 1}} \times \text{CSSF}_{\text{intra}}$
DRX cycle $\leq$ 320ms	$\max(600\text{ms}, \text{ceil}(1.5 \times M_{\text{pss/sss\_sync\_w/o\_gaps}} \times K_p \times K_{\text{layer1\_measurement}}) \times \max(\text{SMTC period}, \text{DRX cycle})) \times \text{CSSF}_{\text{intra}}$
DRX cycle $>$ 320ms	$\text{ceil}(M_{\text{pss/sss\_sync\_w/o\_gaps}} \times K_p \times K_{\text{layer1\_measurement}}) \times \text{DRX cycle} \times \text{CSSF}_{\text{intra}}$
NOTE:	If different SMTC periodicities are configured for different cells, the SMTC period in the requirement is the one used by the cell being identified

[TS38.133, clause 9.2.5.2]

The measurement period for intra frequency measurements without gaps is as shown in table 5.6.1.0.1-2. If the higher layer signalling in TS38.331 [2] signalling of *smtc2* is present and *smtc1* is fully overlapping with measurement and *smtc2* is partially overlapping with measurement gaps, requirements are not specified for  $T_{\text{SSB\_measurement\_period\_intra}}$

If SCG DRX is in use, intra frequency measurement period requirements specified in Table 5.6.1.0.1-2 shall depend on the SCG DRX cycle. Otherwise, the requirements for when DRX is not in use shall apply.

**Table 5.6.1.0.1-2: Measurement period for intrafrequency measurements without gaps(Frequency FR2)**

DRX cycle	$T_{\text{SSB\_measurement\_period\_intra}}$
No DRX	$\max(400\text{ms}, \text{ceil}(M_{\text{meas\_period\_w/o\_gaps}} \times K_p \times K_{\text{layer1\_measurement}}) \times \text{SMTC period})^{\text{Note 1}} \times \text{CSSF}_{\text{intra}}$
DRX cycle $\leq$ 320ms	$\max(400\text{ms}, \text{ceil}(1.5 \times M_{\text{meas\_period\_w/o\_gaps}} \times K_p \times K_{\text{layer1\_measurement}}) \times \max(\text{SMTC period}, \text{DRX cycle})) \times \text{CSSF}_{\text{intra}}$
DRX cycle $>$ 320ms	$\text{ceil}(M_{\text{meas\_period\_w/o\_gaps}} \times K_p \times K_{\text{layer1\_measurement}}) \times \text{DRX cycle} \times \text{CSSF}_{\text{intra}}$
NOTE:	If different SMTC periodicities are configured for different cells, the SMTC period in the requirement is the one used by the cell being identified

The normative reference for this requirement is TS 38.133 [6] clause 9.2.2, 9.2.4.3, 9.2.5.1, 9.2.5.2.

#### 5.6.1.0.2 Minimum conformance requirements for event-triggered measurement with gap

[TS38.133, clause 9.2.2]

The requirements in Section 9.2 apply, provided:

- The cell being identified or measured is detectable.

An intra-frequency cell shall be considered detectable when for each relevant SSB:

- SS-RSRP related side conditions given in Sections 10.1.2 and 10.1.3 for FR1 and FR2, respectively, for a corresponding Band,
- SS-RSRQ related side conditions given in Sections 10.1.7 and 10.1.8 for FR1 and FR2, respectively, for a corresponding Band,
- SS-SINR related side conditions given in Sections 10.1.12 and 10.1.13 for FR1 and FR2, respectively, for a corresponding Band,
- SSB<sub>RP</sub> and SSB  $\hat{E}_s/I_{ot}$  according to Annex B.2.2 for a corresponding Band.

[TS38.133, clause 9.2.4.3]

Reported RSRP, RSRQ, and RS-SINR measurements contained in periodically triggered measurement reports shall meet the requirements in clauses 10.1.2.1, 10.1.3.1, 10.1.7.1, 10.1.8.1, 10.1.12.1 and 10.1.13.1, respectively.

The UE shall not send any event triggered measurement reports as long as no reporting criteria are fulfilled.

The measurement reporting delay is defined as the time between an event that will trigger a measurement report and the point when the UE starts to transmit the measurement report over the air interface. This requirement assumes that the measurement report is not delayed by other RRC signalling on the DCCH. This measurement reporting delay excludes a delay uncertainty resulted when inserting the measurement report to the TTI of the uplink DCCH. The delay uncertainty is:  $2 \times TTI_{DCCH}$ . This measurement reporting delay excludes a delay which caused by no UL resources for UE to send the measurement report.

The event triggered measurement reporting delay, measured without L3 filtering shall be less than  $T_{\text{identify\_intra\_with\_index}}$  or  $T_{\text{identify\_intra\_without\_index}}$  defined in clause 9.2.5.1 or clause 9.2.6.2. When L3 filtering is used an additional delay can be expected.

A cell is detectable only if at least one SSBs measured from the Cell being configured remains detectable during the time period  $T_{\text{identify\_intra\_without\_index}}$  or  $T_{\text{identify\_intra\_with\_index}}$  defined in clause 9.2.5.1 or clause 9.2.6.2. If a cell which has been detectable at least for the time period  $T_{\text{identify\_intra\_without\_index}}$  or  $T_{\text{identify\_intra\_with\_index}}$  defined in clause 9.2.5.1 or clause 9.2.6.2 becomes undetectable for a period and then the cell becomes detectable again and triggers an event, the event triggered measurement reporting delay shall be less than  $T_{SSB\_measurement\_period\_intra}$  provided the timing to that cell has not changed more than  $\pm 3200 T_c$  while the measurement gap has not been available and the L3 filter has not been used. When L3 filtering is used, an additional delay can be expected.

[TS38.133, clause 9.2.6.2]

The UE shall be able to identify a new detectable intra frequency cell within  $T_{\text{identify\_intra\_without\_index}}$  if UE is not indicated to report SSB based RRM measurement result with the associated SSB index (*reportQuantityRsIndexes* or *maxNrofRSIndexesToReport* is not configured), or the UE has been indicated that the neighbour cell is synchronous with the serving cell (*deriveSSB-IndexFromCell* is enabled). Otherwise UE shall be able to identify a new detectable intra frequency cell within  $T_{\text{identify\_intra\_with\_index}}$ . The UE shall be able to identify a new detectable intra frequency SS block of an already detected cell within  $T_{\text{identify\_intra\_without\_index}}$ . It is assumed that *deriveSSB-IndexFromCell* is always enabled for FR1 TDD and FR2.

$$T_{\text{identify\_intra\_without\_index}} = (T_{\text{PSS/SSS\_sync\_intra}} + T_{\text{SSB\_measurement\_period\_intra}}) \text{ ms}$$

Where:

$T_{\text{PSS/SSS\_sync\_intra}}$ : it is the time period used in PSS/SSS detection given in table 5.6.1.0.2-1

$T_{\text{SSB\_measurement\_period\_intra}}$ : equal to a measurement period of SSB based measurement given in table 5.6.1.0.2-2

$CSSF_{\text{intra}}$ : it is a carrier specific scaling factor and is determined according to  $CSSF_{\text{within\_gap},i}$  in clause 9.1.5.2 for measurement conducted within measurement gaps.

$M_{\text{pss/sss\_sync\_with\_gaps}}$ : For a UE supporting FR2 power class 1,  $M_{\text{pss/sss\_sync\_with\_gaps}}=40$ . For a UE supporting FR2 power class 2,  $M_{\text{pss/sss\_sync\_with\_gaps}}=24$ . For a UE supporting FR2 power class 3,  $M_{\text{pss/sss\_sync\_with\_gaps}}=24$ . For a UE supporting power class 4,  $M_{\text{pss/sss\_sync\_with\_gaps}}=24$

$M_{\text{meas\_period\_with\_gaps}}$ : For a UE supporting power class 1,  $M_{\text{meas\_period\_with\_gaps}}=40$ . For a UE supporting power class 2,  $M_{\text{meas\_period\_with\_gaps}}=24$ . For a UE supporting power class 3,  $M_{\text{meas\_period\_with\_gaps}}=24$ . For a UE supporting power class 4,  $M_{\text{meas\_period\_with\_gaps}}=24$ .

If the higher layer signalling in TS 38.331 [2] signalling of *smtc2* is present and *smtc1* is fully overlapping with measurement gaps and *smtc2* is partially overlapping with measurement gaps, requirements are not specified for  $T_{\text{identify\_intra\_without\_index}}$  or  $T_{\text{identify\_intra\_with\_index}}$ .

If SCG DRX is in use, intrafrequency cell identification requirements specified in Table 5.6.1.0.2-1 shall depend on the SCG DRX cycle. Otherwise, the requirements for when DRX is not in use shall apply.

**Table 5.6.1.0.2-1: Time period for PSS/SSS detection (Frequency range FR2)**

DRX cycle	$T_{\text{PSS/SSS\_sync\_intra}}$
No DRX	$\max(600\text{ms}, M_{\text{pss/sss\_sync\_with\_gaps}} \times \max(\text{MGRP}, \text{SMTC period})) \times \text{CSSF}_{\text{intra}}$
DRX cycle $\leq 320\text{ms}$	$\max(600\text{ms}, \text{ceil}(1.5 \times M_{\text{pss/sss\_sync\_with\_gaps}})) \times \max(\text{MGRP}, \text{SMTC period}, \text{DRX cycle}) \times \text{CSSF}_{\text{intra}}$
DRX cycle $> 320\text{ms}$	$M_{\text{pss/sss\_sync\_with\_gaps}} \times \max(\text{MGRP}, \text{DRX cycle}) \times \text{CSSF}_{\text{intra}}$

[TS38.133, clause 9.2.6.3]

The measurement period for FR2 intra frequency measurements with gaps is as shown in table 5.6.1.0.2-2.

If SCG DRX is in use, intrafrequency measurement period requirements specified in Table 5.6.1.0.2-2 shall depend on the SCG DRX cycle. Otherwise, the requirements for when DRX is not in use shall apply.

**Table 5.6.1.0.2-2: Measurement period for intrafrequency measurements with gaps(Frequency Range FR2)**

DRX cycle	$T_{\text{SSB\_measurement\_period\_intra}}$
No DRX	$\max(400\text{ms}, M_{\text{meas\_period\_with\_gaps}} \times \max(\text{MGRP}, \text{SMTC period})) \times \text{CSSF}_{\text{intra}}$
DRX cycle $\leq 320\text{ms}$	$\max(400\text{ms}, \text{ceil}(1.5 \times M_{\text{meas\_period\_with\_gaps}})) \times \max(\text{MGRP}, \text{SMTC period}, \text{DRX cycle}) \times \text{CSSF}_{\text{intra}}$ <sup>Note 1</sup>
DRX cycle $> 320\text{ms}$	$M_{\text{meas\_period\_with\_gaps}} \times \max(\text{MGRP}, \text{DRX cycle}) \times \text{CSSF}_{\text{intra}}$

The normative reference for this requirement is TS 38.133 [6] clause 9.2.2, 9.2.4.3, 9.2.6.2, 9.2.6.3.

### 5.6.1.1 EN-DC FR2 event-triggered reporting without gap in non-DRX

**Editor's Note: This test case has been completed for the following configurations:**

-Test frequency  $f \leq 40.8$  GHz

-UE PC3

This test case is incomplete for UE power classes other than PC3

This test case is incomplete for test frequencies  $> 40.8$  GHz

#### 5.6.1.1.1 Test purpose

To verify the UE's ability to make a correct reporting of an event within intra-frequency cell search without gap under non-DRX. This test will partly verify the TDD intra-frequency cell search requirements in TS 38.133 [6] clause 9.2.5.1 and 9.2.5.2

#### 5.6.1.1.2 Test applicability

This test applies to all types of E-UTRA UE release 15 forward, supporting EN-DC.

#### 5.6.1.1.3 Minimum conformance requirements

The minimum conformance requirements are specified in clause 5.6.1.0.1.

The normative reference for this requirement is TS 38.133 [6] clause A.5.6.1.1.

5.6.1.1.4 Test description

5.6.1.1.4.1 Initial conditions

This test shall be tested using any of the test configurations in Table 5.6.1.1.4.1-1.

**Table 5.6.1.1.4.1-1: Supported test configurations for EN-DC FR2 event-triggered reporting without gap under non-DRX**

Configuration	Description
5.6.1.1-1	LTE FDD, 120 kHz SSB SCS, 100MHz bandwidth, TDD duplex mode
5.6.1.1-2	LTE TDD, 120 kHz SSB SCS, 100MHz bandwidth, TDD duplex mode
5.6.1.1-3	LTE FDD, 240 kHz SSB SCS, 100MHz bandwidth, TDD duplex mode
5.6.1.1-4	LTE TDD, 240 kHz SSB SCS, 100MHz bandwidth, TDD duplex mode
NOTE: The UE is only required to be tested in one of the supported test configurations.	

Configure the test requirement and the DUT according to the parameters in Table 5.6.1.1.4.1-2.

**Table 5.6.1.1.4.1-2: Initial conditions for EN-DC FR2 event-triggered reporting without gap under non-DRX**

Parameter	Value	Comment
Test environment	NC	As specified in TS 38.508-1 [14] clause 4.1.
Test frequencies	As specified in Annex E, Table E.3-1 and TS 38.508-1 [14] clause 4.3.1 for E-UTRA, 7.2.3 for NR FR2.	
Channel bandwidth	As specified by the test configuration selected from Table 5.6.1.1.4.1-1.	
Propagation conditions	AWGN	As specified in clause C.2.2
Connection Diagram	TE Part	A.3.3.1.1
	DUT Part	A.3.4.1.1
Exceptions to connection diagram	TBD	

1. The test parameters for PSCell and neighbour cell are given in Table 5.6.1.1.4.1-3 below.
2. Message contents are defined in clause 5.6.1.1.4.3.
3. There are three cells in the test, E-UTRAN PCell (Cell 1), FR2 PSCell (Cell 2) and a FR2 neighbour cell (Cell 3) on the same frequency as the PSCell. The power levels and settings for Cell 1 are set according to Annex A.6. Cell 2 is the PSCell and Cell 3 is the target cell. The power levels and settings for Cell 2 and Cell 3 are set according to clause C.1.1 and C.1.2.

**Table 5.6.1.1.4.1-3: General test parameters for EN-DC FR2 intra-frequency event triggered reporting tests without gap under non-DRX**

Parameter	Unit	Config	Value	Comment
Active cell		1~4	E-UTRAN PCell (Cell 1) PSCell (Cell 2)	
Neighbour cell		1~4	Cell 3	Cell to be identified.
RF Channel Number		1~4	1: Cell 1 2: Cell 2 and Cell 3	One TDD carrier frequency is used for the NR cells and one TDD or FDD carrier frequency is used for E-UTRAN cell.
SMTc configuration		1~4	SMTc.1	
A3-Offset	dB	1~4	-11	
CP length		1~4	Normal	
Hysteresis	dB	1~4	0	
Time To Trigger	s	1~4	0	
Filter coefficient		1~4	0	L3 filtering is not used
DRX		1~4	OFF	
Time offset between Cell 1 and Cell 2		1~4	3 $\mu$ s	Synchronous EN-DC

Parameter	Unit	Config	Value	Comment
Time offset between Cell 2 and Cell 3		1~4	3 $\mu$ s	Synchronous cells
T1	s	1~4	5	
T2	s	1~4	5	

#### 5.6.1.1.4.2 Test procedure

There are three cells in the test, E-UTRAN PCell (Cell 1), FR2 PSCell (Cell 2) and a FR2 neighbour cell (Cell 3) on the same frequency as the PSCell.

In the measurement control information a measurement object is configured for the frequency of the PSCell, and it is indicated to the UE that event-triggered reporting with Event A3 is used.

The test consists of two successive time periods, with time duration of T1, and T2 respectively. During time duration T1, the UE shall not have any timing information of cell 3.

1. Ensure the UE is in state RRC\_CONNECTED with generic procedure parameters Connectivity EN-DC, DC bearer MCG and SCG, Connected without release *On* according to TS 38.508-1 [14] clause 4.5.
2. Set the parameters according to T1 in Table 5.6.1.1.5-1.
3. SS shall transmit an *RRCConnectionReconfiguration* message with event A3 configured.
4. The UE shall transmit *RRCConnectionReconfigurationComplete* message.
5. When T1 expires, the SS shall switch the power setting from T1 to T2 as specified in Table 5.6.1.1.5-1. T2 starts.
6. UE shall transmit a *MeasurementReport* message triggered by Event A3 embedded in E-UTRA RRC message *ULInformationTransferMRDC*. If the overall delays measured from the beginning of time period T2 is less than 1442 ms, then the number of successful tests is increased by one. If the UE fails to report the event within the overall delays measured requirement then the number of failure tests is increased by one.
7. After the SS receive the *MeasurementReport* message in step 6 or when T2 expires, the SS shall transmit *RRCConnectionReconfiguration* message with condition EN-DC\_PSCell\_Rel according to TS 36.508 [25] Table 4.6.1-8 to release NR cell (PSCell). The UE shall transmit *RRCConnectionReconfigurationComplete* message.
8. Set Cell 3 physical cell identity = ((current cell 3 physical cell identity + 1) mod 1008) for next iteration of the test procedure loop.
9. The SS shall transmit *RRCConnectionReconfiguration* message with condition MCG\_and\_SCG according to TS 36.508 [25] Table 4.6.1-8 to add NR cell (PSCell). The UE shall transmit *RRCConnectionReconfigurationComplete* message. If either of the reconfiguration in step 7 or step 9 fails, SS switches off and on the UE and ensures the UE is in state RRC\_CONNECTED with generic procedure parameters Connectivity EN-DC, DC bearer MCG and SCG, Connected without release *On* according to TS 38.508-1 [14] clause 4.5.
10. Repeat step 2-9 until the confidence level according to Tables G.2.3-1 in Annex G clause G.2 is achieved.

#### 5.6.1.1.4.3 Message contents

Message contents are according to TS 38.508-1 [14] clause 7.3 with the following exceptions:

**Table 5.6.1.1.4.3-1: Common Exception messages EN-DC FR2 intra frequency event triggered reporting tests without gap under non-DRX**

Default Message Contents	
Common contents of system information blocks exceptions	
Default RRC messages and information elements contents exceptions	Table H.3.1-1 Table H.3.1-2 Table H.3.1-4 with A3-offset = -11dB Table H.3.1-7 with Condition INTRA-FREQ Table H.3.4-1 Table H.3.4-2

**Table 5.6.1.1.4.3-2: MeasObjectNR (Step 3, test procedure)**

Derivation Path: Table H.3.1-3 with condition INTRA-FREQ MO, Synchronous cells and NOT SS-SINR			
Information Element	Value/remark	Comment	Condition
MeasObjectNR ::= SEQUENCE {			
ssbSubcarrierSpacing	SubcarrierSpacing specified in 38.508-1 [14] Table 7.3.1-3a with condition SSB.3 FR2		5.6.1.1-1, 5.6.1.1-2
	SubcarrierSpacing specified in 38.508-1 [14] Table 7.3.1-3a with condition SSB.4 FR2		5.6.1.1-3, 5.6.1.1-4
smtc1	SSB-MTC specified in 38.508-1 [14] Table 7.3.1-3 with condition SMTC.1		
cellsToAddModList SEQUENCE (SIZE (1..maxNrofCellMeas)) OF CellsToAddMod {	1 entry		
CellsToAddMod[1] SEQUENCE {		entry 1	
physCellId	PhysCellId of Cell 3		
cellIndividualOffset SEQUENCE {			
rsrpOffsetSSB	dB16		
rsrqOffsetSSB	Not present		
sinrOffsetSSB	Not present		
rsrpOffsetCSI-RS	Not present		
rsrqOffsetCSI-RS	Not present		
sinrOffsetCSI-RS	Not present		
}			
}			
}			
}			

5.6.1.1.5 Test requirement

Tables 5.6.1.1.4.1-3, 5.6.1.1.5-1 and 5.6.1.1.5-2 define the primary level settings including test tolerances for EN-DC FR2 event triggered reporting test without gap under non-DRX.

**Table 5.6.1.1.5-1: NR Cell specific test parameters for intra-frequency event triggered reporting for EN-DC with TDD PSCell in FR2 without gap under non-DRX**

Parameter	Unit	Config	Cell 2		Cell 3	
			T1	T2	T1	T2
TDD configuration		1~4	TDDConf.3.1		TDDConf.3.1	
BW <sub>channel</sub>	MHz	1~4	100: N <sub>RB,c</sub> = 66		100: N <sub>RB,c</sub> = 66	
Data RBs allocated		1,2	24		24	
		3,4	48		48	
Initial BWP configuration		1~4	DLBWP.0.1 ULBWP.0.1		DLBWP.0.1 ULBWP.0.1	



Active DL BWP configuration		1~4	DLBWP.1.1	DLBWP.1.1
Active UL BWP configuration		1~4	ULBWP.1.1	ULBWP.1.1
RLM-RS		1~4	SSB	SSB
PDSCH RMC configuration		1,2	SR.3.2 TDD	N/A
		3,4	SR.3.3 TDD	
RMSI CORESET RMC configuration		1,2	CR.3.1 TDD	CR.3.1 TDD
		3,4	CR.3.2 TDD	CR.3.2 TDD
Dedicated CORESET RMC configuration		1,2	CCR.3.1 TDD	CCR.3.1 TDD
		3,4	CCR.3.7 TDD	CCR.3.7 TDD
PDSCH/PDCCH subcarrier spacing	kHz	1~4	120	120
OCNG Patterns		1~4	OP.5	N/A
TRS configuration		1~4	TRS.2.1 TDD	N/A
PDSCH/PDCCH TCI state		1~4	TCI.State.2	N/A
cellIndividualOffset	dB	1~4	N/A	16
SSB configuration		1, 2	SSB.3 FR2	SSB.7 FR2
		3, 4	SSB.4 FR2	SSB.8 FR2
Propagation Condition		1~4	AWGN	

**Table 5.6.1.1.5-2: NR OTA Cell specific test parameters for intra-frequency event triggered reporting for EN-DC with TDD PSCell in FR2 without gap under non-DRX**

Parameter	Unit	Config	Cell 2		Cell 3	
			T1	T2	T1	T2
AoA setup		1~4	Setup 3 defined in A.9.3			
			AoA1		AoA2	
Assumption for UE beams <sup>Note 4</sup>		1~4	Rough		Rough	
$E_s$	dBm/SCS	1, 2	-89		-89	
		3, 4	-86		-86	
$\hat{E}_s / I_{otBB}$ <sup>Note 5</sup>	dB	1~4	-0.12	-0.12	-Infinity	-0.12
SSB_RP	dBm/SCS	1, 2	-89	-89	-Infinity	-89
		3, 4	-86	-86	-Infinity	-86
$I_o$	dBm/95.04MHz	1,2	-64.41	-64.41	-Infinity	-64.41
		3,4	-61.41	-61.41	-Infinity	-61.41
Time multiplexing of the downlink transmissions from each AoA	1~4	Defined in Figure 5.6.1.1.5-1	Time multiplexing of the downlink transmissions from each AoA		1~4	
NOTE 1: The resources for uplink transmission are assigned to the UE prior to the start of time period T2.						
NOTE 2: Interference from other cells and noise sources not specified in the test is assumed to be constant over subcarriers and time and shall be modelled as AWGN of appropriate power for $N_{oc}$ to be fulfilled.						
NOTE 3: SS-RSRP levels have been derived from other parameters for information purposes. They are not settable parameters themselves.						
Note 4: Information about types of UE beam is given in B.2.1.3, and does not limit UE implementation or test system implementation.						
Note 5: Calculation of $E_s/I_{otBB}$ includes the effect of UE internal noise up to the value assumed for the associated Refsens requirement in clause 7.3.2 of TS 38.101-2 [19], and an allowance of 1dB for UE multi-band relaxation factor $\Delta MB_P$ from TS 38.101-2 [19] Table 6.2.1.3-4.						

In the test, the UE shall send one Event A3 triggered measurement report, with a measurement reporting delay less than 1440 ms from the beginning of time period T2.

The UE is not required to read the neighbour cell SSB index in this test.

The UE shall not send event triggered measurement reports, as long as the reporting criteria are not fulfilled.

The rate of correct events observed during repeated tests shall be at least 90%.

NOTE: The actual overall delays measured in the test may be up to  $2 \times TTI_{DCCH}$  higher than the measurement reporting delays above because of TTI insertion uncertainty of the measurement report in DCCH.

The overall delays measured shall be less than a total of 1442 ms in this test case (note: this gives a total measurement reporting delay plus 2 ms for TTI insertion uncertainty).

For the test to pass, the total number of successful tests shall be more than 90% of the cases with a confidence level of 95%.

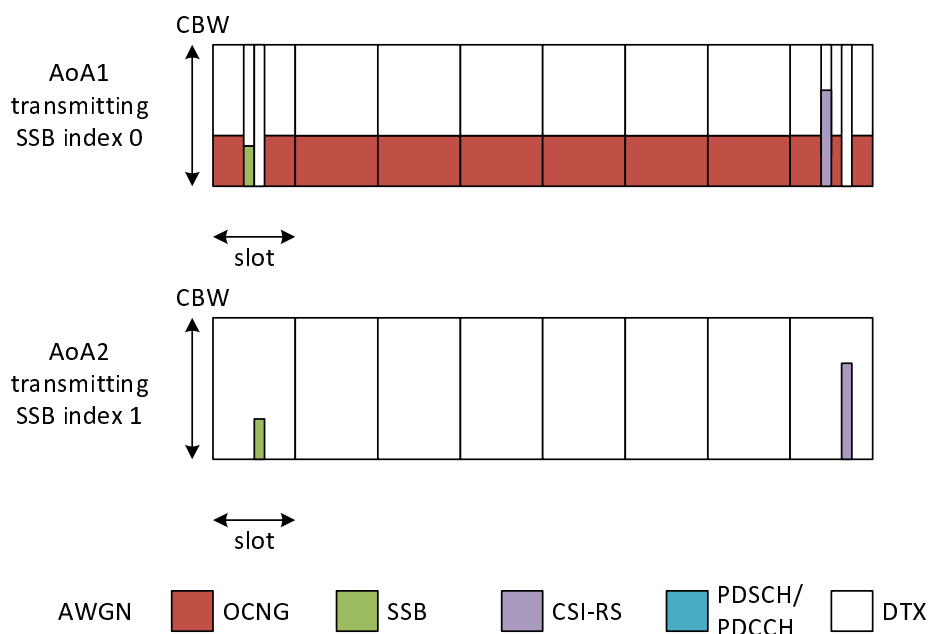

Figure 5.6.1.1.5-1: Time multiplexed downlink transmissions (Config 1,2 example)

### 5.6.1.2 EN-DC FR2 event-triggered reporting without gap in DRX

Editor's Note: This test case has been completed for the following configurations:

- Test frequency  $f \leq 40.8$  GHz
- UE PC3
- The test is incomplete for UE power classes other than PC3
- The test is incomplete for test frequencies  $> 40.8$  GHz

- The test is incomplete for test frequencies  $> 40.8$  GHz

5.6.1.2.1 Test purpose  
 To verify the UE's ability to make a correct reporting of an event within intra-frequency cell search without gap in DRX. This test will partly verify the TDD intra-frequency cell search requirements in TS 38.133 [6] clause 9.2.5.1 and 9.2.5.2

#### 5.6.1.2.2 Test applicability

This test applies to all types of E-UTRA UE release 15 forward, supporting EN-DC and long DRX cycle.

#### 5.6.1.2.3 Minimum conformance requirements

The minimum conformance requirements are specified in clause 5.6.1.0.1.

The normative reference for this requirement is TS 38.133 [6] clause A.5.6.1.2.

#### 5.6.1.2.4 Test description

##### 5.6.1.2.4.1 Initial conditions

This test shall be tested using any of the test configurations in Table 5.6.1.2.4.1-1.

**Table 5.6.1.2.4.1-1: Supported test configurations for EN-DC FR2 event-triggered reporting without gap in DRX**

Configuration	Description
5.6.1.2-1	LTE FDD, 120 kHz SSB SCS, 100MHz bandwidth, TDD duplex mode
5.6.1.2-2	LTE TDD, 120 kHz SSB SCS, 100MHz bandwidth, TDD duplex mode
5.6.1.2-3	LTE FDD, 240 kHz SSB SCS, 100MHz bandwidth, TDD duplex mode
5.6.1.2-4	LTE TDD, 240 kHz SSB SCS, 100MHz bandwidth, TDD duplex mode
NOTE: The UE is only required to be tested in one of the supported test configurations.	

Configure the test requirement and the DUT according to the parameters in Table 5.6.1.2.4.1-2.

**Table 5.6.1.2.4.1-2: Initial conditions for EN-DC FR2 event-triggered reporting without gap in DRX**

Parameter	Value		Comment
Test environment	NC		As specified in TS 38.508-1 [14] clause 4.1.
Test frequencies	As specified in Annex E, Table E.3-1 and TS 38.508-1 [14] clause 4.3.1 for E-UTRA, 7.2.3 for NR FR2.		
Channel bandwidth	As specified by the test configuration selected from Table 5.6.1.2.4.1-1.		
Propagation conditions	AWGN		As specified in clause C.2.2
Connection Diagram	TE Part	A.3.3.3.1-1	As specified in TS 38.508-1 [14] Annex A.
	DUT Part	A.3.4.3	
Exceptions to connection diagram	TBD		

1. The test parameters for PSCell and neighbour cell are given in Table 5.6.1.2.4.1-3 below.
2. Message contents are defined in clause 5.6.1.2.4.3.
3. There are three cells in the test, E-UTRAN PCell (Cell 1), FR2 PSCell (Cell 2) and a FR2 neighbour cell (Cell 3) on the same frequency as the PSCell. The power levels and settings for Cell 1 are set according to Annex A.6. Cell 2 is the PSCell and Cell 3 is the target cell. The power levels and settings for Cell 2 and Cell 3 are set according to clause C.1.1 and C.1.2.

**Table 5.6.1.2.4.1-3: General test parameters for EN-DC FR2 intra-frequency event triggered reporting tests without gap in DRX**

Parameter	Unit	Config	Value		Comment
			Test 1	Test 2	
Active cell		1~4	E-UTRAN PCell (Cell 1) PSCell (Cell 2)		
Neighbour cell		1~4	Cell 3		Cell to be identified.
RF Channel Number		1~4	1: Cell 1 2: Cell 2 and Cell 3		One TDD carrier frequency is used for the NR cells and one TDD or FDD carrier frequency is used for E-UTRAN cell.
SMTC configuration		1~4	SMTC.1		
A3-Offset	dB	1~4	-7 (Note1)		
CP length		1~4	Normal		
Hysteresis	dB	1~4	0		
Time To Trigger	s	1~4	0		

Parameter	Unit	Config	Value		Comment
			Test 1	Test 2	
Filter coefficient		1~4	0		L3 filtering is not used
DRX		1~4	DRX.1	DRX. 7	DRX related parameters are defined in Table 5.6.1.2.5-2
Time offset between Cell 1 and Cell 2		1~4	3 $\mu$ s		Synchronous EN-DC
Time offset between Cell 2 and Cell 3		1~4	3 $\mu$ s		Synchronous cells
T1	s	1~4	5		
T2	s	1~4	10	52	

NOTE: Test tolerance of -1dB applied

#### 5.6.1.2.4.2 Test procedure

There are three cells in the test, E-UTRAN PCell (Cell 1), FR2 PSCell (Cell 2) and a FR2 neighbour cell (Cell 3) on the same frequency as the PSCell.

In the measurement control information a measurement object is configured for the frequency of the PSCell, and it is indicated to the UE that event-triggered reporting with Event A3 is used.

The test consists of two successive time periods, with time duration of T1, and T2 respectively. During time duration T1, the UE shall not have any timing information of cell 3.

1. Ensure the UE is in state RRC\_CONNECTED with generic procedure parameters Connectivity DC, DC bearer MCG and SCG, Connected without release *On* according to TS 38.508-1 [14] clause 4.5.
2. Set the parameters according to T1 in Table 5.6.1.2.5-1.
3. SS shall transmit an *RRCConnectionReconfiguration* message with event A3 configured.
4. The UE shall transmit *RRCConnectionReconfigurationComplete* message.
5. When T1 expires, the SS shall switch the power setting from T1 to T2 as specified in Table 5.6.1.2.5-1. T2 starts.
6. UE shall transmit a *MeasurementReport* message triggered by Event A3 embedded in E-UTRA RRC message *ULInformationTransferMRDC*. If the overall delays measured from the beginning of time period T2 is less than 4322 ms for Test 1 and 30722 ms for Test 2, then the number of successful tests is increased by one. If the UE fails to report the event within the overall delays measured requirement then the number of failure tests is increased by one.
7. After the SS receive the *MeasurementReport* message in step 6 or when T2 expires, the SS shall transmit *RRCConnectionReconfiguration* message with condition EN-DC\_PSCell\_Rel according to TS 36.508 [25] Table 4.6.1-8 to release NR cell (PSCell). The UE shall transmit *RRCConnectionReconfigurationComplete* message.
8. Set Cell 3 physical cell identity = ((current cell 3 physical cell identity + 1) mod 1008) for next iteration of the test procedure loop.
9. The SS then shall transmit *RRCConnectionReconfiguration* message with condition MCG\_and\_SCG according to TS 36.508 [25] Table 4.6.1-8 to add NR cell (PSCell). The UE shall transmit *RRCConnectionReconfigurationComplete* message.
10. If any the reconfiguration fails, switch off and on the UE and ensure the UE is in RRC\_CONNECTED with generic procedure parameters Connectivity EN-DC, DC bearer MCG and SCG, Connected without release *On* according to TS 38.508-1 [14] clause 4.5].
11. Repeat step 2-10 until the confidence level according to Tables G.2.3-1 in Annex G clause G.2 is achieved.
12. Repeat step 1-11 for each sub-test in Table 5.6.1.2.4.1-3 as appropriate.

#### 5.6.1.2.4.3 Message contents

Message contents are according to TS 38.508-1 [14] clause 7.3 with the following exceptions:

**Table 5.6.1.2.4.3-1: Common Exception messages EN-DC FR2 intra frequency event triggered reporting tests without gap in DRX**

Default Message Contents	
Common contents of system information blocks exceptions	
Default RRC messages and information elements contents exceptions	Table H.3.1-1 Table H.3.1-2 Table H.3.1-3 with Condition INTRA-FREQ MO, Synchronous cells and NOT SS-SINR Table H.3.1-4 with A3-offset = -7dB  Table H.3.1-7 with Condition INTRA-FREQ Table H.3.4-1 Table H.3.4-2 Table H.3.7-1 with Condition DRX.1 for Test 1 Table H.3.7-1 with Condition DRX. 7 for Test 2 Table 7.3.1-3 in TS 38.508-1 [14] with condition SMTC.1
Specific message contents exceptions for Test Configuration 5.6.1.2-1 and 5.6.1.2-2	Table 7.3.1-3a in TS 38.508-1 [14] with condition SSB.3 FR2
Specific message contents exceptions for Test Configuration 5.6.1.2-3 and 5.6.1.2-4	Table 7.3.1-3a in TS 38.508-1 [14] with condition SSB.4 FR2

#### 5.6.1.2.5 Test requirement

Tables 5.6.1.2.4.1-3, 5.6.1.2.5-1 and 5.6.1.2.5-2 define the primary level settings including test tolerances for EN-DC FR2 event triggered reporting test without gap in DRX.

**Table 5.6.1.2.5-1: NR Cell specific test parameters for intra-frequency event triggered reporting for EN-DC with TDD PSCell in FR2 without gap in DRX**

Parameter	Unit	Config	Cell 2		Cell 3	
			T1	T2	T1	T2
TDD configuration		1~4	TDDConf.3.1		TDDConf.3.1	
BW <sub>channel</sub>	MHz	1~4	100: N <sub>RB,c</sub> = 66		100: N <sub>RB,c</sub> = 66	
Data RBs allocated		1~4	66		66	
Initial BWP configuration		1~4	DLBWP.0.1 ULBWP.0.1		DLBWP.0.1 ULBWP.0.1	
Active DL BWP configuration		1~4	DLBWP.1.1		DLBWP.1.1	
Active UL BWP configuration		1~4	ULBWP.1.1		ULBWP.1.1	
RLM-RS		1~4	SSB		SSB	
PDSCH RMC configuration		1,2	SR.3.2 TDD		N/A	
		3,4	SR.3.3 TDD			
RMSI CORESET RMC configuration		1,2	CR.3.1 TDD		N/A	
		3,4	CR.3.2 TDD			
Dedicated CORESET RMC configuration		1,2	CCR.3.1 TDD		N/A	
		3,4	CCR.3.7 TDD			
PDSCH/PDCCH subcarrier spacing	kHz	1~4	120		120	
OCNG Patterns		1~4	OP.1		OP.1	
PDSCH/PDCCH TCI state		1~4	TCI.State.2		N/A	
CSI-RS for tracking		1~4	TRS.2.1 TDD		N/A	
SSB configuration		1, 2	SSB.3 FR2		SSB.3 FR2	
		3, 4	SSB.4 FR2		SSB.4 FR2	
Propagation Condition		1~4	AWGN		AWGN	

**Table 5.6.1.2.5-2: NR OTA Cell specific test parameters for intra-frequency event triggered reporting for EN-DC with TDD PSCell in FR2 without gap in DRX**

Parameter	Unit	Config	Cell 2		Cell 3	
			T1	T2	T1	T2
AoA setup		1~4	Setup 1 defined in A.9.1			
$\hat{E}_s/I_{ot}$ <small>BB Note 5</small>	dB	1~4	3.77	-1.52	-Infinity	-1.52
$N_{oc}$ <small>Note 2</small>	dBm/15 KHz	1~4	-101.5			
$N_{oc}$ <small>Note 2</small>	dBm/SCS	1, 2	-92.5			
		3, 4	-89.5			
SSB_RP	dBm/SCS	1, 2	-88.47	-88.47	-Infinity	-88.47
		3, 4	-85.46	-85.46	-Infinity	-85.46
$\hat{E}_s/N_{oc}$	dB	1~4	4	4	-Infinity	4
$I_o$	dBm/95.04MHz	1~4	-58.03	-55.68	See Cell 2 columns	
<p>NOTE 1: The resources for uplink transmission are assigned to the UE prior to the start of time period T2.</p> <p>NOTE 2: Interference from other cells and noise sources not specified in the test is assumed to be constant over subcarriers and time and shall be modelled as AWGN of appropriate power for <math>N_{oc}</math> to be fulfilled.</p> <p>NOTE 3: <math>E_s/I_{ot}</math>, SSB_RP and <math>I_o</math> levels have been derived from other parameters for information purposes. They are not settable parameters themselves.</p> <p>NOTE 4: Information about types of UE beam is given in B.2.1.3, and does not limit UE implementation or test system implementation.</p> <p>NOTE 5: Calculation of <math>E_s/I_{ot}</math> includes the effect of UE internal noise up to the value assumed for the associated Refsens requirement in clause 7.3.2 of TS 38.101-2 [19], and an allowance of 1dB for UE multi-band relaxation factor <math>\Delta MB_P</math> from TS 38.101-2 [19] Table 6.2.1.3-4.</p>						

In test 1, the UE shall send one Event A3 triggered measurement report, with a measurement reporting delay less than 4.32s from the beginning of time period T2.

In test 2, the UE shall send one Event A3 triggered measurement report, with a measurement reporting delay less than 30.72s from the beginning of time period T2.

The UE is not required to read the neighbour cell SSB index in this test.

The UE shall not send event triggered measurement reports, as long as the reporting criteria are not fulfilled.

The rate of correct events observed during repeated tests shall be at least 90%.

NOTE: The actual overall delays measured in the test may be up to  $2 \times TTI_{DCC}$  higher than the measurement reporting delays above because of TTI insertion uncertainty of the measurement report in DCC.

The overall delays measured shall be less than a total of 4322 ms for Test 1 and 30722 ms for Test 2 in this test case (note: this gives a total measurement reporting delay plus 2 ms for TTI insertion uncertainty).

For the test to pass, the total number of successful tests shall be more than 90% of the cases with a confidence level of 95%.

### 5.6.1.3 EN-DC FR2 event-triggered reporting with gap in non-DRX

**Editor's Note: This test case has been completed for the following configurations:**

- Test frequency  $f \leq 40.8$  GHz
- UE PC3

This test case is incomplete for UE power classes other than PC3

This test case is incomplete for test frequencies  $> 40.8$  GHz

### 5.6.1.3.1 Test purpose

To verify the UE's ability to make a correct reporting of an event within intra-frequency cell search with gap in non-DRX. This test will partly verify the TDD intra-frequency cell search requirements in TS 38.133 [6] clause 9.2.5.1 and 9.2.5.2

### 5.6.1.3.2 Test applicability

This test applies to all types of E-UTRA UE release 15 forward, supporting EN-DC. This test applies to UE that support CSI-RS based RLM and BWP operation without bandwidth restriction.

### 5.6.1.3.3 Minimum conformance requirements

The minimum conformance requirements are specified in clause 5.6.1.0.2.

The normative reference for this requirement is TS 38.133 [6] clause A.5.6.1.3.

### 5.6.1.3.4 Test description

#### 5.6.1.3.4.1 Initial conditions

This test shall be tested using any of the test configurations in Table 5.6.1.3.4.1-1.

**Table 5.6.1.3.4.1-1: Supported test configurations for EN-DC FR2 event-triggered reporting with gap in non-DRX**

Configuration	Description
5.6.1.3-1	LTE FDD, 120 kHz SSB SCS, 100MHz bandwidth, TDD duplex mode
5.6.1.3-2	LTE TDD, 120 kHz SSB SCS, 100MHz bandwidth, TDD duplex mode
5.6.1.3-3	LTE FDD, 240 kHz SSB SCS, 100MHz bandwidth, TDD duplex mode
5.6.1.3-4	LTE TDD, 240 kHz SSB SCS, 100MHz bandwidth, TDD duplex mode

NOTE: The UE is only required to be tested in one of the supported test configurations.

Configure the test requirement and the DUT according to the parameters in Table 5.6.1.3.4.1-2.

**Table 5.6.1.3.4.1-2: Initial conditions for EN-DC FR2 event-triggered reporting with gap in non-DRX**

Parameter	Value	Comment
Test environment	NC	As specified in TS 38.508-1 [14] clause 4.1.
Test frequencies	As specified in Annex E, Table E.3-1 and TS 38.508-1 [14] clause 4.3.1 for E-UTRA, 7.2.3 for NR FR2.	
Channel bandwidth	As specified by the test configuration selected from Table 5.6.1.3.4.1-1.	
Propagation conditions	AWGN	As specified in clause C.2.2
Connection Diagram	TE Part	A.3.3.1.1
	DUT Part	A.3.4.1.1
Exceptions to connection diagram	TBD	

1. The test parameters for PSCell and neighbour cell are given in Table 5.6.1.3.4.1-3 below.

2. Message contents are defined in clause 5.6.1.3.4.3.

3. There are three cells in the test, E-UTRAN PCell (Cell 1), FR2 PSCell (Cell 2) and a FR2 neighbour cell (Cell 3) on the same frequency as the PSCell. The power levels and settings for Cell 1 are set according to Annex A.6. Cell 2 is the PSCell and Cell 3 is the target cell. The power levels and settings for Cell 2 and Cell 3 are set according to clause C.1.1 and C.1.2.

**Table 5.6.1.3.4.1-3: General test parameters for intra-frequency event triggered reporting for EN-DC with TDD PSCell in FR2 with per-UE gaps without DRX**

Parameter	Unit	Config	Value	Comment
-----------	------	--------	-------	---------

Active cell		1~4	E-UTRAN PCell (Cell 1) PSCell (Cell 2)	
Neighbour cell		1~4	Cell 3	Cell to be identified.
RF Channel Number		1~4	1: Cell 1 2: Cell 2 and Cell 3	One TDD carrier frequency is used for the NR cells and one TDD or FDD carrier frequency is used for E-UTRAN cell.
Gap type		1~4	Per-UE gaps	
Measurement gap repetition periodicity	ms	1~4	40	
Measurement gap length	ms	1~4	6	
Measurement gap offset	ms	1~4	39	
SMTC configuration		1~4	SMTC.1	
CSI-RS parameters		1~4	CSI-RS.3.2 TDD	
A3-Offset	dB	1~4	-11	
CP length		1~4	Normal	
Hysteresis	dB	1~4	0	
Time To Trigger	s	1~4	0	
Filter coefficient		1~4	0	L3 filtering is not used
DRX		1~4	OFF	
Time offset between Cell 1 and Cell 2		1~4	3 $\mu$ s	Synchronous EN-DC
Time offset between Cell 2 and Cell 3		1~4	3 $\mu$ s	Synchronous cells
T1	s	1~4	5	
T2	s	1~4	5	

#### 5.6.1.3.4.2 Test procedure

There are three cells in the test, E-UTRAN PCell (Cell 1), FR2 PSCell (Cell 2) and a FR2 neighbour cell (Cell 3) on the same frequency as the PSCell.

There are two BWPs configured in Cell 2, BWP1 which contains the cell defining SSB, and BWP2 which does not contain any SSB of Cell 2. During the whole test, BWP2 is always scheduled as the active BWP for the UE.

In the measurement control information a measurement object is configured for the frequency of the PSCell, and it is indicated to the UE that event-triggered reporting with Event A3 is used.

The test consists of two successive time periods, with time duration of T1, and T2 respectively. During time duration T1, the UE shall not have any timing information of cell 3.

1. Ensure the UE is in state RRC\_CONNECTED with generic procedure parameters Connectivity EN-DC, DC bearer MCG and SCG, Connected without release *On* according to TS 38.508-1 [14] clause 4.5.
2. Set the parameters according to T1 in Table 5.6.1.3.5-1.
3. SS shall transmit an *RRCConnectionReconfiguration* message with event A3 configured.
4. The UE shall transmit *RRCConnectionReconfigurationComplete* message.
5. When T1 expires, the SS shall switch the power setting from T1 to T2 as specified in Table 5.6.1.3.5-1. T2 starts.
6. UE shall transmit a *MeasurementReport* message triggered by Event A3 embedded in E-UTRA RRC message *ULInformationTransferMRDC*. If the overall delays measured from the beginning of time period T2 is less than 1922 ms, then the number of successful tests is increased by one. If the UE fails to report the event within the overall delays measured requirement then the number of failure tests is increased by one.
7. After the SS receive the *MeasurementReport* message in step 6 or when T2 expires, the SS shall transmit *RRCConnectionReconfiguration* message with condition EN-DC\_PSCell\_Rel according to TS 36.508 [25] Table 4.6.1-8 to release NR cell (PSCell). The UE shall transmit *RRCConnectionReconfigurationComplete* message.
8. Set Cell 3 physical cell identity = ((current cell 3 physical cell identity + 1) mod 1008) for next iteration of the test procedure loop.



9. The SS shall transmit RRCConnectionReconfiguration message with condition MCG\_and\_SCG according to TS 36.508 [25] Table 4.6.1-8 to add NR cell (PSCell). The UE shall transmit RRCConnectionReconfigurationComplete message. If either of the reconfiguration in step 7 or step 9 fails, SS switches off and on the UE and ensures the UE is in state RRC\_CONNECTED with generic procedure parameters Connectivity EN-DC, DC bearer MCG and SCG, Connected without release *On* according to TS 38.508-1 [14] clause 4.5.

10. Repeat step 2-9 until the confidence level according to Tables G.2.3-1 in Annex G clause G.2 is achieved.

5.6.1.3.4.3 Message contents

Message contents are according to TS 38.508-1 [14] clause 7.3 with the following exceptions:

**Table 5.6.1.3.4.3-1: Common Exception messages EN-DC FR2 intra frequency event triggered reporting tests with gap in non-DRX**

Default Message Contents	
Common contents of system information blocks exceptions	
Default RRC messages and information elements contents exceptions	Table H.3.1-1 Table H.3.1-2 with Condition INTRA-FREQ and GAP NEEDED Table H.3.1-4 with A3-offset =-11dB Table H.3.1-7 with Condition INTRA-FREQ Table H.3.4-1 Table H.3.4-2 Table H.3.4-4 with Condition gapUE Table H.3.4-5 with Condition Pattern #0

**Table 5.6.1.3.4.3-2: MeasObjectNR (Step 3, test procedure)**

Derivation Path: Table H.3.1-3 with condition INTRA-FREQ MO, Synchronous cells and NOT SS-SINR			
Information Element	Value/remark	Comment	Condition
MeasObjectNR ::= SEQUENCE {			
ssbSubcarrierSpacing	SubcarrierSpacing specified in 38.508-1 [14] Table 7.3.1-3a with condition SSB.3 FR2		5.6.1.3-1, 5.6.1.3-2
	SubcarrierSpacing specified in 38.508-1 [14] Table 7.3.1-3a with condition SSB.4 FR2		5.6.1.3-3, 5.6.1.3-4
smtc1	SSB-MTC specified in 38.508-1 [14] Table 7.3.1-3 with condition SMTC.1		
cellsToAddModList SEQUENCE (SIZE (1..maxNrofCellMeas)) OF CellsToAddMod {	1 entry		
CellsToAddMod[1] SEQUENCE {		entry 1	
physCellId	PhysCellId of Cell 3		
cellIndividualOffset SEQUENCE {			
rsrpOffsetSSB	dB16		
rsrqOffsetSSB	Not present		
sinrOffsetSSB	Not present		
rsrpOffsetCSI-RS	Not present		
rsrqOffsetCSI-RS	Not present		
sinrOffsetCSI-RS	Not present		
}			
}			
}			

5.6.1.3.5 Test requirement

Tables 5.6.1.3.4.1-3, 5.6.1.3.5-1 and 5.6.1.3.5-2 define the primary level settings including test tolerances for EN-DC FR2 event triggered reporting test with gap under non-DRX.

**Table 5.6.1.3.5-1: NR Cell specific test parameters for intra-frequency event triggered reporting for EN-DC with TDD PSCell in FR2 with per-UE gaps without DRX**

Parameter	Unit	Config	Cell 2		Cell 3	
			T1	T2	T1	T2
TDD configuration		1~4	TDDConf.3.1		TDDConf.3.1	
BW <sub>channel</sub>	MHz	1~4	100: N <sub>RB,c</sub> = 66		100: N <sub>RB,c</sub> = 66	
Data RBs allocated		1,2	24		24	
		3,4	48		48	
Initial BWP configuration		1~4	DLBWP.0.1 ULBWP.0.1		DLBWP.0.1 ULBWP.0.1	
Active DL BWP configuration		1~4	DLBWP.1.2		DLBWP.1.1	
Active UL BWP configuration		1~4	ULBWP.1.2		ULBWP.1.1	
RLM-RS		1~4	CSI-RS		SSB	
PDSCH RMC configuration		1,2	SR.3.2 TDD		N/A	
		3,4	SR.3.3 TDD			
RMSI CORESET RMC configuration		1,2	CR.3.1 TDD		CR.3.1 TDD	
		3,4	CR.3.2 TDD		CR.3.2 TDD	
Dedicated CORESET RMC configuration		1,2	CCR.3.1 TDD		CCR.3.1 TDD	
		3,4	CCR.3.7 TDD		CCR.3.7 TDD	
TRS configuration		1~4	TRS.2.1 TDD		N/A	
PDSCH/PDCCH TCI state		1~4	TCI.State.2		N/A	
PDSCH/PDCCH subcarrier spacing	kHz	1~4	120		120	
OCNG Patterns		1~4	OP.5		N/A	
cellIndividualOffset	dB	1~4	N/A		16	
SSB		1, 2	SSB.3 FR2		SSB.7 FR2	
		3, 4	SSB.4 FR2		SSB.8 FR2	
Propagation Condition		1~4	AWGN			

**Table 5.6.1.3.5-2: NR OTA Cell specific test parameters for intra-frequency event triggered reporting for EN-DC with TDD PSCell in FR2 with per-UE gaps without DRX**

Parameter	Unit	Config	Cell 2		Cell 3	
			T1	T2	T1	T2
AoA setup		1~4	Setup 3 defined in A.3.9.3			
			AoA1		AoA2	
Assumption for UE beams <sup>Note 4</sup>		1~4	Rough		Rough	
E <sub>s</sub>	dBm/SCS	1,2	-89		-89	
		3,4	-86		-86	
$\hat{E}_s / I_{ot}^{BB}$ <sup>Note 5</sup>	dB	1~4	-0.12	-0.12	-Infinity	-0.12
SSB <sub>RP</sub>	dBm/SCS	1, 2	-89	-89	-Infinity	-89
		<u>3, 4</u>	-86	-86	-Infinity	-86
I <sub>o</sub>	dBm/95.04MHz	1,2	-64.41	-64.41	-Infinity	-64.41
		3,4	-61.41	-61.41	-Infinity	-61.41
Time multiplexing of the downlink transmissions from each AoA	1~4	Defined in Figure 5.6.1.3.5-1	Time multiplexing of the downlink transmissions from each AoA		Time multiplexing of the downlink transmissions from each AoA	

NOTE 1: The resources for uplink transmission are assigned to the UE prior to the start of time period T2.

NOTE 2: Interference from other cells and noise sources not specified in the test is assumed to be constant over subcarriers and time and shall be modelled as AWGN of appropriate power for  $N_{oc}$  to be fulfilled.

NOTE 3: SS-RSRP levels have been derived from other parameters for information purposes. They are not settable parameters themselves.

Note 4: Information about types of UE beam is given in B.2.1.3, and does not limit UE implementation or test system implementation.

Note 5: Calculation of  $E_s/lot_{BB}$  includes the effect of UE internal noise up to the value assumed for the associated Refsens requirement in clause 7.3.2 of TS 38.101-2 [19], and an allowance of 1dB for UE multi-band relaxation factor  $\Delta MB_P$  from TS 38.101-2 [19] Table 6.2.1.3-4.

In the test, the UE shall send one Event A3 triggered measurement report, with a measurement reporting delay less than 1.92s from the beginning of time period T2

The UE is not required to read the neighbour cell SSB index in this test.

The UE shall not send event triggered measurement reports, as long as the reporting criteria are not fulfilled.

The rate of correct events observed during repeated tests shall be at least 90%.

NOTE: The actual overall delays measured in the test may be up to  $2 \times TTI_{DCCCH}$  higher than the measurement reporting delays above because of TTI insertion uncertainty of the measurement report in DCCCH.

The overall delays measured shall be less than a total of 1922 ms in this test case (note: this gives a total measurement reporting delay plus 2 ms for TTI insertion uncertainty).

For the test to pass, the total number of successful tests shall be more than 90% of the cases with a confidence level of 95%.

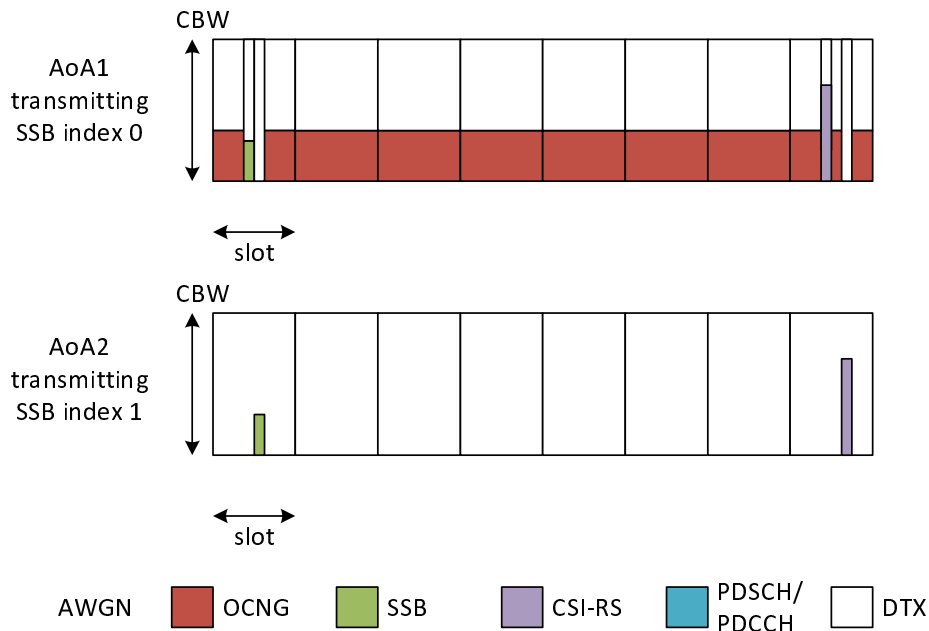

Figure 5.6.1.3.5-1: Time multiplexed downlink transmissions (Config 1,2 example)

### 5.6.1.4 EN-DC FR2 event-triggered reporting with gap in DRX

Editor's Note: This test case has been completed for the following configurations:

- Test frequency  $f \leq 40.8$  GHz
- UE PC3

- The test is incomplete for UE power classes other than PC3

- The test is incomplete for test frequencies > 40.8 GHz

#### 5.6.1.4.1 Test purpose

To verify the UE's ability to make a correct reporting of an event within intra-frequency cell search with gap in DRX. This test will partly verify the TDD intra-frequency cell search requirements in TS 38.133 [6] clause 9.2.5.1 and 9.2.5.2

#### 5.6.1.4.2 Test applicability

This test applies to all types of E-UTRA UE release 15 forward, supporting EN-DC, This test applies to UE that support CSI-RS based RLM, BWP operation without bandwidth restriction and long DRX cycle.

#### 5.6.1.4.3 Minimum conformance requirements

The minimum conformance requirements are specified in clause 5.6.1.0.2.

The normative reference for this requirement is TS 38.133 [6] clause A.5.6.1.4.

#### 5.6.1.4.4 Test description

##### 5.6.1.4.4.1 Initial conditions

This test shall be tested using any of the test configurations in Table 5.6.1.4.4.1-1.

**Table 5.6.1.4.4.1-1: Supported test configurations for EN-DC FR2 event-triggered reporting with gap in DRX**

Configuration	Description
5.6.1.4-1	LTE FDD, 120 kHz SSB SCS, 100MHz bandwidth, TDD duplex mode
5.6.1.4-2	LTE TDD, 120 kHz SSB SCS, 100MHz bandwidth, TDD duplex mode
5.6.1.4-3	LTE FDD, 240 kHz SSB SCS, 100MHz bandwidth, TDD duplex mode
5.6.1.4-4	LTE TDD, 240 kHz SSB SCS, 100MHz bandwidth, TDD duplex mode
NOTE: The UE is only required to be tested in one of the supported test configurations.	

Configure the test requirement and the DUT according to the parameters in Table 5.6.1.4.4.1-2.

**Table 5.6.1.4.4.1-2: Initial conditions for EN-DC FR2 event-triggered reporting with gap in DRX**

Parameter	Value	Comment
Test environment	NC	As specified in TS 38.508-1 [14] clause 4.1.
Test frequencies	As specified in Annex E, Table E.3-1 and TS 38.508-1 [14] clause 4.3.1 for E-UTRA, 7.2.3 for NR FR2.	
Channel bandwidth	As specified by the test configuration selected from Table 5.6.1.4.4.1-1.	
Propagation conditions	AWGN	As specified in clause C.2.2
Connection Diagram	TE Part	As specified in TS 38.508-1 [14] Annex A.
	DUT Part	
Exceptions to connection diagram	TBD	

1. The test parameters for PSCell and neighbour cell are given in Table 5.6.1.4.4.1-3 below.
2. Message contents are defined in clause 5.6.1.4.4.3.
3. There are three cells in the test, E-UTRAN PCell (Cell 1), FR2 PSCell (Cell 2) and a FR2 neighbour cell (Cell 3) on the same frequency as the PSCell. The power levels and settings for Cell 1 are set according to Annex A.6. Cell 2 is the PSCell and Cell 3 is the target cell. The power levels and settings for Cell 2 and Cell 3 are set according to clause C.1.1 and C.1.2.

**Table 5.6.1.4.4.1-3: General test parameters for intra-frequency event triggered reporting for EN-DC with TDD PSCell in FR2 with per-UE gaps with DRX**

Parameter	Unit	Config	Value		Comment
			Test 1	Test 2	
Active cell		1~4	E-UTRAN PCell (Cell 1) PSCell (Cell 2)		
Neighbour cell		1~4	Cell 3		Cell to be identified.
RF Channel Number		1~4	1: Cell 1 2: Cell 2 and Cell 3		One TDD carrier frequency is used for the NR cells and one TDD or FDD carrier frequency is used for E-UTRAN cell.
Gap type		1~4	Per-UE gaps		
Measurement gap repetition periodicity	ms	1~4	40		
Measurement gap length	ms	1~4	6		
Measurement gap offset	ms	1~4	39		
SMTC configuration		1~4	SMTC.1		
CSI-RS parameters		1~4	CSI-RS.3.2 TDD		
A3-Offset	dB	1~4	-7(Note1)		
CP length		1~4	Normal		
Hysteresis	dB	1~4	0		
Time To Trigger	s	1~4	0		
Filter coefficient		1~4	0		L3 filtering is not used
DRX		1~4	DRX.1	DRX. 7	DRX related parameters are defined in Table 5.6.1.4.5-2
Time offset between Cell 1 and Cell 2		1~4	3µs		Synchronous EN-DC
Time offset between Cell 2 and Cell 3		1~4	3µs		Synchronous cells
T1	s	1~4	5		
T2	s	1~4	10	52	
Note1 : Test tolerance of -1dB applied					

#### 5.6.1.4.4.2 Test procedure

There are three cells in the test, E-UTRAN PCell (Cell 1), FR2 PSCell (Cell 2) and a FR2 neighbour cell (Cell 3) on the same frequency as the PSCell.

In the measurement control information a measurement object is configured for the frequency of the PSCell, and it is indicated to the UE that event-triggered reporting with Event A3 is used.

The test consists of two successive time periods, with time duration of T1, and T2 respectively. During time duration T1, the UE shall not have any timing information of cell 3.

There are two BWPs configured in Cell 2, BWP1 which contains the cell defining SSB, and BWP2 which does not contain any SSB of Cell 2. During the whole test, BWP2 is always scheduled as the active BWP for the UE.

1. Ensure the UE is in state RRC\_CONNECTED with generic procedure parameters Connectivity EN-DC, DC bearer MCG and SCG, Connected without release *On* according to TS 38.508-1 [14] clause 4.5.
2. Set the parameters according to T1 in Table 5.6.1.4.5-1.
3. SS shall transmit an *RRCConnectionReconfiguration* message with event A3 configured.
4. The UE shall transmit *RRCConnectionReconfigurationComplete* message.
5. When T1 expires, the SS shall switch the power setting from T1 to T2 as specified in Table 5.6.1.4.5-1. T2 starts.
6. UE shall transmit a *MeasurementReport* message triggered by Event A3 embedded in E-UTRA RRC message *ULInformationTransferMRDC*. If the overall delays measured from the beginning of time period T2 is less than 4322 ms for Test 1 and 30722 ms for Test 2, then the number of successful tests is increased by one. If the UE fails to report the event within the overall delays measured requirement then the number of failure tests is increased by one.

7. After the SS receive the *MeasurementReport* message in step 6 or when T2 expires, the SS shall transmit *RRCConnectionReconfiguration* message with condition EN-DC\_PSCell\_Rel according to TS 36.508 [25] Table 4.6.1-8 to release NR cell (PSCell). The UE shall transmit *RRCConnectionReconfigurationComplete* message.
8. Set Cell 3 physical cell identity = ((current cell 3 physical cell identity + 1) mod 1008) for next iteration of the test procedure loop.
9. The SS then shall transmit *RRCConnectionReconfiguration* message with condition MCG\_and\_SCG according to TS 36.508 [25] Table 4.6.1-8 to add NR cell (PSCell). The UE shall transmit *RRCConnectionReconfigurationComplete* message.
10. If any the reconfiguration fails, switch off and on the UE and ensure the UE is in RRC\_CONNECTED with generic procedure parameters Connectivity EN-DC, DC bearer MCG and SCG, Connected without release On according to TS 38.508-1 [14] clause 4.5].
11. Repeat step 2-10 until the confidence level according to Tables G.2.3-1 in Annex G clause G.2 is achieved.
12. Repeat step 1-11 for each sub-test in Table 5.6.1.2.4.1-3 as appropriate.

5.6.1.4.4.3 Message contents

Message contents are according to TS 38.508-1 [14] clause 7.3 with the following exceptions:

**Table 5.6.1.4.4.3-1: Common Exception messages EN-DC FR2 intra frequency event triggered reporting tests with gap in DRX**

Default Message Contents	
Common contents of system information blocks exceptions	
Default RRC messages and information elements contents exceptions	Table H.3.1-1 Table H.3.1-2 with Condition INTRA-FREQ and GAP NEEDED Table H.3.1-3 with Condition INTRA-FREQ MO, Synchronous cells and NOT SS-SINR Table H.3.1-4 with A3-offset = -7dB Table H.3.1-7 with Condition INTRA-FREQ Table H.3.4-1 Table H.3.4-2 Table H.3.4-4 with Condition gapUE Table H.3.4-5 with Condition Pattern #0 Table H.3.7-1 with Condition DRX.1 and Gap for test 1 Table H.3.7-1 with Condition DRX. 7 and Gap for test 2 Table 7.3.1-3 in TS 38.508-1 [14] with condition SMTC.1
Specific message contents exceptions for Test Configuration 5.6.1.4-1 and 5.6.1.4-2	Table 7.3.1-3a in TS 38.508-1 [14] with condition SSB.3 FR2
Specific message contents exceptions for Test Configuration 5.6.1.4-3 and 5.6.1.4-4	Table 7.3.1-3a in TS 38.508-1 [14] with condition SSB.4 FR2

5.6.1.4.5 Test requirement

Tables 5.6.1.4.4.1-3, 5.6.1.4.5-1 and 5.6.1.4.5-2 define the primary level settings including test tolerances for EN-DC FR2 event triggered reporting test with gap in DRX.

**Table 5.6.1.4.5-1: NR Cell specific test parameters for intra-frequency event triggered reporting for EN-DC with TDD PSCell in FR2 with per-UE gaps with DRX**

Parameter	Unit	Config	Cell 2		Cell 3	
			T1	T2	T1	T2
TDD configuration		1~4	TDDConf.3.1		TDDConf.3.1	
BW <sub>channel</sub>	MHz	1~4	100: N <sub>RB,c</sub> = 66		100: N <sub>RB,c</sub> = 66	
Data RBs allocated		1~4	66		66	
Initial BWP configuration		1~4	DLBWP.0.1 ULBWP.0.1		DLBWP.0.1 ULBWP.0.1	

Active DL BWP configuration		1~4	DLBWP.1.2	DLBWP.1.1
Active UL BWP configuration		1~4	ULBWP.1.2	ULBWP.1.1
RLM-RS		1~4	CSI-RS	SSB
PDSCH RMC configuration		1,2	SR.3.2 TDD	N/A
		3,4	SR.3.3 TDD	
RMSI CORESET RMC configuration		1,2	CR.3.1 TDD	CR.3.1 TDD
		3,4	CR.3.2 TDD	CR.3.2 TDD
Dedicated CORESET RMC configuration		1,2	CCR.3.1 TDD	CCR.3.1 TDD
		3,4	CCR.3.7 TDD	CCR.3.7 TDD
TRS configuration		1~4	TRS.2.1 TDD	N/A
PDSCH/PDCCH TCI state		1~4	TCI.State.2	N/A
PDSCH/PDCCH subcarrier spacing	kHz	1~4	120	120
OCNG Patterns		1~4	OP.1	OP.1
SSB		1, 2	SSB.3 FR2	SSB.3 FR2
		3, 4	SSB.4 FR2	SSB.4 FR2
Propagation Condition		1~4	AWGN	AWGN

**Table 5.6.1.4.5-2: NR OTA Cell specific test parameters for intra-frequency event triggered reporting for EN-DC with TDD PSCell in FR2 with per-UE gaps with DRX**

Parameter	Unit	Config	Cell 2		Cell 3	
			T1	T2	T1	T2
AoA setup		1~4	Setup 1 defined in A.3.9.1			
$\hat{E}_s/I_{ot}$ <sup>BB Note 5</sup>	dB	1~4	3.77	-1.52	-Infinity	-1.52
$N_{oc}$ <sup>Note 2</sup>	dBm/15 KHz	1~4	-101.5			
$N_{oc}$ <sup>Note 2</sup>	dBm/SCS	1, 2	-92.5			
		3, 4	-89.5			
SSB_RP	dBm/SCS	1, 2	-88.47	-88.47	-Infinity	-88.47
		3, 4	-85.46	-85.46	-Infinity	-85.46
$\hat{E}_s/N_{oc}$	dB	1~4	4	4	-Infinity	4
$I_o$	dBm/95.04MHz	1, 2	-58.03	-55.68	See Cell 2 columns	
NOTE 1: The resources for uplink transmission are assigned to the UE prior to the start of time period T2.						
NOTE 2: Interference from other cells and noise sources not specified in the test is assumed to be constant over subcarriers and time and shall be modelled as AWGN of appropriate power for $N_{oc}$ to be fulfilled.						
NOTE 3: $E_s/I_{ot}$ , SSB_RP and $I_o$ levels have been derived from other parameters for information purposes. They are not settable parameters themselves.						
NOTE 4: Information about types of UE beam is given in B.2.1.3, and does not limit UE implementation or test system implementation.						
NOTE 5: Calculation of $E_s/I_{ot_{BB}}$ includes the effect of UE internal noise up to the value assumed for the associated Refsens requirement in clause 7.3.2 of TS 38.101-2 [3], and an allowance of 1dB for UE multi-band relaxation factor $\Delta MB_P$ from TS 38.101-2 [3] Table 6.2.1.3-4.						

In test 1, the UE shall send one Event A3 triggered measurement report, with a measurement reporting delay less than 4.32s from the beginning of time period T2

In test 2, the UE shall send one Event A3 triggered measurement report, with a measurement reporting delay less than 30.72s from the beginning of time period T2.

The UE is not required to read the neighbour cell SSB index in this test.

The UE shall not send event triggered measurement reports, as long as the reporting criteria are not fulfilled.

The rate of correct events observed during repeated tests shall be at least 90%.

NOTE: The actual overall delays measured in the test may be up to  $2 \times T_{TTI_{DCCH}}$  higher than the measurement reporting delays above because of TTI insertion uncertainty of the measurement report in DCCH.

The overall delays measured shall be less than a total of 4322 ms for Test 1 and 30722 ms for Test 2 in this test case (note: this gives a total measurement reporting delay plus 2 ms for TTI insertion uncertainty).

For the test to pass, the total number of successful tests shall be more than 90% of the cases with a confidence level of 95%.

## 5.6.2 Inter-frequency measurements

### 5.6.2.0 Minimum conformance requirements for Inter-frequency measurements

The requirements in Section 9.3 apply, provided:

- The cell being identified or measured is detectable.

An inter-frequency cell shall be considered detectable when for each relevant SSB:

- SS-RSRP related side conditions given in Sections 10.1.4 and 10.1.5 for FR1 and FR2, respectively, for a corresponding Band,
- SS-RSRQ related side conditions given in Sections 10.1.9 and 10.1.10 for FR1 and FR2, respectively, for a corresponding Band,
- SS-SINR related side conditions given in Sections 10.1.14 and 10.1.15 for FR1 and FR2, respectively, for a corresponding Band,
- SSB<sub>RP</sub> and SSB  $\hat{E}_s/I_{ot}$  according to Annex B.2.3 for a corresponding Band.

When measurement gaps are provided, or the UE supports capability of conducting such measurements without gaps, the UE shall be able to identify a new detectable inter frequency cell within  $T_{\text{identify\_inter\_without\_index}}$  if UE is not indicated to report SSB based RRM measurement result with the associated SSB index (*reportQuantityRsIndexes* or *maxNrofRSIndexesToReport* is not configured). Otherwise UE shall be able to identify a new detectable inter frequency cell within  $T_{\text{identify\_inter\_with\_index}}$ . The UE shall be able to identify a new detectable inter frequency SS block of an already detected cell within  $T_{\text{identify\_inter\_without\_index}}$ .

$$T_{\text{identify\_inter\_without\_index}} = (T_{\text{PSS/SSS\_sync\_inter}} + T_{\text{SSB\_measurement\_period\_inter}}) \text{ ms}$$

$$T_{\text{identify\_inter\_with\_index}} = (T_{\text{PSS/SSS\_sync\_inter}} + T_{\text{SSB\_measurement\_period\_inter}} + T_{\text{SSB\_time\_index\_inter}}) \text{ ms}$$

Where:

$T_{\text{PSS/SSS\_sync\_inter}}$ : it is the time period used in PSS/SSS detection given in table 9.3.4-1 and table 9.3.4-2.

$T_{\text{SSB\_time\_index\_inter}}$ : it is the time period used to acquire the index of the SSB being measured given in table 9.3.4-3 and table 9.3.4-4.

$T_{\text{SSB\_measurement\_period\_inter}}$ : equal to a measurement period of SSB based measurement given in table 9.3.5-1 and table 9.3.5-2.

$M_{\text{pss/sss\_sync\_inter}}$ : For a UE supporting FR2 power class 1,  $M_{\text{pss/sss\_sync\_inter}} = 64$  samples. For a UE supporting FR2 power class 2,  $M_{\text{pss/sss\_sync\_inter}} = 40$  samples. For a UE supporting FR2 power class 3,  $M_{\text{pss/sss\_sync\_inter}} = 40$  samples. For a UE supporting FR2 power class 4,  $M_{\text{pss/sss\_sync\_inter}} = 40$  samples.

$M_{\text{SSB\_index\_inter}}$ : For a UE supporting power FR2 class 1,  $M_{\text{SSB\_index\_inter}} = 40$  samples. For a vehicle mounted UE supporting power class 2,  $M_{\text{SSB\_index\_inter}} = 24$  samples. For a UE supporting power class 3,  $M_{\text{SSB\_index\_inter}} = 24$  samples. For a UE supporting power class 4,  $M_{\text{meas\_period\_inter}} = 24$  samples.



$M_{\text{meas\_period\_inter}}$ : For a UE supporting FR2 power class 1,  $M_{\text{meas\_period\_inter}} = 64$  samples. For a UE supporting FR2 power class 2,  $M_{\text{meas\_period\_inter}} = 40$  samples. For a UE supporting FR2 power class 3,  $M_{\text{meas\_period\_inter}} = 40$  samples. For a UE supporting FR2 power class 4,  $M_{\text{meas\_period\_inter}} = 40$  samples.

$\text{CSSF}_{\text{inter}}$ : it is a carrier specific scaling factor and is determined according to  $\text{CSSF}_{\text{within\_gap},i}$  in clause 9.1.5.2 for measurement conducted within measurement gaps.

**Table 9.3.4-2: Time period for PSS/SSS detection, (Frequency range FR2)**

Condition <sup>NOTE1,2</sup>	$T_{\text{PSS/SSS\_sync\_inter}}$
No DRX	$\text{Max}(600\text{ms}, M_{\text{pss/sss\_sync\_inter}} \times \text{Max}(\text{MGRP, SMTC period})) \times \text{CSSF}_{\text{inter}}$
DRX cycle $\leq$ 320ms	$\text{Max}(600\text{ms}, (1.5 \times M_{\text{pss/sss\_sync\_inter}}) \times \text{Max}(\text{MGRP, SMTC period, DRX cycle})) \times \text{CSSF}_{\text{inter}}$
DRX cycle $>$ 320ms	$M_{\text{pss/sss\_sync\_inter}} \times \text{DRX cycle} \times \text{CSSF}_{\text{inter}}$
NOTE 1: DRX or non DRX requirements apply according to the conditions described in clause 3.6.1	
NOTE 2: In EN-DC operation, the parameters, timers and scheduling requests referred to in clause 3.6.1 are for the secondary cell group. The DRX cycle is the DRX cycle of the secondary cell group.	

**Table 9.3.4-4: Time period for time index detection (Frequency range FR2)**

Condition <sup>NOTE1,2</sup>	$T_{\text{SSB\_time\_index\_inter}}$
No DRX	$\text{Max}(200\text{ms}, M_{\text{SSB\_index\_inter}} \times \text{Max}(\text{MGRP, SMTC period})) \times \text{CSSF}_{\text{inter}}$
DRX cycle $\leq$ 320ms	$\text{Max}(200\text{ms}, (1.5 \times M_{\text{SSB\_index\_inter}}) \times \text{Max}(\text{MGRP, SMTC period, DRX cycle})) \times \text{CSSF}_{\text{inter}}$
DRX cycle $>$ 320ms	$M_{\text{SSB\_index\_inter}} \times \text{DRX cycle} \times \text{CSSF}_{\text{inter}}$
NOTE 1: DRX or non DRX requirements apply according to the conditions described in clause 3.6.1	
NOTE 2: In EN-DC operation, the parameters, timers and scheduling requests referred to in clause 3.6.1 are for the secondary cell group. The DRX cycle is the DRX cycle of the secondary cell group.	

When measurement gaps are provided for inter frequency measurements, or the UE supports capability of conducting such measurements without gaps, the UE physical layer shall be capable of reporting SS-RSRP, SS-RSRQ and SS-SINR measurements to higher layers with measurement accuracy as specified in clauses 10.1.4, 10.1.5, 10.1.9, 10.1.10, 10.1.14 and 10.1.15, respectively, as shown in table 9.3.5-1 and 9.3.5-2:

**Table 9.3.5-2: Measurement period for inter-frequency measurements with gaps (Frequency FR2)**

Condition <sup>NOTE1,2</sup>	$T_{\text{SSB\_measurement\_period\_inter}}$
No DRX	$\text{Max}(400\text{ms}, M_{\text{meas\_period\_inter}} \times \text{Max}(\text{MGRP, SMTC period})) \times \text{CSSF}_{\text{inter}}$
DRX cycle $\leq$ 320ms	$\text{Max}(400\text{ms}, (1.5 \times M_{\text{meas\_period\_inter}}) \times \text{Max}(\text{MGRP, SMTC period, DRX cycle})) \times \text{CSSF}_{\text{inter}}$
DRX cycle $>$ 320ms	$M_{\text{meas\_period\_inter}} \times \text{DRX cycle} \times \text{CSSF}_{\text{inter}}$
NOTE 1: DRX or non DRX requirements apply according to the conditions described in clause 3.6.1	
NOTE 2: In EN-DC operation, the parameters, timers and scheduling requests referred to in clause 3.6.1 are for the secondary cell group. The DRX cycle is the DRX cycle of the secondary cell group.	

Reported SS-RSRP, SS-RSRQ, and SS-SINR measurements contained in event triggered measurement reports shall meet the requirements in clauses 10.1.4.1, 10.1.5.1, 10.1.9.1, 10.1.10.1, 10.1.14.1 and 10.1.15.1, respectively.

The UE shall not send any event triggered measurement reports, as long as no reporting criteria are fulfilled.

The measurement reporting delay is defined as the time between an event that will trigger a measurement report and the point when the UE starts to transmit the measurement report over the air interface. This requirement assumes that the measurement report is not delayed by other RRC signalling on the DCCH. This measurement reporting delay excludes a delay uncertainty resulted when inserting the measurement report to the TTI of the uplink DCCH. The delay uncertainty is:  $2 \times T_{\text{TI}_{\text{DCCH}}}$ . This measurement reporting delay excludes a delay which caused by no UL resources for UE to send the measurement report.

The event triggered measurement reporting delay, measured without L3 filtering shall be within  $T_{\text{identify\_inter\_without\_index}}$  if UE is not indicated to report SSB based RRM measurement result with the associated SSB index. Otherwise UE shall be able to identify a new detectable inter frequency cell within  $T_{\text{identify\_inter\_with\_index}}$ . Both  $T_{\text{identify\_inter\_without\_index}}$  and  $T_{\text{identify\_inter\_with\_index}}$  are defined in clause 9.3.4. When L3 filtering is used an additional delay can be expected.

If a cell which has been detectable at least for the time period  $T_{\text{identify\_inter\_without\_index}}$  or  $T_{\text{identify\_inter\_with\_index}}$  defined in clause 9.3.4 and then triggers the measurement report as per TS 38.331 [2], the event triggered measurement reporting

delay shall be less than  $T_{SSB\_measurement\_period\_inter}$  defined in clause 9.3.5 provided the timing to that cell has not changed more than  $\pm 3200 T_c$  while measurement gap has not been available and the L3 filter has not been used. When L3 filtering is used an additional delay can be expected.

The normative reference for this requirement is TS 38.133 [6] clause 9.3.2, 9.3.4, 9.3.5, 9.3.6.3.

5.6.2.1 EN-DC FR2-FR2 event-triggered reporting in non-DRX

Editor's Note: This test case has been completed for the following configurations:

- Test frequency  $f \leq 40.8$  GHz
- UE PC3
- The test is incomplete for UE power classes other than PC3
- The test is incomplete for test frequencies  $> 40.8$  GHz

5.6.2.1.1 Test purpose

The purpose of this test is to verify that the UE makes correct reporting of an event within inter-frequency cell search requirements.

5.6.2.1.2 Test applicability

This test applies to all types of E-UTRA UE release 15 and forward, supporting EN-DC. Test 1 is applicable to UEs not supporting per-FR gap (*IndependentGapConfig*, as defined in TS 38.306) and Test 2 is applicable only to UEs supporting per-FR gap (*IndependentGapConfig*, as defined in TS 38.306) and Gap Pattern Id 13.

5.6.2.1.3 Minimum conformance requirements

The minimum conformance requirements are specified in clause 5.6.2.0.

The normative reference for this requirement is TS 38.133 [6] clause A.5.6.2.1.

5.6.2.1.4 Test description

5.6.2.1.4.1 Initial conditions

This test shall be tested using any of the test configurations in Table 5.6.2.1.4.1-1.

**Table 5.6.2.1.4.1-1: EN-DC FR2-FR2 event triggered reporting tests in non-DRX supported test configurations**

Test Case ID	Description
5.6.2.1-1	LTE FDD, 120 kHz SSB SCS, 100MHz bandwidth, TDD duplex mode
5.6.2.1-2	LTE TDD, 120 kHz SSB SCS, 100MHz bandwidth, TDD duplex mode
NOTE 1: The UE is only required to be tested in one of the supported test configurations	
NOTE 2: target NR cell has the same SCS, BW and duplex mode as NR serving cell	

**Table 5.6.2.1.4.1-2: General test parameters for EN-DC inter-frequency event triggered reporting without SSB time index detection**

Parameter	Unit	Test configuration	Value		Comment
			Test 1	Test 2	
E-UTRA RF Channel Number		Config 1,2	1		One E-UTRAN TDD carrier frequencies is used.
NR RF Channel Number		Config 1,2	1, 2		Two FR2 NR carrier frequencies is used.

Active cell		Config 1,2	LTE Cell 1 (PCell) and NR cell 2 (PScell)		LTE Cell 1 is on E-UTRA RF channel number 1. NR Cell 2 is on NR RF channel number 1.
Neighbour cell		Config 1,2	NR cell 3		NR cell 3 is on NR RF channel number 2.
Gap Pattern Id		Config 1,2	0	13	As specified in TS 38.133 [6] clause 9.1.2-1.
Measurement gap offset		Config 1,2	39	39	
SMTC-SSB parameters		Config 1,2	SSB.3 FR2		As specified in clause A.3.2
offsetMO	dB	Config 1,2	16		Applied to NR Cell 3 measurement object
A3-Offset	dB	Config 1,2	-11		
Hysteresis	dB	Config 1,2	0		
CP length		Config 1,2	Normal		
TimeToTrigger	s	Config 1,2	0		
Filter coefficient		Config 1,2	0		L3 filtering is not used
DRX		Config 1,2	OFF		DRX is not used
Time offset between PCell and PScell		Config 1,2	3 $\mu$ s		Synchronous EN-DC
Time offset between serving and neighbour cells		Config 1,2	3 $\mu$ s		Synchronous cells.
T1	s	Config 1,2	5		
T2	s	Config 1,2	5.2 for PC1; 3.5 for other PC	5.2 for PC1; 3.5 for other PC	PC1 - power class 1 as specified in TS 38.101-2 [3] Table 6.2.1.0

**Table 5.6.2.1.4.1-3: Test Environment test parameters for EN-DC inter-frequency event triggered reporting without SSB time index detection in non-DRX**

Parameter	Value		Comment
Test environment	NC		As specified in TS 38.508-1 [14] clause 4.1.
Test frequencies	As specified in Annex E, Table E.3-1 and TS 38.508-1 [14] clause 4.3.1 for E-UTRA, 7.2.3 for NR FR2.		
Channel bandwidth	As specified by the test configuration selected from Table 5.6.2.1.4.1-1.		
Propagation conditions	AWGN		As specified in clause C.2.2.
Connection Diagram	TE Part	A.3.3.3.1	As specified in TS 38.508-1 [14] Annex A.
	DUT Part	A.3.4.1.1	
Exceptions to connection diagram			

1. Message contents are defined in clause 5.6.2.1.4.3.
2. Cell 1 is the E-UTRA serving cell (PCell) for the EN-DC setup. The power levels and settings for Cell 1 are set according to Annex A.6. Cell 2 and Cell 3 are NR FR1 cells in different frequencies. Cell 2 is the PScell and Cell 3 is the target cell. The power levels and settings for Cell 2 are set according to clause C.1.2 and clause C.1.3. Cell 3 is switched off during the initial connection setup.
3. If a UE supports per-FR gap and gap pattern configuration #13, it is only required to pass test 2. Otherwise it is only required to pass test 1.
4. The AoA setup for this test is Setup 3 as defined in clause A.9. The UE RX spherical coverage direction has been obtained previously using one of the search procedures as described in Annex I.

#### 5.6.2.1.4.2 Test procedure

In this test, there are three cells: LTE cell 1 as PCell on E-UTRA RF channel 1, NR cell 2 as PScell in FR2 on NR RF channel 1 and NR cell 3 as neighbour cell in FR2 on NR RF channel 2.

In test 1 measurement gap pattern configuration # 0 as defined in Table 5.6.2.1.4.1-2 is provided for UE that does not support per-FR gap and in test 2 measurement gap pattern configuration #13 as defined in Table 5.6.2.1.4.1-2 is provided for UE that supports per-FR gap.

In the measurement control information, it is indicated to the UE that event-triggered reporting with Event A3 is used. The test consists of two successive time periods, with time duration of T1, and T2 respectively. During time duration T1, the UE shall not have any timing information of NR cell 3.

1. Ensure the UE is in state RRC\_CONNECTED with generic procedure parameters Connectivity EN-DC, DC bearer MCG and SCG, Connected without release *On* according to TS 38.508-1 [14] clause 4.5.
2. Set the parameters according to T1 in Table 5.6.2.1.4.1-2. The TE shall ensure that the NR FR2 cells are from the set of directions corresponding to the EIS spherical coverage percentile of the DUT as defined in clause 7.3.4 of TS 38.101-2 [3] and relative angular offset between active probes are according to Table A.9.3-1. T1 starts.
3. The SS shall transmit an RRCConnectionReconfiguration message on Cell 1.
4. The UE shall transmit RRCConnectionReconfigurationComplete message.
5. When T1 expires, the SS shall switch the power setting from T1 to T2 as specified in Table 5.6.2.1.4.1-2. T2 starts.
6. UE shall transmit a MeasurementReport message triggered by Event A3 embedded in E-UTRA RRC message *ULInformationTransferMRDC*. If the overall delay measured from the beginning of time period T2 is less than 5122 ms for UE supporting power class 1, or 3202 ms for UE supporting other power class for Test 1 and Test 2 then the number of successful tests is increased by one. If the UE fails to report the event within the overall delays measured requirement then the number of failure tests is increased by one.
7. After the SS receives the MeasurementReport message in step 6 or when T2 expires, the SS shall transmit RRCConnectionReconfiguration message with condition EN-DC\_PSCell\_Rel according to TS 36.508 [25] Table 4.6.1-8 to release NR cell (PSCell). The UE shall transmit RRCConnectionReconfigurationComplete message.
8. Set Cell 3 physical cell identity = [(current cell 3 physical cell identity + 1) mod 1008] for next iteration of the test procedure loop.]
9. TE shall change the active probes in such way that relative angular offset between active probes differs in the following iteration.
10. The SS shall transmit RRCConnectionReconfiguration message with condition MCG\_and\_SCG according to TS 36.508 [25] Table 4.6.1-8 to add NR cell (PSCell). The UE shall transmit RRCConnectionReconfigurationComplete message. If either of the reconfiguration in step 7 or step 10 fails, SS switches off and on the UE and ensures the UE is in state RRC\_CONNECTED with generic procedure parameters Connectivity EN-DC, DC bearer MCG and SCG, Connected without release *On* according to TS 38.508-1 [14] clause 4.5..
11. Repeat step 2-10 until the confidence level according to Tables G.2.3-1 in Annex G clause G.2 is achieved.
12. Repeat step 1-11 for each sub-test in Table 5.6.2.1.4.1-2 as appropriate.

5.6.2.1.4.3 Message contents

Message contents are according to TS 38.508-1 [14] clause 4.6 with the following exceptions:

**Table 5.6.2.1.4.3-1: Common Exception messages for Additional EN-DC FR2-FR2 event triggered reporting tests in non-DRX test requirement**

Default Message Contents	
Common contents of system information blocks exceptions	

Default RRC messages and information elements contents exceptions	Table H.3.1-1 Table H.3.1-2 with Condition INTER-FREQ for Test 1. For Test 2, additionally with condition GAP NEEDED Table H.3.1-3 with Conditions INTER-FREQ MO and Synchronous cells Table H.3.1-4 with A3-offset = -11dB Table H.3.1-6 with Conditions gapFR2 and Pattern #13 for Test 2 Table H.3.4-4 with Condition gapUE Test 1 Table H.3.4-5 with Condition Pattern #0 for Test 1 Table H.3.1-7 with Condition INTER-FREQ Table H.3.4-1 Table H.3.4-2 Table H.3.4-3
---	--

**Table 5.6.2.1.4.3-2: MeasObjectNR-DEFAULT: EN-DC FR2-FR2 measurement object configuration**

Derivation Path: Table H.3.1-3			
Information Element	Value/remark	Comment	Condition
MeasObjectNR ::= SEQUENCE {			
offsetMO SEQUENCE {			
rsrpOffsetSSB	dB16		
}			

5.6.2.1.5 Test requirement

Table 5.6.2.3.5-1 defines the primary level settings including test tolerances for all tests.

**Table 5.6.2.1.5-1: Cell specific test parameters for EN-DC inter-frequency event triggered reporting without SSB time index detection**

Parameter	Unit	Test configuration	Cell 2		Cell 3	
			T1	T2	T1	T2
AoA setup		Config 1,2	Setup 3 as specified in clause A.9			
			AoA1		AoA2	
Assumption for UE beams <sup>Note 7</sup>		Config 1,2	Rough		Rough	
NR RF Channel Number		Config 1,2	1		2	
Duplex mode		Config 1,2	TDD		TDD	
BW <sub>channel</sub>	MHz	Config 1,2	100: N <sub>RB,c</sub> = 66		100: N <sub>RB,c</sub> = 66	
Data RBs allocated		Config 1,2	66		66	
BWP BW	MHz	Config 1,2	100: N <sub>RB,c</sub> = 66		100: N <sub>RB,c</sub> = 66	
TDD configuration		Config 1,2	TDDConf.3.1		TDDConf.3.1	
Initial DL BWP		Config 1,2	DLBWP.0.1		NA	
Initial UL BWP		Config 1,2	ULBWP.0.1		NA	
Dedicated DL BWP		Config 1,2	DLBWP.1.1		NA	
Dedicated UL BWP		Config 1,2	ULBWP.1.1		NA	
OCNG Patterns		Config 1,2	OP.1		OP.1	
TRS configuration		Config 1,2	TRS.2.1 TDD		NA	
PDSCH/PDCCH TCI state		Config 1,2	TCI.State.2		NA	
PDSCH Reference measurement channel		Config 1,2	SR.3.1 TDD		-	
RMSI CORESET Reference Channel		Config 1,2	CR.3.1 TDD		-	
Dedicated CORESET Reference Channel		Config 1,2	CCR.3.1 TDD		-	
SMTc configuration		Config 1,2	SMTc.1		SMTc.1	
PDSCH/PDCCH subcarrier spacing	kHz	Config 1,2	120		120	
EPRE ratio of PSS to SSS		Config 1,2	0		0	
EPRE ratio of PBCH DMRS to SSS						
EPRE ratio of PBCH to PBCH DMRS						

EPRE ratio of PDCCH DMRS to SSS						
EPRE ratio of PDCCH to PDCCH DMRS						
EPRE ratio of PDSCH DMRS to SSS						
EPRE ratio of PDSCH to PDSCH						
EPRE ratio of OCNG DMRS to SSS(Note 1)						
EPRE ratio of OCNG to OCNG DMRS (Note 1)						
$\hat{E}_s$	dBm/SC S	Config 1,2	-87	-87	-Infinity	-87
SSB-RP <sup>Note 3</sup>	dBm/SC S <sup>Note5</sup>	Config 1,2	-87	-87	-Infinity	-87
$\hat{E}_s / I_{ot\ BB}$ <sup>Note 8</sup>	dB	Config 1,2	1.89	1.89	-Infinity	1.89
$I_o$ <sup>Note3</sup>	dBm/95.04 MHz <sup>Note5</sup>	Config 1,2	-58.01	-58.01	-Infinity	-58.01
Propagation Condition		Config 1,2	AWGN		AWGN	
<p>NOTE 1: OCNG shall be used such that both cells are fully allocated and a constant total transmitted power spectral density is achieved for all OFDM symbols.</p> <p>NOTE 2: Void</p> <p>NOTE 3: SSB-RP, <math>E_s/I_{ot}</math> and <math>I_o</math> levels have been derived from other parameters for information purposes. They are not settable parameters themselves.</p> <p>NOTE 4: Void</p> <p>NOTE 5: Equivalent power received by an antenna with 0dBi gain at the centre of the quiet zone</p> <p>NOTE 6: As observed with 0dBi gain antenna at the centre of the quiet zone</p> <p>NOTE 7: Information about types of UE beam is given in TS 38.133 [6] Annex B.2.1.3, and does not limit UE implementation or test system implementation.</p> <p>NOTE 8: Calculation of <math>E_s/I_{ot\ BB}</math> includes the effect of UE internal noise up to the value assumed for the associated Refsens requirement in clause 7.3.2 of TS 38.101-2 [3], and an allowance of 1dB for UE multi-band relaxation factor <math>\Delta MB_S</math> from TS 38.101-2 [3] Table 6.2.1.3-4.</p>						

In test 1 with per-UE gap and in test 2 with per-FR gap, the UE shall send one Event A3 triggered measurement report, with a measurement reporting delay less than X ms from the beginning of time period T2, where X is

- 5120 for UE supporting power class 1, or
- 3200 for UE supporting other power class.

In test 1 and 2 UE is not required to report SSB time index. The UE shall not send event triggered measurement reports, as long as the reporting criteria are not fulfilled. The rate of correct events observed during repeated tests shall be at least 90% with a confidence level of 95%.

NOTE: The actual overall delays measured in the test may be up to  $2 \times TTI_{DCCH}$  higher than the measurement reporting delays above because of TTI insertion uncertainty of the measurement report in DCCH.

$TTI$  insertion uncertainty =  $TTI_{DCCH} = 1$  ms;  $2 \times TTI_{DCCH} = 2$  ms

The overall delays measured shall be less than a total of 5122 ms in this test for power class UE and 3202 ms for other power classes.

### 5.6.2.2 EN-DC FR2-FR2 event-triggered reporting in DRX

Editor's Note: This test case has been completed for the following configurations:

- Test frequency  $f \leq 40.8$  GHz
- UE PC3
- The test is incomplete for UE power classes other than PC3
- The test is incomplete for test frequencies  $> 40.8$  GHz

## 5.6.2.2.1 Test purpose

The purpose of this test is to verify that the UE makes correct reporting of an event within inter-frequency cell search requirements.

## 5.6.2.2.2 Test applicability

This test applies to all types of E-UTRA UE release 15 and forward, supporting EN-DC FR2 and long DRX cycle. Tests 1 and 2 are applicable to UEs not supporting per-FR gap (*IndependentGapConfig*, as defined in TS 38.306) and Tests 3 and 4 are applicable only to UEs supporting per-FR gap (*IndependentGapConfig*, as defined in TS 38.306) and Gap Pattern Id 13.

## 5.6.2.2.3 Minimum conformance requirements

The minimum conformance requirements are specified in clause 5.6.2.0.

The normative reference for this requirement is TS 38.133 [6] clause A.5.6.2.2.

## 5.6.2.2.4 Test description

## 5.6.2.2.4.1 Initial conditions

This test shall be tested using any of the test configurations in Table 5.6.2.2.4.1-1.

**Table 5.6.2.2.4.1-1: EN-DC FR2-FR2 event triggered reporting tests in DRX supported test configurations**

Test Case ID	Description
5.6.2.2-1	LTE FDD, 120 kHz SSB SCS, 100MHz bandwidth, TDD duplex mode
5.6.2.2-2	LTE TDD, 120 kHz SSB SCS, 100MHz bandwidth, TDD duplex mode
NOTE 1: The UE is only required to be tested in one of the supported test configurations	
NOTE 2: target NR cell has the same SCS, BW and duplex mode as NR serving cell	

**Table 5.6.2.2.4-2: General test parameters for EN-DC inter-frequency event triggered reporting without SSB time index detection**

Parameter	Unit	Test configuration	Value				Comment
			Test 1	Test 2	Test 3	Test 4	
E-UTRA RF Channel Number		Config 1,2	1				One E-UTRAN TDD carrier frequencies is used.
NR RF Channel Number		Config 1,2	1, 2				Two FR1 NR carrier frequencies is used.
Active cell		Config 1,2	LTE Cell 1 (PCell) and NR cell 2 (PSCell)				LTE Cell 1 is on E-UTRA RF channel number 1. NR Cell 2 is on NR RF channel number 1.
Neighbour cell		Config 1,2	NR cell 3				NR cell 3 is on NR RF channel number 2.
Gap Pattern Id		Config 1,2	0		13		As specified in TS 38.133 clause 9.1.2-1.
Measurement gap offset		Config 1,2	39		39		
SMTC-SSB parameters		Config 1,2	SSB.3 FR2				As specified in clause A.3
A3-Offset	dB	Config 1,2	-12				Value modified by TT
Hysteresis	dB	Config 1,2	0				
CP length		Config 1,2	Normal				
TimeToTrigger	s	Config 1,2	0				
Filter coefficient		Config 1,2	0				L3 filtering is not used
DRX		Config 1,2	DRX.1	DRX.7	DRX.1	DRX.7	As specified in clause A.5
Time offset between PCell and PSCell		Config 1,2	3 μs				Synchronous EN-DC

Time offset between serving and neighbour cells		Config 1,2	3μs				Synchronous cells.
T1	s	Config 1,2	5				
T2	s	Config 1,2	8 for PC1; 5 for other PC	82 for PC1; 52 for other PC	8 for PC1; 5 for other PC	82 for PC1; 52 for other PC	PC1 - power class 1 as specified in TS 38.101-2 [3] Table 6.2.1.0

**Table 5.6.2.2.4.1-3: Test Environment test parameters for EN-DC inter-frequency event triggered reporting with SSB time index detection in non-DRX**

Parameter	Value		Comment
Test environment	NC		As specified in TS 38.508-1 [14] clause 4.1.
Test frequencies	As specified in Annex E, Table E.2-1 and TS 38.508-1 [14] clause 4.3.1 for E-UTRA, 7.2.3 for NR FR2.		
Channel bandwidth	As specified by the test configuration selected from Table 5.6.2.2.4.1-1.		
Propagation conditions	AWGN		As specified in clause C.2.2.
Connection Diagram	TE Part	A.3.3.3.1	As specified in TS 38.508-1 [14] Annex A.
	DUT Part	A.3.4.1.1	
Exceptions to connection diagram			

1. Message contents are defined in clause 5.6.2.2.4.3.
2. Cell 1 is the E-UTRA serving cell (PCell) for the EN-DC setup. The power levels and settings for Cell 1 are set according to Annex A.6. Cell 2 and Cell 3 are NR FR1 cells in different frequencies. Cell 2 is the PSCell and Cell 3 is the target cell. The power levels and settings for Cell 2 and Cell 3 are set according to clause C.1.2.
3. If a UE supports per-FR gap and gap pattern configuration #13, it is only required to pass test 3&4. Otherwise it is only required to pass test 1&2.
4. The UE Rx beam peak direction for Cell 2 has been obtained previously using one of the Rx beam peak search procedures as described in Annex I.

#### 5.6.2.2.4.2 Test procedure

In this test, there are three cells: LTE cell 1 as PCell on E-UTRA RF channel 1, NR cell 2 as PSCell in FR2 on NR RF channel 1 and NR cell 3 as neighbour cell in FR2 on NR RF channel 2.

In test 1&2 measurement gap pattern configuration # 0 as defined in Table 5.6.2.2.4.1-2 is provided for UE that does not support per-FR gap and in test 3&4 measurement gap pattern configuration #13 as defined in Table 5.6.2.2.4.1-2 is provided for UE that supports per-FR gap.

In the measurement control information, it is indicated to the UE that event-triggered reporting with Event A3 is used. The test consists of two successive time periods, with time duration of T1, and T2 respectively. During time duration T1, the UE shall not have any timing information of NR cell 3.

UE needs to be provided at least once every 500ms with new Timing Advance Command MAC control element to restart the Time alignment timer to keep UE uplink time alignment. Furthermore, UE is allocated with PUSCH resource at every DRX cycle.

1. Ensure the UE is in state RRC\_CONNECTED with generic procedure parameters Connectivity EN-DC, DC bearer MCG and SCG, Connected without release *On* according to TS 38.508-1 [14] clause 4.5.
2. Set the parameters according to T1 in Table 5.6.2.2.4.1-2. The TE shall ensure that the NR FR2 cell will be received by the UE from the Rx beam peak direction. T1 starts.
3. The SS shall transmit an RRCConnectionReconfiguration message on Cell 1.
4. The UE shall transmit RRCConnectionReconfigurationComplete message.



5. When T1 expires, the SS shall switch the power setting from T1 to T2 as specified in Table 5.6.2.2.4.1-2.
6. UE shall transmit a MeasurementReport message triggered by Event A3 embedded in E-UTRA RRC message *ULInformationTransferMRDC*. If the overall delay measured from the beginning of time period T2 is less than 7682 ms for UE supporting power class 1, or 4802 ms for UE supporting other power class for Test 1 and Test 3 and 81922 ms for UE supporting power class 1, or 51202 ms for UE supporting other power class for Test 2 and Test 4, then the number of successful tests is increased by one. If the UE fails to report the event within the overall delays measured requirement then the number of failure tests is increased by one.
7. After the SS receives the MeasurementReport message in step 6 or when T2 expires, the SS shall transmit RRCConnectionReconfiguration message with condition EN-DC\_PSCell\_Rel according to TS 36.508 [25] Table 4.6.1-8 to release NR cell (PSCell). The UE shall transmit RRCConnectionReconfigurationComplete message.
8. Set Cell 3 physical cell identity = [(current cell 2 physical cell identity + 1) mod 1008] for next iteration of the test procedure loop.]
9. The SS shall transmit RRCConnectionReconfiguration message with condition MCG\_and\_SCG according to TS 36.508 [25] Table 4.6.1-8 to add NR cell (PSCell). The UE shall transmit RRCConnectionReconfigurationComplete message. If either of the reconfiguration in step 7 or step 9 fails, SS switches off and on the UE and ensures the UE is in state RRC\_CONNECTED with generic procedure parameters Connectivity EN-DC, DC bearer MCG and SCG, Connected without release *On* according to TS 38.508-1 [14] clause 4.5.
10. Repeat step 2-9 until the confidence level according to Tables G.2.3-1 in Annex G clause G.2 is achieved.
11. Repeat step 1-10 for each sub-test in Table 5.6.2.2.4.1-2 as appropriate.

5.6.2.2.4.3 Message contents

Message contents are according to TS 38.508-1 [14] clause 7.3 with the following exceptions:

**Table 5.6.2.2.4.3-1: Common Exception messages for Additional EN-DC FR2-FR2 event triggered reporting tests without SSB time index detection in DRX test requirement**

Default Message Contents	
Common contents of system information blocks exceptions	
Default RRC messages and information elements contents exceptions	Table H.3.1-1 Table H.3.1-2 with Condition INTER-FREQ. For Test 3 and Test 4, with condition GAP NEEDED additionally. Table H.3.1-3 with Conditions INTER-FREQ MO and Synchronous cells Table H.3.1-4 with A3-offset = -12dB Table H.3.1-6 with Conditions gapFR2 and Pattern #13 for Test 3 and Test 4 Table H.3.4-4 with Condition gapUE Test 1 and Test 2 Table H.3.4-5 with Condition Pattern #0 for Test 1 and Test 2 Table H.3.1-7 with Condition INTER-FREQ Table H.3.7-1 with Condition DRX.1 for Test 1 and Test 3 Table H.3.7-1 with Condition DRX.7 for Test 2 and Test 4 Table H.3.4-1 Table H.3.4-2 Table H.3.4-3

5.6.2.2.5 Test requirement

Table 5.6.2.2.5-1 defines the primary level settings including test tolerances for all tests.

**Table 5.6.2.2.5-1: Cell specific test parameters for EN-DC inter-frequency event triggered reporting without SSB time index detection**

Parameter	Unit	Test configuration	Cell 2		Cell 3	
			T1	T2	T1	T2
AoA setup		Config 1,2	Setup 1 as specified in clause A.9			

Parameter	Unit	Test configuration	Cell 2		Cell 3	
			T1	T2	T1	T2
Assumption for UE beams <sup>Note 7</sup>		Config 1,2	Rough			
NR RF Channel Number		Config 1,2	1		2	
Duplex mode		Config 1,2	TDD		TDD	
BW <sub>channel</sub>	MHz	Config 1,2	100: N <sub>RB,c</sub> = 66		100: N <sub>RB,c</sub> = 66	
Data RBs allocated		Config 1,2	66		66	
BWP BW	MHz	Config 1,2	100: N <sub>RB,c</sub> = 66		100: N <sub>RB,c</sub> = 66	
TDD configuration		Config 1,2	TDDConf.3.1		TDDConf.3.1	
Initial DL BWP		Config 1,2	DLBWP.0.1		NA	
Initial UL BWP		Config 1,2	ULBWP.0.1		NA	
Dedicated DL BWP		Config 1,2	DLBWP.1.1		NA	
Dedicated UL BWP		Config 1,2	ULBWP.1.1		NA	
OCNG Patterns		Config 1,2	OP.1		OP.1	
TRS configuration		Config 1,2	TRS.2.1 TDD		NA	
TRS configuration		Config 1,2	TRS.2.1 TDD		NA	
PDSCH Reference measurement channel		Config 1,2	SR.3.1 TDD		-	
CORESET Reference Channel		Config 1,2	CR.3.1 TDD		-	
SMTTC configuration		Config 1,2	SMTTC.1		SMTTC.1	
PDSCH/PDCCH subcarrier spacing	kHz	Config 1,2 Config 1,2	120 0		120 0	
EPRE ratio of PSS to SSS						
EPRE ratio of PBCH DMRS to SSS						
EPRE ratio of PBCH to PBCH DMRS						
EPRE ratio of PDCCH DMRS to SSS						
EPRE ratio of PDCCH to PDCCH DMRS						
EPRE ratio of PDSCH DMRS to SSS						
EPRE ratio of PDSCH to PDSCH						
EPRE ratio of OCNG DMRS to SSS(Note 1)						
EPRE ratio of OCNG to OCNG DMRS (Note 1)						
$N_{oc}$ <sup>Note2</sup>	dBm/15k Hz Note5		-104.7		-104.7	
$N_{oc}$ <sup>Note2</sup>	dBm/SC S Note4	Config 1,2	-95.7	-95.7	-Infinity	-86.7
SSB_RP <sup>Note 3</sup>	dBm/SC S Note5	Config 1,2	-89.7	-89.7	-Infinity	9
$\hat{E}_s / I_{ot}$	dB	Config 1,2	6	6	-Infinity	9
$\hat{E}_s / N_{oc}$	dB	Config 1,2	6	6	-66.7	-57.2
$I_o$ <sup>Note3</sup>	dBm/95.04 MHz Note5	Config 1,2	-59.7			
Propagation Condition						

In test 1 with per-UE gap and in test 3 with per-FR gap, the UE shall send one Event A3 triggered measurement report, with a measurement reporting delay less than X1 ms from the beginning of time period T2, where X1 is

7680 for UE supporting power class 1, or

4800 for UE supporting other power class.

In test 2 with per-UE gap and in test 4 with per-FR gap, the UE shall send one Event A3 triggered measurement report, with a measurement reporting delay less than X2 ms from the beginning of time period T2, where X2 is

81920 for UE supporting power class 1, or

51200 for UE supporting other power class.

In test 1, 2, 3 and 4 UE is not required to report SSB time index. The UE shall not send event triggered measurement reports, as long as the reporting criteria are not fulfilled. The rate of correct events observed during repeated tests shall be at least 90% with a confidence level of 95%. In test 1, 2, 3 and 4 UE is not required to report SSB time index.

NOTE: The actual overall delays measured in the test may be up to  $2 \times TTI_{DCCH}$  higher than the measurement reporting delays above because of TTI insertion uncertainty of the measurement report in DCCH.

TTI insertion uncertainty =  $TTI_{DCCH} = 1 \text{ ms}$ ;  $2 \times TTI_{DCCH} = 2 \text{ ms}$

The overall delays measured shall be less than a total of 7682 ms for power class 1 UE and 4802 ms for other power classes in test 1 and 81922 for power class 1 UE and 51202 ms for other power classes in test 2.

### 5.6.2.3 EN-DC FR2-FR2 event-triggered reporting in non-DRX with SSB time index detection

**Editor's Note: This test case has been completed for the following configurations:**

- Test frequency  $f \leq 40.8 \text{ GHz}$
- UE PC3
- The test is incomplete for UE power classes other than PC3
- The test is incomplete for test frequencies  $> 40.8 \text{ GHz}$

#### 5.6.2.3.1 Test purpose

The purpose of this test is to verify that the UE makes correct reporting of an event within inter-frequency cell search requirements.

#### 5.6.2.3.2 Test applicability

This test applies to all types of E-UTRA UE release 15 and forward, supporting EN-DC. Test 1 is applicable to UEs not supporting per-FR gap (*IndependentGapConfig*, as defined in TS 38.306) and Test 2 is applicable only to UEs supporting per-FR gap (*IndependentGapConfig*, as defined in TS 38.306) and Gap Pattern Id 13.

#### 5.6.2.3.3 Minimum conformance requirements

The minimum conformance requirements are specified in clause 5.6.2.0.

The normative reference for this requirement is TS 38.133 [6] clause A.5.6.2.3.

#### 5.6.2.3.4 Test description

##### 5.6.2.3.4.1 Initial conditions

This test shall be tested using any of the test configurations in Table 5.6.2.3.4.1-1.

**Table 5.6.2.3.4.1-1: EN-DC FR2-FR2 event triggered reporting tests in non-DRX with SSB time index detection supported test configurations**

Test Case ID	Description
5.6.2.3-1	LTE FDD, 120 kHz SSB SCS, 100MHz bandwidth, TDD duplex mode
5.6.2.3-2	LTE TDD, 120 kHz SSB SCS, 100MHz bandwidth, TDD duplex mode
NOTE 1: The UE is only required to be tested in one of the supported test configurations	
NOTE 2: target NR cell has the same SCS, BW and duplex mode as NR serving cell	

**Table 5.6.2.3.4.1-2: General test parameters for EN-DC inter-frequency event triggered reporting with SSB time index detection in DRX**

Parameter	Unit	Test configuration	Value		Comment
			Test 1	Test 2	
E-UTRA RF Channel Number		Config 1,2	1		One E-UTRAN TDD carrier frequencies is used.
NR RF Channel Number		Config 1,2	1, 2		Two FR2 NR carrier frequencies is used.
Active cell		Config 1,2	LTE Cell 1 (PCell) and NR cell 2 (PScell)		LTE Cell 1 is on E-UTRA RF channel number 1. NR Cell 2 is on NR RF channel number 1.
Neighbour cell		Config 1,2	NR cell 3		NR cell 3 is on NR RF channel number 2.
Gap Pattern Id		Config 1,2	0	13	As specified in TS 38.133 clause 9.1.2-1.
Measurement gap offset		Config 1,2	39	39	
SMTC-SSB parameters		Config 1,2	SSB. 3 FR2		As specified in clause A.3
offsetMO	dB	Config 1,2	16		Applied to NR Cell 3 measurement object
A3-Offset	dB	Config 1,2	-11		
Hysteresis	dB	Config 1,2	0		
CP length		Config 1,2	Normal		
TimeToTrigger	s	Config 1,2	0		
Filter coefficient		Config 1,2	0		L3 filtering is not used
DRX		Config 1,2	OFF		DRX is not used
Time offset between PCell and PScell		Config 1,2	3 $\mu$ s		Synchronous EN-DC
Time offset between serving and neighbour cells		Config 1,2	3 $\mu$ s		Synchronous cells.
T1	s	Config 1,2	5		
T2	s	Config 1,2	7 for PC1; 4.5 for other PC	7 for PC1; 4.5 for other PC	PC1 - power class 1 as specified in TS 38.101-2 [3] Table 6.2.1.0

**Table 5.6.2.3.4.1-3: Test Environment test parameters for EN-DC inter-frequency event triggered reporting with SSB time index detection in non-DRX**

Parameter	Value		Comment
Test environment	NC		As specified in TS 38.508-1 [14] clause 4.1.
Test frequencies	As specified in Annex E, Table E.3-1 and TS 38.508-1 [14] clause 4.3.1 for E-UTRA, 7.2.3 for NR FR2.		
Channel bandwidth	As specified by the test configuration selected from Table 5.6.2.3.4.1-1.		
Propagation conditions	AWGN		As specified in clause C.2.2.
Connection Diagram	TE Part	A.3.3.3.1	As specified in TS 38.508-1 [14] Annex A.
	DUT Part	A.3.4.1.1	
Exceptions to connection diagram			

1. Message contents are defined in clause 5.6.2.3.4.3.
2. Cell 1 is the E-UTRA serving cell (PCell) for the EN-DC setup. The power levels and settings for Cell 1 are set according to Annex A.6. Cell 2 and Cell 3 are NR FR1 cells in different frequencies. Cell 2 is the PScell and Cell 3 is the target cell. The power levels and settings for Cell 2 and are set according to clause C.1.2 and clause C.1.3. Cell 3 is switched off during the initial connection setup.
3. If a UE supports per-FR gap and gap pattern configuration #13, it is only required to pass test 2. Otherwise it is only required to pass test 1.

4. The AoA setup for this test is Setup 3 as defined in clause A.9. The UE RX spherical coverage direction has been obtained previously using one of the search procedures as described in Annex I.

#### 5.6.2.3.4.2 Test procedure

In this test, there are three cells: LTE cell 1 as PCell on E-UTRA RF channel 1, NR cell 2 as PSCell in FR2 on NR RF channel 1 and NR cell 3 as neighbour cell in FR2 on NR RF channel 2.

In test 1 measurement gap pattern configuration # 0 as defined in Table 5.6.2.3.4.1-1 is provided for UE that does not support per-FR gap and in test 2 measurement gap pattern configuration #13 as defined in Table 5.6.2.3.4.1-1 is provided for UE that supports per-FR gap.

In the measurement control information, it is indicated to the UE that event-triggered reporting with Event A3 is used. The test consists of two successive time periods, with time duration of T1, and T2 respectively. During time duration T1, the UE shall not have any timing information of NR cell 3.

1. Ensure the UE is in state RRC\_CONNECTED with generic procedure parameters Connectivity EN-DC, DC bearer MCG and SCG, Connected without release *On* according to TS 38.508-1 [14] clause 4.5.
2. Set the parameters according to T1 in Table 5.6.2.3.4.1-2. The TE shall ensure that the NR FR2 cells are from the set of directions corresponding to the EIS spherical coverage percentile of the DUT as defined in clause 7.3.4 of TS 38.101-2 [3] and relative angular offset between active probes are according to Table A.9.3-1. T1 starts.
3. The SS shall transmit an RRCConnectionReconfiguration message on Cell 1.
4. The UE shall transmit RRCConnectionReconfigurationComplete message.
5. When T1 expires, the SS shall switch the power setting from T1 to T2 as specified in Table 5.6.2.3.4.1-2. T2 starts.
6. UE shall transmit a MeasurementReport message triggered by Event A3 embedded in E-UTRA RRC message *ULInformationTransferMRDC*. If the overall delay measured from the beginning of time period T2 is less than 6722 ms for UE supporting power class 1, or 4162 ms for UE supporting other power class for Test 1 and Test 2, then the number of successful tests is increased by one. If the UE fails to report the event within the overall delays measured requirement then the number of failure tests is increased by one.
7. After the SS receives the MeasurementReport message in step 6 or when T2 expires, the SS shall transmit RRCConnectionReconfiguration message with condition EN-DC\_PSCell\_Rel according to TS 36.508 [25] Table 4.6.1-8 to release NR cell (PSCell). The UE shall transmit RRCConnectionReconfigurationComplete message.
8. Set Cell 3 physical cell identity = [(current cell 3 physical cell identity + 1) mod 1008] for next iteration of the test procedure loop.]
9. TE shall change the active probes in such way that relative angular offset between active probes differs in the following iteration.
10. The SS shall transmit RRCConnectionReconfiguration message with condition MCG\_and\_SCG according to TS 36.508 [25] Table 4.6.1-8 to add NR cell (PSCell). The UE shall transmit RRCConnectionReconfigurationComplete message. If either of the reconfiguration in step 7 or step 10 fails, SS switches off and on the UE and ensures the UE is in state RRC\_CONNECTED with generic procedure parameters Connectivity EN-DC, DC bearer MCG and SCG, Connected without release *On* according to TS 38.508-1 [14] clause 4.5.
11. Repeat step 2-10 until the confidence level according to Tables G.2.3-1 in Annex G clause G.2 is achieved.
12. Repeat step 1-11 for each sub-test in Table 5.6.2.3.4.1-2 as appropriate.

#### 5.6.2.3.4.3 Message contents

Message contents are according to TS 38.508-1 [14] clause 7.3 with the following exceptions:

**Table 5.6.2.3.4.3-1: Common Exception messages for Additional EN-DC FR2-FR2 event triggered reporting tests without SSB time index detection in non-DRX test requirement**

Default Message Contents	
Common contents of system information blocks exceptions	
Default RRC messages and information elements contents exceptions	Table H.3.1-1 Table H.3.1-2 with condition INTER-FREQ. For Test 2, additionally with condition GAP NEEDED. Table H.3.1-3 with conditions INTER-FREQ MO and and Synchronous cells Table H.3.1-4 with condition SSB Index and A3-offset = -11dB Table H.3.1-6 with conditions gapFR2 and Pattern #13 for Test 2 Table H.3.4-4 with condition gapUE for Test 1 Table H.3.4-5 with condition Pattern #0 for Test 1 Table H.3.1-7 with condition SSB Index and INTER-FREQ Table H.3.4-1 Table H.3.4-2 Table H.3.4-3

**Table 5.6.2.3.4.3-2: MeasObjectNR-DEFAULT: EN-DC FR2-FR2 measurement object configuration**

Derivation Path: Table H.3.1-3			
Information Element	Value/remark	Comment	Condition
MeasObjectNR ::= SEQUENCE {			
offsetMO SEQUENCE {			
rsrpOffsetSSB	dB16		
}			

5.6.2.3.5 Test requirement

Table 5.6.2.3.5-1 defines the primary level settings including test tolerances for all tests.

**Table 5.6.2.3.5-1: Cell specific test parameters for EN-DC inter-frequency event triggered reporting with SSB time index detection in DRX**

Parameter	Unit	Test configuration	Cell 2		Cell 3	
			T1	T2	T1	T2
AoA setup		Config 1,2	Setup 3 as specified in clause A.3.9			
			AoA1		AoA2	
Assumption for UE beams <sup>Note 7</sup>		Config 1,2	Rough		Rough	
NR RF Channel Number		Config 1,2	1		2	
Duplex mode		Config 1,2	TDD		TDD	
BW <sub>channel</sub>	MHz	Config 1,2	100: N <sub>RB,c</sub> = 66		100: N <sub>RB,c</sub> = 66	
Data RBs allocated		Config 1,2	66		66	
BWP BW	MHz	Config 1,2	100: N <sub>RB,c</sub> = 66		100: N <sub>RB,c</sub> = 66	
TDD configuration		Config 1,2	TDDConf.3.1		TDDConf.3.1	
Initial DL BWP		Config 1,2	DLBWP.0.1		NA	
Dedicated DL BWP		Config 1,2	DLBWP.1.1		NA	
Initial UL BWP		Config 1,2	DLBWP.0.1		NA	
Dedicated UL BWP		Config 1,2	ULBWP.1.1		NA	
OCNG Patterns		Config 1,2	OP.1		OP.1	
PDSCH Reference measurement channel		Config 1,2	SR.3.1 TDD		-	
RMSI CORESET Reference Channel		Config 1,2	CR.3.1 TDD		-	
Dedicated CORESET Reference Channel		Config 1,2	CCR.3.1 TDD		-	
TRS configuration		Config 1,2	TRS.2.1 TDD		NA	
PDSCH/PDCCH TCI state		Config 1,2	TCI.State.2		NA	
SMTC configuration		Config 1,2	SMTC.1		SMTC.1	
PDSCH/PDCCH subcarrier spacing	kHz	Config 1,2	120		120	
EPRE ratio of PSS to SSS		Config 1,2	0		0	
EPRE ratio of PBCH DMRS to SSS						
EPRE ratio of PBCH to PBCH DMRS						

Parameter	Unit	Test configuration	Cell 2		Cell 3	
			T1	T2	T1	T2
EPRE ratio of PDCCH DMRS to SSS						
EPRE ratio of PDCCH to PDCCH DMRS						
EPRE ratio of PDSCH DMRS to SSS						
EPRE ratio of PDSCH to PDSCH						
EPRE ratio of OCNG DMRS to SSS(Note 1)						
EPRE ratio of OCNG to OCNG DMRS (Note 1)						
$\hat{E}_s$	dBm/SC S	Config 1	-87	-87	-Infinity	-87
SSB-RP <sup>Note 3</sup>	dBm/SC S <sup>Note5</sup>	Config 1,2	-87	-87	-Infinity	-87
$\hat{E}_s / I_{ot\ BB}$ <sup>Note8</sup>	dB	Config 1,2	1.89	1.89	-Infinity	1.89
$I_o$ <sup>Note3</sup>	dBm/95.04 MHz <sup>Note5</sup>	Config 1,2	-58.01	-58.01	-Infinity	-58.01
Propagation Condition		Config 1,2	AWGN		AWGN	
NOTE 1: OCNG shall be used such that both cells are fully allocated and a constant total transmitted power spectral density is achieved for all OFDM symbols.						
NOTE 2: Void						
NOTE 3: SSB-RP, $E_s/I_{ot}$ and $I_o$ levels have been derived from other parameters for information purposes. They are not settable parameters themselves.						
NOTE 4: Void						
NOTE 5: Equivalent power received by an antenna with 0dBi gain at the centre of the quiet zone						
NOTE 6: As observed with 0dBi gain antenna at the centre of the quiet zone						
NOTE 7: Information about types of UE beam is given in TS 38.133 [6] Annex B.2.1.3, and does not limit UE implementation or test system implementation						
NOTE 8: Calculation of $E_s/I_{ot\ BB}$ includes the effect of UE internal noise up to the value assumed for the associated Refsens requirement in clause 7.3.2 of TS 38.101-2 [3], and an allowance of 1dB for UE multi-band relaxation factor $\Delta MB_S$ from TS 38.101-2 [3] Table 6.2.1.3-4.						

In test 1 with per-UE gap and in test 2 with per-FR gap, the UE shall send one Event A3 triggered measurement report, with a measurement reporting delay less than X ms from the beginning of time period T2, where X is

6720 for UE supporting power class 1, or

4160 for UE supporting other power class.

In test 1 and 2 UE is required to report SSB time index. The UE shall not send event triggered measurement reports, as long as the reporting criteria are not fulfilled. The rate of correct events observed during repeated tests shall be at least 90% with a confidence level of 95%. In test 1 and 2 UE is required to report SSB time index.

NOTE: The actual overall delays measured in the test may be up to  $2 \times TTI_{DCCH}$  higher than the measurement reporting delays above because of TTI insertion uncertainty of the measurement report in DCCH.

TTI insertion uncertainty =  $TTI_{DCCH} = 1$  ms;  $2 \times TTI_{DCCH} = 2$  ms

The overall delays measured shall be less than a total of 6722 ms in this test for power class UE and 4162 ms for other power classes.

#### 5.6.2.4 EN-DC FR2-FR2 event-triggered reporting in DRX with SSB time index detection

**Editor's Note:** This test case has been completed for the following configurations:

- Test frequency  $f \leq 40.8$  GHz

- UE PC3

- The test is incomplete for UE power classes other than PC3

- The test is incomplete for test frequencies > 40.8 GHz

#### 5.6.2.4.1 Test purpose

The purpose of this test is to verify that the UE makes correct reporting of an event within inter-frequency cell search requirements.

#### 5.6.2.4.2 Test applicability

This test applies to all types of E-UTRA UE release 15 and forward, supporting EN-DC FR2 and long DRX cycle. Test 1 is applicable to UEs not supporting per-FR gap (*IndependentGapConfig*, as defined in TS 38.306) and Test 2 is applicable only to UEs supporting per-FR gap (*IndependentGapConfig*, as defined in TS 38.306) and Gap Pattern Id 13.

#### 5.6.2.4.3 Minimum conformance requirements

The minimum conformance requirements are specified in clause 5.6.2.0.

The normative reference for this requirement is TS 38.133 [6] clause A.5.6.2.4.

#### 5.6.2.4.4 Test description

##### 5.6.2.4.4.1 Initial conditions

This test shall be tested using any of the test configurations in Table 5.6.2.4.4.1-1.

**Table 5.6.2.4.4.1-1: EN-DC FR2-FR2 event triggered reporting tests in DRX with SSB time index detection supported test configurations**

Test Case ID	Description
5.6.2.4-1	LTE FDD, 120 kHz SSB SCS, 100MHz bandwidth, TDD duplex mode
5.6.2.4-2	LTE TDD, 120 kHz SSB SCS, 100MHz bandwidth, TDD duplex mode
NOTE 1: The UE is only required to be tested in one of the supported test configurations	
NOTE 2: target NR cell has the same SCS, BW and duplex mode as NR serving cell	

**Table 5.6.2.4.4.1-2: General test parameters for EN-DC inter-frequency event triggered reporting with SSB time index detection in DRX**

Parameter	Unit	Test configuration	Value				Comment
			Test 1	Test 2	Test 3	Test 4	
E-UTRA RF Channel Number		Config 1,2	1				One E-UTRAN TDD carrier frequencies is used.
NR RF Channel Number		Config 1,2	1, 2				Two FR1 NR carrier frequencies is used.
Active cell		Config 1,2	LTE Cell 1 (PCell) and NR cell 2 (PScell)				LTE Cell 1 is on E-UTRA RF channel number 1. NR Cell 2 is on NR RF channel number 1.
Neighbour cell		Config 1,2	NR cell 3				NR cell 3 is on NR RF channel number 2.
Gap Pattern Id		Config 1,2	0		13		As specified in TS 38.133 clause 9.1.2-1.
Measurement gap offset		Config 1,2	39		39		
SMTC-SSB parameters		Config 1,2	SSB.3 FR2				As specified in clause A.3
A3-Offset	dB	Config 1,2	-12				Value modified by TT
Hysteresis	dB	Config 1,2	0				
CP length		Config 1,2	Normal				
TimeToTrigger	s	Config 1,2	0				
Filter coefficient		Config 1,2	0				L3 filtering is not used
DRX		Config 1,2	DRX.1	DRX.7	DRX.1	DRX.7	As specified in clause A.5
Time offset between PCell and PScell		Config 1,2	3 μs				Synchronous EN-DC



Parameter	Unit	Test configuration	Value				Comment
			Test 1	Test 2	Test 3	Test 4	
Time offset between serving and neighbour cells		Config 1,2	3 $\mu$ s				Synchronous cells.
T1	s	Config 1,2	5				
T2	s	Config 1,2	11 for PC1; 6.5 for other PC	108 for PC1; 67 for other PC	11 for PC1; 6.5 for other PC	108 for PC1; 67 for other PC	PC1 - power class 1 as specified in TS 38.101-2 [3] Table 6.2.1.0

**Table 5.6.2.4.4.1-3: Test Environment test parameters for EN-DC inter-frequency event triggered reporting with SSB time index detection in DRX**

Parameter	Value		Comment
Test environment	NC		As specified in TS 38.508-1 [14] clause 4.1.
Test frequencies	As specified in Annex E, Table E.2-1 and TS 38.508-1 [14] clause 4.3.1 for E-UTRA, 7.2.3 for NR FR2.		
Channel bandwidth	As specified by the test configuration selected from Table 5.6.2.4.4.1-1.		
Propagation conditions	AWGN		As specified in clause C.2.2.
Connection Diagram	TE Part	A.3.3.3.1	As specified in TS 38.508-1 [14] Annex A.
	DUT Part	A.3.4.1.1	
Exceptions to connection diagram			

1. Message contents are defined in clause 5.6.2.4.4.3.
2. Cell 1 is the E-UTRA serving cell (PCell) for the EN-DC setup. The power levels and settings for Cell 1 are set according to Annex A.6. Cell 2 and Cell 3 are NR FR1 cells in different frequencies. Cell 2 is the PSCell and Cell 3 is the target cell. The power levels and settings for Cell 2 and are set according to clause C.1.2 and clause C.1.3. Cell 3 is switched off during the initial connection setup.
3. If a UE supports per-FR gap and gap pattern configuration #13, it is only required to pass test 3&4. Otherwise it is only required to pass test 1&2.
4. The UE Rx beam peak direction for Cell 2 has been obtained previously using one of the Rx beam peak search procedures as described in Annex I.

#### 5.6.2.4.4.2 Test procedure

In this test, there are three cells: LTE cell 1 as PCell on E-UTRA RF channel 1, NR cell 2 as PSCell in FR2 on NR RF channel 1 and NR cell 3 as neighbour cell in FR2 on NR RF channel 2.

In test 1&2 measurement gap pattern configuration # 0 as defined in Table 5.6.2.4.4.1-2 is provided for UE that does not support per-FR gap and in test 3&4 measurement gap pattern configuration #13 as defined in Table 5.6.2.4.4.1-2 is provided for UE that supports per-FR gap.

In the measurement control information, it is indicated to the UE that event-triggered reporting with Event A3 is used. The test consists of two successive time periods, with time duration of T1, and T2 respectively. During time duration T1, the UE shall not have any timing information of NR cell 3.

UE needs to be provided at least once every 500ms with new Timing Advance Command MAC control element to restart the Time alignment timer to keep UE uplink time alignment. Furthermore, UE is allocated with PUSCH resource at every DRX cycle.

1. Ensure the UE is in state RRC\_CONNECTED with generic procedure parameters Connectivity EN-DC, DC bearer MCG and SCG, Connected without release *On* according to TS 38.508-1 [14] clause 4.5.
2. Set the parameters according to T1 in Table 5.6.2.4.4.1-2.
3. The SS shall transmit an RRCConnectionReconfiguration message on Cell 1.

4. The UE shall transmit RRCConnectionReconfigurationComplete message.
5. When T1 expires, the SS shall switch the power setting from T1 to T2 as specified in Table 5.6.2.4.4.1-2.
6. UE shall transmit a MeasurementReport message triggered by Event A3 embedded in E-UTRA RRC message *ULInformationTransferMRDC*. If the overall delay measured from the beginning of time period T2 is less than 10082 ms for UE supporting power class 1, or 6242 ms for UE supporting other power class for Test 1 and Test 3 and 107522 ms for UE supporting power class 1, or 66562 ms for UE supporting other power class for Test 2 and Test 4, then the number of successful tests is increased by one. If the UE fails to report the event within the overall delays measured requirement then the number of failure tests is increased by one.
7. After the SS receives the MeasurementReport message in step 6 or when T2 expires, the SS shall transmit RRCConnectionReconfiguration message with condition EN-DC\_PSCell\_Rel according to TS 36.508 [25] Table 4.6.1-8 to release NR cell (PSCell). The UE shall transmit RRCConnectionReconfigurationComplete message.
8. Set Cell 3 physical cell identity = [(current cell 2 physical cell identity + 1) mod 1008] for next iteration of the test procedure loop.]
9. The SS shall transmit RRCConnectionReconfiguration message with condition MCG\_and\_SCG according to TS 36.508 [25] Table 4.6.1-8 to add NR cell (PSCell). The UE shall transmit RRCConnectionReconfigurationComplete message. If either of the reconfiguration in step 7 or step 9 fails, SS switches off and on the UE and ensures the UE is in state RRC\_CONNECTED with generic procedure parameters Connectivity EN-DC, DC bearer MCG and SCG, Connected without release *On* according to TS 38.508-1 [14] clause 4.5.
10. Repeat step 2-9 until the confidence level according to Tables G.2.3-1 in Annex G clause G.2 is achieved.
11. Repeat step 1-10 for each sub-test in Table 5.6.2.4.4.1-2 as appropriate.

5.6.2.4.4.3 Message contents

Message contents are according to TS 38.508-1 [14] clause 7.3 with the following exceptions:

**Table 5.6.2.4.4.3-1: Common Exception messages for Additional EN-DC FR2-FR2 event triggered reporting tests with SSB time index detection in DRX test requirement**

Default Message Contents	
Common contents of system information blocks exceptions	
Default RRC messages and information elements contents exceptions	Table H.3.1-1 Table H.3.1-2 with condition INTER-FREQ. For Test 3 and Test 4, additionally with condition GAP NEEDED Table H.3.1-3 with conditions INTER-FREQ MO and and Synchronous cells Table H.3.1-4 with condition SSB Index and A3-offset = -12dB Table H.3.1-6 with conditions gapFR2 and Pattern #13 for Test 3 and Test 4 Table H.3.4-4 with condition gapUE for Test 1 and Test 2 Table H.3.4-5 with condition Pattern #0 for Test 1 and Test 2 Table H.3.1-7 with condition SSB Index and INTER-FREQ Table H.3.7-1 with condition DRX.1 for Test 1 and Test 3 Table H.3.7-1 with condition DRX.7 for Test 2 and Test 4 Table H.3.4-1 Table H.3.4-2 Table H.3.4-3

5.6.2.4.5 Test requirement

Table 5.6.2.4.5-1 defines the primary level settings including test tolerances for all tests.

**Table 5.6.2.4.5-1: Cell specific test parameters for EN-DC inter-frequency event triggered reporting with SSB time index detection in DRX**

Parameter	Unit	Test configuration	Cell 2		Cell 3	
			T1	T2	T1	T2
AoA setup		Config 1,2	Setup 1 as specified in clause A.3.9			
Assumption for UE beams <sup>Note 7</sup>		Config 1,2	Rough			
NR RF Channel Number		Config 1,2	1		2	
Duplex mode		Config 1,2	TDD		TDD	
$BW_{channel}$	MHz	Config 1,2	100: $N_{RB,c} = 66$		100: $N_{RB,c} = 66$	
Data RBs allocated		Config 1,2	66		66	
BWP BW	MHz	Config 1,2	100: $N_{RB,c} = 66$		100: $N_{RB,c} = 66$	
TDD configuration		Config 1,2	TDDConf.3.1		TDDConf.3.1	
Initial DL BWP		Config 1,2	DLBWP.0.1		NA	
Dedicated DL BWP		Config 1,2	DLBWP.1.1		NA	
Initial UL BWP		Config 1,2	ULBWP.0.1		NA	
Dedicated UL BWP		Config 1,2	ULBWP.1.1		NA	
OCNG Patterns		Config 1,2	OP.1		OP.1	
PDSCH Reference measurement channel		Config 1,2	SR.3.1 TDD		-	
CORESET Reference Channel		Config 1,2	CR.3.1 TDD		-	
TRS configuration		Config 1,2	TRS.2.1 TDD		NA	
PDSCH/PDCCH TCI state		Config 1,2	TCI.State.2		NA	
SMTTC configuration		Config 1,2	SMTTC.1		SMTTC.1	
PDSCH/PDCCH subcarrier spacing	kHz	Config 1,2	120		120	
EPRE ratio of PSS to SSS		Config 1,2	0		0	
EPRE ratio of PBCH DMRS to SSS						
EPRE ratio of PBCH to PBCH DMRS						
EPRE ratio of PDCCH DMRS to SSS						
EPRE ratio of PDCCH to PDCCH DMRS						
EPRE ratio of PDSCH DMRS to SSS						
EPRE ratio of PDSCH to PDSCH						
EPRE ratio of OCNG DMRS to SSS(Note 1)						
EPRE ratio of OCNG to OCNG DMRS (Note 1)						
$N_{oc}$ <sup>Note2</sup>	dBm/15k Hz Note5		-104.7		-104.7	
$N_{oc}$ <sup>Note2</sup>	dBm/SC S Note4	Config 1,2	-95.7		-95.7	
SSB_RP <sup>Note 3</sup>	dBm/SC S Note5	Config 1,2	-89.7	-89.7	-89.7	-89.7
$\hat{E}_s / I_{ot}$	dB	Config 1,2	6	6	6	6
$\hat{E}_s / N_{oc}$	dB	Config 1,2	6	6	6	6
$I_o$ <sup>Note3</sup>	dBm/95.04 MHz Note5	Config 1,2	-59.7	-59.7	-59.7	-59.7
Propagation Condition		Config 1,2	AWGN			

Parameter	Unit	Test configuration	Cell 2		Cell 3	
			T1	T2	T1	T2
NOTE 1: OCNG shall be used such that both cells are fully allocated and a constant total transmitted power spectral density is achieved for all OFDM symbols.						
NOTE 2: Interference from other cells and noise sources not specified in the test is assumed to be constant over subcarriers and time and shall be modelled as AWGN of appropriate power for $N_{oc}$ to be fulfilled.						
NOTE 3: SSB_RP and lo levels have been derived from other parameters for information purposes. They are not settable parameters themselves.						
NOTE 4: Void						
NOTE 5: Equivalent power received by an antenna with 0dBi gain at the centre of the quiet zone						
NOTE 6: As observed with 0dBi gain antenna at the centre of the quiet zone						
NOTE 7: Information about types of UE beam is given in TS 38.133 Annex B.2.1.3, and does not limit UE implementation or test system implementation						

In test 1 with per-UE gap and in test 3 with per-FR gap, the UE shall send one Event A3 triggered measurement report, with a measurement reporting delay less than X1 ms from the beginning of time period T2, where X1 is

10080 for UE supporting power class 1, or

6240 for UE supporting other power class.

In test 2 with per-UE gap and in test 4 with per-FR gap, the UE shall send one Event A3 triggered measurement report, with a measurement reporting delay less than X2 ms from the beginning of time period T2, where X2 is

107520 for UE supporting power class 1, or

66560 for UE supporting other power class.

In test 1, 2, 3 and 4 UE is required to report SSB time index. The UE shall not send event triggered measurement reports, as long as the reporting criteria are not fulfilled. The rate of correct events observed during repeated tests shall be at least 90% with a confidence level of 95%. In test 1, 2, 3 and 4 UE is required to report SSB time index.

NOTE 1: The actual overall delays measured in the test may be up to  $2 \times TTI_{DCCH}$  higher than the measurement reporting delays above because of TTI insertion uncertainty of the measurement report in DCCH.

NOTE 2: The actual overall delays measured in the test may be up to  $2 \times TTI_{DCCH}$  higher than the measurement reporting delays above because of TTI insertion uncertainty of the measurement report in DCCH.

$TTI$  insertion uncertainty =  $TTI_{DCCH} = 1$  ms;  $2 \times TTI_{DCCH} = 2$  ms

The overall delays measured shall be less than a total of 10082 ms for power class 1 UE and 6242 ms for other power classes in test 1 and 107522 for power class 1 UE and 66562 ms for other power classes in test 2.

### 5.6.2.5 EN-DC FR1-FR2 event-triggered reporting in non-DRX

Editor's Note: This test case has been completed for the following configurations:

- Test frequency  $f \leq 40.8$  GHz
- UE PC3
- The test is incomplete for UE power classes other than PC3
- The test is incomplete for test frequencies  $> 40.8$  GHz

#### 5.6.2.5.1 Test purpose

The purpose of this test is to verify that the UE makes correct reporting of an event within inter-frequency cell search requirements.

#### 5.6.2.5.2 Test applicability

This test applies to all types of E-UTRA UE release 15 and forward, supporting EN-DC. Test 1 is applicable to UEs not supporting per-FR gap (*IndependentGapConfig*, as defined in TS 38.306) and Test 2 is applicable only to UEs supporting per-FR gap (*IndependentGapConfig*, as defined in TS 38.306) and Gap Pattern Id 13.

### 5.6.2.5.3 Minimum conformance requirements

The minimum conformance requirements are specified in clause 5.6.2.0.

The normative reference for this requirement is TS 38.133 [6] clause A.5.6.2.5.

### 5.6.2.5.4 Test description

#### 5.6.2.5.4.1 Initial conditions

This test shall be tested using any of the test configurations in Table 5.6.2.5.4.1-1. Configure the test equipment and the DUT according to the parameters in Table 5.6.2.5.4.1-2. Test environment parameters are given in Table 5.6.2.5.4.1-3.

**Table 5.6.2.5.4.1-1 EN-DC FR1-FR2 event triggered reporting tests in non-DRX supported test configurations**

Test Case ID	Description of serving cell	Description of target cell
5.6.2.5-1	LTE FDD, NR 15 kHz SSB SCS, 10MHz bandwidth, FDD duplex mode	120 kHz SSB SCS, 100MHz bandwidth, TDD duplex mode
5.6.2.5-2	LTE FDD, NR 15 kHz SSB SCS, 10MHz bandwidth, TDD duplex mode	
5.6.2.5-3	LTE FDD, NR 30kHz SSB SCS, 40MHz bandwidth, TDD duplex mode	
5.6.2.5-4	LTE TDD, NR 15 kHz SSB SCS, 10MHz bandwidth, FDD duplex mode	
5.6.2.5-5	LTE TDD, NR 15 kHz SSB SCS, 10MHz bandwidth, TDD duplex mode	
5.6.2.5-6	LTE TDD, NR 30kHz SSB SCS, 40MHz bandwidth, TDD duplex mode	
NOTE 1: The UE is only required to be tested in one of the supported test configurations		
NOTE 2: The target NR cell3 has the same SCS, BW and duplex mode as NR serving cell2		

**Table 5.6.2.5.4-2: General test parameters for EN-DC inter-frequency event triggered reporting without SSB time index detection in non-DRX**

Parameter	Unit	Test configuration	Value		Comment
			Test 1	Test 2	
E-UTRA RF Channel Number		Config 1,2,3,4,5,6	1		One E-UTRAN TDD carrier frequencies is used.
NR RF Channel Number		Config 1,2,3,4,5,6	1, 2		One FR1 and one FR2 NR carrier frequency is used.
Active cell		Config 1,2,3,4,5,6	LTE Cell 1 (PCell) and NR cell 2 (PScell)		LTE Cell 1 is on E-UTRA RF channel number 1. NR Cell 2 is on NR RF channel number 1.
Neighbour cell		Config 1,2,3,4,5,6	NR cell 3		NR cell 3 is on NR RF channel number 2.
Gap Pattern Id		Config 1,2,3,4,5,6	0	13	As specified in TS 38.133 clause 9.1.2-1.
Measurement gap offset		Config 1,2,3,4,5,6	39	39	
SMTC-SSB parameters on NR RF Channel 1		Config 1,4	SSB.1 FR1		As specified in clause A.3
		Config 2,5	SSB.1 FR1		As specified in clause A.3
		Config 3,6	SSB.2 FR1		As specified in clause A.3
SMTC-SSB parameters on NR RF Channel 2		Config 1,2,3,4,5,6	SSB.3 FR2		As specified in clause A.3
offsetMO	dB	Config 1,2,3,4,5,6	6		
Hysteresis	dB	Config 1,2,3,4,5,6	0		
a4-Threshold	dBm	Config 1,2,3,4,5,6	-105		
CP length		Config 1,2,3,4,5,6	Normal		

TimeToTrigger	s	Config 1,2,3,4,5,6	0		
Filter coefficient		Config 1,2,3,4,5,6	0		L3 filtering is not used
DRX		Config 1,2,3,4,5,6	OFF		DRX is not used
Time offset between PCell and PSCell		Config 1,2,3,4,5,6	3 $\mu$ s		Synchronous EN-DC
Time offset between serving and neighbour cells		Config 1,4	3ms		Asynchronous cells. The timing of Cell 3 is 3ms later than the timing of Cell 2.
		Config 2,3,5,6	3 $\mu$ s		Synchronous cells.
T1	s	Config 1,2,3,4,5,6	5		
T2	s	Config 1,2,3,4,5,6	5.2 for PC1; 3.5 for other PC	5.2 for PC1; 3.5 for other PC	PC1 - power class 1 as specified in TS 38.101-2 [3] Table 6.2.1.0

**Table 5.6.2.5.4-3: Test Environment test parameters for EN-DC inter-frequency event triggered reporting without SSB time index detection in non-DRX**

Parameter	Value		Comment
Test environment	NC		As specified in TS 38.508-1 [14] clause 4.1.
Test frequencies	As specified in Annex E, Table TBD and TS 38.508-1 [14] clause 4.3.1 for E-UTRA and NR FR1, 7.2.3 for NR FR2.		
Channel bandwidth	As specified by the test configuration selected from Table 5.6.2.5.4.1-1.		
Propagation conditions	AWGN		As specified in clause C.2.2.
Connection Diagram	TE Part	A.3.3.3.1	As specified in TS 38.508-1 [14] Annex A.
	DUT Part	A.3.4.1.1	
Exceptions to connection diagram			

1. Message contents are defined in clause 5.6.2.5.4.3.
2. Cell 1 is the E-UTRA serving cell (PCell) for the EN-DC setup. The power levels and settings for Cell 1 are set according to Annex A.6. Cell 2 and Cell 3 are NR FR2 cells in different frequencies. Cell 2 is the PSCell and Cell 3 is the target cell. The power levels and settings for Cell 2 and Cell 3 are set according to Annex TBD
3. If a UE supports per-FR gap and gap pattern configuration #13, it is only required to pass test 2. Otherwise it is only required to pass test 1.
4. The UE Rx beam peak direction for Cell 3 has been obtained previously using one of the Rx beam peak search procedures as described in Annex I.

#### 5.6.2.5.4.2 Test procedure

In this test, there are three cells: LTE cell 1 as PCell on E-UTRA RF channel 1, NR cell 2 as PSCell in FR1 on NR RF channel 1 and NR cell 3 as neighbour cell in FR2 on NR RF channel 2.

In test 1 measurement gap pattern configuration # 0 as defined in Table 5.6.2.5.4.1-2 is provided for a UE that does not support per-FR gap and in test 2 measurement gap pattern configuration #13 as defined in Table 5.6.2.5.4.1-2 is provided for UE that support per-FR gap.

In the measurement control information, it is indicated to the UE that event-triggered reporting with Event A3 is used. The test consists of two successive time periods, with time duration of T1, and T2 respectively. During time duration T1, the UE shall not have any timing information of NR cell 3.

1. Ensure the UE is in state RRC\_CONNECTED with generic procedure parameters Connectivity EN-DC, DC bearer MCG and SCG, Connected without release *On* according to TS 38.508-1 [14] clause 4.5.

2. Set the parameters according to T1 in Table 5.6.2.5.4.1-2. The TE shall ensure that the NR FR2 cell will be received by the UE from the Rx beam peak direction. T1 starts.
3. The SS shall transmit an RRCConnectionReconfiguration message on Cell 1.
4. The UE shall transmit RRCConnectionReconfigurationComplete message.
5. When T1 expires, the SS shall switch the power setting from T1 to T2 as specified in Table 5.6.2.5.4.1-2.
6. UE shall transmit a MeasurementReport message triggered by Event A3 embedded in E-UTRA RRC message *ULInformationTransferMRDC*. If the overall delay measured from the beginning of time period T2 is less than 5122 ms for UE supporting power class 1, or 3202 ms for UE supporting other power class for Test 1 and Test 2 then the number of successful tests is increased by one. If the UE fails to report the event within the overall delays measured requirement then the number of failure tests is increased by one.
7. After the SS receives the MeasurementReport message in step 6 or when T2 expires, the SS shall transmit RRCConnectionRelease message to release the RRC connection which includes the release of the established radio bearers as well as all radio resources.
8. Set Cell 3 physical cell identity = [(current cell 2 physical cell identity + 1) mod 1008] for next iteration of the test procedure loop.]
9. After the RRC connection release, the SS:
  - transmits in Cell 1 a Paging message (including PagingRecord with ue-Identity) for the UE and ensures the UE in state RRC\_CONNECTED with generic procedure parameters Connectivity EN-DC, DC bearer MCG and SCG, Connected without release *On* according to TS 38.508-1 [14] clause 4.5. (if the paging fails, switches off and on the UE and ensures the UE is in state RRC\_CONNECTED with generic procedure parameters Connectivity EN-DC, DC bearer MCG and SCG, Connected without release *On* according to TS 38.508-1 [14] clause 4.5.),
  - or:
  - switches off and on the UE and ensures the UE is in state RRC\_CONNECTED with generic procedure parameters Connectivity EN-DC, DC bearer MCG and SCG, Connected without release *On* according to TS 38.508-1 [14] clause 4.5.
10. Repeat step 2-9 until the confidence level according to Tables G.2.3-1 in Annex G clause G.2 is achieved.
11. Repeat step 1-10 for each sub-test in Table 4.6.2.1.4.1-2 as appropriate.

5.6.2.5.4.3 Message contents

Message contents are according to TS 38.508-1 [14] clause 7.3 with the following exceptions:

**Table 5.6.2.5.4.3-1: Common Exception messages for Additional EN-DC FR1-FR2 event triggered reporting tests without SSB time index detection in non-DRX test requirement**

Default Message Contents	
Common contents of system information blocks exceptions	
Default RRC messages and information elements contents exceptions	Table H.3.1-1 Table H.3.1-2 with Condition INTER-FREQ. For Test 2, additionally with condition GAP NEEDED Table H.3.1-3 with Conditions INTER-FREQ MO and Synchronous cells Table H.3.1-4AA with A4-threshold = -105 Table H.3.1-6 with Conditions gapFR2 and Pattern #13 for Test 2 Table H.3.4-4 with Condition gapUE Test 1 Table H.3.4-5 with Condition Pattern #0 for Test 1 Table H.3.1-7 with Condition INTER-FREQ Table H.3.4-1 Table H.3.4-2 Table H.3.4-3

**Table 5.6.2.5.4.3-2: MeasObjectNR-DEFAULT: EN-DC FR1-FR2 measurement object configuration**

Derivation Path: Table H.3.1-3			
Information Element	Value/remark	Comment	Condition
MeasObjectNR ::= SEQUENCE {			
offsetMO SEQUENCE {			
rsrpOffsetSSB	6 dB		
}			

5.6.2.5.5 Test requirement

Table 5.6.2.5.5-1 defines the primary level settings including test tolerances for all tests.

**Table 5.6.2.5.5-1: Cell specific test parameters for EN-DC inter-frequency event triggered reporting without SSB time index detection in non-DRX**

Parameter	Unit	Test configuration	Cell 2		Cell 3	
			T1	T2	T1	T2
AoA setup		Config 1,2,3,4,5,6	NA		Setup 1	
Assumption for UE beams <sup>Note 7</sup>		Config 1,2,3,4,5,6	N/A		Rough	
NR RF Channel Number		Config 1,2,3,4,5,6	1		2	
Duplex mode		Config 1,4	FDD		TDD	
		Config 2,3,5,6	TDD		TDD	
BW <sub>channel</sub>	MHz	Config 1,4	10: N <sub>RB,c</sub> = 52		100: N <sub>RB,c</sub> = 66	
		Config 2,5	10: N <sub>RB,c</sub> = 52		100: N <sub>RB,c</sub> = 66	
		Config 3,6	40: N <sub>RB,c</sub> = 106		100: N <sub>RB,c</sub> = 66	
BWP BW	MHz	Config 1,4	10: N <sub>RB,c</sub> = 52		100: N <sub>RB,c</sub> = 66	
		Config 2,5	10: N <sub>RB,c</sub> = 52		100: N <sub>RB,c</sub> = 66	
		Config 3,6	40: N <sub>RB,c</sub> = 106		100: N <sub>RB,c</sub> = 66	
TDD configuration		Config 2,5	TDDConf.1.1		TDDConf.3.1	
		Config 3,6	TDDConf.2.1		TDDConf.3.1	
Initial DL BWP		Config 1,2,3,4,5,6	DLBWP.0.1		NA	
Initial UL BWP		Config 1,2,3,4,5,6	ULBWP.0.1		NA	
Dedicated DL BWP		Config 1,2,3,4,5,6	DLBWP.1.1		NA	
Dedicated UL BWP		Config 1,2,3,4,5,6	ULBWP.1.1		NA	
OCNG Patterns		Config 1,2,3,4,5,6	OP.1		OP.1	
PDSCH Reference measurement channel		Config 1,4	SR.1.1 FDD		-	
		Config 2,5	SR.1.1 TDD			
		Config 3,6	SR.2.1 TDD			
RMSI CORESET Reference Channel		Config 1,4	CR.1.1 FDD		-	
		Config 2,5	CR.1.1 TDD			
		Config 3,6	CR.2.1 TDD			
Dedicated CORESET RMC configuration		Config 1,4	CCR.1.1 FDD		CCR.3.1 TDD	
		Config 2,5	CCR.1.1 TDD		CCR.3.1 TDD	
		Config 3,6	CCR.2.1 TDD		CCR.3.1 TDD	
SMTC configuration		Config 1,4	SMTC.2		SMTC.2	
		Config 2,3,5,6	SMTC.1		SMTC.1	
PDSCH/PDCCH subcarrier spacing	kHz	Config 1,2,4,5	15		120	
		Config 3,6	30		120	
EPRE ratio of PSS to SSS		Config 1,2,3,4,5,6	0		0	
EPRE ratio of PBCH DMRS to SSS						
EPRE ratio of PBCH to PBCH DMRS						
EPRE ratio of PDCCH DMRS to SSS						



Parameter	Unit	Test configuration	Cell 2		Cell 3	
			T1	T2	T1	T2
EPRE ratio of PDCCH to PDCCH DMRS						
EPRE ratio of PDSCH DMRS to SSS						
EPRE ratio of PDSCH to PDSCH						
EPRE ratio of OCNG DMRS to SSS(Note 1)						
EPRE ratio of OCNG to OCNG DMRS (Note 1)						
$\hat{E}_s$	dBm/SC S	Config 1,2,3,4,5,6	Link only, see clause A.3.7A	-Infinity	-87	
SSB_RP <sup>Note 3</sup>	dBm/SC S Note5	Config 1,2,3,4,5,6		-Infinity	-87	
$\hat{E}_s / I_{ot\_BB}$ <sup>Note 8</sup>	dB	Config 1,2,3,4,5,6		-Infinity	14.69	
$I_o$ <sup>Note3</sup>	dBm/95.04 MHz Note5	Config 1,2,3,4,5,6		-Infinity	-58.01	
Propagation Condition		Config 1,2,3,4,5,6		AWGN		
<p>NOTE 1: OCNG shall be used such that both cells are fully allocated and a constant total transmitted power spectral density is achieved for all OFDM symbols.</p> <p>NOTE 2: Void</p> <p>NOTE 3: SSB_RP, <math>E_s/I_{ot}</math> and <math>I_o</math> levels have been derived from other parameters for information purposes. They are not settable parameters themselves.</p> <p>NOTE 4: Void.</p> <p>NOTE 5: Equivalent power received by an antenna with 0dBi gain at the centre of the quiet zone</p> <p>NOTE 6: As observed with 0dBi gain antenna at the centre of the quiet zone</p> <p>NOTE 7: Information about types of UE beam is given in B.2.1.3, and does not limit UE implementation or test system implementation</p> <p>NOTE 8: Calculation of <math>E_s/I_{ot\_BB}</math> includes the effect of UE internal noise up to the value assumed for the associated Refsens requirement in clause 7.3.2 of TS 38.101-2 [19], and an allowance of 1dB for UE multi-band relaxation factor <math>\Delta MB_s</math> from TS 38.101-2 [19] Table 6.2.1.3-4.</p>						

In test 1 with per-UE gap and in test 2 with per-FR gap, the UE shall send one Event A4 triggered measurement report, with a measurement reporting delay less than X ms from the beginning of time period T2, where X is

- 5120 for UE supporting power class 1, or
- 3200 for UE supporting other power class.

In test 1 and 2 UE is not required to report SSB time index. The UE shall not send event triggered measurement reports, as long as the reporting criteria are not fulfilled. The rate of correct events observed during repeated tests shall be at least 90% with a confidence level of 95%. In test 1 and 2 UE is not required to report SSB time index.

NOTE: The actual overall delays measured in the test may be up to  $2 \times TTI_{DCCH}$  higher than the measurement reporting delays above because of TTI insertion uncertainty of the measurement report in DCCH.

TTI insertion uncertainty =  $TTI_{DCCH} = 1$  ms;  $2 \times TTI_{DCCH} = 2$  ms

The overall delays measured shall be less than a total of 5122 ms in this test for power class UE and 3202 ms for other power classes.

### 5.6.2.6 EN-DC FR1-FR2 event-triggered reporting in DRX

Editor's Note: This test case has been completed for the following configurations:

- Test frequency  $f \leq 40.8$  GHz
- UE PC3
- The test is incomplete for UE power classes other than PC3

- The test is incomplete for test frequencies > 40.8 GHz

#### 5.6.2.6.1 Test purpose

The purpose of this test is to verify that the UE makes correct reporting of an event in DRX within inter-frequency cell search requirements.

#### 5.6.2.6.2 Test applicability

This test applies to all types of E-UTRA UE release 15 and forward, supporting EN-DC FR2 and long DRX cycle. Tests 1 and 2 are applicable to UEs not supporting per-FR gap (*IndependentGapConfig*, as defined in TS 38.306) and Tests 3 and 4 are applicable only to UEs supporting per-FR gap (*IndependentGapConfig*, as defined in TS 38.306) and Gap Pattern Id 13.

#### 5.6.2.6.3 Minimum conformance requirements

The minimum conformance requirements are specified in clause 5.6.2.0.

The normative reference for this requirement is TS 38.133 [6] clause A.5.6.2.6.

#### 5.6.2.6.4 Test description

##### 5.6.2.6.4.1 Initial conditions

This test shall be tested using any of the test configurations in Table 5.6.2.6.4.1-1. Configure the test equipment and the DUT according to the parameters in Table 5.6.2.6.4.1-2. Test environment parameters are given in Table 5.6.2.6.4.1-3.

**Table 5.6.2.6.4.1-1: EN-DC FR1-FR2 event triggered reporting tests in DRX supported test configurations**

Test Case ID	Description of serving cell	Description of target cell
5.6.2.6-1	LTE FDD, NR 15 kHz SSB SCS, 10MHz bandwidth, FDD duplex mode	120 kHz SSB SCS, 100MHz bandwidth, TDD duplex mode
5.6.2.6-2	LTE FDD, NR 15 kHz SSB SCS, 10MHz bandwidth, TDD duplex mode	
5.6.2.6-3	LTE FDD, NR 30kHz SSB SCS, 40MHz bandwidth, TDD duplex mode	
5.6.2.6-4	LTE TDD, NR 15 kHz SSB SCS, 10MHz bandwidth, FDD duplex mode	
5.6.2.6-5	LTE TDD, NR 15 kHz SSB SCS, 10MHz bandwidth, TDD duplex mode	
5.6.2.6-6	LTE TDD, NR 30kHz SSB SCS, 40MHz bandwidth, TDD duplex mode	
NOTE 1: The UE is only required to be tested in one of the supported test configurations		
NOTE 2: The target NR cell3 has the same SCS, BW and duplex mode as NR serving cell2		

**Table 5.6.2.6.4-2: General test parameters for EN-DC inter-frequency event triggered reporting without SSB time index detection**

Parameter	Unit	Test configuration	Value				Comment
			Test 1	Test 2	Test 3	Test 4	
E-UTRA RF Channel Number		Config 1,2,3,4,5,6	1				One E-UTRAN TDD carrier frequencies is used.
NR RF Channel Number		Config 1,2,3,4,5,6	1, 2				One FR1 and one FR2 NR carrier frequency is used.
Active cell		Config 1,2,3,4,5,6	LTE Cell 1 (PCell) and NR cell 2 (PScell)				LTE Cell 1 is on E-UTRA RF channel number 1. NR Cell 2 is on NR RF channel number 1.
Neighbour cell		Config 1,2,3,4,5,6	NR cell 3				NR cell 3 is on NR RF channel number 2.
Gap Pattern Id		Config 1,2,3,4,5,6	0		13		As specified in TS 38.133 clause 9.1.2-1.
Measurement gap offset		Config 1,2,3,4,5,6	39		39		
SMTC-SSB parameters on NR RF Channel 1		Config 1,4	SSB.1 FR1				As specified in clause A.3
		Config 2,5	SSB.1 FR1				As specified in clause A.3
		Config 3,6	SSB.2 FR1				As specified in clause A.3

Parameter	Unit	Test configuration	Value				Comment
			Test 1	Test 2	Test 3	Test 4	
SMTC-SSB parameters on NR RF Channel 2		Config 1,2,3,4,5,6	SSB.3 FR2				As specified in clause A.3
offsetMO	dB	Config 1,2,3,4,5,6	6				
Hysteresis	dB	Config 1,2,3,4,5,6	0				
a4-Threshold	dBm	Config 1,2,3,4,5,6	-105				
CP length		Config 1,2,3,4,5,6	Normal				
TimeToTrigger	s	Config 1,2,3,4,5,6	0				
Filter coefficient		Config 1,2,3,4,5,6	0				L3 filtering is not used
DRX		Config 1,2,3,4,5,6	DRX.1	DRX.2	DRX.1	DRX.2	As specified in clause A.5
Time offset between PCell and PSCell		Config 1,2,3,4,5,6	3 $\mu$ s				Synchronous EN-DC
Time offset between serving and neighbour cells		Config 1,4	3ms				Asynchronous cells. The timing of Cell 3 is 3ms later than the timing of Cell 2.
		Config 2,3,5,6	3 $\mu$ s				Synchronous cells.
T1	s	Config 1,2,3,4,5,6	5				
T2	s	Config 1,2,3,4,5,6	8 for PC1; 5 for other PC	82 for PC1; 52 for other PC	8 for PC1; 5 for other PC	82 for PC1; 52 for other PC	PC1 - power class 1 as specified in TS 38.101-2 [3] Table 6.2.1.0

**Table 5.6.2.6.4-3: Test Environment test parameters for EN-DC inter-frequency event triggered reporting without SSB time index detection in non-DRX**

Parameter	Value		Comment
Test environment	NC		As specified in TS 38.508-1 [14] clause 4.1.
Test frequencies	As specified in Annex E, Table TBD and TS 38.508-1 [14] clause 4.3.1 for E-UTRA and NR FR1, 7.2.3 for NR FR2		
Channel bandwidth	As specified by the test configuration selected from Table 4.6.2.3.4.1-1.		
Propagation conditions	AWGN		As specified in clause C.2.2.
Connection Diagram	TE Part	A.3.3.3.1	As specified in TS 38.508-1 [14] Annex A.
	DUT Part	A.3.4.1.1	
Exceptions to connection diagram			

1. Message contents are defined in clause 4.6.2.3.4.3.
2. Cell 1 is the E-UTRA serving cell (PCell) for the EN-DC setup. The power levels and settings for Cell 1 are set according to Annex A.6. Cell 2 and Cell 3 are NR FR2 cells in different frequencies. Cell 2 is the PSCell and Cell 3 is the target cell. The power levels and settings for Cell 2 and Cell 3 are set according to Annex TBD
3. If a UE supports per-FR gap and gap pattern configuration #13, it is only required to pass test 3&4. Otherwise it is only required to pass test 1&2.
4. The UE Rx beam peak direction for Cell 3 has been obtained previously using one of the Rx beam peak search procedures as described in Annex I.

#### 5.6.2.6.4.2 Test procedure

In this test, there are three cells: LTE cell 1 as PCell on E-UTRA RF channel 1, NR cell 2 as PSCell in FR1 on NR RF channel 1 and NR cell 3 as neighbour cell in FR2 on NR RF channel 2.

In test 1&2 measurement gap pattern configuration # 0 as defined in Table 5.6.2.6.4-2 is provided for a UE that does not support per-FR gap and in test 3&4 measurement gap pattern configuration #13 as defined in Table 5.6.2.6.4-2 is provided for UE that support per-FR gap.

In the measurement control information, it is indicated to the UE that event-triggered reporting with Event A3 is used. The test consists of two successive time periods, with time duration of T1, and T2 respectively. During time duration T1, the UE shall not have any timing information of NR cell 3.

UE needs to be provided at least once every 500ms with new Timing Advance Command MAC control element to restart the Time alignment timer to keep UE uplink time alignment. Furthermore UE is allocated with PUSCH resource at every DRX cycle.

1. Ensure the UE is in state RRC\_CONNECTED with generic procedure parameters Connectivity EN-DC, DC bearer MCG and SCG, Connected without release *On* according to TS 38.508-1 [14] clause 4.5.
2. Set the parameters according to T1 in Table 5.6.2.6.4-2. The TE shall ensure that the NR FR2 cell will be received by the UE from the Rx beam peak direction. T1 starts.
3. The SS shall transmit an RRCConnectionReconfiguration message on Cell 1.
4. The UE shall transmit RRCConnectionReconfigurationComplete message.
5. When T1 expires, the SS shall switch the power setting from T1 to T2 as specified in Table 5.6.2.6.4-2.
6. UE shall transmit a MeasurementReport message triggered by Event A3 embedded in E-UTRA RRC message *ULInformationTransferMRDC*. If the overall delay measured from the beginning of time period T2 is less than 7682 ms for UE supporting power class 1, or 4802 ms for UE supporting other power class for Test 1 and Test 3 and 81922 ms for UE supporting power class 1, or 51202 ms for UE supporting other power class for Test 2 and Test 4, then the number of successful tests is increased by one. If the UE fails to report the event within the overall delays measured requirement then the number of failure tests is increased by one.
7. After the SS receives the MeasurementReport message in step 6 or when T2 expires, the SS shall transmit RRCConnectionRelease message to release the RRC connection which includes the release of the established radio bearers as well as all radio resources.
8. Set Cell 3 physical cell identity = [(current cell 2 physical cell identity + 1) mod 1008] for next iteration of the test procedure loop.]
9. After the RRC connection release, the SS:
  - transmits in Cell 1 a Paging message (including PagingRecord with ue-Identity) for the UE and ensures the UE in state RRC\_CONNECTED with generic procedure parameters Connectivity EN-DC, DC bearer MCG and SCG, Connected without release *On* according to TS 38.508-1 [14] clause 4.5. (if the paging fails, switches off and on the UE and ensures the UE is in state RRC\_CONNECTED with generic procedure parameters Connectivity EN-DC, DC bearer MCG and SCG, Connected without release *On* according to TS 38.508-1 [14] clause 4.5.),
  - or:
  - switches off and on the UE and ensures the UE is in state RRC\_CONNECTED with generic procedure parameters Connectivity EN-DC, DC bearer MCG and SCG, Connected without release *On* according to TS 38.508-1 [14] clause 4.5.
10. Repeat step 2-9 until the confidence level according to Tables G.2.3-1 in Annex G clause G.2 is achieved.
11. Repeat step 1-10 for each sub-test in Table 5.6.2.6.4-2 as appropriate.

#### 5.6.2.6.4.3 Message contents

Message contents are according to TS 38.508-1 [14] clause 7.3 with the following exceptions:

**Table 5.6.2.6.4.3-1: Common Exception messages for Additional EN-DC FR1-FR2 event triggered reporting tests without SSB time index detection in DRX test requirement**

Default Message Contents	
Common contents of system information blocks exceptions	
Default RRC messages and information elements contents exceptions	Table H.3.1-1 Table H.3.1-2 with Condition INTER-FREQ. For Test 3 and 4, additionally with condition GAP NEEDED Table H.3.1-3 with Conditions INTER-FREQ MO and Synchronous cells Table H.3.1-4AA with A4-threshold = -105 Table H.3.1-6 with Conditions gapFR2 and Pattern #13 for Test 3 and Test 4 Table H.3.4-4 with Condition gapUE Test 1 and Test 2 Table H.3.4-5 with Condition Pattern #0 for Test 1 and Test 2 Table H.3.1-7 with Condition INTER-FREQ Table H.3.7-1 with Condition DRX.1 for Test 1 and Test 3 Table H.3.7-1 with Condition DRX.2 for Test 2 and Test 4 Table H.3.4-1 Table H.3.4-2 Table H.3.4-3

**Table 5.6.2.6.4.3-2: MeasObjectNR-DEFAULT: EN-DC FR1-FR2 measurement object configuration**

Derivation Path: Table H.3.1-3			
Information Element	Value/remark	Comment	Condition
MeasObjectNR::= SEQUENCE {			
offsetMO SEQUENCE {			
rsrpOffsetSSB	6 dB		
}			

5.6.2.6.5 Test requirement

Table 5.6.2.6.5-1 defines the primary level settings including test tolerances for all tests.

**Table 5.6.2.6.5-1: Cell specific test parameters for EN-DC inter-frequency event triggered reporting without SSB time index detection**

Parameter	Unit	Test configuration	Cell 2		Cell 3	
			T1	T2	T1	T2
AoA setup		Config 1,2,3,4,5,6	NA		Setup 1 as specified in clause A.9	
Assumption for UE beams <sup>Note 7</sup>		Config 1,2,3,4,5,6	N/A		Rough	
NR RF Channel Number		Config 1,2,3,4,5,6	1		2	
Duplex mode		Config 1,4	FDD		TDD	
		Config 2,3,5,6	TDD		TDD	
BW <sub>channel</sub>	MHz	Config 1,4	10: N <sub>RB,c</sub> = 52		100: N <sub>RB,c</sub> = 66	
		Config 2,5	10: N <sub>RB,c</sub> = 52		100: N <sub>RB,c</sub> = 66	
		Config 3,6	40: N <sub>RB,c</sub> = 106		100: N <sub>RB,c</sub> = 66	
BWP BW	MHz	Config 1,4	10: N <sub>RB,c</sub> = 52		100: N <sub>RB,c</sub> = 66	
		Config 2,5	10: N <sub>RB,c</sub> = 52		100: N <sub>RB,c</sub> = 66	
		Config 3,6	40: N <sub>RB,c</sub> = 106		100: N <sub>RB,c</sub> = 66	
TDD configuration		Config 2,5	TDDConf.1.1		TDDConf.3.1	
		Config 3,6	TDDConf.2.1		TDDConf.3.1	
Initial DL BWP		Config 1,2,3,4,5,6	DLBWP.0.1		NA	
Initial UL BWP		Config 1,2,3,4,5,6	ULBWP.0.1		NA	
Dedicated DL BWP		Config 1,2,3,4,5,6	DLBWP.1.1		NA	
Dedicated UL BWP		Config 1,2,3,4,5,6	ULBWP.1.1		NA	
OCNG Patterns		Config 1,2,3,4,5,6	OP.1		OP.1	
PDSCH Reference measurement channel		Config 1,4	SR.1.1 FDD		-	
		Config 2,5	SR.1.1 TDD			
		Config 3,6	SR2.1 TDD			
RMSI CORESET Reference		Config 1,4	CR.1.1 FDD		-	

Parameter	Unit	Test configuration	Cell 2		Cell 3	
			T1	T2	T1	T2
Channel		Config 2,5	CR.1.1 TDD			
		Config 3,6	CR2.1 TDD			
Dedicated CORESET RMC configuration		Config 1,4	CCR.1.1 FDD		CCR.3.1 TDD	
		Config 2,5	CCR.1.1 TDD		CCR.3.1 TDD	
		Config 3,6	CCR.2.1 TDD		CCR.3.1 TDD	
SMTC configuration		Config 1,4	SMTC.2		SMTC.2	
		Config 2,3,5,6	SMTC.1		SMTC.1	
PDSCH/PDCCH subcarrier spacing	kHz	Config 1,2,4,5	15		120	
		Config 3,6	30		120	
EPRE ratio of PSS to SSS		Config 1,2,3,4,5,6	0		0	
EPRE ratio of PBCH DMRS to SSS						
EPRE ratio of PBCH to PBCH DMRS						
EPRE ratio of PDCCH DMRS to SSS						
EPRE ratio of PDCCH to PDCCH DMRS						
EPRE ratio of PDSCH DMRS to SSS						
EPRE ratio of PDSCH to PDSCH						
EPRE ratio of OCNG DMRS to SSS(Note 1)						
EPRE ratio of OCNG to OCNG DMRS (Note 1)						
$N_{oc}^{Note2}$	dBm/15kHz Note5					
$N_{oc}^{Note2}$	dBm/SCS Note4	Config 1,2,4,5	-95.7			
		Config 3,6	-95.7			
SSB_RP <sup>Note 3</sup>	dBm/SCS Note5	Config 1,2,4,5	-Infinity	-86.7		
		Config 3,6	-Infinity	-86.7		
$\hat{E}_s / I_{at}$	dB	Config 1,2,3,4,5,6	-Infinity	9		
$\hat{E}_s / N_{oc}$	dB	Config 1,2,3,4,5,6	-Infinity	9		
$I_o^{Note3}$	dBm/9.36MHz	Config 1,2,4,5	-	-		
	dBm/38.16MHz	Config 3,6	-	-		
	dBm/95.04 MHz Note5	Config 1,2,3,4,5,6	-66.7	-57.2		
Propagation Condition		Config 1,2,3,4,5,6			AWGN	

NOTE 1: OCNG shall be used such that both cells are fully allocated and a constant total transmitted power spectral density is achieved for all OFDM symbols.

NOTE 2: Interference from other cells and noise sources not specified in the test is assumed to be constant over subcarriers and time and shall be modelled as AWGN of appropriate power for  $N_{oc}$  to be fulfilled.

NOTE 3: SSB\_RP and  $I_o$  levels have been derived from other parameters for information purposes. They are not settable parameters themselves.

NOTE 4: SSB\_RP minimum requirements are specified assuming independent interference and noise at each receiver antenna port.

NOTE 5: Equivalent power received by an antenna with 0 dBi gain at the centre of the quiet zone

NOTE 6: As observed with 0 dBi gain antenna at the centre of the quiet zone

NOTE 7: Information about types of UE beam is given in B.2.1.3, and does not limit UE implementation or test system implementation

In test 1 with per-UE gap and in test 3 with per-FR gap, the UE shall send one Event A4 triggered measurement report, with a measurement reporting delay less than  $X1$  ms from the beginning of time period T2, where  $X1$  is

- 7680 for UE supporting power class 1, or
- 4800 for UE supporting other power class.

In test 2 with per-UE gap and in test 4 with per-FR gap, the UE shall send one Event A4 triggered measurement report, with a measurement reporting delay less than  $X2$  ms from the beginning of time period T2, where  $X2$  is

- 81920 for UE supporting power class 1, or
- 51200 for UE supporting other power class.

In test 1, 2, 3 and 4 UE is not required to report SSB time index. The UE shall not send event triggered measurement reports, as long as the reporting criteria are not fulfilled. The rate of correct events observed during repeated tests shall be at least 90% with the confidence level of 95%.

In test 1, 2, 3 and 4 UE is not required to report SSB time index.

NOTE: The actual overall delays measured in the test may be up to  $2xTTI_{DCCH}$  higher than the measurement reporting delays above because of TTI insertion uncertainty of the measurement report in DCCH.

TTI insertion uncertainty =  $TTI_{DCCH} = 1$  ms;  $2xTTI_{DCCH} = 2$  ms

The overall delays measured shall be less than a total of 7682 ms for power class 1 UE and 4802 ms for other power classes in test 1 and test 3 and 81922 for power class 1 UE and 51202 ms for other power classes in test 2 and test 4.

### 5.6.2.7 EN-DC FR1-FR2 event-triggered reporting in non-DRX with SSB time index detection

Editor's Note: This test case has been completed for the following configurations:

- Test frequency  $f \leq 40.8$  GHz
- UE PC3
- The test is incomplete for UE power classes other than PC3
- The test is incomplete for test frequencies  $> 40.8$  GHz

#### 5.6.2.7.1 Test purpose

The purpose of this test is to verify that the UE makes correct reporting of an event within inter-frequency cell search requirements with SSB time index detection.

#### 5.6.2.7.2 Test applicability

This test applies to all types of E-UTRA UE release 15 and forward, supporting EN-DC. Test 1 is applicable to UEs not supporting per-FR gap (*IndependentGapConfig*, as defined in TS 38.306) and Test 2 is applicable only to UEs supporting per-FR gap (*IndependentGapConfig*, as defined in TS 38.306) and Gap Pattern Id 13.

#### 5.6.2.7.3 Minimum conformance requirements

The minimum conformance requirements are specified in clause 5.6.2.0.

The normative reference for this requirement is TS 38.133 [6] clause A.5.6.2.7.

#### 5.6.2.7.4 Test description

##### 5.6.2.7.4.1 Initial conditions

This test shall be tested using any of the test configurations in Table 5.6.2.7.4.1-1. Configure the test equipment and the DUT according to the parameters in Table 5.6.2.7.4.1-2. Test environment parameters are given in Table 5.6.2.7.4.1-3.

**Table 5.6.2.7.4.1-1: EN-DC FR1-FR2 event triggered reporting tests in non-DRX with SSB time index detection supported test configurations**

Test Case ID	Description of serving cell	Description of target cell
5.6.2.7-1	LTE FDD, NR 15 kHz SSB SCS, 10MHz bandwidth, FDD duplex mode	120 kHz SSB SCS, 100MHz bandwidth, TDD duplex mode
5.6.2.7-2	LTE FDD, NR 15 kHz SSB SCS, 10MHz bandwidth, TDD duplex mode	
5.6.2.7-3	LTE FDD, NR 30kHz SSB SCS, 40MHz bandwidth, TDD duplex mode	
5.6.2.7-4	LTE TDD, NR 15 kHz SSB SCS, 10MHz bandwidth, FDD duplex mode	
5.6.2.7-5	LTE TDD, NR 15 kHz SSB SCS, 10MHz bandwidth, TDD duplex mode	
5.6.2.7-6	LTE TDD, NR 30kHz SSB SCS, 40MHz bandwidth, TDD duplex mode	
NOTE 1: The UE is only required to be tested in one of the supported test configurations		
NOTE 2: The target NR cell3 has the same SCS, BW and duplex mode as NR serving cell2		

**Table 5.6.2.7.4-2: General test parameters for EN-DC inter-frequency event triggered reporting with SSB time index detection**

Parameter	Unit	Test configuration	Value		Comment
			Test 1	Test 2	
E-UTRA RF Channel Number		Config 1,2,3,4,5,6	1		One E-UTRAN TDD carrier frequencies is used.
NR RF Channel Number		Config 1,2,3,4,5,6	1, 2		One FR1 and one FR2 NR carrier frequency is used.
Active cell		Config 1,2,3,4,5,6	LTE Cell 1 (PCell) and NR cell 2 (PScell)		LTE Cell 1 is on E-UTRA RF channel number 1. NR Cell 2 is on NR RF channel number 1.
Neighbour cell		Config 1,2,3,4,5,6	NR cell 3		NR cell 3 is on NR RF channel number 2.
Gap Pattern Id		Config 1,2,3,4,5,6	0	13	As specified in TS 38.133 clause 9.1.2-1.
Measurement gap offset		Config 1,2,3,4,5,6	39	39	
SMTC-SSB parameters on NR RF Channel 1		Config 1,4	SSB.1 FR1		As specified in clause A.3
		Config 2,5	SSB.1 FR1		As specified in clause A.3
		Config 3,6	SSB.2 FR1		As specified in clause A.3
SMTC-SSB parameters on NR RF Channel 2		Config 1,2,3,4,5,6	SSB.3 FR2		As specified in clause A.3
offsetMO	dB	Config 1,2,3,4,5,6	6		
Hysteresis	dB	Config 1,2,3,4,5,6	0		
a4-Threshold	dBm	Config 1,2,3,4,5,6	-105		
CP length		Config 1,2,3,4,5,6	Normal		
TimeToTrigger	s	Config 1,2,3,4,5,6	0		
Filter coefficient		Config 1,2,3,4,5,6	0		L3 filtering is not used
DRX		Config 1,2,3,4,5,6	OFF		DRX is not used
Time offset between PCell and PScell		Config 1,2,3,4,5,6	3 μs		Synchronous EN-DC
Time offset between serving and neighbour cells		Config 1,4	3ms		Asynchronous cells. The timing of Cell 3 is 3ms later than the timing of Cell 2.
		Config 2,3,5,6	3μs		Synchronous cells.
T1	s	Config 1,2,3,4,5,6	5		
T2	s	Config 1,2,3,4,5,6	7 for PC1; 4.5 for other PC	7 for PC1; 4.5 for other PC	PC1 – power class 1 as specified in TS 38.101-2 [3] Table 6.2.1.0



**Table 5.6.2.7.4-3: Test Environment test parameters for EN-DC inter-frequency event triggered reporting without SSB time index detection in non-DRX**

Parameter	Value		Comment
Test environment	NC		As specified in TS 38.508-1 [14] clause 4.1.
Test frequencies	As specified in Annex E, Table TBD and TS 38.508-1 [14] clause 4.3.1 for E-UTRA and NR FR1, 7.2.3 for NR FR2		
Channel bandwidth	As specified by the test configuration selected from Table 4.6.2.3.4.1-1.		
Propagation conditions	AWGN		As specified in clause C.2.2.
Connection Diagram	TE Part	A.3.3.3.1	As specified in TS 38.508-1 [14] Annex A.
	DUT Part	A.3.4.1.1	
Exceptions to connection diagram			

1. Message contents are defined in clause 5.6.2.7.4.3.
2. Cell 1 is the E-UTRA serving cell (PCell) for the EN-DC setup. The power levels and settings for Cell 1 are set according to Annex A.6. Cell 2 and Cell 3 are NR FR2 cells in different frequencies. Cell 2 is the PCell and Cell 3 is the target cell. The power levels and settings for Cell 2 and Cell 3 are set according to Annex TBD
3. If a UE supports per-FR gap and gap pattern configuration #13, it is only required to pass test 2. Otherwise it is only required to pass test 1.
4. The UE Rx beam peak direction for Cell 3 has been obtained previously using one of the Rx beam peak search procedures as described in Annex I.

#### 5.6.2.7.4.2 Test procedure

In this test, there are three cells: LTE cell 1 as Pcell on E-UTRA RF channel 1, NR cell 2 as PCell in FR1 on NR RF channel 1 and NR cell 3 as neighbour cell in FR2 on NR RF channel 2.

In test 1 measurement gap pattern configuration # 0 as defined in Table 5.6.2.7.4.1-2 is provided for a UE that does not support per-FR gap and in test 2 measurement gap pattern configuration #13 as defined in Table 5.6.2.7.4.1-2 is provided for UE that support per-FR gap.

In the measurement control information, it is indicated to the UE that event-triggered reporting with Event A3 is used. The test consists of two successive time periods, with time duration of T1, and T2 respectively. During time duration T1, the UE shall not have any timing information of NR cell 3.

1. Ensure the UE is in state RRC\_CONNECTED with generic procedure parameters Connectivity EN-DC, DC bearer MCG and SCG, Connected without release *On* according to TS 38.508-1 [14] clause 4.5.
2. Set the parameters according to T1 in Table 5.6.2.7.4-2 The TE shall ensure that the NR FR2 cell will be received by the UE from the Rx beam peak direction. T1 starts.
3. The SS shall transmit an RRCConnectionReconfiguration message on Cell 1.
4. The UE shall transmit RRCConnectionReconfigurationComplete message.
5. When T1 expires, the SS shall switch the power setting from T1 to T2 as specified in Table 5.6.2.7.4.1-2.
6. UE shall transmit a MeasurementReport message triggered by Event A3 embedded in E-UTRA RRC message *ULInformationTransferMRDC*. If the overall delay measured from the beginning of time period T2 is less than 6722 ms for UE supporting power class 1, or 4162 ms for UE supporting other power class for Test 1 and Test 2 then the number of successful tests is increased by one. If the UE fails to report the event within the overall delays measured requirement then the number of failure tests is increased by one.
7. After the SS receives the MeasurementReport message in step 6 or when T2 expires, the SS shall transmit RRCConnectionRelease message to release the RRC connection which includes the release of the established radio bearers as well as all radio resources.
8. Set Cell 3 physical cell identity = [(current cell 2 physical cell identity + 1) mod 1008] for next iteration of the test procedure loop.]

9. After the RRC connection release, the SS:

- transmits in Cell 1 a Paging message (including PagingRecord with ue-Identity) for the UE and ensures the UE in state RRC\_CONNECTED with generic procedure parameters Connectivity EN-DC, DC bearer MCG and SCG, Connected without release *On* according to TS 38.508-1 [14] clause 4.5. (if the paging fails, switches off and on the UE and ensures the UE is in state RRC\_CONNECTED with generic procedure parameters Connectivity EN-DC, DC bearer MCG and SCG, Connected without release *On* according to TS 38.508-1 [14] clause 4.5.),
- or:
- switches off and on the UE and ensures the UE is in state RRC\_CONNECTED with generic procedure parameters Connectivity EN-DC, DC bearer MCG and SCG, Connected without release *On* according to TS 38.508-1 [14] clause 4.5.

10. Repeat step 2-9 until the confidence level according to Tables G.2.3-1 in Annex G clause G.2 is achieved.

11. Repeat step 1-10 for each sub-test in Table 5.6.2.7.41.-2 as appropriate.

5.6.2.7.4.3 Message contents

Message contents are according to TS 38.508-1 [14] clause 7.3 with the following exceptions:

**Table 5.6.2.7.4.3-1: Common Exception messages for Additional EN-DC FR1-FR2 event triggered reporting tests with SSB time index detection in non-DRX test requirement**

Default Message Contents	
Common contents of system information blocks exceptions	
Default RRC messages and information elements contents exceptions	Table H.3.1-1 Table H.3.1-2 with conditions and INTER-FREQ. For Test 2, additionally with condition GAP NEEDED Table H.3.1-3 with conditions INTER-FREQ MO and Synchronous cells Table H.3.1-4AA with condition SSB Index and A4-threshold = -105 Table H.3.1-6 with conditions gapFR2 and Pattern #13 for Test 2 Table H.3.4-4 with condition gapUE for Test 1 Table H.3.4-5 with condition Pattern #0 for Test 1 Table H.3.1-7 with condition SSB Index and INTER-FREQ Table H.3.4-1 Table H.3.4-2 Table H.3.4-3 Table H.3.1-4 a4 threshold = TBD

**Table 5.6.2.7.4.3-2: MeasObjectNR-DEFAULT: EN-DC FR1-FR2 measurement object configuration**

Derivation Path: Table H.3.1-3			
Information Element	Value/remark	Comment	Condition
MeasObjectNR ::= SEQUENCE {			
offsetMO SEQUENCE {			
rsrpOffsetSSB	6 dB		
}			

5.6.2.7.5 Test requirement

Table 5.6.2.7.5-1 defines the primary level settings including test tolerances for all tests.

**Table 5.6.2.7.5-1: Cell specific test parameters for EN-DC inter-frequency event triggered reporting with SSB time index detection**

Parameter	Unit	Test configuration	Cell 2		Cell 3	
			T1	T2	T1	T2
AoA setup		Config 1,2,3,4,5,6	NA		Setup 1	
Assumption for UE beams <sup>Note 7</sup>		Config 1,2,3,4,5,6	N/A		Rough	
NR RF Channel Number		Config 1,2,3,4,5,6	1		2	
Duplex mode		Config 1,4	FDD		TDD	

Parameter	Unit	Test configuration	Cell 2		Cell 3	
			T1	T2	T1	T2
		Config 2,3,5,6	TDD		TDD	
BW <sub>channel</sub>	MHz	Config 1,4	10: N <sub>RB,c</sub> = 52		100: N <sub>RB,c</sub> = 66	
		Config 2,5	10: N <sub>RB,c</sub> = 52		100: N <sub>RB,c</sub> = 66	
		Config 3,6	40: N <sub>RB,c</sub> = 106		100: N <sub>RB,c</sub> = 66	
BWP BW	MHz	Config 1,4	10: N <sub>RB,c</sub> = 52		100: N <sub>RB,c</sub> = 66	
		Config 2,5	10: N <sub>RB,c</sub> = 52		100: N <sub>RB,c</sub> = 66	
		Config 3,6	40: N <sub>RB,c</sub> = 106		100: N <sub>RB,c</sub> = 66	
OCNG Patterns		Config 1,2,3,4,5,6	OP.1		OP.1	
PDSCH Reference measurement channel		Config 1,4	SR.1.1 FDD		-	
		Config 2,5	SR.1.1 TDD			
		Config 3,6	SR.2.1 TDD			
RMSI CORESET Reference Channel		Config 1,4	CR.1.1 FDD		-	
		Config 2,5	CR.1.1 TDD			
		Config 3,6	CR.2.1 TDD			
Dedicated CORESET RMC configuration		Config 1,4	CCR.1.1 FDD		CCR.3.1 TDD	
		Config 2,5	CCR.1.1 TDD		CCR.3.1 TDD	
		Config 3,6	CCR.2.1 TDD		CCR.3.1 TDD	
TDD configuration		Config 2,5	TDDConf.1.1		TDDConf.3.1	
		Config 3,6	TDDConf.2.1		TDDConf.3.1	
Initial DL BWP		Config 1,2,3,4,5,6	DLBWP.0.1		NA	
Initial UL BWP		Config 1,2,3,4,5,6	ULBWP.0.1		NA	
Dedicated DL BWP		Config 1,2,3,4,5,6	DLBWP.1.1		NA	
Dedicated UL BWP		Config 1,2,3,4,5,6	ULBWP.1.1		NA	
SMTC configuration		Config 1,4	SMTC.2		SMTC.2	
		Config 2,3,5,6	SMTC.1		SMTC.1	
PDSCH/PDCCH subcarrier spacing	kHz	Config 1,2,4,5	15		120	
		Config 3,6	30		120	
EPRE ratio of PSS to SSS		Config 1,2,3,4,5,6	0		0	
EPRE ratio of PBCH DMRS to SSS						
EPRE ratio of PBCH to PBCH DMRS						
EPRE ratio of PDCCH DMRS to SSS						
EPRE ratio of PDCCH to PDCCH DMRS						
EPRE ratio of PDSCH DMRS to SSS						
EPRE ratio of PDSCH to PDSCH						
EPRE ratio of OCNG DMRS to SSS(Note 1)						
EPRE ratio of OCNG to OCNG DMRS (Note 1)						
E <sub>s</sub>	dBm/SC S					
SSB_RP <sup>Note 3</sup>	dBm/SC S Note5	Config 1,2,3,4,5,6	-Infinity	-87		
E <sub>s</sub> /I <sub>ot BB</sub> <sup>Note 8</sup>	dB	Config 1,2,3,4,5,6	-Infinity	14.69		
I <sub>o</sub> <sup>Note3</sup>	dBm/95.04 MHz Note5	Config 1,2,3,4,5,6	-Infinity	-58.01		
Propagation Condition		Config 1,2,3,4,5,6	AWGN			

Parameter	Unit	Test configuration	Cell 2		Cell 3	
			T1	T2	T1	T2
NOTE 1: OCNB shall be used such that both cells are fully allocated and a constant total transmitted power spectral density is achieved for all OFDM symbols.						
NOTE 2: Void						
NOTE 3: SS-RP, Es/lot and lo levels have been derived from other parameters for information purposes. They are not settable parameters themselves.						
NOTE 4: Void						
NOTE 5: Equivalent power received by an antenna with 0dBi gain at the centre of the quiet zone						
NOTE 6: As observed with 0dBi gain antenna at the centre of the quiet zone						
NOTE 7: Information about types of UE beam is given in B.2.1.3, and does not limit UE implementation or test system implementation						
NOTE 8: Calculation of Es/lot <sub>BB</sub> includes the effect of UE internal noise up to the value assumed for the associated Refsens requirement in clause 7.3.2 of TS 38.101-2 [19], and an allowance of 1dB for UE multi-band relaxation factor $\Delta$ MBs from TS 38.101-2 [19] Table 6.2.1.3-4.						

In test 1 with per-UE gap and in test 2 with per-FR gap, the UE shall send one Event A4 triggered measurement report, with a measurement reporting delay less than X ms from the beginning of time period T2, where X is

6720 for UE supporting power class 1, or

4160 for UE supporting other power class.

In test 1 and 2 UE is required to report SSB time index. The UE shall not send event triggered measurement reports, as long as the reporting criteria are not fulfilled. The rate of correct events observed during repeated tests shall be at least 90% with a confidence level of 95%.

In test 1 and 2 UE is required to report SSB time index.

NOTE: The actual overall delays measured in the test may be up to  $2xTTI_{DCCH}$  higher than the measurement reporting delays above because of TTI insertion uncertainty of the measurement report in DCCH.

$TTI$  insertion uncertainty =  $TTIDCCH = 1$  ms;  $2xTTIDCCH = 2$  ms

The overall delays measured shall be less than a total of 6722 ms in this test for power class UE and 4162 ms for other power classes.

### 5.6.2.8 EN-DC FR1-FR2 event-triggered reporting in DRX with SSB time index detection

Editor's Note: This test case has been completed for the following configurations:

- Test frequency  $f \leq 40.8$  GHz
- UE PC3
- The test is incomplete for UE power classes other than PC3
- The test is incomplete for test frequencies  $> 40.8$  GHz

#### 5.6.2.8.1 Test purpose

The purpose of this test is to verify that the UE makes correct reporting of an event in DRX within inter-frequency cell search requirements with SSB time index detection.

#### 5.6.2.8.2 Test applicability

This test applies to all types of E-UTRA UE release 15 and forward, supporting EN-DC FR2 and long DRX cycle. Tests 1 and 2 are applicable to UEs not supporting per-FR gap (*IndependentGapConfig*, as defined in TS 38.306) and Tests 3 and 4 are applicable only to UEs supporting per-FR gap (*IndependentGapConfig*, as defined in TS 38.306) and Gap Pattern Id 13.

#### 5.6.2.8.3 Minimum conformance requirements

The minimum conformance requirements are specified in clause 5.6.2.0.

The normative reference for this requirement is TS 38.133 [6] clause A.5.6.2.8.5.6.2.8.4 Test description

#### 5.6.2.8.4.1 Initial conditions

This test shall be tested using any of the test configurations in Table 5.6.2.8.4.1-1. Configure the test equipment and the DUT according to the parameters in Table 5.6.2.8.4.1-2. Test environment parameters are given in Table 5.6.2.8.4.1-3.

**Table 5.6.2.8.4.1-1: EN-DC FR1-FR2 event triggered reporting tests in DRX with SSB time index detection supported test configurations**

Test Case ID	Description of serving cell	Description of target cell
5.6.2.8-1	LTE FDD, NR 15 kHz SSB SCS, 10MHz bandwidth, FDD duplex mode	120 kHz SSB SCS, 100MHz bandwidth, TDD duplex mode
5.6.2.8-2	LTE FDD, NR 15 kHz SSB SCS, 10MHz bandwidth, TDD duplex mode	
5.6.2.8-3	LTE FDD, NR 30kHz SSB SCS, 40MHz bandwidth, TDD duplex mode	
5.6.2.8-4	LTE TDD, NR 15 kHz SSB SCS, 10MHz bandwidth, FDD duplex mode	
5.6.2.8-5	LTE TDD, NR 15 kHz SSB SCS, 10MHz bandwidth, TDD duplex mode	
5.6.2.8-6	LTE TDD, NR 30kHz SSB SCS, 40MHz bandwidth, TDD duplex mode	
NOTE 1: The UE is only required to be tested in one of the supported test configurations		
NOTE 2: The target NR cell3 has the same SCS, BW and duplex mode as NR serving cell2		

**Table A.5.6.2.8.4.1-2: General test parameters for EN-DC inter-frequency event triggered reporting with SSB time index detection in DRX**

Parameter	Unit	Test configuration	Value				Comment
			Test 1	Test 2	Test 3	Test 4	
E-UTRA RF Channel Number		Config 1,2,3,4,5,6	1				One E-UTRAN TDD carrier frequencies is used.
NR RF Channel Number		Config 1,2,3,4,5,6	1, 2				One FR1 and one FR2 NR carrier frequency is used.
Active cell		Config 1,2,3,4,5,6	LTE Cell 1 (PCell) and NR cell 2 (PSCell)				LTE Cell 1 is on E-UTRA RF channel number 1. NR Cell 2 is on NR RF channel number 1.
Neighbour cell		Config 1,2,3,4,5,6	NR cell 3				NR cell 3 is on NR RF channel number 2.
Gap Pattern Id		Config 1,2,3,4,5,6	0		13		As specified in TS 38.133 clause 9.1.2-1.
Measurement gap offset		Config 1,2,3,4,5,6	39		39		
SMTC-SSB parameters on NR RF Channel 1		Config 1,4	SSB.1 FR1				As specified in clause A.3
		Config 2,5	SSB.1 FR1				As specified in clause A.3
		Config 3,6	SSB.2 FR1				As specified in clause A.3
SMTC-SSB parameters on NR RF Channel 2		Config 1,2,3,4,5,6	SSB.3 FR2				As specified in clause A.3
offsetMO	dB	Config 1,2,3,4,5,6	6				
Hysteresis	dB	Config 1,2,3,4,5,6	0				
a4-Threshold	dBm	Config 1,2,3,4,5,6	-105				
CP length		Config 1,2,3,4,5,6	Normal				
TimeToTrigger	s	Config 1,2,3,4,5,6	0				
Filter coefficient		Config 1,2,3,4,5,6	0				L3 filtering is not used
DRX		Config 1,2,3,4,5,6	DRX.1	DRX.2	DRX.1	DRX.2	As specified in clause A.5
Time offset between PCell and PSCell		Config 1,2,3,4,5,6	3 $\mu$ s				Synchronous EN-DC
Time offset between serving and neighbour cells		Config 1,4	3ms				Asynchronous cells. The timing of Cell 3 is 3ms later than the timing of Cell 2.
		Config 2,3,5,6	3 $\mu$ s				Synchronous cells.

Parameter	Unit	Test configuration	Value				Comment
			Test 1	Test 2	Test 3	Test 4	
T1	s	Config 1,2,3,4,5,6	5				
T2	s	Config 1,2,3,4,5,6	11 for PC1; 6.5 for other PC	108 for PC1; 67 for other PC	11 for PC1; 6.5 for other PC	108 for PC1; 67 for other PC	PC1 - power class 1 as specified in TS 38.101-2 [3] Table 6.2.1.0

**Table 5.6.2.8.4-3: Test Environment test parameters for EN-DC inter-frequency event triggered reporting with SSB time index detection in DRX**

Parameter	Value	Comment
Test environment	NC	As specified in TS 38.508-1 [14] clause 4.1.
Test frequencies	As specified in Annex E, Table TBD and TS 38.508-1 [14] clause 4.3.1 for E-UTRA and NR FR1, 7.2.3 for NR FR2	
Channel bandwidth	As specified by the test configuration selected from Table 4.6.2.3.4.1-1.	
Propagation conditions	AWGN	As specified in clause C.2.2.
Connection Diagram	TE Part	A.3.3.3.1
	DUT Part	A.3.4.1.1
Exceptions to connection diagram		

1. Message contents are defined in clause 5.6.2.8.4.3.
2. Cell 1 is the E-UTRA serving cell (PCell) for the EN-DC setup. The power levels and settings for Cell 1 are set according to Annex A.6. Cell 2 and Cell 3 are NR FR2 cells in different frequencies. Cell 2 is the PSCell and Cell 3 is the target cell. The power levels and settings for Cell 2 and Cell 3 are set according to Annex TBD.
3. If a UE supports per-FR gap and gap pattern configuration #13, it is only required to pass test 3&4. Otherwise it is only required to pass test 1&2.
4. The UE Rx beam peak direction for Cell 3 has been obtained previously using one of the Rx beam peak search procedures as described in Annex I.

#### 5.6.2.8.4.2 Test procedure

In this test, there are three cells: LTE cell 1 as PCell on E-UTRA RF channel 1, NR cell 2 as PSCell in FR1 on NR RF channel 1 and NR cell 3 as neighbour cell in FR2 on NR RF channel 2.

In test 1&2 measurement gap pattern configuration # 0 as defined in Table 5.6.2.8.4.1-2 is provided for a UE that does not support per-FR gap and in test 3&4 measurement gap pattern configuration #13 as defined in Table 5.6.2.8.4.1-2 is provided for UE that support per-FR gap.

In the measurement control information, it is indicated to the UE that event-triggered reporting with Event A3 is used. The test consists of two successive time periods, with time duration of T1, and T2 respectively. During time duration T1, the UE shall not have any timing information of NR cell 3.

1. Ensure the UE is in state RRC\_CONNECTED with generic procedure parameters Connectivity EN-DC, DC bearer MCG and SCG, Connected without release *On* according to TS 38.508-1 [14] clause 4.5.
2. Set the parameters according to T1 in Table 5.6.2.8.4-2 The TE shall ensure that the NR FR2 cell will be received by the UE from the Rx beam peak direction.. T1 starts,
3. The SS shall transmit an RRCConnectionReconfiguration message on Cell 1.
4. The UE shall transmit RRCConnectionReconfigurationComplete message.
5. When T1 expires, the SS shall switch the power setting from T1 to T2 as specified in Table 5.6.2.8.4.1-2.

6. UE shall transmit a MeasurementReport message triggered by Event A3 embedded in E-UTRA RRC message *ULInformationTransferMRDC*. If the overall delay measured from the beginning of time period T2 is less than 10082 ms for UE supporting power class 1, or 6242 ms for UE supporting other power class for Test 1 and Test 3 and 107522 ms for UE supporting power class 1, or 66562 ms for UE supporting other power class for Test 2 and Test 4, then the number of successful tests is increased by one. If the UE fails to report the event within the overall delays measured requirement then the number of failure tests is increased by one.
7. After the SS receives the MeasurementReport message in step 6 or when T2 expires, the SS shall transmit RRCConnectionRelease message to release the RRC connection which includes the release of the established radio bearers as well as all radio resources.
8. Set Cell 3 physical cell identity = [(current cell 2 physical cell identity + 1) mod 1008] for next iteration of the test procedure loop.]
9. After the RRC connection release, the SS:
  - transmits in Cell 1 a Paging message (including PagingRecord with ue-Identity) for the UE and ensures the UE in state RRC\_CONNECTED with generic procedure parameters Connectivity EN-DC, DC bearer MCG and SCG, Connected without release *On* according to TS 38.508-1 [14] clause 4.5. (if the paging fails, switches off and on the UE and ensures the UE is in state RRC\_CONNECTED with generic procedure parameters Connectivity EN-DC, DC bearer MCG and SCG, Connected without release *On* according to TS 38.508-1 [14] clause 4.5.),
  - or:
  - switches off and on the UE and ensures the UE is in state RRC\_CONNECTED with generic procedure parameters Connectivity EN-DC, DC bearer MCG and SCG, Connected without release *On* according to TS 38.508-1 [14] clause 4.5.
10. Repeat step 2-9 until the confidence level according to Tables G.2.3-1 in Annex G clause G.2 is achieved.
11. Repeat step 1-10 for each sub-test in Table 5.6.2.8.4.1-2 as appropriate.

5.6.2.8.4.3 Message contents

Message contents are according to TS 38.508-1 [14] clause 7.3 with the following exceptions:

**Table 5.6.2.8.4.3-1: Common Exception messages for Additional EN-DC FR1-FR2 event triggered reporting tests with SSB time index detection in DRX test requirement**

Default Message Contents	
Common contents of system information blocks exceptions	
Default RRC messages and information elements contents exceptions	Table H.3.1-1 Table H.3.1-2 with condition INTER-FREQ. For Test 3 and 4, additionally with condition GAP NEEDED Table H.3.1-3 with conditions INTER-FREQ MO and Synchronous cells Table H.3.1-4AA with condition SSB Index and A4-threshold = -105 Table H.3.1-6 with conditions gapFR2 and Pattern #13 for Test 3 and Test 4 Table H.3.4-4 with condition gapUE for Test 1 and Test 2 Table H.3.4-5 with condition Pattern #0 for Test 1 and Test 2 Table H.3.1-7 with condition SSB Index and INTER-FREQ Table H.3.7-1 with condition DRX.1 for Test 1 and Test 3 Table H.3.7-1 with condition DRX.2 for Test 2 and Test 4 Table H.3.4-1 Table H.3.4-2 Table H.3.4-3

**Table 5.6.2.5.8.3-2: MeasObjectNR-DEFAULT: EN-DC FR1-FR2 measurement object configuration**

Derivation Path: Table H.3.1-3			
Information Element	Value/remark	Comment	Condition
MeasObjectNR ::= SEQUENCE {			
offsetMO SEQUENCE {			
rsrpOffsetSSB	6 dB		
}			

5.6.2.8.5 Test requirement

Table 5.6.2.8.5-1 defines the primary level settings including test tolerances for all tests.

**Table 5.6.2.8.5-1: Cell specific test parameters for EN-DC inter-frequency event triggered reporting with SSB time index detection in DRX**

Parameter	Unit	Test configuration	Cell 2		Cell 3	
			T1	T2	T1	T2
AoA setup		Config 1,2,3,4,5,6	NA		Setup 1 as specified in clause A.9	
Assumption for UE beams <sup>Note 7</sup>		Config 1,2,3,4,5,6	N/A		Rough	
NR RF Channel Number		Config 1,2,3,4,5,6	1		2	
Duplex mode		Config 1,4	FDD		TDD	
		Config 2,3,5,6	TDD		TDD	
BW <sub>channel</sub>	MHz	Config 1,4	10: N <sub>RB,c</sub> = 52		100: N <sub>RB,c</sub> = 66	
		Config 2,5	10: N <sub>RB,c</sub> = 52		100: N <sub>RB,c</sub> = 66	
		Config 3,6	40: N <sub>RB,c</sub> = 106		100: N <sub>RB,c</sub> = 66	
BWP BW	MHz	Config 1,4	10: N <sub>RB,c</sub> = 52		100: N <sub>RB,c</sub> = 66	
		Config 2,5	10: N <sub>RB,c</sub> = 52		100: N <sub>RB,c</sub> = 66	
		Config 3,6	40: N <sub>RB,c</sub> = 106		100: N <sub>RB,c</sub> = 66	
OCNG Patterns		Config 1,2,3,4,5,6	OP.1		OP.1	
PDSCH Reference measurement channel		Config 1,4	SR.1.1 FDD		-	
		Config 2,5	SR.1.1 TDD			
		Config 3,6	SR2.1 TDD			
RMSI CORESET Reference Channel		Config 1,4	CR.1.1 FDD		-	
		Config 2,5	CR.1.1 TDD			
		Config 3,6	CR2.1 TDD			
Dedicated CORESET RMC configuration		Config 1,4	CCR.1.1 FDD		CCR.3.1 TDD	
		Config 2,5	CCR.1.1 TDD		CCR.3.1 TDD	
		Config 3,6	CCR.2.1 TDD		CCR.3.1 TDD	
TDD configuration		Config 2,5	TDDConf.1.1		TDDConf.3.1	
		Config 3,6	TDDConf.2.1		TDDConf.3.1	
Initial DL BWP		Config 1,2,3,4,5,6	DLBWP.0.1		NA	
Initial UL BWP		Config 1,2,3,4,5,6	ULBWP.0.1		NA	
Dedicated DL BWP		Config 1,2,3,4,5,6	DLBWP.1.1		NA	
Dedicated UL BWP		Config 1,2,3,4,5,6	ULBWP.1.1		NA	
SMTc configuration		Config 1,4	SMTc.2		SMTc.2	
		Config 2,3,5,6	SMTc.1		SMTc.1	
PDSCH/PDCCH subcarrier spacing	kHz	Config 1,2,4,5	15		120	
		Config 3,6	30		120	
EPRE ratio of PSS to SSS		Config 1,2,3,4,5,6	0		0	
EPRE ratio of PBCH DMRS to SSS						
EPRE ratio of PBCH to PBCH DMRS						
EPRE ratio of PDCCH DMRS to SSS						
EPRE ratio of PDCCH to PDCCH DMRS						
EPRE ratio of PDSCH DMRS to SSS						
EPRE ratio of PDSCH to PDSCH						
EPRE ratio of OCNG DMRS to SSS(Note 1)						



Parameter	Unit	Test configuration	Cell 2		Cell 3	
			T1	T2	T1	T2
EPRE ratio of OCNG to OCNG DMRS (Note 1)						
$N_{oc}$ <sup>Note2</sup>	dBm/15 kHz Note5		NA Link only, see clause A.3.7A		-104.7	
$N_{oc}$ <sup>Note2</sup>	dBm/S CS Note4	Config 1,2,4,5			-95.7	
		Config 3,6			-95.7	
SSB_RP <sup>Note 3</sup>	dBm/S CS Note5	Config 1,2,4,5	-Infinity	-86.7		
		Config 3,6	-Infinity	-86.7		
$\hat{E}_s / I_{ot}$	dB	Config 1,2,3,4,5,6	-Infinity	9		
$\hat{E}_s / N_{oc}$	dB	Config 1,2,3,4,5,6	-Infinity	9		
$I_o$ <sup>Note3</sup>	dBm/9.36MHz	Config 1,2,4,5	-	-		
	dBm/38.16MHz	Config 3,6	-	-		
	dBm/95.04 MHz Note5	Config 1,2,3,4,5,6	-66.7	-57.2		
Propagation Condition		Config 1,2,3,4,5,6	AWGN			
<p>NOTE 1: OCNG shall be used such that both cells are fully allocated and a constant total transmitted power spectral density is achieved for all OFDM symbols.</p> <p>NOTE 2: Interference from other cells and noise sources not specified in the test is assumed to be constant over subcarriers and time and shall be modelled as AWGN of appropriate power for <math>N_{oc}</math> to be fulfilled.</p> <p>NOTE 3: SSB_RP and <math>I_o</math> levels have been derived from other parameters for information purposes. They are not settable parameters themselves.</p> <p>NOTE 4: SSB_RP minimum requirements are specified assuming independent interference and noise at each receiver antenna port.</p> <p>NOTE 5: Equivalent power received by an antenna with 0dBi gain at the centre of the quiet zone</p> <p>NOTE 6: As observed with 0dBi gain antenna at the centre of the quiet zone</p> <p>NOTE 7: Information about types of UE beam is given in B.2.1.3, and does not limit UE implementation or test system implementation</p>						

In test 1 with per-UE gap and in test 3 with per-FR gap, the UE shall send one Event A4 triggered measurement report, with a measurement reporting delay less than X1 ms from the beginning of time period T2, where X1 is

- 10080 for UE supporting power class 1, or
- 6240 for UE supporting other power class.

In test 2 with per-UE gap and in test 4 with per-FR gap, the UE shall send one Event A4 triggered measurement report, with a measurement reporting delay less than X2 ms from the beginning of time period T2, where X2 is

- 107520 for UE supporting power class 1, or
- 66560 for UE supporting other power class.

In test 1, 2, 3 and 4 UE is required to report SSB time index. The UE shall not send event triggered measurement reports, as long as the reporting criteria are not fulfilled. The rate of correct events observed during repeated tests shall be at least 90% with a confidence level of 95%.

In test 1, 2, 3 and 4 UE is required to report SSB time index.

NOTE: The actual overall delays measured in the test may be up to  $2 \times TTI_{DCCH}$  higher than the measurement reporting delays above because of TTI insertion uncertainty of the measurement report in DCCH.

TTI insertion uncertainty =  $TTI_{DCCH} = 1 \text{ ms}$ ;  $2 \times TTI_{DCCH} = 2 \text{ ms}$

The overall delays measured shall be less than a total of 10082 ms for power class 1 UE and 6242 ms for other power classes in test 1 and test 3 and 107522 for power class 1 UE and 66562 ms for other power classes in test 2 and test 4.

### 5.6.3 L1-RSRP measurement for beam reporting

#### 5.6.3.0 Minimum conformance requirements

##### 5.6.3.0.1 Minimum conformance requirements for SSB-based L1-RSRP measurement for beam reporting

The UE shall be capable of performing L1-RSRP measurements based on the configured SSB resource for L1-RSRP computation, and the UE physical layer shall be capable of reporting L1-RSRP measured over the measurement period of  $T_{L1-RSRP\_Measurement\_Period\_SSB}$ .

The value of  $T_{L1-RSRP\_Measurement\_Period\_SSB}$  is defined in Table 9.5.4.1-2 for FR2, where

- $M=1$  if higher layer parameter *timeRestrictionForChannelMeasurement* is configured, and  $M=3$  otherwise
- $N=8$ .

For FR2,

- $P = \frac{1}{1 - \frac{T_{SSB}}{T_{SMTCperiod}}}$ , when SSB is not overlapped with measurement gap and SSB is partially overlapped with SMTC occasion ( $T_{SSB} < T_{SMTCperiod}$ ).
- $P$  is  $P_{\text{sharing factor}}$ , when SSB is not overlapped with measurement gap and SSB is fully overlapped with SMTC period ( $T_{SSB} = T_{SMTCperiod}$ ).
- $P = \frac{1}{1 - \frac{T_{SSB}}{MGRP} - \frac{T_{SSB}}{T_{SMTCperiod}}}$ , when SSB is partially overlapped with measurement gap and SSB is partially overlapped with SMTC occasion ( $T_{SSB} < T_{SMTCperiod}$ ) and SMTC occasion is not overlapped with measurement gap and
  - $T_{SMTCperiod} \neq MGRP$  or
  - $T_{SMTCperiod} = MGRP$  and  $T_{SSB} < 0.5 * T_{SMTCperiod}$
- $P$  is  $\frac{P_{\text{sharing factor}}}{1 - \frac{T_{SSB}}{MGRP}}$ , when SSB is partially overlapped with measurement gap and SSB is partially overlapped with SMTC occasion ( $T_{SSB} < T_{SMTCperiod}$ ) and SMTC occasion is not overlapped with measurement gap and  $T_{SMTCperiod} = MGRP$  and  $T_{SSB} = 0.5 * T_{SMTCperiod}$
- $P = \frac{1}{1 - \frac{T_{SSB}}{\min(T_{SMTCperiod}, MGRP)}}$ , when SSB is partially overlapped with measurement gap ( $T_{SSB} < MGRP$ ) and SSB is partially overlapped with SMTC occasion ( $T_{SSB} < T_{SMTCperiod}$ ) and SMTC occasion is partially or fully overlapped with measurement gap.
- $P$  is  $\frac{P_{\text{sharing factor}}}{1 - \frac{T_{SSB}}{MGRP}}$ , when SSB is partially overlapped with measurement gap and SSB is fully overlapped with SMTC occasion ( $T_{SSB} = T_{SMTCperiod}$ ) and SMTC occasion is partially overlapped with measurement gap ( $T_{SMTCperiod} < MGRP$ )
- $P_{\text{sharing factor}} = 1$ , if the SSB configured for L1-RSRP measurement outside measurement gap is
  - not overlapped with the SSB symbols indicated by *SSB-ToMeasure* and 1 data symbol before each consecutive SSB symbols indicated by *SSB-ToMeasure* and 1 data symbol after each consecutive SSB symbols indicated by *SSB-ToMeasure*, given that *SSB-ToMeasure* is configured, and,
  - not overlapped with the RSSI symbols indicated by *ss-RSSI-Measurement* and 1 data symbol before each RSSI symbol indicated by *ss-RSSI-Measurement* and 1 data symbol after each RSSI symbol indicated by *ss-RSSI-Measurement*, given that *ss-RSSI-Measurement* is configured,
- $P_{\text{sharing factor}} = 3$ , otherwise.

Where:

- $T_{SSB} = \text{ssb-periodicityServingCell}$
- $T_{SMTCperiod} = \text{the configured SMTC period}$

If the high layer in TS 38.331 [2] signalling of *smtc2* is configured,  $T_{SMTCperiod}$  corresponds to the value of higher layer parameter *smtc2*; Otherwise  $T_{SMTCperiod}$  corresponds to the value of higher layer parameter *smtc1*.  $T_{SMTCperiod}$  is the shortest SMTC period among all CCs in the same FR2 band, provided the SMTC offset of all CCs in FR2 have the same offset.

Longer evaluation period would be expected if the combination of SSB, SMTC occasion and measurement gap configurations does not meet pervious conditions.

**Table 9.5.4.1-1: Measurement period  $T_{L1-RSRP\_Measurement\_Period\_SSB}$  for FR1**

Configuration	$T_{L1-RSRP\_Measurement\_Period\_SSB}$ (ms)
non-DRX	$\max(T_{Report}, \text{ceil}(M \cdot P) \cdot T_{SSB})$
DRX cycle $\leq 320\text{ms}$	$\max(T_{Report}, \text{ceil}(1.5 \cdot K \cdot M \cdot P) \cdot \max(T_{DRX}, T_{SSB}))$
DRX cycle $> 320\text{ms}$	$\text{ceil}(M \cdot P) \cdot T_{DRX}$
NOTE 1: $T_{SSB} = \text{ssb-periodicityServingCell}$ is the periodicity of the SSB-Index configured for L1-RSRP measurement. $T_{DRX}$ is the DRX cycle length. $T_{Report}$ is configured periodicity for reporting.	
NOTE 2: $K = 1$ when $T_{SSB} \leq 40$ ms and RRM enhancements for high speed are configured; otherwise $K = 1.5$ .	

**Table 9.5.4.1-2: Measurement period  $T_{L1-RSRP\_Measurement\_Period\_SSB}$  for FR2**

Configuration	$T_{L1-RSRP\_Measurement\_Period\_SSB}$ (ms)
non-DRX	$\max(T_{Report}, \text{ceil}(M \cdot P \cdot N) \cdot T_{SSB})$
DRX cycle $\leq 320\text{ms}$	$\max(T_{Report}, \text{ceil}(1.5 \cdot M \cdot P \cdot N) \cdot \max(T_{DRX}, T_{SSB}))$
DRX cycle $> 320\text{ms}$	$\text{ceil}(1.5 \cdot M \cdot P \cdot N) \cdot T_{DRX}$
NOTE: $T_{SSB} = \text{ssb-periodicityServingCell}$ is the periodicity of the SSB-Index configured for L1-RSRP measurement. $T_{DRX}$ is the DRX cycle length. $T_{Report}$ is configured periodicity for reporting.	

The normative reference for this requirement is TS 38.133 [6] clause 9.5.3.1, 9.5.4.1 and 9.5.5.1.

### 5.6.3.0.2 Minimum conformance requirements for CSI-RS-based L1-RSRP measurement for beam reporting

The UE shall be capable of performing L1-RSRP measurements based on the configured CSI-RS resource for L1-RSRP computation, and the UE physical layer shall be capable of reporting L1-RSRP measured over the measurement period of  $T_{L1-RSRP\_Measurement\_Period\_CSI-RS}$ .

The value of  $T_{L1-RSRP\_Measurement\_Period\_CSI-RS}$  is defined in Table 9.5.4.2-2 for FR2, where

- For periodic and semi-persistent CSI-RS resources,  $M=1$  if higher layer parameter *timeRestrictionForChannelMeasurement* is configured, and  $M=3$  otherwise
- For aperiodic CSI-RS resources  $M=1$
- For periodic CSI-RS resources in a resource set configured with higher layer parameter *repetition* set to OFF,  $N=1$ . The requirements apply if *qcl-InfoPeriodicCSI-RS* is configured for all the resources in the resource set and for each resource one RS has QCL-TypeD with
  - SSB for L1-RSRP measurement, or
  - another CSI-RS in resource set configured with repetition ON.
- For periodic CSI-RS resources in a resource set configured with higher layer parameter *repetition* set to ON,  $N=\text{ceil}(\text{maxNumberRxBeam} / N_{\text{res\_per\_set}})$ , where  $N_{\text{res\_per\_set}}$  is number of resources in the resource set. The requirements apply provided *qcl-InfoPeriodicCSI-RS* is configured with QCL-TypeD for all resources in the resource set.

- For semi-persistent CSI-RS resources in a resource set configured with higher layer parameter *repetition* set to OFF,  $N=1$ . The requirements apply provided TCI state is provided for all resources in the resource set in the MAC CE activating the resource set and for each resource one RS has QCL-TypeD with
  - SSB for L1-RSRP measurement, or
  - another CSI-RS in resource set configured with repetition ON.
- For semi-persistent CSI-RS resources in a resource set configured with higher layer parameter *repetition* set to ON,  $N=\text{ceil}(\text{maxNumberRxBeam} / N_{\text{res\_per\_set}})$ , where  $N_{\text{res\_per\_set}}$  is number of resources in the resource set. The requirements apply provided TCI state is provided with QCL-TypeD for all resources in the resource set in the MAC CE activating the resource set.
- For aperiodic CSI-RS resources in a resource set configured with higher layer parameter *repetition* set to OFF,  $N=1$ . The requirements apply provided *qcl-info* is configured for all resources in the resource set and for each resource one RS has QCL-TypeD with
  - SSB for L1-RSRP measurement, or
  - another CSI-RS in resource set configured with repetition ON.
- For aperiodic CSI-RS resources in a resource set configured with higher layer parameter *repetition* set to ON,  $N=1$ . UE is not required to meet the accuracy requirements in clause 10.1.19.2 and 10.1.20.2 if number of resources in the resource set is smaller than *maxNumberRxBeam*. The requirements apply provided *qcl-info* is configured with QCL-TypeD for all resources in the resource set.

For FR2,

- $P=1$ , when CSI-RS is not overlapped with measurement gap and also not overlapped with SMTC occasion.
- $P=\frac{1}{1-\frac{T_{\text{CSI-RS}}}{\text{MGRP}}}$ , when CSI-RS is partially overlapped with measurement gap and CSI-RS is not overlapped with SMTC occasion ( $T_{\text{CSI-RS}} < \text{MGRP}$ )
- $P=\frac{1}{1-\frac{T_{\text{CSI-RS}}}{T_{\text{SMTCperiod}}}}$ , when CSI-RS is not overlapped with measurement gap and CSI-RS is partially overlapped with SMTC occasion ( $T_{\text{CSI-RS}} < T_{\text{SMTCperiod}}$ ).
- $P=P_{\text{sharing factor}}$ , when CSI-RS is not overlapped with measurement gap and CSI-RS is fully overlapped with SMTC occasion ( $T_{\text{CSI-RS}} = T_{\text{SMTCperiod}}$ ).
- $P=\frac{1}{1-\frac{T_{\text{CSI-RS}}}{\text{MGRP}}-\frac{T_{\text{CSI-RS}}}{T_{\text{SMTCperiod}}}}$ , when CSI-RS is partially overlapped with measurement gap and CSI-RS is partially overlapped with SMTC occasion ( $T_{\text{CSI-RS}} < T_{\text{SMTCperiod}}$ ) and SMTC occasion is not overlapped with measurement gap and
  - $T_{\text{SMTCperiod}} \neq \text{MGRP}$  or
  - $T_{\text{SMTCperiod}} = \text{MGRP}$  and  $T_{\text{CSI-RS}} < 0.5 * T_{\text{SMTCperiod}}$
- $P=\frac{3}{1-\frac{T_{\text{CSI-RS}}}{\text{MGRP}}}$ , when CSI-RS is partially overlapped with measurement gap and CSI-RS is partially overlapped with SMTC occasion ( $T_{\text{CSI-RS}} < T_{\text{SMTCperiod}}$ ) and SMTC occasion is not overlapped with measurement gap and  $T_{\text{SMTCperiod}} = \text{MGRP}$  and  $T_{\text{CSI-RS}} = 0.5 * T_{\text{SMTCperiod}}$
- $P=\frac{1}{1-\frac{T_{\text{CSI-RS}}}{\min(T_{\text{SMTCperiod}}, \text{MGRP})}}$ , when CSI-RS is partially overlapped with measurement gap ( $T_{\text{CSI-RS}} < \text{MGRP}$ ) and CSI-RS is partially overlapped with SMTC occasion ( $T_{\text{CSI-RS}} < T_{\text{SMTCperiod}}$ ) and SMTC occasion is partially or fully overlapped with measurement gap.
- $P=\frac{P_{\text{sharing factor}}}{1-\frac{T_{\text{CSI-RS}}}{\text{MGRP}}}$ , when CSI-RS is partially overlapped with measurement gap and CSI-RS is fully overlapped with SMTC occasion ( $T_{\text{CSI-RS}} = T_{\text{SMTCperiod}}$ ) and SMTC occasion is partially overlapped with measurement gap ( $T_{\text{SMTCperiod}} < \text{MGRP}$ )

- $P_{\text{sharing factor}} = 1$ , if the CSI-RS configured for L1-RSRP measurement outside measurement gap is
  - not overlapped with the SSB symbols indicated by *SSB-ToMeasure* and 1 data symbol before each consecutive SSB symbols indicated by *SSB-ToMeasure* and 1 data symbol after each consecutive SSB symbols indicated by *SSB-ToMeasure*, given that *SSB-ToMeasure* is configured, and,
  - not overlapped with the RSSI symbols indicated by *ss-RSSI-Measurement* and 1 data symbol before each RSSI symbol indicated by *ss-RSSI-Measurement* and 1 data symbol after each RSSI symbol indicated by *ss-RSSI-Measurement*, given that *ss-RSSI-Measurement* is configured
- $P_{\text{sharing factor}} = 3$ , otherwise.

Where:

$T_{\text{SMTCperiod}}$  = the configured SMTC period.

$T_{\text{CSI-RS}}$  = the periodicity of CSI-RS configured for L1-RSRP measurement

If the high layer in TS 38.331 [2] signaling of *smtc2* is configured,  $T_{\text{SMTCperiod}}$  corresponds to the value of higher layer parameter *smtc2*; Otherwise  $T_{\text{SMTCperiod}}$  corresponds to the value of higher layer parameter *smtc1*.  $T_{\text{SMTCperiod}}$  is the shortest SMTC period among all CCs in the same FR2 band, provided the SMTC offset of all CCs in FR2 have the same offset.

NOTE: The overlap between CSI-RS for L1-RSRP measurement and SMTC means that CSI-RS for L1-RSRP measurement is within the SMTC window duration.

Longer evaluation period would be expected if the combination of CSI-RS, SMTC occasion and measurement gap configurations does not meet previous conditions.

**Table 9.5.4.2-2: Measurement period  $T_{\text{L1-RSRP\_Measurement\_Period\_CSI-RS}}$  for FR2**

Configuration	$T_{\text{L1-RSRP\_Measurement\_Period\_CSI-RS}}$ (ms)
non-DRX	$\max(T_{\text{Report}}, \text{ceil}(M \cdot P \cdot N) \cdot T_{\text{CSI-RS}})$
DRX cycle $\leq 320\text{ms}$	$\max(T_{\text{Report}}, \text{ceil}(1.5 \cdot M \cdot P \cdot N) \cdot \max(T_{\text{DRX}}, T_{\text{CSI-RS}}))$
DRX cycle $> 320\text{ms}$	$\text{ceil}(M \cdot P \cdot N) \cdot T_{\text{DRX}}$
NOTE 1: $T_{\text{CSI-RS}}$ is the periodicity of CSI-RS configured for L1-RSRP measurement. $T_{\text{DRX}}$ is the DRX cycle length. $T_{\text{Report}}$ is configured periodicity for reporting.	
NOTE 2: the requirements are applicable provided that the CSI-RS resource configured for L1-RSRP measurement is transmitted with Density = 3.	

Reported L1-RSRP measurements contained in aperiodic triggered, aperiodic triggered periodic and aperiodic triggered semi-persistent L1-RSRP reports shall meet the requirements in clauses 10.1.19 for FR1 and 10.1.20 for FR2, respectively.

The UE shall only send aperiodic L1-RSRP measurement reports, if a DCI trigger has been received.

After the UE receives CSI request in DCI, the UE shall transmit the aperiodic L1-RSRP reporting on PUSCH over the air interface at the time specified according to clause 6.2.1.2 in TS 38.214 [26].

For both FR1 and FR2, when the CSI-RS for L1-RSRP measurement is in the same OFDM symbol as SSB for RLM/BFD/CBD/L1-RSRP measurement, UE is not required to receive CSI-RS for L1-RSRP measurement in the PRBs that overlap with an SSB.

For FR2, when the CSI-RS for L1-RSRP measurement is in the same OFDM symbol as SSB for RLM/BFD/L1-RSRP measurement, or in the same symbol as SSB for CBD when beam failure is detected, UE is required to measure one of but not both CSI-RS for L1-RSRP measurement and SSB. Longer measurement period for CSI-RS based L1-RSRP measurement is expected, and no requirements are defined.

For FR2, when the CSI-RS for L1-RSRP measurement is in the same OFDM symbol as another CSI-RS for RLM/BFD/CBD/L1-RSRP measurement,

- In the following cases, UE is required to measure one of but not both CSI-RS for L1-RSRP measurement and the other CSI-RS. Longer measurement period for CSI-RS based L1-RSRP measurement is expected, and no requirements are defined.
  - The CSI-RS for L1-RSRP measurement or the other CSI-RS in a resource set configured with repetition ON, or
  - The other CSI-RS is configured in q1 and beam failure is detected, or
  - The two CSI-RS-es are not QCL-ed w.r.t. QCL-TypeD, or the QCL information is not known to UE,
- Otherwise, UE shall be able to measure the CSI-RS for L1-RSRP measurement without any restriction.

The normative reference for this requirement is TS 38.133 [6] clauses 9.5.3.1, 9.5.4.2 and 9.5.5.2.

### 5.6.3.1 EN-DC FR2 SSB-based L1-RSRP measurement in non-DRX

**Editor's Note:** This test case has been completed for the following configurations:

- Test frequency  $f \leq 40.8$  GHz
- UE PC3
- Normal conditions
- The test is incomplete for UE power classes other than PC3
- The test is incomplete for test frequencies  $> 40.8$  GHz
- The test case is incomplete for extreme conditions

#### 5.6.3.1.1 Test purpose

To verify that the UE makes correct reporting of L1-RSRP measurement in non-DRX within L1-RSRP measurement requirements in TS 38.133 [6] clause 9.5.4.1.

#### 5.6.3.1.2 Test applicability

This test applies to all types of E-UTRA UE release 15 and forward, supporting EN-DC.

#### 5.6.3.1.3 Minimum conformance requirements

The minimum conformance requirements are specified in clause 5.6.3.0.1.

The normative reference for this requirement is TS 38.133 [6] clause A.5.6.3.1.

#### 5.6.3.1.4 Test description

##### 5.6.3.1.4.1 Initial conditions

This test shall be tested using any of the test configurations in Table 5.6.3.1.4.1-1. Configure the test equipment and the DUT according to the parameters in Table 5.6.3.1.4.1-2. Test environment parameters are given in Table 5.6.3.1.4.1-3.

**Table 5.6.3.1.4.1-1: EN-DC SSB based L1-RSRP measurement supported test configurations**

Config	Description
1	LTE FDD, NR 120 kHz SSB SCS, 100 MHz bandwidth, TDD duplex mode
2	LTE TDD, NR 120 kHz SSB SCS, 100 MHz bandwidth, TDD duplex mode
3	LTE FDD, NR 240 kHz SSB SCS, 100 MHz bandwidth, TDD duplex mode
4	LTE TDD, NR 240 kHz SSB SCS, 100 MHz bandwidth, TDD duplex mode

NOTE: The UE is only required to be tested in one of the supported test configurations

**Table 5.6.3.1.4.1-2: General test parameters for EN-DC SSB based L1-RSRP measurement**

Parameter	Config	Unit	Value
SSB GSCN	1~4		freq1
Duplex mode	1~4		TDD
TDD Configuration	1~4		TDDConf.3.1
BW <sub>channel</sub>	1~4	MHz	100: N <sub>RB,c</sub> = 66
Data RBs allocated	1~4		66
PDSCH Reference measurement channel	1,2		SR.3.2 TDD
	3,4		SR.3.3 TDD
RMSI CORESET Reference Channel	1,2		CR.3.1 TDD
	3,4		CR.3.2 TDD
Dedicated CORESET Reference Channel	1,2		CCR.3.1 TDD
	3,4		CCR.3.7 TDD
SSB configuration	1,2		SSB.1 FR2
	3,4		SSB.2 FR2
OCNG Patterns	1~4		OP.1
Initial BWP Configuration	1~4		DLBWP.0.1 ULBWP.0.1
Dedicated BWP configuration	1~4		DLBWP.1.3 ULBWP.1.3
SMTC configuration	1~4		SMTC.1
TRS Configuration	1~4		TRS.2.1 TDD
PDCCH/PDSCH TCI Configuration	1~4		TCI.State.2
DRX configuration	1~4		Off
reportConfigType	1~4		periodic
reportQuantity	1~4		ssb-Index-RSRP
Number of reported RS	1~4		2
L1-RSRP reporting period	1~4	slot	320
T1	1~4	s	5
T2	1~4	s	2
EPRE ratio of PSS to SSS	1~4	dB	0
EPRE ratio of PBCH DMRS to SSS			
EPRE ratio of PBCH to PBCH DMRS			
EPRE ratio of PDCCH DMRS to SSS			
EPRE ratio of PDCCH to PDCCH DMRS			
EPRE ratio of PDSCH DMRS to SSS			
EPRE ratio of PDSCH to PDSCH DMRS			
EPRE ratio of OCNG DMRS to SSS <sup>Note 1</sup>			
EPRE ratio of OCNG to OCNG DMRS <sup>Note 1</sup>			
Propagation condition	1~4		AWGN
NOTE 1: OCNG shall be used such that both cells are fully allocated and a constant total transmitted power spectral density is achieved for all OFDM symbols.			

Table 5.6.3.1.4.1-3: Test Environment parameters for EN-DC SSB based L1-RSRP measurement

Parameter	Value		Comment
Test environment	NC		As specified in TS 38.508-1 [14] clause 4.1.
Test frequencies	As specified in Annex E, Table E.2-1 and TS 38.508-1 [14] clause 4.3.1 for E-UTRA, 7.2.3 for NR FR2.		
Channel bandwidth	As specified by the test configuration selected from Table 5.6.3.1.4.1-1.		
Propagation conditions	AWGN		As specified in clause C.2.2.
Connection Diagram	TE Part	A.3.3.3.1-1	As specified in TS 38.508-1 [14] Annex A.
	DUT Part	A.3.4.1.1	
Exceptions to connection diagram	N/A		

1. Message contents are defined in clause 5.6.3.1.4.3.

2. The AoA setup for this test is Setup 1 as defined in clause A.9. The UE RX Beam Peak direction has been obtained previously using one of the search procedures as described in Annex I.

#### 5.6.3.1.4.2 Test procedure

Prior to the start of the time duration T1, the UE shall be fully synchronized to PSCell. The UE shall be configured for periodic CSI reporting in PUCCH [format 2] with a reporting periodicity as mentioned in the above table 5.6.3.1.4.1-2. Before the test, UE is configured to perform RLM, BFD and L1-RSRP measurement based on the SSBs.

1. Ensure the UE is in state RRC\_CONNECTED with generic procedure parameters Connectivity EN-DC, DC bearer MCG and SCG, Connected without release *On* and Test Mode *On*, according to TS 38.508-1 [14] clause 4.5 and general test parameters set according to Table 5.6.3.1.4.1-2.
2. Set the parameters according to T1 in Table 5.6.3.1.5-1. T1 starts.
3. The UE shall be transmitting CSI on PUCCH with a periodicity of 320 slots.
4. When T1 expires, the SS shall set the parameters according to T2 in 5.6.3.1.5-1. T2 starts.
5. The UE shall start sending valid L1-RSRP reports. The SS shall check the following requirements:
  - R1: the UE shall start to transmit valid L1-RSRP reports no later than 1760ms for UE supporting power class 1 in configuration 1 and 2, no later than 1720 ms for UE supporting power class 1 in configuration 3 and 4, no later than 1280 ms for UE supporting power class other than 1 in configuration 1 and 2, no later than 1240 ms for UE supporting power class other than 1 in configuration 3 and 4 from the beginning of time period T2. A valid report shall meet the absolute L1-RSRP requirement for SSB#1 Table 5.6.3.1.5-2 for test configurations 1 and 2 and the corresponding absolute accuracy requirements in Table 5.6.3.1.5-3 for test configurations 3 and 4. If the first valid report is received before the specified time, the number of passed iterations for R1 is increased by one. Otherwise, the number of failed iterations for R1 is increased by one.
  - R2: the UE shall transmit L1-RSRP reports every 320 slots. If the reports are received accordingly, the number of passed iterations for R2 is increased by one. Otherwise, the number of failed iterations for R2 is increased by one.
  - R3: The L1-RSRP value of SSB#1 reported by the UE is compared to the expected L1-RSRP value for SSB#1. In all consecutive reports after the first valid value is received, if the resulting value is outside the corresponding absolute accuracy requirements in Table 5.6.3.1.5-2 for test configurations 1 and 2 and the corresponding absolute accuracy requirements in Table 5.6.3.1.5-3 for test configurations 3 and 4 the number of failed iterations for R3 is increased by one. Otherwise, the number of passed iterations for R3 is increased by one.
  - R4: The DIFF-RSRP value of SSB#0 reported by the UE is compared to the expected DIFF-RSRP value. In all consecutive reports after the first valid value is received, if the resulting value is outside the corresponding relative accuracy requirements in Table 5.6.3.1.5-4 for all test configurations, the number of failed iterations for R4 is increased by one. Otherwise, the number of passed iterations for R4 is increased by one.
6. The SS waits until T2 expires.
7. The SS shall transmit *RRCConnectionReconfiguration* message with condition EN-DC\_PSCell\_Rel according to TS 36.508 [25] Table 4.6.1-8 to release NR cell (PSCell). The UE shall transmit *RRCConnectionReconfigurationComplete* message.
8. The SS then shall transmit *RRCConnectionReconfiguration* message with condition MCG\_and\_SCG according to TS 36.508 [25] Table 4.6.1-8 to add NR cell (PSCell). The UE shall transmit *RRCConnectionReconfigurationComplete* message.
9. If any the reconfiguration fails, switch off and on the UE and ensure the UE is in RRC\_CONNECTED with generic procedure parameters Connectivity EN-DC, DC bearer MCG and SCG, Connected without release *On* and Test Mode *On* according to TS 38.508-1 [14] clause 4.5.
10. Repeat steps 2-9 until the confidence level according to Tables G.2.3-1 in Annex G clause G.2 is achieved.



5.6.3.1.4.3 Message contents

Message contents are according to TS 38.508-1 [14] clause 7.3 with the following exceptions:

**Table 5.6.3.1.4.3-1: Common Exception messages EN-DC SSB based L1-RSRP measurement**

Default Message Contents	
Common contents of system information blocks exceptions	
Default RRC messages and information elements contents exceptions	Table H.3.6-2 with conditions PERIODIC and SS-RSRP Table H.3.6-3 with condition SSB Table H.3.4-1

**Table 5.6.3.1.4.3-2: RadioLinkMonitoringConfig**

Derivation Path: TS 38.508-1 [14], Table 4.6.3-133

Information Element	Value/remark	Comment	Condition
RadioLinkMonitoringConfig ::= SEQUENCE { failureDetectionResourcesToAddModList SEQUENCE (SIZE(1..maxNrofFailureDetectionResources)) OF SEQUENCE { purpose	1 entry		
	both	UE is configured to perform RLM and BFD based on the SSBs.	
detectionResource CHOICE { ssb-Index	0		
}			
}			
}			

5.6.3.1.5 Test requirement

Table 5.6.3.1.5-1 defines the primary level settings including test tolerances for all tests.

**Table 5.6.3.1.5-1: SSB specific test parameters for EN-DC SSB based L1-RSRP measurement**

Parameter	Config	Unit	SSB#0		SSB#1	
			T1	T2	T1	T2
Angle of arrival configuration			Setup 1 according to A.9			
Assumption for UE beams <sup>Note 4</sup>	1~4		Rough			
$N_{oc}$ <sup>Note2</sup>	1~4	dBm/15kHz	-105			
$N_{oc}$ <sup>Note2</sup>	1,2	dBm/SSB SCS	-96			
	3,4		-93			
$\hat{E}_s / I_{ot}$	1~4	dB	0	0	-Infinity	9
SSB_RP <sup>Note3</sup>	1,2	dBm/SSB SCS	-96	-96	-Infinity	-87
	3,4		-93	-93	-Infinity	-84
$I_o$ <sup>Note3</sup>	1,2	dBm/95.04MHz	-63.97	-63.97	-66.98	-57.47
	3,4		-63.97	-63.97	-66.98	-57.47
$\hat{E}_s / N_{oc}$	1~4	dB	0	0	-Infinity	9

NOTE 1: The resources for uplink transmission are assigned to the UE prior to the start of time period T2.

NOTE 2: Interference from other cells and noise sources not specified in the test is assumed to be constant over subcarriers and time and shall be modelled as AWGN of appropriate power for  $N_{oc}$  to be fulfilled.

NOTE 3: SSB\_RP and  $I_o$  levels have been derived from other parameters for information purposes. They are not settable parameters themselves.

NOTE 4: Information about types of UE beam is given in TS 38.133 Annex B.2.1.3, and does not limit UE implementation or test system implementation

The UE shall send L1-RSRP report every 320 slots. No later than X ms plus 640 slots from the beginning of time period T2, UE shall send L1-RSRP report including the results for both SSB#0 and SSB#1 while meeting the accuracy requirements defined in clause 10.1.20.1, where X is

- 1680 for UE supporting power class 1
- 1200 for UE supporting power class 2, 3 or 4.

Each L1-RSRP measurement report shall meet the corresponding absolute accuracy requirements in Table 5.6.3.1.5-2 for for test configurations 1 and 2 and the corresponding absolute accuracy requirements in Table 5.6.3.1.5-3 for test configurations 3 and 4 and the corresponding relative accuracy requirements in Table 5.6.3.1.5-4 for all test configurations.

**Table 5.6.3.1.5-2: L1-RSRP absolute accuracy requirements for the reported values for test configurations 1 and 2**

Normal Conditions	T1	T2
Lowest reported value (SSB#1)	-	40
Highest reported value (SSB#1)	-	99

**Table 5.6.3.1.5-3: L1-RSRP absolute accuracy requirements for the reported values for test configurations 3 and 4**

Normal Conditions	T1	T2
Lowest reported value (SSB#1)	-	43
Highest reported value (SSB#1)	-	102

**Table 5.6.3.1.5-4: L1-RSRP relative accuracy requirements for the reported values for all test configurations**

	T1	T2
Lowest DIFF RSRP reported (SSB#0)	-	1
Highest DIFF RSRP reported (SSB#0)	-	7

For the test to pass, the ratio of successful reported valued for each requirement (R1 to R4) shall be at least 90% with a confidence level of 95%. Each requirement is evaluated independently of the others.

### 5.6.3.2 EN-DC FR2 SSB-based L1-RSRP measurement in DRX

**Editor's Note:** This test case has been completed for the following configurations:

- Test frequency  $f \leq 40.8$  GHz
- UE PC3
- Normal conditions
- The test is incomplete for UE power classes other than PC3
- The test is incomplete for test frequencies  $> 40.8$  GHz
- The test case is incomplete for extreme conditions

#### 5.6.3.2.1 Test purpose

To verify that the UE makes correct reporting of L1-RSRP measurement in DRX within L1-RSRP measurement requirements in TS 38.133 [6] clause 9.5.4.1.

## 5.6.3.2.2 Test applicability

This test applies to all types of E-UTRA UE release 15 and forward, supporting EN-DC FR2 and long DRX cycle.

## 5.6.3.2.3 Minimum conformance requirements

The minimum conformance requirements are specified in clause 5.6.3.0.1.

The normative reference for this requirement is TS 38.133 [6] clause A.5.6.3.2.

## 5.6.3.2.4 Test description

## 5.6.3.2.4.1 Initial conditions

This test shall be tested using any of the test configurations in Table 5.6.3.2.4.1-1. Configure the test equipment and the DUT according to the parameters in Table 5.6.3.2.4.1-2. Test environment parameters are given in Table 5.6.3.2.4.1-3.

**Table 5.6.3.2.4.1-1: EN-DC SSB based L1-RSRP measurement in DRX supported test configurations**

Config	Description
1	LTE FDD, NR 120 kHz SSB SCS, 100 MHz bandwidth, TDD duplex mode
2	LTE TDD, NR 120 kHz SSB SCS, 100 MHz bandwidth, TDD duplex mode
3	LTE FDD, NR 240 kHz SSB SCS, 100 MHz bandwidth, TDD duplex mode
4	LTE TDD, NR 240 kHz SSB SCS, 100 MHz bandwidth, TDD duplex mode

NOTE: The UE is only required to be tested in one of the supported test configurations

**Table 5.6.3.2.4.1-2: General test parameters for EN-DC SSB based L1-RSRP measurement in DRX**

Parameter	Config	Unit	Value
SSB GSCN	1~4		freq1
Duplex mode	1~4		TDD
TDD Configuration	1~4		TDDConf.3.1
BW <sub>channel</sub>	1~4	MHz	100: N <sub>RB,c</sub> = 66
Data RBs allocated	1~4		66
PDSCH Reference measurement channel	1,2 3,4		SR.3.1 TDD SR.3.3 TDD
RMSI CORESET Reference Channel	1,2 3,4		CR.3.1 TDD CR.3.2 TDD
Dedicated CORESET Reference Channel	1,2 3,4		CCR.3.1 TDD CCR.3.7 TDD
SSB configuration	1,2 3,4		SSB.1 FR2 SSB.2 FR2
OCNG Patterns	1~4		OP.1
Initial BWP Configuration	1~4		DLBWP.0.1 ULBWP.0.1
Dedicated BWP configuration	1~4		DLBWP.1.3 ULBWP.1.3
SMTC configuration	1~4		SMTC.1
TRS Configuration	1~4		TRS.2.1 TDD
PDCCH/PDSCH TCI Configuration	1~4		TCI.State.2
DRX configuration	1~4		DRX.3
reportConfigType	1~4		periodic
reportQuantity	1~4		ssb-Index-RSRP
Number of reported RS	1~4		2
L1-RSRP reporting period	1~4	slot	320
T1	1~4	s	5
T2	1~4	s	3
EPRE ratio of PSS to SSS	1~4	dB	0
EPRE ratio of PBCH DMRS to SSS			
EPRE ratio of PBCH to PBCH DMRS			
EPRE ratio of PDCCH DMRS to SSS			
EPRE ratio of PDCCH to PDCCH DMRS			

Parameter	Config	Unit	Value
EPRE ratio of PDSCH DMRS to SSS			
EPRE ratio of PDSCH to PDSCH DMRS			
EPRE ratio of OCNG DMRS to SSS <sup>Note 1</sup>			
EPRE ratio of OCNG to OCNG DMRS <sup>Note 1</sup>			
Propagation condition	1~4		AWGN
NOTE 1: OCNG shall be used such that both cells are fully allocated and a constant total transmitted power spectral density is achieved for all OFDM symbols.			

**Table 5.6.3.2.4.1-3: Test Environment parameters for EN-DC SSB based L1-RSRP measurement in DRX**

Parameter	Value	Comment
Test environment	NC	As specified in TS 38.508-1 [14] clause 4.1.
Test frequencies	As specified in Annex E, Table E.2-1 and TS 38.508-1 [14] clause 4.3.1 for E-UTRA, 7.2.3 for NR FR2.	
Channel bandwidth	As specified by the test configuration selected from Table 5.6.3.2.4.1-1.	
Propagation conditions	AWGN	As specified in clause C.2.2.
Connection Diagram	TE Part DUT Part	A.3.3.3.1-1 A.3.4.1.1
Exceptions to connection diagram	N/A	

1. Message contents are defined in clause 5.6.3.2.4.3.

2. The AoA setup for this test is Setup 1 as defined in clause A.9. The UE RX Beam Peak direction has been obtained previously using one of the search procedures as described in Annex I.

#### 5.6.3.2.4.2 Test procedure

Same as in 5.6.3.2.4.2 with the following exception:

5. The UE shall start sending valid L1-RSRP reports. The SS shall check the following requirements:

- R1: the UE shall start to transmit valid L1-RSRP reports no later than 2960ms for UE supporting power class 1 in configuration 1 and 2, no later than 2920ms for UE supporting power class 1 in configuration 3 and 4, no later than 2000ms for UE supporting power class other than 1 in configuration 1 and 2, no later than 1960ms for UE supporting power class other than 1 in configuration 3 and 4 from the beginning of time period T2. A valid report shall meet the absolute L1-RSRP requirement for SSB#1 Table 5.6.3.2.5-2 for test configurations 1 and 2 and the corresponding absolute accuracy requirements in Table 5.6.3.2.5-3 for test configurations 3 and 4. If the first valid report is received before the specified time, the number of passed iterations for R1 is increased by one. Otherwise, the number of failed iterations for R1 is increased by one.
- R2: the UE shall transmit L1-RSRP reports every 320 slots. If the reports are received accordingly, the number of passed iterations for R2 is increased by one. Otherwise, the number of failed iterations for R2 is increased by one.
- R3: The L1-RSRP value of SSB#1 reported by the UE is compared to the expected L1-RSRP value for SSB#1. In all consecutive reports after the first valid value is received, if the resulting value is outside the corresponding absolute accuracy requirements in Table 5.6.3.2.5-2 for test configurations 1 and 2 and the corresponding absolute accuracy requirements in Table 5.6.3.2.5-3 for test configurations 3 and 4 the number of failed iterations for R3 is increased by one. Otherwise, the number of passed iterations for R3 is increased by one.
- R4: The DIFF-RSRP value of SSB#0 reported by the UE is compared to the expected DIFF-RSRP value. In all consecutive reports after the first valid value is received, if the resulting value is outside the corresponding relative accuracy requirements in Table 5.6.3.2.5-4 for all test configurations, the number of failed iterations for R4 is increased by one. Otherwise, the number of passed iterations for R4 is increased by one.

5.6.3.2.4.3 Message contents

Same message content as in subclause 5.6.3.1.4.3 with the following exception:

**Table 5.6.3.2.4.3-1: Common Exception messages EN-DC SSB based L1-RSRP measurement in DRX**

Default Message Contents	
Common contents of system information blocks exceptions	
Default RRC messages and information elements contents exceptions	Table H.3.7-1 with condition DRX.3

5.6.3.2.5 Test requirement

Table 5.6.3.2.5-1 defines the primary level settings including test tolerances for all tests.

**Table 5.6.3.2.5-1: SSB specific test parameters for EN-DC SSB based L1-RSRP measurement in DRX**

Parameter	Config	Unit	SSB#0		SSB#1	
			T1	T2	T1	T2
Angle of arrival configuration			Setup 1 according to A.9			
Assumption for UE beams <sup>Note 4</sup>	1~4		Rough			
$N_{oc}$ <sup>Note2</sup>	1~4	dBm/15kHz	-105			
$N_{oc}$ <sup>Note2</sup>	1,2	dBm/SSB SCS	-96			
	3,4		-93			
$\hat{E}_s / I_{ot}$	1~4	dB	0	0	-Infinity	9
SSB_RP <sup>Note3</sup>	1,2	dBm/SSB SCS	-96	-96	-Infinity	-87
	3,4		-93	-93	-Infinity	-84
$I_o$ <sup>Note3</sup>	1,2	dBm/95.04MHz	-63.97	-63.97	-66.98	-57.47
	3,4		-63.97	-63.97	-66.98	-57.47
$\hat{E}_s / N_{oc}$	1~4	dB	0	0	-Infinity	9
NOTE 1: The resources for uplink transmission are assigned to the UE prior to the start of time period T2.						
NOTE 2: Interference from other cells and noise sources not specified in the test is assumed to be constant over subcarriers and time and shall be modelled as AWGN of appropriate power for $N_{oc}$ to be fulfilled.						
NOTE 3: SSB_RP and $I_o$ levels have been derived from other parameters for information purposes. They are not settable parameters themselves.						

The UE shall send L1-RSRP report every 320 slots. No later than X ms plus 640 slots from the beginning of time period T2, UE shall send L1-RSRP report including the results for both SSB#0 and SSB#1 while meeting the accuracy requirements defined in clause 10.1.20.1, where X is

- 2880 for UE supporting power class 1
- 1920 for UE supporting power class 2,3 or 4.

Each L1-RSRP measurement report shall meet the corresponding absolute accuracy requirements in Table 5.6.3.2.5-2 for for test configurations 1 and 2 and the corresponding absolute accuracy requirements in Table 5.6.3.2.5-3 for test configurations 3 and 4 and the corresponding relative accuracy requirements in Table 5.6.3.2.5-4 for all test configurations.

**Table 5.6.3.2.5-2: L1-RSRP absolute accuracy requirements for the reported values for test configurations 1 and 2**

Normal Conditions	T1	T2
Lowest reported value (SSB#1)	-	40
Highest reported value (SSB#1)	-	99

**Table 5.6.3.2.5-3: L1-RSRP absolute accuracy requirements for the reported values for test configurations 3 and 4**

Normal Conditions	T1	T2
Lowest reported value (SSB#1)	-	43
Highest reported value (SSB#1)	-	102

**Table 5.6.3.2.5-4: L1-RSRP relative accuracy requirements for the reported values for all test configurations**

	T1	T2
Lowest DIFF RSRP reported (SSB#0)	-	1
Highest DIFF RSRP reported (SSB#0)	-	7

For the test to pass, the ratio of successful reported values for each requirement (R1 to R4) shall be at least 90% with a confidence level of 95%. Each requirement is evaluated independently of the others.

### 5.6.3.3 EN-DC FR2 CSI-RS-based L1-RSRP measurement in non-DRX

**Editor's Note:** This test case has been completed for the following configurations:

- Test frequency  $f \leq 40.8$  GHz
- UE PC3
- Normal conditions
- The test is incomplete for UE power classes other than PC3
- The test is incomplete for test frequencies  $> 40.8$  GHz
- The test case is incomplete for extreme conditions

#### 5.6.3.3.1 Test purpose

To verify that the UE makes correct reporting of CSI-RS-based L1-RSRP measurement in non-DRX within L1-RSRP measurement requirements in TS 38.133 [6] clause 9.5.4.2.

#### 5.6.3.3.2 Test applicability

This test applies to all types of E-UTRA UE release 15 and forward, supporting EN-DC.

#### 5.6.3.3.3 Minimum conformance requirements

The minimum conformance requirements are specified in clause 4.6.3.0.2.

The normative reference for this requirement is TS 38.133 [6] clause A.5.6.3.3.

#### 5.6.3.3.4 Test description

##### 5.6.3.3.4.1 Initial conditions

This test shall be tested using any of the test configurations in Table 5.6.3.3.4.1-1. Configure the test equipment and the DUT according to the parameters in Table 5.6.3.3.4.1-2. Test environment parameters are given in Table 5.6.3.3.4.1-3.

**Table 5.6.3.3.4.1-1: EN-DC FR2 CSI-RS based L1-RSRP measurement supported test configurations**

Config	Description
1	LTE FDD, NR 120 kHz CSI-RS SCS, 100 MHz bandwidth, TDD duplex mode
2	LTE TDD, NR 120 kHz CSI-RS SCS, 100 MHz bandwidth, TDD duplex mode

NOTE: The UE is only required to be tested in one of the supported test configurations

**Table 5.6.3.3.4.1-2: General test parameters for EN-D FR2 C CSI-RS based L1-RSRP measurement**

Parameter	Config	Unit	Value
SSB GSCN	1~2		freq1
Duplex mode	1~2		TDD
TDD Configuration	1~2		TDDConf.3.1
BW <sub>channel</sub>	1~2	MHz	100: N <sub>RB,c</sub> = 66
Data RBs allocated	1~2		66
PDSCH Reference measurement channel	1~2		SR.3.1 TDD
RMSI CORESET Reference Channel	1~2		CR.3.1 TDD
Dedicated CORESET Reference Channel	1~2		CCR.3.1 TDD
SSB configuration	1~2		SSB.1 FR2
CSI-RS configuration	1~2		CSI-RS.3.3 TDD
OCNG Patterns	1~2		OP.1
Initial BWP Configuration	1~2		DLBWP.0.1 ULBWP.0.1
Dedicated BWP configuration	1~2		DLBWP.1.1 ULBWP.1.1
SMTC configuration	1~2		SMTC.1
TRS Configuration	1~2		TRS.2.1 TDD
PDCCH/PDSCH TCI Configuration	1~2		TCI.State.2
DRX configuration	1~2		Off
reportConfigType	1~2		aperiodic
reportQuantity	1~2		cri-RSRP
Number of reported RS	1~2		2
qcl-Info	1~2		SSB#0 for resource#0 SSB#1 for resource#1
reportSlotOffsetList	1~2		8
Propagation condition	1~2		AWGN
T1	1~2	s	5
EPRE ratio of PSS to SSS	1~2	dB	0
EPRE ratio of PBCH DMRS to SSS			
EPRE ratio of PBCH to PBCH DMRS			
EPRE ratio of PDCCH DMRS to SSS			
EPRE ratio of PDCCH to PDCCH DMRS			
EPRE ratio of PDSCH DMRS to SSS			
EPRE ratio of PDSCH to PDSCH DMRS			
EPRE ratio of OCNG DMRS to SSS <sup>Note 1</sup>			
EPRE ratio of OCNG to OCNG DMRS <sup>Note 1</sup>			
NOTE 1: OCNG shall be used such that both cells are fully allocated and a constant total transmitted power spectral density is achieved for all OFDM symbols.			

**Table 5.6.3.3.4.1-3: Test Environment parameters for EN-DC FR2 CSI-RS L1-RSRP measurement**

Parameter	Value		Comment
Test environment	NC		As specified in TS 38.508-1 [14] clause 4.1.
Test frequencies	As specified in Annex E, Table E.2-1 and TS 38.508-1 [14] clause 4.3.1 for E-UTRA, 7.2.3 for NR FR2.		
Channel bandwidth	As specified by the test configuration selected from Table 5.6.3.3.4.1-1.		
Propagation conditions	AWGN		As specified in clause C.2.2.
Connection Diagram	TE Part	A.3.3.3.1-1	As specified in TS 38.508-1 [14] Annex A.
	DUT Part	A.3.4.1.1	
Exceptions to connection diagram			

1. Message contents are defined in clause 5.6.3.3.4.3.
2. The AoA setup for this test is Setup 1 as defined in clause A.9. The UE RX Beam Peak direction has been obtained previously using one of the search procedures as described in Annex I.

#### 5.6.3.3.4.2 Test procedure

The test consists of a single time period T1, during which the UE is triggered via DCI to report L1-RSRP on aperiodic CSI-RS resources. Prior to the start of the time duration T1, the UE shall be fully synchronized to PSCell. UE is also configured to measure L1-RSRP based on SSB. Upon receiving the DCI trigger, UE provides the report back based on the reporting configuration as defined in table 4.6.4.3.4.1-2.

1. Ensure the UE is in state RRC\_CONNECTED with generic procedure parameters Connectivity EN-DC, DC bearer MCG and SCG, Connected without release *On* and Test Mode *On*, according to TS 38.508-1 [14] clause 4.5.
2. Set the parameters according to T1 in Table 5.6.3.3.5-1. T1 starts.
3. After 480ms from the start of the test the SS transmits the DCI trigger in slot 1.
4. The SS shall check following requirements:

- R1: the UE shall send L1-RSRP report at slot 8 from the reception of DCI trigger. If the report is received at slot 8 from the reception of DCI trigger, the number of passed iterations for R1 is increased by one. Otherwise, the number of failed iterations for R1 is increased by one.

- R2: the L1-RSRP value of CSI-RS#1 reported by the UE is compared to the expected L1-RSRP value for CSI-RS #1. If the resulting value is outside the limits in Table 5.6.3.3.5-2 or the UE fails to report the measurement value for CSI-RS #1, the number of failed iterations for R2 is increased by one. Otherwise, the number of passed iterations for R2 is increased by one.

-R3: The DIFF RSRP value of CSI-RS #0 reported by the UE is compared to the expected DIFF RSRP value. If the resulting value is outside the limits in Table 5.6.3.3.5-4 or the UE fails to report the measurement value for CSI-RS #0, the number of failed iterations for R3 is increased by one. Otherwise, the number of passed iterations for R3 is increased by one.

5. The SS shall transmit *RRCConnectionReconfiguration* message with condition EN-DC\_PSCell\_Rel according to TS 36.508 [25] Table 4.6.1-8 to release NR cell (PSCell). The UE shall transmit *RRCConnectionReconfigurationComplete* message.

The SS then shall transmit *RRCConnectionReconfiguration* message with condition MCG\_and\_SCG according to TS 36.508 [25] Table 4.6.1-8 to add NR cell (PSCell). The UE shall transmit *RRCConnectionReconfigurationComplete* message.

8. If any the reconfiguration fails, switch off and on the UE and ensure the UE is in RRC\_CONNECTED with generic procedure parameters Connectivity EN-DC, DC bearer MCG and SCG, Connected without release *On* and Test Mode *On* according to TS 38.508-1 [14] clause 4.5.
9. Repeat steps 2-8 until the confidence level according to Tables G.2.3-1 in Annex G clause G.2 is achieved.



5.6.3.3.4.3 Message contents

Message contents are according to TS 38.508-1 [14] clause 7.3 with the following exceptions:

**Table 5.6.3.3.4.3-1: Common Exception messages EN-DC CSI-RS based L1-RSRP measurement**

Default Message Contents	
Common contents of system information blocks exceptions	
Default RRC messages and information elements contents exceptions	Table H.3.6-2 with conditions APERIODIC and CSI-RSRP Table H.3.6-3 with conditions CSI-RS and APERIODIC Table H.3.4-1

**Table 5.6.3.3.4.3-2: RadioLinkMonitoringConfig**

Derivation Path: TS 38.508-1 [14], Table 4.6.3-133

Information Element	Value/remark	Comment	Condition
RadioLinkMonitoringConfig ::= SEQUENCE { failureDetectionResourcesToAddModList SEQUENCE (SIZE(1..maxNrofFailureDetectionResources)) OF SEQUENCE { purpose }	1 entry		
	both	UE is configured to perform RLM and BFD based on the SSBs.	
}			
}			

5.6.3.3.5 Test requirement

Table 5.6.3.3.5-1 defines the primary level settings including test tolerances for all tests.

**Table 5.6.3.3.5-1: CSI-RS specific test parameters for EN-DC FR2 CSI-RS L1-RSRP measurement**

Parameter	Config	Unit	CSI-RS#0	CSI-RS#1
Angle of arrival configuration	1~2		Setup 1 according to A.9	
Assumption for UE beams <sup>Note 3</sup>	1~2		Rough	
$N_{oc}$ <sup>Note1</sup>	1~2	dBm/15kHz	-105	
$N_{oc}$ <sup>Note1</sup>	1~2	dBm/SSB SCS	-95.97	
$\hat{E}_s / I_{ot}$	1~2	dB	0	9
CSI-RS RSRP <sup>Note2</sup>	1~2	dBm/SSB SCS	-95.97	-86.97
$I_o$ <sup>Note2</sup>	1~2	dBm/95.04MHz	-63.97	-57.47
$\hat{E}_s / N_{oc}$	1~2	dB	0	9
<p>NOTE 1: Interference from other cells and noise sources not specified in the test is assumed to be constant over subcarriers and time and shall be modelled as AWGN of appropriate power for <math>N_{oc}</math> to be fulfilled.</p> <p>NOTE 2: CSI-RS RSRP and <math>I_o</math> levels have been derived from other parameters for information purposes. They are not settable parameters themselves.</p> <p>NOTE 3: Information about types of UE beam is given in B.2.1.3, and does not limit UE implementation or test system implementation</p>				

After 480ms from the beginning of the test, the UE shall send L1-RSRP report at slot 8 from the reception of DCI triggering the L1-RSRP measurement. The L1-RSRP report shall include the results for both CSI-RS#0 and CSI-RS#1.

Each L1-RSRP measurement report shall meet the corresponding absolute accuracy requirements in Table 5.6.3.3.5-2 the corresponding relative accuracy requirements in Table 5.6.3.3.5-3.

**Table 5.6.3.3.5-2: L1-RSRP absolute accuracy requirements for the reported values**

Normal Conditions	T1
Lowest reported value (CSI-RS#1)	40
Highest reported value (CSI-RS#1)	99

**Table 5.6.3.3.5-3: L1-RSRP relative accuracy requirements for the reported values**

	T1
Lowest DIFF RSRP reported (CSI-RS#0)	1
Highest DIFF RSRP reported (CSI-RS#0)	7

The rate of correct events observed during repeated tests shall be at least 90% with a confidence level of 95%.

NOTE: The actual overall delays measured in the test may be up to  $2 \times TTI_{DCCH}$  higher than the measurement reporting delays above because of TTI insertion uncertainty of the measurement report in DCCH.

#### 5.6.3.4 EN-DC FR2 CSI-RS-based L1-RSRP measurement in DRX

**Editor's Note:** This test case has been completed for the following configurations:

- Test frequency  $f \leq 40.8$  GHz
- UE PC3
- Normal conditions
- The test is incomplete for UE power classes other than PC3
- The test is incomplete for test frequencies  $> 40.8$  GHz
- The test case is incomplete for extreme conditions

##### 5.6.3.4.1 Test purpose

To verify that the UE makes correct reporting of CSI-RS-based L1-RSRP measurement in non-DRX within L1-RSRP measurement requirements in TS 38.133 [6] clause 9.5.4.2.

##### 5.6.3.4.2 Test applicability

This test applies to all types of E-UTRA UE release 15 and forward, supporting EN-DC FR2 and long DRX cycle.

##### 5.6.3.4.3 Minimum conformance requirements

The minimum conformance requirements are specified in clause 4.6.3.0.2.

The normative reference for this requirement is TS 38.133 [6] clause A.5.6.3.4

##### 5.6.3.4.4 Test description

###### 5.6.3.4.4.1 Initial conditions

This test shall be tested using any of the test configurations in Table 5.6.3.3.4.1-1. Configure the test equipment and the DUT according to the parameters in Table 5.6.3.3.4.1-2. Test environment parameters are given in Table 5.6.3.3.4.1-3.

**Table 5.6.3.4.4.1-1: EN-DC FR2 CSI-RS based L1-RSRP measurement in DRX supported test configurations**

Config	Description
1	LTE FDD, NR 120 kHz CSI-RS SCS, 100 MHz bandwidth, TDD duplex mode
2	LTE TDD, NR 120 kHz CSI-RS SCS, 100 MHz bandwidth, TDD duplex mode

NOTE: The UE is only required to be tested in one of the supported test configurations

**Table 5.6.3.4.4.1-2: General test parameters for EN-D FR2 C CSI-RS based L1-RSRP measurement in DRX**

Parameter	Config	Unit	Value
SSB GSCN	1~2		freq1
Duplex mode	1~2		TDD
TDD Configuration	1~2		TDDConf.3.1
BW <sub>channel</sub>	1~2	MHz	100: N <sub>RB,c</sub> = 66
Data RBs allocated	1~2		66
PDSCH Reference measurement channel	1~2		SR.3.1 TDD
RMSI CORESET Reference Channel	1~2		CR.3.1 TDD
Dedicated CORESET Reference Channel	1~2		CCR.3.1 TDD
SSB configuration	1~2		SSB.1 FR2
CSI-RS configuration	1~2		CSI-RS.3.3 TDD
OCNG Patterns	1~2		OP.1
Initial BWP Configuration	1~2		DLBWP.0.1 ULBWP.0.1
Dedicated BWP configuration	1~2		DLBWP.1.3 ULBWP.1.3
SMTc configuration	1~2		SMTc.1
TRS Configuration	1~2		TRS.2.1 TDD
PDCCH/PDSCH TCI Configuration	1~2		TCI.State.2
DRX configuration	1~2		DRX.3
reportConfigType	1~2		aperiodic
reportQuantity	1~2		cri-RSRP
Number of reported RS	1~2		2
qcl-Info	1~2		SSB#0 for resource#0 SSB#1 for resource#1
reportSlotOffsetList	1~2		8
Propagation condition	1~2		AWGN
T1	1~2	s	5
EPRE ratio of PSS to SSS	1~2	dB	0
EPRE ratio of PBCH DMRS to SSS			
EPRE ratio of PBCH to PBCH DMRS			
EPRE ratio of PDCCH DMRS to SSS			
EPRE ratio of PDCCH to PDCCH DMRS			
EPRE ratio of PDSCH DMRS to SSS			
EPRE ratio of PDSCH to PDSCH DMRS			
EPRE ratio of OCNG DMRS to SSS <sup>Note 1</sup>			
EPRE ratio of OCNG to OCNG DMRS <sup>Note 1</sup>			
NOTE 1: OCNG shall be used such that both cells are fully allocated and a constant total transmitted power spectral density is achieved for all OFDM symbols.			

**Table 5.6.3.4.4.1-3: Test Environment parameters for EN-DC FR2 CSI-RS L1-RSRP measurement**

Parameter	Value	Comment
Test environment	NC	As specified in TS 38.508-1 [14] clause 4.1.
Test frequencies	As specified in Annex E, Table E.2-1 and TS 38.508-1 [14] clause 4.3.1 for E-UTRA, 7.2.3 for NR FR2.	

Channel bandwidth	As specified by the test configuration selected from Table 5.6.3.3.4.1-1.	
Propagation conditions	AWGN	As specified in clause C.2.2.
Connection Diagram	TE Part DUT Part	A.3.3.3.1-1 A.3.4.1.1
Exceptions to connection diagram		

1. Message contents are defined in clause 5.6.3.3.4.3.
2. The AoA setup for this test is Setup 1 as defined in clause A.9. The UE RX Beam Peak direction has been obtained previously using one of the search procedures as described in Annex I.

5.6.3.4.4.2 Test procedure

Same test procedure as in subclause 5.6.3.3.4.2 with tables 5.6.3.3.4.1-2 and 5.6.3.3.5-1 replaced by tables 5.6.3.4.4.1-2 and 5.6.3.4.5-1 and following change in step 3.

3. After 1440ms from the start of the test the SS transmits the DCI trigger in slot 1.

5.6.3.4.4.3 Message contents

Same message content as in subclause 5.6.3.3.4.3 with the following exception:

**Table 4.6.4.4.3-1: Common Exception messages EN-DC CSI-RS based L1-RSRP measurement in DRX**

Default Message Contents	
Common contents of system information blocks exceptions	
Default RRC messages and information elements contents exceptions	Table H.3.7-1 with condition DRX.3

5.6.3.4.5 Test requirement

Table 5.6.3.3.5-1 defines the primary level settings including test tolerances for all tests.

**Table 5.6.3.4.5-1: CSI-RS specific test parameters for EN-DC FR2 CSI-RS L1-RSRP measurement in DRX**

Parameter	Config	Unit	CSI-RS#0	CSI-RS#1
Angle of arrival configuration	1~2		Setup 1 according to A.9	
Assumption for UE beams <sup>Note 3</sup>	1~2		Rough	
$N_{oc}$ <sup>Note1</sup>	1~2	dBm/15kHz	-105	
$N_{oc}$ <sup>Note1</sup>	1~2	dBm/SSB SCS	-95.97	
$\hat{E}_s / I_{ot}$	1~2	dB	0	9
CSI-RS RSRP <sup>Note2</sup>	1~2	dBm/SSB SCS	-95.97	-86.97
$I_o$ <sup>Note2</sup>	1~2	dBm/95.04MHz	-63.97	-57.47
$\hat{E}_s / N_{oc}$	1~2	dB	0	9

NOTE 1: Interference from other cells and noise sources not specified in the test is assumed to be constant over subcarriers and time and shall be modelled as AWGN of appropriate power for  $N_{oc}$  to be fulfilled.

NOTE 2: CSI-RS RSRP and  $I_o$  levels have been derived from other parameters for information purposes. They are not settable parameters themselves.

After 1440ms from the beginning of the test, the UE shall send L1-RSRP report at slot 8 from the reception of DCI triggering the L1-RSRP measurement. The L1-RSRP report shall include the results for both CSI-RS#0 and CSI-RS#1. Each L1-RSRP measurement report shall meet the corresponding absolute accuracy requirements in Table 5.6.3.4.5-2 the corresponding relative accuracy requirements in Table 5.6.3.4.5-3.

**Table 5.6.3.4.5-2: L1-RSRP absolute accuracy requirements for the reported values**

Normal Conditions	T1
Lowest reported value (CSI-RS#1)	40
Highest reported value (CSI-RS#1)	99

**Table 5.6.3.4.5-3: L1-RSRP relative accuracy requirements for the reported values**

	T1
Lowest DIFF RSRP reported (CSI-RS#0)	1
Highest DIFF RSRP reported (CSI-RS#0)	7

The rate of correct events observed during repeated tests shall be at least 90% with a confidence level of 95%.

NOTE: The actual overall delays measured in the test may be up to  $2 \times TTI_{DCCH}$  higher than the measurement reporting delays above because of TTI insertion uncertainty of the measurement report in DCCH.

## 5.6.4 CLI measurements

### 5.6.4.0 Minimum conformance requirements

#### 5.6.4.0.1 Minimum conformance requirements for SRS-RSRP measurement period

The UE shall be capable of performing SRS-RSRP measurement based on the configured SRS resource, and the UE shall be capable of reporting SRS-RSRP measured over measurement period of  $T_{SRS\_RSRP\_measurement\_period}$  for FR1 and FR2.

**Table 5.6.4.0.1-1 Measurement period  $T_{SRS\_RSRP\_measurement\_period}$**

Configuration	$T_{SRS\_measurement\_period}$ (ms)
No DRX	$\text{Max}(60, 3 \times T_{SRS})$
DRX cycle $\leq 320$ ms	$\text{Max}(60, \text{Ceil}(1.5 \times 3) \times \text{max}(T_{SRS}, T_{DRX}))$
DRX cycle $> 320$ ms	$3 \times T_{DRX}$
Note:	$T_{SRS}$ is SRS measurement periodicity configured <i>SRS-PeriodicityAndOffset</i> , and $T_{DRX}$ is the DRX cycle length.

If the SRS resources configured for measurement are partially or fully overlapping with SMTC window, SSB or CSI-RS configured for RLM, BFD, CBD or L1-RSRP measurement or measurement gaps, requirements are not specified for  $T_{SRS\_RSRP\_measurement\_period}$ .

When configured by the network, the UE shall be able to perform SRS-RSRP measurements of configured *srs-ResourceConfigCLI*. The requirements apply when the subcarrier spacing for SRS-RSRP measurement resource configuration is the same as the subcarrier spacing of the active DL BWP of serving cell. The UE is not required to measure SRS using different SCS compared to the downlink active BWP SCS of the same carrier.

The requirements as provided:

- SRS resources configured for SRS-RSRP measurements are measurable.

An SRS resource configured for SRS-RSRP shall be considered measurable when for each relevant SRS the following conditions are met:

- SRS-RSRP related side conditions given in clauses 10.1.22.1 for FR1 and FR2 for a corresponding band,
- $SRS\_RP$  and  $SRS \hat{E}_s/I_{ot}$  according to Annex B.2.7 for a corresponding band.

The UE shall send SRS-RSRP reports only for report configurations according to *reportType* which is *cliPeriodical* or *cliEventTriggered* when SRS-RSRP report is configured.

The UE shall report the SRS-RSRP value as a 7-bit value in the range [-140, -44] dBm with 1dB step size according to clause 10.1.22.1 for FR1 and FR2.

Reported SRS-RSRP measurements contained in periodically triggered measurement reports shall meet the requirements in clause 10.1.22.1.

Reported SRS-RSRP measurements contained in periodically triggered measurement reports shall meet the requirements in clauses 10.1.22.1.

The first report in event triggered periodic measurement reporting shall meet the requirements specified in clause 9.7.2.3.3.

Reported SRS-RSRP measurements contained in periodically triggered measurement reports shall meet the requirements in clause 10.1.22.1.

The UE shall not send any event triggered measurement reports as long as no reporting criteria is fulfilled.

The measurement reporting delay is defined as the time between an event that will trigger a measurement report and the point when the UE starts to transmit the measurement report over the air interface. This requirement assumes that the measurement report is not delayed by other RRC signalling on the DCCH. This measurement reporting delay excludes a delay uncertainty resulted when inserting the measurement report to the TTI of the uplink DCCH. The delay uncertainty is:  $2 \times TTI_{DCCH}$ . This measurement reporting delay excludes a delay which caused by no UL resources for UE to send the measurement report on.

The normative reference for this requirement is TS 38.133 [6] clause 9.7.2.5 and 9.7.2.1, 9.7.2.2 and 9.7.2.3

#### 5.6.4.1 EN-DC FR2 SRS-RSRP measurement in non-DRX

**Editor's Note: This test case is incomplete. Following aspects are either missing or TBD**

- The test applicability is FFS
- The test procedure is incomplete
- The message content is FFS
- MU/TT analysis is FFS

##### 5.6.4.1.1 Test purpose

The purpose of this test case is to verify that the UE makes correct reporting of SRS-RSRP measurement in non-DRX within SRS-RSRP measurement requirements in TS 38.133 [6] clause 9.7.2.5

##### 5.6.4.1.2 Test applicability

FFS

##### 5.6.4.1.3 Minimum conformance requirements

The minimum conformance requirements are specified in clause 5.6.4.0.1

The normative reference for this requirement is TS 38.133 [6] clause 9.7.2.5 and A.5.6.4.1.

##### 5.6.4.1.4 Test description

Two cells are deployed in the test, which are E-UTRAN PCell (Cell 1) and FR2 PSCell (Cell 2).

##### 5.6.4.1.4.1 Initial conditions

This test shall be tested using any of the test configurations in Table 5.6.4.1.4.1-1.

**Table 5.6.4.1.4.1-1: Supported test configurations**

Configuration	Description
5.6.4.1 - 1	NR 120 kHz SRS SCS, 100 MHz bandwidth, TDD duplex mode, LTE FDD
5.6.4.1 - 2	NR 120 kHz SRS SCS, 100 MHz bandwidth, TDD duplex mode, LTE TDD
	Note: UE is only required to be tested in one of the supported test configurations

Configure the test equipment and the DUT according to the parameters in Table 5.6.4.1.4.1-2.

**Table 5.6.4.1.4.1-2: Initial conditions EN-DC FR2 SRS-RSRP measurement in non-DRX**

Parameter	Value	Comment
Test environment	NC	As specified in TS 36.508 [25] clause 4.1.
Test frequencies	As specified in Annex E, E.1.1, E.1.3.1 and Table E.3-1 and TS 38.508-1 [14] clause 4.3.1 for E-UTRA and 7.2.3 for NR.	
Channel bandwidth	As specified by the selected test configuration.	
Propagation conditions	AWGN	As specified in clause C.2.1
Connection Diagram	TE Part: A.3.3.1.1 DUT Part: A.3.4.1.1	As specified in TS 38.508-1 [14] Annex A.
Exceptions to connection diagram	N/A	

1. The test parameters are given in Table 5.6.4.1.4.1-3 below.
2. Message contents are defined in clause 5.6.4.1.4.3.
3. Two cells are deployed in the test, which are E-UTRAN PCell (Cell 1) and FR2 PSCell (Cell 2). The test parameters for PSCell is given in Table A.5.6.4.1.4.1-3
  - . The UE Rx beam peak direction has been obtained previously using one of the Rx Beam Peak Search procedures as described in Annex I.

**Table 5.6.4.1.4.1-3: General test parameters for SRS-RSRP event triggered reporting for PSCell in FR2**

Parameter	Unit	Test configuration	Value	Comment
Active cell		1	E-UTRAN Cell 1 and NR Cell 2	
RF Channel Number		1	1: Cell 1 2: Cell 2	
SSB configuration		1	SSB.1 FR2	
SMTC configuration		1	SMTC.1	
SRS configuration		1	SRSCConf.1	Table A.5.6.4.1.2-4
CP length		1	Normal	
i1-Threshold	dBm	1	-103	
Hysteresis	dB	1	0	
Time To Trigger	s	1	0	
Filter coefficient		1	0	L3 filtering is not used
DRX	ms	1	DRX.11	
Time offset between DL from serving cell and SRS from test system	µs	1,2	10.67	
T1	s	1	5	
T2	s	1	1	

#### 5.6.4.1.4.2 Test procedure

There are two cells are deployed in the test, which are E-UTRAN PCell (Cell 1) and FR2 PSCell (Cell 2)

In the measurement control information, a measurement object is configured for the frequency of the PSCell, and it is indicated to the UE that event-triggered reporting with Event I1 is used. The test consists of two successive time periods, with time duration of T1 and T2, respectively.

During the test, the test system transmits SRS resource for measurement in the DL slot according to the SRS configuration in Table 5.6.4.1.5-3 and the test parameters for the (virtual) neighbour cell UE in Table 5.6.4.1.5-23. During the test, the test system does not transmit PDCCH/PDSCH/OCNG on SRS symbol to be transmitted and on 2 data symbols before SRS to be transmitted.

1. Ensure the UE is in State 3A-RF according to TS 36.508 [25] clause 7.2A.3.
2. Set the parameters according to Table 5.6.4.1.5-1 as appropriate.
3. The SS shall transmit an *RRCCoReconfiguration* message on Cell 1 with event I1 configured.
4. The UE shall transmit an *RRCCoReconfigurationComplete* message.

**Editor's note: the rest of the steps are FFS.**

#### 5.6.4.1.4.3 Message contents

Message contents are according to TS 38.508-1 [14] clause 7.3 with the following exceptions:

FFS

#### 5.6.4.1.5 Test requirement

Table 5.7.1.1.5-1 defines the cell specific settings for all tests. Table 5.7.1.1.5-2 defines the OTA primary level settings including test tolerances for all tests.

**Table 5.6.4.1.5-1: NR Cell specific test parameters for SRS-RSRP event triggered reporting for PSCell in FR2**

Parameter	Unit	Test configuration	Cell 2	
			T1	T2
TDD configuration		1	TDDConf.3.1	
PDSCH RMC configuration		1	SR.3.1 TDD	
RMSI CORESET RMC configuration		1	CR.3.1 TDD	
Dedicated CORESET RMC configuration		1	CCR.3.1 TDD	
OCNG Patterns		1	OP.1	
TRS configuration			TRS.2.1. TDD	
PDSCH/PDCCH TCI state		1	TCI.State.2	
Initial BWP configuration		1	DLBWP.0.1 ULBWP.0.1	
Active DL BWP configuration		1	DLBWP.1.1	
Active UL BWP configuration		1	ULBWP.1.1	
Propagation Condition		1	AWGN	



**Table 5.6.4.1.5-2: NR OTA Cell specific test parameters for SRS-RSRP event triggered reporting for PCell and Neighbour cell UE in FR2**

Parameter	Unit	Test configuration	Cell 2		Neighbour cell UE	
			T1	T2	T1	T2
AoA setup		1	Setup 1 defined A.3.15.1			
Beam assumption Note 4		1	Fine			
$N_{oc}$ Note 2	dBm/15 kHz	1	-98		-98	
$N_{oc}$ Note 2	dBm/SCS	1	-89		-89	
$\hat{E}_s / I_{ot}$	dB	1	-	-	-infinity	4
$\hat{E}_s / N_{oc}$	dB	1	-	-	-infinity	4
SRS-RSRP Note 3	dBm/SCS kHz	1	-	-	-infinity	-94
Io	dBm/95.04 MHz	1	-70.01	-68.82	-70.01	-68.82
Note 1:	The resources for uplink transmission are assigned to the UE prior to the start of time period T2.					
Note 2:	Interference from other cells and noise sources not specified in the test is assumed to be constant over subcarriers and time and shall be modelled as AWGN of appropriate power for $N_{oc}$ to be fulfilled.					
Note 3:	SRS-RSRP levels have been derived from other parameters for information purposes. They are not settable parameters themselves.					
Note 4:	Information about types of UE beam is given in B.2.1.3, and does not limit UE implementation or test system implementation					

**Table 5.6.4.1.5-3: SRS configuration for measurement reporting**

	Field	SRSCnf.1	Comments
SRS-ResourceSet	srs-ResourceSetId	0	
	srs-ResourceIdList	0	
	resourceType	Periodic	
	Usage	Codebook	
SRS-Resource	SRS-ResourceId	0	
	nrofSRS-Ports	Port1	
	transmissionComb	n2	
	combOffset-n2	0	
	cyclicShift-n2	0	
	resourceMapping startPosition	0	
	resourceMapping nrofSymbols	n1	
	resourceMapping repetitionFactor	n1	
	freqDomainPosition	0	
	freqDomainShift	0	
	freqHopping c-SRS	12	
	freqHopping b-SRS	0	
	freqHopping b-hop	0	
	groupOrSequenceHopping	Neither	
	resourceType	Periodic	
	periodicityAndOffset	sl160, 25	
sequenceId	0	Any 10 bit number	

The UE shall send one Event I1 triggered measurement report, with a measurement reporting delay less than 60 ms from the beginning of time period T2.

The UE shall not send event triggered measurement reports, as long as the reporting criteria are not fulfilled.

The rate of correct events observed during repeated tests shall be at least 90%.

NOTE: The actual overall delays measured in the test may be up to  $2xTTI_{DCCH}$  higher than the measurement reporting delays above because of TTI insertion uncertainty of the measurement report in DCCH.

## 5.6.5

### 5.6.6 L1-SINR measurement for beam reporting

#### 5.6.6.0 Minimum conformance requirements

##### 5.6.6.0.1 L1-SINR reporting with CSI-RS based CMR and no dedicated IMR configured

The UE shall be capable of performing L1-SINR measurements with the CSI-RS resource configured as CMR and no dedicated resource configured as IMR for L1-SINR computation, and the UE physical layer shall be capable of reporting L1-SINR measured over the measurement period of  $T_{L1-SINR\_Measurement\_Period\_CSI-RS\_CMR\_Only}$ .

The value of  $T_{L1-SINR\_Measurement\_Period\_CSI-RS\_CMR\_Only}$  is defined in Table 9.8.4.1-2 for FR2, where

For the value of M,

- For periodic and semi-persistent CSI-RS resources as CMR, M=1 if higher layer parameter *timeRestrictionForChannelMeasurement* is configured, and M=3 otherwise;
- For aperiodic CSI-RS resources as CMR, M=1.

For the value of N in FR2

- For periodic CSI-RS resources as CMR in a resource set configured with higher layer parameter *repetition* set to OFF, N=1. The requirements apply if *qcl-InfoPeriodicCSI-RS* is configured for all the resources in the resource set and for each resource one RS has QCL-TypeD with
  - SSB for L1-RSRP or L1-SINR measurement, or
  - another CSI-RS in resource set configured with repetition ON.
- For periodic CSI-RS resources as CMR in a resource set configured with higher layer parameter *repetition* set to ON,  $N=\text{ceil}(\text{maxNumberRxBeam} / N_{\text{res\_per\_set}})$ , where  $N_{\text{res\_per\_set}}$  is number of resources in the resource set. The requirements apply provided *qcl-InfoPeriodicCSI-RS* is configured for all resources in the resource set.
- For semi-persistent CSI-RS resources as CMR in a resource set configured with higher layer parameter *repetition* set to OFF, N=1. The requirements apply provided TCI state is provided for all resources in the resource set in the MAC CE activating the resource set and for each resource has QCL-TypeD with
  - SSB for L1-RSRP or L1-SINR measurement, or
  - another CSI-RS in resource set configured with repetition ON.
- For semi-persistent CSI-RS resources as CMR in a resource set configured with higher layer parameter *repetition* set to ON,  $N=\text{ceil}(\text{maxNumberRxBeam} / N_{\text{res\_per\_set}})$ , where  $N_{\text{res\_per\_set}}$  is number of resources in the resource set. The requirements apply provided TCI state is provided for all resources in the resource set in the MAC CE activating the resource set.
- For aperiodic CSI-RS resources as CMR in a resource set configured with higher layer parameter *repetition* set to OFF, N=1. The requirements apply provided *qcl-info* is configured for all resources in the resource set and for each resource has QCL-TypeD with
  - SSB for L1-RSRP or L1-SINR measurement, or
  - another CSI-RS in resource set configured with repetition ON.

- For aperiodic CSI-RS resources as CMR in a resource set configured with higher layer parameter *repetition* set to ON, N=1. UE is not required to meet the accuracy requirements in clause 10.1.28.1 and 10.1.28.3 if number of resources in the resource set is smaller than *maxNumberRxBeam*. The requirements apply provided *qcl-info* is configured for all resources in the resource set.

For the value of P in FR2,

- P=1, when CSI-RS is not overlapped with measurement gap and also not overlapped with SMTC occasion.
- $P = \frac{1}{1 - \frac{T_{\text{CSI-RS}}}{\text{MGRP}}}$ , when CSI-RS is partially overlapped with measurement gap and CSI-RS is not overlapped with SMTC occasion ( $T_{\text{CSI-RS}} < \text{MGRP}$ )
- $P = \frac{1}{1 - \frac{T_{\text{CSI-RS}}}{T_{\text{SMTCperiod}}}}$ , when CSI-RS is not overlapped with measurement gap and CSI-RS is partially overlapped with SMTC occasion ( $T_{\text{CSI-RS}} < T_{\text{SMTCperiod}}$ ).
- P=3, when CSI-RS is not overlapped with measurement gap and CSI-RS is fully overlapped with SMTC occasion ( $T_{\text{CSI-RS}} = T_{\text{SMTCperiod}}$ ).
- $P = \frac{1}{1 - \frac{T_{\text{CSI-RS}}}{\text{MGRP}} - \frac{T_{\text{CSI-RS}}}{T_{\text{SMTCperiod}}}}$ , when CSI-RS is partially overlapped with measurement gap and CSI-RS is partially overlapped with SMTC occasion ( $T_{\text{CSI-RS}} < T_{\text{SMTCperiod}}$ ) and SMTC occasion is not overlapped with measurement gap and
  - $T_{\text{SMTCperiod}} \neq \text{MGRP}$  or
  - $T_{\text{SMTCperiod}} = \text{MGRP}$  and  $T_{\text{CSI-RS}} < 0.5 * T_{\text{SMTCperiod}}$
- $P = \frac{3}{1 - \frac{T_{\text{CSI-RS}}}{\text{MGRP}}}$ , when CSI-RS is partially overlapped with measurement gap and CSI-RS is partially overlapped with SMTC occasion ( $T_{\text{CSI-RS}} < T_{\text{SMTCperiod}}$ ) and SMTC occasion is not overlapped with measurement gap and  $T_{\text{SMTCperiod}} = \text{MGRP}$  and  $T_{\text{CSI-RS}} = 0.5 * T_{\text{SMTCperiod}}$
- $P = \frac{1}{1 - \frac{T_{\text{CSI-RS}}}{\min(T_{\text{SMTCperiod}}, \text{MGRP})}}$ , when CSI-RS is partially overlapped with measurement gap ( $T_{\text{CSI-RS}} < \text{MGRP}$ ) and CSI-RS is partially overlapped with SMTC occasion ( $T_{\text{CSI-RS}} < T_{\text{SMTCperiod}}$ ) and SMTC occasion is partially or fully overlapped with measurement gap.
- $P = \frac{3}{1 - \frac{T_{\text{CSI-RS}}}{\text{MGRP}}}$ , when CSI-RS is partially overlapped with measurement gap and CSI-RS is fully overlapped with SMTC occasion ( $T_{\text{CSI-RS}} = T_{\text{SMTCperiod}}$ ) and SMTC occasion is partially overlapped with measurement gap ( $T_{\text{SMTCperiod}} < \text{MGRP}$ )

Where:

$T_{\text{SMTCperiod}}$  = the configured SMTC1 period or SMTC2 period if configured.

$T_{\text{CSI-RS}}$  = the periodicity of CSI-RS configured for L1-SINR measurement

If the high layer in TS 38.331 [2] signalling of *smtc2* is configured,  $T_{\text{SMTCperiod}}$  corresponds to the value of higher layer parameter *smtc2*; Otherwise  $T_{\text{SMTCperiod}}$  corresponds to the value of higher layer parameter *smtc1*.

Note: The overlap between CSI-RS for L1-SINR measurement and SMTC means that CSI-RS for L1-SINR measurement is within the SMTC window duration.

Longer evaluation period would be expected if the combination of CSI-RS, SMTC occasion and measurement gap configurations does not meet previous conditions.

**Table 9.8.4.1-2: Measurement period  $T_{L1-SINR\_Measurement\_Period\_CSI-RS\_CMR\_Only}$  for FR2**

Configuration	$T_{L1-SINR\_Measurement\_Period\_CSI-RS\_CMR\_Only}$ (ms)
non-DRX	$\max(T_{Report}, \text{ceil}(M \cdot P \cdot N) \cdot T_{CSI-RS})$
DRX cycle $\leq 320$ ms	$\max(T_{Report}, \text{ceil}(1.5 \cdot M \cdot P \cdot N) \cdot \max(T_{DRX}, T_{CSI-RS}))$
DRX cycle $> 320$ ms	$\text{ceil}(M \cdot P \cdot N) \cdot T_{DRX}$
Note 1:	$T_{CSI-RS}$ is the periodicity of CSI-RS configured for L1-SINR measurement. $T_{DRX}$ is the DRX cycle length. $T_{Report}$ is configured periodicity for reporting.
Note 2:	the requirements are applicable provided that the CSI-RS resource configured for L1-SINR measurement is transmitted with Density = 3.

The UE shall send L1-SINR reports only for report configurations configured for the active BWP.

The UE shall report the L1-SINR value as a 7-bit value in the range [-23, 40] dB with 0.5dB step size if *nrofReportedRS* is configured to one. If *nrofReportedRS* is configured to be larger than one, or if *groupBasedBeamReporting* is enabled, the UE shall use differential L1-SINR based reporting. The differential L1-SINR is quantized to a 4-bit value with 1dB step size. The mapping between the reported L1-SINR value and the measured quantity is described in 10.1.16.

Reported L1-SINR measurements contained in aperiodic triggered, aperiodic triggered periodic and aperiodic triggered semi-persistent L1-SINR reports shall meet the requirements in clauses 10.1.27 for FR1 and 10.1.28 for FR2, respectively.

The UE shall only send aperiodic L1-SINR measurement reports, if a DCI for triggering report has been received.

After the UE receives CSI request in DCI, the UE shall transmit the aperiodic L1-SINR reporting on PUSCH over the air interface at the time specified according to clause 5.2.1.4 in TS 38.214 [26].

The UE is required to be capable of measuring L1-SINR without measurement gaps. The UE is required to perform the SSB and CSI-RS/CSI-IM measurements with measurement restrictions as described in the following clauses.

For both FR1 and FR2, when the CSI-RS configured for L1-SINR measurement is in the same OFDM symbol as SSB for RLM, BFD, CBD, L1-RSRP or L1-SINR measurement, UE is not required to receive CSI-RS for L1-SINR measurement in the PRBs that overlap with an SSB.

For FR2, when the CSI-RS configured for L1-SINR measurement on one CC is in the same OFDM symbol as SSB for RLM, BFD, L1-RSRP or L1-SINR measurement on the same CC or different CCs in the same band, or in the same symbol as SSB for CBD measurement on the same CC or different CCs in the same band when beam failure is detected, UE is required to measure one of but not both CSI-RS for L1-SINR measurement and SSB. Longer measurement period for CSI-RS based L1-SINR measurement is expected, and no requirements are defined.

For FR2, when the CSI-RS configured for L1-SINR measurement on one CC is in the same OFDM symbol as another CSI-RS for RLM, BFD, CBD, L1-RSRP or L1-SINR measurement on the same CC or different CCs in the same band,

- In the following cases, UE is required to measure one of but not both CSI-RS for L1-SINR measurement and the other CSI-RS. Longer measurement period for CSI-RS based L1-SINR measurement is expected, and no requirements are defined.
  - The CSI-RS for L1-SINR measurement or the other CSI-RS in a resource set configured with repetition ON, or
  - The CSI-RS or the other CSI-RS is configured as dedicated IMR for L1-SINR computation with SSB as CMR, or
  - The other CSI-RS is configured in q1 and beam failure is detected, or
  - The two CSI-RS-es are not QCL-ed w.r.t. QCL-TypeD, or the QCL information is not known to UE,
- Otherwise, UE shall be able to measure the CSI-RS configured for L1-SINR measurement without any restriction.

The normative reference for this requirement is TS 38.133 [6] clause 9.8.3, 9.8.4.1 and 9.8.5.

### 5.6.6.0.2 L1-SINR reporting with SSB based CMR and dedicated IMR configured

The UE shall be capable of performing L1-SINR measurements with the SSB configured as CMR and dedicated resource configured as IMR for L1-SINR computation, in which the NZP-CSI-RS or CSI-IM resource configured as dedicated IMR shall be 1-to-1 mapped to SSB configured as CMR, with the same periodicity. The UE physical layer shall be capable of reporting L1-SINR measured over the measurement period of  $T_{L1-SINR\_Measurement\_Period\_SSB\_CMR\_IMR}$ .

The requirements in this clause are not applicable if NZP-CSI-RS or CSI-IM resource configured as dedicated IMR is scheduled with different periodicity as SSB configured as CMR.

The value of  $T_{L1-SINR\_Measurement\_Period\_SSB\_CMR\_IMR}$  is defined in Table 9.8.4.2-2 for FR2, where

For the value of M

- For periodic or semi-persistent NZP CSI-RS or CSI-IM resource as dedicated IMR, M=1 if the higher layer parameters *timeRestrictionForChannelMeasurements* and/or *timeRestrictionForInterferenceMeasurements* are configured, and M=3 otherwise;

For the value of N in FR2

- N = 8.

P is defined as the maximum value between  $P_{CMR}$  and  $P_{IMR}$ , i.e.,  $P = \max(P_{CMR}, P_{IMR})$ , where

- the value of  $P_{CMR}$  shall be derived in the same way as the value of P used for SSB based L1-RSRP measurement in clause 9.5.4.1, in which the occasions and period of the SSB for CMR shall be used instead.
- the value of  $P_{IMR}$  shall be derived in the same way as the value of P used for CSI-RS based L1-RSRP measurement in clause 9.5.4.2, in which the occasions and period of the NZP CSI-RS for NZP-IMR or CSI-IM for ZP-IMR shall be used instead.

Longer evaluation period would be expected if the combination of SSB, SMTC occasion and measurement gap configurations does not meet previous conditions.

For L1-SINR measurement with SSB as CMR and CSI-RS or CSI-IM as IMR, the requirement shall apply if the CSI-RS is configured as IMR with repetition field as “repetition = OFF” or CSI-IM is configured as IMR.

For L1-SINR measurement with SSB as CMR and CSI-RS/CSI-IM as IMR, no requirement shall apply if SSB occasions for CMR or CSI-RS/CSI-IM occasions for IMR are fully overlapped with the configured measurement gap.

**Table 9.8.4.2-2: Measurement period  $T_{L1-SINR\_Measurement\_Period\_SSB\_CMR\_IMR}$  for FR2**

Configuration	$T_{L1-SINR\_Measurement\_Period\_SSB\_CMR\_IMR}$ (ms)
non-DRX	$\max(T_{Report}, \text{ceil}(M \cdot P \cdot N) \cdot T_{SSB})$
DRX cycle $\leq 320$ ms	$\max(T_{Report}, \text{ceil}(1.5 \cdot M \cdot P \cdot N) \cdot \max(T_{DRX}, T_{SSB}))$
DRX cycle $> 320$ ms	$\text{ceil}(1.5 \cdot M \cdot P \cdot N) \cdot T_{DRX}$
Note 1:	$T_{SSB}$ = <i>ssb-periodicityServingCell</i> is the periodicity of the SSB-Index configured for L1-SINR measurement. $T_{DRX}$ is the DRX cycle length. $T_{Report}$ is configured periodicity for reporting.
Note 2:	The requirements are applicable provided that the CSI-RS resource configured for interference measurement shall be 1-to-1 mapped to SSB configured for channel measurement, with the same periodicity.

The UE shall send L1-SINR reports only for report configurations configured for the active BWP.

The UE shall report the L1-SINR value as a 7-bit value in the range [-23, 40] dB with 0.5dB step size if *nrofReportedRS* is configured to one. If *nrofReportedRS* is configured to be larger than one, or if *groupBasedBeamReporting* is enabled, the UE shall use differential L1-SINR based reporting. The differential L1-SINR is quantized to a 4-bit value with 1dB step size. The mapping between the reported L1-SINR value and the measured quantity is described in 10.1.16.

The UE shall transmit the periodic L1-SINR reporting on PUCCH over the air interface according to the periodicity defined in clause 5.2.1.4 in TS 38.214 [26].

Reported L1-SINR measurements contained in periodic L1-SINR measurement reports shall meet the requirements in clauses 10.1.27 for FR1 and 10.1.28 for FR2, respectively.

For FR2, when the SSB configured as CMR for L1-SINR measurement on one CC is in the same OFDM symbol as CSI-RS for RLM, BFD, CBD, L1-RSRP or L1-SINR measurement on the same CC or different CCs in the same band, UE is required to measure one of but not both SSB for L1-SINR measurement and CSI-RS. Longer measurement period for SSB based L1-RSRP measurement is expected, and no requirements are defined.

For FR2, there is no measurement restriction allowed when the network configures mixed numerology between SSB configured as CMR for L1-SINR measurement on one FR2 band and CSI-RS for RLM, BFD, CBD, L1-RSRP or L1-SINR measurement on the other FR2 band, provided that UE is capable of independent beam management on this FR2 band pair.

For both FR1 and FR2, when the CSI-RS configured for L1-SINR measurement is in the same OFDM symbol as SSB for RLM, BFD, CBD, L1-RSRP or L1-SINR measurement, UE is not required to receive CSI-RS for L1-SINR measurement in the PRBs that overlap with an SSB.

For FR2, when the CSI-RS configured for L1-SINR measurement on one CC is in the same OFDM symbol as SSB for RLM, BFD, L1-RSRP or L1-SINR measurement on the same CC or different CCs in the same band, or in the same symbol as SSB for CBD measurement on the same CC or different CCs in the same band when beam failure is detected, UE is required to measure one of but not both CSI-RS for L1-SINR measurement and SSB. Longer measurement period for CSI-RS based L1-SINR measurement is expected, and no requirements are defined.

For FR2, when the CSI-RS configured for L1-SINR measurement on one CC is in the same OFDM symbol as another CSI-RS for RLM, BFD, CBD, L1-RSRP or L1-SINR measurement on the same CC or different CCs in the same band,

- In the following cases, UE is required to measure one of but not both CSI-RS for L1-SINR measurement and the other CSI-RS. Longer measurement period for CSI-RS based L1-SINR measurement is expected, and no requirements are defined.
  - The CSI-RS for L1-SINR measurement or the other CSI-RS in a resource set configured with repetition ON, or
  - The CSI-RS or the other CSI-RS is configured as dedicated IMR for L1-SINR computation with SSB as CMR, or
  - The other CSI-RS is configured in q1 and beam failure is detected, or
  - The two CSI-RS-es are not QCL-ed w.r.t. QCL-TypeD, or the QCL information is not known to UE,
- Otherwise, UE shall be able to measure the CSI-RS configured for L1-SINR measurement without any restriction.

For both FR1 and FR2, when the CSI-IM configured for L1-SINR measurement is in the same OFDM symbol as SSB for RLM, BFD, CBD, L1-RSRP or L1-SINR measurement, UE is not required to measure CSI-IM for L1-SINR measurement in the PRBs that overlap with an SSB.

For FR2, when the CSI-IM configured for L1-SINR measurement on one CC is in the same OFDM symbol as SSB for RLM, BFD, L1-RSRP or L1-SINR measurement on the same CC or different CCs in the same band, or in the same symbol as SSB for CBD measurement on the same CC or different CCs in the same band when beam failure is detected, UE is required to measure one of but not both CSI-IM for L1-SINR measurement and SSB. Longer measurement period for L1-SINR measurement is expected, and no requirements are defined.

For FR2, when the CSI-IM configured for L1-SINR measurement on one CC is in the same OFDM symbol as the CSI-RS for RLM, BFD, CBD, L1-RSRP or L1-SINR measurement on the same CC or different CCs in the same band,

- In the following cases, UE is required to measure one of but not both CSI-IM for L1-SINR measurement and CSI-RS. Longer measurement period for L1-SINR measurement is expected, and no requirements are defined.
  - The CSI-RS in a resource set configured with repetition ON, or
  - The CSI-IM or the CSI-RS is configured as dedicated IMR for L1-SINR computation with SSB as CMR, or
  - The CSI-RS is configured in q1 and beam failure is detected, or
  - The CMR for L1-SINR measurement and the CSI-RS are not QCL-ed w.r.t. QCL-TypeD, or the QCL information is not known to UE,

- Otherwise, UE shall be able to measure the CSI-IM configured for L1-SINR measurement without any restriction.

The normative reference for this requirement is TS 38.133 [6] clause 9.8.3, 9.8.4.2 and 9.8.5.

### 5.6.6.0.3 L1-SINR reporting with CSI-RS based CMR and dedicated IMR configured

The UE shall be capable of performing L1-SINR measurements with the CSI-RS resource configured as CMR and dedicated resource configured as IMR for L1-SINR computation, in which the NZP-CSI-RS or CSI-IM resource configured as dedicated IMR shall be 1-to-1 mapped to CSI-RS resource configured as CMR, with the same periodicity. The UE physical layer shall be capable of reporting L1-SINR measured over the measurement period of  $T_{L1-SINR\_Measurement\_Period\_CSI-RS\_CMR\_IMR}$ .

$T_{L1-SINR\_Measurement\_Period\_CSI-RS\_CMR\_IMR}$

The requirements in this clause are not applicable if NZP-CSI-RS or CSI-IM resource configured as dedicated IMR is scheduled with different periodicity as CSI-RS resource configured as CMR.

The value of  $T_{L1-SINR\_Measurement\_Period\_CSI-RS\_CMR\_IMR}$  is defined in Table 9.8.4.3-2 for FR2, where

For the value of M,

- M=1 shall be applied if
  - aperiodic NZP-CSI-RS as CMR or dedicated IMR, or
  - aperiodic CSI-IMR as dedicated IMR, or
  - periodic and semi-persistent NZP-CSI-RS as CMR or dedicated IMR and the higher layer parameters *timeRestrictionForChannelMeasurement* and/or *timeRestrictionForInterferenceMeasurements* are configured, or
  - periodic and semi-persistent CSI-IM as dedicated IMR and the higher layer parameters *timeRestrictionForChannelMeasurement* and/or *timeRestrictionForInterferenceMeasurements* are configured;
- M=3 otherwise.

For the value of N in FR2

- For periodic CSI-RS resources as CMR in a resource set configured with higher layer parameter *repetition* set to OFF, N=1. The requirements apply if *qcl-InfoPeriodicCSI-RS* is configured for all the resources in the resource set and for each resource one RS has QCL-TypeD with
  - SSB for L1-RSRP or L1-SINR measurement, or
  - another CSI-RS in resource set configured with repetition ON.
- For periodic CSI-RS resources as CMR in a resource set configured with higher layer parameter *repetition* set to ON,  $N = \text{ceil}(\text{maxNumberRxBeam} / N_{\text{res\_per\_set}})$ , where  $N_{\text{res\_per\_set}}$  is number of resources in the resource set. The requirements apply provided *qcl-InfoPeriodicCSI-RS* is configured for all resources in the resource set.
- For semi-persistent CSI-RS resources as CMR in a resource set configured with higher layer parameter *repetition* set to OFF, N=1. The requirements apply provided TCI state is provided for all resources in the resource set in the MAC CE activating the resource set and for each resource has QCL-TypeD with
  - SSB for L1-RSRP or L1-SINR measurement, or
  - another CSI-RS in resource set configured with repetition ON.
- For semi-persistent CSI-RS resources as CMR in a resource set configured with higher layer parameter *repetition* set to ON,  $N = \text{ceil}(\text{maxNumberRxBeam} / N_{\text{res\_per\_set}})$ , where  $N_{\text{res\_per\_set}}$  is number of resources in the resource set. The requirements apply provided TCI state is provided for all resources in the resource set in the MAC CE activating the resource set.
- For aperiodic CSI-RS resources as CMR in a resource set configured with higher layer parameter *repetition* set to OFF, N=1. The requirements apply provided *qcl-info* is configured for all resources in the resource set and for each resource has QCL-TypeD with

- SSB for L1-RSRP or L1-SINR measurement, or
- another CSI-RS in resource set configured with repetition ON.
- For aperiodic CSI-RS resources as CMR in a resource set configured with higher layer parameter *repetition* set to ON,  $N=1$ . UE is not required to meet the accuracy requirements in clause 10.1.28.1 and 10.1.28.3 if number of resources in the resource set is smaller than *maxNumberRxBeam*. The requirements apply provided *qcl-info* is configured for all resources in the resource set.

P is defined as the maximum value between  $P_{\text{CMR}}$  and  $P_{\text{IMR}}$ , i.e.,  $P = \max(P_{\text{CMR}}, P_{\text{IMR}})$ , where

- The value of  $P_{\text{CMR}}$  and  $P_{\text{IMR}}$  shall be derived in the same way as the value of P used for CSI-RS based L1-RSRP measurement in clause 9.5.4.2, in which the occasions and period of the CSI-RS for CMR and NZP CSI-RS for NZP-IMR or CSI-IM for ZP-IMR shall be used instead respectively.

Longer evaluation period would be expected if the combination of CSI-RS, SMTC occasion and measurement gap configurations does not meet previous conditions.

For L1-SINR measurement with CSI-RS as CMR and CSI-RS as IMR, the requirement shall apply only if CSI-RS resources as CMR and IMR are configured with the same repetition field and the number of CSI-RS resources in the resource sets for CMR and IMR are same.

For L1-SINR measurement with CSI-RS as CMR and CSI-IM as IMR, the requirement shall apply only if the number of CSI-RS resources in the resource set for CMR and the number of CSI-IM resources in the resource set for IMR are same.

For L1-SINR measurement with CSI-RS as CMR and CSI-RS/CSI-IM as IMR, no requirement shall apply if CSI-RS occasions for CMR or CSI-RS/CSI-IM occasions for IMR are fully overlapped with the configured measurement gap.

**Table 9.8.4.3-2: Measurement period  $T_{\text{L1-SINR\_Measurement\_Period\_CSI-RS\_CMR\_IMR}}$  for FR2**

Configuration	$T_{\text{L1-SINR\_Measurement\_Period\_CSI-RS\_CMR\_IMR}}$ (ms)
non-DRX	$\max(T_{\text{Report}}, \text{ceil}(M \cdot P \cdot N) \cdot T_{\text{CSI-RS}})$
DRX cycle $\leq 320\text{ms}$	$\max(T_{\text{Report}}, \text{ceil}(1.5 \cdot M \cdot P \cdot N) \cdot \max(T_{\text{DRX}}, T_{\text{CSI-RS}}))$
DRX cycle $> 320\text{ms}$	$\text{ceil}(M \cdot P \cdot N) \cdot T_{\text{DRX}}$
Note 1:	$T_{\text{CSI-RS}}$ is the periodicity of CSI-RS configured for L1-SINR measurement. $T_{\text{DRX}}$ is the DRX cycle length. $T_{\text{Report}}$ is configured periodicity for reporting.
Note 2:	the requirements are applicable provided that the CSI-RS resource configured for L1-SINR measurement is transmitted with Density = 3.
Note 3:	The requirements are applicable provided that the CSI-RS resource configured for interference measurement shall be 1-to-1 mapped to CSI-RS configured for channel measurement, with the same periodicity.

The UE shall send L1-SINR reports only for report configurations configured for the active BWP.

The UE shall report the L1-SINR value as a 7-bit value in the range [-23, 40] dB with 0.5dB step size if *nrofReportedRS* is configured to one. If *nrofReportedRS* is configured to be larger than one, or if *groupBasedBeamReporting* is enabled, the UE shall use differential L1-SINR based reporting. The differential L1-SINR is quantized to a 4-bit value with 1dB step size. The mapping between the reported L1-SINR value and the measured quantity is described in 10.1.16.

Reported L1-SINR measurements contained in aperiodic triggered, aperiodic triggered periodic and aperiodic triggered semi-persistent L1-SINR reports shall meet the requirements in clauses 10.1.27 for FR1 and 10.1.28 for FR2, respectively.

The UE shall only send aperiodic L1-SINR measurement reports, if a DCI for triggering report has been received.

After the UE receives CSI request in DCI, the UE shall transmit the aperiodic L1-SINR reporting on PUSCH over the air interface at the time specified according to clause 5.2.1.4 in TS 38.214 [26].

For both FR1 and FR2, when the CSI-RS configured for L1-SINR measurement is in the same OFDM symbol as SSB for RLM, BFD, CBD, L1-RSRP or L1-SINR measurement, UE is not required to receive CSI-RS for L1-SINR measurement in the PRBs that overlap with an SSB.



For FR2, when the CSI-RS configured for L1-SINR measurement on one CC is in the same OFDM symbol as SSB for RLM, BFD, L1-RSRP or L1-SINR measurement on the same CC or different CCs in the same band, or in the same symbol as SSB for CBD measurement on the same CC or different CCs in the same band when beam failure is detected, UE is required to measure one of but not both CSI-RS for L1-SINR measurement and SSB. Longer measurement period for CSI-RS based L1-SINR measurement is expected, and no requirements are defined.

For FR2, when the CSI-RS configured for L1-SINR measurement on one CC is in the same OFDM symbol as another CSI-RS for RLM, BFD, CBD, L1-RSRP or L1-SINR measurement on the same CC or different CCs in the same band,

- In the following cases, UE is required to measure one of but not both CSI-RS for L1-SINR measurement and the other CSI-RS. Longer measurement period for CSI-RS based L1-SINR measurement is expected, and no requirements are defined.
  - The CSI-RS for L1-SINR measurement or the other CSI-RS in a resource set configured with repetition ON, or
  - The CSI-RS or the other CSI-RS is configured as dedicated IMR for L1-SINR computation with SSB as CMR, or
  - The other CSI-RS is configured in  $q_1$  and beam failure is detected, or
  - The two CSI-RS-es are not QCL-ed w.r.t. QCL-TypeD, or the QCL information is not known to UE,
- Otherwise, UE shall be able to measure the CSI-RS configured for L1-SINR measurement without any restriction.

For both FR1 and FR2, when the CSI-IM configured for L1-SINR measurement is in the same OFDM symbol as SSB for RLM, BFD, CBD, L1-RSRP or L1-SINR measurement, UE is not required to measure CSI-IM for L1-SINR measurement in the PRBs that overlap with an SSB.

For FR2, when the CSI-IM configured for L1-SINR measurement on one CC is in the same OFDM symbol as SSB for RLM, BFD, L1-RSRP or L1-SINR measurement on the same CC or different CCs in the same band, or in the same symbol as SSB for CBD measurement on the same CC or different CCs in the same band when beam failure is detected, UE is required to measure one of but not both CSI-IM for L1-SINR measurement and SSB. Longer measurement period for L1-SINR measurement is expected, and no requirements are defined.

For FR2, when the CSI-IM configured for L1-SINR measurement on one CC is in the same OFDM symbol as the CSI-RS for RLM, BFD, CBD, L1-RSRP or L1-SINR measurement on the same CC or different CCs in the same band,

- In the following cases, UE is required to measure one of but not both CSI-IM for L1-SINR measurement and CSI-RS. Longer measurement period for L1-SINR measurement is expected, and no requirements are defined.
  - The CSI-RS in a resource set configured with repetition ON, or
  - The CSI-IM or the CSI-RS is configured as dedicated IMR for L1-SINR computation with SSB as CMR, or
  - The CSI-RS is configured in  $q_1$  and beam failure is detected, or
  - The CMR for L1-SINR measurement and the CSI-RS are not QCL-ed w.r.t. QCL-TypeD, or the QCL information is not known to UE,
- Otherwise, UE shall be able to measure the CSI-IM configured for L1-SINR measurement without any restriction.

The normative reference for this requirement is TS 38.133 [6] clause 9.8.3, 9.8.4.3 and 9.8.5.

#### 5.6.6.1 EN-DC FR2 CSI-RS based CMR and no dedicated IMR L1-SINR measurement in DRX

**Editor's Note: This test case has been completed for the following configurations:**

- Test frequency  $f \leq 40.8$  GHz
- UE PC3

- Normal conditions
- The test is incomplete for UE power classes other than PC3
- The test is incomplete for test frequencies > 40.8 GHz
- The test case is incomplete for extreme conditions

#### 5.6.6.1.1 Test purpose

To verify that the UE makes correct reporting of L1-SINR measurement within L1-SINR measurement requirements in TS 38.133 [6] clause 9.8.4.1.

#### 5.6.6.1.2 Test applicability

This test applies to all types of E-UTRA UE release 16 and forward, supporting EN-DC FR2 and long DRX cycle and L1-SINR measurement.

#### 5.6.6.1.3 Minimum conformance requirements

The minimum conformance requirements are specified in clause 5.6.6.0.1.

The normative reference for this requirement is TS 38.133 [6] clause A.5.6.6.1.

#### 5.6.6.1.4 Test description

##### 5.6.6.1.4.1 Initial conditions

This test shall be tested using any of the test configurations in Table 5.6.6.1.4.1-1. Configure the test equipment and the DUT according to the parameters in Table 5.6.6.1.4.1-2. Test environment parameters are given in Table 5.6.6.1.4.1-3.

**Table 5.6.6.1.4.1-1: Applicable NR configurations for FR2 CSI-RS based L1-SINR test**

Config	Description
1	LTE FDD, NR 120 kHz CSI-RS SCS, 100 MHz bandwidth, TDD duplex mode
2	LTE TDD, NR 120 kHz CSI-RS SCS, 100 MHz bandwidth, TDD duplex mode
Note: The UE is only required to be tested in one of the supported test configurations	

**Table 5.6.6.1.4.1-2: General test parameters for FR2 CSI-RS based L1-SINR test**

Parameter	Config	Unit	Value
SSB GSCN	1~2		freq1
Duplex mode	1~2		TDD
TDD Configuration	1~2		TDDConf.3.1
BW <sub>channel</sub>	1~2	MHz	100: N <sub>RB,c</sub> = 66
PDSCH Reference measurement channel	1~2		SR.3.1 TDD
RMSI CORESET Reference Channel	1~2		CR.3.1 TDD
Dedicated CORESET Reference Channel	1~2		CCR.3.1 TDD
SSB configuration	1~2		SSB.1 FR2
CSI-RS configuration	1~2		CSI-RS.3.3 TDD
OCNG Patterns	1~2		OP.1
Initial BWP Configuration	1~2		DLBWP.0.1 ULBWP.0.1
Dedicated BWP configuration	1~2		DLBWP.1.3 ULBWP.1.3
SMTc configuration	1~2		SMTc.1
TRS Configuration	1~2		TRS.2.1 TDD
PDCCH/PDSCH TCI Configuration	1~2		TCI.State.2
DRX configuration	1~2		DRX.3
reportConfigType	1~2		aperiodic
reportQuantity-r16	1~2		cri-SINR-r16
Number of reported RS	1~2		2
qcl-Info	1~2		SSB#0 for resource#0 SSB#1 for resource#1
reportSlotOffsetList	1~2		26
Propagation condition	1~2		AWGN
T1	1~2	s	5
EPRE ratio of PSS to SSS	1~2	dB	0
EPRE ratio of PBCH DMRS to SSS			
EPRE ratio of PBCH to PBCH DMRS			
EPRE ratio of PDCCH DMRS to SSS			
EPRE ratio of PDCCH to PDCCH DMRS			
EPRE ratio of PDSCH DMRS to SSS			
EPRE ratio of PDSCH to PDSCH DMRS			
EPRE ratio of OCNG DMRS to SSS <sup>Note 1</sup>			
EPRE ratio of OCNG to OCNG DMRS <sup>Note 1</sup>			
Note 1: OCNG shall be used such that both cells are fully allocated and a constant total transmitted power spectral density is achieved for all OFDM symbols.			

**Table 5.6.6.1.4.1-3: Test Environment parameters for FR2 CSI-RS based L1-SINR test**

Parameter	Value	Comment
Test environment	NC	As specified in TS 38.508-1 [14] clause 4.1.
Test frequencies	As specified in Annex E, Table E.2-1 and TS 38.508-1 [14] clause 4.3.1 for E-UTRA, 7.2.3 for NR FR2.	
Channel bandwidth	As specified by the test configuration selected from Table 5.6.6.1.4.1-1.	
Propagation conditions	AWGN	As specified in clause C.2.2.
Connection Diagram	TE Part	A.3.3.3.1-1
	DUT Part	A.3.4.1.1
As specified in TS 38.508-1 [14] Annex A.		

Exceptions to connection diagram	N/A	
----------------------------------	-----	--

1. Message contents are defined in clause 5.6.6.1.4.3.
2. The AoA setup for this test is Setup 1 as defined in clause A.9. The UE RX Beam Peak direction has been obtained previously using one of the search procedures as described in Annex I.

5.6.6.1.4.2 Test procedure

The test consists of a single time period T1, during which the UE is triggered via DCI to report L1-SINR on aperiodic CSI-RS resources. Prior to the start of the time duration T1, the UE shall be fully synchronized to PSCell. UE is also configured to measure L1-SINR based on SSB. Upon receiving the DCI trigger, UE provides the report back based on the reporting configuration as defined in Table 5.6.6.1.4.1-2.

1. Ensure the UE is in state RRC\_CONNECTED with generic procedure parameters Connectivity EN-DC, DC bearer MCG and SCG, Connected without release *On* and Test Mode *On*, according to TS 38.508-1 [14] clause 4.5.
2. Set the parameters according to T1 in Table 5.6.6.1.5-1. T1 starts.
3. After 480ms from the start of the test the SS transmits the DCI trigger in slot 8.
4. The SS shall check following requirements:
  - R1: the UE shall send L1-SINR report at slot 26 from the reception of DCI trigger. If the report is received at slot 26 from the reception of DCI trigger, the number of passed iterations for R1 is increased by one. Otherwise, the number of failed iterations for R1 is increased by one.
  - R2: the L1-SINR value of CSI-RS#1 reported by the UE is compared to the expected L1-SINR value for CSI-RS#1. If the resulting value is outside the limits in Table 5.6.6.1.5-2 or the UE fails to report the measurement value for CSI-RS #1, the number of failed iterations for R2 is increased by one. Otherwise, the number of passed iterations for R2 is increased by one.
  - R3: The DIFF SINR value of CSI-RS#0 reported by the UE is compared to the expected DIFF SINR value. If the resulting value is outside the limits in Table 5.6.6.1.5-3 or the UE fails to report the measurement value for CSI-RS 0, the number of failed iterations for R3 is increased by one. Otherwise, the number of passed iterations for R3 is increased by one.
5. The SS shall transmit *RRCConnectionReconfiguration* message with condition EN-DC\_PSCell\_Rel according to TS 36.508 [25] Table 4.6.1-8 to release NR cell (PSCell). The UE shall transmit *RRCConnectionReconfigurationComplete* message.
6. The SS then shall transmit *RRCConnectionReconfiguration* message with condition MCG\_and\_SCG according to TS 36.508 [25] Table 4.6.1-8 to add NR cell (PSCell). The UE shall transmit *RRCConnectionReconfigurationComplete* message.
7. If any the reconfiguration fails, switch off and on the UE and ensure the UE is in RRC\_CONNECTED with generic procedure parameters Connectivity EN-DC, DC bearer MCG and SCG, Connected without release *On* and Test Mode *On* according to TS 38.508-1 [14] clause 4.5.
8. Repeat steps 2-7 until the confidence level according to Tables G.2.3-1 in Annex G clause G.2 is achieved.

5.6.6.1.4.3 Message contents

Message contents are according to TS 38.508-1 [14] clause 7.3 with the following exceptions:

**Table 5.6.6.1.4.3-1: Common Exception messages for EN-DC FR2 CSI-based CMR and no dedicated IMR L1-SINR measurement**

Default Message Contents	
Common contents of system information blocks exceptions	

Default RRC messages and information elements contents exceptions	Table H.3.6A-1 with conditions APERIODIC and CSI-SINR Table H.3.6A-2 with conditions CSI-RS and APERIODIC Table H.3.4-1 Table H.3.7-1 with condition DRX.3
---	---

**Table 5.6.6.1.4.3-2: RadioLinkMonitoringConfig**

Derivation Path: TS 38.508-1 [14], Table 4.6.3-133			
Information Element	Value/remark	Comment	Condition
RadioLinkMonitoringConfig ::= SEQUENCE {			
failureDetectionResourcesToAddModList SEQUENCE (SIZE(1..maxNrofFailureDetectionResources)) OF SEQUENCE {	1 entry		
purpose	both	UE is configured to perform RLM and BFD based on the SSBs.	
}			
}			

5.6.6.1.5 Test requirement

Table 5.6.6.1.5-1 defines the primary level settings including test tolerances for all tests.

**Table 5.6.6.1.5-1: CSI-RS specific test parameters for EN-DC FR2 CSI-based CMR and no dedicated IMR L1-SINR measurement**

Parameter	Config	Unit	CSI-RS#0	CSI-RS#1
Angle of arrival configuration	1~2		Setup 1 according to A.3.15.1	
Beam assumption <sup>Note 3</sup>	1~2		Rough	
$N_{oc}$ <sup>Note1</sup>	1~2	dBm/15kHz	-105	
$N_{oc}$ <sup>Note1</sup>	1~2	dBm/SSB SCS	-95.97	
$\hat{E}_s / I_{ot}$	1~2	dB	0	9
CSI-RS RSRP <sup>Note2</sup>	1~2	dBm/SSB SCS	-95.97	-86.97
$I_o$ <sup>Note2</sup>	1~2	dBm/95.04MHz	-63.97	-57.47
$\hat{E}_s / N_{oc}$	1~2	dB	0	9
<p>Note 1: Interference from other cells and noise sources not specified in the test is assumed to be constant over subcarriers and time and shall be modelled as AWGN of appropriate power for <math>N_{oc}</math> to be fulfilled.</p> <p>Note 2: CSI-RS RSRP and <math>I_o</math> levels have been derived from other parameters for information purposes. They are not settable parameters themselves.</p> <p>Note 3: Information about types of UE beam is given in B.2.1.3, and does not limit UE implementation or test system implementation</p>				

After 480ms from the beginning of the test, the UE shall send L1-SINR report at slot 26 from the reception of DCI triggering the L1-SINR measurement. The L1-SINR report shall include the results for both CSI-RS#0 and CSI-RS#1. Each L1-SINR measurement report shall meet the corresponding absolute accuracy requirements in Table 5.6.6.1.5-2 and the corresponding relative accuracy requirements in Table 5.6.6.1.5-3.

**Table 5.6.6.1.5-2: L1-SINR absolute accuracy requirements for the reported values**

Normal Conditions	T1
Lowest reported value (CSI-RS#1)	51
Highest reported value (CSI-RS #1)	74

**Table 5.6.6.1.5-3: L1-SINR relative accuracy requirements for the reported values**

Normal Conditions	T1
Lowest DIFF SINR reported (CSI-RS #0)	4
Highest DIFF SINR reported (CSI-RS #0)	13

The rate of correct events observed during repeated tests shall be at least 90% with a confidence level of 95%.

NOTE: The actual overall delays measured in the test may be up to  $2 \times TTI_{DCCH}$  higher than the measurement reporting delays above because of TTI insertion uncertainty of the measurement report in DCCH.

### 5.6.6.2 EN-DC FR2 SSB based CMR and dedicated IMR L1-SINR measurement in non-DRX

*Editor's Note: This test case has been completed for the following configurations:*

- Test frequency  $f \leq 40.8$  GHz
- UE PC3
- Normal conditions
- The test is incomplete for UE power classes other than PC3
- The test is incomplete for test frequencies  $> 40.8$  GHz
- The test case is incomplete for extreme conditions

#### 5.6.6.2.1 Test purpose

To verify that the UE makes correct reporting of L1-SINR measurement in non-DRX within L1-SINR measurement requirements in TS 38.133 [6] clause 9.8.4.2.

#### 5.6.6.2.2 Test applicability

This test applies to all types of E-UTRA UE release 16 and forward, supporting EN-DC FR2 and L1-SINR measurement reporting.

#### 5.6.6.2.3 Minimum conformance requirements

The minimum conformance requirements are specified in clause 5.6.6.0.2.

The normative reference for this requirement is TS 38.133 [6] clause A.5.6.6.2.

#### 5.6.6.2.4 Test description

##### 5.6.6.2.4.1 Initial conditions

This test shall be tested using any of the test configurations in Table 5.6.6.2.4.1-1. Configure the test equipment and the DUT according to the parameters in Table 5.6.6.2.4.1-2. Test environment parameters are given in Table 5.6.6.2.4.1-3.

**Table 5.6.6.2.4.1-1: Applicable NR configurations for FR2 L1-SINR measurement test with SSB based CMR and CSI-RS based IMR**

Config	Description
1	LTE FDD, NR 120 kHz SSB SCS, 100 MHz bandwidth, TDD duplex mode
2	LTE TDD, NR 120 kHz SSB SCS, 100 MHz bandwidth, TDD duplex mode
3	LTE FDD, NR 240 kHz SSB SCS, 100 MHz bandwidth, TDD duplex mode
4	LTE TDD, NR 240 kHz SSB SCS, 100 MHz bandwidth, TDD duplex mode
Note: The UE is only required to be tested in one of the supported test configurations	

**Table 5.6.6.2.4.1-2: General test parameters for FR2 L1-SINR measurement test with SSB based CMR and CSI-RS based IMR**

Parameter	Config	Unit	Value
SSB GSCN	1~4		freq1
Duplex mode	1~4		TDD
TDD Configuration	1~4		TDDConf.3.1
BW <sub>channel</sub>	1~4	MHz	100: N <sub>RB,c</sub> = 66
PDSCH Reference measurement channel	1~4		SR.3.1 TDD
RMSI CORESET Reference Channel	1~4		CR.3.1 TDD
Dedicated CORESET Reference Channel	1~4		CCR.3.1 TDD
SSB configuration	1,2		SSB.1 FR2
	3,4		SSB.2 FR2
CSI-RS configuration	1~4		CSI-RS.3.1A TDD
OCNG Patterns	1~4		OP.1
Initial BWP Configuration	1~4		DLBWP.0.1 ULBWP.0.1
Dedicated BWP configuration	1~4		DLBWP.1.3 ULBWP.1.3
SMTC configuration	1~4		SMTC.1
TRS Configuration	1~4		TRS.2.1 TDD
PDCCH/PDSCH TCI Configuration	1~4		TCI.State.2
DRX configuration	1~4		off
reportConfigType	1~4		periodic
reportQuantity-r16	1~4		ssb-Index-SINR-r16
Number of reported RS	1~4		2
L1-SINR reporting period	1~4	slot	640
T1	1~4	s	5
T2	1~4	s	3
EPRE ratio of PSS to SSS	1~4	dB	0
EPRE ratio of PBCH DMRS to SSS			
EPRE ratio of PBCH to PBCH DMRS			
EPRE ratio of PDCCH DMRS to SSS			
EPRE ratio of PDCCH to PDCCH DMRS			
EPRE ratio of PDSCH DMRS to SSS			
EPRE ratio of PDSCH to PDSCH DMRS			
EPRE ratio of OCNG DMRS to SSS <sup>Note 1</sup>			
EPRE ratio of OCNG to OCNG DMRS <sup>Note 1</sup>			
Propagation condition	1~4		AWGN
Note 1: OCNG shall be used such that both cells are fully allocated and a constant total transmitted power spectral density is achieved for all OFDM symbols.			

**Table 5.6.6.2.4.1-3: Test Environment parameters for FR2 L1-SINR measurement test with SSB based CMR and CSI-RS based IMR**

Parameter	Value		Comment
Test environment	NC		As specified in TS 38.508-1 [14] clause 4.1.
Test frequencies	As specified in Annex E, Table E.2-1 and TS 38.508-1 [14] clause 4.3.1 for E-UTRA, 7.2.3 for NR FR2.		
Channel bandwidth	As specified by the test configuration selected from Table 5.6.6.2.4.1-1.		
Propagation conditions	AWGN		As specified in clause C.2.2.
Connection Diagram	TE Part	A.3.3.3.1-1	As specified in TS 38.508-1 [14] Annex A.
	DUT Part	A.3.4.1.1	
Exceptions to connection diagram	N/A		

1. Message contents are defined in clause 5.6.6.2.4.3.
2. The AoA setup for this test is Setup 1 as defined in clause A.9. The UE RX Beam Peak direction has been obtained previously using one of the search procedures as described in Annex I.

#### 5.6.6.2.4.2 Test procedure

Prior to the start of the time duration T1, the UE shall be fully synchronized to PSCell. The UE shall be configured for periodic CSI reporting in PUCCH [format 2] with a reporting periodicity as mentioned in the above Table 5.6.6.2.4.1-2. Before the test, UE is configured to perform RLM, BFD and L1-SINR measurement based on the SSBs, and UE is configured to perform L1-SINR measurement based on the SSBs as CMR and the CSI-RS resources as IMR.

1. Ensure the UE is in state RRC\_CONNECTED with generic procedure parameters Connectivity EN-DC, DC bearer MCG and SCG, Connected without release *On* and Test Mode *On*, according to TS 38.508-1 [14] clause 4.5 and general test parameters set according to Table 5.6.6.2.4.1-2.
2. Set the parameters according to T1 in Table 5.6.6.2.5-1. T1 starts.
3. The UE shall be transmitting CSI on PUCCH with a periodicity of 640 slots.
4. When T1 expires, the SS shall set the parameters according to T2 in 5.6.6.2.5-1. T2 starts.
5. The UE shall start sending valid L1-SINR reports. The SS shall check the following requirements:
  - R1: the UE shall start to transmit valid L1-SINR reports no later than 2960ms for UE supporting power class 1 in configuration 1 and 2, no later than 2920 ms for UE supporting power class 1 in configuration 3 and 4, no later than 2000 ms for UE supporting power class other than 1 in configuration 1 and 2, no later than 1960 ms for UE supporting power class other than 1 in configuration 3 and 4 from the beginning of time period T2. A valid report shall meet the absolute L1-SINR requirement for SSB#1 in Table 5.6.6.2.5-3 for test configurations 1 and 2 and the corresponding absolute accuracy requirements in Table 5.6.6.2.5-4 for test configurations 3 and 4. If the first valid report is received before the specified time, the number of passed iterations for R1 is increased by one. Otherwise, the number of failed iterations for R1 is increased by one.
  - R2: the UE shall transmit L1-SINR reports every 640 slots. If the reports are received accordingly, the number of passed iterations for R2 is increased by one. Otherwise, the number of failed iterations for R2 is increased by one.
  - R3: The L1-SINR value of SSB#1 reported by the UE is compared to the expected L1-SINR value for SSB#1. In all consecutive reports after the first valid value is received, if the resulting value is outside the corresponding absolute accuracy requirements in Table 5.6.6.2.5-3 for all test configurations, the number of failed iterations for R3 is increased by one. Otherwise, the number of passed iterations for R3 is increased by one.
  - R4: The DIFF-SINR value of SSB#0 reported by the UE is compared to the expected DIFF-SINR value. In all consecutive reports after the first valid value is received, if the resulting value is outside the corresponding relative accuracy requirements in Table 5.6.6.2.5-4 for all test configurations, the number of failed iterations for R4 is increased by one. Otherwise, the number of passed iterations for R4 is increased by one.



6. The SS waits until T2 expires.
7. The SS shall transmit *RRCCONNECTIONRECONFIGURATION* message with condition EN-DC\_PSCell\_Rel according to TS 36.508 [25] Table 4.6.1-8 to release NR cell (PSCell). The UE shall transmit *RRCCONNECTIONRECONFIGURATIONCOMPLETE* message.
8. The SS then shall transmit *RRCCONNECTIONRECONFIGURATION* message with condition MCG\_and\_SCG according to TS 36.508 [25] Table 4.6.1-8 to add NR cell (PSCell). The UE shall transmit *RRCCONNECTIONRECONFIGURATIONCOMPLETE* message.
9. If any the reconfiguration fails, switch off and on the UE and ensure the UE is in RRC\_CONNECTED with generic procedure parameters Connectivity EN-DC, DC bearer MCG and SCG, Connected without release On and Test Mode On according to TS 38.508-1 [14] clause 4.5.
10. Repeat steps 2-9 until the confidence level according to Tables G.2.3-1 in Annex G clause G.2 is achieved.

5.6.6.2.4.3 Message contents

Message contents are according to TS 38.508-1 [14] clause 7.3 with the following exceptions:

**Table 5.6.6.2.4.3-1: Common Exception messages for FR2 L1-SINR measurement test with SSB based CMR and CSI-RS based IMR**

Default Message Contents	
Common contents of system information blocks exceptions	
Default RRC messages and information elements contents exceptions	Table H.3.6A-1 with conditions PERIODIC and SS-SINR and CSI-RS_IMR Table H.3.6A-2 with conditions SSB and PERIODIC Table H.3.6A-3 with conditions PERIODIC Table H.3.4-1

**Table 5.6.6.2.4.3-2: RadioLinkMonitoringConfig**

Derivation Path: TS 38.508-1 [14], Table 4.6.3-133			
Information Element	Value/remark	Comment	Condition
RadioLinkMonitoringConfig ::= SEQUENCE {			
failureDetectionResourcesToAddModList	1 entry		
SEQUENCE (SIZE(1..maxNrofFailureDetectionResources)) OF SEQUENCE {			
purpose	both	UE is configured to perform RLM and BFD based on the SSBs.	
detectionResource CHOICE {			
ssb-Index	0		
}			
}			
}			

5.6.6.2.5 Test requirement

Table 5.6.6.2.5-1 and Table 5.6.6.2.5-1 define the primary level settings including test tolerances for all tests.

**Table 5.6.6.2.5-1: SSB specific test parameters for FR2 L1-SINR measurement test with SSB based CMR and CSI-RS based IMR**

Parameter	Config	Unit	SSB#0		SSB#1	
			T1	T2	T1	T2

Angle of arrival configuration			Setup 1 according to A.3.15.1			
Beam assumption <sup>Note 4</sup>			Rough			
$N_{oc}$ <sup>Note2</sup>	1~4	dBm/15kHz	-105			
$N_{oc}$ <sup>Note2</sup>	1,2	dBm/SSB SCS	-96			
	3,4		-93			
$\hat{E}_s/I_{ot}$	1~4	dB	0	0	-Infinity	9
SSB RSRP <sup>Note3</sup>	1,2	dBm/SSB SCS	-94.5	-94.5	-Infinity	-87
	3,4		-91.5	-91.5	-Infinity	-84
$I_o$ <sup>Note3</sup>	1,2	dBm/95.04MHz	-63.2	-63.2	-67	-57.5
	3,4		-63.2	-63.2	-67	-57.5
$\hat{E}_s/N_{oc}$	1~4	dB	1.5	1.5	-Infinity	9
<p>Note 1: The resources for uplink transmission are assigned to the UE prior to the start of time period T2.</p> <p>Note 2: Interference from other cells and noise sources not specified in the test is assumed to be constant over subcarriers and time and shall be modelled as AWGN of appropriate power for <math>N_{oc}</math> to be fulfilled.</p> <p>Note 3: SSB RSRP and <math>I_o</math> levels have been derived from other parameters for information purposes. They are not settable parameters themselves.</p> <p>Note 4: Information about types of UE beam is given in B.2.1.3, and does not limit UE implementation or test system implementation</p>						

Table 5.6.6.2.5-2: CSI-RS specific test parameters

Parameter	Config	Unit	CSI-RS#0		CSI-RS#1	
			T1	T2	T1	T2
Angle of arrival configuration			Setup 1 according to A.3.15.1			
Beam assumption <sup>Note 4</sup>			Rough			
$N_{oc}$ <sup>Note2</sup>	1~4	dBm/15kHz	-105			
$N_{oc}$ <sup>Note2</sup>	1~4	dBm/CSI-RS SCS	-96			
$\hat{E}_s/I_{ot}$	1~4	dB	1.5	1.5	-Infinity	9
$\hat{E}_s/N_{oc}$	1~4	dB	1.5	1.5	-Infinity	9
CSI-RS RSRP <sup>Note3</sup>	1~4	dBm/ CSI-RS SCS	-94.5	-94.5	-Infinity	-87
$I_o$ <sup>Note3</sup>	1~4	dBm/95.04MHz	-63.2	-63.2	-67	-57.5
<p>Note 1: The resources for uplink transmission are assigned to the UE prior to the start of time period T2.</p> <p>Note 2: Interference from other cells and noise sources not specified in the test is assumed to be constant over subcarriers and time and shall be modelled as AWGN of appropriate power for <math>N_{oc}</math> to be fulfilled.</p> <p>Note 3: CSI-RS RSRP and <math>I_o</math> levels have been derived from other parameters for information purposes. They are not settable parameters themselves.</p> <p>Note 4: Information about types of UE beam is given in B.2.1.3, and does not limit UE implementation or test system implementation</p>						

The UE shall send L1-SINR report every 640 slots. No later than X ms plus 640 slots from the beginning of time period T2, UE shall send L1-SINR report including the results for both SSB#0+CSI-RS#0 and SSB#1+CSI-RS#1 while meeting the accuracy requirements defined in clause 10.1.28.2, where X is

- 2880 for UE supporting power class 1
- 1920 for UE supporting power class 2, 3 or 4.

Each L1-SINR measurement report shall meet the corresponding absolute accuracy requirements in Table 5.6.6.2.5-3 for all test configurations and the corresponding relative accuracy requirements in Table 5.6.6.2.5-4 for all test configurations.

**Table 5.6.6.2.5-3: L1-SINR absolute accuracy requirements for the reported values for all test configurations**

Normal Conditions	T1	T2
Lowest reported value (SSB#1)	-	54
Highest reported value (SSB#1)	-	71

**Table 5.6.6.2.5-4: L1-SINR relative accuracy requirements for the reported values for test configurations**

	T1	T2
Lowest DIFF SINR reported (SSB#0)	-	4
Highest DIFF SINR reported (SSB#0)	-	10

For the test to pass, the ratio of successful reported valued for each requirement (R1 to R4) shall be at least 90% with a confidence level of 95%. Each requirement is evaluated independently the others. NOTE:

The actual overall delays measured in the test may be up to  $2 \times TTI_{DCCH}$  higher than the measurement reporting delays above because of TTI insertion uncertainty of the measurement report in DCCH.

### 5.6.6.3 EN-DC FR2 CSI-RS based CMR and dedicated IMR L1-SINR measurement in non-DRX

**Editor's Note:** This test case has been completed for the following configurations:

- Test frequency  $f \leq 40.8$  GHz
- UE PC3
- Normal conditions
- The test is incomplete for UE power classes other than PC3
- The test is incomplete for test frequencies  $> 40.8$  GHz
- The test case is incomplete for extreme conditions

#### 5.6.6.3.1 Test purpose

To verify that the UE makes correct reporting of L1-SINR measurement within L1-SINR measurement requirements in TS 38.133 [6] clause 9.8.4.3.

#### 5.6.6.3.2 Test applicability

This test applies to all types of E-UTRA UE release 16 and forward, supporting EN-DC FR2 and L1-SINR measurement.

#### 5.6.6.3.3 Minimum conformance requirements

The minimum conformance requirements are specified in clause 5.6.6.0.3.

The normative reference for this requirement is TS 38.133 [6] clause A.5.6.6.3.

## 5.6.6.3.4 Test description

## 5.6.6.3.4.1 Initial conditions

This test shall be tested using any of the test configurations in Table 5.6.6.3.4.1-1. Configure the test equipment and the DUT according to the parameters in Table 5.6.6.3.4.1-2. Test environment parameters are given in Table 5.6.6.3.4.1-3.

**Table 5.6.6.3.4.1-1: Applicable NR configurations for EN-DC FR2 CSI-RS based CMR and CSI-IM based IMR L1-SINR measurement**

Config	Description
1	LTE FDD, NR 120 kHz SSB SCS, 100 MHz bandwidth, TDD duplex mode
2	LTE TDD, NR 120 kHz SSB SCS, 100 MHz bandwidth, TDD duplex mode
Note: The UE is only required to be tested in one of the supported test configurations	

**Table 5.6.6.3.4.1-2: General test parameters for FR2 L1-SINR test with CMR and dedicated IMR**

Parameter	Config	Unit	Value
SSB GSCN	1~2		freq1
Duplex mode	1~2		TDD
TDD Configuration	1~2		TDDConf.3.1
BW <sub>channel</sub>	1~2	MHz	100: N <sub>RB,c</sub> = 66
PDSCH Reference measurement channel	1~2		SR.3.1 TDD
RMSI CORESET Reference Channel	1~2		CR.3.1 TDD
Dedicated CORESET Reference Channel	1~2		CCR.3.1 TDD
SSB configuration	1~2		SSB.1 FR2
CSI-RS configuration	1~2		CSI-RS.3.3 TDD
CSI-IM configuration	1~2		CSI-IM.3.2 TDD
OCNG Patterns	1~2		OP.1
Initial BWP Configuration	1~2		DLBWP.0.1 ULBWP.0.1
Dedicated BWP configuration	1~2		DLBWP.1.3 ULBWP.1.3
SMTc configuration	1~2		SMTc.1
TRS Configuration	1~2		TRS.2.1 TDD
PDCCH/PDSCH TCI Configuration	1~2		TCI.State.2
DRX configuration	1~2		Off
reportConfigType	1~2		aperiodic
reportQuantity-r16	1~2		cri-SINR-r16
Number of reported RS	1~2		2
qcl-Info	1~2		SSB#0 for resource#0 SSB#1 for resource#1

reportSlotOffsetList	1~2		26
T1	1~2	s	5
EPRE ratio of PSS to SSS	1~2	dB	0
EPRE ratio of PBCH DMRS to SSS			
EPRE ratio of PBCH to PBCH DMRS			
EPRE ratio of PDCCH DMRS to SSS			
EPRE ratio of PDCCH to PDCCH DMRS			
EPRE ratio of PDSCH DMRS to SSS			
EPRE ratio of PDSCH to PDSCH DMRS			
EPRE ratio of OCNG DMRS to SSS <sup>Note 1</sup>			
EPRE ratio of OCNG to OCNG DMRS <sup>Note 1</sup>			
Propagation condition	1~2		AWGN
Note 1: OCNG shall be used such that both cells are fully allocated and a constant total transmitted power spectral density is achieved for all OFDM symbols.			

**Table 5.6.6.3.4.1-3: Test Environment parameters for FR2 L1-SINR test with CMR and dedicated IMR**

Parameter	Value		Comment
Test environment	NC		As specified in TS 38.508-1 [14] clause 4.1.
Test frequencies	As specified in Annex E, Table E.2-1 and TS 38.508-1 [14] clause 4.3.1 for E-UTRA, 7.2.3 for NR FR2.		
Channel bandwidth	As specified by the test configuration selected from Table 5.6.6.3.4.1-1.		
Propagation conditions	AWGN		As specified in clause C.2.2.
Connection Diagram	TE Part	A.3.3.3.1-1	As specified in TS 38.508-1 [14] Annex A.
	DUT Part	A.3.4.1.1	
Exceptions to connection diagram	N/A		

1. Message contents are defined in clause 5.6.6.3.4.3.
2. The AoA setup for this test is Setup 1 as defined in clause A.9. The UE RX Beam Peak direction has been obtained previously using one of the search procedures as described in Annex I.

**5.6.6.3.4.2 Test procedure**

The test consists of a single time period T1, during which the UE is triggered via DCI to report L1-SINR on aperiodic CSI-RS resources. Prior to the start of the time duration T1, the UE shall be fully synchronized to PSCell. UE is also configured to measure L1-SINR based on SSB. Upon receiving the DCI trigger, UE provides the report back based on the reporting configuration as defined in Table 5.6.6.3.4.1-2.

1. Ensure the UE is in state RRC\_CONNECTED with generic procedure parameters Connectivity EN-DC, DC bearer MCG and SCG, Connected without release *On* and Test Mode *On*, according to TS 38.508-1 [14] clause 4.5.
2. Set the parameters according to T1 in Table 5.6.6.3.5-1. T1 starts.
3. After 480ms from the start of the test the SS transmits the DCI trigger in slot 8.
4. The SS shall check following requirements:
  - R1: the UE shall send L1-SINR report at slot 26 from the reception of DCI trigger. If the report is received at slot 26 from the reception of DCI trigger, the number of passed iterations for R1 is increased by one. Otherwise, the number of failed iterations for R1 is increased by one.

- R2: the L1-SINR value of CSI-RS#1 reported by the UE is compared to the expected L1-SINR value for CSI-RS#1. If the resulting value is outside the limits in Table 5.6.6.3.5-2 or the UE fails to report the measurement value for CSI-RS #1, the number of failed iterations for R2 is increased by one. Otherwise, the number of passed iterations for R2 is increased by one.
  - R3: The DIFF SINR value of CSI-RS#0 reported by the UE is compared to the expected DIFF SINR value. If the resulting value is outside the limits in Table 5.6.6.3.5-3 or the UE fails to report the measurement value for CSI-RS 0, the number of failed iterations for R3 is increased by one. Otherwise, the number of passed iterations for R3 is increased by one.
5. The SS shall transmit *RRCConnectionReconfiguration* message with condition EN-DC\_PSCell\_Rel according to TS 36.508 [25] Table 4.6.1-8 to release NR cell (PSCell). The UE shall transmit *RRCConnectionReconfigurationComplete* message.
  6. The SS then shall transmit *RRCConnectionReconfiguration* message with condition MCG\_and\_SCG according to TS 36.508 [25] Table 4.6.1-8 to add NR cell (PSCell). The UE shall transmit *RRCConnectionReconfigurationComplete* message.
  7. If any the reconfiguration fails, switch off and on the UE and ensure the UE is in RRC\_CONNECTED with generic procedure parameters Connectivity EN-DC, DC bearer MCG and SCG, Connected without release On and Test Mode On according to TS 38.508-1 [14] clause 4.5.
  8. Repeat steps 2-7 until the confidence level according to Tables G.2.3-1 in Annex G clause G.2 is achieved.

5.6.6.3.4.3 Message contents

Message contents are according to TS 38.508-1 [14] clause 7.3 with the following exceptions:

**Table 5.6.6.3.4.3-1: Common Exception messages for EN-DC FR2 CSI-RS based CMR and CSI-IM based IMR L1-SINR measurement**

Default Message Contents	
Common contents of system information blocks exceptions	
Default RRC messages and information elements contents exceptions	Table H.3.6A-1 with conditions APERIODIC and CSI-SINR and CSI-IM_IMR Table H.3.6A-2 with conditions CSI-RS and APERIODIC Table H.3.6A-4 with conditions APERIODIC Table H.3.4-1

**Table 5.6.6.3.4.3-2: RadioLinkMonitoringConfig**

Derivation Path: TS 38.508-1 [14], Table 4.6.3-133			
Information Element	Value/remark	Comment	Condition
RadioLinkMonitoringConfig ::= SEQUENCE {			
failureDetectionResourcesToAddModList	1 entry		
SEQUENCE (SIZE(1..maxNrofFailureDetectionResources)) OF			
SEQUENCE {			
purpose	both	UE is configured to perform RLM and BFD based on the SSBs.	
}			
}			

5.6.6.3.5 Test requirement

Table 5.6.6.3.5-1 defines the primary level settings including test tolerances for all tests.

**Table 5.6.6.3.5-1: CSI-RS specific test parameters for EN-DC FR2 CSI-RS based CMR and CSI-IM based IMR L1-SINR measurement**

Parameter	Config	Unit	CSI-RS#0	CSI-RS#1
Angle of arrival configuration	1~2		Setup 1 according to A.9	
Assumption for UE beams <sup>Note 3</sup>	1~2		Rough	
$N_{oc}$ <sup>Note1</sup>	1~2	dBm/15kHz	-105	
$N_{oc}$ <sup>Note1</sup>	1~2	dBm/SSB SCS	-95.97	
$\hat{E}_s / I_{ot}$	1~2	dB	0	9
CSI-RS RSRP <sup>Note2</sup>	1~2	dBm/SSB SCS	-95.97	-86.97
$I_o$ <sup>Note2</sup>	1~2	dBm/95.04MHz	-63.97	-57.47
$\hat{E}_s / N_{oc}$	1~2	dB	0	9
<p>Note 1: Interference from other cells and noise sources not specified in the test is assumed to be constant over subcarriers and time and shall be modelled as AWGN of appropriate power for <math>N_{oc}</math> to be fulfilled.</p> <p>Note 2: CSI-RS RSRP and <math>I_o</math> levels have been derived from other parameters for information purposes. They are not settable parameters themselves.</p> <p>Note 3: Information about types of UE beam is given in B.2.1.3, and does not limit UE implementation or test system implementation</p>				

After 480ms from the beginning of the test, the UE shall send L1-SINR report at slot 26 from the reception of DCI triggering the L1-SINR measurement. The L1-SINR report shall include the results for both CSI-RS#0 as CMR + CSI-IM#0 as IMR and CSI-RS#1 as CMR + CSI-IM#1 as IMR. Each L1-SINR measurement report shall meet the corresponding absolute accuracy requirements in Table 5.6.6.3.5-2 and the corresponding relative accuracy requirements in Table 5.6.6.3.5-3. The reported L1-SINR value shall consider the Rx antenna gain in the range of [-10 ~ +20] dB when calculated.

**Table 5.6.6.3.5-2: L1-SINR absolute accuracy requirements for the reported values**

Normal Conditions	T1
Lowest reported value (CSI-RS#1)	53
Highest reported value (CSI-RS #1)	72

**Table 5.6.6.3.5-3: L1-SINR relative accuracy requirements for the reported values**

Normal Conditions	T1
Lowest DIFF SINR reported (CSI-RS #0)	5
Highest DIFF SINR reported (CSI-RS #0)	12

The rate of correct events observed during repeated tests shall be at least 90% with a confidence level of 95%.

NOTE: The actual overall delays measured in the test may be up to  $2 \times TTI_{DCC}$  higher than the measurement reporting delays above because of TTI insertion uncertainty of the measurement report in DCC.

## 5.7 Measurement performance requirements

### 5.7.1 SS-RSRP

#### 5.7.1.0 Minimum conformance requirements

##### 5.7.1.0.1 Intra-frequency SS-RSRP measurement accuracy requirements

###### 5.7.1.0.1.1 Absolute SS-RSRP Accuracy

Unless otherwise specified, the requirements for absolute accuracy of SS-RSRP in this clause apply to a cell on the same frequency as that of the serving cell in FR2.

The accuracy requirements in Table 5.7.1.0.1.1-1 are valid under the following conditions:

- Conditions defined in clause 7.3 of TS 38.101-2 [3] for reference sensitivity are fulfilled.
- Conditions for intra-frequency measurements are fulfilled according to Annex B.2.2 for a corresponding Band for each relevant SSB.
- The measured signals are in the directions covered by the percentile EIS spherical coverage of the UE, defined in clause 7.3.4 of TS 38.101-2 [3].

**Table 5.7.1.0.1.1-1: SS-RSRP Intra frequency absolute accuracy in FR2**

Accuracy		Conditions			
Normal condition	Extreme condition	SSB $\hat{E}_s/\text{lot}$	$I_o$ <sup>Note 2</sup> range		
			Minimum $I_o$		Maximum $I_o$
dB	dB	dB	dBm / $SCS_{SSB}$ <sup>Note 1</sup>		dBm/ $BW_{Channel}$
			$SCS_{SSB} = 120\text{kHz}$	$SCS_{SSB} = 240\text{kHz}$	
$\pm 6$	$\pm 9$	$\geq -6$	Same value as $SSB\_RP$ in Table B.2.2-2, according to UE Power class, operating band and angle of arrival		N/A
$\pm 8$	$\pm 11$		N/A		-70
					-50

NOTE 1: Values based on Refsens and EIS spherical coverage as defined in clauses 7.3.2 and 7.3.4 of TS 38.101-2 [3]. Applicable side condition selected depending on angle of arrival.  
 NOTE 2:  $I_o$  specified at the Reference point, and assumed to have constant EPRE across the bandwidth.  
 NOTE 3: In the test cases, the SSB  $\hat{E}_s/\text{lot}$  and related parameters may need to be adjusted to ensure  $\hat{E}_s/\text{lot}$  at UE baseband is above the value defined in this table.

The reporting range for SS-RSRP is defined from -156dBm to -31dBm with 1dB resolution. The mapping of the measured quantity to the reported value is defined by Table 4.7.1.0.1-2.

###### 5.7.1.0.1.2 Relative SS-RSRP Accuracy

The relative accuracy of SS-RSRP is defined as the SS-RSRP measured from one cell compared to the SS-RSRP measured from another cell on the same frequency, or between any two SS-RSRP levels measured on the same cell in FR2.

- Conditions defined in clause 7.3 of TS 38.101-2 [3] for reference sensitivity are fulfilled.
- Conditions for intra-frequency measurements are fulfilled according to Annex B.2.2 for a corresponding Band for each relevant SSB.
- The measured signals are in the directions covered by the percentile EIS spherical coverage of the UE, defined in clause 7.3.4 of TS 38.101-2 [3].



**Table 5.7.1.0.1.2-1: SS-RSRP Intra frequency relative accuracy in FR2**

Accuracy		Conditions		
Normal condition	Extreme condition	SSB $\hat{E}s/lot$	$I_o$ <sup>Note 2</sup> range	
			Minimum $I_o$	Maximum $I_o$
dB	dB	dB	dBm / $SCS_{SSB}$ <sup>Note 1</sup>	
			$SCS_{SSB} = 120kHz$	$SCS_{SSB} = 240kHz$
				dBm/ $BW_{Channel}$
$\pm 6$	$\pm 9$	$\geq -6$	Same value as SSB_RP in Table B.2.2-2, according to UE Power class, operating band and angle of arrival	
NOTE 1: Values based on Refsens and EIS spherical coverage as defined in clauses 7.3.2 and 7.3.4 of TS 38.101-2 [3]. Applicable side condition selected depending on angle of arrival.				
NOTE 2: $I_o$ specified at the Reference point, and assumed to have constant EPRE across the bandwidth.				
NOTE 3: In the test cases, the SSB $\hat{E}s/lot$ and related parameters may need to be adjusted to ensure $\hat{E}s/lot$ at UE baseband is above the value defined in this table.				
NOTE 4: The parameter SSB $\hat{E}s/lot$ is the minimum SSB $\hat{E}s/lot$ of the pair of cells to which the requirement applies.				

The reporting range for SS-RSRP is defined from -156dBm to -31dBm with 1dB resolution. The mapping of the measured quantity to the reported value is defined by Table 4.7.1.0.1-2.

The normative reference for this requirement is TS 38.133 [6] clauses 10.1.3.1 and 10.1.6.

## 5.7.1.0.2 Inter-frequency SS-RSRP measurement accuracy requirements

### 5.7.1.0.2.1 Absolute SS-RSRP Accuracy

Unless otherwise specified, the requirements for absolute accuracy of SS-RSRP in this clause apply to a cell on a frequency in FR2 that is on a different frequency than the serving cell.

The accuracy requirements in Table 5.7.1.0.2.1-1 are valid under the following conditions:

- Conditions defined in clause 7.3 of TS 38.101-2 [3] for reference sensitivity are fulfilled.
- Conditions for inter-frequency measurements are fulfilled according to Annex B.2.3 for a corresponding Band for each relevant SSB.
- The measured signals are in the directions covered by the percentile EIS spherical coverage of the UE, defined in clause 7.3.4 of TS 38.101-2 [2].

**Table 5.7.1.0.2.1-1: SS-RSRP Inter frequency absolute accuracy in FR2**

Accuracy		Conditions			
Normal condition	Extreme condition	SSB $\hat{E}_s/\text{lot}$	$I_o$ <sup>Note 2</sup> range		
			Minimum $I_o$		Maximum $I_o$
dB	dB	dB	dBm / $SCS_{SSB}$ <sup>Note 1</sup>		dBm/ $BW_{Channel}$
			$SCS_{SSB} = 120\text{kHz}$	$SCS_{SSB} = 240\text{kHz}$	
$\pm 6$	$\pm 9$	$\geq -4$	Same value as $SSB\_RP$ in Table B.2.3-2, according to UE Power class, operating band and angle of arrival		N/A
$\pm 8$	$\pm 11$		N/A		-70
NOTE 1: Values based on Refsens and EIS spherical coverage as defined in clauses 7.3.2 and 7.3.4 of TS 38.101-2 [3]. Applicable side condition selected depending on angle of arrival.					
NOTE 2: $I_o$ specified at the Reference point, and assumed to have constant EPRE across the bandwidth.					
NOTE 3: In the test cases, the SSB $\hat{E}_s/\text{lot}$ and related parameters may need to be adjusted to ensure $\hat{E}_s/\text{lot}$ at UE baseband is above the value defined in this table.					

The reporting range for SS-RSRP is defined from -156dBm to -31dBm with 1dB resolution. The mapping of the measured quantity to the reported value is defined by Table 4.7.1.0.1-2.

The normative reference for this requirement is TS 38.133 [6] clauses 10.1.5.1 and 10.1.6.

**5.7.1.0.2.2 Relative SS-RSRP Accuracy**

The relative accuracy of SS-RSRP is defined as the SS-RSRP measured from one cell on a frequency in FR2 compared to the SS-RSRP measured from another cell on another frequency in FR2.

The accuracy requirements in Table 5.7.1.0.2.2-1 are valid under the following conditions:

- Conditions defined in 38.101-2 [3] Clause 7.3 for reference sensitivity are fulfilled.
- Conditions for inter-frequency measurements are fulfilled according to Annex B.2.3 for a corresponding Band for each relevant SSB.
- $|SSB\_RP1_{dBm} - SSB\_RP2_{dBm}| \leq 27\text{dB}$
- $|Channel\ 1\_I_o - Channel\ 2\_I_o| \leq 20\text{ dB}$
- The measured signals are in the directions covered by the percentile EIS spherical coverage of the UE, defined in clause 7.3.4 of TS 38.101-2 [3].

Table 5.7.1.0.2.2-1: SS-RSRP Inter frequency relative accuracy in FR2

Accuracy		Conditions		
Normal condition	Extreme condition	SSB $\hat{E}_s/\text{lot}$	$l_o$ <sup>Note 2</sup> range	
			Minimum $l_o$	Maximum $l_o$
dB	dB	dB	dBm / $SCS_{SSB}$ <sup>Note 1</sup>	
			$SCS_{SSB} = 120\text{kHz}$	$SCS_{SSB} = 240\text{kHz}$
			dBm/ $BW_{\text{Channel}}$	
$\pm 6$	$\pm 9$	$\geq -4$	Same value as SSB_RP in Table B.2.3-2, according to UE Power class, operating band and angle of arrival	
NOTE 1: Values based on Refsens and EIS spherical coverage as defined in clauses 7.3.2 and 7.3.4 of TS 38.101-2 [3]. Applicable side condition selected depending on angle of arrival.				
NOTE 2: $l_o$ specified at the Reference point, and assumed to have constant EPRE across the bandwidth.				
NOTE 3: In the test cases, the SSB $\hat{E}_s/\text{lot}$ and related parameters may need to be adjusted to ensure $\hat{E}_s/\text{lot}$ at UE baseband is above the value defined in this table.				
NOTE 4: The parameter SSB $\hat{E}_s/\text{lot}$ is the minimum SSB $\hat{E}_s/\text{lot}$ of the pair of cells to which the requirement applies.				

The reporting range for SS-RSRP is defined from -156dBm to -31dBm with 1dB resolution. The mapping of the measured quantity to the reported value is defined by Table 4.7.1.0.1-2.

The normative reference for this requirement is TS 38.133 [6] clauses 10.1.5.1 and 10.1.6.

### 5.7.1.1 EN-DC FR2 SS-RSRP measurement accuracy

**Editor's Note: This test case has been completed for the following configurations:**

- Test frequency  $f \leq 40.8$  GHz
- UE PC3
- Normal conditions
- The test is incomplete for UE power classes other than PC3
- The test is incomplete for test frequencies  $> 40.8$  GHz
- The test is incomplete for extreme conditions

#### 5.7.1.1.1 Test purpose

The purpose of this test is to verify that the intra-frequency SS-RSRP measurement accuracy for NR FR2 is within the specified limits for all bands.

#### 5.7.1.1.2 Test applicability

This test applies to all types of NR UE supporting E-UTRA and EN-DC from Release 15 onwards.

#### 5.7.1.1.3 Minimum conformance requirements

The minimum conformance requirements are specified in clause 5.7.1.0.1.

The normative reference for this requirement is TS 38.133 [6] clause A.5.7.1.1.

#### 5.7.1.1.4 Test description

Three cells are configured in this test: E-UTRA Cell 1 is the E-UTRAN PCell, Cell 2 is the NR FR2 PSCell and Cell 3 is the NR FR2 neighbour cell on the same frequency as the PSCell.

## 5.7.1.1.4.1 Initial conditions

This test shall be tested using any of the test configurations in Table 5.7.1.1.4.1-1.

**Table 5.7.1.1.4.1-1: Supported test configurations**

Configuration	Description
5.7.1.1-1	NR 120 kHz SSB SCS, 100 MHz bandwidth, TDD duplex mode, LTE FDD
5.7.1.1-2	NR 120 kHz SSB SCS, 100 MHz bandwidth, TDD duplex mode, LTE TDD
NOTE: The UE is only required to be tested in one of the supported test configurations	

Configure the test equipment and the DUT according to the parameters in Table 5.7.1.1.4.1-2.

**Table 5.7.1.1.4.1-2: Initial conditions**

Parameter	Value	Comment
Test environment	NC	As specified in TS 36.508 [25] clause 4.1.
Test frequencies	As specified in Annex E, E.1.1, E.1.3.1 and Table E.3-1 and TS 38.508-1 [14] clause 4.3.1 for E-UTRA and 7.2.3 for NR.	
Channel bandwidth	As specified by the selected test configuration.	
Propagation conditions	AWGN	As specified in clause C.2.1
Connection Diagram	TE Part: A.3.3.1.1 DUT Part: A.3.4.1.1	As specified in TS 38.508-1 [14] Annex A.
Exceptions to connection diagram	N/A	

1. Message contents are defined in clause 5.7.1.1.4.3.
2. There are two carriers and three cells specified in the test, where E-UTRA Cell 1 is the E-UTRA PCell on the E-UTRA carrier, Cell 2 is the NR PSCell on the NR FR2 carrier and Cell 3 is the neighbour cell on the same NR FR2 carrier. Cell 3 is the target for the SS-RSRP measurements. E-UTRA Cell 1 is configured according to TS 36.521-3 [26] clause C.1.0 and C.1.1.
3. The UE Rx beam peak direction has been obtained previously using one of the Rx Beam Peak Search procedures as described in Annex I.

## 5.7.1.1.4.2 Test procedure

1. Ensure the UE is in State 3A-RF according to TS 36.508 [25] clause 7.2A.3.
2. Set the parameters according to Table 5.7.1.1.5-1 as appropriate.
3. The SS shall transmit an *RRCCONNECTIONRECONFIGURATION* message on Cell 1.
4. The UE shall transmit an *RRCCONNECTIONRECONFIGURATIONCOMPLETE* message.
5. The UE shall transmit periodically MeasurementReport messages.
6. After 10s wait from Step 3, the SS shall check the SS-RSRP reported values in the periodic MeasurementReport for the following requirements:
  - R1: The SS-RSRP value of Cell 2 reported by the UE is compared to the expected SS-RSRP for Cell 2. If the value is outside the limits in Table 5.7.1.1.5-3 or the UE fails to report the measurement value for Cell 2, the number of failed iterations for R1 is increased by one. Otherwise, the number of passed iterations for R1 is increased by one.
  - R2: The SS-RSRP value of Cell 3 reported by the UE is compared to the expected SS-RSRP for Cell 3. If the value is outside the limits in Table 5.7.1.1.5-3 or the UE fails to report the measurement value for Cell 3, the number of failed iterations for R2 is increased by one. Otherwise, the number of passed iterations for R2 is increased by one.

- R3: The SS-RSRP value of Cell 3 reported by the UE is compared to the reported SS-RSRP of Cell 2. If the resulting value is outside the limits in Table 5.7.1.1.5-4 or the UE fails to report the measurement value for Cell 2 or Cell 3, the number of failed iterations for R3 is increased by one. Otherwise, the number of passed iterations for R3 is increased by one.
7. The SS shall continue checking the MeasurementReport messages transmitted by the UE until the confidence level according to Table G.2.3-1 in Annex G for each of the requirements is achieved. The evaluation of a specific requirement is concluded when the confidence level for that requirement is reached, even if more measurement reports are required for the remaining requirements.
  8. Set the parameters according to Test 2 in Table 5.7.1.1.5-2 as appropriate and repeat steps 5-7. In Step 6, the SS shall check the following requirements:
    - R4: The SS-RSRP value of Cell 2 reported by the UE is compared to the expected SS-RSRP for Cell 2. If the value is outside the limits in Table 5.7.1.1.5-3 or the UE fails to report the measurement value for Cell 2, the number of failed iterations for R4 is increased by one. Otherwise, the number of passed iterations for R4 is increased by one.
    - R5: The SS-RSRP value of Cell 3 reported by the UE is compared to the expected SS-RSRP for Cell 3. If the value is outside the limits in Table 5.7.1.1.5-3 or the UE fails to report the measurement value for Cell 3, the number of failed iterations for R5 is increased by one. Otherwise, the number of passed iterations for R5 is increased by one.
    - R6: The SS-RSRP value of Cell 3 reported by the UE is compared to the reported SS-RSRP of Cell 2. If the resulting value is outside the limits in Table 5.7.1.1.5-4 or the UE fails to report the measurement value for Cell 2 or Cell 3, the number of failed iterations for R6 is increased by one. Otherwise, the number of passed iterations for R6 is increased by one.
    - R7: The SS-RSRP value of Cell 2 reported by the UE during Test 2 is compared to the reported SS-RSRP of Cell 2 during Test 1 for the same iteration. If the resulting value is outside the limits in Table 5.7.1.1.5-5 or the UE fails to report the measurement value for Cell 2, the number of failed iterations for R7 is increased by one. Otherwise, the number of passed iterations for R7 is increased by one.
    - R8: The SS-RSRP value of Cell 3 reported by the UE during Test 2 is compared to the reported SS-RSRP of Cell 3 during Test 1 for the same iteration. If the resulting value is outside the limits in Table 5.7.1.1.5-5 or the UE fails to report the measurement value for Cell 3, the number of failed iterations for R8 is increased by one. Otherwise, the number of passed iterations for R8 is increased by one.
  9. If more measurement reports with Test 1 configuration are needed in order to complete the evaluation R7 or R8, the SS shall set the parameters according to Table 5.7.1.1.5-2 as appropriate and repeat steps 5 to 8, evaluating R7 and / or R8 as appropriate.

5.7.1.1.4.3 Message contents

Message contents are according to TS 38.508-1 [14] clause 7.3 with the following exceptions:

**Table 5.7.1.1.4.3-1: Common Exception messages**

<b>Default Message Contents</b>	
Common contents of system information blocks exceptions	
Default RRC messages and information elements contents exceptions	Table H.3.1-1 Table H.3.1-2 Table H.3.1-3 with Condition Synchronous cells Table H.3.1-5 Table H.3.1-7 Table H.3.4-1 Table H.3.4-1a Table H.3.4-2 Table 7.3.1-3 in TS 38.508-1 [14] with condition SMTC.1

**Table 5.7.1.1.4.3-2: ReportConfigNR-DEFAULT(Periodical)**

Derivation Path: 38.508-1 [14] Table 4.6.3-142 with condition PERIODICAL			
Information Element	Value/remark	Comment	Condition
ReportConfigNR ::= SEQUENCE {			
reportType CHOICE {			
periodical SEQUENCE {			PERIODICAL
reportQuantityCell SEQUENCE {			
rsrq	false		
sinr	false		
}			
maxReportCells	2		
}			
}			
}			

#### 5.7.1.1.5 Test requirement

Table 5.7.1.1.5-1 defines the cell specific settings for all tests. Table 5.7.1.1.5-2 defines the OTA primary level settings including test tolerances for all tests.

The SS-RSRP measurement accuracy shall fulfil the absolute accuracy requirements in clause 5.7.1.0.1.1 and relative accuracy requirements in clause 5.7.1.0.1.2. The following eight requirements are to be verified:

During T1:

R1: Absolute accuracy of Cell 2. The UE is deemed to meet the requirement if the reported SS-RSRP is in the range shown in Table 5.7.1.1.5-3.

R2: Absolute accuracy of Cell 3. The UE is deemed to meet the requirement if the reported SS-RSRP is in the range shown in Table 5.7.1.1.5-3.

R3: Relative accuracy of Cell 3 compared with Cell 2. The UE is deemed to meet the requirement if the difference in reported SS-RSRP meets the requirements in Table 5.7.1.1.5-4.

During T2:

R4: Absolute accuracy of Cell 2. The UE is deemed to meet the requirement if the reported SS-RSRP is in the range shown in table 5.7.1.1.5-3.

R5: Absolute accuracy of Cell 3. The UE is deemed to meet the requirement if the reported SS-RSRP is in the range shown in table 5.7.1.1.5-3.

R6: Relative accuracy of Cell 3 compared with Cell 2. The UE is deemed to meet the requirement if the difference in reported SS-RSRP meets the requirements in Table 5.7.1.1.5-4.

During T1 and T2:

R7: Relative accuracy of Cell 2 during T2 compared with Cell 2 during T1. The UE is deemed to meet the requirement if the difference in reported SS-RSRP meets the requirements in Table 5.7.1.1.5-5.

R8: Relative accuracy of Cell 3 during T2 compared with Cell 3 during T1. The UE is deemed to meet the requirement if the difference in reported SS-RSRP meets the requirements in Table 5.7.1.1.5-5.

**Table 5.7.1.1.5-1: SS-RSRP Intra frequency general test parameters**

Parameter <sup>Note 5</sup>	Unit	T1		T2	
		Cell 2	Cell 3	Cell 2	Cell 3
Physical cell ID		489	0	489	0
SSB ARFCN		freq1		freq1	
Duplex mode		TDD		TDD	
TDD configuration		TDDConf.3.1		TDDConf.3.1	
BW <sub>channel</sub>	MHz	100: N <sub>RB,c</sub> = 66		100: N <sub>RB,c</sub> = 66	
Data RBs allocated		24		24	

Parameter <sup>Note 5</sup>	Unit	T1		T2	
		Cell 2	Cell 3	Cell 2	Cell 3
Downlink initial BWP configuration		DLBWP.0.1	-	DLBWP.0.1	-
Downlink dedicated BWP configuration		DLBWP.1.1	-	DLBWP.1.1	-
Uplink initial BWP configuration		ULBWP.0.1	-	ULBWP.0.1	-
Uplink dedicated BWP configuration		ULBWP.1.1	-	ULBWP.1.1	-
DRX cycle configuration		Not applicable	-	Not applicable	-
TRS configuration		TRS.2.1 TDD	-	TRS.2.1 TDD	-
TCI state		TCI.State.0	-	TCI.State.0	-
PDSCH Reference measurement channel		SR.3.2 TDD	-	SR.3.2 TDD	-
RMSI CORESET Reference Channel		CR.3.1 TDD	-	CR.3.1 TDD	-
Dedicated CORESET Reference Channel		CCR.3.1 TDD	-	CCR.3.1 TDD	-
OCNG Patterns		OP.3	OP.3	OP.3	OP.3
SSB configuration		SSB.3 FR2	SSB.3 FR2	SSB.3 FR2	SSB.3 FR2
SMTC configuration		SMTc.1	SMTc.1	SMTc.1	SMTc.1
Time offset with Cell 2	µs	-	3	-	3
PDSCH/PDCCH subcarrier spacing	kHz	120	120	120	120
EPRE ratio of PSS to SSS	dB	0	0	0	0
EPRE ratio of PBCH_DMRS to SSS					
EPRE ratio of PBCH to PBCH_DMRS					
EPRE ratio of PDCCH_DMRS to SSS					
EPRE ratio of PDCCH to PDCCH_DMRS					
EPRE ratio of PDSCH_DMRS to SSS					
EPRE ratio of PDSCH to PDSCH_DMRS					
EPRE ratio of OCNG DMRS to SSS <sup>Note 1</sup>					
EPRE ratio of OCNG to OCNG DMRS <sup>Note 1</sup>					
Propagation conditions		AWGN	AWGN	AWGN	AWGN
Antenna configuration		1x2	1x2	1x2	1x2
NOTE 1: OCNG shall be used such that both cells are fully allocated and a constant total transmitted power spectral density is achieved for all OFDM symbols.					
NOTE 2: Void					
NOTE 3: Void					
NOTE 4: Void					
NOTE 5: All parameters apply for configuration 1 and 2					
NOTE 6: Void					

**Table 5.7.1.1.5-2: SS-RSRP Intra frequency OTA related test parameters**

Parameter	Unit	T1		T2	
		Cell 2	Cell 3	Cell 2	Cell 3
Angle of arrival configuration		Setup 1			
Assumption for UE beams <sup>Note 8</sup>		Rough			
$N_{oc}$ <sup>Note1</sup>	dBm/15kHz <sup>Note4</sup>	-97.4		N/A	
$N_{oc}$ <sup>Note1</sup>	dBm/SCS <sup>Note4</sup>	-88.37		N/A	

Parameter	Unit	T1		T2	
		Cell 2	Cell 3	Cell 2	Cell 3
$\hat{E}_s / N_{oc}$	dB	6.0	1.4	N/A	N/A
$E_s$	dBm/SCS <sup>No<sub>te4</sub></sup>			(Table B.2.2-2 Rx Beam Peak +9.8dB)	(Table B.2.2-2 Rx Beam Peak +9.8dB)
SSB_RP <sup>Note2</sup>	dBm/SCS	-82.37	-86.97	(Table B.2.2-2 Rx Beam Peak +9.8dB)	(Table B.2.2-2 Rx Beam Peak +9.8dB)
$\hat{E}_s / I_{ot\ BB}$ <sup>Note6</sup>	dB	2.20	-5.59	-1.77	-1.77
$I_o$ <sup>Note2</sup>	dBm/95.04 MHz <sup>Note4</sup>	-55.74		(Table B.2.2-2 Rx Beam Peak +37.40dB)	
<p>NOTE 1: Where used, interference from other cells and noise sources not specified in the test is assumed to be constant over subcarriers and time and shall be modelled as AWGN of appropriate power for <math>N_{oc}</math> to be fulfilled.</p> <p>NOTE 2: SSB_RP, <math>E_s/I_{ot}</math> and <math>I_o</math> levels have been derived from other parameters for information purposes. They are not settable parameters themselves.</p> <p>NOTE 3: Void</p> <p>NOTE 4: Equivalent power received by an antenna with 0 dBi gain at the centre of the quiet zone</p> <p>NOTE 5: Void</p> <p>NOTE 6: Calculation of <math>E_s/I_{ot\ BB}</math> includes the effect of UE internal noise up to the value assumed for the associated Refsens requirement in clause 7.3.2 of TS 38.101-2 [3], and an allowance of 1dB for UE multi-band relaxation factor <math>\Delta MB_P</math> from TS 38.101-2 [3] Table 6.2.1.3-4.</p> <p>NOTE 7: All parameters apply for configurations 1 and 2</p> <p>NOTE 8: Information about types of UE beam is given in B.2.1.3 of TS 38.133 [6], and does not limit UE implementation or test system implementation</p>					

**Table 5.7.1.1.5-3: evaluation limits for the reported values for T1 and T2 absolute accuracy rules R1, R2, R4, R5**

UE power class 3			
Normal Conditions	Test 1 All bands	Test 2	
Lowest reported value (Cell 2)	50	n257, n258, n261	31
		n260	33
		n259	FFS
Highest reported value (Cell 2)	108	n257, n258, n261	88
		n260	90
		n259	FFS
Lowest reported value (Cell 3)	46	n257, n258, n261	31
		n260	33
		n259	FFS
Highest reported value (Cell 3)	103	n257, n258, n261	88
		n260	90
		n259	FFS
Extreme Conditions	Test 1 All bands	Test 2	
Lowest reported value (Cell 2)	47+ FFS	n257, n258, n261	28 + FFS
		n260	30 + FFS
		n259	FFS
Highest reported value (Cell 2)	111+ FFS	n257, n258, n261	91 + FFS
		n260	93 + FFS
		n259	FFS
Lowest reported value (Cell 3)	46+ FFS	n257, n258, n261	28+ FFS
		n260	30+ FFS



UE power class 3			
Normal Conditions	Test 1 All bands	Test 2	
Highest reported value (Cell 3)	106+ FFS	n259	FFS
		n257, n258, n261	91+ FFS
		n260	93+ FFS
		n259	FFS

**Table 5.7.1.1.5-4: evaluation limits for the reported values for T1 and T2 relative accuracy rules R3, R6**

UE power class 3		
Normal Conditions	Test 1 All bands	Test 2 All bands
Lowest reported value (Cell 3)	RSRP_x - 12	RSRP_x - 6
Highest reported value (Cell 3)	RSRP_x + 2	RSRP_x + 6
Extreme Conditions	Test 1 All bands	Test 2 All bands
Lowest reported value (Cell 3)	RSRP_x - 15+ FFS	RSRP_x - 9+ FFS
Highest reported value (Cell 3)	RSRP_x + 5+ FFS	RSRP_x + 9+ FFS
RSRP_x is the reported value of Cell 2		

**Table 5.7.1.1.5-5: evaluation limits for the reported values for T2 with respect to T1 relative accuracy rules R7, R8**

UE power class 3			
Test 2	Bands	Normal Conditions	Extreme Conditions
Lowest reported value (Cell 2)	n257, n258, n261	RSRP_x - 28	RSRP_x - 31+ FFS
	n260	RSRP_x - 26	RSRP_x - 29+ FFS
	n259	FFS	FFS
Highest reported value (Cell 2)	n257, n258, n261	RSRP_x - 12	RSRP_x - 9+ FFS
	n260	RSRP_x - 10	RSRP_x - 7+ FFS
	n259	FFS	FFS
Lowest reported value (Cell 3)	n257, n258, n261	RSRP_y - 24	RSRP_y - 27+ FFS
	n260	RSRP_y - 21	RSRP_y - 24+ FFS
	n259	FFS	FFS
Highest reported value (Cell 3)	n257, n258, n261	RSRP_y - 8	RSRP_y - 5+ FFS
	n260	RSRP_y - 5	RSRP_y - 2+ FFS
	n259	FFS	FFS
RSRP_x is the reported value of Cell 2 during T1 RSRP_y is the reported value of Cell 3 during T1			

For the test to pass, the ratio of successful reported values for each requirement (R1 to R8) shall be more than 90% with a confidence level of 95%. Each requirement is evaluated independently of the others.

**5.7.1.2 EN-DC FR2-FR2 SS-RSRP measurement accuracy**

Editor's Note: This test case has been completed for the following configurations:

- Test frequency  $f \leq 40.8$  GHz
- UE PC3
- Normal conditions
- The test is incomplete for UE power classes other than PC3
- The test is incomplete for test frequencies  $> 40.8$  GHz
- The test is incomplete for extreme conditions

**5.7.1.2.1 Test purpose**

The purpose of this test is to verify that the inter-frequency SS-RSRP measurement accuracy for NR FR2 is within the specified limits for all bands.

#### 5.7.1.2.2 Test applicability

This test applies to all types of NR UE supporting E-UTRA and EN-DC from Release 15 onwards.

#### 5.7.1.2.3 Minimum conformance requirements

The minimum conformance requirements are specified in clause 5.7.1.0.2.

The normative reference for this requirement is TS 38.133 [6] clause A.5.7.1.2.

#### 5.7.1.2.4 Test description

Three cells are configured in this test: E-UTRA Cell 1 is the E-UTRAN PCell, Cell 2 is the NR FR2 PSCell and Cell 3 is the NR FR2 neighbour cell on a different NR FR2 frequency.

##### 5.7.1.2.4.1 Initial conditions

This test shall be tested using any of the test configurations in Table 5.7.1.2.4.1-1.

**Table 5.7.1.2.4.1-1: Supported test configurations**

Configuration	Description
5.7.1.2-1	NR 120 kHz SSB SCS, 100 MHz bandwidth, TDD duplex mode, LTE FDD
5.7.1.2-2	NR 120 kHz SSB SCS, 100 MHz bandwidth, TDD duplex mode, LTE TDD
5.7.1.2-3	NR 240 kHz SSB SCS, 100 MHz bandwidth, TDD duplex mode, LTE FDD
5.7.1.2-4	NR 240 kHz SSB SCS, 100 MHz bandwidth, TDD duplex mode, LTE TDD

NOTE: The UE is only required to be tested in one of the supported test configurations

Configure the test equipment and the DUT according to the parameters in Table 5.7.1.2.4.1-2.

**Table 5.7.1.2.4.1-2: Initial conditions**

Parameter	Value	Comment
Test environment	NC	As specified in TS 36.508 [25] clause 4.1.
Test frequencies	As specified in Annex E, Table E.3-1 and TS 38.508-1 [14] clause 4.3.1 for E-UTRA and 7.2.3 for NR.	
Channel bandwidth	As specified by the selected test configuration.	
Propagation conditions	AWGN	As specified in clause C.2.1
Connection Diagram	TE Part: A.3.3.1.1 DUT Part: A.3.4.1.1	As specified in TS 38.508-1 [14] Annex A.
Exceptions to connection diagram	N/A	

1. The general test parameter settings are set up according to Table 5.7.1.2.4.1-3.
2. Message contents are defined in clause 5.7.1.2.4.3.
3. There are three carriers and three cells specified in the test, where E-UTRA Cell 1 is the E-UTRA PCell on the E-UTRA carrier, Cell 2 is the NR PSCell on one of the NR FR2 carriers and Cell 3 is the neighbour cell on the other NR FR2 carrier. Cell 3 is the target for the SS-RSRP measurements. E-UTRA Cell 1 is configured according to TS 36.521-3 [26] clause C.1.0 and C.1.1.
4. The rx beam peak and directions in which the UE meets the EIS spherical coverage criteria have been found with one of the procedures from Annex I.

##### 5.7.1.2.4.2 Test procedure

1. Configure the positioning system for a valid test point as defined in A.9.4. Ensure the UE is in state RRC\_CONNECTED with generic procedure parameters *Connectivity* EN-DC, DC bearer MCG and SCG, Connected without release *On* and Test Mode *On* according to TS 38.508-1 [14] clause 4.5.
2. Set the parameters according to Table 5.7.1.2.5-1 as appropriate.
3. The SS shall transmit an *RRCCConnectionReconfiguration* message on Cell 1.
4. The UE shall transmit an *RRCCConnectionReconfigurationComplete* message.
5. The UE shall transmit periodically MeasurementReport messages.
6. After 10s wait from Step 3, the SS shall check the SS-RSRP reported values in the periodic MeasurementReport for the following requirements:
  - R1: The SS-RSRP value of Cell 2 reported by the UE is compared to the expected SS-RSRP for Cell 2. If the value is outside the limits in Table 5.7.1.2.5-3 or the UE fails to report the measurement value for Cell 2, the number of failed iterations for R1 is increased by one. Otherwise, the number of passed iterations for R1 is increased by one.
  - R2: The SS-RSRP value of Cell 3 reported by the UE is compared to the expected SS-RSRP for Cell 3. If the value is outside the limits in Table 5.7.1.2.5-3 or the UE fails to report the measurement value for Cell 3, the number of failed iterations for R2 is increased by one. Otherwise, the number of passed iterations for R2 is increased by one.
  - R3: The SS-RSRP value of Cell 3 reported by the UE is compared to the reported SS-RSRP of Cell 2. If the resulting value is outside the limits in Table 5.7.1.2.5-4 or the UE fails to report the measurement value for Cell 2 or Cell 3, the number of failed iterations for R3 is increased by one. Otherwise, the number of passed iterations for R3 is increased by one.
7. The SS shall continue checking the MeasurementReport messages transmitted by the UE until the confidence level according to Table G.2.3-1 in Annex G for each of the requirements is achieved. The evaluation of a specific requirement is concluded when the confidence level for that requirement is reached, even if more measurement reports are required for the remaining requirements.
8. The SS shall select a new test point as defined in A.9.4 and rotate the positioning system for the selected test point.
9. Set the parameters according to Test 2 in Table 5.7.2.1.5-2 as appropriate and repeat steps 5-7. In Step 6, the SS shall check the following requirements:
  - R4: The SS-RSRP value of Cell 2 reported by the UE is compared to the expected SS-RSRP for Cell 2. If the value is outside the limits in Table 5.7.2.1.5-3 or the UE fails to report the measurement value for Cell 2, the number of failed iterations for R4 is increased by one. Otherwise, the number of passed iterations for R4 is increased by one.
  - R5: The SS-RSRP value of Cell 3 reported by the UE is compared to the expected SS-RSRP for Cell 3. If the value is outside the limits in Table 5.7.2.1.5-3 or the UE fails to report the measurement value for Cell 3, the number of failed iterations for R5 is increased by one. Otherwise, the number of passed iterations for R5 is increased by one.
  - R6: The SS-RSRP value of Cell 3 reported by the UE is compared to the reported SS-RSRP of Cell 2. If the resulting value is outside the limits in Table 5.7.2.1.5-4 or the UE fails to report the measurement value for Cell 2 or Cell 3, the number of failed iterations for R6 is increased by one. Otherwise, the number of passed iterations for R6 is increased by one.

5.7.1.2.4.3 Message contents

Message contents are according to TS 38.508-1 [14] clause 7.3 with the following exceptions:

**Table 5.7.1.2.4.3-1: Common Exception messages**

Default Message Contents	
Common contents of system information blocks exceptions	

Default RRC messages and information elements contents exceptions	Table H.3.1-1 Table H.3.1-2 with Condition INTER-FREQ Table H.3.1-3 with Condition INTER-FREQ MO, Synchronous cells Table H.3.1-5 Table H.3.1-7 with Condition INTER-FREQ Table H.3.4-1 Table H.3.4-1a Table H.3.4-2 Table H.3.4-4 with Condition gapUE Table H.3.4-5 with Condition Pattern #0 Table 7.3.1-3 in TS 38.508-1 [14] with condition SMTC.1
---	---

**Table 5.7.1.2.4.3-2: ReportConfigNR-DEFAULT(Periodical)**

Derivation Path: 38.508-1 [14] Table 4.6.3-142 with condition PERIODICAL			
Information Element	Value/remark	Comment	Condition
ReportConfigNR ::= SEQUENCE {			
reportType CHOICE {			
periodical SEQUENCE {			PERIODICAL
reportQuantityCell SEQUENCE {			
rsrq	false		
sinr	false		
}			
maxReportCells	2		
}			
}			
}			

5.7.1.2.5 Test requirement

Table 5.7.1.2.5-1 defines the cell specific settings for all tests. Table 5.7.1.2.5-2 defines the OTA primary level settings including test tolerances for all tests.

The SS-RSRP measurement accuracy shall fulfil the absolute accuracy requirements in clause 5.7.1.0.2.1 and relative accuracy requirements in clause 5.7.1.0.2.2. The following eight requirements are to be verified:

During T1:

R1: Absolute accuracy of Cell 2. The UE is deemed to meet the requirement if the reported SS-RSRP is in the range shown in Table 5.7.1.2.5-3 for test configuration 1 and in Table 5.7.1.2.5-4 for test configuration 2.

R2: Absolute accuracy of Cell 3. The UE is deemed to meet the requirement if the reported SS-RSRP is in the range shown in Table 5.7.1.2.5-3 for test configuration 1 and in Table 5.7.1.2.5-4 for test configuration 2.

R3: Relative accuracy of Cell 3 compared with Cell 2. The UE is deemed to meet the requirement if the difference in reported SS-RSRP meets the requirements in Table 5.7.1.2.5-5.

During T2:

R4: Absolute accuracy of Cell 2. The UE is deemed to meet the requirement if the reported SS-RSRP is in the range shown in table 5.7.1.2.5-3 for test configuration 1 and in Table 5.7.1.2.5-4 for test configuration 2.

R5: Absolute accuracy of Cell 3. The UE is deemed to meet the requirement if the reported SS-RSRP is in the range shown in table 5.7.1.2.5-3 for test configuration 1 and in Table 5.7.1.2.5-4 for test configuration 2.

R6: Relative accuracy of Cell 3 compared with Cell 2. The UE is deemed to meet the requirement if the difference in reported SS-RSRP meets the requirements in Table 5.7.1.2.5-5.

**Table 5.7.1.2.5-1: SS-RSRP Inter frequency general test parameters**

Parameter	Config	Unit	Test 1		Test 2	
			Cell 2	Cell 3	Cell 2	Cell 3
SSB ARFCN	1~4		freq1	freq2	freq1	freq2
BW <sub>channel</sub>	1~4		100:		100:	

			N <sub>RB,c</sub> = 66		N <sub>RB,c</sub> = 66	
Data RBs allocated	1,2		24		24	
	3,4		48		48	
Duplex mode	1~4		TDD		TDD	
TDD configuration	1~4		TDDConf.3.1		TDDConf.3.1	
PDSCH Reference measurement channel	1,2		SR.3.2 TDD	-	SR.3.2 TDD	-
	3,4		SR.3.3 TDD		SR.3.3 TDD	
RMSI CORESET Reference Channel	1,2		CR.3.1 TDD	-	CR.3.1 TDD	-
	3,4		CR.3.2 TDD		CR.3.2 TDD	
Dedicated CORESET Reference Channel	1,2		CCR.3.1 TDD	-	CCR.3.1 TDD	-
	3,4		CCR.3.7 TDD		CCR.3.7 TDD	
SSB configuration	1,2		SSB.3 FR2		SSB.3 FR2	
	3,4		SSB.4 FR2		SSB.4 FR2	
PDSCH/PDCCH subcarrier spacing	1~4	kHz	120		120	
OCNG Patterns	1~4		OP.3		OP.3	
Initial BWP Configuration	1~4		DLBWP.0.1 ULBWP.0.1		DLBWP.0.1 ULBWP.0.1	
Dedicated BWP configuration	1~4		DLBWP.1.3 ULBWP.1.3		DLBWP.1.3 ULBWP.1.3	
TRS Configuration	1~4		TRS.2.1 TDD		TRS.2.1 TDD	
PDCCH/PDSCH TCI Configuration	1~4		TCI.State.2		TCI.State.2	
SMTc configuration	1~4		SMTc.1		SMTc.1	
Time offset between Cell 2 and Cell 3	1~4	μs	3		3	
EPRE ratio of PSS to SSS	1~4	dB	0	0	0	0
EPRE ratio of PBCH DMRS to SSS						
EPRE ratio of PBCH to PBCH DMRS						
EPRE ratio of PDCCH DMRS to SSS						
EPRE ratio of PDCCH to PDCCH DMRS						
EPRE ratio of PDSCH DMRS to SSS						
EPRE ratio of PDSCH to PDSCH DMRS						
EPRE ratio of OCNG DMRS to SSS <sup>Note 1</sup>						
EPRE ratio of OCNG to OCNG DMRS <sup>Note 1</sup>						
Propagation condition			1~4	-	AWGN	AWGN
Antenna configuration	1~4	-	1x2	1x2	1x2	1x2

NOTE 1: OCNG shall be used such that a constant total transmitted power spectral density is achieved for all OFDM symbols.  
NOTE 2: Void

Table 5.7.1.2.5-2: SS-RSRP Inter frequency OTA related test parameters

Parameter	Config	Unit	Test 1		Test 2	
			Cell 2	Cell 3	Cell 2	Cell 3
Angle of arrival configuration	1~4		Setup 4b according to clause A.9.4		Setup 4b according to clause A.9.4	
			AoA1 Spherical coverage	AoA2 Rx Beam Peak	AoA1 Spherical coverage	AoA2 Rx Beam Peak
Assumption for UE beams <sup>Note 7</sup>	1~4		Rough		Rough	
N <sub>oc</sub> <sup>Note1</sup>	1, 2	dBm/15kHz <sup>Note4</sup>	-96.3	-96.3	(Table B.2.3-2 Rx Beam Peak <sup>Note 8</sup> - 4.63dB)	(Table B.2.3-2 Rx Beam Peak <sup>Note 8</sup> - 3.03dB)
	3, 4		-99.3	-99.3		
N <sub>oc</sub> <sup>Note1</sup>	1, 2	dBm/SCS <sup>Note4</sup>	-87.3	-87.3	(Table B.2.3-2 Rx Beam Peak <sup>Note 8</sup> +4.4dB)	(Table B.2.3-2 Rx Beam Peak <sup>Note 8</sup> +6.0dB)

Parameter	Config	Unit	Test 1		Test 2	
			Cell 2	Cell 3	Cell 2	Cell 3
	3, 4		-87.3	-87.3	(Table B.2.3-2 Rx Beam Peak <sup>Note 8</sup> +7.4dB)	(Table B.2.3-2 Rx Beam Peak <sup>Note 8</sup> +9.0dB)
$\hat{E}_s / N_{oc}$	1~4	dB	6.0	6.0	17.0	1.0
SSB_RP <sup>Note2</sup>	1, 2	dBm/SCS	-81.3	-81.3	(Table B.2.3-2 Rx Beam Peak <sup>Note 8</sup> +21.4dB)	(Table B.2.3-2 Rx Beam Peak <sup>Note 8</sup> +7.0dB)
	3, 4		-81.3	-81.3	(Table B.2.3-2 Rx Beam Peak <sup>Note 8</sup> +24.4dB)	(Table B.2.3-2 Rx Beam Peak <sup>Note 8</sup> +10.0dB)
(SSB_RP <sub>Cell 2</sub> – SSB_RP <sub>Cell 3</sub> )	1~4	dB	0		14.40	
$\hat{E}_s / I_{ot\ BB}$ <sup>Note6</sup>	1, 2	dB	5.23	5.93	5.38	-1.46
	3, 4		4.58	5.87		
I <sub>o</sub> <sup>Note2</sup>	1, 2	dBm/95.04 MHz <sup>Note4</sup>	-55.70	-55.70	(Table B.2.3-2 Rx Beam Peak <sup>Note 8</sup> +46.08dB)	(Table B.2.3-2 Rx Beam Peak <sup>Note 8</sup> +35.13dB)
	3, 4		-55.7	-55.7	(Table B.2.3-2 Rx Beam Peak <sup>Note 8</sup> +49.09dB)	(Table B.2.3-2 Rx Beam Peak <sup>Note 8</sup> +38.14dB)
(I <sub>ofreq 1</sub> – I <sub>ofreq 2</sub> )	1~4	dB	0		11.95	
<p>NOTE 1: Where used, interference from other cells and noise sources not specified in the test is assumed to be constant over subcarriers and time and shall be modelled as AWGN of appropriate power for <math>N_{oc}</math> to be fulfilled.</p> <p>NOTE 2: SSB_RP, <math>E_s/I_{ot}</math>, I<sub>o</sub>, (SSB_RP<sub>Cell 3</sub> – SSB_RP<sub>Cell 2</sub>) and (I<sub>ofreq 2</sub> – I<sub>ofreq 1</sub>) levels have been derived from other parameters for information purposes. They are not settable parameters themselves.</p> <p>NOTE 3: Void</p> <p>NOTE 4: Equivalent power received by an antenna with 0 dBi gain at the centre of the quiet zone</p> <p>NOTE 5: Void</p> <p>NOTE 6: Calculation of <math>E_s/I_{ot\ BB}</math> includes the effect of UE internal noise up to the value assumed for the associated Refsens requirement in clause 7.3.2 of TS 38.101-2 [3], and an allowance of 1dB for UE multi-band relaxation factor <math>\Delta MB_P</math> or <math>\Delta MB_S</math> from TS 38.101-2 [3] Table 6.2.1.3-4.</p> <p>NOTE 7: Information about types of UE beam is given in B.2.1.3 of TS 38.133 [6], and does not limit UE implementation or test system implementation</p> <p>NOTE 8: The value in Table B.2.3-2 of TS 38.133 [6] is the Minimum SSB_RP for SCS<sub>SSB</sub> = 120 kHz, selected according to the operating band of Cell 3 and UE power class, without <math>\Delta MB_{P,n}</math> adjustment.</p>						

**Table 5.7.1.2.5-3: evaluation limits for the reported values for T1 and T2 absolute accuracy rules R1, R2, R4, R5 for test configuration 1**

UE power class 3				
Normal Conditions	Test 1		Test 2	
Lowest reported value (Cell 2)	n257, n258, n261	41	n257, n258, n261	33
	n260	39	n260	34
	n259	FFS	n259	FFS
Highest reported value (Cell 2)	All bands: 109		n257, n258, n261	101
			n260	104
			n259	FFS
Lowest reported value (Cell 3)	All bands: 52		n257, n258, n261	32

		n260	34
		n259	FFS
Highest reported value (Cell 3)	All bands: 109	n257, n258, n261	87
		n260	90
		n259	FFS
<b>Extreme Conditions</b>	<b>Test 1</b>	<b>Test 2</b>	
Lowest reported value (Cell 2)	n257, n258, n261	41 + FFS	n257, n258, n261 33 + FFS
	n260	39 + FFS	n260 34 + FFS
	n259	FFS	n259 FFS
Highest reported value (Cell 2)	All bands: 109 + FFS	n257, n258, n261	101 + FFS
		n260	104 + FFS
		n259	FFS
Lowest reported value (Cell 3)	All bands: 52 + FFS	n257, n258, n261	32+ FFS
		n260	34+ FFS
		n259	FFS
Highest reported value (Cell 3)	All bands: 109 + FFS	n257, n258, n261	87+ FFS
		n260	91+ FFS
		n259	FFS

**Table 5.7.1.2.5-4: evaluation limits for the reported values for T1 and T2 absolute accuracy rules R1, R2, R4, R5 for test configuration 2**

<b>UE power class 3</b>				
<b>Normal Conditions</b>	<b>Test 1</b>		<b>Test 2</b>	
Lowest reported value (Cell 2)	n257, n258, n261	41	n257, n258, n261	36
	n260	39	n260	37
	n259	FFS	n259	FFS
Highest reported value (Cell 2)	All bands: 109	n257, n258, n261	104	
		n260	107	
		n259	FFS	
Lowest reported value (Cell 3)	All bands: 52	n257, n258, n261	35	
		n260	37	
		n259	FFS	
Highest reported value (Cell 3)	All bands: 109	n257, n258, n261	90	
		n260	93	
		n259	FFS	
<b>Extreme Conditions</b>	<b>Test 1</b>	<b>Test 2</b>		
Lowest reported value (Cell 2)	n257, n258, n261	41 + FFS	n257, n258, n261	28 + FFS
	n260	39 + FFS	n260	30 + FFS
	n259	FFS	n259	FFS
Highest reported value (Cell 2)	All bands: 109 + FFS	n257, n258, n261	91 + FFS	
		n260	93 + FFS	
		n259	FFS	
Lowest reported value (Cell 3)	All bands: 52 + FFS	n257, n258, n261	28+ FFS	
		n260	30+ FFS	
		n259	FFS	
Highest reported value (Cell 3)	All bands: 109 + FFS	n257, n258, n261	91+ FFS	
		n260	93+ FFS	
		n259	FFS	

**Table 5.7.1.2.5-5: evaluation limits for the reported values for T1 and T2 relative accuracy rules R3, R6**

<b>UE power class 3</b>				
<b>Normal Conditions</b>	<b>Test 1</b>		<b>Test 2 All bands</b>	
Lowest value (RSRP report Cell 3 – RSRP report Cell 2)	All bands: -15		-29	
Highest value (RSRP report Cell 3 – RSRP report Cell 2)	n257, n258, n261	+25	n257, n258, n261	+11
	n260	+27	n260	+13
	n259	FFS	n259	FFS
<b>Extreme Conditions</b>	<b>Test 1</b>		<b>Test 2 All bands</b>	

Lowest value (RSRP report Cell 3 – RSRP report Cell 2)	-15 + FFS		-29+ FFS	
Highest value (RSRP report Cell 3 – RSRP report Cell 2)	n257, n258, n261	+25 + FFS	n257, n258, n261	+11 + FFS
	n260	+27+ FFS	n260	+13 + FFS
	n259	FFS	n259	FFS

For the test to pass, the ratio of successful reported values for each requirement (R1 to R6) shall be more than 90% with a confidence level of 95%. Each requirement is evaluated independently of the others.

### 5.7.1.3 EN-DC FR1-FR2 SS-RSRP measurement accuracy

**Editor's note: This test case is incomplete. The following aspects are either missing or TBD**

- Message contents are not complete.
- TT analysis is missing.
- Test procedure is FFS

#### 5.7.1.3.1 Test purpose

The purpose of this test is to verify that the inter-frequency SS-RSRP measurement accuracy for NR FR2 is within the specified limits for all bands, when the PSCell is on an NR FR1 carrier.

#### 5.7.1.3.2 Test applicability

This test applies to all types of NR UE supporting E-UTRA and EN-DC from Release 15 onwards.

#### 5.7.1.3.3 Minimum conformance requirements

The minimum conformance requirements are specified in clause 5.7.1.0.2.

The normative reference for this requirement is TS 38.133 [6] clause A.5.7.1.3.

#### 5.7.1.3.4 Test description

Three cells are configured in this test: E-UTRA Cell 1 is the E-UTRAN PCell, Cell 2 is the NR FR1 PSCell and Cell 3 is the NR FR2 neighbour cell on a NR FR2 carrier.

##### 5.7.1.3.4.1 Initial conditions

This test shall be tested using any of the test configurations in Table 5.7.1.3.4.1-1.

**Table 5.7.1.3.4.1-1: Supported test configurations**

Configuration	Description
5.7.1.3-1	NR 120 kHz SSB SCS, 100 MHz bandwidth, TDD duplex mode, LTE FDD
5.7.1.3-2	NR 120 kHz SSB SCS, 100 MHz bandwidth, TDD duplex mode, LTE TDD

NOTE: The UE is only required to be tested in one of the supported test configurations

Configure the test equipment and the DUT according to the parameters in Table 5.7.1.3.4.1-2.

**Table 5.7.1.3.4.1-2: Initial conditions**

Parameter	Value	Comment
Test environment	NC	As specified in TS 36.508 [25] clause 4.1.
Test frequencies	As specified in Annex E, Table E.3-1 and TS 38.508-1 [14] clause 4.3.1 for E-UTRA and 7.2.3 for NR.	
Channel bandwidth	As specified by the selected test configuration.	
Propagation conditions	AWGN	As specified in clause C.2.1



Connection Diagram	FFS	As specified in TS 38.508-1 [14] Annex A.
Exceptions to connection diagram	N/A	

1. The general test parameter settings are set up according to Table 5.7.1.3.4.1-3.
2. Message contents are defined in clause 5.7.1.3.4.3.
3. There are three carriers and three cells specified in the test, where E-UTRA Cell 1 is the E-UTRA PCell on the E-UTRA carrier, Cell 2 is the NR PSCell on the NR FR1 carrier and Cell 3 is the neighbour cell on the NR FR2 carrier. Cell 3 is the target for the SS-RSRP measurements. E-UTRA Cell 1 is configured according to TS 36.521-3 [26] clause C.1.0 and C.1.1.

5.7.1.3.4.2 Test procedure

1. Ensure the UE is in State 3A-RF according to TS 36.508 [25] clause 7.2A.3.
2. Set the parameters according to Table 5.7.1.3.5-1 as appropriate.
3. The SS shall transmit an *RRCCONNECTIONRECONFIGURATION* message on Cell 1.
4. The UE shall transmit an *RRCCONNECTIONRECONFIGURATIONCOMPLETE* message.
5. FFS

5.7.1.3.4.3 Message contents

Message contents are according to TS 38.508-1 [14] clause 7.3 with the following exceptions:

**Table 5.7.1.3.4.3-1: Common Exception messages**

Default Message Contents	
Common contents of system information blocks exceptions	TBD
Default RRC messages and information elements contents exceptions	TBD

5.7.1.3.5 Test requirement

FFS

5.7.2 SS-RSRQ

5.7.2.0 Minimum conformance requirements

5.7.2.0.1 Intra-frequency SS-RSRQ measurement accuracy requirements

Unless otherwise specified, the requirements for absolute accuracy of SS-RSRQ in this clause apply to a cell on the same frequency as that of the serving cell in FR2.

The accuracy requirements in Table 5.7.2.0.1-1 are valid under the following conditions:

- Conditions defined in clause 7.3 of TS 38.101-2 [3] for reference sensitivity are fulfilled.
- Conditions for intra-frequency measurements are fulfilled according to Annex B.2.2 for a corresponding Band for each relevant SSB.
- The measured signals are in the directions covered by the percentile EIS spherical coverage of the UE, defined in clause 7.3.4 of TS 38.101-2 [3].

**Table 5.7.2.0.1-1: SS-RSRQ Intra frequency absolute accuracy in FR2**

Accuracy		Conditions		
Normal condition	Extreme condition	SSB $\hat{E}_s/\text{lot}$	$I_o$ <sup>Note 2</sup> range	
			Minimum $I_o$	Maximum $I_o$
dB	dB	dB	dBm / $SCS_{SSB}$ <sup>Note 1</sup>	
			$SCS_{SSB} = 120\text{kHz}$	$SCS_{SSB} = 240\text{kHz}$
$\pm 2.5$	$\pm 4$	$\geq -3$	Same value as SSB_RP in Table B.2.2-2, according to UE Power class, operating band and angle of arrival	
$\pm 3.5$	$\pm 4$	$\geq -6$		
NOTE 1: Values based on Refsens and EIS spherical coverage as defined in clauses 7.3.2 and 7.3.4 of TS 38.101-2 [3]. Applicable side condition selected depending on angle of arrival.				
NOTE 2: $I_o$ specified at the Reference point, and assumed to have constant EPRE across the bandwidth.				
NOTE 3: In the test cases, the SSB $\hat{E}_s/\text{lot}$ and related parameters may need to be adjusted to ensure $\hat{E}_s/\text{lot}$ at UE baseband is above the value defined in this table.				

The reporting range of SS-RSRQ is defined from -43 dB to 20 dB with 0.5 dB resolution. The mapping of measured quantity is defined in Table 4.7.2.0.1-2. The range in the signalling may be larger than the guaranteed accuracy range.

The normative reference for this requirement is TS 38.133 [6] clauses 10.1.8.1 and 10.1.11.

### 5.7.2.0.2 Inter-frequency SS-RSRQ measurement accuracy requirements

#### 5.7.2.0.2.1 Absolute SS-RSRQ Accuracy

The requirements for absolute accuracy of SS-RSRQ in this clause apply to a cell on a frequency in FR2 that has different carrier frequency from the serving cell.

The accuracy requirements in Table 5.7.2.0.2.1-1 are valid under the following conditions:

- Conditions defined in clause 7.3 of TS 38.101-2 [3] for reference sensitivity are fulfilled.
- Conditions for inter-frequency measurements are fulfilled according to Annex B.2.3 for a corresponding Band for each relevant SSB.
- The measured signals are in the directions covered by the percentile EIS spherical coverage of the UE, defined in clause 7.3.4 of TS 38.101-2 [3].

**Table 5.7.2.0.2.1-1: SS-RSRQ Inter frequency absolute accuracy in FR2**

Accuracy		Conditions		
Normal condition	Extreme condition	SSB $\hat{E}_s/\text{lot}$	$I_o$ <sup>Note 2</sup> range	
			Minimum $I_o$	Maximum $I_o$
dB	dB	dB	dBm / $SCS_{SSB}$ <sup>Note 1</sup>	
			$SCS_{SSB} = 120\text{kHz}$	$SCS_{SSB} = 240\text{kHz}$
$\pm 2.5$	$\pm 4$	$\geq -3$	Same value as SSB_RP in Table B.2.2-2, according to UE Power class, operating band and angle of arrival	
$\pm 3.5$	$\pm 4$	$\geq -4$		
NOTE 1: Values based on Refsens and EIS spherical coverage as defined in clauses 7.3.2 and 7.3.4 of TS 38.101-2 [3]. Applicable side condition selected depending on angle of arrival.				
NOTE 2: $I_o$ specified at the Reference point, and assumed to have constant EPRE across the bandwidth.				
NOTE 3: In the test cases, the SSB $\hat{E}_s/\text{lot}$ and related parameters may need to be adjusted to ensure $\hat{E}_s/\text{lot}$ at UE baseband is above the value defined in this table.				

The reporting range of SS-RSRQ is defined from -43 dB to 20 dB with 0.5 dB resolution. The mapping of measured quantity is defined in Table 4.7.2.0.1-2. The range in the signalling may be larger than the guaranteed accuracy range.

The normative reference for this requirement is TS 38.133 [6] clauses 10.1.10.1 and 10.1.11.

#### 5.7.2.0.2.2 Relative SS-RSRQ Accuracy

The relative accuracy of SS-RSRQ in inter frequency case is defined as the RSRQ measured from one cell on a frequency in FR2 compared to the RSRP measured from another cell on a different frequency in FR2.

The accuracy requirements in Table 5.7.2.0.2.2-1 are valid under the following conditions:

- Conditions defined in clause 7.3 of TS 38.101-2 [3] for reference sensitivity are fulfilled.
- Conditions for inter-frequency measurements are fulfilled according to Annex B.2.3 for a corresponding Band for each relevant SSB.
- $|\text{SSB\_RP1}_{\text{dBm}} - \text{SSB\_RP2}_{\text{dBm}}| \leq 27 \text{ dB}$
- $|\text{Channel 1\_Io} - \text{Channel 2\_Io}| \leq 20 \text{ dB}$
- The measured signals are in the directions covered by the percentile EIS spherical coverage of the UE, defined in clause 7.3.4 of TS 38.101-2 [3].

**Table 5.7.2.0.2.2-1: SS-RSRQ Inter frequency relative accuracy in FR2**

Accuracy		Conditions			
Normal condition	Extreme condition	SSB $\hat{E}_s/\text{lot}$	$l_o$ <sup>Note 2</sup> range		
			Minimum $l_o$		Maximum $l_o$
dB	dB	dB	dBm / $\text{SCS}_{\text{SSB}}$ <sup>Note 1</sup>		dBm/BW <sub>Channel</sub>
			$\text{SCS}_{\text{SSB}} = 120\text{kHz}$	$\text{SCS}_{\text{SSB}} = 240\text{kHz}$	
$\pm 3$	$\pm 4$	$\geq -3$	Same value as SSB_RP in Table B.2.2-2, according to UE Power class, operating band and angle of arrival		-50
$\pm 4$	$\pm 4$	$\geq -4$			

NOTE 1: Values based on Refsens and EIS spherical coverage as defined in clauses 7.3.2 and 7.3.4 of TS 38.101-2 [3]. Applicable side condition selected depending on angle of arrival.

NOTE 2:  $l_o$  specified at the Reference point, and assumed to have constant EPRE across the bandwidth.

NOTE 3: The parameter SSB  $\hat{E}_s/\text{lot}$  is the minimum SSB  $\hat{E}_s/\text{lot}$  of the pair of cells to which the requirement applies.

NOTE 4: In the test cases, the SSB  $\hat{E}_s/\text{lot}$  and related parameters may need to be adjusted to ensure  $\hat{E}_s/\text{lot}$  at UE baseband is above the value defined in this table.

The reporting range of SS-RSRQ is defined from -43 dB to 20 dB with 0.5 dB resolution. The mapping of measured quantity is defined in Table 4.7.2.0.1-2. The range in the signalling may be larger than the guaranteed accuracy range.

The normative reference for this requirement is TS 38.133 [6] clauses 10.1.10.1 and 10.1.11.

### 5.7.2.1 EN-DC FR2 SS-RSRQ measurement accuracy

**Editor's Note: This test case has been completed for the following configurations:**

- Test frequency  $f \leq 40.8 \text{ GHz}$
- UE PC3
- Normal conditions
- The test is incomplete for UE power classes other than PC3
- The test is incomplete for test frequencies  $> 40.8 \text{ GHz}$
- The test is incomplete for extreme conditions

#### 5.7.2.1.1 Test purpose

The purpose of this test is to verify that the intra-frequency SS-RSRQ measurement accuracy for NR FR2 is within the specified limits for all bands.

#### 5.7.2.1.2 Test applicability

This test applies to all types of NR UE supporting E-UTRA and EN-DC from Release 15 onwards.

#### 5.7.2.1.3 Minimum conformance requirements

The minimum conformance requirements are specified in clause 5.7.2.0.1.

The normative reference for this requirement is TS 38.133 [6] clause A.5.7.2.1.

#### 5.7.2.1.4 Test description

Three cells are configured in this test: E-UTRA Cell 1 is the E-UTRAN PCell, Cell 2 is the NR FR2 PSCell and Cell 3 is the NR FR2 neighbour cell on the same frequency as the PSCell.

##### 5.7.2.1.4.1 Initial conditions

This test shall be tested using any of the test configurations in Table 5.7.2.1.4.1-1.

**Table 5.7.2.1.4.1-1: Supported test configurations**

Configuration	Description
5.7.2.1-1	NR 120 kHz SSB SCS, 100 MHz bandwidth, TDD duplex mode, LTE FDD
5.7.2.1-2	NR 120 kHz SSB SCS, 100 MHz bandwidth, TDD duplex mode, LTE TDD
NOTE: The UE is only required to be tested in one of the supported test configurations	

Configure the test equipment and the DUT according to the parameters in Table 5.7.2.1.4.1-2.

**Table 5.7.2.1.4.1-2: Initial conditions**

Parameter	Value	Comment
Test environment	NC	As specified in TS 36.508 [25] clause 4.1.
Test frequencies	As specified in Annex E, E.1.1, E.1.3.1 and Table E.3-1 and TS 38.508-1 [14] clause 4.3.1 for E-UTRA and 7.2.3 for NR.	
Channel bandwidth	As specified by the selected test configuration.	
Propagation conditions	AWGN	As specified in clause C.2.1
Connection Diagram	TE Part: A.3.3.1.1 DUT Part: A.3.4.1.1	As specified in TS 38.508-1 [14] Annex A.
Exceptions to connection diagram	N/A	

1. Message contents are defined in clause 5.7.2.1.4.3.
2. There are two carriers and three cells specified in the test, where E-UTRA Cell 1 is the E-UTRA PCell on the E-UTRA carrier, Cell 2 is the NR PSCell on the NR FR2 carrier and Cell 3 is the neighbour cell on the same NR FR2 carrier. Cell 3 is the target for the SS-RSRQ measurements. E-UTRA Cell 1 is configured according to TS 36.521-3 [26] clause C.1.0 and C.1.1.
3. The UE Rx beam peak direction has been obtained previously using one of the Rx Beam Peak Search procedures as described in Annex I.

##### 5.7.2.1.4.2 Test procedure

1. Ensure the UE is in State 3A-RF according to TS 36.508 [25] clause 7.2A.3.
2. Set the parameters according to Table 5.7.2.1.5-1 as appropriate.
3. The SS shall transmit an *RRCCConnectionReconfiguration* message on Cell 1.
4. The UE shall transmit an *RRCCConnectionReconfigurationComplete* message.
5. The UE shall transmit periodically MeasurementReport messages.

6. After 10s wait from Step 3, the SS shall check the SS-RSRQ reported values in the periodic MeasurementReport. The SS-RSRQ value of Cell 3 reported by the UE is compared to the expected SS-RSRQ. If the value is outside the limits in Table 5.7.2.1.5-3 or the UE fails to report the measurement value for Cell 3, the number of failed iterations is increased by one. Otherwise, the number of passed iterations is increased by one.
7. The SS shall continue checking the MeasurementReport messages transmitted by the UE until the confidence level according to Table G.2.3-1 in Annex G is achieved.
8. Set the parameters according to each sub-test in Table 5.7.2.1.5-2 as appropriate and repeat steps 5-7.

5.7.2.1.4.3 Message contents

Message contents are according to TS 38.508-1 [14] clause 7.3 with the following exceptions:

**Table 5.7.2.1.4.3-1: Common Exception messages**

Default Message Contents	
Common contents of system information blocks exceptions	
Default RRC messages and information elements contents exceptions	Table H.3.1-1 Table H.3.1-2 Table H.3.1-3 with Condition Synchronous cells Table H.3.1-5 Table H.3.1-7 Table H.3.4-1 Table H.3.4-1a Table H.3.4-2 Table 7.3.1-3 in TS 38.508-1 [14] with condition SMTC.1

**Table 5.7.2.1.4.3-2: ReportConfigNR-DEFAULT(Periodical)**

Derivation Path: 38.508-1 [14] Table 4.6.3-142 with condition PERIODICAL			
Information Element	Value/remark	Comment	Condition
ReportConfigNR ::= SEQUENCE {			
reportType CHOICE {			
periodical SEQUENCE {			PERIODICAL
reportQuantityCell SEQUENCE {			
rsrp	false		
sinr	false		
}			
maxReportCells	2		
}			
}			
}			

5.7.2.1.5 Test requirement

Table 5.7.2.1.5-1 defines the cell specific settings for all tests. Table 5.7.2.1.5-2 defines the OTA primary level settings including test tolerances for all tests.

Each SS-RSRQ measurement report for each of the tests in Table 5.7.2.1.5-2 shall meet the corresponding absolute accuracy requirements in Table 5.7.2.1.5-3.

**Table 5.7.2.1.5-1: SS-RSRQ Intra frequency test parameters**

Parameter	Unit	Test 1		Test 2	
		Cell 2	Cell 3	Cell 2	Cell 3
SSB ARFCN		Freq1		Freq1	
Duplex mode		TDD		TDD	
TDD configuration		TDDConf.3.1		TDDConf.3.1	
BW <sub>channel</sub>	MHz	100: N <sub>RB,c</sub> = 66		100: N <sub>RB,c</sub> = 66	
BWP configuration	Initial DL BWP	DLBWP.0.1			

Parameter	Unit	Test 1		Test 2	
		Cell 2	Cell 3	Cell 2	Cell 3
SSB ARFCN		Freq1		Freq1	
Dedicated DL BWP Initial UL BWP Dedicated UL BWP		DLBWP.1.1			
		ULBWP.0.1			
		ULBWP.1.1			
TRS configuration		TRS.2.1 TDD		TRS.2.1 TDD	
TCI state		TCI.State. 0		TCI.State. 0	
PDSCH Reference measurement channel		SR.3.1 TDD		SR.3.1 TDD	
RMSI CORESET Reference Channel		CR.3.1 TDD	-	CR.3.1 TDD	-
Control channel RMC		CCR.3.1 TDD	-	CCR.3.1 TDD	-
OCNG Patterns		OP.1	OP.1	OP.1	OP.1
SMTC configuration		SMTC.1			
SSB configuration		SSB.3 FR2	SSB.3 FR2	SSB.3 FR2	SSB.3 FR2
PDSCH/PDCCH subcarrier spacing	kHz	120	120	120	120
SS-RSSI-Measurement		Not Applicable			
EPRE ratio of PSS to SSS	dB	0	0	0	0
EPRE ratio of PBCH_DMRS to SSS					
EPRE ratio of PBCH to PBCH_DMRS					
EPRE ratio of PDCCH_DMRS to SSS					
EPRE ratio of PDCCH to PDCCH_DMRS					
EPRE ratio of PDSCH_DMRS to SSS					
EPRE ratio of PDSCH to PDSCH_DMRS					
EPRE ratio of OCNG DMRS to SSS <sup>Note 1</sup>					
EPRE ratio of OCNG to OCNG DMRS <sup>Note 1</sup>					
Propagation condition		AWGN		AWGN	
Antenna Configuration		1x2		1x2	
NOTE 1: OCNG shall be used such that both cells are fully allocated and a constant total transmitted power spectral density is achieved for all OFDM symbols.					
NOTE 2: Void.					
NOTE 3: Void.					
NOTE 4: Void.					
NOTE 5: Void					

**Table 5.7.2.1.5-2: SS-RSRQ Intra frequency OTA related test parameters**

Parameter	Unit	Test 1		Test 2	
		Cell 2	Cell 3	Cell 2	Cell 3
Angle of arrival configuration		Setup 1		Setup 1	
Assumption for UE beams <sup>Note 9</sup>		Rough			
$N_{oc}$ <sup>Note1</sup>	dBm/15kHz <sup>Note4</sup>	-100.7		-96.7	
$N_{oc}$ <sup>Note1</sup>	dBm/SCS <sup>Note3</sup>	-91.67		-87.67	
SSB_RP <sup>Note2</sup>	dBm/SCS <sup>Note4</sup>	-88.67	-88.67	-90.67	-90.67
SS-RSRQ <sup>Note2</sup>	dB	-14.81	-14.81	-16.84	-16.84
$\hat{E}_s/I_{ot}$	dB	-1.76	-1.76	-4.76	-4.76
$\hat{E}_s/N_{oc}$	dB	3	3	-3	-3
$I_o$ <sup>Note2</sup>	dBm/95.04 MHz <sup>Note4</sup>	-55.7		-55.67	-55.67

NOTE 1: Interference from other cells and noise sources not specified in the test is assumed to be constant over subcarriers and time and shall be modelled as AWGN of appropriate power for  $N_{oc}$  to be fulfilled.

NOTE 2: SS-RSRQ, SSB\_RP, and  $I_o$  levels have been derived from other parameters for information purposes. They are not settable parameters themselves.

NOTE 3: SS-RSRQ and SSB\_RP minimum requirements are specified assuming independent interference and noise at each receiver antenna port.

NOTE 4: Equivalent power received by an antenna with 0dBi gain at the centre of the quiet zone

NOTE 5: As observed with 0dBi gain antenna at the centre of the quiet zone

NOTE 6: Void.

NOTE 7: Void

NOTE 8: Void

NOTE 9: Information about types of UE beam is given in B.2.1.3 of TS 38.133 [6], and does not limit UE implementation or test system implementation

**Table 5.7.2.1.5-3: SS-RSRQ Intra frequency absolute accuracy requirements for the reported values**

UE Power Class 3	Test 1 (All bands)	Test 2	
Normal Conditions			
Lowest reported value (Cell 3)	SS-RSRQ_41	n257, n258, n261	SS-RSRQ_35
		n260	SS-RSRQ_34
		n259	FFS
Highest reported value (Cell 3)	SS-RSRQ_73	All bands	SS-RSRQ_71
Extreme Conditions			
Lowest reported value (Cell 3)	SS-RSRQ_38+ FFS	n257, n258, n261	SS-RSRQ_34+ FFS
		n260	SS-RSRQ_33+ FFS
		n259	FFS
Highest reported value (Cell 3)	SS-RSRQ_76+ FFS	All bands	SS-RSRQ_72+ FFS

For the test to pass, the ratio of successful reported values in each test shall be more than 90% with a confidence level of 95%.

**5.7.2.2 EN-DC FR2-FR2 SS-RSRQ measurement accuracy**

*Editor's Note: This test case has been completed for the following configurations:*

- Test frequency  $f \leq 40.8$  GHz
- UE PC3
- Normal conditions
- The test is incomplete for UE power classes other than PC3
- The test is incomplete for test frequencies  $> 40.8$  GHz
- The test is incomplete for extreme conditions

**5.7.2.2.1 Test purpose**

The purpose of this test is to verify that the inter-frequency SS-RSRQ measurement accuracy for NR FR2 is within the specified limits for all bands.

**5.7.2.2.2 Test applicability**

This test applies to all types of NR UE supporting E-UTRA and EN-DC from Release 15 onwards.

**5.7.2.2.3 Minimum conformance requirements**

The minimum conformance requirements are specified in clause 5.7.2.0.2.

The normative reference for this requirement is TS 38.133 [6] clause A.5.7.2.2.

#### 5.7.2.2.4 Test description

Three cells are configured in this test: E-UTRA Cell 1 is the E-UTRAN PCell, Cell 2 is the NR FR2 PSCell and Cell 3 is the NR FR2 neighbour cell on a different NR FR2 frequency.

##### 5.7.2.2.4.1 Initial conditions

This test shall be tested using any of the test configurations in Table 5.7.2.2.4.1-1.

**Table 5.7.2.2.4.1-1: Supported test configurations**

Configuration	Description
5.7.2.2-1	NR 120 kHz SSB SCS, 100 MHz bandwidth, TDD duplex mode, LTE FDD
5.7.2.2-2	NR 120 kHz SSB SCS, 100 MHz bandwidth, TDD duplex mode, LTE TDD

NOTE: The UE is only required to be tested in one of the supported test configurations

Configure the test equipment and the DUT according to the parameters in Table 5.7.2.2.4.1-2.

**Table 5.7.2.2.4.1-2: Initial conditions**

Parameter	Value	Comment
Test environment	NC	As specified in TS 36.508 [25] clause 4.1.
Test frequencies	As specified in Annex E, Table E.3-1 and TS 38.508-1 [14] clause 4.3.1 for E-UTRA and 7.2.3 for NR.	
Channel bandwidth	As specified by the selected test configuration.	
Propagation conditions	AWGN	As specified in clause C.2.1
Connection Diagram	TE Part: A.3.3.1.1 DUT Part: A.3.4.1.1	As specified in TS 38.508-1 [14] Annex A.
Exceptions to connection diagram	N/A	

1. The general test parameter settings are set up according to Table 5.7.2.2.4.1-3.
2. Message contents are defined in clause 5.7.2.2.4.3.
3. There are three carriers and three cells specified in the test, where E-UTRA Cell 1 is the E-UTRA PCell on the E-UTRA carrier, Cell 2 is the NR PSCell on one of the NR FR2 carriers and Cell 3 is the neighbour cell on the other NR FR2 carrier. Cell 3 is the target for the SS-RSRQ measurements. E-UTRA Cell 1 is configured according to TS 36.521-3 [26] clause C.1.0 and C.1.1.
4. The UE Rx beam peak direction has been obtained previously using one of the Rx Beam Peak Search procedures as described in Annex I.

##### 5.7.2.2.4.2 Test procedure

1. Ensure the UE is in state RRC\_CONNECTED with generic procedure parameters *Connectivity* EN-DC, DC bearer MCG and SCG, Connected without release *On* and Test Mode *On* according to TS 38.508-1 [14] clause 4.5..
2. Set the parameters according to Table 5.7.2.2.5-1 as appropriate.
3. The SS shall transmit an *RRCConnectionReconfiguration* message on Cell 1.
4. The UE shall transmit an *RRCConnectionReconfigurationComplete* message.
5. The UE shall transmit periodically MeasurementReport messages.



6. After 10s wait from Step 3, the SS shall check the SS-RSRQ reported values in the periodic MeasurementReport for the following requirements:
  - R1: The SS-RSRQ value of Cell 2 reported by the UE is compared to the expected SS-RSRQ for Cell 2. If the value is outside the limits in Table 5.7.2.2.5-3 or the UE fails to report the measurement value for Cell 2, the number of failed iterations for R1 is increased by one. Otherwise, the number of passed iterations for R1 is increased by one.
  - R2: The SS-RSRQ value of Cell 3 reported by the UE is compared to the expected SS-RSRQ for Cell 3. If the value is outside the limits in Table 5.7.2.2.5-3 or the UE fails to report the measurement value for Cell 3, the number of failed iterations for R2 is increased by one. Otherwise, the number of passed iterations for R2 is increased by one.
  - R3: The SS-RSRQ value of Cell 3 reported by the UE is compared to the reported SS-RSRQ of Cell 2. If the resulting value is outside the limits in Table 5.7.2.2.5-4 or the UE fails to report the measurement value for Cell 2 or Cell 3, the number of failed iterations for R3 is increased by one. Otherwise, the number of passed iterations for R3 is increased by one.
7. The SS shall continue checking the MeasurementReport messages transmitted by the UE until the confidence level according to Table G.2.3-1 in Annex G is achieved.
8. Set the parameters according to each sub-test in Table 5.7.2.2.5-2 as appropriate and repeat steps 5-7. In Step 6, the SS shall check the following requirements:
  - R4: The SS-RSRQ value of Cell 2 reported by the UE is compared to the expected SS-RSRQ for Cell 2. If the value is outside the limits in Table 5.7.2.2.5-3 or the UE fails to report the measurement value for Cell 2, the number of failed iterations for R4 is increased by one. Otherwise, the number of passed iterations for R4 is increased by one.
  - R5: The SS-RSRQ value of Cell 3 reported by the UE is compared to the expected SS-RSRQ for Cell 3. If the value is outside the limits in Table 5.7.2.2.5-3 or the UE fails to report the measurement value for Cell 3, the number of failed iterations for R5 is increased by one. Otherwise, the number of passed iterations for R5 is increased by one.
  - R6: The SS-RSRQ value of Cell 3 reported by the UE is compared to the reported SS-RSRQ of Cell 2. If the resulting value is outside the limits in Table 5.7.2.2.5-4 or the UE fails to report the measurement value for Cell 2 or Cell 3, the number of failed iterations for R6 is increased by one. Otherwise, the number of passed iterations for R6 is increased by one.

5.7.2.2.4.3 Message contents

Message contents are according to TS 38.508-1 [14] clause 7.3 with the following exceptions:

**Table 5.7.2.2.4.3-1: Common Exception messages**

Default Message Contents	
Common contents of system information blocks exceptions	
Default RRC messages and information elements contents exceptions	Table H.3.1-1 Table H.3.1-2 with Condition INTER-FREQ Table H.3.1-3 with Condition INTER-FREQ MO, Synchronous cells Table H.3.1-5 Table H.3.1-7 with Condition INTER-FREQ Table H.3.4-1 Table H.3.4-1a Table H.3.4-2 Table H.3.4-4 with Condition gapUE Table H.3.4-5 with Condition Pattern #0 Table 7.3.1-3 in TS 38.508-1 [14] with condition SMTC.1

**Table 5.7.2.2.4.3-2: ReportConfigNR-DEFAULT(Periodical)**

Derivation Path: 38.508-1 [14] Table 4.6.3-142 with condition PERIODICAL			
Information Element	Value/remark	Comment	Condition

ReportConfigNR ::= SEQUENCE {			
reportType CHOICE {			
periodical SEQUENCE {			PERIODICAL
reportQuantityCell SEQUENCE {			
rsrp	false		
sinr	false		
}			
maxReportCells	2		
}			
}			
}			

5.7.2.2.5 Test requirement

Table 5.7.2.2.5-1 defines the cell specific settings for all tests. Table 5.7.2.2.5-2 defines the OTA primary level settings including test tolerances for all tests.

The SS-RSRQ measurement accuracy shall fulfil the absolute accuracy requirements in clause 5.7.2.0.2.1 and relative accuracy requirements in clause 5.7.2.0.2.2. The following eight requirements are to be verified:

During T1:

R1: Absolute accuracy of Cell 2. The UE is deemed to meet the requirement if the reported SS-RSRQ is in the range shown in Table 5.7.2.2.5-3.

R2: Absolute accuracy of Cell 3. The UE is deemed to meet the requirement if the reported SS-RSRQ is in the range shown in Table 5.7.2.2.5-3.

R3: Relative accuracy of Cell 3 compared with Cell 2. The UE is deemed to meet the requirement if the difference in reported SS-RSRQ meets the requirements in Table 5.7.2.2.5-4.

During T2:

R4: Absolute accuracy of Cell 2. The UE is deemed to meet the requirement if the reported SS-RSRQ is in the range shown in table 5.7.2.2.5-3.

R5: Absolute accuracy of Cell 3. The UE is deemed to meet the requirement if the reported SS-RSRQ is in the range shown in table 5.7.2.2.5-3.

R6: Relative accuracy of Cell 3 compared with Cell 2. The UE is deemed to meet the requirement if the difference in reported SS-RSRQ meets the requirements in Table 5.7.2.2.5-4.

**Table 5.7.2.2.5-1: SS-RSRQ Inter frequency general test parameters**

Parameter	Unit	Test 1		Test 2	
		Cell 2	Cell 3	Cell 2	Cell 3
SSB ARFCN		Freq1	freq2	freq1	Freq2
Duplex mode		TDD		TDD	
TDD configuration		TDDConf.3.1		TDDConf.3.1	
BW <sub>channel</sub>	MHz	100: N <sub>RB,C</sub> = 66		100: N <sub>RB,C</sub> = 66	
Data RBs allocated		66		66	
Downlink initial BWP configuration		DLBWP. 0.1	-	DLBWP. 0.1	-
Downlink dedicated BWP configuration		DLBWP. 1.1	-	DLBWP. 1.1	-
Uplink initial BWP configuration		ULBWP. 0.1	-	ULBWP. 0.1	-
Uplink dedicated BWP configuration		ULBWP. 1.1	-	ULBWP. 1.1	-
DRX cycle configuration		Not applicab le	-	Not applicab le	-
TRS configuration		TRS.2.1 TDD	-	TRS.2.1 TDD	-

Parameter	Unit	Test 1		Test 2	
		Cell 2	Cell 3	Cell 2	Cell 3
TCI state		TCI.Stat e.0	-	TCI.Stat e.0	-
PDSCH Reference measurement channel		SR.3.1 TDD	-	SR.3.1 TDD	-
RMSI CORESET Reference Channel		CR.3.1 TDD	-	CR.3.1 TDD	-
OCNG Patterns		OP.1	OP.1	OP.1	OP.1
SSB configuration		SSB.3 FR2	SSB.3 FR2	SSB.3 FR2	SSB.3 FR2
SMTC configuration		SMTC.1 FR2	SMTC.1 FR2	SMTC.1 FR2	SMTC.1 FR2
PDSCH/PDCCH subcarrier spacing	kHz	120	120	120	120
EPRE ratio of PSS to SSS	dB	0	0	0	0
EPRE ratio of PBCH_DMRS to SSS					
EPRE ratio of PBCH to PBCH_DMRS					
EPRE ratio of PDCCH_DMRS to SSS					
EPRE ratio of PDCCH to PDCCH_DMRS					
EPRE ratio of PDSCH_DMRS to SSS					
EPRE ratio of PDSCH to PDSCH_DMRS					
EPRE ratio of OCNG DMRS to SSS <sup>Note 1</sup>					
EPRE ratio of OCNG to OCNG DMRS <sup>Note 1</sup>					
Propagation conditions		AWGN	AWGN	AWGN	AWGN
Antenna configuration		1x2	1x2	1x2	1x2
NOTE 1: OCNG shall be used such that both cells are fully allocated and a constant total transmitted power spectral density is achieved for all OFDM symbols.					
NOTE 2: Void					
NOTE 3: Void					
NOTE 4: Void					

**Table 5.7.2.2.5-2: SS-RSRQ Inter frequency OTA related test parameters**

Parameter	Unit	Test 1		Test 2	
		Cell 2	Cell 3	Cell 2	Cell 3
AoA setup		Setup 1		Setup 1	
Assumption for UE beams <sup>Note 8</sup>		Rough		Rough	
$N_{oc}$ <sup>Note1</sup>	$\text{dBm}/15\text{kHz}$ <sup>Note4</sup>	-95.93	-95.93	-95.44	-95.44
$N_{oc}$ <sup>Note1</sup>	$\text{dBm}/\text{SCS}$ <sup>Note3</sup>	-86.9	-86.9	-86.41	-86.41
$\hat{E}_s / N_{oc}$	dB	-1.75	-1.75	-3	-3
SSB_RP <sup>Note2</sup>	$\text{dBm}/\text{SCS}$ <sup>Note4</sup>	-88.65	-88.65	-89.41	-89.41
SS-RSRQ <sup>Note2</sup>	dB	-14.75	-14.75	-15.56	-15.56
$\hat{E}_s / I_{ot}$	dB	-1.75	-1.75	-3	-3
$I_o$ <sup>Note2</sup>	$\text{dBm}/95.04 \text{ MHz}$ <sup>Note4</sup>	-55.7	-55.7	-55.7	-55.7
NOTE 1: Interference from other cells and noise sources not specified in the test is assumed to be constant over subcarriers and time and shall be modelled as AWGN of appropriate power for $N_{oc}$ to be fulfilled.					
NOTE 2: SS-RSRQ, SSB_RP, and $I_o$ levels have been derived from other parameters for information purposes. They are not settable parameters themselves.					
NOTE 3: SS-RSRQ and SS-RSRP minimum requirements are specified assuming independent interference and noise at each receiver antenna port.					
NOTE 4: Equivalent power received by an antenna with 0dBi gain at the centre of the quiet zone					
NOTE 5: As observed with 0dBi gain antenna at the centre of the quiet zone					
NOTE 6: Void					
NOTE 7: Void					
NOTE 8: Information about types of UE beam is given in B.2.1.3 of TS 38.133 [6], and does not limit UE implementation or test system implementation					

**Table 5.7.2.2.5-3: evaluation limits for the reported values for T1 and T2 absolute accuracy rules R1, R2, R4, R5**

UE power class 3		
Normal Conditions	Test 1 All bands	Test 2 All bands
Lowest reported value (Cell 2)	RSRQ_41	RSRQ_37
Highest reported value (Cell 2)	RSRQ_73	RSRQ_74
Lowest reported value (Cell 3)	RSRQ_41	RSRQ_37
Highest reported value (Cell 3)	RSRQ_73	RSRQ_74
Extreme Conditions	Test 1 All bands	Test 2 All bands
Lowest reported value (Cell 2)	RSRQ_41 + FFS	RSRQ_37 + FFS
Highest reported value (Cell 2)	RSRQ_73 + FFS	RSRQ_74 + FFS
Lowest reported value (Cell 3)	RSRQ_41 + FFS	RSRQ_37 + FFS
Highest reported value (Cell 3)	RSRQ_73 + FFS	RSRQ_74 + FFS

**Table 5.7.2.2.5-4: evaluation limits for the reported values for T1 and T2 relative accuracy rules R3, R6**

UE power class 3		
Normal Conditions	Test 1 All bands	Test 2 All bands
Lowest value (RSRQ report Cell 3 – RSRQ report Cell 2)	- 7	- 9
Highest value (RSRQ report Cell 3 – RSRQ report Cell 2)	+ 7	+ 9
Extreme Conditions	Test 1 All bands	Test 2 All bands
Lowest value (RSRQ report Cell 3 – RSRQ report Cell 2)	- 7 + FFS	- 9 + FFS
Highest value (RSRQ report Cell 3 – RSRQ report Cell 2)	+ 7 + FFS	+ 9 + FFS

For the test to pass, the ratio of successful reported values for each requirement (R1 to R6) shall be more than 90% with a confidence level of 95%. Each requirement is evaluated independently of the others.

## 5.7.3 SS-SINR

### 5.7.3.0 Minimum conformance requirements

#### 5.7.3.0.1 Intra-frequency SS-SINR measurement accuracy requirements

Unless otherwise specified, the requirements for absolute accuracy of SS-SINR in this clause apply to a cell on the same frequency as that of the serving cell in FR2.

The accuracy requirements in Table 5.7.3.0.1-1 are valid under the following conditions:

- Conditions defined in clause 7.3 of TS 38.101-2 [3] for reference sensitivity are fulfilled.
- Conditions for intra-frequency measurements are fulfilled according to Annex B.2.2 for a corresponding Band.
- The measured signals are in the directions covered by the percentile EIS spherical coverage of the UE, defined in clause 7.3.4 of TS 38.101-2 [3].

Table 5.7.3.0.1-1: SS-SINR Intra frequency absolute accuracy in FR2

Accuracy		Conditions		
Normal condition	Extreme condition	SSB $\hat{E}_s/\text{lot}$	$l_o$ <sup>Note 2</sup> range	
			Minimum $l_o$	Maximum $l_o$
dB	dB	dB	dBm / $SCS_{SSB}$ <sup>Note 1</sup>	
			$SCS_{SSB} = 120\text{kHz}$	$SCS_{SSB} = 240\text{kHz}$
$\pm 3$	$\pm 4$	$\geq -3$	Same value as SSB_RP in Table B.2.2-2, according to UE Power class, operating band and angle of arrival	
$\pm 3.5$	$\pm 4$	$\geq -6$		
-50				
NOTE 1: Values based on Refsens and EIS spherical coverage as defined in clauses 7.3.2 and 7.3.4 of TS 38.101-2 [3]. Applicable side condition selected depending on angle of arrival.				
NOTE 2: $l_o$ specified at the Reference point, and assumed to have constant EPRE across the bandwidth.				
NOTE 3: In the test cases, the SSB $\hat{E}_s/\text{lot}$ and related parameters may need to be adjusted to ensure $\hat{E}_s/\text{lot}$ at UE baseband is above the value defined in this table.				
NOTE 4: The requirements apply for SSB $\hat{E}_s/\text{lot} \leq 25$ dB.				

The reporting range of SS-SINR and CSI-SINR is defined from -23 dB to 40 dB with 0.5 dB resolution. The mapping of measured quantity is defined in Table 4.7.3.0.1-2. The range in the signalling may be larger than the guaranteed accuracy range.

The normative reference for this requirement is TS 38.133 [6] clauses 10.1.13.1 and 10.1.16.

### 5.7.3.0.2 Inter-frequency SS-SINR measurement accuracy requirements

#### 5.7.3.0.2.1 Absolute SS-SINR Accuracy

The requirements for absolute accuracy of SS-SINR in this clause apply to a cell on a frequency in FR2 that has different carrier frequency from the serving cell.

The accuracy requirements in Table 5.7.3.0.2.1-1 are valid under the following conditions:

- Conditions defined in clause 7.3 of TS 38.101-2 [3] for reference sensitivity are fulfilled.
- Conditions for inter-frequency measurements are fulfilled according to Annex B.2.3 for a corresponding Band.
- The measured signals are in the directions covered by the percentile EIS spherical coverage of the UE, defined in clause 7.3.4 of TS 38.101-2 [3].

Table 5.7.3.0.2.1-1: SS-SINR Inter frequency absolute accuracy in FR2

Accuracy		Conditions		
Normal condition	Extreme condition	SSB $\hat{E}_s/\text{lot}$	$l_o$ <sup>Note 2</sup> range	
			Minimum $l_o$	Maximum $l_o$
dB	dB	dB	dBm / $SCS_{SSB}$ <sup>Note 1</sup>	
			$SCS_{SSB} = 120\text{kHz}$	$SCS_{SSB} = 240\text{kHz}$
$\pm 3$	$\pm 4$	$\geq -3$	Same value as SSB_RP in Table B.2.2-2, according to UE Power class, operating band and angle of arrival	
$\pm 3.5$	$\pm 4$	$\geq -4$		
-50				
NOTE 1: Values based on Refsens and EIS spherical coverage as defined in clauses 7.3.2 and 7.3.4 of TS 38.101-2 [3]. Applicable side condition selected depending on angle of arrival.				
NOTE 2: $l_o$ specified at the Reference point, and assumed to have constant EPRE across the bandwidth.				
NOTE 3: In the test cases, the SSB $\hat{E}_s/\text{lot}$ and related parameters may need to be adjusted to ensure $\hat{E}_s/\text{lot}$ at UE baseband is above the value defined in this table.				
NOTE 4: The requirements apply for SSB $\hat{E}_s/\text{lot} \leq 25$ dB.				

The reporting range of SS-SINR and CSI-SINR is defined from -23 dB to 40 dB with 0.5 dB resolution. The mapping of measured quantity is defined in Table 4.7.3.0.1-2. The range in the signalling may be larger than the guaranteed accuracy range.

The normative reference for this requirement is TS 38.133 [6] clauses 10.1.15.1 and 10.1.16.

5.7.3.0.2.2 Relative SS-SINR Accuracy

The relative accuracy of SS-SINR in inter frequency case is defined as the SS-SINR measured from one cell on a frequency in FR2 compared to the SS-SINR measured from another cell on a different frequency in FR2.

The accuracy requirements in Table 5.7.3.0.2.2-1 are valid under the following conditions:

- Conditions defined in clause 7.3 of TS 38.101-2 [3] for reference sensitivity are fulfilled.
- Conditions for inter-frequency measurements are fulfilled according to Annex B.2.3 for a corresponding Band.
- $|SSB\_RP1_{dBm} - SSB\_RP2_{dBm}| \leq 27$  dB
- $|Channel\ 1\_Io - Channel\ 2\_Io| \leq 20$  dB
- The measured signals are in the directions covered by the percentile EIS spherical coverage of the UE, defined in clause 7.3.4 of TS 38.101-2 [3].

**Table 5.7.3.0.2.2-1: SS-SINR Inter frequency relative accuracy in FR2**

Accuracy		Conditions		
Normal condition	Extreme condition	SSB $\hat{E}s/lot$	$Io$ <sup>Note 2</sup> range	
			Minimum $Io$	Maximum $Io$
dB	dB	dB	dBm / $SCS_{SSB}$ <sup>Note 1</sup>	
			$SCS_{SSB} = 120kHz$	$SCS_{SSB} = 240kHz$
			dBm/BW <sub>Channel</sub>	
$\pm 3.5$	$\pm 4$	$\geq -3$	Same value as SSB_RP in Table B.2.2-2, according to UE Power class, operating band and angle of arrival	
$\pm 4$	$\pm 4$	$\geq -6$		

NOTE 1: Values based on Refsens and EIS spherical coverage as defined in clauses 7.3.2 and 7.3.4 of TS 38.101-2 [3]. Applicable side condition selected depending on angle of arrival.  
 NOTE 2:  $Io$  specified at the Reference point, and assumed to have constant EPRE across the bandwidth.  
 NOTE 3: The parameter SSB  $\hat{E}s/lot$  is the minimum SSB  $\hat{E}s/lot$  of the pair of cells to which the requirement applies.  
 NOTE 4: In the test cases, the SSB  $\hat{E}s/lot$  and related parameters may need to be adjusted to ensure  $\hat{E}s/lot$  at UE baseband is above the value defined in this table.  
 NOTE 5: The requirements apply for SSB  $\hat{E}s/lot \leq 25$  dB.

The reporting range of SS-SINR and CSI-SINR is defined from -23 dB to 40 dB with 0.5 dB resolution. The mapping of measured quantity is defined in Table 4.7.3.0.1-2. The range in the signalling may be larger than the guaranteed accuracy range.

The normative reference for this requirement is TS 38.133 [6] clauses 10.1.15.1 and 10.1.16.

5.7.3.1 EN-DC FR2 SS-SINR measurement accuracy

**Editor's Note: This test case has been completed for the following configurations:**

- Test frequency  $f \leq 40.8$  GHz
- UE PC3
- Normal conditions
- The test is incomplete for UE power classes other than PC3
- The test is incomplete for test frequencies  $> 40.8$  GHz
- The test is incomplete for extreme conditions

5.7.3.1.1 Test purpose

The purpose of this test is to verify that the intra-frequency SS-SINR measurement accuracy for NR FR2 is within the specified limits for all bands.

### 5.7.3.1.2 Test applicability

This test applies to all types of NR UE supporting E-UTRA and EN-DC from Release 15 onwards, which support ss-SINR-Meas.

### 5.7.3.1.3 Minimum conformance requirements

The minimum conformance requirements are specified in clause 5.7.3.0.1.

The normative reference for this requirement is TS 38.133 [6] clause A.5.7.3.1.

### 5.7.3.1.4 Test description

Three cells are configured in this test: E-UTRA Cell 1 is the E-UTRAN PCell, Cell 2 is the NR FR2 PSCell and Cell 3 is the NR FR2 neighbour cell on the same frequency as the PSCell.

#### 5.7.3.1.4.1 Initial conditions

This test shall be tested using any of the test configurations in Table 5.7.3.1.4.1-1.

**Table 5.7.3.1.4.1-1: Supported test configurations**

Configuration	Description
5.7.3.1-1	NR 120 kHz SSB SCS, 100 MHz bandwidth, TDD duplex mode, LTE FDD
5.7.3.1-2	NR 120 kHz SSB SCS, 100 MHz bandwidth, TDD duplex mode, LTE TDD

NOTE: The UE is only required to be tested in one of the supported test configurations

Configure the test equipment and the DUT according to the parameters in Table 5.7.3.1.4.1-2.

**Table 5.7.3.1.4.1-2: Initial conditions**

Parameter	Value	Comment
Test environment	NC	As specified in TS 36.508 [25] clause 4.1.
Test frequencies	As specified in Annex E, E.1.1, E.1.3.1 and Table E.3-1 and TS 38.508-1 [14] clause 4.3.1 for E-UTRA and 7.2.3 for NR.	
Channel bandwidth	As specified by the selected test configuration.	
Propagation conditions	AWGN	As specified in clause C.2.1
Connection Diagram	TE Part: A.3.3.1.1 DUT Part: A.3.4.1.1	As specified in TS 38.508-1 [14] Annex A.
Exceptions to connection diagram	N/A	

1. Message contents are defined in clause 5.7.3.1.4.3.
2. There are two carriers and three cells specified in the test, where E-UTRA Cell 1 is the E-UTRA PCell on the E-UTRA carrier, Cell 2 is the NR PSCell on the NR FR2 carrier and Cell 3 is the neighbour cell on the same NR FR2 carrier. Cell 3 is the target for the SS-SINR measurements. E-UTRA Cell 1 is configured according to TS 36.521-3 [26] clause C.1.0 and C.1.1.
3. The UE Rx beam peak direction has been obtained previously using one of the Rx Beam Peak Search procedures as described in Annex I.

#### 5.7.3.1.4.2 Test procedure

1. Ensure the UE is in State 3A-RF according to TS 36.508 [25] clause 7.2A.3.
2. Set the parameters according to Table 5.7.3.1.5-1 as appropriate.
3. The SS shall transmit an *RRConnectionReconfiguration* message on Cell 1.
4. The UE shall transmit an *RRConnectionReconfigurationComplete* message.

5. The UE shall transmit periodically MeasurementReport messages.
6. After 10s wait from Step 3, the SS shall check the SS-SINR reported values in the periodic MeasurementReport. The SS-SINR value of Cell 3 reported by the UE is compared to the expected SS-SINR. If the value is outside the limits in Table 5.7.3.1.5-2 or the UE fails to report the measurement value for Cell 3, the number of failed iterations is increased by one. Otherwise, the number of passed iterations is increased by one.
7. The SS shall continue checking the MeasurementReport messages transmitted by the UE until the confidence level according to Table G.2.3-1 in Annex G is achieved.
8. Set the parameters according to each sub-test in Table 5.7.3.1.5-1 as appropriate and repeat steps 5-7.

5.7.3.1.4.3 Message contents

Message contents are according to TS 38.508-1 [14] clause 7.3 with the following exceptions:

**Table 5.7.3.1.4.3-1: Common Exception messages**

Default Message Contents	
Common contents of system information blocks exceptions	
Default RRC messages and information elements contents exceptions	Table H.3.1-1 Table H.3.1-2 Table H.3.1-3 with Condition Synchronous cells Table H.3.1-5 Table H.3.1-7 Table H.3.4-1 Table H.3.4-1a Table H.3.4-2 Table 7.3.1-3 in TS 38.508-1 [14] with condition SMTC.1

**Table 5.7.3.1.4.3-2: ReportConfigNR-DEFAULT(Periodical)**

Derivation Path: 38.508-1 [14] Table 4.6.3-142 with condition PERIODICAL			
Information Element	Value/remark	Comment	Condition
ReportConfigNR ::= SEQUENCE {			
reportType CHOICE {			
periodical SEQUENCE {			PERIODICAL
reportQuantityCell SEQUENCE {			
rsrp	false		
rsrq	false		
}			
maxReportCells	2		
}			
}			
}			

5.7.3.1.5 Test requirement

Table 5.7.3.1.5-1 defines the cell specific settings for all tests. Table 5.7.3.1.5-2 defines the OTA primary level settings including test tolerances for all tests.

Each SS-SINR measurement report for each of the tests in Table 5.7.3.1.5-2 shall meet the corresponding absolute accuracy requirements in Table 5.7.3.1.5-3.

**Table 5.7.3.1.5-1: SS-SINR Intra frequency test parameters**

Parameter	Unit	Test 1		Test 2	
		Cell 2	Cell 3	Cell 2	Cell 3
SSB ARFCN		Freq2		Freq2	
Duplex mode		TDD		TDD	
TDD configuration		TDDConf.3.1		TDDConf.3.1	
BW <sub>channel</sub>	MHz	100: N <sub>RB,c</sub> = 66		100: N <sub>RB,c</sub> = 66	



Downlink initial BWP configuration		DLBWP.0.1			
Downlink dedicated BWP configuration		DLBWP.1.1			
Uplink initial BWP configuration		ULBWP.0.1			
Uplink dedicated BWP configuration		ULBWP.1.1			
DRX cycle configuration	ms	Not applicable			
TRS configuration		TRS.2.1 TDD			
TCI state		TCI.State.0			
PDSCH Reference measurement channel		SR.3.1 TDD		SR.3.1 TDD	
RMSI CORESET Reference Channel		CR.3.1 TDD	-	CR.3.1 TDD	-
Dedicated RMSI CORESET Reference Channel		CCR.3.1 TDD	-	CCR.3.1 TDD	-
OCNG Patterns		OP.1	OP.1	OP.1	OP.1
SMTC configuration		SMTC.1			
SSB configuration		SSB.3 FR2	SSB.3 FR2	SSB.3 FR2	SSB.3 FR2
PDSCH/PDCCH subcarrier spacing	kHz	120	120	120	120
SS-RSSI-Measurement		Not Applicable			
EPRE ratio of PSS to SSS	dB	0	0	0	0
EPRE ratio of PBCH_DMRS to SSS					
EPRE ratio of PBCH to PBCH_DMRS					
EPRE ratio of PDCCH_DMRS to SSS					
EPRE ratio of PDCCH to PDCCH_DMRS					
EPRE ratio of PDSCH_DMRS to SSS					
EPRE ratio of PDSCH to PDSCH_DMRS					
EPRE ratio of OCNG DMRS to SSS <sup>Note 1</sup>					
EPRE ratio of OCNG to OCNG DMRS <sup>Note 1</sup>					
Propagation condition		AWGN		AWGN	
Antenna Configuration		1x2		1x2	
NOTE 1: OCNG shall be used such that both cells are fully allocated and a constant total transmitted power spectral density is achieved for all OFDM symbols.					
NOTE 2: Void					
NOTE 3: Void					
NOTE 4: Void					

**Table 5.7.3.1.5-2: SS-SINR Intra frequency OTA related test parameters**

Parameter	Unit	Test 1		Test 2	
		Cell 2	Cell 3	Cell 2	Cell 3
Angle of arrival configuration		Setup 1		Setup 1	
Assumption for UE beams <sup>Note 9</sup>		Rough		Rough	
$N_{oc}$ <sup>Note1</sup>	dBm/15kHz <sup>Note4</sup>	-105		-105	
$N_{oc}$ <sup>Note1</sup>	dBm/SCS <sup>Note3</sup>	-96		-96	
SSB_RP <sup>Note2</sup>	dBm/SCS <sup>Note4</sup>	-91.46	-93.34	-98.8	-98.8
SS-SINR <sup>Note2</sup>	n257, 258, n261	-0.18	-3.32	-4.95	-4.95
	n260	-0.31	-3.42	-5.20	-5.20
	n259	-0.39	-3.48	-5.48	-5.48
$\hat{E}_s / I_{ot}$	n257, 258, n261	-0.18	-3.32	-4.95	-4.95
	n260	-0.31	-3.42	-5.20	-5.20
	n259	-0.39	-3.48	-5.48	-5.48
$\hat{E}_s / N_{oc}$	dB	4.54	2.66	-3	-3
$I_o$ <sup>Note2</sup>	dBm/95.04 MHz <sup>Note4</sup>	-59.43		-63.87	
NOTE 1: Interference from other cells and noise sources not specified in the test is assumed to be constant over subcarriers and time and shall be modelled as AWGN of appropriate power for $N_{oc}$ to be fulfilled.					
NOTE 2: SS-SINR, SSB_RP, and $I_o$ levels have been derived from other parameters for information purposes. They are not settable parameters themselves.					

Parameter	Unit	Test 1		Test 2	
		Cell 2	Cell 3	Cell 2	Cell 3
NOTE 3: SS-SINR and SSB_RP minimum requirements are specified assuming independent interference and noise at each receiver antenna port.					
NOTE 4: Equivalent power received by an antenna with 0dBi gain at the centre of the quiet zone					
NOTE 5: As observed with 0dBi gain antenna at the centre of the quiet zone					
NOTE 6: Void					
NOTE 7: Void					
NOTE 8: Void					
NOTE 9: Information about types of UE beam is given in B.2.1.3 of TS 38.133 [6], and does not limit UE implementation or test system implementation					

**Table 5.7.3.1.5-3: SS-SINR Intra frequency absolute accuracy requirements for the reported values**

UE Power Class 3	Test 1		Test 2	
Normal Conditions				
Lowest reported value (Cell 3)	n257, n258, n261	SS-SINR_22	All bands	SS-SINR_18
	n260	SS-SINR_21		
	n259	FFS		
Highest reported value (Cell 3)	All bands	SS-SINR_58	n257, n258, n261	SS-SINR_55
			n260	SS-SINR_54
			n259	FFS
Extreme Conditions				
Lowest reported value (Cell 3)	n257, n258, n261	SS-SINR_21+ FFS	All bands	SS-SINR_17+ FFS
	n260	SS-SINR_20+ FFS		
	n259	FFS		
Highest reported value (Cell 3)	All bands	SS-SINR_59+ FFS	n257, n258, n261	SS-SINR_56+ FFS
			n260	SS-SINR_55+ FFS
			n259	FFS

For the test to pass, the ratio of successful reported values in each test shall be more than 90% with a confidence level of 95%.

### 5.7.3.2 EN-DC FR2-FR2 SS-SINR measurement accuracy

**Editor's Note:** This test case has been completed for the following configurations:

- Test frequency  $f \leq 40.8$  GHz
- UE PC3
- Normal conditions
- The test is incomplete for UE power classes other than PC3
- The test is incomplete for test frequencies  $> 40.8$  GHz
- The test is incomplete for extreme conditions

#### 5.7.3.2.1 Test purpose

The purpose of this test is to verify that the inter-frequency SS-SINR measurement accuracy for NR FR2 is within the specified limits for all bands

#### 5.7.3.2.2 Test applicability

This test applies to all types of NR UE supporting E-UTRA and EN-DC from Release 15 onwards, which support ss-SINR-Meas.

### 5.7.3.2.3 Minimum conformance requirements

The minimum conformance requirements are specified in clause 5.7.3.0.2.

The normative reference for this requirement is TS 38.133 [6] clause A.5.7.3.2.

### 5.7.3.2.4 Test description

Two cells are configured in this test: E-UTRA Cell 1 is the E-UTRAN PCell and Cell 2 is the inter-RAT NR FR2 neighbour cell.

#### 5.7.3.2.4.1 Initial conditions

Three cells are configured in this test: E-UTRA Cell 1 is the E-UTRAN PCell, Cell 2 is the NR FR2 PSCell and Cell 3 is the NR FR2 neighbour cell on a different NR FR2 frequency.

**Table 5.7.3.2.4.1-1: Supported test configurations**

Configuration	Description
5.7.3.2-1	NR 120 kHz SSB SCS, 100 MHz bandwidth, TDD duplex mode, LTE FDD
5.7.3.2-2	NR 120 kHz SSB SCS, 100 MHz bandwidth, TDD duplex mode, LTE TDD
NOTE: The UE is only required to be tested in one of the supported test configurations	

Configure the test equipment and the DUT according to the parameters in Table 5.7.3.2.4.1-2.

**Table 5.7.3.2.4.1-2: Initial conditions**

Parameter	Value	Comment
Test environment	NC	As specified in TS 36.508 [25] clause 4.1.
Test frequencies	As specified in Annex E, Table E.3-1 and TS 38.508-1 [14] clause 4.3.1 for E-UTRA and 7.2.3 for NR.	
Channel bandwidth	As specified by the selected test configuration.	
Propagation conditions	AWGN	As specified in clause C.2.1
Connection Diagram	TE Part: A.3.3.1.1 DUT Part: A.3.4.1.1	As specified in TS 38.508-1 [14] Annex A.
Exceptions to connection diagram	N/A	

1. The general test parameter settings are set up according to Table 5.7.3.2.4.1-3.
2. Message contents are defined in clause 5.7.3.2.4.3.
3. There are three carriers and three cells specified in the test, where E-UTRA Cell 1 is the E-UTRA PCell on the E-UTRA carrier, Cell 2 is the NR PSCell on one of the NR FR2 carriers and Cell 3 is the neighbour cell on the other NR FR2 carrier. Cell 3 is the target for the SS-SINR measurements. E-UTRA Cell 1 is configured according to TS 36.521-3 [26] clause C.1.0 and C.1.1.
4. The UE Rx beam peak direction has been obtained previously using one of the Rx Beam Peak Search procedures as described in Annex I.

#### 5.7.3.2.4.2 Test procedure

1. Ensure the UE is in state RRC\_CONNECTED with generic procedure parameters *Connectivity* EN-DC, DC bearer MCG and SCG, Connected without release *On* and Test Mode *On* according to TS 38.508-1 [14] clause 4.5
2. Set the parameters according to Table 5.7.3.2.5-1 as appropriate.
3. The SS shall transmit an *RRCCConnectionReconfiguration* message on Cell 1.
4. The UE shall transmit an *RRCCConnectionReconfigurationComplete* message.

5. The UE shall transmit periodically MeasurementReport messages.
6. After 10s wait from Step 3, the SS shall check the SS-SINR reported values in the periodic MeasurementReport for the following requirements:
  - R1: The SS-SINR value of Cell 2 reported by the UE is compared to the expected SS-SINR for Cell 2. If the value is outside the limits in Table 5.7.3.2.5-3 or the UE fails to report the measurement value for Cell 2, the number of failed iterations for R1 is increased by one. Otherwise, the number of passed iterations for R1 is increased by one.
  - R2: The SS-SINR value of Cell 3 reported by the UE is compared to the expected SS-SINR for Cell 3. If the value is outside the limits in Table 5.7.3.2.5-3 or the UE fails to report the measurement value for Cell 3, the number of failed iterations for R2 is increased by one. Otherwise, the number of passed iterations for R2 is increased by one.
  - R3: The SS-SINR value of Cell 3 reported by the UE is compared to the reported SS-SINR of Cell 2. If the resulting value is outside the limits in Table 5.7.3.2.5-4 or the UE fails to report the measurement value for Cell 2 or Cell 3, the number of failed iterations for R3 is increased by one. Otherwise, the number of passed iterations for R3 is increased by one.
7. The SS shall continue checking the MeasurementReport messages transmitted by the UE until the confidence level according to Table G.2.3-1 in Annex G is achieved.
8. Set the parameters according to each sub-test in Table 5.7.3.2.5-2 as appropriate and repeat steps 5-7. In Step 6, the SS shall check the following requirements for Test 2:
  - R4: The SS-SINR value of Cell 2 reported by the UE is compared to the expected SS-SINR for Cell 2. If the value is outside the limits in Table 5.7.3.2.5-3 or the UE fails to report the measurement value for Cell 2, the number of failed iterations for R4 is increased by one. Otherwise, the number of passed iterations for R4 is increased by one.
  - R5: The SS-SINR value of Cell 3 reported by the UE is compared to the expected SS-SINR for Cell 3. If the value is outside the limits in Table 5.7.3.2.5-3 or the UE fails to report the measurement value for Cell 3, the number of failed iterations for R5 is increased by one. Otherwise, the number of passed iterations for R5 is increased by one.
  - R6: The SS-SINR value of Cell 3 reported by the UE is compared to the reported SS-SINR of Cell 2. If the resulting value is outside the limits in Table 5.7.3.2.5-4 or the UE fails to report the measurement value for Cell 2 or Cell 3, the number of failed iterations for R6 is increased by one. Otherwise, the number of passed iterations for R6 is increased by one.

And the following requirements for Test 3:

- R7: The SS-SINR value of Cell 2 reported by the UE is compared to the expected SS-SINR for Cell 2. If the value is outside the limits in Table 5.7.3.2.5-3 or the UE fails to report the measurement value for Cell 2, the number of failed iterations for R7 is increased by one. Otherwise, the number of passed iterations for R7 is increased by one.
- R8: The SS-SINR value of Cell 3 reported by the UE is compared to the expected SS-SINR for Cell 3. If the value is outside the limits in Table 5.7.3.2.5-3 or the UE fails to report the measurement value for Cell 3, the number of failed iterations for R8 is increased by one. Otherwise, the number of passed iterations for R8 is increased by one.
- R9: The SS-SINR value of Cell 3 reported by the UE is compared to the reported SS-SINR of Cell 2. If the resulting value is outside the limits in Table 5.7.3.2.5-4 or the UE fails to report the measurement value for Cell 2 or Cell 3, the number of failed iterations for R9 is increased by one. Otherwise, the number of passed iterations for R9 is increased by one.

#### 5.7.3.2.4.3 Message contents

Message contents are according to TS 38.508-1 [14] clause 7.3 with the following exceptions:

**Table 5.7.3.2.4.3-1: Common Exception messages**

Default Message Contents
--------------------------

Common contents of system information blocks exceptions	
Default RRC messages and information elements contents exceptions	Table H.3.1-1 Table H.3.1-2 with Condition INTER-FREQ Table H.3.1-3 with Condition INTER-FREQ MO, Synchronous cells Table H.3.1-5 Table H.3.1-7 with Condition INTER-FREQ Table H.3.4-1 Table H.3.4-1a Table H.3.4-2 Table H.3.4-4 with Condition gapUE Table H.3.4-5 with Condition Pattern #0 Table 7.3.1-3 in TS 38.508-1 [14] with condition SMTC.1

**Table 5.7.3.1.4.3-2: ReportConfigNR-DEFAULT(Periodical)**

Derivation Path: 38.508-1 [14] Table 4.6.3-142 with condition PERIODICAL			
Information Element	Value/remark	Comment	Condition
ReportConfigNR ::= SEQUENCE {			
reportType CHOICE {			
periodical SEQUENCE {			PERIODICAL
reportQuantityCell SEQUENCE {			
rsrp	false		
rsrq	false		
}			
maxReportCells	2		
}			
}			
}			

5.7.3.2.5 Test requirement

Table 5.7.3.2.5-1 defines the cell specific settings for all tests. Table 5.7.3.2.5-2 defines the OTA primary level settings including test tolerances for all tests.

The SS-SINR measurement accuracy shall fulfil the absolute accuracy requirements in clause 5.7.3.0.2.1 and relative accuracy requirements in clause 5.7.3.0.2.2. The following eight requirements are to be verified:

During Test 1:

R1: Absolute accuracy of Cell 2. The UE is deemed to meet the requirement if the reported SS-SINR is in the range shown in Table 5.7.3.2.5-3.

R2: Absolute accuracy of Cell 3. The UE is deemed to meet the requirement if the reported SS-SINR is in the range shown in Table 5.7.3.2.5-3.

R3: Relative accuracy of Cell 3 compared with Cell 2. The UE is deemed to meet the requirement if the difference in reported SS-SINR meets the requirements in Table 5.7.3.2.5-4.

During Test 2:

R4: Absolute accuracy of Cell 2. The UE is deemed to meet the requirement if the reported SS-SINR is in the range shown in table 5.7.3.2.5-3.

R5: Absolute accuracy of Cell 3. The UE is deemed to meet the requirement if the reported SS-SINR is in the range shown in table 5.7.3.2.5-3.

R6: Relative accuracy of Cell 3 compared with Cell 2. The UE is deemed to meet the requirement if the difference in reported SS-SINR meets the requirements in Table 5.7.3.2.5-4.

During Test 3:

R7: Absolute accuracy of Cell 2. The UE is deemed to meet the requirement if the reported SS-SINR is in the range shown in table 5.7.3.2.5-3.

R8: Absolute accuracy of Cell 3. The UE is deemed to meet the requirement if the reported SS-SINR is in the range shown in table 5.7.3.2.5-3.

R9: Relative accuracy of Cell 3 compared with Cell 2. The UE is deemed to meet the requirement if the difference in reported SS-SINR meets the requirements in Table 5.7.3.2.5-4.

**Table 5.7.3.2.5-1: SS-SINR Inter frequency general test parameters**

Parameter	Unit	Test 1		Test 2		Test 3	
		Cell 2	Cell 3	Cell 2	Cell 3	Cell 2	Cell 3
SSB ARFCN		Freq1	freq2	freq1	freq2	freq1	freq2
Duplex mode		TDD		TDD		TDD	
TDD configuration		TDDConf.3.1		TDDConf.3.1		TDDConf.3.1	
BW <sub>channel</sub>	MHz	100: N <sub>RB,c</sub> = 66		100: N <sub>RB,c</sub> = 66		100: N <sub>RB,c</sub> = 66	
Data RBs allocated		66		66		66	
Downlink initial BWP configuration		DLBWP.0.1					
Downlink dedicated BWP configuration		DLBWP.1.1					
Uplink initial BWP configuration		ULBWP.0.1					
Uplink dedicated BWP configuration		ULBWP.1.1					
DRX cycle configuration	ms	Not applicable					
TRS configuration		TRS.2.1 TDD					
TCI state		TCI.State.0					
PDSCH Reference measurement channel		SR.3.1 TDD	-	SR.3.1 TDD	-	SR.3.1 TDD	-
RMSI CORESET Reference Channel		CR.3.1 TDD	-	CR.3.1 TDD	-	CR.3.1 TDD	-
OCNG Patterns		OP.1	OP.1	OP.1	OP.1	OP.1	OP.1
SMTC configuration		SMTC.1 FR2	SMTC.1 FR2	SMTC.1 FR2	SMTC.1 FR2	SMTC.1 FR2	SMTC.1 FR2
SSB configuration		SSB.3 FR2	SSB.3 FR2	SSB.3 FR2	SSB.3 FR2	SSB.3 FR2	SSB.3 FR2
PDSCH/PDCCH subcarrier spacing	kHz	120	120	120	120	120	120
EPRE ratio of PSS to SSS	dB	0	0	0	0	0	0
EPRE ratio of PBCH_DMRS to SSS							
EPRE ratio of PBCH to PBCH_DMRS							
EPRE ratio of PDCCH_DMRS to SSS							
EPRE ratio of PDCCH to PDCCH_DMRS							
EPRE ratio of PDSCH_DMRS to SSS							
EPRE ratio of PDSCH to PDSCH_DMRS							
EPRE ratio of OCNG DMRS to SSS <sup>Note 1</sup>							
EPRE ratio of OCNG to OCNG DMRS <sup>Note 1</sup>							
Propagation conditions		AWGN	AWGN	AWGN	AWGN	AWGN	AWGN
Antenna Configuration		1x2	1x2	1x2	1x2	1x2	1x2

NOTE 1: OCNG shall be used such that both cells are fully allocated and a constant total transmitted power spectral density is achieved for all OFDM symbols.  
 NOTE 2: Void  
 NOTE 3: Void  
 NOTE 4: Void

**Table 5.7.3.2.5-2: SS-SINR Inter frequency OTA related test parameters**

Parameter	Unit	Test 1		Test 2		Test 3	
		Cell 2	Cell 3	Cell 2	Cell 3	Cell 2	Cell 3
Angle of arrival configuration	degrees	Setup 1		Setup 1		Setup 1	
Assumption for UE beams <sup>Note 10</sup>		Rough		Rough		Rough	
$N_{oc}$ <sup>Note1</sup>	dBm/15kHz <sup>Note4</sup>	-105	-105	-105.1	-105.1	-105	-105
$N_{oc}$ <sup>Note1</sup>	dBm/SCS <sup>Note3</sup>	-96	-96	-96.1	-96.1	-96	-96
$\hat{E}_s / N_{oc}$	dB	-0.5	-0.5	11	11	-2.1	-2.1
SS-RSRP <sup>Note2</sup>	dBm/SCS <sup>Note4</sup>	-96.5	-96.5	-85.1	-85.1	-98.1	-98.1
SS-SINR <sup>Note2</sup>	dB	-0.5	-0.5	11	11	-2.1	-2.1
$\hat{E}_s / I_{ot}$	dB	-0.5	-0.5	11	11	-2.1	-2.1

$I_o$ <sup>Note2</sup>	dBm/95.04 MHz <sup>Note4</sup>	-69.3	-69.3	-55.75	-55.75	-64.9	-64.9
<p>NOTE 1: Interference from other cells and noise sources not specified in the test is assumed to be constant over subcarriers and time and shall be modelled as AWGN of appropriate power for <math>N_{oc}</math> to be fulfilled.</p> <p>NOTE 2: SS-SINR, SSB_RP, and <math>I_o</math> levels have been derived from other parameters for information purposes. They are not settable parameters themselves.</p> <p>NOTE 3: SS-SINR and SS-RSRP minimum requirements are specified assuming independent interference and noise at each receiver antenna port.</p> <p>NOTE 4: Equivalent power received by an antenna with 0dBi gain at the centre of the quiet zone</p> <p>NOTE 5: As observed with 0dBi gain antenna at the centre of the quiet zone</p> <p>NOTE 6: Void</p> <p>NOTE 7: Void</p> <p>NOTE 8: Void</p> <p>NOTE 9: Void</p> <p>NOTE 10: Information about types of UE beam is given in B.2.1.3 of TS 38.133 [6], and does not limit UE implementation or test system implementation</p>							

**Table 5.7.3.2.5-3: evaluation limits for the reported values for T1 and T2 absolute accuracy rules R1, R2, R4, R5**

UE power class 3						
Normal Conditions	Test 1 All bands		Test 2 All bands		Test 3 All bands	
Lowest reported value (Cell 2)	SINR_27		SINR_48		n257, n258, n261	SINR_23
					n260	SINR_22
					n259	FFS
Highest reported value (Cell 2)	n257, n258, n261	SINR_62	n257, n258, n261	SINR_87	n257, n258, n261	SINR_60
	n260	SINR_61	n260	SINR_86	n260	SINR_59
	n259	FFS	n259	FFS	n259	FFS
Lowest reported value (Cell 3)	SINR_27		SINR_48		n257, n258, n261	SINR_23
					n260	SINR_22
					n259	FFS
Highest reported value (Cell 3)	n257, n258, n261	SINR_62	n257, n258, n261	SINR_87	n257, n258, n261	SINR_60
	n260	SINR_61	n260	SINR_86	n260	SINR_59
	n259	FFS	n259	FFS	n259	FFS
Extreme Conditions	Test 1 All bands		Test 2 All bands		Test 3 All bands	
Lowest reported value (Cell 2)	SINR_27 + FFS		SINR_48 + FFS		n257, n258, n261	SINR_23 + FFS
					n260	SINR_22 + FFS
					n259	FFS
Highest reported value (Cell 2)	n257, n258, n261	SINR_62 + FFS	n257, n258, n261	SINR_87 + FFS	n257, n258, n261	SINR_60 + FFS
	n260	SINR_61 + FFS	n260	SINR_86 + FFS	n260	SINR_59 + FFS
	n259	FFS	n259	FFS	n259	FFS
Lowest reported value (Cell 3)	SINR_27 + FFS		SINR_48 + FFS		n257, n258, n261	SINR_23 + FFS
					n260	SINR_22 + FFS
					n259	FFS
Highest reported value (Cell 3)	n257, n258, n261	SINR_62 + FFS	n257, n258, n261	SINR_87 + FFS	n257, n258, n261	SINR_60 + FFS
	n260	SINR_61 + FFS	n260	SINR_86 + FFS	n260	SINR_59 + FFS
	n259	FFS	n259	FFS	n259	FFS

**Table 5.7.3.2.5-4: evaluation limits for the reported values for T1 and T2 relative accuracy rules R3, R6**

UE power class 3			
Normal Conditions	Test 1 All bands	Test 2 All bands	Test 3 All bands

Lowest value (SINR report Cell 3 – SINR report Cell 2)	- 8	- 17	- 9
Highest value (SINR report Cell 3 – SINR report Cell 2)	+ 8	+ 17	+ 9
<b>Extreme Conditions</b>	<b>Test 1 All bands</b>	<b>Test 2 All bands</b>	<b>Test 3 All bands</b>
Lowest value (SINR report Cell 3 – SINR report Cell 2)	- 8 + FFS	- 17 + FFS	- 9 + FFS
Highest value (SINR report Cell 3 – SINR report Cell 2)	+ 8 + FFS	+ 17 + FFS	+ 9 + FFS

For the test to pass, the ratio of successful reported values for each requirement (R1 to R6) shall be more than 90% with a confidence level of 95%. Each requirement is evaluated independently of the others.

## 5.7.4 L1-RSRP

### 5.7.4.0 Minimum conformance requirements

#### 5.7.4.0.1 SSB-based L1-RSRP absolute measurement accuracy requirements

Unless otherwise specified, the requirements for absolute accuracy of SSB based L1-RSRP in this clause apply to all SSBs of the serving cell configured for L1-RSRP measurement.

The accuracy requirements in Table 5.7.4.0.1-1 are valid under the following conditions:

- Conditions defined in clause 7.3 of TS 38.101-2 [3] for reference sensitivity are fulfilled.
- Conditions for L1-RSRP measurements are fulfilled according to Annex B.2.4.1 for a corresponding Band for each relevant SSB.
- The measured signals are in the directions covered by the percentile EIS spherical coverage of the UE, defined in clause 7.3.4 of TS 38.101-2 [3].

**Table 5.7.4.0.1-1: SSB based L1-RSRP absolute accuracy in FR2**

Accuracy		Conditions			
Normal condition	Extreme condition	SSB $\hat{E}_s/\text{lot}$	$I_o$ <sup>Note 1</sup> range		
			Minimum $I_o$		Maximum $I_o$
dB	dB	dB	$\text{dBm} / \text{SCS}_{\text{SSB}}$ <sup>Note 2</sup>		$\text{dBm}/\text{BW}_{\text{Channel}}$
			$\text{SCS}_{\text{SSB}} = 120\text{kHz}$	$\text{SCS}_{\text{SSB}} = 240\text{kHz}$	
$\pm 6.5$	$\pm 9.5$	$\geq -3$	Same value as SSB_RP in Table B.2.4.1-2, according to UE Power class, operating band and angle of arrival		-70
$\pm 8.5$	$\pm 11.5$	$\geq -3$	N/A		-50

NOTE 1:  $I_o$  specified at the Reference point, and assumed to have constant EPRE across the bandwidth.  
 NOTE 2: Values based on Refsens and EIS spherical coverage as defined in clauses 7.3.2 and 7.3.4 of TS 38.101-2 [3]. Applicable side condition selected depending on angle of arrival.  
 NOTE 3: In the test cases, the SSB  $\hat{E}_s/\text{lot}$  and related parameters may need to be adjusted to ensure  $\hat{E}_s/\text{lot}$  at UE baseband is above the value defined in this table.

The reporting range of SS-RSRP and CSI-RSRP for L1 reporting is defined from -140 to -44 dBm with 1 dB resolution.

The mapping of measured quantity is defined in Table 4.7.4.0.1-2. The range in the signalling may be larger than the guaranteed accuracy range.

The normative reference for this requirement is TS 38.133 [6] clauses 10.1.20.1.1 and 10.1.6.

#### 5.7.4.0.2 SSB-based L1-RSRP relative measurement accuracy requirements



The relative accuracy of SSB based L1-RSRP is defined as the L1-RSRP measured from one SSB compared to the largest measured value of L1-RSRP among all SSBs of the serving cell.

The accuracy requirements in Table 5.7.4.0.2-1 are valid under the following conditions:

- Conditions defined in clause 7.3 of TS 38.101-2 [3] for reference sensitivity are fulfilled.
- Conditions for L1-RSRP measurements are fulfilled according to Annex B.2.4.1 of TS 38.133 [6] for a corresponding Band for each relevant SSB.
- The measured signals are in the directions covered by the percentile EIS spherical coverage of the UE, defined in clause 7.3.4 of TS 38.101-2 [3].

**Table 5.7.4.0.2-1: SSB based L1-RSRP relative accuracy in FR2**

Accuracy		Conditions			
Normal condition	Extreme condition	SSB $\hat{E}s/lot$	$I_o$ <sup>Note 1</sup> range		Maximum $I_o$
			Minimum $I_o$		
dB	dB	dB	dBm / $SCS_{SSB}$ <sup>Note 3</sup>		dBm/ $BW_{Channel}$
			$SCS_{SSB} = 120kHz$	$SCS_{SSB} = 240kHz$	
$\pm 6.5$	$\pm 9.5$	$\geq -3$	Same value as $SSB\_RP$ in Table B.2.4.1-2, according to UE Power class, operating band and angle of arrival		-50
NOTE 1: $I_o$ specified at the Reference point, and assumed to have constant EPRE across the bandwidth.					
NOTE 2: The parameter SSB $\hat{E}s/lot$ is the minimum SSB $\hat{E}s/lot$ of the pair of SSBs to which the requirement applies.					
NOTE 3: Values based on Refsens and EIS spherical coverage as defined in clauses 7.3.2 and 7.3.4 of TS 38.101-2 [3]. Applicable side condition selected depending on angle of arrival.					
NOTE 4: In the test cases, the SSB $\hat{E}s/lot$ and related parameters may need to be adjusted to ensure $\hat{E}s/lot$ at UE baseband is above the value defined in this table.					

The reporting range of SS-RSRP and CSI-RSRP for L1 reporting is defined from -140 to -44 dBm with 1 dB resolution.

The mapping of measured quantity is defined in Table 4.7.4.0.1-2. The range in the signalling may be larger than the guaranteed accuracy range.

The normative reference for this requirement is TS 38.133 [6] clauses 10.1.20.1.2 and 10.1.6.

### 5.7.4.0.3 CSI-RS-based L1-RSRP absolute measurement accuracy requirements

Unless otherwise specified, the requirements for absolute accuracy of CSI-RS based L1-RSRP in this clause apply to all CSI-RS resources of the serving cell configured for L1-RSRP measurement.

The accuracy requirements in Table 5.7.4.0.3-1 are valid under the following conditions:

- Conditions defined in clause 7.3 of TS 38.101-2 [3] for reference sensitivity are fulfilled.
- Conditions for L1-RSRP measurements are fulfilled according to Annex B.2.4.2 of TS 38.133 [6] for a corresponding Band for each relevant CSI-RS.
- The bandwidth of CSI-RS is 48 PRBs and the density is 3.
- The measured signals are in the directions covered by the percentile EIS spherical coverage of the UE, defined in clause 7.3.4 of TS 38.101-2 [3].

The performance with larger bandwidth of CSI-RS is equal to or better than the accuracy requirements in Table 5.7.4.0.3-1.

Table 5.7.4.0.3-1: CSI-RS based L1-RSRP absolute accuracy in FR2

Accuracy		Conditions			
Normal condition	Extreme condition	CSI-RS $\hat{E}_s/\text{lot}$	$I_o$ <sup>Note 1</sup> range		
			Minimum $I_o$		Maximum $I_o$
dB	dB	dB	dBm / $SCS_{\text{CSI-RS}}$ <sup>Note 2</sup>		dBm/ $BW_{\text{Channel}}$
			$SCS_{\text{CSI-RS}} = 60\text{kHz}$	$SCS_{\text{CSI-RS}} = 120\text{kHz}$	
$\pm 6.5$	$\pm 9.5$	$\geq -3$	Same value as CSI-RS_RP in Table B.2.4.2-2, according to UE Power class, operating band and angle of arrival		-70
$\pm 8.5$	$\pm 11.5$	$\geq -3$	N/A		-50

NOTE 1:  $I_o$  specified at the Reference point, and assumed to have constant EPRE across the bandwidth.  
NOTE 2: Values based on Refsens and EIS spherical coverage as defined in clauses 7.3.2 and 7.3.4 of TS 38.101-2 [3]. Applicable side condition selected depending on angle of arrival.  
NOTE 3: In the test cases, the CSI-RS  $\hat{E}_s/\text{lot}$  and related parameters may need to be adjusted to ensure  $\hat{E}_s/\text{lot}$  at UE baseband is above the value defined in this table.

The reporting range of SS-RSRP and CSI-RSRP for L1 reporting is defined from -140 to -44 dBm with 1 dB resolution.

The mapping of measured quantity is defined in Table 4.7.4.0.1-2. The range in the signalling may be larger than the guaranteed accuracy range.

The normative reference for this requirement is TS 38.133 [6] clauses 10.1.20.2.1 and 10.1.6.

#### 5.7.4.0.4 CSI-RS-based L1-RSRP relative measurement accuracy requirements

The relative accuracy of CSI-RS based L1-RSRP is defined as the L1-RSRP measured from one CSI-RS compared to the largest measured value of L1-RSRP among all CSI-RS resources of the serving cell.

The accuracy requirements in Table 5.7.4.0.4-1 are valid under the following conditions:

- Conditions defined in clause 7.3 of TS 38.101-2 [3] for reference sensitivity are fulfilled.
- Conditions for L1-RSRP measurements are fulfilled according to Annex B.2.4.2 of TS 38.133 for a corresponding Band for each relevant CSI-RS.
- The bandwidth of CSI-RS is 48 PRBs and the density is 3.
- The measured signals are in the directions covered by the percentile EIS spherical coverage of the UE, defined in clause 7.3.4 of TS 38.101-2 [3].

The performance with larger bandwidth of CSI-RS is equal to or better than the accuracy requirements in Table 5.7.4.0.4-1.

Table 5.7.4.0.4-1: CSI-RS based L1-RSRP relative accuracy in FR2

Accuracy		Conditions		
Normal condition	Extreme condition	CSI-RS $\hat{E}s/lot$	$Io$ <sup>Note 1</sup> range	
			Minimum $Io$	Maximum $Io$
dB	dB	dB	dBm / $SCS_{CSI-RS}$	
			$SCS_{CSI-RS} = 60kHz$	$SCS_{CSI-RS} = 120kHz$
$\pm 6.5$	$\pm 9.5$	$\geq -3$	Same value as CSI-RS RP in Table B.2.4.2-2, according to UE Power class, operating band and angle of arrival	
NOTE 1: $Io$ specified at the Reference point, and assumed to have constant EPRE across the bandwidth. NOTE 2: The parameter CSI-RS $\hat{E}s/lot$ is the minimum CSI-RS $\hat{E}s/lot$ of the pair of CSI-RS resources to which the requirement applies. NOTE 3: Values based on Refsens and EIS spherical coverage as defined in clauses 7.3.2 and 7.3.4 of TS 38.101-2 [3]. Applicable side condition selected depending on angle of arrival. NOTE 4: In the test cases, the CSI-RS $\hat{E}s/lot$ and related parameters may need to be adjusted to ensure $\hat{E}s/lot$ at UE baseband is above the value defined in this table.				

The reporting range of SS-RSRP and CSI-RSRP for L1 reporting is defined from -140 to -44 dBm with 1 dB resolution.

The mapping of measured quantity is defined in Table 4.7.4.0.1-2. The range in the signalling may be larger than the guaranteed accuracy range.

The normative reference for this requirement is TS 38.133 [6] clauses 10.1.20.2.2 and 10.1.6.

#### 5.7.4.1 EN-DC FR2 SSB based L1-RSRP measurement accuracy

**Editor's Note:** This test case has been completed for the following configurations:

- Test frequency  $f \leq 40.8$  GHz
- UE PC3
- Normal conditions
- The test is incomplete for UE power classes other than PC3
- The test is incomplete for test frequencies  $> 40.8$  GHz
- The test is incomplete for extreme conditions

##### 5.7.4.1.1 Test purpose

The purpose of this test is to verify that the SSB based L1-RSRP absolute measurement accuracy is within the specified limits for all bands.

##### 5.7.4.1.2 Test applicability

This test applies to all types of NR UE supporting E-UTRA and EN-DC from Release 15 onwards.

##### 5.7.4.1.3 Minimum conformance requirements

The minimum conformance requirements are specified in clause 5.7.4.0.1 and 5.7.4.0.2.

The normative reference for this requirement is TS 38.133 [6] clause A.5.7.4.1.

## 5.7.4.1.4 Test description

## 5.7.4.1.4.1 Initial conditions

This test shall be tested using any of the test configurations in Table 5.7.4.1.4.1-1.

**Table 5.7.4.1.4.1-1: Supported test configurations**

Test Case ID	Description
5.7.4.1-1	LTE FDD, NR 120 kHz SSB SCS, 100 MHz bandwidth, TDD duplex mode
5.7.4.1-2	LTE TDD, NR 120 kHz SSB SCS, 100 MHz bandwidth, TDD duplex mode
5.7.4.1-3	LTE FDD, NR 240 kHz SSB SCS, 100 MHz bandwidth, TDD duplex mode
5.7.4.1-4	LTE TDD, NR 240 kHz SSB SCS, 100 MHz bandwidth, TDD duplex mode
Note: The UE is only required to be tested in one of the supported test configurations	

Configure the test equipment and the DUT according to the parameters in Table 5.7.4.1.4.1-2.

**Table 5.7.4.1.4.1-2: Initial conditions**

Parameter	Value		Comment
Test environment	NC, TL/VL, TL/VH, TH/VL, TH/VH		As specified in TS 38.508-1 [14] clause 4.1.
Test frequencies	As specified in Annex E, Table E.4-1 and TS 38.508-1 [14] clause 4.3.1.		
Channel bandwidth	As specified by the test configuration selected from Table 5.7.4.1.4.1-1.		
Propagation conditions	AWGN		As specified in Annex C.2.2.
Connection Diagram	TE Part	A.3.3.3.1-1	As specified in TS 38.508-1 [14] Annex A.
	DUT Part	A.3.4.1.1	
Exceptions to connection diagram	N/A		

1. Message contents are defined in clause 5.7.4.1.4.3.
2. Cell 1 is the E-UTRA serving cell (PCell) for the EN-DC setup. The power levels and settings for Cell 1 are set according to Annex A.6. Cell 2 is the NR FR2 cell. Cell 2 is the PSCell and the target for SSB-based L1-RSRP measurements. The UE is configured to perform RLM, BFD and L1-RSRP measurement based on the SSBs. The connection setup is done according to the settings in Annex C.1.1.
3. The UE Rx beam peak direction has been obtained previously using one of the Rx Beam Peak Search procedures as described in Annex I.

## 5.7.4.1.4.2 Test procedure

Prior to the start of the time duration T1, the UE shall be fully synchronized to PSCell. The UE shall be configured for periodic CSI reporting in PUCCH [format 2] with a reporting periodicity as mentioned in the above table 5.7.4.1.4.1-2.

1. Ensure the UE is in state RRC\_CONNECTED with generic procedure parameters Connectivity EN-DC, DC bearer MCG and SCG, Connected without release *On* and Test Mode *On*, according to TS 38.508-1 [14] clause 4.5 and general test parameters set according to Table 5.7.4.1.4.1-2.
2. Set the parameters according to T1 in Table 5.7.4.1.5-1.
3. After 320 ms from the beginning of T1, the UE shall start sending L1-RSRP report including results of both SSB#0 and SSB#1 every 80 slots.
4. The SS shall check the L1-RSRP reported values of SSB#0 and SSB#1 in the periodic L1-RSRP reports for the following requirements:
  - R1: The L1-RSRP value of SSB#0 reported by the UE is compared to the expected L1-RSRP value for SSB#0. If the value is outside the limits in Table 5.7.4.1.5-3 or Table 5.7.4.1.5-4 (depending on the test

- configuration) or the UE fails to report the measurement value for SSB#0, the number of failed iterations for R1 is increased by one. Otherwise, the number of passed iterations for R1 is increased by one.
- R2: The L1-RSRP value of SSB#1 reported by the UE is compared to the expected L1-RSRP value for SSB#1. If the value is outside the limits in Table 5.7.4.1.5-3 or Table 5.7.4.1.5-4 (depending on the test configuration) or the UE fails to report the measurement value for SSB#1, the number of failed iterations for R2 is increased by one. Otherwise, the number of passed iterations for R2 is increased by one.
  - R3: The L1-RSRP value of SSB#1 reported by the UE is compared to the reported L1-RSRP value of SSB#0. If the resulting value is outside the limits in Table 5.7.1.1.5-5 or the UE fails to report the measurement value for SSB#0 or SSB#1, the number of failed iterations for R3 is increased by one. Otherwise, the number of passed iterations for R3 is increased by one.
5. The SS shall continue checking the L1-RSRP report messages transmitted by the UE until the confidence level according to Table G.2.3-1 in Annex G is achieved.
  6. Set the parameters according to each sub-test in Table 5.7.4.1.5-1 as appropriate and repeat steps 3-5. In Step 4, the SS shall check for the following requirements.
    - R4: The L1-RSRP value of SSB#0 reported by the UE is compared to the expected L1-RSRP value for SSB#0. If the value is outside the limits in Table 5.7.4.1.5-3 or Table 5.7.4.1.5-4 (depending on the test configuration) or the UE fails to report the measurement value for SSB#0, the number of failed iterations for R1 is increased by one. Otherwise, the number of passed iterations for R4 is increased by one.
    - R5: The L1-RSRP value of SSB#1 reported by the UE is compared to the expected L1-RSRP value for SSB#1. If the value is outside the limits in Table 5.7.4.1.5-3 or Table 5.7.4.1.5-4 (depending on the test configuration) or the UE fails to report the measurement value for SSB#1, the number of failed iterations for R2 is increased by one. Otherwise, the number of passed iterations for R5 is increased by one.
    - R6: The L1-RSRP value of SSB#1 reported by the UE is compared to the reported L1-RSRP value of SSB#0. If the resulting value is outside the limits in Table 5.7.1.1.5-5 or the UE fails to report the measurement value for SSB#0 or SSB#1, the number of failed iterations for R3 is increased by one. Otherwise, the number of passed iterations for R6 is increased by one.

5.7.4.1.4.3 Message contents

Message contents are according to TS 38.508-1 [14] clause 7.3 with the following exceptions:

**Table 5.7.4.1.4.3-1: Common Exception messages EN-DC SSB based L1-RSRP measurement**

Default Message Contents	
Common contents of system information blocks exceptions	
Default RRC messages and information elements contents exceptions	Table H.3.6-2 with conditions PERIODIC and SS-RSRP Table H.3.6-3 with conditions SSB and PERIODIC Table H.3.4-1 Table 7.3.1-3 in TS 38.508-1 [14] with condition SMTC.1

**Table 5.7.4.1.4.3-2: RadioLinkMonitoringConfig**

Derivation Path: TS 38.508-1 [14], Table 4.6.3-133			
Information Element	Value/remark	Comment	Condition
RadioLinkMonitoringConfig ::= SEQUENCE {			
failureDetectionResourcesToAddModList	1 entry		
SEQUENCE			
(SIZE(1..maxNrofFailureDetectionResources)) OF			
SEQUENCE {			
purpose	both	UE is configured to perform RLM and BFD based on the SSBs.	
detectionResource CHOICE {			
ssb-Index	0		
}			
}			
}			

5.7.4.1.5 Test requirement

Table 5.7.4.1.5-1 defines the primary level settings including test tolerances for all tests.

Each L1-RSRP measurement report for each of the tests in Table 5.7.4.1.5-1 shall meet the corresponding absolute accuracy requirements in Table 5.7.4.1.5-2 for test configurations 1, 2, 4 and 5, and the corresponding absolute accuracy requirements in Table 5.7.4.1.5-3 for test configurations 3 and 6.

**Table 5.7.4.1.5-1: L1-RSRP test parameters**

Parameter	Config	Unit	Test 1	Test 2
SSB GSCN	1~4		freq1	freq1
Duplex mode	1~4		TDD	TDD
TDD Configuration	1~4		TDDConf.3.1	TDDConf.3.1
BW <sub>channel</sub>	1~4	MHz	100: N <sub>RB,c</sub> = 66	100: N <sub>RB,c</sub> = 66
Data RBs allocated	1~4		66	66
PDSCH Reference measurement channel	1,2		SR.3.2 TDD	SR.3.2 TDD
	3,4		SR.3.3 TDD	SR.3.3 TDD
RMSI CORESET Reference Channel	1,2		CR.3.1 TDD	CR.3.1 TDD
	3,4		CR.3.2 TDD	CR.3.2 TDD
Dedicated CORESET Reference Channel	1,2		CCR.3.1 TDD	CCR.3.1 TDD
	3,4		CCR.3.7 TDD	CCR.3.7 TDD
SSB configuration	1,2		SSB.1 FR2	SSB.1 FR2
	3,4		SSB.2 FR2	SSB.2 FR2

OCNG Patterns	1~4		OP.1	OP.1
Initial BWP Configuration	1~4		DLBWP.0.1 ULBWP.0.1	DLBWP.0.1 ULBWP.0.1
Dedicated BWP configuration	1~4		DLBWP.1.3 ULBWP.1.3	DLBWP.1.3 ULBWP.1.3
TRS Configuration	1~4		TRS.2.1 TDD	TRS.2.1 TDD
PDCCH/PDSCH TCI Configuration	1~4		TCI.State.2	TCI.State.2
SMTTC configuration	1~4		SMTTC.1	SMTTC.1
reportConfigType	1~4		periodic	periodic
reportQuantity	1~4		ssb-Index-RSRP	ssb-Index-RSRP
Number of reported RS	1~4		2	2
L1-RSRP reporting period	1~4		slot320	slot320
Propagation condition	1~4		AWGN	AWGN
Antenna configuration			1x2	1x2
EPRE ratio of PSS to SSS	1~4	dB	0	0
EPRE ratio of PBCH DMRS to SSS				
EPRE ratio of PBCH to PBCH DMRS				
EPRE ratio of PDCCH DMRS to SSS				
EPRE ratio of PDCCH to PDCCH DMRS				
EPRE ratio of PDSCH DMRS to SSS				
EPRE ratio of PDSCH to PDSCH DMRS				
EPRE ratio of OCNG DMRS to SSS <sup>Note 1</sup>				
EPRE ratio of OCNG to OCNG DMRS <sup>Note 1</sup>				
<p>Note 1: OCNG shall be used such that both cells are fully allocated and a constant total transmitted power spectral density is achieved for all OFDM symbols.</p> <p>Note 2: Interference from other cells and noise sources not specified in the test is assumed to be constant over subcarriers and time and shall be modelled as AWGN of appropriate power for <math>N_{oc}</math> to be fulfilled.</p>				

Table 5.7.4.1.5-2: L1-RSRP OTA related test parameters

Parameter	Config	Unit	Test 1		Test 2 <sup>NOTE 3</sup>	
			SSB0	SSB1	SSB0	SSB1
Angle of arrival configuration			Setup 1 according to A.3.15.1		Setup 1 according to A.3.15.1	
Assumption for UE beams <sup>Note 4</sup>			Rough		Rough	
$N_{oc}$	1~4	dBm/15 kHz	-104.1		n.a.	
$N_{oc}$	1,2	dBm/SS	-95.1		n.a.	
	3,4	B SCS	-92.1		n.a.	
$\hat{E}_s / I_{\alpha}$	1~4	dB	10	-1.6	n.a.	
SSB_RP <sup>Note1</sup>	1,2	dBm/SC	-85.1	-96.9	As in Table B.2.4-2 + 5.7	
	3,4	S	-78	-90	As in Table B.2.4-2 + 5.7	

$I_o$ <sup>Note1</sup>	1~4	dBm/ 95.04M Hz	-55.67		SSB_RP+34.68
$\hat{E}_s / N_{oc}$	1~4	dB	10	-1.6	n.a.
<p>Note 1: SSB_RP and <math>I_o</math> levels have been derived from other parameters for information purposes. They are not settable parameters themselves.</p> <p>Note 2: Void</p> <p>Note 3: No additional noise is added by the test system in Test 2.</p> <p>Note 4: Information about types of UE beam is given in B.2.1.3, and does not limit UE implementation or test system implementation</p>					

**Table 5.7.4.1.5-3: L1-RSRP absolute accuracy requirements for the reported values for test configurations 1 and 2 for the absolute accuracy rules R1, R2, R4, R5**

UE power class 3			
Normal Conditions	Test 1 All bands	Test 2	
Lowest reported value (SSB#0)	42	n257, n258, n261	27
		n260	30
		n259	FFS
Highest reported value (SSB#0)	101	n257, n258, n261	83
		n260	86
		n259	FFS
Lowest reported value (SSB#1)	31	n257, n258, n261	27
		n260	30
		n259	FFS
Highest reported value (SSB#1)	89	n257, n258, n261	83
		n260	86
		n259	FFS
Extreme Conditions	Test 1 All bands	Test 2	
Lowest reported value (SSB#0)	39+ FFS	n257, n258, n261	24 + FFS
		n260	27 + FFS
		n259	FFS
Highest reported value (SSB#0)	104+ FFS	n257, n258, n261	86 + FFS
		n260	89 + FFS
		n259	FFS
Lowest reported value (SSB#1)	28+ FFS	n257, n258, n261	24+ FFS
		n260	27+ FFS
		n259	FFS
Highest reported value (SSB#1)	92+ FFS	n257, n258, n261	86+ FFS
		n260	89+ FFS
		n259	FFS



**Table 5.7.4.1.5-4: L1-RSRP absolute accuracy requirements for the reported values for test configurations 3 and 4 for the absolute accuracy rules R1, R2, R4, R5**

UE power class 3			
Normal Conditions	Test 1 All bands	Test 2	
Lowest reported value (SSB#0)	45	n257, n258, n261	30
		n260	33
		n259	FFS
Highest reported value (SSB#0)	104	n257, n258, n261	86
		n260	89
		n259	FFS
Lowest reported value (SSB#1)	34	n257, n258, n261	30
		n260	33
		n259	FFS
Highest reported value (SSB#1)	92	n257, n258, n261	86
		n260	89
		n259	FFS
Extreme Conditions	Test 1 All bands	Test 2	
Lowest reported value (SSB#0)	42+ FFS	n257, n258, n261	27 + FFS
		n260	30 + FFS
		n259	FFS
Highest reported value (SSB#0)	107+ FFS	n257, n258, n261	89 + FFS
		n260	92 + FFS
		n259	FFS
Lowest reported value (SSB#1)	31+ FFS	n257, n258, n261	27+ FFS
		n260	30+ FFS
		n259	FFS
Highest reported value (SSB#1)	95+ FFS	n257, n258, n261	89+ FFS
		n260	92+ FFS
		n259	FFS

**Table 5.7.4.1.5-5: evaluation limits for the reported values for T1 and T2 relative accuracy rules R3, R6**

UE power class 3		
Normal Conditions	Test 1 All bands	Test 2 All bands
Lowest reported value (L1-RSRP SSB#1 – L1-RSRP SSB#0)	- 9	- 4
Highest reported value ((L1-RSRP SSB#1 – L1-RSRP SSB#0))	-2	+4
Extreme Conditions	Test 1 All bands	Test 2 All bands
Lowest reported value ((L1-RSRP SSB#1 – L1-RSRP SSB#0))	- 12+ FFS	- 7+ FFS
Highest reported value ((L1-RSRP SSB#1 – L1-RSRP SSB#0))	+ 1+ FFS	+ 7+ FFS

For the test to pass, the ratio of successful reported values for each requirement (R1 to R6) shall be more than 90% with a confidence level of 95%. Each requirement is evaluated independently of the others.

#### 5.7.4.2 EN-DC FR2 CSI-RS based L1-RSRP measurement accuracy

Editor's Note: This test case has been completed for the following configurations:

- Test frequency  $f \leq 40.8$  GHz
- UE PC3
- Normal conditions

- The test is incomplete for UE power classes other than PC3
- The test is incomplete for test frequencies > 40.8 GHz
- The test is incomplete for extreme conditions

#### 5.7.4.2.1 Test purpose

The purpose of this test is to verify that the CSI-RS based L1-RSRP absolute measurement accuracy is within the specified limits for all bands.

#### 5.7.4.2.2 Test applicability

This test applies to all types of NR UE supporting E-UTRA and EN-DC from Release 15 onwards.

#### 5.7.4.2.3 Minimum conformance requirements

The minimum conformance requirements are specified in clause 5.7.4.0. 3 and 5.7.4.0.4.

The normative reference for this requirement is TS 38.133 [6] clause A.5.7.4.1.

#### 5.7.4.2.4 Test description

##### 5.7.4.2.4.1 Initial conditions

This test shall be tested using any of the test configurations in Table 5.7.4.2.4.1-1.

**Table 5.7.4.2.4.1-1: Supported test configurations**

Test Case ID	Description
5.7.4.2-1	LTE FDD, NR 120 kHz SSB SCS, 100 MHz bandwidth, TDD duplex mode
5.7.4.2-2	LTE TDD, NR 120 kHz SSB SCS, 100 MHz bandwidth, TDD duplex mode
Note: The UE is only required to be tested in one of the supported test configurations	

Configure the test equipment and the DUT according to the parameters in Table 5.7.4.2.4.1-2.

**Table 5.7.4.2.4.1-2: Initial conditions**

Parameter	Value		Comment
Test environment	NC, TL/VL, TL/VH, TH/VL, TH/VH		As specified in TS 38.508-1 [14] clause 4.1.
Test frequencies	As specified in Annex E, Table E.4-1 and TS 38.508-1 [14] clause 4.3.1.		
Channel bandwidth	As specified by the test configuration selected from Table 5.7.4.2.4.1-1.		
Propagation conditions	AWGN		As specified in Annex C.2.2.
Connection Diagram	TE Part	A.3.3.1.1	As specified in TS 38.508-1 [14] Annex A.
	DUT Part	A.3.4.1.1	
Exceptions to connection diagram	N/A		

1. Message contents are defined in clause 5.7.4.2.4.3.
2. Cell 1 is the E-UTRA serving cell (PCell) for the EN-DC setup. The power levels and settings for Cell 1 are set according to Annex A.6. Cell 2 is the NR FR2 cell. Cell 2 is the PSCell and the target for CSI-RS-based L1-RSRP measurements. The UE is configured to perform RLM, BFD and L1-RSRP measurement based on the SSBs. The connection setup is done according to the settings in Annex C.1.1.
3. The UE Rx beam peak direction has been obtained previously using one of the Rx Beam Peak Search procedures as described in Annex I.

#### 5.7.4.2.4.2 Test procedure

Prior to the start of the time duration T1, the UE shall be fully synchronized to PSCell. The UE shall be configured for periodic CSI reporting in PUCCH [format 2] with a reporting periodicity as mentioned in the above table 5.7.4.2.4.1-2.

1. Ensure the UE is in state RRC\_CONNECTED with generic procedure parameters Connectivity EN-DC, DC bearer MCG and SCG, Connected without release *On* and Test Mode *On*, according to TS 38.508-1 [14] clause 4.5 and general test parameters set according to Table 5.7.4.2.4.1-2.
2. Set the parameters according to T1 in Table 5.7.4.2.5-1.
3. After 320 ms from the beginning of T1, the UE shall start sending L1-RSRP report including results of both CSI-RS0 and CSI-RS1.
4. The SS shall check the L1-RSRP reported values of CSI-RS0 and CSI-RS1 in the periodic L1-RSRP reports for the following requirements:
  - R1: The L1-RSRP value of CSI-RS0 reported by the UE is compared to the expected L1-RSRP value for CSI-RS0. If the value is outside the limits in Table 5.7.4.2.5-3 or Table 5.7.4.2.5-4 (depending on the test configuration) or the UE fails to report the measurement value for CSI-RS0, the number of failed iterations for R1 is increased by one. Otherwise, the number of passed iterations for R1 is increased by one.
  - R2: The L1-RSRP value of CSI-RS1 reported by the UE is compared to the expected L1-RSRP value for CSI-RS1. If the value is outside the limits in Table 5.7.4.2.5-3 or Table 5.7.4.2.5-4 (depending on the test configuration) or the UE fails to report the measurement value for CSI-RS1, the number of failed iterations for R2 is increased by one. Otherwise, the number of passed iterations for R2 is increased by one.
  - R3: The L1-RSRP value of CSI-RS1 reported by the UE is compared to the reported L1-RSRP value of CSI-RS0. If the resulting value is outside the limits in Table 5.7.1.1.5-5 or the UE fails to report the measurement value for CSI-RS0 or CSI-RS1, the number of failed iterations for R3 is increased by one. Otherwise, the number of passed iterations for R3 is increased by one.
5. The SS shall continue checking the L1-RSRP report messages transmitted by the UE until the confidence level according to Table G.2.3-1 in Annex G is achieved.
6. Set the parameters according to each sub-test in Table 5.7.4.2.5-1 as appropriate and repeat steps 3-5. In Step 4, the SS shall check for the following requirements.
  - R4: The L1-RSRP value of CSI-RS0 reported by the UE is compared to the expected L1-RSRP value for CSI-RS0. If the value is outside the limits in Table 5.7.4.2.5-3 or Table 5.7.4.2.5-4 (depending on the test configuration) or the UE fails to report the measurement value for CSI-RS0, the number of failed iterations for R1 is increased by one. Otherwise, the number of passed iterations for R4 is increased by one.
  - R5: The L1-RSRP value of CSI-RS1 reported by the UE is compared to the expected L1-RSRP value for CSI-RS1. If the value is outside the limits in Table 5.7.4.2.5-3 or Table 5.7.4.2.5-4 (depending on the test configuration) or the UE fails to report the measurement value for CSI-RS1, the number of failed iterations for R2 is increased by one. Otherwise, the number of passed iterations for R5 is increased by one.
  - R6: The L1-RSRP value of CSI-RS1 reported by the UE is compared to the reported L1-RSRP value of CSI-RS0. If the resulting value is outside the limits in Table 5.7.1.1.5-5 or the UE fails to report the measurement value for CSI-RS0 or CSI-RS1, the number of failed iterations for R3 is increased by one. Otherwise, the number of passed iterations for R6 is increased by one.

#### 5.7.4.2.4.3 Message contents

Message contents are according to TS 38.508-1 [14] clause 7.3 with the following exceptions:

**Table 5.7.4.2.4.3-1: Common Exception messages EN-DC CSI-RS based L1-RSRP measurement**

Default Message Contents	
Common contents of system information blocks exceptions	
Default RRC messages and information elements contents exceptions	Table H.3.6-2 with conditions PERIODIC and CSI-RSRP Table H.3.6-3 with conditions CSI-RS and PERIODIC Table H.3.4-1 Table 7.3.1-3 in TS 38.508-1 [14] with condition SMTC.1

**Table 5.7.4.2.4.3-2: RadioLinkMonitoringConfig**

Derivation Path: TS 38.508-1 [14], Table 4.6.3-133			
Information Element	Value/remark	Comment	Condition
RadioLinkMonitoringConfig ::= SEQUENCE {			
failureDetectionResourcesToAddModList	1 entry		
SEQUENCE			
(SIZE(1..maxNrofFailureDetectionResources)) OF			
SEQUENCE {			
purpose	both	UE is configured to perform RLM and BFD based on the SSBs.	
detectionResource CHOICE {			
csi-RS-Index	0		
}			
}			
}			

5.7.4.2.5 Test requirement

Table 5.7.4.2.5-1 defines the primary level settings including test tolerances for all tests.

Each L1-RSRP measurement report for each of the tests in Table 5.7.4.2.5-1 shall meet the corresponding absolute accuracy requirements in Table 5.7.4.2.5-2 for test configurations 1, 2, 4 and 5, and the corresponding absolute accuracy requirements in Table 5.7.4.2.5-3 for test configurations 3 and 6.

Table 5.7.4.2.5-1: L1-RSRP test parameters

Parameter	Config	Unit	Test 1	Test 2
SSB GSCN	1~2		freq1	freq1
Duplex mode	1~2		TDD	TDD
TDD Configuration	1~2		TDDConf.3.1	TDDConf.3.1
BW <sub>channel</sub>	1~2	MHz	100: N <sub>RB,c</sub> = 66	100: N <sub>RB,c</sub> = 66
PDSCH Reference measurement channel	1~2		SR.3.1 TDD	SR.3.1 TDD
RMSI CORESET Reference Channel	1~2		CR.3.1 TDD	CR.3.1 TDD
Dedicated CORESET Reference Channel	1~2		CCR.3.1 TDD	CCR.3.1 TDD
SSB configuration	1~2		SSB.1 FR2	SSB.1 FR2
OCNG Patterns	1~2		OP.1	OP.1
Initial BWP Configuration	1~2		DLBWP.0.1 ULBWP.0.1	DLBWP.0.1 ULBWP.0.1
Dedicated BWP configuration	1~2		DLBWP.1.1 ULBWP.1.1	DLBWP.1.1 ULBWP.1.1
TRS Configuration	1~2		TRS.2.1 TDD	TRS.2.1 TDD
PDCCH/PDSCH TCI Configuration	1~2		TCI.State.2	TCI.State.2
SMTc configuration	1~2		SMTc.1	SMTc.1
CSI-RS	1~2		CSI-RS.3.2 TDD	CSI-RS.3.2 TDD
reportConfigType	1~2		periodic	periodic
reportQuantity	1~2		cri-RSRP	cri-RSRP
Number of reported RS	1~2		2	2
L1-RSRP reporting period	1~2		slot320	slot320
Propagation condition	1~2		AWGN	AWGN
Antenna configuration	1~2		1x2	1x2
EPRE ratio of PSS to SSS	1~2	dB	0	0
EPRE ratio of PBCH DMRS to SSS				
EPRE ratio of PBCH to PBCH DMRS				
EPRE ratio of PDCCH DMRS to SSS				
EPRE ratio of PDCCH to PDCCH DMRS				
EPRE ratio of PDSCH DMRS to SSS				
EPRE ratio of PDSCH to PDSCH DMRS				
EPRE ratio of OCNG DMRS to SSS <sup>Note 1</sup>				
EPRE ratio of OCNG to OCNG DMRS <sup>Note 1</sup>				
<p>Note 1: OCNG shall be used such that both cells are fully allocated and a constant total transmitted power spectral density is achieved for all OFDM symbols.</p> <p>Note 2: Interference from other cells and noise sources not specified in the test is assumed to be constant over subcarriers and time and shall be modelled as AWGN of appropriate power for <math>N_{oc}</math> to be fulfilled.</p>				

**Table 5.7.4.2.5-2: L1-RSRP OTA related test parameters**

Parameter	Config	Unit	Test 1		Test 2 <sup>NOTE 3</sup>	
			CSI-RS0	CSI-RS1	CSI-RS0	CSI-RS1
Angle of arrival configuration			Setup 1 according to A.3.15.1		Setup 1 according to A.3.15.1	
Assumption for UE beams <sup>Note 4</sup>			Rough		Rough	
$N_{oc}$	1~2	dBm/15 kHz	-104.10		n.a.	
$N_{oc}$	1~2	dBm/SS B SCS	-95.11		n.a. n.a.	
$\hat{E}_s / I_{ot}$	1~2	dB	10	-1.8	n.a.	
CSI-RS_RP <sup>Note1</sup>	1~2	dBm/SC S	-85.11	-96.93	As in Table B.2.4.2-2 + 5.7	
$I_o$ <sup>Note1</sup>	1~2	dBm/95.04M Hz	-55.67		CSI-RS_RP+34.68	
$\hat{E}_s / N_{oc}$	1~2	dB	10	-1.82	n.a.	
<p>Note 1: RSRP and <math>I_o</math> levels have been derived from other parameters for information purposes. They are not settable parameters themselves.</p> <p>Note 2: RSRP minimum requirements are specified assuming independent interference and noise at each receiver antenna port.</p> <p>Note 3: No additional noise is added by the test system in Test 2.</p> <p>Note 4: Information about types of UE beam is given in B.2.1.3, and does not limit UE implementation or test system implementation</p>						

**Table 5.7.4.2.5-3: L1-RSRP absolute accuracy requirements for the reported values for the absolute accuracy rules R1, R2, R4, R5**

UE power class 3			
Normal Conditions	Test 1 All bands	Test 2	
Lowest reported value (CSI-RS0)	48	n257, n258, n261	27
		n260	30
		n259	FFS
Highest reported value (CSI-RS0)	95	n257, n258, n261	83
		n260	86
		n259	FFS
Lowest reported value (CSI-RS1)	30	n257, n258, n261	27
		n260	30
		n259	FFS
Highest reported value (CSI-RS1)	89	n257, n258, n261	83
		n260	86
		n259	FFS
Extreme Conditions	Test 1 All bands	Test 2	
Lowest reported value (CSI-RS0)	45+ FFS	n257, n258, n261	25 + FFS
		n260	27 + FFS
		n259	FFS
Highest reported value (CSI-RS0)	98+ FFS	n257, n258, n261	86 + FFS
		n260	89 + FFS
		n259	FFS
Lowest reported value (CSI-RS1)	27+ FFS	n257, n258, n261	25 + FFS
		n260	27 + FFS
		n259	FFS
Highest reported value (CSI-RS1)	92+ FFS	n257, n258, n261	86 + FFS
		n260	89 + FFS
		n259	FFS

**Table 5.7.4.2.5-4: evaluation limits for the reported values for T1 and T2 relative accuracy rules R3, R6**

UE power class 3		
Normal Conditions	Test 1 All bands	Test 2 All bands
Lowest reported value (L1-RSRP CSI-RS1 – L1-RSRP CSI-RS0)	- 9	- 4
Highest reported value ((L1-RSRP CSI-RS1 – L1-RSRP CSI-RS0))	- 2	+ 4
Extreme Conditions	Test 1 All bands	Test 2 All bands
Lowest reported value ((L1-RSRP CSI-RS1 – L1-RSRP CSI-RS0))	- 12+ FFS	- 7+ FFS
Highest reported value ((L1-RSRP CSI-RS1 – L1-RSRP CSI-RS0))	+ 1+ FFS	+ 7+ FFS

For the test to pass, the ratio of successful reported values for each requirement (R1 to R6) shall be more than 90% with a confidence level of 95%. Each requirement is evaluated independently of the others.

## 5.7.5 SRS-RSRP

### 5.7.5.0 Minimum conformance requirements

#### 5.7.5.0.1 Minimum conformance requirements for SRS-RSRP measurement accuracy

The SRS-RSRP measurement reported by the UE shall fulfil the accuracy requirements defined in Table 5.7.5.0.1-1 for FR1 and Table 5.7.7.0.1-2 for FR2, provided that the following conditions are met. The accuracy requirements in this clause are derived based on AWGN radio propagation conditions.

- Conditions defined in clause 7.3 of TS 38.101-1 [18] for reference sensitivity are fulfilled.
- Conditions for SRS-RSRP measurements are fulfilled according to Annex B.2.z for a corresponding Band for each relevant SRS resource configured for measurement.
- The time difference between UE's DL reference timing in the serving cell and SRS arrival time is no larger than  $T_{\text{error\_SRS\_RSRP}}$ , where
  - $T_{\text{error\_SRS\_RSRP}} = T_C \times N_{\text{TA\_offset}} + 4.67\text{us}$  for FR1
  - $T_{\text{error\_SRS\_RSRP}} = T_C \times N_{\text{TA\_offset}} + 3.67\text{us}$  for FR2
  - $N_{\text{TA\_offset}}$  is defined in Table 7.1.2-2
  - $T_C$  is 0.509ns
- The number of SRS ports in the SRS resource configured for measurement is 1,
- The number of symbols in the SRS resource configured for measurement is 1,
- The number of repetitions in the SRS resource configured for measurement is 1,
- Frequency hopping, sequence group hopping or sequence hopping is disabled in the SRS resource configured for measurement,
- The bandwidth of the SRS resource is 48 PRBs.
- One of the following conditions is met
  - There is no other SRS resource with the same root sequence and on the same symbol and with same comb as the relevant SRS resource.
  - If multiple SRS resources are on the same symbol and with same comb, the distance between cyclic shifts of any two resources is no less than 6 if  $\text{transmissionComb} = n_4$ , and no less than 4 if  $\text{transmissionComb} = n_2$ .

Table 5.7.5.0.1-1: SRS-RSRP absolute accuracy in FR1

Accuracy						Conditions						
Normal condition			Extreme condition			SRS Ês/lot	I <sub>o</sub> <sup>Note 1</sup> range					
							NR operating band groups <sup>Note 2</sup>	Minimum I <sub>o</sub>			Maximum I <sub>o</sub>	
dB						dB		dBm / SCS <sub>SRS</sub>			dBm/BW Channel	dBm/BW Channel
SCS <sub>SRS</sub> (kHz)			SCS <sub>SRS</sub> (kHz)					SCS <sub>SRS</sub> s = 15 kHz	SCS <sub>SRS</sub> s = 30 kHz	SCS <sub>SRS</sub> s = 60 kHz		
15	30	60	15	30	60							
±3	±3.5	±5	±7.5	±8	±9.5	≥1	NR_TDD_FR1_A , NR_TDD_FR1_C , NR_TDD_FR1_D , NR_TDD_FR1_E	-120	-117	-114	N/A	-70
±6.5	±7	±8.5	±9.5	±10	±11.5	≥1	NR_TDD_FR1_A , NR_TDD_FR1_C , NR_TDD_FR1_D , NR_TDD_FR1_E	N/A	N/A	N/A	-70	-50

NOTE 1: I<sub>o</sub> is assumed to have constant EPRE across the bandwidth.

NOTE 2: NR operating band groups in FR1 are as defined in clause 3.5.2.

Table 5.7.5.0.1-2: SRS-RSRP absolute accuracy in FR2

Accuracy				Conditions				
Normal condition		Extreme condition		SRS Ês/lot	I <sub>o</sub> <sup>Note 1</sup> range			
					Minimum I <sub>o</sub>		Maximum I <sub>o</sub>	
dB				dB	dBm / SCS <sub>SRS</sub> <sup>Note 2</sup>		dBm/BW <sub>Channel</sub>	dBm/BW <sub>Channel</sub>
SCS <sub>SRS</sub> (kHz)		SCS <sub>SRS</sub> (kHz)			SCS <sub>SRS</sub> = 60kHz	SCS <sub>SRS</sub> = 120kHz		
60	120	60	120					
±6	±8.5	±9	±11.5	≥1	Same value as SRS_RP in Table B.2.7-2, according to UE Power class, operating band and angle of arrival		N/A	-70
±9	±11.5	±11	±13.5	≥1	N/A		-70	-50

NOTE 1: I<sub>o</sub> specified at the Reference point, and assumed to have constant EPRE across the bandwidth.

NOTE 2: Values based on Refsens and EIS spherical coverage as defined in clauses 7.3.2 and 7.3.4 of TS 38.101-2 [19]. Applicable side condition selected depending on angle of arrival.

NOTE 3: In the test cases, the SSB Ês/lot and related parameters may need to be adjusted to ensure Ês/lot at UE baseband is above the value defined in this table.

5.7.5.0.1.1 SRS-RSRP report mapping

The reporting range of SRS-RSRP is defined from -140 dBm to -44 dBm with 1 dB resolution. The mapping of measured quantity is defined in Table 5.7.7.0.1.2-1. The range in the signalling may be larger than the guaranteed accuracy range.



**Table 5.7.7.0.1.2-1: SRS-RSRP measurement report mapping**

Reported value	Measured quantity value	Unit
SRS-RSRP_0	SRS-RSRP<-140	dBm
SRS-RSRP_1	-140≤ SRS-RSRP<-139	dBm
SRS-RSRP_2	-139≤ SRS-RSRP<-138	dBm
SRS-RSRP_3	-138≤ SRS-RSRP<-137	dBm
SRS-RSRP_4	-137≤ SRS-RSRP<-136	dBm
..	..	...
SRS-RSRP_95	-46≤ SRS-RSRP<-45	dBm
SRS-RSRP_96	-45≤ SRS-RSRP<-44	dBm
SRS-RSRP_97	-44≤ SRS-RSRP	dBm
SRS-RSRP_98	Infinity	
Note:	'Infinity' means that UE cannot detect SRS due to too strong signal to measure.	

The normative reference for this requirement is TS 38.133 [6] clause 10.1.22.1.

### 5.7.5.1 EN-DC FR2 SRS-RSRP measurement accuracy

**Editor's Note: This test case is incomplete. Following aspects are either missing or TBD:**

- The test procedure is incomplete
- The message content is FFS
- MU/TT analysis is FFS

#### 5.7.5.1.1 Test purpose

The purpose of this test is to verify that the SRS-RSRP measurement accuracy is within the specified limits with SRS-RSRP measurement requirements in TS 38.133 [6] clause 10.1.22.1.1.

#### 5.7.5.1.2 Test applicability

This test applies to all types of NR UE supporting E-UTRA and EN-DC from Release 16 onwards and CLI-SRS-RSRP

#### 5.7.5.1.3 Minimum conformance requirements

The minimum conformance requirements are specified in clause 5.7.5.0.1.

The normative reference for this requirement is TS 38.133 [6] clause A.5.7.5.1.

#### 5.7.5.1.4 Test description

##### 5.7.5.1.4.1 Initial conditions

This test shall be tested using any of the test configurations in Table 5.7.5.1.4.1-1.

**Table 5.7.5.1.4.1-1: EN-DC FR2 SRS-RSRP accuracy supported test configurations**

Config	Description
5.7.5.1 - 1	LTE FDD, NR 120 kHz SRS SCS, 100 MHz bandwidth, TDD duplex mode
5.7.5.1 - 2	LTE TDD, NR 120 kHz SRS SCS, 100 MHz bandwidth, TDD duplex mode
Note:	The UE is only required to be tested in one of the supported test configurations in each supported band

Configure the test equipment and the DUT according to the parameters in Table 5.7.5.1.4.1-2.

**Table 5.7.5.1.4.1-2: Initial conditions EN-DC FR2 SRS-RSRP measurement accuracy**

Parameter	Value	Comment
Test environment	NC	As specified in TS 36.508 [25] clause 4.1.
Test frequencies	As specified in Annex E, E.1.1, E.1.3.1 and Table E.3-1 and TS 38.508-1 [14] clause 4.3.1 for E-UTRA and 7.2.3 for NR.	
Channel bandwidth	As specified by the selected test configuration.	
Propagation conditions	AWGN	As specified in clause C.2.1
Connection Diagram	TE Part: A.3.3.1.1 DUT Part: A.3.4.1.1	As specified in TS 38.508-1 [14] Annex A.
Exceptions to connection diagram	N/A	

1. Message contents are defined in clause 5.7.5.1.4.3.
2. In this set of test cases there are two cells in the test, E-UTRAN PCell (Cell 1), FR2 PSCell (Cell 2).
3. The UE Rx beam peak direction has been obtained previously using one of the Rx Beam Peak Search procedures as described in Annex I.

#### 5.7.5.1.4.2 Test procedure

There are two cells are deployed in the test, which are E-UTRAN PCell (Cell 1) and FR2 PSCell (Cell 2)

The test parameters and applicability for Cell 1 are defined in A.3.7.2 of 38.133. The test parameters for the Cell 2 are given in Table 5.7.5.1.5-1 and 5.7.5.1.5-2 below. The test parameter for the (virtual) neighbour cell UE transmitting SRS are given in Table 5.7.5.1.5-2.

Before the test UE is configured to perform SRS-RSRP measurement. During the test, the test system transmits SRS resources for measurement in the DL slots according to the SRS configuration in Table 5.7.5.1.5-3. There is no measurement gap configured in the test. During the test, the test system does not transmit PDCCH/PDSCH/OCNG on SRS symbol to be transmitted and on 2 data symbols before SRS to be transmitted.

1. Ensure the UE is in State 3A-RF according to TS 36.508 [25] clause 7.2A.3.
2. Set the parameters according to Table 5.7.5.1.5-1 as appropriate.
3. The SS shall transmit an *RRCConnectionReconfiguration* message on Cell 1.
4. The UE shall transmit an *RRCConnectionReconfigurationComplete* message.
5. The UE shall transmit periodically MeasurementReport messages.

<rest of the steps are FFS>

#### 5.7.5.1.4.3 Message contents

Message contents are according to TS 38.508-1 [14] clause 7.3 with the following exceptions:

FFS

#### 5.7.5.1.5 Test requirement

Table 5.7.5.1.5-1 defines the cell specific settings for all tests. Table 5.7.5.1.5-2 defines the OTA primary level settings including test tolerances for all tests.

The SS-RSRP measurement accuracy shall fulfil the absolute accuracy requirements in table 5.7.5.1.5-3 and absolute accuracy requirements in table 5.7.5.1.5-4. The following requirements are to be verified:

During T1:

The UE is deemed to meet the requirement if the reported SRS-RSRP is in the range shown in table 5.7.5.1.5-4.

During T2:

The UE is deemed to meet the requirement if the reported SRS-RSRP is in the range shown in table 5.7.5.1.5-4.

**Table 5.7.5.1.5-1: FR2 test parameters for SRS-RSRP accuracy**

Parameter	Config	Unit	Test 1	Test 2
SSB GSCN	1~2		freq1	freq1
Duplex mode	1~2		TDD	TDD
TDD configuration	1~2		TDDConf.3.1	TDDConf.3.1
BW <sub>channel</sub>	1~2	MHz	100: N <sub>RB,c</sub> = 66	100: N <sub>RB,c</sub> = 66
PDSCH Reference measurement channel	1~2		SR.3.1 TDD	SR.3.1 TDD
RMSI CORESET Reference Channel	1~2		CR.3.1 TDD	CR.3.1 TDD
Dedicated CORESET Reference Channel	1~2		CCR.3.1 TDD	CCR.3.1 TDD
SSB configuration	1~2		SSB.3 FR2	SSB.3 FR2
OCNG Patterns	1~2		OP.1	OP.1
TRS configuration	1~2		TRS.2.1 TDD	TRS.2.1 TDD
Initial BWP Configuration	1~2		DLBWP.0.1 ULBWP.0.1	DLBWP.0.1 ULBWP.0.1
Dedicated BWP configuration	1~2		DLBWP.1.3 ULBWP.1.3	DLBWP.1.3 ULBWP.1.3
SMTC configuration	1~2		SMTc.1	SMTc.1
Time offset between DL from serving cell and SRS from test system	1~2	μs	10.76	10.67
EPRE ratio of PSS to SSS	1~2	dB	0	0
EPRE ratio of PBCH DMRS to SSS				
EPRE ratio of PBCH to PBCH DMRS				
EPRE ratio of PDCCH DMRS to SSS				
EPRE ratio of PDCCH to PDCCH DMRS				
EPRE ratio of PDSCH DMRS to SSS				
EPRE ratio of PDSCH to PDSCH DMRS				
EPRE ratio of OCNG DMRS to SSS <sup>Note 1</sup>				
EPRE ratio of OCNG to OCNG DMRS <sup>Note 1</sup>				
Propagation condition	1~2		AWGN	AWGN
Antenna configuration	1~2		1x2	1x2
SRS configuration	1~2		SRSCConf.1	SRSCConf.1
Note 1: OCNG shall be used such that a constant total transmitted power spectral density is achieved for all OFDM symbols.				

**Table 5.7.5.1.5-2: SRS-RSRP accuracy OTA related test parameters for PSCell and Neighbour cell UE in FR2**

Parameter	Unit	T1	T2
Angle of arrival configuration		Setup 1 defined A.3.15.1	Setup 1 defined A.3.15.1
Beam assumption Note 5		Fine	Fine
$N_{oc}$ Note1	dBm/15kHz z <sup>Note3</sup>	-100	N/A
$N_{oc}$ Note1	dBm/SCS Note3	-91	N/A
$\hat{E}_s / N_{oc}$	dB	2	N/A
$E_s$	dBm/SCS Note3		(Table B.2.7-2 Rx Beam Peak)
SRS_RP <sup>Note2</sup>	dBm/SCS	-89	(Table B.2.7-2 Rx Beam Peak)
$\hat{E}_s / I_{ot\ BB}$ Note4	dB	>1	1
$I_o$ <sup>Note2</sup>	dBm/95.04 MHz Note3	-57.89	(Table B.2.7-2 Rx Beam Peak +50.79dB)
Note 1:	Where used, interference from other cells and noise sources not specified in the test is assumed to be constant over subcarriers and time and shall be modelled as AWGN of appropriate power for $N_{oc}$ to be fulfilled.		
Note 2:	SRS_RP, $E_s/I_o$ and $I_o$ levels have been derived from other parameters for information purposes. They are not settable parameters themselves.		
Note 3:	Equivalent power received by an antenna with 0 dBi gain at the centre of the quiet zone		
Note 4:	Calculation of $E_s/I_{ot\ BB}$ includes the effect of UE internal noise up to the value assumed for the associated Refsens requirement in clause 7.3.2 of TS 36.101-2 [19], and an allowance of 2dB for UE multi-band relaxation factor $\Sigma MB_P$ from TS 38.101-2 [19] Table 6.2.1.3-4.		
Note 5:	Information about types of UE beam is given in B.2.1.3, and does not limit UE implementation or test system implementation.		

**Table 5.7.5.1.5-3: SRS configuration parameters for FR2 SRS-RSRP accuracy**

	Field	SRSCnf.1
SRS-ResourceSet	srs-ResourceSetId	0
	srs-ResourceIdList	0
	resourceType	Periodic
	Usage	Codebook
SRS-Resource	SRS-ResourceId	0
	nrofSRS-Ports	Port1
	transmissionComb	n2
	combOffset-n2	0
	cyclicShift-n2	0
	resourceMapping startPosition	0
	resourceMapping nrofSymbols	n1
	resourceMapping repetitionFactor	n1
	freqDomainPosition	0
	freqDomainShift	0
	freqHopping c-SRS	12
	freqHopping b-SRS	0
	freqHopping b-hop	0
	groupOrSequenceHopping	Neither
	resourceType	Periodic
	periodicityAndOffset-p	s160,25
	sequenceId	0

**Table 5.7.5.1.5-4: SRS-RSRP absolute accuracy test requirement**

Test requirement <sup>Notes1,2,3</sup>	
SRS	$SRS\_RP - \delta + G_{min} \leq \text{Reported SRS-RSRP(dBm)} \leq SRS\_RP + \delta + G_{max}$
Note 1:	SRS_RP is the equivalent power received by an antenna with 0dBi gain at the centre of the quiet zone configured in the test
Note 2:	$\delta$ is the RSRP absolute accuracy requirement from Table 10.1.22.1.1-2, selected according to the $I_o$ used in the test
Note 3:	$G_{min}$ and $G_{max}$ are the minimum and maximum UE gain values from Table B.2.1.5.1-1, selected according to the UE power class

The SRS-RSRP measurement accuracy shall fulfil the absolute accuracy requirements in clauses 5.7.5.0.10.1 The following requirements are to be verified:

During T1:

The UE is deemed to meet the requirement if the reported SRS-RSRP is in the range shown in table 5.7.5.1.5-4.

During T2:

The UE is deemed to meet the requirement if the reported SRS-RSRP is in the range shown in table 5.7.5.1.5-4.

For the test to pass, the ratio of successful reported values for each requirement shall be more than 90% with a confidence level of 95%. Each requirement is evaluated independently of the others.

## 6 NR standalone in FR1

### 6.0 General

This clause contains test scenarios for NR standalone. This configuration is also known as NR/5GC. All NR cells are in Frequency Range 1.

### 6.1 RRC\_IDLE state mobility

#### 6.1.1 NR cell re-selection

##### 6.1.1.0 Minimum conformance requirements

##### 6.1.1.0.1 Minimum conformance requirements for intra-frequency cell re-selection

The cell re-selection delay shall be less than  $T_{\text{evaluate\_NR\_Intra}} + T_{\text{SI-NR}}$  in RRC\_IDLE state.

The UE shall be able to identify new intra-frequency cells and perform SS-RSRP and SS-RSRQ measurements of the identified intra-frequency cells without an explicit intra-frequency neighbour list containing physical layer cell identities.

The UE shall be able to evaluate whether a newly detectable intra-frequency cell meets the reselection criteria defined in TS38.304 [30] within  $T_{\text{detect,NR\_Intra}}$  as defined in table 4.2.2.3-1 of TS 38.133 [6] when that  $T_{\text{reselection}} = 0$ . An intra frequency cell is considered to be detectable according to the conditions defined in Annex B.1.2 of TS 38.133 [6] for a corresponding Band.

The UE shall measure SS-RSRP and SS-RSRQ at least every  $T_{\text{measure,NR\_Intra}}$  (see table 4.2.2.3-1 of TS 38.133 [6]) for intra-frequency cells that are identified and measured according to the measurement rules.

The UE shall filter SS-RSRP and SS-RSRQ measurements of each measured intra-frequency cell using at least 2 measurements. Within the set of measurements used for the filtering, at least two measurements shall be spaced by at least  $T_{\text{measure,NR\_Intra}}/2$ .

The UE shall not consider a NR neighbour cell in cell reselection, if it is indicated as not allowed in the measurement control system information of the serving cell.

For an intra-frequency cell that has been already detected, but that has not been reselected to, the filtering shall be such that the UE shall be capable of evaluating that the intra-frequency cell has met reselection criterion defined within  $T_{\text{evaluate,NR\_Intra}}$  when  $T_{\text{reselection}} = 0$  as specified in table 4.2.2.3-1 of TS 38.133 [6] provided that the cell has at least [3]dB better ranked.

When evaluating cells for reselection, the SSB side conditions apply to both serving and non-serving intra-frequency cells.

If  $T_{\text{reselection}}$  timer has a non-zero value and the intra-frequency cell is satisfied with the reselection criteria which are defined in TS38.304 [30], the UE shall evaluate this intra-frequency cell for the  $T_{\text{reselection}}$  time. If this cell remains satisfied with the reselection criteria within this duration, then the UE shall reselect that cell.

The normative reference for this requirement is TS 38.133 [6] clause 4.2.2.2 and 4.2.2.3.

##### 6.1.1.0.2 Minimum conformance requirements for inter-frequency cell re-selection

The cell re-selection delay shall be less than  $T_{\text{evaluate\_NR\_Intra}} + T_{\text{SI-NR}}$  in RRC\_IDLE state.

The UE shall be able to identify new inter-frequency cells and perform SS-RSRP or SS-RSRQ measurements of identified inter-frequency cells if carrier frequency information is provided by the serving cell, even if no explicit neighbour list with physical layer cell identities is provided.

If  $S_{\text{rxlev}} > S_{\text{nonIntraSearchP}}$  and  $S_{\text{qual}} > S_{\text{nonIntraSearchQ}}$  then the UE shall search for inter-frequency layers of higher priority at least every  $T_{\text{higher\_priority\_search}}$  where  $T_{\text{higher\_priority\_search}}$  is described in clause 4.2.2.7 of TS 38.133 [6].

If  $S_{rxlev} \leq S_{nonIntraSearchP}$  or  $S_{qual} \leq S_{nonIntraSearchQ}$  then the UE shall search for and measure inter-frequency layers of higher, equal or lower priority in preparation for possible reselection. In this scenario, the minimum rate at which the UE is required to search for and measure higher priority layers shall be the same as that defined below in this clause.

The UE shall be able to evaluate whether a newly detectable inter-frequency cell meets the reselection criteria defined in TS38.304 [30] within  $K_{carrier} * T_{detect,NR\_Inter}$  if at least carrier frequency information is provided for inter-frequency neighbour cells by the serving cells when  $T_{reselection} = 0$  provided that the reselection criteria is met by a margin of at least [5] dB for reselections based on ranking or [6]dB for SS-RSRP reselections based on absolute priorities or [4]dB for SS-RSRQ reselections based on absolute priorities. The parameter  $K_{carrier}$  is the number of NR inter-frequency carriers indicated by the serving cell. An inter-frequency cell is considered to be detectable according to the conditions defined in Annex B.1.3 of TS 38.133 [6] for a corresponding Band.

When higher priority cells are found by the higher priority search, they shall be measured at least every  $T_{measure,NR\_Inter}$ . If, after detecting a cell in a higher priority search, it is determined that reselection has not occurred then the UE is not required to continuously measure the detected cell to evaluate the ongoing possibility of reselection. However, the minimum measurement filtering requirements specified later in this clause shall still be met by the UE before it makes any determination that it may stop measuring the cell. If the UE detects on a NR carrier a cell whose physical identity is indicated as not allowed for that carrier in the measurement control system information of the serving cell, the UE is not required to perform measurements on that cell.

The UE shall measure SS-RSRP or SS-RSRQ at least every  $K_{carrier} * T_{measure,NR\_Inter}$  (see table 4.2.2.4-1 of TS 38.133 [6]) for identified lower or equal priority inter-frequency cells. If the UE detects on a NR carrier a cell whose physical identity is indicated as not allowed for that carrier in the measurement control system information of the serving cell, the UE is not required to perform measurements on that cell.

The UE shall filter SS-RSRP or SS-RSRQ measurements of each measured higher, lower and equal priority inter-frequency cell using at least 2 measurements. Within the set of measurements used for the filtering, at least two measurements shall be spaced by at least  $T_{measure,NR\_Inter}/2$ .

The UE shall not consider a NR neighbour cell in cell reselection, if it is indicated as not allowed in the measurement control system information of the serving cell.

For an inter-frequency cell that has been already detected, but that has not been reselected to, the filtering shall be such that the UE shall be capable of evaluating that the inter-frequency cell has met reselection criterion defined TS 38.304 [30] within  $K_{carrier} * T_{evaluate,NR\_Inter}$  when  $T_{reselection} = 0$  as specified in table 4.2.2.4-1 of TS 38.133 [6] provided that the reselection criteria is met by

- the condition when performing equal priority reselection and the cell has at least [5]dB better ranked
- [6]dB for SS-RSRP reselections based on absolute priorities or
- [4]dB for SS-RSRQ reselections based on absolute priorities.

When evaluating cells for reselection, the SSB side conditions apply to both serving and inter-frequency cells.

If  $T_{reselection}$  timer has a non-zero value and the inter-frequency cell is satisfied with the reselection criteria, the UE shall evaluate this inter-frequency cell for the  $T_{reselection}$  time. If this cell remains satisfied with the reselection criteria within this duration, then the UE shall reselect that cell.

The UE is not expected to meet the measurement requirements for an inter-frequency carrier under DRX cycle=320 ms defined in Table 4.2.2.4-1 of TS 38.133 [6] under the following conditions:

- $T_{SMTC\_intra} = T_{SMTC\_inter} = 160$  ms; where  $T_{SMTC\_intra}$  and  $T_{SMTC\_inter}$  are periodicities of the SMTC occasions configured for the intra-frequency carrier and the inter-frequency carrier respectively, and
- SMTC occasions configured for the inter-frequency carrier occur up to 1 ms before the start or up to TBD ms after the end of the SMTC occasions configured for the intra-frequency carrier, and
- SMTC occasions configured for the intra-frequency carrier and for the inter-frequency carrier occur up to TBD ms before the start or up to TBD ms after the end of the paging occasion [1].

The normative reference for this requirement is TS 38.133 [6] clause 4.2.2.4.

### 6.1.1.0.3 Minimum conformance requirements for intra-frequency cell re-selection for UE configured with highSpeedMeasFlag-r16

The cell re-selection delay shall be less than  $T_{\text{evaluate, NR\_Intra}} + T_{\text{SI-NR}}$  in RRC\_IDLE state.

The UE shall be able to identify new intra-frequency cells and perform SS-RSRP and SS-RSRQ measurements of the identified intra-frequency cells without an explicit intra-frequency neighbour list containing physical layer cell identities.

The UE shall be able to evaluate whether a newly detectable intra-frequency cell meets the reselection criteria defined in TS38.304 [30] within  $T_{\text{detect, NR\_Intra}}$  as defined in table 4.2.2.3-2 of TS 38.133 [6] when that  $T_{\text{reselection}} = 0$ . An intra frequency cell is considered to be detectable according to the conditions defined in Annex B.1.2 of TS 38.133 [6] for a corresponding Band.

The UE shall measure SS-RSRP and SS-RSRQ at least every  $T_{\text{measure, NR\_Intra}}$  (see table 4.2.2.3-2 of TS 38.133 [6]) for intra-frequency cells that are identified and measured according to the measurement rules.

The UE shall filter SS-RSRP and SS-RSRQ measurements of each measured intra-frequency cell using at least 2 measurements. Within the set of measurements used for the filtering, at least two measurements shall be spaced by at least  $T_{\text{measure, NR\_Intra}}/2$ .

The UE shall not consider a NR neighbour cell in cell reselection, if it is indicated as not allowed in the measurement control system information of the serving cell.

For an intra-frequency cell that has been already detected, but that has not been reselected to, the filtering shall be such that the UE shall be capable of evaluating that the intra-frequency cell has met reselection criterion defined within  $T_{\text{evaluate, NR\_Intra}}$  when  $T_{\text{reselection}} = 0$  as specified in table 4.2.2.3-2 of TS 38.133 [6] provided that the cell has at least 3dB better ranked.

When evaluating cells for reselection, the SSB side conditions apply to both serving and non-serving intra-frequency cells.

If  $T_{\text{reselection}}$  timer has a non-zero value and the intra-frequency cell is satisfied with the reselection criteria which are defined in TS38.304 [30], the UE shall evaluate this intra-frequency cell for the  $T_{\text{reselection}}$  time. If this cell remains satisfied with the reselection criteria within this duration, then the UE shall reselect that cell.

The normative reference for this requirement is TS 38.133 [6] clause 4.2.2.2 and 4.2.2.3.

### 6.1.1.0.4 Minimum conformance requirements for intra-frequency cell re-selection when UE configured with relaxed measurement criterion

[TS 38.133, clause 4.2.2.3]

An intra frequency cell is considered to be detectable according to the conditions defined in Annex B.1.2 for a corresponding Band.

The UE shall measure SS-RSRP and SS-RSRQ at least every  $T_{\text{measure, NR\_Intra}}$  for intra-frequency cells that are identified and measured according to the measurement rules.

The UE shall filter SS-RSRP and SS-RSRQ measurements of each measured intra-frequency cell using at least 2 measurements. Within the set of measurements used for the filtering, at least two measurements shall be spaced by at least  $T_{\text{measure, NR\_Intra}}/2$ .

The UE shall not consider a NR neighbour cell in cell reselection, if it is indicated as not allowed in the measurement control system information of the serving cell.

For an intra-frequency cell that has been already detected, but that has not been reselected to, the filtering shall be such that the UE shall be capable of evaluating that the intra-frequency cell has met reselection criterion defined in TS38.304 [1] within  $T_{\text{evaluate, NR\_Intra}}$  when  $T_{\text{reselection}} = 0$  provided that:

when *rangeToBestCell* is not configured:

- the cell is at least 3dB better ranked in FR1.

When evaluating cells for reselection, the SSB side conditions apply to both serving and non-serving intra-frequency cells.



[TS 38.133, clause 4.2.2.9.2]

This clause contains requirements for measurements on intra-frequency NR cells provided that:

- UE is configured with *lowMobilityEvaluation* [2] criterion and UE has fulfilled, or
- UE is configured with both *lowMobilityEvaluation* [2] criterion and *cellEdgeEvaluation* [2] criterion and *combineRelaxedMeasCondition* [2] not configured, and UE has fulfilled only the *lowMobilityEvaluation* [2] criterion.

The requirements defined in clause 4.2.2.3 apply for this clause except that:

- $T_{\text{detect,NR\_Intra}}$  as specified in Table 4.2.2.9.2-1.
- $T_{\text{measure,NR\_Intra}}$  as specified in Table 4.2.2.9.2-1.
- $T_{\text{evaluate,NR\_Intra}}$  as specified in Table 4.2.2.9.2-1.

**Table 4.2.2.9.2-1:  $T_{\text{detect,NR\_Intra}}$ ,  $T_{\text{measure,NR\_Intra}}$  and  $T_{\text{evaluate,NR\_Intra}}$**

DRX cycle length [s]	Scaling Factor (N1)		$T_{\text{detect,NR\_Intra}}$ [s] (number of DRX cycles)	$T_{\text{measure,NR\_Intra}}$ [s] (number of DRX cycles)	$T_{\text{evaluate,NR\_Intra}}$ [s] (number of DRX cycles)
	FR1	FR2 <sup>Note1</sup>			
0.32	1	8	$11.52 \times N1 \times M2 \times K1$ (36 x $N1 \times M2 \times K1$ )	$1.28 \times N1 \times M2 \times K1$ (4 x $N1 \times M2 \times K1$ )	$5.12 \times N1 \times M2 \times K1$ (16 x $N1 \times M2 \times K1$ )
0.64		5	$17.92 \times N1 \times K1$ (28 x $N1 \times K1$ )	$1.28 \times N1 \times K1$ (2 x $N1 \times K1$ )	$5.12 \times N1 \times K1$ (8 x $N1 \times K1$ )
1.28		4	$32 \times N1 \times K1$ (25 x $N1 \times K1$ )	$1.28 \times N1 \times K1$ (1 x $N1 \times K1$ )	$6.4 \times N1 \times K1$ (5 x $N1 \times K1$ )
2.56		3	$58.88 \times N1 \times K1$ (23 x $N1 \times K1$ )	$2.56 \times N1 \times K1$ (1 x $N1 \times K1$ )	$7.68 \times N1 \times K1$ (3 x $N1 \times K1$ )
Note 1: Applies for UE supporting power class 2&3&4. For UE supporting power class 1, N1 = 8 for all DRX cycle length. Note 2: M2 = 1.5 if SMTTC periodicity of measured intra-frequency cell > 20 ms; otherwise M2=1. Note 3: K1 = 3 is the measurement relaxation factor applicable for UE fulfilling the <i>lowMobilityEvaluation</i> [13] criterion.					

[TS 38.133, clause 4.2.2.9.3]

This clause contains requirements for measurements on intra-frequency NR cells provided that:

- UE is configured with *cellEdgeEvaluation* [2] criterion and UE has fulfilled, or
- UE is configured with both *lowMobilityEvaluation* [2] criterion and *cellEdgeEvaluation* [2] criteria and *combineRelaxedMeasCondition* [2] not configured, and UE has fulfilled only the *cellEdgeEvaluation* [2] criterion.

The requirements defined in clause 4.2.2.3 apply for this clause except that:

- $T_{\text{detect,NR\_Intra}}$  as specified in Table 4.2.2.9.3-1.
- $T_{\text{measure,NR\_Intra}}$  as specified in Table 4.2.2.9.3-1.
- $T_{\text{evaluate,NR\_Intra}}$  as specified in Table 4.2.2.9.3-1.

**Table 4.2.2.9.3-1:  $T_{\text{detect,NR\_Intra}}$ ,  $T_{\text{measure,NR\_Intra}}$  and  $T_{\text{evaluate,NR\_Intra}}$** 

DRX cycle length [s]	Scaling Factor (N1)		$T_{\text{detect,NR\_Intra}}$ [s] (number of DRX cycles)	$T_{\text{measure,NR\_Intra}}$ [s] (number of DRX cycles)	$T_{\text{evaluate,NR\_Intra}}$ [s] (number of DRX cycles)
	FR1	FR2 <sup>Note1</sup>			
0.32	1	8	$11.52 \times N1 \times M2 \times K1$ ( $36 \times N1 \times M2 \times K1$ )	$1.28 \times N1 \times M2 \times K1$ ( $4 \times N1 \times M2 \times K1$ )	$5.12 \times N1 \times M2 \times K1$ ( $16 \times N1 \times M2 \times K1$ )
0.64		5	$17.92 \times N1 \times K1$ ( $28 \times N1 \times K1$ )	$1.28 \times N1 \times K1$ ( $2 \times N1 \times K1$ )	$5.12 \times N1 \times K1$ ( $8 \times N1 \times K1$ )
1.28		4	$32 \times N1 \times K1$ ( $25 \times N1 \times K1$ )	$1.28 \times N1 \times K1$ ( $1 \times N1 \times K1$ )	$6.4 \times N1 \times K1$ ( $5 \times N1 \times K1$ )
2.56		3	$58.88 \times N1 \times K1$ ( $23 \times N1 \times K1$ )	$2.56 \times N1 \times K1$ ( $1 \times N1 \times K1$ )	$7.68 \times N1 \times K1$ ( $3 \times N1 \times K1$ )

Note 1: Applies for UE supporting power class 2&3&4. For UE supporting power class 1, N1 = 8 for all DRX cycle length.  
Note 2: M2 = 1.5 if SMTC periodicity of measured intra-frequency cell > 20 ms; otherwise M2=1.  
Note 3: K1 = 3 is the measurement relaxation factor applicable for UE fulfilling the *cellEdgeEvaluation* [2] criterion.

[TS 38.133, Annex B.1.2]

This clause defines the following conditions for NR intra-frequency measurements performed based on SSBs for cell re-selection: SSB<sub>RP</sub> and SSB  $\dot{E}_s/I_{ot}$ , applicable for a corresponding operating band.

The conditions are defined in Table B.1.2-1 for FR1 NR cells.

**Table B.1.2-1: Conditions for intra-frequency cell re-selection in FR1**

Parameter	NR operating band groups <sup>Note1</sup>	Minimum SSB <sub>RP</sub>		SSB $\dot{E}_s/I_{ot}$
		dBm / SCS <sub>SSB</sub>		dB
		SCS <sub>SSB</sub> = 15 kHz	SCS <sub>SSB</sub> = 30 kHz	
Conditions	Depending on band group	$-124 + \Delta_{BG\_offset}$	$-121 + \Delta_{BG\_offset}$	$\geq -4$

NOTE 1: NR operating band groups are defined in TS 38.133 [6] clause 3.5.2.  
NOTE 2: For NR operating band groups,  $\Delta_{BG\_offset}$  is defined in clause 3A.4, Table 3A.4.1-2.

#### 6.1.1.0.5 Minimum conformance requirements for inter-frequency cell re-selection when UE configured with relaxed measurement criterion

[TS 38.133, clause 4.2.2.4]

An inter-frequency cell is considered to be detectable according to the conditions defined in Annex B.1.3 for a corresponding Band.

When higher priority cells are found by the higher priority search, they shall be measured at least every  $T_{\text{measure,NR\_Inter}}$ . If, after detecting a cell in a higher priority search, it is determined that reselection has not occurred then the UE is not required to continuously measure the detected cell to evaluate the ongoing possibility of reselection. However, the minimum measurement filtering requirements specified later in this clause shall still be met by the UE before it makes any determination that it may stop measuring the cell. If the UE detects on a NR carrier a cell whose physical identity is indicated as not allowed for that carrier in the measurement control system information of the serving cell, the UE is not required to perform measurements on that cell.

The UE shall measure SS-RSRP or SS-RSRQ at least every  $K_{\text{carrier}} * T_{\text{measure,NR\_Inter}}$  for identified lower or equal priority inter-frequency cells. If the UE detects on a NR carrier a cell whose physical identity is indicated as not allowed for that carrier in the measurement control system information of the serving cell, the UE is not required to perform measurements on that cell.

The UE shall filter SS-RSRP or SS-RSRQ measurements of each measured higher, lower and equal priority inter-frequency cell using at least 2 measurements. Within the set of measurements used for the filtering, at least two measurements shall be spaced by at least  $T_{\text{measure,NR\_Inter}}/2$ .

The UE shall not consider a NR neighbour cell in cell reselection, if it is indicated as not allowed in the measurement control system information of the serving cell.

For an inter-frequency cell that has been already detected, but that has not been reselected to, the filtering shall be such that the UE shall be capable of evaluating that the inter-frequency cell has met reselection criterion defined TS 38.304 [1] within  $K_{\text{carrier}} * T_{\text{evaluate,NR\_Inter}}$  when  $T_{\text{reselection}} = 0$  provided that the reselection criteria is met by

- the condition when performing equal priority reselection and
- 6dB in FR1 or 7.5dB in FR2 for SS-RSRP reselections based on absolute priorities

When evaluating cells for reselection, the SSB side conditions apply to both serving and inter-frequency cells.

[TS 38.133, clause 4.2.2.10.2]

This clause contains requirements for measurements on inter-frequency NR cells provided that:

- T331 timer is not running for EMR measurements on inter-frequency NR carrier, and
- UE is configured with *lowMobilityEvaluation* [2] criterion and UE has fulfilled, or
- UE is configured with both *lowMobilityEvaluation* [2] and *cellEdgeEvaluation* [2] criterion and *combineRelaxedMeasCondition* [2] not configured, and
- UE has fulfilled only the *lowMobilityEvaluation* [2] criterion.

When  $S_{\text{rxlev}} \leq S_{\text{nonIntraSearchP}}$  or  $S_{\text{qual}} \leq S_{\text{nonIntraSearchQ}}$  then the requirements defined in clause 4.2.2.4 apply for this clause except that:

- $T_{\text{detect,NR\_Inter}}$  as specified in Table 4.2.2.10.2-1.
- $T_{\text{measure,NR\_Inter}}$  as specified in Table 4.2.2.10.2-1.
- $T_{\text{evaluate,NR\_Inter}}$  as specified in Table 4.2.2.10.2-1.

**Table 4.2.2.10.2-1:  $T_{\text{detect,NR\_Inter}}$ ,  $T_{\text{measure,NR\_Inter}}$  and  $T_{\text{evaluate,NR\_Inter}}$**

DRX cycle length [s]	Scaling Factor (N1)		$T_{\text{detect,NR\_Inter}}$ [s] (number of DRX cycles)	$T_{\text{measure,NR\_Inter}}$ [s] (number of DRX cycles)	$T_{\text{evaluate,NR\_Inter}}$ [s] (number of DRX cycles)
	FR1	FR2 <sup>Note1</sup>			
0.32	1	8	$11.52 \times N1 \times 1.5 \times K1$ (36 x N1 x 1.5 x K1)	$1.28 \times N1 \times 1.5 \times K1$ (4 x N1 x 1.5 x K1)	$5.12 \times N1 \times 1.5 \times K1$ (16 x N1 x 1.5 x K1)
0.64		5	$17.92 \times N1 \times K1$ (28 x N1 x K1)	$1.28 \times N1 \times K1$ (2 x N1 x K1)	$5.12 \times N1 \times K1$ (8 x N1 x K1)
1.28		4	$32 \times N1 \times K1$ (25 x N1 x K1)	$1.28 \times N1 \times K1$ (1 x N1 x K1)	$6.4 \times N1 \times K1$ (5 x N1 x K1)
2.56		3	$58.88 \times N1 \times K1$ (23 x N1 x K1)	$2.56 \times N1 \times K1$ (1 x N1 x K1)	$7.68 \times N1 \times K1$ (3 x N1 x K1)

Note 1: Applies for UE supporting power class 2&3&4. For UE supporting power class 1, N1 = 8 for all DRX cycle length.

Note 2: K1 = 3 is the measurement relaxation factor applicable for UE fulfilling the low mobility.

[TS 38.133, clause 4.2.2.10.3]

This clause contains requirements for measurements on inter-frequency NR cells provided that:

- T331 timer is not running for EMR measurements on inter-frequency NR carrier, and
- UE is configured with *cellEdgeEvaluation* [2] criterion, and UE has fulfilled or
- UE is configured with both *lowMobilityEvaluation* [2] criterion and *cellEdgeEvaluation* [2] criterion and *combineRelaxedMeasCondition* [2] not configured, and
- UE has fulfilled only the *cellEdgeEvaluation* [2] criterion.

When  $S_{\text{rxlev}} \leq S_{\text{nonIntraSearchP}}$  or  $S_{\text{qual}} \leq S_{\text{nonIntraSearchQ}}$  then the requirements defined in clause 4.2.2.4 apply for this clause except that:

- $T_{\text{detect,NR\_Inter}}$  as specified in Table 4.2.2.10.3-1.

- $T_{measure,NR\_Inter}$  as specified in Table 4.2.2.10.3-1.
- $T_{evaluate,NR\_Inter}$  as specified in Table 4.2.2.10.3-1.

**Table 4.2.2.10.3-1:  $T_{detect,NR\_Inter}$ ,  $T_{measure,NR\_Inter}$  and  $T_{evaluate,NR\_Inter}$**

DRX cycle length [s]	Scaling Factor (N1)		$T_{detect,NR\_Inter}$ [s] (number of DRX cycles)	$T_{measure,NR\_Inter}$ [s] (number of DRX cycles)	$T_{evaluate,NR\_Inter}$ [s] (number of DRX cycles)
	FR1	FR2 <sup>Note1</sup>			
0.32	1	8	$11.52 \times N1 \times 1.5 \times K1$ (36 x $N1 \times 1.5 \times K1$ )	$1.28 \times N1 \times 1.5 \times K1$ (4 x $N1 \times 1.5 \times K1$ )	$5.12 \times N1 \times 1.5 \times K1$ (16 x $N1 \times 1.5 \times K1$ )
0.64		5	$17.92 \times N1 \times K1$ (28 x $N1 \times K1$ )	$1.28 \times N1 \times K1$ (2 x $N1 \times K1$ )	$5.12 \times N1 \times K1$ (8 x $N1 \times K1$ )
1.28		4	$32 \times N1 \times K1$ (25 x $N1 \times K1$ )	$1.28 \times N1 \times K1$ (1 x $N1 \times K1$ )	$6.4 \times N1 \times K1$ (5 x $N1 \times K1$ )
2.56		3	$58.88 \times N1 \times K1$ (23 x $N1 \times K1$ )	$2.56 \times N1 \times K1$ (1 x $N1 \times K1$ )	$7.68 \times N1 \times K1$ (3 x $N1 \times K1$ )

Note 1: Applies for UE supporting power class 2&3&4. For UE supporting power class 1, N1 = 8 for all DRX cycle length.  
 Note 2: K1 = 3 is the measurement relaxation factor applicable for UE fulfilling the *cellEdgeEvaluation* [2] criterion.

[TS 38.133, Annex B.1.3]

This clause defines the following conditions for NR inter-frequency measurements performed based on SSBs for cell re-selection:  $SSB\_RP$  and  $SSB \hat{E}s/Iot$ , applicable for a corresponding operating band.

The conditions defined in Table B.1.2-1 for FR1 NR intra-frequency cell re-selection shall also apply for FR1 NR inter-frequency cells in this clause.

[TS 38.133, Annex B.1.2]

This clause defines the following conditions for NR intra-frequency measurements performed based on SSBs for cell re-selection:  $SSB\_RP$  and  $SSB \hat{E}s/Iot$ , applicable for a corresponding operating band.

The conditions are defined in Table B.1.2-1 for FR1 NR cells.

**Table B.1.2-1: Conditions for intra-frequency cell re-selection in FR1**

Parameter	NR operating band groups <sup>Note1</sup>	Minimum $SSB\_RP$		$SSB \hat{E}s/Iot$
		dBm / $SCS_{SSB}$		dB
		$SCS_{SSB} = 15 \text{ kHz}$	$SCS_{SSB} = 30 \text{ kHz}$	
Conditions	Depending on band group	$-124 + \Delta_{BG\_offset}$	$-121 + \Delta_{BG\_offset}$	$\geq -4$

NOTE 1: NR operating band groups are defined in TS 38.133 [6] clause 3.5.2.  
 NOTE 2: For NR operating band groups,  $\Delta_{BG\_offset}$  is defined in clause 3A.4, Table 3A.4.1-2.

### 6.1.1.1 NR SA FR1 cell re-selection

#### 6.1.1.1.1 Test purpose

The purpose of this test is to verify that when the current and target cell operates on the same carrier frequency the UE is able to search and measure cells to meet the intra-frequency NR cell re-selection requirements.

#### 6.1.1.1.2 Test applicability

This test applies to all types of NR UE from release 15 onwards.

#### 6.1.1.1.3 Minimum conformance requirements

The minimum conformance requirements are specified in clause 6.1.1.0.1.

The normative reference for this requirement is TS 38.133 [6] clause A.6.1.1.1.

6.1.1.1.4 Test description

6.1.1.1.4.1 Initial conditions

This test shall be run in one of the configurations defined in Table 6.1.1.1.4.1-1.

**Table 6.1.1.1.4.1-1: Supported test configurations for NR SA FR1 cell re-selection**

Configuration	Description
6.1.1.1-1	15 kHz SSB SCS, 10MHz bandwidth, FDD duplex mode
6.1.1.1-2	15 kHz SSB SCS, 10MHz bandwidth, TDD duplex mode
6.1.1.1-3	30 kHz SSB SCS, 40MHz bandwidth, TDD duplex mode
Note:	The UE is only required to be tested in one of the supported test configurations.

Configure the test equipment and the DUT according to the parameters in Table 6.1.1.1.4.1-2.

**Table 6.1.1.1.4.1-2: Initial conditions for NR SA FR1 cell re-selection**

Parameter	Value	Comment
Test environment	NC	As specified in TS 38.508-1 [14] clause 4.1.
Test frequencies	As specified in Annex E, table E.4-1 and TS 38.508-1 [14] clause 4.3.1.	
Channel bandwidth	As specified by the test configuration selected from Table 6.1.1.1.4.1-1.	
Propagation conditions	AWGN	As specified in Annex C.2.2.
Connection Diagram	TE Part	A.3.1.8.2
	DUT Part	A.3.2.3.4
Exceptions to connection diagram	- Without LTE link - For 4Rx capable UEs without any 2Rx RF bands use A.3.2.5.2 for DUT part and A.3.1.8.4 for TE part.	

1. The general test parameter settings are set up according to Table 6.1.1.1.4.1-3.
2. Message contents are defined in clause 6.1.1.1.4.3.
3. There is one NR carrier and 2 NR Cells specified in the test. Cell 1 is the PCell and Cell 2 is the neighbour cell. Cell 1 and Cell 2 are configured according to Annex C.1.1 and C.1.2.

Table 6.1.1.1.4.1-3: General test parameters for NR SA FR1 cell re-selection

Parameter		Unit	Test configuration	Value	Comment
Initial condition	Active cell		1, 2, 3	Cell1	
T2 end condition	Active cell		1, 2, 3	Cell2	
	Neighbour cells		1, 2, 3	Cell1	
Final condition	Active cell		1, 2, 3	Cell1	
	Neighbour cell		1, 2, 3	Cell2	
RF Channel Number			1, 2, 3	1	
Time offset between cells			1	3 ms	Asynchronous cells
			2	3 $\mu$ s	Synchronous cells
			3	3 $\mu$ s	Synchronous cells
Access Barring Information		-	1, 2, 3	Not Sent	No additional delays in random access procedure.
SSB configuration			1	SSB.1 FR1	
			2	SSB.1 FR1	
			3	SSB.2 FR1	
SMTC configuration			1	SMTC.2	Configured in SIB2 of Cell 1
				SMTC.6	Configured in SIB2 of Cell 2
			2	SMTC.1	
				SMTC.1	
DRX cycle length		s	1, 2, 3	1.28	The value shall be used for all cells in the test.
PRACH configuration index			1, 2, 3	102	The detailed configuration is specified in TS 38.211 clause 6.3.3.2
rangeToBestCell			1, 2, 3	Not configured	
T1		s	1, 2, 3	>7	During T1, Cell 2 shall be powered off, and during the off time the physical cell identity shall be changed. The intention is to ensure that Cell 2 has not been detected by the UE prior to the start of period T2
T2		s	1, 2, 3	40	T2 needs to be defined so that cell re-selection reaction time is taken into account.
T3		s	1, 2, 3	15	T3 needs to be defined so that cell re-selection reaction time is taken into account.

#### 6.1.1.1.4.2 Test procedure

Two cells are deployed in the test, which are one FR1 NR PCell (Cell 1) and an NR neighbour cell (Cell 2) on the same frequency. The test consists of 3 successive time periods, with time duration of T1, T2, and T3 respectively. Only cell 1 is already identified by the UE prior to the start of the test. Cell 1 and cell 2 belong to different tracking areas. Furthermore, UE has not registered with network for the tracking area containing cell 2.

In the following test procedure "UE responds" means "UE starts transmitting preamble on PRACH for sending the *RRCSetupRequest* message to perform a Registration procedure for mobility.

1. Ensure the UE is in state RRC\_IDLE with generic procedure parameters connectivity NR with Test Mode On according to TS 38.508-1 [14] clause 4.5 on Cell 1. Set Cell 2 physical cell identity = initial cell 2 physical cell identity.
2. Set the parameters according to T1 in Table 6.1.1.1.5-1. T1 starts.
3. Set Cell 2 physical cell identity = ((current Cell 2 physical cell identity + 1) mod 14 + 2) for one iteration of the test procedure loop.
4. When T1 expires, the SS shall switch the power setting from T1 to T2 as specified in Table 6.1.1.1.5-1. T2 starts.

5. The SS waits for random access requests information from the UE to perform cell re-selection to a newly detectable cell, Cell 2.
6. If the UE responds on the newly detectable cell, Cell 2 during time duration T2 within 34 seconds from the beginning of time period T2, then count a success for the event “Re-select newly detected Cell 2”. Otherwise count a fail for the event “Re-select newly detected Cell 2”.
7. If the UE has re-selected Cell 2 within T2, after the re-selection or when T2 expires, continue with step 7a. Otherwise, if T2 expires and the UE has not yet re-selected Cell 2, the TE shall switch off and on the UE and skip to step 12.
- 7a The SS shall send an *RRCRelease* message to ensure that the UE is in state RRC\_IDLE on Cell 2.
8. The SS shall switch the power setting from T2 to T3 as specified in Table 6.1.1.1.5-1. T3 starts.
9. The SS waits for random access requests information from the UE to perform cell re-selection to an already detected cell, Cell 1.
10. If the UE responds on the already detected cell, Cell 1 during time duration T3 within 8 seconds from the beginning of time period T3, then count a success for the event “Re-select already detected Cell 1”. Otherwise count a fail for the event “Re-select already detected Cell 1”.
11. If the UE has re-selected Cell 1 within T3, after the re-selection or when T3 expires, continue with step 11a. Otherwise, if T3 expires and the UE has not yet re-selected Cell 1, the TE shall switch off and on the UE and skip to step 12.
- 11a. The SS shall send an *RRCRelease* message to ensure that the UE is in state RRC\_IDLE on Cell 1. 12. Ensure the UE is in state RRC\_IDLE with generic procedure parameters connectivity NR according to TS 38.508-1 [14] clause 4.5 in Cell 1.
13. Repeat step 2-12 until a test verdict has been achieved. Each of the events “Re-select newly detected Cell 2” and “Re-select already detected Cell 1” is evaluated independently for the statistic, resulting in an event verdict: pass or fail. Each event is evaluated only until the confidence level according to Table G.2.3-1 in Annex G clause G.2 is achieved. Different events may require different times for a verdict. If both events pass, the test passes. If one event fails, the test fails.

6.1.1.1.4.3 Message contents

Message contents are according to TS 38.508-1 [14] clause 4.6 with the following exceptions:

**Table 6.1.1.1.4.3-1: Common Exception messages**

Default Message Contents	
Common contents of system information blocks exceptions	Table H.2.1-2
Default RRC messages and information elements contents exceptions	

**Table 6.1.1.1.4.3-2: SIB1 (Cell 1 and Cell 2)**

Derivation Path: Table H.2.1-3			
Information Element	Value/remark	Comment	Condition
SIB1 ::= SEQUENCE {			
cellSelectionInfo SEQUENCE {			
q-RxLevMin	-65	-130 is actual value in dBm (-65 * 2 dBm)	6.1.1.1-1, 6.1.1.1-2
	-64	-128 is actual value in dBm (-64 * 2 + 1 dBm)	6.1.1.1-3
}			
}			

Table 6.1.1.1.4.3-3: SIB2 (Cell 1 and Cell 2)

Derivation Path: Table H.2.1-1			
Information Element	Value/remark	Comment	Condition
SIB2 ::= SEQUENCE {			
intraFreqCellReselectionInfo SEQUENCE {			
q-RxLevMin	-65	Actual value is -65*2 = -130dBm	6.1.1.1-1, 6.1.1.1-2
	-64	Actual value is -64*2 = -128dBm	6.1.1.1-3
smtc	SSB-MTC specified in TS 38.508-1 [14] Table 7.3.1-3 with condition SMTC.2		6.1.1.1-1 AND Cell 1
	SSB-MTC specified in TS 38.508-1 [14] Table 7.3.1-3 with condition SMTC.6		6.1.1.1-1 AND Cell 2
	SSB-MTC specified in TS 38.508-1 [14] Table 7.3.1-3 with condition SMTC.2		6.1.1.1-2, 6.1.1.1-3
deriveSSB-IndexFromCell	false		6.1.1.1-1
	true		6.1.1.1-2, 6.1.1.1-3
}			
}			

#### 6.1.1.1.5 Test requirement

Tables 6.1.1.1.4.1-3 and 6.1.1.1.5-1 define the primary level settings including test tolerances for intra frequency NR cell re-selection test case.



Table 6.1.1.1.5-1: Cell specific test parameters for NR SA FR1 cell re-selection

Parameter	Unit	Test configuration	Cell 1			Cell 2		
			T1	T2	T3	T1	T2	T3
TDD configuration		1	N/A			N/A		
		2	TDDConf.1.1			TDDConf.1.1		
		3	TDDConf.2.1			TDDConf.2.1		
PDSCH RMC configuration		1	SR.1.1 FDD			SR.1.1 FDD		
		2	SR.1.1 TDD			SR.1.1 TDD		
		3	SR.2.1 TDD			SR.2.1 TDD		
RMSI CORESET RMC configuration		1	CR.1.1 FDD			CR.1.1 FDD		
		2	CR.1.1 TDD			CR.1.1 TDD		
		3	CR.2.1 TDD			CR.2.1 TDD		
Dedicated CORESET RMC configuration		1	CCR.1.1 FDD			CCR.1.1 FDD		
		2	CCR.1.1 TDD			CCR.1.1 TDD		
		3	CCR.2.1 TDD			CCR.2.1 TDD		
OCNG Pattern		1, 2, 3	OP.1 defined in A.2.1-1			OP.1 defined in A.2.1-1		
Initial DL BWP configuration		1, 2, 3	DLBWP.0.1			DLBWP.0.1		
Initial UL BWP configuration		1, 2, 3	ULBWP.0.1			ULBWP.0.1		
RLM-RS		1, 2, 3	SSB			SSB		
Qrxlevmin	dBm/SCS	1, 2	-130			-130		
		3	-127			-127		
Pcompensation	dB	1, 2, 3	0			0		
Qhyst <sub>s</sub>	dB	1, 2, 3	0			0		
Qoffset <sub>s,n</sub>	dB	1, 2, 3	0			0		
Cell_selection_and_reselection_quality_measurement		1, 2, 3	SS-RSRP			SS-RSRP		
$\hat{E}_s / I_{ot}$	dB	1	16	-3.55	3.24	-infinity	3.24	-3.55
		2						
		3						
$N_{oc}$ <sup>Note2</sup>	dBm/SCS	1	-98					
		2	-98					
		3	-95					
$N_{oc}$ <sup>Note2</sup>	dBm/15 kHz	1	-98					
		2						
		3						
$\hat{E}_s / N_{oc}$	dB	1	16	13	16.45	-infinity	16.45	13
		2						
		3						
SS-RSRP <sup>Note3</sup>	dBm/SCS	1	-82	-85	-81.55	-infinity	-81.55	-85
		2	-82	-85	-81.55	-infinity	-81.55	-85
		3	-79	-82	-78.54	-infinity	-78.54	-82
I <sub>o</sub>	dBm/9.36 MHz	1	-53.94	-51.91	-51.91	Specified in Cell 1 columns		
	dBm/9.36 MHz	2	-53.94	-51.91	-51.91			
	dBm/38.16 MHz	3	-47.85	-45.81	-45.81			
Treselection	s	1, 2, 3	0	0	0	0	0	0
SintrasearchP	dB	1, 2, 3	60			60		
Propagation Condition		1, 2, 3	AWGN					
Note 1:	OCNG shall be used such that both cells are fully allocated and a constant total transmitted power spectral density is achieved for all OFDM symbols.							
Note 2:	Interference from other cells and noise sources not specified in the test is assumed to be constant over subcarriers and time and shall be modelled as AWGN of appropriate power for $N_{oc}$ to be fulfilled.							
Note 3:	SS-RSRP levels have been derived from other parameters for information purposes. They are not settable parameters themselves.							

The cell re-selection delay to a newly detectable cell is defined as the time from the beginning of time period T2, to the moment when the UE camps on Cell 2, and starts to send preambles on the PRACH for sending the *RRCSetupRequest* message to perform a Registration procedure for mobility and periodic registration update on Cell 2.

The cell re-selection delay to a newly detectable cell test requirement in this case is expressed as:

Cell re-selection delay to a newly detectable cell =  $T_{\text{detect,NR\_Intra}} + T_{\text{SI-NR}}$

$T_{\text{detect,NR\_Intra}} = 32$  s; as specified in TS 38.133 [6] clause 4.2.2.3.

$T_{\text{SI-NR}} = 1280$  ms; maximum repetition period of relevant system info blocks that needs to be received by the UE to camp on a cell is assumed in this test.

The cell re-selection delay to a newly detectable cell shall be less than a total of 33.28 seconds in this test case (note: this gives a total of 33.28 seconds but the test allows 34 seconds).

The cell re-selection delay to an already detected cell is defined as the time from the beginning of time period T3, to the moment when the UE camps on Cell 1, and starts to send preambles on the PRACH for sending the *RRCSetupRequest* message to perform a Registration procedure for mobility and periodic registration update on Cell 1.

The cell re-selection delay to an already detected cell test requirement in this case is expressed as:

Cell re-selection to an already detected cell delay =  $T_{\text{evaluate,NR\_Intra}} + T_{\text{SI-NR}}$

$T_{\text{evaluate,NR\_Intra}} = 6.4$  s; as specified in TS 38.133 [6] clause 4.2.2.3.

$T_{\text{SI-NR}} = 1280$  ms; maximum repetition period of relevant system info blocks that needs to be received by the UE to camp on a cell is assumed in this test.

The cell re-selection delay to an already detected cell shall be less than a total of 7.68 seconds in this test case (note: this gives a total of 7.68 seconds but the test allows 8 seconds).

For the test to pass, both events above shall pass.

The statistical pass/fail decisions are done separated for each event. For an event to pass, the total number of successful loops shall be more than 90% of the cases with a confidence level of 95%.

## 6.1.1.2 NR SA FR1-FR1 cell re-selection

### 6.1.1.2.1 Test purpose

The purpose of this test is to verify the requirement for the inter frequency NR cell reselection.

### 6.1.1.2.2 Test applicability

This test applies to all types of NR UE from Release 15 onwards.

### 6.1.1.2.3 Minimum conformance requirements

The minimum conformance requirements are specified in clause 6.1.1.0.2.

The normative reference for this requirement is TS 38.133 [6] clause A.6.1.1.2.

### 6.1.1.2.4 Test description

#### 6.1.1.2.4.1 Initial conditions

This test shall be run in one of the configurations defined in Table 6.1.1.2.4.1-1.

**Table 6.1.1.2.4.1-1: Supported test configurations for NR SA FR1-FR1 cell re-selection**

Configuration	Description of serving cell	Description of target cell
6.1.1.2-1	15 kHz SSB SCS, 10MHz bandwidth, FDD duplex mode	15 kHz SSB SCS, 10MHz bandwidth, FDD duplex mode
6.1.1.2-2	15 kHz SSB SCS, 10MHz bandwidth, TDD duplex mode	15 kHz SSB SCS, 10MHz bandwidth, TDD duplex mode
6.1.1.2-3	30 kHz SSB SCS, 40MHz bandwidth, TDD duplex mode	30 kHz SSB SCS, 40MHz bandwidth, TDD duplex mode
Note:	The UE is only required to be tested in one of the supported test configurations.	

Configure the test equipment and the DUT according to the parameters in Table 6.1.1.2.4.1-2.

**Table 6.1.1.2.4.1-2: Initial conditions for NR SA FR1-FR1 cell re-selection**

Parameter	Value		Comment
Test environment	NC		As specified in TS 38.508-1 [14] clause 4.1.
Test frequencies	As specified in Annex E, table E.4-1 and TS 38.508-1 [14] clause 4.3.1.		
Channel bandwidth	As specified by the test configuration selected from Table 6.1.1.2.4.1-1.		
Propagation conditions	AWGN		As specified in Annex C.2.2.
Connection Diagram	TE Part	A.3.1.8.2	As specified in TS 38.508-1 [14] Annex A.
	DUT Part	A.3.2.3.4	
Exceptions to connection diagram	N/A		

1. The general test parameter settings are set up according to Table 6.1.1.2.4.1-3.
2. Message contents are defined in clause 6.1.1.2.4.3.
3. There is two NR carrier and 2 NR Cells specified in the test. Cell 2 is the PCell and Cell 1 is the neighbour cell in a different carrier than cell 2. Cell 1 and Cell 2 are configured according to Annex C.1.2.

**Table 6.1.1.2.4.1-3: General test parameters for NR SA FR1-FR1 cell re-selection**

Parameter		Unit	Test configuration	Value	Comment
Initial condition	Active cell		1, 2, 3	Cell2	The UE camps on cell 2 in the initial phase and during T1 period the UE reselects to cell 1
	Neighbour cell		1, 2, 3	Cell1	
T1 end condition	Active cell		1, 2, 3	Cell1	The UE shall perform reselection to cell 1 during T1
	Neighbour cells		1, 2, 3	Cell2	
T3 end condition	Active cell		1, 2, 3	Cell2	The UE shall perform reselection to cell 2 with higher priority during T3
	Neighbour cell		1, 2, 3	Cell1	
RF Channel Number			1, 2, 3	1, 2	
Time offset between cells			1	3 ms	Asynchronous cells
			2	3 $\mu$ s	Synchronous cells
			3	3 $\mu$ s	Synchronous cells
Access Barring Information		-	1, 2, 3	Not Sent	No additional delays in random access procedure.
SSB configuration			1	SSB.1 FR1	
			2	SSB.1 FR1	
			3	SSB.2 FR1	
SMTC configuration			1	SMTC 2	Configured in SIB4 of Cell 1
			2	SMTC 1	Configured in SIB4 of Cell 2
			3	SMTC 1	
DRX cycle length		s	1, 2, 3	1.28	The value shall be used for all cells in the test.
PRACH configuration index			1, 2, 3	102	The detailed configuration is specified in TS 38.211 clause 6.3.3.2
rangeToBestCell			1, 2, 3	Not configured	
T1		s	1, 2, 3	15	T1 needs to be defined so that cell re-selection reaction time is taken into account.
T2		s	1, 2, 3	>7	During T2, cell 2 shall be powered off, and during the off time the physical cell identity shall be changed. The intention is to ensure that cell 2 has not been detected by the UE prior to the start of period T3.
T3		s	1, 2, 3	75	T3 needs to be defined so that cell re-selection reaction time is taken into account.

#### 6.1.1.2.4.2 Test procedure

The test consists of one active cell and one neighbour cell. The UE is requested to monitor the neighbouring cell on one of the NR carriers. The test consists of three successive time periods, with time duration of T1, T2, and T3 respectively. Both cell 1 and cell 2 are already identified by the UE prior to the start of the test. Cell 1 and cell 2 belong to different tracking areas and cell 2 is of higher priority than cell 1.

In the following test procedure “UE responds” means “UE starts transmitting preamble on PRACH for sending the *RRCSetupRequest* message to perform a Registration procedure for mobility.

1. Ensure the UE is in state RRC\_IDLE with generic procedure parameters connectivity NR with Test Mode *On* according to TS 38.508-1 [14] clause 4.5 on Cell 2.
2. Set the parameters according to T1 in Table 6.1.1.2.5-1. T1 starts.
3. The SS waits for random access requests information from the UE to perform cell re-selection on the lower priority cell, Cell 1.
4. If the UE responds on lower priority cell, Cell 1 during time duration T1 within 8 seconds from the beginning of time period T1, then count a success for the event “Re-select lower priority Cell 1”. Otherwise count a fail for the event “Re-select lower priority Cell 1”.
5. If the UE has re-selected Cell 1 within T1, after the re-selection or when T1 expires, continue with step 5a. Otherwise, if T1 expires and the UE has not yet re-selected Cell 1, the TE shall switch off and on the UE and skip to step 11.
- 5a. The SS shall send an *RRCRelease* message to ensure that the UE is in state RRC\_IDLE on Cell 1.
6. The SS shall switch the power setting from T1 to T2 as specified in Table 6.1.1.2.5-1. T2 starts. During time duration T2, Cell 2 shall be powered OFF and the physical cell identity = ((current Cell 2 physical cell identity + 1) mod 1008) shall be changed to ensure Cell 2 is not detected by the UE.
7. When T2 expires, the SS shall switch the power setting from T2 to T3 as specified in Table 6.1.1.2.5-1. T3 starts.
8. The SS waits for random access requests information from the UE to perform cell re-selection on the higher priority cell, Cell 2.
9. If the UE responds on higher priority cell, Cell 2 during time duration T3 within 68 seconds from the beginning of time period T3, then count a success for the event “Re-select higher priority Cell 2”. Otherwise count a fail for the event “Re-select higher priority Cell 2”.
10. If the UE has re-selected Cell 2 within T3, after the re-selection or when T3 expires, continue with step 10a. Otherwise, if T3 expires and the UE has not yet re-selected Cell 2, the TE shall switch off and on the UE and skip to step 11.
- 10a. The SS shall send an *RRCRelease* message to ensure that the UE is in state RRC\_IDLE on Cell 2.
11. Ensure the UE is in state RRC\_IDLE with generic procedure parameters connectivity NR according to TS 38.508-1 [14] clause 4.5 on Cell 2.
12. Repeat step 2-11 until a test verdict has been achieved.  
Each of the events “Re-select lower priority Cell 1” and “Re-select higher priority Cell 2” is evaluated independently for the statistic, resulting in an event verdict: pass or fail. Each event is evaluated only until the confidence level according to Table G.2.3-1 in Annex G clause G.2 is achieved. Different events may require different times for a verdict.  
If both events pass, the test passes. If one event fails, the test fails.

#### 6.1.1.2.4.3 Message contents

Message contents are according to TS 38.508-1 [14] clause 4.6 with the following exceptions:

**Table 6.1.1.2.4.3-1: Common Exception messages**

Default Message Contents	
Common contents of system information blocks exceptions	Table H.2.2-1  Table H.2.2-2 with Condition SSB.1 FR1, SMTC.2 and Asynchronous cells for configuration 6.1.1.2-1 and Cell 1 Table H.2.2-2 with Condition SSB.1 FR1, SMTC.6 and Asynchronous cells for configuration 6.1.1.2-1 and Cell 2 Table H.2.2-2 with Condition SSB.1 FR1, SMTC.1 and synchronous cells for configuration 6.1.1.2-2 Table H.2.2-2 with Condition SSB.2 FR1, SMTC.1 and synchronous cells for configuration 6.1.1.2-3  Table H.2.2-3
Default RRC messages and information elements contents exceptions	

6.1.1.2.5 Test requirement

Tables 6.1.1.2.4.1-3 and 6.1.1.2.5-1 define the primary level settings including test tolerances for inter frequency NR cell re-selection test case.

**Table 6.1.1.2.5-1: Cell specific test parameters for NR SA FR1-FR1 cell re-selection**

Parameter	Unit	Test configuration	Cell 1			Cell 2		
			T1	T2	T3	T1	T2	T3
TDD configuration		1	N/A			N/A		
		2	TDDConf.1.1			TDDConf.1.1		
		3	TDDConf.2.1			TDDConf.2.1		
PDSCH RMC configuration		1	SR.1.1 FDD			SR.1.1 FDD		
		2	SR.1.1 TDD			SR.1.1 TDD		
		3	SR.2.1 TDD			SR.2.1 TDD		
RMSI CORESET RMC configuration		1	CR.1.1 FDD			CR.1.1 FDD		
		2	CR.1.1 TDD			CR.1.1 TDD		
		3	CR.2.1 TDD			CR.2.1 TDD		
Dedicated CORESET RMC configuration		1	CCR.1.1 FDD			CCR.1.1 FDD		
		2	CCR.1.1 TDD			CCR.1.1 TDD		
		3	CCR.2.1 TDD			CCR.2.1 TDD		
OCNG Pattern		1, 2, 3	OP.1 defined in A.2.1-1			OP.1 defined in A.2.1-1		
Initial DL BWP configuration		1, 2, 3	DLBWP.0.1			DLBWP.0.1		
Initial UL BWP configuration		1, 2, 3	ULBWP.0.1			ULBWP.0.1		
RLM-RS		1, 2, 3	SSB			SSB		
Qrxlevmin	dBm/SCS	1, 2	-140			-140		
		3	-137			-137		
Pcompensation	dB	1, 2, 3	0			0		
Cell_selection_and_reselection_quality_measurement		1, 2, 3	SS-RSRP			SS-RSRP		
$\hat{E}_s / I_{ot}$	dB	1	15.6	15.6	15.6	-3.6	-infinity	13.6
		2						
		3						
$N_{oc}$ <small>Note2</small>	dBm/SCS	1	-98			-100	-98	-98
		2	-98			-100	-98	-98
		3	-95			-97	-95	-95
$N_{oc}$ <small>Note2</small>	dBm/15 kHz	1	-98			-100	-98	-98
		2						
		3						
$\hat{E}_s / N_{oc}$	dB	1	15.6	15.6	15.6	-3.6	-infinity	13.6
		2						
		3						

Parameter	Unit	Test configuration	Cell 1			Cell 2		
			T1	T2	T3	T1	T2	T3
SS-RSRP <sup>Note3</sup>	dBm/SCS	1	-82.4	-82.4	-82.4	-103.6	-infinity	-84.4
		2	-82.4	-82.4	-82.4	-103.6	-infinity	-84.4
		3	-79.39	-79.39	-79.39	-100.59	-infinity	-81.39
Io	dBm/9.36 MHz	1	-54.33	-54.33	-54.33	-70.46	-infinity	-56.26
	dBm/9.36 MHz	2	-54.33	-54.33	-54.33	-70.46	-infinity	-56.26
	dBm/38.16 MHz	3	-48.23	-48.23	-48.23	-67.37	-infinity	-53.17
Treselection	s	1, 2, 3	0	0	0	0	0	0
SnonintrasearchP	dB	1, 2, 3	50			50		
Thresh <sub>x, highP</sub>	dB	1, 2, 3	48			48		
Thresh <sub>serv, lowP</sub>	dB	1, 2, 3	44			44		
Thresh <sub>x, lowP</sub>	dB	1, 2, 3	50			50		
Propagation Condition		1, 2, 3	AWGN					
Note 1:	OCNG shall be used such that both cells are fully allocated and a constant total transmitted power spectral density is achieved for all OFDM symbols.							
Note 2:	Interference from other cells and noise sources not specified in the test is assumed to be constant over subcarriers and time and shall be modelled as AWGN of appropriate power for $N_{oc}$ to be fulfilled.							
Note 3:	SS-RSRP levels have been derived from other parameters for information purposes. They are not settable parameters themselves.							

The cell reselection delay to a higher priority cell is defined as the time from the beginning of time period T3, to the moment when the UE camps again on cell 2, and starts to send preambles on the PRACH for sending the *RRCSetupRequest* message to perform a Registration procedure for mobility and periodic registration update on cell 2.

The cell re-selection delay to a higher priority cell shall be less than 68 s.

The cell reselection delay to a lower priority cell is defined as the time from the beginning of time period T1, to the moment when the UE camps on cell 1, and starts to send preambles on the PRACH for sending the *RRCSetupRequest* message to perform a Registration procedure for mobility and periodic registration update on cell 1.

The cell re-selection delay to a lower priority cell shall be less than 8 s.

The rate of correct cell reselections observed during repeated tests shall be at least 90%.

NOTE: The cell re-selection delay to a higher priority cell can be expressed as:  $T_{\text{higher\_priority\_search}} + T_{\text{evaluate, NR\_inter}} + T_{\text{SI-NR}}$ , and to a lower priority cell can be expressed as:  $T_{\text{evaluate, NR\_inter}} + T_{\text{SI-NR}}$ .

Where:

$T_{\text{higher\_priority\_search}}$  See clause 4.2.2.7 of TS 38.133 [6]

$T_{\text{evaluate, NR\_inter}}$  See Table 4.2.2.4-1 in clause 4.2.2.4 of TS 38.133 [6]

$T_{\text{SI-NR}}$  Maximum repetition period of relevant system info blocks that needs to be received by the UE to camp on a cell; 1280 ms is assumed in this test case.

This gives a total of 67.68 s, allow 68 s for the cell re-selection delay to a higher priority cell and 7.68 s for the cell re-selection delay to a lower priority cell in the test case, which we allow 8 s.

For the test to pass, both events above shall pass.

The statistical pass/fail decisions are done separated for each event. For an event to pass, the total number of successful loops shall be more than 90% of the cases with a confidence level of 95%.

### 6.1.1.3 NR SA FR1 cell re-selection for UE fulfilling low mobility relaxed measurement criterion

#### 6.1.1.3.1 Test purpose

The purpose of this test is to verify the requirement for the intra frequency NR cell reselection requirements for UE fulfilling low mobility criterion specified in TS 38.133 [6] clause 4.2.2.9.2.

## 6.1.1.3.2 Test applicability

This test applies to all types of NR UE from release 16 onwards and supporting relaxed measurement.

## 6.1.1.3.3 Minimum conformance requirements

The minimum conformance requirements are specified in clause 6.1.1.0.3.

The normative reference for this requirement is TS 38.133 [6] clause A.6.1.1.3.

## 6.1.1.3.4 Test description

## 6.1.1.3.4.1 Initial conditions

This test shall be run in one of the configurations defined in Table 6.1.1.3.4.1-1.

**Table 6.1.1.3.4.1-1: Supported test configurations for NR SA FR1 cell re-selection for UE fulfilling low mobility relaxed measurement criterion**

Configuration	Description
6.1.1.3-1	15 kHz SSB SCS, 10 MHz bandwidth, FDD duplex mode
6.1.1.3-2	15 kHz SSB SCS, 10 MHz bandwidth, TDD duplex mode
6.1.1.3-3	30 kHz SSB SCS, 40 MHz bandwidth, TDD duplex mode
Note:	The UE is only required to be tested in one of the supported test configurations.

Configure the test equipment and the DUT according to the parameters in Table 6.1.1.3.4.1-2.

**Table 6.1.1.3.4.1-2: Initial conditions for NR SA FR1 cell re-selection for UE fulfilling low mobility relaxed measurement criterion**

Parameter	Value	Comment
Test environment	NC	As specified in TS 38.508-1 [14] clause 4.1.
Test frequencies	As specified in Annex E, table E.4-1 and TS 38.508-1 [14] clause 4.3.1.	
Channel bandwidth	As specified by the test configuration selected from Table 6.1.1.3.4.1-1.	
Propagation conditions	AWGN	As specified in Annex C.2.2.
Connection Diagram	TE Part DUT Part	A.3.1.8.2 A.3.2.3.4
Exceptions to connection diagram	- Without LTE link - For 4Rx capable UEs without any 2Rx RF bands use A.3.2.5.2 for DUT part and A.3.1.8.4 for TE part.	

1. The general test parameter settings are set up according to Table 6.1.1.3.4.1-3.
2. Message contents are defined in clause 6.1.1.3.4.3.
3. There is one NR carrier and 2 NR Cells specified in the test. Cell 1 is the PCell and Cell 2 is the neighbour cell. Cell 1 and Cell 2 are configured according to Annex C.1.1 and C.1.2.

**Table 6.1.1.3.4.1-3: General test parameters for NR SA FR1 cell re-selection for UE fulfilling low mobility relaxed measurement criterion**

Parameter		Unit	Test configuration	Value	Comment
Initial condition	Active cell		1, 2, 3	Cell1	The UE camps on cell 1 in the initial phase
	Neighbour cells		1, 2, 3	Cell2	
T1 end condition	Active cell		1, 2, 3	Cell2	The UE reselects to cell 2 during T1 period
	Neighbour cells		1, 2, 3	Cell1	
Final condition	Active cell		1, 2, 3	Cell1	The UE reselects to cell 1 during T2 period
	Neighbour cells		1, 2, 3	Cell2	
RF Channel Number			1, 2, 3	1	
Time offset between cells			1	3 ms	Asynchronous cells
			2	3 $\mu$ s	Synchronous cells
			3	3 $\mu$ s	Synchronous cells
Access Barring Information		-	1, 2, 3	Not Sent	No additional delays in random access procedure.
SSB configuration			1	SSB.1 FR1	
			2	SSB.1 FR1	
			3	SSB.2 FR1	
SMTC configuration			1	SMTC pattern 2	Configured in SIB2 of Cell 1
				SMTC pattern 6	Configured in SIB2 of Cell 2
			2	SMTC pattern 1	
				3	SMTC pattern 1
DRX cycle length		s	1, 2, 3	0.64	The value shall be used for all cells in the test.
PRACH configuration index			1, 2, 3	102	The detailed configuration is specified in TS 38.211 clause 6.3.3.2
rangeToBestCell			1, 2, 3	Not configured	
T1		s	1, 2, 3	25	T1 needs to be defined so that cell re-selection reaction time is taken into account.
T2		s	1, 2, 3	25	T2 needs to be defined so that cell re-selection reaction time is taken into account.

#### 6.1.1.3.4.2 Test procedure

Two cells are deployed in the test, which are one FR1 NR PCell (Cell 1) and an NR neighbour cell (Cell 2) on the same frequency. The test consists of 2 successive time periods, with time duration of T1, and T2 respectively. Both cell 1 and cell 2 are already identified by the UE prior to the start of the test. Cell 1 and cell 2 belong to different tracking areas. Furthermore, UE has not registered with network for the tracking area containing cell 2.

In the following test procedure "UE responds" means "UE starts transmitting preamble on PRACH for sending the *RRCSetupRequest* message to perform a Registration procedure for mobility.

Ensure the UE is in state RRC\_IDLE with generic procedure parameters connectivity NR with Test Mode *On* according to TS 38.508-1 [14] clause 4.5 on Cell 1. *lowMobilityEvaluation-r16* is provided in SIB2 of Cell 1 and Cell 2. Set Cell 2 physical cell identity = initial cell 2 physical cell identity.

SIB2 of Cell 1 and Cell 2 are configured as follows:

- *lowMobilityEvaluation-r16* is configured according to the parameters listed in Table 6.1.1.3.5-1.
- *cellEdgeEvaluation-r16* and *combineRelaxedMeasCondition* are not configured.



1. Set the parameters according to T2 in Table 6.1.1.3.5-1. Then wait 54s to ensure that Cell 2 has been detected by the UE.
2. Set the parameters according to T1 in Table 6.1.1.3.5-1. T1 starts.
3. The SS waits for random access requests information from the UE to perform cell re-selection to Cell 2.
4. If the UE responds on Cell 2 within 34 seconds from the beginning of time period T1, then count a success for the event "Re-select Cell 2". Otherwise count a fail for the event "Re-select Cell 2".
5. If the UE has re-selected Cell 2 within T1, after the re-selection or when T1 expires, continue with step 7. Otherwise, if T1 expires and the UE has not yet re-selected Cell 2, the TE shall switch off and on the UE and skip to step 13.
6. The SS shall send an *RRCRelease* message to ensure that the UE is in state RRC\_IDLE on Cell 2.
7. The SS shall switch the power setting from T1 to T2 as specified in Table 6.1.1.3.5-1. T2 starts.
8. The SS waits for random access requests information from the UE to perform cell re-selection to Cell 1.
9. If the UE responds on Cell 1 within 17 seconds from the beginning of time period T2, then count a success for the event "Re-select Cell 1". Otherwise count a fail for the event "Re-select Cell 1".
10. If the UE has re-selected Cell 1 within T2, after the re-selection or when T2 expires, continue with step 12. Otherwise, if T2 expires and the UE has not yet re-selected Cell 1, the TE shall switch off and on the UE and skip to step 13.
11. The SS shall send an *RRCRelease* message to ensure that the UE is in state RRC\_IDLE on Cell 1. skip to 15
12. Ensure the UE is in state RRC\_IDLE with generic procedure parameters connectivity NR according to TS 38.508-1 [14] clause 4.5 in Cell 1.
13. Set the parameters according to T2 in Table 6.1.1.3.5-1. Then wait 54s to ensure that Cell 2 has been detected by the UE.
14. Repeat step 2-14 until a test verdict has been achieved. Each of the events "Re-select Cell 2" and "Re-select Cell 1" is evaluated independently for the statistic, resulting in an event verdict: pass or fail. Each event is evaluated only until the confidence level according to Table G.2.3-1 in Annex G clause G.2 is achieved. Different events may require different times for a verdict. If both events pass, the test passes. If one event fails, the test fails.

#### 6.1.1.3.4.3 Message contents

Message contents are according to TS 38.508-1 [14] clause 7.3 with the following exceptions:

**Table 6.1.1.3.4.3-1: Common Exception messages**

Default Message Contents	
Common contents of system information blocks exceptions	Table H.2.1-2
Default RRC messages and information elements contents exceptions	

Table 6.1.1.3.4.3-2: SIB1 (Cell 1 and Cell 2)

Derivation Path: Table H.2.1-3			
Information Element	Value/remark	Comment	Condition
SIB1 ::= SEQUENCE {			
servingCellConfigCommon SEQUENCE {			
downlinkConfigCommon SEQUENCE {			
pcch-Config SEQUENCE {			
defaultPagingCycle	rf64		
}			
}			
}			
}			

Table 6.1.1.3.4.3-3: SIB2 (Cell 1)

Derivation Path: Table H.2.1-1			
Information Element	Value/remark	Comment	Condition
SIB2 ::= SEQUENCE {			
intraFreqCellReselectionInfo SEQUENCE {			
smtc	SSB-MTC specified in 38.508-1 [14] Table 7.3.1-3 with condition SMTC.2		6.1.1.3-1
	SSB-MTC specified in 38.508-1 [14] Table 7.3.1-3 with condition SMTC.1		6.1.1.3-2, 6.1.1.3-3
deriveSSB-IndexFromCell	false		6.1.1.3-1
	true		6.1.1.3-2, 6.1.1.3-3
}			
relaxedMeasurement-r16 SEQUENCE {			
lowMobilityEvaluation-r16 SEQUENCE {			
s-SearchDeltaP-r16	dB6		
t-SearchDeltaP-r16	s5		
}			
cellEdgeEvaluation-r16	Not present		
combineRelaxedMeasCondition-r16	Not present		
highPriorityMeasRelax-r16	Not present		
}			
}			

Table 6.1.1.3.4.3-4: SIB2 (Cell 2)

Derivation Path: Table H.2.1-1			
Information Element	Value/remark	Comment	Condition
SIB2 ::= SEQUENCE {			
intraFreqCellReselectionInfo SEQUENCE {			
smtc	SSB-MTC specified in 38.508-1 [14] Table 7.3.1-3 with condition SMTC.6		6.1.1.3-1
	SSB-MTC specified in 38.508-1 [14] Table 7.3.1-3 with condition SMTC.1		6.1.1.3-2, 6.1.1.3-3
deriveSSB-IndexFromCell	false		6.1.1.3-1
	true		6.1.1.3-2, 6.1.1.3-3
}			
relaxedMeasurement-r16 SEQUENCE {			
lowMobilityEvaluation-r16 SEQUENCE {			
s-SearchDeltaP-r16	dB6		
t-SearchDeltaP-r16	s5		
}			
cellEdgeEvaluation-r16	Not present		
combineRelaxedMeasCondition-r16	Not present		
highPriorityMeasRelax-r16	Not present		
}			
}			

}			
---	--	--	--

6.1.1.3.5 Test requirement

Tables 6.1.1.3.4.1-3 and 6.1.1.3.5-1 define the primary level settings including test tolerances for NR SA FR1 cell re-selection for UE fulfilling low mobility relaxed measurement criterion test case.

**Table 6.1.1.3.5-1: Cell specific test parameters for NR SA FR1 cell re-selection for UE fulfilling low mobility relaxed measurement criterion**

Parameter	Unit	Test configuration	Cell 1		Cell 2	
			T1	T2	T1	T2
TDD configuration		1	N/A		N/A	
		2	TDDConf.1.1		TDDConf.1.1	
		3	TDDConf.2.1		TDDConf.2.1	
PDSCH RMC configuration		1	SR.1.1 FDD		N/A	
		2	SR.1.1 TDD			
		3	SR.2.1 TDD			
RMSI CORESET RMC configuration		1	CR.1.1 FDD		CR.1.1 FDD	
		2	CR.1.1 TDD		CR.1.1 TDD	
		3	CR.2.1 TDD		CR.2.1 TDD	
Dedicated CORESET RMC configuration		1	CCR.1.1 FDD		CCR.1.1 FDD	
		2	CCR.1.1 TDD		CCR.1.1 TDD	
		3	CCR.2.1 TDD		CCR.2.1 TDD	
OCNG Pattern		1, 2, 3	OP.1 defined in A.3.2.1		OP.1 defined in A.3.2.1	
Initial DL BWP configuration		1, 2, 3	DLBWP.0.1		DLBWP.0.1	
Initial UL BWP configuration		1, 2, 3	ULBWP.0.1		ULBWP.0.1	
RLM-RS		1, 2, 3	SSB		SSB	
Qrxlevmin	dBm/SCS	1, 2	-140		-140	
		3	-137		-137	
Pcompensation	dB	1, 2, 3	0		0	
Qhysts	dB	1, 2, 3	0		0	
Qoffset <sub>s, n</sub>	dB	1, 2, 3	0		0	
S <sub>SearchDeltaP</sub>	dB	1, 2, 3	6		6	
T <sub>SearchDeltaP</sub>	s	1, 2, 3	5		5	
Cell_selection_and_reselection_quality_measurement		1, 2, 3	SS-RSRP		SS-RSRP	
$\hat{E}_s / I_{ot}$	dB	1, 2, 3	-3.56	3.22	3.22	-3.56
$N_{oc}$ <sup>Note2</sup>	dBm/SCS	1	-98			
		2	-98			
		3	-95			
$N_{oc}$ <sup>Note2</sup>	dBm/15 kHz	1, 2, 3	-98			
$\hat{E}_s / N_{oc}$	dB	1, 2, 3	12.55	16	16	12.55
SS-RSRP <sup>Note3</sup>	dBm/SCS	1	-85.45	-82	-82	-85.45
		2	-85.45	-82	-82	-85.45
		3	-82.45	-79	-79	-82.45
I <sub>o</sub>	dBm/9.36 MHz	1	-52.35	-52.35	specified in Cell 1 columns-	
	dBm/9.36 MHz	2	-52.35	-52.35		
	dBm/38.16 MHz	3	-46.25	-46.25		
Treselection	s	1, 2, 3	0	0	0	0
SinrasearchP	dB	1, 2, 3	60		60	
Propagation Condition		1, 2, 3	AWGN			
<p>Note 1: OCNG shall be used such that both cells are fully allocated and a constant total transmitted power spectral density is achieved for all OFDM symbols.</p> <p>Note 2: Interference from other cells and noise sources not specified in the test is assumed to be constant over subcarriers and time and shall be modelled as AWGN of appropriate power for <math>N_{oc}</math> to be fulfilled.</p> <p>Note 3: SS-RSRP levels have been derived from other parameters for information purposes. They are not settable parameters themselves.</p>						

The cell re-selection delay to detected cell for UE fulfilling low mobility criterion is defined as the time from the beginning of time period T1, to the moment when the UE camps on Cell 2, and starts to send preambles on the PRACH

for sending the *RRCSetupRequest* message to perform a Registration procedure for mobility and periodic registration update on Cell 2.

The cell re-selection delay to detected cell for UE fulfilling low mobility criterion is also defined as the time from the beginning of time period T2, to the moment when the UE camps on Cell 1, and starts to send preambles on the PRACH for sending the *RRCSetupRequest* message to perform a Registration procedure for mobility and periodic registration update on Cell 1.

The cell re-selection delay to a detected cell test requirement for UE fulfilling low mobility criterion in this case is expressed as:

$$\text{Cell re-selection delay to an already detected cell} = T_{\text{evaluate,NR\_Intra}} + T_{\text{SI-NR}}$$

$T_{\text{evaluate,NR\_Intra}} = 15.36$  s; as specified in TS 38.133 [6] Table 4.2.2.9.2-1.

$T_{\text{SI-NR}} = 1.28$  s; maximum repetition period of relevant system info blocks that needs to be received by the UE to camp on a cell is assumed in this test.

This gives a total of 16.64 s, allow 17 s for the cell re-selection delay to an already detected cell for UE fulfilling low mobility criterion in the test case.

For the test to pass, both events above shall pass.

The statistical pass/fail decisions are done separated for each event. For an event to pass, the total number of successful loops shall be more than 90% of the cases with a confidence level of 95%.

#### 6.1.1.4 NR SA FR1 cell re-selection for UE fulfilling not-at-cell edge relaxed measurement criterion

##### 6.1.1.4.1 Test purpose

The purpose of this test is to verify the requirement for the intra frequency NR cell reselection requirements for UE fulfilling not-at-cell edge criterion specified in TS 38.133 [6] clause 4.2.2.9.3.

##### 6.1.1.4.2 Test applicability

This test applies to all types of NR UE from release 16 onwards and supporting relaxed measurement.

##### 6.1.1.4.3 Minimum conformance requirements

The minimum conformance requirements are specified in clause 6.1.1.0.3.

The normative reference for this requirement is TS 38.133 [6] clause A.6.1.1.4.

##### 6.1.1.4.4 Test description

###### 6.1.1.4.4.1 Initial conditions

This test shall be run in one of the configurations defined in Table 6.1.1.4.4.1-1.

**Table 6.1.1.4.4.1-1: Supported test configurations for NR SA FR1 cell re-selection for UE fulfilling not-at-cell edge relaxed measurement criterion**

Configuration	Description
6.1.1.4-1	15 kHz SSB SCS, 10 MHz bandwidth, FDD duplex mode
6.1.1.4-2	15 kHz SSB SCS, 10 MHz bandwidth, TDD duplex mode
6.1.1.4-3	30 kHz SSB SCS, 40 MHz bandwidth, TDD duplex mode
Note:	The UE is only required to be tested in one of the supported test configurations.

Configure the test equipment and the DUT according to the parameters in Table 6.1.1.4.4.1-2.

**Table 6.1.1.4.4.1-2: Initial conditions for NR SA FR1 cell re-selection for UE fulfilling not-at-cell edge relaxed measurement criterion**

Parameter	Value		Comment
Test environment	NC		As specified in TS 38.508-1 [14] clause 4.1.
Test frequencies	As specified in Annex E, table E.4-1 and TS 38.508-1 [14] clause 4.3.1.		
Channel bandwidth	As specified by the test configuration selected from Table 6.1.1.4.4.1-1.		
Propagation conditions	AWGN		As specified in Annex C.2.2.
Connection Diagram	TE Part	A.3.1.8.2	As specified in TS 38.508-1 [14] Annex A.
	DUT Part	A.3.2.3.4	
Exceptions to connection diagram	- Without LTE link - For 4Rx capable UEs without any 2Rx RF bands use A.3.2.5.2 for DUT part and A.3.1.8.4 for TE part.		

1. The general test parameter settings are set up according to Table 6.1.1.4.4.1-3.
2. Message contents are defined in clause 6.1.1.4.4.3.
3. There is one NR carrier and 2 NR Cells specified in the test. Cell 1 is the PCell and Cell 2 is the neighbour cell. Cell 1 and Cell 2 are configured according to Annex C.1.1 and C.1.2.

**Table 6.1.1.4.4.1-3: General test parameters for NR SA FR1 cell re-selection for UE fulfilling not-at-cell edge relaxed measurement criterion**

Parameter		Unit	Test configuration	Value	Comment
Initial condition	Active Cell		1, 2, 3	Cell1	The UE camps on Cell 1 in the initial phase
	Neighbour Cells		1, 2, 3	Cell2	
T1 end condition	Active Cell		1, 2, 3	Cell2	The UE shall fulfil the not-at-cell edge criterion and reselect to cell 2 during T1 period during T1.
	Neighbour Cells		1, 2, 3	Cell1	
T2 end condition	Active Cell		1, 2, 3	Cell1	The UE shall perform reselection to Cell 1 during T2
	Neighbour Cells		1, 2, 3	Cell2	
RF Channel Number			1, 2, 3	1	
Time offset between Cells			1	3 ms	Asynchronous Cells
			2	3 $\mu$ s	Synchronous Cells
			3	3 $\mu$ s	Synchronous Cells
Access Barring Information		-	1, 2, 3	Not Sent	No additional delays in random access procedure.
SSB configuration			1	SSB.1 FR1	
			2	SSB.1 FR1	
			3	SSB.2 FR1	
SMTC configuration			1	SMTC pattern 2	Configured in SIB2 of Cell 1
				SMTC pattern 6	Configured in SIB2 of Cell 2
			2	SMTC pattern 1	
				SMTC pattern 1	
DRX cycle length		s	1, 2, 3	0.64	The value shall be used for all Cells in the test.
PRACH configuration index			1, 2, 3	102	The detailed configuration is specified in TS 38.211 clause 6.3.3.2
rangeToBestCell			1, 2, 3	Not configured	
T1		s	1, 2, 3	20	T1 needs to be defined so that Cell re-selection reaction time is taken into account.
T2		s	1, 2, 3	20	T2 needs to be defined so that Cell re-selection reaction time is taken into account.

#### 6.1.1.4.4.2 Test procedure

Two cells are deployed in the test, which are one FR1 NR PCell (Cell 1) and an NR neighbour cell (Cell 2) on the same frequency. The test consists of 2 successive time periods, with time duration of T1, and T2 respectively. Both cell 1 and cell 2 are already identified by the UE prior to the start of the test. Cell 1 and cell 2 belong to different tracking areas. Furthermore, UE has not registered with network for the tracking area containing cell 2.

In the following test procedure "UE responds" means "UE starts transmitting preamble on PRACH for sending the *RRCSetupRequest* message to perform a Registration procedure for mobility.

1. Ensure the UE is in state RRC\_IDLE with generic procedure parameters connectivity NR with Test Mode *On* according to TS 38.508-1 [14] clause 4.5 on Cell 1. *cellEdgeEvaluation-r16* is provided in SIB2 of Cell 1 and Cell 2. Set Cell 2 physical cell identity = initial cell 2 physical cell identity.
2. Set the parameters according to T2 in Table 6.1.1.4.5-1. Then wait 54s to ensure that Cell 2 has been detected by the UE.
3. Set the parameters according to T1 in Table 6.1.1.4.5-1. T1 starts.
4. The SS waits for random access requests information from the UE to perform cell re-selection to Cell 2.
5. If the UE responds on Cell 2 within 34 seconds from the beginning of time period T1, then count a success for the event "Re-select Cell 2". Otherwise count a fail for the event "Re-select Cell 2".
6. If the UE has re-selected Cell 2 within T1, after the re-selection or when T1 expires, continue with step 7. Otherwise, if T2 expires and the UE has not yet re-selected Cell 2, the TE shall switch off and on the UE and skip to step 13.
7. The SS shall send an *RRCRelease* message to ensure that the UE is in state RRC\_IDLE on Cell 2.
8. The SS shall switch the power setting from T1 to T2 as specified in Table 6.1.1.4.5-1. T2 starts.
9. The SS waits for random access requests information from the UE to perform cell re-selection to Cell 1.
10. If the UE responds on Cell 1 within 17 seconds from the beginning of time period T2, then count a success for the event "Re-select Cell 1". Otherwise count a fail for the event "Re-select Cell 1".
11. If the UE has re-selected Cell 1 within T2, after the re-selection or when T2 expires, continue with step 12. Otherwise, if T2 expires and the UE has not yet re-selected Cell 1, the TE shall switch off and on the UE and skip to step 13.
12. The SS shall send an *RRCRelease* message to ensure that the UE is in state RRC\_IDLE on Cell 1. skip to 15
13. Ensure the UE is in state RRC\_IDLE with generic procedure parameters connectivity NR according to TS 38.508-1 [14] clause 4.5 in Cell 1.
14. Set the parameters according to T2 in Table 6.1.1.4.5-1. Then wait 54s to ensure that Cell 2 has been detected by the UE.
15. Repeat step 2-14 until a test verdict has been achieved. Each of the events "Re-select Cell 2" and "Re-select Cell 1" is evaluated independently for the statistic, resulting in an event verdict: pass or fail. Each event is evaluated only until the confidence level according to Table G.2.3-1 in Annex G clause G.2 is achieved. Different events may require different times for a verdict. If both events pass, the test passes. If one event fails, the test fails.

#### 6.1.1.4.4.3 Message contents

Message contents are according to TS 38.508-1 [14] clause 7.3 with the following exceptions:

**Table 6.1.1.4.4.3-1: Common Exception messages**

Default Message Contents	
Common contents of system information blocks exceptions	Table H.2.1-2
Default RRC messages and information elements contents exceptions	

**Table 6.1.1.4.4.3-2: SIB1 (Cell 1 and Cell 2)**

Derivation Path: TS 38.508-1 [14], Table 4.6.1-28			
Information Element	Value/remark	Comment	Condition
SIB1 ::= SEQUENCE {			
servingCellConfigCommon SEQUENCE {			
downlinkConfigCommon SEQUENCE {			
pcch-Config SEQUENCE {			
defaultPagingCycle	rf64		
}			
}			
}			
}			

**Table 6.1.1.4.4.3-3: SIB2 (Cell 1)**

Derivation Path: Table H.2.1-1			
Information Element	Value/remark	Comment	Condition
SIB2 ::= SEQUENCE {			
intraFreqCellReselectionInfo SEQUENCE {			
smtc	SSB-MTC specified in 38.508-1 [14] Table 7.3.1-3 with condition SMTC.2		6.1.1.4-1
	SSB-MTC specified in 38.508-1 [14] Table 7.3.1-3 with condition SMTC.1		6.1.1.4-2, 6.1.1.4-3
deriveSSB-IndexFromCell	false		6.1.1.4-1
	true		6.1.1.4-2, 6.1.1.4-3
}			
relaxedMeasurement-r16 SEQUENCE {			
cellEdgeEvaluation-r16 SEQUENCE {			
s-SearchThresholdP-r16	25	Actual value is 35*2 = 50dB	T1
	Not present		T2
s-SearchThresholdQ-r16	Not present		
}			
cellEdgeEvaluation-r16	Not present		
combineRelaxedMeasCondition-r16	Not present		
highPriorityMeasRelax-r16	Not present		
}			
}			

**Table 6.1.1.4.4.3-4: SIB2 (Cell 2)**

Derivation Path: Table H.2.1-1			
Information Element	Value/remark	Comment	Condition
SIB2 ::= SEQUENCE {			
intraFreqCellReselectionInfo SEQUENCE {			



smtc	SSB-MTC specified in 38.508-1 [14] Table 7.3.1-3 with condition SMTc.6		6.1.1.4-1
	SSB-MTC specified in 38.508-1 [14] Table 7.3.1-3 with condition SMTc.1		6.1.1.4-2, 6.1.1.4-3
deriveSSB-IndexFromCell	false		6.1.1.4-1
	true		6.1.1.4-2, 6.1.1.4-3
}			
relaxedMeasurement-r16 SEQUENCE {			
cellEdgeEvaluation-r16 SEQUENCE {			
s-SearchThresholdP-r16	25	Actual value is $35 \times 2 = 50\text{dB}$	T2
	Not present		T1
s-SearchThresholdQ-r16	Not present		
}			
cellEdgeEvaluation-r16	Not present		
combineRelaxedMeasCondition-r16	Not present		
highPriorityMeasRelax-r16	Not present		
}			
}			

#### 6.1.1.4.5 Test requirement

Tables 6.1.1.4.4.1-3 and 6.1.1.4.5-1 define the primary level settings including test tolerances for NR SA FR1 cell re-selection for UE fulfilling not-at-cell edge relaxed measurement criterion test case.

**Table 6.1.1.4.5-1: Cell specific test parameters for NR SA FR1 cell re-selection for UE fulfilling not-at-cell edge relaxed measurement criterion**

Parameter	Unit	Test configuration	Cell 1		Cell 2	
			T1	T2	T1	T2
TDD configuration		1	N/A		N/A	
		2	TDDConf.1.1		TDDConf.1.1	
		3	TDDConf.2.1		TDDConf.2.1	
PDSCH RMC configuration		1	SR.1.1 FDD		N/A	
		2	SR.1.1 TDD			
		3	SR.2.1 TDD			
RMSI CORESET RMC configuration		1	CR.1.1 FDD		CR.1.1 FDD	
		2	CR.1.1 TDD		CR.1.1 TDD	
		3	CR.2.1 TDD		CR.2.1 TDD	
Dedicated CORESET RMC configuration		1	CCR.1.1 FDD		CCR.1.1 FDD	
		2	CCR.1.1 TDD		CCR.1.1 TDD	
		3	CCR.2.1 TDD		CCR.2.1 TDD	
OCNG Pattern		1, 2, 3	OP.1 defined in A.3.2.1		OP.1 defined in A.3.2.1	
Initial DL BWP configuration		1, 2, 3	DLBWP.0.1		DLBWP.0.1	
Initial UL BWP configuration		1, 2, 3	ULBWP.0.1		ULBWP.0.1	
RLM-RS		1, 2, 3	SSB		SSB	
Qrxlevmin	dBm/SCS	1, 2	-140		-140	
		3	-137		-137	
Pcompensation	dB	1, 2, 3	0		0	
Qhyst <sub>s</sub>	dB	1, 2, 3	0		0	
Qoffset <sub>s, n</sub>	dB	1, 2, 3	0		0	

Parameter	Unit	Test configuration	Cell 1		Cell 2	
			T1	T2	T1	T2
Cell_selection_and_reselection_quality_measurement		1, 2, 3	SS-RSRP		SS-RSRP	
$\hat{E}_s / I_{ot}$	dB	1	-3.56	3.22	3.22	-3.56
		2				
		3				
$N_{oc}$ Note2	dBm/SCS	1	-98			
		2	-98			
		3	-95			
$N_{oc}$ Note2	dBm/15 kHz	1	-98			
		2				
		3				
$\hat{E}_s / N_{oc}$	dB	1	12.55	16	16	12.55
		2				
		3				
SS-RSRP Note3	dBm/SCS	1	-85.45	-82	-82	-85.45
		2	-85.45	-82	-82	-85.45
		3	-82.45	-79	-79	-82.45
I <sub>o</sub>	dBm/9.36 MHz	1	-52.35	-52.35	-52.35	-52.35
	dBm/9.36 MHz	2	-52.35	-52.35	-52.35	-52.35
	dBm/38.16 MHz	3	-46.25	-46.25	-46.25	-46.25
Treselection	s	1, 2, 3	0	0	0	0
SintrasearchP	dB	1, 2, 3	60		60	
S <sub>searchThresholdP</sub>	dB	1, 2, 3	50	Not sent	Not sent	50
Propagation Condition		1, 2, 3	AWGN			
Note 1: OCNG shall be used such that both Cells are fully allocated and a constant total transmitted power spectral density is achieved for all OFDM symbols.						
Note 2: Interference from other Cells and noise sources not specified in the test is assumed to be constant over subcarriers and time and shall be modelled as AWGN of appropriate power for $N_{oc}$ to be fulfilled.						
Note 3: SS-RSRP levels have been derived from other parameters for information purposes. They are not settable parameters themselves.						

The cell re-selection delay to detected cell for UE fulfilling not-at-cell edge criterion is defined as the time from the beginning of time period T1, to the moment when the UE camps on Cell 2, and starts to send preambles on the PRACH for sending the *RRCSetupRequest* message to perform a Registration procedure for mobility and periodic registration update on Cell 2.

The cell re-selection delay to detected cell for UE fulfilling not-at-cell edge criterion is also defined as the time from the beginning of time period T2, to the moment when the UE camps on Cell 1, and starts to send preambles on the PRACH for sending the *RRCSetupRequest* message to perform a Registration procedure for mobility and periodic registration update on Cell 1.

The cell re-selection delay to a detected cell test requirement for UE fulfilling not-at-cell edge criterion in this case is expressed as:

$$\text{Cell re-selection delay to a detected cell} = T_{\text{evaluate,NR\_Intra}} + T_{\text{SI-NR}}$$

$$T_{\text{evaluate,NR\_Intra}} = 15.36 \text{ s; as specified in TS 38.133 [6] Table 4.2.2.9.3-1.}$$

$$T_{\text{SI-NR}} = 1.28 \text{ s; maximum repetition period of relevant system info blocks that needs to be received by the UE to camp on a cell is assumed in this test.}$$

This gives a total of 16.64 s, allow 17 s for the cell re-selection delay to an already detected cell for UE fulfilling not-at-cell edge criterion in the test case.

For the test to pass, both events above shall pass.

The statistical pass/fail decisions are done separated for each event. For an event to pass, the total number of successful loops shall be more than 90% of the cases with a confidence level of 95%.

### 6.1.1.5 NR SA FR1-FR1 cell re-selection for UE fulfilling low mobility relaxed measurement criterion

#### 6.1.1.5.1 Test purpose

The purpose of this test is to verify the requirement for the inter-frequency NR cell reselection requirements for UE fulfilling low mobility criterion specified in TS 38.133 [6] clause 4.2.2.10.2.

#### 6.1.1.5.2 Test applicability

This test applies to all types of NR UE from release 16 onwards and supporting relaxed measurement.

#### 6.1.1.5.3 Minimum conformance requirements

The minimum conformance requirements are specified in clause 6.1.1.0.4.

The normative reference for this requirement is TS 38.133 [6] clause A.6.1.1.5.

#### 6.1.1.5.4 Test description

##### 6.1.1.5.4.1 Initial conditions

This test shall be run in one of the configurations defined in Table 6.1.1.5.4.1-1.

**Table 6.1.1.5.4.1-1: Supported test configurations for NR SA FR1-FR1 cell re-selection for UE fulfilling low mobility relaxed measurement criterion**

Configuration	Description of serving cell	Description of target cell
6.1.1.5-1	15 kHz SSB SCS, 10 MHz bandwidth, FDD duplex mode	15 kHz SSB SCS, 10 MHz bandwidth, FDD duplex mode
6.1.1.5-2	15 kHz SSB SCS, 10 MHz bandwidth, TDD duplex mode	15 kHz SSB SCS, 10 MHz bandwidth, TDD duplex mode
6.1.1.5-3	30 kHz SSB SCS, 40 MHz bandwidth, TDD duplex mode	30 kHz SSB SCS, 40 MHz bandwidth, TDD duplex mode

Note: The UE is only required to be tested in one of the supported test configurations.

Configure the test equipment and the DUT according to the parameters in Table 6.1.1.5.4.1-2.

**Table 6.1.1.5.4.1-2: Initial conditions for NR SA FR1-FR1 cell re-selection for UE fulfilling low mobility relaxed measurement criterion**

Parameter	Value	Comment
Test environment	NC	As specified in TS 38.508-1 [14] clause 4.1.
Test frequencies	As specified in Annex E, table E.4-1 and TS 38.508-1 [14] clause 4.3.1.	
Channel bandwidth	As specified by the test configuration selected from Table 6.1.1.5.4.1-1.	
Propagation conditions	AWGN	As specified in Annex C.2.2.
Connection Diagram	TE Part DUT Part	A.3.1.8.2 A.3.2.3.4
Exceptions to connection diagram	- Without LTE link - For 4Rx capable UEs without any 2Rx RF bands use A.3.2.5.2 for DUT part and A.3.1.8.4 for TE part.	

1. The general test parameter settings are set up according to Table 6.1.1.5.4.1-3.
2. Message contents are defined in clause 6.1.1.5.4.3.
3. There is 2 NR carriers and 2 NR Cells specified in the test. Cell 1 is the PCell and Cell 2 is the neighbour cell. Cell 1 and Cell 2 are configured according to Annex C.1.1 and C.1.2.

**Table 6.1.1.5.4.1-3: General test parameters for NR SA FR1-FR1 cell re-selection for UE fulfilling low mobility relaxed measurement criterion**

Parameter		Unit	Test configuration	Value	Comment
Initial condition	Active cell		1, 2, 3	Cell2	The UE camps on cell 2 in the initial phase, it fulfils Low Mobility relaxation measurements criterion, and during T1 period the UE reselects to cell 1
	Neighbour cells		1, 2, 3	Cell1	
T1 end condition	Active cell		1, 2, 3	Cell1	The UE shall perform reselection to cell 1 during T1
	Neighbour cells		1, 2, 3	Cell2	
T2 end condition	Active cell		1, 2, 3	Cell2	The UE shall perform reselection to cell 2 with higher priority during T2
	Neighbour cells		1, 2, 3	Cell1	
RF Channel Number			1, 2, 3	1, 2	
Time offset between cells			1	3 ms	Asynchronous cells
			2	3 $\mu$ s	Synchronous cells
			3	3 $\mu$ s	Synchronous cells
Access Barring Information		-	1, 2, 3	Not Sent	No additional delays in random access procedure.
SSB Configuration			1	SSB.1 FR1	
			2	SSB.1 FR1	
			3	SSB.2 FR1	
SMTC configuration			1	SMTC pattern 2	Configured in SIB4 of Cell 1
				SMTC pattern 6	Configured in SIB4 of Cell 2
			2	SMTC pattern 1	
				3	SMTC pattern 1
DRX cycle length		s	1, 2, 3	0.64	The value shall be used for all cells in the test.
PRACH configuration index			1, 2, 3	102	The detailed configuration is specified in TS 38.211 clause 6.3.3.2
rangeToBestCell			1, 2, 3	Not configured	
T1		s	1, 2, 3	25 s	T1 is defined so that cell re-selection reaction time is taken into account.
T2		s	1, 2, 3	25 s	T2 is defined so that cell re-selection reaction time is taken into account.

#### 6.1.1.5.4.2 Test procedure

Two cells are deployed in the test, which are one FR1 NR Cell 1 and Cell 2 on different frequencies. The test consists of 2 successive time periods, with time duration of T1, and T2 respectively. Both cell 1 and cell 2 are already identified by the UE prior to the start of the test. Cell 1 and cell 2 belong to different tracking areas and Cell 2 is of higher priority than Cell 1. Furthermore, UE has not registered with network for the tracking area containing cell 1.

In the following test procedure "UE responds" means "UE starts transmitting preamble on PRACH for sending the *RRCSetupRequest* message to perform a Registration procedure for mobility.

1. Ensure the UE is in state RRC\_IDLE with generic procedure parameters connectivity NR with Test Mode On according to TS 38.508-1 [14] clause 4.5 on Cell 2. SIB2 of Cell 1 and Cell 2 are configured as follows:

*lowMobilityEvaluation-r16* is configured according to the parameters listed in Table 6.1.1.5.5-1.

*cellEdgeEvaluation-r16* and *combineRelaxedMeasCondition* are not configured.

2. Set the parameters according to T1 in Table 6.1.1.5.5-1. T1 starts.
3. The SS waits for random access requests information from the UE to perform cell re-selection to Cell 1.
4. If the UE responds on Cell 1 within 17 seconds from the beginning of time period T1, then count a success for the event "Re-select Cell 1". Otherwise count a fail for the event "Re-select Cell 1".

5. If the UE has re-selected Cell 1 within T1, after the re-selection or when T1 expires, continue with step 6. Otherwise, if T2 expires and the UE has not yet re-selected Cell 1, the TE shall switch off and on the UE and skip to step 12.
6. The SS shall send an *RRCRelease* message to ensure that the UE is in state RRC\_IDLE on Cell 1.
7. The SS shall switch the power setting from T1 to T2 as specified in Table 6.1.1.5.5-1. T2 starts.
8. The SS waits for random access requests information from the UE to perform cell re-selection to Cell 2.
9. If the UE responds on Cell 2 within 17 seconds from the beginning of time period T2, then count a success for the event “Re-select Cell 2”. Otherwise count a fail for the event “Re-select Cell 2”.
10. If the UE has re-selected Cell 2 within T2, after the re-selection or when T2 expires, continue with step 11. Otherwise, if T2 expires and the UE has not yet re-selected Cell 2, the TE shall switch off and on the UE and skip to step 12.
11. The SS shall send an *RRCRelease* message to ensure that the UE is in state RRC\_IDLE on Cell 2. skip to 13
12. Ensure the UE is in state RRC\_IDLE with generic procedure parameters connectivity *NR* according to TS 38.508-1 [14] clause 4.5 in Cell 2.
13. Repeat step 2-12 until a test verdict has been achieved. Each of the events “Re-select Cell 2” and “Re-select Cell 1” is evaluated independently for the statistic, resulting in an event verdict: pass or fail. Each event is evaluated only until the confidence level according to Table G.2.3-1 in Annex G clause G.2 is achieved. Different events may require different times for a verdict. If both events pass, the test passes. If one event fails, the test fails.

#### 6.1.1.5.4.3 Message contents

**Message contents are according to TS 38.508-1 [14] clause 7.3 with the following exceptions: Table 6.1.1.5.4.3-1: SIB1 (Cell 1 and Cell 2)**

Derivation Path: TS 38.508-1 [14], Table 4.6.1-28			
Information Element	Value/remark	Comment	Condition
SIB1 ::= SEQUENCE {			
servingCellConfigCommon SEQUENCE {			
downlinkConfigCommon SEQUENCE {			
pcch-Config SEQUENCE {			
defaultPagingCycle	rf64		
}			
}			
}			
}			

**Table 6.1.1.5.4.3-2: SIB2 (Cell 1)**

Derivation Path: Table H.2.2-1			
Information Element	Value/remark	Comment	Condition
SIB2 ::= SEQUENCE {			
cellReselectionServingFreqInfo SEQUENCE {			
s-NonIntraSearchP	Not present		
threshServingLowP	22	Actual value = 22*2 = 44dB	
}			
relaxedMeasurement-r16 SEQUENCE {			
lowMobilityEvaluation-r16 SEQUENCE {			
s-SearchDeltaP-r16	dB3		
t-SearchDeltaP-r16	s5		
}			
cellEdgeEvaluation-r16	Not present		
combineRelaxedMeasCondition-r16	Not present		
highPriorityMeasRelax-r16	Not present		
}			
}			

Table 6.1.1.5.4.3-3: SIB2 (Cell 2)

Derivation Path: Table H.2.2-1			
Information Element	Value/remark	Comment	Condition
SIB2 ::= SEQUENCE {			
cellReselectionServingFreqInfo SEQUENCE {			
s-NonIntraSearchP	Not present		
threshServingLowP	23	Actual value = 23*2 = 46dB	Cell 2
}			
relaxedMeasurement-r16 SEQUENCE {			
lowMobilityEvaluation-r16 SEQUENCE {			
s-SearchDeltaP-r16	dB15		Cell 2
t-SearchDeltaP-r16	s5		
}			
cellEdgeEvaluation-r16	Not present		
combineRelaxedMeasCondition-r16	Not present		
highPriorityMeasRelax-r16	Not present		
}			
}			

Table 6.1.1.5.4.3-4: SIB4 (Cell 1)

Derivation Path: Table H.2.2-2			
Information Element	Value/remark	Comment	Condition
SIB4 ::= SEQUENCE {			
interFreqCarrierFreqList SEQUENCE (SIZE (1..maxFreq)) OF InterFreqCarrierFreqInfo {	1 entry		
InterFreqCarrierFreqInfo[1] SEQUENCE {		entry 1	
dl-CarrierFreq	ARFCN-ValueNR for Cell 2		
smtc	SSB-MTC specified in 38.508-1 [14] Table 7.3.1-3 with condition SMTC.2		6.1.1.5-1
	SSB-MTC specified in 38.508-1 [14] Table 7.3.1-3 with condition SMTC.1		6.1.1.5-2, 6.1.1.5-3
deriveSSB-IndexFromCell	false		6.1.1.5-1
	true		6.1.1.5-2, 6.1.1.5-3
threshX-HighP	24	Actual value = 24*2 = 48dB	
threshX-LowP	24	Actual value = 24*2 = 48dB	
cellReselectionPriority	5	Same as the priority in SIB 2 of Cell 2.	
}			
}			
}			

**Table 6.1.1.5.4.3-5: SIB4 (Cell 2)**

Derivation Path: Table H.2.2-2			
Information Element	Value/remark	Comment	Condition
SIB4 ::= SEQUENCE {			
interFreqCarrierFreqList SEQUENCE (SIZE (1..maxFreq)) OF InterFreqCarrierFreqInfo {	1 entry		
InterFreqCarrierFreqInfo[1] SEQUENCE {		entry 1	
dl-CarrierFreq	ARFCN-ValueNR for Cell 1 SSB		Cell 2
smtc	SSB-MTC specified in 38.508-1 [14] Table 7.3.1-3 with condition SMTC.6		6.1.1.5-1
	SSB-MTC specified in 38.508-1 [14] Table 7.3.1-3 with condition SMTC.1		6.1.1.5-2, 6.1.1.5-3
deriveSSB-IndexFromCell	false		6.1.1.5-1
	true		6.1.1.5-2, 6.1.1.5-3
threshX-HighP	22	Actual value = 22*2 = 44dB	Cell 2
threshX-LowP	25	Actual value = 25*2 = 50dB	Cell 2
cellReselectionPriority	4	Same as the priority in SIB 2 of Cell 1.	Cell 2
}			
}			
}			

6.1.1.5.5 Test requirement

Tables 6.1.1.5.4.1-3 and 6.1.1.5.5-1 define the primary level settings including test tolerances for NR SA FR1-FR1 cell re-selection for UE fulfilling low mobility relaxed measurement criterion test case.

**Table 6.1.1.5.5-1: Cell specific test parameters for NR SA FR1-FR1 cell re-selection for UE fulfilling low mobility relaxed measurement criterion**

Parameter	Unit	Test configuration	Cell 1		Cell 2	
			T1	T2	T1	T2
TDD configuration		1	N/A		N/A	
		2	TDDConf.1.1		TDDConf.1.1	
		3	TDDConf.2.1		TDDConf.2.1	
PDSCH RMC configuration		1	SR.1.1 FDD		SR.1.1 FDD	
		2	SR.1.1 TDD		SR.1.1 TDD	
		3	SR.2.1 TDD		SR.2.1 TDD	
RMSI CORESET RMC configuration		1	CR.1.1 FDD		CR.1.1 FDD	
		2	CR.1.1 TDD		CR.1.1 TDD	
		3	CR.2.1 TDD		CR.2.1 TDD	
Dedicated CORESET RMC configuration		1	CCR.1.1 FDD		CCR.1.1 FDD	
		2	CCR.1.1 TDD		CCR.1.1 TDD	
		3	CCR.2.1 TDD		CCR.2.1 TDD	
OCNG Pattern		1, 2, 3	OP.1 defined in A.3.2.1		OP.1 defined in A.3.2.1	
Initial DL BWP configuration		1, 2, 3	DLBWP.0.1		DLBWP.0.1	
Initial UL BWP configuration		1, 2, 3	ULBWP.0.1		ULBWP.0.1	
RLM-RS		1, 2, 3	SSB		SSB	
Qrxlevmin	dBm/SCS	1, 2	-140		-140	
		3	-137		-137	
Pcompensation	dB	1, 2, 3	0		0	

Parameter	Unit	Test configuration	Cell 1		Cell 2	
			T1	T2	T1	T2
Qhyst <sub>s</sub>	dB	1, 2, 3	0		0	
Qoffset <sub>s, n</sub>	dB	1, 2, 3	0		0	
Cell_selection_and_reselection_quality_measurement		1, 2, 3	SS-RSRP		SS-RSRP	
$\hat{E}_s / I_{ot}$	dB	1	14	14	-3.70	9.75
		2				
		3				
$N_{oc}$ Note2	dBm/SCS	1	-98			
		2	-98			
		3	-95			
$N_{oc}$ Note2	dBm/15 kHz	1	-98			
		2				
		3				
$\hat{E}_s / N_{oc}$	dB	1	14	14	-3.70	9.75
		2				
		3				
SS-RSRP Note3	dBm/SCS	1	-84	-84	-101.70	-88.25
		2	-84	-84	-101.70	-88.25
		3	-81	-81	-98.70	-85.25
I <sub>o</sub>	dBm/9.36 MHz	1	-55.88	-55.88	-68.50	-59.86
	dBm/9.36 MHz	2	-55.88	-55.88	-68.50	-59.86
	dBm/38.16 MHz	3	-49.79	-49.79	-62.40	-53.76
Treselection	s	1, 2, 3	0	0	0	0
SnonintrasearchP	dB	1, 2, 3	Not sent		Not sent	
Thresh <sub>x, highP</sub>	dB	1, 2, 3	48		44	
Thresh <sub>serv, lowP</sub>	dB	1, 2, 3	44		46	
Thresh <sub>x, lowP</sub>	dB	1, 2, 3	48		50	
S <sub>SearchDeltaP</sub>	dB	1, 2, 3	3		15	
T <sub>SearchDeltaP</sub>	s	1, 2, 3	5		5	
Propagation Condition		1, 2, 3	AWGN			
Note 1: OCNG shall be used such that both cells are fully allocated and a constant total transmitted power spectral density is achieved for all OFDM symbols.						
Note 2: Interference from other cells and noise sources not specified in the test is assumed to be constant over subcarriers and time and shall be modelled as AWGN of appropriate power for $N_{oc}$ to be fulfilled.						
Note 3: SS-RSRP levels have been derived from other parameters for information purposes. They are not settable parameters themselves.						

The cell re-selection delay to detected lower priority cell for UE fulfilling low mobility criterion is defined as the time from the beginning of time period T1, to the moment when the UE camps on Cell 2, and starts to send preambles on the PRACH for sending the *RRCSetupRequest* message to perform a Registration procedure for mobility and periodic registration update on Cell 2.

The cell re-selection delay to a detected cell test requirement for UE fulfilling low mobility criterion in this case is expressed as:

$$\text{Cell re-selection delay to a detected lower priority cell} = T_{\text{evaluate,NR\_Inter}} + T_{\text{SI-NR}}$$

$$T_{\text{evaluate,NR\_Inter}} = 15.36 \text{ s; as specified in TS 38.133 [6] Table 4.2.2.10.2-1.}$$



$T_{SI-NR} = 1.28$  s; maximum repetition period of relevant system info blocks that needs to be received by the UE to camp on a cell is assumed in this test.

This gives a total of 16.64 s, allow 17 s for the cell re-selection delay to an already detected lower priority cell for UE fulfilling low mobility criterion in the test case.

The cell re-selection delay to detected higher priority cell for UE fulfilling low mobility criterion is defined as the time from the beginning of time period T2, to the moment when the UE camps on Cell 1, and starts to send preambles on the PRACH for sending the *RRCSetupRequest* message to perform a Registration procedure for mobility and periodic registration update on Cell 1.

The cell re-selection delay to a detected higher priority cell test requirement for UE fulfilling low mobility criterion in this case is expressed as:

Cell re-selection delay to a detected higher priority cell =  $T_{evaluate,NR\_Inter} + T_{SI-NR}$

$T_{evaluate,NR\_Inter} = 15.36$  s; as specified in TS 38.133 [6] Table 4.2.2.10.2-1.

$T_{SI-NR} = 1.28$  s; maximum repetition period of relevant system info blocks that needs to be received by the UE to camp on a cell is assumed in this test.

This gives a total of 16.64 s, allow 17 s for the cell re-selection delay to an already detected higher priority cell for UE fulfilling low mobility criterion in the test case.

For the test to pass, both events above shall pass.

The statistical pass/fail decisions are done separated for each event. For an event to pass, the total number of successful loops shall be more than 90% of the cases with a confidence level of 95%.

### 6.1.1.6 NR SA FR1-FR1 cell re-selection for UE fulfilling not-at-cell edge relaxed measurement criterion

#### 6.1.1.6.1 Test purpose

The purpose of this test is to verify the requirement for the inter-frequency NR cell reselection requirements for UE fulfilling not-at-cell edge criterion specified in TS 38.133 [6] clause 4.2.2.10.3.

#### 6.1.1.6.2 Test applicability

This test applies to all types of NR UE from release 16 onwards and supporting relaxed measurement.

#### 6.1.1.6.3 Minimum conformance requirements

The minimum conformance requirements are specified in clause 6.1.1.0.4.

The normative reference for this requirement is TS 38.133 [6] clause A.6.1.1.6.

#### 6.1.1.6.4 Test description

##### 6.1.1.6.4.1 Initial conditions

This test shall be run in one of the configurations defined in Table 6.1.1.6.4.1-1.

**Table 6.1.1.6.4.1-1: Supported test configurations for NR SA FR1-FR1 cell re-selection for UE fulfilling not-at-cell edge relaxed measurement criterion**

Configuration	Description of serving cell	Description of target cell
6.1.1.6-1	15 kHz SSB SCS, 10 MHz bandwidth, FDD duplex mode	15 kHz SSB SCS, 10 MHz bandwidth, FDD duplex mode
6.1.1.6-2	15 kHz SSB SCS, 10 MHz bandwidth, TDD duplex mode	15 kHz SSB SCS, 10 MHz bandwidth, TDD duplex mode
6.1.1.6-3	30 kHz SSB SCS, 40 MHz bandwidth, TDD duplex mode	30 kHz SSB SCS, 40 MHz bandwidth, TDD duplex mode
Note:	The UE is only required to be tested in one of the supported test configurations.	

Configure the test equipment and the DUT according to the parameters in Table 6.1.1.6.4.1-2.

**Table 6.1.1.6.4.1-2: Initial conditions for NR SA FR1-FR1 cell re-selection for UE fulfilling not-at-cell edge relaxed measurement criterion**

Parameter	Value		Comment
Test environment	NC		As specified in TS 38.508-1 [14] clause 4.1.
Test frequencies	As specified in Annex E, table E.4-1 and TS 38.508-1 [14] clause 4.3.1.		
Channel bandwidth	As specified by the test configuration selected from Table 6.1.1.6.4.1-1.		
Propagation conditions	AWGN		As specified in Annex C.2.2.
Connection Diagram	TE Part	A.3.1.8.2	As specified in TS 38.508-1 [14] Annex A.
	DUT Part	A.3.2.3.4	
Exceptions to connection diagram	- Without LTE link - For 4Rx capable UEs without any 2Rx RF bands use A.3.2.5.2 for DUT part and A.3.1.8.4 for TE part.		

1. The general test parameter settings are set up according to Table 6.1.1.6.4.1-3.
2. Message contents are defined in clause 6.1.1.6.4.3.
3. There is 2 NR carriers and 2 NR Cells specified in the test. Cell 1 is the PCell and Cell 2 is the neighbour cell. Cell 1 and Cell 2 are configured according to Annex C.1.1 and C.1.2.

**Table 6.1.1.6.4.1-3: General test parameters for NR SA FR1-FR1 cell re-selection for UE fulfilling not-at-cell edge relaxed measurement criterion**

Parameter		Unit	Test configuration	Value	Comment
Initial condition	Active cell		1, 2, 3	Cell2	The UE camps on cell 2 in the initial phase, it fulfils Not-at-cell edge relaxation measurements criterion, and during T1 period the UE reselects to cell 1
	Neighbour cells		1, 2, 3	Cell1	
T1 end condition	Active cell		1, 2, 3	Cell1	The UE shall perform reselection to cell 1 during T1
	Neighbour cells		1, 2, 3	Cell2	
T2 end condition	Active cell		1, 2, 3	Cell2	The UE shall perform reselection to cell 2 with higher priority during T2
	Neighbour cells		1, 2, 3	Cell1	
RF Channel Number			1, 2, 3	1, 2	
Time offset between cells			1	3 ms	Asynchronous cells
			2	3 $\mu$ s	Synchronous cells
			3	3 $\mu$ s	Synchronous cells
Access Barring Information		-	1, 2, 3	Not Sent	No additional delays in random access procedure.
SSB Configuration			1	SSB.1 FR1	
			2	SSB.1 FR1	
			3	SSB.2 FR1	
SMTC configuration			1	SMTC pattern 2	Configured in SIB4 of Cell 1
				SMTC pattern 6	Configured in SIB4 of Cell 2
			2	SMTC pattern 1	
				SMTC pattern 1	
DRX cycle length		s	1, 2, 3	0.64	The value shall be used for all cells in the test.
PRACH configuration index			1, 2, 3	102	The detailed configuration is specified in TS 38.211 clause 6.3.3.2
rangeToBestCell			1, 2, 3	Not configured	
T1		s	1, 2, 3	20 s	T1 is defined so that cell re-selection reaction time is taken into account.
T2		s	1, 2, 3	20 s	T2 is defined so that cell re-selection reaction time is taken into account.

#### 6.1.1.6.4.2 Test procedure

Two cells are deployed in the test, which are FR1 NR Cell 1 and Cell 2 on different frequencies. The test consists of 2 successive time periods, with time duration of T1, and T2 respectively. Both cell 1 and cell 2 are already identified by the UE prior to the start of the test. Cell 1 and cell 2 belong to different tracking areas and Cell 2 is of higher priority than Cell 1. Furthermore, UE has not registered with network for the tracking area containing cell 1.

In the following test procedure "UE responds" means "UE starts transmitting preamble on PRACH for sending the *RRCSetupRequest* message to perform a Registration procedure for mobility.

1. Ensure the UE is in state *RRC\_IDLE* with generic procedure parameters connectivity *NR* with Test Mode *On* according to TS 38.508-1 [14] clause 4.5 on Cell 2. SIB2 of Cell 1 and Cell 2 are configured as follows:
  - *cellEdgeEvaluation-r16* is configured according to the parameters listed in Table 6.1.1.6.5-1.
  - *lowMobilityEvaluation-r16* and *combineRelaxedMeasCondition* are not configured.
2. Set the parameters according to T1 in Table 6.1.1.6.5-1. T1 starts.
3. The SS waits for random access requests information from the UE to perform cell re-selection to Cell 1.
4. If the UE responds on Cell 1 within 17 seconds from the beginning of time period T1, then count a success for the event "Re-select Cell 1". Otherwise count a fail for the event "Re-select Cell 1".
5. If the UE has re-selected Cell 1 within T1, after the re-selection or when T1 expires, continue with step 6. Otherwise, if T2 expires and the UE has not yet re-selected Cell 1, the TE shall switch off and on the UE and skip to step 12.
6. The SS shall send an *RRCRelease* message to ensure that the UE is in state *RRC\_IDLE* on Cell 1.
7. The SS shall switch the power setting from T1 to T2 as specified in Table 6.1.1.6.5-1. T2 starts.
8. The SS waits for random access requests information from the UE to perform cell re-selection to Cell 1.
9. If the UE responds on Cell 2 within 17 seconds from the beginning of time period T2, then count a success for the event "Re-select Cell 2". Otherwise count a fail for the event "Re-select Cell 2".
10. If the UE has re-selected Cell 2 within T2, after the re-selection or when T2 expires, continue with step 11. Otherwise, if T2 expires and the UE has not yet re-selected Cell 2, the TE shall switch off and on the UE and skip to step 12.
11. The SS shall send an *RRCRelease* message to ensure that the UE is in state *RRC\_IDLE* on Cell 2. skip to 13
12. Ensure the UE is in state *RRC\_IDLE* with generic procedure parameters connectivity *NR* according to TS 38.508-1 [14] clause 4.5 in Cell 2.
13. Repeat step 2-12 until a test verdict has been achieved. Each of the events "Re-select Cell 2" and "Re-select Cell 1" is evaluated independently for the statistic, resulting in an event verdict: pass or fail. Each event is evaluated only until the confidence level according to Table G.2.3-1 in Annex G clause G.2 is achieved. Different events may require different times for a verdict. If both events pass, the test passes. If one event fails, the test fails.

#### 6.1.1.6.4.3 Message contents

Message contents are according to TS 38.508-1 [14] clause 7.3 with the following exceptions:

Table 6.1.1.6.4.3-1: SIB1 (Cell 1 and Cell 2)

Derivation Path: TS 38.508-1 [14], Table 4.6.1-28			
Information Element	Value/remark	Comment	Condition
SIB1 ::= SEQUENCE {			
servingCellConfigCommon SEQUENCE {			
downlinkConfigCommon SEQUENCE {			
pcch-Config SEQUENCE {			
defaultPagingCycle	rf64		
}			
}			
}			
}			

Table 6.1.1.6.4.3-2: SIB2 (Cell 1)

Derivation Path: Table H.2.2-1			
Information Element	Value/remark	Comment	Condition
SIB2 ::= SEQUENCE {			
cellReselectionServingFreqInfo SEQUENCE {			
s-NonIntraSearchP	Not present		
}			
relaxedMeasurement-r16 SEQUENCE {			
lowMobilityEvaluation-r16	Not present		
cellEdgeEvaluation-r16 SEQUENCE {	Not present		
s-SearchThresholdP-r16	25	Actual value = 25*2 = 50dB	
s-SearchThresholdQ-r16	Not present		
}			
combineRelaxedMeasCondition-r16	Not present		
highPriorityMeasRelax-r16	Not present		
}			
}			

Table 6.1.1.6.4.3-3: SIB2 (Cell 2)

Derivation Path: Table H.2.2-1			
Information Element	Value/remark	Comment	Condition
SIB2 ::= SEQUENCE {			
cellReselectionServingFreqInfo SEQUENCE {			
s-NonIntraSearchP	Not present		
}			
relaxedMeasurement-r16 SEQUENCE {			
lowMobilityEvaluation-r16	Not present		
cellEdgeEvaluation-r16 SEQUENCE {	Not present		
s-SearchThresholdP-r16	17	Actual value = 17*2 = 34dB	
s-SearchThresholdQ-r16	Not present		
}			
combineRelaxedMeasCondition-r16	Not present		
highPriorityMeasRelax-r16	Not present		
}			
}			

Table 6.1.1.6.4.3-4: SIB4 (Cell 1)

Derivation Path: Table H.2.2-2			
Information Element	Value/remark	Comment	Condition
SIB4 ::= SEQUENCE {			
interFreqCarrierFreqList SEQUENCE (SIZE (1..maxFreq)) OF InterFreqCarrierFreqInfo {	1 entry		
InterFreqCarrierFreqInfo[1] SEQUENCE {		entry 1	
dl-CarrierFreq	ARFCN-ValueNR for Cell 2 SSB		
smtc	SSB-MTC specified in 38.508-1 [14] Table 7.3.1-3 with condition SMTC.2		6.1.1.6-1
	SSB-MTC specified in 38.508-1 [14] Table 7.3.1-3 with condition SMTC.1		6.1.1.6-2, 6.1.1.6-3
deriveSSB-IndexFromCell	false		6.1.1.6-1
	true		6.1.1.6-2, 6.1.1.6-3
cellReselectionPriority	5	Same as the priority in SIB 2 of Cell 2.	
}			
}			
}			

Table 6.1.1.6.4.3-5: SIB4 (Cell 2)

Derivation Path: Table H.2.2-2			
Information Element	Value/remark	Comment	Condition
SIB4 ::= SEQUENCE {			
interFreqCarrierFreqList SEQUENCE (SIZE (1..maxFreq)) OF InterFreqCarrierFreqInfo {	1 entry		
InterFreqCarrierFreqInfo[1] SEQUENCE {		entry 1	
dl-CarrierFreq	ARFCN-ValueNR for Cell 1 SSB		
smtc	SSB-MTC specified in 38.508-1 [14] Table 7.3.1-3 with condition SMTC.6		6.1.1.6-1
	SSB-MTC specified in 38.508-1 [14] Table 7.3.1-3 with condition SMTC.1		6.1.1.6-2, 6.1.1.6-3
deriveSSB-IndexFromCell	false		6.1.1.6-1
	true		6.1.1.6-2, 6.1.1.6-3
cellReselectionPriority	4	Same as the priority in SIB 2 of Cell 1.	Cell 2
}			
}			
}			

#### 6.1.1.6.5 Test requirement

Tables 6.1.1.6.4.1-3 and 6.1.1.6.5-1 define the primary level settings including test tolerances for NR SA FR1-FR1 cell re-selection for UE fulfilling not-at-cell edge relaxed measurement criterion test case.

**Table 6.1.1.6.5-1: Cell specific test parameters for NR SA FR1-FR1 cell re-selection for UE fulfilling not-at-cell edge relaxed measurement criterion**

Parameter	Unit	Test configuration	Cell 1		Cell 2	
			T1	T2	T1	T2
TDD configuration		1	N/A		N/A	
		2	TDDConf.1.1		TDDConf.1.1	
		3	TDDConf.2.1		TDDConf.2.1	
PDSCH RMC configuration		1	SR.1.1 FDD		SR.1.1 FDD	
		2	SR.1.1 TDD		SR.1.1 TDD	
		3	SR.2.1 TDD		SR.2.1 TDD	
RMSI CORESET RMC configuration		1	CR.1.1 FDD		CR.1.1 FDD	
		2	CR.1.1 TDD		CR.1.1 TDD	
		3	CR.2.1 TDD		CR.2.1 TDD	
Dedicated CORESET RMC configuration		1	CCR.1.1 FDD		CCR.1.1 FDD	
		2	CCR.1.1 TDD		CCR.1.1 TDD	
		3	CCR.2.1 TDD		CCR.2.1 TDD	
OCNG Pattern		1, 2, 3	OP.1 defined in A.3.2.1		OP.1 defined in A.3.2.1	
Initial DL BWP configuration		1, 2, 3	DLBWP.0.1		DLBWP.0.1	
Initial UL BWP configuration		1, 2, 3	ULBWP.0.1		ULBWP.0.1	
RLM-RS		1, 2, 3	SSB		SSB	
Qrxlevmin	dBm/SCS	1, 2	-140		-140	
		3	-137		-137	
Pcompensation	dB	1, 2, 3	0		0	
Qhyst <sub>s</sub>	dB	1, 2, 3	0		0	
Qoffset <sub>s, n</sub>	dB	1, 2, 3	0		0	
Cell_selection_and_reselection_quality_measurement		1, 2, 3	SS-RSRP		SS-RSRP	
$\hat{E}_s / I_{ot}$	dB	1	16	14	-3.65	16
		2				
		3				
$N_{oc}$ <sup>Note2</sup>	dBm/SCS	1	-98		-100	
		2	-98		-100	
		3	-95		-97	
$N_{oc}$ <sup>Note2</sup>	dBm/15 kHz	1	-98		-100	
		2				
		3				
$\hat{E}_s / N_{oc}$	dB	1	16	14	-3.65	16
		2				
		3				
SS-RSRP <sup>Note3</sup>	dBm/SCS	1	-82	-84	-103.65	-84
		2	-82	-84	-103.65	-84
		3	-79	-81	-100.65	-81
I <sub>o</sub>	dBm/9.36 MHz	1	-53.94	-55.88	-70.49	-55.94
	dBm/9.36 MHz	2	-53.94	-55.88	-70.49	-55.94
	dBm/38.16 MHz	3	-47.84	-49.79	-63.39	-49.84
Treselection	s	1, 2, 3	0	0	0	0
SnonintrasearchP	dB	1, 2, 3	Not sent		Not sent	
Thresh <sub>x, highP</sub>	dB	1, 2, 3	48		48	
Thresh <sub>servicing, lowP</sub>	dB	1, 2, 3	44		44	

Parameter	Unit	Test configuration	Cell 1		Cell 2	
			T1	T2	T1	T2
Thresh <sub>x, lowP</sub>	dB	1, 2, 3	50		50	
S <sub>SearchDeltaP</sub>	dB	1, 2, 3	3		3	
T <sub>SearchDeltaP</sub>	s	1, 2, 3	5		5	
Propagation Condition		1, 2, 3	AWGN			
Note 1:	OCNG shall be used such that both cells are fully allocated and a constant total transmitted power spectral density is achieved for all OFDM symbols.					
Note 2:	Interference from other cells and noise sources not specified in the test is assumed to be constant over subcarriers and time and shall be modelled as AWGN of appropriate power for $N_{oc}$ to be fulfilled.					
Note 3:	SS-RSRP levels have been derived from other parameters for information purposes. They are not settable parameters themselves.					

The cell re-selection delay to detected lower priority cell for UE fulfilling not-at-cell edge criterion is defined as the time from the beginning of time period T1, to the moment when the UE camps on Cell 2, and starts to send preambles on the PRACH for sending the *RRCSetupRequest* message to perform a Registration procedure for mobility and periodic registration update on Cell 2.

The cell re-selection delay to a detected cell test requirement for UE fulfilling not-at-cell edge criterion in this case is expressed as:

$$\text{Cell re-selection delay to a detected lower priority cell} = T_{\text{evaluate,NR\_Inter}} + T_{\text{SI-NR}}$$

$$T_{\text{evaluate,NR\_Inter}} = 15.36 \text{ s; as specified in TS 38.133 [6] Table 4.2.2.10.2-1.}$$

$$T_{\text{SI-NR}} = 1.28 \text{ s; maximum repetition period of relevant system info blocks that needs to be received by the UE to camp on a cell is assumed in this test.}$$

This gives a total of 16.64 s, allow 17 s for the cell re-selection delay to an already detected lower priority cell for UE fulfilling not-at-cell edge criterion in the test case.

The cell re-selection delay to detected higher priority cell for UE fulfilling not-at-cell edge criterion is defined as the time from the beginning of time period T2, to the moment when the UE camps on Cell 1, and starts to send preambles on the PRACH for sending the *RRCSetupRequest* message to perform a Registration procedure for mobility and periodic registration update on Cell 1.

The cell re-selection delay to a detected higher priority cell test requirement for UE fulfilling not-at-cell edge criterion in this case is expressed as:

$$\text{Cell re-selection delay to a detected higher priority cell} = T_{\text{evaluate,NR\_Inter}} + T_{\text{SI-NR}}$$

$$T_{\text{evaluate,NR\_Inter}} = 15.36 \text{ s; as specified in TS 38.133 [6] Table 4.2.2.10.2-1.}$$

$$T_{\text{SI-NR}} = 1.28 \text{ s; maximum repetition period of relevant system info blocks that needs to be received by the UE to camp on a cell is assumed in this test.}$$

This gives a total of 16.64 s, allow 17 s for the cell re-selection delay to an already detected higher priority cell for UE fulfilling not-at-cell edge criterion in the test case.

For the test to pass, both events above shall pass.

The statistical pass/fail decisions are done separated for each event. For an event to pass, the total number of successful loops shall be more than 90% of the cases with a confidence level of 95%.

### 6.1.1.7 NR SA FR1 cell re-selection for UE configured with highSpeedMeasFlag-r16

#### 6.1.1.7.1 Test purpose

The purpose of this test is to verify that when the current and target cell operates on the same carrier frequency the UE configured with *highSpeedMeasFlag-r16* is able to search and measure cells to meet the intra-frequency NR cell re-selection requirements.

## 6.1.1.7.2 Test applicability

This test applies to all types of NR UE from release 15 onwards that supports measurement enhancements in high speed scenario

## 6.1.1.7.3 Minimum conformance requirements

The minimum conformance requirements are specified in clause 6.1.1.0.3.

The normative reference for this requirement is TS 38.133 [6] clause A.6.1.1.7.

## 6.1.1.7.4 Test description

## 6.1.1.7.4.1 Initial conditions

This test shall be run in one of the configurations defined in Table 6.1.1.7.4.1-1.

**Table 6.1.1.7.4.1-1: Supported test configurations for NR SA FR1 cell re-selection for UE configured with highSpeedMeasFlag-r16**

Configuration	Description
6.1.1.7-1	15 kHz SSB SCS, 10MHz bandwidth, FDD duplex mode
6.1.1.7-2	15 kHz SSB SCS, 10MHz bandwidth, TDD duplex mode
6.1.1.7-3	30 kHz SSB SCS, 40MHz bandwidth, TDD duplex mode
Note:	The UE is only required to be tested in one of the supported test configurations.

Configure the test equipment and the DUT according to the parameters in Table 6.1.1.7.4.1-2.

**Table 6.1.1.7.4.1-2: Initial conditions for NR SA FR1 cell re-selection for UE configured with highSpeedMeasFlag-r16**

Parameter	Value		Comment
Test environment	NC		As specified in TS 38.508-1 [14] clause 4.1.
Test frequencies	As specified in Annex E, table E.4-1 and TS 38.508-1 [14] clause 4.3.1.		
Channel bandwidth	As specified by the test configuration selected from Table 6.1.1.7.4.1-1.		
Propagation conditions	AWGN		As specified in Annex C.2.2.
Connection Diagram	TE Part	A.3.1.8.2	As specified in TS 38.508-1 [14] Annex A.
	DUT Part	A.3.2.3.4	
Exceptions to connection diagram	- Without LTE link - For 4Rx capable UEs without any 2Rx RF bands use A.3.2.5.2 for DUT part and A.3.1.8.4 for TE part.		

1. The general test parameter settings are set up according to Table 6.1.1.7.4.1-3.
2. Message contents are defined in clause 6.1.1.7.4.3.
3. There is one NR carrier and 2 NR Cells specified in the test. Cell 1 is the PCell and Cell 2 is the neighbour cell. Cell 1 and Cell 2 are configured according to Annex C.1.1 and C.1.2.

**Table 6.1.1.7.4.1-3: General test parameters for NR SA FR1 cell re-selection for UE configured with highSpeedMeasFlag-r16**

Parameter		Unit	Test configuration	Value	Comment
Initial condition	Active cell		1, 2, 3	Cell1	
	Neighbour cells		1, 2, 3	Cell2	
T2 end condition	Active cell		1, 2, 3	Cell2	
	Neighbour cells		1, 2, 3	Cell1	



Final condition	Active cell		1, 2, 3	Cell1	
RF Channel Number			1, 2, 3	1	
Time offset between cells			1	3 ms	Asynchronous cells
			2	3 $\mu$ s	Synchronous cells
			3	3 $\mu$ s	Synchronous cells
Access Barring Information	-		1, 2, 3	Not Sent	No additional delays in random access procedure.
SSB configuration			1	SSB.1 FR1	
			2	SSB.1 FR1	
			3	SSB.2 FR1	
SMTC configuration			1	SMTC.2	Configured in SIB2 of Cell 1
				SMTC.6	Configured in SIB2 of Cell 2
			2	SMTC.1	
				3	SMTC.1
DRX cycle length	s		1, 2, 3	0.32	The value shall be used for all cells in the test.
PRACH configuration index			1, 2, 3	102	The detailed configuration is specified in TS 38.211 clause 6.3.3.2
rangeToBestCell			1, 2, 3	Not configured	
T1	s		1, 2, 3	>7	During T1, Cell 2 shall be powered off, and during the off time the physical cell identity shall be changed, The intention is to ensure that Cell 2 has not been detected by the UE prior to the start of period T2
T2	s		1, 2, 3	4	T2 needs to be defined so that cell re-selection reaction time is taken into account.
T3	s		1, 2, 3	3	T3 needs to be defined so that cell re-selection reaction time is taken into account.

#### 6.1.1.7.4.2 Test procedure

Two cells are deployed in the test, which are one FR1 NR PCell (Cell 1) and an NR neighbour cell (Cell 2) on the same frequency. The test consists of 3 successive time periods, with time duration of T1, T2, and T3 respectively. Only cell 1 is already identified by the UE prior to the start of the test. Cell 1 and cell 2 belong to different tracking areas. Furthermore, UE has not registered with network for the tracking area containing cell 2. *highSpeedMeasFlag-r16* is broadcasted to UE.

In the following test procedure "UE responds" means "UE starts transmitting preamble on PRACH for sending the *RRCSetupRequest* message to perform a Registration procedure for mobility.

1. Ensure the UE is in state RRC\_IDLE with generic procedure parameters connectivity NR with Test Mode On according to TS 38.508-1 [14] clause 4.5 on Cell 1. Set Cell 2 physical cell identity = initial Cell 2 physical cell identity.
2. Set the parameters according to T1 in Table 6.1.1.7.5-1. T1 starts.
3. Set Cell 2 physical cell identity = ((current Cell 2 physical cell identity + 1) mod 1008) for one iteration of the test procedure loop.
4. When T1 expires, the SS shall switch the power setting from T1 to T2 as specified in Table 6.1.1.7.5-1. T2 starts.
5. The SS waits for random access requests information from the UE to perform cell re-selection to a newly detectable cell, Cell 2.
6. If the UE responds on the newly detectable cell, Cell 2 during time duration T2 within 4 seconds from the beginning of time period T2, then count a success for the event "Re-select newly detected Cell 2". Otherwise count a fail for the event "Re-select newly detected Cell 2".

7. If the UE has re-selected Cell 2 within T2, after the re-selection or when T2 expires, continue with step 7a. Otherwise, if T2 expires and the UE has not yet re-selected Cell 2, the TE shall switch off and on the UE and skip to step 12.
- 7a The SS shall send an *RRCRelease* message to ensure that the UE is in state RRC\_IDLE on Cell 2.
8. The SS shall switch the power setting from T2 to T3 as specified in Table 6.1.1.7.5-1. T3 starts.
9. The SS waits for random access requests information from the UE to perform cell re-selection to an already detected cell, Cell 1.
10. If the UE responds on the already detected cell, Cell 1 during time duration T3 within 3 seconds from the beginning of time period T3, then count a success for the event “Re-select already detected Cell 1”. Otherwise count a fail for the event “Re-select already detected Cell 1”.
11. If the UE has re-selected Cell 1 within T3, after the re-selection or when T3 expires, continues with step 11a. Otherwise, if T3 expires and the UE has not yet re-selected Cell 1, the TE shall switch off and on the UE and skip to step 12.
- 11a. The SS shall send an *RRCRelease* message to ensure that the UE is in state RRC\_IDLE on Cell 1.
12. Ensure the UE is in state RRC\_IDLE with generic procedure parameters connectivity NR according to TS 38.508-1 [14] clause 4.5 on Cell 1.
13. Repeat step 2-12 until a test verdict has been achieved.  
 Each of the events “Re-select newly detected Cell 2” and “Re-select already detected Cell 1” is evaluated independently for the statistic, resulting in an event verdict: pass or fail. Each event is evaluated only until the confidence level according to Table G.2.3-1 in Annex G clause G.2 is achieved. Different events may require different times for a verdict.  
 If both events pass, the test passes. If one event fails, the test fails.

6.1.1.7.4.3 Message contents

Message contents are according to TS 38.508-1 [14] clause 4.6 with the following exceptions:

**Table 6.1.1.7.4.3-1: Common Exception messages**

Default Message Contents	
Common contents of system information blocks on condition of HighSpeedMeas with exceptions	Table H.2.1-1 with Condition SMTC.2 and Asynchronous cells for configuration 6.1.1.7-1 and Cell 1 Table H.2.1-1 with Condition SMTC.6 and Asynchronous cells for configuration 6.1.1.7-1 and Cell 2 Table H.2.1-1 with Condition SMTC.1 and synchronous cells for configuration 6.1.1.7-2 Table H.2.1-1 with Condition SMTC.1 and synchronous cells for configuration 6.1.1.7-3 Table H.2.1-2 Table H.2.1-3 with Condition HighSpeedMeas
Default RRC messages and information elements contents exceptions	

6.1.1.7.5 Test requirement

Tables 6.1.1.7.4.1-3 and 6.1.1.7.5-1 define the primary level settings including test tolerances for intra frequency NR cell re-selection test case for UE configured with highSpeedMeasFlag-r16.

**Table 6.1.1.7.5-1: Cell specific test parameters for intra frequency NR cell re-selection test case for UE configured with highSpeedMeasFlag-r16**

Parameter	Unit	Test configuration	Cell 1			Cell 2		
			T1	T2	T3	T1	T2	T3
TDD configuration		1	N/A			N/A		
		2	TDDConf.1.1			TDDConf.1.1		
		3	TDDConf.2.1			TDDConf.2.1		
PDSCH RMC configuration		1	SR.1.1 FDD			SR.1.1 FDD		
		2	SR.1.1 TDD			SR.1.1 TDD		
		3	SR.2.1 TDD			SR.2.1 TDD		
RMSI CORESET RMC configuration		1	CR.1.1 FDD			CR.1.1 FDD		
		2	CR.1.1 TDD			CR.1.1 TDD		
		3	CR.2.1 TDD			CR.2.1 TDD		
Dedicated CORESET RMC configuration		1	CCR.1.1 FDD			CCR.1.1 FDD		
		2	CCR.1.1 TDD			CCR.1.1 TDD		
		3	CCR.2.1 TDD			CCR.2.1 TDD		
OCNG Pattern		1, 2, 3	OP.1 defined in A.2.1-1			OP.1 defined in A.2.1-1		
Initial DL BWP configuration		1, 2, 3	DLBWP.0.1			DLBWP.0.1		
Initial UL BWP configuration		1, 2, 3	ULBWP.0.1			ULBWP.0.1		
RLM-RS		1, 2, 3	SSB			SSB		
Qrxlevmin	dBm/SCS	1, 2	-140			-140		
		3	-137			-137		
Pcompensation	dB	1, 2, 3	0			0		
Qhysts	dB	1, 2, 3	0			0		
Qoffsets,n	dB	1, 2, 3	0			0		
Cell_selection_and_reselection_quality_measurement		1, 2, 3	SS-RSRP			SS-RSRP		
$\hat{E}_s / I_{ot}$	dB	1	16	-3.55	3.24	-infinity	3.24	-3.55
		2						
		3						
$N_{oc}$ <sup>Note2</sup>	dBm/SCS	1	-98					
		2	-98					
		3	-95					
$N_{oc}$ <sup>Note2</sup>	dBm/15 kHz	1	-98					
		2						
		3						
$\hat{E}_s / N_{oc}$	dB	1	16	13	16.45	-infinity	16.45	13
		2						
		3						
SS-RSRP <sup>Note3</sup>	dBm/SCS	1	-82	-85	81.55	-infinity	-81.55	-85
		2	-82	-85	-81.55	-infinity	-81.55	-85
		3	-79	-82	-78.54	-infinity	-78.54	-82
Io	dBm/9.36 MHz	1	-53.94	-51.91	-51.91	specified in Cell 1 columns-		
	dBm/9.36 MHz	2	-53.94	-51.91	-51.91			
	dBm/38.16 MHz	3	-47.85	-45.81	-45.81			
Treselection	s	1, 2, 3	0	0	0	0	0	0
SintrasearchP	dB	1, 2, 3	50			50		
Propagation Condition		1, 2	AWGN			AWGN 1944Hz <sup>Note4</sup>		
Propagation Condition		3	AWGN			AWGN 3334Hz <sup>Note5</sup>		

Note 1: OCNG shall be used such that both cells are fully allocated and a constant total transmitted power spectral density is achieved for all OFDM symbols.

Note 2: Interference from other cells and noise sources not specified in the test is assumed to be constant over subcarriers

and time and shall be modelled as AWGN of appropriate power for  $N_{oc}$  to be fulfilled.

Note 3: SS-RSRP levels have been derived from other parameters for information purposes. They are not settable parameters themselves.

Note 4: The AWGN 1944 Hz condition is a non-fading propagation channel with one tap. Doppler shift is a constant 1944 Hz.

Note 5: The AWGN 3334 Hz condition is a non-fading propagation channel with one tap. Doppler shift is a constant 3334 Hz.

The cell reselection delay to a newly detectable cell is defined as the time from the beginning of time period T2, to the moment when the UE camps on Cell 2, and starts to send preambles on the PRACH for sending the *RRCSetupRequest* message to perform a Tracking Area Update procedure on Cell 2.

The cell re-selection delay to a newly detectable cell test requirement in this case is expressed as:

$$\text{Cell re-selection delay to a newly detectable cell} = T_{\text{detect,NR\_Intra}} + T_{\text{SI-NR}}$$

$T_{\text{detect,NR\_Intra}} = 2.56$  s; as specified in Table 4.2.2.3-2 in clause 4.2.2.3 TS 38.133 [6].

$T_{\text{SI-NR}} = 1280$  ms; maximum repetition period of relevant system info blocks that needs to be received by the UE to camp on a cell is assumed in this test.

The cell re-selection delay to a newly detectable cell shall be less than a total of 3.84 seconds in this test case (note: this gives a total of 3.84 seconds but the test allows 4 seconds).

The cell reselection delay to an already detected cell is defined as the time from the beginning of time period T3, to the moment when the UE camps on cell 1, and starts to send preambles on the PRACH for sending the *RRCSetupRequest* message to perform a Tracking Area Update procedure on cell 1.

The cell re-selection delay to an already detected cell test requirement in this case is expressed as:

$$\text{Cell re-selection to an already detected cell delay} = T_{\text{evaluate,NR\_Intra}} + T_{\text{SI-NR}}$$

$T_{\text{evaluate,NR\_Intra}} = 0.96$  s; as specified in Table 4.2.2.3-2 in clause 4.2.2.3 TS 38.133 [6].

$T_{\text{SI-NR}} = 1280$  ms; maximum repetition period of relevant system info blocks that needs to be received by the UE to camp on a cell is assumed in this test.

The cell re-selection delay to an already detected cell shall be less than a total of 2.24 seconds in this test case (note: this gives a total of 2.24 seconds but the test allows 3 seconds).

For the test to pass, both events above shall pass.

The statistical pass/fail decisions are done separated for each event. For an event to pass, the total number of successful loops shall be more than 90% of the cases with a confidence level of 95%.

## 6.1.2 NR – E-UTRA cell re-selection

### 6.1.2.0 Minimum conformance requirements

#### 6.1.2.0.1 Minimum conformance requirements for NR – E-UTRA cell re-selection

The cell re-selection delay to a higher priority cell shall be less than  $T_{\text{higher\_priority\_search}} + T_{\text{evaluate, EUTRAN}} + T_{\text{SI-E-UTRA}}$  in RRC\_IDLE state.

The cell re-selection delay to a lower priority E-UTRA cell shall be less than  $T_{\text{evaluate, E-UTRAN}} + T_{\text{SI-E-UTRA}}$  in RRC\_IDLE state.

If  $S_{\text{rxlev}} > S_{\text{nonIntraSearchP}}$  and  $S_{\text{qual}} > S_{\text{nonIntraSearchQ}}$  then the UE shall search for inter-RAT E-UTRAN layers of higher priority at least every  $T_{\text{higher\_priority\_search}}$  where  $T_{\text{higher\_priority\_search}}$  is described in clause 4.2.2 of TS 38.133 [6].

If  $S_{\text{rxlev}} \leq S_{\text{nonIntraSearchP}}$  or  $S_{\text{qual}} \leq S_{\text{nonIntraSearchQ}}$  then the UE shall search for and measure inter-RAT E-UTRAN layers of higher, lower priority in preparation for possible reselection. In this scenario, the minimum rate at which the UE is required to search for and measure higher priority inter-RAT E-UTRAN layers shall be the same as that defined below for lower priority RATs.

The requirements in this section apply for inter-RAT E-UTRAN FDD measurements and E-UTRA TDD measurements. When the measurement rules indicate that inter-RAT E-UTRAN cells are to be measured, the UE shall measure RSRP and RSRQ of detected E-UTRA cells in the neighbour frequency list at the minimum measurement rate specified in this section. The parameter  $N_{\text{EUTRA\_carrier}}$  is the total number of configured E-UTRA carriers in the neighbour frequency list. The UE shall filter RSRP and RSRQ measurements of each measured E-UTRA cell using at least 2 measurements. Within the set of measurements used for the filtering, at least two measurements shall be spaced by at least  $T_{\text{measure,EUTRAN}}/2$ .

The parameter  $N_{\text{EUTRA\_carrier}}$  is the total number of configured E-UTRA carriers indicated to meet non high speed requirements in the neighbour frequency list. The parameter  $N_{\text{EUTRA\_carrier\_HST}}$  is the total number of configured E-UTRA carriers indicated to meet high speed requirements in the neighbour frequency list. If  $S_{\text{rxlev}} \leq S_{\text{nonIntraSearchP}}$  or  $S_{\text{qual}} \leq S_{\text{nonIntraSearchQ}}$ , an inter-RAT E-UTRAN layer is indicated to meet high speed requirements if `highSpeedMeasFlag-r16` is configured and the carrier to be measured is configured with `highSpeedEUTRACarrier-r16` and UE supports the enhanced inter-RAT E-UTRAN measurement requirements. If  $S_{\text{rxlev}} > S_{\text{nonIntraSearchP}}$  and  $S_{\text{qual}} > S_{\text{nonIntraSearchQ}}$ , UE is required to meet non high speed requirements no matter whether `highSpeedMeasFlag-r16` or `highSpeedEUTRACarrier-r16` is configured or not.

An inter-RAT E-UTRA cell is considered to be detectable provided the following conditions are fulfilled:

- the same conditions as for inter-frequency RSRP measurements specified in TS 36.133 [15, Annex B.1.2] are fulfilled for a corresponding Band, and
- the same conditions as for inter-frequency RSRQ measurements specified in TS 36.133 [15, Annex B.1.2] are fulfilled for a corresponding Band.
- SCH conditions specified in TS 36.133 [15, Annex B.1.2] are fulfilled for a corresponding Band.

The UE shall be able to evaluate whether a newly detectable inter-RAT E-UTRAN cell meets the reselection criteria defined in TS38.304 [1] within  $N_{\text{EUTRA\_carrier\_HST}} * T_{\text{detect,EUTRAN\_HST}} + N_{\text{EUTRA\_carrier}} * T_{\text{detect,EUTRAN}}$  when  $S_{\text{rxlev}} \leq S_{\text{nonIntraSearchP}}$  or  $S_{\text{qual}} \leq S_{\text{nonIntraSearchQ}}$  when  $T_{\text{reselection}} = 0$  provided that the reselection criteria is met by a margin of at least 6dB for RSRP reselections based on absolute priorities or 4dB for RSRQ reselections based on absolute priorities.

Cells which have been detected shall be measured at least every  $(N_{\text{EUTRA\_carrier}}) * T_{\text{measure,EUTRAN}}$  when  $S_{\text{rxlev}} \leq S_{\text{nonIntraSearchP}}$  or  $S_{\text{qual}} \leq S_{\text{nonIntraSearchQ}}$ .

When higher priority cells are found by the higher priority search, they shall be measured at least every  $T_{\text{measure,EUTRAN}}$ . If, after detecting a cell in a higher priority search, it is determined that reselection has not occurred then the UE is not required to continuously measure the detected cell to evaluate the ongoing possibility of reselection. However, the minimum measurement filtering requirements specified later in this section shall still be met by the UE before it makes any determination that it may stop measuring the cell.

If the UE detects on an inter-RAT E-UTRAN carrier a cell whose physical identity is indicated as not allowed for that carrier in the measurement control system information of the serving cell, the UE is not required to perform measurements on that cell.

The UE shall not consider an inter-RAT E-UTRA cell in cell reselection, if it is indicated as not allowed in the measurement control system information of the serving cell.

For a cell that has been already detected, but that has not been reselected to, the filtering shall be such that the UE shall be capable of evaluating that an already identified inter-RAT E-UTRA cell has met reselection criterion defined in TS 38.304 [30] within  $(N_{\text{EUTRA\_carrier}}) * T_{\text{evaluate,EUTRAN}}$  when  $T_{\text{reselection}} = 0$  as specified in table 4.2.2.5-1 of TS 38.133 [6] provided that the reselection criteria is met by a margin of at least 6dB for RSRP reselections based on absolute priorities or 4dB for RSRQ reselections based on absolute priorities.

If  $T_{\text{reselection}}$  timer has a non-zero value and the inter-RAT E-UTRA cell is satisfied with the reselection criteria which are defined in TS 38.304 [30], the UE shall evaluate this E-UTRA cell for the  $T_{\text{reselection}}$  time. If this cell remains satisfied with the reselection criteria within this duration, then the UE shall reselect that cell.

The normative reference for this requirement is TS 38.133 [6] clause 4.2.2.5.

**Table 6.1.2.0.1-1:  $T_{\text{detect,EUTRAN}}$ ,  $T_{\text{measure,EUTRAN}}$ , and  $T_{\text{evaluate,EUTRAN}}$**

DRX cycle length [s]	$T_{\text{detect,EUTRAN}}$ [s] (number of DRX cycles)	$T_{\text{measure,EUTRAN}}$ [s] (number of DRX cycles)	$T_{\text{evaluate,EUTRAN}}$ [s] (number of DRX cycles)
0.32	11.52 (36)	1.28 (4)	5.12 (16)
0.64	17.92 (28)	1.28 (2)	5.12 (8)
1.28	32(25)	1.28 (1)	6.4 (5)
2.56	58.88 (23)	2.56 (1)	7.68 (3)

**Table 6.1.2.0.1-2:  $T_{\text{detect,EUTRAN\_HST}}$ ,  $T_{\text{measure,EUTRAN\_HST}}$ , and  $T_{\text{evaluate,EUTRAN\_HST}}$  for UE configured with highSpeedMeasFlag-r16**

DRX cycle length [s]	$T_{\text{detect,EUTRAN\_HST}}$ [s] (number of DRX cycles)	$T_{\text{measure,EUTRAN\_HST}}$ [s] (number of DRX cycles)	$T_{\text{evaluate,EUTRAN\_HST}}$ [s] (number of DRX cycles)
0.32	4.16 (13)	0.64 (2)	0.96 (3)
0.64	7.68 (12)	1.28 (2)	1.92 (3)
1.28	8.96 (7)	1.28 (1)	3.84 (3)
2.56	58.88 (23)	2.56 (1)	7.68 (3)

Note 1: When highSpeedMeasFlag-r16 is configured, the requirements apply only to UE supporting either *measurementEnhancement-r16* or [*interRAT-MeasurementEnhancement-r16*].

The requirements in Table 6.1.2.0.1-2 apply only when the UE supports *measurementEnhancement-r16* or *interRAT-MeasurementEnhancement-r16*. For UE not supporting either *measurementEnhancement-r16* or *interRAT-MeasurementEnhancement-r16*, the UE is not required to meet the requirements specified in Table 6.1.2.0.1-2.

### 6.1.2.0.2 Minimum conformance requirement for inter-RAT E-UTRAN cells for UE configured with relaxed measurement criterion

#### 6.1.2.0.2.1 Introduction

This clause contains the requirements for measurements on inter-RAT E-UTRAN cells when the UE is configured with any of following relaxed measurement criteria:

- Relaxed measurement criterion for UE with low mobility defined in clause 5.2.4.9.1 in TS 38.304 [30],
- Relaxed measurement criterion for UE not-at-cell edge defined in clause 5.2.4.9.2 in TS 38.304 [30],
- Both low mobility criterion and not-at-cell edge criterion as defined in clauses 5.2.4.9.1 and 5.2.4.9.2 in TS 38.304 [30] respectively.

#### 6.1.2.0.2.2 Measurements for UE fulfilling low mobility criterion

This clause contains requirements for measurements on inter-RAT E-UTRAN cells provided that:

- T331 timer is not running for EMR measurements on inter-RAT E-UTRAN, and
- UE is configured with *lowMobilityEvaluation* [13] criterion and UE has fulfilled, or
- UE is configured with both *lowMobilityEvaluation* [13] criterion and *cellEdgeEvaluation* [13] criterion and *combineRelaxedMeasCondition* [13] not configured, and
- UE has fulfilled only the *lowMobilityEvaluation* [13] criterion.

When  $S_{\text{rxlev}} \leq S_{\text{nonIntraSearchP}}$  or  $S_{\text{qual}} \leq S_{\text{nonIntraSearchQ}}$  then the requirements defined in clause 6.1.2.0.1 apply for this clause except that:

- $T_{\text{detect,EUTRAN}}$  as specified in Table 6.1.2.0.2.2-1.
- $T_{\text{measure,EUTRAN}}$  as specified in Table 6.1.2.0.2.2-1.
- $T_{\text{evaluate,EUTRAN}}$  as specified in Table 6.1.2.0.2.2-1.

When  $S_{\text{rxlev}} > S_{\text{nonIntraSearchP}}$  and  $S_{\text{qual}} > S_{\text{nonIntraSearchQ}}$  and the UE is configured with *highPriorityMeasRelax* [13] then the UE shall search for E-UTRA inter-RAT frequency layers of higher priority at least every  $K2 * T_{\text{higher\_priority\_search}}$  seconds where  $T_{\text{higher\_priority\_search}}$  is described in clause 4.2.2.7 of TS 38.133 [6] and,  $K2 = 60$ . Otherwise if the UE is not configured with *highPriorityMeasRelax* [13] then the UE shall search for E-UTRA inter-RAT frequency layers of higher priority at least every  $T_{\text{higher\_priority\_search}}$  where  $T_{\text{higher\_priority\_search}}$  is described in clause 4.2.2.7 of TS 38.133 [6].

**Table 6.1.2.0.2.2-1:  $T_{\text{detect,EUTRAN}}$ ,  $T_{\text{measure,EUTRAN}}$ , and  $T_{\text{evaluate,EUTRAN}}$** 

DRX cycle length [s]	$T_{\text{detect,EUTRAN}}$ [s] (number of DRX cycles)	$T_{\text{measure,EUTRAN}}$ [s] (number of DRX cycles)	$T_{\text{evaluate,EUTRAN}}$ [s] (number of DRX cycles)
0.32	11.52 x K1 (36 x K1)	1.28 x K1 (4 x K1)	5.12 x K1 (16 x K1)
0.64	17.92 x K1 (28 x K1)	1.28 x K1 (2 x K1)	5.12 x K1 (8 x K1)
1.28	32 x K1 (25 x K1)	1.28 x K1 (1 x K1)	6.4 x K1 (5 x K1)
2.56	58.88 x K1 (23 x K1)	2.56 x K1 (1 x K1)	7.68 x K1 (3 x K1)
Note 1:	K1 = 3 is the measurement relaxation factor applicable for UE fulfilling the <i>lowMobilityEvaluation</i> [13] criterion.		

#### 6.1.2.0.2.3 Measurements for UE fulfilling with not-at-cell edge criterion

This clause contains requirements for measurements on inter-RAT E-UTRAN cells provided that:

- T331 timer is not running for EMR measurements on inter-RAT E-UTRAN, and
- UE is configured with *cellEdgeEvaluation* [13] criterion and UE has fulfilled, or
- UE is configured with both *lowMobilityEvaluation* [13] criterion and *cellEdgeEvaluation* [13] criterion and *combineRelaxedMeasCondition* [13] not configured, and
- UE has fulfilled only the *cellEdgeEvaluation* [13] criterion.

When  $S_{\text{rxlev}} \leq S_{\text{nonIntraSearchP}}$  or  $S_{\text{qual}} \leq S_{\text{nonIntraSearchQ}}$  then the requirements defined in clause 6.1.2.0.1 apply for this clause except that:

- $T_{\text{detect,EUTRAN}}$  as specified in Table 6.1.2.0.2.3-1.
- $T_{\text{measure,EUTRAN}}$  as specified in Table 6.1.2.0.2.3-1.
- $T_{\text{evaluate,EUTRAN}}$  as specified in Table 6.1.2.0.2.3-1.

When  $S_{\text{rxlev}} > S_{\text{nonIntraSearchP}}$  and  $S_{\text{qual}} > S_{\text{nonIntraSearchQ}}$  and regardless of whether the UE is configured with *highPriorityMeasRelax* [13] or not, the UE shall search for inter-RAT E-UTRAN frequency layers of higher priority at least every  $T_{\text{higher\_priority\_search}}$  where  $T_{\text{higher\_priority\_search}}$  is described in clause 4.2.2.7 of TS 38.133 [6].

**Table 6.1.2.0.2.3-1:  $T_{\text{detect,EUTRAN}}$ ,  $T_{\text{measure,EUTRAN}}$ , and  $T_{\text{evaluate,EUTRAN}}$** 

DRX cycle length [s]	$T_{\text{detect,EUTRAN}}$ [s] (number of DRX cycles)	$T_{\text{measure,EUTRAN}}$ [s] (number of DRX cycles)	$T_{\text{evaluate,EUTRAN}}$ [s] (number of DRX cycles)
0.32	11.52 x K1 (36 x K1)	1.28 x K1 (4 x K1)	5.12 x K1 (16 x K1)
0.64	17.92 x K1 (28 x K1)	1.28 x K1 (2 x K1)	5.12 x K1 (8 x K1)
1.28	32 x K1 (25 x K1)	1.28 x K1 (1 x K1)	6.4 x K1 (5 x K1)
2.56	58.88 x K1 (23 x K1)	2.56 x K1 (1 x K1)	7.68 x K1 (3 x K1)
Note 1:	K1 = 3 is the measurement relaxation factor applicable for UE fulfilling the <i>lowMobilityEvaluation</i> [13] criterion.		

#### 6.1.2.0.2.4 Measurements for UE fulfilling low mobility and not-at-cell edge criterion

This clause contains requirements for measurements on inter-RAT E-UTRAN cells provided that:

- T331 timer is not running for EMR measurements on inter-RAT E-UTRAN, and
- UE is configured with both *lowMobilityEvaluation* [13] criterion and *cellEdgeEvaluation* [13] criterion, and
- has also fulfilled both criteria, and
- less than 1 hour have passed since measurements for cell reselection were last performed,

In this case the UE is not required to meet  $T_{\text{detect,EUTRAN}}$ ,  $T_{\text{measure,EUTRAN}}$  and  $T_{\text{evaluate,EUTRAN}}$  as defined in Table 6.1.2.0.1-1.

The normative reference for this requirement is TS 38.133 [6] clause 4.2.2.11.

## 6.1.2.1 NR SA FR1 – E-UTRA cell re-selection to higher priority E-UTRA

### 6.1.2.1.1 Test purpose

This test is to verify the requirement for the NR to E-UTRAN inter-RAT cell reselection requirements specified in clause 4.2.2.5 of TS 38.133 [6] when the E-UTRAN cell is of higher priority.

### 6.1.2.1.2 Test applicability

This test applies to all types of NR UE from Release 15 onwards.

### 6.1.2.1.3 Minimum conformance requirements

The minimum conformance requirements are specified in clause 6.1.2.0.1.

The normative reference for this requirement is TS 38.133 [6] clause A.6.1.2.1.

### 6.1.2.1.4 Test description

#### 6.1.2.1.4.1 Initial conditions

The Test shall be tested using any of the test configuration in Table 6.1.2.1.4.1-1.

**Table 6.1.2.1.4.1-1: Supported test configurations**

Configuration	Description of serving cell	Description of target cell
6.1.2.1-1	NR 15 kHz SSB SCS, 10MHz bandwidth, FDD duplex mode	LTE 10MHz bandwidth, TDD duplex mode
6.1.2.1-2	NR 15 kHz SSB SCS, 10MHz bandwidth, TDD duplex mode	LTE 10MHz bandwidth, TDD duplex mode
6.1.2.1-3	NR 30 kHz SSB SCS, 40MHz bandwidth, TDD duplex mode	LTE 10MHz bandwidth, TDD duplex mode
6.1.2.1-4	NR 15 kHz SSB SCS, 10MHz bandwidth, FDD duplex mode	LTE 10MHz bandwidth, FDD duplex mode
6.1.2.1-5	NR 15 kHz SSB SCS, 10MHz bandwidth, TDD duplex mode	LTE 10MHz bandwidth, FDD duplex mode
6.1.2.1-6	NR 30 kHz SSB SCS, 40MHz bandwidth, TDD duplex mode	LTE 10MHz bandwidth, FDD duplex mode

Note: The UE is only required to be tested in one of the supported test configurations.

Configure the test requirement and the DUT according to the parameters in Table 6.1.2.1.4.1-2.

**Table 6.1.2.1.4.1-2: Initial conditions for NR SA FR1 – E-URTA cell re-selection to higher priority E-UTRA**

Parameter	Value		Comment
Test environment	NC		As specified in TS 38.508-1 [14] clause 4.1.
Test frequencies	As specified in Annex E, Table E.4-2 and TS 38.508-1 [14] clause 4.3.1.		
Channel bandwidth	As specified by the test configuration selected from Table 6.1.2.1.4.1-1.		
Propagation conditions	AWGN		As specified in Annex C.2.2.
Connection Diagram	TE Part	A.3.1.6.1	As specified in TS 38.508-1 [14] Annex A.
	DUT Part	A.3.2.3.2	
Exceptions to connection diagram	N/A		

1. The general test parameter settings are set up according to Table 6.1.2.1.4.1-3.
2. Message contents are defined in clause 6.1.2.1.4.3.



3. The test scenario comprises of one NR cell and one E-UTRAN cell. Cell 1 is the NR PCell and Cell 2 is the E-UTRA neighbour cell. Cell 1 is configured according to Annex C.1.1 and C.1.2, Cell 2 is configured according to TS 36.521-3 [26] Annex C.1.0 and C.1.1.

**Table 6.1.2.1.4.1-3: General test parameters for NR to higher priority E-UTRAN cell re-selection test case**

Parameter		Unit	Test configuration	Value	Comment
Initial condition	Active cell		1, 2, 3, 4, 5, 6	Cell1	The UE camps on cell 1 in the initial phase and during T2 period the UE reselects to cell 2.
T2 end condition	Active cell		1, 2, 3, 4, 5, 6	Cell2	The UE shall perform reselection to cell 2 during T2.
	Neighbour cell		1, 2, 3, 4, 5, 6	Cell1	
T3 end condition	Active cell		1, 2, 3, 4, 5, 6	Cell1	The UE shall perform reselection to cell 1 during T3 for iteration of the tests.
	Neighbour cell		1, 2, 3, 4, 5, 6	Cell2	
Access Barring Information		-	1, 2, 3, 4, 5, 6	Not Sent	No additional delays in random access procedure.
DRX cycle length		s	1, 2, 3, 4, 5, 6	1.28	The value shall be used for all cells in the test.
NR PRACH configuration index			1, 2, 3, 4, 5, 6	102	The detailed configuration is specified in TS 38.211 clause 6.3.3.2
E-UTRAN PRACH configuration index			1, 2, 3	53	As specified in table 5.7.1-2 in TS 36.211
			4, 5, 6	4	
T1		s	1, 2, 3, 4, 5, 6	>7	During T1, cell 2 shall be powered off, and during the off time the physical cell identity shall be changed. The intention is to ensure that cell 2 has not been detected by the UE prior to the start of period T2.
T2		s	1, 2, 3, 4, 5, 6	75	T2 needs to be defined so that cell re-selection reaction time is taken into account.
T3		s	1, 2, 3, 4, 5, 6	15	T3 needs to be defined so that cell re-selection reaction time is taken into account.

#### 6.1.2.1.4.2 Test procedure

Two cells are deployed in the test, which are one FR1 NR PCell (Cell 1) and an E-UTRA neighbour cell (Cell 2). The test consists of three successive time periods, with time duration of T1, T2, and T3 respectively. NR cell 1 is already identified by the UE prior to the start of the test. E-UTRAN cell 2 is of higher priority than cell 1.

Before T1 the UE is camped on to cell 1. During T1, cell 2 shall be powered off. At the start of T2 the UE is expected to detect cell 2, send preambles on the PRACH for sending the RRC CONNECTION REQUEST message to perform a Tracking Area Update procedure on cell 2. At the start of T3 cell 2 becomes weaker than cell 1, and the UE reselects to Cell 1.

In the following test procedure “UE responds” means “UE starts transmitting preamble on PRACH for sending the RRC CONNECTION REQUEST message to perform a Tracking Area Update procedure.

1. Ensure the UE is in state RRC\_IDLE with generic procedure parameters connectivity NR with Test Mode On according to TS 38.508-1 [14] clause 4.5 on Cell 1.
2. Set the parameters according to T1 in Table 6.1.2.1.5-1 and 6.1.2.1.5-2. T1 starts.
3. During T1, Cell 2 shall be powered off and set Cell 2 physical cell identity = ((current Cell 2 physical cell identity + 1) mod 14 + 2) for one iteration of the test procedure loop.
4. When T1 expires, the SS shall switch the power setting from T1 to T2 as specified in Table 6.1.2.1.5-1 and 6.1.2.1.5-2. T2 starts.
5. The SS waits for random access requests information from the UE to perform cell re-selection to a higher priority cell, Cell 2.

6. If the UE responds on Cell 2 during time duration T2 within 68 seconds from the beginning of time period T2, then the number of successful tests is increased by one. Otherwise, the number of failure tests is increased by one.
7. If the UE has re-selected Cell 2 within T2, after the re-selection or when T2 expires, continue with step 7a. Otherwise, if T2 expires and the UE has not yet re-selected Cell 2, the TE shall switch off and on the UE and skip to step 11.
- 7a The SS shall send an *RRCConnectionRelease* message to ensure that the UE is in state RRC\_IDLE on Cell 2.
8. The SS shall switch the power setting from T2 to T3 as specified in Table 6.1.2.1.5-1 and 6.1.2.1.5-2. T3 starts.
9. The SS waits for random access requests information from the UE to perform cell re-selection to a lower priority cell, Cell 1.
10. If the UE has re-selected Cell 1 within T3, after the re-selection or when T3 expires, continue with step 10a. Otherwise, if T3 expires and the UE has not yet re-selected Cell 1, the TE shall switch off and on the UE and skip to step 11.
- 10a. The SS shall send an *RRCRelease* message to ensure that the UE is in state RRC\_IDLE on Cell 1.
11. Ensure the UE is in state RRC\_IDLE with generic procedure parameters connectivity NR according to TS 38.508-1 [14] clause 4.5.
12. Repeat step 2-11 until a test verdict has been achieved.

6.1.2.1.4.3 Message contents

Message contents are according to TS 38.508-1 [14] clause 4.6 with the following exceptions:

**Table 6.1.2.1.4.3-1: Common Exception messages**

Default Message Contents	
Common contents of system information blocks exceptions	Table H.2.3-1  Table H.2.3-2 with Condition SMTC 1 and higher priority for configuration 6.1.2.1-2, 6.1.2.1-3, 6.1.2.1-5 and 6.1.2.1-6 Table H.2.3-2 with Condition SMTC 2 and higher priority for configuration 6.1.2.1-1 and 6.1.2.1-4  Table H.2.3-3 with Condition higher priority
Default RRC messages and information elements contents exceptions	

**Table 6.1.2.1.4.3-2: SystemInformationBlockType3**

Derivation Path: TS 36.508 [25] Table 4.4.3.3-2			
Information Element	Value/remark	Comment	Condition
SystemInformationBlockType3 ::= SEQUENCE {			
cellReselectionServingFreqInfo SEQUENCE {			
threshServingLow	22	Actual value = 44 dB	
cellReselectionPriority	5		higher priority E-UTRA
}			
}			

Table 6.1.2.1.4.3-3: SystemInformationBlockType24

Derivation Path: TS 36.508 [25] Table 4.4.3.3-20			
Information Element	Value/remark	Comment	Condition
SystemInformationBlockType24-r15 ::= SEQUENCE {			
carrierFreqListNR-r15 SEQUENCE (SIZE (1..maxFreq)) OF SEQUENCE {	1 entry		
cellReselectionPriority-r15[n]	4		higher priority E-UTRA
threshX-High-r15[1]	24	Actual value = 48 dB	
threshX-Low-r15[1]	25	Actual value = 50 dB	
}			
}			

## 6.1.2.1.5 Test requirement

Tables 6.1.2.1.4.1-3, 6.1.2.1.5-1 and 6.1.2.1.5-2 define the primary level settings including test tolerances for higher priority E-UTRA cell re-selection test case.

Table 6.1.2.1.5-1: Cell specific test parameters for NR cell 1

Parameter	Unit	Test configuration	Cell 1		
			T1	T2	T3
TDD configuration		1, 4	N/A		
		2, 5	TDDConf.1.1		
		3, 6	TDDConf.2.1		
PDSCH parameters		1, 4	SR.1.1 FDD		
		2, 5	SR.1.1 TDD		
		3, 6	SR.2.1 TDD		
RMSI CORESET parameters		1, 4	CR.1.1 FDD		
		2, 5	CR.1.1 TDD		
		3, 6	CR.2.1 TDD		
Dedicated CORESET parameters		1, 4	CCR.1.1 FDD		
		2, 5	CCR.1.1 TDD		
		3, 6	CCR.2.1 TDD		
SSB parameters		1, 4	SSB.1 FR1		
		2, 5	SSB.1 FR1		
		3, 6	SSB.2 FR1		
NR SMTc parameters		1, 4	SMTc 2		
		2, 5	SMTc 1		
		3, 6	SMTc 1		
OCNG Pattern		1, 2, 3, 4, 5, 6	OP.1 defined in A.2.1-1		
Initial DL BWP configuration		1, 2, 3, 4, 5, 6	DLBWP.0.1		
Initial UL BWP configuration		1, 2, 3, 4, 5, 6	ULBWP.0.1		
RLM-RS		1, 2, 3, 4, 5, 6	SSB		
Qrxlevmin	dBm/SCS	1, 2, 4, 5	-140		
		3, 6	-137		
$N_{oc}$	dBm/SCS	1, 4	-98		
		2, 5	-98		
		3, 6	-95		
		1, 2, 3, 4, 5, 6	-98		
SS-RSRP	dBm/SCS	1, 4	-84	-82.4	-82.4
		2, 5	-84	-82.4	-82.4
		3, 6	-81	-79.39	-79.39
$\hat{E}_s/I_{ot}$	dB	1, 4	14	15.6	15.6
		2, 5			
		3, 6			
$\hat{E}_s/N_{oc}$	dB	1, 4	14	15.6	15.6
		2, 5			
		3, 6			
Io	dBm/9.36 MHz	1, 4	-55.88	-54.33	-54.33
	dBm/9.36 MHz	2, 5	-55.88	-54.33	-54.33

Parameter	Unit	Test configuration	Cell 1		
			T1	T2	T3
	dBm/38.16 MHz	3, 6	-49.79	-48.23	-48.23
Treselection	S	1, 2, 3, 4, 5, 6	0		
SnonintrasearchP	dB	1, 2, 3, 4, 5, 6	50		
Thresh <sub>x, highP</sub> (Note 2)	dB	1, 2, 3, 4, 5, 6	48		
Thresh <sub>serv, lowP</sub>	dB	1, 2, 3, 4, 5, 6	44		
Thresh <sub>x, lowP</sub>	dB	1, 2, 3, 4, 5, 6	50		
Propagation Condition		1, 2, 3, 4, 5, 6	AWGN		
Note 1:	OCNG shall be used such that both cells are fully allocated and a constant total transmitted power spectral density is achieved for all OFDM symbols.				
Note 2:	This refers to the value of threshX-High which is included in NR system information, and is a threshold for the E-UTRA target cell.				

Table 6.1.2.1.5-2: Cell specific test parameters for E-UTRA cell 2

Parameter	Unit	Cell 2		
		T1	T2	T3
E-UTRA RF Channel number		1		
BW <sub>channel</sub>	MHz	10		
OCNG Patterns defined in TS 36.133 clause A.3.2		OP.2 TDD for test configuration 1, 2, 3; OP.2 FDD for test configuration 4, 5, 6		
PBCH_RA	dB	0		
PBCH_RB	dB			
PSS_RA	dB			
SSS_RA	dB			
PCFICH_RB	dB			
PHICH_RA	dB			
PHICH_RB	dB			
PDCCH_RA	dB			
PDCCH_RB	dB			
PDSCH_RA	dB			
PDSCH_RB	dB			
OCNG_RA <sup>Note 1</sup>	dB			
OCNG_RB <sup>Note 1</sup>	dB			
Qrxlevmin	dBm			
$N_{oc}$	dBm/15 kHz	-98	-98	-100
RSRP	dBm/15 KHz	-infinity	-84.4	-103.6
$\hat{E}_s / I_{ot}$	dB	-infinity	13.6	-3.6
$\hat{E}_s / N_{oc}$	dB	-infinity	13.6	-3.6
Treselection <sub>EUTRAN</sub>	S	0		
SnonintrasearchP	dB	Not sent		
Thresh <sub>x, highP</sub>	dB	48		
Thresh <sub>serv, lowP</sub>	dB	44		
Thresh <sub>x, lowP</sub> (Note 2)	dB	50		
Propagation Condition		AWGN		
Note 1:	OCNG shall be used such that both cells are fully allocated and a constant total transmitted power spectral density is achieved for all OFDM symbols.			
Note 2:	This refers to the value of threshX-Low-r15 which is included in E-UTRA system information, and is a threshold for the NR target cell.			

The cell reselection delay to a higher priority E-UTRAN cell is defined as the time from the beginning of time period T2, to the moment when the UE camps on cell 2, and starts to send preambles on the PRACH for sending the RRC CONNECTION REQUEST message to perform a Tracking Area Update procedure on cell 2.

The cell re-selection delay to a higher priority cell shall be less than 68 s.

The rate of correct cell reselections observed during repeated tests shall be at least 90%.

NOTE: The cell re-selection delay to a higher priority cell can be expressed as:  $T_{\text{higher\_priority\_search}} + T_{\text{evaluate, E-UTRAN}} + T_{\text{SI-E-UTRA}}$

Where:

$T_{\text{higher\_priority\_search}}$  See clause 4.2.2.7 of TS 38.133 [6]

$T_{\text{evaluate, E-UTRAN}}$  See Table 4.2.2.5-1 in clause 4.2.2.5 of TS 38.133 [6]

$T_{\text{SI-E-UTRA}}$  Maximum repetition period of relevant system info blocks that needs to be received by the UE to camp on a cell; 1280 ms is assumed in this test case.

This gives a total of 67.68 s, allow 68 s for the cell re-selection delay to a higher priority E-UTRAN cell.

## 6.1.2.2 NR SA FR1 – E-UTRA cell re-selection to lower priority E-UTRA

### 6.1.2.2.1 Test purpose

This test is to verify the requirement for the NR to E-UTRAN inter-RAT cell reselection requirements specified in clause 4.2.2.5 of TS 38.133 [6] when the E-UTRAN cell is of lower priority.

### 6.1.2.2.2 Test applicability

This test applies to all types of NR UE from Release 15 onwards.

### 6.1.2.2.3 Minimum conformance requirements

The minimum conformance requirements are specified in clause 6.1.2.0.1.

The normative reference for this requirement is TS 38.133 [6] clause A.6.1.2.2.

### 6.1.2.2.4 Test description

#### 6.1.2.2.4.1 Initial conditions

The Test shall be tested using any of the test configuration in Table 6.1.2.2.4.1-1.

**Table 6.1.2.2.4.1-1: Supported test configurations**

Configuration	Description of serving cell	Description of target cell
6.1.2.2-1	NR 15 kHz SSB SCS, 10MHz bandwidth, FDD duplex mode	LTE 10MHz bandwidth, TDD duplex mode
6.1.2.2-2	NR 15 kHz SSB SCS, 10MHz bandwidth, TDD duplex mode	LTE 10MHz bandwidth, TDD duplex mode
6.1.2.2-3	NR 30 kHz SSB SCS, 40MHz bandwidth, TDD duplex mode	LTE 10MHz bandwidth, TDD duplex mode
6.1.2.2-4	NR 15 kHz SSB SCS, 10MHz bandwidth, FDD duplex mode	LTE 10MHz bandwidth, FDD duplex mode
6.1.2.2-5	NR 15 kHz SSB SCS, 10MHz bandwidth, TDD duplex mode	LTE 10MHz bandwidth, FDD duplex mode
6.1.2.2-6	NR 30 kHz SSB SCS, 40MHz bandwidth, TDD duplex mode	LTE 10MHz bandwidth, FDD duplex mode

Note: The UE is only required to be tested in one of the supported test configurations.

Configure the test requirement and the DUT according to the parameters in Table 6.1.2.2.4.1-2.

**Table 6.1.2.2.4.1-2: Initial conditions for NR SA FR1 – E-URTA cell re-selection to lower priority E-UTRA**

Parameter	Value		Comment
Test environment	NC		As specified in TS 38.508-1 [14] clause 4.1.
Test frequencies	As specified in Annex E, Table E.4-1 and TS 38.508-1 [14] clause 4.3.1.		
Channel bandwidth	As specified by the test configuration selected from Table 6.1.2.2.4.1-1.		
Propagation conditions	AWGN		As specified in Annex C.2.2.
Connection Diagram	TE Part	A.3.1.6.1	As specified in TS 38.508-1 [14] Annex A.
	DUT Part	A.3.2.3.2	
Exceptions to connection diagram	N/A		

1. The general test parameter settings are set up according to Table 6.1.2.2.4.1-3.
2. Message contents are defined in clause 6.1.2.2.4.3.
3. The test scenario comprises of one NR cell and one E-UTRAN cell. Cell 1 is the NR PCell and Cell 2 is the E-UTRA neighbour cell. Cell 1 is configured according to Annex C.1.1 and C.1.2, Cell 2 is configured according to TS 36.521-3 [26] Annex C.1.0 and C.1.1.

**Table 6.1.2.2.4.1-3: General test parameters for NR to lower priority E-UTRAN cell re-selection test case**

Parameter		Unit	Test configuration	Value	Comment
Initial condition	Active cell		1, 2, 3, 4, 5, 6	Cell1	The UE camps on cell 1 in the initial phase.
	Neighbour cell		1, 2, 3, 4, 5, 6	Cell2	
T1 end condition	Active cell		1, 2, 3, 4, 5, 6	Cell2	The UE shall perform reselection to cell 2 during T1.
	Neighbour cell		1, 2, 3, 4, 5, 6	Cell1	
T2 end condition	Active cell		1, 2, 3, 4, 5, 6	Cell1	The UE shall perform reselection to cell 1 during T2 for iteration of the tests.
	Neighbour cell		1, 2, 3, 4, 5, 6	Cell2	
Access Barring Information		-	1, 2, 3, 4, 5, 6	Not Sent	No additional delays in random access procedure.
DRX cycle length		s	1, 2, 3, 4, 5, 6	1.28	The value shall be used for all cells in the test.
NR PRACH configuration index			1, 2, 3, 4, 5, 6	102	The detailed configuration is specified in TS 38.211 clause 6.3.3.2
E-UTRAN PRACH configuration index			1, 2, 3	53	As specified in table 5.7.1-2 in TS 36.211
			4, 5, 6	4	
T1		s	1, 2, 3, 4, 5, 6	15	T1 needs to be defined so that cell re-selection reaction time is taken into account.
T2		s	1, 2, 3, 4, 5, 6	75	T2 needs to be defined so that cell re-selection reaction time is taken into account.

#### 6.1.2.2.4.2 Test procedure

Two cells are deployed in the test, which are one FR1 NR PCell (Cell 1) and an E-UTRA neighbour cell (Cell 2). The test consists of two successive time periods, with time duration of T1 and T2 respectively. Both NR cell 1 and E-UTRAN cell 2 are already identified by the UE prior to the start of the test. E-UTRAN cell 2 is of lower priority than cell 1.

The cell reselection delay to a lower priority E-UTRAN cell is defined as the time from the beginning of time period T1, to the moment when the UE camps on cell 2, and starts to send preambles on the PRACH for sending the RRC CONNECTION REQUEST message to perform a Tracking Area Update procedure on cell 2.

1. Ensure the UE is in state RRC\_IDLE with generic procedure parameters connectivity *NR* according to TS 38.508-1 [14] clause 4.5 on Cell 1.

- 1a. Set the parameters according to T2 in Table 6.1.2.2.5-1 and 6.1.2.2.5-2. SS waits at least for  $32\text{sec}(T_{\text{detect,EUTRAN}})$  to ensure the UE can detect E-UTRA neighbor cell(Cell2).
2. Set the parameters according to T1 in Table 6.1.2.2.5-1 and 6.1.2.2.5-2. T1 starts.
3. The SS waits for random access requests information from the UE to perform cell re-selection on Cell 2.
4. If the UE responds on Cell 2 during time duration T1 within 8 seconds from the beginning of time period T1 then the number of successful tests is increased by one. Otherwise, the number of failure tests is increased by one.
5. If the UE has re-selected Cell 2 within T1, after the re-selection or when T1 expires, continue with step 5a. Otherwise, if T1 expires and the UE has not yet re-selected Cell 2, the TE shall switch off and on the UE and skip to step 9.
- 5a The SS shall send an *RRCConnectionRelease* message to ensure that the UE is in state RRC\_IDLE on Cell 2.
6. The SS shall switch the power setting from T1 to T2 as specified in Table 6.1.2.2.5-1 and 6.1.2.2.5-2. T2 starts.
7. The SS waits for random access requests information from the UE to perform cell re-selection on Cell 1.
8. If the UE has re-selected Cell 1 within T2, after the re-selection or when T2 expires, continue with step 8a. Otherwise, if T2 expires and the UE has not yet re-selected Cell 1, the TE shall switch on and off the UE and skip to step 9.
- 8a. The SS shall send an *RRCRelease* message to ensure that the UE is in state RRC\_IDLE on Cell 1.
9. Ensure the UE is in state RRC\_IDLE with generic procedure parameters connectivity NR according to TS 38.508-1 [14] clause 4.5.
- 9a. Set the parameters according to T2 in Table 6.1.2.2.5-1 and 6.1.2.2.5-2. SS waits at least for  $32\text{sec}(T_{\text{detect,EUTRAN}})$  to ensure the UE can detect E-UTRA neighbor cell(Cell2).
10. Repeat step 2-9 until the confidence level according to Tables G.2.3-1 in Annex G clause G.2 is achieved.

6.1.2.2.4.3 Message contents

Message contents are according to TS 38.508-1 [14] clause 4.6 with the following exceptions:

**Table 6.1.2.2.4.3-1: Common Exception messages**

Default Message Contents	
Common contents of system information blocks exceptions	Table H.2.3-1 Table H.2.3-3 with Condition lower priority
Default RRC messages and information elements contents exceptions	

**Table 6.1.2.2.4.3-1A: SIB2**

Derivation Path: Table H.2.3-2 with condition lower priority			
Information Element	Value/remark	Comment	Condition
SIB2 ::= SEQUENCE {			
cellReselectionServingFreqInfo SEQUENCE {			
s-NonIntraSearchP	Not present	UE applies the default value of infinity	
}			
intraFreqCellReselectionInfo SEQUENCE {			
smtc	SSB-MTC specified in TS 38.508-1 [14] Table 7.3.1-3 with condition SMTC.1		6.1.2.2-2, 6.1.2.2-3, 6.1.2.2-5, 6.1.2.2-6
	SSB-MTC specified in TS 38.508-1 [14] Table 7.3.1-3 with condition SMTC.2		6.1.2.2-1, 6.1.2.2-4,
}			

--	--	--

**Table 6.1.2.2.4.3-2: SystemInformationBlockType3**

Derivation Path: TS 36.508 [25] Table 4.4.3.3-2			
Information Element	Value/remark	Comment	Condition
SystemInformationBlockType3 ::= SEQUENCE {			
cellReselectionServingFreqInfo SEQUENCE {			
threshServingLow	22	Actual value = 44 dB	
cellReselectionPriority	4		lower priority E-UTRA
}			
}			

**Table 6.1.2.2.4.3-3: SystemInformationBlockType24**

Derivation Path: TS 36.508 [25] Table 4.4.3.3-20			
Information Element	Value/remark	Comment	Condition
SystemInformationBlockType24-r15 ::= SEQUENCE {			
carrierFreqListNR-r15 SEQUENCE (SIZE (1..maxFreq)) OF SEQUENCE {	1 entry		
cellReselectionPriority-r15[n]	5		lower priority E-UTRA
threshX-High-r15[1]	24	Actual value = 48 dB	
threshX-Low-r15[1]	25	Actual value = 50 dB	
}			
}			

#### 6.1.2.2.5 Test requirement

Tables 6.1.2.2.4.1-3, 6.1.2.2.5-1 and 6.1.2.2.5-2 define the primary level settings including test tolerances for lower priority E-UTRA cell re-selection test case.



Table 6.1.2.2.5-1: Cell specific test parameters for NR cell 1

Parameter	Unit	Test configuration	Cell 1	
			T1	T2
TDD configuration		1, 4	N/A	
		2, 5	TDDConf.1.1	
		3, 6	TDDConf.2.1	
PDSCH RMC configuration		1, 4	SR.1.1 FDD	
		2, 5	SR.1.1 TDD	
		3, 6	SR.2.1 TDD	
RMSI CORESET RMC configuration		1, 4	CR.1.1 FDD	
		2, 5	CR.1.1 TDD	
		3, 6	CR.2.1 TDD	
Dedicated CORESET RMC configuration		1, 4	CCR.1.1 FDD	
		2, 5	CCR.1.1 TDD	
		3, 6	CCR.2.1 TDD	
SSB configuration		1, 4	SSB.1 FR1	
		2, 5	SSB.1 FR1	
		3, 6	SSB.2 FR1	
SMTC configuration		1, 4	SMTC pattern 2	
		2, 5	SMTC pattern 1	
		3, 6	SMTC pattern 1	
OCNG Pattern		1, 2, 3, 4, 5, 6	OP.1 defined in A.2.1-1	
Initial DL BWP configuration		1, 2, 3, 4, 5, 6	DLBWP.0.1	
Initial UL BWP configuration		1, 2, 3, 4, 5, 6	ULBWP.0.1	
RLM-RS		1, 2, 3, 4, 5, 6	SSB	
Qrxlevmin	dBm/SCS	1, 2, 4, 5	-140	
		3, 6	-137	
$N_{oc}$	dBm/SCS	1, 4	-100	-98
		2, 5	-100	-98
		3, 6	-97	-95
$N_{oc}$	dBm/15 kHz	1, 2, 3, 4, 5, 6	-100	-98
SS-RSRP	dBm/SCS	1, 4	-103.6	-84.4
		2, 5	-103.6	-84.4
		3, 6	-100.59	-81.39
$\hat{E}_s/I_{ot}$	dB	1, 4	-3.6	13.6
		2, 5		
		3, 6		
$\hat{E}_s/N_{oc}$	dB	1, 4	-3.6	13.6
		2, 5		
		3, 6		
Io	dBm/9.36 MHz	1, 4	-70.46	-56.26
	dBm/9.36 MHz	2, 5	-70.46	-56.26
	dBm/38.16 MHz	3, 6	-64.38	-50.16
Treselection	S	1, 2, 3, 4, 5, 6	0	
SnonintrasearchP	dB	1, 2, 3, 4, 5, 6	Not sent	
Thresh <sub>x, highP</sub>	dB	1, 2, 3, 4, 5, 6	48	
Thresh <sub>-serving, lowP</sub>	dB	1, 2, 3, 4, 5, 6	44	
Thresh <sub>x, low P (Note 2)</sub>	dB	1, 2, 3, 4, 5, 6	50	
Propagation Condition		1, 2, 3, 4, 5, 6	AWGN	
Note 1:	OCNG shall be used such that both cells are fully allocated and a constant total transmitted power spectral density is achieved for all OFDM symbols.			
Note 2:	This refers to the value of Thresh <sub>x, LowP</sub> which is included in NR system information, and is a threshold for the E-UTRA target cell			

Table 6.1.2.2.5-2: Cell specific test parameters for E-UTRA cell 2

Parameter	Unit	Cell 2	
		T1	T2 T3
E-UTRA RF Channel number		1	
$BW_{\text{channel}}$	MHz	10	
OCNG Patterns defined in TS 36.133 clause A.3.2		OP.2 TDD for test configuration 1, 2, 3; OP.2 FDD for test configuration 4, 5, 6	
PBCH_RA	dB	0	
PBCH_RB	dB		
PSS_RA	dB		
SSS_RA	dB		
PCFICH_RB	dB		
PHICH_RA	dB		
PHICH_RB	dB		
PDCCH_RA	dB		
PDCCH_RB	dB		
PDSCH_RA	dB		
PDSCH_RB	dB		
OCNG_RA <sup>Note 1</sup>	dB		
OCNG_RB <sup>Note 1</sup>	dB		
$Q_{rxlevmin}$	dBm	-140	
$N_{oc}$	dBm/15 kHz	-98	
RSRP	dBm/15 KHz	-82.4	-84
$\hat{E}_s / I_{ot}$	dB	15.6	14
$\hat{E}_s / N_{oc}$	dB	15.6	14
Trerelection <sub>EUTRAN</sub>	S	0	
SnonintrasearchP	dB	Not sent	
Thresh <sub>x, highP</sub> (Note 2)	dB	48	
Thresh <sub>serv, lowP</sub>	dB	44	
Thresh <sub>x, lowP</sub>	dB	50	
Propagation Condition		AWGN	
Note 1: OCNG shall be used such that both cells are fully allocated and a constant total transmitted power spectral density is achieved for all OFDM symbols.			
Note 2: This refers to the value of Thresh <sub>x, highP</sub> which is included in E-UTRA system information, and is a threshold for the NR target cell			

The cell reselection delay to a lower priority E-UTRAN cell is defined as the time from the beginning of time period T1, to the moment when the UE camps on cell 2, and starts to send preambles on the PRACH for sending the RRC CONNECTION REQUEST message to perform a Tracking Area Update procedure on cell 2.

The cell re-selection delay to a lower priority cell shall be less than 8 s.

The rate of correct cell reselections observed during repeated tests shall be at least 90%.

NOTE: The cell re-selection delay to a lower priority cell can be expressed as:  $T_{\text{evaluate, E-UTRAN}} + T_{\text{SI-E-UTRA}}$ ,

Where:

$T_{\text{evaluate, E-UTRAN}}$  See Table 4.2.2.5-1 in clause 4.2.2.5 of TS 38.133 [6]

$T_{\text{SI-E-UTRA}}$  Maximum repetition period of relevant system info blocks that needs to be received by the UE to camp on a cell; 1280 ms is assumed in this test case.

This gives a total of 7.68 s, allow 8 s for the cell re-selection delay to a lower priority E-UTRAN cell.

### 6.1.2.3 NR SA FR1 – E-UTRA cell re-selection to lower priority E-UTRAN for UE fulfilling low mobility relaxed measurement criterion

#### 6.1.2.3.1 Test purpose

This test is to verify the requirement for the NR to E-UTRAN inter-RAT cell reselection when UE fulfils the low mobility criterion specified in clause 4.2.2.11.2 of TS 38.133 [6] and the E-UTRAN cell is of lower priority.

#### 6.1.2.3.2 Test applicability

This test applies to all types of NR UE from Release 16 onwards supporting relaxed RRM measurement.

#### 6.1.2.3.3 Minimum conformance requirements

The minimum conformance requirements are specified in clause 6.1.2.0.2.

The normative reference for this requirement is TS 38.133 [6] clause A.6.1.2.3.

#### 6.1.2.3.4 Test description

##### 6.1.2.3.4.1 Initial conditions

The Test shall be tested using any of the test configuration in Table 6.1.2.3.4.1-1.

**Table 6.1.2.3.4.1-1: Supported test configurations**

Configuration	Description of serving cell	Description of target cell
6.1.2.3-1	NR 15 kHz SSB SCS, 10MHz bandwidth, FDD duplex mode	LTE 10MHz bandwidth, TDD duplex mode
6.1.2.3-2	NR 15 kHz SSB SCS, 10MHz bandwidth, TDD duplex mode	LTE 10MHz bandwidth, TDD duplex mode
6.1.2.3-3	NR 30 kHz SSB SCS, 40MHz bandwidth, TDD duplex mode	LTE 10MHz bandwidth, TDD duplex mode
6.1.2.3-4	NR 15 kHz SSB SCS, 10MHz bandwidth, FDD duplex mode	LTE 10MHz bandwidth, FDD duplex mode
6.1.2.3-5	NR 15 kHz SSB SCS, 10MHz bandwidth, TDD duplex mode	LTE 10MHz bandwidth, FDD duplex mode
6.1.2.3-6	NR 30 kHz SSB SCS, 40MHz bandwidth, TDD duplex mode	LTE 10MHz bandwidth, FDD duplex mode

Note: The UE is only required to be tested in one of the supported test configurations.

Configure the test requirement and the DUT according to the parameters in Table 6.1.2.3.4.1-2.

**Table 6.1.2.3.4.1-2: Initial conditions for NR SA FR1 – E-URTA cell re-selection to lower priority E-UTRA for UE fulfilling low mobility relaxed measurement criterion**

Parameter	Value		Comment
Test environment	NC		As specified in TS 38.508-1 [14] clause 4.1.
Test frequencies	As specified in Annex E, Table E.4-1 and TS 38.508-1 [14] clause 4.3.1.		
Channel bandwidth	As specified by the test configuration selected from Table 6.1.2.3.4.1-1.		
Propagation conditions	AWGN		As specified in Annex C.2.2.
Connection Diagram	TE Part	A.3.1.6.1	As specified in TS 38.508-1 [14] Annex A.
	DUT Part	A.3.2.3.2	
Exceptions to connection diagram	N/A		

1. The general test parameter settings are set up according to Table 6.1.2.3.4.1-3.
2. Message contents are defined in clause 6.1.2.3.4.3.
3. The test scenario comprises of one NR cell and one E-UTRAN cell. Cell 1 is the NR PCell and Cell 2 is the E-UTRA neighbour cell. Cell 1 is configured according to Annex C.1.1 and C.1.2, Cell 2 is configured according to TS 36.521-3 [26] Annex C.1.0 and C.1.1.

**Table 6.1.2.3.4.1-3: General test parameters for NR to lower priority E-UTRAN cell re-selection test case**

Parameter		Unit	Test configuration	Value	Comment
Initial condition	Active cell		1, 2, 3, 4, 5, 6	Cell1	The UE camps on cell 1 in the initial phase, it fulfils Low Mobility relaxation measurements criterion, and during T1 period the UE reselects to cell 2.
	Neighbour cell		1, 2, 3, 4, 5, 6	Cell2	
T1 end condition	Active cell		1, 2, 3, 4, 5, 6	Cell2	The UE shall perform reselection to cell 2 during T1.
	Neighbour cell		1, 2, 3, 4, 5, 6	Cell1	
T2 end condition	Active cell		1, 2, 3, 4, 5, 6	Cell1	The UE shall perform reselection to cell 1 with higher priority during T2 for iteration of the tests.
	Neighbour cell		1, 2, 3, 4, 5, 6	Cell2	
Access Barring Information		-	1, 2, 3, 4, 5, 6	Not Sent	No additional delays in random access procedure.
DRX cycle length		s	1, 2, 3, 4, 5, 6	0.64	The value shall be used for all cells in the test.
NR PRACH configuration index			1, 2, 3, 4, 5, 6	102	The detailed configuration is specified in TS 38.211 clause 6.3.3.2
E-UTRAN PRACH configuration index			1, 2, 3	53	As specified in table 5.7.1-2 in TS 36.211
			4, 5, 6	4	
T1		s	1, 2, 3, 4, 5, 6	24	T1 needs to be defined so that cell re-selection reaction time is taken into account.
T2		s	1, 2, 3, 4, 5, 6	24	T2 needs to be defined so that cell re-selection reaction time is taken into account.

#### 6.1.2.3.4.2 Test procedure

Two cells are deployed in the test, which are one FR1 NR PCell (Cell 1) and an E-UTRA neighbour cell (Cell 2). The test consists of two successive time periods, with time duration of T1 and T2 respectively. Both NR cell 1 and E-UTRAN cell 2 are already identified by the UE prior to the start of the test. E-UTRAN cell 2 is of lower priority than cell 1.

The UE is configured with the relaxed measurement criterion for UE with low mobility defined in clause 5.2.4.9.1 in TS 38.304 [30]. So, Cell 1 configures the UE as follows:

- *lowMobilityEvaluation* [13] criterion is configured according to the parameters listed in Table 6.1.2.3.5-1;
- *cellEdgeEvaluation* [13] criterion is not configured;
- *combineRelaxedMeasCondition* [13] is not configured

The cell reselection delay to a lower priority E-UTRAN cell with UE fulfilling low mobility criterion is defined as the time from the beginning of time period T1, to the moment when the UE camps on cell 2, and starts to send preambles on the PRACH for sending the RRC CONNECTION REQUEST message to perform a Tracking Area Update procedure on cell 2.

1. Ensure the UE is in state RRC\_IDLE with generic procedure parameters Connectivity NR according to TS 38.508-1 [14] clause 4.5.
2. Set the parameters according to T1 in Table 6.1.2.3.5-1 and 6.1.2.3.5-2. T1 starts.
3. The SS waits for random access requests information from the UE to perform cell re-selection on Cell 2.
4. If the UE responds on Cell 2 during time duration T1 within 17 seconds from the beginning of time period T1 then the number of successful tests is increased by one. Otherwise, the number of failure tests is increased by one.
5. If the UE has re-selected Cell 2 within T1, after the re-selection or when T1 expires, continue with step 6. Otherwise, if T1 expires and the UE has not yet re-selected Cell 2, the TE shall switch off and on the UE and skip to step 11.

- 6 The SS shall send an RRCConnectionRelease to ensure that the UE is in state RRC\_IDLE.
7. The SS shall switch the power setting from T1 to T2 as specified in Table 6.1.2.3.5-1 and 6.1.2.3.5-2. T2 starts.
8. The SS waits for random access requests information from the UE to perform cell re-selection on Cell 1.
9. If the UE has re-selected Cell 1 within T2, after the re-selection or when T2 expires, continue with step 10. Otherwise, if T2 expires and the UE has not yet re-selected Cell 1, the TE shall switch off and on the UE and skip to step 11.
- 10 The SS shall send an RRCConnectionRelease to ensure that the UE is in state RRC\_IDLE, and then skip to step 12.
11. Ensure the UE is in state RRC\_IDLE with generic procedure parameters Connectivity NR according to TS 38.508-1 [14] clause 4.5.
12. Repeat step 2-11 until the confidence level according to Tables G.2.3-1 in Annex G clause G.2 is achieved.

6.1.2.3.4.3 Message contents

Message contents are according to TS 38.508-1 [14] clause 4.6 with the following exceptions:

**Table 6.1.2.3.4.3-1: Common Exception messages**

Default Message Contents	
Common contents of system information blocks exceptions	Table H.2.3-1  Table H.2.3-2 with Condition SMTC 1 and lower priority for configuration 6.1.2.3-2, 6.1.2.3-3, 6.1.2.3-5 and 6.1.2.3-6 Table H.2.3-2 with Condition SMTC 2 and lower priority for configuration 6.1.2.3-1 and 6.1.2.3-4  Table H.2.3-3 with Condition lower priority
Default RRC messages and information elements contents exceptions	Table H.3.2-1

**Table 6.1.2.3.4.3-2: SIB2**

Derivation Path: TS 38.508-1 [14] Table 4.6.2-1			
Information Element	Value/remark	Comment	Condition
SIB2 ::= SEQUENCE {			
relaxedMeasurement-r16 SEQUENCE {			
lowMobilityEvaluation-r16 SEQUENCE {			
s-SearchDeltaP-r16	dB3		
t-SearchDeltaP-r16	s5		
}			
cellEdgeEvaluation-r16	Not present		
combineRelaxedMeasCondition-r16	Not present		
highPriorityMeasRelax-r16	Not present		
}			
}			

**Table 6.1.2.3.4.3-3: SystemInformationBlockType3**

Derivation Path: TS 36.508 [25] Table 4.4.3.3-2			
Information Element	Value/remark	Comment	Condition
SystemInformationBlockType3 ::= SEQUENCE {			
relaxedMeasurement-r16 SEQUENCE {			
threshServingLow	22	Actual value = 44 dB	
cellReselectionPriority	4		lower priority E-UTRA
}			
}			

**Table 6.1.2.3.4.3-4: SystemInformationBlockType24**

Derivation Path: TS 36.508 [25] Table 4.4.3.3-20			
Information Element	Value/remark	Comment	Condition
SystemInformationBlockType24-r15 ::= SEQUENCE {			
carrierFreqListNR-r15 SEQUENCE (SIZE (1..maxFreq)) OF SEQUENCE {	1 entry		
cellReselectionPriority-r15[n]	5		lower priority E-UTRA
threshX-High-r15[1]	24	Actual value = 48 dB	
threshX-Low-r15[1]	25	Actual value = 50 dB	
}			
}			

#### 6.1.2.3.5 Test requirement

Tables 6.1.2.3.4.1-3, 6.1.2.3.5-1 and 6.1.2.3.5-2 define the primary level settings including test tolerances for lower priority E-UTRA cell re-selection test case.

Table 6.1.2.3.5-1: Cell specific test parameters for NR cell 1

Parameter	Unit	Test configuration	Cell 1	
			T1	T2
TDD configuration		1, 4	N/A	
		2, 5	TDDConf.1.1	
		3, 6	TDDConf.2.1	
PDSCH RMC configuration		1, 4	SR.1.1 FDD	
		2, 5	SR.1.1 TDD	
		3, 6	SR.2.1 TDD	
RMSI CORESET RMC configuration		1, 4	CR.1.1 FDD	
		2, 5	CR.1.1 TDD	
		3, 6	CR.2.1 TDD	
Dedicated CORESET RMC configuration		1, 4	CCR.1.1 FDD	
		2, 5	CCR.1.1 TDD	
		3, 6	CCR.2.1 TDD	
SSB configuration		1, 4	SSB.1 FR1	
		2, 5	SSB.1 FR1	
		3, 6	SSB.2 FR1	
SMTC configuration		1, 4	SMTC pattern 2	
		2, 5	SMTC pattern 1	
		3, 6	SMTC pattern 1	
OCNG Pattern		1, 2, 3, 4, 5, 6	OP.1 defined in A.3.2.1	
Initial DL BWP configuration		1, 2, 3, 4, 5, 6	DLBWP.0.1	
Initial UL BWP configuration		1, 2, 3, 4, 5, 6	ULBWP.0.1	
RLM-RS		1, 2, 3, 4, 5, 6	SSB	
Qrxlevmin	dBm/SCS	1, 2, 4, 5	-140	
		3, 6	-137	
$N_{oc}$	dBm/SCS	1, 4	-100	-98
		2, 5	-100	-98
		3, 6	-97	-95
$N_{oc}$	dBm/15 kHz	1, 2, 3, 4, 5, 6	-100	-98
SS-RSRP	dBm/SCS	1, 4	-103.6	-84.4
		2, 5	-103.6	-84.4
		3, 6	-100.6	-81.4
$\hat{E}_s/I_{ot}$	dB	1, 4	-3.6	13.6
		2, 5		
		3, 6		
$\hat{E}_s/N_{oc}$	dB	1, 4	-3.6	13.6
		2, 5		
		3, 6		
Io	dBm/9.36 MHz	1, 4	-70.48	-56.26
	dBm/9.36 MHz	2, 5	-70.48	-56.26
	dBm/38.16 MHz	3, 6	-64.37	-50.16
Treselection	S	1, 2, 3, 4, 5, 6	0	
SnonintrasearchP	dB	1, 2, 3, 4, 5, 6	50	
Thresh <sub>x, highP</sub>	dB	1, 2, 3, 4, 5, 6	48	
Thresh <sub>serv, lowP</sub>	dB	1, 2, 3, 4, 5, 6	44	
Thresh <sub>x, low P (Note 2)</sub>	dB	1, 2, 3, 4, 5, 6	50	
S <sub>SearchDeltaP</sub>	dB	1, 2, 3, 4, 5, 6	3	
T <sub>SearchDeltaP</sub>	s	1, 2, 3, 4, 5, 6	5	
Propagation Condition		1, 2, 3, 4, 5, 6	AWGN	
Note 1: OCNG shall be used such that both cells are fully allocated and a constant total transmitted power spectral density is achieved for all OFDM symbols.				
Note 2: This refers to the value of Thresh <sub>x, Low</sub> which is included in NR system information, and is a threshold for the E-UTRA target cell				

Table 6.1.2.3.5-2: Cell specific test parameters for E-UTRA cell 2

Parameter	Unit	Cell 2	
		T1	T2 T3
E-UTRA RF Channel number		1	
$BW_{\text{channel}}$	MHz	10	
OCNG Patterns defined in TS 36.133 clause A.3.2		OP.2 TDD for test configuration 1, 2, 3; OP.2 FDD for test configuration 4, 5, 6	
PBCH_RA	dB	0	
PBCH_RB	dB		
PSS_RA	dB		
SSS_RA	dB		
PCFICH_RB	dB		
PHICH_RA	dB		
PHICH_RB	dB		
PDCCH_RA	dB		
PDCCH_RB	dB		
PDSCH_RA	dB		
PDSCH_RB	dB		
OCNG_RA <sup>Note 1</sup>	dB		
OCNG_RB <sup>Note 1</sup>	dB		
$Q_{rxlevmin}$	dBm	-140	
$N_{oc}$	dBm/15 kHz	-98	
RSRP	dBm/15 KHz	-82.4	-84
$\hat{E}_s / I_{ot}$	dB	15.6	14
$\hat{E}_s / N_{oc}$	dB	15.6	14
$T_{reselectionEUTRAN}$	S	0	
$S_{nonintrasearchP}$	dB	Not sent	
$Thresh_{x, highP}$ (Note 2)	dB	48	
$Thresh_{serving, lowP}$	dB	44	
$Thresh_{x, lowP}$	dB	50	
Propagation Condition		AWGN	
Note 1: OCNG shall be used such that both cells are fully allocated and a constant total transmitted power spectral density is achieved for all OFDM symbols.			
Note 2: This refers to the value of $Thresh_{x, high}$ which is included in E-UTRA system information, and is a threshold for the NR target cell			

The cell reselection delay to a lower priority E-UTRAN cell with UE fulfilling low mobility criterion is defined as the time from the beginning of time period T1, to the moment when the UE camps on cell 2, and starts to send preambles on the PRACH for sending the *RRCCConnectionRequest* message to perform a Tracking Area Update procedure on cell 2.

The cell re-selection delay to a lower priority cell shall be less than 17 s.

The rate of correct cell reselections observed during repeated tests shall be at least 90%.

NOTE: The cell re-selection delay to a lower priority cell can be expressed as:  $T_{\text{evaluate, E-UTRAN}} + T_{\text{SI-E-UTRA}}$ ,

Where:

$T_{\text{evaluate, E-UTRAN}}$  See Table 4.2.2.11.2-1 in clause 4.2.2.11.2 of TS 38.133 [6]

$T_{\text{SI-E-UTRA}}$  Maximum repetition period of relevant system info blocks that needs to be received by the UE to camp on a cell; 1280 ms is assumed in this test case.

This gives a total of 16.64 s, allow 17 s for the cell re-selection delay to a lower priority E-UTRAN cell for UE fulfilling low mobility criterion.



## 6.1.2.4 NR SA FR1 – E-UTRA cell re-selection to lower priority E-UTRAN for UE fulfilling not-at-cell edge relaxed measurement criterion

### 6.1.2.4.1 Test purpose

This test is to verify the requirement for the NR to E-UTRAN inter-RAT cell reselection when UE fulfils the not-at-cell edge criterion specified in clause 4.2.2.11.3 of TS 38.133 [6] and the E-UTRAN cell is of lower priority.

### 6.1.2.4.2 Test applicability

This test applies to all types of NR UE from Release 16 onwards supporting relaxed RRM measurement.

### 6.1.2.4.3 Minimum conformance requirements

The minimum conformance requirements are specified in clause 6.1.2.0.2.

The normative reference for this requirement is TS 38.133 [6] clause A.6.1.2.4.

### 6.1.2.4.4 Test description

#### 6.1.2.4.4.1 Initial conditions

The Test shall be tested using any of the test configuration in Table 6.1.2.4.4.1-1.

**Table 6.1.2.4.4.1-1: Supported test configurations**

Configuration	Description of serving cell	Description of target cell
6.1.2.4-1	NR 15 kHz SSB SCS, 10MHz bandwidth, FDD duplex mode	LTE 10MHz bandwidth, TDD duplex mode
6.1.2.4-2	NR 15 kHz SSB SCS, 10MHz bandwidth, TDD duplex mode	LTE 10MHz bandwidth, TDD duplex mode
6.1.2.4-3	NR 30 kHz SSB SCS, 40MHz bandwidth, TDD duplex mode	LTE 10MHz bandwidth, TDD duplex mode
6.1.2.4-4	NR 15 kHz SSB SCS, 10MHz bandwidth, FDD duplex mode	LTE 10MHz bandwidth, FDD duplex mode
6.1.2.4-5	NR 15 kHz SSB SCS, 10MHz bandwidth, TDD duplex mode	LTE 10MHz bandwidth, FDD duplex mode
6.1.2.4-6	NR 30 kHz SSB SCS, 40MHz bandwidth, TDD duplex mode	LTE 10MHz bandwidth, FDD duplex mode

Note: The UE is only required to be tested in one of the supported test configurations.

Configure the test requirement and the DUT according to the parameters in Table 6.1.2.4.4.1-2.

**Table 6.1.2.4.4.1-2: Initial conditions for NR SA FR1 – E-URTA cell re-selection to lower priority E-UTRA for UE fulfilling not-at-cell edge relaxed measurement criterion**

Parameter	Value		Comment
Test environment	NC		As specified in TS 38.508-1 [14] clause 4.1.
Test frequencies	As specified in Annex E, Table E.4-1 and TS 38.508-1 [14] clause 4.3.1.		
Channel bandwidth	As specified by the test configuration selected from Table 6.1.2.4.4.1-1.		
Propagation conditions	AWGN		As specified in Annex C.2.2.
Connection Diagram	TE Part	A.3.1.6.1	As specified in TS 38.508-1 [14] Annex A.
	DUT Part	A.3.2.3.2	
Exceptions to connection diagram	N/A		

1. The general test parameter settings are set up according to Table 6.1.2.4.4.1-3.
2. Message contents are defined in clause 6.1.2.4.4.3.
3. The test scenario comprises of one NR cell and one E-UTRAN cell. Cell 1 is the NR PCell and Cell 2 is the E-UTRA neighbour cell. Cell 1 is configured according to Annex C.1.1 and C.1.2, Cell 2 is configured according to TS 36.521-3 [26] Annex C.1.0 and C.1.1.

**Table 6.1.2.4.4.1-3: General test parameters for NR to lower priority E-UTRAN cell re-selection test case**

Parameter		Unit	Test configuration	Value	Comment
Initial condition	Active cell		1, 2, 3, 4, 5, 6	Cell1	The UE camps on cell 1 in the initial phase and fulfil the not at the cell edge criteria.
	Neighbour cell		1, 2, 3, 4, 5, 6	Cell2	
T1 end condition	Active cell		1, 2, 3, 4, 5, 6	Cell2	The UE shall perform reselection to cell 2 during T1.
	Neighbour cell		1, 2, 3, 4, 5, 6	Cell1	
T2 end condition	Active cell		1, 2, 3, 4, 5, 6	Cell1	The UE shall perform reselection to cell 1 during T2 for iteration of the tests.
	Neighbour cell		1, 2, 3, 4, 5, 6	Cell2	
Access Barring Information		-	1, 2, 3, 4, 5, 6	Not Sent	No additional delays in random access procedure.
DRX cycle length		s	1, 2, 3, 4, 5, 6	0.64	The value shall be used for all cells in the test.
NR PRACH configuration index			1, 2, 3, 4, 5, 6	102	The detailed configuration is specified in TS 38.211 clause 6.3.3.2
E-UTRAN PRACH configuration index			1, 2, 3	53	As specified in table 5.7.1-2 in TS 36.211
			4, 5, 6	4	
T1		s	1, 2, 3, 4, 5, 6	24	T1 needs to be defined so that cell re-selection reaction time is taken into account.
T2		s	1, 2, 3, 4, 5, 6	24	T2 needs to be defined so that cell re-selection reaction time is taken into account.

#### 6.1.2.4.4.2 Test procedure

Two cells are deployed in the test, which are one FR1 NR PCell (Cell 1) and an E-UTRA neighbour cell (Cell 2). The test consists of two successive time periods, with time duration of T1 and T2 respectively. Both NR cell 1 and E-UTRAN cell 2 are already identified by the UE prior to the start of the test. E-UTRAN cell 2 is of lower priority than cell 1.

The UE is configured with the relaxed measurement criterion for UE with not-at-cell edge defined in clause 5.2.4.9.2 in TS 38.304 [30]. So, Cell 1 configures the UE as follows:

- *lowMobilityEvaluation* [2] criterion is not configured;
- *cellEdgeEvaluation* [2] criterion is configured according to the parameters listed in Table 6.1.2.4.5-1;
- *combineRelaxedMeasCondition* [2] is not configured

The cell reselection delay to a lower priority E-UTRAN cell with UE fulfilling not-at-cell edge criterion is defined as the time from the beginning of time period T1, to the moment when the UE camps on cell 2, and starts to send preambles on the PRACH for sending the RRC CONNECTION REQUEST message to perform a Tracking Area Update procedure on cell 2.

1. Ensure the UE is in state RRC\_IDLE with generic procedure parameters Connectivity NR according to TS 38.508-1 [14] clause 4.5.
2. Set the parameters according to T1 in Table 6.1.2.4.5-1 and 6.1.2.4.5-2. T1 starts.
3. The SS waits for random access requests information from the UE to perform cell re-selection on Cell 2.
4. If the UE responds on Cell 2 during time duration T1 within 17 seconds from the beginning of time period T1 then the number of successful tests is increased by one. Otherwise, the number of failure tests is increased by one.
5. If the UE has re-selected Cell 2 within T1, after the re-selection or when T1 expires, continue with step 6. Otherwise, if T1 expires and the UE has not yet re-selected Cell 2, the TE shall switch off and on the UE and skip to step 11.
6. The SS shall send an RRCConnectionRelease to ensure that the UE is in state RRC\_IDLE.
7. The SS shall switch the power setting from T1 to T2 as specified in Table 6.1.2.4.5-1 and 6.1.2.4.5-2. T2 starts.

8. The SS waits for random access requests information from the UE to perform cell re-selection on Cell 1.
9. If the UE has re-selected Cell 1 within T2, after the re-selection or when T2 expires, continue with step 10. Otherwise, if T2 expires and the UE has not yet re-selected Cell 1, the TE shall switch off and on the UE and skip to step 11.
- 10 The SS shall send an RRCConnectionRelease to ensure that the UE is in state RRC\_IDLE, and then skip to step 12.
11. Ensure the UE is in state RRC\_IDLE with generic procedure parameters Connectivity NR according to TS 38.508-1 [14] clause 4.5.
12. Repeat step 2-11 until the confidence level according to Tables G.2.3-1 in Annex G clause G.2 is achieved.

6.1.2.4.4.3 Message contents

Message contents are according to TS 38.508-1 [14] clause 4.6 with the following exceptions:

**Table 6.1.2.4.4.3-1: Common Exception messages**

Default Message Contents	
Common contents of system information blocks exceptions	Table H.2.3-1 Table H.2.3-2 with Condition SMTC 1 and lower priority for configuration 6.1.2.4-2, 6.1.2.4-3, 6.1.2.4-5 and 6.1.2.4-6 Table H.2.3-2 with Condition SMTC 2 and lower priority for configuration 6.1.2.4-1 and 6.1.2.4-4 Table H.2.3-3 with Condition lower priority
Default RRC messages and information elements contents exceptions	Table H.3.2-1

**Table 6.1.2.3.4.3-2: SIB2**

Derivation Path: TS 38.508-1 [14] Table 4.6.2-1			
Information Element	Value/remark	Comment	Condition
SIB2 ::= SEQUENCE {			
relaxedMeasurement-r16 SEQUENCE {			
lowMobilityEvaluation-r16	Not present		
cellEdgeEvaluation-r16 SEQUENCE {			
s-SearchThresholdP-r16	32		
}			
combineRelaxedMeasCondition-r16	Not present		
highPriorityMeasRelax-r16	Not present		
}			
}			

**Table 6.1.2.4.4.3-3: SystemInformationBlockType3**

Derivation Path: TS 36.508 [25] Table 4.4.3.3-2			
Information Element	Value/remark	Comment	Condition
SystemInformationBlockType3 ::= SEQUENCE {			
cellReselectionServingFreqInfo SEQUENCE {			
threshServingLow	22	Actual value = 44 dB	
cellReselectionPriority	4		lower priority E-UTRA
}			
}			

Table 6.1.2.4.4.3-4: SystemInformationBlockType24

Derivation Path: TS 36.508 [25] Table 4.4.3.3-20			
Information Element	Value/remark	Comment	Condition
SystemInformationBlockType24-r15 ::= SEQUENCE {			
carrierFreqListNR-r15 SEQUENCE (SIZE (1..maxFreq)) OF SEQUENCE {	1 entry		
cellReselectionPriority-r15[n]	5		lower priority E-UTRA
threshX-High-r15[1]	24	Actual value = 48 dB	
threshX-Low-r15[1]	25	Actual value = 50 dB	
}			
}			

## 6.1.2.4.5 Test requirement

Tables 6.1.2.4.4.1-3, 6.1.2.4.5-1 and 6.1.2.4.5-2 define the primary level settings including test tolerances for lower priority E-UTRA cell re-selection test case.

Table 6.1.2.4.5-1: Cell specific test parameters for NR cell 1

Parameter	Unit	Test configuration	Cell 1	
			T1	T2
TDD configuration		1, 4	N/A	
		2, 5	TDDConf.1.1	
		3, 6	TDDConf.2.1	
PDSCH RMC configuration		1, 4	SR.1.1 FDD	
		2, 5	SR.1.1 TDD	
		3, 6	SR.2.1 TDD	
RMSI CORESET RMC configuration		1, 4	CR.1.1 FDD	
		2, 5	CR.1.1 TDD	
		3, 6	CR.2.1 TDD	
Dedicated CORESET RMC configuration		1, 4	CCR.1.1 FDD	
		2, 5	CCR.1.1 TDD	
		3, 6	CCR.2.1 TDD	
SSB configuration		1, 4	SSB.1 FR1	
		2, 5	SSB.1 FR1	
		3, 6	SSB.2 FR1	
SMTC configuration		1, 4	SMTC pattern 2	
		2, 5	SMTC pattern 1	
		3, 6	SMTC pattern 1	
OCNG Pattern		1, 2, 3, 4, 5, 6	OP.1 defined in A.3.2.1	
Initial DL BWP configuration		1, 2, 3, 4, 5, 6	DLBWP.0.1	
Initial UL BWP configuration		1, 2, 3, 4, 5, 6	ULBWP.0.1	
RLM-RS		1, 2, 3, 4, 5, 6	SSB	
Qrxlevmin	dBm/SCS	1, 2, 4, 5	-140	
		3, 6	-137	
$N_{oc}$	dBm/SCS	1, 4	-100	-98
		2, 5	-100	-98
		3, 6	-97	-95
$N_{oc}$	dBm/15 kHz	1, 2, 3, 4, 5, 6	-100	-98
SS-RSRP	dBm/SCS	1, 4	-103.6	-84.4
		2, 5	-103.6	-84.4
		3, 6	-100.6	-81.4
$\hat{E}_s/I_{ot}$	dB	1, 4	-3.6	13.6
		2, 5		
		3, 6		
$\hat{E}_s/N_{oc}$	dB	1, 4	-3.6	13.6
		2, 5		
		3, 6		
S <sub>SearchThresholdP</sub>	dB	1, 2, 3, 4, 5, 6	32	32
Io	dBm/9.36 MHz	1, 4	-70.48	-56.26

Parameter	Unit	Test configuration	Cell 1	
			T1	T2
			dBm/9.36 MHz	2, 5
	dBm/38.16 MHz	3, 6	-64.38	-50.17
Treselection	S	1, 2, 3, 4, 5, 6	0	
SnonintrasearchP	dB	1, 2, 3, 4, 5, 6	60	
Thresh <sub>x, highP</sub>	dB	1, 2, 3, 4, 5, 6	48	
Thresh <sub>servicing, lowP</sub>	dB	1, 2, 3, 4, 5, 6	44	
Thresh <sub>x, low P (Note 2)</sub>	dB	1, 2, 3, 4, 5, 6	50	
Propagation Condition		1, 2, 3, 4, 5, 6	AWGN	
Note 1:	OCNG shall be used such that both cells are fully allocated and a constant total transmitted power spectral density is achieved for all OFDM symbols.			
Note 2:	This refers to the value of Thresh <sub>x, Low</sub> which is included in NR system information, and is a threshold for the E-UTRA target cell			

Table 6.1.2.4.5-2: Cell specific test parameters for E-UTRA cell 2

Parameter	Unit	Cell 2	
		T1	T2 T3
E-UTRA RF Channel number		1	
BW <sub>channel</sub>	MHz	10	
OCNG Patterns defined in TS 36.133 clause A.3.2		OP.2 TDD for test configuration 1, 2, 3; OP.2 FDD for test configuration 4, 5, 6	
PBCH_RA	dB	0	
PBCH_RB	dB		
PSS_RA	dB		
SSS_RA	dB		
PCFICH_RB	dB		
PHICH_RA	dB		
PHICH_RB	dB		
PDCCH_RA	dB		
PDCCH_RB	dB		
PDSCH_RA	dB		
PDSCH_RB	dB		
OCNG_RA <sup>Note 1</sup>	dB		
OCNG_RB <sup>Note 1</sup>	dB		
Qrxlevmin	dBm		
N <sub>oc</sub>	dBm/15 kHz	-98	
RSRP	dBm/15 KHz	-82.4	-84
$\hat{E}_s/I_{ot}$	dB	15.6	14
$\hat{E}_s/N_{oc}$	dB	15.6	14
Treselection <sub>EUTRAN</sub>	S	0	
SnonintrasearchP	dB	Not sent	
Thresh <sub>x, highP (Note 2)</sub>	dB	48	
Thresh <sub>servicing, lowP</sub>	dB	44	
Thresh <sub>x, lowP</sub>	dB	50	
Propagation Condition		AWGN	
Note 1:	OCNG shall be used such that both cells are fully allocated and a constant total transmitted power spectral density is achieved for all OFDM symbols.		
Note 2:	This refers to the value of Thresh <sub>x, high</sub> which is included in E-UTRA system information, and is a threshold for the NR target cell		

The cell reselection delay to a lower priority E-UTRAN cell with UE fulfilling not-at-cell edge criterion is defined as the time from the beginning of time period T1, to the moment when the UE camps on cell 2, and starts to send preambles on the PRACH for sending the *RRConnectionRequest* message to perform a Tracking Area Update procedure on cell 2.

The cell re-selection delay to a lower priority cell shall be less than 17 s.

The rate of correct cell reselections observed during repeated tests shall be at least 90%.

NOTE: The cell re-selection delay to a lower priority cell can be expressed as:  $T_{\text{evaluate, E-UTRAN}} + T_{\text{SI-E-UTRA}}$ ,

Where:

$T_{\text{evaluate, E-UTRAN}}$  See Table 4.2.2.11.3-1 in clause 4.2.2.11.3 of TS 38.133 [6]

$T_{\text{SI-E-UTRA}}$  Maximum repetition period of relevant system info blocks that needs to be received by the UE to camp on a cell; 1280 ms is assumed in this test case.

This gives a total of 16.64 s, allow 17 s for the cell re-selection delay to a lower priority E-UTRAN cell for UE fulfilling not-at-cell edge criterion.

### 6.1.2.5 NR SA FR1 – E-UTRA cell re-selection to lower priority E-UTRA for UE configured with highSpeedMeasFlag-r16

#### 6.1.2.5.1 Test purpose

This test is to verify the requirement for the NR to E-UTRAN inter-RAT cell reselection requirements specified in TS 38.133 [6] clause 4.2.2.5 when the E-UTRAN cell is of lower priority.

#### 6.1.2.5.2 Test applicability

This test applies to all types of NR UE from Release 16 onwards and supporting measurement enhancements in high speed scenario.

#### 6.1.2.5.3 Minimum conformance requirements

The minimum conformance requirements are specified in clause 6.1.2.0.1.

The normative reference for this requirement is TS 38.133 [6] clause A.6.1.2.5.

#### 6.1.2.5.4 Test description

##### 6.1.2.5.4.1 Initial conditions

The Test shall be tested using any of the test configuration in Table 6.1.2.5.4.1-1.

**Table 6.1.2.5.4.1-1: Supported test configurations for NR SA FR1 – E-UTRA cell re-selection to lower priority E-UTRA for UE configured with highSpeedMeasFlag-r16**

Configuration	Description of serving cell	Description of target cell
6.1.2.5-1	NR 15 kHz SSB SCS, 10 MHz bandwidth, FDD duplex mode	LTE 10 MHz bandwidth, TDD duplex mode
6.1.2.5-2	NR 15 kHz SSB SCS, 10 MHz bandwidth, TDD duplex mode	LTE 10 MHz bandwidth, TDD duplex mode
6.1.2.5-3	NR 30 kHz SSB SCS, 40 MHz bandwidth, TDD duplex mode	LTE 10 MHz bandwidth, TDD duplex mode
6.1.2.5-4	NR 15 kHz SSB SCS, 10 MHz bandwidth, FDD duplex mode	LTE 10 MHz bandwidth, FDD duplex mode
6.1.2.5-5	NR 15 kHz SSB SCS, 10 MHz bandwidth, TDD duplex mode	LTE 10 MHz bandwidth, FDD duplex mode
6.1.2.5-6	NR 30 kHz SSB SCS, 40 MHz bandwidth, TDD duplex mode	LTE 10 MHz bandwidth, FDD duplex mode

Note: The UE is only required to be tested in one of the supported test configurations.

Configure the test requirement and the DUT according to the parameters in Table 6.1.2.5.4.1-2.

**Table 6.1.2.5.4.1-2: Initial conditions for NR SA FR1 – E-UTRA cell re-selection to lower priority E-UTRA for UE configured with highSpeedMeasFlag-r16**

Parameter	Value		Comment
Test environment	NC		As specified in TS 38.508-1 [14] clause 4.1.
Test frequencies	As specified in Annex E, Table E.4-2 and TS 38.508-1 [14] clause 4.3.1.		
Channel bandwidth	As specified by the test configuration selected from Table 6.1.2.5.4.1-1.		
Propagation conditions	AWGN		As specified in Annex C.2.2.
Connection Diagram	TE Part	A.3.1.6.1	As specified in TS 38.508-1 [14] Annex A.
	DUT Part	A.3.2.3.2	
Exceptions to connection diagram	N/A		

1. The general test parameter settings are set up according to Table 6.1.2.5.4.1-3.
2. Message contents are defined in clause 6.1.2.5.4.3.
3. The test scenario comprises of one NR cell and one E-UTRAN cell. Cell 1 is the NR PCell and Cell 2 is the E-UTRA neighbour cell. Cell 1 is configured according to Annex C.1.1 and C.1.2, Cell 2 is configured according to TS 36.521-3 [26] Annex C.1.0 and C.1.1.

**Table 6.1.2.5.4.1-3: General test parameters for NR SA FR1 – E-UTRA cell re-selection to lower priority E-UTRA for UE configured with highSpeedMeasFlag-r16**

Parameter		Unit	Test configuration	Value	Comment
Initial condition	Active cell		1, 2, 3, 4, 5, 6	Cell1	The UE camps on cell 1 in the initial phase.
T1 end condition	Active cell		1, 2, 3, 4, 5, 6	Cell2	The UE shall perform reselection to cell 2 during T1.
	Neighbour cells		1, 2, 3, 4, 5, 6	Cell1	
T2 end condition	Active cell		1, 2, 3, 4, 5, 6	Cell1	The UE shall perform reselection to cell 1 during T2 for iteration of the tests.
	Neighbour cells		1, 2, 3, 4, 5, 6	Cell2	
Access Barring Information		-	1, 2, 3, 4, 5, 6	Not Sent	No additional delays in random access procedure.
DRX cycle length		s	1, 2, 3, 4, 5, 6	320ms	The value shall be used for all cells in the test.
NR PRACH configuration index			1, 2, 3, 4, 5, 6	77	The detailed configuration is specified in TS 38.211 clause 6.3.3.2
E-UTRAN PRACH configuration index			1, 2, 3	53	As specified in table 5.7.1-2 in TS 36.211 [23]
			4, 5, 6	4	
T1		s	1, 2, 3, 4, 5, 6	15	T1 needs to be defined so that cell re-selection reaction time is taken into account.
T2		s	1, 2, 3, 4, 5, 6	75	T2 needs to be defined so that cell re-selection reaction time is taken into account.

#### 6.1.2.5.4.2 Test procedure

Two cells are deployed in the test, which are one FR1 NR PCell (Cell 1) and an E-UTRA low priority neighbour cell (Cell 2) on different frequencies. The test consists of 2 successive time periods, with time duration of T1, and T2 respectively. Both Cell 1 and Cell 2 are already identified by the UE prior to the start of the test. Cell 1 and cell 2 belong to different tracking areas. Furthermore, UE has not registered with network for the tracking area containing Cell 2. The E-UTRAN Cell 2 is indicated by NR Cell 1 as an HST cell.

In the following test procedure "UE responds" means "UE starts transmitting preamble on PRACH for sending the *RRCSetupRequest* or *RRCConnectionRequest* message to perform a Registration procedure for mobility on NR Cell or E-UTRA Cell respectively.

1. Ensure the UE is in state RRC\_IDLE with generic procedure parameters connectivity NR with Test Mode *On* according to TS 38.508-1 [14] clause 4.5 on Cell 1. Set Cell 2 physical cell identity = initial cell 2 physical cell identity. *highSpeedMeasFlag-r16* is provided by SIB1 of Cell 1.
2. Set the parameters according to T2 in Table 6.1.2.5.5-1 and 6.1.2.5.5-1. Then wait 5s to ensure that Cell 2 has been detected by the UE.
3. Set the parameters according to T1 in Table 6.1.2.5.5-1 and 6.1.2.5.5-1. T1 starts.
4. The SS waits for random access requests information from the UE to perform cell re-selection to Cell 2.
5. If the UE responds on Cell 2 within 3 seconds from the beginning of time period T1, then count a success for the event “Re-select Cell 2”. Otherwise count a failure for the event “Re-select Cell 2”.
6. If the UE has re-selected Cell 2 within T1, after the re-selection or when T1 expires, continue with step 7. Otherwise, if T1 expires and the UE has not yet re-selected Cell 2, the TE shall switch off and on the UE and skip to step 13.
7. The SS shall send an *RRCConnectionRelease* message to ensure that the UE is in state RRC\_IDLE on Cell 2.
8. The SS shall switch the power setting from T1 to T2 as specified in Table 6.1.2.5.5-1 and 6.1.2.5.5-1. T2 starts.
9. The SS waits for random access requests information from the UE to perform cell re-selection to Cell 1.
10. If the UE has re-selected Cell 1 within T2, after the re-selection or when T2 expires, continue with step 11. Otherwise, if T2 expires and the UE has not yet re-selected Cell 1, the TE shall switch off and on the UE and skip to step 12.
11. The SS shall send an *RRCRelease* message to ensure that the UE is in state RRC\_IDLE on Cell 1. skip to 13
12. Ensure the UE is in state RRC\_IDLE with generic procedure parameters connectivity NR according to TS 38.508-1 [14] clause 4.5 in Cell 1.
13. Set the parameters according to T2 in Table 6.1.2.5.5-1. Then wait 5s to ensure that Cell 2 has been detected by the UE.
14. Repeat step 3-13 until a test verdict for the event “Re-select Cell 2” has been achieved, resulting in an event verdict: pass or fail. The event is evaluated only until the confidence level according to Table G.2.3-1 in Annex G clause G.2 is achieved. The test passes if the event pass, otherwise the test fails.

#### 6.1.2.5.4.3 Message contents

Same as message contents in 6.1.2.2.4.3 except that

- Table H.2.3-1 in common contents of SIB exceptions is replaced by Table 6.1.2.5.4.3-1.
- Table H.2.3-3 in common contents of SIB exceptions is replaced by Table 6.1.2.5.4.3-3.
- In addition to the message contents mentioned above, exceptions given in Table 6.1.2.5.4.3-4 and Table 6.1.2.5.4.3-5 also apply.

**Table 6.1.2.5.4.3-1: SIB1 (Cell 2)**

Derivation Path: TS 38.508-1 [14], Table 4.6.1-28			
Information Element	Value/remark	Comment	Condition
SIB1 ::= SEQUENCE {			
servingCellConfigCommon	ServingCellConfigComm onSIB	Table 6.1.2.5.4.3- 2	
}			



**Table 6.1.2.5.4.3-2: ServingCellConfigCommonSIB (Table 6.1.2.5.4.3-1)**

Derivation Path: TS 38.508-1 [14], Table 4.6.1-28 with condition HST			
Information Element	Value/remark	Comment	Condition
ServingCellConfigCommonSIB ::= SEQUENCE {			
highSpeedConfig-r16 SEQUENCE {			
highSpeedMeasFlag-r16	true		
}			
}			

**Table 6.1.2.5.4.3-3: SIB5 (Cell 1)**

Derivation Path: Table H.2.3-3 with Condition lower priority			
Information Element	Value/remark	Comment	Condition
SIB5 ::= SEQUENCE {			
carrierFreqListEUTRA-v1610 SEQUENCE (SIZE (1..maxEUTRA-Carrier)) OF CarrierFreqEUTRA-v1610 {	1 entry	carrierFreqListEUTRA-v1610 and carrierFreqListEUTRA contain same number of entries. And the entries are listed in the same order	
CarrierFreqEUTRA-v1610[1] SEQUENCE {		entry 1	
highSpeedEUTRACarrier-r16	true		
}			
}			
}			

**Table 6.1.2.5.4.3-4: SystemInformationBlockType2 (Cell2)**

Derivation Path: TS 36.508 [25] Table 4.4.3.3-1			
Information Element	Value/remark	Comment	Condition
SystemInformationBlockType2 ::= SEQUENCE {			
radioResourceConfigCommon SEQUENCE {			
highSpeedInterRAT-NR-r16	true		
}			
}			

**Table 6.1.2.5.4.3-5: SystemInformationBlockType24 (Cell2)**

Derivation Path: TS 36.508 [25], Table 4.4.3.3-20			
Information Element	Value/remark	Comment	Condition
SystemInformationBlockType24-r15 ::= SEQUENCE {			
carrierFreqListNR-v1610 SEQUENCE (SIZE (1..maxFreq)) OF CarrierFreqNR-v1610 {	1 entry		
CarrierFreqNR-v1610[1] SEQUENCE {		entry 1	
highSpeedCarrierNR-r16	true		
}			
}			
}			

6.1.2.5.5 Test requirement

Tables 6.1.2.5.4.1-3, 6.1.2.5.5-1 and 6.1.2.5.5-2 define the primary level settings including test tolerances for NR SA FR1 – E-UTRA cell re-selection to lower priority E-UTRA for UE configured with highSpeedMeasFlag-r16 test case.

**Table 6.1.2.5.5-1: NR cell specific test parameters for NR SA FR1 – E-UTRA cell re-selection to lower priority E-UTRA for UE configured with highSpeedMeasFlag-r16**

Parameter	Unit	Test configuration	Cell 1	
			T1	T2
TDD configuration		1, 4	N/A	
		2, 5	TDDConf.1.1	

Parameter	Unit	Test configuration	Cell 1	
			T1	T2
PDSCH RMC configuration		3, 6	TDDConf.2.1	
		1, 4	SR.1.1 FDD	
		2, 5	SR.1.1 TDD	
		3, 6	SR.2.1 TDD	
RMSI CORESET RMC configuration		1, 4	CR.1.1 FDD	
		2, 5	CR.1.1 TDD	
		3, 6	CR.2.1 TDD	
Dedicated CORESET RMC configuration		1, 4	CCR.1.1 FDD	
		2, 5	CCR.1.1 TDD	
		3, 6	CCR.2.1 TDD	
SSB configuration		1, 4	SSB.1 FR1	
		2, 5	SSB.1 FR1	
		3, 6	SSB.2 FR1	
SMTC configuration		1, 4	SMTC pattern 2	
		2, 5	SMTC pattern 1	
		3, 6	SMTC pattern 1	
OCNG Pattern		1, 2, 3, 4, 5, 6	OP.1 defined in A. 2.1	
Initial DL BWP configuration		1, 2, 3, 4, 5, 6	DLBWP.0	
Initial UL BWP configuration		1, 2, 3, 4, 5, 6	ULBWP.0	
RLM-RS		1, 2, 3, 4, 5, 6	SSB	
Qrxlevmin	dBm/SCS	1, 2, 4, 5	-140	
		3, 6	-137	
$N_{oc}$	dBm/SCS	1, 4	-100	-98
		2, 5	-100	-98
		3, 6	-97	-95
$N_{oc}$	dBm/15 kHz	1, 2, 3, 4, 5, 6	-100	-98
SS-RSRP	dBm/SCS	1, 4	-103.60	-84.40
		2, 5	-103.60	-84.40
		3, 6	-100.60	-81.40
$\hat{E}_s/I_{ot}$	dB	1, 4	-3.6	13.6
		2, 5		
		3, 6		
$\hat{E}_s/N_{oc}$	dB	1, 4	-3.6	13.6
		2, 5		
		3, 6		
Io	dBm/9.36 MHz	1, 4	-70.46	-56.26
	dBm/9.36 MHz	2, 5	-70.46	-56.26
	dBm/38.16 MHz	3, 6	-64.38	-50.16
Treselection	S	1, 2, 3, 4, 5, 6	0	
Snonintrasearch	dB	1, 2, 3, 4, 5, 6	50	
Thresh <sub>x, high</sub> (Note 2)	dB	1, 2, 3, 4, 5, 6	48	
Thresh <sub>serv, low</sub>	dB	1, 2, 3, 4, 5, 6	44	
Thresh <sub>x, low</sub>	dB	1, 2, 3, 4, 5, 6	50	
Propagation Condition		1, 2, 3, 4, 5, 6	AWGN 1944Hz <sup>Note3</sup>	
Note 1: OCNG shall be used such that both cells are fully allocated and a constant total transmitted power spectral density is achieved for all OFDM symbols.				
Note 2: This refers to the value of Thresh <sub>x, high</sub> which is included in NR system information, and is a threshold for the E-UTRA target cell.				
Note 3: The AWGN 1944 Hz condition is a non-fading propagation channel with one tap. Doppler shift is a constant 1944 Hz.				

**Table 6.1.2.5.5-2: E-UTRA cell specific test parameters for NR SA FR1 – E-UTRA cell re-selection to lower priority E-UTRA for UE configured with highSpeedMeasFlag-r16**

Parameter	Unit	Cell 2	
		T1	T2
E-UTRA RF Channel number		1	
$BW_{channel}$	MHz	10	
OCNG Patterns defined in TS 36.133 [15] clause A.3.2		OP.2 TDD for test configuration 1, 2, 3; OP.2 FDD for test configuration 4, 5, 6	
PBCH_RA	dB	0	
PBCH_RB	dB		
PSS_RA	dB		
SSS_RA	dB		
PCFICH_RB	dB		
PHICH_RA	dB		
PHICH_RB	dB		
PDCCH_RA	dB		
PDCCH_RB	dB		
PDSCH_RA	dB		
PDSCH_RB	dB		
OCNG_RA <sup>Note 1</sup>	dB		
OCNG_RB <sup>Note 1</sup>	dB		
Qrxlevmin	dBm	-140	
$N_{oc}$	dBm/15 kHz	-98	
RSRP	dBm/15 KHz	-82.40	-84
$\hat{E}_s/I_{ot}$	dB	15.60	14
$\hat{E}_s/N_{oc}$	dB	15.60	14
Trerelection <sup>EUTRAN</sup>	S	0	
Snonintrasearch	dB	Not sent	
Thresh <sub>x, high</sub> (Note 2)	dB	48	
Thresh <sub>-serving, low</sub>	dB	44	
Thresh <sub>x, low</sub>	dB	50	
Propagation Condition		AWGN 1944Hz	
Note 1: OCNG shall be used such that both cells are fully allocated and a constant total transmitted power spectral density is achieved for all OFDM symbols.			
Note 2: This refers to the value of Thresh <sub>x, high</sub> which is included in E-UTRA system information, and is a threshold for the NR target cell			

The cell reselection delay to a lower priority E-UTRAN cell for UE configured with *highSpeedMeasFlag-r16* is defined as the time from the beginning of time period T1, to the moment when the UE camps on Cell 2, and starts to send preambles on the PRACH for sending the *RRCConnectionRequest* message to perform a Tracking Area Update procedure on cell 2.

The cell re-selection delay to a lower priority cell shall be less than 3 s.

The rate of correct cell reselections observed during repeated tests shall be at least 90%.

NOTE: The cell re-selection delay to a lower priority cell can be expressed as:  $T_{evaluate, E-UTRAN} + T_{SI-E-UTRA}$ ,

Where:

$T_{evaluate, E-UTRAN} = 0.96s$ , as defined in TS 38.133 [6] Table 4.2.2.5-2.

$T_{SI-E-UTRA} = 1.28s$ , is the maximum repetition period of relevant system info blocks that needs to be received by the UE to camp on a cell.

This gives a total of 2.24 s, allow 3 s for the cell re-selection delay to a lower priority E-UTRAN cell for UE configured with *highSpeedMeasFlag-r16*.

## 6.2 RRC\_INACTIVE state mobility

## 6.3 RRC\_CONNECTED state mobility

### 6.3.1 Handover

#### 6.3.1.0 Minimum conformance requirements

##### 6.3.1.0.1 Minimum conformance requirements for NR – E-UTRAN handover

When the UE receives a RRC message implying handover to E-UTRAN the UE shall be ready to start the transmission of the uplink PRACH channel in E-UTRA within  $D_{\text{handover}}$  seconds from the end of the last TTI containing the RRC command.  $D_{\text{handover}}$  is defined as

$$D_{\text{handover}} = T_{\text{RRC\_procedure\_delay}} + T_{\text{interruption}}$$

Where:

$T_{\text{RRC\_procedure\_delay}}$ : it is the RRC procedure delay, which is 50ms

$T_{\text{interruption}}$ : it is the time between end of the last TTI containing the RRC command on the NR PDSCH and the time the UE starts transmission of the PRACH in E-UTRAN, excluding  $T_{\text{RRC\_procedure\_delay}}$ .

When the inter-RAT handover to E-UTRAN is commanded, the interruption time shall be less than  $T_{\text{interrupt}}$

$$T_{\text{interrupt}} = T_{\text{search}} + T_{\text{IU}} + 20 \text{ ms}$$

Where:

$T_{\text{search}}$  is the time required to search the target cell when the target cell is not already known when the handover command is received by the UE. If the target cell is known, then  $T_{\text{search}} = 0$  ms. If the target cell is unknown and signal quality is sufficient for successful cell detection on the first attempt, then  $T_{\text{search}} = 80$  ms. Regardless of whether DRX is in use by the UE,  $T_{\text{search}}$  shall still be based on non-DRX target cell search times.

$T_{\text{IU}}$  is the interruption uncertainty in acquiring the first available PRACH occasion in the new cell.  $T_{\text{IU}}$  can be up to 30 ms.

NOTE: The actual value of  $T_{\text{IU}}$  shall depend upon the PRACH configuration used in the target cell.

In the interruption requirement a cell is known if it has been meeting the relevant cell identification requirement during the last 5 seconds otherwise it is unknown. Relevant cell identification requirements are described in TS 36.133 [6] clause [9.4.1].

The normative reference for this requirement is TS 38.133 [6] clause 6.1.2.1.

##### 6.3.1.0.2 Minimum conformance requirements for NR FR1 – NR FR1 handover

When the UE receives a RRC message implying handover the UE shall be ready to start the transmission of the new uplink PRACH channel within  $D_{\text{handover}}$  seconds from the end of the last TTI containing the RRC command.

Where:

$D_{\text{handover}}$  equals the maximum RRC procedure delay to be defined in clause 12 in TS 38.331 [2] plus the interruption time stated in clause 6.1.1.2.2.

The interruption time is the time between end of the last TTI containing the RRC command on the old PDSCH and the time the UE starts transmission of the new PRACH, excluding the RRC procedure delay.

When intra-frequency or inter-frequency handover is commanded, the interruption time shall be less than  $T_{\text{interrupt}}$

$$T_{\text{interrupt}} = T_{\text{search}} + T_{\text{IU}} + 20 + T_{\Delta} \text{ ms}$$

Where:

$T_{\text{search}}$  is the time required to search the target cell when the target cell is not already known when the handover command is received by the UE. If the target cell is known, then  $T_{\text{search}} = 0$  ms. If the target cell is an unknown intra-frequency cell and the target cell  $E_s/I_{ot} \geq [-2]$  dB, then  $T_{\text{search}} = T_{\text{rs}} + 2$  ms. If the target cell is an unknown inter-frequency cell and the target cell  $E_s/I_{ot} \geq [-2]$  dB, then  $T_{\text{search}} = [3 * T_{\text{rs}} + 2]$  ms. Regardless of whether DRX is in use by the UE,  $T_{\text{search}}$  shall still be based on non-DRX target cell search times.

$T_{\Delta}$  is time for fine time tracking and acquiring full timing information of the target cell.  $T_{\Delta} = T_{\text{rs}}$ .

$T_{\text{IU}}$  is the interruption uncertainty in acquiring the first available PRACH occasion in the new cell.  $T_{\text{IU}}$  can be up to the summation of SSB to PRACH occasion association period and 10 ms. SSB to PRACH occasion associated period is defined in the table 8.1-1 of TS 38.213 [3].

$T_{\text{rs}}$  is the SMTC periodicity of the target NR cell if the UE has been provided with an SMTC configuration for the target cell in the handover command, otherwise  $T_{\text{rs}}$  is the SMTC configured in the measObjectNR having the same SSB frequency and subcarrier spacing. If the UE is not provided SMTC configuration or measurement object on this frequency, the requirement in this section is applied with  $T_{\text{rs}} = [5]$  ms assuming the SSB transmission periodicity is 5 ms. There is no requirement if the SSB transmission periodicity is not 5 ms.

NOTE 1: The actual value of  $T_{\text{IU}}$  shall depend upon the PRACH configuration used in the target cell.

In the interruption requirement a cell is known if it has been meeting the relevant cell identification requirement during the last 5 seconds otherwise it is unknown. Relevant cell identification requirements are described in Clause [9.2.5] for intra-frequency handover and Clause [9.3.1] for inter-frequency handover.

The normative reference for this requirement is TS 38.133 [6] clause 6.1.1.2.

### 6.3.1.0.3 Minimum conformance requirements for NR – UTRAN handover

When the UE receives a RRC message implying handover to UTRAN the UE shall be ready to start the transmission of the new UTRA uplink DPCH within  $D_{\text{handover}}$  ms from the end of the last NR TTI containing the RRC MobilityFromNRCommand command.

where:

- $D_{\text{handover}}$  equals the RRC procedure delay, which is 50 ms plus the interruption time stated in TS 38.133 [6] clause 6.1.2.2.3.

The interruption time is the time between the end of the last TTI containing the RRC command on the NR PDSCH and the time the UE starts transmission on the uplink DPCH in UTRAN, excluding the RRC procedure delay. The interruption time depends on whether the target cell is known to the UE or not.

The target cell is known if it has been measured by the UE during the last 5 seconds otherwise it is unknown. The UE shall always perform a UTRA synchronisation procedure as part of the handover procedure.

If the target cell is known the interruption time shall be less than  $T_{\text{interrupt1}}$

$$T_{\text{interrupt1}} = T_{\text{IU}} + T_{\text{sync}} + 50 + 10 * F_{\text{max}} + T_{\text{MC}} \text{ ms}$$

If the target cell is unknown the interruption time shall be less than  $T_{\text{interrupt2}}$

$$T_{\text{interrupt2}} = T_{\text{IU}} + T_{\text{sync}} + 150 + 10 * F_{\text{max}} + T_{\text{MC}} \text{ ms}$$

This requirement shall be met, provided that there is one target cell in the MobilityFromNRCommand command. Performance requirements for E-UTRA to UTRA soft handover are not specified. When UE is connected to an NR cell, UTRA SFN timing measurements are not reported. This implies that the timing of the DPCH of the UTRA target cells in the active set cannot be configured by UTRAN to guarantee that all target cells fall within the UE reception window of  $T_0 \pm 148$  chips.

Where:

- $T_{\text{IU}}$  is the interruption uncertainty when changing the timing from the NR to the new UTRAN cell.  $T_{\text{IU}}$  can be up to one UTRA frame (10 ms).

- $F_{max}$  denotes the maximum number of radio frames within the transmission time intervals of all transport channels that are multiplexed into the same CCTrCH on the UTRA target cell. If HS-PDSCH is configured in the UTRA target cell,  $F_{max}$  is 4 radio frames.
- $T_{sync}$  is the time required for measuring the downlink DPCCCH channel as stated in TS 25.214, clause 4.3.1.2. In case higher layers indicate the usage of a post-verification period  $T_{sync}=0$  ms. Otherwise  $T_{sync}=40$  ms.
- $T_{MC}$  is 0ms if a single UTRA cell is configured as the handover target, otherwise 20ms if handover to UTRA with 1, 2 or 3 UTRA carriers with secondary HS-PDSCH is configured.

The phase reference is the primary CPICH.

The requirements in this clause assume that  $N_{312}$  has the smallest possible value i.e. only one insync is required.

#### 6.3.1.0.4 Minimum conformance requirements for NR FR1- NR FR1 DAPS handover

The requirements in this clause are applicable to both intra-frequency and inter-frequency handovers from NR FR1 cell to NR FR1 cell. A DAPS handover is intra-frequency if the centre frequency of the SSB of the source cell and the centre frequency of the SSB of the target cell are the same, and the subcarrier spacing of the two SSBs are also the same.

Note 1: For intra-frequency DAPS handover, no requirement applies if active DL and UL BWP of target cell is not confined within the active DL and UL BWP of the source cell respectively.

Note 2: For inter-frequency DAPS handover, no requirement applies if the BWP of target cell is overlapped with the BWP of source cell in frequency domain.

An FR1 DAPS handover is synchronous if it meets the conditions in table 6.3.1.0.4-1, otherwise it is asynchronous

**Table 6.3.1.0.4-1: Sync conditions for FR1 DAPS handover**

Type of handover	Maximum receive timing difference between source and target cell ( $\mu$ s) for sync DAPS handover	Maximum transmit timing difference between source and target cell ( $\mu$ s) for sync DAPS handover
Intra-frequency <sup>Note 1,2,3</sup>	6 $\mu$ s	7.6 $\mu$ s
Intra-band inter-frequency <sup>Note 1,2,3</sup>	6 $\mu$ s	7.6 $\mu$ s
Inter-band inter-frequency	33 $\mu$ s	34.6 $\mu$ s
<p>Note 1: For synchronous DAPS handover, if the receive time difference exceeds the cyclic prefix length of that SCS, demodulation performance degradation is expected for the first symbol of the slot. For asynchronous DAPS handover, if the receive time difference exceeds the cyclic prefix length of that SCS, interruptions may occur depending on UE implementation. The duration and frequency of occurrence of such interruptions is not specified.</p> <p>Note 2: For DAPS handover on a TDD band, a UE is not expected to transmit in the uplink earlier than <math>N_{RX-TX}</math> after the end of the last received downlink symbol in the same cell where <math>N_{RX-TX}=25600T_c</math>.</p> <p>Note 3: For DAPS handover on a TDD band, a UE is not expected to receive in the downlink earlier than <math>N_{TX-RX}</math> after the end of the last transmitted uplink symbol in the same cell where <math>N_{TX-RX}=25600T_c</math>.</p>		

When the UE receives a RRC message implying DAPS handover to NR FR1 the UE shall be ready to start the transmission of the new uplink PRACH channel in NR within  $D_{handover1}$  seconds from the end of the last TTI containing the RRC command when UE is configured with dual active protocol stack handover.

$$D_{handover1} = T_{RRC\_procedure} + T_{search} + T_{IU} + T_{processing} + T_{\Delta} + T_{margin} \text{ ms}$$

Where:

$T_{RRC\_procedure}$  is the maximum RRC procedure delay as specified in clause 12 in TS 38.331 [13].

$T_{search}$ ,  $T_{IU}$ ,  $T_{processing}$ ,  $T_{\Delta}$  and  $T_{margin}$  are defined in TS 38.133 [6] clause 6.1.1.2.2.

After successful RACH procedure of the target cell, when the UE receives an RRC message implying source cell release command, the UE shall accomplish the release actions specified in TS 38.331 [13] within  $D_{\text{handover2}}$ .

$$D_{\text{handover2}} = T_{\text{RRC\_procedure}} + T_{\text{interrupt2}}$$

Where:

$T_{\text{RRC\_procedure}}$  is the RRC procedure delay as specified in clause 12 in TS 38.331 [2].

$T_{\text{interrupt2}}$  is defined in TS 38.133 [6] clause 6.3.1.0.4.

During  $D_{\text{handover1}}$ , the UE is allowed an interruption of up to  $T_{\text{interrupt1}}$  on source cell.

For FR1-to-FR1 intra-frequency handover,  $T_{\text{interrupt1}}$  is specified in Table 6.3.1.0.4-2.

**Table 6.3.1.0.4-2:  $T_{\text{interrupt1}}$  for FR1-to-FR1 intra-frequency DAPS HO**

$\mu$	NR Slot length (ms)	Interruption length $T_{\text{interrupt1}}$ (slots <sup>Note 1</sup> ), synchronous DAPS HO	Interruption length $T_{\text{interrupt1}}$ (slots <sup>Note 1</sup> ), asynchronous DAPS HO
0	1	1	2
1	0.5	2	3
2	0.25	4	5

Note 1: The same SCS of source cell and target cell is assumed.  
 Note 2: It is assumed that the BWP of target cell is not larger than the BWP of source cell. It is assumed that the CBW of target cell is not larger than the CBW of source cell  
 Note 3: Void

For FR1-to-FR1 intra-band inter-frequency handover,  $T_{\text{interrupt1}}$  is specified in Table 6.3.1.0.4-3.

**Table 6.3.1.0.4-3:  $T_{\text{interrupt1}}$  for FR1-to-FR1 intra-band inter-frequency DAPS HO**

$\mu$	NR Slot length (ms)	$T_{\text{interrupt1}}$ (slots <sup>Note 1</sup> ), synchronous DAPS HO	$T_{\text{interrupt1}}$ (slots <sup>Note 1</sup> ), asynchronous DAPS HO
0	1	$1 + T_{\text{SMTC\_duration}} * N_{\text{slot}}^{\text{subframe},\mu}$	$2 + T_{\text{SMTC\_duration}} * N_{\text{slot}}^{\text{subframe},\mu}$
1	0.5	$2 + T_{\text{SMTC\_duration}} * N_{\text{slot}}^{\text{subframe},\mu}$	$3 + T_{\text{SMTC\_duration}} * N_{\text{slot}}^{\text{subframe},\mu}$
2	0.25	$4 + T_{\text{SMTC\_duration}} * N_{\text{slot}}^{\text{subframe},\mu}$	$5 + T_{\text{SMTC\_duration}} * N_{\text{slot}}^{\text{subframe},\mu}$

Note 1: The same SCS of source cell and target cell is assumed.  
 Note 2:  $T_{\text{SMTC\_duration}}$  measured in subframes is the longest SMTC duration between source cell and target cell.  
 Note 3: Void  
 Note 4:  $N_{\text{slot}}^{\text{subframe},\mu}$  is as defined in TS 38.211 [6].

For FR1-to-FR1 inter-band handover,  $T_{\text{interrupt1}}$  is specified in Table 6.3.1.0.4-4.

**Table 6.3.1.0.4-4:  $T_{\text{interrupt1}}$  for FR1-to-FR1 inter-band DAPS HO**

$\mu$	NR Slot length (ms) of source cell	$T_{\text{interrupt1}}$ (slots)	
		Sync	Async
0	1	1	2
1	0.5	2	3
2	0.25	5	5

For FR1-to-FR1 intra-frequency handover,  $T_{\text{interrupt2}}$  is specified in Table 6.3.1.0.4-5 when the BWP of target cell is smaller than the BWP of source cell, and  $T_{\text{interrupt2}}$  is specified in Table 6.3.1.0.4-6 when the same BWP is used for target cell and source cell.

**Table 6.3.1.0.4-5:  $T_{\text{interrupt2}}$  for FR1-to-FR1 intra-frequency DAPS HO**

$\mu$	NR Slot length (ms)	Interruption length X (slots <sup>Note 1</sup> )	$T_{\text{interrupt2}}$ (slots <sup>Note 1</sup> ) for asynchronous DAPS HO
0	1	2	3
1	0.5	4	5
2	0.25	8	9

Note 1: The same SCS of source cell and target cell is assumed.  
Note 2: It is assumed that the BWP of target cell is smaller than the BWP of source cell.

**Table 6.3.1.0.4-6:  $T_{\text{interrupt2}}$  for FR1-to-FR1 intra-frequency DAPS HO**

$\mu$	NR Slot length (ms)	Interruption length X (slots <sup>Note 1</sup> )	$T_{\text{interrupt2}}$ (slots <sup>Note 1</sup> ) for asynchronous DAPS HO
0	1	1	2
1	0.5	2	3
2	0.25	4	5

Note 1: The same SCS of source cell and target cell is assumed.  
Note 2: It is assumed that the BWP of target cell is the same as the BWP of source cell.  
Note 3: Void

For FR1-to-FR1 intra-band inter-frequency handover,  $T_{\text{interrupt2}}$  is specified in Table 6.3.1.0.4-7.

**Table 6.3.1.0.4-7:  $T_{\text{interrupt2}}$  for FR1-to-FR1 intra-band inter-frequency DAPS HO**

$\mu$	NR Slot length (ms)	$T_{\text{interrupt2}}$ (slots <sup>Note 1</sup> ) for synchronous DAPS HO	$T_{\text{interrupt2}}$ (slots <sup>Note 1</sup> ) for asynchronous DAPS HO
0	1	$1 + T_{\text{SMTC\_duration}} * N_{\text{slot}}^{\text{subframe},\mu}$	$2 + T_{\text{SMTC\_duration}} * N_{\text{slot}}^{\text{subframe},\mu}$
1	0.5	$2 + T_{\text{SMTC\_duration}} * N_{\text{slot}}^{\text{subframe},\mu}$	$3 + T_{\text{SMTC\_duration}} * N_{\text{slot}}^{\text{subframe},\mu}$
2	0.25	$4 + T_{\text{SMTC\_duration}} * N_{\text{slot}}^{\text{subframe},\mu}$	$5 + T_{\text{SMTC\_duration}} * N_{\text{slot}}^{\text{subframe},\mu}$

Note 1: The same SCS of source cell and target cell is assumed.  
Note 2:  $T_{\text{SMTC\_duration}}$  measured in subframes is the longest SMTC duration between source cell and target cell.  
Note 3: Void.  
Note 4:  $N_{\text{slot}}^{\text{subframe},\mu}$  is as defined in TS 38.211 [6].

For FR1-to-FR1 inter-band handover,  $T_{\text{interrupt2}}$  is specified in Table 6.3.1.0.4-8.

**Table 6.3.1.0.4-8:  $T_{\text{interrupt2}}$  for FR1-to-FR1 inter-band DAPS HO**

$\mu$	NR slot length (ms) of target cell	$T_{\text{interrupt2}}$ (slots)	
		Sync	Async
0	1	1	2
1	0.5	2	3
2	0.25	5	5

The normative reference for this requirement is TS 38.133 [6] clause 6.1.1.2.

### 6.3.1.1 NR SA FR1 handover with known target cell

#### 6.3.1.1.1 Test purpose

To verify the UE's ability to perform NR FR1-NR FR1 intra frequency handover in RRC\_CONNECTED state by meeting the delay requirement and interruption length for handover to a known target cell.

#### 6.3.1.1.2 Test applicability

This test applies to all types of NR UE from Release 15 onwards.



### 6.3.1.1.3 Minimum conformance requirements

The minimum conformance requirements are specified in clause 6.3.1.0.2.

The normative reference for this requirement is TS 38.133 [6] clause A.6.3.1.1.

### 6.3.1.1.4 Test description

#### 6.3.1.1.4.1 Initial conditions

Initial conditions are a set of test configurations the UE needs to be tested in and the steps for the SS to take with the UE to reach the correct measurement state.

This test shall be tested using any of the test configurations in Table 6.3.1.1.4.1-1.

**Table 6.3.1.1.4.1-1: Intra-frequency handover from FR1 to FR1 test configurations**

Config	Description
1	Source cell: NR 15 kHz SSB SCS, 10 MHz bandwidth, FDD duplex mode Target cell: NR 15 kHz SSB SCS, 10 MHz bandwidth, FDD duplex mode
2	Source cell: NR 15 kHz SSB SCS, 10 MHz bandwidth, TDD duplex mode Target cell: NR 15 kHz SSB SCS, 10 MHz bandwidth, TDD duplex mode
3	Source cell: NR 30 kHz SSB SCS, 40 MHz bandwidth, TDD duplex mode Target cell: NR 30 kHz SSB SCS, 40 MHz bandwidth, TDD duplex mode
Note:	The UE is only required to be tested in one of the supported test configurations

Configure the test equipment and the DUT according to the parameters in Table 6.3.1.1.4.1-2

**Table 6.3.1.1.4.1-2: Initial conditions for NR SA FR1 handover with known target cell**

Parameter	Value	Comment
Test environment	NC	As specified in TS 38.508-1 [14] clause 4.1.
Test frequencies	As specified in Annex E, Table E.4-1 and TS 38.508-1 [14] clause 4.3.1.	
Channel bandwidth	As specified by the test configuration selected from Table 6.3.1.1.4.1-1	
Propagation conditions	AWGN	As specified in Annex C.2.2.
Connection Diagram	TE Part	A.3.1.8.2
	DUT Part	A.3.2.3.4
Exceptions to connection diagram	N/A	

1. Message contents are defined in clause 6.3.1.1.4.3.
2. The power levels and settings for NR Cell 1 are set according to Annex C.1.2 and C.1.3. Cell 2 is NR FR1 target Cell, and its power levels and settings are also set according to Annex C.1.2 and C.1.3.
3. The test parameters are given in Table 6.3.1.1.4.1-3 below, with A3-Offset modified by Test Tolerance.

**Table 6.3.1.1.4.1-3: General test parameters Intra-frequency handover from FR1 to FR1**

Parameter	Unit	Value	Comment
Initial conditions	Active cell	Cell 1	
	Neighbouring cell	Cell 2	
Final condition	Active cell	Cell 2	
A3-Offset	dB	-1	Original Value 0dB, post TT Analysis, its -1 dB
Hysteresis	dB	0	
Time To Trigger	s	0	
Filter coefficient		0	L3 filtering is not used
Access Barring Information	-	Not Sent	No additional delays in random access procedure.
Time offset between cells		3 $\mu$ s	Synchronous cells
T1	s	5	
T2	s	$\leq 5$	

T3	s	1	
----	---	---	--

6.3.1.1.4.2 Test procedure

The test scenario comprises of one NR carrier and two cells as given in tables 6.3.1.1.4.1-3 and 6.3.1.1.5-1. No gap patterns are configured in the test case. The test consists of three successive time periods, with time durations of T1, T2 and T3 respectively. At the start of time duration T1, the UE does not have any timing information of Cell 2. Starting T2, Cell 2 becomes detectable and the UE is expected to detect and send measurement report A3. An RRC message implying handover shall be sent to the UE during period T2, after the UE has reported Event A3. The start of T3 is the instant when the last TTI containing the RRC message implying handover is sent to the UE.

1. Ensure the UE is in State RRC\_CONNECTED with generic procedure parameters Connectivity NR, Connected without release On according to TS 38.508-1 [14] clause 4.5. Establish SRB2 and DRB in the RRC Reconfiguration message. Cell 1 is the active cell.
2. Set the parameters according to T1 in Table 6.3.1.1.5-1. Propagation conditions are set according to Annex C clause C.2.2. T1 starts.
3. SS shall transmit an RRCReconfiguration message, configuring measurement object.
4. UE shall transmit RRCReconfigurationComplete message.
5. When T1 expires, the SS shall switch the power setting from T1 to T2 as specified in Table 6.3.1.15-1.
6. UE shall transmit a MeasurementReport message triggered by Event A3.
7. SS shall transmit the RRCReconfiguration message implying handover is sent to the UE, at that instant the SS shall switch the power settings from T2 to T3 as specified in Table 6.3.1.1.5-1. T3 starts.
8. The UE shall transmit RRCReconfigurationComplete message.
9. If the UE transmits the uplink PRACH channel to Cell 2 less than 72 ms from the beginning of time period T3 then the number of successful tests is increased by one. Otherwise, the number of failure tests is increased by one.
10. After T3 expires, cause UE handover back to Cell 1 (if the handover fails, switch off the UE) or switch off the UE. Then ensure the UE is in State RRC\_CONNECTED with generic procedure parameters Connectivity NR, Connected without release On according to TS 38.508-1 [14] clause 4.5. Cell 1 is the active cell.
11. Set Cell 2 physical cell identity = ((current cell 2 physical cell identity + 1) mod 14 + 2) for next iteration of the test procedure loop.
12. Repeat steps 2-8 until the confidence level according to Tables G.2.3-1 in Annex G clause G.2 is achieved.

6.3.1.1.4.3 Message contents

Message contents are according to TS 38.508-1 [14] clause 4.6 with the following exceptions:

**Table 6.3.1.1.4.3-1: Common Exception messages**

Default Message Contents	
Common contents of system information blocks exceptions	
Default RRC messages and information elements contents exceptions	Table H.3.1-1 Table H.3.1-2 with Condition INTRA-FREQ and no GAP NEEDED Table H.3.1-3 with Condition INTRA-FREQ MO, SSB.1 FR1, SMTC pattern 1 and Synchronous cells for Config 1 and 2 Table H.3.1-3 with Condition INTRA-FREQ MO, SSB.2 FR1, SMTC pattern 1 and Synchronous cells for Config 3 Table H.3.1-4 with A3-offset = -1dB Table H.3.1-5 Table H.3.1-7 with Condition INTRA-FREQ Table H.3.2-2 with Condition RBConfig_KeyChange

6.3.1.1.5 Test requirements

Table 6.3.1.1.5-1 defines the primary level settings including test tolerances for all tests.

**Table 6.3.1.1.5-1: Cell specific test parameters for NR FR1-FR1 Intra frequency handover test case**

Parameter		Unit	Cell 1			Cell 2		
			T1	T2	T3	T1	T2	T3
NR RF Channel Number			1			1		
Duplex mode	Config 1		FDD					
	Config 2,3		TDD					
TDD configuration	Config 1		Not Applicable					
	Config 2		TDDConf.1.1					
	Config 3		TDDConf.2.1					
BW <sub>channel</sub>	Config 1	MHz	10: N <sub>RB,c</sub> = 52					
	Config 2		10: N <sub>RB,c</sub> = 52					
	Config 3		40: N <sub>RB,c</sub> = 106					
BWP BW	Config 1	MHz	10: N <sub>RB,c</sub> = 52					
	Config 2		10: N <sub>RB,c</sub> = 52					
	Config 3		40: N <sub>RB,c</sub> = 106					
DRx Cycle		ms	Not Applicable					
PDSCH Reference measurement channel	Config 1		SR.1.1 FDD					
	Config 2		SR.1.1 TDD					
	Config 3		SR2.1 TDD					
CORESET Reference Channel	Config 1		CR.1.1 FDD					
	Config 2		CR.1.1 TDD					
	Config 3		CR2.1 TDD					
TRS configuration	Config 1		TRS.1.1 FDD					
	Config 2		TRS.1.1 TDD					
	Config 3		TRS.1.2 TDD					
OCNG Patterns			OP.1					
SMTc Configuration			SMTc.1					
SSB Configuration	Config 1,2		SSB.1 FR1					
	Config 3		SSB.2 FR1					
PDSCH/PDCCH subcarrier spacing	Config 1,2	kHz	15 kHz					
	Config 3		30 kHz					
PUCCH/PUSCH subcarrier spacing	Config 1,2	kHz	15 kHz					
	Config 3		30 kHz					
PRACH configuration			PRACH.1 FR1					
BWP configuration	Initial DL BWP		DLBWP.0.1					
	Dedicated DL BWP		DLBWP.1.1					
	Initial UL BWP		ULBWP.0.1					
	Dedicated UL BWP		ULBWP.1.1					
EPRE ratio of PSS to SSS		dB	0					
EPRE ratio of PBCH DMRS to SSS								
EPRE ratio of PBCH to PBCH DMRS								
EPRE ratio of PDCCH DMRS to SSS								
EPRE ratio of PDCCH to PDCCH DMRS								
EPRE ratio of PDSCH DMRS to SSS								
EPRE ratio of PDSCH to PDSCH								
EPRE ratio of OCNG DMRS to SSS(Note 1)								
EPRE ratio of OCNG to OCNG DMRS (Note 1)								
N <sub>oc</sub> Note2		dBm/15kHz	-98			-98		
N <sub>oc</sub> Note2	Config 1,2	dBm/SCS	-98			-98		
	Config 3		-95			-95		
Ĥ <sub>s</sub> /I <sub>ot</sub>	Config 1,2	dB	8	-2.41	-2.41	-Infinity	1.36	1.36
	Config 3	dB	8	-2.41	-2.41	-Infinity	1.36	1.36
Ĥ <sub>s</sub> /N <sub>oc</sub>	Config 1,2	dB	8	8	8	-Infinity	10	10
	Config 3	dB	8	8	8	-Infinity	10	10
SSB_RP	Config 1,2	dBm/SCS	-90	-90	-90	Infinity	-88	-88
	Config 3	dBm/SCS	-87	-87	-87	Infinity	-84.99	-84.99
I <sub>o</sub> Note3	Config 1,2	dBm/9.36MHz	-61.41	-57.67	-57.67	-61.41	-57.67	-57.67
	Config 3	dBm/	-55.31	-51.56	-51.56	-55.31	-51.56	-51.56

Parameter	Unit	Cell 1			Cell 2		
		T1	T2	T3	T1	T2	T3
	38.16MHz						
Propagation condition	-	AWGN					
Note 1:	OCNG shall be used such that both cells are fully allocated, and a constant total transmitted power spectral density is achieved for all OFDM symbols.						
Note 2:	Interference from other cells and noise sources not specified in the test is assumed to be constant over subcarriers and time and shall be modelled as AWGN of appropriate power for $N_{oc}$ to be fulfilled.						
Note 3:	Io levels have been derived from other parameters for information purposes. They are not settable parameters themselves.						

The UE shall start to transmit the PRACH to Cell 2 less than 72 ms from the beginning of time period T3. The rate of correct handovers observed during repeated tests shall be at least 90%.

NOTE: The handover delay can be expressed as: RRC procedure delay +  $T_{interrupt}$ , where:

RRC procedure delay = 10 ms and is specified in clause 12 in TS 38.331 [2].

$T_{interrupt}$  = 62 ms in the test.  $T_{interrupt}$  is defined in clause 6.3.1.0.2.

This gives a total of 72 ms.

### 6.3.1.2 NR SA FR1 handover with unknown target cell

#### 6.3.1.2.1 Test purpose

To verify the UE’s ability to perform NR FR1-NR FR1 intra frequency handover in RRC\_CONNECTED state by meeting the delay requirement and interruption length for handover to an unknown target cell.

#### 6.3.1.2.2 Test applicability

This test applies to all types of NR UE from Release 15 onwards.

#### 6.3.1.2.3 Minimum conformance requirements

The minimum conformance requirements are specified in clause 6.3.1.0.2.

The normative reference for this requirement is TS 38.133 [6] clause A.6.3.1.2.

#### 6.3.1.2.4 Test description

##### 6.3.1.2.4.1 Initial conditions

Initial conditions are a set of test configurations the UE needs to be tested in and the steps for the SS to take with the UE to reach the correct measurement state.

This test shall be tested using any of the test configurations in Table 6.3.1.2.4.1-1.

**Table 6.3.1.2.4.1-1: Intra-frequency handover from FR1 to FR1 test configurations**

Config	Description
1	Source cell: NR 15 kHz SSB SCS, 10 MHz bandwidth, FDD duplex mode Target cell: NR 15 kHz SSB SCS, 10 MHz bandwidth, FDD duplex mode
2	Source cell: NR 15 kHz SSB SCS, 10 MHz bandwidth, TDD duplex mode Target cell: NR 15 kHz SSB SCS, 10 MHz bandwidth, TDD duplex mode
3	Source cell: NR 30 kHz SSB SCS, 40 MHz bandwidth, TDD duplex mode Target cell: NR 30 kHz SSB SCS, 40 MHz bandwidth, TDD duplex mode
Note:	The UE is only required to be tested in one of the supported test configurations

Configure the test equipment and the DUT according to the parameters in Table 6.3.1.2.4.1-2

**Table 6.3.1.2.4.1-2: Initial conditions for NR SA FR1 handover with unknown target cell**

Parameter	Value		Comment
Test environment	NC		As specified in TS 38.508-1 [14] clause 4.1.
Test frequencies	As specified in Annex E, Table E.4-1 and TS 38.508-1 [14] clause 4.3.1.		
Channel bandwidth	As specified by the test configuration selected from Table 6.3.1.2.4.1-1		
Propagation conditions	AWGN		As specified in Annex C.2.2.
Connection Diagram	TE Part	A.3.1.8.2	As specified in TS 38.508-1 [14] Annex A.
	DUT Part	A.3.2.3.4	
Exceptions to connection diagram	N/A		

1. Message contents are defined in clause 6.3.1.2.4.3.
2. The power levels and settings for NR Cell 1 are set according to Annex C.1.2 and C.1.3. Cell 2 is NR FR1 target Cell, and its power levels and settings are also set according to Annex C.1.2 and C.1.3.
3. The test parameters are given in Table 6.3.1.2.4.1-4 below.

**Table 6.3.1.2.4.1-3: General test parameters Intra-frequency handover from FR1 to FR1**

Parameter	Unit	Value	Comment
Initial conditions	Active cell	Cell 1	
	Neighbouring cell	Cell 2	
Final condition	Active cell	Cell 2	
Access Barring Information	-	Not Sent	No additional delays in random access procedure.
Time offset between cells		3 $\mu$ s	Synchronous cells
T1	s	5	
T2	s	$\leq 5$	

#### 6.3.1.2.4.2 Test procedure

The test scenario comprises of two NR carriers and one cell on each carrier as given in tables 6.3.1.2.4.1-3 and 6.3.1.2.5-1. No gap patterns are configured in the test case. The test consists of two successive time periods, with time durations of T1 and T2 respectively. At the start of time duration T1, the UE does not have any timing information of Cell 2. Starting T2, Cell 2 becomes detectable and the UE is expected to detect and start to transmit the PRACH to Cell 2. The start of T2 is the instant when the last TTI containing the RRC message implying handover is sent to the UE.

1. Ensure the UE is in State RRC\_CONNECTED with generic procedure parameters Connectivity NR, Connected without release On according to TS 38.508-1 [14] clause 4.5. Establish SRB2 and DRB in the RRC Reconfiguration message. Cell 1 is the active cell.
2. Set the parameters according to T1 in Table 6.3.1.2.5-1. Propagation conditions are set according to Annex C clause C.2.2. T1 starts.
3. SS shall transmit an RRCReconfiguration message implying handover to Cell 2.
4. The start of T2 is the instant when the last TTI containing the RRC reconfiguration message implying handover is sent to the UE, at that instant the SS shall switch the power settings from T1 to T2 as specified in Table 6.3.1.2.5-1. T2 starts.
5. The UE shall transmit RRCReconfigurationComplete message.
6. If the UE transmits the uplink PRACH channel to Cell 2 less than 92 ms from the beginning of time period T2 then the number of successful tests is increased by one. Otherwise, the number of failure tests is increased by one.
7. After T2 expires, cause UE handover back to Cell 1 (if the handover fails, switch off the UE) or switch off the UE. Then ensure the UE is in State RRC\_CONNECTED with generic procedure parameters Connectivity NR, Connected without release On according to TS 38.508-1 [14] clause 4.5. Cell 1 is the active cell.

8. Set Cell 2 physical cell identity = ((current cell 2 physical cell identity + 1) mod 14 + 2) for next iteration of the test procedure loop.
9. Repeat step 2-8 until the confidence level according to Tables G.2.3-1 in Annex G clause G.2 is achieved.

6.3.1.2.4.3 Message contents

Message contents are according to TS 38.508-1 [14] clause 4.6 with the following exceptions:

**Table 6.3.1.2.4.3-1: Common Exception messages**

Default Message Contents	
Common contents of system information blocks exceptions	
Default RRC messages and information elements contents exceptions	Table H.3.2-2 with Condition RBCConfig_KeyChange

6.3.1.2.5 Test requirements

Table 6.3.1.2.5-1 defines the primary level settings including test tolerances for all tests.

**Table 6.3.1.2.5-1: Cell specific test parameters for NR FR1-FR1 Intra frequency handover test case**

Parameter	Unit	Cell 1		Cell 2	
		T1	T2	T1	T2
NR RF Channel Number		1		1	
Duplex mode	Config 1	FDD			
	Config 2,3	TDD			
TDD configuration	Config 1	Not Applicable			
	Config 2	TDDConf. 1.1			
	Config 3	TDDConf. 2.1			
BW <sub>channel</sub>	Config 1	MHz	10: N <sub>RB,c</sub> = 52		
	Config 2		10: N <sub>RB,c</sub> = 52		
	Config 3		40: N <sub>RB,c</sub> = 106		
BWP BW	Config 1	MHz	10: N <sub>RB,c</sub> = 52		
	Config 2		10: N <sub>RB,c</sub> = 52		
	Config 3		40: N <sub>RB,c</sub> = 106		
DRx Cycle	ms	Not Applicable			
PDSCH Reference measurement channel	Config 1	SR.1.1 FDD			
	Config 2	SR.1.1 TDD			
	Config 3	SR2.1 TDD			
CORESET Reference Channel	Config 1	CR.1.1 FDD			
	Config 2	CR.1.1 TDD			
	Config 3	CR2.1 TDD			
TRS configuration	Config 1	TRS.1.1 FDD			
	Config 2	TRS.1.1 TDD			
	Config 3	TRS.1.2 TDD			
OCNG Patterns		OP.1			
SMTC Configuration		SMTC.1 FR1			
SSB configuration	Config 1,2	SSB.1 FR1			
	Config 3	SSB.2 FR1			
PDSCH/PDCCH subcarrier spacing	Config 1,2	kHz	15 kHz		
	Config 3		30 kHz		
PUCCH/PUSCH subcarrier spacing	Config 1,2	kHz	15 kHz		
	Config 3		30 kHz		
PRACH configuration		PRACH.1 FR1			
BWP configuration	Initial DL BWP	DLBWP.0.1			
	Dedicated DL BWP	DLBWP.1.1			
	Initial UL BWP	ULBWP.0.1			
	Dedicated UL BWP	ULBWP.1.1			
EPRE ratio of PSS to SSS	dB	0			
EPRE ratio of PBCH DMRS to SSS					
EPRE ratio of PBCH to PBCH DMRS					
EPRE ratio of PDCCH DMRS to SSS					
EPRE ratio of PDCCH to PDCCH DMRS					

Parameter	Unit	Cell 1		Cell 2		
		T1	T2	T1	T2	
EPRE ratio of PDSCH DMRS to SSS						
EPRE ratio of PDSCH to PDSCH						
EPRE ratio of OCNG DMRS to SSS(Note 1)						
EPRE ratio of OCNG to OCNG DMRS (Note 1)						
$N_{oc}$ <sup>Note2</sup>	dBm/15kHz	-98		-98		
$N_{oc}$ <sup>Note2</sup>	Config 1,2	-98		-98		
	Config 3	-95		-95		
$\hat{E}_s / I_{ot}$	dB	8	-0.64	-Infinity	-0.64	
$\hat{E}_s / N_{oc}$	dB	8	8	-Infinity	8	
SSB_RP	Config 1,2	-90	-90	-Infinity	-90	
	Config 3	-87	-87	-Infinity	-87	
$I_o$ <sup>Note3</sup>	Config 1,2	dBm/ 9.36MHz	-61.41	-57.95	-61.41	-57.95
	Config 3	dBm/ 38.16MHz	-55.31	-51.84	-55.31	-51.84
Propagation condition	-	AWGN				
Note 1: OCNG shall be used such that both cells are fully allocated and a constant total transmitted power spectral density is achieved for all OFDM symbols.						
Note 2: Interference from other cells and noise sources not specified in the test is assumed to be constant over subcarriers and time and shall be modelled as AWGN of appropriate power for $N_{oc}$ to be fulfilled.						
Note 3: $I_o$ levels have been derived from other parameters for information purposes. They are not settable parameters themselves.						

The UE shall start to transmit the PRACH to Cell 2 less than 92 ms from the beginning of time period T2. The rate of correct handovers observed during repeated tests shall be at least 90%.

NOTE: The handover delay can be expressed as: RRC procedure delay +  $T_{interrupt}$ , where:

RRC procedure delay = 10 ms and is specified in clause 12 in TS 38.331 [2].

$T_{interrupt}$  = 82 ms in the test.  $T_{interrupt}$  is defined in clause 6.3.1.0.2.

This gives a total of 92 ms.

### 6.3.1.3 NR SA FR1-FR1 handover with unknown target cell

#### 6.3.1.3.1 Test purpose

To verify the UE's ability to perform NR FR1-NR FR1 inter frequency handover in RRC\_CONNECTED state by meeting the delay requirement and interruption length for handover to an unknown target cell.

#### 6.3.1.3.2 Test applicability

This test applies to all types of NR UE from Release 15 onwards.

#### 6.3.1.3.3 Minimum conformance requirements

The minimum conformance requirements are specified in clause 6.3.1.0.2.

The normative reference for this requirement is TS 38.133 [6] clause A.6.3.1.3.

#### 6.3.1.3.4 Test description

##### 6.3.1.3.4.1 Initial conditions

Initial conditions are a set of test configurations the UE needs to be tested in and the steps for the SS to take with the UE to reach the correct measurement state.

This test shall be tested using any of the test configurations in Table 6.3.1.3.4-1.

**Table 6.3.1.3.4.1-1: Inter-frequency handover from FR1 to FR1 test configurations**

Config	Description
1	Source cell: NR 15 kHz SSB SCS, 10 MHz bandwidth, FDD duplex mode Target cell: NR 15 kHz SSB SCS, 10 MHz bandwidth, FDD duplex mode
2	Source cell: NR 15 kHz SSB SCS, 10 MHz bandwidth, TDD duplex mode Target cell: NR 15 kHz SSB SCS, 10 MHz bandwidth, TDD duplex mode
3	Source cell: NR 30 kHz SSB SCS, 40 MHz bandwidth, TDD duplex mode Target cell: NR 30 kHz SSB SCS, 40 MHz bandwidth, TDD duplex mode
Note:	The UE is only required to be tested in one of the supported test configurations

Configure the test equipment and the DUT according to the parameters in Table 6.3.1.3.4-2

**Table 6.3.1.3.4.1-2: Initial conditions for NR SA FR1 handover with unknown target cell**

Parameter	Value	Comment
Test environment	NC	As specified in TS 38.508-1 [14] clause 4.1.
Test frequencies	As specified in Annex E, Table E.4-1 and TS 38.508-1 [14] clause 4.3.1.	
Channel bandwidth	As specified by the test configuration selected from Table 6.3.1.3.4-3	
Propagation conditions	AWGN	As specified in Annex C.2.2.
Connection Diagram	TE Part	A.3.1.8.2
	DUT Part	A.3.2.3.4
Exceptions to connection diagram	N/A	

1. Message contents are defined in clause 6.3.1.3.4.3.
2. The power levels and settings for NR Cell 1 are set according to Annex C.1.2 and C.1.3. Cell 2 is NR FR1 target Cell, and its power levels and settings are also set according to Annex C.1.2 and C.1.3.
3. The test parameters are given in Tables 6.3.1.3.4.1-3 and 6.3.1.3.5-1 below.

**Table 6.3.1.3.4.1-3: General test parameters Inter-frequency handover from FR1 to FR1**

Parameter	Unit	Value	Comment
Initial conditions	Active cell	Cell 1	
	Neighbouring cell	Cell 2	
Final condition	Active cell	Cell 2	
Access Barring Information	-	Not Sent	No additional delays in random access procedure.
T1	s	5	
T2	s	≤5	

#### 6.3.1.3.4.2 Test procedure

The test scenario comprises of two NR carriers and one cell on each carrier as given in tables 6.3.1.3.4-3 and 6.3.1.3.5-1. No gap patterns are configured in the test case. The test consists of two successive time periods, with time durations of T1 and T2 respectively. At the start of time duration T1, the UE does not have any timing information of Cell 2. Starting T2, Cell 2 becomes detectable and the UE is expected to detect and start to transmit the PRACH to Cell 2.

1. Ensure the UE is in State RRC\_CONNECTED with generic procedure parameters Connectivity NR, Connected without release On according to TS 38.508-1 [14] clause 4.5. Establish SRB2 and DRB in the RRC Reconfiguration message. Cell 1 is the active cell.
2. Set the parameters according to T1 in Table 6.3.1.3.5-1. Propagation conditions are set according to Annex C clause C.2.2. T1 starts.
3. SS shall transmit an RRCReconfiguration message implying handover to Cell 2.
4. The start of T2 is the instant when the last TTI containing the RRC reconfiguration message implying handover is sent to the UE, at that instant the SS shall switch the power settings from T1 to T2 as specified in Table 6.3.1.3.5-1. T2 starts.



5. The UE shall transmit RRCReconfigurationComplete message.
6. If the UE transmits the uplink PRACH channel to Cell 2 less than 132 ms from the beginning of time period T2 then the number of successful tests is increased by one. Otherwise, the number of failure tests is increased by one.
7. After T2 expires, cause UE handover back to Cell 1 (if the handover fails, switch off the UE) or switch off the UE. Then ensure the UE is in State RRC\_CONNECTED with generic procedure parameters Connectivity NR, Connected without release On according to TS 38.508-1 [14] clause 4.5. Cell 1 is the active cell.
8. Set Cell 2 physical cell identity = ((current cell 2 physical cell identity + 1) mod 14 + 2) for next iteration of the test procedure loop.
9. Repeat step 2-8 until the confidence level according to Tables G.2.3-1 in Annex G clause G.2 is achieved.

6.3.1.3.4.3 Message contents

Message contents are according to TS 38.508-1 [14] clause 4.6 with the following exceptions:

**Table 6.3.1.3.4.3-1: Common Exception messages**

Default Message Contents	
Common contents of system information blocks exceptions	
Default RRC messages and information elements contents exceptions	Table H.3.2-2 with Condition RBConfig_KeyChange

6.3.1.3.5 Test requirements

Table 6.3.1.3.5-1 defines the primary level settings including test tolerances for all tests.

**Table 6.3.1.3.5-1: Cell specific test parameters for NR FR1-FR1 Intra frequency handover test case**

Parameter		Unit	Cell 1		Cell 2	
			T1	T2	T1	T2
NR RF Channel Number			1		2	
Duplex mode	Config 1		FDD			
	Config 2,3		TDD			
TDD configuration	Config 1		Not Applicable			
	Config 2		TDDConf.1.1			
	Config 3		TDDConf.2.1			
BW <sub>channel</sub>	Config 1	MHz	10: N <sub>RB,c</sub> = 52			
	Config 2		10: N <sub>RB,c</sub> = 52			
	Config 3		40: N <sub>RB,c</sub> = 106			
BWP BW	Config 1	MHz	10: N <sub>RB,c</sub> = 52			
	Config 2		10: N <sub>RB,c</sub> = 52			
	Config 3		40: N <sub>RB,c</sub> = 106			
TRS configuration	Config 1		TRS.1.1 FDD			
	Config 2		TRS.1.1 TDD			
	Config 3		TRS.1.2 TDD			
DRx Cycle		ms	Not Applicable			
PDSCH Reference measurement channel	Config 1		SR.1.1 FDD			
	Config 2		SR.1.1 TDD			
	Config 3		SR2.1 TDD			
CORESET Reference Channel	Config 1		CR.1.1 FDD			
	Config 2		CR.1.1 TDD			
	Config 3		CR2.1 TDD			
OCNG Patterns			OP.1			
SMTC configuration	Config 1,2		SMTC.1 FR1			
	Config 3		SMTC.2 FR1			
PDSCH/PDCCH subcarrier spacing	Config 1,2	kHz	15 kHz			
	Config 3		30 kHz			
PUCCH/PUSCH subcarrier spacing	Config 1,2	kHz	15 kHz			
	Config 3		30 kHz			
PRACH configuration			FR1 PRACH configuration 1			

Parameter		Unit	Cell 1		Cell 2	
			T1	T2	T1	T2
BWP	Initial DL BWP		DLBWP.0.1			
	Dedicated DL BWP		DLBWP.1.1			
	Initial UL BWP		ULBWP.0.1			
	Dedicated UL BWP		ULBWP.1.1			
EPRE ratio of PSS to SSS		dB	0			
EPRE ratio of PBCH DMRS to SSS						
EPRE ratio of PBCH to PBCH DMRS						
EPRE ratio of PDCCH DMRS to SSS						
EPRE ratio of PDCCH to PDCCH DMRS						
EPRE ratio of PDSCH DMRS to SSS						
EPRE ratio of PDSCH to PDSCH						
EPRE ratio of OCNG DMRS to SSS(Note 1)						
EPRE ratio of OCNG to OCNG DMRS (Note 1)						
$N_{oc}^{Note2}$		dBm/15kHz	-98		-98	
$N_{oc}^{Note2}$	Config 1,2	dBm/SCS	-98		-98	
	Config 3		-95		-95	
$\hat{E}_s / I_{ot}$		dB	4	4	-Infinity	6.7
$\hat{E}_s / N_{oc}$		dB	4	4	-Infinity	6.7
SSB_RP	Config 1,2	dBm/SCS	-94	-94	-Infinity	-91.3
	Config 3	dBm/SCS	-91	-91	-Infinity	-88.3
$I_o^{Note3}$	Config 1,2	dBm/ 9.36MHz	-64.59	-64.59	-70.05	-62.51
	Config 3	dBm/ 38.16MHz	-58.49	-58.49	-63.94	-56.40
Propagation condition		-	AWGN		AWGN	
Note 1: OCNG shall be used such that both cells are fully allocated and a constant total transmitted power spectral density is achieved for all OFDM symbols.						
Note 2: Interference from other cells and noise sources not specified in the test is assumed to be constant over subcarriers and time and shall be modelled as AWGN of appropriate power for $N_{oc}$ to be fulfilled.						
Note 3: $I_o$ levels have been derived from other parameters for information purposes. They are not settable parameters themselves.						

The UE shall start to transmit the PRACH to Cell 2 less than 132 ms from the beginning of time period T2. The rate of correct handovers observed during repeated tests shall be at least 90%.

NOTE: The handover delay can be expressed as: RRC procedure delay +  $T_{interrupt}$ , where:

RRC procedure delay = 10 ms and is specified in clause 12 in TS 38.331 [2].

$T_{interrupt}$  = 122 ms in the test.  $T_{interrupt}$  is defined in clause 6.3.1.0.2.

This gives a total of 132 ms.

### 6.3.1.4 NR SA FR1 – E-UTRA handover with known target cell

#### 6.3.1.4.1 Test purpose

To verify that the UE can make correct inter-RAT E-UTRAN handover when operating in standalone (SA) operation with PCell in FR1.

#### 6.3.1.4.2 Test applicability

This test applies to all types of NR UE from Release 15 onwards.

#### 6.3.1.4.3 Minimum conformance requirements

The minimum conformance requirements are specified in clause 6.3.1.0.1.

The normative reference for this requirement is TS 38.133 [6] clause A.6.3.1.4.

#### 6.3.1.4.4 Test description

##### 6.3.1.4.4.1 Initial conditions

The Test shall be tested using any of the test configuration in Table 6.3.1.4.4.1-1.

**Table 6.3.1.4.4.1-1: Supported test configurations**

Configuration	Description
6.3.1.4-1	NR 15 kHz SSB SCS, 10MHz bandwidth, FDD duplex mode, LTE FDD
6.3.1.4-2	NR 15 kHz SSB SCS, 10MHz bandwidth, TDD duplex mode, LTE FDD
6.3.1.4-3	NR 30 kHz SSB SCS, 40MHz bandwidth, TDD duplex mode, LTE FDD
6.3.1.4-4	NR 15 kHz SSB SCS, 10MHz bandwidth, FDD duplex mode, LTE TDD
6.3.1.4-5	NR 15 kHz SSB SCS, 10MHz bandwidth, TDD duplex mode, LTE TDD
6.3.1.4-6	NR 30 kHz SSB SCS, 40MHz bandwidth, TDD duplex mode, LTE TDD

Note: The UE is only required to be tested in one of the supported test configurations.

Configure the test requirement and the DUT according to the parameters in Table 6.3.1.4.4.1-2.

**Table 6.3.1.4.4.1-2: Initial conditions for NR SA FR1 – E-UTRA handover with known target cell**

Parameter	Value		Comment
Test environment	NC		As specified in TS 38.508-1 [14] clause 4.1.
Test frequencies	As specified in Annex E, Table E.4-1 and TS 38.508-1 [14] clause 4.3.1.		
Channel bandwidth	As specified by the test configuration selected from Table 6.3.1.4.4.1-1.		
Propagation conditions	AWGN		As specified in Annex C.2.2.
Connection Diagram	TE Part	A.3.1.6.1	As specified in TS 38.508-1 [14] Annex A.
	DUT Part	A.3.2.3.2	
Exceptions to connection diagram	N/A		

1. The general test parameter settings are set up according to Table 6.3.1.4.4.1-3.
2. Message contents are defined in clause 6.3.1.4.4.3.
3. The test comprises of one NR carrier and one E-UTRA carrier. There are two cells and one cell on each carrier. Cell 1 is the NR PCell and Cell 2 is an inter-RAT E-UTRAN neighbour cell. Cell 1 is configured according to Annex C.1.1 and C.1.2, Cell 2 is configured according to TS 36.521-3 [26] Annex C.1.0 and C.1.1.

**Table 6.3.1.4.4.1-3: General test parameters for SA inter-RAT E-UTRAN handover**

Parameter		Unit	Value	Comment
NR RF Channel Number			1	1 NR carrier frequency is used in the test
LTE RF Channel Number			2	1 E-UTRAN carrier frequency is used in the test
Initial conditions	Active cell		Cell 1	NR cell
	Neighbouring cell		Cell 2	E-UTRAN cell
Final condition	Active cell		Cell 2	
NR measurement quantity			SS-RSRP	
E-UTRAN measurement quantity			RSRP	
b2-Threshold1		dBm	As specified in Table 6.3.1.4.5-1	Absolute NR SS-RSRP threshold for event B2
b2-Threshold2EUTRAN		dBm	-98	Absolute E-UTRAN RSRP threshold for event B2
Hysteresis		dB	0	
TimeToTrigger		s	0	
Filter coefficient			0	L3 filtering is not used
DRX			OFF	Non-DRX test
Access Barring Information		-	Not sent	No additional delays in random access procedure
Time offset between cells			3 ms	Asynchronous cells
Gap pattern configuration Id			0	As specified in TS 38.133 [6], table 9.1.2-1 started before T2 starts
T1		s	5	
T2		s	≤5	
T3		s	1	

#### 6.3.1.4.4.2 Test procedure

The test comprises of one NR carrier and one E-UTRA carrier. There are two cells and one cell on each carrier. Cell 1 is the NR PCell and Cell 2 is an inter-RAT E-UTRAN neighbour cell. The test consists of three successive time periods, with time durations of T1, T2 and T3 respectively. At the start of time duration T1, the UE does not have any timing information of Cell 2. Starting T2, Cell 2 becomes detectable and the UE is expected to detect and send a measurement report. Gap pattern configuration with id #0 as specified in Table 9.1.2-1 of TS 38.133 [6] is configured before T2 begins to enable inter-RAT frequency monitoring.

A RRC message implying handover shall be sent to the UE during period T2 after the UE has reported Event B2. The start of T3 is the instant when the last TTI containing the RRC message implying handover is sent to the UE. The handover message shall contain Cell 2 as the target cell.

1. Ensure the UE is in State RRC\_CONNECTED with generic procedure parameters Connectivity NR, Connected without release On and Test Mode On according to TS 38.508-1 [14] clause 4.5. Establish SRB2 and DRB in the RRC Reconfiguration message. Cell 1 is the active cell.
2. Set the parameters according to T1 in Table 6.3.1.4.5-1 and 6.3.1.4.5-2. T1 starts.
3. The SS shall transmit an RRCReconfiguration message.
4. The UE shall transmit RRCReconfigurationComplete message.
5. When T1 expires, the SS shall switch the power setting from T1 to T2 as specified in Table 6.3.1.4.5-1 and 6.3.1.4.5-2.
6. UE shall transmit a MeasurementReport message triggered by Event B2.
7. SS shall transmit an RRCReconfiguration message implying handover to Cell 2.
8. The start of T3 is the instant when the last TTI containing the RRCReconfiguration message implying handover is sent to the UE, at that instant the SS shall switch the power setting from T2 to T3 as specified in Table 6.3.1.4.5-1 and 6.3.1.4.5-2.
9. The UE shall transmit RRCConnectionReconfigurationComplete message on Cell 2.

10. If the UE transmits the uplink PRACH channel to Cell 2 less than 85 ms from the beginning of time period T3 then the number of successful tests is increased by one. Otherwise, the number of failure tests is increased by one.
11. After T3 expires, cause UE handover back to Cell 1 (if the handover fails, switch off the UE) or switch off the UE. Then ensure the UE is in State RRC\_CONNECTED with generic procedure parameters Connectivity NR, Connected without release *On* according to TS 38.508-1 [14] clause 4.5. Cell 1 is the active cell.
12. Set Cell 2 physical cell identity = ((current cell 2 physical cell identity + 1) mod 14 + 2) for next iteration of the test procedure loop.
13. Repeat step 2-12 until the confidence level according to Tables G.2.3-1 in Annex G clause G.2 is achieved.

6.3.1.4.4.3 Message contents

Message contents are according to TS 38.508-1 [14] clause 7.3 with the following exceptions:

**Table 6.3.1.4.4.3-1: Common Exception messages**

Default Message Contents	
Common contents of system information blocks exceptions	
Default RRC messages and information elements contents exceptions	Table H.3.1-1 Table H.3.1-2 with Condition INTER-RAT and GAP NEEDED Table H.3.1-3A Table H.3.1-4A Table H.3.1-5 Table H.3.1-6 with Condition Pattern #0 Table H.3.1-7 with Condition INTER-RAT Table H.3.3-1
Specific message contents exceptions for Test Configuration 6.3.1.4-1, 6.3.1.4-2, 6.3.1.4-4 and 6.3.1.4-5	Table H.3.1-3 with Condition SSB.1 FR1 Table 7.3.1-3 in TS 38.508-1 [14] with condition SMTC.1
Specific message contents exceptions for Test Configuration 6.3.1.4-3 and 6.3.1.4-6	Table H.3.1-3 with Condition SSB.2 FR1 Table 7.3.1-3 in TS 38.508-1 [14] with condition SMTC.1

**Table 6.3.1.4.4.3-2: PRACH-Config-DEFAULT: Inter-RAT handover to E-UTRAN known cell**

Derivation Path: TS 36.508 [25], Table 4.6.3-7			
Information Element	Value/remark	Comment	Condition
PRACH-Config-DEFAULT ::= SEQUENCE {			
prach-ConfigInfo SEQUENCE {			
prach-ConfigIndex	4		Config 1, 2, 3
	53		Config 4, 5, 6
}			
}			

**Table 6.3.1.4.4.3-3: RRCConnectionReconfiguration: Inter-RAT handover to E-UTRAN known cell**

Derivation Path: TS 36.508 [25], Table 4.6.1-8			
Information Element	Value/remark	Comment	Condition
RRCConnectionReconfiguration ::= SEQUENCE {			
securityConfigHO	Not present		
nonCriticalExtension SEQUENCE {		RRCCConnectionReconfiguration-v890-IEs	
nonCriticalExtension SEQUENCE {		RRCCConnectionReconfiguration-v920-IEs	
nonCriticalExtension SEQUENCE {		RRCCConnectionReconfiguration-v1020-IEs	
nonCriticalExtension SEQUENCE {		RRCCConnectionReconfiguration-v1130-IEs	
nonCriticalExtension SEQUENCE {		RRCCConnectionReconfiguration-v1250-IEs	
nonCriticalExtension SEQUENCE {		RRCCConnectionReconfiguration-v1310-IEs	
nonCriticalExtension SEQUENCE {		RRCCConnectionReconfiguration-v1430-IEs	
nonCriticalExtension SEQUENCE {		RRCCConnectionReconfiguration-v1510-IEs	
nonCriticalExtension SEQUENCE {		RRCCConnectionReconfiguration-v1530-IEs	
securityConfigHO-v1530 {			
handoverType-v1530 CHOICE {	fivegc-ToEPC-r15		
fivegc-ToEPC-r15 {			
securityAlgorithmConfig-r15 {			
cipheringAlgorithm	eea0		
integrityProtAlgorithm	eia1		
}			
nextHopChainingCount-r15	2		
}			
}			
}			
}			
}			
}			
}			
}			
}			

6.3.1.4.5 Test requirement

Tables 6.3.1.4.4.1-3, 6.3.1.4.5-1 and 6.3.1.4.5-2 define the primary level settings including test tolerances for intra frequency NR cell re-selection test case.

**Table 6.3.1.4.5-1: Cell specific test parameters for SA inter-RAT E-UTRA handover (Cell 1)**

Parameter	Unit	Configuration	Cell 1		
			T1	T2	T3
RF channel number		1, 2, 3, 4, 5, 6		1	
Duplex mode		1, 4		FDD	
		2, 3, 5, 6		TDD	

Parameter	Unit	Configuration	Cell 1		
			T1	T2	T3
TDD Configuration		2, 5	TDDConf.1.1		
		3, 6	TDDConf.2.1		
BW <sub>channel</sub>	MHz	1, 4	10: N <sub>RB,c</sub> = 52 (FDD)		
		2, 5	10: N <sub>RB,c</sub> = 52 (TDD)		
		3, 6	40: N <sub>RB,c</sub> = 106 (TDD)		
PDSCH reference measurement channel		1, 4	SR.1.1 FDD		
		2, 5	SR.1.1 TDD		
		3, 6	SR.2.1 TDD		
CORSET reference channel		1, 4	CR.1.1 FDD		
		2, 5	CR.1.1 TDD		
		3, 6	CR.2.1 TDD		
OCNG pattern <sup>Note1</sup>		1, 2, 3, 4, 5, 6	OP.1		
BWP	Initial DL BWP	1, 2, 3, 4, 5, 6	DL BWP.0.1		
	Dedicated DL BWP		DL BWP.1.1		
	Initial UL BWP		UL BWP.0.1		
	Dedicated UL BWP		UL BWP.1.1		
SMTC configuration		1, 2, 3, 4, 5, 6	SMTC.1		
SSB configuration		1, 2, 4, 5	SSB.1 FR1		
		3, 6	SSB.2 FR1		
b2-Threshold1	dBm	1, 2, 4, 5	-96		
		3, 6	-93		
EPRE ratio of PSS to SSS	dB	1, 2, 3, 4, 5, 6	0		
EPRE ratio of PBCH_DMRS to SSS					
EPRE ratio of PBCH to PBCH_DMRS					
EPRE ratio of PDCCH_DMRS to SSS					
EPRE ratio of PDCCH to PDCCH_DMRS					
EPRE ratio of PDSCH_DMRS to SSS					
EPRE ratio of PDSCH to PDSCH_DMRS					
EPRE ratio of OCNG DMRS to SSS					
EPRE ratio of OCNG to OCNG DMRS					
N <sub>oc</sub> <sup>Note2</sup>					
N <sub>oc</sub> <sup>Note2</sup>	dBm/SCS	1, 2, 4, 5	-100	-104	-100
		3, 6	-97	-101	-97
$\hat{E}_s/N_{oc}$	dB	1, 2, 3, 4, 5, 6	13.55	-1.55	-5.55
$\hat{E}_s/I_{ot}$ <sup>Note3</sup>	dB	1, 2, 3, 4, 5, 6	13.55	-1.55	-5.55
SS-RSRP <sup>Note3</sup>	dBm/SCS	1, 2, 4, 5	-86.45	-105.55	-105.55
		3, 6	-83.44	-102.54	-102.54
I <sub>o</sub> <sup>Note3</sup>	dBm/9.36 MHz	1, 2, 4, 5	-58.31	-73.04	-70.98
	dBm/38.16 MHz	3, 6	-52.21	-66.94	-64.88
Propagation condition		1, 2, 3, 4, 5, 6	AWGN		
Antenna Configuration and Correlation Matrix		1, 2, 3, 4, 5, 6	1x2 Low		
<p>Note 1: OCNG shall be used such that both cells are fully allocated and a constant total transmitted power spectral density is achieved for all OFDM symbols.</p> <p>Note 2: Interference from other cells and noise sources not specified in the test is assumed to be constant over subcarriers and time and shall be modelled as AWGN of appropriate power for N<sub>oc</sub> to be fulfilled.</p> <p>Note 3: <math>\hat{E}_s/I_{ot}</math>, SS-RSRP, and I<sub>o</sub> levels have been derived from other parameters for information purposes. They are not settable parameters themselves.</p>					

**Table 6.3.1.4.5-2: Cell specific test parameters for SA inter-RAT E-UTRA handover (Cell 2)**

Parameter	Unit	Configuration	Cell 2		
			T1	T2	T3
RF channel number		1, 2, 3, 4, 5, 6	2		
Duplex mode		1, 2, 3	FDD		
		4, 5, 6	TDD		
TDD special subframe configuration <sup>Note1</sup>		4, 5, 6	6		
TDD uplink-downlink configuration <sup>Note1</sup>		4, 5, 6	1		
BW <sub>channel</sub>	MHz	1, 2, 3, 4, 5, 6	5MHz: N <sub>RB,c</sub> = 25 10MHz: N <sub>RB,c</sub> = 50 20MHz: N <sub>RB,c</sub> = 100		
PRACH Configuration <sup>Note2</sup>		1, 2, 3	4		
		4, 5, 6	53		
PDSCH parameters: DL Reference Measurement Channel <sup>Note3</sup>		1, 2, 3	5MHz: R.7 FDD 10MHz: R.3 FDD 20MHz: R.6 FDD		
		4, 5, 6	5MHz: R.4 TDD 10MHz: R.0 TDD 20MHz: R.3 TDD		
PCFICH/PDCCH/PHICH parameters: DL Reference Measurement Channel <sup>Note3</sup>		1, 2, 3	5MHz: R.11 FDD 10MHz: R.6 FDD 20MHz: R.10 FDD		
		4, 5, 6	5MHz: R.11 TDD 10MHz: R.6 TDD 20MHz: R.10 TDD		
OCNG Patterns <sup>Note3</sup>		1, 2, 3	5MHz: OP.20 FDD 10MHz: OP.10 FDD 20MHz: OP.17 FDD		
		4, 5, 6	5MHz: OP.9 TDD 10MHz: OP.1 TDD 20MHz: OP.7 TDD		
PBCH_RA	dB	1, 2, 3, 4, 5, 6	0		
PBCH_RB					
PSS_RA					
SSS_RA					
PCFICH_RB					
PHICH_RA					
PHICH_RB					
PDCCH_RA					
PDCCH_RB					
PDSCH_RA					
PDSCH_RB					
OCNG_RA <sup>Note4</sup>					
OCNG_RB <sup>Note4</sup>					
N <sub>oc</sub> <sup>Note5</sup>	dBm/15kHz	1, 2, 3, 4, 5, 6	-98		
$\bar{E}_s/N_{oc}$	dB	1, 2, 3, 4, 5, 6	-Infinity	9.55	9.55
$\bar{E}_s/I_{ot}$ <sup>Note6</sup>	dB	1, 2, 3, 4, 5, 6	-Infinity	9.55	9.55
RSRP <sup>Note6</sup>	dBm/15kHz	1, 2, 3, 4, 5, 6	-Infinity	-88.45	-88.45
SCH_RP <sup>Note6</sup>	dBm/15kHz	1, 2, 3, 4, 5, 6	-Infinity	-88.45	-88.45
I <sub>o</sub> <sup>Note6</sup>	dBm/Ch BW	1, 2, 3, 4, 5, 6	-67.21 +10log (N <sub>RB,c</sub> /100)	-57.20 +10log (N <sub>RB,c</sub> /100)	-57.20 +10log (N <sub>RB,c</sub> /100)
Propagation Condition		1, 2, 3, 4, 5, 6	AWGN		
Antenna Configuration and Correlation Matrix <sup>Note7</sup>		1, 2, 3, 4, 5, 6	1x2 Low		
<p>Note 1: Special subframe and uplink-downlink configurations are specified in table 4.2-1 in TS 36.211.</p> <p>Note 2: PRACH configurations are specified in table 5.7.1-2 and table 5.7.1-3 in TS 36.211.</p> <p>Note 3: DL RMCs and OCNG patterns are specified in sections A 3.1 and A 3.2 of TS 36.133 respectively.</p> <p>Note 4: OCNG shall be used such that all cells are fully allocated and a constant total transmitted power spectral density is achieved for all OFDM symbols.</p> <p>Note 5: Interference from other cells and noise sources not specified in the test is assumed to be constant over subcarriers and time and shall be modelled as AWGN of appropriate power for N<sub>oc</sub> to be fulfilled.</p> <p>Note 6: <math>\bar{E}_s/I_{ot}</math>, RSRP, SCH_RP and I<sub>o</sub> levels have been derived from other parameters for information purposes. They are not settable parameters themselves.</p>					



Parameter	Unit	Configuration	Cell 2		
			T1	T2	T3
Note 7: Propagation condition and correlation matrix are defined in section B.2 in TS 36.101 [27].					

The UE shall start to transmit the PRACH to Cell 2 less than 85 ms from the beginning of time period T3.

The rate of correct handovers observed during repeated tests shall be at least 90%.

NOTE: The handover delay can be expressed as: RRC procedure delay +  $T_{\text{interrupt}}$ , where:

RRC procedure delay = 50 ms and is specified in section 6.1.2.1 of TS 38.133 [6].

$T_{\text{interrupt}}$  = 35 ms in the test;  $T_{\text{interrupt}}$  is defined in section 6.1.2.1 of TS 38.133 [6].

This gives a total of 85 ms.

### 6.3.1.5 NR SA FR1 – E-UTRA handover with unknown target cell

#### 6.3.1.5.1 Test purpose

To verify that the UE can make correct inter-RAT E-UTRAN handover when operating in standalone (SA) operation with PCell in FR1. This test shall verify the NR to E-UTRAN handover requirements for the case when the target E-UTRAN cell is unknown as specified in section 6.1.2.1 of TS 38.133 [6].

#### 6.3.1.5.2 Test applicability

This test applies to all types of NR UE from Release 15 onwards.

#### 6.3.1.5.3 Minimum conformance requirements

The minimum conformance requirements are specified in clause 6.3.1.0.1.

The normative reference for this requirement is TS 38.133 [6] clause A.6.3.1.2.

#### 6.3.1.5.4 Test description

##### 6.3.1.5.4.1 Initial conditions

The Test shall be tested using any of the test configuration in Table 6.3.1.5.4.1-1.

**Table 6.3.1.5.4.1-1: Supported test configurations for SA inter-RAT E-UTRAN handover tests**

Configuration	Description
6.3.1.5-1	NR 15 kHz SSB SCS, 10MHz bandwidth, FDD duplex mode, LTE FDD
6.3.1.5-2	NR 15 kHz SSB SCS, 10MHz bandwidth, TDD duplex mode, LTE FDD
6.3.1.5-3	NR 30 kHz SSB SCS, 40MHz bandwidth, TDD duplex mode, LTE FDD
6.3.1.5-4	NR 15 kHz SSB SCS, 10MHz bandwidth, FDD duplex mode, LTE TDD
6.3.1.5-5	NR 15 kHz SSB SCS, 10MHz bandwidth, TDD duplex mode, LTE TDD
6.3.1.5-6	NR 30kHz SSB SCS, 40MHz bandwidth, TDD duplex mode, LTE TDD
Note:	The UE is only required to be tested in one of the supported test configurations.

Configure the test requirement and the DUT according to the parameters in Table 6.3.1.5.4.1-2.

**Table 6.3.1.5.4.1-2: Initial conditions for NR SA FR1 – E-UTRA handover with unknown target cell**

Parameter	Value		Comment
Test environment	NC		As specified in TS 38.508-1 [14] clause 4.1.
Test frequencies	As specified in Annex E, Table E.4-1 and TS 38.508-1 [14] clause 4.3.1.		
Channel bandwidth	As specified by the test configuration selected from Table 6.3.1.5.4.1-1.		
Propagation conditions	AWGN		As specified in Annex C.2.2.
Connection Diagram	TE Part	A.3.1.6.1	As specified in TS 38.508-1 [14] Annex A.
	DUT Part	A.3.2.3.2	
Exceptions to connection diagram	N/A		

1. The general test parameter settings are set up according to Table 6.3.1.5.4.1-3.
2. Message contents are defined in clause 6.3.1.5.4.3.
3. The test comprises of one NR carrier and one E-UTRA carrier. There are two cells and one cell on each carrier. Cell 1 is the NR PCell and Cell 2 is the E-UTRAN neighbour cell. Cell 1 is configured according to Annex C.1.1 and C.1.2. Cell 2 is configured according to TS 36.521-3 [26] Annex C.1.0 and C.1.1.

**Table 6.3.1.5.4.1-3: General test parameters for SA inter-RAT E-UTRAN handover**

Parameter	Unit	Value	Comment
NR RF Channel Number		1	1 NR carrier frequency is used in the test
LTE RF Channel Number		2	1 E-UTRAN carrier frequency is used in the test
Initial conditions	Active cell	Cell 1	NR cell
	Neighbouring cell	Cell 2	E-UTRAN cell
Final condition	Active cell	Cell 2	
NR measurement quantity		SS-RSRP	
E-UTRAN measurement quantity		RSRP	
DRX		OFF	Non-DRX test
Access Barring Information	-	Not sent	No additional delays in random access procedure
Time offset between cells		3 ms	Asynchronous cells
T1	s	≤5	
T2	s	1	

#### 6.3.1.5.4.2 Test procedure

The test comprises of one NR carrier and one E-UTRA carrier. There are two cells and one cell on each carrier. Cell 1 is the NR PCell and Cell 2 is an inter-RAT E-UTRAN neighbour cell. The test consists of two successive time periods, with time durations of T1 and T2. At the start of time duration T1, the UE does not have any timing information of Cell 2. Starting T2, Cell 2 becomes detectable. No Gap pattern shall be configured.

An RRC message implying handover shall be sent to the UE during period T1. The start of T2 is the instant when the last subframe containing the RRC message implying handover is sent to the UE. Starting T2, Cell 2 becomes detectable and the UE is expected to detect and start to transmit the PRACH to Cell 2.

1. Ensure the UE is in State RRC\_CONNECTED with generic procedure parameters Connectivity NR, Connected without release *On* and Test Mode *On* according to TS 38.508-1 [14] clause 4.5. Establish SRB2 and DRB in the RRC Reconfiguration message. Cell 1 is the active cell.
2. Set the parameters according to T1 in Table 6.3.1.5.5-1 and 6.3.1.5.5-2. T1 starts.
3. SS shall transmit an RRCReconfiguration message implying handover to Cell 2.
4. The start of T2 is the instant when the last subframe containing the RRC Reconfiguration message implying handover is sent to the UE, at that instant the SS shall switch the power settings from T1 to T2 as specified in Table 6.3.1.5.5-1 and 6.3.1.5.5-2. T2 starts.
5. The UE shall transmit RRCConnectionReconfigurationComplete message on Cell 2.

6. If the UE transmits the uplink PRACH channel to Cell 2 less than 165 ms from the beginning of time period T2 then the number of successful tests is increased by one. Otherwise, the number of failure tests is increased by one.
7. After T2 expires, cause UE handover back to Cell 1 (if the handover fails, switch off the UE) or switch off the UE. Then ensure the UE is in State RRC\_CONNECTED with generic procedure parameters Connectivity NR, Connected without release *On* according to TS 38.508-1 [14] clause 4.5. Cell 1 is the active cell.
8. Set Cell 2 physical cell identity = ((current cell 2 physical cell identity + 1) mod 14 + 2) for next iteration of the test procedure loop.
9. Repeat step 2-8 until the confidence level according to Tables G.2.3-1 in Annex G clause G.2 is achieved.

6.3.1.5.4.3 Message contents

Message contents are according to TS 38.508-1 [14] clause 4.6 with the following exceptions:

**Table 6.3.1.5.4.3-1: Common Exception messages**

Default Message Contents	
Common contents of system information blocks exceptions	
Default RRC messages and information elements contents exceptions	Table H.3.3-1

**Table 6.3.1.5.4.3-2: PRACH-Config-DEFAULT: Inter-RAT handover to E-UTRAN unknown cell**

Derivation Path: TS 36.508 [25], Table 4.6.3-7			
Information Element	Value/remark	Comment	Condition
PRACH-Config-DEFAULT ::= SEQUENCE {			
prach-ConfigInfo SEQUENCE {			
prach-ConfigIndex	4		Config 1, 2, 3
	53		Config 4, 5, 6
}			
}			

6.3.1.5.5 Test requirement

Tables 6.3.1.5.4.1-3, 6.3.1.5.5-1 and 6.3.1.5.5-2 define the primary level settings including test tolerances for inter-RAT E-UTRAN handover: unknown target cell test.

**Table 6.3.1.5.5-1: Cell specific test parameters for SA inter-RAT E-UTRA handover (Cell 1)**

Parameter		Unit	Configuration	Cell 1	
				T1	T2
RF channel number			1, 2, 3, 4, 5, 6	1	
Duplex mode			1, 4	FDD	
			2, 3, 5, 6	TDD	
TDD Configuration			2, 5	TDDConf.1.1	
			3, 6	TDDConf. 2.1	
BW <sub>channel</sub>		MHz	1, 4	10: N <sub>RB,c</sub> = 52 (FDD)	
			2, 5	10: N <sub>RB,c</sub> = 52 (TDD)	
			3, 6	40: N <sub>RB,c</sub> = 106 (TDD)	
PDSCH reference measurement channel			1, 4	SR.1.1 FDD	
			2, 5	SR.1.1 TDD	
			3, 6	SR.2.1 TDD	
CORSET reference channel			1, 4	CR.1.1 FDD	
			2, 5	CR.1.1 TDD	
			3, 6	CR.2.1 TDD	
OCNG pattern <sup>Note1</sup>			1, 2, 3, 4, 5, 6	OP.1	
BWP	Initial DL BWP		1, 2, 3, 4, 5, 6	DLBWP.0.1	
	Dedicated DL BWP			DLBWP.1.1	
	Initial UL BWP			ULBWP.0.1	
	Dedicated UL BWP			ULBWP.1.1	
SMTC configuration			1, 2, 3, 4, 5, 6	SMTC.1	
SSB configuration			1, 2, 4, 5	SSB.1 FR1	
			3, 6	SSB.2 FR1	
EPRE ratio of PSS to SSS		dB	1, 2, 3, 4, 5, 6	0	
EPRE ratio of PBCH_DMRS to SSS					
EPRE ratio of PBCH to PBCH_DMRS					
EPRE ratio of PDCCH_DMRS to SSS					
EPRE ratio of PDCCH to PDCCH_DMRS					
EPRE ratio of PDSCH_DMRS to SSS					
EPRE ratio of PDSCH to PDSCH_DMRS					
EPRE ratio of OCNG DMRS to SSS					
EPRE ratio of OCNG to OCNG DMRS					
N <sub>oc</sub> <sup>Note2</sup>					
N <sub>oc</sub> <sup>Note2</sup>		dBm/SCS	1, 2, 4, 5	-98	
			3, 6	-95	
E <sub>s</sub> /N <sub>oc</sub>		dB	1, 2, 3, 4, 5, 6	0	0
E <sub>s</sub> /I <sub>ot</sub> <sup>Note3</sup>		dB	1, 2, 3, 4, 5, 6	0	0
SS-RSRP <sup>Note3</sup>		dBm/SCS	1, 2, 4, 5	-98	-98
			3, 6	-95	-95
I <sub>o</sub> <sup>Note3</sup>		dBm/9.36 MHz dBm/38.16 MHz	1, 2, 4, 5	-67.04	-67.04
			3, 6	-60.94	-60.94
Propagation condition			1, 2, 3, 4, 5, 6	AWGN	
Antenna Configuration and Correlation Matrix			1, 2, 3, 4, 5, 6	1x2 Low	
<p>Note 1: OCNG shall be used such that both cells are fully allocated and a constant total transmitted power spectral density is achieved for all OFDM symbols.</p> <p>Note 2: Interference from other cells and noise sources not specified in the test is assumed to be constant over subcarriers and time and shall be modelled as AWGN of appropriate power for N<sub>oc</sub> to be fulfilled.</p> <p>Note 3: E<sub>s</sub>/I<sub>ot</sub>, SS-RSRP, and I<sub>o</sub> levels have been derived from other parameters for information purposes. They are not settable parameters themselves.</p>					

**Table 6.3.1.5.5-2: Cell specific test parameters for SA inter-RAT E-UTRA handover (Cell 2)**

Parameter	Unit	Configuration	Cell 2	
			T1	T2
RF channel number		1, 2, 3, 4, 5, 6	2	
Duplex mode		1, 2, 3	FDD	
		4, 5, 6	TDD	
TDD special subframe configuration <sup>Note1</sup>		4, 5, 6	6	
TDD uplink-downlink configuration <sup>Note1</sup>		4, 5, 6	1	
BW <sub>channel</sub>	MHz	1, 2, 3, 4, 5, 6	5MHz: N <sub>RB,c</sub> = 25 10MHz: N <sub>RB,c</sub> = 50 20MHz: N <sub>RB,c</sub> = 100	
PRACH Configuration <sup>Note2</sup>		1, 2, 3	4	
		4, 5, 6	53	
PDSCH parameters: DL Reference Measurement Channel <sup>Note3</sup>		1, 2, 3	5MHz: R.7 FDD 10MHz: R.3 FDD 20MHz: R.6 FDD	
		4, 5, 6	5MHz: R.4 TDD 10MHz: R.0 TDD 20MHz: R.3 TDD	
PCFICH/PDCCH/PHICH parameters: DL Reference Measurement Channel <sup>Note3</sup>		1, 2, 3	5MHz: R.11 FDD 10MHz: R.6 FDD 20MHz: R.10 FDD	
		4, 5, 6	5MHz: R.11 TDD 10MHz: R.6 TDD 20MHz: R.10 TDD	
OCNG Patterns <sup>Note3</sup>		1, 2, 3	5MHz: OP.20 FDD 10MHz: OP.10 FDD 20MHz: OP.17 FDD	
		4, 5, 6	5MHz: OP.9 TDD 10MHz: OP.1 TDD 20MHz: OP.7 TDD	
PBCH_RA	dB	1, 2, 3, 4, 5, 6	0	
PBCH_RB				
PSS_RA				
SSS_RA				
PCFICH_RB				
PHICH_RA				
PHICH_RB				
PDCCH_RA				
PDCCH_RB				
PDSCH_RA				
PDSCH_RB				
OCNG_RA <sup>Note4</sup>				
OCNG_RB <sup>Note4</sup>				
N <sub>oc</sub> <sup>Note5</sup>				
$\hat{E}_s/N_{oc}$	dB	1, 2, 3, 4, 5, 6	-Infinity	7
$\hat{E}_s/I_{ot}$ <sup>Note6</sup>	dB	1, 2, 3, 4, 5, 6	-Infinity	7
RSRP <sup>Note6</sup>	dBm/15kHz	1, 2, 3, 4, 5, 6	-Infinity	-91
SCH_RP <sup>Note6</sup>	dBm/15kHz	1, 2, 3, 4, 5, 6	-Infinity	-91
I <sub>o</sub> <sup>Note6</sup>	dBm/9MHz	1, 2, 3, 4, 5, 6	-70.22	-62.43
Propagation Condition		1, 2, 3, 4, 5, 6	AWGN	
Antenna Configuration and Correlation Matrix <sup>Note7</sup>		1, 2, 3, 4, 5, 6	1x2 Low	

Note 1: Special subframe and uplink-downlink configurations are specified in table 4.2-1 in TS 36.211.  
 Note 2: PRACH configurations are specified in table 5.7.1-2 and table 5.7.1-3 in TS 36.211.  
 Note 3: DL RMCs and OCNG patterns are specified in sections A 3.1 and A 3.2 of TS 36.133 respectively.  
 Note 4: OCNG shall be used such that all cells are fully allocated and a constant total transmitted power spectral density is achieved for all OFDM symbols.  
 Note 5: Interference from other cells and noise sources not specified in the test is assumed to be constant over subcarriers and time and shall be modelled as AWGN of appropriate power for N<sub>oc</sub> to be fulfilled.  
 Note 6:  $\hat{E}_s/I_{ot}$ , RSRP, SCH\_RP and I<sub>o</sub> levels have been derived from other parameters for information purposes. They are not settable parameters themselves.  
 Note 7: Propagation condition and correlation matrix are defined in section B.2 in TS 36.101 [27].

The UE shall start to transmit the PRACH to Cell 2 less than 165 ms from the beginning of time period T2.

The rate of correct handovers observed during repeated tests shall be at least 90%.

NOTE: The handover delay can be expressed as: RRC procedure delay +  $T_{\text{interrupt}}$ , where:

RRC procedure delay = 50 ms and is specified in section 6.1.2.1 of TS 38.133 [6].

$T_{\text{interrupt}}$  = 115 ms in the test;  $T_{\text{interrupt}}$  is defined in section 6.1.2.1 of TS 38.133 [6].

This gives a total of 165 ms.

### 6.3.1.6 NR SA FR1 – UTRAN FDD handover with known target cell

#### 6.3.1.6.1 Test purpose

To verify that the UE can make correct inter-RAT UTRAN handover when operating in standalone (SA) operation with PCell in FR1.

#### 6.3.1.6.2 Test applicability

This test applies to all types of NR UE from Release 16 onwards and support UTRA FDD.

#### 6.3.1.6.3 Minimum conformance requirements

The minimum conformance requirements are specified in clause 6.3.1.0.3.

The normative reference for this requirement is TS 38.133 [6] clause A.6.3.1.6.

#### 6.3.1.6.4 Test description

##### 6.3.1.6.4.1 Initial conditions

The Test shall be tested using any of the test configuration in Table 6.3.1.6.4.1-1.

**Table 6.3.1.6.4.1-1: Supported test configurations**

Configuration	Description
6.3.1.6-1	NR 15 kHz SSB SCS, 10MHz bandwidth, FDD duplex mode, UTRAN FDD
6.3.1.6-2	NR 15 kHz SSB SCS, 10MHz bandwidth, TDD duplex mode, UTRAN FDD
6.3.1.6-3	NR 30 kHz SSB SCS, 40MHz bandwidth, TDD duplex mode, UTRAN FDD
Note: The UE is only required to be tested in one of the supported test configurations.	

Configure the test requirement and the DUT according to the parameters in Table 6.3.1.6.4.1-2.

**Table 6.3.1.6.4.1-2: Initial conditions for NR SA FR1 – UTRAN handover with known target cell**

Parameter	Value	Comment
Test environment	NC	As specified in TS 38.508-1 [14] clause 4.1.
Test frequencies	As specified in Annex E, Table E.4-3 and TS 38.508-1 [14] clause 4.3.1.	
Channel bandwidth	As specified by the test configuration selected from Table 6.3.1.6.4.1-1.	
Propagation conditions	AWGN	As specified in Annex C.2.2.
Connection Diagram	TE Part A.3.1.8.2 UE Part A.3.2.3.2	As specified in TS 38.508-1 [14] Annex A.
Exceptions to connection diagram	SS LTE in Figure A.3.1.8.2 is replaced by SS UTRA Faders in Figure A.3.1.8.2 are removed. LTE TX/RX in Figure A.3.2.3.2 is replaced by UTRA TX/RX	

1. The general test parameter settings are set up according to Table 6.3.1.6.4.1-3.

2. Message contents are defined in clause 6.3.1.6.4.3.

3. The test comprises of one NR carrier and one UTRAN carrier. There are two cells and one cell on each carrier. Cell 1 is the NR PCell and Cell 2 is an inter-RAT UTRAN neighbour cell. Cell 1 is configured according to Annex C.1.1 and C.1.2, Cell 2 is configured according to TS 36.521-3 Annex C.0 and C.1.

**Table 6.3.1.6.4.1-3: General test parameters for SA inter-RAT UTRAN handover**

Parameter		Unit	Value	Comment
NR RF Channel Number			1	1 NR carrier frequency is used in the test
UTRA RF Channel Number			2	1 UTRAN carrier frequency is used in the test
Initial conditions	Active cell		Cell 1	NR cell
	Neighbouring cell		Cell 2	UTRAN cell
Final condition	Active cell		Cell 2	
NR measurement quantity			SS-RSRP	
Inter-RAT (UTRAN FDD) measurement quantity			CPICH Ec/N0	
b2-Threshold1		dBm	As specified in Table 6.3.1.6.5-1	Absolute NR SS-RSRP threshold for event B2
b2-Threshold2UTRA-FDD		dB	-18	Absolute UTRAN CPICH Ec/Io threshold for event B2
Hysteresis		dB	0	
TimeToTrigger		s	0	
Filter coefficient			0	L3 filtering is not used
DRX			OFF	Non-DRX test
Access Barring Information		-	Not sent	No additional delays in random access procedure
Time offset between cells			3 ms	Asynchronous cells
Gap pattern configuration Id			0	As specified in TS 38.133 [6] Table 9.1.2-1 started before T2 starts
T1		s	5	
T2		s	≤5	
T3		s	1	

#### 6.3.1.6.4.2 Test procedure

The test comprises of one NR carrier and one UTRAN carrier. There are two cells and one cell on each carrier. Cell 1 is the NR PCell and Cell 2 is an inter-RAT UTRAN neighbour cell. The test consists of three successive time periods, with time durations of T1, T2 and T3 respectively. At the start of time duration T1, the UE does not have any timing information of Cell 2. Starting T2, Cell 2 becomes detectable and the UE is expected to detect and send a measurement report. Gap pattern configuration with id #0 as specified in Table 9.1.2-1 of TS 38.133 [6] is configured before T2 begins to enable inter-RAT frequency monitoring.

A RRC message implying handover shall be sent to the UE during period T2 after the UE has reported Event B2. The start of T3 is the instant when the last TTI containing the RRC message implying handover is sent to the UE. The handover message shall contain Cell 2 as the target cell.

1. Ensure the UE is in State RRC\_CONNECTED with generic procedure parameters Connectivity NR, Connected without release On and Test Mode On according to TS 38.508-1 [14] clause 4.5. Cell 1 is the active cell.
2. Set the parameters according to T1 in Table 6.3.1.6.5-1 and 6.3.1.6.5-2. T1 starts.
3. The SS shall transmit an *RRCReconfiguration* message to configure Event B2 measurement reporting.
4. The UE shall transmit an *RRCReconfigurationComplete* message.
5. When T1 expires, the SS shall switch the power setting from T1 to T2 as specified in Table 6.3.1.6.5-1 and 6.3.1.6.5-2.
6. UE shall transmit a *MeasurementReport* message triggered by Event B2.
7. SS shall transmit a *MobilityFromNRCommand* message implying handover to Cell 2.

8. T3 starts when the last TTI containing the *MobilityFromNRCommand* message implying handover is sent to the UE, at that instant the SS shall switch the power setting from T2 to T3 as specified in Table 6.3.1.6.5-1 and 6.3.1.6.5-2.
9. If the UE transmits the uplink PRACH channel to Cell 2 less than 85 ms from the beginning of time period T3 then the number of successful tests is increased by one. Otherwise, the number of failure tests is increased by one.
10. The UE shall transmit HANDOVER TO UTRAN COMPLETE message on Cell 2.
11. After T3 expires, cause UE handover back to Cell 1 (if the handover fails, switch off the UE) or switch off the UE. Then ensure the UE is in State RRC\_CONNECTED with generic procedure parameters Connectivity NR, Connected without release *On* according to TS 38.508-1 [14] clause 4.5. Cell 1 is the active cell.
12. The SS shall set Cell 2 primary scrambling code = ((current cell 2 primary scrambling code - 50) mod 200 + 100) for next iteration of the test procedure loop.
13. Repeat step 2-12 until the confidence level according to Tables G.2.3-1 in Annex G clause G.2 is achieved.

#### 6.3.1.6.4.3 Message contents

**Table 6.3.1.6.4.3-1: RRCReconfiguration (Step 3)**

Derivation Path: TS 38.508-1 [14] Table 4.6.1-13 with condition NR_MEAS			
Information Element	Value/remark	Comment	Condition
RRCReconfiguration ::= SEQUENCE {			
criticalExtensions CHOICE {			
rrcReconfiguration SEQUENCE {			
measConfig	MeasConfig	Table 6.3.1.6.4.3-2	
}			
}			
}			



**Table 6.3.1.6.4.3-2: MeasConfig (Table 6.3.1.6.4.3-1)**

Derivation Path: Table H.3.1-2 with condition INTER-RAT and GAP NEEDED			
Information Element	Value/remark	Comment	Condition
MeasConfig ::= SEQUENCE {			
measObjectToAddModList SEQUENCE (SIZE (1..maxNrofMeasId)) OF MeasObjectToAddMod {	2 entries		
MeasObjectToAddMod[1] SEQUENCE {		entry 1	
measObjectId	1		
measObject CHOICE {			
measObjectNR	MeasObjectNR-DEFAULT specified in Table H.3.1-3 with condition INTRA-FREQ MO		
}			
}			
MeasObjectToAddMod[2] SEQUENCE {		entry 2	
measObjectId	2		
measObject CHOICE {			
measObjectUTRA-FDD-r16	MeasObjectUTRA-FDD	Table 6.3.1.6.4.3-3	
}			
}			
reportConfigToAddModList SEQUENCE (SIZE (1..maxReportConfigId)) OF ReportConfigToAddMod {	1 entry		
ReportConfigToAddMod[1] SEQUENCE {		entry 1	
reportConfigId	1		
reportConfig CHOICE {			
reportConfigInterRAT	ReportConfigInterRAT(13, 60) specified in 38.508-1 [14] Table 4.6.3-141 with condition EVENT_B2_UTRA	Actual value of thresholds are:  UTRA threshold = (13-49)/2 = -18dB NR threshold = 60-156 = -96dBm	6.6.1.6-1, 6.6.1.6-2
}	ReportConfigInterRAT(13, 63) specified in 38.508-1 [14] Table 4.6.3-141 with condition EVENT_B2_UTRA	Actual value of thresholds are:  UTRA threshold = (13-49)/2 = -18dB NR threshold = 63-156 = -93dBm	6.6.1.6-3
}			
}			
measGapConfig	MeasGapConfig specified in Table H.3.1-6 with condition gapUE and Pattern #0		
}			

**Table 6.3.1.6.4.3-3: MeasObjectUTRA-FDD (Table 6.3.1.6.4.3-2)**

Derivation Path: TS 38.508-1 [14], Table 4.6.3-77A			
Information Element	Value/remark	Comment	Condition
MeasObjectUTRA-FDD-r16 ::= SEQUENCE {			
carrierFreq-r16	ARFCN-ValueUTRA-FDD-r16 for UTRA Cell 2		
}			

**Table 6.3.1.6.4.3-4: MeasurementReport (Step 6)**

Derivation Path: TS 38.508-1 [14], Table 4.6.1-5A			
Information Element	Value/remark	Comment	Condition
MeasurementReport ::= SEQUENCE {			
criticalExtensions CHOICE {			
measurementReport SEQUENCE {			
measResults	MeasResults	Table 6.3.1.6.4.3-5	
}			
}			
}			

**Table 6.3.1.6.4.3-5: MeasResults (Table 6.3.1.6.4.3-4)**

Derivation Path: TS 38.508-1 [14] Table 4.6.3-79 with condition B2_UTRA			
Information Element	Value/remark	Comment	Condition
MeasResults ::= SEQUENCE {			
measResultNeighCells CHOICE {			
measResultListUTRA-FDD-r16 SEQUENCE (SIZE (1..maxCellReport)) OF MeasResultUTRA-FDD-r16 {	1 entry		
MeasResultUTRA-FDD-r16[1] SEQUENCE {		entry 1	
physCellId-r16	PhysCellIdUTRA-FDD-r16 of UTRA Cell 2		
measResult-r16 SEQUENCE {			
utra-FDD-EcN0-r16	INTEGER (0..49)		
}			
}			
}			
}			

**Table 6.3.1.6.4.3-6: MobilityFromNRCommand (Step 7)**

Derivation Path: TS 38.508-1 [14] Table 4.6.1-8 with condition HO-TO-UTRA_FDD
---

### 6.3.1.6.5 Test requirement

Tables 6.3.1.6.5-1 and 6.3.1.6.5-2 define the primary level settings including test tolerances for intra frequency NR cell re-selection test case.

**Table 6.3.1.6.5-1: Cell specific test parameters for SA inter-RAT UTRAN FDD handover (Cell 1)**

Parameter	Unit	Configuration	Cell 1		
			T1	T2	T3
RF channel number		1, 2, 3	1		
Duplex mode		1	FDD		
		2, 3	TDD		
TDD Configuration		2	TDDConf.1.1		
		3	TDDConf.2.1		
BW <sub>channel</sub>	MHz	1	10: N <sub>RB,c</sub> = 52 (FDD)		
		2	10: N <sub>RB,c</sub> = 52 (TDD)		
		3	40: N <sub>RB,c</sub> = 106 (TDD)		
PDSCH reference measurement channel		1	SR.1.1 FDD		
		2	SR.1.1 TDD		
		3	SR.2.1 TDD		
CORSET reference channel		1	CR.1.1 FDD		
		2	CR.1.1 TDD		
		3	CR.2.1 TDD		
TRS configuration		1	TRS.1.1 FDD		
		2	TRS.1.1 TDD		
		3	TRS.1.2 TDD		

Parameter	Unit	Configuration	Cell 1		
			T1	T2	T3
OCNG pattern <sup>Note1</sup>		1, 2, 3	OP.1		
BWP	Initial DL BWP	1, 2, 3	DLBWP.0.1		
	Dedicated DL BWP		DLBWP.1.1		
	Initial UL BWP		ULBWP.0.1		
	Dedicated UL BWP		ULBWP.1.1		
SMTC configuration		1, 2, 3	SMTC.1		
SSB configuration		1, 2	SSB.1 FR1		
		3	SSB.2 FR1		
b2-Threshold1	dBm	1, 2	-96		
		3	-93		
EPRE ratio of PSS to SSS	dB	1, 2, 3	0		
EPRE ratio of PBCH_DMRS to SSS					
EPRE ratio of PBCH to PBCH_DMRS					
EPRE ratio of PDCCH_DMRS to SSS					
EPRE ratio of PDCCH to PDCCH_DMRS					
EPRE ratio of PDSCH_DMRS to SSS					
EPRE ratio of PDSCH to PDSCH_DMRS					
EPRE ratio of OCNG DMRS to SSS					
EPRE ratio of OCNG to OCNG DMRS					
$N_{oc}$ <sup>Note2</sup>					
$N_{oc}$ <sup>Note2</sup>	dBm/SCS	1, 2,	-101.54		
		3	-98.54		
$\bar{E}_s/N_{oc}$	dB	1, 2, 3	12	-4	-4
$\bar{E}_s/I_{ot}$ <sup>Note3</sup>	dB	1, 2, 3	12	-4	-4
SS-RSRP <sup>Note3</sup>	dBm/SCS	1, 2	-89.54	-105.54	-105.54
		3	-86.54	-102.54	-102.54
$I_o$ <sup>Note3</sup>	dBm/9.36 MHz	1, 2	-61.32	-72.13	-72.13
	dBm/38.16 MHz	3	-55.22	-66.03	-66.03
Propagation condition		1, 2, 3	AWGN		
Antenna Configuration and Correlation Matrix		1, 2, 3	1x2 Low		
<p>Note 1: OCNG shall be used such that both cells are fully allocated and a constant total transmitted power spectral density is achieved for all OFDM symbols.</p> <p>Note 2: Interference from other cells and noise sources not specified in the test is assumed to be constant over subcarriers and time and shall be modelled as AWGN of appropriate power for <math>N_{oc}</math> to be fulfilled.</p> <p>Note 3: <math>\bar{E}_s/I_{ot}</math>, SS-RSRP, and <math>I_o</math> levels have been derived from other parameters for information purposes. They are not settable parameters themselves.</p>					

**Table 6.3.1.6.5-2: Cell specific test parameters for SA inter-RAT UTRAN FDD handover (Cell 2)**

Parameter	Unit	Cell 2 (UTRA)		
		T1	T2	T3
UTRA RF Channel Number		2		
CPICH_Ec/I <sub>or</sub>	dB	-10		
PCCPCH_Ec/I <sub>or</sub>	dB	-12		
SCH_Ec/I <sub>or</sub>	dB	-12		
PICH_Ec/I <sub>or</sub>	dB	-15		
DCH_Ec/I <sub>or</sub>	dB	N/A	N/A	Note 1
OCNS_Ec/I <sub>or</sub>	dB	-0.941	0.941	Note 2
$\hat{I}_{or} / I_{oc}$	dB	-infinity	-1.8	-1.8
$I_{oc}$	dBm/3,84 MHz	-70	-70	-70
CPICH_Ec/I <sub>o</sub>	dB	-infinity	-14	-14
Propagation Condition		AWGN		
Note 1: The DPCH level is controlled by the power control loop				
Note 2: The power of the OCNS channel that is added shall make the total power from the cell to be equal to I <sub>or</sub> .				

The UE shall start to transmit the UL DPCH to Cell 2 less than 190 ms from the beginning of time period T3.

The rate of correct handovers observed during repeated tests shall be at least 90%.

NOTE: The handover delay can be expressed as: RRC procedure delay + T<sub>interrupt</sub>, where:

RRC procedure delay = 50 ms, which is specified in clause 5.3.1.1.1.

T<sub>interrupt</sub> = 140 ms in the test; T<sub>interrupt</sub> is defined in clause 5.3.1.1.2. This gives a total of 190 ms.

### 6.3.1.7 NR SA FR1 synchronous DAPS handover

#### 6.3.1.7.1 Test purpose

To verify the requirement for the NR FR1-NR FR1 intra frequency DAPS handover requirements in synchronous scenario specified in clause 38.133 [6] clause 6.1.3.2.

#### 6.3.1.7.2 Test applicability

This test applies to all types of NR UE from Release 16 onwards and support intra-frequency DAPS handover.

#### 6.3.1.7.3 Minimum conformance requirements

The minimum conformance requirements are specified in clause 6.3.1.0.4.

The normative reference for this requirement is TS 38.133 [6] clause A.6.3.1.7.

#### 6.3.1.7.4 Test description

##### 6.3.1.7.4.1 Initial conditions

Initial conditions are a set of test configurations the UE needs to be tested in and the steps for the SS to take with the UE to reach the correct measurement state.

This test shall be tested using any of the test configurations in Table 6.3.1.7.4.1-1.

**Table 6.3.1.7.4.1-1: NR SA FR1 synchronous DAPS handover test configurations**

Config	Description
6.3.1.7-1	Source cell: NR 15 kHz SSB SCS, 10 MHz bandwidth, FDD duplex mode Target cell: NR 15 kHz SSB SCS, 10 MHz bandwidth, FDD duplex mode
6.3.1.7-2	Source cell: NR 15 kHz SSB SCS, 10 MHz bandwidth, TDD duplex mode Target cell: NR 15 kHz SSB SCS, 10 MHz bandwidth, TDD duplex mode
6.3.1.7-3	Source cell: NR 30 kHz SSB SCS, 40 MHz bandwidth, TDD duplex mode Target cell: NR 30 kHz SSB SCS, 40 MHz bandwidth, TDD duplex mode
Note:	The UE is only required to be tested in one of the supported test configurations

Configure the test equipment and the DUT according to the parameters in Table 6.3.1.7.4.1-2

**Table 6.3.1.7.4.1-2: Initial conditions for NR SA FR1 synchronous DAPS handover**

Parameter	Value	Comment
Test environment	NC	As specified in TS 38.508-1 [14] clause 4.1.
Test frequencies	As specified in Annex E, Table E.4-1 and TS 38.508-1 [14] clause 4.3.1.	
Channel bandwidth	As specified by the test configuration selected from Table 6.3.1.7.4.1-1	
Propagation conditions	AWGN	As specified in Annex C.2.2.
Connection Diagram	TE Part	A.3.1.8.2
	DUT Part	A.3.2.3.4
Exceptions to connection diagram	N/A	

1. Message contents are defined in clause 6.3.1.7.4.3.
2. The power levels and settings for NR Cell 1 are set according to Annex C.1.2 and C.1.3. Cell 2 is NR FR1 target Cell, and its power levels and settings are also set according to Annex C.1.2 and C.1.3.
3. The test parameters are given in Table 6.3.1.7.4.1-3 below, with A3-Offset modified by Test Tolerance.

**Table 6.3.1.7.4.1-3: General test parameters for NR SA FR1 synchronous DAPS handover**

Parameter	Unit	Value	Comment
Initial conditions	Active cell	Cell 1	
	Neighbouring cell	Cell 2	
Final condition	Active cell	Cell 2	
A3-Offset	dB	-1	
Hysteresis	dB	0	
Time To Trigger	s	0	
Filter coefficient		0	L3 filtering is not used
Access Barring Information	-	Not Sent	No additional delays in random access procedure.
Time offset between cells		3 $\mu$ s	Synchronous cells
T1	s	5	
T2	s	$\leq 5$	
T3	s	1	
T4	ms	$D_{\text{handover}2}$	$D_{\text{Handover}2}$ is defined in TS 38.133 [6] clause 6.1.3.2.1
T5	ms	100	

#### 6.3.1.7.4.2 Test procedure

The test scenario comprises of 1 NR carrier and two cells, Cell 1 and Cell 2, on this carrier. General parameters and Cell-specific parameters for Cell 1 and Cell 2 are given in Table 6.3.1.7.4.1-3 and 6.3.1.7.5-1 respectively. No measurement gap is configured in the test case. Both Cell 1 and Cell 2 belong to the same TAG.

The test consists of five successive time periods, with time durations of T1, T2, T3, T4 and T5 respectively.

Before the start of T1, the UE is connected to the Cell 1 and not aware of the Cell 2. During T1, the UE does not have any timing information of the Cell 2.

From start of T2, the Cell 2 becomes detectable. During T2, the UE performs cell detection and measurements on the Cell 2 and shall send event report to the network. After receiving the event report A3, the network sends a RRC message implying DAPS handover command for target cell addition to the UE.

T3 starts from the instant when the last TTI containing DAPS handover command for target cell addition sent to the UE. During T3, UE shall be able to perform random access, DL reception or UL transmission in the Cell 2 while the DL scheduling and UL feedback in the Cell 1 shall be avoided. After successful RACH procedure on the Cell 2, UE is scheduled with PDSCH from Cell 1 and Cell 2 in alternative TTIs. In the end of T3 the network sends a RRC message implying DAPS handover command for source cell release to the UE. During T3, the handover delay  $D_{\text{handover}1}$  for target cell addition need to be verified.

T4 starts from the instant when the last TTI containing DAPS handover command for source cell release sent to the UE. During T4, the UE shall accomplish the release actions within  $D_{\text{handover}2}$

From start of T5, the UE shall stop sending periodical CSI report on Cell 1.

1. Ensure the UE is in State RRC\_CONNECTED with generic procedure parameters Connectivity NR, Connected without release On according to TS 38.508-1 [14] clause 4.5. Establish SRB2 and DRB in the *RRCReconfiguration message*. Cell 1 is the active cell. Set Cell 2 physical cell identity to the initial physical cell identity.
2. Set the parameters according to T1 in Table 6.3.1.7.5-1. Propagation conditions are set according to Annex C clause C.2.2. T1 starts and the SS starts continuously scheduling the UE to perform DL reception in every DL slot on Cell 1 and monitoring corresponding ACK/NACK feedbacks sent by the UE.
3. Set Cell 2 physical cell identity = ((current cell 2 physical cell identity + 1) mod 14 + 2).
4. The SS shall transmit an *RRCReconfiguration* message to configure event A3 triggered measurement reporting on the intra-frequency carrier and periodical CSI reporting on Cell 1.
5. The UE shall transmit an *RRCReconfigurationComplete* message.
6. When T1 expires, the SS shall switch the power setting from T1 to T2 as specified in Table 6.3.1.7.5-1.
7. UE shall transmit a *MeasurementReport* message triggered by Event A3.
8. SS shall transmit an *RRCReconfiguration* with *reconfigurationWithSync* message which reconfiguring DRB as a DAPS radio bearer to the UE, at that instant the SS shall switch the power settings from T2 to T3 as specified in Table 6.3.1.7.5-1. T3 starts and the SS stops scheduling the UE to perform DL reception on Cell 1.
9. If the UE transmits PRACH preamble to Cell 2 within  $D_{\text{handover}1}$  from the beginning of time period T3 then the number of successful tests is increased by one, continue to step 10. Otherwise, the number of failure tests is increased by one, go to step 17. where:
  - $D_{\text{handover}1} = 72$  ms.
10. The UE transmits an *RRCReconfigurationComplete* message on Cell 2.
11. Upon receiving *RRCReconfigurationComplete* message sent by UE, the SS immediately starts scheduling UE to perform DL reception in Cell 1 and Cell 2 in an alternative manner, and monitoring corresponding ACK/NACK feedbacks sent by the UE.
12. Upon T3 expiring, the SS immediately transmit an *RRCReconfiguration* with *daps-SourceRelease-r16 = true* on Cell 2 to the UE. T4 starts.
13. The UE transmits an *RRCReconfigurationComplete* message on Cell 2.
14. When T4 expires, T5 starts.
15. If
  - a) The UE can report ACK/NACK from the first DL reception scheduled on Cell 2 after the beginning of time period T5,

and

b) The UE doesn't send periodical CSI report during entire time period T5.

then the number of successful tests is increased by one. Otherwise, the number of failure tests is increased by one.

16. After T5 expires, the SS sends an *RRCReconfiguration* with *reconfigurationWithSync* to cause UE handover back to Cell 1.

17. If UE is not in state RRC\_CONNECTED with generic procedure parameters Connectivity NR, Connected without release *On* according to TS 38.508-1 [14] clause 4.5 on Cell 1, switch off and on the UE. Then ensure the UE is in State RRC\_CONNECTED with generic procedure parameters Connectivity NR, Connected without release *On* according to TS 38.508-1 [14] clause 4.5 on Cell 1.

18. Repeat steps 2-17 until the confidence level according to Tables G.2.3-1 in Annex G clause G.2 is achieved.

6.3.1.7.4.3 Message contents

Message contents are according to TS 38.508-1 [14] clause 7.3 with the following exceptions:

**Table 6.3.1.7.4.3-1: RRCReconfiguration (Step 4)**

Derivation Path: TS 38.508-1 [14], 4.6.1-13 with condition NR_MEAS			
Information Element	Value/remark	Comment	Condition
RRCReconfiguration ::= SEQUENCE {			
criticalExtensions CHOICE {			
rrcReconfiguration SEQUENCE {			
measConfig	MeasConfig	Table 6.3.1.7.4.3-3	
nonCriticalExtension SEQUENCE {			
masterCellGroup SEQUENCE {			
spCellConfigDedicated	ServingCellConfig	Table 6.3.1.7.4.3-2	
}			
}			
}			
}			
}			

**Table 6.3.1.7.4.3-2: ServingCellConfig (Table 6.3.1.7.4.3-1)**

Derivation Path: TS 38.508-1 [14], Table 4.6.3-167 with condition MEAS			
Information Element	Value/remark	Comment	Condition
ServingCellConfig ::= SEQUENCE {			
csi-MeasConfig	CSI-MeasConfig for RRM Specified in TS 38.508-1 [14] Table 7.3.1-6		
}			

**Table 6.3.1.7.4.3-3: MeasConfig (Table 6.3.1.7.4.3-1)**

Derivation path: Table H.3.1-2			
Information Element	Value/Remark	Comment	Condition
measConfig ::= SEQUENCE {			
reportConfigToAddModList SEQUENCE(SIZE (1..maxReportConfigId)) OF SEQUENCE {	1 entry		
reportConfig[1] CHOICE {			
reportConfigNR	ReportConfigNR(-1) specified in Table H.3.1-4	Actual value of A3-offset is -1dB	
}			
}			
}			

Table 6.3.1.7.4.3-4: MeasurementReport (Step 7)

Derivation Path: TS 38.508-1 [14], Table 4.6.1-5A			
Information Element	Value/remark	Comment	Condition
MeasurementReport ::= SEQUENCE {			
criticalExtensions CHOICE {			
measurementReport SEQUENCE {			
measResults	MeasResults specified in Table H.3.1-7 with condition INTRA-FREQ		
}			
}			
}			

Table 6.3.1.7.4.3-5: RRCReconfiguration (Step 8)

Derivation Path: TS 38.508-1 [4], Table 4.8.1-1A with Condition RBConfig_NoKeyChange			
Information Element	Value/remark	Comment	Condition
RRCReconfiguration ::= SEQUENCE {			
criticalExtensions CHOICE {			
rrcReconfiguration SEQUENCE {			
radioBearerConfig	RadioBearerConfig	Table 6.3.1.7.4.3-6	
nonCriticalExtension SEQUENCE{			
masterCellGroup	CellGroupConfig	Table 6.3.1.7.4.3-7	
}			
}			
}			
}			

Table 6.3.1.7.4.3-6: RadioBearerConfig (Table 6.3.1.7.4.3-5)

Derivation Path: TS 38.508-1 [14], Table 4.6.3-132 with condition DRB1			
Information Element	Value/remark	Comment	Condition
RadioBearerConfig ::= SEQUENCE {			
drb-ToAddModList SEQUENCE (SIZE (1..maxDRB)) OF DRB-ToAddMod {	1 entry		
DRB-ToAddMod[1] SEQUENCE {		entry 1	
drb-Identity	DRB-Identity using condition DRBn	DRB #n is a DRB established before DAPS HO.  Actual value of n is left to TE implementation	
daps-Config-r16	true		
}			
}			
}			



**Table 6.3.1.7.4.3-7: CellGroupConfig (Table 6.3.1.7.4.3-6)**

Derivation Path: TS 38.508-1 [14], Table 4.6.3-19 with condition PCell_change			
Information Element	Value/remark	Comment	Condition
CellGroupConfig ::= SEQUENCE {			
rlc-BearerToAddModList	Not present		
spCellConfig SEQUENCE {			
reconfigurationWithSync SEQUENCE {			
spCellConfigCommon SEQUENCE {			
physCellId	PhysCellId for Cell 2		
}			
}			
}			
}			

**Table 6.3.1.7.4.3-8: RRCReconfiguration (Step 12)**

Derivation Path: TS 38.508-1 [14], Table 4.6.1-13 with condition DAPS_HO_ReleaseSource
--

### 6.3.1.7.5 Test requirements

Table 6.3.1.7.5-1 defines the primary level settings including test tolerances for all tests.

**Table 6.3.1.7.5-1: Cell specific test parameters for NR SA FR1 synchronous DAPS handover**

Parameter		Unit	Cell 1		Cell 2	
			T1	T2 – T5	T1	T2 – T5
NR RF Channel Number			1			
Duplex mode	Config 1		FDD			
	Config 2,3		TDD			
TDD configuration	Config 1		Not Applicable			
	Config 2		TDDConf.1.1			
	Config 3		TDDConf.2.1			
BW <sub>channel</sub>	Config 1	MHz	10: N <sub>RB,c</sub> = 52			
	Config 2		10: N <sub>RB,c</sub> = 52			
	Config 3		40: N <sub>RB,c</sub> = 106			
BWP BW	Config 1	MHz	10: N <sub>RB,c</sub> = 52			
	Config 2		10: N <sub>RB,c</sub> = 52			
	Config 3		40: N <sub>RB,c</sub> = 106			
DRX Cycle		ms	Not Applicable			
PDSCH Reference measurement channel	Config 1		SR.1.1 FDD			
	Config 2		SR.1.1 TDD			
	Config 3		SR.2.1 TDD			
CORESET Reference Channel	Config 1		CR.1.1 FDD			
	Config 2		CR.1.1 TDD			
	Config 3		CR.2.1 TDD			
TRS configuration	Config 1		TRS.1.1 FDD			
	Config 2		TRS.1.1 TDD			
	Config 3		TRS.1.2 TDD			
OCNG Patterns			OP.1			
SMTC Configuration			SMTC.1			
SSB Configuration	Config 1,2		SSB.1 FR1			
	Config 3		SSB.2 FR1			
PDSCH/PDCCH subcarrier spacing	Config 1,2	kHz	15 kHz			
	Config 3		30 kHz			
PUCCH/PUSCH subcarrier spacing	Config 1,2	kHz	15 kHz			
	Config 3		30 kHz			
PRACH configuration			FR1 PRACH configuration 1			
BWP configuration	Initial DL BWP		DLBWP.0.1			
	Dedicated DL BWP		DLBWP.1.1			
	Initial UL BWP		ULBWP.0.1			
	Dedicated UL BWP		ULBWP.1.1			
EPRE ratio of PSS to SSS		dB	0			
EPRE ratio of PBCH DMRS to SSS						
EPRE ratio of PBCH to PBCH DMRS						
EPRE ratio of PDCCH DMRS to SSS						
EPRE ratio of PDCCH to PDCCH DMRS						
EPRE ratio of PDSCH DMRS to SSS						
EPRE ratio of PDSCH to PDSCH						
EPRE ratio of OCNG DMRS to SSS(Note 1)						
EPRE ratio of OCNG to OCNG DMRS (Note 1)						
$N_{oc}^{Note2}$						
$N_{oc}^{Note2}$	Config 1,2	dBm/SCS	-98			
	Config 3		-95			
$\hat{E}_s / I_{ot}$		dB	8	-2.41	-Infinity	1.36
$\hat{E}_s / N_{oc}$		dB	8	8	-Infinity	10
SSB <sub>RP</sub>	Config 1,2	dBm/SCS	-90	-90	-Infinity	-88
	Config 3	dBm/SCS	-87	-87	-Infinity	-85
$I_o^{Note3}$	Config 1,2	dBm/9.36MHz	-61.41	-57.67	-61.41	-57.67

	Config 3	dBm/ 38.16MHz	-55.31	-51.56	-55.31	-51.56
Propagation condition		AWGN				
Note 1:	OCNG shall be used such that both cells are fully allocated and a constant total transmitted power spectral density is achieved for all OFDM symbols.					
Note 2:	Interference from other cells and noise sources not specified in the test is assumed to be constant over subcarriers and time and shall be modelled as AWGN of appropriate power for $N_{oc}$ to be fulfilled.					
Note 3:	lo levels have been derived from other parameters for information purposes. They are not settable parameters themselves.					

The UE shall start to transmit the PRACH to Cell 2 less than  $D_{handover1}$  from the beginning of time period T3. The rate of correct handovers observed during repeated tests shall be at least 90%, where:

$$D_{handover1} = T_{RRC\_procedure} + T_{search} + T_{IU} + T_{processing} + T_{\Delta} + T_{margin}$$

- $T_{RRC\_procedure} = 10$  ms, is the RRC procedure delay specified in 38.331 [13] clause 12;
- $T_{search} = 0$  ms for known target cell, is the time required to search the target cell specified in 38.133 [6] clause 6.1.1.2.2;
- $T_{IU} = 20$  ms, is the interruption uncertainty in acquiring the first available PRACH occasion in the new cell specified in 38.133 [6] clause 6.1.1.2.2.
- $T_{processing} = 20$  ms, is the time for UE processing specified in 38.133 [6] clause 6.1.1.2.2.
- $T_{\Delta} = 20$  ms, is the time for fine time tracking and acquiring full timing information of the target cell specified in 38.133 [6] clause 6.1.1.2.2.
- $T_{margin} = 2$  ms, is the time for SSB post-processing specified in 38.133 [6] clause 6.1.1.2.2.

This gives a total of 72 ms.

After successful RACH to cell 2 and until the start of time period T4, UE shall be able to receive PDSCH alternatively from cell 1 and cell 2. UE is not expected to transmit UL to both cell 1 and cell 2 in the same TTI.

The UE shall release Cell 1 less than  $D_{handover2}$  from the beginning of time period T4, where:

$$D_{handover2} = T_{RRC\_procedure} + T_{interrupt2}$$

- $T_{RRC\_procedure} = 10$  ms, is the RRC procedure delay specified in 38.331 [13] clause 12;
- $T_{interrupt2} = 1$  ms for sync intra-frequency DAPS handover, is the allowed interruption length during  $D_{handover2}$  as in 38.133 [13] clause 6.1.1.2.2;

This gives a total of 11 ms.

UE shall not report CSI to Cell 1 during T5.

### 6.3.1.8 NR SA FR1 asynchronous DAPS handover

#### 6.3.1.8.1 Test purpose

To verify the requirement for the NR FR1-NR FR1 intra-frequency DAPS handover requirements in asynchronous scenario specified in clause 38.133 [6] clause 6.1.3.2.

#### 6.3.1.8.2 Test applicability

This test applies to all types of NR UE from Release 16 onwards and support intra-frequency asynchronous DAPS handover.

#### 6.3.1.8.3 Minimum conformance requirements

The minimum conformance requirements are specified in clause 6.3.1.0.4.

The normative reference for this requirement is TS 38.133 [6] clause A.6.3.1.8.

## 6.3.1.8.4 Test description

## 6.3.1.8.4.1 Initial conditions

Initial conditions are a set of test configurations the UE needs to be tested in and the steps for the SS to take with the UE to reach the correct measurement state.

This test shall be tested using any of the test configurations in Table 6.3.1.8.4.1-1.

**Table 6.3.1.8.4.1-1: NR SA FR1 asynchronous DAPS handover test configurations**

Config	Description
6.3.1.8-1	Source cell: NR 15 kHz SSB SCS, 10 MHz bandwidth, FDD duplex mode Target cell: NR 15 kHz SSB SCS, 10 MHz bandwidth, FDD duplex mode
6.3.1.8-2	Source cell: NR 15 kHz SSB SCS, 10 MHz bandwidth, TDD duplex mode Target cell: NR 15 kHz SSB SCS, 10 MHz bandwidth, TDD duplex mode
6.3.1.8-3	Source cell: NR 30 kHz SSB SCS, 40 MHz bandwidth, TDD duplex mode Target cell: NR 30 kHz SSB SCS, 40 MHz bandwidth, TDD duplex mode
Note:	The UE is only required to be tested in one of the supported test configurations

Configure the test equipment and the DUT according to the parameters in Table 6.3.1.8.4.1-2

**Table 6.3.1.8.4.1-2: Initial conditions for NR SA FR1 asynchronous DAPS handover**

Parameter	Value		Comment
Test environment	NC		As specified in TS 38.508-1 [14] clause 4.1.
Test frequencies	As specified in Annex E, Table E.4-1 and TS 38.508-1 [14] clause 4.3.1.		
Channel bandwidth	As specified by the test configuration selected from Table 6.3.1.8.4.1-1		
Propagation conditions	AWGN		As specified in Annex C.2.2.
Connection Diagram	TE Part	A.3.1.8.2	As specified in TS 38.508-1 [14] Annex A.
	DUT Part	A.3.2.3.4	
Exceptions to connection diagram	N/A		

1. Message contents are defined in clause 6.3.1.8.4.3.
2. The power levels and settings for NR Cell 1 are set according to Annex C.1.2 and C.1.3. Cell 2 is NR FR1 target Cell, and its power levels and settings are also set according to Annex C.1.2 and C.1.3.
3. The test parameters are given in Table 6.3.1.8.4.1-3 below, with A3-Offset modified by Test Tolerance.

**Table 6.3.1.8.4.1-3: General test parameters for NR SA FR1 asynchronous DAPS handover**

Parameter	Unit	Value	Comment
Initial conditions	Active cell	Cell 1	
	Neighbouring cell	Cell 2	
Final condition	Active cell	Cell 2	
A3-Offset	dB	-1	
Hysteresis	dB	0	
Time To Trigger	s	0	
Filter coefficient		0	L3 filtering is not used
Access Barring Information	-	Not Sent	No additional delays in random access procedure.
Time offset between cells		7 $\mu$ s	Asynchronous cells
T1	s	5	
T2	s	$\leq 5$	
T3	s	1	
T4	ms	$D_{\text{handover}2}$	$D_{\text{Handover}2}$ is defined in clause 6.1.3.2.1
T5	ms	100	

#### 6.3.1.8.4.2 Test procedure

Same test procedure as described in section 6.3.1.7.4.2.

#### 6.3.1.8.4.3 Message contents

Same message contents as described in section 6.3.1.7.4.3.

#### 6.3.1.8.5 Test requirements

Table 6.3.1.8.5-1 defines the primary level settings including test tolerances for all tests.

**Table 6.3.1.8.5-1: Cell specific test parameters for NR SA FR1 asynchronous DAPS handover**

Parameter		Unit	Cell 1		Cell 2	
			T1	T2 – T5	T1	T2 – T5
NR RF Channel Number			1			
Duplex mode	Config 1		FDD			
	Config 2,3		TDD			
TDD configuration	Config 1		Not Applicable			
	Config 2		TDDConf.1.1			
	Config 3		TDDConf.2.1			
BW <sub>channel</sub>	Config 1	MHz	10: N <sub>RB,c</sub> = 52			
	Config 2		10: N <sub>RB,c</sub> = 52			
	Config 3		40: N <sub>RB,c</sub> = 106			
BWP BW	Config 1	MHz	10: N <sub>RB,c</sub> = 52			
	Config 2		10: N <sub>RB,c</sub> = 52			
	Config 3		40: N <sub>RB,c</sub> = 106			
DRX Cycle		ms	Not Applicable			
PDSCH Reference measurement channel	Config 1		SR.1.1 FDD			
	Config 2		SR.1.1 TDD			
	Config 3		SR.2.1 TDD			
CORESET Reference Channel	Config 1		CR.1.1 FDD			
	Config 2		CR.1.1 TDD			
	Config 3		CR.2.1 TDD			
TRS configuration	Config 1		TRS.1.1 FDD			
	Config 2		TRS.1.1 TDD			
	Config 3		TRS.1.2 TDD			
OCNG Patterns			OP.1			
SMTC Configuration			SMTC.1			
SSB Configuration	Config 1,2		SSB.1 FR1			
	Config 3		SSB.2 FR1			
PDSCH/PDCCH subcarrier spacing	Config 1,2	kHz	15 kHz			
	Config 3		30 kHz			
PUCCH/PUSCH subcarrier spacing	Config 1,2	kHz	15 kHz			
	Config 3		30 kHz			
PRACH configuration			FR1 PRACH configuration 1			
BWP configuration	Initial DL BWP		DLBWP.0.1			
	Dedicated DL BWP		DLBWP.1.1			
	Initial UL BWP		ULBWP.0.1			
	Dedicated UL BWP		ULBWP.1.1			
EPRE ratio of PSS to SSS		dB	0			
EPRE ratio of PBCH DMRS to SSS						
EPRE ratio of PBCH to PBCH DMRS						
EPRE ratio of PDCCH DMRS to SSS						
EPRE ratio of PDCCH to PDCCH DMRS						
EPRE ratio of PDSCH DMRS to SSS						
EPRE ratio of PDSCH to PDSCH						
EPRE ratio of OCNG DMRS to SSS(Note 1)						
EPRE ratio of OCNG to OCNG DMRS (Note 1)						
N <sub>oc</sub> <sup>Note2</sup>						
N <sub>oc</sub> <sup>Note2</sup>	Config 1,2	dBm/SCS	-98			
	Config 3		-95			
Ê <sub>s</sub> / I <sub>ot</sub>		dB	8	-2.41	-Infinity	1.36
Ê <sub>s</sub> / N <sub>oc</sub>		dB	8	8	-Infinity	10
SSB <sub>RP</sub>	Config 1,2	dBm/SCS	-90	-90	-Infinity	-88
	Config 3	dBm/SCS	-87	-87	-Infinity	-85
I <sub>o</sub> <sup>Note3</sup>	Config 1,2	dBm/ 9.36MHz	-61.41	-57.67	-61.41	-57.67



	Config 3	dBm/ 38.16MHz	-55.31	-51.56	-55.31	-51.56
Propagation condition		AWGN				
Note 1:	OCNG shall be used such that both cells are fully allocated and a constant total transmitted power spectral density is achieved for all OFDM symbols.					
Note 2:	Interference from other cells and noise sources not specified in the test is assumed to be constant over subcarriers and time and shall be modelled as AWGN of appropriate power for $N_{oc}$ to be fulfilled.					
Note 3:	Io levels have been derived from other parameters for information purposes. They are not settable parameters themselves.					

Same test procedure as described in section 6.3.1.7.5 except:

The UE shall release Cell 1 less than  $D_{handover2}$  from the beginning of time period T4, where:

$$D_{handover2} = T_{RRC\_procedure} + T_{interrupt2}$$

- $T_{RRC\_procedure} = 10$  ms, is the RRC procedure delay specified in 38.331 [13] clause 12;
- $T_{interrupt2} = 2$  slots for test configuration 6.3.1.8-1/2 and  $T_{interrupt2} = 3$  slots for test configuration 6.3.1.8-3, is the allowed interruption length during  $D_{handover2}$  as in 38.133 [13] clause 6.1.1.2.2;

This gives a total of 10 ms + 2 slots for test configuration 6.3.1.8-1/2 and 10 ms + 3 slots for test configuration 6.3.1.8-3.

### 6.3.1.9 NR SA FR1 Intra-band inter-frequency synchronous DAPS handover

#### 6.3.1.9.1 Test purpose

To verify the requirement for the NR FR1-NR FR1 intra-band inter-frequency DAPS handover requirements in synchronous scenario specified in clause 38.133 [6] clause 6.1.3.2.

#### 6.3.1.9.2 Test applicability

This test applies to all types of NR UE from Release 16 onwards and support intra-band inter-frequency DAPS handover.

#### 6.3.1.9.3 Minimum conformance requirements

The minimum conformance requirements are specified in clause 6.3.1.0.4.

The normative reference for this requirement is TS 38.133 [6] clause A.6.3.1.9.

#### 6.3.1.9.4 Test description

##### 6.3.1.9.4.1 Initial conditions

Initial conditions are a set of test configurations the UE needs to be tested in and the steps for the SS to take with the UE to reach the correct measurement state.

This test shall be tested using any of the test configurations in Table 6.3.1.9.4.1-1.

**Table 6.3.1.9.4.1-1: NR SA FR1 Intra-band inter-frequency synchronous DAPS handover test configurations**

Config	Description
6.3.1.9-1	Source cell: NR 15 kHz SSB SCS, 10 MHz bandwidth, FDD duplex mode Target cell: NR 15 kHz SSB SCS, 10 MHz bandwidth, FDD duplex mode
6.3.1.9-2	Source cell: NR 15 kHz SSB SCS, 10 MHz bandwidth, TDD duplex mode Target cell: NR 15 kHz SSB SCS, 10 MHz bandwidth, TDD duplex mode
6.3.1.9-3	Source cell: NR 30 kHz SSB SCS, 40 MHz bandwidth, TDD duplex mode Target cell: NR 30 kHz SSB SCS, 40 MHz bandwidth, TDD duplex mode
Note:	The UE is only required to be tested in one of the supported test configurations

Configure the test equipment and the DUT according to the parameters in Table 6.3.1.9.4.1-2

**Table 6.3.1.9.4.1-2: Initial conditions for NR SA FR1 Intra-band inter-frequency synchronous DAPS handover**

Parameter	Value		Comment
Test environment	NC		As specified in TS 38.508-1 [14] clause 4.1.
Test frequencies	As specified in Annex E, Table E.4-1 and TS 38.508-1 [14] clause 4.3.1.		
Channel bandwidth	As specified by the test configuration selected from Table 6.3.1.9.4.1-1		
Propagation conditions	AWGN		As specified in Annex C.2.2.
Connection Diagram	TE Part	A.3.1.8.2	As specified in TS 38.508-1 [14] Annex A.
	DUT Part	A.3.2.3.4	
Exceptions to connection diagram	N/A		

1. Message contents are defined in clause 6.3.1.9.4.3.
2. The power levels and settings for NR Cell 1 are set according to Annex C.1.2 and C.1.3. Cell 2 is NR FR1 target Cell, and its power levels and settings are also set according to Annex C.1.2 and C.1.3.
3. The test parameters are given in Table 6.3.1.9.4.1-3 below, with A3-Offset modified by Test Tolerance.

**Table 6.3.1.9.4.1-3: General test parameters for NR SA FR1 Intra-band inter-frequency synchronous DAPS handover**

Parameter	Unit	Value	Comment
Initial conditions	Active cell	Cell 1	
	Neighbouring cell	Cell 2	
Final condition	Active cell	Cell 2	
A3-Offset	dB	-3	
Hysteresis	dB	0	
Time To Trigger	s	0	
Filter coefficient		0	L3 filtering is not used
Access Barring Information	-	Not Sent	No additional delays in random access procedure.
Time offset between cells		0 $\mu$ s	Synchronous cells
T1	s	5	
T2	s	$\leq 5$	
T3	s	1	
T4	ms	$10 + T_{\text{interrupt}2}$	$T_{\text{interrupt}2}$ is defined in TS 38.133 [6] 6.1.3.2.2 Table 6.1.3.2.2-5
T5	ms	100	

#### 6.3.1.9.4.2 Test procedure

The test scenario comprises of two NR carriers and one cell on each carrier, Cell 1 and Cell 2. General parameters and Cell-specific parameters for Cell 1 and Cell 2 are given in Table 6.3.1.9.4.1-3 and 6.3.1.9.5-1 respectively.

The test consists of five successive time periods, with time durations of T1, T2, T3, T4 and T5 respectively.

Before the start of T1, the UE is connected to the Cell 1 and not aware of the Cell 2. During T1, the UE may not have any timing information of the Cell 2. Gap pattern ID gp0 is configured as specified in 38.133 [6] Table 9.1.2-1 before T2 in the test case.

From start of T2, the Cell 2 becomes detectable. During T2, the UE performs cell detection and measurements on the Cell 2 and shall send event report to the network. After receiving the event report A3, the network sends a RRC message implying DAPS handover command for target cell addition to the UE.

T3 starts from the instant when the last TTI containing DAPS handover command for target cell addition sent to the UE. During T3, UE shall be able to perform random access, DL reception or UL transmission in the Cell 2 while the DL scheduling and UL feedback in the Cell 1 shall be avoided. After successful RACH procedure on the Cell 2, UE is scheduled with PDSCH from Cell 1 and Cell 2 in alternative TTIs. In the end of T3 the network sends a RRC message implying DAPS handover command for source cell release to the UE. During T3, the handover delay  $D_{\text{handover}1}$  for target cell addition need to be verified.

T4 starts from the instant when the last TTI containing DAPS handover command for source cell release sent to the UE. Cell 2 is continuously scheduled in DL during T4. During T4, the UE shall accomplish the release actions within  $D_{\text{handover}2}$

From start of T5, the UE shall stop sending periodical CSI report on Cell 1. And the test system shall observe the periodic reporting of CSI for Cell 1 during T5.

1. Ensure the UE is in State `RRC_CONNECTED` with generic procedure parameters `Connectivity NR`, Connected without release `On` according to TS 38.508-1 [14] clause 4.5. Establish SRB2 and DRB in the RRC Reconfiguration message. Cell 1 is the active cell. Set Cell 2 physical cell identity to the initial physical cell identity.
2. Set the parameters according to T1 in Table 6.3.1.9.5-1. Propagation conditions are set according to Annex C clause C.2.2. T1 starts and the SS starts continuously scheduling the UE to perform DL reception in every DL slot on Cell 1 and monitoring corresponding ACK/NACK feedbacks sent by the UE.
3. Set Cell 2 physical cell identity = ((current cell 2 physical cell identity + 1) mod 14 + 2).
4. The SS shall transmit an `RRCReconfiguration` message to configure event A3 triggered measurement reporting on the intra-band inter-frequency carrier and periodical CSI reporting on Cell 1.
5. The UE shall transmit an `RRCReconfigurationComplete` message.
6. When T1 expires, the SS shall switch the power setting from T1 to T2 as specified in Table 6.3.1.9.5-1.
7. UE shall transmit a `MeasurementReport` message triggered by Event A3.
8. SS shall transmit an `RRCReconfiguration` with `reconfigurationWithSync` message which reconfiguring DRB as a DAPS radio bearer to the UE, at that instant the SS shall switch the power settings from T2 to T3 as specified in Table 6.3.1.9.5-1. T3 starts and the SS stops scheduling the UE to perform DL reception on Cell 1.
9. If the UE transmits PRACH preamble to Cell 2 within  $D_{\text{handover}1}$  from the beginning of time period T3 then the number of successful tests is increased by one, continue to step 10. Otherwise, the number of failure tests is increased by one, go to step 17. where:
  - $D_{\text{handover}1} = 72 \text{ ms}$ .
10. The UE transmits an `RRCReconfigurationComplete` message on Cell 2.
11. Upon receiving `RRCReconfigurationComplete` message sent by UE, the SS immediately starts scheduling UE to perform DL reception in Cell 1 and Cell 2 in an alternative manner, and monitoring corresponding ACK/NACK feedbacks sent by the UE.
12. Upon T3 expiring, the SS immediately transmit an `RRCReconfiguration` with `daps-SourceRelease-r16 = true` on Cell 2 to the UE. T4 starts.
13. The UE transmits an `RRCReconfigurationComplete` message on Cell 2.
14. When T4 expires, T5 starts.
15. If
  - c) The UE can report ACK/NACK from the first DL reception scheduled on Cell 2 after the beginning of time period T5,
 and
  - d) The UE doesn't send periodical CSI report during entire time period T5.
 then the number of successful tests is increased by one. Otherwise, the number of failure tests is increased by one.
16. After T5 expires, the SS sends an `RRCReconfiguration` with `reconfigurationWithSync` to cause UE handover back to Cell 1.

17. If UE is not in state RRC\_CONNECTED with generic procedure parameters Connectivity NR, Connected without release On according to TS 38.508-1 [14] clause 4.5 on Cell 1, switch off and on the UE. Then ensure the UE is in State RRC\_CONNECTED with generic procedure parameters Connectivity NR, Connected without release On according to TS 38.508-1 [14] clause 4.5 on Cell 1. Cell 1 is the active cell.

18. Repeat steps 2-17 until the confidence level according to Tables G.2.3-1 in Annex G clause G.2 is achieved.

6.3.1.9.4.3 Message contents

Message contents are according to TS 38.508-1 [14] clause 7.3 with the following exceptions:

**Table 6.3.1.9.4.3-1: RRCReconfiguration (Step 4)**

Derivation Path: TS 38.508-1 [14], 4.6.1-13 with condition NR_MEAS			
Information Element	Value/remark	Comment	Condition
RRCReconfiguration ::= SEQUENCE {			
criticalExtensions CHOICE {			
rrcReconfiguration SEQUENCE {			
measConfig	MeasConfig	Table 6.3.1.9.4.3-3	
nonCriticalExtension SEQUENCE {			
masterCellGroup SEQUENCE {			
spCellConfigDedicated	ServingCellConfig	Table 6.3.1.9.4.3-2	
}			
}			
}			
}			
}			

**Table 6.3.1.9.4.3-2: ServingCellConfig (Table 6.3.1.9.4.3-1)**

Derivation Path: TS 38.508-1 [14], Table 4.6.3-167 with condition MEAS			
Information Element	Value/remark	Comment	Condition
ServingCellConfig ::= SEQUENCE {			
csi-MeasConfig	CSI-MeasConfig for RRM Specified in TS 38.508-1 [14] Table 7.3.1-6		
}			

**Table 6.3.1.9.4.3-3: MeasConfig (Table 6.3.1.9.4.3-1)**

Derivation path: Table H.3.1-2 with condition INTER-FREQ			
Information Element	Value/Remark	Comment	Condition
measConfig ::= SEQUENCE {			
reportConfigToAddModList SEQUENCE(SIZE (1..maxReportConfigId)) OF SEQUENCE {	1 entry		
reportConfig[1] CHOICE {			
reportConfigNR	ReportConfigNR(-3) specified in Table H.3.1-4	Actual value of A3-threshold is -3 dBm	
}			
}			
}			

**Table 6.3.1.9.4.3-4: MeasurementReport (Step 7)**

Derivation Path: TS 38.508-1 [14], Table 4.6.1-5A			
Information Element	Value/remark	Comment	Condition
MeasurementReport ::= SEQUENCE {			
criticalExtensions CHOICE {			
measurementReport SEQUENCE {			
measResults	MeasResults specified in Table H.3.1-7 with condition INTER-FREQ		
}			
}			
}			

**Table 6.3.1.9.4.3-5: RRCReconfiguration (Step 8)**

Derivation Path: TS 38.508-1 [4], Table 4.8.1-1A with Condition RBConfig_NoKeyChange			
Information Element	Value/remark	Comment	Condition
RRCReconfiguration ::= SEQUENCE {			
criticalExtensions CHOICE {			
rrcReconfiguration SEQUENCE {			
radioBearerConfig	RadioBearerConfig	Table 6.3.1.9.4.3-6	
nonCriticalExtension SEQUENCE{			
masterCellGroup	CellGroupConfig	Table 6.3.1.9.4.3-7	
}			
}			
}			
}			

**Table 6.3.1.9.4.3-6: RadioBearerConfig (Table 6.3.1.9.4.3-5)**

Derivation Path: TS 38.508-1 [14], Table 4.6.3-132 with condition DRB1			
Information Element	Value/remark	Comment	Condition
RadioBearerConfig ::= SEQUENCE {			
drb-ToAddModList SEQUENCE (SIZE (1..maxDRB)) OF DRB-ToAddMod {	1 entry		
DRB-ToAddMod[1] SEQUENCE {		entry 1	
drb-Identity	DRB-Identity using condition DRBn	DRB #n is a DRB established before DAPS HO.  Actual value of n is left to TE implementation	
daps-Config-r16	true		
}			
}			
}			

**Table 6.3.1.9.4.3-7: CellGroupConfig (Table 6.3.1.9.4.3-5)**

Derivation Path: TS 38.508-1 [14], Table 4.6.3-19 with condition PCell_change			
Information Element	Value/remark	Comment	Condition
CellGroupConfig ::= SEQUENCE {			
rlc-BearerToAddModList	Not present		
spCellConfig SEQUENCE {			
reconfigurationWithSync SEQUENCE {			
spCellConfigCommon SEQUENCE {			
physCellId	PhysCellId for Cell 2		
}			
}			
}			
}			

**Table 6.3.1.9.4.3-8: RRCReconfiguration (Step 12)**

Derivation Path: TS 38.508-1 [14], Table 4.6.1-13 with condition DAPS_HO_ReleaseSource
--

### 6.3.1.9.5 Test requirements

Table 6.3.1.9.5-1 defines the primary level settings including test tolerances for all tests.

**Table 6.3.1.9.5-1: Cell specific test parameters for NR SA FR1 Intra-band inter-frequency synchronous DAPS handover**

Parameter		Unit	Cell 1					Cell 2				
			T1	T2	T3	T4	T5	T1	T2	T3	T4	T5
NR RF Channel Number			1					2				
Duplex mode	Config 1		FDD									
	Config 2,3		TDD									
TDD configuration	Config 1		Not Applicable									
	Config 2		TDDConf.1.1									
	Config 3		TDDConf.2.1									
BW <sub>channel</sub>	Config 1	MHz	10: N <sub>RB,c</sub> = 52									
	Config 2		10: N <sub>RB,c</sub> = 52									
	Config 3		40: N <sub>RB,c</sub> = 106									
BWP BW	Config 1	MHz	10: N <sub>RB,c</sub> = 52									
	Config 2		10: N <sub>RB,c</sub> = 52									
	Config 3		40: N <sub>RB,c</sub> = 106									
DRX Cycle		ms	Not Applicable									
PDSCH Reference measurement channel	Config 1		SR.1.1 FDD									
	Config 2		SR.1.1 TDD									
	Config 3		SR.2.1 TDD									
CORESET Reference Channel	Config 1		CR.1.1 FDD									
	Config 2		CR.1.1 TDD									
	Config 3		CR.2.1 TDD									
TRS configuration	Config 1		TRS.1.1 FDD									
	Config 2		TRS.1.1 TDD									
	Config 3		TRS.1.2 TDD									
OCNG Patterns			OP.1									
SMTC Configuration			SMTC.1									
SSB Configuration	Config 1,2		SSB.1 FR1									
	Config 3		SSB.2 FR1									
PDSCH/PDCCH subcarrier spacing	Config 1,2	kHz	15 kHz									
	Config 3		30 kHz									
PUCCH/PUSCH subcarrier spacing	Config 1,2	kHz	15 kHz									
	Config 3		30 kHz									
PRACH configuration			FR1 PRACH configuration 1									
BWP configuration	Initial DL BWP		DLBWP.0.1									
	Dedicated DL BWP		DLBWP.1.1									
	Initial UL BWP		ULBWP.0.1									
	Dedicated UL BWP		ULBWP.1.1									
EPRE ratio of PSS to SSS		dB	0									
EPRE ratio of PBCH DMRS to SSS												
EPRE ratio of PBCH to PBCH DMRS												
EPRE ratio of PDCCH DMRS to SSS												
EPRE ratio of PDCCH to PDCCH DMRS												
EPRE ratio of PDSCH DMRS to SSS												
EPRE ratio of PDSCH to PDSCH												



EPRE ratio of OCNG DMRS to SSS(Note 1)						
EPRE ratio of OCNG to OCNG DMRS (Note 1)						
$N_{oc}^{Note2}$		dBm/15kHz	-98			
$N_{oc}^{Note2}$	Config 1,2	dBm/SCS	-98			
	Config 3		-95			
$\hat{E}_s / I_{ot}$		dB	8	8	- Infinity	11.7
$\hat{E}_s / N_{oc}$		dB	8	8	- Infinity	11.7
SSB_RP	Config 1,2	dBm/SCS	-90	-90	- Infinity	-86.3
	Config 3	dBm/SCS	- 86.99	-86.99	- Infinity	-83.29
$I_o^{Note3}$	Config 1,2	dBm/ 9.36MHz	- 61.41	-61.41	-70.05	-58.06
	Config 3	dBm/ 38.16MHz	- 55.31	-55.31	-63.94	-51.96
Propagation condition			AWGN			
<p>Note 1: OCNG shall be used such that both cells are fully allocated and a constant total transmitted power spectral density is achieved for all OFDM symbols.</p> <p>Note 2: Interference from other cells and noise sources not specified in the test is assumed to be constant over subcarriers and time and shall be modelled as AWGN of appropriate power for <math>N_{oc}</math> to be fulfilled.</p> <p>Note 3: <math>I_o</math> levels have been derived from other parameters for information purposes. They are not settable parameters themselves.</p>						

The UE shall start to transmit the PRACH to Cell 2 less than  $D_{handover1}$  from the beginning of time period T3. The rate of correct handovers observed during repeated tests shall be at least 90%, where:

$$D_{handover1} = T_{RRC\_procedure} + T_{search} + T_{IU} + T_{processing} + T_{\Delta} + T_{margin}$$

- $T_{RRC\_procedure} = 10$  ms, is the RRC procedure delay specified in 38.331 [13] clause 12;
- $T_{search} = 0$  ms for known target cell, is the time required to search the target cell specified in 38.133 [6] clause 6.1.1.2.2;
- $T_{IU} = 20$  ms, is the interruption uncertainty in acquiring the first available PRACH occasion in the new cell specified in 38.133 [6] clause 6.1.1.2.2.
- $T_{processing} = 20$  ms, is the time for UE processing specified in 38.133 [6] clause 6.1.1.2.2.
- $T_{\Delta} = 20$  ms, is the time for fine time tracking and acquiring full timing information of the target cell specified in 38.133 [6] clause 6.1.1.2.2.
- $T_{margin} = 2$  ms, is the time for SSB post-processing specified in 38.133 [6] clause 6.1.1.2.2.

This gives a total of 72 ms.

During T3 UE is allowed to cause  $T_{interrupt1}$  interruption to cell 1.  $T_{interrupt1}$  is defined in 38.133 [6] clause 6.1.3.2.2 Table 6.1.3.2.2-2. When UE is transmitting PRACH preamble to cell 2, interruption to cell 1 is allowed.

During T4 UE is allowed to cause  $T_{interrupt2}$  interruption to cell 1.  $T_{interrupt2}$  is defined in 38.133 [6] clause 6.1.3.2.2 Table 6.1.3.2.2-6.

UE shall finish cell 1 release in T4 and shall not send any CSI reports to cell 1 during T5.

### 6.3.1.10 NR SA FR1 Intra-band inter-frequency asynchronous DAPS handover

#### 6.3.1.10.1 Test purpose

To verify the requirement for the NR FR1-NR FR1 intra-band inter-frequency DAPS handover requirements in asynchronous scenario specified in clause 38.133 [6] clause 6.1.3.2.

#### 6.3.1.10.2 Test applicability

This test applies to all types of NR UE from Release 16 onwards and support intra-band inter-frequency DAPS handover.

### 6.3.1.10.3 Minimum conformance requirements

The minimum conformance requirements are specified in clause 6.3.1.0.4.

The normative reference for this requirement is TS 38.133 [6] clause A.6.3.1.10.

### 6.3.1.10.4 Test description

#### 6.3.1.10.4.1 Initial conditions

Initial conditions are a set of test configurations the UE needs to be tested in and the steps for the SS to take with the UE to reach the correct measurement state.

This test shall be tested using any of the test configurations in Table 6.3.1.10.4.1-1.

**Table 6.3.1.10.4.1-1: NR SA FR1 Intra-band inter-frequency asynchronous DAPS handover test configurations**

Config	Description
6.3.1.10-1	Source cell: NR 15 kHz SSB SCS, 10 MHz bandwidth, FDD duplex mode Target cell: NR 15 kHz SSB SCS, 10 MHz bandwidth, FDD duplex mode
Note: The UE is only required to be tested in one of the supported test configurations	

Configure the test equipment and the DUT according to the parameters in Table 6.3.1.10.4.1-2

**Table 6.3.1.10.4.1-2: Initial conditions for NR SA FR1 Intra-band inter-frequency asynchronous DAPS handover**

Parameter	Value		Comment
Test environment	NC		As specified in TS 38.508-1 [14] clause 4.1.
Test frequencies	As specified in Annex E, Table E.4-1 and TS 38.508-1 [14] clause 4.3.1.		
Channel bandwidth	As specified by the test configuration selected from Table 6.3.1.10.4.1-1		
Propagation conditions	AWGN		As specified in Annex C.2.2.
Connection Diagram	TE Part	A.3.1.8.2	As specified in TS 38.508-1 [14] Annex A.
	DUT Part	A.3.2.3.4	
Exceptions to connection diagram	N/A		

1. Message contents are defined in clause 6.3.1.10.4.3.
2. The power levels and settings for NR Cell 1 are set according to Annex C.1.2 and C.1.3. Cell 2 is NR FR1 target Cell, and its power levels and settings are also set according to Annex C.1.2 and C.1.3.
3. The test parameters are given in Table 6.3.1.10.4.1-3 below, with A3-Offset modified by Test Tolerance.

**Table 6.3.1.10.4.1-3: General test parameters for NR SA FR1 Intra-band inter-frequency asynchronous DAPS handover**

Parameter	Unit	Value	Comment
Initial conditions	Active cell	Cell 1	
	Neighbouring cell	Cell 2	
Final condition	Active cell	Cell 2	
A3-Offset	dB	-3	
Hysteresis	dB	0	
Time To Trigger	s	0	
Filter coefficient		0	L3 filtering is not used
Access Barring Information	-	Not Sent	No additional delays in random access procedure.
Time offset between cells		10 $\mu$ s	Asynchronous cells
T1	s	5	

T2	s	$\leq 5$	
T3	s	1	
T4	ms	$10 + T_{\text{interrupt}2}$	$T_{\text{interrupt}2}$ is defined in TS 38.133 [6] 6.1.3.2.2 Table 6.1.3.2.2-5
T5	ms	100	

#### 6.3.1.10.4.2 Test procedure

The test scenario comprises of two NR carriers and one cell on each carrier, Cell 1 and Cell 2. General parameters and Cell-specific parameters for Cell 1 and Cell 2 are given in Table 6.3.1.10.4.1-3 and 6.3.1.10.5-1 respectively.

The test consists of five successive time periods, with time durations of T1, T2, T3, T4 and T5 respectively.

Before the start of T1, the UE is connected to the Cell 1 and not aware of the Cell 2. During T1, the UE may not have any timing information of the Cell 2. Gap pattern ID gp0 is configured as specified in 38.133 [6] Table 9.1.2-1 before T2 in the test case.

From start of T2, the Cell 2 becomes detectable. During T2, the UE performs cell detection and measurements on the Cell 2 and shall send event report to the network. After receiving the event report A3, the network sends a RRC message implying DAPS handover command for target cell addition to the UE.

T3 starts from the instant when the last TTI containing DAPS handover command for target cell addition sent to the UE. During T3, UE shall be able to perform random access, DL reception or UL transmission in the Cell 2 while the DL scheduling and UL feedback in the Cell 1 shall be avoided. After successful RACH procedure on the Cell 2, UE is scheduled with PDSCH from Cell 1 and Cell 2 in alternative TTIs. In the end of T3 the network sends a RRC message implying DAPS handover command for source cell release to the UE. During T3, the handover delay  $D_{\text{handover}1}$  for target cell addition need to be verified.

T4 starts from the instant when the last TTI containing DAPS handover command for source cell release sent to the UE. During T4, the UE shall accomplish the release actions within  $D_{\text{handover}2}$

From start of T5, the UE shall stop sending periodical CSI report on Cell 1. And the test system shall observe the periodic reporting of CSI for cell 1 during T5.

1. Ensure the UE is in State RRC\_CONNECTED with generic procedure parameters Connectivity NR, Connected without release On according to TS 38.508-1 [14] clause 4.5. Establish SRB2 and DRB in the RRC Reconfiguration message. Cell 1 is the active cell. Set Cell 2 physical cell identity to the initial physical cell identity.
2. Set the parameters according to T1 in Table 6.3.1.10.5-1. Propagation conditions are set according to Annex C clause C.2.2. T1 starts and the SS starts continuously scheduling the UE to perform DL reception in every DL slot on Cell 1 and monitoring corresponding ACK/NACK feedbacks sent by the UE.
3. Set Cell 2 physical cell identity = ((current cell 2 physical cell identity + 1) mod 14 + 2).
4. The SS shall transmit an *RRCReconfiguration* message to configure event A3 triggered measurement reporting on the intra-band inter-frequency carrier and periodical CSI reporting on Cell 1.
5. The UE shall transmit an *RRCReconfigurationComplete* message.
6. When T1 expires, the SS shall switch the power setting from T1 to T2 as specified in Table 6.3.1.10.5-1.
7. UE shall transmit a *MeasurementReport* message triggered by Event A3.
8. SS shall transmit an *RRCReconfiguration* with *reconfigurationWithSync* message which reconfiguring DRB as a DAPS radio bearer to the UE, at that instant the SS shall switch the power settings from T2 to T3 as specified in Table 6.3.1.10.5-1. T3 starts and the SS stops scheduling the UE to perform DL reception on Cell 1.
9. If the UE transmits PRACH preamble to Cell 2 within  $D_{\text{handover}1}$  from the beginning of time period T3 then the number of successful tests is increased by one, continue to step 10. Otherwise, the number of failure tests is increased by one, go to step 17. where:

- $D_{\text{handover}1} = 72$  ms.

10. The UE transmits an *RRCReconfigurationComplete* message on Cell 2.

11. Upon receiving *RRCReconfigurationComplete* message sent by UE, the SS immediately starts scheduling UE to perform DL reception in Cell 1 and Cell 2 in an alternative manner, and monitoring corresponding ACK/NACK feedbacks sent by the UE.
12. Upon T3 expiring, the SS immediately transmit an *RRCReconfiguration* with *daps-SourceRelease-r16 = true* on Cell 2 to the UE. T4 starts.
13. The UE transmits an *RRCReconfigurationComplete* message on Cell 2.
14. When T4 expires, T5 starts.
15. If
  - e) The UE can report ACK/NACK from the first DL reception scheduled on Cell 2 after the beginning of time period T5,
  - and
  - f) The UE doesn't send periodical CSI report during entire time period T5.
 then the number of successful tests is increased by one. Otherwise, the number of failure tests is increased by one.
16. After T5 expires, the SS sends an *RRCReconfiguration* with *reconfigurationWithSync* to cause UE handover back to Cell 1.
17. If UE is not in state RRC\_CONNECTED with generic procedure parameters Connectivity NR, Connected without release On according to TS 38.508-1 [14] clause 4.5 on Cell 1, switch off and on the UE. Then ensure the UE is in State RRC\_CONNECTED with generic procedure parameters Connectivity NR, Connected without release On according to TS 38.508-1 [14] clause 4.5 on Cell 1. Cell 1 is the active cell.
18. Repeat steps 2-17 until the confidence level according to Tables G.2.3-1 in Annex G clause G.2 is achieved.

6.3.1.10.4.3 Message contents

Message contents are according to TS 38.508-1 [14] clause 7.3 with the following exceptions:

**Table 6.3.1.10.4.3-1: RRCReconfiguration (Step 4)**

Derivation Path: TS 38.508-1 [14], 4.6.1-13 with condition NR_MEAS			
Information Element	Value/remark	Comment	Condition
RRCReconfiguration ::= SEQUENCE {			
criticalExtensions CHOICE {			
rrcReconfiguration SEQUENCE {			
measConfig	MeasConfig	Table 6.3.1.10.4.3-3	
nonCriticalExtension SEQUENCE {			
masterCellGroup SEQUENCE {			
spCellConfigDedicated	ServingCellConfig	Table 6.3.1.10.4.3-2	
}			
}			
}			
}			
}			

**Table 6.3.1.10.4.3-2: ServingCellConfig (Table 6.3.1.10.4.3-1)**

Derivation Path: TS 38.508-1 [14], Table 4.6.3-167 with condition MEAS			
Information Element	Value/remark	Comment	Condition
ServingCellConfig ::= SEQUENCE {			
csi-MeasConfig	CSI-MeasConfig for RRM Specified in TS 38.508-1 [14] Table 7.3.1-6		
}			

**Table 6.3.1.10.4.3-3: MeasConfig (Table 6.3.1.10.4.3-1)**

Derivation path: Table H.3.1-2 with condition INTER-FREQ			
Information Element	Value/Remark	Comment	Condition
measConfig ::= SEQUENCE {			
reportConfigToAddModList SEQUENCE(SIZE (1..maxReportConfigId)) OF SEQUENCE {	1 entry		
reportConfig[1] CHOICE {			
reportConfigNR	ReportConfigNR(-3) specified in Table H.3.1-4	Actual value of A3-threshold is -3 dBm	
}			
}			
}			

**Table 6.3.1.10.4.3-4: MeasurementReport (Step 7)**

Derivation Path: TS 38.508-1 [14], Table 4.6.1-5A			
Information Element	Value/remark	Comment	Condition
MeasurementReport ::= SEQUENCE {			
criticalExtensions CHOICE {			
measurementReport SEQUENCE {			
measResults	MeasResults specified in Table H.3.1-7 with condition INTER-FREQ		
}			
}			
}			

**Table 6.3.1.10.4.3-5: RRCReconfiguration (Step 8)**

Derivation Path: TS 38.508-1 [4], Table 4.8.1-1A with Condition RBConfig_NoKeyChange			
Information Element	Value/remark	Comment	Condition
RRCReconfiguration ::= SEQUENCE {			
criticalExtensions CHOICE {			
rrcReconfiguration SEQUENCE {			
radioBearerConfig	RadioBearerConfig	Table 6.3.1.10.4.3-6	
nonCriticalExtension SEQUENCE{			
masterCellGroup	CellGroupConfig	Table 6.3.1.10.4.3-7	
}			
}			
}			
}			

**Table 6.3.1.10.4.3-6: RadioBearerConfig (Table 6.3.1.10.4.3-5)**

Derivation Path: TS 38.508-1 [14], Table 4.6.3-132 with condition DRB1			
Information Element	Value/remark	Comment	Condition
RadioBearerConfig ::= SEQUENCE {			
drb-ToAddModList SEQUENCE (SIZE (1..maxDRB))	1 entry		
OF DRB-ToAddMod {			
DRB-ToAddMod[1] SEQUENCE {		entry 1	
drb-Identity	DRB-Identity using condition DRBn	DRB #n is a DRB established before DAPS HO.  Actual value of n is left to TE implementation	
daps-Config-r16	true		
}			
}			
}			

**Table 6.3.1.10.4.3-7: CellGroupConfig (Table 6.3.1.10.4.3-5)**

Derivation Path: TS 38.508-1 [14], Table 4.6.3-19 with condition PCell_change			
Information Element	Value/remark	Comment	Condition
CellGroupConfig ::= SEQUENCE {			
rlc-BearerToAddModList	Not present		
spCellConfig SEQUENCE {			
reconfigurationWithSync SEQUENCE {			
spCellConfigCommon SEQUENCE {			
physCellId	PhysCellId for Cell 2		
}			
}			
}			
}			

**Table 6.3.1.10.4.3-8: RRCReconfiguration (Step 12)**

Derivation Path: TS 38.508-1 [14], Table 4.6.1-13 with condition DAPS_HO_ReleaseSource			
--	--	--	--

### 6.3.1.10.5 Test requirements

Table 6.3.1.10.5-1 defines the primary level settings including test tolerances for all tests.

**Table 6.3.1.10.5-1: Cell specific test parameters for NR SA FR1 Intra-band inter-frequency asynchronous DAPS handover**

Parameter		Unit	Cell 1					Cell 2				
			T1	T2	T3	T4	T5	T1	T2	T3	T4	T5
NR RF Channel Number			1					2				
Duplex mode	Config 1		FDD									
	Config 2,3		TDD									
TDD configuration	Config 1		Not Applicable									
	Config 2		TDDConf.1.1									
	Config 3		TDDConf.2.1									
BW <sub>channel</sub>	Config 1	MHz	10: N <sub>RB,c</sub> = 52									
	Config 2		10: N <sub>RB,c</sub> = 52									
	Config 3		40: N <sub>RB,c</sub> = 106									
BWP BW	Config 1	MHz	10: N <sub>RB,c</sub> = 52									
	Config 2		10: N <sub>RB,c</sub> = 52									
	Config 3		40: N <sub>RB,c</sub> = 106									
DRX Cycle		ms	Not Applicable									
PDSCH Reference measurement channel	Config 1		SR.1.1 FDD									
	Config 2		SR.1.1 TDD									
	Config 3		SR.2.1 TDD									
CORESET Reference Channel	Config 1		CR.1.1 FDD									
	Config 2		CR.1.1 TDD									
	Config 3		CR.2.1 TDD									
TRS configuration	Config 1		TRS.1.1 FDD									
	Config 2		TRS.1.1 TDD									
	Config 3		TRS.1.2 TDD									
OCNG Patterns			OP.1									
SMTC Configuration			SMTC.1									
SSB Configuration	Config 1,2		SSB.1 FR1									
	Config 3		SSB.2 FR1									
PDSCH/PDCCH subcarrier spacing	Config 1,2	kHz	15 kHz									
	Config 3		30 kHz									
PUCCH/PUSCH subcarrier spacing	Config 1,2	kHz	15 kHz									
	Config 3		30 kHz									
PRACH configuration			FR1 PRACH configuration 1									
BWP configuration	Initial DL BWP		DLBWP.0.1									
	Dedicated DL BWP		DLBWP.1.1									
	Initial UL BWP		ULBWP.0.1									
	Dedicated UL BWP		ULBWP.1.1									
EPRE ratio of PSS to SSS		dB	0									
EPRE ratio of PBCH DMRS to SSS												
EPRE ratio of PBCH to PBCH DMRS												
EPRE ratio of PDCCH DMRS to SSS												
EPRE ratio of PDCCH to PDCCH DMRS												
EPRE ratio of PDSCH DMRS to SSS												
EPRE ratio of PDSCH to PDSCH												

EPRE ratio of OCNG DMRS to SSS(Note 1)						
EPRE ratio of OCNG to OCNG DMRS (Note 1)						
$N_{oc}^{Note2}$		dBm/15kHz	-98			
$N_{oc}^{Note2}$	Config 1,2	dBm/SCS	-98			
	Config 3		-95			
$\hat{E}_s / I_{ot}$		dB	8	8	- Infinity	11.7
$\hat{E}_s / N_{oc}$		dB	8	8	- Infinity	11.7
SSB_RP	Config 1,2	dBm/SCS	-90	-90	- Infinity	-86.3
	Config 3	dBm/SCS	- 86.99	-86.99	- Infinity	-83.29
$I_o^{Note3}$	Config 1,2	dBm/ 9.36MHz	- 61.41	-61.41	-70.05	-58.06
	Config 3	dBm/ 38.16MHz	- 55.31	-55.31	-63.94	-51.96
Propagation condition			AWGN			
<p>Note 1: OCNG shall be used such that both cells are fully allocated and a constant total transmitted power spectral density is achieved for all OFDM symbols.</p> <p>Note 2: Interference from other cells and noise sources not specified in the test is assumed to be constant over subcarriers and time and shall be modelled as AWGN of appropriate power for <math>N_{oc}</math> to be fulfilled.</p> <p>Note 3: <math>I_o</math> levels have been derived from other parameters for information purposes. They are not settable parameters themselves.</p>						

The UE shall start to transmit the PRACH to Cell 2 less than  $D_{handover1}$  from the beginning of time period T3. The rate of correct handovers observed during repeated tests shall be at least 90%, where:

$$D_{handover1} = T_{RRC\_procedure} + T_{search} + T_{IU} + T_{processing} + T_{\Delta} + T_{margin}$$

- $T_{RRC\_procedure} = 10$  ms, is the RRC procedure delay specified in 38.331 [13] clause 12;
- $T_{search} = 0$  ms for known target cell, is the time required to search the target cell specified in 38.133 [6] clause 6.1.1.2.2;
- $T_{IU} = 20$  ms, is the interruption uncertainty in acquiring the first available PRACH occasion in the new cell specified in 38.133 [6] clause 6.1.1.2.2.
- $T_{processing} = 20$  ms, is the time for UE processing specified in 38.133 [6] clause 6.1.1.2.2.
- $T_{\Delta} = 20$  ms, is the time for fine time tracking and acquiring full timing information of the target cell specified in 38.133 [6] clause 6.1.1.2.2.
- $T_{margin} = 2$  ms, is the time for SSB post-processing specified in 38.133 [6] clause 6.1.1.2.2.

This gives a total of 72 ms.

During T3 UE is allowed to cause  $T_{interrupt1}$  interruption to cell 1.  $T_{interrupt1}$  is defined in 38.133 [6] clause 6.1.3.2.2 Table 6.1.3.2.2-2. When UE is transmitting PRACH preamble to cell 2, interruption to cell 1 is allowed.

During T4 UE is allowed to cause  $T_{interrupt2}$  interruption to cell 1.  $T_{interrupt2}$  is defined in 38.133 [6] clause 6.1.3.2.2 Table 6.1.3.2.2-5.

UE shall finish cell 1 release in T4 and shall not send any CSI reports to cell 1 during T5.

### 6.3.1.11 NR SA FR1 Inter-band inter-frequency synchronous DAPS handover

#### 6.3.1.11.1 Test purpose

To verify the requirement for the NR FR1-NR FR1 inter-band inter-frequency DAPS handover requirements in synchronous scenario specified in clause 38.133 [6] clause 6.1.3.2.

#### 6.3.1.11.2 Test applicability



This test applies to all types of NR UE from Release 16 onwards and support inter-band inter-frequency DAPS handover.

### 6.3.1.11.3 Minimum conformance requirements

The minimum conformance requirements are specified in clause 6.3.1.0.4.

The normative reference for this requirement is TS 38.133 [6] clause A.6.3.1.11.

### 6.3.1.11.4 Test description

#### 6.3.1.11.4.1 Initial conditions

Initial conditions are a set of test configurations the UE needs to be tested in and the steps for the SS to take with the UE to reach the correct measurement state.

This test shall be tested using any of the test configurations in Table 6.3.1.11.4.1-1.

**Table 6.3.1.11.4.1-1: NR SA FR1 Inter-band inter-frequency synchronous DAPS handover test configurations**

Config	Description
6.3.1.11-1	Source cell: NR 15 kHz SSB SCS, 10 MHz bandwidth, FDD duplex mode Target cell: NR 15 kHz SSB SCS, 10 MHz bandwidth, FDD duplex mode
6.3.1.11-2	Source cell: NR 15 kHz SSB SCS, 10 MHz bandwidth, TDD duplex mode Target cell: NR 15 kHz SSB SCS, 10 MHz bandwidth, FDD duplex mode
6.3.1.11-3	Source cell: NR 30 kHz SSB SCS, 40 MHz bandwidth, TDD duplex mode Target cell: NR 15 kHz SSB SCS, 10 MHz bandwidth, FDD duplex mode
6.3.1.11-4	Source cell: NR 15 kHz SSB SCS, 10 MHz bandwidth, FDD duplex mode Target cell: NR 15 kHz SSB SCS, 10 MHz bandwidth, TDD duplex mode
6.3.1.11-5	Source cell: NR 15 kHz SSB SCS, 10 MHz bandwidth, TDD duplex mode Target cell: NR 15 kHz SSB SCS, 10 MHz bandwidth, TDD duplex mode
6.3.1.11-6	Source cell: NR 30 kHz SSB SCS, 40 MHz bandwidth, TDD duplex mode Target cell: NR 15 kHz SSB SCS, 10 MHz bandwidth, TDD duplex mode
6.3.1.11-7	Source cell: NR 15 kHz SSB SCS, 10 MHz bandwidth, FDD duplex mode Target cell: NR 30 kHz SSB SCS, 40 MHz bandwidth, TDD duplex mode
6.3.1.11-8	Source cell: NR 15 kHz SSB SCS, 10 MHz bandwidth, TDD duplex mode Target cell: NR 30 kHz SSB SCS, 40 MHz bandwidth, TDD duplex mode
6.3.1.11-9	Source cell: NR 30 kHz SSB SCS, 40 MHz bandwidth, TDD duplex mode Target cell: NR 30 kHz SSB SCS, 40 MHz bandwidth, TDD duplex mode
Note:	The UE is only required to be tested in one of the supported test configurations

Configure the test equipment and the DUT according to the parameters in Table 6.3.1.11.4.1-2

**Table 6.3.1.11.4.1-2: Initial conditions for NR SA FR1 Inter-band inter-frequency synchronous DAPS handover**

Parameter	Value	Comment
Test environment	NC	As specified in TS 38.508-1 [14] clause 4.1.
Test frequencies	As specified in Annex E, Table E.4-1 and TS 38.508-1 [14] clause 4.3.1.	
Channel bandwidth	As specified by the test configuration selected from Table 6.3.1.11.4.1-1	
Propagation conditions	AWGN	As specified in Annex C.2.2.
Connection Diagram	TE Part	A.3.1.8.2
	DUT Part	A.3.2.3.4
Exceptions to connection diagram	N/A	

1. Message contents are defined in clause 6.3.1.11.4.3.
2. The power levels and settings for NR Cell 1 are set according to Annex C.1.2 and C.1.3. Cell 2 is NR FR1 target Cell, and its power levels and settings are also set according to Annex C.1.2 and C.1.3.
3. The test parameters are given in Table 6.3.1.11.4.1-3 below, with A3-Offset modified by Test Tolerance.

**Table 6.3.1.11.4.1-3: General test parameters for NR SA FR1 Inter-band inter-frequency synchronous DAPS handover**

Parameter		Unit	Value	Comment
Initial conditions	Active cell		Cell 1	PCell on RF channel number 1
	Neighbouring cell		Cell 2	Neighbour cell on RF channel number 2
Final condition	Active cell		Cell 2	PCell on RF channel number 2
	Neighbouring cell		Cell 1	Neighbour cell on RF channel number 1
A3-Offset	Config 1,2,4,5,9	dB	-7 (Note 1)	
	Config 3,6	dB	-10 (Note 1)	
	Config 7,8	dB	-4	
Hysteresis		dB	0	
Time To Trigger		s	0	
Filter coefficient			0	L3 filtering is not used
Access Barring Information		-	Not Sent	No additional delays in random access procedure.
Time offset between cells		$\mu$ s	33	Synchronous cells
DRX			OFF	
Measurement gap pattern Id			#0	Gaps are configured before T2.
T1		s	5	
T2		s	<5	
T3		s	<0.5	
T4		ms	$10+T_{\text{interrupt}2}$	$T_{\text{interrupt}2}$ as defined in TS 38.133 [6] Table 6.1.3.2.2-6 for synchronous DAPS HO
T5		ms	100	
Note 1: Including test tolerance given in Annex F.1.3.2				

#### 6.3.1.11.4.2 Test procedure

The test scenario comprises of two NR bands and one cell on each band, Cell 1 and Cell 2. General parameters and Cell-specific parameters for Cell 1 and Cell 2 are given in Table 6.3.1.11.4.1-3, 6.3.1.11.5-1 and 6.3.1.11.5-2 respectively.

The test consists of five successive time periods, with time durations of T1, T2, T3, T4 and T5 respectively.

Before the start of T1, the UE is connected to the Cell 1 and not aware of the Cell 2. During T1, the UE does not have any timing information of the Cell 2. Gap pattern ID gp0 is configured as specified in 38.133 [6] Table 9.1.2-1 before T2 in the test case.

From start of T2, the Cell 2 becomes detectable. During T2, the UE performs cell detection and measurements on the Cell 2 and shall send event report to the network. After receiving the event report A3, the network sends a RRC message implying DAPS handover command for target cell addition to the UE.

T3 starts from the instant when the last TTI containing DAPS handover command for target cell addition sent to the UE. During T3, UE shall be able to perform random access, DL reception or UL transmission in the Cell 2 while the DL scheduling and UL feedback in the Cell 1 shall be avoided. After successful RACH procedure on the Cell 2, UE is scheduled with PDSCH from Cell 1 and Cell 2 in alternative TTIs. In the end of T3 the network sends a RRC message implying DAPS handover command for source cell release to the UE. During T3, the handover delay  $D_{\text{handover}1}$  for target cell addition need to be verified.

T4 starts from the instant when the last TTI containing DAPS handover command for source cell release sent to the UE. During T4, the UE shall accomplish the release actions within  $D_{\text{handover}2}$

From start of T5, the UE shall stop sending periodical CSI report on Cell 1. And the test system shall observe the periodic reporting of CSI for cell 1 during T5.

1. Ensure the UE is in State RRC\_CONNECTED with generic procedure parameters Connectivity NR, Connected without release On according to TS 38.508-1 [14] clause 4.5. Establish SRB2 and DRB in the RRC Reconfiguration message. Cell 1 is the active cell. Set Cell 2 physical cell identity to the initial physical cell identity.

2. Set the parameters according to T1 in Table 6.3.1.11.5-1 and Table 6.3.1.11.5-2. Propagation conditions are set according to Annex C clause C.2.2. T1 starts and the SS starts continuously scheduling the UE to perform DL reception in every DL slot on Cell 1 and monitoring corresponding ACK/NACK feedbacks sent by the UE.
3. Set Cell 2 physical cell identity = ((current cell 2 physical cell identity + 1) mod 14 + 2).
4. The SS shall transmit an *RRCReconfiguration* message to configure event A3 triggered measurement reporting on the inter-band inter-frequency carrier and periodical CSI reporting on Cell 1.
5. The UE shall transmit an *RRCReconfigurationComplete* message.
6. When T1 expires, the SS shall switch the power setting from T1 to T2 as specified in Table 6.3.1.11.5-1 and Table 6.3.1.11.5-2.
7. UE shall transmit a *MeasurementReport* message triggered by Event A3.
8. SS shall transmit an *RRCReconfiguration* with *reconfigurationWithSync* message which reconfiguring DRB as a DAPS radio bearer to the UE, at that instant the SS shall switch the power settings from T2 to T3 as specified in Table 6.3.1.11.5-1 and Table 6.3.1.11.5-2. T3 starts and the SS stops scheduling the UE to perform DL reception on Cell 1.
9. If the UE transmits PRACH preamble to Cell 2 within  $D_{\text{handover1}}$  from the beginning of time period T3 then the number of successful tests is increased by one, continue to step 10. Otherwise, the number of failure tests is increased by one, go to step 17. where:
  - $D_{\text{handover1}} = 72$  ms.
10. The UE transmits an *RRCReconfigurationComplete* message on Cell 2.
11. Upon receiving *RRCReconfigurationComplete* message sent by UE, the SS immediately starts scheduling UE to perform DL reception in Cell 1 and Cell 2 in an alternative manner, and monitoring corresponding ACK/NACK feedbacks sent by the UE.
12. Upon T3 expiring, the SS immediately transmit an *RRCReconfiguration* with *daps-SourceRelease-r16 = true* on Cell 2 to the UE. T4 starts.
13. The UE transmits an *RRCReconfigurationComplete* message on Cell 2.
14. When T4 expires, T5 starts.
15. If
  - g) The UE can report ACK/NACK from the first DL reception scheduled on Cell 2 after the beginning of time period T5,
  - and
  - h) The UE doesn't send periodical CSI report during entire time period T5.
 then the number of successful tests is increased by one. Otherwise, the number of failure tests is increased by one.
16. After T5 expires, the SS sends an *RRCReconfiguration* with *reconfigurationWithSync* to cause UE handover back to Cell 1.
17. If UE is not in state RRC\_CONNECTED with generic procedure parameters Connectivity NR, Connected without release On according to TS 38.508-1 [14] clause 4.5 on Cell 1, switch off and on the UE. Then ensure the UE is in State RRC\_CONNECTED with generic procedure parameters Connectivity NR, Connected without release On according to TS 38.508-1 [14] clause 4.5 on Cell 1. Cell 1 is the active cell.
18. Repeat steps 2-17 until the confidence level according to Tables G.2.3-1 in Annex G clause G.2 is achieved.

#### 6.3.1.11.4.3 Message contents

Message contents are according to TS 38.508-1 [14] clause 7.3 with the following exceptions:

**Table 6.3.1.11.4.3-1: RRCReconfiguration (Step 4)**

Derivation Path: TS 38.508-1 [14], 4.6.1-13 with condition NR_MEAS			
Information Element	Value/remark	Comment	Condition
RRCReconfiguration ::= SEQUENCE {			
criticalExtensions CHOICE {			
rrcReconfiguration SEQUENCE {			
measConfig	MeasConfig	Table 6.3.1.11.4.3-3	
nonCriticalExtension SEQUENCE {			
masterCellGroup SEQUENCE {			
spCellConfigDedicated	ServingCellConfig	Table 6.3.1.11.4.3-2	
}			
}			
}			
}			
}			

**Table 6.3.1.11.4.3-2: ServingCellConfig (Table 6.3.1.11.4.3-1)**

Derivation Path: TS 38.508-1 [14], Table 4.6.3-167 with condition MEAS			
Information Element	Value/remark	Comment	Condition
ServingCellConfig ::= SEQUENCE {			
csi-MeasConfig	CSI-MeasConfig for RRM Specified in TS 38.508-1 [14] Table 7.3.1-6		
}			

**Table 6.3.1.11.4.3-3: MeasConfig (Table 6.3.1.11.4.3-1)**

Derivation path: Table H.3.1-2 with condition INTER-FREQ			
Information Element	Value/Remark	Comment	Condition
measConfig ::= SEQUENCE {			
reportConfigToAddModList SEQUENCE(SIZE (1..maxReportConfigId)) OF SEQUENCE {	1 entry		
reportConfig[1] CHOICE {			
reportConfigNR	ReportConfigNR(-7) specified in Table H.3.1-4	Acutal value of a3-Offset is -7 dB	6.3.1.11-1, 6.3.1.11-2, 6.3.1.11-4, 6.3.1.11-5, 6.3.1.11-9.
	ReportConfigNR(-10) specified in Table H.3.1-4	Acutal value of a3-Offset is -10 dB	6.3.1.11-3, 6.3.1.11-6
	ReportConfigNR(-4) specified in Table H.3.1-4	Acutal value of a3-Offset is -4 dB	6.3.1.11-7, 6.3.1.11-8
}			
}			
}			

**Table 6.3.1.11.4.3-4: MeasurementReport (Step 7)**

Derivation Path: TS 38.508-1 [14], Table 4.6.1-5A			
Information Element	Value/remark	Comment	Condition
MeasurementReport ::= SEQUENCE {			
criticalExtensions CHOICE {			
measurementReport SEQUENCE {			
measResults	MeasResults specified in Table H.3.1-7 with condition INTER-FREQ		
}			
}			
}			

**Table 6.3.1.11.4.3-5: RRCReconfiguration (Step 8)**

Derivation Path: TS 38.508-1 [4], Table 4.8.1-1A with Condition RBConfig_NoKeyChange			
Information Element	Value/remark	Comment	Condition
RRCReconfiguration ::= SEQUENCE {			
criticalExtensions CHOICE {			
rrcReconfiguration SEQUENCE {			
radioBearerConfig	RadioBearerConfig	Table 6.3.1.11.4.3-6	
nonCriticalExtension SEQUENCE{			
masterCellGroup	CellGroupConfig	Table 6.3.1.11.4.3-7	
}			
}			
}			
}			

**Table 6.3.1.11.4.3-6: RadioBearerConfig (Table 6.3.1.11.4.3-5)**

Derivation Path: TS 38.508-1 [14], Table 4.6.3-132 with condition DRB1			
Information Element	Value/remark	Comment	Condition
RadioBearerConfig ::= SEQUENCE {			
drb-ToAddModList SEQUENCE (SIZE (1..maxDRB)) OF DRB-ToAddMod {	1 entry		
DRB-ToAddMod[1] SEQUENCE {		entry 1	
drb-Identity	DRB-Identity using condition DRBn	DRB #n is a DRB established before DAPS HO.  Actual value of n is left to TE implementation	
daps-Config-r16	true		
}			
}			
}			

**Table 6.3.1.11.4.3-7: CellGroupConfig (Table 6.3.1.11.4.3-5)**

Derivation Path: TS 38.508-1 [14], Table 4.6.3-19 with condition PCell_change			
Information Element	Value/remark	Comment	Condition
CellGroupConfig ::= SEQUENCE {			
rlc-BearerToAddModList	Not present		
spCellConfig SEQUENCE {			
reconfigurationWithSync SEQUENCE {			
spCellConfigCommon SEQUENCE {			
physCellId	PhysCellId for Cell 2		
}			
}			
}			
}			

**Table 6.3.1.11.4.3-8: RRCReconfiguration (Step 12)**

Derivation Path: TS 38.508-1 [14], Table 4.6.1-13 with condition DAPS_HO_ReleaseSource
--

6.3.1.11.5 Test requirements

Table 6.3.1.11.5-1, Table 6.3.1.11.5-2 defines the primary level settings including test tolerances for all tests.

**Table 6.3.1.11.5-1: Cell specific test parameters for NR SA FR1 Inter-band inter-frequency synchronous DAPS handover( Cell 1)**

Parameter		Unit	Cell 1				
			T1	T2	T3	T4	T5
NR RF Channel Number			1				
Duplex mode	Config 1,4,7		FDD				
	Config 2,3,5,6,8,9		TDD				
TDD configuration	Config 1,4,7		Not Applicable				
	Config 2,5,8		TDDConf.1.1				
	Config 3,6,9		TDDConf.2.1				
BW <sub>channel</sub>	Config 1,4,7	MHz	10: N <sub>RB,c</sub> = 52				
	Config 2,5,8		10: N <sub>RB,c</sub> = 52				
	Config 3,6,9		40: N <sub>RB,c</sub> = 106				
BWP BW	Config 1,4,7	MHz	10: N <sub>RB,c</sub> = 52				
	Config 2,5,8		10: N <sub>RB,c</sub> = 52				
	Config 3,6,9		40: N <sub>RB,c</sub> = 106				
TRS configuration	Config 1,4,7		TRS.1.1 FDD				
	Config 2,5,8		TRS.1.1 TDD				
	Config 3,6,9		TRS.1.2 TDD				
DRX Cycle		ms	Not Applicable				
PDSCH Reference measurement channel	Config 1,4,7		SR.1.1 FDD				
	Config 2,5,8		SR.1.1 TDD				
	Config 3,6,9		SR2.1 TDD				
CORESET Reference Channel	Config 1,4,7		CR.1.1 FDD				
	Config 2,5,8		CR.1.1 TDD				
	Config 3,6,9		CR2.1 TDD				
OCNG Patterns			OCNG pattern 1				
SMTC Configuration			SMTC pattern 1				
SSB Configuration	Config 1,2,4,5,7,8		SSB.1 FR1				
	Config 3,6,9		SSB.2 FR1				
PDSCH/PDCCH subcarrier spacing	Config 1,2,4,5,7,8	kHz	15 kHz				
	Config 3,6,9		30 kHz				
PUCCH/PUSCH subcarrier spacing	Config 1,2,4,5,7,8	kHz	15 kHz				
	Config 3,6,9		30 kHz				
PRACH configuration			FR1 PRACH configuration 2				
BWP	Initial DL BWP		DLBWP.0.1				
	Dedicated DL BWP		DLBWP.1.3				
	Initial UL BWP		ULBWP.0.1				
	Dedicated UL BWP		ULBWP.1.3				

Parameter		Unit	Cell 1				
			T1	T2	T3	T4	T5
EPRE ratio of PSS to SSS		dB	0				
EPRE ratio of PBCH DMRS to SSS							
EPRE ratio of PBCH to PBCH DMRS							
EPRE ratio of PDCCH DMRS to SSS							
EPRE ratio of PDCCH to PDCCH DMRS							
EPRE ratio of PDSCH DMRS to SSS							
EPRE ratio of PDSCH to PDSCH							
EPRE ratio of OCNG DMRS to SSS(Note 1)							
EPRE ratio of OCNG to OCNG DMRS (Note 1)							
$N_{oc}$ Note2		dBm/15kHz	-98	-98	-98	-98	-98
$N_{oc}$ Note2	Config 1,2,4,5,7,8	dBm/SCS	-98	-98	-98	-98	-98
	Config 3,6,9		-95	-95	-95	-95	-95
$\hat{E}_s / I_{ot}$		dB	4	4	4	4	4
$\hat{E}_s / N_{oc}$		dB	4	4	4	4	4
SSB_RP	Config 1,2,4,5,7,8	dBm/SCS	-94	-94	-94	-94	-94
	Config 3,6,9	dBm/SCS	-91	-91	-91	-91	-91
$I_o$ Note3	Config 1,2,4,5,7,8	dBm/ 9.36MHz	-64.59	-64.59	-64.59	-64.59	-64.59
	Config 3,6,9	dBm/ 38.16MHz	-58.49	-58.49	-58.49	-58.49	-58.49
Propagation condition		-	AWGN				
<p>Note 1: OCNG shall be used such that the cell is fully allocated and a constant total transmitted power spectral density is achieved for all OFDM symbols.</p> <p>Note 2: Interference from other cells and noise sources not specified in the test is assumed to be constant over subcarriers and time and shall be modelled as AWGN of appropriate power for <math>N_{oc}</math> to be fulfilled.</p> <p>Note 3: <math>I_o</math> levels have been derived from other parameters for information purposes. They are not settable parameters themselves.</p>							

**Table 6.3.1.11.5-2: Cell specific test parameters for NR SA FR1 Inter-band inter-frequency synchronous DAPS handover( Cell 2)**

Parameter		Unit	Cell 2				
			T1	T2	T3	T4	T5
NR RF Channel Number			2				
Duplex mode	Config 1,2,3		FDD				
	Config 4,5,6,7,8,9						
TDD configuration	Config 1,2,3		Not Applicable				
	Config 4,5,6						
	Config 7,8,9						
$BW_{channel}$	Config 1,2,3	MHz	10: $N_{RB,c} = 52$				
	Config 4,5,6		10: $N_{RB,c} = 52$				
	Config 7,8,9		40: $N_{RB,c} = 106$				
BWP BW	Config 1,2,3	MHz	10: $N_{RB,c} = 52$				
	Config 4,5,6		10: $N_{RB,c} = 52$				
	Config 7,8,9		40: $N_{RB,c} = 106$				
TRS configuration	Config 1,2,3		TRS.1.1 FDD				
	Config 4,5,6		TRS.1.1 TDD				
	Config 7,8,9		TRS.1.2 TDD				
DRx Cycle		ms	Not Applicable				
PDSCH Reference measurement channel	Config 1,2,3		SR.1.1 FDD				
	Config 4,5,6		SR.1.1 TDD				
	Config 7,8,9		SR2.1 TDD				
CORESET Reference Channel	Config 1,2,3		CR.1.1 FDD				
	Config 4,5,6		CR.1.1 TDD				
	Config 7,8,9		CR2.1 TDD				
OCNG Patterns			OCNG pattern 1				

Parameter		Unit	Cell 2				
			T1	T2	T3	T4	T5
SMTC Configuration			SMTC pattern 1				
SSB Configuration	Config 1,2,3,4,5,6		SSB.1 FR1				
	Config 7,8,9		SSB.2 FR1				
PDSCH/PDCCH subcarrier spacing	Config 1,2,3,4,5,6	kHz	15 kHz				
	Config 7,8,9		30 kHz				
PUCCH/PUSCH subcarrier spacing	Config 1,2,3,4,5,6	kHz	15 kHz				
	Config 7,8,9		30 kHz				
PRACH configuration			FR1 PRACH configuration 2				
BWP	Initial DL BWP		DLBWP.0.1				
	Dedicated DL BWP		DLBWP.1.3				
	Initial UL BWP		ULBWP.0.1				
	Dedicated UL BWP		ULBWP.1.3				
EPRE ratio of PSS to SSS		dB	0				
EPRE ratio of PBCH DMRS to SSS							
EPRE ratio of PBCH to PBCH DMRS							
EPRE ratio of PDCCH DMRS to SSS							
EPRE ratio of PDCCH to PDCCH DMRS							
EPRE ratio of PDSCH DMRS to SSS							
EPRE ratio of PDSCH to PDSCH							
EPRE ratio of OCNG DMRS to SSS(Note 1)							
EPRE ratio of OCNG to OCNG DMRS (Note 1)							
$N_{oc}$ <sup>Note2</sup>							
$N_{oc}$ <sup>Note2</sup>	Config 1,2,3,4,5,6	dBm/SCS	-98	-98	-98	-98	-98
	Config 7,8,9		-95	-95	-95	-95	-95
$\hat{E}_s / I_{ot}$		dB	-Infinity	4	4	4	4
$\hat{E}_s / N_{oc}$		dB	-Infinity	4	4	4	4
SSB_RP	Config 1,2,3,4,5,6	dBm/SCS	-Infinity	-94	-94	-94	-94
	Config 7,8,9	dBm/SCS	-Infinity	-91	-91	-91	-91
$l_o$ <sup>Note3</sup>	Config 1,2,3,4,5,6	dBm/ 9.36MHz	-70.05	-64.59	-64.59	-64.59	-64.59
	Config 7,8,9	dBm/ 38.16MHz	-63.94	-58.49	-58.49	-58.49	-58.49
Propagation condition		-	AWGN				
<p>Note 1: OCNG shall be used such that the cell is fully allocated and a constant total transmitted power spectral density is achieved for all OFDM symbols.</p> <p>Note 2: Interference from other cells and noise sources not specified in the test is assumed to be constant over subcarriers and time and shall be modelled as AWGN of appropriate power for <math>N_{oc}</math> to be fulfilled.</p> <p>Note 3: <math>l_o</math> levels have been derived from other parameters for information purposes. They are not settable parameters themselves.</p>							

The UE shall start to transmit the PRACH to Cell 2 less than  $D_{handover1}$  from the beginning of time period T3. The rate of correct handovers observed during repeated tests shall be at least 90%, where:

$$D_{handover1} = T_{RRC\_procedure} + T_{search} + T_{IU} + T_{processing} + T_{\Delta} + T_{margin}$$

- $T_{RRC\_procedure} = 10$  ms, is the RRC procedure delay specified in 38.331 [13] clause 12;
- $T_{search} = 0$  ms for known target cell, is the time required to search the target cell specified in 38.133 [6] clause 6.1.1.2.2;
- $T_{IU} = 20$  ms, is the interruption uncertainty in acquiring the first available PRACH occasion in the new cell specified in 38.133 [6] clause 6.1.1.2.2.
- $T_{processing} = 20$  ms, is the time for UE processing specified in 38.133 [6] clause 6.1.1.2.2.
- $T_{\Delta} = 20$  ms, is the time for fine time tracking and acquiring full timing information of the target cell specified in 38.133 [6] clause 6.1.1.2.2.
- $T_{margin} = 2$  ms, is the time for SSB post-processing specified in 38.133 [6] clause 6.1.1.2.2.



This gives a total of 72 ms.

The UE shall complete to release Cell 1 less than  $(10 \text{ ms} + T_{\text{interrupt}2})$  from the beginning of time period T4. During  $D_{\text{handover}2}$ , the interruption on Cell 2 shall not exceed  $T_{\text{interrupt}2}$  as defined in TS 38.133 [6] Table 6.1.3.2.2-6 for synchronous DAPS HO.

The handover delay  $D_{\text{handover}2}$  can be expressed as:  $T_{\text{RRC\_procedure}} + T_{\text{interrupt}2}$ , where:

$T_{\text{RRC\_procedure}} = 10 \text{ ms}$  and is specified in clause 12 in TS 38.331 [13].

### 6.3.1.12 NR SA FR1 Inter-band inter-frequency asynchronous DAPS handover

#### 6.3.1.12.1 Test purpose

To verify the requirement for the NR FR1-NR FR1 inter-band inter-frequency DAPS handover requirements in asynchronous scenario specified in clause 38.133 [6] clause 6.1.3.2.

#### 6.3.1.12.2 Test applicability

This test applies to all types of NR UE from Release 16 onwards and support inter-band inter-frequency DAPS handover.

#### 6.3.1.12.3 Minimum conformance requirements

The minimum conformance requirements are specified in clause 6.3.1.0.4.

The normative reference for this requirement is TS 38.133 [6] clause A.6.3.1.12.

#### 6.3.1.12.4 Test description

##### 6.3.1.12.4.1 Initial conditions

Initial conditions are a set of test configurations the UE needs to be tested in and the steps for the SS to take with the UE to reach the correct measurement state.

This test shall be tested using any of the test configurations in Table 6.3.1.12.4.1-1.

**Table 6.3.1.12.4.1-1: NR SA FR1 Inter-band inter-frequency asynchronous DAPS handover test configurations**

Config	Description
6.3.1.12-1	Source cell: NR 15 kHz SSB SCS, 10 MHz bandwidth, FDD duplex mode Target cell: NR 15 kHz SSB SCS, 10 MHz bandwidth, FDD duplex mode
6.3.1.12-2	Source cell: NR 15 kHz SSB SCS, 10 MHz bandwidth, TDD duplex mode Target cell: NR 15 kHz SSB SCS, 10 MHz bandwidth, FDD duplex mode
6.3.1.12-3	Source cell: NR 30 kHz SSB SCS, 40 MHz bandwidth, TDD duplex mode Target cell: NR 15 kHz SSB SCS, 10 MHz bandwidth, FDD duplex mode
6.3.1.12-4	Source cell: NR 15 kHz SSB SCS, 10 MHz bandwidth, FDD duplex mode Target cell: NR 15 kHz SSB SCS, 10 MHz bandwidth, TDD duplex mode
6.3.1.12-5	Source cell: NR 15 kHz SSB SCS, 10 MHz bandwidth, TDD duplex mode Target cell: NR 15 kHz SSB SCS, 10 MHz bandwidth, TDD duplex mode
6.3.1.12-6	Source cell: NR 30 kHz SSB SCS, 40 MHz bandwidth, TDD duplex mode Target cell: NR 15 kHz SSB SCS, 10 MHz bandwidth, TDD duplex mode
6.3.1.12-7	Source cell: NR 15 kHz SSB SCS, 10 MHz bandwidth, FDD duplex mode Target cell: NR 30 kHz SSB SCS, 40 MHz bandwidth, TDD duplex mode
6.3.1.12-8	Source cell: NR 15 kHz SSB SCS, 10 MHz bandwidth, TDD duplex mode Target cell: NR 30 kHz SSB SCS, 40 MHz bandwidth, TDD duplex mode
6.3.1.12-9	Source cell: NR 30 kHz SSB SCS, 40 MHz bandwidth, TDD duplex mode Target cell: NR 30 kHz SSB SCS, 40 MHz bandwidth, TDD duplex mode
Note:	The UE is only required to be tested in one of the supported test configurations

Configure the test equipment and the DUT according to the parameters in Table 6.3.1.12.4.1-2

**Table 6.3.1.12.4.1-2: Initial conditions for NR SA FR1 Inter-band inter-frequency asynchronous DAPS handover**

Parameter	Value		Comment
Test environment	NC		As specified in TS 38.508-1 [14] clause 4.1.
Test frequencies	As specified in Annex E, Table E.4-1 and TS 38.508-1 [14] clause 4.3.1.		
Channel bandwidth	As specified by the test configuration selected from Table 6.3.1.12.4.1-1		
Propagation conditions	AWGN		As specified in Annex C.2.2.
Connection Diagram	TE Part	A.3.1.8.2	As specified in TS 38.508-1 [14] Annex A.
	DUT Part	A.3.2.3.4	
Exceptions to connection diagram	N/A		

1. Message contents are defined in clause 6.3.1.12.4.3.
2. The power levels and settings for NR Cell 1 are set according to Annex C.1.2 and C.1.3. Cell 2 is NR FR1 target Cell, and its power levels and settings are also set according to Annex C.1.2 and C.1.3.
3. The test parameters are given in Table 6.3.1.12.4.1-3 below, with A3-Offset modified by Test Tolerance.

**Table 6.3.1.12.4.1-3: General test parameters for NR SA FR1 Inter-band inter-frequency asynchronous DAPS handover**

Parameter	Unit	Value	Comment
Initial conditions	Active cell		Cell 1
	Neighbouring cell		Cell 2
Final condition	Active cell		Cell 2
A3-Offset	Config 1,2,4,5,9	dB	-7(Note 1)
	Config 3,6	dB	-10(Note 1)
	Config 7,8	dB	-4
Hysteresis	dB	0	
Time To Trigger	s	0	
Filter coefficient		0	L3 filtering is not used
Access Barring Information	-	Not Sent	No additional delays in random access procedure.
Time offset between cells	Config 1,2,4,5	ms	0.5
	Config 3,6,7,8,9	ms	0.25
DRX		OFF	
Measurement gap pattern Id		#0	Gaps are configured before T2.
T1	s	5	
T2	s	<5	
T3	s	<0.5	
T4	ms	10+T <sub>interrupt2</sub>	T <sub>interrupt2</sub> as defined in TS 38.133 [6] Table 6.1.3.2.2-6 for asynchronous DAPS HO.
T5	ms	100	

Note 1: Including test tolerance given in Annex F.1.3.2

#### 6.3.1.12.4.2 Test procedure

The test scenario comprises of two NR bands and one cell on each band, Cell 1 and Cell 2. General parameters and Cell-specific parameters for Cell 1 and Cell 2 are given in Table 6.3.1.12.4.1-3, 6.3.1.12.5-1 and 6.3.1.12.5-2 respectively.

The test consists of five successive time periods, with time durations of T1, T2, T3, T4 and T5 respectively.

Before the start of T1, the UE is connected to the Cell 1 and not aware of the Cell 2. During T1, the UE does not have any timing information of the Cell 2. Gap pattern ID gp0 is configured as specified in 38.133 [6] Table 9.1.2-1 before T2 in the test case.

From start of T2, the Cell 2 becomes detectable. During T2, the UE performs cell detection and measurements on the Cell 2 and shall send event report to the network. After receiving the event report A3, the network sends a RRC message implying DAPS handover command for target cell addition to the UE.

T3 starts from the instant when the last TTI containing DAPS handover command for target cell addition sent to the UE. During T3, UE shall be able to perform random access, DL reception or UL transmission in the Cell 2 while the DL scheduling and UL feedback in the Cell 1 shall be avoided. After successful RACH procedure on the Cell 2, UE is scheduled with PDSCH from Cell 1 and Cell 2 in alternative TTIs. In the end of T3 the network sends a RRC message implying DAPS handover command for source cell release to the UE. During T3, the handover delay  $D_{\text{handover1}}$  for target cell addition need to be verified.

T4 starts from the instant when the last TTI containing DAPS handover command for source cell release sent to the UE. During T4, the UE shall accomplish the release actions within  $D_{\text{handover2}}$

From start of T5, the UE shall stop sending periodical CSI report on Cell 1. And the test system shall observe the periodic reporting of CSI for cell 1 during T5.

1. Ensure the UE is in State RRC\_CONNECTED with generic procedure parameters Connectivity NR, Connected without release *On* according to TS 38.508-1 [14] clause 4.5. Establish SRB2 and DRB in the RRC Reconfiguration message. Cell 1 is the active cell. Set Cell 2 physical cell identity to the initial physical cell identity.
2. Set the parameters according to T1 in Table 6.3.1.12.5-1 and Table 6.3.1.12.5-2. Propagation conditions are set according to Annex C clause C.2.2. T1 starts and the SS starts continuously scheduling the UE to perform DL reception in every DL slot on Cell 1 and monitoring corresponding ACK/NACK feedbacks sent by the UE.
3. Set Cell 2 physical cell identity = ((current cell 2 physical cell identity + 1) mod 14 + 2).
4. The SS shall transmit an *RRCReconfiguration* message to configure event A3 triggered measurement reporting on the inter-band inter-frequency carrier and periodical CSI reporting on Cell 1.
5. The UE shall transmit an *RRCReconfigurationComplete* message.
6. When T1 expires, the SS shall switch the power setting from T1 to T2 as specified in Table 6.3.1.12.5-1 and Table 6.3.1.12.5-2.
7. UE shall transmit a *MeasurementReport* message triggered by Event A3.
8. SS shall transmit an *RRCReconfiguration* with *reconfigurationWithSync* message which reconfiguring DRB as a DAPS radio bearer to the UE, at that instant the SS shall switch the power settings from T2 to T3 as specified in Table 6.3.1.12.5-1 and Table 6.3.1.12.5-2. T3 starts and the SS stops scheduling the UE to perform DL reception on Cell 1.
9. If the UE transmits PRACH preamble to Cell 2 within  $D_{\text{handover1}}$  from the beginning of time period T3 then the number of successful tests is increased by one, continue to step 10. Otherwise, the number of failure tests is increased by one, go to step 17. where:
  - $D_{\text{handover1}} = 72$  ms.
10. The UE transmits an *RRCReconfigurationComplete* message on Cell 2.
11. Upon receiving *RRCReconfigurationComplete* message sent by UE, the SS immediately starts scheduling UE to perform DL reception in Cell 1 and Cell 2 in an alternative manner, and monitoring corresponding ACK/NACK feedbacks sent by the UE.
12. Upon T3 expiring, the SS immediately transmit an *RRCReconfiguration* with *daps-SourceRelease-r16 = true* on Cell 2 to the UE. T4 starts.
13. The UE transmits an *RRCReconfigurationComplete* message on Cell 2.
14. When T4 expires, T5 starts.
15. If
  - i) The UE can report ACK/NACK from the first DL reception scheduled on Cell 2 after the beginning of time period T5,
  - and
  - j) The UE doesn't send periodical CSI report during entire time period T5.

then the number of successful tests is increased by one. Otherwise, the number of failure tests is increased by one.

16. After T5 expires, the SS sends an *RRCReconfiguration* with *reconfigurationWithSync* to cause UE handover back to Cell 1.

17. If UE is not in state RRC\_CONNECTED with generic procedure parameters Connectivity NR, Connected without release On according to TS 38.508-1 [14] clause 4.5 on Cell 1, switch off and on the UE. Then ensure the UE is in State RRC\_CONNECTED with generic procedure parameters Connectivity NR, Connected without release On according to TS 38.508-1 [14] clause 4.5 on Cell 1. Cell 1 is the active cell.

18. Repeat steps 2-17 until the confidence level according to Tables G.2.3-1 in Annex G clause G.2 is achieved.

6.3.1.12.4.3 Message contents

Message contents are according to TS 38.508-1 [14] clause 7.3 with the following exceptions:

**Table 6.3.1.12.4.3-1: RRCReconfiguration (Step 4)**

Derivation Path: TS 38.508-1 [14], 4.6.1-13 with condition NR_MEAS			
Information Element	Value/remark	Comment	Condition
RRCReconfiguration ::= SEQUENCE {			
criticalExtensions CHOICE {			
rrcReconfiguration SEQUENCE {			
measConfig	MeasConfig	Table 6.3.1.12.4.3-3	
nonCriticalExtension SEQUENCE {			
masterCellGroup SEQUENCE {			
spCellConfigDedicated	ServingCellConfig	Table 6.3.1.12.4.3-2	
}			
}			
}			
}			
}			

**Table 6.3.1.12.4.3-2: ServingCellConfig (Table 6.3.1.12.4.3-1)**

Derivation Path: TS 38.508-1 [14], Table 4.6.3-167 with condition MEAS			
Information Element	Value/remark	Comment	Condition
ServingCellConfig ::= SEQUENCE {			
csi-MeasConfig	CSI-MeasConfig for RRM Specified in TS 38.508-1 [14] Table 7.3.1-6		
}			

**Table 6.3.1.12.4.3-3: MeasConfig (Table 6.3.1.12.4.3-1)**

Derivation path: Table H.3.1-2 with condition INTER-FREQ			
Information Element	Value/Remark	Comment	Condition
measConfig ::= SEQUENCE {			
reportConfigToAddModList SEQUENCE(SIZE (1..maxReportConfigId)) OF SEQUENCE {	1 entry		
reportConfig[1] CHOICE {			
reportConfigNR	ReportConfigNR(-7) specified in Table H.3.1-4	Actual value of a3-Offset is -7 dB	6.3.1.11-1, 6.3.1.11-2, 6.3.1.11-4, 6.3.1.11-5, 6.3.1.11-9.
	ReportConfigNR(-10) specified in Table H.3.1-4	Actual value of a3-Offset is -10 dB	6.3.1.11-3, 6.3.1.11-6
	ReportConfigNR(-4) specified in Table H.3.1-4	Actual value of a3-Offset is -4 dB	6.3.1.11-7, 6.3.1.11-8
}			
}			
}			

**Table 6.3.1.12.4.3-4: MeasurementReport (Step 7)**

Derivation Path: TS 38.508-1 [14], Table 4.6.1-5A			
Information Element	Value/remark	Comment	Condition
MeasurementReport ::= SEQUENCE {			
criticalExtensions CHOICE {			
measurementReport SEQUENCE {			
measResults	MeasResults specified in Table H.3.1-7 with condition INTER-FREQ		
}			
}			
}			

**Table 6.3.1.12.4.3-5: RRCReconfiguration (Step 8)**

Derivation Path: TS 38.508-1 [4], Table 4.8.1-1A with Condition RBConfig_NoKeyChange			
Information Element	Value/remark	Comment	Condition
RRCReconfiguration ::= SEQUENCE {			
criticalExtensions CHOICE {			
rrcReconfiguration SEQUENCE {			
radioBearerConfig	RadioBearerConfig	Table 6.3.1.12.4.3-6	
nonCriticalExtension SEQUENCE{			
masterCellGroup	CellGroupConfig	Table 6.3.1.12.4.3-7	
}			
}			
}			
}			

**Table 6.3.1.12.4.3-6: RadioBearerConfig (Table 6.3.1.12.4.3-5)**

Derivation Path: TS 38.508-1 [14], Table 4.6.3-132 with condition DRB1			
Information Element	Value/remark	Comment	Condition
RadioBearerConfig ::= SEQUENCE {			
drb-ToAddModList SEQUENCE (SIZE (1..maxDRB))	1 entry		
OF DRB-ToAddMod {			
DRB-ToAddMod[1] SEQUENCE {		entry 1	
drb-Identity	DRB-Identity using condition DRBn	DRB #n is a DRB established before DAPS HO.  Actual value of n is left to TE implementation	
daps-Config-r16	true		
}			
}			
}			

**Table 6.3.1.12.4.3-7: CellGroupConfig (Table 6.3.1.12.4.3-5)**

Derivation Path: TS 38.508-1 [14], Table 4.6.3-19 with condition PCell_change			
Information Element	Value/remark	Comment	Condition
CellGroupConfig ::= SEQUENCE {			
rlc-BearerToAddModList	Not present		
spCellConfig SEQUENCE {			
reconfigurationWithSync SEQUENCE {			
spCellConfigCommon SEQUENCE {			
physCellId	PhysCellId for Cell 2		
}			
}			
}			
}			

**Table 6.3.1.12.4.3-8: RRCReconfiguration (Step 12)**

Derivation Path: TS 38.508-1 [14], Table 4.6.1-13 with condition DAPS\_HO\_ReleaseSource

6.3.1.12.5 Test requirements

Table 6.3.1.12.5-1, Table 6.3.1.12.5-2 defines the primary level settings including test tolerances for all tests.

**Table 6.3.1.12.5-1: Cell specific test parameters for NR SA FR1 Inter-band inter-frequency asynchronous DAPS handover (Cell 1)**

Parameter		Unit	Cell 1				
			T1	T2	T3	T4	T5
NR RF Channel Number			1				
Duplex mode	Config 1,4,7		FDD				
	Config 2,3,5,6,8,9		TDD				
TDD configuration	Config 1,4,7		Not Applicable				
	Config 2,5,8		TDDConf.1.1				
	Config 3,6,9		TDDConf.2.1				
BW <sub>channel</sub>	Config 1,4,7	MHz	10: N <sub>RB,c</sub> = 52				
	Config 2,5,8		10: N <sub>RB,c</sub> = 52				
	Config 3,6,9		40: N <sub>RB,c</sub> = 106				
BWP BW	Config 1,4,7	MHz	10: N <sub>RB,c</sub> = 52				
	Config 2,5,8		10: N <sub>RB,c</sub> = 52				
	Config 3,6,9		40: N <sub>RB,c</sub> = 106				
TRS configuration	Config 1,4,7		TRS.1.1 FDD				
	Config 2,5,8		TRS.1.1 TDD				
	Config 3,6,9		TRS.1.2 TDD				
DRX Cycle		ms	Not Applicable				

Parameter		Unit	Cell 1				
			T1	T2	T3	T4	T5
PDSCH Reference measurement channel	Config 1,4,7		SR.1.1 FDD				
	Config 2,5,8		SR.1.1 TDD				
	Config 3,6,9		SR2.1 TDD				
CORESET Reference Channel	Config 1,4,7		CR.1.1 FDD				
	Config 2,5,8		CR.1.1 TDD				
	Config 3,6,9		CR2.1 TDD				
OCNG Patterns			OCNG pattern 1				
SMTC Configuration			SMTC pattern 1				
SSB Configuration	Config 1,2,4,5,7,8		SSB.1 FR1				
	Config 3,6,9		SSB.2 FR1				
PDSCH/PDCCH subcarrier spacing	Config 1,2,4,5,7,8	kHz	15 kHz				
	Config 3,6,9		30 kHz				
PUCCH/PUSCH subcarrier spacing	Config 1,2,4,5,7,8	kHz	15 kHz				
	Config 3,6,9		30 kHz				
PRACH configuration			FR1 PRACH configuration 2				
BWP	Initial DL BWP		DLBWP.0.1				
	Dedicated DL BWP		DLBWP.1.3				
	Initial UL BWP		ULBWP.0.1				
	Dedicated UL BWP		ULBWP.1.3				
EPRE ratio of PSS to SSS		dB	0				
EPRE ratio of PBCH DMRS to SSS							
EPRE ratio of PBCH to PBCH DMRS							
EPRE ratio of PDCCH DMRS to SSS							
EPRE ratio of PDCCH to PDCCH DMRS							
EPRE ratio of PDSCH DMRS to SSS							
EPRE ratio of PDSCH to PDSCH							
EPRE ratio of OCNG DMRS to SSS(Note 1)							
EPRE ratio of OCNG to OCNG DMRS (Note 1)							
$N_{oc}^{Note2}$		dBm/15kHz	-98	-98	-98	-98	-98
$N_{oc}^{Note2}$	Config 1,2,4,5,7,8	dBm/SCS	-98	-98	-98	-98	-98
	Config 3,6,9		-95	-95	-95	-95	-95
$\hat{E}_s / I_{ot}$		dB	4	4	4	4	4
$\hat{E}_s / N_{oc}$		dB	4	4	4	4	4
SSB <sub>RP</sub>	Config 1,2,4,5,7,8	dBm/SCS	-94	-94	-94	-94	-94
	Config 3,6,9	dBm/SCS	-91	-91	-91	-91	-91
$I_o^{Note3}$	Config 1,2,4,5,7,8	dBm/ 9.36MHz	-64.59	-64.59	-64.59	-64.59	-64.59
	Config 3,6,9	dBm/ 38.16MHz	-58.49	-58.49	-58.49	-58.49	-58.49
Propagation condition		-	AWGN				
Note 1: OCNG shall be used such that the cell is fully allocated and a constant total transmitted power spectral density is achieved for all OFDM symbols.							
Note 2: Interference from other cells and noise sources not specified in the test is assumed to be constant over subcarriers and time and shall be modelled as AWGN of appropriate power for $N_{oc}$ to be fulfilled.							
Note 3: $I_o$ levels have been derived from other parameters for information purposes. They are not settable parameters themselves.							

**Table 6.3.1.12.5-2: Cell specific test parameters for NR SA FR1 Inter-band inter-frequency asynchronous DAPS handover (Cell 2)**

Parameter		Unit	Cell 2				
			T1	T2	T3	T4	T5
NR RF Channel Number			2				
Duplex mode	Config 1,2,3		FDD				
	Config 4,5,6,7,8,9		TDD				

Parameter		Unit	Cell 2				
			T1	T2	T3	T4	T5
TDD configuration	Config 1,2,3		Not Applicable				
	Config 4,5,6		TDDConf.1.1				
	Config 7,8,9		TDDConf.2.1				
BW <sub>channel</sub>	Config 1,2,3	MHz	10: N <sub>RB,c</sub> = 52				
	Config 4,5,6		10: N <sub>RB,c</sub> = 52				
	Config 7,8,9		40: N <sub>RB,c</sub> = 106				
BWP BW	Config 1,2,3	MHz	10: N <sub>RB,c</sub> = 52				
	Config 4,5,6		10: N <sub>RB,c</sub> = 52				
	Config 7,8,9		40: N <sub>RB,c</sub> = 106				
TRS configuration	Config 1,2,3		TRS.1.1 FDD				
	Config 4,5,6		TRS.1.1 TDD				
	Config 7,8,9		TRS.1.2 TDD				
DRx Cycle		ms	Not Applicable				
PDSCH Reference measurement channel	Config 1,2,3		SR.1.1 FDD				
	Config 4,5,6		SR.1.1 TDD				
	Config 7,8,9		SR2.1 TDD				
CORESET Reference Channel	Config 1,2,3		CR.1.1 FDD				
	Config 4,5,6		CR.1.1 TDD				
	Config 7,8,9		CR2.1 TDD				
OCNG Patterns			OCNG pattern 1				
SMTc Configuration			SMTc pattern 1				
SSB Configuration	Config 1,2,3,4,5,6		SSB.1 FR1				
	Config 7,8,9		SSB.2 FR1				
PDSCH/PDCCH subcarrier spacing	Config 1,2,3,4,5,6	kHz	15 kHz				
	Config 7,8,9		30 kHz				
PUCCH/PUSCH subcarrier spacing	Config 1,2,3,4,5,6	kHz	15 kHz				
	Config 7,8,9		30 kHz				
PRACH configuration			FR1 PRACH configuration 2				
BWP	Initial DL BWP		DLBWP.0.1				
	Dedicated DL BWP		DLBWP.1.3				
	Initial UL BWP		ULBWP.0.1				
	Dedicated UL BWP		ULBWP.1.3				
EPRE ratio of PSS to SSS		dB	0				
EPRE ratio of PBCH DMRS to SSS							
EPRE ratio of PBCH to PBCH DMRS							
EPRE ratio of PDCCH DMRS to SSS							
EPRE ratio of PDCCH to PDCCH DMRS							
EPRE ratio of PDSCH DMRS to SSS							
EPRE ratio of PDSCH to PDSCH							
EPRE ratio of OCNG DMRS to SSS(Note 1)							
EPRE ratio of OCNG to OCNG DMRS (Note 1)							
N <sub>oc</sub> <sup>Note2</sup>			dBm/15kHz	-98	-98	-98	-98
N <sub>oc</sub> <sup>Note2</sup>	Config 1,2,3,4,5,6	dBm/SCS	-98	-98	-98	-98	-98
	Config 7,8,9		-95	-95	-95	-95	-95
$\hat{E}_s / I_{ot}$		dB	-Infinity	4	4	4	4
$\hat{E}_s / N_{oc}$		dB	-Infinity	4	4	4	4
SSB <sub>RP</sub>	Config 1,2,3,4,5,6	dBm/SCS	-Infinity	-94	-94	-94	-94
	Config 7,8,9	dBm/SCS	-Infinity	-91	-91	-91	-91
I <sub>o</sub> <sup>Note3</sup>	Config 1,2,3,4,5,6	dBm/ 9.36MHz	-70.05	-64.59	-64.59	-64.59	-64.59
	Config 7,8,9	dBm/ 38.16MHz	-63.94	-58.49	-58.49	-58.49	-58.49
Propagation condition		-	AWGN				
Note 1: OCNG shall be used such that the cell is fully allocated and a constant total transmitted power spectral density is achieved for all OFDM symbols.							



Parameter	Unit	Cell 2				
		T1	T2	T3	T4	T5
Note 2:	Interference from other cells and noise sources not specified in the test is assumed to be constant over subcarriers and time and shall be modelled as AWGN of appropriate power for $N_{oc}$ to be fulfilled.					
Note 3:	lo levels have been derived from other parameters for information purposes. They are not settable parameters themselves.					

The UE shall start to transmit the PRACH to Cell 2 less than  $D_{\text{handover1}}$  from the beginning of time period T3. The rate of correct handovers observed during repeated tests shall be at least 90%, where:

$$D_{\text{handover1}} = T_{\text{RRC\_procedure}} + T_{\text{search}} + T_{\text{IU}} + T_{\text{processing}} + T_{\Delta} + T_{\text{margin}}$$

- $T_{\text{RRC\_procedure}} = 10$  ms, is the RRC procedure delay specified in 38.331 [13] clause 12;
- $T_{\text{search}} = 0$  ms for known target cell, is the time required to search the target cell specified in 38.133 [6] clause 6.1.1.2.2.
- $T_{\text{IU}} = 20$  ms, is the interruption uncertainty in acquiring the first available PRACH occasion in the new cell specified in 38.133 [6] clause 6.1.1.2.2.
- $T_{\text{processing}} = 20$  ms, is the time for UE processing specified in 38.133 [6] clause 6.1.1.2.2.
- $T_{\Delta} = 20$  ms, is the time for fine time tracking and acquiring full timing information of the target cell specified in 38.133 [6] clause 6.1.1.2.2.
- $T_{\text{margin}} = 2$  ms, is the time for SSB post-processing specified in 38.133 [6] clause 6.1.1.2.2.

This gives a total of 72 ms.

The UE shall complete to release Cell 1 less than  $(10 \text{ ms} + T_{\text{interrupt2}})$  from the beginning of time period T4. During  $D_{\text{handover2}}$ , the interruption on Cell 2 shall not exceed  $T_{\text{interrupt2}}$  as defined in TS 38.133 [6] Table 6.1.3.2.2-6 for asynchronous DAPS HO.

The handover delay  $D_{\text{handover2}}$  can be expressed as:  $T_{\text{RRC\_procedure}} + T_{\text{interrupt2}}$ , where:

$T_{\text{RRC\_procedure}} = 10$  ms and is specified in clause 12 in TS 38.331 [13].

## 6.3.2 RRC connection mobility control

### 6.3.2.1 RRC re-establishment

#### 6.3.2.1.0 Minimum conformance requirements

##### 6.3.2.1.0.1 Minimum conformance requirements for FR1 RRC re-establishment

In RRC\_CONNECTED state the UE shall be capable of sending *RRCReestablishmentRequest* message within  $T_{\text{re-establish\_delay}}$  seconds from the moment it detects a loss in RRC connection. The total RRC connection delay ( $T_{\text{re-establish\_delay}}$ ) shall be less than:

$$T_{\text{re-establish\_delay}} = T_{\text{UE\_re-establish\_delay}} + T_{\text{UL\_grant}}$$

$T_{\text{UL\_grant}}$ : It is the time required to acquire and process uplink grant from the target PCell. The uplink grant is required to transmit *RRCReestablishmentRequest* message.

The UE re-establishment delay ( $T_{\text{UE\_re-establish\_delay}}$ ) is the time between the moments when any of the conditions requiring RRC re-establishment as defined in clause 5.3.7 in TS 38.331 [2] is detected by the UE and when the UE sends PRACH to the target PCell. The UE re-establishment delay ( $T_{\text{UE\_re-establish\_delay}}$ ) requirement shall be less than:

$$T_{\text{UE\_re-establish\_delay}} = 50 + T_{\text{identify\_intra\_NR}} + \sum_{i=1}^{N_{\text{freq}}-1} T_{\text{identify\_inter\_NR},i} + T_{\text{SI-NR}} + T_{\text{PRACH}}$$

The intra-frequency target NR cell shall be considered detectable when for each relevant SSB can satisfy that:

- SS-RSRP related side conditions given in Section 10.1.2 and 10.1.3 are fulfilled for a corresponding NR Band for FR1 and FR2, respectively,
- the conditions of SSB<sub>RP</sub> and SSB  $\hat{E}_s/I_{ot}$  according to Annex B.2.2 for a corresponding NR Band are fulfilled.

The inter-frequency target NR cell shall be considered detectable when for each relevant SSB:

- SS-RSRP related side conditions given in Section 10.1.4 and 10.1.5 are fulfilled for a corresponding NR Band for FR1 and FR2, respectively,
- the conditions of SSB<sub>RP</sub> and SSB  $\hat{E}_s/I_{ot}$  according to Annex B.2.2 for a corresponding NR Band are fulfilled.

$T_{\text{identify\_intra\_NR}}$ : It is the time to identify the target intra-frequency NR cell and it depends on whether the target NR cell is known cell or unknown cell and on the frequency range (FR) of the target NR cell. If the UE is not configured with intra-frequency NR carrier for RRC re-establishment then  $T_{\text{identify\_intra\_NR}}=0$ ; otherwise  $T_{\text{identify\_intra\_NR}}$  shall not exceed the values defined in table 6.3.2.1.0.1-1.

$T_{\text{identify\_inter\_NR},i}$ : It is the time to identify the target inter-frequency NR cell on inter-frequency carrier  $i$  configured for RRC re-establishment and it depends on whether the target NR cell is known cell or unknown cell and on the frequency range (FR) of the target NR cell.  $T_{\text{identify\_inter\_NR},i}$  shall not exceed the values defined in table 6.3.2.1.0.1-2.

$T_{\text{SMTC}}$ : It is the periodicity of the SMTC occasion configured for the intra-frequency carrier. If the UE has been provided with higher layer in TS 38.331 [2] signalling of  $\text{smtc}2$ ,  $T_{\text{smtc}}$  follows  $\text{smtc}1$  or  $\text{smtc}2$  according to the physical cell ID of the target cell.

$T_{\text{SMTC},i}$ : It is the periodicity of the SMTC occasion configured for the inter-frequency carrier  $i$ . If it is not configured, the UE may assume that the target SSB periodicity is no larger than 20 ms.

$T_{\text{SI-NR}}$  = It is the time required for receiving all the relevant system information according to the reception procedure and the RRC procedure delay of system information blocks defined in TS 38.331 [2] for the target NR cell.

$T_{\text{PRACH}}$ : It is the delay uncertainty in acquiring the first available PRACH occasion in the target NR cell.  $T_{\text{PRACH}}$  can be up to the summation of SSB to PRACH occasion association period and 10 ms. SSB to PRACH occasion associated period is defined in the table 8.1-1 of TS 38.213 [3].

$N_{\text{freq}}$ : It is the total number of NR frequencies to be monitored for RRC re-establishment;  $N_{\text{freq}} = 1$  if the target intra-frequency NR cell is known, else  $N_{\text{freq}} = 2$  and  $T_{\text{identify\_intra\_NR}} = 0$  if the target inter-frequency NR cell is known.

There is no requirement if the target cell does not contain the UE context.

In the requirement defined in the below tables, the target FR1 cell is known if it has been meeting the relevant cell identification requirement during the last 5 seconds otherwise it is unknown.

**Table 6.3.2.1.0.1-1: Time to identify target NR cell for RRC connection re-establishment to NR intra-frequency cell**

Serving cell SSB $\hat{E}_s/I_{ot}$ (dB)	Frequency range (FR) of target NR cell	$T_{\text{identify\_intra\_NR}}$ (ms)	
		Known NR cell	Unknown NR cell
$\geq -8$	FR1	MAX (200 ms, 5 x $T_{\text{SMTC}}$ )	MAX (800 ms, 10 x $T_{\text{SMTC}}$ )
$\geq -8$	FR2	N/A	MAX (1000 ms, 80 x $T_{\text{SMTC}}$ )
$< -8$	FR1	N/A	800 <sup>Note1</sup>
$< -8$	FR2	N/A	3520 <sup>Note1</sup>

Note 1: The UE is not required to successfully identify a cell on any NR frequency layer when  $T_{\text{SMTC}} > 20$  ms and serving cell SSB  $\hat{E}_s/I_{ot} < -8$  dB.

**Table 6.3.2.1.0.1-2: Time to identify target NR cell for RRC connection re-establishment to NR inter-frequency cell**

Serving cell SSB $\hat{E}_s/I_{ot}$ (dB)	Frequency range (FR) of target NR cell	$T_{\text{identify\_inter\_NR},i}$ (ms)	
		Known NR cell	Unknown NR cell
$\geq -8$	FR1	MAX (200 ms, 6 x $T_{\text{SMTC},i}$ )	MAX (800 ms, 13 x $T_{\text{SMTC},i}$ )
$\geq -8$	FR2	N/A	MAX (1000 ms, 104 x $T_{\text{SMTC},i}$ )
$< -8$	FR1	N/A	800 <sup>Note1</sup>

< -8	FR2	N/A	4000 <sup>Note1</sup>
Note 1: The UE is not required to successfully identify a cell on any NR frequency layer when $T_{SMTc,i} > 20$ ms and serving cell SSB $\bar{E}_s/\text{lot} < -8$ dB.			

The normative reference for this requirement is TS 38.133 [6] clauses 6.2.1.2.1.

### 6.3.2.1.1 NR SA FR1 RRC re-establishment

#### 6.3.2.1.1.1 Test purpose

The purpose is to verify that the NR intra-frequency RRC re-establishment delay in FR1 with known target cell is within the specified limits.

#### 6.3.2.1.1.2 Test applicability

This test applies to all types of NR UE from Release 15 onwards.

#### 6.3.2.1.1.3 Minimum conformance requirements

The minimum conformance requirements are specified in clause 6.3.2.1.0.1.

The normative reference for this requirement is TS 38.133 [6] clause A.6.3.2.1.1.

#### 6.3.2.1.1.4 Test description

##### 6.3.2.1.1.4.1 Initial conditions

The Test shall be tested using any of the test configuration in Table 6.3.2.1.1.4.1-1

**Table 6.3.2.1.1.4.1-1: Supported test configurations**

Configuration	Description
6.3.2.1.1-1	15 kHz SSB SCS, 10MHz bandwidth, FDD duplex mode
6.3.2.1.1-2	15 kHz SSB SCS, 10MHz bandwidth, TDD duplex mode
6.3.2.1.1-3	30 kHz SSB SCS, 40MHz bandwidth, TDD duplex mode
Note: The UE is only required to be tested in one of the supported test configurations.	

Configure the test requirement and the DUT according to the parameters in Table 6.3.2.1.1.4.1-2

**Table 6.3.2.1.1.4.1-2: Initial conditions for NR Intra-frequency RRC Re-establishment in FR1**

Parameter	Value	Comment
Test environment	NC	As specified in TS 38.508-1 [14] clause 4.1.
Test frequencies	As specified in Annex E, Table E.4-1 and TS 38.508-1 [14] clause 4.3.1.	
Channel bandwidth	As specified by the test configuration selected from Table 6.3.2.1.1.4.1-1.	
Propagation conditions	AWGN	As specified in Annex C.2.2.
Connection Diagram	TE Part DUT Part	A.3.1.8.2 A.3.2.3.4
Exceptions to connection diagram	- Without LTE link - For 4Rx capable UEs without any 2 Rx RF bands use A.3.2.5.2 for DUT part and A.3.1.8.4 for TE Part	

1. The general test parameter settings are set up according to Table 6.3.2.1.1.4.1-3.
2. Message contents are defined in clause 6.3.2.1.1.4.3.

There is one NR carrier and two cells specified in the test. Cell 1 is the cell used for registration with the power level set according to Annex C.1.1 and C.1.2 for this test.

**Table 6.3.2.1.1.4.1-3: General test parameters for NR intra-frequency RRC Re-establishment test case in FR1**

Parameter		Unit	Test configuration	Value	Comment
Initial condition	Active cell		1, 2, 3	Cell1	
	Neighbour cells		1, 2, 3	Cell2	
Final condition	Active cell		1, 2, 3	Cell2	
RF Channel Number			1, 2, 3	1	
Time offset between cells			1	3 ms	Asynchronous cells
			2	3 $\mu$ s	Synchronous cells
			3	3 $\mu$ s	Synchronous cells
N310		-	1, 2, 3	1	Maximum consecutive out-of-sync indications from lower layers
N311		-	1, 2, 3	1	Minimum consecutive in-sync indications from lower layers
T310		ms	1, 2, 3	0	Radio link failure timer
T311		ms	1, 2, 3	3000	RRC re-establishment timer
Access Barring Information		-	1, 2, 3	Not Sent	No additional delays in random access procedure.
SSB configuration			1	SSB.1 FR1	
			2	SSB.1 FR1	
			3	SSB.2 FR1	
SMTC configuration			1	SMTC.2	
			2	SMTC.1	
			3	SMTC.1	
DRX cycle length		s	1, 2, 3	OFF	
PRACH configuration			1, 2, 3	PRACH.1 FR1	Table A.7.1-1
T1		s	1, 2, 3	5	
T2		ms	1, 2, 3	200	Time for the UE to detect RLF
T3		s	1, 2, 3	2	

#### 6.3.2.1.1.4.2 Test procedure

The test consists of 3 successive time periods, with time duration of T1, T2 and T3 respectively. At the start of time period T2, cell 1, which is the active cell, is deactivated. The time period T3 starts after the occurrence of the radio link failure.

1. Ensure the UE is in state RRC\_CONNECTED with generic procedure parameters Connectivity NR, Connected without release On and Test Mode On according to TS 38.508-1 [14] clause 4.5. Establish SRB2 and DRB in the RRC Reconfiguration message.
2. Set the parameters according to T1 in Table 6.3.2.1.1.5-1. T1 starts.
3. SS shall transmit an RRCReconfiguration message.
4. The UE shall transmit RRCReconfigurationComplete message.
5. When T1 expires, the SS shall switch the power setting from T1 to T2 as specified in Table 6.3.2.1.1.5-1. T2 starts
6. When T2 expires, the SS shall switch the power setting from T2 to T3 as specified in Table 6.3.2.1.1.5-1. T3 starts
7. If the UE starts to send PRACH preambles to cell 2 for sending the RRCReestablishmentRequest message to cell 2 within 1.6 s from the beginning of time period T3, then the number of successful tests is increased by one. Otherwise, the number of failure tests is increased by one.
8. After T3 expires, cause UE handover back to Cell 1 (if the handover fails, switch off the UE) or switch off the UE. Then ensure the UE is in state RRC\_CONNECTED with generic procedure parameters Connectivity NR, Connected without release On according to TS 38.508-1 [14] clause 4.5. Cell 1 is the active cell.
9. Repeat step 2-8 until the confidence level according to Table G.2.3-1 in Annex G clause G.2 is achieved.

6.3.2.1.1.4.3 Message contents

Message contents are according to TS 38.508-1 [14] clause 7.3 with the following exceptions:

**Table 6.3.2.1.1.4.3-1: Common Exception messages intra-frequency RRC re-establishment**

Default Message Contents	
Common contents of system information blocks exceptions	
Default RRC messages and information elements contents exceptions	
Specific message contents exceptions for Test Configuration 6.3.2.1.1-1	Table H.3.1-3 with Condition INTRA-FREQ MO, SSB.1 FR1 Table 7.3.1-3 in TS 38.508-1 [14] with condition SMTC.2
Specific message contents exceptions for Test Configuration 6.3.2.1.1-2	Table H.3.1-3 with Condition INTRA-FREQ MO, SSB.1 FR1 and synchronous cells Table 7.3.1-3 in TS 38.508-1 [14] with condition SMTC.1
Specific message contents exceptions for Test Configuration 6.3.2.1.1-3	Table H.3.1-3 with Condition INTRA-FREQ MO, SSB.2 FR1 and synchronous cells Table 7.3.1-3 in TS 38.508-1 [14] with condition SMTC.1

**Table 6.3.2.1.1.4.3-2: RLF-TimersAndConstants for intra-frequency RRC re-establishment**

Derivation Path: TS 38.508-1 [14], Table 4.6.3-150			
Information Element	Value/remark	Comment	Condition
RLF-TimersAndConstants ::= SEQUENCE {			
t310	ms0		
t311	ms3000		
}			

**Table 6.3.2.1.1.4.3-3: MeasConfig for intra-frequency RRC re-establishment**

Derivation Path: TS 38.508-1 [14], Table 4.6.3-69			
Information Element	Value/remark	Comment	Condition
MeasConfig ::= SEQUENCE {			
reportConfigToAddModList	Not present		
measIdToAddModList	Not present		
quantityConfig	Not present		
}			

6.3.2.1.1.5 Test requirement

Table 6.3.2.1.1.5-1 defines the primary level settings including test tolerances for NR Intra-frequency RRC Re-establishment in FR1 test case.

**Table 6.3.2.1.1.5-1: Cell specific test parameters for NR intra-frequency RRC Re-establishment test case in FR1**

Parameter	Unit	Test configuration	Cell 1			Cell 2		
			T1	T2	T3	T1	T2	T3
TDD configuration		1	N/A			N/A		
		2	TDDConf.1.1			TDDConf.1.1		
		3	TDDConf.2.1			TDDConf.2.1		
PDSCH RMC configuration		1	SR.1.1 FDD			SR.1.1 FDD		
		2	SR.1.1 TDD			SR.1.1 FDD		
		3	SR.2.1 TDD			SR.2.1 FDD		
RMSI CORESET RMC configuration		1	CR.1.1 FDD			CR.1.1 FDD		
		2	CR.1.1 TDD			CR.1.1 TDD		
		3	CR.2.1 TDD			CR.2.1 TDD		
Dedicated CORESET RMC configuration		1	CCR.1.1 FDD			CCR.1.1 FDD		
		2	CCR.1.1 TDD			CCR.1.1 TDD		
		3	CCR.2.1 TDD			CCR.2.1 TDD		
OCNG Pattern		1, 2, 3	OP.1 defined in A.3.2.1			OP.1 defined in A.3.2.1		
TRS configuration		1	TRS.1.1 FDD			TRS.1.1 FDD		
		2	TRS.1.1 TDD			TRS.1.1 TDD		

Parameter	Unit	Test configuration	Cell 1			Cell 2		
			T1	T2	T3	T1	T2	T3
		3	TRS.1.2 TDD			TRS.1.2 TDD		
Initial DL BWP configuration		1, 2, 3	DLBWP.0.1			DLBWP.0.1		
Initial UL BWP configuration		1, 2, 3	ULBWP.0.1			ULBWP.0.1		
Active DL BWP configuration		1, 2, 3	DLBWP.1.1	N/A	N/A	N/A	N/A	DLBWP.1.1
Active UL BWP configuration		1, 2, 3	ULBWP.1.1	N/A	N/A	N/A	N/A	ULBWP.1.1
RLM-RS		1, 2, 3	SSB			SSB		
$\hat{E}_s / I_{ot}$	dB	1	1.54	-infinity	-infinity	-3.79	4	4
		2						
		3						
$N_{oc}$ Note2	dBm/SCS	1	-98					
		2	-98					
		3	-95					
$N_{oc}$ Note2	dBm/15 kHz	1	-98					
		2						
		3						
$\hat{E}_s / N_{oc}$	dB	1	7	-infinity	-infinity	4	4	4
		2						
		3						
SS-RSRP Note3	dBm/SCS	1	-91	-infinity	-infinity	-94	-94	-94
		2	-91	-infinity	-infinity	-94	-94	-94
		3	-88	-infinity	-infinity	-91	-91	-91
Io	dBm/9.36 MHz	1	-60.74	-64.59	-64.59	-60.74	-64.59	-64.59
	dBm/9.36 MHz	2	-60.74	-64.59	-64.59	-60.74	-64.59	-64.59
	dBm/38.16 MHz	3	-54.65	-58.50	-58.50	-54.65	-58.50	-58.50
Propagation Condition		1, 2, 3	AWGN					
Note 1:	OCNG shall be used such that both cells are fully allocated and a constant total transmitted power spectral density is achieved for all OFDM symbols.							
Note 2:	Interference from other cells and noise sources not specified in the test is assumed to be constant over subcarriers and time and shall be modelled as AWGN of appropriate power for $N_{oc}$ to be fulfilled.							
Note 3:	SS-RSRP levels have been derived from other parameters for information purposes. They are not settable parameters themselves.							

The RRC re-establishment delay is defined as the time from the start of time period T3, to the moment when the UE starts to send PRACH preambles to cell 2 for sending the *RRCReestablishmentRequest* message to cell 2.

The RRC re-establishment delay to a known NR intra frequency cell shall be less than 1.6 s.

The rate of correct RRC re-establishments observed during repeated tests shall be at least 90%.

NOTE: The RRC re-establishment delay in the test is derived from the following expression:

$$T_{\text{re-establish\_delay}} = T_{\text{UL\_grant}} + T_{\text{UE\_re-establish\_delay}}$$

Where:

$T_{\text{UL\_grant}}$  = It is the time required to acquire and process uplink grant from the target cell. The PRACH reception at the system simulator is used as a trigger for the completion of the test; hence  $T_{\text{UL\_grant}}$  is not used.

$$T_{\text{UE\_re-establish\_delay}} = 50 + T_{\text{identify\_intra\_NR}} + \sum_{i=1}^{N_{\text{freq}}-1} T_{\text{identify\_inter\_NR},i} + T_{\text{SI-NR}} + T_{\text{PRACH}}$$

$$N_{\text{freq}} = 1$$

$$T_{\text{identify\_intra\_NR}} = 200 \text{ ms}$$

$T_{\text{SI}} = 1280 \text{ ms}$ ; it is the time required for receiving all the relevant system information as defined in TS 38.331 for the target intra-frequency NR cell.

$T_{\text{PRACH}} = 15 \text{ ms}$ ; it is the additional delay caused by the random access procedure.

This gives a total of 1545 ms, allow 1.6 s in the test case.

### 6.3.2.1.2 NR SA FR1 - FR1 RRC re-establishment

#### 6.3.2.1.2.1 Test purpose

The purpose is to verify that the NR inter-frequency RRC re-establishment delay in FR1 without known target cell is within the specified limits.

#### 6.3.2.1.2.2 Test applicability

This test applies to all types of NR UE from Release 15 onwards.

#### 6.3.2.1.2.3 Minimum conformance requirements

The minimum conformance requirements are specified in clause 6.3.2.1.0.1.

The normative reference for this requirement is TS 38.133 [6] A.6.3.2.1.2.

#### 6.3.2.1.2.4 Test description

##### 6.3.2.1.2.4.1 Initial conditions

The Test shall be tested using any of the test configuration in Table 6.3.2.1.2.4.1-1

**Table 6.3.2.1.2.4.1-1: Supported test configurations**

Configuration	Description of serving cell	Description of target cell
6.3.2.1.2-1	15 kHz SSB SCS, 10MHz bandwidth, FDD duplex mode	15 kHz SSB SCS, 10MHz bandwidth, FDD duplex mode
6.3.2.1.2-2	15 kHz SSB SCS, 10MHz bandwidth, TDD duplex mode	15 kHz SSB SCS, 10MHz bandwidth, TDD duplex mode
6.3.2.1.2-3	30 kHz SSB SCS, 40MHz bandwidth, TDD duplex mode	30 kHz SSB SCS, 40MHz bandwidth, TDD duplex mode

Note: The UE is only required to be tested in one of the supported test configurations.

Configure the test requirement and the DUT according to the parameters in Table 6.3.2.1.2.4.1-2

**Table 6.3.2.1.2.4.1-2: Initial conditions for NR Inter-frequency RRC Re-establishment in FR1**

Parameter	Value		Comment
Test environment	NC		As specified in TS 38.508-1 [14] clause 4.1.
Test frequencies	As specified in Annex E, Table E.4-1 and TS 38.508-1 [14] clause 4.3.1.		
Channel bandwidth	As specified by the test configuration selected from Table 6.3.2.1.2.4.1-1.		
Propagation conditions	AWGN		As specified in Annex C.2.2.
Connection Diagram	TE Part	A.3.1.8.2	As specified in TS 38.508-1 [14] Annex A.
	DUT Part	A.3.2.3.4	
Exceptions to connection diagram	Without LTE link - For 4Rx capable UEs without any 2 Rx RF bands use A.3.2.5.2 for DUT part and A.3.1.8.4 for TE Part		

1. The general test parameter settings are set up according to Table 6.3.2.1.2.4.1-3.
2. Message contents are defined in clause 6.3.2.1.2.4.3.

There are two NR carriers and two cells specified in the test. Cell 1 is the cell used for registration with the power level set according to Annex C.1.1 and C.1.2 for this test.

**Table 6.3.2.1.2.4.1-3: General test parameters for NR inter-frequency RRC Re-establishment test case in FR1**

Parameter	Unit	Test configuration	Value	Comment
Active cell		1, 2, 3	Cell1	

Initial condition	Neighbour cells		1, 2, 3	Cell2	
Final condition	Active cell		1, 2, 3	Cell2	
RF Channel Number			1, 2, 3	1, 2	
Time offset between cells			1	3 ms	Asynchronous cells
			2	3 $\mu$ s	Synchronous cells
			3	3 $\mu$ s	Synchronous cells
N310	-		1, 2, 3	1	Maximum consecutive out-of-sync indications from lower layers
N311	-		1, 2, 3	1	Minimum consecutive in-sync indications from lower layers
T310	ms		1, 2, 3	0	Radio link failure timer
T311	ms		1, 2, 3	5000	RRC re-establishment timer
Access Barring Information		-	1, 2, 3	Not Sent	No additional delays in random access procedure.
SSB configuration			1	SSB.1 FR1	
			2	SSB.1 FR1	
			3	SSB.2 FR1	
SMTC configuration			1	SMTC.2	
			2	SMTC.1	
			3	SMTC.1	
DRX cycle length	s		1, 2, 3	OFF	
PRACH configuration			1, 2, 3	PRACH.1 FR1	Table A.7.1-1
T1	s		1, 2, 3	5	
T2	ms		1, 2, 3	200	Time for the UE to detect RLF
T3	s		1, 2, 3	5	

#### 6.3.2.1.2.4.2 Test procedure

The test consists of 3 successive time periods, with time duration of T1, T2 and T3 respectively. At the start of time period T2, cell 1, which is the active cell, becomes inactive. The time period T3 starts after the occurrence of the radio link failure. During T1, the UE shall be configured with the carrier frequency of cell 2 (with RF Channel Number #2) to ensure that the UE has the context of the carrier frequency of cell 2 by the end of T1.

1. Ensure the UE is in state RRC\_CONNECTED with generic procedure parameters Connectivity NR, Connected without release On and Test Mode On according to TS 38.508-1 [14] clause 4.5. Establish SRB2 and DRB in the RRC Reconfiguration message.
2. Set the parameters according to T1 in Table 6.3.2.1.2.5-1. T1 starts.
3. SS shall transmit an RRCReconfiguration message.
4. The UE shall transmit RRCReconfigurationComplete message.
5. When T1 expires, the SS shall switch the power setting from T1 to T2 as specified in Table 6.3.2.1.2.5-1. T2 starts
6. When T2 expires, the SS shall switch the power setting from T2 to T3 as specified in Table 6.3.2.1.2.5-1. T3 starts
7. If the UE starts to send PRACH preambles to cell 2 for sending the RRCReestablishmentRequest message to cell 2 within 3 s from the beginning of time period T3, then the number of successful tests is increased by one. Otherwise, the number of failure tests is increased by one.
8. After T3 expires, cause UE handover back to Cell 1 (if the handover fails, switch off the UE) or switch off the UE. Then ensure the UE is in state RRC\_CONNECTED with generic procedure parameters Connectivity NR, Connected without release On according to TS 38.508-1 [14] clause 4.5. Cell 1 is the active cell.
9. Set cell 2 physical cell identity = ((current cell 2 physical cell identity + 1) mod 14 + 2) for next iteration of the test procedure loop.
10. Repeat step 2-9 until the confidence level according to Table G.2.3-1 in Annex G clause G.2 is achieved.



6.3.2.1.2.4.3 Message contents

Message contents are according to TS 38.508-1 [14] clause 7.3 with the following exceptions:

**Table 6.3.2.1.2.4.3-1: Common Exception messages inter-frequency RRC re-establishment**

Default Message Contents	
Common contents of system information blocks exceptions	
Default RRC messages and information elements contents exceptions	
Specific message contents exceptions for Test Configuration 6.3.2.1.2-1	Table H.3.1-3 with Condition INTER-FREQ MO, SSB.1 FR1 Table 7.3.1-3 in TS 38.508-1 [14] with condition SMTC.2
Specific message contents exceptions for Test Configuration 6.3.2.1.2-2	Table H.3.1-3 with Condition INTER-FREQ MO, SSB.1 FR1 and Synchronous cells Table 7.3.1-3 in TS 38.508-1 [14] with condition SMTC.1
Specific message contents exceptions for Test Configuration 6.3.2.1.2-3	Table H.3.1-3 with Condition INTER-FREQ MO, SSB.2 FR1 and Synchronous cells Table 7.3.1-3 in TS 38.508-1 [14] with condition SMTC.1

**Table 6.3.2.1.2.4.3-2: RLF-TimersAndConstants for inter-frequency RRC re-establishment**

Derivation Path: TS 38.508-1 [14], Table 4.6.3-150			
Information Element	Value/remark	Comment	Condition
RLF-TimersAndConstants ::= SEQUENCE {			
t310	ms0		
t311	ms5000		
}			

**Table 6.3.2.1.2.4.3-3: MeasConfig for inter-frequency RRC re-establishment**

Derivation Path: TS 38.508-1 [14], Table 4.6.3-69			
Information Element	Value/remark	Comment	Condition
MeasConfig ::= SEQUENCE {			
reportConfigToAddModList	Not present		
measIdToAddModList	Not present		
quantityConfig	Not present		
}			

6.3.2.1.2.5 Test requirement

Table 6.3.2.1.2.5-1 defines the primary level settings including test tolerances for NR Inter-frequency RRC Re-establishment in FR1 test case.

**Table 6.3.2.1.2.5-1: Cell specific test parameters for NR inter-frequency RRC Re-establishment test case in FR1**

Parameter	Unit	Test configuration	Cell 1			Cell 2		
			T1	T2	T3	T1	T2	T3
RF Channel Number		1, 2, 3	1			2		
TDD configuration		1	N/A			N/A		
		2	TDDConf.1.1			TDDConf.1.1		
		3	TDDConf.2.1			TDDConf.2.1		
PDSCH RMC configuration		1	SR.1.1 FDD			SR.1.1 FDD		
		2	SR.1.1 TDD			SR.1.1 TDD		
		3	SR.2.1 TDD			SR.2.1 TDD		
RMSI CORESET RMC configuration		1	CR.1.1 FDD			CR.1.1 FDD		
		2	CR.1.1 TDD			CR.1.1 TDD		
		3	CR.2.1 TDD			CR.2.1 TDD		
Dedicated CORESET RMC configuration		1	CCR.1.1 FDD			CCR.1.1 FDD		
		2	CCR.1.1 TDD			CCR.1.1 TDD		
		3	CCR.2.1 TDD			CCR.2.1 TDD		
OCNG Pattern		1, 2, 3	OP.1 defined in A.3.2.1			OP.1 defined in A.3.2.1		
TRS configuration		1	TRS.1.1 FDD			TRS.1.1 FDD		

Parameter	Unit	Test configuration	Cell 1			Cell 2		
			T1	T2	T3	T1	T2	T3
			2	TRS.1.1 TDD		TRS.1.1 TDD		
		3	TRS.1.2 TDD		TRS.1.2 TDD			
Initial DL BWP configuration		1, 2, 3	DLBWP.0.1			DLBWP.0.1		
Initial UL BWP configuration		1, 2, 3	ULBWP.0.1			ULBWP.0.1		
Active DL BWP configuration		1, 2, 3	DLBWP.1.1	N/A	N/A	N/A	N/A	DLBW P.1.1
Active UL BWP configuration		1, 2, 3	ULBWP.1.1	N/A	N/A	N/A	N/A	ULBW P.1.1
RLM-RS		1, 2, 3	SSB			SSB		
$\hat{E}_s / I_{ot}$	dB	1	4	-infinity	-infinity	-infinity	-infinity	7
		2						
		3						
$N_{oc}$ <sup>Note2</sup>	dBm/SCS	1	-98					
		2	-98					
		3	-95					
$N_{oc}$ <sup>Note2</sup>	dBm/15 kHz	1	-98					
		2						
		3						
$\hat{E}_s / N_{oc}$	dB	1	4	-infinity	-infinity	-infinity	-infinity	7
		2						
		3						
SS-RSRP <sup>Note3</sup>	dBm/SCS	1	-94	-infinity	-infinity	-infinity	-infinity	-91
		2	-94	-infinity	-infinity	-infinity	-infinity	-91
		3	-91	-infinity	-infinity	-infinity	-infinity	-88
Io	dBm/9.36 MHz	1	-64.59	-70.05	-70.05	-70.05	-70.05	-62.26
	dBm/9.36 MHz	2	-64.59	-70.05	-70.05	-70.05	-70.05	-62.26
	dBm/38.16 MHz	3	-58.50	-63.94	-63.94	-63.94	-63.94	-56.15
Propagation Condition		1, 2, 3	AWGN					
Note 1:	OCNG shall be used such that both cells are fully allocated and a constant total transmitted power spectral density is achieved for all OFDM symbols.							
Note 2:	Interference from other cells and noise sources not specified in the test is assumed to be constant over subcarriers and time and shall be modelled as AWGN of appropriate power for $N_{oc}$ to be fulfilled.							
Note 3:	SS-RSRP levels have been derived from other parameters for information purposes. They are not settable parameters themselves.							

The RRC re-establishment delay is defined as the time from the start of time period T3, to the moment when the UE starts to send PRACH preambles to cell 2 for sending the *RRCReestablishmentRequest* message to cell 2.

The RRC re-establishment delay to an unknown NR inter frequency cell shall be less than 3 s.

The rate of correct RRC re-establishments observed during repeated tests shall be at least 90%.

NOTE: The RRC re-establishment delay in the test is derived from the following expression:

$$T_{\text{re-establish\_delay}} = T_{\text{UL\_grant}} + T_{\text{UE\_re-establish\_delay}}$$

Where:

$T_{\text{UL\_grant}}$  = It is the time required to acquire and process uplink grant from the target cell. The PRACH reception at the system simulator is used as a trigger for the completion of the test; hence  $T_{\text{UL\_grant}}$  is not used.

$$T_{\text{UE\_re-establish\_delay}} = 50 + T_{\text{identify\_intra\_NR}} + \sum_{i=1}^{N_{\text{freq}}-1} T_{\text{identify\_inter\_NR},i} + T_{\text{SI-NR}} + T_{\text{PRACH}}$$

$$N_{\text{freq}} = 2$$

$$T_{\text{identify\_intra\_NR}} = 800 \text{ ms}$$

$$T_{\text{identify\_inter\_NR}} = 800 \text{ ms}$$

$T_{SI} = 1280$  ms; it is the time required for receiving all the relevant system information as defined in TS 38.331 for the target inter-frequency NR cell.

$T_{PRACH} = 15$  ms; it is the additional delay caused by the random access procedure.

This gives a total of 2945 ms, allow 3 s in the test case.

### 6.3.2.1.3 NR SA FR1 RRC re-establishment without serving cell timing

#### 6.3.2.1.3.1 Test purpose

The purpose is to verify that the NR intra-frequency RRC re-establishment delay in FR1 without serving cell timing is within the specified limits and to verify the requirements in TS 38.133 [6] clause 6.2.1

#### 6.3.2.1.3.2 Test applicability

This test applies to all types of NR UE from Release 15 onwards.

#### 6.3.2.1.3.3 Minimum conformance requirements

The minimum conformance requirements are specified in clause 6.3.2.1.0.1.

The normative reference for this requirement is TS 38.133 [6] clause A.6.3.2.1.3.

#### 6.3.2.1.3.4 Test description

##### 6.3.2.1.3.4.1 Initial conditions

The test shall be tested using any of the test configuration in Table 6.3.2.1.3.4.1-1

**Table 6.3.2.1.3.4.1-1: Supported test configurations**

Configuration	Description
6.3.2.1.3-1	15 kHz SSB SCS, 10MHz bandwidth, FDD duplex mode
6.3.2.1.3-2	15 kHz SSB SCS, 10MHz bandwidth, TDD duplex mode
6.3.2.1.3-3	30 kHz SSB SCS, 40MHz bandwidth, TDD duplex mode
Note: The UE is only required to be tested in one of the supported test configurations.	

Configure the test requirement and the DUT according to the parameters in Table 6.3.2.1.3.4.1-2

**Table 6.3.2.1.3.4.1-2: Initial conditions for NR SA FR1 RRC re-establishment without serving cell timing**

Parameter	Value	Comment
Test environment	NC	As specified in TS 38.508-1 [14] clause 4.1.
Test frequencies	As specified in Annex E, Table E.4-1 and TS 38.508-1 [14] clause 4.3.1.	
Channel bandwidth	As specified by the test configuration selected from Table 6.3.2.1.3.4.1-1.	
Propagation conditions	AWGN	As specified in Annex C.2.2.
Connection Diagram	TE Part DUT Part	A.3.1.8.2 A.3.2.3.4
Exceptions to connection diagram	- Without LTE link - For 4Rx capable UEs without any 2 Rx RF bands use A.3.2.5.2 for DUT part and A.3.1.8.4 for TE Part	

1. The general test parameter settings are set up according to Table 6.3.2.1.3.4.1-3.
2. Message contents are defined in clause 6.3.2.1.3.4.3.
3. There is one NR carrier and two cells specified in the test. Cell 1 is the cell used for connection setup with the power level set according to Annex C.1.2 and C.1.3 for this test.

**Table 6.3.2.1.3.4.1-3: General test parameters for NR SA FR1 RRC re-establishment without serving cell timing**

Parameter		Unit	Test configuration	Value	Comment
Initial condition	Active cell		1, 2, 3	Cell1	
	Neighbour cells		1, 2, 3	Cell2	
Final condition	Active cell		1, 2, 3	Cell2	
RF Channel Number			1, 2, 3	1	
Time offset between cells			1	3 ms	Asynchronous cells
			2	3 $\mu$ s	Synchronous cells
			3	3 $\mu$ s	Synchronous cells
N310		-	1, 2, 3	1	Maximum consecutive out-of-sync indications from lower layers
N311		-	1, 2, 3	1	Minimum consecutive in-sync indications from lower layers
T310		ms	1, 2, 3	6000	Radio link failure timer configured by <i>RLF-TimersAndConstants</i>
T311		ms	1, 2, 3	3000	RRC re-establishment timer
Access Barring Information		-	1, 2, 3	Not Sent	No additional delays in random access procedure.
SSB configuration			1	SSB.1 FR1	
			2	SSB.1 FR1	
			3	SSB.2 FR1	
SMTC configuration			1	SMTC.2	
			2	SMTC.1	
			3	SMTC.1	
DRX cycle length		s	1, 2, 3	OFF	
PRACH configuration			1, 2, 3	PRACH.1 FR1	
T1		s	1, 2, 3	5	
T2		s	1, 2, 3	6.24	Time for the UE to detect RLF (Summation of TEvaluate_out_SSB defined in clause 8.1 in TS 38.133 [6], T310 and the period for UE turns off transmitter defined in clause 8.1.5 in TS 38.133 [6] )
T3		s	1, 2, 3	3	

#### 6.3.2.1.3.4.2 Test procedure

The test consists of 3 successive time periods, with time duration of T1, T2 and T3 respectively. At the start of time period T2, cell 1, which is the active cell, is deactivated. The time period T3 starts after the occurrence of the radio link failure.

1. Ensure the UE is in state RRC\_CONNECTED with generic procedure parameters Connectivity NR, Connected without release On and Test Mode On according to TS 38.508-1 [14] clause 4.5. Establish SRB2 and DRB in the RRC Reconfiguration message.
2. Set the parameters according to T1 in Table 6.3.2.1.3.5-1. T1 starts.
3. SS shall transmit an RRCReconfiguration message.
4. The UE shall transmit RRCReconfigurationComplete message.
5. When T1 expires, the SS shall switch the power setting from T1 to T2 as specified in Table 6.3.2.1.3.5-1. T2 starts
6. When T2 expires, the SS shall switch the power setting from T2 to T3 as specified in Table 6.3.2.1.3.5-1. T3 starts
7. If the UE starts to send PRACH preambles to cell 2 for sending the *RRCReestablishmentRequest* message to cell 2 within 2.2 s from the beginning of time period T3, then the number of successful tests is increased by one. Otherwise, the number of failure tests is increased by one.

8. After T3 expires, switch off the UE. Then ensure the UE is in state RRC\_CONNECTED with generic procedure parameters Connectivity NR, Connected without release On and Test Mode On according to TS 38.508-1 [14] clause 4.5. Cell 1 is the active cell.
9. Set cell 2 physical cell identity = ((current cell 2 physical cell identity + 1) mod 14 + 2) for next iteration of the test procedure loop.
10. Repeat step 2-9 until the confidence level according to Table G.2.3-1 in Annex G clause G.2 is achieved.

6.3.2.1.3.4.3 Message contents

Message contents are according to TS 38.508-1 [14] clause 7.3 with the following exceptions:

**Table 6.3.2.1.3.4.3-1: Common Exception messages for NR SA FR1 RRC re-establishment without serving cell timing**

Default Message Contents	
Common contents of system information blocks exceptions	
Default RRC messages and information elements contents exceptions	
Specific message contents exceptions for Test Configuration 6.3.2.1.3-1	Table H.3.1-3 with Condition INTRA-FREQ MO, SSB.1 FR1 Table 7.3.1-3 in TS 38.508-1 [14] with condition SMTC.2
Specific message contents exceptions for Test Configuration 6.3.2.1.3-2	Table H.3.1-3 with Condition INTRA-FREQ MO, SSB.1 FR1 and synchronous cells Table 7.3.1-3 in TS 38.508-1 [14] with condition SMTC.1
Specific message contents exceptions for Test Configuration 6.3.2.1.3-3	Table H.3.1-3 with Condition INTRA-FREQ MO, SSB.2 FR1 and synchronous cells Table 7.3.1-3 in TS 38.508-1 [14] with condition SMTC.1

**Table 6.3.2.1.3.4.3-2: RLF-TimersAndConstants for intra-frequency RRC re-establishment**

Derivation Path: TS 38.508-1 [14], Table 4.6.3-150			
Information Element	Value/remark	Comment	Condition
RLF-TimersAndConstants ::= SEQUENCE {			
t310	ms6000		
t311	ms3000		
}			

**Table 6.3.2.1.3.4.3-3: MeasConfig for intra-frequency RRC re-establishment**

Derivation Path: TS 38.508-1 [14], Table 4.6.3-69			
Information Element	Value/remark	Comment	Condition
MeasConfig ::= SEQUENCE {			
reportConfigToAddModList	Not present		
measIdToAddModList	Not present		
quantityConfig	Not present		
}			

6.3.2.1.3.5 Test requirement

Table 6.3.2.1.3.5-1 defines the primary level settings including test tolerances for NR SA FR1 RRC re-establishment without serving cell timing test case.

**Table 6.3.2.1.3.5-1: Cell specific test parameters for NR SA FR1 RRC re-establishment without serving cell timing**

Parameter	Unit	Test configuration	Cell 1			Cell 2		
			T1	T2	T3	T1	T2	T3
TDD configuration		1	N/A			N/A		
		2	TDDConf.1.1			TDDConf.1.1		
		3	TDDConf.2.1			TDDConf.2.1		
PDSCH RMC configuration		1	SR.1.1 FDD			SR.1.1 FDD		
		2	SR.1.1 TDD			SR.1.1 TDD		
		3	SR.2.1 TDD			SR.2.1 TDD		
RMSI CORESET RMC configuration		1	CR.1.1 FDD			CR.1.1 FDD		
		2	CR.1.1 TDD			CR.1.1 TDD		
		3	CR.2.1 TDD			CR.2.1 TDD		
Dedicated CORESET RMC configuration		1	CCR.1.1 FDD			CCR.1.1 FDD		
		2	CCR.1.1 TDD			CCR.1.1 TDD		
		3	CCR.2.1 TDD			CCR.2.1 TDD		
OCNG Pattern		1, 2, 3	OP.1			OP.1		
TRS Configuration		1	TRS.1.1.FDD			TRS.1.1.FDD		
		2	TRS.1.1.TDD			TRS.1.1.TDD		
		3	TRS.1.2.FDD			TRS.1.2.TDD		
Initial DL BWP configuration		1, 2, 3	DLBWP.0.1			DLBWP.0.1		
Initial UL BWP configuration		1, 2, 3	ULBWP.0.1			ULBWP.0.1		
RLM-RS		1, 2, 3	SSB			SSB		
$\hat{E}_s / I_{ot}$	dB	1	4	-infinity	-infinity	-infinity	-infinity	4
	2							
	3							
$N_{oc}$ <sup>Note2</sup>	dBm/SCS	1	-98					
		2	-98					
		3	-95					
$N_{oc}$ <sup>Note2</sup>	dBm/15 kHz	1	-98					
		2						
		3						
$\hat{E}_s / N_{oc}$	dB	1	4	-infinity	-infinity	-infinity	-infinity	4
		2						
		3						
SS-RSRP <sup>Note3</sup>	dBm/SCS	1	-94	-infinity	-infinity	-infinity	-infinity	-94
		2	-94	-infinity	-infinity	-infinity	-infinity	-94
		3	-91	-infinity	-infinity	-infinity	-infinity	-91
Io	dBm/9.36 MHz	1	-64.59	-70.05	-70.05	-70.05	-70.05	-64.59
	dBm/9.36 MHz	2	-64.59	-70.05	-70.05	-70.05	-70.05	-64.59
	dBm/38.16 MHz	3	-58.50	-63.94	-63.94	-63.94	-63.94	-58.50
Propagation Condition		1, 2, 3	AWGN					
<p>Note 1: OCNG shall be used such that both cells are fully allocated and a constant total transmitted power spectral density is achieved for all OFDM symbols.</p> <p>Note 2: Interference from other cells and noise sources not specified in the test is assumed to be constant over subcarriers and time and shall be modelled as AWGN of appropriate power for <math>N_{oc}</math> to be fulfilled.</p> <p>Note 3: SS-RSRP levels have been derived from other parameters for information purposes. They are not settable parameters themselves.</p>								

The RRC re-establishment delay is defined as the time from the start of time period T3, to the moment when the UE starts to send PRACH preambles to cell 2 for sending the *RRCReestablishmentRequest* message to cell 2.

The RRC re-establishment delay to an unknown NR intra frequency cell without serving cell timing shall be less than 2.2 s.

The rate of correct RRC re-establishments observed during repeated tests shall be at least 90%.

NOTE: The RRC re-establishment delay in the test is derived from the following expression:

$$T_{\text{re-establish\_delay}} = T_{\text{UL\_grant}} + T_{\text{UE\_re-establish\_delay}}$$

Where:

$T_{UL\_grant}$  = It is the time required to acquire and process uplink grant from the target cell. The PRACH reception at the system simulator is used as a trigger for the completion of the test; hence  $T_{UL\_grant}$  is not used.

$$T_{UE\_re-establish\_delay} = 50 + T_{identify\_intra\_NR} + \sum_{i=1}^{N_{freq}-1} T_{identify\_inter\_NR,i} + T_{SI-NR} + T_{PRACH}$$

$$N_{freq} = 1$$

$$T_{identify\_intra\_NR} = 800 \text{ ms}$$

$T_{SI} = 1280 \text{ ms}$ ; it is the time required for receiving all the relevant system information as defined in TS 38.331 [13] for the target intra-frequency NR cell.

$T_{PRACH} = 15 \text{ ms}$ ; it is the additional delay caused by the random access procedure.

This gives a total of 2145 ms, allow 2.2 s in the test case.

## 6.3.2.2 Random access

### 6.3.2.2.0 Minimum conformance requirements

#### 6.3.2.2.0.1 Minimum conformance requirements for Contention based random access

The random access procedure is used when establishing the layer 1 communication between the UE and NG-RAN. The random access is as defined in TS 38.213 [8] clause 7.4 and the control of the RACH transmission is as defined in TS 38.321 [12] clause 5.1.

The UE shall have capability to calculate PRACH transmission power according to the PRACH power formula as defined in TS 38.213 [8] clause 7.4 and apply this power level at the first preamble or additional preambles. The absolute power applied to the first preamble shall have an accuracy as defined in TS 38.101-1 [2] Table 6.3.4.2-1. The relative power applied to additional preambles shall have an accuracy as specified in TS 38.101-1 [2] Table 6.3.4.3-1.

The UE shall indicate a Random Access problem to upper layers if the maximum number of preamble transmission counter has been reached for the random access procedure on PCell or PSCell as specified in TS 38.321 [12] clause 5.1.4.

With the UE selected SSB with SS-RSRP above  $rsrp-ThresholdSSB$ , UE shall have the capability to select a Random Access Preamble randomly with equal probability from the Random Access Preambles associated with the selected SSB if the association between Random Access Preambles and SS blocks is configured, as specified in clause 5.1.2 in TS 38.321 [12].

With the UE selected SSB with SS-RSRP above  $rsrp-ThresholdSSB$ , UE shall have the capability to transmit Random Access Preamble on the next available PRACH occasion from the PRACH occasions corresponding to the selected SSB permitted by the restrictions given by the  $ra-ssb-OccasionMaskIndex$  if configured, if the association between PRACH occasions and SSBs is configured, and PRACH occasion shall be randomly selected with equal probability amongst the selected SSB associated PRACH occasions occurring simultaneously but on different subcarriers, as specified in clause 5.1.2 in TS 38.321 [12].

The UE may stop monitoring for Random Access Response(s) and shall transmit the msg3 if the Random Access Response contains a Random Access Preamble identifier corresponding to the transmitted Random Access Preamble.

The UE shall again perform the Random Access Resource selection procedure defined in clause 5.1.2 in TS 38.321 [12], and transmit with the calculated PRACH transmission power when the backoff time expires if all received Random Access Responses contain Random Access Preamble identifiers that do not match the transmitted Random Access Preamble.

The UE shall again perform the Random Access Resource selection procedure defined in clause 5.1.2 in TS 38.321 [12], and transmit with the calculated PRACH transmission power when the backoff time expires if no Random Access Response is received within the RA Response window defined in clause 5.1.4 in TS 38.321 [12].

The UE shall re-transmit the msg3 upon the reception of an UL grant for msg3 retransmission.

The UE shall send ACK if the Contention Resolution is successful.

The UE shall again perform the Random Access Resource selection procedure defined in clause 5.1.2 in TS 38.321 [12], and transmit with the calculated PRACH transmission power when the backoff time expires unless the received message includes a UE Contention Resolution Identity MAC control element and the UE Contention Resolution Identity included in the MAC control element matches the CCCH SDU transmitted in the uplink message.

The UE shall re-select a preamble and transmit with the calculated PRACH transmission power when the backoff time expires if the Contention Resolution Timer expires.

The normative reference for this requirement is TS 38.133 [6] clauses 6.2.2.

#### 6.3.2.2.0.2 Minimum conformance requirements for Non-Contention based random access

The random access procedure is used when establishing the layer 1 communication between the UE and NG-RAN. The random access is as defined in TS 38.213 [8] clause 7.4 and the control of the RACH transmission is as defined in TS 38.321 [12] clause 5.1.

The UE shall have capability to calculate PRACH transmission power according to the PRACH power formula as defined in TS 38.213 [8] clause 7.4 and apply this power level at the first preamble or additional preambles. The absolute power applied to the first preamble shall have an accuracy as defined in TS 38.101-1 [2] Table 6.3.4.2-1. The relative power applied to additional preambles shall have an accuracy as specified in TS 38.101-1 [2] Table 6.3.4.3-1.

The UE shall indicate a Random Access problem to upper layers if the maximum number of preamble transmission counter has been reached for the random access procedure on PCell or PSCell as specified in TS 38.321 [12] clause 5.1.4.

If the contention-free Random Access Resources and the contention-free PRACH occasions associated with SSBs is configured, with the UE selected SSB with *SS-RSRP* above *rsrp-ThresholdSSB* amongst the associated SSBs, UE shall have the capability to select the Random Access Preamble corresponding to the selected SSB, and to transmit Random Access Preamble on the next available PRACH occasion from the PRACH occasions corresponding to the selected SSB permitted by the restrictions given by the *ra-ssb-OccasionMaskIndex* if configured, and PRACH occasion shall be randomly selected with equal probability amongst the selected SSB associated PRACH occasions occurring simultaneously but on different subcarriers, as specified in clause 5.1.2 in TS 38.321 [12].

If the contention-free Random Access Resources and the contention-free PRACH occasions associated with CSI-RSs is configured, with the UE selected CSI-RS with *CSI-RSRP* above *cfra-csirs-DedicatedRACH-Threshold* amongst the associated CSI-RSs, UE shall have the capability to select the Random Access Preamble corresponding to the selected CSI-RS, and to transmit Random Access Preamble on the next available PRACH occasion from the PRACH occasions in *ra-OccasionList* corresponding to the selected CSI-RS, and PRACH occasion shall be randomly selected with equal probability amongst the selected CSI-RS associated PRACH occasions occurring simultaneously but on different subcarriers, as specified in clause 5.1.2 in TS 38.321 [12].

The UE may stop monitoring for Random Access Response(s), if the Random Access Response contains a Random Access Preamble identifier corresponding to the transmitted Random Access Preamble, unless the random access procedure is initialized for Other SI request from UE.

The UE shall again perform the Random Access Resource selection procedure defined in clause 5.1.2 in TS 38.321 [12] for the next available PRACH occasion, and transmit the preamble with the calculated PRACH transmission power if all received Random Access Responses contain Random Access Preamble identifiers that do not match the transmitted Random Access Preamble.

The UE shall again perform the Random Access Resource selection procedure defined in clause 5.1.2 in TS 38.321 [12] for the next available PRACH occasion, and transmit the preamble with the calculated PRACH transmission power, if no Random Access Response is received within the RA Response window configured in *RACH-ConfigCommon* or if no PDCCH addressed to UE's C-RNTI is received within the RA Response window configured in *BeamFailureRecoveryConfig*, as defined in clause 5.1.4 in TS 38.321 [12].

The normative reference for this requirement is TS 38.133 [6] clauses 6.2.2.

Non-contention based random access procedure is not initialized for Other SI requested from UE or for beam failure recovery, so the requirements related to those features are omitted.



### 6.3.2.2.1 NR SA FR1 contention based random access

#### 6.3.2.2.1.1 Test purpose

The purpose of this test is to verify that the behaviour of the random access procedure is according to the requirements and that the PRACH power settings and timing are within specified limits.

#### 6.3.2.2.1.2 Test applicability

This test applies to all types of NR UE from Release 15 onwards.

#### 6.3.2.2.1.3 Minimum conformance requirement

The minimum conformance requirements are specified in clause 6.3.2.2.0.1.

The normative reference for this requirement is TS 38.133 [6] clauses A.6.3.2.2.1.

#### 6.3.2.2.1.4 Test description

##### 6.3.2.2.1.4.1 Initial conditions

This test can be run in the configurations defined in Table 6.3.2.2.1.4.1-1.

**Table 6.3.2.2.1.4.1-1: Contention based random access test in FR1 for NR standalone supported test configurations**

Test Case ID	Test Config Index	Description
6.3.2.2.1-1	1	NR: 15 kHz SSB SCS, 10MHz bandwidth, FDD
6.3.2.2.1-2	2	NR: 30 kHz SSB SCS, 40MHz bandwidth, TDD
Note: The UE is only required to be tested in one of the supported test configurations		

Configure the test equipment and the DUT according to the parameters in Table 6.3.2.2.1.4.1-2.

**Table 6.3.2.2.1.4.1-2: Initial conditions for Contention based random access test in FR1 for NR standalone**

Parameter	Value		Comment
Test environment	NC		As specified in TS 38.508-1 [14] clause 4.1.
Test frequencies	As specified in Annex E, Table E.4-1 and TS 38.508-1 [14] clause 4.3.1.		
Channel bandwidth	As specified by the test configuration selected from Table 6.3.2.2.1.4.1-1.		
Propagation conditions	AWGN		As specified in Annex C.2.2.
Connection Diagram	TE Part	A.3.1.7.1	As specified in TS 38.508-1 [14] Annex A.
	DUT Part	A.3.2.3.4	
Exceptions to connection diagram	N/A		

1. Message contents are defined in clause 6.3.2.2.1.4.3.

2. Cell 1 is the NR FR1 serving cell (PCell). The connection setup is done according to the settings in Annex C.1.1 and C.1.2.

#### 6.3.2.2.1.4.2 Test procedure

The test consists of a single cell, configured as PCell in FR1. The System Simulator shall not explicitly assign a random access preamble via dedicated signalling in the downlink.

1. Ensure the UE is in state RRC\_IDLE with generic procedure parameters Connectivity *NR* and Test Mode *On* according to TS 38.508-1 [14] clause 4.5.

2. Set the parameters according to Table 6.3.2.2.1.5-1.

3. The UE shall establish a connection setup with SS, the random access procedure within the connection setup is used in the test.

4. Test 1: Correct behaviour when transmitting Random Access Preamble
  - 4.1. The UE shall send a preamble to the System Simulator. The System Simulator shall check that the Random Access Preamble belongs to one of the Random Access Preambles associated with the SSB with index 0, which has SS-RSRP above the configured  $\text{rsrp-ThresholdSSB}$ .
5. Test 2: Correct behaviour when receiving Random Access Response
  - 5.1. Repeat steps 1-3.
  - 5.2. The UE shall send preambles to the System Simulator. In response to the first 4 preambles, the System Simulator shall transmit a Random Access Response containing Random Access Preamble identifiers that do not match the transmitted Random Access Preamble.
  - 5.3. As the received Random Access Responses contain Random Access Preamble identifiers that do not match the transmitted Random Access Preamble, the UE shall perform the Random Access Resource selection procedure specified in clause 5.1.2 in TS 38.321 [12], and transmit with the calculated PRACH transmission power when the backoff time expires.
  - 5.4. The System Simulator shall transmit a Random Access Response containing a Random Access Preamble identifier matching the transmitted Random Access Preamble after 5 preambles have been received by the System Simulator.
  - 5.5. As the received Random Access Response contains a Random Access Preamble identifier that matches the transmitted Random Access Preamble, the UE shall transmit the msg3.
  - 5.6. Measure the power and timing of the first preamble and it shall not exceed the values specified in 6.3.2.2.1.5. Measure the relative power and timing applied to additional preambles (last 4 preambles) and it shall not exceed the values specified in 6.3.2.2.1.5.
6. Test 3: Correct behaviour when not receiving Random Access Response
  - 6.1. Repeat steps 1-3.
  - 6.2. The UE shall send preambles to the System Simulator. The System Simulator shall not respond to the first 4 preambles.
  - 6.3. As no Random Access Response was received within the RA Response window, the UE shall perform the Random Access Resource selection procedure specified in clause 5.1.2 in TS 38.321 [12], and transmit with the calculated PRACH transmission power when the backoff time expires.
  - 6.4. The System Simulator shall transmit a Random Access Response containing a Random Access Preamble identifier matching the transmitted Random Access Preamble after 5 preambles have been received by the System Simulator.
  - 6.5. As the received Random Access Response contains a Random Access Preamble identifier that matches the transmitted Random Access Preamble, the UE shall transmit the msg3.
  - 6.6. Measure the power and timing of the first preamble and it shall not exceed the values specified in 6.3.2.2.1.5. Measure the relative power and timing applied to additional preambles (last 4 preambles) and it shall not exceed the values specified in 6.3.2.2.1.5.
7. Test 4: Correct behaviour when receiving an UL grant for msg3 retransmission
  - 7.1. Repeat steps 1-3.
  - 7.2. The UE shall send a preamble to the System Simulator. The System Simulator shall transmit a Random Access Response containing a Random Access Preamble identifier matching the transmitted Random Access Preamble.
  - 7.3. As the received Random Access Response contains a Random Access Preamble identifier that matches the transmitted Random Access Preamble, the UE shall transmit the msg3.
  - 7.4. The System Simulator shall send PDCCH addressed to the Temporary C-RNTI after receiving the msg3.
  - 7.5. The UE shall re-transmit the msg3.

- 7.6. The System Simulator shall check if UE re-transmit the msg3.
8. Test 5: Correct behaviour when receiving an unsuccessful UE Contention Resolution
- 8.1. Repeat steps 1-3.
- 8.2. The UE shall send a preamble to the System Simulator. The System Simulator shall transmit a Random Access Response containing a Random Access Preamble identifier matching the transmitted Random Access Preamble.
- 8.3. As the received Random Access Response contains a Random Access Preamble identifier that matches the transmitted Random Access Preamble, the UE shall transmit the msg3.
- 8.4. The System Simulator shall send a message addressed to the temporary C-RNTI with a UE Contention Resolution Identity included in the MAC control element not matching the CCCH SDU transmitted in msg3 uplink message.
- 8.5. As the UE Contention Resolution Identity included in the MAC control element did not match the CCCH SDU transmitted in the uplink message, the UE shall perform the Random Access Resource selection procedure specified in clause 5.1.2 in TS 38.321 [12], and transmit with the calculated PRACH transmission power when the backoff time expires.
- 8.6. Measure the power and timing of the first preamble and it shall not exceed the values specified in 6.3.2.2.1.5.
9. Test 6: Correct behaviour when receiving a successful UE Contention Resolution
- 9.1. Repeat steps 1-3.
- 9.2. The UE shall send a preamble to the System Simulator. The System Simulator shall transmit a Random Access Response containing a Random Access Preamble identifier matching the transmitted Random Access Preamble.
- 9.3. As the received Random Access Response contains a Random Access Preamble identifier that matches the transmitted Random Access Preamble, the UE shall transmit the msg3.
- 9.4. The System Simulator shall send a message addressed to the temporary C-RNTI with a UE Contention Resolution Identity included in the MAC control element matching the CCCH SDU transmitted in msg3 uplink message.
- 9.5. As the UE Contention Resolution Identity included in the MAC control element matches the CCCH SDU, the Contention Resolution is successful and the UE shall send ACK.
10. Test 7: Correct behaviour when contention Resolution timer expires
- 10.1. Repeat steps 1-3.
- 10.2. The UE shall send a preamble to the System Simulator. The System Simulator shall transmit a Random Access Response containing a Random Access Preamble identifier matching the transmitted Random Access Preamble.
- 10.3. As the received Random Access Response contains a Random Access Preamble identifier that matches the transmitted Random Access Preamble, the UE shall transmit the msg3.
- 10.4. The System Simulator shall not send a response.
- 10.5. As there was no response, the UE shall perform the Random Access Resource selection procedure specified in clause 5.1.2 in TS 38.321 [12], and transmit with the calculated PRACH transmission power when the Contention Resolution Timer expires and then after the backoff timer expires.
- 10.6. Measure the power and timing of the first preamble and it shall not exceed the values specified in 6.3.2.2.1.5.

#### 6.3.2.2.1.4.3 Message contents

Message contents are according to TS 38.508-1 [14] clause 4.6 with the following exceptions:

**Table 6.3.2.2.1.4.3-0: Common Exception messages**

Default Message Contents	
Common contents of system information blocks exceptions	
Default RRC messages and information elements contents exceptions	
Common exceptions to the contents of TS 38.508-1 [14]	Table 4.6.3-115 with SSB-Index 0 Table 4.6.3-120 with SSB-Index 0

**Table 6.3.2.2.1.4.3-1: FrequencyInfoUL-SIB for Contention Based Random Access**

Derivation Path: TS 38.508-1 [14], table 4.6.3-62			
Information Element	Value/remark	Comment	Condition
FrequencyInfoUL-SIB SEQUENCE {			
p-Max	23	23 dBm	
}			

**Table 6.3.2.2.1.4.3-2: RACH-ConfigCommon for Contention Based Random Access**

Derivation Path: TS 38.508-1 [14], table 4.6.3-128			
Information Element	Value/remark	Comment	Condition
RACH-ConfigCommon ::= SEQUENCE {			
rach-ConfigGeneric	RACH-ConfigGeneric		
totalNumberOfRA-Preambles	48		
ssb-perRACH-OccasionAndCB-PreamblesPerSSB CHOICE {			
oneFourth	n48		FR1
}			
groupBconfigured SEQUENCE {			
numberOfRA-PreamblesGroupA	48		
}			
ra-ContentionResolutionTimer	sf48		
rsrp-ThresholdSSB	RSRP_51		
prach-RootSequenceIndex CHOICE {			
0			
}			
msg1-SubcarrierSpacing	kHz 15 kHz 30		
}			

**Table 6.3.2.2.1.4.3-3: RACH-ConfigGeneric for Contention Based Random Access**

Derivation Path: TS 38.508-1 [14], table 4.6.3-130			
Information Element	Value/remark	Comment	Condition
RACH-ConfigGeneric ::= SEQUENCE {			
prach-ConfigurationIndex	102		FR1
msg1-FDM	one		FR1
zeroCorrelationZoneConfig	11		
preambleReceivedTargetPower	-120		
preambleTransMax	n6		
powerRampingStep	dB2		
ra-ResponseWindow	sl10		
}			

**Table 6.3.2.2.1.4.3-4: ServingCellConfigCommonSIB for Contention Based Random Access**

Derivation Path: TS 38.508-1 [14], table 4.6.3-169			
Information Element	Value/remark	Comment	Condition
ServingCellConfigCommonSIB ::= SEQUENCE {			
ssb-PositionsInBurst SEQUENCE {			
inOneGroup	'1100 0000'B		
}			
ss-PBCH-BlockPower	-5		
}			

6.3.2.2.1.5 Test requirement

Table 6.3.2.2.1.5-1 defines the primary level settings for contention based random access test in FR1 for NR Standalone. Tables 6.3.2.2.1.5-2, 6.3.2.2.1.5-3 and 6.3.2.2.1.5-4 define the Absolute power limits, Relative power limits and uplink timing error limits respectively, and all include test tolerances.

**Table 6.3.2.2.1.5-1: General test parameters for contention based random access test in FR1 for NR Standalone**

Parameter	Unit	Test-1	Comments		
SSB Configuration	Config 1	SSB.1 FR1	As defined in A.3.1, except for number of SSBs per SS-burst and SS/PBCH block index as below		
	Config 2	SSB.2 FR1			
Number of SSBs per SS-burst		2	Different from the definition in A.3.1		
SS/PBCH block index		0,1	Different from the definition in A.3.1		
Duplex Mode for Cell 2	Config 1	FDD			
	Config 2	TDD			
TDD Configuration	Config 2	TDDConf.2.1			
CSI-RS for tracking	Config 1	TRS.1.1 FDD			
	Config 2	TRS.1.2 TDD			
OCNG Pattern <sup>Note 1</sup>		OP.1	As defined in A.2.1		
PDSCH parameters <sup>Note 4</sup>	Config 1	SR.1.1 FDD	As defined in A.1.1		
	Config 2	SR.2.1 TDD			
RMSI CORESET	Config 1	CR.1.1 FDD			
Reference Channel	Config 2	CR.2.1 TDD			
Dedicated CORESET	Config 1	CCR.1.1 FDD			
Reference Channel	Config 2	CCR.2.1 TDD			
NR RF Channel Number		1			
EPRE ratio of PSS to SSS	dB	0			
EPRE ratio of PBCH_DMRS to SSS	dB				
EPRE ratio of PBCH to PBCH_DMRS	dB				
EPRE ratio of PDCCH_DMRS to SSS	dB				
EPRE ratio of PDCCH to PDCCH_DMRS	dB				
EPRE ratio of PDSCH_DMRS to SSS	dB				
EPRE ratio of PDSCH to PDSCH_DMRS	dB				
SSB with index 0	$\hat{E}_s / I_{ot}$	dB	3	Power of SSB with index 0 is set to be above configured <i>rsrp-ThresholdSSB</i>	
	$N_{oc}$	Config 1	dBm/15kHz		-98
		Config 2			-101
	$\hat{E}_s / N_{oc}$	dB			3
	SS-RSRP	Config 1	dBm/15kHz		-95
Config 2			-98		
SS-RSRP	dBm/ SCS		-95		

Parameter		Unit	Test-1	Comments		
SSB with index 1	$\hat{E}_s / I_{ot}$	dB	-17	Power of SSB with index 1 is set to be below configured <i>rsrp-ThresholdSSB</i>		
	$N_{oc}$	Config 1	dBm/15kHz		-98	
		Config 2			-101	
	$\hat{E}_s / N_{oc}$	dB	-17			
	SS-RSRP	Config 1	dBm/15kHz		-115	
		Config 2			-118	
SS-RSRP		dBm/ SCS	-115			
$I_o$ <small>Note 2</small>	Config 1	dBm	-65.3/9.36MHz	For symbols without SSB index 1		
	Config 2		-62.2/38.16MHz			
ss-PBCH-BlockPower		dBm/ SCS	-5	As defined in clause 6.3.2 in TS 38.331 [13].		
Configured UE transmitted power ( $P_{C_{MAX,f,c}}$ )		dBm	23	As defined in clause 6.2.4 in TS 38.101-1 [2].		
PRACH Configuration			FR1 PRACH configuration 1	As defined in A.3.x.		
Propagation Condition		-	AWGN			
<p>Note 1: OCNG shall be used such that the cell is fully allocated and a constant total transmitted power spectral density is achieved for all OFDM symbols. The OCNG pattern is chosen during the test according to the presence of a DL reference measurement channel.</p> <p>Note 2: <math>E_s/I_{ot}</math>, SS-RSRP and <math>I_o</math> level have been derived from other parameters for information purpose. They are not settable parameters.</p> <p>Note 3: Void.</p> <p>Note 4: The DL PDSCH reference measurement channel is used in the test only when a downlink transmission dedicated to the UE under test is required.</p>						

Test 1: Correct behaviour when transmitting Random Access Preamble

- The Random Access Preamble shall be one of the Random Access Preambles associated with SSB index 0.

Test 2: Correct behaviour when receiving Random Access Response

- The power of the first preamble shall be -22 dBm within the accuracy specified in Table 6.3.2.2.1.5-2.
- The relative power for preamble ramping step shall be 2 dB within the accuracy specified in Table 6.3.2.2.1.5-3.
- The transmit timing of all PRACH transmissions shall be within the accuracy specified in Table 6.3.2.2.1.5-4.

Test 3: Correct behaviour when not receiving Random Access Response

- The power of the first preamble shall be -22 dBm within the accuracy specified in Table 6.3.2.2.1.5-2.
- The relative power for preamble ramping step shall be 2 dB within the accuracy specified in Table 6.3.2.2.1.5-3.
- The transmit timing of all PRACH transmissions shall be within the accuracy specified in Table 6.3.2.2.1.5-4.

Test 4: Correct behaviour when receiving an UL grant for msg3 retransmission

- The UE shall re-transmit the msg3 upon the reception of an UL grant for msg3 retransmission.

Test 5: Correct behaviour when receiving an incorrect message over Temporary C-RNTI

- The UE shall re-select a preamble and transmit with the calculated PRACH transmission power when the back off time expires.
- The power of the first preamble shall be -22 dBm within the accuracy specified in Table 6.3.2.2.1.5-2.
- The transmit timing of the PRACH transmission shall be within the accuracy specified in Table 6.3.2.2.1.5-4.

Test 6: Correct behaviour when receiving a correct message over Temporary C-RNTI

- The UE shall send ACK if the contention resolution is successful.

Test 7: Correct behaviour when contention resolution timer expires

- The UE shall re-select a preamble and transmit with the calculated PRACH transmission power when the back off time expires if the contention resolution timer expires.
- The power of the first preamble shall be -22 dBm within the accuracy specified in Table 6.3.2.2.1.5-2.
- The transmit timing of the PRACH transmission shall be within the accuracy specified in Table 6.3.2.2.1.5-4.

**Table 6.3.2.2.1.5-2 Absolute power tolerance Test requirements**

Conditions	Tolerance
Normal	$\pm 11.1$ dB

**Table 6.3.2.2.1.5-3 Relative power tolerance Test requirements**

Power step $\Delta P$ (Up or down) (dB)	PRACH (dB)
$2 \leq \Delta P < 3$	$\pm 3.2$

**Table 6.3.2.2.1.5-4:  $T_e$  Timing error Test requirements**

Frequency Range	SCS of SSB signals (kHz)	SCS of uplink signals s(KHz)	$T_e$
1	15	15	$880 * T_c$
	30	30	$624 * T_c$
Note 1: $T_c$ is the basic timing unit defined in TS 38.211 [7]			

### 6.3.2.2.2 NR SA FR1 non-contention based random access

#### 6.3.2.2.2.1 Test purpose

The purpose of this test is to verify that the behaviour of the random access procedure is according to the requirements and that the PRACH power settings and timing are within specified limits.

#### 6.3.2.2.2.2 Test applicability

This test applies to all types of NR UE from Release 15 onwards. Additionally Test 2 is applicable to UE that supports CSI-RS based Random Access Preamble which requires UE to support csi-RSRP-AndRSRQ-MeasWithSSB or csi-RSRP-AndRSRQ-MeasWithoutSSB.

#### 6.3.2.2.2.3 Minimum conformance requirement

The minimum conformance requirements are specified in clause 6.3.2.2.0.2.

The normative reference for this requirement is TS 38.133 [6] clauses A.6.3.2.2.2.

#### 6.3.2.2.2.4 Test description

##### 6.3.2.2.2.4.1 Initial conditions

This test can be run in the configurations defined in Table 6.3.2.2.2.4.1-1.

**Table 6.3.2.2.2.4.1-1: Non-Contention based random access test in FR1 for NR standalone supported test configurations**

Test Case ID	Test Config Index	Description
6.3.2.2.2-1	1	NR: 15 kHz SSB SCS, 10MHz bandwidth, FDD
6.3.2.2.2-2	2	NR: 30 kHz SSB SCS, 40MHz bandwidth, TDD
Note: The UE is only required to be tested in one of the supported test configurations		

Configure the test equipment and the DUT according to the parameters in Table 6.3.2.2.2.4.1-2.

**Table 6.3.2.2.4.1-2: Initial conditions for Non-Contention based random access test in FR1 for NR standalone**

Parameter	Value		Comment
Test environment	NC		As specified in TS 38.508-1 [14] clause 4.1.
Test frequencies	As specified in Annex E, Table E.4-1 and TS 38.508-1 [14] subclause 4.3.1.		
Channel bandwidth	As specified by the test configuration selected from Table 6.3.2.2.4.1-1.		
Propagation conditions	AWGN		As specified in Annex C.2.2.
Connection Diagram	TE Part	A.3.1.7.1	As specified in TS 38.508-1 [14] Annex A.
	DUT Part	A.3.2.3.4	
Exceptions to connection diagram	N/A		

1. Message contents are defined in clause 6.3.2.2.4.3.
2. Cell 1 is the NR FR1 serving cell (PCell). The connection setup is done according to the settings in Annex C.1.1 and C.1.2.

#### 6.3.2.2.4.2 Test procedure

The test consists of a single cell, configured as PCell in FR1. The System Simulator shall explicitly assign a random access preamble via dedicated signalling in the downlink. There are two subtests, to test both SSB-based non-contention based random access (subtest 1) and CSI-RS-based non-contention based random access (subtest 2).

1. Ensure the UE is in state RRC\_CONNECTED with generic procedure parameters Connectivity *NR*, Connected without release *On* and Test Mode *On* according to TS 38.508-1 [14] clause 4.5. Establish SRB2 and DRB in the RRC Reconfiguration message.
2. Set the parameters according to Table 6.3.2.2.5-1 Subtest 1.
3. The SS shall signal a Random Access Preamble ID via a RRCReconfiguration message to the UE and initiate a Non-contention based Random Access procedure according to Table 6.3.2.2.4.3-3 and Table 6.3.2.2.4.3-4.
4. Test 1: Correct behaviour when transmitting SSB-based Random Access Preamble
  - 4.1. The UE shall send a preamble to the System Simulator. The System Simulator shall check that the Random Access Preamble has the Preamble Index associated with the SSB with index 0, that it arrives on a PRACH occasion which belongs to the PRACH occasions corresponding to the SSB with index 0, and that the selected PRACH occasion belongs to the PRACH occasions permitted by the restrictions given by the *ra-ssb-OccasionMaskIndex*.
5. Test 2: Correct behaviour when transmitting CSI-RS-based Random Access Preamble
  - 5.1. Set the parameters according to Table 6.3.2.2.5-1 Subtest 2.
  - 5.2. Repeat steps 1-3.
  - 5.3. The UE shall send a preamble to the System Simulator. The System Simulator shall check that the Random Access Preamble has the Preamble Index associated with the CSI-RS configured, that it arrives on a PRACH occasion which belongs to the PRACH occasions corresponding to the CSI-RS configured, and that the selected PRACH occasion belongs to the PRACH occasions permitted by the restrictions given by the *ra-OccasionList*.
6. Test 3: Correct behaviour when receiving Random Access Response
  - 6.1. Repeat steps 1-3.
  - 6.2. The UE shall send preambles to the System Simulator. In response to the first 4 preambles, the System Simulator shall transmit a Random Access Response containing Random Access Preamble identifiers that do not match the transmitted Random Access Preamble.



- 6.3. As the received Random Access Responses contain Random Access Preamble identifiers that do not match the transmitted Random Access Preamble, the UE shall perform the Random Access Resource selection procedure specified in clause 5.1.2 in TS 38.321 [12], and transmit with the calculated PRACH transmission power.
  - 6.4. The System Simulator shall transmit a Random Access Response containing a Random Access Preamble identifier matching the transmitted Random Access Preamble after 5 preambles have been received by the System Simulator.
  - 6.5. As the received Random Access Response contains a Random Access Preamble identifier that matches the transmitted Random Access Preamble, the UE may stop monitoring for Random Access Response(s).
  - 6.6. Measure the power and timing of the first preamble and it shall not exceed the values specified in 6.3.2.2.2.5. Measure the relative power and timing applied to additional preambles (last 4 preambles) and it shall not exceed the values specified in 6.3.2.2.2.5.
7. Test 4: Correct behaviour when not receiving Random Access Response
- 7.1. Repeat steps 1-3.
  - 7.2. The UE shall send preambles to the System Simulator. The System Simulator shall not respond to the first 4 preambles.
  - 7.3. As no Random Access Response was received within the RA Response window configured in *RACH-ConfigCommon*, the UE shall perform the Random Access Resource selection procedure specified in clause 5.1.2 in TS 38.321 [12], and transmit with the calculated PRACH transmission power.
  - 7.4. The System Simulator shall transmit a Random Access Response containing a Random Access Preamble identifier matching the transmitted Random Access Preamble after 5 preambles have been received by the System Simulator.
  - 7.5. As the received Random Access Response contains a Random Access Preamble identifier that matches the transmitted Random Access Preamble, the UE may stop monitoring for Random Access Response(s).
  - 7.6. Measure the power and timing of the first preamble and it shall not exceed the values specified in 6.3.2.2.2.5. Measure the relative power and timing applied to additional preambles (last 4 preambles) and it shall not exceed the values specified in 6.3.2.2.2.5.

6.3.2.2.2.4.3 Message contents

Message contents are according to TS 38.508-1 [14] clause 4.6 with the following exceptions:

**Table 6.3.2.2.2.4.3-0: Common Exception messages**

Default Message Contents	
Common contents of system information blocks exceptions	
Default RRC messages and information elements contents exceptions	
Common exceptions to the contents of TS 38.508-1 [14]	Table 4.6.3-115 with SSB-Index 0 Table 4.6.3-120 with SSB-Index 0

**Table 6.3.2.2.2.4.3-1: *FrequencyInfoUL-SIB* for Non-Contention Based Random Access**

Derivation Path: TS 38.508-1 [14], table 4.6.3-62			
Information Element	Value/remark	Comment	Condition
FrequencyInfoUL-SIB SEQUENCE {			
p-Max	23	23 dBm	
}			

**Table 6.3.2.2.4.3-2: RACH-ConfigCommon for Non-Contention Based Random Access**

Derivation Path: TS 38.508-1 [14], table 4.6.3-128			
Information Element	Value/remark	Comment	Condition
RACH-ConfigCommon ::= SEQUENCE {			
rach-ConfigGeneric	RACH-ConfigGeneric		
totalNumberOfRA-Preambles	48		
groupBconfigured SEQUENCE {			
numberOfRA-PreamblesGroupA	48		
}			
rsrp-ThresholdSSB	RSRP_51		Subtest 1
prach-RootSequenceIndex CHOICE {			
0			
}			
msg1-SubcarrierSpacing	kHz 15 kHz 30		
}			

**Table 6.3.2.2.4.3-3: CellGroupConfig for Non-Contention Based Random Access**

Derivation Path: TS 38.508-1 [14], table 4.6.3-19			
Information Element	Value/remark	Comment	Condition
CellGroupConfig ::= SEQUENCE {			
spCellConfig SEQUENCE {			
servCellIndex	ServCellIndex		
reconfigurationWithSync SEQUENCE {			
newUE-Identity	1		
t304	ms1000		
rach-ConfigDedicated			
uplink	RACH-ConfigDedicated		
}			
spCellConfigDedicated SEQUENCE {			
uplinkConfig SEQUENCE {			
initialUplinkBWP SEQUENCE {			
srs-Config	SRS-Config		
}			
}			
}			
}			

**Table 6.3.2.2.4.3-4: RACH-ConfigDedicated for Non-Contention Based Random Access**

Derivation Path: TS 38.508-1 [14], table 4.6.3-129			
Information Element	Value/remark	Comment	Condition
RACH-ConfigDedicated ::= SEQUENCE {			
cfra SEQUENCE {			
occasions SEQUENCE {			
ssb-perRACH-Occasion	oneFourth		
}			
resources CHOICE {			
ssb SEQUENCE {			
ssb-ResourceList SEQUENCE (SIZE(1..maxRA-SSB-Resources)) OF {	1 entry		
ssb[1]	0		
ra-PreambleIndex[1]	50		Subtest 1
}			
ra-ssb-OccasionMaskIndex	1		Subtest 1
}			
csirs SEQUENCE {			
csirs-ResourceList SEQUENCE (SIZE(1..maxRA-CSIRS-Resources)) OF {			
ra-OccasionList	1		Subtest 2
ra-PreambleIndex[1]	50		Subtest 2
}			
rsrp-ThresholdCSI-RS	RSRP_51		Subtest 2
}			
}			
}			

**Table 6.3.2.2.4.3-5: RACH-ConfigGeneric for Non-Contention Based Random Access**

Derivation Path: TS 38.508-1 [14], table 4.6.3-130			
Information Element	Value/remark	Comment	Condition
RACH-ConfigGeneric ::= SEQUENCE {			
prach-ConfigurationIndex	102		
msg1-FDM	one		
zeroCorrelationZoneConfig	11		
preambleReceivedTargetPower	-120		
preambleTransMax	n6		
powerRampingStep	dB2		
ra-ResponseWindow	sl10		
}			

**Table 6.3.2.2.4.3-6: ServingCellConfigCommonSIB for Non-Contention Based Random Access**

Derivation Path: TS 38.508-1 [14], table 4.6.3-169			
Information Element	Value/remark	Comment	Condition
ServingCellConfigCommonSIB ::= SEQUENCE {			
ssb-PositionsInBurst SEQUENCE {			
inOneGroup	'1100 0000'B		
}			
ss-PBCH-BlockPower	-5		
}			

### 6.3.2.2.5 Test requirement

Table 6.3.2.2.5-1 defines the primary level settings for non-contention based random access test in FR1 for NR Standalone. Tables 6.3.2.2.5-2, 6.3.2.2.5-3 and 6.3.2.2.5-4 define the Absolute power limits, Relative power limits and uplink timing error limits respectively, and all include test tolerances.

**Table 6.3.2.2.5-1: General test parameters for non-contention based random access test in FR1 for NR Standalone**

Parameter		Unit	Subtest 1	Subtest 2	Comments	
SSB Configuration	Config 1		SSB.1 FR1	SSB.1 FR1	As defined in A.3.10, except for number of SSBs per SS-burst and SS/PBCH block index as below	
	Config 2		SSB.2 FR1	SSB.2 FR1		
Number of SSBs per SS-burst			2	2	Different from the definition in A.3.10	
SS/PBCH block index			0,1	0,1	Different from the definition in A.3.10	
CSI-RS Configuration	Config 1		N/A	CSI-RS.1.1 FDD	As defined in A.3.1.4	
	Config 2			CSI-RS.2.1 TDD		
Duplex Mode for Cell 2	Config 1		FDD	FDD		
	Config 2		TDD	TDD		
TDD Configuration	Config 2		TDDConf.2.1	TDDConf.2.1		
CSI-RS for tracking	Config 1		TRS.1.1 FDD	TRS.1.1 FDD		
	Config 2		TRS.1.2 TDD	TRS.1.2 TDD		
OCNG Pattern <sup>Note 1</sup>			OCNG pattern 1	OCNG pattern 1	As defined in A.3.2.1.	
PDSCH parameters <sup>Note 4</sup>	Config 1		SR.1.1 FDD	SR.1.1 FDD	As defined in A.3.1.1.	
	Config 2		SR.2.1 TDD	SR.2.1 TDD		
RMSI CORESET Reference Channel	Config 1		CR.1.1 TDD	CR.1.1 TDD		
	Config 2		CR.2.1 TDD	CR.2.1 TDD		
Dedicated CORESET Reference Channel	Config 1		CCR.1.1 TDD	CCR.1.1 TDD		
	Config 2		CCR.2.1 TDD	CCR.2.1 TDD		
NR RF Channel Number			1	1		
EPRE ratio of PSS to SSS		dB	0	0		
EPRE ratio of PBCH_DMRS to SSS		dB				
EPRE ratio of PBCH to PBCH_DMRS		dB				
EPRE ratio of PDCCH_DMRS to SSS		dB				
EPRE ratio of PDCCH to PDCCH_DMRS		dB				
EPRE ratio of PDSCH_DMRS to SSS		dB				
EPRE ratio of PDSCH to PDSCH_DMRS		dB				
SSB with index 0	$\hat{E}_s / I_{ot}$	dB	3	3	Power of SSB with index 0 is set to be above configured <i>rsrp-ThresholdSSB</i>	
	$N_{oc}$	Config 1	-98	-98		
		Config 2	-101	-101		
	$\hat{E}_s / N_{oc}$	dB	3	3		
	SS-RSRP <sup>Note 3</sup>	Config 1	dBm/15kHz	-95		-95
		Config 2		-98		-98
SS-RSRP <sup>Note 3</sup>		dBm/ SCS	-95	-95		
SSB with index 1	$\hat{E}_s / I_{ot}$	dB	-17	-17	Power of SSB with index 1 is set to be below configured <i>rsrp-ThresholdSSB</i>	
	$N_{oc}$	Config 1	-98	-98		
		Config 2	-101	-101		
	$\hat{E}_s / N_{oc}$	dB	-17	-17		
	SS-RSRP <sup>Note 3</sup>	Config 1	dBm/15kHz	-115		-115
		Config 2		-118		-118
SS-RSRP <sup>Note 3</sup>		dBm/ SCS	-115	-115		
I <sub>o</sub> <sup>Note 2</sup>	Config 1	dBm	-65.3/9.36MHz	-65.3/9.36MHz	For symbols without SSB index 1	
	Config 2		-62.2/38.16MHz	-62.2/38.16MHz		
ss-PBCH-BlockPower		dBm/ SCS	-5	-5	As defined in clause 6.3.2 in TS 38.331 [13].	
Configured UE transmitted power ( $P_{CMAX, f,c}$ )		dBm	23	23	As defined in clause 6.2.4 in TS 38.101-1 [2].	
PRACH Configuration			FR1 PRACH configuration 2	FR1 PRACH configuration 3	As defined in A.3.8.	
Propagation Condition		-	AWGN	AWGN		

Note 1:	OCNG shall be used such that the cell is fully allocated and a constant total transmitted power spectral density is achieved for all OFDM symbols. The OCNG pattern is chosen during the test according to the presence of a DL reference measurement channel.
Note 2:	Es/Iot, SS-RSRP and I <sub>o</sub> level have been derived from other parameters for information purpose. They are not settable parameters.
Note 3:	Void.
Note 4:	The DL PDSCH reference measurement channel is used in the test only when a downlink transmission dedicated to the UE under test is required.

Test 1: Correct behaviour when transmitting SSB-based Random Access Preamble

- The Random Access Preamble shall be one of the Random Access Preambles associated with SSB index 0.
- The Random Access Preamble shall arrive on a PRACH occasion which belongs to the PRACH occasions corresponding to the SSB with index 0.
- The selected PRACH occasion shall belong to the PRACH occasions permitted by the restrictions given by the *ra-ssb-OccasionMaskIndex*.

Test 2: Correct behaviour when transmitting CSI-RS-based Random Access Preamble

- The Random Access Preamble shall have the Preamble Index associated with the CSI-RS configured.
- The Random Access Preamble shall arrive on a PRACH occasion which belongs to the PRACH occasions corresponding to the CSI-RS configured.
- The selected PRACH occasion belongs to the PRACH occasions permitted by the restrictions given by the *ra-OccasionList*.

Test 3: Correct behaviour when receiving Random Access Response

- The power of the first preamble shall be -22 dBm within the accuracy specified in Table 6.3.2.2.2.5-2.
- The relative power for preamble ramping step shall be 2 dB within the accuracy specified in Table 6.3.2.2.2.5-3.
- The transmit timing of all PRACH transmissions shall be within the accuracy specified in Table 6.3.2.2.2.5-4.

Test 4: Correct behaviour when not receiving Random Access Response

- The power of the first preamble shall be -22 dBm within the accuracy specified in Table 6.3.2.2.2.5-2.
- The relative power for preamble ramping step shall be 2 dB within the accuracy specified in Table 6.3.2.2.2.5-3.
- The transmit timing of all PRACH transmissions shall be within the accuracy specified in Table 6.3.2.2.2.5-4.

**Table 6.3.2.2.2.5-2 Absolute power tolerance Test requirements**

Conditions	Tolerance
Normal	$\pm 11.1$ dB

**Table 6.3.2.2.2.5-3 Relative power tolerance Test requirements**

Power step $\Delta P$ (Up or down) (dB)	PRACH (dB)
$2 \leq \Delta P < 3$	$\pm 3.2$

**Table 6.3.2.2.2.5-4: T<sub>e</sub> Timing error Test requirements**

Frequency Range	SCS of SSB signals (kHz)	SCS of uplink signals s(KHz)	T <sub>e</sub>
1	15	15	$880 \cdot T_c$
	30	30	$624 \cdot T_c$
Note 1: T <sub>c</sub> is the basic timing unit defined in TS 38.211 [7]			

### 6.3.2.2.3 NR SA FR2 2-step contention based random access

**Editor's note:** This test case is incomplete. The following aspects are either missing or TBD

- TT analysis and test requirements are missing.

#### 6.3.2.2.3.1 Test purpose

The purpose of this test is to verify that the behaviour of the random access procedure is according to the requirements and that the MsgA PRACH and MsgA PUSCH power settings and timing are within specified limits.

#### 6.3.2.2.3.2 Test applicability

This test applies to all types of NR UE from Release 16 onwards.

#### 6.3.2.2.3.3 Minimum conformance requirement

Same as in clause 4.3.2.2.3.3.

The normative reference for this requirement is TS 38.133 [6] clause 6.2.2 and A.6.3.2.2.3.

#### 6.3.2.2.3.4 Test description

##### 6.3.2.2.3.4.1 Initial conditions

This test can be run in the configurations defined in Table 6.3.2.2.3.4.1-1.

**Table 6.3.2.2.3.4.1-1: Supported test configurations**

Test Case ID	Test Config Index	Description
6.3.2.2.3-1	1	NR: 15 kHz SSB SCS, 10MHz bandwidth, FDD
6.3.2.2.3-2	2	NR: 30 kHz SSB SCS, 40MHz bandwidth, TDD
Note: The UE is only required to be tested in one of the supported test configurations		

Before the test procedure, Downlink and Uplink calibrations are carried out to derive signalled parameter values. This is necessary to ensure that the test case operates within the specified ranges. The detail of the calibration process is implementation dependent, but shall derive the values of  $\Delta_{DL}$  and  $\Delta_{UL}$  according to the following principles:

With the UE configured to report SS-RSRP, the  $\Delta_{DL}$  value is calculated as  $(RSRP_{REP} - RSRP_{76})$ , where  $RSRP_{REP}$  is the SS-RSRP Reported value according to TS 38.133 [6] Table 10.1.6.1-1 with -80.6dBm/SCS applied at the Reference point. For a Reported value  $RSRP_x$ , x is treated as a positive integer value.

With the UE configured to send a first PRACH preamble,  $\Delta_{UL}$  value is calculated as  $-\text{ROUND}(\text{PPRACH0} - 1)$ , where PPRACH0 is the measured first PRACH power with -80.6dBm/SCS applied at the Reference point, and with signalled values  $preambleReceivedTargetPower = -100\text{dBm}$  and  $ss\text{-PBCH-BlockPower} = 20\text{dBm}$ .

Configure the test equipment and the DUT according to the parameters in Table 6.3.2.2.3.4.1-2.

**Table 6.3.2.2.3.4.1-2: Initial conditions**

Parameter	Value		Comment
Test environment	NC		As specified in TS 38.508-1 [14] clause 4.1.
Test frequencies	As specified in Annex E, E.1.1, E.1.3.1 and Table E.3-1 and TS 38.508-1 [14] clause 4.3.1.		
Channel bandwidth	As specified by the test configuration selected from Table 4.3.2.2.1.4.1-1.		
Propagation conditions	AWGN		As specified in Annex C.2.2.
Connection Diagram	TE Part	A.3.1.7.1	As specified in TS 38.508-1 [14] Annex A.
	DUT Part	A.3.2.3.4	
Exceptions to connection diagram	N/A		

1. Message contents are defined in clause 6.3.2.2.3.4.3.

2. Cell 1 is the NR FR1 serving cell (PCell). The connection setup is done according to the settings in Annex C.1.1 and C.1.2.

#### 6.3.2.2.3.4.2 Test procedure

The test consists of a single cell, configured as PCell in FR1. The System Simulator shall not explicitly assign a random access preamble via dedicated signalling in the downlink.

1. Ensure the UE is in state RRC\_IDLE with generic procedure parameters Connectivity *NR* and Test Mode *On* according to TS 38.508-1 [14] clause 4.5.
2. Set the parameters according to Table 6.3.2.2.1.5-1.
3. The UE shall establish a connection setup with SS, the random access procedure within the connection setup is used in the test.
4. Test 1: Correct behaviour when transmitting MsgA:
  - 4.1. The UE shall send a MsgA to the System Simulator. The System Simulator shall check that the MsgA preamble belongs to one of the Random Access Preambles associated with the SSB with index 0, which has SSB\_RP above the configured *rsrp-ThresholdSSB*.
5. Test 2: Correct behaviour when receiving MsgB:
  - 5.1. Repeat steps 1-3.
  - 5.2. The UE shall send preambles to the System Simulator. In response to the first 4 preambles, the System Simulator shall transmit a MsgB containing identifiers that do not match the transmitted Random Access Preamble.
  - 5.3. As the received MsgB contain Random Access Preamble identifiers that do not match the transmitted Random Access Preamble, the UE shall perform the Random Access Resource selection procedure specified in clause 5.1.2a in TS 38.321 [12], and transmit with the calculated MsgA PRACH transmission power when the backoff time expires.
  - 5.4. The System Simulator shall transmit a MsgB containing a Random Access Preamble identifier matching the transmitted Random Access Preamble after 5 preambles have been received by the System Simulator.
  - 5.5. As the received MsgB contains a Random Access Preamble identifier that matches the transmitted Random Access Preamble, the UE shall transmit an ACK and stop monitoring for MsgB.
  - 5.6. Measure the power and timing of the first preamble and it shall not exceed the values specified in clause 6.3.2.2.3.5. Measure the relative power and timing applied to additional preambles (last 4 preambles) and it shall not exceed the values specified in clause 6.3.2.2.3.5.
6. Test 3: Correct behaviour when not receiving MsgB:
  - 6.1. Repeat steps 1-3.
  - 6.2. The UE shall send preambles to the System Simulator. The System Simulator shall not respond to the first 4 preambles.
  - 6.3. As no MsgB was received within the RA Response window, the UE shall perform the Random Access Resource selection procedure specified in clause 5.1.2a in TS 38.321 [12], and transmit with the calculated MsgA PRACH transmission power when the backoff time expires.
  - 6.4. The System Simulator shall transmit a MsgB containing a Random Access Preamble identifier matching the transmitted Random Access Preamble after 5 preambles have been received by the System Simulator.
  - 6.5. As the received MsgB contains a Random Access Preamble identifier that matches the transmitted Random Access Preamble, the UE shall transmit an ACK and stop monitoring for MsgB.

#### 6.3.2.2.3.4.3 Message contents

Message contents are according to TS 38.508-1 [14] clause 7.3.1 with the following exceptions:

**Table 6.3.2.2.3.4.3-0: Common Exception messages**

Default Message Contents	
Common contents of system information blocks exceptions	
Default RRC messages and information elements contents exceptions	
Common exceptions to the contents of TS 38.508-1 [14]	Table 4.6.3-115 with SSB-Index 0 Table 4.6.3-120 with SSB-Index 0

6.3.2.2.3.5 Test requirement

Table 6.3.2.2.3.5-2 defines the primary level settings for contention based random access test in FR2 for NR Standalone. The test requirements are FFS.

Table 6.3.2.2.1.5-1: General test parameters

Parameter		Unit	Test-1	Comments	
SSB Configuration	Config 1		SSB.1 FR1	As defined in A.3.1, except for number of SSBs per SS-burst and SS/PBCH block index as below	
	Config 2		SSB.2 FR1		
Number of SSBs per SS-burst			2	Different from the definition in A.3.1	
SS/PBCH block index			0,1	Different from the definition in A.3.1	
Duplex Mode for Cell 2	Config 1		FDD		
	Config 2		TDD		
TDD Configuration	Config 2		TDDConf.2.1		
CSI-RS for tracking	Config 1		TRS.1.1 FDD		
	Config 2		TRS.1.2 TDD		
OCNG Pattern <sup>Note 1</sup>			OP.1	As defined in A.2.1	
PDSCH parameters <sup>Note 4</sup>	Config 1		SR.1.1 FDD	As defined in A.1.1	
	Config 2		SR.2.1 TDD		
NR RF Channel Number			1		
EPRE ratio of PSS to SSS		dB			
EPRE ratio of PBCH_DMRS to SSS		dB			
EPRE ratio of PBCH to PBCH_DMRS		dB			
EPRE ratio of PDCCH_DMRS to SSS		dB	0		
EPRE ratio of PDCCH to PDCCH_DMRS		dB			
EPRE ratio of PDSCH_DMRS to SSS		dB			
EPRE ratio of PDSCH to PDSCH_DMRS		dB			
SSB with index 0	$\hat{E}_s / I_{ot}$		dB	3	Power of SSB with index 0 is set to be above configured <i>rsrp-ThresholdSSB</i>
	$N_{oc}$	Config 1	dBm/15kHz	-98	
		Config 2		-101	
	$\hat{E}_s / N_{oc}$		dB	3	
	SS-RSRP	Config 1	dBm/15kHz	-95	
Config 2			-98		
SS-RSRP		dBm/ SCS	-95		
SSB with index 1	$\hat{E}_s / I_{ot}$		dB	-17	Power of SSB with index 1 is set to be below configured <i>rsrp-ThresholdSSB</i>
	$N_{oc}$	Config 1	dBm/15kHz	-98	
		Config 2		-101	
	$\hat{E}_s / N_{oc}$		dB	-17	
	SS-RSRP	Config 1	dBm/15kHz	-115	
Config 2			-118		
SS-RSRP		dBm/ SCS	-115		
$I_o$ <sup>Note 2</sup>	Config 1	dBm	-65.3/9.36MHz	For symbols without SSB index 1	
	Config 2		-62.2/38.16MHz		
ss-PBCH-BlockPower		dBm/ SCS	-5	As defined in clause 6.3.2 in TS 38.331 [13].	
Configured UE transmitted power ( $P_{CMAX,f,c}$ )		dBm	23	As defined in clause 6.2.4 in TS 38.101-1 [2].	



Parameter	Unit	Test-1	Comments
MsgA Configuration		FR1 MsgA configuration 1	As defined in FFS.
<i>msgA-RSRP-ThresholdSSB</i>	dBm	RSRP_51	The actual value of the threshold is -105dBm, as defined in TS 38.331 [13].
Propagation Condition	-	AWGN	
<p>Note 1: OCNG shall be used such that the cell is fully allocated and a constant total transmitted power spectral density is achieved for all OFDM symbols. The OCNG pattern is chosen during the test according to the presence of a DL reference measurement channel.</p> <p>Note 2: SS-RSRP, Es/lot and Io levels have been derived from other parameters for information purpose. They are not settable parameters.</p> <p>Note 3: The DL PDSCH reference measurement channel is used in the test only when a downlink transmission dedicated to the UE under test is required.</p>			

Test 1: Correct behaviour when transmitting MsgA:

- The MsgA shall be one of the Random Access Preambles associated with SSB index 0.

Test 2: Correct behaviour when receiving MsgB:

- The power of the first preamble shall be -22 dBm within the accuracy specified in Table 6.3.2.2.3.5-2.
- The relative power for preamble ramping step shall be FFS within the accuracy specified in Table 6.3.2.2.3.5-3.
- The transmit timing of all MsgA PRACH transmissions shall be within the accuracy specified in Table 6.3.2.2.3.5-4.

Test 3: Correct behaviour when not receiving MsgB:

- The power of the first preamble shall be -22 dBm within the accuracy specified in Table 6.3.2.2.3.5-2.
- The relative power for preamble ramping step shall be FFS within the accuracy specified in Table 6.3.2.2.3.5-3.
- The transmit timing of all MsgA PRACH transmissions shall be within the accuracy specified in Table 6.3.2.2.3.5-4.

**Table 6.3.2.2.3.5-2: Absolute power tolerance Test requirements**

Conditions	Tolerance
Normal	$\pm 11.1$ dB

**Table 6.3.2.2.3.5-3: Relative power tolerance Test requirements**

Power step $\Delta P$ (Up or down) (dB)	MsgA PRACH (dB)
FFS	FFS

**Table 6.3.2.2.3.5-4:  $T_e$  Timing error Test requirements**

Frequency Range	SCS of SSB signals (kHz)	SCS of uplink signals s(KHz)	$T_e$
1	15	15	$880 * T_c$
	30	30	$624 * T_c$
NOTE: $T_c$ is the basic timing unit defined in TS 38.211 [7]			

#### 6.3.2.2.4 NR SA FR2 2-step non-contention based random access

**Editor's note: This test case is incomplete. The following aspects are either missing or TBD**

- **TT analysis and test requirements are missing.**

##### 6.3.2.2.4.1 Test purpose

The purpose of this test is to verify that the behaviour of the random access procedure is according to the requirements and that the MsgA PRACH and MsgA PUSCH power settings and timing are within specified limits.

#### 6.3.2.2.4.2 Test applicability

This test applies to all types of NR UE from Release 16 onwards.

#### 6.3.2.2.4.3 Minimum conformance requirement

Same as in clause 4.3.2.2.4.3.

The normative reference for this requirement is TS 38.133 [6] clause 6.2.2 and A.6.3.2.2.4.

#### 6.3.2.2.4.4 Test description

##### 6.3.2.2.4.4.1 Initial conditions

This test can be run in the configurations defined in Table 6.3.2.2.4.4.1-1.

**Table 6.3.2.2.4.4.1-1: Supported test configurations**

Test Case ID	Test Config Index	Description
6.3.2.2.4-1	1	NR: 15 kHz SSB SCS, 10MHz bandwidth, FDD
6.3.2.2.4-2	2	NR: 30 kHz SSB SCS, 40MHz bandwidth, TDD
Note: The UE is only required to be tested in one of the supported test configurations		

Before the test procedure, Downlink and Uplink calibrations are carried out to derive signalled parameter values. This is necessary to ensure that the test case operates within the specified ranges. The detail of the calibration process is implementation dependent, but shall derive the values of  $\Delta_{DL}$  and  $\Delta_{UL}$  according to the following principles:

With the UE configured to report SS-RSRP, the  $\Delta_{DL}$  value is calculated as  $(RSRP_{REP} - RSRP_{76})$ , where  $RSRP_{REP}$  is the SS-RSRP Reported value according to TS 38.133 [6] Table 10.1.6.1-1 with -80.6dBm/SCS applied at the Reference point. For a Reported value  $RSRP_x$ , x is treated as a positive integer value.

With the UE configured to send a first PRACH preamble,  $\Delta_{UL}$  value is calculated as  $-\text{ROUND}(\text{PPRACH0} - 1)$ , where PPRACH0 is the measured first PRACH power with -80.6dBm/SCS applied at the Reference point, and with signalled values  $preambleReceivedTargetPower = -100\text{dBm}$  and  $ss\text{-PBCH-BlockPower} = 20\text{dBm}$ .

Configure the test equipment and the DUT according to the parameters in Table 6.3.2.2.4.4.1-2.

**Table 6.3.2.2.4.4.1-2: Initial conditions**

Parameter	Value		Comment
Test environment	NC		As specified in TS 38.508-1 [14] clause 4.1.
Test frequencies	As specified in Annex E, E.1.1, E.1.3.1 and Table E.3-1 and TS 38.508-1 [14] clause 4.3.1.		
Channel bandwidth	As specified by the test configuration selected from Table 4.3.2.2.1.4.1-1.		
Propagation conditions	AWGN		As specified in Annex C.2.2.
Connection Diagram	TE Part	A.3.1.7.1	As specified in TS 38.508-1 [14] Annex A.
	DUT Part	A.3.2.3.4	
Exceptions to connection diagram	N/A		

1. Message contents are defined in clause 6.3.2.2.4.4.3.
2. Cell 1 is the NR FR1 serving cell (PCell). The connection setup is done according to the settings in Annex C.1.1 and C.1.2.

#### 6.3.2.2.4.4.2 Test procedure

The test consists of a single cell, configured as PCell in FR1. The System Simulator shall not explicitly assign a random access preamble via dedicated signalling in the downlink.

1. Ensure the UE is in state RRC\_IDLE with generic procedure parameters Connectivity NR and Test Mode On according to TS 38.508-1 [14] clause 4.5.
2. Set the parameters according to Table 6.3.2.2.1.5-1.
3. The UE shall establish a connection setup with SS, the random access procedure within the connection setup is used in the test.
4. Test 1: Correct behaviour when transmitting MsgA:
  - 4.1. The UE shall send a MsgA to the System Simulator. The System Simulator shall check that the MsgA preamble belongs to one of the Random Access Preambles associated with the SSB with index 0, that it arrives on a PRACH occasion which belongs to the PRACH occasions corresponding to the SSB with index 0, and that the selected PRACH occasion belongs to the PRACH occasions permitted by the restrictions given by the *msgA-SSB-SharedRO-MaskIndex*.
5. Test 2: Correct behaviour when receiving MsgB:
  - 5.1. Repeat steps 1-3.
  - 5.2. The UE shall send preambles to the System Simulator. In response to the first 4 preambles, the System Simulator shall transmit a MsgB containing identifiers that do not match the transmitted Random Access Preamble.
  - 5.3. As the received MsgB contain Random Access Preamble identifiers that do not match the transmitted Random Access Preamble, the UE shall perform the Random Access Resource selection procedure specified in clause 5.1.2a in TS 38.321 [12], and transmit with the calculated MsgA PRACH transmission power when the backoff time expires.
  - 5.4. The System Simulator shall transmit a MsgB containing a Random Access Preamble identifier matching the transmitted Random Access Preamble after 5 preambles have been received by the System Simulator.
  - 5.5. As the received MsgB contains a Random Access Preamble identifier that matches the transmitted Random Access Preamble, the UE shall transmit an ACK and stop monitoring for MsgB.
  - 5.6. Measure the power and timing of the first preamble and it shall not exceed the values specified in clause 6.3.2.2.4.5. Measure the relative power and timing applied to additional preambles (last 4 preambles) and it shall not exceed the values specified in clause 6.3.2.2.4.5.
6. Test 3: Correct behaviour when not receiving MsgB:
  - 6.1. Repeat steps 1-3.
  - 6.2. The UE shall send preambles to the System Simulator. The System Simulator shall not respond to the first 4 preambles.
  - 6.3. As no MsgB was received within the MsgB Response window configured in *RACH-ConfigGenericTwoStepRA*, the UE shall perform the Random Access Resource selection procedure specified in clause 5.1.2a in TS 38.321 [12], and transmit with the calculated MsgA PRACH transmission power when the backoff time expires.
  - 6.4. The System Simulator shall transmit a MsgB containing a Random Access Preamble identifier matching the transmitted Random Access Preamble after 5 preambles have been received by the System Simulator.
  - 6.5. As the received MsgB contains a Random Access Preamble identifier that matches the transmitted Random Access Preamble, the UE shall transmit an ACK and stop monitoring for MsgB.
  - 6.6. Measure the power and timing of the first preamble and it shall not exceed the values specified in clause 6.3.2.2.3.5. Measure the relative power and timing applied to additional preambles (last 4 preambles) and it shall not exceed the values specified in clause 6.3.2.2.3.5.

#### 6.3.2.2.4.4.3 Message contents

Message contents are according to TS 38.508-1 [14] clause 7.3.1 with the following exceptions:

**Table 6.3.2.2.4.4.3-0: Common Exception messages**

Default Message Contents	
Common contents of system information blocks exceptions	
Default RRC messages and information elements contents exceptions	
Common exceptions to the contents of TS 38.508-1 [14]	Table 4.6.3-115 with SSB-Index 0 Table 4.6.3-120 with SSB-Index 0

6.3.2.2.4.5 Test requirement

Table 6.3.2.2.4.5-2 defines the primary level settings for non-contention based random access test in FR2 for NR Standalone. The test requirements are FFS.

Table 6.3.2.2.1.5-1: General test parameters

Parameter		Unit	Test-1	Comments	
SSB Configuration	Config 1		SSB.1 FR1	As defined in A.3.1, except for number of SSBs per SS-burst and SS/PBCH block index as below	
	Config 2		SSB.2 FR1		
Number of SSBs per SS-burst			2	Different from the definition in A.3.1	
SS/PBCH block index			0,1	Different from the definition in A.3.1	
Duplex Mode for Cell 2	Config 1		FDD		
	Config 2		TDD		
TDD Configuration	Config 2		TDDConf.2.1		
CSI-RS for tracking	Config 1		TRS.1.1 FDD		
	Config 2		TRS.1.2 TDD		
OCNG Pattern <sup>Note 1</sup>			OP.1	As defined in A.2.1	
PDSCH parameters <sup>Note 4</sup>	Config 1		SR.1.1 FDD	As defined in A.1.1	
	Config 2		SR.2.1 TDD		
NR RF Channel Number			1		
EPRE ratio of PSS to SSS		dB	0		
EPRE ratio of PBCH_DMRS to SSS		dB			
EPRE ratio of PBCH to PBCH_DMRS		dB			
EPRE ratio of PDCCH_DMRS to SSS		dB			
EPRE ratio of PDCCH to PDCCH_DMRS		dB			
EPRE ratio of PDSCH_DMRS to SSS		dB			
EPRE ratio of PDSCH to PDSCH_DMRS		dB			
SSB with index 0	$\hat{E}_s / I_{ot}$	dB	3	Power of SSB with index 0 is set to be above configured <i>rsrp-ThresholdSSB</i>	
	$N_{oc}$	Config 1	dBm/15kHz		-98
		Config 2			-101
	$\hat{E}_s / N_{oc}$	dB	3		
	SS-RSRP	Config 1	dBm/15kHz		-95
Config 2			-98		
SS-RSRP		dBm/ SCS	-95		
SSB with index 1	$\hat{E}_s / I_{ot}$	dB	-17	Power of SSB with index 1 is set to be below configured <i>rsrp-ThresholdSSB</i>	
	$N_{oc}$	Config 1	dBm/15kHz		-98
		Config 2			-101
	$\hat{E}_s / N_{oc}$	dB	-17		
	SS-RSRP	Config 1	dBm/15kHz		-115
Config 2			-118		
SS-RSRP		dBm/ SCS	-115		
$I_o$ <sup>Note 2</sup>	Config 1	dBm	-65.3/9.36MHz	For symbols without SSB index 1	
	Config 2		-62.2/38.16MHz		
ss-PBCH-BlockPower		dBm/ SCS	-5	As defined in clause 6.3.2 in TS 38.331 [13].	
Configured UE transmitted power ( $P_{CMAX,f,c}$ )		dBm	23	As defined in clause 6.2.4 in TS 38.101-1 [2].	

Parameter	Unit	Test-1	Comments
MsgA Configuration		FR1 MsgA configuration 2	As defined in FFS.
<i>msgA-RSRP-ThresholdSSB</i>	dBm	RSRP_51	The actual value of the threshold is -105dBm, as defined in TS 38.331 [13].
Propagation Condition	-	AWGN	
<p>Note 1: OCNG shall be used such that the cell is fully allocated and a constant total transmitted power spectral density is achieved for all OFDM symbols. The OCNG pattern is chosen during the test according to the presence of a DL reference measurement channel.</p> <p>Note 2: SS-RSRP, Es/Iot and Io levels have been derived from other parameters for information purpose. They are not settable parameters.</p> <p>Note 3: The DL PDSCH reference measurement channel is used in the test only when a downlink transmission dedicated to the UE under test is required.</p>			

Test 1: Correct behaviour when transmitting MsgA:

- The MsgA shall be one of the Random Access Preambles associated with SSB index 0.
- The MsgA shall arrive on a PRACH occasion which belongs to the PRACH occasions corresponding to the SSB with index 0.
- The selected PRACH occasion shall belong to the PRACH occasions permitted by the restrictions given by the *msgA-SSB-SharedRO-MaskIndex*.

Test 2: Correct behaviour when receiving MsgB:

- The power of the first preamble shall be -22 dBm within the accuracy specified in Table 6.3.2.2.4.5-2.
- The relative power for preamble ramping step shall be FFS within the accuracy specified in Table 6.3.2.2.4.5-3.
- The transmit timing of all PRACH transmissions shall be within the accuracy specified in Table 6.3.2.2.4.5-4.

Test 3: Correct behaviour when not receiving MsgB:

- The power of the first preamble shall be -22 dBm within the accuracy specified in Table 6.3.2.2.4.5-2.
- The relative power for preamble ramping step shall be FFS within the accuracy specified in Table 6.3.2.2.4.5-3.
- The transmit timing of all PRACH transmissions shall be within the accuracy specified in Table 6.3.2.2.4.5-4.

**Table 6.3.2.2.4.5-2: Absolute power tolerance Test requirements**

Conditions	Tolerance
Normal	± 11.1 dB

**Table 6.3.2.2.4.5-3: Relative power tolerance Test requirements**

Power step $\Delta P$ (Up or down) (dB)	MsgA PRACH (dB)
FFS	FFS

**Table 6.3.2.2.4.5-4:  $T_e$  Timing error Test requirements**

Frequency Range	SCS of SSB signals (kHz)	SCS of uplink signals s(KHz)	$T_e$
1	15	15	$880 * T_c$
	30	30	$624 * T_c$
NOTE: $T_c$ is the basic timing unit defined in TS 38.211 [7]			

### 6.3.2.3 RRC connection release with redirection

#### 6.3.2.3.0 Minimum conformance requirements

### 6.3.2.3.0.1 Minimum conformance requirements for FR1 RRC connection release with redirection

The UE shall be capable of performing the RRC connection release with redirection to the target NR cell within  $T_{\text{connection\_release\_redirect\_NR}}$ .

The time delay ( $T_{\text{connection\_release\_redirect\_NR}}$ ) is the time between the end of the last slot containing the RRC command, “*RRCRelease*” (TS 38.331 [2]) on the NR PDSCH and the time the UE starts to send random access to the target NR cell. The time delay ( $T_{\text{connection\_release\_redirect\_NR}}$ ) shall be less than:

$$T_{\text{connection\_release\_redirect\_NR}} = T_{\text{RRC\_procedure\_delay}} + T_{\text{identify-NR}} + T_{\text{SI-NR}} + T_{\text{RACH}}$$

The target NR cell shall be considered detectable when for each relevant SSB, the side conditions should be met that,

- SSB<sub>RP</sub> and SSB  $\hat{E}_s/I_{ot}$  according to Annex B.2.5 for a corresponding NR Band.

$T_{\text{RRC\_procedure\_delay}}$ : It is the RRC procedure delay for processing the received message “*RRCRelease*” as defined in clause 6.2.2 of TS 38.331 [2].

$T_{\text{identify-NR}}$ : It is the time to identify the target NR cell and depend on the frequency range (FR) of the target NR cell. It is defined in table 6.3.2.3.0.1-1. Note that  $T_{\text{identify-NR}} = T_{\text{PSS/SSS-sync}} + T_{\text{meas}}$ , in which  $T_{\text{PSS/SSS-sync}}$  is the cell search time and  $T_{\text{meas}}$  is the measurement time due to cell selection criteria evaluation.

$T_{\text{SI-NR}}$ : It is the time required for acquiring all the relevant system information of the target NR cell. This time depends upon whether the UE is provided with the relevant system information of the target NR cell or not by the old NR cell before the RRC connection is released.  $T_{\text{SI-NR}} = 0$  provided the UE is provided with the SI (including MIB and all relevant SIBs) of the target NR cell before the RRC connection is released by the old NR cell.

$T_{\text{RACH}}$ : It is the delay caused due to the random access procedure when sending random access to the target NR cell. This delay depends on the PRACH configuration defined in Table 6.3.3.2-2 [6] or Table 6.3.3.2-3 [6] for FR1 and in Table 6.3.3.2-4 [6] for FR2.

$T_{\text{rs}}$  is the SMTC periodicity of the target NR cell if the UE has been provided with an SMTC configuration for the target cell in the redirection command, otherwise  $T_{\text{rs}}$  is the SMTC configured in the measObjectNR having the same SSB frequency and subcarrier spacing configured for the RRC connection release with redirection. If the UE is not provided with SMTC configuration or measurement object for the frequency which is also configured for the RRC connection release with redirection then:

- the requirement in this section is applied with  $T_{\text{rs}} = 20$  ms assuming the SSB transmission periodicity is not larger than 20 ms,
- there is no requirement if the SSB transmission periodicity is larger than 20ms.

**Table 6.3.2.3.0.1-1: Time to identify target NR cell for RRC connection release with redirection to NR**

Frequency range (FR) of target NR cell	$T_{\text{identify-NR}}$
FR1	MAX (680 ms, [11] x $T_{\text{rs}}$ )
FR2	MAX (880 ms, 8x[11] x $T_{\text{rs}}$ )
Note :	If the UE has been provided with higher layer in TS 38.331 [2] signalling of <i>smtc2</i> prior to the redirection command, SMTC follows <i>smtc1</i> or <i>smtc2</i> according to the physical cell ID of the target cell.

The normative reference for this requirement is TS 38.133 [6] clauses 6.2.3.2.1.

### 6.3.2.3.0.2 Minimum conformance requirements for FR1 – E-UTRAN RRC connection release with redirection

The UE shall be capable of performing the RRC connection release with redirection to the target E-UTRAN cell within  $T_{\text{connection\_release\_redirect\_E-UTRA}}$ .

The time delay ( $T_{\text{connection\_release\_redirect\_E-UTRA}}$ ) is the time between the end of the last slot containing the RRC command, “*RRCRelease*” (TS 38.331 [2]) on the PDSCH and the time the UE starts to send random access to the target E-UTRA cell. The time delay ( $T_{\text{connection\_release\_redirect\_E-UTRA}}$ ) shall be less than:

$$T_{\text{connection\_release\_redirect\_E-UTRA}} = T_{\text{RRC\_procedure\_delay}} + T_{\text{identify-E-UTRA}} + T_{\text{SI-E-UTRA}} + T_{\text{RACH}}$$

The target E-UTRA FDD or TDD cell shall be considered detectable when for each relevant SSB:

- RSRP related conditions in the accuracy requirements in Section 10.2.2 are fulfilled for a corresponding Band, together with the corresponding side conditions in Annex B.2 and Annex B.3 of TS 36.133 [15],
- RSRQ related conditions in the accuracy requirements in Section 10.2.3 are fulfilled for a corresponding Band, together with the corresponding side conditions in Annex B.2 and Annex B.3 of TS 36.133 [15],
- RS-SINR related conditions in the accuracy requirements in Section 10.2.5 are fulfilled for a corresponding Band, together with the corresponding side conditions in Annex B.2 and Annex B.3 of TS 36.133 [15].

$T_{\text{RRC\_procedure\_delay}}$ : It is the RRC procedure delay for processing the received message “*RRCRelease*” as defined in clause 6.2.2 of TS 38.331 [2].

$T_{\text{identify-E-UTRA}}$ : It is the time to identify the target E-UTRA cell. It shall be less than 320 ms.

$T_{\text{SI-E-UTRA}}$ : It is the time required for acquiring all the relevant system information of the target E-UTRA cell. This time depends upon whether the UE is provided with the relevant system information (SI) of the target E-UTRA cell or not by the old NR cell before the RRC connection is released.  $T_{\text{SI-E-UTRA}} = 0$  provided the UE is provided with the SI (including MIB and all relevant SIBs) of the target E-UTRA cell before the RRC connection is released by the old NR cell.

$T_{\text{RACH}}$ : It is the delay caused due to the random access procedure when sending random access to the target E-UTRA cell.

The normative reference for this requirement is TS 38.133 [6] clauses 6.2.3.2.2.

### 6.3.2.3.1 NR SA FR1 RRC connection release with redirection

#### 6.3.2.3.1.1 Test purpose

This test is to verify RRC connection release with redirection from NR to NR.

#### 6.3.2.3.1.2 Test applicability

This test applies to all types of NR UE from Release 15 onwards.

#### 6.3.2.3.1.3 Minimum conformance requirement

The minimum conformance requirements are specified in clause 6.3.2.3.0.1.

The normative reference for this requirement is TS 38.133 [6] A.6.3.2.3.1.

#### 6.3.2.3.1.4 Test description

##### 6.3.2.3.1.4.1 Initial conditions

This test can be run in the configurations defined in Table 6.3.2.3.1.4.1-1.

**Table 6.3.2.3.1.4.1-1: Redirection from NR to NR test configurations**

Configuration	Description
6.3.2.3.1-1	Source cell: NR 15 kHz SSB SCS, 10MHz bandwidth, FDD duplex mode Target cell: NR 15 kHz SSB SCS, 10MHz bandwidth, FDD duplex mode
6.3.2.3.1-2	Source cell: NR 15 kHz SSB SCS, 10MHz bandwidth, TDD duplex mode Target cell: NR 15 kHz SSB SCS, 10MHz bandwidth, TDD duplex mode
6.3.2.3.1-3	Source cell: NR 30 kHz SSB SCS, 40MHz bandwidth, TDD duplex mode Target cell: NR 30 kHz SSB SCS, 40MHz bandwidth, TDD duplex mode
Note:	The UE is only required to be tested in one of the supported test configurations.

Configure the test equipment and the DUT according to the parameters in Table 6.3.2.3.1.4.1-2.

**Table 6.3.2.3.1.4.1-2: Initial conditions for Redirection from NR to NR test case**

Parameter	Value	Comment
Test environment	NC	As specified in TS 38.508-1 [14] clause 4.1.
Test frequencies	As specified in Annex E, Table E.4-1 and TS 38.508-1 [14] clause 4.3.1.	
Channel bandwidth	As specified by the test configuration selected from Table 6.3.2.3.1.4.1-1.	

Propagation conditions	AWGN		As specified in Annex C.2.2.
Connection Diagram	TE Part	A.3.1.8.2	As specified in TS 38.508-1 [14] Annex A.
	DUT Part	A.3.2.3.4	
Exceptions to connection diagram	N/A		

1. The general test parameters for PCell and neighbour cell are given in Table 6.3.2.3.1.4.1-3 below.
2. Message contents are defined in clause 6.3.2.3.1.4.3.
3. There are two carriers and two NR cells specified in the test. Cell 1 and Cell 2 are configured according to Annex C.1.1 and C.1.2.

**Table 6.3.2.3.1.4.1-3: General test parameters for Redirection from NR to NR test case**

Parameter	Unit	Value	Comment
Initial conditions	Active cell	Cell 1	
	Neighbouring cell	Cell 2	
Final condition	Active cell	Cell 2	
Filter coefficient		0	L3 filtering is not used
Access Barring Information	-	Not Sent	No additional delays in random access procedure.
Time offset between cells		3 $\mu$ s	Synchronous cells
T1	s	5	
T2	s	2.3	

#### 6.3.2.3.1.4.2 Test procedure

The test consists of two successive time periods, with time duration of T1, and T2 respectively. The “*RRCRelease*” message shall be sent to the UE during period T1 and the start of T2 is the instant when the last TTI containing the RRC message is sent to the UE. Prior to time duration T2, the UE shall not have any timing information of Cell 2. Cell 2 is powered up at the beginning of the T2. Cell 1 and Cell 2 belong to different tracking areas.

1. Ensure the UE is in state RRC\_CONNECTED with generic procedure parameters Connectivity NR, Connected without release On and Test Mode On according to TS 38.508-1 [14] clause 4.5. Cell 1 is the active cell.
2. Set the parameters according to T1 in Table 6.3.2.3.1.5-1. T1 starts.
3. SS shall transmit an *RRCRelease* during period T1.
4. The SS shall switch the power setting from T1 to T2 as specified in Table 6.3.2.3.1.5-1. When the last TTI containing the *RRCRelease* message is sent to UE, T2 starts.
5. If the UE transmits the PRACH to Cell 2 less than 2240 ms from the beginning of time period T2 then the number of successful tests is increased by one. Otherwise, the number of failure tests is increased by one.
6. After T2 expires, the UE shall be switched off. Then ensure the UE is in state RRC\_CONNECTED with generic procedure parameters Connectivity NR, Connected without release On and Test Mode On according to TS 38.508-1 [14] clause 4.5. Cell 1 is the active cell and Cell 2 shall be powered OFF.
7. The SS shall set Cell 2 physical cell identity = ((current cell 2 physical cell identity + 1) mod 1008) for next iteration of the test procedure loop.
8. Repeat step 2-7 until the confidence level according to Table G.2.3-1 in Annex G clause G.2 is achieved.

#### 6.3.2.3.1.4.3 Message contents

Message contents are according to TS 38.508-1 [14] clause 7.3 with the following exceptions:

**Table 6.3.2.3.1.4.3-1: RRCRelease for NR RRC redirection**

Derivation Path: TS 38.508-1 [14], Table 4.6.1-16			
Information Element	Value/remark	Comment	Condition



RRCRelease ::= SEQUENCE {			
criticalExtensions CHOICE {			
rrcRelease SEQUENCE {			
redirectedCarrierInfo CHOICE {			
nr SEQUENCE {			
carrierFreq	ARFCN-ValueNR	Frequency of Cell 2	
ssbSubcarrierSpacing	kHz15		Config 1,2
	kHz30		Config 3
smtc SEQUENCE {			
duration	sf1		SMTC.1
	sf5		SMTC.2
}			
}			
}			
}			
}			
}			

**Table 6.3.2.3.1.4.3-2: SIB2**

Derivation Path: TS 38.508-1 [14], Table 4.6.2-1			
Information Element	Value/remark	Comment	Condition
SIB2 ::= SEQUENCE {			
cellReselectionInfoCommon SEQUENCE {			
rangeToBestCell	Not present		
}			

6.3.2.3.1.5 Test requirement

Table 6.3.2.3.1.5-1 defines the primary level settings for Redirection from NR to NR test case.

**Table 6.3.2.3.1.5-1: Cell specific test parameters for Redirection from NR to NR test case**

Parameter	Unit	Cell 1		Cell 2	
		T1	T2	T1	T2
NR RF Channel Number		1		2	
Duplex mode	Config 1	FDD			
	Config 2,3	TDD			
SSB Configuration	Config 1	SSB.1 FR1			
	Config 2	SSB.1 FR1			
	Config 3	SSB.2 FR1			
CSI-RS for tracking	Config 1	TRS.1.1 FDD			
	Config 2	TRS.1.1 TDD			
	Config 3	TRS.1.2 TDD			
TDD configuration	Config 1	Not Applicable			
	Config 2	TDDConf.1.1			
	Config 3	TDDConf.2.1			
BW <sub>channel</sub>	Config 1	10: N <sub>RB,c</sub> = 52			
	Config 2	10: N <sub>RB,c</sub> = 52			
	Config 3	40: N <sub>RB,c</sub> = 106			
BWP BW	Config 1	10: N <sub>RB,c</sub> = 52			
	Config 2	10: N <sub>RB,c</sub> = 52			
	Config 3	40: N <sub>RB,c</sub> = 106			
DRx Cycle	ms	Not Applicable			
PDSCH Reference measurement channel	Config 1	SR.1.1 FDD			
	Config 2	SR.1.1 TDD			
	Config 3	SR 2.1 TDD			
CORESET Reference Channel	Config 1	CR.1.1 FDD			
	Config 2	CR.1.1 TDD			
	Config 3	CR 2.1 TDD			
OCNG Patterns		OP.1			
SMTC configuration	Config 1,2	SMTC.1			
	Config 3	SMTC.2			
	kHz	15 kHz			

PDSCH/PDCCH subcarrier spacing	Config 3		30 kHz			
PUCCH/PUSCH subcarrier spacing	Config 1,2	kHz	15 kHz			
	Config 3		30 kHz			
PRACH configuration			FR1 PRACH configuration 1			
BWP configuration	Initial DL BWP		DLBWP.0.1			
	Dedicated DL BWP		DLBWP.1.1			
	Initial UL BWP		ULBWP.0.1			
	Dedicated UL BWP		ULBWP.1.1			
EPRE ratio of PSS to SSS		dB	0			
EPRE ratio of PBCH DMRS to SSS						
EPRE ratio of PBCH to PBCH DMRS						
EPRE ratio of PDCCH DMRS to SSS						
EPRE ratio of PDCCH to PDCCH DMRS						
EPRE ratio of PDSCH DMRS to SSS						
EPRE ratio of PDSCH to PDSCH						
EPRE ratio of OCNG DMRS to SSS(Note 1)						
EPRE ratio of OCNG to OCNG DMRS (Note 1)						
$N_{oc}^{Note2}$		dBm/15kHz	-98			
$N_{oc}^{Note2}$	Config 1,2	dBm/SCS	-98			
	Config 3		-95			
$\hat{E}_s/I_{ot}$		dB	4	4	-infinity	4
$\hat{E}_s/N_{oc}$		dB	4	4	-infinity	4
$Io^{Note3}$	Config 1,2	dBm/ 9.36MHz	-64.59	-64.59	-70.05	-64.59
	Config 3	dBm/ 38.16MHz	-58.49	-58.49	-63.94	-58.49
Propagation condition		-	AWGN			
Note 1: OCNG shall be used such that both cells are fully allocated and a constant total transmitted power spectral density is achieved for all OFDM symbols.						
Note 2: Interference from other cells and noise sources not specified in the test is assumed to be constant over subcarriers and time and shall be modelled as AWGN of appropriate power for $N_{oc}$ to be fulfilled.						
Note 3: $Io$ levels have been derived from other parameters for information purposes. They are not settable parameters themselves.						

The UE shall start to transmit the PRACH to Cell 2 less than 2240 ms from the beginning of time period T2.

The rate of correct RRC connection release redirection to NR observed during repeated tests shall be at least 90%.

NOTE: The redirection delay can be expressed as:

$$T_{\text{connection\_release\_redirect\_NR}} = T_{\text{RRC\_procedure\_delay}} + T_{\text{identify-NR}} + T_{\text{SI-NR}} + T_{\text{RACH}},$$

where:

$T_{\text{RRC\_procedure\_delay}} = 110$  ms and is specified in clause 12 in TS 38.331 [13].

$T_{\text{identify-NR}} = 680$  ms in the test.

$T_{\text{SI-NR}} = 1280$  ms is assumed, it is the time required for receiving all the relevant system information as defined in TS 38.331 for the target NR cell.

$T_{\text{RACH}} = 170$  ms in the test.

This gives a total of 2240 ms.

### 6.3.2.3.2 NR SA FR1 – E-UTRA RRC connection release with redirection

#### 6.3.2.3.2.1 Test purpose

This test is to verify RRC connection release with redirection from NR to E-UTRAN.

## 6.3.2.3.2.2 Test applicability

This test applies to all types of NR UE from Release 15 onwards.

## 6.3.2.3.2.3 Minimum conformance requirement

The minimum conformance requirements are specified in clause 6.3.2.3.0.2.

The normative reference for this requirement is TS 38.133 [6] A.6.3.2.3.2.

## 6.3.2.3.2.4 Test description

## 6.3.2.3.2.4.1 Initial conditions

This test can be run in the configurations defined in Table 6.3.2.3.2.4.1-1.

**Table 6.3.2.3.2.4.1-1: Redirection from NR to E-UTRAN test configurations**

Configuration	Description
6.3.2.3.2-1	NR 15 kHz SSB SCS, 10MHz bandwidth, FDD duplex mode, LTE FDD
6.3.2.3.2-2	NR 15 kHz SSB SCS, 10MHz bandwidth, TDD duplex mode, LTE FDD
6.3.2.3.2-3	NR 30 kHz SSB SCS, 40MHz bandwidth, TDD duplex mode, LTE FDD
6.3.2.3.2-4	NR 15 kHz SSB SCS, 10MHz bandwidth, FDD duplex mode, LTE TDD
6.3.2.3.2-5	NR 15 kHz SSB SCS, 10MHz bandwidth, TDD duplex mode, LTE TDD
6.3.2.3.2-6	NR 30 kHz SSB SCS, 40MHz bandwidth, TDD duplex mode, LTE TDD
Note: The UE is only required to be tested in one of the supported test configurations	

Configure the test equipment and the DUT according to the parameters in Table 6.3.2.3.2.4.1-2.

**Table 6.3.2.3.2.4.1-2: Initial conditions for Redirection from NR to E-UTRAN test case**

Parameter	Value		Comment
Test environment	NC		As specified in TS 38.508-1 [14] clause 4.1.
Test frequencies	As specified in Annex E, Table E.4-1 and TS 38.508-1 [14] clause 4.3.1.		
Channel bandwidth	As specified by the test configuration selected from Table 6.3.2.3.2.4.1-1.		
Propagation conditions	AWGN		As specified in Annex C.2.2.
Connection Diagram	TE Part	A.3.1.6.1	As specified in TS 38.508-1 [14] Annex A.
	DUT Part	A.3.2.3.2	
Exceptions to connection diagram	N/A		

1. The general test parameters settings are given in Table 6.3.2.3.2.4.1-3 below.
2. Message contents are defined in clause 6.3.2.3.2.4.3.
3. There are two cells specified in the test. Cell 1 is the NR PCell and Cell 2 is the E-UTRAN neighbour cell. Cell 1 is configured according to Annex C.1.1 and C.1.2, Cell 2 is configured according to TS 36.521-3 [26] Annex C.1.0 and C.1.1.

**Table 6.3.2.3.2.4.1-3: General test parameters for Redirection from NR to E-UTRAN test case**

Parameter	Unit	Value	Comment
Initial conditions	Active cell	Cell 1	
	Neighbouring cell	Cell 2	
Final condition	Active cell	Cell 2	
Filter coefficient		0	L3 filtering is not used
Access Barring Information	-	Not Sent	No additional delays in random access procedure.
Time offset between cells		3 $\mu$ s	Synchronous cells
T1	s	5	
T2	s	2.3	

6.3.2.3.2.4.2 Test procedure

The test consists of two successive time periods, with time duration of T1, and T2 respectively. The “*RRCRelease*” message shall be sent to the UE during period T1 and the start of T2 is the instant when the last TTI containing the RRC message is sent to the UE. Prior to time duration T2, the UE shall not have any timing information of Cell 2. Cell 2 is powered up at the beginning of the T2.

1. Ensure the UE is in state RRC\_CONNECTED with generic procedure parameters Connectivity NR, Connected without release On and Test Mode On according to TS 38.508-1 [14] clause 4.5. Cell 1 is the active cell.
2. Set the parameters according to T1 in Table 6.3.2.3.2.5-1 and 6.3.2.3.2.5-2. T1 starts.
3. SS shall transmit an *RRCRelease* during period T1.
4. The SS shall start T2 timer when the last TTI containing the *RRCRelease* message is sent to UE.
5. When T2 starts, the SS shall switch the power setting from T1 to T2 as specified in Table 6.3.2.3.2.5-1 for Cell 1 and Table 6.3.2.3.2.5-2 for Cell 2.
6. The UE shall transmit RRCConnectionRequest message.
7. If the UE transmits the PRACH to Cell 2 less than 2205 ms from the beginning of time period T2 then the number of successful tests is increased by one. Otherwise, the number of failure tests is increased by one.
8. After T2 expires, the UE shall be switched off. Then ensure the UE is in state RRC\_CONNECTED with generic procedure parameters Connectivity NR, Connected without release On according to TS 38.508-1 [14] clause 4.5. Cell 1 is the active cell and Cell 2 shall be powered OFF.
9. The SS shall set Cell 2 physical cell identity = ((current cell 2 physical cell identity + 1) mod 14+2) for next iteration of the test procedure loop.
10. Repeat step 2-9 until the confidence level according to Table G.2.3-1 in Annex G clause G.2 is achieved.

6.3.2.3.2.4.3 Message contents

Message contents are according to TS 38.508-1 [14] clause 4.6 with the following exceptions:

**Table 6.3.2.3.2.4.3-1: RRCRelease for Inter-RAT RRC redirection**

Derivation Path: TS 38.508-1 [14], Table 4.6.1-16			
Information Element	Value/remark	Comment	Condition
RRCRelease ::= SEQUENCE {			
criticalExtensions CHOICE {			
rrcRelease SEQUENCE {			
redirectedCarrierInfo CHOICE {			
eutra SEQUENCE {			
eutraFrequency	ARFCN-ValueEUTRA	Frequency of Cell 2	
cnType	epc		
}			
}			
}			
}			
}			

6.3.2.3.2.5 Test requirement

Table 6.3.2.3.2.5-1 and 6.3.2.3.2.5-2 define the primary level settings for Redirection from NR to E-UTRAN test case.

**Table 6.3.2.3.2.5-1: Cell specific test parameters for Redirection from NR to E-UTRAN test case(Cell 1)**

Parameter	Unit	Cell 1	
		T1	T2
RF Channel Number			1
Duplex mode	Config 1,4		FDD
	Config 2,3,5,6		TDD
SSB Configuration	Config 1		SSB.1 FR1

Parameter		Unit	Cell 1	
			T1	T2
CSI-RS for tracking	Config 2		SSB.1 FR1	
	Config 3		SSB.2 FR1	
	Config 1		TRS.1.1 FDD	
TDD configuration	Config 2		TRS.1.1 TDD	
	Config 3		TRS.1.2 TDD	
	Config 1,4		Not Applicable	
BW <sub>channel</sub>	Config 2,5	MHz	TDDConf.1.1	
	Config 3,6		TDDConf.2.1	
	Config 1,4		10: N <sub>RB,c</sub> = 52	
BWP BW	Config 2,5	MHz	10: N <sub>RB,c</sub> = 52	
	Config 3,6		40: N <sub>RB,c</sub> = 106	
	Config 1,4		10: N <sub>RB,c</sub> = 52	
DRx Cycle		ms	10: N <sub>RB,c</sub> = 52	
PDSCH Reference measurement channel	Config 2,5		40: N <sub>RB,c</sub> = 106	
	Config 3,6		Not Applicable	
	Config 1,4		SR.1.1 FDD	
CORESET Reference Channel	Config 2,5		SR.1.1 TDD	
	Config 3,6		SR2.1 TDD	
	Config 1,4		CR.1.1 FDD	
OCNG Patterns	Config 2,5		CR.1.1 TDD	
	Config 3,6		CR2.1 TDD	
	Config 1,2,4,5		OCNG pattern 1	
SMTC configuration	Config 3,6		SMTc.1 FR1	
	Config 1,2,4,5		SMTc.2 FR1	
PDSCH/PDCCH subcarrier spacing	Config 3,6	kHz	15 kHz	
	Config 1,2,4,5		30 kHz	
PUCCH/PUSCH subcarrier spacing	Config 3,6	kHz	15 kHz	
	Config 1,2,4,5		30 kHz	
PRACH configuration			FR1 PRACH configuration 1	
BWP configuration	Initial DL BWP		DLBWP.0.1	
	Dedicated DL BWP		DLBWP.1.1	
	Initial UL BWP		ULBWP.0.1	
	Dedicated UL BWP		ULBWP.1.1	
EPRE ratio of PSS to SSS		dB	0	
EPRE ratio of PBCH DMRS to SSS				
EPRE ratio of PBCH to PBCH DMRS				
EPRE ratio of PDCCH DMRS to SSS				
EPRE ratio of PDCCH to PDCCH DMRS				
EPRE ratio of PDSCH DMRS to SSS				
EPRE ratio of PDSCH to PDSCH				
EPRE ratio of OCNG DMRS to SSS(Note 1)				
EPRE ratio of OCNG to OCNG DMRS (Note 1)				
N <sub>oc</sub> <sup>Note2</sup>		dBm/15kHz	-98	
N <sub>oc</sub> <sup>Note2</sup>	Config 1,2,4,5	dBm/SCS	-98	
	Config 3,6		-95	
$\hat{E}_s / I_{ot}$		dB	4	4
$\hat{E}_s / N_{oc}$		dB	4	4
I <sub>o</sub> <sup>Note3</sup>	Config 1,2,4,5	dBm/ 9.36MHz	-64.59	-64.59
	Config 3,6	dBm/ 38.16MHz	-58.49	-58.49
Propagation condition		-	AWGN	
Note 1: OCNG shall be used such that both cells are fully allocated and a constant total transmitted power spectral density is achieved for all OFDM symbols.				
Note 2: Interference from other cells and noise sources not specified in the test is assumed to be constant over subcarriers and time and shall be modelled as AWGN of appropriate power for N <sub>oc</sub> to be fulfilled.				
Note 3: I <sub>o</sub> levels have been derived from other parameters for information purposes. They are not settable parameters themselves.				

**Table 6.3.2.3.2.5-1: Cell specific test parameters for Redirection from NR to E-UTRAN test case(Cell 2)**

Parameter	Unit	Configuration	Cell 2	
			T1	T2
RF channel number		1, 2, 3, 4, 5, 6	2	
Duplex mode		1, 2, 3	FDD	
		4, 5, 6	TDD	
TDD special subframe configuration <sup>Note1</sup>		4, 5, 6	6	
TDD uplink-downlink configuration <sup>Note1</sup>		4, 5, 6	1	
BW <sub>channel</sub>	MHz	1, 2, 3, 4, 5, 6	5MHz: N <sub>RB,c</sub> = 25 10MHz: N <sub>RB,c</sub> = 50 20MHz: N <sub>RB,c</sub> = 100	
PRACH Configuration <sup>Note2</sup>		1, 2, 3	4	
		4, 5, 6	53	
PDSCH parameters: DL Reference Measurement Channel <sup>Note3</sup>		1, 2, 3	5MHz: R.7 FDD 10MHz: R.3 FDD 20MHz: R.6 FDD	
		4, 5, 6	5MHz: R.4 TDD 10MHz: R.0 TDD 20MHz: R.3 TDD	
PCFICH/PDCCH/PHICH parameters: DL Reference Measurement Channel <sup>Note3</sup>		1, 2, 3	5MHz: R.11 FDD 10MHz: R.6 FDD 20MHz: R.10 FDD	
		4, 5, 6	5MHz: R.11 TDD 10MHz: R.6 TDD 20MHz: R.10 TDD	
OCNG Patterns <sup>Note3</sup>		1, 2, 3	5MHz: OP.20 FDD 10MHz: OP.10 FDD 20MHz: OP.17 FDD	
		4, 5, 6	5MHz: OP.9 TDD 10MHz: OP.1 TDD 20MHz: OP.7 TDD	
PBCH_RA	dB	1, 2, 3, 4, 5, 6	0	
PBCH_RB				
PSS_RA				
SSS_RA				
PCFICH_RB				
PHICH_RA				
PHICH_RB				
PDCCH_RA				
PDCCH_RB				
PDSCH_RA				
PDSCH_RB				
OCNG_RA <sup>Note4</sup>				
OCNG_RB <sup>Note4</sup>				
N <sub>oc</sub> <sup>Note5</sup>				
$\bar{E}_s/N_{oc}$	dB	1, 2, 3, 4, 5, 6	-Infinity	4
$\bar{E}_s/I_{ot}$ <sup>Note6</sup>	dB	1, 2, 3, 4, 5, 6	-Infinity	4
RSRP <sup>Note6</sup>	dBm/15kHz	1, 2, 3, 4, 5, 6	-Infinity	-94
SCH_RP <sup>Note6</sup>	dBm/15kHz	1, 2, 3, 4, 5, 6	-Infinity	-94
I <sub>o</sub> <sup>Note6</sup>	dBm/9MHz	1, 2, 3, 4, 5, 6	-70.22	-64.76
Propagation Condition		1, 2, 3, 4, 5, 6	AWGN	
<p>Note 1: Special subframe and uplink-downlink configurations are specified in table 4.2-1 in TS 36.211.</p> <p>Note 2: PRACH configurations are specified in table 5.7.1-2 and table 5.7.1-3 in TS 36.211.</p> <p>Note 3: DL RMCs and OCNG patterns are specified in sections A 3.1 and A 3.2 of TS 36.133 respectively.</p> <p>Note 4: OCNG shall be used such that all cells are fully allocated and a constant total transmitted power spectral density is achieved for all OFDM symbols.</p> <p>Note 5: Interference from other cells and noise sources not specified in the test is assumed to be constant over subcarriers and time and shall be modelled as AWGN of appropriate power for N<sub>oc</sub> to be fulfilled.</p> <p>Note 6: <math>\bar{E}_s/I_{ot}</math>, RSRP, SCH_RP and I<sub>o</sub> levels have been derived from other parameters for information purposes. They are not settable parameters themselves.</p> <p>Note 7: Propagation condition and correlation matrix are defined in section B.2 in TS 36.101 [27].</p>				

The UE shall start to transmit the PRACH to Cell 2 less than 2205 ms from the beginning of time period T2.

The rate of correct RRC connection release redirection to E-UTRAN observed during repeated tests shall be at least 90%.

NOTE: The redirection delay can be expressed as:

$$T_{\text{connection\_release\_redirect\_E-UTRA}} = T_{\text{RRC\_procedure\_delay}} + T_{\text{identify-E-UTRA}} + T_{\text{SI-E-UTRA}} + T_{\text{RACH}},$$

where:

$T_{\text{RRC\_procedure\_delay}} = 110$  ms and is specified in clause 12 in TS 38.331 [2].

$T_{\text{identify-E-UTRA}} = 800$  ms in the test.

$T_{\text{SI-E-UTRA}} = 1280$  ms is assumed, it is the time required for receiving all the relevant system information as defined in TS 38.331 for the target E-UTRAN cell.

$T_{\text{RACH}} = 15$  ms in the test.

This gives a total of 2205 ms.

## 6.3.3 Conditional handover

### 6.3.3.0 Minimum conformance requirements

#### 6.3.3.0.1 Minimum conformance requirements for NR FR1 intra-frequency conditional handover

[TS 38.133, clause 6.1.4.2.1]

Procedure delays for all procedures that can command a conditional handover are specified in TS 38.331 [13].

When the UE receives a RRC message implying conditional handover the UE shall be ready to start the transmission of the new uplink PRACH channel within  $D_{\text{handover}}$  seconds from the end of the last TTI containing the RRC command.

$$D_{\text{CHO}} = T_{\text{RRC}} + T_{\text{Event\_DU}} + T_{\text{measure}} + T_{\text{interrupt}} + T_{\text{CHO\_execution}}$$

Where:

$T_{\text{RRC}}$  is the RRC procedure delay defined in clause 12 in TS 38.331 [13].

$T_{\text{Event\_DU}}$  is the delay uncertainty which is the time from when the UE successfully decodes a conditional handover command until a condition exists at the measurement reference point which will trigger the conditional handover.

$T_{\text{measure}}$  is the measurements time stated in TS 38.133 [6] clause 6.1.4.2.2.

$T_{\text{CHO\_execution}}$  is the conditional execution preparation time in TS 38.133 [6] clause 6.1.4.2.3.

$T_{\text{interrupt}}$  is the interruption time stated in TS 38.133 [6] clause 6.1.4.2.4.

[TS 38.133, clause 6.1.4.2.2]

The measurement time delay is defined from the end of  $T_{\text{Event\_DU}}$  until UE executes a handover to a target cell and interruption time starts.

For intra-frequency handover, the measurement time delay measured without Time To Trigger (TTT) and L3 filtering shall be less than  $T_{\text{identify\_intra\_with\_index}}$  or  $T_{\text{identify\_intra\_without\_index}}$  defined in clause 9.2.5.1 or clause 9.2.6.2.

When TTT or L3 filtering is used an additional delay can be expected.

A cell is detectable only if at least one SSB measured from the cell being configured remains detectable during the time period  $T_{\text{identify\_intra\_without\_index}}$  or  $T_{\text{identify\_intra\_with\_index}}$  for intra-frequency handover or  $T_{\text{identify\_inter\_without\_index}}$  for inter-frequency handover. If a cell which has been detectable at least for the time period  $T_{\text{identify\_intra\_without\_index}}$  or  $T_{\text{identify\_intra\_with\_index}}$  for intra-frequency handover or  $T_{\text{identify\_inter\_without\_index}}$  for inter-frequency handover becomes undetectable for a period and then the cell becomes detectable again and triggers a handover, the measurement time delay shall be less than  $T_{\text{SSB\_measurement\_period\_intra}}$  or  $T_{\text{SSB\_measurement\_period\_inter}}$  provided the timing to that cell has not changed

more than  $\pm 3200 T_c$  while the measurement gap has not been available and the L3 filter has not been used. When L3 filtering is used, an additional delay can be expected.

[TS 38.133, clause 6.1.4.2.3]

$T_{\text{CHO\_execution}}$  is the UE execution preparation time for conditional handover, and starts after UE realizes the condition of CHO is met and identity of the target cell is determined.  $T_{\text{CHO\_execution}}$  can be up to 10ms.

[TS 38.133, clause 6.1.4.2.4]

The interruption time is the time between when the UE starts to execute the conditional handover to the target cell and the time the UE starts transmission of the new PRACH.

For intra-frequency or inter-frequency conditional conditional handover, the measurement time shall be less than

$$T_{\text{interrupt}} = T_{\text{processing}} + T_{\text{IU}} + T_{\Delta} + T_{\text{margin}} \text{ ms}$$

Where:

$T_{\text{processing}}$  is time for UE processing.  $T_{\text{processing}}$  can be up to 20ms.

$T_{\text{IU}}$  is the interruption uncertainty in acquiring the first available PRACH occasion in the new cell.  $T_{\text{IU}}$  can be up to the summation of SSB to PRACH occasion association period and 10 ms. SSB to PRACH occasion associated period is defined in the table 8.1-1 of TS 38.213 [8]

$T_{\Delta}$  is time for fine time tracking and acquiring full timing information of the target cell.  $T_{\Delta} = T_{\text{rs}}$ .

$T_{\text{margin}}$  is time for SSB post-processing.  $T_{\text{margin}}$  can be up to 2ms.

$T_{\text{rs}}$  is the SMTC periodicity of the target NR cell if the UE has been provided with an SMTC configuration for the target cell in the handover command, otherwise  $T_{\text{rs}}$  is the SMTC configured in the measObjectNR having the same SSB frequency and subcarrier spacing. If the UE is not provided SMTC configuration or measurement object on this frequency, the requirement in this clause is applied with  $T_{\text{rs}}=5\text{ms}$  assuming the SSB transmission periodicity is 5ms. There is no requirement if the SSB transmission periodicity is not 5ms. If the UE has been provided with higher layer in TS 38.331 [13] signaling of *smtc2* prior to the handover command,  $T_{\text{rs}}$  follows *smtc1* or *smtc2* according to the physical cell ID of the target cell.

NOTE 1: The actual value of  $T_{\text{IU}}$  shall depend upon the PRACH configuration used in the target cell. [TS 38.133, clause 9.2.2]

The requirements in TS 38.133 [6] clause 9.2 apply, provided:

- The cell being identified or measured is detectable.

An intra-frequency cell shall be considered detectable when for each relevant SSB:

- SS-RSRP related side conditions given in TS 38.133 [6] clauses 10.1.2 for FR1, for a corresponding Band,
- SSB<sub>RP</sub> and SSB  $\hat{E}_s/I_{ot}$  according to TS 38.133 [6] Annex B.2.2 for a corresponding Band.

[TS 38.133, clause 9.2.5.1]

The UE shall be able to identify a new detectable intra-frequency cell within  $T_{\text{identify\_intra\_without\_index}}$  if the UE is not indicated to report SSB based RRM measurement result with the associated SSB index (*reportQuantityRsIndexes* or *maxNrofRSIndexesToReport* is not configured), or the UE is indicated that the neighbour cell is synchronous with the serving cell (*deriveSSB-IndexFromCell* is enabled). Otherwise UE shall be able to identify a new detectable intra frequency cell within  $T_{\text{identify\_intra\_with\_index}}$ . The UE shall be able to identify a new detectable intra frequency SS block of an already detected cell within  $T_{\text{identify\_intra\_without\_index}}$ . It is assumed that *deriveSSB-IndexFromCell* is always enabled for FR1 TDD and FR2.

$$T_{\text{identify\_intra\_without\_index}} = (T_{\text{PSS/SSS\_sync\_intra}} + T_{\text{SSB\_measurement\_period\_intra}}) \text{ ms}$$

$$T_{\text{identify\_intra\_with\_index}} = (T_{\text{PSS/SSS\_sync\_intra}} + T_{\text{SSB\_measurement\_period\_intra}} + T_{\text{SSB\_time\_index\_intra}}) \text{ ms}$$

Where:

$T_{\text{PSS/SSS\_sync\_intra}}$ : it is the time period used in PSS/SSS detection given in TS 38.133 [6] Table 9.2.5.1-1.



$T_{SSB\_time\_index\_intra}$ : it is the time period used to acquire the index of the SSB being measured given in TS 38.133 [6] Table 9.2.5.1-3.

$T_{SSB\_measurement\_period\_intra}$ : equal to a measurement period of SSB based measurement given in TS 38.133[6] Table 9.2.5.2-1.

$CSSF_{intra}$ : it is a carrier specific scaling factor and is determined

according to  $CSSF_{outside\_gap,i}$  in TS 38.133 [6] clause 9.1.5.1 for measurement conducted outside measurement gaps, i.e. when intra-frequency SMTC is fully non overlapping or partially overlapping with measurement gaps.

When intra-frequency SMTC is fully non overlapping with measurement gaps or intra-frequency SMTC is fully overlapping with MGs,  $K_p=1$

**Table 9.2.5.1-1: Time period for PSS/SSS detection, (Frequency range FR1)**

DRX cycle	$T_{PSS/SSS\_sync\_intra}$
No DRX	$\max(600\text{ms}, \text{ceil}(5 \times K_p) \times \text{SMTC period})^{\text{Note 1}} \times CSSF_{intra}$
DRX cycle $\leq 320\text{ms}$	$\max(600\text{ms}, \text{ceil}(M2^{\text{Note 2}} \times 5 \times K_p) \times \max(\text{SMTC period}, \text{DRX cycle})) \times CSSF_{intra}$
DRX cycle $> 320\text{ms}$	$\text{ceil}(5 \times K_p) \times \text{DRX cycle} \times CSSF_{intra}$
NOTE 1: If different SMTC periodicities are configured for different cells, the SMTC period in the requirement is the one used by the cell being identified NOTE 2: When <i>highSpeedMeasFlag-r16</i> is not configured, $M2 = 1.5$ ; When <i>highSpeedMeasFlag-r16</i> is configured, $M2 = 1.5$ if SMTC periodicity $> 40\text{ms}$ ; otherwise $M2=1$ . NOTE 3: When <i>highSpeedMeasFlag-r16</i> is configured, the requirements apply only to UE supporting either <i>measurementEnhancement-r16</i> or [ <i>intraRAT-MeasurementEnhancement-r16</i> ] on measurements of the primary component carrier and do not apply to measurements of a secondary component carrier with active SCell.	

**Table 9.2.5.1-3: Time period for time index detection (FR1)**

DRX cycle	$T_{SSB\_time\_index\_intra}$
No DRX	$\max(120\text{ms}, \text{ceil}(3 \times K_p) \times \text{SMTC period})^{\text{Note 1}} \times CSSF_{intra}$
DRX cycle $\leq 320\text{ms}$	$\max(120\text{ms}, \text{ceil}(M2^{\text{Note 2}} \times 3 \times K_p) \times \max(\text{SMTC period}, \text{DRX cycle})) \times CSSF_{intra}$
DRX cycle $> 320\text{ms}$	$\text{Ceil}(3 \times K_p) \times \text{DRX cycle} \times CSSF_{intra}$
NOTE 1: If different SMTC periodicities are configured for different cells, the SMTC period in the requirement is the one used by the cell being identified NOTE 2: When <i>highSpeedMeasFlag-r16</i> is not configured, $M2 = 1.5$ ; When <i>highSpeedMeasFlag-r16</i> is configured, $M2 = 1.5$ if SMTC periodicity $> 40\text{ms}$ ; otherwise $M2=1$ NOTE 3: When <i>highSpeedMeasFlag-r16</i> is configured, the requirements apply only to UE supporting either <i>measurementEnhancement-r16</i> or [ <i>intraRAT-MeasurementEnhancement-r16</i> ] on measurements of the primary component carrier and do not apply to measurements of a secondary component carrier with active SCell.	

[TS 38.133, clause 9.2.5.2]

The measurement period for intra-frequency measurements without gaps is as shown in TS 38.133 [6] Table 9.2.5.2-1.

**Table 9.2.5.2-1: Measurement period for intra-frequency measurements without gaps(FR1)**

DRX cycle	$T_{SSB\_measurement\_period\_intra}$
No DRX	$\max(200\text{ms}, \text{ceil}(5 \times K_p) \times \text{SMTC period})^{\text{Note 1}} \times CSSF_{intra}$
DRX cycle $\leq 320\text{ms}$	$\max(200\text{ms}, \text{ceil}(1.5 \times 5 \times K_p) \times \max(\text{SMTC period}, \text{DRX cycle})) \times CSSF_{intra}$
DRX cycle $> 320\text{ms}$	$\text{ceil}(5 \times K_p) \times \text{DRX cycle} \times CSSF_{intra}$
NOTE 1: If different SMTC periodicities are configured for different cells, the SMTC period in the requirement is the one used by the cell being identified	

[TS 38.133, clause 10.1.2.1.1]

Unless otherwise specified, the requirements for absolute accuracy of SS-RSRP in this clause apply to a cell on the same frequency as that of the serving cell in FR1. The accuracy requirements in this clause are also applicable when *highSpeedMeasFlag-r16* is configured.

The accuracy requirements in TS 38.133 [6] Table 10.1.2.1.1-1 are valid under the following conditions:

- Conditions defined in clause 7.3 of TS 38.101-1 [2] for reference sensitivity are fulfilled.
- Conditions for intra-frequency measurements are fulfilled according to 38.133 [6] Annex B.2.2 for a corresponding Band for each relevant SSB.

**Table 10.1.2.1.1-1: SS-RSRP Intra frequency absolute accuracy in FR1**

Accuracy		Conditions					
Normal condition	Extreme condition	SSB $\hat{E}_s/\text{lot}$	$I_o$ <sup>Note 1</sup> range				
			NR operating band groups <sup>Note 2</sup>	Minimum $I_o$		Maximum $I_o$	
dB	dB	dB		dBm / $SCS_{SSB}$		dBm/BW <sub>Channel</sub>	dBm/BW <sub>Channel</sub>
				$SCS_{SSB} = 15$ kHz	$SCS_{SSB} = 30$ kHz		
$\pm 4.5$	$\pm 9$	$\geq -6$	Depending on band group	-121+ $\Delta_{BG\_offset}$	-118+ $\Delta_{BG\_offset}$	N/A	-70
$\pm 8$	$\pm 11$	$\geq -6$	Depending on band group	N/A	N/A	-70	-50

NOTE 1:  $I_o$  is assumed to have constant EPRE across the bandwidth.  
 NOTE 2: NR operating band groups in FR1 are as defined in clause 3.5.2.  
 NOTE 3: For NR operating band groups,  $\Delta_{BG\_offset}$  is defined in clause 3A.4, Table 3A.4.1-2.

[TS 38.133, annex B.2.2]

This clause defines the following conditions for NR intra-frequency measurements and corresponding procedures performed based on SSBs: SSB<sub>RP</sub> and SSB  $\hat{E}_s/\text{lot}$ , applicable for a corresponding operating band.

The conditions are defined in Table B.2.2-1 for FR1 NR cells.

**Table B.2.2-1: Conditions for intra-frequency measurements in FR1**

Parameter	NR operating band groups <sup>Note1</sup>	Minimum SSB <sub>RP</sub>		SSB $\hat{E}_s/\text{lot}$
		dBm / $SCS_{SSB}$		dB
		$SCS_{SSB} = 15$ kHz	$SCS_{SSB} = 30$ kHz	
Conditions	Depending on band group	-127+ $\Delta_{BG\_offset}$	-124+ $\Delta_{BG\_offset}$	$\geq -6$

NOTE 1: NR operating band groups are defined in clause 3.5.2.  
 NOTE 2: For NR operating band groups,  $\Delta_{BG\_offset}$  is defined in clause 3A.4, Table 3A.4.1-2.

**6.3.3.0.2 Minimum conformance requirements for NR FR1 inter-frequency conditional handover**

[TS 38.133, clause 6.1.4.2.1]

Procedure delays for all procedures that can command a conditional handover are specified in TS 38.331 [13].

When the UE receives a RRC message implying conditional handover the UE shall be ready to start the transmission of the new uplink PRACH channel within  $D_{handover}$  seconds from the end of the last TTI containing the RRC command.

$$D_{CHO} = T_{RRC} + T_{Event\_DU} + T_{measure} + T_{interrupt} + T_{CHO\_execution}$$

Where:

$T_{RRC}$  is the RRC procedure delay defined in clause 12 in TS 38.331 [13].

$T_{\text{Event\_DU}}$  is the delay uncertainty which is the time from when the UE successfully decodes a conditional handover command until a condition exists at the measurement reference point which will trigger the conditional handover.

$T_{\text{measure}}$  is the measurements time stated in TS 38.133 [6] clause 6.1.4.2.2.

$T_{\text{CHO\_execution}}$  is the conditional execution preparation time in TS 38.133 [6] clause 6.1.4.2.3.

$T_{\text{interrupt}}$  is the interruption time stated in TS 38.133 [6] clause 6.1.4.2.4.

[TS 38.133, clause 6.1.4.2.2]

The measurement time delay is defined from the end of  $T_{\text{Event\_DU}}$  until UE executes a handover to a target cell and interruption time starts.

For intra-frequency handover, the measurement time delay measured without Time To Trigger (TTT) and L3 filtering shall be less than  $T_{\text{identify\_intra\_with\_index}}$  or  $T_{\text{identify\_intra\_without\_index}}$  defined in clause 9.2.5.1 or clause 9.2.6.2.

For inter-frequency handover, the measurement time delay measured without Time To Trigger (TTT) and L3 filtering shall be less than  $T_{\text{identify\_inter\_with\_index}}$  or  $T_{\text{identify\_inter\_without\_index}}$  defined in clause 9.3.4.

When TTT or L3 filtering is used an additional delay can be expected.

A cell is detectable only if at least one SSB measured from the cell being configured remains detectable during the time period  $T_{\text{identify\_intra\_without\_index}}$  or  $T_{\text{identify\_intra\_with\_index}}$  for intra-frequency handover or  $T_{\text{identify\_inter\_without\_index}}$  for inter-frequency handover. If a cell which has been detectable at least for the time period  $T_{\text{identify\_intra\_without\_index}}$  or  $T_{\text{identify\_intra\_with\_index}}$  for intra-frequency handover or  $T_{\text{identify\_inter\_without\_index}}$  for inter-frequency handover becomes undetectable for a period and then the cell becomes detectable again and triggers a handover, the measurement time delay shall be less than  $T_{\text{SSB\_measurement\_period\_intra}}$  or  $T_{\text{SSB\_measurement\_period\_inter}}$  provided the timing to that cell has not changed more than  $\pm 3200 T_c$  while the measurement gap has not been available and the L3 filter has not been used. When L3 filtering is used, an additional delay can be expected.

[TS 38.133, clause 6.1.4.2.3]

$T_{\text{CHO\_execution}}$  is the UE execution preparation time for conditional handover, and starts after UE realizes the condition of CHO is met and identity of the target cell is determined.  $T_{\text{CHO\_execution}}$  can be up to 10ms.

[TS 38.133, clause 6.1.4.2.4]

The interruption time is the time between when the UE starts to execute the conditional handover to the target cell and the time the UE starts transmission of the new PRACH.

For intra-frequency or inter-frequency conditional conditional handover, the measurement time shall be less than

$$T_{\text{interrupt}} = T_{\text{processing}} + T_{\text{IU}} + T_{\Delta} + T_{\text{margin}} \text{ ms}$$

Where:

$T_{\text{processing}}$  is time for UE processing.  $T_{\text{processing}}$  can be up to 20ms.

$T_{\text{IU}}$  is the interruption uncertainty in acquiring the first available PRACH occasion in the new cell.  $T_{\text{IU}}$  can be up to the summation of SSB to PRACH occasion association period and 10 ms. SSB to PRACH occasion associated period is defined in the table 8.1-1 of TS 38.213 [8]

$T_{\Delta}$  is time for fine time tracking and acquiring full timing information of the target cell.  $T_{\Delta} = T_{\text{rs}}$ .

$T_{\text{margin}}$  is time for SSB post-processing.  $T_{\text{margin}}$  can be up to 2ms.

$T_{\text{rs}}$  is the SMTC periodicity of the target NR cell if the UE has been provided with an SMTC configuration for the target cell in the handover command, otherwise  $T_{\text{rs}}$  is the SMTC configured in the measObjectNR having the same SSB frequency and subcarrier spacing. If the UE is not provided SMTC configuration or measurement object on this frequency, the requirement in this clause is applied with  $T_{\text{rs}}=5\text{ms}$  assuming the SSB transmission periodicity is 5ms. There is no requirement if the SSB transmission periodicity is not 5ms. If the UE has been provided with higher layer in TS 38.331 [13] signaling of *smtc2* prior to the handover command,  $T_{\text{rs}}$  follows *smtc1* or *smtc2* according to the physical cell ID of the target cell.

NOTE 1: The actual value of  $T_{IU}$  shall depend upon the PRACH configuration used in the target cell.

[TS 38.133, clause 9.3.2]

The requirements in clause 9.3 apply, provided:

- The cell being identified or measured is detectable.

An inter-frequency cell shall be considered detectable when for each relevant SSB:

- SS-RSRP related side conditions given in TS 38.133 [6] clauses 10.1.4 for FR1, for a corresponding Band,
- SSB<sub>RP</sub> and SSB  $\hat{E}_s/I_{ot}$  according to TS 38.133 [6] Annex B.2.3 for a corresponding Band.

[TS 38.133, clause 9.3.4]

When measurement gaps are provided, or the UE supports capability of conducting such measurements without gaps, the UE shall be able to identify a new detectable inter frequency cell within  $T_{\text{identify\_inter\_without\_index}}$  if UE is not indicated to report SSB based RRM measurement result with the associated SSB index (*reportQuantityRSIndexes* or *maxNrofRSIndexesToReport* is not configured). Otherwise UE shall be able to identify a new detectable inter frequency cell within  $T_{\text{identify\_inter\_with\_index}}$ . The UE shall be able to identify a new detectable inter frequency SS block of an already detected cell within  $T_{\text{identify\_inter\_without\_index}}$ .

$$T_{\text{identify\_inter\_without\_index}} = (T_{\text{PSS/SSS\_sync\_inter}} + T_{\text{SSB\_measurement\_period\_inter}}) \text{ ms}$$

$$T_{\text{identify\_inter\_with\_index}} = (T_{\text{PSS/SSS\_sync\_inter}} + T_{\text{SSB\_measurement\_period\_inter}} + T_{\text{SSB\_time\_index\_inter}}) \text{ ms}$$

Where:

$T_{\text{PSS/SSS\_sync\_inter}}$ : it is the time period used in PSS/SSS detection given in 38.133 [6] Table 9.3.4-1.

$T_{\text{SSB\_time\_index\_inter}}$ : it is the time period used to acquire the index of the SSB being measured given in 38.133 [6] Table 9.3.4-3.

$T_{\text{SSB\_measurement\_period\_inter}}$ : equal to a measurement period of SSB based measurement given in 38.133 [6] Table 9.3.5-1.

$\text{CSSF}_{\text{inter}}$ : it is a carrier specific scaling factor and is determined according to  $\text{CSSF}_{\text{within\_gap},i}$  in 38.133 [6] clause 9.1.5.2 for measurement conducted within measurement gaps.

**Table 9.3.4-1: Time period for PSS/SSS detection (Frequency range FR1)**

Condition <sup>NOTE1,2</sup>	$T_{\text{PSS/SSS\_sync\_inter}}$
No DRX	$\text{Max}(600\text{ms}, 8 \times \text{Max}(\text{MGRP}, \text{SMTC period})) \times \text{CSSF}_{\text{inter}}$
DRX cycle $\leq$ 320ms	$\text{Max}(600\text{ms}, \text{Ceil}(8 \times 1.5)) \times \text{Max}(\text{MGRP}, \text{SMTC period}, \text{DRX cycle}) \times \text{CSSF}_{\text{inter}}$
DRX cycle $>$ 320ms	$8 \times \text{DRX cycle} \times \text{CSSF}_{\text{inter}}$
NOTE 1: DRX or non DRX requirements apply according to the conditions described in clause 3.6.1	
NOTE 2: In EN-DC operation, the parameters, timers and scheduling requests referred to in clause 3.6.1 are for the secondary cell group. The DRX cycle is the DRX cycle of the secondary cell group.	

**Table 9.3.4-3: Time period for time index detection (Frequency range FR1)**

Condition <sup>NOTE1,2</sup>	$T_{\text{SSB\_time\_index\_inter}}$
No DRX	$\text{Max}(120\text{ms}, 3 \times \text{Max}(\text{MGRP}, \text{SMTC period})) \times \text{CSSF}_{\text{inter}}$
DRX cycle $\leq$ 320ms	$\text{Max}(120\text{ms}, \text{Ceil}(3 \times 1.5)) \times \text{Max}(\text{MGRP}, \text{SMTC period}, \text{DRX cycle}) \times \text{CSSF}_{\text{inter}}$
DRX cycle $>$ 320ms	$3 \times \text{DRX cycle} \times \text{CSSF}_{\text{inter}}$
NOTE 1: DRX or non DRX requirements apply according to the conditions described in clause 3.6.1	
NOTE 2: In EN-DC operation, the parameters, timers and scheduling requests referred to in clause 3.6.1 are for the secondary cell group. The DRX cycle is the DRX cycle of the secondary cell group.	

[TS 38.133, clause 9.3.5]

When measurement gaps are provided for inter frequency measurements, or the UE supports capability of conducting such measurements without gaps, the UE physical layer shall be capable of reporting SS-RSRP, SS-RSRQ and SS-

SINR measurements to higher layers with measurement accuracy as specified in TS 38.133 [6] clauses 10.1.4, 10.1.5, 10.1.9, 10.1.10, 10.1.14 and 10.1.15, respectively, as shown in table 9.3.5-1 and 9.3.5-2:

**Table 9.3.5-1: Measurement period for inter-frequency measurements with gaps (Frequency FR1)**

Condition <sup>NOTE1,2</sup>	$T_{SSB\_measurement\_period\_inter}$
No DRX	$\text{Max}(200\text{ms}, 8 \times \text{Max}(\text{MGRP}, \text{SMTC period})) \times \text{CSSF}_{inter}$
DRX cycle $\leq 320\text{ms}$	$\text{Max}(200\text{ms}, \text{Ceil}(8 \times 1.5) \times \text{Max}(\text{MGRP}, \text{SMTC period}, \text{DRX cycle})) \times \text{CSSF}_{inter}$
DRX cycle $> 320\text{ms}$	$8 \times \text{DRX cycle} \times \text{CSSF}_{inter}$
NOTE 1: DRX or non DRX requirements apply according to the conditions described in clause 3.6.1	
NOTE 2: In EN-DC operation, the parameters, timers and scheduling requests referred to in clause 3.6.1 are for the secondary cell group. The DRX cycle is the DRX cycle of the secondary cell group.	

[TS 38.133, clause 10.1.4.1.1]

The requirements for absolute accuracy of SS-RSRP in this clause apply to a cell on a frequency in FR1 that has different carrier frequency from the serving cell.

The accuracy requirements in Table 10.1.4.1.1-1 are valid under the following conditions:

- Conditions defined in clause 7.3 of TS 38.101-1 [2] for reference sensitivity are fulfilled.
- Conditions for inter-frequency measurements are fulfilled according to TS 38.133 [6] Annex B.2.3 for a corresponding Band for each relevant SSB.

**Table 10.1.4.1.1-1: SS-RSRP Inter frequency Absolute accuracy in FR1**

Accuracy		Conditions					
Normal condition	Extreme condition	SSB $\hat{E}_s/I_{ot}$ <sup>Note 2</sup>	$I_o$ <sup>Note 1</sup> range				
			NR operating band groups <sup>Note 3</sup>	Minimum $I_o$		Maximum $I_o$	
dB	dB	dB		dBm / $SCS_{SSB}$			dBm/ $BW_{Channel}$
			$SCS_{SSB} = 15 \text{ kHz}$	$SCS_{SSB} = 30 \text{ kHz}$			
$\pm 4.5$	$\pm 9$	$\geq -6$	Depending on band group	$-121 + \Delta_{BG\_offset}$	$-118 + \Delta_{BG\_offset}$	N/A	-70
$\pm 8$	$\pm 11$	$\geq -6$	Depending on band group	N/A	N/A	-70	-50
NOTE 1: $I_o$ is assumed to have constant EPRE across the bandwidth.							
NOTE 2: Void							
NOTE 3: NR operating band groups in FR1 are as defined in clause 3.5.2.							
NOTE 4: For NR operating band groups, $\Delta_{BG\_offset}$ is defined in clause 3A.4, Table 3A.4.1-2.							

[TS 38.133, annex B.2.3]

This clause defines the following conditions for NR inter-frequency measurements and corresponding procedures performed based on SSBs: SSB<sub>RP</sub> and SSB  $\hat{E}_s/I_{ot}$ , applicable for a corresponding operating band.

The conditions are defined in Table B.2.3-1 for FR1 NR cells.

**Table B.2.3-1: Conditions for inter-frequency measurements in FR1**

Parameter	NR operating band groups <sup>Note1</sup>	Minimum SSB <sub>RP</sub>		SSB $\hat{E}_s/I_{ot}$ dB
		dBm / $SCS_{SSB}$		
		$SCS_{SSB} = 15 \text{ kHz}$	$SCS_{SSB} = 30 \text{ kHz}$	
Conditions	Depending on band group	$-125 + \Delta_{BG\_offset}$	$-122 + \Delta_{BG\_offset}$	$\geq -4$
NOTE 1: NR operating band groups are defined in clause 3.5.2.				
NOTE 2: For NR operating band groups, $\Delta_{BG\_offset}$ is defined in clause 3A.4, Table 3A.4.1-2.				

6.3.3.1 NR SA FR1 conditional handover

6.3.3.1.1 Test purpose

To verify the requirement for the NR FR1 intra-frequency conditional handover requirements specified in 38.133 [6] clause 6.1.4.2

### 6.3.3.1.2 Test applicability

This test applies to all types of NR UE from Release 16 onwards and supporting conditional handover.

### 6.3.3.1.3 Minimum conformance requirements

The minimum conformance requirements are specified in clause 6.3.3.0.1.

The normative reference for this requirement is TS 38.133 [6] clause A.6.3.3.1.

### 6.3.3.1.4 Test description

#### 6.3.3.1.4.1 Initial conditions

Initial conditions are a set of test configurations the UE needs to be tested in and the steps for the SS to take with the UE to reach the correct measurement state.

This test shall be tested using any of the test configurations in Table 6.3.3.1.4.1-1.

**Table 6.3.3.1.4.1-1: NR SA FR1 conditional handover test configurations**

Config	Description
6.3.3.1-1	Source cell: NR 15 kHz SSB SCS, 10 MHz bandwidth, FDD duplex mode Target cell: NR 15 kHz SSB SCS, 10 MHz bandwidth, FDD duplex mode
6.3.3.1-2	Source cell: NR 15 kHz SSB SCS, 10 MHz bandwidth, TDD duplex mode Target cell: NR 15 kHz SSB SCS, 10 MHz bandwidth, TDD duplex mode
6.3.3.1-3	Source cell: NR 30 kHz SSB SCS, 40 MHz bandwidth, TDD duplex mode Target cell: NR 30 kHz SSB SCS, 40 MHz bandwidth, TDD duplex mode
Note:	The UE is only required to be tested in one of the supported test configurations

Configure the test equipment and the DUT according to the parameters in Table 6.3.3.1.4.1-2

**Table 6.3.3.1.4.1-2: Initial conditions for NR SA FR1 conditional handover**

Parameter	Value	Comment
Test environment	NC	As specified in TS 38.508-1 [14] clause 4.1.
Test frequencies	As specified in Annex E.1.1, Table E.4-1 and TS 38.508-1 [14] clause 4.3.1.	
Channel bandwidth	As specified by the test configuration selected from Table 6.3.3.1.4.1-1	
Propagation conditions	AWGN	As specified in Annex C.2.2.
Connection Diagram	TE Part A.3.1.8.2 DUT Part A.3.2.3.4	As specified in TS 38.508-1 [14] Annex A.
Exceptions to connection diagram	N/A	

1. Message contents are defined in clause 6.3.3.1.4.3.
2. The power levels and settings for NR Cell 1 are set according to Annex C.1.2 and C.1.3. Cell 2 is NR FR1 target Cell, and its power levels and settings are also set according to Annex C.1.2 and C.1.3.
3. The test parameters are given in Table 6.3.3.1.4.1-3 below, with A3-Offset modified by Test Tolerance.

**Table 6.3.3.1.4.1-3: General test parameters NR SA FR1 conditional handover**

Parameter	Unit	Value	Comment
Initial conditions	Active cell	Cell 1	
	Neighbouring cell	Cell 2	
Final condition	Active cell	Cell 2	
A3-Offset in condition	dB	-1	
Hysteresis	dB	0	
Time To Trigger	s	0	
Filter coefficient		0	L3 filtering is not used

Access Barring Information	-	Not Sent	No additional delays in random access procedure.
PRACH configuration index		FR1 PRACH configuration 1	As specified in table Table 6.3.3.2-3 in TS 38.211 [7]
Time offset between cells		3 $\mu$ s	Synchronous cells
T1	s	5	
T2	s	$\leq 2$	

#### 6.3.3.1.4.2 Test procedure

The test scenario comprises of 1 NR carrier and two cells, Cell 1 and Cell 2, on this carrier. General parameters and Cell-specific parameters for Cell 1 and Cell 2 are given in Table 6.3.3.1.4.1-3 and 6.3.3.1.5-1 respectively. No measurement gap is configured in the test case.

The test consists of two successive time periods, with time durations of T1 and T2 respectively.

At the start of time duration T1, the UE may not have any timing information of cell 2. The UE is configured with a condition implying handover to Cell 2 at a time earlier than  $T_{RRC}$  ms before the beginning of T2. No interruption shall be observed in time period T1, where

- $T_{RRC} = 10\text{ms}$ , is the RRC procedure delay defined in clause 12 in TS 38.331 [13].

From start of T2, the Cell 2 becomes detectable and handover condition is satisfied. During T2, the UE performs measurement on Cell 2 and evaluates the execution condition, and starts handover procedure when execution condition is satisfied. The UE shall sent PRACH to Cell 2 less than  $T_{\text{measure}} + T_{\text{CHO\_execution}} + T_{\text{interrupt}}$  ms from the start of T2. The Interruption length  $T_{\text{interrupt}}$  shall also be verified in T2.

1. Ensure the UE is in State RRC\_CONNECTED with generic procedure parameters Connectivity NR, Connected without release *On* according to TS 38.508-1 [14] clause 4.5. Establish SRB2 and DRB in the *RRCReconfiguration* message. Cell 1 is the active cell. Set Cell 2 physical cell identity to the initial physical cell identity.
2. Set the parameters according to T1 in Table 6.3.3.1.5-1. Propagation conditions are set according to Annex C clause C.2.2. T1 starts. The SS starts continuously scheduling the UE to perform DL reception in every DL slot on Cell 1 and monitoring corresponding ACK/NACK feedbacks sent by the UE.
3. Set Cell 2 physical cell identity = ((current cell 2 physical cell identity + 1) mod 14 + 2).
4. The SS shall transmit an *RRCReconfiguration* message with *conditionalReconfiguration* on Cell 1 to configure CHO execution condition for the UE.
5. The UE shall transmit an *RRCReconfigurationComplete* message.
6. When T1 expires, the SS shall switch the power setting from T1 to T2 as specified in Table 6.3.3.1.5-1. T2 starts.
7. If
  - a) the UE transmits the PRACH preambles to Cell 2 less than  $T_{\text{measure}} + T_{\text{CHO\_execution}} + T_{\text{interrupt}}$  ms from the beginning of time period T2,

and

  - b) no longer than X consecutive ACK/NACK DTXs are observed by the SS from the start of T2 to the instant the UE transmits the first PRACH preamble, where
    - $X = T_{\text{interrupt}} + k_1$  for test configuration 6.3.3.1-1
    - $X = T_{\text{interrupt}}$  for test configuration 6.3.3.1-2
    - $X = 2 \cdot T_{\text{interrupt}}$  for test configuration 6.3.3.1-3.

then the number of successful tests is increased by one. Otherwise, the number of failure tests is increased by one.

8. After T2 expires, the SS sends an *RRCReconfiguration* with *reconfigurationWithSync* to cause UE handover back to Cell 1.
9. If UE is not in state RRC\_CONNECTED with generic procedure parameters Connectivity NR, Connected without release *On* according to TS 38.508-1 [14] clause 4.5 on Cell 1, switch off and on the UE. Then ensure the UE is in State RRC\_CONNECTED with generic procedure parameters Connectivity NR, Connected without release *On* according to TS 38.508-1 [14] clause 4.5 on Cell 1.
10. Repeat steps 2-9 until the confidence level according to Tables G.2.3-1 in Annex G clause G.2 is achieved.

6.3.3.1.4.3 Message contents

**Message contents are according to TS 38.508-1 [14] clause 7.3 with the following exceptions: Table 6.3.3.1.4.3-1: RRCReconfiguration (Step 4)**

Derivation Path: TS 38.508-1 [14], Table 4.6.1-13 with condition NR_MEAS and CHO			
Information Element	Value/remark	Comment	Condition
RRCReconfiguration ::= SEQUENCE {			
criticalExtensions CHOICE {			
rrcReconfiguration SEQUENCE {			
measConfig	MeasConfig	Table 6.3.3.1.4.3-2	
nonCriticalExtension SEQUENCE {			
nonCriticalExtension SEQUENCE {			
nonCriticalExtension SEQUENCE {			
nonCriticalExtension SEQUENCE {			
conditionalReconfiguration-r16	ConditionalReconfiguration	Table 6.3.3.1.4.3-5	
}			
}			
}			
}			
}			
}			
}			



Table 6.3.3.1.4.3-2: MeasConfig (Table 6.3.3.1.4.3-1)

Derivation Path: Table H.3.1-2			
Information Element	Value/remark	Comment	Condition
MeasConfig ::= SEQUENCE {			
measObjectToAddModList SEQUENCE (SIZE (1..maxNrofObjectId)) OF MeasObjectToAddMod {	1 entry		
MeasObjectToAddMod[1] SEQUENCE {		entry 1	
measObjectId	1		
measObject CHOICE {			
measObjectNR	MeasObjectNR	Table 6.3.3.1.4.3-3	
}			
}			
reportConfigToAddModList SEQUENCE (SIZE (1..maxReportConfigId)) OF ReportConfigToAddMod {	1 entry		
ReportConfigToAddMod[1] SEQUENCE {		entry 1	
reportConfigId	1		
reportConfig CHOICE {			
reportConfigNR	ReportConfigNR	Table 6.3.3.1.4.3-4	
}			
}			
measIdToAddModList SEQUENCE (SIZE (1..maxNrofMeasId)) OF MeasIdToAddMod {	1 entry		
MeasIdToAddMod[1] SEQUENCE {			
measId	1		
measObjectId	1		
reportConfigId	1		
}			
}			
quantityConfig	QuantityConfig specified in Table H.3.1-5		
}			

Table 6.3.3.1.4.3-3: MeasObjectNR (Table 6.3.3.1.4.3-2)

Derivation Path: TS 38.508-1[14], Table 4.6.3-76			
Information Element	Value/remark	Comment	Condition
MeasObjectNR ::= SEQUENCE {			
ssbFrequency	ARFCN-ValueNR for PCell		
smtc1	SSB-MTC specified in TS 38.508-1[14] Table 7.3.1-3 with condition SMTC.1		
referenceSignalConfig SEQUENCE {			
ssb-ConfigMobility SEQUENCE {			
ssb-ToMeasure	Not present		
}			
}			
absThreshSS-BlocksConsolidation	Not present		
}			

**Table 6.3.3.1.4.3-4: ReportConfigNR (Table 6.3.3.1.4.3-2)**

Derivation Path: TS 38.508-1[14], Table 4.6.3-142 with condition CHO			
Information Element	Value/remark	Comment	Condition
ReportConfigNR ::= SEQUENCE {			
reportType CHOICE {			
condTriggerConfig SEQUENCE {			
condEventId CHOICE {			
condEventA3 SEQUENCE {			
a3-Offset CHOICE {			
rsp	-2	actual value = -2*0.5 = -1dB	
}			
hysteresis	0	actual value = 0*0.5 = 0dB	
timeToTrigger	ms0		
}			
}			
}			

**Table 6.3.3.1.4.3-5: ConditionalReconfiguration (Table 6.3.3.1.4.3-1)**

Derivation Path: TS 38.508-1[14], Table 4.6.3-25D			
Information Element	Value/remark	Comment	Condition
ConditionalReconfiguration-r16 ::= SEQUENCE {			
condReconfigToAddModList-r16 SEQUENCE (SIZE (1.. maxNrofCondCells-r16)) OF	1 entry		
CondReconfigToAddMod-r16 {		entry 1	
CondReconfigToAddMod-r16 [1] SEQUENCE {			
condReconfigId-r16	1		
condExecutionCond-r16 SEQUENCE (SIZE (1..2)) OF MeasId {	1 entry		
MeasId[1]	1	The MeasId configured in Table 6.3.3.1.4.3-2	
}			
condRRCReconfig-r16	OCTET STRING (CONTAINING RRCReconfiguration Specified in Table 4.8.1-1A with condition RBCConfig_NoKeyChange)		
}			
}			

6.3.3.1.5 Test requirements

Table 6.3.3.1.5-1 defines the primary level settings including test tolerances for all tests.

**Table 6.3.3.1.5-1: Cell specific test parameters for NR SA FR1 conditional handover**

Parameter		Unit	Cell 1		Cell 2	
			T1	T2	T1	T2
NR RF Channel Number			1		1	
Duplex mode	Config 1		FDD			
	Config 2,3		TDD			
TDD configuration	Config 1		Not Applicable			
	Config 2		TDDConf.1.1			
	Config 3		TDDConf.2.1			
BW <sub>channel</sub>	Config 1	MHz	10: N <sub>RB,c</sub> = 52			
	Config 2		10: N <sub>RB,c</sub> = 52			

Parameter		Unit	Cell 1		Cell 2	
			T1	T2	T1	T2
BWP BW	Config 3	MHz	40: $N_{RB,c} = 106$			
	Config 1		10: $N_{RB,c} = 52$			
	Config 2		10: $N_{RB,c} = 52$			
	Config 3		40: $N_{RB,c} = 106$			
DRx Cycle		ms	Not Applicable			
PDSCH Reference measurement channel	Config 1		SR.1.1 FDD			
	Config 2		SR.1.1 TDD			
	Config 3		SR2.1 TDD			
CORESET Reference Channel	Config 1		CR.1.1 FDD			
	Config 2		CR.1.1 TDD			
	Config 3		CR2.1 TDD			
TRS configuration	Config 1		TRS.1.1 FDD			
	Config 2		TRS.1.1 TDD			
	Config 3		TRS.1.2 TDD			
OCNG Patterns			OCNG pattern 1			
SMTc Configuration			SMTc pattern 1			
SSB Configuration	Config 1,2		SSB.1 FR1			
	Config 3		SSB.2 FR1			
PDSCH/PDCCH subcarrier spacing	Config 1,2	kHz	15 kHz			
	Config 3		30 kHz			
PUCCH/PUSCH subcarrier spacing	Config 1,2	kHz	15 kHz			
	Config 3		30 kHz			
PRACH configuration			FR1 PRACH configuration 1			
BWP configuration	Initial DL BWP		DLBWP.0.1			
	Dedicated DL BWP		DLBWP.1.1			
	Initial UL BWP		ULBWP.0.1			
	Dedicated UL BWP		ULBWP.1.1			
EPRE ratio of PSS to SSS		dB	0			
EPRE ratio of PBCH DMRS to SSS						
EPRE ratio of PBCH to PBCH DMRS						
EPRE ratio of PDCCH DMRS to SSS						
EPRE ratio of PDCCH to PDCCH DMRS						
EPRE ratio of PDSCH DMRS to SSS						
EPRE ratio of PDSCH to PDSCH						
EPRE ratio of OCNG DMRS to SSS(Note 1)						
EPRE ratio of OCNG to OCNG DMRS (Note 1)						
$N_{oc}$ <sup>Note2</sup>		dBm/15kHz	-98			
$N_{oc}$ <sup>Note2</sup>	Config 1,2	dBm/SCS	-98			
	Config 3		-95			
$\hat{E}_s / I_{ot}$		dB	8	-2.41	-Infinity	1.36
$\hat{E}_s / N_{oc}$		dB	8	8	-Infinity	10
SSB <sub>RP</sub>	Config 1,2	dBm/SCS	-90	-90	-Infinity	-88
	Config 3	dBm/SCS	-87	-87	-Infinity	-85
$I_o$ <sup>Note3</sup>	Config 1,2	dBm/ 9.36MHz	-61.41	-57.67	-61.41	-57.67
	Config 3	dBm/ 38.16MHz	-55.31	-50.56	-55.31	-50.56
Propagation condition			AWGN			
<p>Note 1: OCNG shall be used such that both cells are fully allocated and a constant total transmitted power spectral density is achieved for all OFDM symbols.</p> <p>Note 2: Interference from other cells and noise sources not specified in the test is assumed to be constant over subcarriers and time and shall be modelled as AWGN of appropriate power for <math>N_{oc}</math> to be fulfilled.</p> <p>Note 3: <math>I_o</math> levels have been derived from other parameters for information purposes. They are not settable parameters themselves.</p>						

The rate of correct handovers observed during repeated tests shall be at least 90%.

The test shall verify that there are no interruptions during T1.

The UE shall start to transmit the PRACH to Cell 2 less than  $T_{\text{measure}} + T_{\text{CHO\_execution}} + T_{\text{interrupt}}$  from the start of T2. where:

- $T_{\text{measure}} = 800$  ms, is the measurements time specified in 38.133 [6] clause 6.1.4.2.2.
- $T_{\text{CHO\_execution}} = 10$  ms, is the conditional execution preparation time specified in 38.133 [6] clause 6.1.4.2.2.
- $T_{\text{interrupt}} = T_{\text{processing}} + T_{\text{IU}} + T_{\Delta} + T_{\text{margin}}$  ms, is the interruption time specified in 38.133 [6] 6.1.4.2.4.
  - $T_{\text{processing}} = 20$  ms, is time for UE processing;
  - $T_{\text{IU}} = 20$  ms, is the interruption uncertainty in acquiring the first available PRACH occasion in the new cell;
  - $T_{\Delta} = 20$  ms, is time for fine time tracking and acquiring full timing information of the target cell;
  - $T_{\text{margin}} = 2$  ms, is time for SSB post-processing.

This gives a total of 872 ms

The interruption during T2 shall not exceed  $T_{\text{interrupt}} = 62$ ms.

### 6.3.3.2 NR SA FR1-FR1 conditional handover

#### 6.3.3.2.1 Test purpose

To verify the requirement for the NR conditional FR1-NR FR1 inter-frequency conditional handover requirements specified in clause 6.1.4.2.

#### 6.3.3.2.2 Test applicability

This test applies to all types of NR UE from Release 16 onwards and supporting conditional handover.

#### 6.3.3.2.3 Minimum conformance requirements

The minimum conformance requirements are specified in clause 6.3.3.0.2.

The normative reference for this requirement is TS 38.133 [6] clause A.6.3.3.2.

#### 6.3.3.2.4 Test description

##### 6.3.3.2.4.1 Initial conditions

Initial conditions are a set of test configurations the UE needs to be tested in and the steps for the SS to take with the UE to reach the correct measurement state.

This test shall be tested using any of the test configurations in Table 6.3.3.2.4.1-1.

**Table 6.3.3.2.4.1-1: NR SA FR1-FR1 conditional handover test configurations**

Config	Description
6.3.3.2-1	Source cell: NR 15 kHz SSB SCS, 10 MHz bandwidth, FDD duplex mode Target cell: NR 15 kHz SSB SCS, 10 MHz bandwidth, FDD duplex mode
6.3.3.2-2	Source cell: NR 15 kHz SSB SCS, 10 MHz bandwidth, TDD duplex mode Target cell: NR 15 kHz SSB SCS, 10 MHz bandwidth, TDD duplex mode
6.3.3.2-3	Source cell: NR 30 kHz SSB SCS, 40 MHz bandwidth, TDD duplex mode Target cell: NR 30 kHz SSB SCS, 40 MHz bandwidth, TDD duplex mode
Note:	The UE is only required to be tested in one of the supported test configurations

Configure the test equipment and the DUT according to the parameters in Table 6.3.3.2.4.1-2

**Table 6.3.3.2.4.1-2: Initial conditions for NR SA FR1-FR1 conditional handover**

Parameter	Value	Comment
Test environment	NC	As specified in TS 38.508-1 [14] clause 4.1.
Test frequencies	As specified in Annex E.1.1, Table E.4-1 and TS 38.508-1 [14] clause 4.3.1.	
Channel bandwidth	As specified by the test configuration selected from Table 6.3.3.2.4.1-1	

Propagation conditions	AWGN		As specified in Annex C.2.2.
Connection Diagram	TE Part	A.3.1.8.2	As specified in TS 38.508-1 [14] Annex A.
	DUT Part	A.3.2.3.4	
Exceptions to connection diagram	N/A		

1. Message contents are defined in clause 6.3.3.2.4.3.
2. The power levels and settings for NR Cell 1 are set according to Annex C.1.2 and C.1.3. Cell 2 is NR FR1 target Cell, and its power levels and settings are also set according to Annex C.1.2 and C.1.3.
3. The test parameters are given in Table 6.3.3.2.4.1-3 below, with A3-Offset modified by Test Tolerance.

**Table 6.3.3.2.4.1-3: General test parameters NR SA FR1-FR1 conditional handover**

Parameter		Unit	Value	Comment
Initial conditions	Active cell		Cell 1	
	Neighbouring cell		Cell 2	
Final condition	Active cell		Cell 2	
A3-Offset in handover condition		dB	-4	
Hysteresis		dB	0	
Time To Trigger		s	0	
Filter coefficient			0	L3 filtering is not used
Access Barring Information		-	Not Sent	No additional delays in random access procedure.
T1		s	5	
T2		s	≤2	

#### 6.3.3.2.4.2 Test procedure

The test scenario comprises of 2 NR carrier and two cells, Cell 1 and Cell 2, on each carrier respectively. General parameters and Cell-specific parameters for Cell 1 and Cell 2 are given in Table 6.3.3.2.4.1-3 and 6.3.3.2.5-1 respectively. Measurement gap (gap pattern #0) is configured in the test case.

The test consists of two successive time periods, with time durations of T1 and T2 respectively.

At the start of time duration T1, the UE may not have any timing information of cell 2. The UE is configured with a condition implying handover to Cell 2 at a time earlier than  $T_{RRC}$  ms before the beginning of T2. No interruption shall be observed in time period T1, where

- $T_{RRC} = 10\text{ms}$ , is the RRC procedure delay defined in clause 12 in TS 38.331 [13].

From start of T2, the Cell 2 becomes detectable and handover condition is satisfied. During T2, the UE performs measurement on Cell 2 and evaluates the execution condition, and starts handover procedure when execution condition is satisfied. The UE shall sent PRACH to Cell 2 less than  $T_{\text{measure}} + T_{\text{CHO\_execution}} + T_{\text{interrupt}}$  ms from the start of T2. The Interruption length  $T_{\text{interrupt}}$  shall also be verified in T2.

1. Ensure the UE is in State RRC\_CONNECTED with generic procedure parameters Connectivity NR, Connected without release On according to TS 38.508-1 [14] clause 4.5. Establish SRB2 and DRB in the RRCReconfiguration message. Cell 1 is the active cell. Set Cell 2 physical cell identity to the initial physical cell identity.
2. Set the parameters according to T1 in Table 6.3.3.2.5-1. Propagation conditions are set according to Annex C clause C.2.2. T1 starts. The SS starts continuously scheduling the UE to perform DL reception in every DL slot on Cell 1 and monitoring corresponding ACK/NACK feedbacks sent by the UE.
3. Set Cell 2 physical cell identity = ((current cell 2 physical cell identity + 1) mod 14 + 2).
4. The SS shall transmit an RRCReconfiguration message with conditionalReconfiguration on Cell 1 to configure CHO execution condition and measurement gap pattern #0 for the UE.
5. The UE shall transmit an RRCReconfigurationComplete message.

6. When T1 expires, the SS shall switch the power setting from T1 to T2 as specified in Table 6.3.3.2.5-1. T2 starts.
7. If
  - c) the UE transmits the PRACH preambles to Cell 2 less than  $T_{\text{measure}} + T_{\text{CHO\_execution}} + T_{\text{interrupt}}$  ms from the beginning of time period T2,
 and
  - d) no longer than X consecutive ACK/NACK DTXs are observed by the SS from the start of T2 to the instant the UE transmits the first PRACH preamble, where
    - $X = T_{\text{interrupt}} + k_1$  for test configuration 6.3.3.2-1
    - $X = T_{\text{interrupt}}$  for test configuration 6.3.3.2-2
    - $X = 2 \cdot T_{\text{interrupt}}$  for test configuration 6.3.3.2-3.
 then the number of successful tests is increased by one. Otherwise, the number of failure tests is increased by one.
8. After T2 expires, the SS sends an *RRCReconfiguration* with *reconfigurationWithSync* to cause UE handover back to Cell 1.
9. If UE is not in state RRC\_CONNECTED with generic procedure parameters Connectivity NR, Connected without release *On* according to TS 38.508-1 [14] clause 4.5 on Cell 1, switch off and on the UE. Then ensure the UE is in State RRC\_CONNECTED with generic procedure parameters Connectivity NR, Connected without release *On* according to TS 38.508-1 [14] clause 4.5 on Cell 1.
10. Repeat steps 2-9 until the confidence level according to Tables G.2.3-1 in Annex G clause G.2 is achieved.

6.3.3.2.4.3 Message contents

Message contents are according to TS 38.508-1 [14] clause 7.3 with the following exceptions:

**Table 6.3.3.2.4.3-1: RRCReconfiguration (Step 4)**

Derivation Path: TS 38.508-1 [14], Table 4.6.1-13 with condition NR_MEAS and CHO			
Information Element	Value/remark	Comment	Condition
RRCReconfiguration ::= SEQUENCE {			
criticalExtensions CHOICE {			
rrcReconfiguration SEQUENCE {			
measConfig	MeasConfig	Table 6.3.3.2.4.3-2	
nonCriticalExtension SEQUENCE {			
nonCriticalExtension SEQUENCE {			
nonCriticalExtension SEQUENCE {			
conditionalReconfiguration-r16	ConditionalReconfiguration	Table 6.3.3.2.4.3-6	
}			
}			
}			
}			
}			
}			
}			

**Table 6.3.3.2.4.3-2: MeasConfig (Table 6.3.3.2.4.3-1)**

Derivation Path: Table H.3.1-2			
Information Element	Value/remark	Comment	Condition
MeasConfig ::= SEQUENCE {			
measObjectToAddModList SEQUENCE (SIZE (1..maxNrofObjectId)) OF MeasObjectToAddMod {	2 entry		
MeasObjectToAddMod[1] SEQUENCE {		entry 1	
measObjectId	1		
measObject CHOICE {			
measObjectNR	MeasObjectNR-f1	Table 6.3.3.2.4.3-3	
}			
}			
MeasObjectToAddMod[2] SEQUENCE {		entry 2	
measObjectId	2		
measObject CHOICE {			
measObjectNR	MeasObjectNR-f2	Table 6.3.3.2.4.3-4	
}			
}			
reportConfigToAddModList SEQUENCE (SIZE (1..maxReportConfigId)) OF ReportConfigToAddMod {	1 entry		
ReportConfigToAddMod[1] SEQUENCE {		entry 1	
reportConfigId	1		
reportConfig CHOICE {			
reportConfigNR	ReportConfigNR	Table 6.3.3.2.4.3-5	
}			
}			
measIdToAddModList SEQUENCE (SIZE (1..maxNrofMeasId)) OF MeasIdToAddMod {	1 entry		
MeasIdToAddMod[1] SEQUENCE {			
measId	1		
measObjectId	2		
reportConfigId	1		
}			
}			
measGapConfig	MeasGapConfig specified in Table H.3.1-6 with condition gapUE and Pattern #0		
quantityConfig	QuantityConfig specified in Table H.3.1-5		
}			

Table 6.3.3.2.4.3-3: MeasObjectNR-f1 (Table 6.3.3.2.4.3-2)

Derivation Path: TS 38.508-1[14], Table 4.6.3-76			
Information Element	Value/remark	Comment	Condition
MeasObjectNR ::= SEQUENCE {			
ssbFrequency	ARFCN-ValueNR for Cell 1		
smtc1	SSB-MTC specified in TS 38.508-1[14] Table 7.3.1-3 with condition SMTC.1		
referenceSignalConfig SEQUENCE {			
ssb-ConfigMobility SEQUENCE {			
ssb-ToMeasure	Not present		
}			
}			
absThreshSS-BlocksConsolidation	Not present		
}			

Table 6.3.3.2.4.3-4: MeasObjectNR-f2 (Table 6.3.3.2.4.3-2)

Derivation Path: TS 38.508-1[14], Table 4.6.3-76			
Information Element	Value/remark	Comment	Condition
MeasObjectNR ::= SEQUENCE {			
ssbFrequency	ARFCN-ValueNR for Cell 2		
smtc1	SSB-MTC specified in TS 38.508-1[14] Table 7.3.1-3 with condition SMTC.1		
referenceSignalConfig SEQUENCE {			
ssb-ConfigMobility SEQUENCE {			
ssb-ToMeasure	Not present		
}			
}			
absThreshSS-BlocksConsolidation	Not present		
}			

Table 6.3.3.2.4.3-5: ReportConfigNR (Table 6.3.3.2.4.3-2)

Derivation Path: TS 38.508-1[14], Table 4.6.3-142 with condition CHO			
Information Element	Value/remark	Comment	Condition
ReportConfigNR ::= SEQUENCE {			
reportType CHOICE {			
condTriggerConfig SEQUENCE {			
condEventId CHOICE {			
condEventA3 SEQUENCE {			
a3-Offset CHOICE {			
rsrp	-8	actual value = -8*0.5 = -4dB	
}			
hysteresis	0	actual value = 0*0.5 = 0dB	
timeToTrigger	ms0		
}			
}			
}			
}			
}			



**Table 6.3.3.2.4.3-6: ConditionalReconfiguration (Table 6.3.3.2.4.3-1)**

Derivation Path: TS 38.508-1[14], Table 4.6.3-25D			
Information Element	Value/remark	Comment	Condition
ConditionalReconfiguration-r16 ::= SEQUENCE {			
condReconfigToAddModList-r16 SEQUENCE (SIZE (1.. maxNrofCondCells-r16)) OF	1 entry		
CondReconfigToAddMod-r16 {		entry 1	
CondReconfigToAddMod-r16 [1] SEQUENCE {			
condReconfigId-r16	1		
condExecutionCond-r16 SEQUENCE (SIZE (1..2)) OF MeasId {	1 entry		
MeasId[1]	1	The MeasId configured in Table 6.3.3.2.4.3-2	
}			
condRRCReconfig-r16	OCTET STRING (CONTAINING RRCReconfiguration Specified in Table 4.8.1-1A with condition RBCConfig_NoKeyChange)		
}			
}			
}			
}			

6.3.3.2.5 Test requirements

Table 6.3.3.2.5-1 defines the primary level settings including test tolerances for all tests.

**Table 6.3.3.2.5-1: Cell specific test parameters for NR SA FR1-FR1 conditional handover**

Parameter		Unit	Cell 1		Cell 2	
			T1	T2	T1	T2
NR RF Channel Number			1		2	
Duplex mode	Config 1		FDD			
	Config 2,3		TDD			
TDD configuration	Config 1		Not Applicable			
	Config 2		TDDConf.1.1			
	Config 3		TDDConf.2.1			
BW <sub>channel</sub>	Config 1	MHz	10: N <sub>RB,c</sub> = 52			
	Config 2		10: N <sub>RB,c</sub> = 52			
	Config 3		40: N <sub>RB,c</sub> = 106			
BWP BW	Config 1	MHz	10: N <sub>RB,c</sub> = 52			
	Config 2		10: N <sub>RB,c</sub> = 52			
	Config 3		40: N <sub>RB,c</sub> = 106			
TRS configuration	Config 1		TRS.1.1 FDD			
	Config 2		TRS.1.1 TDD			
	Config 3		TRS.1.2 TDD			
DRx Cycle		ms	Not Applicable			
Gap pattern ID			gp0			
PDSCH Reference measurement channel	Config 1		SR.1.1 FDD			
	Config 2		SR.1.1 TDD			
	Config 3		SR2.1 TDD			
CORESET Reference Channel	Config 1		CR.1.1 FDD			
	Config 2		CR.1.1 TDD			
	Config 3		CR2.1 TDD			
OCNG Patterns			OCNG pattern 1			
SMTC Configuration			SMTC pattern 1			
SSB Configuration	Config 1,2		SSB.1 FR1			
	Config 3		SSB.2 FR1			

Parameter		Unit	Cell 1		Cell 2	
			T1	T2	T1	T2
PDSCH/PDCCH subcarrier spacing	Config 1,2	kHz	15 kHz			
	Config 3		30 kHz			
PUCCH/PUSCH subcarrier spacing	Config 1,2	kHz	15 kHz			
	Config 3		30 kHz			
PRACH configuration			FR1 PRACH configuration 1			
BWP	Initial DL BWP		DLBWP.0.1			
	Dedicated DL BWP		DLBWP.1.1			
	Initial UL BWP		ULBWP.0.1			
	Dedicated UL BWP		ULBWP.1.1			
EPRE ratio of PSS to SSS		dB	0			
EPRE ratio of PBCH DMRS to SSS						
EPRE ratio of PBCH to PBCH DMRS						
EPRE ratio of PDCCH DMRS to SSS						
EPRE ratio of PDCCH to PDCCH DMRS						
EPRE ratio of PDSCH DMRS to SSS						
EPRE ratio of PDSCH to PDSCH						
EPRE ratio of OCNG DMRS to SSS(Note 1)						
EPRE ratio of OCNG to OCNG DMRS (Note 1)						
$N_{oc}^{Note2}$			dBm/15kHz	-98		-98
$N_{oc}^{Note2}$	Config 1,2	dBm/SCS	-98		-98	
	Config 3		-95		-95	
$\hat{E}_s/I_{ot}$		dB	4	4	-Infinity	6.70
$\hat{E}_s/N_{oc}$		dB	4	4	-Infinity	6.70
SSB_RP	Config 1,2	dBm/SCS	-94	-94	-Infinity	-91.30
	Config 3	dBm/SCS	-91	-91	-Infinity	-88.30
$Io^{Note3}$	Config 1,2	dBm/ 9.36MHz	-64.59	-64.59	-70.05	-62.51
	Config 3	dBm/ 38.16MHz	-58.49	-58.49	-63.94	-56.40
Propagation condition		-	AWGN		AWGN	
Note 1: OCNG shall be used such that both cells are fully allocated and a constant total transmitted power spectral density is achieved for all OFDM symbols.						
Note 2: Interference from other cells and noise sources not specified in the test is assumed to be constant over subcarriers and time and shall be modelled as AWGN of appropriate power for $N_{oc}$ to be fulfilled.						
Note 3: $Io$ levels have been derived from other parameters for information purposes. They are not settable parameters themselves.						

The rate of correct handovers observed during repeated tests shall be at least 90%.

The test shall verify that there are no interruptions during T1.

The UE shall start to transmit the PRACH to Cell 2 less than  $T_{measure} + T_{CHO\_execution} + T_{interrupt}$  from the start of T2. where:

- $T_{measure} = 920$  ms, is the measurements time specified in 38.133 [6] clause 6.1.4.2.2.
- $T_{CHO\_execution} = 10$  ms, is the conditional execution preparation time specified in 38.133 [6] clause 6.1.4.2.2.
- $T_{interrupt} = T_{processing} + T_{IU} + T_{\Delta} + T_{margin}$  ms, is the interruption time specified in 38.133 [6] 6.1.4.2.4.
- $T_{processing} = 20$  ms, is time for UE processing;
- $T_{IU} = 20$  ms, is the interruption uncertainty in acquiring the first available PRACH occasion in the new cell;
- $T_{\Delta} = 20$  ms, is time for fine time tracking and acquiring full timing information of the target cell;
- $T_{margin} = 2$  ms, is time for SSB post-processing.

This gives a total of 992 ms

The interruption during T2 shall not exceed  $T_{\text{interrupt}} = 62\text{ms}$ .

## 6.4 Timing

### 6.4.1 UE transmit timing

#### 6.4.1.0 Minimum conformance requirements

##### 6.4.1.0.1 Minimum conformance requirements for UE transmit timing accuracy

The UE initial transmission timing error shall be less than or equal to  $\pm T_e$  where the timing error limit value  $T_e$  is specified in Table 6.4.1.0.1-1. This requirement applies:

- when it is the first transmission in a DRX cycle for PUCCH, PUSCH and SRS or it is the PRACH transmission.

The UE shall meet the  $T_e$  requirement for an initial transmission provided that at least one SSB is available at the UE during the last 160 ms. The reference point for the UE initial transmit timing control requirement shall be the downlink timing of the reference cell minus  $(N_{TA} + N_{TA\text{ offset}}) \times T_c$ . The downlink timing is defined as the time when the first detected path (in time) of the corresponding downlink frame is received from the reference cell.  $N_{TA}$  for PRACH is defined as 0.

$(N_{TA} + N_{TA\text{ offset}}) \times T_c$  (in  $T_c$  units) for other channels is the difference between UE transmission timing and the downlink timing immediately after when the last timing advance in clause 7.3 was applied.  $N_{TA}$  for other channels is not changed until next timing advance is received. The value of  $N_{TA\text{ offset}}$  depends on the duplex mode of the cell in which the uplink transmission takes place and the frequency range (FR).  $N_{TA\text{ offset}}$  is defined in Table 6.4.1.0.1-2.

**Table 6.4.1.0.1-1:  $T_e$  Timing Error Limit**

Frequency Range	SCS of SSB signals (KHz)	SCS of uplink signals s(KHz)	$T_e$
1	15	15	$12 \cdot 64 \cdot T_c$
		30	$10 \cdot 64 \cdot T_c$
		60	$10 \cdot 64 \cdot T_c$
	30	15	$8 \cdot 64 \cdot T_c$
		30	$8 \cdot 64 \cdot T_c$
		60	$7 \cdot 64 \cdot T_c$
2	120	60	$3.5 \cdot 64 \cdot T_c$
		120	$3.5 \cdot 64 \cdot T_c$
	240	60	$3 \cdot 64 \cdot T_c$
		120	$3 \cdot 64 \cdot T_c$

Note 1:  $T_c$  is the basic timing unit defined in TS 38.211 [6]

**Table 6.4.1.0.1-2: The Value of  $N_{TA\text{ offset}}$**

Frequency range and band of cell used for uplink transmission	$N_{TA\text{ offset}}$ (Unit: $T_c$ )
FR1 FDD band without LTE-NR coexistence case or FR1 TDD band without LTE-NR coexistence case	25600 (Note 1)
FR1 FDD band with LTE-NR coexistence case	0 (Note 1)
FR1 TDD band with LTE-NR coexistence case	39936 (Note 1)
FR2	13792

Note 1: The UE identifies  $N_{TA\text{ offset}}$  based on the information n-TimingAdvanceOffset according to [2]. If UE is not provided with the information n-TimingAdvanceOffset, the default value of  $N_{TA\text{ offset}}$  is set as 25600 for FR1 band. In case of multiple UL carriers in the same TAG, UE expects that the same value of n-TimingAdvanceOffset is provided for all the UL carriers according to section 4.2 in [3] and the value 39936 of  $N_{TA\text{ offset}}$  can also be provided for a FDD serving cell.

When it is not the first transmission in a DRX cycle or there is no DRX cycle, and when it is the transmission for PUCCH, PUSCH and SRS transmission, the UE shall be capable of changing the transmission timing according to the received downlink frame of the reference cell except when the timing advance in clause 7.3 is applied.

When the transmission timing error between the UE and the reference timing exceeds  $\pm T_e$ , the UE is required to adjust its timing to within  $\pm T_e$ . The reference timing shall be  $(N_{TA} + N_{TA\text{ offset}}) \times T_c$  before the downlink timing of the reference cell. All adjustments made to the UE uplink timing shall follow these rules:

- 1) The maximum amount of the magnitude of the timing change in one adjustment shall be  $T_q$ .
- 2) The minimum aggregate adjustment rate shall be  $T_p$  per second.
- 3) The maximum aggregate adjustment rate shall be  $T_q$  per [200]ms.

where the maximum autonomous time adjustment step  $T_q$  and the aggregate adjustment rate  $T_p$  are specified in Table 6.4.1.0.1-3.

**Table 6.4.1.0.1-3:  $T_q$  Maximum Autonomous Time Adjustment Step and  $T_p$  Minimum Aggregate Adjustment rate**

Frequency Range	SCS of uplink signals (KHz)	$T_q$	$T_p$
1	15	$5.5 \cdot 64 \cdot T_c$	$5.5 \cdot 64 \cdot T_c$
	30	$5.5 \cdot 64 \cdot T_c$	$5.5 \cdot 64 \cdot T_c$
	60	$5.5 \cdot 64 \cdot T_c$	$5.5 \cdot 64 \cdot T_c$
2	60	$2.5 \cdot 64 \cdot T_c$	$2.5 \cdot 64 \cdot T_c$
	120	$2.5 \cdot 64 \cdot T_c$	$2.5 \cdot 64 \cdot T_c$
NOTE 1: $T_c$ is the basic timing unit defined in TS 38.211 [6]			

The normative reference for this requirement is TS.38.133 [6] clause 7.1.2.

#### 6.4.1.1 NR SA FR1 UE transmit timing accuracy

##### 6.4.1.1.1 Test purpose

The purpose of this test is to verify that the UE can follow frame timing change of the connected gNodeB and that the UE initial transmit timing accuracy, maximum amount of timing change in one adjustment, minimum and maximum adjustment rate are within the specified limits. This test will verify the requirements in TS 38.133 [6] clause 7.1.2.

##### 6.4.1.1.2 Test applicability

This test applies to all types of NR UE from Release 15 onwards.

##### 6.4.1.1.3 Minimum conformance requirements

The minimum conformance requirements are specified in clause 6.4.1.0.1.

The normative reference for this requirement is TS.38.133 [6] clause A.6.4.1.1

##### 6.4.1.1.4 Test Description

###### 6.4.1.1.4.1 Initial Conditions

Initial conditions are a set of test configurations the UE needs to be tested in and the steps for the SS to take with the UE to reach the correct measurement state.

The initial test configurations consist of environmental conditions, test frequencies, test channel bandwidths and sub-carrier spacing based on NR operating bands specified in Table 5.3.5-1 of 38.521-1 [17].

This test can be run in one of the configurations defined in Table 6.4.1.1.4.1-1.

**Table 6.4.1.1.4.1-1: Supported test configurations for FR1 PCell**

Configuration	Description
6.4.1.1-1	NR FDD, SSB SCS 15 kHz, data SCS 15 kHz, BW 10 MHz

6.4.1.1-2	NR TDD, SSB SCS 15 kHz, data SCS 15 kHz, BW 10 MHz
6.4.1.1-3	NR TDD, SSB SCS 30 kHz, data SCS 30 kHz, BW 40 MHz
Note: The UE is only required to be tested in one of the supported test configurations in FR1 depending on UE capability.	

Configure the test equipment and the DUT according to the parameters in Table 6.4.1.1.4.1-2

**Table 6.4.1.1.4.1-2: Initial conditions for NR SA FR1 transmit timing accuracy**

Parameter	Value		Comment
Test environment	NC		As specified in TS 38.508-1 [14] clause 4.1.
Test frequencies	As specified in Annex E.1.2, Table E.4-1 and TS 38.508-1 [14] clause 4.3.1.		
Channel bandwidth	As specified by the test configuration selected from Table 6.4.1.1.4.1-1		
Propagation conditions	AWGN		As specified in Annex C.2.2.
Connection Diagram	TE Part	A.3.1.7.1	As specified in TS 38.508-1 [14] Annex A.
	DUT Part	A.3.2.3.4	
Exceptions to connection diagram	Without LTE link		

1. Message contents are defined in clause 6 6.4.1.1.4.3.

2. A single NR cell is used. The connection setup is done according to the settings in Annex C.1.3, and the downlink signal levels as per Annex C.1. The general test parameters are given in Table 6.4.1.1.5-1 below.

#### 6.4.1.1.4.2 Test procedure

The test consists of a single NR cell (PCell). The downlink timing of the NR Cell is changed and the changes in UE transmit timing are observed. The transmit timing is verified by the UE transmitting SRS used as a measurement reference facilitating the SS timing estimation.

The test sequence shall be carried out in RRC\_CONNECTED for every test case.

Following will be the test sequence for this test

1. Ensure the UE is in state RRC\_CONNECTED with generic procedure parameters *Connectivity* NR, Connected without release *On* according to TS 38.508-1 [6] clause 4.5.
2. Set up NR Cell according to parameters given in Table 6.4.1.1.4.1-1.
3. The SS shall transmit an RRCReconfiguration message configuring the UE with the message content defined in clause 6.4.1.1.4.3.
4. The UE shall transmit RRCReconfigurationComplete message.
5. After connection set up with the cell and during 2 seconds before DL timing adjustment, the test equipment shall monitor all SRS transmissions and verify that, for each received SRS, the timing of the NR cell is within  $(N_{TA} + N_{TA\_offset}) \times T_c \pm T_e$  of the first detected path of DL SSB.
  - a. The  $N_{TA}$  offset value (in  $T_c$  units) is 25600 for FR1
  - b. The  $T_e$  values depend on the DL and UL SCS for which the test is being run and are given in Table 6.4.1.1.5-4
6. The test system shall adjust the timing of the DL path by values given in Table 6.4.1.1.4.2-1. For Test 2, the DL timing change shall be applied within the first half of the DRX cycle upon expiration of the preceding DRX ON duration.

**Table 6.4.1.1.4.2-1: Adjustment Value for DL Timing**

SCS of SSB signals (KHz)	Adjustment Value	
	Test1	Test2
15	+64*64Tc	+32*64Tc
30	+32*64Tc	+16*64Tc

7. The test system shall verify that the adjustment step size and the adjustment rate shall be according to requirements specified in Table 6.4.1.1.5-5. This will only be done for Test1. The test system samples the UE Transmit Timing once per SRS transmission (as per configured SRS periodicity). To check Rule 1, the SS shall check that the maximum time adjustment step size  $T_q$  between one SRS transmission to next consecutive SRS transmission of a valid UL slot is within Rule 1 as specified in clause 6.4.1.0.1 and Table 6.4.1.0.1-3. To check that the minimum adjustment rate is within Rule 2 as specified in clause 6.4.1.0.1 and Table 6.4.1.0.1-3, the SS shall measure the change in SRS transmission timing over a  $1 + \text{offset}$  seconds sliding window (offset in ms to the next consecutive SRS transmission), with step size  $p$  (where  $p$  is the periodicity of SRS) , as long as the resulting slot is a valid UL slot. To check that the maximum adjustment rate is within Rule 3 as specified in clause 6.4.1.0.1 and Table 6.4.1.0.1-3, the SS shall measure the change in SRS transmission timing over a 200ms – offset sliding window of previous SRS transmission, with step size  $p$  (where  $p$  is the periodicity of SRS) , as long as the resulting slot is a valid UL slot. The three rules apply until the UE transmit timing offset is within the limits specified in 6.4.1.0.1 and Table 6.4.1.0.1-3 with respect to the first detected path (in time) of the corresponding downlink frame of Cell 1. The test system will wait till evaluation interval of  $T$  seconds is met to ensure UE transmit timing is stable at the end of the step, where  $T = \text{DL\_timing\_change}[Ts]/5.5Ts$  and  $\text{DL\_timing\_change}$  is specified in Table 6.4.1.1.4.2-1.
8. After the UE transmit timing is within the limits specified in step 7, and during 2 seconds, the test system shall monitor all SRS transmissions and verify that, for each received SRS, the UE transmit timing offset stays within  $(N_{TA} + N_{TA\_offset}) \times T_c \pm T_e$  of the first detected path of DL SSB. For Test 2 the UE transmit timing offset shall be verified for the first transmission in the DRX cycle immediately after DL timing adjustment.

**6.4.1.1.4.3 Message contents**

Message contents are according to TS 38.508-1 [14] clause 7.3 with the following exceptions:

**Table 6.4.1.1.4.3-0: Common Exception messages**

Default Message Contents	
Common contents of system information blocks exceptions	
Default RRC messages and information elements contents exceptions	Table H.3.9-1

**Table 6.4.1.1.4.3-1: SRS-Config : Additional test requirement for UE transmit timing accuracy for NR SA FR1 UE**

Derivation Path: TS 38.508-1 [14], Table 4.6.3-182			
Information Element	Value/remark	Comment	Condition
SRS-Config ::= SEQUENCE {			
srs-ResourceSetToAddModList SEQUENCE (SIZE(0..maxNrofSRS-ResourceSets)) OF SEQUENCE {			
SRS-ResourceSet[1] SEQUENCE {		entry 1	
resourceType CHOICE {			
periodic SEQUENCE {			
}			
}			
}			
srs-ResourceToAddModList SEQUENCE (SIZE(1..maxNrofSRS-Resources)) OF SEQUENCE {			
SRS-Resource[1] SEQUENCE {		entry 1	
freqHopping SEQUENCE {			
c-SRS	14		SCS15
	25		SCS30
}			
groupOrSequenceHopping	neither		
resourceType CHOICE {			
periodic SEQUENCE {			
periodicityAndOffset-p CHOICE {			
sl1	0		Test 1
sl320	3		Test 2 and SCS15
sl640	5		Test 2 and SCS30
}			
}			
}			
}			
}			
}			

**Table 6.4.1.1.4.3-2: DRX-Config : Additional test requirement for UE transmit timing accuracy Test 2 for NR SA FR1**

Derivation Path: TS 38.508-1 [14], Table 4.6.3-56			
Information Element	Value/remark	Comment	Condition
DRX-Config ::= CHOICE {			
drx-InactivityTimer	ms1		
drx-RetransmissionTimerDL	sl1		
drx-RetransmissionTimerUL	sl1		
drx-LongCycleStartOffset CHOICE {			
ms320	0		
}			
}			

6.4.1.1.5 Test Requirements

**Table 6.4.1.1.5-1: Cell Specific Test Parameters for UL Transmit Timing test**

Parameter	Unit	Config	Test1	Test2
SSB ARFCN		1,2,3	Freq1	Freq1
NR Channel Number		1,2,3	2	2
TDD configuration		1	Not Applicable	
		2	TDDConf.1.1	
		3	TDDConf.2.1	



BW <sub>channel</sub>	MHz	1	10: N <sub>RB,c</sub> = 52	
		2	10: N <sub>RB,c</sub> = 52	
		3	40: N <sub>RB,c</sub> = 106	
Initial BWP Configuration		1,2,3	DLBWP.0.1 ULBWP.0.1	
Dedicated BWP Configuration		1,2,3	DLBWP.1.1 ULBWP.1.1	
DRx Cycle	ms	1,2,3	N/A	DRX.8 <sup>Note5</sup>
PDSCH Reference measurement channel		1	SR.1.1 FDD	
		2	SR.1.1 TDD	
		3	SR.2.1 TDD	
RMSI CORESET Reference Channel		1	CR.1.1 FDD	
		2	CR.1.1 TDD	
		3	CR.2.1 TDD	
Dedicated CORESET Reference Channel		1	CCR.1.1 FDD	
		2	CCR.1.1 TDD	
		3	CCR.2.1 TDD	
OCNG Patterns		1,2,3	OP.1	
SSB configuration		1,2	SSB.1 FR1	
		3	SSB.2 FR1	
SMTC		1	SMTC.1	
		3	SMTC.2	
TRS configuration		1	TRS.1.1 FDD	
		2	TRS.1.1 TDD	
		3	TRS.1.2 TDD	
EPRE ratio of PSS to SSS	dB	1,2,3	0	0
EPRE ratio of PBCH DMRS to SSS				
EPRE ratio of PBCH to PBCH DMRS				
EPRE ratio of PDCCH DMRS to SSS				
EPRE ratio of PDCCH to PDCCH DMRS				
EPRE ratio of PDSCH DMRS to SSS				
EPRE ratio of PDSCH to PDSCH				
EPRE ratio of OCNG DMRS to SSS(Note 1)				
EPRE ratio of OCNG to OCNG DMRS (Note 1)				
$N_{oc}$ <sup>Note2</sup>				
$N_{oc}$ <sup>Note2</sup>	dBm/SCS	1,2	-98	-98
		3	-95	-95
$\hat{E}_s / I_{ot}$		1,2,3	3.3	3.3
$\hat{E}_s / N_{oc}$		1,2,3	3.3	3.3
SS-RSRP <sup>Note3</sup>	dBm/SCS	1,2	-95	-95
		3	-92	-92
I <sub>o</sub> <sup>Note3</sup>	dBm/9.36MHz	1,2	-65.08	-65.08
	dBm/38.1MHz	3	-61.99	-61.99
Propagation condition		1,2,3	AWGN	
SRS Config		1	SRSCConf.1 <sup>Note6</sup>	SRSCConf.3 <sup>Note6</sup>
		2,3	SRSCConf.1 <sup>Note6</sup>	SRSCConf.2 <sup>Note6</sup>
<p>Note 1: OCNG shall be used such that both cells are fully allocated and a constant total transmitted power spectral density is achieved for all OFDM symbols.</p> <p>Note 2: Interference from other cells and noise sources not specified in the test is assumed to be constant over subcarriers and time and shall be modelled as AWGN of appropriate power for <math>N_{oc}</math> to be fulfilled.</p>				

- Note 3: SS-RSRP and Io levels have been derived from other parameters for information purposes. They are not settable parameters themselves.
- Note 4: SS-RSRP minimum requirements are specified assuming independent interference and noise at each receiver antenna port.
- Note 5: DRX related parameters are given in Table 6.4.1.1.5-3 or Table A.5.-1
- Note 6: SRS configs are given in Table 6.4.1.1.5-2

**Table 6.4.1.1.5-2: SRS Configuration for Timing Accuracy Test**

	Field	SRSCConf.1	SRSCConf.2	SRSCConf.3	Comments
SRS-ResourceSet	srs-ResourceSetId	0	0	0	
	srs-ResourceSetList	0	0	0	
	resourceType	Periodic	Periodic	Periodic	
	Usage	Codebook	Codebook	Codebook	
	SRS-ResourceSetId	0	0	0	
SRS-Resource	nrofSRS-Ports	Port1	Port1	Port1	
	transmissionComb	n2	n2	n2	
	combOffset-n2	0	0	0	
	cyclicShift-n2	0	0	0	
	resourceMapping startPosition	0	0	0	
	resourceMapping nrofSymbols	n1	n1	n1	
	resourceMapping repetitionFactor	n1	n1	n1	
	freqDomainPosition	0	0	0	
	freqDomainShift	0	0	0	
	freqHopping c-SRS	14 for test configuration 1,2 25 for test configuration 3	25	14	Matches $N_{RB,c}$
	freqHopping b-SRS	0	0	0	
	freqHopping b-hop	0	0	0	
	groupOrSequenceHopping	Neither	Neither	Neither	
	resourceType	Periodic	Periodic	Periodic	
	periodicityAndOffset-p	sl1	sl640,5	sl320,3	Offset to align with DRX periodicity
sequenceId	0	0	0	Any 10 bit number	

**Table 6.4.1.1.5-3: DRX-Configuration for UL Timing Tests**

Field	Test 2 Value
drx-onDurationTimer	6 ms
drx-InactivityTimer	1 ms
drx-RetransmissionTimerDL	1 slot
drx-RetransmissionTimerUL	1 slot
longDRX-CycleStartOffset	320 ms
shortDRX	disable
TimeAlignmentTimer	Infinity

Note: The DRX cycle and time alignment timer parameters are specified in clause 6.3.2 in TS 38.331 [13]

**Table 6.4.1.1.5-4:  $T_e$  Timing Error Limit**

Frequency Range	SCS of SSB signals (KHz)	SCS of uplink signals (KHz)	$T_e$
1	15	15	$13.75 \cdot 64 \cdot T_c$
		30	$11.75 \cdot 64 \cdot T_c$
		60	$11.75 \cdot 64 \cdot T_c$
	30	15	$9.75 \cdot 64 \cdot T_c$

		30	$9.75 \cdot 64 \cdot T_c$
		60	$8.75 \cdot 64 \cdot T_c$
Note 1: $T_c$ is the basic timing unit defined in TS 38.211 [6]			

**Table 6.4.1.1.5-5:  $T_q$  Maximum Autonomous Time Adjustment Step and  $T_p$  Minimum Aggregate Adjustment rate**

Frequency Range	SCS of uplink signals (KHz)	$T_q$	$T_p$	Maximum Adjustment Rate
1	15	$6.0 \cdot 64 \cdot T_c$	$1.9 \cdot 64 \cdot T_c$	$6.6 \cdot 64 \cdot T_c$
	30	$6.0 \cdot 64 \cdot T_c$	$1.9 \cdot 64 \cdot T_c$	$6.6 \cdot 64 \cdot T_c$
	60	$6.0 \cdot 64 \cdot T_c$	$1.9 \cdot 64 \cdot T_c$	$6.6 \cdot 64 \cdot T_c$
NOTE 1: $T_c$ is the basic timing unit defined in TS 38.211 [6]				

## 6.4.2 UE timer accuracy

## 6.4.3 Timing advance

### 6.4.3.0 Minimum conformance requirement

#### 6.4.3.0.1 Minimum conformance requirement for timing advance adjustment

The UE shall adjust the timing of its transmissions with a relative accuracy better than or equal to the UE Timing Advance adjustment accuracy requirement in Table 6.4.3.1.3-1, to the signalled timing advance value compared to the timing of preceding uplink transmission. The timing advance command step is defined in TS38.213 [8].

**Table 6.4.3.1.3-1: UE Timing Advance adjustment accuracy**

Sub Carrier Spacing, SCS kHz	15	30	60	120
UE Timing Advance adjustment accuracy	$\pm 256 T_c$	$\pm 256 T_c$	$\pm 128 T_c$	$\pm 32 T_c$

#### 6.4.3.1 NR SA FR1 timing advance adjustment accuracy

##### 6.4.3.1.1 Test purpose

The purpose of the test is to verify UE timing advance adjustment delay and accuracy requirement defined in clause 7.3 of TS 38.133 [6].

##### 6.4.3.1.2 Test applicability

This test applies to all types of NR UE from Release 15 onwards.

##### 6.4.3.1.3 Minimum conformance requirement

The minimum conformance requirements are specified in clause 6.4.3.0.1.

The normative reference for this requirement is TS 38.133 [6] clause A.6.4.3.1.

##### 6.4.3.1.4 Test description

###### 6.4.3.1.4.1 Initial conditions

This test shall be tested using any of the test configurations in Table 6.4.3.1.4.1-1.

**Table 6.4.3.1.4.1-1: NR SA FR1 timing advance adjustment accuracy supported test configurations**

Config	Description
1	NR 15 kHz SSB SCS, 10MHz bandwidth, FDD duplex mode
2	NR 15 kHz SSB SCS, 10MHz bandwidth, TDD duplex mode
3	NR 30 kHz SSB SCS, 40MHz bandwidth, TDD duplex mode

Note: The UE is only required to be tested in one of the supported test configurations

Configure the test equipment and the DUT according to the parameters in Table 6.4.3.1.4.1-2

**Table 6.4.3.1.4.1-2: Initial conditions for NR SA FR1 timing advance adjustment accuracy**

Parameter	Value	Comment
Test environment	NC	As specified in TS 38.508-1 [14] clause 4.1.
Test frequencies	As specified in Annex E.1.2, Table E.4-1 and TS 38.508-1 [14] clause 4.3.1.	
Channel bandwidth	As specified by the test configuration selected from Table 6.4.3.1.4.1-1	
Propagation conditions	AWGN	As specified in Annex C.2.2.
Connection Diagram	TE Part	A.3.1.7.1
	DUT Part	A.3.2.3.4
Exceptions to connection diagram	Without LTE Link	

**Table 6.4.3.1.4.1-3: General test parameters for timing advance**

Parameter	Unit	Value	Comment
RF channel number		1	
Initial DL BWP		DLBWP.0.1	As specified in Table A.8.1-1
Dedicated DL BWP		DLBWP.1.1	As specified in Table A.8.1-2
Initial UL BWP		ULBWP.0.1	As specified in Table A.8.2-1
Dedicated UL BWP		ULBWP.1.1	As specified in Table A.8.2-2
Timing Advance Command ( $T_A$ ) value during T1		31	$N_{TA\_new} = N_{TA\_old}$ for the purpose of establishing a reference value from which the timing advance adjustment accuracy can be measured during T2
Timing Advance Command ( $T_A$ ) value during T2		39	For SCS = 15kHz : $N_{TA\_new} = N_{TA\_old} + 8192 * T_c$ (based on equation in TS38.213 section 4.2) For SCS = 30kHz : $N_{TA\_new} = N_{TA\_old} + 4096 * T_c$ (based on equation in TS38.213 section 4.2)
T1	s	5	
T2	s	5	

1. Message contents are defined in clause 6.4.3.1.4.3.
2. Single Cell is used, which is NR FR1 PCell. The connection setup is done according to the settings in Annex C.1.2 and C.1.3.
3. The test parameters are given in Table 6.4.3.1.4.1-3 above.
4. Downlink signals for NR cell are initially set up according to Annex C.1.2 and C.1.3.
5. Ensure the UE is in state RRC\_CONNECTED with generic procedure parameters Connectivity NR, Connected without release On and Test Mode On according to TS 38.508-1 [10] clause 4.5.

#### 6.4.3.1.4.2 Test Procedure

The test consists of single cell. The test consists of two successive time periods, with time durations of T1 and T2 respectively. In each time period, timing advance commands are sent to the UE and Sounding Reference Signals (SRS), as specified in table 6.4.3.1.5-1 and table 6.4.3.1.4.1-3, are sent from the UE and received by the test equipment. By

measuring the reception of the SRS, the transmit timing, and hence the timing advance adjustment accuracy, can be measured. The UE Time Alignment Timer, described in Clause 5.2 in TS 38.321, shall be configured so that it does not expire in the duration of the test.

1. Set the parameters according to values in Tables 6.4.3.1.4.1-3.
2. SS shall transmit an RRCReconfiguration message.
3. The UE shall transmit RRCReconfigurationComplete message.
4. During time period T1, the test equipment shall send one message with a Timing Advance Command MAC Control Element, as specified in Clause 6.1.3.4 in TS 38.321. The Timing Advance Command value shall be set to 31, which according to Clause 4.2 in TS 38.213 results in zero adjustment of the Timing Advance. In this way, a reference value for the timing advance used by the UE is established.
5. During time period T2, the test equipment shall send a sequence of messages with Timing Advance Command MAC Control Elements, with Timing Advance Command value 39 as specified in table 6.4.3.1.4.1-3. This value shall result in changes of the timing advance used by the UE, and the accuracy of the change shall then be measured, using the SRS sent from the UE.
6. As specified in Clause 7.3.2.1 of TS 38.133 [6], the UE adjusts its uplink timing at slot  $n+k+1$  for a timing advance command received in slot  $n$ . This delay must be taken into account when measuring the timing advance adjustment accuracy, via the SRS sent from the UE.
7. The UE Time Alignment Timer, described in Clause 5.2 in TS 38.321, shall be configured so that it does not expire in the duration of the test.
8. The result from the SRS and adjustment of the timing advance in step 7) is used to measure that the UE adjusts the timing of its transmission with a relative accuracy better than or equal to value specified in Table 6.4.3.1.3-1 to the signalled timing advance value compared to the timing of preceding uplink transmission.
9. If the UE adjust the timing of its transmission within a relative accuracy greater than or equal to value specified in Table 6.4.3.1.3-1 to the signalled timing advance value compared to the timing of preceding uplink transmission then the number of successful tests is increased by one. Otherwise, the number of failure tests is increased by one.
10. The SS shall transmit RRCRelease message to release the RRC connection which includes the release of the established radio bearers as well as all radio resources.
11. After the RRC connection release, the SS transmits in Cell a Paging message (including PagingRecord with ue-Identity) for the UE and ensures the UE is in State RRC\_CONNECTED according to TS 38.508-1 [14] clause 4.5.4 or if the paging fails, switch off and on the UE and ensure the UE is in RRC\_CONNECTED according to TS 38.508-1 [14] clause 4.5.4.
12. Repeat step 2-11 until the confidence level according to Tables G.2.3-1 in Annex G clause G.2 is achieved.

#### 6.4.3.1.4.3 Message Contents

Message contents are according to TS 38.508-1 [14] clause 7.3, with the following exceptions:

**Table 6.4.3.1.4.3-0: Common Exception messages**

Default Message Contents	
Common contents of system information blocks exceptions	
Default RRC messages and information elements contents exceptions	Table H.3.9-1

**Table 6.4.3.1.4.3-1: srs-Config setup**

Derivation Path: TS 38.508-1, Table 4.6.3-182			
Information Element	Value/remark	Comment	Condition
SRS-Config ::= SEQUENCE {			
srs-ResourceSetToAddModList SEQUENCE (SIZE(0..maxNrofSRS-ResourceSets)) OF SEQUENCE {	1 entry		
SRS-ResourceSet[1] SEQUENCE {		entry 1	
resourceType CHOICE {			
periodic SEQUENCE {			
}			
}			
}			
srs-ResourceToAddModList SEQUENCE (SIZE(1..maxNrofSRS-Resources)) OF SEQUENCE {	1 entry		
SRS-Resource[1] SEQUENCE {		entry 1	
freqHopping SEQUENCE {			
c-SRS	12	Config 1,2	
	24	Config 3	
}			
groupOrSequenceHopping	neither		
resourceType CHOICE {			
periodic SEQUENCE {	periodic		
periodicityAndOffset-p CHOICE {			
sl5	2	Once every 5 Slots	SCS15
sl5	4	Once every 5 Slots	SCS30
}			
}			
}			
}			
}			
}			

**6.4.3.1.5 Test Requirement**

The UE shall apply the signalled Timing Advance value to the transmission timing at the designated activation time i.e. *k* slots after the reception of the timing advance command, where:

*k* = 5 for Config 1, 2, and 3

The Timing Advance adjustment accuracy shall be within the limits specified in Table 6.4.3.1.5-3.

The rate of correct Timing Advance adjustments observed during repeated tests shall be at least 90%.

Table 6.4.3.1.5-1 and Table 6.4.3.1.5-2 define the primary level settings.

**Table 6.4.3.1.5-1: Cell specific test parameters for timing advance**

Parameter	Unit	Test1	
		T1	T2

Duplex mode	Config 1		FDD
	Config 2,3		TDD
TDD configuration	Config 1		Not Applicable
	Config 2		TDDConf.1.1
	Config 3		TDDConf.2.1
BW <sub>channel</sub>	Config 1	MHz	10: N <sub>RB,c</sub> = 52
	Config 2		10: N <sub>RB,c</sub> = 52
	Config 3		40: N <sub>RB,c</sub> = 106
BWP BW	Config 1	MHz	10: N <sub>RB,c</sub> = 52
	Config 2		10: N <sub>RB,c</sub> = 52
	Config 3		40: N <sub>RB,c</sub> = 106
DRx Cycle		ms	Not Applicable
PDSCH Reference measurement channel	Config 1		SR.1.1 FDD
	Config 2		SR.1.1 TDD
	Config 3		SR2.1 TDD
RMSI CORESET Reference Channel	Config 1		CR.1.1 FDD
	Config 2		CR.1.1 TDD
	Config 3		CR2.1 TDD
Dedicated CORESET Reference Channel	Config 1		CCR.1.1 FDD
	Config 2		CCR.1.1 TDD
	Config 3		CCR.2.1 TDD
TRS Configuration	Config 1		TRS.1.1 FDD
	Config 2		TRS.1.1 TDD
	Config 3		TRS.1.2 TDD
OCNG Patterns			OCNG pattern 1
SMTc configuration	Config 1,2		SMTc.1 FR1
	Config 3		SMTc.2 FR1
PDSCH/PDCCH subcarrier spacing	Config 1,2	kHz	15 kHz
	Config 3		30 kHz
PUCCH/PUSCH subcarrier spacing	Config 1,2	kHz	15 kHz
	Config 3		30 kHz
EPRE ratio of PSS to SSS		dB	0
EPRE ratio of PBCH DMRS to SSS			
EPRE ratio of PBCH to PBCH DMRS			
EPRE ratio of PDCCH DMRS to SSS			
EPRE ratio of PDCCH to PDCCH DMRS			
EPRE ratio of PDSCH DMRS to SSS			
EPRE ratio of PDSCH to PDSCH			
EPRE ratio of OCNG DMRS to SSS(Note 1)			
EPRE ratio of OCNG to OCNG DMRS (Note 1)			
N <sub>oc</sub> <sup>Note2</sup>		dBm/15kHz	-98
N <sub>oc</sub> <sup>Note2</sup>	Config 1,2	dBm/SCS	-98
	Config 3		-95
$\hat{E}_s / I_{ot}$		dB	3
$\hat{E}_s / N_{oc}$		dB	3
I <sub>o</sub> <sup>Note3</sup>	Config 1,2	dBm/9.36MHz	-67.57
	Config 3	dBm/38.16MHz	-62.58
Propagation condition		-	AWGN
Note 1:	OCNG shall be used such that both cells are fully allocated and a constant total transmitted power spectral density is achieved for all OFDM symbols.		
Note 2:	Interference from other cells and noise sources not specified in the test is assumed to be constant over subcarriers and time and shall be modelled as AWGN of appropriate power for N <sub>oc</sub> to be fulfilled.		
Note 3:	I <sub>o</sub> levels have been derived from other parameters for information purposes. They are not settable parameters themselves.		

**Table 6.4.3.1.5-2: Sounding Reference Symbol Configuration for timing advance**

Field		Value	Comment
c-SRS	Config 1,2	12	Frequency hopping is disabled
	Config 3	24	
b-SRS		0	
b-hop		0	Frequency domain position of SRS
freqDomainPosition		0	
freqDomainShift		0	
groupOrSequenceHopping		neither	No group or sequence hopping
SRS-PeriodicityAndOffset		sl5@2 for SCS 15kHz sl5@4 for SCS 30kHz	Once every 5 slots
pathlossReferenceRS		ssb-Index=0	SSB #0 is used for SRS path loss estimation
usage		Codebook	Codebook based UL transmission
startPosition		0	resourceMapping setting. SRS on last symbol of slot, and 1symbols for SRS without repetition.
nrofSymbols		n1	
repetitionFactor		n1	
combOffset-n2		0	transmissionComb setting
cyclicShift-n2		0	
nrofSRS-Ports		port1	Number of antenna ports used for SRS transmission

Note: For further information see clause 6.3.2 in TS 38.331.

**Table 6.4.3.1.5-3: UE Timing Advance adjustment accuracy**

Sub Carrier Spacing, SCS kHz	15	30	60
UE Timing Advance adjustment accuracy	$\pm 344 T_c$	$\pm 344 T_c$	$\pm 216 T_c$

For the test to pass, the total number of successful tests shall be more than 90% of the cases with a confidence level of 95%.

## 6.5 Signaling characteristics

### 6.5.1 Radio link monitoring

#### 6.5.1.00 General

The UE shall monitor the downlink link quality based on the reference signal in the configured RLM-RS resource(s) in order to detect the downlink radio link quality of the PCell and PCell as specified in [3]. The configured RLM-RS resources can be all SSBs, or all CSI-RSs, or a mix of SSBs and CSI-RSs. UE is not required to perform RLM outside the active DL BWP.

On each RLM-RS resource, the UE shall estimate the downlink radio link quality and compare it to the thresholds  $Q_{out}$  and  $Q_{in}$  for the purpose of monitoring downlink radio link quality of the cell.

The threshold  $Q_{out}$  is defined as the level at which the downlink radio link cannot be reliably received and shall correspond to the out-of-sync block error rate ( $BLER_{out}$ ) as defined in Table 6.5.1-1.

The threshold  $Q_{in}$  is defined as the level at which the downlink radio link quality can be significantly more reliably received than at  $Q_{out}$  and shall correspond to the in-sync block error rate ( $BLER_{in}$ ) as defined in Table 6.5.1-1.

The out-of-sync block error rate ( $BLER_{out}$ ) and in-sync block error rate ( $BLER_{in}$ ) are determined from the network configuration via parameter *rlmInSyncOutOfSyncThreshold* signalled by higher layers. When UE is not configured with *RLM-IS-OOS-thresholdConfig* from the network, UE determines out-of-sync and in-sync block error rates from Configuration #0 in Table 6.5.1-1 as default. All requirements here are applicable for BLER Configuration #0 in Table 6.5.1-1.



**Table 6.5.1-1: Out-of-sync and in-sync block error rates**

Configuration	BLER <sub>out</sub>	BLER <sub>in</sub>
0	10%	2%

UE shall be able to monitor up to  $X_{\text{RLM-RS}}$  RLM-RS resources of the same or different types in each corresponding carrier frequency range, where  $X_{\text{RLM-RS}}$  is specified in Table 6.5.1-2, and meet the requirements as specified in this section.

**Table 6.5.1-2: Maximum number of RLM-RS resources  $X_{\text{RLM-RS}}$** 

Maximum number of RLM-RS resources, $X_{\text{RLM-RS}}$	Carrier frequency range of PCell/Pcell
2	FR1, $\leq 3$ GHz
4	FR1, $> 3$ GHz
8	FR2

If different SCS is used for CSI-RS based RLM-RS and SSB, then CSI-RS based RLM-RS and SSB shall be TDMed. If same SCS is used for CSI-RS based RLM-RS and SSB, then CSI-RS based RLM-RS and SSB can be FDMed or TDMed.

Any uplink signal transmitted by the UE is used for detecting the In-/Out-of-Sync state of the UE. In terms of measurement, the uplink signal is verified on the basis of the UE output power:

For intra-band contiguous carrier aggregation, transmit OFF power is measured as the mean power per component carrier.

For UE with multiple transmit antennas, transmit OFF power is measured as the mean power at each transmit connector.

- UE output power higher than Transmit OFF power -50 dBm (as defined in TS 38.101-3 [4]) means uplink signal
- UE output power equal to or less than Transmit OFF power -50 dBm (as defined in TS 38.101-3 [4]) means no uplink signal.

## 6.5.1.0 Minimum conformance requirements

### 6.5.1.0.1 Minimum conformance requirements for out-of-sync SSB-based RLM

UE shall be able to evaluate whether the downlink radio link quality on the configured RLM-RS resource estimated over the last  $T_{\text{Evaluate\_out\_SSB}}$  [ms] period becomes worse than the threshold  $Q_{\text{out\_SSB}}$  within  $T_{\text{Evaluate\_out\_SSB}}$  [ms] evaluation period. The requirements in this section apply for each SSB based RLM-RS resource configured for PSCell, provided that the SSB configured for RLM is transmitted within UE active DL BWP during the entire evaluation period defined in Table 6.5.1.0.1-1.

$T_{\text{Evaluate\_out\_SSB}}$  is defined in Table 6.5.1.0.1-1 for FR1.

**Table 6.5.1.0.1-1: Evaluation period  $T_{\text{Evaluate\_out}}$  for FR1**

Configuration	$T_{\text{Evaluate\_out\_SSB}}$ (ms)
no DRX	$\max(200, \text{ceil}(10 \cdot P) \cdot T_{\text{SSB}})$
DRX cycle $\leq 320$	$\max(200, \text{ceil}(15 \cdot P) \cdot \max(T_{\text{DRX}}, T_{\text{SSB}}))$
DRX cycle $> 320$	$\text{ceil}(10 \cdot P) \cdot T_{\text{DRX}}$
NOTE: $T_{\text{SSB}}$ is the periodicity of SSB configured for RLM.	

For FR1,

- $P=1/(1 - T_{\text{SSB}}/\text{MGRP})$ , when in the monitored cell there are measurement gaps configured for intra-frequency, inter-frequency or inter-RAT measurements, which are overlapping with some but not all occasions of the SSB; and
- $P=1$  when in the monitored cell there are no measurement gaps overlapping with any occasion of the SSB.

If the high layer in TS 38.331 [13] signaling of *smtc2* is present,  $T_{\text{SMTCPERIOD}}$  follows *smtc2*; otherwise  $T_{\text{SMTCPERIOD}}$  follows *smtc1*.

Longer evaluation period would be expected if the combination of RLM-RS, SMTc occasion and measurement gap configurations does not meet previous conditions.

When the downlink radio link quality on all the configured RLM-RS resources is worse than  $Q_{\text{out}}$ , Layer 1 of the UE shall send an out-of-sync indication for the cell to the higher layers. A Layer 3 filter shall be applied to the out-of-sync indications as specified in TS 38.331 [13].

The out-of-sync and in-sync evaluations for the configured RLM-RS resources shall be performed as specified in clause 5 in TS 38.213 [8]. Two successive indications from Layer 1 shall be separated by at least  $T_{\text{Indication\_interval}}$ .

If DRX is used, when the UE transitions between DRX and no DRX or when DRX cycle periodicity changes, for each RLM-RS resource, for a duration of time equal to the evaluation period corresponding to the second mode after the transition occurs, the UE shall use an evaluation period that is no less than the minimum of evaluation period corresponding to the first mode and the second mode. Subsequent to this duration, the UE shall use an evaluation period corresponding to the second mode for each RLM-RS resource. This requirement shall be applied to both out-of-sync evaluation and in-sync evaluation of the monitored cell.

When

- the UE transitions from a first configuration of RLM-RS resources to a second configuration of RLM-RS resources that is different from the first configuration,

or

- the UE transitions between DRX and no DRX or DRX cycle periodicity changes,

for each RLM-RS resource, for a duration of time equal to the evaluation period corresponding to the second configuration after the transition occurs, the UE shall use an evaluation period that is no less than the minimum of evaluation periods corresponding to the first configuration and the second configuration. Subsequent to this duration, the UE shall use an evaluation period corresponding to the second configuration for each RLM-RS resource present in the second configuration. This requirement shall be applied to both out-of-sync evaluation and in-sync evaluation of the monitored cell.

When DRX is not used  $T_{\text{Indication\_interval}}$  is  $\max(10\text{ms}, T_{\text{RLM-RS,M}})$ , where  $T_{\text{RLM-RS,M}}$  is the shortest periodicity of all configured RLM-RS resources for the monitored cell, which corresponds to  $T_{\text{SSB}}$  specified in section 8.1.2 if the RLM-RS resource is SSB.

When DRX is used,  $T_{\text{Indication\_interval}}$  is  $\max(10\text{ms}, 1.5 \cdot \text{DRX\_cycle\_length}, 1.5 \cdot T_{\text{RLM-RS,M}})$  if DRX cycle\_length is less than or equal to 320ms, and  $T_{\text{Indication\_interval}}$  is DRX\_cycle\_length if DRX cycle\_length is greater than 320ms. Upon start of T310 timer as specified in TS 38.331 [13], the UE shall monitor the configured RLM-RS resources for recovery using the evaluation period and Layer 1 indication interval corresponding to the no DRX mode until the expiry or stop of T310 timer.

The transmitter power of the UE in the monitored cell shall be turned off within 40ms after expiry of T310 timer as specified in TS 38.331 [13].

There are no scheduling restrictions due to radio link monitoring performed with a same subcarrier spacing as PDSCH/PDCCH on FR1.

For UE which support *simultaneousRxDataSSB-DiffNumerology* [14] there are no restrictions on scheduling availability due to radio link monitoring based on SSB as RLM-RS. For UE which do not support *simultaneousRxDataSSB-DiffNumerology* [11] the following restrictions apply due to radio link monitoring based on SSB as RLM-RS.

- The UE is not expected to transmit PUCCH/PUSCH or receive PDCCH/PDSCH on SSB symbols to be measured for radio link monitoring.

The normative reference for this requirement is TS 38.133 [6] clauses 8.1.2, 8.1.4, 8.1.5, 8.1.6 and 8.1.7.

### 6.5.1.0.2 Minimum conformance requirements for in-sync SSB-based RLM

UE shall be able to evaluate whether the downlink radio link quality on the configured RLM-RS resource estimated over the last  $T_{\text{Evaluate\_in\_SSB}}$  [ms] period becomes better than the threshold  $Q_{\text{in\_SSB}}$  within  $T_{\text{Evaluate\_in\_SSB}}$  [ms] evaluation period.

$T_{\text{Evaluate\_out\_SSB}}$  and  $T_{\text{Evaluate\_in\_SSB}}$  are defined in Table 6.5.1.0.2-1 for FR1.

For FR1,

- $P=1/(1 - T_{\text{SSB}}/M_{\text{GRP}})$ , when in the monitored cell there are measurement gaps configured for intra-frequency, inter-frequency or inter-RAT measurements, which are overlapping with some but not all occasions of the SSB; and
- $P=1$  when in the monitored cell there are no measurement gaps overlapping with any occasion of the SSB.

If the high layer in TS 38.331 [2] signaling of *smtc2* is present,  $T_{\text{SMTCperiod}}$  follows *smtc2*; Otherwise  $T_{\text{SMTCperiod}}$  follows *smtc1*.

Note: The overlap between CSI-RS RLM and SMTC means that CSI-RS based RLM is within the SMTC window duration. Longer evaluation period would be expected if the combination of RLM-RS, SMTC occasion and measurement gap configurations does not meet previous conditions.

The values of  $M_{\text{out}}$  and  $M_{\text{in}}$  used in Table 6.5.1.2.3-1 are defined as:

- $M_{\text{out}} = 20$  and  $M_{\text{in}} = 10$ , if the CSI-RS resource configured for RLM is transmitted with Density =3.

**Table 6.5.1.0.2-1: Evaluation period  $T_{\text{Evaluate\_out}}$  and  $T_{\text{Evaluate\_in}}$  for FR1**

Configuration	$T_{\text{Evaluate\_out}}$ (ms)	$T_{\text{Evaluate\_in}}$ (ms)
no DRX	$\max(200, \text{ceil}(M_{\text{out}} \times P) \times T_{\text{CSI-RS}})$	$\max(100, \text{ceil}(M_{\text{in}} \times P) \times T_{\text{CSI-RS}})$
$\text{DRX} \leq 320\text{ms}$	$\max(200, \text{ceil}(1.5 \times M_{\text{out}} \times P) \times \max(T_{\text{DRX}}, T_{\text{CSI-RS}}))$	$\max(100, \text{ceil}(1.5 \times M_{\text{in}} \times P) \times \max(T_{\text{DRX}}, T_{\text{CSI-RS}}))$
$\text{DRX} > 320\text{ms}$	$\text{ceil}(M_{\text{out}} \times P) \times T_{\text{DRX}}$	$\text{ceil}(M_{\text{in}} \times P) \times T_{\text{DRX}}$

NOTE:  $T_{\text{CSI-RS}}$  is the periodicity of CSI-RS resource configured for RLM.  $T_{\text{DRX}}$  is the DRX cycle length.

If the high layer in TS 38.331 [2] signaling of *smtc2* is present,  $T_{\text{SMTCperiod}}$  follows *smtc2*; Otherwise  $T_{\text{SMTCperiod}}$  follows *smtc1*.

When the downlink radio link quality on at least one of the configured RLM-RS resources is better than  $Q_{\text{in}}$ , Layer 1 of the UE shall send an in-sync indication for the cell to the higher layers. A Layer 3 filter shall be applied to the in-sync indications as specified in TS 38.331 [2].

The in-sync evaluations for the configured RLM-RS resources shall be performed as specified in clause 5 in TS 38.213 [3]. Two successive indications from Layer 1 shall be separated by at least  $T_{\text{Indication\_interval}}$ .

When DRX is not used  $T_{\text{Indication\_interval}}$  is  $\max(10\text{ms}, T_{\text{RLM-RS,M}})$ , where  $T_{\text{RLM-RS,M}}$  is the shortest periodicity of all configured RLM-RS resources for the monitored cell, which corresponds to  $T_{\text{SSB}}$  specified in section 8.1.2 of TS 38.133 [6] if the RLM-RS resource is SSB, or  $T_{\text{CSI-RS}}$  specified later in this if the RLM-RS resource is CSI-RS.

When DRX is used,  $T_{\text{Indication\_interval}}$  is  $\max(10\text{ms}, 1.5 \times \text{DRX\_cycle\_length}, 1.5 \times T_{\text{RLM-RS,M}})$  if  $\text{DRX\_cycle\_length}$  is less than or equal to 320ms, and  $T_{\text{Indication\_interval}}$  is  $\text{DRX\_cycle\_length}$  if  $\text{DRX\_cycle\_length}$  is greater than 320ms. Upon start of T310 timer as specified in TS 38.331 [2], the UE shall monitor the configured RLM-RS resources for recovery using the evaluation period and Layer 1 indication interval corresponding to the no DRX mode until the expiry or stop of T310 timer.

When the UE transitions between DRX and no DRX or when DRX cycle periodicity changes, for each RLM-RS resource, for a duration of time equal to the evaluation period corresponding to the second mode after the transition occurs, the UE shall use an evaluation period that is no less than the minimum of evaluation period corresponding to the first mode and the second mode. Subsequent to this duration, the UE shall use an evaluation period corresponding to the second mode for each RLM-RS resource. This requirement shall be applied to both out-of-sync evaluation and in-sync evaluation of the monitored cell.

When the UE transitions from a first configuration of RLM-RS resources to a second configuration of RLM-RS resources that is different from the first configuration, for each RLM-RS resource present in the second configuration,

for a duration of time equal to the evaluation period corresponding to the second configuration after the transition occurs, the UE shall use an evaluation period that is no less than the minimum of evaluation periods corresponding to the first configuration and the second configuration. Subsequent to this duration, the UE shall use an evaluation period corresponding to the second configuration for each RLM-RS resource present in the second configuration. This requirement shall be applied to both out-of-sync evaluation and in-sync evaluation of the monitored cell.

The transmitter power of the UE in the monitored cell shall be turned off within 40ms after expiry of T310 timer as specified in TS 38.331 [13].

There are no scheduling restrictions due to radio link monitoring performed with a same subcarrier spacing as PDSCH/PDCCH on FR1.

For UE which support *simultaneousRxDataSSB-DiffNumerology* [14] there are no restrictions on scheduling availability due to radio link monitoring based on SSB as RLM-RS. For UE which do not support *simultaneousRxDataSSB-DiffNumerology* [11] the following restrictions apply due to radio link monitoring based on SSB as RLM-RS.

- The UE is not expected to transmit PUCCH/PUSCH or receive PDCCH/PDSCH on SSB symbols to be measured for radio link monitoring.

The normative reference for this requirement is TS 38.133 [6] clauses 8.1.2, 8.1.4, 8.1.5, 8.1.6, 8.1.7 and A.7.5.1.

### 6.5.1.0.3 Minimum conformance requirements for out-of-sync and in-sync CSI-RS based RLM

[TS 38.133 clause 8.1.3.2]

UE shall be able to evaluate whether the downlink radio link quality on the configured RLM-RS resource estimated over the last  $T_{\text{Evaluate\_out\_CSI-RS}}$  [ms] period becomes worse than the threshold  $Q_{\text{out\_CSI-RS}}$  within  $T_{\text{Evaluate\_out\_CSI-RS}}$  [ms] evaluation period.

UE shall be able to evaluate whether the downlink radio link quality on the configured RLM-RS resource estimated over the last  $T_{\text{Evaluate\_in\_CSI-RS}}$  [ms] period becomes better than the threshold  $Q_{\text{in\_CSI-RS}}$  within  $T_{\text{Evaluate\_in\_CSI-RS}}$  [ms] evaluation period.

- $T_{\text{Evaluate\_out\_CSI-RS}}$  and  $T_{\text{Evaluate\_in\_CSI-RS}}$  are defined in Table 8.1.3.2-1 for FR1.

For FR1,

- $P=1/(1 - T_{\text{CSI-RS}}/\text{MGRP})$ , when in the monitored cell there are measurement gaps configured for intra-frequency, inter-frequency or inter-RAT measurements, which are overlapping with some but not all occasions of the CSI-RS; and
- $P=1$  when in the monitored cell there are no measurement gaps overlapping with any occasion of the CSI-RS.

If the high layer in TS 38.331 [2] signaling of *smtc2* is present,  $T_{\text{SMTCperiod}}$  follows *smtc2*; Otherwise  $T_{\text{SMTCperiod}}$  follows *smtc1*.

Note: The overlap between CSI-RS RLM and SMTC means that CSI-RS based RLM is within the SMTC window duration. Longer evaluation period would be expected if the combination of RLM-RS, SMTC occasion and measurement gap configurations does not meet previous conditions.

The values of  $M_{\text{out}}$  and  $M_{\text{in}}$  used in Table 8.1.3.2-1 are defined as:

- $M_{\text{out}} = 20$  and  $M_{\text{in}} = 10$ , if the CSI-RS resource configured for RLM is transmitted with Density =3.

**Table 6.5.1.0.3-1: Evaluation period  $T_{\text{Evaluate\_out}}$  and  $T_{\text{Evaluate\_in}}$  for FR1**

Configuration	$T_{\text{Evaluate\_out}}$ (ms)	$T_{\text{Evaluate\_in}}$ (ms)
no DRX	$\max(200, \text{ceil}(M_{\text{out}} \times P) \times T_{\text{CSI-RS}})$	$\max(100, \text{ceil}(M_{\text{in}} \times P) \times T_{\text{CSI-RS}})$
$\text{DRX} \leq 320\text{ms}$	$\max(200, \text{ceil}(1.5 \times M_{\text{out}} \times P) \times \max(T_{\text{DRX}}, T_{\text{CSI-RS}}))$	$\max(100, \text{ceil}(1.5 \times M_{\text{in}} \times P) \times \max(T_{\text{DRX}}, T_{\text{CSI-RS}}))$
$\text{DRX} > 320\text{ms}$	$\text{ceil}(M_{\text{out}} \times P) \times T_{\text{DRX}}$	$\text{ceil}(M_{\text{in}} \times P) \times T_{\text{DRX}}$
NOTE: $T_{\text{CSI-RS}}$ is the periodicity of CSI-RS resource configured for RLM. $T_{\text{DRX}}$ is the DRX cycle length.		

[TS 38.133 clause 8.1.6]

When the downlink radio link quality on all the configured RLM-RS resources is worse than  $Q_{out}$ , Layer 1 of the UE shall send an out-of-sync indication for the cell to the higher layers. A Layer 3 filter shall be applied to the out-of-sync indications as specified in TS 38.331 [2].

When the downlink radio link quality on at least one of the configured RLM-RS resources is better than  $Q_{in}$ , Layer 1 of the UE shall send an in-sync indication for the cell to the higher layers. A Layer 3 filter shall be applied to the in-sync indications as specified in TS 38.331 [2].

The out-of-sync and in-sync evaluations for the configured RLM-RS resources shall be performed as specified in clause 5 in TS 38.213 [3]. Two successive indications from Layer 1 shall be separated by at least  $T_{Indication\_interval}$ .

When DRX is not used  $T_{Indication\_interval}$  is  $\max(10\text{ms}, T_{RLM-RS,M})$ , where  $T_{RLM-RS,M}$  is the shortest periodicity of all configured RLM-RS resources for the monitored cell, which corresponds to  $T_{SSB}$  specified in section 8.1.2 if the RLM-RS resource is SSB, or  $T_{CSI-RS}$  specified in section 8.1.3 if the RLM-RS resource is CSI-RS.

In case DRX is used,  $T_{Indication\_interval}$  is  $\max(10\text{ms}, 1.5 \cdot \text{DRX\_cycle\_length}, 1.5 \cdot T_{RLM-RS,M})$  if DRX cycle\_length is less than or equal to 320ms, and  $T_{Indication\_interval}$  is DRX\_cycle\_length if DRX cycle\_length is greater than 320ms. Upon start of T310 timer as specified in TS 38.331 [2], the UE shall monitor the configured RLM-RS resources for recovery using the evaluation period and Layer 1 indication interval corresponding to the no DRX mode until the expiry or stop of T310 timer.

[TS 38.133 clause 8.1.5]

The transmitter power of the UE in the monitored cell shall be turned off within 40ms after expiry of T310 timer as specified in TS 38.331 [2].

The normative reference for this requirement is TS 38.133 [6] clause 8.1.3.2, 8.1.6 and 8.1.5.

### 6.5.1.1 NR SA FR1 radio link monitoring out-of-sync test for PCell configured with SSB-based RLM RS in non-DRX mode

#### 6.5.1.1.1 Test purpose

The purpose of this test is to verify that the UE properly detects the out of sync for the purpose of monitoring downlink radio link quality of the PCell configured with SSB-based RLM RS in non-DRX mode. This test will partly verify the NR cell radio link monitoring requirements in TS 38.133 [6] section 8.1.2.

#### 6.5.1.1.2 Test applicability

This test applies to all types of NR UE from Release 15 onwards.

#### 6.5.1.1.3 Minimum conformance requirement

The minimum conformance requirements are specified in clause 6.5.1.0.1.

The normative reference for this requirement is TS 38.133 [6] clause A.6.5.1.1.

#### 6.5.1.1.4 Test description

There is one cell (Cell 1), which is the active NR cell, in the test. The test consists of three successive time periods, with time duration of T1, T2 and T3 respectively. Figure 6.5.1.1.4-1 shows the variation of the downlink SNR in the active cell to emulate out-of-sync and in-sync states. Prior to the start of the time duration T1, the UE shall be fully synchronized to Cell 1. The UE shall be configured for periodic CSI reporting with a reporting periodicity of 5 ms. The UE is configured to perform inter-frequency measurements using Gap Pattern ID #0 (40ms) in test 1.

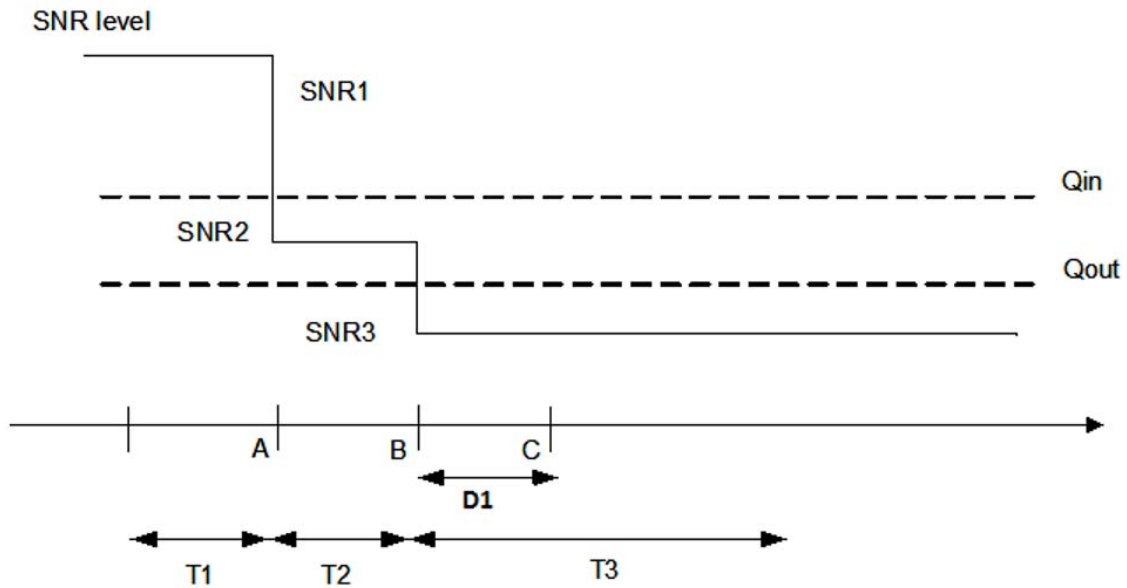

Figure 6.5.1.1.4-1: SNR variation for out-of-sync testing

6.5.1.1.4.1 Initial conditions

This test shall be tested using any of the test configurations in Table 6.5.1.1.4.1-1.

Table 6.5.1.1.4.1-1: NA SA FR1 radio link monitoring out-of-sync test for PCell configured with SSB-based RLM RS in non-DRX mode supported test configurations

Configuration	Description
6.5.1.1-1	FDD, SSB SCS 15 KHz, data SCS 15KHz, BW 10MHz
6.5.1.1-2	TDD, SSB SCS 15 KHz, data SCS 15KHz, BW 10MHz
6.5.1.1-3	TDD, SSB SCS 30 KHz, data SCS 30KHz, BW 40MHz
Note: The UE is only required to pass in one of the supported test configurations in FR1.	

Configure the test equipment and the DUT according to the parameters in Table 6.5.1.1.4.1-2.

Table 6.5.1.1.4.1-2: Initial conditions for NR SA FR1 radio link monitoring out-of-sync test for PCell configured with SSB-based RLM RS in non-DRX mode

Parameter	Value	Comment
Test environment	NC	As specified in TS 38.508-1 [14] clause 4.1.
Test frequencies	As specified in Annex E.1.2, Table E.4-1 and TS 38.508-1 [14] clause 4.3.1.	
Channel bandwidth	As specified by the test configuration selected from Table 6.5.1.1.4.1-1	
Propagation conditions	AWGN	As specified in Annex C.2.2.
Connection Diagram	TE Part	A.3.1.7.1
	DUT Part	A.3.2.3.4
Exceptions to connection diagram	For 4Rx capable UEs without any 2 Rx RF bands use A.3.2.5.2 for DUT part and A.3.1.7.4 for TE Part	

**Table 6.5.1.1.4.1-3: Void**

1. Message contents are defined in clause 6.5.1.1.4.3.
2. Single Cell is used, which is NR FR1 Pcell. The connection setup is done according to the settings in Annex C.1.2 and C.1.3.
3. The test parameters are given in Table 6.5.1.1.4.1-4 below.
4. Downlink signals for NR cell are initially set up according to Annex C.1.2 and C.1.3.

**Table 6.5.1.1.4.1-4: General test parameters for FR1 out-of-sync testing in non-DRX mode**

Parameter		Unit	Value
			Test 1
Active PCell			Cell 1
RF Channel Number			1
Duplex mode	Config 1		FDD
	Config 2, 3		TDD
BW <sub>channel</sub>	Config 1	MHz	10: N <sub>RB,c</sub> = 52
	Config 2		10: N <sub>RB,c</sub> = 52
	Config 3		40: N <sub>RB,c</sub> = 106
DL initial BWP configuration		Config 1, 2, 3	DLBWP.0.1
DL dedicated BWP configuration		Config 1, 2, 3	DLBWP.1.1
UL initial BWP configuration		Config 1, 2, 3	ULBWP.0.1
UL dedicated BWP configuration		Config 1, 2, 3	ULBWP.1.1
TDD Configuration	Config 1		Not Applicable
	Config 2		TDDConf.1.1
	Config 3		TDDConf.2.1
RMSI CORESET Reference Channel	Config 1		CR.1.1 FDD
	Config 2		CR.1.1 TDD
	Config 3		CR.2.1 TDD
Dedicated CORESET Reference Channel	Config 1		CCR.1.3 FDD
	Config 2		CCR.1.3 TDD
	Config 3		CCR.2.2 TDD
SSB Configuration	Config 1		SSB.1 FR1
	Config 2		SSB.1 FR1
	Config 3		SSB.2 FR1
SMTC Configuration	Config 1, 2		SMTC.1
	Config 3		SMTC.1
PDSCH/PDCCH subcarrier spacing	Config 1, 2		15 KHz
	Config 3		30 KHz
PRACH Configuration	Config 1, 2		Table A.7.1-1, PRACH.1 FR1
	Config 3		Table A.7.1-1, PRACH.1 FR1
SSB index assigned as RLM RS			0
OCNG parameters			OP.1
CP length			Normal
Correlation Matrix and Antenna Configuration			2x2 Low
Out of sync transmission parameters	DCI format		1-0
	Number of Control OFDM symbols		2
	Aggregation level		CCE
	Ratio of hypothetical PDCCH RE energy to average SSS RE energy		dB
	Ratio of hypothetical PDCCH DMRS energy to average SSS RE energy		dB
	DMRS precoder granularity		

	REG bundle size		6
DRX			OFF
Gap pattern ID			gp0
Layer 3 filtering			Enabled
T310 timer	ms		0
T311 timer	ms		1000
N310			1
N311			1
CSI-RS configuration for CSI reporting	Config 1, 4		CSI-RS.1.1 FDD
	Config 2, 5		CSI-RS.1.1 TDD
	Config 3, 6		CSI-RS.2.1 TDD
CSI-RS for tracking	Config 1, 4		TRS.1.1 FDD
	Config 2, 5		TRS.1.1 TDD
	Config 3, 6		TRS.1.2 TDD
T1	s		0.2
T2	s		0.48
T3	s		0.48
D1	s		0.44
Note 1: All configurations are assigned to the UE prior to the start of time period T1.			
Note 2: UE-specific PDCCH is not transmitted after T1 starts.			

#### 6.5.1.1.4.2 Test Procedure

There is one cell (Cell 1), which is the active NR cell, in the test. Prior to the start of the time duration T1, the UE shall be fully synchronized to PCell. The UE shall be configured for periodic CQI reporting in PUCCH [format 1] with a reporting periodicity as mentioned in the above table 6.5.1.1.4.1-4.

1. Ensure the UE is in state RRC\_CONNECTED with generic procedure parameters *Connectivity* NR, Connected without release *On* and Test Mode *On* according to TS 38.508-1 [6] clause 4.5.
2. The SS shall transmit an RRCReconfiguration message configuring the UE for inter-frequency measurements.
3. The UE shall transmit RRCReconfigurationComplete message.
4. Set the parameters according to T1 in Table 6.5.1.1.5-1. Propagation conditions are set according to Annex C.2.3. T1 starts.
5. When T1 expires the SS shall change the SNR value to T2 as specified in Table 6.5.1.1.5-1. T2 starts.
6. When T2 expires the SS shall change the SNR value to T3 as specified in Table 6.5.1.1.5-1. T3 starts.
7. If the SS:
  - a) detects uplink power equal to or higher than minimum output power defined in TS 38.521-1 [17] clause 6.3.1.5 in each subframe configured for CQI transmission (according to configured CQI periodicity on PUCCH [format 1]) during the period from time point A to time point B

and

  - b) does not detect any uplink power higher than OFF power defined in TS 38.521-1 [17] clause 6.3.2.5 from time point C (D1 after the start of T3) until T3 expires, the number of successful tests is increased by one.
8. Otherwise the number of failed tests is increased by one.
9. When T3 expires the SS shall change the SNR value to T1 as specified in Table 6.5.1.1.5-1.
10. If the UE has not re-established the connection in at least 1s, the UE is switched off and then on. Ensure the UE is in state RRC\_CONNECTED with generic procedure parameters *Connectivity* NR, Connected without release *On* according to TS 38.508-1 [10] clause 4.5.
11. Repeat steps 4-10 until the confidence level according to Tables G.2.3-1 in Annex G clause G.2 is achieved.



6.5.1.1.4.3 Message Contents

Message contents are according to TS 38.508-1 [14] clause 4.6.1 and 7.3.1 with condition “Short\_DCI” and with the following exceptions:

**Table 6.5.1.1.4.3-0: Common Exception messages for NR SA FR1 radio link monitoring out-of-sync test for PCell configured with SSB-based RLM RS in non-DRX mode test requirement**

Default Message Contents	
Common contents of system information blocks exceptions	
Default RRC messages and information elements contents exceptions	Table H.3.1-1 Table H.3.1-2 with Condition INTER-FREQ, L3 FILTERING NEEDED, GAP_NEEDED Table H.3.1-3 with Condition INTER-FREQ MO (where ssbFrequency is set to the ARFCN value of carrier center of High range) Table H.3.1-4 with A3-offset = 0 Table H.3.1-1 Table H.3.1-6 with conditions gapUE and RLM Table H.3.5-4 Table H.3.5-9

**Table 6.5.1.1.4.3-1: Void**

**Table 6.5.1.1.4.3-2: RLF-TimersAndConstants**

Derivation Path: TS 38.508-1 [14], Table 4.6.3-150			
Information Element	Value/remark	Comment	Condition
RLF-TimersAndConstants ::= SEQUENCE {			
t310	ms0		
n310	n1		
t311	ms1000		
n311	n1		
}			

**Table 6.5.1.1.4.3-3: Void**

**Table 6.5.1.1.4.3-4 SIB1**

Derivation Path: TS 38.508-1 [14], Table 4.6.1-28			
Information Element	Value/remark	Comment	Condition
SIB1 ::= SEQUENCE {			
cellSelectionInfo SEQUENCE {			
q-RxLevMin	-53	-106 is actual value in dBm (-53 * 2 dBm)	dBm/15kHz
	-51	-102 is actual value in dBm (-51 * 2 dBm)	dBm/30kHz
}			
}			

6.5.1.1.5 Test Requirement

Table 6.5.1.1.5-1 defines the cell specific primary level settings.

The UE behavior in each test during time durations T1, T2 and T3 shall be as follows:

During the period from time point A to time point B the UE shall transmit uplink signal at least in all uplink slots configured for CSI transmission according to the configured periodic CSI reporting.

The UE shall stop transmitting uplink signal no later than time point C (D1 second after the start of the time duration T3).

The rate of correct events observed during repeated tests shall be at least 90%.

**Table 6.5.1.1.5-1: Cell specific test parameters for FR1 (Cell 1) for out-of-sync radio link monitoring tests in non-DRX mode**

Parameter	Unit	Test 1			
		T1	T2	T3	
EPRE ratio of PDCCH DMRS to SSS	dB	4			
EPRE ratio of PDCCH to PDCCH DMRS	dB	0			
EPRE ratio of PBCH DMRS to SSS	dB	0			
EPRE ratio of PBCH to PBCH DMRS	dB				
EPRE ratio of PSS to SSS	dB				
EPRE ratio of PDSCH DMRS to SSS	dB				
EPRE ratio of PDSCH to PDSCH DMRS	dB				
EPRE ratio of OCNG DMRS to SSS	dB				
EPRE ratio of OCNG to OCNG DMRS	dB				
SNR on RLM-RS	Config 1				dB
	Config 2		1.9	-6.1	-15.9
	Config 3		1.9	-6.1	-15.9
$N_{oc}$	Config 1	dBm/	-98		
	Config 2	15kHz	-98		
	Config 3	z	-98		
$N_{oc}$	Config 1	dBm/	-98		
	Config 2	SCS	-98		
	Config 3		-95		
Propagation condition			TDL-C 300ns 100Hz		
Note 1: OCNG shall be used such that the resources in Cell 1 are fully allocated and a constant total transmitted power spectral density is achieved for all OFDM symbols.					
Note 2: The signal contains PDCCH for UEs other than the device under test as part of OCNG.					
Note 3: SNR levels correspond to the signal to noise ratio over the SSS REs.					
Note 4: The SNR in time periods T1, T2 and T3 is denoted as SNR1, SNR2 and SNR3 respectively in Figure 6.5.1.1.4-1.					
Note 5: The SNR values are specified for a UE with 2RX antennas connected under test. For a UE with 4RX antennas connected under test, the SNR during T3 from D.4.1.1, is -18dB-TT = -18.9dB (including test tolerances).					

**Table 6.5.1.1.5-2: Measurement gap configuration for out-of-sync tests in non-DRX mode**

Field	Test 1
	Value
gapOffset	0
Note Ensure that RLM RS is partially overlapped with measurement gap	

For the test to pass, the total number of successful tests shall be more than 90% of the cases with a confidence level of 95%.

### 6.5.1.2 NR SA FR1 radio link monitoring in-sync test for PCell configured with SSB-based RLM RS in non-DRX mode

#### 6.5.1.2.1 Test purpose

The purpose of this test is to verify that the UE properly detects in sync for the purpose of monitoring downlink radio link quality of the PCell, when DRX is not used. This test will partly verify the FR1 radio link monitoring requirements in clause 8.1.2.

#### 6.5.1.2.2 Test applicability

This test applies to all types of NR UEs supporting Release 15 and forwarded

6.5.1.2.3 Minimum conformance requirements

The minimum conformance requirements are specified in clause 6.5.1.0.2.

The normative reference for this requirement is TS 38.133 [6] clause A.6.5.1.2.

6.5.1.2.4 Test Description

There is one cell (Cell 1), which is the active NR cell, in the test. The test consists of three successive time periods, with time duration of T1, T2, T3, T4 and T5 respectively. Figure 6.5.1.2.4-1 shows the variation of the downlink SNR in the active cell to emulate out-of-sync and in-sync states. Prior to the start of the time duration T1, the UE shall be fully synchronized to Cell 1. The UE shall be configured for periodic CSI reporting with a reporting periodicity of 5 ms.

Figure 6.5.1.2.4-1 - SNR variation for in-sync testing

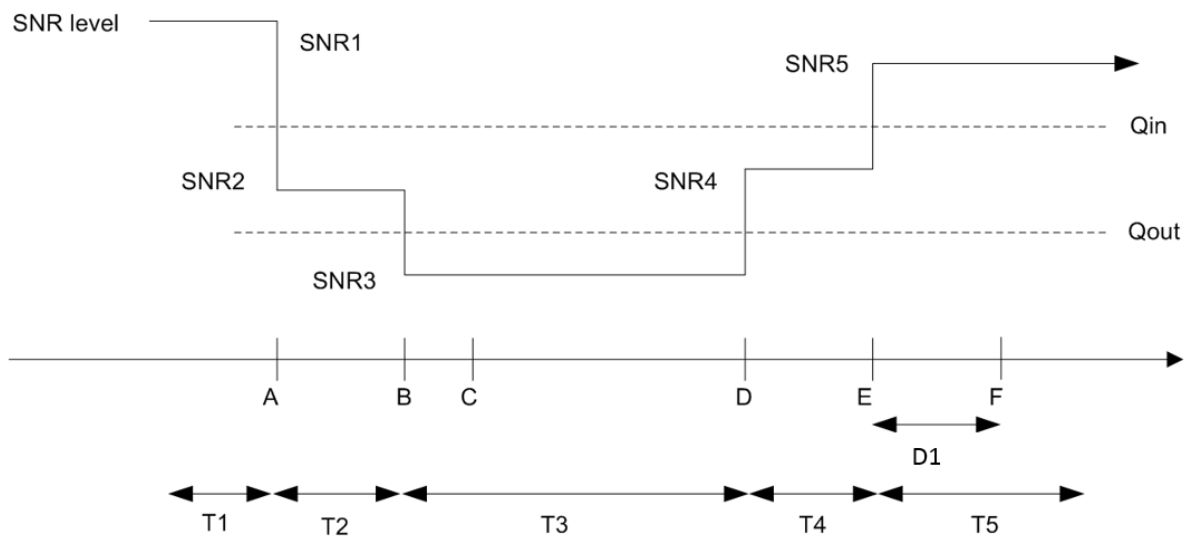

6.5.1.2.4 Test Requirements

6.5.1.2.4.1 Initial Conditions

This test shall be tested using any of the test configurations in Table 6.5.1.2.4.1-1.

Table 6.5.1.2.4.1-1: Supported test configurations for FR1 PSCell

Configuration	Description
6.5.1.2-1	FDD, SSB SCS 15 KHz, data SCS 15KHz, BW 10MHz
6.5.1.2-2	TDD, SSB SCS 15 KHz, data SCS 15KHz, BW 10MHz
6.5.1.2-3	TDD, SSB SCS 30 KHz, data SCS 30KHz, BW 40MHz
Note:	The UE is only required to pass in one of the supported test configurations in FR1

Configure the test equipment and the DUT according to the parameters in Table 6.5.1.2.4.1-2.

**Table 6.5.1.2.4.1-2: Initial conditions for SA FR1 radio link monitoring in-sync test for PSCell configured with SSB-based RLM RS in non-DRX mode**

Parameter	Value		Comment
Test environment	NC		As specified in TS 38.508-1 [14] clause 4.1.
Test frequencies	As specified in Annex E.1.1, Table E.2-1 and TS 38.508-1 [14] clause 4.3.1.		
Channel bandwidth	As specified by the test configuration selected from Table 6.5.1.2.4.1-1		
Propagation conditions	AWGN		As specified in Annex C.2.2.
Connection Diagram	TE Part	A.3.1.7.1	As specified in TS 38.508-1 [14] Annex A.
	DUT Part	A.3.2.3.4	
Exceptions to connection diagram	For 4Rx capable UEs without any 2 Rx RF bands use A.3.2.5.2 for DUT part and A.3.1.7.4 for TE Part		

**Table 6.5.1.2.4.1-3: Void**

1. Message contents are defined in clause 6.5.1.2.4.3.
2. The power levels and settings for Cell 1 are set according to Annex A.6, Table A.6.1.1-1. The connection setup is done according to the settings in Annex C.1.3, and the downlink signal levels as per Annex C.1.2
3. The general test parameters are given in Table 6.5.1.2.4.1-4 below.
4. Downlink signals for NR cell are initially set up according to Annex C.1.

**Table 6.5.1.2.4.1-4: General test parameters for FR1 in-sync testing in non-DRX mode**

Parameter		Unit	Value
Active PCell			Cell 1
RF Channel Number			1
Duplex mode	Config 1		FDD
	Config 2, 3		TDD
BW <sub>channel</sub>	Config 1	MHz	10: N <sub>RB,c</sub> = 52
	Config 2		10: N <sub>RB,c</sub> = 52
	Config 3		40: N <sub>RB,c</sub> = 106
DL initial BWP configuration	Config 1, 2, 3		DLBWP.0.1
DL dedicated BWP configuration	Config 1, 2, 3		DLBWP.1.1
UL initial BWP configuration	Config 1, 2, 3		ULBWP.0.1
UL dedicated BWP configuration	Config 1, 2, 3		ULBWP.1.1
TDD Configuration	Config 1		Not Applicable
	Config 2		TDDConf.1.1
	Config 3		TDDConf.2.1
RMSI CORESET Reference Channel	Config 1		CR.1.1 FDD
	Config 2		CR.1.1 TDD
	Config 3		CR.2.1 TDD
Dedicated CORESET Reference Channel	Config 1		CCR.1.1 FDD
	Config 2		CCR.1.1 TDD
	Config 3		CCR.2.1 TDD
SSB Configuration	Config 1		SSB.1 FR1
	Config 2		SSB.1 FR1
	Config 3		SSB.2 FR1
SMTC Configuration	Config 1, 2		SMTC.1
	Config 3		SMTC.1
PDSCH/PDCCH subcarrier spacing	Config 1, 2		15 KHz
	Config 3		30 KHz
PRACH Configuration	Config 1, 2		Table A.7.1-1, PRACH.1 FR1
	Config 3		Table A.7.1-1, PRACH.1 FR1
SSB index assigned as RLM RS			0
OCNG parameters			OP.1
CP length			Normal
Correlation Matrix and Antenna Configuration			2x2 Low
In sync transmission parameters	DCI format		1-0
	Number of Control OFDM symbols		2
	Aggregation level	CCE	4
	Ratio of hypothetical PDCCH RE energy to average SSS RE energy	dB	0
	Ratio of hypothetical PDCCH DMRS energy to average SSS RE energy	dB	0
	DMRS precoder granularity		REG bundle size
	REG bundle size		6
Out of sync transmission parameters	DCI format		1-0
	Number of Control OFDM symbols		2
	Aggregation level	CCE	8
	Ratio of hypothetical PDCCH RE energy to average SSS RE energy	dB	4
	Ratio of hypothetical PDCCH DMRS energy to average SSS RE energy	dB	4

	DMRS precoder granularity		REG bundle size
	REG bundle size		6
DRX			OFF
Gap pattern ID			N.A.
Layer 3 filtering			Enabled
T310 timer	ms		1000
T311 timer	ms		1000
N310			1
N311			1
CSI-RS configuration for CSI reporting	Config 1		CSI-RS.1.1 FDD
	Config 2		CSI-RS.1.1 TDD
	Config 3		CSI-RS.2.1 TDD
CSI-RS for tracking	Config 1, 4		TRS.1.1 FDD
	Config 2, 5		TRS.1.1 TDD
	Config 3, 6		TRS.1.2 TDD
T1	s		0.2
T2	s		0.2
T3	s		0.24
T4	s		0.2
T5	s		0.88
D1	s		0.84
Note 1: All configurations are assigned to the UE prior to the start of time period T1.			
Note 2: UE-specific PDCCH is not transmitted after T1 starts.			

#### 6.5.1.2.4.2 Test Procedure

There is one cell (Cell 1), which is the active NR cell, in the test. The test consists of five successive time periods, with time duration of T1, T2, T3, T4 and T5 respectively. Figure 6.5.1.2.4-1 shows the variation of the downlink SNR in the active cell to emulate out-of-sync and in-sync states. Prior to the start of the time duration T1, the UE shall be fully synchronized to PCell. The UE shall be configured for periodic CQI reporting in PUCCH [format 1] with a reporting periodicity as mentioned in the above table 6.5.1.2.4.1-4.

1. Ensure the UE is in state RRC\_CONNECTED with generic procedure parameters *Connectivity* NR, Connected without release *On* and Test Mode *On* according to TS 38.508-1 [6] clause 4.5.
2. Set the parameters according to T1 in Table 6.5.1.2.5-1 for subtest 1 and 2. Propagation conditions are set according to Annex C.2.3. T1 starts.
3. When T1 expires the SS shall change the SNR value to T2 as specified in Table 6.5.1.2.5-1. T2 starts.
4. When T2 expires the SS shall change the SNR value to T3 as specified in Table 6.5.1.2.5-1. T3 starts.
5. When T3 expires the SS shall change the SNR value to T4 as specified in Table 6.5.1.2.5-1. T4 starts.
6. When T4 expires the SS shall change the SNR value to T5 as specified in Table 6.5.1.2.5-1. T5 starts.
7. If the SS detects uplink power equal to or higher than the minimum output power defined in TS 38.521-1 [17] clause 6.3.1.5 in the subframe according the configured CQI reporting mode (PUCCH 1-0) during the period from time point A to time point F (D1 after the start of time duration T5) the number of successful tests is increased by one.

Otherwise the number of failed tests is increased by one.

8. Ensure the UE is in state RRC\_CONNECTED with generic procedure parameters *Connectivity* NR, Connected without release *On* and Test Mode *On* according to TS 38.508-1 [6] clause 4.5.
9. Repeat steps 2-7 for all subtests until the confidence level according to Tables G.2.3-1 in Annex G clause G.2 is achieved.

#### 6.5.1.2.4.3 Message Contents

Message contents are according to TS 38.508-1 [14] clause 4.6.1 and 7.3.1 with condition "Short\_DCI" and with the following exceptions:

**Table 6.5.1.2.4.3-0: Common Exception messages for NR SA FR1 radio link monitoring in-sync test for PCell configured with SSB-based RLM RS in non-DRX mode test requirement**

Default Message Contents	
Common contents of system information blocks exceptions	
Default RRC messages and information elements contents exceptions	Table H.3.5-4 Table H.3.5-9

**Table 6.5.1.2.4.3-1: Void**

**Table 6.5.1.2.4.3-2: RLF-TimersAndConstants**

Derivation Path: TS 38.508-1 [14], Table 4.6.3-150			
Information Element	Value/remark	Comment	Condition
RLF-TimersAndConstants ::= SEQUENCE {			
t310	ms1000		
n310	n1		
t311	ms1000		
n311	n1		
}			

**Table 6.5.1.2.4.3-3: Void**

**6.5.1.2.5 Test Requirement**

The requirements in this section apply for each SSB based RLM-RS resource configured for the PCell, provided that the SSB configured for RLM are actually transmitted within UE active DL BWP during the entire evaluation period specified in section 6.5.1.2.3.

Table 6.5.1.2.5-1 defines the cell specific primary level settings.

The UE behaviour in each test during time durations T1, T2, T3, T4 and T5 shall be as follows:

During the period from time point A to time point F (D1 second after the start of time duration T5) the UE shall transmit uplink signal at least in all uplink slots configured for CSI transmission according to the configured periodic CSI reporting.

The rate of correct events observed during repeated tests shall be at least 90% with a confidence interval of 95%.



**Table 6.5.1.2.5-1: Cell specific test parameters for FR1 for in-sync radio link monitoring tests in non-DRX mode**

Parameter		Unit	Test 1				
			T1	T2	T3	T4	T5
EPRE ratio of PDCCH DMRS to SSS		dB	0				
EPRE ratio of PDCCH to PDCCH DMRS		dB	0				
EPRE ratio of PBCH DMRS to SSS		dB	0				
EPRE ratio of PBCH to PBCH DMRS		dB					
EPRE ratio of PSS to SSS		dB					
EPRE ratio of PDSCH DMRS to SSS		dB					
EPRE ratio of PDSCH to PDSCH DMRS		dB					
EPRE ratio of OCNG DMRS to SSS		dB					
EPRE ratio of OCNG to OCNG DMRS		dB					
SNR on RLM-RS	Config 1	dB					
	Config 2		1.8	-6.2	-15.8	-5.3	1.8
	Config 3		1.8	-6.2	-15.8	-5.3	1.8
$N_{oc}$	Config 1	dBm/ 15 kHz	-98				
	Config 2		-98				
	Config 3		-98				
$N_{oc}$	Config 1	dBm/ SCS	-98				
	Config 2		-98				
	Config 3		-95				
Propagation condition			TDL-C 300ns 100Hz				
<p>Note 1: OCNG shall be used such that the resources in Cell 1 are fully allocated and a constant total transmitted power spectral density is achieved for all OFDM symbols.</p> <p>Note 2: The signal contains PDCCH for UEs other than the device under test as part of OCNG.</p> <p>Note 3: SNR levels correspond to the signal to noise ratio over the SSS REs.</p> <p>Note 4: The SNR in time periods T1, T2, T3, T4 and T5 is denoted as SNR1, SNR2, SNR3, SNR4 and SNR5 respectively in Figure 6.5.1.2.4-1.</p> <p>Note 5: The SNR values are specified for a UE with 2RX antennas connected under test. For a UE with 4RX antennas connected under test, the SNR during T3 and T4 from D.4.1.1 are -18.0-TT and -8.0-TT, which are -18.8dB and -8.8dB(including test tolerances)</p>							

### 6.5.1.3 NR SA FR1 radio link monitoring out-of-sync test for PCell configured with SSB-based RLM RS in DRX mode

#### 6.5.1.3.1 Test purpose

The purpose of this test is to verify that the UE properly detects the out of sync for the purpose of monitoring downlink radio link quality of the PCell configured with SSB-based RLM RS when DRX is used. This test will partly verify the NR cell radio link monitoring requirements in TS 38.133 [6] section 8.1.2.

#### 6.5.1.3.2 Test applicability

This test applies to all types of NR UE Release 15 and forward supporting 5GS NR SA FR1 and long DRX cycle.

#### 6.5.1.3.3 Minimum conformance requirement

The minimum conformance requirements are specified in clause 6.5.1.0.1.

The normative reference for this requirement is TS 38.133 [6] clause A.6.5.1.3.

6.5.1.3.4 Test description

There is one cell (Cell 1), which is the active NR cell, in the test. The test consists of three successive time periods, with time duration of T1, T2 and T3 respectively. Figure 6.5.1.3.4-1 shows the variation of the downlink SNR in the active cell to emulate out-of-sync and in-sync states. Prior to the start of the time duration T1, the UE shall be fully synchronized to Cell 1. The UE shall be configured for periodic CSI reporting with a reporting periodicity of 5 ms. In the test, DRX configuration is enabled and DRX inactivity timer has already been expired, i.e. UE tries to decode PDCCH and to send periodic CSI during the period when On-duration timer is running. Time alignment timers shall be set to “infinity” so that UL timing alignment is maintained during the test.

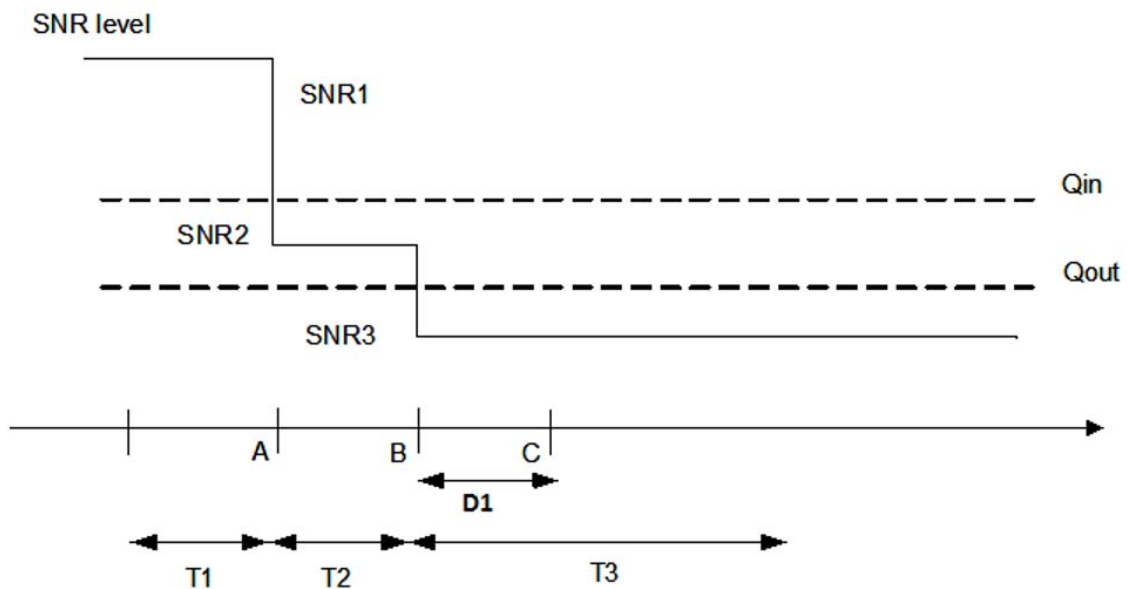

Figure 6.5.1.3.4-1: SNR variation for out-of-sync testing

6.5.1.3.4.1 Initial conditions

This test shall be tested using any of the test configurations in Table 6.5.1.3.4.1-1.

**Table 6.5.1.3.4.1-1: NA SA FR1 radio link monitoring out-of-sync test for PCell configured with SSB-based RLM RS in DRX mode supported test configurations**

Configuration	Description
6.5.1.3-1	FDD, SSB SCS 15 KHz, data SCS 15KHz, BW 10MHz
6.5.1.3-2	TDD, SSB SCS 15 KHz, data SCS 15KHz, BW 10MHz
6.5.1.3-3	TDD, SSB SCS 30 KHz, data SCS 30KHz, BW 40MHz
Note:	The UE is only required to pass in one of the supported test configurations in FR1.

Configure the test equipment and the DUT according to the parameters in Table 6.5.1.3.4.1-2.

**Table 6.5.1.3.4.1-2: Initial conditions for NR SA FR1 radio link monitoring out-of-sync test for PCell configured with SSB-based RLM RS in DRX mode**

Parameter	Value		Comment
Test environment	NC		As specified in TS 38.508-1 [14] clause 4.1.
Test frequencies	As specified in Annex E.1.2, Table E.4-1 and TS 38.508-1 [14] clause 4.3.1.		
Channel bandwidth	As specified by the test configuration selected from Table 6.5.1.3.4.1-1		
Propagation conditions	AWGN		As specified in Annex C.2.2.
Connection Diagram	TE Part	A.3.1.7.1	As specified in TS 38.508-1 [14] Annex A.
	DUT Part	A.3.2.3.4	
Exceptions to connection diagram	For 4Rx capable UEs without any 2 Rx RF bands use A.3.2.5.2 for DUT part and A.3.1.7.4 for TE Part		

**Table 6.5.1.3.4.1-3: Void**

1. Message contents are defined in clause 6.5.1.3.4.3.
2. Single Cell is used, which is NR FR1 PCell. The connection setup is done according to the settings in Annex C.1.2 and C.1.3.
3. The test parameters are given in Table 6.5.1.3.4.1-4 below.
4. Downlink signals for NR cell are initially set up according to Annex C.1.2 and C.1.3.

**Table 6.5.1.3.4.1-4: General test parameters for FR1 out-of-sync testing in DRX mode**

Parameter		Unit	Value Test 1
Active PCell			Cell 1
RF Channel Number			1
Duplex mode	Config 1		FDD
	Config 2, 3		TDD
BW <sub>channel</sub>	Config 1	MHz	10: N <sub>RB,c</sub> = 52
	Config 2		10: N <sub>RB,c</sub> = 52
	Config 3		40: N <sub>RB,c</sub> = 106
DL initial BWP configuration	Config 1, 2, 3		DLBWP.0.1
DL dedicated BWP configuration	Config 1, 2, 3		DLBWP.1.1
UL initial BWP configuration	Config 1, 2, 3		ULBWP.0.1
UL dedicated BWP configuration	Config 1, 2, 3		ULBWP.1.1
TDD Configuration	Config 1		Not Applicable
	Config 2		TDDConf.1.1
	Config 3		TDDConf.2.1
RMSI CORESET Reference Channel	Config 1		CR.1.1 FDD
	Config 2		CR.1.1 TDD
	Config 3		CR.2.1 TDD
Dedicated CORESET Reference Channel	Config 1		CCR.1.3 FDD
	Config 2		CCR.1.3 TDD
	Config 3		CCR.2.2 TDD
SSB Configuration	Config 1		SSB.1 FR1
	Config 2		SSB.1 FR1
	Config 3		SSB.2 FR1
SMTC Configuration	Config 1, 2		SMTC.1
	Config 3		SMTC.1
	Config 1, 2		15 KHz

PDSCH/PDCCH subcarrier spacing	Config 3		30 KHz
PRACH Configuration	Config 1, 2		Table A.7.1-1, PRACH.1 FR1
	Config 3		Table A.7.1-1, PRACH.1 FR1
SSB index assigned as RLM RS			0
OCNG parameters			OP.1
CP length			Normal
Correlation Matrix and Antenna Configuration			2x2 Low
Out of sync transmission parameters	DCI format		1-0
	Number of Control OFDM symbols		2
	Aggregation level	CCE	8
	Ratio of hypothetical PDCCH RE energy to average SSS RE energy	dB	4
	Ratio of hypothetical PDCCH DMRS energy to average SSS RE energy	dB	4
	DMRS precoder granularity		REG bundle size
	REG bundle size		6
DRX Configuration			DRX.3
Gap pattern ID			N.A.
Layer 3 filtering			<i>Enabled</i>
T310 timer		ms	0
T311 timer		ms	1000
N310			1
N311			1
CSI-RS configuration	Config 1		CSI-RS.1.1 FDD
	Config 2		CSI-RS.1.1 TDD
	Config 3		CSI-RS.2.1 TDD
CSI-RS for tracking	Config 1		TRS.1.1 FDD
	Config 2		TRS.1.1 TDD
	Config 3		TRS.1.2 TDD
T1		s	0.2
T2		s	0.68
T3		s	0.68
D1		s	0.64
Note 1: All configurations are assigned to the UE prior to the start of time period T1.			
Note 2: UE-specific PDCCH is not transmitted after T1 starts.			

#### 6.5.1.3.4.2 Test Procedure

There is one cell (Cell 1), which is the active NR cell, in the test. Prior to the start of the time duration T1, the UE shall be fully synchronized to PCell. The UE shall be configured for periodic CQI reporting in PUCCH [format 1] with a reporting periodicity as mentioned in the above table 6.5.1.3.4.1-4.

1. Ensure the UE is in state RRC\_CONNECTED with generic procedure parameters *Connectivity NR*, Connected without release *On* and Test Mode *On* according to TS 38.508-1 [6] clause 4.5.
2. Set the parameters according to T1 in Table 6.5.1.3.5-1. Propagation conditions are set according to Annex C.2.3. T1 starts.
3. When T1 expires the SS shall change the SNR value to T2 as specified in Table 6.5.1.3.5-1. T2 starts.
4. When T2 expires the SS shall change the SNR value to T3 as specified in Table 6.5.1.3.5-1. T3 starts.
5. If the SS:
  - a) detects uplink power equal to or higher than minimum output power defined in TS 38.521-1 [17] clause

6.3.1.5 in each subframe configured for CQI transmission (according to configured CQI periodicity on PUCCH [format 1]) during the period from time point A to time point B

and

b) does not detect any uplink power higher than OFF power defined in TS 38.521-1 [17] clause 6.3.2.5 from time point C (D1 after the start of T3) until T3 expires, the number of successful tests is increased by one.

Otherwise the number of failed tests is increased by one.

6. When T3 expires the SS shall change the SNR value to T1 as specified in Table 6.5.1.3.5-1.

7. If the UE has not re-established the connection in at least 1s, the UE is switched off and then on. Ensure the UE is in state RRC\_CONNECTED with generic procedure parameters Connectivity NR, Connected without release On according to TS 38.508-1 [10] clause 4.5.

8. Repeat steps 2-8 until the confidence level according to Tables G.2.3-1 in Annex G clause G.2 is achieved.

6.5.1.3.4.3 Message Contents

Message contents are according to TS 38.508-1 [14] clause 4.6.1 and 7.3.1 with condition “Short\_DCI” and with the following exceptions:

**Table 6.5.1.3.4.3-0: Common Exception messages for NR SA FR1 radio link monitoring out-of-sync test for PCell configured with SSB-based RLM RS in DRX mode test requirement**

Default Message Contents	
Common contents of system information blocks exceptions	
Default RRC messages and information elements contents exceptions	Table H.3.5-4 Table H.3.5-9 Table H.3.7-1 with condition DRX.3

**Table 6.5.1.3.4.3-1: Void**

**Table 6.5.1.3.4.3-2: RLF-TimersAndConstant**

Derivation Path: TS 38.508-1 [14], Table 4.6.3-150			
Information Element	Value/remark	Comment	Condition
RLF-TimersAndConstants ::= SEQUENCE {			
t310	ms0		
n310	n1		
n311	n1		
t311	ms1000		
}			

**Table 6.5.1.3.4.3-3: Void**

**Table 6.5.1.3.4.3-4 SIB1**

Derivation Path: TS 38.508-1 [14], Table 4.6.1-28			
Information Element	Value/remark	Comment	Condition
SIB1 ::= SEQUENCE {			
cellSelectionInfoSEQUENCE {			
q-RxLevMin	-53	-106 is actual value in dBm (-53 * 2 dBm)	dBm/15kHz
	-51	-102 is actual value in dBm (-51 * 2 dBm)	dBm/30kHz

}		
}		

6.5.1.3.5 Test Requirement

Table 6.5.1.3.5-1 defines the cell specific primary level settings.

The UE behavior in each test during time durations T1, T2 and T3 shall be as follows:

During the period from time point A to time point B the UE shall transmit uplink signal at least in all uplink slots configured for CSI transmission according to the configured periodic CSI reporting.

The UE shall stop transmitting uplink signal no later than time point C (D1 second after the start of the time duration T3).

The rate of correct events observed during repeated tests shall be at least 90%.

**Table 6.5.1.3.5-1: Cell specific test parameters for FR1 (Cell 1) for out-of-sync radio link monitoring tests in DRX mode**

Parameter		Unit	Test 1						
			T1	T2	T3				
EPRE ratio of PDCCH DMRS to SSS		dB	4						
EPRE ratio of PDCCH to PDCCH DMRS			0						
EPRE ratio of PBCH DMRS to SSS		dB	0						
EPRE ratio of PBCH to PBCH DMRS									
EPRE ratio of PSS to SSS									
EPRE ratio of PDSCH DMRS to SSS									
EPRE ratio of PDSCH to PDSCH DMRS									
EPRE ratio of OCNB DMRS to SSS									
EPRE ratio of OCNB to OCNB DMRS									
SNR on RLM-RS	Config 1					dB	1.8	-6.2	-15.8
	Config 2						1.8	-6.2	-15.8
	Config 3	1.8	-6.2	-15.8					
$N_{oc}$	Config 1	dBm/15 kHz	-98						
	Config 2		-98						
	Config 3		-98						
$N_{oc}$	Config 1	dBm/S CS	-98						
	Config 2		-98						
	Config 3		-95						
Propagation condition			TDL-C 300ns 100Hz						
Note 1: OCNB shall be used such that the resources in Cell 1 are fully allocated and a constant total transmitted power spectral density is achieved for all OFDM symbols. Note 2: The signal contains PDCCH for UEs other than the device under test as part of OCNB. Note 3: SNR levels correspond to the signal to noise ratio over the SSS REs. Note 4: The SNR in time periods T1, T2 and T3 is denoted as SNR1, SNR2 and SNR3 respectively in Figure 6.5.1.3.4-1. Note 5: The SNR values are specified for a UE with 2RX antennas connected under test. For a UE with 4RX antennas connected under test, the SNR during T3 from D.4.1.1, is -18dB-TT = -18.9dB (including test tolerances)..									

For the test to pass, the total number of successful tests shall be more than 90% of the cases with a confidence level of 95%.

6.5.1.4 NR SA FR1 radio link monitoring in-sync test for PCell configured with SSB-based RLM RS in DRX mode

6.5.1.4.1 Test purpose

The purpose of this test is to verify that the UE properly detects in sync for the purpose of monitoring downlink radio link quality of the Pcell when DRX is used. This test will partly verify the FR1 radio link monitoring requirements in clause 8.1.2.

6.5.1.4.2 Test applicability

This test applies to all types of NR UE Release 15 and forward supporting 5GS NR SA FR1 and long DRX cycle.

6.5.1.4.3 Minimum conformance requirements

The minimum conformance requirements are specified in clause 6.5.1.0.2.

The normative reference for this requirement is TS 38.133 [6] clause A.6.5.1.4.

6.5.1.4.4 Test Description

There is one cell (Cell 1), which is the active NR cell, in the test. The test consists of five successive time periods, with time duration of T1, T2, T3, T4 and T5 respectively. Figure 6.5.1.4.4-1 shows the variation of the downlink SNR in the active cell to emulate out-of-sync and in-sync states. Prior to the start of the time duration T1, the UE shall be fully synchronized to Cell 1. The UE shall be configured for periodic CSI reporting with a reporting periodicity of 5 ms. In the test, DRX configuration is enabled and DRX inactivity timer has already been expired, i.e. UE tries to decode PDCCH and to send periodic CSI during the period when On-duration timer is running. Time alignment timers shall be set to “infinity” so that UL timing alignment is maintained during the test. Editor note: whether to revise power level to be gradually changed

Figure 6.5.1.4.4-1 - SNR variation for in-sync testing

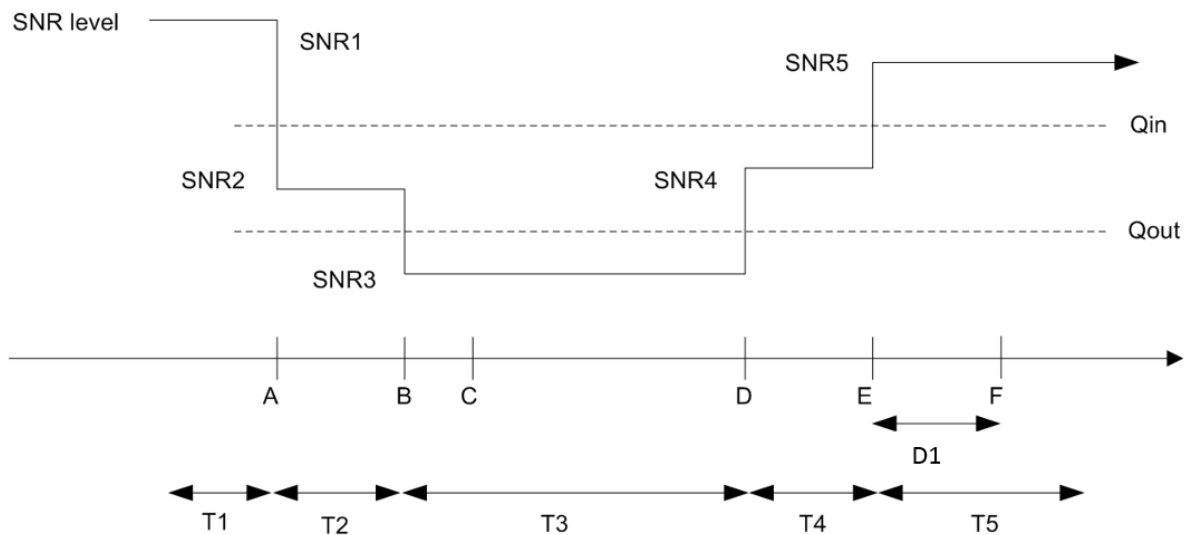

6.5.1.4.4.1 Initial Conditions

This test shall be tested using any of the test configurations in Table 6.5.1.4.4.1-1.

Table 6.5.1.4.4.1-1: Supported test configurations for NR FR1 PCell

Configuration	Description
6.5.1.4-1	FDD, SSB SCS 15 KHz, data SCS 15KHz, BW 10MHz
6.5.1.4-2	TDD, SSB SCS 15 KHz, data SCS 15KHz, BW 10MHz
6.5.1.4-3	TDD, SSB SCS 30 KHz, data SCS 30KHz, BW 40MHz
Note:	The UE is only required to pass in one of the supported test configurations in FR1.

Configure the test equipment and the DUT according to the parameters in Table 6.5.1.4.4.1-2.

**Table 6.5.1.4.4.1-2: Initial conditions for SA FR1 radio link monitoring in-sync test for NR PCell configured with SSB-based RLM RS in DRX mode**

Parameter	Value		Comment
Test environment	NC		As specified in TS 38.508-1 [14] clause 4.1.
Test frequencies	As specified in Annex E.1.2, Table E.4-1 and TS 38.508-1 [14] clause 4.3.1.		
Channel bandwidth	As specified by the test configuration selected from Table 6.5.1.4.4.1-1		
Propagation conditions	AWGN		As specified in Annex C.2.2.
Connection Diagram	TE Part	A.3.1.7.1	As specified in TS 38.508-1 [14] Annex A.
	DUT Part	A.3.2.3.4	
Exceptions to connection diagram	For 4Rx capable UEs without any 2 Rx RF bands use A.3.2.5.2 for DUT part and A.3.1.7.4 for TE Part		

**Table 6.5.1.4.4.1-3: Void**

1. Message contents are defined in clause 6.5.1.4.4.3.
2. There is one cell (Cell 1), which is the active NR cell, in the test. The power levels and settings are set according to Annex A.6, Table A.6.1.1-1. The connection setup is done according to the settings in Annex C.1.3, and the downlink signal levels as per Annex C.1.2.
3. The general test parameters are given in Table 6.5.1.4.4.1-4 below.
4. Downlink signals for NR cell are initially set up according to Annex C.1.



**Table 6.5.1.4.4.1-4: General test parameters for FR1 in-sync testing in DRX mode**

Parameter		Unit	Value
			Test 1
Active PCell			Cell 1
RF Channel Number			1
Duplex mode	Config 1		FDD
	Config 2, 3		TDD
BW <sub>channel</sub>	Config 1	MHz	10: N <sub>RB,c</sub> = 52
	Config 2		10: N <sub>RB,c</sub> = 52
	Config 3		40: N <sub>RB,c</sub> = 106
DL initial BWP configuration	Config 1, 2, 3		DLBWP.0.1
DL dedicated BWP configuration	Config 1, 2, 3		DLBWP.1.1
UL initial BWP configuration	Config 1, 2, 3		ULBWP.0.1
UL dedicated BWP configuration	Config 1, 2, 3		ULBWP.1.1
TDD Configuration	Config 1		Not Applicable
	Config 2		TDDConf.1.1
	Config 3		TDDConf.2.1
RMSI CORESET Reference Channel	Config 1		CR.1.1 FDD
	Config 2		CR.1.1 TDD
	Config 3		CR.2.1 TDD
Dedicated CORESET Reference Channel	Config 1		CCR.1.1 FDD
	Config 2		CCR.1.1 TDD
	Config 3		CCR.2.1 TDD
SSB Configuration	Config 1		SSB.1 FR1
	Config 2		SSB.1 FR1
	Config 3		SSB.2 FR1
SMTTC Configuration	Config 1, 2		SMTTC.1
	Config 3		SMTTC.1
PDSCH/PDCCH subcarrier spacing	Config 1, 2		15 KHz
	Config 3		30 KHz
PRACH Configuration	Config 1, 2		Table A.7.1-1, PRACH.1 FR1
	Config 3		Table A.7.1-1, PRACH.1 FR1
SSB index assigned as RLM RS			0
OCNG parameters			OP.1
CP length			Normal
Correlation Matrix and Antenna Configuration			2x2 Low
In sync transmission parameters	DCI format		1-0
	Number of Control OFDM symbols		2
	Aggregation level	CCE	4
	Ratio of hypothetical PDCCH RE energy to average SSS RE energy	dB	0
	Ratio of hypothetical PDCCH DMRS energy to average SSS RE energy	dB	0
	DMRS precoder granularity		REG bundle size
	REG bundle size		6
Out of sync transmission parameters	DCI format		1-0
	Number of Control OFDM symbols		2
	Aggregation level	CCE	8
	Ratio of hypothetical PDCCH RE energy to average SSS RE energy	dB	4
	Ratio of hypothetical PDCCH DMRS energy to average SSS RE energy	dB	4
	DMRS precoder granularity		REG bundle size

	REG bundle size		6
DRX Configuration			DRX.3
Gap pattern ID			N.A.
Layer 3 filtering			<i>Enabled</i>
T310 timer		ms	2000
T311 timer		ms	1000
N310			1
N311			1
CSI-RS configuration for CSI reporting	Config 1		CSI-RS.1.1 FDD
	Config 2		CSI-RS.1.1 TDD
	Config 3		CSI-RS.2.1 TDD
CSI-RS for tracking	Config 1		TRS.1.1 FDD
	Config 2		TRS.1.1 TDD
	Config 3		TRS.1.2 TDD
T1		s	0.2
T2		s	0.2
T3		s	0.64
T4		s	0.2
T5		s	0.88
D1		s	0.84
Note 1: All configurations are assigned to the UE prior to the start of time period T1.			
Note 2: UE-specific PDCCH is not transmitted after T1 starts.			

#### 6.5.1.4.4.2 Test Procedure

There is one cell (Cell 1), which is the active NR cell, in the test. The test consists of five successive time periods, with time duration of T1, T2, T3, T4 and T5 respectively. Figure 6.5.1.4.4-1 shows the variation of the downlink SNR in the active cell to emulate out-of-sync and in-sync states. Prior to the start of the time duration T1, the UE shall be fully synchronized to PCell. The UE shall be configured for periodic CQI reporting in PUCCH [format 1] with a reporting periodicity as mentioned in the above table 6.5.1.4.4.1-4.

1. Ensure the UE is in state RRC\_CONNECTED with generic procedure parameters *Connectivity* NR, Connected without release *On* and Test Mode *On* according to TS 38.508-1 [6] clause 4.5.
2. Set the parameters according to T1 in Table 6.5.1.4.5-1 for subtest 1 and 2. Propagation conditions are set according to Annex C.2.3. T1 starts.
3. When T1 expires the SS shall change the SNR value to T2 as specified in Table 6.5.1.4.5-1. T2 starts.
4. When T2 expires the SS shall change the SNR value to T3 as specified in Table 6.5.1.4.5-1. T3 starts.
5. When T3 expires the SS shall change the SNR value to T4 as specified in Table 6.5.1.4.5-1. T4 starts.
6. When T4 expires the SS shall change the SNR value to T5 as specified in Table 6.5.1.4.5-1. T5 starts.
7. If the SS detects uplink power equal to or higher than the minimum output power defined in TS 38.521-1 [17] clause 6.3.1.5 in the On-duration part of every DRX cycle in the subframe according the configured CQI reporting mode (PUCCH 1-0) during the period from time point A to time point F (D1 second after the start of time duration T5) the number of successful tests is increased by one.

Otherwise the number of failed tests is increased by one.

8. Ensure the UE is in state RRC\_CONNECTED with generic procedure parameters *Connectivity* NR, Connected without release *On* and Test Mode *On* according to TS 38.508-1 [6] clause 4.5.
9. Repeat steps 2-7 for all subtests until the confidence level according to Tables G.2.3-1 in Annex G clause G.2 is achieved.

#### 6.5.1.4.4.3 Message Contents

Message contents are according to TS 38.508-1 [14] clause 4.6.1 and 7.3.1 with condition "Short\_DCI" and with the following exceptions:

**Table 6.5.1.4.4.3-0: Common Exception messages for NR SA FR1 radio link monitoring in-sync test for PCell configured with SSB-based RLM RS in DRX mode test requirement**

Default Message Contents	
Common contents of system information blocks exceptions	
Default RRC messages and information elements contents exceptions	Table H.3.5-4 Table H.3.5-9 Table H.3.7-1 with condition DRX.3

**Table 6.5.1.4.4.3-1: Void**

**Table 6.5.1.4.4.3-2: RLF-TimersAndConstant**

Derivation Path: TS 38.508-1 [14], Table 4.6.3-150			
Information Element	Value/remark	Comment	Condition
RLF-TimersAndConstants ::= SEQUENCE {			
t310	ms2000		
n310	n1		
n311	n1		
t311-v1530	ms1000		
}			

**Table 6.5.1.4.4.3-3: Void**

**6.5.1.4.5 Test Requirement**

The requirements in this section apply for each SSB based RLM-RS resource configured for the PCell, provided that the SSB configured for RLM are actually transmitted within UE active DL BWP during the entire evaluation period specified in section 6.5.1.4.3.

Table 6.5.1.4.5-1 defines the cell specific primary level settings.

The UE behaviour in each test during time durations T1, T2, T3, T4 and T5 shall be as follows:

During the period from time point A to time point F (D1 second after the start of time duration T5) the UE shall transmit uplink signal at least in all uplink slots configured for CSI transmission according to the configured periodic CSI reporting.

The rate of correct events observed during repeated tests shall be at least 90% with a confidence interval of 95%.

**Table 6.5.1.4.5-1: Cell specific test parameters for FR1 for in-sync radio link monitoring tests in DRX mode**

Parameter		Unit	Test 1				
			T1	T2	T3	T4	T5
EPRE ratio of PDCCH DMRS to SSS		dB	0				
EPRE ratio of PDCCH to PDCCH DMRS			0				
EPRE ratio of PBCH DMRS to SSS		dB	0				
EPRE ratio of PBCH to PBCH DMRS							
EPRE ratio of PSS to SSS							
EPRE ratio of PDSCH DMRS to SSS							
EPRE ratio of PDSCH to PDSCH DMRS							
EPRE ratio of OCNG DMRS to SSS							
EPRE ratio of OCNG to OCNG DMRS							
SNR on RLM-RS	Config 1						
	Config 2	1.8	-6.2	-15.8	-5.3	1.8	
	Config 3	1.8	-6.2	-15.8	-5.3	1.8	
$N_{oc}$	Config 1	dBm/15 kHz	-98				
	Config 2		-98				
	Config 3		-98				
$N_{oc}$	Config 1	dBm/S CS	-98				
	Config 2		-98				
	Config 3		-95				
Propagation condition			TDL-C 300ns 100Hz				
<p>Note 1: OCNG shall be used such that the resources in Cell 1 are fully allocated and a constant total transmitted power spectral density is achieved for all OFDM symbols.</p> <p>Note 2: The signal contains PDCCH for UEs other than the device under test as part of OCNG.</p> <p>Note 3: SNR levels correspond to the signal to noise ratio over the SSS REs.</p> <p>Note 4: The SNR in time periods T1, T2, T3, T4 and T5 is denoted as SNR1, SNR2, SNR3, SNR4 and SNR5 respectively in Figure 6.5.1.4.4-1.</p> <p>Note 5: The SNR values are specified for a UE with 2RX antennas connected under test. For a UE with 4RX antennas connected under test, the SNR during T3 and T4 from D.4.1.1 are -18.0-TT and -8.0-TT, which are -18.8dB and -8.8dB(including test tolerances).</p>							

### 6.5.1.5 NR SA FR1 radio link monitoring out-of-sync test for PCell configured with CSI-RS-based RLM RS in non-DRX mode

#### 6.5.1.5.1 Test purpose

The purpose of this test is to verify that the UE properly detects the out of sync for the purpose of monitoring downlink CSI-RS based radio link quality of the PCell when no DRX is used. This test will partly verify the FR1 PCell CSI-RS Out-of-sync radio link monitoring requirements in TS 38.133 [6] clause 8.1.

#### 6.5.1.5.2 Test applicability

This test applies to all types of NR UE release 15 and forward supporting CSI-RS based RLM.

#### 6.5.1.5.3 Minimum conformance requirements

The minimum conformance requirements are specified in clause 6.5.1.0.3.

The normative reference for this requirement is TS 38.133 [6] clause A.6.5.1.5.

#### 6.5.1.5.4 Test description

The test consists of three successive time periods, with time duration of T1, T2 and T3 respectively. Figure 6.5.1.5.4-1 shows the three different time durations and the corresponding variation of the downlink SNR in the active cell to emulate out-of-sync states.

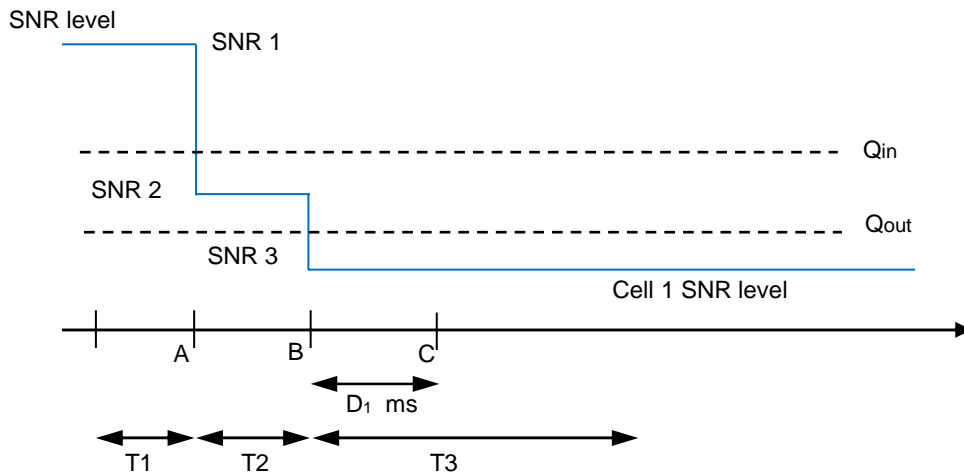

Figure 6.5.1.5.4-1: SNR variation for out-of-sync testing

6.5.1.5.4.1 Initial conditions

This test shall be tested using any of the test configurations in Table 6.5.1.5.4.1-1.

**Table 6.5.1.5.4.1-1: Supported test configurations for NR SA FR1 radio link monitoring out-of-sync test for PCell configured with CSI-RS-based RLM RS in non-DRX**

Configuration	Description
6.5.1.5-1	FDD duplex mode, 15 kHz SSB SCS, 10MHz bandwidth
6.5.1.5-2	TDD duplex mode, 15 kHz SSB SCS, 10MHz bandwidth
6.5.1.5-3	TDD duplex mode, 30 kHz SSB SCS, 40MHz bandwidth
Note:	The UE is only required to pass in one of the supported test configurations in FR1

Configure the test equipment and the DUT according to the parameters in Table 6.5.1.5.4.1-2.

**Table 6.5.1.5.4.1-2: Initial conditions for NR SA radio link monitoring NR SA FR1 radio link monitoring out-of-sync test for PCell configured with CSI-RS-based RLM RS in non-DRX**

Parameter	Value	Comment
Test environment	NC	As specified in TS 38.508-1 [14] clause 4.1.
Test frequencies	As specified in Annex E, Table E.4-1 and TS 38.508-1 [14] clause 4.3.1.	
Channel bandwidth	As specified by the test configuration selected from Table 6.5.1.5.4.1-1.	
Propagation conditions	AWGN	As specified in Annex C.2.2
Connection Diagram	TE Part	A.3.1.7.1
	DUT Part	A.3.2.3.4
Exceptions to connection diagram	For 4Rx capable UEs without any 2 Rx RF bands use A.3.2.5.2 for DUT part and A.3.1.7.4 for TE Part	

1. The general test parameter settings are set up according to Table 6.5.1.5.4.1-3. The measurement gap configuration is according to Table 6.5.1.5.4.1-4.
2. Message contents are defined in clause 6.5.1.5.4.3.
3. There are one cell in the test, where Cell 1 is the NR PCell on the NR carrier. Cell 1 is the cell used for connection setup with the power level set according to Table 6.5.1.5.5-1 for this test. Cell 1 is configured according to Annex C.1.2 and C.1.3.

**Table 6.5.1.5.4.1-3: General test parameters for NR SA FR1 radio link monitoring out-of-sync test for PCell configured with CSI-RS-based RLM RS in non-DRX**

Parameter		Unit	Value
Active PCell			Cell 1
RF Channel Number			1
Duplex mode	Config 1		FDD
	Config 2, 3		TDD
TDD Configuration	Config 1		Not Applicable
	Config 2		TDDConf.1.1
	Config 3		TDDConf.2.1
DL initial BWP configuration	Config 1, 2, 3		DLBWP.0.1
DL dedicated BWP configuration	Config 1, 2, 3		DLBWP.1.1
UL initial BWP configuration	Config 1, 2, 3		ULBWP.0.1
UL dedicated BWP configuration	Config 1, 2, 3		ULBWP.1.1
RMSI CORESET Reference Channel	Config 1		CR.1.1 FDD
	Config 2		CR.1.1 TDD
	Config 3		CR.2.1 TDD
Dedicated CORESET Reference Channel	Config 1		CCR.1.3 FDD
	Config 2		CCR.1.3 TDD
	Config 3		CCR.2.2 TDD
SSB Configuration	Config 1		SSB.1 FR1
	Config 2		SSB.1 FR1
	Config 3		SSB.2 FR1
SMTTC Configuration	Config 1, 2		SMTTC.1
	Config 3		SMTTC.1
PDSCH/PDCCH subcarrier spacing	Config 1, 2		15 kHz
	Config 3		30 kHz
TRS configuration	Config 1		TRS.1.1 FDD
	Config 2		TRS.1.1 TDD
	Config 3		TRS.1.2 TDD
CSI-RS for RLM	Config 1		Resource #4 in TRS.1.1 FDD
	Config 2		Resource #4 in TRS.1.1 TDD
	Config 3		Resource #4 in TRS.1.2 TDD
TCI configuration for PDCCH/PDSCH			TCI.State.2
OCNG parameters			OP.1
CP length			Normal
Correlation Matrix and Antenna Configuration			2x2 Low
Out of sync transmission parameters	DCI format		1-0
	Number of Control OFDM symbols		2
	Aggregation level	CCE	8
	Ratio of hypothetical PDCCH RE energy to average CSI-RS RE energy	dB	4
	Ratio of hypothetical PDCCH DMRS energy to average CSI-RS RE energy	dB	4
	DMRS precoder granularity		REG bundle size
REG bundle size			6
DRX			OFF
Gap pattern ID			gp0
Layer 3 filtering			Enabled
T310 timer		ms	0
T311 timer		ms	1000
N310			1
N311			1
CSI-RS configuration	Config 1		CSI-RS.1.1 FDD
	Config 2		CSI-RS.1.1 TDD
	Config 3		CSI-RS.2.1 TDD
T1		s	0.2
T2		s	0.48
T3		s	0.48



D1	s	0.44
Note 1: UE-specific PDCCH is not transmitted after T1 starts.		

**Table 6.5.1.5.4.1-4: Measurement gap configuration for NR SA FR1 radio link monitoring out-of-sync test for PCell configured with CSI-RS-based RLM RS in non-DRX**

Field	Test 1
	Value
gapOffset	0

#### 6.5.1.5.4.2 Test procedure

Prior to the start of the time duration T1, the UE shall be fully synchronized to Cell 1. The UE shall be configured for periodic CSI reporting with a reporting periodicity of 5ms. In the test, DRX configuration is not enabled. The UE is configured to perform inter-frequency measurements using GP ID #0 (40ms) in test.

1. Ensure the UE is in state RRC\_CONNECTED with generic procedure parameters Connectivity NR, Connected without release *On* and Test Mode *On* according to TS 38.508-1 [14] clause 4.5.
2. The SS shall transmit an RRCReconfiguration message configuring the UE for inter-frequency measurements.
3. The UE shall transmit RRCReconfigurationComplete message.
4. Set the parameters of Cell 1 according to T1 in Table 6.5.1.5.5-1. Propagation conditions are set according to Annex C.2.3. T1 starts.
5. When T1 expires the SS shall change the SNR value to T2 as specified in Table 6.5.1.5.5-1. T2 starts.
6. When T2 expires the SS shall change the SNR value to T3 as specified in Table 6.5.1.5.5-1. T3 starts.
7. If the SS:
  - a) detects uplink power equal to or higher than minimum output power defined in TS 38.521-1 [17] clause 6.3.1.5 in each slot configured for CSI transmission (according CSI reporting on PUCCH) during the period from time point A to time point B

and

  - b) does not detect any uplink power higher than OFF power defined in TS 38.521-1 [17] clause 6.3.2.5 from time point C (D1 after the start of T3) until T3 expires,

the number of successful tests is increased by one.

Otherwise the number of failed tests is increased by one.
8. When T3 expires the SS shall change the SNR value to T1 as specified in Table 6.5.1.5.5-1.
9. If the UE has not re-established the connection in at least 1s, the UE is switched off and then on. Ensure the UE is in state RRC\_CONNECTED with generic procedure parameters Connectivity NR, Connected without release *On* according to TS 38.508-1 [14] clause 4.5.
10. Repeat steps 4-9 until the confidence level according to Tables G.2.3-1 in Annex G clause G.2 is achieved.

#### 6.5.1.5.4.3 Message contents

Message contents are according to TS 38.508-1 [14] clause 4.6 and 7.3.1 with condition "Short\_DCI" and with the following exceptions:

**Table 6.5.1.5.4.3-1: Common Exception messages for NR SA FR1 radio link monitoring out-of-sync test for PCell configured with CSI-RS-based RLM RS in non-DRX mode**

Default Message Contents	
Common contents of system information blocks exceptions	
Default RRC messages and information elements contents exceptions	Table H.3.1-1 Table H.3.1-2 with Condition INTER-FREQ, L3 FILTERING NEEDED, GAP_NEEDED Table H.3.1-3 with Condition INTER-FREQ MO (where ssbFrequency is set to the ARFCN value of carrier center of High range) Table H.3.1-4 with A3-offset = 0 Table H.3.1-6 with conditions gapUE and RLM Table H.3.5-4 Table H.3.5-9 with Condition CSI-RS RLM

**Table 6.5.1.5.4.3-2 SIB1**

Derivation Path: TS 38.508-1 [14], Table 4.6.1-28			
Information Element	Value/remark	Comment	Condition
SIB1 ::= SEQUENCE {			
cellSelectionInfoSEQUENCE {			
q-RxLevMin	-46	-92 is actual value in dBm (-46 * 2 dBm)	dBm/15kHz or dBm/30kHz
}			
}			

**Table 6.5.1.5.4.3-2: RLF-TimersAndConstants**

Derivation Path: TS 38.508-1 [14], Table 4.6.3-150			
Information Element	Value/remark	Comment	Condition
RLF-TimersAndConstants ::= SEQUENCE {			
t310	ms0		
n310	n1		
t311	ms1000		
n311	n1		
}			

6.5.1.5.5 Test requirement

Tables 6.5.1.5.4.1-3 and 6.5.1.5.5-1 define the primary level settings including test tolerances for Radio Link Monitoring Out-of-sync Test for FR1 PCell configured with CSI-RS-based RLM in non-DRX mode.

**Table 6.5.1.5.5-1: Cell specific test parameters for NR SA FR1 radio link monitoring out-of-sync test for PCell configured with CSI-RS-based RLM RS in non-DRX mode**

Parameter		Unit	Test 1		
			T1	T2	T3
EPRE ratio of PDCCH DMRS to SSS		dB	4		
EPRE ratio of PDCCH to PDCCH DMRS		dB	0		
EPRE ratio of PBCH DMRS to SSS		dB			
EPRE ratio of PBCH to PBCH DMRS		dB			
EPRE ratio of PBCH to PBCH DMRS		dB			
EPRE ratio of PDSCH DMRS to SSS		dB			
EPRE ratio of PDSCH to PDSCH DMRS		dB			
EPRE ratio of OCNG DMRS to SSS		dB			
EPRE ratio of OCNG to OCNG DMRS		dB			
SNR on RLM-RS	Config 1	dB			
	Config 2		1.8	-6.2	-15.8
	Config 3		1.8	-6.2	-15.8
$N_{oc}$	Config 1	dBm/15KHz	-98		
	Config 2		-98		
	Config 3		-98		
Propagation condition			TDL-C 300ns 100Hz		
<p>Note 1: OCNG shall be used such that the resources in Cell 1 are fully allocated and a constant total transmitted power spectral density is achieved for all OFDM symbols.</p> <p>Note 2: The uplink resources for CSI reporting are assigned to the UE prior to the start of time period T1.</p> <p>Note 3: NZP CSI-RS resource set configuration for CSI reporting are assigned to the UE prior to the start of time period T1.</p> <p>Note 4: Measurement gap configuration is assigned to the UE prior to the start of time period T1.</p> <p>Note 5: The timers and layer 3 filtering related parameters are configured prior to the start of time period T1.</p> <p>Note 6: The signal contains PDCCH for UEs other than the device under test as part of OCNG.</p> <p>Note 7: SNR levels correspond to the signal to noise ratio over the SSS REs.</p> <p>Note 8: The SNR in time periods T1, T2 and T3 is denoted as SNR1, SNR2 and SNR3 respectively in figure 6.5.1.5.4-1.</p> <p>Note 9: The SNR values are specified for testing a UE which supports 2RX on at least one band. For testing of a UE which supports 4RX on all bands, the SNR during T3 from D.4.1.1 is -18 -TT, which is -18.8dB (including test tolerances).</p>					

The UE behaviour during time durations T1, T2 and T3 shall be as follows:

During time durations T1, T2 and T3, the UE shall transmit uplink signal at least in all subframes configured for CSI transmission on Cell 1.

During the period from time point A to time point B the UE shall transmit uplink signal in Cell 1 at least in all uplink slots configured for CSI transmission according to the configured periodic CSI reporting for Cell 1.

The UE shall stop transmitting uplink signal in Cell 1 no later than time point C ( $D_1$  ms after the start of the time duration T3) on the PCell.

The rate of correct events observed during repeated tests shall be at least 90% with a confidence level of 95%.

6.5.1.6 NR SA FR1 radio link monitoring in-sync test for PCell configured with CSI-RS-based RLM RS in non-DRX mode

6.5.1.6.1 Test purpose

The purpose of this test is to verify that the UE properly detects the in sync for the purpose of monitoring downlink CSI-RS based radio link quality of the PCell when no DRX is used. This test will partly verify the FR1 PCell CSI-RS in-sync radio link monitoring requirements in TS 38.133 [6] clause 8.1.

6.5.1.6.2 Test applicability

This test applies to all types of NR UE release 15 and forward supporting CSI-RS based RLM.

6.5.1.6.3 Minimum conformance requirements

The minimum conformance requirements are specified in clause 6.5.1.0.3.

The normative reference for this requirement is TS 38.133 [6] clause A.6.5.1.6.

6.5.1.6.4 Test description

The test consists of five successive time periods, with time duration of T1, T2, T3, T4 and T5 respectively. Figure 6.5.1.6.4-1 shows the five different time durations and the corresponding variation of the downlink SNR in the Pcell to emulate out-of-sync and in-sync states.

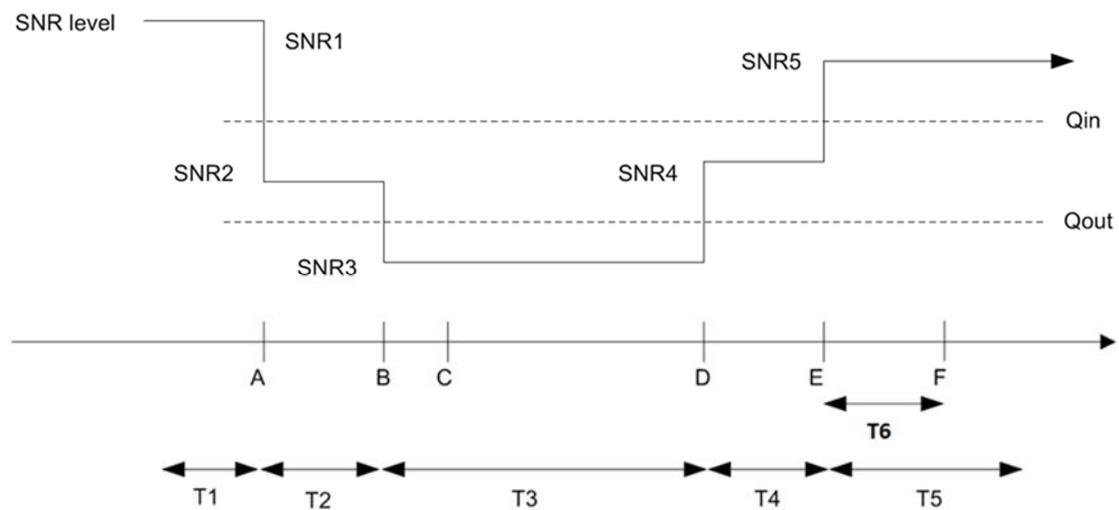

Figure 6.5.1.6.4-1: SNR variation for In-sync testing

6.5.1.6.4.1 Initial conditions

This test shall be tested using any of the test configurations in Table 6.5.1.6.4.1-1.

Table 6.5.1.6.4.1-1: Supported test configurations for NR SA FR1 radio link monitoring in-sync test for PCell configured with CSI-RS-based RLM RS in non-DRX mode

Configuration	Description
6.5.1.6-1	FDD duplex mode, 15 kHz SSB SCS, 10MHz bandwidth
6.5.1.6-2	TDD duplex mode, 15 kHz SSB SCS, 10MHz bandwidth
6.5.1.6-3	TDD duplex mode, 30 kHz SSB SCS, 40MHz bandwidth
Note:	The UE is only required to pass in one of the supported test configurations in FR1

Configure the test equipment and the DUT according to the parameters in Table 6.5.1.6.4.1-2.

**Table 6.5.1.6.4.1-2: Initial conditions for for NR SA FR1 radio link monitoring in-sync test for PCell configured with CSI-RS-based RLM RS in non-DRX mode**

Parameter	Value		Comment
Test environment	NC		As specified in TS 38.508-1 [14] clause 4.1.
Test frequencies	As specified in Annex E, Table E.4-1 and TS 38.508-1 [14] clause 4.3.1.		
Channel bandwidth	As specified by the test configuration selected from Table 6.5.1.6.4.1-1.		
Propagation conditions	AWGN		As specified in Annex C.2.2
Connection Diagram	TE Part	A.3.1.7.1	As specified in TS 38.508-1 [14] Annex A.
	DUT Part	A.3.2.3.4	
Exceptions to connection diagram	For 4Rx capable UEs without any 2 Rx RF bands use A.3.2.5.2 for DUT part and A.3.1.7.4 for TE Part		

1. The general test parameter settings are set up according to Table 6.5.1.6.4.1-3.
2. Message contents are defined in clause 6.5.1.6.4.3.
3. There is one cell in the test, where Cell 1 is the NR PCell on the NR carrier. Cell 1 is the cell used for connection setup with the power level set according to Table 6.5.1.6.5-1 for this test. Cell 1 is configured according to Annex C.1.2 and C.1.3.

**Table 6.5.1.6.4.1-3: General test parameters for NR SA FR1 radio link monitoring in-sync test for PCell configured with CSI-RS-based RLM RS in non-DRX mode**

Parameter		Unit	Value
Active PCell			Cell 1
RF Channel Number			1
Duplex mode	Config 1		FDD
	Config 2, 3		TDD
TDD Configuration	Config 1		Not Applicable
	Config 2		TDDConf.1.1
	Config 3		TDDConf.2.1
DL initial BWP configuration	Config 1, 2, 3		DLBWP.0.1
DL dedicated BWP configuration	Config 1, 2, 3		DLBWP.1.1
UL initial BWP configuration	Config 1, 2, 3		ULBWP.0.1
UL dedicated BWP configuration	Config 1, 2, 3		ULBWP.1.1
RMSI CORESET Reference Channel	Config 1		CR.1.1 FDD
	Config 2		CR.1.1 TDD
	Config 3		CR.2.1 TDD
Dedicated CORESET Reference Channel	Config 1		CCR.1.1 FDD
	Config 2		CCR.1.1 TDD
	Config 3		CCR.2.1 TDD
SSB Configuration	Config 1		SSB.1 FR1
	Config 2		SSB.1 FR1
	Config 3		SSB.2 FR1
SMTC Configuration	Config 1, 2		SMTC.1
	Config 3		SMTC.1
PDSCH/PDCCH subcarrier spacing	Config 1, 2		15 kHz
	Config 3		30 kHz
TRS configuration	Config 1		TRS.1.1 FDD
	Config 2		TRS.1.1 TDD
	Config 3		TRS.1.2 TDD
CSI-RS for RLM	Config 1		Resource #4 in TRS.1.1 FDD
	Config 2		Resource #4 in TRS.1.1 TDD
	Config 3		Resource #4 in TRS.1.2 TDD
TCI configuration for PDCCH/PDSCH			TCI.State.2
OCNG parameters			OP.1
CP length			Normal
Correlation Matrix and Antenna Configuration			2x2 Low
Out of sync transmission parameters	DCI format		1-0
	Number of Control OFDM symbols		2
	Aggregation level	CCE	8
	Ratio of hypothetical PDCCH RE energy to average CSI-RS RE energy	dB	4
	Ratio of hypothetical PDCCH DMRS energy to average CSI-RS RE energy	dB	4
	DMRS precoder granularity		REG bundle size
	REG bundle size		6
In sync transmission parameters	DCI format		1-0
	Number of Control OFDM symbols		2
	Aggregation level	CCE	4
	Ratio of hypothetical PDCCH RE energy to average CSI-RS RE energy	dB	0
	Ratio of hypothetical PDCCH DMRS energy to average CSI-RS RE energy	dB	0
	DMRS precoder granularity		REG bundle size
	REG bundle size		6

DRX			OFF
Gap pattern ID			N.A.
Layer 3 filtering			Enabled
T310 timer		ms	1000
T311 timer		ms	1000
N310			1
N311			1
CSI-RS configuration	Config 1		CSI-RS.1.1 FDD
	Config 2		CSI-RS.1.1 TDD
	Config 3		CSI-RS.2.1 TDD
T1		s	0.2
T2		s	0.2
T3		s	0.44
T4		s	0.2
T5		s	0.88
D1		s	0.84
Note 1: UE-specific PDCCH is not transmitted after T1 starts.			

6.5.1.6.4.2 Test procedure

Prior to the start of the time duration T1, the UE shall be fully synchronized to Cell 1. The UE shall be configured for periodic CSI reporting with a reporting periodicity of 5ms. In the test, DRX configuration is not enabled.

1. Ensure the UE is in state RRC\_CONNECTED with generic procedure parameters Connectivity NR, Connected without release *On* and Test Mode *On* according to TS 38.508-1 [14] clause 4.5.
2. Set the parameters of Cell 1 according to T1 in Table 6.5.1.6.5-1. Propagation conditions are set according to Annex C.2.3. T1 starts.
3. When T1 expires the SS shall change the SNR value to T2 as specified in Table 6.5.1.6.5-1. T2 starts.
4. When T2 expires the SS shall change the SNR value to T3 as specified in Table 6.5.1.6.5-1. T3 starts.
5. When T3 expires the SS shall change the SNR value to T4 as specified in Table 6.5.1.6.5-1. T4 starts.
6. When T4 expires the SS shall change the SNR value to T5 as specified in Table 6.5.1.6.5-1. T5 starts.
7. If the SS detects uplink power equal to or higher than minimum output power defined in TS 38.521-1 [17] clause 6.3.1.5 in each slot configured for CSI transmission (according CSI reporting on PUCCH) during the period from time point A to time point F (T6 after the start of time duration T5) the number of successful tests is increased by one.

Otherwise the number of failed tests is increased by one.

8. If the UE has not re-established the connection in at least 1s, the UE is switched off and then on. Ensure the UE is in state RRC\_CONNECTED with generic procedure parameters Connectivity NR, Connected without release *On* according to TS 38.508-1 [14] clause 4.5.
9. After T5 expires, repeat steps 2-7 for both subtests until the confidence level according to Tables G.2.3-1 in Annex G clause G.2 is achieved.

6.5.1.6.4.3 Message contents

Message contents are according to TS 38.508-1 [14] clause 4.6 and 7.3.1 with the following exceptions:

**Table 6.5.1.6.4.3-1: Common Exception messages for NR SA FR1 radio link monitoring in-sync test for PCell configured with CSI-RS-based RLM RS in non-DRX mode**

Default Message Contents	
Common contents of system information blocks exceptions	
Default RRC messages and information elements contents exceptions	Table H.3.5-4 Table H.3.5-9 with Condition CSI-RS RLM



6.5.1.6.5 Test requirement

Tables 6.5.1.6.4.1-3 and 6.5.1.6.5-1 define the primary level settings including test tolerances for Radio Link Monitoring In-sync Test for FR1 PCell configured with CSI-RS-based RLM in non-DRX mode.

**Table 6.5.1.6.5-1: Cell specific test parameters for NR SA FR1 radio link monitoring in-sync test for PCell configured with CSI-RS-based RLM RS in non-DRX mode**

Parameter		Unit	Test 1				
			T1	T2	T3	T4	T5
EPRE ratio of PDCCH DMRS to SSS		dB	0				
EPRE ratio of PDCCH to PDCCH DMRS		dB	0				
EPRE ratio of PBCH DMRS to SSS		dB					
EPRE ratio of PBCH to PBCH DMRS		dB					
EPRE ratio of PBCH to PBCH DMRS		dB					
EPRE ratio of PDSCH DMRS to SSS		dB					
EPRE ratio of PDSCH to PDSCH DMRS		dB					
EPRE ratio of OCNG DMRS to SSS		dB					
EPRE ratio of OCNG to OCNG DMRS		dB					
SNR on RLM-RS	Config 1	dB					
	Config 2		1.8	-6.2	-15.8	-5.3	1.8
	Config 3		1.8	-6.2	-15.8	-5.3	1.8
$N_{oc}$	Config 1	dBm/15kHz	-98				
	Config 2		-98				
	Config 3		-98				
Propagation condition			TDL-C 300ns 100Hz				
<p>Note 1: OCNG shall be used such that the resources in Cell 1 are fully allocated and a constant total transmitted power spectral density is achieved for all OFDM symbols.</p> <p>Note 2: The uplink resources for CSI reporting are assigned to the UE prior to the start of time period T1.</p> <p>Note 3: NZP CSI-RS resource set configuration for CSI reporting are assigned to the UE prior to the start of time period T1.</p> <p>Note 4: Measurement gap configuration is assigned to the UE prior to the start of time period T1.</p> <p>Note 5: The timers and layer 3 filtering related parameters are configured prior to the start of time period T1.</p> <p>Note 6: The signal contains PDCCH for UEs other than the device under test as part of OCNG.</p> <p>Note 7: SNR levels correspond to the signal to noise ratio over the SSS REs.</p> <p>Note 8: The SNR in time periods T1, T2, T3, T4 and T5 is denoted as SNR1, SNR2, SNR3, SNR4 and SNR5 respectively in figure 6.5.1.6.4-1.</p> <p>Note 9: The SNR values are specified for testing a UE which supports 2RX on at least one band. For testing of a UE which supports 4RX on all bands, the SNR during T3 and T4 from D.4.1.1 are -18.0-TT and -8.0-TT, which are -18.8dB and -8.8dB(including test tolerances).</p>							

The UE behaviour in each test during time durations T1, T2, T3, T4 and T5 shall be as follows:

During the period from time point A to time point F (T6 second after the start of time duration T5) the UE shall transmit uplink signal at least in all uplink slots configured for CSI transmission according to the configured periodic CSI reporting on the PCell.

The rate of correct events observed during repeated tests shall be at least 90% with a confidence level of 95%.

### 6.5.1.7 NR SA FR1 radio link monitoring out-of-sync test for PCell configured with CSI-RS-based RLM RS in DRX mode

#### 6.5.1.7.1 Test purpose

The purpose of this test is to verify that the UE properly detects the out of sync for the purpose of monitoring downlink CSI-RS based radio link quality of the PCell when DRX is used. This test will partly verify the FR1 PCell CSI-RS Out-of-sync radio link monitoring requirements in TS 38.133 [6] clause 8.1.

#### 6.5.1.7.2 Test applicability

This test applies to all types of NR UE release 15 and forward supporting 5GS NR SA FR1, CSI-RS based RLM and long DRX cycle.

#### 6.5.1.7.3 Minimum conformance requirements

The minimum conformance requirements are specified in clause 6.5.1.0.3.

The normative reference for this requirement is TS 38.133 [6] clause A.6.5.1.7.

#### 6.5.1.7.4 Test description

The test consists three successive time periods, with time duration of T1, T2 and T3 respectively. Figure 6.5.1.7.4-1 shows the three different time durations and the corresponding variation of the downlink SNR in the active cell to emulate out-of-sync states.

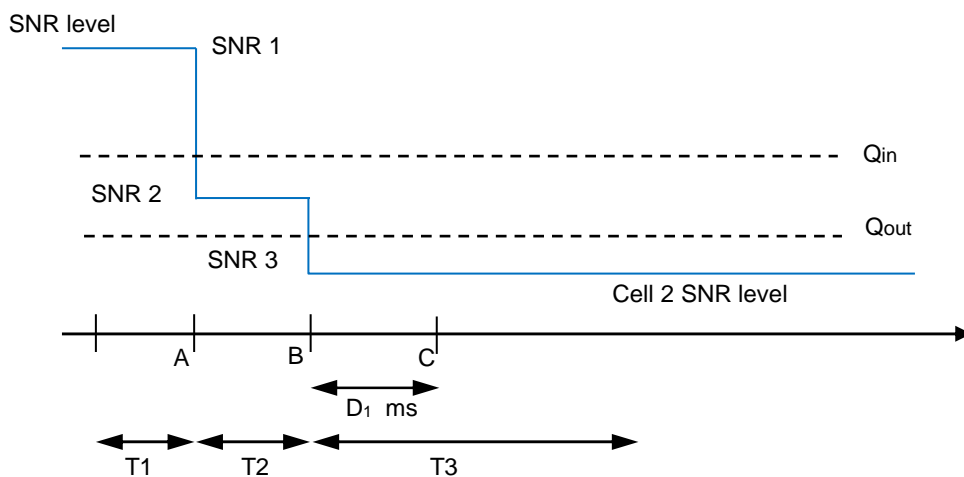

**Figure 6.5.1.7.4-1: SNR variation for out-of-sync testing**

#### 6.5.1.7.4.1 Initial conditions

This test shall be run in one of the configurations defined in Table 6.5.1.7.4.1-1.

**Table 6.5.1.7.4.1-1: Supported test configurations for NR SA FR1 radio link monitoring out-of-sync test for PCell configured with CSI-RS-based RLM RS in DRX mode**

Configuration	Description
6.5.1.7-1	FDD duplex mode, 15 kHz SSB SCS, 10MHz bandwidth
6.5.1.7-2	TDD duplex mode, 15 kHz SSB SCS, 10MHz bandwidth
6.5.1.7-3	TDD duplex mode, 30 kHz SSB SCS, 40MHz bandwidth
Note:	The UE is only required to pass in one of the supported test configurations in FR1

Configure the test equipment and the DUT according to the parameters in Table 6.5.1.7.4.1-2.

**Table 6.5.1.7.4.1-2: Initial conditions for NR SA radio link monitoring for NR SA FR1 radio link monitoring out-of-sync test for PCell configured with CSI-RS-based RLM RS in DRX mode**

Parameter	Value		Comment
Test environment	NC		As specified in TS 38.508-1 [14] clause 4.1.
Test frequencies	As specified in Annex E, Table E.4-1 and TS 38.508-1 [14] clause 4.3.1.		
Channel bandwidth	As specified by the test configuration selected from Table 6.5.1.7.4.1-1.		
Propagation conditions	AWGN		As specified in Annex C.2.2
Connection Diagram	TE Part	A.3.1.7.1	As specified in TS 38.508-1 [14] Annex A.
	DUT Part	A.3.2.3.4	
Exceptions to connection diagram	For 4Rx capable UEs without any 2 Rx RF bands use A.3.2.5.2 for DUT part and A.3.1.7.4 for TE Part		

1. The general test parameter settings are set up according to Table 6.5.1.7.4.1-3.
2. Message contents are defined in clause 6.5.1.7.4.3.
3. There is one cell in the test, where Cell 1 is the NR PCell on the NR carrier. Cell 1 is the cell used for connection setup with the power level set according to Table 6.5.1.7.5-1 for this test. Cell 1 is configured according to Annex C.1.2 and C.1.3.

**Table 6.5.1.7.4.1-3: General test parameters for NR SA FR1 radio link monitoring out-of-sync test for PCell configured with CSI-RS-based RLM RS in DRX mode**

Parameter		Unit	Value
Active PCell			Cell 1
RF Channel Number			1
Duplex mode	Config 1		FDD
	Config 2, 3		TDD
TDD Configuration	Config 1		Not Applicable
	Config 2		TDDConf.1.1
	Config 3		TDDConf.2.1
DL initial BWP configuration	Config 1, 2, 3		DLBWP.0.1
DL dedicated BWP configuration	Config 1, 2, 3		DLBWP.1.1
UL initial BWP configuration	Config 1, 2, 3		ULBWP.0.1
UL dedicated BWP configuration	Config 1, 2, 3		ULBWP.1.1
RMSI CORESET Reference Channel	Config 1		CR.1.1 FDD
	Config 2		CR.1.1 TDD
	Config 3		CR.2.1 TDD
Dedicated CORESET Reference Channel	Config 1		CCR.1.3 FDD
	Config 2		CCR.1.3 TDD
	Config 3		CCR.2.2 TDD
SSB Configuration	Config 1		SSB.1 FR1
	Config 2		SSB.1 FR1
	Config 3		SSB.2 FR1
SMTTC Configuration	Config 1, 2		SMTTC.1
	Config 3		SMTTC.1
PDSCH/PDCCH subcarrier spacing	Config 1, 2		15 kHz
	Config 3		30 kHz
TRS configuration	Config 1		TRS.1.1 FDD
	Config 2		TRS.1.1 TDD
	Config 3		TRS.1.2 TDD
CSI-RS for RLM	Config 1		Resource #4 in TRS.1.1 FDD
	Config 2		Resource #4 in TRS.1.1 TDD
	Config 3		Resource #4 in TRS.1.2 TDD
TCI configuration for PDCCH/PDSCH			TCI.State.2
OCNG parameters			OP.1
CP length			Normal
Correlation Matrix and Antenna Configuration			2x2 Low
Out of sync transmission parameters	DCI format		1-0
	Number of Control OFDM symbols		2
	Aggregation level	CCE	8
	Ratio of hypothetical PDCCH RE energy to average CSI-RS RE energy	dB	4
	Ratio of hypothetical PDCCH DMRS energy to average CSI-RS RE energy	dB	4
	DMRS precoder granularity		REG bundle size
REG bundle size			6
DRX			DRX.3
Gap pattern ID			N.A.
Layer 3 filtering			<i>Enabled</i>
T310 timer		ms	0
T311 timer		ms	1000
N310			1
N311			1
CSI-RS configuration for CSI reporting	Config 1		CSI-RS.1.1 FDD
	Config 2		CSI-RS.1.1 TDD
	Config 3		CSI-RS.2.1 TDD
T1		s	0.2
T2		s	1.28
T3		s	1.28

D1	s	1.24
Note 1: UE-specific PDCCH is not transmitted after T1 starts.		

6.5.1.7.4.2 Test procedure

Prior to the start of the time duration T1, the UE shall be fully synchronized to Cell 1. The UE shall be configured for periodic CSI reporting with a reporting periodicity of 5ms. In the test, DRX configuration is enabled in PCell and DRX inactivity timer has already been expired, i.e. UE tries to decode PDCCH and to send periodic CQI during the period when On-duration timer is running. Time alignment timers shall be set to “infinity” so that UL timing alignment is maintained during the test.

1. Ensure the UE is in state RRC\_CONNECTED with generic procedure parameters Connectivity NR, Connected without release *On* and Test Mode *On* according to TS 38.508-1 [14] clause 4.5. Establish SRB2 and DRB in the RRC Reconfiguration message.
2. Set the parameters of Cell 1 according to T1 in Table 6.5.1.7.5-1. Propagation conditions are set according to Annex C.2.3. T1 starts.
3. When T1 expires the SS shall change the SNR value to T2 as specified in Table 6.5.1.7.5-1. T2 starts.
4. When T2 expires the SS shall change the SNR value to T3 as specified in Table 6.5.1.7.5-1. T3 starts.
5. If the SS:
  - a) detects uplink power equal to or higher than minimum output power defined in TS 38.521-1 [17] clause 6.3.1.5 in the On-duration part of every DRX cycle in the slots configured for CSI transmission (according CSI reporting on PUCCH) during the period from time point A to time point B

and

  - b) does not detect any uplink power higher than OFF power defined in TS 38.521-1 [17] clause 6.3.2.5 from time point C (D1 after the start of T3) until T3 expires,

the number of successful tests is increased by one.

Otherwise the number of failed tests is increased by one.
6. When T3 expires the SS shall change the SNR value to T1 as specified in Table 6.5.1.7.5-1.
7. If the UE has not re-established the connection in at least 1s, the UE is switched off and then on. Ensure the UE is in state RRC\_CONNECTED with generic procedure parameters Connectivity NR, Connected without release *On* according to TS 38.508-1 [14] clause 4.5.
8. Repeat steps 2-7 until the confidence level according to Tables G.2.3-1 in Annex G clause G.2 is achieved.

6.5.1.7.4.3 Message contents

Message contents are according to TS 38.508-1 [14] clause 4.6 and 7.3.1 with the following exceptions:

**Table 6.5.1.7.4.3-1: Common Exception messages for NR SA FR1 radio link monitoring out-of-sync test for PCell configured with CSI-RS-based RLM RS in DRX mode**

Default Message Contents	
Common contents of system information blocks exceptions	
Default RRC messages and information elements contents exceptions	Table H.3.1-9 Table H.3.5-4 Table H.3.5-9 with Condition CSI-RS RLM Table H.3.7-1 with condition DRX.3

Table 6.5.1.7.4.3-2 *SIB1*

Derivation Path: TS 38.508-1 [14], Table 4.6.1-28			
Information Element	Value/remark	Comment	Condition
SIB1 ::= SEQUENCE {			
cellSelectionInfoSEQUENCE {			
q-RxLevMin	-46	-92 is actual value in dBm (-46 * 2 dBm)	dBm/15kHz or dBm/30kHz
}			
}			

Table 6.5.1.7.4.3-3: RLF-TimersAndConstant

Derivation Path: TS 38.508-1 [14], Table 4.6.3-150			
Information Element	Value/remark	Comment	Condition
RLF-TimersAndConstants ::= SEQUENCE {			
t310	ms0		
}			

#### 6.5.1.7.5 Test requirement

Tables 6.5.1.7.4.1-3 and 6.5.1.7.5-1 define the primary level settings including test tolerances for Radio Link Monitoring Out-of-sync Test for FR1 PCell configured with CSI-RS-based RLM in DRX mode.

**Table 6.5.1.7.5-1: Cell specific test parameters for FR1 for NR SA FR1 radio link monitoring out-of-sync test for PCell configured with CSI-RS-based RLM RS in DRX mode**

Parameter		Unit	Test 1		
			T1	T2	T3
EPRE ratio of PDCCH DMRS to SSS		dB	4		
EPRE ratio of PDCCH to PDCCH DMRS			0		
EPRE ratio of PBCH DMRS to SSS					
EPRE ratio of PBCH to PBCH DMRS					
EPRE ratio of PBCH to PBCH DMRS					
EPRE ratio of PDSCH DMRS to SSS					
EPRE ratio of PDSCH to PDSCH DMRS					
EPRE ratio of OCNB DMRS to SSS					
EPRE ratio of OCNB to OCNB DMRS					
SNR on RLM-RS	Config 1	dB	1.8	-6.2	-15.8
	Config 2		1.8	-6.2	-15.8
	Config 3		1.8	-6.2	-15.8
$N_{oc}$	Config 1	dBm/15kHz	-98		
	Config 2		-98		
	Config 3		-98		
Propagation condition			TDL-C 300ns 100Hz		
<p>Note 1: OCNB shall be used such that the resources in Cell 1 are fully allocated and a constant total transmitted power spectral density is achieved for all OFDM symbols.</p> <p>Note 2: The uplink resources for CSI reporting are assigned to the UE prior to the start of time period T1.</p> <p>Note 3: NZP CSI-RS resource set configuration for CSI reporting are assigned to the UE prior to the start of time period T1.</p> <p>Note 4: Measurement gap configuration is assigned to the UE prior to the start of time period T1.</p> <p>Note 5: The timers and layer 3 filtering related parameters are configured prior to the start of time period T1.</p> <p>Note 6: The signal contains PDCCH for UEs other than the device under test as part of OCNB.</p> <p>Note 7: SNR levels correspond to the signal to noise ratio over the SSS REs.</p> <p>Note 8: The SNR in time periods T1, T2 and T3 is denoted as SNR1, SNR2 and SNR3 respectively in figure A.6.5.1.7.1-1.</p> <p>Note 9: The SNR values are specified for testing a UE which supports 2RX on at least one band. For testing of a UE which supports 4RX on all bands, the SNR during T3 from D.4.1.1 is -18 -TT, which is -18.8dB (including test tolerances).</p>					

The UE behaviour in each test during time durations T1, T2 and T3 shall be as follows:

During time durations T1, T2 and T3, the UE shall transmit uplink signal at least in all subframes configured for CSI transmission on PCell.

During the period from time point A to time point B the UE shall transmit uplink signal in Cell 1 (PCell) at least in all uplink slots configured for CSI transmission according to the configured periodic CSI reporting for Cell 1.

The UE shall stop transmitting uplink signal in Cell 1 (PCell) no later than time point C ( $D_1$  ms after the start of the time duration T3) on the PCell.

The rate of correct events observed during repeated tests shall be at least 90% with a confidence level of 95%.



### 6.5.1.8 NR SA FR1 radio link monitoring in-sync test for PCell configured with CSI-RS-based RLM RS in DRX mode

#### 6.5.1.8.1 Test purpose

The purpose of this test is to verify that the UE properly detects the in sync for the purpose of monitoring downlink CSI-RS based radio link quality of the PCell when DRX is used. This test will partly verify the FR1 PCell CSI-RS in-sync radio link monitoring requirements in TS 38.133 [6] clause 8.1.

#### 6.5.1.8.2 Test applicability

This test applies to all types of NR UE release 15 and forward supporting 5GS NR SA FR1, CSI-RS based RLM and long DRX cycle.

#### 6.5.1.8.3 Minimum conformance requirements

The minimum conformance requirements are specified in clause 6.5.1.0.3.

The normative reference for this requirement is TS 38.133 [6] clause A.6.5.1.8.

#### 6.5.1.8.4 Test description

The test consists of five successive time periods, with time duration of T1, T2, T3, T4 and T5 respectively. Figure 6.5.1.8.4-1 shows the five different time durations and the corresponding variation of the downlink SNR in the active cell to emulate in-sync states.

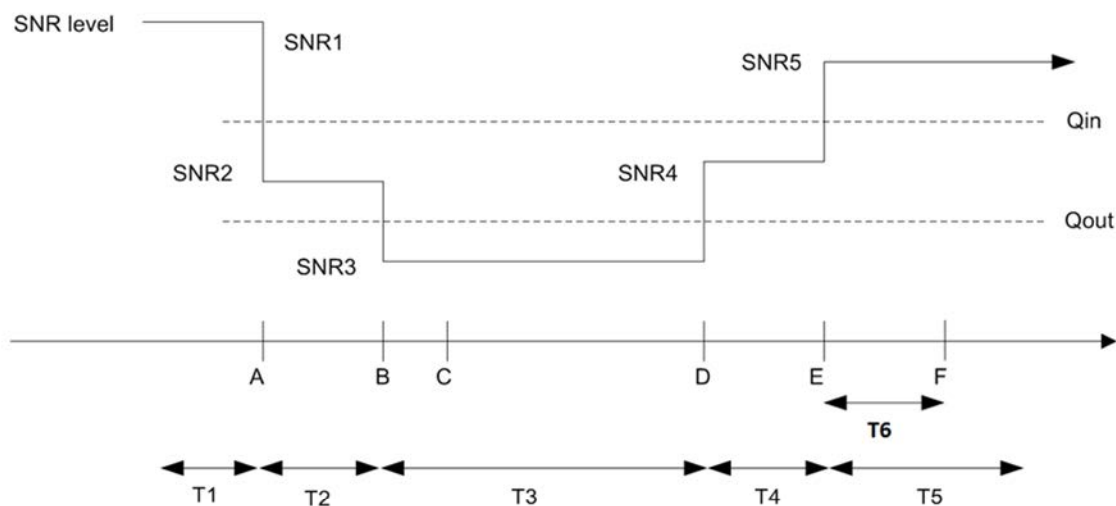

Figure 6.5.1.8.4-1: SNR variation for In-sync testing

#### 6.5.1.8.4.1 Initial conditions

This test shall be run in one of the configurations defined in Table 6.5.1.8.4.1-1.

**Table 6.5.1.8.4.1-1: Supported test configurations for NR SA FR1 radio link monitoring in-sync test for PCell configured with CSI-RS-based RLM RS in DRX mode**

Configuration	Description
6.5.1.8-1	FDD duplex mode, 15 kHz SSB SCS, 10MHz bandwidth
6.5.1.8-2	TDD duplex mode, 15 kHz SSB SCS, 10MHz bandwidth
6.5.1.8-3	TDD duplex mode, 30 kHz SSB SCS, 40MHz bandwidth
Note:	The UE is only required to pass in one of the supported test configurations in FR1

Configure the test equipment and the DUT according to the parameters in Table 6.5.1.8.4.1-2.

**Table 6.5.1.8.4.1-2: Initial conditions for NR SA FR1 radio link monitoring in-sync test for PCell configured with CSI-RS-based RLM RS in DRX mode**

Parameter	Value		Comment
Test environment	NC		As specified in TS 38.508-1 [14] clause 4.1.
Test frequencies	As specified in Annex E, Table E.4-1 and TS 38.508-1 [14] clause 4.3.1.		
Channel bandwidth	As specified by the test configuration selected from Table 6.5.1.8.4.1-1.		
Propagation conditions	AWGN		As specified in Annex C.2.2
Connection Diagram	TE Part	A.3.1.7.1	As specified in TS 38.508-1 [14] Annex A.
	DUT Part	A.3.2.3.4	
Exceptions to connection diagram	For 4Rx capable UEs without any 2 Rx RF bands use A.3.2.5.2 for DUT part and A.3.1.7.4 for TE Part		

1. The general test parameter settings are set up according to Table 6.5.1.8.4.1-3. The measurement gap configuration for subtest 2 is according to Table 6.5.1.8.4.1-4.
2. Message contents are defined in clause 6.5.1.8.4.3.
3. There are one cell in the test, where Cell 1 is the NR PCell on the NR carrier. Cell 1 is the cell used for connection setup with the power level set according to Table A.6.1.1-1 for this test. Cell 1 is configured according to Annex C.1.2 and C.1.3.

**Table 6.5.1.8.4.1-3: General test parameters for NR SA FR1 radio link monitoring in-sync test for PCell configured with CSI-RS-based RLM RS in DRX mode**

Parameter		Unit	Value
			Test 1
Active PCell			Cell 1
RF Channel Number			1
Duplex mode	Config 1		FDD
	Config 2, 3		TDD
TDD Configuration	Config 1		Not Applicable
	Config 2		TDDConf.1.1
	Config 3		TDDConf.2.1
DL initial BWP configuration	Config 1, 2, 3		DLBWP.0.1
DL dedicated BWP configuration	Config 1, 2, 3		DLBWP.1.1
UL initial BWP configuration	Config 1, 2, 3		ULBWP.0.1
UL dedicated BWP configuration	Config 1, 2, 3		ULBWP.1.1
RMSI CORESET Reference Channel	Config 1		CR.1.1 FDD
	Config 2		CR.1.1 TDD
	Config 3		CR.2.1 TDD
Dedicated CORESET Reference Channel	Config 1		CCR.1.1 FDD
	Config 2		CCR.1.1 TDD
	Config 3		CCR.2.1 TDD
SSB Configuration	Config 1		SSB.1 FR1
	Config 2		SSB.1 FR1
	Config 3		SSB.2 FR1
SMTC Configuration	Config 1, 2		SMTC.1
	Config 3		SMTC.1
PDSCH/PDCCH subcarrier spacing	Config 1, 2		15 kHz
	Config 3		30 kHz
TRS configuration	Config 1		TRS.1.1 FDD
	Config 2		TRS.1.1 TDD
	Config 3		TRS.1.2 TDD
CSI-RS for RLM	Config 1		Resource #4 in TRS.1.1 FDD
	Config 2		Resource #4 in TRS.1.1 TDD
	Config 3		Resource #4 in TRS.1.2 TDD
TCI configuration for PDCCH/PDSCH			TCI.State.2
OCNG parameters			OP.1
CP length			Normal
Correlation Matrix and Antenna Configuration			2x2 Low
Out of sync transmission parameters	DCI format		1-0
	Number of Control OFDM symbols		2
	Aggregation level	CCE	8
	Ratio of hypothetical PDCCH RE energy to average CSI-RS RE energy	dB	4
	Ratio of hypothetical PDCCH DMRS energy to average CSI-RS RE energy	dB	4
	DMRS precoder granularity		REG bundle size
	REG bundle size		6
In sync transmission parameters	DCI format		1-0
	Number of Control OFDM symbols		2
	Aggregation level	CCE	4
	Ratio of hypothetical PDCCH RE energy to average CSI-RS RE energy	dB	0
	Ratio of hypothetical PDCCH DMRS energy to average CSI-RS RE energy	dB	0
	DMRS precoder granularity		REG bundle size
	REG bundle size		6

DRX		DRX.3
Gap pattern ID		<i>gp0</i>
Layer 3 filtering		<i>Enabled</i>
T310 timer	ms	2000
T311 timer	ms	1000
N310		1
N311		1
CSI-RS configuration for CSI reporting	Config 1	CSI-RS.1.1 FDD
	Config 2	CSI-RS.1.1 TDD
	Config 3	CSI-RS.2.1 TDD
T1	s	0.2
T2	s	0.2
T3	s	1.24
T4		0.2
T5		1.88
T6	s	1.84
Note 1: UE-specific PDCCH is not transmitted after T1 starts.		

**Table 6.5.1.8.4.1-4: Measurement gap configuration for NR SA FR1 radio link monitoring in-sync test for PCell configured with CSI-RS-based RLM RS in DRX mode**

Field	Test 1
	Value
gapOffset	0
Note 1: Void	

#### 6.5.1.8.4.2 Test procedure

Prior to the start of the time duration T1, the UE shall be fully synchronized to Cell 1. The UE shall be configured for periodic CSI reporting with a reporting periodicity of 5ms. In the test, DRX configuration is enabled in PCell and DRX inactivity timer has already been expired, i.e. UE tries to decode PDCCH and to send periodic CQI during the period when On-duration timer is running. Time alignment timers shall be set to “infinity” so that UL timing alignment is maintained during the test. The UE is configured to perform inter-frequency measurements using GP ID #0 (40ms).

1. Ensure the UE is in state RRC\_CONNECTED with generic procedure parameters Connectivity NR, Connected without release *On* and Test Mode *On* according to TS 38.508-1 [14] clause 4.5.
2. The SS shall transmit an RRCReconfiguration message configuring the UE for inter-frequency measurements.
3. The UE shall transmit RRCReconfigurationComplete message.
4. Set the parameters of Cell 1 according to T1 in Table 6.5.1.8.5-1. Propagation conditions are set according to Annex C.2.3. T1 starts.
5. When T1 expires the SS shall change the SNR value to T2 as specified in Table 6.5.1.8.5-1. T2 starts.
6. When T2 expires the SS shall change the SNR value to T3 as specified in Table 6.5.1.8.5-1. T3 starts.
7. When T3 expires the SS shall change the SNR value to T4 as specified in Table 6.5.1.8.5-1. T4 starts.
8. When T4 expires the SS shall change the SNR value to T5 as specified in Table 6.5.1.8.5-1. T5 starts.
9. If the SS detects uplink power equal to or higher than minimum output power defined in TS 38.521-1 [17] clause 6.3.1.5 in the On-duration part of every DRX cycle in the configured slots for CSI transmission (according CSI reporting on PUCCH) during the period from time point A to time point F (T6 after the start of time duration T5) the number of successful tests is increased by one.

Otherwise the number of failed tests is increased by one.

10. If the UE has not re-established the connection in at least 1s, the UE is switched off and then on. Ensure the UE is in state RRC\_CONNECTED with generic procedure parameters Connectivity NR, Connected without release *On* according to TS 38.508-1 [14] clause 4.5.

11. Repeat steps 4-10 for both subtests until the confidence level according to Tables G.2.3-1 in Annex G clause G.2 is achieved.

6.5.1.8.4.3 Message contents

Message contents are according to TS 38.508-1 [14] clause 4.6 and 7.3.1 with the following exceptions:

**Table 6.5.1.8.4.3-1: Common Exception messages for NR SA FR1 radio link monitoring in-sync test for PCell configured with CSI-RS-based RLM RS in DRX mode**

Default Message Contents	
Common contents of system information blocks exceptions	
Default RRC messages and information elements contents exceptions	Table H.3.1-1 Table H.3.1-2 with Condition INTER-FREQ, L3 FILTERING NEEDED, GAP_NEEDED Table H.3.1-3 with Condition INTER-FREQ MO (where ssbFrequency is set to the ARFCN value of carrier center of High range) Table H.3.1-4 with A3-offset = 0 Table H.3.5-4 Table H.3.5-9 with Condition CSI-RS RLM Table H.3.7-1 with condition DRX.3 and Gap

**Table 6.5.1.8.4.3-2: RLF-TimersAndConstant**

Derivation Path: TS 38.508-1 [14], Table 4.6.3-150			
Information Element	Value/remark	Comment	Condition
RLF-TimersAndConstants ::= SEQUENCE {			
t310	ms2000		
}			

6.5.1.8.5 Test requirement

Tables 6.5.1.8.4.1-3 and 6.5.1.8.5-1 define the primary level settings including test tolerances for Radio Link Monitoring In-sync Test for FR1 PCell configured with CSI-RS-based RLM in DRX mode.

**Table 6.5.1.8.5-1: Cell specific test parameters for NR SA FR1 radio link monitoring in-sync test for PCell configured with CSI-RS-based RLM RS in DRX mode**

Parameter		Unit	Test 1				
			T1	T2	T3	T4	T5
EPRE ratio of PDCCH DMRS to SSS		dB	4				
EPRE ratio of PDCCH to PDCCH DMRS		dB	0				
EPRE ratio of PBCH DMRS to SSS		dB					
EPRE ratio of PBCH to PBCH DMRS		dB					
EPRE ratio of PBCH to PBCH DMRS		dB					
EPRE ratio of PDSCH DMRS to SSS		dB					
EPRE ratio of PDSCH to PDSCH DMRS		dB					
EPRE ratio of OCNG DMRS to SSS		dB					
EPRE ratio of OCNG to OCNG DMRS		dB					
SNR on RLM-RS	Config 1	dB					
	Config 2		1.8	-6.2	-15.8	-5.3	1.8
	Config 3		1.8	-6.2	-15.8	-5.3	1.8
$N_{oc}$	Config 1	dBm/15kHz	-98				
	Config 2		-98				
	Config 3		-98				
Propagation condition			TDL-C 300ns 100Hz				
<p>Note 1: OCNG shall be used such that the resources in Cell 1 are fully allocated and a constant total transmitted power spectral density is achieved for all OFDM symbols.</p> <p>Note 2: The uplink resources for CSI reporting are assigned to the UE prior to the start of time period T1.</p> <p>Note 3: NZP CSI-RS resource set configuration for CSI reporting are assigned to the UE prior to the start of time period T1.</p> <p>Note 4: Measurement gap configuration is assigned to the UE prior to the start of time period T1.</p> <p>Note 5: The timers and layer 3 filtering related parameters are configured prior to the start of time period T1..</p> <p>Note 6: The signal contains PDCCH for UEs other than the device under test as part of OCNG.</p> <p>Note 7: SNR levels correspond to the signal to noise ratio over the SSS REs.</p> <p>Note 8: The SNR in time periods T1, T2, T3, T4 and T5 is denoted as SNR1, SNR2, SNR3, SNR4 and SNR5 respectively in figure 6.5.1.8.4-1.</p> <p>Note 9: The SNR values are specified for testing a UE which supports 2RX on at least one band. For testing of a UE which supports 4RX on all bands, the SNR during T3 and T4 from D.4.1.1 are -18.0-TT and -8.0-TT, which are -18.8dB and -8.8dB(including test tolerances)</p>							

The UE behaviour in each test during time durations T1, T2, T3, T4 and T5 shall be as follows:

During the period from time point A to time point F (T6 second after the start of time duration T5) the UE shall transmit uplink signal at least in all uplink slots configured for CSI transmission according to the configured periodic CSI reporting on the PCell.

The rate of correct events observed during repeated tests shall be at least 90% with a confidence level of 95%.

## 6.5.2 Interruption

### 6.5.2.0 Minimum conformance requirements

#### 6.5.2.0.1 Minimum conformance requirements for interruptions during measurements on deactivated NR SCC

Interruptions on PCell due to measurements when an SCell is deactivated are allowed with up to 0.5% probability of missed ACK/NACK when the configured *measCycleSCell* [13] is 640 ms or longer.

If the PCell is not in the same band as the deactivated SCell, the UE is only allowed to cause interruptions on PCell immediately before and immediately after an SMTC. Each interruption shall not exceed requirement in Table 6.5.2.0.1-1

If the PCell is in the same band as the deactivated SCell, the UE is only allowed to cause an interruption on PCell no earlier than X slots before  $T_{SMTC\_duration}$  and no later than X slots after  $T_{SMTC\_duration}$ , provided the cell specific reference signals from the active serving cells and the deactivated SCell are available in the same slot, where X and  $T_{SMTC\_duration}$  are given by Table 6.5.2.0.1-2. The interruption shall not exceed requirements in Table 6.5.2.0.1-2.

Interruptions on active SCells due to measurements when an SCell is deactivated are allowed with up to 0.5% probability of missed ACK/NACK when the configured *measCycleSCell* [13] is 640 ms or longer.

If the activated SCell is not in the same band as the deactivated SCell, the UE is only allowed to cause interruptions on an activated SCell immediately before and immediately after an SMTC. Each interruption shall not exceed requirement in Table 6.5.2.0.1-1

If the activated SCell is in the same band as the deactivated SCell, the UE is only allowed to cause an interruption on the activated SCell no earlier than X slots before  $T_{SMTC\_duration}$  and no later than X slots after  $T_{SMTC\_duration}$ , provided the cell specific reference signals from the active serving cells and the deactivated SCell are available in the same slot, where X and  $T_{SMTC\_duration}$  are given by Table 6.5.2.0.1-2. The interruption shall not exceed requirements in Table 6.5.2.0.1-2.

**Table 6.5.2.0.1-1: Interruption duration for SCell activation/deactivation for inter-band CA**

$\mu$	NR Slot length (ms) of victim cell	Interruption length (slot)	
0	1		1
1	0.5		1
2	0.25	Both aggressor cell and victim cell are on FR2	2
		Either aggressor cell or victim cell is on FR1	3
3	0.125	Aggressor cell is on FR2	4
		Aggressor cell is on FR1	5

**Table 6.5.2.0.1-2: Interruption duration for SCell activation/deactivation for intra-band CA**

$\mu$	NR Slot length (ms)	X (slots)	Interruption length (slots)
0	1	1	$2 + T_{SMTC\_duration} * N_{slot}^{subframe,\mu}$
1	0.5	1	$2 + T_{SMTC\_duration} * N_{slot}^{subframe,\mu}$
2	0.25	2	$4 + T_{SMTC\_duration} * N_{slot}^{subframe,\mu}$
3	0.125	4	$8 + T_{SMTC\_duration} * N_{slot}^{subframe,\mu}$
NOTE 1: $T_{SMTC\_duration}$ measured in subframes is the longest SMTC duration among all above active serving cells and the deactivated SCell to be measured;			
NOTE 2: $N_{slot}^{subframe,\mu}$ is as defined in TS 38.211 [7].			

The normative reference for this requirement is TS 38.133 [6] clause 8.2.2.2.

**6.5.2.1 NR SA FR1 interruptions during measurements on deactivated NR SCC**

**6.5.2.1.1 Test purpose**

To verify UE’s ability to complete NR PCell interruptions during the measurement on the deactivated NR SCC within the missed ACK/NACK rate in standalone NR requirements.

**6.5.2.1.2 Test applicability**

This test applies to all types of NR UE release 15 and forward supporting 2DL CA.



### 6.5.2.1.3 Minimum conformance requirements

The minimum conformance requirements are defined in clause 6.5.2.0.1.

The normative reference for this requirement is TS 38.133 [6] clause A.6.5.2.1.

### 6.5.2.1.4 Test description

#### 6.5.2.1.4.1 Initial conditions

Test 6.5.2.1 can be run in one of the configurations defined in Table 6.5.2.1.4.1-1.

**Table 6.5.2.1.4.1-1: Supported test configurations**

Config	Description
6.5.2.1-1	NR 15 kHz SSB SCS, $\geq 10$ MHz bandwidth, FDD – FDD duplex mode
6.5.2.1-2	NR 15 kHz SSB SCS, $\geq 10$ MHz bandwidth, TDD – TDD duplex mode
6.5.2.1-3	NR 15 kHz SSB SCS, $\geq 10$ MHz bandwidth, TDD – FDD duplex mode
6.5.2.1-4	NR 15 kHz SSB SCS, $\geq 10$ MHz bandwidth, FDD – TDD duplex mode
6.5.2.1-5	NR 30 kHz SSB SCS, $\geq 40$ MHz bandwidth, TDD – TDD duplex mode
Note 1:	The UE is only required to be tested in one of the supported test configurations.
Note 2:	The UE is only required to be tested in one with smallest aggregated channel bandwidth from supported band combinations which is composed of CCs $\geq$ the bandwidth ( $BW_{\text{channel}}$ ) defined in each test configuration.

Configure the test equipment and the DUT according to the parameters in Table 6.5.2.1.4.1-2.

**Table 6.5.2.1.4.1-2: Initial conditions for NR SA FR1 interruptions during measurements on deactivated NR SCC**

Parameter	Value		Comment
Test environment	NC		As specified in TS 38.508-1 [14] clause 4.1.
Test frequencies	As specified in Annex E, table E.4-1 and TS 38.508-1 [14] clause 4.3.1 and 4.4.2.		
Channel bandwidth	As specified by the test configuration selected from Table 6.5.2.1.4.1-1.		
Propagation conditions	AWGN		As specified in Annex C.2.2.
Connection Diagram	TE Part	A.3.1.8.1	As specified in TS 38.508-1 [14] Annex A.
	DUT Part	A.3.2.3.4	
Exceptions to connection diagram	N/A		

1. The general test parameter settings are set up according to Table 6.5.2.1.4.1-3
2. Message contents are defined in clause 6.5.2.1.4.3.
3. There are two NR carriers and two cells specified in the test. Cell 1 is the PCell on one NR carrier, Cell 2 is the SCell on the other NR carrier. Cell 1 and Cell 2 shall be configured according to Annex C.1.1 and C.1.2.

**Table 6.5.2.1.4.1-3: General test parameters for NR SA FR1 interruptions during measurements on deactivated NR SCC**

Parameter	Unit	Value	Comment
RF Channel Number		1, 2	Two NR RF channels
Active PCell		Cell1	PCell on NR RF channel number 1.
Configured deactivated SCell		Cell2	Deactivated SCell on NR RF channel number 2.
CP length		Normal	Applicable to Cell1 and Cell 2
DRX		OFF	
Measurement gap pattern Id		OFF	
SCell measurement cycle (measCycleSCell)	ms	640	
T1	s	10	

#### 6.5.2.1.4.2 Test procedure

The test consists of two cells: Cell1 and Cell2. Cell1 is PCell and Cell2 is deactivated SCell. The test consists of one time period, with duration of T1. Prior to the start of the time duration T1, the UE shall be connected to Cell1 and Cell2 and the RRC message including *measCycleSCell* or *allowInterruptions* for the deactivated NR SCells is received at the UE antenna connector. Cell1 shall be configured as PCell and Cell2 shall be configured as SCell.. During T1, PCell is continuously scheduled in DL.

1. Ensure the UE is in state RRC\_CONNECTED with generic procedure parameters Connectivity NR, Connected without release On and Test Mode On according to TS 38.508-1 [14] clause 4.5.
2. The SS shall transmit an RRCReconfiguration message including measCycleSCell or allowInterruptions for the deactivated NR SCell.
3. The UE shall transmit RRCReconfigurationComplete message.
4. Set the parameters according to Table 6.5.2.1.5-1. Propagation conditions are set according to Annex C.2.1. T1 starts.
5. SS schedules on PCell continuously and UE shall start sending ACK/NACK reports. The SS shall monitor ACK/NACK/DTX on PCell.
6. If more than 99.5% of uplink transmissions are received by SS then count a success for the event "ACK/NACK". Otherwise count a fail for the event "ACK/NACK".
7. If no longer than X consecutive DTX is observed by the SS, then count a success for the event "DTX". Otherwise count a fail for the event "DTX". Where
  - For test configuration 6.5.2.1-1 and 6.5.2.1-4,
    - $X = \text{interruption length} + k_1$  if  $k_1 \leq \text{interruption length}$
    - $X = \text{interruption length}$  if  $k_1 > \text{interruption length}$
 Note: UE expects that the SS won't use  $k_1 = 3$  for test configuration 4.5.2.3-1 and 4.5.2.3-4.
  - For test configuration 6.5.2.1-2, 6.5.2.1-3 and 6.5.2.1-5,
    - $X = \text{interruption length}$ .
  - interruption length is given in table 6.5.2.1.5-2 for inter-band case and in 6.5.2.1.5-3 for intra-band case.
8. After the RRC connection release, the SS:
  - transmits in Cell 1 a Paging message (including PagingRecord with UE-Identity) for the UE and ensures the UE is in state RRC\_CONNECTED TS 38.508-1 [14] clause 4.5. (if the paging fails, switches off and on the UE and ensures the UE is in state RRC\_CONNECTED TS 38.508-1 [14] clause 4.5),

or

- switches off and on the UE and ensures the UE is in state RRC\_CONNECTED with generic procedure parameters Connectivity NR, Connected without release On according to TS 38.508-1 [14] clause 4.5.

9. Repeat step 2-8 until a test verdict has been achieved.

Each of the events "ACK/NACK" and "DTX" is evaluated independently for the statistic, resulting in an event verdict: pass or fail. Each event is evaluated only until the confidence level according to Table G.2.3-1 in Annex G.2 is achieved. Different events may require different times for a verdict.

If all events pass, the test passes. If one event fails, the test fails.

6.5.2.1.4.3 Message contents

Message contents are according to TS 38.508-1 [14] clause 7.3 with the following exceptions:

**Table 6.5.2.1.4.3-1: Common Exception messages**

Default Message Contents	
Common contents of system information blocks exceptions	
Default RRC messages and information elements contents exceptions	Table H.3.1-2 with Condition Deactivated SCell; Table H.3.1-4 with A3-offset = 15
Specific message contents exceptions for Test Configuration 6.5.2.1-1, 6.5.2.1-2, 6.5.2.1-3 and 6.5.2.1-4	Table H.3.1-3 with Condition Deactivated SCell and SSB.1 FR1 Table 7.3.1-3 in TS 38.508-1 [14] with condition SMTC.1
Specific message contents exceptions for Test Configuration 6.5.2.1-5	Table H.3.1-3 with Condition Deactivated SCell and SSB.2 FR1 Table 7.3.1-3 in TS 38.508-1 [14] with condition SMTC.1

**Table 6.5.2.1.4.3-2: ServingCellConfig (Cell 2)**

Derivation Path: TS 38.508-1 [14], Table 4.6.3-167 with condition MEAS			
Information Element	Value/remark	Comment	Condition
ServingCellConfig ::= SEQUENCE {			
servingCellMO	2	MeasObjectId for SCell in Table H.3.1-2	
}			

6.5.2.1.5 Test requirement

Table 6.5.2.1.5-1 defines the primary level settings including test tolerances for NR SA FR1 interruptions during measurements on deactivated NR SCC.

**Table 6.5.2.1.5-1: NR cell specific test parameters for NR SA FR1 interruptions during measurements on deactivated NR SCC**

Parameter		Unit	Cell1	Cell2
Frequency Range			FR1	FR1
Duplex mode	Config 1		FDD	FDD
	Config 2,5		TDD	TDD
	Config 3		TDD	FDD
	Config 4		FDD	TDD
TDD configuration	Config 1		Not Applicable	Not Applicable
	Config 2		TDDConf.1.1	TDDConf.1.1
	Config 3		TDDConf.1.1	Not Applicable
	Config 4		Not Applicable	TDDConf.1.1
	Config 5		TDDConf.2.1	TDDConf.2.1
BW <sub>channel</sub>	Config 1,2,3,4		Note 9	Note 9
	Config 5		Note 9	Note 9
BW <sub>occupied</sub>	Config 1,2,3,4	RB	52 <sup>Note 7</sup>	52 <sup>Note 7</sup>
	Config 5		106 <sup>Note 8</sup>	106 <sup>Note 8</sup>
Initial DL BWP Configuration	Config 1,2,3,4		DLBWP.0.1	DLBWP.0.1
	Config 5		DLBWP.0.1	DLBWP.0.1
Dedicated DL BWP Configuration	Config 1,2,3,4		DLBWP.1.1	DLBWP.1.1
	Config 5		DLBWP.1.1	DLBWP.1.1
Initial UL BWP Configuration	Config 1,2,3,4		ULBWP.0.1	
	Config 5		ULBWP.0.1	
Dedicated UL BWP Configuration	Config 1,2,3,4		ULBWP.1.1	
	Config 5		ULBWP.1.1	
PDSCH Reference measurement channel	Config 1		SR.1.1 FDD	SR.1.1 FDD
	Config 2		SR.1.2 TDD	SR.1.2 TDD
	Config 3		SR.1.2 TDD	SR.1.1 FDD
	Config 4		SR.1.1 FDD	SR.1.2 TDD
	Config 5		SR.2.1 TDD	SR.2.1 TDD
RMSI CORESET parameters	Config 1		CR.1.1 FDD	CR.1.1 FDD
	Config 2		CR.1.1 TDD	CR.1.1 TDD
	Config 3		CR.1.1 TDD	CR.1.1 FDD
	Config 4		CR.1.1 FDD	CR.1.1 TDD
	Config 5		CR.2.1 TDD	CR.2.1 TDD
Dedicated CORESET parameters	Config 1		CCR.1.1 FDD	CCR.1.1 FDD
	Config 2		CCR.1.1 TDD	CCR.1.1 TDD
	Config 3		CCR.1.1 TDD	CCR.1.1 FDD
	Config 4		CCR.1.1 FDD	CCR.1.1 TDD
	Config 5		CCR.2.1 TDD	CCR.2.1 TDD
OCNG Patterns	Config 1,2,3,4		OP.1 <sup>Note 7</sup>	OP.1 <sup>Note 7</sup>
	Config 5		OP.1 <sup>Note 8</sup>	OP.1 <sup>Note 8</sup>
SMTc Configuration			SMTc.1	SMTc.4
SSB Configuration	Config 1,2,3,4		SSB.1 FR1	SSB.5 FR1
	Config 5		SSB.2 FR1	SSB.6 FR1
Correlation Matrix and Antenna Configuration			1x2 Low	1x2 Low
EPRE ratio of PSS to SSS		dB	0	0
EPRE ratio of PBCH DMRS to SSS				
EPRE ratio of PBCH to PBCH DMRS				
EPRE ratio of PDCCH DMRS to SSS				
EPRE ratio of PDCCH to PDCCH DMRS				
EPRE ratio of PDSCH DMRS to SSS				
EPRE ratio of PDSCH to PDSCH				
EPRE ratio of OCNG DMRS to SSS(Note 1)				
EPRE ratio of OCNG to OCNG DMRS (Note 1)				
N <sub>oc</sub> <sup>Note 2</sup>		dBm/15 kHz	-104	-104
SS-RSRP <sup>Note 3</sup>		dBm/15 kHz	-87	-87
$\hat{E}_s/I_{ot}$		dB	17	17
$\hat{E}_s/N_{oc}$		dB	17	17
N <sub>oc</sub> <sup>Note 2</sup>	Config 1,2,3,4	dBm/SCS	-104	-104
	Config 5		-101	-101
I <sub>o</sub> <sup>Note 3</sup>	Config 1,2,3,4	dBm/9.36MHz	-58.96	-58.96

	Config 5	dBm/ 38.16MHz	-52.86	-52.86
Time offset to Cell1 <sup>Note 5</sup>		$\mu$ s	-	3
Propagation Condition			AWGN	AWGN
Note 1:	OCNG shall be used such that both cells are fully allocated and a constant total transmitted power spectral density is achieved for all OFDM symbols.			
Note 2:	Interference from other cells and noise sources not specified in the test is assumed to be constant over subcarriers and time and shall be modelled as AWGN of appropriate power for $N_{oc}$ to be fulfilled within $BW_{occupied}$ .			
Note 3:	SS-RSRP and $l_0$ levels have been derived from other parameters for information purposes. They are not settable parameters themselves.			
Note 4:	Void			
Note 5:	Receive time difference between slot boundaries of signals received from the two cells at the UE antenna connector including time alignment error between the two cells.			
Note 6:	For unpaired spectrum, a DL BWP is linked with an UL BWP. DLBWP.0.2 is linked with ULBWP.0.2 defined in clause 12 of TS 38.213 [8].			
Note 7:	All UL/DL transmission shall be confined within $BW_{occupied}$ (i.e. 10 MHz, 52 RBs) from $F_{C,low}$ , and $l_0$ is independent of the $BW_{channel}$ configured.			
Note 8:	All UL/DL transmission shall be confined within $BW_{occupied}$ (i.e. 40 MHz, 106 RBs) from $F_{C,low}$ , and $l_0$ is independent of the $BW_{channel}$ configured.			
Note 9:	$N_{RB,C}$ is derived from Table 5.3.2-1 in TS38.101-1[2] with configured $BW_{channel}$ .			

The UE shall be continuously scheduled on PCell during the entire length of T1. During the time duration T1 the UE shall transmit at least 99.5% of ACK/NACK on PCell.

If the NR PCell is not in the same band as the deactivated SCell, the UE is only allowed to cause interruptions on NR PCell immediately before and immediately after an SMTC. Each interruption on NR PCell shall not exceed the value defined in Table 6.5.2.1.5-2.

If the NR PCell is in the same band as the deactivated SCell, the UE is only allowed to cause an interruption on PCell no earlier than 1 slot before an SMTC and no later than 1 slot after the SMTC. the interruption on NR PCell shall not exceed the value defined in Table 6.5.2.1.5-3.

**Table 6.5.2.1.5-2: Interruption duration if the PCell is not in the same band as the deactivated SCell**

$\mu$	NR Slot length (ms)	Interruption length
0	1	1
1	0.5	1

**Table 6.5.2.1.5-3: Interruption duration if the PCell is in the same band as the deactivated SCell**

$\mu$	NR Slot length (ms)	Interruption length
0	1	2 + SMTC duration
1	0.5	2 + SMTC duration

The rate of correct events observed during repeated tests shall be at least 90%.

### 6.5.3 SCell activation and deactivation delay

#### 6.5.3.0 Minimum conformance requirements

##### 6.5.3.0.1 Minimum conformance requirements for SCell activation and deactivation delay

Same as in clause 4.5.3.0.1.

### 6.5.3.1 NR SA FR1 SCell activation and deactivation of known SCell in non-DRX for 160ms SCell measurement cycle

#### 6.5.3.1.1 Test purpose

This test is to verify that the SCell activation and deactivation times are within the requirements in TS 38.133 [6] clause 8.3, when the SCell in FR1 is known by the UE at the time of activation.

#### 6.5.3.1.2 Test applicability

This test applies to all types of NR UE from Release 15 onwards and supporting 2DL CA.

#### 6.5.3.1.3 Minimum conformance requirements

The minimum conformance requirements are defined in clause 6.5.3.0.1.

The normative reference for this requirement is TS 38.133 [6] clause A.6.5.3.1.

#### 6.5.3.1.4 Test description

##### 6.5.3.1.4.1 Initial conditions

This test shall be tested using any of the test configurations in Table 6.5.3.1.4.1-1.

**Table 6.5.3.1.4.1-1: supported test configurations**

Test Case ID	Description
6.5.3.1-1	NR 15 kHz SSB SCS, $\geq 10$ MHz bandwidth, FDD duplex mode
6.5.3.1-2	NR 15 kHz SSB SCS, $\geq 10$ MHz bandwidth, TDD duplex mode
6.5.3.1-3	NR 30 kHz SSB SCS, $\geq 40$ MHz bandwidth, TDD duplex mode
Note 1:	The UE is only required to be tested in one of the supported test configurations.
Note 2:	The UE is only required to be tested in one with smallest aggregated channel bandwidth from supported band combinations which is composed of CCs $\geq$ the bandwidth ( $BW_{channel}$ ) defined in each test configuration.

Configure the test equipment and the DUT according to the parameters in Table 6.5.3.1.4.1-2 and Table 6.5.3.1.4.1-3.

**Table 6.5.3.1.4.1-2: Initial conditions for known FR1 SCell activation case**

Parameter	Value	Comment
Test environment	NC	As specified in TS 38.508-1 [14] clause 4.1.
Test frequencies	As specified in Annex E, Table E.4-1 and TS 38.508-1 [14] clause 4.3.1.	
Channel bandwidth	As specified by the test configuration selected from Table 6.5.3.1.5-1	
Propagation conditions	AWGN	As specified in Annex C.2.2.
Connection Diagram	TE Part	A.3.1.7.1
	DUT Part	A.3.2.3.1
Exceptions to connection diagram	<ul style="list-style-type: none"> <li>- Without LTE link</li> <li>- For 4Rx capable UEs without any 2Rx RF bands use A.3.2.5.2 for DUT part and A.3.1.8.4 for TE part.</li> </ul>	

**Table 6.5.3.1.4.1-3: General test parameters for known FR1 SCell activation case, 160ms SCell measurement cycle**

Parameter	Unit	Value	Comment
RF Channel Number		1,2	Two NR radio channel (1, 2) are used for this test
Active PCell		Cell 1	Primary cell on NR RF channel number 1.
Configured deactivated SCell		Cell 2	Configured deactivated secondary cell on NR RF channel number 2
CP length		Normal	
DRX		OFF	Continuous monitoring of primary cell
Cell-individual offset for cells on NR channel number	dB	0	Individual offset for cells on primary component carrier.
SCell measurement cycle (measCycleSCell)	ms	160	
Cell2 timing offset to cell1	μs	0	
Time alignment error between cell2 and cell1	μs	≤ Time alignment error as specified in TS 38.104 [13] clause 6.5.3.1.	The value of time alignment error depends upon the type of carrier aggregation.
T1	s	7	During this time the PCell shall be known and the SCell configured and detected.
T2	s	1	During this time the UE shall activate the SCell.
T3	s	1	During this time the UE shall deactivate the SCell.
T <sub>HARQ</sub>	ms	Config 1: 2 Config 2: 3 Config 3: 2.5	$k_1 \times \text{NR slot length}$  $k_1$ is a number of slots and is indicated by the PDSCH-to-HARQ-timing-indicator field in the DCI format, if present, or provided by <i>dl-DataToUL-ACK</i> , the value of $k$ should be the minimum value defined in TS 38.213 [8] that will meet the timing constraints of this test case.
T <sub>CSI_Reporting</sub>	ms	15	the delay (in ms) including uncertainty in acquiring the first available downlink CSI reference resource, UE processing time for CSI reporting (clause 5.2.2.5 in TS 38.214) and uncertainty in acquiring the first available CSI reporting resources as specified in TS 38.331 [13].

1. Message contents are defined in clause 6.5.3.1.4.3.

2. There are two NR carriers, each with one cell. Cell 1 is NR FR1 PCell and Cell 2 is the deactivated SCell. Cell 1 and Cell 2 are configured according to Annex C.1.2 and C.1.3.

#### 6.5.3.1.4.2 Test procedure

The test consists of three successive time periods, with duration of T1, T2 and T3, respectively. Before the test starts the UE is connected to Cell 1, but is not aware of Cell2. The UE is only monitoring the PCC. The UE shall be continuously scheduled in the PCell throughout the whole test.

The point in time at which the MAC message is received at the UE antenna connector, in slot # denoted  $n$ , defines the start of time period T2. The UE shall be able to report valid CSI in PCell for the activated SCell at latest in slot  $n + \frac{T_{\text{HARQ}} + T_{\text{activation\_time}} + T_{\text{CSI\_Reporting}}}{\text{NR slot length}}$ , as defined in TS 38.133 [6] clause 8.3. The UE shall start reporting CSI in PCell after at least one CSI-RS transmission occasion for channel measurement and reporting after slot  $n + \frac{T_{\text{HARQ}} + 3\text{ms}}{\text{NR slot length}}$  and shall report CQI index 0 (out-of-range) until the SCell activation has been completed. Any PCell interruption due to activation of SCell shall occur in the slot  $n + 1 + \frac{T_{\text{HARQ}}}{\text{NR slot length}}$  to  $n + 1 + \frac{T_{\text{HARQ}} + 3\text{ms} + T_X}{\text{NR slot length}} + N_{\text{interruption}}$ , as defined in TS 38.133 [6] clause 8.3, where  $N_{\text{interruption}}$  is the interruption length given in TS 38.133 [6] clause 8.2.



Time period T3 starts when a MAC message for deactivation of SCell, sent from the test equipment to the UE in a slot # denoted  $m$ , is received at the UE antenna connector. The UE shall carry out deactivation of the SCell in a slot  $m + \frac{T_{HARQ}+3ms}{NR\ slot\ length}$ , as defined in TS 38.133 [6] clause 8.3, and The starting point of any PCell interruption due to the deactivation shall occur in the slot  $m + 1 + \frac{T_{HARQ}}{NR\ slot\ length}$  to  $m + 1 + \frac{T_{HARQ}+3ms}{NR\ slot\ length}$ , as defined in TS 38.133 [6] clause 8.3.

1. Ensure the UE is in state RRC\_CONNECTED with generic procedure parameters Connectivity NR, Connected without release *On* and Test Mode *On* according to TS 38.508-1 [14] clause 4.5.
2. Set the parameters according to T1 in Tables 6.5.3.1.4.1-3 and 6.5.3.1.5-1. Propagation conditions are set according to Annex C clauses C.2.2..
3. T1 starts. Immediately after, the SS shall configure SCell (Cell 2) on the SCC as per TS 38.508-1 [14] clause 7.5.1 and provide measurement configurations.
- 3a. The UE sends a *MeasurementReport* message.
4. The SS shall configure transmission of PDSCH with a maximum number of 1 HARQ transmission.
5. The SS activates SCC by sending the activation MAC-CE (Refer TS 38.321 [12], clauses 5.9, 6.1.3.10) in a slot # denoted  $n$  and T2 starts in slot  $n$ . If the SS receives ACK for MAC-CE sent by the UE, the test proceeds to step 6, otherwise go to step 9.
6. After at least one CSI-RS transmission occasion for channel measurement, the UE shall start sending CSI reports for SCell and the SS shall monitor CSI reports for SCell sent from the UE and ACK/NACK sent in PCell according to the following criteria:
  - If the first CSI report for SCell is received by the SS no later than slot  $n + 1 + \frac{T_{HARQ}+3ms+T_{CSI\_Reporting}}{NR\ slot\ length}$ ,
  - or slot  $n + 1 + \frac{T_{HARQ}+3ms+T_{CSI\_Reporting}+T_X}{NR\ slot\ length} + N_{interruption} + 1$  if the slot  $n + 1 + \frac{T_{HARQ}+3ms+T_{CSI\_Reporting}}{NR\ slot\ length}$  was subject to interruption,
  - and CSI report with non-zero CQI index is received by the SS earlier than or equal to slot  $n + \frac{T_{HARQ}+T_{activation\_time}+T_{CSI\_Reporting}}{NR\ slot\ length}$ ,
  - or the next available uplink resource if there are no uplink resources for reporting the valid CSI in a slot  $n + \frac{T_{HARQ}+T_{activation\_time}+T_{CSI\_Reporting}}{NR\ slot\ length}$
  - and DTX is not observed by the SS outside the slot  $n + 1 + \frac{T_{HARQ}}{NR\ slot\ length}$  to  $n + 1 + \frac{T_{HARQ}+3ms+T_X}{NR\ slot\ length} + N_{interruption} + \frac{T_{HARQ}}{NR\ slot\ length}$  up to the end of T2
  - Then the number of successes for the event “Activation” is increased by one. Otherwise, count a fail for the event “Activation” and go to step 9.
7. When T2 expires, the SS deactivate SCC by sending the deactivation MAC-CE (Refer TS 38.321 [12], clauses 5.9, 6.1.3.10) in a slot # denoted  $m$  and T3 starts in slot  $m$ . If the SS receives ACK for MAC-CE sent by the UE, the test proceeds to step 8, otherwise go to step 9.
8. The UE shall stop sending CSI reports for SCell and the SS shall monitor CSI reports for SCell sent from the UE and ACK/NACK sent in PCell during SCell deactivation.
  - If the last CSI report is received by the SS earlier than or equal to slot  $m + \frac{T_{HARQ}+3ms}{NR\ slot\ length}$
  - and DTX is not observed by the SS outside the slot  $m + 1 + \frac{T_{HARQ}}{NR\ slot\ length}$  to  $m + 1 + \frac{T_{HARQ}+3ms}{NR\ slot\ length} + N_{interruption} + \frac{T_{HARQ}}{NR\ slot\ length}$  up to the end of T3,
  - Then the number of successes for the event “Deactivation” is increased by one. Otherwise, count a fail for the event “Deactivation”.

9. When T3 expires, or Activation in step 5 was not acknowledged, or a fail was counted for the event “Activation” in step 6, or Deactivation in step 7 was not acknowledged, the SS shall transmit a RRCRelease message to release the RRC connection which includes the release of the established radio bearers as well as all radio resources.
10. Set Cell 2 physical cell identity = ((current cell 2 physical cell identity + 1) mod 1008) for next iteration of the test procedure loop.
11. After the RRC connection release, the SS:
  - transmits in Cell 1 a Paging message (including PagingRecord with UE-Identity) for the UE and ensures the UE is in state RRC\_CONNECTED with generic procedure parameters Connectivity NR, Connected without release On and Test Mode On according to TS 38.508-1 [14] clause 4.5 (if the paging fails, switches off and on the UE and ensures the UE is in state RRC\_CONNECTED with generic procedure parameters Connectivity NR, Connected without release On and Test Mode On according to TS 38.508-1 [14] clause 4.5),
  - or
  - switches off and on the UE and ensures the UE is in state RRC\_CONNECTED with generic procedure parameters Connectivity NR, Connected without release On and Test Mode On according to TS 38.508-1 [14] clause 4.5.
12. Repeat steps 2-11 until a test verdict has been achieved.

Each of the events “Activation” and “Deactivation” is evaluated independently for the statistic, resulting in an event verdict: pass or fail. Each event is evaluated only until the confidence level according to Table G.2.3-1 in Annex G.2 is achieved. Different events may require different times for a verdict. If all events pass, the test passes. If one event fails, the test fails.

6.5.3.1.4.3 Message contents

Message contents are according to TS 38.508-1 [14] clause 7.3 with the following exceptions:

**Table 6.5.3.1.4.3-1: Common Exception messages**

Default Message Contents	
Common contents of system information blocks exceptions	
Default RRC messages and information elements contents exceptions	Table H.3.1-7 with Condition Deactivated SCell;

**Table 6.5.3.1.4.3-2: RRCReconfiguration: SCell addition**

Derivation Path: TS 38.508-1 [14], Table 4.6.1-13 with condition NR_MEAS and SCell_add			
Information Element	Value/remark	Comment	Condition
RRCReconfiguration ::= SEQUENCE {			
criticalExtensions CHOICE {			
rrcReconfiguration ::= SEQUENCE {			
measConfig	MeasConfig	Table 6.5.3.1.4.3-2A	
nonCriticalExtension SEQUENCE {			
masterCellGroup	CellGroupConfig-SCell	Table 6.5.3.1.4.3-5	
}			
}			
}			
}			

**Table 6.5.3.1.4.3-2A: MeasConfig (Table 6.5.3.1.4.3-2)**

Derivation path: Table H.3.1-2 with condition Deactivated SCell			
Information Element	Value/Remark	Comment	Condition
measConfig ::= SEQUENCE {			
measObjectToAddModList SEQUENCE (SIZE (1..maxNrofMeasId)) OF SEQUENCE {	2 entries		
measObject{2} CHOICE {			
measObjectNR	MeasObjectNR for SCell	entry 2 Table 6.5.3.1.4.3-3	
}			
}			
reportConfigToAddModList SEQUENCE (SIZE (1..maxReportConfigId)) OF ReportConfigToAddMod {	1 entry		
ReportConfigToAddMod{1} SEQUENCE {		entry 1	
reportConfigId	ReportConfigId		
reportConfig CHOICE {			
reportConfigNR	ReportConfigNR	Table 6.5.3.1.4.3-4	
}			
}			
}			
}			

**Table 6.5.3.1.4.3-3: MeasObjectNR for SCell**

Derivation Path: Table H.3.1-3 with condition Deactivated SCell and Synchronous cells			
Information Element	Value/remark	Comment	Condition
MeasObjectNR ::= SEQUENCE {			
smc1	SSB-MTC specified in TS 38.508-1 [14] Table 7.3.1-3 with condition SMTC.1		
measCycleSCell-v1530	sf160		
}			

**Table 6.5.3.1.4.3-4: ReportConfigNR**

Derivation Path: Table H.3.1-4			
Information Element	Value/remark	Comment	Condition
ReportConfigNR ::= SEQUENCE {			
reportType CHOICE {			
eventTriggered SEQUENCE {			
eventId CHOICE {			
eventA3 SEQUENCE {			
a3-Offset CHOICE {			
rsrp	-30	To ensure reporting can always be triggered	
}			
}			
}			
}			
}			
}			

**Table 6.5.3.1.4.3-5: CellGroupConfig-SCell (Table 6.5.3.1.4.3-2)**

Derivation Path: TS 38.508-1 [14], Table 4.6.3-19 with condition MEAS and SCell_add			
Information Element	Value/remark	Comment	Condition
CellGroupConfig ::= SEQUENCE {			
spCellConfig SEQUENCE {			
servCellIndex	Not present	PCell always uses servCellIndex=0	
reconfigurationWithSync	Not present		
rlf-TimersAndConstants	Not present		
rlmInSyncOutOfSyncThreshold	Not present		
spCellConfigDedicated	ServingCellConfig-SpCell	Table 6.5.3.1.4.3-6	
}			
sCellToAddModList SEQUENCE (SIZE (1..maxNrofSCells)) OF SCellConfig {	1 entry		
SCellConfig[1] SEQUENCE {		entry 1	
sCellConfigDedicated	ServingCellConfig-SCell	Table 6.5.3.1.4.3-7	
smtc	SSB-MTC specified in TS 38.508-1 [14] Table 7.3.1-3 with condition SMTC.1		
}			
}			
}			

**Table 6.5.3.1.4.3-6: ServingCellConfig-SpCell (Table 6.5.3.1.4.3-5)**

Derivation Path: TS 38.508-1 [14], Table 4.6.3-167 with condition MEAS			
Information Element	Value/remark	Comment	Condition
ServingCellConfig ::= SEQUENCE {			
csi-MeasConfig	CSI-MeasConfig for RRM specified in TS 38.508-1 [14] Table 7.3.1-6		
servingCellMO	1		
}			

**Table 6.5.3.1.4.3-7: ServingCellConfig-SCell (Table 6.5.3.1.4.3-5)**

Derivation Path: TS 38.508-1 [14], Table 4.6.3-167 with condition No_UL			
Information Element	Value/remark	Comment	Condition
ServingCellConfig ::= SEQUENCE {			
csi-MeasConfig	CSI-MeasConfig for RRM specified in TS 38.508-1 [14] Table 7.3.1-6		
servingCellMO	2		
}			

### 6.5.3.1.5 Test requirement

Table 6.5.3.1.5-1 defines the primary level settings including test tolerances for all tests.

**Table 6.5.3.1.5-1: Cell specific test parameters for known FR1 SCell activation case, 160ms SCell measurement cycle**

Parameter		Unit	Cell 1			Cell 2		
			T1	T2	T3	T1	T2	T3
Duplex mode	Config 1		FDD					
	Config 2,3		TDD					
TDD configuration	Config 1		Not applicable					
	Config 2		TDDConf.1.1					
	Config 3		TDDConf.2.1					
BW <sub>channel</sub>	Config 1,2	MHz	Note 7					
	Config 3		Note 7					
BW <sub>occupied</sub>	Config 1,2	RB	52 <sup>Note 5</sup>					
	Config 3		106 <sup>Note 6</sup>					
Initial BWP configuration			DLBWP.0.2					
TCI state			TCI.State.0					
TRS Configuration	Config 1		TRS.1.1 FDD					
	Config 2		TRS.1.1 TDD					
	Config 3		TRS.1.2 TDD					
PDSCH Reference measurement channel	Config 1		SR.1.1 FDD			-		
	Config 2		SR.1.1 TDD			-		
	Config 3		SR.2.1 TDD			-		
Dedicated CORESET parameters	Config 1		CCR.1.1 FDD			-		
	Config 2		CCR.1.1 TDD			-		
	Config 3		CCR.2.1 TDD			-		
RMSI CORESET parameters	Config 1		CR.1.1 FDD			-		
	Config 2		CR.1.1 TDD			-		
	Config 3		CR.2.1 TDD			-		
OCNG Patterns	Config 1,2		OP.1 <sup>Note 5</sup>					
	Config 3		OP.1 <sup>Note 6</sup>					
SSB Configuration	Config 1,2		SSB.1 FR1					
	Config 3		SSB.2 FR1					
CSI-RS configuration for CSI reporting (Note 8)	Config 1		CSI-RS.1.1 FDD					
	Config 2		CSI-RS.1.1 TDD					
	Config 3		CSI-RS.2.1 TDD					
SMTC configuration			SMTC.1					
reportConfigType			periodic			N/A		
reportQuantity			cri-RI-PMI-CQI			N/A		
CSI reporting periodicity for PCell	Config 1,2	slot	5			N/A		
	Config 3		10			N/A		
CSI reporting offset for PCell	Config 1,2	slot	3			N/A		
	Config 3		5			N/A		
CSI reporting periodicity for SCell	Config 1,2	slot	5			N/A		
	Config 3		10			N/A		
CSI reporting offset for SCell	Config 1,2	slot	2			N/A		
	Config 3		4			N/A		
EPRE ratio of PSS to SSS		dB	0					
EPRE ratio of PBCH DMRS to SSS								
EPRE ratio of PBCH to PBCH DMRS								
EPRE ratio of PDCCH DMRS to SSS								
EPRE ratio of PDCCH to PDCCH DMRS								
EPRE ratio of PDSCH DMRS to SSS								
EPRE ratio of PDSCH to PDSCH								
EPRE ratio of OCNG DMRS to SSS <sup>Note 1</sup>								
EPRE ratio of OCNG to OCNG DMRS <sup>Note 1</sup>								
N <sub>oc</sub> <sup>Note2</sup>	Config 1,2	dBm/SC S	-104					
	Config 3		-101					
$\hat{E}_s/I_{ot}$		dB	17					
$\hat{E}_s/N_{oc}$		dB	17					
SS-RSRP <sup>Note3</sup>	Config 1,2	dBm/SC S	-87					
	Config 3		-84					
SCH_RP <sup>Note 3</sup>		dBm/15 kHz	-87					
I <sub>o</sub> <sup>Note3</sup>	Config 1,2	dBm/ 9.36MHz	-58.96					

	Config 3	dBm/ 38.16MH z	-52.87
Propagation condition		-	AWGN
Note 1:	OCNG shall be used such that both cells are fully allocated and a constant total transmitted power spectral density is achieved for all OFDM symbols.		
Note 2:	Interference from other cells and noise sources not specified in the test is assumed to be constant over subcarriers and time and shall be modelled as AWGN of appropriate power for $N_{oc}$ to be fulfilled within $BW_{occupied}$ .		
Note 3:	SS-RSRP and SCH_RP levels have been derived from other parameters for information purposes. They are not settable parameters themselves.		
Note 4:	The uplink resources for CSI reporting are assigned to the UE prior to the start of time period T2.		
Note 5:	All UL/DL transmission shall be confined within $BW_{occupied}$ (i.e. 10 MHz, 52 RBs) from $F_{C,low}$ , and $l_0$ is independent of the $BW_{channel}$ configured.		
Note 6:	All UL/DL transmission shall be confined within $BW_{occupied}$ (i.e. 40 MHz, 106 RBs) from $F_{C,low}$ , and $l_0$ is independent of the $BW_{channel}$ configured.		
Note 7:	$N_{RB,c}$ is derived from Table 5.3.2-1 in TS38.101-1[2] with configured $BW_{channel}$ .		
Note 8:	On top of the reference configurations, CSI-RS offset should be set to meet the CSI reference resource timing definition in TS 38.214 cl. 5.2.2.5.		

During T2 the UE shall send the first CSI report for SCell no later than the first available uplink resource after at least one CSI-RS transmission occasion for channel measurement and reporting after slot  $n + 1 + \frac{T_{HARQ} + 3ms}{NR\ slot\ length}$ . UE is allowed to postpone CSI report to next available uplink resource if an available uplink resource is subject to interruption. Whether CSI report in slot  $n + 1 + \frac{T_{HARQ} + 3ms + T_{CSI\_Reporting}}{NR\ slot\ length}$  was interrupted or not is checked by monitoring ACK/NACK sent in PCell in slot  $n + 1 + \frac{T_{HARQ} + 3ms + T_{CSI\_Reporting}}{NR\ slot\ length}$ .

During T2 the UE shall start sending CSI reports for SCell with non-zero CQI index at latest in a slot  $n + \frac{T_{HARQ} + T_{activation\_time} + T_{CSI\_Reporting}}{NR\ slot\ length}$ ,  $T_{activation\_time} = T_{FirstSSB} + 5ms$ , as defined in TS 38.133 [6] section 8.3.

During T2 interruption of PCell/PSCell during SCell activation shall not happen outside the slot  $n + 1 + \frac{T_{HARQ}}{NR\ slot\ length}$  to  $n + 1 + \frac{T_{HARQ} + 3ms + T_X}{NR\ slot\ length} + N_{interruption}$ , as defined in TS 38.133 [6] section 8.3.

Figures 6.5.3.1.5-1 shows the derivation of the Test procedure requirement for DTX during T2, based on the core requirements for interruption.

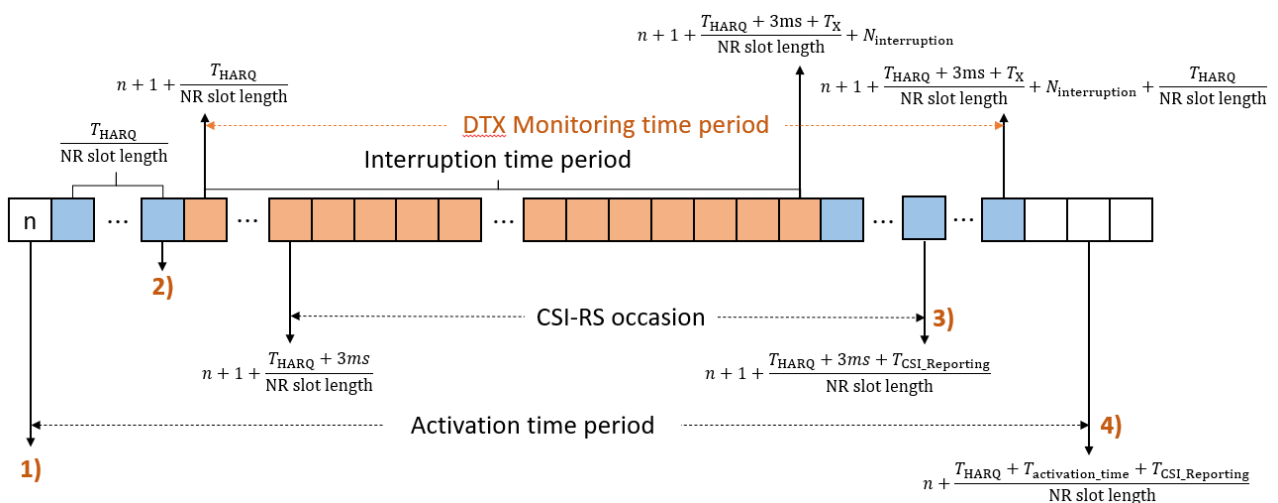

Figure 6.5.3.1.5-1: Procedure derivation for Activation

- 1) Activation command for SCell
- 2) ACK for MAC-CE for SCell1 activation

- 3) First CSI report timing (could be invalid CQI)
- 4) First non-zero CSI report transmission

During T3 the UE shall stop sending CSI reports for SCell at latest in a slot  $m + \frac{T_{HARQ} + 3ms}{NR\ slot\ length}$ , as defined in TS 38.133 [6] section 8.3.

During T3 interruption of PCell during SCell deactivation shall not happen outside the slot  $m + 1 + \frac{T_{HARQ}}{NR\ slot\ length}$  to  $m + 1 + \frac{T_{HARQ} + 3ms}{NR\ slot\ length}$ , as defined in TS 38.133 [6] section 8.3.

Figures 6.5.3.1.5-2 shows the derivation of the Test procedure requirement for NR PSCell DTX during T3, based on the core requirements for interruption.

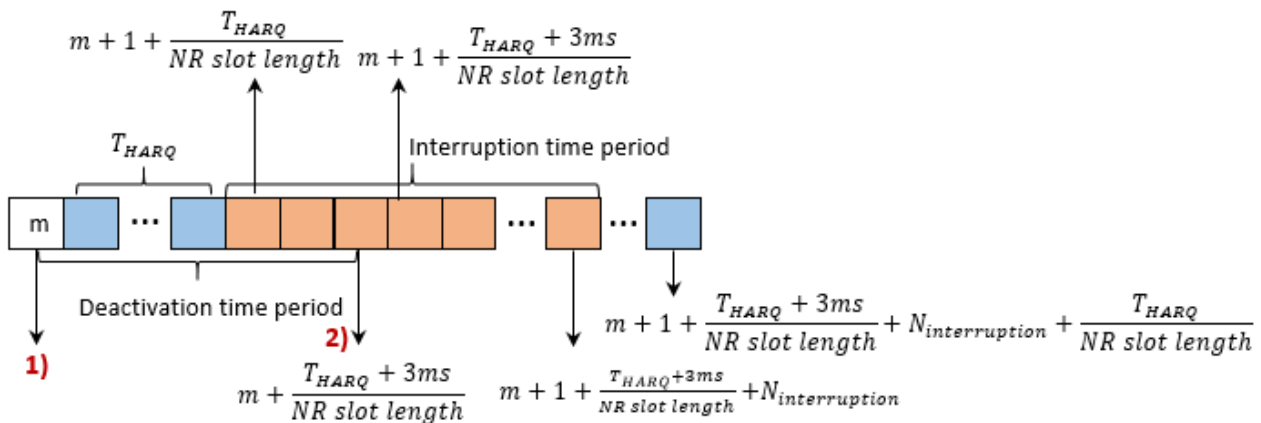

Figure 6.5.3.1.5-2: Procedure derivation for Deactivation

- 1) Deactivation command for SCell
- 2) Latest slot stop sending CSI reports for SCell

The interruption on any activated serving cell shall not be more than the values specified for SA in TS 38.133 [6] clause 8.2.2.2.2.

All of the above test requirements shall be fulfilled in order for the observed SCell activation delay and SCell deactivation delay to be counted as correct. The rate of correct observed SCell activation delay and SCell deactivation delay during repeated tests shall be at least 90%.

NOTE: During T2 if there are no uplink resources for reporting the valid CSI in a slot  $n + \frac{T_{HARQ} + T_{activation\_time} + T_{CSI\_Reporting}}{NR\ slot\ length}$  as defined in TS 38.133 [6] section 8.3 then the UE shall use the next available uplink resource for reporting the corresponding valid CSI.

### 6.5.3.2 NR SA FR1 SCell activation and deactivation of known SCell in non-DRX for 640ms SCell measurement cycle

#### 6.5.3.2.1 Test purpose

This test is to verify that the SCell activation and deactivation times are within the requirements in TS 38.133 [6] clause 8.3, when the SCell in FR1 is known by the UE at the time of activation.

#### 6.5.3.2.2 Test applicability

This test applies to all types of NR UE from Release 15 onwards and supporting 2DL CA.



### 6.5.3.2.3 Minimum conformance requirements

The minimum conformance requirements are defined in clause 6.5.3.0.1.

The normative reference for this requirement is TS 38.133 [6] clause A.6.5.3.2.

### 6.5.3.2.4 Test description

#### 6.5.3.2.4.1 Initial conditions

Same initial conditions as described in section 6.5.3.1.4.1 with following exception:

- The supported test configurations is replaced by Table 6.5.3.2.4.1-1.
- The listed parameter values in Tables 6.5.3.2.4.1-2 will replace the values of corresponding parameters in Tables 6.5.3.1.4.1-3.

**Table 6.5.3.2.4.1-1: supported test configurations**

Test Case ID	Description
6.5.3.2-1	NR 15 kHz SSB SCS, $\geq 10$ MHz bandwidth, FDD duplex mode
6.5.3.2-2	NR 15 kHz SSB SCS, $\geq 10$ MHz bandwidth, TDD duplex mode
6.5.3.2-3	NR 30 kHz SSB SCS, $\geq 40$ MHz bandwidth, TDD duplex mode
Note 1:	The UE is only required to be tested in one of the supported test configurations.
Note 2:	The UE is only required to be tested in one with smallest aggregated channel bandwidth from supported band combinations which is composed of CCs $\geq$ the bandwidth ( $BW_{\text{channel}}$ ) defined in each test configuration.

**Table 6.5.3.2.4.1-2: General test parameters for known FR1 SCell activation case, 640ms SCell measurement cycle**

Parameter	Unit	Value	Comment
SCell measurement cycle (measCycleSCell)	ms	640	

#### 6.5.3.2.4.2 Test procedure

Same test procedure as described in section 6.5.3.1.4.2.

#### 6.5.3.2.4.3 Message contents

Same message contents as described in section 6.5.3.1.4.3 with following exception:

- Table 6.5.3.1.4.3-3 is replaced by Table 6.5.3.2.4.3-1.

**Table 6.5.3.2.4.3-1: MeasObjectNR for SCell**

Derivation Path: Table H.3.1-3 with condition Deactivated SCell and Synchronous cells			
Information Element	Value/remark	Comment	Condition
MeasObjectNR ::= SEQUENCE { smtc1	SSB-MTC specified in TS 38.508-1 [14] Table 7.3.1-3 with condition SMTC.1		

#### 6.5.3.2.5 Test requirement

Same test requirement as described in section 6.5.3.1.5, except  $T_{\text{activation\_time}}$  will be replaced with the value  $T_{\text{FirstSSB\_MAX}} + T_{\text{RS}} + 5\text{ms}$ .

### 6.5.3.3 NR SA FR1 SCell activation and deactivation of unknown SCell in non-DRX

#### 6.5.3.3.1 Test purpose

This test is to verify that the SCell activation and deactivation times are within the requirements stated in TS 38.133 [6] clause 8.3, when the SCell in FR1 is unknown by the UE at the time of activation.

#### 6.5.3.3.2 Test applicability

This test applies to all types of NR UE from Release 15 onwards and supporting 2DL CA.

#### 6.5.3.3.3 Minimum conformance requirements

The minimum conformance requirements are defined in clause 6.5.3.0.1.

The normative reference for this requirement is TS 38.133 [6] clause A.6.5.3.3.

#### 6.5.3.3.4 Test description

##### 6.5.3.3.4.1 Initial conditions

Same initial conditions as described in section 6.5.3.1.4.1 with following exception:

- The supported test configurations is replaced by Table 6.5.3.3.4.1-1.
- The listed parameter values in Tables 6.5.3.3.4.1-2 will replace the values of corresponding parameters in Tables 6.5.3.1.4.1-3.

**Table 6.5.3.3.4.1-1: supported test configurations**

Test Case ID	Description
6.5.3.3-1	NR 15 kHz SSB SCS, $\geq 10$ MHz bandwidth, FDD duplex mode
6.5.3.3-2	NR 15 kHz SSB SCS, $\geq 10$ MHz bandwidth, TDD duplex mode
6.5.3.3-3	NR 30 kHz SSB SCS, $\geq 40$ MHz bandwidth, TDD duplex mode
Note 1:	The UE is only required to be tested in one of the supported test configurations.
Note 2:	The UE is only required to be tested in one with smallest aggregated channel bandwidth from supported band combinations which is composed of CCs $\geq$ the bandwidth ( $BW_{channel}$ ) defined in each test configuration.

**Table 6.5.3.3.4.1-2: General test parameters for unknown FR1 SCell activation case, 160ms SCell measurement cycle**

Parameter	Unit	Value	Comment
T1	ms	100	During this time the PSCell shall be known and the SCell configured, but not detected.

##### 6.5.3.3.4.2 Test procedure

Same test procedure as described in section 6.5.3.1.4.2, except step3 and step 5 are replaced by following steps:

3. T1 starts. Immediately after, the SS shall configure SCell (Cell 2) on the SCC as per TS 38.508-1 [14] clause 7.5.1. The SCell (Cell 2) shall be powered OFF till T2 starts.
5. The SS activates SCC by sending the activation MAC-CE (Refer TS 38.321 [12], clauses 5.9, 6.1.3.10) in a slot # denoted n, power ON the SCell (Cell2), T2 starts in slot n. If the SS receives ACK for MAC-CE sent by the UE, the test proceeds to step 6, otherwise go to step 9.

and,

- step 3a is removed.

##### 6.5.3.3.4.3 Message contents

Message contents are according to TS 38.508-1 [14] clause 7.3 with the following exceptions:

**Table 6.5.3.3.4.3-1: RRCReconfiguration in step 3: SCell addition**

Derivation Path: TS 38.508-1 [14], Table 4.6.1-13 with condition SCell_add			
Information Element	Value/remark	Comment	Condition
RRCReconfiguration ::= SEQUENCE {			
criticalExtensions CHOICE {			
rrcReconfiguration ::= SEQUENCE {			
nonCriticalExtension SEQUENCE {			
masterCellGroup	CellGroupConfig	Table 6.5.3.3.4.3-2	
}			
}			
}			
}			

**Table 6.5.3.3.4.3-2: CellGroupConfig (Table 6.5.3.3.4.3-1)**

Derivation Path: TS 38.508-1 [14], Table 4.6.3-19 with condition SCell_add			
Information Element	Value/remark	Comment	Condition
CellGroupConfig ::= SEQUENCE {			
spCellConfig SEQUENCE {			
spCellConfigDedicated	ServingCellConfig-SpCell	Table 6.5.3.3.4.3-3	
}			
sCellToAddModList SEQUENCE (SIZE (1..maxNrofSCells)) OF SCellConfig {	1 entry		
SCellConfig[1] SEQUENCE {		entry 1	
sCellConfigDedicated	ServingCellConfig-SCell	Table 6.5.3.3.4.3-4	
smtc	SSB-MTC specified in TS 38.508-1 [14] Table 7.3.1-3 with condition SMTC.1		
}			
}			
}			

**Table 6.5.3.3.4.3-3: ServingCellConfig-SpCell (Table 6.5.3.3.4.3-2)**

Derivation Path: TS 38.508-1 [14], Table 4.6.3-167			
Information Element	Value/remark	Comment	Condition
ServingCellConfig ::= SEQUENCE {			
csi-MeasConfig	CSI-MeasConfig for RRM specified in TS 38.508-1 [14] Table 7.3.1-6		
}			

**Table 6.5.3.3.4.3-4: ServingCellConfig-SCell (Table 6.5.3.3.4.3-2)**

Derivation Path: TS 38.508-1 [14], Table 4.6.3-167 with condition No_UL			
Information Element	Value/remark	Comment	Condition
ServingCellConfig ::= SEQUENCE {			
csi-MeasConfig	CSI-MeasConfig for RRM specified in TS 38.508-1 [14] Table 7.3.1-6		
}			

### 6.5.3.3.5 Test requirement

Same test requirement as described in section 6.5.3.1.5, except  $T_{\text{activation\_time}}$  will be replaced with the value  $T_{\text{FirstSSB\_MAX}} + T_{\text{SMTC\_MAX}} + 2 * T_{\text{TS}} + 5\text{ms}$

## 6.5.4 UE UL carrier RRC reconfiguration delay

### 6.5.4.0 Minimum conformance requirements

#### 6.5.4.0.1 Minimum conformance requirements for UL carrier RRC reconfiguration delay

[TS 38.133, clause 8.4.2]

When the UE receives a RRC message implying NR UL or Supplementary UL carrier configuration, the UE shall be ready to start transmission on the newly configured carrier within  $T_{UL\_carrier\_config}$  from the end of the last slot containing the RRC command.

$T_{UL\_carrier\_config}$  equals the maximum RRC procedure delay defined in clause x.y in TS 38.331 [2] plus the interruption time specified in TS 38.133 [6] section 8.2.1.2.6.

[TS 38.133, clause 8.4.3]

When the UE receives a RRC message implying NR UL or Supplementary UL carrier deconfiguration RRC signalling, the UE shall stop UL signalling on the deconfigured UL carrier within  $T_{UL\_carrier\_deconfig}$  from the end of the last slot containing the RRC command.

$T_{UL\_carrier\_deconfig}$  equals the maximum RRC procedure delay defined in clause x.y in TS 38.331 [2].

The normative reference for this requirement is TS 38.133 [6] clause 8.4.

### 6.5.4.1 NR SA FR1 UE UL carrier RRC reconfiguration delay

#### 6.5.4.1.1 Test purpose

To verify that when the UE receives a RRC message implying NR UL or Supplementary UL carrier configuration, the UE shall be ready to start transmission on the newly configured carrier within the time limits specified in TS 38.133 [6] section 8.4.2 and 8.4.3 for configuring and deconfiguring, respectively.

#### 6.5.4.1.2 Test applicability

This test applies to all types of NR UE release 15 and forward supporting SUL.

#### 6.5.4.1.3 Minimum conformance requirements

The minimum conformance requirements are specified in clause 6.5.4.0.1.

The normative reference for this requirement is TS 38.133 [6] clause A.6.5.4.1.

#### 6.5.4.1.4 Test description

##### 6.5.4.1.4.1 Initial conditions

The Test shall be tested using any of the test configuration in Table 6.5.4.1.4.1-1.

**Table 6.5.4.1.4.1-1: Supported test configurations**

Configuration	PSCell (Cell 1)	SCell (Cell 2)
6.5.4.1-1	15 kHz SSB SCS, $\geq 10$ MHz bandwidth, FDD duplex mode	DL and UL: 15 kHz SSB SCS, $\geq 10$ MHz bandwidth, FDD duplex mode; SUL: 15 kHz SCS, $\geq 10$ MHz bandwidth, SUL duplex mode
6.5.4.1-2	15 kHz SSB SCS, $\geq 10$ MHz bandwidth, FDD duplex mode	DL and UL: 15 kHz SSB SCS, $\geq 10$ MHz bandwidth, TDD duplex mode; SUL: 15 kHz SCS, $\geq 10$ MHz bandwidth, SUL duplex mode
6.5.4.1-3	15 kHz SSB SCS, $\geq 10$ MHz bandwidth, FDD duplex mode	DL and UL: 30 kHz SSB SCS, $\geq 40$ MHz bandwidth, TDD duplex mode; SUL: 30 kHz SCS, $\geq 40$ MHz bandwidth, SUL duplex mode
6.5.4.1-4	15 kHz SSB SCS, $\geq 10$ MHz bandwidth, TDD duplex mode	DL and UL: 15 kHz SSB SCS, $\geq 10$ MHz bandwidth, FDD duplex mode; SUL: 15 kHz SCS, $\geq 10$ MHz bandwidth, SUL duplex mode
6.5.4.1-5	15 kHz SSB SCS, $\geq 10$ MHz bandwidth, TDD duplex mode	DL and UL: 15 kHz SSB SCS, $\geq 10$ MHz bandwidth, TDD duplex mode; SUL: 15 kHz SCS, $\geq 10$ MHz bandwidth, SUL duplex mode
6.5.4.1-6	15 kHz SSB SCS, $\geq 10$ MHz bandwidth, TDD duplex mode	DL and UL: 30 kHz SSB SCS, $\geq 40$ MHz bandwidth, TDD duplex mode; SUL: 30 kHz SCS, $\geq 40$ MHz bandwidth, SUL duplex mode
6.5.4.1-7	30 kHz SSB SCS, $\geq 40$ MHz bandwidth, TDD duplex mode	DL and UL: 15 kHz SSB SCS, $\geq 10$ MHz bandwidth, FDD duplex mode; SUL: 15 kHz SCS, $\geq 10$ MHz bandwidth, SUL duplex mode
6.5.4.1-8	30 kHz SSB SCS, $\geq 40$ MHz bandwidth, TDD duplex mode	DL and UL: 15 kHz SSB SCS, $\geq 10$ MHz bandwidth, TDD duplex mode; SUL: 15 kHz SCS, $\geq 10$ MHz bandwidth, SUL duplex mode
6.5.4.1-9	30 kHz SSB SCS, $\geq 40$ MHz bandwidth, TDD duplex mode	DL and UL: 30 kHz SSB SCS, $\geq 40$ MHz bandwidth, TDD duplex mode; SUL: 30 kHz SCS, $\geq 40$ MHz bandwidth, SUL duplex mode
Note 1: The UE is only required to be tested in one of the supported test configurations.		
Note 2: The UE is only required to be tested in one with smallest aggregated channel bandwidth from supported band combinations which is composed of CCs $\geq$ the bandwidth ( $BW_{\text{channel}}$ ) defined in each test configuration.		

Configure the test requirement and the DUT according to the parameters in Table 6.5.4.1.4.1-2.

**Table 6.5.4.1.4.1-2: Initial conditions for NR SA FR1 UE UL carrier RRC reconfiguration delay**

Parameter	Value		Comment
Test environment	NC		As specified in TS 38.508-1 [14] clause 4.1.
Test frequencies	As specified in Annex E, Table E.4-1 and TS 38.508-1 [14] clause 4.3.1.		
Channel bandwidth	As specified by the test configuration selected from Table 6.5.4.1.4.1-1.		
Propagation conditions	AWGN		As specified in Annex C.2.1.
Connection Diagram	TE Part	A.3.1.8.2	As specified in TS 38.508-1 [14] Annex A.
	DUT Part	A.3.2.3.4	
Exceptions to connection diagram	N/A		

1. The general test parameter settings are set up according to Table 6.5.4.1.4.1-3.
2. Message contents are defined in clause 6.5.4.1.4.3.

3. There are two NR FR1 carriers and two cells in the test. Cell 1 is PCell on the primary component carrier, Cell 2 is SCell on the secondary component carrier. Cell 1 is the cell used for connection setup with the power levels set according to Table A.6.5.4.1.5-1 for this test. Cell 2 is configured according to Annex C.1.1 and C.1.2.

**Table 6.5.4.1.4.1-3: General test parameters for NR standalone UE UL carrier RRC reconfiguration Delay on Pcell**

Parameter	Unit	Test configuration	Value	Comment
RF Channel Number		Config 1,2,3, 4, 5, 6, 7, 8, 9	1, 2	Two radio channels are used for these two tests.
Active cell		Config 1,2,3, 4, 5, 6, 7, 8, 9	Cell 1: FR1 PCell Cell 2: FR1 SCell	FR1 PCell on RF channel number 1 FR1 SCell on RF channel number 2
CP length		Config 1,2,3, 4, 5, 6, 7, 8, 9	Normal	
DRX		Config 1,2,3, 4, 5, 6, 7, 8, 9	OFF	
Measurement gap pattern Id		Config 1,2,3, 4, 5, 6, 7, 8, 9	OFF	
Filter coefficient		Config 1,2,3, 4, 5, 6, 7, 8, 9	0	L3 filtering is not used
T1	s	Config 1,2,3, 4, 5, 6, 7, 8, 9	5	
T2	s	Config 1,2,3, 4, 5, 6, 7, 8, 9	5	
T3	s	Config 1,2,3, 4, 5, 6, 7, 8, 9	5	

#### 6.5.4.1.4.2 Test procedure

There are two cells: FR1 PCell (cell 1) and FR1 SCell (cell 2). Both NR uplink and supplementary uplink are broadcast by *ServingCellConfigCommonSIB*. In test 1, the test consists of three time periods, with duration of T1, T2 and T3 respectively. During time duration T1, NR uplink of cell 2 is configured to UE. At the start of T2, a supplementary uplink of cell 2 is configured to UE through *RRCReconfiguration*, then UE shall start transmission both on the NR uplink and supplementary uplink. At the start of T3, the supplementary uplink is released through *RRCReconfiguration*.

In test 2, the test consists of three time periods, with duration of T1, T2 and T3 respectively. During time duration T1, supplementary uplink on cell 2 is configured to UE. At the start of T2, a NR uplink is configured to UE through *RRCReconfiguration*, then UE shall start transmission both on the NR uplink and supplementary uplink. At the start of T3, the NR uplink is released through *RRCReconfiguration*.

1. Ensure the UE is in state RRC\_CONNECTED with generic procedure parameters Connectivity NR, Connected without release On and Test Mode On according to TS 38.508-1 [14] clause 4.5.
2. Setup PCell (Cell 1) according to parameters given in Table 6.5.4.1.5-1. Propagation conditions are set according to Annex C clause C.2.2.
3. For SCell (Cell 2), both NR uplink and supplementary uplink are broadcast by *ServingCellConfigCommonSIB*.
4. For Test 1: NR uplink of SCell is configured to UE during T1
  - 4.1 During time duration T1, NR uplink of SCell is configured to UE. Setup SCell (Cell 2) according to parameters given in Table 6.5.4.1.5-2
  - 4.2 At the start of T2, a supplementary uplink of SCell (Cell 2) is configured to UE through *RRCReconfiguration*, then UE shall start transmission on both the NR uplink and supplementary uplink on SCell (Cell 2) within 20ms. If UE transmits data on both the NR uplink and supplementary uplink on SCell (Cell 2) within 20ms from the start of T2, then count a success for the event “reconfiguration” otherwise count a failure for event “reconfiguration”
  - 4.3 At the start of T3, the supplementary uplink is released through *RRCReconfiguration*, then UE shall transmit data only on the NR uplink carrier on SCell (Cell 2) within 20ms. If UE stop transmitting data on supplementary uplink carrier on SCell (Cell 2) within 20ms from the start of T3, then count a success for the event “deconfiguration” otherwise count a failure for event “deconfiguration”.

5. For Test 2: Supplementary uplink of SCell is configured to UE during T1

5.1 During time duration T1, Supplementary uplink of SCell is configured to UE. Setup SCell (Cell 2) according to parameters given in Table 6.5.4.1.5-2

5.2 At the start of T2, a NR uplink of SCell (Cell 2) is configured to UE through RRCReconfiguration, then UE shall start transmission on both the NR uplink and supplementary uplink on SCell (Cell 2) within 20ms. If UE transmits data on both the NR uplink and supplementary uplink on SCell (Cell 2) within 20ms from the start of T2, then count a success for the event “reconfiguration” otherwise count a failure for event “reconfiguration”

5.3 At the start of T3, the NR uplink is released through RRCReconfiguration, then UE shall transmit data only on the Supplementary uplink carrier on SCell (Cell 2) within 20ms. If UE stop transmitting data on NR uplink carrier on SCell (Cell 2) within 20ms from the start of T3, then count a success for the event “deconfiguration” otherwise count a failure for event “deconfiguration”.

6. Repeat steps 1-5 until a test verdict has been achieved.

Each of the events “reconfiguration” and “deconfiguration” is evaluated independently for the statistic, resulting in an event verdict: pass or fail. Each event is evaluated only until the confidence level according to Table G.2.3-1 in Annex G.2 is achieved. Different events may require different times for a verdict.

If all events pass, the test passes. If one event fails, the test fails.

6.5.4.1.4.3 Message contents

Message contents are according to TS 38.508-1 [14] clause 4.6 with the following exceptions:

**Table 6.5.4.1.4.3-1: Common Exception messages**

Default Message Contents	
Common contents of system information blocks exceptions	
Default RRC messages and information elements contents exceptions	Table H.3.8-1 Table H.3.8-2

6.5.4.1.5 Test requirement

Table 6.5.4.1.5.1-1 and 6.5.4.1.5-2 define the primary level settings including test tolerances for UE UL carrier RRC reconfiguration delay test.

**Table 6.5.4.1.5-1: NR Cell specific test parameters for NR standalone UE UL carrier RRC reconfiguration Delay on PCell (Cell 1)**

Parameter	Unit	Test Configuration	Test 1			Test 2		
			T1	T2	T3	T1	T2	T3
Channel number		Conf 1, 2, 3, 4, 5, 6, 7, 8, 9	1			1		
TDD configuration		Conf 1, 2, 3	N/A			N/A		
		Conf 4, 5, 6	TDD Conf.1.1			TDD Conf.1.1		
		Conf 7, 8, 9	TDD Conf.2.1			TDD Conf.2.1		
BW <sub>channel</sub>	MHz	Conf 1, 2, 3	Note 6			Note 6		
		Conf 4, 5, 6	Note 6			Note 6		
		Conf 7, 8, 9	Note 6			Note 6		
BW <sub>occupied</sub>	RB	Conf 1, 2, 3	52 <sup>Note 4</sup>			52 <sup>Note 4</sup>		
		Conf 4, 5, 6	52 <sup>Note 4</sup>			52 <sup>Note 4</sup>		
		Conf 7, 8, 9	106 <sup>Note 5</sup>			106 <sup>Note 5</sup>		
PDSCH reference measurement channel as defined in A.3.1.1		Conf 1, 2, 3	SR.1.1 FDD			SR.1.1 FDD		
		Conf 4, 5, 6	SR.1.1 TDD			SR.1.1 TDD		
		Conf 7, 8, 9	SR.2.1 TDD			SR.2.1 TDD		
		Conf 1, 2, 3	CR.1.1 FDD			CR.1.1 FDD		
		Conf 4, 5, 6	CR.1.1 TDD			CR.1.1 TDD		

RMSI CORESET reference measurement channel as defined in A.3.1.2		Conf 7, 8, 9	CR.2.1 TDD			CR.2.1 TDD		
RMC CORESET reference measurement channel as defined in A.3.1.3		Conf 1, 2, 3	CCR.1.1 FDD			CCR.1.1 FDD		
		Conf 4, 5, 6	CCR.1.1 TDD			CCR.1.1 TDD		
		Conf 7, 8, 9	CCR.2.1 TDD			CCR.2.1 TDD		
OCNG Pattern <sup>Note 1</sup>		Conf 1, 2, 3, 4, 5, 6, 7, 8, 9	OP.1			OP.1		
SSB configuration		Conf 1, 2, 3, 4, 5, 6	SSB.1 FR1			SSB.1 FR1		
		Conf 7, 8, 9	SSB.2 FR1			SSB.2 FR1		
SMTC configuration		Conf 1, 2, 3, 4, 5, 6, 7, 8, 9	SMTC.1			SMTC.1		
CSI-RS for tracking		Conf 1	TRS.1.1 FDD			TRS.1.1 FDD		
		Conf 2	TRS.1.1 FDD			TRS.1.1 FDD		
		Conf 3	TRS.1.1 FDD			TRS.1.1 FDD		
		Conf 4	TRS.1.1 TDD			TRS.1.1 TDD		
		Conf 5	TRS.1.1 TDD			TRS.1.1 TDD		
		Conf 6	TRS.1.1 TDD			TRS.1.1 TDD		
		Conf 7	TRS.1.2 TDD			TRS.1.2 TDD		
		Conf 8	TRS.1.2 TDD			TRS.1.2 TDD		
	Conf 9	TRS.1.2 TDD			TRS.1.2 TDD			
DL initial BWP configuration		Conf 1, 2, 3, 4, 5, 6, 7, 8, 9	DLBWP.0.1			DLBWP.0.1		
DL dedicated BWP configuration		Conf 1, 2, 3, 4, 5, 6, 7, 8, 9	DLBWP.1.1			DLBWP.1.1		
UL dedicated BWP configuration		Conf 1, 2, 3, 4, 5, 6, 7, 8, 9	ULBWP.1.1			ULBWP.1.1		
EPRE ratio of PSS to SSS	dB	Conf 1, 2, 3, 4, 5, 6, 7, 8, 9	0			0		
EPRE ratio of PBCH_DMRS to SSS								
EPRE ratio of PBCH to PBCH_DMRS								
EPRE ratio of PDCCH_DMRS to SSS								
EPRE ratio of PDCCH to PDCCH_DMRS								
EPRE ratio of PDSCH_DMRS to SSS								
EPRE ratio of PDSCH to PDSCH_DMRS								
EPRE ratio of OCNG DMRS to SSS								
EPRE ratio of OCNG to OCNG DMRS								
$N_{oc}$ <sup>Note 2</sup>	dBm / 15kHz	Conf 1, 2, 3, 4, 5, 6, 7, 8, 9	-102			-102		
	dBm/SCS	Conf 1,2,3,4,5,6	-102			-102		
		Conf 7,8,9	-99			-99		
$\hat{E}_s / N_{oc}$	dB	Conf 1, 2, 3, 4, 5, 6, 7, 8, 9	16	16	16	16	16	16
$\hat{E}_s / I_{ot}$ <sup>Note 3</sup>	dB	Conf 1, 2, 3, 4, 5, 6, 7, 8, 9	16	16	16	16	16	16



SS-RSRP <sup>Note 3</sup>	dBm/ SCS	Conf 1,2,3,4,5,6	-86	-86	-86	-86	-86	-86
		Conf 7,8,9	-83	-83	-83	-83	-83	-83
I <sub>o</sub> <sup>Note 3</sup>	dBm/ 9.36 MHz	Conf 1,2,3,4,5,6	-57.9	-57.9	-57.9	-57.9	-57.9	-57.9
	dBm/ 38.16 MHz	Conf 7,8,9	-51.8	-51.8	-51.8	-51.8	-51.8	-51.8
Propagation Condition		Conf 1, 2, 3, 4, 5, 6, 7, 8, 9	AWGN			AWGN		
Antenna configuration		Conf 1, 2, 3, 4, 5, 6, 7, 8, 9	1 x 2			1 x 2		
<p>NOTE 1: OCNG shall be used such that both cells are fully allocated, and a constant total transmitted power spectral density is achieved for all OFDM symbols.</p> <p>NOTE 2: Interference from other cells and noise sources not specified in the test is assumed to be constant over subcarriers and time and shall be modelled as AWGN of appropriate power for <math>N_{oc}</math> to be fulfilled within <math>BW_{occupied}</math>.</p> <p>NOTE 3: <math>\hat{E}_s/I_{ot}</math>, <math>I_o</math>, and SS-RSRP levels have been derived from other parameters for information purposes. They are not settable parameters themselves.</p> <p>NOTE 4: All UL/DL transmission shall be confined within <math>BW_{occupied}</math> (i.e. 10 MHz, 52 RBs) from <math>F_{C,low}</math>, and <math>I_o</math> is independent of the <math>BW_{channel}</math> configured.</p> <p>NOTE 5: All UL/DL transmission shall be confined within <math>BW_{occupied}</math> (i.e. 40 MHz, 106 RBs) from <math>F_{C,low}</math>, and <math>I_o</math> is independent of the <math>BW_{channel}</math> configured.</p> <p>NOTE 6: <math>N_{RB,c}</math> is derived from Table 5.3.2-1 in TS38.101-1[2] with configured <math>BW_{channel}</math>.</p>								

**Table 6.5.4.1.5-2 : NR Cell specific test parameters for NR standalone UE UL carrier RRC reconfiguration Delay on SCell (Cell 2)**

Parameter	Unit	Test Configuration	Test 1			Test 2		
			T1	T2	T3	T1	T2	T3

Channel number		Conf 1, 2, 3, 4, 5, 6, 7, 8, 9	2			2		
TDD configuration		Conf 1, 4, 7	N/A			N/A		
		Conf 2, 5, 8	TDDConf.1.1			TDDConf.1.1		
		Conf 3, 6, 9	TDDConf.2.1			TDDConf.2.1		
BW <sub>channel</sub>	MHz	Conf 1, 4, 7	Note 6			Note 6		
		Conf 2, 5, 8	Note 6			Note 6		
		Conf 3, 6, 9	Note 6			Note 6		
BW <sub>occupied</sub>	RB	Conf 1, 4, 7	52 <sup>Note 4</sup>			52 <sup>Note 4</sup>		
		Conf 2, 5, 8	52 <sup>Note 4</sup>			52 <sup>Note 4</sup>		
		Conf 3, 6, 9	106 <sup>Note 5</sup>			106 <sup>Note 5</sup>		
PUSCH parameters for NR UL carrier		Conf 1, 4, 7	G-FR1-A3-10 in [28]	G-FR1-A3-10 in [28]	G-FR1-A3-10 in [28]	N/A	G-FR1-A3-10 in [28]	N/A
		Conf 2, 5, 8	G-FR1-A3-10 in [28]	G-FR1-A3-10 in [28]	G-FR1-A3-10 in [28]	N/A	G-FR1-A3-10 in [28]	N/A
		Conf 3, 6, 9	G-FR1-A3-14 in [28]	G-FR1-A3-14 in [28]	G-FR1-A3-14 in [28]	N/A	G-FR1-A3-14 in [28]	N/A
PUCCH parameters For NR UL carrier		Conf 1, 4, 7	Table 8.3.3.1.2-1 in [28]	Table 8.3.3.1.2-1 in [28]	Table 8.3.3.1.2-1 in [28]	N/A	N/A	N/A
		Conf 2, 5, 8	Table 8.3.3.1.2-1 in [28]	Table 8.3.3.1.2-1 in [28]	Table 8.3.3.1.2-1 in [28]	N/A	N/A	N/A
		Conf 3, 6, 9	Table 8.3.3.1.2-2 in [28]	Table 8.3.3.1.2-2 in [28]	Table 8.3.3.1.2-2 in [28]	N/A	N/A	N/A
PUSCH parameters for supplementary UL		Conf 1, 4, 7	N/A	G-FR1-A3-10 in [28]	N/A	G-FR1-A3-10 in [28]	G-FR1-A3-10 in [28]	G-FR1-A3-10 in [28]
		Conf 2, 5, 8	N/A	G-FR1-A3-10 in [28]	N/A	G-FR1-A3-10 in [28]	G-FR1-A3-10 in [28]	G-FR1-A3-10 in [28]
		Conf 3, 6, 9	N/A	G-FR1-A3-14 in [28]	N/A	G-FR1-A3-14 in [28]	G-FR1-A3-14 in [28]	G-FR1-A3-14 in [28]
PUCCH parameters for supplementary UL		Conf 1, 4, 7	N/A	N/A	N/A	Table 8.3.3.1.2-1 in [28]	Table 8.3.3.1.2-1 in [28]	Table 8.3.3.1.2-1 in [28]
		Conf 2, 5, 8	N/A	N/A	N/A	Table 8.3.3.1.2-1 in [28]	Table 8.3.3.1.2-1 in [28]	Table 8.3.3.1.2-1 in [28]
		Conf 3, 6, 9	N/A	N/A	N/A	Table 8.3.3.1.2-2 in [28]	Table 8.3.3.1.2-2 in [28]	Table 8.3.3.1.2-2 in [28]
PDSCH reference measurement channel as defined in A.3.1.1		Conf 1, 4, 7	SR.1.1 FDD			SR.1.1 FDD		
		Conf 2, 5, 8	SR.1.1 TDD			SR.1.1 TDD		
		Conf 3, 6, 9	SR 2.1 TDD			SR 2.1 TDD		
RMSI CORESET reference measurement channel as defined in A.3.1.2		Conf 1, 4, 7	CR.1.1 FDD			CR.1.1 FDD		
		Conf 2, 5, 8	CR.1.1 TDD			CR.1.1 TDD		
		Conf 3, 6, 9	CR.2.1 TDD			CR.2.1 TDD		
		Conf 1, 4, 7	CCR.1.1 FDD			CCR.1.1 FDD		
		Conf 2, 5, 8	CCR.1.1 TDD			CCR.1.1 TDD		

RMC CORESET reference measurement channel as defined in A.3.1.3		Conf 3, 6, 9	CCR.2.1 TDD			CCR.2.1 TDD		
OCNG Pattern <sup>Note 1</sup>		Conf 1, 2, 4, 5, 7, 8	OP.1 <sup>Note 4</sup>			OP.1 <sup>Note 4</sup>		
		Conf 3, 6, 9	OP.1 <sup>Note 5</sup>			OP.1 <sup>Note 5</sup>		
SSB configuration		Conf 1, 2, 4, 5, 7, 8	SSB.1 FR1			SSB.1 FR1		
		Conf 3, 6, 9	SSB.2 FR1			SSB.2 FR1		
SMTC configuration		Conf 1, 2, 3, 4, 5, 6, 7, 8, 9	SMTC.1			SMTC.1		
CSI-RS for tracking		Conf 1	TRS.1.1 FDD			TRS.1.1 FDD		
		Conf 2	TRS.1.1 TDD			TRS.1.1 TDD		
		Conf 3	TRS.1.2 TDD			TRS.1.2 TDD		
		Conf 4	TRS.1.1 FDD			TRS.1.1 FDD		
		Conf 5	TRS.1.1 TDD			TRS.1.1 TDD		
		Conf 6	TRS.1.2 TDD			TRS.1.2 TDD		
		Conf 7	TRS.1.1 FDD			TRS.1.1 FDD		
		Conf 8	TRS.1.1 TDD			TRS.1.1 TDD		
	Conf 9	TRS.1.2 TDD			TRS.1.2 TDD			
DL initial BWP configuration		Conf 1, 2, 3, 4, 5, 6, 7, 8, 9	DLBWP.0.1			DLBWP.0.1		
DL dedicated BWP configuration		Conf 1, 2, 3, 4, 5, 6, 7, 8, 9	DLBWP.1.1			DLBWP.1.1		
UL dedicated BWP configuration		Conf 1, 2, 3, 4, 5, 6, 7, 8, 9	ULBWP.1.1			ULBWP.1.1		
EPRE ratio of PSS to SSS	dB	Conf 1, 2, 3, 4, 5, 6, 7, 8, 9	0	0	0	0	0	0
EPRE ratio of PBCH_DMRS to SSS								
EPRE ratio of PBCH to PBCH_DMRS								
EPRE ratio of PDCCH_DMRS to SSS								
EPRE ratio of PDCCH to PDCCH_DMRS								
EPRE ratio of PDSCH_DMRS to SSS								
EPRE ratio of PDSCH to PDSCH_DMRS								
EPRE ratio of OCNG DMRS to SSS								
EPRE ratio of OCNG to OCNG DMRS								
$N_{oc}$ <sup>Note 2</sup>								
	dBm/SCS	Conf 1, 2, 4, 5, 7, 8	-102			-102		
		Conf 3, 6, 9	-99			-99		
$\hat{E}_s / N_{oc}$	dB	Conf 1, 2, 3, 4, 5, 6, 7, 8, 9	16	16	16	16	16	16
$\hat{E}_s / I_{ot}$ <sup>Note 3</sup>	dB	Conf 1, 2, 3, 4, 5, 6, 7, 8, 9	16	16	16	16	16	16
SS-RSRP <sup>Note 3</sup>	dBm/SCS	Conf 1, 2, 4, 5, 7, 8	-86	-86	-86	-86	-86	-86
		Conf 3, 6, 9	-83	-83	-83	-83	-83	-83

I <sub>o</sub> <sup>Note 3</sup>	dBm/ 9.36 MHz	Conf 1, 2, 4, 5, 7,8	-57.9	-57.9	-57.9	-57.9	-57.9	-57.9
	dBm/ 38.16 MHz	Conf 3, 6, 9	-51.8	-51.8	-51.8	-51.8	-51.8	-51.8
Propagation Condition		Conf 1, 2, 3, 4, 5, 6, 7, 8, 9	AWGN			AWGN		
Antenna configuration		Conf 1, 2, 3, 4, 5, 6, 7, 8, 9	1 x 2			1 x 2		
<p>NOTE 1: OCNG shall be used such that both cells are fully allocated, and a constant total transmitted power spectral density is achieved for all OFDM symbols.</p> <p>NOTE 2: Interference from other cells and noise sources not specified in the test is assumed to be constant over subcarriers and time and shall be modelled as AWGN of appropriate power for <math>N_{oc}</math> to be fulfilled within <math>BW_{occupied}</math>.</p> <p>NOTE 3: <math>\hat{E}_s/I_{ot}</math>, I<sub>o</sub>, and SS-RSRP levels have been derived from other parameters for information purposes. They are not settable parameters themselves.</p> <p>NOTE 4: All UL/DL transmission shall be confined within <math>BW_{occupied}</math> (i.e. 10 MHz, 52 RBs) from <math>F_{C,low}</math>, and I<sub>o</sub> is independent of the <math>BW_{channel}</math> configured.</p> <p>NOTE 5: All UL/DL transmission shall be confined within <math>BW_{occupied}</math> (i.e. 40 MHz, 106 RBs) from <math>F_{C,low}</math>, and I<sub>o</sub> is independent of the <math>BW_{channel}</math> configured.</p> <p>NOTE 6: <math>N_{RB,c}</math> is derived from Table 5.3.2-1 in TS38.101-1[2] with configured <math>BW_{channel}</math>.</p>								

In test 1 the UE shall be ready to start transmission on the supplementary uplink carrier on SCell within 20 ms from the start of T2.

In test 1 the UE shall stop the transmission on the supplementary uplink carrier on SCell within 20 ms from the start of T3.

In test 2 the UE shall be ready to start transmission on the NR uplink carrier on SCell within 20 ms from the start of T2.

In test 2 the UE shall stop the transmission on the NR uplink carrier on SCell within 20 ms from the start of T3.

All of the above test requirements shall be fulfilled in order for the observed UE UL carrier configuration delay and UE UL carrier release delay to be counted as correct. The rate of correct observed UE UL carrier configuration delay and UE UL carrier release delay during repeated tests shall be at least 90%.

## 6.5.5 Link recovery procedures

### 6.5.5.0 Minimum conformance requirements

#### 6.5.5.0.1 Minimum conformance requirements for SSB-based BFD and link recovery procedures

Same as in the clause 4.5.5.0.1.

#### 6.5.5.0.3 Scheduling availability of UE during beam failure detection and candidate beam detection

Same as in the clause 4.5.5.0.3.

#### 6.5.5.0.4 Requirements for Beam Failure Recovery in SCell

Same as in the clause 4.5.5.0.4.

#### 6.5.5.0.2 Minimum conformance requirements for CSI-RS-based BFD and link recovery procedures

UE shall be able to evaluate whether the downlink radio link quality on the configured CSI-RS resource in set  $\bar{q}_0$  estimated over the last  $T_{Evaluate\_BFD\_CSI-RS}$  [ms] period becomes worse than the threshold  $Q_{out\_LR\_CSI-RS}$  within  $T_{Evaluate\_BFD\_CSI-RS}$  [ms] period.

The value of  $T_{Evaluate\_BFD\_CSI-RS}$  is defined in Table 8.5.3.2-1 for FR1.

For FR1,

- $P=1/(1 - T_{\text{CSI-RS}}/\text{MGRP})$ , when in the monitored cell there are measurement gaps configured for intra-frequency, inter-frequency or inter-RAT measurements, which are overlapping with some but not all occasions of the CSI-RS; and
- $P=1$  when in the monitored cell there are no measurement gaps overlapping with any occasion of the CSI-RS.

Longer evaluation period would be expected if the combination of BFD-RS, SMTC occasion and measurement gap configurations does not meet previous conditions.

The values of  $M_{\text{BFD}}$  used in Table 6.5.5.0.2-1 is defined as

- $M_{\text{BFD}} = 10$ , if the CSI-RS resource configured for BFD is transmitted with Density = 3.

**Table 6.5.5.0.2-1: Evaluation period  $T_{\text{Evaluate\_BFD\_CSI-RS}}$  for FR1**

Configuration	$T_{\text{Evaluate\_BFD\_CSI-RS}}$ (ms)
no DRX	$\max([50], [M_{\text{BFD}} * P] * T_{\text{CSI-RS}})$
DRX cycle $\leq 320\text{ms}$	$\max([50], [1.5 * M_{\text{BFD}} * P] * \max(T_{\text{DRX}}, T_{\text{CSI-RS}}))$
DRX cycle $> 320\text{ms}$	$[M_{\text{BFD}} * P] * T_{\text{DRX}}$
Note:	$T_{\text{CSI-RS}}$ is the periodicity of CSI-RS resource in the set $\bar{q}_0$ . $T_{\text{DRX}}$ is the DRX cycle length.

When the radio link quality on all the configured RS resources in set  $\bar{q}_0$  is worse than  $Q_{\text{out\_LR}}$ , Layer 1 of the UE shall send a beam failure instance indication to the higher layers. A Layer 3 filter may be applied to the beam failure instance indications as specified in TS 38.331 [13].

The beam failure instance evaluation for the configured RS resources in set  $\bar{q}_0$  shall be performed as specified in section 6 in TS 38.213 [8]. Two successive indications from Layer 1 shall be separated by at least  $T_{\text{Indication\_interval\_BFD}}$ .

When DRX is not used,  $T_{\text{Indication\_interval\_BFD}}$  is  $\max(2\text{ms}, T_{\text{BFD-RS,M}})$ , where  $T_{\text{BFD-RS,M}}$  is the shortest periodicity of all configured RS resources in set  $\bar{q}_0$  for the accessed cell, corresponding to either the shortest periodicity of the SSB in the set  $\bar{q}_0$  or CSI-RS resource in the set  $\bar{q}_0$ .

When DRX is used,  $T_{\text{Indication\_interval\_BFD}}$  is  $\max(1.5 * \text{DRX\_cycle\_length}, 1.5 * T_{\text{BFD-RS,M}})$  if DRX cycle\_length is less than or equal to 320ms, and  $T_{\text{Indication\_interval}}$  is DRX\_cycle\_length if DRX cycle\_length is greater than 320ms.

UE shall be able to evaluate whether the L1-RSRP measured on the configured CSI-RS resource in set  $\bar{q}_1$  estimated over the last  $T_{\text{Evaluate\_CBD\_CSI-RS}}$  [ms] period becomes better than the threshold  $Q_{\text{in\_LR}}$  within  $T_{\text{Evaluate\_CBD\_CSI-RS}}$  [ms] period provided CSI-RS  $\hat{E}_s/\text{Iot}$  is according to Annex Table B.2.4.2 for a corresponding band.

The value of  $T_{\text{Evaluate\_CBD\_CSI-RS}}$  is defined in Table 6.5.5.0.2-2 for FR1.

For FR1,

- $P=1/(1 - T_{\text{CSI-RS}}/\text{MGRP})$ , when in the monitored cell there are measurement gaps configured for intra-frequency, inter-frequency or inter-RAT measurements, which are overlapping with some but not all occasions of the CSI-RS; and
- $P=1$  when in the monitored cell there are no measurement gaps overlapping with any occasion of the CSI-RS.

In both FR1 and FR2, if different SCS is used for SSB and CSI-RS, and the UE does not support *simultaneousRxDataSSB-DiffNumerology*, it is assumed that the CSI-RS configured for candidate beam detection and each SSB shall be TDMed transmitted.

The values of  $M_{\text{CBD}}$  used in Table 6.5.5.0.2-2 is defined as

- $M_{\text{CBD}} = 3$ , if the CSI-RS resource configured in the set  $\bar{q}_1$  is transmitted with Density = 3.

**Table 6.5.5.0.2-2: Evaluation period  $T_{\text{Evaluate\_CBD\_CSI-RS}}$  for FR1**

Configuration	$T_{\text{Evaluate\_CBD\_CSI-RS}}$ (ms)
non-DRX	$\max([25], \text{ceil}(M_{\text{CBD}} * P) * T_{\text{CSI-RS}})$
DRX cycle $\leq 320\text{ms}$	$\text{ceil}(M_{\text{CBD}} * P * N) * \max(T_{\text{DRX}}, T_{\text{CSI-RS}})$
DRX cycle $> 320\text{ms}$	$\text{ceil}(M_{\text{CBD}} * P) * T_{\text{DRX}}$
Note:	$T_{\text{CSI-RS}}$ is the periodicity of CSI-RS resource in the set $\bar{q}_1$ . $T_{\text{DRX}}$ is the DRX cycle length.

The normative reference for this requirement is TS 38.133 [6] clause 8.5.3.2, 8.5.4 and 8.5.6.2.

**6.5.5.1 NR SA FR1 SSB-based beam failure detection and link recovery in non-DRX**

**6.5.5.1.1 Test purpose**

The purpose of this test is to verify that the UE properly detects SSB-based beam failure in the set  $q_0$  configured for a serving cell and that the UE performs correct SSB-based link recovery based on beam candidate set  $q_1$ . The purpose is to test the downlink monitoring for beam failure detection within the UEs active DL BWP, during the evaluation period, and link recovery, when no DRX is used. This test will partly verify the SSB based beam failure detection and link recovery for an FR1 serving cell requirements in TS 38.133 [6] clause 8.5.

**6.5.5.1.2 Test applicability**

This test applies to all types of NR UE release 15 and forward supporting 5GS NR SA FR1 and link recovery.

**6.5.5.1.3 Minimum conformance requirements**

The minimum conformance requirements are specified in clause 6.5.5.0.1.

The normative reference for this requirement is TS 38.133 [6] clause A.6.5.5.1.

**6.5.5.1.4 Test description**

The test consists of five successive time periods, with time duration of T1, T2, T3, T4 and T5 respectively. Figure 6.5.5.1.4-1 shows the five different time durations and the corresponding variation of the downlink SNR in the active cell to emulate SSB based beam failure. Figure 6.5.5.1.4-1 additionally shows the variation of the downlink L1-RSRP of the SSB in set  $q_1$  of the candidate beam used for link recovery

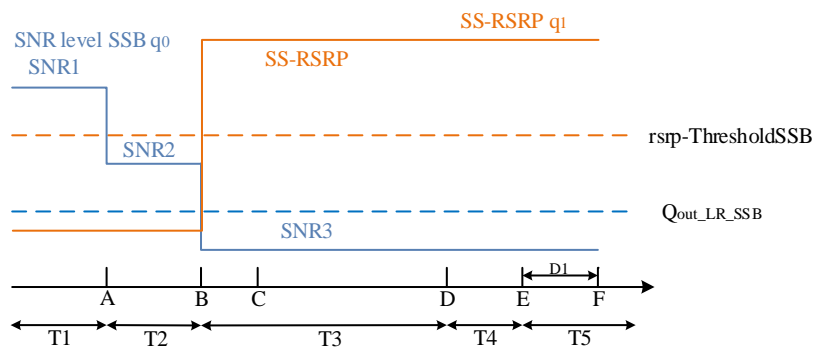

**Figure 6.5.5.1.4-1: SNR and L1-RSRP variation for NR SA FR1 SSB-based beam failure detection and link recovery in non-DRX mode**

**6.5.5.1.4.1 Initial conditions**

This test shall be tested using any of the test configurations in Table 6.5.5.1.4.1-1.

**Table 6.5.5.1.4.1-1: Supported test configurations for NR SA FR1 SSB-based beam failure detection and link recovery in non-DRX mode**

Configuration	Description
6.5.5.1-1	FDD duplex mode, 15 kHz SSB SCS, 10MHz bandwidth
6.5.5.1-2	TDD duplex mode, 15 kHz SSB SCS, 10MHz bandwidth
6.5.5.1-3	TDD duplex mode, 30 kHz SSB SCS, 40MHz bandwidth
Note:	The UE is only required to pass in one of the supported test configurations in FR1

Configure the test equipment and the DUT according to the parameters in Table 6.5.5.1.4.1-2.

**Table 6.5.5.1.4.1-2: Initial conditions for NR SA FR1 SSB-based beam failure detection and link recovery in non-DRX mode**

Parameter	Value	Comment
Test environment	NC	As specified in TS 38.508-1 [14] clause 4.1.
Test frequencies	As specified in Annex E, table E.4-1 and TS 38.508-1 [14] clause 4.3.1 and 4.4.2.	
Channel bandwidth	As specified by the test configuration selected from Table 6.5.5.1.4.1-1.	
Propagation conditions	AWGN	As specified in Annex C.2.2.
Connection Diagram	TE Part	A.3.1.7.1
	DUT Part	A.3.2.3.4
Exceptions to connection diagram	- Without LTE link - For 4Rx capable UEs without any 2 Rx RF bands use A.3.2.5.2 for DUT part and A.3.1.8.4 for TE Part	

1. The general test parameter settings are set up according to Table 6.5.5.1.4.1-3.
2. Message contents are defined in clause 6.5.5.1.4.3.
3. There is one NR carrier and one NR cells specified in the test. Cell 1 is the NR cell used for connection setup with the power level set according to Annex C.1.2 and C.1.3 for this test.

**Table 6.5.5.1.4.1-3: General test parameters for NR SA FR1 SSB-based beam failure detection and link recovery in non-DRX mode**



Parameter		Unit	Value	Comment
			Test 1	
Active PSCell			Cell 1	
RF Channel Number			1	
Duplex mode	Config 1		FDD	
	Config 2, 3		TDD	
BWchannel	Config 1	MHz	10: NRB,c = 52	
	Config 2		10: NRB,c = 52	
	Config 3		40: NRB,c = 106	
DL initial BWP configuration	Config 1, 2, 3		DLBWP.0.1	
DL dedicated BWP configuration	Config 1, 2, 3		DLBWP.1.1	
UL initial BWP configuration	Config 1, 2, 3		ULBWP.0.1	
UL dedicated BWP configuration	Config 1, 2, 3		ULBWP.1.1	
TDD Configuration	Config 1		Not Applicable	
	Config 2		TDDConf.1.1	
	Config 3		TDDConf.2.1	
CORESET Reference Channel	Config 1		CR.1.1 FDD	
	Config 2		CR.1.1 TDD	
	Config 3		CR.2.1 TDD	
SSB Configuration	Config 1		SSB.3 FR1	
	Config 2		SSB.3 FR1	
	Config 3		SSB.4 FR1	
SMTC Configuration	Config 1, 2		SMTC.1	
	Config 3		SMTC.1	
PDSCH/PDCCH subcarrier spacing	Config 1, 2		15 KHz	
	Config 3		30 KHz	
PRACH Configuration	Config 1, 2		PRACH.2 FR1	
	Config 3		PRACH.2 FR1	
SSB Index assigned as BFD RS ( $q_0$ )			0	
SSB Index assigned as CBD RS ( $q_1$ )			1	
OCNG parameters			OP.1	
CP length			Normal	
Correlation Matrix and Antenna Configuration			2x2 Low	
Beam failure detection transmission parameters	DCI format		1-0	
	Number of Control OFDM symbols		2	
	Aggregation level	CCE	8	
	Ratio of hypothetical PDCCH RE energy to average CSI-RS RE energy	dB	0	
	Ratio of hypothetical PDCCH DMRS energy to average CSI-RS RE energy	dB	0	
	DMRS precoder granularity		REG bundle size	
	REG bundle size		6	
DRX			OFF	
Gap pattern ID			gp0	
gapOffset			0	

rlmInSyncOutOfSyncThreshold			absent	When the field is absent, the UE applies the value 0.
rsrp-ThresholdSSB	Config 1, 2	dBm/SCS kHz	-98	Threshold used for $Q_{in\_LR\_SSB}$
	Config 3	dBm/SCS kHz	-95	Threshold used for $Q_{in\_LR\_SSB}$
powerControlOffsetSS			db0	Used for deriving rsrp-ThresholdCSI-RS
beamFailureInstanceMaxCount			n1	see clause 5.17 of TS 38.321 [12]
beamFailureDetectionTimer			pbfd4	see clause 5.17 of TS 38.321 [12]
CSI-RS configuration for CSI reporting	Config 1		CSI-RS.1.1 FDD	
	Config 2		CSI-RS.1.1 TDD	
	Config 3		CSI-RS.2.1 TDD	
CSI-RS for tracking	Config 1		TRS.1.1 FDD	
	Config 2		TRS.1.1 TDD	
	Config 3		TRS.1.2 TDD	
SSB Index assigned as RLM RS			0, 1	
T310 Timer		ms	1000	
N310			2	
T1		s	0.2	During this time the UE shall be fully synchronized to cell 1
T2		s	0.37	
T3		s	0.24	
T4		s	0	
T5		s	0.17	
D1		s	0.13	
Note 1: All configurations are assigned to the UE prior to the start of time period T1.				
Note 2: UE-specific PDCCH is not transmitted after T1 starts.				

#### 6.5.5.1.4.2 Test procedure

Prior to the start of the time duration T1, the UE shall be fully synchronized to NR Cell 1. The UE shall be configured for periodic CSI reporting with a reporting periodicity of 5 ms. In the test, DRX configuration is not enabled. The UE is configured to perform inter-frequency measurements using GP ID #0 (40ms) in test 1

1. Ensure the UE is in state RRC\_CONNECTED with generic procedure parameters Connectivity NR, Connected without release On and Test Mode On according to TS 38.508-1 [14] clause 4.5.
2. The SS sends an RRCReconfiguration message to the UE to configure inter-frequency measurement.
3. The UE sends an RRCReconfigurationComplete message.
4. Set the parameters of NR Cell 1 according to T1 in Table 6.5.5.1.5-1. Propagation conditions are set according to Annex C.2.3. T1 starts.
5. When T1 expires the SS shall change the SNR value to T2 as specified in Table 6.5.5.1.5-1. T2 starts.
6. When T2 expires the SS shall change the SNR value to T3 as specified in Table 6.5.5.1.5-1. T3 starts.
7. When T3 expires the SS shall change the SNR value to T4 as specified in Table 6.5.5.1.5-1. T4 starts.

8. When T4 expires the SS shall change the SNR value to T5 as specified in Table 6.5.5.1.5-1. T5 starts.
9. If the SS:
  - a) detects uplink power on NR carrier equal to or higher than minimum output power defined in TS 38.521-1 [17] clause 6.3.1.5 in each slot configured for CSI transmission (according CSI reporting on PUCCH) during the period from time point A to time point B

and

  - b) does not detect preamble on a beam associated with the candidate beam set  $q_1$  before time point B

and

  - c) detects preamble on a beam associated with the candidate beam set  $q_1$  before time point F (D1 after the start of T5),

the number of successful tests is increased by one.

Otherwise the number of failed tests is increased by one.

10. If the iteration or random access procedure for BFD fails, switch the UE off and on. Ensure the UE is in RRC\_CONNECTED with generic procedure parameters Connectivity NR, Connected without release On and Test Mode *On* according to TS 38.508-1 [14] clause 4.5.11. Repeat steps 4-10 for all subtests until the confidence level according to Tables G.2.3-1 in Annex G clause G.2 is achieved.

6.5.5.1.4.3 Message contents

Message contents are according to TS 38.508-1 [14] clause 4.6 and clause 7.3 with the following exceptions:

**Table 6.5.5.1.4.3-1: Common Exception messages for NR SA FR1 SSB-based beam failure detection and link recovery in non-DRX mode**

Default Message Contents	
Common contents of system information blocks exceptions	
Default RRC messages and information elements contents exceptions	Table H.3.1-6 with Condition BFD Table H.3.1-1 Table H.3.1-2 with Condition INTER-FREQ, L3 FILTERING NEEDED, GAP_NEEDED Table H.3.1-3 with Condition INTER-FREQ MO (where <i>ssbFrequency</i> is set to the ARFCN value of carrier center of High range) Table H.3.1-4 with <i>A3-offset</i> = 0  Table H.3.1-8 with Condition SSB BFD  Table H.3.1-10 with Condition SSB  Table H.3.1-10A Table H.3.5-4 Table 7.3.1-3 in TS 38.508-1 [14] with condition SMTC.1

**Table 6.5.5.1.4.3-2: PDCCH Search Space for BFR**

Derivation Path: TS 38.508-1 [14], Table 4.6.3-162			
Information Element	Value/remark	Comment	Condition
SearchSpace ::= SEQUENCE {			
searchSpaceId	4	BFR	
controlResourceSetId	2	BFR	
monitoringSlotPeriodicityAndOffset CHOICE {			
sl1	NULL		
}			
monitoringSymbolsWithinSlot	10000000000000	Symbol 0	
nrofCandidates SEQUENCE {			
aggregationLevel1	n0		
aggregationLevel2	n0		
aggregationLevel4	n0		
aggregationLevel8	n1	AL8	
aggregationLevel16	n0		
}			
searchSpaceType CHOICE {			
ue-Specific SEQUENCE {			USS
dci-Formats	formats0-0-And-1-0	DCI Format 1_0	
}			
}			
}			

**Table 6.5.5.1.4.3-3: RLF-TimersAndConstants**

Derivation Path: TS 38.508-1 [14], Table 4.6.3-150			
Information Element	Value/remark	Comment	Condition
RLF-TimersAndConstants ::= SEQUENCE {			
n310	n2		
}			

**Table 6.5.5.1.4.3-4: Void**

**Table 6.5.5.1.4.3-5: PDCCH-Config**

Derivation Path: TS 38.501-1 [14], Table 4.6.3-95			
Information Element	Value/remark	Comment	Condition
PDCCH-Config ::= SEQUENCE {			
controlResourceSetToAddModList	2 entries		
SEQUENCE(SIZE (1..3)) OF ControlResourceSet {			
ControlResourceSet[2]	ControlResourceSet	entry 2, BFR	
}			
controlResourceSetToReleaseList	Not present		
searchSpacesToAddModList SEQUENCE(SIZE (1..10)) OF SearchSpace {	2 entries		
SearchSpace[2]	SearchSpace	entry 2, BFR	
}			
searchSpacesToReleaseList	Not present		
downlinkPreemption	Not present		
tpc-PUSCH	Not present		
tpc-PUCCH	Not present		
tpc-SRS	Not present		
}			

**Table 6.5.5.1.4.3-6: ControlResourceSet for BFR**

Derivation Path: TS 38.501-1 [14], Table 7.3.1-15			
Information Element	Value/remark	Comment	Condition
ControlResourceSet ::= SEQUENCE {			
controlResourceSetId	2		
duration	2		
cce-REG-MappingType CHOICE {			
interleaved ::= SEQUENCE {			
reg-BundleSize	n6		
interleaverSize	n2		
shiftIndex	0		
}			
tci-StatesPDCCH-ToAddList	Not present		
}			

6.5.5.1.5 Test requirement

Tables 6.5.5.1.4.1-3 and 6.5.5.1.5-1 define the primary level settings including test tolerances for NR SA FR1 SSB-based beam failure detection and link recovery in DRX.

**Table 6.5.5.1.5-1: NR Cell specific test parameters for NR SA FR1 SSB-based beam failure detection and link recovery in non-DRX mode**

Parameter		Unit	Test 1				
			T1	T2	T3	T4	T5
EPRE ratio of PDCCH DMRS to SSS		dB	0				
EPRE ratio of PDCCH to PDCCH DMRS							
EPRE ratio of PBCH DMRS to SSS							
EPRE ratio of PBCH to PBCH DMRS							
EPRE ratio of PSS to SSS							
EPRE ratio of PDSCH DMRS to SSS							
EPRE ratio of PDSCH to PDSCH DMRS							
EPRE ratio of OCNG DMRS to SSS							
EPRE ratio of OCNG to OCNG DMRS							
SNR_SSB of set q <sub>0</sub>	Config 1	dB	5.8	-2.2	-12.8	-12.8	-12.8
	Config 2		5.8	-2.2	-12.8	-12.8	-12.8
	Config 3		5.8	-2.2	-12.8	-12.8	-12.8
SNR_SSB of set q <sub>1</sub>	Config 1	dB	-10.2	-10.2	10.2	10.2	10.2
	Config 2		-10.2	-10.2	10.2	10.2	10.2
	Config 3		-10.2	-10.2	10.2	10.2	10.2
SSB_RP of set q <sub>1</sub>	Config 1	dBm/S CS kHz	-108.2	-108.2	-87.8	-87.8	-87.8
	Config 2		-108.2	-108.2	-87.8	-87.8	-87.8
	Config 3		-105.2	-105.2	-84.8	-84.8	-84.8
$N_{oc}$	Config 1	dBm/15 kHz	-98				
	Config 2		-98				
	Config 3		-98				
Propagation condition			TDL-C 300ns 100Hz				
<p>Note 1: OCNG shall be used such that the resources in Cell 1 are fully allocated and a constant total transmitted power spectral density is achieved for all OFDM symbols.</p> <p>Note 2: The uplink resources for CSI reporting are assigned to the UE prior to the start of time period T1.</p> <p>Note 3: NZP CSI-RS resource set configuration for CSI reporting are assigned to the UE prior to the start of time period T1.</p> <p>Note 4: Measurement gap configuration is assigned to the UE prior to the start of time period T1</p> <p>Note 5: The timers and layer 3 filtering related parameters are configured prior to the start of time period T1.</p> <p>Note 6: The signal contains PDCCH for UEs other than the device under test as part of OCNG.</p> <p>Note 7: SNR levels correspond to the signal to noise ratio over the SSS REs.</p> <p>Note 8: The SNR in time periods T1, T2, T3, T4 and T5 is denoted as SNR1, SNR2 and SNR3 respectively in figure 6.5.5.1.4-1.</p> <p>Note 9: The SNR values are specified for a UE with 2RX antennas connected under test. For a UE with 4RX antennas connected under test, the SNR for RS in set q<sub>0</sub> during T3, T4, and T5 from D.4.1.1, is -15dB-TT = -15.8dB (including test tolerances).</p>							

**Table 6.5.5.1.5-2: Void**

The UE behaviour during time durations T1, T2, T3, T4 and T5 shall be as follows:

During the time duration T1 and T2, the UE shall transmit uplink signal at least in all subframes configured for CSI transmission on Cell 1.

During the period from time point A to time point B the UE shall transmit uplink signal in Cell 1 in all uplink slots configured for CSI transmission according to the configured periodic CSI reporting for Cell 1.

During T3 the UE shall detect beam failure and initiate link recovery. During T4 and T5 the UE measures and evaluate beam candidate from beam candidate set  $q_1$ .

No later than time point F occurring no later than  $D1 = 130$  ms after the start of T5, the UE shall transmit preamble on a beam associated with the candidate beam set  $q_1$ . The UE shall not transmit preamble on a beam associated with the candidate beam set  $q_1$  earlier than time point B.

Test is concluded once the test equipment has received the initial preamble transmission from the UE. The rate of correct events observed during repeated tests shall be at least 90%.

### 6.5.5.2 NR SA FR1 SSB-based beam failure detection and link recovery in DRX

#### 6.5.5.2.1 Test purpose

The purpose of this test is to verify that the UE properly detects SSB-based beam failure in the set  $q_0$  configured for a serving cell and that the UE performs correct SSB-based link recovery based on beam candidate set  $q_1$ . The purpose is to test the downlink monitoring for beam failure detection within the UEs active DL BWP, during the evaluation period, and link recovery, when DRX is used. This test will partly verify the SSB based beam failure detection and link recovery for an FR1 serving cell requirements in TS 38.133 [6] clause 8.5.

#### 6.5.5.2.2 Test applicability

This test applies to all types of NR UE release 15 and forward supporting 5GS NR SA FR1, link recovery and long DRX cycle.

#### 6.5.5.2.3 Minimum conformance requirements

The minimum conformance requirements are specified in clause 6.5.5.0.1.

The normative reference for this requirement is TS 38.133 [6] clause A.6.5.5.2.

#### 6.5.5.2.4 Test description

The test consists of five successive time periods, with time duration of T1, T2, T3, T4 and T5 respectively. Figure 6.5.5.2.4-1 shows the five different time durations and the corresponding variation of the downlink SNR in the active cell to emulate SSB based beam failure. Figure 6.5.5.2.4-1 additionally shows the variation of the downlink L1-RSRP of the SSB in set  $q_1$  of the candidate beam used for link recovery.

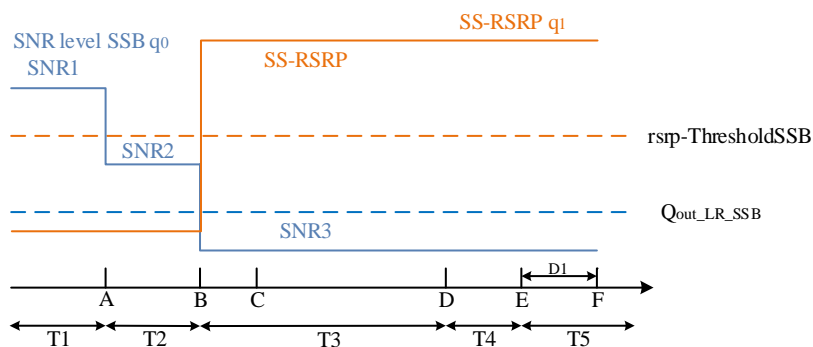

**Figure 6.5.5.2.4-1: SNR and L1-RSRP variation for NR SA FR1 SSB-based beam failure detection and link recovery in DRX**

## 6.5.5.2.4.1 Initial conditions

This test shall be tested using any of the test configurations in Table 6.5.5.2.4.1-1.

**Table 6.5.5.2.4.1-1: Supported test configurations for NR SA FR1 SSB-based beam failure detection and link recovery in DRX**

Configuration	Description
6.5.5.2-1	FDD duplex mode, 15 kHz SSB SCS, 10MHz bandwidth
6.5.5.2-2	TDD duplex mode, 15 kHz SSB SCS, 10MHz bandwidth
6.5.5.2-3	TDD duplex mode, 30 kHz SSB SCS, 40MHz bandwidth
Note:	The UE is only required to pass in one of the supported test configurations in FR1

Configure the test equipment and the DUT according to the parameters in Table 6.5.5.2.4.1-2.

**Table 6.5.5.2.4.1-2: Initial conditions for NR SA FR1 SSB-based beam failure detection and link recovery in DRX**

Parameter	Value	Comment
Test environment	NC	As specified in TS 38.508-1 [14] clause 4.1.
Test frequencies	As specified in Annex E, table E.4-1 and TS 38.508-1 [14] clause 4.3.1 and 4.4.2.	
Channel bandwidth	As specified by the test configuration selected from Table 6.5.5.2.4.1-1.	
Propagation conditions	AWGN	As specified in Annex C.2.2.
Connection Diagram	TE Part	A.3.1.7.1
	DUT Part	A.3.2.3.4
Exceptions to connection diagram	- Without LTE link - For 4Rx capable UEs without any 2 Rx RF bands use A.3.2.5.2 for DUT part and A.3.1.8.4 for TE Part	

1. The general test parameter settings are set up according to Table 6.5.5.2.4.1-3.
2. Message contents are defined in clause 6.5.5.2.4.3.
3. There is one NR carrier and one NR cells specified in the test. Cell 1 is the NR cell used for connection setup with the power level set according to Annex C.1.2 and C.1.3 for this test.

**Table 6.5.5.2.4.1-3: General test parameters for NR SA FR1 SSB-based beam failure detection and link recovery in DRX**



Parameter		Unit	Value	Comment
			Test 1	
Active PSCell			Cell 1	
RF Channel Number			1	
Duplex mode	Config 1		FDD	
	Config 2, 3		TDD	
BWchannel	Config 1	MHz	10: NRB,c = 52	
	Config 2		10: NRB,c = 52	
	Config 3		40: NRB,c = 106	
DL initial BWP configuration	Config 1, 2, 3		DLBWP.0.1	
DL dedicated BWP configuration	Config 1, 2, 3		DLBWP.1.1	
UL initial BWP configuration	Config 1, 2, 3		ULBWP.0.1	
UL dedicated BWP configuration	Config 1, 2, 3		ULBWP.1.1	
TDD Configuration	Config 1		Not Applicable	
	Config 2		TDDConf.1.1	
	Config 3		TDDConf.2.1	
CORESET Reference Channel	Config 1		CR.1.1 FDD	
	Config 2		CR.1.1 TDD	
	Config 3		CR.2.1 TDD	
SSB Configuration	Config 1		SSB.3 FR1	
	Config 2		SSB.3 FR1	
	Config 3		SSB.4 FR1	
SMTC Configuration	Config 1, 2		SMTC.1	
	Config 3		SMTC.1	
PDSCH/PDCCH subcarrier spacing	Config 1, 2		15 KHz	
	Config 3		30 KHz	
PRACH Configuration	Config 1, 2		PRACH.2 FR1	
	Config 3		PRACH.2 FR1	
SSB Index assigned as BFD RS ( $q_0$ )			0	
SSB Index assigned as CBD RS ( $q_1$ )			1	
OCNG parameters			OP.1	
CP length			Normal	
Correlation Matrix and Antenna Configuration			2x2 Low	
Beam failure detection transmission parameters	DCI format		1-0	
	Number of Control OFDM symbols		2	
	Aggregation level	CCE	8	
	Ratio of hypothetical PDCCH RE energy to average CSI-RS RE energy	dB	0	
	Ratio of hypothetical PDCCH DMRS energy to average CSI-RS RE energy	dB	0	
	DMRS precoder granularity		REG bundle size	
	REG bundle size		6	
DRX			DRX.7	see clause A.3.3.7 of TS 38.133 [6]

Gap pattern ID			N.A.	
rlmInSyncOutOfSyncThreshold			absent	When the field is absent, the UE applies the value 0.
rsrp-ThresholdSSB	Config 1, 2	dBm/SCS kHz	-98	Threshold used for $Q_{in\_LR\_SSB}$
	Config 3	dBm/SCS kHz	-95	Threshold used for $Q_{in\_LR\_SSB}$
powerControlOffsetSS			db0	Used for deriving rsrp-ThresholdCSI-RS
beamFailureInstanceMaxCount			n1	see clause 5.17 of TS 38.321 [12]
beamFailureDetectionTimer			pbfd4	see clause 5.17 of TS 38.321 [12]
CSI-RS configuration for CSI reporting	Config 1		CSI-RS.1.1 FDD	
	Config 2		CSI-RS.1.1 TDD	
	Config 3		CSI-RS.2.1 TDD	
CSI-RS for tracking	Config 1		TRS.1.1 FDD	
	Config 2		TRS.1.1 TDD	
	Config 3		TRS.1.2 TDD	
SSB Index assigned as RLM RS			0, 1	
T310 Timer		ms	1000	
N310			2	
T1		s	1	During this time the UE shall be fully synchronized to cell 1
T2		s	5.17	
T3		s	3.24	
T4		s	0	
T5		s	1.97	
D1		s	1.93	
Note 1: All configurations are assigned to the UE prior to the start of time period T1.				
Note 2: UE-specific PDCCH is not transmitted after T1 starts.				

#### 6.5.5.2.4.2 Test procedure

Prior to the start of the time duration T1, the UE shall be fully synchronized to NR Cell 1. The UE shall be configured for periodic CSI reporting with a reporting periodicity of 5 ms. In the test, DRX configuration is enabled.

1. Ensure the UE is in state RRC\_CONNECTED with generic procedure parameters Connectivity NR, Connected without release On and Test Mode On according to TS 38.508-1 [14] clause 4.5.
2. Set the parameters of NR Cell 1 according to T1 in Table 6.5.5.2.5-1. Propagation conditions are set according to Annex C.2.3. T1 starts.
3. When T1 expires the SS shall change the SNR value to T2 as specified in Table 6.5.5.2.5-1. T2 starts.
4. When T2 expires the SS shall change the SNR value to T3 as specified in Table 6.5.5.2.5-1. T3 starts.
5. When T3 expires the SS shall change the SNR value to T4 as specified in Table 6.5.5.2.5-1. T4 starts.
6. When T4 expires the SS shall change the SNR value to T5 as specified in Table 6.5.5.2.5-1. T5 starts.
7. If the SS:

a) detects uplink power on NR carrier equal to or higher than minimum output power defined in TS 38.521-1 [17] clause 6.3.1.5 in each slot configured for CSI transmission (according CSI reporting on PUCCH) during the period from time point A to time point B

and

b) does not detect preamble on a beam associated with the candidate beam set  $q_1$  before time point B

and

c) detects preamble on a beam associated with the candidate beam set  $q_1$  before time point F (D1 after the start of T5),

the number of successful tests is increased by one.

Otherwise the number of failed tests is increased by one.

8. If the iteration or the random access procedure for BFD fails, switch the UE off and on. Ensure the UE is in RRC\_CONNECTED with generic procedure parameters Connectivity NR, Connected without release On and Test Mode On according to TS 38.508-1 [14] clause 4.5.

9. Repeat steps 2-8 for all subtests until the confidence level according to Tables G.2.3-1 in Annex G clause G.2 is achieved. 6.5.5.2.4.3 Message contents

Message contents are according to TS 38.508-1 [14] clause 4.6 and clause 7.3 with the following exceptions:

**Table 6.5.5.2.4.3-1: Common Exception messages for NR SA FR1 SSB-based beam failure detection and link recovery in DRX**

Default Message Contents	
Common contents of system information blocks exceptions	
Default RRC messages and information elements contents exceptions	Table H.3.1-8 with Condition SSB BFD Table H.3.1-10 with Condition SSB Table H.3.1-10A Table H.3.5-4 Table H.3.7-1 with Condition DRX.7 Table 7.3.1-3 in TS 38.508-1 [14] with condition SMTC.1

**Table 6.5.5.2.4.3-2: PDCCH Search Space for BFR**

Derivation Path: TS 38.508-1 [14], Table 4.6.3-162			
Information Element	Value/remark	Comment	Condition
SearchSpace ::= SEQUENCE {			
searchSpaceId	4	BFR	
controlResourceSetId	2	BFR	
monitoringSlotPeriodicityAndOffset CHOICE {			
sl1	NULL		
}			
monitoringSymbolsWithinSlot	10000000000000	Symbol 0	
nrofCandidates SEQUENCE {			
aggregationLevel1	n0		
aggregationLevel2	n0		
aggregationLevel4	n0		
aggregationLevel8	n1	AL8	
aggregationLevel16	n0		
}			
searchSpaceType CHOICE {			
ue-Specific SEQUENCE {			USS
dci-Formats	formats0-0-And-1-0	DCI Format 1_0	
}			
}			
}			

**Table 6.5.5.2.4.3-3: RLF-TimersAndConstants**

Derivation Path: TS 38.508-1 [14], Table 4.6.3-150			
Information Element	Value/remark	Comment	Condition
RLF-TimersAndConstants ::= SEQUENCE {			
n310	n2		
}			

**Table 6.5.5.2.4.3-4: Void**

**Table 6.5.5.2.4.3-5: PDCCH-Config**

Derivation Path: TS 38.501-1 [14], Table 4.6.3-95			
Information Element	Value/remark	Comment	Condition
PDCCH-Config ::= SEQUENCE {			
controlResourceSetToAddModList	2 entries		
SEQUENCE(SIZE (1..3)) OF ControlResourceSet {			
ControlResourceSet[2]	ControlResourceSet	entry 2, BFR	
}			
controlResourceSetToReleaseList	Not present		
searchSpacesToAddModList SEQUENCE(SIZE (1..10)) OF SearchSpace {	2 entries		
SearchSpace[2]	SearchSpace	entry 2, BFR	
}			
searchSpacesToReleaseList	Not present		
downlinkPreemption	Not present		
tpc-PUSCH	Not present		
tpc-PUCCH	Not present		
tpc-SRS	Not present		
}			

**Table 6.5.5.2.4.3-6: ControlResourceSet for BFR**

Derivation Path: TS 38.501-1 [14], Table 7.3.1-15			
Information Element	Value/remark	Comment	Condition
ControlResourceSet ::= SEQUENCE {			
controlResourceSetId	2		
duration	2		
cce-REG-MappingType CHOICE {			
interleaved ::= SEQUENCE {			
reg-BundleSize	n6		
interleaverSize	n2		
shiftIndex	0		
}			
tci-StatesPDCCH-ToAddList	Not present		
}			

6.5.5.2.5 Test requirement

Tables 6.5.5.2.4.1-3 and 6.5.5.2.5-1 define the primary level settings including test tolerances for NR SA FR1 SSB-based beam failure detection and link recovery in DRX.

**Table 6.5.5.2.5-1: NR Cell specific test parameters for NR SA FR1 SSB-based beam failure detection and link recovery in DRX**

Parameter	Unit	Test 1				
		T1	T2	T3	T4	T5

EPRE ratio of PDCCH DMRS to SSS		dB	0				
EPRE ratio of PDCCH to PDCCH DMRS		dB					
EPRE ratio of PBCH DMRS to SSS		dB					
EPRE ratio of PBCH to PBCH DMRS		dB					
EPRE ratio of PSS to SSS		dB					
EPRE ratio of PDSCH DMRS to SSS		dB					
EPRE ratio of PDSCH to PDSCH DMRS		dB					
EPRE ratio of OCNG DMRS to SSS		dB					
EPRE ratio of OCNG to OCNG DMRS		dB					
SNR_SSB of set q <sub>0</sub>	Config 1	dB	5.8	-2.2	-12.8	-12.8	-12.8
	Config 2		5.8	-2.2	-12.8	-12.8	-12.8
	Config 3		5.8	-2.2	-12.8	-12.8	-12.8
SNR_SSB of set q <sub>1</sub>	Config 1	dB	-10.2	-10.2	10.2	10.2	10.2
	Config 2		-10.2	-10.2	10.2	10.2	10.2
	Config 3		-10.2	-10.2	10.2	10.2	10.2
SSB_RP of set q <sub>1</sub>	Config 1	dBm/S CS kHz	-108.2	-108.2	-87.8	-87.8	-87.8
	Config 2		-108.2	-108.2	-87.8	-87.8	-87.8
	Config 3		-105.2	-105.2	-84.8	-84.8	-84.8
$N_{oc}$	Config 1	dBm/15 kHz	-98				
	Config 2		-98				
	Config 3		-98				
Propagation condition			TDL-C 300ns 100Hz				
<p>Note 1: OCNG shall be used such that the resources in Cell 1 are fully allocated and a constant total transmitted power spectral density is achieved for all OFDM symbols.</p> <p>Note 2: The uplink resources for CSI reporting are assigned to the UE prior to the start of time period T1.</p> <p>Note 3: NZP CSI-RS resource set configuration for CSI reporting are assigned to the UE prior to the start of time period T1.</p> <p>Note 4: Void.</p> <p>Note 5: The timers and layer 3 filtering related parameters are configured prior to the start of time period T1.</p> <p>Note 6: The signal contains PDCCH for UEs other than the device under test as part of OCNG.</p> <p>Note 7: SNR levels correspond to the signal to noise ratio over the SSS REs.</p> <p>Note 8: The SNR in time periods T1, T2, T3, T4 and T5 is denoted as SNR1, SNR2 and SNR3 respectively in figure 6.5.5.2.4-1.</p> <p>Note 9: The SNR values are specified for a UE with 2RX antennas connected under test. For a UE with 4RX antennas connected under test, the SNR for RS in set q<sub>0</sub> during T3, T4, and T5 from D.4.1.1, is -15dB-TT = -15.8dB (including test tolerances).</p>							

The UE behaviour during time durations T1, T2, T3, T4 and T5 shall be as follows:

During the time duration T1 and T2, the UE shall transmit uplink signal at least in all subframes configured for CSI transmission on Cell 1.

During the period from time point A to time point B the UE shall transmit uplink signal in Cell 1 in all uplink slots configured for CSI transmission according to the configured periodic CSI reporting for Cell 1.

During T3 the UE shall detect beam failure and initiate link recovery. During T4 and T5 the UE measures and evaluate beam candidate from beam candidate set q<sub>1</sub>.

No later than time point F occurring no later than D1 = 1930 ms after the start of T5, the UE shall transmit preamble on a beam associated with the candidate beam set q<sub>1</sub>. The UE shall not transmit preamble on a beam associated with the candidate beam set q<sub>1</sub> earlier than time point B.

Test is concluded once the test equipment has received the initial preamble transmission from the UE. The rate of correct events observed during repeated tests shall be at least 90%.

### 6.5.5.3 NR SA FR1 CSI-RS-based beam failure detection and link recovery in non-DRX

#### 6.5.5.3.1 Test purpose

The purpose of this test is to verify that the UE properly detects CSI-RS-based beam failure in the set q<sub>0</sub> configured for a serving cell and that the UE performs correct CSI-RS-based link recovery based on beam candidate set q<sub>1</sub>. To test the downlink monitoring for beam failure detection within the UEs active DL BWP, during the evaluation period, and link

recovery, when no DRX is used. This test will partly verify the CSI-RS based beam failure detection and link recovery for an FR1 serving cell requirements in TS 38.133 [6] clause 8.5.

6.5.5.3.2 Test applicability

This test applies to all types of NR UE release 15 and forward supporting 5GS NR SA FR1, CSI-RS based RLM and link recovery.

6.5.5.3.3 Minimum conformance requirements

The minimum conformance requirements are specified in clause 6.5.5.0.2.

The normative reference for this requirement is TS 38.133 [6] clause A.6.5.5.3.

6.5.5.3.4 Test description

The test consists of five successive time periods, with time duration of T1, T2, T3, T4 and T5 respectively. Figure 6.5.5.3.4-1 shows the five different time durations and the corresponding variation of the downlink SNR of the CSI-RS in set q0 in the active cell to emulate CSI-RS based beam failure and the variation of the downlink L1-RSRP of the CSI-RS in set q1 of the candidate beam used for link recovery.

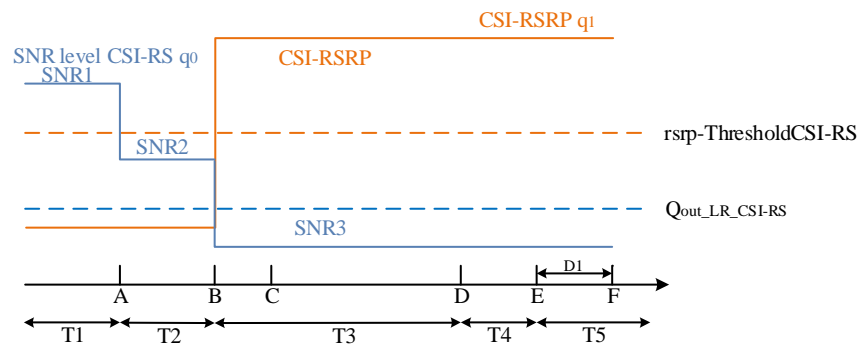

Figure 6.5.5.3.4-1: SNR and L1-RSRP variation for NR SA FR1 CSI-RS-based beam failure detection and link recovery in non-DRX

6.5.5.3.4.1 Initial conditions

This test shall be tested using any of the test configurations in Table 6.5.5.3.4.1-1.

Table 6.5.5.3.4.1-1: Supported test configurations for NR SA FR1 CSI-RS-based beam failure detection and link recovery in non-DRX

Configuration	Description
6.5.5.3-1	FDD duplex mode, 15 kHz SSB SCS, 10MHz bandwidth
6.5.5.3-2	TDD duplex mode, 15 kHz SSB SCS, 10MHz bandwidth
6.5.5.3-3	TDD duplex mode, 30 kHz SSB SCS, 40MHz bandwidth
Note:	The UE is only required to pass in one of the supported test configurations in FR1

Configure the test equipment and the DUT according to the parameters in Table 6.5.5.3.4.1-2.

**Table 6.5.5.3.4.1-2: Initial conditions for NR SA FR1 CSI-RS-based beam failure detection and link recovery in non-DRX**

Parameter	Value		Comment
Test environment	NC		As specified in TS 38.508-1 [14] clause 4.1.
Test frequencies	As specified in Annex E, table E.4-1 and TS 38.508-1 [14] clause 4.3.1 and 4.4.2.		
Channel bandwidth	As specified by the test configuration selected from Table 6.5.5.3.4.1-1.		
Propagation conditions	AWGN		As specified in Annex C.2.2.
Connection Diagram	TE Part	A.3.1.7.1	As specified in TS 38.508-1 [14] Annex A.
	DUT Part	A.3.2.3.4	
Exceptions to connection diagram	- Without LTE link - For 4Rx capable UEs without any 2Rx RF bands use A.3.2.5.2 for DUT part and A.3.1.8.4 for TE Part		

1. The general test parameter settings are set up according to Table 6.5.5.3.4.1-3.
2. Message contents are defined in clause 6.5.5.3.4.3.
3. There is one NR carrier and one NR cell specified in the test. Cell 1 is the NR cell used for connection setup with the power level set according to Annex C.1.2 and C.1.3 for this test.

**Table 6.5.5.3.4.1-3: General test parameters for NR SA FR1 CSI-RS-based beam failure detection and link recovery in non-DRX**



Parameter		Unit	Value	Comment
			<b>Test 1</b>	
Active PCell			Cell 1	
RF Channel Number			1	
Duplex mode	Config 1		FDD	
	Config 2, 3		TDD	
TDD Configuration	Config 1		Not Applicable	
	Config 2		TDDConf.1.1	
	Config 3		TDDConf.2.1	
CORESET Reference Channel	Config 1		CR.1.1 FDD	
	Config 2		CR.1.1 TDD	
	Config 3		CR.2.1 TDD	
SSB Configuration	Config 1		SSB.3 FR1	
	Config 2		SSB.3 FR1	
	Config 3		SSB.4 FR1	
SMTc Configuration	Config 1, 2		SMTc.1	
	Config 3		SMTc.1	
PDSCH/PDCCH subcarrier spacing	Config 1, 2		15 KHz	
	Config 3		30 KHz	
PRACH Configuration	Config 1, 2		PRACH.4 FR1	
	Config 3		PRACH.4 FR1	
csi-RS-Index assigned as beam failure detection RS in set $q_0$			0	
OCNG parameters			OP.1	
CP length			Normal	
Correlation Matrix and Antenna Configuration			2x2 Low	
Beam failure detection transmission parameters	DCI format		1-0	
	Number of Control OFDM symbols		2	
	Aggregation level	CCE	8	
	Ratio of hypothetical PDCCH RE energy to average CSI-RS RE energy	dB	0	
	Ratio of hypothetical PDCCH DMRS energy to average CSI-RS RE energy	dB	0	
	DMRS precoder granularity		REG bundle size	
	REG bundle size		6	
DRX			OFF	
Gap pattern ID			N.A.	
csi-RS-Index assigned as candidate beam detection RS in set $q_1$			1	N
rimInSyncOutOfSyncThreshold			absent	When the field is absent, the UE applies the value 0.
rsrp-ThresholdSSB	Config 1, 2	dBm/SCS kHz	-98	Threshold used for $Q_{in\_LR\_SSB}$
	Config 3	dBm/SCS kHz	-95	Threshold used for $Q_{in\_LR\_SSB}$
powerControlOffsetSS			db0	Used for deriving rsrp-ThresholdCSI-RS
beamFailureInstanceMaxCount			n1	see TS 38.321 [12], section 5.17
beamFailureDetectionTimer			pbfd4	see TS 38.321 [12], section 5.17
CSI-RS configuration for $q_0$ and $q_1$	Config 1		CSI-RS.1.2 FDD	
	Config 2		CSI-RS.1.2 TDD	
	Config 3		CSI-RS.2.2 TDD	
	Config 1		CSI-RS.1.1 FDD	

CSI-RS configuration for CSI reporting	Config 2		CSI-RS.1.1 TDD	
	Config 3		CSI-RS.2.1 TDD	
TRS configuration	Config 1		TRS.1.1 FDD	
	Config 2		TRS.1.1 TDD	
	Config 3		TRS.1.2 TDD	
CSI-RS-Index assigned as RLM RS	Config 1		CSI-RS.1.2 FDD	
	Config 2		CSI-RS.1.2 TDD	
	Config 3		CSI-RS.2.2 TDD	
T310 Timer		ms	1000	
N310			2	
T1		s	0.2	During this time the UE shall be fully synchronized to cell 1
T2		s	0.18	
T3		s	0.14	
T4		s	0	
T5		s	0.08	
D1		s	0.04	
Note 1: UE-specific PDCCH is not transmitted after T1 starts.				

#### 6.5.5.3.4.2 Test procedure

Prior to the start of the time duration T1, the UE shall be fully synchronized to NR Cell 1. The UE shall be configured for periodic CSI reporting with a reporting periodicity of 5 ms. In the test, DRX configuration is not enabled.

1. Ensure the UE is in state RRC\_CONNECTED with generic procedure parameters Connectivity NR, Connected without release On and Test Mode On according to TS 38.508-1 [14] clause 4.5.
2. Set the parameters of NR Cell 1 according to T1 in Table 6.5.5.3.5-1. Propagation conditions are set according to Annex C.2.3. T1 starts.
3. When T1 expires the SS shall change the SNR value to T2 as specified in Table 6.5.5.3.5-1. T2 starts.
4. When T2 expires the SS shall change the SNR value to T3 as specified in Table 6.5.5.3.5-1. T3 starts.
5. When T3 expires the SS shall change the SNR value to T4 as specified in Table 6.5.5.3.5-1. T4 starts.
6. When T4 expires the SS shall change the SNR value to T5 as specified in Table 6.5.5.3.5-1. T5 starts.
7. If the SS:
  - a) detects uplink power on NR carrier equal to or higher than minimum output power defined in TS 38.521-1 [17] clause 6.3.1.5 in each slot configured for CSI transmission (according CSI reporting on PUCCH) during the period from time point A to time point B
  - and
  - b) does not detect preamble on a beam associated with the candidate beam set  $q_1$  before time point B
  - and
  - c) detects preamble on a beam associated with the candidate beam set  $q_1$  before time point F (D1 after the start of T5),

the number of successful tests is increased by one.

Otherwise the number of failed tests is increased by one.
8. If iteration or the random access procedure for BFD fails, switch the UE off and on. Ensure the UE is in RRC\_CONNECTED with generic procedure parameters Connectivity NR, Connected without release On and Test Mode On according to TS 38.508-1 [14] clause 4.5.
9. Repeat steps 2-8 for all subtests until the confidence level according to Tables G.2.3-1 in Annex G clause G.2 is achieved.

6.5.5.3.4.3 Message contents

Message contents are according to TS 38.508-1 [14] clause 7.3 with the following exceptions:

**Table 6.5.5.3.4.3-1: Common Exception messages for NR SA FR1 CSI-RS-based beam failure detection and link recovery in non-DRX**

Default Message Contents	
Common contents of system information blocks exceptions	
Default RRC messages and information elements contents exceptions	Table H.3.1-8 with Condition CSI-RS BFD Table H.3.1-10 with Condition CSI-RS Table H.3.1-10A Table H.3.1-11 with Condition CSI-RS Table H.3.5-4 Table 7.3.1-3 in TS 38.508-1 [14] with condition SMTC.1

**Table 6.5.5.3.4.3-2: PDCCH Search Space for BFR**

Derivation Path: TS 38.508-1 [14], Table 4.6.3-162			
Information Element	Value/remark	Comment	Condition
SearchSpace ::= SEQUENCE {			
searchSpaceId	4	BFR	
controlResourceSetId	2	BFR	
monitoringSlotPeriodicityAndOffset CHOICE {			
s1	NULL		
}			
monitoringSymbolsWithinSlot	10000000000000	Symbol 0	
nrofCandidates SEQUENCE {			
aggregationLevel1	n0		
aggregationLevel2	n0		
aggregationLevel4	n0		
aggregationLevel8	n1	AL8	
aggregationLevel16	n0		
}			
searchSpaceType CHOICE {			
ue-Specific SEQUENCE {			USS
dci-Formats	formats0-0-And-1-0	DCI Format 1_0	
}			
}			
}			

**Table 6.5.5.3.4.3-3: RLF-TimersAndConstants**

Derivation Path: TS 38.508-1 [14], Table 4.6.3-150			
Information Element	Value/remark	Comment	Condition
RLF-TimersAndConstants ::= SEQUENCE {			
n310	n2		
}			

**Table 6.5.5.3.4.3-4: Void**

**Table 6.5.5.3.4.3-5: NZP-CSI-RS-Resource**

Derivation Path: TS 38.508-1 [14], Table 4.6.3-85			
Information Element	Value/remark	Comment	Condition
NZP-CSI-RS-Resource ::= SEQUENCE {			
powerControlOffsetSS	db0		
}			

**Table 6.5.5.3.4.3-6: PDCCH-Config**

Derivation Path: TS 38.501-1 [14], Table 4.6.3-95			
Information Element	Value/remark	Comment	Condition
PDCCH-Config ::= SEQUENCE {			
controlResourceSetToAddModList	2 entries		
SEQUENCE(SIZE (1..3)) OF ControlResourceSet {			
ControlResourceSet[2]	ControlResourceSet	entry 2, BFR	
}			
controlResourceSetToReleaseList	Not present		
searchSpacesToAddModList SEQUENCE(SIZE (1..10)) OF SearchSpace {	2 entries		
SearchSpace[2]	SearchSpace	entry 2, BFR	
}			
searchSpacesToReleaseList	Not present		
downlinkPreemption	Not present		
tpc-PUSCH	Not present		
tpc-PUCCH	Not present		
tpc-SRS	Not present		
}			

**Table 6.5.5.3.4.3-7: ControlResourceSet for BFR**

Derivation Path: TS 38.501-1 [14], Table 7.3.1-15			
Information Element	Value/remark	Comment	Condition
ControlResourceSet ::= SEQUENCE {			
controlResourceSetId	2		
duration	2		
cce-REG-MappingType CHOICE {			
interleaved ::= SEQUENCE {			
reg-BundleSize	n6		
interleaverSize	n2		
shiftIndex	0		
}			
tci-StatesPDCCH-ToAddList	Not present		
}			

6.5.5.3.5 Test requirement

Tables 6.5.5.3.4.1-3 and 6.5.5.3.5-1 define the primary level settings including test tolerances for NR SA FR1 CSI-RS-based beam failure detection and link recovery in non-DRX.

**Table 6.5.5.3.5-1: NR Cell specific test parameters for NR SA FR1 CSI-RS-based beam failure detection and link recovery in non-DRX**

Parameter	Unit	Test 1				
		T1	T2	T3	T4	T5
EPRE ratio of PDCCH DMRS to SSS	dB	0				
EPRE ratio of PDCCH to PDCCH DMRS						
EPRE ratio of PBCH DMRS to SSS						
EPRE ratio of PBCH to PBCH DMRS						
EPRE ratio of PSS to SSS						
EPRE ratio of PDSCH DMRS to SSS						
EPRE ratio of PDSCH to PDSCH DMRS						
EPRE ratio of OCNG DMRS to SSS						
EPRE ratio of OCNG to OCNG DMRS						
SNR_CSI-RS of set q <sub>0</sub>	Config 1	5.8	-2.2	-12.8	-12.8	-12.8
	Config 2	5.8	-2.2	-12.8	-12.8	-12.8
	Config 3	5.8	-2.2	-12.8	-12.8	-12.8
SNR_CSI-RS of set q <sub>1</sub>	Config 1	-10.2	-10.2	10.2	10.2	10.2
	Config 2	-10.2	-10.2	10.2	10.2	10.2
	Config 3	-10.2	-10.2	10.2	10.2	10.2
CSI-RS_RP of set q <sub>1</sub>	Config 1	-108.2	-108.2	-87.8	-87.8	-87.8

	Config 2	dBm/S	-108.2	-108.2	-87.8	-87.8	-87.8
	Config 3	CS kHz	-105.2	-105.2	-84.8	-84.8	-84.8
$N_{oc}$	Config 1	dBm/15 kHz	-98				
	Config 2		-98				
	Config 3		-98				
Propagation condition		TDL-C 300ns 100Hz					
<p>Note 1: OCNG shall be used such that the resources in Cell 1 are fully allocated and a constant total transmitted power spectral density is achieved for all OFDM symbols.</p> <p>Note 2: The uplink resources for CSI reporting are assigned to the UE prior to the start of time period T1.</p> <p>Note 3: NZP CSI-RS resource set configuration for CSI reporting are assigned to the UE prior to the start of time period T1.</p> <p>Note 4: Void</p> <p>Note 5: The timers and layer 3 filtering related parameters are configured prior to the start of time period T1.</p> <p>Note 6: The signal contains PDCCH for UEs other than the device under test as part of OCNG.</p> <p>Note 7: SNR levels correspond to the signal to noise ratio over the REs carrying CSI-RS.</p> <p>Note 8: The SNR in time periods T1, T2, T3, T4 and T5 is denoted as SNR1, SNR2 and SNR3 respectively in figure 6.5.5.3.4-1.</p> <p>Note 9: The SNR values are specified for a UE with 2RX antennas connected under test. For a UE with 4RX antennas connected under test, the SNR for RS in set q0 during T3, T4, and T5 from D.4.1.1, is -15dB-TT = -15.8dB (including test tolerances).</p>							

The UE behaviour in each test during time durations T1, T2, T3, T4 and T5 shall be as follows:

During the time duration T1 and T2, the UE shall transmit uplink signal at least in all subframes configured for CSI transmission on Cell 1.

During the period from time point A to time point B the UE shall transmit uplink signal in Cell 1 in all uplink slots configured for CSI transmission according to the configured periodic CSI reporting for Cell 1.

During T3 the UE shall detect beam failure and initiate link recovery. During T4 and T5 the UE measures and evaluate beam candidate from beam candidate set  $q_1$ .

No later than time point F occurring no later than  $D1 = 40$  ms after the start of T5, the UE shall transmit preamble on a beam associated with the candidate beam set  $q_1$ . The UE shall not transmit preamble on a beam associated with the candidate beam set  $q_1$  earlier than time point B

Test is concluded once the test equipment has received the initial preamble transmission from the UE. The rate of correct events observed during repeated tests shall be at least 90%.

## 6.5.5.4 NR SA FR1 CSI-RS-based beam failure detection and link recovery in DRX

### 6.5.5.4.1 Test purpose

The purpose of this test is to verify that the UE properly detects CSI-RS-based beam failure in the set  $q_0$  configured for a serving cell and that the UE performs correct CSI-RS-based link recovery based on beam candidate set  $q_1$ . To test the downlink monitoring for beam failure detection within the UEs active DL BWP, during the evaluation period, and link recovery, when DRX is used. This test will partly verify the CSI-RS based beam failure detection and link recovery for an FR1 serving cell requirements in TS 38.133 [6] clause 8.5.

### 6.5.5.4.2 Test applicability

This test applies to all types of NR UE release 15 and forward supporting 5GS NR SA FR1, CSI-RS based RLM, link recovery and long DRX cycle.

### 6.5.5.4.3 Minimum conformance requirements

The minimum conformance requirements are specified in clause 6.5.5.0.2.

The normative reference for this requirement is TS 38.133 [6] clause A.6.5.5.4.

### 6.5.5.4.4 Test description

The test consists of five successive time periods, with time duration of T1, T2, T3, T4 and T5 respectively. Figure 6.5.5.4.4-1 shows the five different time durations and the corresponding variation of the downlink SNR in the active

cell to emulate CSI-RS based beam failure. Figure 6.5.5.4.4-1 additionally shows the variation of the downlink L1-RSRP of the CSI-RS in set  $q_1$  of the candidate beam used for link recovery.

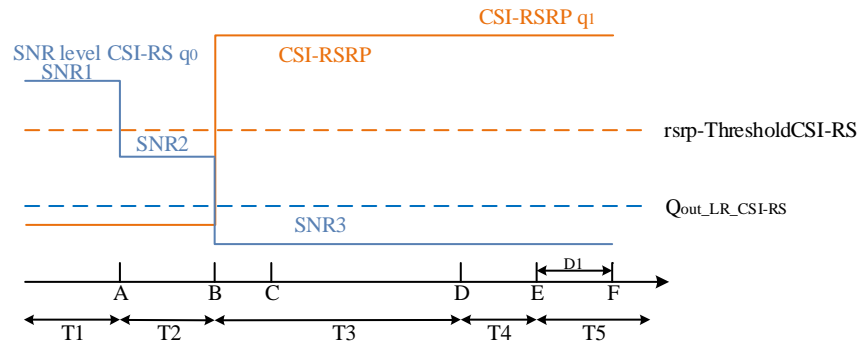

**Figure 6.5.5.4.4-1: SNR and L1-RSRP variation for NR SA FR1 CSI-RS-based beam failure detection and link recovery in DRX**

6.5.5.4.4.1 Initial conditions

This test shall be tested using any of the test configurations in Table 6.5.5.4.4.1-1.

**Table 6.5.5.4.4.1-1: Supported test configurations for NR SA FR1 CSI-RS-based beam failure detection and link recovery in DRX**

Configuration	Description
6.5.5.4-1	FDD duplex mode, 15 kHz SSB SCS, 10MHz bandwidth
6.5.5.4-2	TDD duplex mode, 15 kHz SSB SCS, 10MHz bandwidth
6.5.5.4-3	TDD duplex mode, 30 kHz SSB SCS, 40MHz bandwidth
Note: The UE is only required to pass in one of the supported test configurations in FR1	

Configure the test equipment and the DUT according to the parameters in Table 6.5.5.4.4.1-2.

**Table 6.5.5.4.4.1-2: Initial conditions for NR SA FR1 CSI-RS-based beam failure detection and link recovery in DRX**

Parameter	Value		Comment
Test environment	NC		As specified in TS 38.508-1 [14] clause 4.1.
Test frequencies	As specified in Annex E, table E.4-1 and TS 38.508-1 [14] clause 4.3.1 and 4.4.2.		
Channel bandwidth	As specified by the test configuration selected from Table 6.5.5.4.4.1-1.		
Propagation conditions	AWGN		As specified in Annex C.2.2.
Connection Diagram	TE Part	A.3.1.7.1	As specified in TS 38.508-1 [14] Annex A.
	DUT Part	A.3.2.3.4	
Exceptions to connection diagram	- Without LTE link - For 4Rx capable UEs without any 2Rx RF bands use A.3.2.5.2 for DUT part and A.3.1.8.4 for TE Part		

1. The general test parameter settings are set up according to Table 6.5.5.4.4.1-3.
2. Message contents are defined in clause 6.5.5.4.4.3.
3. There is one NR carrier and one NR cells specified in the test. Cell 1 is the NR cell used for connection setup with the power level set according to Annex C.1.2 and C.1.3 for this test.

**Table 6.5.5.4.1-3: General test parameters for NR SA FR1 CSI-RS-based beam failure detection and link recovery in DRX**

Parameter		Unit	Value	Comment
			Test 1	
Active PCell			Cell 1	
RF Channel Number			1	
Duplex mode	Config 1		FDD	
	Config 2, 3		TDD	
TDD Configuration	Config 1		Not Applicable	
	Config 2		TDDConf.1.1	
	Config 3		TDDConf.2.1	
CORESET Reference Channel	Config 1		CR.1.1 FDD	
	Config 2		CR.1.1 TDD	
	Config 3		CR.2.1 TDD	
SSB Configuration	Config 1		SSB.3 FR1	
	Config 2		SSB.3 FR1	
	Config 3		SSB.4 FR1	
SMTTC Configuration	Config 1, 2		SMTTC.1	
	Config 3		SMTTC.1	
PDSCH/PDCCH subcarrier spacing	Config 1, 2		15 KHz	
	Config 3		30 KHz	
PRACH Configuration	Config 1, 2		PRACH.4 FR1	
	Config 3		PRACH.4 FR1	
csi-RS-Index assigned as beam failure detection RS in set $q_0$			0	
OCNG parameters			OP.1	
CP length			Normal	
Correlation Matrix and Antenna Configuration			2x2 Low	
Beam failure detection transmission parameters	DCI format		1-0	
	Number of Control OFDM symbols		2	
	Aggregation level	CCE	8	
	Ratio of hypothetical PDCCH RE energy to average CSI-RS RE energy	dB	0	
	Ratio of hypothetical PDCCH DMRS energy to average CSI-RS RE energy	dB	0	
	DMRS precoder granularity		REG bundle size	
	REG bundle size		6	
DRX			DRX.7	
Gap pattern ID			N.A.	
csi-RS-Index assigned as candidate beam detection RS in set $q_1$			1	
rlmInSyncOutOfSyncThreshold			absent	When the field is absent, the UE applies the value 0.
rsrp-ThresholdSSB	Config 1, 2	dBm/S CS kHz	-98	Threshold used for $Q_{in\_LR\_SSB}$
	Config 3	dBm/S CS kHz	-95	Threshold used for $Q_{in\_LR\_SSB}$
powerControlOffsetSS			db0	Used for deriving rsrp-ThresholdCSI-RS
beamFailureInstanceMaxCount			n1	see TS 38.321 [12], section 5.17
beamFailureDetectionTimer			pbfd4	see TS 38.321 [12], section 5.17
CSI-RS configuration for $q_0$ and $q_1$	Config 1		CSI-RS.1.2 FDD	
	Config 2		CSI-RS.1.2 TDD	
	Config 3		CSI-RS.2.2 TDD	
	Config 1		CSI-RS.1.1 FDD	



CSI-RS configuration for CSI reporting	Config 2		CSI-RS.1.1 TDD	
	Config 3		CSI-RS.2.1 TDD	
TRS configuration	Config 1		TRS.1.1 FDD	
	Config 2		TRS.1.1 TDD	
	Config 3		TRS.1.2 TDD	
CSI-RS-Index assigned as RLM RS	Config 1		CSI-RS.1.2 FDD	
	Config 2		CSI-RS.1.2 TDD	
	Config 3		CSI-RS.2.2 TDD	
T310 Timer		ms	1000	
N310			2	
T1		s	1	During this time the UE shall be fully synchronized to cell 1
T2		s	8.37	
T3		s	6.44	
T4		s	0	
T5		s	1.97	
D1		s	1.93	
Note 1: UE-specific PDCCH is not transmitted after T1 starts.				

#### 6.5.5.4.4.2 Test procedure

Prior to the start of the time duration T1, the UE shall be fully synchronized to NR Cell 1. The UE shall be configured for periodic CSI reporting with a reporting periodicity of 5 ms. In the test, DRX configuration is enabled.

1. Ensure the UE is in state RRC\_CONNECTED with generic procedure parameters Connectivity NR, Connected without release *On* and Test Mode *On* according to TS 38.508-1 [14] clause 4.5.
2. Set the parameters of NR Cell 1 according to T1 in Table 6.5.5.4.5-1. Propagation conditions are set according to Annex C.2.3. T1 starts.
3. When T1 expires the SS shall change the SNR value to T2 as specified in Table 6.5.5.4.5-1. T2 starts.
4. When T2 expires the SS shall change the SNR value to T3 as specified in Table 6.5.5.4.5-1. T3 starts.
5. When T3 expires the SS shall change the SNR value to T4 as specified in Table 6.5.5.4.5-1. T4 starts.
6. When T4 expires the SS shall change the SNR value to T5 as specified in Table 6.5.5.4.5-1. T5 starts.
7. If the SS:
  - a) detects uplink power on NR carrier equal to or higher than minimum output power defined in TS 38.521-1 [17] clause 6.3.1.5 in each slot configured for CSI transmission (according CSI reporting on PUCCH) during the period from time point A to time point B
  - and
  - b) does not detect preamble on a beam associated with the candidate beam set  $q_1$  before time point B
  - and
  - c) detects preamble on a beam associated with the candidate beam set  $q_1$  before time point F (D1 after the start of T5),

the number of successful tests is increased by one.

Otherwise the number of failed tests is increased by one.
8. If iteration or the random access procedure for BFD fails, switch the UE off and on. Ensure the UE is in RRC\_CONNECTED with generic procedure parameters Connectivity NR, Connected without release *On* and Test Mode *On* according to TS 38.508-1 [14] clause 4.5.
9. Repeat steps 2-8 for all subtests until the confidence level according to Tables G.2.3-1 in Annex G clause G.2 is achieved.

6.5.5.4.4.3 Message contents

Message contents are according to TS 38.508-1 [14] clause 7.3 with the following exceptions:

**Table 6.5.5.4.4.3-1: Common Exception messages for NR SA FR1 CSI-RS-based beam failure detection and link recovery in DRX**

Default Message Contents	
Common contents of system information blocks exceptions	
Default RRC messages and information elements contents exceptions	Table H.3.1-8 with Condition CSI-RS BFD Table H.3.1-10 with Condition CSI-RS Table H.3.1-10A Table H.3.1-11 with Condition CSI-RS Table H.3.5-4 Table H.3.7-1 with Condition DRX.7Table 7.3.1-3 in TS 38.508-1 [14] with condition SMTC.1

**Table 6.5.5.4.4.3-2: PDCCH Search Space for BFR**

Derivation Path: TS 38.508-1 [14], Table 4.6.3-162			
Information Element	Value/remark	Comment	Condition
SearchSpace ::= SEQUENCE {			
searchSpaceId	4	BFR	
controlResourceSetId	2	BFR	
monitoringSlotPeriodicityAndOffset CHOICE {			
s1	NULL		
}			
monitoringSymbolsWithinSlot	10000000000000	Symbol 0	
nrofCandidates SEQUENCE {			
aggregationLevel1	n0		
aggregationLevel2	n0		
aggregationLevel4	n0		
aggregationLevel8	n1	AL8	
aggregationLevel16	n0		
}			
searchSpaceType CHOICE {			
ue-Specific SEQUENCE {			USS
dci-Formats	formats0-0-And-1-0	DCI Format 1_0	
}			
}			
}			

**Table 6.5.5.4.4.3-3: RLF-TimersAndConstants**

Derivation Path: TS 38.508-1 [14], Table 4.6.3-150			
Information Element	Value/remark	Comment	Condition
RLF-TimersAndConstants ::= SEQUENCE {			
n310	n2		
}			

**Table 6.5.5.4.4.3-4: Void**

**Table 6.5.5.3.4.3-5: NZP-CSI-RS-Resource**

Derivation Path: TS 38.508-1 [14], Table 4.6.3-85			
Information Element	Value/remark	Comment	Condition
NZP-CSI-RS-Resource ::= SEQUENCE {			
powerControlOffsetSS	db0		
}			

**Table 6.5.5.4.4.3-6: PDCCH-Config**

Derivation Path: TS 38.501-1 [14], Table 4.6.3-95			
Information Element	Value/remark	Comment	Condition
PDCCH-Config ::= SEQUENCE {			
controlResourceSetToAddModList	2 entries		
SEQUENCE(SIZE (1..3)) OF ControlResourceSet {			
ControlResourceSet[2]	ControlResourceSet	entry 2, BFR	
}			
controlResourceSetToReleaseList	Not present		
searchSpacesToAddModList SEQUENCE(SIZE (1..10)) OF SearchSpace {	2 entries		
SearchSpace[2]	SearchSpace	entry 2, BFR	
}			
searchSpacesToReleaseList	Not present		
downlinkPreemption	Not present		
tpc-PUSCH	Not present		
tpc-PUCCH	Not present		
tpc-SRS	Not present		
}			

**Table 6.5.5.4.4.3-7: ControlResourceSet for BFR**

Derivation Path: TS 38.501-1 [14], Table 7.3.1-15			
Information Element	Value/remark	Comment	Condition
ControlResourceSet ::= SEQUENCE {			
controlResourceSetId	2		
duration	2		
cce-REG-MappingType CHOICE {			
interleaved ::= SEQUENCE {			
reg-BundleSize	n6		
interleaverSize	n2		
shiftIndex	0		
}			
tci-StatesPDCCH-ToAddList	Not present		
}			

6.5.5.4.5 Test requirement

Tables 6.5.5.4.4.1-3 and 6.5.5.4.5-1 define the primary level settings including test tolerances for NR SA FR1 CSI-RS-based beam failure detection and link recovery in DRX.

**Table 6.5.5.4.5-1: NR Cell specific test parameters for NR SA FR1 CSI-RS-based beam failure detection and link recovery in DRX**

Parameter	Unit	Test 1				
		T1	T2	T3	T4	T5
EPRE ratio of PDCCH DMRS to SSS	dB	0				
EPRE ratio of PDCCH to PDCCH DMRS						
EPRE ratio of PBCH DMRS to SSS						
EPRE ratio of PBCH to PBCH DMRS						
EPRE ratio of PSS to SSS						
EPRE ratio of PDSCH DMRS to SSS						
EPRE ratio of PDSCH to PDSCH DMRS						
EPRE ratio of OCNG DMRS to SSS						
EPRE ratio of OCNG to OCNG DMRS						
SNR_CSI-RS of set q <sub>0</sub>	Config 1	5.8	-2.2	-12.8	-12.8	-12.8
	Config 2	5.8	-2.2	-12.8	-12.8	-12.8
	Config 3	5.8	-2.2	-12.8	-12.8	-12.8
SNR_CSI-RS of set q <sub>1</sub>	Config 1	-10.2	-10.2	10.2	10.2	10.2
	Config 2	-10.2	-10.2	10.2	10.2	10.2
	Config 3	-10.2	-10.2	10.2	10.2	10.2
CSI-RS_RP of set q <sub>1</sub>	Config 1	-108.2	-108.2	-87.8	-87.8	-87.8

	Config 2	dBm/S	-108.2	-108.2	-87.8	-87.8	-87.8
	Config 3	CS kHz	-105.2	-105.2	-84.8	-84.8	-84.8
$N_{oc}$	Config 1	dBm/15 kHz	-98				
	Config 2		-98				
	Config 3		-98				
Propagation condition		TDL-C 300ns 100Hz					
<p>Note 1: OCNG shall be used such that the resources in Cell 1 are fully allocated and a constant total transmitted power spectral density is achieved for all OFDM symbols.</p> <p>Note 2: The uplink resources for CSI reporting are assigned to the UE prior to the start of time period T1.</p> <p>Note 3: NZP CSI-RS resource set configuration for CSI reporting are assigned to the UE prior to the start of time period T1.</p> <p>Note 4: Void</p> <p>Note 5: The timers and layer 3 filtering related parameters are configured prior to the start of time period T1.</p> <p>Note 6: The signal contains PDCCH for UEs other than the device under test as part of OCNG.</p> <p>Note 7: SNR levels correspond to the signal to noise ratio over the REs carrying CSI-RS.</p> <p>Note 8: The SNR in time periods T1, T2, T3, T4 and T5 is denoted as SNR1, SNR2 and SNR3 respectively in figure 6.5.5.4-1.</p> <p>Note 9: The SNR values are specified for a UE with 2RX antennas connected under test. For a UE with 4RX antennas connected under test, the SNR for RS in set q0 during T3, T4, and T5 from D.4.1.1, is -15dB-TT = -15.8dB (including test tolerances).</p>							

The UE behaviour during time durations T1, T2, T3, T4 and T5 shall be as follows:

During the time duration T1 and T2, the UE shall transmit uplink signal at least in all subframes configured for CSI transmission on Cell 1.

During the period from time point A to time point B the UE shall transmit uplink signal in Cell 1 in all uplink slots configured for CSI transmission according to the configured periodic CSI reporting for Cell 1.

During T3 the UE shall detect beam failure and initiate link recovery. During T4 and T5 the UE measures and evaluate beam candidate from beam candidate set  $q_1$ .

No later than time point F occurring no later than  $D1 = 1930$  ms after the start of T5, the UE shall transmit preamble on a beam associated with the candidate beam set  $q_1$ . The UE shall not transmit preamble on a beam associated with the candidate beam set  $q_1$  earlier than time point B.

Test is concluded once the test equipment has received the initial preamble transmission from the UE. The rate of correct events observed during repeated tests shall be at least 90%.

### 6.5.5.5 NR SA FR1 SCell CSI-RS-based beam failure detection and SSB-based link recovery in non-DRX

**Editor's note: This test case is incomplete. The following aspects are either missing or not yet determined:**

- The MU and TT are FFS.
- Cell mapping in Annex E is FFS.

#### 6.5.5.5.1 Test purpose

The purpose of this test is to verify that the UE properly detects CSI-RS-based beam failure in the set  $q_0$  configured for a serving cell and that the UE performs correct SSB-based link recovery based on beam candidate set  $q_1$ . To test the downlink monitoring for beam failure detection within the UEs active DL BWP without *schedulingRequestID-BFR-SCell-r16* configuration, during the evaluation period, and link recovery, when no DRX is used. This test will partly verify the beam failure detection and link recovery for an FR1 serving cell requirements in TS 38.133 [6] clause 8.5.

#### 6.5.5.5.2 Test applicability

This test applies to all types of NR UE release 16 and forward supporting 5GS NR SA FR1, CSI-RS based RLM, SSB link recovery and SCell beam failure recovery.

#### 6.5.5.5.3 Minimum conformance requirements

The minimum conformance requirements are specified in clause 6.5.5.0.2 and 6.5.5.0.4.

The normative reference for this requirement is TS 38.133 [6] clause A.6.5.5.5.

6.5.5.5.4 Test description

The test consists of five successive time periods, with time duration of T1, T2, T3, T4 and T5 respectively. Figure 6.5.5.5.4-1 shows the SNR of the CSI-RS in set  $q_0$  in the active SCell to emulate beam failure. Figure 6.5.5.5.4-1 additionally shows the variation of the downlink L1-RSRP of the SSB in set  $q_1$  of the candidate beam used for link recovery.

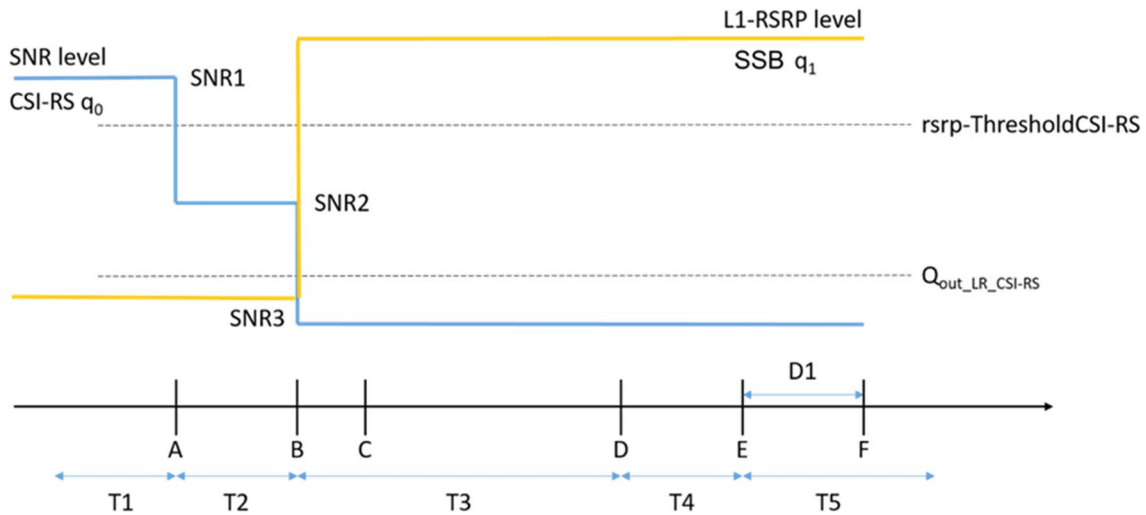

Figure 6.5.5.5.4-1: SNR and L1-RSRP variation for NR SA FR1 CSI-RS-based beam failure detection and SSB-based link recovery in non-DRX

6.5.5.5.4.1 Initial conditions

This test shall be tested using any of the test configurations in Table 6.5.5.5.4.1-1.

Table 6.5.5.5.4.1-1: Supported test configurations for FR1 PCell and SCell

Configuration	Description
6.5.5.5-1	FDD duplex mode, 15 kHz SSB SCS, 10MHz bandwidth
6.5.5.5-2	TDD duplex mode, 15 kHz SSB SCS, 10MHz bandwidth
6.5.5.5-3	TDD duplex mode, 30 kHz SSB SCS, 40MHz bandwidth
Note:	The UE is only required to pass in one of the supported test configurations in FR1

Configure the test equipment and the DUT according to the parameters in Table 6.5.5.5.4.1-2.

Table 6.5.5.5.4.1-2: Initial conditions for NR SA FR1 CSI-RS-based beam failure detection and SSB-based link recovery in non-DRX

Parameter	Value	Comment
Test environment	NC	As specified in TS 38.508-1 [14] clause 4.1.
Test frequencies	As specified in Annex E, table E.4-1 and TS 38.508-1 [14] clause 4.3.1 and 4.4.2.	
Channel bandwidth	As specified by the test configuration selected from Table 6.5.5.5.4.1-1.	
Propagation conditions	AWGN	As specified in Annex C.2.2.
Connection Diagram	TE Part	A.3.1.7.1
	DUT Part	A.3.2.3.4
Exceptions to connection diagram	- Without LTE link - For 4Rx capable UEs without any 2Rx RF bands use A.3.2.5.2 for DUT part and A.3.1.8.4 for TE Part	

1. The general test parameter settings are set up according to Table 6.5.5.4.1-3.
2. Message contents are defined in clause 6.5.5.4.3.
3. There is one NR carrier and two NR cells specified in the test. Cell 1 is the NR cell (PCell) used for connection setup and Cell 2 is the NR cell (SCell) with the power level set according to Annex C.1.2 and C.1.3 for this test.

**Table 6.5.5.4.1-3: General test parameters for NR SA FR1 CSI-RS-based beam failure detection and SSB-based link recovery in non-DRX**

Parameter		Unit	Value	Comment
			Test 1	
Active PCell			Cell 1	
RF Channel Number for PCell			1	
Active SCell			Cell 2	
RF Channel Number for SCell			2	
Duplex mode	Config 1		FDD	
	Config 2, 3		TDD	
BW channel	Config 1	MHz	10: NRB,c = 52	
	Config 2		10: NRB,c = 52	
	Config 3		40: NRB,c = 106	
TDD Configuration	Config 1		Not Applicable	
	Config 2		TDDConf.1.1	
	Config 3		TDDConf.2.1	
CORESET Reference Channel	Config 1		CR.1.1 FDD	A.1.2
	Config 2		CR.1.1 TDD	
	Config 3		CR.2.1 TDD	
SSB Configuration	Config 1		SSB.1 FR1	A.3
	Config 2		SSB.1 FR1	
	Config 3		SSB.2 FR1	
SMTTC Configuration	Config 1, 2		SMTTC.1	A.4
	Config 3		SMTTC.1	
PDSCH/PDCCH subcarrier spacing	Config 1, 2	kHz	15	
	Config 3		30	
PRACH Configuration	Config 1, 2		PRACH.2 FR1	Table A.7.1-1
	Config 3		PRACH.2 FR1	Table A.7.1-1
csi-RS-Index assigned as beam failure detection RS in set $q_0$ in activated SCell			0	
OCNG parameters			OP.1	A.2.1
CP length			Normal	
Correlation Matrix and Antenna Configuration			2x2 Low	
Beam failure detection transmission parameters	DCI format		1-0	
	Number of Control OFDM symbols		2	
	Aggregation level	CCE	8	
	Ratio of hypothetical PDCCH RE energy to average CSI-RS RE energy	dB	0	
	Ratio of hypothetical PDCCH DMRS energy to average CSI-RS RE energy	dB	0	
	DMRS precoder granularity		REG bundle size	
	REG bundle size		6	

DRX			OFF	
Gap pattern ID			N.A.	
schedulingRequestID-BFR-SCell-r16			absent	When the field is absent, the random access procedure will be triggered for SCell BFR
SSB Index assigned as CBD RS (q1) in activated SCell			0	
rlmInSyncOutOfSyncThreshold			absent	When the field is absent, the UE applies the value 0. (TS 38.133 [6] Table 8.1.1-1).
rsrp-ThresholdBFR	Config 1, 2	dBm/SCS kHz	-98	Threshold used for $Q_{in\_LR\_SSB}$
	Config 3		-95	
powerControlOffsetSS			db0	Used for deriving rsrp-ThresholdCSI-RS
beamFailureInstanceMaxCount			n1	see clause 5.17 of TS 38.321 [12]
beamFailureDetectionTimer			pbfd4	see clause 5.17 of TS 38.321 [12]
CSI-RS configuration for $q_0$ in activated SCell	Config 1		CSI-RS.1.2 FDD	A.1.4
	Config 2		CSI-RS.1.2 TDD	
	Config 3		CSI-RS.2.2 TDD	
CSI-RS configuration for CSI reporting	Config 1		CSI-RS.1.1 FDD	A.1.4
	Config 2		CSI-RS.1.1 TDD	
	Config 3		CSI-RS.2.1 TDD	
TRS configuration	Config 1		TRS.1.1 FDD	
	Config 2		TRS.1.1 TDD	
	Config 3		TRS.1.2 TDD	
CSI-RS-Index assigned as RLM RS in PCell	Config 1		CSI-RS.1.2 FDD	A.1.4
	Config 2		CSI-RS.1.2 TDD	
	Config 3		CSI-RS.2.2 TDD	
T310 Timer		ms	1000	
N310			2	
T1		s	0.2	During this time the UE shall be fully synchronized to cell 1
T2		s	0.18	
T3		s	0.14	
T4		s	0	
T5		s	0.17	
D1		s	0.13	
Note 1: UE-specific PDCCH is not transmitted after T1 starts.				

#### 6.5.5.4.2 Test procedure

Same test procedure as described in section 6.5.5.3.4.2, except following exception and steps 7 and 8:

Prior to the start of the time duration T1, the UE shall be fully synchronized to cell 1 and cell 2. The UE shall be configured for periodic CSI reporting with a reporting periodicity of 5 ms. In the test, DRX configuration is not enabled.

#### 7. If the SS:

- a) detects uplink power on the PCell equal to or higher than minimum output power defined in TS 38.521-1 [17] clause 6.3.1.5 in each slot configured for CSI transmission (according CSI reporting on PUCCH) during the period from time point A to time point B

and

b) does not detect preamble on the PCell before time point B

and

c) detects preamble on the preconfigured PRACH resource before time point F (D1 after the start of T5).

And

d) SS transmits a RAR to UE after receiving the preamble transmitted by the UE. SS detects the MAC-CE on the PCell transmitted by the UE providing the index for the activated SCell, and the index for the SSB provided by higher layer.

the number of successful tests is increased by one.

Otherwise the number of failed tests is increased by one.

8. If the iteration or random access procedure for BFD fails, the SS shall first attempt to release and add the FR1 SCell, by ensuring the UE is in state RRC\_CONNECTED with generic procedure parameter *Connectivity* NR, Connected without release *On* and Test Mode *On* according to TS 38.508-1 [6] clause 4.5. If that also fails, then the UE is switched OFF/ON to proceed with the next iteration.

6.5.5.4.3 Message contents

Message contents are according to TS 38.508-1 [14] clause 7.3 with the following exceptions:

**Table 6.5.5.4.3-1: Common Exception messages for NR SA FR1 SCell CSI-RS-based beam failure detection and SSB-based link recovery in DRX**

Default Message Contents	
Common contents of system information blocks exceptions	
Default RRC messages and information elements contents exceptions	Table H.3.1-8 with Condition CSI-RS BFD Table H.3.1-10 with Condition SSB Table H.3.1-10A Table H.3.5-4 Table 7.3.1-3 in TS 38.508-1 [14] with condition SMTC.1

**Table 6.5.5.4.3-2: PDCCH Search Space for BFR**

Derivation Path: TS 38.508-1 [14], Table 4.6.3-162			
Information Element	Value/remark	Comment	Condition
SearchSpace ::= SEQUENCE {			
searchSpaceId	4	BFR	
controlResourceSetId	2	BFR	
monitoringSlotPeriodicityAndOffset CHOICE {			
s1	NULL		
}			
monitoringSymbolsWithinSlot	10000000000000	Symbol 0	
nrofCandidates SEQUENCE {			
aggregationLevel1	n0		
aggregationLevel2	n0		
aggregationLevel4	n0		
aggregationLevel8	n1	AL8	
aggregationLevel16	n0		
}			
searchSpaceType CHOICE {			
ue-Specific SEQUENCE {			USS
dci-Formats	formats0-0-And-1-0	DCI Format 1_0	
}			
}			
}			



**Table 6.5.5.4.3-3: RLF-TimersAndConstants**

Derivation Path: TS 38.508-1 [14], Table 4.6.3-150			
Information Element	Value/remark	Comment	Condition
RLF-TimersAndConstants ::= SEQUENCE {			
n310	n2		
}			

**Table 6.5.5.4.3-4: PDCCH-Config**

Derivation Path: TS 38.501-1 [14], Table 4.6.3-95			
Information Element	Value/remark	Comment	Condition
PDCCH-Config ::= SEQUENCE {			
controlResourceSetToAddModList	2 entries		
SEQUENCE(SIZE (1..3)) OF ControlResourceSet {			
ControlResourceSet[2]	ControlResourceSet	entry 2, BFR	
}			
controlResourceSetToReleaseList	Not present		
searchSpacesToAddModList SEQUENCE(SIZE (1..10)) OF SearchSpace {	2 entries		
SearchSpace[2]	SearchSpace	entry 2, BFR	
}			
searchSpacesToReleaseList	Not present		
downlinkPreemption	Not present		
tpc-PUSCH	Not present		
tpc-PUCCH	Not present		
tpc-SRS	Not present		
}			

**Table 6.5.5.4.3-5: ControlResourceSet for BFR**

Derivation Path: TS 38.501-1 [14], Table 7.3.1-15			
Information Element	Value/remark	Comment	Condition
ControlResourceSet ::= SEQUENCE {			
controlResourceSetId	2		
duration	2		
cce-REG-MappingType CHOICE {			
interleaved ::= SEQUENCE {			
reg-BundleSize	n6		
interleaverSize	n2		
shiftIndex	0		
}			
tci-StatesPDCCH-ToAddList	Not present		
}			

6.5.5.5 Test requirement

Tables 6.5.5.4.1-3 and 6.5.5.5.1 define the primary level settings including test tolerances for NR SA FR1 SCell CSI-RS-based beam failure detection and SSB-based link recovery in non-DRX.

**Table 6.5.5.5-1: NR Cell specific test parameters for NR SA FR1 SCell CSI-RS-based beam failure detection and SSB-based link recovery in non-DRX**

Parameter	Unit	Test 1				
		T1	T2	T3	T4	T5

EPRE ratio of PDCCH DMRS to SSS		dB	0				
EPRE ratio of PDCCH to PDCCH DMRS		dB					
EPRE ratio of PBCH DMRS to SSS		dB					
EPRE ratio of PBCH to PBCH DMRS		dB					
EPRE ratio of PSS to SSS		dB					
EPRE ratio of PDSCH DMRS to SSS		dB					
EPRE ratio of PDSCH to PDSCH DMRS		dB					
EPRE ratio of OCNG DMRS to SSS		dB					
EPRE ratio of OCNG to OCNG DMRS		dB					
SNR_CSI-RS of set q <sub>0</sub>	Config 1	dB	5.8	-2.2	-12.8	-12.8	-12.8
	Config 2		5.8	-2.2	-12.8	-12.8	-12.8
	Config 3		5.8	-2.2	-12.8	-12.8	-12.8
SNR_SSB of set q <sub>1</sub>	Config 1	dB	-10.2	-10.2	10.2	10.2	10.2
	Config 2		-10.2	-10.2	10.2	10.2	10.2
	Config 3		-10.2	-10.2	10.2	10.2	10.2
CSI-RS_RP of set q <sub>1</sub>	Config 1	dBm/S CS kHz	-108.2	-108.2	-87.8	-87.8	-87.8
	Config 2		-108.2	-108.2	-87.8	-87.8	-87.8
	Config 3		-105.2	-105.2	-84.8	-84.8	-84.8
$N_{oc}$	Config 1	dBm/15 kHz	-98				
	Config 2		-98				
	Config 3		-98				
Propagation condition			TDL-C 300ns 100Hz				
<p>Note 1: OCNG shall be used such that the resources in Cell 1 are fully allocated and a constant total transmitted power spectral density is achieved for all OFDM symbols.</p> <p>Note 2: The uplink resources for CSI reporting are assigned to the UE prior to the start of time period T1.</p> <p>Note 3: NZP CSI-RS resource set configuration for CSI reporting are assigned to the UE prior to the start of time period T1.</p> <p>Note 4: Void</p> <p>Note 5: The timers and layer 3 filtering related parameters are configured prior to the start of time period T1.</p> <p>Note 6: The signal contains PDCCH for UEs other than the device under test as part of OCNG.</p> <p>Note 7: SNR levels correspond to the signal to noise ratio over the REs carrying CSI-RS.</p> <p>Note 8: The SNR in time periods T1, T2, T3, T4 and T5 is denoted as SNR1, SNR2 and SNR3 respectively in figure 6.5.5.4-1.</p> <p>Note 9: The SNR values are specified for a UE with 2RX antennas connected under test. For a UE with 4RX antennas connected under test, the SNR for RS in set q<sub>0</sub> during T3, T4, and T5 from D.4.1.1, is -15dB-TT = -15.8dB (including test tolerances).</p>							

The UE behaviour during time durations T1, T2, T3, T4 and T5 shall be as follows:

During the time duration T1 and T2, the UE shall transmit uplink signal at least in all subframes configured for CSI transmission on Cell 1.

During the period from time point A to time point B the UE shall transmit uplink signal in Cell 1 in all uplink slots configured for CSI transmission according to the configured periodic CSI reporting for Cell 1.

During T3 the UE shall detect beam failure and initiate link recovery. During T4 and T5 the UE measures and evaluate beam candidate from beam candidate set q<sub>1</sub>.

No later than time point F occurring no later than D1 = 120+10 ms after the start of T5, the UE shall transmit preamble for UL-SCH resource application, followed by MAC-CE on the assigned uplink resources containing a beam associated with the candidate beam set q<sub>1</sub>. The UE shall not transmit preamble earlier than time point B.

During T5, the System Simulator shall transmit a Random Access Response to UE after the System Simulator receives the preamble from UE. The UE shall transmit the msg.3 containing candidate beam set q<sub>1</sub> for SCell BFR if UE receives the Random Access Response.

Test is concluded once the test equipment has received the initial preamble transmission from the UE. The rate of correct events observed during repeated tests shall be at least 90%.

### 6.5.5.6 NR SA FR1 Scell CSI-RS-based beam failure detection and SSB-based link recovery in DRX

**Editor's note: This test case is incomplete. The following aspects are either missing or not yet determined:**

- The MU and TT are FFS.
- Cell mapping in Annex E is FFS.

6.5.5.6.1 Test purpose

The purpose of this test is to verify that the UE properly detects CSI-RS-based beam failure in the set  $q_0$  configured for a serving cell and that the UE performs correct SSB-based link recovery based on beam candidate set  $q_1$ . To test the downlink monitoring for beam failure detection within the UEs active DL BWP without *schedulingRequestID-BFR-SCell-r16* configuration, during the evaluation period, and link recovery, when DRX is used. This test will partly verify the beam failure detection and link recovery for an FR1 serving cell requirements in TS 38.133 [6] clause 8.5.

6.5.5.6.2 Test applicability

This test applies to all types of NR UE release 16 and forward supporting 5GS NR SA FR1, CSI-RS based RLM, SSB link recovery and SCell beam failure recovery.

6.5.5.6.3 Minimum conformance requirements

The minimum conformance requirements are specified in clause 6.5.5.0.2 and 6.5.5.0.4.

The normative reference for this requirement is TS 38.133 [6] clause A.6.5.5.6.

6.5.5.6.4 Test description

The test consists of five successive time periods, with time duration of T1, T2, T3, T4 and T5 respectively. Figure 6.5.5.6.4-1 shows the SNR of the CSI-RS in set  $q_0$  in the active SCell to emulate beam failure. Figure 6.5.5.6.4-1 additionally shows the variation of the downlink L1-RSRP of the SSB in set  $q_1$  of the candidate beam used for link recovery.

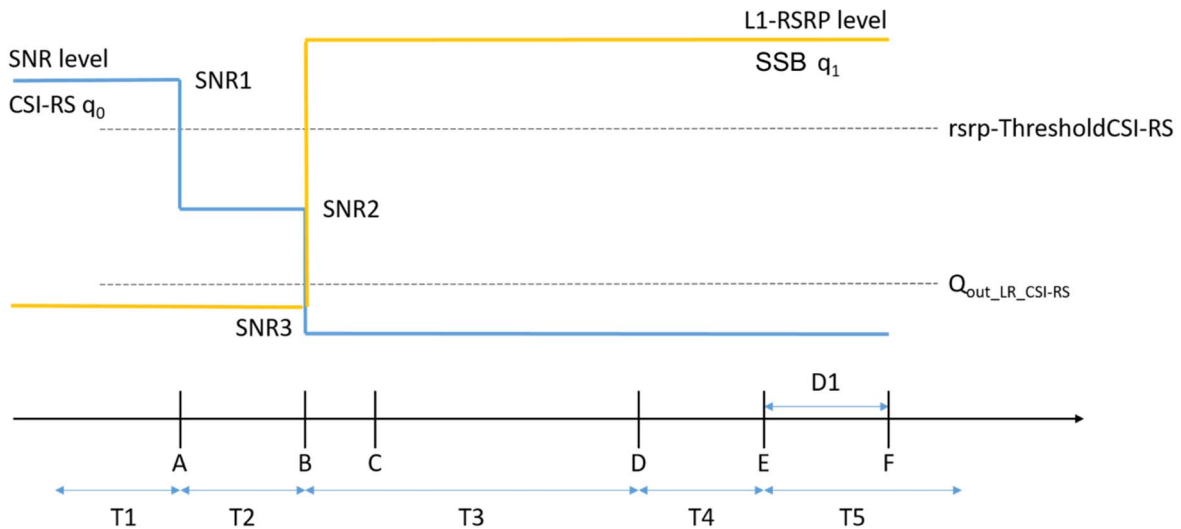

**Figure 6.5.5.6.4-1: SNR and L1-RSRP variation for NR SA FR1 CSI-RS-based beam failure detection and SSB-based link recovery for SCell in DRX**

6.5.5.6.4.1 Initial conditions

This test shall be tested using any of the test configurations in Table 6.5.5.6.4.1-1.

**Table 6.5.5.6.4.1-1: Supported test configurations for FR1 PCell and SCell**

Configuration	Description
6.5.5.6-1	FDD duplex mode, 15 kHz SSB SCS, 10MHz bandwidth
6.5.5.6-2	TDD duplex mode, 15 kHz SSB SCS, 10MHz bandwidth
6.5.5.6-3	TDD duplex mode, 30 kHz SSB SCS, 40MHz bandwidth
Note:	The UE is only required to pass in one of the supported test configurations in FR1

Configure the test equipment and the DUT according to the parameters in Table 6.5.5.6.4.1-2.

**Table 6.5.5.6.4.1-2: Initial conditions for NR SA FR1 CSI-RS-based beam failure detection and SSB-based link recovery for SCell in DRX**

Parameter	Value	Comment
Test environment	NC	As specified in TS 38.508-1 [14] clause 4.1.
Test frequencies	As specified in Annex E, table E.4-1 and TS 38.508-1 [14] clause 4.3.1 and 4.4.2.	
Channel bandwidth	As specified by the test configuration selected from Table 6.5.5.6.4.1-1.	
Propagation conditions	AWGN	As specified in Annex C.2.2.
Connection Diagram	TE Part	A.3.1.7.1
	DUT Part	A.3.2.3.4
Exceptions to connection diagram	- Without LTE link - For 4Rx capable UEs without any 2Rx RF bands use A.3.2.5.2 for DUT part and A.3.1.8.4 for TE Part	

1. The general test parameter settings are set up according to Table 6.5.5.6.4.1-3.
2. Message contents are defined in clause 6.5.5.6.4.3.
3. There is one NR carrier and two NR cells specified in the test. Cell 1 is the NR cell (PCell) used for connection setup and Cell 2 is the NR cell (SCell) with the power level set according to Annex C.1.2 and C.1.3 for this test.

**Table 6.5.5.6.4.1-3: General test parameters for NR SA FR1 CSI-RS-based beam failure detection and SSB-based link recovery for SCell in DRX**

Parameter	Unit	Value	Comment
		Test 1	
Active PCell		Cell 1	
RF Channel Number for PCell		1	
Active SCell		Cell 2	
RF Channel Number for SCell		2	
Duplex mode	Config 1	FDD	
	Config 2, 3	TDD	
BWchannel	Config 1	10: NRB,c = 52	
	Config 2	10: NRB,c = 52	
	Config 3	40: NRB,c = 106	
TDD Configuration	Config 1	Not Applicable	
	Config 2	TDDConf.1.1	
	Config 3	TDDConf.2.1	
CORESET Reference Channel	Config 1	CR.1.1 FDD	A.1.2
	Config 2	CR.1.1 TDD	
	Config 3	CR.2.1 TDD	
SSB Configuration	Config 1	SSB.1 FR1	A.3
	Config 2	SSB.1 FR1	
	Config 3	SSB.2 FR1	
SMTC Configuration	Config 1, 2	SMTC.1	A.4
	Config 3	SMTC.1	

PDSCH/PDCCH subcarrier spacing	Config 1, 2	kHz	15	
	Config 3		30	
PRACH Configuration	Config 1, 2		PRACH.2 FR1	Table A.7.1-1
	Config 3		PRACH.2 FR1	Table A.7.1-1
csi-RS-Index assigned as beam failure detection RS in set $q_0$ in activated SCell			0	
OCNG parameters			OP.1	A.2.1
CP length			Normal	
Correlation Matrix and Antenna Configuration			2x2 Low	
Beam failure detection transmission parameters	DCI format		1-0	
	Number of Control OFDM symbols		2	
	Aggregation level	CCE	8	
	Ratio of hypothetical PDCCH RE energy to average CSI-RS RE energy	dB	0	
	Ratio of hypothetical PDCCH DMRS energy to average CSI-RS RE energy	dB	0	
	DMRS precoder granularity		REG bundle size	
	REG bundle size		6	
DRX			DRX.7	A.5
Gap pattern ID			N.A.	
schedulingRequestID-BFR-SCell-r16			absent	When the field is absent, the random access procedure will be triggered for SCell BFR
SSB Index assigned as CBD RS ( $q_1$ ) in activated SCell			0	
rlmInSyncOutOfSyncThreshold			absent	When the field is absent, the UE applies the value 0. (TS 38.133 [6] Table 8.1.1-1).
rsrp-ThresholdBFR	Config 1, 2	dBm/SCS	-98	Threshold used for $Q_{in\_LR\_SSB}$
	Config 3		-95	
powerControlOffsetSS			db0	Used for deriving rsrp-ThresholdCSI-RS
beamFailureInstanceMaxCount			n1	see clause 5.17 of TS 38.321 [12]
beamFailureDetectionTimer			pbfd4	see clause 5.17 of TS 38.321 [12]
CSI-RS configuration for $q_0$ in activated SCell	Config 1		CSI-RS.1.2 FDD	A.1.4
	Config 2		CSI-RS.1.2 TDD	
	Config 3		CSI-RS.2.2 TDD	
CSI-RS configuration for CSI reporting	Config 1		CSI-RS.1.1 FDD	A.1.4
	Config 2		CSI-RS.1.1 TDD	
	Config 3		CSI-RS.2.1 TDD	
TRS configuration	Config 1		TRS.1.1 FDD	
	Config 2		TRS.1.1 TDD	
	Config 3		TRS.1.2 TDD	
CSI-RS-Index assigned as RLM RS in PCell	Config 1		CSI-RS.1.2 FDD	A.1.4
	Config 2		CSI-RS.1.2 TDD	

	Config 3		CSI-RS.2.2 TDD	
T310 Timer		ms	1000	
N310			2	
T1		s	1	During this time the UE shall be fully synchronized to cell 1
T2		s	8.37	
T3		s	6.44	
T4		s	0	
T5		s	1.97	
D1		s	1.93	
Note 1: UE-specific PDCCH is not transmitted after T1 starts.				

#### 6.5.5.6.4.2 Test procedure

Same test procedure as described in section 6.5.5.3.4.2, except following exception and step 7 and 8:

Prior to the start of the time duration T1, the UE shall be fully synchronized to cell 1 and cell 2. The UE shall be configured for periodic CSI reporting with a reporting periodicity of 5 ms. In the test, DRX configuration is not enabled.

##### 7. If the SS:

- a) detects uplink power on the PCell equal to or higher than minimum output power defined in TS 38.521-1 [17] clause 6.3.1.5 in each slot configured for CSI transmission (according CSI reporting on PUCCH) during the period from time point A to time point B

and

- b) does not detect preamble on the PCell before time point B

and

- c) detects preamble on the preconfigured PRACH resource before time point F (D1 after the start of T5).

And

- d) SS transmits a RAR to UE after receiving the preamble transmitted by the UE. SS detects the MAC-CE on the PCell transmitted by the UE providing the index for the activated SCell, and the index for the SSB provided by higher layer.

the number of successful tests is increased by one.

Otherwise the number of failed tests is increased by one.

8. If the iteration or random access procedure for BFD fails, the SS shall first attempt to release and add the FR1 SCell, by ensuring the UE is in state RRC\_CONNECTED with generic procedure parameters *Connectivity* NR, Connected without release *On* and Test Mode *On* according to TS 38.508-1 [6] clause 4.5. If that also fails, then the UE is switched OFF/ON to proceed with the next iteration.

#### 6.5.5.6.4.3 Message contents

Message contents are according to TS 38.508-1 [14] clause 7.3 with the following exceptions:

**Table 6.5.5.6.4.3-1: Common Exception messages for NR SA FR1 SCell CSI-RS-based beam failure detection and SSB-based link recovery in DRX**

Default Message Contents	
Common contents of system information blocks exceptions	
Default RRC messages and information elements contents exceptions	Table H.3.1-8 with Condition CSI-RS BFD Table H.3.1-10 with Condition SSB Table H.3.1-10A Table H.3.5-4 Table H.3.7-1 with Condition 'DRX.7' Table 7.3.1-3 in TS 38.508-1 [14] with condition SMTC.1

**Table 6.5.5.6.4.3-2: PDCCH Search Space for BFR**

Derivation Path: TS 38.508-1 [14], Table 4.6.3-162			
Information Element	Value/remark	Comment	Condition
SearchSpace ::= SEQUENCE {			
searchSpaceId	4	BFR	
controlResourceSetId	2	BFR	
monitoringSlotPeriodicityAndOffset CHOICE {			
s1	NULL		
}			
monitoringSymbolsWithinSlot	10000000000000	Symbol 0	
nrofCandidates SEQUENCE {			
aggregationLevel1	n0		
aggregationLevel2	n0		
aggregationLevel4	n0		
aggregationLevel8	n1	AL8	
aggregationLevel16	n0		
}			
searchSpaceType CHOICE {			
ue-Specific SEQUENCE {			USS
dci-Formats	formats0-0-And-1-0	DCI Format 1_0	
}			
}			
}			

**Table 6.5.5.6.4.3-3: RLF-TimersAndConstants**

Derivation Path: TS 38.508-1 [14], Table 4.6.3-150			
Information Element	Value/remark	Comment	Condition
RLF-TimersAndConstants ::= SEQUENCE {			
n310	n2		
}			

**Table 6.5.5.6.4.3-4: PDCCH-Config**

Derivation Path: TS 38.501-1 [14], Table 4.6.3-95			
Information Element	Value/remark	Comment	Condition
PDCCH-Config ::= SEQUENCE {			
controlResourceSetToAddModList	2 entries		
SEQUENCE(SIZE (1..3)) OF ControlResourceSet {			
ControlResourceSet[2]	ControlResourceSet	entry 2, BFR	
}			
controlResourceSetToReleaseList	Not present		
searchSpacesToAddModList SEQUENCE(SIZE (1..10)) OF SearchSpace {	2 entries		
SearchSpace[2]	SearchSpace	entry 2, BFR	
}			
searchSpacesToReleaseList	Not present		
downlinkPreemption	Not present		
tpc-PUSCH	Not present		
tpc-PUCCH	Not present		
tpc-SRS	Not present		
}			

**Table 6.5.5.6.4.3-5: ControlResourceSet for BFR**

Derivation Path: TS 38.501-1 [14], Table 7.3.1-15			
Information Element	Value/remark	Comment	Condition
ControlResourceSet ::= SEQUENCE {			
controlResourceSetId	2		
duration	2		
cce-REG-MappingType CHOICE {			
interleaved ::= SEQUENCE {			
reg-BundleSize	n6		
interleaverSize	n2		
shiftIndex	0		
}			
tci-StatesPDCCH-ToAddList	Not present		
}			

6.5.5.6.5 Test requirement

Tables 6.5.5.6.4.1-3 and 6.5.5.6.5-1 define the primary level settings including test tolerances for NR SA FR1 SCell CSI-RS-based beam failure detection and SSB-based link recovery in DRX.

**Table 6.5.5.6.5-1: NR Cell specific test parameters for NR SA FR1 SCell CSI-RS-based beam failure detection and SSB-based link recovery in DRX**

Parameter	Unit	Test 1				
		T1	T2	T3	T4	T5
EPRE ratio of PDCCH DMRS to SSS	dB	5.8	-2.2	-12.8	-12.8	-12.8
EPRE ratio of PDCCH to PDCCH DMRS						
EPRE ratio of PBCH DMRS to SSS						
EPRE ratio of PBCH to PBCH DMRS						
EPRE ratio of PSS to SSS						
EPRE ratio of PDSCH DMRS to SSS						
EPRE ratio of PDSCH to PDSCH DMRS						
EPRE ratio of OCNG DMRS to SSS						
EPRE ratio of OCNG to OCNG DMRS						
SNR_CSI-RS of set q <sub>0</sub>	Config 1	5.8	-2.2	-12.8	-12.8	-12.8
	Config 2	5.8	-2.2	-12.8	-12.8	-12.8
	Config 3	5.8	-2.2	-12.8	-12.8	-12.8
SNR_SSB of set q <sub>1</sub>	Config 1	-10.2	-10.2	10.2	10.2	10.2
	Config 2	-10.2	-10.2	10.2	10.2	10.2
	Config 3	-10.2	-10.2	10.2	10.2	10.2
SSB_RP of set q <sub>1</sub>	Config 1	-108.2	-108.2	-87.8	-87.8	-87.8



	Config 2	dBm/S	-108.2	-108.2	-87.8	-87.8	-87.8
	Config 3	CS kHz	-105.2	-105.2	-84.8	-84.8	-84.8
$N_{oc}$	Config 1	dBm/15 kHz	-98				
	Config 2		-98				
	Config 3		-98				
Propagation condition			TDL-C 300ns 100Hz				
<p>Note 1: OCNG shall be used such that the resources in Cell 1 are fully allocated and a constant total transmitted power spectral density is achieved for all OFDM symbols.</p> <p>Note 2: The uplink resources for CSI reporting are assigned to the UE prior to the start of time period T1.</p> <p>Note 3: NZP CSI-RS resource set configuration for CSI reporting are assigned to the UE prior to the start of time period T1.</p> <p>Note 4: Void</p> <p>Note 5: The timers and layer 3 filtering related parameters are configured prior to the start of time period T1.</p> <p>Note 6: The signal contains PDCCH for UEs other than the device under test as part of OCNG.</p> <p>Note 7: SNR levels correspond to the signal to noise ratio over the REs carrying CSI-RS.</p> <p>Note 8: The SNR in time periods T1, T2, T3, T4 and T5 is denoted as SNR1, SNR2 and SNR3 respectively in figure 6.5.5.6.4-1.</p> <p>Note 9: The SNR values are specified for a UE with 2RX antennas connected under test. For a UE with 4RX antennas connected under test, the SNR for RS in set q0 during T3, T4, and T5 from D.4.1.1, is -15dB-TT = -15.8dB (including test tolerances).</p>							

The UE behaviour during time durations T1, T2, T3, T4 and T5 shall be as follows:

During the time duration T1 and T2, the UE shall transmit uplink signal at least in all subframes configured for CSI transmission on Cell 1.

During the period from time point A to time point B the UE shall transmit uplink signal in Cell 1 in all uplink slots configured for CSI transmission according to the configured periodic CSI reporting for Cell 1.

During T3 the UE shall detect beam failure and initiate link recovery. During T4 and T5 the UE measures and evaluate beam candidate from beam candidate set  $q_1$ .

No later than time point F occurring no later than  $D1 = 120+10$  ms after the start of T5, the UE shall transmit preamble for UL-SCH resource application, followed by MAC-CE on the assigned uplink resources containing a beam associated with the candidate beam set  $q_1$ . The UE shall not transmit preamble earlier than time point B.

During T5, the System Simulator shall transmit a Random Access Response to UE after the System Simulator receives the preamble from UE. The UE shall transmit the msg.3 containing candidate beam set  $q_1$  for SCell BFR if UE receives the Random Access Response.

Test is concluded once the test equipment has received the initial preamble transmission from the UE. The rate of correct events observed during repeated tests shall be at least 90%.

## 6.5.6 Active BWP switch delay

### 6.5.6.1 DCI-based and time-based active BWP switch

#### 6.5.6.1.0 Minimum conformance requirements

##### 6.5.6.1.0.1 Minimum conformance requirements for DCI-based and time-based active BWP switch

For DCI-based BWP switch, after the UE receives BWP switching request at DL slot  $n$  on a serving cell, UE shall be able to receive PDSCH (for DL active BWP switch) or transmit PUSCH (for UL active BWP switch) on the new BWP on the serving cell on which BWP switch on the first DL or UL slot occurs right after a time duration of  $T_{BWPswitchDelay}$  which starts from the beginning of DL slot  $n$ .

The UE is not required to transmit UL signals or receive DL signals until the first DL or UL slot occurs right after a time duration of  $T_{BWPswitchDelay}$  which starts from the beginning of DL slot  $n$  except DCI triggering BWP switch on the cell where DCI-based BWP switch occurs. The UE is not required to follow the requirements defined in this clause when performing a DCI-based BWP switch between the BWPs in disjoint channel bandwidths or in partially overlapping channel bandwidths.

For timer-based BWP switch, the UE shall start BWP switch at DL slot  $n$ , where slot  $n$  is the first slot of a DL subframe (FR1) or DL half-subframe (FR2) immediately after a BWP-inactivity timer *bwp-InactivityTimer* [13] expires on a serving cell, and the UE shall be able to receive PDSCH (for DL active BWP switch) or transmit PUSCH (for UL active BWP switch) on the new BWP on the serving cell on which BWP switch on the first DL or UL slot occurs right after a time duration of  $T_{\text{BWPswitchDelay}}$  which starts from the beginning of DL slot  $n$ .

The UE is not required to transmit UL signals or receive DL signals during time duration  $T_{\text{BWPswitchDelay}}$  after *bwp-InactivityTimer* [13] expires on the cell where timer-based BWP switch occurs.

Depending on UE capability *bwp-SwitchingDelay* [13], UE shall finish BWP switch within the time duration  $T_{\text{BWPswitchDelay}}$  defined in Table 6.5.6.1.0.1-1.

**Table 6.5.6.1.0.1-1: BWP switch delay**

$\mu$	NR Slot length (ms)	BWP switch delay $T_{\text{BWPswitchDelay}}$ (slots)	
		Type 1 <sup>Note 1</sup>	Type 2 <sup>Note 1</sup>
0	1	1	3
1	0.5	2	5
2	0.25	3	9
3	0.125	6	18
Note 1: Depends on UE capability. Note 2: If the BWP switch involves changing of SCS, the BWP switch delay is determined by the smaller SCS between the SCS before BWP switch and the SCS after BWP switch.			

Provided the UE does not have the required TCI-state information to receive PDCCH and PDSCH in the new BWP, the UE shall use old TCI-states before the BWP switch until a new MAC CE updating the required TCI-state information for PDCCH and PDSCH is received after the BWP switch.

If UE has the information on the required TCI-state information to receive PDCCH and PDSCH in the new BWP,

- UE shall be able to receive PDCCH and PDSCH with old TCI-states before the delay as specified in TS 38.133 [6] Clause 8.10 in the new BWP.
- UE shall be able to receive PDCCH and PDSCH with new TCI-states after the delay as specified in TS 38.133 [6] Clause 8.10 in the new BWP.

If the BWP switch is triggered within DRX active time, and one of the two BWPs in a BWP switching is a dormant BWP [TS 38.321, 12], UE shall be able to complete active BWP switching within

- $T_{\text{BWPswitchDelay}}$ , provided that the BWP switching request is received in any of the first 3 OFDM symbols of a slot corresponding to the serving cell where BWP switching occurs, or
- $T_{\text{BWPswitchDelay}} + 1$ , provided that the BWP switching request is received after the first 3 OFDM symbols of a slot corresponding to the serving cell where BWP switching occurs

When either of the DCI-based, timer-based or RRC-based downlink BWP switch and/or uplink BWP switch occur on multiple CCs simultaneously or over partially overlapping period, the interruption requirements described in this section apply for each BWP switch.

When UE receives a DCI indicating UE to switch its active BWP involving changes in any of the parameters listed in Table 6.5.6.1.0.1-3, the UE is allowed to cause interruption of up to X slot to other active serving cells if the UE is not capable of per-FR gap, or if the BWP switching involves SCS changing. When the BWP switch imposes changes in any of the parameters listed in Table 6.5.6.1.0.1-3 and the UE is capable of per-FR gap the UE is allowed to cause interruption of up to X slot to other active serving cells in the same frequency range wherein the UE is performing BWP switching. X is defined in Table 6.5.6.1.0.1-2. The starting time of interruption is only allowed within the BWP switching delay  $T_{\text{BWPswitchDelay}}$  as defined in TS 38.133 [6] clause 8.6.2. Interruptions are not allowed during BWP switch involving any other parameter change.

When a BWP timer *bwp-InactivityTimer* defined in TS 38.331 [13] expires, UE is allowed to cause interruption of up to X slot to other active serving cells due to switching its active BWP involving changes in any of the parameters listed in Table 6.5.6.1.0.1-3 if the UE is not capable of per-FR gap, or if the BWP switching involves SCS changing. When the BWP switch imposes changes in any of the parameters listed in Table 6.5.6.1.0.1-3 and the UE is capable of per-FR

gap, the UE is allowed to cause interruption of up to X slot to other active serving cells in the same frequency range wherein the UE is performing BWP switching. X is defined in Table 6.5.6.1.0.1-2. The starting time of interruption is only allowed within the BWP switching delay  $T_{\text{BWPswitchDelay}}$  as defined in TS 38.133 [6] clause 8.6.2. Interruptions are not allowed during BWP switch involving any other parameter change.

**Table 6.5.6.1.0.1-2: Interruption length X**

$\mu$	NR Slot length (ms)	interruption length X (slots)
0	1	1
1	0.5	1
2	0.25	3
3	0.125	5
Note1:	void	

**Table 6.5.6.1.0.1-3: Parameters which cause interruption other than SCS**

Parameters	Comment
<i>locationAndBandwidth</i>	From TS 38.331 [13]
<i>nrofSRS-Ports</i>	
<i>maxMIMO-Layers-r16</i>	

The normative reference for this requirement is TS 38.133 [6] clauses 8.6.2 and 8.2.1.2.7

#### 6.5.6.1.1 NR SA FR1-FR1 DCI-based DL active BWP switch in non-DRX

##### 6.5.6.1.1.1 Test purpose

The purpose of this test is to verify the DL BWP switch delay requirement defined in TS 38.133 [6] clause 8.6, and interruption requirement on other active serving cell defined in TS 38.133 [6] clause 8.2.2.2.5.

##### 6.5.6.1.1.2 Test applicability

This test applies to all types of NR UE release 15 onwards supporting BWP adaptation of at least 2 BWPs, DCI and timer-based active BWP switching delay Type1 or Type2 and 2DL CA.

##### 6.5.6.1.1.3 Minimum conformance requirements

The minimum conformance requirements are specified in clause 6.5.6.1.0.1.

The normative reference for this requirement is TS 38.133 [6] clause A.6.5.6.1.1.

##### 6.5.6.1.1.4 Test description

##### 6.5.6.1.1.4.1 Initial conditions

This test shall be tested using any of the test configurations in Table 6.5.6.1.1.4.1-1.

**Table 6.5.6.1.1.4.1-1: Supported test configurations for NR SA FR1-FR1 DCI-based DL active BWP switch with SCell in non-DRX**

Config	Description
6.5.6.1.1-1	NR 15 kHz SSB SCS, $\geq 10$ MHz bandwidth, FDD – FDD duplex mode
6.5.6.1.1-2	NR 15 kHz SSB SCS, $\geq 10$ MHz bandwidth, TDD – TDD duplex mode
6.5.6.1.1-3	NR 15 kHz SSB SCS, $\geq 10$ MHz bandwidth, TDD – FDD duplex mode
6.5.6.1.1-4	NR 15 kHz SSB SCS, $\geq 10$ MHz bandwidth, FDD – TDD duplex mode
6.5.6.1.1-5	NR 30 kHz SSB SCS, $\geq 40$ MHz bandwidth, TDD – TDD duplex mode
Note 1:	The UE is only required to be tested in one of the supported test configurations.
Note 2:	The UE is only required to be tested in one with smallest aggregated channel bandwidth from supported band combinations which is composed of CCs $\geq$ the bandwidth ( $BW_{\text{channel}}$ ) defined in each test configuration.

Configure the test equipment and the DUT according to the parameters in Table 6.5.6.1.1.4.1-2.

**Table 6.5.6.1.1.4.1-2: Initial conditions for NR SA FR1-FR1 DCI-based DL active BWP switch in non-DRX**

Parameter	Value	Comment
Test environment	NC	As specified in TS 38.508-1 [14] clause 4.1.
Test frequencies	As specified in Annex E, Table E.4-1 and TS 38.508-1 [14] clause 4.3.1.	
Channel bandwidth	As specified by the test configuration selected from Table 6.5.6.1.1.4.1-1.	
Propagation conditions	AWGN	As specified in Annex C.2.2
Connection Diagram	TE Part	A.3.1.8.2
	DUT Part	A.3.2.3.4
Exceptions to connection diagram	- Without LTE link - For 4Rx capable UEs without any 2Rx RF bands use A.3.2.5.2 for DUT part and A.3.1.8.4 for TE part.	

1. The general test parameter settings are set up according to Table 6.5.6.1.1.4.1-3.
2. Message contents are defined in clause 6.5.6.1.1.4.3.
3. The test scenario comprises of one NR PCell (Cell 1) and one NR SCell (Cell 2). Cell 1 and Cell 2 are configured according to Annex C.1.2 and C.1.3.

**Table 6.5.6.1.1.4.1-3: General test parameters for DL BWP switch in SA**

Parameter	Unit	Value	Comment
NR RF Channel Number		1, 2	Two NR radio channels are used for this test
Active PCell		Cell 1	PCell on RF channel number 1.
Active SCell		Cell 2	SCell on RF channel number 2.
CP length		Normal	
DRX		OFF	For both PCell and SCell
<i>bwp-InactivityTimer</i>	ms	200	
Cell-individual offset for cells on RF channel number 1	dB	0	Individual offset for cells on PCC.
Cell-individual offset for cells on RF channel number 2	dB	0	Individual offset for cells on SCC.
Cell2 timing offset to cell1	$\mu$ s	3	Time alignment error as specified in TS 38.104 [28] clause 6.5.3.1.
T1	s	0.2	
T2	s	0.2	
T3	s	0.2	

#### 6.5.6.1.1.4.2 Test procedure

The test consists of 3 successive time periods, with durations of T1, T2, and T3, respectively.

PDCCHs indicating new transmissions shall be sent continuously on SCell (Cell 2) to ensure that the UE would have ACK/NACK sending except for the time duration when BWP is switching on Cell 2 and the time duration of T2.

PDCCHs indicating new transmissions shall be sent continuously on PCell (Cell 1) to ensure that the UE will have ACK/NACK sending.

Before the test starts,

- UE is connected to Cell 1 (PCell) on radio channel 1 (PCC), and Cell 2 (SCell) on radio channel 2 (SCC).
- UE is configured with 2 different UE-specific downlink bandwidth parts for SCell, BWP-1 and BWP-2, in Cell 2 before starting the test. BWP-1 and BWP-2 always include bandwidth of the initial DL BWP and SSB.
- UE is configured with 1 UE-specific downlink bandwidth parts the same as initial BWP for PCell, BWP-0 in Cell 1 before starting the test.
- UE is indicated in *firstActiveDownlinkBWP-Id* that the active DL BWP is BWP-1 in SCell.
- UE is indicated in *firstActiveDownlinkBWP-Id* that the active DL BWP is BWP-0 in PCell.
- UE is configured with a *bwp-InactivityTimer* timer value for SCell.

All cells have constant signal levels throughout the test.

1. Ensure the UE is in state RRC\_CONNECTED with generic procedure parameters Connectivity NR, Connected without release *On* and Test Mode *On* according to TS 38.508-1 [14] clause 4.5.
2. The SS shall configure SCell (Cell 2) on the SCC as per TS 38.508-1 [14] clause 7.5.1. Set the parameters according to Tables 6.5.6.1.1.4.1-3 and 6.5.6.1.1.5-1. Propagation conditions are set according to Annex C clauses C.2.2.
3. The SS shall transmit an *RRCReconfiguration* message releasing the dedicated configuration of the *initialDownlinkBWP* and the *initialUplinkBWP* of Cell 2. This message also configures 2 different UE-specific bandwidth parts for Cell 2, BWP-1 and BWP-2 and indicates BWP-1 as the active DL BWP using *firstActiveDownlinkBWP-Id*, according to Table 6.5.6.1.1.4.3-2.
4. The SS shall send a DCI format 1\_1 command for SCell DL BWP switch.
5. The UE shall receive the DCI format 1\_1 command in SCell's slot # denoted *i*, then T1 starts and the UE switch its bandwidth part from BWP-1 to BWP-2:
  - a) If the UE starts to report valid ACK/NACK for SCell on PCell from the first UL slot that occurs after the beginning of DL slot ( $i + T_{\text{BWPswitchDelay}} + k_1$ )

and

  - b) If the UE starts to report valid ACK/NACK for PCell from the first UL slot that occurs after the beginning of DL slot ( $i + T_{\text{BWPswitchDelay}} + \text{Interruption length} + k_1$ )

and

  - c) If the number of consecutive missing ACK/NACK for PCell is no more than 1

Then, the number of successful subtests is increased by one. Otherwise, count a fail for the test, switch off/on the UE and go to step 1.
6. If the UE sends valid ACK/NACK for the SCell on BWP-2, T2 starts. During T2, the SS shall not transmit DCI format for PDSCH reception on SCell.
7. T3 starts from the first slot #*j* of the DL subframe immediately after the slot wherein *bwp-InactivityTimer* timer expires and the SS restarts to send DCI format for PDSCH reception on SCell. Then, the UE shall switch its bandwidth part from BWP-2 back to the default bandwidth part – BWP-1:
  - a) If the UE starts to report valid ACK/NACK for SCell on PCell from the first UL slot that occurs after the beginning of DL slot ( $j + T_{\text{BWPswitchDelay}} + k_1$ )

and

b) If the UE starts to report valid ACK/NACK for PCell from the first UL slot that occurs after the beginning of DL slot ( $j + T_{BWPswitchDelay} + \text{Interruption length} + k_1$ )

and

c) If the number of consecutive missing ACK/NACK for PCell is no more than 1.

Then, the number of successful subtests is increased by one. Otherwise, count a fail for the test, switch off/on the UE and go to step 1.

8. Repeat steps 4-7 until the confidence level according to Tables G.2.3-1 in Annex G clause G.2 is achieved.

The SS verifies the DL BWP switch time in SCell by counting the slots from the time when the BWP switch command is received or *bwp-InactivityTimer* timer expires till an ACK/NACK is received.

The SS verifies that potential interruption to PCell is carried out in the correct time span by monitoring ACK/NACK sent in PCell during BWP switch of SCell, respectively.

Interruption length is defined in TS 38.133 [6] Table 8.2.2.5-1-1.

If all subtests pass, the test passes. If one subtest fails, the test fails.

6.5.6.1.1.4.3 Message contents

Message contents are according to TS 38.508-1 [14] clause 7.3 with the following exceptions:

**Table 6.5.6.1.1.4.3-1: Common Exception messages for NR SA FR1-FR1 DCI-based DL active BWP switch in non-DRX**

Default Message Contents	
Common contents of system information blocks exceptions	

**Table 6.5.6.1.1.4.3-1A: RRCReconfiguration (Step 3)**

Derivation Path: TS 38.508-1 [14], Table 4.8.1-1B			
Information Element	Value/remark	Comment	Condition
RRCReconfiguration ::= SEQUENCE {			
criticalExtensions CHOICE {			
rrcReconfiguration SEQUENCE {			
nonCriticalExtension SEQUENCE {			
masterCellGroup	CellGroupConfig	Table 6.5.6.1.1.4.3-1B	
}			
}			
}			
}			

**Table 6.5.6.1.1.4.3-1B: CellGroupConfig (Table 6.5.6.1.1.4.3-1A)**

Derivation Path: TS 38.508-1 [14], Table 4.8.1-2 with condition SCell_add			
Information Element	Value/remark	Comment	Condition
CellGroupConfig ::= SEQUENCE {			
sCellToAddModList SEQUENCE (SIZE (1..maxNrofSCells)) OF SCellConfig {	1 entry		
SCellConfig[1] SEQUENCE {		entry 1	
sCellConfigDedicated	ServingCellConfig	Table 6.5.6.1.1.4.3-2	
}			
}			
}			

**Table 6.5.6.1.1.4.3-2: ServingCellConfig (Table 6.5.6.1.1.4.3-1B)**

Derivation Path: TS 38.508-1 [14], Table 4.6.3-167			
Information Element	Value/remark	Comment	Condition
ServingCellConfig ::= SEQUENCE {			
initialDownlinkBWP SEQUENCE {			
pdcch-Config CHOICE {			
release	NULL		
}			
pdsch-Config CHOICE {			
release	NULL		
}			
radioLinkMonitoringConfig CHOICE {			
release	NULL		
}			
}			
downlinkBWP-ToAddModList SEQUENCE (SIZE (1..maxNrofBWPs)) OF SEQUENCE {	2 entries		
BWP-Downlink[1]	BWP-Downlink with condition BWP1	entry 1 Table 6.5.6.1.1.4.3-3	
BWP-Downlink[2]	BWP-Downlink with condition BWP2	entry 2 Table 6.5.6.1.1.4.3-3	
}			
firstActiveDownlinkBWP-Id	1	According to BWP-1	
bwp-InactivityTimer	ms200		
defaultDownlinkBWP-Id	1	According to BWP-1	
}			

**Table 6.5.6.1.1.4.3-3: BWP-Downlink (Table 6.5.6.1.1.4.3-2)**

Derivation Path: TS 38.508-1 [14], Table 4.6.3-9			
Information Element	Value/remark	Comment	Condition
BWP-Downlink ::= SEQUENCE {			
bwp-Id	1	BWP-1	BWP1
	2	BWP-2	BWP2
bwp-Common SEQUENCE {			
genericParameters	RIV defined in TS 38.214 [9] that corresponds to DLBWP.1.1		BWP1
	RIV defined in TS 38.214 [9] that corresponds to DLBWP.1.3		BWP2
}			
}			

**Table 6.5.6.1.1.4.3-4: Void**

**Table 6.5.6.1.1.4.3-5: Void**

**Table 6.5.6.1.1.4.3-6: PDSCH-TimeDomainResourceAllocationList**

Derivation Path: TS 38.508-1 [14], Table 4.6.3-103			
Information Element	Value/remark	Comment	Condition
PDSCH-TimeDomainResourceAllocationList ::= SEQUENCE(SIZE(1..maxNrofDL-Allocations)) OF PDSCH-TimeDomainResourceAllocation {	4 entries		
PDSCH-TimeDomainResourceAllocation[1] SEQUENCE {		entry 1	
k0	Not present		
mappingType	typeA		
startSymbolAndLength	53	Start symbol(S)=2, Length(L)=12	
}			
PDSCH-TimeDomainResourceAllocation[2] SEQUENCE {		entry 2	
k0	Not present		
mappingType	typeA		
startSymbolAndLength	72	S=2, L=6	
}			
PDSCH-TimeDomainResourceAllocation[3] SEQUENCE {		entry 3	
k0	T <sub>BWPswitchDelay</sub>	Defined in Table 6.5.6.1.0.1-1	The DCI indicating BWP switch
mappingType	typeA		
startSymbolAndLength	53	Start symbol(S)=2, Length(L)=12	
}			
PDSCH-TimeDomainResourceAllocation[4] SEQUENCE {		entry 4	
k0	1		First DCI right after DCI-based BWP switch
mappingType	typeA		
startSymbolAndLength	53	Start symbol(S)=2, Length(L)=12	
}			
}			

**Table 6.5.6.1.1.4.3-7: Void**

## 6.5.6.1.1.5 Test requirements

Tables 6.5.6.1.1.4.1-3 and 6.5.6.1.1.5-1 define the primary level settings including test tolerances.



**Table 6.5.6.1.1.5-1: NR Cell specific test parameters for DL BWP switch in SA**

Parameter		Unit	Cell 1	Cell2
Frequency Range			FR1	FR1
Duplex mode	Config 1		FDD	FDD
	Config 2,5		TDD	TDD
	Config 3		TDD	FDD
	Config 4		FDD	TDD
TDD configuration	Config 1		Not Applicable	Not Applicable
	Config 2		TDDConf.1.1	TDDConf.1.1
	Config 3		TDDConf.1.1	Not Applicable
	Config 4		Not Applicable	TDDConf.1.1
	Config 5		TDDConf.2.1	TDDConf.2.1
BW <sub>channel</sub>	Config 1,2,3,4		Note 7	Note 7
	Config 5		Note 7	Note 7
BW <sub>occupied</sub>	Config 1,2,3,4	RB	52 <sup>Note 5</sup>	52 <sup>Note 5</sup>
	Config 5		106 <sup>Note 6</sup>	106 <sup>Note 6</sup>
Active BWP ID			0	1, 2
Initial DL BWP Configuration			DLBWP.0.2 <sup>Note4</sup>	
Initial UL BWP Configuration			ULBWP.0.2 <sup>Note4</sup>	N.A.
Active DL BWP-0 Configuration			DLBWP.0.2 <sup>Note4</sup>	N.A.
Active DL BWP-1 Configuration			N.A.	DLBWP.1.1 <sup>Note4</sup>
Active DL BWP-2 Configuration			N.A.	DLBWP.1.3 <sup>Note4</sup>
Active UL BWP-0 Configuration			ULBWP.0.2 <sup>Note4</sup>	N.A.
Active UL BWP-1 Configuration			N.A.	N.A.
Active UL BWP-2 Configuration			N.A.	N.A.
PDSCH Reference measurement channel	Config 1		SR.1.1 FDD	SR.1.1 FDD
	Config 2		SR.1.1 TDD	SR.1.1 TDD
	Config 3		SR.1.1 TDD	SR.1.1 FDD
	Config 4		SR.1.1 FDD	SR.1.1 TDD
	Config 5		SR.2.1 TDD	SR.2.1 TDD
RMSI CORESET parameters	Config 1		CR.1.1 FDD	CR.1.1 FDD
	Config 2		CR.1.1 TDD	CR.1.1 TDD
	Config 3		CR.1.1 TDD	CR.1.1 FDD
	Config 4		CR.1.1 FDD	CR.1.1 TDD
	Config 5		CR.2.1 TDD	CR.2.1 TDD
Dedicated CORESET parameters	Config 1		CCR.1.2 FDD	CCR.1.2 FDD
	Config 2		CCR.1.2 TDD	CCR.1.2 TDD
	Config 3		CCR.1.2 TDD	CCR.1.2 FDD
	Config 4		CCR.1.2 FDD	CCR.1.2 TDD
	Config 5		CCR.2.4 TDD	CCR.2.4 TDD
TRS Configuration	Config 1		TRS.1.1 FDD	TRS.1.1 FDD
	Config 2		TRS.1.1 TDD	TRS.1.1 TDD
	Config 3		TRS.1.1 TDD	TRS.1.1 FDD
	Config 4		TRS.1.1 FDD	TRS.1.1 TDD
	Config 5		TRS.1.2 TDD	TRS.1.2 TDD
OCNG Patterns	Config 1,2,3,4		OP.1 <sup>Note 5</sup>	
	Config 5		OP.1 <sup>Note 6</sup>	
SSB Configuration	Config 1,2,3,4		SSB.1 FR1	
	Config 5		SSB.2 FR1	
SMTC Configuration			SMTC.1	
Correlation Matrix and Antenna Configuration			1x2 Low	
EPRE ratio of PSS to SSS		dB	0	0
EPRE ratio of PBCH DMRS to SSS				
EPRE ratio of PBCH to PBCH DMRS				
EPRE ratio of PDCCH DMRS to SSS				
EPRE ratio of PDCCH to PDCCH DMRS				
EPRE ratio of PDSCH DMRS to SSS				
EPRE ratio of PDSCH to PDSCH				
EPRE ratio of OCNG DMRS to SSS(Note 1)				
EPRE ratio of OCNG to OCNG DMRS (Note 1)				
N <sub>oc</sub> <sup>Note 2</sup>	Config 1,2,3,4	dBm/SCS	-104	-104
	Config 5		-101	-101

$N_{oc}$ <sup>Note 2</sup>		dBm/15KH z	-104	-104
SS-RSRP <sup>Note 3</sup>	Config 1,2,3,4	dBm/SCS	-87	-87
	Config 5		-84	-84
$\bar{E}_s/I_{ot}$		dB	17	17
$\bar{E}_s/N_{oc}$		dB	17	17
$I_o$ <sup>Note 3</sup>	Config 1,2,3,4	dBm/ 9.36MHz	-58.96	-58.96
	Config 5	dBm/ 38.16MHz	-52.86	-52.86
Propagation Condition			AWGN	AWGN
<p>Note 1: OCNB shall be used such that both cells are fully allocated and a constant total transmitted power spectral density is achieved for all OFDM symbols.</p> <p>Note 2: Interference from other cells and noise sources not specified in the test is assumed to be constant over subcarriers and time and shall be modelled as AWGN of appropriate power for <math>N_{oc}</math> to be fulfilled within <math>BW_{occupied}</math>.</p> <p>Note 3: SS-RSRP and <math>I_o</math> levels have been derived from other parameters for information purposes. They are not settable parameters themselves.</p> <p>Note 4: For unpaired spectrum, a DL BWP is linked with an UL BWP. DLBWP.0.2 is linked with ULBWP.0.2; DLBWP.1.1 is linked with ULBWP.1.1; DLBWP.1.3 is linked with ULBWP.1.3 defined in clause 12 of TS 38.213 [8].</p> <p>Note 5: All UL/DL transmission shall be confined within <math>BW_{occupied}</math> (i.e. 10 MHz, 52 RBs) from <math>F_{C,low}</math>, and <math>I_o</math> is independent of the <math>BW_{channel}</math> configured.</p> <p>Note 6: All UL/DL transmission shall be confined within <math>BW_{occupied}</math> (i.e. 40 MHz, 106 RBs) from <math>F_{C,low}</math>, and <math>I_o</math> is independent of the <math>BW_{channel}</math> configured.</p> <p>Note 7: <math>N_{RB,C}</math> is derived from Table 5.3.2-1 in TS38.101-1[2] with configured <math>BW_{channel}</math>.</p>				

During T1, the UE shall start to send the ACK/NACK for SCell on PCell from the first UL slot that occurs after the beginning of DL slot ( $i + T_{BWPswitchDelay} + k_1$ ).

During T3, the UE shall start to send the ACK/NACK for SCell on PCell from the first UL slot that occurs after the beginning of DL slot ( $j + T_{BWPswitchDelay} + k_1$ ).

Where,  $k_1$  is the timing between DL data receiving and acknowledgement as specified in [9].

Depending on UE capability *bwp-SwitchingDelay* [13], UE shall finish BWP switch within the time duration  $T_{BWPswitchDelay}$  defined in TS 38.133 [6] Table 8.6.2-1.

All of the above test requirements shall be fulfilled in order for the observed SCell active BWP switch delay to be counted as correct.

The rate of correct events observed during repeated tests shall be at least 90%.

During T1 and T3, the start time of PCell interruption during SCell active BWP switch shall not happen outside the BWP switch delay.

The interruption of PCell shall not be longer than the interruption duration specified for active BWP switch in TS 38.133 [6] clause 8.2.2.2.5.

All of the above test requirements shall be fulfilled in order for the observed SCell active BWP switch interruption to be counted as correct.

The rate of correct events observed during repeated tests shall be at least 90%.

NOTE: During T1, T3 if there are no uplink resources for reporting the ACK/NACK in the first UL slot that occurs after the beginning of DL slot ( $i + T_{BWPswitchDelay} + k_1$ ), ( $j + T_{BWPswitchDelay} + k_1$ ), then the UE shall use the next available uplink resource for reporting the corresponding ACK/NACK.

### 6.5.6.1.2 NR SA FR1 DCI-based DL active BWP switch in non-DRX

#### 6.5.6.1.2.1 Test purpose

The purpose of this test is to verify the DL BWP switch delay requirement defined in TS 38.133 [6] clause 8.6.

## 6.5.6.1.2.2 Test applicability

This test applies to all types of NR UE release 15 onwards supporting BWP adaptation of at least 2 BWPs, DCI and timer-based active BWP switching delay Type1 or Type2.

## 6.5.6.1.2.3 Minimum conformance requirements

The minimum conformance requirements are specified in clause 6.5.6.1.0.1.

The normative reference for this requirement is TS 38.133 [6] clause A.6.5.6.1.2.

## 6.5.6.1.2.4 Test description

## 6.5.6.1.2.4.1 Initial conditions

This test shall be tested using any of the test configurations in Table 6.5.6.1.2.4.1-1.

**Table 6.5.6.1.2.4.1-1: Supported test configurations for NR SA FR1 DCI-based DL active BWP switch in non-DRX**

Config	Description
6.5.6.1.2-1	NR 15 kHz SSB SCS, 10 MHz bandwidth, FDD duplex mode
6.5.6.1.2-2	NR 15 kHz SSB SCS, 10 MHz bandwidth, TDD duplex mode
6.5.6.1.2-3	NR 30 kHz SSB SCS, 40 MHz bandwidth, TDD duplex mode
Note 1: The UE is only required to be tested in one of the supported test configurations	
Note 2: A UE which fulfils the requirements in test case A.6.5.6.1.1 can skip the test cases in A.6.5.6.1.2	

Configure the test equipment and the DUT according to the parameters in Table 6.5.6.1.2.4.1-2.

**Table 6.5.6.1.2.4.1-2: Initial conditions for NR SA FR1 DCI-based DL active BWP switch in non-DRX**

Parameter	Value		Comment
Test environment	NC		As specified in TS 38.508-1 [14] clause 4.1.
Test frequencies	As specified in Annex E, Table E.4-1 and TS 38.508-1 [14] clause 4.3.1.		
Channel bandwidth	As specified by the test configuration selected from Table 6.5.6.1.2.4.1-1.		
Propagation conditions	AWGN		As specified in Annex C.2.2
Connection Diagram	TE Part	A.3.1.8.2	As specified in TS 38.508-1 [14] Annex A.
	DUT Part	A.3.2.3.4	
Exceptions to connection diagram	- Without LTE link - For 4Rx capable UEs without any 2Rx RF bands use A.3.2.5.2 for DUT part and A.3.1.8.4 for TE part.		

1. The general test parameter settings are set up according to Table 6.5.6.1.2.4.1-3.
2. Message contents are defined in clause 6.5.6.1.2.4.3.
3. The test scenario comprises of one NR PCell (Cell 1). Cell 1 is configured according to Annex C.1.2 and C.1.3.

**Table 6.5.6.1.2.4.1-3: General test parameters for DL BWP switch in SA**

Parameter	Unit	Value	Comment
NR RF Channel Number		1	One NR radio channel is used for this test
Active Cell		Cell 1	Cell1 on RF channel number 1.
CP length		Normal	
DRX		OFF	
<i>bwp-InactivityTimer</i>	ms	200	
T1	s	0.2	
T2	s	0.2	
T3	s	0.2	

#### 6.5.6.1.2.4.2 Test procedure

The test consists of 3 successive time periods, with durations of T1, T2, and T3, respectively.

PDCCHs indicating new transmissions shall be sent continuously on Cell 1 to ensure that the UE would have ACK/NACK sending except for the time duration when BWP is switching on Cell 1 and the time duration of T2.

Before the test starts,

- UE is connected to Cell 1 on radio channel 1.
- UE is configured with 2 different UE-specific downlink bandwidth parts, BWP-1 and BWP-2 before starting the test. BWP-1 and BWP-2 always include bandwidth of the initial DL BWP and SSB.
- UE is indicated in *firstActiveDownlinkBWP-Id* that the active DL BWP is BWP-1.
- UE is configured with a *bwp-InactivityTimer* timer value for PCell.

The Cell 1 has constant signal levels throughout the test.

1. Ensure the UE is in state RRC\_CONNECTED with generic procedure parameters Connectivity NR, Connected without release *On* and Test Mode *On* according to TS 38.508-1 [14] clause 4.5.
2. Set the parameters according to Tables 6.5.6.1.2.4.1-3 and 6.5.6.1.2.5-1. Propagation conditions are set according to Annex C clauses C.2.2.
3. The SS shall transmit an *RRCReconfiguration* message releasing the dedicated configuration of the *initialDownlinkBWP* and the *initialUplinkBWP*. This message also configures 2 different UE-specific bandwidth parts, BWP-1 and BWP-2 and indicates BWP-1 as the active DL BWP using *firstActiveDownlinkBWP-Id*, according to Table 6.5.6.1.2.4.3-2.
4. The SS shall send a DCI format 1\_1 command for Cell 1 DL BWP switch.
5. The UE shall receive the DCI format 1\_1 command in slot # denoted *i*, then T1 starts and the UE switch its bandwidth part from BWP-1 to BWP-2:

If the UE starts to report valid ACK/NACK for Cell 1 from the first UL slot that occurs after the beginning of DL slot ( $i + T_{\text{BWPswitchDelay}} + k_i$ ). The number of successful subtests is increased by one. Otherwise, count a fail for the test, switch off/on the UE and go to step 1.

6. If the UE sends valid ACK/NACK for the Cell 1 on BWP-2, T2 starts. During T2, the SS shall not transmit DCI format for PDSCH reception on Cell 1.
7. T3 starts from the first slot #*j* of the DL subframe immediately after the slot wherein *bwp-InactivityTimer* timer expires and the SS restarts to send DCI format for PDSCH reception on PCell. Then, the UE shall switch its bandwidth part from BWP-2 back to the default bandwidth part, BWP-1:

If the UE starts to report valid ACK/NACK for PCell from the first UL slot that occurs after the beginning of DL slot ( $j + T_{\text{BWPswitchDelay}} + k_j$ ). The number of successful subtests is increased by one and go to step 8 after T3 expires. Otherwise, count a fail for the test, switch off/on the UE and go to step 1.

8. Repeat steps 4-7 until the confidence level according to Tables G.2.3-1 in Annex G clause G.2 is achieved.

The SS verifies the DL BWP switch time by counting the slots from the time when the BWP switch command is received or *bwp-InactivityTimer* timer expires till an ACK/NACK is received.

If all subtests pass, the test passes. If one subtest fails, the test fails.

#### 6.5.6.1.2.4.3 Message contents

Message contents are according to TS 38.508-1 [14] clause 7.3 with the following exceptions:

**Table 6.5.6.1.2.4.3-1: Common Exception messages for NR SA FR1 DCI-based DL active BWP switch in non-DRX**

Default Message Contents	
Common contents of system information blocks exceptions	

**Table 6.5.6.1.2.4.3-1A: Void**

**Table 6.5.6.1.2.4.3-1B: Void**

**Table 6.5.6.1.2.4.3-1C: RRCReconfiguration (Step 3)**

Derivation Path: TS 38.508-1 [14], Table 4.8.1-1B			
Information Element	Value/remark	Comment	Condition
RRCReconfiguration ::= SEQUENCE {			
criticalExtensions CHOICE {			
rrcReconfiguration SEQUENCE {			
nonCriticalExtension SEQUENCE {			
masterCellGroup	CellGroupConfig	Table 6.5.6.1.2.4.3-1D	
}			
}			
}			
}			

**Table 6.5.6.1.2.4.3-1D: CellGroupConfig (Table 6.5.6.1.2.4.3-1C)**

Derivation Path: TS 38.508-1 [14], Table 4.8.1-2			
Information Element	Value/remark	Comment	Condition
CellGroupConfig ::= SEQUENCE {			
spCellConfig SEQUENCE {			
spCellConfigDedicated	ServingCellConfig	Table 6.5.6.1.2.4.3-2	
}			
}			

**Table 6.5.6.1.2.4.3-2: ServingCellConfig (Table 6.5.6.1.2.4.3-1D)**

Derivation Path: TS 38.508-1 [14], Table 4.6.3-167			
Information Element	Value/remark	Comment	Condition
ServingCellConfig ::= SEQUENCE {			
initialDownlinkBWP SEQUENCE {			
pdcch-Config CHOICE {			
release	NULL		
}			
pdsch-Config CHOICE {			
release	NULL		
}			
radioLinkMonitoringConfig CHOICE {			
release	NULL		
}			
}			
downlinkBWP-ToAddModList SEQUENCE (SIZE (1..maxNrofBWPs)) OF SEQUENCE {	2 entries		
BWP-Downlink[1]	BWP-Downlink with condition BWP1	entry 1 Table 6.5.6.1.2.4.3-3	
BWP-Downlink[2]	BWP-Downlink with condition BWP2	entry 2 Table 6.5.6.1.2.4.3-3	
}			
firstActiveDownlinkBWP-Id	1	According to BWP-1	
bwp-InactivityTimer	ms200		
defaultDownlinkBWP-Id	1	According to BWP-1	
uplinkConfig SEQUENCE {			
initialUplinkBWP SEQUENCE {			
pucch-Config CHOICE {			
release	NULL		
}			
pusch-Config CHOICE {			
release	NULL		
}			
srs-Config CHOICE {			
release	NULL		
}			
uplinkBWP-ToAddModList SEQUENCE (SIZE (1..maxNrofBWPs)) OF SEQUENCE {			
BWP-Uplink[1]	BWP-Uplink with condition BWP1	entry 1 Table 6.5.6.1.2.4.3-4	
BWP-Uplink[2]	BWP-Uplink with condition BWP2	entry 2 Table 6.5.6.1.2.4.3-4	
firstActiveUplinkBWP-Id	1	According to BWP-1	
}			
}			
}			
}			

**Table 6.5.6.1.2.4.3-3: BWP-Downlink (Table 6.5.6.1.2.4.3-2)**

Derivation Path: TS 38.508-1 [14], Table 4.6.3-9			
Information Element	Value/remark	Comment	Condition
BWP-Downlink ::= SEQUENCE {			
bwp-Id	1	BWP-1	BWP1
	2	BWP-2	BWP2
bwp-Common SEQUENCE {			
genericParameters	RIV defined in TS 38.214 [9] that corresponds to DLBWP.1.1		BWP1
	RIV defined in TS 38.214 [9] that corresponds to DLBWP.1.3		BWP2
}			
}			

**Table 6.5.6.1.2.4.3-4: BWP-Uplink (Table 6.5.6.1.2.4.3-2)**

Derivation Path: TS 38.508-1 [14], Table 4.6.3-13			
Information Element	Value/remark	Comment	Condition
BWP-Uplink ::= SEQUENCE {			
bwp-Id	1	BWP-1	BWP1
	2	BWP-2	BWP2
bwp-Common SEQUENCE {			
genericParameters	RIV defined in TS 38.214 [9] that corresponds to ULBWP.1.1	BWP-1	BWP1
	RIV defined in TS 38.214 [9] that corresponds to ULBWP.1.3	BWP-2	BWP2
}			
}			

**Table 6.5.6.1.2.4.3-5: Void**



**Table 6.5.6.1.2.4.3-6: PDSCH-TimeDomainResourceAllocationList**

Derivation Path: TS 38.508-1 [14], Table 4.6.3-103			
Information Element	Value/remark	Comment	Condition
PDSCH-TimeDomainResourceAllocationList ::= SEQUENCE(SIZE(1..maxNrofDL-Allocations)) OF PDSCH-TimeDomainResourceAllocation {	4 entries		
PDSCH-TimeDomainResourceAllocation[1] SEQUENCE {		entry 1	
k0	Not present		
mappingType	typeA		
startSymbolAndLength	53	Start symbol(S)=2, Length(L)=12	
}			
PDSCH-TimeDomainResourceAllocation[2] SEQUENCE {		entry 2	
k0	Not present		
mappingType	typeA		
startSymbolAndLength	72	S=2, L=6	
}			
PDSCH-TimeDomainResourceAllocation[3] SEQUENCE {		entry 3	
k0	T <sub>BWPswitchDelay</sub>	Defined in Table 6.5.6.1.0.1-1	The DCI indicating BWP switch
mappingType	typeA		
startSymbolAndLength	53	Start symbol(S)=2, Length(L)=12	
}			
PDSCH-TimeDomainResourceAllocation[4] SEQUENCE {		entry 4	
k0	1		First DCI right after DCI-based BWP switch
mappingType	typeA		
startSymbolAndLength	53	Start symbol(S)=2, Length(L)=12	
}			
}			

#### 6.5.6.1.2.5 Test requirements

Tables 6.5.6.1.2.4.1-3 and 6.5.6.1.2.5-1 define the primary level settings including test tolerances.

**Table 6.5.6.1.2.5-1: NR Cell specific test parameters for DL BWP switch in SA**

Parameter		Unit	Cell 1
Frequency Range			FR1
Duplex mode	Config 1		FDD
	Config 2,3		TDD
TDD configuration	Config 1		Not Applicable
	Config 2		TDDConf.1.1
	Config 3		TDDConf.2.1
BW <sub>channel</sub>	Config 1		10 MHz: N <sub>RB,c</sub> = 52
	Config 2		10 MHz: N <sub>RB,c</sub> = 52
	Config 3		40 MHz: N <sub>RB,c</sub> = 106
Active BWP ID			1, 2
Initial DL BWP Configuration	Config 1,2,3		DLBWP.0.2 <sup>Note 4</sup>
Active DL BWP-1 Configuration	Config 1,2,3		DLBWP.1.1 <sup>Note 4</sup>
Active DL BWP-2 Configuration	Config 1,2,3		DLBWP.1.3 <sup>Note 4</sup>
Initial UL BWP Configuration	Config 1,2,3		ULBWP.0.2 <sup>Note 4</sup>
Active UL BWP-1 Configuration	Config 1,2,3		ULBWP.1.1 <sup>Note 4</sup>
Active UL BWP-2 Configuration	Config 1		N/A
	Config 2,3		ULBWP.1.3 <sup>Note 4</sup>
PDSCH Reference measurement channel	Config 1		SR.1.1 FDD
	Config 2		SR.1.1 TDD
	Config 3		SR.2.1 TDD
RMSI CORESET parameters	Config 1		CR.1.1 FDD
	Config 2		CR.1.1 TDD
	Config 3		CR.2.1 TDD
Dedicated CORESET parameters	Config 1		CCR.1.2 FDD
	Config 2		CCR.1.2 TDD
	Config 3		CCR.2.4 TDD
OCNG Patterns			OP.1
SSB Configuration	Config 1,2		SSB.1 FR1
	Config 3		SSB.2 FR1
SMTc Configuration			SMTc.1
Correlation Matrix and Antenna Configuration			1x2 Low
TRS Configuration	Config 1,4		TRS.1.1 FDD
	Config 2,5		TRS.1.1 TDD
	Config 3,6		TRS.1.2 TDD
EPRE ratio of PSS to SSS		dB	0
EPRE ratio of PBCH DMRS to SSS			
EPRE ratio of PBCH to PBCH DMRS			
EPRE ratio of PDCCH DMRS to SSS			
EPRE ratio of PDCCH to PDCCH DMRS			
EPRE ratio of PDSCH DMRS to SSS			
EPRE ratio of PDSCH to PDSCH			
EPRE ratio of OCNG DMRS to SSS(Note 1)			
EPRE ratio of OCNG to OCNG DMRS (Note 1)			
N <sub>oc</sub> <sup>Note 2</sup>	Config 1,2		
	Config 3	-101	
N <sub>oc</sub> <sup>Note 2</sup>		dBm/15kHz	-104
SS-RSRP <sup>Note 3</sup>	Config 1,2	dBm/SCS	-87
	Config 3		-84
Ē <sub>s</sub> /I <sub>ot</sub>		dB	17
Ē <sub>s</sub> /N <sub>oc</sub>		dB	17
I <sub>o</sub> <sup>Note 3</sup>	Config 1,2	dBm/9.36MHz	-58.96
	Config 3	dBm/38.16MHz	-52.86
Propagation Condition			AWGN

Note 1:	OCNG shall be used such that both cells are fully allocated and a constant total transmitted power spectral density is achieved for all OFDM symbols.
Note 2:	Interference from other cells and noise sources not specified in the test is assumed to be constant over subcarriers and time and shall be modelled as AWGN of appropriate power for Noc to be fulfilled.
Note 3:	SS-RSRP and $I_0$ levels have been derived from other parameters for information purposes. They are not settable parameters themselves.
Note 4:	For unpaired spectrum, a DL BWP is linked with an UL BWP. DLBWP.0.2 is linked with ULBWP.0.2; DLBWP.1.1 is linked with ULBWP.1.1; DLBWP.1.3 is linked with ULBWP.1.3 defined in clause 12 of TS 38.213 [8].

During T1, the UE shall start to send the ACK/NACK for PCell from the first UL slot that occurs after the beginning of DL slot ( $i+T_{BWPswitchDelay}+k_1$ ).

During T3, the UE shall start to send the ACK/NACK for PCell from the first UL slot that occurs right after the beginning of DL slot ( $j+T_{BWPswitchDelay}+k_1$ ).

Where,  $k_1$  is the timing between DL data receiving and acknowledgement as specified in 38.214[9].

Depending on UE capability *bwp-SwitchingDelay* [13], UE shall finish BWP switch within the time duration  $T_{BWPswitchDelay}$  defined in TS 38.133 [6] Table 8.6.2-1.

All of the above test requirements shall be fulfilled in order for the observed PCell active BWP switch delay to be counted as correct.

The rate of correct events observed during repeated tests shall be at least 90%.

NOTE: During T1, T3 if there are no uplink resources for reporting the ACK/NACK in the first UL slot that occurs after beginning of DL slot ( $i+T_{BWPswitchDelay}+k_1$ ), ( $j+T_{BWPswitchDelay}+k_1$ ), then the UE shall use the next available uplink resource for reporting the corresponding ACK/NACK.

## 6.5.6.2 RRC-based active BWP switch

### 6.5.6.2.0 Minimum conformance requirements

#### 6.5.6.2.0.1 Minimum conformance requirements for RRC-based active BWP switch

For RRC-based BWP switch, after the UE receives RRC reconfiguration involving active BWP switching or parameter change of its active BWP, UE shall be able to receive PDSCH/PDCCH (for DL active BWP switch) or transmit PUSCH (for UL active BWP switch) on the new BWP on the serving cell on which BWP switch occurs on the first DL or UL slot right after a time duration of  $\frac{T_{RRCprocessingDelay}+T_{BWPswitchDelayRRC}}{NR\ Slot\ length}$  slots which begins from the beginning of DL slot  $n$ , where

DL slot  $n$  is the last slot containing the RRC command, and

$T_{RRCprocessingDelay}$  is the length of the RRC procedure delay in ms as defined in clause 12 in TS 38.331 [13], and

$T_{BWPswitchDelayRRC} = 6ms$  is the time used by the UE to perform BWP switch.

The UE is not required to transmit UL signals or receive DL signals during the time defined by  $T_{RRCprocessingDelay} + T_{BWPswitchDelayRRC}$  on the cell where RRC-based BWP switch occurs.

The normative reference for this requirement is TS 38.133 [6] clauses 8.6.3.

### 6.5.6.2.1 NR SA FR1 RRC-based DL active BWP switch in non-DRX

#### 6.5.6.2.1.1 Test purpose

The purpose of this test is to verify the DL BWP switch delay requirement for RRC-based BWP switch defined in TS 38.133 [6] clause 8.6.

#### 6.5.6.2.1.2 Test applicability

This test applies to all types of NR UE release 15 onwards supporting BWP adaptation of at least 2 BWPs.

### 6.5.6.2.1.3 Minimum conformance requirements

The minimum conformance requirements are specified in clause 6.5.6.2.0.1.

The normative reference for this requirement is TS 38.133 [6] clause A.6.5.6.2.1.

### 6.5.6.2.1.4 Test description

#### 6.5.6.2.1.4.1 Initial conditions

This test shall be tested using any of the test configurations in Table 6.5.6.2.1.4.1-1.

**Table 6.5.6.2.1.4.1-1: Supported test configurations for NR SA FR1 RRC-based DL active BWP switch in non-DRX**

Config	Description
6.5.6.2.1-1	NR 15 kHz SSB SCS, 10 MHz bandwidth, FDD duplex mode
6.5.6.2.1-2	NR 15 kHz SSB SCS, 10 MHz bandwidth, TDD duplex mode
6.5.6.2.1-3	NR 30 kHz SSB SCS, 40 MHz bandwidth, TDD duplex mode
Note 1: The UE is only required to be tested in one of the supported test configurations	

Configure the test equipment and the DUT according to the parameters in Table 6.5.6.2.1.4.1-2.

**Table 6.5.6.2.1.4.1-2: Initial conditions for NR SA FR1 RRC-based DL active BWP switch in non-DRX**

Parameter	Value		Comment
Test environment	NC		As specified in TS 38.508-1 [14] clause 4.1.
Test frequencies	As specified in Annex E, Table E.4-1 and TS 38.508-1 [14] clause 4.3.1.		
Channel bandwidth	As specified by the test configuration selected from Table 6.5.6.2.1.4.1-1.		
Propagation conditions	AWGN		As specified in Annex C.2.2
Connection Diagram	TE Part	A.3.1.8.2	As specified in TS 38.508-1 [14] Annex A.
	DUT Part	A.3.2.3.4	
Exceptions to connection diagram	- Without LTE link - For 4Rx capable UEs without any 2Rx RF bands use A.3.2.5.2 for DUT part and A.3.1.8.4 for TE part.		

1. The general test parameter settings are set up according to Table 6.5.6.2.1.4.1-3.
2. Message contents are defined in clause 6.5.6.2.1.4.3.
3. The test scenario comprises of one NR Cell (Cell 1). Cell 1 is configured according to Annex C.1.2 and C.1.3.

**Table 6.5.6.2.1.4.1-3: General test parameters for DL BWP switch in SA**

Parameter	Unit	Value	Comment
NR RF Channel Number		1	One NR radio channel is used for this test
Active Cell		Cell 1	PCell on RF channel number 1.
CP length		Normal	
DRX		OFF	
T1	s	0.2	

#### 6.5.6.2.1.4.2 Test procedure

The test consists of 1 time period, with duration of T1.

PDCCHs indicating new transmissions shall be sent continuously on Cell 1 to ensure that the UE will have ACK/NACK sending.

Before the test starts,

- UE is connected to Cell 1 on radio channel 1.

- UE has bandwidth part BWP-1 in its RRC-configuration for Cell 1.
- UE is indicated in firstActiveDownlinkBWP-Id that the active DL BWP is BWP-1 of initial condition in Cell 1.

Cell 1 has constant signal level throughout the test.

1. Ensure the UE is in state RRC\_CONNECTED with generic procedure parameters Connectivity NR, Connected without release On and Test Mode On according to TS 38.508-1 [14] clause 4.5.
2. Set the parameters according to Tables 6.5.6.2.1.4.1-3 and 6.5.6.2.1.5-1. Propagation conditions are set according to Annex C clauses C.2.2.
3. The SS shall send an RRCReconfiguration message releasing the dedicated configuration of the initialDownlinkBWP and the initialUplinkBWP. This message also configures another UE-specific bandwidth part, BWP-1 and indicates BWP-1 as the active DL BWP using firstActiveDownlinkBWP-Id, according to the initial condition of Active BWP-1 in Table 6.5.6.2.1.5-1.
4. The UE shall transmit an RRCReconfigurationComplete message.
5. The SS shall send an RRCReconfiguration message with updated bandwidth part configuration for DL BWP switch, change the BWP according to the final condition of Active BWP-1 in Table 6.5.6.2.1.5-1. T1 starts.
6. The UE shall receive the RRCReconfiguration in PCell's slot # denoted i and reconfigure its bandwidth part with the updated bandwidth part configuration.
7. If the UE starts to report valid ACK/NACK for PCell from the first UL slot that occurs after the beginning of DL slot  $i + \frac{T_{RRCprocessingDelay} + T_{BWPswitchDelayRRC}}{NR\ Slot\ length} + k1$  then the number of successful tests is increased by one. Otherwise, the number of failure tests is increased by one.
8. After the SS receives the ACK/NACK in step 7) or when T1 expires, the SS shall transmit RRCRelease message to release the RRC connection.
9. After the RRC connection release, the SS:
  - transmits in NR Cell 1 a Paging message for the UE and ensures the UE is in state RRC\_CONNECTED with generic procedure parameters Connectivity NR, Connected without release On according to TS 38.508-1 [14] clause 4.5 (if the paging fails, switches off and on the UE and ensures the UE is in state RRC\_CONNECTED with generic procedure parameters Connectivity NR, Connected without release On according to TS 38.508-1 [14] clause 4.5),
  - or
  - switches off and on the UE and ensures the UE is in state RRC\_CONNECTED with generic procedure parameters Connectivity NR, Connected without release On according to TS 38.508-1 [14] clause 4.5.
10. Repeat steps 2-9 until the confidence level according to Tables G.2.3-1 in Annex G clause G.2 is achieved.

The SS verifies the DL BWP switch time in PCell by counting the slots from the time when the RRC Reconfiguration message including updated BWP configuration is sent till a valid ACK/NACK is received.

6.5.6.2.1.4.3 Message contents

Message contents are according to TS 38.508-1 [14] clause 7.3 with the following exceptions:

**Table 6.5.6.2.1.4.3-1: Common Exception messages for NR SA FR1 RRC-based DL active BWP switch in non-DRX**

Default Message Contents	
Common contents of system information blocks exceptions	

**Table 6.5.6.2.1.4.3-1A: Void**

**Table 6.5.6.2.1.4.3-1B: Void**

**Table 6.5.6.2.1.4.3-1C: RRCReconfiguration (1, Step 3, Step 5)**

Derivation Path: TS 38.508-1 [14], Table 4.6.1-13 with condition NR			
Information Element	Value/remark	Comment	Condition
RRCReconfiguration ::= SEQUENCE {			
criticalExtensions CHOICE {			
rrcReconfiguration SEQUENCE {			
radioBearerConfig	Not present		
nonCriticalExtension SEQUENCE {			
masterCellGroup	CellGroupConfig	Table 6.5.6.2.1.4.3-1D	
dedicatedNAS-MessageList	Not present		
}			
}			
}			

**Table 6.5.6.2.1.4.3-1D: CellGroupConfig (Table 6.5.6.2.1.4.3-1C)**

Derivation Path: TS 38.508-1 [14], Table 4.6.3-19			
Information Element	Value/remark	Comment	Condition
CellGroupConfig ::= SEQUENCE {			
spCellConfig SEQUENCE {			
spCellConfigDedicated	ServingCellConfig	Table 6.5.6.2.1.4.3-1E	
}			
}			

Table 6.5.6.2.1.4.3-1E: *ServingCellConfig* (Table 6.5.6.2.1.4.3-1D)

Derivation Path: TS 38.508-1 [14], Table 4.6.3-167			
Information Element	Value/remark	Comment	Condition
<i>ServingCellConfig</i> ::= SEQUENCE {			
initialDownlinkBWP SEQUENCE {			
pdcch-Config CHOICE {			
release	NULL		
}			
pdsch-Config CHOICE {			
release	NULL		
}			
radioLinkMonitoringConfig CHOICE {			
release	NULL		
}			
}			
downlinkBWP-ToAddModList SEQUENCE (SIZE (1..maxNrofBWPs)) OF BWP-Downlink {	1 entry		
BWP-Downlink[1] SEQUENCE {	BWP-Downlink	entry 1 Table 6.5.6.2.1.4.3-1F	
}			
firstActiveDownlinkBWP-Id	1	BWP-1	
defaultDownlinkBWP-Id	1	BWP-1	
uplinkConfig SEQUENCE {			
initialUplinkBWP SEQUENCE {			
pucch-Config CHOICE {			
release	NULL		
}			
pusch-Config CHOICE {			
release	NULL		
}			
srs-Config CHOICE {			
release	NULL		
}			
}			
uplinkBWP-ToAddModList SEQUENCE (SIZE (1..maxNrofBWPs)) OF BWP-Uplink {	1 entry		
BWP-Uplink[1]	BWP-Uplink	entry 1 Table 6.5.6.2.1.4.3-1G	
}			
firstActiveUplinkBWP-Id	1	BWP-1	
}			
}			

Table 6.5.6.2.1.4.3-1F: *BWP-Downlink* (Table 6.5.6.2.1.4.3-1E)

Derivation Path: TS 38.508-1 [14], Table 4.6.3-9			
Information Element	Value/remark	Comment	Condition
<i>BWP-Downlink</i> ::= SEQUENCE {			
bwp-Id	1		
bwp-Common SEQUENCE {			
genericParameters	RIV defined in TS 38.214 [9] that corresponds to DLBWP.1.3		Step 3
}	RIV defined in TS 38.214 [9] that corresponds to DLBWP.1.1		Step 5
}			
}			



**Table 6.5.6.2.1.4.3-1G: BWP-Uplink (Table 6.5.6.2.1.4.3-1E)**

Derivation Path: TS 38.508-1 [14], Table 4.6.3-13			
Information Element	Value/remark	Comment	Condition
BWP-Uplink ::= SEQUENCE {			
bwp-Id	1		
bwp-Common SEQUENCE {			
genericParameters	RIV defined in TS 38.214 [9] that corresponds to ULBWP.1.3		Step 3
	RIV defined in TS 38.214 [9] that corresponds to ULBWP.1.1		Step 5
}			
}			

**Table 6.5.6.2.1.4.3-2: Void**

## 6.5.6.2.1.5 Test requirements

Tables 6.5.6.2.1.4.1-3 and 6.5.6.2.1.5-1 define the primary level settings including test tolerances.

**Table 6.5.6.2.1.5-1: NR Cell specific test parameters for DL BWP switch**

Parameter		Unit	Cell 1
Frequency Range			FR1
Duplex mode	Config 1		FDD
	Config 2,3		TDD
TDD configuration	Config 1		Not Applicable
	Config 2		TDDConf.1.1
	Config 3		TDDConf.2.1
BW <sub>channel</sub>	Config 1		10 MHz: N <sub>RB,c</sub> = 52
	Config 2		10 MHz: N <sub>RB,c</sub> = 52
	Config 3		40 MHz: N <sub>RB,c</sub> = 106
Active BWP ID			1
Initial DL BWP Configuration	Config 1,2,3		DLBWP.0.2
Initial UL BWP Configuration	Config 1,2,3		ULBWP.0.2
Initial Condition	Active DL BWP-1 Configuration	Config 1,2,3	DLBWP.1.3
	Active UL BWP-1 Configuration	Config 1,2,3	ULBWP.1.3
Final Condition	Active DL BWP-1 Configuration	Config 1,2,3	DLBWP.1.1
	Active UL BWP-1 Configuration	Config 1,2,3	ULBWP.1.1
PDSCH Reference measurement channel	Config 1		SR.1.1 FDD
	Config 2		SR.1.1 TDD
	Config 3		SR.2.1 TDD
RMSI CORESET parameters	Config 1		CR.1.1 FDD
	Config 2		CR.1.1 TDD
	Config 3		CR.2.1 TDD
Dedicated CORESET parameters	Config 1		CCR.1.1 FDD
	Config 2		CCR.1.1 TDD
	Config 3		CCR.2.3 TDD
OCNG Patterns			OP.1
SSB Configuration	Config 1,2		SSB.1 FR1
	Config 3		SSB.2 FR1
SMTC Configuration			SMTC.1
TRS Configuration	Config 1		TRS.1.1 FDD
	Config 2		TRS.1.1 TDD
	Config 3		TRS.1.2 TDD
Antenna Configuration			1x2 Low
Propagation Condition			AWGN
EPRE ratio of PSS to SSS		dB	0
EPRE ratio of PBCH DMRS to SSS			
EPRE ratio of PBCH to PBCH DMRS			
EPRE ratio of PDCCH DMRS to SSS			
EPRE ratio of PDCCH to PDCCH DMRS			
EPRE ratio of PDSCH DMRS to SSS			
EPRE ratio of PDSCH to PDSCH			
EPRE ratio of OCNG DMRS to SSS <sup>(Note 1)</sup>			
EPRE ratio of OCNG to OCNG DMRS <sup>(Note 1)</sup>			
N <sub>oc</sub> <sup>Note 2</sup>	Config 1,2		
	Config 3	-101	
SS-RSRP <sup>Note 3</sup>	Config 1,2	dBm/SCS	-87
	Config 3		-84
E <sub>s</sub> /I <sub>ot</sub>		dB	17
E <sub>s</sub> /N <sub>oc</sub>		dB	17

I <sub>o</sub> <sup>Note3</sup>	Config 1,2	dBm/ 9.36MHz	-58.96
	Config 3	dBm/ 38.16MHz	-52.86
Note 1:	OCNG shall be used such that both cells are fully allocated and a constant total transmitted power spectral density is achieved for all OFDM symbols.		
Note 2:	Interference from other cells and noise sources not specified in the test is assumed to be constant over subcarriers and time and shall be modelled as AWGN of appropriate power for N <sub>oc</sub> to be fulfilled.		
Note 3:	SS-RSRP and I <sub>o</sub> levels have been derived from other parameters for information purposes. They are not settable parameters themselves.		
Note 4:	Note 4: For unpaired spectrum, a DL BWP is linked with an UL BWP. DLBWP.0.2 is linked with ULBWP.0.2; DLBWP.1.1 is linked with ULBWP.1.1; DLBWP.1.3 is linked with ULBWP.1.3 defined in clause 12 of TS 38.213 [8].		

During T1, the UE shall be ready for the reception of uplink grant for Cell from the first DL slot that occurs right after the beginning of slot  $i + \frac{T_{\text{RRCprocessingDelay}} + T_{\text{BWPswitchDelayRRC}}}{\text{NR Slot length}}$  and starts to report valid ACK/NACK for PCell from the first UL slot that occurs after the beginning of DL slot  $i + \frac{T_{\text{RRCprocessingDelay}} + T_{\text{BWPswitchDelayRRC}}}{\text{NR Slot length}} + k1$ .

Where,  $k1$  is the timing between DL data receiving and acknowledgement as specified in [12].

All of the above test requirements shall be fulfilled in order for the observed Cell active BWP switch delay to be counted as correct.

The rate of correct events observed during repeated tests shall be at least 90%.

## 6.5.7 DL interruptions at switching between two uplink carriers

### 6.5.7.0 Minimum conformance requirements

The DL interruption requirements at dynamic switching between two uplink carriers specified in this clause are applicable for an uplink band pair of an inter-band UL CA configuration when the capability *uplinkTxSwitchingPeriod* is present, and is only applicable for uplink switching mechanism specified in clause 6.1.6 of TS 38.214 [9], where NR uplink carrier 1 is capable of one transmit antenna connector and NR uplink carrier 2 is capable of two transmit antenna connectors, and the two uplink carriers are in different bands with different carrier frequencies.

When dynamic switching between two uplink carriers is conducted, UE is allowed to cause DL interruption of X OFDM symbols in NR downlink carrier(s) as indicated by *uplinkTxSwitching-DL-Interruption* [13]. The DL interruption starts from the first OFDM symbol which fully or partially overlaps with the UL switching period located in either NR carrier 1 or carrier 2 as indicated in RRC signalling [13]. The DL interruption lengths of X are defined in Table 6.5.7.0-1.

No DL interruption is allowed in the NR downlink carrier(s) which is not indicated by *uplinkTxSwitching-DL-Interruption*. No DL interruption is allowed for some inter-band UL CA configurations as specified in clause 5.2A.2 of TS 38.101-1 [2].

**Table 6.5.7.0-1: DL interruption length on NR carrier(s) in the unit of OFDM symbols (X) for switching between two uplink carriers**

$\mu$	NR Slot length (ms)	Uplink Tx switching period <sup>Note1</sup>		
		35us	140us	210us
0	1	2	3	4
1	0.5	3	6	7
2	0.25	4	10	14
Note 1: Uplink Tx switching period depends on UE capability <i>uplinkTxSwitchingPeriod</i>				

The normative reference for this requirement is TS 38.133 [6] clauses 8.2.2.2.10.

### 6.5.7.1 NR SA FR1 DL Interruptions at switching between two uplink carriers in FDD-TDD CA

**Editor's note: This test case is incomplete. The following aspects are either missing or TBD**

**- TT analysis is missing**

#### 6.5.7.1.1 Test purpose

The purpose of this test is to verify the DL interruption requirements during UE dynamic switching between two uplink carriers.

#### 6.5.7.1.2 Test applicability

This test applies to all types of NR UE release 16 onwards, configured with *uplinkTxSwitchingPeriod*.

#### 6.5.7.1.3 Minimum conformance requirements

The minimum conformance requirements are specified in clause 6.5.7.0.

The normative reference for this requirement is TS 38.133 [6] clause 8.2.2.2.10 and A.6.5.7.1

#### 6.5.7.1.4 Test description

##### 6.5.7.1.4.1 Initial conditions

This test shall be tested using any of the test configurations in Table 6.5.7.1.4.1-1.

**Table 6.5.7.1.4.1-1: Supported test configurations**

Config	Description
6.5.7.1-1	NR Cell 1: 15 kHz SSB SCS, 10 MHz bandwidth, FDD duplex mode NR Cell 2: 30 kHz SSB SCS, 40 MHz bandwidth, TDD duplex mode

Configure the test equipment and the DUT according to the parameters in Table 6.5.7.1.4.1-2.

**Table 6.5.7.1.4.1-2: Initial conditions for DL interruptions at switching between two uplink carriers in FDD-TDD CA**

Parameter	Value		Comment
Test environment	NC		As specified in TS 38.508-1 [14] clause 4.1.
Test frequencies	As specified in Annex E, Table E.4-1 and TS 38.508-1 [14] clause 4.3.1.		
Channel bandwidth	As specified by the test configuration selected from Table 6.5.7.1.4.1-1.		
Propagation conditions	AWGN		As specified in Annex C.2.2
Connection Diagram	TE Part	A.3.1.8.2a	As specified in TS 38.508-1 [14] Annex A.
	DUT Part	A.3.2.3.4	
Exceptions to connection diagram	- For 4Rx capable UEs without any 2Rx RF bands use A.3.2.5.2 for DUT part and A.3.1.8.4 for TE part. - Without LTE link - Without Faders		

1. The general test parameter settings are set up according to Table 6.5.7.1.4.1-3.
2. Message contents are defined in clause 6.5.7.1.4.3.
3. The test scenario comprises of two NR Cells. (Cell 1 and Cell 2). Cell 1 is configured according to Annex C.1.2 and C.1.3.

**Table 6.5.7.1.4.1-3: General test parameters for DL interruptions at switching between two uplink carriers in FDD-TDD CA**

Parameter	Unit	Test configuration	Value	Comment
RF Channel Number		Config 1	1, 2	Two radio channels are used for this test.
Active cell		Config 1	Cell 1: FR1 PCell Cell 2: FR1 SCell	FR1 PCell on RF channel number 1 FR1 SCell on RF channel number 2
CP length		Config 1	Normal	
DRX		Config 1	OFF	
Measurement gap pattern Id		Config 1	OFF	
Filter coefficient		Config 1	0	L3 filtering is not used
CSI-RS configuration for L1-RSRP reporting		Config 1	Cell 1: CSI-RS.1.5 FDD Cell 2: CSI-RS.2.5 TDD	
T1	s	Config 1	5	

#### 6.5.7.1.4.2 Test procedure

The test consists of two active NR cells: Cell1( PCell) and Cell2(SCell). The test consists of one time period, with duration of T1. Prior to the start of the time duration T1, the UE shall be connected to Cell1 and Cell2 and the RRC message including *uplinkTxSwitching* is received at the UE antenna connector.

UE is configured to transmit SRS on both PCell and SCell on the last 2 symbols of special slot. DL interruption is expected to take place prior to the SRS symbols.

1. Ensure the UE is in state RRC\_CONNECTED with generic procedure parameters Connectivity NR, Connected without release *On* and Test Mode *On* according to TS 38.508-1 [14] clause 4.5.
2. Configure PCell (Cell1) and SCell(Cell2) according to Table 6.5.7.1.5-1. Propagation conditions are set according to Annex C clause C.2.2.
3. The SS shall transmit an RRCReconfiguration message to configure PCell (Cell1) and SCell(Cell2) as per TS 38.508-1 [7] clause 7 with the message content exceptions defined in clause 6.5.7.1.4.3. *UplinkTxSwitching* is configured to the UE.
4. The UE shall transmit *RRCReconfigurationComplete* message.
5. Set the parameters according to T1 in Tables 6.5.7.1.5-1. T1 starts.
6. SS schedules UL transmission on PCell continuously on the DL slots of SCell.
7. SS triggers aperiodic CSI-RS for L1-RSRP reporting on following symbol on the special slot on PCell and SCell:

PCell (Cell1)

- symbol#12 if UE does not report *uplinkTxSwitching-DL-Interruption-r16*;
- otherwise,
- symbol #8 if UE capability *uplinkTxSwitchingPeriod* is 210us or
- symbol #9 if UE capability *uplinkTxSwitchingPeriod* is 140us or
- symbol #10 if UE capability *uplinkTxSwitchingPeriod* is 35us.

SCell(Cell2)

- symbol#10 if UE does not report *uplinkTxSwitching-DL-Interruption-r16*;
- otherwise,

- symbol #4 if UE capability uplinkTxSwitchingPeriod is 210us or
  - symbol #5 if UE capability uplinkTxSwitchingPeriod is 140us or
  - symbol #8 if UE capability uplinkTxSwitchingPeriod is 35us.
8. After SS transmits the DCI trigger, the UE shall send L1-RSRP report containing valid L1-RSRP report for CSI-RS#0 and CSI-RS#1 at slot 5 from the reception of DCI trigger, if so increase the number of passed iterations by one otherwise increase the number of failed iterations by one and switch off the UE.
9. SS transmits in Cell 1 a Paging message (including PagingRecord with UE-Identity) for the UE and ensures the UE is in state RRC\_CONNECTED TS 38.508-1 [14] clause 4.5. (if the paging fails, switches off and on the UE and ensures the UE is in state RRC\_CONNECTED TS 38.508-1 [14] clause 4.5),
- or
- switches off and on the UE and ensures the UE is in state RRC\_CONNECTED with generic procedure parameters Connectivity NR, Connected without release On according to TS 38.508-1 [14] clause 4.5.
10. Repeat step 3-9 until a test verdict has been achieved.

6.5.7.1.4.3 Message contents

Message contents are according to TS 38.508-1 [14] clause 7.3 with the following exceptions:

**Table 6.5.7.1.4.3-1: Common Exception messages for DL interruptions at switching between two uplink carriers in FDD-TDD CA**

Default Message Contents	
Common contents of system information blocks exceptions	

**Table 6.5.7.1.4.3-2: ServingCellConfig**

Derivation Path: TS 38.508-1 [14], Table 4.6.3-167			
Information Element	Value/remark	Comment	Condition
ServingCellConfig ::= SEQUENCE {			
uplinkConfig SEQUENCE {			
uplinkTxSwitching-r16 SEQUENCE {			
uplinkTxSwitchingPeriodLocation-r16	TRUE		
uplinkTxSwitchingCarrier-r16	carrier1 carrier2	TE configures one of the two uplink carriers involved in dynamic UL TX switching as carrier1 and the other as carrier2	
}			
}			
}			

Table 6.5.7.1.4.3-3: *CellGroupConfig*

Derivation Path: TS 38.508-1 [14], , Table 4.6.3-19			
Information Element	Value/remark	Comment	Condition
CellGroupConfig ::= SEQUENCE {			
uplinkTxSwitchingOption-r16	switchedUL		UE reports 'switchedUL' or 'both' for capability IE <i>uplinkTxSwitchingOptionSupport-r16</i>
	dualUL		UE reports 'dualUL' for capability IE <i>uplinkTxSwitchingOptionSupport-r16</i>
}			

6.5.7.1.4.3-4: TDD-UL-DL-ConfigCommon

Derivation Path: TS 38.508-1 [14], Table 7.3.1-1 with condition TDDConf.2.1			
Information Element	Value/remark	Comment	Condition
TDD-UL-DL-ConfigCommon ::= SEQUENCE {			
pattern1 SEQUENCE {			
nrofDownlinkSymbols	11		
nrofUplinkSymbols	2		
}			
}			



6.5.7.1.4.3-5: SRS-Config

Derivation Path: TS 38.508-1 [14], Table 4.6.3-182			
Information Element	Value/remark	Comment	Condition
SRS-Config ::= SEQUENCE {			
srs-ResourceSetToAddModList SEQUENCE (SIZE(0..maxNrofSRS-ResourceSets)) OF SEQUENCE {			
SRS-ResourceSet[1] SEQUENCE {		entry 1	
resourceType CHOICE {			
periodic SEQUENCE {			
}			
}			
}			
srs-ResourceToAddModList SEQUENCE (SIZE(1..maxNrofSRS-Resources)) OF SEQUENCE {			
SRS-Resource[1] SEQUENCE {		entry 1	
nrofSRS-Ports	ports2		
resourceMapping SEQUENCE {			
startPosition	0		
nrofSymbols	n2		
}			
freqHopping SEQUENCE {			
c-SRS	0		
}			
groupOrSequenceHopping	neither		
resourceType CHOICE {			
periodic SEQUENCE {			
periodicityAndOffset-p CHOICE {			
sl8	3		
}			
}			
}			
}			
}			
}			

**Table 6.5.7.1.4.3-6: *CSI-MeasConfig***

Derivation Path: TS 38.508-1 [14], Table 4.6.3-38			
Information Element	Value/remark	Comment	Condition
CSI-MeasConfig ::= SEQUENCE {			
nzp-CSI-RS-ResourceToAddModList SEQUENCE (SIZE (1..maxNrofNzp-CSI-RS-Resources)) OF NZP-CSI-RS-Resource {			
NZP-CSI-RS-Resource[1] SEQUENCE {		entry 1	
nzp-CSI-RS-ResourceId	0		
resourceMapping SEQUENCE {			
frequencyDomainAllocation CHOICE {			
other	000001		
}			
nrofPorts	p1		
firstOFDMSymbolInTimeDomain	12		UE does not report uplinkTxSwitching-DL- Interruption-r16
	8		UE capability uplinkTxSwitchingPeriod is 210us
	9		UE capability uplinkTxSwitchingPeriod is 140us
	10		UE capability uplinkTxSwitchingPeriod is 35us
firstOFDMSymbolInTimeDomain2	Not present		
cdm-Type	noCDM		
density CHOICE {			
three			
}			
freqBand SEQUENCE {			
startingRB	0		
nrofRBs	106		
}			
}			
powerControlOffset	0		
scramblingID	0		
periodicityAndOffset	Not Present		
qcl-InfoPeriodicCSI-RS	Not Present		
}			
}			
NZP-CSI-RS-Resource[2] SEQUENCE {		entry 2	
nzp-CSI-RS-ResourceId	1		
resourceMapping SEQUENCE {			
frequencyDomainAllocation CHOICE {			
other	000001		
}			
nrofPorts	p1		
firstOFDMSymbolInTimeDomain	10		UE does not report uplinkTxSwitching-DL- Interruption-r16

	4		UE capability uplinkTxSwitchingPeriod is 210us
	5		UE capability uplinkTxSwitchingPeriod is 140us
	8		UE capability uplinkTxSwitchingPeriod is 35us
firstOFDMSymbolInTimeDomain2	Not present		
cdm-Type	noCDM		
density CHOICE {			
three			
}			
freqBand SEQUENCE {			
startingRB	0		
nrofRBs	52		
}			
powerControlOffset	0		
scramblingID	0		
periodicityAndOffset	Not Present		
qcl-InfoPeriodicCSI-RS	Not Present		
}			
nzp-CSI-RS-ResourceSetToAddModList SEQUENCE (SIZE (1..maxNrofNZP-CSI-RS-ResourceSets)) OF NZP-CSI-RS-ResourceSetId {	1 entry		
NZP-CSI-RS-ResourceSet[1]	NZP-CSI-RS-ResourceSet	entry 1 6.5.7.1.4.3-7	
}			
csi-ResourceConfigToAddModList SEQUENCE (SIZE (1..maxNrofCSI-ResourceConfigurations)) OF CSI-ResourceConfig {	1 entry		
CSI-ResourceConfig[1]		entry 1 Table 6.5.7.1.4.3-8	
}			
csi-ReportConfigToAddModList SEQUENCE (SIZE (1..maxNrofCSI-ReportConfigurations)) OF CSI-ReportConfig {	1 entry		
CSI-ReportConfig[1]	CSI-ReportConfig	entry 1 Table 6.5.7.1.4.3-9	
}			
}			

**Table 6.5.7.1.4.3-7: NZP-CSI-RS-ResourceSet**

Derivation Path: TS 38.508-1 [14], Table 4.6.3-87			
Information Element	Value/remark	Comment	Condition
NZP-CSI-RS-ResourceSet ::= SEQUENCE {			
nzp-CSI-ResourceSetId	0	For CSI-RS#0	
	1	For CSI-RS#1	
nzp-CSI-RS-Resources SEQUENCE (SIZE (1..maxNrofNZP-CSI-RS-ResourcesPerSet)) OF NZP-CSI-RS-ResourceId {	1 entry		
NZP-CSI-RS-ResourceId[1]	0	entry 1	
}			
repetition	off		
aperiodicTriggeringOffset	6		
trs-Info	Not present		
}			

**Table 6.5.7.1.4.3-8: CSI-ResourceConfig**

Derivation Path: TS 38.508-1 [14], Table 4.6.3-41			
Information Element	Value/remark	Comment	Condition
CSI-ResourceConfig ::= SEQUENCE {			
csi-ResourceConfigId	0	For CSI-RS#0	
	1	For CSI-RS#1	
csi-RS-ResourceSetList CHOICE {			
nzp-CSI-RS-SSB SEQUENCE {			
nzp-CSI-RS-ResourceSetList SEQUENCE (SIZE (1..maxNrofNZP-CSI-RS-ResourceSetsPerConfig)) OF NZP-CSI-RS-ResourceSetId {			
NZP-CSI-RS-ResourceSetId [1]	0		
}			
csi-SSB-ResourceSetList	Not present		
}			
}			
bwp-Id	0		
resourceType	aperiodic		
}			

Table 6.5.7.1.4.3-9: CSI-ReportConfig

Derivation Path: TS 38.508-1 [14], Table 4.6.3-39			
Information Element	Value/remark	Comment	Condition
CSI-ReportConfig ::= SEQUENCE {			
reportConfigId	0		
carrier	ServCellIndex		
resourcesForChannelMeasurement	0		
csi-IM-ResourcesForInterference	Not present		
nzp-CSI-RS-ResourcesForInterference	Not present		
reportConfigType CHOICE {			
Aperiodic SEQUENCE {			
reportSlotOffsetList SEQUENCE (SIZE (1..maxNrofUL-Allocations)) OF INTEGER {			
INTEGER	5		
INTEGER	5		
}			
}			
reportQuantity CHOICE {			
cri-RSRP	NULL		
}			
reportFreqConfiguration	Not present		
timeRestrictionForChannelMeasurements	Not present		
timeRestrictionForInterferenceMeasurements	Not present		
codebookConfig	Not present		
dummy	Not present		
groupBasedBeamReporting	Not present		
cqi-Table	Not present		
subbandSize	Not present		
non-PMI-PortIndication	Not present		
semiPersistentOnPUSCH-v1530	Not present		
semiPersistentOnPUSCH-v1610	Not present		
aperiodic-v1610 SEQUENCE {			
reportSlotOffsetListDCI-0-2-r16	Not present		
reportSlotOffsetListDCI-0-1-r16 SEQUENCE (SIZE (1..maxNrofUL-Allocations-r16)) OF INTEGER {			
INTEGER	5		
INTEGER	5		
}			
}			
reportQuantity-r16	Not present		
codebookConfig-r16	Not present		
}			

### 6.5.7.1.5 Test requirements

Table 6.5.7.1.5-1 defines the primary level settings including test tolerances for DL interruptions at switching between two uplink carriers in FDD-TDD CA.

**Table 6.5.7.1.5-1: Cell specific test parameters for DL interruptions at switching between two uplink carriers in FDD-TDD CA**

Parameter		Unit	Cell1	Cell2
Frequency Range			FR1	FR1
Duplex mode	Config 1		FDD	TDD
TDD configuration	Config 1		N/A	TDDConf.2.1 except that: S='11DL:1GP:2UL'; nrofDownlinkSymbols:11 nrofUplinkSymbols: 2
BW <sub>channel</sub>	Config 1		10 MHz: N <sub>RB,c</sub> = 52	40 MHz: N <sub>RB,c</sub> = 106
Initial BWP Configuration	Config 1		DLBWP.0.1	DLBWP.0.1
DL dedicated BWP configuration	Config 1		DLBWP.1.1	DLBWP.1.1
UL dedicated BWP configuration	Config 1		ULBWP.1.1	ULBWP.1.1
SRS configuration	Config 1		SRS configuration in Table 4.4.1.1.5-2 is applied except that: resourceMappingstartPosition: 0 resourceMappingnrofSymbols: n2	SRS configuration in Table 4.4.1.1.5-2 is applied except that: resourceMappingstartPosition: 0 resourceMappingnrofSymbols: n2
PDSCH Reference measurement channel	Config 1		SR.1.1 FDD	SR.2.1 TDD
RMSI CORESET parameters	Config 1		CR.1.1 FDD	CR.2.1 TDD
Dedicated CORESET parameters	Config 1		CCR.1.1 FDD	CCR.2.1 TDD
OCNG Patterns			OP.1	OP.1
SMTC Configuration			SMTC.1	SMTC.1
SSB Configuration	Config 1		SSB.1 FR1	SSB.2 FR1
Correlation Matrix and Antenna Configuration			1x2 Low	2x2 Low
EPRE ratio of PSS to SSS		dB	0	0
EPRE ratio of PBCH DMRS to SSS				
EPRE ratio of PBCH to PBCH DMRS				
EPRE ratio of PDCCH DMRS to SSS				
EPRE ratio of PDCCH to PDCCH DMRS				
EPRE ratio of PDSCH DMRS to SSS				
EPRE ratio of PDSCH to PDSCH				
EPRE ratio of OCNG DMRS to SSS(Note 1)				
EPRE ratio of OCNG to OCNG DMRS (Note 1)				
N <sub>oc</sub> <sup>Note 2</sup>		dBm/15 kHz	-104+TT	-104+TT
SS-RSRP <sup>Note 3</sup>		dBm/ SSB SCS	-87+TT	-84+TT
CSI-RS RSRP <sup>Note 6</sup>		dBm/SCS	-87	-84
$\tilde{E}_s/I_{ot}$		dB	17+TT	17+TT
$\tilde{E}_s/N_{oc}$		dB	17+TT	17+TT
N <sub>oc</sub> <sup>Note 2</sup>	Config 1	dBm/SCS	-104+TT	-101+TT
I <sub>o</sub> <sup>Note 3</sup>	Config 1	dBm/9.36 MHz	-58.96+TT	-
		dBm/38.16MHz	-	-52.86+TT
Time offset to Cell1 <sup>Note 5</sup>		μs	-	0
Propagation Condition			AWGN	AWGN



Note 1:	OCNG shall be used such that both cells are fully allocated and a constant total transmitted power spectral density is achieved for all OFDM symbols.
Note 2:	Interference from other cells and noise sources not specified in the test is assumed to be constant over subcarriers and time and shall be modelled as AWGN of appropriate power for $N_{oc}$ to be fulfilled.
Note 3:	SS-RSRP and $l_0$ levels have been derived from other parameters for information purposes. They are not settable parameters themselves.
Note 4:	Void
Note 5:	Receive time difference between slot boundaries of signals received from the two cells at the UE antenna connector including time alignment error between the two cells.
Note 6:	CSI-RS RSRP and $l_0$ levels have been derived from other parameters for information purposes. They are not settable parameters themselves.

UE shall send L1-RSRP report while meeting the accuracy requirements defined in TS 38.133 clause 10.1.19.2.

The DL interruption lengths of X are defined in Table 6.5.7.1.5-2

**Table 6.5.7.1.5-2: DL interruption length on NR carrier(s) in the unit of OFDM symbols (X) for switching between two uplink carriers**

$\mu$	NR Slot length (ms)	Uplink Tx switching period <sup>Note1</sup>		
		35us	140us	210us
0	1	2	3	4
1	0.5	3	6	7
2	0.25	4	10	14
Note 1: Uplink Tx switching period depends on UE capability <i>uplinkTxSwitchingPeriod</i>				

The UE shall send L1-RSRP report at slot 5 from the reception of DCI trigger. The L1-RSRP report shall include the results of CSI-RS#0. Each L1-RSRP measurement report shall meet the corresponding absolute accuracy requirements in Table 6.5.7.1.5-4.

**Table 6.5.7.1.5-3: L1-RSRP absolute accuracy requirements for the reported values of CSI-RS#0**

Normal Conditions	T1
Lowest reported value (CSI-RS#0)	TBD
Highest reported value (CSI-RS#0)	TBD

**Table 6.5.7.1.5-4: L1-RSRP absolute accuracy requirements for the reported values of CSI-RS#1**

Normal Conditions	T1
Lowest reported value (CSI-RS#0)	TBD
Highest reported value (CSI-RS#0)	TBD

The rate of correct events observed during repeated tests shall be at least 90% with a confidence level of 95%.

#### 6.5.7.2 NR SA FR1 DL Interruptions at switching between two uplink carriers in TDD-TDD CA

**Editor's note: This test case is incomplete. The following aspects are either missing or TBD**

**- TT analysis is missing**

##### 6.5.7.2.1 Test purpose

The purpose of this test is to verify the DL interruption requirements during UE dynamic switching between two uplink carriers.

##### 6.5.7.2.2 Test applicability

This test applies to all types of NR UE release 16 onwards, configured with *uplinkTxSwitchingPeriod*.

## 6.5.7.2.3 Minimum conformance requirements

The minimum conformance requirements are specified in clause 6.5.7.0.

The normative reference for this requirement is TS 38.133 [6] clause 8.2.2.2.10 and A.6.5.7.2

## 6.5.7.2.4 Test description

## 6.5.7.2.4.1 Initial conditions

This test shall be tested using any of the test configurations in Table 6.5.7.2.4.1-1.

**Table 6.5.7.2.4.1-1: Supported test configurations**

Config	Description
6.5.7.2-1	NR Cell 1: 30 kHz SSB SCS, 40 MHz bandwidth, TDD duplex mode NR Cell 2: 30 kHz SSB SCS, 40 MHz bandwidth, TDD duplex mode

Configure the test equipment and the DUT according to the parameters in Table 6.5.7.2.4.1-2.

**Table 6.5.7.2.4.1-2: Initial conditions for DL interruptions at switching between two uplink carriers in TDD-TDD CA**

Parameter	Value		Comment
Test environment	NC		As specified in TS 38.508-1 [14] clause 4.1.
Test frequencies	As specified in Annex E, Table E.4-1 and TS 38.508-1 [14] clause 4.3.1.		
Channel bandwidth	As specified by the test configuration selected from Table 6.5.7.2.4.1-1.		
Propagation conditions	AWGN		As specified in Annex C.2.2
Connection Diagram	TE Part	A.3.1.8.2a	As specified in TS 38.508-1 [14] Annex A.
	DUT Part	A.3.2.3.4	
Exceptions to connection diagram	- For 4Rx capable UEs without any 2Rx RF bands use A.3.2.5.2 for DUT part and A.3.1.8.4 for TE part. - Without LTE link - Without Faders		

1. The general test parameter settings are set up according to Table 6.5.7.2.4.1-3.
2. Message contents are defined in clause 6.5.7.2.4.3.
3. The test scenario comprises of one NR Cell (Cell 1). Cell 1 is configured according to Annex C.1.2 and C.1.3.

**Table 6.5.7.2.4.1-3: General test parameters for DL interruptions at switching between two uplink carriers in TDD-TDD CA**

Parameter	Unit	Test configuration	Value	Comment
RF Channel Number		Config 1	1, 2	Two radio channels are used for this test.
Active cell		Config 1	Cell 1: FR1 PCell Cell 2: FR1 SCell	FR1 PCell on RF channel number 1 FR1 SCell on RF channel number 2
CP length		Config 1	Normal	
DRX		Config 1	OFF	
Measurement gap pattern Id		Config 1	OFF	
Filter coefficient		Config 1	0	L3 filtering is not used
CSI-RS configuration for L1-RSRP reporting		Config 1	Cell 1: CSI-RS.2.5 TDD Cell 2: CSI-RS.2.5 TDD	
T1	s	Config 1	5	

#### 6.5.7.2.4.2 Test procedure

Same as in 6.5.7.1.4.2 with the following exception in step 7.

7. SS triggers aperiodic CSI-RS for L1-RSRP reporting on following symbol on the special slot on PCell and SCell:

- symbol#10 if UE does not report uplinkTxSwitching-DL-Interruption-r16;
- otherwise,
  - o symbol #4 if UE capability uplinkTxSwitchingPeriod is 210us or
  - o symbol #5 if UE capability uplinkTxSwitchingPeriod is 140us or
  - o symbol #8 if UE capability uplinkTxSwitchingPeriod is 35us.

#### 6.5.7.2.4.3 Message contents

Same as in 6.5.7.1.4.2 with the following exception:

**Table 6.5.7.2.4.3-6: *CSI-MeasConfig***

Derivation Path: TS 38.508-1 [14], Table 4.6.3-38			
Information Element	Value/remark	Comment	Condition
CSI-MeasConfig ::= SEQUENCE {			
nzp-CSI-RS-ResourceToAddModList SEQUENCE (SIZE (1..maxNrofNZP-CSI-RS-Resources)) OF NZP-CSI-RS-Resource {			
NZP-CSI-RS-Resource[1] SEQUENCE {		entry 1	
nzp-CSI-RS-ResourceId	0		
resourceMapping SEQUENCE {			
frequencyDomainAllocation CHOICE {			
other	000001		
}			
nrofPorts	p1		
firstOFDMSymbolInTimeDomain	10		UE does not report uplinkTxSwitching-DL- Interruption-r16
	4		UE capability uplinkTxSwitchingPeriod is 210us
	5		UE capability uplinkTxSwitchingPeriod is 140us
	8		UE capability uplinkTxSwitchingPeriod is 35us
firstOFDMSymbolInTimeDomain2	Not present		
cdm-Type	noCDM		
density CHOICE {			
three			
}			
freqBand SEQUENCE {			
startingRB	0		
nrofRBs	106		
}			
}			
powerControlOffset	0		
powerControlOffsetSS	db6		
scramblingID	0		
periodicityAndOffset	Not Present		
qcl-InfoPeriodicCSI-RS	Not Present		
}			
}			
NZP-CSI-RS-Resource[2] SEQUENCE {		entry 2	
nzp-CSI-RS-ResourceId	1		
resourceMapping SEQUENCE {			
frequencyDomainAllocation CHOICE {			
other	000001		
}			
nrofPorts	p1		
firstOFDMSymbolInTimeDomain	10		UE does not report uplinkTxSwitching-DL- Interruption-r16

	4		UE capability uplinkTxSwitchingPeriod is 210us
	5		UE capability uplinkTxSwitchingPeriod is 140us
	8		UE capability uplinkTxSwitchingPeriod is 35us
firstOFDMsymbolInTimeDomain2	Not present		
cdm-Type	noCDM		
density CHOICE {			
three			
}			
freqBand SEQUENCE {			
startingRB	0		
nrofRBs	52		
}			
powerControlOffset	0		
powerControlOffsetSS	db6		
scramblingID	0		
periodicityAndOffset	Not Present		
qcl-InfoPeriodicCSI-RS	Not Present		
}			
nzp-CSI-RS-ResourceSetToAddModList SEQUENCE (SIZE (1..maxNrofNzp-CSI-RS-ResourceSets)) OF Nzp-CSI-RS-ResourceSetId {	1 entry		
Nzp-CSI-RS-ResourceSet[1]	Nzp-CSI-RS-ResourceSet	entry 1 6.5.7.1.4.3-7	
}			
csi-ResourceConfigToAddModList SEQUENCE (SIZE (1..maxNrofCSI-ResourceConfigurations)) OF CSI-ResourceConfig {	1 entry		
CSI-ResourceConfig[1]		entry 1 Table 6.5.7.1.4.3-8	
}			
csi-ReportConfigToAddModList SEQUENCE (SIZE (1..maxNrofCSI-ReportConfigurations)) OF CSI-ReportConfig {	1 entry		
CSI-ReportConfig[1]	CSI-ReportConfig	entry 1 Table 6.5.7.1.4.3-9	
}			
}			

#### 6.5.7.2.5 Test requirements

Table 6.5.7.1.5-1 defines the primary level settings including test tolerances for DL interruptions at switching between two uplink carriers in FDD-TDD CA.

**Table 6.5.7.2.5-1: Cell specific test parameters for DL interruptions at switching between two uplink carriers in TDD-TDD CA**

Parameter		Unit	Cell1	Cell2
Frequency Range			FR1	FR1
Duplex mode	Config 1		TDD	TDD
TDD configuration	Config 1		TDDConf.2.1 except that S='1DL:1GP:2UL'; nrofDownlinkSymbols:11 nrofUplinkSymbols: 2	TDDConf.2.2
BW <sub>channel</sub>	Config 1		40 MHz: N <sub>RB,c</sub> = 106	40 MHz: N <sub>RB,c</sub> = 106
Initial BWP Configuration	Config 1		DLBWP.0.1	DLBWP.0.1
DL dedicated BWP configuration	Config 1		DLBWP.1.1	DLBWP.1.1
UL dedicated BWP configuration	Config 1		ULBWP.1.1	ULBWP.1.1
SRS configuration	Config 1		SRS configuration in Table 4.4.1.1.5-2 is applied except that: resourceMappingstartPosition: 0 resourceMappingnrofSymbols: n2	SRS configuration in Table 4.4.1.1.5-2 is applied except that: resourceMappingstartPosition: 0 resourceMappingnrofSymbols: n2
PDSCH Reference measurement channel	Config 1		SR.2.1 TDD	SR.2.1 TDD
RMSI CORESET parameters	Config 1		CR.2.1 TDD	CR.2.1 TDD
Dedicated CORESET parameters	Config 1		CCR.2.1 TDD	CCR.2.1 TDD
OCNG Patterns			OP.1	OP.1
SMTc Configuration			SMTc.1	SMTc.1
SSB Configuration	Config 1		SSB.2 FR1	SSB.2 FR1
Correlation Matrix and Antenna Configuration			1x2 Low	2x2 Low
EPRE ratio of PSS to SSS		dB	0	0
EPRE ratio of PBCH DMRS to SSS				
EPRE ratio of PBCH to PBCH DMRS				
EPRE ratio of PDCCH DMRS to SSS				
EPRE ratio of PDCCH to PDCCH DMRS				
EPRE ratio of PDSCH DMRS to SSS				
EPRE ratio of PDSCH to PDSCH				
EPRE ratio of OCNG DMRS to SSS(Note 1)				
EPRE ratio of OCNG to OCNG DMRS (Note 1)				
N <sub>oc</sub> <sup>Note 2</sup>		dBm/15 kHz	-104+TT	-104+TT
SS-RSRP <sup>Note 3</sup>		dBm/ SSB SCS	-84+TT	-84+TT
CSI-RS RSRP <sup>Note 6</sup>		dBm/SCS	-87	-84
$\tilde{E}_s/I_{ot}$		dB	17+TT	17+TT
$\tilde{E}_s/N_{oc}$		dB	17+TT	17+TT
N <sub>oc</sub> <sup>Note 2</sup>	Config 1	dBm/SCS	-104+TT	-101+TT
I <sub>o</sub> <sup>Note 3</sup>	Config 1	dBm/ 38.16MHz	-52.86	-52.86
Time offset to Cell1 <sup>Note 5</sup>		µs	-	0
Propagation Condition			AWGN	AWGN
<p>Note 1: OCNG shall be used such that both cells are fully allocated and a constant total transmitted power spectral density is achieved for all OFDM symbols.</p> <p>Note 2: Interference from other cells and noise sources not specified in the test is assumed to be constant over subcarriers and time and shall be modelled as AWGN of appropriate power for N<sub>oc</sub> to be fulfilled.</p> <p>Note 3: SS-RSRP and I<sub>o</sub> levels have been derived from other parameters for information purposes. They are not settable parameters themselves.</p> <p>Note 4: Void</p> <p>Note 5: Receive time difference between slot boundaries of signals received from the two cells at the UE antenna connector including time alignment error between the two cells.</p> <p>Note 6: CSI-RS RSRP and I<sub>o</sub> levels have been derived from other parameters for information purposes. They are not settable parameters themselves.</p>				



UE shall send L1-RSRP report while meeting the accuracy requirements defined in TS 38.133 clause 10.1.19.2.

The DL interruption lengths of X are defined in Table 6.5.7.2.5-2

**Table 6.5.7.2.5-2: DL interruption length on NR carrier(s) in the unit of OFDM symbols (X) for switching between two uplink carriers**

$\mu$	NR Slot length (ms)	Uplink Tx switching period <sup>Note1</sup>		
		35us	140us	210us
0	1	2	3	4
1	0.5	3	6	7
2	0.25	4	10	14
Note 1: Uplink Tx switching period depends on UE capability <i>uplinkTxSwitchingPeriod</i>				

The UE shall send L1-RSRP report at slot 5 from the reception of DCI trigger. The L1-RSRP report shall include the results of CSI-RS#0 and CSI-RS#1. Each L1-RSRP measurement report shall meet the corresponding absolute accuracy requirements in Table 6.5.7.1.5-4.

**Table 6.5.7.2.5-3: L1-RSRP absolute accuracy requirements for the reported values of CSI-RS#0 and CSI-RS#1**

Normal Conditions	T1
Lowest reported value (CSI-RS#0)	TBD
Highest reported value (CSI-RS#0)	TBD

The rate of correct events observed during repeated tests shall be at least 90% with a confidence level of 95%.

## 6.6 Measurement procedures

### 6.6.1 Intra-frequency measurements

#### 6.6.1.0 Minimum conformance requirements

##### 6.6.1.0.1 Minimum conformance requirements for event-triggered measurement without gap

[TS 38.133, clause 9.2.5.1 and 9.2.5.2]

The UE shall be able to identify a new detectable intra frequency cell within  $T_{\text{identify\_intra\_without\_index}}$  if UE is not indicated to report SSB based RRM measurement result with the associated SSB index (*reportQuantityRsIndexes* or *maxNrofRSIndexesToReport* is not configured), or the UE is indicated that the neighbour cell is synchronous with the serving cell (*deriveSSB-IndexFromCell* is enabled). The UE shall be able to identify a new detectable intra frequency SS block of an already detected cell within  $T_{\text{identify\_intra\_without\_index}}$ . It is assumed that *deriveSSB-IndexFromCell* is always enabled for FR1 TDD and FR2.

$$T_{\text{identify\_intra\_without\_index}} = (T_{\text{PSS/SSS\_sync\_intra}} + T_{\text{SSB\_measurement\_period\_intra}}) \text{ ms}$$

Where:

$T_{\text{PSS/SSS\_sync\_intra}}$ : it is the time period used in PSS/SSS detection given in table 6.6.1.0.1-1.

$T_{\text{SSB\_measurement\_period\_intra}}$ : equal to a measurement period of SSB based measurement given in table 6.6.1.0.1-2.

$\text{CSSF}_{\text{intra}}$ : it is a carrier specific scaling factor and is determined according to  $\text{CSSF}_{\text{outside\_gap},i}$  in TS 38.133 [6] clause 9.1.5.1 for measurement conducted outside measurement gaps.

When intra-frequency SMTC is fully non overlapping with measurement gaps or intrafrequency SMTC is fully overlapping with MGs,  $K_p=1$ .

When intrafrequency SMTC is partially overlapping with measurement gaps,  $K_p = 1/(1 - (\text{SMTC period} / \text{MGRP}))$ , where SMTC period < MGRP

**Table 6.6.1.0.1-1: Time period for PSS/SSS detection (Frequency range FR1)**

DRX cycle	$T_{\text{PSS/SSS\_sync\_intra}}$
No DRX	$\max(600\text{ms}, \text{ceil}(5 \times K_p) \times \text{SMTC period})^{\text{Note 1}} \times \text{CSSF}_{\text{intra}}$
DRX cycle $\leq 320\text{ms}$	$\max(600\text{ms}, \text{ceil}(1.5 \times 5 \times K_p) \times \max(\text{SMTC period}, \text{DRX cycle})) \times \text{CSSF}_{\text{intra}}$
DRX cycle $> 320\text{ms}$	$\text{ceil}([5] \times K_p) \times \text{DRX cycle} \times \text{CSSF}_{\text{intra}}$
NOTE 1: If different SMTC periodicities are configured for different cells, the SMTC period in the requirement is the one used by the cell being identified	

**Table 6.6.1.0.1-2: Measurement period for intra-frequency measurements without gaps (Frequency Range FR1)**

DRX cycle	$T_{\text{SSB\_measurement\_period\_intra}}$
No DRX	$\max(200\text{ms}, \text{ceil}(5 \times K_p) \times \text{SMTC period})^{\text{Note 1}} \times \text{CSSF}_{\text{intra}}$
DRX cycle $\leq 320\text{ms}$	$\max(200\text{ms}, \text{ceil}(1.5 \times 5 \times K_p) \times \max(\text{SMTC period}, \text{DRX cycle})) \times \text{CSSF}_{\text{intra}}$
DRX cycle $> 320\text{ms}$	$\text{ceil}(5 \times K_p) \times \text{DRX cycle} \times \text{CSSF}_{\text{intra}}$
NOTE 1: If different SMTC periodicities are configured for different cells, the SMTC period in the requirement is the one used by the cell being identified	

[TS 38.133, clause 9.2.4.3]

Reported RSRP, RSRQ, and RS-SINR measurements contained in periodically triggered measurement reports shall meet the requirements in TS 38.133 [6] clause 10.1.2.1, 10.1.7.1 and 10.1.12.1, respectively.

The UE shall not send any event triggered measurement reports, as long as no reporting criteria are fulfilled.

The measurement reporting delay is defined as the time between an event that will trigger a measurement report and the point when the UE starts to transmit the measurement report over the air interface. This requirement assumes that the measurement report is not delayed by other RRC signalling on the DCCH. This measurement reporting delay excludes a delay uncertainty resulted when inserting the measurement report to the TTI of the uplink DCCH. The delay uncertainty is:  $2 \times TTI_{DCCH}$ . This measurement reporting delay excludes a delay which caused by no UL resources for UE to send the measurement report.

The event triggered measurement reporting delay, measured without L3 filtering shall be less than  $T_{\text{identify\_intra\_without\_index}}$  defined in TS 38.133 [6] clause 9.2.5.1. When L3 filtering is used an additional delay can be expected.

If a cell which has been detectable at least for the time period than  $T_{\text{identify\_intra\_without\_index}}$  defined in TS 38.133 [6] clause 9.2.5.1 becomes undetectable for a period and then the cell becomes detectable again and triggers an event, the event triggered measurement reporting delay shall be less than  $T_{\text{measurement\_Intra}}$  provided the timing to that cell has not changed more than  $\pm 3200 T_c$  while the measurement gap has not been available and the L3 filter has not been used. When L3 filtering is used, an additional delay can be expected.

[TS 38.133, clause 9.2.2]

The requirements given above apply, provided:

- The cell being identified or measured is detectable.

An intra-frequency cell shall be considered detectable when for each relevant SSB:

- SS-RSRP related side conditions given in TS 38.133 [6] sections 10.1.2 are fulfilled for a corresponding Band,
- SS-RSRQ related side conditions given in TS 38.133 [6] sections 10.1.7 are fulfilled for a corresponding Band,
- SS-SINR related side conditions given in TS 38.133 [6] sections 10.1.12 are fulfilled for a corresponding Band,
- SSB<sub>RP</sub> and SSB  $\hat{E}_s/I_{ot}$  according to TS 38.133 [6] Annex B.2.2 for a corresponding Band.

References: The conformance requirements covered in the current TC are specified in: TS 38.133 [6], clauses 9.2.2, 9.2.4.3, 9.2.5.1 and 9.2.5.2.

### 6.6.1.0.2 Minimum conformance requirements for event-triggered measurement with gap

[TS 38.133 [6], clause 9.2.6.2, 9.2.6.3]

The UE shall be able to identify a new detectable intra frequency cell within  $T_{\text{identify\_intra\_without\_index}}$  if UE is not indicated to report SSB based RRM measurement result with the associated SSB index (*reportQuantityRSIndexes* or *maxNrofRSIndexesToReport* is not configured), or the UE is indicated that the neighbour cell is synchronous with the serving cell (*deriveSSB-IndexFromCell* is enabled). It is assumed that *deriveSSB-IndexFromCell* is always enabled for FR1 TDD and FR2.

$$T_{\text{identify\_intra\_without\_index}} = T_{\text{PSS/SSS\_sync\_intra}} + T_{\text{SSB\_measurement\_period\_intra}} \text{ ms}$$

Where:

$T_{\text{PSS/SSS\_sync\_intra}}$ : it is the time period used in PSS/SSS detection given in table 6.6.1.0.2-1.

$T_{\text{SSB\_measurement\_period\_intra}}$ : equal to a measurement period of SSB based measurement given in table 6.6.1.0.2-2.

$CSSF_{\text{intra}}$ : it is a carrier specific scaling factor and is determined according to  $CSSF_{\text{within\_gap},i}$  in TS 38.133 [6] section 9.1.5.2.2 for measurement within outside measurement gaps.

**Table 6.6.1.0.2-1: Time period for PSS/SSS detection (Frequency range FR1)**

DRX cycle	$T_{\text{PSS/SSS\_sync\_intra}}$
No DRX	$\max(600\text{ms}, 5 \times \max(\text{MGRP}, \text{SMTC period})) \times CSSF_{\text{intra}}$
DRX cycle $\leq 320\text{ms}$	$\max(600\text{ms}, \text{ceil}(1.5 \times 5) \times \max(\text{MGRP}, \text{SMTC period}, \text{DRX cycle})) \times CSSF_{\text{intra}}$
DRX cycle $> 320\text{ms}$	$5 \times \max(\text{MGRP}, \text{DRX cycle}) \times CSSF_{\text{intra}}$

**Table 6.6.1.0.2-2: Measurement period for intra-frequency measurements with gaps (Frequency Range FR1)**

DRX cycle	$T_{SSB\_measurement\_period\_intra}$
No DRX	$\max(200\text{ms}, 5 \times \max(\text{MGRP}, \text{SMTC period})) \times \text{CSSF}_{intra}$
DRX cycle $\leq 320\text{ms}$	$\max(200\text{ms}, \text{ceil}(1.5 \times 5) \times \max(\text{MGRP}, \text{SMTC period}, \text{DRX cycle})) \times \text{CSSF}_{intra}$
DRX cycle $> 320\text{ms}$	$5 \times \max(\text{MGRP}, \text{DRX cycle}) \times \text{CSSF}_{intra}$

[TS 38.133 [6], clause 9.2.2]

The requirements given above apply, provided:

- The cell being identified or measured is detectable.

An intra-frequency cell shall be considered detectable when for each relevant SSB:

- SS-RSRP related side conditions given in TS 38.133 [6] sections 10.1.2 are fulfilled for a corresponding Band,
- SS-RSRQ related side conditions given in TS 38.133 [6] sections 10.1.7 are fulfilled for a corresponding Band,
- SS-SINR related side conditions given in TS 38.133 [6] Sections 10.1.12 are fulfilled for a corresponding Band,
- SSB<sub>RP</sub> and SSB  $\hat{E}_s/I_{ot}$  according to TS 38.133 [6] Annex B.2.2 for a corresponding Band.

[TS 38.133 [6], clause 9.2.4.2]

The RSRP measurement accuracy for all measured cells shall be as specified in TS 38.133 [6] clauses 10.1.2.1.1 and 10.1.2.1.2, the RSRQ measurement accuracy for all measured cells shall be as specified in TS 38.133 [6] clauses 10.1.7.1.1, and the SINR measurement accuracy for all measured cells shall be as specified in the TS 38.133 [6] clause 10.1.12.1.1.

Reported RSRP, RSRQ and SINR measurements contained in event triggered measurement reports shall meet the requirements in TS 38.133 [6] clauses 10.1.2.1.1, 10.1.2.1.2, 10.1.7.1.1 and 10.1.12.1.1, respectively.

The UE shall not send any event triggered measurement reports, as long as no reporting criteria are fulfilled.

The measurement reporting delay is defined as the time between an event that will trigger a measurement report and the point when the UE starts to transmit the measurement report over the air interface. This requirement assumes that the measurement report is not delayed by other RRC signalling on the DCCH. This measurement reporting delay excludes a delay uncertainty resulted when inserting the measurement report to the TTI of the uplink DCCH. The delay uncertainty is:  $2 \times TTI_{DCCH}$ . This measurement reporting delay excludes a delay which caused by no UL resources for UE to send the measurement report.

The event triggered measurement reporting delay, measured without L3 filtering shall be less than  $T_{identify\_intra\_without\_index}$  defined in TS 38.133 [6] section 9.2.6.2. When L3 filtering is used an additional delay can be expected.

The normative reference for this requirement is TS 38.133 [6] clauses 9.2.2, 9.2.4.2, 9.2.6.2 and 9.2.6.3.

### 6.6.1.0.3 Minimum conformance requirements for event-triggered measurement without gap with SSB index reading

[TS 38.133 [6], clause 9.2.5.1, 9.2.5.2]

UE shall be able to identify a new detectable intra frequency cell within  $T_{identify\_intra\_with\_index}$ .

$$T_{identify\_intra\_with\_index} = T_{PSS/SSS\_sync\_intra} + T_{SSB\_measurement\_period\_intra} + T_{SSB\_time\_index\_intra} \text{ ms}$$

Where:

$T_{PSS/SSS\_sync\_intra}$ : it is the time period used in PSS/SSS detection given in table 6.6.1.0.3-1.

$T_{SSB\_time\_index\_intra}$ : it is the time period used to acquire the index of the SSB being measured given in table 6.6.1.0.3-2.

$T_{SSB\_measurement\_period\_intra}$ : equal to a measurement period of SSB based measurement given in table 6.6.1.0.3-3.

$CSSF_{intra}$ : it is a carrier specific scaling factor and is determined according to  $CSSF_{outside\_gap,i}$  in TS 38.133 [6] section 9.1.5.1 for measurement conducted outside measurement gaps

When intrafrequency SMTC is fully non overlapping with measurement gaps or intrafrequency SMTC is fully overlapping with MGs,  $K_p=1$

When intrafrequency SMTC is partially overlapping with measurement gaps,  $K_p = 1/(1 - (SMTC \text{ period} / MGRP))$ , where SMTC period < MGRP

**Table 6.6.1.0.3-1: Time period for PSS/SSS detection (Frequency range FR1)**

DRX cycle	$T_{PSS/SSS\_sync\_intra}$
No DRX	$\max(600\text{ms}, \text{ceil}(5 \times K_p) \times \text{SMTC period})^{\text{Note 1}} \times CSSF_{intra}$
DRX cycle $\leq 320\text{ms}$	$\max(600\text{ms}, \text{ceil}(1.5 \times 5 \times K_p) \times \max(\text{SMTC period}, \text{DRX cycle})) \times CSSF_{intra}$
DRX cycle > 320ms	$\text{ceil}(5 \times K_p) \times \text{DRX cycle} \times CSSF_{intra}$

NOTE 1: If different SMTC periodicities are configured for different cells, the SMTC period in the requirement is the one used by the cell being identified

**Table 6.6.1.0.3-2: Time period for time index detection (Frequency range FR1)**

DRX cycle	$T_{SSB\_time\_index\_intra}$
No DRX	$\max(120\text{ms}, \text{ceil}(3 \times K_p) \times \text{SMTC period})^{\text{Note 1}} \times CSSF_{intra}$
DRX cycle $\leq 320\text{ms}$	$\max(120\text{ms}, \text{ceil}(1.5 \times 3 \times K_p) \times \max(\text{SMTC period}, \text{DRX cycle})) \times CSSF_{intra}$
DRX cycle > 320ms	$\text{Ceil}(3 \times K_p) \times \text{DRX cycle} \times CSSF_{intra}$

NOTE 1: If different SMTC periodicities are configured for different cells, the SMTC period in the requirement is the one used by the cell being identified

**Table 6.6.1.0.3-3: Measurement period for intra-frequency measurements with gaps (Frequency Range FR1)**

DRX cycle	$T_{SSB\_measurement\_period\_intra}$
No DRX	$\max(200\text{ms}, \text{ceil}(5 \times K_p) \times \text{SMTC period})^{\text{Note 1}} \times CSSF_{intra}$
DRX cycle $\leq 320\text{ms}$	$\max(200\text{ms}, \text{ceil}(1.5 \times 5 \times K_p) \times \max(\text{SMTC period}, \text{DRX cycle})) \times CSSF_{intra}$
DRX cycle > 320ms	$\text{ceil}(5 \times K_p) \times \text{DRX cycle} \times CSSF_{intra}$

NOTE 1: If different SMTC periodicities are configured for different cells, the SMTC period in the requirement is the one used by the cell being identified

[TS 38.133 [6], clause 9.2.2]

The requirements given above apply, provided:

- The cell being identified or measured is detectable.

An intra-frequency cell shall be considered detectable when for each relevant SSB:

- SS-RSRP related side conditions given in TS 38.133 [6] sections 10.1.2 are fulfilled for a corresponding Band,
- SS-RSRQ related side conditions given in TS 38.133 [6] sections 10.1.7 are fulfilled for a corresponding Band,
- SS-SINR related side conditions given in TS 38.133 [6] Sections 10.1.12 are fulfilled for a corresponding Band,
- SSB<sub>RP</sub> and SSB  $\hat{E}_s/I_{ot}$  according to TS 38.133 [6] Annex B.2.2 for a corresponding Band.

[TS 38.133 [6], clause 9.2.4.2]

The RSRP measurement accuracy for all measured cells shall be as specified in TS 38.133 [6] clauses 10.1.2.1.1 and 10.1.2.1.2, the RSRQ measurement accuracy for all measured cells shall be as specified in TS 38.133 [6] clauses

10.1.7.1.1, and the SINR measurement accuracy for all measured cells shall be as specified in the TS 38.133 [6] clause 10.1.12.1.1.

Reported RSRP, RSRQ and SINR measurements contained in event triggered measurement reports shall meet the requirements in TS 38.133 [6] clauses 10.1.2.1.1, 10.1.2.1.2, 10.1.7.1.1 and 10.1.12.1.1, respectively.

The UE shall not send any event triggered measurement reports, as long as no reporting criteria are fulfilled.

The measurement reporting delay is defined as the time between an event that will trigger a measurement report and the point when the UE starts to transmit the measurement report over the air interface. This requirement assumes that the measurement report is not delayed by other RRC signalling on the DCCH. This measurement reporting delay excludes a delay uncertainty resulted when inserting the measurement report to the TTI of the uplink DCCH. The delay uncertainty is:  $2 \times TTI_{DCCH}$ . This measurement reporting delay excludes a delay which caused by no UL resources for UE to send the measurement report.

The event triggered measurement reporting delay, measured without L3 filtering shall be less than  $T_{identify\_intra\_with\_index}$  defined in TS 38.133 [6] section 9.2.5.1. When L3 filtering is used an additional delay can be expected.

The normative reference for this requirement is TS 38.133 [6] clauses 9.2.2, 9.2.4.2, 9.2.5.1 and 9.2.5.2.

#### 6.6.1.0.4 Minimum conformance requirements for event-triggered measurement with gap with SSB index reading

[TS 38.133 [6], clause 9.2.6.2, 9.2.6.3]

UE shall be able to identify a new detectable intra frequency cell within  $T_{identify\_intra\_with\_index}$ .

$$T_{identify\_intra\_with\_index} = T_{PSS/SSS\_sync\_intra} + T_{SSB\_measurement\_period\_intra} + T_{SSB\_time\_index\_intra} \text{ ms}$$

Where:

$T_{PSS/SSS\_sync\_intra}$ : it is the time period used in PSS/SSS detection given in table 6.6.1.0.4-1.

$T_{SSB\_time\_index\_intra}$ : it is the time period used to acquire the index of the SSB being measured given in table 6.6.1.0.4-2.

$T_{SSB\_measurement\_period\_intra}$ : equal to a measurement period of SSB based measurement given in table 6.6.1.0.4-3.

$CSSF_{intra}$ : it is a carrier specific scaling factor and is determined according to  $CSSF_{within\_gap, i}$  in TS 38.133 section 9.1.5.2.2 for measurement conducted within measurement gaps.

When intrafrequency SMTC is fully non overlapping with measurement gaps or intrafrequency SMTC is fully overlapping with MGs,  $K_p=1$

When intrafrequency SMTC is partially overlapping with measurement gaps,  $K_p = 1/(1 - (\text{SMTC period} / \text{MGRP}))$ , where SMTC period < MGRP.

**Table 6.6.1.0.4-1: Time period for PSS/SSS detection (Frequency range FR1)**

DRX cycle	$T_{PSS/SSS\_sync\_intra}$
No DRX	$\max(600\text{ms}, 5 \times \max(\text{MGRP}, \text{SMTC period})) \times CSSF_{intra}$
DRX cycle $\leq 320\text{ms}$	$\max(600\text{ms}, \text{ceil}(1.5 \times 5) \times \max(\text{MGRP}, \text{SMTC period}, \text{DRX cycle})) \times CSSF_{intra}$
DRX cycle $> 320\text{ms}$	$[5] \times \max(\text{MGRP}, \text{DRX cycle}) \times CSSF_{intra}$

**Table 6.6.1.0.4-2: Time period for time index detection (Frequency range FR1)**

DRX cycle	$T_{SSB\_time\_index\_intra}$
No DRX	$\max(120\text{ms}, \text{ceil}(3 \times K_p) \times \text{SMTC period})^{\text{Note 1}} \times CSSF_{intra}$
DRX cycle $\leq 320\text{ms}$	$\max(120\text{ms}, \text{ceil}(1.5 \times 3 \times K_p) \times \max(\text{SMTC period}, \text{DRX cycle})) \times CSSF_{intra}$
DRX cycle $> 320\text{ms}$	$\text{ceil}(3 \times K_p) \times \text{DRX cycle} \times CSSF_{intra}$

NOTE 1: If different SMTC periodicities are configured for different cells, the SMTC period in the requirement is the one used by the cell being identified

**Table 6.6.1.0.4-3: Measurement period for intra-frequency measurements with gaps (Frequency Range FR1)**

DRX cycle	$T_{SSB\_measurement\_period\_intra}$
No DRX	$\max(200\text{ms}, 5 \times \max(\text{MGRP}, \text{SMTC period})) \times \text{CSSF}_{intra}$
DRX cycle $\leq 320\text{ms}$	$\max(200\text{ms}, \text{ceil}(1.5 \times 5) \times \max(\text{MGRP}, \text{SMTC period}, \text{DRX cycle})) \times \text{CSSF}_{intra}$
DRX cycle $> 320\text{ms}$	$5 \times \max(\text{MGRP}, \text{DRX cycle}) \times \text{CSSF}_{intra}$

[TS 38.133 [6], clause 9.2.2]

The requirements given above apply, provided:

- The cell being identified or measured is detectable.

An intra-frequency cell shall be considered detectable when for each relevant SSB:

- SS-RSRP related side conditions given in TS 38.133 [6] sections 10.1.2 are fulfilled for a corresponding Band,
- SS-RSRQ related side conditions given in TS 38.133 [6] sections 10.1.7 are fulfilled for a corresponding Band,
- SS-SINR related side conditions given in TS 38.133 [6] sections 10.1.12 are fulfilled for a corresponding Band,
- SSB<sub>RP</sub> and SSB  $\hat{E}_s/I_{ot}$  according to TS 38.133 [6] Annex B.2.2 for a corresponding Band.

[TS 38.133 [6], clause 9.2.4.2]

The RSRP measurement accuracy for all measured cells shall be as specified in TS 38.133 [6] clauses 10.1.2.1.1 and 10.1.2.1.2, the RSRQ measurement accuracy for all measured cells shall be as specified in TS 38.133 [6] clauses 10.1.7.1.1, and the SINR measurement accuracy for all measured cells shall be as specified in the TS 38.133 [6] clause 10.1.12.1.1.

Reported RSRP, RSRQ and SINR measurements contained in event triggered measurement reports shall meet the requirements in TS 38.133 [6] clauses 10.1.2.1.1, 10.1.2.1.2, 10.1.7.1.1 and 10.1.12.1.1, respectively.

The UE shall not send any event triggered measurement reports, as long as no reporting criteria are fulfilled.

The measurement reporting delay is defined as the time between an event that will trigger a measurement report and the point when the UE starts to transmit the measurement report over the air interface. This requirement assumes that the measurement report is not delayed by other RRC signalling on the DCCH. This measurement reporting delay excludes a delay uncertainty resulted when inserting the measurement report to the TTI of the uplink DCCH. The delay uncertainty is:  $2 \times TTI_{DCCH}$ . This measurement reporting delay excludes a delay which caused by no UL resources for UE to send the measurement report.

The event triggered measurement reporting delay, measured without L3 filtering shall be less than  $T_{identify\_intra\_with\_index}$  defined in TS 38.133 [6] section 9.2.6.2. When L3 filtering is used an additional delay can be expected.

The normative reference for this requirement is TS 38.133 [6] clauses 9.2.2, 9.2.4.2, 9.2.6.2 and 9.2.6.3.

#### 6.6.1.0.5 Minimum conformance requirements for event-triggered measurement without gap for UE configured with highSpeedMeasFlag-r16

[TS 38.133, clause 9.2.5.1 and 9.2.5.2]

The UE shall be able to identify a new detectable intra frequency cell within  $T_{identify\_intra\_without\_index}$  if UE is not indicated to report SSB based RRM measurement result with the associated SSB index (*reportQuantityRSIndexes* or *maxNrofRSIndexesToReport* is not configured), or the UE is indicated that the neighbour cell is synchronous with the serving cell (*deriveSSB-IndexFromCell* is enabled). The UE shall be able to identify a new detectable intra frequency SS block of an already detected cell within  $T_{identify\_intra\_without\_index}$ . It is assumed that *deriveSSB-IndexFromCell* is always enabled for FR1 TDD and FR2.

$$T_{identify\_intra\_without\_index} = (T_{PSS/SSS\_sync\_intra} + T_{SSB\_measurement\_period\_intra}) \text{ ms}$$

Where:

$T_{\text{PSS/SSS\_sync\_intra}}$ : it is the time period used in PSS/SSS detection given in table 6.6.1.0.1-1.

$T_{\text{SSB\_measurement\_period\_intra}}$ : it is specified in Table 6.6.1.0.5-1 when *highSpeedMeasFlag-r16* is configured,

$\text{CSSF}_{\text{intra}}$ : it is a carrier specific scaling factor and is determined according to  $\text{CSSF}_{\text{outside\_gap},i}$  in TS 38.133 [6] clause 9.1.5.1 for measurement conducted outside measurement gaps.

When intra-frequency SMTC is fully non overlapping with measurement gaps or intrafrequency SMTC is fully overlapping with MGs,  $K_p=1$ .

When intrafrequency SMTC is partially overlapping with measurement gaps,  $K_p = 1/(1 - (\text{SMTC period} / \text{MGRP}))$ , where SMTC period < MGRP

**Table 6.6.1.0.5-1:  $T_{\text{SSB\_measurement\_period\_intra}}$  When *highSpeedMeasFlag-r16* is configured (Frequency range FR1)**

DRX cycle	$T_{\text{SSB\_measurement\_period\_intra}}$
No DRX <sup>Note 2</sup>	$\max(200\text{ms}, \text{ceil}(5 \times K_p) \times \text{SMTC period})^{\text{Note 1}} \times \text{CSSF}_{\text{intra}}$
DRX cycle $\leq 160\text{ms}$	$\max(200\text{ms}, \text{ceil}(5 \times M2^{\text{Note 2}} \times K_p) \times \max(\text{SMTC period}, \text{DRX cycle})) \times \text{CSSF}_{\text{intra}}$
$160\text{ms} < \text{DRX cycle} \leq 320\text{ms}$	$\text{ceil}(4 \times M2^{\text{Note 2}} \times K_p) \times \max(\text{SMTC period}, \text{DRX cycle})$
DRX cycle $> 320\text{ms}$	$\text{ceil}(Y^{\text{Note 3}} \times K_p) \times \text{DRX cycle} \times \text{CSSF}_{\text{intra}}$
NOTE 1: If different SMTC periodicities are configured for different cells, the SMTC period in the requirement is the one used by the cell being identified	
NOTE 2: $M2 = 1.5$ if SMTC periodicity $> 40$ ms, otherwise $M2=1$	
NOTE 3: $Y=3$ when SMTC $\leq 40\text{ms}$ , $Y=5$ when SMTC $> 40\text{ms}$	

[TS 38.133, clause 9.2.4.3]

Reported RSRP, RSRQ, and RS-SINR measurements contained in periodically triggered measurement reports shall meet the requirements in TS 38.133 [6] clause 10.1.2.1, 10.1.7.1 and 10.1.12.1, respectively.

The UE shall not send any event triggered measurement reports, as long as no reporting criteria are fulfilled.

The measurement reporting delay is defined as the time between an event that will trigger a measurement report and the point when the UE starts to transmit the measurement report over the air interface. This requirement assumes that the measurement report is not delayed by other RRC signalling on the DCCH. This measurement reporting delay excludes a delay uncertainty resulted when inserting the measurement report to the TTI of the uplink DCCH. The delay uncertainty is:  $2 \times \text{TTI}_{\text{DCCH}}$ . This measurement reporting delay excludes a delay which caused by no UL resources for UE to send the measurement report.

The event triggered measurement reporting delay, measured without L3 filtering shall be less than  $T_{\text{identify intra without index}}$  defined in TS 38.133 [6] clause 9.2.5.1. When L3 filtering is used an additional delay can be expected.

If a cell which has been detectable at least for the time period than  $T_{\text{identify intra without index}}$  defined in TS 38.133 [6] clause 9.2.5.1 becomes undetectable for a period and then the cell becomes detectable again and triggers an event, the event triggered measurement reporting delay shall be less than  $T_{\text{measurement, Intra}}$  provided the timing to that cell has not changed more than  $\pm 3200 T_c$  while the measurement gap has not been available and the L3 filter has not been used. When L3 filtering is used, an additional delay can be expected.

[TS 38.133, clause 9.2.2]

The requirements given above apply, provided:

- The cell being identified or measured is detectable.

An intra-frequency cell shall be considered detectable when for each relevant SSB:

- SS-RSRP related side conditions given in TS 38.133 [6] sections 10.1.2 are fulfilled for a corresponding Band,
- SS-RSRQ related side conditions given in TS 38.133 [6] sections 10.1.7 are fulfilled for a corresponding Band,
- SS-SINR related side conditions given in TS 38.133 [6] sections 10.1.12 are fulfilled for a corresponding Band,



- SSB\_RP and SSB  $\hat{E}_s/I_{ot}$  according to TS 38.133 [6] Annex B.2.2 for a corresponding Band.

References: The conformance requirements covered in the current TC are specified in: TS 38.133 [6], clauses 9.2.2, 9.2.4.3, 9.2.5.1 and 9.2.5.2.

## 6.6.1.1 NR SA FR1 event-triggered reporting without gap in non-DRX

### 6.6.1.1.1 Test purpose

To verify the UE's ability to make a correct reporting of an event within intra-frequency cell search without gap under non-DRX.

### 6.6.1.1.2 Test applicability

This test applies to all types of NR UE release 15 onwards.

### 6.6.1.1.3 Minimum conformance requirements

The minimum conformance requirements are specified in clause 6.6.1.0.1.

The normative reference for this requirement is TS 38.133 [6] clause A.6.6.1.1.

### 6.6.1.1.4 Test description

#### 6.6.1.1.4.1 Initial conditions

This test shall be tested using any of the test configurations in Table 6.6.1.1.4.1-1.

**Table 6.6.1.1.4.1-1: Supported test configurations for NR SA FR1 event-triggered reporting without gap in non-DRX**

Test Case ID	Description
6.6.1.1-1	15 kHz SSB SCS, 10MHz bandwidth, FDD duplex mode
6.6.1.1-2	15 kHz SSB SCS, 10MHz bandwidth, TDD duplex mode
6.6.1.1-3	30 kHz SSB SCS, 40MHz bandwidth, TDD duplex mode
Note: The UE is only required to be tested in one of the supported test configurations.	

Configure the test requirement and the DUT according to the parameters in Table 6.6.1.1.4.1-2.

**Table 6.6.1.1.4.1-2: Initial conditions for NR SA FR1 event-triggered reporting without gap in non-DRX**

Parameter	Value		Comment
Test environment	NC		As specified in TS 38.508-1 [14] clause 4.1.
Test frequencies	As specified in Annex E, Table E.4-1 and TS 38.508-1 [14] clause 4.3.1.		
Channel bandwidth	As specified by the test configuration selected from Table 6.6.1.1.4.1-1.		
Propagation conditions	AWGN		As specified in Annex C.2.2
Connection Diagram	TE Part	A.3.1.8.2	As specified in TS 38.508-1 [14] Annex A.
	DUT Part	A.3.2.3.4	
Exceptions to connection diagram	- Without LTE link - For 4Rx capable UEs without any 2Rx RF bands use A.3.2.5.2 for DUT part and A.3.1.8.4 for TE part.		

1. The test parameters for PCell and neighbour cell are given in Table 6.6.1.1.4.1-3 below.
2. Message contents are defined in clause 6.6.1.1.4.3.
3. There is one carrier and two cells specified in the test. NR Cell 1 is the cell used for connection setup with the power level set according to Annex C.1.1 and C.1.2 for this test.

**Table 6.6.1.1.4.1-3: General test parameters for SA intra-frequency event triggered reporting tests without gap for FR1 under non-DRX**

Parameter	Unit	Test configuration	Value	Comment
Active cell		1, 2, 3	Cell 1	
Neighbour cell		1, 2, 3	Cell 2	Cell to be identified.
RF Channel Number		1, 2, 3	1: Cell 1 and Cell 2	
SSB configuration		1	SSB.1 FR1	
		2	SSB.1 FR1	
		3	SSB.2 FR1	
SMTC configuration		1	SMTC.2	
		2	SMTC.1	
		3	SMTC.1	
A3-Offset	dB	1, 2, 3	-4.5	
CP length		1, 2, 3	Normal	
Hysteresis	dB	1, 2, 3	0	
Time To Trigger	s	1, 2, 3	0	
Filter coefficient		1, 2, 3	0	L3 filtering is not used
DRX		1, 2, 3		OFF
Time offset between serving and neighbour cells		1	3 ms	Asynchronous cells. The timing of Cell 2 is 3 ms later than the timing of Cell 1.
		2	3 $\mu$ s	Synchronous cells
		3	3 $\mu$ s	Synchronous cells
T1	s	1, 2, 3	5	
T2	s	1, 2, 3	5	

#### 6.6.1.1.4.2 Test procedure

Two cells are deployed in the test, which are FR1 PCell (NR Cell 1) and a FR1 neighbour cell (NR Cell 2) on the same frequency as the PCell. The general and cell specific test parameters for PCell and neighbour cell are given in Table 6.6.1.1.4.1-3 and Table 6.6.1.1.5-1, respectively. In the measurement control information a measurement object is configured for the frequency of the PCell, and it is indicated to the UE that event-triggered reporting with Event A3 is used. The test consists of two successive time periods, with time duration of T1, and T2 respectively. During time duration T1, the UE shall not have any timing information of NR Cell 2.

1. Ensure the UE is in state RRC\_CONNECTED with generic procedure parameters Connectivity NR, Connected without release On and Test Mode On according to TS 38.508-1 [14] clause 4.5.
2. Set the parameters according to T1 in Table 6.6.1.1.5-1.
3. SS shall transmit an *RRCReconfiguration* message.
4. The UE shall transmit *RRCReconfigurationComplete* message. T1 starts.
5. When T1 expires, the SS shall switch the power setting from T1 to T2 as specified in Table 6.6.1.1.5-1. T2 starts.
6. UE shall transmit a *MeasurementReport* message triggered by Event A3. If the overall delays measured from the beginning of time period T2 is less than 802 ms then the number of successful tests is increased by one. If the UE fails to report the event within the overall delays measured requirement then the number of failure tests is increased by one.
7. After the SS receive the *MeasurementReport* message in step 6) or when T2 expires, the SS shall:
  - transmit *RRCRelease* message to release the RRC connection which includes the release of the established radio bearers as well as all radio resources
- OR
- switch the UE off.
8. Set NR Cell 2 physical cell identity = ((current NR cell 2 physical cell identity + 1) mod 14 + 2) for next iteration of the test procedure loop.

9. Depending on the choice in Step 7, the SS:

- if the RRC Connection Release has been sent, transmits in NR Cell 1 a Paging message (including PagingRecord with UE-Identity) for the UE and ensures the UE is in state RRC\_CONNECTED with generic procedure parameters Connectivity NR, Connected without release On according to TS 38.508-1 [14] clause 4.5 (if the paging fails, switches off and on the UE and ensures the UE is in state RRC\_CONNECTED with generic procedure parameters Connectivity NR, Connected without release On according to TS 38.508-1 [14] clause 4.5),

Or

- if the device has been switched off, switches on the UE and ensures the UE is in state RRC\_CONNECTED with generic procedure parameters Connectivity NR, Connected without release On according to TS 38.508-1 [14] clause 4.5.

10. Repeat step 2-9 until the confidence level according to Tables G.2.3-1 in Annex G clause G.2 is achieved.

6.6.1.1.4.3 Message contents

Message contents are according to TS 38.508-1 [14] clause 4.6 with the following exceptions:

**Table 6.6.1.1.4.3-1: Common Exception messages SA intra frequency event triggered reporting tests without gap under non-DRX**

Default Message Contents	
Common contents of system information blocks exceptions	
Default RRC messages and information elements contents exceptions	Table H.3.1-1 Table H.3.1-2 with Condition INTRA-FREQ Table H.3.1-3 with Condition INTRA-FREQ MO, SSB.1 FR1, SMTC.2 for configuration 6.6.1.1-1 Table H.3.1-3 with Condition INTRA-FREQ MO, SSB.1 FR1, SMTC.1 and synchronous cells for configuration 6.6.1.1-2 Table H.3.1-3 with Condition INTRA-FREQ MO, SSB.2 FR1, SMTC.1 and synchronous cells for configuration 6.6.1.1-3 Table H.3.1-4 with A3-offset = -4.5dB Table H.3.1-5 with Condition INTRA-FREQ Table H.3.1-7 with Condition INTRA-FREQ Table H.3.1-8 with Condition SSB RLM

6.6.1.1.5 Test requirement

Table 6.6.1.1.4.1-3 and Table 6.6.1.1.5-1 define the primary level settings including test tolerances for NR SA event triggered reporting test without gap under non-DRX.

**Table 6.6.1.1.5-1: NR Cell specific test parameters for SA intra-frequency event triggered reporting tests without gap under non-DRX**

Parameter	Unit	Test configuration	Cell 1		Cell 2	
			T1	T2	T1	T2
TDD configuration		1	N/A		N/A	
		2	TDDConf.1.1		TDDConf.1.1	
		3	TDDConf.2.1		TDDConf.2.1	
PDSCH RMC configuration		1	SR.1.1 FDD		N/A	
		2	SR.1.1 TDD			
		3	SR.2.1 TDD			
RMSI CORESET RMC configuration		1	CR.1.1 FDD		CR.1.1 FDD	
		2	CR.1.1 TDD		CR.1.1 TDD	
		3	CR.2.1 TDD		CR.2.1 TDD	
Dedicated CORESET RMC configuration		1	CCR.1.1 FDD		CCR.1.1 FDD	
		2	CCR.1.1 TDD		CCR.1.1 TDD	
		3	CCR.2.1 TDD		CCR.2.1 TDD	
OCNG Patterns		1, 2, 3	OP.1		OP.1	
TRS Configuration		1	TRS.1.1 FDD		N/A	
		2	TRS.1.1 TDD		N/A	
		3	TRS.1.2 TDD		N/A	
Initial BWP configuration		1, 2, 3	DLBWP.0.1 ULBWP.0.1		DLBWP.0.1 ULBWP.0.1	
Active DL BWP configuration		1, 2, 3	DLBWP.1.1		DLBWP.1.1	
Active UL BWP configuration		1, 2, 3	ULBWP.1.1		ULBWP.1.1	
RLM-RS		1, 2, 3	SSB		SSB	
$N_{oc}$ <sup>Note 2</sup>	dBm/SCS	1	-98			
		2	-98			
		3	-95			
$N_{oc}$ <sup>Note 2</sup>	dBm/15 KHz	1	-98			
		2				
		3				
$\hat{E}_s/I_{ot}$	dB	1	4	-1.46	-Infinity	-1.46
		2				
		3				
$\hat{E}_s/N_{oc}$	dB	1	4	4	-Infinity	4
		2				
		3				
SS-RSRP <sup>Note 3</sup>	dBm/SCS KHz	1	-94	-94	-Infinity	-94
		2	-94	-94	-Infinity	-94
		3	-91	-91	-Infinity	-91
I <sub>o</sub>	dBm/9.36 MHz	1	-64.60	-62.25	Specified in Cell 1 columns	
	dBm/9.36 MHz	2	-64.60	-62.25		
	dBm/38.16 MHz	3	-58.50	-56.16		
Propagation Condition		1, 2, 3	AWGN			
<p>Note 1: The resources for uplink transmission are assigned to the UE prior to the start of time period T2.</p> <p>Note 2: Interference from other cells and noise sources not specified in the test is assumed to be constant over subcarriers and time and shall be modelled as AWGN of appropriate power for <math>N_{oc}</math> to be fulfilled.</p> <p>Note 3: SS-RSRP levels have been derived from other parameters for information purposes. They are not settable parameters themselves.</p>						

The overall delays measured is defined as the time from the beginning of time period T2, to the moment the UE send one Event A3 triggered measurement report to NR Cell 2.

The overall delays measured in the test may be up to  $2xTTI_{DCC}$  higher than the measurement reporting delays because of TTI insertion uncertainty of the measurement report in DCC.

The overall delays measured test requirement is expressed as:

Overall delays measured = measurement reporting delay + TTI insertion uncertainty

Measurement reporting delay =  $T_{\text{identify\_intra\_without\_index}}$

$$T_{\text{identify\_intra\_without\_index}} = (T_{\text{PSS/SSS\_sync\_intra}} + T_{\text{SSB\_measurement\_period\_intra}}) \text{ ms}$$

$$T_{\text{PSS/SSS\_sync\_intra}} = \max [ 600 \text{ ms, } \text{ceil} ( 5 \times K_p ) \times \text{SMTC period} ] \times \text{CSSF}_{\text{intra}} = 600 \text{ ms}$$

$$T_{\text{SSB\_measurement\_period\_intra}} = \max [ 200 \text{ ms, } \text{ceil} ( 5 \times K_p ) \times \text{SMTC period} ] \times \text{CSSF}_{\text{intra}} = 200 \text{ ms}$$

TTI insertion uncertainty = 2 ms

The overall delays measured shall be less than a total of 802 ms in this test case (note: this gives a total of 800 ms for measurement reporting delay plus 2 ms for TTI insertion uncertainty).

For the test to pass, the total number of successful tests shall be more than 90% of the cases with a confidence level of 95%.

## 6.6.1.2 NR SA FR1 event-triggered reporting without gap in DRX

### 6.6.1.2.1 Test purpose

To verify the UE's ability to make a correct reporting of an event within intra-frequency cell search without gap under DRX.

### 6.6.1.2.2 Test applicability

This test applies to all types of NR UE release 15 and forward supporting 5GS NR SA FR1 and long DRX cycle.

### 6.6.1.2.3 Minimum conformance requirements

The minimum conformance requirements are specified in clause 6.6.1.0.1.

The normative reference for this requirement is TS 38.133 [6] clause A.6.6.1.2.

### 6.6.1.2.4 Test description

#### 6.6.1.2.4.1 Initial conditions

This test shall be tested using any of the test configurations in Table 6.6.1.2.4.1-1.

**Table 6.6.1.2.4.1-1: Supported test configurations for NR SA FR1 event-triggered reporting without gap in DRX**

Test Case ID	Description
6.6.1.2-1	15 kHz SSB SCS, 10MHz bandwidth, FDD duplex mode
6.6.1.2-2	15 kHz SSB SCS, 10MHz bandwidth, TDD duplex mode
6.6.1.2-3	30 kHz SSB SCS, 40MHz bandwidth, TDD duplex mode
Note: The UE is only required to be tested in one of the supported test configurations.	

Configure the test equipment and the DUT according to the parameters in Table 6.6.1.2.4.1-2.

**Table 6.6.1.2.4.1-2: Initial conditions for NR SA FR1 event-triggered reporting without gap in DRX**

Parameter	Value		Comment
Test environment	NC		As specified in TS 38.508-1 [14] clause 4.1.
Test frequencies	As specified in Annex E, table E.4-1 and TS 38.508-1 [14] clause 4.3.1.		
Channel bandwidth	As specified by the test configuration selected from Table 6.6.1.2.4.1-1.		
Propagation conditions	AWGN		As specified in Annex C.2.2.
Connection Diagram	TE Part	A.3.1.8.2	As specified in TS 38.508-1 [14] Annex A.
	DUT Part	A.3.2.3.4	
Exceptions to connection diagram	- Without LTE link - For 4Rx capable UEs without any 2Rx RF bands use A.3.2.5.2 for DUT part and A.3.1.8.4 for TE part.		

1. The test parameters for PCell and neighbour cell are given in Table 6.6.1.2.4.1-3 below.
2. Message contents are defined in clause 6.6.1.2.4.3.
3. There is one carrier and two cells specified in the test. NR Cell 1 is the cell used for connection setup with the power level set according to Annex C.1.1 and C.1.2 for this test.

**Table 6.6.1.2.4.1-3: General test parameters for SA intra-frequency event triggered reporting tests without gap for FR1 under DRX**

Parameter	Unit	Test configuration	Value		Comment
			Test 1	Test 2	
Active cell		1, 2, 3	Cell 1		
Neighbour cell		1, 2, 3	Cell 2		Cell to be identified.
RF Channel Number		1, 2, 3	1: Cell 1 and Cell 2		
SSB configuration		1	SSB.1 FR1		
		2	SSB.1 FR1		
		3	SSB.2 FR1		
SMTC configuration		1	SMTC.2		
		2	SMTC.1		
		3	SMTC.1		
A3-Offset	dB	1, 2, 3	-4.5		
CP length		1, 2, 3	Normal		
Hysteresis	dB	1, 2, 3	0		
Time To Trigger	s	1, 2, 3	0		
Filter coefficient		1, 2, 3	0		L3 filtering is not used
DRX	ms	1, 2, 3	DRX.1	DRX.7	
Time offset between serving and neighbour cells		1	3 ms		Asynchronous cells. The timing of Cell 2 is 3ms later than the timing of Cell 1
		2	3 us		Synchronous cells
		3	3 us		Synchronous cells
T1	s	1, 2, 3	5		
T2	s	1, 2, 3	5	10	

#### 6.6.1.2.4.2 Test procedure

Two cells are deployed in the test, which are FR1 PCell (NR Cell 1) and a FR1 neighbour cell (NR Cell 2) on the same frequency as the PCell. The general and cell specific test parameters for PCell and neighbour cell are given in Table 6.6.1.2.4.1-3 and Table 6.6.1.2.5-1, respectively. In the measurement control information a measurement object is configured for the frequency of the PCell, and it is indicated to the UE that event-triggered reporting with Event A3 is used. The test consists of two successive time periods, with time duration of T1, and T2 respectively. During time duration T1, the UE shall not have any timing information of NR Cell 2.

1. Ensure the UE is in state RRC\_CONNECTED with generic procedure parameters Connectivity NR, Connected without release *On* and Test Mode *On* according to TS 38.508-1 [14] clause 4.5.

2. Set the parameters according to T1 in Table 6.6.1.2.5-1.
3. SS shall transmit an *RRCReconfiguration* message.
4. The UE shall transmit *RRCReconfigurationComplete* message. T1 starts.
5. When T1 expires, the SS shall switch the power setting from T1 to T2 as specified in Table 6.6.1.2.5-1. T2 starts.
6. UE shall transmit a *MeasurementReport* message triggered by Event A3. If the overall delays measured from the beginning of time period T2 is less than 922 ms for Test 1 or less than 6402 ms for Test 2 then the number of successful tests is increased by one. If the UE fails to report the event within the overall delays measured requirement then the number of failure tests is increased by one.
7. After the SS receive the *MeasurementReport* message in step 6) or when T2 expires, the SS shall:
  - transmit *RRCRelease* message to release the RRC connection which includes the release of the established radio bearers as well as all radio resourcesOR
  - switch the UE off.
8. Set NR Cell 2 physical cell identity = ((current NR cell 2 physical cell identity + 1) mod 14 + 2) for next iteration of the test procedure loop.
9. Depending on the choice in Step 7, the SS:
  - if the RRC Connection Release has been sent, transmits in NR Cell 1 a Paging message (including PagingRecord with UE-Identity) for the UE and ensures the UE is in state RRC\_CONNECTED with generic procedure parameters Connectivity NR, Connected without release On according to TS 38.508-1 [14] clause 4.5 (if the paging fails, switches off and on the UE and ensures the UE is in state RRC\_CONNECTED with generic procedure parameters Connectivity NR, Connected without release On according to TS 38.508-1 [14] clause 4.5),OR
  - if the device has been switched off, switches on the UE and ensures the UE is in state RRC\_CONNECTED with generic procedure parameters Connectivity NR, Connected without release On according to TS 38.508-1 [14] clause 4.5.
10. Repeat step 2-9 until the confidence level according to Tables G.2.3-1 in Annex G clause G.2 is achieved.
11. Repeat step 1-10 for each sub-test in Table 6.6.1.2.4.1-1 as appropriate.

#### 6.6.1.2.4.3 Message contents

Message contents are according to TS 38.508-1 [14] clause 4.6 with the following exceptions:

**Table 6.6.1.2.4.3-1: Common Exception messages for SA intra frequency event triggered reporting tests without gap under DRX**

<b>Default Message Contents</b>	
Common contents of system information blocks exceptions	
Default RRC messages and information elements contents exceptions	Table H.3.1-1 Table H.3.1-2 with Condition INTRA-FREQ Table H.3.1-3 with Condition INTRA-FREQ MO SSB.1 FR1, SMTC.2 for configuration 6.6.1.2-1 Table H.3.1-3 with Condition INTRA-FREQ MO SSB.1 FR1, SMTC.1 and synchronous cells for configuration 6.6.1.2-2 Table H.3.1-3 with Condition INTRA-FREQ MO SSB.2 FR1, SMTC.1 and synchronous cells for configuration 6.6.1.2-3 Table H.3.1-4 with A3-offset = -4.5dB Table H.3.1-5 with Condition INTRA-FREQ Table H.3.1-7 with Condition INTRA-FREQ Table H.3.1-8 with Condition SSB RLM Table H.3.7-1 with Condition DRX.1 and Offset for test 1 Table H.3.7-1 with Condition DRX.7 and Offset for test 2

#### 6.6.1.2.5 Test requirement

Table 6.6.1.2.4.1-3 and Table 6.6.1.2.5-1 define the primary level settings including test tolerances for NR event triggered reporting in synchronous cells when DRX is used test.



**Table 6.6.1.2.5-1: NR Cell specific test parameters for SA intra-frequency event triggered reporting tests without gap under DRX**

Parameter	Unit	Test configuration	Cell 1		Cell 2	
			T1	T2	T1	T2
TDD configuration		1	N/A		N/A	
		2	TDDConf.1.1		TDDConf.1.1	
		3	TDDConf.2.1		TDDConf.2.1	
PDSCH RMC configuration		1	SR.1.1 FDD		N/A	
		2	SR.1.1 TDD			
		3	SR.2.1 TDD			
RMSI CORESET RMC configuration		1	CR.1.1 FDD		CR.1.1 FDD	
		2	CR.1.1 TDD		CR.1.1 TDD	
		3	CR.2.1 TDD		CR.2.1 TDD	
Dedicated CORESET RMC configuration		1	CCR.1.1 FDD		CCR.1.1 FDD	
		2	CCR.1.1 TDD		CCR.1.1 TDD	
		3	CCR.2.1 TDD		CCR.2.1 TDD	
OCNG Patterns		1, 2, 3	OP.1		OP.1	
TRS Configuration		1	TRS.1.1 FDD		N/A	
		2	TRS.1.1 TDD		N/A	
		3	TRS.1.2 TDD		N/A	
Initial BWP configuration		1, 2, 3	DLBWP.0.1 ULBWP.0.1		DLBWP.0.1 ULBWP.0.1	
Active DL BWP configuration		1, 2, 3	DLBWP.1.1		DLBWP.1.1	
Active UL BWP configuration		1, 2, 3	ULBWP.1.1		ULBWP.1.1	
RLM-RS		1, 2, 3	SSB		SSB	
$N_{oc}$ <sup>Note 2</sup>	dBm/SCS	1	-98			
		2	-98			
		3	-95			
$N_{oc}$ <sup>Note 2</sup>	dBm/15 KHz	1	-98			
		2				
		3				
$\hat{E}_s/I_{ot}$	dB	1	4	-1.46	-Infinity	-1.46
		2				
		3				
$\hat{E}_s/N_{oc}$	dB	1	4	4	-Infinity	4
		2				
		3				
SS-RSRP <sup>Note 3</sup>	dBm/SCS KHz	1	-94	-94	-Infinity	-94
		2	-94	-94	-Infinity	-94
		3	-91	-91	-Infinity	-91
I <sub>o</sub>	dBm/9.36 MHz	1	-64.60	-62.25	Specified in Cell 1 columns	
	dBm/9.36 MHz	2	-64.60	-62.25		
	dBm/38.16 MHz	3	-58.50	-56.16		
Propagation Condition		1, 2, 3	AWGN			
<p>Note 1: The resources for uplink transmission are assigned to the UE prior to the start of time period T2.</p> <p>Note 2: Interference from other cells and noise sources not specified in the test is assumed to be constant over subcarriers and time and shall be modelled as AWGN of appropriate power for <math>N_{oc}</math> to be fulfilled.</p> <p>Note 3: SS-RSRP levels have been derived from other parameters for information purposes. They are not settable parameters themselves.</p>						

In Test 1 when DRX cycle length = 40 ms, the overall delay measured is defined as the time from the beginning of time period T2 to the moment the UE send one Event A3 triggered measurement report on PUSCH.

In Test 2 when DRX cycle length = 640 ms, the overall delay measured is defined as the time from the beginning of time period T2 to the moment the UE starts to send preambles on the PRACH for Scheduling Request (SR) to obtain allocation to send the measurement report to NR Cell 2 on PUSCH.

For both tests:

The overall delays measured is defined as the time from the beginning of time period T2 to the moment the UE send one Event A3 triggered measurement report to NR Cell 2.

The overall delays measured in the test may be up to  $2 \times TTI_{DCCH}$  higher than the measurement reporting delays because of TTI insertion uncertainty of the measurement report in DCCH.

The overall delay measured when DRX cycle length is 40 ms test requirement is expressed as:

Overall delays measured = measurement reporting delay + TTI insertion uncertainty

Measurement reporting delay =  $T_{\text{identify\_intra\_without\_index}}$

$$T_{\text{identify\_intra\_without\_index}} = (T_{\text{PSS/SSS\_sync\_intra}} + T_{\text{SSB\_measurement\_period\_intra}}) \text{ ms}$$

$$T_{\text{PSS/SSS\_sync\_intra}} = \max[600\text{ms}, \text{ceil}(1.5 \times 5 \times K_p) \times \max(\text{SMTC period}, \text{DRX cycle})] \times \text{CSSF}_{\text{intra}} = 600\text{ms}$$

$$T_{\text{SSB\_measurement\_period\_intra}} = \max[200\text{ms}, \text{ceil}(1.5 \times 5 \times K_p) \times \max(\text{SMTC period}, \text{DRX cycle})] \times \text{CSSF}_{\text{intra}} = 320\text{ms}$$

TTI insertion uncertainty = 2 ms

The overall delay measured when DRX cycle length is 40 ms shall be less than a total of 922 ms.

The overall delay measured when DRX cycle length is 640 ms test requirement is expressed as:

Overall delays measured = measurement reporting delay + TTI insertion uncertainty

Measurement reporting delay =  $T_{\text{identify\_intra\_without\_index}}$

$$T_{\text{identify\_intra\_without\_index}} = (T_{\text{PSS/SSS\_sync\_intra}} + T_{\text{SSB\_measurement\_period\_intra}}) \text{ ms}$$

$$T_{\text{PSS/SSS\_sync\_intra}} = \text{ceil}(5 \times K_p) \times \text{DRX cycle} \times \text{CSSF}_{\text{intra}} = 3200\text{ms}$$

$$T_{\text{SSB\_measurement\_period\_intra}} = \text{ceil}(5 \times K_p) \times \text{DRX cycle} \times \text{CSSF}_{\text{intra}} = 3200\text{ms}$$

TTI insertion uncertainty = 2 ms

The overall delay measured when DRX cycle length is 640 ms shall be less than a total of 6402 ms.

For the test to pass, the total number of successful tests shall be more than 90% of the cases with a confidence level of 95%.

### 6.6.1.3 NR SA FR1 event-triggered reporting with gap in non-DRX

#### 6.6.1.3.1 Test purpose

The purpose of this test is to verify UE's ability to make a correct reporting of an event with gaps under non-DRX within intra-frequency cell search with gaps requirements.

#### 6.6.1.3.2 Test applicability

This test applies to all types of NR UE release 15 onwards supporting 5GS NR SA FR1, CSI-RS-based RLM and BWP operation without bandwidth restriction.

#### 6.6.1.3.3 Minimum conformance requirements

The minimum conformance requirements are specified in clause 6.6.1.0.2.

The normative reference for this requirement is TS 38.133 [6] clause A.6.6.1.3.

#### 6.6.1.3.4 Test description

##### 6.6.1.3.4.1 Initial conditions

This test shall be tested using any of the test configurations in Table 6.6.1.3.4.1-1.

**Table 6.6.1.3.4.1-1: Supported test configurations for NR SA FR1 event-triggered reporting with gap in non-DRX**

Test Case ID	Description
6.6.1.3-1	NR 15 kHz SSB SCS, 10MHz bandwidth, FDD duplex mode
6.6.1.3-2	NR 15 kHz SSB SCS, 10MHz bandwidth, TDD duplex mode
6.6.1.3-3	NR 30 kHz SSB SCS, 40MHz bandwidth, TDD duplex mode
Note 1: The UE is only required to be tested in one of the supported test configurations	

Configure the test equipment and the DUT according to the parameters in Table 6.6.1.3.4.1-2.

**Table 6.6.1.3.4.1-2: Initial conditions for NR SA FR1 event-triggered reporting with gap in non-DRX**

Parameter	Value	Comment
<b>Test environment</b>	<b>NC</b>	<b>As specified in TS 38.508-1 [14] clause 4.1.</b>
Test frequencies	As specified in Annex E, table E.4-1 and TS 38.508-1 [14] clause 4.3.1 and 4.4.2.	
Channel bandwidth	As specified by the test configuration selected from Table 6.6.1.3.4.1-1.	
Propagation conditions	AWGN	As specified in Annex C.2.2.
Connection Diagram	TE Part	A.3.1.8.2
	DUT Part	A.3.2.3.4
Exceptions to connection diagram	- Without LTE link - For 4Rx capable UEs without any 2Rx RF bands use A.3.2.5.2 for DUT part and A.3.1.8.4 for TE part.	

1. The general test parameter settings are set up according to Table 6.6.1.3.4.1-3.
2. Message contents are defined in clause 6.6.1.3.4.3.
3. There is one NR carrier and two cells specified in the test. Cell 1 is the cell used for connection setup with the power level set according to Annex C.1.1 and C.1.2 for this test.

**Table 6.6.1.3.4.1-3: General test parameters for NR SA FR1 event-triggered reporting with gap in non-DRX**

Parameter	Unit	Test configuration	Value	Comment
Active cell		1, 2, 3	Cell 1	
Neighbour cell		1, 2, 3	Cell 2	Cell to be identified.
RF Channel Number		1, 2, 3	1: Cell 1 and Cell 2	
Measurement gap type		1, 2, 3	Per-UE gaps	
Measurement gap repetition periodicity	ms	1, 2, 3	40	
Measurement gap length	ms	1, 2, 3	6	
Measurement gap offset	ms	1, 2, 3	39	
SSB configuration		1	SSB.1 FR1	
		2	SSB.1 FR1	
		3	SSB.2 FR1	
SMTTC configuration		1	SMTTC.2	
		2	SMTTC.1	
		3	SMTTC.1	
CSI-RS parameters		1	CSI-RS.1.2 FDD resource #0	
		2	CSI-RS.1.2 TDD resource #0	
		3	CSI-RS.2.2 TDD resource #0	
A3-Offset	dB	1, 2, 3	-4.5	
CP length		1, 2, 3	Normal	
Hysteresis	dB	1, 2, 3	0	
Time To Trigger	s	1, 2, 3	0	
Filter coefficient		1, 2, 3	0	L3 filtering is not used
DRX	ms	1, 2, 3		OFF
Time offset between serving and neighbour cells		1	3 ms	Asynchronous cells. The timing of Cell 2 is 3ms later than the timing of Cell 1.
		2	3 $\mu$ s	Synchronous cells
		3	3 $\mu$ s	Synchronous cells
T1	s	1, 2, 3	5	
T2	s	1, 2, 3	5	

#### 6.6.1.3.4.2 Test procedure

Two cells are deployed in the test, which are FR1 PCell (Cell 1) and a FR1 neighbour cell (Cell 2) on the same frequency as the PCell. The general and cell specific test parameters for PCell and neighbour cell are given in Table 6.6.1.3.4.1-3 and Table 6.6.1.3.5-1, respectively. In the measurement control information a measurement object is configured for the frequency of the PCell, and it is indicated to the UE that event-triggered reporting with Event A3 is used. The test consists of two successive time periods, with time duration of T1, and T2 respectively. During time duration T1, the UE shall not have any timing information of Cell 2.

There are two BWPs configured in Cell 1, BWP1 which contains the cell defining SSB, and BWP2 which does not contain any SSB of Cell 1. During the whole test, BWP2 is always scheduled as the active BWP for the UE.

1. Ensure the UE is in state RRC\_CONNECTED with generic procedure parameters Connectivity NR, Connected without release On and Test Mode On according to TS 38.508-1 [14] clause 4.5.
2. Set the parameters according to T1 in Table 6.6.1.3.5-1.
3. SS shall transmit an *RRCReconfiguration* message.
4. The UE shall transmit *RRCReconfigurationComplete* message. T1 starts.
5. When T1 expires, the SS shall switch the power setting from T1 to T2 as specified in Table 6.6.1.3.5-1.
6. UE shall transmit a *MeasurementReport* message triggered by Event A3. If the overall delays measured from the beginning of time period T2 is less than 802 ms then the number of successful tests is increased by one. If the

UE fails to report the event within the overall delays measured requirement then the number of failure tests is increased by one.

7. After the SS receive the MeasurementReport message in step 6) or when T2 expires, the SS shall:
  - transmit RRCRelease message to release the RRC connection which includes the release of the established radio bearers as well as all radio resources

OR

  - switch the UE off.
8. Set Cell 2 physical cell identity = ((current cell 2 physical cell identity + 1) mod 14 + 2) for next iteration of the test procedure loop.
9. Depending on the choice in Step 7, the SS:
  - if the RRC Connection Release has been sent, transmits in Cell 1 a Paging message (including PagingRecord with UE-Identity) for the UE and ensures the UE is in state RRC\_CONNECTED with generic procedure parameters Connectivity NR, Connected without release On according to TS 38.508-1 [14] clause 4.5 (if the paging fails, switches off and on the UE and ensures the UE is in state RRC\_CONNECTED with generic procedure parameters Connectivity NR, Connected without release On according to TS 38.508-1 [14] clause 4.5),
  - OR
  - if the device has been switched off, switches on the UE and ensures the UE is in state RRC\_CONNECTED with generic procedure parameters Connectivity NR, Connected without release On according to TS 38.508-1 [14] clause 4.5.
10. Repeat step 2-9 until the confidence level according to Tables G.2.3-1 in Annex G clause G.2 is achieved.

6.6.1.3.4.3 Message contents

Message contents are according to TS 38.508-1 [14] clause 4.6 with the following exceptions:

**Table 6.6.1.3.4.3-1: Common Exception messages for NR SA FR1 event-triggered reporting with gap in non-DRX**

Default Message Contents	
Common contents of system information blocks exceptions	
Default RRC messages and information elements contents exceptions	Table H.3.1-1 Table H.3.1-2 with Condition INTRA-FREQ and GAP NEEDED Table H.3.1-3 with Condition INTRA-FREQ MO, SSB.1 FR1, SMTC.2 for Configuration 6.6.1.3-1 Table H.3.1-3 with Condition INTRA-FREQ MO, SSB.1 FR1, SMTC.1 and Synchronous cells for Configuration 6.6.1.3-2 Table H.3.1-3 with Condition INTRA-FREQ MO, SSB.2 FR1, SMTC.1 and Synchronous cells for Configuration 6.6.1.3-3 Table H.3.1-4 with A3-offset = -4.5dB Table H.3.1-5 with Condition INTRA-FREQ Table H.3.1-6 with Condition Pattern #0 Table H.3.1-7 with Condition INTRA-FREQ Table H.3.1-8 with Condition CSI-RS RLM

Table 6.6.1.3.4.3-2: *ServingCellConfig*

Derivation Path: TS 38.508-1 [14], Table 4.6.3-167			
Information Element	Value/remark	Comment	Condition
ServingCellConfig ::= SEQUENCE {			
downlinkBWP-ToAddModList SEQUENCE (SIZE (1..maxNrofBWPs)) OF SEQUENCE {			
BWP-Downlink[1]	BWP-Downlink with condition BWP-Id1	DLBWP.1.2 configuration	
}			
firstActiveDownlinkBWP-Id	1	Active DL BWP-ID (BWP2)	BWP-Id1
defaultDownlinkBWP-Id	0	Initial BWP (BWP1)	
uplinkConfig SEQUENCE {			
uplinkBWP-ToAddModList SEQUENCE (SIZE (1..maxNrofBWPs)) OF SEQUENCE {			
BWP-Uplink[1]	BWP-Uplink with condition BWP-Id1	ULBWP.1.2 configuration	
}			
firstActiveUplinkBWP-Id	1	Active UL BWP-ID (BWP2)	BWP-Id1
}			
}			

Condition	Explanation
BWP-Id1	Active BWP (BWP2)

#### 6.6.1.3.5 Test requirement

Table 6.6.1.3.4.1-3 and Table 6.6.1.3.5-1 define the primary level settings including test tolerances for NR SA FR1 event-triggered reporting with gap in non-DRX test.

**Table 6.6.1.3.5-1: NR Cell specific test parameters for NR SA FR1 event-triggered reporting with gap in non-DRX**

Parameter	Unit	Test configuration	Cell 1		Cell 2	
			T1	T2	T1	T2
TDD configuration		1	N/A		N/A	
		2	TDDConf.1.1		TDDConf.1.1	
		3	TDDConf.2.1		TDDConf.2.1	
PDSCH RMC configuration		1	SR.1.1 FDD		N/A	
		2	SR.1.1 TDD			
		3	SR.2.1 TDD			
RMSI CORESET RMC configuration		1	CR.1.1 FDD		CR.1.1 FDD	
		2	CR.1.1 TDD		CR.1.1 TDD	
		3	CR.2.1 TDD		CR.2.1 TDD	
Dedicated CORESET RMC configuration		1	CCR.1.2 FDD		CCR.1.1 FDD	
		2	CCR.1.2 TDD		CCR.1.1 TDD	
		3	CCR.2.1 TDD		CCR.2.1 TDD	
OCNG Patterns		1, 2, 3	OP.1		OP.1	
TRS Configuration		1	TRS.1.1 FDD		N/A	
		2	TRS.1.1 TDD		N/A	
		3	TRS.1.2 TDD		N/A	
Initial BWP configuration		1, 2, 3	DLBWP.0.1 ULBWP.0.1		DLBWP.0.1 ULBWP.0.1	
Active DL BWP configuration		1, 2, 3	DLBWP.1.2		DLBWP.1.1	
Active UL BWP configuration		1, 2, 3	ULBWP.1.2		ULBWP.1.1	
RLM-RS		1, 2, 3	CSI-RS		SSB	
$N_{oc}$ <sup>Note 2</sup>	dBm/SCS	1	-98			
		2	-98			
		3	-95			
$N_{oc}$ <sup>Note 2</sup>	dBm/15 KHz	1	-98			
		2				
		3				
$\hat{E}_s/I_{ot}$	dB	1	4	-1.46	-Infinity	-1.46
		2				
		3				
$\hat{E}_s/N_{oc}$	dB	1	4	4	-Infinity	4
		2				
		3				
SS-RSRP <sup>Note 3</sup>	dBm/SCS KHz	1	-94	-94	-Infinity	-94
		2	-94	-94	-Infinity	-94
		3	-91	-91	-Infinity	-91
I <sub>o</sub>	dBm/9.36 MHz	1	-64.60	-62.25	Specified in Cell 1 columns	
	dBm/9.36 MHz	2	-64.60	-62.25		
	dBm/38.16 MHz	3	-58.50	-56.16		
Propagation Condition		1, 2, 3	AWGN			
<p>Note 1: The resources for uplink transmission are assigned to the UE prior to the start of time period T2.</p> <p>Note 2: Interference from other cells and noise sources not specified in the test is assumed to be constant over subcarriers and time and shall be modelled as AWGN of appropriate power for <math>N_{oc}</math> to be fulfilled.</p> <p>Note 3: SS-RSRP levels have been derived from other parameters for information purposes. They are not settable parameters themselves.</p>						

The overall delays measured is defined as the time from the beginning of time period T2, to the moment the UE send one Event A3 triggered measurement report.

The overall delays measured in the test may be up to  $2 \times TTI_{DCCH}$  higher than the measurement reporting delays because of TTI insertion uncertainty of the measurement report in DCCH.

The overall delays measured test requirement is expressed as:

Overall delays measured = measurement reporting delay + TTI insertion uncertainty

Measurement reporting delay =  $T_{\text{identify\_intra\_without\_index}}$

$$T_{\text{identify\_intra\_without\_index}} = T_{\text{PSS/SSS\_sync\_intra}} + T_{\text{SSB\_measurement\_period\_intra}}$$

$$T_{\text{PSS/SSS\_sync\_intra}} = 600 \text{ ms}$$

$$T_{\text{SSB\_measurement\_period\_intra}} = 200 \text{ ms}$$

TTI insertion uncertainty = 2 ms

The overall delays measured shall be less than a total of 802 ms in this test case (note: this gives a total of 800 ms for measurement reporting delay plus 2 ms for TTI insertion uncertainty).

For the test to pass, the total number of successful tests shall be more than 90% of the cases with a confidence level of 95%.

### 6.6.1.4 NR SA FR1 event-triggered reporting with gap in DRX

#### 6.6.1.4.1 Test purpose

The purpose of this test is to verify UE's ability to make a correct reporting of an event with gaps under DRX within intra-frequency cell search with gaps requirements.

#### 6.6.1.4.2 Test applicability

This test applies to all types of NR UE release 15 and forward supporting 5GS NR SA FR1, CSI-RS-based RLM, BWP operation without bandwidth restriction and long DRX cycle.

#### 6.6.1.4.3 Minimum conformance requirements

The minimum conformance requirements are specified in clause 6.6.1.0.2.

The normative reference for this requirement is TS 38.133 [6] clause A.6.6.1.4.

#### 6.6.1.4.4 Test description

##### 6.6.1.4.4.1 Initial conditions

This test shall be tested using any of the test configurations in Table 6.6.1.4.4.1-1.

**Table 6.6.1.4.4.1-1: Supported test configurations for NR SA FR1 event-triggered reporting with gap in DRX**

Test Case ID	Description
6.6.1.4-1	NR 15 kHz SSB SCS, 10MHz bandwidth, FDD duplex mode
6.6.1.4-2	NR 15 kHz SSB SCS, 10MHz bandwidth, TDD duplex mode
6.6.1.4-3	NR 30 kHz SSB SCS, 40MHz bandwidth, TDD duplex mode
Note 1: The UE is only required to be tested in one of the supported test configurations	

Configure the test equipment and the DUT according to the parameters in Table 6.6.1.4.4.1-2.



**Table 6.6.1.4.4.1-2: Initial conditions for NR SA FR1 event-triggered reporting with gap in DRX**

Parameter	Value		Comment
Test environment	NC		As specified in TS 38.508-1 [14] clause 4.1.
Test frequencies	As specified in Annex E, table E.4-1 and TS 38.508-1 [14] clause 4.3.1 and 4.4.2.		
Channel bandwidth	As specified by the test configuration selected from Table 6.6.1.4.4.1-1.		
Propagation conditions	AWGN		As specified in Annex C.2.2.
Connection Diagram	TE Part	A.3.1.8.2	As specified in TS 38.508-1 [14] Annex A.
	DUT Part	A.3.2.3.4	
Exceptions to connection diagram	- Without LTE link - For 4Rx capable UEs without any 2Rx RF bands use A.3.2.5.2 for DUT part and A.3.1.8.4 for TE part.		

1. The general test parameter settings are set up according to Table 6.6.1.4.4.1-3.
2. Message contents are defined in clause 6.6.1.4.4.3.
3. There is one NR carrier and two cells specified in the test. Cell 1 is the cell used for connection setup with the power level set according to Annex C.1.1 and C.1.2 for this test.

**Table 6.6.1.4.4.1-3: General test parameters for NR SA FR1 event-triggered reporting with gap in DRX**

Parameter	Unit	Test configuration	Value		Comment
			Test 1	Test 2	
Active cell		1, 2, 3	Cell 1		
Neighbour cell		1, 2, 3	Cell 2		Cell to be identified.
RF Channel Number		1, 2, 3	1: Cell 1 and Cell 2		
Measurement gap type		1, 2, 3	Per-UE gaps		
Measurement gap repetition periodicity	ms	1, 2, 3	40		
Measurement gap length	ms	1, 2, 3	6		
Measurement gap offset	ms	1, 2, 3	39		
SSB configuration		1	SSB.1 FR1		
		2	SSB.1 FR1		
		3	SSB.2 FR1		
SMTC configuration		1	SMTC.2		
		2	SMTC.1		
		3	SMTC.1		
CSI-RS parameters		1	CSI-RS.1.2 FDD resource #0		
		2	CSI-RS.1.2 TDD resource #0		
		3	CSI-RS.2.2 TDD resource #0		
A3-Offset	dB	1, 2, 3	-4.5		
CP length		1, 2, 3	Normal		
Hysteresis	dB	1, 2, 3	0		
Time To Trigger	s	1, 2, 3	0		
Filter coefficient		1, 2, 3	0		L3 filtering is not used
DRX	ms	1, 2, 3	DRX.1	DRX.7	
Time offset between serving and neighbour cells		1	3 ms		Asynchronous cells. The timing of Cell 2 is 3ms later than the timing of Cell 1.
		2	3 $\mu$ s		Synchronous cells
		3	3 $\mu$ s		Synchronous cells
T1	s	1, 2, 3	5		
T2	s	1, 2, 3	5	10	

#### 6.6.1.4.4.2 Test procedure

Two cells are deployed in the test, which are FR1 PCell (Cell 1) and a FR1 neighbour cell (Cell 2) on the same frequency as the PCell. The general and cell specific test parameters for PCell and neighbour cell are given in Table 6.6.1.4.4.1-3 and Table 6.6.1.4.4.2-1, respectively. In the measurement control information a measurement object is configured for the frequency of the PCell, and it is indicated to the UE that event-triggered reporting with Event A3 is used. The test consists of two successive time periods, with time duration of T1, and T2 respectively. During time duration T1, the UE shall not have any timing information of Cell 2.

There are two BWPs configured in Cell 1, BWP1 which contains the cell defining SSB, and BWP2 which does not contain any SSB of Cell 1. During the whole test, BWP2 is always scheduled as the active BWP for the UE.

In Test 1 when DRX cycle = 40 ms is used, UE needs to be provided at least once every 500 ms with new Timing Advance Command MAC control element to restart the Timer Alignment Timer to keep the UE uplink time alignment. Furthermore, the UE is allocated with PUSCH resource at every DRX cycle. In Test 2 when DRX = 640 ms is used, the uplink time alignment is not maintained and the UE needs to use RACH to obtain uplink allocation for measurement reporting.

1. Ensure the UE is in state RRC\_CONNECTED with generic procedure parameters Connectivity NR, Connected without release On and Test Mode On according to TS 38.508-1 [14] clause 4.5.
2. Set the parameters according to T1 in Table 6.6.1.4.5-1.
3. SS shall transmit an *RRCReconfiguration* message.
4. The UE shall transmit *RRCReconfigurationComplete* message. T1 starts.
5. When T1 expires, the SS shall switch the power setting from T1 to T2 as specified in Table 6.6.1.4.5-1.
6. UE shall transmit a *MeasurementReport* message triggered by Event A3. If the overall delays measured from the beginning of time period T2 is less than 922 ms for Test 1 or less than 6402 ms for Test 2 then the number of successful tests is increased by one. If the UE fails to report the event within the overall delays measured requirement then the number of failure tests is increased by one.
7. After the SS receive the *MeasurementReport* message in step 6) or when T2 expires, the SS shall:
  - transmit *RRCRelease* message to release the RRC connection which includes the release of the established radio bearers as well as all radio resources

OR

  - switch the UE off.
8. Set Cell 2 physical cell identity = ((current cell 2 physical cell identity + 1) mod 14 + 2) for next iteration of the test procedure loop.
9. Depending on the choice in Step 7, the SS:
  - if the RRC Connection Release has been sent, transmits in Cell 1 a Paging message (including PagingRecord with UE-Identity) for the UE and ensures the UE is in state RRC\_CONNECTED with generic procedure parameters Connectivity NR, Connected without release On according to TS 38.508-1 [14] clause 4.5 (if the paging fails, switches off and on the UE and ensures the UE is in state RRC\_CONNECTED with generic procedure parameters Connectivity NR, Connected without release On according to TS 38.508-1 [14] clause 4.5),
  - OR
  - if the device has been switched off, switches on the UE and ensures the UE is in state RRC\_CONNECTED with generic procedure parameters Connectivity NR, Connected without release On according to TS 38.508-1 [14] clause 4.5.
10. Repeat step 2-9 until the confidence level according to Tables G.2.3-1 in Annex G clause G.2 is achieved.
11. Repeat step 1-10 for each sub-test in Table 6.6.1.4.4.1-3 as appropriate.

#### 6.6.1.4.4.3 Message contents

Message contents are according to TS 38.508-1 [14] clause 4.6 with the following exceptions:

**Table 6.6.1.4.4.3-1: Common Exception messages for NR SA FR1 event-triggered reporting with gap in DRX**

Default Message Contents	
Common contents of system information blocks exceptions	
Default RRC messages and information elements contents exceptions	Table H.3.1-1 Table H.3.1-2 with Condition INTRA-FREQ and GAP NEEDED Table H.3.1-3 with Condition INTRA-FREQ MO, SSB.1 FR1, SMTC.2 for configuration 6.6.1.4-1 Table H.3.1-3 with Condition INTRA-FREQ MO, SSB.1 FR1, SMTC.1 and synchronous cells for configuration 6.6.1.4-2 Table H.3.1-3 with Condition INTRA-FREQ MO, SSB.2 FR1, SMTC.1 and synchronous cells for configuration 6.6.1.4-3 Table H.3.1-4 with A3-offset = -4.5dB Table H.3.1-5 with Condition INTRA-FREQ Table H.3.1-6 with Condition Pattern #0 Table H.3.1-7 with Condition INTRA-FREQ Table H.3.7-1 with Condition DRX.1 and Gap for test 1 Table H.3.7-1 with Condition DRX.7 and Gap for test 2 Table H.3.1-8 with Condition CSI-RS RLM

**Table 6.6.1.4.4.3-2: *ServingCellConfig***

Derivation Path: TS 38.508-1 [14], Table 4.6.3-167			
Information Element	Value/remark	Comment	Condition
ServingCellConfig ::= SEQUENCE {			
downlinkBWP-ToAddModList SEQUENCE (SIZE (1..maxNrofBWPs)) OF SEQUENCE {			
BWP-Downlink[1]	BWP-Downlink with condition BWP-Id1	DLBWP.1.2 configuration	
}			
firstActiveDownlinkBWP-Id	1	Active DL BWP-ID (BWP2)	BWP-Id1
defaultDownlinkBWP-Id	0	Initial BWP (BWP1)	
uplinkConfig SEQUENCE {			
uplinkBWP-ToAddModList SEQUENCE (SIZE (1..maxNrofBWPs)) OF SEQUENCE {			
BWP-Uplink[1]	BWP-Uplink with condition BWP-Id1	ULBWP.1.2 configuration	
}			
firstActiveUplinkBWP-Id	1	Active UL BWP-ID (BWP2)	BWP-Id1
}			
}			

Condition	Explanation
BWP-Id1	Active BWP (BWP2)

6.6.1.4.5 Test requirement

Table 6.6.1.4.4.1-3 and Table 6.6.1.4.5-1 define the primary level settings including test tolerances for NR SA FR1 event-triggered reporting with gap in DRX test.

**Table 6.6.1.4.5-1: NR Cell specific test parameters for NR SA FR1 event-triggered reporting with gap in DRX**

Parameter	Unit	Test configuration	Cell 1		Cell 2	
			T1	T2	T1	T2
TDD configuration		1	N/A		N/A	
		2	TDDConf.1.1		TDDConf.1.1	
		3	TDDConf.2.1		TDDConf.2.1	
PDSCH RMC configuration		1	SR.1.1 FDD		N/A	
		2	SR.1.1 TDD			
		3	SR.2.1 TDD			
RMSI CORESET RMC configuration		1	CR.1.1 FDD		CR.1.1 FDD	
		2	CR.1.1 TDD		CR.1.1 TDD	
		3	CR.2.1 TDD		CR.2.1 TDD	
Dedicated CORESET RMC configuration		1	CCR.1.2 FDD		CCR.1.1 FDD	
		2	CCR.1.2 TDD		CCR.1.1 TDD	
		3	CCR.2.1 TDD		CCR.2.1 TDD	
OCNG Patterns		1, 2, 3	OP.1		OP.1	
TRS configuration		1	TRS.1.1 FDD		N/A	
		2	TRS.1.1 TDD		N/A	
		3	TRS.1.2 TDD		N/A	
Initial BWP configuration		1, 2, 3	DLBWP.0.1 ULBWP.0.1		DLBWP.0.1 ULBWP.0.1	
Active DL BWP configuration		1, 2, 3	DLBWP.1.2		DLBWP.1.1	
Active UL BWP configuration		1, 2, 3	ULBWP.1.2		ULBWP.1.1	
RLM-RS		1, 2, 3	CSI-RS		SSB	
$N_{oc}$ <sup>Note 2</sup>	dBm/SCS	1	-98			
		2	-98			
		3	-95			
$N_{oc}$ <sup>Note 2</sup>	dBm/15 KHz	1	-98			
		2				
		3				
$\hat{E}_s/I_{ot}$	dB	1	4	-1.46	-Infinity	-1.46
		2				
		3				
$\hat{E}_s/N_{oc}$	dB	1	4	4	-Infinity	4
		2				
		3				
SS-RSRP <sup>Note 3</sup>	dBm/SCS KHz	1	-94	-94	-Infinity	-94
		2	-94	-94	-Infinity	-94
		3	-91	-91	-Infinity	-91
I <sub>o</sub>	dBm/9.36 MHz	1	-64.60	-62.25	Specified in Cell 1 columns	
	dBm/9.36 MHz	2	-64.60	-62.25		
	dBm/38.16 MHz	3	-58.50	-56.16		
Propagation Condition		1, 2, 3	AWGN			
<p>Note 1: The resources for uplink transmission are assigned to the UE prior to the start of time period T2.</p> <p>Note 2: Interference from other cells and noise sources not specified in the test is assumed to be constant over subcarriers and time and shall be modelled as AWGN of appropriate power for <math>N_{oc}</math> to be fulfilled.</p> <p>Note 3: SS-RSRP levels have been derived from other parameters for information purposes. They are not settable parameters themselves.</p>						

In Test 1 when DRX cycle length = 40 ms is used, the overall delay measured is defined as the time from the beginning of time period T2, to the moment the UE send one Event A3 triggered measurement report on PUSCH.

In Test 2 when DRX cycle length = 640 ms is used, the overall delay measured is defined as the time from the beginning of time period T2, to the moment the UE starts to send preambles on the PRACH for Scheduling Request (SR) to obtain allocation to send the measurement report on PUSCH.

For both tests:

The overall delays measured in the test may be up to  $2 \times T_{TTI_{DCCH}}$  higher than the measurement reporting delays because of TTI insertion uncertainty of the measurement report in DCCH.

NOTE 1: The actual overall delays measured in the test may be up to one DRX cycle higher than the measurement reporting delays above because UE is allowed to delay the initiation of the measurement reporting procedure to the next until the Active Time.

NOTE 2: In order to calculate the rate of correct events the system simulator shall verify that it has received correct Event A3 measurement report.

The overall delays measured test requirement is expressed as:

Overall delays measured = measurement reporting delay + TTI insertion uncertainty

Measurement reporting delay =  $T_{\text{identify\_intra\_without\_index}}$

$T_{\text{identify\_intra\_without\_index}} = T_{\text{PSS/SSS\_sync\_intra}} + T_{\text{SSB\_measurement\_period\_intra}}$

$T_{\text{PSS/SSS\_sync\_intra}} = 600$  ms for Test 1, and  $T_{\text{PSS/SSS\_sync\_intra}} = 3200$  ms for Test 2

$T_{\text{SSB\_measurement\_period\_intra}} = 320$  ms for Test 1, and  $T_{\text{SSB\_measurement\_period\_intra}} = 3200$  ms for Test 2

TTI insertion uncertainty = 2 ms

For Test 1, the overall delays measured shall be less than a total of 922 ms (note: this gives a total of 920 ms for measurement reporting delay plus 2 ms for TTI insertion uncertainty).

For Test 2, the overall delays measured shall be less than a total of 6402 ms (note: this gives a total of 6400 ms for measurement reporting delay plus 2 ms for TTI insertion uncertainty).

For the test to pass, the total number of successful tests shall be more than 90% of the cases with a confidence level of 95%.

### 6.6.1.5 NR SA FR1 event-triggered reporting without gap in non-DRX with SSB index reading

#### 6.6.1.5.1 Test purpose

The purpose of this test is to verify UE's ability to make a correct reporting of an event within intra-frequency cell search without gaps requirements.

#### 6.6.1.5.2 Test applicability

This test applies to all types of NR UE release 15 onwards.

#### 6.6.1.5.3 Minimum conformance requirements

The minimum conformance requirements are specified in clause 6.6.1.0.3.

The normative reference for this requirement is TS 38.133 [6] clause A.6.6.1.5.

#### 6.6.1.5.4 Test description

##### 6.6.1.5.4.1 Initial conditions

This test shall be tested using any of the test configurations in Table 6.6.1.5.4.1-1.

**Table 6.6.1.5.4.1-1: Supported test configurations for NR SA FR1 event-triggered reporting without gap in non-DRX with SSB index reading**

Configuration	Description
6.6.1.5-1	15 kHz SSB SCS, 10MHz bandwidth, FDD duplex mode
Note:	The UE is only required to be tested in one of the supported test configurations.

Configure the test equipment and the DUT according to the parameters in Table 6.6.1.5.4.1-2.

**Table 6.6.1.5.4.1-2: Initial conditions for NR SA FR1 event-triggered reporting without gap in non-DRX with SSB index reading**

Parameter	Value		Comment
Test environment	NC		As specified in TS 38.508-1 [14] clause 4.1.
Test frequencies	As specified in Annex E, table E.4-1 and TS 38.508-1 [14] clause 4.3.1 and 4.4.2.		
Channel bandwidth	As specified by the test configuration selected from Table 6.6.1.5.4.1-1.		
Propagation conditions	AWGN		As specified in Annex C.2.2.
Connection Diagram	TE Part	A.3.1.8.2	As specified in TS 38.508-1 [14] Annex A.
	DUT Part	A.3.2.3.4	
Exceptions to connection diagram	- Without LTE link - For 4Rx capable UEs without any 2Rx RF bands use A.3.2.5.2 for DUT part and A.3.1.8.4 for TE part.		

1. The general test parameter settings are set up according to Table 6.6.1.5.4.1-3.
2. Message contents are defined in clause 6.6.1.5.4.3.
3. There is one NR carrier and two cells specified in the test. Cell 1 is the cell used for connection setup with the power level set according to Annex C.1.1 and C.1.2 for this test.

**Table 6.6.1.5.4.1-3: General test parameters for NR SA FR1 event-triggered reporting without gap in non-DRX with SSB index reading**

Parameter	Unit	Test configuration	Value	Comment
Active cell		1	Cell 1	
Neighbour cell		1	Cell 2	Cell to be identified.
RF Channel Number		1	1: Cell 1 and Cell 2	
SSB configuration		1	SSB.1 FR1	
SMTC configuration		1	SMTC.2	
A3-Offset	dB	1	-4.5	
CP length		1	Normal	
Hysteresis	dB	1	0	
Time To Trigger	s	1	0	
Filter coefficient		1	0	L3 filtering is not used
DRX	ms	1		OFF
Time offset between serving and neighbour cells		1	3 ms	Asynchronous cells. The timing of Cell 2 is 3ms later than the timing of Cell 1.
T1	s	1	5	
T2	s	1	5	

#### 6.6.1.5.4.2 Test procedure

Two cells are deployed in the test, which are FR1 PCell (Cell 1) and a FR1 neighbour cell (Cell 2) on the same frequency as the PCell. The general and cell specific test parameters for PCell and neighbour cell are given in Table 6.6.1.5.4.1-3 and Table 6.6.1.5.5-1, respectively. In the measurement control information a measurement object is configured for the frequency of the PCell, and it is indicated to the UE that event-triggered reporting with Event A3 is used. The test consists of two successive time periods, with time duration of T1, and T2 respectively. During time duration T1, the UE shall not have any timing information of Cell 2.

1. Ensure the UE is in state RRC\_CONNECTED with generic procedure parameters Connectivity NR, Connected without release On and Test Mode On according to TS 38.508-1 [14] clause 4.5.
2. Set the parameters according to T1 in Table 6.6.1.5.5-1.
3. SS shall transmit an *RRCReconfiguration* message.
4. The UE shall transmit *RRCReconfigurationComplete* message. T1 starts.

5. When T1 expires, the SS shall switch the power setting from T1 to T2 as specified in Table 6.6.1.5.5-1.
6. UE shall transmit a *MeasurementReport* message triggered by Event A3. If the overall delays measured from the beginning of time period T2 is less than 922 ms then the number of successful tests is increased by one. If the UE fails to report the event within the overall delays measured requirement then the number of failure tests is increased by one.
7. After the SS receive the *MeasurementReport* message in step 6) or when T2 expires, the SS shall:
  - transmit RRCRelease message to release the RRC connection which includes the release of the established radio bearers as well as all radio resources

OR

  - switch the UE off.
8. Set Cell 2 physical cell identity = ((current cell 2 physical cell identity + 1) mod 14 + 2) for next iteration of the test procedure loop.
9. Depending on the choice in Step 7, the SS:
  - if the RRC Connection Release has been sent, transmits in Cell 1 a Paging message (including PagingRecord with UE-Identity) for the UE and ensures the UE is in state RRC\_CONNECTED with generic procedure parameters Connectivity NR, Connected without release On according to TS 38.508-1 [14] clause 4.5 (if the paging fails, switches off and on the UE and ensures the UE is in state RRC\_CONNECTED with generic procedure parameters Connectivity NR, Connected without release On according to TS 38.508-1 [14] clause 4.5),

OR

  - if the device has been switched off, switches on the UE and ensures the UE is in state RRC\_CONNECTED with generic procedure parameters Connectivity NR, Connected without release On according to TS 38.508-1 [14] clause 4.5.
10. Repeat step 2-9 until the confidence level according to Tables G.2.3-1 in Annex G clause G.2 is achieved.

6.6.1.5.4.3 Message contents

Message contents are according to TS 38.508-1 clause 4.6 with the following exceptions:

**Table 6.6.1.5.4.3-1: Common Exception messages for NR SA FR1 event-triggered reporting without gap in non-DRX with SSB index reading**

Default Message Contents	
Common contents of system information blocks exceptions	
Default RRC messages and information elements contents exceptions	Table H.3.1-1 Table H.3.1-2 with Condition INTRA-FREQ Table H.3.1-3 with Condition INTRA-FREQ MO, SSB.1 FR1, SMTC.2 for Configuration 6.6.1.5-1 Table H.3.1-4 with SSB Index and A3-offset = -4.5 dB Table H.3.1-5 with Condition INTRA-FREQ Table H.3.1-7 with Condition INTRA-FREQ and SSB Index Table H.3.1-8 with Condition SSB RLM

6.6.1.5.5 Test requirement

Table 6.6.1.5.4.1-3 and Table 6.6.1.5.5-1 define the primary level settings including test tolerances for SA event triggered reporting without gap under non-DRX with SSB index reading test.

**Table 6.6.1.5.5-1: NR Cell specific test parameters for NR SA FR1 event-triggered reporting without gap in non-DRX with SSB index reading**

Parameter	Unit	Test configuration	Cell 1		Cell 2	
			T1	T2	T1	T2
TDD configuration		1	N/A		N/A	
PDSCH RMC configuration		1	SR.1.1 FDD		N/A	
RMSI CORESET RMC configuration		1	CR.1.1 FDD		CR.1.1 FDD	
Dedicated CORESET RMC configuration		1	CCR.1.1 FDD		CCR.1.1 FDD	
OCNG Patterns		1	OP.1		OP.1	
TRS configuration		1	TRS.1.1 FDD		N/A	
Initial BWP configuration		1	DLBWP.0.1 ULBWP.0.1		DLBWP.0.1 ULBWP.0.1	
Active DL BWP configuration		1	DLBWP.1.1		DLBWP.1.1	
Active UL BWP configuration		1	ULBWP.1.1		ULBWP.1.1	
RLM-RS		1	SSB		SSB	
$N_{oc}$ <sup>Note 2</sup>	dBm/SCS	1	-98			
$N_{oc}$ <sup>Note 2</sup>	dBm/15 KHz	1	-98			
$\hat{E}_s / I_{ot}$	dB	1	4	-1.46	-Infinity	-1.46
$\hat{E}_s / N_{oc}$	dB	1	4	4	-Infinity	4
SS-RSRP <sup>Note 3</sup>	dBm/SCS KHz	1	-94	-94	-Infinity	-94
Io	dBm/9.36 MHz	1	-64.60	-62.25	Specified in Cell 1 columns	
Propagation Condition		1	AWGN			
<p>Note 1: The resources for uplink transmission are assigned to the UE prior to the start of time period T2.</p> <p>Note 2: Interference from other cells and noise sources not specified in the test is assumed to be constant over subcarriers and time and shall be modelled as AWGN of appropriate power for <math>N_{oc}</math> to be fulfilled.</p> <p>Note 3: SS-RSRP levels have been derived from other parameters for information purposes. They are not settable parameters themselves.</p>						

The overall delays measured is defined as the time from the beginning of time period T2, to the moment the UE send one Event A3 triggered measurement report.

The overall delays measured in the test may be up to  $2xTTI_{DCCH}$  higher than the measurement reporting delays because of TTI insertion uncertainty of the measurement report in DCCH.

The overall delays measured test requirement is expressed as:

Overall delays measured = measurement reporting delay + TTI insertion uncertainty

Measurement reporting delay =  $T_{\text{identify\_intra\_with\_index}}$

$T_{\text{identify\_intra\_with\_index}} = T_{\text{PSS/SSS\_sync\_intra}} + T_{\text{SSB\_measurement\_period\_intra}} + T_{\text{SSB\_time\_index\_intra}}$

$T_{\text{PSS/SSS\_sync\_intra}} = 600 \text{ ms}$

$T_{\text{SSB\_time\_index\_intra}} = 120 \text{ ms}$

$T_{\text{SSB\_measurement\_period\_intra}} = 200 \text{ ms}$

TTI insertion uncertainty = 2 ms



The overall delays measured shall be less than a total of 922 ms in this test case (note: this gives a total of 920 ms for measurement reporting delay plus 2 ms for TTI insertion uncertainty).

For the test to pass, the total number of successful tests shall be more than 90% of the cases with a confidence level of 95%.

### 6.6.1.6 NR SA FR1 event-triggered reporting with gap in non-DRX with SSB index reading

#### 6.6.1.6.1 Test purpose

The purpose of this test is to verify UE's ability to make a correct reporting of an event within intra-frequency cell search with gaps requirements.

#### 6.6.1.6.2 Test applicability

This test applies to all types of NR UE release 15 onwards supporting 5GS NR SA FR1, CSI-RS-based RLM and BWP operation without bandwidth restriction.

#### 6.6.1.6.3 Minimum conformance requirements

The minimum conformance requirements are specified in clause 6.6.1.0.4.

The normative reference for this requirement is TS 38.133 [6] clause A.6.6.1.6.

#### 6.6.1.6.4 Test description

##### 6.6.1.6.4.1 Initial conditions

This test shall be tested using any of the test configurations in Table 6.6.1.6.4.1-1.

**Table 6.6.1.6.4.1-1: Supported test configurations for NR SA FR1 event-triggered reporting with gap in non-DRX with SSB index reading**

Configuration	Description
6.6.1.6-1	15 kHz SSB SCS, 10MHz bandwidth, FDD duplex mode
Note: The UE is only required to be tested in one of the supported test configurations.	

Configure the test equipment and the DUT according to the parameters in Table 6.6.1.3.4.1-2.

**Table 6.6.1.6.4.1-2: Initial conditions for NR SA FR1 event-triggered reporting with gap in non-DRX with SSB index reading**

Parameter	Value	Comment
Test environment	NC	As specified in TS 38.508-1 [14] clause 4.1.
Test frequencies	As specified in Annex E, table E.4-1 and TS 38.508-1 [14] clause 4.3.1 and 4.4.2.	
Channel bandwidth	As specified by the test configuration selected from Table 6.6.1.6.4.1-1.	
Propagation conditions	AWGN	As specified in Annex C.2.2.
Connection Diagram	TE Part	A.3.1.8.2
	DUT Part	A.3.2.3.4
Exceptions to connection diagram	- Without LTE link - For 4Rx capable UEs without any 2Rx RF bands use A.3.2.5.2 for DUT part and A.3.1.8.4 for TE part.	

1. The general test parameter settings are set up according to Table 6.6.1.6.4.1-3.
2. Message contents are defined in clause 6.6.1.6.4.3.
3. There is one NR carrier and two cells specified in the test. Cell 1 is the cell used for connection setup with the power level set according to Annex C.1.1 and C.1.2 for this test.

**Table 6.6.1.6.4.1-3: General test parameters for NR SA FR1 event-triggered reporting with gap in non-DRX with SSB index reading**

Parameter	Unit	Test configuration	Value	Comment
Active cell		1	Cell 1	
Neighbour cell		1	Cell 2	Cell to be identified.
RF Channel Number		1	1: Cell 1 and Cell 2	
Measurement gap type		1	Per-UE gaps	
Measurement gap repetition periodicity	ms	1	40	
Measurement gap length	ms	1	6	
Measurement gap offset	ms	1	39	
SSB configuration		1	SSB.1 FR1	
SMTC configuration		1	SMTC.2	
CSI-RS parameters		1	CSI-RS.1.2 FDD resource #0	
A3-Offset	dB	1	-4.5	
CP length		1	Normal	
Hysteresis	dB	1	0	
Time To Trigger	s	1	0	
Filter coefficient		1	0	L3 filtering is not used
DRX	ms	1		OFF
Time offset between serving and neighbour cells		1	3 ms	Asynchronous cells. The timing of Cell 2 is 3ms later than the timing of Cell 1.
T1	s	1	5	
T2	s	1	5	

#### 6.6.1.6.4.2 Test procedure

Two cells are deployed in the test, which are FR1 PCell (Cell 1) and a FR1 neighbour cell (Cell 2) on the same frequency as the PCell. The general and cell specific test parameters for PCell and neighbour cell are given in Table 6.6.1.6.4.1-3 and Table 6.6.1.6.5-1, respectively. In the measurement control information a measurement object is configured for the frequency of the PCell, and it is indicated to the UE that event-triggered reporting with Event A3 is used. The test consists of two successive time periods, with time duration of T1, and T2 respectively. During time duration T1, the UE shall not have any timing information of Cell 2.

There are two BWPs configured in Cell 1, BWP1 which contains the cell defining SSB, and BWP2 which does not contain any SSB of Cell 1. During the whole test, BWP2 is always scheduled as the active BWP for the UE.

1. Ensure the UE is in state RRC\_CONNECTED with generic procedure parameters Connectivity *NR*, Connected without release *On* and Test Mode *On* according to TS 38.508-1 [14] clause 4.5.
2. Set the parameters according to T1 in Table 6.6.1.6.5-1.
3. SS shall transmit an RRCReconfiguration message.
4. The UE shall transmit RRCReconfigurationComplete message. T1 starts.
5. When T1 expires, the SS shall switch the power setting from T1 to T2 as specified in Table 6.6.1.3.5-1.
6. UE shall transmit a MeasurementReport message triggered by Event A3. If the overall delays measured from the beginning of time period T2 is less than 922 ms then the number of successful tests is increased by one. If the UE fails to report the event within the overall delays measured requirement then the number of failure tests is increased by one.
7. After the SS receive the MeasurementReport message in step 6) or when T2 expires, the SS shall:
  - transmit RRCRelease message to release the RRC connection which includes the release of the established radio bearers as well as all radio resources

OR

- switch the UE off.

8. Set Cell 2 physical cell identity = ((current cell 2 physical cell identity + 1) mod 14 + 2) for next iteration of the test procedure loop.

9. Depending on the choice in Step 7, the SS:

- if the RRC Connection Release has been sent, transmits in Cell 1 a Paging message (including PagingRecord with UE-Identity) for the UE and ensures the UE is in state RRC\_CONNECTED with generic procedure parameters Connectivity NR, Connected without release On according to TS 38.508-1 [14] clause 4.5 (if the paging fails, switches off and on the UE and ensures the UE is in state RRC\_CONNECTED with generic procedure parameters Connectivity NR, Connected without release On according to TS 38.508-1 [14] clause 4.5),

OR

- if the device has been switched off, switches on the UE and ensures the UE is in state RRC\_CONNECTED with generic procedure parameters Connectivity NR, Connected without release On according to TS 38.508-1 [14] clause 4.5.

10. Repeat step 2-9 until the confidence level according to Tables G.2.3-1 in Annex G clause G.2 is achieved.

6.6.1.6.4.3 Message contents

Message contents are according to TS 38.508-1 clause 4.6 with the following exceptions:

**Table 6.6.1.6.4.3-1: Common Exception messages for NR SA FR1 event-triggered reporting with gap in non-DRX with SSB index reading**

Default Message Contents	
Common contents of system information blocks exceptions	
Default RRC messages and information elements contents exceptions	Table H.3.1-1 Table H.3.1-2 with Condition INTRA-FREQ and GAP NEEDED Table H.3.1-3 with Condition INTRA-FREQ MO, SSB.1 FR1, SMTC.2 for Configuration 6.6.1.6-1 Table H.3.1-4 with SSB index and A3-offset = -4.5dB. Table H.3.1-5 with Condition INTRA-FREQ Table H.3.1-6 with Condition Pattern #0 Table H.3.1-7 with Condition INTRA-FREQ and SSB index  Table H.3.1-8 with Condition CSI-RS RLM

**Table 6.6.1.6.4.3-2: ServingCellConfig**

Derivation Path: TS 38.508-1 [14], Table 4.6.3-167			
Information Element	Value/remark	Comment	Condition
ServingCellConfig ::= SEQUENCE {			
downlinkBWP-ToAddModList SEQUENCE (SIZE (1..maxNrofBWPs)) OF SEQUENCE {			
BWP-Downlink[1]	BWP-Downlink with condition BWP-Id1	DLBWP.1.2 configuration	
}			
firstActiveDownlinkBWP-Id	1	Active DL BWP-ID (BWP2)	BWP-Id1
defaultDownlinkBWP-Id	0	Initial BWP (BWP1)	
uplinkConfig SEQUENCE {			
uplinkBWP-ToAddModList SEQUENCE (SIZE (1..maxNrofBWPs)) OF SEQUENCE {			
BWP-Uplink[1]	BWP-Uplink with condition BWP-Id1	ULBWP.1.2 configuration	
}			
firstActiveUplinkBWP-Id	1	Active UL BWP-ID (BWP2)	BWP-Id1
}			
}			

Condition	Explanation
BWP-Id1	Active BWP (BWP2)

### 6.6.1.6.5 Test requirement

Table 6.6.1.6.4.1-3 and Table 6.6.1.6.5-1 define the primary level settings including test tolerances for SA event triggered reporting tests with per-UE gaps under non-DRX with SSB index reading test.

**Table 6.6.1.6.5-1: NR Cell specific test parameters for NR SA FR1 event-triggered reporting with gap in non-DRX with SSB index reading**

Parameter	Unit	Test configuration	Cell 1		Cell 2	
			T1	T2	T1	T2
TDD configuration		1	N/A		N/A	
PDSCH RMC configuration		1	SR.1.1 FDD		N/A	
RMSI CORESET RMC configuration		1	CR.1.1 FDD		CR.1.1 FDD	
Dedicated CORESET RMC configuration		1	CCR.1.2 FDD		CCR.1.1 FDD	
OCNG Patterns		1	OP.1		OP.1	
TRS configuration		1	TRS.1.1 FDD		N/A	
Initial BWP configuration		1	DLBWP.0.1 ULBWP.0.1		DLBWP.0.1 ULBWP.0.1	
Active DL BWP configuration		1	DLBWP.1.2		DLBWP.1.1	
Active UL BWP configuration		1	ULBWP.1.2		ULBWP.1.1	
RLM-RS		1	CSI-RS		SSB	
$N_{oc}$ <sup>Note 2</sup>	dBm/SCS	1	-98			
$N_{oc}$ <sup>Note 2</sup>	dBm/15 KHz	1	-98			
$\hat{E}_s/I_{ot}$	dB	1	4	-1.46	-Infinity	-1.46
$\hat{E}_s/N_{oc}$	dB	1	4	4	-Infinity	4
SS-RSRP <sup>Note 3</sup>	dBm/SCS KHz	1	-94	-94	-Infinity	-94
Io	dBm/9.36 MHz	1	-64.60	-62.25	Specified in Cell 1 columns	
Propagation Condition		1	AWGN			
<p>Note 1: The resources for uplink transmission are assigned to the UE prior to the start of time period T2.</p> <p>Note 2: Interference from other cells and noise sources not specified in the test is assumed to be constant over subcarriers and time and shall be modelled as AWGN of appropriate power for <math>N_{oc}</math> to be fulfilled.</p> <p>Note 3: SS-RSRP levels have been derived from other parameters for information purposes. They are not settable parameters themselves.</p>						

The overall delays measured is defined as the time from the beginning of time period T2, to the moment the UE send one Event A3 triggered measurement report.

The overall delays measured in the test may be up to  $2xTTIDCCH$  higher than the measurement reporting delays because of TTI insertion uncertainty of the measurement report in DCCH.

The overall delays measured test requirement is expressed as:

Overall delays measured = measurement reporting delay + TTI insertion uncertainty

Measurement reporting delay =  $T_{\text{identify\_intra\_with\_index}}$

$T_{\text{identify\_intra\_with\_index}} = T_{\text{PSS/SSS\_sync\_intra}} + T_{\text{SSB\_measurement\_period\_intra}} + T_{\text{SSB\_time\_index\_intra}}$

$T_{\text{PSS/SSS\_sync\_intra}} = 600 \text{ ms}$

$T_{\text{SSB\_time\_index\_intra}} = 120 \text{ ms}$

$T_{\text{SSB\_measurement\_period\_intra}} = 200 \text{ ms}$

TTI insertion uncertainty = 2 ms

The overall delays measured shall be less than a total of 922 ms in this test case (note: this gives a total of 920 ms for measurement reporting delay plus 2 ms for TTI insertion uncertainty).

For the test to pass, the total number of successful tests shall be more than 90% of the cases with a confidence level of 95%.

### 6.6.1.7 NR SA FR1 event-triggered reporting without gap in DRX for UE configured with highSpeedMeasFlag-r16

#### 6.6.1.7.1 Test purpose

To verify the UE's ability to make a correct reporting of an event within intra-frequency cell search without gap under DRX for UE configured with highSpeedMeasFlag-r16.

#### 6.6.1.7.2 Test applicability

This test applies to all types of NR UE release 16 onwards that supports measurement enhancements in high speed scenario.

#### 6.6.1.7.3 Minimum conformance requirements

The minimum conformance requirements are specified in clause 6.6.1.0.5.

The normative reference for this requirement is TS 38.133 [6] clause A.6.6.1.7.

#### 6.6.1.7.4 Test description

##### 6.6.1.7.4.1 Initial conditions

This test shall be tested using any of the test configurations in Table 6.6.1.7.4.1-1.

**Table 6.6.1.7.4.1-1: Supported test configurations for NR SA FR1 event-triggered reporting without gap in DRX for UE configured with highSpeedMeasFlag-r16**

Configuration	Description
6.6.1.7-1	15 kHz SSB SCS, 10 MHz bandwidth, FDD duplex mode
6.6.1.7-2	15 kHz SSB SCS, 10 MHz bandwidth, TDD duplex mode
6.6.1.7-3	30 kHz SSB SCS, 40 MHz bandwidth, TDD duplex mode
Note:	The UE is only required to be tested in one of the supported test configurations.

Configure the test equipment and the DUT according to the parameters in Table 6.6.1.7.4.1-2.

**Table 6.6.1.7.4.1-2: Initial conditions for NR SA FR1 event-triggered reporting without gap in DRX for UE configured with highSpeedMeasFlag-r16**

Parameter	Value		Comment
Test environment	NC		As specified in TS 38.508-1 [14] clause 4.1.
Test frequencies	As specified in Annex E, table E.4-1 and TS 38.508-1 [14] clause 4.3.1.		
Channel bandwidth	As specified by the test configuration selected from Table 6.6.1.2.4.1-1.		
Propagation conditions	AWGN		As specified in Annex C.2.2.
Connection Diagram	TE Part	A.3.1.8.2	As specified in TS 38.508-1 [14] Annex A.
	DUT Part	A.3.2.3.4	
Exceptions to connection diagram	- Without LTE link - For 4Rx capable UEs without any 2Rx RF bands use A.3.2.5.2 for DUT part and A.3.1.8.4 for TE part.		

1. The test parameters for PCell and neighbour cell are given in Table 6.6.1.7.4.1-3 below.
2. Message contents are defined in clause 6.6.1.7.4.3.
3. There is one carrier and two cells specified in the test. NR Cell 1 is the cell used for connection setup with the power level set according to Annex C.1.1 and C.1.2 for this test.

**Table 6.6.1.7.4.1-3: General test parameters for SA intra-frequency event triggered reporting tests without gap for FR1 under DRX for UE configured with highSpeedMeasFlag-r16**

Parameter	Unit	Test configuration	Value	Comment
<i>highSpeedMeasFlag-r16</i>		1,2,3	Present	To enable high speed measurement enhancements
Active cell		1, 2, 3	Cell 1	
Neighbour cell		1, 2, 3	Cell 2	Cell to be identified.
RF Channel Number		1, 2, 3	1: Cell 1 and Cell 2	
SSB configuration		1	SSB.1 FR1	
		2	SSB.1 FR1	
		3	SSB.2 FR1	
SMTTC configuration		1	SMTTC.2	
		2	SMTTC.1	
		3	SMTTC.1	
A3-Offset	dB	1, 2, 3	-4.5	
CP length		1, 2, 3	Normal	
Hysteresis	dB	1, 2, 3	0	
Time To Trigger	s	1, 2, 3	0	
Filter coefficient		1, 2, 3	0	L3 filtering is not used
DRX		1, 2, 3	DRX.7	640ms DRX cycle
Time offset between serving and neighbour cells		1	3 ms	Asynchronous cells. The timing of Cell 2 is 3ms later than the timing of Cell 1.
		2	3 μs	Synchronous cells
		3	3 μs	Synchronous cells
T1	s	1, 2, 3	5	
T2	s	1, 2, 3	6	

#### 6.6.1.7.4.2 Test procedure

Two cells are deployed in the test, which are FR1 PCell (NR Cell 1) and a FR1 neighbour cell (NR Cell 2) on the same frequency as the PCell. The general and cell specific test parameters for PCell and neighbour cell are given in Table 6.6.1.7.4.1-3 and Table 6.6.1.7.5-1, respectively. In the measurement control information a measurement object is configured for the frequency of the PCell, and it is indicated to the UE that event-triggered reporting with Event A3 is used. The test consists of two successive time periods, with time duration of T1, and T2 respectively. During time duration T1, the UE shall not have any timing information of NR Cell 2.

1. Ensure the UE is in state RRC\_CONNECTED with generic procedure parameters Connectivity NR, Connected without release On and Test Mode On according to TS 38.508-1 [14] clause 4.5.
2. Set the parameters according to T1 in Table 6.6.1.7.5-1.
3. SS shall transmit an RRCReconfiguration message.
4. The UE shall transmit RRCReconfigurationComplete message. T1 starts.
5. When T1 expires, the SS shall switch the power setting from T1 to T2 as specified in Table 6.6.1.7.5-1. T2 starts.
6. UE shall transmit a MeasurementReport message triggered by Event A3. If the overall delays measured from the beginning of time period T2 is less than 5122 ms then the number of successful tests is increased by one. If the UE fails to report the event within the overall delays measured requirement then the number of failure tests is increased by one.
7. After the SS receive the MeasurementReport message in step 6) or when T2 expires, the SS shall:
  - transmit RRCRelease message to release the RRC connection which includes the release of the established radio bearers as well as all radio resources
- OR
- switch the UE off.
8. Set NR Cell 2 physical cell identity = ((current cell 2 physical cell identity + 1) mod 1008) for next iteration of the test procedure loop.
9. Depending on the choice in Step 7, the SS:
  - if the RRC Connection Release has been sent, transmits in NR Cell 1 a Paging message (including PagingRecord with UE-Identity) for the UE and ensures the UE is in state RRC\_CONNECTED with generic procedure parameters Connectivity NR, Connected without release On according to TS 38.508-1 [14] clause 4.5 (if the paging fails, switches off and on the UE and ensures the UE is in state RRC\_CONNECTED with generic procedure parameters Connectivity NR, Connected without release On according to TS 38.508-1 [14] clause 4.5),
- OR
- if the device has been switched off, switches on the UE and ensures the UE is in state RRC\_CONNECTED with generic procedure parameters Connectivity NR, Connected without release On according to TS 38.508-1 [14] clause 4.5.
10. Repeat step 2-9 until the confidence level according to Tables G.2.3-1 in Annex G clause G.2 is achieved.

#### 6.6.1.7.4.3 Message contents

Message contents are according to TS 38.508-1 [14] clause 4.6 with the following exceptions:

**Table 6.6.1.7.4.3-1: Common Exception messages for SA intra frequency event triggered reporting tests without gap under DRX for UE configured with highSpeedMeasFlag-r16**

<b>Default Message Contents</b>	
Common contents of system information blocks exceptions	Table H.2.1-3 with Condition HighSpeedMeas
Default RRC messages and information elements contents exceptions	Table H.3.1-1 Table H.3.1-2 Table H.3.1-4 with A3-offset = -4.5dB Table H.3.1-5 Table H.3.1-7 with Condition INTRA-FREQ Table H.3.1-8 with Condition SSB RLM Table H.3.7-1 with Condition DRX.7 and Offset
Specific message contents exceptions for Test Configuration 6.6.1.7-1	Table H.3.1-3 with Condition INTRA-FREQ MO Table 7.3.1-3 in TS 38.508-1 [14] with condition SMTC.2 Table 7.3.1-3a in TS 38.508-1 [14] with condition SSB.1 FR1
Specific message contents exceptions for Test Configuration 6.6.1.7-2	Table H.3.1-3 with Condition INTRA-FREQ MO and synchronous cells Table 7.3.1-3 in TS 38.508-1 [14] with condition SMTC.1 Table 7.3.1-3a in TS 38.508-1 [14] with condition SSB.1 FR1
Specific message contents exceptions for Test Configuration 6.6.1.7-3	Table H.3.1-3 with Condition INTRA-FREQ MO and synchronous cells Table 7.3.1-3 in TS 38.508-1 [14] with condition SMTC.1 Table 7.3.1-3a in TS 38.508-1 [14] with condition SSB.2 FR1

6.6.1.7.5 Test requirement

Table 6.6.1.7.4.1-3 and Table 6.6.1.7.5-1 define the primary level settings including test tolerances for NR event triggered reporting in synchronous cells when DRX is used



**Table 6.6.1.7.5-1: NR Cell specific test parameters for SA intra-frequency event triggered reporting tests without gap under DRX for UE configured with highSpeedMeasFlag-r16**

Parameter	Unit	Test configuration	Cell 1		Cell 2	
			T1	T2	T1	T2
TDD configuration		1	TN/A		TN/A	
		2	TDDConf.1.1		TDDConf.1.1	
		3	TDDConf.2.1		TDDConf.2.1	
PDSCH RMC configuration		1	SR.1.1 FDD		N/A	
		2	SR.1.1 TDD			
		3	SR.2.1 TDD			
RMSI CORESET RMC configuration		1	CR.1.1 FDD		CR.1.1 FDD	
		2	CR.1.1 TDD		CR.1.1 TDD	
		3	CR.2.1 TDD		CR.2.1 TDD	
Dedicated CORESET RMC configuration		1	CCR.1.1 FDD		CCR.1.1 FDD	
		2	CCR.1.1 TDD		CCR.1.1 TDD	
		3	CCR.2.1 TDD		CCR.2.1 TDD	
OCNG Patterns		1, 2, 3	OP.1		OP.1	
TRS configuration		1	TRS.1.1 FDD		N/A	
		2	TRS.1.1 TDD		N/A	
		3	TRS.1.2 TDD		N/A	
Initial BWP configuration		1, 2, 3	DLBWP.0.1 ULBWP.0.1		DLBWP.0.1 ULBWP.0.1	
Active DL BWP configuration		1, 2, 3	DLBWP.1.1		DLBWP.1.1	
Active UL BWP configuration		1, 2, 3	ULBWP.1.1		ULBWP.1.1	
RLM-RS		1, 2, 3	SSB		SSB	
$N_{oc}$ <sup>Note 2</sup>	dBm/SCS	1	-98			
		2	-98			
		3	-95			
$N_{oc}$ <sup>Note 2</sup>	dBm/15 kHz	1	-98			
		2				
		3				
$\hat{E}_s/I_{ot}$	dB	1	4	-1.46	-Infinity	-1.46
		2				
		3				
$\hat{E}_s/N_{oc}$	dB	1	4	4	-Infinity	4
		2				
		3				
SS-RSRP <sup>Note 3</sup>	dBm/SCS kHz	1	-94+TT	-94	-Infinity	-94
		2	-94	-94	-Infinity	-94
		3	-91	-91	-Infinity	-91
I <sub>o</sub>	dBm/9.36 MHz	1	-64.60	-62.25	-64.60	-62.25
	dBm/9.36 MHz	2	-64.60	-62.25T	-64.60	-62.25
	dBm/38.16 MHz	3	-58.50	-56.16	-58.50	-56.16
Propagation Condition		1, 2	AWGN		AWGN 1944Hz <sup>Note 4</sup>	
		3	AWGN		AWGN 3334Hz <sup>Note 5</sup>	
<p>Note 1: The resources for uplink transmission are assigned to the UE prior to the start of time period T2.</p> <p>Note 2: Interference from other cells and noise sources not specified in the test is assumed to be constant over subcarriers and time and shall be modelled as AWGN of appropriate power for <math>N_{oc}</math> to be fulfilled.</p> <p>Note 3: SS-RSRP levels have been derived from other parameters for information purposes. They are not settable parameters themselves.</p> <p>Note 4: The AWGN 1944 Hz condition is a non fading propagation channel with one tap. Doppler shift is a constant 1944Hz.</p> <p>Note 5: The AWGN 3334 Hz condition is a non fading propagation channel with one tap. Doppler shift is a constant 3334Hz.</p>						

The overall delays measured is defined as the time from the beginning of time period T2 to the moment the UE send one Event A3 triggered measurement report to NR Cell 2. When DRX cycle length = 640 ms, the overall delay

measured is defined as the time from the beginning of time period T2 to the moment the UE starts to send preambles on the PRACH for Scheduling Request (SR) to obtain allocation to send the measurement report to NR Cell 2 on PUSCH.

The overall delays measured in the test may be up to  $2 \times TTI_{DCCH}$  higher than the measurement reporting delays because of TTI insertion uncertainty of the measurement report in DCCH.

The overall delay measured when DRX cycle length is 640 ms test requirement is expressed as:

Overall delays measured = measurement reporting delay + TTI insertion uncertainty

Measurement reporting delay =  $T_{\text{identify\_intra\_without\_index}}$

$$T_{\text{identify\_intra\_without\_index}} = (T_{\text{PSS/SSS\_sync\_intra}} + T_{\text{SSB\_measurement\_period\_intra}}) \text{ ms}$$

$$T_{\text{PSS/SSS\_sync\_intra}} = \text{ceil}(5 \times K_p) \times \text{DRX cycle} \times \text{CSSF}_{\text{intra}} = 3200 \text{ms}$$

$$T_{\text{SSB\_measurement\_period\_intra}} = \text{ceil}(Y \times K_p) \times \text{DRX cycle} \times \text{CSSF}_{\text{intra}} = 1920 \text{ms}$$

TTI insertion uncertainty = 2 ms

The overall delay measured when DRX cycle length is 640 ms shall be less than a total of 5122 ms.

For the test to pass, the total number of successful tests shall be more than 90% of the cases with a confidence level of 95%.

## 6.6.2 Inter-frequency measurements

### 6.6.2.0 Minimum conformance requirements for Inter-frequency measurements

Same as clause 4.6.2.0.

The normative reference for this requirement is TS 38.133 [6] clause 9.3.2, 9.3.4, 9.3.5, 9.3.6.3.

### 6.6.2.1 NR SA FR1-FR1 event-triggered reporting in non-DRX

#### 6.6.2.1.1 Test purpose

To verify that the UE makes correct reporting of an event in non-DRX within inter-frequency NR cell search requirements without SSB time index detection in TS 38.133 [6] clause 9.3.4.

#### 6.6.2.1.2 Test applicability

This test applies to all types of NR UE from Release 15 onwards. Test 1 is applicable to UEs not supporting per-FR gap (IndependentGapConfig, as defined in TS 38.306 [11]) and Test 2 is applicable only to UEs supporting per-FR gap and Gap Pattern Id 4.

#### 6.6.2.1.3 Minimum conformance requirements

The minimum conformance requirements are specified in clause 6.6.2.0.

The normative reference for this requirement is TS 38.133 [6] clause A.6.6.2.1.

#### 6.6.2.1.4 Test description

##### 6.6.2.1.4.1 Initial conditions

This test shall be tested using any of the test configurations in Table 6.6.2.1.4.1-1. Configure the test equipment and the DUT according to the parameters in Table 6.6.2.1.4.1-2. Test environment parameters are given in Table 6.6.2.1.4.1-3.

**Table 6.6.2.1.4.1-1: SA FR1-FR1 event triggered reporting tests in non-DRX supported test configurations**

Test Case ID	Description
6.6.2.1-1	NR 15 kHz SSB SCS, 10MHz bandwidth, FDD duplex mode
6.6.2.1-2	NR 15 kHz SSB SCS, 10MHz bandwidth, TDD duplex mode
6.6.2.1-3	NR 30 kHz SSB SCS, 40MHz bandwidth, TDD duplex mode
Note 1: The UE is only required to be tested in one of the supported test configurations	
Note 2: target NR cell has the same SCS, BW and duplex mode as NR serving cell	

**Table 6.6.2.1.4.1-2: SA FR1-FR1 general test parameters for SA inter-frequency event triggered reporting for FR1 without SSB time index detection in non DRX**

Parameter	Unit	Test configuration	Value		Comment
			Test 1	Test 2	
NR RF Channel Number		Config 1,2,3	1, 2		Two FR1 NR carrier frequencies are used.
Active cell		Config 1,2,3	NR cell 1 (Pcell)		NR Cell 1 is on NR RF channel number 1.
Neighbour cell		Config 1,2,3	NR cell2		NR cell 2 is on NR RF channel number 2.
Gap Pattern Id		Config 1,2,3	0	4	As specified in TS 38.133 clause 9.1.2-1.
Measurement gap offset		Config 1,2,3	9	9	
A3-Offset	dB	Config 1,2,3	-6		
Hysteresis	dB	Config 1,2,3	0		
CP length		Config 1,2,3	Normal		
TimeToTrigger	s	Config 1,2,3	0		
Filter coefficient		Config 1,2,3	0		L3 filtering is not used
DRX		Config 1,2,3	OFF		DRX is not used
Time offset between serving and neighbour cells		Config 1	3ms		Asynchronous cells. The timing of Cell 2 is 3ms later than the timing of Cell 1.
		Config 2,3	3µs		Synchronous cells.
T1	s	Config 1,2,3	5		
T2	s	Config 1,2,3	1	1	

**Table 6.6.2.1.4.1-3: Test Environment parameters for SA inter-frequency event triggered reporting without SSB time index detection in non-DRX**

Parameter	Value	Comment

Test environment	NC	As specified in TS 38.508-1 [14] clause 4.1.
Test frequencies	As specified in Annex E, Table E.4-1 and TS 38.508-1 [14] clause 4.3.1 and 4.4.2.	
Channel bandwidth	As specified by the test configuration selected from Table 6.6.2.1.4.1-1.	
Propagation conditions	AWGN	As specified in Annex C.2.2.
Connection Diagram	TE Part	A.3.1.8.2
	DUT Part	A.3.2.3.4
Exceptions to connection diagram	- Without LTE link - For 4Rx capable UEs without any 2Rx RF bands use A.3.2.5.1 for DUT part and A.3.1.8.4 for TE part.	

1. Message contents are defined in clause 6.6.2.1.4.3.

2. There are two NR cells on two carriers specified in the test. Cell 1 is the cell used for connection setup and Cell 2 is a target cell on a different carrier than Cell 1. The power levels and settings for Cell 2 are set according to Annex C.1.2.

#### 6.6.2.1.4.2 Test procedure

In this test, there are two cells: NR cell 1 as PCell in FR1 on NR RF channel 1 and NR cell 2 as neighbour cell in FR1 on NR RF channel 2.

In test 1 measurement gap pattern configuration # 0 as defined in Table 6.6.2.1.4.1-2 is provided for UE that does not support per-FR gap and in test 2 measurement gap pattern configuration #4 as defined in Table 6.6.2.1.4.1-2 is provided for UE that supports per-FR gap.

In the measurement control information, it is indicated to the UE that event-triggered reporting with Event A3 is used. The test consists of two successive time periods, with time duration of T1, and T2 respectively. During time duration T1, the UE shall not have any timing information of NR cell 2.

1. Ensure the UE is in state RRC\_CONNECTED with generic procedure parameters Connectivity NR SA, Connected without release *On* and Test Mode *On* according to TS 38.508-1 [14] clause 4.5.
2. Set the parameters according to T1 in Table 6.6.2.1.4.1-2.
3. The SS shall transmit an *RRCReconfiguration* message.
4. The UE shall transmit *RRCReconfigurationComplete* message. T1 starts.
5. When T1 expires, the SS shall switch the power setting from T1 to T2 as specified in Table 6.6.2.1.4.1-2. T2 Starts.
6. UE shall transmit a *MeasurementReport* message triggered by Event A3. If the overall delays measured from the beginning of time period T2 is less than 920 ms for Test 1 and 760 ms for Test 2 then the number of successful tests is increased by one. If the UE fails to report the event within the overall delays measured requirement then the number of failure tests is increased by one.
7. After the SS receives the *MeasurementReport* message in step 6 or when T2 expires, the SS shall:
  - transmit RRCRelease message to release the RRC connection which includes the release of the established radio bearers as well as all radio resources

OR

  - switch the UE off.
8. Set Cell 3 physical cell identity = ((current cell 3 physical cell identity + 1) mod 14 + 2) for next iteration of the test procedure loop.
9. Depending on the choice in Step 7, the SS:
  - if the RRC Connection Release has been sent, transmits in Cell 1 a *Paging* message (including *PagingRecord* with ue-Identity) for the UE and ensures the UE in state RRC\_CONNECTED with generic procedure parameters

Connectivity NR SA, Connected without release *On* according to TS 38.508-1 [14] clause 4.5. (if the paging fails, switches off and on the UE and ensures the UE is in state RRC\_CONNECTED with generic procedure parameters Connectivity NR SA, Connected without release *On* according to TS 38.508-1 [14] clause 4.5.), OR:

- if the device has been switched off, switches on the UE and ensures the UE is in state RRC\_CONNECTED with generic procedure parameters Connectivity NR SA, Connected without release *On* according to TS 38.508-1 [14] clause 4.5.

10. Repeat step 2-9 until the confidence level according to Tables G.2.3-1 in Annex G clause G.2 is achieved.

11. Repeat step 1-10 for each sub-test in Table 6.6.2.1.4.1-2 as appropriate.

6.6.2.1.4.3 Message contents

Message contents are according to TS 38.508-1 [14] clause 7.3 with the following exceptions:

**Table 6.6.2.1.4.3-1: Common Exception messages SA inter frequency event triggered reporting without SSB time index detection in non-DRX**

Default Message Contents	
Common contents of system information blocks exceptions	
Default RRC messages and information elements contents exceptions	Table H.3.1-1 Table H.3.1-2 with Conditions GAP NEEDED and INTER-FREQ Table H.3.1-4 with A3-offset = -6dB Table H.3.1-5 Table H.3.1-6 with Conditions gapUE, Pattern #0 and gap offset = 9 for Test 1 Table H.3.1-6 with Conditions gapFR1, Pattern #4 and gap offset = 9 for Test 2 Table H.3.1-7 with Condition INTER-FREQ
Specific message contents exceptions for Test Configuration 6.6.2.1-1	Table H.3.1-3 with Conditions INTER-FREQ MO Table 7.3.1-3 in TS 38.508-1 [14] with condition SMTC.5
Specific message contents exceptions for Test Configuration 6.6.2.1-2	Table H.3.1-3 with Conditions INTER-FREQ MO and Synchronous cells Table 7.3.1-3 in TS 38.508-1 [14] with condition SMTC.4
Specific message contents exceptions for Test Configuration 6.6.2.1-3	Table H.3.1-3 with Conditions INTER-FREQ MO and Synchronous cells Table 7.3.1-3 in TS 38.508-1 [14] with condition SMTC.4

6.6.2.1.5 Test requirement

Table 6.6.2.1.5-1 defines the primary level settings including test tolerances for all tests.

**Table 6.6.2.1.5-1: Cell specific test parameters for SA inter-frequency event triggered reporting for FR1 without SSB time index detection in non-DRX**

Parameter		Unit	Test configuration	Cell 1		Cell 2	
				T1	T2	T1	T2
NR RF Channel Number			Config 1,2,3	1		2	
Duplex mode			Config 1	FDD			
			Config 2,3	TDD			
TDD configuration			Config 1	Not Applicable			
			Config 2	TDDConf.1.1			
			Config 3	TDDConf.2.1			
BW <sub>channel</sub>		MHz	Config 1,2	10: N <sub>RB,c</sub> = 52			
			Config 3	40: N <sub>RB,c</sub> = 106			
BWP BW		MHz	Config 1,2	10: N <sub>RB,c</sub> = 52			
			Config 3	40: N <sub>RB,c</sub> = 106			
BWP configuration	Initial DL BWP		Config 1, 2, 3	DLBWP.0.1		NA	
	Initial UL BWP			ULBWP.0.1		NA	
	Dedicated DL BWP			DLBWP.1.1		NA	
	Dedicated UL BWP			ULBWP.1.1		NA	
TRS configuration			Config 1	TRS.1.1 FDD		NA	
			Config 2	TRS.1.1 TDD		NA	
			Config 3	TRS.1.2 TDD		NA	
OCNG Patterns			Config 1,2,3	OP.1		OP.1	
PDSCH Reference measurement channel			Config 1	SR.1.1 FDD		-	
			Config 2	SR.1.1 TDD			
			Config 3	SR.2.1 TDD			
RMSI CORESET Reference Channel			Config 1	CR.1.1 FDD		-	
			Config 2	CR.1.1 TDD			
			Config 3	CR.2.1 TDD			
Dedicated CORESET Reference Channel			Config 1	CCR.1.1 FDD		-	
			Config 2	CCR.1.1 TDD			
			Config 3	CCR.2.1 TDD			
SSB parameters			Config 1	SSB.1 FR1		SSB.5 FR1	
			Config 2	SSB.1 FR1		SSB.5 FR1	
			Config 3	SSB.2 FR1		SSB.6 FR1	
SMTC configuration			Config 1	SMTC.2		SMTC.5	
			Config 2, 3	SMTC.1		SMTC.4	
PDSCH/PDCCH subcarrier spacing		kHz	Config 1,2	15			
			Config 3	30			
EPRE ratio of PSS to SSS			Config 1,2,3	0		0	
EPRE ratio of PBCH DMRS to SSS							
EPRE ratio of PBCH to PBCH DMRS							
EPRE ratio of PDCCH DMRS to SSS							
EPRE ratio of PDCCH to PDCCH DMRS							
EPRE ratio of PDSCH DMRS to SSS							
EPRE ratio of PDSCH to PDSCH							
EPRE ratio of OCNG DMRS to SSS(Note 1)							
EPRE ratio of OCNG to OCNG DMRS (Note 1)							

$N_{oc}$ Note2	dBm/15 kHz		-98		-98	
$N_{oc}$ Note2	dBm/S	Config 1,2	-98		-98	
	CS	Config 3	-95		-95	
SS-RSRP Note 3	dBm/S	Config 1,2	-94	-94	-Infinity	-91
	CS	Config 3	-91	-91	-Infinity	-88
$\hat{E}_s/I_{ot}$	dB	Config 1,2,3,4,5,6	4	4	-Infinity	7
$\hat{E}_s/N_{oc}$	dB	Config 1,2,3	4	4	-Infinity	7
$I_o$ Note3	dBm/9.3 6MHz	Config 1,2	-64.59	-64.59	-70.05	-62.26
	dBm/38. 16MHz	Config 3	-58.49	-58.49	-63.94	-56.15
Propagation Condition		Config 1,2,3	AWGN		AWGN	
Note 1:	OCNG shall be used such that both cells are fully allocated and a constant total transmitted power spectral density is achieved for all OFDM symbols.					
Note 2:	Interference from other cells and noise sources not specified in the test is assumed to be constant over subcarriers and time and shall be modelled as AWGN of appropriate power for $N_{oc}$ to be fulfilled.					
Note 3:	SS-RSRP and $I_o$ levels have been derived from other parameters for information purposes. They are not settable parameters themselves.					
Note 4:	SS-RSRP minimum requirements are specified assuming independent interference and noise at each receiver antenna port.					

In test 1 with per-UE gap, the UE shall send one Event A3 triggered measurement report, with a measurement reporting delay less than 920 ms from the beginning of time period T2. The UE shall not send event triggered measurement reports, as long as the reporting criteria are not fulfilled. The rate of correct events observed during repeated tests shall be at least 90%. with a confidence level of 95%

In test 2 with per-FR gap, the UE shall send one Event A3 triggered measurement report, with a measurement reporting delay less than 760 ms from the beginning of time period T2. The UE shall not send event triggered measurement reports, as long as the reporting criteria are not fulfilled. The rate of correct events observed during repeated tests shall be at least 90% with a confidence level of 95%.

In test 1 and 2 UE is not required to report SSB time index.

NOTE: The actual overall delays measured in the test may be up to  $2 \times TTI_{DCCH}$  higher than the measurement reporting delays above because of TTI insertion uncertainty of the measurement report in DCCH.

## 6.6.2.2 NR SA FR1-FR1 event-triggered reporting in DRX

### 6.6.2.2.1 Test purpose

To verify that the UE makes correct reporting of an event in DRX within inter-frequency NR cell search requirements without SSB time index detection in TS 38.133 [6] clause 9.3.4.

### 6.6.2.2.2 Test applicability

This test applies to all types of NR UE Release 15 and forward supporting 5GS NR SA FR1 and long DRX cycle. Test 1 and Test 2 are applicable to UEs not supporting per-FR gap (IndependentGapConfig, as defined in TS 38.306 [11]) and Test 3 and Test 4 are applicable only to UEs supporting per-FR gap and Gap Pattern Id 4.

### 6.6.2.2.3 Minimum conformance requirements

The minimum conformance requirements are specified in clause 6.6.2.0.

The normative reference for this requirement is TS 38.133 [6] clause A.6.6.2.2.



6.6.2.2.4 Test description

6.6.2.2.4.1 Initial conditions

This test shall be tested using any of the test configurations in Table 6.6.2.2.4.1-1. Configure the test equipment and the DUT according to the parameters in Table 6.6.2.2.4.1-2. Test environment parameters are given in Table 6.6.2.2.4.1-3.

**Table 6.6.2.2.4.1-1: SA FR1-FR1 event triggered reporting tests in DRX supported test configurations**

Test Case ID	Description
6.6.2.2-1	NR 15 kHz SSB SCS, 10MHz bandwidth, FDD duplex mode
6.6.2.2-2	NR 15 kHz SSB SCS, 10MHz bandwidth, TDD duplex mode
6.6.2.2-3	NR 30 kHz SSB SCS, 40MHz bandwidth, TDD duplex mode
Note 1: The UE is only required to be tested in one of the supported test configurations	
Note 2: target NR cell has the same SCS, BW and duplex mode as NR serving cell	

**Table 6.6.2.2.4.1-2: General test parameters for SA inter-frequency event triggered reporting for FR1 without SSB time index detection in DRX**

Parameter	Unit	Test configuration	Value				Comment
			Test 1	Test 2	Test 3	Test 4	
NR RF Channel Number		Config 1,2,3	1, 2				Two FR1 NR carrier frequencies are used
Active cell		Config 1,2,3	NR cell 1 (Pcell)				NR Cell 1 is on NR RF channel number 1
Neighbour cell		Config 1,2,3	NR cell2				NR cell 2 is on NR RF channel number 2.
Gap Pattern Id		Config 1,2,3	0	4			As specified in TS 38.133 clause 9.1.2-1
Measurement gap offset		Config 1,2,3	9	9			
A3-Offset	dB	Config 1,2,3	-6				
Hysteresis	dB	Config 1,2,3	0				
CP length		Config 1,2,3	Normal				
TimeToTrigger	s	Config 1,2,3	0				
Filter coefficient		Config 1,2,3	0				L3 filtering is not used
DRX		Config 1,2,3	DRX .1	DRX .7	DRX .1	DRX .7	As specified in clause A.5
Time offset between serving and neighbour cells		Config 1	3ms				Asynchronous cells. The timing of Cell 2 is 3ms later than the timing of Cell 1.
		Config 2,3	3µs				Synchronous cells
T1	s	Config 1,2,3	5				
T2	s	Config 1,2,3	1.1	11	1.1	11	

**Table 6.6.2.2.4.1-3: Test Environment parameters for SA inter-frequency event triggered reporting for FR1 without SSB time index detection in DRX**

Parameter	Value		Comment
Test environment	NC		As specified in TS 38.508-1 [14] clause 4.1.
Test frequencies	As specified in Annex E, Table E.4-1 and TS 38.508-1 [14] clause 4.3.1 and 4.4.2.		
Channel bandwidth	As specified by the test configuration selected from Table 6.6.2.2.4.1-1.		
Propagation conditions	AWGN		As specified in Annex C.2.2.
Connection Diagram	TE Part	A.3.1.8.2	As specified in TS 38.508-1 [14] Annex A.
	DUT Part	A.3.2.3.4	
Exceptions to connection diagram	- Without LTE link - For 4Rx capable UEs without any 2Rx RF bands use A.3.2.5.1 for DUT part and A.3.1.8.4 for TE part.		

1. Message contents are defined in clause 6.6.2.2.4.3.

2. There are two NR cells on two carriers specified in the test. Cell 1 is the cell used for connection setup and Cell 2 is a target cell on a different carrier than Cell 1. The power levels and settings for Cell 2 are set according to Annex C.1.2.

#### 6.6.2.2.4.2 Test procedure

In this test, there are two cells: NR cell 1 as PCell in FR1 on NR RF channel 1 and NR cell 2 as neighbour cell in FR1 on NR RF channel 2.

In test 1&2 measurement gap pattern configuration # 0 as defined in Table 6.6.2.2.4.1-2 is provided for UE that does not support per-FR gap and in test 3&4 measurement gap pattern configuration #4 as defined in Table 6.6.2.2.4.1-2 is provided for UE that supports per-FR gap.

In the measurement control information, it is indicated to the UE that event-triggered reporting with Event A3 is used. The test consists of two successive time periods, with time duration of T1, and T2 respectively. During time duration T1, the UE shall not have any timing information of NR cell 2.

UE needs to be provided at least once every 500ms with new Timing Advance Command MAC control element to restart the Time alignment timer to keep UE uplink time alignment. Furthermore UE is allocated with PUSCH resource at every DRX cycle.

1. Ensure the UE is in state RRC\_CONNECTED with generic procedure parameters Connectivity NR SA, Connected without release *On* and Test Mode *On* according to TS 38.508-1 [14] clause 4.5.
2. Set the parameters according to T1 in Table 6.6.2.2.4.1-2 and 6.6.2.2.5-1.
3. The SS shall transmit an *RRCReconfiguration* message.
4. The UE shall transmit *RRCReconfigurationComplete* message. T1 starts.
5. When T1 expires, the SS shall switch the power setting from T1 to T2 as specified in Table 6.6.2.2.5-1. T2 Starts.
6. UE shall transmit a *MeasurementReport* message triggered by Event A3. If the overall delays measured from the beginning of time period T2 is less than 1080 ms for Test 1, 10240 ms for Test 2, 1080 ms for Test 3 and 10240 ms for Test 4 then the number of successful tests is increased by one. If the UE fails to report the event within the overall delays measured requirement then the number of failure tests is increased by one.
7. After the SS receives the *MeasurementReport* message in step 6 or when T2 expires, the SS shall:
  - transmit *RRCRelease* message to release the RRC connection which includes the release of the established radio bearers as well as all radio resources

OR

- switch the UE off.

8. Set Cell 3 physical cell identity = ((current cell 3 physical cell identity + 1) mod 14 + 2) for next iteration of the test procedure loop.

9. Depending on the choice in Step 7, the SS:

- if the RRC Connection Release has been sent, transmits in Cell 1 a *Paging* message (including PagingRecord with ue-Identity) for the UE and ensures the UE in state RRC\_CONNECTED with generic procedure parameters Connectivity NR SA, Connected without release *On* according to TS 38.508-1 [14] clause 4.5. (if the paging fails, switches off and on the UE and ensures the UE is in state RRC\_CONNECTED with generic procedure parameters Connectivity NR SA, Connected without release *On* according to TS 38.508-1 [14] clause 4.5.), OR
- if the device has been switched off, switches on the UE and ensures the UE is in state RRC\_CONNECTED with generic procedure parameters Connectivity NR SA, Connected without release *On* according to TS 38.508-1 [14] clause 4.5.

10. Repeat step 2-9 until the confidence level according to Tables G.2.3-1 in Annex G clause G.2 is achieved.

11. Repeat step 1-10 for each sub-test in Table 6.6.2.2.4.1-2 as appropriate.

6.6.2.2.4.3 Message contents

Message contents are according to TS 38.508-1 [14] clause 7.3 with the following exceptions:

**Table 6.6.2.2.4.3-1: Common Exception messages SA inter frequency event triggered reporting without SSB time index detection in non-DRX**

Default Message Contents	
Common contents of system information blocks exceptions	
Default RRC messages and information elements contents exceptions	Table H.3.1-1 Table H.3.1-2 with Conditions GAP NEEDED and INTER-FREQ Table H.3.1-4 with A3-offset = -6dB Table H.3.1-5 Table H.3.1-6 with Conditions gapUE, Pattern #0 and gap offset = 9 for Test 1 and Test 2 Table H.3.1-6 with Conditions gapFR1, Pattern #4 and gap offset = 9 for Test 3 and Test 4 Table H.3.1-7 with Condition INTER-FREQ Table H.3.7-1 with Condition DRX.1 and Gap and INTER-FREQ for Test 1 and Test 3 Table H.3.7-1 with Condition DRX.7 and Gap and INTER-FREQ for Test 2 and Test 4
Specific message contents exceptions for Test Configuration 6.6.2.2-1	Table H.3.1-3 with Conditions INTER-FREQ MO and Table 7.3.1-3 in TS 38.508-1 [14] with condition SMTC.5
Specific message contents exceptions for Test Configuration 6.6.2.2-2	Table H.3.1-3 with Conditions INTER-FREQ MO and Synchronous cells Table 7.3.1-3 in TS 38.508-1 [14] with condition SMTC.4
Specific message contents exceptions for Test Configuration 6.6.2.2-3	Table H.3.1-3 with Conditions INTER-FREQ MO and Synchronous cells Table 7.3.1-3 in TS 38.508-1 [14] with condition SMTC.4

6.6.2.2.5 Test requirement

Table 6.6.2.2.5-1 defines the primary level settings including test tolerances for all tests.

**Table 6.6.2.2.5-1: Cell specific test parameters for SA inter-frequency event triggered reporting for FR1 without SSB time index detection**

Parameter		Unit	Test configuration	Cell 1		Cell 2	
				T1	T2	T1	T2
NR RF Channel Number			Config 1,2,3	1		2	
Duplex mode			Config 1	FDD			
			Config 2,3	TDD			
TDD configuration			Config 1	Not Applicable			
			Config 2	TDDConf.1.1			
			Config 3	TDDConf.2.1			
BW <sub>channel</sub>		MHz	Config 1,2	10: N <sub>RB,c</sub> = 52			
			Config 3	40: N <sub>RB,c</sub> = 106			
BWP BW		MHz	Config 1,2	10: N <sub>RB,c</sub> = 52			
			Config 3	40: N <sub>RB,c</sub> = 106			
BWP configuration	Initial DL BWP		Config 1, 2, 3	DLBWP.0.1	NA		
	Initial UL BWP			ULBWP.0.1	NA		
	Dedicated DL BWP			DLBWP.1.1	NA		
	Dedicated UL BWP			ULBWP.1.1	NA		
TRS configuration			Config 1	TRS.1.1 FDD	NA		
			Config 2	TRS.1.1 TDD	NA		
			Config 3	TRS.1.2 TDD	NA		
OCNG Patterns			Config 1,2,3	OP.1	OP.1		
PDSCH Reference measurement channel			Config 1	SR.1.1 FDD	-		
			Config 2	SR.1.1 TDD			
			Config 3	SR.2.1 TDD			
RMSI CORESET Reference Channel			Config 1	CR.1.1 FDD	-		
			Config 2	CR.1.1 TDD			
			Config 3	CR.2.1 TDD			
Dedicated CORESET Reference Channel			Config 1	CCR.1.1 FDD	-		
			Config 2	CCR.1.1 TDD			
			Config 3	CCR.2.1 TDD			
SSB parameters			Config 1	SSB.1 FR1	SSB.5 FR1		
			Config 2	SSB.1 FR1	SSB.5 FR1		
			Config 3	SSB.2 FR1	SSB.6 FR1		
SMTC configuration			Config 1	SMTC.2	SMTC.5		
			Config 2, 3	SMTC.1	SMTC.4		
PDSCH/PDCCH subcarrier spacing		kHz	Config 1,2	15			
			Config 3	30			
EPRE ratio of PSS to SSS			Config 1,2,3	0		0	
EPRE ratio of PBCH DMRS to SSS							
EPRE ratio of PBCH to PBCH DMRS							
EPRE ratio of PDCCH DMRS to SSS							
EPRE ratio of PDCCH to PDCCH DMRS							
EPRE ratio of PDSCH DMRS to SSS							
EPRE ratio of PDSCH to PDSCH							
EPRE ratio of OCNG DMRS to SSS(Note 1)							
EPRE ratio of OCNG to OCNG DMRS (Note 1)							
N <sub>oc</sub> <sup>Note2</sup>		dBm/15 kHz					

$N_{oc}$ <sup>Note2</sup>	dBm/S CS	Config 1,2	-98		-98	
		Config 3	-95		-95	
SS-RSRP <sup>Note 3</sup>	dBm/S CS	Config 1,2	-94	-94	-Infinity	-91
		Config 3	-91	-91	-Infinity	-88
$\hat{E}_s/I_{ot}$	dB	Config 1,2,3,4,5,6	4	4	-Infinity	7
$\hat{E}_s/N_{oc}$	dB	Config 1,2,3	4	4	-Infinity	7
$I_o$ <sup>Note3</sup>	dBm/9. 36MHz	Config 1,2	-64.59	-64.59	-70.05	-62.2
	dBm/38 .16MHz	Config 3	-58.49	-58.49	-63.94	-56.15
Propagation Condition		Config 1,2,3	AWGN		AWGN	
<p>Note 1: OCNG shall be used such that both cells are fully allocated and a constant total transmitted power spectral density is achieved for all OFDM symbols.</p> <p>Note 2: Interference from other cells and noise sources not specified in the test is assumed to be constant over subcarriers and time and shall be modelled as AWGN of appropriate power for <math>N_{oc}</math> to be fulfilled.</p> <p>Note 3: SS-RSRP and <math>I_o</math> levels have been derived from other parameters for information purposes. They are not settable parameters themselves.</p> <p>Note 4: SS-RSRP minimum requirements are specified assuming independent interference and noise at each receiver antenna port.</p>						

In test 1 with per-UE gap, the UE shall send one Event A3 triggered measurement report, with a measurement reporting delay less than 1080 ms from the beginning of time period T2. The UE shall not send event triggered measurement reports, as long as the reporting criteria are not fulfilled. The rate of correct events observed during repeated tests shall be at least 90% with a confidence level of 95%.

In test 2 with per-UE gap, the UE shall send one Event A3 triggered measurement report, with a measurement reporting delay less than 10240 ms from the beginning of time period T2. The UE shall not send event triggered measurement reports, as long as the reporting criteria are not fulfilled. The rate of correct events observed during repeated tests shall be at least 90% with a confidence level of 95%.

In test 3 with per-FR gap, the UE shall send one Event A3 triggered measurement report, with a measurement reporting delay less than 1080 ms from the beginning of time period T2. The UE shall not send event triggered measurement reports, as long as the reporting criteria are not fulfilled. The rate of correct events observed during repeated tests shall be at least 90% with a confidence level of 95%.

In test 4 with per-FR gap, the UE shall send one Event A3 triggered measurement report, with a measurement reporting delay less than 10240 ms from the beginning of time period T2. The UE shall not send event triggered measurement reports, as long as the reporting criteria are not fulfilled. The rate of correct events observed during repeated tests shall be at least 90% with a confidence level of 95%.

In test 1, 2, 3 and 4 UE is not required to report SSB time index.

NOTE: The actual overall delays measured in the test may be up to  $2 \times TTI_{DCCH}$  higher than the measurement reporting delays above because of TTI insertion uncertainty of the measurement report in DCCH.

6.6.2.3 Void

6.6.2.4 Void

6.6.2.5 NR SA FR1-FR1 event-triggered reporting in non-DRX with SSB time index detection

6.6.2.5.1 Test purpose

To verify that the UE makes correct reporting of an event in non-DRX within inter-frequency NR cell search requirements with SSB time index detection in TS 38.133 [6] clause 9.3.4.

#### 6.6.2.5.2 Test applicability

This test applies to all types of NR UE from Release 15 onwards. Test 1 is applicable to UEs not supporting per-FR gap (IndependentGapConfig, as defined in TS 38.306 [11]) and Test 2 is applicable only to UEs supporting per-FR gap and Gap Pattern Id 4.

#### 6.6.2.5.3 Minimum conformance requirements

The minimum conformance requirements are specified in clause 6.6.2.0.

The normative reference for this requirement is TS 38.133 [6] clause A.6.6.2.5.

#### 6.6.2.5.4 Test description

##### 6.6.2.5.4.1 Initial conditions

This test shall be tested using any of the test configurations in Table 6.6.2.5.4.1-1. Configure the test equipment and the DUT according to the parameters in Table 6.6.2.5.4.1-2. Test environment parameters are given in Table 6.6.2.5.4.1-3.

**Table 6.6.2.5.4.1-1: SA FR1-FR1 event triggered reporting tests in non-DRX with SSB time index detection supported test configurations**

Test Case ID	Description
6.6.2.5-1	NR 15 kHz SSB SCS, 10MHz bandwidth, FDD duplex mode
6.6.2.5-2	NR 15 kHz SSB SCS, 10MHz bandwidth, TDD duplex mode
6.6.2.5-3	NR 30 kHz SSB SCS, 40MHz bandwidth, TDD duplex mode
Note 1: The UE is only required to be tested in one of the supported test configurations	
Note 2: target NR cell has the same SCS, BW and duplex mode as NR serving cell	

**Table 6.6.2.5.4.1-2: General test parameters for SA inter-frequency event triggered reporting for FR1 with SSB time index detection in non-DRX**

Parameter	Unit	Test configuration	Value		Comment
			Test 1	Test 2	
NR RF Channel Number		Config 1,2,3	1, 2		Two FR1 NR carrier frequencies are used
Active cell		Config 1,2,3	NR cell 1 (Pcell)		NR Cell 1 is on NR RF channel number 1
Neighbour cell		Config 1,2,3	NR cell2		NR cell 2 is on NR RF channel number 2
Gap Pattern Id		Config 1,2,3	0	4	As specified in TS 38.133 clause 9.1.2-1
Measurement gap offset		Config 1,2,3	9	9	
A3-Offset	dB	Config 1,2,3	-6		
Hysteresis	dB	Config 1,2,3	0		
CP length		Config 1,2,3	Normal		
TimeToTrigger	s	Config 1,2,3	0		
Filter coefficient		Config 1,2,3	0		L3 filtering is not used
DRX		Config 1,2,3	OFF		DRX is not used
Time offset between serving and neighbour cells		Config 1	3ms		Asynchronous cells. The timing of Cell 2 is 3ms later than the timing of Cell 1.
		Config 2,3	3µs		Synchronous cells
T1	s	Config 1,2,3	5		
T2	s	Config 1,2,3	1.1	1	

**Table 6.6.2.5.4.1-3: Environment test parameters for SA inter-frequency event triggered reporting for FR1 without SSB time index detection in non-DRX**

Parameter	Value	Comment
Test environment	NC	As specified in TS 38.508-1 [14] clause 4.1.
Test frequencies	As specified in Annex E, Table E.4-1 and TS 38.508-1 [14] clause 4.3.1 and 4.4.2.	
Channel bandwidth	As specified by the test configuration selected from Table 6.6.2.5.4.1-1.	
Propagation conditions	AWGN	As specified in Annex C.2.2.
Connection Diagram	TE Part	A.3.1.8.2
	DUT Part	A.3.2.3.4
Exceptions to connection diagram	- Without LTE link - For 4Rx capable UEs without any 2Rx RF bands use A.3.2.5.1 for DUT part and A.3.1.8.4 for TE part.	

1. Message contents are defined in clause 6.6.2.5.4.3.

2. There are two NR cells on two carriers specified in the test. Cell 1 is the cell used for connection setup and Cell 2 is a target cell on a different carrier than Cell 1. The power levels and settings for Cell 2 are set according to Annex C.1.2.



#### 6.6.2.5.4.2 Test procedure

In this test, there are two cells: NR cell 1 as PCell in FR1 on NR RF channel 1 and NR cell 2 as neighbour cell in FR1 on NR RF channel 2.

In test 1 measurement gap pattern configuration # 0 as defined in Table 6.6.2.5.4.1-2 is provided for UE that does not support per-FR gap and in test 2 measurement gap pattern configuration #4 as defined in Table 6.6.2.5.4.1-2 is provided for UE that supports per-FR gap.

In the measurement control information, it is indicated to the UE that event-triggered reporting with Event A3 is used. The test consists of two successive time periods, with time duration of T1, and T2 respectively. During time duration T1, the UE shall not have any timing information of NR cell 2.

1. Ensure the UE is in state RRC\_CONNECTED with generic procedure parameters Connectivity NR SA, Connected without release *On* and Test Mode *On* according to TS 38.508-1 [14] clause 4.5.
2. Set the parameters according to T1 in Table 6.6.2.5.4.1-2.
3. The SS shall transmit an *RRCReconfiguration* message.
4. The UE shall transmit *RRCReconfigurationComplete* message. T1 starts.
5. When T1 expires, the SS shall switch the power setting from T1 to T2 as specified in Table 6.6.2.5.4.1-2. T2 Starts.
6. UE shall transmit a *MeasurementReport* message triggered by Event A3. If the overall delays measured from the beginning of time period T2 is less than 1040 ms for Test 1 and 880 ms for Test 2 then the number of successful tests is increased by one. If the UE fails to report the event within the overall delays measured requirement then the number of failure tests is increased by one.
7. After the SS receives the *MeasurementReport* message in step 6 or when T2 expires, the SS shall:
  - transmit *RRCRelease* message to release the RRC connection which includes the release of the established radio bearers as well as all radio resources

OR

  - switch the UE off.
8. Set Cell 3 physical cell identity = ((current cell 3 physical cell identity + 1) mod 14 + 2) for next iteration of the test procedure loop.
9. Depending on the choice in Step 7, the SS:
  - if the RRC Connection Release has been sent, transmits in Cell 1 a *Paging* message (including *PagingRecord* with ue-Identity) for the UE and ensures the UE in state RRC\_CONNECTED with generic procedure parameters Connectivity NR SA, Connected without release *On* according to TS 38.508-1 [14] clause 4.5. (if the paging fails, switches off and on the UE and ensures the UE is in state RRC\_CONNECTED with generic procedure parameters Connectivity NR SA, Connected without release *On* according to TS 38.508-1 [14] clause 4.5.),
  - OR
  - if the device has been switched off, switches on the UE and ensures the UE is in state RRC\_CONNECTED with generic procedure parameters Connectivity NR SA, Connected without release *On* according to TS 38.508-1 [14] clause 4.5.
10. Repeat step 2-9 until the confidence level according to Tables G.2.3-1 in Annex G clause G.2 is achieved.
11. Repeat step 1-10 for each sub-test in Table 6.6.2.5.4.1-2 as appropriate.

#### 6.6.2.5.4.3 Message contents

Message contents are according to TS 38.508-1 [14] clause 7.3 with the following exceptions:

**Table 6.6.2.5.4.3-1: Common Exception messages SA inter frequency event triggered reporting without SSB time index detection in non-DRX**

<b>Default Message Contents</b>	
Common contents of system information blocks exceptions	
Default RRC messages and information elements contents exceptions	Table H.3.1-1 Table H.3.1-2 with Conditions GAP NEEDED and INTER-FREQ Table H.3.1-4 with A3-offset = -6dB and Condition SSB Index Table H.3.1-5 Table H.3.1-6 with Conditions gapUE, Pattern #0 and gap offset = 9 for Test 1 Table H.3.1-6 with Conditions gapFR1, Pattern #4 and gap offset = 9 for Test 2 Table H.3.1-7 with Conditions INTER-FREQ and SSB Index
Specific message contents exceptions for Test Configuration 6.6.2.5-1	Table H.3.1-3 with Conditions INTER-FREQ MO Table 7.3.1-3 in TS 38.508-1 [14] with condition SMTC.5
Specific message contents exceptions for Test Configuration 6.6.2.5-2	Table H.3.1-3 with Conditions INTER-FREQ MO and Synchronous cells Table 7.3.1-3 in TS 38.508-1 [14] with condition SMTC.4
Specific message contents exceptions for Test Configuration 6.6.2.5-3	Table H.3.1-3 with Conditions INTER-FREQ MO and Synchronous cells Table 7.3.1-3 in TS 38.508-1 [14] with condition SMTC.4

#### 6.6.2.5.5 Test requirement

Table 6.6.2.4.5-1 defines the primary level settings including test tolerances for all tests.

**Table 6.6.2.5.1-3: Cell specific test parameters for SA inter-frequency event triggered reporting for FR1 with SSB time index detection**

Parameter		Unit	Test configuration	Cell 1		Cell 2	
				T1	T2	T1	T2
NR RF Channel Number			Config 1,2,3	1		2	
Duplex mode			Config 1	FDD			
			Config 2,3	TDD			
TDD configuration			Config 1	Not Applicable			
			Config 2	TDDConf.1.1			
			Config 3	TDDConf.2.1			
BW <sub>channel</sub>		MHz	Config 1,2	10: N <sub>RB,c</sub> = 52			
			Config 3	40: N <sub>RB,c</sub> = 106			
BWP BW		MHz	Config 1,2	10: N <sub>RB,c</sub> = 52			
			Config 3	40: N <sub>RB,c</sub> = 106			
BWP configuration	Initial DL BWP		Config 1, 2, 3	DLBWP.0.1		NA	
	Initial UL BWP			ULBWP.0.1		NA	
	Dedicated DL BWP			DLBWP.1.1		NA	
	Dedicated UL BWP			ULBWP.1.1		NA	
TRS configuration			Config 1	TRS.1.1 FDD		NA	
			Config 2	TRS.1.1 TDD		NA	
			Config 3	TRS.1.2 TDD		NA	
OCNG Patterns			Config 1,2,3	OP.1		OP.1	
PDSCH Reference measurement channel			Config 1	SR.1.1 FDD		-	
			Config 2	SR.1.1 TDD			
			Config 3	SR.2.1 TDD			
RMSI CORESET Reference Channel			Config 1	CR.1.1 FDD		-	
			Config 2	CR.1.1 TDD			
			Config 3	CR.2.1 TDD			
Dedicated CORESET Reference Channel			Config 1	CCR.1.1 FDD		-	
			Config 2	CCR.1.1 TDD			
			Config 3	CCR.2.1 TDD			
SSB parameters			Config 1	SSB.1 FR1		SSB.5 FR1	
			Config 2	SSB.1 FR1		SSB.5 FR1	
			Config 3	SSB.2 FR1		SSB.6 FR1	
SMTC configuration			Config 1	SMTC.2		SMTC.5	
			Config 2, 3	SMTC.1		SMTC.4	
PDSCH/PDCCH subcarrier spacing		kHz	Config 1,2	15			
			Config 3	30			
EPRE ratio of PSS to SSS			Config 1,2,3	0		0	
EPRE ratio of PBCH DMRS to SSS							
EPRE ratio of PBCH to PBCH DMRS							
EPRE ratio of PDCCH DMRS to SSS							
EPRE ratio of PDCCH to PDCCH DMRS							
EPRE ratio of PDSCH DMRS to SSS							
EPRE ratio of PDSCH to PDSCH							
EPRE ratio of OCNG DMRS to SSS(Note 1)							
EPRE ratio of OCNG to OCNG DMRS (Note 1)							
<i>N<sub>oc</sub></i> <sup>Note2</sup>	dBm/15 kHz			-98		-98	
			Config 1,2	-98		-98	

$N_{oc}$ <sup>Note2</sup>	dBm/S CS	Config 3	-95		-95	
SS-RSRP <sup>Note3</sup>	dBm/S CS	Config 1,2	-94	-94	-Infinity	-91
		Config 3	-91	-91	-Infinity	-88
$\hat{E}_s/I_{ot}$	dB	Config 1,2,3	4	4	-Infinity	7
$\hat{E}_s/N_{oc}$	dB	Config 1,2,3	4	4	-Infinity	7
$I_o$ <sup>Note3</sup>	dBm/9.3 6MHz	Config 1,2	-64.59	-64.59	-70.05	-62.2
	dBm/38. 16MHz	Config 3	-58.4	-58.49	-63.94	-56.15
Propagation Condition		Config 1,2,3	AWGN		AWGN	
Note 1:	OCNG shall be used such that both cells are fully allocated and a constant total transmitted power spectral density is achieved for all OFDM symbols.					
Note 2:	Interference from other cells and noise sources not specified in the test is assumed to be constant over subcarriers and time and shall be modelled as AWGN of appropriate power for $N_{oc}$ to be fulfilled.					
Note 3:	SS-RSRP and $I_o$ levels have been derived from other parameters for information purposes. They are not settable parameters themselves.					
Note 4:	SS-RSRP minimum requirements are specified assuming independent interference and noise at each receiver antenna port.					

In test 1 with per-UE gap, the UE shall send one Event A3 triggered measurement report, with a measurement reporting delay less than 1040 ms from the beginning of time period T2. The UE shall not send event triggered measurement reports, as long as the reporting criteria are not fulfilled. The rate of correct events observed during repeated tests shall be at least 90% with a confidence level of 95%.

In test 2 with per-FR gap, the UE shall send one Event A3 triggered measurement report, with a measurement reporting delay less than 880 ms from the beginning of time period T2. The UE shall not send event triggered measurement reports, as long as the reporting criteria are not fulfilled. The rate of correct events observed during repeated tests shall be at least 90% with a confidence level of 95%.

In test 1 and 2 UE is required to report SSB time index.

NOTE: The actual overall delays measured in the test may be up to  $2xTTI_{DCCH}$  higher than the measurement reporting delays above because of TTI insertion uncertainty of the measurement report in DCCH.

## 6.6.2.6 NR SA FR1-FR1 event-triggered reporting in DRX with SSB time index detection

### 6.6.2.6.1 Test purpose

To verify that the UE makes correct reporting of an event in DRX within inter-frequency NR cell search requirements with SSB time index detection in TS 38.133 [6] clause 9.3.4.

### 6.6.2.6.2 Test applicability

This test applies to all types of NR UE Release 15 and forward supporting 5GS NR SA FR1 and long DRX cycle. Test 1 and Test 2 are applicable to UEs not supporting per-FR gap (IndependentGapConfig, as defined in TS 38.306 [11]) and Test 3 and Test 4 are applicable only to UEs supporting per-FR gap and Gap Pattern Id 4.

### 6.6.2.6.3 Minimum conformance requirements

The minimum conformance requirements are specified in clause 6.6.2.0.

The normative reference for this requirement is TS 38.133 [6] clause A.6.6.2.6.

6.6.2.6.4 Test description

6.6.2.6.4.1 Initial conditions

This test shall be tested using any of the test configurations in Table 6.6.2.6.4.1-1. Configure the test equipment and the DUT according to the parameters in Table 6.6.2.6.4.1-2. Test environment parameters are given in Table 6.6.2.6.4.1-3.

**Table 6.6.2.6.4.1-1: SA FR1-FR1 event triggered reporting tests in DRX with SSB time index detection supported test configurations**

Test Case ID	Description
6.6.2.6-1	NR 15 kHz SSB SCS, 10MHz bandwidth, FDD duplex mode
6.6.2.6-2	NR 15 kHz SSB SCS, 10MHz bandwidth, TDD duplex mode
6.6.2.6-3	NR 30 kHz SSB SCS, 40MHz bandwidth, TDD duplex mode
Note 1: The UE is only required to be tested in one of the supported test configurations	
Note 2: target NR cell has the same SCS, BW and duplex mode as NR serving cell	

**Table 6.6.2.6.4.1-2: General test parameters for SA inter-frequency event triggered reporting for FR1 with SSB time index detection**

Parameter	Unit	Test configuration	Value				Comment
			Test 1	Test 2	Test 3	Test 4	
NR RF Channel Number		Config 1,2,3	1, 2				Two FR1 NR carrier frequencies are used
Active cell		Config 1,2,3	NR cell 1 (Pcell)				NR Cell 1 is on NR RF channel number 1
Neighbour cell		Config 1,2,3	NR cell2				NR cell 2 is on NR RF channel number 2
Gap Pattern Id		Config 1,2,3	0	4			As specified in TS 38.133 clause 9.1.2-1
Measurement gap offset		Config 1,2,3	9	9			
A3-Offset	dB	Config 1,2,3	-6				
Hysteresis	dB	Config 1,2,3	0				
CP length		Config 1,2,3	Normal				
TimeToTrigger	s	Config 1,2,3	0				
Filter coefficient		Config 1,2,3	0				L3 filtering is not used
DRX		Config 1,2,3	DRX .1	DRX .7	DRX .1	DRX .7	As specified in clause A.5
Time offset between serving and neighbour cells		Config 1	3ms				Asynchronous cells. The timing of Cell 2 is 3ms later than the timing of Cell 1.
		Config 2,3	3µs				Synchronous cells
T1	s	Config 1,2,3	5				
T2	s	Config 1,2,3	1.3	13.5	1.3	13.5	

**Table 6.6.2.6.4.1-3: Test Environment parameters for SA inter-frequency event triggered reporting for FR1 without SSB time index detection in DRX**

Parameter	Value		Comment
Test environment	NC		As specified in TS 38.508-1 [14] clause 4.1.
Test frequencies	As specified in Annex E, Table E.4-1 and TS 38.508-1 [14] clause 4.3.1 and 4.4.2.		
Channel bandwidth	As specified by the test configuration selected from Table 6.6.2.6.4.1-1.		
Propagation conditions	AWGN		As specified in Annex C.2.2.
Connection Diagram	TE Part	A.3.1.8.2	As specified in TS 38.508-1 [14] Annex A.
	DUT Part	A.3.2.3.4	
Exceptions to connection diagram	- Without LTE link - For 4Rx capable UEs without any 2Rx RF bands use A.3.2.5.1 for DUT part and A.3.1.8.4 for TE part.		

1. Message contents are defined in clause 6.6.2.6.4.3.

2. There are two NR cells on two carriers specified in the test. Cell 1 is the cell used for connection setup and Cell 2 is a target cell on a different carrier than Cell 1. The power levels and settings for Cell 2 are set according to Table Annex C.1.2.

#### 6.6.2.6.4.2 Test procedure

In this test, there are two cells: NR cell 1 as PCell in FR1 on NR RF channel 1 and NR cell 2 as neighbour cell in FR1 on NR RF channel 2.

In test 1&2 measurement gap pattern configuration # 0 as defined in Table 6.6.2.6.4.1-2 is provided for UE that does not support per-FR gap and in test 3&4 measurement gap pattern configuration #4 as defined in Table 6.6.2.6.4.1-2 is provided for UE that supports per-FR gap.

In the measurement control information, it is indicated to the UE that event-triggered reporting with Event A3 is used. The test consists of two successive time periods, with time duration of T1, and T2 respectively. During time duration T1, the UE shall not have any timing information of NR cell 2.

1. Ensure the UE is in state RRC\_CONNECTED with generic procedure parameters Connectivity NR SA, Connected without release *On* and Test Mode *On* according to TS 38.508-1 [14] clause 4.5.
  2. Set the parameters according to T1 in Table 6.6.2.6.4.1-2 and Table 6.6.2.6.5-1.
  3. The SS shall transmit an *RRCReconfiguration* message.
  4. The UE shall transmit *RRCReconfigurationComplete* message. T1 starts.
  5. When T1 expires, the SS shall switch the power setting from T1 to T2 as specified in Table 6.6.2.6.5-1. T2 Starts.
  6. UE shall transmit a *MeasurementReport* message triggered by Event A3. If the overall delays measured from the beginning of time period T2 is less than 1280 ms for Test 1, 13440 ms for Test 2, 1280 ms for Test 3 and 13440 ms for Test 4, then the number of successful tests is increased by one. If the UE fails to report the event within the overall delays measured requirement then the number of failure tests is increased by one.
  7. After the SS receives the *MeasurementReport* message in step 6 or when T2 expires, the SS shall:
    - transmit RRCRelease message to release the RRC connection which includes the release of the established radio bearers as well as all radio resources
- OR
- switch the UE off.
8. Set Cell 3 physical cell identity = ((current cell 3 physical cell identity + 1) mod 14 + 2) for next iteration of the test procedure loop.

9. Depending on the choice in Step 7, the SS:

- if the RRC Connection Release has been sent, transmits in Cell 1 a *Paging* message (including *PagingRecord* with *ue-Identity*) for the UE and ensures the UE in state *RRC\_CONNECTED* with generic procedure parameters *Connectivity NR SA, Connected without release On* according to TS 38.508-1 [14] clause 4.5. (if the paging fails, switches off and on the UE and ensures the UE is in state *RRC\_CONNECTED* with generic procedure parameters *Connectivity NR SA, Connected without release On* according to TS 38.508-1 [14] clause 4.5.),  
OR
- if the device has been switched off, switches on the UE and ensures the UE is in state *RRC\_CONNECTED* with generic procedure parameters *Connectivity NR SA, Connected without release On* according to TS 38.508-1 [14] clause 4.5.

10. Repeat step 2-9 until the confidence level according to Tables G.2.3-1 in Annex G clause G.2 is achieved.

11. Repeat step 1-10 for each sub-test in Table 6.6.2.6.4.1-2 as appropriate.

6.6.2.6.4.3 Message contents

Message contents are according to TS 38.508-1 [14] clause 7.3 with the following exceptions:

**Table 6.6.2.6.4.3-1: Common Exception messages SA inter frequency event triggered reporting without SSB time index detection in non-DRX**

Default Message Contents	
Common contents of system information blocks exceptions	
Default RRC messages and information elements contents exceptions	Table H.3.1-1 Table H.3.1-2 with Conditions GAP NEEDED and INTER-FREQ Table H.3.1-4 with A3-offset = -6dB and Condition SSB Index Table H.3.1-5 Table H.3.1-6 with Conditions gapUE, Pattern #0 and gap offset = 9 for Test 1 and Test 2 Table H.3.1-6 with Conditions gapFR1 and Pattern #4 and gap offset = 9 for Test 3 and Test 4 Table H.3.1-7 with Conditions INTER-FREQ and SSB Index Table H.3.7-1 with Condition DRX.1 and Gap and INTER-FREQ for Test 1 and Test 3 Table H.3.7-1 with Condition DRX.7 and Gap and INTER-FREQ for Test 2 and Test 4
Specific message contents exceptions for Test Configuration 6.6.2.6-1	Table H.3.1-3 with Conditions INTER-FREQ MO Table 7.3.1-3 in TS 38.508-1 [14] with condition SMTC.5
Specific message contents exceptions for Test Configuration 6.6.2.6-2	Table H.3.1-3 with Conditions INTER-FREQ MO and Synchronous cells Table 7.3.1-3 in TS 38.508-1 [14] with condition SMTC.4
Specific message contents exceptions for Test Configuration 6.6.2.6-3	Table H.3.1-3 with Conditions INTER-FREQ MO and Synchronous cells Table 7.3.1-3 in TS 38.508-1 [14] with condition SMTC.4

6.6.2.6.5 Test requirement

Table 6.6.2.6.5-1 defines the primary level settings including test tolerances for all tests.



**Table 6.6.2.6.5-1: Cell specific test parameters for SA inter-frequency event triggered reporting for FR1 with SSB time index detection**

Parameter		Unit	Test configuration	Cell 1		Cell 2	
				T1	T2	T1	T2
NR RF Channel Number			Config 1,2,3	1		2	
Duplex mode			Config 1	FDD			
			Config 2,3	TDD			
TDD configuration			Config 1	Not Applicable			
			Config 2	TDDConf.1.1			
			Config 3	TDDConf.2.1			
BW <sub>channel</sub>		MHz	Config 1,2	10: N <sub>RB,c</sub> = 52			
			Config 3	40: N <sub>RB,c</sub> = 106			
BWP BW		MHz	Config 1,2	10: N <sub>RB,c</sub> = 52			
			Config 3	40: N <sub>RB,c</sub> = 106			
BWP configuration	Initial DL BWP		Config 1, 2, 3	DLBWP.0.1		NA	
	Initial UL BWP			ULBWP.0.1		NA	
	Dedicated DL BWP			DLBWP.1.1		NA	
	Dedicated UL BWP			ULBWP.1.1		NA	
TRS configuration			Config 1	TRS.1.1 FDD		NA	
			Config 2	TRS.1.1 TDD		NA	
			Config 3	TRS.1.2 TDD		NA	
OCNG Patterns			Config 1,2,3	OP.1		OP.1	
PDSCH Reference measurement channel			Config 1	SR.1.1 FDD		-	
			Config 2	SR.1.1 TDD			
			Config 3	SR.2.1 TDD			
RMSI CORESET Reference Channel			Config 1	CR.1.1 FDD		-	
			Config 2	CR.1.1 TDD			
			Config 3	CR.2.1 TDD			
Dedicated CORESET Reference Channel			Config 1	CCR.1.1 FDD		-	
			Config 2	CCR.1.1 TDD			
			Config 3	CCR.2.1 TDD			
SSB parameters			Config 1	SSB.1 FR1		SSB.5 FR1	
			Config 2	SSB.1 FR1		SSB.5 FR1	
			Config 3	SSB.2 FR1		SSB.6 FR1	
SMTC configuration			Config 1	SMTC.2		SMTC.5	
			Config 2, 3	SMTC.1		SMTC.4	
PDSCH/PDCCH subcarrier spacing		kHz	Config 1,2	15			
			Config 3	30			
EPRE ratio of PSS to SSS			Config 1,2,3	0		0	
EPRE ratio of PBCH DMRS to SSS							
EPRE ratio of PBCH to PBCH DMRS							
EPRE ratio of PDCCH DMRS to SSS							
EPRE ratio of PDCCH to PDCCH DMRS							
EPRE ratio of PDSCH DMRS to SSS							
EPRE ratio of PDSCH to PDSCH							
EPRE ratio of OCNG DMRS to SSS(Note 1)							
EPRE ratio of OCNG to OCNG DMRS (Note 1)							
$N_{oc}$ <sup>Note2</sup>	dBm/15 kHz			-98		-98	
$N_{oc}$ <sup>Note2</sup>	dBm/S CS		Config 1,2	-98		-98	
			Config 3	-95		-95	
SS-RSRP <sup>Note 3</sup>			Config 1,2	-94	-94	-Infinity	-91

	dBm/S CS	Config 3	-91	-91	-Infinity	-88
$\hat{E}_s/I_{ot}$	dB	Config 1,2,3,4,5,6	4	4	-Infinity	7
$\hat{E}_s/N_{oc}$	dB	Config 1,2,3	4	4	-Infinity	7
$I_o^{Note3}$	dBm/9.3 6MHz	Config 1,2	-64.59	-64.59	-70.05	-62.26
	dBm/38. 16MHz	Config 3	-58.49	-58.49	-63.94	-56.15
Propagation Condition		Config 1,2,3	AWGN		AWGN	
<p>Note 1: OCNG shall be used such that both cells are fully allocated and a constant total transmitted power spectral density is achieved for all OFDM symbols.</p> <p>Note 2: Interference from other cells and noise sources not specified in the test is assumed to be constant over subcarriers and time and shall be modelled as AWGN of appropriate power for <math>N_{oc}</math> to be fulfilled.</p> <p>Note 3: SS-RSRP and <math>I_o</math> levels have been derived from other parameters for information purposes. They are not settable parameters themselves.</p> <p>Note 4: SS-RSRP minimum requirements are specified assuming independent interference and noise at each receiver antenna port.</p>						

In test 1 with per-UE gap, the UE shall send one Event A3 triggered measurement report, with a measurement reporting delay less than 1280 ms from the beginning of time period T2. The UE shall not send event triggered measurement reports, as long as the reporting criteria are not fulfilled. The rate of correct events observed during repeated tests shall be at least 90% with a confidence level of 95%.

In test 2 with per-UE gap, the UE shall send one Event A3 triggered measurement report, with a measurement reporting delay less than 13440 ms from the beginning of time period T2. The UE shall not send event triggered measurement reports, as long as the reporting criteria are not fulfilled. The rate of correct events observed during repeated tests shall be at least 90% with a confidence level of 95%.

In test 3 with per-FR gap, the UE shall send one Event A3 triggered measurement report, with a measurement reporting delay less than 1280 ms from the beginning of time period T2. The UE shall not send event triggered measurement reports, as long as the reporting criteria are not fulfilled. The rate of correct events observed during repeated tests shall be at least 90% with a confidence level of 95%.

In test 4 with per-FR gap, the UE shall send one Event A3 triggered measurement report, with a measurement reporting delay less than 13440 ms from the beginning of time period T2. The UE shall not send event triggered measurement reports, as long as the reporting criteria are not fulfilled. The rate of correct events observed during repeated tests shall be at least 90% with a confidence level of 95%.

In test 1, 2, 3 and 4 UE is required to report SSB time index.

NOTE: The actual overall delays measured in the test may be up to  $2 \times TTI_{DCCH}$  higher than the measurement reporting delays above because of TTI insertion uncertainty of the measurement report in DCCH.

6.6.2.7 Void

6.6.2.8 Void

## 6.6.3 Inter-RAT Measurements

### 6.6.3.0 Minimum conformance requirements

#### 6.6.3.0.1 Minimum conformance requirements for inter-RAT event triggered reporting to E-UTRAN FDD

The requirements are applicable for NR–E-UTRAN FDD RSRP, RSRQ, and RS-SINR measurements.

In the requirements, an E-UTRAN FDD cell is considered to be detectable when:

- RSRP related conditions in the accuracy requirements in TS 38.133 [6] Section 10.2.2 are fulfilled for a corresponding Band, together with the corresponding side conditions in Annex B.2.3 and Annex B.3.3 of TS 36.133 [23],
- RSRQ related conditions in the accuracy requirements in TS 38.133 [6] Section 10.2.3 are fulfilled for a corresponding Band, together with the corresponding side conditions in Annex B.2.3 and Annex B.3.3 of TS 36.133 [23],
- RS-SINR related conditions in the accuracy requirements in TS 38.133 [6] Section 10.2.5 are fulfilled for a corresponding Band, together with the corresponding side conditions in Annex B.2.3 and Annex B.3.19 of TS 36.133 [23].

#### 6.6.3.0.1.1 Requirements when no DRX is used

When the UE requires measurement gaps to identify and measure inter-RAT cells and an appropriate measurement gap pattern is scheduled, the UE shall be able to identify a new detectable FDD cell within  $T_{Identify, E-UTRAN FDD}$  according to the following expression:

$$T_{Identify, E-UTRAN FDD} = T_{BasicIdentify} * \frac{480}{T_{Inter1}} * CSSF_{interRAT} \text{ ms},$$

where:

$T_{BasicIdentify} = 480 \text{ ms}$ ,

$T_{Inter1}$  is defined in TS 38.133 [6] section 9.4.1,

$CSSF_{interRAT} = CSSF_{within\_gap\_i}$  is the scaling factor for the measured inter-RAT E-UTRA carrier  $i$  which is calculated as specified in TS 38.133 [6] section 9.1.5.2.

Identification of a cell shall include detection of the cell and additionally performing a single measurement with measurement period of  $T_{Measure, E-UTRAN FDD}$  defined in Table 6.6.3.0.1.1-1.

**Table 6.6.3.0.1.1-1: Measurement period and measurement bandwidth**

Configuration	Physical Layer Measurement period: $T_{Measure, E-UTRAN FDD}$ [ms]	Measurement bandwidth [RB]
0	$480 \times CSSF_{interRAT}$	6
1 (note 1)	$240 \times CSSF_{interRAT}$	50
NOTE 1: This configuration is optional.		

The UE shall be capable of identifying and performing NR – E-UTRAN FDD RSRP, RSRQ, and RS-SINR measurements of at least 4 E-UTRAN FDD cells per E-UTRA FDD carrier frequency layer for up to 7 E-UTRA FDD carrier frequency layers.

If higher layer filtering is used, an additional cell identification delay can be expected.

The NR – E-UTRAN FDD RSRP measurement accuracy for all measured cells shall be as specified in TS 38.133 [6] section 10.2.2. The NR – E-UTRAN FDD RSRQ measurement accuracy for all measured cells shall be as specified in TS 38.133 [6] section 10.2.3. The NR – E-UTRAN FDD RS-SINR measurement accuracy for all measured cells shall be as specified in TS 38.133 [6] section 10.2.5.

#### 6.6.3.0.1.2 Requirements when DRX is used

When DRX is in use and measurement gaps are configured, the UE shall be able to identify a new detectable E-UTRAN FDD cell within  $T_{Identify, E-UTRAN FDD}$  specified in Table 6.6.3.0.1.2-1. When RRM enhancement for high speed is configured the UE shall be able to identify a new detectable E-UTRAN FDD cell within  $T_{Identify, E-UTRAN FDD}$  specified in Table 6.6.3.0.1.2-2.

**Table 6.6.3.0.1.2-1: Requirement to identify a newly detectable E-UTRAN FDD cell**

DRX cycle length (s)	$T_{\text{Identify, E-UTRAN FDD}}$ (s) (DRX cycles)	
	Gap period = 40 ms, 20 ms	Gap period = 80 ms
$\leq 0.16$	Non-DRX requirements in Section 6.6.3.0.1.1 apply	Non-DRX requirements in Section 6.6.3.0.1.1 apply
0.256	$5.12 \cdot K (20 \cdot \text{CSSF}_{\text{interRAT}})$	$7.68 \cdot K (30 \cdot \text{CSSF}_{\text{interRAT}})$
0.32	$6.4 \cdot K (20 \cdot \text{CSSF}_{\text{interRAT}})$	$7.68 \cdot K (24 \cdot \text{CSSF}_{\text{interRAT}})$
$0.32 < \text{DRX-cycle} \leq 10.24$	Note1 ( $20 \cdot \text{CSSF}_{\text{interRAT}}$ )	Note1 ( $20 \cdot \text{CSSF}_{\text{interRAT}}$ )

NOTE 1: The time depends on the DRX cycle length.  
NOTE 2:  $\text{CSSF}_{\text{interRAT}}$  is as defined in Section 6.6.3.0.1.1.

**Table 6.6.3.0.1.2-2: Requirement to identify a newly detectable E-UTRAN FDD cell for UE configured with RRM enhancement for high speed**

DRX cycle length (s)	$T_{\text{Identify, E-UTRAN FDD}}$ (s) (DRX cycles)	
	Gap period = 40 ms, 20 ms	Gap period = 80 ms
$\leq 0.16$	Non-DRX requirements in clause 9.4.2.2 apply	Non-DRX requirements in clause 9.4.2.2 apply
$0.16 < \text{DRx cycle} \leq 0.32$	Note 1 ( $15 \cdot \text{CSSF}_{\text{interRAT}}$ )	
$0.32 < \text{DRx cycle} \leq 0.64$	Note 1 ( $10 \cdot \text{CSSF}_{\text{interRAT}}$ )	
DRx cycle = 1.024	Note 1 ( $10 \cdot \text{CSSF}_{\text{interRAT}}$ )	Note 1 ( $10 \cdot \text{CSSF}_{\text{interRAT}}$ )
DRx cycle = 1.28	Note 1 ( $8 \cdot \text{CSSF}_{\text{interRAT}}$ )	Note 1 ( $8 \cdot \text{CSSF}_{\text{interRAT}}$ )
$1.28 < \text{DRX-cycle} \leq 10.24$	Note1 ( $20 \cdot \text{CSSF}_{\text{interRAT}}$ )	Note1 ( $20 \cdot \text{CSSF}_{\text{interRAT}}$ )

NOTE 1: The time depends on the DRX cycle length.  
NOTE 2:  $\text{CSSF}_{\text{interRAT}}$  is as defined in clause 9.4.2.2.

When DRX is in use, the UE shall be capable of performing NR – E-UTRAN FDD RSRP, RSRQ, and RS-SINR measurements of at least 4 identified E-UTRAN FDD cells per E-UTRA FDD frequency layer during each layer 1 measurement period, for up to 7 E-UTRA FDD carrier frequency layers, and the UE physical layer shall be capable of reporting NR – E-UTRAN FDD RSRP, RSRQ, and RS-SINR measurements to higher layers with the measurement period  $T_{\text{measure, E-UTRAN FDD}}$  specified in Table 6.6.3.0.1.2-3.

**Table 6.6.3.0.1.2-3: Requirement to measure E-UTRAN FDD cells**

DRX cycle length (s)	$T_{\text{measure, E-UTRAN FDD}}$ (s) (DRX cycles)
$\leq 0.08$	Non-DRX requirements in Section 6.6.3.0.1.1 apply
$0 < \text{DRX-cycle} \leq 10.24$	Note1 ( $5 \cdot \text{CSSF}_{\text{interRAT}}$ )

NOTE 1: The time depends on the DRX cycle length.  
NOTE 2:  $\text{CSSF}_{\text{interRAT}}$  is as defined in Section 6.6.3.0.1.1.

If higher layer filtering is used, an additional cell identification delay can be expected.

The NR – E-UTRAN FDD RSRP measurement accuracy for all measured cells shall be as specified in TS 38.133 [6] Section 10.2.2. The NR – E-UTRAN FDD RSRQ measurement accuracy for all measured cells shall be as specified in TS 38.133 [6] Section 10.2.3. The NR – E-UTRAN FDD RS-SINR measurement accuracy for all measured cells shall be as specified in TS 38.133 [6] Section 10.2.5.

#### 6.6.3.0.1.3 Measurement reporting requirements for Event-Triggered Reporting

The reported NR – E-UTRAN FDD RSRP, RSRQ, and RS-SINR measurements contained in event-triggered measurement reports shall meet the requirements in TS 38.133 [6] clauses 10.2.2, 10.2.3, and 10.2.5, respectively.

The UE shall not send any event-triggered measurement reports, as long as no reporting criteria are fulfilled.

The measurement reporting delay is defined as the time between an event that will trigger a measurement report and the point when the UE starts to transmit the measurement report over the air interface. This requirement assumes that the measurement report is not delayed by other RRC signalling on the DCCH. This measurement reporting delay excludes a delay uncertainty resulted when inserting the measurement report to the TTI of the uplink DCCH. The delay uncertainty is:  $2 \times \text{TTI}_{\text{DCCH}}$  where  $\text{TTI}_{\text{DCCH}}$  is the duration of subframe or slot or subslot when the measurement report is

transmitted on the PUSCH with subframe or slot or subslot duration. This measurement reporting delay excludes a delay which caused by no UL resources for UE to send the measurement report.

The event triggered measurement reporting delay, measured without L3 filtering shall be less than  $T_{Identify, E-UTRAN FDD}$  defined in clauses 6.6.3.0.1.1 and 6.6.3.0.1.2 without DRX and with DRX, respectively. When L3 filtering is used, an additional delay can be expected.

If a cell which has been detectable at least for the time period  $T_{Identify, E-UTRAN FDD}$  becomes undetectable for a period  $\leq 5$  seconds and then the cell becomes detectable again and triggers an event as per TS 38.331 [13], the event triggered measurement reporting delay shall be less than  $T_{Measure, E-UTRAN FDD}$  provided the timing to that cell has not changed more than  $\pm 50 T_s$  while measurement gap has not been available and the L3 filter has not been used.

The normative reference for this requirement is TS 38.133 [6] clause 9.4.2.

### 6.6.3.0.2 Minimum conformance requirements for inter-RAT event triggered reporting to E-UTRAN TDD

The requirements are applicable for NR–E-UTRAN TDD RSRP, RSRQ, and RS-SINR measurements.

In the requirements, an E-UTRAN TDD cell is considered to be detectable when:

- RSRP related conditions in the accuracy requirements in TS 38.133 [6] Section 10.2.2 are fulfilled for a corresponding Band, together with the corresponding side conditions in Annex B.2.3 and Annex B.3.3 of TS 36.133 [23],
- RSRQ related conditions in the accuracy requirements in TS 38.133 [6] Section 10.2.3 are fulfilled for a corresponding Band, together with the corresponding side conditions in Annex B.2.3 and Annex B.3.3 of TS 36.133 [23],
- RS-SINR related conditions in the accuracy requirements in TS 38.133 [6] Section 10.2.5 are fulfilled for a corresponding Band, together with the corresponding side conditions in Annex B.2.3 and Annex B.3.19 of TS 36.133 [23].

#### 6.6.3.0.2.1 Requirements when no DRX is used

When the UE requires measurement gaps to identify and measure inter-RAT cells and an appropriate measurement gap pattern is scheduled, the UE shall be able to identify a new detectable TDD cell within  $T_{Identify, E-UTRAN TDD}$  according to the following expression:

- When configuration 0 or configuration 1 in Table 6.6.3.0.2-1 is applied,

$$T_{Identify, E-UTRAN TDD} = T_{BasicIdentify} * \frac{480}{T_{Inter1}} * CSSF_{interRAT} \text{ ms},$$

- When configuration 2 or configuration 3 in Table 6.6.3.0.2-1 is applied,

$$T_{Identify, E-UTRAN TDD} = (T_{BasicIdentify} * \frac{480}{T_{Inter1}} + 240) * CSSF_{interRAT} \text{ ms},$$

where:

$T_{BasicIdentify} = 480 \text{ ms}$ ,

$T_{Inter1}$  is defined in TS 38.133 [6] section 9.4.1,

$CSSF_{interRAT} = CSSF_{within\_gap\_i}$  is the scaling factor for the measured inter-RAT E-UTRA carrier  $i$  which is calculated as specified in TS 38.133 [6] section 9.1.5.2.

Identification of a cell shall include detection of the cell and additionally performing a single measurement with measurement period of  $T_{Measure, E-UTRAN TDD}$  defined in Table 6.6.3.0.2.1-1.

**Table 6.6.3.0.2.1-1:  $T_{Measure, E-UTRAN TDD}$  for different configurations**

Configuration	Measurement bandwidth [RB]	Number of UL/DL sub-frames per half frame (5 ms)		DwPTS		$T_{Measure, E-UTRAN TDD}$ [ms]
		DL	UL	Normal CP	Extended CP	

0	6	2	2	$19760 \cdot T_s$	$20480 \cdot T_s$	480 x CSSF <sub>interRAT</sub>
1 (note 1)	50	2	2	$19760 \cdot T_s$	$20480 \cdot T_s$	240 x CSSF <sub>interRAT</sub>
2	6	1	3	$19760 \cdot T_s$	$20480 \cdot T_s$	720 x CSSF <sub>interRAT</sub>
3 (Note 1)	50	1	3	$19760 \cdot T_s$	$20480 \cdot T_s$	480 x CSSF <sub>interRAT</sub>
NOTE 1: This configuration is optional.						
NOTE 2: Void						

The UE shall be capable of identifying and performing NR – E-UTRAN TDD RSRP, RSRQ, and RS-SINR measurements of at least 4 E-UTRAN TDD cells per E-UTRA TDD carrier frequency layer for up to 7 E-UTRA TDD carrier frequency layers.

If higher layer filtering is used, an additional cell identification delay can be expected.

The NR – E-UTRAN TDD RSRP measurement accuracy for all measured cells shall be as specified in TS 38.133 [6] section 10.2.2. The NR – E-UTRAN TDD RSRQ measurement accuracy for all measured cells shall be as specified in TS 38.133 [6] section 10.2.3. The NR – E-UTRAN TDD RS-SINR measurement accuracy for all measured cells shall be as specified in TS 38.133 [6] section 10.2.5.

#### 6.6.3.0.2.1 Requirements when DRX is used

When DRX is in use and measurement gaps are configured, the UE shall be able to identify a new detectable E-UTRAN TDD cell within  $T_{\text{Identify, E-UTRAN TDD}}$  specified in Table 6.6.3.0.2.1-1. When RRM enhancement for high speed is configured the UE shall be able to identify a new detectable E-UTRAN TDD cell within  $T_{\text{Identify, E-UTRAN TDD}}$  specified in Table 6.6.3.0.2.1-2.

**Table 6.6.3.0.2.1-1: Requirement to identify a newly detectable E-UTRAN TDD cell**

DRX cycle length (s)	$T_{\text{Identify, E-UTRAN TDD}}$ (s) (DRX cycles)	
	Gap period = 40 ms, 20 ms	Gap period = 80 ms
$\leq 0.16$	Non-DRX requirements in Section 6.6.3.0.2.1 apply	Non-DRX requirements in Section 6.6.3.0.2.1 apply
0.256	$5.12 \cdot K (20 \cdot \text{CSSF}_{\text{interRAT}})$	$7.68 \cdot K (30 \cdot \text{CSSF}_{\text{interRAT}})$
0.32	$6.4 \cdot K (20 \cdot \text{CSSF}_{\text{interRAT}})$	$7.68 \cdot K (24 \cdot \text{CSSF}_{\text{interRAT}})$
$0.32 < \text{DRX-cycle} \leq 10.24$	Note1 ( $20 \cdot \text{CSSF}_{\text{interRAT}}$ )	Note1 ( $20 \cdot \text{CSSF}_{\text{interRAT}}$ )
NOTE 1: The time depends on the DRX cycle length.		
NOTE 2: $\text{CSSF}_{\text{interRAT}}$ is as defined in Section 6.6.3.0.2.1.		

**Table 6.6.3.0.2.1-2: Requirement to identify a newly detectable E-UTRAN TDD cell for UE configured with RRM enhancement for high speed**

DRX cycle length (s)	$T_{\text{Identify, E-UTRAN TDD}}$ (s) (DRX cycles)	
	Gap period = 40 ms, 20 ms	Gap period = 80 ms
$\leq 0.16$	Non-DRX requirements in clause 9.4.3.2 apply	Non-DRX requirements in clause 9.4.3.2 apply
$0.16 < \text{DRx cycle} \leq 0.32$	Note 1 ( $15 \cdot \text{CSSF}_{\text{interRAT}}$ )	
$0.32 < \text{DRx cycle} \leq 0.64$	Note 1 ( $10 \cdot \text{CSSF}_{\text{interRAT}}$ )	
DRx cycle = 1.024	Note 1 ( $10 \cdot \text{CSSF}_{\text{interRAT}}$ )	Note 1 ( $10 \cdot \text{CSSF}_{\text{interRAT}}$ )
DRx cycle = 1.28	Note 1 ( $8 \cdot \text{CSSF}_{\text{interRAT}}$ )	Note 1 ( $8 \cdot \text{CSSF}_{\text{interRAT}}$ )
$1.28 < \text{DRX-cycle} \leq 10.24$	Note1 ( $20 \cdot \text{CSSF}_{\text{interRAT}}$ )	Note1 ( $20 \cdot \text{CSSF}_{\text{interRAT}}$ )
NOTE 1: The time depends on the DRX cycle length.		
NOTE 2: $\text{CSSF}_{\text{interRAT}}$ is as defined in clause 9.4.3.2.		

When DRX is in use, the UE shall be capable of performing NR – E-UTRAN TDD RSRP, RSRQ, and RS-SINR measurements of at least 4 identified E-UTRAN TDD cells per E-UTRA TDD frequency layer during each layer 1 measurement period, for up to 7 E-UTRA TDD carrier frequency layers, and the UE physical layer shall be capable of reporting NR – E-UTRAN TDD RSRP, RSRQ, and RS-SINR measurements to higher layers with the measurement period  $T_{\text{measure, E-UTRAN TDD}}$  specified in Table 6.6.3.0.2.1-3.

**Table 6.6.3.0.2.1-3: Requirement to measure E-UTRAN TDD cells**

DRX cycle length (s)	$T_{\text{measure, E-UTRAN TDD}}$ (s) (DRX cycles)
$\leq 0.08$	Non-DRX Requirements in Section 6.6.3.0.2.1 apply
0.128	For configuration 2, non-DRX requirements in section 6.6.3.0.2.1 apply, Otherwise: Note1 ( $5 \cdot \text{CSSF}_{\text{interRAT}}$ )
$0.128 < \text{DRX-cycle} \leq 10.24$	Note1 ( $5 \cdot \text{CSSF}_{\text{interRAT}}$ )
NOTE 1: The time depends on the DRX cycle length.	
NOTE 2: $\text{CSSF}_{\text{interRAT}}$ is as defined in Section 6.6.3.0.2.1.	

If higher layer filtering is used, an additional cell identification delay can be expected.

The NR – E-UTRAN TDD RSRP measurement accuracy for all measured cells shall be as specified in TS 38.133 [6] Section 10.2.2. The NR – E-UTRAN TDD RSRQ measurement accuracy for all measured cells shall be as specified in TS 38.133 [6] Section 10.2.3. The NR – E-UTRAN TDD RS-SINR measurement accuracy for all measured cells shall be as specified in TS 38.133 [6] Section 10.2.5.

#### 6.6.3.0.2.3 Measurement reporting requirements for Event-Triggered Reporting

The reported NR – E-UTRAN TDD RSRP, RSRQ, and RS-SINR measurements contained in event-triggered measurement reports shall meet the requirements in TS 38.133 [6] clauses 10.2.2, 10.2.3, and 10.2.5, respectively.

The UE shall not send any event-triggered measurement reports, as long as no reporting criteria are fulfilled.

The measurement reporting delay is defined as the time between an event that will trigger a measurement report and the point when the UE starts to transmit the measurement report over the air interface. This requirement assumes that the measurement report is not delayed by other RRC signalling on the DCCH. This measurement reporting delay excludes a delay uncertainty resulted when inserting the measurement report to the TTI of the uplink DCCH. The delay uncertainty is:  $2 \times \text{TTI}_{\text{DCCH}}$  where  $\text{TTI}_{\text{DCCH}}$  is the duration of subframe or slot or subslot when the measurement report is transmitted on the PUSCH with subframe or slot or subslot duration. This measurement reporting delay excludes a delay which caused by no UL resources for UE to send the measurement report.

The event triggered measurement reporting delay, measured without L3 filtering shall be less than  $T_{\text{Identify, E-UTRAN TDD}}$  defined in clauses 6.6.3.0.2.1 and 6.6.3.0.2.2 without DRX and with DRX, respectively. When L3 filtering is used, an additional delay can be expected.

If a cell which has been detectable at least for the time period  $T_{\text{Identify, E-UTRAN TDD}}$  becomes undetectable for a period  $\leq 5$  seconds and then the cell becomes detectable again and triggers an event as per TS 38.331 [13], the event triggered measurement reporting delay shall be less than  $T_{\text{Measure, E-UTRAN TDD}}$  provided the timing to that cell has not changed more than  $\pm 50 T_s$  while measurement gap has not been available and the L3 filter has not been used.

The normative reference for this requirement is TS 38.133 [6] clause 9.4.3.

### 6.6.3.1 NR SA FR1 – E-UTRAN event-triggered reporting in non-DRX

#### 6.6.3.1.1 Test purpose

This test is to verify that the UE makes correct event-triggered reporting of inter-RAT E-UTRAN measurements when operating in standalone (SA) operation with PCell in FR1 under the cell search and measurement requirements.

#### 6.6.3.1.2 Test applicability

This test applies to all types of NR UE supporting SA FR1 from Release 15 onwards.

#### 6.6.3.1.3 Minimum conformance requirements

The normative reference for this requirement is TS 38.133 [6] clause A.6.6.3.1.

##### 6.6.3.1.3.1 NR – E-UTRAN FDD requirement

The minimum conformance requirements are specified in clause 6.6.3.0.1.



## 6.6.3.1.3.2 NR – E-UTRAN TDD requirement

The minimum conformance requirements are specified in clause 6.6.3.0.2.

## 6.6.3.1.4 Test description

## 6.6.3.1.4.1 Initial conditions

This test shall be tested using any of the test configurations in Table 6.6.3.1.4.1-1.

**Table 6.6.3.1.4.1-1: supported test configurations**

Test Case ID	Description
6.6.3.1-1	NR 15 kHz SSB SCS, 10MHz bandwidth, FDD duplex mode, LTE FDD
6.6.3.1-2	NR 15 kHz SSB SCS, 10MHz bandwidth, TDD duplex mode, LTE FDD
6.6.3.1-3	NR 30 kHz SSB SCS, 40MHz bandwidth, TDD duplex mode, LTE FDD
6.6.3.1-4	NR 15 kHz SSB SCS, 10MHz bandwidth, FDD duplex mode, LTE TDD
6.6.3.1-5	NR 15 kHz SSB SCS, 10MHz bandwidth, TDD duplex mode, LTE TDD
6.6.3.1-6	NR 30 kHz SSB SCS, 40MHz bandwidth, TDD duplex mode, LTE TDD
NOTE: The UE is only required to be tested in one of the supported test configurations	

Configure the test equipment and the DUT according to the parameters in Table 6.6.3.1.4.1-2 and Table 6.6.3.1.4.1-3.

**Table 6.6.3.1.4.1-2: Initial conditions for SA inter-RAT E-UTRAN event triggered reporting in non-DRX with PCell in FR1**

Parameter	Value		Comment
Test environment	NC		As specified in TS 38.508-1 [14] clause 4.1.
Test frequencies	As specified in Annex E, Table E.4-2 and TS 38.508-1 [14] clause 4.3.1.		
Channel bandwidth	As specified by the test configuration selected from Table 6.6.3.1.5-1 and Table 6.6.3.1.5-2..		
Propagation conditions	AWGN		As specified in Annex C.2.2.
Connection Diagram	TE Part	A.3.1.8.3	As specified in TS 38.508-1 [14] Annex A.
	DUT Part	A.3.2.3.2	
Exceptions to connection diagram	N/A		

**Table 6.6.3.1.4.1-3: General test parameters for SA inter-RAT E-UTRAN event triggered reporting in non-DRX with PCell in FR1**

Parameter	Unit	Value	Comment
NR RF Channel Number		1	1 NR carrier frequency is used in the test
LTE RF Channel Number		1	1 LTE carrier frequency is used in the test
Channel Bandwidth	MHz	As specified in Tables 6.6.3.1.5-1 and 6.6.3.1.5-2.	
Active cell		Cell 1	Cell 1 is on RF channel number 1
Neighbour cell		Cell 2	Cell 2 is on RF channel number 2
Gap Pattern Id		0	As specified in Clause TS 38.133 [6] Table 9.1.2-1. Per-UE gap pattern.
NR measurement quantity		SS-RSRP	Measurement quantity for Cell 1
Inter-RAT E-UTRAN measurement quantity		RSRP	Measurement quantity for Cell 2
b2-Threshold1	dBm	Note 1	SS-RSRP threshold for SS-RSRP measurement on cell1 for event B2
b2-Threshold2EUTRA	dBm	-97	E-UTRAN RSRP threshold for SS-RSRP measurement on cell1 for event B2
Hysteresis	dB	0	
TimeToTrigger	s	0	
Filter coefficient		0	L3 filtering is not used
DRX		OFF	OFF
T1	s	5	
T2	s	5	
NOTE 1: Values are defined in Table 6.6.3.1.5-1			

1. Message contents are defined in clause 6.6.3.1.4.3.
2. Cell 1 is the NR PCell and Cell 2 is an inter-RAT E-UTRAN inter-RAT neighbour cell. The connection setup is done according to the settings in Annex C.1.1 and C.1.2.

#### 6.6.3.1.4.2 Test procedure

The test consists of two successive time periods, with time durations of T1 and T2 respectively. During time duration T1, the UE shall not have any timing information of cell 2. Gap pattern configuration is configured before T2 begins to enable inter-frequency monitoring.

1. Ensure the UE is in state RRC\_CONNECTED with generic procedure parameters Connectivity NR, Connected without release *On* and Test Mode *On* according to TS 38.508-1 [14] clause 4.5.
2. Set the parameters according to T1 in Table 6.6.3.1.5-1 and 6.6.3.1.5-2. Propagation conditions are set according to Annex C clause C.2.2.
3. SS shall transmit an *RRCReconfiguration* message.
4. The UE shall transmit *RRCReconfigurationComplete* message. T1 starts.
5. When T1 expires, the SS shall switch the power setting from T1 to T2 as specified in Table 6.6.3.1.5-1 and 6.6.3.1.5-2.
6. UE shall transmit a MeasurementReport message triggered by Event B2. If the measurement reporting delay from the beginning of time period T2 is less than 3842ms the number of successful tests is increased by one. If the UE fails to report the event within the measurement reporting delay requirement then the number of failure tests is increased by one.
7. After the SS receive the MeasurementReport message in step 6 or when T2 expires, the SS shall:
  - transmit *RRCRelease* message to release the RRC connection which includes the release of the established radio bearers as well as all radio resources

OR

  - switch the UE off.

8. Set Cell 2 physical cell identity = ((current cell 2 physical cell identity + 1) mod 14 + 2) for next iteration of the test procedure loop.
9. Depending on the choice in Step 7, the SS:
  - if the RRC Connection Release has been sent, transmits in Cell 1 a Paging message (including PagingRecord with UE-Identity) for the UE and ensures the UE is in state RRC\_CONNECTED according to TS 38.508-1 [14] clause 4.5.4 (if the paging fails, switches off and on the UE and ensures the UE is in the state RRC\_CONNECTED with generic procedure parameters Connectivity NR, Connected without release On according to TS 38.508-1 [14] clause 4.5,
  - OR
  - if the device has been switched off, switches on the UE and ensures the UE is in state RRC\_CONNECTED with generic procedure parameters Connectivity NR, Connected without release On according to TS 38.508-1 [14] clause 4.5.
10. Repeat step 2-9 until the confidence level according to Tables G.2.3-1 in Annex G clause G.2 is achieved.

6.6.3.1.4.3 Message contents

Message contents are according to TS 38.508-1 [14] clause 4.6 with the following exceptions:

**Table 6.6.3.1.4.3-1: Common Exception messages NR SA FR1 – E-UTRAN event-triggered reporting in non-DRX**

Default Message Contents	
Common contents of system information blocks exceptions	
Default RRC messages and information elements contents exceptions	Table H.3.1-1 Table H.3.1-2 with Conditions GAP NEEDED and INTER-RAT Table H.3.1-3A Table H.3.1-4A Table H.3.1-5 with Condition INTER-RAT Table H.3.1-6 with Condition Pattern #0 Table H.3.1-7 with Condition INTER-RAT
Specific message content exceptions for Test Configurations 6.6.3.1-1 and 6.6.3.1-4	Table H.3.1-3 Table 7.3.1-3 in TS 38.508-1 [14] with condition SMTC.1
Specific message content exceptions for Test Configurations 6.6.3.1-2, 6.6.3.1-3, 6.6.3.1-5 and 6.6.3.1-6	Table H.3.1-3 with Condition Synchronous cells Table 7.3.1-3 in TS 38.508-1 [14] with condition SMTC.1

6.6.3.1.5 Test requirement

Table 6.6.3.1.5-1 and Table 6.6.3.1.5-2 define the primary level settings including test tolerances for all tests.

**Table 6.6.3.1.5-1: PCell specific test parameters for SA inter-RAT E-UTRA event triggered reporting in non-DRX with PCell in FR1**

Parameter		Unit	Configuration	Cell 1	
				T1	T2
RF channel number			1, 2, 3, 4, 5, 6	1	
Duplex mode			1, 2, 3	FDD	
			4, 5, 6	TDD	
TDD Configuration	SCS=15 KHz		2, 5	TDDConf.1.1	
	SCS=30 KHz		3, 6	TDDConf.2.1	
BW <sub>channel</sub>		MHz	1, 4	10: N <sub>RB,c</sub> = 52 (FDD)	
			2, 5	10: N <sub>RB,c</sub> = 52 (TDD)	
			3, 6	40: N <sub>RB,c</sub> = 106 (TDD)	
PDSCH reference measurement channel			1, 4	SR.1.1 FDD	
			2, 5	SR.1.1 TDD	
			3, 6	SR.2.1 TDD	
CORESET reference channel			1, 4	CR.1.1 FDD	
			2, 5	CR.1.1 TDD	
			3, 6	CR.2.1 TDD	
Dedicated CORESET reference channel			1, 4	CCR.1.1 FDD	
			2, 5	CCR.1.1 TDD	
			3, 6	CCR.2.1 TDD	
BWP configurations	Initial DL BWP		1, 2, 3, 4, 5, 6	DLBWP.0.1	
	Dedicated DL BWP		1, 2, 3, 4, 5, 6	DLBWP.1.1	
	Initial UL BWP		1, 2, 3, 4, 5, 6	ULBWP.0.1	
	UL BWP		1, 2, 3, 4, 5, 6	ULBWP.1.1	
OCNG pattern <sup>note1</sup>			1, 2, 3, 4, 5, 6	OP.1	
SMTTC configuration			1, 2, 3, 4, 5, 6	SMTTC.1	
SSB configuration			1, 2, 4, 5	SSB.1 FR1	
			3, 6	SSB.2 FR1	
CSI-RS for tracking			1, 4	TRS.1.1 FDD	
			2, 5	TRS.1.1 TDD	
			3, 6	TRS.1.2 TDD	
b2-Threshold1		dBm	1, 2, 4, 5	-98	
			3, 6	-95	
EPRE ratio of PSS to SSS		dB	1, 2, 3, 4, 5, 6	0	
EPRE ratio of PBCH_DMRS to SSS					
EPRE ratio of PBCH to PBCH_DMRS					
EPRE ratio of PDCCH_DMRS to SSS					
EPRE ratio of PDCCH to PDCCH_DMRS					
EPRE ratio of PDSCH_DMRS to SSS					
EPRE ratio of PDSCH to PDSCH_DMRS					
EPRE ratio of OCNG DMRS to SSS					
EPRE ratio of OCNG to OCNG DMRS					
N <sub>oc</sub> <sup>note2</sup>		dBm/15 KHz	1, 2, 3, 4, 5, 6	-106	
N <sub>oc</sub> <sup>note2</sup>		dBm/SCS	1, 2, 4, 5	-106	
			3, 6	-103	
E <sub>s</sub> /N <sub>oc</sub>		dB	1, 2, 3, 4, 5, 6	19.65	-3.65
E <sub>s</sub> /I <sub>ot</sub> <sup>note3</sup>		dB	1, 2, 3, 4, 5, 6	19.65	-3.65
SS-RSRP <sup>note3</sup>		dBm/SCS	1, 2, 4, 5	-86.35	-109.65
			3, 6	-83.35	-106.65
SSB_RP <sup>note3</sup>		dBm/SCS	1, 2, 4, 5	-86.35	-109.65
			3, 6	-83.35	-106.65
I <sub>o</sub> <sup>note3</sup>		dBm/9.36 MHz	1, 2, 4, 5	-58.35	-76.49
			dBm/38.16 MHz	3, 6	-52.25
Propagation condition			1, 2, 3, 4, 5, 6	TDL-C 300ns 100Hz	
Antenna Configuration and Correlation Matrix			1, 2, 3, 4, 5, 6	1x2 Low	

- NOTE 1: OCNG shall be used such that both cells are fully allocated and a constant total transmitted power spectral density is achieved for all OFDM symbols.
- NOTE 2: Interference from other cells and noise sources not specified in the test is assumed to be constant over subcarriers and time and shall be modelled as AWGN of appropriate power for  $N_{oc}$  to be fulfilled.
- NOTE 3:  $\hat{E}_s/I_{ot}$ , SS-RSRP, SSB\_RP and  $I_o$  levels have been derived from other parameters for information purposes. They are not settable parameters themselves.

**Table 6.6.3.1.5-2: E-UTRAN neighbour cell specific test parameters for SA inter-RAT E-UTRAN event triggered reporting in non-DRX with PCell in FR1**

Parameter	Unit	Configuration	Cell 2	
			T1	T2
RF channel number		1, 2, 3, 4, 5, 6	2	
Duplex mode		1, 2, 3	FDD	
		4, 5, 6	TDD	
TDD special subframe configuration <sup>note1</sup>		4, 5, 6	6	
TDD uplink-downlink configuration <sup>note1</sup>		4, 5, 6	1	
BW <sub>channel</sub>	MHz	1, 2, 3, 4, 5, 6	5MHz: N <sub>RB,c</sub> = 25 10MHz: N <sub>RB,c</sub> = 50 20MHz: N <sub>RB,c</sub> = 100	
PDSCH parameters: DL Reference Measurement Channel <sup>note2</sup>		1, 2, 3	5MHz: R.7 FDD 10MHz: R.3 FDD 20MHz: R.6 FDD	
		4, 5, 6	5MHz: R.4 TDD 10MHz: R.0 TDD 20MHz: R.3 TDD	
PCFICH/PDCCH/PHICH parameters: DL Reference Measurement Channel <sup>note2</sup>		1, 2, 3	5MHz: R.11 FDD 10MHz: R.6 FDD 20MHz: R.10 FDD	
		4, 5, 6	5MHz: R.11 TDD 10MHz: R.6 TDD 20MHz: R.10 TDD	
OCNG Patterns <sup>note2</sup>		1, 2, 3	5MHz: OP.20 FDD 10MHz: OP.10 FDD 20MHz: OP.17 FDD	
		4, 5, 6	5MHz: OP.9 TDD 10MHz: OP.1 TDD 20MHz: OP.7 TDD	
PBCH_RA	dB	1, 2, 3, 4, 5, 6	0	
PBCH_RB				
PSS_RA				
SSS_RA				
PCFICH_RB				
PHICH_RA				
PHICH_RB				
PDCCH_RA				
PDCCH_RB				
PDSCH_RA				
PDSCH_RB				
OCNG_RA <sup>note3</sup>				
OCNG_RB <sup>note3</sup>				
N <sub>oc</sub> <sup>note4</sup>	dBm/15kHz	1, 2, 3, 4, 5, 6	-106	
$\hat{E}_s/N_{oc}$	dB	1, 2, 3, 4, 5, 6	-Infinity	20.65
$\hat{E}_s/I_{ot}$ <sup>note5</sup>	dB	1, 2, 3, 4, 5, 6	-Infinity	20.65
RSRP <sup>note5</sup>	dBm/15kHz	1, 2, 3, 4, 5, 6	-Infinity	-85.35
SCH_RP <sup>note5</sup>	dBm/15kHz	1, 2, 3, 4, 5, 6	-Infinity	-85.35
I <sub>o</sub> <sup>note5</sup>	dBm/9MHz	1, 2, 3, 4, 5, 6	$-78.22+10\log(N_{RB,c}/50)$	$-57.53+10\log(N_{RB,c}/50)$
Propagation Condition <sup>not 6</sup>		1, 2, 3, 4, 5, 6	ETU70	
Antenna Configuration and Correlation Matrix <sup>note6</sup>		1, 2, 3, 4, 5, 6	1x2 Low	

NOTE 1: Special subframe and uplink-downlink configurations are specified in table 4.2-1 in TS 36.211 [24].  
 NOTE 2: DL RMCs and OCNG patterns are specified in sections A 3.1 and A 3.2 of TS 36.133 [23] respectively.  
 NOTE 3: OCNG shall be used such that all cells are fully allocated and a constant total transmitted power spectral density is achieved for all OFDM symbols.  
 NOTE 4: Interference from other cells and noise sources not specified in the test is assumed to be constant over subcarriers and time and shall be modelled as AWGN of appropriate power for N<sub>oc</sub> to be fulfilled.  
 NOTE 5:  $\hat{E}_s/I_{ot}$ , RSRP, SCH\_RP and I<sub>o</sub> levels have been derived from other parameters for information purposes. They are not settable parameters themselves.  
 NOTE 6: Propagation condition and correlation matrix are defined in section B.2 in TS 36.101 [27].

The UE shall send one Event B2 triggered measurement report for Cell 2 to the PCell, with a measurement reporting delay less than 3842ms from the start of period T2. The measurement reporting delay is defined as the time from the beginning of time period T2 to the moment when the UE sends the measurement report on PUSCH.

The UE shall not send event-triggered measurement reports as long as the reporting criteria is not fulfilled.

The overall delays measured test requirement is expressed as:

$$T_{\text{identify,E-UTRAN FDD}} = T_{\text{BasicIdentify}} * 480 / T_{\text{Inter1}} * \text{CSSF}_{\text{interRAT}} \text{ ms}$$

Which:

$$T_{\text{BasicIdentify}} = 480,$$

$$T_{\text{Inter1}} = 60,$$

$$\text{CSSF}_{\text{interRAT}} = 1$$

$$\text{TTI insertion uncertainty} = \text{TTI}_{\text{DCCH}} = 1 \text{ ms}; 2 \times \text{TTI}_{\text{DCCH}} = 2 \text{ ms}$$

The overall delays measured shall be less than a total of 3842 ms in this test case (note: this gives a total of 3840 ms for measurement reporting delay plus 2 ms for TTI insertion uncertainty).

The rate of correct events observed during repeated tests shall be at least 90% with confidence level of 95%.

### 6.6.3.2 NR SA FR1 – E-UTRAN event-triggered reporting in DRX

#### 6.6.3.2.1 Test purpose

This test is to verify that the UE makes correct event-triggered reporting of inter-RAT E-UTRAN measurements when operating in standalone (SA) operation with PCell in FR1 when DRX is used under the cell search and measurement requirements.

#### 6.6.3.2.2 Test applicability

This test applies to all types of NR UE Release 15 and forward supporting 5GS NR SA FR1, E-UTRAN and long DRX cycle.

#### 6.6.3.2.3 Minimum conformance requirements

The minimum conformance requirements are specified in clauses 6.6.3.0.1 and 6.6.3.0.2.

The normative reference for this requirement is TS 38.133 [6] clause A.6.6.3.2.

#### 6.6.3.2.4 Test description

##### 6.6.3.2.4.1 Initial conditions

This test shall be tested using any of the test configurations in Table 6.6.3.2.4.1-1.

**Table 6.6.3.2.4.1-1: Supported test configurations in SA inter-RAT E-UTRAN event triggered reporting in DRX with PCell in FR1**

Test Case ID	Description
6.6.3.2-1	NR 15 kHz SSB SCS, 10MHz bandwidth, FDD duplex mode, LTE FDD
6.6.3.2-2	NR 15 kHz SSB SCS, 10MHz bandwidth, TDD duplex mode, LTE FDD
6.6.3.2-3	NR 30 kHz SSB SCS, 40MHz bandwidth, TDD duplex mode, LTE FDD
6.6.3.2-4	NR 15 kHz SSB SCS, 10MHz bandwidth, FDD duplex mode, LTE TDD
6.6.3.2-5	NR 15 kHz SSB SCS, 10MHz bandwidth, TDD duplex mode, LTE TDD
6.6.3.2-6	NR 30 kHz SSB SCS, 40MHz bandwidth, TDD duplex mode, LTE TDD
NOTE: The UE is only required to be tested in one of the supported test configurations	

Configure the test equipment and the DUT according to the parameters in Table 6.6.3.2.4.1-2 and Table 6.6.3.2.4.1-3.



**Table 6.6.3.2.4.1-2: Initial conditions for SA inter-RAT E-UTRAN event triggered reporting in DRX with PCell in FR1**

Parameter	Value		Comment
Test environment	NC		As specified in TS 38.508-1 [14] clause 4.1.
Test frequencies	As specified in Annex E, Table E.4-2 and TS 38.508-1 [14] sclause 4.3.1.		
Channel bandwidth	As specified by the test configuration selected from Table 6.6.3.2.4.1-1.		
Propagation conditions	AWGN		As specified in Annex C.2.2.
Connection Diagram	TE Part	A.3.1.8.3	As specified in TS 38.508-1 [14] Annex A.
	DUT Part	A.3.2.3.2	
Exceptions to connection diagram	N/A		

**Table 6.6.3.2.4.1-3: General test parameters for SA inter-RAT E-UTRAN event triggered reporting in DRX with PCell in FR1**

Parameter	Unit	Value		Comment
NR RF Channel Number		1		1 NR carrier frequency is used in the test
LTE RF Channel Number		2		1 LTE carrier frequency is used in the test
Channel Bandwidth	MHz	As specified in Tables 6.6.3.2.5-1 and 6.6.3.2.5-2.		
Active cell		Cell 1		Cell 1 is on RF channel number 1
Neighbour cell		Cell 2		Cell 2 is on RF channel number 2
Gap Pattern Id		0		As specified in Clause TS 38.133 [6] Table 9.1.2-1. Per-UE gap pattern.
NR measurement quantity		SS-RSRP		Measurement quantity for Cell 1
Inter-RAT E-UTRAN measurement quantity		RSRP		Measurement quantity for Cell 2
b2-Threshold1	dBm	note 1		SS-RSRP threshold for SS-RSRP measurement on cell1 for event B2
b2-Threshold2EUTRA	dBm	-97		E-UTRAN RSRP threshold for SS-RSRP measurement on cell1 for event B2
Hysteresis	dB	0		
TimeToTrigger	s	0		
Filter coefficient		0		L3 filtering is not used
DRX		DRX.1	DRX.7	DRX cycle configurations DRX.1 and DRX.7 are defined in Table A.3.3.1-1 and Table A.3.3.2-1 respectively.
T1	s	5		
T2	s	5	15	
NOTE 1: Values are defined in Table 6.6.3.2.5-1				

1. Message contents are defined in clause 6.6.3.2.4.3.
2. There are two cells: Cell 1 and Cell 2. Cell 1 is the NR PCell and Cell 2 is an inter-RAT E-UTRAN inter-RAT neighbour cell. Cell 1 is configured according to Annex C.1.1 and C.1.2, Cell 2 is configured according to TS 36.521-3 [26] Annex C.1.0 and C.1.1.

#### 6.6.3.2.4.2 Test procedure

In each test there are two cells: Cell 1 and Cell 2. Cell 1 is the NR PCell and Cell 2 is an inter-RAT E-UTRAN inter-RAT neighbour cell. In the measurement control information from the PCell it is indicated to the UE that event-triggered reporting with Event B2 (PCell becomes worse than threshold1 and inter RAT neighbour becomes better than threshold2) is to be used. Each test consists of two consecutive time periods, with durations T1 and T2, respectively. Prior to the start of time duration T1, the UE shall be fully synchronized to Cell 1. During T1, the UE shall not have any information on Cell 2.

In each test the UE shall be provided at least once every 500ms with new Timing Advance Command MAC control element to restart the Time alignment timer to keep UE uplink time alignment. Furthermore the UE shall be allocated with PUSCH resource at every DRX cycle.

1. Ensure the UE is in state RRC\_CONNECTED with generic procedure parameters Connectivity NR, Connected without release On and Test Mode On according to TS 38.508-1 [14] clause 4.5.
2. Set the parameters according to T1 in Table 6.6.3.2.5-1 and 6.6.3.2.5-2.
3. SS shall transmit an RRCReconfiguration message.
4. The UE shall transmit RRCReconfigurationComplete message. T1 starts.
5. When T1 expires, the SS shall switch the power setting from T1 to T2 as specified in Tables 6.6.3.2.5-1 and 6.6.3.2.5-2. T2 starts.
6. UE shall transmit a MeasurementReport message triggered by Event B2. If the overall delays measured from the beginning of time period T2 is less than 3.48 s for Test 1 or less than 12.8 s for Test 2 then the number of successful tests is increased by one. If the UE fails to report the event within the overall delays measured requirement then the number of failure tests is increased by one.
7. After the SS receive the MeasurementReport message in step 6) or when T2 expires, the SS shall:
  - transmit *RRCRelease* message to release the RRC connection which includes the release of the established radio bearers as well as all radio resourcesOR
  - switch the UE off .
8. Set Cell 2 physical cell identity = ((current cell 2 physical cell identity + 1) mod 14+2) for next iteration of the test procedure loop.
9. Depending on the choice in Step 7, the SS:
  - if the RRC Connection Release has been sent, transmits in Cell 1 a Paging message (including PagingRecord with ue-Identity) for the UE and ensures the UE is in state RRC\_CONNECTED with generic procedure parameters Connectivity NR, Connected without release On according to TS 38.508-1 [14] clause 4.5 (if the paging fails, switches off and on the UE and ensures the UE is in state RRC\_CONNECTED with generic procedure parameters Connectivity NR, Connected without release On according to TS 38.508-1 [14] clause 4.5),OR
  - if the device has been switched off, switches on the UE and ensures the UE is in state RRC\_CONNECTED with generic procedure parameters Connectivity NR, Connected without release On according to TS 38.508-1 [14] clause 4.5.
10. Repeat step 2-9 until the confidence level according to Tables G.2.3-1 in Annex G clause G.2 is achieved.

#### 6.6.3.2.4.3 Message contents

Message contents are according to TS 38.508-1 [14] clause 4.6 with the following exceptions:

**Table 6.6.3.2.4.3-1: Common Exception messages NR SA FR1 – E-UTRAN event-triggered reporting in DRX**

<b>Default Message Contents</b>	
Common contents of system information blocks exceptions	
Default RRC messages and information elements contents exceptions	Table H.3.1-1 Table H.3.1-2 with Conditions GAP NEEDED and INTER-RAT Table H.3.1-3A Table H.3.1-4A Table H.3.1-5 with Condition INTER-RAT Table H.3.1-6 with Condition Pattern #0 Table H.3.1-7 with Condition INTER-RAT Table H.3.7-1 with Condition DRX.1 and Gap for Test 1 Table H.3.7-1 with Condition DRX.7 and OFFSET for Test 2
Specific message content exceptions for Test Configurations 6.6.3.2-1 and 6.6.3.2-4	Table H.3.1-3 Table 7.3.1-3 in TS 38.508-1 [14] with condition SMTC.1
Specific message content exceptions for Test Configurations 6.6.3.2-2, 6.6.3.2-3, 6.6.3.2-5 and 6.6.3.2-6	Table H.3.1-3 with Condition Synchronous cells Table 7.3.1-3 in TS 38.508-1 [14] with condition SMTC.1

6.6.3.2.5 Test requirement

Table 6.6.3.2.5-1 and Table 6.6.3.2.5-2 defines the primary level settings including test tolerances for all tests.

**Table 6.6.3.2.5-1: PCell specific test parameters for SA inter-RAT E-UTRA event triggered reporting in DRX with PCell in FR1**

Parameter	Unit	Configuration	Cell 1	
			T1	T2

RF channel number			1, 2, 3, 4, 5, 6	1	
Duplex mode			1, 2, 3	FDD	
			4, 5, 6	TDD	
TDD Configuration	SCS=15 KHz		2, 5	TDDConf.1.1	
	SCS=30 KHz		3, 6	TDDConf.2.1	
BW <sub>channel</sub>		MHz	1, 4	10: N <sub>RB,c</sub> = 52 (FDD)	
			2, 5	10: N <sub>RB,c</sub> = 52 (TDD)	
			3, 6	40: N <sub>RB,c</sub> = 106 (TDD)	
PDSCH reference measurement channel			1, 4	SR.1.1 FDD	
			2, 5	SR.1.1 TDD	
			3, 6	SR.2.1 TDD	
RMSI CORESET reference channel			1, 4	CR.1.1 FDD	
			2, 5	CR.1.1 TDD	
			3, 6	CR.2.1 TDD	
Dedicated CORSET reference channel			1, 4	CCR.1.1 FDD	
			2, 5	CCR.1.1 TDD	
			3, 6	CCR.2.1 TDD	
BWP configurations	Initial DL BWP		1, 2, 3, 4, 5, 6	DLBWP.0.1	
	Dedicated DL BWP		1, 2, 3, 4, 5, 6	DLBWP.1.1	
	Initial UL BWP		1, 2, 3, 4, 5, 6	ULBWP.0.1	
	Dedicated UL BWP		1, 2, 3, 4, 5, 6	ULBWP.1.1	
OCNG pattern <sup>Note1</sup>			1, 2, 3, 4, 5, 6	OP.1	
SMTC configuration			1, 2, 3, 4, 5, 6	SMTC.1	
SSB configuration			1, 2, 4, 5	SSB.1 FR1	
			3, 6	SSB.2 FR1	
CSI-RS for tracking			1, 4	TRS.1.1 FDD	
			2, 5	TRS.1.1 TDD	
			3, 6	TRS.1.2 TDD	
b2-Threshold1	dBm		1, 2, 4, 5	-98	
			3, 6	-95	
EPRE ratio of PSS to SSS		dB	1, 2, 3, 4, 5, 6	0	
EPRE ratio of PBCH_DMRS to SSS					
EPRE ratio of PBCH to PBCH_DMRS					
EPRE ratio of PDCCH_DMRS to SSS					
EPRE ratio of PDCCH to PDCCH_DMRS					
EPRE ratio of PDSCH_DMRS to SSS					
EPRE ratio of PDSCH to PDSCH_DMRS					
EPRE ratio of OCNG DMRS to SSS					
EPRE ratio of OCNG to OCNG DMRS					
N <sub>oc</sub> <sup>Note2</sup>	dBm/15 KHz		1, 2, 3, 4, 5, 6	-106	
N <sub>oc</sub> <sup>Note2</sup>	dBm/SCS		1, 2, 4, 5	-106	
			3, 6	-103	
$\hat{E}_s/N_{oc}$	dB		1, 2, 3, 4, 5, 6	19.65	-3.65
$\hat{E}_s/I_{ot}$ <sup>Note3</sup>	dB		1, 2, 3, 4, 5, 6	19.65	-3.65
SS-RSRP <sup>Note3</sup>	dBm/SCS		1, 2, 4, 5	-86.35	-109.65
			3, 6	-83.35	-106.65
SSB_RP <sup>Note3</sup>	dBm/SCS		1, 2, 4, 5	-86.35	-109.65
			3, 6	-83.35	-106.65
I <sub>o</sub> <sup>Note3</sup>	dBm/9.36 MHz		1, 2, 4, 5	-58.35	-76.49
			dBm/38.16 MHz	3, 6	-52.25
Propagation condition				1, 2, 3, 4, 5, 6	TDL-C 300ns 100Hz
Antenna Configuration and Correlation Matrix			1, 2, 3, 4, 5, 6	1x2 Low	
Note 1: OCNG shall be used such that both cells are fully allocated and a constant total transmitted power spectral density is achieved for all OFDM symbols.					
Note 2: Interference from other cells and noise sources not specified in the test is assumed to be constant over subcarriers and time and shall be modelled as AWGN of appropriate power for N <sub>oc</sub> to be fulfilled.					
Note 3: $\hat{E}_s/I_{ot}$ , SS-RSRP, SSB_RP and I <sub>o</sub> levels have been derived from other parameters for information purposes. They are not settable parameters themselves.					

**Table 6.6.3.2.5-2: E-UTRAN neighbour cell specific test parameters for SA inter-RAT E-UTRAN event triggered reporting in DRX with PCell in FR1**

Parameter	Unit	Configuration	Cell 2	
			T1	T2
RF channel number		1, 2, 3, 4, 5, 6	2	
Duplex mode		1, 2, 3	FDD	
		4, 5, 6	TDD	
TDD special subframe configuration <sup>Note1</sup>		4, 5, 6	6	
TDD uplink-downlink configuration <sup>Note1</sup>		4, 5, 6	1	
BW <sub>channel</sub>	MHz	1, 2, 3, 4, 5, 6	5MHz: N <sub>RB,c</sub> = 25 10MHz: N <sub>RB,c</sub> = 50 20MHz: N <sub>RB,c</sub> = 100	
PDSCH parameters: DL Reference Measurement Channel <sup>Note2</sup>		1, 2, 3	5MHz: R.7 FDD 10MHz: R.3 FDD 20MHz: R.6 FDD	
		4, 5, 6	5MHz: R.4 TDD 10MHz: R.0 TDD 20MHz: R.3 TDD	
PCFICH/PDCCH/PHICH parameters: DL Reference Measurement Channel <sup>Note2</sup>		1, 2, 3	5MHz: R.11 FDD 10MHz: R.6 FDD 20MHz: R.10 FDD	
		4, 5, 6	5MHz: R.11 TDD 10MHz: R.6 TDD 20MHz: R.10 TDD	
OCNG Patterns <sup>Note2</sup>		1, 2, 3	5MHz: OP.20 FDD 10MHz: OP.10 FDD 20MHz: OP.17 FDD	
		4, 5, 6	5MHz: OP.9 TDD 10MHz: OP.1 TDD 20MHz: OP.7 TDD	
PBCH_RA	dB	1, 2, 3, 4, 5, 6	0	
PBCH_RB				
PSS_RA				
SSS_RA				
PCFICH_RB				
PHICH_RA				
PHICH_RB				
PDCCH_RA				
PDCCH_RB				
PDSCH_RA				
PDSCH_RB				
OCNG_RA <sup>Note3</sup>				
OCNG_RB <sup>Note3</sup>				
N <sub>oc</sub> <sup>Note4</sup>	dBm/15kHz	1, 2, 3, 4, 5, 6	-106	
$\hat{E}_s/N_{oc}$	dB	1, 2, 3, 4, 5, 6	-Infinity	20.65
$\hat{E}_s/I_{ot}$ <sup>Note5</sup>	dB	1, 2, 3, 4, 5, 6	-Infinity	20.65
RSRP <sup>Note5</sup>	dBm/15kHz	1, 2, 3, 4, 5, 6	-Infinity	-85.35
SCH_RP <sup>Note5</sup>	dBm/15kHz	1, 2, 3, 4, 5, 6	-Infinity	-85.35
I <sub>o</sub> <sup>Note5</sup>	dBm/9MHz	1, 2, 3, 4, 5, 6	-78.22+10log (N <sub>RB,c</sub> /50)	-57.53+10log (N <sub>RB,c</sub> /50)
Propagation Condition <sup>Note6</sup>		1, 2, 3, 4, 5, 6	ETU70	
Antenna Configuration and Correlation Matrix <sup>Note6</sup>		1, 2, 3, 4, 5, 6	1x2 Low	
<p>Note 1: Special subframe and uplink-downlink configurations are specified in table 4.2-1 in TS 36.211.</p> <p>Note 2: DL RMCs and OCNG patterns are specified in sections A 3.1 and A 3.2 of TS 36.133 respectively.</p> <p>Note 3: OCNG shall be used such that all cells are fully allocated and a constant total transmitted power spectral density is achieved for all OFDM symbols.</p> <p>Note 4: Interference from other cells and noise sources not specified in the test is assumed to be constant over subcarriers and time and shall be modelled as AWGN of appropriate power for N<sub>oc</sub> to be fulfilled.</p> <p>Note 5: <math>\hat{E}_s/I_{ot}</math>, RSRP, SCH_RP and I<sub>o</sub> levels have been derived from other parameters for information purposes. They are not settable parameters themselves.</p> <p>Note 6: Propagation condition and correlation matrix are defined in section B.2 in TS 36.101 [27].</p>				

In test 1, the UE shall send one Event B2 triggered measurement report for Cell 2 to the PCell, with a measurement reporting delay less than 3.84s from the start of period T2. The measurement reporting delay is defined as the time from the beginning of time period T2 to the moment when the UE sends the measurement report on PUSCH.

In test 2, the UE shall send one Event B2 triggered measurement report for Cell 2 to the PCell, with a measurement reporting delay less than 12.8s from the start of period T2. The measurement reporting delay is defined as the time from the beginning of time period T2 to the moment when the UE sends the measurement report on PUSCH.

The UE shall not send event-triggered measurement reports as long as the reporting criteria is not fulfilled.

The rate of correct events observed during repeated tests shall be at least 90%.

### 6.6.3.3 NR SA FR1 – E-UTRAN event-triggered reporting in DRX for UE configured with highSpeedMeasFlag-r16

#### 6.6.3.3.1 Test purpose

This test is to verify that the UE makes correct event-triggered reporting of inter-RAT E-UTRAN measurements when operating in standalone (SA) operation with PCell in FR1 when DRX is used under the cell search and measurement requirements for UE configured with RRM enhancement for high speed.

#### 6.6.3.3.2 Test applicability

This test applies to all types of NR UE supporting SA FR1 configured with RRM enhancement for high speed from Release 16 onwards.

#### 6.6.3.3.3 Minimum conformance requirements

The minimum conformance requirements are specified in clauses 6.6.3.0.1 and 6.6.3.0.2.

The normative reference for this requirement is TS 38.133 [6] clause A.6.6.3.3.

#### 6.6.3.3.4 Test description

##### 6.6.3.3.4.1 Initial conditions

This test shall be tested using any of the test configurations in Table 6.6.3.3.4.1-1.

**Table 6.6.3.3.4.1-1: Supported test configurations in SA inter-RAT E-UTRAN event triggered reporting in DRX with PCell in FR1 for UE configured with highSpeedMeasFlag-r16**

Test Case ID	Description
6.6.3.3-1	NR 15 kHz SSB SCS, 10MHz bandwidth, FDD duplex mode, LTE FDD
6.6.3.3-2	NR 15 kHz SSB SCS, 10MHz bandwidth, TDD duplex mode, LTE FDD
6.6.3.3-3	NR 30 kHz SSB SCS, 40MHz bandwidth, TDD duplex mode, LTE FDD
6.6.3.3-4	NR 15 kHz SSB SCS, 10MHz bandwidth, FDD duplex mode, LTE TDD
6.6.3.3-5	NR 15 kHz SSB SCS, 10MHz bandwidth, TDD duplex mode, LTE TDD
6.6.3.3-6	NR 30 kHz SSB SCS, 40MHz bandwidth, TDD duplex mode, LTE TDD
NOTE: The UE is only required to be tested in one of the supported test configurations	

Configure the test equipment and the DUT according to the parameters in Table 6.6.3.3.4.1-2 and Table 6.6.3.3.4.1-3.

**Table 6.6.3.3.4.1-2: Initial conditions for SA inter-RAT E-UTRAN event triggered reporting in DRX with PCell in FR1 for UE configured with highSpeedMeasFlag-r16**

Parameter	Value		Comment
Test environment	NC		As specified in TS 38.508-1 [14] clause 4.1.
Test frequencies	As specified in Annex E, Table E.4-2 and TS 38.508-1 [14] clause 4.3.1.		
Channel bandwidth	As specified by the test configuration selected from Table 6.6.3.3.4.1-1.		
Propagation conditions	AWGN		As specified in Annex C.2.2.
Connection Diagram	TE Part	A.3.1.8.3	As specified in TS 38.508-1 [14] Annex A.
	DUT Part	A.3.2.3.2	

Exceptions to connection diagram	N/A	
----------------------------------	-----	--

**Table 6.6.3.3.4.1-3: General test parameters for SA inter-RAT E-UTRAN event triggered reporting in DRX with PCell in FR1 for UE configured with highSpeedMeasFlag-r16**

Parameter	Unit	Value	Comment
NR RF Channel Number		1	1 NR carrier frequency is used in the test
LTE RF Channel Number		2	1 LTE carrier frequency is used in the test
Channel Bandwidth	MHz	As specified in Tables A.6.6.3.3.1-2 and A.6.6.3.3.1-3.	
Active cell		Cell 1	Cell 1 is on RF channel number 1
Neighbour cell		Cell 2	Cell 2 is on RF channel number 2
Gap Pattern Id		0	As specified in Clause Table 9.1.2-1. Per-UE gap pattern.
NR measurement quantity		SS-RSRP	Measurement quantity for Cell 1
Inter-RAT E-UTRAN measurement quantity		RSRP	Measurement quantity for Cell 2
b2-Threshold1	dBm	Note 1	SS-RSRP threshold for SS-RSRP measurement on cell1 for event B2
b2-Threshold2EUTRA	dBm	-97	E-UTRAN RSRP threshold for SS-RSRP measurement on cell1 for event B2
Hysteresis	dB	0	
TimeToTrigger	s	0	
Filter coefficient		0	L3 filtering is not used
DRX		DRX.6	DRX cycle configurations DRX.6 is defined in Table A.3.3.1-6.
T1	s	5	
T2	s	5	
Note 1: Values are defined in TS 38.133 Table 6.6.3.3.5-1			

1. Message contents are defined in clause 6.6.3.3.4.3.
2. Cell 1 is the NR PCell and Cell 2 is an inter-RAT E-UTRAN inter-RAT neighbour cell. The connection setup is done according to the settings in Annex C.1.1 and C.1.2.
3. UE is configured with highSpeedMeasFlag-r16

#### 6.6.3.3.4.2 Test procedure

In each test there are two cells: Cell 1 and Cell 2. Cell 1 is the NR PCell and Cell 2 is an inter-RAT E-UTRAN inter-RAT neighbour cell. In the measurement control information from the PCell it is indicated to the UE that event-triggered reporting with Event B2 (PCell becomes worse than threshold1 and inter RAT neighbour becomes better than threshold2) is to be used. Each test consists of two consecutive time periods, with durations T1 and T2, respectively. Prior to the start of time duration T1, the UE shall be fully synchronized to Cell 1. During T1, the UE shall not have any information on Cell 2.

In each test the UE shall be provided at least once every 500ms with new Timing Advance Command MAC control element to restart the Time alignment timer to keep UE uplink time alignment. Furthermore the UE shall be allocated with PUSCH resource at every DRX cycle.

1. Ensure the UE is in state RRC\_CONNECTED with generic procedure parameters Connectivity NR, Connected without release On and Test Mode On according to TS 38.508-1 [14] clause 4.5.
2. Set the parameters according to T1 in Table 6.6.3.3.5-1 and 6.6.3.3.5-2.
3. SS shall transmit an RRCReconfiguration message.
4. The UE shall transmit RRCReconfigurationComplete message. T1 starts.
5. When T1 expires, the SS shall switch the power setting from T1 to T2 as specified in Tables 6.6.3.3.5-1 and 6.6.3.3.5-2. T2 starts.

6. UE shall transmit a MeasurementReport message triggered by Event B2. If the overall delays measured from the beginning of time period T2 is less than 4.8s then the number of successful tests is increased by one. If the UE fails to report the event within the overall delays measured requirement then the number of failure tests is increased by one.
7. After the SS receive the MeasurementReport message in step 6) or when T2 expires, the SS shall:
  - transmit *RRCRelease* message to release the RRC connection which includes the release of the established radio bearers as well as all radio resources

OR

  - switch the UE off .
8. Set Cell 2 physical cell identity = ((current cell 2 physical cell identity + 1) mod 14+2) for next iteration of the test procedure loop.
9. Depending on the choice in Step 7, the SS:
  - if the RRC Connection Release has been sent, transmits in Cell 1 a Paging message (including PagingRecord with ue-Identity) for the UE and ensures the UE is in state RRC\_CONNECTED with generic procedure parameters Connectivity NR, Connected without release On according to TS 38.508-1 [14] clause 4.5 (if the paging fails, switches off and on the UE and ensures the UE is in state RRC\_CONNECTED with generic procedure parameters Connectivity NR, Connected without release On according to TS 38.508-1 [14] clause 4.5),
  - OR
  - if the device has been switched off, switches on the UE and ensures the UE is in state RRC\_CONNECTED with generic procedure parameters Connectivity NR, Connected without release On according to TS 38.508-1 [14] clause 4.5.
10. Repeat step 2-9 until the confidence level according to Tables G.2.3-1 in Annex G clause G.2 is achieved.

6.6.3.3.4.3 Message contents

Message contents are according to TS 38.508-1 [14] clause 7.3 with the following exceptions:

**Table 6.6.3.3.4.3-1: Common Exception messages**

Default Message Contents	
Common contents of system information blocks on condition of HighSpeedMeas with exceptions	Table H.2.1-3 with Condition HighSpeedMeas
Default RRC messages and information elements contents exceptions	Table H.3.1-1 Table H.3.1-2 with Conditions GAP NEEDED and INTER-RAT Table H.3.1-3 with Condition SSB.1 FR1 for configuration 6.6.3.3-1, 6.6.3.3-2, 6.6.3.3-4, 6.6.3.3-5 Table H.3.1-3 with Condition SSB.2 FR1 for configuration 6.6.3.3-3, 6.6.3.3-6 Table H.3.1-3A Table H.3.1-4A Table H.3.1-5 with Condition INTER-RAT Table H.3.1-6 with Condition Pattern #0 Table H.3.1-7 with Condition INTER-RAT Table H.3.7-1 with Condition DRX.6 and Gap

6.6.3.3.5 Test requirement

Table 6.6.3.3.5-1 and Table 6.6.3.3.5-2 defines the primary level settings including test tolerances for all tests.



**Table 6.6.3.3.5-1: PCell specific test parameters for SA inter-RAT E-UTRA event triggered reporting in DRX with PCell in FR1 for UE configured with highSpeedMeasFlag-r16**

Parameter		Unit	Configuration	Cell 1	
				T1	T2
RF channel number			1, 2, 3, 4, 5, 6	1	
Duplex mode			1, 2, 3	FDD	
			4, 5, 6	TDD	
TDD Configuration	SCS=15 KHz		2, 5	TDDConf.1.1	
	SCS=30 KHz		3, 6	TDDConf.2.1	
BW <sub>channel</sub>		MHz	1, 4	10: N <sub>RB,c</sub> = 52 (FDD)	
			2, 5	10: N <sub>RB,c</sub> = 52 (TDD)	
			3, 6	40: N <sub>RB,c</sub> = 106 (TDD)	
PDSCH reference measurement channel			1, 4	SR.1.1 FDD	
			2, 5	SR.1.1 TDD	
			3, 6	SR.2.1 TDD	
CORSET reference channel			1, 4	CR.1.1 FDD	
			2, 5	CR.1.1 TDD	
			3, 6	CR.2.1 TDD	
BWP configurations	Initial DL BWP		1, 2, 3, 4, 5, 6	DLBWP.0.1	
	Dedicated DL BWP		1, 2, 3, 4, 5, 6	DLBWP.1.1	
	Initial UL BWP		1, 2, 3, 4, 5, 6	ULBWP.0.1	
	Dedicated UL BWP		1, 2, 3, 4, 5, 6	ULBWP.1.1	
OCNG pattern <sup>Note1</sup>			1, 2, 3, 4, 5, 6	OP.1	
SMTC configuration			1, 2, 3, 4, 5, 6	SMTC.1	
SSB configuration			1, 2, 4, 5	SSB.1 FR1	
			3, 6	SSB.2 FR1	
b2-Threshold1		dBm	1, 2, 4, 5	-98	
			3, 6	-95	
EPRE ratio of PSS to SSS		dB	1, 2, 3, 4, 5, 6	0	
EPRE ratio of PBCH_DMRS to SSS					
EPRE ratio of PBCH to PBCH_DMRS					
EPRE ratio of PDCCH_DMRS to SSS					
EPRE ratio of PDCCH to PDCCH_DMRS					
EPRE ratio of PDSCH_DMRS to SSS					
EPRE ratio of PDSCH to PDSCH_DMRS					
EPRE ratio of OCNG DMRS to SSS					
EPRE ratio of OCNG to OCNG DMRS					
N <sub>oc</sub> <sup>Note2</sup>					
N <sub>oc</sub> <sup>Note2</sup>		dBm/SCS	1, 2, 4, 5	-106	
			3, 6	-103	
Ē <sub>s</sub> /N <sub>oc</sub>		dB	1, 2, 3, 4, 5, 6	18	-2
Ē <sub>s</sub> /I <sub>ot</sub> <sup>Note3</sup>		dB	1, 2, 3, 4, 5, 6	18	-2
SS-RSRP <sup>Note3</sup>		dBm/SCS	1, 2, 4, 5	-88	-108
			3, 6	-85	-105
SSB_RP <sup>Note3</sup>		dBm/SCS	1, 2, 4, 5	-88	-108
			3, 6	-85	-105
I <sub>o</sub> <sup>Note3</sup>		dBm/9.36 MHz	1, 2, 4, 5	-59.98	-75.92
			dBm/38.16 MHz	3, 6	-53.88
Propagation condition			1, 2, 3, 4, 5, 6	AWGN	
Antenna Configuration and Correlation Matrix			1, 2, 3, 4, 5, 6	1x2 Low	
Note 1: OCNG shall be used such that both cells are fully allocated and a constant total transmitted power spectral density is achieved for all OFDM symbols.					
Note 2: Interference from other cells and noise sources not specified in the test is assumed to be constant over subcarriers and time and shall be modelled as AWGN of appropriate power for N <sub>oc</sub> to be fulfilled.					
Note 3: Ē <sub>s</sub> /I <sub>ot</sub> , SS-RSRP, SSB_RP and I <sub>o</sub> levels have been derived from other parameters for information purposes. They are not settable parameters themselves.					

**Table 6.6.3.3.5-2: E-UTRAN neighbour cell specific test parameters for SA inter-RAT E-UTRAN event triggered reporting in DRX with PCell in FR1 for UE configured with highSpeedMeasFlag-r16**

Parameter	Unit	Configuration	Cell 2	
			T1	T2
RF channel number		1, 2, 3, 4, 5, 6	2	
Duplex mode		1, 2, 3	FDD	
		4, 5, 6	TDD	
TDD special subframe configuration <sup>Note1</sup>		4, 5, 6	6	
TDD uplink-downlink configuration <sup>Note1</sup>		4, 5, 6	1	
BW <sub>channel</sub>	MHz	1, 2, 3, 4, 5, 6	5 MHz: N <sub>RB,c</sub> = 25 10 MHz: N <sub>RB,c</sub> = 50 20 MHz: N <sub>RB,c</sub> = 100	
PDSCH parameters: DL Reference Measurement Channel <sup>Note2</sup>		1, 2, 3	5 MHz: R.7 FDD 10 MHz: R.3 FDD 20 MHz: R.6 FDD	
		4, 5, 6	5 MHz: R.4 TDD 10 MHz: R.0 TDD 20 MHz: R.3 TDD	
PCFICH/PDCCH/PHICH parameters: DL Reference Measurement Channel <sup>Note2</sup>		1, 2, 3	5 MHz: R.11 FDD 10 MHz: R.6 FDD 20 MHz: R.10 FDD	
		4, 5, 6	5 MHz: R.11 TDD 10 MHz: R.6 TDD 20 MHz: R.10 TDD	
OCNG Patterns <sup>Note2</sup>		1, 2, 3	5 MHz: OP.20 FDD 10 MHz: OP.10 FDD 20 MHz: OP.17 FDD	
		4, 5, 6	5 MHz: OP.9 TDD 10 MHz: OP.1 TDD 20 MHz: OP.7 TDD	
PBCH_RA	dB	1, 2, 3, 4, 5, 6	0	
PBCH_RB				
PSS_RA				
SSS_RA				
PCFICH_RB				
PHICH_RA				
PHICH_RB				
PDCCH_RA				
PDCCH_RB				
PDSCH_RA				
PDSCH_RB				
OCNG_RA <sup>Note3</sup>				
OCNG_RB <sup>Note3</sup>				
N <sub>oc</sub> <sup>Note4</sup>				
$\hat{E}_s/N_{oc}$	dB	1, 2, 3, 4, 5, 6	-Infinity	19
$\hat{E}_s/I_{ot}$ <sup>Note5</sup>	dB	1, 2, 3, 4, 5, 6	-Infinity	19
RSRP <sup>Note5</sup>	dBm/15kHz	1, 2, 3, 4, 5, 6	-Infinity	-87
SCH_RP <sup>Note5</sup>	dBm/15kHz	1, 2, 3, 4, 5, 6	-Infinity	-87
I <sub>o</sub> <sup>Note5</sup>	dBm/9MHz	1, 2, 3, 4, 5, 6	$-78.22+10\log(N_{RB,c}/50)$	$-59.16+10\log(N_{RB,c}/50)$
Propagation Condition <sup>Note6</sup>		1, 2, 3, 4, 5, 6	AWGN1944	
Antenna Configuration and Correlation Matrix <sup>Note6</sup>		1, 2, 3, 4, 5, 6	1x2 Low	
<p>Note 1: Special subframe and uplink-downlink configurations are specified in table 4.2-1 in TS 36.211 [23].</p> <p>Note 2: DL RMCs and OCNG patterns are specified in clauses A 3.1 and A 3.2 of TS 36.133 [15] respectively.</p> <p>Note 3: OCNG shall be used such that all cells are fully allocated and a constant total transmitted power spectral density is achieved for all OFDM symbols.</p> <p>Note 4: Interference from other cells and noise sources not specified in the test is assumed to be constant over subcarriers and time and shall be modelled as AWGN of appropriate power for N<sub>oc</sub> to be fulfilled.</p> <p>Note 5: <math>\hat{E}_s/I_{ot}</math>, RSRP, SCH_RP and I<sub>o</sub> levels have been derived from other parameters for information purposes. They are not settable parameters themselves.</p> <p>Note 6: Propagation condition and correlation matrix are defined in clause B.2 in TS 36.101 [25].</p>				

The UE shall send one Event B2 triggered measurement report for Cell 2 to the PCell, with a measurement reporting delay less than 4.8s from the start of period T2. The measurement reporting delay is defined as the time from the beginning of time period T2 to the moment when the UE sends the measurement report on PUSCH.

The UE shall not send event-triggered measurement reports as long as the reporting criteria is not fulfilled.

The rate of correct events observed during repeated tests shall be at least 90% with a confidence level of 95%.

## 6.6.4 L1-RSRP measurement for beam reporting

### 6.6.4.0 Minimum conformance requirements

#### 6.6.4.0.1 Minimum conformance requirements for SSB-based L1-RSRP measurement for beam reporting

Same as clause 4.6.4.0.1

The normative reference for this requirement is TS 38.133 [6] clause 9.5.3.1, 9.5.4.1 and 9.5.5.1.

#### 6.6.4.0.2 Minimum conformance requirements for CSI-RS-based L1-RSRP measurement for beam reporting

Same as clause 4.6.4.0.2

The normative reference for this requirement is TS 38.133 [6] clauses 9.5.3.1, 9.5.4.2 and 9.5.5.2.

### 6.6.4.1 NR SA FR1 SSB-based L1-RSRP measurement in non-DRX

#### 6.6.4.1.1 Test purpose

To verify that the UE makes correct reporting of L1-RSRP measurement in non-DRX within L1-RSRP measurement requirements in TS 38.133 [6] clause 9.5.4.1.

#### 6.6.4.1.2 Test applicability

This test applies to all types of NR UE release 15 and forward.

#### 6.6.4.1.3 Minimum conformance requirements

The minimum conformance requirements are specified in clause 6.6.4.0.1.

The normative reference for this requirement is TS 38.133 [6] clause A.6.6.4.1.

#### 6.6.4.1.4 Test description

##### 6.6.4.1.4.1 Initial conditions

This test shall be tested using any of the test configurations in Table 6.6.4.1.4.1-1. Configure the test equipment and the DUT according to the parameters in Table 6.6.4.1.4.1-2. Test environment parameters are given in Table 6.6.4.1.4.1-3.

**Table 6.6.4.1.4.1-1: NR SA SSB based L1-RSRP measurement supported test configurations**

Test Case ID	Description
6.6.4.1-1	NR 15 kHz SSB SCS, 10 MHz bandwidth, FDD duplex mode
6.6.4.1-2	NR 15 kHz SSB SCS, 10 MHz bandwidth, TDD duplex mode
6.6.4.1-3	NR 30 kHz SSB SCS, 40 MHz bandwidth, TDD duplex mode

Note: The UE is only required to be tested in one of the supported test configurations

**Table 6.6.4.1.4.1-2: General test parameters for NR SA SSB based L1-RSRP measurement**

Parameter	Config	Unit	Value
SSB GSCN	1~3		freq1
Duplex mode	1		FDD
	2		TDD
	3		TDD

TDD Configuration	1		N/A
	2		TDDConf.1.1
	3		TDDConf.2.1
BW <sub>channel</sub>	1	MHz	10: N <sub>RB,c</sub> = 52
	2		10: N <sub>RB,c</sub> = 52
	3		40: N <sub>RB,c</sub> = 106
PDSCH Reference measurement channel	1		SR.1.1 FDD
	2		SR.1.1 TDD
	3		SR.2.1 TDD
RMSI CORESET Reference Channel	1		CR.1.1 FDD
	2		CR.1.1 TDD
	3		CR.2.1 TDD
Dedicated CORESET Reference Channel	1		CCR.1.1 FDD
	2		CCR.1.1 TDD
	3		CCR.2.1 TDD
SSB configuration	1		SSB.3 FR1
	2		SSB.3 FR1
	3		SSB.4 FR1
OCNG Patterns	1~3		OP.1
Initial BWP Configuration	1~3		DLBWP.0.1 ULBWP.0.1
Dedicated BWP configuration	1~3		DLBWP.1.1 ULBWP.1.1
SMTC configuration	1~3		SMTC.1
TRS Configuration	1		TRS.1.1 FDD
	2		TRS.1.1 TDD
	3		TRS.1.2 TDD
DRX configuration	1~3		Off
reportConfigType	1~3		periodic
reportQuantity	1~3		ssb-Index-RSRP
Number of reported RS	1~3		2
L1-RSRP reporting period	1~3	slot	80
T1	1~3	s	5
T2	1~3	s	1
EPRE ratio of PSS to SSS	1~3	dB	0
EPRE ratio of PBCH DMRS to SSS			
EPRE ratio of PBCH to PBCH DMRS			
EPRE ratio of PDCCH DMRS to SSS			
EPRE ratio of PDCCH to PDCCH DMRS			
EPRE ratio of PDSCH DMRS to SSS			
EPRE ratio of PDSCH to PDSCH DMRS			
EPRE ratio of OCNG DMRS to SSS <sup>Note 1</sup>			
EPRE ratio of OCNG to OCNG DMRS <sup>Note 1</sup>			
Propagation condition	1~3		AWGN
Note 1: OCNG shall be used such that both cells are fully allocated and a constant total transmitted power spectral density is achieved for all OFDM symbols.			

**Table 6.6.4.1.4.1-3: Test Environment parameters for NR SA SSB based L1-RSRP measurement**

Parameter	Value		Comment
Test environment	NC		As specified in TS 38.508-1 [14] clause 4.1.
Test frequencies	As specified in Annex E, Table E.2-1 and TS 38.508-1 [14] clause 4.3.1 and 4.4.2.		
Channel bandwidth	As specified by the test configuration selected from Table 4.6.3.1.4.1-1.		
Propagation conditions	AWGN		As specified in Annex C.2.2.
Connection Diagram	TE Part	A.3.1.7.1	As specified in TS 38.508-1 [14] Annex A.
	DUT Part	A.3.2.3.4	
Exceptions to connection diagram	For 4Rx capable UEs without any 2 Rx RF bands use A.3.2.5.2 for DUT part and A.3.1.8.4 for TE Part		

1. Message contents are defined in clause 6.6.4.1.4.3.
2. Single Cell is used, which is NR FR1 Pcell. The connection setup is done according to the settings in Annex C.1.2 and C.1.3. The test parameters are given in tables 6.6.4.1.4.1-2 and 6.6.4.1.5-1. UE is configured to perform RLM and BFD based on the SSBs.

#### 6.6.4.1.4.2 Test procedure

Prior to the start of the time duration T1, the UE shall be configured for periodic CSI reporting in PUCCH [format 2] with a reporting periodicity as mentioned in the above table 4.6.4.1.4.1-2. Before the test, UE is configured to perform RLM, BFD and L1-RSRP measurement based on the SSBs.

1. Ensure the UE is in state RRC\_CONNECTED with generic procedure parameters Connectivity NR SA, Connected without release *On* and Test Mode *On*, according to TS 38.508-1 [14] clause 4.5 and general test parameters set according to Table 6.6.4.1.4.1-2.
2. Set the parameters according to T1 in Table 6.6.4.1.5-1. T1 starts.
3. The UE shall be transmitting CSI on PUCCH with a periodicity of 80 slots.
4. When T1 expires, the SS shall set the parameters according to T2 in 6.6.4.1.5-1. T2 starts.
5. The UE shall start sending valid L1-RSRP reports. The SS shall check following requirements:
  - R1: the UE shall start to transmit valid reports no later than 720 ms for configuration 1, 2, 4 and 5 and no later than 680 ms for configuration 3 and 6 from the beginning of time period T2. A valid report shall meet the absolute L1-RSRP requirement for SSB#1 (Table 6.6.4.1.5-2 for test configurations 1, 2, 4 and 5 and Table 6.6.4.1.5-3 for test configurations 3 and 6) and the relative L1-RSRP requirement for SSB#0 in Table 6.6.4.1.5-4. If the first valid report is received earlier than the specified time, the number of passed iterations for R1 is increased by one. Otherwise, the number of failed iterations for R1 is increased by one.
  - R2: the UE shall transmit reports every 80 slots until the end of time period T2. If the reports are received accordingly, the number of passed iterations for R2 is increased by one. Otherwise, the number of failed iterations for R2 is increased by one.
  - R3: The L1-RSRP value of SSB#1 reported by the UE is compared to the expected L1-RSRP value for SSB#1. In all consecutive reports after the first valid value is received, if the resulting value is outside the limits in Table 6.6.4.1.5-2 for test configurations 1, 2, 4 and 5 and in Table 6.6.4.1.5-3 for test configurations 3 and 6 or the UE fails to report the measurement value for SSB#1, the number of failed iterations for R3 is increased by one. Otherwise, the number of passed iterations for R3 is increased by one.
  - R4: The DIFF RSRP value of SSB#0 reported by the UE is compared to the expected DIFF RSRP value. In all consecutive reports after the first valid value is received, if the resulting value is outside the limits in Table 6.6.4.1.5-4 or the UE fails to report the measurement value for SSB#0, the number of failed iterations for R4 is increased by one. Otherwise, the number of passed iterations for R4 is increased by one.
6. The SS waits until T2 expires.
7. The SS shall transmit *RRCRelease* message to release the RRC connection which includes the release of the established radio bearers as well as all radio resources.

8. After the RRC connection release, the SS:

- transmits in Cell 1 a *Paging* message (including PagingRecord with ue-Identity) for the UE and ensures the UE in state RRC\_CONNECTED with generic procedure parameters Connectivity NR SA, Connected without release *On* and Test Mode *On* according to TS 38.508-1 [14] clause 4.5. (if the paging fails, switches off and on the UE and ensures the UE is in state RRC\_CONNECTED with generic procedure parameters Connectivity NR SA, Connected without release *On* and Test Mode *On* according to TS 38.508-1 [14] clause 4.5.),
- or:
- switches off and on the UE and ensures the UE is in state RRC\_CONNECTED with generic procedure parameters Connectivity NR SA, Connected without release *On* and Test Mode *On* according to TS 38.508-1 [14] clause 4.5.

9. Repeat steps 2-8 until the confidence level according to Tables G.2.3-1 in Annex G clause G.2 is achieved.

6.6.4.1.4.3 Message contents

Message contents are according to TS 38.508-1 [14] clause 7.3 with the following exceptions:

**Table 6.6.4.1.4.3-1: Common Exception messages NR SA SSB based L1-RSRP measurement**

Default Message Contents	
Common contents of system information blocks exceptions	
Default RRC messages and information elements contents exceptions	Table H.3.6-2 with conditions PERIODIC and SS-RSRP Table H.3.6-3 with conditions SSB and PERIODIC

**Table 6.6.4.1.4.3-2: RadioLinkMonitoringConfig**

Derivation Path: TS 38.508-1 [14], Table 4.6.3-133			
Information Element	Value/remark	Comment	Condition
RadioLinkMonitoringConfig ::= SEQUENCE {			
failureDetectionResourcesToAddModList	1 entry		
SEQUENCE			
(SIZE(1..maxNrofFailureDetectionResources)) OF			
SEQUENCE {			
purpose	both	UE is configured to perform RLM and BFD based on the SSBs.	
detectionResource CHOICE {			
ssb-Index	0		
}			
}			
}			
}			

6.6.4.1.5 Test requirement

Table 6.6.4.1.5-1 defines the primary level settings including test tolerances for all tests.

**Table 6.6.4.1.5-1: SSB specific test parameters for NR SA SSB based L1-RSRP measurement**

Parameter	Config	Unit	SSB#0		SSB#1	
			T1	T2	T1	T2
$N_{oc}$ <sup>Note2</sup>	1~3	dBm/15kHz	-94.65			
$N_{oc}$ <sup>Note2</sup>	1,2	dBm/SSB SCS	-94.65			
	3		-91.65			
$\hat{E}_s/I_{ot}$	1~3	dB	0	0	-Infinity	3.5
SSB RSRP <sup>Note3</sup>	1,2	dBm/SSB SCS	-94.65	-94.65	-Infinity	-91.15
	3		-91.65	-91.65	-Infinity	-88.14
$I_o$ <sup>Note3</sup>	1,2	dBm/9.36 MHz	-63.69	-63.69	-66.70	-61.59

	3	dBm/38.16 MHz	-57.59	-57.59	-60.61	-55.49
$\hat{E}_s/N_{oc}$	1~3	dB	0	0	-Infinity	3.5
Note 1:	The resources for uplink transmission are assigned to the UE prior to the start of time period T2.					
Note 2:	Interference from other cells and noise sources not specified in the test is assumed to be constant over subcarriers and time and shall be modelled as AWGN of appropriate power for $N_{oc}$ to be fulfilled.					
Note 3:	SS-RSRP and $I_o$ levels have been derived from other parameters for information purposes. They are not settable parameters themselves.					

The UE shall send L1-RSRP report every 80 slots. No later than 640ms plus 80 slots from the beginning of time period T2, UE shall send L1-RSRP report including results of both SSB0 and SSB1. Each L1-RSRP measurement report shall meet the corresponding absolute accuracy requirements in Table 4.6.4.1.5-2 for test configurations 1, 2, 4 and 5 and the corresponding absolute accuracy requirements in Table 4.6.4.1.5-3 for test configurations 3 and 6 and the corresponding relative accuracy requirements in Table 4.6.4.1.5-4 for all test configurations.

**Table 6.6.4.1.5-2: L1-RSRP absolute accuracy requirements for the reported values for test configurations 1 and 2**

Normal Conditions	T1	T2
Lowest reported value (SSB#1)	-	55
Highest reported value (SSB#1)	-	75

**Table 6.6.4.1.5-3: L1-RSRP absolute accuracy requirements for the reported values for test configurations 3**

Normal Conditions	T1	T2
Lowest reported value (SSB#1)	-	58
Highest reported value (SSB#1)	-	78

**Table 6.6.4.1.5-4: L1-RSRP relative accuracy requirements for the reported values for all test configurations**

	T1	T2
Lowest DIFF RSRP reported (SSB#0)	-	0
Highest DIFF RSRP reported (SSB#0)	-	3

For the test to pass, the ratio of successful reported values for each requirement (R1 to R4) shall be more than 90% with a confidence level of 95%. Each requirement is evaluated independently of the others. NOTE:

The actual overall delays measured in the test may be up to  $2 \times TTI_{DCCH}$  higher than the measurement reporting delays above because of TTI insertion uncertainty of the measurement report in DCCH.

## 6.6.4.2 NR SA FR1 SSB-based L1-RSRP measurement in DRX

### 6.6.4.2.1 Test purpose

To verify that the UE makes correct reporting of L1-RSRP measurement in DRX within L1-RSRP measurement requirements in TS 38.133 [6] clause 9.5.4.1.

### 6.6.4.2.2 Test applicability

This test applies to all types of NR UE release 15 and forward supporting 5GS NR SA FR1 and long DRX cycle.

### 6.6.4.2.3 Minimum conformance requirements

The minimum conformance requirements are specified in clause 6.6.4.0.1.

The normative reference for this requirement is TS 38.133 [6] clause A.6.6.4.2.

#### 6.6.4.2.4 Test description

##### 6.6.4.2.4.1 Initial conditions

This test shall be tested using any of the test configurations in Table 6.6.4.2.4.1-1. Configure the test equipment and the DUT according to the parameters in Table 6.6.4.2.4.1-2. Test environment parameters are given in Table 6.6.4.2.4.1-3.

**Table 6.6.4.2.4.1-1: SA SSB based L1-RSRP measurement supported test configurations**

Test Case ID	Description
6.6.4.2-1	NR 15 kHz SSB SCS, 10 MHz bandwidth, FDD duplex mode
6.6.4.2-2	NR 15 kHz SSB SCS, 10 MHz bandwidth, TDD duplex mode
6.6.4.2-3	NR 30 kHz SSB SCS, 40 MHz bandwidth, TDD duplex mode
Note:	The UE is only required to be tested in one of the supported test configurations

**Table 6.6.4.2.4.1-2: General test parameters for NR SA SSB based L1-RSRP measurement**

Parameter	Config	Unit	Value
SSB GSCN	1~3		freq1
Duplex mode	1		FDD
	2		TDD
	3		TDD
TDD Configuration	1		N/A
	2		TDDConf.1.1
	3		TDDConf.2.1
BW <sub>channel</sub>	1	MHz	10: N <sub>RB,c</sub> = 52
	2		10: N <sub>RB,c</sub> = 52
	3		40: N <sub>RB,c</sub> = 106
PDSCH Reference measurement channel	1		SR.1.1 FDD
	2		SR.1.1 TDD
	3		SR.2.1 TDD
RMSI CORESET Reference Channel	1		CR.1.1 FDD
	2		CR.1.1 TDD
	3		CR.2.1 TDD
Dedicated CORESET Reference Channel	1		CCR.1.1 FDD
	2		CCR.1.1 TDD
	3		CCR.2.1 TDD
SSB configuration	1		SSB.3 FR1
	2		SSB.3 FR1
	3		SSB.4 FR1
OCNG Patterns	1~3		OP.1
Initial BWP Configuration	1~3		DLBWP.0.1 ULBWP.0.1
Dedicated BWP configuration	1~3		DLBWP.1.1 ULBWP.1.1
SMTTC configuration	1~3		SMTTC.1
TRS Configuration	1		TRS.1.1 FDD
	2		TRS.1.1 TDD
	3		TRS.1.2 TDD



DRX configuration	1~3		DRX.3
reportConfigType	1~3		periodic
reportQuantity	1~3		ssb-Index-RSRP
Number of reported RS	1~3		2
L1-RSRP reporting period	1~3	slot	80
T1	1~3	s	5
T2	1~3	s	1
EPRE ratio of PSS to SSS	1~3	dB	0
EPRE ratio of PBCH DMRS to SSS			
EPRE ratio of PBCH to PBCH DMRS			
EPRE ratio of PDCCH DMRS to SSS			
EPRE ratio of PDCCH to PDCCH DMRS			
EPRE ratio of PDSCH DMRS to SSS			
EPRE ratio of PDSCH to PDSCH DMRS			
EPRE ratio of OCN <sup>Note 1</sup> DMRS to SSS			
EPRE ratio of OCN <sup>Note 1</sup> to OCN <sup>Note 1</sup> DMRS			
Propagation condition			
Note 1: OCN shall be used such that both cells are fully allocated and a constant total transmitted power spectral density is achieved for all OFDM symbols.			

**Table 6.6.4.2.4.1-3: Test Environment parameters for NR SA SSB based L1-RSRP measurement**

Parameter	Value		Comment
Test environment	NC		As specified in TS 38.508-1 [14] clause 4.1.
Test frequencies	As specified in Annex E, Table E.2-1 and TS 38.508-1 [14] clause 4.3.1 and 4.4.2.		
Channel bandwidth	As specified by the test configuration selected from Table 4.6.3.1.4.1-1.		
Propagation conditions	AWGN		As specified in Annex C.2.2.
Connection Diagram	TE Part	A.3.1.7.1	As specified in TS 38.508-1 [14] Annex A.
	DUT Part	A.3.2.3.4	
Exceptions to connection diagram	For 4Rx capable UEs without any 2 Rx RF bands use A.3.2.5.2 for DUT part and A.3.1.8.4 for TE Part		

1. Message contents are defined in clause 6.6.4.2.4.3.
2. Single Cell is used, which is NR FR1 Pcell. The connection setup is done according to the settings in Annex C.1.2 and C.1.3. The test parameters are given in tables 6.6.4.2.4.1-2 and 6.6.4.2.5-1. UE is configured to perform RLM and BFD based on the SSBs. DRX is configured as specified in Table 6.6.4.2.4.1-2.

**6.6.4.2.4.2 Test procedure**

Same test procedure as in subclause 6.6.4.1.4.2 with tables 6.6.4.1.4.1-2 and 6.6.4.1.5-1 replaced by tables 6.6.4.2.4.1-2 and 6.6.4.2.5-1.

**6.6.4.2.4.3 Message contents**

Same message content as in subclause 6.6.4.1.4.3 with the following exception:

**Table 6.6.4.2.4.3-1: Common Exception messages EN-DC SSB based L1-RSRP measurement in DRX**

Default Message Contents	
Common contents of system information blocks exceptions	
Default RRC messages and information elements contents exceptions	Table H.3.7-1 with condition DRX.3

## 6.6.4.2.5 Test requirement

Table 6.6.4.2.5-1 defines the primary level settings including test tolerances for all tests.

**Table 6.6.4.2.5-1: SSB specific test parameters for NR SA SSB based L1-RSRP measurement**

Parameter	Config	Unit	SSB#0		SSB#1	
			T1	T2	T1	T2
$N_{oc}$ <sup>Note2</sup>	1~3	dBm/15kHz	-94.65			
$N_{oc}$ <sup>Note2</sup>	1,2	dBm/SSB SCS	-94.65			
	3		-91.65			
$\hat{E}_s/I_{ot}$	1~3	dB	0	0	-Infinity	3.5
SSB RSRP <sup>Note3</sup>	1,2	dBm/SSB SCS	-94.65	-94.65	-Infinity	-91.15
	3		-91.65	-91.65	-Infinity	-88.14
$I_o$ <sup>Note3</sup>	1,2	dBm/9.36 MHz	-63.69	-63.69	-66.70	-61.59
	3	dBm/38.16 MHz	-57.59	-57.59	-60.61	-55.49
$\hat{E}_s/N_{oc}$	1~3	dB	0	0	-Infinity	3.5
Note 1:	The resources for uplink transmission are assigned to the UE prior to the start of time period T2.					
Note 2:	Interference from other cells and noise sources not specified in the test is assumed to be constant over subcarriers and time and shall be modelled as AWGN of appropriate power for $N_{oc}$ to be fulfilled.					
Note 3:	SS-RSRP and $I_o$ levels have been derived from other parameters for information purposes. They are not settable parameters themselves.					

The UE shall send L1-RSRP report every 80 slots. No later than 640ms plus 80 slots from the beginning of time period T2, UE shall send L1-RSRP report including results of both SSB0 and SSB1. Each L1-RSRP measurement report shall meet the corresponding absolute accuracy requirements in Table 6.6.4.2.5-2 for for test configurations 1, 2, 4 and 5 and the corresponding absolute accuracy requirements in Table 6.6.4.2.5-3 for test configurations 3 and 6 and the corresponding relative accuracy requirements in Table 6.6.4.2.5-4 for all test configurations.

**Table 6.6.4.2.5-2: L1-RSRP absolute accuracy requirements for the reported values for test configurations 1 and 2**

Normal Conditions	T1	T2
Lowest reported value (SSB#1)	-	55
Highest reported value (SSB#1)	-	75

**Table 6.6.4.2.5-3: L1-RSRP absolute accuracy requirements for the reported values for test configurations 3**

Normal Conditions	T1	T2
Lowest reported value (SSB#1)	-	58
Highest reported value (SSB#1)	-	78

**Table 6.6.4.2.5-4: L1-RSRP relative accuracy requirements for the reported values for all test configurations**

	T1	T2
Lowest DIFF RSRP reported (SSB#0)	-	0
Highest DIFF RSRP reported (SSB#0)	-	3

The rate of correct events observed during repeated tests shall be at least 90% with a confidence level of 95%.

NOTE: The actual overall delays measured in the test may be up to  $2 \times TTI_{DCCH}$  higher than the measurement reporting delays above because of TTI insertion uncertainty of the measurement report in DCCH.

### 6.6.4.3 NR SA FR1 CSI-RS-based L1-RSRP measurement in non-DRX

#### 6.6.4.3.1 Test purpose

To verify that the UE makes correct reporting of L1-RSRP measurement in non-DRX within L1-RSRP measurement requirements in TS 38.133 [6] clause 9.5.4.1.

#### 6.6.4.3.2 Test applicability

This test applies to all types of NR UE release 15 and forward.

#### 6.6.4.3.3 Minimum conformance requirements

The minimum conformance requirements are specified in clause 6.6.4.0.2.

The normative reference for this requirement is TS 38.133 [6] clause A.6.6.4.3.

#### 6.6.4.3.4 Test description

##### 6.6.4.3.4.1 Initial conditions

This test shall be tested using any of the test configurations in Table 6.6.4.3.4.1-1. Configure the test equipment and the DUT according to the parameters in Table 6.6.4.3.4.1-2. Test environment parameters are given in Table 6.6.4.3.4.1-3.

**Table 6.6.4.3.4.1-1: NR SA SSB based L1-RSRP measurement supported test configurations**

Test Case ID	Description
6.6.4.3-1	NR 15 kHz SSB SCS, 10 MHz bandwidth, FDD duplex mode
6.6.4.3-2	NR 15 kHz SSB SCS, 10 MHz bandwidth, TDD duplex mode
6.6.4.3-3	NR 30 kHz SSB SCS, 40 MHz bandwidth, TDD duplex mode
Note:	The UE is only required to be tested in one of the supported test configurations

**Table 6.6.4.3.4.1-2: General test parameters for NR SA SSB based L1-RSRP measurement**

Parameter	Config	Unit	Value
SSB GSCN	1~3		freq1
Duplex mode	1		FDD
	2		TDD
	3		TDD
TDD Configuration	1		N/A
	2		TDDConf.1.1
	3		TDDConf.2.1
BW <sub>channel</sub>	1	MHz	10: N <sub>RB,c</sub> = 52
	2		10: N <sub>RB,c</sub> = 52
	3		40: N <sub>RB,c</sub> = 106
PDSCH Reference measurement channel	1		SR.1.1 FDD
	2		SR.1.1 TDD
	3		SR.2.1 TDD

RMSI CORESET Reference Channel	1		CR.1.1 FDD
	2		CR.1.1 TDD
	3		CR.2.1 TDD
Dedicated CORESET Reference Channel	1		CCR.1.1 FDD
	2		CCR.1.1 TDD
	3		CCR.2.1 TDD
SSB configuration	1		SSB.3 FR1
	2		SSB.3 FR1
	3		SSB.4 FR1
CSI-RS configuration	1		CSI-RS 1.3 FDD
	2		CSI-RS 1.3 TDD
	3		CSI-RS 2.3 TDD
OCNG Patterns	1~3		OP.1
TRS Configuration	1		TRS.1.1 FDD
	2		TRS.1.1 TDD
	3		TRS.1.2 TDD
Initial BWP Configuration	1~3		DLBWP.0.1 ULBWP.0.1
Dedicated BWP configuration	1~3		DLBWP.1.1 ULBWP.1.1
SMTC configuration	1~3		SMTC.1
DRX configuration	1~3		Off
reportConfigType	1~3		aperiodic
reportQuantity	1~3		cri-RSRP
Number of reported RS	1~3		2
qcl-Info	1~3		SSB#0 for resource#0
			SSB#1 for resource#1
reportSlotOffsetList	1~3	slots	8
T1	1~3	s	5
EPRE ratio of PSS to SSS	1~3	dB	0
EPRE ratio of PBCH DMRS to SSS			
EPRE ratio of PBCH to PBCH DMRS			
EPRE ratio of PDCCH DMRS to SSS			
EPRE ratio of PDCCH to PDCCH DMRS			
EPRE ratio of PDSCH DMRS to SSS			
EPRE ratio of PDSCH to PDSCH DMRS			
EPRE ratio of OCNG DMRS to SSS <sup>Note 1</sup>			
EPRE ratio of OCNG to OCNG DMRS <sup>Note 1</sup>			
Propagation condition	1~3		AWGN
Note 1: OCNG shall be used such that both cells are fully allocated and a constant total transmitted power spectral density is achieved for all OFDM symbols.			

Table 6.6.4.3.4.1-3: Test Environment parameters for NR SA SSB based L1-RSRP measurement

Parameter	Value		Comment
Test environment	NC		As specified in TS 38.508-1 [14] clause 4.1.
Test frequencies	As specified in Annex E, Table E.2-1 and TS 38.508-1 [14] clause 4.3.1 and 4.4.2.		
Channel bandwidth	As specified by the test configuration selected from Table 4.6.3.1.4.1-1.		
Propagation conditions	AWGN		As specified in Annex C.2.2.
Connection Diagram	TE Part	A.3.1.7.1	As specified in TS 38.508-1 [14] Annex A.
	DUT Part	A.3.2.3.4	
Exceptions to connection diagram	For 4Rx capable UEs without any 2 Rx RF bands use A.3.2.5.2 for DUT part and A.3.1.8.4 for TE Part		

1. Message contents are defined in clause 6.6.4.3.4.3.
2. Single Cell is used, which is NR FR1 Pcell. The connection setup is done according to the settings in Annex C.1.2 and C.1.3. The test parameters are given in tables 6.6.4.3.4.1-2 and 6.6.4.3.5-1. UE is configured to perform RLM and BFD based on the SSBs.

#### 6.6.4.3.4.2 Test procedure

The test consists of a single time period T1, during which the UE is triggered via DCI to report L1-RSRP on aperiodic CSI-RS resources. Prior to the start of the time duration T1, the UE shall be fully synchronized to PCell. UE is also configured to measure L1-RSRP based on SSB. Upon receiving the DCI trigger, UE provides the report back based on the reporting configuration as defined in table 6.6.4.3.4.1-2.

1. Ensure the UE is in state RRC\_CONNECTED with generic procedure parameters Connectivity NR SA, Connected without release *On* and Test Mode *On*, according to TS 38.508-1 [14] clause 4.5.
2. Set the parameters according to T1 in Table 6.6.4.3.5-1. T1 starts.
3. After 80ms from the start of the test the SS transmits the DCI trigger in slot 0 for configuration 1,2 and slot 8 for configuration 3. The corresponding CSI-RS set is transmitted with the offset of 4 slots after the DCI trigger.
4. The SS shall check following requirements:
  - R1: the UE shall send L1-RSRP report at slot 8 from the reception of DCI trigger. If the report is received at slot 8 from the reception of DCI trigger, the number of passed iterations for R1 is increased by one. Otherwise, the number of failed iterations for R1 is increased by one.
  - R2: The L1-RSRP value of CSI-RS#1 reported by the UE is compared to the expected L1-RSRP value for CSI-RS #1. If the resulting value is outside the limits in Table 4.6.4.3.5-2 for test configurations 1, 2, 4 and 5 and in Table 4.6.4.3.5-3 for test configurations 3 and 6 or the UE fails to report the measurement value for CSI-RS #1, the number of failed iterations for R2 is increased by one. Otherwise, the number of passed iterations for R2 is increased by one.
  - R3: The DIFF RSRP value of CSI-RS #0 reported by the UE is compared to the expected DIFF RSRP value. If the resulting value is outside the limits in Table 4.6.4.3.5-4 or the UE fails to report the measurement value for CSI-RS #0, the number of failed iterations for R3 is increased by one. Otherwise, the number of passed iterations for R3 is increased by one.
5. Void.
6. The SS shall transmit *RRCRelease* message to release the RRC connection which includes the release of the established radio bearers as well as all radio resources.
7. After the RRC connection release, the SS:
  - transmits in Cell 1 a *Paging* message (including *PagingRecord* with *ue-Identity*) for the UE and ensures the UE in state RRC\_CONNECTED with generic procedure parameters Connectivity NR SA, Connected without release *On* and Test Mode *On* according to TS 38.508-1 [14] clause 4.5. (if the paging fails, switches off and on the UE and ensures the UE is in state RRC\_CONNECTED with generic procedure parameters Connectivity NR SA, Connected without release *On* and Test Mode *On* according to TS 38.508-1 [14] clause 4.5.),
  - or:
  - switches off and on the UE and ensures the UE is in state RRC\_CONNECTED with generic procedure parameters Connectivity NR SA, Connected without release *On* and Test Mode *On* according to TS 38.508-1 [14] clause 4.5.
8. Repeat steps 2-7 until the confidence level according to Tables G.2.3-1 in Annex G clause G.2 is achieved.

#### 6.6.4.3.4.3 Message contents

Message contents are according to TS 38.508-1 [14] clause 7.3 with the following exceptions:

**Table 6.6.4.3.4.3-1: Common Exception messages NR SA CSI-RS-based L1-RSRP measurement**

Default Message Contents	
Common contents of system information blocks exceptions	
Default RRC messages and information elements contents exceptions	Table H.3.6-2 with conditions APERIODIC and CSI-RSRP Table H.3.6-3 with conditions CSI-RS and APERIODIC

**Table 6.6.4.3.4.3-2: RadioLinkMonitoringConfig**

Derivation Path: TS 38.508-1 [14], Table 4.6.3-133			
Information Element	Value/remark	Comment	Condition
RadioLinkMonitoringConfig ::= SEQUENCE {			
failureDetectionResourcesToAddModList	1 entry		
SEQUENCE			
(SIZE(1..maxNrofFailureDetectionResources)) OF			
SEQUENCE {			
purpose	both	UE is configured to perform RLM and BFD based on the SSBs.	
}			
}			
}			

6.6.4.3.5 Test requirement

Table 6.6.4.3.5-1 defines the primary level settings including test tolerances for all tests.

**Table 6.6.4.3.5-1: SSB specific test parameters for NR SA SSB based L1-RSRP measurement**

Parameter	Config	Unit	CSI-RS#0	CSI-RS#1
$N_{oc}$ <sup>Note1</sup>	1~3	dBm/15kHz	-94.65	
$N_{oc}$ <sup>Note1</sup>	1,2	dBm/SSB SCS	-94.65	
	3		-91.65	
$\hat{E}_s / I_{ot}$	1~3	dB	0	3.5
CSI-RS RSRP <sup>Note2</sup>	1,2	dBm/SSB SCS	-94.65	-91.15
	3		-91.65	-88.14
$I_o$ <sup>Note2</sup>	1,2	dBm/9.36 MHz	-63.69	-61.59
	3	dBm/38.16 MHz	-57.59	-55.49
$\hat{E}_s / N_{oc}$	1~3	dB	0	3.5
Note 1: Void Note 2: Interference from other cells and noise sources not specified in the test is assumed to be constant over subcarriers and time and shall be modelled as AWGN of appropriate power for $N_{oc}$ to be fulfilled. Note 3: CSI-RS RSRP and $I_o$ levels have been derived from other parameters for information purposes. They are not settable parameters themselves.				

After 80ms from the beginning of the test, the UE shall send L1-RSRP report at slot 8 from the reception of DCI triggering the L1-RSRP measurement. The L1-RSRP report shall include the results for both CSI-RS#0 and CSI-RS#1.

Each L1-RSRP measurement report shall meet the corresponding absolute accuracy requirements in Table 6.6.4.3.5-2 for for test configurations 1, 2, 4 and 5 and the corresponding absolute accuracy requirements in Table 6.6.4.3.5-3 for

test configurations 3 and 6 and the corresponding relative accuracy requirements in Table 6.6.4.3.5-4 for all test configurations.

**Table 6.6.4.3.5-2: L1-RSRP absolute accuracy requirements for the reported values for test configurations 1 and 2**

Normal Conditions	T1
Lowest reported value (CSI-RS#1)	55
Highest reported value (CSI-RS#1)	75

**Table 6.6.4.3.5-3: L1-RSRP absolute accuracy requirements for the reported values for test configurations 3**

Normal Conditions	T1
Lowest reported value (CSI-RS#1)	58
Highest reported value (CSI-RS#1)	78

**Table 6.6.4.3.5-4: L1-RSRP relative accuracy requirements for the reported values for all test configurations**

	T1
Lowest DIFF RSRP reported (CSI-RS#0)	0
Highest DIFF RSRP reported (CSI-RS#0)	3

For the test to pass, the ratio of successful reported values for each requirement (R1 to R3) shall be more than 90% with a confidence level of 95%. Each requirement is evaluated independently of the others. NOTE:

The actual overall delays measured in the test may be up to  $2 \times TTI_{DCCH}$  higher than the measurement reporting delays above because of TTI insertion uncertainty of the measurement report in DCCH.

## 6.6.4.4 NR SA FR1 CSI-RS-based L1-RSRP measurement in DRX

### 6.6.4.4.1 Test purpose

To verify that the UE makes correct reporting of L1-RSRP measurement in DRX within L1-RSRP measurement requirements in TS 38.133 [6] clause 9.5.4.1.

### 6.6.4.4.2 Test applicability

This test applies to all types of NR UE release 15 and forward supporting 5GS NR SA FR1 and long DRX cycle.

### 6.6.4.4.3 Minimum conformance requirements

The minimum conformance requirements are specified in clause 6.6.4.0.2.

The normative reference for this requirement is TS 38.133 [6] clause A.6.6.4.4.

### 6.6.4.4.4 Test description

#### 6.6.4.4.4.1 Initial conditions

This test shall be tested using any of the test configurations in Table 6.6.4.4.4.1-1. Configure the test equipment and the DUT according to the parameters in Table 6.6.4.4.4.1-2. Test environment parameters are given in Table 6.6.4.4.4.1-3.

**Table 6.6.4.4.4.1-1: NR SA SSB based L1-RSRP measurement supported test configurations**

Test Case ID	Description
6.6.4.4-1	NR 15 kHz SSB SCS, 10 MHz bandwidth, FDD duplex mode
6.6.4.4-2	NR 15 kHz SSB SCS, 10 MHz bandwidth, TDD duplex mode
6.6.4.4-3	NR 30 kHz SSB SCS, 40 MHz bandwidth, TDD duplex mode
Note:	The UE is only required to be tested in one of the supported test configurations

Table 6.6.4.4.1-2: General test parameters for NR SA SSB based L1-RSRP measurement

Parameter	Config	Unit	Value
SSB GSCN	1~3		freq1
Duplex mode	1		FDD
	2		TDD
	3		TDD
TDD Configuration	1		N/A
	2		TDDConf.1.1
	3		TDDConf.2.1
BW <sub>channel</sub>	1	MHz	10: N <sub>RB,c</sub> = 52
	2		10: N <sub>RB,c</sub> = 52
	3		40: N <sub>RB,c</sub> = 106
PDSCH Reference measurement channel	1		SR.1.1 FDD
	2		SR.1.1 TDD
	3		SR.2.1 TDD
RMSI CORESET Reference Channel	1		CR.1.1 FDD
	2		CR.1.1 TDD
	3		CR.2.1 TDD
Dedicated CORESET Reference Channel	1		CCR.1.1 FDD
	2		CCR.1.1 TDD
	3		CCR.2.1 TDD
SSB configuration	1		SSB.3 FR1
	2		SSB.3 FR1
	3		SSB.4 FR1
CSI-RS configuration	1		CSI-RS 1.3 FDD
	2		CSI-RS 1.3 TDD
	3		CSI-RS 2.3 TDD
OCNG Patterns	1~3		OP.1
TRS Configuration	1		TRS.1.1 FDD
	2		TRS.1.1 TDD
	3		TRS.1.2 TDD
Initial BWP Configuration	1~3		DLBWP.0.1 ULBWP.0.1
Dedicated BWP configuration	1~3		DLBWP.1.1 ULBWP.1.1
SMTc configuration	1~3		SMTc.1
DRX configuration	1~3		DRX.3
reportConfigType	1~3		aperiodic
reportQuantity	1~3		cri-RSRP
Number of reported RS	1~3		2
qcl-Info	1~3		SSB#0 for resource#0
			SSB#1 for resource#1
reportSlotOffsetList	1~3	slots	8
T1	1~3	s	5
EPRE ratio of PSS to SSS	1~3	dB	0
EPRE ratio of PBCH DMRS to SSS			
EPRE ratio of PBCH to PBCH DMRS			
EPRE ratio of PDCCH DMRS to SSS			
EPRE ratio of PDCCH to PDCCH DMRS			
EPRE ratio of PDSCH DMRS to SSS			
EPRE ratio of PDSCH to PDSCH DMRS			
EPRE ratio of OCNG DMRS to SSS <sup>Note 1</sup>			
EPRE ratio of OCNG to OCNG DMRS <sup>Note 1</sup>			
Propagation condition	1~3		AWGN
Note 1: OCNG shall be used such that both cells are fully allocated and a constant total transmitted power spectral density is achieved for all OFDM symbols.			



**Table 6.6.4.4.1-3: Test Environment parameters for NR SA SSB based L1-RSRP measurement**

Parameter	Value		Comment
Test environment	NC		As specified in TS 38.508-1 [14] clause 4.1.
Test frequencies	As specified in Annex E, Table E.2-1 and TS 38.508-1 [14] clause 4.3.1 and 4.4.2.		
Channel bandwidth	As specified by the test configuration selected from Table 4.6.3.1.4.1-1.		
Propagation conditions	AWGN		As specified in Annex C.2.2.
Connection Diagram	TE Part	A.3.1.7.1	As specified in TS 38.508-1 [14] Annex A.
	DUT Part	A.3.2.3.4	
Exceptions to connection diagram	For 4Rx capable UEs without any 2 Rx RF bands use A.3.2.5.2 for DUT part and A.3.1.8.4 for TE Part		

1. Message contents are defined in clause 6.6.4.4.3.
2. Single Cell is used, which is NR FR1 Pcell. The connection setup is done according to the settings in Annex C.1.2 and C.1.3. The test parameters are given in tables 6.6.4.4.1-2 and 6.6.4.4.5-1. UE is configured to perform RLM and BFD based on the SSBs.

#### 6.6.4.4.2 Test procedure

Same test procedure as in subclause 6.6.4.3.4.2 with tables 6.6.4.3.4.1-2 and 6.6.4.3.5-1 replaced by tables 6.6.4.4.1-2 and 6.6.4.4.5-1.

#### 6.6.4.4.3 Message contents

Same message content as in subclause 6.6.4.3.4.3 with the following exception:

**Table 6.6.4.4.3-1: Common Exception messages NR SA CSI-RS-based L1-RSRP measurement**

Default Message Contents	
Common contents of system information blocks exceptions	
Default RRC messages and information elements contents exceptions	Table H.3.7-1 with condition DRX.3

#### 6.6.4.4.5 Test requirement

Table 6.6.4.4.5-1 defines the primary level settings including test tolerances for all tests.

**Table 6.6.4.4.5-1: SSB specific test parameters for NR SA SSB based L1-RSRP measurement**

Parameter	Config	Unit	CSI-RS#0	CSI-RS#1
$N_{oc}$ <sup>Note1</sup>	1~3	dBm/15kHz	-94.65	
$N_{oc}$ <sup>Note1</sup>	1,2	dBm/SSB SCS	-94.65	
	3		-91.65	
$\hat{E}_s/I_{ot}$	1~3	dB	0	3.5
CSI-RS RSRP <sup>Note2</sup>	1,2	dBm/SSB SCS	-94.65	-91.15
	3		-91.65	-88.14
$I_o$ <sup>Note2</sup>	1,2	dBm/9.36 MHz	-63.69	-61.59
	3		dBm/38.16 MHz	-57.59

$\hat{E}_s / N_{oc}$	1~3	dB	0	3.5
Note 1:	Void			
Note 2:	Interference from other cells and noise sources not specified in the test is assumed to be constant over subcarriers and time and shall be modelled as AWGN of appropriate power for $N_{oc}$ to be fulfilled.			
Note 3:	CSI-RS RSRP and Io levels have been derived from other parameters for information purposes. They are not settable parameters themselves.			

After 80ms from the beginning of the test, the UE shall send L1-RSRP report at slot 8 from the reception of DCI triggering the L1-RSRP measurement. The L1-RSRP report shall include the results for both CSI-RS#0 and CSI-RS#1.

Each L1-RSRP measurement report shall meet the corresponding absolute accuracy requirements in Table 6.6.4.4.5-2 for test configurations 1, 2, 4 and 5 and the corresponding absolute accuracy requirements in Table 6.6.4.4.5-3 for test configurations 3 and 6 and the corresponding relative accuracy requirements in Table 6.6.4.4.5-4 for all test configurations.

**Table 6.6.4.4.5-2: L1-RSRP absolute accuracy requirements for the reported values for test configurations 1 and 2**

Normal Conditions	T1
Lowest reported value (CSI-RS#1)	55
Highest reported value (CSI-RS#1)	75

**Table 6.6.4.4.5-3: L1-RSRP absolute accuracy requirements for the reported values for test configurations 3**

Normal Conditions	T1
Lowest reported value (CSI-RS#1)	58
Highest reported value (CSI-RS#1)	78

**Table 6.6.4.4.5-4: L1-RSRP relative accuracy requirements for the reported values for all test configurations**

	T1
Lowest DIFF RSRP reported (CSI-RS#0)	0
Highest DIFF RSRP reported (CSI-RS#0)	3

The rate of correct events observed during repeated tests shall be at least 90% with a confidence level of 95%.

NOTE: The actual overall delays measured in the test may be up to  $2 \times TTI_{DCCH}$  higher than the measurement reporting delays above because of TTI insertion uncertainty of the measurement report in DCCH.

## 6.6.4.5 NR SA FR1 SSB-based L1-RSRP measurement in DRX for UE configured with highSpeedMeasFlag-r16

### 6.6.4.5.1 Test purpose

To verify that the UE makes correct reporting of L1-RSRP measurement in DRX within L1-RSRP measurement requirements for UE configured with highSpeedMeasFlag-r16 in TS 38.133 clause 9.5.4.1

### 6.6.4.5.2 Test applicability

This test applies to all types of NR UE release 16 and forward supporting 5GS NR SA FR1, measurement enhancements in high speed scenario and long DRX cycle

### 6.6.4.5.3 Minimum conformance requirements

The minimum conformance requirements are specified in clause 6.6.4.0.1.

The normative reference for this requirement is TS 38.133 [6] clause A.6.6.4.5.

#### 6.6.4.5.4 Test description

##### 6.6.4.5.4.1 Initial conditions

This test shall be tested using any of the test configurations in Table 6.6.4.5.4.1-1. Configure the test equipment and the DUT according to the parameters in Table 6.6.4.5.4.1-2. Test environment parameters are given in Table 6.6.4.5.4.1-3.

**Table 6.6.4.5.4.1-1: SA SSB based L1-RSRP measurement supported test configurations for UE configured with highSpeedMeasFlag-r16**

Test Case ID	Description
6.6.4.5-1	NR 15 kHz SSB SCS, 10 MHz bandwidth, FDD duplex mode
6.6.4.5-2	NR 15 kHz SSB SCS, 10 MHz bandwidth, TDD duplex mode
6.6.4.5-3	NR 30 kHz SSB SCS, 40 MHz bandwidth, TDD duplex mode
Note:	The UE is only required to be tested in one of the supported test configurations

**Table 6.6.4.5.4.1-2: General test parameters for NR SA SSB based L1-RSRP measurement for UE configured with highSpeedMeasFlag-r16**

Parameter	Config	Unit	Value
SSB GSCN	1~3		freq1
Duplex mode	1		FDD
	2		TDD
	3		TDD
TDD Configuration	1		N/A
	2		TDDConf.1.1
	3		TDDConf.2.1
BW <sub>channel</sub>	1	MHz	10: N <sub>RB,c</sub> = 52
	2		10: N <sub>RB,c</sub> = 52
	3		40: N <sub>RB,c</sub> = 106
PDSCH Reference measurement channel	1		SR.1.1 FDD
	2		SR.1.1 TDD
	3		SR.2.1 TDD
RMSI CORESET Reference Channel	1		CR.1.1 FDD
	2		CR.1.1 TDD
	3		CR.2.1 TDD
Dedicated CORESET Reference Channel	1		CCR.1.1 FDD
	2		CCR.1.1 TDD
	3		CCR.2.1 TDD
SSB configuration	1		SSB.3 FR1
	2		SSB.3 FR1
	3		SSB.4 FR1
OCNG Patterns	1~3		OP.1
Initial BWP Configuration	1~3		DLBWP.0.1 ULBWP.0.1
Dedicated BWP configuration	1~3		DLBWP.1.1 ULBWP.1.1
SMTC configuration	1~3		SMTC.1
TRS Configuration	1		TRS.1.1 FDD
	2		TRS.1.1 TDD
	3		TRS.1.2 TDD
DRX configuration	1~3		DRX.3
reportConfigType	1~3		periodic
reportQuantity	1~3		ssb-Index-RSRP
Number of reported RS	1~3		2
L1-RSRP reporting period	1~3	slot	80
T1	1~3	s	5
T2	1~3	s	2
EPRE ratio of PSS to SSS	1~3	dB	0
EPRE ratio of PBCH DMRS to SSS			
EPRE ratio of PBCH to PBCH DMRS			
EPRE ratio of PDCCH DMRS to SSS			
EPRE ratio of PDCCH to PDCCH DMRS			
EPRE ratio of PDSCH DMRS to SSS			
EPRE ratio of PDSCH to PDSCH DMRS			
EPRE ratio of OCNG DMRS to SSS <sup>Note 1</sup>			
EPRE ratio of OCNG to OCNG DMRS <sup>Note 1</sup>			
Propagation condition			
	3		AWGN 3334 Hz
Note 1: OCNG shall be used such that both cells are fully allocated and a constant total transmitted power spectral density is achieved for all OFDM symbols.			

**Table 6.6.4.5.4.1-3: Test Environment parameters for NR SA SSB based L1-RSRP measurement**

Parameter	Value		Comment
Test environment	NC		As specified in TS 38.508-1 [14] clause 4.1.
Test frequencies	As specified in Annex E, Table E.4-1 and TS 38.508-1 [14] clause 4.3.1 and 4.4.2.		
Channel bandwidth	As specified by the test configuration selected from Table 6.6.4.5.4.1-1.		
Propagation conditions	AWGN		As specified in Annex C.2.2.
Connection Diagram	TE Part	A.3.1.8.2 with n=1	As specified in TS 38.508-1 [14] Annex A.
	DUT Part	A.3.2.3.4	
Exceptions to connection diagram	- Without LTE link - For 4Rx capable UEs without any 2 Rx RF bands use A.3.2.5.2 for DUT part and A.3.1.8.4 with n=1 for TE Part		

1. Message contents are defined in clause 6.6.4.5.4.3.
2. Single Cell is used, which is NR FR1 Pcell. The connection setup is done according to the settings in Annex C.1.2 and C.1.3. The test parameters are given in Table 6.6.4.5.4.1-2 and 6.6.4.5.5-1. UE is configured to perform RLM, BFD and L1-RSRP measurement based on the SSBs. DRX is configured as specified in Table 6.6.4.5.4.1-2.

#### 6.6.4.5.4.2 Test procedure

Prior to the start of the time duration T1, the UE shall be configured for periodic CSI reporting in PUCCH [format 2] with a reporting periodicity as mentioned in the above table 6.6.4.5.4.1-2. Before the test, UE is configured to perform RLM, BFD and L1-RSRP measurement based on the SSBs.

1. Ensure the UE is in state RRC\_CONNECTED with generic procedure parameters Connectivity NR SA, Connected without release *On* and Test Mode *On*, according to TS 38.508-1 [14] clause 4.5 and general test parameters set according to Table 6.6.4.1.4.1-2.
2. Set the parameters according to T1 in Table 6.6.4.1.5-1. T1 starts.
3. The UE shall be transmitting CSI on PUCCH with a periodicity of 80 slots.
4. When T1 expires, the SS shall set the parameters according to T2 in 6.6.4.1.5-1. T2 starts.
5. If the UE sends L1-RSRP reports meeting the corresponding absolute accuracy requirements in Table 6.6.4.5.5-2 for test configurations 1 and 2 the corresponding absolute accuracy requirements in Table 6.6.4.5.5-3 for test configurations 3 and the corresponding relative accuracy requirements in Table 6.6.4.5.5-4 for all test configurations every 80 slots from no later than 1920 ms plus 80 slots for all configurations from the beginning of time period T2 until the end of time period T2, the number of passed iterations is increased by one, otherwise the number of failed iterations is increased by one.
6. The SS waits until T2 expires.
7. The SS shall transmit *RRCRelease* message to release the RRC connection which includes the release of the established radio bearers as well as all radio resources.
8. After the RRC connection release, the SS:
  - transmits in Cell 1 a *Paging* message (including PagingRecord with ue-Identity) for the UE and ensures the UE in state RRC\_CONNECTED with generic procedure parameters Connectivity NR SA, Connected without release *On* and Test Mode *On* according to TS 38.508-1 [14] clause 4.5. (if the paging fails, switches off and on the UE and ensures the UE is in state RRC\_CONNECTED with generic procedure parameters Connectivity NR SA, Connected without release *On* and Test Mode *On* according to TS 38.508-1 [14] clause 4.5.),
  - or:
  - switches off and on the UE and ensures the UE is in state RRC\_CONNECTED with generic procedure parameters Connectivity NR SA, Connected without release *On* and Test Mode *On* according to TS 38.508-1 [14] clause 4.5.
9. Repeat steps 2-8 until the confidence level according to Tables G.2.3-1 in Annex G clause G.2 is achieved.

6.6.4.5.4.3 Message contents

Message contents are according to TS 38.508-1 [14] clause 7.3 with the following exceptions:

**Table 6.6.4.5.4.3-1: Common Exception messages NR SA SSB based L1-RSRP measurement**

Default Message Contents	
Common contents of system information blocks exceptions	Table H.2.1-3 with Condition HighSpeedMeas
Default RRC messages and information elements contents exceptions	Table H.3.6-2 with conditions PERIODIC and SS-RSRP Table H.3.6-3 with conditions SSB Table H.3.7-1 with condition DRX.3

**Table 6.6.4.5.4.3-2: RadioLinkMonitoringConfig**

Derivation Path: TS 38.508-1 [14], Table 4.6.3-133			
Information Element	Value/remark	Comment	Condition
RadioLinkMonitoringConfig ::= SEQUENCE {			
failureDetectionResourcesToAddModList	1 entry		
SEQUENCE (SIZE(1..maxNrofFailureDetectionResources)) OF SEQUENCE {			
purpose	both	UE is configured to perform RLM and BFD based on the SSBs.	
detectionResource CHOICE {			
ssb-Index	0		
}			
}			
}			

6.6.4.5.5 Test requirement

**Table 6.6.4.5.5-1: SSB specific test parameters for UE configured with *highSpeedMeasFlag-r16***

Parameter	Config	Unit	SSB#0		SSB#1	
			T1	T2	T1	T2
$N_{oc}$ <sup>Note2</sup>	1~3	dBm/15kHz	-94.6			
$N_{oc}$ <sup>Note2</sup>	1,2	dBm/SSB SCS	-94.65			
	3		-91.65			
$\hat{E}_s / I_{ot}$	1~3	dB	0	0	-Infinity	3.53
SSB RSRP <sup>Note3</sup>	1,2	dBm/SSB SCS	-94.65	-94.65	-Infinity	-91.15
	3		-91.65	-91.65	-Infinity	-88.14
$I_o$ <sup>Note3</sup>	1,2	dBm/9.36 MHz	-63.69	-63.69	-66.70	-61.59
	3		-57.59	-57.59	-60.61	-55.49
$\hat{E}_s / N_{oc}$	1~3	dB	0	0	-Infinity	3.5
<p>Note 1: The resources for uplink transmission are assigned to the UE prior to the start of time period T2.</p> <p>Note 2: Interference from other cells and noise sources not specified in the test is assumed to be constant over subcarriers and time and shall be modelled as AWGN of appropriate power for <math>N_{oc}</math> to be fulfilled.</p> <p>Note 3: SS-RSRP and <math>I_o</math> levels have been derived from other parameters for information purposes. They are not settable parameters themselves.</p>						

The UE shall send L1-RSRP report every 80 slots. No later than 1920ms plus 80 slots from the beginning of time period T2, UE shall send L1-RSRP report including results of both SSB0 and SSB1. Each L1-RSRP measurement report shall meet the corresponding absolute accuracy requirements in Table 6.6.4.5.5-2 for for test configurations 1 and 2 and the

corresponding absolute accuracy requirements in Table 6.6.4.5.5-3 for test configurations 3 and the corresponding relative accuracy requirements in Table 6.6.4.5.5-4 for all test configurations.

**Table 6.6.4.5.5-2: L1-RSRP absolute accuracy requirements for the reported values for test configurations 1 and 2**

Normal Conditions	T1	T2
Lowest reported value (SSB#1)	-	55
Highest reported value (SSB#1)	-	75

**Table 6.6.4.5.5-3: L1-RSRP absolute accuracy requirements for the reported values for test configurations 3**

Normal Conditions	T1	T2
Lowest reported value (SSB#1)	-	58
Highest reported value (SSB#1)	-	78

**Table 6.6.4.5.5-4: L1-RSRP relative accuracy requirements for the reported values for all test configurations**

	T1	T2
Lowest DIFF RSRP reported (SSB#0)	-	0
Highest DIFF RSRP reported (SSB#0)	-	3

The rate of correct events observed during repeated tests shall be at least 90% with a confidence level of 95%.

NOTE: The actual overall delays measured in the test may be up to  $2xTTI_{DCCH}$  higher than the measurement reporting delays above because of TTI insertion uncertainty of the measurement report in DCCH.

## 6.6.5 UTRAN inter-RAT measurement

### 6.6.5.1 NR SA FR1 – UTRAN event-triggered reporting in non-DRX

#### 6.6.5.1.1 Test purpose

This test is to verify that the UE makes correct event-triggered reporting of inter-RAT UTRAN measurements when operating in standalone (SA) operation with PCell in FR1 under the cell search and measurement requirements.

#### 6.6.5.1.2 Test applicability

This test applies to all types of NR UE supporting SA FR1 from Release 16 onwards and support UTRA FDD.

#### 6.6.5.1.3 Minimum conformance requirements

The minimum conformance requirements are specified in clause 6.3.1.0.3.

The normative reference for this requirement is TS 38.133 [6] clause A.6.6.5.1.

#### 6.6.5.1.4 Test description

##### 6.6.5.1.4.1 Initial conditions

This test shall be tested using any of the test configurations in Table 6.6.5.1.4.1-1.

**Table 6.6.5.1.4.1-1: supported test configurations**

Test Case ID	Description
6.6.5.1-1	NR 15 kHz SSB SCS, 10MHz bandwidth, FDD duplex mode, UTRAN FDD
6.6.5.1-2	NR 15 kHz SSB SCS, 10MHz bandwidth, TDD duplex mode, UTRAN FDD
6.6.5.1-3	NR 30 kHz SSB SCS, 40MHz bandwidth, TDD duplex mode, UTRAN FDD
NOTE: The UE is only required to be tested in one of the supported test configurations	

Configure the test equipment and the DUT according to the parameters in Table 6.6.5.1.4.1-2 and Table 6.6.5.1.4.1-3.

**Table 6.6.5.1.4.1-2: Initial conditions for SA inter-RAT UTRAN event triggered reporting in non-DRX with PCell in FR1**

Parameter	Value		Comment
Test environment	NC		As specified in TS 38.508-1 [14] clause 4.1.
Test frequencies	As specified in Annex E, Table E.4-3 and TS 38.508-1 [14] clause 4.3.1.		
Channel bandwidth	As specified by the test configuration selected from Table 6.6.5.1.5-1 and Table 6.6.5.1.5-2.		
Propagation conditions	AWGN		As specified in Annex C.2.2.
Connection Diagram	TE Part	A.3.1.8.2	As specified in TS 38.508-1 [14] Annex A.
	UE Part	A.3.2.3.2	
Exceptions to connection diagram	SS LTE in Figure A.3.1.8.2 is replaced by SS UTRA LTE TX/RX in Figure A.3.2.3.2 is replaced by UTRA TX/RX		

**Table 6.6.5.1.4.1-3: General test parameters for SA inter-RAT UTRAN FDD event triggered reporting in non-DRX with PCell in FR1**

Parameter	Unit	Value	Comment
NR RF Channel Number		1	1 NR carrier frequency is used in the test
UTRA RF Channel Number		2	1 UTRA carrier frequency is used in the test
Channel Bandwidth	MHz	As specified in Table 6.6.5.1.5-1 and Table 6.6.5.1.5-2	
Active cell		Cell 1	Cell 1 is on RF channel number 1
Neighbour cell		Cell 2	Cell 2 is on RF channel number 2
Gap Pattern Id		0	As specified in Clause Table FFS Per-UE gap pattern.
Inter-RAT UTRA measurement quantity		CPICH Ec/Io	Measurement quantity for Cell 2
b1-ThresholdUTRA-FDD	dB	-16.5	CPICH Ec/Io threshold for SS-RSRP measurement on cell1 for event B1
Hysteresis	dB	0	
TimeToTrigger	s	0	
Filter coefficient		0	L3 filtering is not used
DRX		OFF	OFF
T1	s	5	
T2	s	5	
Note 1: Values are defined in Table A.6.6.5.1.1-3			

1. Message contents are defined in clause 6.6.5.1.4.3.
2. Cell 1 is the NR PCell and Cell 2 is an inter-RAT UTRAN inter-RAT neighbour cell. Cell 1 is configured according to Annex C.1.1 and C.1.2, Cell 2 is configured according to TS 36.521-3 Annex C.0 and C.1.

#### 6.6.5.1.4.2 Test procedure

The test consists of two successive time periods, with time durations of T1 and T2 respectively. During time duration T1, the UE shall not have any timing information of cell 2. Gap pattern configuration is configured before T2 begins to enable inter-frequency monitoring.

1. Ensure the UE is in state RRC\_CONNECTED with generic procedure parameters Connectivity NR, Connected without release On and Test Mode On according to TS 38.508-1 [14] clause 4.5.
2. Set the parameters according to T1 in Table 6.6.5.1.5-1 and 6.6.5.1.5-2. Propagation conditions are set according to Annex C clause C.2.2.T1 starts.
3. SS shall transmit an RRCReconfiguration message to configure Event B1 measurement reporting.



4. The UE shall transmit an *RRCReconfigurationComplete* message.
5. When T1 expires, the SS shall switch the power setting from T1 to T2 as specified in Table 6.6.5.1.5-1 and 6.6.5.1.5-2.
6. UE shall transmit a *MeasurementReport* message triggered by Event B1. If the measurement reporting delay from the beginning of time period T2 is less than 3842ms the number of successful tests is increased by one. If the UE fails to report the event within the measurement reporting delay requirement then the number of failure tests is increased by one.
7. After the SS receive the *MeasurementReport* message in step 6 or when T2 expires, the SS shall:
  - transmit *RRCRelease* message to release the RRC connection which includes the release of the established radio bearers as well as all radio resources

OR

  - switch the UE off.
8. Set Cell 2 primary scrambling code = ((current cell 2 primary scrambling code - 50) mod 200 + 100) for next iteration of the test procedure loop.
9. Depending on the choice in Step 7, the SS:
  - if the RRC Connection Release has been sent, transmits in Cell 1 a Paging message (including PagingRecord with UE-Identity) for the UE and ensures the UE is in state RRC\_CONNECTED according to TS 38.508-1 [14] clause 4.5.4 (if the paging fails, switches off and on the UE and ensures the UE is in the state RRC\_CONNECTED with generic procedure parameters Connectivity NR, Connected without release On according to TS 38.508-1 [14] clause 4.5,
  - OR
  - if the device has been switched off, switches on the UE and ensures the UE is in state RRC\_CONNECTED with generic procedure parameters Connectivity NR, Connected without release On according to TS 38.508-1 [14] clause 4.5.
- 10.Repeat step 2-9 until the confidence level according to Tables G.2.3-1 in Annex G clause G.2 is achieved.

6.6.5.1.4.3 Message contents

**Table 6.6.5.1.4.3-1: RRCReconfiguration (Step 3)**

Derivation Path: TS 38.508-1 [14] Table 4.6.1-13 with condition NR_MEAS			
Information Element	Value/remark	Comment	Condition
RRCReconfiguration ::= SEQUENCE {			
criticalExtensions CHOICE {			
rrcReconfiguration SEQUENCE {			
measConfig	MeasConfig	Table 6.6.5.1.4.3-2	
}			
}			
}			

**Table 6.6.5.1.4.3-2: MeasConfig (Table 6.6.5.1.4.3-1)**

Derivation Path: Table H.3.1-2 with condition INTER-RAT and GAP NEEDED			
Information Element	Value/remark	Comment	Condition
MeasConfig ::= SEQUENCE {			
measObjectToAddModList SEQUENCE (SIZE (1..maxNrofMeasId)) OF MeasObjectToAddMod {	2 entries		
MeasObjectToAddMod[1] SEQUENCE {		entry 1	
measObjectId	1		
measObject CHOICE {			
measObjectNR	MeasObjectNR-DEFAULT specified in Table H.3.1-3 with condition INTRA-FREQ MO		
}			
}			
MeasObjectToAddMod[2] SEQUENCE {		entry 2	
measObjectId	2		
measObject CHOICE {			
measObjectUTRA-FDD-r16	MeasObjectUTRA-FDD	Table 6.6.5.1.4.3-3	
}			
}			
reportConfigToAddModList SEQUENCE (SIZE (1..maxReportConfigId)) OF ReportConfigToAddMod {	1 entry		
ReportConfigToAddMod[1] SEQUENCE {		entry 1	
reportConfigId	1		
reportConfig CHOICE {			
reportConfigInterRAT	ReportConfigInterRAT(16) specified in 38.508-1 [14] Table 4.6.3-141 with condition EVENT_B1_UTRA	Actual value of UTRA threshold = (16-49)/2 = -16.5dB	
}			
}			
measGapConfig	MeasGapConfig specified in Table H.3.1-6 with condition gapUE and Pattern #0		
}			

**Table 6.6.5.1.4.3-3: MeasObjectUTRA-FDD (Table 6.6.5.1.4.3-2)**

Derivation Path: TS 38.508-1 [14], Table 4.6.3-77A			
Information Element	Value/remark	Comment	Condition
MeasObjectUTRA-FDD-r16 ::= SEQUENCE {			
carrierFreq-r16	ARFCN-ValueUTRA-FDD-r16 for UTRA Cell 2		
}			

**Table 6.6.5.1.4.3-4: MeasurementReport (Step 6)**

Derivation Path: TS 38.508-1 [14], Table 4.6.1-5A			
Information Element	Value/remark	Comment	Condition
MeasurementReport ::= SEQUENCE {			
criticalExtensions CHOICE {			
measurementReport SEQUENCE {			
measResults	MeasResults	Table 6.6.5.1.4.3-5	
}			
}			
}			

**Table 6.6.5.1.4.3-5: MeasResults (Table 6.6.5.1.4.3-4)**

Derivation Path: TS 38.508-1 [14] Table 4.6.3-79 with condition B1_UTRA			
Information Element	Value/remark	Comment	Condition
MeasResults ::= SEQUENCE {			
measResultNeighCells CHOICE {			
measResultListUTRA-FDD-r16 SEQUENCE (SIZE (1..maxCellReport)) OF MeasResultUTRA-FDD-r16 {	1 entry		
MeasResultUTRA-FDD-r16[1] SEQUENCE {		entry 1	
physCellId-r16	PhysCellIdUTRA-FDD-r16 of UTRA Cell 2		
measResult-r16 SEQUENCE {			
utra-FDD-EcN0-r16	INTEGER (0..49)		
}			
}			
}			
}			

#### 6.6.5.1.5 Test requirement

Table 6.6.5.1.5-1 and Table 6.6.5.1.5-2 define the primary level settings including test tolerances for all tests.

**Table 6.6.5.1.5-1: PCell specific test parameters for SA inter-RAT UTRA FDD event triggered reporting in non-DRX with PCell in FR1**

Parameter		Unit	Configuration	Cell 1	
				T1	T2
RF channel number			1, 2, 3	1	
Duplex mode			1, 2, 3	FDD	
TDD Configuration	SCS=15 KHz		2	TDDConf.1.1	
	SCS=30 KHz		3	TDDConf.1.2	
BW <sub>channel</sub>		MHz	1	10: N <sub>RB,c</sub> = 52 (FDD)	
			2	10: N <sub>RB,c</sub> = 52 (TDD)	
			3	40: N <sub>RB,c</sub> = 106 (TDD)	
PDSCH reference measurement channel			1	SR.1.1 FDD	
			2	SR.1.1 TDD	
			3	SR.2.1 TDD	
CORSET reference channel			1	CR.1.1 FDD	
			2	CR.1.1 TDD	
			3	CR.2.1 TDD	
BWP configurations	Initial DL BWP		1, 2, 3	DLBWP.0.1	
	Dedicated DL BWP		1, 2, 3	DLBWP.1.1	
	Initial UL BWP		1, 2, 3	ULBWP.0.1	
	Dedicated UL BWP		1, 2, 3	ULBWP.1.1	
OCNG pattern <sup>Note1</sup>			1, 2, 3	OP.1	
SMTTC configuration			1, 2, 3	SMTTC.1	
SSB configuration			1, 2	SSB.1 FR1	
			3	SSB.2 FR1	
CSI-RS for tracking			1	TRS.1.1 FDD	
			2	TRS.1.1 TDD	
			3	TRS.1.2 TDD	
EPRE ratio of PSS to SSS	dB	1, 2, 3	0		
EPRE ratio of PBCH_DMRS to SSS					
EPRE ratio of PBCH to PBCH_DMRS					
EPRE ratio of PDCCH_DMRS to SSS					
EPRE ratio of PDCCH to PDCCH_DMRS					
EPRE ratio of PDSCH_DMRS to SSS					
EPRE ratio of PDSCH to PDSCH_DMRS					
EPRE ratio of OCNG DMRS to SSS					
EPRE ratio of OCNG to OCNG DMRS					
N <sub>oc</sub> <sup>Note2</sup>	dBm/15 KHz	1, 2, 3	-106		
N <sub>oc</sub> <sup>Note2</sup>	dBm/SCS	1, 2	-106		
		3	-103		
$\hat{E}_s/N_{oc}$	dB	1, 2, 3	18	-2	
$\hat{E}_s/I_{ot}$ <sup>Note3</sup>	dB	1, 2, 3	18	-2	
SS-RSRP <sup>Note3</sup>	dBm/SCS	1, 2	-88	-108	
		3	-85	-105	
SSB_RP <sup>Note3</sup>	dBm/SCS	1, 2	-88	-108	
		3	-85	-105	
I <sub>o</sub> <sup>Note3</sup>	dBm/9.36 MHz	1, 2	-59.98	-75.92	
	dBm/38.16 MHz	3	-53.88	-69.82	
Propagation condition			1, 2, 3	ETDLA30	
Antenna Configuration and Correlation Matrix			1, 2, 3	1x2 Low	
<p>Note 1: OCNG shall be used such that both cells are fully allocated and a constant total transmitted power spectral density is achieved for all OFDM symbols.</p> <p>Note 2: Interference from other cells and noise sources not specified in the test is assumed to be constant over subcarriers and time and shall be modelled as AWGN of appropriate power for <math>N_{oc}</math> to be fulfilled.</p> <p>Note 3: <math>\hat{E}_s/I_{ot}</math>, SS-RSRP, SSB_RP and I<sub>o</sub> levels have been derived from other parameters for information purposes. They are not settable parameters themselves.</p>					

**Table 6.6.5.1.5-2: UTRAN neighbour cell specific test parameters for SA inter-RAT UTRAN FDD event triggered reporting in non-DRX with PCell in FR1**

Parameter	Unit	Cell 2	
		T1	T2
UTRA RF Channel Number		2	
CPICH_Ec/I <sub>or</sub>	dB	-10	
PCCPCH_Ec/I <sub>or</sub>	dB	-12	
SCH_Ec/I <sub>or</sub>	dB	-12	
PICH_Ec/I <sub>or</sub>	dB	-15	
DPCH_Ec/I <sub>or</sub>	dB	N/A	
OCNS		-0.941	
$\hat{I}_{or}/I_{oc}$	dB	-Infinity	-1.8
$I_{oc}$	dBm/3.84 MHz	-70	
CPICH_Ec/I <sub>o</sub>	dB	-Infinity	-14
Propagation Condition		AWGN	
Note 1:	The DPCH level is controlled by the power control loop.		
Note 2:	The power of the OCNS channel that is added shall make the total power from the cell to be equal to I <sub>or</sub> .		

The UE shall send one Event B1 triggered measurement report for Cell 2 to the PCell, with a measurement reporting delay less than 2.4s from the start of period T2, i.e. when Cell 2 becomes detectable. The measurement reporting delay is defined as the time from the beginning of time period T2 to the moment when the UE sends the measurement report on PUSCH.

The UE shall not send event-triggered measurement reports as long as the reporting criteria is not fulfilled.

The rate of correct events observed during repeated tests shall be at least 90%.

## 6.6.6 to 6.6.7

## 6.6.8 L1-SINR measurement for beam reporting

### 6.6.8.0 Minimum conformance requirements

#### 6.6.8.0.1 L1-SINR reporting with CSI-RS based CMR and no dedicated IMR configured

Same as clause 4.6.7.0.1

The normative reference for this requirement is TS 38.133 [6] clause 9.8.3, 9.8.4.1 and 9.8.5.2.

#### 6.6.8.0.2 L1-SINR reporting with SSB based CMR and dedicated IMR configured

Same as clause 4.6.7.0.2

The normative reference for this requirement is TS 38.133 [6] clause 9.8.3, 9.8.4.2 and 9.8.5.

#### 6.6.8.0.3 L1-SINR reporting with CSI-RS based CMR and dedicated IMR configured

Same as clause 4.6.7.0.3

The normative reference for this requirement is TS 38.133 [6] clause 9.8.3, 9.8.4.3 and 9.8.5.

### 6.6.8.1 NR SA FR1 CSI-RS based CMR and no dedicated IMR L1-SINR measurement in DRX

#### 6.6.8.1.1 Test purpose

To verify that the UE makes correct reporting of L1-SINR measurement in DRX within L1-SINR measurement requirements in TS 38.133 [6] clause 9.8.4.1.

## 6.6.8.1.2 Test applicability

This test applies to all types of NR UE release 16 and forward, supporting L1-SINR measurement and long DRX cycle.

## 6.6.8.1.3 Minimum conformance requirements

The minimum conformance requirements are specified in clause 6.6.8.0.1.

The normative reference for this requirement is TS 38.133 [6] clause A.6.6.8.1.

## 6.6.8.1.4 Test description

## 6.6.8.1.4.1 Initial conditions

This test shall be tested using any of the test configurations in Table 6.6.8.1.4.1-1. Configure the test equipment and the DUT according to the parameters in Table 6.6.8.1.4.1-2. Test environment parameters are given in Table 6.6.8.1.4.1-3.

**Table 6.6.8.1.4.1-1: NR SA CSI-RS based CMR and no dedicated IMR L1-SINR measurement supported test configurations**

Config	Description
1	NR 15 kHz SSB SCS, 10 MHz bandwidth, FDD duplex mode
2	NR 15 kHz SSB SCS, 10 MHz bandwidth, TDD duplex mode
3	NR 30 kHz SSB SCS, 40 MHz bandwidth, TDD duplex mode
Note:	The UE is only required to be tested in one of the supported test configurations

**Table 6.6.8.1.4.1-2: General test parameters for NR SA CSI-RS based CMR and no dedicated IMR L1-SINR measurement**

Parameter	Config	Unit	Value
SSB GSCN	1~3		freq1
Duplex mode	1		FDD
	2		TDD
	3		TDD
TDD Configuration	1		N/A
	2		TDDConf.1.1
	3		TDDConf.2.1
BW <sub>channel</sub>	1	MHz	10: N <sub>RB,c</sub> = 52
	2		10: N <sub>RB,c</sub> = 52
	3		40: N <sub>RB,c</sub> = 106
PDSCH Reference measurement channel	1		SR.1.1 FDD
	2		SR.1.1 TDD
	3		SR.2.1 TDD
RMSI CORESET Reference Channel	1		CR.1.1 FDD
	2		CR.1.1 TDD
	3		CR.2.1 TDD
Dedicated CORESET Reference Channel	1		CCR.1.1 FDD
	2		CCR.1.1 TDD
	3		CCR.2.1 TDD
SSB configuration	1		SSB.3 FR1
	2		SSB.3 FR1
	3		SSB.4 FR1
CSI-RS configuration	1		CSI-RS 1.3 FDD
	2		CSI-RS 1.3 TDD
	3		CSI-RS 2.3 TDD
OCNG Patterns	1~3		OP.1
TRS Configuration	1		TRS.1.1 FDD
	2		TRS.1.1 TDD
	3		TRS.1.2 TDD
Initial BWP Configuration	1~3		DLBWP.0.1 ULBWP.0.1
Dedicated BWP configuration	1~3		DLBWP.1.1 ULBWP.1.1
SMTC configuration	1~3		SMTC.1
DRX configuration	1~3		DRX.3
reportConfigType	1~3		aperiodic
reportQuantity-r16	1~3		cri-SINR-r16
Number of reported RS	1~3		2
qcl-Info	1~3		SSB#0 for resource#0
			SSB#1 for resource#1
reportSlotOffsetList	1~3	slots	26
T1	1~3	s	5
EPRE ratio of PSS to SSS	1~3	dB	0
EPRE ratio of PBCH DMRS to SSS			
EPRE ratio of PBCH to PBCH DMRS			
EPRE ratio of PDCCH DMRS to SSS			
EPRE ratio of PDCCH to PDCCH DMRS			
EPRE ratio of PDSCH DMRS to SSS			
EPRE ratio of PDSCH to PDSCH DMRS			
EPRE ratio of OCNG DMRS to SSS <sup>Note 1</sup>			
EPRE ratio of OCNG to OCNG DMRS <sup>Note 1</sup>			
Propagation condition	1~3		AWGN
Note 1: OCNG shall be used such that both cells are fully allocated and a constant total transmitted power spectral density is achieved for all OFDM symbols.			



**Table 6.6.8.1.4.1-3: Test Environment parameters for NR SA CSI-RS based CMR and no dedicated IMR L1-SINR measurement**

Parameter	Value		Comment
Test environment	NC		As specified in TS 38.508-1 [14] clause 4.1.
Test frequencies	As specified in Annex E, Table E.2-1 and TS 38.508-1 [14] clause 4.3.1 and 4.4.2.		
Channel bandwidth	As specified by the test configuration selected from Table 6.6.8.1.4.1-1.		
Propagation conditions	AWGN		As specified in Annex C.2.2.
Connection Diagram	TE Part	A.3.1.8.2 with $n = 1$	As specified in TS 38.508-1 [14] Annex A.
	DUT Part	A.3.2.3.4	
Exceptions to connection diagram	For 4Rx capable UEs without any 2 Rx RF bands use A.3.2.5.2 for DUT part and A.3.1.8.5 for TE Part		

1. Message contents are defined in clause 6.6.8.1.4.3.
2. Single Cell is used, which is NR FR1 Pcell. The connection setup is done according to the settings in Annex C.1.2 and C.1.3. The test parameters are given in tables 6.6.8.1.4.1-2 and 6.6.8.1.5-1. UE is configured to perform RLM and BFD based on the SSBs.

#### 6.6.8.1.4.2 Test procedure

The test consists of a single time period T1, during which the UE is triggered via DCI to report L1-SINR on aperiodic CSI-RS resources. Prior to the start of the time duration T1, the UE shall be fully synchronized to PCell. UE is also configured to measure L1-SINR based on SSB. Upon receiving the DCI trigger, UE provides the report back based on the reporting configuration as defined in Table 6.6.8.1.4.1-2.

1. Ensure the UE is in state RRC\_CONNECTED with generic procedure parameters Connectivity NR SA, Connected without release *On* and Test Mode *On*, according to TS 38.508-1 [14] clause 4.5.
2. Set the parameters according to T1 in Table 6.6.8.1.5-1. T1 starts.
3. After 80ms from the start of the test the SS transmits the DCI trigger in slot 1 for configuration 1, 2 and slot 8 for configuration 3. The corresponding CSI-RS set is transmitted with the offset of 4 slots after the DCI trigger.
4. The SS shall check following requirements:
  - R1: the UE shall send L1-SINR report at slot 26 from the reception of DCI trigger. If the report is received at slot 26 from the reception of DCI trigger, the number of passed iterations for R1 is increased by one. Otherwise, the number of failed iterations for R1 is increased by one.
  - R2: The L1-SINR value of CSI-RS#1 reported by the UE is compared to the expected L1-SINR value for CSI-RS#1. If the resulting value is outside the limits in Table 6.6.8.1.5-2 for all test configurations or the UE fails to report the measurement value for CSI-RS #1, the number of failed iterations for R2 is increased by one. Otherwise, the number of passed iterations for R2 is increased by one.
  - R3: The DIFF SINR value of CSI-RS #0 reported by the UE is compared to the expected DIFF SINR value. If the resulting value is outside the limits in Table 6.6.8.1.5-4 or the UE fails to report the measurement value for CSI-RS#0, the number of failed iterations for R3 is increased by one. Otherwise, the number of passed iterations for R3 is increased by one..
5. If after T1 expiry no report is received or received report did not contain L1-SINR of both CSI-RS#0 and CSI-RS#1 or UE sent the L1-SINR report at different slot than 26 from the reception of DCI trigger, the number of 'failed' iterations is increased by one, otherwise, the number of 'passed' iterations is increased by one.
6. The SS shall transmit *RRCRelease* message to release the RRC connection which includes the release of the established radio bearers as well as all radio resources.
7. After the RRC connection release, the SS:
  - transmits in Cell 1 a *Paging* message (including PagingRecord with ue-Identity) for the UE and ensures the UE in state RRC\_CONNECTED with generic procedure parameters Connectivity NR SA, Connected without release *On* and Test Mode *On* according to TS 38.508-1 [14] clause 4.5. (if the paging fails, switches off and on

the UE and ensures the UE is in state RRC\_CONNECTED with generic procedure parameters Connectivity NR SA, Connected without release *On* and Test Mode *On* according to TS 38.508-1 [14] clause 4.5.),

or:

- switches off and on the UE and ensures the UE is in state RRC\_CONNECTED with generic procedure parameters Connectivity NR SA, Connected without release *On* and Test Mode *On* according to TS 38.508-1 [14] clause 4.5.

8. Repeat steps 2-7 until the confidence level according to Tables G.2.3-1 in Annex G clause G.2 is achieved.

6.6.8.1.4.3 Message contents

Message contents are according to TS 38.508-1 [14] clause 7.3 with the following exceptions:

**Table 6.6.8.1.4.3-1: Common Exception messages NR SA CSI-RS based CMR and no dedicated IMR L1-SINR measurement**

Default Message Contents	
Common contents of system information blocks exceptions	
Default RRC messages and information elements contents exceptions	Table H.3.6A-1 with conditions APERIODIC and CSI-SINR Table H.3.6A-2 with conditions CSI-RS and APERIODIC Table H.3.7-1 with condition DRX.3

**Table 6.6.8.1.4.3-2: RadioLinkMonitoringConfig**

Derivation Path: TS 38.508-1 [14], Table 4.6.3-133			
Information Element	Value/remark	Comment	Condition
RadioLinkMonitoringConfig ::= SEQUENCE {			
failureDetectionResourcesToAddModList	1 entry		
SEQUENCE (SIZE(1..maxNrofFailureDetectionResources)) OF SEQUENCE {			
purpose	both	UE is configured to perform RLM and BFD based on the SSBs.	
}			
}			

6.6.8.1.5 Test requirement

Table 6.6.8.1.5-1 defines the primary level settings including test tolerances for all tests.

**Table 6.6.8.1.5-1: CSI-RS specific test parameters for NR SA CSI-RS based CMR and no dedicated IMR L1-SINR measurement**

Parameter	Config	Unit	CSI-RS#0	CSI-RS#1
$N_{oc}$ <sup>Note1</sup>	1~3	dBm/15kHz	-94.65	
$N_{oc}$ <sup>Note1</sup>	1,2	dBm/SSB SCS	-94.65	
	3		-91.65	
$\hat{E}_s / I_{ot}$	1~3	dB	0	3
CSI-RS RSRP <sup>Note3</sup>	1,2	dBm/SSB SCS	-94.65	-91.65
	3		-91.65	-88.65
$I_o$ <sup>Note2</sup>	1,2	dBm/9.36 MHz	-63.69	-61.93
	3	dBm/38.16 MHz	-57.59	-55.84
$\hat{E}_s / N_{oc}$	1~3	dB	0	3
Note 2: Interference from other cells and noise sources not specified in the test is assumed to be constant over subcarriers and time and shall be modelled as AWGN of appropriate power for $N_{oc}$ to be fulfilled. Note 3: CSI-RS RSRP and $I_o$ levels have been derived from other parameters for information purposes. They are not settable parameters themselves.				

After 80ms from the beginning of the test, the UE shall send L1-SINR report at slot 26 from the reception of DCI triggering the L1-SINR measurement. The L1-SINR report shall include the results for both CSI-RS#0 and CSI-RS#1.

Each L1-SINR measurement report shall meet the corresponding absolute accuracy requirements in Table 6.6.8.1.5-2 for all test configurations and the corresponding relative accuracy requirements in Table 6.6.8.1.5-4 for all test configurations.

**Table 6.6.8.1.5-2: L1-SINR absolute accuracy requirements for the reported values for all test configurations**

Normal Conditions	T1
Lowest reported value (CSI-RS#1)	41
Highest reported value (CSI-RS#1)	64

**Table 6.6.8.1.5-3: Void**

**Table 6.6.8.1.5-4: L1-SINR relative accuracy requirements for the reported values for all test configurations**

	T1
Lowest DIFF SINR reported (CSI-RS#0)	0
Highest DIFF SINR reported (CSI-RS#0)	7

For the test to pass, the ratio of successful reported values for each requirement (R1 to R3) shall be more than 90% with a confidence level of 95%. Each requirement is evaluated independently of the others..

NOTE: The actual overall delays measured in the test may be up to  $2 \times TTI_{DCCH}$  higher than the measurement reporting delays above because of TTI insertion uncertainty of the measurement report in DCCH.

## 6.6.8.2 NR SA FR1 SSB based CMR and dedicated IMR L1-SINR measurement in non-DRX

### 6.6.8.2.1 Test purpose

To verify that the UE makes correct reporting of L1-SINR measurement in non-DRX within L1-SINR measurement requirements in TS 38.133 [6] clause 9.8.4.2.

### 6.6.8.2.2 Test applicability

This test applies to all types of NR UE release 16 and forward, supporting L1-SINR measurement.

### 6.6.8.2.3 Minimum conformance requirements

The minimum conformance requirements are specified in clause 6.6.8.0.2.

The normative reference for this requirement is TS 38.133 [6] clause A.6.6.8.2.

### 6.6.8.2.4 Test description

#### 6.6.8.2.4.1 Initial conditions

This test shall be tested using any of the test configurations in Table 6.6.8.2.4.1-1. Configure the test equipment and the DUT according to the parameters in Table 6.6.8.2.4.1-2. Test environment parameters are given in Table 6.6.8.2.4.1-3.

**Table 6.6.8.2.4.1-1: NR SA SSB based CMR and dedicated IMR L1-SINR measurement supported test configurations**

Config	Description
1	NR 15 kHz SSB SCS, 10 MHz bandwidth, FDD duplex mode
2	NR 15 kHz SSB SCS, 10 MHz bandwidth, TDD duplex mode
3	NR 30 kHz SSB SCS, 40 MHz bandwidth, TDD duplex mode
Note:	The UE is only required to be tested in one of the supported test configurations

**Table 6.6.8.2.4.1-2: General test parameters for NR SA SSB based CMR and dedicated IMR L1-SINR measurement**

Parameter	Config	Unit	Value
SSB GSCN	1~3		freq1
Duplex mode	1		FDD
	2		TDD
	3		TDD
TDD Configuration	1		N/A
	2		TDDConf.1.1
	3		TDDConf.2.1
BW <sub>channel</sub>	1	MHz	10: N <sub>RB,c</sub> = 52
	2		10: N <sub>RB,c</sub> = 52
	3		40: N <sub>RB,c</sub> = 106
PDSCH Reference measurement channel	1		SR.1.1 FDD
	2		SR.1.1 TDD
	3		SR.2.1 TDD
RMSI CORESET Reference Channel	1		CR.1.1 FDD
	2		CR.1.1 TDD
	3		CR.2.1 TDD
Dedicated CORESET Reference Channel	1		CCR.1.1 FDD
	2		CCR.1.1 TDD
	3		CCR.2.1 TDD
SSB configuration	c		SSB.3 FR1
	2		SSB.3 FR1
	3		SSB.4 FR1
CSI-RS configuration	1		CSI-RS 1.1A FDD
	2		CSI-RS 1.1A TDD
	3		CSI-RS 2.1A TDD
OCNG Patterns	1~3		OP.1
Initial BWP Configuration	1~3		DLBWP.0.1 ULBWP.0.1
Dedicated BWP configuration	1~3		DLBWP.1.1 ULBWP.1.1
SMTc configuration	1~3		SMTc.1
TRS Configuration	1		TRS.1.1 FDD
	2		TRS.1.1 TDD
	3		TRS.1.2 TDD
DRX configuration	1~3		off
reportConfigType	1~3		periodic
reportQuantity-r16	1~3		ssb-Index-SINR-r16
Number of reported RS	1~3		2
L1-SINR reporting period	1~3	slot	80
T1	1~3	s	5
T2	1~3	s	1
EPRE ratio of PSS to SSS	1~3	dB	0
EPRE ratio of PBCH DMRS to SSS			
EPRE ratio of PBCH to PBCH DMRS			
EPRE ratio of PDCCH DMRS to SSS			
EPRE ratio of PDCCH to PDCCH DMRS			
EPRE ratio of PDSCH DMRS to SSS			
EPRE ratio of PDSCH to PDSCH DMRS			
EPRE ratio of OCNG DMRS to SSS <sup>Note 1</sup>			
EPRE ratio of OCNG to OCNG DMRS <sup>Note 1</sup>			
Propagation condition			
Note 1: OCNG shall be used such that both cells are fully allocated and a constant total transmitted power spectral density is achieved for all OFDM symbols.			

**Table 6.6.8.2.4.1-3: Test Environment parameters for NR SA SSB based CMR and dedicated IMR L1-SINR measurement**

Parameter	Value		Comment
Test environment	NC		As specified in TS 38.508-1 [14] clause 4.1.
Test frequencies	As specified in Annex E, Table E.2-1 and TS 38.508-1 [14] clause 4.3.1 and 4.4.2.		
Channel bandwidth	As specified by the test configuration selected from Table 6.6.8.2.4.1-1.		
Propagation conditions	AWGN		As specified in Annex C.2.2.
Connection Diagram	TE Part	A.3.1.8.2 with n = 1TBD	As specified in TS 38.508-1 [14] Annex A.
	DUT Part	A.3.2.3.4TBD	
Exceptions to connection diagram	For 4Rx capable UEs without any 2 Rx RF bands use A.3.2.5.2 for DUT part and A.3.1.8.5 for TE Part		

1. Message contents are defined in clause 6.6.8.2.4.3.
2. Single Cell is used, which is NR FR1 Pcell. The connection setup is done according to the settings in Annex C.1.2 and C.1.3. The test parameters are given in tables 6.6.8.2.4.1-2, 6.6.8.2.5-1 and 6.6.8.2.5-2. UE is configured to perform RLM and BFD based on the SSBs.

#### 6.6.8.2.4.2 Test procedure

Prior to the start of the time duration T1, the UE shall be configured for periodic CSI reporting in PUCCH [format 2] with a reporting periodicity as mentioned in the above Table 6.6.8.2.4.1-2. Before the test, UE is configured to perform RLM, BFD and L1-SINR measurement based on the SSBs.

1. Ensure the UE is in state RRC\_CONNECTED with generic procedure parameters Connectivity NR SA, Connected without release *On* and Test Mode *On*, according to TS 38.508-1 [14] clause 4.5 and general test parameters set according to Table 6.6.8.2.4.1-2.
2. Set the parameters according to T1 in Table 6.6.8.2.5-1 and Table 6.6.8.2.5-2. T1 starts. SS transmits CSI-RS as IMR with a periodicity of 20 slots.
3. The UE shall be transmitting CSI on PUCCH with a periodicity of 80 slots.
4. When T1 expires, the SS shall set the parameters according to T2 in Table 6.6.8.2.5-1 and Table 6.6.8.2.5-2. T2 starts. SS transmits CSI-RS as IMR with a periodicity of 20 slots.
5. If the UE sends L1-SINR reports meeting the corresponding absolute accuracy requirements in Table 6.6.8.2.5-3 for test configurations 1 and 2 the corresponding absolute accuracy requirements in Table 6.6.8.2.5-4 for test configurations 3 and the corresponding relative accuracy requirements in Table 6.6.8.2.5-5 for all test configurations every 80 slots from no later than 720 ms for configuration 1 and 2 and no later than 680 ms for configuration 3 from the beginning of time period T2 until the end of time period T2, the number of passed iterations is increased by one, otherwise the number of failed iterations is increased by one. The UE shall start sending valid L1-SINR reports. The SS shall check following requirements:
  - R1: the UE shall start to transmit valid reports no later than 720 ms for configuration 1,2 and no later than 680 ms for configuration 3 from the beginning of time period T2. A valid report shall meet the absolute L1-SINR requirement for SSB#1 (Table 6.6.8.2.5-3 for all configurations) and the relative L1-SINR requirement for SSB#0 in Table 6.6.8.2.5-5. If the first valid report is received earlier than the specified time, the number of passed iterations for R1 is increased by one. Otherwise, the number of failed iterations for R1 is increased by one.
  - R2: the UE shall transmit reports every 80 slots until the end of time period T2. If the reports are received accordingly, the number of passed iterations for R2 is increased by one. Otherwise, the number of failed iterations for R2 is increased by one.
  - R3: The L1-SINR value of SSB#1 reported by the UE is compared to the expected L1-SINR value for SSB#1. In all consecutive reports after the first valid value is received, if the resulting value is outside the limits in Table 6.6.8.2.5-3 for all configurations or the UE fails to report the measurement value for SSB#1, the number of failed iterations for R3 is increased by one. Otherwise, the number of passed iterations for R3 is increased by one.

-R4: The DIFF SINR value of SSB#0 reported by the UE is compared to the expected DIFF SINR value. In all consecutive reports after the first valid value is received, if the resulting value is outside the limits in Table 6.6.8.2.5-5 for all configurations or the UE fails to report the measurement value for SSB#0, the number of failed iterations for R4 is increased by one. Otherwise, the number of passed iterations for R4 is increased by one.

6. The SS waits until T2 expires.

7. The SS shall transmit *RRCRelease* message to release the RRC connection which includes the release of the established radio bearers as well as all radio resources.

8. After the RRC connection release, the SS:

- transmits in Cell 1 a *Paging* message (including *PagingRecord* with *ue-Identity*) for the UE and ensures the UE is in state *RRC\_CONNECTED* with generic procedure parameters *Connectivity NR SA, Connected without release On* and *Test Mode On* according to TS 38.508-1 [14] clause 4.5. (if the paging fails, switches off and on the UE and ensures the UE is in state *RRC\_CONNECTED* with generic procedure parameters *Connectivity NR SA, Connected without release On* and *Test Mode On* according to TS 38.508-1 [14] clause 4.5.),

or:

- switches off and on the UE and ensures the UE is in state *RRC\_CONNECTED* with generic procedure parameters *Connectivity NR SA, Connected without release On* and *Test Mode On* according to TS 38.508-1 [14] clause 4.5.

9. Repeat steps 2-8 until the confidence level according to Tables G.2.3-1 in Annex G clause G.2 is achieved.

6.6.8.2.4.3 Message contents

Message contents are according to TS 38.508-1 [14] clause 7.3 with the following exceptions:

**Table 6.6.8.2.4.3-1: Common Exception messages NR SA SSB based CMR and dedicated IMR L1-SINR measurement**

Default Message Contents	
Common contents of system information blocks exceptions	
Default RRC messages and information elements contents exceptions	Table H.3.6A-1 with conditions PERIODIC and SS-SINR and CSI-RS_IMR Table H.3.6A-2 with conditions SSB and PERIODIC Table H.3.6A-3 with condition PERIODIC

**Table 6.6.8.2.4.3-2: RadioLinkMonitoringConfig**

Derivation Path: TS 38.508-1 [14], Table 4.6.3-133			
Information Element	Value/remark	Comment	Condition
<b>RadioLinkMonitoringConfig ::= SEQUENCE {</b>			
<b>failureDetectionResourcesToAddModList</b>	1 entry		
<b>SEQUENCE</b>			
<b>(SIZE(1..maxNrofFailureDetectionResources)) OF</b>			
<b>SEQUENCE {</b>			
<b>purpose</b>	both	UE is configured to perform RLM and BFD based on the SSBs.	
<b>detectionResource CHOICE {</b>			
<b>ssb-Index</b>	0		
<b>}</b>			
<b>}</b>			
<b>}</b>			

6.6.8.2.5 Test requirement

Table 6.6.8.2.5-1 and Table 6.6.8.2.5-2 define the primary level settings including test tolerances for all tests.



**Table 6.6.8.2.5-1: SSB specific test parameters for NR SA SSB based CMR and dedicated IMR L1-SINR measurement**

Parameter	Config	Unit	SSB#0		SSB#1	
			T1	T2	T1	T2
$N_{oc}$ <sup>Note2</sup>	1~3	dBm/15kHz	-94.65			
$N_{oc}$ <sup>Note2</sup>	1,2	dBm/SSB SCS	-94.65			
	3		-91.65			
$\hat{E}_s/I_{ot}$	1~3	dB	0.5	0.5	-Infinity	3
SSB RSRP <sup>Note3</sup>	1,2	dBm/SSB SCS	-94.15	-94.15	-Infinity	-91.65
	3		-91.14	-91.14	-Infinity	-88.65
$I_o$ <sup>Note3</sup>	1,2	dBm/9.36 MHz	-63.43	-63.43	-66.70	-61.93
	3	dBm/38.16 MHz	-57.33	-57.33	-60.61	-55.84
$\hat{E}_s/N_{oc}$	1~3	dB	0.5	0.5	-Infinity	3
<p>Note 1: The resources for uplink transmission are assigned to the UE prior to the start of time period T2.</p> <p>Note 2: Interference from other cells and noise sources not specified in the test is assumed to be constant over subcarriers and time and shall be modelled as AWGN of appropriate power for <math>N_{oc}</math> to be fulfilled.</p> <p>Note 3: SS-RSRP and <math>I_o</math> levels have been derived from other parameters for information purposes. They are not settable parameters themselves.</p>						

**Table 6.6.8.2.5-2: CSI-RS specific test parameters for NR SA SSB based CMR and dedicated IMR L1-SINR measurement**

Parameter	Config	Unit	CSI-RS#0		CSI-RS#1	
			T1	T2	T1	T2
$N_{oc}$ <sup>Note2</sup>	1~3	dBm/15kHz	-94.65			
$N_{oc}$ <sup>Note2</sup>	1,2	dBm/CSI-RS SCS	-94.65			
	3		-91.65			
$\hat{E}_s/I_{ot}$	1~3	dB	0.5	0.5	-Infinity	3
CSI-RS RSRP <sup>Note3</sup>	1,2	dBm/CSI-RS SCS	-94.15	-94.15	-Infinity	-91.65
	3		-91.14	-91.14	-Infinity	-88.65
$I_o$ <sup>Note3</sup>	1,2	dBm/9.36 MHz	-63.43	-63.43	-66.70	-61.93
	3	dBm/38.16 MHz	-57.33	-57.33	-60.61	-55.84
$\hat{E}_s/N_{oc}$	1~3	dB	0.5	0.5	-Infinity	3
<p>Note 1: The resources for uplink transmission are assigned to the UE prior to the start of time period T2.</p> <p>Note 2: Interference from other cells and noise sources not specified in the test is assumed to be constant over subcarriers and time and shall be modelled as AWGN of appropriate power for <math>N_{oc}</math> to be fulfilled.</p> <p>Note 3: SS-RSRP and <math>I_o</math> levels have been derived from other parameters for information purposes. They are not settable parameters themselves.</p>						

The UE shall send L1-SINR report every 80 slots. No later than 640ms plus 80 slots from the beginning of time period T2, UE shall send L1-SINR report including results of both SSB#0+CSI-RS#0 and SSB#1+CSI-RS#1. Each L1-SINR measurement report shall meet the corresponding absolute accuracy requirements in Table 6.6.8.2.5-3 for all test configurations and the corresponding relative accuracy requirements in Table 6.6.8.2.5-4 for all test configurations.

**Table 6.6.8.2.5-3: L1-SINR absolute accuracy requirements for the reported values for all test configurations**

Normal Conditions	T1	T2
Lowest reported value (SSB#1)	-	44
Highest reported value (SSB#1)	-	61

**Table 6.6.8.2.5-4: Void****Table 6.6.8.2.5-5: L1-SINR relative accuracy requirements for the reported values for all test configurations**

	T1	T2
Lowest DIFF SINR reported (SSB#0)	-	0
Highest DIFF SINR reported (SSB#0)	-	5

For the test to pass, the ratio of successful reported values for each requirement (R1 to R4) shall be more than 90% with a confidence level of 95%. Each requirement is evaluated independently of the others..

NOTE: The actual overall delays measured in the test may be up to  $2 \times TTI_{DCCCH}$  higher than the measurement reporting delays above because of TTI insertion uncertainty of the measurement report in DCCCH.

### 6.6.8.3 NR SA FR1 CSI-RS based CMR and dedicated IMR L1-SINR measurement in non-DRX

#### 6.6.8.3.1 Test purpose

To verify that the UE makes correct reporting of L1-SINR measurement in non-DRX within L1-SINR measurement requirements in TS 38.133 [6] clause 9.8.4.3.

#### 6.6.8.3.2 Test applicability

This test applies to all types of NR UE release 16 and forward, supporting L1-SINR measurement.

#### 6.6.8.3.3 Minimum conformance requirements

The minimum conformance requirements are specified in clause 6.6.8.0.3.

The normative reference for this requirement is TS 38.133 [6] clause A.6.6.8.3.

#### 6.6.8.3.4 Test description

##### 6.6.8.3.4.1 Initial conditions

This test shall be tested using any of the test configurations in Table 6.6.8.3.4.1-1. Configure the test equipment and the DUT according to the parameters in Table 6.6.8.3.4.1-2. Test environment parameters are given in Table 6.6.8.3.4.1-3.

**Table 6.6.8.3.4.1-1: NR SA CSI-RS based CMR and dedicated IMR L1-SINR measurement supported test configurations**

Config	Description
1	NR 15 kHz SSB SCS, 10 MHz bandwidth, FDD duplex mode
2	NR 15 kHz SSB SCS, 10 MHz bandwidth, TDD duplex mode
3	NR 30 kHz SSB SCS, 40 MHz bandwidth, TDD duplex mode
Note:	The UE is only required to be tested in one of the supported test configurations

**Table 6.6.8.3.4.1-2: General test parameters for NR SA CSI-RS based CMR and dedicated IMR L1-SINR measurement**

Parameter	Config	Unit	Value
SSB GSCN	1~3		freq1
Duplex mode	1		FDD
	2		TDD
	3		TDD
TDD Configuration	1		N/A
	2		TDDConf.1.1
	3		TDDConf.2.1
BW <sub>channel</sub>	1	MHz	10: N <sub>RB,c</sub> = 52
	2		10: N <sub>RB,c</sub> = 52
	3		40: N <sub>RB,c</sub> = 106
PDSCH Reference measurement channel	1		SR.1.1 FDD
	2		SR.1.1 TDD
	3		SR.2.1 TDD
RMSI CORESET Reference Channel	1		CR.1.1 FDD
	2		CR.1.1 TDD
	3		CR.2.1 TDD
Dedicated CORESET Reference Channel	1		CCR.1.1 FDD
	2		CCR.1.1 TDD
	3		CCR.2.1 TDD
SSB configuration	1		SSB.3 FR1
	2		SSB.3 FR1
	3		SSB.4 FR1
CSI-RS configuration	1		CSI-RS 1.3 FDD
	2		CSI-RS 1.3 TDD
	3		CSI-RS 2.3 TDD
CSI-IM configuration	1		CSI-IM.1.2 FDD
	2		CSI-IM.1.2 TDD
	3		CSI-IM.2.2 TDD
OCNG Patterns	1~3		OP.1
TRS Configuration	1		TRS.1.1 FDD
	2		TRS.1.1 TDD
	3		TRS.1.2 TDD
Initial BWP Configuration	1~3		DLBWP.0.1 ULBWP.0.1
Dedicated BWP configuration	1~3		DLBWP.1.1 ULBWP.1.1
SMTC configuration	1~3		SMTC.1
DRX configuration	1~3		Off
reportConfigType	1~3		aperiodic
reportQuantity-r16	1~3		cri-SINR-r16
Number of reported RS	1~3		2
qcl-Info	1~3		SSB#0 for resource#0
			SSB#1 for resource#1
reportSlotOffsetList	1~3	slots	26
T1	1~3	s	5
EPRE ratio of PSS to SSS	1~3	dB	0
EPRE ratio of PBCH DMRS to SSS			
EPRE ratio of PBCH to PBCH DMRS			
EPRE ratio of PDCCH DMRS to SSS			
EPRE ratio of PDCCH to PDCCH DMRS			
EPRE ratio of PDSCH DMRS to SSS			
EPRE ratio of PDSCH to PDSCH DMRS			
EPRE ratio of OCNG DMRS to SSS <sup>Note 1</sup>			
EPRE ratio of OCNG to OCNG DMRS <sup>Note 1</sup>			
Propagation condition	1~3		AWGN
Note 1: OCNG shall be used such that both cells are fully allocated and a constant total transmitted power spectral density is achieved for all OFDM symbols.			

**Table 6.6.8.3.4.1-3: Test Environment parameters for NR SA CSI-RS based CMR and dedicated IMR L1-SINR measurement**

Parameter	Value		Comment
Test environment	NC		As specified in TS 38.508-1 [14] clause 4.1.
Test frequencies	As specified in Annex E, Table E.2-1 and TS 38.508-1 [14] clause 4.3.1 and 4.4.2.		
Channel bandwidth	As specified by the test configuration selected from Table 6.6.8.3.4.1-1.		
Propagation conditions	AWGN		As specified in Annex C.2.2.
Connection Diagram	TE Part	A.3.1.8.2 with $n = 1$	As specified in TS 38.508-1 [14] Annex A.
	DUT Part	A.3.2.3.4	
Exceptions to connection diagram	For 4Rx capable UEs without any 2 Rx RF bands use A.3.2.5.2 for DUT part and A.3.1.8.5 for TE Part		

1. Message contents are defined in clause 6.6.8.3.4.3.
2. Single Cell is used, which is NR FR1 Pcell. The connection setup is done according to the settings in Annex C.1.2 and C.1.3. The test parameters are given in tables 6.6.8.3.4.1-2 and 6.6.8.3.5-1. UE is configured to perform RLM and BFD based on the SSBs.

#### 6.6.8.3.4.2 Test procedure

The test consists of a single time period T1, during which the UE is triggered via DCI to report L1-SINR on aperiodic CSI-RS resources. Prior to the start of the time duration T1, the UE shall be fully synchronized to PCell. UE is also configured to measure L1-SINR based on SSB. Upon receiving the DCI trigger, UE provides the report back based on the reporting configuration as defined in table 6.6.8.3.4.1-2.

1. Ensure the UE is in state RRC\_CONNECTED with generic procedure parameters Connectivity NR SA, Connected without release *On* and Test Mode *On*, according to TS 38.508-1 [14] clause 4.5.
2. Set the parameters according to T1 in Table 6.6.8.3.5-1. T1 starts.
3. After 80ms from the start of the test the SS transmits the DCI trigger in slot 1 for configuration 1, 2 and slot 8 for configuration 3. The corresponding CSI-RS set is transmitted with the offset of 4 slots after the DCI trigger.
4. The SS shall check following requirements:
  - R1: the UE shall send L1-SINR report at slot 26 from the reception of DCI trigger. If the report is received at slot 26 from the reception of DCI trigger, the number of passed iterations for R1 is increased by one. Otherwise, the number of failed iterations for R1 is increased by one.
  - R2: The L1-SINR value of CSI-RS#1 reported by the UE is compared to the expected L1-SINR value for CSI-RS#1. If the resulting value is outside the limits in Table 6.6.8.3.5-2 for all test configurations or the UE fails to report the measurement value for CSI-RS #1, the number of failed iterations for R2 is increased by one. Otherwise, the number of passed iterations for R2 is increased by one.
  - R3: The DIFF SINR value of CSI-RS #0 reported by the UE is compared to the expected DIFF SINR value. If the resulting value is outside the limits in Table 6.6.8.3.5-4 or the UE fails to report the measurement value for CSI-RS#0, the number of failed iterations for R3 is increased by one. Otherwise, the number of passed iterations for R3 is increased by one.5. If after T1 expiry no report is received or received report did not contain L1-SINR of both CSI-RS#0 as CMR + CSI-IM#0 as IMR and CSI-RS#1 as CMR + CSI-IM#1 as IMR or UE sent the L1-SINR report at different slot than 26 from the reception of DCI trigger, the number of 'failed' iterations is increased by one, otherwise, the number of 'passed' iterations is increased by one.
6. The SS shall transmit *RRCRelease* message to release the RRC connection which includes the release of the established radio bearers as well as all radio resources.
7. After the RRC connection release, the SS:
  - transmits in Cell 1 a *Paging* message (including *PagingRecord* with ue-Identity) for the UE and ensures the UE in state RRC\_CONNECTED with generic procedure parameters Connectivity NR SA, Connected without release *On* and Test Mode *On* according to TS 38.508-1 [14] clause 4.5. (if the paging fails, switches off and on

the UE and ensures the UE is in state RRC\_CONNECTED with generic procedure parameters Connectivity NR SA, Connected without release *On* and Test Mode *On* according to TS 38.508-1 [14] clause 4.5.),

or:

- switches off and on the UE and ensures the UE is in state RRC\_CONNECTED with generic procedure parameters Connectivity NR SA, Connected without release *On* and Test Mode *On* according to TS 38.508-1 [14] clause 4.5.

8. Repeat steps 2-7 until the confidence level according to Tables G.2.3-1 in Annex G clause G.2 is achieved.

6.6.8.3.4.3 Message contents

Message contents are according to TS 38.508-1 [14] clause 7.3 with the following exceptions:

**Table 6.6.8.3.4.3-1: Common Exception messages NR SA CSI-RS based CMR and dedicated IMR L1-SINR measurement**

Default Message Contents	
Common contents of system information blocks exceptions	
Default RRC messages and information elements contents exceptions	Table H.3.6A-1 with conditions APERIODIC and CSI-SINR and CSI-IM_IMR Table H.3.6A-2 with conditions CSI-RS and APERIODIC Table H.3.6A-4 with condition APERIODIC

**Table 6.6.8.3.4.3-2: RadioLinkMonitoringConfig**

Derivation Path: TS 38.508-1 [14], Table 4.6.3-133			
Information Element	Value/remark	Comment	Condition
RadioLinkMonitoringConfig ::= SEQUENCE {			
failureDetectionResourcesToAddModList	1 entry		
SEQUENCE (SIZE(1..maxNrofFailureDetectionResources)) OF SEQUENCE {			
purpose	both	UE is configured to perform RLM and BFD based on the SSBs.	
}			
}			

6.6.8.3.5 Test requirement

Table 6.6.8.3.5-1 defines the primary level settings including test tolerances for all tests.

**Table 6.6.8.3.5-1: CSI-RS specific test parameters for NR SA CSI-RS based CMR and dedicated IMR L1-SINR measurement**

Parameter	Config	Unit	CSI-RS#0	CSI-RS#1
$N_{oc}$ <sup>Note1</sup>	1~3	dBm/15kHz	-94.65	
$N_{oc}$ <sup>Note1</sup>	1,2	dBm/SSB SCS	-94.65	
	3		-91.65	
$\hat{E}_s / I_{ot}$	1~3	dB	0	3
CSI-RS RSRP <sup>Note2</sup>	1,2	dBm/SSB SCS	-94.65	-91.65
	3		-91.65	-88.65
$I_o$ <sup>Note2</sup>	1,2	dBm/9.36 MHz	-63.69	-61.93
	3	dBm/38.16 MHz	-57.59	-55.84
$\hat{E}_s / N_{oc}$	1~3	dB	0	3
<p>Note 1: Interference from other cells and noise sources not specified in the test is assumed to be constant over subcarriers and time and shall be modelled as AWGN of appropriate power for <math>N_{oc}</math> to be fulfilled.</p> <p>Note 2: CSI-RS RSRP and <math>I_o</math> levels have been derived from other parameters for information purposes. They are not settable parameters themselves.</p>				

After 80ms from the beginning of the test, the UE shall send L1-SINR report at slot 26 from the reception of DCI triggering the L1-SINR measurement. The L1-SINR report shall include the results for both CSI-RS#0 as CMR + CSI-IM#0 as IMR and CSI-RS#1 as CMR + CSI-IM#1 as IMR.

Each L1-SINR measurement report shall meet the corresponding absolute accuracy requirements in Table 6.6.8.3.5-2 for all test configurations and the corresponding relative accuracy requirements in Table 6.6.8.3.5-4 for all test configurations.

**Table 6.6.8.3.5-2: L1-SINR absolute accuracy requirements for the reported values for test configurations 1 and 2**

Normal Conditions	T1
Lowest reported value (CSI-RS#1)	43
Highest reported value (CSI-RS#1)	62

**Table 6.6.8.3.5-3: Void****Table 6.6.8.3.5-4: L1-SINR relative accuracy requirements for the reported values for all test configurations**

	T1
Lowest DIFF SINR reported (CSI-RS#0)	0
Highest DIFF SINR reported (CSI-RS#0)	6

For the test to pass, the ratio of successful reported values for each requirement (R1 to R3) shall be more than 90% with a confidence level of 95%. Each requirement is evaluated independently of the others.

NOTE: The actual overall delays measured in the test may be up to  $2xTTI_{DCCH}$  higher than the measurement reporting delays above because of TTI insertion uncertainty of the measurement report in DCCH.

## 6.6.9 Idle Mode CA/DC Measurements

### 6.6.9.0 Minimum conformance requirements

TBD

### 6.6.9.1 NR SA FR1 SA Idle mode CA/DC measurement for FR1

Editor's note: This test case is incomplete. The following aspects are either missing or TBD

- Minimum conformance requirement is TBD
- Test case applicability is missing
- Cell configuration in Annex E is missing
- Test procedure
- Message contents
- TT analysis is missing
- Initial conditions and test requirements are contain []

#### 6.6.9.1.1 Test purpose

The purpose of this test is to verify the TBD

#### 6.6.9.1.2 Test applicability

This test applies to all types of NR UE release TBD onwards, configured with *TBD*

#### 6.6.9.1.3 Minimum conformance requirements

The minimum conformance requirements are specified in clause TBD.

The normative reference for this requirement is TS 38.133 [6] clause TBD and A.6.6.9.1

#### 6.6.9.1.4 Test description

##### 6.6.9.1.4.1 Initial conditions

This test shall be tested using any of the test configurations in Table 6.6.9.1.4.1-1.

**Table 6.6.9.1.4.1-1: Supported test configurations**

Test Case ID	Description
6.6.15.1-1	NR 15 kHz SSB SCS, 10 MHz bandwidth, FDD duplex mode
6.6.15.1-2	NR 15 kHz SSB SCS, 10 MHz bandwidth, TDD duplex mode
6.6.15.1-3	NR 30kHz SSB SCS, 40 MHz bandwidth, TDD duplex mode
Note 1:	The UE is only required to be tested in one of the supported test configurations
Note 2:	Target NR cell has the same SCS, BW and duplex mode as NR serving cell

Test environment parameters are given in Table 6.6.9.1.4.1-2.

**Table 6.6.9.1.4.1-2: Initial conditions for SA Idle mode CA/DC measurement for FR1**

Parameter	Value		Comment
Test environment	NC		As specified in TS 38.508-1 [14] clause 4.1.
Test frequencies	As specified in Annex E, Table E.4-1 and TS 38.508-1 [14] clause 4.3.1.		
Channel bandwidth	As specified by the test configuration selected from Table 6.6.9.1.4.1-1.		
Propagation conditions	AWGN		As specified in Annex C.2.2
Connection Diagram	TE Part	TBD	As specified in TS 38.508-1 [14] Annex A.
	DUT Part	TBD	



Exceptions to connection diagram		
----------------------------------	--	--

1. The general test parameter settings are set up according to Table 6.6.9.1.4.1-3.
2. Message contents are defined in clause 6.6.9.1.4.3.
3. The test scenario comprises of two NR Cells. NR Cell 1 is the cell used for connection setup with the power level set according to Annex C.1.1 and C.1.2 for this test.

**Table 6.6.9.1.4.1-3: General test parameters for SA Idle mode CA/DC measurement for FR1**

Parameter	Unit	Test configuration	Value	Comment
NR RF Channel Number		Config 1,2,3	1, 2	Two FR1 NR carrier frequencies is used
Active cell		Config 1,2,3	NR cell 1 (Pcell)	NR Cell 1 is on NR RF channel number 1.
Neighbour cell		Config 1,2,3	NR cell2	NR cell 2 is on NR RF channel number 2.
SMTC-SSB parameters		Config 1	SSB.1 FR1	As specified in clause A.3.10.1
		Config 2	SSB.1 FR1	As specified in clause A.3.10.1
		Config 3	SSB.2 FR1	As specified in clause A.3.10.1
Hysteresis	dB	Config 1,2,3	0	
PRACH configuration index		Config 1,2,3	102	The detailed configuration is specified in TS 38.211 clause 6.3.3.2
CP length		Config 1,2,3	Normal	
TimeToTrigger	s	Config 1,2,3	0	
Filter coefficient		Config 1,2,3	0	L3 filtering is not used
DRX in connected mode		Config 1,2,3	OFF	DRX is not used
DRX in idle mode	s	Config 1,2,3	[0.32]	The value shall be used for all cells in the test.
T331	s		300	
Time offset between serving and neighbour cells		Config 1	3ms	Asynchronous cells. The timing of Cell 2 is 3ms later than the timing of Cell 1.
		Config 2,3	3µs	Synchronous cells
T1	s	Config 1,2,3	10	
T2	s	Config 1,2,3	[11.52]	
T3	s	Config 1,2,3	10	

6.6.9.1.4.2 Test procedure

TBD

6.6.9.1.4.3 Message contents

Message contents are according to TS 38.508-1 [14] clause 7.3 with the following exceptions:

**Table 6.6.9.1.4.3-1: Common Exception messages for SA Idle mode CA/DC measurement for FR1**

<b>Default Message Contents</b>	
Common contents of system information blocks exceptions	

#### 6.6.9.1.5 Test requirements

Table 6.6.9.1.5-1 defines the primary level settings including test tolerances for SA Idle mode CA/DC measurement for FR1

**Table 6.6.9.1.5-1: Cell specific test parameters for connected mode for SA Idle mode CA/DC measurement for FR1**

Parameter		Unit	Test configuration	Cell 1			Cell 2		
				T1	T2	T3	T1	T2	T3
NR RF Channel Number			Config 1,2,3	1			2		
Duplex mode			Config 1	FDD					
			Config 2,3	TDD					
TDD configuration			Config 1	Not Applicable					
			Config 2	TDDConf.1.1					
			Config 3	TDDConf.2.1					
BW <sub>channel</sub>		MHz	Config 1,2	10: N <sub>RB,c</sub> = 52					
			Config 3	40: N <sub>RB,c</sub> = 106					
BWP BW		MHz	Config 1,2	10: N <sub>RB,c</sub> = 52					
			Config 3	40: N <sub>RB,c</sub> = 106					
BWP configuration	Initial DL BWP		Config 1, 2, 3	DLBWP.0.1			NA		
	Initial UL BWP			ULBWP.0.1			NA		
	Dedicated DL BWP			DLBWP.1.1			NA		
	Dedicated UL BWP			ULBWP.1.1			NA		
TRS configuration			Config 1	TRS.1.1 FDD			NA		
			Config 2	TRS.1.1 TDD			NA		
			Config 3	TRS.1.2 TDD			NA		
OCNG Patterns defined in A.3.2.1.1 (OP.1)			Config 1,2,3	OP.1			OP.1		
PDSCH Reference measurement channel			Config 1	SR.1.1 FDD			SR.1.1 FDD		
			Config 2	SR.1.1 TDD			SR.1.1 TDD		
			Config 3	SR2.1 TDD			SR2.1 TDD		
CORESET Reference Channel			Config 1	CR.1.1 FDD			CR.1.1 FDD		
			Config 2	CR.1.1 TDD			CR.1.1 TDD		
			Config 3	CR2.1 TDD			CR2.1 TDD		
SSB parameters			Config 1	SSB.1 FR1			SSB.5 FR1		
			Config 2	SSB.1 FR1			SSB.5 FR1		
			Config 3	SSB.2 FR1			SSB.6 FR1		
SMTC configuration defined in A.3.11			Config 1	SMTC.2			SMTC.5		
			Config 2, 3	SMTC.1			SMTC.4		
PDSCH/PDCCH subcarrier spacing		kHz	Config 1,2	15					
			Config 3	30					
EPRE ratio of PSS to SSS			Config 1,2,3	0			0		
EPRE ratio of PBCH DMRS to SSS									
EPRE ratio of PBCH to PBCH DMRS									
EPRE ratio of PDCCH DMRS to SSS									
EPRE ratio of PDCCH to PDCCH DMRS									
EPRE ratio of PDSCH DMRS to SSS									
EPRE ratio of PDSCH to PDSCH									
EPRE ratio of OCNG DMRS to SSS(Note 1)									
EPRE ratio of OCNG to OCNG DMRS (Note 1)									
$N_{oc}$ <sup>Note2</sup>		dBm/15 kHz		-98			-98		
$N_{oc}$ <sup>Note2</sup>			Config 1,2	-98			-98		
			Config 3	-95			-95		

SS-RSRP <sup>Note 3</sup>	dBm/S CS	Config 1,2	-91	-91	-91	- infinite	-98	-98
		Config 3	-88	-88	-88	- infinite	-95	-95
$\hat{E}_s/I_{oc}$	dB	Config 1,2,3,4,5,6	7	7	7	- infinite	0	0
$\hat{E}_s/N_{oc}$	dB	Config 1,2,3	7	7	7	infinite	0	0
I <sub>o</sub> <sup>Note3</sup>	dBm/9. 36MHz	Config 1,2	- 62.2 6	- 62.2 6	- 62.26	-70.5	- 67.04	- 67.04
	dBm/38 .16MHz	Config 3	- 56.1 5	- 56.1 5	- 56.15	- 63.94	- 60.93	- 60.93
Propagation Condition		Config 1,2,3	AWGN			AWGN		
<p>Note 1: OCNG shall be used such that both cells are fully allocated and a constant total transmitted power spectral density is achieved for all OFDM symbols.</p> <p>Note 2: Interference from other cells and noise sources not specified in the test is assumed to be constant over subcarriers and time and shall be modelled as AWGN of appropriate power for <math>N_{oc}</math> to be fulfilled.</p> <p>Note 3: SS-RSRP and I<sub>o</sub> levels have been derived from other parameters for information purposes. They are not settable parameters themselves.</p> <p>Note 4: SS-RSRP minimum requirements are specified assuming independent interference and noise at each receiver antenna port.</p>								

**Table 6.6.9.1.5-2: Cell specific test parameters for idle mode for SA Idle mode CA/DC measurement for FR1**

Parameter	Unit	Test configuration	Cell 1			Cell 2		
			T1	T2	T3	T1	T2	T3

NR RF Channel Number		1,2,3	1			2		
TDD configuration		1	N/A			N/A		
		2	TDDConf.1.1			TDDConf.1.1		
		3	TDDConf.2.1			TDDConf.2.1		
PDSCH RMC configuration		1	SR.1.1 FDD			SR.1.1 FDD		
		2	SR.1.1 TDD			SR.1.1 TDD		
		3	SR.2.1 TDD			SR.2.1 TDD		
RMSI CORESET RMC configuration		1	CR.1.1 FDD			CR.1.1 FDD		
		2	CR.1.1 TDD			CR.1.1 TDD		
		3	CR.2.1 TDD			CR.2.1 TDD		
Dedicated CORESET RMC configuration		1	CCR.1.1 FDD			CCR.1.1 FDD		
		2	CCR.1.1 TDD			CCR.1.1 TDD		
		3	CCR.2.1 TDD			CCR.2.1 TDD		
OCNG Pattern		1, 2, 3	OP.1 defined in A.3.2.1			OP.1 defined in A.3.2.1		
Initial DL BWP configuration		1, 2, 3	DLBWP.0.1			DLBWP.0.1		
Initial UL BWP configuration		1, 2, 3	ULBWP.0.1			ULBWP.0.1		
RLM-RS		1, 2, 3	SSB			SSB		
Qrxlevmin	dBm/SCS	1, 2	-140			-140		
		3	-137			-137		
Pcompensation	dB	1, 2, 3	0			0		
Cell_selection_and_reselection_quality_measurement		1, 2, 3	SS-RSRP			SS-RSRP		
$\hat{E}_s / I_{\alpha}$	dB	1	[14]	[14]	[14]	-infinity	[12]	[12]
		2						
		3						
$N_{oc}$ Note2	dBm/SCS	1	[-98]					
		2	[-98]					
		3	[-95]					
$N_{oc}$ Note2	dBm/15 kHz	1	[-98]					
		2						
		3						
$\hat{E}_s / N_{oc}$	dB	1	[7]	[7]	[7]	-infinity	[0]	[0]
		2						
		3						
SS-RSRP Note3	dBm/SCS	1	[-91]	[-91]	[-91]	-infinity	[-98]	[-98]
		2	[-91]	[-91]	[-91]	-infinity	[-98]	[-98]
		3	[-88]	[-88]	[-88]	-infinity	[-95]	[-95]
Io	dBm/9.36 MHz	1	[-62.26]	[-62.26]	[-62.26]	[-70.5]	[-67.04]	[-67.04]
		2	[-62.26]	[-62.26]	[-62.26]	[-70.5]	[-67.04]	[-67.04]
	dBm/38.16 MHz	3	[-56.15]	[-56.15]	[-56.15]	[-63.94]	[-60.93]	[-60.93]
Treselection	s	1, 2, 3	0	0	0	0	0	0
SnonintrasearchP	dB	1, 2, 3	Not sent			Not sent		
Propagation Condition		1, 2, 3	AWGN					
<p>Note 1: OCNG shall be used such that both cells are fully allocated and a constant total transmitted power spectral density is achieved for all OFDM symbols.</p> <p>Note 2: Interference from other cells and noise sources not specified in the test is assumed to be constant over subcarriers and time and shall be modelled as AWGN of appropriate power for <math>N_{oc}</math> to be fulfilled.</p> <p>Note 3: SS-RSRP levels have been derived from other parameters for information purposes. They are not settable parameters themselves.</p>								

During the time period T2 the UE is in Idle mode and the signal level of cell 2 is changed. The UE shall not perform reselection. The UE shall perform Idle Mode CA measurement according to Section 4.4.

At the start of T3 the UE is paged for connection setup. During the connection setup the UE is requested to transmit early measurement report for cell 2. The UE shall send early measurement report to the PCell.

After receiving the requested early measurement report, the test equipment verifies the accuracy of measurement reported for Cell 2 meets the requirements in Section 10.X and test ends.

The rate of correct events observed during repeated tests shall be at least 90% with a confidence level of 95%.

## 6.6.10 to 6.6.14

### 6.6.15 Idle Mode inter-RAT CA/DC Measurements

#### 6.6.15.0 Minimum conformance requirements

TBD

#### 6.6.15.1 NR SA FR1 Idle Mode measurements of inter-RAT CA candidate cells for early reporting

**Editor's note: This test case is incomplete. The following aspects are either missing or TBD**

- Minimum conformance requirement is TBD
- Test case applicability is missing
- Cell configuration in Annex E is missing
- Test procedure
- Message contents
- TT analysis is missing
- Initial conditions and test requirements are contain []

##### 6.6.15.1.1 Test purpose

The purpose of this test is to verify the TBD

##### 6.6.15.1.2 Test applicability

This test applies to all types of NR UE release TBD, configured with *TBD*.

##### 6.6.15.1.3 Minimum conformance requirements

The minimum conformance requirements are specified in clause 6.5.15.0.

The normative reference for this requirement is TS 38.133 [6] clause TBD and A.6.6.15

##### 6.6.15.1.4 Test description

###### 6.6.15.1.4.1 Initial conditions

This test shall be tested using any of the test configurations in Table 6.6.15.1.4.1-1.

**Table 6.6.15.1.4.1-1: Supported test configurations**

Test Case ID	Description
6.6.15.1-1	FR1 FDD SSB SCS 15kHz BW 10MHz – LTE FDD 10MHz
6.6.15.1-2	FR1 FDD SSB SCS 15kHz BW 10MHz – LTE TDD 10MHz
6.6.15.1-3	FR1 TDD SSB SCS 30kHz BW 40MHz – LTE FDD 10MHz
6.6.15.1-4	FR1 TDD SSB SCS 30kHz BW 40MHz – LTE TDD 10MHz
Note 1: The UE is only required to be tested in one of the supported test configurations	

Configure the test equipment and the DUT according to the parameters in Table 6.6.15.1.4.1-2.

**Table 6.6.15.1.4.1-2: Initial conditions for DL interruptions at switching between two uplink carriers in FDD-TDD CA**

Parameter	Value		Comment
Test environment	NC		As specified in TS 38.508-1 [14] clause 4.1.
Test frequencies	As specified in Annex E, Table E.4-1 and TS 38.508-1 [14] clause 4.3.1.		
Channel bandwidth	As specified by the test configuration selected from Table 6.6.15.1.4.1-1.		
Propagation conditions	AWGN		As specified in Annex C.2.2
Connection Diagram	TE Part	TBD	As specified in TS 38.508-1 [14] Annex A.
	DUT Part	TBD	
Exceptions to connection diagram			

1. The general test parameter settings are set up according to Table 6.6.15.1.4.1-3.
2. Message contents are defined in clause 6.6.15.1.4.3.
3. The test scenario comprises of two NR Cells. (Cell 1 and Cell 2). Cell 1 is configured according to Annex C.1.2 and C.1.3.

**Table 6.6.15.1.4.1-3: General test parameters for Idle Mode measurements of inter-frequency CA candidate cells for early reporting**

Parameter	Unit	Value	Comment
RF Channel Number		1, 2	Two radio channels are used for this test
Active PCell		Cell 1	PCell on RF channel number 1 in FR1
PSCell		Cell 2	PSCell on RF channel number 2 in LTE
DRX		OFF	For both PCell and PSCell once configured
PRACH configuration in Cell 2		[PRACH_2CE]	PRACH configuration as specified in Clause A.3.16 in TS 36.133
CSI reporting periodicity and offset configuration for Cell 2	ms	2	
T1	s	[0.5]	During this time the PCell is known and PSCell is configured.
T2	s	[0.5]	PSCell access.
T3 + T4	s	[66]	During this time the UE is configured to perform inter-frequency measurements in idle mode on the PSCell carrier.
T5	s	[0.5]	UE is paged and connection is setup. Network requests measurement report from the UE.

6.6.15.1.4.2 Test procedure

TBD

6.6.15.1.4.3 Message contents

Message contents are according to TS 38.508-1 [14] clause 7.3 with the following exceptions:

**Table 6.6.15.1.4.3-1: Common Exception messages for**

Default Message Contents	
Common contents of system information blocks exceptions	

6.6.15.1.5 Test requirements

Table 6.6.15.1.5-1 defines the primary level settings including test tolerances for



**Table 6.6.15.1.5-1: Cell specific test parameters for NR cell for Idle Mode measurements of inter-frequency CA candidate cells for early reporting**

Parameter	Unit	Config	Test 1				
			Cell 1				
			T1	T2	T3	T4	T5
AoA setup		1,2,3,4	N/A				
Assumption for UE beams <sup>Note 5</sup> R: Rough		1,2,3,4	N/A	N/A	R	R	N/A
Frequency Range		1,2,3,4	FR1				
Duplex mode		1, 2	FDD				
		3, 4	TDD				
TDD Configuration 1: TDDConf.1.1 2: TDDConf.2.1		1,2	-				
		3,4	1	1	2	2	1
BW <sub>channel</sub> 1: 10: N <sub>RB,c</sub> = 52 2: 40: N <sub>RB,c</sub> = 106	MHz	1, 2	1	1	-	-	1
		3, 4	2	2	-	-	2
Initial Downlink BWP configuration		1,2,3,4	DLBWP.0.1				
Initial Uplink BWP configuration		1,2,3,4	ULBWP.0.1				
Dedicated Downlink BWP configuration 1: DLBWP.1.1		1,2,3,4	1	1	-	-	1
Dedicated Uplink BWP configuration 1: ULBWP.1.1		1,2,3,4	1	1	-	-	1
PDSCH Reference Measurement Channel 1: SR.1.1 FDD 2: SR.2.1 TDD	FDD	1,2	1	1	1	1	1
	TDD	3,4	2	2	2	2	2
TRS configuration		1,2,3,4	-				
TCI state		1,2,3,4	-				
RMSI CORESET parameters	FDD	1,2	CR.1.1 FDD				
	TDD	3,4	CR.2.1 TDD				
Dedicated CORESET parameters	FDD	1,2	CCR.1.1 FDD				
	TDD	3,4	CCR.2.1 TDD				
OCNG Patterns <sup>Note1</sup>		1,2,3,4	OP.1 defined in A.3.2.1				
SSB configuration 1: SSB.1 FR1 2: SSB.2 FR1		1,2	1				
		3,4	2				
SMTc configuration		1,2,3,4	SMTc.2				
Correlation Matrix and Antenna config		1,2,3,4	1x2 Low				
EPRE ratio of PSS to SSS	dB	1,2,3,4	0	0	-	-	0
EPRE ratio of PBCH DMRS to SSS			0	0	-	-	0
EPRE ratio of PBCH to PBCH DMRS			0	0	-	-	0
EPRE ratio of PDCCH DMRS to SSS			0	0	-	-	0
EPRE ratio of PDCCH to PDCCH DMRS			0	0	-	-	0
EPRE ratio of PDSCH DMRS to SSS			0	0	-	-	0
EPRE ratio of PDSCH to PDSCH			0	0	-	-	0
EPRE ratio of OCNG DMRS to SSS			0	0	-	-	0
N <sub>oc</sub> <sup>Note2</sup>			dBm/ 15kHz	1,2	[-98]	[-98]	[-98]
	3,4						
N <sub>oc</sub> <sup>Note2</sup>	dBm/SCS	1,2	[-98]	[-98]	[-98]	[-98]	[-98]
		3,4	[-95]	[-95]	[-95]	[-95]	[-95]
$\hat{E}_s/I_{ot}$	dB	1,2,3,4	[5]	[5]	[5]	[5]	[5]
$\hat{E}_s/N_{oc}$	dB	1,2,3,4	[5]	[5]	[5]	[5]	[5]
SS-RSRP <sup>Note3,4</sup>	dBm/SCS	1,2	[-93]	[-93]	[-93]	[-93]	[-93]
		3,4	[-90]	[-90]	[-90]	[-90]	[-90]
I <sub>o</sub> <sup>Note3,4</sup>	dBm/ 9.36 MHz	1,2	[-63.85]	[-63.85]	-[-63.85]	-[-63.85]	[-63.85]

	dBm/ 38.16 MHz	3,4	[-57.76]	[-57.76]	-[-57.76]	-[-57.76]	[-57.76]
Qrxlevmin	dBm/SCS	1	-	-	[-140]		-
		2	-	-	[-137]		-
		3	-	-	[TBD]	[TBD]	-
		4	-	-	[TBD]	[TBD]	-
Pcompensation	dB	1,2,3,4	-	-	0	0	-
Qhyst <sub>s</sub>	dB	1,2,3,4	-	-	0	0	-
Qoffset <sub>s, n</sub>	dB	1,2,3,4	-	-	0	0	-
Cell_selection_and_reselection_quality_measurement		1,2,3,4	SS-RSRP				
Treselection	s	1,2,3,4	-	-	0	-	-
SnonintrasearchP	dB	1,2,3,4	-	-	[TBD]	-	-
SnonintrasearchQ	dB	1,2,3,4	-	-	[TBD]	-	-
Thresh <sub>x, high</sub>	dB	1,2,3,4	-	-	[48]	-	-
Thresh <sub>serv, low</sub>	dB	1,2,3,4	-	-	[44]	-	-
Thresh <sub>x, low</sub>	dB	1,2,3,4	-	-	[50]	-	-
Propagation Condition	dB	1,2,3,4	-	-	AWGN	-	-

**Table 6.6.15.1.5-2: Cell specific test parameters for LTE cell for Idle Mode measurements of inter-frequency CA candidate cells for early reporting**

Parameter	Unit	Config	Test 1				
			Cell 2				
			T1	T2	T3	T4	T5
Frequency Range		1,2,3,4	LTE				
Duplex mode		1, 3	FDD				
		2, 4	TDD				
BW <sub>channel</sub>	MHz	1,2,3,4	10	10	-	-	10
Measurement bandwidth	$n_{PRB}$	1,2,3,4	-	-	22-27	22-27	-
PDSCH Reference Measurement Channel 1: R.1 FDD 2: R.1 TDD	FDD	1,3	1	1	-	-	1
	TDD	2,4	2	2	-	-	2
PDCCH/PCFICH/PHICH Reference measurement channel defined in A.3.1.2.1 and A.3.1.2.2 in 36.133 1: R.6 FDD 2: R.6 TDD		1,3	1	1	-	-	1
		2,4	2	2	-	-	2
OCNG Patterns defined in A.3.2.1.1 (OP.2 FDD) and A.3.2.1.2 (OP.2 TDD) in 36.133 1: OP.2 FDD 2: OP.2 TDD		1,3	1				
		2,4	2				
Correlation Matrix and Antenna config		1,2,3,4	1x2 Low				
PBCH_RA	dB	1,2,3,4	N/A	N/A	0	0	N/A
PBCH_RB			N/A	N/A	0	0	N/A
PSS_RA			N/A	N/A	0	0	N/A
SSS_RA			N/A	N/A	0	0	N/A
PCFICH_RB			N/A	N/A	0	0	N/A
PHICH_RA			N/A	N/A	0	0	N/A
PHICH_RB			N/A	N/A	0	0	N/A
PDCCH_RA			N/A	N/A	0	0	N/A
PDCCH_RB			N/A	N/A	0	0	N/A
PDSCH_RA			N/A	N/A	0	0	N/A
PDSCH_RB			N/A	N/A	0	0	N/A
OCNG_RA <sup>Note 1</sup>			N/A	N/A	0	0	N/A
OCNG_RB <sup>Note 1</sup>			N/A	N/A	0	0	N/A
N <sub>oc</sub> <sup>Note 2</sup>			dBm/ 15kHz	1,2	[-98]	[-98]	[-98]
	3,4						
$\bar{E}_s/I_{ot}$	dB	1,2,3,4	[5]	[5]	[-3]	[8]	[5]
$\bar{E}_s/N_{oc}$	dB	1,2,3,4	[5]	[5]	[-3]	[8]	[5]
SS-RSRP <sup>Note 3,4</sup>	dBm/SCS	1,2,3,4	[-93]	[-93]	[-101]	[-90]	[-93]
I <sub>o</sub> <sup>Note 3,4</sup>	dBm/ 9.36 MHz	1, 2, 3, 4	FFS	FFS	[FFS]	[FFS]	FFS
Qrxlevmin	dBm/SCS	1	-	-	[-140]		-
		2	-	-	[-137]		-
		3	-	-	[TBD]	[TBD]	-
		4	-	-	[TBD]	[TBD]	-
Pcompensation	dB	1,2,3,4	-	-	0	0	-
Qhyst <sub>s</sub>	dB	1,2,3,4	-	-	0	0	-
Qoffset <sub>s,n</sub>	dB	1,2,3,4	-	-	0	0	-
Cell_selection_and_reselection_quality_measurement		1,2,3,4	RSRP and RSRQ				
Treselection	s	1,2,3,4	-	-	0		-
SnonintrasearchP	dB	1,2,3,4	-	-	[TBD]		-
SnonintrasearchQ	dB	1,2,3,4	-	-	[TBD]		-
Thresh <sub>x,high</sub>	dB	1,2,3,4	-	-	[48]		-

Thresh <sub>serv<sub>ing</sub>, low</sub>	dB	1,2,3,4	-	[44]	-
Thresh <sub>x, low</sub>	dB	1,2,3,4	-	[50]	-
Propagation Condition	dB	1,2,3,4	-	AWGN	-

During time durations T1 the UE shall start transmitting preamble on PSCell. During T2 the UE perform intra-frequency measurements on the PCell and the PSCell.

During the time-period T3 the connection is released, and UE enters idle mode. During the time period T3 and T4 the UE is camped in Idle mode and at T4 the signal level of cell 2 is changed. The UE shall not perform reselection. The UE shall perform Idle Mode CA measurement according to Section 4.4.

At the start of T5 the UE is paged for connection setup. During the connection setup the UE is requested to transmit early measurement report. The UE shall send early measurement report to the PCell including idle mode CA/DC measurement from cell 2.

After receiving the requested early measurement report, the test equipment verifies that the accuracy of measurement reported for serving Cell 1 and Cell 2 meets the requirements in Sections 10.1.2B and 10.1.7B and Sections 10.2.4 and 10.2.5, respectively and test ends.

The rate of correct events observed during repeated tests shall be at least 90% with a confidence level of 95%.

## 6.7 Measurement performance requirements

### 6.7.1 SS-RSRP

#### 6.7.1.0 Minimum conformance requirements

##### 6.7.1.0.1 Intra-frequency absolute SS-RSRP measurement accuracy requirements

Same as in clause 4.7.1.0.1.

##### 6.7.1.0.2 Intra-frequency relative SS-RSRP measurement accuracy requirements

Same as in clause 4.7.1.0.2.

##### 6.7.1.0.3 Inter-frequency absolute SS-RSRP measurement accuracy requirements

Same as in clause 4.7.1.0.3.

##### 6.7.1.0.4 Inter-frequency relative SS-RSRP measurement accuracy requirements

Same as in clause 4.7.1.0.4.

#### 6.7.1.1 Intra-frequency measurements

##### 6.7.1.1.1 NR SA FR1 SS-RSRP absolute measurement accuracy

###### 6.7.1.1.1.1 Test purpose

The purpose of this test is to verify that the intra-frequency SS-RSRP absolute measurement accuracy is within the specified limits for all bands.

###### 6.7.1.1.1.2 Test applicability

This test applies to all types of NR UE from Release 15 onwards.

###### 6.7.1.1.1.3 Minimum conformance requirements

The minimum conformance requirements are specified in clause 6.7.1.0.1.

The normative reference for this requirement is TS 38.133 [6] clause A.6.7.1.1.

6.7.1.1.1.4 Test description

6.7.1.1.1.4.1 Initial conditions

This test shall be tested using any of the test configurations in Table 6.7.1.1.1.4.1-1.

**Table 6.7.1.1.1.4.1-1: NR SA FR1 SS-RSRP measurement accuracy supported test configurations**

Test Case ID	Description
6.7.1.1.1-1	NR: 15 kHz SSB SCS, 10MHz bandwidth, FDD
6.7.1.1.1-2	NR: 15 kHz SSB SCS, 10MHz bandwidth, TDD
6.7.1.1.1-3	NR: 30 kHz SSB SCS, 40MHz bandwidth, TDD
Note: The UE is only required to be tested in one of the supported test configurations	

Configure the test equipment and the DUT according to the parameters in Table 6.7.1.1.1.4.1-2.

**Table 6.7.1.1.1.4.1-2: Initial conditions for SS-RSRP intra frequency absolute accuracy in FR1**

Parameter	Value		Comment
Test environment	NC, TL/VL, TL/VH, TH/VL, TH/VH		As specified in TS 38.508-1 [14] clause 4.1.
Test frequencies	As specified in Annex E, Table E.4-1 and TS 38.508-1 [14] clause 4.3.1.		
Channel bandwidth	As specified by the test configuration selected from Table 6.7.1.1.1.4.1-1.		
Propagation conditions	AWGN		As specified in Annex C.2.2.
Connection Diagram	TE Part 2Rx	A.3.1.8.2 with $n = 2$ and $\varphi_1 = 5$ Hz	As specified in TS 38.508-1 [14] Annex A.
	TE Part 4Rx	A.3.1.8.5 with $n = 2$ and $\varphi_{1,1} = 5$ Hz, $\varphi_{1,2} = 10$ Hz, $\varphi_{1,3} = 15$ Hz	
	DUT Part 2Rx	A.3.2.3.4	
	DUT Part 4Rx	A.3.2.5.2	
Exceptions to connection diagram	- Without LTE link		

1. Message contents are defined in clause 6.7.1.1.1.4.3.
2. Cell 1 is the NR FR1 serving cell (PCell) and Cell 2 is the NR neighbour in the same frequency and the target cell for SS-RSRP measurements. The connection setup is done according to the settings in Annex C.1.1 and C.1.2.

6.7.1.1.1.4.2 Test procedure

1. Ensure the UE is in state RRC\_CONNECTED with generic procedure parameters Connectivity NR, Connected without release On and Test Mode On according to TS 38.508-1 [14] clause 4.5.
2. Set the parameters according to Table 6.7.1.1.1.5-1 as appropriate.
3. The SS shall transmit an RRCReconfiguration message on Cell 1.
4. The UE shall transmit an RRCReconfigurationComplete message.
5. The UE shall transmit periodically MeasurementReport messages.
6. After 10s wait from Step 3, the SS shall check the SS-RSRP reported values in the periodic MeasurementReport. The SS-RSRP value of Cell 2 reported by the UE is compared to the expected SS-RSRP. If the value is outside the limits in Table 6.7.1.1.1.5-2 or the UE fails to report the measurement value for Cell 2, the number of failed iterations is increased by one. Otherwise, the number of passed iterations is increased by one.
7. The SS shall continue checking the MeasurementReport messages transmitted by the UE until the confidence level according to Table G.2.3-1 in Annex G is achieved.
8. Set the parameters according to each sub-test in Table 6.7.1.1.1.5-1 as appropriate and repeat steps 5-7.

6.7.1.1.1.4.3 Message contents

Message contents are according to TS 38.508-1 [14] clause 7.3 with the following exceptions:

**Table 6.7.1.1.1.4.3-1: Common Exception messages for NR SA FR1 SS-RSRP absolute measurement accuracy**

Default Message Contents	
Common contents of system information blocks exceptions	
Default RRC messages and information elements contents exceptions	Table H.3.1-1 Table H.3.1-2 Table H.3.1-5 Table H.3.1-7
Specific message contents exceptions for Test Configuration 6.7.1.1.1-1	Table H.3.1-3 with Condition SSB.1 FR1 Table 7.3.1-3 in TS 38.508-1 [14] with condition SMTC.2
Specific message contents exceptions for Test Configuration 6.7.1.1.1-2	Table H.3.1-3 with Condition SSB.1 FR1 and Synchronous cells Table 7.3.1-3 in TS 38.508-1 [14] with condition SMTC.1
Specific message contents exceptions for Test Configuration 6.7.1.1.1-3	Table H.3.1-3 with Condition SSB.2 FR1 and Synchronous cells Table 7.3.1-3 in TS 38.508-1 [14] with condition SMTC.1

**Table 6.7.1.1.1.4.3-2: ReportConfigNR-DEFAULT(Periodical) for NR SA FR1 SS-RSRP Accuracy**

Derivation Path: 38.508-1 [14] Table 4.6.3-142 with condition PERIODICAL			
Information Element	Value/remark	Comment	Condition
ReportConfigNR ::= SEQUENCE {			
reportType CHOICE {			
periodical SEQUENCE {			PERIODICAL
reportQuantityCell SEQUENCE {			
rsrq	false		
sinr	false		
}			
maxReportCells	2		
}			
}			
}			

6.7.1.1.1.5 Test requirement

Table 6.7.1.1.1.5-1 defines the primary level settings including test tolerances for all tests.

Each SS-RSRP measurement report for each of the tests in Table 6.7.1.1.1.5-1 shall meet the corresponding absolute accuracy requirements in Table 6.7.1.1.1.5-2 for test configurations 1 and 2, and the corresponding absolute accuracy requirements in Table 6.7.1.1.1.5-3 for test configuration 3.



**Table 6.7.1.1.1.5-1: NR SA FR1 SS-RSRP measurement accuracy test parameters**

Parameter		Unit	Test 1		Test 2		Test 3	
			Cell 1	Cell 2	Cell 1	Cell 2	Cell 1	Cell 2
Physical cell ID			489	0	489	0	489	0
SSB ARFCN			freq1		freq1		freq1	
Duplex mode	Config 1		FDD					
	Config 2,3		TDD					
TDD configuration	Config 1		Not Applicable					
	Config 2		TDDConf.1.1					
	Config 3		TDDConf.2.1					
BW <sub>channel</sub>	Config 1	MHz	10: N <sub>RB,c</sub> = 52					
	Config 2		10: N <sub>RB,c</sub> = 52					
	Config 3		40: N <sub>RB,c</sub> = 106					
BWP BW	Config 1		10: N <sub>RB,c</sub> = 52					
	Config 2		10: N <sub>RB,c</sub> = 52					
	Config 3		40: N <sub>RB,c</sub> = 106					
Downlink initial BWP configuration			DLBWP.0.1					
Downlink dedicated BWP configuration			DLBWP.1.1					
Uplink initial BWP configuration			ULBWP.0.1					
Uplink dedicated BWP configuration			ULBWP.1.1					
DRx Cycle		ms	Not Applicable					
TRS Configuration	Config 1		TRS.1.1 FDD		TRS.1.1 FDD		TRS.1.1 FDD	
	Config 2		TRS.1.1 TDD	-	TRS.1.1 TDD	-	TRS.1.1 TDD	-
	Config 3		TRS.1.2 TDD		TRS.1.2 TDD		TRS.1.2 TDD	
PDSCH Reference measurement channel	Config 1		SR.1.1 FDD		SR.1.1 FDD		SR.1.1 FDD	
	Config 2		SR.1.1 TDD	-	SR.1.1 TDD	-	SR.1.1 TDD	-
	Config 3		SR2.1 TDD		SR2.1 TDD		SR2.1 TDD	
RMSI CORESET Reference Channel	Config 1		CR.1.1 FDD		CR.1.1 FDD		CR.1.1 FDD	
	Config 2		CR.1.1 TDD	-	CR.1.1 TDD	-	CR.1.1 TDD	-
	Config 3		CR2.1 TDD		CR2.1 TDD		CR2.1 TDD	
Control Channel RMC	Config 1		CCR.1.1 FDD		CCR.1.1 FDD		CCR.1.1 FDD	
	Config 2		CCR.1.1 TDD	-	CCR.1.1 TDD	-	CCR.1.1 TDD	-
	Config 3		CCR2.1 TDD		CCR2.1 TDD		CCR2.1 TDD	
SSB configuration	Config 1		SSB 1.FR1	SSB.1 FR1	SSB 1.FR1	SSB.1 FR1	SSB 1.FR1	SSB.1 FR1
	Config 2		SSB 1.FR1	SSB.1 FR1	SSB 1.FR1	SSB.1 FR1	SSB 1.FR1	SSB.1 FR1
	Config 3		SSB 2.FR1	SSB.2 FR1	SSB 2.FR1	SSB.2 FR1	SSB 2.FR1	SSB.2 FR1
Time offset with Cell 2	Config 1	ms	-	3	-	3	-	3
	Config 2,3	µs	-	3	-	3	-	3
SMTC Configuration			SMTC.2					

		Config 2,3		SMTC.1					
OCNG Patterns				OP.1					
PDSCH/PDCCH subcarrier spacing	Config 1,2		kHz	15 kHz					
	Config 3			30kHz					
EPRE ratio of PSS to SSS			dB	0	0	0	0	0	
EPRE ratio of PBCH DMRS to SSS									
EPRE ratio of PBCH to PBCH DMRS									
EPRE ratio of PDCCH DMRS to SSS									
EPRE ratio of PDCCH to PDCCH DMRS									
EPRE ratio of PDSCH DMRS to SSS									
EPRE ratio of PDSCH to PDSCH									
EPRE ratio of OCNG DMRS to SSS(Note 1)									
EPRE ratio of OCNG to OCNG DMRS (Note 1)									
$N_{oc}$ <sup>Note2</sup>	Config 1,2	Depending on band group							dBm/15Kh Z
	Config 3	Depending on band group	N/A <sup>Note 6</sup>		-94		$-116 + \Delta_{BG\_offset}$		
$N_{oc}$ <sup>Note2</sup>	Config 1,2		dBm/SCS	-107.4		-88		Same as Noc/15kHz	
	Config 3	Depending on band group		N/A <sup>Note 6</sup>		-91		$-113 + \Delta_{BG\_offset}$	
$\hat{E}_s/I_{ot}$			dB	1.88	-5.57	1.88	-5.57	0.09	-5.56
$\hat{E}_s/N_{oc}$			dB	6	1.4	6	1.4	3	-0.8
SS-RSRP <sup>Not e3</sup>	Config 1,2	Depending on band group	dBm/SCS	-101.5	-- 106.1	-82	-86.6	$-113 + \Delta_{BG\_offset}$	$-116.8 + \Delta_{BG\_offset}$
	Config 3	Depending on band group		N/A <sup>Note 6</sup>	N/A <sup>Not e 6</sup>	-85	-89.6	$-110 + \Delta_{BG\_offset}$	$113.8 + \Delta_{BG\_offset}$
$I_o$ <sup>Note3</sup>	Config 1,2	Depending on band group	dBm/9.36MHz	-71.68		-52.18		$-82.39 + \Delta_{BG\_offset}$	
	Config 3	Depending on band group	dBm/38.16MHz	N/A <sup>Note 6</sup>		-51.91		$-76.12 + \Delta_{BG\_offset}$	
Propagation condition			-	AWGN					
Antenna configuration				1x2					
<p>Note 1: OCNG shall be used such that both cells are fully allocated and a constant total transmitted power spectral density is achieved for all OFDM symbols.</p> <p>Note 2: Interference from other cells and noise sources not specified in the test is assumed to be constant over subcarriers and time and shall be modelled as AWGN of appropriate power for <math>N_{oc}</math> to be fulfilled.</p> <p>Note 3: SS-RSRP and <math>I_o</math> levels have been derived from other parameters for information purposes. They are not settable parameters themselves.</p> <p>Note 4: SS-RSRP minimum requirements are specified assuming independent interference and noise at each receiver antenna port.</p> <p>Note 5: <math>\Delta_{BG\_offset}</math> is defined in clause 3A.4, Table 3A.4.1-2.</p> <p>Note 6: Subtest 1 is not used when testing with 30kHz SSB SCS.</p>									

**Table 6.7.1.1.1.5-2: SS-RSRP Intra frequency absolute accuracy requirements for the reported values for test configurations 1 and 2**

<b>Normal Conditions</b>	<b>Test 1 All bands</b>	<b>Test 2 All bands</b>	<b>Test 3</b>	
Lowest reported value (Cell 2)	44	60	Bands NR_FDD_FR1_A, NR_TDD_FR1_A	34
			Bands NR_FDD_FR1_B	34
			Bands NR_TDD_FR1_C	35
			Bands NR_FDD_FR1_D, NR_TDD_FR1_D	35
			Bands NR_FDD_FR1_E, Bands NR_TDD_FR1_E	36
			Bands NR_FDD_FR1_G	37
			Bands NR_FDD_FR1_H	37
Highest reported value (Cell 2)	56	79	NR_FDD_FR1_A, NR_TDD_FR1_A	46
			NR_FDD_FR1_B	46
			NR_TDD_FR1_C	47
			NR_FDD_FR1_D, NR_TDD_FR1_D	47
			NR_FDD_FR1_E, NR_TDD_FR1_E	48
			NR_FDD_FR1_G	49
			NR_FDD_FR1_H	49
<b>Extreme Conditions</b>	<b>Test 1 All bands</b>	<b>Test 2 All bands</b>	<b>Test 3</b>	
Lowest reported value (Cell 2)	40	57	Bands NR_FDD_FR1_A, NR_TDD_FR1_A	29
			Bands NR_FDD_FR1_B	30
			Bands NR_TDD_FR1_C	30
			Bands NR_FDD_FR1_D, NR_TDD_FR1_D	31
			Bands NR_FDD_FR1_E, Bands NR_TDD_FR1_E	31
			Bands NR_FDD_FR1_G	33
			Bands NR_FDD_FR1_H	34
Highest reported value (Cell 2)	61	82	Bands NR_FDD_FR1_A, NR_TDD_FR1_A	50
			Bands NR_FDD_FR1_B	51
			Bands NR_TDD_FR1_C	51
			Bands NR_FDD_FR1_D, NR_TDD_FR1_D	52
			Bands NR_FDD_FR1_E, Bands NR_TDD_FR1_E	52
			Bands NR_FDD_FR1_G	53
			Bands NR_FDD_FR1_H	54

Note 1: NR operating band groups are as defined in Section 3A.4.1.

**Table 6.7.1.1.5-3: SS-RSRP Intra frequency absolute accuracy requirements for the reported values for test configuration 3**

Normal Conditions	Test 1 All bands	Test 2 All bands	Test 3	
Lowest reported value (Cell 2)	N/A	57	Bands NR_FDD_FR1_A, NR_TDD_FR1_A	37
			Bands NR_FDD_FR1_B	37
			Bands NR_TDD_FR1_C	38
			Bands NR_FDD_FR1_D, NR_TDD_FR1_D	38
			Bands NR_FDD_FR1_E, Bands NR_TDD_FR1_E	39
			Bands NR_FDD_FR1_G	40
			Bands NR_FDD_FR1_H	40
Highest reported value (Cell 2)	N/A	76	Bands NR_FDD_FR1_A, NR_TDD_FR1_A	49
			Bands NR_FDD_FR1_B	49
			Bands NR_TDD_FR1_C	50
			Bands NR_FDD_FR1_D, NR_TDD_FR1_D	50
			Bands NR_FDD_FR1_E, Bands NR_TDD_FR1_E	51
			Bands NR_FDD_FR1_G	52
			Bands NR_FDD_FR1_H	52
Extreme Conditions	Test 1 All bands	Test 2 All bands	Test 3	
Lowest reported value (Cell 2)	N/A	54	Bands NR_FDD_FR1_A, NR_TDD_FR1_A	32
			Bands NR_FDD_FR1_B	33
			Bands NR_TDD_FR1_C	33
			Bands NR_FDD_FR1_D, NR_TDD_FR1_D	34
			Bands NR_FDD_FR1_E, Bands NR_TDD_FR1_E	34
			Bands NR_FDD_FR1_G	35
			Bands NR_FDD_FR1_H	36
Highest reported value (Cell 2)	N/A	79	Bands NR_FDD_FR1_A, NR_TDD_FR1_A	53
			Bands NR_FDD_FR1_B	54
			Bands NR_TDD_FR1_C	54
			Bands NR_FDD_FR1_D, NR_TDD_FR1_D	55
			Bands NR_FDD_FR1_E, Bands NR_TDD_FR1_E	55
			Bands NR_FDD_FR1_G	56
			Bands NR_FDD_FR1_H	57

Note 1: NR operating band groups are as defined in Section 3A.4.1.

For the test to pass, the ratio of successful reported values in each test shall be more than 90% with a confidence level of 95%.

#### 6.7.1.1.2 NR SA FR1 SS-RSRP relative measurement accuracy

##### 6.7.1.1.2.1 Test purpose

The purpose of this test is to verify that the intra-frequency SS-RSRP relative measurement accuracy is within the specified limits for all bands.

##### 6.7.1.1.2.2 Test applicability

This test applies to all types of NR UE from Release 15 onwards.

##### 6.7.1.1.2.3 Minimum conformance requirements

The minimum conformance requirements are specified in clause 6.7.1.0.2.

The normative reference for this requirement is TS 38.133 [6] clause A.6.7.1.1.

#### 6.7.1.1.2.4 Test description

##### 6.7.1.1.2.4.1 Initial conditions

This test shall be tested using any of the test configurations in Table 6.7.1.1.2.4.1-1.

**Table 6.7.1.1.2.4.1-1: NR SA FR1 SS-RSRP measurement accuracy supported test configurations**

Test Case ID	Description
6.7.1.1.2-1	NR: 15 kHz SSB SCS, 10MHz bandwidth, FDD
6.7.1.1.2-2	NR: 15 kHz SSB SCS, 10MHz bandwidth, TDD
6.7.1.1.2-3	NR: 30 kHz SSB SCS, 40MHz bandwidth, TDD
Note: The UE is only required to be tested in one of the supported test configurations	

Configure the test equipment and the DUT according to the parameters in Table 6.7.1.1.2.4.1-2.

**Table 6.7.1.1.2.4.1-2: Initial conditions for SS-RSRP intra frequency relative accuracy in FR1**

Parameter	Value		Comment
Test environment	NC, TL/VL, TL/VH, TH/VL, TH/VH		As specified in TS 38.508-1 [14] clause 4.1.
Test frequencies	As specified in Annex E, Table E.4-1 and TS 38.508-1 [14] clause 4.3.1.		
Channel bandwidth	As specified by the test configuration selected from Table 6.7.1.1.2.4.1-1.		
Propagation conditions	AWGN		As specified in Annex C.2.2.
Connection Diagram	TE Part 2Rx	A.3.1.8.2 with $n = 2$ and $\phi_1 = 5$ Hz	As specified in TS 38.508-1 [14] Annex A.
	TE Part 4Rx	A.3.1.8.5 with $n = 2$ and $\phi_{1,1} = 5$ Hz, $\phi_{1,2} = 10$ Hz, $\phi_{1,3} = 15$ Hz	
	DUT Part 2Rx	A.3.2.3.4	
	DUT Part 4Rx	A.3.2.5.2	
Exceptions to connection diagram	- Without LTE link		

1. Message contents are defined in clause 6.7.1.1.2.4.3.

2. Cell 1 is the NR FR1 serving cell (PCell) and Cell 2 is the NR neighbour in the same frequency and the target cell for SS-RSRP measurements. The connection setup is done according to the settings in Annex C.1.1 and C.1.2.

##### 6.7.1.1.2.4.2 Test procedure

1. Ensure the UE is in state RRC\_CONNECTED with generic procedure parameters Connectivity NR Connected without release *On* and Test Mode *On* according to TS 38.508-1 [14] clause 4.5.

2. Set the parameters according to Table 6.7.1.1.2.5-1 as appropriate.

3. The SS shall transmit an RRCReconfiguration message on Cell 1.

4. The UE shall transmit an RRCReconfigurationComplete message.

5. The UE shall transmit periodically MeasurementReport messages.

6. After 10s wait from Step 3, the SS shall check the SS-RSRP reported values of Cell 1 and Cell 2 in the periodic MeasurementReport. The SS-RSRP value of Cell 2 reported by the UE is compared to the reported SS-RSRP of Cell 1. If the resulting value is outside the limits in Table 6.7.1.1.2.5-2 or the UE fails to report the measurement value for Cell 1 or Cell 2, the number of failed iterations is increased by one. Otherwise, the number of passed iterations is increased by one.

7. The SS shall continue checking the MeasurementReport messages transmitted by the UE until the confidence level according to Table G.2.3-1 in Annex G is achieved.

8. Set the parameters according to each sub-test in Table 6.7.1.1.2.5-1 as appropriate and repeat steps 5-7.

6.7.1.1.2.4.3 Message contents

Message contents are same as in clause 6.7.1.1.1.4.3.

6.7.1.1.2.5 Test requirement

Table 6.7.1.1.2.5-1 defines the primary level settings including test tolerances for all tests.

Each SS-RSRP measurement report for each of the tests in Table 6.7.1.1.2.5-1 shall meet the corresponding absolute accuracy requirements in Table 6.7.1.1.2.5-2.

**Table 6.7.1.1.2.5-1: Same as Table 6.7.1.1.1.5-1 with the following exceptions:**

Parameter			Unit	Test 1		Test 2		Test 3	
				Cell 1	Cell 2	Cell 1	Cell 2	Cell 1	Cell 2
$N_{oc}$ <sup>Note2</sup>	Config 1,2	Depending on band group	dBm/15Kh Z	-106		-88		$-116 + \Delta_{BG\_offset}$	
	Config 3	Depending on band group		N/A <sup>Note 6</sup>		-94		$-116 + \Delta_{BG\_offset}$	
$N_{oc}$ <sup>Note2</sup>	Config 1,2		dBm/SCS	Same as Noc/15kHz		Same as Noc/15kHz		Same as Noc/15kHz	
	Config 3,6	Depending on band group		N/A <sup>Note 6</sup>		-91		$-113 + \Delta_{BG\_offset}$	
$\hat{E}_s / I_{ot}$			dB	1.88	-4.97	1.88	-4.97	-0.01	-4.76
$\hat{E}_s / N_{oc}$			dB	6	2	6	2	3	0
SS-RSRP <sup>Not e3</sup>	Config 1,2	Depending on band group	dBm/SCS	-100	-104	-82	-86	$-113 + \Delta_{BG\_offset}$	$-116 + \Delta_{BG\_offset}$
	Config 3	Depending on band group		N/A <sup>Note 6</sup>	N/A <sup>Note 6</sup>	-85	-89	$-110 + \Delta_{BG\_offset}$	$-113 + \Delta_{BG\_offset}$
$I_o$ <sup>Note3</sup>	Config 1,2	Depending on band group	dBm/9.36MHz	-70.05		-52.05		$-82.20 + \Delta_{BG\_offset}$	
	Config 3	Depending on band group	dBm/38.16MHz	N/A <sup>Note 6</sup>		-51.77		$-75.93 + \Delta_{BG\_offset}$	

**Table 6.7.1.1.2.5-2: SS-RSRP Intra frequency relative accuracy requirements for the reported values**

	Test 1	Test 2	Test 3
	All bands	All bands	All bands
Normal Conditions			
Lowest reported value (Cell 2)	RSRP_x - 8	RSRP_x - 8	RSRP_x - 7
Highest reported value (Cell 2)	RSRP_x - 1	RSRP_x - 1	RSRP_x + 1
Extreme Conditions			
Lowest reported value (Cell 2)	RSRP_x - 8	RSRP_x - 8	RSRP_x - 7
Highest reported value (Cell 2)	RSRP_x - 1	RSRP_x - 1	RSRP_x + 1
RSRP_x is the reported value of Cell 1			

For the test to pass, the ratio of successful reported values in each test shall be more than 90% with a confidence level of 95%.

6.7.1.2 Inter-frequency measurements

6.7.1.2.1 NR SA FR1-FR1 SS-RSRP absolute measurement accuracy

6.7.1.2.1.1 Test purpose

The purpose of this test is to verify that the inter-frequency SS-RSRP absolute measurement accuracy is within the specified limits for all bands.

## 6.7.1.2.1.2 Test applicability

This test applies to all types of NR UE from Release 15 onwards.

## 6.7.1.2.1.3 Minimum conformance requirements

The minimum conformance requirements are specified in clause 6.7.1.0.3.

The normative reference for this requirement is TS 38.133 [6] clause A.6.7.1.2.

## 6.7.1.2.1.4 Test description

## 6.7.1.2.1.4.1 Initial conditions

This test shall be tested using any of the test configurations in Table 6.7.1.2.1.4.1-1.

**Table 6.7.1.2.1.4.1-1: NR SA FR1-FR1 SS-RSRP measurement accuracy supported test configurations**

Test Case ID	Description
6.7.1.2.1-1	NR: 15 kHz SSB SCS, 10MHz bandwidth, FDD
6.7.1.2.1-2	NR: 15 kHz SSB SCS, 10MHz bandwidth, TDD
6.7.1.2.1-3	NR: 30 kHz SSB SCS, 40MHz bandwidth, TDD

Note: The UE is only required to be tested in one of the supported test configurations

Configure the test equipment and the DUT according to the parameters in Table 6.7.1.2.1.4.1-2.

**Table 6.7.1.2.1.4.1-2: Initial conditions for SS-RSRP inter frequency absolute accuracy in FR1**

Parameter	Value		Comment
Test environment	NC, TL/VL, TL/VH, TH/VL, TH/VH		As specified in TS 38.508-1 [14] clause 4.1.
Test frequencies	As specified in Annex E, Table E.4-1 and TS 38.508-1 [14] clause 4.3.1.		
Channel bandwidth	As specified by the test configuration selected from Table 6.7.1.2.1.4.1-1.		
Propagation conditions	AWGN		As specified in Annex C.2.2.
Connection Diagram	TE Part 2Rx	A.3.1.8.2 with $n = 2$ and $\phi_1 = 5$ Hz	As specified in TS 38.508-1 [14] Annex A.
	TE Part 4Rx	A.3.1.8.5 with $n = 2$ and $\phi_{1,1} = 5$ Hz, $\phi_{1,2} = 10$ Hz, $\phi_{1,3} = 15$ Hz	
	DUT Part 2Rx	A.3.2.3.4	
	DUT Part 4Rx	A.3.2.5.2	
Exceptions to connection diagram	- Without the LTE link		

1. Message contents are defined in clause 6.7.1.2.1.4.3.

2. Cell 1 is the NR FR1 serving cell (PCell) and Cell 2 is the NR neighbour in a different FR1 frequency and the target cell for SS-RSRP measurements. The connection setup is done according to the settings in Annex C.1.1 and C.1.2.

## 6.7.1.2.1.4.2 Test procedure

Same as in clause 6.7.1.1.1.4.2 but replacing Table 6.7.1.1.1.5-1 and 6.7.1.1.1.5-2 with 6.7.1.2.1.5-1 and 6.7.1.2.1.5-2, respectively.

## 6.7.1.2.1.4.3 Message contents

Message contents are according to TS 38.508-1 [14] clause 7.3 with the following exceptions:



**Table 6.7.1.2.1.4.3-1: Common Exception messages for NR SA FR1-FR1 SS-RSRP absolute measurement accuracy**

Default Message Contents	
Common contents of system information blocks exceptions	
Default RRC messages and information elements contents exceptions	Table H.3.1-1 Table H.3.1-2 with condition INTER-FREQ and GAP NEEDED Table H.3.1-5 Table H.3.1-7 with condition INTER-FREQ Table H.3.1-6 with condition Pattern #0
Specific message contents exceptions for Test Configuration 6.7.1.2.1-1	Table H.3.1-3 with Conditions INTER-FREQ MO, SSB.1 FR1 Table 7.3.1-3 in TS 38.508-1 [14] with condition SMTC.2
Specific message contents exceptions for Test Configuration 6.7.1.2.1-2	Table H.3.1-3 with Conditions INTER-FREQ MO, SSB.1 FR1 and Synchronous cells Table 7.3.1-3 in TS 38.508-1 [14] with condition SMTC.1
Specific message contents exceptions for Test Configuration 6.7.1.2.1-3	Table H.3.1-3 with Conditions INTER-FREQ MO, SSB.2 FR1 and Synchronous cells Table 7.3.1-3 in TS 38.508-1 [14] with condition SMTC.1

**Table 6.7.1.2.1.4.3-2: ReportConfigNR-DEFAULT(Periodical) for NR SA FR1 SS-RSRP Accuracy**

Derivation Path: 38.508-1 [14] Table 4.6.3-142 with condition PERIODICAL			
Information Element	Value/remark	Comment	Condition
ReportConfigNR ::= SEQUENCE {			
reportType CHOICE {			
periodical SEQUENCE {			PERIODICAL
reportQuantityCell SEQUENCE {			
rsrq	false		
sinr	false		
}			
maxReportCells	2		
}			
}			
}			

6.7.1.2.1.5 Test requirement

Table 6.7.1.2.1.5-1 defines the primary level settings including test tolerances for all tests.

Each SS-RSRP measurement report for each of the tests in Table 6.7.1.2.1.5-1 shall meet the corresponding absolute accuracy requirements in Table 6.7.1.2.1.5-2 for test configurations 1 and 2, and the corresponding absolute accuracy requirements in Table 6.7.1.2.1.5-3 for test configuration 3.

**Table 6.7.1.2.1.5-1: SS-RSRP inter-frequency test parameters**

Parameter	Config	Unit	Test 1		Test 2		
			Cell 1	Cell 2	Cell 1	Cell 2	
SSB ARFCN	1~3		freq1	freq2	freq1	freq2	
BW <sub>channel</sub>	1	MHz	10: N <sub>RB,c</sub> = 52		10: N <sub>RB,c</sub> = 52		
	2		10: N <sub>RB,c</sub> = 52		10: N <sub>RB,c</sub> = 52		
	3		40: N <sub>RB,c</sub> = 106		40: N <sub>RB,c</sub> = 106		
Gap pattern ID			0		0		
Duplex mode	1		FDD		FDD		
	2		TDD		TDD		
	3		TDD		TDD		
TDD configuration	1		N/A		N/A		
	2		TDDConf.1.1		TDDConf.1.1		
	3		TDDConf.2.1		TDDConf.2.1		
PDSCH Reference measurement channel	1		SR.1.1 FDD	-	SR.1.1 FDD	-	
	2		SR.1.1 TDD		SR.1.1 TDD		
	3		SR.2.1 TDD		SR.2.1 TDD		
RMSI CORESET Reference Channel	1		CR.1.1 FDD	-	CR.1.1 FDD	-	
	2		CR.1.1 TDD		CR.1.1 TDD		
	3		CR.2.1 TDD		CR.2.1 TDD		
Dedicated CORESET Reference Channel	1		CCR.1.1 FDD	-	CCR.1.1 FDD	-	
	2		CCR.1.1 TDD		CCR.1.1 TDD		
	3		CCR.2.1 TDD		CCR.2.1 TDD		
SSB configuration	1		SSB.1 FR1		SSB.1 FR1		
	2		SSB.1 FR1		SSB.1 FR1		
	3		SSB.2 FR1		SSB.2 FR1		
OCNG Patterns	1~3		OP.1		OP.1		
TRS configuration	1		TRS.1.1 FDD	-	TRS.1.1 FDD	-	
	2		TRS.1.1 TDD		TRS.1.1 TDD		
	3		TRS.1.2 TDD		TRS.1.2 TDD		
Initial BWP Configuration	1~3		DLBWP.0.1 ULBWP.0.1		DLBWP.0.1 ULBWP.0.1		
Dedicated BWP configuration	1~3		DLBWP.1.1 ULBWP.1.1		DLBWP.1.1 ULBWP.1.1		
SMTC configuration	1		SMTC.2		SMTC.2		
	2,3		SMTC.1		SMTC.1		
Time offset between Cell 2 and Cell 3	1	ms	3		3		
	2,3	µs	3		3		
EPRE ratio of PSS to SSS	1~3	dB	0	0	0	0	
EPRE ratio of PBCH DMRS to SSS							
EPRE ratio of PBCH to PBCH DMRS							
EPRE ratio of PDCCH DMRS to SSS							
EPRE ratio of PDCCH to PDCCH DMRS							
EPRE ratio of PDSCH DMRS to SSS							
EPRE ratio of PDSCH to PDSCH DMRS							
EPRE ratio of OCNG DMRS to SSS <sup>Note 1</sup>							
EPRE ratio of OCNG to OCNG DMRS <sup>Note 1</sup>							
N <sub>oc</sub> <sup>Note 2</sup>							Depending on band group

$N_{oc}$ <sup>Note2</sup>	Depending on band group	3	dBm/15 kHz	-96	-96	( $N_{oc}$ for Cell 2 +8dB) + $\Delta_{BG\_offset}$	-115+ $\Delta_{BG\_offset}$
$N_{oc}$ <sup>Note2</sup>	Depending on band group	1,2	dBm/SS B SCS	-94.65	-94.65	( $N_{oc}$ for Cell 2 +8dB) + $\Delta_{BG\_offset}$	-115+ $\Delta_{BG\_offset}$
	Depending on band group	3		-93	-93	( $N_{oc}$ for Cell 2 +8dB) + $\Delta_{BG\_offset}$	- 112.00+ $\Delta_{BG\_offset}$
$\hat{E}_s/I_{ot}$		1~3	dB	10	10	13	-3
SS-RSRP <sup>Note3</sup>	Depending on band group	1,2,	dBm/SC S	-84.65	-84.65	(RSRP for Cell 2 +25dB) + $\Delta_{BG\_offset}$	- 118.00+ $\Delta_{BG\_offset}$
	Depending on band group	3		-83	-83	(RSRP for Cell 2 +25dB) + $\Delta_{BG\_offset}$	- 115.00+ $\Delta_{BG\_offset}$
$I_o$ <sup>Note3</sup>	Depending on band group	1,2	dBm/9.36MHz	56.28	56.28	( $I_o$ for Channel 2 +19.75dB) + $\Delta_{BG\_offset}$	-85.28+ $\Delta_{BG\_offset}$
	Depending on band group	3	dBm/38.16MHz	-51.53	-51.53	( $I_o$ for Channel 2 +19.75dB) + $\Delta_{BG\_offset}$	-79.19+ $\Delta_{BG\_offset}$
$\hat{E}_s/N_{oc}$		1~3	dB	10	10	13	-3
Propagation condition		1~3	-	AWGN		AWGN	
Antenna configuration				1x2		1x2	
<p>Note 1: OCNG shall be used such that both cells are fully allocated and a constant total transmitted power spectral density is achieved for all OFDM symbols.</p> <p>Note 2: Interference from other cells and noise sources not specified in the test is assumed to be constant over subcarriers and time and shall be modelled as AWGN of appropriate power for <math>N_{oc}</math> to be fulfilled.</p> <p>Note 3: RSRP and <math>I_o</math> levels have been derived from other parameters for information purposes. They are not settable parameters themselves.</p> <p>Note 4: RSRP minimum requirements are specified assuming independent interference and noise at each receiver antenna port.</p> <p>Note 5: The test configuration excludes support for band n51 and it is not required to run this test on band n51 in this release of the specification.</p> <p>Note 6: <math>\Delta_{BG\_offset}</math> is defined in clause 3A.4, Table 3A.4.1-2.</p>							

**Table 6.7.1.2.1.5-2: SS-RSRP Inter frequency absolute accuracy requirements for the reported values for test configurations 1, 2, 4 and 5**

Normal Conditions	Test 1 All bands	Test 2	
Lowest reported value (Cell 2)	62	Bands NR_FDD_FR1_A, NR_TDD_FR1_A	32
		Bands NR_FDD_FR1_B	33
		Bands NR_TDD_FR1_C	33
		Bands NR_FDD_FR1_D, NR_TDD_FR1_D	34
		Bands NR_FDD_FR1_E, NR_TDD_FR1_E	34
		Bands NR_FDD_FR1_G	35
		Bands NR_FDD_FR1_H	36
Highest reported value (Cell 2)	81	Bands NR_FDD_FR1_A, NR_TDD_FR1_A	45
		Bands NR_FDD_FR1_B	45
		Bands NR_TDD_FR1_C	46
		Bands NR_FDD_FR1_D, NR_TDD_FR1_D	46
		Bands NR_FDD_FR1_E, NR_TDD_FR1_E	47
		Bands NR_FDD_FR1_G	48
		Bands NR_FDD_FR1_H	48
Extreme Conditions	Test 1 All bands	Test 2	
Lowest reported value (Cell 2)	59	Bands NR_FDD_FR1_A, NR_TDD_FR1_A	28
		Bands NR_FDD_FR1_B	28
		Bands NR_TDD_FR1_C	29
		Bands NR_FDD_FR1_D, NR_TDD_FR1_D	29
		Bands NR_FDD_FR1_E, NR_TDD_FR1_E	30
		Bands NR_FDD_FR1_G	31
		Bands NR_FDD_FR1_H	31
Highest reported value (Cell 2)	84	Bands NR_FDD_FR1_A, NR_TDD_FR1_A	49
		Bands NR_FDD_FR1_B	50
		Bands NR_TDD_FR1_C	50
		Bands NR_FDD_FR1_D, NR_TDD_FR1_D	51
		Bands NR_FDD_FR1_E, NR_TDD_FR1_E	51
		Bands NR_FDD_FR1_G	52
		Bands NR_FDD_FR1_H	53

Note 1: NR operating band groups are defined in clause 3A.4, Table 3A.4.1-2.

**Table 6.7.1.2.1.5-3: SS-RSRP Inter frequency absolute accuracy requirements for the reported values for test configurations 3 and 6**

Normal Conditions	Test 1 All bands	Test 2	
Lowest reported value (Cell 2)	64	Bands NR_FDD_FR1_A, NR_TDD_FR1_A	35
		Bands NR_FDD_FR1_B	36
		Bands NR_TDD_FR1_C	36
		Bands NR_FDD_FR1_D, NR_TDD_FR1_D	37
		Bands NR_FDD_FR1_E, NR_TDD_FR1_E	37
		Bands NR_FDD_FR1_G	38
		Bands NR_FDD_FR1_H	39
Highest reported value (Cell 2)	83	Bands NR_FDD_FR1_A, NR_TDD_FR1_A	48
		Bands NR_FDD_FR1_B	48
		Bands NR_TDD_FR1_C	49
		Bands NR_FDD_FR1_D, NR_TDD_FR1_D	49
		Bands NR_FDD_FR1_E, NR_TDD_FR1_E	50
		Bands NR_FDD_FR1_G	51
		Bands NR_FDD_FR1_H	51
Extreme Conditions	Test 1 All bands	Test 2	
Lowest reported value (Cell 2)	61	Bands NR_FDD_FR1_A, NR_TDD_FR1_A	31
		Bands NR_FDD_FR1_B	31
		Bands NR_TDD_FR1_C	32
		Bands NR_FDD_FR1_D, NR_TDD_FR1_D	32
		Bands NR_FDD_FR1_E, NR_TDD_FR1_E	33
		Bands NR_FDD_FR1_G	34
		Bands NR_FDD_FR1_H	34
Highest reported value (Cell 2)	86	Bands NR_FDD_FR1_A, NR_TDD_FR1_A	52
		Bands NR_FDD_FR1_B	53
		Bands NR_TDD_FR1_C	53
		Bands NR_FDD_FR1_D, NR_TDD_FR1_D	54
		Bands NR_FDD_FR1_E, NR_TDD_FR1_E	54
		Bands NR_FDD_FR1_G	55
		Bands NR_FDD_FR1_H	56

Note 1: NR operating band groups are defined in clause 3A.4, Table 3A.4.1-2

For the test to pass, the ratio of successful reported values in each test shall be more than 90% with a confidence level of 95%.

**6.7.1.2.2 NR SA FR1-FR1 SS-RSRP relative measurement accuracy**

**6.7.1.2.2.1 Test purpose**

The purpose of this test is to verify that the inter-frequency SS-RSRP absolute measurement accuracy is within the specified limits for all bands.

**6.7.1.2.2.2 Test applicability**

This test applies to all types of NR UE from Release 15 onwards.

**6.7.1.2.2.3 Minimum conformance requirements**

The minimum conformance requirements are specified in clause 6.7.1.0.4.

The normative reference for this requirement is TS 38.133 [6] clause A.6.7.1.2.

#### 6.7.1.2.2.4 Test description

##### 6.7.1.2.2.4.1 Initial conditions

This test shall be tested using any of the test configurations in Table 6.7.1.2.2.4.1-1.

**Table 6.7.1.2.2.4.1-1: NR SA FR1-FR1 SS-RSRP relative measurement accuracy supported test configurations**

Test Case ID	Description
6.7.1.2.2-1	NR: 15 kHz SSB SCS, 10MHz bandwidth, FDD
6.7.1.2.2-2	NR: 15 kHz SSB SCS, 10MHz bandwidth, TDD
6.7.1.2.2-3	NR: 30 kHz SSB SCS, 40MHz bandwidth, TDD
Note: The UE is only required to be tested in one of the supported test configurations	

Configure the test equipment and the DUT according to the parameters in Table 6.7.1.2.2.4.1-2.

**Table 6.7.1.2.2.4.1-2: Initial conditions for SS-RSRP inter frequency relative accuracy in FR1**

Parameter	Value		Comment
Test environment	NC, TL/VL, TL/VH, TH/VL, TH/VH		As specified in TS 38.508-1 [14] clause 4.1.
Test frequencies	As specified in Annex E, Table E.4-1 and TS 38.508-1 [14] clause 4.3.1.		
Channel bandwidth	As specified by the test configuration selected from Table 6.7.1.2.2.4.1-1.		
Propagation conditions	AWGN		As specified in Annex C.2.2.
Connection Diagram	TE Part 2Rx	A.3.1.8.2 with $n = 2$ and $\phi_1 = 5$ Hz	As specified in TS 38.508-1 [14] Annex A.
	TE Part 4Rx	A.3.1.8.5 with $n = 2$ and $\phi_{1,1} = 5$ Hz, $\phi_{1,2} = 10$ Hz, $\phi_{1,3} = 15$ Hz	
	DUT Part 2Rx	A.3.2.3.4	
	DUT Part 4Rx	A.3.2.5.2	
Exceptions to connection diagram	- Without the LTE link		

1. Message contents are defined in clause 6.7.1.2.2.4.3.

2. Cell 1 is the NR FR1 serving cell (PCell) and Cell 2 is the NR neighbour in a different FR1 frequency and the target cell for SS-RSRP measurements. The connection setup is done according to the settings in Annex C.1.1 and C.1.2.

##### 6.7.1.2.2.4.2 Test procedure

Same as in clause 6.7.1.1.2.4.2 but replacing Table 6.7.1.1.2.5-1 and 6.7.1.1.2.5-2 with 6.7.1.2.2.5-1 and 6.7.1.2.2.5-2, respectively.

##### 6.7.1.2.2.4.3 Message contents

Message contents are same as in Clause 6.7.1.2.1.4.3.

##### 6.7.1.2.2.5 Test requirement

Table 6.7.1.2.2.5-1 defines the primary level settings including test tolerances for all tests.

Each SS-RSRP measurement report for each of the tests in Table 6.7.1.2.2.5-1 shall meet the corresponding absolute accuracy requirements in Table 6.7.1.2.2.5-2.

**Table 6.7.1.2.2.5-1: same as Table 6.7.1.2.1.5-1****Table 6.7.1.2.2.5-2: SS-RSRP Intra frequency relative accuracy requirements for the reported values**

	<b>Test 1</b>	<b>Test 2</b>
	All bands	All bands
Normal Conditions		
Lowest reported value (Cell 2)	SS-RSRP <sub>x</sub> - 7	SS-RSRP <sub>x</sub> - 31
Highest reported value (Cell 2)	SS-RSRP <sub>x</sub> + 7	SS-RSRP <sub>x</sub> - 18
Extreme Conditions		
Lowest reported value (Cell 2)	SS-RSRP <sub>x</sub> - 9	SS-RSRP <sub>x</sub> - 33
Highest reported value (Cell 2)	SS-RSRP <sub>x</sub> + 9	SS-RSRP <sub>x</sub> - 17
SS-RSRP <sub>x</sub> is the reported value of Cell 1		

For the test to pass, the ratio of successful reported values in each test shall be more than 90% with a confidence level of 95%.

## 6.7.2 SS-RSRQ

### 6.7.2.0 Minimum conformance requirements

#### 6.7.2.0.1 Intra-frequency SS-RSRQ measurement accuracy requirements

Same as in clause 4.7.2.0.1.

#### 6.7.2.0.2 Inter-frequency SS-RSRQ absolute measurement accuracy requirements

Same as in clause 4.7.2.0.2.

#### 6.7.2.0.3 Inter-frequency SS-RSRQ relative measurement accuracy requirements

Same as in clause 4.7.2.0.3.

### 6.7.2.1 NR SA FR1 SS-RSRQ measurement accuracy

#### 6.7.2.1.1 Test purpose

The purpose of this test is to verify that the intra-frequency SS-RSRQ measurement accuracy is within the specified limits for all bands.

#### 6.7.2.1.2 Test applicability

This test applies to all types of NR UE from Release 15 onwards.

#### 6.7.2.1.3 Minimum conformance requirements

The minimum conformance requirements are specified in clause 6.7.2.0.1.

The normative reference for this requirement is TS 38.133 [6] clause A.6.7.2.1.

#### 6.7.2.1.4 Test description

##### 6.7.2.1.4.1 Initial conditions

This test shall be tested using any of the test configurations in Table 6.7.2.1.4.1-1.

**Table 6.7.2.1.4.1-1: NR SA FR1 SS-RSRQ measurement accuracy supported test configurations**

<b>Test Case ID</b>	<b>Description</b>
6.7.2.1-1	NR: 15 kHz SSB SCS, 10MHz bandwidth, FDD
6.7.2.1-2	NR: 15 kHz SSB SCS, 10MHz bandwidth, TDD
6.7.2.1-3	NR: 30 kHz SSB SCS, 40MHz bandwidth, TDD
Note: The UE is only required to be tested in one of the supported test configurations	

Configure the test equipment and the DUT according to the parameters in Table 6.7.2.1.4.1-2.



**Table 6.7.2.1.4.1-2: Initial conditions for SS-RSRQ intra frequency accuracy in FR1**

Parameter	Value		Comment
Test environment	NC, TL/VL, TL/VH, TH/VL, TH/VH		As specified in TS 38.508-1 [14] clause 4.1.
Test frequencies	As specified in Annex E, Table E.4-1 and TS 38.508-1 [14] clause 4.3.1.		
Channel bandwidth	As specified by the test configuration selected from Table 6.7.2.1.4.1-1.		
Propagation conditions	AWGN		As specified in Annex C.2.2.
Connection Diagram	TE Part 2Rx	A.3.1.8.2 with $n = 2$ and $\varphi_1 = 5$ Hz	As specified in TS 38.508-1 [14] Annex A.
	TE Part 4Rx	A.3.1.8.5 with $n = 2$ and $\varphi_{1,1} = 5$ Hz, $\varphi_{1,2} = 10$ Hz, $\varphi_{1,3} = 15$ Hz	
	DUT Part 2Rx	A.3.2.3.4	
	DUT Part 4Rx	A.3.2.5.2	
Exceptions to connection diagram	- Without the LTE link		

1. Message contents are defined in clause 6.7.2.1.4.3.

2. Cell 1 is the NR serving cell (PCell). The power levels and settings for Cell 1 are set according to Annex A.6. Cell 2 is an NR FR1 cell in the same frequency as Cell 1. Cell 2 is the target cell for SS-RSRQ measurements. The connection setup is done according to the settings in Annex C.1.3.

#### 6.7.2.1.4.2 Test procedure

1. Ensure the UE is in state RRC\_CONNECTED with generic procedure parameters Connectivity *NR*, Connected without release *On* and Test Mode *On* according to TS 38.508-1 [14] clause 4.5.
2. Set the parameters according to Table 6.7.2.1.5-1 as appropriate.
3. The SS shall transmit an RRCReconfiguration message on Cell 1.
4. The UE shall transmit an RRCReconfigurationComplete message.
5. The UE shall transmit periodically MeasurementReport messages.
6. After 10s wait from Step 3, the SS shall check the SS-RSRQ reported values in the periodic MeasurementReport. The SS-RSRQ value of Cell 2 reported by the UE is compared to the expected SS-RSRQ. If the value is outside the limits in Table 6.7.2.1.5-2 or the UE fails to report the measurement value for Cell 2, the number of failed iterations is increased by one. Otherwise, the number of passed iterations is increased by one.
7. The SS shall continue checking the MeasurementReport messages transmitted by the UE until the confidence level according to Table G.2.3-1 in Annex G is achieved.
8. Set the parameters according to each sub-test in Table 6.7.2.1.5-1 as appropriate and repeat steps 5-7.

#### 6.7.2.1.4.3 Message contents

Message contents are according to TS 38.508-1 [14] clause 7.3 with the following exceptions:

**Table 6.7.2.1.4.3-1: Common Exception messages for NR SA FR1 SS-RSRQ measurement accuracy**

Default Message Contents	
Common contents of system information blocks exceptions	
Default RRC messages and information elements contents exceptions	Table H.3.1-1 Table H.3.1-2 Table H.3.1-5 Table H.3.1-7
Specific message contents exceptions for Test Configuration 6.7.2.1-1	Table H.3.1-3 with Condition SSB.1 FR1 Table 7.3.1-3 in TS 38.508-1 [14] with condition SMTC.2
Specific message contents exceptions for Test Configuration 6.7.2.1-2	Table H.3.1-3 with Condition SSB.1 FR1 and Synchronous cells Table 7.3.1-3 in TS 38.508-1 [14] with condition SMTC.1
Specific message contents exceptions for Test Configuration 6.7.2.1-3	Table H.3.1-3 with Condition SSB.2 FR1 and Synchronous cells Table 7.3.1-3 in TS 38.508-1 [14] with condition SMTC.1

**Table 6.7.2.1.4.3-2: ReportConfigNR-DEFAULT(Periodical) for NR SA FR1 SS-RSRQ Accuracy**

Derivation Path: 38.508-1 [14] Table 4.6.3-142 with condition PERIODICAL			
Information Element	Value/remark	Comment	Condition
ReportConfigNR ::= SEQUENCE {			
reportType CHOICE {			
periodical SEQUENCE {			PERIODICAL
reportQuantityCell SEQUENCE {			
rsrp	false		
sinr	false		
}			
maxReportCells	2		
}			
}			
}			

6.7.2.1.5 Test requirement

Table 6.7.2.1.5-1 defines the primary level settings including test tolerances for all tests.

Each SS-RSRQ measurement report for each of the tests in Table 6.7.2.1.5-1 shall meet the corresponding absolute accuracy requirements in Table 6.7.2.1.5-2.

**Table 6.7.2.1.5-1: SS-RSRQ Intra frequency test parameters**

Parameter		Unit	Test 1		Test 2		Test 3	
			Cell 1	Cell 2	Cell 1	Cell 2	Cell 1	Cell 2
SSB ARFCN			freq1		freq1		freq1	
Duplex mode	Config 1		FDD					
	Config 2,3		TDD					
TDD configuration	Config 1		Not Applicable					
	Config 2		TDDConf.1.1					
	Config 3		TDDConf.2.1					
BW <sub>channel</sub>	Config 1	MHz	10: N <sub>RB,c</sub> = 52					
	Config 2		10: N <sub>RB,c</sub> = 52					
	Config 3		40: N <sub>RB,c</sub> = 106					
BWP configuration	Initial DL BWP		DLBWP.0.1					
	Dedicated DL BWP		DLBWP.1.1					
	Initial UL BWP		ULBWP.0.1					
	Dedicated UL BWP		ULBWP.1.1					
DRX Cycle		ms	Not Applicable					
	Config 1		SR.1.1 FDD	-	SR.1.1 FDD	-	SR.1.1 FDD	-

PDSCH Reference measurement channel	Config 2		SR.1.1 TDD		SR.1.1 TDD		SR.1.1 TDD		
	Config 3		SR2.1 TDD		SR2.1 TDD		SR2.1 TDD		
RMSI CORESET Reference Channel	Config 1		CR.1.1 FDD		CR.1.1 FDD		CR.1.1 FDD		
	Config 2		CR.1.1 TDD		CR.1.1 TDD		CR.1.1 TDD		
	Config 3		CR.2.1 TDD		CR.2.1 TDD		CR.2.1 TDD		
Control Channel RMC	Config 1		CCR.1.1 FDD		CCR.1.1 FDD		CCR.1.1 FDD		
	Config 2		CCR.1.1 TDD		CCR.1.1 TDD		CCR.1.1 TDD		
	Config 3		CCR.2.1 TDD		CCR.2.1 TDD		CCR.2.1 TDD		
TRS Configuration	Config 1		TRS.1.1 FDD		TRS.1.1 FDD		TRS.1.1 FDD		
	Config 2		TRS.1.1 TDD		TRS.1.1 TDD		TRS.1.1 TDD		
	Config 3		TRS.1.2 TDD		TRS.1.2 TDD		TRS.1.2 TDD		
OCNG Patterns			OP.1						
SS-RSSI-Measurement			Not Applicable						
Time offset with Cell 1	Config 2, 3	μs	-	3	-	3	-	3	
	Config 1	ms	-	3	-	3	-	3	
SMTc configuration	Config 2, 3		SMTc.1						
	Config 1		SMTc.2						
SSB configuration	Config 1,2		SSB.1 FR1						
	Config 3		SSB.2 FR1						
PDSCH/PDCCH subcarrier spacing	Config 1,2	kHz	15 kHz						
	Config 3		30kHz						
EPRE ratio of PSS to SSS		dB	0	0	0	0	0	0	
EPRE ratio of PBCH DMRS to SSS									
EPRE ratio of PBCH to PBCH DMRS									
EPRE ratio of PDCCH DMRS to SSS									
EPRE ratio of PDCCH to PDCCH DMRS									
EPRE ratio of PDSCH DMRS to SSS									
EPRE ratio of PDSCH to PDSCH									
EPRE ratio of OCNG DMRS to SSS(Note 1)									
EPRE ratio of OCNG to OCNG DMRS (Note 1)									
$N_{oc}$ Note2	Config 1,2	Depending on band group	dBm/15k Hz	-86.5		-101		-114+ $\Delta_{BG\_offset}$	
	Config 3	Depending on band group		-92.6		-		-114+ $\Delta_{BG\_offset}$	
$N_{oc}$ Note2	Config 1,2	Depending on band group	dBm/SC S	-86.5		-101		-114+ $\Delta_{BG\_offset}$	
	Config 3	Depending on band group		-89.6		-		-111+ $\Delta_{BG\_offset}$	
$\hat{E}_s / I_{ot}$			dB	-1.76		-4.7		-5.46	-5.46
$\hat{E}_s / N_{oc}$			dB	3	3	-2.9	-2.9	-4	-4
SS-RSRP Note3	Config 1,2	Depending on band group	dBm/SC S	-83.5	-83.5	-103.9	-103.9	-	-118+ $\Delta_{BG\_offset}$
	Config 3	Depending on band group		-86.6	-86.6	-	-	-115+ $\Delta_{BG\_offset}$	-115+ $\Delta_{BG\_offset}$
SS-RSRQ Note3			dB	-14.77	-14.77	-16.76	-16.76	-17.34	-17.34
$I_o$ Note3	Config 1,2	Depending on band group	dBm/9.36MHz	-51.57		-70		-83.28+ $\Delta_{BG\_offset}$	
	Config 3	Depending on band group	dBm/38.16M Hz	-51.56		-		-76.67+ $\Delta_{BG\_offset}$	
Propagation condition			-	AWGN	AWGN	AWGN	AWGN	AWGN	AWGN

Antenna configuration		1x2	1x2	1x2	1x2	1x2	1x2
Note 1:	OCNG shall be used such that both cells are fully allocated and a constant total transmitted power spectral density is achieved for all OFDM symbols.						
Note 2:	Interference from other cells and noise sources not specified in the test is assumed to be constant over subcarriers and time and shall be modelled as AWGN of appropriate power for $N_{oc}$ to be fulfilled.						
Note 3:	SS-RSRQ, SS-RSRP, and $I_o$ levels have been derived from other parameters for information purposes. They are not settable parameters themselves.						
Note 4:	SS-RSRQ, SS-RSRP minimum requirements are specified assuming independent interference and noise at each receiver antenna port.						
Note 5:	$\Delta_{BG\_offset}$ is defined in clause 3A.4, Table 3A.4.1-2.						
Note 6:	Subtest 2 is not used when testing with 30kHz SSB SCS.						
Note 7:	The test configuration excludes support for band n51 and it is not required to run this test on band n51 in this release of the specification.						

**Table 6.7.2.1.5-2: SS-RSRQ Intra frequency absolute accuracy requirements for the reported values**

	Test 1	Test 2	Test 3
	All bands	All bands	All bands
Normal Conditions			
Lowest reported value (Cell 2)	SS-RSRQ_52	SS-RSRQ_46	SS-RSRQ_44
Highest reported value (Cell 2)	SS-RSRQ_62	SS-RSRQ_60	SS-RSRQ_59
Extreme Conditions			
Lowest reported value (Cell 2)	SS-RSRQ_49	SS-RSRQ_45	SS-RSRQ_43
Highest reported value (Cell 2)	SS-RSRQ_65	SS-RSRQ_61	SS-RSRQ_60

For the test to pass, the ratio of successful reported values in each test shall be more than 90% with a confidence level of 95%.

### 6.7.2.2 Inter-Frequency SS-RSRQ measurement accuracy

#### 6.7.2.2.1 NR SA FR1-FR1 SS-RSRQ absolute measurement accuracy

##### 6.7.2.2.1.1 Test purpose

The purpose of this test is to verify that the inter-frequency SS-RSRQ absolute measurement accuracy is within the specified limits for all bands.

##### 6.7.2.2.1.2 Test applicability

This test applies to all types of NR UE from Release 15 onwards.

##### 6.7.2.2.1.3 Minimum conformance requirements

The minimum conformance requirements are specified in clause 6.7.2.0.2.

The normative reference for this requirement is TS 38.133 [6] clause A.6.7.2.2.1.

##### 6.7.2.2.1.4 Test description

###### 6.7.2.2.1.4.1 Initial conditions

This test shall be tested using any of the test configurations in Table 6.7.2.2.1.4.1-1.

**Table 6.7.2.2.1.4.1-1: NR SA FR1-FR1 SS-RSRQ measurement accuracy supported test configurations**

Test Case ID	Description
6.7.2.2.1-1	NR: 15 kHz SSB SCS, 10MHz bandwidth, FDD
6.7.2.2.1-2	NR: 15 kHz SSB SCS, 10MHz bandwidth, TDD
6.7.2.2.1-3	NR: 30 kHz SSB SCS, 40MHz bandwidth, TDD
Note: The UE is only required to be tested in one of the supported test configurations	

Configure the test equipment and the DUT according to the parameters in Table 6.7.2.2.1.4.1-2.

**Table 6.7.2.2.1.4.1-2: Initial conditions for SS-RSRQ inter frequency accuracy in FR1**

Parameter	Value		Comment
Test environment	NC, TL/VL, TL/VH, TH/VL, TH/VH		As specified in TS 38.508-1 [14] clause 4.1.
Test frequencies	As specified in Annex E, Table E.4-1 and TS 38.508-1 [14] clause 4.3.1.		
Channel bandwidth	As specified by the test configuration selected from Table 6.7.2.2.1.4.1-1.		
Propagation conditions	AWGN		As specified in Annex C.2.2.
Connection Diagram	TE Part 2Rx	A.3.1.8.2 with $n = 2$ and $\phi_1 = 5$ Hz	As specified in TS 38.508-1 [14] Annex A.
	TE Part 4Rx	A.3.1.8.5 with $n = 2$ and $\phi_{1,1} = 5$ Hz, $\phi_{1,2} = 10$ Hz, $\phi_{1,3} = 15$ Hz	
	DUT Part 2Rx	A.3.2.3.4	
	DUT Part 4Rx	A.3.2.5.2	
Exceptions to connection diagram	- Without the LTE link		

1. Message contents are defined in clause 6.7.2.2.1.4.3.

2. Cell 1 is the NR serving cell (PCell). The power levels and settings for Cell 1 are set according to Annex A.6. Cell 2 is an NR FR1 cell in the different frequency as Cell 1. Cell 2 is the target cell for SS-RSRQ measurements. The connection setup is done according to the settings in Annex C.1.1.

**6.7.2.2.1.4.2 Test procedure**

Same as in clause 6.7.2.1.1.4.2 but replacing Table 6.7.2.1.1.5-1 and 6.7.2.1.1.5-2 with 6.7.2.2.1.5-1 and 6.7.2.2.1.5-2, respectively.

**6.7.2.2.1.4.3 Message contents**

Message contents are according to TS 38.508-1 [14] clause 7.3 with the following exceptions:

**Table 6.7.2.2.1.4.3-1: Common Exception messages for NR SA FR1-FR1 SS-RSRQ absolute measurement accuracy**

Default Message Contents	
Common contents of system information blocks exceptions	
Default RRC messages and information elements contents exceptions	Table H.3.1-1 Table H.3.1-2 with condition INTER-FREQ and GAP NEEDED Table H.3.1-5 Table H.3.1-7 with condition INTER-FREQ Table H.3.1-6 with condition Pattern #0
Specific message contents exceptions for Test Configuration 6.7.2.2.1-1	Table H.3.1-3 with Conditions INTER-FREQ MO, SSB.1 FR1 Table 7.3.1-3 in TS 38.508-1 [14] with condition SMTC.2
Specific message contents exceptions for Test Configuration 6.7.2.2.1-2	Table H.3.1-3 with Conditions INTER-FREQ MO, SSB.1 FR1 and Synchronous cells Table 7.3.1-3 in TS 38.508-1 [14] with condition SMTC.1
Specific message contents exceptions for Test Configuration 6.7.2.2.1-3	Table H.3.1-3 with Conditions INTER-FREQ MO, SSB.2 FR1 and Synchronous cells Table 7.3.1-3 in TS 38.508-1 [14] with condition SMTC.1

**Table 6.7.2.2.1.4.3-2: ReportConfigNR-DEFAULT(Periodical) for NR SA FR1 SS-RSRQ Accuracy**

Derivation Path: 38.508-1 [14] Table 4.6.3-142 with condition PERIODICAL			
Information Element	Value/remark	Comment	Condition
ReportConfigNR ::= SEQUENCE {			
reportType CHOICE {			
periodical SEQUENCE {			PERIODICAL
reportQuantityCell SEQUENCE {			
rsrp	false		
sinr	false		
}			
maxReportCells	2		
}			
}			
}			

#### 6.7.2.2.1.5 Test requirement

Table 6.7.2.2.1.5-1 defines the primary level settings including test tolerances for all tests.

Each SS-RSRP measurement report for each of the tests in Table 6.7.2.2.1.5-1 shall meet the corresponding absolute accuracy requirements in Table 6.7.2.2.1.5-2.

**Table 6.7.2.2.1.5-1: SS-RSRQ Inter frequency test parameters**

Parameter		Unit	Test 1		Test 2		Test 3	
			Cell 1	Cell 2	Cell 1	Cell 2	Cell 1	Cell 2
SSB ARFCN			freq1	freq2	freq1	freq2	freq1	freq2
Duplex mode	Config 1		FDD					
	Config 2,3		TDD					
TDD configuration	Config 1		Not Applicable					
	Config 2		TDDConf.1.1					
	Config 3		TDDConf.2.1					
BW <sub>channel</sub>	Config 1	MHz	10: N <sub>RB,c</sub> = 52					
	Config 2		10: N <sub>RB,c</sub> = 52					
	Config 3		40: N <sub>RB,c</sub> = 106					
Gap pattern ID			0					
BWP configuration	Initial DL BWP		DLBWP.0.1					
	Dedicated DL BWP		DLBWP.1.1					
	Initial UL BWP		ULBWP.0.1					
	Dedicated UL BWP		ULBWP.1.1					
DRX Cycle		ms	Not Applicable					
PDSCH Reference measurement channel	Config 1		SR.1.1 FDD	-	SR.1.1 FDD	-	SR.1.1 FDD	-
	Config 2		SR.1.1 TDD	-	SR.1.1 TDD	-	SR.1.1 TDD	-
	Config 3		SR2.1 TDD	-	SR2.1 TDD	-	SR2.1 TDD	-
RMSI CORESET Reference Channel	Config 1		CR.1.1 FDD	-	R.1.1 FDD	-	CR.1.1 FDD	-
	Config 2		CR.1.1 TDD	-	CR.1.1 TDD	-	CR.1.1 TDD	-
	Config 3		CR2.1 TDD	-	CR2.1 TDD	-	CR2.1 TDD	-
Dedicated CORESET Reference Channel	Config 1		CCR.1.1 FDD	-	CCR.1.1 FDD	-	CCR.1.1 FDD	-
	Config 2		CCR.1.1 TDD	-	CCR.1.1 TDD	-	CCR.1.1 TDD	-
	Config 3		CCR2.1 TDD	-	CCR2.1 TDD	-	CCR2.1 TDD	-
TRS Configuration	Config 1		TRS.1.1 FDD	-	TRS.1.1 FDD	-	TRS.1.1 FDD	-
	Config 2		TRS.1.1 TDD	-	TRS.1.1 TDD	-	TRS.1.1 TDD	-
	Config 3		TRS.1.2 TDD	-	TRS.1.2 TDD	-	TRS.1.2 TDD	-

OCNG Patterns			OP.1						
Time offset with Cell 1	Config 2, 3		$\mu\text{s}$	3					
	Config 1		ms	3					
SMTC configuration	Config 2, 3			SMTC.1					
	Config 1			SMTC.2					
SSB configuration	Config 1,2			SSB.1 in FR1					
	Config 3			SSB.2 in FR1					
PDSCH/PDCCH subcarrier spacing	Config 1,2		kHz	15 kHz					
	Config 3			30 kHz					
EPRE ratio of PSS to SSS			dB	0	0	0	0	0	0
EPRE ratio of PBCH DMRS to SSS									
EPRE ratio of PBCH to PBCH DMRS									
EPRE ratio of PDCCH DMRS to SSS									
EPRE ratio of PDCCH to PDCCH DMRS									
EPRE ratio of PDSCH DMRS to SSS									
EPRE ratio of PDSCH to PDSCH									
EPRE ratio of OCNG DMRS to SSS(Note 1)									
EPRE ratio of OCNG to OCNG DMRS (Note 1)									
$N_{oc}$ <sup>Note2</sup>	Config 1,2	Depending on band group	dBm/15kHz	-81.68	-81.68	-106	-106	-116 + $\Delta_{BG\_off}$ set	-116 + $\Delta_{BG\_off}$ set
$N_{oc}$ <sup>Note2</sup>	Config 3	Depending on band group	dBm/15kHz	-87.80	-87.80	-113	-113	-116+ $\Delta_{BG\_off}$ set	-116+ $\Delta_{BG\_off}$ set
$N_{oc}$ <sup>Note2</sup>	Config 1,2	Depending on band group	dBm/SCS	-81.68	-81.68	-106	-106	-116 + $\Delta_{BG\_off}$ set	-116 + $\Delta_{BG\_off}$ set
	Config 3	Depending on band group		-84.8	-84.8	-110	-110	-113+ $\Delta_{BG\_off}$ set	-113+ $\Delta_{BG\_off}$ set
$\hat{E}_s / I_{ot}$			dB	-1.75	-1.75	-1.75	-1.75	3	-1.75
$\hat{E}_s / N_{oc}$			dB	-1.75	-1.75	-1.75	-1.75	3	-1.75
SS-RSRP <sup>Note3</sup>	Config 1,2	Depending on band group	dBm/SCS	-83.43	-83.43	-	-	-113+ $\Delta_{BG\_off}$ set	-
	Config 3	Depending on band group		-86.54	-86.54	-	-	-110+ $\Delta_{BG\_off}$ set	-
SS-RSRQ <sup>Note3</sup>			dB	-14.76	-14.76	-14.76	-14.76	-12.56	-14.76
$I_o$ <sup>Note3</sup>	Config 1,2	Depending on band group	dBm/Ch BW	-51.51	-51.51	-75.83	-75.83	83.28 + $\Delta_{BG\_off}$ set	85.83 + $\Delta_{BG\_off}$ set
	Config 3	Depending on band group		-51.52	-51.52	-76.73	-76.73	77.19 + $\Delta_{BG\_off}$ set	79.73 + $\Delta_{BG\_off}$ set
Propagation condition			-	AWGN	AWGN	AWGN	AWGN	AWGN	AWGN
Antenna configuration				1x2	1x2	1x2	1x2	1x2	1x2



Note 1:	OCNG shall be used such that both cells are fully allocated and a constant total transmitted power spectral density is achieved for all OFDM symbols.
Note 2:	Interference from other cells and noise sources not specified in the test is assumed to be constant over subcarriers and time and shall be modelled as AWGN of appropriate power for $N_{oc}$ to be fulfilled.
Note 3:	SS-RSRQ, SS-RSRP, and $I_0$ levels have been derived from other parameters for information purposes. They are not settable parameters themselves.
Note 4:	SS-RSRQ, SS-RSRP minimum requirements are specified assuming independent interference and noise at each receiver antenna port.
Note 5:	$\Delta_{BG\_offset}$ is defined in clause 3A.4, Table 3A.4.1-2
Note 6:	The test configuration excludes support for band n51 and it is not required to run this test on band n51 in this release of the specification.

**Table 6.7.2.2.1.5-2: SS-RSRQ Intra frequency absolute accuracy requirements for the reported values**

	Test 1	Test 2	Test 3
	All bands	All bands	All bands
Normal Conditions			
Lowest reported value (Cell 2)	SS-RSRQ_52	SS-RSRQ_52	SS-RSRQ_52
Highest reported value (Cell 2)	SS-RSRQ_62	SS-RSRQ_62	SS-RSRQ_62
Extreme Conditions			
Lowest reported value (Cell 2)	SS-RSRQ_49	SS-RSRQ_49	SS-RSRQ_49
Highest reported value (Cell 2)	SS-RSRQ_65	SS-RSRQ_65	SS-RSRQ_65

For the test to pass, the ratio of successful reported values in each test shall be more than 90% with a confidence level of 95%.

6.7.2.2.2 NR SA FR1-FR1 SS-RSRQ relative measurement accuracy

6.7.2.2.2.1 Test purpose

The purpose of this test is to verify that the inter-frequency SS-RSRQ relative measurement accuracy is within the specified limits for all bands.

6.7.2.2.2.2 Test applicability

This test applies to all types of NR UE from Release 15 onwards.

6.7.2.2.2.3 Minimum conformance requirements

The minimum conformance requirements are specified in clause 6.7.2.0.3.

The normative reference for this requirement is TS 38.133 [6] clause A.6.7.2.2.2.

6.7.2.2.2.4 Test description

6.7.2.2.2.4.1 Initial conditions

This test shall be tested using any of the test configurations in Table 6.7.2.2.4.1-1.

**Table 6.7.2.2.4.1-1: NR SA FR1-FR1 SS-RSRQ measurement accuracy supported test configurations**

Test Case ID	Description
6.7.2.2.2-1	NR: 15 kHz SSB SCS, 10MHz bandwidth, FDD
6.7.2.2.2-2	NR: 15 kHz SSB SCS, 10MHz bandwidth, TDD
6.7.2.2.2-3	NR: 30 kHz SSB SCS, 40MHz bandwidth, TDD
Note: The UE is only required to be tested in one of the supported test configurations	

Configure the test equipment and the DUT according to the parameters in Table 6.7.2.2.4.1-2.

**Table 6.7.2.2.4.1-2: Initial conditions for SS-RSRQ inter frequency accuracy in FR1**

Parameter	Value		Comment
Test environment	NC, TL/VL, TL/VH, TH/VL, TH/VH		As specified in TS 38.508-1 [14] clause 4.1.
Test frequencies	As specified in Annex E, Table E.4-1 and TS 38.508-1 [14] clause 4.3.1.		
Channel bandwidth	As specified by the test configuration selected from Table 6.7.2.2.4.1-1.		
Propagation conditions	AWGN		As specified in Annex C.2.2.
Connection Diagram	TE Part 2Rx	A.3.1.8.2 with $n = 2$ and $\phi_1 = 5$ Hz	As specified in TS 38.508-1 [14] Annex A.
	TE Part 4Rx	A.3.1.8.5 with $n = 2$ and $\phi_{1,1} = 5$ Hz, $\phi_{1,2} = 10$ Hz, $\phi_{1,3} = 15$ Hz	
	DUT Part 2Rx	A.3.2.3.4	
	DUT Part 4Rx	A.3.2.5.2	
Exceptions to connection diagram	- Without the LTE link		

1. Message contents are defined in clause 6.7.2.2.4.3.
2. Cell 1 is the NR serving cell (PCell). The power levels and settings for Cell 1 are set according to Annex A.6. Cell 2 is an NR FR1 cell in the same frequency as Cell 1. Cell 2 is the target cell for SS-RSRQ measurements. The connection setup is done according to the settings in Annex C.1.1.

#### 6.7.2.2.4.2 Test procedure

1. Ensure the UE is in state RRC\_CONNECTED CONNECTED with generic procedure parameters Connectivity NR, Connected without release On and Test Mode On according to TS 38.508-1 [14] clause 4.5.
2. Set the parameters according to Table 6.7.2.2.5-1 as appropriate.
3. The SS shall transmit an RRCReconfiguration message on Cell 1.
4. The UE shall transmit an RRCReconfigurationComplete message.
5. The UE shall transmit periodically MeasurementReport messages.
6. After 10s wait from Step 3, the SS shall check the SS-RSRQ reported values in the periodic MeasurementReport. The SS-RSRQ value of Cell 2 reported by the UE is compared to the SS-RSRQ value of Cell 1 reported by the UE. If the difference between both values is outside the limits in Table 6.7.2.2.5-2 or the UE fails to report the measurement value for Cell 2 or Cell 1, the number of failed iterations is increased by one. Otherwise, the number of passed iterations is increased by one.
7. The SS shall continue checking the MeasurementReport messages transmitted by the UE until the confidence level according to Table G.2.3-1 in Annex G is achieved.
8. Set the parameters according to each sub-test in Table 6.7.2.2.5-1 as appropriate and repeat steps 5-7.

#### 6.7.2.2.4.3 Message contents

Message contents are same as in Clause 6.7.2.2.1.4.3.

#### 6.7.2.2.5 Test requirement

Table 6.7.2.2.5-1 defines the primary level settings including test tolerances for all tests.

Each SS-RSRQ measurement report for each of the tests in Table 6.7.2.2.5-1 shall meet the corresponding absolute accuracy requirements in Table 6.7.2.2.5-2.

**Table 6.7.2.2.5-1: same as Table 6.7.2.2.1.5-1****Table 6.7.2.2.5-2: SS-RSRQ Inter frequency relative accuracy requirements for the reported values**

	<b>Test 1</b>	<b>Test 2</b>	<b>Test 3</b>
	All bands	All bands	All bands
Normal Conditions			
Lowest reported value (Cell 2)	SS-RSRQ <sub>x</sub> - 7	SS-RSRQ <sub>x</sub> - 7	SS-RSRQ <sub>x</sub> - 11
Highest reported value (Cell 2)	SS-RSRQ <sub>x</sub> + 7	SS-RSRQ <sub>x</sub> + 7	SS-RSRQ <sub>x</sub> + 2
Extreme Conditions			
Lowest reported value (Cell 2)	SS-RSRQ <sub>x</sub> - 9	SS-RSRQ <sub>x</sub> - 9	SS-RSRQ <sub>x</sub> - 13
Highest reported value (Cell 2)	SS-RSRQ <sub>x</sub> + 9	SS-RSRQ <sub>x</sub> + 9	SS-RSRQ <sub>x</sub> + 4
RSRQ <sub>x</sub> is the reported value of Cell 1			

For the test to pass, the ratio of successful reported values in each test shall be more than 90% with a confidence level of 95%.

## 6.7.3 SS-SINR

### 6.7.3.0 Minimum conformance requirements

#### 6.7.3.0.1 Intra-frequency SS-SINR measurement accuracy requirements

Same as in clause 4.7.3.0.1.

#### 6.7.3.0.2 Inter-frequency absolute SS-SINR measurement accuracy requirements

Same as in clause 4.7.3.0.2.

#### 6.7.3.0.3 Inter-frequency relative SS-SINR measurement accuracy requirements

Same as in clause 4.7.3.0.3.

### 6.7.3.1 NR SA FR1 SS-SINR measurement accuracy

#### 6.7.3.1.1 Test purpose

The purpose of this test is to verify that the intra-frequency SS-SINR measurement accuracy is within the specified limits for all bands.

#### 6.7.3.1.2 Test applicability

This test applies to all types of NR UE from Release 15 onwards, which support ss-SINR-Meas.

#### 6.7.3.1.3 Minimum conformance requirements

The minimum conformance requirements are specified in clause 6.7.3.0.1.

The normative reference for this requirement is TS 38.133 [6] clause A.6.7.3.1.

#### 6.7.3.1.4 Test description

##### 6.7.3.1.4.1 Initial conditions

This test shall be tested using any of the test configurations in Table 6.7.3.1.4.1-1.

**Table 6.7.3.1.4.1-1: NR SA FR1 SS-SINR measurement accuracy supported test configurations**

<b>Test Case ID</b>	<b>Description</b>
6.7.3.1-1	NR: 15 kHz SSB SCS, 10MHz bandwidth, FDD
6.7.3.1-2	NR: 15 kHz SSB SCS, 10MHz bandwidth, TDD
6.7.3.1-3	NR: 30 kHz SSB SCS, 40MHz bandwidth, TDD
Note: The UE is only required to be tested in one of the supported test configurations	

Configure the test equipment and the DUT according to the parameters in Table 6.7.3.1.4.1-2.

**Table 6.7.3.1.4.1-2: Initial conditions for SS-SINR intra frequency accuracy in FR1**

Parameter	Value		Comment
Test environment	NC, TL/VL, TL/VH, TH/VL, TH/VH		As specified in TS 38.508-1 [14] clause 4.1.
Test frequencies	As specified in Annex E, Table E.4-1 and TS 38.508-1 [14] clause 4.3.1.		
Channel bandwidth	As specified by the test configuration selected from Table 6.7.3.1.4.1-1.		
Propagation conditions	AWGN		As specified in Annex C.2.2.
Connection Diagram	TE Part 2Rx	A.3.1.8.2 with $n = 2$ and $\phi_1 = 5$ Hz	As specified in TS 38.508-1 [14] Annex A.
	TE Part 4Rx	A.3.1.8.5 with $n = 2$ and $\phi_{1,1} = 5$ Hz, $\phi_{1,2} = 10$ Hz, $\phi_{1,3} = 15$ Hz	
	DUT Part 2Rx	A.3.2.3.4	
	DUT Part 4Rx	A.3.2.5.2	
Exceptions to connection diagram	- Without the LTE link		

1. Message contents are defined in clause 6.7.3.1.4.3.

2. Cell 1 is the NR serving cell (PCell). The power levels and settings for Cell 1 are set according to Annex A.6. Cell 2 is an NR FR1 cell in the same frequency as Cell 1. Cell 2 is the target cell for SS-SINR measurements. The connection setup is done according to the settings in Annex C.1.1.

#### 6.7.3.1.4.2 Test procedure

- Ensure the UE is in state RRC\_CONNECTED CONNECTED with generic procedure parameters Connectivity NR, Connected without release On and Test Mode On according to TS 38.508-1 [14] clause 4.5.
- Set the parameters according to Table 6.7.3.1.5-1 as appropriate.
- The SS shall transmit an RRCReconfiguration message on Cell 1.
- The UE shall transmit an RRCReconfigurationComplete message.
- The UE shall transmit periodically MeasurementReport messages.
- After 10s wait from Step 3, the SS shall check the SS-SINR reported values in the periodic MeasurementReport. The SS-SINR value of Cell 2 reported by the UE is compared to the expected SS-SINR. If the value is outside the limits in Table 6.7.3.1.5-2 or the UE fails to report the measurement value for Cell 2, the number of failed iterations is increased by one. Otherwise, the number of passed iterations is increased by one.
- The SS shall continue checking the MeasurementReport messages transmitted by the UE until the confidence level according to Table G.2.3-1 in Annex G is achieved.
- Set the parameters according to each sub-test in Table 6.7.3.1.5-1 as appropriate and repeat steps 5-7.

#### 6.7.3.1.4.3 Message contents

Message contents are according to TS 38.508-1 [14] clause 7.3 with the following exceptions:

**Table 6.7.3.1.4.3-1: Common Exception messages for NR SA FR1 SS-SINR measurement accuracy**

Default Message Contents	
Common contents of system information blocks exceptions	
Default RRC messages and information elements contents exceptions	Table H.3.1-1 Table H.3.1-2 Table H.3.1-5 Table H.3.1-7
Specific message contents exceptions for Test Configuration 6.7.3.1-1	Table H.3.1-3 with Condition SS-SINR Table 7.3.1-3 in TS 38.508-1 [14] with condition SMTC.2
Specific message contents exceptions for Test Configuration 6.7.3.1-2	Table H.3.1-3 with Condition Synchronous cells and SS-SINR Table 7.3.1-3 in TS 38.508-1 [14] with condition SMTC.1
Specific message contents exceptions for Test Configuration 6.7.3.1-3	Table H.3.1-3 with Condition Synchronous cells and SS-SINR Table 7.3.1-3 in TS 38.508-1 [14] with condition SMTC.1

**Table 6.7.3.1.4.3-2: ReportConfigNR-DEFAULT(Periodical) for NR SA FR1 SS-SINR Accuracy**

Derivation Path: 38.508-1 [14] Table 4.6.3-142 with condition PERIODICAL			
Information Element	Value/remark	Comment	Condition
ReportConfigNR ::= SEQUENCE {			
reportType CHOICE {			
periodical SEQUENCE {			PERIODICAL
reportQuantityCell SEQUENCE {			
rsrp	false		
rsrq	false		
sinr	true		
}			
maxReportCells	2		
}			
}			
}			

6.7.3.1.5 Test requirements

Table 6.7.3.1.5-1 defines the primary level settings including test tolerances for all tests.

Each SS-SINR measurement report for each of the tests in Table 6.7.3.1.5-1 shall meet the corresponding absolute accuracy requirements in Table 6.7.3.1.5-2

**Table 6.7.3.1.5-1: SS-SINR Intra frequency test parameters**

Parameter		Unit	Test 1		Test 2	
			Cell 1	Cell 2	Cell 1	Cell 2
SSB ARFCN			freq1		freq1	
Duplex mode	Config 1		FDD			
	Config 2,3		TDD			
TDD configuration	Config 1		Not Applicable			
	Config 2		TDDConf.1.1			
	Config 3		TDDConf.2.1			
Downlink initial BWP configuration			DLBWP.0.1			
Downlink dedicated BWP configuration			DLBWP.1.1			
Uplink initial BWP configuration			ULBWP.0.1			
Uplink dedicated BWP configuration			ULBWP.1.1			
DRX Cycle configuration		ms	Not Applicable			

TRS configuration	Config 1		TRS.1.1 FDD		TRS.1.1 FDD	
	Config 2		TRS.1.1 TDD	-	TRS.1.1 TDD	-
	Config 3		TRS.1.2 TDD		TRS.1.2 TDD	
PDSCH Reference measurement channel	Config 1		SR.1.1 FDD		SR.1.1 FDD	
	Config 2		SR.1.1 TDD	-	SR.1.1 TDD	-
	Config 3		SR.2.1 TDD		SR.2.1 TDD	
RMSI CORESET Reference Channel	Config 1		CR.1.1 FDD		CR.1.1 FDD	
	Config 2		CR.1.1 TDD	-	CR.1.1 TDD	-
	Config 3		CR.2.1 TDD		CR.2.1 TDD	
Dedicated CORESET Reference Channel	Config 1		CCR.1.1 FDD		CCR.1.1 FDD	
	Config 2		CCR.1.1 TDD	-	CCR.1.1 TDD	-
	Config 3		CCR.2.1 TDD		CCR.2.1 TDD	
OCNG Patterns			OP.1			
SS-RSSI-Measurement			Not Applicable			
Time offset with Cell 1	Config 2, 3	$\mu$ s	-	3	-	3
	Config 1	ms	-	3	-	3
SMTC configuration	Config 2, 3		SMTC.1			
	Config 1		SMTC.2			
SSB configuration	Config 1,2		SSB.1 FR1			
	Config 3		SSB.2 FR1			
PDSCH/PDCCH subcarrier spacing	Config 1,2	kHz	15			
	Config 3		30			
EPRE ratio of PSS to SSS			dB	0	0	0
EPRE ratio of PBCH DMRS to SSS						
EPRE ratio of PBCH to PBCH DMRS						
EPRE ratio of PDCCH DMRS to SSS						
EPRE ratio of PDCCH to PDCCH DMRS						
EPRE ratio of PDSCH DMRS to SSS						
EPRE ratio of PDSCH to PDSCH						
EPRE ratio of OCNG DMRS to SSS(Note 1)						
EPRE ratio of OCNG to OCNG DMRS (Note 1)						
$N_{oc}$ <sup>Note2</sup>	Depending on band group		dBm/15kHz		-93	-116+ $\Delta_{BG\_offset}$
$N_{oc}$ <sup>Note2</sup>	Config 1,2		dBm/SCS		-93.2	Same as $N_{oc}$ for 15kHz
	Config 3	Depending on band group			-90.2	-113+ $\Delta_{BG\_offset}$
$\hat{E}_s / I_{ot}$			dB		0	-3.19
$\hat{E}_s / N_{oc}$			dB		4.54	2.66
SS-RSRP <sup>Not e3</sup>	Config 1,2	Depending on band group	dBm/SCS		-88.46	-90.34
	Config 3	Depending on band group			-85.65	-87.53
SS-SINR <sup>Note3</sup>			dB		0	-3.19
$I_o$ <sup>Note3</sup>	Config 1,2	Depending on band group	dBm/9.36MHz		-57.5	
	Config 3	Depending on band group	dBm/38.16MHz		-51.59	
Propagation condition			- AWGN			
Antenna configuration			- 1x2			

Note 1:	OCNG shall be used such that both cells are fully allocated and a constant total transmitted power spectral density is achieved for all OFDM symbols.
Note 2:	Interference from other cells and noise sources not specified in the test is assumed to be constant over subcarriers and time and shall be modelled as AWGN of appropriate power for $N_{oc}$ to be fulfilled.
Note 3:	SS-SINR, SS-RSRP, and $I_0$ levels have been derived from other parameters for information purposes. They are not settable parameters themselves.
Note 4:	SS-SINR, SS-RSRP minimum requirements are specified assuming independent interference and noise at each receiver antenna port.
Note 5:	$\Delta_{BG\_offset}$ is defined in clause 3A.4, Table 3A.4.1-2
Note 6:	The test configuration excludes support for band n51 and it is not required to run this test on band n51 in this release of the specification

**Table 6.7.3.1.5-3: SS-SINR Intra frequency absolute accuracy requirements for the reported values**

	Test 1	Test 2
	All bands	All bands
Normal Conditions		
Lowest reported value (Cell 2)	SS-SINR_31	SS-SINR_28
Highest reported value (Cell 2)	SS-SINR_49	SS-SINR_45
Extreme Conditions		
Lowest reported value (Cell 2)	SS-SINR_30	SS-SINR_27
Highest reported value (Cell 2)	SS-SINR_50	SS-SINR_46

For the test to pass, the ratio of successful reported values in each test shall be more than 90% with a confidence level of 95%.

### 6.7.3.2 Inter-Frequency SS-SINR measurement accuracy

#### 6.7.3.2.1 NR SA FR1-FR1 SS-SINR absolute measurement accuracy

##### 6.7.3.2.1.1 Test purpose

The purpose of this test is to verify that the inter-frequency SS-SINR absolute measurement accuracy is within the specified limits for all bands.

##### 6.7.3.2.1.2 Test applicability

This test applies to all types of NR UE from Release 15 onwards, which support ss-SINR-Meas.

##### 6.7.3.2.1.3 Minimum conformance requirements

The minimum conformance requirements are specified in clause 6.7.3.0.2.

The normative reference for this requirement is TS 38.133 [6] clause A.6.7.3.2.1.

##### 6.7.3.2.1.4 Test description

###### 6.7.3.2.1.4.1 Initial conditions

This test shall be tested using any of the test configurations in Table 6.7.3.2.1.4.1-1.

**Table 6.7.3.2.1.4.1-1: NR SA FR1-FR1 SS-SINR measurement accuracy supported test configurations**

Test Case ID	Description
6.7.3.2.1-1	NR: 15 kHz SSB SCS, 10MHz bandwidth, FDD
6.7.3.2.1-2	NR: 15 kHz SSB SCS, 10MHz bandwidth, TDD
6.7.3.2.1-3	NR: 30 kHz SSB SCS, 40MHz bandwidth, TDD

Note: The UE is only required to be tested in one of the supported test configurations

Configure the test equipment and the DUT according to the parameters in Table 6.7.3.2.1.4.1-2.

**Table 6.7.3.2.1.4.1-2: Initial conditions for SS-SINR inter frequency accuracy in FR1**

Parameter	Value		Comment
Test environment	NC, TL/VL, TL/VH, TH/VL, TH/VH		As specified in TS 38.508-1 [14] clause 4.1.
Test frequencies	As specified in Annex E, Table E.4-1 and TS 38.508-1 [14] clause 4.3.1.		
Channel bandwidth	As specified by the test configuration selected from Table 6.7.3.2.1.4.1-1.		
Propagation conditions	AWGN		As specified in Annex C.2.2.
Connection Diagram	TE Part 2Rx	A.3.1.8.2 with $n = 2$ and $\phi_1 = 5$ Hz	As specified in TS 38.508-1 [14] Annex A.
	TE Part 4Rx	A.3.1.8.5 with $n = 2$ and $\phi_{1,1} = 5$ Hz, $\phi_{1,2} = 10$ Hz, $\phi_{1,3} = 15$ Hz	
	DUT Part 2Rx	A.3.2.3.4	
	DUT Part 4Rx	A.3.2.5.2	
Exceptions to connection diagram	- Without the LTE link		

1. Message contents are defined in clause 6.7.3.2.1.4.3.

2. Cell 1 is the NR serving cell (PCell). The power levels and settings for Cell 1 are set according to Annex A.6. Cell 2 is an NR FR1 cell in the same frequency as Cell 1. Cell 2 is the target cell for SS-SINR measurements. The connection setup is done according to the settings in Annex C.1.1.

**6.7.3.2.1.4.2 Test procedure**

Same as in clause 6.7.3.1.4.2 but replacing Table 6.7.3.1.5-1 and 6.7.3.1.5-2 with 6.7.3.2.1.5-1 and 6.7.3.2.1.5-2, respectively.

**6.7.3.2.1.4.3 Message contents**

Message contents are according to TS 38.508-1 [14] clause 7.3 with the following exceptions:

**Table 6.7.3.2.1.4.3-1: Common Exception messages for NR SA FR1-FR1 SS-SINR absolute measurement accuracy**

Default Message Contents	
Common contents of system information blocks exceptions	
Default RRC messages and information elements contents exceptions	Table H.3.1-1 Table H.3.1-2 with condition INTER-FREQ and GAP NEEDED Table H.3.1-5 Table H.3.1-7 with condition INTER-FREQ Table H.3.1-6 with condition Pattern #0
Specific message contents exceptions for Test Configuration 6.7.3.2.1-1	Table H.3.1-3 with Conditions INTER-FREQ MO and SS-SINR Table 7.3.1-3 in TS 38.508-1 [14] with condition SMTC.2
Specific message contents exceptions for Test Configuration 6.7.3.2.1-2	Table H.3.1-3 with Conditions INTER-FREQ MO, and Synchronous cells and SS-SINR Table 7.3.1-3 in TS 38.508-1 [14] with condition SMTC.1
Specific message contents exceptions for Test Configuration 6.7.3.2.1-3	Table H.3.1-3 with Conditions INTER-FREQ MO, and Synchronous cells and SS-SINR Table 7.3.1-3 in TS 38.508-1 [14] with condition SMTC.1



**Table 6.7.3.2.1.4.3-2: ReportConfigNR-DEFAULT(Periodical) for NR SA FR1 SS-SINR Accuracy**

Derivation Path: 38.508-1 [14] Table 4.6.3-142 with condition PERIODICAL			
Information Element	Value/remark	Comment	Condition
ReportConfigNR ::= SEQUENCE {			
reportType CHOICE {			
periodical SEQUENCE {			PERIODICAL
reportQuantityCell SEQUENCE {			
rsrp	false		
rsrq	false		
sinr	true		
}			
maxReportCells	2		
}			
}			
}			

6.7.3.2.1.5 Test requirements

Table 6.7.3.2.1.5-1 defines the primary level settings including test tolerances for all tests.

Each SS-SINR measurement report for each of the tests in Table 6.7.3.2.1.5-1 shall meet the corresponding absolute accuracy requirements in Table 6.7.3.2.1.5-2.

**Table 6.7.3.2.1.5-1: SS-SINR Inter frequency test parameters**

Parameter		Unit	Test 1		Test 2		Test 3	
			Cell 1	Cell 2	Cell 1	Cell 2	Cell 1	Cell 2
SSB ARFCN			freq1	freq2	freq1	freq2	freq1	freq2
Duplex mode	Config 1		FDD					
	Config 2,3		TDD					
TDD configuration	Config 1		Not Applicable					
	Config 2		TDDConf.1.1					
	Config 3		TDDConf.2.1					
Downlink initial BWP configuration			DLBWP.0.1					
Downlink dedicated BWP configuration			DLBWP.1.1					
Uplink initial BWP configuration			ULBWP.0.1					
Uplink dedicated BWP configuration			ULBWP.1.1					
DRX Cycle configuration		ms	Not Applicable					
Gap pattern ID			0	-	0	-	0	-
TRS configuration	Config 1		TRS.1.1 FDD		TRS.1.1 FDD		TRS.1.1 FDD	
	Config 2		TRS.1.1 TDD	-	TRS.1.1 TDD	-	TRS.1.1 TDD	-
	Config 3		TRS.1.2 TDD		TRS.1.2 TDD		TRS.1.2 TDD	
PDSCH Reference measurement channel	Config 1		SR.1.1 FDD		SR.1.1 FDD		SR.1.1 FDD	
	Config 2		SR.1.1 TDD	-	SR.1.1 TDD	-	SR.1.1 TDD	-
	Config 3		SR.2.1 TDD		SR.2.1 TDD		SR.2.1 TDD	
RMSI CORESET Reference Channel	Config 1		CR.1.1 FDD		CR.1.1 FDD		CR.1.1 FDD	
	Config 2		CR.1.1 TDD	-	CR.1.1 TDD	-	CR.1.1 TDD	-
	Config 3		CR.2.1 TDD		CR.2.1 TDD		CR.2.1 TDD	

Dedicated CORESET Reference Channel	Config 1		CCR.1.1 FDD		CCR.1.1 FDD		CCR.1.1 FDD		
	Config 2		CCR.1.1 TDD	-	CCR.1.1 TDD	-	CCR.1.1 TDD	-	
	Config 3		CCR.2.1 TDD		CCR.2.1 TDD		CCR.2.1 TDD		
OCNG Patterns			OP.1						
SS-RSSI-Measurement			Not Applicable						
Time offset with Cell 1	Config 2, 3	µs	-	3	-	3	-	3	
	Config 1	ms	-	3	-	3	-	3	
SMTC configuration	Config 2, 3		SMTC.1						
	Config 1		SMTC.2						
SSB configuration	Config 1,2		SSB.1 FR1						
	Config 3		SSB.2 FR1						
PDSCH/PDCCH subcarrier spacing	Config 1,2	kHz	15						
	Config 3		30						
EPRE ratio of PSS to SSS		dB	0	0	0	0	0	0	
EPRE ratio of PBCH DMRS to SSS									
EPRE ratio of PBCH to PBCH DMRS									
EPRE ratio of PDCCH DMRS to SSS									
EPRE ratio of PDCCH to PDCCH DMRS									
EPRE ratio of PDSCH DMRS to SSS									
EPRE ratio of PDSCH to PDSCH									
EPRE ratio of OCNG DMRS to SSS(Note 1)									
EPRE ratio of OCNG to OCNG DMRS (Note 1)									
$N_{oc}$ Note2	Config 1,2	Depending on band group	dBm/15kHz	-88	-88	-108.5	-108.5	-119.5+ $\Delta_{BG\_offse}$ t	-119.5+ $\Delta_{BG\_offse}$ t
$N_{oc}$ Note2	Config 1,2		dBm/SC S	-88	-88	-108.5	-108.5	Same as Noc for 15kHz	Same as Noc for 15kHz
	Config 3	Depending on band group		-85	-85	-105.5	-105.5	-116.5+ $\Delta_{BG\_offse}$ t	116.5+ $\Delta_{BG\_offse}$ t
$\hat{E}_s / I_{ot}$			dB	-1.75	-1.75	20	20	-3.2	-3.2
$\hat{E}_s / N_{oc}$			dB	-1.75	-1.75	20	20	-3.2	-3.2
SS-RSRP <sup>Not e3</sup>	Config 1,2	Depending on band group	dBm/SC S	-89.75	-89.75	-88.5	-88.5	-122.7+ $\Delta_{BG\_offse}$ t	-122.7+ $\Delta_{BG\_offse}$ t
	Config 3	Depending on band group		-86.75	-86.75	-85.5	-85.5	-119.7+ $\Delta_{BG\_offse}$ t	-119.7+ $\Delta_{BG\_offse}$ t
SS-SINR <sup>Note3</sup>			dB	-1.75	-1.75	-1.75	-1.75	-3.2	-3.2
$I_o$ <sup>Note3</sup>	Config 1,2	Depending on band group	dBm/9.36MHz	-57.83	-57.83	-60.5	-60.5	-89.85+ $\Delta_{BG\_offse}$ t	-89.85+ $\Delta_{BG\_offse}$ t
	Config 3	Depending on band group		dBm/38.16MHz	-51.73	-51.73	-54.41	-54.41	-83.75+ $\Delta_{BG\_offse}$ t

Propagation condition	-	AWGN
Antenna configuration	-	1x2
Note 1:	OCNG shall be used such that both cells are fully allocated and a constant total transmitted power spectral density is achieved for all OFDM symbols.	
Note 2:	Interference from other cells and noise sources not specified in the test is assumed to be constant over subcarriers and time and shall be modelled as AWGN of appropriate power for $N_{oc}$ to be fulfilled.	
Note 3:	SS-SINR, SS-RSRP, and $l_0$ levels have been derived from other parameters for information purposes. They are not settable parameters themselves.	
Note 4:	SS-SINR, SS-RSRP minimum requirements are specified assuming independent interference and noise at each receiver antenna port.	
Note 5:	$\Delta_{BG\_offset}$ is defined in clause 3A.4, Table 3A.4.1-2	
Note 6:	The test configuration excludes support for band n51 and it is not required to run this test on band n51 in this release of the specification	

**Table 6.7.3.2.1.5-2: SS-SINR Inter frequency absolute accuracy requirements for the reported values**

	Test 1	Test 2	Test 3
	All bands	All bands	All bands
Normal Conditions			
Lowest reported value (Cell 2)	SS-SINR_35	SS-SINR_79	SS-SINR_32
Highest reported value (Cell 2)	SS-SINR_51	SS-SINR_94	SS-SINR_49
Extreme Conditions			
Lowest reported value (Cell 2)	SS-SINR_33	SS-SINR_77	SS-SINR_31
Highest reported value (Cell 2)	SS-SINR_53	SS-SINR_96	SS-SINR_50

For the test to pass, the ratio of successful reported values in each test shall be more than 90% with a confidence level of 95%.

**6.7.3.2.2 NR SA FR1-FR1 SS-SINR relative measurement accuracy**

**6.7.3.2.2.1 Test purpose**

The purpose of this test is to verify that the inter-frequency SS-SINR relative measurement accuracy is within the specified limits for all bands.

**6.7.3.2.2.2 Test applicability**

This test applies to all types of NR UE from Release 15 onwards, which support ss-SINR-Meas.

**6.7.3.2.2.3 Minimum conformance requirements**

The minimum conformance requirements are specified in clause 6.7.2.0.3.

The normative reference for this requirement is TS 38.133 [6] clause A.6.7.3.2.2.

**6.7.3.2.2.4 Test description**

**6.7.3.2.2.4.1 Initial conditions**

This test shall be tested using any of the test configurations in Table 6.7.3.2.2.4.1-1.

**Table 6.7.3.2.2.4.1-1: NR SA FR1-FR1 SS-SINR measurement accuracy supported test configurations**

Test Case ID	Description
6.7.3.2.2-1	NR: 15 kHz SSB SCS, 10MHz bandwidth, FDD
6.7.3.2.2-2	NR: 15 kHz SSB SCS, 10MHz bandwidth, TDD
6.7.3.2.2-3	NR: 30 kHz SSB SCS, 40MHz bandwidth, TDD

Note: The UE is only required to be tested in one of the supported test configurations

Configure the test equipment and the DUT according to the parameters in Table 6.7.3.2.2.4.1-2.

**Table 6.7.3.2.2.4.1-2: Initial conditions for SS-SINR inter frequency accuracy in FR1**

Parameter	Value		Comment
Test environment	NC, TL/VL, TL/VH, TH/VL, TH/VH		As specified in TS 38.508-1 [14] clause 4.1.
Test frequencies	As specified in Annex E, Table E.4-1 and TS 38.508-1 [14] clause 4.3.1.		
Channel bandwidth	As specified by the test configuration selected from Table 6.7.3.2.2.4.1-1.		
Propagation conditions	AWGN		As specified in Annex C.2.2.
Connection Diagram	TE Part 2Rx	A.3.1.8.2 with $n = 2$ and $\phi_1 = 5$ Hz	As specified in TS 38.508-1 [14] Annex A.
	TE Part 4Rx	A.3.1.8.5 with $n = 2$ and $\phi_{1,1} = 5$ Hz, $\phi_{1,2} = 10$ Hz, $\phi_{1,3} = 15$ Hz	
	DUT Part 2Rx	A.3.2.3.4	
	DUT Part 4Rx	A.3.2.5.2	
Exceptions to connection diagram	- Without the LTE link		

1. Message contents are defined in clause 6.7.3.2.2.4.3.
2. Cell 1 is the NR serving cell (PCell). The power levels and settings for Cell 1 are set according to Annex A.6. Cell 2 is an NR FR1 cell in the same frequency as Cell 1. Cell 2 is the target cell for SS-SINR measurements. The connection setup is done according to the settings in Annex C.1.1.

#### 6.7.3.2.2.4.2 Test procedure

1. Ensure the UE is in state RRC\_CONNECTED CONNECTED with generic procedure parameters Connectivity NR, Connected without release *On* and Test Mode *On* according to TS 38.508-1 [14] clause 4.5.
2. Set the parameters according to Table 6.7.3.2.2.5-1 as appropriate.
3. The SS shall transmit an RRCReconfiguration message on Cell 1.
4. The UE shall transmit an RRCReconfigurationComplete message.
5. The UE shall transmit periodically MeasurementReport messages.
6. After 10s wait from Step 3, the SS shall check the SS-SINR reported values in the periodic MeasurementReport. The SS- SINR value of Cell 2 reported by the UE is compared to the SS- SINR value of Cell 1 reported by the UE. If the difference between both values is outside the limits in Table 6.7.3.2.2.5-2 or the UE fails to report the measurement value for Cell 2 or Cell 1, the number of failed iterations is increased by one. Otherwise, the number of passed iterations is increased by one.
7. The SS shall continue checking the MeasurementReport messages transmitted by the UE until the confidence level according to Table G.2.3-1 in Annex G is achieved.
8. Set the parameters according to each sub-test in Table 6.7.3.2.2.5-1 as appropriate and repeat steps 5-7.

#### 6.7.3.2.2.4.3 Message contents

Message contents are same as in Clause 6.7.3.2.1.4.3.

#### 6.7.3.2.2.5 Test requirements

Table 6.7.3.2.2.5-1 defines the primary level settings including test tolerances for all tests.

Each SS-SINR measurement report for each of the tests in Table 6.7.3.2.2.5-1 shall meet the corresponding relative accuracy requirements in Table 6.7.3.2.2.5-2

Table 6.7.3.2.2.5-1: same as Table 6.7.3.2.2.1.5-1

Table 6.7.3.2.2.5-2: SS-SINR Inter frequency relative accuracy requirements for the reported values

	Test 1	Test 2	Test 3
	All bands	All bands	All bands
Normal Conditions			
Lowest reported value (Cell 2)	SS-SINR <sub>x</sub> - 10	SS-SINR <sub>x</sub> - 10	SS-SINR <sub>x</sub> - 11
Highest reported value (Cell 2)	SS-SINR <sub>x</sub> + 10	SS-SINR <sub>x</sub> + 10	SS-SINR <sub>x</sub> + 11
Extreme Conditions			
Lowest reported value (Cell 2)	SS-SINR <sub>x</sub> - 12	SS-SINR <sub>x</sub> - 12	SS-SINR <sub>x</sub> - 12
Highest reported value (Cell 2)	SS-SINR <sub>x</sub> + 12	SS-SINR <sub>x</sub> + 12	SS-SINR <sub>x</sub> + 12
RSRQ <sub>x</sub> is the reported value of Cell 1			

For the test to pass, the ratio of successful reported values in each test shall be more than 90% with a confidence level of 95%.

## 6.7.4 L1-RSRP

### 6.7.4.0 Minimum conformance requirements

#### 6.7.4.0.1 SSB based absolute L1-RSRP measurement accuracy requirements

Same as 4.7.4.0.1.

#### 6.7.4.0.2 SSB based relative L1-RSRP measurement accuracy requirements

Same as 4.7.4.0.2.

#### 6.7.4.0.3 CSI-RS based absolute L1-RSRP measurement accuracy requirements

Same as 4.7.4.0.3.

#### 6.7.4.0.4 CSI-RS based relative L1-RSRP measurement accuracy requirements

Same as 4.7.4.0.4.

### 6.7.4.1 SSB based L1-RSRP measurements

#### 6.7.4.1.1 NR SA FR1 SSB based L1-RSRP absolute measurement accuracy

##### 6.7.4.1.1.1 Test purpose

The purpose of this test is to verify that the SSB based L1-RSRP absolute measurement accuracy is within the specified limits for all bands.

##### 6.7.4.1.1.2 Test applicability

This test applies to all types of NR UE from Release 15 onwards.

##### 6.7.4.1.1.3 Minimum conformance requirements

The minimum conformance requirements are specified in clause 6.7.4.0.1.

The normative reference for this requirement is TS 38.133 [6] clause A.6.7.4.1.

##### 6.7.4.1.1.4 Test description

##### 6.7.4.1.1.4.1 Initial conditions

This test shall be tested using any of the test configurations in Table 6.7.4.1.1.4.1-1.

**Table 6.7.4.1.1.4.1-1: NR SA FR1 SSB based L1-RSRP absolute measurement accuracy supported test configurations**

Test Case ID	Description
6.7.4.1.1-1	NR: 15 kHz SSB SCS, 10MHz bandwidth, FDD
6.7.4.1.1-2	NR: 15 kHz SSB SCS, 10MHz bandwidth, TDD
6.7.4.1.1-3	NR: 30 kHz SSB SCS, 40MHz bandwidth, TDD
Note: The UE is only required to be tested in one of the supported test configurations	

Configure the test equipment and the DUT according to the parameters in Table 6.7.4.1.1.4.1-2.

**Table 6.7.4.1.1.4.1-2: Initial conditions for SSB based L1-RSRP absolute accuracy in FR1**

Parameter	Value	Comment
Test environment	NC, TL/VL, TL/VH, TH/VL, TH/VH	As specified in TS 38.508-1 [14] clause 4.1.
Test frequencies	As specified in Annex E, Table E.4-1 and TS 38.508-1 [14] clause 4.3.1.	
Channel bandwidth	As specified by the test configuration selected from Table 6.7.4.1.1.4.1-1.	
Propagation conditions	AWGN	As specified in Annex C.2.2.
Connection Diagram	TE Part 2Rx	A.3.1.8.2 with n = 1
	TE Part 4Rx	A.3.1.8.5 with n = 1
	DUT Part 2Rx	A.3.2.3.4
	DUT Part 4Rx	A.3.2.5.2
Exceptions to connection diagram	N/A	

1. Message contents are defined in clause 6.7.4.1.1.4.3.

2. Cell 1 is the NR FR1 cell. Cell 1 is the target for SSB-based L1-RSRP measurements. The UE is configured to perform RLM, BFD and L1-RSRP measurement based on the SSBs. The connection setup is done according to the settings in Annex C.1.1.

#### 6.7.4.1.1.4.2 Test procedure

The UE shall be configured for periodic CSI reporting in PUCCH [format 2] with a reporting periodicity as mentioned in the above table 6.7.4.1.1.4.1-2.

1. Ensure the UE is in state RRC\_CONNECTED with generic procedure parameters Connectivity NR SA, Connected without release *On* and Test Mode *On*, according to TS 38.508-1 [14] clause 4.5 and general test parameters set according to Table 6.7.4.1.1.4.1-2.
2. Set the parameters according to T1 in Table 6.7.4.1.1.5-1.
3. The UE shall start sending L1-RSRP report including results of both SSB#0 and SSB#1 every 80 slots.
4. The SS shall check the L1-RSRP reported values of SSB#0 and SSB#1 in the periodic L1-RSRP reports. If the value for both SSBs is within the limits in Table 6.7.4.1.1.5-2 or Table 6.7.4.1.1.5-3 (depending on the test configuration), the number of passed iterations is increased by one, otherwise the number of failed iterations is increased by one.
5. The SS shall continue checking the L1-RSRP report messages transmitted by the UE until the confidence level according to Table G.2.3-1 in Annex G is achieved.
6. Set the parameters according to each sub-test in Table 6.7.4.1.1.5-1 as appropriate and repeat steps 3-5.

#### 6.7.4.1.1.4.3 Message contents

Message contents are according to TS 38.508-1 [14] clause 7.3 with the following exceptions:

**Table 6.7.4.1.1.4.3-1: Common Exception messages NR SA SSB based L1-RSRP measurement**

Default Message Contents	
Common contents of system information blocks exceptions	
Default RRC messages and information elements contents exceptions	Table H.3.6-2 with conditions PERIODIC and SS-RSRP Table H.3.6-3 with conditions SSB and PERIODIC Table H.3.5-8 Table 7.3.1-3 in TS 38.508-1 [14] with condition SMTC.1

**Table 6.7.4.1.1.4.3-2: RadioLinkMonitoringConfig**

Derivation Path: TS 38.508-1 [14], Table 4.6.3-133			
Information Element	Value/remark	Comment	Condition
RadioLinkMonitoringConfig ::= SEQUENCE {			
failureDetectionResourcesToAddModList	1 entry		
SEQUENCE			
(SIZE(1..maxNrofFailureDetectionResources)) OF			
SEQUENCE {			
purpose	both	UE is configured to perform RLM and BFD based on the SSBs.	
detectionResource CHOICE {			
ssb-Index	0		
}			
}			
}			
}			

#### 6.7.4.1.1.5 Test requirement

Table 6.7.4.1.1.5-1 defines the primary level settings including test tolerances for all tests.

Each L1-RSRP measurement report for each of the tests in Table 6.7.4.1.1.5-1 shall meet the corresponding absolute accuracy requirements in Table 6.7.4.1.1.5-2 for test configurations 1 and 2, and the corresponding absolute accuracy requirements in Table 6.7.4.1.1.5-3 for test configuration 3.

**Table 6.7.4.1.1.5-1: L1-RSRP test parameters**

Parameter	Config	Unit	Test 1	Test 2
SSB GSCN	1~3		freq1	freq1
Duplex mode	1		FDD	FDD
	2		TDD	TDD
	3		TDD	TDD
TDD Configuration	1		N/A	N/A
	2		TDDConf.1.1	TDDConf.1.1
	3		TDDConf.2.1	TDDConf.2.1
BW <sub>channel</sub>	1	MHz	10: N <sub>RB,c</sub> = 52	10: N <sub>RB,c</sub> = 52
	2		10: N <sub>RB,c</sub> = 52	10: N <sub>RB,c</sub> = 52
	3		40: N <sub>RB,c</sub> = 106	40: N <sub>RB,c</sub> = 106
PDSCH Reference measurement channel	1		SR.1.1 FDD	SR.1.1 FDD
	2		SR.1.1 TDD	SR.1.1 TDD
	3		SR.2.1 TDD	SR.2.1 TDD
RMSI CORESET Reference Channel	1		CR.1.1 FDD	CR.1.1 FDD
	2		CR.1.1 TDD	CR.1.1 TDD
	3		CR.2.1 TDD	CR.2.1 TDD
Dedicated CORESET Reference Channel	1		CCR.1.1 FDD	CCR.1.1 FDD
	2		CCR.1.1 TDD	CCR.1.1 TDD
	3		CCR.2.1 TDD	CCR.2.1 TDD
SSB configuration	1		SSB.3 FR1	SSB.3 FR1
	2		SSB.3 FR1	SSB.3 FR1

		3		SSB.4 FR1	SSB.4 FR1
OCNG Patterns		1~3		OP.1	OP.1
TRS configuration		1		TRS.1.1 FDD	TRS.1.1 FDD
		2		TRS.1.1 TDD	TRS.1.1 TDD
		3		TRS.1.2 TDD	TRS.1.2 TDD
Initial BWP Configuration		1~3	DLBWP.0.1 ULBWP.0.1	DLBWP.0.1 ULBWP.0.1	
Dedicated BWP configuration		1~3	DLBWP.1.1 ULBWP.1.1	DLBWP.1.1 ULBWP.1.1	
SMTC configuration		1~3	SMTC.1	SMTC.1	
reportConfigType		1~3	periodic	periodic	
reportQuantity		1~3	ssb-Index-RSRP	ssb-Index-RSRP	
Number of reported RS		1~3	2	2	
L1-RSRP reporting period		1~3	slot80	slot80	
EPRE ratio of PSS to SSS		1~3	dB	0	0
EPRE ratio of PBCH DMRS to SSS					
EPRE ratio of PBCH to PBCH DMRS					
EPRE ratio of PDCCH DMRS to SSS					
EPRE ratio of PDCCH to PDCCH DMRS					
EPRE ratio of PDSCH DMRS to SSS					
EPRE ratio of PDSCH to PDSCH DMRS					
EPRE ratio of OCNG DMRS to SSS <sup>Note 1</sup>					
EPRE ratio of OCNG to OCNG DMRS <sup>Note 1</sup>					
$N_{oc}$ Note2					
	3	-96.00	$117 + \Delta_{BG\_offset}$		
$N_{oc}$ Note2	1,2	dBm/SSB SCS	-94.65	$-117 + \Delta_{BG\_offset}$	
	3		-93.00	$-114 + \Delta_{BG\_offset}$	
$\hat{E}_s / I_{ot}$		1~3	dB	10	-2.2
SSB RSRP Note3	Depending on band group	1,2	dBm/SSB SCS	-84.65	$-119.2 + \Delta_{BG\_offset}$
		3		-83.00	$-116.2 + \Delta_{BG\_offset}$
$I_o$ Note3	Depending on band group	1,2	dBm/9.36 MHz	-56.28	$-87.00 + \Delta_{BG\_offset}$
		3	dBm/38.16 MHz	-51.53	$-80.90 + \Delta_{BG\_offset}$
$\hat{E}_s / N_{oc}$		1~3	dB	10	-2.2
Propagation condition		1~3		AWGN	AWGN
Antenna configuration		1~3		1x2	1x2



- Note 1: OCNG shall be used such that both cells are fully allocated and a constant total transmitted power spectral density is achieved for all OFDM symbols.
- Note 2: Interference from other cells and noise sources not specified in the test is assumed to be constant over subcarriers and time and shall be modelled as AWGN of appropriate power for  $N_{oc}$  to be fulfilled.
- Note 3: RSRP and  $I_o$  levels have been derived from other parameters for information purposes. They are not settable parameters themselves.
- Note 4: RSRP minimum requirements are specified assuming independent interference and noise at each receiver antenna port.
- Note 5: The test configuration excludes support for band n51 and it is not required to run this test on band n51 in this release of the specification

**Table 6.7.4.1.1.5-2: L1-RSRP absolute accuracy requirements for the reported values for test configurations 1 and 2**

Normal Conditions	Test 1 All bands	Test 2	
Lowest reported value (Cell 1)	62	Bands NR_FDD_FR1_A, NR_TDD_FR1_A	31
		Bands NR_FDD_FR1_B	31
		Bands NR_TDD_FR1_C	32
		Bands NR_FDD_FR1_D, NR_TDD_FR1_D	32
		Bands NR_FDD_FR1_E, NR_TDD_FR1_E	33
		Bands NR_FDD_FR1_G	34
		Bands NR_FDD_FR1_H	34
		Highest reported value (Cell 1)	82
Bands NR_FDD_FR1_B	45		
Bands NR_TDD_FR1_C	45		
Bands NR_FDD_FR1_D, NR_TDD_FR1_D	46		
Bands NR_FDD_FR1_E, NR_TDD_FR1_E	46		
Bands NR_FDD_FR1_G	47		
Bands NR_FDD_FR1_H	48		
Extreme Conditions	Test 1 All bands		
Lowest reported value (Cell 1)	61	Bands NR_FDD_FR1_A, NR_TDD_FR1_A	30
		Bands NR_FDD_FR1_B	30
		Bands NR_TDD_FR1_C	31
		Bands NR_FDD_FR1_D, NR_TDD_FR1_D	31
		Bands NR_FDD_FR1_E, NR_TDD_FR1_E	32
		Bands NR_FDD_FR1_G	33
		Bands NR_FDD_FR1_H	33
		Highest reported value (Cell 1)	83
Bands NR_FDD_FR1_B	46		
Bands NR_TDD_FR1_C	46		
Bands NR_FDD_FR1_D, NR_TDD_FR1_D	47		
Bands NR_FDD_FR1_E, NR_TDD_FR1_E	47		
Bands NR_FDD_FR1_G	48		
Bands NR_FDD_FR1_H	49		

Note 1: NR operating band groups are defined in clause 3A.4, Table 3A.4.1-2.

**Table 6.7.4.1.1.5-3: L1-RSRP absolute accuracy requirements for the reported values for test configuration 3**

Normal Conditions	Test 1 All bands	Test 2	
Lowest reported value (Cell 1)	63	Bands NR_FDD_FR1_A, NR_TDD_FR1_A	34
		Bands NR_FDD_FR1_B	34
		Bands NR_TDD_FR1_C	35
		Bands NR_FDD_FR1_D, NR_TDD_FR1_D	35
		Bands NR_FDD_FR1_E, NR_TDD_FR1_E	36
		Bands NR_FDD_FR1_G	37
		Bands NR_FDD_FR1_H	37
Highest reported value (Cell 1)	84	Bands NR_FDD_FR1_A, NR_TDD_FR1_A	47
		Bands NR_FDD_FR1_B	48
		Bands NR_TDD_FR1_C	48
		Bands NR_FDD_FR1_D, NR_TDD_FR1_D	49
		Bands NR_FDD_FR1_E, NR_TDD_FR1_E	49
		Bands NR_FDD_FR1_G	50
		Bands NR_FDD_FR1_H	51
Extreme Conditions	Test 1 All bands	Test 2	
Lowest reported value (Cell 1)	62	Bands NR_FDD_FR1_A, NR_TDD_FR1_A	33
		Bands NR_FDD_FR1_B	33
		Bands NR_TDD_FR1_C	34
		Bands NR_FDD_FR1_D, NR_TDD_FR1_D	34
		Bands NR_FDD_FR1_E, NR_TDD_FR1_E	35
		Bands NR_FDD_FR1_G	36
		Bands NR_FDD_FR1_H	36
Highest reported value (Cell 1)	85	Bands NR_FDD_FR1_A, NR_TDD_FR1_A	48
		Bands NR_FDD_FR1_B	49
		Bands NR_TDD_FR1_C	49
		Bands NR_FDD_FR1_D, NR_TDD_FR1_D	50
		Bands NR_FDD_FR1_E, NR_TDD_FR1_E	50
		Bands NR_FDD_FR1_G	51
		Bands NR_FDD_FR1_H	52
Note 1: NR operating band groups are defined in clause 3A.4, Table 3A.4.1-2			

For the test to pass, the ratio of successful reported values in each test shall be more than 90% with a confidence level of 95%.

#### 6.7.4.1.2 NR SA FR1 SSB based L1-RSRP relative measurement accuracy

##### 6.7.4.1.2.1 Test purpose

The purpose of this test is to verify that the SSB based L1-RSRP relative measurement accuracy is within the specified limits for all bands.

##### 6.7.4.1.2.2 Test applicability

This test applies to all types of NR UE from Release 15 onwards.

##### 6.7.4.1.2.3 Minimum conformance requirements

The minimum conformance requirements are specified in clause 6.7.4.0.2.

The normative reference for this requirement is TS 38.133 [6] clause A.6.7.4.1.

#### 6.7.4.1.2.4 Test description

##### 6.7.4.1.2.4.1 Initial conditions

This test shall be tested using any of the test configurations in Table 6.7.4.1.2.4.1-1.

**Table 6.7.4.1.2.4.1-1: NR SA FR1 SSB based L1-RSRP relative measurement accuracy supported test configurations**

Test Case ID	Description
6.7.4.1.2-1	NR: 15 kHz SSB SCS, 10MHz bandwidth, FDD
6.7.4.1.2-2	NR: 15 kHz SSB SCS, 10MHz bandwidth, TDD
6.7.4.1.2-3	NR: 30 kHz SSB SCS, 40MHz bandwidth, TDD
Note: The UE is only required to be tested in one of the supported test configurations	

Configure the test equipment and the DUT according to the parameters in Table 6.7.4.1.2.4.1-2.

**Table 6.7.4.1.2.4.1-2: Initial conditions for SSB based L1-RSRP relative accuracy in FR1**

Parameter	Value		Comment
Test environment	NC, TL/VL, TL/VH, TH/VL, TH/VH		As specified in TS 38.508-1 [14] clause 4.1.
Test frequencies	As specified in Annex E, Table E.4-1 and TS 38.508-1 [14] clause 4.3.1.		
Channel bandwidth	As specified by the test configuration selected from Table 6.7.4.1.2.4.1-1.		
Propagation conditions	AWGN		As specified in Annex C.2.2.
Connection Diagram	TE Part 2Rx	A.3.1.8.2 with n = 1	As specified in TS 38.508-1 [14] Annex A.
	TE Part 4Rx	A.3.1.8.5 with n = 1	
	DUT Part 2Rx	A.3.2.3.4	
	DUT Part 4Rx	A.3.2.5.2	
Exceptions to connection diagram	N/A		

1. Message contents are defined in clause 6.7.4.1.2.4.3.

2. Cell 1 is the NR FR1 cell. Cell 1 is the target for SSB-based L1-RSRP measurements. The UE is configured to perform RLM, BFD and L1-RSRP measurement based on the SSBs. The connection setup is done according to the settings in Annex C.1.1.

#### 6.7.4.1.2.4.2 Test procedure

The UE shall be configured for periodic CSI reporting in PUCCH [format 2] with a reporting periodicity as mentioned in the above table 6.7.4.1.2.4.1-2.

1. Ensure the UE is in state RRC\_CONNECTED with generic procedure parameters Connectivity NR SA, Connected without release *On* and Test Mode *On*, according to TS 38.508-1 [14] clause 4.5 and general test parameters set according to Table 6.7.4.1.2.4.1-2.
2. Set the parameters according to T1 in Table 6.7.4.1.2.5-1.
3. The UE shall start sending L1-RSRP report including results of both SSB#0 and SSB#1 every 80 slots.
4. The SS shall check the L1-RSRP reported values of SSB#0 and SSB#1 in the periodic L1-RSRP reports. The L1-RSRP value for SSB#1 is compared to the L1-RSRP value for SSB#0. If the difference is within the limits in Table 6.7.4.1.2.5-2, the number of passed iterations is increased by one, otherwise the number of failed iterations is increased by one.

5. The SS shall continue checking the L1-RSRP report messages transmitted by the UE until the confidence level according to Table G.2.3-1 in Annex G is achieved.

6. Set the parameters according to each sub-test in Table 6.7.4.1.2.5-1 as appropriate and repeat steps 3-5.

#### 6.7.4.1.2.4.3 Message contents

Message contents are same as in Clause 6.7.4.1.1.4.3.

#### 6.7.4.1.2.5 Test requirement

Table 6.7.4.1.2.5-1 defines the primary level settings including test tolerances for all tests.

Each L1-RSRP measurement report for each of the tests in Table 6.7.4.1.2.5-1 shall meet the corresponding absolute accuracy requirements in Table 6.7.4.1.2.5-2.

**Table 6.7.4.1.2.5-1: Same as Table 6.7.4.1.1.5-1**

**Table 6.7.4.1.2.5-2: L1-RSRP relative accuracy requirements for the reported values**

	Test 1	Test 2
	All bands	All bands
Normal Conditions		
Lowest reported value (Cell 1 SSB resource 1)	RSRP <sub>x</sub> - 3	RSRP <sub>x</sub> - 3
Highest reported value (Cell 1 SSB resource 1)	RSRP <sub>x</sub> + 3	RSRP <sub>x</sub> + 3
Extreme Conditions		
Lowest reported value (Cell 1 SSB resource 1))	RSRP <sub>x</sub> - 4	RSRP <sub>x</sub> - 4
Highest reported value (Cell 1 SSB resource 1)	RSRP <sub>x</sub> + 4	RSRP <sub>x</sub> + 4
RSRP <sub>x</sub> is the reported value of Cell 1 SSB resource 0		

For the test to pass, the ratio of successful reported values in each test shall be more than 90% with a confidence level of 95%.

### 6.7.4.2 CSI-RS based L1-RSRP measurements

#### 6.7.4.2.1 NR SA FR1 CSI-RS based L1-RSRP absolute measurement accuracy

##### 6.7.4.2.1.1 Test purpose

The purpose of this test is to verify that the CSI-RS based L1-RSRP absolute measurement accuracy is within the specified limits for all bands.

##### 6.7.4.2.1.2 Test applicability

This test applies to all types of NR UE from Release 15 onwards.

##### 6.7.4.2.1.3 Minimum conformance requirements

The minimum conformance requirements are specified in clause 6.7.4.0.3.

The normative reference for this requirement is TS 38.133 [6] clause A.6.7.4.2.

##### 6.7.4.2.1.4 Test description

##### 6.7.4.2.1.4.1 Initial conditions

This test shall be tested using any of the test configurations in Table 6.7.4.2.1.4.1-1.

**Table 6.7.4.2.1.4.1-1: NR SA FR1 CSI-RS based L1-RSRP absolute measurement accuracy supported test configurations**

Test Case ID	Description
6.7.4.2.1-1	NR: 15 kHz SSB SCS, 10MHz bandwidth, FDD
6.7.4.2.1-2	NR: 15 kHz SSB SCS, 10MHz bandwidth, TDD
6.7.4.2.1-3	NR: 30 kHz SSB SCS, 40MHz bandwidth, TDD
Note: The UE is only required to be tested in one of the supported test configurations	

Configure the test equipment and the DUT according to the parameters in Table 6.7.4.2.1.4.1-2.

**Table 6.7.4.2.1.4.1-2: Initial conditions for CSI-RS based L1-RSRP absolute accuracy in FR1**

Parameter	Value	Comment
Test environment	NC, TL/VL, TL/VH, TH/VL, TH/VH	As specified in TS 38.508-1 [14] clause 4.1.
Test frequencies	As specified in Annex E, Table E.4-1 and TS 38.508-1 [14] clause 4.3.1.	
Channel bandwidth	As specified by the test configuration selected from Table 6.7.4.2.1.4.1-1.	
Propagation conditions	AWGN	As specified in Annex C.2.2.
Connection Diagram	TE Part 2Rx	A.3.1.8.2 with n = 1
	TE Part 4Rx	A.3.1.8.5 with n = 1
	DUT Part 2Rx	A.3.2.3.4
	DUT Part 4Rx	A.3.2.5.2
Exceptions to connection diagram	N/A	

1. Message contents are defined in clause 6.7.4.2.1.4.3.

2. Cell 1 is the NR FR1 cell. Cell 1 is the target for CSI-RS based L1-RSRP measurements. The UE is configured to perform RLM and BFD measurement based on the SSB. The connection setup is done according to the settings in Annex C.1.1.

#### 6.7.4.2.1.4.2 Test procedure

The UE shall be configured for periodic CSI reporting in PUCCH [format 2] with a reporting periodicity as mentioned in the above table 6.7.4.2.1.4.1-2.

1. Ensure the UE is in state RRC\_CONNECTED with generic procedure parameters Connectivity NR SA, Connected without release *On* and Test Mode *On*, according to TS 38.508-1 [14] clause 4.5 and general test parameters set according to Table 6.7.4.2.1.4.1-2.
2. Set the parameters according to T1 in Table 6.7.4.2.1.5-1.
3. The UE shall start sending L1-RSRP report including results of both CSI-RS#0 and CSI-RS#1 every 80 slots.
4. The SS shall check the L1-RSRP reported values of CSI-RS#0 and CSI-RS#1 in the periodic L1-RSRP reports. If the value for both CSI-RSs is within the limits in Table 6.7.4.2.1.5-2 or Table 6.7.4.2.1.5-3 (depending on the test configuration), the number of passed iterations is increased by one, otherwise the number of failed iterations is increased by one.
5. The SS shall continue checking the L1-RSRP report messages transmitted by the UE until the confidence level according to Table G.2.3-1 in Annex G is achieved.
6. Set the parameters according to each sub-test in Table 6.7.4.2.1.5-1 as appropriate and repeat steps 3-5.

#### 6.7.4.2.1.4.3 Message contents

Message contents are according to TS 38.508-1 [14] clause 7.3 with the following exceptions:

**Table 6.7.4.2.1.4.3-1: Common Exception messages EN-DC CSI-RS-based L1-RSRP measurement**

Default Message Contents	
Common contents of system information blocks exceptions	
Default RRC messages and information elements contents exceptions	Table H.3.6-2 with conditions PERIODIC and CSI-RSRP Table H.3.6-3 with conditions CSI-RS and PERIODIC Table 7.3.1-3 in TS 38.508-1 [14] with condition SMTC.1

**Table 6.7.4.2.1.4.3-2: RadioLinkMonitoringConfig**

Derivation Path: TS 38.508-1 [14], Table 4.6.3-133			
Information Element	Value/remark	Comment	Condition
RadioLinkMonitoringConfig ::= SEQUENCE {			
failureDetectionResourcesToAddModList	1 entry		
SEQUENCE			
(SIZE(1..maxNrofFailureDetectionResources)) OF			
SEQUENCE {			
purpose	both	UE is configured to perform RLM and BFD based on the SSB.	
detectionResource CHOICE {			
ssb-Index	0		
}			
}			
}			

6.7.4.2.1.5 Test requirement

Table 6.7.4.2.1.5-1 defines the primary level settings including test tolerances for all tests.

Each L1-RSRP measurement report for each of the tests in Table 6.7.4.2.1.5-1 shall meet the corresponding absolute accuracy requirements in Table 6.7.4.2.1.5-2 for test configurations 1 and 2, and the corresponding absolute accuracy requirements in Table 6.7.4.2.1.5-3 for test configuration 3.

**Table 6.7.4.2.1.5-1: L1-RSRP test parameters**

Parameter	Config	Unit	Test 1	Test 2
SSB GSCN	1~3		freq1	freq1
Duplex mode	1		FDD	FDD
	2		TDD	TDD
	3		TDD	TDD
TDD Configuration	1		N/A	N/A
	2		TDDConf.1.1	TDDConf.1.1
	3		TDDConf.2.1	TDDConf.2.1
BW <sub>channel</sub>	1	MHz	10: N <sub>RB,c</sub> = 52	10: N <sub>RB,c</sub> = 52
	2		10: N <sub>RB,c</sub> = 52	10: N <sub>RB,c</sub> = 52
	3		40: N <sub>RB,c</sub> = 106	40: N <sub>RB,c</sub> = 106
PDSCH Reference measurement channel	1		SR.1.1 FDD	SR.1.1 FDD
	2		SR.1.1 TDD	SR.1.1 TDD
	3		SR.2.1 TDD	SR.2.1 TDD
RMSI CORESET Reference Channel	1		CR.1.1 FDD	CR.1.1 FDD
	2		CR.1.1 TDD	CR.1.1 TDD
	3		CR.2.1 TDD	CR.2.1 TDD
Dedicated CORESET Reference Channel	1		CCR.1.1 FDD	CCR.1.1 FDD
	2		CCR.1.1 TDD	CCR.1.1 TDD
	3		CCR.2.1 TDD	CCR.2.1 TDD
SSB configuration	1		SSB.3 FR1	SSB.3 FR1
	2		SSB.3 FR1	SSB.3 FR1
	3		SSB.4 FR1	SSB.4 FR1

OCNG Patterns		1~3		OP.1	OP.1	
TRS configuration		1		TRS.1.1 FDD	TRS.1.1 FDD	
		2		TRS.1.1 TDD	TRS.1.1 TDD	
		3		TRS.1.2 TDD	TRS.1.2 TDD	
Initial BWP Configuration		1~3		DLBWP.0.1 ULBWP.0.1	DLBWP.0.1 ULBWP.0.1	
Dedicated BWP configuration		1~3		DLBWP.1.1 ULBWP.1.1	DLBWP.1.1 ULBWP.1.1	
SMTC configuration		1~3		SMTC.1	SMTC.1	
CSI-RS		1,4		CSI-RS 1.2 FDD	CSI-RS 1.2 FDD	
		2,5		CSI-RS 1.2 TDD	CSI-RS 1.2 TDD	
		3,6		CSI-RS 2.2 TDD	CSI-RS 2.2 FDD	
reportConfigType		1~3		periodic	periodic	
reportQuantity		1~3		cri-RSRP	cri-RSRP	
Number of reported RS		1~3		2	2	
L1-RSRP reporting period		1~3		slot80	slot80	
EPRE ratio of PSS to SSS		1~3	dB	0	0	
EPRE ratio of PBCH DMRS to SSS						
EPRE ratio of PBCH to PBCH DMRS						
EPRE ratio of PDCCH DMRS to SSS						
EPRE ratio of PDCCH to PDCCH DMRS						
EPRE ratio of PDSCH DMRS to SSS						
EPRE ratio of PDSCH to PDSCH DMRS						
EPRE ratio of OCNG DMRS to SSS <sup>Note 1</sup>						
EPRE ratio of OCNG to OCNG DMRS <sup>Note 1</sup>						
$N_{oc}$ Note2	Depending on band group					1,2
		3	-96.00	117+ $\Delta_{BG\_offset}$		
$N_{oc}$ Note2		1,2	dBm/CSI-RS SCS	-94.65	-117+ $\Delta_{BG\_offset}$	
		3		-93.00	-114+ $\Delta_{BG\_offset}$	
$\hat{E}_s / I_{ot}$		1~3	dB	10	-2.2	
CSI-RSRP Note3		Depending on band group	1,2	dBm/CSI-RS SCS	-84.65	-119.2 + $\Delta_{BG\_offset}$
			3		-83.00	-116.2 + $\Delta_{BG\_offset}$
$I_o$ Note3		Depending on band group	1,2	dBm/9.36 MHz	-56.28	-87.00 + $\Delta_{BG\_offset}$
			3	dBm/38.16 MHz	-51.53	-80.90 + $\Delta_{BG\_offset}$
$\hat{E}_s / N_{oc}$		1~3	dB	10	-2.2	
Propagation condition		1~3		AWGN	AWGN	
Antenna configuration		1~3		1x2	1x2	

Note 1:	OCNG shall be used such that both cells are fully allocated and a constant total transmitted power spectral density is achieved for all OFDM symbols.
Note 2:	Interference from other cells and noise sources not specified in the test is assumed to be constant over subcarriers and time and shall be modelled as AWGN of appropriate power for $N_{oc}$ to be fulfilled.
Note 3:	RSRP and $I_o$ levels have been derived from other parameters for information purposes. They are not settable parameters themselves.
Note 4:	RSRP minimum requirements are specified assuming independent interference and noise at each receiver antenna port.
Note 5:	The test configuration excludes support for band n51 and it is not required to run this test on band n51 in this release of the specification

**Table 6.7.4.2.1.5-2: Same as Table 6.7.4.1.1.5-2**

**Table 6.7.4.2.1.5-3: Same as Table 6.7.4.1.1.5-3**

For the test to pass, the ratio of successful reported values in each test shall be more than 90% with a confidence level of 95%.

**6.7.4.2.2 NR SA FR1 CSI-RS based L1-RSRP relative measurement accuracy**

**6.7.4.2.2.1 Test purpose**

The purpose of this test is to verify that the CSI-RS based L1-RSRP relative measurement accuracy is within the specified limits for all bands.

**6.7.4.2.2.2 Test applicability**

This test applies to all types of NR UE from Release 15 onwards.

**6.7.4.2.2.3 Minimum conformance requirements**

The minimum conformance requirements are specified in clause 6.7.4.0.4.

The normative reference for this requirement is TS 38.133 [6] clause A.6.7.4.2.

**6.7.4.2.2.4 Test description**

**6.7.4.2.2.4.1 Initial conditions**

This test shall be tested using any of the test configurations in Table 6.7.4.2.2.4.1-1.

**Table 6.7.4.2.2.4.1-1: NR SA FR1 CSI-RS based L1-RSRP relative measurement accuracy supported test configurations**

Test Case ID	Description
6.7.4.2.2-1	NR: 15 kHz SSB SCS, 10MHz bandwidth, FDD
6.7.4.2.2-2	NR: 15 kHz SSB SCS, 10MHz bandwidth, TDD
6.7.4.2.2-3	NR: 30 kHz SSB SCS, 40MHz bandwidth, TDD
Note: The UE is only required to be tested in one of the supported test configurations	

Configure the test equipment and the DUT according to the parameters in Table 6.7.4.2.2.4.1-2.



**Table 6.7.4.2.2.4.1-2: Initial conditions for CSI-RS based L1-RSRP relative accuracy in FR1**

Parameter	Value		Comment
Test environment	NC, TL/VL, TL/VH, TH/VL, TH/VH		As specified in TS 38.508-1 [14] clause 4.1.
Test frequencies	As specified in Annex E, Table E.4-1 and TS 38.508-1 [14] clause 4.3.1.		
Channel bandwidth	As specified by the test configuration selected from Table 6.7.4.2.2.4.1-1.		
Propagation conditions	AWGN		As specified in Annex C.2.2.
Connection Diagram	TE Part 2Rx	A.3.1.8.2 with n = 1	As specified in TS 38.508-1 [14] Annex A.
	TE Part 4Rx	A.3.1.8.5 with n = 1	
	DUT Part 2Rx	A.3.2.3.4	
	DUT Part 4Rx	A.3.2.5.2	
Exceptions to connection diagram	N/A		

1. Message contents are defined in clause 6.7.4.2.2.4.3.

2. Cell 1 is the NR FR1 cell. Cell 1 is the target for CSI-RS based L1-RSRP measurements. The UE is configured to perform RLM and BFD measurement based on the SSB. The connection setup is done according to the settings in Annex C.1.1.

#### 6.7.4.2.2.4.2 Test procedure

The UE shall be configured for periodic CSI reporting in PUCCH [format 2] with a reporting periodicity as mentioned in the above table 6.7.4.2.2.4.1-2.

1. Ensure the UE is in state RRC\_CONNECTED with generic procedure parameters Connectivity NR SA, Connected without release *On* and Test Mode *On*, according to TS 38.508-1 [14] clause 4.5 and general test parameters set according to Table 6.7.4.2.2.4.1-2.
2. Set the parameters according to T1 in Table 6.7.4.2.2.5-1.
3. The UE shall start sending L1-RSRP report including results of both CSI-RS#0 and CSI-RS#1 every 80 slots.
4. The SS shall check the L1-RSRP reported values of CSI-RS#0 and CSI-RS#1 in the periodic L1-RSRP reports. The L1-RSRP value for CSI-RS #1 is compared to the L1-RSRP value for CSI-RS #0. If the difference is within the limits in Table 6.7.4.2.2.5-2, the number of passed iterations is increased by one, otherwise the number of failed iterations is increased by one.
5. The SS shall continue checking the L1-RSRP report messages transmitted by the UE until the confidence level according to Table G.2.3-1 in Annex G is achieved.
6. Set the parameters according to each sub-test in Table 6.7.4.2.2.5-1 as appropriate and repeat steps 3-5.

#### 6.7.4.2.2.4.3 Message contents

Message contents are same as in Clause 6.7.4.2.1.4.3.

#### 6.7.4.2.2.5 Test requirement

Table 6.7.4.2.2.5-1 defines the primary level settings including test tolerances for all tests.

Each L1-RSRP measurement report for each of the tests in Table 6.7.4.2.2.5-1 shall meet the corresponding absolute accuracy requirements in Table 6.7.4.2.2.5-2.

**Table 6.7.4.2.2.5-1: Same as Table 6.7.4.2.1.5-1**

**Table 6.7.4.2.2.5-2: Same as Table 6.7.4.1.2.5-2**

For the test to pass, the ratio of successful reported values in each test shall be more than 90% with a confidence level of 95%.

## 6.7.5 E-UTRAN RSRP

### 6.7.5.0 Minimum conformance requirements

#### 6.7.5.0.1 E-UTRAN RSRP absolute accuracy

The measurement period of E-UTRA RSRP in RRC\_CONNECTED state is specified in clause 9.4.2 and 9.4.3 of TS 38.133 [6].

The accuracy requirements of E-UTRA RSRP measurements in RRC\_CONNECTED state and the corresponding side conditions shall be the same as the inter-frequency RSRP Accuracy Requirements in clause 9.1.3 of TS 36.133 [23]:

The requirements for absolute accuracy of RSRP in this clause apply to a cell that has different carrier frequency from the serving cell.

The accuracy requirements in Table 6.7.5.0.1-1 are valid under the following conditions:

Cell specific reference signals are transmitted either from one, two or four antenna ports.

Conditions defined in 36.101 [27] Clause 7.3 for reference sensitivity are fulfilled.

RSRP[dBm] according to Annex B.3.3 of TS 36.133 [23] for a corresponding Band.

**Table 6.7.5.0.1-1: RSRP Inter frequency absolute accuracy**

Accuracy		Conditions				
Normal condition	Extreme condition	$\hat{E}_s/\text{lot}$	$I_o$ <sup>Note 1</sup> range			
			E-UTRA operating band groups <sup>Note 3</sup>	Minimum $I_o$		Maximum $I_o$
dB	dB	dB		dBm/15kHz <sup>Note 2</sup>	dBm/BW <sub>Channel</sub>	dBm/BW <sub>Channel</sub>
±4.5	±9	≥-6 dB	FDD_A, TDD_A	-121	N/A	-70
			FDD_B1, FDD_B2	-120.5	N/A	-70
			FDD_C, TDD_C	-120	N/A	-70
			FDD_D	-119.5	N/A	-70
			FDD_E, TDD_E	-119	N/A	-70
			FDD_F	-118.5	N/A	-70
			FDD_G	-118	N/A	-70
			FDD_H	-117.5	N/A	-70
			FDD_N	-114.5	N/A	-70
±8	±11	≥-6 dB	FDD_A, TDD_A, FDD_B1, FDD_B2, FDD_C, TDD_C, FDD_D, FDD_E, TDD_E, FDD_F, FDD_G, FDD_H, FDD_N	N/A	-70	-50

NOTE 1:  $I_o$  is assumed to have constant EPRE across the bandwidth.  
NOTE 2: The condition level is increased by  $\Delta > 0$ , when applicable, as described in Sections B.4.2 and B.4.3 of TS 36.133 [23].  
NOTE 3: E-UTRA operating band groups are as defined in Section 3.5 of TS 36.133 [23].

The reporting range and mapping specified for RSRP measurements in clause 9.1.4 of TS 36.133 [23] shall apply:

The reporting range of RSRP is defined from -156 dBm to -44 dBm with 1 dB resolution.

The mapping of measured quantity is defined in Table 6.7.5.0.1-2. The range in the signalling may be larger than the guaranteed accuracy range.

**Table 6.7.5.0.1-2: RSRP measurement report mapping**

Reported value	Measured quantity value	Unit
RSRP_-17	RSRP < -156	dBm
RSRP_-16	-156 ≤ RSRP < -155	dBm
...	...	...
RSRP_-03	-143 ≤ RSRP < -142	dBm
RSRP_-02	-142 ≤ RSRP < -141	dBm
RSRP_-01	-141 ≤ RSRP < -140	dBm
RSRP_00	RSRP < -140	dBm
RSRP_01	-140 ≤ RSRP < -139	dBm
RSRP_02	-139 ≤ RSRP < -138	dBm
...	...	...
RSRP_95	-46 ≤ RSRP < -45	dBm
RSRP_96	-45 ≤ RSRP < -44	dBm
RSRP_97	-44 ≤ RSRP	dBm

### 6.7.5.1 NR SA FR1 – E-UTRAN RSRP absolute measurement accuracy

#### 6.7.5.1.1 Test purpose

The purpose of this test is to verify that the inter-RAT E-UTRAN RSRP absolute measurement accuracy is within the specified limits for all bands, when the serving cell is NR FR1 and the target cell is E-UTRA.

#### 6.7.5.1.2 Test applicability

This test applies to all types of NR UE from Release 15 onwards supporting E-UTRA.

#### 6.7.5.1.3 Minimum conformance requirements

The minimum conformance requirements are specified in clause 6.7.5.0.1.

The normative reference for this requirement is TS 38.133 [6] clause A.6.7.5.1.

#### 6.7.5.1.4 Test description

##### 6.7.5.1.4.1 Initial conditions

This test shall be tested using any of the test configurations in Table 6.7.5.1.4.1-1.

**Table 6.7.5.1.4.1-1: test configurations**

Test Case ID	Description
6.7.5.1-1	NR: 15 kHz SSB SCS, 10MHz bandwidth, FDD, E-UTRAN: FDD
6.7.5.1-2	NR: 15 kHz SSB SCS, 10MHz bandwidth, TDD, E-UTRAN: FDD
6.7.5.1-3	NR: 30 kHz SSB SCS, 40MHz bandwidth, TDD, E-UTRAN: FDD
6.7.5.1-4	NR: 15 kHz SSB SCS, 10MHz bandwidth, FDD, E-UTRAN: TDD
6.7.5.1-5	NR: 15 kHz SSB SCS, 10MHz bandwidth, TDD, E-UTRAN: TDD
6.7.5.1-6	NR: 30 kHz SSB SCS, 40MHz bandwidth, TDD, E-UTRAN: TDD

Note: The UE is only required to be tested in one of the supported test configurations

Configure the test equipment and the DUT according to the parameters in Table 6.7.5.1.4.1-2.

**Table 6.7.5.1.4.1-2: initial conditions**

Parameter	Value		Comment
Test environment	NC, TL/VL, TL/VH, TH/VL, TH/VH		As specified in TS 38.508-1 [14] clause 4.1.
Test frequencies	As specified in Annex E, Table E.4-2 and TS 38.508-1 [14] clause 4.3.1.		
Channel bandwidth	As specified by the test configuration selected from Table 6.7.5.1.4.1-1.		
Propagation conditions	AWGN		As specified in Annex C.2.2.
Connection Diagram	TE Part 2Rx	A.3.1.7.2	As specified in TS 38.508-1 [14] Annex A.
	TE Part 4Rx	A.3.1.7.3	
	DUT Part 2Rx	A.3.2.3.4	
	DUT Part 4Rx	A.3.2.5.2	
Exceptions to connection diagram	N/A		

1. Message contents are defined in clause 6.7.5.1.4.3.

2. There are two carriers and two cells specified in the test, where NR Cell 1 is the NR PCell on the NR carrier and Cell 2 is the E-UTRA neighbour cell on the E-UTRA carrier and the target for the measurements.

**6.7.5.1.4.2 Test procedure**

1. Ensure the UE is in state RRC\_CONNECTED with generic procedure parameters Connectivity *NR*, Connected without release *On* and Test Mode *On* according to TS 38.508-1 [14] clause 4.5.
2. Set the parameters according to Table 6.7.5.1.5-1 and Table 6.7.5.1.5-2 as appropriate.
3. The SS shall transmit an RRCReconfiguration message on Cell 1.
4. The UE shall transmit an RRCReconfigurationComplete message.
5. The UE shall transmit periodically MeasurementReport messages.
6. After 10s wait from Step 3, the SS shall check the RSRP reported values in the periodic MeasurementReport. The RSRP value of Cell 2 reported by the UE is compared to the expected RSRP. If the value is outside the limits in Table 6.7.5.1.5-2 or the UE fails to report the measurement value for Cell 2, the number of failed iterations is increased by one. Otherwise, the number of passed iterations is increased by one.
7. The SS shall continue checking the MeasurementReport messages transmitted by the UE until the confidence level according to Table G.2.3-1 in Annex G is achieved.
8. Set the parameters according to each sub-test in Table 6.7.5.1.5-2 as appropriate and repeat steps 5-7.

**6.7.5.1.4.3 Message contents**

Message contents are according to TS 38.508-1 [14] clause 7.3 with the following exceptions:

**Table 6.7.5.1.4.3-1: Common Exception messages**

Default Message Contents	
Common contents of system information blocks exceptions	
Default RRC messages and information elements contents exceptions	Table H.3.1-1 Table H.3.1-2 with condition INTER-RAT and GAP NEEDED Table H.3.1-3 Table H.3.1-3a Table H.3.1-7 with condition INTER-RAT Table 7.3.1-3 in TS 38.508-1 [14] with condition SMTC.1

**Table 6.7.5.1.4.3-1A: MeasConfig (Test procedure step 3)**

Derivation path: Table H.3.1-2 with condition INTER-RAT and GAP NEEDED			
Information Element	Value/Remark	Comment	Condition
measConfig ::= SEQUENCE {			
reportConfigToAddModList SEQUENCE(SIZE (1..maxReportConfigId)) OF ReportConfigToAddMod {	2 entries		
ReportConfigToAddMod[1] SEQUENCE {		entry 1	
reportConfigId	1		
reportConfig CHOICE {			
reportConfigInterRAT	ReportConfigE-UTRA-DEFAULT(Periodical)	Table 6.7.5.1.4.3-2	
}			
}			
ReportConfigToAddMod[2] SEQUENCE {		entry 2	
reportConfigId	2		
reportConfig CHOICE {			
reportConfigInterRAT	ReportConfigInterRAT-EVENT	Table 6.7.5.1.4.3-1B	
}			
}			
}			
measIdToAddModList SEQUENCE (SIZE (1..maxNrofMeasId)) OF MeasIdToAddMod {	2 entries		
MeasIdToAddMod[1] SEQUENCE {		entry 1	
measId	1		
measObjectId	2		
reportConfigId	1		
}			
MeasIdToAddMod[2] SEQUENCE {		entry 2	
measId	2		
measObjectId	2		
reportConfigId	2		
}			
}			
}			

**Table 6.7.5.1.4.3-1B: ReportConfigInterRAT-EVENT (Table 6.7.5.1.4.3-1A)**

Derivation Path: TS 38.508-1 [14] Table 4.6.3-141 with condition EVENT_B1			
Information Element	Value/remark	Comment	Condition
ReportConfigInterRAT ::= SEQUENCE {			
reportType CHOICE {			
eventTriggered SEQUENCE {			
eventId CHOICE {			
eventB1 SEQUENCE {			
b1-ThresholdEUTRA CHOICE {			
rsp	97	Set threshold to -44dBm to ensure measId 2 will never be triggered	
}			
}			
}			
}			
}			
}			

**Table 6.7.5.1.4.3-2: ReportConfigE-UTRA-DEFAULT(Periodical)**

Derivation Path: 38.508-1 [14] Table 4.6.3-141 with Condition PERIODICAL			
Information Element	Value/remark	Comment	Condition
ReportConfigInterRAT::= SEQUENCE {			
reportType CHOICE {			
periodical SEQUENCE {			
reportQuantityCell SEQUENCE {			
rsrq	false		
}			
maxReportCells	2		
}			
}			
}			

#### 6.7.5.1.5 Test requirement

Table 6.7.5.1.5-1 defines the primary level settings including test tolerances for all tests.

Each SS-RSRP measurement report for each of the tests in Tables 6.7.5.1.5-1 and 6.7.5.1.5-2 shall meet the corresponding absolute accuracy requirements in Table 6.7.5.1.5-3.

Table 6.7.5.1.5-1: NR Cell specific test parameters for SA Inter-RAT E-UTRAN RSRP test parameters

Parameter		Unit	Cell 1
NR RF channel number			1
Duplex mode	Config 1, 4		FDD
	Config 2, 3, 5, 6		TDD
TDD Configuration	Config 1, 4		N/A
	Config 2, 5		TDDConf.1.1
	Config 3, 6		TDDConf.2.1
BW <sub>channel</sub>	Config 1, 4	MHz	10: N <sub>RB,c</sub> = 52 (FDD)
	Config 2, 5		10: N <sub>RB,c</sub> = 52 (TDD)
	Config 3, 6		40: N <sub>RB,c</sub> = 106 (TDD)
Gap pattern Id			0
PDSCH reference measurement channel	Config 1, 4		SR.1.1 FDD
	Config 2, 5		SR.1.1 TDD
	Config 3, 6		SR.2.1 TDD
RMSI CORSET reference channel	Config 1, 4		CR.1.1 FDD
	Config 2, 5		CR.1.1 TDD
	Config 3, 6		CR.2.1 TDD
Dedicated CORSET reference channel	Config 1, 4		CCR.1.1 FDD
	Config 2, 5		CCR.1.1 TDD
	Config 3, 6		CCR.2.1 TDD
BWP configurations	Initial DL BWP		DLBWP.0.1
	Dedicated DL BWP		DLBWP.1.1
	Initial UL BWP		ULBWP.0.1
	Dedicated UL BWP		ULBWP.1.1
OCNG pattern <sup>Note1</sup>			OP.1
SMTC configuration			SMTC.1
SSB configuration	Config 1, 2, 4, 5		SSB.1 FR1
	Config 3, 6		SSB.2 FR1
EPRE ratio of PSS to SSS		dB	0
EPRE ratio of PBCH_DMRS to SSS			
EPRE ratio of PBCH to PBCH_DMRS			
EPRE ratio of PDCCH_DMRS to SSS			
EPRE ratio of PDCCH to PDCCH_DMRS			
EPRE ratio of PDSCH_DMRS to SSS			
EPRE ratio of PDSCH to PDSCH_DMRS			
EPRE ratio of OCNG DMRS to SSS			
EPRE ratio of OCNG to OCNG DMRS			
N <sub>oc</sub> <sup>Note2</sup>		dBm/15 kHz	-104
N <sub>oc</sub> <sup>Note2</sup>	Config 1, 2, 4, 5	dBm/SCS	-104
	Config 3, 6		-101
$\hat{E}_s/N_{oc}$		dB	17
$\hat{E}_s/I_{ot}$ <sup>Note3</sup>		dB	17
SS-RSRP <sup>Note3</sup>	Config 1, 2, 4, 5	dBm/SCS	-87
	Config 3, 6		-84
SSB_RP <sup>Note3</sup>	Config 1, 2, 4, 5	dBm/SCS	-87
	Config 3, 6		-84
I <sub>o</sub> <sup>Note3</sup>	Config 1, 2, 4, 5	dBm/9.36 MHz	-58.96
	Config 3, 6	dBm/38.16 MHz	-52.87
Propagation condition			AWGN
Antenna Configuration and Correlation Matrix			1x2
Note 1: OCNG shall be used such that both cells are fully allocated and a constant total transmitted power spectral density is achieved for all OFDM symbols.			
Note 2: Interference from other cells and noise sources not specified in the test is assumed to be constant over subcarriers and time and shall be modelled as AWGN of appropriate power for N <sub>oc</sub> to be fulfilled.			
Note 3: $\hat{E}_s/I_{ot}$ , SS-RSRP, SSB_RP and I <sub>o</sub> levels have been derived from other parameters for information purposes. They are not settable parameters themselves.			

**Table 6.7.5.1.5-2: E-UTRAN Cell specific test parameters for SA Inter-RAT E-UTRAN RSRP test parameters**



Parameter		Unit	Cell 2	
			Test 1	Test 2
E-UTRA RF channel number			1	
Duplex mode	Config 1, 2, 3		FDD	
	Config 4, 5, 6		TDD	
TDD special subframe configuration <sup>Note1</sup>	Config 1, 2, 3		N/A	
	Config 4, 5, 6		6	
TDD uplink-downlink configuration <sup>Note1</sup>	Config 1, 2, 3		N/A	
	Config 4, 5, 6		1	
BW <sub>channel</sub>		MHz	5 MHz: N <sub>RB,c</sub> = 25 10 MHz: N <sub>RB,c</sub> = 50 20 MHz: N <sub>RB,c</sub> = 100	
PDSCH parameters: DL Reference Measurement Channel <sup>Note2</sup>			-	
PCFICH/PDCCH/PHICH parameters: DL Reference Measurement Channel <sup>Note2</sup>	Config 1, 2, 3		5 MHz: R.11 FDD 10 MHz: R.6 FDD 20 MHz: R.10 FDD	
	Config 4, 5, 6		5 MHz: R.11 TDD 10 MHz: R.6 TDD 20 MHz: R.10 TDD	
OCNG Patterns <sup>Note2</sup>	Config 1, 2, 3		5 MHz: OP.19 FDD 10 MHz: OP.6 FDD 20 MHz: OP.14 FDD	
	Config 4, 5, 6		5 MHz: OP.10 TDD 10 MHz: OP.2 TDD 20 MHz: OP.8 TDD	
PBCH_RA		dB	0	
PBCH_RB				
PSS_RA				
SSS_RA				
PCFICH_RB				
PHICH_RA				
PHICH_RB				
PDCCH_RA				
PDCCH_RB				
PDSCH_RA				
PDSCH_RB				
OCNG_RA <sup>Note3</sup>				
OCNG_RB <sup>Note3</sup>				
N <sub>oc</sub> <sup>Note4</sup>	Depending on band group			
$\bar{E}_s/N_{oc}$		dB	10	-3.2
$\bar{E}_s/I_{ot}$ <sup>Note5</sup>		dB	10	-3.2
RSRP <sup>Note5</sup>	Depending on band group	dBm/15kHz	-81.65	-120.2+ Δ <sub>BG_offset</sub>
SCH_RP <sup>Note5</sup>	Depending on band group	dBm/15kHz	-81.65	-120.2+ Δ <sub>BG_offset</sub>
I <sub>o</sub> <sup>Note5</sup>	Depending on band group	dBm/Ch BW	-53.45 + 10log(N <sub>RB,c</sub> /50)	-87.52+ Δ <sub>BG_offset</sub> + 10log(N <sub>RB,c</sub> /50)
Propagation Condition			AWGN	
Antenna Configuration and Correlation Matrix			1x2	
<p>Note 1: Special subframe and uplink-downlink configurations are specified in table 4.2-1 in TS 36.211 [24].</p> <p>Note 2: DL RMCs and OCNG patterns are specified in clauses A 3.1 and A 3.2 of TS 36.133 [23] respectively.</p> <p>Note 3: OCNG shall be used such that all cells are fully allocated and a constant total transmitted power spectral density is achieved for all OFDM symbols.</p> <p>Note 4: Interference from other cells and noise sources not specified in the test is assumed to be constant over subcarriers and time and shall be modelled as AWGN of appropriate power for N<sub>oc</sub> to be fulfilled.</p> <p>Note 5: <math>\bar{E}_s/I_{ot}</math>, RSRP, SCH_RP and I<sub>o</sub> levels have been derived from other parameters for information purposes. They are not settable parameters themselves.</p> <p>Note 6: E-UTRA operating band groups are as defined in clause 3.5 of TS 36.133 [23].</p> <p>Note 7: Void</p> <p>Note 8: Void.</p> <p>Note 9: Void</p> <p>Note 10: Void</p> <p>Note 11: Δ<sub>BG_offset</sub> for LTE band group is defined in TS 36.521-3 [26] clause 3.5.1, Table 3.5.1-1A.</p>				

**Table 6.7.5.1.5-3: SS-RSRP Intra frequency absolute accuracy requirements for the reported values**

Normal Conditions	Test 1 All bands	Test 2	
Lowest reported value (Cell 2)	48	FDD_A, TDD_A	14
		FDD_B	15
		TDD_C	15
		FDD_D, TDD_D	16
		FDD_E, TDD_E	16
		FDD_G	17
		FDD_H	18
Highest reported value (Cell 2)	70	FDD_A, TDD_A	27
		FDD_B	27
		TDD_C	28
		FDD_D, TDD_D	28
		FDD_E, TDD_E	29
		FDD_G	30
		FDD_H	30
Extreme Conditions	Test 1 All bands	Test 2	
Lowest reported value (Cell 2)	46	FDD_A, TDD_A	11
		FDD_B	11
		TDD_C	12
		FDD_D, TDD_D	12
		FDD_E, TDD_E	13
		FDD_G	14
		FDD_H	14
Highest reported value (Cell 2)	72	FDD_A, TDD_A	30
		FDD_B	31
		TDD_C	31
		FDD_D, TDD_D	32
		FDD_E, TDD_E	32
		FDD_G	33
		FDD_H	34
Note 1: E-UTRA operating band groups are as defined in TS 36.521-3 [26] clause 3.5.1			

For the test to pass, the ratio of successful reported values in each test shall be more than 90% with a confidence level of 95%.

## 6.7.6 E-UTRAN RSRQ

### 6.7.6.0 Minimum conformance requirements

#### 6.7.6.0.1 E-UTRAN RSRQ absolute accuracy

The measurement period of E-UTRA RSRQ in RRC\_CONNECTED state is specified in clause 9.4.2 and 9.4.3 on TS 38.133 [6].

The accuracy requirements of E-UTRA RSRQ measurements in RRC\_CONNECTED state and the corresponding side conditions shall be the same as the inter-frequency RSRQ Accuracy Requirements in clause 9.1.6 of TS 36.133 [23]:

The requirements for absolute accuracy of RSRQ in this clause apply to a cell that has different carrier frequency from the serving cell.

The accuracy requirements in Table 6.7.6.0.1-1 are valid under the following conditions:

Cell specific reference signals are transmitted either from one, two or four antenna ports.

Conditions defined in 36.101 [27] Clause 7.3 for reference sensitivity are fulfilled.

RSRP[dBm according to Annex B.3.3 of TS 36.133 [23] for a corresponding Band

Table 6.7.6.0.1-1: RSRQ Inter frequency absolute accuracy

Accuracy		Conditions			
Normal condition	Extreme condition	Ês/lot	I <sub>o</sub> <sup>Note 1</sup> range		
			E-UTRA operating band groups <sup>Note 4</sup>	Minimum I <sub>o</sub>	Maximum I <sub>o</sub>
dB	dB	dB	dBm/15kHz <sup>Note 3</sup>	dBm/BW <sub>Channel</sub>	
±2.5	±4	≥-3 dB	FDD_A, TDD_A	-121	-50
			FDD_B1, FDD_B2	-120.5	-50
			FDD_C, TDD_C	-120	-50
			FDD_D	-119.5	-50
			FDD_E, TDD_E	-119	-50
			FDD_F	-118.5	-50
			FDD_G	-118	-50
			FDD_H	-117.5	-50
±3.5	±4	≥-6 dB	FDD_N	-114.5	-50
			Note 2	Note 2	Note 2

NOTE 1: I<sub>o</sub> is assumed to have constant EPRE across the bandwidth.  
NOTE 2: The same bands and the same I<sub>o</sub> conditions for each band apply for this requirement as for the corresponding highest accuracy requirement.  
NOTE 3: The condition level is increased by Δ>0, when applicable, as described in Sections B.4.2 and B.4.3 of TS 36.133 [23].  
NOTE 4: E-UTRA operating band groups are as defined in Section 3.5 of TS 36.133 [23].

The reporting range and mapping specified for RSRQ measurements in clause 9.1.7 of TS 36.133 [23] shall apply:

The reporting range of RSRQ is defined from -34 dB to 2.5 dB with 0.5 dB resolution.

The mapping of measured quantity is defined in table 6.7.6.0.1-2. The range in the signalling may be larger than the guaranteed accuracy range.

Table 6.7.6.0.1-2: RSRQ measurement report mapping

Reported value	Measured quantity value	Unit
RSRQ_-30	RSRQ < -34	dB
RSRQ_-29	-34 ≤ RSRQ < -33.5	dB
...	...	...
RSRQ_-02	-20.5 ≤ RSRQ < -20	dB
RSRQ_-01	-20 ≤ RSRQ < -19.5	dB
RSRQ_00	RSRQ < -19.5	dB
RSRQ_01	-19.5 ≤ RSRQ < -19	dB
RSRQ_02	-19 ≤ RSRQ < -18.5	dB
...	...	...
RSRQ_32	-4 ≤ RSRQ < -3.5	dB
RSRQ_33	-3.5 ≤ RSRQ < -3	dB
RSRQ_34	-3 ≤ RSRQ	dB
RSRQ_35	-3 ≤ RSRQ < -2.5	dB
RSRQ_36	-2.5 ≤ RSRQ < -2	dB
...	...	...
RSRQ_45	2 ≤ RSRQ < 2.5	dB
RSRQ_46	2.5 ≤ RSRQ	dB

Note: The ranges from RSRQ\_-30 to RSRQ\_-01 and from RSRQ\_35 to RSRQ\_46 apply for the UE who can support extended RSRQ range.

## 6.7.6.1 NR SA FR1 – E-UTRAN RSRQ absolute measurement accuracy

### 6.7.6.1.1 Test purpose

The purpose of this test is to verify that the inter-RAT E-UTRAN RSRQ absolute measurement accuracy is within the specified limits for all bands, when the serving cell is NR FR1 and the target cell is E-UTRA.

## 6.7.6.1.2 Test applicability

This test applies to all types of NR UE from Release 15 onwards supporting E-UTRA.

## 6.7.6.1.3 Minimum conformance requirements

The minimum conformance requirements are specified in clause 6.7.6.0.1.

The normative reference for this requirement is TS 38.133 [6] clause A.6.7.6.1.

## 6.7.6.1.4 Test description

## 6.7.6.1.4.1 Initial conditions

This test shall be tested using any of the test configurations in Table 6.7.6.1.4.1-1.

**Table 6.7.6.1.4.1-1: test configurations**

Test Case ID	Description
6.7.6.1-1	NR: 15 kHz SSB SCS, 10MHz bandwidth, FDD, E-UTRAN: FDD
6.7.6.1-2	NR: 15 kHz SSB SCS, 10MHz bandwidth, TDD, E-UTRAN: FDD
6.7.6.1-3	NR: 30 kHz SSB SCS, 40MHz bandwidth, TDD, E-UTRAN: FDD
6.7.6.1-4	NR: 15 kHz SSB SCS, 10MHz bandwidth, FDD, E-UTRAN: TDD
6.7.6.1-5	NR: 15 kHz SSB SCS, 10MHz bandwidth, TDD, E-UTRAN: TDD
6.7.6.1-6	NR: 30 kHz SSB SCS, 40MHz bandwidth, TDD, E-UTRAN: TDD

Note: The UE is only required to be tested in one of the supported test configurations

Configure the test equipment and the DUT according to the parameters in Table 6.7.6.1.4.1-2.

**Table 6.7.6.1.4.1-2: initial conditions**

Parameter	Value		Comment
Test environment	NC, TL/VL, TL/VH, TH/VL, TH/VH		As specified in TS 38.508-1 [14] clause 4.1.
Test frequencies	As specified in Annex E, Table E.4-2 and TS 38.508-1 [14] clause 4.3.1.		
Channel bandwidth	As specified by the test configuration selected from Table 6.7.6.1.4.1-1.		
Propagation conditions	AWGN		As specified in Annex C.2.2.
Connection Diagram	TE Part 2Rx	A.3.1.7.2	As specified in TS 38.508-1 [14] Annex A.
	TE Part 4Rx	A.3.1.7.3	
	DUT Part 2Rx	A.3.2.3.4	
	DUT Part 4Rx	A.3.2.5.2	
Exceptions to connection diagram	N/A		

1. Message contents are defined in clause 6.7.6.1.4.3.

2. There are two carriers and two cells specified in the test, where NR Cell 1 is the NR PCell on the NR carrier and Cell 2 is the E-UTRA neighbour cell on the E-UTRA carrier and the target for the measurements.

## 6.7.6.1.4.2 Test procedure

1. Ensure the UE is in state RRC\_CONNECTED with generic procedure parameters Connectivity NR, Connected without release On and Test Mode On according to TS 38.508-1 [14] clause 4.5.

2. Set the parameters according to Table 6.7.6.1.5-1 and Table 6.7.6.1.5-2 as appropriate.

3. The SS shall transmit an RRCReconfiguration message on Cell 1.

4. The UE shall transmit an RRCReconfigurationComplete message.

5. The UE shall transmit periodically MeasurementReport messages.

6. After 10s wait from Step 3, the SS shall check the RSRQ reported values in the periodic MeasurementReport. The RSRQ value of Cell 2 reported by the UE is compared to the expected RSRQ. If the value is outside the limits in Table 6.7.6.1.5-2 or the UE fails to report the measurement value for Cell 2, the number of failed iterations is increased by one. Otherwise, the number of passed iterations is increased by one.
7. The SS shall continue checking the MeasurementReport messages transmitted by the UE until the confidence level according to Table G.2.3-1 in Annex G is achieved.
8. Set the parameters according to each sub-test in Table 6.7.6.1.5-2 as appropriate and repeat steps 5-7.

6.7.6.1.4.3 Message contents

Message contents are according to TS 38.508-1 [14] clause 7.3 with the following exceptions:

**Table 6.7.6.1.4.3-1: Common Exception messages**

Default Message Contents	
Common contents of system information blocks exceptions	
Default RRC messages and information elements contents exceptions	Table H.3.1-1 Table H.3.1-2 with condition INTER-RAT and GAP NEEDED Table H.3.1-3 Table H.3.1-3a Table H.3.1-7 with condition INTER-RAT Table 7.3.1-3 in TS 38.508-1 [14] with condition SMTC.1

**Table 6.7.6.1.4.3-1A: MeasConfig (Test procedure step 3)**

Derivation path: Table H.3.1-2 with condition INTER-RAT and GAP NEEDED			
Information Element	Value/Remark	Comment	Condition
measConfig ::= SEQUENCE {			
reportConfigToAddModList SEQUENCE(SIZE (1..maxReportConfigId)) OF ReportConfigToAddMod {	2 entries		
ReportConfigToAddMod[1] SEQUENCE {		entry 1	
reportConfigId	1		
reportConfig CHOICE {			
reportConfigInterRAT	ReportConfigE-UTRA-DEFAULT(Periodical)	Table 6.7.6.1.4.3-2	
}			
}			
ReportConfigToAddMod[2] SEQUENCE {		entry 2	
reportConfigId	2		
reportConfig CHOICE {			
reportConfigInterRAT	ReportConfigInterRAT-EVENT	Table 6.7.6.1.4.3-1B	
}			
}			
}			
measIdToAddModList SEQUENCE (SIZE (1..maxNrofMeasId)) OF MeasIdToAddMod {	2 entries		
MeasIdToAddMod[1] SEQUENCE {		entry 1	
measId	1		
measObjectId	2		
reportConfigId	1		
}			
MeasIdToAddMod[2] SEQUENCE {		entry 2	
measId	2		
measObjectId	2		
reportConfigId	2		
}			
}			
}			

**Table 6.7.6.1.4.3-1B: ReportConfigInterRAT-EVENT (Table 6.7.6.1.4.3-1A)**

Derivation Path: TS 38.508-1 [14] Table 4.6.3-141 with condition EVENT_B1			
Information Element	Value/remark	Comment	Condition
ReportConfigInterRAT ::= SEQUENCE {			
reportType CHOICE {			
eventTriggered SEQUENCE {			
eventId CHOICE {			
eventB1 SEQUENCE {			
b1-ThresholdEUTRA CHOICE {			
rsrq	34	Set threshold to -3dB to ensure measId 2 will never be triggered	
}			
}			
}			
}			
}			
}			

**Table 6.7.6.1.4.3-2: ReportConfigE-UTRA-DEFAULT(Periodical)**

Derivation Path: 38.508-1 [14] Table 4.6.3-141 with Condition PERIODICAL			
Information Element	Value/remark	Comment	Condition
ReportConfigInterRAT ::= SEQUENCE {			
reportType CHOICE {			
periodical SEQUENCE {			
reportQuantityCell SEQUENCE {			
rsrp	false		
}			
maxReportCells	2		
}			
}			
}			

6.7.6.1.5 Test requirement

Table 6.7.6.1.5-1 defines the primary level settings including test tolerances for all tests.

Each SS-RSRP measurement report for each of the tests in Tables 6.7.6.1.5-1 and 6.7.6.1.5-2 shall meet the corresponding absolute accuracy requirements in Table 6.7.6.1.5-3.

**Table 6.7.6.1.5-1: NR Cell specific test parameters for SA Inter-RAT E-UTRAN RSRQ test parameters**

Parameter		Unit	Cell 1
NR RF channel number			1
Duplex mode	Config 1, 4		FDD
	Config 2, 3, 5, 6		TDD
TDD Configuration	Config 1, 4		N/A
	Config 2, 5		TDDConf.1.1
	Config 3, 6		TDDConf.2.1
BW <sub>channel</sub>	Config 1, 4	MHz	10: N <sub>RB,c</sub> = 52 (FDD)
	Config 2, 5		10: N <sub>RB,c</sub> = 52 (TDD)
	Config 3, 6		40: N <sub>RB,c</sub> = 106 (TDD)
Gap pattern Id			0
PDSCH reference measurement channel	Config 1, 4		SR.1.1 FDD
	Config 2, 5		SR.1.1 TDD
	Config 3, 6		SR.2.1 TDD
RMSI CORSET reference channel	Config 1, 4		CR.1.1 FDD
	Config 2, 5		CR.1.1 TDD
	Config 3, 6		CR.2.1 TDD
Dedicated CORSET reference channel	Config 1, 4		CCR.1.1 FDD
	Config 2, 5		CCR.1.1 TDD
	Config 3, 6		CCR.2.1 TDD
BWP configurations	Initial DL BWP		DLBWP.0.1
	Dedicated DL BWP		DLBWP.1.1
	Initial UL BWP		ULBWP.0.1
	Dedicated UL BWP		ULBWP.1.1
OCNG pattern <sup>Note1</sup>			OP.1
SMTC configuration			SMTC.1
SSB configuration	Config 1, 2, 4, 5		SSB.1 FR1
	Config 3, 6		SSB.2 FR1
EPRE ratio of PSS to SSS		dB	0
EPRE ratio of PBCH_DMRS to SSS			
EPRE ratio of PBCH to PBCH_DMRS			
EPRE ratio of PDCCH_DMRS to SSS			
EPRE ratio of PDCCH to PDCCH_DMRS			
EPRE ratio of PDSCH_DMRS to SSS			
EPRE ratio of PDSCH to PDSCH_DMRS			
EPRE ratio of OCNG DMRS to SSS			
EPRE ratio of OCNG to OCNG DMRS			
N <sub>oc</sub> <sup>Note2</sup>			
N <sub>oc</sub> <sup>Note2</sup>	Config 1, 2, 4, 5	dBm/SCS	-104
	Config 3, 6		-101
E <sub>s</sub> /N <sub>oc</sub>		dB	17
E <sub>s</sub> /I <sub>ot</sub> <sup>Note3</sup>		dB	17
SS-RSRP <sup>Note3</sup>	Config 1, 2, 4, 5	dBm/SCS	-87
	Config 3, 6		-84
SSB_RP <sup>Note3</sup>	Config 1, 2, 4, 5	dBm/SCS	-87
	Config 3, 6		-84
I <sub>o</sub> <sup>Note3</sup>	Config 1, 2, 4, 5	dBm/9.36 MHz	-58.96
	Config 3, 6	dBm/38.16 MHz	-52.87
Propagation condition			AWGN
Antenna Configuration and Correlation Matrix			1x2
<p>Note 1: OCNG shall be used such that both cells are fully allocated and a constant total transmitted power spectral density is achieved for all OFDM symbols.</p> <p>Note 2: Interference from other cells and noise sources not specified in the test is assumed to be constant over subcarriers and time and shall be modelled as AWGN of appropriate power for N<sub>oc</sub> to be fulfilled.</p> <p>Note 3: E<sub>s</sub>/I<sub>ot</sub>, SS-RSRP, SSB_RP and I<sub>o</sub> levels have been derived from other parameters for information purposes. They are not settable parameters themselves.</p>			

**Table 6.7.6.1.5-2: E-UTRAN Cell specific test parameters for SA Inter-RAT E-UTRAN RSRQ test parameters**

Parameter	Unit	Cell 2		
		Test 1	Test 2	Test 3

E-UTRA RF channel number			1		
Duplex mode	Config 1, 2, 3		FDD		
	Config 4, 5, 6		TDD		
TDD special subframe configuration <sup>Note1</sup>	Config 1, 2, 3		N/A		
	Config 4, 5, 6		6		
TDD uplink-downlink configuration <sup>Note1</sup>	Config 1, 2, 3		N/A		
	Config 4, 5, 6		1		
BW <sub>channel</sub>		MHz	5 MHz: N <sub>RB,c</sub> = 25 10 MHz: N <sub>RB,c</sub> = 50 20 MHz: N <sub>RB,c</sub> = 100		
PDSCH parameters: DL Reference Measurement Channel <sup>Note2</sup>			-		
PCFICH/PDCCH/PHICH parameters: DL Reference Measurement Channel <sup>Note2</sup>	Config 1, 2, 3		5 MHz: R.11 FDD 10 MHz: R.6 FDD 20 MHz: R.10 FDD		
	Config 4, 5, 6		5 MHz: R.11 TDD 10 MHz: R.6 TDD 20 MHz: R.10 TDD		
OCNG Patterns <sup>Note2</sup>	Config 1, 2, 3		5 MHz: OP.19 FDD 10 MHz: OP.6 FDD 20 MHz: OP.14 FDD		
	Config 4, 5, 6		5 MHz: OP.10 TDD 10 MHz: OP.2 TDD 20 MHz: OP.8 TDD		
PBCH_RA		dB	0		
PBCH_RB					
PSS_RA					
SSS_RA					
PCFICH_RB					
PHICH_RA					
PHICH_RB					
PDCCH_RA					
PDCCH_RB					
PDSCH_RA					
PDSCH_RB					
OCNG_RA <sup>Note3</sup>					
OCNG_RB <sup>Note3</sup>					
N <sub>oc</sub> <sup>Note4</sup>	Depending on band group				
$\bar{E}_s/N_{oc}$		dB	-1.75	-3.2	-3.2
$\bar{E}_s/I_{ot}$ <sup>Note5</sup>		dB	-1.75	-3.2	-3.2
RSRP <sup>Note5</sup>	Depending on band group	dBm/15kHz	-84.75	-107.90	-122.7+ Δ <sub>BG_offset</sub>
RSRQ <sup>Note5</sup>	Depending on band group	dB	-14.76	-15.69	-15.69
I <sub>o</sub> <sup>Note5</sup>	Depending on band group	dBm/Ch BW	-53 + 10log(N <sub>RB,c</sub> /50)	-75.22 + 10log(N <sub>RB,c</sub> /50)	-90.02+ Δ <sub>BG_offset</sub> + 10log(N <sub>RB,c</sub> /50)
Propagation Condition			AWGN		
Antenna Configuration and Correlation Matrix			1x2		
<p>Note 1: Special subframe and uplink-downlink configurations are specified in table 4.2-1 in TS 36.211 [24].</p> <p>Note 2: DL RMCs and OCNG patterns are specified in clauses A 3.1 and A 3.2 of TS 36.133 [23] respectively.</p> <p>Note 3: OCNG shall be used such that all cells are fully allocated and a constant total transmitted power spectral density is achieved for all OFDM symbols.</p> <p>Note 4: Interference from other cells and noise sources not specified in the test is assumed to be constant over subcarriers and time and shall be modelled as AWGN of appropriate power for N<sub>oc</sub> to be fulfilled.</p> <p>Note 5: <math>\bar{E}_s/I_{ot}</math>, RSRP, RSRQ and I<sub>o</sub> levels have been derived from other parameters for information purposes. They are not settable parameters themselves.</p> <p>Note 6: E-UTRA operating band groups are as defined in clause 3.5 of TS 36.133 [23].</p> <p>Note 7: Void</p> <p>Note 8: Void</p> <p>Note 9: Void</p> <p>Note 10: Void</p> <p>Note 11: Δ<sub>BG_offset</sub> for LTE band group is defined in TS 36.521-3 [26] clause 3.5.1, Table 3.5.1-1A.</p>					



**Table 6.7.6.1.5-3: SS-RSRQ Intra frequency absolute accuracy requirements for the reported values**

<b>Normal Conditions</b>	<b>Test 1 All bands</b>	<b>Test 2 All bands</b>	<b>Test 3 All bands</b>
Lowest reported value (Cell 2)	4	0	0
Highest reported value (Cell 2)	16	16	16
<b>Extreme Conditions</b>	<b>Test 1 All bands</b>	<b>Test 2 All bands</b>	<b>Test 3 All bands</b>
Lowest reported value (Cell 2)	1	0	0
Highest reported value (Cell 2)	19	17	17

For the test to pass, the ratio of successful reported values in each test shall be more than 90% with a confidence level of 95%.

## 6.7.7 E-UTRAN RS-SINR

### 6.7.7.0 Minimum conformance requirements

#### 6.7.7.0.1 E-UTRAN RS-SINR absolute accuracy

The measurement period of E-UTRA RS-SINR in RRC\_CONNECTED state is specified in clause 9.4.2 and 9.4.3 of TS 38.133 [6].

The accuracy requirements of E-UTRA RS-SINR measurements in RRC\_CONNECTED state and the corresponding side conditions shall be the same as the inter-frequency RS-SINR Accuracy Requirements in clause 9.1.17.3 of TS 36.133 [23]:

The reporting range and mapping for E-UTRA RS-SINR measurements shall be the same as specified for RS-SINR measurements in clause 9.1.17.1 of TS 36.133 [23]:

The requirements for absolute accuracy of intra-frequency RS-SINR in this clause apply to a cell on the same frequency as that of the serving cell.

The accuracy requirements in Table 6.7.7.0.1-1 are valid under the following conditions:

Cell specific reference signals are transmitted either from one, two or four antenna ports.

Conditions defined in 36.101 [27] Clause 7.3 for reference sensitivity are fulfilled.

RSRP|dBm according to Annex B.3.18 of TS 36.133 [23] for a corresponding Band.

Table 6.7.7.0.1-1: Intra-frequency RS-SINR absolute accuracy

Accuracy		Conditions			
Normal condition	Extreme condition	$\hat{E}s/lot$	$I_o$ <sup>Note 1</sup> range		
			E-UTRA operating band groups <sup>Note 4</sup>	Minimum $I_o$	Maximum $I_o$
dB	dB	dB		dBm/15kHz <sup>Note 3</sup>	dBm/BW <sub>Channel</sub>
±3.0	±4	≥-3 dB <sup>Note 5</sup>	FDD_A, TDD_A	-121	-50
			FDD_B1, FDD_B2	-120.5	-50
			FDD_C, TDD_C	-120	-50
			FDD_D	-119.5	-50
			FDD_E, TDD_E	-119	-50
			FDD_F	-118.5	-50
			FDD_G	-118	-50
			FDD_H	-117.5	-50
			FDD_N	-114.5	-50
±3.5	±4	≥-6 dB	Note 2	Note 2	Note 2

NOTE 1:  $I_o$  is assumed to have constant EPRE across the bandwidth.  
NOTE 2: The same bands and the same  $I_o$  conditions for each band apply for this requirement as for the corresponding highest accuracy requirement.  
NOTE 3: The condition level is increased by  $\Delta > 0$ , when applicable, as described in Sections B.4.2 and B.4.3 of TS 36.133 [23].  
NOTE 4: E-UTRA operating band groups are as defined in Section 3.5 of TS 36.133 [23].  
NOTE 5: The requirements apply for  $\hat{E}s/lot \leq 25$  dB.

The reporting range of RS-SINR measurement is defined from -23 dB to 40 dB with 0.5 dB resolution.

The mapping of the measured quantity is defined in table 6.7.7.0.1-2. The range in the signalling may be larger than the guaranteed accuracy range.

Table 6.7.7.0.1-2: RS-SINR measurement report mapping

Reported Value	Measured Quantity Value	Unit
RS-SINR_000	RS-SINR < -23	dB
RS-SINR_001	-23 ≤ RS-SINR < -22.5	dB
...	...	...
RS-SINR_126	39.5 ≤ RS-SINR < 40	dB
RS-SINR_127	40 ≤ RS-SINR	dB

## 6.7.7.1 NR SA FR1 – E-UTRAN RS-SINR absolute measurement accuracy

### 6.7.7.1.1 Test purpose

The purpose of this test is to verify that the inter-RAT E-UTRAN RS-SINR absolute measurement accuracy is within the specified limits for all bands, when the serving cell is NR FR1 and the target cell is E-UTRA.

### 6.7.7.1.2 Test applicability

This test applies to all types of NR UE from Release 15 onwards supporting E-UTRA and *rs-SINR-MeasEUTRA*.

### 6.7.7.1.3 Minimum conformance requirements

The minimum conformance requirements are specified in clause 6.7.7.0.1.

The normative reference for this requirement is TS 38.133 [6] clause A.6.7.7.1.

### 6.7.7.1.1.4 Test description

#### 6.7.7.1.1.4.1 Initial conditions

This test shall be tested using any of the test configurations in Table 6.7.7.1.4.1-1.

**Table 6.7.7.1.4.1-1: test configurations**

Test Case ID	Description
6.7.7.1-1	NR: 15 kHz SSB SCS, 10MHz bandwidth, FDD, E-UTRAN: FDD
6.7.7.1-2	NR: 15 kHz SSB SCS, 10MHz bandwidth, TDD, E-UTRAN: FDD
6.7.7.1-3	NR: 30 kHz SSB SCS, 40MHz bandwidth, TDD, E-UTRAN: FDD
6.7.7.1-4	NR: 15 kHz SSB SCS, 10MHz bandwidth, FDD, E-UTRAN: TDD
6.7.7.1-5	NR: 15 kHz SSB SCS, 10MHz bandwidth, TDD, E-UTRAN: TDD
6.7.7.1-6	NR: 30 kHz SSB SCS, 40MHz bandwidth, TDD, E-UTRAN: TDD
Note: The UE is only required to be tested in one of the supported test configurations	

Configure the test equipment and the DUT according to the parameters in Table 6.7.7.1.4.1-2.

**Table 6.7.7.1.4.1-2: initial conditions**

Parameter	Value	Comment	
Test environment	NC, TL/VL, TL/VH, TH/VL, TH/VH	As specified in TS 38.508-1 [14] clause 4.1.	
Test frequencies	As specified in Annex E, Table E.4-2 and TS 38.508-1 [14] clause 4.3.1.		
Channel bandwidth	As specified by the test configuration selected from Table 6.7.7.1.4.1-1.		
Propagation conditions	AWGN	As specified in Annex C.2.2.	
Connection Diagram	TE Part 2Rx	A.3.1.7.2	As specified in TS 38.508-1 [14] Annex A.
	TE Part 4Rx	A.3.1.7.3	
	DUT Part 2Rx	A.3.2.3.4	
	DUT Part 4Rx	A.3.2.5.2	
Exceptions to connection diagram	N/A		

1. Message contents are defined in clause 6.7.7.1.4.3.

2. There are two carriers and two cells specified in the test, where NR Cell 1 is the NR PCell on the NR carrier and Cell 2 is the E-UTRA neighbour cell on the E-UTRA carrier and the target for the measurements.

#### 6.7.7.1.4.2 Test procedure

1. Ensure the UE is in state RRC\_CONNECTED with generic procedure parameters Connectivity NR, Connected without release On and Test Mode On according to TS 38.508-1 [14] clause 4.5.
2. Set the parameters according to Table 6.7.7.1.5-1 and Table 6.7.7.1.5-2 as appropriate.
3. The SS shall transmit an RRCReconfiguration message on Cell 1.
4. The UE shall transmit an RRCReconfigurationComplete message.
5. The UE shall transmit periodically MeasurementReport messages.
6. After 10s wait from Step 3, the SS shall check the RS-SINR reported values in the periodic MeasurementReport. The RS-SINR value of Cell 2 reported by the UE is compared to the expected RS-SINR. If the value is outside the limits in Table 6.7.7.1.5-2 or the UE fails to report the measurement value for Cell 2, the number of failed iterations is increased by one. Otherwise, the number of passed iterations is increased by one.
7. The SS shall continue checking the MeasurementReport messages transmitted by the UE until the confidence level according to Table G.2.3-1 in Annex G is achieved.
8. Set the parameters according to each sub-test in Table 6.7.7.1.5-2 as appropriate and repeat steps 5-7.

#### 6.7.7.1.4.3 Message contents

Message contents are according to TS 38.508-1 [14] clause 7.3 with the following exceptions:

**Table 6.7.7.1.4.3-1: Common Exception messages**

Default Message Contents	
Common contents of system information blocks exceptions	
Default RRC messages and information elements contents exceptions	Table H.3.1-1 Table H.3.1-2 with condition INTER-RAT and GAP NEEDED Table H.3.1-3 Table H.3.1-3a Table H.3.1-7 with condition INTER-RAT Table 7.3.1-3 in TS 38.508-1 [14] with condition SMTC.1

**Table 6.7.7.1.4.3-1A: MeasConfig (Test procedure step 3)**

Derivation path: Table H.3.1-2 with condition INTER-RAT and GAP NEEDED			
Information Element	Value/Remark	Comment	Condition
measConfig ::= SEQUENCE {			
reportConfigToAddModList SEQUENCE(SIZE (1..maxReportConfigId)) OF ReportConfigToAddMod {	2 entries		
ReportConfigToAddMod[1] SEQUENCE {		entry 1	
reportConfigId	1		
reportConfig CHOICE {			
reportConfigInterRAT	ReportConfigE-UTRA-DEFAULT(Periodical)	Table 6.7.7.1.4.3-2	
}			
}			
ReportConfigToAddMod[2] SEQUENCE {		entry 2	
reportConfigId	2		
reportConfig CHOICE {			
reportConfigInterRAT	ReportConfigInterRAT-EVENT	Table 6.7.7.1.4.3-1B	
}			
}			
}			
measIdToAddModList SEQUENCE (SIZE (1..maxNrofMeasId)) OF MeasIdToAddMod {	2 entries		
MeasIdToAddMod[1] SEQUENCE {		entry 1	
measId	1		
measObjectId	2		
reportConfigId	1		
}			
MeasIdToAddMod[2] SEQUENCE {		entry 2	
measId	2		
measObjectId	2		
reportConfigId	2		
}			
}			
}			

**Table 6.7.7.1.4.3-1B: ReportConfigInterRAT-EVENT (Table 6.7.7.1.4.3-1A)**

Derivation Path: TS 38.508-1 [14] Table 4.6.3-141 with condition EVENT_B1			
Information Element	Value/remark	Comment	Condition
ReportConfigInterRAT ::= SEQUENCE {			
reportType CHOICE {			
eventTriggered SEQUENCE {			
eventId CHOICE {			
eventB1 SEQUENCE {			
b1-ThresholdEUTRA CHOICE {			
sinr	127	Set threshold to 40dB to ensure measId 2 will never be triggered	
}			
}			
}			
}			
}			
}			

**Table 6.7.7.1.4.3-2: ReportConfigE-UTRA-DEFAULT(Periodical)**

Derivation Path: 38.508-1 [14] Table 4.6.3-141 with Condition PERIODICAL			
Information Element	Value/remark	Comment	Condition
ReportConfigInterRAT ::= SEQUENCE {			
reportType CHOICE {			
periodical SEQUENCE {			
reportQuantityCell SEQUENCE {			
rsrp	false		
rsrq	false		
sinr	true		
}			
maxReportCells	2		
}			
}			
}			

6.7.7.1.5 Test requirement

Table 6.7.7.1.5-1 defines the primary level settings including test tolerances for all tests.

Each SS-RSRP measurement report for each of the tests in Tables 6.7.7.1.5-1 and 6.7.7.1.5-2 shall meet the corresponding absolute accuracy requirements in Table 6.7.7.1.5-3.

**Table 6.7.7.1.5-1: NR Cell specific test parameters for SA Inter-RAT E-UTRAN RS-SINR test parameters**

Parameter		Unit	Cell 1
NR RF channel number			1
Duplex mode	Config 1, 4		FDD
	Config 2, 3, 5, 6		TDD
TDD Configuration	Config 1, 4		N/A
	Config 2, 5		TDDConf.1.1
	Config 3, 6		TDDConf.2.1
$BW_{\text{channel}}$	Config 1, 4	MHz	10: $N_{RB,c} = 52$ (FDD)
	Config 2, 5		10: $N_{RB,c} = 52$ (TDD)
	Config 3, 6		40: $N_{RB,c} = 106$ (TDD)
Gap pattern Id			0
PDSCH reference measurement channel	Config 1, 4		SR.1.1 FDD
	Config 2, 5		SR.1.1 TDD
	Config 3, 6		SR.2.1 TDD
RMSI CORSET reference channel	Config 1, 4		CR.1.1 FDD
	Config 2, 5		CR.1.1 TDD
	Config 3, 6		CR.2.1 TDD
Dedicated CORSET reference channel	Config 1, 4		CCR.1.1 FDD
	Config 2, 5		CCR.1.1 TDD
	Config 3, 6		CCR.2.1 TDD
BWP configurations	Initial DL BWP		DLBWP.0.1
	Dedicated DL BWP		DLBWP.1.1
	Initial UL BWP		ULBWP.0.1
	Dedicated UL BWP		ULBWP.1.1
OCNG pattern <sup>Note1</sup>			OP.1
SMTc configuration			SMTc.1
SSB configuration	Config 1, 2, 4, 5		SSB.1 FR1
	Config 3, 6		SSB.2 FR1
EPRE ratio of PSS to SSS		dB	0
EPRE ratio of PBCH_DMRS to SSS			
EPRE ratio of PBCH to PBCH_DMRS			
EPRE ratio of PDCCH_DMRS to SSS			
EPRE ratio of PDCCH to PDCCH_DMRS			
EPRE ratio of PDSCH_DMRS to SSS			
EPRE ratio of PDSCH to PDSCH_DMRS			
EPRE ratio of OCNG DMRS to SSS			
EPRE ratio of OCNG to OCNG DMRS			
$N_{oc}$ <sup>Note2</sup>		dBm/15 kHz	-104
$N_{oc}$ <sup>Note2</sup>	Config 1, 2, 4, 5	dBm/SCS	-104
	Config 3, 6		-101
$\hat{E}_s/N_{oc}$		dB	17
$\hat{E}_s/I_{ot}$ <sup>Note3</sup>		dB	17
SS-RSRP <sup>Note3</sup>	Config 1, 2, 4, 5	dBm/SCS	-87
	Config 3, 6		-84
SSB_RP <sup>Note3</sup>	Config 1, 2, 4, 5	dBm/SCS	-87
	Config 3, 6		-84
$I_o$ <sup>Note3</sup>	Config 1, 2, 4, 5	dBm/9.36 MHz	-58.96
	Config 3, 6	dBm/38.16 MHz	-52.87
Propagation condition			AWGN
Antenna Configuration and Correlation Matrix			1x2
Note 1: OCNG shall be used such that both cells are fully allocated and a constant total transmitted power spectral density is achieved for all OFDM symbols.			
Note 2: Interference from other cells and noise sources not specified in the test is assumed to be constant over subcarriers and time and shall be modelled as AWGN of appropriate power for $N_{oc}$ to be fulfilled.			
Note 3: $\hat{E}_s/I_{ot}$ , SS-RSRP, SSB_RP and $I_o$ levels have been derived from other parameters for information purposes. They are not settable parameters themselves.			

**Table 6.7.7.1.5-2: E-UTRAN Cell specific test parameters for SA Inter-RAT E-UTRAN RS-SINR test parameters**

Parameter		Unit	Cell 2		
			Test 1	Test 2	Test 3
E-UTRA RF channel number			1		
Duplex mode	Config 1, 2, 3		FDD		
	Config 4, 5, 6		TDD		
TDD special subframe configuration <sup>Note1</sup>	Config 1, 2, 3		N/A		
	Config 4, 5, 6		6		
TDD uplink-downlink configuration <sup>Note1</sup>	Config 1, 2, 3		N/A		
	Config 4, 5, 6		1		
BW <sub>channel</sub>		MHz	5 MHz: N <sub>RB,c</sub> = 25 10 MHz: N <sub>RB,c</sub> = 50 20 MHz: N <sub>RB,c</sub> = 100		
PDSCH parameters: DL Reference Measurement Channel <sup>Note2</sup>			-		
PCFICH/PDCCH/PHICH parameters: DL Reference Measurement Channel <sup>Note2</sup>	Config 1, 2, 3		5 MHz: R.11 FDD 10 MHz: R.6 FDD 20 MHz: R.10 FDD		
	Config 4, 5, 6		5 MHz: R.11 TDD 10 MHz: R.6 TDD 20 MHz: R.10 TDD		
OCNG Patterns <sup>Note2</sup>	Config 1, 2, 3		5 MHz: OP.19 FDD 10 MHz: OP.6 FDD 20 MHz: OP.14 FDD		
	Config 4, 5, 6		5 MHz: OP.10 TDD 10 MHz: OP.2 TDD 20 MHz: OP.8 TDD		
PBCH_RA		dB	0		
PBCH_RB					
PSS_RA					
SSS_RA					
PCFICH_RB					
PHICH_RA					
PHICH_RB					
PDCCH_RA					
PDCCH_RB					
PDSCH_RA					
PDSCH_RB					
OCNG_RA <sup>Note3</sup>					
OCNG_RB <sup>Note3</sup>					
N <sub>oc1</sub> <sup>Note4</sup>	Depending on band group				
CRS E <sub>s</sub> /N <sub>oc1</sub>		dB	-1.75	20.0	-3.2
CRS E <sub>s</sub> /I <sub>ot</sub> <sup>Note5</sup>		dB	-1.75	20.0	-3.2
RSRP <sup>Note5</sup>	Depending on band group	dBm/15kHz	-89.75	-88.50	-122.7+ Δ <sub>BG_offset</sub>
RS-SINR <sup>Note5</sup>		dB	-1.75	20	-3.2
I <sub>o</sub> <sup>Note5</sup>	Depending on band group	dBm/Ch BW	-58.00 + 10log(N <sub>RB,c</sub> /50)	-60.68 + 10log(N <sub>RB,c</sub> /50)	-90.02+ Δ <sub>BG_offset</sub> + 10log(N <sub>RB,c</sub> /50)
Propagation Condition			AWGN		
Antenna Configuration and Correlation Matrix			1x2		



Note 1:	Special subframe and uplink-downlink configurations are specified in table 4.2-1 in TS 36.211 [24].
Note 2:	DL RMCs and OCNG patterns are specified in clauses A 3.1 and A 3.2 of TS 36.133 [23] respectively.
Note 3:	OCNG shall be used such that all cells are fully allocated and a constant total transmitted power spectral density is achieved for all OFDM symbols.
Note 4:	Interference from other cells and noise sources not specified in the test is assumed to be constant over CRS subcarriers and time and shall be modelled as AWGN of appropriate power for $N_{oc1}$ to be fulfilled.
Note 4a:	Void
Note 5:	CRS $\hat{E}_s/I_{ot}$ , RSRP, RS-SINR and $I_o$ levels have been derived from other parameters for information purposes. They are not settable parameters themselves.
Note 6:	E-UTRA operating band groups are as defined in clause 3.5 of TS 36.133 [23].
Note 7:	Void
Note 8:	Void
Note 9:	Void
Note 10:	Void
Note 11:	$\Delta_{BG\_offset}$ for LTE band group is defined in TS 36.521-3 [26] clause 3.5.1, Table 3.5.1-1A.

**Table 6.7.7.1.5-3: RS-SINR Intra frequency absolute accuracy requirements for the reported values**

Normal Conditions	Test 1 All bands	Test 2 All bands	Test 3 All bands
Lowest reported value (Cell 2)	35	79	32
Highest reported value (Cell 2)	51	94	49
Extreme Conditions	Test 1 All bands	Test 2 All bands	Test 3 All bands
Lowest reported value (Cell 2)	33	77	31
Highest reported value (Cell 2)	53	96	50

For the test to pass, the ratio of successful reported values in each test shall be more than 90% with a confidence level of 95%.

## 6.7.8

### 6.7.9 L1-SINR measurement for beam reporting

#### 6.7.9.0 Minimum conformance requirements

##### 6.7.9.0.1 Minimum conformance requirements for CSI-RS based CMR and no dedicated IMR configured and CSI-RS resource set with repetition off

The UE shall be capable of performing L1-SINR measurements with the CSI-RS configured as CMR and no dedicated resource configured as IMR for L1-SINR computation, and the UE physical layer shall be capable of reporting L1-SINR measured over the measurement period of  $T_{L1-SINR\_Measurement\_Period\_CSI-RS\_CMR\_Only}$ .

The value of  $T_{L1-SINR\_Measurement\_Period\_CSI-RS\_CMR\_Only}$  is defined in Table 6.7.9.0.1-1 for FR1 and in Table 6.7.9.0.1-2 for FR2, where

For the value of  $M$ ,

- For periodic and semi-persistent CSI-RS resources as CMR,  $M=1$  if higher layer parameter *timeRestrictionForChannelMeasurement* is configured, and  $M=3$  otherwise;
- For aperiodic CSI-RS resources as CMR,  $M=1$ .

For the value of  $N$  in FR2

- For periodic CSI-RS resources as CMR in a resource set configured with higher layer parameter *repetition* set to OFF,  $N=1$ . The requirements apply if *qcl-InfoPeriodicCSI-RS* is configured for all the resources in the resource set and for each resource one RS has QCL-TypeD with
  - SSB for L1-RSRP or L1-SINR measurement, or
  - another CSI-RS in resource set configured with repetition ON.
- For periodic CSI-RS resources as CMR in a resource set configured with higher layer parameter *repetition* set to ON,  $N=\text{ceil}(\text{maxNumberRxBeam} / N_{\text{res\_per\_set}})$ , where  $N_{\text{res\_per\_set}}$  is number of resources in the resource set. The requirements apply provided *qcl-InfoPeriodicCSI-RS* is configured for all resources in the resource set.
- For semi-persistent CSI-RS resources as CMR in a resource set configured with higher layer parameter *repetition* set to OFF,  $N=1$ . The requirements apply provided TCI state is provided for all resources in the resource set in the MAC CE activating the resource set and for each resource has QCL-TypeD with
  - SSB for L1-RSRP or L1-SINR measurement, or
  - another CSI-RS in resource set configured with repetition ON.
- For semi-persistent CSI-RS resources as CMR in a resource set configured with higher layer parameter *repetition* set to ON,  $N=\text{ceil}(\text{maxNumberRxBeam} / N_{\text{res\_per\_set}})$ , where  $N_{\text{res\_per\_set}}$  is number of resources in the resource set. The requirements apply provided TCI state is provided for all resources in the resource set in the MAC CE activating the resource set.
- For aperiodic CSI-RS resources as CMR in a resource set configured with higher layer parameter *repetition* set to OFF,  $N=1$ . The requirements apply provided *qcl-info* is configured for all resources in the resource set and for each resource has QCL-TypeD with
  - SSB for L1-RSRP or L1-SINR measurement, or
  - another CSI-RS in resource set configured with repetition ON.
- For aperiodic CSI-RS resources as CMR in a resource set configured with higher layer parameter *repetition* set to ON,  $N=1$ . UE is not required to meet the accuracy requirements in clause 10.1.28.1 and 10.1.28.3 of TS 38.133 [6] if number of resources in the resource set is smaller than *maxNumberRxBeam*. The requirements apply provided *qcl-info* is configured for all resources in the resource set.

For the value of P in FR1,

- $P = \frac{1}{1 - \frac{T_{\text{CSI-RS}}}{\text{MRGP}}}$ , when in the monitored cell there are measurement gaps configured for intra-frequency, inter-frequency or inter-RAT measurements, which are overlapping with some but not all occasions of the CSI-RS; and
- $P=1$  when in the monitored cell there are no measurement gaps overlapping with any occasion of the CSI-RS.

For the value of P in FR2,

- $P=1$ , when CSI-RS is not overlapped with measurement gap and also not overlapped with SMTC occasion.
- $P = \frac{1}{1 - \frac{T_{\text{CSI-RS}}}{\text{MRGP}}}$ , when CSI-RS is partially overlapped with measurement gap and CSI-RS is not overlapped with SMTC occasion ( $T_{\text{CSI-RS}} < \text{MRGP}$ )
- $P = \frac{1}{1 - \frac{T_{\text{CSI-RS}}}{T_{\text{SMTCperiod}}}}$ , when CSI-RS is not overlapped with measurement gap and CSI-RS is partially overlapped with SMTC occasion ( $T_{\text{CSI-RS}} < T_{\text{SMTCperiod}}$ ).
- $P=3$ , when CSI-RS is not overlapped with measurement gap and CSI-RS is fully overlapped with SMTC occasion ( $T_{\text{CSI-RS}} = T_{\text{SMTCperiod}}$ ).
- $P = \frac{1}{1 - \frac{T_{\text{CSI-RS}}}{\text{MRGP}} - \frac{T_{\text{CSI-RS}}}{T_{\text{SMTCperiod}}}}$ , when CSI-RS is partially overlapped with measurement gap and CSI-RS is partially overlapped with SMTC occasion ( $T_{\text{CSI-RS}} < T_{\text{SMTCperiod}}$ ) and SMTC occasion is not overlapped with measurement gap and

- $T_{\text{SMTCperiod}} \neq \text{MGRP}$  or
- $T_{\text{SMTCperiod}} = \text{MGRP}$  and  $T_{\text{CSI-RS}} < 0.5 * T_{\text{SMTCperiod}}$
- $P = \frac{3}{1 - \frac{T_{\text{CSI-RS}}}{\text{MGRP}}}$ , when CSI-RS is partially overlapped with measurement gap and CSI-RS is partially overlapped with SMTC occasion ( $T_{\text{CSI-RS}} < T_{\text{SMTCperiod}}$ ) and SMTC occasion is not overlapped with measurement gap and  $T_{\text{SMTCperiod}} = \text{MGRP}$  and  $T_{\text{CSI-RS}} = 0.5 * T_{\text{SMTCperiod}}$
- $P = \frac{1}{1 - \frac{T_{\text{CSI-RS}}}{\min(T_{\text{SMTCperiod}}, \text{MGRP})}}$ , when CSI-RS is partially overlapped with measurement gap ( $T_{\text{CSI-RS}} < \text{MGRP}$ ) and CSI-RS is partially overlapped with SMTC occasion ( $T_{\text{CSI-RS}} < T_{\text{SMTCperiod}}$ ) and SMTC occasion is partially or fully overlapped with measurement gap.
- $P = \frac{3}{1 - \frac{T_{\text{CSI-RS}}}{\text{MGRP}}}$ , when CSI-RS is partially overlapped with measurement gap and CSI-RS is fully overlapped with SMTC occasion ( $T_{\text{CSI-RS}} = T_{\text{SMTCperiod}}$ ) and SMTC occasion is partially overlapped with measurement gap ( $T_{\text{SMTCperiod}} < \text{MGRP}$ )

Where:

$T_{\text{SMTCperiod}}$  = the configured SMTC1 period or SMTC2 period if configured.

$T_{\text{CSI-RS}}$  = the periodicity of CSI-RS configured for L1-SINR measurement

If the high layer in TS 38.331 [2] signalling of *smtc2* is configured,  $T_{\text{SMTCperiod}}$  corresponds to the value of higher layer parameter *smtc2*; Otherwise  $T_{\text{SMTCperiod}}$  corresponds to the value of higher layer parameter *smtc1*.

Note: The overlap between CSI-RS for L1-SINR measurement and SMTC means that CSI-RS for L1-SINR measurement is within the SMTC window duration.

Longer evaluation period would be expected if the combination of CSI-RS, SMTC occasion and measurement gap configurations does not meet pervious conditions.

**Table 6.7.9.0.1-1: Measurement period  $T_{\text{L1-SINR\_Measurement\_Period\_CSI-RS\_CMR\_Only}}$  for FR1**

Configuration	$T_{\text{L1-SINR\_Measurement\_Period\_CSI-RS\_CMR\_Only}}$ (ms)
non-DRX	$\max(T_{\text{Report}}, \text{ceil}(M * P) * T_{\text{CSI-RS}})$
DRX cycle $\leq$ 320ms	$\max(T_{\text{Report}}, \text{ceil}(1.5 * M * P) * \max(T_{\text{DRX}}, T_{\text{CSI-RS}}))$
DRX cycle $>$ 320ms	$\text{ceil}(M * P) * T_{\text{DRX}}$
Note 1:	$T_{\text{CSI-RS}}$ is the periodicity of CSI-RS configured for L1-SINR measurement. $T_{\text{DRX}}$ is the DRX cycle length. $T_{\text{Report}}$ is configured periodicity for reporting.
Note 2:	the requirements are applicable provided that the CSI-RS resource configured for L1-SINR measurement is transmitted with Density = 3.

**Table 6.7.9.0.1-2: Measurement period  $T_{\text{L1-SINR\_Measurement\_Period\_CSI-RS\_CMR\_Only}}$  for FR2**

Configuration	$T_{\text{L1-SINR\_Measurement\_Period\_CSI-RS\_CMR\_Only}}$ (ms)
non-DRX	$\max(T_{\text{Report}}, \text{ceil}(M * P * N) * T_{\text{CSI-RS}})$
DRX cycle $\leq$ 320ms	$\max(T_{\text{Report}}, \text{ceil}(1.5 * M * P * N) * \max(T_{\text{DRX}}, T_{\text{CSI-RS}}))$
DRX cycle $>$ 320ms	$\text{ceil}(M * P * N) * T_{\text{DRX}}$
Note 1:	$T_{\text{CSI-RS}}$ is the periodicity of CSI-RS configured for L1-SINR measurement. $T_{\text{DRX}}$ is the DRX cycle length. $T_{\text{Report}}$ is configured periodicity for reporting.
Note 2:	the requirements are applicable provided that the CSI-RS resource configured for L1-SINR measurement is transmitted with Density = 3.

The accuracy requirements in Table 6.7.9.0.1-3 are valid under the following conditions:

- Conditions defined in clause 7.3 of TS 38.101-1 [18] for reference sensitivity are fulfilled.
- Conditions for L1-SINR measurements are fulfilled according to Annex B.2.8.1 for a corresponding Band for each relevant CSI-RS based CMR.

- The bandwidth of CSI-RS as CMR is 48 PRBs and the density is 3.
- AWGN radio propagation conditions.

The performance with larger bandwidth of CSI-RS as CMR is equal to or better than the accuracy requirements in Table 6.7.9.0.1-3.

**Table 6.7.9.0.1-3: L1-SINR absolute accuracy for CSI-RS based CMR only in FR1**

Accuracy		Conditions						
Normal condition	Extreme condition	CSI-RS CMR $\hat{E}$ s/lot	$I_o$ <sup>Note 1</sup> range					
			NR operating band groups <sup>Note 2</sup>	Minimum $I_o$			Maximum $I_o$	
dB	dB	dB		dBm / $SCS_{CSI-RS}$			dBm/BW Channel	dBm/BW <sub>Channel</sub>
				$SCS_{CSI-RS} = 15$ kHz	$SCS_{CSI-RS} = 30$ kHz	$SCS_{CSI-RS} = 60$ kHz		
$\pm 5.5$	$\pm 6.5$	$\geq 3$	NR_FDD_FR1_A, NR_TDD_FR1_A, NR_SDL_FR1_A	-121	-118	-115	N/A	-50
			NR_FDD_FR1_B	-120.5	-117.5	-114.5	N/A	-50
			NR_TDD_FR1_C	-120	-117	-114	N/A	-50
			NR_FDD_FR1_D, NR_TDD_FR1_D	-119.5	-116.5	-113.5	N/A	-50
			NR_FDD_FR1_E, NR_TDD_FR1_E	-119	-116	-113	N/A	-50
			NR_FDD_FR1_F	-118.5	-115.5	-112.5	N/A	-50
			NR_FDD_FR1_G	-118	-115	-112	N/A	-50
			NR_FDD_FR1_H	-117.5	-114.5	-111.5	N/A	-50

NOTE 1:  $I_o$  is assumed to have constant EPRE across the bandwidth.  
 NOTE 2: NR operating band groups in FR1 are as defined in clause 3.5.2.

The normative reference for this requirement is TS 38.133 [6] clauses 9.8.4.1 and 10.1.27.1.

**6.7.9.0.2 Minimum conformance requirements for SSB based CMR and dedicated IMR**

The UE shall be capable of performing L1-SINR measurements with the SSB configured as CMR and dedicated resource configured as IMR for L1-SINR computation, in which the NZP-CSI-RS or CSI-IM resource configured as dedicated IMR shall be 1-to-1 mapped to SSB configured as CMR, with the same periodicity. The UE physical layer shall be capable of reporting L1-SINR measured over the measurement period of  $T_{L1-SINR\_Measurement\_Period\_SSB\_CMR\_IMR}$ .

The requirements in this clause are not applicable if NZP-CSI-RS or CSI-IM resource configured as dedicated IMR is scheduled with different periodicity as SSB configured as CMR.

The value of  $T_{L1-SINR\_Measurement\_Period\_SSB\_CMR\_IMR}$  is defined in Table 6.7.9.0.2-1 for FR1 and in Table 6.7.9.0.2-2 for FR2, where

For the value of M

- For periodic or semi-persistent NZP CSI-RS or CSI-IM resource as dedicated IMR,  $M=1$  if the higher layer parameters *timeRestrictionForChannelMeasurements* and/or *timeRestrictionForInterferenceMeasurements* are configured, and  $M=3$  otherwise;

For the value of N in FR2

- $N = 8$ .

P is defined as the maximum value between  $P_{CMR}$  and  $P_{IMR}$ , i.e.,  $P = \max(P_{CMR}, P_{IMR})$ , where

- the value of  $P_{CMR}$  shall be derived in the same way as the value of P used for SSB based L1-RSRP measurement in clause 9.5.4.1 of TS 38.133 [6], in which the occasions and period of the SSB for CMR shall be used instead.

- the value of  $P_{IMR}$  shall be derived in the same way as the value of  $P$  used for CSI-RS based L1-RSRP measurement in clause 9.5.4.2 of TS 38.133 [6], in which the occasions and period of the NZP CSI-RS for NZP-IMR or CSI-IM for ZP-IMR shall be used instead.

Longer evaluation period would be expected if the combination of SSB, SMTC occasion and measurement gap configurations does not meet previous conditions.

For L1-SINR measurement with SSB as CMR and CSI-RS or CSI-IM as IMR, the requirement shall apply if the CSI-RS is configured as IMR with repetition field as “repetition = OFF” or CSI-IM is configured as IMR.

For L1-SINR measurement with SSB as CMR and CSI-RS/CSI-IM as IMR, no requirement shall apply if SSB occasions for CMR or CSI-RS/CSI-IM occasions for IMR are fully overlapped with the configured measurement gap

**Table 6.7.9.0.2-1: Measurement period  $T_{L1-SINR\_Measurement\_Period\_SSB\_CMR\_IMR}$  for FR1**

Configuration	$T_{L1-SINR\_Measurement\_Period\_SSB\_CMR\_IMR}$ (ms)
non-DRX	$\max(T_{Report}, \text{ceil}(M \cdot P) \cdot T_{SSB})$
DRX cycle $\leq 320$ ms	$\max(T_{Report}, \text{ceil}(1.5 \cdot M \cdot P) \cdot \max(T_{DRX}, T_{SSB}))$
DRX cycle $> 320$ ms	$\text{ceil}(M \cdot P) \cdot T_{DRX}$
Note 1:	$T_{SSB} = \text{ssb-periodicityServingCell}$ is the periodicity of the SSB-Index configured for L1-SINR channel measurement. $T_{DRX}$ is the DRX cycle length. $T_{Report}$ is configured periodicity for reporting.
Note 2:	The requirements are applicable provided that the CSI-RS resource configured for interference measurement shall be 1-to-1 mapped to SSB configured for channel measurement, with the same periodicity.

**Table 6.7.9.0.2-2: Measurement period  $T_{L1-SINR\_Measurement\_Period\_SSB\_CMR\_IMR}$  for FR2**

Configuration	$T_{L1-SINR\_Measurement\_Period\_SSB\_CMR\_IMR}$ (ms)
non-DRX	$\max(T_{Report}, \text{Ceil}(M \cdot P \cdot N) \cdot T_{SSB})$
DRX cycle $\leq 320$ ms	$\max(T_{Report}, \text{ceil}(1.5 \cdot M \cdot P \cdot N) \cdot \max(T_{DRX}, T_{SSB}))$
DRX cycle $> 320$ ms	$\text{ceil}(1.5 \cdot M \cdot P \cdot N) \cdot T_{DRX}$
Note 1:	$T_{SSB} = \text{ssb-periodicityServingCell}$ is the periodicity of the SSB-Index configured for L1-SINR measurement. $T_{DRX}$ is the DRX cycle length. $T_{Report}$ is configured periodicity for reporting.
Note 2:	The requirements are applicable provided that the CSI-RS resource configured for interference measurement shall be 1-to-1 mapped to SSB configured for channel measurement, with the same periodicity.

The accuracy requirements in Tables 6.7.9.0.2-3 and 6.7.9.0.2-4 are valid under the following conditions:

- Conditions defined in clause 7.3 of TS 38.101-1 [18] for reference sensitivity are fulfilled.
- Conditions for L1-SINR measurements are fulfilled according to Annex B.2.8.2 for a corresponding Band for each relevant SSB based CMR and IMR.
- The bandwidth of NZP-IMR and ZP-IMR is 48 PRBs and the density is 3.
- AWGN radio propagation conditions.

The performance with larger bandwidth of NZP-IMR and ZP-IMR is equal to or better than the accuracy requirements in Tables 6.7.9.0.2-3 and 6.7.9.0.2-4.

Table 6.7.9.0.2-3: L1-SINR absolute accuracy for SSB based CMR and NZP-IMR in FR1

Accuracy		Conditions						
Normal condition	Extreme condition	SSB-CMR Es/lot	NZP-IMR Es/lot	Io <sup>Note 1</sup> range				
				NR operating band groups <sup>Note 2</sup>	Minimum Io		Maximum Io	
dB	dB	dB	dB		dBm / SCS <sub>SSB</sub>		dBm/BW <sub>Channel</sub>	dBm/BW <sub>Channel</sub>
					SCS <sub>SSB</sub> = 15 kHz	SCS <sub>SSB</sub> = 30 kHz		
±4.0	±5.0	≥0	≥0	NR_FDD_FR1_A, NR_TDD_FR1_A, NR_SDL_FR1_A	-121	-118	N/A	-50
				NR_FDD_FR1_B	-120.5	-117.5	N/A	-50
				NR_TDD_FR1_C	-120	-117	N/A	-50
				NR_FDD_FR1_D, NR_TDD_FR1_D	-119.5	-116.5	N/A	-50
				NR_FDD_FR1_E, NR_TDD_FR1_E	-119	-116	N/A	-50
				NR_FDD_FR1_F	-118.5	-115.5	N/A	-50
				NR_FDD_FR1_G	-118	-115	N/A	-50
				NR_FDD_FR1_H	-117.5	-114.5	N/A	-50

NOTE 1: Io is assumed to have constant EPRE across the bandwidth.  
NOTE 2: NR operating band groups in FR1 are as defined in clause 3.5.2.

Table 6.7.9.0.2-4: L1-SINR absolute accuracy for SSB based CMR and ZP-IMR in FR1

Accuracy		Conditions						
Normal condition	Extreme condition	SSB-CMR Es/lot	Io <sup>Note 1</sup> range					
			NR operating band groups <sup>Note 2</sup>	Minimum Io		Maximum Io		
dB	dB	dB		dBm / SCS <sub>SSB</sub>		dBm/BW <sub>Channel</sub>	dBm/BW <sub>Channel</sub>	
				SCS <sub>SSB</sub> = 15 kHz	SCS <sub>SSB</sub> = 30 kHz			
±4.5	±5.5	≥-3	NR_FDD_FR1_A, NR_TDD_FR1_A, NR_SDL_FR1_A	-121	-118	N/A	-50	
			NR_FDD_FR1_B	-120.5	-117.5	N/A	-50	
			NR_TDD_FR1_C	-120	-117	N/A	-50	
			NR_FDD_FR1_D, NR_TDD_FR1_D	-119.5	-116.5	N/A	-50	
			NR_FDD_FR1_E, NR_TDD_FR1_E	-119	-116	N/A	-50	
			NR_FDD_FR1_F	-118.5	-115.5	N/A	-50	
			NR_FDD_FR1_G	-118	-115	N/A	-50	
			NR_FDD_FR1_H	-117.5	-114.5	N/A	-50	

NOTE 1: Io is assumed to have constant EPRE across the bandwidth.  
NOTE 2: NR operating band groups in FR1 are as defined in clause 3.5.2.

The normative reference for this requirement is TS 38.133 [6] clauses 9.8.4.2 and 10.1.27.2.

6.7.9.0.3 Minimum conformance requirements for CSI-RS based CMR and dedicated IMR

The UE shall be capable of performing L1-SINR measurements with the CSI-RS resource configured as CMR and dedicated resource configured as IMR for L1-SINR computation, in which the NZP-CSI-RS or CSI-IM resource configured as dedicated IMR shall be 1-to-1 mapped to CSI-RS resource configured as CMR, with the same periodicity. The UE physical layer shall be capable of reporting L1-SINR measured over the measurement period of T<sub>L1</sub>.

SINR\_Measurement\_Period\_CSI-RS\_CMR\_IMR.

The requirements in this clause are not applicable if NZP-CSI-RS or CSI-IM resource configured as dedicated IMR is scheduled with different periodicity as CSI-RS resource configured as CMR.

The value of  $T_{L1-SINR\_Measurement\_Period\_CSI-RS\_CMR\_IMR}$  is defined in Table 6.7.9.0.3-1 for FR1 and in Table 6.7.9.0.3-2 for FR2, where

For the value of M,

- M=1 shall be applied if
  - aperiodic NZP-CSI-RS as CMR or dedicated IMR, or
  - aperiodic CSI-IMR as dedicated IMR, or
  - periodic and semi-persistent NZP-CSI-RS as CMR or dedicated IMR and the higher layer parameters *timeRestrictionForChannelMeasurement* and/or *timeRestrictionForInterferenceMeasurements* are configured, or
  - periodic and semi-persistent CSI-IM as dedicated IMR and the higher layer parameters *timeRestrictionForChannelMeasurement* and/or *timeRestrictionForInterferenceMeasurements* are configured;
- M=3 otherwise.

For the value of N in FR2

- For periodic CSI-RS resources as CMR in a resource set configured with higher layer parameter *repetition* set to OFF, N=1. The requirements apply if *qcl-InfoPeriodicCSI-RS* is configured for all the resources in the resource set and for each resource one RS has QCL-TypeD with
  - SSB for L1-RSRP or L1-SINR measurement, or
  - another CSI-RS in resource set configured with repetition ON.
- For periodic CSI-RS resources as CMR in a resource set configured with higher layer parameter *repetition* set to ON,  $N = \text{ceil}(\text{maxNumberRxBeam} / N_{\text{res\_per\_set}})$ , where  $N_{\text{res\_per\_set}}$  is number of resources in the resource set. The requirements apply provided *qcl-InfoPeriodicCSI-RS* is configured for all resources in the resource set.
- For semi-persistent CSI-RS resources as CMR in a resource set configured with higher layer parameter *repetition* set to OFF, N=1. The requirements apply provided TCI state is provided for all resources in the resource set in the MAC CE activating the resource set and for each resource has QCL-TypeD with
  - SSB for L1-RSRP or L1-SINR measurement, or
  - another CSI-RS in resource set configured with repetition ON.
- For semi-persistent CSI-RS resources as CMR in a resource set configured with higher layer parameter *repetition* set to ON,  $N = \text{ceil}(\text{maxNumberRxBeam} / N_{\text{res\_per\_set}})$ , where  $N_{\text{res\_per\_set}}$  is number of resources in the resource set. The requirements apply provided TCI state is provided for all resources in the resource set in the MAC CE activating the resource set.
- For aperiodic CSI-RS resources as CMR in a resource set configured with higher layer parameter *repetition* set to OFF, N=1. The requirements apply provided *qcl-info* is configured for all resources in the resource set and for each resource has QCL-TypeD with
  - SSB for L1-RSRP or L1-SINR measurement, or
  - another CSI-RS in resource set configured with repetition ON.
- For aperiodic CSI-RS resources as CMR in a resource set configured with higher layer parameter *repetition* set to ON, N=1. UE is not required to meet the accuracy requirements in clause 10.1.28.1 and 10.1.28.3 of TS 38.133 [6] if number of resources in the resource set is smaller than *maxNumberRxBeam*. The requirements apply provided *qcl-info* is configured for all resources in the resource set.

P is defined as the maximum value between  $P_{\text{CMR}}$  and  $P_{\text{IMR}}$ , i.e.,  $P = \max(P_{\text{CMR}}, P_{\text{IMR}})$ , where

- The value of  $P_{CMR}$  and  $P_{IMR}$  shall be derived in the same way as the value of  $P$  used for CSI-RS based L1-RSRP measurement in clause 9.5.4.2 of TS 38.133 [6], in which the occasions and period of the CSI-RS for CMR and NZP CSI-RS for NZP-IMR or CSI-IM for ZP-IMR shall be used instead respectively.

Longer evaluation period would be expected if the combination of CSI-RS, SMTC occasion and measurement gap configurations does not meet previous conditions.

For L1-SINR measurement with CSI-RS as CMR and CSI-RS as IMR, the requirement shall apply only if CSI-RS resources as CMR and IMR are configured with the same repetition field and the number of CSI-RS resources in the resource sets for CMR and IMR are same.

For L1-SINR measurement with CSI-RS as CMR and CSI-IM as IMR, the requirement shall apply only if the number of CSI-RS resources in the resource set for CMR and the number of CSI-IM resources in the resource set for IMR are same.

For L1-SINR measurement with CSI-RS as CMR and CSI-RS/CSI-IM as IMR, no requirement shall apply if CSI-RS occasions for CMR or CSI-RS/CSI-IM occasions for IMR are fully overlapped with the configured measurement gap.

**Table 6.7.9.0.3-1: Measurement period  $T_{L1-SINR\_Measurement\_Period\_CSI-RS\_CMR\_IMR}$  for FR1**

Configuration	$T_{L1-SINR\_Measurement\_Period\_CSI-RS\_CMR\_IMR}$ (ms)
non-DRX	$\max(T_{Report}, \text{ceil}(M \cdot P) \cdot T_{CSI-RS})$
DRX cycle $\leq 320$ ms	$\max(T_{Report}, \text{ceil}(1.5 \cdot M \cdot P) \cdot \max(T_{DRX}, T_{CSI-RS}))$
DRX cycle $> 320$ ms	$\text{ceil}(M \cdot P) \cdot T_{DRX}$
Note 1:	$T_{CSI-RS}$ is the periodicity of CSI-RS configured for L1-SINR measurement. $T_{DRX}$ is the DRX cycle length. $T_{Report}$ is configured periodicity for reporting.
Note 2:	the requirements are applicable provided that the CSI-RS resource configured for L1-SINR measurement is transmitted with Density = 3.
Note 3:	The requirements are applicable provided that the CSI-RS resource configured for interference measurement shall be 1-to-1 mapped to CSI-RS configured for channel measurement, with the same periodicity.

**Table 6.7.9.0.3-2: Measurement period  $T_{L1-SINR\_Measurement\_Period\_CSI-RS\_CMR\_IMR}$  for FR2**

Configuration	$T_{L1-SINR\_Measurement\_Period\_CSI-RS\_CMR\_IMR}$ (ms)
non-DRX	$\max(T_{Report}, \text{ceil}(M \cdot P \cdot N) \cdot T_{CSI-RS})$
DRX cycle $\leq 320$ ms	$\max(T_{Report}, \text{ceil}(1.5 \cdot M \cdot P \cdot N) \cdot \max(T_{DRX}, T_{CSI-RS}))$
DRX cycle $> 320$ ms	$\text{ceil}(M \cdot P \cdot N) \cdot T_{DRX}$
Note 1:	$T_{CSI-RS}$ is the periodicity of CSI-RS configured for L1-SINR measurement. $T_{DRX}$ is the DRX cycle length. $T_{Report}$ is configured periodicity for reporting.
Note 2:	the requirements are applicable provided that the CSI-RS resource configured for L1-SINR measurement is transmitted with Density = 3.
Note 3:	The requirements are applicable provided that the CSI-RS resource configured for interference measurement shall be 1-to-1 mapped to CSI-RS configured for channel measurement, with the same periodicity.

The accuracy requirements in Tables 6.7.9.0.3-3 and 6.7.9.0.3-4 are valid under the following conditions:

- Conditions defined in clause 7.3 of TS 38.101-1 [18] for reference sensitivity are fulfilled.
- Conditions for L1-SINR measurements are fulfilled according to Annex B.2.8.3 for a corresponding Band for each relevant CSI-RS based CMR and IMR.
- The bandwidth of CSI-RS as CMR, NZP-IMR and ZP-IMR is 48 PRBs and the density is 3.
- AWGN radio propagation conditions.

The performance with larger bandwidth of CSI-RS as CMR, NZP-IMR and ZP-IMR is equal to or better than the accuracy requirements in Tables 6.7.9.0.3-3 and 6.7.9.0.3-4.



**Table 6.7.9.0.3-3: L1-SINR absolute accuracy for CSI-RS based CMR and NZP-IMR in FR1**

Accuracy		Conditions							
Normal condition	Extreme condition	CSI-RS CMR $\hat{E}_s/\text{lot}$	NZP-IMR $\hat{E}_s/\text{lot}$	$I_o$ <sup>Note 1</sup> range					
				NR operating band groups <sup>Note 2</sup>	Minimum $I_o$			Maximum $I_o$	
dB	dB	dB	dB	dBm / $SCS_{CSI-RS}$			dBm/BW <sub>Channel</sub>	dBm/BW <sub>Channel</sub>	
				$SCS_{SI-RS} = 15$ kHz	$SCS_{CSI-RS} = 30$ kHz	$SCS_{SI-RS} = 60$ kHz			
$\pm 4.0$	$\pm 5.0$	$\geq 0$	$\geq 0$	NR_FDD_FR1_A, NR_TDD_FR1_A, NR_SDL_FR1_A	-121	-118	-115	N/A	-50
				NR_FDD_FR1_B	-120.5	-117.5	-114.5	N/A	-50
				NR_TDD_FR1_C	-120	-117	-114	N/A	-50
				NR_FDD_FR1_D, NR_TDD_FR1_D	-119.5	-116.5	-113.5	N/A	-50
				NR_FDD_FR1_E, NR_TDD_FR1_E	-119	-116	-113	N/A	-50
				NR_FDD_FR1_F	-118.5	-115.5	-112.5	N/A	-50
				NR_FDD_FR1_G	-118	-115	-112	N/A	-50
				NR_FDD_FR1_H	-117.5	-114.5	-111.5	N/A	-50

NOTE 1:  $I_o$  is assumed to have constant EPRE across the bandwidth.  
 NOTE 2: NR operating band groups in FR1 are as defined in clause 3.5.2.

**Table 6.7.9.0.3-4: L1-SINR absolute accuracy for CSI-RS based CMR and ZP-IMR in FR1**

Accuracy		Conditions						
Normal condition	Extreme condition	CSI-RS CMR $\hat{E}_s/\text{lot}$	$I_o$ <sup>Note 1</sup> range					
			NR operating band groups <sup>Note 2</sup>	Minimum $I_o$			Maximum $I_o$	
dB	dB	dB	dBm / $SCS_{CSI-RS}$			dBm/BW <sub>Channel</sub>	dBm/BW <sub>Channel</sub>	
			$SCS_{SI-RS} = 15$ kHz	$SCS_{CSI-RS} = 30$ kHz	$SCS_{SI-RS} = 60$ kHz			
$\pm 4.5$	$\pm 5.5$	$\geq -3$	NR_FDD_FR1_A, NR_TDD_FR1_A, NR_SDL_FR1_A	-121	-118	-115	N/A	-50
			NR_FDD_FR1_B	-120.5	-117.5	-114.5	N/A	-50
			NR_TDD_FR1_C	-120	-117	-114	N/A	-50
			NR_FDD_FR1_D, NR_TDD_FR1_D	-119.5	-116.5	-113.5	N/A	-50
			NR_FDD_FR1_E, NR_TDD_FR1_E	-119	-116	-113	N/A	-50
			NR_FDD_FR1_F	-118.5	-115.5	-112.5	N/A	-50
			NR_FDD_FR1_G	-118	-115	-112	N/A	-50
			NR_FDD_FR1_H	-117.5	-114.5	-111.5	N/A	-50

NOTE 1:  $I_o$  is assumed to have constant EPRE across the bandwidth.  
 NOTE 2: NR operating band groups in FR1 are as defined in clause 3.5.2.

The normative reference for this requirement is TS 38.133 [6] clauses 9.8.4.3 and 10.1.27.3.

### 6.7.9.1 NR SA FR1 CSI-RS based CMR and no dedicated IMR configured and CSI-RS resource set with repetition off L1-SINR measurement accuracy

**Editor's note:** This test case is incomplete. The following aspects are either missing or not yet determined:

- Test Tolerance is FFS

#### 6.7.9.1.1 Test purpose

The purpose of this test is to verify that the L1-SINR measurement accuracy is within the specified limits.

#### 6.7.9.1.2 Test applicability

This test applies to all types of NR UE from Release 16 onwards. Applicability requires support of L1-SINR measurements.

#### 6.7.9.1.3 Minimum conformance requirements

The minimum conformance requirements are specified in clause 6.7.9.0.1.

The normative reference for this requirement is TS 38.133 [6] clause A.6.7.9.1.

#### 6.7.9.1.4 Test description

##### 6.7.9.1.4.1 Initial conditions

This test shall be tested using any of the test configurations in Table 6.7.9.1.4.1-1.

**Table 6.7.9.1.4.1-1: Applicable NR configurations for FR1 L1-SINR test with CSI-RS based CMR and no dedicated IMR configured**

Config	Description
1	NR 15 kHz CSI-RS SCS, 10 MHz bandwidth, FDD duplex mode
2	NR 15 kHz CSI-RS SCS, 10 MHz bandwidth, TDD duplex mode
3	NR 30kHz CSI-RS SCS, 40 MHz bandwidth, TDD duplex mode
Note: The UE is only required to be tested in one of the supported test configurations in each supported band	

Configure the test equipment and the DUT according to the parameters in Table 6.7.9.1.4.1-2.

**Table 6.7.9.1.4.1-2: Initial conditions for CSI-RS based L1-SINR absolute accuracy in FR1**

Parameter	Value		Comment
Test environment	NC, TL/VL, TL/VH, TH/VL, TH/VH		As specified in TS 38.508-1 [14] clause 4.1.
Test frequencies	As specified in Annex E, Table E.4-1 and TS 38.508-1 [14] clause 4.3.1.		
Channel bandwidth	As specified by the test configuration selected from Table 6.7.9.1.4.1-1.		
Propagation conditions	AWGN		As specified in Annex C.2.2.
Connection Diagram	TE Part 2Rx	A.3.1.8.2 with n = 1	As specified in TS 38.508-1 [14] Annex A.
	TE Part 4Rx	A.3.1.8.5 with n = 1	
	DUT Part 2Rx	A.3.2.3.4	
	DUT Part 4Rx	A.3.2.5.2	
Exceptions to connection diagram	N/A		

1. Message contents are defined in clause 6.7.9.1.4.3.

2. Cell 1 is the NR FR1 cell. Cell 1 is the target for CSI-RS based L1-SINR measurements. The UE is configured to perform RLM and BFD measurement based on the CSI-RS. The connection setup is done according to the settings in Annex C.1.1.

6.7.9.1.4.2 Test procedure

The UE shall be configured for periodic CSI reporting in PUCCH [format 2] with a reporting periodicity as mentioned in the above table 6.7.9.1.4.1-2.

1. Ensure the UE is in state RRC\_CONNECTED with generic procedure parameters Connectivity NR SA, Connected without release *On* and Test Mode *On*, according to TS 38.508-1 [14] clause 4.5 and general test parameters set according to Table 6.7.9.1.4.1-2.
2. Set the parameters according to T1 in Table 6.7.9.1.5-1.
3. The UE shall start sending L1-SINR report including results of both CSI-RS#0 and CSI-RS#1 every 80 slots.
4. The SS shall check the L1-SINR reported values of CSI-RS#0 and CSI-RS#1 in the periodic L1-RSRP reports. If the value for both CSI-RSs is within the limits in Table 6.7.4.2.1.5-2 or Table 6.7.4.2.1.5-3 (depending on the test configuration), the number of passed iterations is increased by one, otherwise the number of failed iterations is increased by one.
5. The SS shall continue checking the L1-SINR report messages transmitted by the UE until the confidence level according to Table G.2.3-1 in Annex G is achieved.
6. Set the parameters according to each sub-test in Table 6.7.4.2.1.5-1 as appropriate and repeat steps 3-5.

6.7.9.1.4.3 Message contents

Message contents are according to TS 38.508-1 [14] clause 7.3 with the following exceptions:

**Table 6.7.9.1.4.3-1: Common Exception messages NR SA CSI-RS-based L1-RSRP measurement**

Default Message Contents	
Common contents of system information blocks exceptions	
Default RRC messages and information elements contents exceptions	Table H.3.6A-1 with conditions PERIODIC and CSI-SINR Table H.3.6A-2 with conditions CSI-RS and PERIODIC Table H.3.6A-3 with condition PERIODIC Table 7.3.1-3 in TS 38.508-1 [14] with condition SMTC.1

**Table 6.7.9.1.4.3-2: RadioLinkMonitoringConfig**

Derivation Path: TS 38.508-1 [14], Table 4.6.3-133			
Information Element	Value/remark	Comment	Condition
RadioLinkMonitoringConfig ::= SEQUENCE {			
failureDetectionResourcesToAddModList	1 entry		
SEQUENCE (SIZE(1..maxNrofFailureDetectionResources)) OF SEQUENCE {			
purpose	both	UE is configured to perform RLM and BFD based on the SSB.	
}			
}			

6.7.9.1.5 Test requirement

Table 6.7.9.1.5-1 defines the primary level settings excluding test tolerances for all tests.

Each L1-SINR measurement report for each of the tests in Table 6.7.9.1.5-1 shall meet the corresponding absolute accuracy requirements in Table 6.7.9.1.5-2 for test configurations 1 and 2, and the corresponding absolute accuracy requirements in Table 6.7.9.1.5-3 for test configuration 3.

Table 6.7.9.1.5-1: FR1 CSI-RS based L1-SINR test parameters

Parameter	Config	Unit	Test 1	Test 2
SSB GSCN	1~3		freq1	freq1
Duplex mode	1		FDD	FDD
	2		TDD	TDD
	3		TDD	TDD
TDD Configuration	1		N/A	N/A
	2		TDDConf.1.1	TDDConf.1.1
	3		TDDConf.2.1	TDDConf.2.1
BW <sub>channel</sub>	1	MHz	10: N <sub>RB,c</sub> = 52	10: N <sub>RB,c</sub> = 52
	2		10: N <sub>RB,c</sub> = 52	10: N <sub>RB,c</sub> = 52
	3		40: N <sub>RB,c</sub> = 106	40: N <sub>RB,c</sub> = 106
PDSCH Reference measurement channel	1		SR.1.1 FDD	SR.1.1 FDD
	2		SR.1.1 TDD	SR.1.1 TDD
	3		SR.2.1 TDD	SR.2.1 TDD
RMSI CORESET Reference Channel	1		CR.1.1 FDD	CR.1.1 FDD
	2		CR.1.1 TDD	CR.1.1 TDD
	3		CR.2.1 TDD	CR.2.1 TDD
Dedicated CORESET Reference Channel	1		CCR.1.1 FDD	CCR.1.1 FDD
	2		CCR.1.1 TDD	CCR.1.1 TDD
	3		CCR.2.1 TDD	CCR.2.1 TDD
SSB configuration	1		SSB.1 FR1	SSB.1 FR1
	2		SSB.1 FR1	SSB.1 FR1
	3		SSB.2 FR1	SSB.2 FR1
OCNG Patterns	1~3		OP.1	OP.1
TRS configuration	1		TRS.1.1 FDD	TRS.1.1 FDD
	2		TRS.1.1 TDD	TRS.1.1 TDD
	3		TRS.1.2 TDD	TRS.1.2 TDD
Initial BWP Configuration	1~3		DLBWP.0.1 ULBWP.0.1	DLBWP.0.1 ULBWP.0.1
Dedicated BWP configuration	1~3		DLBWP.1.1 ULBWP.1.1	DLBWP.1.1 ULBWP.1.1
SMTc configuration	1~3		SMTc.1	SMTc.1
CSI-RS	1		CSI-RS 1.2 FDD	CSI-RS 1.2 FDD
	2		CSI-RS 1.2 TDD	CSI-RS 1.2 TDD
	3		CSI-RS 2.2 TDD	CSI-RS 2.2 FDD
reportConfigType	1~3		periodic	periodic
reportQuantity-r16	1~3		cri-SINR-r16	cri-SINR-r16
nrofReportedRS	1~3		2	2
L1-SINR reporting period	1~3		slot80	slot80
EPRE ratio of PSS to SSS	1~3	dB	0	0
EPRE ratio of PBCH DMRS to SSS				
EPRE ratio of PBCH to PBCH DMRS				
EPRE ratio of PDCCH DMRS to SSS				
EPRE ratio of PDCCH to PDCCH DMRS				
EPRE ratio of PDSCH DMRS to SSS				
EPRE ratio of PDSCH to PDSCH DMRS				
EPRE ratio of OCNG DMRS to SSS <sup>Note 1</sup>				
EPRE ratio of OCNG to OCNG DMRS <sup>Note 1</sup>				
$N_{oc}$ Note2	1~3	dBm/15kHz	-94.65+TT	-117+TT
				-116.5+TT
				-116+TT

	NR_FDD_FR1_D, NR_TDD_FR1_D				-115.5+TT
	NR_FDD_FR1_E, NR_TDD_FR1_E				-115+TT
	NR_FDD_FR1_F				-114.5+TT
	NR_FDD_FR1_G				-114+TT
	NR_FDD_FR1_H				-113.5+TT
<i>N<sub>oc</sub></i> Note2	NR_FDD_FR1_A, NR_TDD_FR1_A NOTE 5	1,2	dBm/CSI-RS SCS	-94.65+TT	-117+TT
	NR_FDD_FR1_B				-116.5+TT
	NR_TDD_FR1_C				-116+TT
	NR_FDD_FR1_D, NR_TDD_FR1_D				-115.5+TT
	NR_FDD_FR1_E, NR_TDD_FR1_E				-115+TT
	NR_FDD_FR1_F				-114.5+TT
	NR_FDD_FR1_G	-114+TT			
	NR_FDD_FR1_H	-113.5+TT			
	NR_FDD_FR1_A, NR_TDD_FR1_A NOTE 5	3		-91.65+TT	-114+TT
	NR_FDD_FR1_B				-113.5+TT
	NR_TDD_FR1_C				-114+TT
	NR_FDD_FR1_D, NR_TDD_FR1_D				-112.5+TT
	NR_FDD_FR1_E, NR_TDD_FR1_E				-112+TT
	NR_FDD_FR1_F				-111.5+TT
	NR_FDD_FR1_G	-111+TT			
	NR_FDD_FR1_H	-110.5+TT			
$\hat{E}_s/I_{\alpha}$	1~3	dB	10+TT	-3+TT	
CSI-RS RSRP Note3	NR_FDD_FR1_A, NR_TDD_FR1_A NOTE 5	1,2	dBm/CSI-RS SCS	-84.65+TT	-120+TT
	NR_FDD_FR1_B				-119.5+TT
	NR_TDD_FR1_C				-119+TT
	NR_FDD_FR1_D, NR_TDD_FR1_D				-118.5+TT
	NR_FDD_FR1_E, NR_TDD_FR1_E				-118+TT
	NR_FDD_FR1_F				-117.5+TT
	NR_FDD_FR1_G	-117+TT			
	NR_FDD_FR1_H	-116.5+TT			
	NR_FDD_FR1_A, NR_TDD_FR1_A NOTE 5	3		-81.65+TT	-117+TT
	NR_FDD_FR1_B				-116.5+TT
	NR_TDD_FR1_C				-116+TT
	NR_FDD_FR1_D, NR_TDD_FR1_D				-115.5+TT
	NR_FDD_FR1_E, NR_TDD_FR1_E				-115+TT
	NR_FDD_FR1_F				-114.5+TT
	NR_FDD_FR1_G	-114+TT			
	NR_FDD_FR1_H	-113.5+TT			
<i>I<sub>o</sub></i> Note3	NR_FDD_FR1_A, NR_TDD_FR1_A NOTE 5	1,2	dBm/9.36 MHz	-56.28+TT	-87.28+TT
	NR_FDD_FR1_B				-86.78+TT
	NR_TDD_FR1_C				-86.28+TT
	NR_FDD_FR1_D, NR_TDD_FR1_D				-85.78+TT
	NR_FDD_FR1_E, NR_TDD_FR1_E				-85.28+TT
	NR_FDD_FR1_F				-84.78+TT

	NR_FDD_FR1_G				-84.28+TT
	NR_FDD_FR1_H				-83.78+TT
	NR_FDD_FR1_A, NR_TDD_FR1_A NOTE 5	3	dBm/38.16 MHz	-50.19+TT	-81.19+TT
	NR_FDD_FR1_B				-80.69+TT
	NR_TDD_FR1_C				-80.19+TT
	NR_FDD_FR1_D, NR_TDD_FR1_D				-79.69+TT
	NR_FDD_FR1_E, NR_TDD_FR1_E				-79.19+TT
	NR_FDD_FR1_F				-78.69+TT
	NR_FDD_FR1_G				-78.19+TT
	NR_FDD_FR1_H				-77.69+TT
	$\hat{E}_s/N_{oc}$				1~3
	Propagation condition	1~3		AWGN	AWGN
	Antenna configuration	1~3		1x2	1x2
<p>Note 1: OCNB shall be used such that both cells are fully allocated and a constant total transmitted power spectral density is achieved for all OFDM symbols.</p> <p>Note 2: Interference from other cells and noise sources not specified in the test is assumed to be constant over subcarriers and time and shall be modelled as AWGN of appropriate power for <math>N_{oc}</math> to be fulfilled.</p> <p>Note 3: RSRP and <math>I_o</math> levels have been derived from other parameters for information purposes. They are not settable parameters themselves.</p> <p>Note 4: RSRP minimum requirements are specified assuming independent interference and noise at each receiver antenna port.</p> <p>Note 5: The test configuration excludes support for band n51 and it is not required to run this test on band n51 in this release of the specification.</p>					

**Table 6.7.9.1.5-2: L1-SINR absolute accuracy requirements for the reported values for test configurations 1 and 2**

FFS

**Table 6.7.9.1.5-3: L1-SINR absolute accuracy requirements for the reported values for test configuration 3**

FFS

For the test to pass, the ratio of successful reported values in each test shall be more than 90% with a confidence level of 95%.

**6.7.9.2 NR SA FR1 SSB based CMR and dedicated IMR L1-SINR absolute measurement accuracy**

**Editor's note:** This clause is incomplete. The following aspects are either missing or not yet determined:

- MU & TT needs further study

**6.7.9.2.1 Test purpose**

The purpose of this test is to verify that the L1-SINR measurement accuracy is within the specified limits.

**6.7.9.2.2 Test applicability**

This test applies to all types of NR UE from Release 16 onwards. Applicability requires support of L1-SINR measurements.

**6.7.9.2.3 Minimum conformance requirements**

The minimum conformance requirements are specified in clause 6.7.9.0.2.

The normative reference for this requirement is TS 38.133 [6] clause A.6.7.9.2.

6.7.9.2.4 Test description

6.7.9.2.4.1 Initial conditions

This test shall be tested using any of the test configurations in Table 6.7.9.2.4.1-1.

**Table 6.7.9.2.4.1-1: Applicable NR configurations for FR1 L1-SINR measurement test with SSB based CMR and CSI-RS based IMR**

Config	Description
1	NR 15 kHz SSB SCS, 10 MHz bandwidth, FDD duplex mode
2	NR 15 kHz SSB SCS, 10 MHz bandwidth, TDD duplex mode
3	NR 30kHz SSB SCS, 40 MHz bandwidth, TDD duplex mode
Note:	The UE is only required to be tested in one of the supported test configurations in each supported band

Configure the test equipment and the DUT according to the parameters in Table 6.7.9.2.4.1-2.

**Table 6.7.9.2.4.1-2: Initial conditions for SSB based and CSI-RS based L1-SINR absolute accuracy in FR1**

Parameter	Value	Comment
Test environment	NC, TL/VL, TL/VH, TH/VL, TH/VH	As specified in TS 38.508-1 [14] clause 4.1.
Test frequencies	As specified in Annex E, Table E.4-1 and TS 38.508-1 [14] clause 4.3.1.	
Channel bandwidth	As specified by the test configuration selected from Table 6.7.9.2.4.1-1.	
Propagation conditions	AWGN	As specified in Annex C.2.2.
Connection Diagram	TE Part 2Rx	A.3.1.8.2 with n = 1
	TE Part 4Rx	A.3.1.8.5 with n = 1
	DUT Part 2Rx	A.3.2.3.4
	DUT Part 4Rx	A.3.2.5.2
Exceptions to connection diagram	N/A	

1. Message contents are defined in clause 6.7.9.2.4.3.
2. Cell 1 is the NR FR1 cell. Cell 1 is the target for SSB-based L1-RSRP measurements. The UE is configured to perform RLM, BFD and L1-RSRP measurement based on the SSBs and CSI-RSs. The connection setup is done according to the settings in Annex C.1.2 and C.1.3.

6.7.9.2.4.2 Test procedure

Prior to the start of the time duration T1, the UE shall be fully synchronized to PSCell. The UE shall be configured for periodic CSI reporting in PUCCH [format 2] with a reporting periodicity as mentioned in the above table 6.7.9.2.4.1-2.

1. Ensure the UE is in state RRC\_CONNECTED with generic procedure parameters Connectivity NR SA, Connected without release  $O_n$  and Test Mode  $O_n$ , according to TS 38.508-1 [14] clause 4.5 and general test parameters set according to Table 6.7.9.2.4.1-2.
2. Set the parameters according to T1 in Table 6.7.9.2.5-1. SS transmits CSI-RS as IMR with a periodicity of 20 slots.
3. The UE shall start sending L1-SINR report including results of both SSB#0 and SSB#1 every 80 slots.
4. The SS shall check the L1-SINR reported values of CSI-RS#0 and CSI-RS#1 in the periodic L1-RSRP reports. If the value for both CSI-RSs is within the limits in Table 6.7.9.2.5-2 and Table 6.7.9.2.5-3 (depending on the test configuration), the number of passed iterations is increased by one, otherwise the number of failed iterations is increased by one.

5. The SS shall continue checking the L1-SINR report messages transmitted by the UE until the confidence level according to Table G.2.3-1 in Annex G is achieved.
6. Set the parameters according to each sub-test in Table 6.7.9.2.5-1 as appropriate and repeat steps 3-5.

6.7.9.2.4.3 Message contents

Message contents are according to TS 38.508-1 [14] clause 7.3 with the following exceptions:

**Table 6.7.4.1.1.4.3-1: Common Exception messages NR SA SSB based L1-RSRP measurement**

Default Message Contents	
Common contents of system information blocks exceptions	
Default RRC messages and information elements contents exceptions	Table H.3.6A-1 with conditions PERIODIC and SS-SINR and CSI-RS_IMR Table H.3.6A-2 with conditions SSB and PERIODIC Table H.3.6A-3 with condition PERIODIC Table 7.3.1-3 in TS 38.508-1 [14] with condition SMTC.1

**Table 6.7.4.1.1.4.3-2: RadioLinkMonitoringConfig**

Derivation Path: TS 38.508-1 [14], Table 4.6.3-133			
Information Element	Value/remark	Comment	Condition
RadioLinkMonitoringConfig ::= SEQUENCE {			
failureDetectionResourcesToAddModList	1 entry		
SEQUENCE (SIZE(1..maxNrofFailureDetectionResources)) OF			
SEQUENCE {			
purpose	both	UE is configured to perform RLM and BFD based on the SSBs.	
detectionResource CHOICE {			
ssb-Index	0		
}			
}			
}			
}			

6.7.9.2.5 Test requirement

Table 6.7.9.2.5-1 defines the primary level settings including test tolerances for all tests.

Each L1-RSRP measurement report for each of the tests in Table 6.7.4.1.1.5-1 shall meet the corresponding absolute accuracy requirements in Table 6.7.4.1.1.5-2 for test configurations 1 and 2, and the corresponding absolute accuracy requirements in Table 6.7.4.1.1.5-3 for test configuration 3.

**Table 6.7.9.2.5-1: FR1 SSB based L1-SINR test parameters**

Parameter	Config	Unit	Test 1	Test 2
SSB GSCN	1~3		freq1	freq1
Duplex mode	1		FDD	FDD
	2		TDD	TDD
	3		TDD	TDD
TDD Configuration	1		N/A	N/A
	2		TDDConf.1.1	TDDConf.1.1
	3		TDDConf.2.1	TDDConf.2.1
BW <sub>channel</sub>	1	MHz	10: N <sub>RB,c</sub> = 52	10: N <sub>RB,c</sub> = 52
	2		10: N <sub>RB,c</sub> = 52	10: N <sub>RB,c</sub> = 52
	3		40: N <sub>RB,c</sub> = 106	40: N <sub>RB,c</sub> = 106
PDSCH Reference measurement channel	1		SR.1.1 FDD	SR.1.1 FDD
	2		SR.1.1 TDD	SR.1.1 TDD
	3		SR.2.1 TDD	SR.2.1 TDD



RMSI CORESET Reference Channel	1		CR.1.1 FDD	CR.1.1 FDD	
	2		CR.1.1 TDD	CR.1.1 TDD	
	3		CR.2.1 TDD	CR.2.1 TDD	
Dedicated CORESET Reference Channel	1		CCR.1.1 FDD	CCR.1.1 FDD	
	2		CCR.1.1 TDD	CCR.1.1 TDD	
	3		CCR.2.1 TDD	CCR.2.1 TDD	
SSB configuration	1		SSB.3 FR1	SSB.3 FR1	
	2		SSB.3 FR1	SSB.3 FR1	
	3		SSB.4 FR1	SSB.4 FR1	
CSI-RS configuration	1		CSI-RS 1.1A FDD	CSI-RS 1.1A FDD	
	2		CSI-RS 1.1A TDD	CSI-RS 1.1A TDD	
	3		CSI-RS 2.1A TDD	CSI-RS 2.1A TDD	
OCNG Patterns	1~3		OP.1	OP.1	
Initial BWP Configuration	1~3		DLBWP.0.1 ULBWP.0.1	DLBWP.0.1 ULBWP.0.1	
TRS configuration	1		TRS.1.1 FDD	TRS.1.1 FDD	
	2		TRS.1.1 TDD	TRS.1.1 TDD	
	3		TRS.1.2 TDD	TRS.1.2 TDD	
Dedicated BWP configuration	1~3		DLBWP.1.1 ULBWP.1.1	DLBWP.1.1 ULBWP.1.1	
SMTC configuration	1~3		SMTC.1	SMTC.1	
reportConfigType	1~3		periodic	periodic	
reportQuantity-r16	1~3		ssb-Index-SINR-r16	ssb-Index-SINR-r16	
Number of reported RS	1~3		2	2	
L1-SINR reporting period	1~3		slot80	slot80	
EPRE ratio of PSS to SSS	1~3	dB	0	0	
EPRE ratio of PBCH DMRS to SSS					
EPRE ratio of PBCH to PBCH DMRS					
EPRE ratio of PDCCH DMRS to SSS					
EPRE ratio of PDCCH to PDCCH DMRS					
EPRE ratio of PDSCH DMRS to SSS					
EPRE ratio of PDSCH to PDSCH DMRS					
EPRE ratio of OCNG DMRS to SSS <sup>Note 1</sup>					
EPRE ratio of OCNG to OCNG DMRS <sup>Note 1</sup>					
$N_{oc}$ Note2	NR_FDD_FR1_A, NR_TDD_FR1_A NOTE 5	1~3	dBm/15kHz	-94.65+TT	-117+TT
	NR_FDD_FR1_B				-116.5+TT
	NR_TDD_FR1_C				-116+TT
	NR_FDD_FR1_D, NR_TDD_FR1_D				-115.5+TT
	NR_FDD_FR1_E, NR_TDD_FR1_E				-115+TT
	NR_FDD_FR1_F				-114.5+TT
	NR_FDD_FR1_G				-114+TT
	NR_FDD_FR1_H				-113.5+TT
$N_{oc}$ Note2	NR_FDD_FR1_A, NR_TDD_FR1_A NOTE 5	1,2	dBm/SSB SCS	-94.65+TT	-117+TT
	NR_FDD_FR1_B				-116.5+TT
	NR_TDD_FR1_C				-116+TT
	NR_FDD_FR1_D, NR_TDD_FR1_D				-115.5+TT

	NR_FDD_FR1_E, NR_TDD_FR1_E	3		-91.65+TT	-115+TT
	NR_FDD_FR1_F				-114.5+TT
	NR_FDD_FR1_G				-114+TT
	NR_FDD_FR1_H				-113.5+TT
	NR_FDD_FR1_A, NR_TDD_FR1_A NOTE 5				-114+TT
	NR_FDD_FR1_B				-113.5+TT
	NR_TDD_FR1_C				-114+TT
	NR_FDD_FR1_D, NR_TDD_FR1_D				-112.5+TT
	NR_FDD_FR1_E, NR_TDD_FR1_E				-112+TT
	NR_FDD_FR1_F				-111.5+TT
	NR_FDD_FR1_G				-111+TT
	NR_FDD_FR1_H				-110.5+TT
$\hat{E}_s/I_{ot}$		1~3	dB	10+TT	0+TT
$\hat{E}_s/N_{oc}$		1~6	dB	10+TT	0+TT
SSB RSRP Note3	NR_FDD_FR1_A, NR_TDD_FR1_A NOTE 5	1,2	dBm/SSB SCS	-84.65+TT	-117+TT
	NR_FDD_FR1_B				-116.5+TT
	NR_TDD_FR1_C				-116+TT
	NR_FDD_FR1_D, NR_TDD_FR1_D				-115.5+TT
	NR_FDD_FR1_E, NR_TDD_FR1_E				-115+TT
	NR_FDD_FR1_F				-114.5+TT
	NR_FDD_FR1_G				-114+TT
	NR_FDD_FR1_H				-113.5+TT
	NR_FDD_FR1_A, NR_TDD_FR1_A NOTE 5	3		-81.65+TT	-114+TT
	NR_FDD_FR1_B				-113.5+TT
	NR_TDD_FR1_C				-114+TT
	NR_FDD_FR1_D, NR_TDD_FR1_D				-112.5+TT
	NR_FDD_FR1_E, NR_TDD_FR1_E				-112+TT
	NR_FDD_FR1_F				-111.5+TT
NR_FDD_FR1_G	-111+TT				
NR_FDD_FR1_H	-110.5+TT				
CSI-RS RSRP Note3	NR_FDD_FR1_A, NR_TDD_FR1_A NOTE 5	1,2	dBm/CSI-RS SCS	-84.65+TT	-117+TT
	NR_FDD_FR1_B				-116.5+TT
	NR_TDD_FR1_C				-116+TT
	NR_FDD_FR1_D, NR_TDD_FR1_D				-115.5+TT
	NR_FDD_FR1_E, NR_TDD_FR1_E				-115+TT
	NR_FDD_FR1_F				-114.5+TT
	NR_FDD_FR1_G				-114+TT
	NR_FDD_FR1_H				-113.5+TT
	NR_FDD_FR1_A, NR_TDD_FR1_A NOTE 5	3		-81.65+TT	-114+TT
	NR_FDD_FR1_B				-113.5+TT
	NR_TDD_FR1_C				-113+TT
	NR_FDD_FR1_D, NR_TDD_FR1_D				-112.5+TT
	NR_FDD_FR1_E, NR_TDD_FR1_E				-112+TT
	NR_FDD_FR1_E				-112+TT

	NR_FDD_FR1_F				-111.5+TT
	NR_FDD_FR1_G				-111+TT
	NR_FDD_FR1_H				-110.5+TT
I <sub>o</sub> Note3	NR_FDD_FR1_A, NR_TDD_FR1_A NOTE 5	1,2	dBm/9.36 MHz	-56.28+TT	-86.04+TT
	NR_FDD_FR1_B				-85.54+TT
	NR_TDD_FR1_C				-85.04+TT
	NR_FDD_FR1_D, NR_TDD_FR1_D				-84.54+TT
	NR_FDD_FR1_E, NR_TDD_FR1_E				-84.04+TT
	NR_FDD_FR1_F				-83.54+TT
	NR_FDD_FR1_G				-83.04+TT
	NR_FDD_FR1_H				-82.54+TT
	NR_FDD_FR1_A, NR_TDD_FR1_A NOTE 5	3	dBm/38.16 MHz	-50.19+TT	-79.94+TT
	NR_FDD_FR1_B				-79.44+TT
	NR_TDD_FR1_C				-78.94+TT
	NR_FDD_FR1_D, NR_TDD_FR1_D				-78.44+TT
	NR_FDD_FR1_E, NR_TDD_FR1_E				-77.94+TT
	NR_FDD_FR1_F				-77.44+TT
	NR_FDD_FR1_G				-76.94+TT
	NR_FDD_FR1_H				-76.44+TT
Propagation condition		1~3		AWGN	AWGN
Antenna configuration		1~3		1x2	1x2
<p>Note 1: OCNG shall be used such that both cells are fully allocated and a constant total transmitted power spectral density is achieved for all OFDM symbols.</p> <p>Note 2: Interference from other cells and noise sources not specified in the test is assumed to be constant over subcarriers and time and shall be modelled as AWGN of appropriate power for <math>N_{oc}</math> to be fulfilled.</p> <p>Note 3: RSRP and I<sub>o</sub> levels have been derived from other parameters for information purposes. They are not settable parameters themselves.</p> <p>Note 4: RSRP minimum requirements are specified assuming independent interference and noise at each receiver antenna port.</p> <p>Note 5: The test configuration excludes support for band n51 and it is not required to run this test on band n51 in this release of the specification.</p>					

**Table 6.7.9.2.5-2: Same as Table 6.7.9.1.5-2**

**Table 6.7.9.2.5-3: Same as Table 6.7.9.1.5-3**

For the test to pass, the ratio of successful reported values in each test shall be more than 90% with a confidence level of 95%.

### 6.7.9.3 NR SA FR1 CSI-RS based CMR and dedicated IMR L1-SINR measurement accuracy

**Editor's note:** This clause is incomplete. The following aspects are either missing or not yet determined:

- MU & TT needs further study
- Message content is incomplete

#### 6.7.9.3.1 Test purpose

The purpose of this test is to verify that the L1-SINR measurement accuracy is within the specified limits.

## 6.7.9.3.2 Test applicability

This test applies to all types of NR UE from Release 16 onwards. Applicability requires support of L1-SINR measurements.

## 6.7.9.3.3 Minimum conformance requirements

The minimum conformance requirements are specified in clause 6.7.9.0.3.

The normative reference for this requirement is TS 38.133 [6] clause A.6.7.9.3.

## 6.7.9.3.4 Test description

## 6.7.9.3.4.1 Initial conditions

This test shall be tested using any of the test configurations in Table 6.7.9.3.4.1-1.

**Table 6.7.9.3.4.1-1: Applicable NR configurations for FR1 L1-SINR measurement test with CSI-RS based CMR and CSI-IM based IMR**

Config	Description
1	NR 15 kHz CSI-RS SCS, 10 MHz bandwidth, FDD duplex mode
2	NR 15 kHz CSI-RS SCS, 10 MHz bandwidth, TDD duplex mode
3	NR 30kHz CSI-RS SCS, 40 MHz bandwidth, TDD duplex mode
Note: The UE is only required to be tested in one of the supported test configurations in each supported band	

Configure the test equipment and the DUT according to the parameters in Table 6.7.9.3.4.1-2.

**Table 6.7.9.3.4.1-2: Initial conditions for CSI-RS based CMR and CSI-IM based IMR absolute accuracy in FR1**

Parameter	Value		Comment
Test environment	NC, TL/VL, TL/VH, TH/VL, TH/VH		As specified in TS 38.508-1 [14] clause 4.1.
Test frequencies	As specified in Annex E, Table E.4-1 and TS 38.508-1 [14] clause 4.3.1.		
Channel bandwidth	As specified by the test configuration selected from Table 6.7.9.1.4.1-1.		
Propagation conditions	AWGN		As specified in Annex C.2.2.
Connection Diagram	TE Part 2Rx	A.3.1.8.2 with n = 1	As specified in TS 38.508-1 [14] Annex A.
	TE Part 4Rx	A.3.1.8.5 with n = 1	
	DUT Part 2Rx	A.3.2.3.4	
	DUT Part 4Rx	A.3.2.5.2	
Exceptions to connection diagram	N/A		

1. Message contents are defined in clause 6.7.9.3.4.3.

2. Cell 1 is the NR FR1 cell. Cell 1 is the target for CSI-RS based CMR and CSI-IM based IMR measurements. The UE is configured to perform RLM and BFD measurement based on the CSI-RS. The connection setup is done according to the settings in Annex C.1.1.

2. Cell 1 is the NR FR1 cell. Cell 1 is the target for CSI-RS based CMR and CSI-IM measurements. The UE is configured to perform RLM, BFD and L1-SINR measurement based on the CSI-RSs. The connection setup is done according to the settings in Annex C.1.2 and C.1.3.

## 6.7.9.3.4.2 Test procedure

Prior to the start of the time duration T1, the UE shall be fully synchronized to PSCell. The UE shall be configured for periodic CSI reporting in PUCCH [format 2] with a reporting periodicity as mentioned in the above table 6.7.9.3.4.1-2.

1. Ensure the UE is in state RRC\_CONNECTED with generic procedure parameters Connectivity NR SA, Connected without release *On* and Test Mode *On*, according to TS 38.508-1 [14] clause 4.5 and general test parameters set according to Table 6.7.9.3.4.1-2.
2. Set the parameters according to T1 in Table 6.7.9.3.5-1. SS transmits CSI-RS as IMR with a periodicity of 20 slots.
3. The UE shall start sending L1-SINR report including results of both SSB#0 and SSB#1 every 80 slots.
4. The SS shall check the L1-SINR reported values of CSI-RS #0 and CSI-RS #1 in the periodic L1-SINR reports. If the value for both CSI-RSs is within the limits in Table 6.7.9.3.5-2 and Table 6.7.9.3.5-3 (depending on the test configuration), the number of passed iterations is increased by one, otherwise the number of failed iterations is increased by one.
5. The SS shall continue checking the L1-SINR report messages transmitted by the UE until the confidence level according to Table G.2.3-1 in Annex G is achieved.
6. Set the parameters according to each sub-test in Table 6.7.9.3.5-1 as appropriate and repeat steps 3-5.

6.7.9.3.4.3 Message contents

Same message content as in subclause 6.7.9.1.4.3 with the following exception:

Message contents are according to TS 38.508-1 [14] clause 7.3 with the following exceptions:

**Table 6.7.9.3.4.3-1: Common Exception messages NR SA CSI-RS based CMR and dedicated IMR L1-SINR measurement**

Default Message Contents	
Common contents of system information blocks exceptions	
Default RRC messages and information elements contents exceptions	Table H.3.6A-1 with conditions PERIODIC and CSI-SINR and CSI-IM_IMR Table H.3.6A-2 with conditions CSI-RS and PERIODIC Table H.3.6A-3 with condition PERIODIC Table 7.3.1-3 in TS 38.508-1 [14] with condition SMTC.1

**Table 6.7.9.3.4.3-2: RadioLinkMonitoringConfig**

Derivation Path: TS 38.508-1 [14], Table 4.6.3-133			
Information Element	Value/remark	Comment	Condition
RadioLinkMonitoringConfig ::= SEQUENCE {			
failureDetectionResourcesToAddModList	1 entry		
SEQUENCE			
(SIZE(1..maxNrofFailureDetectionResources)) OF			
SEQUENCE {			
purpose	both	UE is configured to perform RLM and BFD based on the SSBs.	
}			
}			
}			

6.7.9.3.5 Test requirement

Table 6.7.9.3.5-1 defines the primary level settings including test tolerances for all tests.

Each L1-SINR measurement report for each of the tests in Table 6.7.9.3.5-1 shall meet the corresponding absolute accuracy requirements in Table 6.7.9.3.5-2 for test configurations 1 and 2, and the corresponding absolute accuracy requirements in Table 6.7.9.3.5-3 for test configuration 3.

**Table 6.7.9.3.5-1: FR1 CSI-RS based L1-SINR test parameters**

Parameter	Config	Unit	Test 1	Test 2	
SSB GSCN	1~3		freq1	freq1	
Duplex mode	1		FDD	FDD	
	2		TDD	TDD	
	3		TDD	TDD	
TDD Configuration	1		N/A	N/A	
	2		TDDConf.1.1	TDDConf.1.1	
	3		TDDConf.2.1	TDDConf.2.1	
BW <sub>channel</sub>	1	MHz	10: N <sub>RB,c</sub> = 52	10: N <sub>RB,c</sub> = 52	
	2		10: N <sub>RB,c</sub> = 52	10: N <sub>RB,c</sub> = 52	
	3		40: N <sub>RB,c</sub> = 106	40: N <sub>RB,c</sub> = 106	
PDSCH Reference measurement channel	1		SR.1.1 FDD	SR.1.1 FDD	
	2		SR.1.1 TDD	SR.1.1 TDD	
	3		SR.2.1 TDD	SR.2.1 TDD	
RMSI CORESET Reference Channel	1		CR.1.1 FDD	CR.1.1 FDD	
	2		CR.1.1 TDD	CR.1.1 TDD	
	3		CR.2.1 TDD	CR.2.1 TDD	
Dedicated CORESET Reference Channel	1		CCR.1.1 FDD	CCR.1.1 FDD	
	2		CCR.1.1 TDD	CCR.1.1 TDD	
	3		CCR.2.1 TDD	CCR.2.1 TDD	
SSB configuration	1		SSB.1 FR1	SSB.1 FR1	
	2		SSB.1 FR1	SSB.1 FR1	
	3		SSB.2 FR1	SSB.2 FR1	
OCNG Patterns	1~3		OP.1	OP.1	
TRS configuration	1		TRS.1.1 FDD	TRS.1.1 FDD	
	2		TRS.1.1 TDD	TRS.1.1 TDD	
	3		TRS.1.2 TDD	TRS.1.2 TDD	
Initial BWP Configuration	1~3		DLBWP.0.1 ULBWP.0.1	DLBWP.0.1 ULBWP.0.1	
Dedicated BWP configuration	1~3		DLBWP.1.1 ULBWP.1.1	DLBWP.1.1 ULBWP.1.1	
SMTC configuration	1~3		SMTC.1	SMTC.1	
CSI-RS	1		CSI-RS 1.2 FDD	CSI-RS 1.2 FDD	
	2		CSI-RS 1.2 TDD	CSI-RS 1.2 TDD	
	3		CSI-RS 2.2 TDD	CSI-RS 2.2 FDD	
reportConfigType	1~3		periodic	periodic	
reportQuantity-r16	1~3		cri-SINR-r16	cri-SINR-r16	
nrofReportedRS	1~3		2	2	
L1-SINR reporting period	1~3		slot80	slot80	
EPRE ratio of PSS to SSS	1~3	dB	0	0	
EPRE ratio of PBCH DMRS to SSS					
EPRE ratio of PBCH to PBCH DMRS					
EPRE ratio of PDCCH DMRS to SSS					
EPRE ratio of PDCCH to PDCCH DMRS					
EPRE ratio of PDSCH DMRS to SSS					
EPRE ratio of PDSCH to PDSCH DMRS					
EPRE ratio of OCNG DMRS to SSS <sup>Note 1</sup>					
EPRE ratio of OCNG to OCNG DMRS <sup>Note 1</sup>					
$N_{oc}$ <sup>Note2</sup>	NR_FDD_FR1_A, NR_TDD_FR1_A <sup>NOTE 5</sup>	1~3	dBm/15kHz	-94.65+TT	-117+TT
	NR_FDD_FR1_B				-116.5+TT
	NR_TDD_FR1_C				-116+TT

	NR_FDD_FR1_D, NR_TDD_FR1_D				-115.5+TT
	NR_FDD_FR1_E, NR_TDD_FR1_E				-115+TT
	NR_FDD_FR1_F				-114.5+TT
	NR_FDD_FR1_G				-114+TT
	NR_FDD_FR1_H				-113.5+TT
<i>N<sub>oc</sub></i> Note2	NR_FDD_FR1_A, NR_TDD_FR1_A NOTE 5	1,2	dBm/CSI-RS SCS	-94.65+TT	-117+TT
	NR_FDD_FR1_B				-116.5+TT
	NR_TDD_FR1_C				-116+TT
	NR_FDD_FR1_D, NR_TDD_FR1_D				-115.5+TT
	NR_FDD_FR1_E, NR_TDD_FR1_E				-115+TT
	NR_FDD_FR1_F				-114.5+TT
	NR_FDD_FR1_G	-114+TT			
	NR_FDD_FR1_H	-113.5+TT			
	NR_FDD_FR1_A, NR_TDD_FR1_A NOTE 5	3		-91.65+TT	-114+TT
	NR_FDD_FR1_B				-113.5+TT
	NR_TDD_FR1_C				-114+TT
	NR_FDD_FR1_D, NR_TDD_FR1_D				-112.5+TT
	NR_FDD_FR1_E, NR_TDD_FR1_E				-112+TT
	NR_FDD_FR1_F				-111.5+TT
	NR_FDD_FR1_G				-111+TT
	NR_FDD_FR1_H				-110.5+TT
$\hat{E}_s/I_{\alpha}$	1~3	dB	10+TT	-3+TT	
CSI-RS RSRP Note3	NR_FDD_FR1_A, NR_TDD_FR1_A NOTE 5	1,2	dBm/CSI-RS SCS	-84.65+TT	-120+TT
	NR_FDD_FR1_B				-119.5+TT
	NR_TDD_FR1_C				-119+TT
	NR_FDD_FR1_D, NR_TDD_FR1_D				-118.5+TT
	NR_FDD_FR1_E, NR_TDD_FR1_E				-118+TT
	NR_FDD_FR1_F				-117.5+TT
	NR_FDD_FR1_G	-117+TT			
	NR_FDD_FR1_H	-116.5+TT			
	NR_FDD_FR1_A, NR_TDD_FR1_A NOTE 5	3		-81.65+TT	-117+TT
	NR_FDD_FR1_B				-116.5+TT
	NR_TDD_FR1_C				-116+TT
	NR_FDD_FR1_D, NR_TDD_FR1_D				-115.5+TT
	NR_FDD_FR1_E, NR_TDD_FR1_E				-115+TT
	NR_FDD_FR1_F				-114.5+TT
	NR_FDD_FR1_G				-114+TT
	NR_FDD_FR1_H				-113.5+TT
<i>I<sub>o</sub></i> Note3	NR_FDD_FR1_A, NR_TDD_FR1_A NOTE 5	1,2	dBm/9.36 MHz	-56.28+TT	-87.28+TT
	NR_FDD_FR1_B				-86.78+TT
	NR_TDD_FR1_C				-86.28+TT
	NR_FDD_FR1_D, NR_TDD_FR1_D				-85.78+TT
	NR_FDD_FR1_E, NR_TDD_FR1_E				-85.28+TT
	NR_FDD_FR1_F				-84.78+TT

	NR_FDD_FR1_G				-84.28+TT
	NR_FDD_FR1_H				-83.78+TT
	NR_FDD_FR1_A, NR_TDD_FR1_A NOTE 5	3	dBm/38.16 MHz	-50.19+TT	-81.19+TT
	NR_FDD_FR1_B				-80.69+TT
	NR_TDD_FR1_C				-80.19+TT
	NR_FDD_FR1_D, NR_TDD_FR1_D				-79.69+TT
	NR_FDD_FR1_E, NR_TDD_FR1_E				-79.19+TT
	NR_FDD_FR1_F				-78.69+TT
	NR_FDD_FR1_G				-78.19+TT
	NR_FDD_FR1_H				-77.69+TT
	$\hat{E}_s/N_{oc}$				1~3
	Propagation condition	1~3		AWGN	AWGN
	Antenna configuration	1~3		1x2	1x2
<p>Note 1: OCNG shall be used such that both cells are fully allocated and a constant total transmitted power spectral density is achieved for all OFDM symbols.</p> <p>Note 2: Interference from other cells and noise sources not specified in the test is assumed to be constant over subcarriers and time and shall be modelled as AWGN of appropriate power for <math>N_{oc}</math> to be fulfilled.</p> <p>Note 3: RSRP and <math>I_0</math> levels have been derived from other parameters for information purposes. They are not settable parameters themselves.</p> <p>Note 4: RSRP minimum requirements are specified assuming independent interference and noise at each receiver antenna port.</p> <p>Note 5: The test configuration excludes support for band n51 and it is not required to run this test on band n51 in this release of the specification.</p>					

Table 6.7.9.3.5-2: Same as Table 6.7.9.1.5-2

Table 6.7.9.3.5-3: Same as Table 6.7.9.1.5-3

For the test to pass, the ratio of successful reported values in each test shall be more than 90% with a confidence level of 95%.



## 7 NR standalone with at least one NR cell in FR2

### 7.0 General

This section contains test scenarios for NR standalone. This configuration is also known as NR/5GC. At least one NR cell is in Frequency Range 2.

For conformance testing involving FR2 test cases in this specification, the UE under test shall be pre-configured with UL Tx diversity schemes disabled to account for single polarization System Simulator (SS) in the test environment. The UE under test may transmit with dual polarization.

### 7.1 RRC\_IDLE state mobility

#### 7.1.1 NR cell re-selection

##### 7.1.1.0 Minimum conformance requirements

##### 7.1.1.0.1 Minimum conformance requirements for intra-frequency cell re-selection

The cell re-selection delay shall be less than  $T_{\text{evaluate NR\_Intra}} + T_{\text{SI-NR}}$  in RRC\_IDLE state.

The UE shall be able to identify new intra-frequency cells and perform SS-RSRP and SS-RSRQ measurements of the identified intra-frequency cells without an explicit intra-frequency neighbour list containing physical layer cell identities.

The UE shall be able to evaluate whether a newly detectable intra-frequency cell meets the reselection criteria defined in TS38.304 [30] within  $T_{\text{detect,NR\_Intra}}$  as defined in table 4.2.2.3-1 of TS 38.133 [6] when that  $T_{\text{reselection}} = 0$ . An intra frequency cell is considered to be detectable according to the conditions defined in Annex B.1.2 of TS 38.133 [6] for a corresponding Band.

The UE shall measure SS-RSRP and SS-RSRQ at least every  $T_{\text{measure,NR\_Intra}}$  (see table 4.2.2.3-1 of TS 38.133 [6]) for intra-frequency cells that are identified and measured according to the measurement rules.

The UE shall filter SS-RSRP and SS-RSRQ measurements of each measured intra-frequency cell using at least 2 measurements. Within the set of measurements used for the filtering, at least two measurements shall be spaced by at least  $T_{\text{measure,NR\_Intra}}/2$ .

The UE shall not consider a NR neighbour cell in cell reselection, if it is indicated as not allowed in the measurement control system information of the serving cell.

For an intra-frequency cell that has been already detected, but that has not been reselected to, the filtering shall be such that the UE shall be capable of evaluating that the intra-frequency cell has met reselection criterion defined within  $T_{\text{evaluate,NR\_Intra}}$  when  $T_{\text{reselection}} = 0$  as specified in table 4.2.2.3-1 of TS 38.133 [6] provided that the cell has at least [3]dB better ranked.

When evaluating cells for reselection, the SSB side conditions apply to both serving and non-serving intra-frequency cells.

If  $T_{\text{reselection}}$  timer has a non-zero value and non-zeroa-frequency cell is satisfied with the reselection criteria which are defined in TS38.304 [30], the UE shall evaluate this intra-frequency cell for the  $T_{\text{reselection}}$  time. If this cell remains satisfied with the reselection criteria within this duration, then the UE shall reselect that cell.

The normative reference for this requirement is TS 38.133 [6] clause 4.2.2.2 and 4.2.2.3.

##### 7.1.1.0.2 Minimum conformance requirements for inter-frequency cell re-selection

The cell re-selection delay shall be less than  $T_{\text{evaluate NR\_Intra}} + T_{\text{SI-NR}}$  in RRC\_IDLE state.

The UE shall be able to identify new inter-frequency cells and perform SS-RSRP or SS-RSRQ measurements of identified inter-frequency cells if carrier frequency information is provided by the serving cell, even if no explicit neighbour list with physical layer cell identities is provided.

If  $S_{rxlev} > S_{nonIntraSearchP}$  and  $S_{qual} > S_{nonIntraSearchQ}$  then the UE shall search for inter-frequency layers of higher priority at least every  $T_{higher\_priority\_search}$  where  $T_{higher\_priority\_search}$  is described in clause 4.2.2.7 of TS 38.133 [6].

If  $S_{rxlev} \leq S_{nonIntraSearchP}$  or  $S_{qual} \leq S_{nonIntraSearchQ}$  then the UE shall search for and measure inter-frequency layers of higher, equal or lower priority in preparation for possible reselection. In this scenario, the minimum rate at which the UE is required to search for and measure higher priority layers shall be the same as that defined below in this subclause.

The UE shall be able to evaluate whether a newly detectable inter-frequency cell meets the reselection criteria defined in TS38.304 [30] within  $K_{carrier} * T_{detect,NR\_Inter}$  if at least carrier frequency information is provided for inter-frequency neighbour cells by the serving cells when  $T_{reselection} = 0$  provided that the reselection criteria is met by a margin of at least [5] dB for reselections based on ranking or [6]dB for SS-RSRP reselections based on absolute priorities or [4]dB for SS-RSRQ reselections based on absolute priorities. The parameter  $K_{carrier}$  is the number of NR inter-frequency carriers indicated by the serving cell. An inter-frequency cell is considered to be detectable according to the conditions defined in Annex B.1.3 of TS 38.133 [6] for a corresponding Band.

When higher priority cells are found by the higher priority search, they shall be measured at least every  $T_{measure,NR\_Inter}$ . If, after detecting a cell in a higher priority search, it is determined that reselection has not occurred then the UE is not required to continuously measure the detected cell to evaluate the ongoing possibility of reselection. However, the minimum measurement filtering requirements specified later in this section shall still be met by the UE before it makes any determination that it may stop measuring the cell. If the UE detects on a NR carrier a cell whose physical identity is indicated as not allowed for that carrier in the measurement control system information of the serving cell, the UE is not required to perform measurements on that cell.

The UE shall measure SS-RSRP or SS-RSRQ at least every  $K_{carrier} * T_{measure,NR\_Inter}$  (see table 4.2.2.4-1 of TS 38.133 [6]) for identified lower or equal priority inter-frequency cells. If the UE detects on a NR carrier a cell whose physical identity is indicated as not allowed for that carrier in the measurement control system information of the serving cell, the UE is not required to perform measurements on that cell.

The UE shall filter SS-RSRP or SS-RSRQ measurements of each measured higher, lower and equal priority inter-frequency cell using at least 2 measurements. Within the set of measurements used for the filtering, at least two measurements shall be spaced by at least  $T_{measure,NR\_Inter}/2$ .

The UE shall not consider a NR neighbour cell in cell reselection, if it is indicated as not allowed in the measurement control system information of the serving cell.

For an inter-frequency cell that has been already detected, but that has not been reselected to, the filtering shall be such that the UE shall be capable of evaluating that the inter-frequency cell has met reselection criterion defined TS 38.304 [30] within  $K_{carrier} * T_{evaluate,NR\_Inter}$  when  $T_{reselection} = 0$  as specified in table 4.2.2.4-1 of TS 38.133 [6] provided that the reselection criteria is met by

- the condition when performing equal priority reselection and the cell has at least [5]dB better ranked
- [6]dB for SS-RSRP reselections based on absolute priorities or
- [4]dB for SS-RSRQ reselections based on absolute priorities.

When evaluating cells for reselection, the SSB side conditions apply to both serving and inter-frequency cells.

If  $T_{reselection}$  timer has a non-zero value and the inter-frequency cell is satisfied with the reselection criteria, the UE shall evaluate this inter-frequency cell for the  $T_{reselection}$  time. If this cell remains satisfied with the reselection criteria within this duration, then the UE shall reselect that cell.

The UE is not expected to meet the measurement requirements for an inter-frequency carrier under DRX cycle=320 ms defined in Table 4.2.2.4-1 of TS 38.133 [6] under the following conditions:

- $T_{SMTC\_intra} = T_{SMTC\_inter} = 160$  ms; where  $T_{SMTC\_intra}$  and  $T_{SMTC\_inter}$  are periodicities of the SMTC occasions configured for the intra-frequency carrier and the inter-frequency carrier respectively,
- SMTC occasions configured for the inter-frequency carrier occur up to TBD ms before the start or up to TBD ms after the end of the SMTC occasions configured for the intra-frequency carrier and
- SMTC occasions configured for the intra-frequency carrier and for the inter-frequency carrier occur up to TBD ms before the start or up to TBD ms after the end of the paging occasion [1].

The normative reference for this requirement is TS 38.133 [6] clause 4.2.2.4.

### 7.1.1.0.3 Minimum conformance requirements for intra-frequency cell re-selection for UE configured with relaxed measurement criterion

The cell re-selection delay shall be less than  $T_{\text{evaluate\_NR\_Intra}} + T_{\text{SI-NR}}$  in RRC\_IDLE state.

#### 7.1.1.0.3.1 Introduction

This clause contains the requirements for measurements on intra-frequency NR cells when  $S_{\text{rxlev}} \leq S_{\text{IntraSearchP}}$  or  $S_{\text{qual}} \leq S_{\text{IntraSearchQ}}$  and when the UE is configured any of the following relaxed measurement criteria:

- Relaxed measurement criterion for UE with low mobility defined in clause 5.2.4.9.1 in TS 38.304 [30],
- Relaxed measurement criterion for UE not-at-cell edge defined in clause 5.2.4.9.2 in TS 38.304 [30],
- Both low mobility criterion and not-at-cell edge criterion as defined in clauses 5.2.4.9.1 and 5.2.4.9.2 in TS 38.304 [30] respectively.

#### 7.1.1.0.3.2 Measurements for UE fulfilling low mobility criterion

This clause contains requirements for measurements on intra-frequency NR cells provided that:

- UE is configured with *lowMobilityEvaluation* [13] criterion and UE has fulfilled, or
- UE is configured with both *lowMobilityEvaluation* [13] criterion and *cellEdgeEvaluation* [13] criterion and *combineRelaxedMeasCondition* [13] not configured, and UE has fulfilled only the *lowMobilityEvaluation* [13] criterion.

The requirements defined in clause 7.1.1.0.1 apply for this clause except that:

- $T_{\text{detect,NR\_Intra}}$  as specified in Table 4.2.2.9.2-1 in TS 38.133 [6].
- $T_{\text{measure,NR\_Intra}}$  as specified in Table 4.2.2.9.2-1 in TS 38.133 [6].
- $T_{\text{evaluate,NR\_Intra}}$  as specified in Table 4.2.2.9.2-1 in TS 38.133 [6].

#### 7.1.1.0.3.3 Measurements for UE fulfilling not-at-cell edge criterion

This clause contains requirements for measurements on intra-frequency NR cells provided that:

- UE is configured with *cellEdgeEvaluation* [13] criterion and UE has fulfilled, or
- UE is configured with both *lowMobilityEvaluation* [13] criterion and *cellEdgeEvaluation* [13] criteria and *combineRelaxedMeasCondition* [13] not configured, and UE has fulfilled only the *cellEdgeEvaluation* [13] criterion.

The requirements defined in clause 7.1.1.0.1 apply for this clause except that:

- $T_{\text{detect,NR\_Intra}}$  as specified in Table 4.2.2.9.3-1 in TS 38.133 [6].
- $T_{\text{measure,NR\_Intra}}$  as specified in Table 4.2.2.9.3-1 in TS 38.133 [6].
- $T_{\text{evaluate,NR\_Intra}}$  as specified in Table 4.2.2.9.3-1 in TS 38.133 [6].

#### 7.1.1.0.3.4 Measurements for UE fulfilling low mobility and not-at-cell edge criteria

This clause contains requirements for measurements on intra-frequency NR cells provided that:

- UE is configured with both *lowMobilityEvaluation* [13] criterion and *cellEdgeEvaluation* [13] criterion, and
- has also fulfilled both criteria, and
- less than 1 hour have passed since measurements for cell reselection were last performed

In this case the UE is not required to meet  $T_{\text{detect,NR\_Intra}}$ ,  $T_{\text{measure,NR\_Intra}}$  and  $T_{\text{evaluate,NR\_Intra}}$  as defined in Table 4.2.2.3-1 of TS 38.133[6].

The normative reference for this requirement is TS 38.133 [6] clause 4.2.2.9.

#### 7.1.1.0.4 Minimum conformance requirements for inter-frequency cell re-selection for UE configured with relaxed measurement criterion

The cell re-selection delay shall be less than  $T_{\text{evaluate\_NR\_Inter}} + T_{\text{SI-NR}}$  in RRC\_IDLE state.

##### 7.1.1.0.4.1 Introduction

This clause contains the requirements for measurements on inter-frequency NR cells when the UE is configured with any of following relaxed measurement criteria:

- Relaxed measurement criterion for UE with low mobility defined in clause 5.2.4.9.1 in TS 38.304 [30],
- Relaxed measurement criterion for UE not-at-cell edge defined in clause 5.2.4.9.2 in TS 38.304 [30],
- Both low mobility criterion and not-at-cell edge criterion as defined in clauses 5.2.4.9.1 and 5.2.4.9.2 in TS 38.304 [30] respectively.

##### 7.1.1.0.4.2 Measurements for UE fulfilling low mobility criterion

This clause contains requirements for measurements on inter-frequency NR cells provided that:

- T331 timer is not running for EMR measurements on inter-frequency NR carrier, and
- UE is configured with *lowMobilityEvaluation* [13] criterion and UE has fulfilled, or
- UE is configured with both *lowMobilityEvaluation* [13] and *cellEdgeEvaluation* [13] criterion and *combineRelaxedMeasCondition* [13] not configured, and UE has fulfilled only the *lowMobilityEvaluation* [13] criterion.

When  $S_{\text{rxlev}} \leq S_{\text{nonIntraSearchP}}$  or  $S_{\text{qual}} \leq S_{\text{nonIntraSearchQ}}$  then the requirements defined in clause 4.2.2.4 apply for this clause except that:

- $T_{\text{detect,NR\_Inter}}$  as specified in Table 4.2.2.10.2-1 in TS 38.133 [6].
- $T_{\text{measure,NR\_Inter}}$  as specified in Table 4.2.2.10.2-1 in TS 38.133 [6].
- $T_{\text{evaluate,NR\_Inter}}$  as specified in Table 4.2.2.10.2-1 in TS 38.133 [6].

When  $S_{\text{rxlev}} > S_{\text{nonIntraSearchP}}$  and  $S_{\text{qual}} > S_{\text{nonIntraSearchQ}}$  and the UE is configured with *highPriorityMeasRelax* [13] then the UE shall search for inter-frequency layers of higher priority at least every  $K2 \cdot T_{\text{higher\_priority\_search}}$  where  $T_{\text{higher\_priority\_search}}$  is described in clause 4.2.2.7 and,  $K2 = 60$ . Otherwise if the UE is not configured with *highPriorityMeasRelax* [13] then the UE shall search for inter-frequency layers of higher priority at least every  $T_{\text{higher\_priority\_search}}$  where  $T_{\text{higher\_priority\_search}}$  is described in clause 4.2.2.7 of TS 38.133[6].

##### 7.1.1.0.4.3 Measurements for UE fulfilling not-at-cell edge criterion

This clause contains requirements for measurements on inter-frequency NR cells provided that:

- T331 timer is not running for EMR measurements on inter-frequency NR carrier, and
- UE is configured with *cellEdgeEvaluation* [13] criterion, and UE has fulfilled or
- UE is configured with both *lowMobilityEvaluation* [13] criterion and *cellEdgeEvaluation* [13] criterion and *combineRelaxedMeasCondition* [13] not configured, and UE has fulfilled only the *cellEdgeEvaluation* [13] criterion.

When  $S_{\text{rxlev}} \leq S_{\text{nonIntraSearchP}}$  or  $S_{\text{qual}} \leq S_{\text{nonIntraSearchQ}}$  then the requirements defined in clause 4.2.2.4 apply for this clause except that:

- $T_{\text{detect,NR\_Inter}}$  as specified in Table 4.2.2.10.3-1 in TS 38.133 [6].
- $T_{\text{measure,NR\_Inter}}$  as specified in Table 4.2.2.10.3-1 in TS 38.133 [6].
- $T_{\text{evaluate,NR\_Inter}}$  as specified in Table 4.2.2.10.3-1 in TS 38.133 [6].

When  $Srxlev > SnonIntraSearchP$  and  $Squal > SnonIntraSearchQ$  and regardless of whether the UE is configured with *highPriorityMeasRelax* [13] or not, the UE shall search for inter-frequency layers of higher priority at least every  $T_{higher\_priority\_search}$  where  $T_{higher\_priority\_search}$  is described in clause 4.2.2.7

#### 7.1.1.0.4.4 Measurements for UE fulfilling low mobility and not-at-cell edge criterion

This clause contains requirements for measurements on inter-frequency NR cells provided that:

- T331 timer is not running for EMR measurements on inter-frequency NR carrier, and
- UE is configured with both *lowMobilityEvaluation* [13] criterion and *cellEdgeEvaluation* [13] criterion, and
- Has also fulfilled both criteria, and
- less than 1 hour have passed since measurements for cell reselection were last performed

In this case the UE is not required to meet  $T_{detect,NR\_Inter}$ ,  $T_{measure,NR\_Inter}$  and  $T_{evaluate,NR\_Inter}$  as defined in Table 4.2.2.4-1 of TS 38.133[6].

The normative reference for this requirement is TS 38.133 [6] clause 4.2.2.10.

### 7.1.1.1 NR SA FR2 cell re-selection

**Editor's note: This test case is incomplete. The following aspects are either missing or TBD**

- TT analysis is missing.

- Connection diagram is TBD.

#### 7.1.1.1.1 Test purpose

The purpose of this test is to verify the requirement for the intra frequency NR cell reselection requirements specified in TS 38.133 clause 4.2.2.3.

#### 7.1.1.1.2 Test applicability

This test applies to all types of NR UE from Release 15 onwards.

#### 7.1.1.1.3 Minimum conformance requirements

The minimum conformance requirements are specified in clause 7.1.1.0.1.

The normative reference for this requirement is TS 38.133 [6] clause A.7.1.1.1.

#### 7.1.1.1.4 Test description

##### 7.1.1.1.4.1 Initial conditions

This test shall be run in one of the configurations defined in Table 7.1.1.1.4.1-1.

**Table 7.1.1.1.4.1-1: Supported test configurations for NR SA FR2 cell re-selection**

Configuration	Description
7.1.1.1-1	120 kHz SSB SCS, 100 MHz bandwidth, TDD duplex mode
7.1.1.1-2	240 kHz SSB SCS, 100 MHz bandwidth, TDD duplex mode
Note:	The UE is only required to be tested in one of the supported test configurations.

Configure the test equipment and the DUT according to the parameters in Table 7.1.1.1.4.1-2.

**Table 7.1.1.1.4.1-2: Initial conditions for NR SA FR2 cell re-selection**

Parameter	Value		Comment
Test environment	NC		As specified in TS 38.508-1 [14] clause 4.1.
Test frequencies	As specified in Annex E, table E.4-1 and TS 38.508-1 [14] clause 4.3.1.		
Channel bandwidth	As specified by the test configuration selected from Table 7.1.1.1.4.1-1.		
Propagation conditions	AWGN		As specified in Annex C.2.2.
Connection Diagram	TE Part	TBD	As specified in TS 38.508-1 [14] Annex A.
	DUT Part	TBD	
Exceptions to connection diagram	N/A		

1. The general test parameter settings are set up according to Table 7.1.1.1.4.1-3.
2. Message contents are defined in clause 7.1.1.1.4.3.
3. There is one NR carrier and 2 NR Cells specified in the test. Cell 1 is the PCell and Cell 2 is the neighbour cell. Cell 1 and Cell 2 are configured according to Annex C.1.1 and C.1.2.

**Table 7.1.1.1.4.1-3: General test parameters for NR SA FR2 cell re-selection**

Parameter		Unit	Test configuration	Value	Comment
Initial condition	Active cell		1, 2	Cell1	
	Neighbour cells		1, 2	Cell2	
T2 end condition	Active cell		1, 2	Cell2	
	Neighbour cells		1, 2	Cell1	
Final condition	Visited cell		1, 2	Cell1	
RF Channel Number			1, 2	1	
Time offset between cells			1, 2	3 $\mu$ s	Synchronous cells
Access Barring Information		-	1, 2	Not Sent	No additional delays in random access procedure.
SMTC configuration			1, 2	SMTC.1	
DRX cycle length		s	1, 2	1.28	The value shall be used for all cells in the test.
PRACH configuration index			1, 2	190	The detailed configuration is specified in TS 38.211 clause 6.3.3.2
rangeToBestCell			1, 2	Not configured	
T1		s	1, 2	>7	During T1, Cell 2 shall be powered off, and during the off time the physical cell identity shall be changed, The intention is to ensure that Cell 2 has not been detected by the UE prior to the start of period T2
T2		s	1, 2	135	T2 needs to be defined so that cell re-selection reaction time is taken into account.
T3		s	1, 2	35	T3 needs to be defined so that cell re-selection reaction time is taken into account.

#### 7.1.1.1.4.2 Test procedure

Two cells are deployed in the test, which are one FR2 NR PCell (Cell 1) and an NR neighbour cell (Cell 2) on the same frequency. The test consists of 3 successive time periods, with time duration of T1, T2, and T3 respectively. Only cell 1

is already identified by the UE prior to the start of the test. Cell 1 and cell 2 belong to different tracking areas. Furthermore, UE has not registered with network for the tracking area containing cell 2.

In the following test procedure “UE responds” means “UE starts transmitting preamble on PRACH for sending the RRC SETUP REQUEST message to perform a Registration procedure for mobility.

1. Ensure the UE is in state RRC\_IDLE with generic procedure parameters connectivity *NR*, connected without release *On* and Test Mode *On* according to TS 38.508-1 [14] clause 4.5 on Cell 1. Set Cell 2 physical cell identity = initial Cell 2 physical cell identity.
2. Set the parameters according to T1 in Table 7.1.1.1.5-1. T1 starts.
3. Set Cell 2 physical cell identity = ((current Cell 2 physical cell identity + 1) mod 1008) for one iteration of the test procedure loop.
4. When T1 expires, the SS shall switch the power setting from T1 to T2 as specified in Table 7.1.1.1.5-1.
5. The SS waits for random access requests information from the UE to perform cell re-selection to a newly detectable cell, Cell 2.
6. If the UE responds on the newly detectable cell, Cell 2 during time duration T2 within 130 seconds from the beginning of time period T2, then count a success for the event “Re-select newly detected Cell 2”. Otherwise count a fail for the event “Re-select newly detected Cell 2”.
7. If the UE has re-selected Cell 2 within T2, after the re-selection or when T2 expires, continue with step 7a. Otherwise, if T2 expires and the UE has not yet re-selected Cell 2, the TE shall switch off and on the UE and skip to step 12.
- 7a. The SS shall send an *RRCRelease* message to ensure that the UE is in state RRC\_IDLE on Cell 2.
8. The SS shall switch the power setting from T2 to T3 as specified in Table 7.1.1.1.5-1.
9. The SS waits for random access requests information from the UE to perform cell re-selection to an already detected cell, Cell 1.
10. If the UE responds on the already detected cell, Cell 1 during time duration T3 within 27 seconds from the beginning of time period T3, then count a success for the event “Re-select already detected Cell 1”. Otherwise count a fail for the event “Re-select already detected Cell 1”.
11. If the UE has re-selected Cell 1 within T3, after the re-selection or when T3 expires, continues with step 11a. Otherwise, if T3 expires and the UE has not yet re-selected Cell 1, the TE shall switch off and on the UE and skip to step 12.
- 11a. The SS shall send an *RRCRelease* message to ensure that the UE is in state RRC\_IDLE on Cell 1.
12. Ensure the UE is in state RRC\_IDLE with generic procedure parameters connectivity *NR*, connected without release *On* and Test Mode *On* according to TS 38.508-1 [14] clause 4.5 on Cell 1.
13. Repeat step 2-12 until a test verdict has been achieved.  
Each of the events “Re-select newly detected Cell 2” and “Re-select already detected Cell 1” is evaluated independently for the statistic, resulting in an event verdict: pass or fail. Each event is evaluated only until the confidence level according to Table G.2.3-1 in Annex G clause G.2 is achieved. Different events may require different times for a verdict.  
If both events pass, the test passes. If one event fails, the test fails.

#### 7.1.1.1.4.3 Message contents

Message contents are according to TS 38.508-1 [14] clause 7.3 with the following exceptions:

**Table 7.1.1.1.4.3-1: Common Exception messages**

Default Message Contents	
Common contents of system information blocks exceptions	Table H.2.1-1 with Condition SMTC.1 and Synchronous cells  Table H.2.1-2  Table H.2.1-3
Default RRC messages and information elements contents exceptions	

**Table 7.1.1.1.4.3-2: RACH-ConfigGeneric: NR cell re-selection**

Derivation Path: TS 38.508-1 [14], Table 4.6.3-130			
Information Element	Value/remark	Comment	Condition
RACH-ConfigGeneric ::= SEQUENCE {			
prach-ConfigurationIndex	190		
}			

7.1.1.1.5 Test requirement

Tables 7.1.1.1.4.1-3 and 7.1.1.1.5-1 define the primary level settings including test tolerances for intra frequency NR cell re-selection test case.



Table 7.1.1.1.5-1: Cell specific test parameters for NR SA FR2 cell re-selection

Parameter	Unit	Test configuration	Cell 1			Cell 2		
			T1	T2	T3	T1	T2	T3
TDD configuration		1, 2	TDDConf.3.1			TDDConf.3.1		
PDSCH RMC configuration		1	SR.3.1 TDD			SR.3.1 TDD		
		2	SR.3.1 TDD			SR.3.1 TDD		
RMSI CORESET RMC configuration		1	CR.3.1 TDD			CR.3.1 TDD		
		2	CR.3.1 TDD			CR.3.1 TDD		
Dedicated CORESET RMC configuration		1	CCR.3.1 TDD			CCR.3.1 TDD		
		2	CCR.3.1 TDD			CCR.3.1 TDD		
SSB configuration		1	SSB.3 FR2			SSB.7 FR2		
		2	SSB.4 FR2			SSB.8 FR2		
OCNG Pattern		1, 2	OP.4			OP.4		
Initial DL BWP configuration		1, 2	DLBWP.0.1			DLBWP.0.1		
Initial UL BWP configuration		1, 2	ULBWP.0.1			ULBWP.0.1		
RLM-RS		1, 2	SSB			SSB		
Qrxlevmin	dBm/SCS	1	-140			-140		
		2	-137			-137		
Pcompensation	dB	1, 2	0			0		
Qhyst <sub>s</sub>	dB	1, 2	0			0		
Qoffset <sub>s, n</sub>	dB	1, 2	0			0		
Cell_selection_and_reselection_quality_measurement		1, 2	SS-RSRP			SS-RSRP		
AoA setup		1, 2	Setup 1 defined in A. 9.1			Setup 1 defined in A. 9.1		
$\hat{E}_s / I_{ot}$	dB	1	8	-3	1.5	-infinity	1.5	-3
		2						
$N_{oc}$ Note2	dBm/SCS	1	-93					
		2	-90					
$N_{oc}$ Note2	dBm/15 kHz	1	-102					
		2						
$\hat{E}_s / N_{oc}$	dB	1	8	-3	1.5	-infinity	1.5	-3
		2						
SS-RSRP Note3	dBm/SCS	1	-85	-96	-91.5	-infinity	-91.5	-96
		2	-82	-93	-88.5	-infinity	-88.5	-93
I <sub>o</sub>	dBm/95.04 MHz	1	-59.37	-63.40	-62.47	-64.01	-62.47	-63.40
		2	-57.18	-62.86	-61.67	-64.01	-61.67	-62.86
Treselection	s	1, 2	0	0	0	0	0	0
SintrasearchP	dB	1, 2	50			50		
Propagation Condition		1, 2	AWGN					
<p>Note 1: OCNG shall be used such that both cells are fully allocated and a constant total transmitted power spectral density is achieved for all OFDM symbols.</p> <p>Note 2: Interference from other cells and noise sources not specified in the test is assumed to be constant over subcarriers and time and shall be modelled as AWGN of appropriate power for <math>N_{oc}</math> to be fulfilled.</p> <p>Note 3: SS-RSRP levels have been derived from other parameters for information purposes. They are not settable parameters themselves.</p>								

The cell re-selection delay to a newly detectable cell is defined as the time from the beginning of time period T2, to the moment when the UE camps on Cell 2, and starts to send preambles on the PRACH for sending the RRC SETUP REQUEST message to perform a Registration procedure for mobility on Cell 2.

The cell re-selection delay to a newly detectable cell test requirement in this case is expressed as:

$$\text{Cell re-selection delay to a newly detectable cell} = T_{\text{detect,NR\_Intra}} + T_{\text{SI-NR}}$$

$$T_{\text{detect,NR\_Intra}} = 128 \text{ s; as specified in TS 38.133 [6] clause 4.2.2.3.}$$

$$T_{\text{SI-NR}} = 1280 \text{ ms; maximum repetition period of relevant system info blocks that needs to be received by the UE to camp on a cell is assumed in this test.}$$

The cell re-selection delay to a newly detectable cell shall be less than a total of 129.28 seconds in this test case (note: this gives a total of 129.28 seconds but the test allows 130 seconds).

The cell re-selection delay to an already detected cell is defined as the time from the beginning of time period T3, to the moment when the UE camps on Cell 1, and starts to send preambles on the PRACH for sending the RRC SETUP REQUEST message to perform a Registration procedure for mobility on Cell 1.

The cell re-selection delay to an already detected cell test requirement in this case is expressed as:

$$\text{Cell re-selection to an already detected cell delay} = T_{\text{evaluate,NR\_Intra}} + T_{\text{SI-NR}}$$

$$T_{\text{evaluate,NR\_Intra}} = 25.6 \text{ s; as specified in TS 38.133 [6] clause 4.2.2.3.}$$

$$T_{\text{SI-NR}} = 1280 \text{ ms; maximum repetition period of relevant system info blocks that needs to be received by the UE to camp on a cell is assumed in this test.}$$

The cell re-selection delay to an already detected cell shall be less than a total of 26.88 seconds in this test case (note: this gives a total of 26.88 seconds but the test allows 27 seconds).

For the test to pass, both events above shall pass.

The statistical pass/ fail decisions are done separated for each event. For an event to pass, the total number of successful loops shall be more than 90% of the cases with a confidence level of 95%.

### 7.1.1.2 NR SA FR2-FR2 cell re-selection

**Editor's note: This test case is incomplete. The following aspects are either missing or TBD**

- TT analysis is missing.

- Connect diagram is TBD

#### 7.1.1.2.1 Test purpose

The purpose of this test is to verify the requirement for the inter frequency NR cell reselection requirements specified in TS 38.133 clause 4.2.2.4.

#### 7.1.1.2.2 Test applicability

This test applies to all types of NR UE from Release 15 onwards.

#### 7.1.1.2.3 Minimum conformance requirements

The minimum conformance requirements are specified in clause 7.1.1.0.2.

The normative reference for this requirement is TS 38.133 [6] clause A.7.1.1.2.

#### 7.1.1.2.4 Test description

##### 7.1.1.2.4.1 Initial conditions

This test shall be run in one of the configurations defined in Table 7.1.1.2.4.1-1.

**Table 7.1.1.2.4.1-1: Supported test configurations for NR SA FR2-FR2 cell re-selection**

Configuration	Description for serving cell	Description for target cell
7.1.1.2-1	120 kHz SSB SCS, 100 MHz bandwidth, TDD duplex mode	120 kHz SSB SCS, 100 MHz bandwidth, TDD duplex mode
7.1.1.2-2	240 kHz SSB SCS, 100 MHz bandwidth, TDD duplex mode	240 kHz SSB SCS, 100 MHz bandwidth, TDD duplex mode
Note: The UE is only required to be tested in one of the supported test configurations.		

Configure the test equipment and the DUT according to the parameters in Table 7.1.1.2.4.1-2.

**Table 7.1.1.2.4.1-2: Initial conditions for NR SA FR2-FR2 cell re-selection**

Parameter	Value		Comment
Test environment	NC		As specified in TS 38.508-1 [14] clause 4.1.
Test frequencies	As specified in Annex E, table E.4-1 and TS 38.508-1 [14] clause 4.3.1.		
Channel bandwidth	As specified by the test configuration selected from Table 7.1.1.2.4.1-1.		
Propagation conditions	AWGN		As specified in Annex C.2.2.
Connection Diagram	TE Part	TBD	As specified in TS 38.508-1 [14] Annex A.
	DUT Part	TBD	
Exceptions to connection diagram	N/A		

1. The general test parameter settings are set up according to Table 7.1.1.2.4.1-3.
2. Message contents are defined in clause 7.1.1.2.4.3.
3. There is two NR carrier and 2 NR Cells specified in the test. Cell 2 is the PCell and Cell 1 is the neighbour cell in a different carrier than cell 2. Cell 1 and Cell 2 are configured according to Annex C.1.2.

**Table 7.1.1.2.4.1-3: General test parameters for NR SA FR2-FR2 cell re-selection**

Parameter		Unit	Test configuration	Value	Comment
Initial condition	Active cell		1, 2	Cell2	The UE camps on cell 2 in the initial phase and during T1 period the UE reselects to cell 1
T1 end condition	Active cell		1, 2	Cell1	The UE shall perform reselection to cell 1 during T1
	Neighbour cells		1, 2	Cell2	
T3 end condition	Active cell		1, 2	Cell2	The UE shall perform reselection to cell 2 with higher priority during T3
RF Channel Number			1, 2	1, 2	
Time offset between cells			1, 2	3 $\mu$ s	Synchronous cells
Access Barring Information		-	1, 2	Not Sent	No additional delays in random access procedure.
SSB configuration			1	SSB.1 FR2	
			2	SSB.2 FR2	
SMTC configuration			1, 2	SMTC.1	
DRX cycle length		s	1, 2	1.28	The value shall be used for all cells in the test.
PRACH configuration index			1, 2	190	The detailed configuration is specified in TS 38.211 clause 6.3.3.2
rangeToBestCell			1, 2	Not configured	
T1		s	1, 2	35	T1 needs to be defined so that cell re-selection reaction time is taken into account.
T2		s	1, 2	>7	During T2, cell 2 shall be powered off, and during the off time the physical cell identity shall be changed. The intention is to ensure that cell 2 has not been detected by the UE prior to the start of period T3.
T3		s	1, 2	95	T3 needs to be defined so that cell re-selection reaction time is taken into account.

#### 7.1.1.2.4.2 Test procedure

The test consists of one active cell and one neighbour cell. The UE is requested to monitor the neighbouring cell on one of the NR carriers. The test consists of three successive time periods, with time duration of T1, T2, and T3 respectively. Both cell 1 and cell 2 are already identified by the UE prior to the start of the test. Cell 1 and cell 2 belong to different

tracking areas and cell 2 is of higher priority than cell 1. Furthermore, UE has not registered with network for the tracking area containing cell 1.

In the following test procedure “UE responds” means “UE starts transmitting preamble on PRACH for sending the RRC SETUP REQUEST message to perform a Registration procedure for mobility.

1. Ensure the UE is in state RRC\_IDLE with generic procedure parameters connectivity *NR*, connected without release *On* and Test Mode *On* according to TS 38.508-1 [14] clause 4.5 on Cell 2.
2. Set the parameters according to T1 in Table 7.1.1.2.5-1. Propagation conditions are set according to Annex B clause B.1.1. T1 starts.
3. Void.
4. The SS waits for random access requests information from the UE to perform cell re-selection on the lower priority cell, Cell 1.
5. If the UE responds on lower priority cell, Cell 1 during time duration T1 within 27 seconds from the beginning of time period T1, then count a success for the event “Re-select lower priority Cell 1”. Otherwise count a fail for the event “Re-select lower priority Cell 1”.
6. If the UE has re-selected Cell 1 within T1, after the re-selection or when T1 expires, continue with step 6a. Otherwise, if T1 expires and the UE has not yet re-selected Cell 1, the TE shall switch off and on the UE and skip to step 12.
- 6a. The SS shall send an *RRCRelease* message to ensure that the UE is in state RRC\_IDLE on Cell 1.
7. The SS shall switch the power setting from T1 to T2 as specified in Table 7.1.1.2.5-1. During time duration T2, Cell 2 shall be powered OFF and the physical cell identity = ((current Cell 2 physical cell identity + 1) mod 1008) shall be changed to ensure Cell 2 is not detected by the UE.
8. When T2 expires, the SS shall switch the power setting from T2 to T3 as specified in Table 7.1.1.2.5-1.
9. The SS waits for random access requests information from the UE to perform cell re-selection on the higher priority cell, Cell 2.
10. If the UE responds on higher priority cell, Cell 2 during time duration T3 within 87 seconds from the beginning of time period T3, then count a success for the event “Re-select higher priority Cell 2”. Otherwise count a fail for the event “Re-select higher priority Cell 2”.
11. If the UE has re-selected Cell 2 within T3, after the re-selection or when T3 expires, continues with step 11a. Otherwise, if T3 expires and the UE has not yet re-selected Cell 2, the TE shall switch off and on the UE and continue with step 12.
- 11a. The SS shall send an *RRCRelease* message to ensure that the UE is in state RRC\_IDLE on Cell 2.
12. Ensure the UE is in state RRC\_IDLE with generic procedure parameters connectivity *NR*, connected without release *On* and Test Mode *On* according to TS 38.508-1 [14] clause 4.5 on Cell 2.
13. Repeat step 3-12 until a test verdict has been achieved.  
Each of the events “Re-select lower priority Cell 1” and “Re-select higher priority Cell 2” is evaluated independently for the statistic, resulting in an event verdict: pass or fail. Each event is evaluated only until the confidence level according to Table G.2.3-1 in Annex G clause G.2 is achieved. Different events may require different times for a verdict.  
If both events pass, the test passes. If one event fails, the test fails.

#### 7.1.1.2.4.3 Message contents

Message contents are according to TS 38.508-1 [14] clause 7.3 with the following exceptions:

**Table 7.1.1.2.4.3-1: Common Exception messages**

Default Message Contents	
Common contents of system information blocks exceptions	Table H.2.2-1 Table H.2.2-3
Default RRC messages and information elements contents exceptions	
Specific message contents exceptions for Test Configuration 7.1.1.2-1	Table H.2.2-2 with Condition SSB.1 FR2 and Synchronous cells Table 7.3.1-3 in TS 38.508-1 [14] with condition SMTC.1
Specific message contents exceptions for Test Configuration 7.1.1.2-2	Table H.2.2-2 with Condition SSB.2 FR2 and Synchronous cells Table 7.3.1-3 in TS 38.508-1 [14] with condition SMTC.1

**Table 7.1.1.2.4.3-2: RACH-ConfigGeneric: NR cell re-selection**

Derivation Path: TS 38.508-1 [14], Table 4.6.3-130			
Information Element	Value/remark	Comment	Condition
RACH-ConfigGeneric ::= SEQUENCE {			
prach-ConfigurationIndex	190		
}			

#### 7.1.1.2.5 Test requirement

Tables 7.1.1.2.4.1-3 and 7.1.1.2.5-1 define the primary level settings including test tolerances for inter frequency NR cell re-selection test case.

Table 7.1.1.2.5-1: Cell specific test parameters for NR SA FR2-FR2 cell re-selection

Parameter	Unit	Test configuration	Cell 1			Cell 2		
			T1	T2	T3	T1	T2	T3
TDD configuration		1, 2	TDDConf.3.1			TDDConf.3.1		
PDSCH RMC configuration		1, 2	SR.3.1 TDD			SR.3.1 TDD		
RMSI CORESET parameters		1, 2	CR.3.1 TDD			CR.3.1 TDD		
RMSI CORESET RMC configuration		1, 2	CCR.3.1 TDD			CCR.3.1 TDD		
OCNG Pattern		1, 2	OP.1			OP.1		
Initial DL BWP configuration		1, 2	DLBWP.0.1			DLBWP.0.1		
Initial UL BWP configuration		1, 2	ULBWP.0.1			ULBWP.0.1		
RLM-RS		1, 2	SSB			SSB		
Qrxlevmin	dBm/SCS	1	-140			-140		
		2	-137			-137		
Pcompensation	dB	1, 2	0			0		
Qhyst <sub>s</sub>	dB	1, 2	0			0		
Qoffset <sub>s, n</sub>	dB	1, 2	0			0		
Cell_selection_and_reselection_quality_measurement		1, 2	SS-RSRP			SS-RSRP		
AoA setup		1, 2	Setup 1 defined in A.9.1			Setup 1 defined in A.9.1		
$\hat{E}_s / I_{ot}$	dB	1	8	8	8	-3	-	8
		2					infinity	
$N_{oc}$ Note2	dBm/SCS	1	-93					
		2	-90					
$N_{oc}$ Note2	dBm/15 kHz	1	-102					
		2						
$\hat{E}_s / N_{oc}$	dB	1	8	8	8	-3	-	8
		2					infinity	
SS-RSRP Note3	dBm/SCS	1	-85	-85	-85	-96	-	-85
		2	-82	-82	-82	-93	-	-82
							infinity	
Io	dBm/95.04 MHz	1	-	-	-	-	-	-
			55.37	55.37	55.37	62.25	infinity	55.37
		2	-	-	-	-	-	-
			52.37	52.37	52.37	59.25	infinity	52.37
Treselection	s	1, 2	0	0	0	0	0	0
SnonintrasearchP	dB	1, 2	50			Not sent		
Thresh <sub>x, highP</sub>	dB	1, 2	48			48		
Thresh <sub>servng, lowP</sub>	dB	1, 2	44			44		
Thresh <sub>x, lowP</sub>	dB	1, 2	50			50		
Propagation Condition		1, 2	AWGN					
Note 1:	OCNG shall be used such that both cells are fully allocated and a constant total transmitted power spectral density is achieved for all OFDM symbols.							
Note 2:	Interference from other cells and noise sources not specified in the test is assumed to be constant over subcarriers and time and shall be modelled as AWGN of appropriate power for $N_{oc}$ to be fulfilled.							
Note 3:	SS-RSRP levels have been derived from other parameters for information purposes. They are not settable parameters themselves.							

The cell reselection delay to a higher priority cell is defined as the time from the beginning of time period T3, to the moment when the UE camps again on cell 2, and starts to send preambles on the PRACH for sending the RRC SETUP REQUEST message to perform a Registration procedure for mobility on cell 2.

The cell re-selection delay to a higher priority cell test requirement in this case is expressed as:

$$\text{Cell re-selection delay to a higher priority cell} = T_{\text{higher\_priority\_search}} + T_{\text{evaluate, NR\_inter}} + T_{\text{SI-NR}}$$

$$T_{\text{higher\_priority\_search}} = 60 \text{ s, as specified in TS 38.133 [6] clause 4.2.2.7;}$$

$$T_{\text{evaluate, NR\_inter}} = 25.6 \text{ s, as specified in TS 38.133 [6] clause 4.2.2.4;}$$

$T_{SI-NR} = 1280$  ms; maximum repetition period of relevant system info blocks that needs to be received by the UE to camp on a cell is assumed in this test.

The cell re-selection delay to a higher priority cell shall be less than a total of 86.88 seconds in this test case (note: this gives a total of 86.88 seconds but this test allows 87 seconds)

The cell reselection delay to a lower priority cell is defined as the time from the beginning of time period T1, to the moment when the UE camps on cell 1, and starts to send preambles on the PRACH for sending the RRC SETUP REQUEST message to perform a Registration procedure for mobility on cell 1.

The cell re-selection delay to a lower priority cell test requirement in this case is expressed as:

$$\text{Cell re-selection delay to a lower priority cell} = T_{\text{evaluate, NR\_inter}} + T_{SI-NR}$$

$T_{\text{evaluate, NR\_inter}} = 25.6$  s, as specified in TS 38.133 [6] clause 4.2.2.4;

$T_{SI-NR} = 1280$  ms; maximum repetition period of relevant system info blocks that needs to be received by the UE to camp on a cell is assumed in this test.

The cell re-selection delay to a lower priority cell shall be less than a total of 26.88 seconds in this test case (note: this gives a total of 26.88 seconds but this test allows 27 seconds)

For the test to pass, both events above shall pass.

The statistical pass/fail decisions are done separated for each event. For an event to pass, the total number of successful loops shall be more than 90% of the cases with a confidence level of 95%.

### 7.1.1.3 NR SA FR2 cell re-selection for UE fulfilling low mobility relaxed measurement criterion

**Editor's note: This test case is incomplete. The following aspects are either missing or not yet determined:**

- **The Test tolerances and Test system uncertainties applicable to this test are undefined.**

#### 7.1.1.3.1 Test purpose

The purpose of this test is to verify the requirement for the intra frequency NR cell reselection requirements when UE fulfils the low mobility relaxed measurement criterion specified in TS 38.133 clause 4.2.2.9.

#### 7.1.1.3.2 Test applicability

This test applies to all types of NR UE from Release 16 onwards supporting relaxed RRM measurement.

#### 7.1.1.3.3 Minimum conformance requirements

The minimum conformance requirements are specified in clause 7.1.1.0.3.

The normative reference for this requirement is TS 38.133 [6] clause A.7.1.1.3.

#### 7.1.1.3.4 Test description

##### 7.1.1.3.4.1 Initial conditions

This test shall be run in one of the configurations defined in Table 7.1.1.3.4.1-1.

**Table 7.1.1.3.4.1-1: Supported test configurations for NR SA FR2 cell re-selection for UE fulfilling low mobility relaxed measurement criterion**

Configuration	Description
7.1.1.3-1	120 kHz SSB SCS, 100 MHz bandwidth, TDD duplex mode
7.1.1.3-2	240 kHz SSB SCS, 100 MHz bandwidth, TDD duplex mode
Note:	The UE is only required to be tested in one of the supported test configurations.

Configure the test equipment and the DUT according to the parameters in Table 7.1.1.3.4.1-2.

**Table 7.1.1.3.4.1-2: Initial conditions for NR SA FR2 cell re-selection for UE fulfilling low mobility relaxed measurement criterion**

Parameter	Value		Comment
Test environment	NC		As specified in TS 38.508-1 [14] clause 4.1.
Test frequencies	As specified in Annex E, table E.4-1 and TS 38.508-1 [14] clause 4.3.1.		
Channel bandwidth	As specified by the test configuration selected from Table 7.1.1.3.4.1-1.		
Propagation conditions	AWGN		As specified in Annex C.2.2.
Connection Diagram	TE Part	A.3.1.6.1	As specified in TS 38.508-1 [14] Annex A.
	DUT Part	A.3.2.3.2	
Exceptions to connection diagram	N/A		

1. The general test parameter settings are set up according to Table 7.1.1.3.4.1-3.
2. Message contents are defined in clause 7.1.1.3.4.3.
3. There is one NR carrier and 2 NR Cells specified in the test. Cell 1 is the PCell and Cell 2 is the neighbour cell. Cell 1 and Cell 2 are configured according to Annex C.1.1 and C.1.2.

**Table 7.1.1.3.4.1-3: General test parameters for NR SA FR2 cell re-selection for UE fulfilling low mobility relaxed measurement criterion**

Parameter		Unit	Test configuration	Value	Comment
Initial condition	Active cell		1, 2	Cell1	The UE camps on cell 1 in the initial phase
	Neighbour cells		1, 2	Cell2	
T1 end condition	Active cell		1, 2	Cell2	The UE reselects to cell 2 during T1 period
	Neighbour cells		1, 2	Cell1	
Final condition	Active cell		1, 2	Cell1	The UE reselects to cell 1 during T2 period
	Neighbour cells		1,2	Cell2	
RF Channel Number			1, 2	1	
Time offset between cells			1, 2	3 $\mu$ s	Synchronous cells
Access Barring Information		-	1, 2	Not Sent	No additional delays in random access procedure.
SMTC configuration			1, 2	SMTC pattern 1	
DRX cycle length		s	1, 2	0.64	The value shall be used for all cells in the test.
PRACH configuration index			1, 2	190	The detailed configuration is specified in TS 38.211 clause 6.3.3.2
rangeToBestCell			1, 2	Not configured	
T1		s	1, 2	100	
T2		s	1, 2	100	

#### 7.1.1.3.4.2 Test procedure

Two cells are deployed in the test, which are one FR2 NR PCell (Cell 1) and an NR neighbour cell (Cell 2) on the same frequency. The test consists of 2 successive time periods, with time duration of T1, T2 respectively. Both cell 1 and cell2 are already identified by the UE prior to the start of the test. Cell 1 and cell 2 belong to different tracking areas.

The UE is configured only low mobility criterion defined in clause 5.2.4.9.1 in TS 38.304 [30]. So, Cell 1 configures the UE as follows:

- *lowMobilityEvaluation* [2] is configured according to the parameters listed in Table 7.1.1.3.5-1;



- *cellEdgeEvaluation* [2] is not configured;
- *combineRelaxedMeasCondition* [2] is not configured

In the following test procedure “UE responds” means “UE starts transmitting preamble on PRACH for sending the RRC SETUP REQUEST message to perform a Registration procedure for mobility.

1. Ensure the UE is in state RRC\_IDLE with generic procedure parameters Connectivity NR, Connected without release *On* and Test Mode *On* according to TS 38.508-1 [14] clause 4.5.
2. Set the parameters according to T1 in Table 7.1.1.3.5-1. T1 starts.
3. The SS waits for random access requests information from the UE to perform cell re-selection to Cell 2.
4. If the UE responds on Cell 2 during time duration T1 within 100 seconds from the beginning of time period T1, then count a success for cell reselection. Otherwise count a fail for cell reselection.
5. If the UE has re-selected Cell 2 within T1, after the re-selection or when T1 expires, continue with step 6. Otherwise, if T1 expires and the UE has not yet re-selected Cell 2, the TE shall switch off and on the UE and skip to step 10.
- 5a The SS shall send an RRCConnectionRelease to ensure that the UE is in state RRC\_IDLE.
6. The SS shall switch the power setting from T1 to T2 as specified in Table 7.1.1.3.5-1. T2 starts.
7. The SS waits for random access requests information from the UE to perform cell re-selection to an already detected cell, Cell 1.
8. If the UE responds to Cell 1 during time duration T2 within 100 seconds from the beginning of time period T2, then count a success for cell reselection. Otherwise count a fail for cell reselection.
9. If the UE has re-selected Cell 1 within T2, after the re-selection or when T2 expires, continue with step 10. Otherwise, if T2 expires and the UE has not yet re-selected Cell 1, the TE shall switch off and on the UE and continue with step 10.
10. Ensure the UE is in state RRC\_IDLE with generic procedure parameters Connectivity NR, Connected without release *On* and Test Mode *On* according to TS 38.508-1 [14] clause 4.5.
11. Repeat step 2-10 until the confidence level according to Tables G.2.3-1 in Annex G clause G.2 is achieved.

7.1.1.3.4.3 Message contents

Message contents are according to TS 38.508-1 [14] clause 7.3 with the following exceptions:

**Table 7.1.1.3.4.3-1: Common Exception messages**

Default Message Contents	
Common contents of system information blocks exceptions	Table H.2.1-1 with Condition SMTC.1 and Synchronous cells  Table H.2.1-2  Table H.2.1-3
Default RRC messages and information elements contents exceptions	

**Table 7.1.1.3.4.3-2: RACH-ConfigGeneric: NR cell re-selection**

Derivation Path: TS 38.508-1 [14], Table 4.6.3-130			
Information Element	Value/remark	Comment	Condition
RACH-ConfigGeneric ::= SEQUENCE {			
prach-ConfigurationIndex	190		
}			

Table 7.1.1.3.4.3-3: SIB2

Derivation Path: TS 38.508-1 [14] Table 4.6.2-1			
Information Element	Value/remark	Comment	Condition
SIB2 ::= SEQUENCE {			
relaxedMeasurement-r16 SEQUENCE {			
lowMobilityEvaluation-r16 SEQUENCE {			
s-SearchDeltaP-r16	dB6		
t-SearchDeltaP-r16	s5		
}			
cellEdgeEvaluation-r16	Not present		
combineRelaxedMeasCondition-r16	Not present		
highPriorityMeasRelax-r16	Not present		
}			
}			

#### 7.1.1.3.5 Test requirement

Tables 7.1.1.3.4.1-3 and 7.1.1.3.5-1 define the primary level settings including test tolerances for intra frequency NR cell re-selection test case for UE fulfilling low mobility relaxed measurement criterion.

**Table 7.1.1.3.5-1: Cell specific test parameters for NR SA FR2 cell re-selection for UE fulfilling low mobility relaxed measurement criterion**

Parameter	Unit	Test configuration	Cell 1		Cell 2	
			T1	T2	T1	T2
TDD configuration		1, 2	TDDConf.3.1		TDDConf.3.1	
PDSCH RMC configuration		1	SR.3.1 TDD		SR.3.1 TDD	
		2	SR.3.1 TDD		SR.3.1 TDD	
RMSI CORESET RMC configuration		1	CR.3.1 TDD		CR.3.1 TDD	
		2	CR.3.1 TDD		CR.3.1 TDD	
Dedicated CORESET RMC configuration		1	CCR.3.1 TDD		CCR.3.1 TDD	
		2	CCR.3.1 TDD		CCR.3.1 TDD	
SSB configuration		1	SSB.3 FR2		SSB.7 FR2	
		2	SSB.4 FR2		SSB.8 FR2	
OCNG Pattern		1, 2	OP.4		OP.4	
Initial DL BWP configuration		1, 2	DLBWP.0.1		DLBWP.0.1	
Initial UL BWP configuration		1, 2	ULBWP.0.1		ULBWP.0.1	
RLM-RS		1, 2	SSB		SSB	
Qrxlevmin	dBm/SCS	1	-140		-140	
		2	-137		-137	
S <sub>SearchDeltaP</sub>	dB	1, 2	6		6	
T <sub>SearchDeltaP</sub>	s	1,2	5		5	
P <sub>compensation</sub>	dB	1, 2	0		0	
Q <sub>hyst<sub>s</sub></sub>	dB	1, 2	0		0	
Q <sub>offset<sub>s, n</sub></sub>	dB	1, 2	0		0	
Cell_selection_and_reselection_quality_measurement		1, 2	SS-RSRP		SS-RSRP	
AoA setup		1, 2	Setup 1 defined in A.3.15.1		Setup 1 defined in A.3.15.1	
Beam assumption <sup>Note 4</sup>		1,2	Rough		Rough	
$\hat{E}_s / I_{ot}$	dB	1	-3	1.5	1.5	-3
		2				
$N_{oc}$ <sup>Note2</sup>	dBm/SCS	1	-93			
		2	-90			
$N_{oc}$ <sup>Note2</sup>	dBm/15 kHz	1	-102			
		2				
$\hat{E}_s / N_{oc}$	dB	1	-3	1.5	1.5	-3
		2				
SS-RSRP <sup>Note3</sup>	dBm/SCS	1	-96	-91.5	-91.5	-96
		2	-93	-88.5	-88.5	-93
Io on SSB symbols of each cell	dBm/95.04 MHz	1	-63.40	-62.47	-62.47	-63.40
		2	-62.86	-61.67	-61.67	-62.86

Treselection	s	1, 2	0	0	0	0
SintrasearchP	dB	1, 2	50		50	
Propagation Condition		1, 2	AWGN			
<p>Note 1: OCNG shall be used such that both cells are fully allocated and a constant total transmitted power spectral density is achieved for all OFDM symbols.</p> <p>Note 2: Interference from other cells and noise sources not specified in the test is assumed to be constant over subcarriers and time and shall be modelled as AWGN of appropriate power for <math>N_{oc}</math> to be fulfilled.</p> <p>Note 3: SS-RSRP levels have been derived from other parameters for information purposes. They are not settable parameters themselves.</p> <p>Note 4: Information about types of UE beam is given in B.2.1.3, and does not limit UE implementation or test system implementation</p>						

The cell reselection delay to an already detected cell for UE fulfilling low mobility relaxed criterion is defined as the time from the beginning of time period T1, to the moment when the UE camps on Cell 2, and starts to send preambles on the PRACH for sending the *RRCSetupRequest* message to perform a Tracking Area Update procedure on Cell 2.

The cell reselection delay to an already detected cell for UE fulfilling low mobility relaxed criterion is also defined as the time from the beginning of time period T2, to the moment when the UE camps on Cell 1, and starts to send preambles on the PRACH for sending the *RRCSetupRequest* message to perform a Tracking Area Update procedure on Cell 1.

The cell re-selection delay to an already detected cell shall be less than 79 s.

The rate of correct cell reselections observed during repeated tests shall be at least 90%.

The cell re-selection delay to an already detected cell test requirement in this case is expressed as:

Cell re-selection to an already detected cell delay =  $T_{\text{evaluate,NR\_Intra}} + T_{\text{SI-NR}}$

$T_{\text{evaluate,NR\_Intra}} = 76.8$  s; as specified in TS 38.133 [6] clause 4.2.2.9.

$T_{\text{SI-NR}} = 1280$  ms; maximum repetition period of relevant system info blocks that needs to be received by the UE to camp on a cell is assumed in this test.

This gives a total of 78.08 s, allow 79s for the cell re-selection delay to an already detected cell for UE fulfilling low mobility criterion in the test case.

#### 7.1.1.4 NR SA FR2 cell re-selection for UE fulfilling not-at-cell edge relaxed measurement criterion

**Editor's note: This test case is incomplete. The following aspects are either missing or not yet determined:**

- **The Test tolerances and Test system uncertainties applicable to this test are undefined.**

##### 7.1.1.4.1 Test purpose

The purpose of this test is to verify the requirement for the intra frequency NR cell reselection requirements when UE fulfils the not-at-cell edge relaxed measurement criterion specified in TS 38.133 clause 4.2.2.9.

##### 7.1.1.4.2 Test applicability

This test applies to all types of NR UE from Release 16 onwards supporting relaxed RRM measurement.

##### 7.1.1.4.3 Minimum conformance requirements

The minimum conformance requirements are specified in clause 7.1.1.0.3.

The normative reference for this requirement is TS 38.133 [6] clause A.7.1.1.4.

7.1.1.4.4 Test description

7.1.1.4.4.1 Initial conditions

This test shall be run in one of the configurations defined in Table 7.1.1.4.4.1-1.

**Table 7.1.1.4.4.1-1: Supported test configurations for NR SA FR2 cell re-selection for UE fulfilling not-at-cell edge relaxed measurement criterion**

Configuration	Description
7.1.1.4-1	120 kHz SSB SCS, 100 MHz bandwidth, TDD duplex mode
7.1.1.4-2	240 kHz SSB SCS, 100 MHz bandwidth, TDD duplex mode
Note:	The UE is only required to be tested in one of the supported test configurations.

Configure the test equipment and the DUT according to the parameters in Table 7.1.1.4.4.1-2.

**Table 7.1.1.4.4.1-2: Initial conditions for NR SA FR2 cell re-selection for UE fulfilling not-at-cell edge relaxed measurement criterion**

Parameter	Value	Comment
Test environment	NC	As specified in TS 38.508-1 [14] clause 4.1.
Test frequencies	As specified in Annex E, table E.4-1 and TS 38.508-1 [14] clause 4.3.1.	
Channel bandwidth	As specified by the test configuration selected from Table 7.1.1.4.4.1-1.	
Propagation conditions	AWGN	As specified in Annex C.2.2.
Connection Diagram	TE Part	A.3.1.6.1
	DUT Part	A.3.2.3.2
Exceptions to connection diagram	N/A	

1. The general test parameter settings are set up according to Table 7.1.1.4.4.1-3.
2. Message contents are defined in clause 7.1.1.4.4.3.
3. There is one NR carrier and 2 NR Cells specified in the test. Cell 1 is the PCell and Cell 2 is the neighbour cell. Cell 1 and Cell 2 are configured according to Annex C.1.1 and C.1.2.

**Table 7.1.1.4.4.1-3: General test parameters for NR SA FR2 cell re-selection for UE fulfilling not-at-cell edge relaxed measurement criterion**

Parameter	Unit	Test configuration	Value	Comment	
Initial condition	Active cell		1, 2	Cell1	The UE camps on cell 1 in the initial phase
	Neighbour cells		1, 2	Cell2	
T1 end condition	Active cell		1, 2	Cell2	The UE reselects to cell 2 during T1 period
	Neighbour cells		1, 2	Cell1	
Final condition	Active cell		1, 2	Cell1	
	Neighbour cells		1,2	Cell2	

RF Channel Number		1, 2	1	
Time offset between cells		1, 2	3 $\mu$ s	Synchronous cells
Access Barring Information	-	1, 2	Not Sent	No additional delays in random access procedure.
SMTC configuration		1, 2	SMTC pattern 1	
DRX cycle length	s	1, 2	0.64	The value shall be used for all cells in the test.
PRACH configuration index		1, 2	190	The detailed configuration is specified in TS 38.211 clause 6.3.3.2
rangeToBestCell		1, 2	Not configured	
T1	s	1, 2	100	
T2	s	1, 2	100	

#### 7.1.1.4.4.2 Test procedure

Two cells are deployed in the test, which are one FR2 NR PCell (Cell 1) and an NR neighbour cell (Cell 2) on the same frequency. The test consists of 2 successive time periods, with time duration of T1, T2 respectively. Both cell 1 and cell2 are already identified by the UE prior to the start of the test. Cell 1 and cell 2 belong to different tracking areas.

The UE is configured only not-at-cell edge criterion defined in clause 5.2.4.9.1 in TS 38.304 [30]. So, Cell 1 configures the UE as follows:

- *lowMobilityEvaluation* [2] is not configured;
- *cellEdgeEvaluation* [2] is configured according to the parameters listed in Table 7.1.1.4.5-1;
- *combineRelaxedMeasCondition* [2] is not configured

In the following test procedure “UE responds” means “UE starts transmitting preamble on PRACH for sending the RRC SETUP REQUEST message to perform a Registration procedure for mobility.

1. Ensure the UE is in state RRC\_IDLE with generic procedure parameters Connectivity NR, Connected without release *On* and Test Mode *On* according to TS 38.508-1 [14] clause 4.5.
2. Set the parameters according to T1 in Table 7.1.1.4.5-1. T1 starts.
3. The SS waits for random access requests information from the UE to perform cell re-selection to Cell 2.
4. If the UE responds on Cell 2 during time duration T1 within 100 seconds from the beginning of time period T1, then count a success for cell reselection. Otherwise count a fail for cell reselection.
5. If the UE has re-selected Cell 2 within T1, after the re-selection or when T1 expires, continue with step 6. Otherwise, if T1 expires and the UE has not yet re-selected Cell 2, the TE shall switch off and on the UE and skip to step 10.
- 5a The SS shall send an RRCConnectionRelease to ensure that the UE is in state RRC\_IDLE.
6. The SS shall switch the power setting from T1 to T2 as specified in Table 7.1.1.4.5-1. T2 starts.
7. The SS waits for random access requests information from the UE to perform cell re-selection to an already detected cell, Cell 1.
8. If the UE responds to Cell 1 during time duration T2 within 100 seconds from the beginning of time period T2, then count a success for cell reselection. Otherwise count a fail for cell reselection.
9. If the UE has re-selected Cell 1 within T2, after the re-selection or when T2 expires, continue with step 10. Otherwise, if T2 expires and the UE has not yet re-selected Cell 1, the TE shall switch off and on the UE and continue with step 10.
10. Ensure the UE is in state RRC\_IDLE with generic procedure parameters Connectivity NR, Connected without release *On* and Test Mode *On* according to TS 38.508-1 [14] clause 4.5.
11. Repeat step 2-10 until the confidence level according to Tables G.2.3-1 in Annex G clause G.2 is achieved.

## 7.1.1.4.4.3 Message contents

Message contents are according to TS 38.508-1 [14] clause 7.3 with the following exceptions:

**Table 7.1.1.4.4.3-1: Common Exception messages**

Default Message Contents	
Common contents of system information blocks exceptions	Table H.2.1-1 with Condition SMTC.1 and Synchronous cells  Table H.2.1-2  Table H.2.1-3
Default RRC messages and information elements contents exceptions	

**Table 7.1.1.4.4.3-2: RACH-ConfigGeneric: NR cell re-selection**

Derivation Path: TS 38.508-1 [14], Table 4.6.3-130			
Information Element	Value/remark	Comment	Condition
RACH-ConfigGeneric ::= SEQUENCE {			
prach-ConfigurationIndex	190		
}			

**Table 7.1.1.4.4.3-3: SIB2**

Derivation Path: TS 38.508-1 [14] Table 4.6.2-1			
Information Element	Value/remark	Comment	Condition
SIB2 ::= SEQUENCE {			
relaxedMeasurement-r16 SEQUENCE {			
lowMobilityEvaluation-r16	Not present		
cellEdgeEvaluation-r16 SEQUENCE {			
s-SearchThresholdP-r16	35		
}			
combineRelaxedMeasCondition-r16	Not present		
highPriorityMeasRelax-r16	Not present		
}			
}			

## 7.1.1.4.5 Test requirement

Tables 7.1.1.4.4.1-3 and 7.1.1.4.5-1 define the primary level settings including test tolerances for intra frequency NR cell re-selection test case for UE fulfilling not-at-cell edge relaxed measurement criterion.

**Table 7.1.1.4.5-1: Cell specific test parameters for NR SA FR2 cell re-selection for UE fulfilling not-at-cell edge relaxed measurement criterion**

Parameter	Unit	Test configuration	Cell 1		Cell 2	
			T1	T2	T1	T2
TDD configuration		1, 2	TDDConf.3.1		TDDConf.3.1	
PDSCH RMC configuration		1	SR.3.1 TDD		SR.3.1 TDD	
		2	SR.3.1 TDD		SR.3.1 TDD	
RMSI CORESET RMC configuration		1	CR.3.1 TDD		CR.3.1 TDD	
		2	CR.3.1 TDD		CR.3.1 TDD	
Dedicated CORESET RMC configuration		1	CCR.3.1 TDD		CCR.3.1 TDD	
		2	CCR.3.1 TDD		CCR.3.1 TDD	
SSB configuration		1	SSB.3 FR2		SSB.7 FR2	
		2	SSB.4 FR2		SSB.8 FR2	
OCNG Pattern		1, 2	OP.4		OP.4	
Initial DL BWP configuration		1, 2	DLBWP.0.1		DLBWP.0.1	
Initial UL BWP configuration		1, 2	ULBWP.0.1		ULBWP.0.1	
RLM-RS		1, 2	SSB		SSB	
Qrxlevmin	dBm/SCS	1	-140		-140	
		2	-137		-137	
Pcompensation	dB	1, 2	0		0	
Qhyst <sub>s</sub>	dB	1, 2	0		0	
Qoffset <sub>s, n</sub>	dB	1, 2	0		0	
Cell_selection_and_reselection_quality_measurement		1, 2	SS-RSRP		SS-RSRP	
AoA setup		1, 2	Setup 1 defined in A.3.15.1		Setup 1 defined in A.3.15.1	
Beam assumption <sup>Note 4</sup>		1,2	Rough		Rough	
$\hat{E}_s / I_{ot}$	dB	1	-3	1.5	1.5	-3
		2				
$N_{oc}$ <sup>Note2</sup>	dBm/SCS	1	-93			
		2	-90			
$N_{oc}$ <sup>Note2</sup>	dBm/15 kHz	1	-102			
		2				
$\hat{E}_s / N_{oc}$	dB	1	-3	1.5	1.5	-3
		2				
SS-RSRP <sup>Note3</sup>	dBm/SCS	1	-96	-91.5	-91.5	-96
		2	-93	-88.5	-88.5	-93
Io on SSB symbols of each cell	dBm/95.04 MHz	1	-63.40	-62.47	-62.47	-63.40
		2	-62.86	-61.67	-61.67	-62.86



Treselection	s	1, 2	0	0	0	0
S <sub>SearchThresholdP</sub>		1, 2	35	35	35	35
S <sub>IntrasearchP</sub>	dB	1, 2	50		50	
Propagation Condition		1, 2	AWGN			
<p>Note 1: OCNG shall be used such that both cells are fully allocated and a constant total transmitted power spectral density is achieved for all OFDM symbols.</p> <p>Note 2: Interference from other cells and noise sources not specified in the test is assumed to be constant over subcarriers and time and shall be modelled as AWGN of appropriate power for <math>N_{oc}</math> to be fulfilled.</p> <p>Note 3: SS-RSRP levels have been derived from other parameters for information purposes. They are not settable parameters themselves.</p> <p>Note 4: Information about types of UE beam is given in B.2.1.3, and does not limit UE implementation or test system implementation</p>						

The cell reselection delay to an already detected cell for UE fulfilling not-at-cell edge relaxed criterion is defined as the time from the beginning of time period T1, to the moment when the UE camps on Cell 2, and starts to send preambles on the PRACH for sending the *RRCSetupRequest* message to perform a Tracking Area Update procedure on Cell 2.

The cell reselection delay to an already detected cell for UE fulfilling not-at-cell edge relaxed criterion is also defined as the time from the beginning of time period T2, to the moment when the UE camps on Cell 1, and starts to send preambles on the PRACH for sending the *RRCSetupRequest* message to perform a Tracking Area Update procedure on Cell 1.

The cell re-selection delay to an already detected cell shall be less than 79 s.

The rate of correct cell reselections observed during repeated tests shall be at least 90%.

The cell re-selection delay to an already detected cell test requirement in this case is expressed as:

$$\text{Cell re-selection to an already detected cell delay} = T_{\text{evaluate,NR\_Intra}} + T_{\text{SI-NR}}$$

$$T_{\text{evaluate,NR\_Intra}} = 76.8 \text{ s; as specified in TS 38.133 [6] clause 4.2.2.9.}$$

$$T_{\text{SI-NR}} = 1280 \text{ ms; maximum repetition period of relevant system info blocks that needs to be received by the UE to camp on a cell is assumed in this test.}$$

This gives a total of 78.08 s, allow 79s for the cell re-selection delay to an already detected cell for UE fulfilling not-at-cell edge criterion in the test case.

### 7.1.1.5 NR SA FR2-FR2 cell re-selection for UE fulfilling low mobility relaxed measurement criterion

**Editor's note: This test case is incomplete. The following aspects are either missing or not yet determined:**

- **The Test tolerances and Test system uncertainties applicable to this test are undefined.**

#### 7.1.1.5.1 Test purpose

The purpose of this test is to verify the requirement for the inter frequency NR cell reselection requirements when UE fulfils the low mobility relaxed measurement criterion specified in TS 38.133 clause 4.2.2.10.

#### 7.1.1.5.2 Test applicability

This test applies to all types of NR UE from Release 16 onwards supporting relaxed RRM measurement.

#### 7.1.1.5.3 Minimum conformance requirements

The minimum conformance requirements are specified in clause 7.1.1.0.4.

The normative reference for this requirement is TS 38.133 [6] clause A.7.1.1.5.

7.1.1.5.4 Test description

7.1.1.5.4.1 Initial conditions

This test shall be run in one of the configurations defined in Table 7.1.1.5.4.1-1.

**Table 7.1.1.5.4.1-1: Supported test configurations for NR SA FR2-FR2 cell re-selection for UE fulfilling low mobility relaxed measurement criterion**

Configuration	Description
7.1.1.5-1	120 kHz SSB SCS, 100 MHz bandwidth, TDD duplex mode
7.1.1.5-2	240 kHz SSB SCS, 100 MHz bandwidth, TDD duplex mode
Note:	The UE is only required to be tested in one of the supported test configurations.

Configure the test equipment and the DUT according to the parameters in Table 7.1.1.5.4.1-2.

**Table 7.1.1.5.4.1-2: Initial conditions for NR SA FR2-FR2 cell re-selection for UE fulfilling low mobility relaxed measurement criterion**

Parameter	Value		Comment
Test environment	NC		As specified in TS 38.508-1 [14] clause 4.1.
Test frequencies	As specified in Annex E, table E.4-1 and TS 38.508-1 [14] clause 4.3.1.		
Channel bandwidth	As specified by the test configuration selected from Table 7.1.1.5.4.1-1.		
Propagation conditions	AWGN		As specified in Annex C.2.2.
Connection Diagram	TE Part	A.3.1.6.1	As specified in TS 38.508-1 [14] Annex A.
	DUT Part	A.3.2.3.2	
Exceptions to connection diagram	N/A		

1. The general test parameter settings are set up according to Table 7.1.1.5.4.1-3.
2. Message contents are defined in clause 7.1.1.5.4.3.
3. There is one NR carrier and 2 NR Cells specified in the test. Cell 1 is the PCell and Cell 2 is the neighbour cell. Cell 1 and Cell 2 are configured according to Annex C.1.1 and C.1.2.

**Table 7.1.1.5.4.1-3: General test parameters for NR SA FR2-FR2 cell re-selection for UE fulfilling low mobility relaxed measurement criterion**

Parameter		Unit	Test configuration	Value	Comment
Initial condition	Active cell		1, 2	Cell2	The UE camps on cell2 and fulfils low mobility ( <i>lowMobilityEvaluation</i> [2]) criterion.
	Neighbour cell		1, 2	Cell1	
T1 final condition	Active cell		1, 2	Cell1	The UE reselects to low priority cell1 during T1
	Neighbour cell		1, 2	Cell2	
T2 final condition	Active cell		1, 2	Cell2	The UE reselects to high priority cell2 during T2
	Neighbour cell			Cell1	
RF Channel Number			1, 2	1, 2	
Time offset between cells			1, 2	3 $\mu$ s	Synchronous cells
Access Barring Information		-	1, 2	Not Sent	No additional delays in random access procedure.
SSB configuration			1	SSB.1 FR2	
			2	SSB.2 FR2	

SMTC configuration		1, 2	SMTC pattern 1	
DRX cycle length	s	1, 2	0.64	The value shall be used for all cells in the test.
PRACH configuration index		1, 2	190	The detailed configuration is specified in TS 38.211 clause 6.3.3.2
rangeToBestCell		1, 2	Not configured	
T1	s	1, 2	85	T1 needs to be long enough to allow cell re-selection to already known cell1
T2	s	1, 2	85	T2 needs to be long enough to allow cell re-selection to already known cell2

#### 7.1.1.5.4.2 Test procedure

The test consists of one active cell and one neighbour cell. The UE is requested to monitor the neighbouring cell on one of the NR carriers. The test consists of two successive time periods, with time duration of T1, T2 respectively. Both Cell 1 and Cell 2 are already identified by the UE prior to the start of the test. Cell 1 and Cell 2 belong to different tracking areas and Cell 2 is of higher priority than Cell 1.

The UE is configured only low mobility criterion defined in clause 5.2.4.9.1 in TS 38.304 [30]. So, Cell 1 configures the UE as follows:

- *lowMobilityEvaluation* [2] is configured according to the parameters listed in Table 7.1.1.5.5-1;
- *cellEdgeEvaluation* [2] is not configured;
- *combineRelaxedMeasCondition* [2] is not configured

In the following test procedure “UE responds” means “UE starts transmitting preamble on PRACH for sending the RRC SETUP REQUEST message to perform a Registration procedure for mobility.

1. Ensure the UE is in state RRC\_IDLE with generic procedure parameters Connectivity NR, Connected without release *On* and Test Mode *On* according to TS 38.508-1 [14] clause 4.5.
2. Set the parameters according to T1 in Table 7.1.1.5.5-1. T1 starts.
3. The SS waits for random access requests information from the UE to perform cell re-selection to Cell 1.
4. If the UE responds on lower priority Cell 1 during time duration T1 within 85 seconds from the beginning of time period T1, then count a success for the event “Re-select lower priority Cell 1”. Otherwise count a fail for the event “Re-select lower priority Cell 1”
5. If the UE has re-selected Cell 1 within T1, after the re-selection or when T1 expires, continue with step 6. Otherwise, if T1 expires and the UE has not yet re-selected Cell 1, the TE shall switch off and on the UE and skip to step 10.
- 5a The SS shall send an RRCConnectionRelease to ensure that the UE is in state RRC\_IDLE.
6. The SS shall switch the power setting from T1 to T2 as specified in Table 7.1.1.5.5-1. T2 starts.
7. The SS waits for random access requests information from the UE to perform cell re-selection to an already detected cell, Cell 2.
8. If the UE responds to higher priority Cell 2 during time duration T2 within 85 seconds from the beginning of time period T2, then count a success for the event “Re-select higher priority Cell 2”. Otherwise count a fail for the event “Re-select higher priority Cell 2”
9. If the UE has re-selected Cell 2 within T2, after the re-selection or when T2 expires, continue with step 10. Otherwise, if T2 expires and the UE has not yet re-selected Cell 2, the TE shall switch off and on the UE and continue with step 10.
10. Ensure the UE is in state RRC\_IDLE with generic procedure parameters Connectivity NR, Connected without release *On* and Test Mode *On* according to TS 38.508-1 [14] clause 4.5.

11. Repeat step 2-10 until a test verdict has been achieved.

Each of the events “Re-select lower priority Cell 1” and “Re-select higher priority Cell 2” is evaluated independently for the statistic, resulting in an event verdict: pass or fail. Each event is evaluated only until the confidence level according to Table G.2.3-1 in Annex G clause G.2 is achieved. Different events may require different times for a verdict.

If both events pass, the test passes. If one event fails, the test fails.

7.1.1.5.4.3 Message contents

Message contents are according to TS 38.508-1 [14] clause 7.3 with the following exceptions:

**Table 7.1.1.5.4.3-1: Common Exception messages**

Default Message Contents	
Common contents of system information blocks exceptions	Table H.2.1-1 with Condition SMTC.1 and Synchronous cells  Table H.2.1-2  Table H.2.1-3
Default RRC messages and information elements contents exceptions	

**Table 7.1.1.5.4.3-2: RACH-ConfigGeneric: NR cell re-selection**

Derivation Path: TS 38.508-1 [14], Table 4.6.3-130			
Information Element	Value/remark	Comment	Condition
RACH-ConfigGeneric ::= SEQUENCE {			
prach-ConfigurationIndex	190		
}			

**Table 7.1.1.5.4.3-3: SIB2**

Derivation Path: TS 38.508-1 [14] Table 4.6.2-1			
Information Element	Value/remark	Comment	Condition
SIB2 ::= SEQUENCE {			
relaxedMeasurement-r16 SEQUENCE {			
lowMobilityEvaluation-r16 SEQUENCE {			
s-SearchDeltaP-r16	dB6		
t-SearchDeltaP-r16	s5		
}			
cellEdgeEvaluation-r16	Not present		
combineRelaxedMeasCondition-r16	Not present		
highPriorityMeasRelax-r16	Not present		
}			
}			

7.1.1.5.5 Test requirement

Tables 7.1.1.5.4.1-3 and 7.1.1.5.5-1 define the primary level settings including test tolerances for inter frequency NR cell re-selection test case for UE fulfilling low mobility relaxed measurement criterion.

**Table 7.1.1.5.5-1: Cell specific test parameters for NR SA FR2-FR2 cell re-selection for UE fulfilling low mobility relaxed measurement criterion**

Parameter	Unit	Test configuration	Cell 1		Cell 2	
			T1	T2	T1	T2

TDD configuration		1, 2	TDDConf.3.1		TDDConf.3.1	
PDSCH RMC configuration		1, 2	SR.3.1 TDD		SR.3.1 TDD	
RMSI CORESET parameters		1, 2	CR.3.1 TDD		CR.3.1 TDD	
RMSI CORESET RMC configuration		1, 2	CCR.3.1 TDD		CCR.3.1 TDD	
OCNG Pattern		1, 2	OP.1 defined in A.3.2.1		OP.1 defined in A.3.2.1	
Initial DL BWP configuration		1, 2	DLBWP.0.1		DLBWP.0.1	
Initial UL BWP configuration		1, 2	ULBWP.0.1		ULBWP.0.1	
RLM-RS		1, 2	SSB		SSB	
Qrxlevmin	dBm/SCS	1	-140		-140	
		2	-137		-137	
Pcompensation	dB	1, 2	0		0	
Qhysts	dB	1, 2	0		0	
Qoffset <sub>s, n</sub>	dB	1, 2	0		0	
Cell_selection_and_reselection_quality_measurement		1, 2	SS-RSRP		SS-RSRP	
AoA setup		1, 2	Setup 1 defined in A.3.15.1		Setup 1 defined in A.3.15.1	
Beam assumption <sup>Note 4</sup>		1, 2	Rough		Rough	
$\hat{E}_s / I_{oc}$	dB	1, 2	8	[8]	-3	[8]
$N_{oc}$ <sup>Note2</sup>	dBm/SCS	1	-93		-93	
		2	-90		-90	
$N_{oc}$ <sup>Note2</sup>	dBm/15 kHz	1, 2	-102		-102	
$\hat{E}_s / N_{oc}$	dB	1, 2	8	8	-3	8
SS-RSRP <sup>Note3</sup>	dBm/SCS	1	-85	-85	-96	-85
		2	-82	-82	-93	-82
I <sub>o</sub>	dBm/95.04 MHz	1	-55.37	-55.37	-62.25	-55.37
		2	-52.37	-52.37	-59.25	-52.37
TreselectionNR	s	1, 2	0		0	
SnonintrasearchP	dB	1, 2	50		Not sent	
S <sub>SearchDeltaP</sub>	dB	1, 2	6		6	
T <sub>SearchDeltaP</sub>	s	1, 2	5		5	
Thresh <sub>x, high</sub>	dB	1, 2	48		48	
Thresh <sub>serv, low</sub>	dB	1, 2	44		44	
Thresh <sub>x, low</sub>	dB	1, 2	50		50	
Propagation Condition		1, 2	AWGN		AWGN	
<p>Note 1: OCNG shall be used such that both cells are fully allocated and a constant total transmitted power spectral density is achieved for all OFDM symbols.</p> <p>Note 2: Interference from other cells and noise sources not specified in the test is assumed to be constant over subcarriers and time and shall be modelled as AWGN of appropriate power for <math>N_{oc}</math> to be fulfilled.</p> <p>Note 3: SS-RSRP levels have been derived from other parameters for information purposes. They are not settable parameters themselves.</p> <p>Note 4: Information about types of UE beam is given in B.2.1.3, and does not limit UE implementation or test system implementation</p>						

The cell reselection delay to an already detected low priority cell (Cell 1) for UE fulfilling low mobility criterion is defined as the time from the beginning of time period T1, to the moment when the UE camps on Cell 1, and starts to send preambles on the PRACH for sending the *RRCSetupRequest* message to perform a Tracking Area Update procedure on Cell 1.

The cell re-selection delay to an already detected high priority cell, Cell 2, shall be less than 79 s.

The cell reselection delay to an already detected high priority cell (Cell 2) for UE fulfilling low mobility criterion is defined as the time from the beginning of time period T2, to the moment when the UE camps on Cell 2, and starts to send preambles on the PRACH for sending the *RRCSetupRequest* message to perform a Tracking Area Update procedure on Cell 2.

The cell re-selection delay to an already detected high priority cell, Cell 2, shall be less than [79] s.

NOTE 1: The cell re-selection delay to an already detected low priority cell can be expressed as:  $T_{\text{evaluate, NR\_inter}} + T_{\text{SI-NR}}$

NOTE 2: The cell re-selection delay to an already detected higher priority cell can be expressed as:  $T_{\text{evaluate, NR\_inter}} + T_{\text{SI-NR}}$

Where:

$T_{\text{evaluate, NR\_inter}}$  as specified in TS 38.133 Table 4.2.2.10.2-1 in clause 4.2.2.10.2

$T_{\text{SI-NR}}$  Maximum repetition period of relevant system info blocks that needs to be received by the UE to camp on a cell; 1280 ms is assumed in this test case.

This gives a total of 78.08 s, allow 79 s for the cell re-selection delay to an already detected low priority cell for UE fulfilling low mobility criterion in the test case.

This gives a total of 78.08 s, allow 79 s for the cell re-selection delay to an already detected high priority cell for UE fulfilling low mobility criterion in the test case.

For the test to pass, both events above shall pass.

The statistical pass/fail decisions are done separated for each event. For an event to pass, the total number of successful loops shall be more than 90% of the cases with a confidence level of 95%.

### 7.1.1.6 NR SA FR2-FR2 cell re-selection for UE fulfilling not-at-cell edge relaxed measurement criterion

**Editor's note: This test case is incomplete. The following aspects are either missing or not yet determined:**

- **The Test tolerances and Test system uncertainties applicable to this test are undefined.**

#### 7.1.1.6.1 Test purpose

The purpose of this test is to verify the requirement for the inter frequency NR cell reselection requirements when UE fulfils the not-at-cell edge relaxed measurement criterion specified in TS 38.133 clause 4.2.2.10.

#### 7.1.1.6.2 Test applicability

This test applies to all types of NR UE from Release 16 onwards supporting relaxed RRM measurement.

#### 7.1.1.6.3 Minimum conformance requirements

The minimum conformance requirements are specified in clause 7.1.1.0.4.

The normative reference for this requirement is TS 38.133 [6] clause A.7.1.1.6.

#### 7.1.1.6.4 Test description

##### 7.1.1.6.4.1 Initial conditions

This test shall be run in one of the configurations defined in Table 7.1.1.6.4.1-1.

**Table 7.1.1.6.4.1-1: Supported test configurations for NR SA FR2-FR2 cell re-selection for UE fulfilling not-at-cell edge relaxed measurement criterion**

Configuration	Description
7.1.1.6-1	120 kHz SSB SCS, 100 MHz bandwidth, TDD duplex mode
7.1.1.6-2	240 kHz SSB SCS, 100 MHz bandwidth, TDD duplex mode
Note: The UE is only required to be tested in one of the supported test configurations.	

Configure the test equipment and the DUT according to the parameters in Table 7.1.1.6.4.1-2.

**Table 7.1.1.6.4.1-2: Initial conditions for NR SA FR2-FR2 cell re-selection for UE fulfilling not-at-cell edge relaxed measurement criterion**

Parameter	Value		Comment
Test environment	NC		As specified in TS 38.508-1 [14] clause 4.1.
Test frequencies	As specified in Annex E, table E.4-1 and TS 38.508-1 [14] clause 4.3.1.		
Channel bandwidth	As specified by the test configuration selected from Table 7.1.1.6.4.1-1.		
Propagation conditions	AWGN		As specified in Annex C.2.2.
Connection Diagram	TE Part	A.3.1.6.1	As specified in TS 38.508-1 [14] Annex A.
	DUT Part	A.3.2.3.2	
Exceptions to connection diagram	N/A		

1. The general test parameter settings are set up according to Table 7.1.1.6.4.1-3.
2. Message contents are defined in clause 7.1.1.6.4.3.
3. There is one NR carrier and 2 NR Cells specified in the test. Cell 1 is the PCell and Cell 2 is the neighbour cell. Cell 1 and Cell 2 are configured according to Annex C.1.1 and C.1.2.

**Table 7.1.1.6.4.1-3: General test parameters for NR SA FR2-FR2 cell re-selection for UE fulfilling not-at-cell edge relaxed measurement criterion**

Parameter		Unit	Test configuration	Value	Comment
Initial condition	Active cell		1, 2	Cell2	The UE camps on cell2 and fulfils not-at-cell edge ( <i>cellEdgeEvaluation</i> [2]) criterion.
	Neighbour cell		1, 2	Cell1	
T1 final condition	Active cell		1, 2	Cell1	The UE reselects to low priority cell1 during T1
	Neighbour cell		1, 2	Cell2	
T2 final condition	Active cell		1, 2	Cell2	The UE reselects to high priority cell2 during T2
	Neighbour cell		1, 2	Cell1	
RF Channel Number			1, 2	1, 2	
Time offset between cells			1, 2	3 $\mu$ s	Synchronous cells
Access Barring Information		-	1, 2	Not Sent	No additional delays in random access procedure.
SSB configuration			1	SSB.1 FR2	
			2	SSB.2 FR2	

SMTC configuration		1, 2	SMTC pattern 1	
DRX cycle length	s	1, 2	0.64	The value shall be used for all cells in the test.
PRACH configuration index		1, 2	190	The detailed configuration is specified in TS 38.211 clause 6.3.3.2
rangeToBestCell		1, 2	Not configured	
T1	s	1, 2	85	T1 needs to be long enough to allow cell re-selection to already known cell.
T2	s	1, 2	85	T2 needs to be long enough to allow cell re-selection to already known cell.

#### 7.1.1.6.4.2 Test procedure

The test consists of one active cell and one neighbour cell. The UE is requested to monitor the neighbouring cell on one of the NR carriers. The test consists of two successive time periods, with time duration of T1, T2 respectively. Both Cell 1 and Cell 2 are already identified by the UE prior to the start of the test. Cell 1 and Cell 2 belong to different tracking areas and Cell 2 is of higher priority than Cell 1.

The UE is configured only not-at-cell edge criterion defined in clause 5.2.4.9.1 in TS 38.304 [30]. So, Cell 1 configures the UE as follows:

- *lowMobilityEvaluation* [2] is not configured;
- *cellEdgeEvaluation* [2] is configured according to the parameters listed in Table 7.1.1.6.5-1;
- *combineRelaxedMeasCondition* [2] is not configured

In the following test procedure “UE responds” means “UE starts transmitting preamble on PRACH for sending the RRC SETUP REQUEST message to perform a Registration procedure for mobility.

1. Ensure the UE is in state RRC\_IDLE with generic procedure parameters Connectivity NR, Connected without release *On* and Test Mode *On* according to TS 38.508-1 [14] clause 4.5.
2. Set the parameters according to T1 in Table 7.1.1.6.5-1. T1 starts.
3. The SS waits for random access requests information from the UE to perform cell re-selection to Cell 1.
4. If the UE responds on lower priority Cell 1 during time duration T1 within 85 seconds from the beginning of time period T1, then count a success for the event “Re-select lower priority Cell 1”. Otherwise count a fail for the event “Re-select lower priority Cell 1”
5. If the UE has re-selected Cell 1 within T1, after the re-selection or when T1 expires, continue with step 6. Otherwise, if T1 expires and the UE has not yet re-selected Cell 1, the TE shall switch off and on the UE and skip to step 10.
- 5a The SS shall send an RRCConnectionRelease to ensure that the UE is in state RRC\_IDLE.
6. The SS shall switch the power setting from T1 to T2 as specified in Table 7.1.1.6.5-1. T2 starts.
7. The SS waits for random access requests information from the UE to perform cell re-selection to an already detected cell, Cell 2.
8. If the UE responds to higher priority Cell 2 during time duration T2 within 85 seconds from the beginning of time period T2, then count a success for the event “Re-select higher priority Cell 2”. Otherwise count a fail for the event “Re-select higher priority Cell 2”
9. If the UE has re-selected Cell 2 within T2, after the re-selection or when T2 expires, continue with step 10. Otherwise, if T2 expires and the UE has not yet re-selected Cell 2, the TE shall switch off and on the UE and continue with step 10.
10. Ensure the UE is in state RRC\_IDLE with generic procedure parameters Connectivity NR, Connected without release *On* and Test Mode *On* according to TS 38.508-1 [14] clause 4.5.



11. Repeat step 2-10 until a test verdict has been achieved.

Each of the events “Re-select lower priority Cell 1” and “Re-select higher priority Cell 2” is evaluated independently for the statistic, resulting in an event verdict: pass or fail. Each event is evaluated only until the confidence level according to Table G.2.3-1 in Annex G clause G.2 is achieved. Different events may require different times for a verdict.

If both events pass, the test passes. If one event fails, the test fails.

7.1.1.6.4.3 Message contents

Message contents are according to TS 38.508-1 [14] clause 7.3 with the following exceptions:

**Table 7.1.1.6.4.3-1: Common Exception messages**

Default Message Contents	
Common contents of system information blocks exceptions	Table H.2.1-1 with Condition SMTC.1 and Synchronous cells  Table H.2.1-2  Table H.2.1-3
Default RRC messages and information elements contents exceptions	

**Table 7.1.1.6.4.3-2: RACH-ConfigGeneric: NR cell re-selection**

Derivation Path: TS 38.508-1 [14], Table 4.6.3-130			
Information Element	Value/remark	Comment	Condition
RACH-ConfigGeneric ::= SEQUENCE {			
prach-ConfigurationIndex	190		
}			

**Table 7.1.1.6.4.3-3: SIB2**

Derivation Path: TS 38.508-1 [14] Table 4.6.2-1			
Information Element	Value/remark	Comment	Condition
SIB2 ::= SEQUENCE {			
relaxedMeasurement-r16 SEQUENCE {			
lowMobilityEvaluation-r16	Not present		
cellEdgeEvaluation-r16 SEQUENCE {			
s-SearchThresholdP-r16	35		
}			
combineRelaxedMeasCondition-r16	Not present		
highPriorityMeasRelax-r16	Not present		
}			
}			

7.1.1.6.5 Test requirement

Tables 7.1.1.6.4.1-3 and 7.1.1.6.5-1 define the primary level settings including test tolerances for inter frequency NR cell re-selection test case for UE fulfilling not-at-cell edge relaxed measurement criterion.

**Table 7.1.1.6.5-1: Cell specific test parameters for NR SA FR2-FR2 cell re-selection for UE fulfilling not-at-cell edge relaxed measurement criterion**

Parameter	Unit	Test configuration	Cell 1		Cell 2	
			T1	T2	T1	T2

TDD configuration		1, 2	TDDConf.3.1		TDDConf.3.1	
PDSCH RMC configuration		1, 2	SR.3.1 TDD		SR.3.1 TDD	
RMSI CORESET parameters		1, 2	CR.3.1 TDD		CR.3.1 TDD	
RMSI CORESET RMC configuration		1, 2	CCR.3.1 TDD		CCR.3.1 TDD	
OCNG Pattern		1, 2	OP.1 defined in A.3.2.1		OP.1 defined in A.3.2.1	
Initial DL BWP configuration		1, 2	DLBWP.0.1		DLBWP.0.1	
Initial UL BWP configuration		1, 2	ULBWP.0.1		ULBWP.0.1	
RLM-RS		1, 2	SSB		SSB	
Qrxlevmin	dBm/SCS	1	-140		-140	
		2	-137		-137	
Pcompensation	dB	1, 2	0		0	
Qhysts	dB	1, 2	0		0	
Qoffset <sub>s, n</sub>	dB	1, 2	0		0	
Cell_selection_and_reselection_quality_measurement		1, 2	SS-RSRP		SS-RSRP	
AoA setup		1, 2	Setup 1 defined in A.3.15.1		Setup 1 defined in A.3.15.1	
Beam assumption <sup>Note 4</sup>		1, 2	Rough		Rough	
$\hat{E}_s / I_{oc}$	dB	1, 2	8	8	-3	8
$N_{oc}$ <sup>Note2</sup>	dBm/SCS	1	-93		-93	
		2	-90		-90	
$N_{oc}$ <sup>Note2</sup>	dBm/15 kHz	1, 2	-102		-102	
$\hat{E}_s / N_{oc}$	dB	1, 2	8	8	-3	8
SS-RSRP <sup>Note3</sup>	dBm/SCS	1	-85	-85	-96	-85
		2	-82	-82	-93	-82
I <sub>o</sub>	dBm/95.04 MHz	1	-55.37	-55.37	-62.25	-55.37
		2	-52.37	-52.37	-59.25	-52.37
S <sub>SearchThresholdP</sub>		1, 2	35	35	35	35
T <sub>reselectionNR</sub>	s	1, 2	0		0	
S <sub>nonintrasearchP</sub>	dB	1, 2	50		Not sent	
Thresh <sub>x, high</sub>	dB	1, 2	48		48	
Thresh <sub>serv, low</sub>	dB	1, 2	44		44	
Thresh <sub>x, low</sub>	dB	1, 2	50		50	
Propagation Condition		1, 2	AWGN		AWGN	
<p>Note 1: OCNG shall be used such that both cells are fully allocated and a constant total transmitted power spectral density is achieved for all OFDM symbols.</p> <p>Note 2: Interference from other cells and noise sources not specified in the test is assumed to be constant over subcarriers and time and shall be modelled as AWGN of appropriate power for <math>N_{oc}</math> to be fulfilled.</p> <p>Note 3: SS-RSRP levels have been derived from other parameters for information purposes. They are not settable parameters themselves.</p> <p>Note 4: Information about types of UE beam is given in B.2.1.3, and does not limit UE implementation or test system implementation</p>						

The cell reselection delay to an already detected low priority cell (Cell 1) for UE fulfilling not-at-cell edge criterion is defined as the time from the beginning of time period T1, to the moment when the UE camps on Cell 1, and starts to send preambles on the PRACH for sending the *RRCSetupRequest* message to perform a Tracking Area Update procedure on Cell 1.

The cell re-selection delay to an already detected high priority cell, Cell 2, shall be less than 79 s.

The cell reselection delay to an already detected high priority cell (Cell 2) for UE fulfilling not-at-cell edge criterion is defined as the time from the beginning of time period T2, to the moment when the UE camps on Cell 2, and starts to send preambles on the PRACH for sending the *RRCSetupRequest* message to perform a Tracking Area Update procedure on Cell 2.

The cell re-selection delay to an already detected high priority cell, Cell 2, shall be less than [79] s.

NOTE 1: The cell re-selection delay to an already detected low priority cell can be expressed as:  $T_{\text{evaluate, NR\_inter}} + T_{\text{SI-NR}}$

NOTE 2: The cell re-selection delay to an already detected higher priority cell can be expressed as:  $T_{\text{evaluate, NR\_inter}} + T_{\text{SI-NR}}$

Where:

$T_{\text{evaluate, NR\_inter}}$  as specified in TS 38.133 Table 4.2.2.10.2-1 in clause 4.2.2.10.2

$T_{\text{SI-NR}}$  Maximum repetition period of relevant system info blocks that needs to be received by the UE to camp on a cell; 1280 ms is assumed in this test case.

This gives a total of 78.08 s, allow 79 s for the cell re-selection delay to an already detected low priority cell for UE fulfilling not-at-cell edge criterion in the test case.

This gives a total of 78.08 s, allow 79 s for the cell re-selection delay to an already detected high priority cell for UE fulfilling not-at-cell edge criterion in the test case.

For the test to pass, both events above shall pass.

The statistical pass/fail decisions are done separated for each event. For an event to pass, the total number of successful loops shall be more than 90% of the cases with a confidence level of 95%.

## 7.2 RRC\_INACTIVE state mobility

## 7.3 RRC\_CONNECTED state mobility

### 7.3.1 Handover

#### 7.3.1.4 NR SA FR1-FR2 synchronous DAPS handover

##### Editor's Note:

- This test cases is incomplete since FR1-FR2 OTA testability is still FFS.
- MU and TT analysis is complete for UE PC3 and test frequenc  $f \leq 40.8$  GHz.
- MU and TT analysis is incomplete for test frequency  $f > 40.8$  GHz

MU and TT analysis is incomplete for UE power class other than PC3.7.3.1.4.1 Test purpose

To verify the requirement for the NR FR1-NR FR2 inter-band inter-frequency synchronous DAPS handover requirements in synchronous scenario specified in 38.133 [6] clause 6.1.3.4.

##### 7.3.1.4.2 Test applicability

This test applies to all types of NR UE from Release 16 onwards and support inter-frequency DAPS handover.

##### 7.3.1.4.3 Minimum conformance requirements

The minimum conformance requirements are specified in clause 7.3.1.0.1.

The normative reference for this requirement is TS 38.133 [6] clause A.7.3.1.4.

7.3.1.4.4 Test description

7.3.1.4.4.1 Initial conditions

Initial conditions are a set of test configurations the UE needs to be tested in and the steps for the SS to take with the UE to reach the correct measurement state.

This test shall be tested using any of the test configurations in Table 7.3.1.4.4.1-1.

**Table 7.3.1.4.4.1-1: NR SA FR1-FR2 synchronous DAPS handover test configurations**

Config	Description
7.3.1.4-1	Source cell: NR 15 kHz SSB SCS, 10 MHz bandwidth, FDD duplex mode Target cell: NR 120 kHz SSB SCS, 100 MHz bandwidth, TDD duplex mode
7.3.1.4-2	Source cell: NR 15 kHz SSB SCS, 10 MHz bandwidth, TDD duplex mode Target cell: NR 120 kHz SSB SCS, 100 MHz bandwidth, TDD duplex mode
7.3.1.4-3	Source cell: NR 30 kHz SSB SCS, 40 MHz bandwidth, TDD duplex mode Target cell: NR 120 kHz SSB SCS, 100 MHz bandwidth, TDD duplex mode
Note:	The UE is only required to be tested in one of the supported test configurations

Configure the test equipment and the DUT according to the parameters in Table 7.3.1.4.4.1-2

**Table 7.3.1.4.4.1-2: Initial conditions for NR SA FR1-FR2 synchronous DAPS handover**

Parameter	Value		Comment
Test environment	NC		As specified in TS 38.508-1 [14] clause 4.1.
Test frequencies	As specified in Annex E.1.1, Table E.4-1 and TS 38.508-1 [14] clause 4.3.1.		
Channel bandwidth	As specified by the test configuration selected from Table 7.3.1.4.4.1-1		
Propagation conditions	AWGN		As specified in Annex C.2.2.
Connection Diagram	TE Part	A.3.3.3.1-1	As specified in TS 38.508-1 [14] Annex A.
	DUT Part	A.3.4.1.1	
Exceptions to connection diagram	N/A		

1. Message contents are defined in clause 7.3.1.4.4.3.
2. The power levels and settings for NR FR1 Cell 1 are set according to Annex C.1.2 and C.1.3. Cell 2 is NR FR2 target Cell, and its power levels and settings are also set according to Annex C.1.2 and C.1.3.
3. The test parameters are given in Table 7.3.1.4.4.1-3 below, with A4-Threshold modified by Test Tolerance.

**Table 7.3.1.4.4.1-3: General test parameters for NR SA FR1-FR2 synchronous DAPS handover**

Parameter	Unit	Value	Comment
Initial conditions	Active cell	Cell 1	
	Neighbouring cell	Cell 2	
Final condition	Active cell	Cell 2	
A4-Threshold	dBm	-120	
Hysteresis	dB	0	
Time To Trigger	s	0	
Filter coefficient		0	L3 filtering is not used
Access Barring Information	-	Not Sent	No additional delays in random access procedure.
Time offset between cells	µs	33	Synchronous cells
T1	s	5	
T2	s	<5	
T3	s	<0.5	
T4	ms	10+T <sub>interrupt2</sub>	T <sub>interrupt2</sub> as defined in 38.133 [6] Table 6.1.3.4.2-2 for synchronous DAPS HO
T5	ms	100	

#### 7.3.1.4.4.2 Test procedure

The test scenario comprises of two NR carriers each with one cell. NR Cell 1 is the source PCell on a FR1 carrier and NR Cell 2 is the target PCell on a FR2 carrier. General parameters for Cell 1 and Cell 2 are given in Table 7.3.1.4.4.1-3 and Table 7.3.1.4.4.1-4 respectively.

The test consists of five successive time periods, with time durations of T1, T2, T3, T4 and T5 respectively.

Before the start of T1, the UE is connected to the Cell 1 and not aware of the Cell 2. During T1, the UE does not have any timing information of the Cell 2.

Before the start of T2, the UE is configured with event A4 triggered measurement reporting on target carrier and measurement gaps (gap pattern ID # 0). From start of T2, the Cell 2 becomes detectable. The UE performs cell detection and measurements on the Cell 2 and shall send event report to the network. After receiving the event report A4, the network sends a RRC message implying DAPS handover command for target cell addition to the UE.

T3 starts from the instant when the test system receives the ACK of the PDSCH corresponding to the last TTI containing DAPS handover command for target cell addition sent to the UE. During T3, UE shall be able to perform random access, DL schedule and UL feedback to cell 1 shall be avoided when UE is required to perform DL reception or UL transmission in PRACH procedure in cell 2, except preamble transmission. After successful RACH procedure on the Cell 2, UE is scheduled with PDSCH from Cell 1 and Cell 2 in alternative TTIs. In the end of T3 the network sends a RRC message implying DAPS handover command for source cell release to the UE. During T3, the handover delay  $D_{\text{handover}1}$  for target cell addition need to be verified.

T4 starts from the instant when the test system receives the ACK of the PDSCH corresponding to the last TTI containing DAPS handover command for source cell release sent to the UE. During T4, the UE shall accomplish the release actions within  $D_{\text{handover}2}$

From start of T5, the UE shall stop sending periodical CSI report on Cell 1.

1. Ensure the UE is in State RRC\_CONNECTED with generic procedure parameters Connectivity NR, Connected without release *On* according to TS 38.508-1 [14] clause 4.5. Establish SRB2 and DRB in the RRC Reconfiguration message. Cell 1 is the active cell. Set Cell 2 physical cell identity to the initial physical cell identity.
2. Set the parameters according to T1 in Table 7.3.1.4.5-1 and Table 7.3.1.4.5-2 respectively. Propagation conditions are set according to Annex C clause C.2.2. T1 starts and the SS starts continuously scheduling the UE to perform DL reception in every DL slot on Cell 1 and monitoring corresponding ACK/NACK feedbacks sent by the UE.
3. Set Cell 2 physical cell identity = ((current cell 2 physical cell identity + 1) mod 14 + 2).
4. The SS shall transmit an *RRCReconfiguration* message to configure event A4 triggered measurement reporting on the inter-frequency carrier and periodical CSI reporting on Cell 1.
5. The UE shall transmit an *RRCReconfigurationComplete* message.
6. When T1 expires, the SS shall switch the power setting from T1 to T2 as specified in Table 7.3.1.4.5-1 and Table 7.3.1.4.5-2 respectively.
7. UE shall transmit a *MeasurementReport* message triggered by Event A4.
8. SS shall transmit an *RRCReconfiguration* with *reconfigurationWithSync* message which reconfiguring DRB as a DAPS radio bearer to the UE, at that instant the SS receives the ACK of the PDSCH corresponding to the *RRCReconfiguration* with *reconfigurationWithSync* message the SS shall switch the power settings from T2 to T3 as specified in Table 7.3.1.4.5-1 and Table 7.3.1.4.5-2. T3 starts and the SS stops scheduling the UE to perform DL reception on Cell 1.
9. If the UE transmits PRACH preamble to Cell 2 within  $D_{\text{handover}1}$  from the beginning of time period T3 then the number of successful tests is increased by one, continue to step 10. Otherwise, the number of failure tests is increased by one, go to step 17. where:
  - $D_{\text{handover}1} = 92$  ms.
10. The UE transmits an *RRCReconfigurationComplete* message on Cell 2.

11. Upon receiving *RRCReconfigurationComplete* message sent by UE, the SS immediately starts scheduling UE to perform DL reception in Cell 1 and Cell 2 in an alternative manner, and monitoring corresponding ACK/NACK feedbacks sent by the UE.
12. Upon T3 expiring, the SS immediately transmit an *RRCReconfiguration* with *daps-SourceRelease-r16 = true* on Cell 2 to the UE. T4 starts when the SS receives the ACK of the PDSCH corresponding to the *RRCReconfiguration* with *daps-SourceRelease-r16 = true*.
13. The UE transmits an *RRCReconfigurationComplete* message on Cell 2.
14. When T4 expires, T5 starts.
15. If
  - a) The UE can report ACK/NACK from the first DL reception scheduled on Cell 2 after the beginning of time period T5,
  - and
  - b) The UE doesn't send periodical CSI report during entire time period T5.
 then the number of successful tests is increased by one. Otherwise, the number of failure tests is increased by one.
16. After T5 expires, the SS sends an *RRCReconfiguration* with *reconfigurationWithSync* to cause UE handover back to Cell 1.
17. If UE is not in state RRC\_CONNECTED with generic procedure parameters Connectivity NR, Connected without release *On* according to TS 38.508-1 [14] clause 4.5 on Cell 1, switch off and on the UE. Then ensure the UE is in State RRC\_CONNECTED with generic procedure parameters Connectivity NR, Connected without release *On* according to TS 38.508-1 [14] clause 4.5 on Cell 1.
18. Repeat steps 2-17 until the confidence level according to Tables G.2.3-1 in Annex G clause G.2 is achieved.

7.3.1.4.4.3 Message contents

Message contents are according to TS 38.508-1 [14] clause 7.3 with the following exceptions:

**Table 7.3.1.4.4.3-1: RRCReconfiguration (Step 4)**

Derivation Path: TS 38.508-1 [14], 4.6.1-13 with condition NR_MEAS			
Information Element	Value/remark	Comment	Condition
RRCReconfiguration ::= SEQUENCE {			
criticalExtensions CHOICE {			
rrcReconfiguration SEQUENCE {			
measConfig	MeasConfig	Table 7.3.1.4.4.3-3	
nonCriticalExtension SEQUENCE {			
masterCellGroup SEQUENCE {			
spCellConfigDedicated	ServingCellConfig	Table 7.3.1.4.4.3-2	
}			
}			
}			
}			
}			

**Table 7.3.1.4.4.3-2: ServingCellConfig (Table 7.3.1.4.4.3-1)**

Derivation Path: TS 38.508-1 [14], Table 4.6.3-167 with condition MEAS			
Information Element	Value/remark	Comment	Condition
ServingCellConfig ::= SEQUENCE {			
csi-MeasConfig	CSI-MeasConfig for RRM Specified in TS 38.508-1 [14] Table 7.3.1-6		
}			

**Table 7.3.1.4.4.3-3: MeasConfig (Table 7.3.1.4.4.3-1)**

Derivation path: Table H.3.1-2 with condition INTER-FREQ			
Information Element	Value/Remark	Comment	Condition
measConfig ::= SEQUENCE {			
reportConfigToAddModList SEQUENCE(SIZE (1..maxReportConfigId)) OF SEQUENCE {	1 entry		
reportConfig[1] CHOICE {			
reportConfigNR	ReportConfigNR(-120) specified in Table H.3.1-4AA	Actual value of A4-threshold is -120dBm	
}			
}			
}			

**Table 7.3.1.4.4.3-4: MeasurementReport (Step 7)**

Derivation Path: TS 38.508-1 [14], Table 4.6.1-5A			
Information Element	Value/remark	Comment	Condition
MeasurementReport ::= SEQUENCE {			
criticalExtensions CHOICE {			
measurementReport SEQUENCE {			
measResults	MeasResults specified in Table H.3.1-7 with condition INTER-FREQ		
}			
}			
}			

**Table 7.3.1.4.4.3-5: RRCReconfiguration (Step 8)**

Derivation Path: TS 38.508-1 [4], Table 4.8.1-1A with Condition RBConfig_NoKeyChange			
Information Element	Value/remark	Comment	Condition
RRCReconfiguration ::= SEQUENCE {			
criticalExtensions CHOICE {			
rrcReconfiguration SEQUENCE {			
radioBearerConfig	RadioBearerConfig	Table 7.3.1.4.4.3-6	
nonCriticalExtension SEQUENCE{			
masterCellGroup	CellGroupConfig	Table 7.3.1.4.4.3-7	
}			
}			
}			
}			

**Table 7.3.1.4.4.3-6: RadioBearerConfig (Table 7.3.1.4.4.3-5)**

Derivation Path: TS 38.508-1 [14], Table 4.6.3-132 with condition DRB1			
Information Element	Value/remark	Comment	Condition
RadioBearerConfig ::= SEQUENCE {			
drb-ToAddModList SEQUENCE (SIZE (1..maxDRB))	1 entry		
OF DRB-ToAddMod {			
DRB-ToAddMod[1] SEQUENCE {		entry 1	
drb-Identity	DRB-Identity using condition DRBn	DRB #n is a DRB established before DAPS HO.  Actual value of n is left to TE implementation	
}			
}			
daps-Config-r16	true		
}			
}			
}			

**Table 7.3.1.4.4.3-7: CellGroupConfig (Table 7.3.1.4.4.3-6)**

Derivation Path: TS 38.508-1 [14], Table 4.6.3-19 with condition PCell_change			
Information Element	Value/remark	Comment	Condition
CellGroupConfig ::= SEQUENCE {			
rlc-BearerToAddModList	Not present		
spCellConfig SEQUENCE {			
reconfigurationWithSync SEQUENCE {			
spCellConfigCommon SEQUENCE {			
physCellId	PhysCellId for Cell 2		
}			
}			
}			
}			
}			

**Table 7.3.1.4.4.3-8: RRCReconfiguration (Step 12)**

Derivation Path: TS 38.508-1 [14], Table 4.6.1-13 with condition DAPS_HO_ReleaseSource			
--	--	--	--

#### 7.3.1.4.5 Test requirements

Table 7.3.1.4.5-1 and Table 7.3.1.4.5-2 defines the primary level settings including test tolerances for all tests.



**Table 7.3.1.4.5-1: Cell specific test parameters for NR SA FR1-FR2 synchronous DAPS handover (Cell 1 in FR1)**

Parameter		Unit	Cell 1				
			T1	T2	T3	T4	T5
NR RF Channel Number			1				
Duplex mode	Config 1		FDD				
	Config 2,3		TDD				
TDD configuration	Config 1		Not Applicable				
	Config 2		TDDConf.1.1				
	Config 3		TDDConf.2.1				
BW <sub>channel</sub>	Config 1	MHz	10: N <sub>RB,c</sub> = 52				
	Config 2		10: N <sub>RB,c</sub> = 52				
	Config 3		40: N <sub>RB,c</sub> = 106				
BWP BW	Config 1	MHz	10: N <sub>RB,c</sub> = 52				
	Config 2		10: N <sub>RB,c</sub> = 52				
	Config 3		40: N <sub>RB,c</sub> = 106				
TRS configuration	Config 1		TRS.1.1 FDD				
	Config 2		TRS.1.1 TDD				
	Config 3		TRS.1.2 TDD				
DRx Cycle		ms	Not Applicable				
PDSCH Reference measurement channel	Config 1		SR.1.1 FDD				
	Config 2		SR.1.1 TDD				
	Config 3		SR2.1 TDD				
CORESET Reference Channel	Config 1		CR.1.1 FDD				
	Config 2		CR.1.1 TDD				
	Config 3		CR2.1 TDD				
OCNG Patterns			OCNG pattern 1				
SSB Configuration	Config 1,2		SSB.1 FR1				
	Config 3		SSB.2 FR1				
SMTc Configuration	Config 1,2		SMTc.1				
	Config 3		SMTc.2				
PDSCH/PDCCH subcarrier spacing	Config 1,2	kHz	15 kHz				
	Config 3		30 kHz				
PUCCH/PUSCH subcarrier spacing	Config 1,2	kHz	15 kHz				
	Config 3		30 kHz				
PRACH configuration			FR1 PRACH configuration 2				
BWP	Initial DL BWP		DLBWP.0.1				
	Dedicated DL BWP		DLBWP.1.3				
	Initial UL BWP		ULBWP.0.1				
	Dedicated UL BWP		ULBWP.1.3				
EPRE ratio of PSS to SSS		dB	0				
EPRE ratio of PBCH DMRS to SSS							
EPRE ratio of PBCH to PBCH DMRS							
EPRE ratio of PDCCH DMRS to SSS							
EPRE ratio of PDCCH to PDCCH DMRS							
EPRE ratio of PDSCH DMRS to SSS							
EPRE ratio of PDSCH to PDSCH							
EPRE ratio of OCNG DMRS to SSS(Note 1)							
EPRE ratio of OCNG to OCNG DMRS (Note 1)							
$N_{oc}$ <sup>Note2</sup>		dBm/15kHz z	NA Link only, see clause A.3.7A				
$N_{oc}$ <sup>Note2</sup>	Config 1,2	dBm/SCS					
	Config 3						
$\hat{E}_s/I_{ot}$		dB					
$\hat{E}_s/N_{oc}$		dB					
$I_o$ <sup>Note3</sup>	Config 1,2	dBm/ 9.36MHz					
	Config 3	dBm/ 38.16MHz					
Propagation condition		-	AWGN				

- |         |  |
|---------|--|
| Note 1: | OCNG shall be used such that the cell is fully allocated and a constant total transmitted power spectral density is achieved for all OFDM symbols.   |
| Note 2: | Interference from other cells and noise sources not specified in the test is assumed to be constant over subcarriers and time and shall be modelled as AWGN of appropriate power for $N_{oc}$ to be fulfilled. |
| Note 3: | Io levels have been derived from other parameters for information purposes. They are not settable parameters themselves.   |

**Table 7.3.1.4.5-2: Cell specific test parameters for NR SA FR1-FR2 synchronous DAPS handover (Cell 2 in FR2)**

Parameter		Unit	Cell 2				
			T1	T2	T3	T4	T5
Assumption for UE beams <sup>Note 6</sup>			Rough				
AoA setup			Setup 1 as defined in A.3.15				
NR RF Channel Number			2				
Duplex mode	Config 1,2,3		TDD				
TDD configuration	Config 1,2,3		TDDConf.3.1				
BW <sub>channel</sub>	Config 1,2,3	MHz	100: N <sub>RB,c</sub> = 66				
BWP BW	Config 1,2,3	MHz	100: N <sub>RB,c</sub> = 66				
TRS configuration	Config 1,2,3		TRS.2.1 TDD				
DRX Cycle		ms	Not Applicable				
PDSCH Reference measurement channel	Config 1,2,3		SR3.1 TDD				
CORESET Reference Channel	Config 1,2,3		CR3.1 TDD				
OCNG Patterns			OCNG pattern 1				
SSB Configuration	Config 1,2,3		SSB.1 FR2				
SMTTC Configuration			SMTTC.1				
PDSCH/PDCCH subcarrier spacing	Config 1,2,3	kHz	120 kHz				
PUCCH/PUSCH subcarrier spacing	Config 1,2,3	kHz	120 kHz				
PRACH configuration			FR2 PRACH configuration 2				
TCI configuration			CSI-RS.Config.0				
BWP	Initial DL BWP		DLBWP.0.1				
	Dedicated DL BWP		DLBWP.1.3				
	Initial UL BWP		ULBWP.0.1				
	Dedicated UL BWP		ULBWP.1.3				
EPRE ratio of PSS to SSS		dB	0				
EPRE ratio of PBCH DMRS to SSS							
EPRE ratio of PBCH to PBCH DMRS							
EPRE ratio of PDCCH DMRS to SSS							
EPRE ratio of PDCCH to PDCCH DMRS							
EPRE ratio of PDSCH DMRS to SSS							
EPRE ratio of PDSCH to PDSCH							
EPRE ratio of OCNG DMRS to SSS(Note 1)							
EPRE ratio of OCNG to OCNG DMRS (Note 1)							
$N_{oc}$ <sup>Note2</sup>							
$N_{oc}$ <sup>Note2</sup>		dBm/SCS	-95.7	-95.7	-95.7	-95.7	-95.7
$\hat{E}_s / I_{ot}$		dB	-Infinity	10	10	10	10
$\hat{E}_s / N_{oc}$		dB	-Infinity	10	10	10	10
$I_o$ <sup>Note3</sup>		dBm/9.36MHz	-66.7	-55.4	-55.4	-55.4	-55.4
Propagation condition		-	AWGN				
<p>Note 1: OCNG shall be used such that the cell is fully allocated and a constant total transmitted power spectral density is achieved for all OFDM symbols.</p> <p>Note 2: Interference from other cells and noise sources not specified in the test is assumed to be constant over subcarriers and time and shall be modelled as AWGN of appropriate power for <math>N_{oc}</math> to be fulfilled.</p> <p>Note 3: <math>I_o</math> levels have been derived from other parameters for information purposes. They are not settable parameters themselves.</p> <p>Note 4: Equivalent power received by an antenna with 0 dBi gain at the centre of the quiet zone</p> <p>Note 5: As observed with 0 dBi gain antenna at the centre of the quiet zone.</p> <p>Note 6: Information about types of UE beam is given in 38.133 [6] B.2.1.3, and does not limit UE implementation or test system implementation.</p>							

The UE shall start to transmit the PRACH to Cell 2 less than  $D_{\text{handover1}}$  from the beginning of time period T3. The interruption on Cell 1 shall not exceed  $T_{\text{interrupt1}}$  as defined in TS 38.133 [6] Table 6.1.3.4.2-1 for synchronous DAPS HO. The rate of correct handovers observed during repeated tests shall be at least 90%, where:

$$D_{\text{handover1}} = T_{\text{RRC\_procedure}} + T_{\text{search}} + T_{\text{IU}} + T_{\text{processing}} + T_{\Delta} + T_{\text{margin}}$$

- $T_{\text{RRC\_procedure}} = 10$  ms, is the RRC procedure delay specified in 38.331 [13] clause 12;
- $T_{\text{search}} = 0$  ms for known target cell, is the the time required to search the target cell specified in 38.133 [6] clause 6.1.1.2.2;
- $T_{\text{IU}} = 20$  ms, is the interruption uncertainty in acquiring the first available PRACH occasion in the new cell specified in 38.133 [6] clause 6.1.1.2.2.
- $T_{\text{processing}} = 40$  ms, is the time for UE processing specified in 38.133 [6] clause 6.1.1.2.2.
- $T_{\Delta} = 20$  ms, is the time for fine time tracking and acquiring full timing information of the target cell specified in 38.133 [6] clause 6.1.1.2.2.
- $T_{\text{margin}} = 2$  ms, is the time for SSB post-processing specified in 38.133 [6] clause 6.1.1.2.2.

This gives a total of 92 ms.

After successful RACH to cell 2 and until the start of time period T4, UE shall be able to receive PDSCH alternatively from Cell 1 and Cell 2. UE is not expected to transmit UL to both cell 1 and cell 2 in the same TTI.

The UE shall release Cell 1 less than  $D_{\text{handover2}}$  from the beginning of time period T4, where:

$$D_{\text{handover2}} = T_{\text{RRC\_procedure}} + T_{\text{interrupt2}}$$

- $T_{\text{RRC\_procedure}} = 10$  ms, is the RRC procedure delay specified in 38.331 [13] clause 12;
- $T_{\text{interrupt2}} = 1.125$  ms for sync intra-frequency DAPS handover, is the allowed interruption length during  $D_{\text{handover2}}$  as in 38.133 [13] clause 6.1.1.2.2;

This gives a total of 11.125 ms.

UE shall not report CSI to Cell 1 during T5.

### 7.3.1.5 NR SA FR1-FR2 asynchronous DAPS handover

#### Editor's Note:

- This test cases is incomplete since FR1-FR2 OTA testability is still FFS.
- MU and TT analysis is complete for UE PC3 and test frequenc  $f \leq 40.8$  GHz.
- MU and TT analysis is incomplete for test frequency  $f > 40.8$  GHz
- MU and TT analysis is incomplete for UE power class other than PC3.

#### 7.3.1.5.1 Test purpose

To verify the requirement for the NR FR1-NR FR2 inter-band inter-frequency asynchronous DAPS handover requirements in synchronous scenario specified in 38.133 [6] clause 6.1.3.4.

#### 7.3.1.5.2 Test applicability

This test applies to all types of NR UE from Release 16 onwards and supporting inter-frequency asynchronous DAPS handover and supporting different SCSs in source PCell and inter-frequency target PCell in DAPS handover.

#### 7.3.1.5.3 Minimum conformance requirements

The minimum conformance requirements are specified in clause 7.3.1.0.1.

The normative reference for this requirement is TS 38.133 [6] clause A.7.3.1.5.

7.3.1.5.4 Test description

7.3.1.5.4.1 Initial conditions

Initial conditions are a set of test configurations the UE needs to be tested in and the steps for the SS to take with the UE to reach the correct measurement state.

This test shall be tested using any of the test configurations in Table 7.3.1.5.4.1-1.

**Table 7.3.1.5.4.1-1: NR SA FR1-FR2 asynchronous DAPS handover test configurations**

Config	Description
7.3.1.5-1	Source cell: NR 15 kHz SSB SCS, 10 MHz bandwidth, FDD duplex mode Target cell: NR 120 kHz SSB SCS, 100 MHz bandwidth, TDD duplex mode
7.3.1.5-2	Source cell: NR 15 kHz SSB SCS, 10 MHz bandwidth, TDD duplex mode Target cell: NR 120 kHz SSB SCS, 100 MHz bandwidth, TDD duplex mode
7.3.1.5-3	Source cell: NR 30 kHz SSB SCS, 40 MHz bandwidth, TDD duplex mode Target cell: NR 120 kHz SSB SCS, 100 MHz bandwidth, TDD duplex mode
Note:	The UE is only required to be tested in one of the supported test configurations

Configure the test equipment and the DUT according to the parameters in Table 7.3.1.5.4.1-2

**Table 7.3.1.5.4.1-2: Initial conditions for NR SA FR1-FR2 asynchronous DAPS handover**

Parameter	Value		Comment
Test environment	NC		As specified in TS 38.508-1 [14] clause 4.1.
Test frequencies	As specified in Annex E.1.1, Table E.4-1 and TS 38.508-1 [14] clause 4.3.1.		
Channel bandwidth	As specified by the test configuration selected from Table 7.3.1.5.4.1-1		
Propagation conditions	AWGN		As specified in Annex C.2.2.
Connection Diagram	TE Part	A.3.3.3.1-1	As specified in TS 38.508-1 [14] Annex A.
	DUT Part	A.3.4.1.1	
Exceptions to connection diagram	N/A		

1. Message contents are defined in clause 7.3.1.5.4.3.
2. The power levels and settings for NR FR1 Cell 1 are set according to Annex C.1.2 and C.1.3. Cell 2 is NR FR2 target Cell, and its power levels and settings are also set according to Annex C.1.2 and C.1.3.
3. The test parameters are given in Table 7.3.1.5.4.1-3 below, with A4-Threshold modified by Test Tolerance.

**Table 7.3.1.5.4.1-3: General test parameters for NR SA FR1-FR2 asynchronous DAPS handover**

Parameter	Unit	Value	Comment
Initial conditions	Active cell	Cell 1	
	Neighbouring cell	Cell 2	
Final condition	Active cell	Cell 2	
A4-Threshold	dBm	-120	
Hysteresis	dB	0	
Time To Trigger	s	0	
Filter coefficient		0	L3 filtering is not used
Access Barring Information	-	Not Sent	No additional delays in random access procedure.
Time offset between cells	µs	62.5	Asynchronous cells
T1	s	5	
T2	s	<5	
T3	s	<0.5	
T4	ms	10+T <sub>interrupt2</sub>	T <sub>interrupt2</sub> as defined in Table 6.1.3.4.2-2 for asynchronous DAPS HO.
T5	ms	100	

7.3.1.5.4.2 Test procedure

Same test procedure as described in clause 7.3.1.4.4.2.

7.3.1.5.4.3 Message contents

Same message contents as described in clause 7.3.1.4.4.3.

7.3.1.5.5 Test requirements

Table 7.3.1.5.5-1 and Table 7.3.1.5.5-2 defines the primary level settings including test tolerances for all tests.



**Table 7.3.1.5.5-1: Cell specific test parameters for NR SA FR1-FR2 asynchronous DAPS handover  
(Cell 1 in FR1)**

Parameter		Unit	Cell 1				
			T1	T2	T3	T4	T5
NR RF Channel Number			1				
Duplex mode	Config 1		FDD				
	Config 2,3		TDD				
TDD configuration	Config 1		Not Applicable				
	Config 2		TDDConf.1.1				
	Config 3		TDDConf.2.1				
BW <sub>channel</sub>	Config 1	MHz	10: N <sub>RB,c</sub> = 52				
	Config 2		10: N <sub>RB,c</sub> = 52				
	Config 3		40: N <sub>RB,c</sub> = 106				
BWP BW	Config 1	MHz	10: N <sub>RB,c</sub> = 52				
	Config 2		10: N <sub>RB,c</sub> = 52				
	Config 3		40: N <sub>RB,c</sub> = 106				
TRS configuration	Config 1		TRS.1.1 FDD				
	Config 2		TRS.1.1 TDD				
	Config 3		TRS.1.2 TDD				
DRx Cycle		ms	Not Applicable				
PDSCH Reference measurement channel	Config 1		SR.1.1 FDD				
	Config 2		SR.1.1 TDD				
	Config 3		SR2.1 TDD				
CORESET Reference Channel	Config 1		CR.1.1 FDD				
	Config 2		CR.1.1 TDD				
	Config 3		CR2.1 TDD				
OCNG Patterns			OCNG pattern 1				
SSB Configuration	Config 1,2		SSB.1 FR1				
	Config 3		SSB.2 FR1				
SMTc Configuration	Config 1,2		SMTc.1				
	Config 3		SMTc.2				
PDSCH/PDCCH subcarrier spacing	Config 1,2	kHz	15 kHz				
	Config 3		30 kHz				
PUCCH/PUSCH subcarrier spacing	Config 1,2	kHz	15 kHz				
	Config 3		30 kHz				
PRACH configuration			FR1 PRACH configuration 2				
BWP	Initial DL BWP		DLBWP.0.1				
	Dedicated DL BWP		DLBWP.1.3				
	Initial UL BWP		ULBWP.0.1				
	Dedicated UL BWP		ULBWP.1.3				
EPRE ratio of PSS to SSS		dB	0				
EPRE ratio of PBCH DMRS to SSS							
EPRE ratio of PBCH to PBCH DMRS							
EPRE ratio of PDCCH DMRS to SSS							
EPRE ratio of PDCCH to PDCCH DMRS							
EPRE ratio of PDSCH DMRS to SSS							
EPRE ratio of PDSCH to PDSCH							
EPRE ratio of OCNG DMRS to SSS(Note 1)							
EPRE ratio of OCNG to OCNG DMRS (Note 1)							
$N_{oc}^{Note2}$		dBm/15kHz	NA				
$N_{oc}^{Note2}$	Config 1,2	dBm/SCS	Link only, see clause A.3.7A				
	Config 3						
$\hat{E}_s / I_{ot}$		dB					
$\hat{E}_s / N_{oc}$		dB					
$I_o^{Note3}$	Config 1,2	dBm/9.36MHz					
	Config 3	dBm/38.16MHz					

Propagation condition	-	AWGN
Note 1:	OCNG shall be used such that the cell is fully allocated and a constant total transmitted power spectral density is achieved for all OFDM symbols.	
Note 2:	Interference from other cells and noise sources not specified in the test is assumed to be constant over subcarriers and time and shall be modelled as AWGN of appropriate power for $N_{oc}$ to be fulfilled.	
Note 3:	Io levels have been derived from other parameters for information purposes. They are not settable parameters themselves.	

**Table 7.3.1.5.5-2: Cell specific test parameters for NR SA FR1-FR2 asynchronous DAPS handover (Cell 2 in FR2)**

Parameter	Unit	Cell 2				
		T1	T2	T3	T4	T5

Assumption for UE beams <sup>Note 6</sup>			Rough				
AoA setup			Setup 1 as defined in A.3.15				
NR RF Channel Number			2				
Duplex mode	Config 1,2,3		TDD				
TDD configuration	Config 1,2,3		TDDConf.3.1				
BW <sub>channel</sub>	Config 1,2,3	MHz	100: N <sub>RB,c</sub> = 66				
BWP BW	Config 1,2,3	MHz	100: N <sub>RB,c</sub> = 66				
TRS configuration	Config 1,2,3		TRS.2.1 TDD				
DRX Cycle		ms	Not Applicable				
PDSCH Reference measurement channel	Config 1,2,3		SR3.1 TDD				
CORESET Reference Channel	Config 1,2,3		CR3.1 TDD				
OCNG Patterns			OCNG pattern 1				
SSB Configuration	Config 1,2,3		SSB.1 FR2				
SMTC Configuration			SMTC.1				
PDSCH/PDCCH subcarrier spacing	Config 1,2,3	kHz	120 kHz				
PUCCH/PUSCH subcarrier spacing	Config 1,2,3	kHz	120 kHz				
PRACH configuration			FR2 PRACH configuration 2				
TCI configuration			CSI-RS.Config.0				
BWP	Initial DL BWP		DLBWP.0.1				
	Dedicated DL BWP		DLBWP.1.3				
	Initial UL BWP		ULBWP.0.1				
	Dedicated UL BWP		ULBWP.1.3				
EPRE ratio of PSS to SSS		dB	0				
EPRE ratio of PBCH DMRS to SSS							
EPRE ratio of PBCH to PBCH DMRS							
EPRE ratio of PDCCH DMRS to SSS							
EPRE ratio of PDCCH to PDCCH DMRS							
EPRE ratio of PDSCH DMRS to SSS							
EPRE ratio of PDSCH to PDSCH							
EPRE ratio of OCNG DMRS to SSS(Note 1)							
EPRE ratio of OCNG to OCNG DMRS (Note 1)							
$N_{oc}$ <sup>Note2</sup>							
$N_{oc}$ <sup>Note2</sup>		dBm/SCS	-95.7	-95.7	-95.7	-95.7	-95.7
$\hat{E}_s / I_{ot}$		dB	-Infinity	10	10	10	10
$\hat{E}_s / N_{oc}$		dB	-Infinity	10	10	10	10
$I_o$ <sup>Note3</sup>		dBm/9.36MHz	-66.7	-55.4	-55.4	-55.4	-55.4
Propagation condition		-	AWGN				
<p>Note 1: OCNG shall be used such that the cell is fully allocated and a constant total transmitted power spectral density is achieved for all OFDM symbols.</p> <p>Note 2: Interference from other cells and noise sources not specified in the test is assumed to be constant over subcarriers and time and shall be modelled as AWGN of appropriate power for <math>N_{oc}</math> to be fulfilled.</p> <p>Note 3: <math>I_o</math> levels have been derived from other parameters for information purposes. They are not settable parameters themselves.</p> <p>Note 4: Equivalent power received by an antenna with 0 dBi gain at the centre of the quiet zone</p> <p>Note 5: As observed with 0 dBi gain antenna at the centre of the quiet zone.</p> <p>Note 6: Information about types of UE beam is given in B.2.1.3, and does not limit UE implementation or test system implementation.</p>							

Same Test requirements as described in clause 7.3.1.4.5.

## 7.3.2 RRC connection mobility control

### 7.3.2.1 RRC re-establishment

#### 7.3.2.1.0 Minimum conformance requirements

In RRC\_CONNECTED state the UE shall be capable of sending *RRCReestablishmentRequest* message within  $T_{\text{re-establish\_delay}}$  seconds from the moment it detects a loss in RRC connection. The total RRC connection delay ( $T_{\text{re-establish\_delay}}$ ) shall be less than:

$$T_{\text{re-establish\_delay}} = T_{\text{UE\_re-establish\_delay}} + T_{\text{UL\_grant}}$$

$T_{\text{UL\_grant}}$ : It is the time required to acquire and process uplink grant from the target PCell. The uplink grant is required to transmit *RRCReestablishmentRequest* message.

The UE re-establishment delay ( $T_{\text{UE\_re-establish\_delay}}$ ) is the time between the moments when any of the conditions requiring RRC re-establishment as defined in clause 5.3.7 in TS 38.331 [2] is detected by the UE and when the UE sends PRACH to the target PCell. The UE re-establishment delay ( $T_{\text{UE\_re-establish\_delay}}$ ) requirement shall be less than:

$$T_{\text{UE\_re-establish\_delay}} = 50\text{ms} + T_{\text{identify\_intra\_NR}} + \sum_{i=1}^{N_{\text{freq}}-1} T_{\text{identify\_inter\_NR},i} + T_{\text{SI-NR}} + T_{\text{PRACH}}$$

The intra-frequency target NR cell shall be considered detectable when for each relevant SSB can satisfy that:

- SS-RSRP related side conditions given in Section 10.1.2 and 10.1.3 are fulfilled for a corresponding NR Band for FR1 and FR2, respectively,
- the conditions of SSB\_RP and SSB  $\hat{E}_s/I_{ot}$  according to Annex B.2.2 for a corresponding NR Band are fulfilled.

The inter-frequency target NR cell shall be considered detectable when for each relevant SSB:

- SS-RSRP related side conditions given in Section 10.1.4 and 10.1.5 are fulfilled for a corresponding NR Band for FR1 and FR2, respectively,
- the conditions of SSB\_RP and SSB  $\hat{E}_s/I_{ot}$  according to Annex B.2.2 for a corresponding NR Band are fulfilled.

$T_{\text{identify\_intra\_NR}}$ : It is the time to identify the target intra-frequency NR cell and it depends on whether the target NR cell is known cell or unknown cell and on the frequency range (FR) of the target NR cell. If the UE is not configured with intra-frequency NR carrier for RRC re-establishment then  $T_{\text{identify\_intra\_NR}}=0$ ; otherwise  $T_{\text{identify\_intra\_NR}}$  shall not exceed the values defined in table 6.2.1.2.1-1.

$T_{\text{identify\_inter\_NR},i}$ : It is the time to identify the target inter-frequency NR cell on inter-frequency carrier  $i$  configured for RRC re-establishment and it depends on whether the target NR cell is known cell or unknown cell and on the frequency range (FR) of the target NR cell.  $T_{\text{identify\_inter\_NR},i}$  shall not exceed the values defined in table 6.2.1.2.1-2.

$T_{\text{SMTC}}$ : It is the periodicity of the SMTC occasion configured for the intra-frequency carrier. If the UE has been provided with higher layer in TS 38.331 [2] signalling of *smtc2*,  $T_{\text{smtc}}$  follows *smtc1* or *smtc2* according to the physical cell ID of the target cell.

$T_{\text{SMTC},i}$ : It is the periodicity of the SMTC occasion configured for the inter-frequency carrier  $i$ . If it is not configured, the UE may assume that the target SSB periodicity is no larger than 20 ms.

$T_{\text{SI-NR}}$  = It is the time required for receiving all the relevant system information according to the reception procedure and the RRC procedure delay of system information blocks defined in TS 38.331 [2] for the target NR cell.

$T_{\text{PRACH}}$  = It is the delay uncertainty in acquiring the first available PRACH occasion in the target NR cell.  $T_{\text{PRACH}}$  can be up to the summation of SSB to PRACH occasion association period and 10 ms. SSB to PRACH occasion associated period is defined in the table 8.1-1 of TS 38.213 [3].

$N_{\text{freq}}$ : It is the total number of NR frequencies to be monitored for RRC re-establishment;  $N_{\text{freq}} = 1$  if the target intra-frequency NR cell is known, else  $N_{\text{freq}} = 2$  and  $T_{\text{identify\_intra\_NR}} = 0$  if the target inter-frequency NR cell is known.

There is no requirement if the target cell does not contain the UE context.

**Table 6.2.1.2.1-1: Time to identify target NR cell for RRC connection re-establishment to NR intra-frequency cell**

Serving cell SSB $\hat{E}_s/\text{lot}$ (dB)	Frequency range (FR) of target NR cell	$T_{\text{identify\_intra\_NR}}$ (ms)	
		Known NR cell	Unknown NR cell
$\geq -8$	FR1	MAX (200 ms, $5 \times T_{\text{SMTc}}$ )	MAX (800 ms, $10 \times T_{\text{SMTc}}$ )
$\geq -8$	FR2	N/A	MAX (1000 ms, $80 \times T_{\text{SMTc}}$ )
$< -8$	FR1	N/A	800 <sup>Note1</sup>
$< -8$	FR2	N/A	3520 <sup>Note1</sup>

Note 1: The UE is not required to successfully identify a cell on any NR frequency layer when  $T_{\text{SMTc}} > 20$  ms and serving cell SSB  $\hat{E}_s/\text{lot} < [-8]$  dB.

**Table 6.2.1.2.1-2: Time to identify target NR cell for RRC connection re-establishment to NR inter-frequency cell**

Serving cell SSB $\hat{E}_s/\text{lot}$ (dB)	Frequency range (FR) of target NR cell	$T_{\text{identify\_inter\_NR}, i}$ (ms)	
		Known NR cell	Unknown NR cell
$\geq -8$	FR1	MAX (200 ms, $6 \times T_{\text{SMTc}, i}$ )	MAX (800 ms, $13 \times T_{\text{SMTc}, i}$ )
$\geq -8$	FR2	N/A	MAX (1000 ms, $104 \times T_{\text{SMTc}, i}$ )
$< -8$	FR1	N/A	800 <sup>Note1</sup>
$< -8$	FR2	N/A	4000 <sup>Note1</sup>

Note 1: The UE is not required to successfully identify a cell on any NR frequency layer when  $T_{\text{SMTc}, i} > 20$  ms and serving cell SSB  $\hat{E}_s/\text{lot} < -8$  dB.

The normative reference for this requirement is TS 38.133 [6] clause 6.2.1.

### 7.3.2.1.1 NR SA FR2 RRC re-establishment

**Editor's Note: This test case has been completed for the following configurations:**

- Test frequency  $f \leq 40.8$  GHz
- UE PC3
- The test is incomplete for UE power classes other than PC3
- The test is incomplete for test frequencies  $> 40.8$  GHz

#### 7.3.2.1.1.1 Test purpose

The purpose of this test is to verify that the NR intra-frequency RRC re-establishment delay in FR2 without known target cell is within the specified limits.

#### 7.3.2.1.1.2 Test applicability

This test applies to all types of NR UE from Release 15 onwards.

#### 7.3.2.1.1.3 Minimum conformance requirement

The minimum conformance requirements are specified in clause 7.3.2.1.0

The normative reference for this requirement is TS 38.133 [6] clause A.7.3.2.1.1

#### 7.3.2.1.1.4 Test description

##### 7.3.2.1.1.4.1 Initial conditions

This test shall be tested using any of the test configurations in Table 7.3.2.1.1.4.1-1. Configure the test equipment and the DUT according to the parameters in Table 7.3.2.1.1.4.1-2. Test environment parameters are given in Table 7.3.2.1.1.4.1-3.

**Table 7.3.2.1.1.4.1-1: Intra-frequency RRC re-establishment in FR2 supported test configurations**

Config	Description
1	NR 120 kHz SSB SCS, 100MHz bandwidth, TDD duplex mode
Note: The UE is only required to be tested in one of the supported test configurations depending on UE capability	

**Table 7.3.2.1.1.4.1-2: General test parameters for Intra-frequency RRC re-establishment in FR2**

Parameter		Unit	Test configuration	Value	Comment
Initial condition	Active cell		1	Cell1	
	Neighbour cells		1	Cell2	
Final condition	Active cell		1	Cell2	
RF Channel Number			1	1	
Time offset between cells			1	3 $\mu$ s	Synchronous cells
N310		-	1	1	Maximum consecutive out-of-sync indications from lower layers
N311		-	1	1	Minimum consecutive in-sync indications from lower layers
T310		ms	1	0	Radio link failure timer; T310 is disabled
T311		ms	1	5000	RRC re-establishment timer
Access Barring Information		-	1	Not Sent	No additional delays in random access procedure.
SSB configuration			1	SSB.1 FR2	
SMTC configuration			1	SMTC.1	
DRX cycle length		s	1	OFF	
PRACH configuration			1	PRACH.1 FR2	As specified in Annex A.7
T1		s	1	5	
T2		s	1	4.84	Time for the UE to detect RLF (Summation of $T_{Evaluate\_out\_SSB}$ defined in clause 8.1 in TS 38.133, T310 and the period for UE turns off transmitter defined in clause 8.1.5 in TS 38.133)
T3		s	1	5	

**Table 7.3.2.1.1.4.1-3: Test Environment Intra-frequency RRC re-establishment in FR2**

Parameter	Value		Comment
Test environment	NC		As specified in TS 38.508-1 [14] clause 4.1.
Test frequencies	As specified in Annex E, Table E.5.1 and TS 38.508-1 [14] clause 4.3.1 and 4.4.2		
Channel bandwidth	As specified by the test configuration selected from Table 7.3.2.1.1.4.1-1		
Propagation conditions	AWGN		As specified in Annex C.2.2.
Connection Diagram	TE Part	A.3.3.3.1	As specified in TS 38.508-1 [14] Annex A.
	DUT Part	A.3.4.1.1	
Exceptions to connection diagram			

1. Message contents are defined in clause 7.3.2.1.1.4.3.
2. There is one NR carrier and two cells specified in the test. Cell 1 is the cell used for registration with the power level set according to Annex C.1.1 and C.1.2 for this test.
3. The AoA setup for this test is Setup 1 as defined in clause A.9

7.3.2.1.1.4.2 Test procedure

The test consists of 3 successive time periods, with time duration of T1, T2 and T3 respectively. At the start of time period T2, cell 1, which is the active cell, becomes inactive. The time period T3 starts after the occurrence of the radio link failure.

1. Ensure the UE is in RRC\_CONNECTED state with generic procedure parameters Connectivity NR, Connected without release On according to TS 38.508-1 [14] clause 4.5.
2. Set the parameters according to T1 in Table 7.3.2.1.1.5-1. T1 starts.
3. SS shall transmit an RRCReconfiguration message.
4. The UE shall transmit RRCReconfigurationComplete message.
5. When T1 expires, the SS shall switch the power setting from T1 to T2 as specified in Table 7.3.2.1.1.5-1. T2 starts
6. When T2 expires, the SS shall switch the power setting from T2 to T3 as specified in Table 7.3.2.1.1.5-1. T3 starts
7. If the UE starts to send PRACH preambles to cell 2 for sending the RRCReestablishmentRequest message to cell 2 within 3 s from the beginning of time period T3, then the number of successful tests is increased by one. Otherwise, the number of failure tests is increased by one.
8. After T3 expires, cause UE handover back to Cell 1 (if the handover fails, switch off the UE) or switch off the UE. Then ensure the UE is in state RRC\_CONNECTED with generic procedure parameters Connectivity NR, Connected without release On according to TS 38.508-1 [14] clause 4.5. Cell 1 is the active cell.
9. Set cell 2 physical cell identity = ((current cell 2 physical cell identity + 1) mod 1008) for next iteration of the test procedure loop.
10. Repeat step 2-9 until the confidence level according to Table G.2.3-1 in Annex G clause G.2 is achieved.

7.3.2.1.1.4.3 Message contents

Message contents are according to TS 38.508-1 [14] clause 7.3 with the following exceptions:

**Table 7.3.2.1.1.4.3-1: Common Exception messages for NR intra-frequency RRC re-establishment test case in FR2**

Default Message Contents	
Common contents of system information blocks exceptions	
Default RRC messages and information elements contents exceptions	Table H.3.5-9 with condition SSB RLM

**Table 7.3.2.1.1.4.3-2: RLF-TimersAndConstants for intra-frequency RRC re-establishment**

Derivation Path: TS 38.508-1 [14], Table 4.6.3-150			
Information Element	Value/remark	Comment	Condition
RLF-TimersAndConstants ::= SEQUENCE {			
t310	ms0		
t311	ms5000		
}			



Table 7.3.2.1.1.4.3-3: *MeasConfig* for intra-frequency RRC re-establishment

Derivation Path: TS 38.508-1 [14], Table 4.6.3-69			
Information Element	Value/remark	Comment	Condition
MeasConfig::= SEQUENCE {			
reportConfigToAddModList	Not present		
measIdToAddModList	Not present		
quantityConfig	Not present		
}			

## 7.3.2.1.1.5 Test requirement

Table 7.3.2.1.1.5-1 defines the primary level settings including test tolerances for all tests.

Table 7.3.2.1.1.5-1: Cell specific test parameters for NR intra-frequency RRC re-establishment test case in FR2

Parameter	Unit	Test configuration	Cell 1			Cell 2		
			T1	T2	T3	T1	T2	T3
Assumption for UE beams <sup>Note 4</sup>			Rough			Rough		
TDD configuration		1	TDDConf.3.1			TDDConf.3.1		
BW <sub>channel</sub>	MHz	1	100: N <sub>RB,c</sub> = 66			100: N <sub>RB,c</sub> = 66		
Data RBs allocated		1	66			66		
PDSCH RMC configuration		1	SR.3.1 TDD			N/A		
RMSI CORESET RMC configuration		1	CR.3.1 FDD			CR.3.1 FDD		
Dedicated CORESET RMC configuration		1	CCR.3.1 FDD			CCR.3.1 FDD		
TRS configuration		1	TRS.2.1 TDD			N/A		
PDSCH/PDCCH TCI state		1	TCI.State.2			N/A		
OCNG Pattern		1	OP.1			OP.1		
Initial DL BWP configuration		1	DLBWP.0.1			DLBWP.0.1		
Initial UL BWP configuration		1	ULBWP.0.1			ULBWP.0.1		
RLM-RS		1	SSB			SSB		
AoA setup		1	Setup 1			Setup 1		
$\hat{E}_s / I_{ot}$	dB	1	-0.12	-infinity	-infinity	-3.46	2	2
$N_{oc}$ <sup>Note2</sup>	dBm/SCS	1	-104.7					
$N_{oc}$ <sup>Note2</sup>	dBm/15 kHz	1	-95.7					
$\hat{E}_s / N_{oc}$	dB	1	4	-infinity	-infinity	2	2	2
SS-RSRP <sup>Note3</sup>	dBm/SCS	1	-91.7	-infinity	-infinity	-93.7	-93.7	-93.7
Io	dBm/95.04 MHz	1	-59.64	-62.59	-62.59	-59.94	-62.59	-62.59
Propagation Condition		1	AWGN					
Note 1: OCNG shall be used such that both cells are fully allocated and a constant total transmitted power spectral density is achieved for all OFDM symbols.								
Note 2: Interference from other cells and noise sources not specified in the test is assumed to be constant over subcarriers and time and shall be modelled as AWGN of appropriate power for $N_{oc}$ to be fulfilled.								
Note 3: SS-RSRP levels have been derived from other parameters for information purposes. They are not settable parameters themselves.								
Note 4: Information about types of UE beam is given in TS 38.133 in Annex B.2.1.3, and does not limit UE implementation or test system implementation								

The RRC re-establishment delay is defined as the time from the start of time period T3, to the moment when the UE starts to send PRACH preambles to cell 2 for sending the *RRCReestablishmentRequest* message to cell 2.

The RRC re-establishment delay to an unknown NR intra frequency cell shall be less than 5 s.

The rate of correct RRC re-establishments observed during repeated tests shall be at least 90% with a confidence level of 95%.

### 7.3.2.1.2 NR SA FR2 - FR2 RRC re-establishment

**Editor's Note:** This test case has been completed for the following configurations:

- Test frequency  $f \leq 40.8$  GHz
- UE PC3
- The test is incomplete for UE power classes other than PC3
- The test is incomplete for test frequencies  $> 40.8$  GHz

#### 7.3.2.1.2.1 Test purpose

The purpose of this test is to verify that the NR inter-frequency RRC re-establishment delay in FR2 without known target cell is within the specified limits.

#### 7.3.2.1.2.2 Test applicability

This test applies to all types of NR UE from Release 15 onwards.

#### 7.3.2.1.2.3 Minimum conformance requirement

The minimum conformance requirements are specified in clause 7.3.2.1.0

The normative reference for this requirement is TS 38.133 [6] clause A.7.3.2.1.2

#### 7.3.2.1.2.4 Test description

##### 7.3.2.1.2.4.1 Initial conditions

This test shall be tested using any of the test configurations in Table 7.3.2.1.2.4.1-1. Configure the test equipment and the DUT according to the parameters in Table 7.3.2.1.2.4.1-2. Test environment parameters are given in Table 7.3.2.1.2.4.1-3.

**Table 7.3.2.1.2.4.1-1: Inter-frequency RRC re-establishment in FR2 supported test configurations**

Config	Description
1	NR 120 kHz SSB SCS, 100MHz bandwidth, TDD duplex mode
Note: The UE is only required to be tested in one of the supported test configurations depending on UE capability	

**Table 7.3.2.1.2.4.1-2: General test parameters for Inter-frequency RRC re-establishment in FR2**

Parameter		Unit	Test configuration	Value	Comment
Initial condition	Active cell		1	Cell1	
	Neighbour cells		1	Cell2	
Final condition	Active cell		1	Cell2	
RF Channel Number			1	1, 2	
Time offset between cells			1	3 $\mu$ s	Synchronous cells
N310		-	1	1	Maximum consecutive out-of-sync indications from lower layers
N311		-	1	1	Minimum consecutive in-sync indications from lower layers
T310		ms	1	0	Radio link failure timer; T310 is disabled
T311		ms	1	5000	RRC re-establishment timer
Access Barring Information		-	1	Not Sent	No additional delays in random access procedure.
SSB configuration			1	SSB.1 FR2	
SMTC configuration			1	SMTC.1	
DRX cycle length		s	1	OFF	
PRACH configuration			1	PRACH.1 FR2	As specified in Annex A.7
T1		s	1	5	
T2		s	1	4.84	Time for the UE to detect RLF (Summation of T <sub>Evaluate_out_SSB</sub> defined in clause 8.1 in TS 38.133, T310 and the period for UE turns off transmitter defined in clause 8.1.5 in TS 38.133 )
T3		s	1	6	

**Table 7.3.2.1.2.4.1-3: Test Environment Inter-frequency RRC re-establishment in FR2**

Parameter	Value		Comment
Test environment	NC		As specified in TS 38.508-1 [14] clause 4.1.
Test frequencies	As specified in Annex E, Table FFS and TS 38.508-1 [14] clause 4.3.1 and 4.4.2		
Channel bandwidth	As specified by the test configuration selected from Table 7.3.2.1.2.4.1-1		
Propagation conditions	AWGN		As specified in Annex C2.2
Connection Diagram	TE Part	A.3.3.3.1	As specified in TS 38.508-1 [14] Annex A.
	DUT Part	A.3.4.1.1	
Exceptions to connection diagram			

1. Message contents are defined in clause 7.3.2.1.2.4.3
2. There are two cells on two NR carriers specified in the test. Cell 1 is the cell used for registration with the power level set according to Annex C.1.1 and C.1.2 for this test.
3. The AoA setup for this test is Setup 1 as defined in clause A.9

#### 7.3.2.1.2.4.2 Test procedure

The test consists of 3 successive time periods, with time duration of T1, T2 and T3 respectively. At the start of time period T2, cell 1, which is the active cell, becomes inactive. The time period T3 starts after the occurrence of the radio link failure. During T1, the UE shall be configured with the carrier frequency of cell 2 (with RF Channel Number #2) to ensure that the UE has the context of the carrier frequency of cell 2 by the end of T1.

1. Ensure the UE is in RRC\_CONNECTED state with generic procedure parameters Connectivity NR, Connected without release *On* according to TS 38.508-1 [14] clause 4.5.

2. Set the parameters according to T1 in Table 7.3.2.1.2.5-1. T1 starts.
3. SS shall transmit an RRCReconfiguration message.
4. The UE shall transmit RRCReconfigurationComplete message.
5. When T1 expires, the SS shall switch the power setting from T1 to T2 as specified in Table 7.3.2.1.2.5-1. T2 starts
6. When T2 expires, the SS shall switch the power setting from T2 to T3 as specified in Table 7.3.2.1.2.5-1. T3 starts
7. If the UE starts to send PRACH preambles to cell 2 for sending the *RRCReestablishmentRequest* message to cell 2 within 6 seconds from the beginning of time period T3, then the number of successful tests is increased by one. Otherwise, the number of failure tests is increased by one.
8. After T3 expires, cause UE handover back to Cell 1 (if the handover fails, switch off the UE) or switch off the UE. Then ensure the UE is in state RRC\_CONNECTED with generic procedure parameters Connectivity NR, Connected without release *On* according to TS 38.508-1 [14] clause 4.5. Cell 1 is the active cell.
9. Set cell 2 physical cell identity = ((current cell 2 physical cell identity + 1) mod 1008) for next iteration of the test procedure loop.
10. Repeat step 2-9 until the confidence level according to Table G.2.3-1 in Annex G clause G.2 is achieved.

7.3.2.1.2.4.3 Message contents

Same message content as in 7.3.2.1.1.4.3. Table 7.3.2.1.2.4.3-1: Void

**Table 7.3.2.1.2.4.3-2: RLF-TimersAndConstants for intra-frequency RRC re-establishment**

Derivation Path: TS 38.508-1 [14], Table 4.6.3-150			
Information Element	Value/remark	Comment	Condition
RLF-TimersAndConstants ::= SEQUENCE {			
t310	ms0		
t311	ms5000		
}			

**Table 7.3.2.1.2.4.3-3: MeasConfig for intra-frequency RRC re-establishment**

Derivation Path: TS 38.508-1 [14], Table 4.6.3-69			
Information Element	Value/remark	Comment	Condition
MeasConfig ::= SEQUENCE {			
reportConfigToAddModList	Not present		
measIdToAddModList	Not present		
quantityConfig	Not present		
}			

7.3.2.1.2.5 Test requirement

Table 7.3.2.1.2.5-1 defines the primary level settings including test tolerances for all tests.

**Table 7.3.2.1.2.5-1: Cell specific test parameters for NR intra-frequency RRC re-establishment test case in FR2**

Parameter	Unit	Test configuration	Cell 1			Cell 2		
			T1	T2	T3	T1	T2	T3
Assumption for UE beams <sup>Note 4</sup>			Rough			Rough		
AoA setup		1	Setup 3					
			AoA1			AoA2		
TDD configuration		1	TDDConf.3.1			TDDConf.3.1		
PDSCH RMC configuration		1	SR.3.1 TDD			N/A		
RMSI CORESET RMC configuration		1	CR.3.1 FDD			CR.3.1 FDD		
Dedicated CORESET RMC configuration		1	CCR.3.1 FDD			CCR.3.1 FDD		
TRS configuration		1	TRS.2.1 TDD			N/A		
PDSCH/PDCCH TCI state		1	TCI.State.2			N/A		
OCNG Pattern		1	OP.1			OP.1		
Initial DL BWP configuration		1	DLBWP.0.1			DLBWP.0.1		
Initial UL BWP configuration		1	ULBWP.0.1			ULBWP.0.1		
RLM-RS		1	SSB			SSB		
$\hat{E}_s / I_{ot}$	dB	1	5+TT	-infinity	-infinity	-infinity	-infinity	8+TT
$N_{oc}$ <sup>Note2</sup>	dBm/SCS	1	-98+TT					
$N_{oc}$ <sup>Note2</sup>	dBm/15 kHz	1	-89+TT					
$\hat{E}_s / N_{oc}$	dB	1	5+TT	-infinity	-infinity	-infinity	-infinity	8+TT
SS-RSRP <sup>Note3</sup>	dBm/SCS	1	-84+TT	-infinity	-infinity	-infinity	-infinity	-81+TT
Io	dBm/95.04 MHz	1	-53.82+TT	-infinity	-infinity	-infinity	-infinity	-51.37+TT
Propagation Condition		1	AWGN					
<p>Note 1: OCNG shall be used such that both cells are fully allocated and a constant total transmitted power spectral density is achieved for all OFDM symbols.</p> <p>Note 2: Interference from other cells and noise sources not specified in the test is assumed to be constant over subcarriers and time and shall be modelled as AWGN of appropriate power for <math>N_{oc}</math> to be fulfilled.</p> <p>Note 3: SS-RSRP levels have been derived from other parameters for information purposes. They are not settable parameters themselves.</p> <p>Note 4: Information about types of UE beam is given in B.2.1.3, and does not limit UE implementation or test system implementation</p>								

The RRC re-establishment delay is defined as the time from the start of time period T3, to the moment when the UE starts to send PRACH preambles to cell 2 for sending the *RRCReestablishmentRequest* message to cell 2.

The RRC re-establishment delay to an unknown NR inter frequency cell shall be less than 6 s.

The rate of correct RRC re-establishments observed during repeated tests shall be at least 90% with a confidence level of 95%.

### 7.3.2.1.3 NR SA FR2 RRC re-establishment without serving cell timing

**Editor's note: This test case is incomplete. The following aspects are either missing or not yet determined:**

-The test tolerances and test system uncertainties applicable to this test are undefined.

-Antenna diagram is TBD

-Message content is TBD

7.3.2.1.3.1 Test purpose

The purpose of this test is to verify that the NR intra-frequency RRC re-establishment delay in FR2 without serving cell timing is within the specified limits, and to verify the requirements in TS 38.133 [6] clause 6.2.1

7.3.2.1.3.2 Test applicability

This test applies to all types of NR UE from Release 15 onwards.

7.3.2.1.3.3 Minimum conformance requirement

The minimum conformance requirements are specified in clause 7.3.2.1.0

The normative reference for this requirement is TS 38.133 [6] clause A.7.3.2.1.3

7.3.2.1.3.4 Test description

7.3.2.1.3.4.1 Initial conditions

The test shall be tested using any of the test configuration in Table 7.3.2.1.3.4.1-1.

**Table 7.3.2.1.3.4.1-1: Supported test configurations for NR SA FR2 - FR2 RRC re-establishment without serving cell timing**

Config	Description
1	NR 120 kHz SSB SCS, 100MHz bandwidth, TDD duplex mode
Note: The UE is only required to be tested in one of the supported test configurations depending on UE capability	

Configure the test requirement and the DUT according to the parameters in Table 7.3.2.1.3.4.1-2.

**Table 7.3.2.1.3.4.1-2: Initial conditions for NR SA FR2 - FR2 RRC re-establishment without serving cell timing**

Parameter	Value	Comment
Test environment	NC	As specified in TS 38.508-1 [14] clause 4.1.
Test frequencies	As specified in Annex E, Table E.5.1 and TS 38.508-1 [14] clause 4.3.1 and 4.4.2	
Channel bandwidth	As specified by the test configuration selected from Table 7.3.2.1.3.4.1-1	
Propagation conditions	AWGN	As specified in Annex C.2.2.
Connection Diagram	TE Part	FFS
	DUT Part	FFS
Exceptions to connection diagram		

1. The general test parameter settings are set up according to Table 7.3.2.1.3.4.1-3.
2. Message contents are defined in clause 7.3.2.1.3.4.3.

There is one NR carrier and two cells specified in the test. Cell 1 is the cell used for registration with the power level set according to Annex C.1.1 and C.1.2 for this test.

**Table 7.3.2.1.3.4.1-3: General test parameters for NR SA FR2 - FR2 RRC re-establishment without serving cell timing**

Parameter		Unit	Test configuration	Value	Comment
Initial condition	Active cell		1	Cell1	
	Neighbour cells		1	Cell2	
Final condition	Active cell		1	Cell2	
RF Channel Number			1	1	
Time offset between cells			1	3 $\mu$ s	Synchronous cells
N310		-	1	1	Maximum consecutive out-of-sync indications from lower layers
N311		-	1	1	Minimum consecutive in-sync indications from lower layers
T310		ms	1	6000	Radio link failure timer configured by <i>RLF-TimersAndConstants</i>
T311		ms	1	5000	RRC re-establishment timer
Access Barring Information		-	1	Not Sent	No additional delays in random access procedure.
SSB configuration			1	SSB.1 FR2	
SMTC configuration			1	SMTC pattern 1	
DRX cycle length		s	1	OFF	
PRACH configuration index			1	PRACH.1 FR2	
T1		s	1	5	
T2		s	1	10.84	Time for the UE to detect RLF (Summation of TEvaluate_out_SSB defined in clause 8.1 in TS 38.133 [6], T310 and the period for UE turns off transmitter defined in clause 8.1.5 in TS 38.133 [6])
T3		s	1	5	

#### 7.3.2.1.3.4.2 Test procedure

The test consists of 3 successive time periods, with time duration of T1, T2 and T3 respectively. At the start of time period T2, cell 1, which is the active cell, becomes inactive. The time period T3 starts after the occurrence of the radio link failure.

1. Ensure the UE is in state RRC\_CONNECTED with generic procedure parameters Connectivity NR, Connected without release On and Test Mode On according to TS 38.508-1 [14] clause 4.5.
2. Set the parameters according to T1 in Table 7.3.2.1.3.5-1. T1 starts.
3. SS shall transmit an RRCReconfiguration message.
4. The UE shall transmit RRCReconfigurationComplete message.
5. When T1 expires, the SS shall switch the power setting from T1 to T2 as specified in Table 7.3.2.1.3.5-1. T2 starts
6. When T2 expires, the SS shall switch the power setting from T2 to T3 as specified in Table 7.3.2.1.3.5-1. T3 starts
7. If the UE starts to send PRACH preambles to cell 2 for sending the RRCReestablishmentRequest message to cell 2 within 5 s from the beginning of time period T3, then the number of successful tests is increased by one. Otherwise, the number of failure tests is increased by one.
8. After T3 expires, cause UE handover back to Cell 1 (if the handover fails, switch off the UE) or switch off the UE. Then ensure the UE is in state RRC\_CONNECTED with generic procedure parameters Connectivity NR, Connected without release On and Test Mode On according to TS 38.508-1 [14] clause 4.5. Cell 1 is the active cell.

9. Set cell 2 physical cell identity = ((current cell 2 physical cell identity + 1) mod 14 + 2) for next iteration of the test procedure loop.

10. Repeat step 2-9 until the confidence level according to Table G.2.3-1 in Annex G clause G.2 is achieved.

#### 7.3.2.1.3.4.3 Message contents

Message contents are according to TS 38.508-1 [14] clause 7.3 with the following exceptions:

**Table 7.3.2.1.3.4.3-1: Common Exception messages for NR SA FR2 - FR2 RRC re-establishment without serving cell timing**

Default Message Contents	
Common contents of system information blocks exceptions	FFS
Default RRC messages and information elements contents exceptions	FFS

#### 7.3.2.1.3.5 Test requirement

Table 7.3.2.1.3.5-1 defines the primary level settings including test tolerances for NR SA FR2 - FR2 RRC re-establishment without serving cell timing tests.



**Table 7.3.2.1.3.5-1: Cell specific test parameters for NR SA FR2 - FR2 RRC re-establishment without serving cell timing**

Parameter	Unit	Test configuration	Cell 1			Cell 2		
			T1	T2	T3	T1	T2	T3
Assumption for UE beams <sup>Note 4</sup>			Rough			Rough		
TDD configuration		1	TDDConf.3.1			TDDConf.3.1		
PDSCH RMC configuration		1	SR.3.1 TDD			N/A		
RMSI CORESET RMC configuration		1	CR.3.1 FDD			CR.3.1 FDD		
Dedicated CORESET RMC configuration		1	CCR.3.1 FDD			CCR.3.1 FDD		
TRS configuration		1	TRS.2.1 TDD			N/A		
TCI state		1	CSI-RS.Config.0			N/A		
OCNG Pattern		1	OP.1 defined in A.2.1			OP.1 defined in A.2.1		
Initial DL BWP configuration		1	DLBWP.0.1			DLBWP.0.1		
Initial UL BWP configuration		1	ULBWP.0.1			ULBWP.0.1		
RLM-RS		1	SSB			SSB		
AoA setup		1	Setup 1 defined in A. 9			Setup 1 defined in A.9		
$\hat{E}_s / I_{ot}$	dB	1	5	-infinity	-infinity	-infinity	-infinity	5
$N_{oc}$ <sup>Note2</sup>	dBm/SCS	1	-98					
$N_{oc}$ <sup>Note2</sup>	dBm/15 kHz	1	-89					
$\hat{E}_s / N_{oc}$	dB	1	5	-infinity	-infinity	-infinity	-infinity	5
SS-RSRP <sup>Note3</sup>	dBm/SCS	1	-93	-infinity	-infinity	-infinity	-infinity	-93
Io	dBm/95.04 MHz	1	-62.82	-infinity	-infinity	-infinity	-infinity	-62.82
Propagation Condition		1	AWGN					
Note 1:	OCNG shall be used such that both cells are fully allocated and a constant total transmitted power spectral density is achieved for all OFDM symbols.							
Note 2:	Interference from other cells and noise sources not specified in the test is assumed to be constant over subcarriers and time and shall be modelled as AWGN of appropriate power for $N_{oc}$ to be fulfilled.							
Note 3:	SS-RSRP levels have been derived from other parameters for information purposes. They are not settable parameters themselves.							
Note 4:	Information about types of UE beam is given in TS 38.133 [6] clause B.2.1.3, and does not limit UE implementation or test system implementation							

The RRC re-establishment delay is defined as the time from the start of time period T3, to the moment when the UE starts to send PRACH preambles to cell 2 for sending the *RRCReestablishmentRequest* message to cell 2.

The RRC re-establishment delay to an unknown NR intra frequency cell without serving cell timing shall be less than 5 s.

The rate of correct RRC re-establishments observed during repeated tests shall be at least 90% with a confidence level of 95%.

NOTE: The RRC re-establishment delay in the test is derived from the following expression:

$$T_{\text{re-establish\_delay}} = T_{\text{UL\_grant}} + T_{\text{UE\_re-establish\_delay}}$$

Where:

$T_{\text{UL\_grant}}$  = It is the time required to acquire and process uplink grant from the target cell. The PRACH reception at the system simulator is used as a trigger for the completion of the test; hence  $T_{\text{UL\_grant}}$  is not used.

$$T_{\text{UE\_re-establish\_delay}} = 50 + T_{\text{identify\_intra\_NR}} + \sum_{i=1}^{N_{\text{freq}}-1} T_{\text{identify\_inter\_NR},i} + T_{\text{SI-NR}} + T_{\text{PRACH}}$$

$$N_{\text{freq}} = 1$$

$T_{\text{identify\_intra\_NR}} = 3520$  ms

$T_{\text{SI}} = 1280$  ms; it is the time required for receiving all the relevant system information as defined in TS 38.331 for the target intra-frequency NR cell.

$T_{\text{PRACH}} = 15$  ms; it is the additional delay caused by the random access procedure.

This gives a total of 4865 ms, allow 5 s in the test case.

## 7.3.2.2 Random access

### 7.3.2.2.0 Minimum conformance requirements

#### 7.3.2.2.0.1 Minimum conformance requirements for Contention based random access

The random access procedure is used when establishing the layer 1 communication between the UE and NG-RAN. The random access is as defined in TS 38.213 [8] clause 7.4 and the control of the RACH transmission is as defined in TS 38.321 [12] clause 5.1.

The UE shall have capability to calculate PRACH transmission power according to the PRACH power formula as defined in TS 38.213 [8] clause 7.4 and apply this power level at the first preamble or additional preambles. The absolute power applied to the first preamble shall have an accuracy as defined in TS 38.101-2 [3] Table 6.3.4.2-1. The relative power applied to additional preambles shall have an accuracy as specified in TS 38.101-2 [3] Tables 6.3.4.3-1 and 6.3.4.3-2.

The UE shall indicate a Random Access problem to upper layers if the maximum number of preamble transmission counter has been reached for the random access procedure on PCell or PSCell as specified in TS 38.321 [12] clause 5.1.4.

With the UE selected SSB with SS-RSRP above *rsrp-ThresholdSSB*, UE shall have the capability to select a Random Access Preamble randomly with equal probability from the Random Access Preambles associated with the selected SSB if the association between Random Access Preambles and SS blocks is configured, as specified in clause 5.1.2 in TS 38.321 [12].

With the UE selected SSB with SS-RSRP above *rsrp-ThresholdSSB*, UE shall have the capability to transmit Random Access Preamble on the next available PRACH occasion from the PRACH occasions corresponding to the selected SSB permitted by the restrictions given by the *ra-ssb-OccasionMaskIndex* if configured, if the association between PRACH occasions and SSBs is configured, and PRACH occasion shall be randomly selected with equal probability amongst the selected SSB associated PRACH occasions occurring simultaneously but on different subcarriers, as specified in clause 5.1.2 in TS 38.321 [12].

The UE may stop monitoring for Random Access Response(s) and shall transmit the msg3 if the Random Access Response contains a Random Access Preamble identifier corresponding to the transmitted Random Access Preamble.

The UE shall again perform the Random Access Resource selection procedure defined in clause 5.1.2 in TS 38.321 [12], and transmit with the calculated PRACH transmission power when the backoff time expires if all received Random Access Responses contain Random Access Preamble identifiers that do not match the transmitted Random Access Preamble.

The UE shall again perform the Random Access Resource selection procedure defined in clause 5.1.2 in TS 38.321 [12], and transmit with the calculated PRACH transmission power when the backoff time expires if no Random Access Response is received within the RA Response window defined in clause 5.1.4 in TS 38.321 [12].

The UE shall re-transmit the msg3 upon the reception of an UL grant for msg3 retransmission.

The UE shall send ACK if the Contention Resolution is successful.

The UE shall again perform the Random Access Resource selection procedure defined in clause 5.1.2 in TS 38.321 [12], and transmit with the calculated PRACH transmission power when the backoff time expires unless the received message includes a UE Contention Resolution Identity MAC control element and the UE Contention Resolution Identity included in the MAC control element matches the CCCH SDU transmitted in the uplink message.

The UE shall re-select a preamble and transmit with the calculated PRACH transmission power when the backoff time expires if the Contention Resolution Timer expires.

The normative reference for this requirement is TS 38.133 [6] clause 6.2.2.

#### 7.3.2.2.0.2 Minimum conformance requirements for Non-Contention based random access

The random access procedure is used when establishing the layer 1 communication between the UE and NG-RAN. The random access is as defined in TS 38.213 [8] clause 7.4 and the control of the RACH transmission is as defined in TS 38.321 [12] clause 5.1.

The UE shall have capability to calculate PRACH transmission power according to the PRACH power formula as defined in TS 38.213 [8] clause 7.4 and apply this power level at the first preamble or additional preambles. The absolute power applied to the first preamble shall have an accuracy as defined in TS 38.101-2 [3] Table 6.3.4.2-1. The relative power applied to additional preambles shall have an accuracy as specified in TS 38.101-2 [3] Tables 6.3.4.3-1 and 6.3.4.3-2.

The UE shall indicate a Random Access problem to upper layers if the maximum number of preamble transmission counter has been reached for the random access procedure on PCell or PSCell as specified in TS 38.321 [12] clause 5.1.4.

If the contention-free Random Access Resources and the contention-free PRACH occasions associated with SSBs is configured, with the UE selected SSB with *SS-RSRP* above *rsrp-ThresholdSSB* amongst the associated SSBs, UE shall have the capability to select the Random Access Preamble corresponding to the selected SSB, and to transmit Random Access Preamble on the next available PRACH occasion from the PRACH occasions corresponding to the selected SSB permitted by the restrictions given by the *ra-ssb-OccasionMaskIndex* if configured, and PRACH occasion shall be randomly selected with equal probability amongst the selected SSB associated PRACH occasions occurring simultaneously but on different subcarriers, as specified in clause 5.1.2 in TS 38.321 [12].

If the contention-free Random Access Resources and the contention-free PRACH occasions associated with CSI-RSs is configured, with the UE selected CSI-RS with *CSI-RSRP* above *cfra-csirs-DedicatedRACH-Threshold* amongst the associated CSI-RSs, UE shall have the capability to select the Random Access Preamble corresponding to the selected CSI-RS, and to transmit Random Access Preamble on the next available PRACH occasion from the PRACH occasions in *ra-OccasionList* corresponding to the selected CSI-RS, and PRACH occasion shall be randomly selected with equal probability amongst the selected CSI-RS associated PRACH occasions occurring simultaneously but on different subcarriers, as specified in clause 5.1.2 in TS 38.321 [12].

The UE may stop monitoring for Random Access Response(s), if the Random Access Response contains a Random Access Preamble identifier corresponding to the transmitted Random Access Preamble, unless the random access procedure is initialized for Other SI request from UE.

The UE shall again perform the Random Access Resource selection procedure defined in clause 5.1.2 in TS 38.321 [12] for the next available PRACH occasion, and transmit the preamble with the calculated PRACH transmission power if all received Random Access Responses contain Random Access Preamble identifiers that do not match the transmitted Random Access Preamble.

The UE shall again perform the Random Access Resource selection procedure defined in clause 5.1.2 in TS 38.321 [12] for the next available PRACH occasion, and transmit the preamble with the calculated PRACH transmission power, if no Random Access Response is received within the RA Response window configured in *RACH-ConfigCommon* or if no PDCCH addressed to UE's C-RNTI is received within the RA Response window configured in *BeamFailureRecoveryConfig*, as defined in clause 5.1.4 in TS 38.321 [12].

The normative reference for this requirement is TS 38.133 [6] clause 6.2.2.

Non-contention based random access procedure is not initialized for Other SI requested from UE or for beam failure recovery, so the requirements related to those features are omitted.

#### 7.3.2.2.1 NR SA FR2 contention based random access

**Editor's note: This test case is incomplete. The following aspects are either missing or not yet determined:**

- The settable window for first preamble uplink power and the uplink calibration process are FFS.
- The test requirement for absolute uplink power is FFS.
- The test requirement for relative uplink power is FFS.

- The uncertainty value and test requirement for PRACH timing are in [ ]
- The results of the TT analysis are provisional until the corresponding MU values are agreed
- Antenna diagram and any exceptions are FFS
- Connection setup in Annex C is FFS

#### 7.3.2.2.1.1 Test purpose

The purpose of this test is to verify that the behaviour of the random access procedure is according to the requirements and that the PRACH power settings and timing are within specified limits.

#### 7.3.2.2.1.2 Test applicability

This test applies to all types of NR UE from Release 15 onwards.

#### 7.3.2.2.1.3 Minimum conformance requirement

The minimum conformance requirements are specified in clause 7.3.2.2.0.1.

The normative reference for this requirement is TS 38.133 [6] clause A.7.3.2.2.1.

#### 7.3.2.2.1.4 Test description

##### 7.3.2.2.1.4.1 Initial conditions

This test can be run in the configurations defined in Table 7.3.2.2.1.4.1-1.

**Table 7.3.2.2.1.4.1-1: Contention based random access test in FR2 for NR standalone supported test configurations**

Test Case ID	Test Config Index	Description
7.3.2.2.1-1	1	NR: 120 kHz SSB SCS, 100MHz bandwidth, TDD duplex mode
Note: The UE is only required to be tested in one of the supported test configurations depending on UE capability		

Before the test procedure, Downlink and Uplink calibrations are carried out to derive signalled parameter values. This is necessary to ensure that the test case operates within the specified ranges. The detail of the calibration process is implementation dependent, but shall derive the values of  $\Delta_{DL}$  and  $\Delta_{UL}$  according to the following principles:

With the UE configured to report SS-RSRP, the  $\Delta_{DL}$  value is calculated as  $(RSRP_{REP} - RSRP_{76})$ , where  $RSRP_{REP}$  is the SS-RSRP Reported value according to TS 38.133 [6] Table 10.1.6.1-1 with -80.6dBm/SCS applied at the Reference point. For a Reported value  $RSRP_x$ , x is treated as a positive integer value.

With the UE configured to send a first PRACH preamble,  $\Delta_{UL}$  value is calculated as  $-\text{ROUND}(\text{PPRACH0} - 1)$ , where  $\text{PPRACH0}$  is the measured first PRACH power with -80.6dBm/SCS applied at the Reference point, and with signalled values  $\text{preambleReceivedTargetPower} = -100\text{dBm}$  and  $\text{ss-PBCH-BlockPower} = 20\text{dBm}$ .

Configure the test equipment and the DUT according to the parameters in Table 7.3.2.2.1.4.1-2.

**Table 7.3.2.2.1.4.1-2: Test Environment for Contention based random access test in FR2 for NR standalone**

Parameter	Value		Comment
Test environment	NC		As specified in TS 38.508-1 [14] clause 4.1.
Test frequencies	As specified in Annex E, Table E.5-1 and TS 38.508-1 [14] subclause 4.3.1.		
Channel bandwidth	As specified by the test configuration selected from Table 7.3.2.2.1.4.1-1.		
Propagation conditions	No interference		As specified in Annex C.2.1.
Connection Diagram	TE Part	FFS	As specified in TS 38.508-1 [14] Annex A.
	DUT Part	FFS	
Exceptions to connection diagram	FFS		

1. Message contents are defined in clause 7.3.2.2.1.4.3.
2. Cell 1 is the NR FR2 serving cell (PCell). The connection setup is done according to the settings in FFS.

#### 7.3.2.2.1.4.2 Test procedure

The test consists of a single cell, configured as PCell in FR2. The System Simulator shall not explicitly assign a random access preamble via dedicated signalling in the downlink.

1. Ensure the UE is in state RRC\_IDLE with generic procedure parameters Connectivity *NR* and Test Mode *On* according to TS 38.508-1 [14] clause 4.5.
2. Set the parameters according to Tables 7.3.2.2.1.5-1 and 7.3.2.2.1.5-2.
3. The UE shall establish a connection setup with SS, the random access procedure within the connection setup is used in the test.
4. Test 1: Correct behaviour when transmitting Random Access Preamble
  - 4.1. The UE shall send a preamble to the System Simulator. The System Simulator shall check that the Random Access Preamble belongs to one of the Random Access Preambles associated with the SSB with index 0, which has SS-RSRP above the configured *rsrp-ThresholdSSB*.
5. Test 2: Correct behaviour when receiving Random Access Response
  - 5.1. Repeat steps 1-3.
  - 5.2. The UE shall send preambles to the System Simulator. In response to the first 2 preambles, the System Simulator shall transmit a Random Access Response containing Random Access Preamble identifiers that do not match the transmitted Random Access Preamble.
  - 5.3. As the received Random Access Responses contain Random Access Preamble identifiers that do not match the transmitted Random Access Preamble, the UE shall perform the Random Access Resource selection procedure specified in clause 5.1.2 in TS 38.321 [12], and transmit with the calculated PRACH transmission power when the backoff time expires.
  - 5.4. The System Simulator shall transmit a Random Access Response containing a Random Access Preamble identifier matching the transmitted Random Access Preamble after 3 preambles have been received by the System Simulator.
  - 5.5. As the received Random Access Response contains a Random Access Preamble identifier that matches the transmitted Random Access Preamble, the UE shall transmit the *msg3*.
  - 5.6. Measure the power and timing of the first preamble and it shall not exceed the values specified in 7.3.2.2.1.5. Measure the relative power and timing applied to additional preambles (last 2 preambles) and it shall not exceed the values specified in 7.3.2.2.1.5.
6. Test 3: Correct behaviour when not receiving Random Access Response

- 6.1. Repeat steps 1-3.
  - 6.2. The UE shall send preambles to the System Simulator. The System Simulator shall not respond to the first 2 preambles.
  - 6.3. As no Random Access Response was received within the RA Response window, the UE shall perform the Random Access Resource selection procedure specified in clause 5.1.2 in TS 38.321 [12], and transmit with the calculated PRACH transmission power when the backoff time expires.
  - 6.4. The System Simulator shall transmit a Random Access Response containing a Random Access Preamble identifier matching the transmitted Random Access Preamble after 3 preambles have been received by the System Simulator.
  - 6.5. As the received Random Access Response contains a Random Access Preamble identifier that matches the transmitted Random Access Preamble, the UE shall transmit the msg3.
  - 6.6. Measure the power and timing of the first preamble and it shall not exceed the values specified in 7.3.2.2.1.5. Measure the relative power and timing applied to additional preambles (last 2 preambles) and it shall not exceed the values specified in 7.3.2.2.1.5.
7. Test 4: Correct behaviour when receiving an UL grant for msg3 retransmission
    - 7.1. Repeat steps 1-3.
    - 7.2. The UE shall send a preamble to the System Simulator. The System Simulator shall transmit a Random Access Response containing a Random Access Preamble identifier matching the transmitted Random Access Preamble.
    - 7.3. As the received Random Access Response contains a Random Access Preamble identifier that matches the transmitted Random Access Preamble, the UE shall transmit the msg3.
    - 7.4. The System Simulator shall send PDCCH addressed to the Temporary C-RNTI after receiving the msg3.
    - 7.5. The UE shall re-transmit the msg3.
    - 7.6. The System Simulator shall check if UE re-transmit the msg3.
  8. Test 5: Correct behaviour when receiving an unsuccessful UE Contention Resolution
    - 8.1. Repeat steps 1-3.
    - 8.2. The UE shall send a preamble to the System Simulator. The System Simulator shall transmit a Random Access Response containing a Random Access Preamble identifier matching the transmitted Random Access Preamble.
    - 8.3. As the received Random Access Response contains a Random Access Preamble identifier that matches the transmitted Random Access Preamble, the UE shall transmit the msg3.
    - 8.4. The System Simulator shall send a message addressed to the temporary C-RNTI with a UE Contention Resolution Identity included in the MAC control element not matching the CCCH SDU transmitted in msg3 uplink message.
    - 8.5. As the UE Contention Resolution Identity included in the MAC control element did not match the CCCH SDU transmitted in the uplink message, the UE shall perform the Random Access Resource selection procedure specified in clause 5.1.2 in TS 38.321 [12], and transmit with the calculated PRACH transmission power when the backoff time expires.
    - 8.6. Measure the power and timing of the first preamble and it shall not exceed the values specified in 7.3.2.2.1.5.
  9. Test 6: Correct behaviour when receiving a successful UE Contention Resolution
    - 9.1. Repeat steps 1-3.

- 9.2. The UE shall send a preamble to the System Simulator. The System Simulator shall transmit a Random Access Response containing a Random Access Preamble identifier matching the transmitted Random Access Preamble.
- 9.3. As the received Random Access Response contains a Random Access Preamble identifier that matches the transmitted Random Access Preamble, the UE shall transmit the msg3.
- 9.4. The System Simulator shall send a message addressed to the temporary C-RNTI with a UE Contention Resolution Identity included in the MAC control element matching the CCCH SDU transmitted in msg3 uplink message.
- 9.5. As the UE Contention Resolution Identity included in the MAC control element matches the CCCH SDU, the Contention Resolution is successful and the UE shall send ACK.

10. Test 7: Correct behaviour when contention Resolution timer expires

- 10.1. Repeat steps 1-3.
- 10.2. The UE shall send a preamble to the System Simulator. The System Simulator shall transmit a Random Access Response containing a Random Access Preamble identifier matching the transmitted Random Access Preamble.
- 10.3. As the received Random Access Response contains a Random Access Preamble identifier that matches the transmitted Random Access Preamble, the UE shall transmit the msg3.
- 10.4. The System Simulator shall not send a response.
- 10.5. As there was no response, the UE shall perform the Random Access Resource selection procedure specified in clause 5.1.2 in TS 38.321 [12], and transmit with the calculated PRACH transmission power when the Contention Resolution Timer expires and then after the backoff timer expires.
- 10.6. Measure the power and timing of the first preamble and it shall not exceed the values specified in 7.3.2.2.1.5.

7.3.2.2.1.4.3 Message contents

Message contents are according to TS 38.508-1 [14] clause 4.6 with the following exceptions:

**Table 7.3.2.2.1.4.3-1: FrequencyInfoUL-SIB for Contention Based Random Access**

Derivation Path: TS 38.508-1 [14], table 4.6.3-62			
Information Element	Value/remark	Comment	Condition
FrequencyInfoUL-SIB SEQUENCE {			
p-Max	23	23 dBm	
}			

**Table 7.3.2.2.1.4.3-2: RACH-ConfigCommon for Contention Based Random Access**

Derivation Path: TS 38.508-1 [14], table 4.6.3-128			
Information Element	Value/remark	Comment	Condition
RACH-ConfigCommon ::= SEQUENCE {			
rach-ConfigGeneric	RACH-ConfigGeneric		
totalNumberOfRA-Preambles	48		
ssb-perRACH-OccasionAndCB-PreamblesPerSSB CHOICE {			
oneFourth	n48		FR2
}			
groupBconfigured SEQUENCE {			
numberOfRA-PreamblesGroupA	48		
}			
ra-ContentionResolutionTimer	sf48		
rsrp-ThresholdSSB	RSRP_69 + $\Delta_{DL}$	$\Delta_{DL}$ is derived from the downlink calibration process	
prach-RootSequenceIndex CHOICE {			
0			
}			
msg1-SubcarrierSpacing	kHz 120		
}			

**Table 7.3.2.2.1.4.3-3: RACH-ConfigGeneric for Contention Based Random Access**

Derivation Path: TS 38.508-1 [14], table 4.6.3-130			
Information Element	Value/remark	Comment	Condition
RACH-ConfigGeneric ::= SEQUENCE {			
prach-ConfigurationIndex	190		FR2
msg1-FDM	one		FR2
zeroCorrelationZoneConfig	11		
preambleReceivedTargetPower	-100		
preambleTransMax	n6		
powerRampingStep	dB2		
ra-ResponseWindow	sl10		
}			

**Table 7.3.2.2.1.4.3-4: ServingCellConfigCommonSIB for Contention Based Random Access**

Derivation Path: TS 38.508-1 [14], table 4.6.3-169			
Information Element	Value/remark	Comment	Condition
ServingCellConfigCommonSIB ::= SEQUENCE {			
ssb-PositionsInBurst SEQUENCE {			
inOneGroup	'1100 0000'B		
}			
ss-PBCH-BlockPower	20 + $\Delta_{UL}$	$\Delta_{UL}$ is derived from the uplink calibration process	
}			

#### 7.3.2.2.1.5 Test requirement

Table 7.3.2.2.1.5-2 defines the primary level settings for contention based random access test in FR2 for NR Standalone. Tables 7.3.2.2.1.5-3, 7.3.2.2.1.5-4 and 7.3.2.2.1.5-5 define the Absolute power limits, Relative power limits and uplink timing error limits respectively, and all include test tolerances.



**Table 7.3.2.1.5-1: General test parameters for contention based random access test in FR2 for NR Standalone**

Parameter		Unit	Test-1	Comments
SSB Configuration	Config 1		SSB.1 FR2	As defined in A.3.2
Duplex Mode for Cell 1	Config 1		TDD	
TDD Configuration	Config 1		TDDConf.3.1	As defined in A.1.5
$BW_{channel}$	Config 1	MHz	100: $N_{RB,c} = 24$	
OCNG Pattern <sup>Note 1</sup>			OP.3	As defined in A.2.1
PDSCH Reference Channel <sup>Note 2</sup>	Config 1		SR.3.1 TDD	As defined in A.1.1
RMSI CORESET Reference Channel	Config 1		CR.3.1 TDD	As defined in A.1.2
NR RF Channel Number			1	
EPRE ratio of PSS to SSS		dB	0	
EPRE ratio of PBCH_DMRS to SSS		dB		
EPRE ratio of PBCH to PBCH_DMRS		dB		
EPRE ratio of PDCCH_DMRS to SSS		dB		
EPRE ratio of PDCCH to PDCCH_DMRS		dB		
EPRE ratio of PDSCH_DMRS to SSS		dB		
EPRE ratio of PDSCH to PDSCH_DMRS		dB		
<i>ss-PBCH-BlockPower</i>		dBm/ SCS	+20 + $\Delta_{UL}$	As defined in TS 38.331 [13]. $\Delta_{UL}$ is derived from the uplink calibration process <sup>Note 3</sup>
Configured UE transmitted power ( $P_{C_{MAX, f, c}}$ )		dBm	maximum value configurable for certain power class	As defined in clause 6.2.4 of TS 38.101-2 [3]
PRACH Configuration			PRACH.1 FR2	As defined in A.7.2, with exceptions as defined below
<i>rsrp-ThresholdSSB</i>		dBm	RSRP_69 + $\Delta_{DL}$	RSRP_69 corresponds to -88dBm. $\Delta_{DL}$ is derived from the downlink calibration process <sup>Note 4</sup>
<i>preambleReceivedTargetPower</i>		dBm	-100	As defined in TS 38.331 [13]
Note 1:	OCNG shall be used such that a constant total transmitted power spectral density is achieved for all OFDM symbols. The OCNG pattern is chosen during the test according to the presence of a DL reference measurement channel.			
Note 2:	The DL PDSCH reference measurement channel is used in the test only when a downlink transmission dedicated to the UE under test is required.			
Note 3:	The $\Delta_{UL}$ value is calculated as $-\text{ROUND}(\text{PPRACH0} - 1)$ , where PPRACH0 is the measured first PRACH power with -80.6dBm/SCS applied, <i>preambleReceivedTargetPower</i> = -100dBm and <i>ss-PBCH-BlockPower</i> = 20dBm. These values are used during the uplink calibration process carried out before the test case is run, with the UE configured to send PRACH.			
Note 4:	The $\Delta_{DL}$ value is calculated as $(\text{RSRP}_{\text{REP}} - \text{RSRP}_{76})$ , where $\text{RSRP}_{\text{REP}}$ is the SS-RSRP Reported value in Table 10.1.6.1-1 with -80.6dBm/SCS applied. These values are used during the downlink calibration process carried out before the test case is run, with the UE configured to report SS-RSRP. For a Reported value $\text{RSRP}_x$ , x is treated as a positive integer value.			

**Table 7.3.2.2.1.5-2: OTA-related test parameters for contention based random access test in FR2 for NR Standalone**

Parameter		Unit	Test-1	Comments
AoA setup			Setup 1	As defined in A.9.1
Assumption for UE beams <sup>Note 2</sup>			Rough	
SSB with index 0	Es <sup>Note1</sup>	dBm/SCS	-80.6	Power of SSB with index 0 is set to be above configured <i>rsrp-ThresholdSSB</i>
	SSB_RP	dBm/SCS	-80.6	
	Es/lot <sub>BB</sub>	dB	21.09	
	lo	dBm/95.04 MHz	-56.01	lo in symbols containing SSB index 0
SSB with index 1	Es <sup>Note1</sup>	dBm/SCS	-95.0	Power of SSB with index 1 is set to be below configured <i>rsrp-ThresholdSSB</i>
	SSB_RP	dBm/SCS	-95.0	
	Es/lot <sub>BB</sub>	dB	6.69	
	lo	dBm/95.04 MHz	-70.41	lo in symbols containing SSB index 1
Propagation Condition		-	AWGN	
Note 1: No artificial noise is applied in this test.				
Note 2: Information about types of UE beam is given in TS 38.133 [6] clause B.2.1.3, and does not limit UE implementation or test system implementation				

Test 1: Correct behaviour when transmitting Random Access Preamble

- The Random Access Preamble shall be one of the Random Access Preambles associated with SSB index 0.

Test 2: Correct behaviour when receiving Random Access Response

- The power of the first preamble shall be 0.6 dBm within the accuracy specified in Table 7.3.2.2.1.5-3.
- The relative power for preamble ramping step shall be 2 dB within the accuracy specified in Table 7.3.2.2.1.5-4.
- The transmit timing of all PRACH transmissions shall be within the accuracy specified in Table 7.3.2.2.1.5-5.

Test 3: Correct behaviour when not receiving Random Access Response

- The power of the first preamble shall be 0.6 dBm within the accuracy specified in Table 7.3.2.2.1.5-3.
- The relative power for preamble ramping step shall be 2 dB within the accuracy specified in Table 7.3.2.2.1.5-4.
- The transmit timing of all PRACH transmissions shall be within the accuracy specified in Table 7.3.2.2.1.5-5.

Test 4: Correct behaviour when receiving an UL grant for msg3 retransmission

- The UE shall re-transmit the msg3 upon the reception of an UL grant for msg3 retransmission.

Test 5: Correct behaviour when receiving an incorrect message over Temporary C-RNTI

- The UE shall re-select a preamble and transmit with the calculated PRACH transmission power when the back off time expires.
- The power of the first preamble shall be 0.6 dBm within the accuracy specified in Table 7.3.2.2.1.5-3.
- The transmit timing of the PRACH transmission shall be within the accuracy specified in Table 7.3.2.2.1.5-5.

Test 6: Correct behaviour when receiving a correct message over Temporary C-RNTI

- The UE shall send ACK if the contention resolution is successful.

Test 7: Correct behaviour when contention resolution timer expires

- The UE shall re-select a preamble and transmit with the calculated PRACH transmission power when the back off time expires if the contention resolution timer expires.

- The power of the first preamble shall be 0.6 dBm within the accuracy specified in Table 7.3.2.2.1.5-3.
- The transmit timing of the PRACH transmission shall be within the accuracy specified in Table 7.3.2.2.1.5-5.

**Table 7.3.2.2.1.5-3: Absolute power tolerance Test requirements**

Conditions	Tolerance
Normal	$\pm$ FFS dB

**Table 7.3.2.2.1.5-4: Relative power tolerance Test requirements**

Measured power	Power step $\Delta P$ (dB)	PRACH (dB)
Measured power of both PRACHs being compared > ( $P_{\max}^{\text{Note1}} - 6\text{dB}$ )	$2 \leq \Delta P < 3$	$\pm (4+\text{FFS})$ .
Measured power of either PRACHs being compared $\leq$ ( $P_{\max}^{\text{Note1}} - 6\text{dB}$ )		$\pm (6+\text{FFS})$
Note 1: $P_{\max}$ is the Min peak EIRP defined in clause 6.2.1 of TS 38.101-2 [3], selected according to power class and operating band.		

**Table 7.3.2.2.1.5-5:  $T_e$  Timing error Test requirements**

Frequency Range	SCS of SSB signals (kHz)	SCS of uplink signals s(KHz)	$T_e$
2	120	120	$224+[48]*T_c$
Note 1: $T_c$ is the basic timing unit defined in TS 38.211 [7]			

### 7.3.2.2.2 NR SA FR2 non-contention based random access

Editor's note: This test case is incomplete. The following aspects are either missing or not yet determined:

- The settable window for first preamble uplink power and the uplink calibration process are FFS.
- The test requirement for absolute uplink power is FFS.
- The test requirement for relative uplink power is FFS.
- The uncertainty value and test requirement for PRACH timing are in [ ]
- The results of the TT analysis are provisional until the corresponding MU values are agreed
- Antenna diagram and any exceptions are FFS
- Connection setup in Annex C is FFS

#### 7.3.2.2.2.1 Test purpose

The purpose of this test is to verify that the behaviour of the random access procedure is according to the requirements and that the PRACH power settings and timing are within specified limits.

#### 7.3.2.2.2.2 Test applicability

This test applies to all types of NR UE from Release 15 onwards. Additionally Test 2 is applicable to UE that supports CSI-RS based Random Access Preamble.

#### 7.3.2.2.2.3 Minimum conformance requirement

The minimum conformance requirements are specified in clause 7.3.2.2.0.2.

The normative reference for this requirement is TS 38.133 [6] clause A.7.3.2.2.2.

## 7.3.2.2.2.4 Test description

## 7.3.2.2.2.4.1 Initial conditions

This test can be run in the configurations defined in Table 7.3.2.2.2.4.1-1.

**Table 7.3.2.2.2.4.1-1: Non-Contention based random access test in FR2 for NR standalone supported test configurations**

Test Case ID	Test Config Index	Description
7.3.2.2.2-1	1	NR: 120 kHz SSB SCS, 100MHz bandwidth, TDD duplex mode
Note: The UE is only required to be tested in one of the supported test configurations		

Before the test procedure, Downlink and Uplink calibrations are carried out to derive signalled parameter values. This is necessary to ensure that the test case operates within the specified ranges. The detail of the calibration process is implementation dependent, but shall derive the values of  $\Delta_{DL}$  and  $\Delta_{UL}$  according to the following principles:

With the UE configured to report SS-RSRP, the  $\Delta_{DL}$  value is calculated as  $(RSRP_{REP} - RSRP_{76})$ , where  $RSRP_{REP}$  is the SS-RSRP Reported value according to TS 38.133 [6] Table 10.1.6.1-1 with -80.6dBm/SCS applied at the Reference point. For a Reported value  $RSRP_x$ ,  $x$  is treated as a positive integer value.

With the UE configured to send a first PRACH preamble,  $\Delta_{UL}$  value is calculated as  $-\text{ROUND}(\text{PPRACH0} - 1)$ , where PPRACH0 is the measured first PRACH power with -80.6dBm/SCS applied at the Reference point, and with signalled values  $preambleReceivedTargetPower = -100\text{dBm}$  and  $ss\text{-PBCH-BlockPower} = 20\text{dBm}$ .

Configure the test equipment and the DUT according to the parameters in Table 7.3.2.2.2.4.1-2.

**Table 7.3.2.2.2.4.1-2: Test Environment for Non-Contention based random access test in FR2 for NR standalone**

Parameter	Value		Comment
Test environment	NC		As specified in TS 38.508-1 [14] clause 4.1.
Test frequencies	As specified in Annex E, Table E.5-1 and TS 38.508-1 [14] subclause 4.3.1.		
Channel bandwidth	As specified by the test configuration selected from Table 7.3.2.2.2.4.1-1.		
Propagation conditions	No interference		As specified in Annex C.2.1.
Connection Diagram	TE Part	FFS	As specified in TS 38.508-1 [14] Annex A.
	DUT Part	FFS	
Exceptions to connection diagram	FFS		

1. Message contents are defined in clause 7.3.2.2.2.4.3.
2. Cell 1 is the NR FR2 serving cell (PCell). The connection setup is done according to the settings in FFS.

## 7.3.2.2.2.4.2 Test procedure

The test consists of a single cell, configured as PCell in FR2. The System Simulator shall explicitly assign a random access preamble via dedicated signalling in the downlink. There are two subtests, to test both SSB-based non-contention based random access (subtest 1) and CSI-RS-based non-contention based random access (subtest 2).

1. Ensure the UE is in state RRC\_CONNECTED with generic procedure parameters Connectivity NR, Connected without release On and Test Mode On according to TS 38.508-1 [14] clause 4.5.
2. Set the parameters according to Table 7.3.2.2.2.5-1 Subtest 1.
3. The SS shall signal a Random Access Preamble ID via a PDCCH order to the UE and initiate a Non-contention based Random Access procedure.
4. Test 1: Correct behaviour when transmitting SSB-based Random Access Preamble

- 4.1. The UE shall send a preamble to the System Simulator. The System Simulator shall check that the Random Access Preamble has the Preamble Index associated with the SSB with index 0, that it arrives on a PRACH occasion which belongs to the PRACH occasions corresponding to the SSB with index 0, and that the selected PRACH occasion belongs to the PRACH occasions permitted by the restrictions given by the *ra-ssb-OccasionMaskIndex*.
5. Test 2: Correct behaviour when transmitting CSI-RS-based Random Access Preamble
    - 5.1. Set the parameters according to Table 7.3.2.2.2.5-1 Subtest 2.
    - 5.2. Repeat steps 1-3
    - 5.3. The UE shall send a preamble to the System Simulator. The System Simulator shall check that the Random Access Preamble has the Preamble Index associated with the CSI-RS configured, that it arrives on a PRACH occasion which belongs to the PRACH occasions corresponding to the CSI-RS configured, and that the selected PRACH occasion belongs to the PRACH occasions permitted by the restrictions given by the *ra-OccasionList*.
  6. Test 3: Correct behaviour when receiving Random Access Response
    - 6.1. Repeat steps 1-3
    - 6.2. The UE shall send preambles to the System Simulator. In response to the first 2 preambles, the System Simulator shall transmit a Random Access Response containing Random Access Preamble identifiers that do not match the transmitted Random Access Preamble.
    - 6.3. As the received Random Access Responses contain Random Access Preamble identifiers that do not match the transmitted Random Access Preamble, the UE shall perform the Random Access Resource selection procedure specified in clause 5.1.2 in TS 38.321 [12], and transmit with the calculated PRACH transmission power.
    - 6.4. The System Simulator shall transmit a Random Access Response containing a Random Access Preamble identifier matching the transmitted Random Access Preamble after 3 preambles have been received by the System Simulator.
    - 6.5. As the received Random Access Response contains a Random Access Preamble identifier that matches the transmitted Random Access Preamble, the UE may stop monitoring for Random Access Response(s).
    - 6.6. Measure the power and timing of the first preamble and it shall not exceed the values specified in 7.3.2.2.2.5. Measure the relative power and timing applied to additional preambles (last 2 preambles) and it shall not exceed the values specified in 7.3.2.2.2.5.
  7. Test 4: Correct behaviour when not receiving Random Access Response
    - 7.1. Repeat steps 1-3.
    - 7.2. The UE shall send preambles to the System Simulator. The System Simulator shall not respond to the first 2 preambles.
    - 7.3. As no Random Access Response was received within the RA Response window configured in *RACH-ConfigCommon*, the UE shall perform the Random Access Resource selection procedure specified in clause 5.1.2 in TS 38.321 [12], and transmit with the calculated PRACH transmission power.
    - 7.4. The System Simulator shall transmit a Random Access Response containing a Random Access Preamble identifier matching the transmitted Random Access Preamble after 3 preambles have been received by the System Simulator.
    - 7.5. As the received Random Access Response contains a Random Access Preamble identifier that matches the transmitted Random Access Preamble, the UE may stop monitoring for Random Access Response(s).
    - 7.6. Measure the power and timing of the first preamble and it shall not exceed the values specified in 7.3.2.2.2.5. Measure the relative power and timing applied to additional preambles (last 2 preambles) and it shall not exceed the values specified in 7.3.2.2.2.5.

## 7.3.2.2.4.3 Message contents

Message contents are according to TS 38.508-1 [14] clause 4.6 with the following exceptions:

**Table 7.3.2.2.4.3-1: FrequencyInfoUL-SIB for Non-Contention Based Random Access**

Derivation Path: TS 38.508-1 [14], table 4.6.3-62			
Information Element	Value/remark	Comment	Condition
FrequencyInfoUL-SIB SEQUENCE {			
p-Max	23	23 dBm	
}			

**Table 7.3.2.2.4.3-2: RACH-ConfigCommon for Non-Contention Based Random Access**

Derivation Path: TS 38.508-1 [14], table 4.6.3-128			
Information Element	Value/remark	Comment	Condition
RACH-ConfigCommon::= SEQUENCE {			
rach-ConfigGeneric	RACH-ConfigGeneric		
totalNumberOfRA-Preambles	48		
groupBconfigured SEQUENCE {			
numberOfRA-PreamblesGroupA	48		
}			
ra-ContentionResolutionTimer	Not present		
rsrp-ThresholdSSB	RSRP <sub>69</sub> + $\Delta_{DL}$	$\Delta_{DL}$ is derived from the downlink calibration process	Subtest 1
prach-RootSequenceIndex CHOICE {			
0			
}			
msg1-SubcarrierSpacing	kHz 120		
}			

Table 7.3.2.2.4.3-3: RACH-ConfigDedicated for Non-Contention Based Random Access

Derivation Path: TS 38.508-1 [14], table 4.6.3-129			
Information Element	Value/remark	Comment	Condition
RACH-ConfigDedicated ::= SEQUENCE {			
cfra SEQUENCE {			
occasions SEQUENCE {			
ssb-perRACH-Occasion	oneFourth		
}			
resources CHOICE {			
ssb SEQUENCE {			
ssb-ResourceList SEQUENCE (SIZE(1..maxRA-SSB-Resources)) OF {	2 entries		
ssb[1]	0		
ssb[2]	1		
ra-PreambleIndex[1]	50		Subtest 1
}			
ra-ssb-OccasionMaskIndex	1		Subtest 1
}			
csirs SEQUENCE {			
csirs-ResourceList SEQUENCE (SIZE(1..maxRA-CSIRS-Resources)) OF {			
ra-OccasionList	1		Subtest 2
ra-PreambleIndex[1]	50		Subtest 2
}			
rsrp-ThresholdCSI-RS	RSRP <sub>69</sub> + Δ <sub>DL</sub>	Δ <sub>DL</sub> is derived from the downlink calibration process	Subtest 2
}			
}			
}			
}			
}			

Table 7.3.2.2.4.3-4: RACH-ConfigGeneric for Non-Contention Based Random Access

Derivation Path: TS 38.508-1 [14], table 4.6.3-130			
Information Element	Value/remark	Comment	Condition
RACH-ConfigGeneric ::= SEQUENCE {			
prach-ConfigurationIndex	190		FR2
msg1-FDM	one		FR2
zeroCorrelationZoneConfig	11		
preambleReceivedTargetPower	-100		
preambleTransMax	n6		
powerRampingStep	dB2		
ra-ResponseWindow	sl10		
}			

Table 7.3.2.2.4.3-5: ServingCellConfigCommonSIB for Non-Contention Based Random Access

Derivation Path: TS 38.508-1 [14], table 4.6.3-169			
Information Element	Value/remark	Comment	Condition
ServingCellConfigCommonSIB ::= SEQUENCE {			
ssb-PositionsInBurst SEQUENCE {			
inOneGroup	'1100 0000'B		
}			
ss-PBCH-BlockPower	20 + Δ <sub>UL</sub>	Δ <sub>UL</sub> is derived from the uplink calibration process	
}			

## 7.3.2.2.2.5 Test requirement

Table 7.3.2.2.2.5-2 defines the primary level settings for non-contention based random access test in FR2 for NR Standalone. Tables 7.3.2.2.2.5-3, 7.3.2.2.2.5-4 and 7.3.2.2.2.5-5 define the Absolute power limits, Relative power limits and uplink timing error limits respectively, and all include test tolerances.

**Table 7.3.2.2.2.5-1: General test parameters for non-contention based random access test in FR2 for NR Standalone**

Parameter		Unit	Test-1	Test-2	Comments
SSB Configuration	Config 1		SSB.1 FR2	SSB.1 FR2	As defined in A.3.2
CSI-RS Configuration	Config 1		N/A	CSI-RS.3.1 TDD	As defined in A.1.4
Duplex Mode for Cell 2	Config 1		TDD	TDD	
TDD Configuration	Config 1		TDDConf.3.1	TDDConf.3.1	As defined in A.1.5
BW <sub>channel</sub>	Config 1	MHz	100: N <sub>RB,c</sub> = 24	100: N <sub>RB,c</sub> = 24	
OCNG Pattern <sup>Note 1</sup>			OP.3	OP.3	As defined in A.2.1.
PDSCH Reference Channel <sup>Note 2</sup>	Config 1		SR3.1 TDD	SR3.1 TDD	As defined in A.1.1.
RMSI CORESET Reference Channel	Config 1		CR.3.1 TDD	CR.3.1 TDD	As defined in A.1.2
NR RF Channel Number			1	1	
EPRE ratio of PSS to SSS		dB	0	0	
EPRE ratio of PBCH_DMRS to SSS		dB			
EPRE ratio of PBCH to PBCH_DMRS		dB			
EPRE ratio of PDCCH_DMRS to SSS		dB			
EPRE ratio of PDCCH to PDCCH_DMRS		dB			
EPRE ratio of PDSCH_DMRS to SSS		dB			
EPRE ratio of PDSCH to PDSCH_DMRS		dB			
ss-PBCH-BlockPower		dBm/ SCS	+20 + $\Delta_{UL}$	+20 + $\Delta_{UL}$	As defined in TS 38.331 [13]. $\Delta_{UL}$ is derived from the uplink calibration process <sup>Note 3</sup>
Configured UE transmitted power ( $P_{C_{MAX,f,c}}$ )		dBm	maximum value configurable for certain power class	maximum value configurable for certain power class	As defined in clause 6.2.4 in TS 38.101-2 [3]
PRACH Configuration			PRACH.2 FR2	PRACH.3 FR2	As defined in A.7.2, with exceptions as defined below.
rsrp-ThresholdSSB		dBm	RSRP <sub>69</sub> + $\Delta_{DL}$	RSRP <sub>69</sub> + $\Delta_{DL}$	RSRP <sub>69</sub> corresponds to -88dBm. $\Delta_{DL}$ is derived from the downlink calibration process <sup>Note 4</sup>
preambleReceivedTargetPower		dBm	-100	-100	As defined in TS 38.331 [13]
Note 1:	OCNG shall be used such that a constant total transmitted power spectral density is achieved for all OFDM symbols. The OCNG pattern is chosen during the test according to the presence of a DL reference measurement channel.				
Note 2:	The DL PDSCH reference measurement channel is used in the test only when a downlink transmission dedicated to the UE under test is required.				
Note 3:	The $\Delta_{UL}$ value is calculated as $-\text{ROUND}(\text{PPRACH0} - 1)$ , where PPRACH0 is the measured first PRACH power with -80.6dBm/SCS applied, $\text{preambleReceivedTargetPower} = -100\text{dBm}$ and $\text{ss-PBCH-BlockPower} = 20\text{dBm}$ . These values are used during the uplink calibration process carried out before the test case is run, with the UE configured to send PRACH.				
Note 4:	The $\Delta_{DL}$ value is calculated as $(\text{RSRP}_{\text{REP}} - \text{RSRP}_{76})$ , where RSRP <sub>REP</sub> is the SS-RSRP Reported value in Table 10.1.6.1-1 with -80.6dBm/SCS applied. These values are used during the downlink calibration process carried out before the test case is run, with the UE configured to report SS-RSRP. For a Reported value RSRP <sub>x</sub> , x is treated as a positive integer value.				



**Table 7.3.2.2.5-2: OTA-related test parameters for non-contention based random access test in FR2 for NR Standalone**

Parameter		Unit	Test-1	Test-2	Comments
AoA setup			Setup 1	Setup 1	As defined in A.9.1
Assumption for UE beams <sup>Note 2</sup>			Rough	Rough	
SSB with index 0	Es <sup>Note1</sup>	dBm/SC S	-80.6	-80.6	Power of SSB with index 0 is set to be above configured <i>rsrp-ThresholdSSB</i>
	SSB_RP	dBm/SC S	-80.6	-80.6	
	Es/lot <sub>BB</sub>	dB	21.09	21.09	
	lo	dBm/95.0 4 MHz	-56.01	-56.01	lo in symbols containing SSB index 0
SSB with index 1	Es <sup>Note1</sup>	dBm/SC S	-95.0	-95.0	Power of SSB with index 1 is set to be below configured <i>rsrp-ThresholdSSB</i>
	SSB_RP	dBm/SC S	-95.0	-95.0	
	Es/lot <sub>BB</sub>	dB	6.69	6.69	
	lo	dBm/95.0 4 MHz	-70.41	-70.41	lo in symbols containing SSB index 1
Propagation Condition		-	AWGN	AWGN	
Note 1: No artificial noise is applied in this test.					
Note 2: Information about types of UE beam is given in TS 38.133 [6] clause B.2.1.3, and does not limit UE implementation or test system implementation					

Test 1: Correct behaviour when transmitting SSB-based Random Access Preamble

- The Random Access Preamble shall be one of the Random Access Preambles associated with SSB index 0.
- The Random Access Preamble shall arrive on a PRACH occasion which belongs to the PRACH occasions corresponding to the SSB with index 0.
- The selected PRACH occasion shall belong to the PRACH occasions permitted by the restrictions given by the *ra-ssb-OccasionMaskIndex*.

Test 2: Correct behaviour when transmitting CSI-RS-based Random Access Preamble

- The Random Access Preamble shall have the Preamble Index associated with the CSI-RS configured.
- The Random Access Preamble shall arrive on a PRACH occasion which belongs to the PRACH occasions corresponding to the CSI-RS configured.
- The selected PRACH occasion belongs to the PRACH occasions permitted by the restrictions given by the *ra-OccasionList*.

Test 3: Correct behaviour when receiving Random Access Response

- The power of the first preamble shall be 0.6 dBm within the accuracy specified in Table 7.3.2.2.5-3.
- The relative power for preamble ramping step shall be 2 dB within the accuracy specified in Table 7.3.2.2.5-4.
- The transmit timing of all PRACH transmissions shall be within the accuracy specified in Table 7.3.2.2.5-5.

Test 4: Correct behaviour when not receiving Random Access Response

- The power of the first preamble shall be 0.6 dBm within the accuracy specified in Table 7.3.2.2.5-3.
- The relative power for preamble ramping step shall be 2 dB within the accuracy specified in Table 7.3.2.2.5-4.
- The transmit timing of all PRACH transmissions shall be within the accuracy specified in Table 7.3.2.2.5-5.

**Table 7.3.2.2.5-3: Absolute power tolerance Test requirements**

Conditions	Tolerance
Normal	$\pm$ FFS dB

**Table 7.3.2.2.5-4: Relative power tolerance Test requirements**

Measured power	Power step $\Delta P$ (dB)	PRACH (dB)
Measured power of both PRACHs being compared > $(P_{\max}^{\text{Note1}} - 6\text{dB})$	$2 \leq \Delta P < 3$	$\pm (4+\text{FFS})$ .
Measured power of either PRACHs being compared $\leq (P_{\max}^{\text{Note1}} - 6\text{dB})$		$\pm (6+\text{FFS})$
Note 1: $P_{\max}$ is the Min peak EIRP defined in clause 6.2.1 of TS 38.101-2 [3], selected according to power class and operating band.		

**Table 7.3.2.2.5-5:  $T_e$  Timing error Test requirements**

Frequency Range	SCS of SSB signals (kHz)	SCS of uplink signals s(KHz)	$T_e$
2	120	120	$224+[48]*T_c$
Note 1: $T_c$ is the basic timing unit defined in TS 38.211 [7]			

### 7.3.2.2.3 NR SA FR2 2-step contention based random access

Editor's note: This test case is incomplete. The following aspects are either missing or not yet determined:

- The settable window for first preamble uplink power and the uplink calibration process are FFS.
- The test requirement for absolute uplink power is FFS.
- The test requirement for relative uplink power is FFS.
- The uncertainty value and test requirement for  $T_e$  Timing error are in [ ]
- TT analysis is missing
- Antenna diagram and any exceptions are FFS
- Connection setup in Annex C is FFS

#### 7.3.2.2.3.1 Test purpose

The purpose of this test is to verify that the behaviour of the 2-step RA type random access procedure is according to the requirements and that the MsgA PRACH and MsgA PUSCH power settings and timing are within specified limits.

#### 7.3.2.2.3.2 Test applicability

This test applies to all types of NR UE supporting 2-step RA type from Release 16 onwards.

#### 7.3.2.2.3.3 Minimum conformance requirement

The minimum conformance requirements are specified in clause 7.3.2.2.0.1.

The normative reference for this requirement is TS 38.133 [6] clause A.7.3.2.2.3.

7.3.2.2.3.4 Test description

7.3.2.2.3.4.1 Initial conditions

This test can be run in the configurations defined in Table 7.3.2.2.3.4.1-1.

**Table 7.3.2.2.3.4.1-1: 2-step contention based random access test in FR2 for NR standalone supported test configurations**

Test Case ID	Test Config Index	Description
7.3.2.2.3-1	1	NR: 120 kHz SSB SCS, 100MHz bandwidth, TDD duplex mode
Note:	The UE is only required to be tested in one of the supported test configurations depending on UE capability	

Before the test procedure, Downlink and Uplink calibrations are carried out to derive signalled parameter values. This is necessary to ensure that the test case operates within the specified ranges. The detail of the calibration process is implementation dependent, but shall derive the values of  $\Delta_{DL}$  and  $\Delta_{UL}$  according to the following principles:

With the UE configured to report SS-RSRP, the  $\Delta_{DL}$  value is calculated as  $(RSRP_{REP} - RSRP_{76})$ , where  $RSRP_{REP}$  is the SS-RSRP Reported value according to TS 38.133 [6] Table 10.1.6.1-1 with -80.6dBm/SCS applied at the Reference point. For a Reported value  $RSRP_x$ , x is treated as a positive integer value.

With the UE configured to send a first PRACH preamble,  $\Delta_{UL}$  value is calculated as  $-\text{ROUND}(\text{PPRACH0} - 1)$ , where PPRACH0 is the measured first PRACH power with -80.6dBm/SCS applied at the Reference point, and with signalled values  $preambleReceivedTargetPower = -100\text{dBm}$  and  $ss\text{-PBCH-BlockPower} = 20\text{dBm}$ .

Configure the test equipment and the DUT according to the parameters in Table 7.3.2.2.3.4.1-2.

**Table 7.3.2.2.3.4.1-2: Test Environment for 2-step RACH contention based random access test in FR2 for NR standalone**

Parameter	Value		Comment
Test environment	NC		As specified in TS 38.508-1 [14] clause 4.1.
Test frequencies	As specified in Annex E, Table E.5-1 and TS 38.508-1 [14] subclause 4.3.1.		
Channel bandwidth	As specified by the test configuration selected from Table 7.3.2.2.3.4.1-1.		
Propagation conditions	No interference		As specified in Annex C.2.1.
Connection Diagram	TE Part	FFS	As specified in TS 38.508-1 [14] Annex A.
	DUT Part	FFS	
Exceptions to connection diagram	FFS		

1. Message contents are defined in clause 7.3.2.2.3.4.3.
2. Cell 1 is the NR FR2 serving cell (PCell). The connection setup is done according to the settings in FFS.

7.3.2.2.3.4.2 Test procedure

The test consists of a single cell, configured as PCell in FR2. The System Simulator shall not explicitly assign a random access preamble via dedicated signalling in the downlink.

1. Ensure the UE is in state RRC\_IDLE with generic procedure parameters Connectivity NR and Test Mode On according to TS 38.508-1 [14] clause 4.5.
2. Set the parameters according to Tables 7.3.2.2.3.5-1 and 7.3.2.2.3.5-2.
3. The UE shall establish a connection setup with SS, the random access procedure within the connection setup is used in the test.
4. Test 1: Correct behaviour when transmitting MsgA

- 4.1. The UE shall send the MsgA PRACH and MsgA PUSCH to the System Simulator with a preamble which belongs to one of the Random Access Preambles associated with the SSB with index 0, which has SS-RSRP above the configured *msgA-RSRP-ThresholdSSB*. The UE shall send the MsgA PUSCH on the MsgA PUSCH occasion that is associated with the chosen preamble.
5. Test 2: Correct behaviour when receiving MsgB
- 5.1. Repeat steps 1-3.
- 5.2. The UE shall send preambles to the System Simulator. In response to the first 2 preambles, the System Simulator shall transmit a MsgB *not* corresponding to the transmitted Random Access Preamble.
- 5.3. The UE shall again perform the Random Access Resource selection procedure specified in clause 5.1.2a in TS 38.321 [20], and transmit MsgA with the calculated MsgA PRACH and MsgA PUSCH transmission power when the backoff time expires if all received MsgB's contain Random Access Preamble identifiers that do not match the transmitted Random Access Preamble of MsgA.
- 5.4 The System Simulator shall transmit a MsgB containing fallbackRAR message with a Random Access Preamble identifier matching the transmitted MsgA PRACH after 3 MsgA transmissions have been received by the System Simulator.
- 5.5 As the received Random Access Response MsgB with a fallbackRAR contains Random Access Preamble identifier corresponding to the transmitted Random Access Preamble, the UE may stop monitoring for MsgB(s) and shall transmit the msg3 on the indicated PUSCH resources.
- 5.6. Measure the power and timing of the first preamble and it shall not exceed the values specified in 7.3.2.2.3.5. Measure the relative power and timing applied to additional preambles (last 2 preambles) and it shall not exceed the values specified in 7.3.2.2.3.5.
6. Test 3: Correct behaviour when not receiving MsgB
- 6.1. Repeat steps 1-3.
- 6.2. The UE shall send preambles to the System Simulator. The System Simulator shall not respond to the first 2 preambles.
- 6.3. The UE shall again perform the Random Access Resource selection procedure specified in clause 5.1.2a in TS 38.321 [20], and transmit with the calculated MsgA PRACH and MsgA PUSCH transmission power when the backoff time expires if no MsgB is received within the MsgB Response window.
- 6.4. Measure the power and timing of the first preamble and it shall not exceed the values specified in 7.3.2.2.3.5. Measure the relative power and timing applied to additional preambles (last 2 preambles) and it shall not exceed the values specified in 7.3.2.2.3.5.

#### 7.3.2.2.3.4.3 Message contents

Message contents are according to TS 38.508-1 [14] clause 4.6 with the following exceptions:

**Table 7.3.2.2.3.4.3-1: *FrequencyInfoUL-SIB* for 2-step contention Based Random Access**

Derivation Path: TS 38.508-1 [14], table 4.6.3-62			
Information Element	Value/remark	Comment	Condition
FrequencyInfoUL-SIB SEQUENCE {			
p-Max	23	23 dBm	
}			

Table 7.3.2.2.3.4.3-2: RACH-ConfigCommon for 2-step contention Based Random Access

Derivation Path: TS 38.508-1 [14], table 4.6.3-128A			
Information Element	Value/remark	Comment	Condition
RACH-ConfigCommonTwoStepRA-r16 ::= SEQUENCE {			
rach-ConfigGenericTwoStepRA-r16	RACH-ConfigGenericTwoStepRA		
msgA-TotalNumberOfRA-Preambles-r16	48		
msgA-SSB-PerRACH-OccasionAndCB-PreamblesPerSSB-r16 CHOICE {	oneFourth, n48		
one	n4		FR2
}			
msgA-CB-PreamblesPerSSB-PerSharedRO-r16	oneFourth, n48		
msgA-SSB-SharedRO-MaskIndex-r16	Not present		
groupB-ConfiguredTwoStepRA-r16	Not present		
msgA-PRACH-RootSequenceIndex-r16 CHOICE {}	Not present		
msgA-TransMax-r16	N8		
msgA-RSRP-Threshold-r16	RSRP <sub>69</sub> + Δ <sub>DL</sub>		
msgA-RSRP-ThresholdSSB-r16	RSRP <sub>69</sub> + Δ <sub>DL</sub>		
msgA-SubcarrierSpacing-r16	120 kHz		
msgA-RestrictedSetConfig-r16	Not present		
ra-PrioritizationForAccessIdentityTwoStep-r16 SEQUENCE {			
ra-Prioritization-r16	RA-Prioritization		
ra-PrioritizationForAI-r16	'10'B		
}			
ra-ContentionResolutionTimer-r16	sf32		
}			

Table 7.3.2.2.3.4.3-3: RACH-ConfigGeneric for 2-step contention Based Random Access

Derivation Path: TS 38.508-1 [14], table 4.6.3-130A			
Information Element	Value/remark	Comment	Condition
RACH-ConfigGenericTwoStepRA-r16 ::= SEQUENCE {			
msgA-PRACH-ConfigurationIndex-r16	190		
msgA-RO-FDM-r16	four		
msgA-RO-FrequencyStart-r16	0		
msgA-ZeroCorrelationZoneConfig-r16	11		
msgA-PreamblePowerRampingStep-r16	dB2		
msgA-PreambleReceivedTargetPower-r16	-100		
msgB-ResponseWindow-r16	sl10		
preambleTransMax-r16	n10		
}			

Table 7.3.2.2.3.4.3-4: ServingCellConfigCommonSIB for 2-step contention Based Random Access

Derivation Path: TS 38.508-1 [14], table 4.6.3-169			
Information Element	Value/remark	Comment	Condition
ServingCellConfigCommonSIB ::= SEQUENCE {			
ssb-PositionsInBurst SEQUENCE {			
inOneGroup	'1100 0000'B		
}			
ss-PBCH-BlockPower	20 + Δ <sub>UL</sub>	Δ <sub>UL</sub> is derived from the uplink calibration process	
}			

**Table 7.3.2.2.3.4.3-5: MsgA-PUSCH-Config for 2-step contention Based Random Access**

Derivation Path: TS 38.508-1 [14], table 4.6.3-81B			
Information Element	Value/remark	Comment	Condition
MsgA-PUSCH-Resource-r16 ::= SEQUENCE {			
msgA-MCS	1		
nrofSlotsMsgA-PUSCH	1		
nrofMsgA-PO-PerSlot	1		
msgA-PUSCH-TimeDomainOffset	1		
msgA-PUSCH-TimeDomainAllocation-r16	3	Equivalent to PUSCH start symbol = 0 and allocation length = 10	
mappingTypeMsgA-PUSCH	typeA		
nrofPRBs-PerMsgA-PO	2		
nrofMsgA-PO-FDM	One		
msgA-DMRS-AdditionalPosition	pos1		
msgA-PUSCH-NrofPorts	1		
msgA-DeltaPreamble	3		
msgA-Alpha	alpha1		
deltaMCS	Disabled		
}			

#### 7.3.2.2.3.5 Test requirement

Table 7.3.2.2.3.5-2 defines the primary level settings for 2-step contention based random access test in FR2 for NR Standalone. Tables 7.3.2.2.3.5-3, 7.3.2.2.3.5-4 and 7.3.2.2.3.5-5 define the Absolute power limits, Relative power limits and uplink timing error limits respectively, and all include test tolerances.

**Table 7.3.2.3.5-1: General test parameters for 2-step contention based random access test in FR2 for NR Standalone**

Parameter		Unit	Test-1	Comments
SSB Configuration	Config 1		SSB.1 FR2	As defined in A.3.2
Duplex Mode for Cell 1	Config 1		TDD	
TDD Configuration	Config 1		TDDConf.3.1	As defined in A.1.5
$BW_{channel}$	Config 1	MHz	100: $N_{RB,c} = 24$	
OCNG Pattern <sup>Note 1</sup>			OCNG pattern 1	As defined in A.2.1
PDSCH Reference Channel <sup>Note 2</sup>	Config 1		SR.3.1 TDD	As defined in A.1.1
RMSI CORESET Reference Channel	Config 1		CR.3.1 TDD	As defined in A.1.2
NR RF Channel Number			1	
EPRE ratio of PSS to SSS		dB	0	
EPRE ratio of PBCH_DMRS to SSS		dB		
EPRE ratio of PBCH to PBCH_DMRS		dB		
EPRE ratio of PDCCH_DMRS to SSS		dB		
EPRE ratio of PDCCH to PDCCH_DMRS		dB		
EPRE ratio of PDSCH_DMRS to SSS		dB		
EPRE ratio of PDSCH to PDSCH_DMRS		dB		
ss-PBCH-BlockPower		dBm/ SCS	+20 + $\Delta_{UL}$	As defined in TS 38.331 [13]. $\Delta_{UL}$ is derived from the uplink calibration process <sup>Note 3</sup>
Configured UE transmitted power ( $P_{C_{MAX, f, c}}$ )		dBm	maximum value configurable for certain power class	As defined in clause 6.2.4 in TS 38.101-2 [3]
MsgA Configuration			FR2 MsgA configuration 1	As defined in A.7.2, with exceptions as defined below
<i>msgA-RSRP-ThresholdSSB</i>		dBm	RSRP_69 + $\Delta_{DL}$	RSRP_69 corresponds to -88dBm. $\Delta_{DL}$ is derived from the downlink calibration process <sup>Note 4</sup>
preambleReceivedTargetPower		dBm	-100	As defined in TS 38.331 [13]
Note 1:	OCNG shall be used such that a constant total transmitted power spectral density is achieved for all OFDM symbols. The OCNG pattern is chosen during the test according to the presence of a DL reference measurement channel.			
Note 2:	The DL PDSCH reference measurement channel is used in the test only when a downlink transmission dedicated to the UE under test is required.			
Note 3:	The $\Delta_{UL}$ value is calculated as $-\text{ROUND}(\text{PMsgA0} - 1)$ , where PMsgA0 is the measured first MsgA PRACH power with -80.6dBm/SCS applied, <i>msgA-PreambleReceivedTargetPower</i> = -100dBm and <i>ss-PBCH-BlockPower</i> = 20dBm. These values are used during the uplink calibration process carried out before the test case is run, with the UE configured to send MsgA.			
Note 4:	The $\Delta_{DL}$ value is calculated as $(\text{RSRP}_{\text{REP}} - \text{RSRP}_{76})$ , where $\text{RSRP}_{\text{REP}}$ is the SS-RSRP Reported value in Table 10.1.6.1-1 with -80.6dBm/SCS applied. These values are used during the downlink calibration process carried out before the test case is run, with the UE configured to report SS-RSRP. For a Reported value $\text{RSRP}_x$ , x is treated as a positive integer value.			

**Table 7.3.2.2.3.5-2: OTA-related test parameters for 2-step contention based random access test in FR2 for NR Standalone**

Parameter		Unit	Test-1	Comments
AoA setup			Setup 2b	As defined in A.9.2.2
Assumption for UE beams <sup>Note 2</sup>			Rough	
SSB with index 0	Es <sup>Note1</sup>	dBm/SCS	-80.6	Power of SSB with index 0 is set to be above configured <i>rsrp-ThresholdSSB</i>
	SSB_RP	dBm/SCS	-80.6	
	Es/lot <sub>BB</sub>	dB	21.09	
	lo	dBm/95.04 MHz	-56.01	lo in symbols containing SSB index 0
SSB with index 1	Es <sup>Note1</sup>	dBm/SCS	-95.0	Power of SSB with index 1 is set to be below configured <i>rsrp-ThresholdSSB</i>
	SSB_RP	dBm/SCS	-95.0	
	Es/lot <sub>BB</sub>	dB	6.69	
	lo	dBm/95.04 MHz	-70.41	lo in symbols containing SSB index 1
Propagation Condition		-	AWGN	
Note 1: No artificial noise is applied in this test.				
Note 2: Information about types of UE beam is given in TS 38.133 [6] clause B.2.1.3, and does not limit UE implementation or test system implementation				

Test 1: Correct behaviour when transmitting MsgA

- The MsgA with preamble shall be one of the Random Access Preambles associated with SSB index 0.

Test 2: Correct behaviour when receiving MsgB

- The power of the first MsgA PRACH preamble shall be 0.6 dBm within the accuracy specified in Table 7.3.2.2.3.5-3.
- The power of the first MsgA PUSCH transmission shall be  $0.6 + 3(\mu + 2)$  dBm with an accuracy specified in clause 6.3.4.2 of TS 38.101-2 [8], where  $\mu$  indicates the MsgA PUSCH numerology.
- The relative power for MsgA ramping step shall be 2 dB within the accuracy specified in Table 7.3.2.2.3.5-4.
- The transmit timing of all MsgA transmissions shall be within the accuracy specified in Table 7.3.2.2.3.5-5.

Test 3: Correct behaviour when not receiving MsgB

- The power of the first MsgA PRACH preamble shall be 0.6 dBm within the accuracy specified in Table 7.3.2.2.3.5-3.
- The power of the first MsgA PUSCH transmission shall be  $0.6 + 3(\mu + 2)$  dBm with an accuracy specified in clause 6.3.4.2 of TS 38.101-2 [8], where  $\mu$  indicates the MsgA PUSCH numerology.
- The relative power for MsgA ramping step shall be 2 dB within the accuracy specified in Table 7.3.2.2.3.5-4.
- The transmit timing of all MsgA transmissions shall be within the accuracy specified in Table 7.3.2.2.3.5-5.

**Table 7.3.2.2.3.5-3: Absolute power tolerance Test requirements**

Conditions	Tolerance
Normal	$\pm$ FFS dB



**Table 7.3.2.2.3.5-4: Relative power tolerance Test requirements**

Measured power	Power step $\Delta P$ (dB)	MsgA (dB)
Measured power of both MsgAs being compared $> (P_{\max}^{\text{Note1}} - 6\text{dB})$	$2 \leq \Delta P < 3$	$\pm (4+\text{FFS})$ .
Measured power of either MsgAs being compared $\leq (P_{\max}^{\text{Note1}} - 6\text{dB})$		$\pm (6+\text{FFS})$
Note 1: $P_{\max}$ is the Min peak EIRP defined in clause 6.2.1 of TS 38.101-2 [3], selected according to power class and operating band.		

**Table 7.3.2.2.3.5-5:  $T_e$  Timing error Test requirements**

Frequency Range	SCS of SSB signals (kHz)	SCS of uplink signals s(KHz)	$T_e$
2	120	120	$224+[48]*T_c$
Note 1: $T_c$ is the basic timing unit defined in TS 38.211 [7]			

#### 7.3.2.2.4 NR SA FR2 2-step non-contention based random access

Editor's note: This test case is incomplete. The following aspects are either missing or TBD

- Message contents are not complete.
- TT analysis and test requirements are missing.
- Test procedure is FFS

##### 7.3.2.2.4.1 Test purpose

The purpose of this test is to verify that the behaviour of the random access procedure is according to the requirements and that the MsgA PRACH and MsgA PUSCH power settings and timing are within specified limits.

##### 7.3.2.2.4.2 Test applicability

This test applies to all types of NR SA FR2 UE from Release 16 onwards.

##### 7.3.2.2.4.3 Minimum conformance requirement

Same as in clause 4.3.2.2.4.3.

The normative reference for this requirement is TS 38.133 [6] clause 6.2.2 and A.7.3.2.2.4.

##### 7.3.2.2.4.4 Test description

###### 7.3.2.2.4.4.1 Initial conditions

This test can be run in the configurations defined in Table 7.3.2.2.4.4.1-1.

**Table 7.3.2.2.4.4.1-1: Supported test configurations**

Config	Description
1	NR PSCell/SCell 120 kHz SSB SCS, 100 MHz bandwidth, TDD duplex mode

Before the test procedure, Downlink and Uplink calibrations are carried out to derive signalled parameter values. This is necessary to ensure that the test case operates within the specified ranges. The detail of the calibration process is implementation dependent, but shall derive the values of  $\Delta_{DL}$  and  $\Delta_{UL}$  according to the following principles:

With the UE configured to report SS-RSRP, the  $\Delta_{DL}$  value is calculated as  $(\text{RSRP}_{\text{REP}} - \text{RSRP}_{76})$ , where  $\text{RSRP}_{\text{REP}}$  is the SS-RSRP Reported value according to TS 38.133 [6] Table 10.1.6.1-1 with -80.6dBm/SCS applied at the Reference point. For a Reported value  $\text{RSRP}_x$ , x is treated as a positive integer value.

With the UE configured to send a first PRACH preamble,  $\Delta_{UL}$  value is calculated as  $-\text{ROUND}(\text{PPRACH0} - 1)$ , where PPRACH0 is the measured first PRACH power with  $-80.6\text{dBm/SCS}$  applied at the Reference point, and with signalled values  $\text{preambleReceivedTargetPower} = -100\text{dBm}$  and  $\text{ss-PBCH-BlockPower} = 20\text{dBm}$ .

Configure the test equipment and the DUT according to the parameters in Table 7.3.2.2.4.4.1-2.

**Table 7.3.2.2.4.4.1-2: Initial conditions**

Parameter	Value		Comment
Test environment	NC		As specified in TS 38.508-1 [14] clause 4.1.
Test frequencies	As specified in Annex E, Table E.5-1 and TS 38.508-1 [14] clause 4.3.1.		
Channel bandwidth	As specified by the test configuration selected from Table 4.3.2.2.1.4.1-1.		
Propagation conditions	AWGN		As specified in Annex C.2.2.
Connection Diagram	TE Part	A.3.3.3.1	As specified in TS 38.508-1 [14] Annex A.
	DUT Part	A.3.4.1.1	
Exceptions to connection diagram	N/A		

1. Message contents are defined in clause 7.3.2.2.4.4.3.
2. Cell 1 is the NR FR2 serving cell (PCell). The connection setup is done according to the settings in Annex C.1.1 and C.1.2.

**7.3.2.2.4.4.2 Test procedure**

The test consists of a single cell, configured as PCell in FR2. The System Simulator shall not explicitly assign a random access preamble via dedicated signalling in the downlink.

1. Ensure the UE is in state RRC\_IDLE with generic procedure parameters Connectivity NR and Test Mode On according to TS 38.508-1 [14] clause 4.5.
2. Set the parameters according to Table 7.3.2.2.1.5-1.
3. The UE shall establish a connection setup with SS, the random access procedure within the connection setup is used in the test.

FFS

**7.3.2.2.4.4.3 Message contents**

Message contents are according to TS 38.508-1 [14] clause 7.3.1 with the following exceptions:

**Table 7.3.2.2.4.4.3-0: Common Exception messages**

Default Message Contents	
Common contents of system information blocks exceptions	
Default RRC messages and information elements contents exceptions	FFS
Common exceptions to the contents of TS 38.508-1 [14]	FFS

**7.3.2.2.4.5 Test requirement**

Table 7.3.2.2.4.5-2 defines the primary level settings for non-contention based random access test in FR2 for NR Standalone. The test requirements are FFS.

**Table 7.3.2.2.1.5-1: General test parameters for non-contention based random access test for 2-step RA type in FR2 for NR Standalone**

Parameter		Unit	Test-1	Comments
SSB Configuration	Config 1		SSB.1 FR2	As defined in A.3.10
Duplex Mode for Cell 2	Config 1		TDD	
TDD Configuration	Config 1		TDDConf.3.1	
BW <sub>channel</sub>	Config 1	MHz	100: N <sub>RB,c</sub> = 24	
OCNG Pattern <sup>Note 1</sup>			OP.3	As defined in A.3.2.1.
PDSCH Reference Channel <sup>Note 2</sup>	Config 1		SR3.1 TDD	As defined in A.3.1.1.
NR RF Channel Number			1	
EPRE ratio of PSS to SSS		dB	0	
EPRE ratio of PBCH_DMRS to SSS		dB		
EPRE ratio of PBCH to PBCH_DMRS		dB		
EPRE ratio of PDCCH_DMRS to SSS		dB		
EPRE ratio of PDCCH to PDCCH_DMRS		dB		
EPRE ratio of PDSCH_DMRS to SSS		dB		
EPRE ratio of PDSCH to PDSCH_DMRS		dB		
ss-PBCH-BlockPower		dBm/ SCS	+20 + $\Delta_{UL}$	As defined in TS 38.331 [2]. $\Delta_{UL}$ is derived from the uplink calibration process <sup>Note 3</sup>
Configured UE transmitted power (P <sub>C<sub>MAX,f,c</sub></sub> )		dBm	maximum value configurable for certain power class	As defined in clause 6.2.4 in TS 38.101-2 [19]
MsgA Configuration			FR2 MsgA configuration 2	As defined in A.3.20.3, with exceptions as defined below.
msgA-RSRP-ThresholdSSB		dBm	RSRP <sub>69</sub> + $\Delta_{DL}$	RSRP <sub>69</sub> corresponds to -88dBm. $\Delta_{DL}$ is derived from the downlink calibration process <sup>Note 4</sup>
msgA-PreambleReceivedTargetPower		dBm	-100	As defined in TS 38.331 [2]
<p>Note 1: OCNG shall be used such that a constant total transmitted power spectral density is achieved for all OFDM symbols. The OCNG pattern is chosen during the test according to the presence of a DL reference measurement channel.</p> <p>Note 2: The DL PDSCH reference measurement channel is used in the test only when a downlink transmission dedicated to the UE under test is required.</p> <p>Note 3: The <math>\Delta_{UL}</math> value is calculated as <math>-\text{ROUND}(\text{P}_{\text{MsgA0}} - 1)</math>, where <math>\text{P}_{\text{MsgA0}}</math> is the measured first MsgA PRACH power with -80.6dBm/SCS applied, <math>\text{msgA-PreambleReceivedTargetPower} = -100\text{dBm}</math> and <math>\text{ss-PBCH-BlockPower} = 20\text{dBm}</math>. These values are used during the uplink calibration process carried out before the test case is run, with the UE configured to send MsgA.</p> <p>Note 4: The <math>\Delta_{DL}</math> value is calculated as <math>(\text{RSRP}_{\text{REP}} - \text{RSRP}_{76})</math>, where <math>\text{RSRP}_{\text{REP}}</math> is the SS-RSRP Reported value in Table 10.1.6.1-1 with -80.6dBm/SCS applied. These values are used during the downlink calibration process carried out before the test case is run, with the UE configured to report SS-RSRP. For a Reported value RSRP<sub>x</sub>, x is treated as a positive integer value.</p>				

**Table 7.3.2.2.1.5-2 OTA-related test parameters for non-contention based random access test for 2-step RA type in FR2 for NR Standalone**

Parameter		Unit	Test-1	Comments
AoA setup			Setup 1	As defined in A.3.15.1
Assumption for UE beams <sup>Note 2</sup>			Rough	
SSB with index 0	$E_s$ <sup>Note 1</sup>	dBm/SCS	-80.6	Power of SSB with index 0 is set to be above configured <i>msgA-RSRP-ThresholdSSB</i>
	SSB_RP	dBm/SCS	-80.6	
	$E_s/10t_{BB}$	dB	21.09	
	$10$	dBm/95.04 MHz	-56.01	$10$ in symbols containing SSB index 0
SSB with index 1	$E_s$ <sup>Note 1</sup>	dBm/SCS	-95.0	Power of SSB with index 1 is set to be below configured <i>msgA-RSRP-ThresholdSSB</i>
	SSB_RP	dBm/SCS	-95.0	
	$E_s/10t_{BB}$	dB	6.69	
	$10$	dBm/95.04 MHz	-70.41	$10$ in symbols containing SSB index 1
Propagation Condition		-	AWGN	
Note 1: No artificial noise is applied in this test.				
Note 2: Information about types of UE beam is given in B.2.1.3, and does not limit UE implementation or test system implementation				

### 7.3.2.3 RRC connection release with redirection

## 7.3.3 Conditional handover

### 7.3.3.0 Minimum conformance requirements

#### 7.3.3.0.1 Minimum conformance requirements for NR FR2 intra-frequency conditional handover

[TS 38.133, clause 6.1.4.4.1]

Procedure delays for all procedures that can command a conditional handover are specified in TS 38.331 [13].

When the UE receives a RRC message implying conditional handover the UE shall be ready to start the transmission of the new uplink PRACH channel within  $D_{handover}$  seconds from the end of the last TTI containing the RRC command.

$$D_{CHO} = T_{RRC} + T_{Event\_DU} + T_{measure} + T_{interrupt} + T_{CHO\_execution}$$

Where:

$T_{RRC}$  is the RRC procedure delay defined in clause 12 in TS 38.331 [13].

$T_{Event\_DU}$  is the delay uncertainty which is the time from when the UE successfully decodes a conditional handover command until a condition exists at the measurement reference point which will trigger the conditional handover.

$T_{measure}$  is the measurements time stated in TS 38.133 [6] clause 6.1.4.4.2.

$T_{CHO\_execution}$  is the conditional execution preparation time in TS 38.133 [6] clause 6.1.4.4.3.

$T_{interrupt}$  is the interruption time stated in TS 38.133 [6] clause 6.1.4.4.4.

[TS 38.133, clause 6.1.4.4.2]

The measurement time delay is defined from the end of  $T_{Event\_DU}$  until UE executes a handover to a target cell and interruption time starts.

For intra-frequency handover, the measurement time delay measured without Time To Trigger (TTT) and L3 filtering shall be less than  $T_{identify\ intra\ with\ index}$  or  $T_{identify\_intra\_without\_index}$  defined in TS 38.133 [6] clause 9.2.5.1 or clause 9.2.6.2.

When TTT or L3 filtering is used an additional delay can be expected.

A cell is detectable only if at least one SSB measured from the cell being configured remains detectable during the time period  $T_{\text{identify\_intra\_without\_index}}$  or  $T_{\text{identify\_intra\_with\_index}}$  for intra-frequency handover or  $T_{\text{identify\_inter\_without\_index}}$  for inter-frequency handover. If a cell which has been detectable at least for the time period  $T_{\text{identify\_intra\_without\_index}}$  or  $T_{\text{identify\_intra\_with\_index}}$  for intra-frequency handover or  $T_{\text{identify\_inter\_without\_index}}$  for inter-frequency handover becomes undetectable for a period and then the cell becomes detectable again and triggers a handover, the measurement time delay shall be less than  $T_{\text{SSB\_measurement\_period\_intra}}$  or  $T_{\text{SSB\_measurement\_period\_inter}}$  provided the timing to that cell has not changed more than  $\pm 3200 T_c$  while the measurement gap has not been available and the L3 filter has not been used. When L3 filtering is used, an additional delay can be expected.

[TS 38.133, clause 6.1.4.4.3]

$T_{\text{CHO\_execution}}$  is the UE execution preparation time for conditional handover, and starts after UE realizes the condition of CHO is met and identity of the target cell is determined.  $T_{\text{CHO\_execution}}$  can be up to 10ms.

[TS 38.133, clause 6.1.4.4.4]

The interruption time is the time between when the UE starts to execute the conditional handover to the target cell and the time the UE starts transmission of the new PRACH.

For intra-frequency or inter-frequency conditional conditional handover, the measurement time shall be less than

$$T_{\text{interrupt}} = T_{\text{processing}} + T_{\text{IU}} + T_{\Delta} + T_{\text{margin}} \text{ ms}$$

Where:

$T_{\text{processing}}$  is time for UE processing.  $T_{\text{processing}}$  can be up to 20ms.

$T_{\text{IU}}$  is the interruption uncertainty in acquiring the first available PRACH occasion in the new cell.  $T_{\text{IU}}$  can be up to the summation of SSB to PRACH occasion association period and 10 ms. SSB to PRACH occasion associated period is defined in the table 8.1-1 of TS 38.213 [8]

$T_{\Delta}$  is time for fine time tracking and acquiring full timing information of the target cell.  $T_{\Delta} = T_{\text{rs}}$ .

$T_{\text{margin}}$  is time for SSB post-processing.  $T_{\text{margin}}$  can be up to 2ms.

$T_{\text{rs}}$  is the SMTC periodicity of the target NR cell if the UE has been provided with an SMTC configuration for the target cell in the handover command, otherwise  $T_{\text{rs}}$  is the SMTC configured in the measObjectNR having the same SSB frequency and subcarrier spacing. If the UE is not provided SMTC configuration or measurement object on this frequency, the requirement in this clause is applied with  $T_{\text{rs}}=5\text{ms}$  assuming the SSB transmission periodicity is 5ms. There is no requirement if the SSB transmission periodicity is not 5ms. If the UE has been provided with higher layer in TS 38.331 [13] signaling of *smtc2* prior to the handover command,  $T_{\text{rs}}$  follows *smtc1* or *smtc2* according to the physical cell ID of the target cell.

NOTE 1: The actual value of  $T_{\text{IU}}$  shall depend upon the PRACH configuration used in the target cell. [TS 38.133, clause 9.2.2]

The requirements in TS 38.133 [6] clause 9.2 apply, provided:

- The cell being identified or measured is detectable.

An intra-frequency cell shall be considered detectable when for each relevant SSB:

- SS-RSRP related side conditions given in TS 38.133 [6] clauses 10.1.3 for FR2, for a corresponding Band,
- SSB<sub>RP</sub> and SSB  $\hat{E}_s/I_{ot}$  according to TS 38.133 [6] Annex B.2.2 for a corresponding Band.

[TS 38.133, clause 9.2.5.1]

The UE shall be able to identify a new detectable intra-frequency cell within  $T_{\text{identify\_intra\_without\_index}}$  if the UE is not indicated to report SSB based RRM measurement result with the associated SSB index (*reportQuantityRsIndexes* or *maxNrofRSIndexesToReport* is not configured), or the UE is indicated that the neighbour cell is synchronous with the serving cell (*deriveSSB-IndexFromCell* is enabled). Otherwise UE shall be able to identify a new detectable intra frequency cell within  $T_{\text{identify\_intra\_with\_index}}$ . The UE shall be able to identify a new detectable intra frequency SS block of an already detected cell within  $T_{\text{identify\_intra\_without\_index}}$ . It is assumed that *deriveSSB-IndexFromCell* is always enabled for FR1 TDD and FR2.

$$T_{\text{identify\_intra\_without\_index}} = (T_{\text{PSS/SSS\_sync\_intra}} + T_{\text{SSB\_measurement\_period\_intra}}) \text{ ms}$$

Where:

$T_{\text{PSS/SSS\_sync\_intra}}$ : it is the time period used in PSS/SSS detection given in TS38.133 [6] Table 9.2.5.1-2

$T_{\text{SSB\_measurement\_period\_intra}}$ : equal to a measurement period of SSB based measurement given in TS38.133 [6] Table 9.2.5.2-2

$\text{CSSF}_{\text{intra}}$ : it is a carrier specific scaling factor and is determined

according to  $\text{CSSF}_{\text{outside\_gap},i}$  in clause 9.1.5.1 for measurement conducted outside measurement gaps, i.e. when intra-frequency SMTC is fully non overlapping or partially overlapping with measurement gaps.

$M_{\text{pss/sss\_sync\_w/o\_gaps}}$ : For a UE supporting FR2 power class 1,  $M_{\text{pss/sss\_sync\_w/o\_gaps}} = 40$ . For a UE supporting power class 2,  $M_{\text{pss/sss\_sync\_w/o\_gaps}} = 24$ . For a UE supporting FR2 power class 3,  $M_{\text{pss/sss\_sync\_w/o\_gaps}} = 24$ . For a UE supporting FR2 power class 4,  $M_{\text{pss/sss\_sync\_w/o\_gaps}} = 24$

$M_{\text{meas\_period\_w/o\_gaps}}$ : For a UE supporting power class 1,  $M_{\text{meas\_period\_w/o\_gaps}} = 40$ . For a UE supporting FR2 power class 2,  $M_{\text{meas\_period\_w/o\_gaps}} = 24$ . For a UE supporting power class 3,  $M_{\text{meas\_period\_w/o\_gaps}} = 24$ . For a UE supporting power class 4,  $M_{\text{meas\_period\_w/o\_gaps}} = 24$ .

When intra-frequency SMTC is fully non overlapping with measurement gaps or intra-frequency SMTC is fully overlapping with MGs,  $K_p = 1$

For FR2,

$$K_{\text{layer1\_measurement}} = 1,$$

- if all of the reference signals configured for RLM, BFD, CBD or L1-RSRP for beam reporting on any FR2 serving frequency in the same band outside measurement gap are not fully overlapped by intra-frequency SMTC occasions

**Table 9.2.5.1-2: Time period for PSS/SSS detection, (Frequency range FR2)**

DRX cycle	$T_{\text{PSS/SSS\_sync\_intra}}$
No DRX	$\max(600\text{ms}, \text{ceil}(M_{\text{pss/sss\_sync\_w/o\_gaps}} \times K_p \times K_{\text{layer1\_measurement}}) \times \text{SMTC period})^{\text{Note 1}} \times \text{CSSF}_{\text{intra}}$
DRX cycle $\leq$ 320ms	$\max(600\text{ms}, \text{ceil}(1.5 \times M_{\text{pss/sss\_sync\_w/o\_gaps}} \times K_p \times K_{\text{layer1\_measurement}}) \times \max(\text{SMTC period}, \text{DRX cycle})) \times \text{CSSF}_{\text{intra}}$
DRX cycle $>$ 320ms	$\text{ceil}(M_{\text{pss/sss\_sync\_w/o\_gaps}} \times K_p \times K_{\text{layer1\_measurement}}) \times \text{DRX cycle} \times \text{CSSF}_{\text{intra}}$
NOTE 1: If different SMTC periodicities are configured for different cells, the SMTC period in the requirement is the one used by the cell being identified	

[TS 38.133, clause 9.2.5.1]

The measurement period for intra-frequency measurements without gaps is as shown in 38.133 [6] Table 9.2.5.2-2.

For FR2, a longer measurement period is allowed, if aperiodic CSI-RS resource is measured for L1-RSRP measurement on any FR2 serving frequency in the same band, and the CSI-RS resource is outside measurement gap and overlapped with any of the SSB symbols and the RSSI symbols, and 1 symbol before each consecutive SSB symbols and the RSSI symbols, and 1 symbol after each consecutive SSB symbols and the RSSI symbols. If *SSB-ToMeasure* or *SS-RSSI-Measurement* is configured, the SSB symbols are indicated by the union set of *SSB-ToMeasure* from all the configured measurement objects on the same band which can be merged and the RSSI symbols are indicated by *SS-RSSI-Measurement*.

**Table 9.2.5.2-2: Measurement period for intra-frequency measurements without gaps(FR2)**

DRX cycle	$T_{SSB\_measurement\_period\_intra}$
No DRX	$\max(400\text{ms}, \text{ceil}(M_{\text{meas\_period\_w/o\_gaps}} \times K_p \times K_{\text{layer1\_measurement}}) \times \text{SMTC period})^{\text{Note 1}} \times \text{CSSF}_{\text{intra}}$
DRX cycle $\leq$ 320ms	$\max(400\text{ms}, \text{ceil}(1.5 \times M_{\text{meas\_period\_w/o\_gaps}} \times K_p \times K_{\text{layer1\_measurement}}) \times \max(\text{SMTC period}, \text{DRX cycle})) \times \text{CSSF}_{\text{intra}}$
DRX cycle $>$ 320ms	$\text{ceil}(M_{\text{meas\_period\_w/o\_gaps}} \times K_p \times K_{\text{layer1\_measurement}}) \times \text{DRX cycle} \times \text{CSSF}_{\text{intra}}$
NOTE 1: If different SMTC periodicities are configured for different cells, the SMTC period in the requirement is the one used by the cell being identified	

[TS 38.133, clause 10.1.3.1.1]

Unless otherwise specified, the requirements for absolute accuracy of SS-RSRP in this clause apply to a cell on the same frequency as that of the serving cell in FR2.

The accuracy requirements in TS 38.133 [6] Table 10.1.3.1.1-1 are valid under the following conditions:

- Conditions defined in clause 7.3 of TS 38.101-2 [3] for reference sensitivity are fulfilled.
- Conditions for intra-frequency measurements are fulfilled according to Annex B.2.2 for a corresponding Band for each relevant SSB.
- The measured signals are in the directions covered by the percentile EIS spherical coverage of the UE, defined in clause 7.3.4 of TS 38.101-2 [3].

**Table 10.1.3.1.1-1: SS-RSRP Intra frequency absolute accuracy in FR2**

Accuracy		Conditions			
Normal condition	Extreme condition	SSB $\hat{E}_s/\text{lot}$	$I_o$ <sup>Note 2</sup> range		
			Minimum $I_o$		Maximum $I_o$
dB	dB	dB	dBm / $SCS_{SSB}$ <sup>Note 1</sup>		dBm/ $BW_{\text{Channel}}$
			$SCS_{SSB} = 120\text{kHz}$	$SCS_{SSB} = 240\text{kHz}$	
$\pm 6$	$\pm 9$	$\geq -6$	Same value as SSB_RP in TS 38.133 [6] Table B.2.2-2, according to UE Power class, operating band and angle of arrival		N/A
$\pm 8$	$\pm 11$		N/A		-70
Note 1: Values based on Refsens and EIS spherical coverage as defined in clauses 7.3.2 and 7.3.4 of TS 38.101-2 [3]. Applicable side condition selected depending on angle of arrival. Note 2: $I_o$ specified at the Reference point, and assumed to have constant EPRE across the bandwidth. Note 3: In the test cases, the SSB $\hat{E}_s/\text{lot}$ and related parameters may need to be adjusted to ensure $\hat{E}_s/\text{lot}$ at UE baseband is above the value defined in this table.					

[TS 38.133, annex B.2.2]

This clause defines the following conditions for NR intra-frequency measurements and corresponding procedures performed based on SSBs: SSB\_RP and SSB  $\hat{E}_s/\text{lot}$ , applicable for a corresponding operating band.

The conditions are defined in TS 38.133 [6] Table B.2.2-2 for FR2 NR cells.

Table B.2.2-2: Conditions for intra-frequency measurements in FR2

Parameter	Angle of arrival	NR operating bands	Minimum SSB <sub>RP</sub> <sup>Note 2, Note 3</sup>					SSB $\hat{E}_s/\text{lot}$		
			dBm / SCS <sub>SSB</sub>					dB		
			SCS <sub>SSB</sub> = 120 kHz			SCS <sub>SSB</sub> = 240 kHz				
			UE Power class						UE Power class	
			1	2	3	4	5		1, 2, 3, 4, 5	
Conditions	Rx Beam Peak	n257	- 128.3+Y <sub>1</sub>	- 113.8	- 112.1	- 127.8+Y <sub>4</sub>	- 123.4+Y <sub>5</sub>	(Value for SCS <sub>SSB</sub> = 120 kHz) +3dB	≥-6	
		n258	- 128.3+Y <sub>1</sub>	- 113.8	- 112.1	- 127.8+Y <sub>4</sub>	- 123.6+Y <sub>5</sub>			
		n260	- 125.3+Y <sub>1</sub>		- 109.5	- 125.8+Y <sub>4</sub>				
		n261	- 128.3+Y <sub>1</sub>	- 113.8	- 112.1	- 127.8+Y <sub>4</sub>				
		n262	- 123.3+Y <sub>1</sub>	- 108,6	- 106.6	- 121.8+Y <sub>4</sub>				
	Spherical coverage <sup>Note 1</sup>	n257	- 120.3+Z <sub>1</sub>	- 102.8	- 101.2	- 118.8+Z <sub>4</sub>	- 115.4+Z <sub>5</sub>	(Value for SCS <sub>SSB</sub> = 120 kHz) +3dB		≥-6
		n258	- 120.3+Z <sub>1</sub>	- 102.8	- 101.2	- 118.8+Z <sub>4</sub>	- 115.6+Z <sub>5</sub>			
		n260	- 117.3+Z <sub>1</sub>		- -96.9	- 113.8+Z <sub>4</sub>				
		n261	- 120.3+Z <sub>1</sub>	- 102.8	- 101.2	- 118.8+Z <sub>4</sub>				
		n262	- 115.1+Z <sub>1</sub>	- -96.7	- -93.5	- 109.7+Z <sub>4</sub>				

Note 1: Values based on EIS spherical coverage as defined in clause 7.3.4 of TS 38.101-2 [3]. Side condition applies for directions in which EIS spherical coverage requirement is met.

Note 2: Values specified at the Reference point to give minimum SSB  $\hat{E}_s/\text{lot}$ , with no applied noise.

Note 3: For UEs that support multiple FR2 bands, Rx Beam Peak values are increased by  $\Delta\text{MB}_{P,n}$  and Spherical coverage values are increased by  $\Delta\text{MB}_{S,n}$ , the UE multi-band relaxation factor in dB specified in clause 6.2.1 of TS 38.101-2 [3].

### 7.3.3.0.2 Minimum conformance requirements for NR FR2 inter-frequency conditional handover

[TS 38.133, clause 6.1.4.4.1]

Procedure delays for all procedures that can command a conditional handover are specified in TS 38.331 [13].

When the UE receives a RRC message implying conditional handover the UE shall be ready to start the transmission of the new uplink PRACH channel within  $D_{\text{handover}}$  seconds from the end of the last TTI containing the RRC command.

$$D_{\text{CHO}} = T_{\text{RRC}} + T_{\text{Event\_DU}} + T_{\text{measure}} + T_{\text{interrupt}} + T_{\text{CHO\_execution}}$$

Where:

$T_{\text{RRC}}$  is the RRC procedure delay defined in clause 12 in TS 38.331 [13].

$T_{\text{Event\_DU}}$  is the delay uncertainty which is the time from when the UE successfully decodes a conditional handover command until a condition exists at the measurement reference point which will trigger the conditional handover.

$T_{\text{measure}}$  is the measurements time stated in TS 38.133 [6] clause 6.1.4.4.2.

$T_{\text{CHO\_execution}}$  is the conditional execution preparation time in TS 38.133 [6] clause 6.1.4.4.3.

$T_{\text{interrupt}}$  is the interruption time stated in TS 38.133 [6] clause 6.1.4.4.4.



[TS 38.133, clause 6.1.4.4.2]

The measurement time delay is defined from the end of  $T_{\text{Event\_DU}}$  until UE executes a handover to a target cell and interruption time starts.

For intra-frequency handover, the measurement time delay measured without Time To Trigger (TTT) and L3 filtering shall be less than  $T_{\text{identify\_intra\_with\_index}}$  or  $T_{\text{identify\_intra\_without\_index}}$  defined in TS 38.133 [6] clause 9.2.5.1 or clause 9.2.6.2.

When TTT or L3 filtering is used an additional delay can be expected.

A cell is detectable only if at least one SSB measured from the cell being configured remains detectable during the time period  $T_{\text{identify\_intra\_without\_index}}$  or  $T_{\text{identify\_intra\_with\_index}}$  for intra-frequency handover or  $T_{\text{identify\_inter\_without\_index}}$  for inter-frequency handover. If a cell which has been detectable at least for the time period  $T_{\text{identify\_intra\_without\_index}}$  or  $T_{\text{identify\_intra\_with\_index}}$  for intra-frequency handover or  $T_{\text{identify\_inter\_without\_index}}$  for inter-frequency handover becomes undetectable for a period and then the cell becomes detectable again and triggers a handover, the measurement time delay shall be less than  $T_{\text{SSB\_measurement\_period\_intra}}$  or  $T_{\text{SSB\_measurement\_period\_inter}}$  provided the timing to that cell has not changed more than  $\pm 3200 T_c$  while the measurement gap has not been available and the L3 filter has not been used. When L3 filtering is used, an additional delay can be expected.

[TS 38.133, clause 6.1.4.4.3]

$T_{\text{CHO\_execution}}$  is the UE execution preparation time for conditional handover, and starts after UE realizes the condition of CHO is met and identity of the target cell is determined.  $T_{\text{CHO\_execution}}$  can be up to 10ms.

[TS 38.133, clause 6.1.4.4.4]

The interruption time is the time between when the UE starts to execute the conditional handover to the target cell and the time the UE starts transmission of the new PRACH.

For intra-frequency or inter-frequency conditional conditional handover, the measurement time shall be less than

$$T_{\text{interrupt}} = T_{\text{processing}} + T_{\text{IU}} + T_{\Delta} + T_{\text{margin}} \text{ ms}$$

Where:

$T_{\text{processing}}$  is time for UE processing.  $T_{\text{processing}}$  can be up to 20ms.

$T_{\text{IU}}$  is the interruption uncertainty in acquiring the first available PRACH occasion in the new cell.  $T_{\text{IU}}$  can be up to the summation of SSB to PRACH occasion association period and 10 ms. SSB to PRACH occasion associated period is defined in the table 8.1-1 of TS 38.213 [8]

$T_{\Delta}$  is time for fine time tracking and acquiring full timing information of the target cell.  $T_{\Delta} = T_{\text{rs}}$ .

$T_{\text{margin}}$  is time for SSB post-processing.  $T_{\text{margin}}$  can be up to 2ms.

$T_{\text{rs}}$  is the SMTC periodicity of the target NR cell if the UE has been provided with an SMTC configuration for the target cell in the handover command, otherwise  $T_{\text{rs}}$  is the SMTC configured in the measObjectNR having the same SSB frequency and subcarrier spacing. If the UE is not provided SMTC configuration or measurement object on this frequency, the requirement in this clause is applied with  $T_{\text{rs}}=5\text{ms}$  assuming the SSB transmission periodicity is 5ms. There is no requirement if the SSB transmission periodicity is not 5ms. If the UE has been provided with higher layer in TS 38.331 [13] signaling of *smtc2* prior to the handover command,  $T_{\text{rs}}$  follows *smtc1* or *smtc2* according to the physical cell ID of the target cell.

NOTE 1: The actual value of  $T_{\text{IU}}$  shall depend upon the PRACH configuration used in the target cell.

[TS 38.133, clause 9.3.2]

The requirements in clause 9.3 apply, provided:

- The cell being identified or measured is detectable.

An inter-frequency cell shall be considered detectable when for each relevant SSB:

- SS-RSRP related side conditions given in TS 38.133 [6] clauses 10.1.5 for FR2, for a corresponding Band,
- SSB<sub>RP</sub> and SSB  $\hat{E}_s/I_{ot}$  according to TS 38.133 [6] Annex B.2.3 for a corresponding Band.

[TS 38.133, clause 9.3.4]

When measurement gaps are provided, or the UE supports capability of conducting such measurements without gaps, the UE shall be able to identify a new detectable inter frequency cell within  $T_{\text{identify\_inter\_without\_index}}$  if UE is not indicated to report SSB based RRM measurement result with the associated SSB index (*reportQuantityRsinIndexes* or *maxNrofRsinIndexesToReport* is not configured). Otherwise UE shall be able to identify a new detectable inter frequency cell within  $T_{\text{identify\_inter\_with\_index}}$ . The UE shall be able to identify a new detectable inter frequency SS block of an already detected cell within  $T_{\text{identify\_inter\_without\_index}}$ .

$$T_{\text{identify\_inter\_without\_index}} = (T_{\text{PSS/SSS\_sync\_inter}} + T_{\text{SSB\_measurement\_period\_inter}}) \text{ ms}$$

$$T_{\text{identify\_inter\_with\_index}} = (T_{\text{PSS/SSS\_sync\_inter}} + T_{\text{SSB\_measurement\_period\_inter}} + T_{\text{SSB\_time\_index\_inter}}) \text{ ms}$$

Where:

$T_{\text{PSS/SSS\_sync\_inter}}$ : it is the time period used in PSS/SSS detection given in 38.133 [6] Table 9.3.4-2.

$T_{\text{SSB\_time\_index\_inter}}$ : it is the time period used to acquire the index of the SSB being measured given in 38.133 [6] Table 9.3.4-4.

$T_{\text{SSB\_measurement\_period\_inter}}$ : equal to a measurement period of SSB based measurement given in 38.133 [6] Table 9.3.5-2.

$M_{\text{pss/sss\_sync\_inter}}$ : For a UE supporting FR2 power class 1,  $M_{\text{pss/sss\_sync\_inter}} = 64$  samples. For a UE supporting FR2 power class 2,  $M_{\text{pss/sss\_sync\_inter}} = 40$  samples. For a UE supporting FR2 power class 3,  $M_{\text{pss/sss\_sync\_inter}} = 40$  samples. For a UE supporting FR2 power class 4,  $M_{\text{pss/sss\_sync\_inter}} = 40$  samples.

$M_{\text{SSB\_index\_inter}}$ : For a UE supporting FR2 power class 1,  $M_{\text{SSB\_index\_inter}} = 40$  samples. For a UE supporting FR2 power class 2,  $M_{\text{SSB\_index\_inter}} = 24$  samples. For a UE supporting FR2 power class 3,  $M_{\text{SSB\_index\_inter}} = 24$  samples. For a UE supporting FR2 power class 4,  $M_{\text{SSB\_index\_inter}} = 24$  samples.

$M_{\text{meas\_period\_inter}}$ : For a UE supporting FR2 power class 1,  $M_{\text{meas\_period\_inter}} = 64$  samples. For a UE supporting FR2 power class 2,  $M_{\text{meas\_period\_inter}} = 40$  samples. For a UE supporting FR2 power class 3,  $M_{\text{meas\_period\_inter}} = 40$  samples. For a UE supporting FR2 power class 4,  $M_{\text{meas\_period\_inter}} = 40$  samples.

$\text{CSSF}_{\text{inter}}$ : it is a carrier specific scaling factor and is determined according to  $\text{CSSF}_{\text{within\_gap},i}$  in clause 9.1.5.2 for measurement conducted within measurement gaps.

**Table 9.3.4-2: Time period for PSS/SSS detection, (Frequency range FR2)**

Condition <sup>NOTE1,2</sup>	$T_{\text{PSS/SSS\_sync\_inter}}$
No DRX	$\text{Max}(600\text{ms}, M_{\text{pss/sss\_sync\_inter}} \times \text{Max}(\text{MGRP}, \text{SMTC period})) \times \text{CSSF}_{\text{inter}}$
DRX cycle $\leq$ 320ms	$\text{Max}(600\text{ms}, (1.5 \times M_{\text{pss/sss\_sync\_inter}}) \times \text{Max}(\text{MGRP}, \text{SMTC period}, \text{DRX cycle})) \times \text{CSSF}_{\text{inter}}$
DRX cycle $>$ 320ms	$M_{\text{pss/sss\_sync\_inter}} \times \text{DRX cycle} \times \text{CSSF}_{\text{inter}}$
NOTE 1: DRX or non DRX requirements apply according to the conditions described in clause 3.6.1	
NOTE 2: In EN-DC operation, the parameters, timers and scheduling requests referred to in clause 3.6.1 are for the secondary cell group. The DRX cycle is the DRX cycle of the secondary cell group.	

**Table 9.3.4-4: Time period for time index detection (Frequency range FR2)**

Condition <sup>NOTE1,2</sup>	$T_{\text{SSB\_time\_index\_inter}}$
No DRX	$\text{Max}(200\text{ms}, M_{\text{SSB\_index\_inter}} \times \text{Max}(\text{MGRP}, \text{SMTC period})) \times \text{CSSF}_{\text{inter}}$
DRX cycle $\leq$ 320ms	$\text{Max}(200\text{ms}, (1.5 \times M_{\text{SSB\_index\_inter}}) \times \text{Max}(\text{MGRP}, \text{SMTC period}, \text{DRX cycle})) \times \text{CSSF}_{\text{inter}}$
DRX cycle $>$ 320ms	$M_{\text{SSB\_index\_inter}} \times \text{DRX cycle} \times \text{CSSF}_{\text{inter}}$
NOTE 1: DRX or non DRX requirements apply according to the conditions described in clause 3.6.1	
NOTE 2: In EN-DC operation, the parameters, timers and scheduling requests referred to in clause 3.6.1 are for the secondary cell group. The DRX cycle is the DRX cycle of the secondary cell group.	

[TS 38.133, clause 9.3.5]

When measurement gaps are provided for inter frequency measurements, or the UE supports capability of conducting such measurements without gaps, the UE physical layer shall be capable of reporting SS-RSRP, SS-RSRQ and SS-

SINR measurements to higher layers with measurement accuracy as specified in TS 38.133 [6] clauses 10.1.4, 10.1.5, 10.1.9, 10.1.10, 10.1.14 and 10.1.15, respectively, as shown in TS 38.133 [6] Table and 9.3.5-2:

**Table 9.3.5-2: Measurement period for inter-frequency measurements with gaps (Frequency FR2)**

Condition <sup>NOTE1,2</sup>	T <sub>SSB_measurement_period_inter</sub>
No DRX	Max(400ms, M <sub>meas_period_inter</sub> × Max(MGRP, SMTC period)) × CSSF <sub>inter</sub>
DRX cycle ≤ 320ms	Max(400ms, (1.5 × M <sub>meas_period_inter</sub> ) × Max(MGRP, SMTC period, DRX cycle)) × CSSF <sub>inter</sub>
DRX cycle > 320ms	M <sub>meas_period_inter</sub> × DRX cycle × CSSF <sub>inter</sub>
NOTE 1: DRX or non DRX requirements apply according to the conditions described in clause 3.6.1	
NOTE 2: In EN-DC operation, the parameters, timers and scheduling requests referred to in clause 3.6.1 are for the secondary cell group. The DRX cycle is the DRX cycle of the secondary cell group.	

[TS 38.133, clause 10.1.5.1.1]

Unless otherwise specified, the requirements for absolute accuracy of SS-RSRP in this clause apply to a cell on a frequency in FR2 that is on a different frequency than the serving cell.

The accuracy requirements in TS 38.133 [6] Table 10.1.5.1.1-1 are valid under the following conditions:

- Conditions defined in clause 7.3 of TS 38.101-2 [3] for reference sensitivity are fulfilled.
- Conditions for inter-frequency measurements are fulfilled according to TS 38.133 [6] Annex B.2.3 for a corresponding Band for each relevant SSB.
- The measured signals are in the directions covered by the percentile EIS spherical coverage of the UE, defined in clause 7.3.4 of TS 38.101-2 [3].

**Table 10.1.5.1.1-1: SS-RSRP Inter frequency absolute accuracy in FR2**

Accuracy		Conditions			
Normal condition	Extreme condition	SSB Ês/lot	I <sub>o</sub> <sup>Note 2</sup> range		
			Minimum I <sub>o</sub>		Maximum I <sub>o</sub>
dB	dB	dB	dBm / SCS <sub>SSB</sub> <sup>Note 1</sup>		dBm/BW <sub>Channel</sub>
			SCS <sub>SSB</sub> = 120kHz	SCS <sub>SSB</sub> = 240kHz	
±6	±9	≥-4	Same value as SSB_RP in Table B.2.3-2, according to UE Power class, operating band and angle of arrival		N/A
±8	±11		N/A		-70
Note 1: Values based on Refsens and EIS spherical coverage as defined in clauses 7.3.2 and 7.3.4 of TS 38.101-2 [3]. Applicable side condition selected depending on angle of arrival. Note 2: I <sub>o</sub> specified at the Reference point, and assumed to have constant EPRE across the bandwidth. Note 3: In the test cases, the SSB Ês/lot and related parameters may need to be adjusted to ensure Ês/lot at UE baseband is above the value defined in this table.					

[TS 38.133, annex B.2.3]

This clause defines the following conditions for NR inter-frequency measurements and corresponding procedures performed based on SSBs: SSB\_RP and SSB Ês/Iot, applicable for a corresponding operating band.

The conditions are defined in Table B.2.3-2 for FR2 NR cells.

Table B.2.3-2: Conditions for inter-frequency measurements in FR2

Parameter	Angle of arrival	NR operating bands	Minimum SSB <sub>RP</sub> <sup>Note 2, Note 3</sup>					SSB $\hat{E}_s/I_{ot}$	
			dBm / SCS <sub>SSB</sub>					dB	
			SCS <sub>SSB</sub> = 120 kHz			SCS <sub>SSB</sub> = 240 kHz			
			UE Power class						UE Power class
			1	2	3	4	5		1, 2, 3, 4, 5
Conditions	Rx Beam Peak	n257	- 126.3+Y <sub>1</sub>	- 111.8	- 110.1	- 125.8+Y <sub>4</sub>	- 121.4+Y <sub>5</sub>	(Value for SCS <sub>SSB</sub> = 120 kHz) +3dB	≥-4
		n258	- 126.3+Y <sub>1</sub>	- 111.8	- 110.1	- 125.8+Y <sub>4</sub>	- 121.6+Y <sub>5</sub>		
		n260	- 123.3+Y <sub>1</sub>		- 107.5	- 123.8+Y <sub>4</sub>			
		n261	- 126.3+Y <sub>1</sub>	- 111.8	- 110.1	- 125.8+Y <sub>4</sub>			
		n262	- 121.3+Y <sub>1</sub>	106.6	104.6	- 119.8+Y <sub>4</sub>			
	Spherical coverage <sup>Note 1</sup>	n257	- 118.3+Z <sub>1</sub>	- 100.8	-99.2	- 116.8+Z <sub>4</sub>	- 113.4+Z <sub>5</sub>	(Value for SCS <sub>SSB</sub> = 120 kHz) +3dB	
		n258	- 118.3+Z <sub>1</sub>	- 100.8	-99.2	- 116.8+Z <sub>4</sub>	- 113.6+Z <sub>5</sub>		
		n260	- 115.3+Z <sub>1</sub>		-94.9	- 111.8+Z <sub>4</sub>			
		n261	- 118.3+Z <sub>1</sub>	- 100.8	-99.2	- 116.8+Z <sub>4</sub>			
		n262	- 113.1+Z <sub>1</sub>	-94.7	-91.5	- 107.7+Z <sub>4</sub>			

NOTE 1: Values based on EIS spherical coverage as defined in clause 7.3.4 of TS 38.101-2 [3]. Side condition applies for directions in which EIS spherical coverage requirement is met.

NOTE 2: Values specified at the Reference point to give minimum SSB  $\hat{E}_s/I_{ot}$ , with no applied noise.

NOTE 3: For UEs that support multiple FR2 bands, Rx Beam Peak values are increased by  $\Delta MB_{P,n}$  and Spherical coverage values are increased by  $\Delta MB_{S,n}$ , the UE multi-band relaxation factor in dB specified in clause 6.2.1 of TS 38.101-2 [3].

### 7.3.3.1 NR SA FR2 conditional handover

**Editor's Note: This test case is complete for the following configurations:**

- Test frequency  $f \leq 40.8$  GHz.
- UE PC3

**This test case is incomplete for Test frequency  $f > 40.8$  GHz**

**This test case is incomplete for UE power class other than PC3.**

#### 7.3.3.1.1 Test purpose

To verify the requirement for the NR FR2 intra frequency conditional handover requirements specified in 38.133 [6] clause 6.1.4.4.

#### 7.3.3.1.2 Test applicability

This test applies to all types of NR UE from Release 16 onwards and supporting conditional handover.

#### 7.3.3.1.3 Minimum conformance requirements

The minimum conformance requirements are specified in clause 7.3.3.0.1.

The normative reference for this requirement is TS 38.133 [6] clause A.7.3.3.1.

## 7.3.3.1.4 Test description

## 7.3.3.1.4.1 Initial conditions

Initial conditions are a set of test configurations the UE needs to be tested in and the steps for the SS to take with the UE to reach the correct measurement state.

This test shall be tested using any of the test configurations in Table 7.3.3.1.4.1-1.

**Table 7.3.3.1.4.1-1: NR SA FR2 conditional handover test configurations**

Config	Description
7.3.3.1-1	Source cell: NR 120 kHz SSB SCS, 100 MHz bandwidth, TDD duplex mode Target cell: NR 120 kHz SSB SCS, 100 MHz bandwidth, TDD duplex mode
Note:	The UE is only required to be tested in one of the supported test configurations

Configure the test equipment and the DUT according to the parameters in Table 7.3.3.1.4.1-2

**Table 7.3.3.1.4.1-2: Initial conditions for NR SA FR2 conditional handover**

Parameter	Value		Comment
Test environment	NC		As specified in TS 38.508-1 [14] clause 4.1.
Test frequencies	As specified in Annex E, table E.4-1 and TS 38.508-1 [14] clause 4.3.1.		
Channel bandwidth	As specified by the test configuration selected from Table 7.1.1.1.4.1-1.		
Propagation conditions	AWGN		As specified in Annex C.2.2.
Connection Diagram	TE Part	A.3.3.3.1	As specified in TS 38.508-1 [14] Annex A.
	DUT Part	A.3.4.1.1	
Exceptions to connection diagram	N/A		

1. Message contents are defined in clause 7.3.3.1.4.3.
2. The power levels and settings for NR Cell 1 are set according to Annex C.1.2 and C.1.3. Cell 2 is NR FR2 target Cell, and its power levels and settings are also set according to Annex C.1.2 and C.1.3.
3. The test parameters are given in Table 7.3.3.1.4.1-3 below, with A3-Offset modified by Test Tolerance.

**Table 7.3.3.1.4.1-3: General test parameters for NR SA FR2 conditional handover**

Parameter	Unit	Value	Comment
Initial conditions	Active cell	Cell 1	
	Neighbouring cell	Cell 2	
Final condition	Active cell	Cell 2	
A3-Offset for condition	dBm	-2 <sup>Note 1</sup>	Trigger HO to cell which may be measured as -1dB relative to cell 1. Actual SS-RSRP is 5dB stronger.
Hysteresis	dB	0	
Time To Trigger	s	0	
Filter coefficient		0	L3 filtering is not used
Access Barring Information	-	Not Sent	No additional delays in random access procedure.
Time offset between cells		3 $\mu$ s	Synchronous cells
T1	s	5	
T2	s	$\leq 2$	

Note 1: Including test tolerance given in Annex F.1.3.2

## 7.3.3.1.4.2 Test procedure

The test scenario comprises of 1 NR carrier and two cells, Cell 1 and Cell 2, on this carrier. General parameters and Cell-specific parameters for Cell 1 and Cell 2 are given in Table 7.3.3.1.4.1-3 and 7.3.3.1.5-1 respectively. No measurement gap is configured in the test case.

The test consists of two successive time periods, with time durations of T1 and T2 respectively.

At the start of time duration T1, the UE may not have any timing information of cell 2. The UE is configured with a condition implying handover to Cell 2 at a time earlier than  $T_{RRC}$  ms before the beginning of T2. No interruption shall be observed in time period T1. where,

- $T_{RRC} = 10\text{ms}$ , is the RRC procedure delay defined in clause 12 in TS 38.331 [13].

From start of T2, the Cell 2 becomes detectable and handover condition is satisfied. During T2, the UE performs measurement on Cell 2 and evaluates the execution condition, and starts handover procedure when execution condition is satisfied. The UE shall sent PRACH to Cell 2 less than  $T_{\text{measure}} + T_{\text{CHO\_execution}} + T_{\text{interrupt}}$  ms from the start of T2. The Interruption length  $T_{\text{interrupt}}$  shall also be verified in T2.

1. Ensure the UE is in State RRC\_CONNECTED with generic procedure parameters Connectivity NR, Connected without release *On* according to TS 38.508-1 [14] clause 4.5. Establish SRB2 and DRB in the *RRCReconfiguration* message. Cell 1 is the active cell. Set Cell 2 physical cell identity to the initial physical cell identity.
2. Set the parameters according to T1 in Table 7.3.3.1.5-1. Propagation conditions are set according to Annex C clause C.2.2. T1 starts. The SS starts continuously scheduling the UE to perform DL reception in every DL slot on Cell 1 and monitoring corresponding ACK/NACK feedbacks sent by the UE.
3. Set Cell 2 physical cell identity = ((current cell 2 physical cell identity + 1) mod 14 + 2).
4. The SS shall transmit an *RRCReconfiguration* message with *conditionalReconfiguration* on Cell 1 to configure CHO execution condition for the UE.
5. The UE shall transmit an *RRCReconfigurationComplete* message.
6. When T1 expires, the SS shall switch the power setting from T1 to T2 as specified in Table 7.3.3.1.5-1. T2 starts.
7. If
  - a) the UE transmits the PRACH preambles to Cell 2 less than  $T_{\text{measure}} + T_{\text{CHO\_execution}} + T_{\text{interrupt}}$  ms from the beginning of time period T2,
  - and
  - b) no longer than X consecutive ACK/NACK DTXs are observed by the SS from the start of T2 to the instant the UE transmits the first PRACH preamble, where
    - $X = 8 \cdot T_{\text{interrupt}}$  for test configuration 7.3.3.1-1

then the number of successful tests is increased by one. Otherwise, the number of failure tests is increased by one.
8. After T2 expires, the SS sends an *RRCReconfiguration* with *reconfigurationWithSync* to cause UE handover back to Cell 1.
9. If UE is not in state RRC\_CONNECTED with generic procedure parameters Connectivity NR, Connected without release *On* according to TS 38.508-1 [14] clause 4.5 on Cell 1, switch off and on the UE. Then ensure the UE is in State RRC\_CONNECTED with generic procedure parameters Connectivity NR, Connected without release *On* according to TS 38.508-1 [14] clause 4.5 on Cell 1.
10. Repeat steps 2-9 until the confidence level according to Tables G.2.3-1 in Annex G clause G.2 is achieved.

#### 7.3.3.1.4.3 Message contents

Message contents are according to TS 38.508-1 [14] clause 7.3 with the following exceptions:

**Table 7.3.3.1.4.3-1: RRCReconfiguration (Step 4)**

Derivation Path: TS 38.508-1 [14], Table 4.6.1-13 with condition NR_MEAS and CHO			
Information Element	Value/remark	Comment	Condition
RRCReconfiguration ::= SEQUENCE {			
criticalExtensions CHOICE {			
rrcReconfiguration SEQUENCE {			
measConfig	MeasConfig	Table 7.3.3.1.4.3-2	
nonCriticalExtension SEQUENCE {			
nonCriticalExtension SEQUENCE {			
nonCriticalExtension SEQUENCE {			
nonCriticalExtension SEQUENCE {			
conditionalReconfiguration-r16	ConditionalReconfiguration	Table 7.3.3.1.4.3-5	
}			
}			
}			
}			
}			
}			
}			

**Table 7.3.3.1.4.3-2: MeasConfig (Table 7.3.3.1.4.3-1)**

Derivation Path: Table H.3.1-2			
Information Element	Value/remark	Comment	Condition
MeasConfig ::= SEQUENCE {			
measObjectToAddModList SEQUENCE (SIZE (1..maxNrofObjectId)) OF MeasObjectToAddMod {	1 entry		
MeasObjectToAddMod[1] SEQUENCE {		entry 1	
measObjectId	1		
measObject CHOICE {			
measObjectNR	MeasObjectNR	Table 7.3.3.1.4.3-3	
}			
}			
}			
reportConfigToAddModList SEQUENCE (SIZE (1..maxReportConfigId)) OF ReportConfigToAddMod {	1 entry		
ReportConfigToAddMod[1] SEQUENCE {		entry 1	
reportConfigId	1		
reportConfig CHOICE {			
reportConfigNR	ReportConfigNR	Table 7.3.3.1.4.3-4	
}			
}			
}			
measIdToAddModList SEQUENCE (SIZE (1..maxNrofMeasId)) OF MeasIdToAddMod {	1 entry		
MeasIdToAddMod[1] SEQUENCE {			
measId	1		
measObjectId	1		
reportConfigId	1		
}			
}			
quantityConfig	QuantityConfig specified in Table H.3.1-5		
}			

Table 7.3.3.1.4.3-3: MeasObjectNR (Table 7.3.3.1.4.3-2)

Derivation Path: TS 38.508-1[14], Table 4.6.3-76			
Information Element	Value/remark	Comment	Condition
MeasObjectNR ::= SEQUENCE {			
ssbFrequency	ARFCN-ValueNR for PCell		
smtc1	SSB-MTC specified in TS 38.508-1[14] Table 7.3.1-3 with condition SMTC.1		
referenceSignalConfig SEQUENCE {			
ssb-ConfigMobility SEQUENCE {			
ssb-ToMeasure	Not present		
}			
}			
absThreshSS-BlocksConsolidation	Not present		
}			

Table 7.3.3.1.4.3-4: ReportConfigNR (Table 7.3.3.1.4.3-2)

Derivation Path: TS 38.508-1[14], Table 4.6.3-142 with condition CHO			
Information Element	Value/remark	Comment	Condition
ReportConfigNR ::= SEQUENCE {			
reportType CHOICE {			
condTriggerConfig SEQUENCE {			
condEventId CHOICE {			
condEventA3 SEQUENCE {			
a3-Offset CHOICE {			
rsp	-4	actual value = -4*0.5 = -2dB	
}			
hysteresis	0	actual value = 0*0.5 = 0dB	
timeToTrigger	ms0		
}			
}			
}			
}			
}			



**Table 7.3.3.1.4.3-5: ConditionalReconfiguration (Table 7.3.3.1.4.3-1)**

Derivation Path: TS 38.508-1[14], Table 4.6.3-25D			
Information Element	Value/remark	Comment	Condition
ConditionalReconfiguration-r16 ::= SEQUENCE {			
condReconfigToAddModList-r16 SEQUENCE (SIZE (1.. maxNrofCondCells-r16)) OF	1 entry		
CondReconfigToAddMod-r16 {			
CondReconfigToAddMod-r16 [1] SEQUENCE {		entry 1	
condReconfigId-r16	1		
condExecutionCond-r16 SEQUENCE (SIZE (1..2)) OF MeasId {	1 entry		
MeasId[1]	1	The MeasId configured in Table 7.3.3.1.4.3-2	
}			
condRRCReconfig-r16	OCTET STRING (CONTAINING RRCReconfiguration Specified in Table 4.8.1-1A with condition RBCConfig_NoKeyChange)		
}			
}			
}			
}			

### 7.3.3.1.5 Test requirements

Table 7.3.3.1.5-1 defines the primary level settings including test tolerances for all tests.

Table 7.3.3.1.5-1: Cell specific test parameters for NR SA FR2 conditional handover

Parameter		Unit	Cell 1		Cell 2	
			T1	T2	T1	T2
NR RF Channel Number			1		1	
AoA setup			Setup 1 as defined in A.3.15			
Assumption for UE beams <sup>Note 6</sup>			Rough			
Duplex mode			TDD			
TDD configuration			TDDConf.3.1			
$BW_{\text{channel}}$		MHz	100: $N_{\text{RB},c} = 66$			
BWP BW		MHz	100: $N_{\text{RB},c} = 66$			
DRx Cycle		ms	Not Applicable			
PDSCH Reference measurement channel			SR3.1 TDD			
CORESET Reference Channel			CR3.1 TDD			
OCNG Patterns			OCNG pattern 1			
SMTC Configuration			SMTC pattern 1			
SSB Configuration			SSB.1 FR2			
PDSCH/PDCCH subcarrier spacing		kHz	120 kHz			
PUCCH/PUSCH subcarrier spacing		kHz	120 kHz			
PRACH configuration			FR2 PRACH configuration 1			
TRS configuration			TRS.2.1 TDD			
TCI configuration			CSI-RS.Config.0			
BWP configuration	Initial DL BWP		DLBWP.0.1			
	Dedicated DL BWP		DLBWP.1.1			
	Initial UL BWP		ULBWP.0.1			
	Dedicated UL BWP		ULBWP.1.1			
EPRE ratio of PSS to SSS		dB	0		0	
EPRE ratio of PBCH DMRS to SSS						
EPRE ratio of PBCH to PBCH DMRS						
EPRE ratio of PDCCH DMRS to SSS						
EPRE ratio of PDCCH to PDCCH DMRS						
EPRE ratio of PDSCH DMRS to SSS						
EPRE ratio of PDSCH to PDSCH						
EPRE ratio of OCNG DMRS to SSS(Note 1)						
EPRE ratio of OCNG to OCNG DMRS (Note 1)						
$N_{oc}$ <sup>Note2</sup>		dBm/15kHz	-106.2 <sup>Note 7</sup>		-106.2 <sup>Note 7</sup>	
$N_{oc}$ <sup>Note2</sup> Config 1		dBm/SCS	-97.2		-97.2	
$\hat{E}_s/\text{lot}_{\text{BB}}$ <sup>Note9</sup>		dB	4.69	-5.44	-Infinity	3.73
$\hat{E}_s/N_{oc}$		dB	6	6	-Infinity	11
$I_o$ <sup>Note3</sup> Config 1		dBm/BW	-61.21	-55.73	-61.21	-55.73
Propagation condition		-	AWGN			
<p>Note 1: OCNG shall be used such that both cells are fully allocated and a constant total transmitted power spectral density is achieved for all OFDM symbols.</p> <p>Note 2: Interference from other cells and noise sources not specified in the test is assumed to be constant over subcarriers and time and shall be modelled as AWGN of appropriate power for <math>N_{oc}</math> to be fulfilled.</p> <p>Note 3: <math>I_o</math> levels have been derived from other parameters for information purposes. They are not settable parameters themselves.</p> <p>Note 4: Equivalent power received by an antenna with 0 dBi gain at the centre of the quiet zone</p> <p>Note 5: As observed with 0 dBi gain antenna at the centre of the quiet zone</p> <p>Note 6: Information about types of UE beam is given in B.2.1.3, and does not limit UE implementation or test system implementation</p> <p>Note 7: Including test tolerance given in Annex F.1.3.2.</p> <p>Note 8: <math>E_s/\text{lot}</math>, SSB_RP and <math>I_o</math> levels have been derived from other parameters for information purposes. They are not settable parameters themselves.</p> <p>Note 9: Calculation of <math>E_s/\text{lot}_{\text{BB}}</math> includes the effect of UE internal noise up to the value assumed for the associated REFSENS requirement in TS 38.101-2 [3] clause 7.3.2, and an allowance of 1dB for UE multi-band relaxation factor <math>\Delta_{\text{MBS}}</math> specified in TS 38.101-2 [3] Table 6.2.1.3-4.</p>						

The rate of correct handovers observed during repeated tests shall be at least 90%.

The test shall verify that there are no interruptions during T1.

The UE shall start to transmit the PRACH to Cell 2 less than  $T_{\text{measure}} + T_{\text{CHO\_execution}} + T_{\text{interrupt}}$  from the start of T2, where:

- $T_{\text{measure}} = 1600$  ms for power class 1 UE and 1080ms for power class 2/3/4 UE, is the measurements time specified in 38.133 [6] clause 6.1.4.2.2.
- $T_{\text{CHO\_execution}} = 10$  ms, is the conditional execution preparation time specified in 38.133 [6] clause 6.1.4.2.2.
- $T_{\text{interrupt}} = T_{\text{processing}} + T_{\text{IU}} + T_{\Delta} + T_{\text{margin}}$  ms, is the interruption time specified in 38.133 [6] 6.1.4.2.4.
- $T_{\text{processing}} = 20$  ms, is time for UE processing;
- $T_{\text{IU}} = 20$  ms, is the interruption uncertainty in acquiring the first available PRACH occasion in the new cell;
- $T_{\Delta} = 20$  ms, is time for fine time tracking and acquiring full timing information of the target cell;
- $T_{\text{margin}} = 2$  ms, is time for SSB post-processing.

This gives a total of 1672 ms for power class 1 UE and 1152 ms for power class 2/3/4 UE.

The interruption during T2 shall not exceed  $T_{\text{interrupt}} = 62$ ms.

### 7.3.3.2 NR SA FR2-FR2 conditional handover

**Editor's Note: This test case is incomplete in following aspects:**

- TT analysis is missing.
- Some test parameters are still FFS

#### 7.3.3.2.1 Test purpose

To verify the requirement for the NR FR2 inter-frequency conditional handover requirements specified in 38.133 [6] clause 6.1.4.4.

#### 7.3.3.2.2 Test applicability

This test applies to all types of NR UE from Release 16 onwards and supporting conditional handover.

#### 7.3.3.2.3 Minimum conformance requirements

The minimum conformance requirements are specified in clause 7.3.3.0.2.

The normative reference for this requirement is TS 38.133 [6] clause A.7.3.3.2.

#### 7.3.3.2.4 Test description

##### 7.3.3.2.4.1 Initial conditions

Initial conditions are a set of test configurations the UE needs to be tested in and the steps for the SS to take with the UE to reach the correct measurement state.

This test shall be tested using any of the test configurations in Table 7.3.3.2.4.1-1.

**Table 7.3.3.2.4.1-1: NR SA FR2-FR2 conditional handover test configurations**

Config	Description
7.3.3.2-1	Source cell: NR 120 kHz SSB SCS, 100 MHz bandwidth, TDD duplex mode Target cell: NR 120 kHz SSB SCS, 100 MHz bandwidth, TDD duplex mode
Note:	The UE is only required to be tested in one of the supported test configurations

Configure the test equipment and the DUT according to the parameters in Table 7.3.3.2.4.1-2

**Table 7.3.3.2.4.1-2: Initial conditions for NR SA FR2-FR2 conditional handover**

Parameter	Value		Comment
Test environment	NC		As specified in TS 38.508-1 [14] clause 4.1.
Test frequencies	As specified in Annex E, table E.4-1 and TS 38.508-1 [14] clause 4.3.1.		
Channel bandwidth	As specified by the test configuration selected from Table 7.1.1.1.4.1-1.		
Propagation conditions	AWGN		As specified in Annex C.2.2.
Connection Diagram	TE Part	A.3.3.3.1	As specified in TS 38.508-1 [14] Annex A.
	DUT Part	A.3.3.4.1	
Exceptions to connection diagram	N/A		

1. Message contents are defined in clause 7.3.3.2.4.3.
2. The power levels and settings for NR Cell 1 are set according to Annex C.1.2 and C.1.3. Cell 2 is NR FR2 target Cell, and its power levels and settings are also set according to Annex C.1.2 and C.1.3.
3. The test parameters are given in Table 7.3.3.2.4.1-3 below, with A3-Offset modified by Test Tolerance.

**Table 7.3.3.2.4.1-3: General test parameters for NR SA FR2-FR2 conditional handover**

Parameter	Unit	Value	Comment
Initial conditions	Active cell	Cell 1	
	Neighbouring cell	Cell 2	
Final condition	Active cell	Cell 2	
A3-Offset for handover condition	dB	FFS	
Hysteresis	dB	0	
Time To Trigger	s	0	
Filter coefficient		0	L3 filtering is not used
Access Barring Information	-	Not Sent	No additional delays in random access procedure.
Time offset between cells		3 $\mu$ s	Synchronous cells
T1	s	5	
T2	s	$\leq 7$	

#### 7.3.3.2.4.2 Test procedure

The test scenario comprises of 2 NR carriers and two cells, Cell 1 and Cell 2, on each carrier respectively. General parameters and Cell-specific parameters for Cell 1 and Cell 2 are given in Table 7.3.3.2.4.1-3 and 7.3.3.2.5-1 respectively. Measurement gap (gap pattern #0) is configured in the test case.

The test consists of two successive time periods, with time durations of T1 and T2 respectively.

At the start of time duration T1, the UE may not have any timing information of cell 2. The UE is configured with a condition implying handover to Cell 2 at a time earlier than  $T_{RRC}$  ms before the beginning of T2. No interruption shall be observed in time period T1. where,

- $T_{RRC} = 10$ ms, is the RRC procedure delay defined in clause 12 in TS 38.331 [13].

From start of T2, the Cell 2 becomes detectable and handover condition is satisfied. During T2, the UE performs measurement on Cell 2 and evaluates the execution condition, and starts handover procedure when execution condition is satisfied. The UE shall sent PRACH to Cell 2 less than  $T_{measure} + T_{CHO\_execution} + T_{interrupt}$  ms from the start of T2. The Interruption length  $T_{interrupt}$  shall also be verified in T2.

1. Ensure the UE is in State RRC\_CONNECTED with generic procedure parameters Connectivity NR, Connected without release On according to TS 38.508-1 [14] clause 4.5. Establish SRB2 and DRB in the RRCReconfiguration message. Cell 1 is the active cell. Set Cell 2 physical cell identity to the initial physical cell identity.

2. Set the parameters according to T1 in Table 7.3.3.2.5-1. Propagation conditions are set according to Annex C clause C.2.2. T1 starts. The SS starts continuously scheduling the UE to perform DL reception in every DL slot on Cell 1 and monitoring corresponding ACK/NACK feedbacks sent by the UE.
3. Set Cell 2 physical cell identity = ((current cell 2 physical cell identity + 1) mod 14 + 2).
4. The SS shall transmit an *RRCReconfiguration* message with *conditionalReconfiguration* on Cell 1 to configure CHO execution condition and measurement gap pattern #0 for the UE.
5. The UE shall transmit an *RRCReconfigurationComplete* message.
6. When T1 expires, the SS shall switch the power setting from T1 to T2 as specified in Table 7.3.3.2.5-1. T2 starts.
7. If
  - c) the UE transmits the PRACH preambles to Cell 2 less than  $T_{\text{measure}} + T_{\text{CHO\_execution}} + T_{\text{interrupt}}$  ms from the beginning of time period T2,

and

  - d) no longer than X consecutive ACK/NACK DTXs are observed by the SS from the start of T2 to the instant the UE transmits the first PRACH preamble, where
    - $X = 8 \cdot T_{\text{interrupt}}$  for test configuration 7.3.3.2-1

then the number of successful tests is increased by one. Otherwise, the number of failure tests is increased by one.
8. After T2 expires, the SS sends an *RRCReconfiguration* with *reconfigurationWithSync* to cause UE handover back to Cell 1.
9. If UE is not in state RRC\_CONNECTED with generic procedure parameters Connectivity NR, Connected without release On according to TS 38.508-1 [14] clause 4.5 on Cell 1, switch off and on the UE. Then ensure the UE is in State RRC\_CONNECTED with generic procedure parameters Connectivity NR, Connected without release On according to TS 38.508-1 [14] clause 4.5 on Cell 1.
10. Repeat steps 2-9 until the confidence level according to Tables G.2.3-1 in Annex G clause G.2 is achieved.

7.3.3.2.4.3 Message contents

Message contents are according to TS 38.508-1 [14] clause 7.3 with the following exceptions:

**Table 7.3.3.2.4.3-1: RRCReconfiguration (Step 4)**

Derivation Path: TS 38.508-1 [14], Table 4.6.1-13 with condition NR_MEAS and CHO			
Information Element	Value/remark	Comment	Condition
RRCReconfiguration ::= SEQUENCE {			
criticalExtensions CHOICE {			
rrcReconfiguration SEQUENCE {			
measConfig	MeasConfig	Table 7.3.3.2.4.3-2	
nonCriticalExtension SEQUENCE {			
nonCriticalExtension SEQUENCE {			
nonCriticalExtension SEQUENCE {			
conditionalReconfiguration-r16	ConditionalReconfiguration	Table 7.3.3.2.4.3-6	
}			
}			
}			
}			
}			
}			
}			

Table 7.3.3.2.4.3-2: MeasConfig (Table 7.3.3.2.4.3-1)

Derivation Path: Table H.3.1-2			
Information Element	Value/remark	Comment	Condition
MeasConfig ::= SEQUENCE {			
measObjectToAddModList SEQUENCE (SIZE (1..maxNrofObjectld)) OF MeasObjectToAddMod {	2 entry		
MeasObjectToAddMod[1] SEQUENCE {		entry 1	
measObjectld	1		
measObject CHOICE {			
measObjectNR	MeasObjectNR-f1	Table 7.3.3.2.4.3-3	
}			
}			
MeasObjectToAddMod[2] SEQUENCE {		entry 2	
measObjectld	2		
measObject CHOICE {			
measObjectNR	MeasObjectNR-f2	Table 7.3.3.2.4.3-4	
}			
}			
reportConfigToAddModList SEQUENCE (SIZE (1..maxReportConfigld)) OF ReportConfigToAddMod {	1 entry		
ReportConfigToAddMod[1] SEQUENCE {		entry 1	
reportConfigld	1		
reportConfig CHOICE {			
reportConfigNR	ReportConfigNR	Table 7.3.3.2.4.3-5	
}			
}			
measldToAddModList SEQUENCE (SIZE (1..maxNrofMeasld)) OF MeasldToAddMod {	1 entry		
MeasldToAddMod[1] SEQUENCE {			
measld	1		
measObjectld	2		
reportConfigld	1		
}			
}			
measGapConfig	MeasGapConfig specified in Table H.3.1-6 with condition gapUE and Pattern #0		
quantityConfig	QuantityConfig specified in Table H.3.1-5		
}			

**Table 7.3.3.2.4.3-3: MeasObjectNR-f1 (Table 7.3.3.2.4.3-2)**

Derivation Path: TS 38.508-1[14], Table 4.6.3-76			
Information Element	Value/remark	Comment	Condition
MeasObjectNR ::= SEQUENCE {			
ssbFrequency	ARFCN-ValueNR for Cell 1		
smtc1	SSB-MTC specified in TS 38.508-1[14] Table 7.3.1-3 with condition SMTC.1		
referenceSignalConfig SEQUENCE {			
ssb-ConfigMobility SEQUENCE {			
ssb-ToMeasure	Not present		
}			
}			
absThreshSS-BlocksConsolidation	Not present		
}			

**Table 7.3.3.2.4.3-4: MeasObjectNR-f2 (Table 7.3.3.2.4.3-2)**

Derivation Path: TS 38.508-1[14], Table 4.6.3-76			
Information Element	Value/remark	Comment	Condition
MeasObjectNR ::= SEQUENCE {			
ssbFrequency	ARFCN-ValueNR for Cell 2		
smtc1	SSB-MTC specified in TS 38.508-1[14] Table 7.3.1-3 with condition SMTC.1		
referenceSignalConfig SEQUENCE {			
ssb-ConfigMobility SEQUENCE {			
ssb-ToMeasure	Not present		
}			
}			
absThreshSS-BlocksConsolidation	Not present		
}			

**Table 7.3.3.2.4.3-5: ReportConfigNR (Table 7.3.3.2.4.3-2)**

Derivation Path: TS 38.508-1[14], Table 4.6.3-142 with condition CHO			
Information Element	Value/remark	Comment	Condition
ReportConfigNR ::= SEQUENCE {			
reportType CHOICE {			
condTriggerConfig SEQUENCE {			
condEventId CHOICE {			
condEventA3 SEQUENCE {			
a3-Offset CHOICE {			
rsrp	FFS		
}			
hysteresis	0	actual value = 0*0.5 = 0dB	
timeToTrigger	ms0		
}			
}			
}			
}			
}			

**Table 7.3.3.2.4.3-6: ConditionalReconfiguration (Table 7.3.3.2.4.3-1)**

Derivation Path: TS 38.508-1[14], Table 4.6.3-25D			
Information Element	Value/remark	Comment	Condition
ConditionalReconfiguration-r16 ::= SEQUENCE {			
condReconfigToAddModList-r16 SEQUENCE (SIZE (1.. maxNrofCondCells-r16)) OF	1 entry		
CondReconfigToAddMod-r16 {			
CondReconfigToAddMod-r16 [1] SEQUENCE {		entry 1	
condReconfigId-r16	1		
condExecutionCond-r16 SEQUENCE (SIZE (1..2)) OF MeasId {	1 entry		
MeasId[1]	1	The MeasId configured in Table 7.3.3.2.4.3-2	
}			
condRRCReconfig-r16	OCTET STRING (CONTAINING RRCReconfiguration Specified in Table 4.8.1-1A with condition RBCOnfig_NoKeyChange)		
}			
}			
}			
}			

### 7.3.3.2.5 Test requirements

Table 7.3.3.2.5-1 defines the primary level settings including test tolerances for all tests.



**Table 7.3.3.2.5-1: Cell specific test parameters for NR SA FR2-FR2 conditional handover**

Parameter		Unit	Cell 1		Cell 2	
			T1	T2	T1	T2
NR RF Channel Number			1		2	
AoA setup			Setup 1 as defined in A.3.15			
Assumption for UE beams <sup>Note 6</sup>			Rough			
Duplex mode			TDD			
TDD configuration			TDDConf.3.1			
BW <sub>channel</sub>		MHz	100: N <sub>RB,c</sub> = 66			
BWP BW		MHz	100: N <sub>RB,c</sub> = 66			
DRx Cycle		ms	Not Applicable			
Gap pattern ID			gp0			
PDSCH Reference measurement channel			SR3.1 TDD			
CORESET Reference Channel			CR3.1 TDD			
OCNG Patterns			OCNG pattern 1			
SMTc Configuration			SMTc pattern 1			
SSB Configuration			SSB.1 FR2			
PDSCH/PDCCH subcarrier spacing		kHz	120 kHz			
PUCCH/PUSCH subcarrier spacing		kHz	120 kHz			
PRACH configuration			FR2 PRACH configuration 1			
TRS configuration			TRS.2.1 TDD			
TCI configuration			CSI-RS.Config.0			
BWP configuration	Initial DL BWP		DLBWP.0.1			
	Dedicated DL BWP		DLBWP.1.1			
	Initial UL BWP		ULBWP.0.1			
	Dedicated UL BWP		ULBWP.1.1			
EPRE ratio of PSS to SSS		dB	0		0	
EPRE ratio of PBCH DMRS to SSS						
EPRE ratio of PBCH to PBCH DMRS						
EPRE ratio of PDCCH DMRS to SSS						
EPRE ratio of PDCCH to PDCCH DMRS						
EPRE ratio of PDSCH DMRS to SSS						
EPRE ratio of PDSCH to PDSCH						
EPRE ratio of OCNG DMRS to SSS(Note 1)						
EPRE ratio of OCNG to OCNG DMRS (Note 1)						
N <sub>oc</sub> <sup>Note2</sup>		dBm/15kHz	-104.7		-104.7	
N <sub>oc</sub> <sup>Note2</sup>	Config 1,2	dBm/SCS	-95.7		-95.7	
	Config 3		-95.7		-95.7	
$\hat{E}_s/I_{ot}$		dB	5	5	-Infinity	5
$\hat{E}_s/N_{oc}$		dB	5	5	-Infinity	5
I <sub>o</sub> <sup>Note3</sup>	Config 1,2	dBm/BW	-60.5	-60.5	-66.7	-60.5
	Config 3	dBm/BW	-60.5	-60.5	-66.7	-60.5
Propagation condition		-	AWGN			
<p>Note 1: OCNG shall be used such that both cells are fully allocated and a constant total transmitted power spectral density is achieved for all OFDM symbols.</p> <p>Note 2: Interference from other cells and noise sources not specified in the test is assumed to be constant over subcarriers and time and shall be modelled as AWGN of appropriate power for N<sub>oc</sub> to be fulfilled.</p> <p>Note 3: I<sub>o</sub> levels have been derived from other parameters for information purposes. They are not settable parameters themselves.</p> <p>Note 4: Equivalent power received by an antenna with 0 dBi gain at the centre of the quiet zone</p> <p>Note 5: As observed with 0 dBi gain antenna at the centre of the quiet zone</p> <p>Note 6: Information about types of UE beam is given in B.2.1.3, and does not limit UE implementation or test system implementation</p>						

The rate of correct handovers observed during repeated tests shall be at least 90%.

The test shall verify that there are no interruptions during T1.

The UE shall start to transmit the PRACH to Cell 2 less than  $T_{\text{measure}} + T_{\text{CHO\_execution}} + T_{\text{interrupt}}$  from the start of T2. where:

- $T_{\text{measure}} = 6720$  ms for power class 1 UE and 4160 ms for power class 2/3/4 UE, is the measurements time specified in 38.133 [6] clause 6.1.4.2.2.
- $T_{\text{CHO\_execution}} = 10$  ms, is the conditional execution preparation time specified in 38.133 [6] clause 6.1.4.2.2.
- $T_{\text{interrupt}} = T_{\text{processing}} + T_{\text{IU}} + T_{\Delta} + T_{\text{margin}}$  ms, is the interruption time specified in 38.133 [6] 6.1.4.2.4.
- $T_{\text{processing}} = 20$  ms, is time for UE processing;
- $T_{\text{IU}} = 20$  ms, is the interruption uncertainty in acquiring the first available PRACH occasion in the new cell;
- $T_{\Delta} = 20$  ms, is time for fine time tracking and acquiring full timing information of the target cell;
- $T_{\text{margin}} = 2$  ms, is time for SSB post-processing.

This gives a total of 6792 ms for power class 1 UE and 4232 ms for power class 2/3/4 UE.

The interruption during T2 shall not exceed  $T_{\text{interrupt}} = 62$ ms.

## 7.4 Timing

### 7.4.1 UE transmit timing

### 7.4.2 UE timer accuracy

### 7.4.3 Timing advance

## 7.5 Signalling characteristics

### 7.5.1 Radio link monitoring

#### 7.5.1.0 Minimum conformance requirements

##### 7.5.1.0.1

##### 7.5.1.0.2

##### 7.5.1.0.3

##### 7.5.1.0.4

#### 7.5.1.0.5 Minimum conformance requirements for UE scheduling restrictions during radio link monitoring

[TS 38.133, clause 8.1.7.3]

The following scheduling restriction applies due to radio link monitoring on an FR2 serving PCell and/or PSCell.

- If the RLM-RS is CSI-RS which is type-D QCLed with active TCI state for PDCCH or PDSCH, and the CSI-RS is not in a CSI-RS resource set with repetition ON,
  - There are no scheduling restrictions due to radio link monitoring based on the CSI-RS.
- Otherwise
  - The UE is not expected to transmit PUCCH, PUSCH or SRS or receive PDCCH, PDSCH or CSI-RS for tracking or CSI-RS for CQI on RLM-RS symbols to be measured for radio link monitoring.

For FR2, if following conditions are met,

- UE has been notified about system information update through paging,

- The gap between UE's reception of PDCCH that UE monitors in the Type2-PDCCH CSS set and that notifies system information update, and the PDCCH that UE monitors in the Type0-PDCCH CSS set, is greater than 2 slots,

For the SSB for RLM and CORESET for RMSI scheduling multiplexing patterns 3, UE is expected to receive the PDCCH that UE monitors in the Type0-PDCCH CSS set, and the corresponding PDSCH, on SSB symbols to be measured for RLM; and

For the SSB for RLM and CORESET for RMSI scheduling multiplexing patterns 2, UE is expected to receive PDSCH that corresponds to the PDCCH that UE monitors in the Type0-PDCCH CSS set, on SSB symbols to be measured for RLM.

### 7.5.1.9 NR SA FR2 radio link monitoring UE scheduling restrictions

**Editor's note: This test case is incomplete. The following aspects are either missing or not yet determined:**

**-The test tolerances and test system uncertainties applicable to this test are undefined.**

**-Message content is TBD**

#### 7.5.1.9.1 Test purpose

The purpose of this test is to verify that the NR UE correctly follows the RLM scheduling restrictions requirements defined in TS 38.133 [6] clause 8.1.7, and to verify that the UE correctly receive the PDCCH scheduled on the symbols right before the RLM SSB symbols without overlap so that it sends ACK/NACK correctly.

#### 7.5.1.9.2 Test applicability

This test applies to all types of NR UE from Release 15 onwards.

This test is only applicable to UE which supports *pdccch-MonitoringAnyOccasions* or *pdccch-MonitoringAnyOccasionsWithSpanGap*.

#### 7.5.1.9.3 Minimum conformance requirement

The minimum conformance requirements are specified in clause 7.5.1.0.5.

The normative reference for this requirement is TS 38.133 [6] clause A.7.5.1.9.

#### 7.5.1.9.4 Test description

There is one cell (Cell 1), which is the active NR cell, in the test. The test consists of one time period with time duration of T1. Figure 5.5.1.9.4-1 shows the Time multiplexed downlink transmissions from each Angle of Arrival. The UE is required during time period T1 to transmit ACK/NACK correctly upon scheduling of PDSCH.

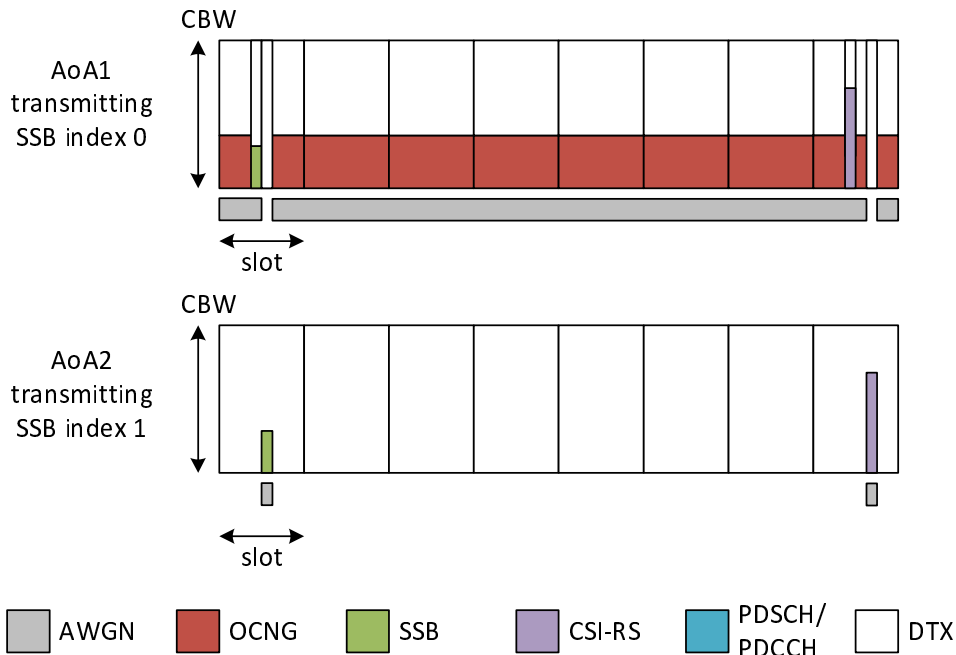

Figure 7.5.1.9.4-1: Time multiplexed downlink transmissions

7.5.1.9.4.1 Initial conditions

This test shall be tested using any of the test configurations in Table 7.5.1.9.4.1-1.

Table 7.5.1.9.4.1-1: Supported test configurations for NR SA FR2 radio link monitoring UE scheduling restrictions

Configuration	Description
7.5.1.9-1	120 kHz SSB SCS, 120 kHz RMC SCS, 100 MHz bandwidth, TDD duplex mode

Configure the test equipment and the DUT according to the parameters in Table 7.5.1.9.4.1-2

Table 7.5.1.9.4.1-2: Initial conditions for NR SA FR2 radio link monitoring UE scheduling restrictions

Parameter	Value	Comment
Test environment	NC	As specified in TS 38.508-1 [14] clause 4.1.
Test frequencies	As specified in Annex E.1.2, Table E.4-1 and TS 38.508-1 [14] clause 4.3.1.	
Channel bandwidth	As specified by the test configuration selected from Table 7.5.1.9.4.1-1	
Propagation conditions	AWGN	As specified in Annex C.2.2.
Connection Diagram	TE Part	A.3.3.3.1
	DUT Part	A.3.3.4.1
Exceptions to connection diagram	N/A	

1. The test parameters for PCell are given in Table 7.5.1.9.4.1-3
2. Message contents are defined in clause 7.5.1.9.4.3.
3. There is one carrier and one cell specified in the test. Cell 1 is the cell used for connection setup with the power level set according to Annex C.1.1 and C.1.2 for this test.

**Table 7.5.1.9.4.1-3: General test parameters for NR SA FR2 radio link monitoring UE scheduling restrictions**

Parameter	Unit	Test configuration	Value	Comment
RF Channel Number		1	1	
SSB configuration		1	SSB.1 FR2	
SMTC configuration		1	SMTC pattern 1	
DRX cycle length	s	1	OFF	
T1	s	1	5	During T1 the UE is required to correctly transmit ACK/NACK

7.5.1.9.4.2 Test Procedure

There is one cell (Cell 1), which is the active NR cell, in the test. Prior to the start of the time duration T1, the UE shall be fully synchronized to PCell. During the test PDCCHs indicating new transmissions shall be sent continuously on PCell (Cell 1) to ensure that the UE would have ACK/NACK sending.

1. Set the parameters according to T1 in Table 7.5.1.9.4.4-1. Propagation conditions are set according to Annex C.2.2. T1 starts.
2. If the SS receives ACK/NACK on each UL transmission occasion scheduled by PDCCH which are not overlapped with SSBs configured for radio link monitoring during T1, the number of successful tests is increased by one. otherwise the number of failed tests is increased by one.
3. The UE is switched off and then on. Ensure the UE is in state RRC\_CONNECTED with generic procedure parameters Connectivity NR, Connected without release *On* according to TS 38.508-1 [10] clause 4.5.
4. Repeat steps 1-3 until the confidence level according to Tables G.2.3-1 in Annex G clause G.2 is achieved.

7.5.1.9.4.3 Message Contents

Message contents are according to TS 38.508-1 [14] clause 7.3 with the following exceptions:

**Table 7.5.1.9.4.3-1: Common Exception messages for NR SA FR2 radio link monitoring UE scheduling restrictions**

Default Message Contents	
Common contents of system information blocks exceptions	TBD
Default RRC messages and information elements contents exceptions	TBD

7.5.1.9.5 Test Requirement

Table 7.5.1.9.4.1-3 and 7.5.1.9.5-1 define the primary level settings including test tolerances for NR SA FR2 radio link monitoring UE scheduling restrictions.

**Table 7.5.1.9.5-1: Cell specific test parameters for NR SA FR2 radio link monitoring UE scheduling restrictions**

Parameter	Unit	Test configuration	Cell 1	
AoA setup		1	Setup 3 defined in A.9.3	
			AoA1	AoA2
Assumption for UE beams <sup>Note 1</sup>			Rough	Rough
TDD configuration		1	TDDConf.3.1	
$BW_{\text{channel}}$	MHz	1	100: $N_{RB,c} = 66$	
Data RBs allocated		1	24	
PDSCH Reference measurement channel		1	SR.3.2 TDD	Not sent
RMSI CORESET RMC configuration		1	CR.3.1 TDD	Not sent
Dedicated CORESET RMC configuration		1	CCR.3.2 TDD	Not sent
TRS configuration		1	TRS.2.1 TDD	TRS.2.2 TDD
PDCCH/PDSCH TCI state		1	TCI.State.2	N/A
OCNG Pattern		1	OP.5	Not sent
Initial DL BWP configuration		1	DLBWP.0.1	
Initial UL BWP configuration		1	ULBWP.0.1	
RLM-RS		1	SSB with index 0	SSB with index 1
$N_{oc}$	dBm/15kHz	1	-92.1	-92.1
$N_{oc}$ <sup>Note2</sup>	dBm/SCS	1	-83.1	-83.1
$\hat{E}_s / N_{oc}$	dB	1	2	2
$\hat{E}_s / I_{ot_{BB}}$ <sup>Note 4</sup>	dB	1	1	1
SSB_RP <sup>Note3</sup>	dBm/SCS	1	-81.1	-81.1
$I_o$	dBm/95.04 MHz	1	-54.35	-54.35
Time multiplexing of the downlink transmissions from each AoA		1	Defined in Figure 7.5.1.9.4-1	
Propagation Condition		1	AWGN	AWGN
<p>Note 1: Information about types of UE beam is given in TS 38.133 [6] B.2.1.3 and does not limit UE implementation or test system implementation.</p> <p>Note 2: Interference from other cells and noise sources not specified in the test is assumed to be constant over subcarriers and time and shall be modelled as AWGN of appropriate power for <math>N_{oc}</math> to be fulfilled.</p> <p>Note 3: <math>E_s/I_{ot}</math>, SSB_RP and <math>I_o</math> levels have been derived from other parameters for information purposes. They are not settable parameters themselves.</p> <p>Note 4: Calculation of <math>E_s/I_{ot_{BB}}</math> includes the effect of UE internal noise up to the value assumed for the associated Refsens requirement in clause 7.3.2 of TS 38.101-2 [3], and an allowance of 1dB for UE multi-band relaxation factor <math>\Delta MB_s</math> from TS 38.101-2 [3] Table 6.2.1.3-4.</p>				

The UE behaviour during time duration T1 follows the requirements defined in TS 38.133 [6] clause 8.1.7.3:

The UE is not expected to transmit PUCCH, PUSCH or SRS or receive PDCCH, PDSCH or CSI-RS for tracking or CSI-RS for CQI on RLM-RS symbols to be measured for radio link monitoring.

For the test to pass, the total number of successful tests shall be more than 90% of the cases with a confidence level of 95%.

## 7.5.2 Interruption

## 7.5.3 SCell activation and deactivation delay

### 7.5.3.0 Minimum conformance requirements

#### 7.5.3.0.1 Minimum conformance requirements for SCell activation delay for deactivated SCell

Upon receiving SCell activation command in slot  $n$ , the UE shall be capable to transmit valid CSI report and apply actions related to the activation command for the SCell being activated no later than in slot

$$n + \frac{T_{\text{HARQ}} + T_{\text{activation\_time}} + T_{\text{CSI\_Reporting}}}{\text{NR slot length}}, \text{ where:}$$

$T_{\text{HARQ}}$  (in ms) is the timing between DL data transmission and acknowledgement as specified in TS 38.213 [8]

$T_{\text{activation\_time}}$  is the SCell activation delay in millisecond.

If the SCell is known and belongs to FR1,  $T_{\text{activation\_time}}$  is:

- $T_{\text{FirstSSB}} + 5\text{ms}$ , if the SCell measurement cycle is equal to or smaller than 160ms.
- $T_{\text{FirstSSB\_MAX}} + T_{\text{rs}} + 5\text{ms}$ , if the SCell measurement cycle is larger than 160ms.

If the SCell is unknown and belongs to FR1, provided that the side condition  $\hat{E}_s/\text{Iot} \geq -2\text{ dB}$  is fulfilled,  $T_{\text{activation\_time}}$  is:

- $T_{\text{FirstSSB\_MAX}} + T_{\text{SMTC\_MAX}} + 2 * T_{\text{rs}} + 5\text{ms}$ .

If the SCell being activated belongs to FR2 and if there is at least one active serving cell on that FR2 band, then  $T_{\text{activation\_time}}$  is  $T_{\text{FirstSSB}} + 5\text{ms}$  provided:

- The UE is provided with SMTC for the target SCell, and
- The SSBs in the serving cell(s) and the SSBs in the SCell fulfil the condition defined in TS 38.133 [6] clause 3.6.3,
- The parameter *ssb-PositionsInBurst* is same for the serving cell(s) and the SCell.

If the SCell being activated belongs to FR2 and if there is at least one active serving cell on that FR2 band, if the UE is not provided with any SMTC for the target SCell,  $T_{\text{activation\_time}}$  is 3 ms, provided

- the RS (s) of SCell being activated is (are) QCL-TypeD with RS (s) of one active serving cell on that FR2 band.

If the SCell being activated belongs to FR2 and if there is no active serving cell on that FR2 band provided that PCell or PSCell is FR1 or in FR2:

If the target SCell is known to UE and semi-persistent CSI-RS is used for CSI reporting, then  $T_{\text{activation\_time}}$  is:

- $3\text{ms} + \max(T_{\text{uncertainty\_MAC}} + T_{\text{FineTiming}} + 2\text{ms}, T_{\text{uncertainty\_SP}})$ , where  $T_{\text{uncertainty\_MAC}}=0$  and  $T_{\text{uncertainty\_SP}}=0$  if UE receives the SCell activation command, semi-persistent CSI-RS activation command and TCI state activation command at the same time.

If the target SCell is known to UE and periodic CSI-RS is used for CSI reporting, then  $T_{\text{activation\_time}}$  is:

- $\max(T_{\text{uncertainty\_MAC}} + 5\text{ms} + T_{\text{FineTiming}}, T_{\text{uncertainty\_RRC}} + T_{\text{RRC\_delay}} - T_{\text{HARQ}})$ , where  $T_{\text{uncertainty\_MAC}}=0$  if UE receives the SCell activation command and TCI state activation commands at the same time.

If the PCell/PSCell and the target SCell are in a band pair with independent beam management and the target SCell is unknown to UE and semi-persistent CSI-RS is used for CSI reporting, provided that the side condition  $\hat{E}_s/\text{Iot} \geq -2\text{dB}$  is fulfilled, then  $T_{\text{activation\_time}}$  is:

- $6\text{ms} + T_{\text{FirstSSB\_MAX}} + 15 * T_{\text{SMTC\_MAX}} + 8 * T_{\text{rs}} + T_{\text{L1-RSRP, measure}} + T_{\text{L1-RSRP, report}} + T_{\text{HARQ}} + \max(T_{\text{uncertainty\_MAC}} + T_{\text{FineTiming}} + 2\text{ms}, T_{\text{uncertainty\_SP}})$ .

If the PCell/PSCell and the target SCell are in a band pair with independent beam management and the target SCell is unknown to UE and periodic CSI-RS is used for CSI reporting, provided that the side condition  $\hat{E}_s/\text{Tot} \geq -2\text{dB}$  is fulfilled, then  $T_{\text{activation\_time}}$  is:

$$- 3\text{ms} + T_{\text{FirstSSB\_MAX}} + 15 * T_{\text{SMTC\_MAX}} + 8 * T_{\text{rs}} + T_{\text{L1-RSRP, measure}} + T_{\text{L1-RSRP, report}} + \{(T_{\text{HARQ}} + T_{\text{uncertainty\_MAC}} + 5\text{ms} + T_{\text{FineTiming}}), (T_{\text{uncertainty\_RRC}} + T_{\text{RRC\_delay}})\}.$$

Where,

$T_{\text{SMTC\_MAX}}$ :

- In FR1, in case of intra-band SCell activation,  $T_{\text{SMTC\_MAX}}$  is the longer SMTC periodicity between active serving cells and SCell being activated provided the cell specific reference signals from the active serving cells and the SCells being activated or released are available in the same slot; in case of inter-band SCell activation,  $T_{\text{SMTC\_MAX}}$  is the SMTC periodicity of SCell being activated.
- In FR2,  $T_{\text{SMTC\_MAX}}$  is the longer SMTC periodicity between active serving cells and SCell being activated provided that in Rel-15 only support FR2 intra-band CA.
- $T_{\text{SMTC\_MAX}}$  is bounded to a minimum value of 10ms.

$T_{\text{rs}}$  is the SMTC periodicity of the SCell being activated if the UE has been provided with an SMTC configuration for the SCell in SCell addition message, otherwise  $T_{\text{rs}}$  is the SMTC configured in the measObjectNR having the same SSB frequency and subcarrier spacing. If the UE is not provided SMTC configuration or measurement object on this frequency, the requirement which involves  $T_{\text{rs}}$  is applied with  $T_{\text{rs}} = 5\text{ms}$  assuming the SSB transmission periodicity is 5ms. There are no requirements if the SSB transmission periodicity is not 5ms

$T_{\text{FirstSSB}}$ : is the time to the end of the first completed SSB burst indicated by the SMTC after slot  $n + \frac{T_{\text{HARQ}} + 3\text{ms}}{\text{NR slot length}}$

$T_{\text{FirstSSB\_MAX}}$ : Is the time to the end of the first completed SSB burst indicated by the SMTC after slot  $n + \frac{T_{\text{HARQ}} + 3\text{ms}}{\text{NR slot length}}$ , further fulfilling:

- In FR1, in case of intra-band SCell activation, the occasion when all active serving cells and SCells being activated or released are transmitting SSB bursts in the same slot; in case of inter-band SCell activation, the first occasion when the SCell being activated is transmitting SSB burst.
- In FR2, the occasion when all active serving cells and SCells being activated or released are transmitting SSB bursts in the same slot.

$T_{\text{FineTiming}}$  is the time period between UE finish processing the last activation command for PDCCH TCI, PDSCH TCI (when applicable) and semi-persistent CSI-RS (when applicable) and the timing of first complete available SSB corresponding to the TCI state.

$T_{\text{L1-RSRP, measure}}$  is L1-RSRP measurement delay  $T_{\text{L1-RSRP\_Measurement\_Period\_SSB}}$  (ms) or  $T_{\text{L1-RSRP\_Measurement\_Period\_CSI-RS}}$  based on applicability as defined in TS 38.133 [6] clause 9.5 assuming  $M=1$ .

$T_{\text{L1-RSRP, report}}$  is delay of acquiring CSI reporting resources.

$T_{\text{uncertainty\_MAC}}$  is the time period between reception of the last activation command for PDCCH TCI, PDSCH TCI (when applicable) and semi-persistent CSI-RS for CQI reporting (when applicable) relative to

- SCell activation command for known case;
- First valid L1-RSRP reporting for unknown case.

$T_{\text{uncertainty\_RRC}}$  is the time period between reception of the RRC configuration message for TCI of periodic CSI-RS for CQI reporting (when applicable) relative to

- SCell activation command for known case;
- First valid L1-RSRP reporting for unknown case.

$T_{\text{RRC\_delay}}$  is the RRC procedure delay as specified in TS 38.331 [13].



Longer delays for RRM measurement requirements, and in case of FR2 also SSB based RLM/BFD/CBD/L1-RSRP measurement requirements, can be expected during the cell detection time for unknown SCell activation.

$T_{\text{CSI\_reporting}}$  is the delay (in ms) including uncertainty in acquiring the first available downlink CSI reference resource, UE processing time for CSI reporting and uncertainty in acquiring the first available CSI reporting resources as specified in TS 38.331 [13].

SCell in FR1 is known if it has been meeting the following conditions:

- During the period equal to  $\max(5 \cdot \text{measCycleSCell}, 5 \cdot \text{DRX cycles})$  for FR1 before the reception of the SCell activation command:
  - the UE has sent a valid measurement report for the SCell being activated and
  - the SSB measured remains detectable according to the cell identification conditions specified in TS 38.133 [6] clause 9.2 and 9.3.
- the SSB measured during the period equal to  $\max(5 \cdot \text{measCycleSCell}, 5 \cdot \text{DRX cycles})$  also remains detectable during the SCell activation delay according to the cell identification conditions specified in TS 38.133 [6] clause 9.2 and 9.3.

Otherwise SCell in FR1 is unknown.

For the first SCell activation in FR2 bands, the SCell is known if it has been meeting the following conditions:

- During the period equal to 4s for UE supporting power class1 and 3s for UE supporting power class 2/3/4 before UE receives the last activation command for PDCCH TCI, PDSCH TCI (when applicable) and semi-persistent CSI-RS for CQI reporting (when applicable):
  - the UE has sent a valid L3-RSRP measurement report with SSB index
  - SCell activation command is received after L3-RSRP reporting and no later than the time when UE receives MAC-CE command for TCI activation
- During the period from L3-RSRP reporting to the valid CQI reporting, the reported SSBs with indexes remain detectable according to the cell identification conditions specified in TS 38.133 [6] clauses 9.2 and 9.3, and the TCI state is selected based on one of the latest reported SSB indexes.

Otherwise, the first SCell in FR2 band is unknown. The requirement for unknown SCell applies provided that the activation commands for PDCCH TCI, PDSCH TCI (when applicable), semi-persistent CSI-RS for CQI reporting (when applicable), and configuration message for TCI of periodic CSI-RS for CQI reporting (when applicable) are based on the latest valid L1-RSRP reporting.

If the UE has been provided with higher layer in TS 38.331 [13] signalling of *smtc2* prior to the activation command,  $T_{\text{SMTc\_Scell}}$  follows *smtc1* or *smtc2* according to the physical cell ID of the target cell being activated.  $T_{\text{SMTc\_MAX}}$  follows *smtc1* or *smtc2* according to the physical cell IDs of the target cells being activated and the active serving cells.

In addition to CSI reporting defined above, UE shall also apply other actions related to the activation command specified in TS 38.331 [13] for a SCell at the first opportunities for the corresponding actions once the SCell is activated.

The interruption on PSCell or any activated SCell in SCG for EN-DC mode specified in TS 38.133 [6] clause 8.2 shall not occur before slot  $n+1 + \frac{T_{\text{HARQ}}}{\text{NR slot length}}$  and not occur after slot  $n+1 + \frac{T_{\text{HARQ}} + 3 + T_{\text{SMTc\_MAX}} + T_{\text{SMTc\_duration}}}{\text{NR slot length}}$ .

The interruption on PCell or any activated SCell in MCG for NR standalone mode specified in TS 38.133 [6] clause 8.2 shall not occur before slot  $n+1 + \frac{T_{\text{HARQ}}}{\text{NR slot length}}$  and not occur after slot  $n+1 + \frac{T_{\text{HARQ}} + 3 + T_{\text{SMTc\_MAX}} + T_{\text{SMTc\_duration}}}{\text{NR slot length}}$ .

Starting from the slot specified in TS 38.213 [8] clause 4.3 (timing for secondary Cell activation/deactivation) and until the UE has completed the SCell activation, the UE shall report out of range if the UE has available uplink resources to report CQI for the SCell.

Starting from the slot specified in TS 38.213 [8] clause 4.3 (timing for secondary Cell activation/deactivation) and until the UE has completed a first L1-RSRP measurement, the UE shall report lowest valid L1 SS-RSRP range if the UE has available uplink resources to report L1-RSRP for the SCell.

The normative reference for this requirement is TS 38.133 [6] clause 8.3.2.

#### 7.5.3.0.2 Minimum conformance requirements for SCell deactivation delay for activated SCell

Upon receiving SCell deactivation command or upon expiry of the *sCellDeactivationTimer* in slot  $n$ , the UE shall accomplish the deactivation actions for the SCell being deactivated no later than in slot  $n + \frac{T_{HARQ} + 3ms}{NR \text{ slot length}}$ .

The interruption on PSCell or any activated SCell in SCG for EN-DC mode specified in TS 38.133 [6] clause 8.2 shall not occur before slot  $n+1 + \frac{T_{HARQ}}{NR \text{ slot length}}$  and not occur after slot  $n+1 + \frac{T_{HARQ} + 3ms}{NR \text{ slot length}}$ .

The interruption on PCell or any activated SCell in MCG for NR standalone mode specified in TS 38.133 [6] clause 8.2 shall not occur before slot  $n+1 + \frac{T_{HARQ}}{NR \text{ slot length}}$  and not occur after slot  $n+1 + \frac{T_{HARQ} + 3ms}{NR \text{ slot length}}$ .

The normative reference for this requirement is TS 38.133 [6] clause 8.3.3.

#### 7.5.3.1 NR SA FR2-FR2 intra-band SCell activation and deactivation delay

Editor's note: This test case is incomplete. The following aspects are either missing or TBD

- Test procedure
- Connection diagram
- Message contents are not complete.
- TT analysis is missing.
- Test Applicability in TS38.522
- Annex F
- Cell configuration mapping in Annex E

##### 7.5.3.1.1 Test purpose

The purpose of this test is:

- To verify the requirement for the SCell activation and deactivation times are within the requirements specified in TS 38.133 [6] clause 8.3, when the PCell and SCell are in FR2 intra-band and SCell is known by the UE at the time of activation.

##### 7.5.3.1.2 Test applicability

This test applies to all types of NR UE from Release 15 onwards and supporting 2DL CA.

##### 7.5.3.1.3 Minimum conformance requirements

The minimum conformance requirements are specified in clauses 7.5.3.0.1 and 7.5.3.0.2.

The normative reference for this requirement is TS 38.133 [6] clause A.7.5.3.1.

##### 7.5.3.1.4 Test description

###### 7.5.3.1.4.1 Initial conditions

This test shall be run in one of the configurations defined in Table 7.5.3.1.4.1-1.

**Table 7.5.3.1.4.1-1: Supported test configurations for NR SA FR2 SCell activation case**

Configuration	Description
7.5.3.1-1	NR 120 kHz SSB SCS, 100MHz bandwidth, TDD duplex mode

Configure the test equipment and the DUT according to the parameters in Table 7.5.3.1.4.1-2.

**Table 7.5.3.1.4.1-2: Initial conditions for NR SA FR2 SCell activation case**

Parameter	Value	Comment
Test environment	NC	As specified in TS 38.508-1 [14] clause 4.1.
Test frequencies	As specified in Annex E, table E.4-1 and TS 38.508-1 [14] clause 4.3.1.	
Channel bandwidth	As specified by the test configuration selected from Table 7.5.3.1.4.1-1.	
Propagation conditions	AWGN	As specified in Annex C.2.2.
Connection Diagram	TE Part	TBD
	DUT Part	TBD
Exceptions to connection diagram	N/A	

1. The general test parameter settings are set up according to Table 7.5.3.1.4.1-3.
2. Message contents are defined in clause 7.5.3.1.4.3.
3. There are two NR carriers and 2 NR Cells specified in the test. Cell 1 is the PCell and Cell 2 is SCell. Cell 1 and Cell 2 are configured according to Annex C.1.1 and C.1.2.

**Table 7.5.3.1.4.1-3: General test parameters for NR SA FR2 SCell activation case**

Parameter	Unit	Value	Comment
RF Channel Number		1,2	Two NR radio channels are used for this test, cell 1 and cell2 use RF channel 1 and 2, respectively.
Active PCell		Cell 1	Primary cell on NR RF channel number 1.
Configured deactivated SCell		Cell 2	Configured deactivated secondary cell on NR RF channel number 2
CP length		Normal	
DRX		OFF	Continuous monitoring of primary cell
Cell-individual offset for cells on NR channel number	dB	0	Individual offset for cells on primary component carrier.
SCell measurement cycle (measCycleSCell)	ms	160	
Cell2 timing offset to cell1	μs	0	
Time alignment error between cell2 and cell1	μs	≤ Time alignment error as specified in TS 38.104 [28] clause 6.5.3.1.	The value of time alignment error depends upon the type of carrier aggregation.
T1	s	7	During this time the PSCell shall be known and the SCell configured and detected.
T2	s	1	During this time the UE shall activate the SCell.
T3	s	1	During this time the UE shall deactivate the SCell.
T <sub>HARQ</sub>	slot	k	k is a number of slots and is indicated by the PDSCH-to-HARQ-timing-indicator field in the DCI format, if present, or provided by <i>dl-DataToUL-ACK</i> , the value of k should be the minimum value defined in TS 38.213 [8] depends on UE's capability
T <sub>CSI_Reporting</sub>	ms	15	the delay (in ms) including uncertainty in acquiring the first available downlink CSI reference resource, UE processing time for CSI reporting (clause 5.2.2.5 in TS 38.214) and uncertainty in acquiring the first available CSI reporting resources as specified in TS 38.331 [13].

## 7.5.3.1.4.2 Test procedure

TBD

## 7.5.3.1.4.3 Message contents

Message contents are according to TS 38.508-1 [14] clause 4.6 with the following exceptions:

**Table 7.5.3.1.4.3-1: Common Exception messages**

Default Message Contents	
Common contents of system information blocks exceptions	
Default RRC messages and information elements contents exceptions	FFS

## 7.5.3.1.5 Test requirement

TBD

## 7.5.3.2 NR SA FR1-FR2 inter-band SCell activation and deactivation delay

Editor's note: This test case is incomplete. The following aspects are either missing or TBD

- Test procedure

- Connection diagram
- Message contents are not complete.
- TT analysis is missing.
- Test Applicability in TS38.522
- Annex F
- Cell configuration mapping in Annex E

#### 7.5.3.2.1 Test purpose

The purpose of this test is:

- To verify the requirement for the SCell activation and deactivation times are within the requirements specified in TS 38.133 [6] clause 8.3, when the PCell is in FR1 and SCell is in FR2 and SCell is known by the UE at the time of activation.

#### 7.5.3.2.2 Test applicability

This test applies to all types of NR UE from Release 15 onwards and supporting 2DL CA.

#### 7.5.3.2.3 Minimum conformance requirements

The minimum conformance requirements are specified in clauses 7.5.3.0.1 and 7.5.3.0.2.

The normative reference for this requirement is TS 38.133 [6] clause A.7.5.3.2.

#### 7.5.3.2.4 Test description

##### 7.5.3.2.4.1 Initial conditions

This test shall be run in one of the configurations defined in Table 7.5.3.2.4.1-1.

**Table 7.5.3.2.4.1-1: Supported test configurations for NR SA FR2 SCell activation case**

Configuration	Description
7.5.3.2-1	PCell: 15 kHz SSB SCS, 10MHz bandwidth, FDD duplex mode Target SCell: 120 kHz SSB SCS, 100MHz bandwidth, TDD duplex mode
7.5.3.2-2	PCell: 15 kHz SSB SCS, 10MHz bandwidth, TDD duplex mode Target SCell: 120 kHz SSB SCS, 100MHz bandwidth, TDD duplex mode
7.5.3.2-3	PCell: 30kHz SSB SCS, 40MHz bandwidth, TDD duplex mode Target SCell: 120 kHz SSB SCS, 100MHz bandwidth, TDD duplex mode
Note: The UE is only required to pass in one of the supported test configurations	

Configure the test equipment and the DUT according to the parameters in Table 7.5.3.2.4.1-2.

**Table 7.5.3.2.4.1-2: Initial conditions for NR SA FR2 SCell activation case**

Parameter	Value		Comment
Test environment	NC		As specified in TS 38.508-1 [14] clause 4.1.
Test frequencies	As specified in Annex E, table E.4-1 and TS 38.508-1 [14] clause 4.3.1.		
Channel bandwidth	As specified by the test configuration selected from Table 7.5.3.2.4.1-1.		
Propagation conditions	AWGN		As specified in Annex C.2.2.
Connection Diagram	TE Part	TBD	As specified in TS 38.508-1 [14] Annex A.
	DUT Part	TBD	
Exceptions to connection diagram	N/A		

1. The general test parameter settings are set up according to Table 7.5.3.2.4.1-3.
2. Message contents are defined in clause 7.5.3.2.4.3.
3. There are two NR carriers and 2 NR Cells specified in the test. Cell 1 is the PCell and Cell 2 is SCell. Cell 1 and Cell 2 are configured according to Annex C.1.1 and C.1.2.

**Table 7.5.3.2.4.1-3: General test parameters for NR SA FR2 SCell activation case**

Parameter	Unit	Value	Comment
RF Channel Number		1,2	Two NR radio channel (1, 2) are used for this test
Active PCell		Cell 1	Primary cell on NR RF channel number 1.
Configured deactivated SCell		Cell 2	Configured deactivated secondary cell on NR RF channel number 2
CP length		Normal	
DRX		OFF	Continuous monitoring of primary cell
Cell-individual offset for cells on NR channel number	dB	0	Individual offset for cells on primary component carrier.
SCell measurement cycle (measCycleSCell)	ms	160	
Cell2 timing offset to cell1	μs	0	
Time alignment error between cell2 and cell1	μs	≤ Time alignment error as specified in TS 38.104 [28] clause 6.5.3.1.	The value of time alignment error depends upon the type of carrier aggregation.
T1	s	7	During this time the PSCell shall be known and the SCell configured and detected.
T2	s	2	During this time the UE shall activate the SCell.
T3	s	1	During this time the UE shall deactivate the SCell.
T <sub>HARQ</sub>	slot	k	k is a number of slots and is indicated by the PDSCH-to-HARQ-timing-indicator field in the DCI format, if present, or provided by <i>dl-DataToUL-ACK</i> , the value of k should be the minimum value defined in TS 38.213 [8] depends on UE's capability
T <sub>CSI_Reporting</sub>	ms	15	the delay (in ms) including uncertainty in acquiring the first available downlink CSI reference resource, UE processing time for CSI reporting (clause 5.2.2.5 in TS 38.214) and uncertainty in acquiring the first available CSI reporting resources as specified in TS 38.331 [13].

#### 7.5.3.2.4.2 Test procedure

TBD

#### 7.5.3.2.4.3 Message contents

Message contents are according to TS 38.508-1 [14] clause 4.6 with the following exceptions:

**Table 7.5.3.2.4.3-1: Common Exception messages**

Default Message Contents	
Common contents of system information blocks exceptions	
Default RRC messages and information elements contents exceptions	FFS

#### 7.5.3.2.5 Test requirement

TBD

## 7.5.4 UE UL carrier RRC reconfiguration delay

## 7.5.5 Link recovery procedures

### 7.5.5.0 Minimum conformance requirements

#### 7.5.5.0.1 Minimum conformance requirements for SSB-based BFD and link recovery procedures

Same as in the clause 5.5.5.0.1.

#### 7.5.5.0.2 Minimum conformance requirements for CSI-RS-based BFD and link recovery procedures

Same as in the clause 5.5.5.0.2.

#### 7.5.5.0.3 Scheduling availability of UE during beam failure detection and candidate beam detection

Same as in the clause 5.5.5.0.3.

#### 7.5.5.0.4 Requirements for Beam Failure Recovery in SCell

Same as in the clause 5.5.5.0.4.

### 7.5.5.1 NR SA FR2 SSB-based beam failure detection and link recovery in non-DRX

**Editor's Note: This test case is complete for the following configurations:**

- Test frequency  $f \leq 40.8$  GHz
- UE PC3

**This test case is incomplete for Test frequency  $f > 40.8$  GHz**

**This test case is incomplete for UE power class other than PC3.**

#### 7.5.5.1.1 Test purpose

The purpose of this test is to verify that the UE properly detects SSB-based beam failure in the set  $q_0$  configured for a serving cell and that the UE performs correct SSB-based link recovery based on beam candidate set  $q_1$ , and to test the downlink monitoring for beam failure detection within the UEs active DL BWP, during the evaluation period, and link recovery, when no DRX is used. This test will partly verify the SSB based beam failure detection and link recovery for an FR2 serving cell requirements in TS 38.133 [6] clause 8.5.

#### 7.5.5.1.2 Test applicability

This test applies to all types of NR UE release 15 onwards.

#### 7.5.5.1.3 Minimum conformance requirements

The minimum conformance requirements are specified in clause 7.5.5.0.1.

The normative reference for this requirement is TS 38.133 [6] clause A.7.5.5.1.

#### 7.5.5.1.4 Test description

There is one NR serving cell configured in this test. This test consists of five successive time periods, with time duration of T1, T2, T3, T4 and T5 respectively. Figure 7.5.5.1.4-1 shows the five different time durations and the corresponding variation of the downlink SNR in the active cell to emulate SSB based beam failure. Figure 7.5.5.1.4-1 additionally shows the variation of the downlink L1-RSRP of the SSB in set  $q_1$  of the candidate beam used for link recovery.

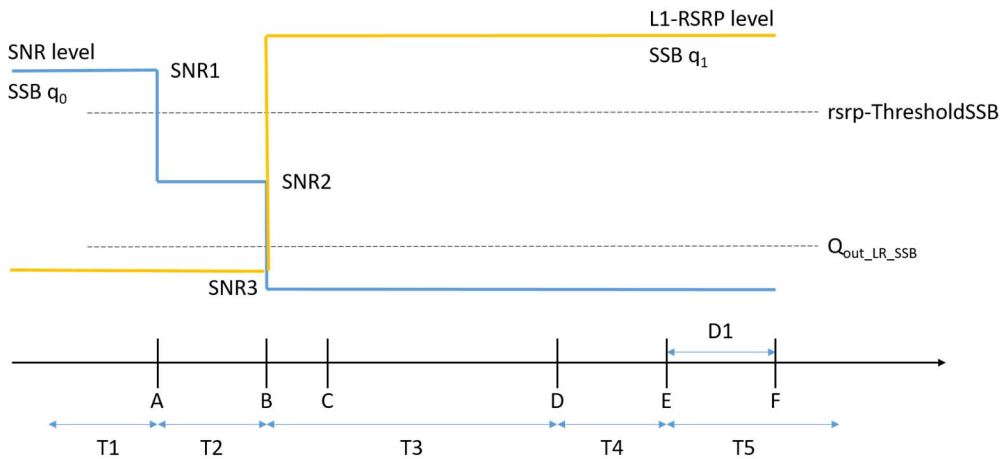

**Figure 7.5.5.1.4-1: SNR and L1-RSRP variation for NR SA FR2 SSB-based beam failure detection and link recovery in non-DRX**

7.5.5.1.4.1 Initial conditions

This test shall be tested using any of the test configurations in Table 7.5.5.1.4.1-1.

**Table 7.5.5.1.4.1-1: Supported test configurations for NR SA FR2 SSB-based beam failure detection and link recovery in non-DRX**

Configuration	Description
7.5.5.1-1	TDD duplex mode, 120 kHz SSB SCS, 100 MHz bandwidth
7.5.5.1-2	TDD duplex mode, 240 kHz SSB SCS, 100 MHz bandwidth
Note:	The UE is only required to pass in one of the supported test configurations in FR2

Configure the test equipment and the DUT according to the parameters in Table 7.5.5.1.4.1-2.

**Table 7.5.5.1.4.1-2: Initial conditions for NR SA FR2 SSB-based beam failure detection and link recovery in non-DRX**

Parameter	Value	Comment
Test environment	NC	As specified in TS 38.508-1 [14] clause 4.1.
Test frequencies	As specified in Annex E, table E.5-1 and TS 38.508-1 [14] clause 4.3.1 and 4.4.2.	
Channel bandwidth	As specified by the test configuration selected from Table 7.5.5.1.4.1-1.	
Propagation conditions	AWGN	As specified in Annex C.2.2.
Connection Diagram	TE Part	As specified in TS 38.508-1 [14] Annex A.
	DUT Part	
Exceptions to connection diagram	N/A	

1. The general test parameter settings are set up according to Table 7.5.5.1.4.1-3. The measurement gap configuration is according to Table 7.5.5.1.4.1-4.
2. Message contents are defined in clause 7.5.5.1.4.3.
3. There is one NR carrier and one NR cells specified in the test. Cell 1 is the NR cell used for connection setup with the power level set according to Annex C.1.1 and C.1.2 for this test.



**Table 7.5.5.1.4.1-3: General test parameters for NR SA FR2 SSB-based beam failure detection and link recovery in non-DRX**

Parameter	Test Config.	Unit	Value	Comment	
			<b>Test 1</b>		
Active PCell	1-2		Cell 1		
RF Channel Number	1-2		1		
Duplex mode	1-2		TDD		
TDD Configuration	1-2		TDDConf.3.1	Table A.1.5-3	
BW <sub>channel</sub>	1-2	MHz	100: N <sub>RB,c</sub> = 66		
Data RBs allocated	1-2		66		
PDSCH/PDCCH subcarrier spacing	1-2	kHz	120		
DL initial BWP configuration	1-2		DLBWP.0.1	Table A.8.1-1	
DL dedicated BWP configuration	1-2		DLBWP.1.1	Table A.8.1-2	
UL initial BWP configuration	1-2		ULBWP.0.1	Table A.8.2-1	
UL dedicated BWP configuration	1-2		ULBWP.1.1	Table A.8.2-2	
PDSCH Reference Channel	1		SR.3.2 TDD	Table A.1.1.2-3	
	2		SR.3.3 TDD		
RMSI CORESET Reference Channel	1		CR.3.1 TDD	Table A.1.2.2-3	
	2		CR.3.2 TDD		
Dedicated CORESET Reference Channel	1		CCR.3.1 TDD	Table A.1.3.2-3	
	2		CCR.3.7 TDD		
OCNG parameters	1-2		OP.1	Table A.2.1-1	
CP length	1-2		Normal		
PDSCH/PDCCH TCI state	1-2		TCI.State.0	Table A.10.2-1	
CSI-RS for tracking	1-2		TRS.2.1 TDD	Table A.1.4A.2.1-1	
SSB Configuration	1		SSB.1 FR2	Table A.3.2-1	
	2		SSB.2 FR2		
SMTc Configuration	1-2		SMTc.3	Table A.4-1	
PRACH Configuration	1-2		PRACH.2 FR2	Table A.7.2-1	
DRX configuration	1-2		OFF		
SSB index assigned as BFD RS (q <sub>0</sub> )	1-2		0		
SSB index assigned as CBD RS (q <sub>1</sub> )	1-2		1		
SSB index assigned as RLM RS	1-2		0,1		
Beam failure detection transmission parameters	DCI format	1-2	1-0		
	Number of Control OFDM symbols	1-2	2		
	Aggregation level	1-2	CCE	8	
	Ratio of hypothetical PDCCH RE energy to average SSS RE energy	1-2	dB	0	
	Ratio of hypothetical PDCCH DMRS energy to average SSS RE energy	1-2	dB	0	
	DMRS precoder granularity	1-2		REG bundle size	
			REG bundle size		
	1-2		6		
Gap pattern ID	1-2		gp0		
gapOffset	1-2	ms	0		
rimInSyncOutOfSyncThreshold	1-2		absent	Value 0 is applied. (TS 38.133 [6] Table 8.1.1-1).	
rsrp-ThresholdSSB	1	dBm/SCS	-109 <sup>Note 3</sup>	Threshold used for Q <sub>in_LR_SSB</sub>	
	2		-106 <sup>Note 3</sup>		

powerControlOffsetSS	1-2		db0	Used for deriving rsrp-ThresholdCSI-RS
beamFailureInstanceMaxCount	1-2		n1	see TS 38.321 [12], clause 5.17
beamFailureDetectionTimer	1-2		pbfd4	see TS 38.321 [12], clause 5.17
CSI-RS configuration for CSI reporting	1-2		CSI-RS.3.1 TDD	Table A.1.4.2-3
reportConfigType	1-2		periodic	
reportQuantity	1-2		cri-RI-PMI-CQI	
CSI reporting periodicity	1-2	slot	40	
CSI reporting offset	1-2	slot	4	
T310	1-2	ms	1000	
N310	1-2		2	
T1	1-2	s	1	The UE shall be fully synchronized to cell 1 during T1
T2	1-2	s	2.61	
T3	1-2	s	1.64	
T4	1-2	s	0	
T5	1-2	s	1.01	
D1	1-2	s	0.97	
Note 1: All configurations are assigned to the UE prior to the start of time period T1.				
Note 2: UE-specific PDCCH is not transmitted after T1 starts.				
Note 3: Including test tolerance given in Annex F.1.3.2.				

Table 7.5.5.1.4.1-4: Void

## 7.5.5.1.4.2 Test procedure

Prior to the start of the time duration T1, the UE shall be fully synchronized to NR Cell 1. The UE shall be configured for periodic CSI reporting with a reporting periodicity of 2 ms. In the test, DRX configuration is not enabled. The UE is configured to perform inter-frequency measurements using GP ID #0 (40ms).

1. Ensure the UE is in state RRC\_CONNECTED with generic procedure parameters Connectivity NR, Connected without release *On* according to TS 38.508-1 [14] clause 4.5.
2. Set the parameters of NR Cell 1 according to T1 in Table 7.5.5.1.5-1. Propagation conditions are set according to Annex C.2.3. T1 starts.
3. When T1 expires the SS shall change the SNR value to T2 as specified in Table 7.5.5.1.5-1. T2 starts.
4. When T2 expires the SS shall change the SNR value to T3 as specified in Table 7.5.5.1.5-1. T3 starts.
5. When T3 expires the SS shall change the SNR value to T4 as specified in Table 7.5.5.1.5-1. T4 starts.
6. When T4 expires the SS shall change the SNR value to T5 as specified in Table 7.5.5.1.5-1. T5 starts.
7. If the SS:
  - a) detects uplink power on NR carrier in each slot configured for CQI transmission (according CQI reporting on PUCCH) during the period from time point A to time point B; and
  - b) does not detect preamble on a beam associated with candidate beam set  $q_1$  before time point B; and
  - c) detects preamble on a beam associated with candidate beam set  $q_1$  before time point F (D1 after the start of T5),

the number of successful tests is increased by one Otherwise the number of failed tests is increased by one.
8. When T5 expires the SS shall change the SNR value to T1 as specified in Table 7.5.5.1.5-1.
9. Wait 1s for the UE to re-establish the connection or continue directly to step 10. If the UE re-establishes the connection within 1s continue to step 11. Otherwise continue to step 10.

10. Switch the UE on and off. Ensure the UE is in RRC\_CONNECTED with generic procedure parameters Connectivity NR, Connected without release On according to TS 38.508-1 [14] clause 4.5.

11. Repeat steps 2-10 for until the confidence level according to Tables G.2.3-1 in Annex G clause G.2 is achieved.

7.5.5.1.4.3 Message contents

Message contents are according to TS 38.508-1 [14] clause 7.3 with the following exceptions:

**Table 7.5.5.1.4.3-1: Common Exception messages for NR SA FR2 SSB-based beam failure detection and link recovery in non-DRX**

Default Message Contents	
Common contents of system information blocks exceptions	
Default RRC messages and information elements contents exceptions	Table H.3.1-2 with condition INTER-FREQ and GAP NEEDED; Table H.3.1-3 with condition INTER-FREQ MO (where ssbFrequency is set to the ARFCN value of carrier centre of High range) Table H.3.1-4 with a3-offset = -6dB; Table H.3.1-6 with condition gapUE and BFD. Table H.3.1-8 with Condition SSB BFD Table H.3.1-10 with Condition SSB Table H.3.1-10A

7.5.5.1.5 Test requirement

Tables 7.5.5.1.4.1-3 and 7.5.5.1.5-1 define the primary level settings including test tolerances for NR SA FR2 SSB-based beam failure detection and link recovery in non-DRX.

**Table 7.5.5.1.5-1: NR Cell specific test parameters for NR SA FR2 SSB-based beam failure detection and link recovery in non-DRX**

Parameter		Unit	Test 1				
			T1	T2	T3	T4	T5
AoA setup			Setup 1 defined in A.9				
Assumption for UE beams <sup>Note 10</sup>			Rough				
EPRE ratio of PDCCH DMRS to SSS		dB	0				
EPRE ratio of PDCCH to PDCCH DMRS		dB					
EPRE ratio of PBCH DMRS to SSS		dB					
EPRE ratio of PBCH to PBCH DMRS		dB					
EPRE ratio of PSS to SSS		dB					
EPRE ratio of PDSCH DMRS to SSS		dB					
EPRE ratio of PDSCH to PDSCH DMRS		dB					
EPRE ratio of OCNG DMRS to SSS		dB					
EPRE ratio of OCNG to OCNG DMRS		dB					
SNR_SSB of set $q_0$	Config 1-2	dB					
SNR_SSB of set $q_1$	Config 1-2	dB	0.2	0.2	20 <sup>Note 12</sup>	20 <sup>Note 12</sup>	20 <sup>Note 12</sup>
SSB_RP of set $q_1$	Config 1	dBm/SC	-104.5	-104.5	-84.7	-84.7	-84.7
	Config 2	S	-101.5	-101.5	-81.7	-81.7	-81.7
$N_{oc}$	Config 1	dBm/12 0 KHz	-104.7				
Propagation condition			TDL-A 30ns 75Hz				
<p>Note 1: OCNG shall be used such that the resources in Cell 1 are fully allocated and a constant total transmitted power spectral density is achieved for all OFDM symbols.</p> <p>Note 2: The uplink resources for CSI reporting are assigned to the UE prior to the start of time period T1.</p> <p>Note 3: NZP CSI-RS resource set configuration for CSI reporting are assigned to the UE prior to the start of time period T1.</p> <p>Note 4: Measurement gap configuration is assigned to the UE prior to the start of time period T1.</p> <p>Note 5: The timers and layer 3 filtering related parameters are configured prior to the start of time period T1.</p> <p>Note 6: The signal contains PDCCH for UEs other than the device under test as part of OCNG.</p> <p>Note 7: SNR levels correspond to the signal to noise ratio over the SSS REs.</p> <p>Note 8: The SNR in time periods T1, T2, T3, T4 and T5 is denoted as SNR1, SNR2 and SNR3 respectively in figure 7.5.5.1.4-1.</p> <p>Note 9: The SNR values are specified for testing a UE which supports 2RX on at least one band. For testing of a UE which supports 4RX on all bands, the SNR during T3 is modified as specified in clause D.4.</p> <p>Note 10: Information about types of UE beam is given in TS 38.133 [6] clause B.2.1.3 and does not limit UE implementation or test system implementation.</p> <p>Note 11: This value allows up to 1dB degradation from applied SNR to UE baseband</p> <p>Note 12: Including test tolerance given in Annex F.1.3.2</p>							

The UE behaviour during time durations T1, T2, T3, T4 and T5 shall be as follows:

During the time duration T1 and T2, the UE shall transmit uplink signal at least in all subframes configured for CSI transmission on Cell 1.

During the period from time point A to time point B the UE shall transmit uplink signal in Cell 1 in all uplink slots configured for CSI transmission according to the configured periodic CSI reporting for Cell 1.

During T3 the UE shall detect beam failure and initiate link recovery. During T4 and T5 the UE measures and evaluate beam candidate from beam candidate set  $q_1$ .

No later than time point F occurring no later than  $D1 = 960 + 10$  ms after the start of T5, the UE shall transmit preamble on a beam associated with the candidate beam set  $q_1$ . The UE shall not transmit preamble on a beam associated with the candidate beam set  $q_1$  earlier than time point B.

Test is concluded once the test equipment has received the initial preamble transmission from the UE. The rate of correct events observed during repeated tests shall be at least 90%.

## 7.5.5.2 NR SA FR2 SSB-based beam failure detection and link recovery in DRX

**Editor's Note:** This test case is complete for the following configurations:

- Test frequency  $f \leq 40.8$  GHz
- UE PC3

This test case is incomplete for Test frequency  $f > 40.8$  GHz

This test case is incomplete for UE power class other than PC3.

7.5.5.2.1 Test purpose

The purpose of this test is to verify that the UE properly detects SSB-based beam failure in the set  $q_0$  configured for a serving cell and that the UE performs correct SSB-based link recovery based on beam candidate set  $q_1$ , and to test the downlink monitoring for beam failure detection within the UEs active DL BWP, during the evaluation period, and link recovery, when DRX is used. This test will partly verify the SSB based beam failure detection and link recovery for an FR2 serving cell requirements in TS 38.133 [6] clause 8.5.

7.5.5.2.2 Test applicability

This test applies to all types of NR UE release 15 and forward supporting 5GS NR SA FR2 and long DRX cycle.

7.5.5.2.3 Minimum conformance requirements

The minimum conformance requirements are specified in clause 7.5.5.0.1.

The normative reference for this requirement is TS 38.133 [6] clause A.7.5.5.2.

7.5.5.2.4 Test description

There are one NR serving cell configured in this test. This test consists of five successive time periods, with time duration of T1, T2, T3, T4 and T5 respectively. Figure 7.5.5.2.4-1 shows the five different time durations and the corresponding variation of the downlink SNR in the active cell to emulate SSB based beam failure. Figure 7.5.5.2.4-1 additionally shows the variation of the downlink L1-RSRP of the SSB in set  $q_1$  of the candidate beam used for link recovery.

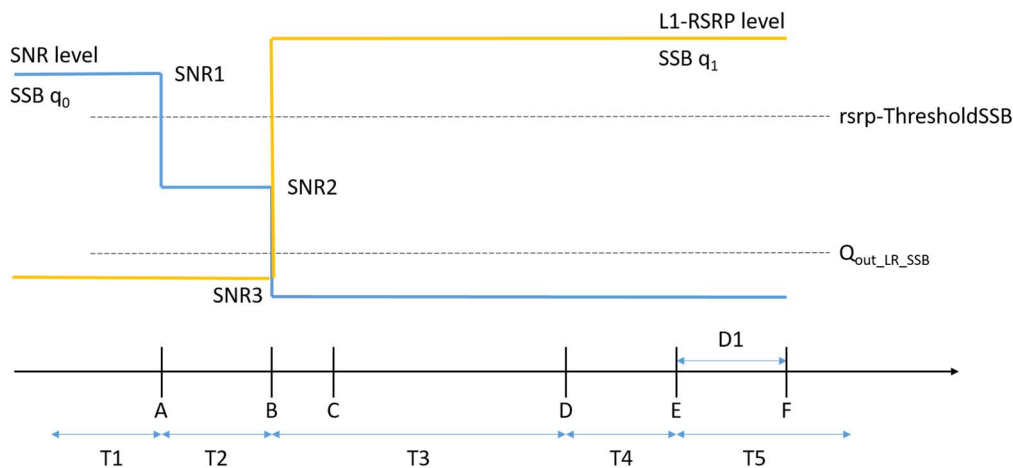

Figure 7.5.5.2.4-1: SNR and L1-RSRP variation for NR SA FR2 SSB-based beam failure detection and link recovery in DRX

7.5.5.2.4.1 Initial conditions

This test shall be tested using any of the test configurations in Table 7.5.5.2.4.1-1.

**Table 7.5.5.2.4.1-1: Supported test configurations for NR SA FR2 SSB-based beam failure detection and link recovery in DRX**

Configuration	Description
7.5.5.2-1	TDD duplex mode, 120 kHz SSB SCS, 100 MHz bandwidth
7.5.5.2-2	TDD duplex mode, 240 kHz SSB SCS, 100 MHz bandwidth
Note: The UE is only required to pass in one of the supported test configurations in FR2	

Configure the test equipment and the DUT according to the parameters in Table 7.5.5.2.4.1-2.

**Table 7.5.5.2.4.1-2: Initial conditions for NR SA FR2 SSB-based beam failure detection and link recovery in DRX**

Parameter	Value		Comment
Test environment	NC		As specified in TS 38.508-1 [14] clause 4.1.
Test frequencies	As specified in Annex E, table E.5-1 and TS 38.508-1 [14] clause 4.3.1 and 4.4.2.		
Channel bandwidth	As specified by the test configuration selected from Table 7.5.5.2.4.1-1.		
Propagation conditions	AWGN		As specified in Annex C.2.2.
Connection Diagram	TE Part	A.3.3.1.1	As specified in TS 38.508-1 [14] Annex A.
	DUT Part	A.3.4.1.1	
Exceptions to connection diagram	N/A		

1. The general test parameter settings are set up according to Table 7.5.5.2.4.1-3. The DRX configuration is according to Table 7.5.5.2.4.1-3. Time alignment timers shall be set to “infinity” so that UL timing alignment is maintained during the test.
2. Message contents are defined in clause 7.5.5.2.4.3.
3. There is one NR carrier and one NR cells specified in the test. Cell 1 is the NR cell used for connection setup with the power level set according to Annex C.1.1 and C.1.2 for this test.

**Table 7.5.5.2.4.1-3: General test parameters for NR SA FR2 SSB-based beam failure detection and link recovery in DRX**

Parameter	Test Config.	Unit	Value	Comment
			<b>Test 1</b>	
Active PCell	1-2		Cell 1	
RF Channel Number	1-2		1	
Duplex mode	1-2		TDD	
TDD Configuration	1-2		TDDConf.3.1	Table A.1.5-3
BW <sub>channel</sub>	1-2	MHz	100: N <sub>RB,c</sub> = 66	
Data RBs allocated	1-2		66	
PDSCH/PDCCH subcarrier spacing	1-2	kHz	120	
DL initial BWP configuration	1-2		DLBWP.0.1	Table A.8.1-1
DL dedicated BWP configuration	1-2		DLBWP.1.1	Table A.8.1-2
UL initial BWP configuration	1-2		ULBWP.0.1	Table A.8.2-1
UL dedicated BWP configuration	1-2		ULBWP.1.1	Table A.8.2-2
PDSCH Reference Channel	1		SR.3.2 TDD	Table A.1.1.2-3
	2		SR.3.3 TDD	
RMSI CORESET Reference Channel	1		CR.3.1 TDD	Table A.1.2.2-3
	2		CR.3.2 TDD	
Dedicated CORESET Reference Channel	1		CCR.3.1 TDD	Table A.1.3.2-3
	2		CCR.3.7 TDD	

OCNG parameters		1-2		OP.1	Table A.2.1-1
CP length		1-2		Normal	
PDSCH/PDCCH TCI state		1-2		TCI.State.0	Table A.10.2-1
CSI-RS for tracking		1-2		TRS.2.1 TDD	Table A.1.4A.2.1-1
SSB Configuration		1		SSB.1 FR2	Table A.3.2-1
		2		SSB.2 FR2	
SMTC Configuration		1-2		SMTC.3	Table A.4-1
PRACH Configuration		1-2		PRACH.2 FR2	Table A.7.2-1
DRX configuration		1-2		DRX.3	Table A.5-1
SSB index assigned as BFD RS ( $q_0$ )		1-2		0	
SSB index assigned as CBD RS ( $q_1$ )		1-2		1	
SSB index assigned as RLM RS		1-2		0,1	
Beam failure detection transmission parameters	DCI format	1-2		1-0	
	Number of Control OFDM symbols	1-2		2	
	Aggregation level	1-2	CCE	8	
	Ratio of hypothetical PDCCH RE energy to average SSS RE energy	1-2	dB	0	
	Ratio of hypothetical PDCCH DMRS energy to average SSS RE energy	1-2	dB	0	
	DMRS precoder granularity	1-2		REG bundle size	
	REG bundle size	1-2		6	
Gap pattern ID		1-2		N/A	
rlmInSyncOutOfSyncThreshold		1-2		absent	Value 0 is applied. (TS 38.133 [6] Table 8.1.1-1).
rsrp-ThresholdSSB	1	dBm/SCS		-109 <sup>Note 3</sup>	Threshold used for $Q_{in\_LR\_SSB}$
	2			-106 <sup>Note 3</sup>	
powerControlOffsetSS		1-2		db0	Used for deriving rsrp-ThresholdCSI-RS
beamFailureInstanceMaxCount		1-2		n1	see TS 38.321 [12], clause 5.17
beamFailureDetectionTimer		1-2		pbfd4	see TS 38.321 [12], clause 5.17
CSI-RS configuration for CSI reporting		1-2		CSI-RS.3.1 TDD	Table A.1.4.2-3
reportConfigType		1-2		periodic	
reportQuantity		1-2		cri-RI-PMI-CQI	
CSI reporting periodicity		1-2	slot	40	
CSI reporting offset		1-2	slot	4	
T310		1-2	ms	1000	
N310		1-2		2	
T1		1-2	s	1	The UE shall be fully synchronized to cell 1 during T1
T2		1-2	s	3.37	
T3		1-2	s	2.8	
T4		1-2	s	0	
T5		1-2	s	0.61	
D1		1-2	s	0.57	
Note 1: All configurations are assigned to the UE prior to the start of time period T1.					
Note 2: UE-specific PDCCH is not transmitted after T1 starts.					
Note 3: Including test tolerance given in Annex F.1.3.2					

Table 7.5.5.2.4.1-4: Void

7.5.5.2.4.2 Test procedure

Prior to the start of the time duration T1, the UE shall be fully synchronized to NR Cell 1. The UE shall be configured for periodic CSI reporting with a reporting periodicity of 5 ms. In the test, DRX configuration is enabled.

1. Ensure the UE is in state RRC\_CONNECTED with generic procedure parameters Connectivity NR, Connected without release On according to TS 38.508-1 [14] clause 4.5.
2. Set the parameters of NR Cell 1 according to T1 in Table 7.5.5.2.5-1. Propagation conditions are set according to Annex C.2.3. T1 starts.
3. When T1 expires the SS shall change the SNR value to T2 as specified in Table 7.5.5.2.5-1. T2 starts.
4. When T2 expires the SS shall change the SNR value to T3 as specified in Table 7.5.5.2.5-1. T3 starts.
5. When T3 expires the SS shall change the SNR value to T4 as specified in Table 7.5.5.2.5-1. T4 starts.
6. When T4 expires the SS shall change the SNR value to T5 as specified in Table 7.5.5.2.5-1. T5 starts.
7. If the SS:
  - a) detects uplink power on NR carrier in each slot configured for CQI transmission (according CQI reporting on PUCCH) during the period from time point A to time point B; and
  - b) does not detect preamble on a beam associated with candidate beam set q1 before time point B; and
  - c) detects preamble on a beam associated with candidate beam set q1 before time point F (D1 after the start of T5),

the number of successful tests is increased by one. Otherwise the number of failed tests is increased by one.
8. When T5 expires the SS shall change the SNR value to T1 as specified in Table 7.5.5.2.5-1.
9. Wait 1s for the UE to re-establish the connection or continue directly to step 10. If the UE re-establishes the connection within 1s continue to step 11. Otherwise continue to step 10.
10. Switch the UE on and off. Ensure the UE is in RRC\_CONNECTED with generic procedure parameters Connectivity NR, Connected without release On according to TS 38.508-1 [14] clause 4.5.
11. Repeat steps 2-10 until the confidence level according to Tables G.2.3-1 in Annex G clause G.2 is achieved.

7.5.5.2.4.3 Message contents

Message contents are according to TS 38.508-1 [14] clause 7.3 with the following exceptions:

**Table 7.5.5.2.4.3-1: Common Exception messages for NR SA FR2 SSB-based beam failure detection and link recovery in DRX**

Default Message Contents	
Common contents of system information blocks exceptions	
Default RRC messages and information elements contents exceptions	Table H.3.1-8 with Condition SSB BFD Table H.3.1-10 with Condition SSB Table H.3.1-10A Table H.3.7-1 with condition DRX.3

7.5.5.2.5 Test requirement

Tables 7.5.5.2.4.1-3 and 7.5.5.2.5-1 define the primary level settings including test tolerances for NR SA FR2 SSB-based beam failure detection and link recovery in DRX.



**Table 7.5.5.2.5-1: NR Cell specific test parameters for NR SA FR2 SSB-based beam failure detection and link recovery in DRX**

Parameter		Unit	Test 1				
			T1	T2	T3	T4	T5
AoA setup			Setup 1 defined in A.9				
Assumption for UE beams <sup>Note 10</sup>			Rough				
EPRE ratio of PDCCH DMRS to SSS		dB	0				
EPRE ratio of PDCCH to PDCCH DMRS		dB					
EPRE ratio of PBCH DMRS to SSS		dB					
EPRE ratio of PBCH to PBCH DMRS		dB					
EPRE ratio of PSS to SSS		dB					
EPRE ratio of PDSCH DMRS to SSS		dB					
EPRE ratio of PDSCH to PDSCH DMRS		dB					
EPRE ratio of OCNG DMRS to SSS		dB					
EPRE ratio of OCNG to OCNG DMRS		dB					
SNR_SSB of set q <sub>0</sub>	Config 1-2	dB					
SNR_SSB of set q <sub>1</sub>	Config 1-2	dB	0.2	0.2	20 <sup>Note 12</sup>	20 <sup>Note 12</sup>	20 <sup>Note 12</sup>
SSB_RP of set q <sub>1</sub>	Config 1	dBm/SC	-104.5	-104.5	-84.7	-84.7	-84.7
	Config 2	S	-101.5	-101.5	-81.7	-81.7	-81.7
N <sub>oc</sub>	Config 1-2	dBm/12 0 KHz	-104.7				
Propagation condition			TDL-A 30ns 75Hz				
<p>Note 1: OCNG shall be used such that the resources in Cell 1 are fully allocated and a constant total transmitted power spectral density is achieved for all OFDM symbols.</p> <p>Note 2: The uplink resources for CSI reporting are assigned to the UE prior to the start of time period T1.</p> <p>Note 3: NZP CSI-RS resource set configuration for CSI reporting are assigned to the UE prior to the start of time period T1.</p> <p>Note 4: Void</p> <p>Note 5: The timers and layer 3 filtering related parameters are configured prior to the start of time period T1.</p> <p>Note 6: The signal contains PDCCH for UEs other than the device under test as part of OCNG.</p> <p>Note 7: SNR levels correspond to the signal to noise ratio over the SSS REs.</p> <p>Note 8: The SNR in time periods T1, T2, T3, T4 and T5 is denoted as SNR1, SNR2 and SNR3 respectively in figure 7.5.5.2.4-1.</p> <p>Note 9: The SNR values are specified for testing a UE which supports 2RX on at least one band. For testing of a UE which supports 4RX on all bands, the SNR during T3 is modified as specified in clause D.4.</p> <p>Note 10: Information about types of UE beam is given in TS 38.133 [6] clause B.2.1.3 and does not limit UE implementation or test system implementation.</p> <p>Note 11: This value allows up to 1dB degradation from applied SNR to UE baseband.</p> <p>Note 12: Including test tolerance given in</p>							

The UE behaviour during time durations T1, T2, T3, T4 and T5 shall be as follows:

During the time duration T1 and T2, the UE shall transmit uplink signal at least in all subframes configured for CSI transmission on Cell 1.

During the period from time point A to time point B the UE shall transmit uplink signal in Cell 1 in all uplink slots configured for CSI transmission according to the configured periodic CSI reporting for Cell 1.

During T3 the UE shall detect beam failure and initiate link recovery. During T4 and T5 the UE measures and evaluate beam candidate from beam candidate set q<sub>1</sub>.

No later than time point F occurring no later than D1 = 560+10 ms after the start of T5, the UE shall transmit preamble on a beam associated with the candidate beam set q<sub>1</sub>. The UE shall not transmit preamble on a beam associated with the candidate beam set q<sub>1</sub> earlier than time point B.

Test is concluded once the test equipment has received the initial preamble transmission from the UE. The rate of correct events observed during repeated tests shall be at least 90%.

### 7.5.5.3 NR SA FR2 CSI-RS-based beam failure detection and link recovery in non-DRX

Editor's Note: This test case is complete for the following configurations:

- Test frequency  $f \leq 40.8$  GHz
- UE PC3

This test case is incomplete for Test frequency  $f > 40.8$  GHz

This test case is incomplete for UE power class other than PC3.

#### 7.5.5.3.1 Test purpose

The purpose of this test is to verify that the UE properly detects CSI-RS-based beam failure in the set  $q_0$  configured for a serving cell and that the UE performs correct CSI-RS-based link recovery based on beam candidate set  $q_1$ , and to test the downlink monitoring for beam failure detection within the UEs active DL BWP, during the evaluation period, and link recovery, when no DRX is used. This test will partly verify the CSI-RS based beam failure detection and link recovery for an FR2 serving cell requirements in TS 38.133 [6] clause 8.5.

#### 7.5.5.3.2 Test applicability

This test applies to all types of NR UE release 15 and forward supporting CSI-RS-based RLM and link recovery .

#### 7.5.5.3.3 Minimum conformance requirements

The minimum conformance requirements are specified in clause 7.5.5.0.2.

The normative reference for this requirement is TS 38.133 [6] clause A.7.5.5.3.

#### 7.5.5.3.4 Test description

There is one NR serving cell configured in this test. This test consists of five successive time periods, with time duration of T1, T2, T3, T4 and T5 respectively. Figure 7.5.5.3.4-1 shows the five different time durations and the corresponding variation of the downlink SNR in the active cell to emulate CSI-RS based beam failure. Figure 7.5.5.3.4-1 additionally shows the variation of the downlink L1-RSRP of the CSI-RS in set  $q_1$  of the candidate beam used for link recovery.

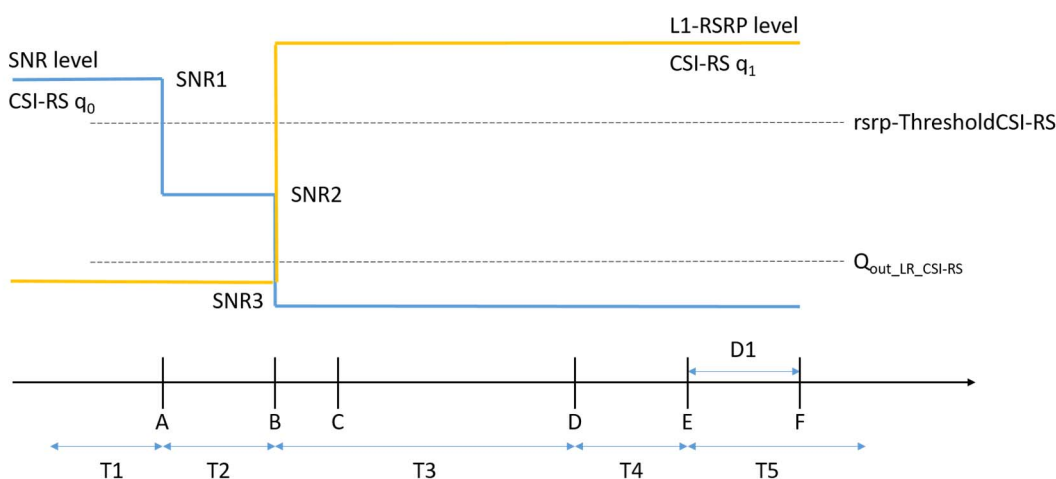

**Figure 7.5.5.3.4-1: SNR and L1-RSRP variation for NR SA FR2 CSI-RS-based beam failure detection and link recovery in non-DRX**

#### 7.5.5.3.4.1 Initial conditions

This test shall be tested using any of the test configurations in Table 7.5.5.3.4.1-1.

**Table 7.5.5.3.4.1-1: Supported test configurations for NR SA FR2 CSI-RS-based beam failure detection and link recovery in non-DRX**

Configuration	Description
7.5.5.3-1	TDD duplex mode, 120 kHz SSB SCS, 100 MHz bandwidth

Configure the test equipment and the DUT according to the parameters in Table 7.5.5.3.4.1-2.

**Table 7.5.5.3.4.1-2: Initial conditions for NR SA FR2 CSI-RS-based beam failure detection and link recovery in non-DRX**

Parameter	Value		Comment
Test environment	NC		As specified in TS 38.508-1 [14] clause 4.1.
Test frequencies	As specified in Annex E, table E.5-1 and TS 38.508-1 [14] clause 4.3.1 and 4.4.2.		
Channel bandwidth	As specified by the test configuration selected from Table 7.5.5.3.4.1-1.		
Propagation conditions	AWGN		As specified in Annex C.2.2.
Connection Diagram	TE Part	A.3.3.1.1	As specified in TS 38.508-1 [14] Annex A.
	DUT Part	A.3.4.1.1	
Exceptions to connection diagram	N/A		

1. The general test parameter settings are set up according to Table 7.5.5.3.4.1-3. The NZP-CSI-RS configuration is according to Table 7.5.5.3.4.1-3.
2. Message contents are defined in clause 7.5.5.3.4.3.
3. There is one NR carrier and one NR cells specified in the test. Cell 1 is the NR cell used for connection setup with the power level set according to Annex C.1.1 and C.1.2 for this test.

**Table 7.5.5.3.4.1-3: General test parameters for NR SA FR2 CSI-RS-based beam failure detection and link recovery in non-DRX**

Parameter	Test Config.	Unit	Value	Comment
			Test 1	

Active PCell	1		Cell 1		
RF Channel Number	1		1		
Duplex mode	1		TDD		
TDD Configuration	1		TDDConf.3.1	Table A.1.5-3	
BW <sub>channel</sub>	1	MHz	100: N <sub>RB,c</sub> = 66		
Data RBs allocated	1		66		
PDSCH/PDCCH subcarrier spacing	1	kHz	120		
DL initial BWP configuration	1		DLBWP.0.1	Table A.8.1-1	
DL dedicated BWP configuration	1		DLBWP.1.1	Table A.8.1-2	
UL initial BWP configuration	1		ULBWP.0.1	Table A.8.2-1	
UL dedicated BWP configuration	1		ULBWP.1.1	Table A.8.2-2	
PDSCH Reference Channel	1		SR.3.2 TDD	Table A.1.1.2-3	
RMSI CORESET Reference Channel	1		CR.3.1 TDD	Table A.1.2.2-3	
Dedicated CORESET Reference Channel	1		CCR.3.1 TDD	Table A.1.3.2-3	
OCNG parameters	1		OP.1	Table A.2.1-1	
CP length	1		Normal		
PDSCH/PDCCH TCI state	1		TCI.State.0	Table A.10.2-1	
CSI-RS for tracking	1		TRS.2.1 TDD	Table A.1.4A.2.1-1	
SSB Configuration	1		SSB.1 FR2	Table A.3.2-1	
SMTc Configuration	1		SMTc.3	Table A.4-1	
PRACH Configuration	1		PRACH.4 FR2	Table A.7.2-1	
DRX configuration	1		OFF		
CSI-RS configuration for BFD/CBD/RLM	1		CSI-RS.3.2 TDD	Table A.1.4.2-3	
CSI-RS index assigned as BFD RS (q <sub>0</sub> )	1		0		
CSI-RS index assigned as CBD RS (q <sub>1</sub> )	1		1		
CSI-RS index assigned as RLM RS	1		0,1		
Beam failure detection transmission parameters	DCI format	1	1-0		
	Number of Control OFDM symbols	1	2		
	Aggregation level	1	CCE	8	
	Ratio of hypothetical PDCCH RE energy to average SSS RE energy	1	dB	0	
	Ratio of hypothetical PDCCH DMRS energy to average SSS RE energy	1	dB	0	
	DMRS precoder granularity	1		REG bundle size	
	REG bundle size	1		6	

Gap pattern ID	1		N/A	
rlmInSyncOutOfSyncThreshold	1		absent	Value 0 is applied. (TS 38.133 [6] Table 8.1.1-1).
rsrp-ThresholdSSB	1	dBm/SCS	-109 <sup>Note 2</sup>	Threshold used for $Q_{in\_LR\_SSB}$
powerControlOffsetSS	1		db0	Used for deriving rsrp-ThresholdCSI-RS
beamFailureInstanceMaxCount	1		n1	see TS 38.321 [12], clause 5.17
beamFailureDetectionTimer	1		pbfd4	see TS 38.321 [12], clause 5.17
CSI-RS configuration for CSI reporting	1		CSI-RS.3.1 TDD	Table A.1.4.2-3
reportConfigType	1		periodic	
reportQuantity	1		cri-RI-PMI-CQI	
CSI reporting periodicity	1	slot	40	
CSI reporting offset	1	slot	4	
T310	1	ms	1000	
N310	1		2	
T1	1	s	1	The UE shall be fully synchronized to cell 1 during T1
T2	1	s	1.17	
T3	1	s	0.9	
T4	1	s	0	
T5	1	s	0.31	
D1	1	s	0.27	
Note 1: UE-specific PDCCH is not transmitted after T1 starts.				
Note 2: Including test tolerance given in Annex F.1.3.2.				

#### 7.5.5.3.4.2 Test procedure

Prior to the start of the time duration T1, the UE shall be fully synchronized to NR Cell 1. The UE shall be configured for periodic CSI reporting with a reporting periodicity of 5 ms. In the test, DRX configuration is not enabled.

1. Ensure the UE is in state RRC\_CONNECTED with generic procedure parameters Connectivity NR, Connected without release  $On$  according to TS 38.508-1 [14] clause 4.5.
2. Set the parameters of NR Cell 1 according to T1 in Table 7.5.5.3.5-1. Propagation conditions are set according to Annex C.2.3. T1 starts.
3. When T1 expires the SS shall change the SNR value to T2 as specified in Table 7.5.5.3.5-1. T2 starts.
4. When T2 expires the SS shall change the SNR value to T3 as specified in Table 7.5.5.3.5-1. T3 starts.
5. When T3 expires the SS shall change the SNR value to T4 as specified in Table 7.5.5.3.5-1. T4 starts.
6. When T4 expires the SS shall change the SNR value to T5 as specified in Table 7.5.5.3.5-1. T5 starts.
7. If the SS:
  - a) detects uplink power on NR carrier in each slot configured for CQI transmission (according CQI reporting on PUCCH) during the period from time point A to time point B; and
  - b) does not detect a preamble on a beam associated with candidate beam set  $q_1$  before time point B; and
  - c) detects preamble on a beam associated with candidate beam set  $q_1$  before time point F (D1 after the start of T5),

the number of successful tests is increased by one. Otherwise the number of failed tests is increased by one.
8. When T5 expires the SS shall change the SNR value to T1 as specified in Table 7.5.5.3.5-1.
9. Wait 1s for the UE to re-establish the connection or continue directly to step 10. If the UE re-establishes the connection within 1s continue to step 11. Otherwise continue to step 10.

10. Switch the UE on and off. Ensure the UE is in RRC\_CONNECTED with generic procedure parameters Connectivity NR, Connected without release *On* according to TS 38.508-1 [14] clause 4.5.

11. Repeat steps 2-10 until the confidence level according to Tables G.2.3-1 in Annex G clause G.2 is achieved.

#### 7.5.5.3.4.3 Message contents

Message contents are according to TS 38.508-1 [14] clause 4.6 with the following exceptions:

**Table 7.5.5.3.4.3-1: Common Exception messages for NR SA FR2 CSI-RS-based beam failure detection and link recovery in non-DRX**

Default Message Contents	
Common contents of system information blocks exceptions	
Default RRC messages and information elements contents exceptions	Table H.3.1-8 with Condition CSI-RS BFD Table H.3.1-10 with Condition CSI-RS Table H.3.1-10A

#### 7.5.5.3.5 Test requirement

Tables 7.5.5.3.4.1-3 and 7.5.5.3.5-1 define the primary level settings including test tolerances for NR SA FR2 CSI-RS-based beam failure detection and link recovery in non-DRX.

**Table 7.5.5.3.5-1: NR Cell specific test parameters for NR SA FR2 CSI-RS-based beam failure detection and link recovery in non-DRX**

Parameter		Unit	Test 1				
			T1	T2	T3	T4	T5
AoA setup			Setup 1 defined in A.9				
Assumption for UE beams <sup>Note 10</sup>			Rough				
EPRE ratio of PDCCH DMRS to SSS		dB	0				
EPRE ratio of PDCCH to PDCCH DMRS		dB					
EPRE ratio of PBCH DMRS to SSS		dB					
EPRE ratio of PBCH to PBCH DMRS		dB					
EPRE ratio of PSS to SSS		dB					
EPRE ratio of PDSCH DMRS to SSS		dB					
EPRE ratio of PDSCH to PDSCH DMRS		dB					
EPRE ratio of OCNG DMRS to SSS		dB					
EPRE ratio of OCNG to OCNG DMRS		dB					
SNR_CSI-RS of set q <sub>0</sub>	Config 1	dB	13.7 <sup>Note 11,12</sup>	13.7 <sup>Note 11,12</sup>	-12	-12	-12
SNR_CSI-RS of set q <sub>1</sub>	Config 1	dB	0.2	0.2	20 <sup>Note 12</sup>	20 <sup>Note 12</sup>	20 <sup>Note 12</sup>
CSI-RS_RP of set q <sub>1</sub>	Config 1	dBm/SC S	-104.5	-104.5	-84.7	-84.7	-84.7
N <sub>oc</sub>	Config 1	dBm/12 0 KHz	-104.7				
Propagation condition			TDL-A 30ns 75Hz				
<p>Note 1: OCNG shall be used such that the resources in Cell 1 are fully allocated and a constant total transmitted power spectral density is achieved for all OFDM symbols.</p> <p>Note 2: The uplink resources for CSI reporting are assigned to the UE prior to the start of time period T1.</p> <p>Note 3: NZP CSI-RS resource set configuration for CSI reporting are assigned to the UE prior to the start of time period T1.</p> <p>Note 4: Void</p> <p>Note 5: The timers and layer 3 filtering related parameters are configured prior to the start of time period T1.</p> <p>Note 6: The signal contains PDCCH for UEs other than the device under test as part of OCNG.</p> <p>Note 7: SNR levels correspond to the signal to noise ratio over the REs carrying CSI-RS.</p> <p>Note 8: The SNR in time periods T1, T2, T3, T4 and T5 is denoted as SNR1, SNR2 and SNR3 respectively in figure 7.5.5.3.4-1.</p> <p>Note 9: The SNR values are specified for testing a UE which supports 2RX on at least one band. For testing of a UE which supports 4RX on all bands, the SNR during T3 is modified as specified in clause D.4.</p> <p>Note 10: Information about types of UE beam is given in TS 38.133 [6] clause B.2.1.3 and does not limit UE implementation or test system implementation.</p> <p>Note 11: This value allows up to 1dB degradation from applied SNR to UE baseband.</p> <p>Note 12: Including test tolerance given in Annex F.1.3.2.</p>							

The UE behaviour during time durations T1, T2, T3, T4 and T5 shall be as follows:

During the time duration T1 and T2, the UE shall transmit uplink signal at least in all subframes configured for CSI transmission on Cell 1.

During the period from time point A to time point B the UE shall transmit uplink signal in Cell 1 in all uplink slots configured for CSI transmission according to the configured periodic CSI reporting for Cell 1.

During T3 the UE shall detect beam failure and initiate link recovery. During T4 and T5 the UE measures and evaluate beam candidate from beam candidate set q<sub>1</sub>.

No later than time point F occurring no later than D1 =260+10 ms after the start of T5, the UE shall transmit preamble on a beam associated with the candidate beam set q<sub>1</sub>. The UE shall not transmit preamble on a beam associated with the candidate beam set q<sub>1</sub> earlier than time point B.

Test is concluded once the test equipment has received the initial preamble transmission from the UE. The rate of correct events observed during repeated tests shall be at least 90%.

#### 7.5.5.4 NR SA FR2 CSI-RS-based beam failure detection and link recovery in DRX

**Editor's Note: This test case is complete for the following configurations:**

- Test frequency  $f \leq 40.8$  GHz
- UE PC3

This test case is incomplete for Test frequency  $f > 40.8$  GHz

This test case is incomplete for UE power class other than PC3.

7.5.5.4.1 Test purpose

The purpose of this test is to verify that the UE properly detects CSI-RS-based beam failure in the set  $q_0$  configured for a serving cell and that the UE performs correct CSI-RS-based link recovery based on beam candidate set  $q_1$ , and to test the downlink monitoring for beam failure detection within the UEs active DL BWP, during the evaluation period, and link recovery, when DRX is used. This test will partly verify the CSI-RS based beam failure detection and link recovery for an FR2 serving cell requirements in TS 38.133 [6] clause 8.5.

7.5.5.4.2 Test applicability

This test applies to all types of NR UE release 15 and forward supporting 5GS NR SA FR2 and CSI-RS-based RLM and link recovery and long DRX cycle.

7.5.5.4.3 Minimum conformance requirements

The minimum conformance requirements are specified in clause 7.5.5.0.2.

The normative reference for this requirement is TS 38.133 [6] clause A.7.5.5.4.

7.5.5.4.4 Test description

There is one NR serving cell configured in this test. This test consists of five successive time periods, with time duration of T1, T2, T3, T4 and T5 respectively. Figure 7.5.5.4.4-1 shows the five different time durations and the corresponding variation of the downlink SNR in the active cell to emulate CSI-RS based beam failure. Figure 7.5.5.4.4-1 additionally shows the variation of the downlink L1-RSRP of the CSI-RS in set  $q_1$  of the candidate beam used for link recovery.

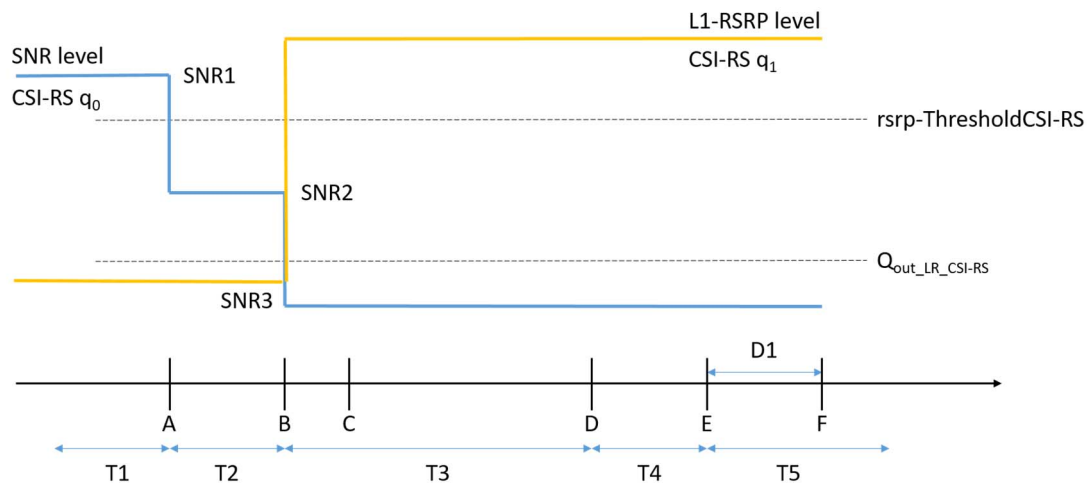

Figure 7.5.5.4.4-1: SNR and L1-RSRP variation for NR SA FR2 CSI-RS-based beam failure detection and link recovery in DRX

7.5.5.4.4.1 Initial conditions

This test shall be tested using any of the test configurations in Table 7.5.5.4.4.1-1.



**Table 7.5.5.4.4.1-1: Supported test configurations for NR SA FR2 CSI-RS-based beam failure detection and link recovery in DRX**

Configuration	Description
7.5.5.4-1	TDD duplex mode, 120 kHz SSB SCS, 100 MHz bandwidth

Configure the test equipment and the DUT according to the parameters in Table 7.5.5.4.4.1-2.

**Table 7.5.5.4.4.1-2: Initial conditions for NR SA FR2 CSI-RS-based beam failure detection and link recovery in DRX**

Parameter	Value		Comment
Test environment	NC		As specified in TS 38.508-1 [14] clause 4.1.
Test frequencies	As specified in Annex E, table E.5-1 and TS 38.508-1 [14] clause 4.3.1 and 4.4.2.		
Channel bandwidth	As specified by the test configuration selected from Table 6.5.5.3.4.1-1.		
Propagation conditions	AWGN		As specified in Annex C.2.2.
Connection Diagram	TE Part	A.3.3.1.1	As specified in TS 38.508-1 [14] Annex A.
	DUT Part	A.3.4.1.1	
Exceptions to connection diagram	N/A		

1. The general test parameter settings are set up according to Table 7.5.5.4.4.1-3. The NZP-CSI-RS configuration is according to Table 7.5.5.4.4.1-3. The DRX configuration for is according to Table 7.5.5.4.4.1-3. Time alignment timers shall be set to “infinity” so that UL timing alignment is maintained during the test.
2. Message contents are defined in clause 7.5.5.4.4.3.
3. There is one NR carrier and one NR cells specified in the test. Cell 1 is the NR cell used for connection setup with the power level set according to Annex C.1.1 and C.1.2 for this test.

**Table 7.5.5.4.4.1-3: General test parameters for NR SA FR2 CSI-RS-based beam failure detection and link recovery in DRX**

Parameter	Test Config.	Unit	Value	Comment
			Test 1	

Active PCell	1		Cell 1		
RF Channel Number	1		1		
Duplex mode	1		TDD		
TDD Configuration	1		TDDConf.3.1	Table A.1.5-3	
BW <sub>channel</sub>	1	MHz	100: N <sub>RB,c</sub> = 66		
Data RBs allocated	1		66		
PDSCH/PDCCH subcarrier spacing	1	kHz	120		
DL initial BWP configuration	1		DLBWP.0.1	Table A.8.1-1	
DL dedicated BWP configuration	1		DLBWP.1.1	Table A.8.1-2	
UL initial BWP configuration	1		ULBWP.0.1	Table A.8.2-1	
UL dedicated BWP configuration	1		ULBWP.1.1	Table A.8.2-2	
PDSCH Reference Channel	1		SR.3.2 TDD	Table A.1.1.2-3	
RMSI CORESET Reference Channel	1		CR.3.1 TDD	Table A.1.2.2-3	
Dedicated CORESET Reference Channel	1		CCR.3.1 TDD	Table A.1.3.2-3	
OCNG parameters	1		OP.1	Table A.2.1-1	
CP length	1		Normal		
PDSCH/PDCCH TCI state	1		TCI.State.0	Table A.10.2-1	
CSI-RS for tracking	1		TRS.2.1 TDD	Table A.1.4A.2.1-1	
SSB Configuration	1		SSB.1 FR2	Table A.3.2-1	
SMTc Configuration	1		SMTc.3	Table A.4-1	
PRACH Configuration	1		PRACH.4 FR2	Table A.7.2-1	
DRX configuration	1		DRX.3	Table A.5-1	
CSI-RS configuration for BFD/CBD/RLM	1		CSI-RS.3.2 TDD	Table A.1.4.2-3	
CSI-RS index assigned as BFD RS (q <sub>0</sub> )	1		0		
CSI-RS index assigned as CBD RS (q <sub>1</sub> )	1		1		
CSI-RS index assigned as RLM RS	1		0,1		
Beam failure detection transmission parameters	DCI format	1	1-0		
	Number of Control OFDM symbols	1	2		
	Aggregation level	1	CCE	8	
	Ratio of hypothetical PDCCH RE energy to average SSS RE energy	1	dB	0	
	Ratio of hypothetical PDCCH DMRS energy to average SSS RE energy	1	dB	0	
	DMRS precoder granularity	1		REG bundle size	
	REG bundle size	1		6	

Gap pattern ID	1		N/A	
rlmInSyncOutOfSyncThreshold	1		absent	Value 0 is applied. (TS 38.133 [6] Table 8.1.1-1).
rsrp-ThresholdSSB	1	dBm/SCS	-109 <sup>Note 2</sup>	Threshold used for $Q_{in\_LR\_SSB}$
powerControlOffsetSS	1		db0	Used for deriving rsrp-ThresholdCSI-RS
beamFailureInstanceMaxCount	1		n1	see TS 38.321 [12], clause 5.17
beamFailureDetectionTimer	1		pbfd4	see TS 38.321 [12], clause 5.17
CSI-RS configuration for CSI reporting	1		CSI-RS.3.1 TDD	Table A.1.4.2-3
reportConfigType	1		periodic	
reportQuantity	1		cri-RI-PMI-CQI	
CSI reporting periodicity	1	slot	40	
CSI reporting offset	1	slot	4	
T310	1	ms	1000	
N310	1		2	
T1	1	s	1	The UE shall be fully synchronized to cell 1 during T1
T2	1	s	5.43	
T3	1	s	5.16	
T4	1	s	0	
T5	1	s	0.31	
D1	1	s	0.27	
Note 1: UE-specific PDCCH is not transmitted after T1 starts.				
Note 2: Including test tolerance given in Annex F.1.3.2				

Table 7.5.5.4.4.1-4: Void

## 7.5.5.4.4.2 Test procedure

Prior to the start of the time duration T1, the UE shall be fully synchronized to NR Cell 1. The UE shall be configured for periodic CSI reporting with a reporting periodicity of 5 ms. In the test, DRX configuration is enabled.

1. Ensure the UE is in state RRC\_CONNECTED with generic procedure parameters Connectivity NR, Connected without release On according to TS 38.508-1 [14] clause 4.5.
2. Set the parameters of NR Cell 1 according to T1 in Table 7.5.5.4.5-1. Propagation conditions are set according to Annex C.2.3. T1 starts.
3. When T1 expires the SS shall change the SNR value to T2 as specified in Table 7.5.5.4.5-1. T2 starts.
4. When T2 expires the SS shall change the SNR value to T3 as specified in Table 7.5.5.4.5-1. T3 starts.
5. When T3 expires the SS shall change the SNR value to T4 as specified in Table 7.5.5.4.5-1. T4 starts.
6. When T4 expires the SS shall change the SNR value to T5 as specified in Table 7.5.5.4.5-1. T5 starts.
7. If the SS:
  - a) detects uplink power on NR carrier in each slot configured for CQI transmission (according CQI reporting on PUCCH) during the period from time point A to time point B; and
  - b) does not detect preamble on a beam associated with candidate beam set  $q_1$  before time point B; and
  - c) detects preamble on a beam associated with candidate beam set  $q_1$  before time point F (D1 after the start of T5),

the number of successful tests is increased by one. Otherwise the number of failed tests is increased by one.

8. When T5 expires the SS shall change the SNR value to T1 as specified in Table 7.5.5.4.5-1.
9. Wait 1s for the UE to re-establish the connection or continue directly to step 10. If the UE re-establishes the connection within 1s continue to step 11. Otherwise continue to step 10.
10. Switch the UE on and off. Ensure the UE is in RRC\_CONNECTED with generic procedure parameters Connectivity NR, Connected without release On according to TS 38.508-1 [14] clause 4.5.
11. Repeat steps 2-10 until the confidence level according to Tables G.2.3-1 in Annex G clause G.2 is achieved.

7.5.5.4.4.3 Message contents

Message contents are according to TS 38.508-1 [14] clause 7.3 with the following exceptions:

**Table 7.5.5.4.4.3-1: Common Exception messages for NR SA FR2 CSI-RS-based beam failure detection and link recovery in DRX**

Default Message Contents	
Common contents of system information blocks exceptions	
Default RRC messages and information elements contents exceptions	Table H.3.1-8 with Condition CSI-RS BFD Table H.3.1-10 with Condition CSI-RS Table H.3.1-10A Table H.3.7-1 with Condition DRX.3

7.5.5.4.5 Test requirement

Tables 7.5.5.4.4.1-3 and 7.5.5.4.5-1 define the primary level settings including test tolerances for NR SA FR2 CSI-RS-based beam failure detection and link recovery in DRX.

**Table 7.5.5.4.5-1: NR Cell specific test parameters for NR SA FR2 CSI-RS-based beam failure detection and link recovery in DRX**

Parameter		Unit	Test 1				
			T1	T2	T3	T4	T5
AoA setup			Setup 1 defined in A.9				
Assumption for UE beams <sup>Note 10</sup>			Rough				
EPRE ratio of PDCCH DMRS to SSS		dB	0				
EPRE ratio of PDCCH to PDCCH DMRS		dB					
EPRE ratio of PBCH DMRS to SSS		dB					
EPRE ratio of PBCH to PBCH DMRS		dB					
EPRE ratio of PSS to SSS		dB					
EPRE ratio of PDSCH DMRS to SSS		dB					
EPRE ratio of PDSCH to PDSCH DMRS		dB					
EPRE ratio of OCNG DMRS to SSS		dB					
EPRE ratio of OCNG to OCNG DMRS		dB					
SNR_CSI-RS of set $q_0$	Config 1	dB					
SNR_CSI-RS of set $q_1$	Config 1	dB	0.2	0.2	20 <sup>Note 12</sup>	20 <sup>Note 12</sup>	20 <sup>Note 12</sup>
CSI-RS_RP of set $q_1$	Config 1	dBm/SC S	-104.5	-104.5	-84.7	-84.7	-84.7
$N_{oc}$	Config 1	dBm/120 KHz	-104.7				
Propagation condition			TDL-A 30ns 75Hz				
<p>Note 1: OCNG shall be used such that the resources in Cell 1 are fully allocated and a constant total transmitted power spectral density is achieved for all OFDM symbols.</p> <p>Note 2: The uplink resources for CSI reporting are assigned to the UE prior to the start of time period T1.</p> <p>Note 3: NZP CSI-RS resource set configuration for CSI reporting are assigned to the UE prior to the start of time period T1.</p> <p>Note 4: Void</p> <p>Note 5: The timers and layer 3 filtering related parameters are configured prior to the start of time period T1.</p> <p>Note 6: The signal contains PDCCH for UEs other than the device under test as part of OCNG.</p> <p>Note 7: SNR levels correspond to the signal to noise ratio over the REs carrying CSI-RS.</p> <p>Note 8: The SNR in time periods T1, T2, T3, T4 and T5 is denoted as SNR1, SNR2 and SNR3 respectively in figure 7.5.5.4.4-1.</p> <p>Note 9: The SNR values are specified for testing a UE which supports 2RX on at least one band. For testing of a UE which supports 4RX on all bands, the SNR during T3 is modified as specified in clause D.4.</p> <p>Note 10: Information about types of UE beam is given in TS 38.133 [6] clause B.2.1.3 and does not limit UE implementation or test system implementation.</p> <p>Note 11: This value allows up to 1dB degradation from applied SNR to UE baseband.</p> <p>Note 12: Including test tolerance given in Annex F.1.3.2.</p>							

The UE behaviour during time durations T1, T2, T3, T4 and T5 shall be as follows:

During the time duration T1 and T2, the UE shall transmit uplink signal at least in all subframes configured for CSI transmission on Cell 1.

During the period from time point A to time point B the UE shall transmit uplink signal in Cell 1 in all uplink slots configured for CSI transmission according to the configured periodic CSI reporting for Cell 1.

During T3 the UE shall detect beam failure and initiate link recovery. During T4 and T5 the UE measures and evaluate beam candidate from beam candidate set  $q_1$ .

No later than time point F occurring no later than  $D1 = 260+10$  ms after the start of T5, the UE shall transmit preamble on a beam associated with the candidate beam set  $q_1$ . The UE shall not transmit preamble on a beam associated with the candidate beam set  $q_1$  earlier than time point B.

Test is concluded once the test equipment has received the initial preamble transmission from the UE. The rate of correct events observed during repeated tests shall be at least 90%.

### 7.5.5.5 NR SA FR2 scheduling availability restriction during SSB-based beam failure detection and link recovery in non-DRX

Editor's Note: This test case is complete for the following configurations:

- Test frequency  $f \leq 40.8$  GHz
- UE PC3

This test case is incomplete for Test frequency  $f > 40.8$  GHz

This test case is incomplete for UE power class other than PC3.

#### 7.5.5.5.1 Test purpose

The purpose of this test is to test scheduling availability restrictions when the UE is performing beam failure detection or when the UE is performing L1-RSRP measurement for candidate beam detection, when no DRX is used, and to verify the scheduling availability restriction requirements for SSB based beam failure detection and link recovery for an FR2 serving cell in TS 38.133 [6] clause 8.5.7 and 8.5.8.

#### 7.5.5.5.2 Test applicability

This test applies to all types of NR UE release 15 onwards.

#### 7.5.5.5.3 Minimum conformance requirements

The minimum conformance requirements are specified in clause 7.5.5.0.1.

The normative reference for this requirement is TS 38.133 [6] clause A.7.5.5.5.

#### 7.5.5.5.4 Test description

There is one NR serving cell configured in this test. This test consists of five successive time periods, with time duration of T1, T2, T3, T4 and T5 respectively. Figure 7.5.5.5.4-1 shows the variation of the downlink SNR of the SSB in set q0 in the active cell to emulate SSB based beam failure. Figure 7.5.5.5.4-1 additionally shows the variation of the downlink L1-RSRP of the SSB in set q1 of the candidate beam used for link recovery.

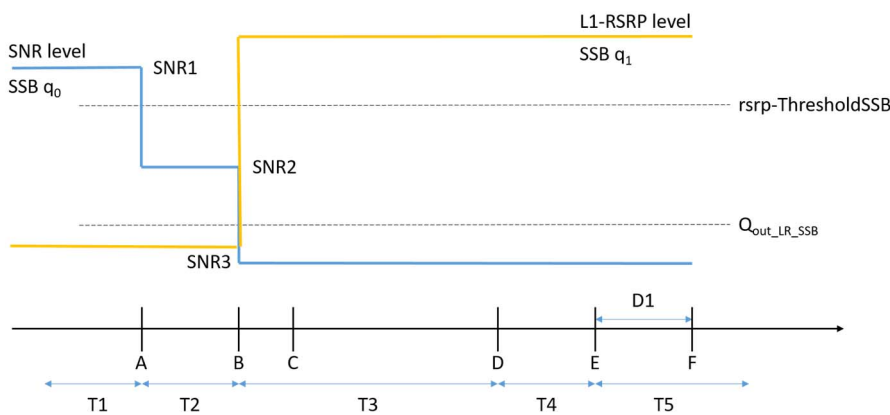

Figure 7.5.5.5.4-1: SNR and L1-

RSRP variation for NR SA FR2 scheduling availability restriction during SSB-based beam failure detection and link recovery in non-DRX

#### 7.5.5.5.4.1 Initial conditions

This test shall be tested using any of the test configurations in Table 7.5.5.5.4.1-1.

**Table 7.5.5.4.1-1: Supported test configurations for NR SA FR2 scheduling availability restriction during SSB-based beam failure detection and link recovery in non-DRX**

Configuration	Description
7.5.5.5-1	NR 120 kHz SSB SCS, 100MHz bandwidth, TDD duplex mode
7.5.5.5-2	NR 240 kHz SSB SCS, 100MHz bandwidth, TDD duplex mode
Note: The UE is only required to be tested in one of the supported test configurations	

Configure the test equipment and the DUT according to the parameters in Table 7.5.5.4.1-2.

**Table 7.5.5.4.1-2: Initial conditions for NR SA FR2 scheduling availability restriction during SSB-based beam failure detection and link recovery in non-DRX**

Parameter	Value		Comment
Test environment	NC		As specified in TS 38.508-1 [14] clause 4.1.
Test frequencies	As specified in Annex E, table E.5-1 and TS 38.508-1 [14] clause 4.3.1 and 4.4.2.		
Channel bandwidth	As specified by the test configuration selected from Table 7.5.5.4.1-1.		
Propagation conditions	AWGN		As specified in Annex C.2.2.
Connection Diagram	TE Part	A.3.3.1.1	As specified in TS 38.508-1 [14] Annex A.
	DUT Part	A.3.4.1.1	
Exceptions to connection diagram	N/A		

1. The general test parameter settings are set up according to Table 7.5.5.4.1-3.
2. Message contents are defined in clause 7.5.5.4.3.
3. There is one NR carrier and one NR cells specified in the test. Cell 1 is the NR cell used for connection setup with the power level set according to Annex C.1.1 and C.1.2 for this test.

**Table 7.5.5.4.1-3: General test parameters for NR SA FR2 scheduling availability restriction during SSB-based beam failure detection and link recovery in non-DRX**

Parameter	Test Config.	Unit	Value	Comment
			<b>Test 1</b>	
Active PCell	1-2		Cell 1	
RF Channel Number	1-2		1	
Duplex mode	1-2		TDD	
TDD Configuration	1-2		TDDConf.3.1	Table A.1.5-3
BW <sub>channel</sub>	1-2	MHz	100: N <sub>RB,c</sub> = 66	
Data RBs allocated	1-2		66	
PDSCH/PDCCH subcarrier spacing	1-2	kHz	120	
DL initial BWP configuration	1-2		DLBWP.0.1	Table A.8.1-1
DL dedicated BWP configuration	1-2		DLBWP.1.1	Table A.8.1-2
UL initial BWP configuration	1-2		ULBWP.0.1	Table A.8.2-1
UL dedicated BWP configuration	1-2		ULBWP.1.1	Table A.8.2-2
PDSCH Reference Channel	1		SR.3.2 TDD	Table A.1.1.2-3
	2		SR.3.3 TDD	
RMSI CORESET Reference Channel	1		CR.3.1 TDD	Table A.1.2.2-3
	2		CR.3.2 TDD	
Dedicated CORESET Reference Channel	1		CCR.3.1 TDD	Table A.1.3.2-3
	2		CCR.3.7 TDD	
OCNG parameters	1-2		OP.1	Table A.2.1-1
CP length	1-2		Normal	
PDSCH/PDCCH TCI state	1-2		TCI.State.0	Table A.10.2-1
CSI-RS for tracking	1-2		TRS.2.1 TDD	
SSB Configuration	1		SSB.1 FR2	Table A.3.2-1
	2		SSB.2 FR2	

SMTC Configuration	1-2		SMTC.1	Table A.4-1
PRACH Configuration	1-2		PRACH.2 FR2	Table A.7.2-1
DRX configuration	1-2		OFF	
SSB index assigned as BFD RS ( $q_0$ )	1-2		0	
SSB index assigned as CBD RS ( $q_1$ )	1-2		1	
Beam failure detection transmission parameters	DCI format	1-2	1-0	
	Number of Control OFDM symbols	1-2	2	
	Aggregation level	1-2	CCE	8
	Ratio of hypothetical PDCCH RE energy to average SSS RE energy	1-2	dB	0
	Ratio of hypothetical PDCCH DMRS energy to average SSS RE energy	1-2	dB	0
	DMRS precoder granularity	1-2		REG bundle size
REG bundle size	1-2		6	
Gap pattern ID	1-2		N/A	
$r_{inSyncOutOfSyncThreshold}$	1-2		absent	Value 0 is applied. (TS 38.133 [6] Table 8.1.1-1).
$rsrp-ThresholdSSB$	1	dBm/SCS	-109 <sup>Note 3</sup>	Threshold used for $Q_{in\_LR\_SSB}$
	2		-106 <sup>Note 3</sup>	
$powerControlOffsetSS$	1-2		db0	Used for deriving $rsrp-ThresholdCSI-RS$
$beamFailureInstanceMaxCount$	1-2		n1	see TS 38.321 [12], clause 5.17
$beamFailureDetectionTimer$	1-2		pbfd4	see TS 38.321 [12], clause 5.17
CSI-RS configuration for CSI reporting	1-2		CSI-RS.3.1 TDD	Table A.1.4.2-3
$reportConfigType$	1-2		periodic	
$reportQuantity$	1-2		cri-RI-PMI-CQI	
CSI reporting periodicity	1-2	slot	40	
CSI reporting offset	1-2	slot	4	
T310	1-2	ms	1000	
N310	1-2		2	
T1	1-2	s	1	The UE shall be fully synchronized to cell 1 during T1
T2	1-2	s	2.6	
T3	1-2	s	1.64	
T4	1-2	s	0	
T5	1-2	s	1.01	
D1	1-2	s	0.97	
Note 1: All configurations are assigned to the UE prior to the start of time period T1.				
Note 2: UE-specific PDCCH is not transmitted after T1 starts.				
Note 3: Including test tolerance given in Annex F.1.3.2.				

#### 7.5.5.5.4.2 Test procedure

Prior to the start of the time duration T1, the UE shall be fully synchronized to cell 1. The UE shall be configured for periodic CSI reporting with a reporting periodicity defined in CSI-RS configuration. This test will focus on the scheduling availability during beam failure detection and candidate beam detection. In the test, DRX configuration is not enabled. During the test the UE is scheduled to transmit continuously in UL.

1. Ensure the UE is in state RRC\_CONNECTED with generic procedure parameters Connectivity NR, Connected without release *On* and Test Mode *On* according to TS 38.508-1 [14] clause 4.5.
2. Set the parameters of NR Cell 1 according to T1 in Table 7.5.5.5.5-1. Propagation conditions are set according to Annex C.2.3. T1 starts.
3. When T1 expires the SS shall change the SNR value to T2 as specified in Table 7.5.5.5.5-1. T2 starts.



4. When T2 expires the SS shall change the SNR value to T3 as specified in Table 7.5.5.5.5-1. T3 starts.
5. When T3 expires the SS shall change the SNR value to T4 as specified in Table 7.5.5.5.5-1. T4 starts.
6. When T4 expires the SS shall change the SNR value to T5 as specified in Table 7.5.5.5.5-1. T5 starts.
7. If the SS:
  - a) detects uplink power on NR carrier in each slot configured for CQI transmission (according CQI reporting on PUCCH) which are not overlapped with SSBs configured for beam failure detection during the period from time point B to time point D

and

  - b) detects uplink power on NR carrier in each slot configured for CQI transmission (according CQI reporting on PUCCH) during the period from time point D until T5 expires,

the number of successful tests is increased by one.

Otherwise the number of failed tests is increased by one.
8. When T5 expires the SS shall change the SNR value to T1 as specified in Table 7.5.5.5.5-1.
9. Wait 1s for the UE to re-establish the connection or continue directly to step 10. If the UE re-establishes the connection within 1s continue to step 11. Otherwise continue to step 10.
10. Switch the UE on and off. Ensure the UE is in RRC\_CONNECTED with generic procedure parameters Connectivity NR, Connected without release On and Test Mode On according to TS 38.508-1 [14] clause 4.5.
11. Repeat steps 2-10 until the confidence level according to Tables G.2.3-1 in Annex G clause G.2 is achieved.

7.5.5.4.3 Message contents

Message contents are according to TS 38.508-1 [14] clause 7.3 with the following exceptions:

**Table 7.5.5.4.3-1: Common Exception messages for NR SA FR2 scheduling availability restriction during SSB-based beam failure detection and link recovery in non-DRX**

Default Message Contents	
Common contents of system information blocks exceptions	
Default RRC messages and information elements contents exceptions	Table H.3.1-8 with Condition SSB BFD Table H.3.1-10 with Condition SSB Table H.3.1-10A

7.5.5.5.5 Test requirement

Table 7.5.5.5.4.1-3 and 7.5.5.5.5-1 define the primary level settings including test tolerances for NR SA FR2 scheduling availability restriction during SSB-based beam failure detection and link recovery in non-DRX.

**Table 7.5.5.5.5-1: NR Cell specific test parameters for NR SA FR2 scheduling availability restriction during SSB-based beam failure detection and link recovery in non-DRX**

Parameter	Unit	Test 1				
		T1	T2	T3	T4	T5

AoA Setup			Setup1 defined in A.3.15.1				
Assumption for UE beams <sup>Note 10</sup>			Rough				
EPRE ratio of PDCCH DMRS to SSS	dB	0					
EPRE ratio of PDCCH to PDCCH DMRS	dB						
EPRE ratio of PBCH DMRS to SSS	dB						
EPRE ratio of PBCH to PBCH DMRS	dB						
EPRE ratio of PSS to SSS	dB						
EPRE ratio of PDSCH DMRS to SSS	dB						
EPRE ratio of PDSCH to PDSCH DMRS	dB						
EPRE ratio of OCNG DMRS to SSS	dB						
EPRE ratio of OCNG to OCNG DMRS	dB						
SNR_SSB of set q <sub>0</sub>	Config 1-2		dB	13.7 <sup>Note 11,12</sup>	5.7 <sup>Note 11,12</sup>	-12	-12
SNR_SSB of set q <sub>1</sub>	Config 1-2	dB	0.2	0.2	20 <sup>Note 12</sup>	20 <sup>Note 12</sup>	20 <sup>Note 12</sup>
SSB_RP of set q <sub>1</sub>	Config 1	dBm/S CS kHz	-104.5	-104.5	-84.7 <sup>Note 12</sup>	-84.7 <sup>Note 12</sup>	-84.7 <sup>Note 12</sup>
	Config 2		-101.5	-101.5	-81.7 <sup>Note 12</sup>	-81.7 <sup>Note 12</sup>	-81.7 <sup>Note 12</sup>
N <sub>oc</sub>	Config 1	dBm/12 0KHz	-104.7				
Propagation condition			TDL-A 30ns 75Hz				
<p>Note 1: OCNG shall be used such that the resources in Cell 1 are fully allocated and a constant total transmitted power spectral density is achieved for all OFDM symbols.</p> <p>Note 2: The uplink resources for CSI reporting are assigned to the UE prior to the start of time period T1.</p> <p>Note 3: NZP CSI-RS resource set configuration for CSI reporting are assigned to the UE prior to the start of time period T1.</p> <p>Note 4: Void</p> <p>Note 5: The timers and layer 3 filtering related parameters are configured prior to the start of time period T1.</p> <p>Note 6: The signal contains PDCCH for UEs other than the device under test as part of OCNG.</p> <p>Note 7: SNR levels correspond to the signal to noise ratio over the SSS REs.</p> <p>Note 8: The SNR in time periods T1, T2, T3, T4 and T5 is denoted as SNR1, SNR2 and SNR3 respectively in figure 7.5.5.4-1.</p> <p>Note 9: The SNR values are specified for testing a UE which supports 2RX on at least one band. For testing of a UE which supports 4RX on all bands, the SNR during T3 is modified as specified in clause D.4.</p> <p>Note 10: Information about types of UE beam is given in TS 38.133 [6] clause B.2.1.3 and does not limit UE implementation or test system implementation.</p> <p>Note 11: This value allows up to 1dB degradation from applied SNR to UE baseband.</p> <p>Note 12: Including test tolerance given in Table F.1.3.2-4</p>							

The UE behaviour during time duration T3 follows the requirements defined in TS 38.133 [6] clause 8.5.7.3:

- The UE is not expected to transmit PUCCH/PUSCH/SRS or receive PDCCH/PDSCH/CSI-RS for tracking/CSI-RS for CQI on BFD-RS symbols to be measured for beam failure detection.

The UE behaviour during time durations T4 and T5 follows the requirements defined in TS 38.133 [6] clause 8.5.8.3:

- The UE is not expected to transmit PUCCH/PUSCH or receive PDCCH/PDSCH on reference symbols to be measured for candidate beam detection.

### 7.5.5.6 NR SA FR2 Scell CSI-RS-based beam failure detection and link recovery in non-DRX

Editor's Note:

- This test case is incomplete for Test frequency  $f > 40.8$  GHz
- This test case is incomplete for UE power class other than PC3.

#### 7.5.5.6.1 Test purpose

The purpose of this test is to verify that the UE properly detects CSI-RS-based beam failure in the set q<sub>0</sub> configured for an active SCell and that the UE performs correct CSI-RS-based link recovery based on beam candidate set q<sub>1</sub>. The

purpose is to test the downlink monitoring for beam failure detection within the UEs active DL BWP of the SCell with *schedulingRequestID-BFR-SCell-r16* configuration, during the evaluation period, and link recovery, when no DRX is used. This test will partly verify the CSI-RS based beam failure detection and link recovery for an FR2 SCell requirements in TS 38.133 [6] clause 8.5.

7.5.5.6.2 Test applicability

This test applies to all types of NR UE release 16 onwards supporting SCell BFR.

7.5.5.6.3 Minimum conformance requirements

The minimum conformance requirements are specified in clause 7.5.5.0.2 and 7.5.5.0.4.

The normative reference for this requirement is TS 38.133 [6] clause A.7.5.5.6.

7.5.5.6.4 Test description

There are two cells configured in this test. Cell 1 is the active PCell and Cell 2 is the active SCell. This test consists of five successive time periods, with time duration of T1, T2, T3, T4 and T5 respectively. Figure 7.5.5.6.4-1 shows the variation of the downlink SNR of the CSI-RS in set  $q_0$  in the active SCell to emulate CSI-RS based beam failure. Figure 7.5.5.6.4-1 additionally shows the variation of the downlink L1-RSRP of the CSI-RS in set  $q_1$  of the candidate beam used for link recovery.

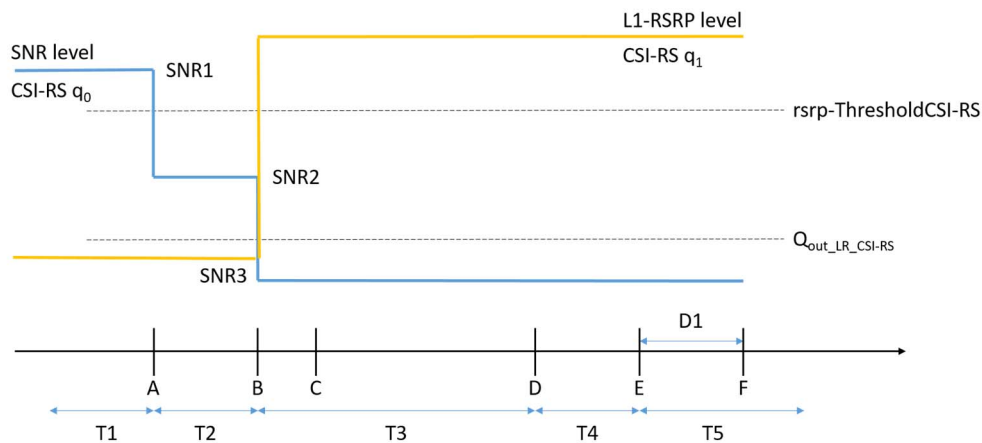

Figure 7.5.5.6.4-1: SNR and L1-RSRP variation for CSI-RS based beam failure detection and link recovery testing for SCell in non-DRX mode

7.5.5.6.4.1 Initial conditions

This test shall be tested using any of the test configurations in Table 7.5.5.6.4.1-1.

Table 7.5.5.6.4.1-1: Supported test configurations for SA FR2 SCell beam failure detection and link recovery testing in non-DRX

Configuration	Description
7.5.5.6-1	TDD duplex mode, 120 kHz SSB SCS, 100 MHz bandwidth
Note:	The UE is only required to be tested in one of the supported test configurations

Configure the test equipment and the DUT according to the parameters in Table 7.5.5.6.4.1-2.

**Table 7.5.5.6.4.1-2: Initial conditions for SA FR2 SCell beam failure detection and link recovery testing in non-DRX**

Parameter	Value		Comment
Test environment	NC		As specified in TS 38.508-1 [14] clause 4.1.
Test frequencies	As specified in Annex E, table E.5-1 and TS 38.508-1 [14] clause 4.3.1		
Channel bandwidth	As specified by the test configuration selected from Table 7.5.5.6.4.1-1.		
Propagation conditions	AWGN		As specified in Annex C.2.2.
Connection Diagram	TE Part	A.3.3.3.1	As specified in TS 38.508-1 [14] Annex A.
	DUT Part	A.3.4.1.1	
Exceptions to connection diagram	N/A		

1. The general test parameter settings are set up according to Table 7.5.5.6.4.1-3.
2. Message contents are defined in clause 7.5.5.6.4.3.
3. There are two NR cells specified in the test. Cell 1 is the cell used for connection setup with the power level set according to Annex C.1.1 and C.1.2 for this test.

**Table 7.5.5.6.4.1-3: General test parameters for FR2 SCell for beam failure detection and link recovery testing in non-DRX mode**

Parameter	Test Config.	Unit	Value	Comment
			<b>Test 1</b>	
Active PCell	1		Cell 1	
RF Channel Number for PCell	1		1	
Active SCell	1		Cell 2	
RF Channel Number for SCell	1		2	
Duplex mode	1		TDD	
TDD Configuration	1		TDDConf.3.1	
BW <sub>channel</sub>	1	MHz	100: N <sub>RB,c</sub> = 66	
Data RBs allocated	1		66	
PDSCH/PDCCH subcarrier spacing	1	kHz	120	
DL initial BWP configuration	1		DLBWP.0.1	
DL dedicated BWP configuration	1		DLBWP.1.1	
UL initial BWP configuration	1		ULBWP.0.1	
UL dedicated BWP configuration	1		ULBWP.1.1	
PDSCH Reference Channel	1		SR.3.2 TDD	
RMSI CORESET Reference Channel	1		CR.3.1 TDD	A.1.2.2
Dedicated CORESET Reference Channel	1		CCR.3.1 TDD	
OCNG parameters	1		OP.1	A.2.1
CP length	1		Normal	
PDSCH/PDCCH TCI state	1		TCI.State.0	
CSI-RS for tracking	1		TRS.2.1 TDD	
SSB Configuration	1		SSB.3 FR2	A.3
SMTc Configuration	1		SMTc.3	A.4
PRACH Configuration	1		FR2 PRACH configuration 4	Table A.7.2-1
DRX configuration	1		OFF	
CSI-RS configuration for BFD/CBD on SCell	1		CSI-RS.3.2 TDD	A.1.4.2
CSI-RS index assigned as BFD RS (q <sub>0</sub> )	1		0	
CSI-RS index assigned as CBD RS (q <sub>1</sub> )	1		1	
CSI-RS configuration for RLM on PCell	1		CSI-RS.3.2 TDD	A.1.4.2
	DCI format	1	1-0	
	Number of Control OFDM symbols	1	2	

Beam failure detection transmission parameters	Aggregation level	1	CCE	8	
	Ratio of hypothetical PDCCH RE energy to average SSS RE energy	1	dB	0	
	Ratio of hypothetical PDCCH DMRS energy to average SSS RE energy	1	dB	0	
	DMRS precoder granularity	1		REG bundle size	
	REG bundle size	1		6	
Gap pattern ID	1			N/A	
schedulingRequestID-BFR-SCell-r16	1			Configured	
Periodicity of PUCCH for SR configuration for BFR on SCell	1	slot		40	5ms
Offset of PUCCH for SR configuration for BFR on SCell	1	slot		4	
PUCCH parameters for SR configuration for BFR on SCell	1			Table 8.3.3.1.2-1 in [28]	
rlmInSyncOutOfSyncThreshold	1			absent	Value 0 is applied. (Table 8.1.1-1 in TS 38.133 [6]).
rsrp-ThresholdSSB	1	dBm/SCS		-109 <sup>Note 2</sup>	Threshold used for $Q_{in\_LR\_SSB}$
powerControlOffsetSS	1			db0	Used for deriving rsrp-ThresholdCSI-RS
beamFailureInstanceMaxCount	1			n1	see TS 38.321 [7], clause 5.17
beamFailureDetectionTimer	1			pbfd4	see TS 38.321 [7], clause 5.17
CSI-RS configuration for CSI reporting	1			CSI-RS.3.1 TDD	A.1.4.2
reportConfigType	1			periodic	
reportQuantity	1			cri-RI-PMI-CQI	
CSI reporting periodicity	1	slot		40	
CSI reporting offset	1	slot		4	
T310	1	ms		1000	
N310	1			2	
T1	1	s		1	The UE shall be fully synchronized to cell 1 during T1
T2	1	s		1.17	
T3	1	s		0.9	
T4	1	s		0	
T5	1	s		0.31	
D1	1	s		0.27	
Note 1: UE-specific PDCCH is not transmitted after T1 starts.					
Note 2: Including test tolerance given in Annex F.1.3.2					

#### 7.5.5.6.4.2 Test procedure

Prior to the start of the time duration T1, the UE shall be fully synchronized to Cell 1 and Cell 2. The UE shall be configured for periodic CSI reporting with a reporting periodicity defined in CSI-RS configuration. In the test, DRX configuration is not enabled. During the test the UE is scheduled to transmit continuously in UL.

1. Ensure the UE is in state RRC\_CONNECTED with generic procedure parameters Connectivity NR, Connected without release *On* and Test Mode *On* according to TS 38.508-1 [14] clause 4.5.4.
2. The SS shall configure SCell (Cell 2) on the SCC as per TS 38.508-1 [14] clause 7.5.2, with the message content exceptions defined in clause 7.5.5.6.4.3. NR RRCReconfiguration message is contained in RRCConnectionReconfiguration and NR RRCReconfigurationComplete message is contained in RRCConnectionReconfigurationComplete.
3. The SS activates SCC by sending the activation MAC-CE (Refer TS 38.321 [12], clauses 5.9, 6.1.3.10).

4. Set the parameters of NR Cell 1 and Cell 2 according to T1 in Table 7.5.5.6.5-1. Propagation conditions are set according to Annex C.2.3. T1 starts.
5. When T1 expires the SS shall change the SNR value to T2 as specified in Table 7.5.5.6.5-1. T2 starts.
6. When T2 expires the SS shall change the SNR value to T3 as specified in Table 7.5.5.6.5-1. T3 starts.
7. When T3 expires the SS shall change the SNR value to T4 as specified in Table 7.5.5.6.5-1. T4 starts.
8. When T4 expires the SS shall change the SNR value to T5 as specified in Table 7.5.5.6.5-1. T5 starts.
9. If the SS:
  - a) detects uplink power on NR carrier equal to or higher than minimum output power defined in TS 38.521-2 [18] clause 6.3.1.5 in each slot configured for CSI transmission (according CSI reporting on PUCCH) during the period from time point A to time point B; and
  - b) does not detect PUCCH with LRR before time point B, and
  - c) detects PUCCH with LRR, followed by BFR MAC CE containing a beam associated with the candidate beam set  $q_1$  before time point F (D1 after the start of T5),

the number of successful tests is increased by one.

Otherwise the number of failed tests is increased by one.
10. When T5 expires the SS shall change the SNR value to T1 as specified in Table 7.5.5.6.5-1.
11. If the iteration fails, the SS shall first attempt to release and add the FR2 SCell. If that also fails, then the UE is switched OFF/ON to proceed with the next iteration, and ensure the UE is in state RRC\_CONNECTED with generic procedure parameters Connectivity *EN-DC*, DC bearer *MCG* and *SCG*, Connected without release *On* and Test Mode *On* according to TS 38.508-1 [14] clause 4.5.4.
12. Repeat steps 2-11 for all subtests until the confidence level according to Tables G.2.3-1 in Annex G clause G.2 is achieved.

7.5.5.6.4.3 Message contents

Message contents are according to TS 38.508-1 [14] clause 7.3 with the following exceptions:

**Table 7.5.5.6.4.3-1: Common Exception messages for SA FR2 SCell for beam failure detection and link recovery testing in non-DRX mode**

Default Message Contents	
Common contents of system information blocks exceptions	
Default RRC messages and information elements contents exceptions	Table H.3.1-8 with Condition CSI-RS BFD Table H.3.1-12 on Cell 3 Table H.3.1-13 on Cell 3

**Table 7.5.5.6.4.3-2: MAC-CellGroupConfig**

Derivation Path: TS 38.508-1 [14], Table 4.6.3-68			
Information Element	Value/remark	Comment	Condition
MAC-CellGroupConfig ::= SEQUENCE {			
schedulingRequestID-BFR-SCell-r16	SchedulingRequestId		
}			

**Table 7.5.5.6.4.3-3: SchedulingRequestResourceConfig**

Derivation Path: TS 38.508-1 [14], Table 4.6.3-157			
Information Element	Value/remark	Comment	Condition
SchedulingRequestResourceConfig ::= SEQUENCE {			
periodicityAndOffset CHOICE {			
sl40	4		
}			
}			

#### 7.5.5.6.5 Test requirement

Tables 7.5.5.6.4.1-3 and 7.5.5.6.5-1 define the primary level settings including test tolerances for SA FR2 SCell for beam failure detection and link recovery testing in non-DRX.

**Table 7.5.5.6.5-1: NR Cell specific test parameters for SA FR2 SCell for beam failure detection and link recovery testing in non-DRX mode**

Parameter		Unit	Cell1 T1 to T5	Cell2 Test 1				
				T1	T2	T3	T4	T5
AoA setup			Setup 1 defined in A.9.1	Setup 1 defined in A.9.1				
Assumption for UE beams <sup>Note 10</sup>			Rough	Rough				
EPRE ratio of PDCCH DMRS to SSS		dB	0	0				
EPRE ratio of PDCCH to PDCCH DMRS		dB						
EPRE ratio of PBCH DMRS to SSS		dB						
EPRE ratio of PBCH to PBCH DMRS		dB						
EPRE ratio of PSS to SSS		dB						
EPRE ratio of PDSCH DMRS to SSS		dB						
EPRE ratio of PDSCH to PDSCH DMRS		dB						
EPRE ratio of OCNG DMRS to SSS		dB						
EPRE ratio of OCNG to OCNG DMRS		dB						
SNR_CSI-RS of set q <sub>0</sub>	Config 1	dB						
SNR_CSI-RS of set q <sub>1</sub>	Config 1	dB	0.2	0.2	0.2	20	20	20
CSI-RS_RP of set q <sub>1</sub>	Config 1	dBm/S CS kHz	-104.5	-104.5	-104.5	-84.7	-84.7	-84.7
N <sub>oc</sub>	Config 1	dBm/12 0kHz	-104.7	-104.7				
Propagation condition			TDL-A 30ns 75Hz	TDL-A 30ns 75Hz				
<p>Note 1: OCNG shall be used such that the resources in Cell 1 are fully allocated and a constant total transmitted power spectral density is achieved for all OFDM symbols.</p> <p>Note 2: The uplink resources for CSI reporting are assigned to the UE prior to the start of time period T1.</p> <p>Note 3: NZP CSI-RS resource set configuration for CSI reporting are assigned to the UE prior to the start of time period T1.</p> <p>Note 4: Void</p> <p>Note 5: The timers and layer 3 filtering related parameters are configured prior to the start of time period T1.</p> <p>Note 6: The signal contains PDCCH for UEs other than the device under test as part of OCNG.</p> <p>Note 7: SNR levels correspond to the signal to noise ratio over the REs carrying CSI-RS.</p> <p>Note 8: The SNR in time periods T1, T2, T3, T4 and T5 is denoted as SNR1, SNR2 and SNR3 respectively in figure 7.5.5.6.4-1.</p> <p>Note 9: The SNR values are specified for testing a UE which supports 2RX on at least one band. For testing of a UE which supports 4RX on all bands, the SNR during T3 is modified as specified in clause D.4.</p> <p>Note 10: Information about types of UE beam is given in B.2.1.3 in TS 38.133 [6], and does not limit UE implementation or test system implementation</p>								

The UE behaviour during time durations T1, T2, T3, T4 and T5 shall be as follows:

During the time duration T1 and T2, the UE shall transmit uplink signal at least in all subframes configured for CSI transmission on Cell 1.

During the period from time point A to time point B the UE shall transmit uplink signal in Cell 1 in all uplink slots configured for CSI transmission according to the configured periodic CSI reporting for Cell 1.

During T3 the UE shall detect beam failure and initial link recovery. During T4 and T5 the UE measures and evaluates beam candidate from beam candidate set q<sub>1</sub>.



No later than time point F occurring no later than  $D1 = 260+10$  ms after the start of T5, the UE shall transmit PUCCH with LRR, followed by BFR MAC CE containing a beam associated with the candidate beam set  $q_1$ . The UE shall not transmit PUCCH with an LRR with the candidate beam set  $q_1$  earlier than time point B.

Test is concluded once the test equipment has received the initial preamble transmission from the UE. The rate of correct events observed during repeated tests shall be at least 90%.

### 7.5.5.7 NR SA FR2 SCell CSI-RS-based beam failure detection and link recovery in DRX

Editor's Note:

- This test case is incomplete for Test frequency  $f > 40.8$  GHz
- This test case is incomplete for UE power class other than PC3.

The purpose of this test is to verify that the UE properly detects CSI-RS-based beam failure in the set  $q_0$  configured for an active SCell and that the UE performs correct CSI-RS-based link recovery based on beam candidate set  $q_1$ . The purpose is to test the downlink monitoring for beam failure detection within the UEs active DL BWP of the SCell with *schedulingRequestID-BFR-SCell-r16* configuration, during the evaluation period, and link recovery, when DRX is used. This test will partly verify the CSI-RS based beam failure detection and link recovery for an FR2 SCell requirements in TS 38.133 [6] clause 8.5.

#### 7.5.5.7.2 Test applicability

This test applies to all types of NR UE release 16 onwards supporting SCell BFR.

#### 7.5.5.7.3 Minimum conformance requirements

The minimum conformance requirements are specified in clause 7.5.5.0.2 and 7.5.5.0.4.

The normative reference for this requirement is TS 38.133 [6] clause A.7.5.5.7.

#### 7.5.5.7.4 Test description

There are two cells configured in this test. Cell 1 is the active PCell and Cell 2 is the active SCell. This test consists of five successive time periods, with time duration of T1, T2, T3, T4 and T5 respectively. Figure 7.5.5.7.4-1 shows the variation of the downlink SNR of the CSI-RS in set  $q_0$  in the active SCell to emulate CSI-RS based beam failure. Figure 7.5.5.7.4-1 additionally shows the variation of the downlink L1-RSRP of the CSI-RS in set  $q_1$  of the candidate beam used for link recovery.

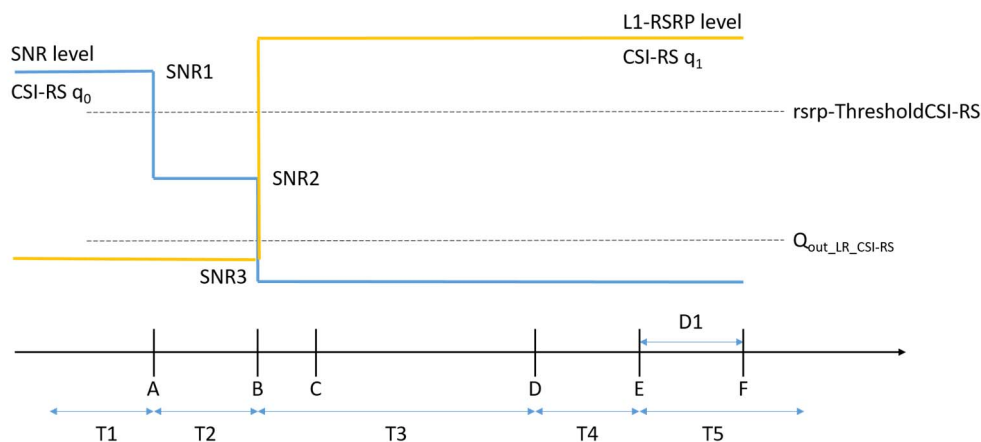

Figure 7.5.5.7.4-1: SNR and L1-RSRP variation for CSI-RS based beam failure detection and link recovery testing for SCell in DRX mode

7.5.5.7.4.1 Initial conditions

This test shall be tested using any of the test configurations in Table 7.5.5.7.4.1-1.

**Table 7.5.5.7.4.1-1: Supported test configurations for SA FR2 SCell beam failure detection and link recovery testing in DRX**

Configuration	Description
7.5.5.7-1	TDD duplex mode, 120 kHz SSB SCS, 100 MHz bandwidth
Note: The UE is only required to be tested in one of the supported test configurations	

Configure the test equipment and the DUT according to the parameters in Table 7.5.5.7.4.1-2.

**Table 7.5.5.7.4.1-2: Initial conditions for SA FR2 SCell beam failure detection and link recovery testing in DRX**

Parameter	Value		Comment
Test environment	NC		As specified in TS 38.508-1 [14] clause 4.1.
Test frequencies	As specified in Annex E, table E.5-1 and TS 38.508-1 [14] clause 4.3.1		
Channel bandwidth	As specified by the test configuration selected from Table 7.5.5.7.4.1-1.		
Propagation conditions	AWGN		As specified in Annex C.2.2.
Connection Diagram	TE Part	A.3.3.3.1	As specified in TS 38.508-1 [14] Annex A.
	DUT Part	A.3.4.1.1	
Exceptions to connection diagram	N/A		

1. The general test parameter settings are set up according to Table 7.5.5.7.4.1-3.
2. Message contents are defined in clause 7.5.5.7.4.3.
3. There are two NR cells specified in the test. Cell 1 is the cell used for connection setup with the power level set according to Annex C.1.1 and C.1.2 for this test.

**Table 7.5.5.7.4.1-3: General test parameters for FR2 SCell for beam failure detection and link recovery testing in DRX mode**

Parameter	Test Config.	Unit	Value	Comment
			Test 1	

Active PCell	1		Cell 1		
RF Channel Number for PCell	1		1		
Active SCell	1		Cell 2		
RF Channel Number for SCell	1		2		
Duplex mode	1		TDD		
TDD Configuration	1		TDDConf.3.1		
BW <sub>channel</sub>	1	MHz	100: N <sub>RB,c</sub> = 66		
Data RBs allocated	1		66		
PDSCH/PDCCH subcarrier spacing	1	kHz	120		
DL initial BWP configuration	1		DLBWP.0.1		
DL dedicated BWP configuration	1		DLBWP.1.1		
UL initial BWP configuration	1		ULBWP.0.1		
UL dedicated BWP configuration	1		ULBWP.1.1		
PDSCH Reference Channel	1		SR.3.2 TDD		
RMSI CORESET Reference Channel	1		CR.3.1 TDD	A.1.2.2	
Dedicated CORESET Reference Channel	1		CCR.3.1 TDD		
OCNG parameters	1		OP.1	A.2.1	
CP length	1		Normal		
PDSCH/PDCCH TCI state	1		TCI.State.0		
CSI-RS for tracking	1		TRS.2.1 TDD		
SSB Configuration	1		SSB.3 FR2	A.3	
SMTTC Configuration	1		SMTTC.3	A.4	
PRACH Configuration	1		FR2 PRACH configuration 4	Table A.7.2-1	
DRX configuration	1		DRX.3	A.5	
CSI-RS configuration for BFD/CBD on SCell	1		CSI-RS.3.2 TDD	A.1.4.2	
CSI-RS index assigned as BFD RS (q <sub>0</sub> )	1		0		
CSI-RS index assigned as CBD RS (q <sub>1</sub> )	1		1		
CSI-RS configuration for RLM on PCell	1		CSI-RS.3.2 TDD	A.1.4.2	
Beam failure detection transmission parameters	DCI format	1	1-0		
	Number of Control OFDM symbols	1	2		
	Aggregation level	1	CCE	8	
	Ratio of hypothetical PDCCH RE energy to average SSS RE energy	1	dB	0	
	Ratio of hypothetical PDCCH DMRS energy to average SSS RE energy	1	dB	0	
	DMRS precoder granularity	1		REG bundle size	
	REG bundle size	1	6		

Gap pattern ID	1		N/A	
schedulingRequestID-BFR-SCell-r16	1		Configured	
Periodicity of PUCCH for SR configuration for BFR on SCell	1	slot	40	5ms
Offset of PUCCH for SR configuration for BFR on SCell	1	slot	4	
PUCCH parameters for SR configuration for BFR on SCell	1		Table 8.3.3.1.2-1 in [28]	
rlmInSyncOutOfSyncThreshold	1		absent	Value 0 is applied. (Table 8.1.1-1 in TS 38.133 [6]).
rsrp-ThresholdSSB	1	dBm/SCS	-109 <sup>Note 2</sup>	Threshold used for $Q_{in\_LR\_SSB}$
powerControlOffsetSS	1		db0	Used for deriving rsrp-ThresholdCSI-RS
beamFailureInstanceMaxCount	1		n1	see TS 38.321 [12], clause 5.17
beamFailureDetectionTimer	1		pbfd4	see TS 38.321 [12], clause 5.17
CSI-RS configuration for CSI reporting	1		CSI-RS.3.1 TDD	A.1.4.2
reportConfigType	1		periodic	
reportQuantity	1		cri-RI-PMI-CQI	
CSI reporting periodicity	1	slot	40	
CSI reporting offset	1	slot	4	
T310	1	ms	1000	
N310	1		2	
T1	1	s	1	The UE shall be fully synchronized to cell 1 during T1
T2	1	s	5.43	
T3	1	s	5.16	
T4	1	s	0	
T5	1	s	0.31	
D1	1	s	0.27	
Note 1: UE-specific PDCCH is not transmitted after T1 starts.				
Note 2: Including test tolerance given in Annex F.1.3.2				

#### 7.5.5.7.4.2 Test procedure

Prior to the start of the time duration T1, the UE shall be fully synchronized to Cell 1 and Cell 2. The UE shall be configured for periodic CSI reporting with a reporting periodicity defined in CSI-RS configuration. In the test, DRX configuration is enabled in PCell and DRX inactivity timer has already been expired, i.e. UE tries to decode PDCCH and to send periodic CQI during the period when On-duration timer is running. Time alignment timers shall be set to “infinity” so that UL timing alignment is maintained during the test. During the test the UE is scheduled to transmit continuously in UL.

1. Ensure the UE is in state RRC\_CONNECTED with generic procedure parameters Connectivity NR, Connected without release On and Test Mode On according to TS 38.508-1 [14] clause 4.5.4.
2. The SS shall configure SCell (Cell 2) on the SCC as per TS 38.508-1 [14] clause 7.5.2, with the message content exceptions defined in clause 7.5.5.7.4.3. NR RRCReconfiguration message is contained in RRCConnectionReconfiguration and NR RRCReconfigurationComplete message is contained in RRCConnectionReconfigurationComplete.
3. The SS activates SCC by sending the activation MAC-CE (Refer TS 38.321 [12], clauses 5.9, 6.1.3.10).
4. Set the parameters of NR Cell 1 and Cell 2 according to T1 in Table 7.5.5.7.5-1. Propagation conditions are set according to Annex C.2.3. T1 starts.
5. When T1 expires the SS shall change the SNR value to T2 as specified in Table 7.5.5.7.5-1. T2 starts.
6. When T2 expires the SS shall change the SNR value to T3 as specified in Table 7.5.5.7.5-1. T3 starts.
7. When T3 expires the SS shall change the SNR value to T4 as specified in Table 7.5.5.7.5-1. T4 starts.

8. When T4 expires the SS shall change the SNR value to T5 as specified in Table 7.5.5.7.5-1. T5 starts.
9. If the SS:
  - a) detects uplink power on NR carrier in each slot configured for CSI transmission (according CSI reporting on PUCCH) during the period from time point A to time point B; and
  - b) does not detect PUCCH with LRR before time point B, and
  - c) detects PUCCH with LRR, followed by BFR MAC CE containing a beam associated with the candidate beam set  $q_1$  before time point F (D1 after the start of T5),

the number of successful tests is increased by one.

Otherwise the number of failed tests is increased by one.
10. When T5 expires the SS shall change the SNR value to T1 as specified in Table 7.5.5.7.5-1.
11. If the iteration fails, the SS shall first attempt to release and add the FR2 SCell. If that also fails, then the UE is switched OFF/ON to proceed with the next iteration, and ensure the UE is in state RRC\_CONNECTED with generic procedure parameters Connectivity *EN-DC*, DC bearer *MCG* and *SCG*, Connected without release *On* and Test Mode *On* according to TS 38.508-1 [14] clause 4.5.4.
12. Repeat steps 2-11 for all subtests until the confidence level according to Tables G.2.3-1 in Annex G clause G.2 is achieved.

7.5.5.7.4.3 Message contents

Message contents are according to TS 38.508-1 [14] clause 7.3 with the following exceptions:

**Table 7.5.5.7.4.3-1: Common Exception messages for SA FR2 SCell for beam failure detection and link recovery testing in DRX mode**

Default Message Contents	
Common contents of system information blocks exceptions	
Default RRC messages and information elements contents exceptions	Table H.3.1-8 with Condition CSI-RS BFD Table H.3.1-12 on Cell 3 Table H.3.1-13 on Cell 3 Table H.3.7-1 with condition DRX.3

**Table 7.5.5.7.4.3-2: MAC-CellGroupConfig**

Derivation Path: TS 38.508-1 [14], Table 4.6.3-68			
Information Element	Value/remark	Comment	Condition
MAC-CellGroupConfig ::= SEQUENCE {			
schedulingRequestID-BFR-SCell-r16	SchedulingRequestId		
}			

**Table 7.5.5.7.4.3-3: SchedulingRequestResourceConfig**

Derivation Path: TS 38.508-1 [14], Table 4.6.3-157			
Information Element	Value/remark	Comment	Condition
SchedulingRequestResourceConfig ::= SEQUENCE {			
periodicityAndOffset CHOICE {			
sl40	4		
}			
}			

7.5.5.7.5 Test requirement

Tables 7.5.5.7.4.1-3 and 7.5.5.7.5-1 define the primary level settings including test tolerances for SA FR2 SCell for beam failure detection and link recovery testing in DRX.

**Table 7.5.5.7.5-1: NR Cell specific test parameters for SA FR2 SCell for beam failure detection and link recovery testing in DRX mode**

Parameter		Unit	Cell1 T1 to T5	Cell2 Test 1				
				T1	T2	T3	T4	T5
AoA setup			Setup 1 defined in A.9.1	Setup 1 defined in A.9.1				
Assumption for UE beams <sup>Note 10</sup>			Rough	Rough				
EPRE ratio of PDCCH DMRS to SSS		dB	0	0				
EPRE ratio of PDCCH to PDCCH DMRS		dB						
EPRE ratio of PBCH DMRS to SSS		dB						
EPRE ratio of PBCH to PBCH DMRS		dB						
EPRE ratio of PSS to SSS		dB						
EPRE ratio of PDSCH DMRS to SSS		dB						
EPRE ratio of PDSCH to PDSCH DMRS		dB						
EPRE ratio of OCNG DMRS to SSS		dB						
EPRE ratio of OCNG to OCNG DMRS		dB						
SNR_CSI-RS of set q <sub>0</sub>	Config 1	dB						
SNR_CSI-RS of set q <sub>1</sub>	Config 1	dB	0.2	0.2	0.2	20	20	20
CSI-RS_RP of set q <sub>1</sub>	Config 1	dBm/S CS kHz	-104.5	-104.5	-104.5	-84.7	-84.7	-84.7
N <sub>oc</sub>	Config 1	dBm/12 0kHz	-104.7	-104.7				
Propagation condition			TDL-A 30ns 75Hz	TDL-A 30ns 75Hz				
<p>Note 1: OCNG shall be used such that the resources in Cell 1 are fully allocated and a constant total transmitted power spectral density is achieved for all OFDM symbols.</p> <p>Note 2: The uplink resources for CSI reporting are assigned to the UE prior to the start of time period T1.</p> <p>Note 3: NZP CSI-RS resource set configuration for CSI reporting are assigned to the UE prior to the start of time period T1.</p> <p>Note 4: Void</p> <p>Note 5: The timers and layer 3 filtering related parameters are configured prior to the start of time period T1.</p> <p>Note 6: The signal contains PDCCH for UEs other than the device under test as part of OCNG.</p> <p>Note 7: SNR levels correspond to the signal to noise ratio over the REs carrying CSI-RS.</p> <p>Note 8: The SNR in time periods T1, T2, T3, T4 and T5 is denoted as SNR1, SNR2 and SNR3 respectively in figure 7.5.5.7.4-1.</p> <p>Note 9: The SNR values are specified for testing a UE which supports 2RX on at least one band. For testing of a UE which supports 4RX on all bands, the SNR during T3 is modified as specified in clause D.4.</p> <p>Note 10: Information about types of UE beam is given in B.2.1.3 in TS 38.133 [6], and does not limit UE implementation or test system implementation</p>								

The UE behaviour during time durations T1, T2, T3, T4 and T5 shall be as follows:

During the time duration T1 and T2, the UE shall transmit uplink signal at least in all subframes configured for CSI transmission on Cell 1.

During the period from time point A to time point B the UE shall transmit uplink signal in Cell 1 in all uplink slots configured for CSI transmission according to the configured periodic CSI reporting for Cell 1.

During T3 the UE shall detect beam failure and initial link recovery. During T4 and T5 the UE measures and evaluates beam candidate from beam candidate set q<sub>1</sub>.

No later than time point F occurring no later than  $D1 = 260 + 10$  ms after the start of T5, the UE shall transmit PUCCH with LRR, followed by BFR MAC CE containing a beam associated with the candidate beam set  $q_1$ . The UE shall not transmit PUCCH with an LRR with the candidate beam set  $q_1$  earlier than time point B.

Test is concluded once the test equipment has received the initial preamble transmission from the UE. The rate of correct events observed during repeated tests shall be at least 90%.

## 7.5.6 Active BWP switch delay

### 7.5.6.1 DCI-based and time-based active BWP switch

#### 7.5.6.1.0 Minimum conformance requirements

[TS 38.133, clause 8.6.2]

The requirements in this clause only apply to the case that the BWP switch is performed on a single CC.

For DCI-based BWP switch, after the UE receives BWP switching request at DL slot  $n$  on a serving cell, UE shall be able to receive PDSCH (for DL active BWP switch) or transmit PUSCH (for UL active BWP switch) on the new BWP on the serving cell on which BWP switch on the first DL or UL slot occurs right after the beginning of DL slot  $n + T_{\text{BWPswitchDelay}}$ .

The UE is not required to transmit UL signals or receive DL signals during time duration  $T_{\text{BWPswitchDelay}}$  on the cell where DCI-based BWP switch occurs. The UE is not required to follow the requirements defined in this clause when performing a DCI-based BWP switch between the BWPs in disjoint channel bandwidths or in partially overlapping channel bandwidths.

Depending on UE capability *bwp-SwitchingDelay* [2], UE shall finish BWP switch within the time duration  $T_{\text{BWPswitchDelay}}$  defined in Table 7.5.6.1.0-1.

**Table 7.5.6.1.0-1: BWP switch delay**

$\mu$	NR Slot length (ms)	BWP switch delay $T_{\text{BWPswitchDelay}}$ (slots)	
		Type 1 <sup>Note 1</sup>	Type 2 <sup>Note 1</sup>
0	1	1	3
1	0.5	2	5
2	0.25	3	9
3	0.125	6	18
Note 1: Depends on UE capability. Note 2: If the BWP switch involves changing of SCS, the BWP switch delay is determined by the smaller SCS between the SCS before BWP switch and the SCS after BWP switch.			

Provided the UE does not have the required TCI-state information to receive PDCCH and PDSCH in the new BWP, the UE shall use old TCI-states before the BWP switch until a new MAC CE updating the required TCI-state information for PDCCH and PDSCH is received after the BWP switch.

If UE has the information on the required TCI-state information to receive PDCCH and PDSCH in the new BWP,

- UE shall be able to receive PDCCH and PDSCH with old TCI-states before the delay as specified in Clause 8.10 in the new BWP.
- UE shall be able to receive PDCCH and PDSCH with new TCI-states after the delay as specified in Clause 8.10 in the new BWP.

#### 7.5.6.1.1 NR SA FR2 DCI-based DL active BWP switch in non-DRX

*Editor's note: This test case is incomplete. The following aspects are either missing or TBD*

*- Test tolerance analysis is missing*

*- Message contents are TBD*

- Cell mapping is TBD

- Test procedure is TBD

- Test applicability needs to be added to TS 38.522

7.5.6.1.1.1 Test purpose

FFS

7.5.6.1.1.2 Test applicability

FFS

7.5.6.1.1.3 Minimum conformance requirements

The minimum conformance requirements are specified in clause 7.5.6.1.0.1.

The normative reference for this requirement is TS 38.133 [6] clause A.7.5.6.1.1.

7.5.6.1.1.4 Test description

7.5.6.1.1.4.1 Initial conditions

FFS

7.5.6.1.1.4.2 Test procedure

FFS

7.5.6.1.1.4.3 Message contents

FFS

7.5.6.1.1.5 Test requirements

FFS

7.5.6.1.2 NR SA FR1-FR2 DCI-based DL active BWP switch in non-DRX

*Editor's note: This test case is incomplete. The following aspects are either missing or TBD*

- Test tolerance analysis is missing

- Message contents are TBD

- Cell mapping is TBD

- Test procedure is TBD

- Test applicability needs to be added to TS 38.522

7.5.6.1.2.1 Test purpose

FFS

7.5.6.1.2.2 Test applicability

FFS

7.5.6.1.2.3 Minimum conformance requirements

The minimum conformance requirements are specified in clause 7.5.6.1.0.2.

The normative reference for this requirement is TS 38.133 [6] clause A.7.5.6.1.2.



7.5.6.1.2.4 Test description

7.5.6.1.2.4.1 Initial conditions

FFS

7.5.6.1.2.4.2 Test procedure

FFS

7.5.6.1.2.4.3 Message contents

FFS

7.5.6.1.2.5 Test requirements

FFS

7.5.6.1.3 NR SA FR2 DCI-based DL active BWP switch in non-DRX

*Editor's note: This test case is incomplete. The following aspects are either missing or TBD*

*- Test tolerance analysis is missing*

*- Message contents are TBD*

*- Cell mapping is TBD*

*- Test procedure is TBD*

*- Test applicability needs to be added to TS 38.522*

7.5.6.1.3.1 Test purpose

The purpose of this test is to verify the DL BWP switch delay requirement defined in TS 38.133 [6] clause 8.6

7.5.6.1.3.2 Test applicability

This test applies to all types of NR UE release 15 onwards.

7.5.6.1.3.3 Minimum conformance requirements

The minimum conformance requirements are specified in clause 7.5.6.1.0.

The normative reference for this requirement is TS 38.133 [6] clause A.7.5.6.1.3.

7.5.6.1.3.4 Test description

There is one cell configured in this test. Cell 1 is PCell. This test consists of three successive time periods, with time duration of T1, T2 and T3 respectively.

7.5.6.1.3.4.1 Initial conditions

This test shall be tested using any of the test configurations in Table 7.5.6.1.3.4.1-1.

**Table 7.5.6.1.3.4.1-1: Supported test configurations for NR SA FR2 DCI-based DL active BWP switch in non-DRX**

Config	Description
7.5.6.1.3-1	NR 120 kHz SSB SCS, 100 MHz bandwidth, TDD duplex mode
Note 1:	A UE which fulfils the requirements in test case 7.5.6.1.1 or 7.5.6.1.2 can skip the test cases in 7.5.6.1.3.

Configure the test equipment and the DUT according to the parameters in Table 7.5.6.1.3.4.1-2.

**Table 7.5.6.1.3.4.1-2: Initial conditions for NR SA FR2 DCI-based DL active BWP switch in non-DRX**

Parameter	Value		Comment
Test environment	NC		As specified in TS 38.508-1 [14] clause 4.1.
Test frequencies	As specified in Annex E, table E.5-1 and TS 38.508-1 [14] clause 4.3.1 and 4.4.2.		
Channel bandwidth	As specified by the test configuration selected from Table 5.5.5.4.1-1.		
Propagation conditions	AWGN		As specified in Annex C.2.2.
Connection Diagram	TE Part	A.3.TBD	As specified in TS 38.508-1 [14] Annex A.
	DUT Part	A.3.TBD	
Exceptions to connection diagram	N/A		

1. The general test parameter settings are set up according to Table 7.5.6.1.3.4.1-3.
2. Message contents are defined in clause 7.5.6.1.3.4.3.
3. There are one NR cell specified in the test. NR Cell 1 is the cell used for connection setup with the power level set according to Annex C.1.1 and C.1.2 for this test.

**Table 7.5.6.1.3.4.1-3: General test parameters for NR SA FR2 DCI-based DL active BWP switch in non-DRX**

Parameter	Unit	Value	Comment
NR RF Channel Number		1	One NR radio channel is used for this test
Active Cell		Cell 1	Cell on RF channel number 1.
CP length		Normal	
DRX		OFF	For both PCell and PSCell
<i>bwp-InactivityTimer</i>	ms	[200]	
T1	s	[0.2]	
T2	s	[0.2]	
T3	s	[0.2]	

7.5.6.1.3.4.2 Test procedure

FFS

7.5.6.1.3.4.3 Message contents

Message contents are according to TS 38.508-1 [14] clause 7.3 with the following exceptions:

**Table 7.5.6.1.3.4.3-1: Common Exception messages for NR SA FR2 DCI-based DL active BWP switch in non-DRX**

Default Message Contents	
Common contents of system information blocks exceptions	
Default RRC messages and information elements contents exceptions	FFS

7.5.6.1.3.5 Test requirements

FFS

7.5.6.2 RRC-based active BWP switch

7.5.6.2.0 Minimum conformance requirements

FFS

### 7.5.6.2.1 NR SA FR2 RRC-based DL active BWP switch in non-DRX

*Editor's note: This test case is incomplete. The following aspects are either missing or TBD*

*- Test tolerance analysis is missing*

*- Message contents are TBD*

*- Cell mapping is TBD*

*- Test procedure is TBD*

*- Test applicability needs to be added to TS 38.522*

#### 7.5.6.2.1.1 Test purpose

FFS

#### 7.5.6.2.1.2 Test applicability

FFS

#### 7.5.6.2.1.3 Minimum conformance requirements

The minimum conformance requirements are specified in clause 7.5.6.2.0.1.

The normative reference for this requirement is TS 38.133 [6] clause A.7.5.6.2.1.

#### 7.5.6.2.1.4 Test description

##### 7.5.6.2.1.4.1 Initial conditions

FFS

##### 7.5.6.2.1.4.2 Test procedure

FFS

##### 7.5.6.2.1.4.3 Message contents

FFS

##### 7.5.6.2.1.5 Test requirements

FFS

## 7.5.7 PSCell addition and release delay

### 7.5.7.0 Minimum conformance requirements

#### 7.5.7.0.1 Minimum conformance requirements for PSCell addition delay

Upon receiving PSCell addition in subframe  $n$ , the UE shall be capable to transmit PRACH preamble towards PSCell in FR2 no later than in subframe  $n + T_{\text{config\_PSCell}}$ :

Where:

$$T_{\text{config\_PSCell}} = T_{\text{RRC\_delay}} + T_{\text{processing}} + T_{\text{search}} + T_{\Delta} + T_{\text{PSCell\_DU}} + 2 \text{ ms}$$

$T_{\text{RRC\_delay}}$  is the RRC procedure delay as specified in TS 38.331 [13].

$T_{\text{processing}}$  is the SW processing time needed by UE, including RF warm up period.  $T_{\text{processing}} = 40 \text{ ms}$ .

$T_{\text{search}}$  is the time for AGC settling and PSS/SSS detection. If the target cell is known,  $T_{\text{search}} = 0 \text{ ms}$ . If the target cell is unknown and the target cell  $\hat{E}_s/I_{ot} \geq -2\text{dB}$ ,  $T_{\text{search}} = 24 * T_{\text{rs}} \text{ ms}$ .

$T_{\Delta}$  is time for fine time tracking and acquiring full timing information of the target cell.  $T_{\Delta} = 1 * T_{rs}$  ms for a known or unknown PSCell.

$T_{PSCell\_DU}$  is the delay uncertainty in acquiring the first available PRACH occasion in the PSCell.  $T_{PSCell\_DU}$  is up to the summation of SSB to PRACH occasion association period and 10 ms. SSB to PRACH occasion associated period is defined in Table 8.1-1 of TS 38.213 [8].

$T_{rs}$  is the SMTC periodicity of the target cell if the UE has been provided with an SMTC configuration for the target cell in PSCell addition message, otherwise  $T_{rs}$  is the SMTC configured in the measObjectNR having the same SSB frequency and subcarrier spacing. If the UE is not provided SMTC configuration or measurement object on this frequency, the requirement in this clause is applied with  $T_{rs} = 5$  ms assuming the SSB transmission periodicity is 5 ms. There is no requirement if the SSB transmission periodicity is not 5 ms.

In FR1 and FR2, the PSCell is known if it has been meeting the following conditions:

During the last 5 seconds before the reception of the PSCell configuration command:

- the UE has sent a valid measurement report for the PSCell being configured and
- One of the SSBs measured from the PSCell being configured remains detectable according to the cell identification conditions specified in TS 38.133 [6] clause 9.3.
- One of the SSBs measured from PSCell being configured also remains detectable during the PSCell configuration delay  $T_{config\_PSCell}$  according to the cell identification conditions specified in TS 38.133 [6] clause 9.3.

otherwise it is unknown.

The PCell interruption specified in TS 38.133 [6] clause 8.2 is allowed only during the RRC reconfiguration procedure in TS 38.331 [13].

The normative reference for this requirement is TS 38.133 [6] clause 8.9.2.

#### 7.5.7.0.2 Minimum conformance requirements for PSCell release delay

The requirements in this clause shall apply for a UE which is configured with PCell and one PSCell.

Upon receiving PSCell release in subframe  $n$ , the UE shall accomplish the release actions specified in TS 38.331 [13] no later than in subframe  $n + T_{RRC\_delay}$ :

Where

$T_{RRC\_delay}$  is the RRC procedure delay as specified in TS 38.331 [13].

The PCell interruption specified in TS 38.133 [6] clause 8.2 is allowed only during the RRC reconfiguration procedure in TS 38.331 [13].

The normative reference for this requirement is TS 38.133 [6] clause 8.9.3.

#### 7.5.7.1 NR SA FR2 addition and release delay of known PSCell

**Editor's note: This test case is incomplete. The following aspects are either missing or TBD**

- Test procedure
- Connection diagram
- Message contents are not complete.
- Test Requirements (still brackets in core-spec for PRACH preamble time [112] ms and CSI report time [20] ms)
- TT analysis is missing.
- Test Applicability in TS38.522

## - Annex F

## - Cell configuration mapping in Annex E

## 7.5.7.1.1 Test purpose

The purpose of this test is:

- To verify the requirement for the PSCell addition and release delay are within the requirements specified in TS 38.133 [6] clause 8.9.2, when the PSCell is known to the UE at the time of addition.

## 7.5.7.1.2 Test applicability

This test applies to all types of NR UE from Release 15 onwards.

## 7.5.7.1.3 Minimum conformance requirements

The minimum conformance requirements are specified in clauses 7.5.7.0.1 and 7.5.7.0.2.

The normative reference for this requirement is TS 38.133 [6] clause A.7.5.7.1.

## 7.5.7.1.4 Test description

## 7.5.7.1.4.1 Initial conditions

This test shall be run in one of the configurations defined in Table 7.5.7.1.4.1-1.

**Table 7.5.7.1.4.1-1: Supported test configurations for NR SA FR2 PSCell**

Config	Description
1	FR1 FDD SSB SCS 15kHz BW 10MHz – FR2 TDD SSB SCS 240kHz BW 100MHz
2	FR1 TDD SSB SCS 15kHz BW 10MHz – FR2 TDD SSB SCS 240kHz BW 100MHz
3	FR1 TDD SSB SCS 30kHz BW 40MHz – FR2 TDD SSB SCS 240kHz BW 100MHz
Note 1: The UE is only required to be tested in one of the supported test configurations	

Configure the test equipment and the DUT according to the parameters in Table 7.5.7.1.4.1-2.

**Table 7.5.7.1.4.1-2: Initial conditions for NR SA FR2 SCell activation case**

Parameter	Value	Comment
Test environment	NC	As specified in TS 38.508-1 [14] clause 4.1.
Test frequencies	As specified in Annex E, table E.4-1 and TS 38.508-1 [14] clause 4.3.1.	
Channel bandwidth	As specified by the test configuration selected from Table 7.5.7.1.4.1-1.	
Propagation conditions	AWGN	As specified in Annex C.2.2.
Connection Diagram	TE Part	TBD
	DUT Part	TBD
Exceptions to connection diagram	N/A	

1. The general test parameter settings are set up according to Table 7.5.7.1.4.1-3.
2. Message contents are defined in clause 7.5.7.1.4.3.
3. There are two NR carriers and 2 NR Cells specified in the test. Cell 1 is the PCell and Cell 2 is the neighbour cell (PSCell-to-be). Cell 1 and Cell 2 are configured according to Annex C.1.1 and C.1.2.

**Table 7.5.7.1.4.1-3: General test parameters for NR SA FR2 PSCell addition and release delay**

Parameter		Unit	Value	Comment
RF Channel Number			1, 2	Two radio channels are used for this test
Active PCell			Cell 1	PCell on RF channel number 1 in FR1
Neighbour cell			Cell 2	Neighbour cell (PSCell-to-be) on RF channel number 2 in FR2
A4	Hysteresis	dB	0	Hysteresis for event A4
	Threshold RSRP	dBm	-97	Threshold for event A4
	Time to Trigger	S	0	Time to trigger for event A4
DRX			OFF	For both PCell and PSCell once activated
Measurement gap pattern ID			0	Gaps are configured before T2 and released before T3.
PRACH configuration in Cell 2			FR2 PRACH configuration 2	PRACH configuration as specified in Clause A.3.8.3.2.
CSI reporting periodicity and offset configuration for Cell 2		ms	[2]	
T1		s	5	During this time the PCell is known and Cell 2 is unknown.
T2		s	1	During this time the UE shall identify neighbour cell 2 and report event B1.
T3		s	1	During this time the UE adds the PSCell.
T4		s	1	During this time the UE sends CSI reports for PSCell.
T5		s	1	During this time the UE releases the PSCell.

## 7.5.7.1.4.2 Test procedure

TBD

## 7.5.7.1.4.3 Message contents

Message contents are according to TS 38.508-1 [14] clause 4.6 with the following exceptions:

**Table 7.5.7.1.4.3-1: Common Exception messages**

Default Message Contents	
Common contents of system information blocks exceptions	
Default RRC messages and information elements contents exceptions	FFS

## 7.5.7.1.5 Test requirement

TBD

## 7.5.7.2 NR SA FR2 addition and release delay of unknown PSCell

Editor's note: This test case is incomplete. The following aspects are either missing or TBD

- Test procedure
- Connection diagram
- Message contents are not complete
- Test Requirements (still brackets in core-spec for PRACH preamble time [572] ms and CSI report time [20] ms)
- TT analysis is missing

- Test Applicability in TS38.522

- Annex F

- Cell configuration mapping in Annex E

#### 7.5.7.2.1 Test purpose

The purpose of this test is:

- To verify the requirement for the PSCell addition and release delay are within the requirements specified in TS 38.133 [6] clause 8.9.2, when the PSCell is unknown to the UE at the time of addition.

#### 7.5.7.2.2 Test applicability

This test applies to all types of NR UE from Release 15 onwards.

#### 7.5.7.2.3 Minimum conformance requirements

The minimum conformance requirements are specified in clauses 7.5.7.0.1 and 7.5.7.0.2.

The normative reference for this requirement is TS 38.133 [6] clause A.7.5.7.2.

#### 7.5.7.2.4 Test description

##### 7.5.7.2.4.1 Initial conditions

This test shall be run in one of the configurations defined in Table 7.5.7.2.4.1-1.

**Table 7.5.7.2.4.1-1: Supported test configurations for NR SA FR2 PSCell**

Config	Description
1	FR1 FDD SSB SCS 15kHz BW 10MHz – FR2 TDD SSB SCS 240kHz BW 100MHz
2	FR1 TDD SSB SCS 15kHz BW 10MHz – FR2 TDD SSB SCS 240kHz BW 100MHz
3	FR1 TDD SSB SCS 30kHz BW 40MHz – FR2 TDD SSB SCS 240kHz BW 100MHz
Note 1: The UE is only required to be tested in one of the supported test configurations	

Configure the test equipment and the DUT according to the parameters in Table 7.5.7.2.4.1-2.

**Table 7.5.7.2.4.1-2: Initial conditions for NR SA FR2 PSCell addition and release delay**

Parameter	Value		Comment
Test environment	NC		As specified in TS 38.508-1 [14] clause 4.1.
Test frequencies	As specified in Annex E, table E.4-1 and TS 38.508-1 [14] clause 4.3.1.		
Channel bandwidth	As specified by the test configuration selected from Table 7.5.3.7.4.1-1.		
Propagation conditions	AWGN		As specified in Annex C.2.2.
Connection Diagram	TE Part	TBD	As specified in TS 38.508-1 [14] Annex A.
	DUT Part	TBD	
Exceptions to connection diagram	N/A		

1. The general test parameter settings are set up according to Table 7.5.7.2.4.1-3.
2. Message contents are defined in clause 7.5.7.2.4.3.
3. There are two NR carriers and 2 NR Cells specified in the test. Cell 1 is the PCell and Cell 2 is the neighbour cell (PSCell-to-be). Cell 1 and Cell 2 are configured according to Annex C.1.1 and C.1.2.

**Table 7.5.7.2.4.1-3: General test parameters for NR SA FR2 PSCell addition and release delay**

Parameter	Unit	Value	Comment
RF Channel Number		1, 2	Two radio channels are used for this test
Active PCell		Cell 1	PCell on RF channel number 1 in FR1
Neighbour cell		Cell 2	Neighbour cell (PSCell-to-be) on RF channel number 2 in FR2
DRX		OFF	For both PCell and PSCell once activated
PRACH configuration in Cell 2		FR2 PRACH configuration 2	PRACH configuration as specified in Clause A.3.8.3.2.
CSI reporting periodicity and offset configuration for Cell 2	ms	[2]	
T1	s	5	During this time the PCell is known and Cell 2 is unknown.
T2	s	1	During this time the UE adds the PSCell.
T3	s	1	During this time the UE sends CSI reports for PSCell.
T4	s	1	During this time the UE releases the PSCell.

#### 7.5.7.2.4.2 Test procedure

TBD

#### 7.5.7.2.4.3 Message contents

Message contents are according to TS 38.508-1 [14] clause 4.6 with the following exceptions:

**Table 7.5.7.2.4.3-1: Common Exception messages**

Default Message Contents	
Common contents of system information blocks exceptions	
Default RRC messages and information elements contents exceptions	FFS

#### 7.5.7.2.5 Test requirement

TBD

## 7.6 Measurement procedures

### 7.6.1 Intra-frequency measurements

#### 7.6.1.0 Minimum conformance requirements

##### 7.6.1.0.1 Minimum conformance requirements for event-triggered measurement without gap

[TS 38.133, clause 9.2.5.1 and 9.2.5.2]

The UE shall be able to identify a new detectable intra frequency cell within  $T_{\text{identify\_intra\_without\_index}}$  if UE is not indicated to report SSB based RRM measurement result with the associated SSB index (*reportQuantityRsinIndexes* or *maxNrofRSIndexesToReport* is not configured), or the UE has been indicated that the neighbour cell is synchronous with the serving cell (*deriveSSB-IndexFromCell* is enabled). The UE shall be able to identify a new detectable intra frequency SS block of an already detected cell within  $T_{\text{identify\_intra\_without\_index}}$ . It is assumed that *deriveSSB-IndexFromCell* is always enabled for FR1 TDD and FR2.

$$T_{\text{identify\_intra\_without\_index}} = (T_{\text{PSS/SSS\_sync\_intra}} + T_{\text{SSB\_measurement\_period\_intra}}) \text{ ms}$$

Where:

$T_{\text{PSS/SSS\_sync\_intr}}$ : it is the time period used in PSS/SSS detection given in table 7.6.1.0.1-1.



$T_{SSB\_measurement\_period\_intra}$ : equal to a measurement period of SSB based measurement given in table 7.6.1.0.1-2.

$CSSF_{intra}$ : it is a carrier specific scaling factor and is determined according to  $CSSF_{outside\_gap,i}$  in TS 38.133 [6] clause 9.1.5.1 for measurement conducted outside measurement gaps.

$M_{pss/sss\_sync\_w/o\_gaps}$  : For a UE supporting FR2 power class 1,  $M_{pss/sss\_sync\_w/o\_gaps} = 40$ . For a UE supporting power class 2,  $M_{pss/sss\_sync\_w/o\_gaps} = 24$ . For a UE supporting FR2 power class 3,  $M_{pss/sss\_sync\_w/o\_gaps} = 24$ . For a UE supporting FR2 power class 4,  $M_{pss/sss\_sync\_w/o\_gaps} = 24$

$M_{meas\_period\_w/o\_gaps}$  : For a UE supporting power class 1,  $M_{meas\_period\_w/o\_gaps} = 40$ . For a UE supporting FR2 power class 2,  $M_{meas\_period\_w/o\_gaps} = 24$ . For a UE supporting power class 3,  $M_{meas\_period\_w/o\_gaps} = 24$ . For a UE supporting power class 4,  $M_{meas\_period\_w/o\_gaps} = 24$ .

When intrafrequency SMTC is fully non-overlapping with measurement gaps or intrafrequency SMTC is fully overlapping with MGs,  $K_p=1$ .

When intrafrequency SMTC is partially overlapping with measurement gaps,  $K_p = 1/(1 - (SMTC\ period / MGRP))$ , where SMTC period < MGRP

For FR2 when any of the reference signals configured for RLM, BFD, CBD or L1-RSRP for beam reporting outside measurement gap is fully overlapping with intra-frequency SMTC,  $K_{layer1\_measurement} = 1.5$ , otherwise  $K_{layer1\_measurement} = 1$ .

**Table 7.6.1.0.1-1: Time period for PSS/SSS detection (Frequency range FR2)**

DRX cycle	$T_{PSS/SSS\_sync\_intra}$
No DRX	$\max(600ms, \text{ceil}(M_{pss/sss\_sync\_w/o\_gaps} \times K_p \times K_{layer1\_measurement}) \times SMTC\ period)^{Note\ 1} \times CSSF_{intra}$
DRX cycle $\leq 320ms$	$\max(600ms, \text{ceil}(1.5 \times M_{pss/sss\_sync\_w/o\_gaps} \times K_p \times K_{layer1\_measurement}) \times \max(SMTC\ period, DRX\ cycle)) \times CSSF_{intra}$
DRX cycle $> 320ms$	$\text{ceil}(M_{pss/sss\_sync\_w/o\_gaps} \times K_p \times K_{layer1\_measurement}) \times DRX\ cycle \times CSSF_{intra}$
NOTE 1: If different SMTC periodicities are configured for different cells, the SMTC period in the requirement is the one used by the cell being identified	

**Table 7.6.1.0.1-2: Measurement period for intra-frequency measurements without gaps (Frequency FR2)**

DRX cycle	$T_{SSB\_measurement\_period\_intra}$
No DRX	$\max(400ms, \text{ceil}(M_{meas\_period\_w/o\_gaps} \times K_p \times K_{layer1\_measurement}) \times SMTC\ period)^{Note\ 1} \times CSSF_{intra}$
DRX cycle $\leq 320ms$	$\max(400ms, \text{ceil}(1.5 \times M_{meas\_period\_w/o\_gaps} \times K_p \times K_{layer1\_measurement}) \times \max(SMTC\ period, DRX\ cycle)) \times CSSF_{intra}$
DRX cycle $> 320ms$	$\text{ceil}(M_{meas\_period\_w/o\_gaps} \times K_p \times K_{layer1\_measurement}) \times DRX\ cycle \times CSSF_{intra}$
NOTE 1: If different SMTC periodicities are configured for different cells, the SMTC period in the requirement is the one used by the cell being identified	

[TS 38.133, clause 9.2.4.3]

Reported RSRP, RSRQ, and RS-SINR measurements contained in periodically triggered measurement reports shall meet the requirements in TS 38.133 [6] clause 10.1.2.1, 10.1.7.1 and 10.1.12.1, respectively.

The UE shall not send any event triggered measurement reports, as long as no reporting criteria are fulfilled.

The measurement reporting delay is defined as the time between an event that will trigger a measurement report and the point when the UE starts to transmit the measurement report over the air interface. This requirement assumes that the measurement report is not delayed by other RRC signalling on the DCCH. This measurement reporting delay excludes a delay uncertainty resulted when inserting the measurement report to the TTI of the uplink DCCH. The delay uncertainty is:  $2 \times TTI_{DCCH}$ . This measurement reporting delay excludes a delay which caused by no UL resources for UE to send the measurement report.

The event triggered measurement reporting delay, measured without L3 filtering shall be less than  $T_{\text{identify\_intra\_without\_index}}$  defined in TS 38.133 [6] clause 9.2.5.1. When L3 filtering is used an additional delay can be expected.

If a cell which has been detectable at least for the time period than  $T_{\text{identify\_intra\_without\_index}}$  defined in TS 38.133 [6] clause 9.2.5.1 becomes undetectable for a period and then the cell becomes detectable again and triggers an event, the event triggered measurement reporting delay shall be less than  $T_{\text{Measurement\_Period, Intra}}$  provided the timing to that cell has not changed more than  $\pm 3200 T_c$  while the measurement gap has not been available and the L3 filter has not been used. When L3 filtering is used, an additional delay can be expected.

[TS 38.133, clause 9.2.2]

The requirements given above apply, provided:

- The cell being identified or measured is detectable.

An intra-frequency cell shall be considered detectable when for each relevant SSB:

- SS-RSRP related side conditions given in TS 38.133 [6] sections 10.1.2 are fulfilled for a corresponding Band,
- SS-RSRQ related side conditions given in TS 38.133 [6] sections 10.1.7 are fulfilled for a corresponding Band,
- SS-SINR related side conditions given in TS 38.133 [6] sections 10.1.12 are fulfilled for a corresponding Band,
- SSB<sub>RP</sub> and SSB  $\hat{E}_s/I_{ot}$  according to TS 38.133 [6] Annex B.2.2 for a corresponding Band.

References: The conformance requirements covered in the current TC are specified in: TS 38.133 [6], clauses 9.2.2, 9.2.4.3, 9.2.5.1 and 9.2.5.2.

### 7.6.1.0.2 Minimum conformance requirements for event-triggered measurement with gap

[TS 38.133 [6], clause 9.2.6.2, 9.2.6.3]

The UE shall be able to identify a new detectable intra frequency cell within  $T_{\text{identify\_intra\_without\_index}}$  if UE is not indicated to report SSB based RRM measurement result with the associated SSB index (*reportQuantityRsIndexes* or *maxNrofRSIndexesToReport* is not configured), or the UE has been indicated that the neighbour cell is synchronous with the serving cell (*deriveSSB-IndexFromCell* is enabled). It is assumed that *deriveSSB-IndexFromCell* is always enabled for FR1 TDD and FR2.

$$T_{\text{identify\_intra\_without\_index}} = T_{\text{PSS/SSS\_sync\_intra}} + T_{\text{SSB\_measurement\_period\_intra}} \text{ ms}$$

Where:

$T_{\text{PSS/SSS\_sync\_intra}}$ : it is the time period used in PSS/SSS detection given in table 7.6.1.0.2-1.

$T_{\text{SSB\_measurement\_period\_intra}}$ : equal to a measurement period of SSB based measurement given in table 7.6.1.0.2-2.

$\text{CSSF}_{\text{intra}}$ : it is a carrier specific scaling factor and is determined according to  $\text{CSSF}_{\text{within\_gap},i}$  in TS 38.133 [6] section 9.1.5.2.2 for measurement conducted within measurement gaps.

$M_{\text{pss/sss\_sync\_with\_gaps}}$ : For a UE supporting FR2 power class 1,  $M_{\text{pss/sss\_sync\_with\_gaps}}=40$ . For a UE supporting FR2 power class 2,  $M_{\text{pss/sss\_sync\_with\_gaps}}=24$ . For a UE supporting FR2 power class 3,  $M_{\text{pss/sss\_sync\_with\_gaps}}=24$ . For a UE supporting power class 4,  $M_{\text{pss/sss\_sync\_with\_gaps}}=24$

$M_{\text{meas\_period\_with\_gaps}}$ : For a UE supporting power class 1,  $M_{\text{meas\_period\_with\_gaps}}=40$ . For a UE supporting power class 2,  $M_{\text{meas\_period\_with\_gaps}}=24$ . For a UE supporting power class 3,  $M_{\text{meas\_period\_with\_gaps}}=24$ . For a UE supporting power class 4,  $M_{\text{meas\_period\_with\_gaps}}=24$ .

**Table 7.6.1.0.2-1: Time period for PSS/SSS detection (Frequency range FR2)**

DRX cycle	$T_{\text{PSS/SSS\_sync\_intra}}$
No DRX	$\max(600\text{ms}, M_{\text{pss/sss\_sync\_with\_gaps}} \times \max(\text{MGRP}, \text{SMTC period})) \times \text{CSSF}_{\text{intra}}$
DRX cycle $\leq 320\text{ms}$	$\max(600\text{ms}, \text{ceil}(1.5 \times M_{\text{pss/sss\_sync\_with\_gaps}}) \times \max(\text{MGRP}, \text{SMTC period}, \text{DRX cycle})) \times \text{CSSF}_{\text{intra}}$
DRX cycle $> 320\text{ms}$	$M_{\text{pss/sss\_sync\_with\_gaps}} \times \max(\text{MGRP}, \text{DRX cycle}) \times \text{CSSF}_{\text{intra}}$

**Table 7.6.1.0.2-2: Measurement period for intra-frequency measurements with gaps (Frequency Range FR2)**

DRX cycle	$T_{SSB\_measurement\_period\_intra}$
No DRX	$\max(400\text{ms}, M_{\text{meas\_period with\_gaps}} \times \max(\text{MGRP}, \text{SMTC period})) \times \text{CSSF}_{\text{intra}}$
$\text{DRX cycle} \leq 320\text{ms}$	$\max(400\text{ms}, \text{ceil}(1.5 \times M_{\text{meas\_period with\_gaps}}) \times \max(\text{MGRP}, \text{SMTC period}, \text{DRX cycle}))^{\text{Note 1}} \times \text{CSSF}_{\text{intra}}$
$\text{DRX cycle} > 320\text{ms}$	$M_{\text{meas\_period with\_gaps}} \times \max(\text{MGRP}, \text{DRX cycle}) \times \text{CSSF}_{\text{intra}}$

[TS 38.133 [6], clause 9.2.2]

The requirements given above apply, provided:

- The cell being identified or measured is detectable.

An intra-frequency cell shall be considered detectable when for each relevant SSB:

- SS-RSRP related side conditions given in TS 38.133 [6] sections 10.1.2 are fulfilled for a corresponding Band,
- SS-RSRQ related side conditions given in TS 38.133 [6] sections 10.1.7 are fulfilled for a corresponding Band,
- SS-SINR related side conditions given in TS 38.133 [6] Sections 10.1.12 are fulfilled for a corresponding Band,
- SSB<sub>RP</sub> and SSB  $\hat{E}_s/I_{ot}$  according to TS 38.133 [6] Annex B.2.2 for a corresponding Band.

[TS 38.133 [6], clause 9.2.4.2]

The RSRP measurement accuracy for all measured cells shall be as specified in TS 38.133 [6] clauses 10.1.2.1.1 and 10.1.2.1.2, the RSRQ measurement accuracy for all measured cells shall be as specified in TS 38.133 [6] clauses 10.1.7.1.1, and the SINR measurement accuracy for all measured cells shall be as specified in the TS 38.133 [6] clause 10.1.12.1.1.

Reported RSRP, RSRQ and SINR measurements contained in event triggered measurement reports shall meet the requirements in TS 38.133 [6] clauses 10.1.2.1.1, 10.1.2.1.2, 10.1.7.1.1 and 10.1.12.1.1, respectively.

The UE shall not send any event triggered measurement reports, as long as no reporting criteria are fulfilled.

The measurement reporting delay is defined as the time between an event that will trigger a measurement report and the point when the UE starts to transmit the measurement report over the air interface. This requirement assumes that the measurement report is not delayed by other RRC signalling on the DCCH. This measurement reporting delay excludes a delay uncertainty resulted when inserting the measurement report to the TTI of the uplink DCCH. The delay uncertainty is:  $2 \times TTI_{DCCH}$ . This measurement reporting delay excludes a delay which caused by no UL resources for UE to send the measurement report.

The event triggered measurement reporting delay, measured without L3 filtering shall be less than  $T_{\text{identify\_intra\_without\_index}}$  defined in TS 38.133 [6] section 9.2.6.2. When L3 filtering is used an additional delay can be expected.

The normative reference for this requirement is TS 38.133 [6] clauses 9.2.2, 9.2.4.2, 9.2.6.2 and 9.2.6.3.

### 7.6.1.1 NR SA FR2 event-triggered reporting without gap in non-DRX

**Editor's Note: This test case has been completed for the following configurations:**

- Test frequency  $f \leq 40.8$  GHz
- UE PC3

This test case is incomplete for UE power classes other than PC3

This test case is incomplete for test frequencies  $> 40.8$  GHz

### 7.6.1.1.1 Test purpose

The purpose of this test is to verify the UE's ability to make a correct reporting of an event within intra-frequency cell search without gap under non-DRX. This test will partly verify the TDD intra-frequency cell search requirements defined in TS 38.133 clause 9.2.5.1 and 9.2.5.2

### 7.6.1.1.2 Test applicability

This test applies to all types of NR UE release 15 onwards.

### 7.6.1.1.3 Minimum conformance requirements

The minimum conformance requirements are specified in clause 7.6.1.0.1.

The normative reference for this requirement is TS 38.133 [6] clause A.7.6.1.1.

### 7.6.1.1.4 Test description

#### 7.6.1.1.4.1 Initial conditions

This test shall be tested using any of the test configurations in Table 7.6.1.1.4.1-1.

**Table 7.6.1.1.4.1-1: Supported test configurations for NR SA FR2 event-triggered reporting without gap in non-DRX**

Test Case ID	Description
7.6.1.1-1	120 kHz SSB SCS, 100MHz bandwidth, TDD duplex mode
7.6.1.1-2	240 kHz SSB SCS, 100MHz bandwidth, TDD duplex mode
Note:	The UE is only required to be tested in one of the supported test configurations.

Configure the test requirement and the DUT according to the parameters in Table 7.6.1.1.4.1-2.

**Table 7.6.1.1.4.1-2: Initial conditions for NR SA FR2 event-triggered reporting without gap in non-DRX**

Parameter	Value	Comment
Test environment	NC	As specified in TS 38.508-1 [14] clause 4.1.
Test frequencies	As specified in Annex E, Table E.5-1 and TS 38.508-1 [14] clause 4.3.1.	
Channel bandwidth	As specified by the test configuration selected from Table 6.6.1.1.4.1-1.	
Propagation conditions	AWGN	As specified in Annex C.2.2
Connection Diagram	TE Part	A.3.3.1.1
	DUT Part	A.3.4.1.1
Exceptions to connection diagram	N/A	

1. The test parameters for PCell and neighbour cell are given in Table 7.6.1.1.4.1-3 below.
2. Message contents are defined in clause 7.6.1.1.4.3.
3. There is one carrier and two cells specified in the test. NR Cell 1 is the cell used for connection setup with the power level set according to Annex C.1.1 and C.1.2 for this test.

**Table 7.6.1.1.4.1-3: General test parameters for NR SA FR2 event-triggered reporting without gap in non-DRX**

Parameter	Unit	Config	Value	Comment
Active cell		1, 2	PCell (Cell 1)	
Neighbour cell		1, 2	Cell 2	Cell to be identified.
RF Channel Number		1, 2	1: Cell 1 and Cell 2	One TDD carrier frequency is used for the NR cells.
SMTC configuration		1, 2	SMTC.1	
A3-Offset	dB	1, 2	11	
CP length		1, 2	Normal	
Hysteresis	dB	1, 2	0	
Time To Trigger	s	1, 2	0	
Filter coefficient		1, 2	0	L3 filtering is not used
DRX		1, 2	OFF	
Time offset between Cell 1 and Cell 2		1, 2	3 $\mu$ s	Synchronous cells
T1	s	1, 2	5	
T2	s	1, 2	5	

#### 7.6.1.1.4.2 Test procedure

Two cells are deployed in the test, which are FR2 PCell (NR Cell 1) and a FR2 neighbour cell (NR Cell 2) on the same frequency as the PCell. The general and cell specific test parameters for PCell and neighbour cell are given in Table 7.6.1.1.4.1-3 and Table 7.6.1.1.5-1, respectively. In the measurement control information a measurement object is configured for the frequency of the PCell, and it is indicated to the UE that event-triggered reporting with Event A3 is used. The test consists of two successive time periods, with time duration of T1, and T2 respectively. During time duration T1, the UE shall not have any timing information of NR Cell 2.

1. Ensure the UE is in state RRC\_CONNECTED with generic procedure parameters Connectivity NR, Connected without release On according to TS 38.508-1 [14] clause 4.5.
2. Set the parameters according to T1 in Table 7.6.1.1.5-1. T1 starts.
3. SS shall transmit an *RRCReconfiguration* message.
4. The UE shall transmit an *RRCReconfigurationComplete* message.
5. When T1 expires, the SS shall switch the power setting from T1 to T2 as specified in Table 7.6.1.1.5-1. T2 starts.
6. UE shall transmit a *MeasurementReport* message triggered by Event A3. If the overall delays measured from the beginning of time period T2 is less than X ms then the number of successful tests is increased by one. If the UE fails to report the event within the overall delays measured requirement then the number of failure tests is increased by one. Where X is
  - 2402 ms for UE supporting power class 1,
  - 1442 ms for UE supporting power class 2, 3 or 4,
7. After the SS receive the *MeasurementReport* message in step 6) or when T2 expires, the SS shall transmit an *RRCRelease* message to release the RRC connection which includes the release of the established radio bearers as well as all radio resources.
8. Set NR Cell 2 physical cell identity = ((current NR Cell 2 physical cell identity + 1) mod 14 + 2) for next iteration of the test procedure loop.
9. After the RRC connection release, the SS:
  - transmits in NR Cell 1 a Paging message (including PagingRecord with UE-Identity) for the UE and ensures the UE is in state RRC\_CONNECTED with generic procedure parameters Connectivity NR, Connected without release On according to TS 38.508-1 [14] clause 4.5 (if the paging fails, switches off and on the UE and ensures the UE is in state RRC\_CONNECTED with generic procedure parameters Connectivity NR, Connected without release On according to TS 38.508-1 [14] clause 4.5),
  - or
  - switches off and on the UE and ensures the UE is in state RRC\_CONNECTED with generic procedure parameters Connectivity NR, Connected without release On according to TS 38.508-1 [14] clause 4.5.

10. Repeat step 2-9 until the confidence level according to Tables G.2.3-1 in Annex G clause G.2 is achieved.

7.6.1.1.4.3 Message contents

Message contents are according to TS 38.508-1 [14] clause 7.3 with the following exceptions:

**Table 7.6.1.1.4.3-1: Common Exception messages for NR SA FR2 event-triggered reporting without gap in non-DRX**

Default Message Contents	
Common contents of system information blocks exceptions	
Default RRC messages and information elements contents exceptions	Table H.3.1-1 Table H.3.1-2 Table H.3.1-4 with A3-offset = -11dB Table H.3.1-7 with Condition INTRA-FREQ

7.6.1.1.5 Test requirement

Table 7.6.1.1.4.1-3, Table 7.6.1.1.5-1 and Table 7.6.1.1.5-2 define the primary level settings including test tolerances for NR SA FR2 event-triggered reporting without gap in non-DRX.

**Table 7.6.1.1.5-1: NR Cell specific test parameters for NR SA FR2 event-triggered reporting without gap in non-DRX**

Parameter	Unit	Config	Cell 1		Cell 2	
			T1	T2	T1	T2
TDD configuration		1, 2	TDDConf.3.1		TDDConf.3.1	
BW <sub>channel</sub>	MHz	1, 2	100: N <sub>RB,C</sub> = 66		100: N <sub>RB,C</sub> = 66	
Data RBs allocated		1	24		24	
		2	48		48	
Initial BWP configuration		1, 2	DLBWP.0.1 ULBWP.0.1	DLBWP.0.1 ULBWP.0.1		
Active DL BWP configuration		1, 2	DLBWP.1.1		DLBWP.1.1	
Active UL BWP configuration		1, 2	ULBWP.1.1		ULBWP.1.1	
RLM-RS		1, 2	SSB		SSB	
PDSCH RMC configuration		1	SR.3.2 TDD		N/A	
		2	SR.3.3 TDD			
RMSI CORESET RMC configuration		1	CR.3.1 TDD		CR.3.1 TDD	
		2	CCR.3.7 TDD		CCR.3.7 TDD	
Dedicated CORESET RMC configuration		1, 2	CCR.3.1 TDD		CCR.3.1 TDD	
TRS configuration		1, 2	TRS.2.1 TDD		N/A	
PDSCH/PDCCH TCI states		1, 2	TCI.state.2		N/A	
PDSCH/PDCCH subcarrier spacing	kHz	1, 2	120		120	
OCNG Patterns		1, 2	OP.1		OP.1	
cellIndividualOffset	dB	1~2	N/A		16	
SSB		1	SSB.3 FR2		SSB.3 FR2	
		2	SSB.4 FR2		SSB.4 FR2	
Propagation Condition		1, 2	AWGN			

**Table 7.6.1.1.5-2: NR OTA Cell specific test parameters for NR SA FR2 event-triggered reporting without gap in non-DRX**

Parameter	Unit	Config	Cell 1		Cell 2	
			T1	T2	T1	T2
AoA setup		1, 2	Setup 3 defined in A.9.3			
			AoA1		AoA2	
Beam assumption <sup>Note 4</sup>		1,2	Rough		Rough	
$E_s$	dBm/SCS	1	-89		-89	
		2	-86		-86	
$\hat{E}_s / I_{ot\ BB}$ <sup>Note 5</sup>	dB	1, 2	-0.12	-0.12	-Infinity	-0.12
SSB_RP	dBm/SCS	1	-89	-89	-Infinity	-89
		2	-86	-86	-Infinity	-86
$I_o$	dBm/95.04MHz	1	-64.41	-64.41	-Infinity	-64.41
		2	-64.41	-64.41	-Infinity	-64.41
Time multiplexing of the downlink transmissions from each AoA		1, 2	Defined in Figure 7.6.1.1.5-1			
<p>Note 1: The resources for uplink transmission are assigned to the UE prior to the start of time period T2.</p> <p>Note 2: Interference from other cells and noise sources not specified in the test is assumed to be constant over subcarriers and time and shall be modelled as AWGN of appropriate power for <math>N_{oc}</math> to be fulfilled.</p> <p>Note 3: SS-RSRP levels have been derived from other parameters for information purposes. They are not settable parameters themselves.</p> <p>Note 4: Information about types of UE beam is given in TS 38.133 [6] clause B.2.1.3, and does not limit UE implementation or test system implementation</p> <p>Note 5: Calculation of <math>E_s/I_{ot\ BB}</math> includes the effect of UE internal noise up to the value assumed for the associated Refsens requirement in clause 7.3.2 of TS 38.101-2 [19], and an allowance of 1dB for UE multi-band relaxation factor <math>\Delta MB_P</math> from TS 38.101-2 [19] Table 6.2.1.3-4.</p>						

In the test, the UE shall send one Event A3 triggered measurement report, with a measurement reporting delay less than X ms from the beginning of time period T2, where X is

- 2.4s for a UE supporting power class 1,
- 1.44s for a UE supporting power class 2, 3 and 4

The UE is not required to read the neighbour cell SSB index in this test.

The UE shall not send event triggered measurement reports, as long as the reporting criteria are not fulfilled.

The rate of correct events observed during repeated tests shall be at least 90%.

NOTE: The actual overall delays measured in the test may be up to  $2xTTI_{DCC}$  higher than the measurement reporting delays above because of TTI insertion uncertainty of the measurement report in DCC.

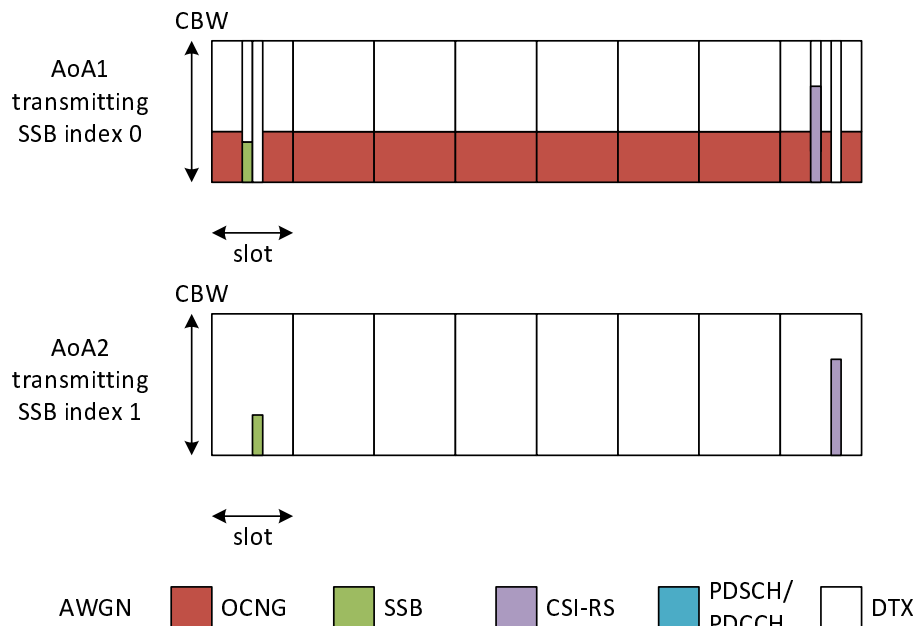

**Figure 7.6.1.1.5-1: Time multiplexed downlink transmissions (Config 1 example)**

## 7.6.1.2 NR SA FR2 event-triggered reporting without gap in DRX

**Editor's Note:** This test case is complete for the following configurations:

- Test frequency  $f \leq 40.8$  GHz
- UE PC3

This test case is incomplete for Test frequency  $f > 40.8$  GHz

This test case is incomplete for UE power class other than PC3.

### 7.6.1.2.1 Test purpose

The purpose of this test is to verify the UE's ability to make a correct reporting of an event within intra-frequency cell search without gap under DRX. This test will partly verify the TDD intra-frequency cell search requirements in TS 38.133 clause 9.2.5.1 and 9.2.5.2.

### 7.6.1.2.2 Test applicability

This test applies to all types of NR UE release 15 and forward supporting 5GS NR SA FR2 and long DRX cycle.

### 7.6.1.2.3 Minimum conformance requirements

The minimum conformance requirements are specified in clause 7.6.1.0.2.

The normative reference for this requirement is TS 38.133 [6] clause A.7.6.1.2.

### 7.6.1.2.4 Test description

#### 7.6.1.2.4.1 Initial conditions

This test shall be tested using any of the test configurations in Table 7.6.1.2.4.1-1.



**Table 7.6.1.2.4.1-1: Supported test configurations for NR SA FR2 event-triggered reporting without gap in DRX**

Test Case ID	Description
7.6.1.2-1	120 kHz SSB SCS, 100MHz bandwidth, TDD duplex mode
7.6.1.2-2	240 kHz SSB SCS, 100MHz bandwidth, TDD duplex mode
Note: The UE is only required to be tested in one of the supported test configurations.	

Configure the test equipment and the DUT according to the parameters in Table 7.6.1.2.4.1-2.

**Table 7.6.1.2.4.1-2: Initial conditions for NR SA FR2 event-triggered reporting without gap in DRX**

Parameter	Value		Comment
Test environment	NC		As specified in TS 38.508-1 [14] clause 4.1.
Test frequencies	As specified in Annex E, table E.5-1 and TS 38.508-1 [14] clause 4.3.1.		
Channel bandwidth	As specified by the test configuration selected from Table 7.6.1.2.4.1-1.		
Propagation conditions	AWGN		As specified in Annex C.2.2.
Connection Diagram	TE Part	A.3.3.1.1	As specified in TS 38.508-1 [14] Annex A.
	DUT Part	A.3.4.1.1	
Exceptions to connection diagram	N/A		

1. The test parameters for PCell and neighbour cell are given in Table 7.6.1.2.4.1-3 below.
2. Message contents are defined in clause 7.6.1.2.4.3.
3. There is one carrier and two cells specified in the test. NR Cell 1 is the cell used for connection setup with the power level set according to Annex C.1.1 and C.1.2 for this test.

**Table 7.6.1.2.4.1-3: General test parameters for NR SA FR2 event-triggered reporting without gap in DRX**

Parameter	Unit	Config	Value		Comment
			Test 1	Test 2	
Active cell		1, 2	PCell (Cell 1)		
Neighbour cell		1, 2	Cell 2		Cell to be identified.
RF Channel Number		1, 2	1: Cell 1 and Cell 2		One TDD carrier frequency is used for the NR cells.
SMTC configuration		1, 2	SMTC.1		
A3-Offset	dB	1, 2	7 <sup>Note 1</sup>		
CP length		1, 2	Normal		
Hysteresis	dB	1, 2	0		
Time To Trigger	s	1, 2	0		
Filter coefficient		1, 2	0		L3 filtering is not used
DRX		1, 2	DRX.1	DRX. 7	
Time offset between Cell 1 and Cell 2		1, 2	3 $\mu$ s		Synchronous cells
T1	s	1, 2	5		
T2	s	1, 2	10	52	
Note 1: Including test tolerance given in Annex F.1.3.2					

#### 7.6.1.2.4.2 Test procedure

Two cells are deployed in the test, which are FR2 PCell (NR Cell 1) and a FR2 neighbour cell (NR Cell 2) on the same frequency as the PCell. The general and cell specific test parameters for PCell and neighbour cell are given in Table 7.6.1.2.4.1-3, Table 7.6.1.2.5-1 and Table 7.6.1.2.5-2, respectively. In the measurement control information a measurement object is configured for the frequency of the PCell, and it is indicated to the UE that event-triggered reporting with Event A3 is used. The test consists of two successive time periods, with time duration of T1, and T2 respectively. During time duration T1, the UE shall not have any timing information of NR Cell 2.

1. Ensure the UE is in state RRC\_CONNECTED with generic procedure parameters Connectivity NR, Connected without release On according to TS 38.508-1 [14] clause 4.5.
2. Set the parameters according to T1 in Table 7.6.1.2.5-1 and Table 7.6.1.2.5-2. T1 starts.
3. SS shall transmit an *RRCReconfiguration* message.
4. The UE shall transmit an *RRCReconfigurationComplete* message.
5. When T1 expires, the SS shall switch the power setting from T1 to T2 as specified in Table 7.6.1.2.5-1 and Table 7.6.1.2.5-2. T2 starts.
6. UE shall transmit a *MeasurementReport* message triggered by Event A3. If the overall delays measured from the beginning of time period T2 is less than X ms for sub-test 1 or less than Y ms for sub-test 2 then the number of successful tests is increased by one. If the UE fails to report the event within the overall delays measured requirement then the number of failure tests is increased by one. Where X is
  - 7202 for UE supporting power class 1,
  - 4322 for UE supporting power class 2, 3 or 4.and Y is
  - 51202 for UE supporting power class 1,
  - 30722 for UE supporting power class 2, 3 or 4.
7. After the SS receive the *MeasurementReport* message in step 6) or when T2 expires, the SS shall transmit an *RRCRelease* message to release the RRC connection which includes the release of the established radio bearers as well as all radio resources.
8. Set NR Cell 2 physical cell identity = ((current NR Cell 2 physical cell identity + 1) mod 14 + 2) for next iteration of the test procedure loop.
9. After the RRC connection release, the SS:
  - transmits in NR Cell 1 a Paging message (including PagingRecord with UE-Identity) for the UE and ensures the UE is in State state RRC\_CONNECTED with generic procedure parameters Connectivity NR, Connected without release On according to TS 38.508-1 [14] clause 4.5 (if the paging fails, switches off and on the UE and ensures the UE is in state RRC\_CONNECTED with generic procedure parameters Connectivity NR, Connected without release On according to TS 38.508-1 [14] clause 4.5),
  - or
  - switches off and on the UE and ensures the UE is in state RRC\_CONNECTED with generic procedure parameters Connectivity NR, Connected without release On according to TS 38.508-1 [14] clause 4.5.
10. Repeat step 2-9 until the confidence level according to Tables G.2.3-1 in Annex G clause G.2 is achieved.
11. Repeat step 1-10 for each sub-test in Table 7.6.1.2.4.1-1 as appropriate.

#### 7.6.1.2.4.3 Message contents

Message contents are according to TS 38.508-1 [14] clause 4.6 with the following exceptions:

**Table 7.6.1.2.4.3-1: Common Exception messages for NR SA FR2 event-triggered reporting without gap in DRX**

Default Message Contents	
Common contents of system information blocks exceptions	
Default RRC messages and information elements contents exceptions	Table H.3.1-1 Table H.3.1-2 with Condition INTRA-FREQ Table H.3.1-3 with Condition INTRA-FREQ MO, Synchronous cells and NOT SS-SINR Table H.3.1-4 with A3-offset = -6dB Table H.3.1-7 with Condition INTRA-FREQ Table H.3.7-1 with Condition DRX.1 for sub-test 1 Table H.3.7-1 with Condition DRX. 7 for sub-test 2 Table 7.3.1-3 in TS 38.508-1 [14] with condition SMTC.1
Specific message contents exceptions for Test Configuration 7.6.1.2-1	Table 7.3.1-3a in TS 38.508-1 [14] with condition SSB.3 FR2
Specific message contents exceptions for Test Configuration 7.6.1.2-2	Table 7.3.1-3a in TS 38.508-1 [14] with condition SSB.4 FR2

7.6.1.2.5 Test requirement

Table 7.6.1.2.4.1-3, Table 7.6.1.2.5-1 and Table 7.6.1.2.5-2 define the primary level settings including test tolerances for NR event triggered reporting in synchronous cells when DRX is used test.

**Table 7.6.1.2.5-1: NR Cell specific test parameters for NR SA FR2 event-triggered reporting without gap in DRX**

Parameter	Unit	Config	Cell 1		Cell 2	
			T1	T2	T1	T2
TDD configuration		1, 2	TDDConf.3.1		TDDConf.3.1	
BW <sub>channel</sub>	MHz	1, 2	100: N <sub>RB,c</sub> = 66		100: N <sub>RB,c</sub> = 66	
Data RBs allocated		1, 2	66		66	
Initial BWP configuration		1, 2	DLBWP.0.1 ULBWP.0.1		DLBWP.0.1 ULBWP.0.1	
Active DL BWP configuration		1, 2	DLBWP.1.1		DLBWP.1.1	
Active UL BWP configuration		1, 2	ULBWP.1.1		ULBWP.1.1	
RLM-RS		1, 2	SSB		SSB	
PDSCH RMC configuration		1	SR.3.2 TDD		N/A	
		2	SR.3.3 TDD			
RMSI CORESET RMC configuration		1	CR.3.1 TDD		CR.3.1 TDD	
		2	CR.3.2 TDD		CR.3.2 TDD	
Dedicated CORESET RMC configuration		1	CCR.3.1 TDD		CCR.3.1 TDD	
		2	CCR.3.7 TDD		CCR.3.7 TDD	
TRS configuration		1, 2	TRS.2.1 TDD		N/A	
PDSCH/PDCCH TCI states		1, 2	TCI.state.2		N/A	
PDSCH/PDCCH subcarrier spacing	kHz	1, 2	120		120	
OCNG Patterns		1, 2	OP.1		OP.1	
SSB		1	SSB.3 FR2		SSB.3 FR2	
		2	SSB.4 FR2		SSB.4 FR2	
Propagation Condition		1, 2	AWGN			

**Table 7.6.1.2.5-2: NR OTA Cell specific test parameters for NR SA FR2 event-triggered reporting without gap in DRX**

Parameter	Unit	Config	Cell 1		Cell 2	
			T1	T2	T1	T2
AoA setup		1, 2	Setup 1 defined in A.9			
Beam assumption <sup>Note 4</sup>		1,2	Rough			
$\hat{E}_s / I_{ot\text{BB}}$ <sup>Note 5</sup>	dB	1, 2	3.514+TT	-1.60-1.46+TT	-Infinity	-1.60-1.46+TT
$N_{oc}$ <sup>Note 2</sup>	dBm/15 KHz	1, 2	-98+TT-101.5 <sup>Note 6</sup>			
$N_{oc}$ <sup>Note 2</sup>	dBm/SCS	1	-89+TT-92.5			
		2	-86+TT-89.5			
SSB_RPSS-RSRP	dBm/SCS	1	-85+TT-88.47	-88.47-85+TT	-Infinity	-88.47-85+TT
		2	-82+TT-85.47	-85.47-82+TT	-Infinity	-85.47-82+TT
$\hat{E}_s / N_{oc}$	dB	1, 2	4+TT	4+TT	-Infinity	4+TT
$I_o$	dBm/95.04MHz	1	54.53+TT-58.03	52.18+TT-55.68	54.53+T-58.03	52.18+T-55.68
Note 1:	The resources for uplink transmission are assigned to the UE prior to the start of time period T2.					
Note 2:	Interference from other cells and noise sources not specified in the test is assumed to be constant over subcarriers and time and shall be modelled as AWGN of appropriate power for $N_{oc}$ to be fulfilled.					
Note 3:	SS-RSRP levels have been derived from other parameters for information purposes. They are not settable parameters themselves.					
Note 4:	Information about types of UE beam is given in TS 38.133 [6] clause B.2.1.3, and does not limit UE implementation or test system implementation.					
Note 5:	Calculation of $E_s/I_{ot\text{BB}}$ includes the effect of UE internal noise up to the value assumed for the associated Refsens requirement in clause 7.3.2 of TS 38.101-2 [19], and an allowance of 1dB for UE multi-band relaxation factor $\Delta\text{MB}_P$ from TS 38.101-2 [19] Table 6.2.1.3-4.					
Note 6:	Including test tolerance given in Annex F.1.3.2					

In Test 1 when DRX cycle length = 40 ms, the overall delay measured is defined as the time from the beginning of time period T2 to the moment the UE send one Event A3 triggered measurement report on PUSCH.

In Test 2 when DRX cycle length = 640 ms, the overall delay measured is defined as the time from the beginning of time period T2 to the moment the UE starts to send preambles on the PRACH for Scheduling Request (SR) to obtain allocation to send the measurement report to NR Cell 2 on PUSCH.

For both tests:

The UE is not required to read the neighbour cell SSB index in this test.

The UE shall not send event triggered measurement reports, as long as the reporting criteria are not fulfilled.

The overall delays measured is defined as the time from the beginning of time period T2 to the moment the UE send one Event A3 triggered measurement report to NR Cell 2.

The overall delays measured in the test may be up to  $2 \times \text{TTI}_{\text{DCCH}}$  higher than the measurement reporting delays because of TTI insertion uncertainty of the measurement report in DCCH.

The overall delay measured when DRX cycle length is 40 ms (sub-test 1) is expressed as:

Overall delays measured = measurement reporting delay + TTI insertion uncertainty

Measurement reporting delay =  $T_{\text{identify\_intra\_without\_index}}$

$$T_{\text{identify\_intra\_without\_index}} = (T_{\text{PSS/SSS\_sync\_intra}} + T_{\text{SSB\_measurement\_period\_intra}}) \text{ ms}$$

For UE supporting power class 1,  $T_{\text{PSS/SSS\_sync\_intra}} = 3600 \text{ ms}$ ,  $T_{\text{SSB\_measurement\_period\_intra}} = 3600 \text{ ms}$ ,

For UE supporting power class 2, 3 or 4,  $T_{\text{PSS/SSS\_sync\_intra}} = 2160 \text{ ms}$ ,  $T_{\text{SSB\_measurement\_period\_intra}} = 2160 \text{ ms}$

TTI insertion uncertainty = 2 ms

The overall delay measured when DRX cycle length is 40 ms shall be less than a total of X ms, where X is

- X = 7202 for UE supporting power class 1,
- X = 4322 for UE supporting power class 2, 3 or 4,

The overall delay measured when DRX cycle length is 640 ms (sub-test 2) is expressed as:

Overall delays measured = measurement reporting delay + TTI insertion uncertainty

Measurement reporting delay =  $T_{\text{identify\_intra\_without\_index}}$

$$T_{\text{identify\_intra\_without\_index}} = (T_{\text{PSS/SSS\_sync\_intra}} + T_{\text{SSB\_measurement\_period\_intra}}) \text{ ms}$$

For UE supporting power class 1,  $T_{\text{PSS/SSS\_sync\_intra}} = 25600 \text{ ms}$ ,  $T_{\text{SSB\_measurement\_period\_intra}} = 25600 \text{ ms}$ ,

For UE supporting power class 2, 3 or 4,  $T_{\text{PSS/SSS\_sync\_intra}} = 15360 \text{ ms}$ ,  $T_{\text{SSB\_measurement\_period\_intra}} = 15360 \text{ ms}$

TTI insertion uncertainty = 2 ms

The overall delay measured when DRX cycle length is 640 ms shall be less than a total of X ms, where

- X = 51202 for UE supporting power class 1,
- X = 30722 for UE supporting power class 2, 3 or 4,

For the test to pass, the total number of successful tests shall be more than 90% of the cases with a confidence level of 95%.

### 7.6.1.3 NR SA FR2 event-triggered reporting with gap in non-DRX

**Editor's Note: This test case has been completed for the following configurations:**

- Test frequency  $f \leq 40.8 \text{ GHz}$
- UE PC3

**This test case is incomplete for UE power classes other than PC3**

**This test case is incomplete for test frequencies  $> 40.8 \text{ GHz}$**

#### 7.6.1.3.1 Test purpose

The purpose of this test is to verify UE's ability to make a correct reporting of an event with gaps under non-DRX within intra-frequency cell search with gaps requirements. This test will partly verify the TDD intra-frequency cell search requirements in TS 38.133 clause 9.2.5.1 and 9.2.5.2.

#### 7.6.1.3.2 Test applicability

This test applies to all types of NR UE release 15 onwards and supporting CSI-RS based RLM and BWP operation without bandwidth restriction.

#### 7.6.1.3.3 Minimum conformance requirements

The minimum conformance requirements are specified in clause 7.6.1.0.2.

The normative reference for this requirement is TS 38.133 [6] clause A.7.6.1.3.

7.6.1.3.4 Test description

7.6.1.3.4.1 Initial conditions

This test shall be tested using any of the test configurations in Table 7.6.1.3.4.1-1.

**Table 7.6.1.3.4.1-1: Supported test configurations for NR SA FR2 event-triggered reporting with gap in non-DRX**

Test Case ID	Description
7.6.1.3-1	120 kHz SSB SCS, 100MHz bandwidth, TDD duplex mode
7.6.1.3-2	240 kHz SSB SCS, 100MHz bandwidth, TDD duplex mode
Note: The UE is only required to be tested in one of the supported test configurations.	

Configure the test equipment and the DUT according to the parameters in Table 7.6.1.3.4.1-2.

**Table 7.6.1.3.4.1-2: Initial conditions for NR SA FR2 event-triggered reporting with gap in non-DRX**

Parameter	Value		Comment
Test environment	NC		As specified in TS 38.508-1 [14] clause 4.1.
Test frequencies	As specified in Annex E, table E.5-1 and TS 38.508-1 [14] clause 4.3.1 and 4.4.2.		
Channel bandwidth	As specified by the test configuration selected from Table 6.6.1.3.4.1-1.		
Propagation conditions	AWGN		As specified in Annex C.2.2.
Connection Diagram	TE Part	A.3.3.1.1	As specified in TS 38.508-1 [14] Annex A.
	DUT Part	A.3.4.1.1	
Exceptions to connection diagram	N/A		

1. The general test parameter settings are set up according to Table 7.6.1.3.4.1-3.
2. Message contents are defined in clause 7.6.1.3.4.3.
3. There is one NR carrier and two cells specified in the test. Cell 1 is the cell used for connection setup with the power level set according to Annex C.1.1 and C.1.2 for this test.

**Table 7.6.1.3.4.1-3: General test parameters for NR SA FR2 event-triggered reporting with gap in non-DRX**

Parameter	Unit	Config	Value	Comment
Active cell		1, 2	PCell (Cell 1)	
Neighbour cell		1, 2	Cell 2	Cell to be identified.
RF Channel Number		1, 2	1: Cell 1 and Cell 2	One TDD carrier frequency is used for the NR cells.
Gap type		1, 2	Per-UE gaps	
Measurement gap repetition periodicity	ms	1, 2	40	
Measurement gap length	ms	1, 2	6	
Measurement gap offset	ms	1, 2	39	
SMTC configuration		1, 2	SMTC.1	
CSI-RS parameters		1, 2	CSI-RS.3.2 TDD	
A3-Offset	dB	1, 2	-11	
CP length		1, 2	Normal	
Hysteresis	dB	1, 2	0	
Time To Trigger	s	1, 2	0	
Filter coefficient		1, 2	0	L3 filtering is not used
DRX		1, 2	OFF	
Time offset between Cell 1 and Cell 2		1, 2	3 $\mu$ s	Synchronous cells
T1	s	1, 2	5	
T2	s	1, 2	5	

#### 7.6.1.3.4.2 Test procedure

Two cells are deployed in the test, which are FR1 PCell (Cell 1) and a FR1 neighbour cell (Cell 2) on the same frequency as the PCell. The general and cell specific test parameters for PCell and neighbour cell are given in Table 7.6.1.3.4.1-3, Table 7.6.1.3.5-1 and Table 7.6.1.3.5-2, respectively. In the measurement control information a measurement object is configured for the frequency of the PCell, and it is indicated to the UE that event-triggered reporting with Event A3 is used. The test consists of two successive time periods, with time duration of T1, and T2 respectively. During time duration T1, the UE shall not have any timing information of Cell 2.

There are two BWPs configured in Cell 1, BWP1 which contains the cell defining SSB, and BWP2 which does not contain any SSB of Cell 1. During the whole test, BWP2 is always scheduled as the active BWP for the UE.

1. Ensure the UE is in state RRC\_CONNECTED with generic procedure parameters Connectivity NR, Connected without release On according to TS 38.508-1 [14] clause 4.5.
2. Set the parameters according to T1 in Table 7.6.1.3.5-1 and Table 7.6.1.3.5-2. T1 starts.
3. SS shall transmit an *RRCReconfiguration* message.
4. The UE shall transmit an *RRCReconfigurationComplete* message.
5. When T1 expires, the SS shall switch the power setting from T1 to T2 as specified in Table 7.6.1.3.5-1 and Table 7.6.1.3.5-2.
6. UE shall transmit a *MeasurementReport* message triggered by Event A3. If the overall delays measured from the beginning of time period T2 is less than X ms then the number of successful tests is increased by one. If the UE fails to report the event within the overall delays measured requirement then the number of failure tests is increased by one. Where X is
  - X = 3202 for UE supporting power class 1,
  - X = 1922 ms for UE supporting power class 2, 3 or 4,
7. After the SS receive the *MeasurementReport* message in step 6) or when T2 expires, the SS shall transmit an *RRCRelease* message to release the RRC connection which includes the release of the established radio bearers as well as all radio resources.

8. Set Cell 2 physical cell identity = ((current Cell 2 physical cell identity + 1) mod 14 + 2) for next iteration of the test procedure loop.
9. After the RRC connection release, the SS:
  - transmits in Cell 1 a Paging message (including PagingRecord with UE-Identity) for the UE and ensures the UE is in state RRC\_CONNECTED with generic procedure parameters Connectivity NR, Connected without release On according to TS 38.508-1 [14] clause 4.5 (if the paging fails, switches off and on the UE and ensures the UE is in state RRC\_CONNECTED with generic procedure parameters Connectivity NR, Connected without release On according to TS 38.508-1 [14] clause 4.5),
  - or
  - switches off and on the UE and ensures the UE is in state RRC\_CONNECTED with generic procedure parameters Connectivity NR, Connected without release On according to TS 38.508-1 [14] clause 4.5.
10. Repeat step 2-9 until the confidence level according to Tables G.2.3-1 in Annex G clause G.2 is achieved.

7.6.1.3.4.3 Message contents

Message contents are according to TS 38.508-1 [14] clause 4.6 with the following exceptions:

**Table 7.6.1.3.4.3-1: Common Exception messages for NR SA FR1 event-triggered reporting with gap in non-DRX**

Default Message Contents	
Common contents of system information blocks exceptions	
Default RRC messages and information elements contents exceptions	Table H.3.1-1 Table H.3.1-2 with Condition INTRA-FREQ and GAP NEEDED Table H.3.1-4 with A3-offset = -11dB Table H.3.1-6 with Condition gapUE and Pattern #0 Table H.3.1-7 with Condition INTRA-FREQ

**Table 7.6.1.3.4.3-2: MeasObjectNR (Step 3, test procedure)**

Derivation Path: Table H.3.1-3 with condition INTRA-FREQ MO, Synchronous cells and NOT SS-SINR			
Information Element	Value/remark	Comment	Condition
MeasObjectNR ::= SEQUENCE {			
ssbSubcarrierSpacing	SubcarrierSpacing specified in 38.508-1 [14] Table 7.3.1-3a with condition SSB.3 FR2		7.6.1.3-1,
	SubcarrierSpacing specified in 38.508-1 [14] Table 7.3.1-3a with condition SSB.4 FR2		7.6.1.3-2,
smtc1	SSB-MTC specified in 38.508-1 [14] Table 7.3.1-3 with condition SMTC.1		
cellsToAddModList SEQUENCE (SIZE (1..maxNrofCellMeas)) OF CellsToAddMod {	1 entry		
CellsToAddMod[1] SEQUENCE {		entry 1	
physCellId	PhysCellId of Cell 2		
cellIndividualOffset SEQUENCE {			
rsrpOffsetSSB	dB16		
rsrqOffsetSSB	Not present		
sinrOffsetSSB	Not present		
rsrpOffsetCSI-RS	Not present		
rsrqOffsetCSI-RS	Not present		
sinrOffsetCSI-RS	Not present		
}			
}			
}			



**Table 7.6.1.3.4.3-3: ServingCellConfig**

Derivation Path: TS 38.508-1 [14], Table 4.6.3-167 with condition BWP-Id1			
Information Element	Value/remark	Comment	Condition
ServingCellConfig ::= SEQUENCE {			
downlinkBWP-ToAddModList SEQUENCE (SIZE (1..maxNrofBWPs)) OF SEQUENCE {			
BWP-Downlink[1]	BWP-Downlink with condition BWP-Id1	DLBWP.1.2 configuration	
}			
firstActiveDownlinkBWP-Id	1	Active DL BWP-ID (BWP2)	BWP-Id1
defaultDownlinkBWP-Id	0	Initial BWP (BWP1)	
uplinkConfig SEQUENCE {			
uplinkBWP-ToAddModList SEQUENCE (SIZE (1..maxNrofBWPs)) OF SEQUENCE {			
BWP-Uplink[1]	BWP-Uplink with condition BWP-Id1	ULBWP.1.2 configuration	
}			
firstActiveUplinkBWP-Id	1	Active UL BWP-ID (BWP2)	BWP-Id1
}			
}			

#### 7.6.1.3.5 Test requirement

Table 7.6.1.3.4.1-3 and Table 7.6.1.3.5-1 define the primary level settings including test tolerances for NR SA FR1 event-triggered reporting with gap in non-DRX test.

**Table 7.6.1.3.5-1: NR Cell specific test parameters for NR SA FR1 event-triggered reporting with gap in non-DRX**

Parameter	Unit	Config	Cell 1		Cell 2	
			T1	T2	T1	T2
TDD configuration		1, 2	TDDConf.3.1		TDDConf.3.1	
BW <sub>channel</sub>	MHz	1, 2	100: N <sub>RB,c</sub> = 66		100: N <sub>RB,c</sub> = 66	
Initial BWP configuration		1, 2	DLBWP.0.1 ULBWP.0.1		DLBWP.0.1 ULBWP.0.1	
Active DL BWP configuration		1, 2	DLBWP.1.2		DLBWP.1.1	
Active UL BWP configuration		1, 2	ULBWP.1.2		ULBWP.1.1	
RLM-RS		1, 2	CSI-RS		SSB	
PDSCH RMC configuration		1	SR.3.2 TDD		N/A	
		2	SR.3.3 TDD			
RMSI CORESET RMC configuration		1	CR.3.1 TDD		CR.3.1 TDD	
		2	CR.3.2 TDD		CR.3.2 TDD	
Dedicated CORESET RMC configuration		1	CCR.3.1 TDD		CCR.3.1 TDD	
		2	CCR.3.7 TDD		CCR.3.7 TDD	
TRS configuration		1, 2	TRS.2.1 TDD		N/A	
PDSCH/PDCCH TCI states		1, 2	TCI.State.2		N/A	
PDSCH/PDCCH subcarrier spacing	kHz	1, 2	120		120	
OCNG Patterns		1, 2	OP.1		OP.1	
cellIndividualOffset	dB	1,2	N/A		16	
SSB		1	SSB.3 FR2		SSB.3 FR2	
		2	SSB.4 FR2		SSB.4 FR2	
Propagation Condition		1, 2	AWGN			

**Table 7.6.1.3.5-2: NR OTA Cell specific test parameters for intra-frequency event triggered reporting for SA with TDD PCell in FR2 with per-UE gaps without DRX**

Parameter	Unit	Config	Cell 1		Cell 2	
			T1	T2	T1	T2
AoA setup		1, 2	Setup 3 defined in A.9			
			AoA1		AoA2	
Beam Assumption <sup>Note 4</sup>		1,2	Rough		Rough	
$E_s$	dBm/SCS	1	-89		-89	
		2	-86		-86	
$\hat{E}_s / I_{ot\_BB}$ <sup>Note 5</sup>	dB	1, 2	-0.12	-0.12	-Infinity	-0.12
SSB_RP	dBm/SCS	1	-89	-89	-Infinity	-89
		2	-86	-86	-Infinity	86
$I_o$	dBm/95.04MHz	1	-64.41	-64.41	-Infinity	-64.41
		2	-61.41	-61.41	-Infinity	-61.41
Time multiplexing of the downlink transmissions from each AoA		1,2	Defined in Figure 7.6.1.3.5-1			
<p>Note 1: The resources for uplink transmission are assigned to the UE prior to the start of time period T2.</p> <p>Note 2: Interference from other cells and noise sources not specified in the test is assumed to be constant over subcarriers and time and shall be modelled as AWGN of appropriate power for <math>N_{oc}</math> to be fulfilled.</p> <p>Note 3: SS-RSRP levels have been derived from other parameters for information purposes. They are not settable parameters themselves.</p> <p>Note 4: Information about types of UE beam is given in TS 38.133 [6] clause B.2.1.3, and does not limit UE implementation or test system implementation</p> <p>Note 5: Calculation of <math>E_s/I_{ot\_BB}</math> includes the effect of UE internal noise up to the value assumed for the associated Refsens requirement in clause 7.3.2 of TS 38.101-2 [19], and an allowance of 1dB for UE multi-band relaxation factor <math>\Delta MB_P</math> from TS 38.101-2 [19] Table 6.2.1.3-4.</p>						

The overall delays measured is defined as the time from the beginning of time period T2, to the moment the UE send one Event A3 triggered measurement report.

The overall delays measured in the test may be up to  $2 \times TTI_{DCCH}$  higher than the measurement reporting delays because of TTI insertion uncertainty of the measurement report in DCCH.

The overall delays measured test requirement is expressed as:

Overall delays measured = measurement reporting delay + TTI insertion uncertainty

Measurement reporting delay =  $T_{identify\_intra\_without\_index}$

$T_{identify\_intra\_without\_index} = T_{PSS/SSS\_sync\_intra} + T_{SSB\_measurement\_period\_intra}$

For UE supporting power class 1,  $T_{PSS/SSS\_sync\_intra} = 1600$  ms,  $T_{SSB\_measurement\_period\_intra} = 1600$  ms,

For UE supporting power class 2, 3 or 4,  $T_{PSS/SSS\_sync\_intra} = 960$  ms,  $T_{SSB\_measurement\_period\_intra} = 960$  ms

TTI insertion uncertainty = 2 ms

The overall delays measured shall be less than a total of X ms in this test case (note: this gives a total of 800 ms for measurement reporting delay plus 2 ms for TTI insertion uncertainty), where

X = 3202 for UE supporting power class 1,

X = 1922 for UE supporting power class 2, 3 or 4,

The UE is not required to read the neighbour cell SSB index in this test.

The UE shall not send event triggered measurement reports, as long as the reporting criteria are not fulfilled.

For the test to pass, the total number of successful tests shall be more than 90% of the cases with a confidence level of 95%.

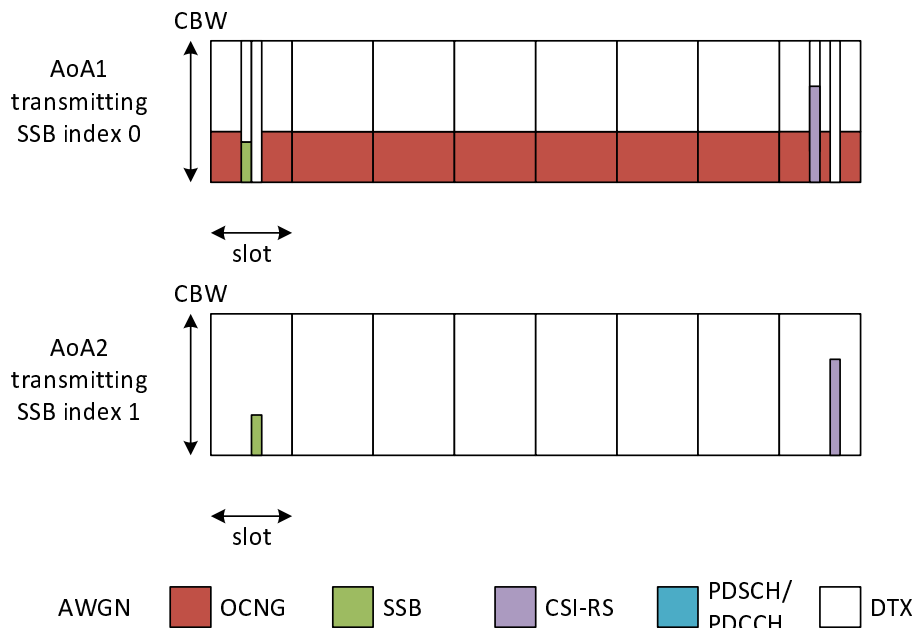

**Figure 7.6.1.3.5-1: Time multiplexed downlink transmissions (Config 1 example)**

#### 7.6.1.4 NR SA FR2 event-triggered reporting with gap in DRX

**Editor's Note:** This test case is complete for the following configurations:

- Test frequency  $f \leq 40.8$  GHz
- UE PC3

This test case is incomplete for Test frequency  $f > 40.8$  GHz

This test case is incomplete for UE power class other than PC3.

##### 7.6.1.4.1 Test purpose

The purpose of this test is to verify UE's ability to make a correct reporting of an event with gaps under DRX within intra-frequency cell search with gaps requirements. This test will partly verify the TDD intra-frequency cell search requirements in TS 38.133 clause 9.2.5.1 and 9.2.5.2.

##### 7.6.1.4.2 Test applicability

This test applies to all types of NR UE release 15 and forward supporting 5GS NR SA FR2, CSI-RS based RLM and long DRX cycle.

##### 7.6.1.4.3 Minimum conformance requirements

The minimum conformance requirements are specified in clause 7.6.1.0.2.

The normative reference for this requirement is TS 38.133 [6] clause A.7.6.1.4.

##### 7.6.1.4.4 Test description

###### 7.6.1.4.4.1 Initial conditions

This test shall be tested using any of the test configurations in Table 7.6.1.4.4.1-1.

**Table 7.6.1.4.4.1-1: Supported test configurations for NR SA FR2 event-triggered reporting with gap in DRX**

Test Case ID	Description
7.6.1.4-1	120 kHz SSB SCS, 100MHz bandwidth, TDD duplex mode
7.6.1.4-2	240 kHz SSB SCS, 100MHz bandwidth, TDD duplex mode
Note: The UE is only required to be tested in one of the supported test configurations.	

Configure the test equipment and the DUT according to the parameters in Table 7.6.1.4.4.1-2.

**Table 7.6.1.4.4.1-2: Initial conditions for NR SA FR2 event-triggered reporting with gap in DRX**

Parameter	Value		Comment
Test environment	NC		As specified in TS 38.508-1 [14] clause 4.1.
Test frequencies	As specified in Annex E, table E.5-1 and TS 38.508-1 [14] clause 4.3.1 and 4.4.2.		
Channel bandwidth	As specified by the test configuration selected from Table 7.6.1.4.4.1-1.		
Propagation conditions	AWGN		As specified in Annex C.2.2.
Connection Diagram	TE Part	A.3.3.1.1	As specified in TS 38.508-1 [14] Annex A.
	DUT Part	A.3.4.1.1	
Exceptions to connection diagram	N/A		

1. The general test parameter settings are set up according to Table 7.6.1.4.4.1-3.
2. Message contents are defined in clause 7.6.1.4.4.3.
3. There is one NR carrier and two cells specified in the test. Cell 1 is the cell used for connection setup with the power level set according to Annex C.1.1 and C.1.2 for this test.

**Table 7.6.1.4.4.1-3: General test parameters for NR SA FR2 event-triggered reporting with gap in DRX**

Parameter	Unit	Config	Value		Comment
			Test 1	Test 2	
Active cell		1, 2	PCell (Cell 1)		
Neighbour cell		1, 2	Cell 2		Cell to be identified.
RF Channel Number		1, 2	1: Cell 1 and Cell 2		One TDD carrier frequency is used for the NR cells.
Gap type		1, 2	Per-UE gaps		
Measurement gap repetition periodicity	ms	1, 2	40		
Measurement gap length	ms	1, 2	6		
Measurement gap offset	ms	1, 2	39		
SMTTC configuration		1, 2	SMTTC.1		
CSI-RS parameters		1, 2	CSI-RS.3.2 TDD		
A3-Offset	dB	1, 2	-7 <sup>Note1</sup>		
CP length		1, 2	Normal		
Hysteresis	dB	1, 2	0		
Time To Trigger	s	1, 2	0		
Filter coefficient		1, 2	0		L3 filtering is not used
DRX		1, 2	DRX.1	DRX.7	
Time offset between Cell 1 and Cell 2		1, 2	3 $\mu$ s		Synchronous cells
T1	s	1, 2	5		
T2	s	1, 2	10	52	
Note 1: Including test tolerance given in Annex F.1.3.2					

#### 7.6.1.4.4.2 Test procedure

Two cells are deployed in the test, which are FR2 PCell (Cell 1) and a FR2 neighbour cell (Cell 2) on the same frequency as the PCell. The general and cell specific test parameters for PCell and neighbour cell are given in Table

7.6.1.4.4.1-3 and Table 7.6.1.4.4.2-1, respectively. In the measurement control information a measurement object is configured for the frequency of the PCell, and it is indicated to the UE that event-triggered reporting with Event A3 is used. The test consists of two successive time periods, with time duration of T1, and T2 respectively. During time duration T1, the UE shall not have any timing information of Cell 2.

There are two BWPs configured in Cell 1, BWP1 which contains the cell defining SSB, and BWP2 which does not contain any SSB of Cell 1. During the whole test, BWP2 is always scheduled as the active BWP for the UE.

In Test 1 when DRX cycle = 40 ms is used, UE needs to be provided at least once every 500 ms with new Timing Advance Command MAC control element to restart the Timer Alignment Timer to keep the UE uplink time alignment. Furthermore, the UE is allocated with PUSCH resource at every DRX cycle. In Test 2 when DRX = 640 ms is used, the uplink time alignment is not maintained and the UE needs to use RACH to obtain uplink allocation for measurement reporting.

1. Ensure the UE is in state RRC\_CONNECTED with generic procedure parameters Connectivity NR, Connected without release On according to TS 38.508-1 [14] clause 4.5.
2. Set the parameters according to T1 in Table 7.6.1.4.5-1 and Table 7.6.1.4.5-2. T1 starts.
3. SS shall transmit an *RRCReconfiguration* message.
4. The UE shall transmit an *RRCReconfigurationComplete* message.
5. When T1 expires, the SS shall switch the power setting from T1 to T2 as specified in Table 7.6.1.4.5-1 and Table 7.6.1.4.5-2.
6. UE shall transmit a *MeasurementReport* message triggered by Event A3. If the overall delays measured from the beginning of time period T2 is less than X ms for Test 1 or less than Y ms for Test 2 then the number of successful tests is increased by one. If the UE fails to report the event within the overall delays measured requirement then the number of failure tests is increased by one. Where X and Y is
  - X = 7202, Y = 51202 for UE supporting power class 1,
  - X = 4322, Y = 30722 for UE supporting power class 2, 3 or 4,
7. After the SS receive the *MeasurementReport* message in step 6) or when T2 expires, the SS shall transmit an *RRCRelease* message to release the RRC connection which includes the release of the established radio bearers as well as all radio resources.
8. Set Cell 2 physical cell identity = ((current Cell 2 physical cell identity + 1) mod 14 + 2) for next iteration of the test procedure loop.
9. After the RRC connection release, the SS:
  - transmits in Cell 1 a Paging message (including PagingRecord with UE-Identity) for the UE and ensures the UE is in state RRC\_CONNECTED with generic procedure parameters Connectivity NR, Connected without release On according to TS 38.508-1 [14] clause 4.5 (if the paging fails, switches off and on the UE and ensures the UE is in state RRC\_CONNECTED with generic procedure parameters Connectivity NR, Connected without release On according to TS 38.508-1 [14] clause 4.5),
  - or
  - switches off and on the UE and ensures the UE is in state RRC\_CONNECTED with generic procedure parameters Connectivity NR, Connected without release On according to TS 38.508-1 [14] clause 4.5.
10. Repeat step 2-9 until the confidence level according to Tables G.2.3-1 in Annex G clause G.2 is achieved.
11. Repeat step 1-10 for each sub-test in Table 7.6.1.4.4.1-3 as appropriate.

#### 7.6.1.4.4.3 Message contents

Message contents are according to TS 38.508-1 [14] clause 4.6 with the following exceptions:

**Table 7.6.1.4.4.3-1: Common Exception messages for NR SA FR2 event-triggered reporting with gap in DRX**

Default Message Contents	
Common contents of system information blocks exceptions	
Default RRC messages and information elements contents exceptions	Table H.3.1-1 Table H.3.1-2 with Condition INTRA-FREQ and GAP NEEDED Table Table H.3.1-3 with Condition INTRA-FREQ MO, Synchronous cells and NOT SS-SINR Table H.3.1-4 with A3-offset = -6dB Table H.3.1-6 with Condition gapUE and Pattern #0 Table H.3.1-7 with Condition INTRA-FREQ Table H.3.7-1 with Condition DRX.1 and Gap for test 1 Table H.3.7-1 with Condition DRX. 7 and Gap for test 2 Table 7.3.1-3 in TS 38.508-1 [14] with condition SMTC.1
Specific message contents exceptions for Test Configuration 7.6.1.4-1	Table 7.3.1-3a in TS 38.508-1 [14] with condition SSB.3 FR2
Specific message contents exceptions for Test Configuration 7.6.1.4-2	Table 7.3.1-3a in TS 38.508-1 [14] with condition SSB.4 FR2

**Table 7.6.1.4.4.3-2: ServingCellConfig**

Derivation Path: TS 38.508-1 [14], Table 4.6.3-167 with condition BWP-Id1			
Information Element	Value/remark	Comment	Condition
ServingCellConfig ::= SEQUENCE {			
downlinkBWP-ToAddModList SEQUENCE (SIZE (1..maxNrofBWPs)) OF SEQUENCE {			
BWP-Downlink[1]	BWP-Downlink with condition BWP-Id1	DLBWP.1.2 configuration	
}			
firstActiveDownlinkBWP-Id	1	Active DL BWP-ID (BWP2)	BWP-Id1
defaultDownlinkBWP-Id	0	Initial BWP (BWP1)	
uplinkConfig SEQUENCE {			
uplinkBWP-ToAddModList SEQUENCE (SIZE (1..maxNrofBWPs)) OF SEQUENCE {			
BWP-Uplink[1]	BWP-Uplink with condition BWP-Id1	ULBWP.1.2 configuration	
}			
firstActiveUplinkBWP-Id	1	Active UL BWP-ID (BWP2)	BWP-Id1
}			
}			

Condition	Explanation
BWP-Id1	Active BWP (BWP2)

7.6.1.4.5 Test requirement

Table 7.6.1.4.4.1-3 , Table 7.6.1.4.5-1 and Table 7.6.1.4.5-2 define the primary level settings including test tolerances for NR SA FR1 event-triggered reporting with gap in DRX test.

**Table 7.6.1.4.5-1: NR Cell specific test parameters for NR SA FR2 event-triggered reporting with gap in DRX**

Parameter	Unit	Config	Cell 1		Cell 2	
			T1	T2	T1	T2
TDD configuration		1, 2	TDDConf.3.1		TDDConf.3.1	
$BW_{\text{channel}}$	MHz	1, 2	100: $N_{\text{RB},c} = 66$		100: $N_{\text{RB},c} = 66$	
Data RBs allocated		1, 2	66		66	
Initial BWP configuration		1, 2	DLBWP.0.1 ULBWP.0.1	DLBWP.0.1 ULBWP.0.1		
Active DL BWP configuration		1, 2	DLBWP.1.2	DLBWP.1.1		
Active UL BWP configuration		1, 2	ULBWP.1.2	ULBWP.1.1		
RLM-RS		1, 2	CSI-RS	SSB		
PDSCH RMC configuration		1	SR.3.2 TDD	N/A		
		2	SR.3.3 TDD			
RMSI CORESET RMC configuration		1	CR.3.1 TDD	CR.3.1 TDD		
		2	CR.3.2 TDD	CR.3.2 TDD		
Dedicated CORESET RMC configuration		1	CCR.3.1 TDD	CCR.3.1 TDD		
		2	CCR.3.7 TDD	CCR.3.7 TDD		
TRS configuration		1, 2	TRS.2.1 TDD	N/A		
PDSCH/PDCCH TCI state		1, 2	TCI.State.2	N/A		
OCNG Patterns		1, 2	OP.1	OP.1		
SSB		1	SSB.3 FR2	SSB.3 FR2		
		2	SSB.4 FR2	SSB.4 FR2		
Propagation Condition		1, 2	AWGN			



**Table 7.6.1.4.5-2: NR OTA Cell specific test parameters for NR SA FR2 event-triggered reporting with gap in DRX**

Parameter	Unit	Config	Cell 1		Cell 2	
			T1	T2	T1	T2
AoA setup		1, 2	Setup 1 defined in A.3.15.1			
Beam Assumption <sup>Note 4</sup>		1,2	Rough			
$\hat{E}_s / I_{ot\ BB}$ <sup>Note 5</sup>	dB	1, 2	3.514+TT	-1.60-1.46+TT	-Infinity	-1.60-1.46+TT
$N_{oc}$ <sup>Note 2</sup>	dBm/15 KHz	1, 2	-98+TT-101.5 <sup>Note 6</sup>			
$N_{oc}$ <sup>Note 2</sup>	dBm/SCS	1	-89+TT-92.5			
		2	-86+TT-89.5			
SSB_RPSS-RSRP	dBm/SCS	1	-88.47-85+TT	-88.47-85+TT	-Infinity	-88.47-85+TT
		2	-85.47-82+TT	-85.47-82+TT	-Infinity	-85.47-82+TT
$\hat{E}_s / N_{oc}$	dB	1, 2	4+TT	4+TT	-Infinity	4+TT
$I_o$	dBm/95.04MHz	1	-58.03-54.53+TT	-55.68-52.18+TT	-58.03-54.53+TT	-55.68-52.18+TT
Note 1:	The resources for uplink transmission are assigned to the UE prior to the start of time period T2.					
Note 2:	Interference from other cells and noise sources not specified in the test is assumed to be constant over subcarriers and time and shall be modelled as AWGN of appropriate power for $N_{oc}$ to be fulfilled.					
Note 3:	SS-RSRP levels have been derived from other parameters for information purposes. They are not settable parameters themselves.					
Note 4:	Information about types of UE beam is given in TS 38.133 [6] clause B.2.1.3, and does not limit UE implementation or test system implementation					
Note 5:	Calculation of $E_s/I_{ot\ BB}$ includes the effect of UE internal noise up to the value assumed for the associated Refsens requirement in clause 7.3.2 of TS 38.101-2 [19], and an allowance of 1dB for UE multi-band relaxation factor $\Delta MB_P$ from TS 38.101-2 [19] Table 6.2.1.3-4.					
Note 6:	Including test tolerance given in Annex F.1.3.2					

In Test 1 when DRX cycle length = 40 ms is used, the overall delay measured is defined as the time from the beginning of time period T2, to the moment the UE send one Event A3 triggered measurement report on PUSCH.

In Test 2 when DRX cycle length = 640 ms is used, the overall delay measured is defined as the time from the beginning of time period T2, to the moment the UE starts to send preambles on the PRACH for Scheduling Request (SR) to obtain allocation to send the measurement report on PUSCH.

For both tests:

The overall delays measured in the test may be up to  $2 \times TTI_{DCH}$  higher than the measurement reporting delays because of TTI insertion uncertainty of the measurement report in DCCH.

NOTE 1: The actual overall delays measured in the test may be up to one DRX cycle higher than the measurement reporting delays above because UE is allowed to delay the initiation of the measurement reporting procedure to the next until the Active Time.

NOTE 2: In order to calculate the rate of correct events the system simulator shall verify that it has received correct Event A3 measurement report.

The overall delay measured when DRX cycle length is 40 ms test requirement is expressed as:

Overall delays measured = measurement reporting delay + TTI insertion uncertainty

Measurement reporting delay =  $T_{identify\_intra\_without\_index}$

$T_{identify\_intra\_without\_index} = (T_{PSS/SSS\_sync\_intra} + T_{SSB\_measurement\_period\_intra})$  ms

For UE supporting power class 1,  $T_{PSS/SSS\_sync\_intra} = 7200$ ms,  $T_{SSB\_measurement\_period\_intra} = 7200$  ms,

For UE supporting power class 2, 3 or 4,  $T_{\text{PSS/SSS\_sync\_intra}} = 2160$  ms,  $T_{\text{SSB\_measurement\_period\_intra}} = 2160$  ms

TTI insertion uncertainty = 2 ms

The overall delay measured when DRX cycle length is 40 ms shall be less than a total of X ms, where X is

- X = 7202 for UE supporting power class 1,
- X = 4322 for UE supporting power class 2, 3 or 4,

The overall delay measured when DRX cycle length is 640 ms test requirement is expressed as:

Overall delays measured = measurement reporting delay + TTI insertion uncertainty

Measurement reporting delay =  $T_{\text{identify\_intra\_without\_index}}$

$T_{\text{identify\_intra\_without\_index}} = (T_{\text{PSS/SSS\_sync\_intra}} + T_{\text{SSB\_measurement\_period\_intra}})$  ms

For UE supporting power class 1,  $T_{\text{PSS/SSS\_sync\_intra}} = 25600$  ms,  $T_{\text{SSB\_measurement\_period\_intra}} = 25600$  ms,

For UE supporting power class 2, 3 or 4,  $T_{\text{PSS/SSS\_sync\_intra}} = 15360$  ms,  $T_{\text{SSB\_measurement\_period\_intra}} = 15360$  ms

TTI insertion uncertainty = 2 ms

The overall delay measured when DRX cycle length is 640 ms shall be less than a total of X ms, where

- X = 51202 for UE supporting power class 1,
- X = 30722 for UE supporting power class 2, 3 or 4,

For the test to pass, the total number of successful tests shall be more than 90% of the cases with a confidence level of 95%.

## 7.6.2 Inter-frequency measurements

### 7.6.2.0 Minimum conformance requirements for Inter-frequency measurements

Same as clause 5.6.2.0.

The normative reference for this requirement is TS 38.133 [6] clause 9.3.2, 9.3.4, 9.3.5, 9.3.6.3.

#### 7.6.2.1 NR SA FR2-FR2 event-triggered reporting in non-DRX

**Editor's Note: This test case has been completed for the following configurations:**

- Test frequency  $f \leq 40.8$  GHz
- UE PC3
- The test is incomplete for UE power classes other than PC3
- The test is incomplete for test frequencies  $> 40.8$  GHz

##### 7.6.2.1.1 Test purpose

The purpose of this test is to verify that the UE makes correct reporting of an event within inter-frequency cell search requirements.

##### 7.6.2.1.2 Test applicability

This test applies to all types of NR UE from Release 15 onwards.

##### 7.6.2.1.3 Minimum conformance requirements

The minimum conformance requirements are specified in clause 7.6.2.0.

The normative reference for this requirement is TS 38.133 [6] clause A.7.6.2.1.

7.6.2.1.4 Test description

7.6.2.1.4.1 Initial conditions

This test shall be tested using any of the test configurations in Table 7.6.2.1.4.1-1.

**Table 7.6.2.1.4.1-1: NR FR2-FR2 event triggered reporting tests in non-DRX supported test configurations**

Test Case ID	Description
7.6.2.1-1	120 kHz SSB SCS, 100MHz bandwidth, TDD duplex mode
Note 1: Void	

**Table 7.6.2.1.4.1-1: General test parameters for SA inter-frequency event triggered reporting for FR2 without SSB time index detection**

Parameter	Unit	Test configuration	Value	Comment
NR RF Channel Number		Config 1	1, 2	Two FR2 NR carrier frequencies is used.
Active cell		Config 1	NR cell 1 (Pcell)	NR Cell 1 is on NR RF channel number 1.
Neighbour cell		Config 1	NR cell 2	NR cell 2 is on NR RF channel number 2.
Gap Pattern Id		Config 1	13	As specified in clause 9.1.2-1.
Measurement gap offset		Config 1	39	
SMTC-SSB parameters		Config 1	SSB.3 FR2	As specified in clause A.3.10.2
offsetMO	dB	Config 1	16	Applied to NR Cell 2 measurement object
A3-Offset	dB	Config 1	-11	
Hysteresis	dB	Config 1	0	
CP length		Config 1	Normal	
TimeToTrigger	s	Config 1	0	
Filter coefficient		Config 1	0	L3 filtering is not used
DRX		Config 1	OFF	DRX is not used
Time offset between serving and neighbour cells		Config 1	3µs	Synchronous cells.
T1	s	Config 1	5	
T2	s	Config 1	5.2 for PC1; 3.5 for other PC	

**Table 7.6.2.1.4-3: Test Environment parameters for SA inter-frequency event triggered reporting without SSB time index detection in non-DRX**

Parameter	Value		Comment
Test environment	NC		As specified in TS 38.508-1 [14] clause 4.1.
Test frequencies	As specified in Annex E, Table E.2-1 and TS 38.508-1 [14] clause 4.3.1 and 4.4.2.		
Channel bandwidth	As specified by the test configuration selected from Table 7.6.2.1.4.1-1.		
Propagation conditions	AWGN		As specified in Annex C.2.2.
Connection Diagram	TE Part	A.3.3.3.1	As specified in TS 38.508-1 [14] Annex A.
	DUT Part	A.3.4.1.1	
Exceptions to connection diagram			

1. Message contents are defined in clause 7.6.2.1.4.3.
2. There are two NR cells on two carriers specified in the test. Cell 1 is the cell used for connection setup and Cell 2 is a target cell on a different carrier than Cell 1. The power levels and settings for Cell 2 are set according to Annex C.1.2.
3. The AoA setup for this test is Setup 3 as defined in clause A.9 The UE RX spherical coverage direction has been obtained previously using one of the search procedures as described in Annex I.

#### 7.6.2.1.4.2 Test procedure

In this test, there are two cells: NR cell 1 as PCell in FR2 on NR RF channel 1 and NR cell 2 as neighbour cell in FR2 on NR RF channel 2.

In test 1 measurement gap pattern configuration # 0 as defined in Table 7.6.2.1.4.1-2 is provided for UE that does not support per-FR gap and in test 2 measurement gap pattern configuration #13 as defined in Table 7.6.2.1.4.1-2 is provided for UE that supports per-FR gap.

In the measurement control information, it is indicated to the UE that event-triggered reporting with Event A3 is used. The test consists of two successive time periods, with time duration of T1, and T2 respectively. During time duration T1, the UE shall not have any timing information of NR cell 2.

1. Ensure the UE is in state RRC\_CONNECTED with generic procedure parameters Connectivity NR SA, Connected without release *On* according to TS 38.508-1 [14] clause 4.5.
2. Set the parameters according to T1 in Table 7.6.2.1.4.1-2. The TE shall ensure that the NR FR2 cells are from the set of directions corresponding to the EIS spherical coverage percentile of the DUT as defined in clause 7.3.4 of TS 38.101-2 [3] and relative angular offset between active probes are according to Table A.9.3-1. T1 starts.
3. The SS shall transmit an *RRCReconfiguration* message.
4. The UE shall transmit *RRCReconfigurationComplete* message.
5. When T1 expires, the SS shall switch the power setting from T1 to T2 as specified in Table 7.6.2.1.4.1-2. T2 starts.
6. UE shall transmit a *MeasurementReport* message triggered by Event A3. If the overall delays measured from the beginning of time period T2 is less than 5122 ms for UE supporting power class 1, or 3202 ms for UE supporting other power class for Test 1 and Test 2 then the number of successful tests is increased by one. If the UE fails to report the event within the overall delays measured requirement then the number of failure tests is increased by one.
7. After the SS receives the *MeasurementReport* message in step 6 or when T2 expires, the SS shall transmit *RRCRelease* message to release the RRC connection which includes the release of the established radio bearers as well as all radio resources.
8. Set Cell 2 physical cell identity = [(current cell 2 physical cell identity + 1) mod 1008] for next iteration of the test procedure loop.]
9. TE shall change the active probes in such way that relative angular offset between active probes differs in the following iteration.
10. After the RRC connection release, the SS:
  - transmits in Cell 1 a *Paging* message (including *PagingRecord* with ue-Identity) for the UE and ensures the UE in state RRC\_CONNECTED with generic procedure parameters Connectivity NR SA, Connected without release *On* according to TS 38.508-1 [14] clause 4.5. (if the paging fails, switches off and on the UE and ensures the UE is in state RRC\_CONNECTED with generic procedure parameters Connectivity NR SA, Connected without release *On* according to TS 38.508-1 [14] clause 4.5.),
  - or:
  - switches off and on the UE and ensures the UE is in state RRC\_CONNECTED with generic procedure parameters Connectivity NR SA, Connected without release *On* according to TS 38.508-1 [14] clause 4.5.
11. Repeat step 2-10 until the confidence level according to Tables G.2.3-1 in Annex G clause G.2 is achieved.

12. Repeat step 1-11 for each sub-test in Table 7.6.2.1.4.1-2 as appropriate.

7.6.2.1.4.3 Message contents

Message contents are according to TS 38.508-1 [14] clause 4.6 with the following exceptions:

**Table 7.6.2.1.4.3-1: Common Exception messages SA inter frequency event triggered reporting without SSB time index detection in non-DRX**

Default Message Contents	
Common contents of system information blocks exceptions	
Default RRC messages and information elements contents exceptions	Table H.3.1-1 Table H.3.1-2 with Conditions GAP NEEDED and INTER-FREQ Table H.3.1-3 with Conditions INTER-FREQ MO and Synchronous cells Table H.3.1-4 with A3-offset = -11dB Table H.3.1-5 Table H.3.1-6 with Conditions gapUE and Pattern #13 Table H.3.1-7 with Condition INTER-FREQ

**Table 7.6.2.1.4.3-2: MeasObjectNR-DEFAULT: SA FR2-FR2 measurement object configuration**

Derivation Path: Table H.3.1-3			
Information Element	Value/remark	Comment	Condition
MeasObjectNR ::= SEQUENCE {			
offsetMO SEQUENCE {			
rsrpOffsetSSB	dB16		
}			

7.6.2.1.5 Test requirement

Table 7.6.2.1.5-1 defines the primary level settings including test tolerances for all tests.

**Table 7.6.2.1.5-1: Cell specific test parameters for SA inter-frequency event triggered reporting for FR2 without SSB time index detection**

Parameter		Unit	Test configuration	Cell 1		Cell 2	
				T1	T2	T1	T2
AoA setup			Config 1	Setup 3 as specified in clause A.9			
				AoA1		AoA2	
Assumption for UE beams <sup>Note 7</sup>			Config 1,2	Rough		Rough	
NR RF Channel Number			Config 1	1		2	
Duplex mode			Config 1	TDD		TDD	
TDD configuration			Config 1	TDDConf.3.1		TDDConf.3.1	
BW <sub>channel</sub>		MHz	Config 1	100: N <sub>RB,c</sub> = 66		100: N <sub>RB,c</sub> = 66	
Data RBs allocated			Config 1	66		66	
BWP BW		MHz	Config 1	100: N <sub>RB,c</sub> = 66		100: N <sub>RB,c</sub> = 66	
BWP configuration	Initial DL BWP		Config 1	DLBWP.0.1		N/A	
	Initial UL BWP			ULBWP.0.1		N/A	
	Dedicated DL BWP			DLBWP.1.1		N/A	
	Dedicated UL BWP			ULBWP.1.1		N/A	

OCNG Patterns		Config 1	OP.1		OP.1	
PDSCH Reference measurement channel		Config 1	SR.3.1 TDD		-	
CORESET Reference Channel		Config 1	CR.3.1 TDD		-	
SMTc configuration		Config 1	SMTc.1		SMTc.1	
PDSCH/PDCCH subcarrier spacing	kHz	Config 1	120		120	
TRS configuration		Config 1	TRS.2.1 TDD		N/A	
PDSCH/PDCCH TCI state		Config 1	TCI.State.2		N/A	
EPRE ratio of PSS to SSS		Config 1	0		0	
EPRE ratio of PBCH DMRS to SSS						
EPRE ratio of PBCH to PBCH DMRS						
EPRE ratio of PDCCH DMRS to SSS						
EPRE ratio of PDCCH to PDCCH DMRS						
EPRE ratio of PDSCH DMRS to SSS						
EPRE ratio of PDSCH to PDSCH						
EPRE ratio of OCNG DMRS to SSS(Note 1)						
EPRE ratio of OCNG to OCNG DMRS (Note 1)						
$\hat{E}_s$	dBm/S CS					
SSB-RP <sup>Note 3</sup>	dBm/S CS Note5	Config 1	-87	-87	-Infinity	-87
$\hat{E}_s / I_{ot\_BB}$ <sup>Note 8</sup>	dB	Config 1	1.89	1.89	-Infinity	1.89
$I_o$ <sup>Note3</sup>	dBm/95 .04 MHz Note5	Config 1	-58.01	-58.01	-Infinity	-58.01
Propagation Condition		Config 1	AWGN		AWGN	
<p>Note 1: OCNG shall be used such that both cells are fully allocated and a constant total transmitted power spectral density is achieved for all OFDM symbols.</p> <p>Note 2: Void</p> <p>Note 3: SSB-RP, <math>E_s/I_{ot}</math> and <math>I_o</math> levels have been derived from other parameters for information purposes. They are not settable parameters themselves.</p> <p>Note 4: Void</p> <p>Note 5: Equivalent power received by an antenna with 0dBi gain at the centre of the quiet zone</p> <p>Note 6: As observed with 0dBi gain antenna at the centre of the quiet zone</p> <p>Note 7: Information about types of UE beam is given in TS 38.133 [6] Annex B.2.1.3, and does not limit UE implementation or test system implementation</p> <p>Note 8: Calculation of <math>E_s/I_{ot\_BB}</math> includes the effect of UE internal noise up to the value assumed for the associated Refsens requirement in clause 7.3.2 of TS 38.101-2 [3], and an allowance of 1dB for UE multi-band relaxation factor <math>\Delta MBs</math> from TS 38.101-2 [3] Table 6.2.1.3-4.</p>						

The UE shall send one Event A3 triggered measurement report, with a measurement reporting delay less than X ms from the beginning of time period T2, where X is

- 5120 for UE supporting power class 1, or
- 3200 for UE supporting other power class.

The UE is not required to report SSB time index. The UE shall not send event triggered measurement reports, as long as the reporting criteria are not fulfilled. The rate of correct events observed during repeated tests shall be at least 90% with a confidence level of 95%.

NOTE: The actual overall delays measured in the test may be up to  $2 \times TTI_{DCCH}$  higher than the measurement reporting delays above because of TTI insertion uncertainty of the measurement report in DCCH.

TTI insertion uncertainty =  $TTI_{DCCH} = 1 \text{ ms}$ ;  $2 \times TTI_{DCCH} = 2 \text{ ms}$

The overall delays measured shall be less than a total of 5122 ms in this test for power class UE and 3202 ms for other power classes.

## 7.6.2.2 NR SA FR2-FR2 event-triggered reporting in DRX

Editor's Note: This test case has been completed for the following configurations:

- Test frequency  $f \leq 40.8 \text{ GHz}$
- UE PC3
- The test is incomplete for UE power classes other than PC3
- The test is incomplete for test frequencies  $> 40.8 \text{ GHz}$

### 7.6.2.2.1 Test purpose

The purpose of this test is to verify that the UE makes correct reporting of an event within inter-frequency cell search requirements.

### 7.6.2.2.2 Test applicability

This test applies to all types of NR UE Release 15 and forward supporting 5GS NR SA FR2 and long DRX cycle.

### 7.6.2.2.3 Minimum conformance requirements

The minimum conformance requirements are specified in clause 7.6.2.0.

The normative reference for this requirement is TS 38.133 [6] clause A.7.6.2.2.

### 7.6.2.2.4 Test description

#### 7.6.2.2.4.1 Initial conditions

This test shall be tested using any of the test configurations in Table 7.6.2.2.4.1-1.

**Table 7.6.2.2.4.1-1: NR FR2-FR2 event triggered reporting tests in DRX supported test configurations**

Test Case ID	Description
7.6.2.2-1	120 kHz SSB SCS, 100MHz bandwidth, TDD duplex mode
Note 1: Void	

**Table 7.6.2.2.4.1-2: General test parameters for SA inter-frequency event triggered reporting for FR2 without SSB time index detection in DRX**

Parameter	Unit	Test configuration	Value		Comment
			Test 1	Test 2	
NR RF Channel Number		Config 1	1, 2		Two FR1 NR carrier frequencies is used.
Active cell		Config 1	NR cell 1 (Pcell)		NR Cell 1 is on NR RF channel number 1.
Neighbour cell		Config 1	NR cell 2		NR cell 2 is on NR RF channel number 2.
Gap Pattern Id		Config 1	13		As specified in clause 9.1.2-1.
Measurement gap offset		Config 1	39		
SMT-C-SSB parameters		Config 1	SSB.3 FR2		As specified in clause A.3.10.2
A3-Offset	dB	Config 1	-12		Value modified by TT
Hysteresis	dB	Config 1	0		
CP length		Config 1	Normal		
TimeToTrigger	s	Config 1	0		
Filter coefficient		Config 1	0		L3 filtering is not used
DRX		Config 1	DRX.1	DRX.2	As specified in clause A.3.3
Time offset between serving and neighbour cells		Config 1	3µs		Synchronous cells.
T1	s	Config 1	5		
T2	s	Config 1	8 for PC1; 5 for other PC	82 for PC1; 52 for other PC	

**Table 7.6.2.2.4.3: Test Environment parameters for SA inter-frequency event triggered reporting without SSB time index detection in DRX**

Parameter	Value		Comment
Test environment	NC		As specified in TS 38.508-1 [14] clause 4.1.
Test frequencies	As specified in Annex E, Table E.2-1 and TS 38.508-1 [14] clause 4.3.1 and 4.4.2.		
Channel bandwidth	As specified by the test configuration selected from Table 7.6.2.2.4.1-1.		
Propagation conditions	AWGN		As specified in Annex C.2.2.
Connection Diagram	TE Part	A.3.3.3.1	As specified in TS 38.508-1 [14] Annex A.
	DUT Part	A.3.4.1.1	
Exceptions to connection diagram			

1. Message contents are defined in clause 7.6.2.2.4.3.
2. There are two NR cells on two carriers specified in the test. Cell 1 is the cell used for connection setup and Cell 2 is a target cell on a different carrier than Cell 1. The power levels and settings for Cell 2 are set according to Annex C.1.2.
3. The UE Rx beam peak direction for Cell 2 has been obtained previously using one of the Rx beam peak search procedures as described in Annex I.

#### 7.6.2.2.4.2 Test procedure

In this test, there are two cells: NR cell 1 as PCell in FR2 on NR RF channel 1 and NR cell 2 as neighbour cell in FR2 on NR RF channel 2.



In test 1&2 measurement gap pattern configuration # 0 as defined in Table 7.6.2.2.4.1-2 is provided for UE that does not support per-FR gap and in test 3&4 measurement gap pattern configuration #13 as defined in Table 7.6.2.2.4.1-2 is provided for UE that supports per-FR gap.

In the measurement control information, it is indicated to the UE that event-triggered reporting with Event A3 is used. The test consists of two successive time periods, with time duration of T1, and T2 respectively. During time duration T1, the UE shall not have any timing information of NR cell 2.

UE needs to be provided at least once every 500ms with new Timing Advance Command MAC control element to restart the Time alignment timer to keep UE uplink time alignment. Furthermore, UE is allocated with PUSCH resource at every DRX cycle.

1. Ensure the UE is in state RRC\_CONNECTED with generic procedure parameters Connectivity NR SA, Connected without release *On* according to TS 38.508-1 [14] clause 4.5.
2. Set the parameters according to T1 in Table 7.6.2.2.4.1-2. T1 starts.
3. The SS shall transmit an *RRCReconfiguration* message.
4. The UE shall transmit *RRCReconfigurationComplete* message.
5. When T1 expires, the SS shall switch the power setting from T1 to T2 as specified in Table 7.6.2.2.4.1-2.
6. UE shall transmit a *MeasurementReport* message triggered by Event A3. If the overall delays measured from the beginning of time period T2 is less than 7682 ms for UE supporting power class 1, or 4802 ms for UE supporting other power class for Test 1 and Test 3 and 81922 ms for UE supporting power class 1, or 51202 ms for UE supporting other power class for Test 2 and Test 4 then the number of successful tests is increased by one. If the UE fails to report the event within the overall delays measured requirement then the number of failure tests is increased by one.
7. After the SS receives the *MeasurementReport* message in step 6 or when T2 expires, the SS shall transmit *RRCRelease* message to release the RRC connection which includes the release of the established radio bearers as well as all radio resources.
8. Set Cell 2 physical cell identity = [(current cell 2 physical cell identity + 1) mod 1008] for next iteration of the test procedure loop.]
9. After the RRC connection release, the SS:
  - transmits in Cell 1 a *Paging* message (including *PagingRecord* with ue-Identity) for the UE and ensures the UE in state RRC\_CONNECTED with generic procedure parameters Connectivity NR SA, Connected without release *On* according to TS 38.508-1 [14] clause 4.5. (if the paging fails, switches off and on the UE and ensures the UE is in state RRC\_CONNECTED with generic procedure parameters Connectivity NR SA, Connected without release *On* according to TS 38.508-1 [14] clause 4.5.),
  - or:
  - switches off and on the UE and ensures the UE is in state RRC\_CONNECTED with generic procedure parameters Connectivity NR SA, Connected without release *On* according to TS 38.508-1 [14] clause 4.5.
10. Repeat step 2-9 until the confidence level according to Tables G.2.3-1 in Annex G clause G.2 is achieved.
11. Repeat step 1-10 for each sub-test in Table 7.6.2.2.4.1-2 as appropriate.

#### 7.6.2.2.4.3 Message contents

Message contents are according to TS 38.508-1 [14] clause 4.6 with the following exceptions:

**Table 7.6.2.2.4.3-1: Common Exception messages SA inter frequency event triggered reporting without SSB time index detection in DRX**

<b>Default Message Contents</b>	
Common contents of system information blocks exceptions	
Default RRC messages and information elements contents exceptions	Table H.3.1-1 Table H.3.1-2 with Conditions GAP NEEDED and INTER-FREQ Table H.3.1-3 with Conditions INTER-FREQ MO and and Synchronous cells Table H.3.1-4 with A3-offset = -12dB Table H.3.1-5 Table H.3.1-6 with Conditions gapUE and Pattern #13 Table H.3.1-7 with Condition INTER-FREQ Table H.3.7-1 with Condition DRX.1 for Test 1 and DRX.2 for Test 2

#### 7.6.2.2.5 Test requirement

Table 7.6.2.2.5-1 defines the primary level settings including test tolerances for all tests.

**Table A.7.6.2.2.1-3: Cell specific test parameters for CA inter-frequency event triggered reporting without SSB time index detection**

Parameter		Unit	Test configuration	Cell 1		Cell 2	
				T1	T2	T1	T2
AoA setup			Config 1	Setup 1 as specified in clause A.9			
Beam Assumption <sup>Note 7</sup>			Config 1	Rough			
NR RF Channel Number			Config 1	1		2	
TDD configuration			Config 1	TDDConf.3.1		TDDConf.3.1	
Duplex mode			Config 1	TDD		TDD	
BW <sub>channel</sub>		MHz	Config 1	100: N <sub>RB,c</sub> = 66		100: N <sub>RB,c</sub> = 66	
Data RBs allocated			Config 1	66		66	
BWP BW		MHz	Config 1	100: N <sub>RB,c</sub> = 66		100: N <sub>RB,c</sub> = 66	
BWP configuration	Initial DL BWP		Config 1	DLBWP.0.1		N/A	
	Dedicated DL BWP			DLBWP.1.1		N/A	
	Dedicated UL BWP			ULBWP.1.1		N/A	
OCNG Patterns			Config 1	OP.1		OP.1	
PDSCH Reference measurement channel			Config 1	SR.3.1 TDD		-	
CORESET Reference Channel			Config 1	CR.3.1 TDD		-	
SMTc configuration			Config 1	SMTc.1		SMTc.1	
PDSCH/PDCCH subcarrier spacing		kHz	Config 1	120		120	
EPRE ratio of PSS to SSS			Config 1	0		0	
EPRE ratio of PBCH DMRS to SSS							
EPRE ratio of PBCH to PBCH DMRS							
EPRE ratio of PDCCH DMRS to SSS							
EPRE ratio of PDCCH to PDCCH DMRS							
EPRE ratio of PDSCH DMRS to SSS							
EPRE ratio of PDSCH to PDSCH							
EPRE ratio of OCNG DMRS to SSS(Note 1)							
EPRE ratio of OCNG to OCNG DMRS (Note 1)							
$N_{oc}$ <sup>Note2</sup>	dBm/15 kHz <sup>Note5</sup>			-104.7		-104.7	
$N_{oc}$ <sup>Note2</sup>	dBm/S CS <sup>Note4</sup>	Config 1		-95.7		-95.7	
SSB <sub>RP</sub> <sup>Note 3</sup>	dBm/S CS <sup>Note5</sup>	Config 1	-89.7	-89.7	-Infinity	-86.7	
$\hat{E}_s / I_{ot}$	dB	Config 1	6	6	-Infinity	9	
$\hat{E}_s / N_{oc}$	dB	Config 1	6	6	-Infinity	9	
$I_o$ <sup>Note3</sup>	dBm/95.04 MHz <sup>Note5</sup>	Config 1	-59.7	-59.7	-66.7	-57.2	
Propagation Condition			Config 1	AWGN		AWGN	

Note 1:	OCNG shall be used such that both cells are fully allocated and a constant total transmitted power spectral density is achieved for all OFDM symbols.
Note 2:	Interference from other cells and noise sources not specified in the test is assumed to be constant over subcarriers and time and shall be modelled as AWGN of appropriate power for $N_{oc}$ to be fulfilled.
Note 3:	SSB_RP and $I_0$ levels have been derived from other parameters for information purposes. They are not settable parameters themselves.
Note 4:	Void
Note 5:	Equivalent power received by an antenna with 0dBi gain at the centre of the quiet zone
Note 6:	As observed with 0dBi gain antenna at the centre of the quiet zone
Note 7:	Information about types of UE beam is given in TS 38.133 Annex B.2.1.3, and does not limit UE implementation or test system implementation

In test 1 the UE shall send one Event A3 triggered measurement report, with a measurement reporting delay less than  $X1$  ms from the beginning of time period  $T2$ , where  $X1$  is

- 7680 for UE supporting power class 1, or
- 4800 for UE supporting other power class.

In test 2 the UE shall send one Event A3 triggered measurement report, with a measurement reporting delay less than  $X2$  ms from the beginning of time period  $T2$ , where  $X2$  is

- 81920 for UE supporting power class 1, or
- 51200 for UE supporting other power class.

In test 1 and 2 UE is not required to report SSB time index.

The UE shall not send event triggered measurement reports, as long as the reporting criteria are not fulfilled. The rate of correct events observed during repeated tests shall be at least 90% with a confidence level of 95%.

NOTE: The actual overall delays measured in the test may be up to  $2 \times TTI_{DCCH}$  higher than the measurement reporting delays above because of TTI insertion uncertainty of the measurement report in DCCH.

$TTI$  insertion uncertainty =  $TTI_{DCCH} = 1$  ms;  $2 \times TTI_{DCCH} = 2$  ms

The overall delays measured shall be less than a total of 7682 ms for power class 1 UE and 4802 ms for other power classes in test 1 and 81922 for power class 1 UE and 51202 ms for other power classes in test 2.

### 7.6.2.3 NR SA FR2-FR2 event-triggered reporting in non-DRX with SSB time index detection

Editor's Note: This test case has been completed for the following configurations:

- Test frequency  $f \leq 40.8$  GHz
- UE PC3
- The test is incomplete for UE power classes other than PC3
- The test is incomplete for test frequencies  $> 40.8$  GHz

#### 7.6.2.3.1 Test purpose

The purpose of this test is to verify that the UE makes correct reporting of an event within inter-frequency cell search requirements.

#### 7.6.2.3.2 Test applicability

This test applies to all types of NR UE from Release 15 onwards.

#### 7.6.2.3.3 Minimum conformance requirements

The minimum conformance requirements are specified in clause 7.6.2.0.

The normative reference for this requirement is TS 38.133 [6] clause A.7.6.2.3.

#### 7.6.2.3.4 Test description

##### 7.6.2.3.4.1 Initial conditions

This test shall be tested using any of the test configurations in Table 7.6.2.3.4.1-1.

**Table 7.6.2.3.4.1-1: NR FR2-FR2 event triggered reporting tests in non-DRX with SSB time index detection supported test configurations**

Test Case ID	Description
7.6.2.3-1	120 kHz SSB SCS, 100MHz bandwidth, TDD duplex mode
Note 1:	Void

**Table 7.6.2.3.4.1-2: General test parameters for SA inter-frequency event triggered reporting for FR2 with SSB time index detection**

Parameter	Unit	Test configuration	Value	Comment
NR RF Channel Number		Config 1	1, 2	Two FR2 NR carrier frequencies is used.
Active cell		Config 1	NR cell 1 (Pcell)	NR Cell 1 is on NR RF channel number 1.
Neighbour cell		Config 1	NR cell 2	NR cell 2 is on NR RF channel number 2.
Gap Pattern Id		Config 1	13	As specified in clause 9.1.2-1.
Measurement gap offset		Config 1	39	
SMT-C-SSB parameters		Config 1	SSB.3 FR2	As specified in clause A.3.10.2
offsetMO	dB	Config 1	16	Applied to NR Cell 2 measurement object
A3-Offset	dB	Config 1	-11	
Hysteresis	dB	Config 1	0	
CP length		Config 1	Normal	
TimeToTrigger	s	Config 1	0	
Filter coefficient		Config 1	0	L3 filtering is not used
DRX		Config 1	OFF	DRX is not used
Time offset between serving and neighbour cells		Config 1	3µs	Synchronous cells.
T1	s	Config 1	5	
T2	s	Config 1	7 for PC1; 4.5 for other PC	

**Table 7.6.2.3.4-3: Test Environment parameters for SA inter-frequency event triggered reporting with SSB time index detection in non-DRX**

Parameter	Value		Comment
Test environment	NC		As specified in TS 38.508-1 [14] clause 4.1.
Test frequencies	As specified in Annex E, Table E.2-1 and TS 38.508-1 [14] clause 4.3.1 and 4.4.2.		
Channel bandwidth	As specified by the test configuration selected from Table 7.6.2.3.4.1-1.		
Propagation conditions	AWGN		As specified in Annex C.2.2.
Connection Diagram	TE Part	A.3.3.3.1	As specified in TS 38.508-1 [14] Annex A.
	DUT Part	A.3.4.1.1	
Exceptions to connection diagram			

1. Message contents are defined in clause 7.6.2.3.4.3.

2. There are two NR cells on two carriers specified in the test. Cell 1 is the cell used for connection setup and Cell 2 is a target cell on a different carrier than Cell 1. The power levels and settings for Cell 2 are set according to Annex C.1.2.
3. The AoA setup for this test is Setup 3 as defined in clause A.9. The UE RX spherical coverage direction has been obtained previously using one of the search procedures as described in Annex I.

#### 7.6.2.3.4.2 Test procedure

In this test, there are two cells: NR cell 1 as PCell in FR2 on NR RF channel 1 and NR cell 2 as neighbour cell in FR2 on NR RF channel 2.

In test 1 measurement gap pattern configuration # 0 as defined in Table 7.6.2.3.4.1-2 is provided for UE that does not support per-FR gap and in test 2 measurement gap pattern configuration #13 as defined in Table 7.6.2.3.4.1-2 is provided for UE that supports per-FR gap.

In the measurement control information, it is indicated to the UE that event-triggered reporting with Event A3 is used. The test consists of two successive time periods, with time duration of T1, and T2 respectively. During time duration T1, the UE shall not have any timing information of NR cell 2.

1. Ensure the UE is in state RRC\_CONNECTED with generic procedure parameters Connectivity NR SA, Connected without release *On* according to TS 38.508-1 [14] clause 4.5.
2. Set the parameters according to T1 in Table 7.6.2.3.4.1-2. The TE shall ensure that the NR FR2 cells are from the set of directions corresponding to the EIS spherical coverage percentile of the DUT as defined in clause 7.3.4 of TS 38.101-2 [3] and relative angular offset between active probes are according to Table A.9.3-1. T1 starts.
3. The SS shall transmit an *RRCReconfiguration* message.
4. The UE shall transmit *RRCReconfigurationComplete* message.
5. When T1 expires, the SS shall switch the power setting from T1 to T2 as specified in Table 7.6.2.3.4.1-2. T2 starts.
6. UE shall transmit a *MeasurementReport* message triggered by Event A3. If the overall delays measured from the beginning of time period T2 is less than 6722 ms for UE supporting power class 1, or 4162 ms for UE supporting other power class for Test 1 and Test 2, then the number of successful tests is increased by one. If the UE fails to report the event within the overall delays measured requirement then the number of failure tests is increased by one.
7. After the SS receives the *MeasurementReport* message in step 6 or when T2 expires, the SS shall transmit *RRCRelease* message to release the RRC connection which includes the release of the established radio bearers as well as all radio resources.
8. Set Cell 2 physical cell identity = [(current cell 2 physical cell identity + 1) mod 1008] for next iteration of the test procedure loop.]
9. TE shall change the active probes in such way that relative angular offset between active probes differs in the following iteration.10. After the RRC connection release, the SS:
  - transmits in Cell 1 a *Paging* message (including *PagingRecord* with ue-Identity) for the UE and ensures the UE in state RRC\_CONNECTED with generic procedure parameters Connectivity NR SA, Connected without release *On* according to TS 38.508-1 [14] clause 4.5. (if the paging fails, switches off and on the UE and ensures the UE is in state RRC\_CONNECTED with generic procedure parameters Connectivity NR SA, Connected without release *On* according to TS 38.508-1 [14] clause 4.5.),
  - or:
  - switches off and on the UE and ensures the UE is in state RRC\_CONNECTED with generic procedure parameters Connectivity NR SA, Connected without release *On* according to TS 38.508-1 [14] clause 4.5.
11. Repeat step 2-10 until the confidence level according to Tables G.2.3-1 in Annex G clause G.2 is achieved.
12. Repeat step 1-11 for each sub-test in Table 7.6.2.3.4.1-2 as appropriate.

#### 7.6.2.3.4.3 Message contents

Message contents are according to TS 38.508-1 [14] clause 4.6 with the following exceptions:

**Table 7.6.2.3.4.3-1: Common Exception messages SA inter frequency event triggered reporting with SSB time index detection in non-DRX**

Default Message Contents	
Common contents of system information blocks exceptions	
Default RRC messages and information elements contents exceptions	Table H.3.1-1 Table H.3.1-2 with Conditions GAP NEEDED and INTER-FREQ Table H.3.1-3 with Conditions INTER-FREQ MO and Synchronous cells Table H.3.1-4 with Condition SSB Index and A3-offset = -11dB Table H.3.1-5 Table H.3.1-6 with Conditions gapUE and Pattern #13 Table H.3.1-7 with Condition INTER-FREQ

**Table 7.6.2.3.4.3-2: MeasObjectNR-DEFAULT: SA FR2-FR2 measurement object configuration**

Derivation Path: Table H.3.1-3			
Information Element	Value/remark	Comment	Condition
MeasObjectNR ::= SEQUENCE {			
offsetMO SEQUENCE {			
rsrpOffsetSSB	dB16		
}			

7.6.2.3.5 Test requirement

Table 7.6.2.3.5-1 defines the primary level settings including test tolerances for all tests.

**Table 7.6.2.3.5-1: Cell specific test parameters for SA inter-frequency event triggered reporting for FR2 with SSB time index detection**

Parameter		Unit	Test configuration	Cell 1		Cell 2	
				T1	T2	T1	T2
AoA setup			Config 1	Setup 3 as specified in clause A.9			
				AoA1		AoA2	
Beam Assumption <sup>Note 7</sup>			Config 1	Rough		Rough	
NR RF Channel Number			Config 1	1		2	
Duplex mode			Config 1	TDD		TDD	
TDD configuration			Config 1	TDDConf.3.1		TDDConf.3.1	
BW <sub>channel</sub>		MHz	Config 1	100: N <sub>RB,c</sub> = 66		100: N <sub>RB,c</sub> = 66	
Data RBs allocated			Config 1	66		66	
BWP BW		MHz	Config 1	100: N <sub>RB,c</sub> = 66		100: N <sub>RB,c</sub> = 66	
BWP configuration	Initial DL BWP		Config 1	DLBWP.0.1		N/A	
	Initial UL BWP			ULBWP.0.1		N/A	
	Dedicated DL BWP			DLBWP.1.1		N/A	
	Dedicated UL BWP			ULBWP.1.1		N/A	



OCNG Patterns		Config 1	OP.1		OP.1	
PDSCH Reference measurement channel		Config 1	SR.3.1 TDD		-	
CORESET Reference Channel		Config 1	CR.3.1 TDD		-	
SMTTC configuration		Config 1	SMTTC.1		SMTTC.1	
PDSCH/PDCCH subcarrier spacing	kHz	Config 1	120		120	
TRS configuration		Config 1	TRS.2.1 TDD		N/A	
PDSCH/PDCCH TCI state		Config 1	TCI.State.2		N/A	
EPRE ratio of PSS to SSS		Config 1	0		0	
EPRE ratio of PBCH DMRS to SSS						
EPRE ratio of PBCH to PBCH DMRS						
EPRE ratio of PDCCH DMRS to SSS						
EPRE ratio of PDCCH to PDCCH DMRS						
EPRE ratio of PDSCH DMRS to SSS						
EPRE ratio of PDSCH to PDSCH						
EPRE ratio of OCNG DMRS to SSS(Note 1)						
EPRE ratio of OCNG to OCNG DMRS (Note 1)						
$\hat{E}_s$	dBm/S CS					
SSB-RP <sup>Note 3</sup>	dBm/S CS Note5	Config 1	-87	-87	-Infinity	-87
$\hat{E}_s / I_{ot\_BB}$ <sup>Note 8</sup>	dB	Config 1	1.89	1.89	-Infinity	1.89
$I_o$ <sup>Note3</sup>	dBm/95.04 MHz Note5	Config 1	-58.01	-58.01	-Infinity	-58.01
Propagation Condition		Config 1	AWGN		AWGN	
<p>Note 1: OCNG shall be used such that both cells are fully allocated and a constant total transmitted power spectral density is achieved for all OFDM symbols.</p> <p>Note 2: Void</p> <p>Note 3: SSB-RP, <math>E_s/I_{ot}</math> and <math>I_o</math> levels have been derived from other parameters for information purposes. They are not settable parameters themselves.</p> <p>Note 4: Void</p> <p>Note 5: Equivalent power received by an antenna with 0dBi gain at the centre of the quiet zone</p> <p>Note 6: As observed with 0dBi gain antenna at the centre of the quiet zone</p> <p>Note 7: Information about types of UE beam is given in TS 38.133 [6] Annex B.2.1.3, and does not limit UE implementation or test system implementation</p> <p>Note 8: Calculation of <math>E_s/I_{ot\_BB}</math> includes the effect of UE internal noise up to the value assumed for the associated Refsens requirement in clause 7.3.2 of TS 38.101-2 [3], and an allowance of 1dB for UE multi-band relaxation factor <math>\Delta MB_s</math> from TS 38.101-2 [3] Table 6.2.1.3-4.</p>						

The UE shall send one Event A3 triggered measurement report, with a measurement reporting delay less than X ms from the beginning of time period T2, where X is

6720 for UE supporting power class 1, or

4160 for UE supporting other power class.

The UE is required to report SSB time index. The UE shall not send event triggered measurement reports, as long as the reporting criteria are not fulfilled. The rate of correct events observed during repeated tests shall be at least 90% with a confidence level of 95%.

NOTE: The actual overall delays measured in the test may be up to  $2 \times TTI_{DCCH}$  higher than the measurement reporting delays above because of TTI insertion uncertainty of the measurement report in DCCH.

TTI insertion uncertainty =  $TTI_{DCCH} = 1 \text{ ms}$ ;  $2 \times TTI_{DCCH} = 2 \text{ ms}$

The overall delays measured shall be less than a total of 6722 ms in this test for power class UE and 4162 ms for other power classes.

#### 7.6.2.4 NR SA FR2-FR2 event-triggered reporting in DRX with SSB time index detection

Editor's Note: This test case has been completed for the following configurations:

- Test frequency  $f \leq 40.8 \text{ GHz}$
- UE PC3
- The test is incomplete for UE power classes other than PC3
- The test is incomplete for test frequencies  $> 40.8 \text{ GHz}$

##### 7.6.2.4.1 Test purpose

The purpose of this test is to verify that the UE makes correct reporting of an event within inter-frequency cell search requirements.

##### 7.6.2.4.2 Test applicability

This test applies to all types of NR UE Release 15 and forward supporting 5GS NR SA FR2 and long DRX cycle.

##### 7.6.2.4.3 Minimum conformance requirements

The minimum conformance requirements are specified in clause 7.6.2.0.

The normative reference for this requirement is TS 38.133 [6] clause A.7.6.2.4.

##### 7.6.2.4.4 Test description

###### 7.6.2.4.4.1 Initial conditions

This test shall be tested using any of the test configurations in Table 7.6.2.4.4.1-1.

**Table 7.6.2.4.4.1-1: NR FR2-FR2 event triggered reporting tests in DRX with SSB time index detection supported test configurations**

Test Case ID	Description
7.6.2.4-1	120 kHz SSB SCS, 100MHz bandwidth, TDD duplex mode
Note 1: Void	

**Table 7.6.2.4.4.1-2: General test parameters for SA inter-frequency event triggered reporting for FR2 with SSB time index detection in DRX**

Parameter	Unit	Test configuration	Value		Comment
			Test 1	Test 2	
NR RF Channel Number		Config 1	1, 2		Two FR1 NR carrier frequencies is used.
Active cell		Config 1	NR cell 1 (Pcell)		NR Cell 1 is on NR RF channel number 1.
Neighbour cell		Config 1	NR cell 2		NR cell 2 is on NR RF channel number 2.
Gap Pattern Id		Config 1	13		As specified in clause 9.1.2-1.
Measurement gap offset		Config 1	39		
SMTC-SSB parameters		Config 1	SSB.3 FR2		As specified in clause A.3.10.2
A3-Offset	dB	Config 1	-12		Value modified by TT
Hysteresis	dB	Config 1	0		
CP length		Config 1	Normal		
TimeToTrigger	s	Config 1	0		
Filter coefficient		Config 1	0		L3 filtering is not used
DRX		Config 1	DRX.1	DRX.2	As specified in clause A.3.3
Time offset between serving and neighbour cells		Config 1	3µs		Synchronous cells.
T1	s	Config 1	5		
T2	s	Config 1	11 for PC1; 6.5 for other PC	108 for PC1; 67 for other PC	

**Table 7.6.2.4.4.3: Test Environment parameters for SA inter-frequency event triggered reporting with SSB time index detection in DRX**

Parameter	Value		Comment
Test environment	NC		As specified in TS 38.508-1 [14] clause 4.1.
Test frequencies	As specified in Annex E, Table E.2-1 and TS 38.508-1 [14] clause 4.3.1 and 4.4.2.		
Channel bandwidth	As specified by the test configuration selected from Table 7.6.2.4.4.1-1.		
Propagation conditions	AWGN		As specified in Annex C.2.2.
Connection Diagram	TE Part	A.3.3.3.1	As specified in TS 38.508-1 [14] Annex A.
	DUT Part	A.3.4.1.1	
Exceptions to connection diagram			

1. Message contents are defined in clause 7.6.2.4.4.3.
2. There are two NR cells on two carriers specified in the test. Cell 1 is the cell used for connection setup and Cell 2 is a target cell on a different carrier than Cell 1. The power levels and settings for Cell 2 are set according to Annex C.1.2.
3. The UE Rx beam peak direction for Cell 2 has been obtained previously using one of the Rx beam peak search procedures as described in Annex I.

#### 7.6.2.4.4.2 Test procedure

In this test, there are two cells: NR cell 1 as PCell in FR2 on NR RF channel 1 and NR cell 2 as neighbour cell in FR2 on NR RF channel 2.

In test 1&2 measurement gap pattern configuration # 0 as defined in Table 7.6.2.4.4.1-2 is provided for UE that does not support per-FR gap and in test 3&4 measurement gap pattern configuration #13 as defined in Table 7.6.2.4.4.1-2 is provided for UE that supports per-FR gap.

In the measurement control information, it is indicated to the UE that event-triggered reporting with Event A3 is used. The test consists of two successive time periods, with time duration of T1, and T2 respectively. During time duration T1, the UE shall not have any timing information of NR cell 2.

UE needs to be provided at least once every 500ms with new Timing Advance Command MAC control element to restart the Time alignment timer to keep UE uplink time alignment. Furthermore, UE is allocated with PUSCH resource at every DRX cycle.

1. Ensure the UE is in state RRC\_CONNECTED with generic procedure parameters Connectivity NR SA, Connected without release *On* according to TS 38.508-1 [14] clause 4.5.
2. Set the parameters according to T1 in Table 7.6.2.4.4.1-2. T1 starts.
3. The SS shall transmit an *RRCReconfiguration* message.
4. The UE shall transmit *RRCReconfigurationComplete* message.
5. When T1 expires, the SS shall switch the power setting from T1 to T2 as specified in Table 7.6.2.4.4.1-2.
6. UE shall transmit a *MeasurementReport* message triggered by Event A3. If the overall delays measured from the beginning of time period T2 is less than 10082 ms for UE supporting power class 1, or 6242 ms for UE supporting other power class for Test 1 and Test 3 and 107522 ms for UE supporting power class 1, or 66562 ms for UE supporting other power class for Test 2 and Test 4, then the number of successful tests is increased by one. If the UE fails to report the event within the overall delays measured requirement then the number of failure tests is increased by one.
7. After the SS receives the *MeasurementReport* message in step 6 or when T2 expires, the SS shall transmit *RRCRelease* message to release the RRC connection which includes the release of the established radio bearers as well as all radio resources.
8. Set Cell 2 physical cell identity = [(current cell 2 physical cell identity + 1) mod 1008] for next iteration of the test procedure loop.]
9. After the RRC connection release, the SS:
  - transmits in Cell 1 a *Paging* message (including *PagingRecord* with *ue-Identity*) for the UE and ensures the UE in state RRC\_CONNECTED with generic procedure parameters Connectivity NR SA, Connected without release *On* according to TS 38.508-1 [14] clause 4.5. (if the paging fails, switches off and on the UE and ensures the UE is in state RRC\_CONNECTED with generic procedure parameters Connectivity NR SA, Connected without release *On* according to TS 38.508-1 [14] clause 4.5.),
  - or:
  - switches off and on the UE and ensures the UE is in state RRC\_CONNECTED with generic procedure parameters Connectivity NR SA, Connected without release *On* according to TS 38.508-1 [14] clause 4.5.
10. Repeat step 2-9 until the confidence level according to Tables G.2.3-1 in Annex G clause G.2 is achieved.
11. Repeat step 1-10 for each sub-test in Table 7.6.2.4.4.1-2 as appropriate.

#### 7.6.2.4.4.3 Message contents

Message contents are according to TS 38.508-1 [14] clause 4.6 with the following exceptions:

**Table 7.6.2.4.4.3-1: Common Exception messages SA inter frequency event triggered reporting with SSB time index detection in DRX**

<b>Default Message Contents</b>	
Common contents of system information blocks exceptions	
Default RRC messages and information elements contents exceptions	Table H.3.1-1 Table H.3.1-2 with Conditions GAP NEEDED and INTER-FREQ Table H.3.1-3 with Conditions INTER-FREQ MO and Synchronous cells Table H.3.1-4 with Condition SSB Index and A3-offset = -12dB Table H.3.1-5 Table H.3.1-6 with Conditions gapUE and Pattern #13 Table H.3.1-7 with Condition INTER-FREQ Table H.3.7-1 with Condition DRX.1 for Test 1 and DRX.2 for Test 2

7.6.2.4.5 Test requirement

Table 7.6.2.4.5-1 defines the primary level settings including test tolerances for all tests.

**Table 7.6.2.4.5-1: Cell specific test parameters for CA inter-frequency event triggered reporting with SSB time index detection**

Parameter		Unit	Test configuration	Cell 1		Cell 2	
				T1	T2	T1	T2
AoA setup			Config 1	Setup 1 as specified in clause A.9			
Beam Assumption <sup>Note 7</sup>			Config 1	Rough			
NR RF Channel Number			Config 1	1		2	
Duplex mode			Config 1	TDD		TDD	
TDD configuration			Config 1	TDDConf.3.1		TDDConf.3.1	
BW <sub>channel</sub>		MHz	Config 1	100: N <sub>RB,c</sub> = 66		100: N <sub>RB,c</sub> = 66	
Data RBs allocated			Config 1	66		66	
BWP BW		MHz	Config 1	100: N <sub>RB,c</sub> = 66		100: N <sub>RB,c</sub> = 66	
BWP configuration	Initial DL BWP		Config 1	DLBWP.0.1		N/A	
	Dedicated DL BWP			DLBWP.1.1		N/A	
	Dedicated UL BWP			ULBWP.1.1		N/A	
OCNG Patterns			Config 1	OP.1		OP.1	
PDSCH Reference measurement channel			Config 1	SR.3.1 TDD		-	
CORESET Reference Channel			Config 1	CR.3.1 TDD		-	
SMTC configuration			Config 1	SMTC.1		SMTC.1	
PDSCH/PDCCH subcarrier spacing		kHz	Config 1	120		120	
EPRE ratio of PSS to SSS			Config 1	0		0	
EPRE ratio of PBCH DMRS to SSS							
EPRE ratio of PBCH to PBCH DMRS							
EPRE ratio of PDCCH DMRS to SSS							
EPRE ratio of PDCCH to PDCCH DMRS							
EPRE ratio of PDSCH DMRS to SSS							
EPRE ratio of PDSCH to PDSCH							
EPRE ratio of OCNG DMRS to SSS(Note 1)							
EPRE ratio of OCNG to OCNG DMRS (Note 1)							
$N_{oc}$ <sup>Note2</sup>	dBm/15 kHz Note5		-104.7		-104.7		
$N_{oc}$ <sup>Note2</sup>	dBm/S CS Note4	Config 1	-95.7		-95.7		
SSB <sub>RP</sub> <sup>Note 3</sup>	dBm/S CS Note5	Config 1	-89.7	-89.7	-Infinity	-86.7	
$\hat{E}_s / I_{ot}$	dB	Config 1	6	6	-Infinity	9	
$\hat{E}_s / N_{oc}$	dB	Config 1	6	6	-Infinity	9	
$I_o$ <sup>Note3</sup>	dBm/95.04 MHz Note5	Config 1	-59.7	-59.7	-66.7	-57.2	
Propagation Condition			Config 1	AWGN			

Note 1:	OCNG shall be used such that both cells are fully allocated and a constant total transmitted power spectral density is achieved for all OFDM symbols.
Note 2:	Interference from other cells and noise sources not specified in the test is assumed to be constant over subcarriers and time and shall be modelled as AWGN of appropriate power for $N_{oc}$ to be fulfilled.
Note 3:	SSB_RP and $I_0$ levels have been derived from other parameters for information purposes. They are not settable parameters themselves.
Note 4:	Void
Note 5:	Equivalent power received by an antenna with 0dBi gain at the centre of the quiet zone
Note 6:	As observed with 0dBi gain antenna at the centre of the quiet zone
Note 7:	Information about types of UE beam is given in TS 38.133 Annex B.2.1.3, and does not limit UE implementation or test system implementation

In test 1 the UE shall send one Event A3 triggered measurement report, with a measurement reporting delay less than  $X1$  ms from the beginning of time period T2, where  $X1$  is

- 10080 for UE supporting power class 1, or
- 6240 for UE supporting other power class.

In test 2, the UE shall send one Event A3 triggered measurement report, with a measurement reporting delay less than  $X2$  ms from the beginning of time period T2, where  $X2$  is

- 107520 for UE supporting power class 1, or
- 66560 for UE supporting other power class.

In test 1 2 UE is required to report SSB time index. The UE shall not send event triggered measurement reports, as long as the reporting criteria are not fulfilled. The rate of correct events observed during repeated tests shall be at least 90% with a confidence level of 95%.

TTI insertion uncertainty = TTIDCCH = 1 ms;  $2 \times \text{TTIDCCH} = 2$  ms

The overall delays measured shall be less than a total of 10082 ms for power class 1 UE and 6242 ms for other power classes in test 1 and 107522 for power class 1 UE and 66562 ms for other power classes in test 2.

### 7.6.2.5 NR SA FR1-FR2 event-triggered reporting in non-DRX

**Editor's Note:** This test case has been completed for the following configurations:

- Test frequency  $f \leq 40.8$  GHz
- UE PC3
- The test is incomplete for UE power classes other than PC3
- The test is incomplete for test frequencies  $> 40.8$  GHz

#### 7.6.2.5.1 Test purpose

The purpose of this test is to verify that the UE makes correct reporting of an event within inter-frequency cell search requirements.

#### 7.6.2.5.2 Test applicability

This test applies to all types of NR UE from Release 15 onwards.

#### 7.6.2.5.3 Minimum conformance requirements

The minimum conformance requirements are specified in clause 7.6.2.0.

The normative reference for this requirement is TS 38.133 [6] clause A.7.6.2.5.



7.6.2.5.4 Test description

7.6.2.5.4.1 Initial conditions

This test shall be tested using any of the test configurations in Table 7.6.2.5.4.1-1.

**Table 7.6.2.5.4.1-1: SA FR1-FR2 event triggered reporting tests in non-DRX supported test configurations**

Test Case ID	Description of serving cell	Description of target cell
7.6.2.5-1	NR 15 kHz SSB SCS, 10MHz bandwidth, FDD duplex mode	120 kHz SSB SCS, 100MHz bandwidth, TDD duplex mode
7.6.2.5-2	NR 15 kHz SSB SCS, 10MHz bandwidth, TDD duplex mode	
7.6.2.5-3	NR 30kHz SSB SCS, 40MHz bandwidth, TDD duplex mode	
Note 1: The UE is only required to be tested in one of the supported test configurations		
Note 2: target NR cell has the same SCS, BW and duplex mode as NR serving cell		

**Table 7.6.2.5.4.1-2: General test parameters for SA inter-frequency event triggered reporting for FR2 without SSB time index detection**

Parameter	Unit	Test configuration	Value		Comment
			Test 1	Test 2	
NR RF Channel Number		Config 1,2,3	1, 2		One NR FR1 and one NR FR2 carrier frequency is used.
Active cell		Config 1,2,3	NR cell 1 (Pcell)		NR Cell 1 is on NR RF channel number 1 in FR1
Neighbour cell		Config 1,2,3	NR cell 2		NR cell 2 is on NR RF channel number 2 in FR2.
Gap Pattern Id		Config 1,2,3	0	Gap not configured	As specified in TS 38.133 [6] clause 9.1.2-1.
Measurement gap offset		Config 1,2,3	39	N/A	
SMTC-SSB parameters on NR RF Channel 1		Config 1	SSB.1 FR1		As specified in clause A.3.1
		Config 2	SSB.1 FR1		As specified in clause A.3.1
		Config 3	SSB.2 FR1		As specified in clause A.3.1
SMTC-SSB parameters on NR RF Channel 2		Config 1,2,3	SSB.3 FR2		As specified in clause A.3.2
<i>offsetMO</i>	dB	Config 1,2,3	6		
Hysteresis	dB	Config 1,2,3	0		
<i>a4-Threshold</i>	dBm	Config 1,2,3	-105		
CP length		Config 1,2,3	Normal		
TimeToTrigger	s	Config 1,2,3	0		
Filter coefficient		Config 1,2,3	0		L3 filtering is not used
DRX		Config 1,2,3	OFF		DRX is not used
Time offset between serving and neighbour cells		Config 1	3ms		Asynchronous cells. The timing of Cell 2 is 3ms later than the timing of Cell 1.
		Config 2,3	3µs		Synchronous cells.
T1	s	Config 1,2,3	5		
T2	s	Config 1,2,3	5.2 for PC1; 3.5 for other PC	3 for PC1; 2 for other PC	PC1 - power class 1 as specified in TS 38.101-2 [3] Table 6.2.1.0

**Table 7.6.2.5.4-3: Test Environment parameters for SA inter-frequency event triggered reporting with SSB time index detection in non-DRX**

Parameter	Value		Comment
Test environment	NC		As specified in TS 38.508-1 [14] clause 4.1.
Test frequencies	As specified in Annex E, Table E.2-1 and TS 38.508-1 [14] clause 4.3.1 and 4.4.2.		
Channel bandwidth	As specified by the test configuration selected from Table 7.6.2.5.4.1-1.		
Propagation conditions	AWGN		As specified in Annex C.2.2.
Connection Diagram	TE Part	A.3.3.3.1	As specified in TS 38.508-1 [14] Annex A.
	DUT Part	A.3.4.1.1	
Exceptions to connection diagram			

1. Message contents are defined in clause 7.6.2.5.4.3.
2. There are two NR cells on two carriers specified in the test. Cell 1 is the cell used for connection setup and Cell 2 is a target cell on a different carrier than Cell 1. The power levels and settings for Cell 2 are set according to Annex C.1.2.
3. If a UE supports per-FR gap it is only required to pass test 2. Otherwise it is only required to pass test 1.
4. The UE Rx beam peak direction for Cell 2 has been obtained previously using one of the Rx beam peak search procedures as described in Annex I.

#### 7.6.2.5.4.2 Test procedure

In this test, there are two cells: NR cell 1 as PCell in FR1 on NR RF channel 2 and NR cell 2 as neighbour cell in FR2 on NR RF channel 2.

In test 1 measurement gap pattern configuration # 0 as defined in Table 7.6.2.5.4.1-2 is provided for a UE that does not support per-FR gap and in test 2 measurement gap pattern configuration #13 as defined in Table 7.6.2.5.4.1-2 is provided for UE that support per-FR gap.

In the measurement control information, it is indicated to the UE that event-triggered reporting with Event A3 is used. The test consists of two successive time periods, with time duration of T1, and T2 respectively. During time duration T1, the UE shall not have any timing information of NR cell 3.

1. Ensure the UE is in state RRC\_CONNECTED with generic procedure parameters Connectivity NR SA, Connected without release *On* according to TS 38.508-1 [14] clause 4.5.
2. Set the parameters according to T1 in Table 7.6.2.5.4.1-2. The TE shall ensure that the NR FR2 cell will be received by the UE from the Rx beam peak direction. T1 starts.
3. The SS shall transmit an *RRCReconfiguration* message.
4. The UE shall transmit *RRCReconfigurationComplete* message.
5. When T1 expires, the SS shall switch the power setting from T1 to T2 as specified in Table 7.6.2.5.4.1-2.
6. UE shall transmit a *MeasurementReport* message triggered by Event A3. If the overall delays measured from the beginning of time period T2 is less than 5122 ms for UE supporting power class 1, or 3202 ms for UE supporting other power class for Test 1 and 2562 ms for UE supporting power class 1, or 1602 ms for UE supporting other power class for Test 2 then the number of successful tests is increased by one. If the UE fails to report the event within the overall delays measured requirement then the number of failure tests is increased by one.
7. After the SS receives the *MeasurementReport* message in step 6 or when T2 expires, the SS shall transmit *RRCRelease* message to release the RRC connection which includes the release of the established radio bearers as well as all radio resources.
8. Set Cell 2 physical cell identity = [(current cell 2 physical cell identity + 1) mod 1008] for next iteration of the test procedure loop.]

9. After the RRC connection release, the SS:

- transmits in Cell 1 a *Paging* message (including PagingRecord with ue-Identity) for the UE and ensures the UE in state RRC\_CONNECTED with generic procedure parameters Connectivity NR SA, Connected without release *On* according to TS 38.508-1 [14] clause 4.5. (if the paging fails, switches off and on the UE and ensures the UE is in state RRC\_CONNECTED with generic procedure parameters Connectivity NR SA, Connected without release *On* according to TS 38.508-1 [14] clause 4.5.),

or:

- switches off and on the UE and ensures the UE is in state RRC\_CONNECTED with generic procedure parameters Connectivity NR SA, Connected without release *On* according to TS 38.508-1 [14] clause 4.5.

10. Repeat step 2-9 until the confidence level according to Tables G.2.3-1 in Annex G clause G.2 is achieved.

11. Repeat step 1-10 for each sub-test in Table 7.6.2.5.4.1-2 as appropriate.

7.6.2.5.4.3 Message contents

Message contents are according to TS 38.508-1 [14] clause TBD with the following exceptions:

**Table 7.6.2.5.4.3-1: Common Exception messages SA inter frequency event triggered reporting without SSB time index detection in non-DRX**

Default Message Contents	
Common contents of system information blocks exceptions	
Default RRC messages and information elements contents exceptions	Table H.3.1-1 Table H.3.1-2 with Conditions GAP NEEDED and INTER-FREQ for Test 1 Table H.3.1-2 with Condition INTER-FREQ for Test 2 Table H.3.1-3 with Conditions INTER-FREQ MO and Synchronous cells Table H.3.1-4AA with A4-threshold= -105dB Table H.3.1-5 Table H.3.1-6 with Conditions gapUE and Pattern #0 for Test 1 Table H.3.1-7 with Condition INTER-FREQ

**Table 7.6.2.5.4.3-2: MeasObjectNR-DEFAULT: SA FR1-FR2 measurement object configuration**

Derivation Path: Table H.3.1-3			
Information Element	Value/remark	Comment	Condition
MeasObjectNR ::= SEQUENCE {			
offsetMO SEQUENCE {			
rsrpOffsetSSB	dB6		
}			

7.6.2.5.5 Test requirement

Table 7.6.2.5.5-1 defines the primary level settings including test tolerances for all tests.

**Table 7.6.2.5.5-1: Cell specific test parameters for SA inter-frequency event triggered reporting for FR2 without SSB time index detection**

Parameter		Unit	Test configuration	Cell 1		Cell 2	
				T1	T2	T1	T2
AoA setup			Config 1,2,3	N/A		Setup 1 as specified in clause A.9	
Beam Assumption <sup>Note 7</sup>			Config 1,2,3	N/A		Rough	
NR RF Channel Number			Config 1,2,3	1		2	
Duplex mode			Config 1	FDD		TDD	
			Config 2,3	TDD		TDD	
TDD configuration			Config 1	Not Applicable		TDDConf.3.1	
			Config 2	TDDConf.1.1		TDDConf.3.1	
			Config 3	TDDConf.2.1		TDDConf.3.1	
BW <sub>channel</sub>		MHz	Config 1	10: N <sub>RB,c</sub> = 52		100: N <sub>RB,c</sub> = 66	
			Config 2	10: N <sub>RB,c</sub> = 52		100: N <sub>RB,c</sub> = 66	
			Config 3	40: N <sub>RB,c</sub> = 106		100: N <sub>RB,c</sub> = 66	
BWP BW		MHz	Config 1	10: N <sub>RB,c</sub> = 52		100: N <sub>RB,c</sub> = 66	
			Config 2	10: N <sub>RB,c</sub> = 52		100: N <sub>RB,c</sub> = 66	
			Config 3	40: N <sub>RB,c</sub> = 106		100: N <sub>RB,c</sub> = 66	
BWP configuration	Initial DL BWP		Config 1,2,3	DLBWP.0.1		N/A	
	Initial UL BWP			ULBWP.0.1		N/A	
	Dedicated DL BWP			DLBWP.1.1		N/A	
	Dedicated UL BWP			ULBWP.1.1		N/A	
OCNG Patterns			Config 1,2,3	OP.1		OP.1	
PDSCH Reference measurement channel			Config 1	SR.1.1 FDD		-	
			Config 2	SR.1.1 TDD			
			Config 3	SR.2.1 TDD			
RMSI CORESET Reference Channel			Config 1	CR.1.1 FDD		-	
			Config 2	CR.1.1 TDD			
			Config 3	CR.2.1 TDD			
Dedicated CORESET RMC configuration			Config 1	CCR.1.1 FDD		CCR.3.1 TDD	
			Config 2	CCR.1.1 TDD		CCR.3.1 TDD	
			Config 3	CCR.2.1 TDD		CCR.3.1 TDD	

SMTC configuration		Config 1	SMTC.2	SMTC.2	
		Config 2,3	SMTC.1	SMTC.1	
PDSCH/PDCCH subcarrier spacing	kHz	Config 1,2	15	120	
		Config 3	30	120	
EPRE ratio of PSS to SSS		Config 1,2,3	0	0	
EPRE ratio of PBCH DMRS to SSS					
EPRE ratio of PBCH to PBCH DMRS					
EPRE ratio of PDCCH DMRS to SSS					
EPRE ratio of PDCCH to PDCCH DMRS					
EPRE ratio of PDSCH DMRS to SSS					
EPRE ratio of PDSCH to PDSCH					
EPRE ratio of OCNG DMRS to SSS(Note 1)					
EPRE ratio of OCNG to OCNG DMRS (Note 1)					
$\hat{E}_s$	dBm/S CS	Config 1,2,3	NA Link only, see clause A.3.7A	-Infinity	-87
SSB_RP <sup>Note 3</sup>	dBm/S CS Note5	Config 1,2		-Infinity	-87
		Config 3		-Infinity	-87
$\hat{E}_s / I_{ot\_BB}$ <sup>Note 8</sup>	dB	Config 1,2,3		-Infinity	14.69
	dBm/95 .04 MHz Note5	Config 1,2,3		-Infinity	-58.01
Propagation Condition		Config 1,2,3	AWGN		
<p>Note 1: OCNG shall be used such that both cells are fully allocated and a constant total transmitted power spectral density is achieved for all OFDM symbols.</p> <p>Note 2: Void</p> <p>Note 3: SSB_RP, Es/lot and lo levels have been derived from other parameters for information purposes. They are not settable parameters themselves.</p> <p>Note 4: Void</p> <p>Note 5: Equivalent power received by an antenna with 0 dBi gain at the centre of the quiet zone</p> <p>Note 6: As observed with 0 dBi gain antenna at the centre of the quiet zone</p> <p>Note 7: Information about types of UE beam is given in B.2.1.3, and does not limit UE implementation or test system implementation</p> <p>Note 8: Calculation of Es/lot<sub>BB</sub> includes the effect of UE internal noise up to the value assumed for the associated Refsens requirement in clause 7.3.2 of TS 38.101-2 [19], and an allowance of 1dB for UE multi-band relaxation factor ΔMBs from TS 38.101-2 [19] Table 6.2.1.3-4.</p>					

In test 1 with per-UE gap the UE shall send one Event A4 triggered measurement report, with a measurement reporting delay less than X ms from the beginning of time period T2, where X is

- 5120 for UE supporting power class 1, or
- 3200 for UE supporting other power class.

In test 2, without the gap, the UE shall send one Event A4 triggered measurement report, with a measurement reporting delay less than X ms from the beginning of time period T2, where X is

- 2560 for UE supporting power class 1, or
- 1600 for UE supporting other power class.

In test 1 and 2 UE is not required to report SSB time index. The UE shall not send event triggered measurement reports, as long as the reporting criteria are not fulfilled. The rate of correct events observed during repeated tests shall be at least 90% with a confidence level of 95%.

NOTE: The actual overall delays measured in the test may be up to  $2 \times TTI_{DCCH}$  higher than the measurement reporting delays above because of TTI insertion uncertainty of the measurement report in DCCH.

TTI insertion uncertainty =  $TTI_{DCCH} = 1 \text{ ms}$ ;  $2 \times TTI_{DCCH} = 2 \text{ ms}$

The overall delays measured shall be less than a total of 5122 ms for power class 1 UE and 3202 ms for other power classes in test 1 and 2562 for power class 1 UE and 1602 ms for other power classes in test 2.

### 7.6.2.6 NR SA FR1-FR2 event-triggered reporting in DRX

Editor's Note: This test case has been completed for the following configurations:

- Test frequency  $f \leq 40.8 \text{ GHz}$
- UE PC3
- The test is incomplete for UE power classes other than PC3
- The test is incomplete for test frequencies  $> 40.8 \text{ GHz}$

#### 7.6.2.6.1 Test purpose

The purpose of this test is to verify that the UE makes correct reporting of an event within inter-frequency cell search requirements.

#### 7.6.2.6.2 Test applicability

This test applies to all types of NR UE Release 15 and forward supporting 5GS NR SA FR2 and long DRX cycle.

#### 7.6.2.6.3 Minimum conformance requirements

The minimum conformance requirements are specified in clause 7.6.2.0.

The normative reference for this requirement is TS 38.133 [6] clause A.7.6.2.6.

#### 7.6.2.6.4 Test description

##### 7.6.2.6.4.1 Initial conditions

This test shall be tested using any of the test configurations in Table 7.6.2.6.4.1-1.

**Table 7.6.2.6.4.1-1: SA FR1-FR2 event triggered reporting tests in DRX supported test configurations**

Test Case ID	Description of serving cell	Description of target cell
7.6.2.6-1	NR 15 kHz SSB SCS, 10MHz bandwidth, FDD duplex mode	120 kHz SSB SCS, 100MHz bandwidth, TDD duplex mode
7.6.2.6-2	NR 15 kHz SSB SCS, 10MHz bandwidth, TDD duplex mode	
7.6.2.6-3	NR 30kHz SSB SCS, 40MHz bandwidth, TDD duplex mode	
Note 1: The UE is only required to be tested in one of the supported test configurations		
Note 2: target NR cell has the same SCS, BW and duplex mode as NR serving cell		

**Table 7.6.2.6.4.1-2: General test parameters for SA inter-frequency event triggered reporting for FR2 without SSB time index detection in DRX**

Parameter	Unit	Test configuration	Value				Comment
			Test 1	Test 2	Test 3	Test 4	
NR RF Channel Number		Config 1,2,3	1, 2				Two NR carrier frequencies is used.
Active cell		Config 1,2,3	NR cell 1 (Pcell)				NR Cell 1 is on NR RF channel number 1.
Neighbour cell		Config 1,2,3	NR cell 2				NR cell 2 is on NR RF channel number 2.
Gap Pattern Id		Config 1,2,3	0		Gap not configured		As specified in TS 38.133 [6] clause 9.1.2-1.
Measurement gap offset		Config 1,2,3	39		N/A		
SMTC-SSB parameters on NR RF Channel 1		Config 1	SSB.1 FR1				As specified in clause A.3.1
		Config 2	SSB.1 FR1				As specified in clause A.3.1
		Config 3	SSB.2 FR1				As specified in clause A.3.1
SMTC-SSB parameters on NR RF Channel 2		Config 1,2,3	SSB.3 FR2				As specified in clause A.3.2
<i>offsetMO</i>	dB	Config 1,2,3	6				
Hysteresis	dB	Config 1,2,3	0				
<i>a4-Threshold</i>	dBm	Config 1,2,3	-105				
CP length		Config 1,2,3	Normal				
TimeToTrigger	s	Config 1,2,3	0				
Filter coefficient		Config 1,2,3	0				L3 filtering is not used
DRX		Config 1,2,3	DRX .1	DRX .2	DRX .1	DRX .2	DRX is used
Time offset between serving and neighbour cells		Config 1	3ms				Asynchronous cells. The timing of Cell 2 is 3ms later than the timing of Cell 1.
		Config 2,3	3µs				Synchronous cells.
T1	s	Config 1,2,3	5				
T2	s	Config 1,2,3	8 for PC1; 5 for other PC	82 for PC1; 52 for other PC	8 for PC1; 5 for other PC	82 for PC1; 52 for other PC	PC1 - power class 1 as specified in TS 38.101-2 [3] Table 6.2.1.0

**Table 7.6.2.6.4-3: Test Environment parameters for SA inter-frequency event triggered reporting without SSB time index detection in DRX**

Parameter	Value		Comment
Test environment	NC		As specified in TS 38.508-1 [14] clause 4.1.
Test frequencies	As specified in Annex E, Table E.2-1 and TS 38.508-1 [14] clause 4.3.1 and 4.4.2.		
Channel bandwidth	As specified by the test configuration selected from Table 7.6.2.6.4.1-1.		
Propagation conditions	AWGN		As specified in Annex C.2.2.
Connection Diagram	TE Part	A.3.3.3.1	As specified in TS 38.508-1 [14] Annex A.
	DUT Part	A.3.4.1.1	
Exceptions to connection diagram			

1. Message contents are defined in clause 7.6.2.6.4.3.
2. There are two NR cells on two carriers specified in the test. Cell 1 is the cell used for connection setup and Cell 2 is a target cell on a different carrier than Cell 1. The power levels and settings for Cell 2 are set according to Annex C.1.2.
3. If a UE supports per-FR gap it is only required to pass test 3&4. Otherwise it is only required to pass test 1&2.
4. The UE Rx beam peak direction for Cell 2 has been obtained previously using one of the Rx beam peak search procedures as described in Annex I.7.6.2.6.4.2 Test procedure

In this test, there are two cells: NR cell 1 as PCell in FR1 on NR RF channel 2 and NR cell 2 as neighbour cell in FR2 on NR RF channel 2.

In test 1&2 measurement gap pattern configuration # 0 as defined in Table 7.6.2.6.4.1-2 is provided for a UE that does not support per-FR gap and in test 3&4 measurement gap pattern configuration #13 as defined in Table 7.6.2.6.4.1-2 is provided for UE that support per-FR gap.

In the measurement control information, it is indicated to the UE that event-triggered reporting with Event A3 is used. The test consists of two successive time periods, with time duration of T1, and T2 respectively. During time duration T1, the UE shall not have any timing information of NR cell 3.

UE needs to be provided at least once every 500ms with new Timing Advance Command MAC control element to restart the Time alignment timer to keep UE uplink time alignment. Furthermore UE is allocated with PUSCH resource at every DRX cycle.

1. Ensure the UE is in state RRC\_CONNECTED with generic procedure parameters Connectivity NR SA, Connected without release *On* according to TS 38.508-1 [14] clause 4.5.
2. Set the parameters according to T1 in Table 7.6.2.6.4.1-2. The TE shall ensure that the NR FR2 cell will be received by the UE from the Rx beam peak direction. T1 starts.
3. The SS shall transmit an *RRCReconfiguration* message.
4. The UE shall transmit *RRCReconfigurationComplete* message.
5. When T1 expires, the SS shall switch the power setting from T1 to T2 as specified in Table 7.6.2.6.4.1-2.
6. UE shall transmit a *MeasurementReport* message triggered by Event A3. If the overall delays measured from the beginning of time period T2 is less than 7682 ms for UE supporting power class 1, or 4802 ms for UE supporting other power class for Test 1 and Test 3 and 81922 ms for UE supporting power class 1, or 51202 ms for UE supporting other power class for Test 2 and Test 4, then the number of successful tests is increased by one. If the UE fails to report the event within the overall delays measured requirement then the number of failure tests is increased by one.
7. After the SS receives the *MeasurementReport* message in step 6 or when T2 expires, the SS shall transmit *RRCRelease* message to release the RRC connection which includes the release of the established radio bearers as well as all radio resources.



8. Set Cell 2 physical cell identity = [(current cell 2 physical cell identity + 1) mod 1008] for next iteration of the test procedure loop.]

9. After the RRC connection release, the SS:

- transmits in Cell 1 a *Paging* message (including PagingRecord with ue-Identity) for the UE and ensures the UE in state RRC\_CONNECTED with generic procedure parameters Connectivity NR SA, Connected without release *On* according to TS 38.508-1 [14] clause 4.5. (if the paging fails, switches off and on the UE and ensures the UE is in state RRC\_CONNECTED with generic procedure parameters Connectivity NR SA, Connected without release *On* according to TS 38.508-1 [14] clause 4.5.),

or:

- switches off and on the UE and ensures the UE is in state RRC\_CONNECTED with generic procedure parameters Connectivity NR SA, Connected without release *On* according to TS 38.508-1 [14] clause 4.5.

10. Repeat step 2-9 until the confidence level according to Tables G.2.3-1 in Annex G clause G.2 is achieved.

11. Repeat step 1-10 for each sub-test in Table 7.6.2.6.4.1-2 as appropriate.

7.6.2.6.4.3 Message contents

Message contents are according to TS 38.508-1 [14] clause TBD with the following exceptions:

**Table 7.6.2.6.4.3-1: Common Exception messages SA inter frequency event triggered reporting without SSB time index detection in DRX**

Default Message Contents	
Common contents of system information blocks exceptions	
Default RRC messages and information elements contents exceptions	Table H.3.1-1 Table H.3.1-2 with Conditions GAP NEEDED and INTER-FREQ for Test 1 and Test 2 Table H.3.1-2 with Condition INTER-FREQ for Test 3 and Test 4 Table H.3.1-3 with Conditions INTER-FREQ MO and Synchronous cells Table H.3.1-4AA with A4-threshold= -105dB Table H.3.1-5 Table H.3.1-6 with Conditions gapUE and Pattern #0 for Test 1 and Test 2 Table H.3.1-7 with Condition INTER-FREQ Table H.3.7-1 with Condition DRX.1 for Test 1 and Test 3 and DRX.2 for Test 2 and Test 4

**Table 7.6.2.6.4.3-2: MeasObjectNR-DEFAULT: SA FR1-FR2 measurement object configuration**

Derivation Path: Table H.3.1-3			
Information Element	Value/remark	Comment	Condition
MeasObjectNR ::= SEQUENCE {			
offsetMO SEQUENCE {			
rsrpOffsetSSB	dB6		
}			

7.6.2.6.5 Test requirement

Table 7.6.2.6.5-1 defines the primary level settings including test tolerances for all tests.

**Table 7.6.2.6.5-1: Cell specific test parameters for SA inter-frequency event triggered reporting for FR2 without SSB time index detection**

Parameter		Unit	Test configuration	Cell 1		Cell 2	
				T1	T2	T1	T2
AoA setup			Config 1,2,3	NA		Setup 1 as specified in clause A.9	
NR RF Channel Number			Config 1,2,3	1		2	
Duplex mode			Config 1	FDD		TDD	
			Config 2,3	TDD		TDD	
TDD configuration			Config 1	Not Applicable		TDDConf.3.1	
			Config 2	TDDConf.1.1		TDDConf.3.1	
			Config 3	TDDConf.2.1		TDDConf.3.1	
BW <sub>channel</sub>		MHz	Config 1	10: N <sub>RB,c</sub> = 52		100: N <sub>RB,c</sub> = 66	
			Config 2	10: N <sub>RB,c</sub> = 52		100: N <sub>RB,c</sub> = 66	
			Config 3	40: N <sub>RB,c</sub> = 106		100: N <sub>RB,c</sub> = 66	
BWP BW		MHz	Config 1	10: N <sub>RB,c</sub> = 52		100: N <sub>RB,c</sub> = 66	
			Config 2	10: N <sub>RB,c</sub> = 52		100: N <sub>RB,c</sub> = 66	
			Config 3	40: N <sub>RB,c</sub> = 106		100: N <sub>RB,c</sub> = 66	
BWP configuration	Initial DL BWP		Config 1,2,3	DLBWP.0.1		N/A	
	Initial UL BWP			ULBWP.0.1		N/A	
	Dedicated DL BWP			DLBWP.1.1		N/A	
	Dedicated UL BWP			ULBWP.1.1		N/A	
OCNG Patterns			Config 1,2,3	OP.1		OP.1	
PDSCH Reference measurement channel			Config 1	SR.1.1 FDD		-	
			Config 2	SR.1.1 TDD			
			Config 3	SR2.1 TDD			
RMSI CORESET Reference Channel			Config 1	CR.1.1 FDD		-	
			Config 2	CR.1.1 TDD			
			Config 3	CR2.1 TDD			
Dedicated CORESET RMC configuration			Config 1	CCR.1.1 FDD		CCR.3.1 TDD	
			Config 2	CCR.1.1 TDD		CCR.3.1 TDD	
			Config 3	CCR.2.1 TDD		CCR.3.1 TDD	

SMTC configuration		Config 1	SMTC.2	SMTC.2
		Config 2,3	SMTC.1	SMTC.1
PDSCH/PDCCH subcarrier spacing	kHz	Config 1,2	15	120
		Config 3	30	120
EPRE ratio of PSS to SSS		Config 1,2,3	0	0
EPRE ratio of PBCH DMRS to SSS				
EPRE ratio of PBCH to PBCH DMRS				
EPRE ratio of PDCCH DMRS to SSS				
EPRE ratio of PDCCH to PDCCH DMRS				
EPRE ratio of PDSCH DMRS to SSS				
EPRE ratio of PDSCH to PDSCH				
EPRE ratio of OCNG DMRS to SSS(Note 1)				
EPRE ratio of OCNG to OCNG DMRS (Note 1)				
$N_{oc}$ <sup>Note2</sup>	dBm/15 kHz Note5			
$N_{oc}$ <sup>Note2</sup>	dBm/S CS Note4	Config 1,2	-95.7	
		Config 3	-95.7	
SSB_RP <sup>Note 3</sup>	dBm/S CS Note5	Config 1,2	-Infinity	-86.7
		Config 3	-Infinity	-86.7
$\hat{E}_s/I_{ot}$	dB	Config 1,2,3	-Infinity	9
$\hat{E}_s/N_{oc}$	dB	Config 1,2,3	-Infinity	9
$I_o$ <sup>Note3</sup>	dBm/9.36MHz	Config 1,2	-	-
	dBm/38.16MHz	Config 3	-	-
	dBm/95.04 MHz Note5	Config 1,2,3	-66.7	-57.2
Propagation Condition		Config 1,2,3	AWGN	
<p>Note 1: OCNG shall be used such that both cells are fully allocated and a constant total transmitted power spectral density is achieved for all OFDM symbols.</p> <p>Note 2: Interference from other cells and noise sources not specified in the test is assumed to be constant over subcarriers and time and shall be modelled as AWGN of appropriate power for <math>N_{oc}</math> to be fulfilled.</p> <p>Note 3: SSB_RP and <math>I_o</math> levels have been derived from other parameters for information purposes. They are not settable parameters themselves.</p> <p>Note 4: SSB_RP minimum requirements are specified assuming independent interference and noise at each receiver antenna port.</p> <p>Note 5: Equivalent power received by an antenna with 0 dBi gain at the centre of the quiet zone</p> <p>Note 6: As observed with 0 dBi gain antenna at the centre of the quiet zone</p>				

In test 1 with per-UE gap and in test 3 without the gap, the UE shall send one Event A3 triggered measurement report, with a measurement reporting delay less than  $X1$  ms from the beginning of time period T2, where  $X1$  is

7680 for UE supporting power class 1, or

4800 for UE supporting other power class.

In test 2 with per-UE gap and in test 4 without the gap, the UE shall send one Event A3 triggered measurement report, with a measurement reporting delay less than  $X2$  ms from the beginning of time period T2, where  $X2$  is

81920 for UE supporting power class 1, or

51200 for UE supporting other power class.

In test 1, 2, 3 and 4 UE is not required to report SSB time index. The UE shall not send event triggered measurement reports, as long as the reporting criteria are not fulfilled. The rate of correct events observed during repeated tests shall be at least 90% with a confidence level of 95%.

NOTE: The actual overall delays measured in the test may be up to  $2xTTI_{DCCH}$  higher than the measurement reporting delays above because of TTI insertion uncertainty of the measurement report in DCCH.

TTI insertion uncertainty =  $TTI_{DCCH} = 1$  ms;  $2xTTI_{DCCH} = 2$  ms

The overall delays measured shall be less than a total of 7682 ms for power class 1 UE and 4802 ms for other power classes in test 1 and test 3 and 81922 for power class 1 UE and 51202 ms for other power classes in test 2 and test 4.

### 7.6.2.7 NR SA FR1-FR2 event-triggered reporting in non-DRX with SSB time index detection

Editor's Note: This test case has been completed for the following configurations:

- Test frequency  $f \leq 40.8$  GHz
- UE PC3
- The test is incomplete for UE power classes other than PC3
- The test is incomplete for test frequencies  $> 40.8$  GHz

#### 7.6.2.7.1 Test purpose

The purpose of this test is to verify that the UE makes correct reporting of an event within inter-frequency cell search requirements.

#### 7.6.2.7.2 Test applicability

This test applies to all types of NR UE from Release 15 onwards.

#### 7.6.2.7.3 Minimum conformance requirements

The minimum conformance requirements are specified in clause 7.6.2.0.

The normative reference for this requirement is TS 38.133 [6] clause A.7.6.2.7.

#### 7.6.2.7.4 Test description

##### 7.6.2.7.4.1 Initial conditions

This test shall be tested using any of the test configurations in Table 7.6.2.7.4.1-1.

**Table 7.6.2.7.4.1-1: SA FR1-FR2 event triggered reporting tests in non-DRX with SSB time index detection supported test configurations**

Test Case ID	Description of serving cell	Description of target cell
7.6.2.7-1	NR 15 kHz SSB SCS, 10MHz bandwidth, FDD duplex mode	120 kHz SSB SCS, 100MHz bandwidth, TDD duplex mode
7.6.2.7-2	NR 15 kHz SSB SCS, 10MHz bandwidth, TDD duplex mode	
7.6.2.7-3	NR 30kHz SSB SCS, 40MHz bandwidth, TDD duplex mode	
Note 1: The UE is only required to be tested in one of the supported test configurations		
Note 2: target NR cell has the same SCS, BW and duplex mode as NR serving cell		

**Table 7.6.2.7.4.1-2: General test parameters for SA inter-frequency event triggered reporting for FR2 with SSB time index detection in non-DRX**

Parameter	Unit	Test configuration	Value		Comment
			Test 1	Test 2	
NR RF Channel Number		Config 1,2,3	1, 2		Two NR carrier frequencies is used
Active cell		Config 1,2,3	NR cell 1 (Pcell)		NR Cell 1 is on NR RF channel number 1.
Neighbour cell		Config 1,2,3	NR cell 2		NR cell 2 is on NR RF channel number 2.
Gap Pattern Id		Config 1,2,3	0	Gap not configured	As specified in TS 38.133 [6] clause 9.1.2-1
Measurement gap offset		Config 1,2,3	39	N/A	
SMTC-SSB parameters on NR RF Channel 1		Config 1	SSB.1 FR1		As specified in clause A.3.1
		Config 2	SSB.1 FR1		As specified in clause A.3.1
		Config 3	SSB.2 FR1		As specified in clause A.3.1
SMTC-SSB parameters on NR RF Channel 2		Config 1,2,3	SSB.3 FR2		As specified in clause A.3.2
<i>offsetMO</i>	dB	Config 1,2,3	6		
Hysteresis	dB	Config 1,2,3	0		
<i>a4-Threshold</i>	dBm	Config 1,2,3,4,5,6	-105		
CP length		Config 1,2,3	Normal		
TimeToTrigger	s	Config 1,2,3	0		
Filter coefficient		Config 1,2,3	0		L3 filtering is not used
DRX		Config 1,2,3	OFF		DRX is not used
Time offset between serving and neighbour cells		Config 1	3ms		Asynchronous cells. The timing of Cell 2 is 3ms later than the timing of Cell 1.
		Config 2,3	3μs		Synchronous cells
T1	s	Config 1,2,3	5		
T2	s	Config 1,2,3	7 for PC1; 4.5 for other PC	3.5 for PC1; 2.5 for other PC	PC1 - power class 1 as specified in TS 38.101-2 [3] Table 6.2.1.0

**Table 7.6.2.7.4.1-3: Test Environment parameters for SA inter-frequency event triggered reporting with SSB time index detection in non-DRX**

Parameter	Value		Comment
Test environment	NC		As specified in TS 38.508-1 [14] clause 4.1.
Test frequencies	As specified in Annex E, Table E.2-1 and TS 38.508-1 [14] clause 4.3.1 and 4.4.2.		
Channel bandwidth	As specified by the test configuration selected from Table 7.6.2.7.4.1-1.		
Propagation conditions	AWGN		As specified in Annex C.2.2.
Connection Diagram	TE Part	A.3.3.3.1	As specified in TS 38.508-1 [14] Annex A.
	DUT Part	A.3.4.1.1	
Exceptions to connection diagram			

1. Message contents are defined in clause 7.6.2.7.4.3.
2. There are two NR cells on two carriers specified in the test. Cell 1 is the cell used for connection setup and Cell 2 is a target cell on a different carrier than Cell 1. The power levels and settings for Cell 2 are set according to Annex C.1.2.
3. If a UE supports per-FR gap it is only required to pass test 2. Otherwise it is only required to pass test 1.
4. The UE Rx beam peak direction for Cell 2 has been obtained previously using one of the Rx beam peak search procedures as described in Annex I.

#### 7.6.2.7.4.2 Test procedure

The purpose of this test is to verify that the UE makes correct reporting of an event. This test will partly verify the SA inter-frequency NR cell search requirements in clause 9.3.4.

In this test, there are two cells: NR cell 1 as PCell in FR1 on NR RF channel 2 and NR cell 2 as neighbour cell in FR2 on NR RF channel 2.

In test 1 measurement gap pattern configuration # 0 as defined in Table 7.6.2.7.4.1-2 is provided for a UE that does not support per-FR gap and in test 2 measurement gap pattern configuration #13 as defined in Table 7.6.2.7.4.1-2 is provided for UE that support per-FR gap.

In the measurement control information, it is indicated to the UE that event-triggered reporting with Event A3 is used. The test consists of two successive time periods, with time duration of T1, and T2 respectively. During time duration T1, the UE shall not have any timing information of NR cell 3.

1. Ensure the UE is in state RRC\_CONNECTED with generic procedure parameters Connectivity NR SA, Connected without release *On* according to TS 38.508-1 [14] clause 4.5.
2. Set the parameters according to T1 in Table 7.6.2.7.4.1-2. The TE shall ensure that the NR FR2 cell will be received by the UE from the Rx beam peak direction. T1 starts.
3. The SS shall transmit an *RRCReconfiguration* message.
4. The UE shall transmit *RRCReconfigurationComplete* message.
5. When T1 expires, the SS shall switch the power setting from T1 to T2 as specified in Table 7.6.2.7.4.1-2.
6. UE shall transmit a *MeasurementReport* message triggered by Event A3. If the overall delays measured from the beginning of time period T2 is less than 6722 ms for UE supporting power class 1, or 4162 ms for UE supporting other power class for Test 1 and 3362 ms for UE supporting power class 1, or 2082 ms for UE supporting other power class for Test 2 then the number of successful tests is increased by one. If the UE fails to report the event within the overall delays measured requirement then the number of failure tests is increased by one.
7. After the SS receives the *MeasurementReport* message in step 6 or when T2 expires, the SS shall transmit *RRCRelease* message to release the RRC connection which includes the release of the established radio bearers as well as all radio resources.

8. Set Cell 2 physical cell identity = [(current cell 2 physical cell identity + 1) mod 1008] for next iteration of the test procedure loop.]

9. After the RRC connection release, the SS:

- transmits in Cell 1 a *Paging* message (including PagingRecord with ue-Identity) for the UE and ensures the UE in state RRC\_CONNECTED with generic procedure parameters Connectivity NR SA, Connected without release *On* according to TS 38.508-1 [14] clause 4.5. (if the paging fails, switches off and on the UE and ensures the UE is in state RRC\_CONNECTED with generic procedure parameters Connectivity NR SA, Connected without release *On* according to TS 38.508-1 [14] clause 4.5.),

or:

- switches off and on the UE and ensures the UE is in state RRC\_CONNECTED with generic procedure parameters Connectivity NR SA, Connected without release *On* according to TS 38.508-1 [14] clause 4.5.

10. Repeat step 2-9 until the confidence level according to Tables G.2.3-1 in Annex G clause G.2 is achieved.

11. Repeat step 1-10 for each sub-test in Table 7.6.2.7.4.1-2 as appropriate.

7.6.2.7.4.3 Message contents

Message contents are according to TS 38.508-1 [14] clause TBD with the following exceptions:

**Table 7.6.2.7.4.3-1: Common Exception messages SA inter frequency event triggered reporting with SSB time index detection in non-DRX**

Default Message Contents	
Common contents of system information blocks exceptions	
Default RRC messages and information elements contents exceptions	Table H.3.1-1 Table H.3.1-2 with Conditions GAP NEEDED and INTER-FREQ for Test 1 Table H.3.1-2 with Condition INTER-FREQ for Test 2 Table H.3.1-3 with Conditions INTER-FREQ MO and Synchronous cells Table H.3.1-4AA with Condition SSB Index and A4-threshold= -105dB Table H.3.1-5 Table H.3.1-6 with Conditions gapUE and Pattern #0 for Test 1 Table H.3.1-7 with Condition INTER-FREQ

**Table 7.6.2.7.4.3-2: MeasObjectNR-DEFAULT: SA FR1-FR2 measurement object configuration**

Derivation Path: Table H.3.1-3			
Information Element	Value/remark	Comment	Condition
MeasObjectNR ::= SEQUENCE {			
offsetMO SEQUENCE {			
rsrpOffsetSSB	dB6		
}			

7.6.2.7.5 Test requirement

Table 7.6.2.7.5-1 defines the primary level settings including test tolerances for all tests.

**Table 7.6.2.7.5-1: Cell specific test parameters for SA inter-frequency event triggered reporting for FR2 with SSB time index detection**

Parameter		Unit	Test configuration	Cell 1		Cell 2	
				T1	T2	T1	T2
AoA setup			Config 1,2,3	NA		Setup 1 as specified in clause A.9	
Beam Assumption <sup>Note 7</sup>			Config 1,2,3	N/A		Rough	
NR RF Channel Number			Config 1,2,3	1		2	
Duplex mode			Config 1	FDD		TDD	
			Config 2,3	TDD		TDD	
TDD configuration			Config 1	Not Applicable		TDDConf.3.1	
			Config 2	TDDConf.1.1		TDDConf.3.1	
			Config 3	TDDConf.2.1		TDDConf.3.1	
BW <sub>channel</sub>		MHz	Config 1	10: N <sub>RB,c</sub> = 52		100: N <sub>RB,c</sub> = 66	
			Config 2	10: N <sub>RB,c</sub> = 52		100: N <sub>RB,c</sub> = 66	
			Config 3	40: N <sub>RB,c</sub> = 106		100: N <sub>RB,c</sub> = 66	
BWP BW		MHz	Config 1	10: N <sub>RB,c</sub> = 52		100: N <sub>RB,c</sub> = 66	
			Config 2	10: N <sub>RB,c</sub> = 52		100: N <sub>RB,c</sub> = 66	
			Config 3	40: N <sub>RB,c</sub> = 106		100: N <sub>RB,c</sub> = 66	
BWP configuration	Initial DL BWP		Config 1,2,3	DLBWP.0.1		N/A	
	Initial UL BWP			ULBWP.0.1		N/A	
	Dedicated DL BWP			DLBWP.1.1		N/A	
	Dedicated UL BWP			ULBWP.1.1		N/A	
OCNG Patterns			Config 1,2,3	OP.1		OP.1	
PDSCH Reference measurement channel			Config 1	SR.1.1 FDD		-	
			Config 2	SR.1.1 TDD			
			Config 3	SR.2.1 TDD			
RMSI CORESET Reference Channel			Config 1	CR.1.1 FDD		-	
			Config 2	CR.1.1 TDD			
			Config 3	CR.2.1 TDD			
Dedicated CORESET RMC configuration			Config 1	CCR.1.1 FDD		CCR.3.1 TDD	
			Config 2	CCR.1.1 TDD		CCR.3.1 TDD	
			Config 3	CCR.2.1 TDD		CCR.3.1 TDD	
SMTC configuration			Config 1	SMTC.2		SMTC.2	
			Config 2,3	SMTC.1		SMTC.1	
PDSCH/PDCCH subcarrier spacing		kHz	Config 1,2	15		120	
			Config 3	30		120	



EPRE ratio of PSS to SSS		Config 1,2,3	0	0	
EPRE ratio of PBCH DMRS to SSS					
EPRE ratio of PBCH to PBCH DMRS					
EPRE ratio of PDCCH DMRS to SSS					
EPRE ratio of PDCCH to PDCCH DMRS					
EPRE ratio of PDSCH DMRS to SSS					
EPRE ratio of PDSCH to PDSCH					
EPRE ratio of OCNG DMRS to SSS(Note 1)					
EPRE ratio of OCNG to OCNG DMRS (Note 1)					
$\hat{E}_s$	dBm/S CS	Config 1,2, 3	NA Link only, see clause A.3.7A	-Infinity	-87
SSB_RP <sup>Note 3</sup>	dBm/S CS Note5	Config 1,2 Config 3		-Infinity	-87
$\hat{E}_s / I_{ot\ BB}$ <sup>Note 8</sup>	dB	Config 1,2,3		-Infinity	14.69
	dBm/95 .04 MHz Note5	Config 1,2,3		Infinity	-58.01
Propagation Condition		Config 1,2,3		AWGN	
<p>Note 1: OCNG shall be used such that both cells are fully allocated and a constant total transmitted power spectral density is achieved for all OFDM symbols.</p> <p>Note 2: Void</p> <p>Note 3: SSB_RP, Es/lot and lo levels have been derived from other parameters for information purposes. They are not settable parameters themselves.</p> <p>Note 4: Void</p> <p>Note 5: Equivalent power received by an antenna with 0 dBi gain at the centre of the quiet zone</p> <p>Note 6: As observed with 0 dBi gain antenna at the centre of the quiet zone</p> <p>Note 7: Information about types of UE beam is given in B.2.1.3, and does not limit UE implementation or test system implementation</p> <p>Note 8: Calculation of Es/lot<sub>BB</sub> includes the effect of UE internal noise up to the value assumed for the associated Refsens requirement in clause 7.3.2 of TS 38.101-2 [19], and an allowance of 1dB for UE multi-band relaxation factor ΔMB<sub>s</sub> from TS 38.101-2 [19] Table 6.2.1.3-4.</p>					

In test 1 with per-UE gap , the UE shall send one Event A3 triggered measurement report, with a measurement reporting delay less than X ms from the beginning of time period T2, where X is

- 6720 for UE supporting power class 1, or
- 4160 for UE supporting other power class.

In test 2 without the gap, the UE shall send one Event A4 triggered measurement report, with a measurement reporting delay less than X ms from the beginning of time period T2, where X is

- 3360 for UE supporting power class 1, or
- 2080 for UE supporting other power class.

In test 1 and 2 UE is required to report SSB time index. The UE shall not send event triggered measurement reports, as long as the reporting criteria are not fulfilled. The rate of correct events observed during repeated tests shall be at least 90% with a confidence level of 95%.

NOTE: The actual overall delays measured in the test may be up to 2xTTI<sub>DCCH</sub> higher than the measurement reporting delays above because of TTI insertion uncertainty of the measurement report in DCCH.

TTI insertion uncertainty = TTIDCCH = 1 ms; 2xTTIDCCH = 2 ms

The overall delays measured shall be less than a total of 6722 ms for power class 1 UE and 4162 ms for other power classes in test 1 and 3362 for power class 1 UE and 2082 ms for other power classes in test 2

## 7.6.2.8 NR SA FR1-FR2 event-triggered reporting in DRX with SSB time index detection

**Editor's Note:** This test case has been completed for the following configurations:

- Test frequency  $f \leq 40.8$  GHz
- UE PC3
- The test is incomplete for UE power classes other than PC3
- The test is incomplete for test frequencies  $> 40.8$  GHz

### 7.6.2.8.1 Test purpose

The purpose of this test is to verify that the UE makes correct reporting of an event within inter-frequency cell search requirements.

### 7.6.2.8.2 Test applicability

This test applies to all types of NR UE Release 15 and forward supporting 5GS NR SA FR2 and long DRX cycle.

### 7.6.2.8.3 Minimum conformance requirements

The minimum conformance requirements are specified in clause 7.6.2.0.

The normative reference for this requirement is TS 38.133 [6] clause A.7.6.2.8.

### 7.6.2.8.4 Test description

#### 7.6.2.8.4.1 Initial conditions

This test shall be tested using any of the test configurations in Table 7.6.2.8.4.1-1.

**Table 7.6.2.8.4.1-1: SA FR1-FR2 event triggered reporting tests in DRX with SSB time index detection supported test configurations**

Test Case ID	Description of serving cell	Description of target cell
7.6.2.8-1	NR 15 kHz SSB SCS, 10MHz bandwidth, FDD duplex mode	120 kHz SSB SCS, 100MHz bandwidth, TDD duplex mode
7.6.2.8-2	NR 15 kHz SSB SCS, 10MHz bandwidth, TDD duplex mode	
7.6.2.8-3	NR 30kHz SSB SCS, 40MHz bandwidth, TDD duplex mode	
Note 1: The UE is only required to be tested in one of the supported test configurations		
Note 2: target NR cell has the same SCS, BW and duplex mode as NR serving cell		

**Table 7.6.2.8.4.1-2: General test parameters for SA inter-frequency event triggered reporting for FR2 with SSB time index detection in DRX**

Parameter	Unit	Test configuration	Value				Comment
			Test 1	Test 2	Test 3	Test 4	
NR RF Channel Number		Config 1,2,3	1, 2				Two NR carrier frequencies is used.
Active cell		Config 1,2,3	NR cell 1 (Pcell)				NR Cell 1 is on NR RF channel number 1.
Neighbour cell		Config 1,2,3	NR cell 2				NR cell 2 is on NR RF channel number 2.
Gap Pattern Id		Config 1,2,3	0	Gap not configured			As specified in TS 38.133 [6] clause 9.1.2-1.
Measurement gap offset		Config 1,2,3	39	N/A			
SMTC-SSB parameters on NR RF Channel 1		Config 1	SSB.1 FR1				As specified in clause A.3.1
		Config 2	SSB.1 FR1				As specified in clause A.3.1
		Config 3	SSB.2 FR1				As specified in clause A.3.1
SMTC-SSB parameters on NR RF Channel 2		Config 1,2,3	SSB.3 FR2				As specified in clause A.3.2
<i>offsetMO</i>	dB	Config 1,2,3	6				
Hysteresis	dB	Config 1,2,3	0				
<i>a4-Threshold</i>	dBm	Config 1,2,3	-105				
CP length		Config 1,2,3	Normal				
TimeToTrigger	s	Config 1,2,3	0				
Filter coefficient		Config 1,2,3	0				L3 filtering is not used
DRX		Config 1,2,3	DRX .1	DRX .2	DRX .1	DRX .2	DRX is used
Time offset between serving and neighbour cells		Config 1	3ms				Asynchronous cells. The timing of Cell 2 is 3ms later than the timing of Cell 1.
		Config 2,3	3µs				Synchronous cells.
T1	s	Config 1,2,3	5				
T2	s	Config 1,2,3	11 for PC1; 6.5 for other PCT BD	108 for PC1; 67 for other PCT BD	11 for PC1; 6.5 for other PCT BD	108 for PC1; 67 for other PCT BD	PC1 - power class 1 as specified in TS 38.101-2 [3] Table 6.2.1.0

**Table 7.6.2.8.4-3: Test Environment parameters for SA inter-frequency event triggered reporting with SSB time index detection in DRX**

Parameter	Value		Comment
Test environment	NC		As specified in TS 38.508-1 [14] clause 4.1.
Test frequencies	As specified in Annex E, Table E.2-1 and TS 38.508-1 [14] clause 4.3.1 and 4.4.2.		
Channel bandwidth	As specified by the test configuration selected from Table 7.6.2.8.4.1-1.		
Propagation conditions	AWGN		As specified in Annex C.2.2.
Connection Diagram	TE Part	A.3.3.3.1	As specified in TS 38.508-1 [14] Annex A.
	DUT Part	A.3.4.1.1	
Exceptions to connection diagram			

1. Message contents are defined in clause 7.6.2.8.4.3.
2. There are two NR cells on two carriers specified in the test. Cell 1 is the cell used for connection setup and Cell 2 is a target cell on a different carrier than Cell 1. The power levels and settings for Cell 2 are set according to Annex C.1.2.
3. If a UE supports per-FR, it is only required to pass test 3&4. Otherwise it is only required to pass test 1&2.
4. The UE Rx beam peak direction for Cell 2 has been obtained previously using one of the Rx beam peak search procedures as described in Annex I.

#### 7.6.2.8.4.2 Test procedure

In this test, there are two cells: NR cell 1 as PCell in FR1 on NR RF channel 2 and NR cell 2 as neighbour cell in FR2 on NR RF channel 2.

In test 1&2 measurement gap pattern configuration # 0 as defined in Table 7.6.2.8.4.1-2 is provided for a UE that does not support per-FR gap and in test 3&4 measurement gap pattern configuration #13 as defined in Table 7.6.2.8.4.1-2 is provided for UE that support per-FR gap.

In the measurement control information, it is indicated to the UE that event-triggered reporting with Event A3 is used. The test consists of two successive time periods, with time duration of T1, and T2 respectively. During time duration T1, the UE shall not have any timing information of NR cell 3.

1. Ensure the UE is in state RRC\_CONNECTED with generic procedure parameters Connectivity NR SA, Connected without release *On* according to TS 38.508-1 [14] clause 4.5.
2. Set the parameters according to T1 in Table 7.6.2.8.4.1-2. The TE shall ensure that the NR FR2 cell will be received by the UE from the Rx beam peak direction. T1 starts.
3. The SS shall transmit an *RRCReconfiguration* message.
4. The UE shall transmit *RRCReconfigurationComplete* message.
5. When T1 expires, the SS shall switch the power setting from T1 to T2 as specified in Table 7.6.2.8.4.1-2.
6. UE shall transmit a *MeasurementReport* message triggered by Event A3. If the overall delays measured from the beginning of time period T2 is less than 10082 ms for UE supporting power class 1, or 6242 ms for UE supporting other power class for Test 1 and Test 3 and 107522 ms for UE supporting power class 1, or 66562 ms for UE supporting other power class for Test 2 and Test 4 then the number of successful tests is increased by one. If the UE fails to report the event within the overall delays measured requirement then the number of failure tests is increased by one.
7. After the SS receives the *MeasurementReport* message in step 6 or when T2 expires, the SS shall transmit *RRCRelease* message to release the RRC connection which includes the release of the established radio bearers as well as all radio resources.
8. Set Cell 2 physical cell identity = [(current cell 2 physical cell identity + 1) mod 1008] for next iteration of the test procedure loop.]

9. After the RRC connection release, the SS:

- transmits in Cell 1 a *Paging* message (including PagingRecord with ue-Identity) for the UE and ensures the UE in state RRC\_CONNECTED with generic procedure parameters Connectivity NR SA, Connected without release *On* according to TS 38.508-1 [14] clause 4.5. (if the paging fails, switches off and on the UE and ensures the UE is in state RRC\_CONNECTED with generic procedure parameters Connectivity NR SA, Connected without release *On* according to TS 38.508-1 [14] clause 4.5.),

or:

- switches off and on the UE and ensures the UE is in state RRC\_CONNECTED with generic procedure parameters Connectivity NR SA, Connected without release *On* according to TS 38.508-1 [14] clause 4.5.

10. Repeat step 2-9 until the confidence level according to Tables G.2.3-1 in Annex G clause G.2 is achieved.

11. Repeat step 1-10 for each sub-test in Table 7.6.2.8.4.1-2 as appropriate.

7.6.2.8.4.3 Message contents

Message contents are according to TS 38.508-1 [14] clause TBD with the following exceptions:

**Table 7.6.2.8.4.3-1: Common Exception messages SA inter frequency event triggered reporting with SSB time index detection in DRX**

Default Message Contents	
Common contents of system information blocks exceptions	
Default RRC messages and information elements contents exceptions	Table H.3.1-1 Table H.3.1-2 with Conditions GAP NEEDED and INTER-FREQ for Test 1 and Test 2 Table H.3.1-2 with Condition INTER-FREQ for Test 3 and Test 4 Table H.3.1-3 with Conditions INTER-FREQ MO and Synchronous cells Table H.3.1-4AA with Condition SSB Index and A4-threshold= -105dB Table H.3.1-5 Table H.3.1-6 with Conditions gapUE and Pattern #0 for Test 1 and Test 2 Table H.3.1-7 with Condition INTER-FREQ Table H.3.7-1 with Condition DRX.1 for Test 1 and Test 3 and DRX.2 for Test 2 and Test 4

**Table 7.6.2.8.4.3-2: MeasObjectNR-DEFAULT: SA FR1-FR2 measurement object configuration**

Derivation Path: Table H.3.1-3			
Information Element	Value/remark	Comment	Condition
MeasObjectNR ::= SEQUENCE {			
offsetMO SEQUENCE {			
rsrpOffsetSSB	dB6		
}			

7.6.2.8.5 Test requirement

Table 7.6.2.8.5-1 defines the primary level settings including test tolerances for all tests.

**Table 7.6.2.8.5-1: Cell specific test parameters for SA inter-frequency event triggered reporting for FR2 with SSB time index detection in DRX**

Parameter		Unit	Test configuration	Cell 1		Cell 2	
				T1	T2	T1	T2
AoA setup			Config 1,2,3	NA		Setup 1 as specified in clause A.9	
Beam Assumption <sup>Note 7</sup>			Config 1,2,3	N/A		Rough	
NR RF Channel Number			Config 1,2,3	1		2	
Duplex mode			Config 1	FDD		TDD	
			Config 2,3	TDD		TDD	
TDD configuration			Config 1	Not Applicable		TDDConf.3.1	
			Config 2	TDDConf.1.1		TDDConf.3.1	
			Config 3	TDDConf.2.1		TDDConf.3.1	
BW <sub>channel</sub>		MHz	Config 1	10: N <sub>RB,c</sub> = 52		100: N <sub>RB,c</sub> = 66	
			Config 2	10: N <sub>RB,c</sub> = 52		100: N <sub>RB,c</sub> = 66	
			Config 3	40: N <sub>RB,c</sub> = 106		100: N <sub>RB,c</sub> = 66	
BWP BW		MHz	Config 1	10: N <sub>RB,c</sub> = 52		100: N <sub>RB,c</sub> = 66	
			Config 2	10: N <sub>RB,c</sub> = 52		100: N <sub>RB,c</sub> = 66	
			Config 3	40: N <sub>RB,c</sub> = 106		100: N <sub>RB,c</sub> = 66	
BWP configuration	Initial DL BWP		Config 1,2,3	DLBWP.0.1		N/A	
	Initial UL BWP			ULBWP.0.1		N/A	
	Dedicated DL BWP			DLBWP.1.1		N/A	
	Dedicated UL BWP			ULBWP.1.1		N/A	
OCNG Patterns			Config 1,2,3	OP.1		OP.1	
PDSCH Reference measurement channel			Config 1	SR.1.1 FDD		-	
			Config 2	SR.1.1 TDD			
			Config 3	SR2.1 TDD			
RMSI CORESET Reference Channel			Config 1	CR.1.1 FDD		-	
			Config 2	CR.1.1 TDD			
			Config 3	CR2.1 TDD			
Dedicated CORESET RMC configuration			Config 1	CCR.1.1 FDD		CCR.3.1 TDD	
			Config 2	CCR.1.1 TDD		CCR.3.1 TDD	
			Config 3	CCR.2.1 TDD		CCR.3.1 TDD	

SMTC configuration		Config 1	SMTC.2	SMTC.2	
		Config 2,3	SMTC.1	SMTC.1	
PDSCH/PDCCH subcarrier spacing	kHz	Config 1,2	15	120	
		Config 3	30	120	
EPRE ratio of PSS to SSS		Config 1,2,3	0	0	
EPRE ratio of PBCH DMRS to SSS					
EPRE ratio of PBCH to PBCH DMRS					
EPRE ratio of PDCCH DMRS to SSS					
EPRE ratio of PDCCH to PDCCH DMRS					
EPRE ratio of PDSCH DMRS to SSS					
EPRE ratio of PDSCH to PDSCH					
EPRE ratio of OCNG DMRS to SSS(Note 1)					
EPRE ratio of OCNG to OCNG DMRS (Note 1)					
$N_{oc}$ <sup>Note2</sup>	dBm/15 kHz Note5			-104.7	
$N_{oc}$ <sup>Note2</sup>	dBm/S CS Note4	Config 1,2		-95.7	
		Config 3		-95.7	
SSB_RP <sup>Note 3</sup>	dBm/S CS Note5	Config 1,2		-Infinity	-86.7
		Config 3		-Infinity	-86.7
$\hat{E}_s/I_{ot}$	dB	Config 1,2,3	NA	-Infinity	9
$\hat{E}_s/N_{oc}$	dB	Config 1,2,3	Link only, see clause A.3.7A	-Infinity	9
$I_o$ <sup>Note3</sup>	dBm/9.36MHz	Config 1,2		-	-
	dBm/38.16MHz	Config 3		-	-
	dBm/95.04 MHz Note5	Config 1,2,3		-66.7	-57.2
Propagation Condition		Config 1,2,3		AWGN	
<p>Note 1: OCNG shall be used such that both cells are fully allocated and a constant total transmitted power spectral density is achieved for all OFDM symbols.</p> <p>Note 2: Interference from other cells and noise sources not specified in the test is assumed to be constant over subcarriers and time and shall be modelled as AWGN of appropriate power for <math>N_{oc}</math> to be fulfilled.</p> <p>Note 3: SSB_RP and <math>I_o</math> levels have been derived from other parameters for information purposes. They are not settable parameters themselves.</p> <p>Note 4: SSB_RP minimum requirements are specified assuming independent interference and noise at each receiver antenna port.</p> <p>Note 5: Equivalent power received by an antenna with 0 dBi gain at the centre of the quiet zone</p> <p>Note 6: As observed with 0 dBi gain antenna at the centre of the quiet zone</p> <p>Note 7: Information about types of UE beam is given in B.2.1.3, and does not limit UE implementation or test system implementation</p>					

In test 1 with per-UE gap and in test 3 without the gap, the UE shall send one Event A3 triggered measurement report, with a measurement reporting delay less than  $X1$  ms from the beginning of time period T2, where  $X1$  is

10080 for UE supporting power class 1, or

6240 for UE supporting other power class.

In test 2 with per-UE gap and in test 4 without the gap, the UE shall send one Event A3 triggered measurement report, with a measurement reporting delay less than  $X2$  ms from the beginning of time period T2, where  $X2$  is

107520 for UE supporting power class 1, or

66560 for UE supporting other power class.

In test 1, 2, 3 and 4 UE is required to report SSB time index. The UE shall not send event triggered measurement reports, as long as the reporting criteria are not fulfilled. The rate of correct events observed during repeated tests shall be at least 90% with a confidence level of 95%.

NOTE: The actual overall delays measured in the test may be up to  $2xTTI_{DCCH}$  higher than the measurement reporting delays above because of TTI insertion uncertainty of the measurement report in DCCH.

TTI insertion uncertainty =  $TTI_{DCCH} = 1$  ms;  $2xTTI_{DCCH} = 2$  ms

The overall delays measured shall be less than a total of 10082 ms for power class 1 UE and 6240 ms for other power classes in test 1 and test 3 and 107522 for power class 1 UE and 66562 ms for other power classes in test 2 and test 4.

### 7.6.3 L1-RSRP measurement for beam reporting

#### 7.6.3.0 Minimum conformance requirements for L1-RSRP measurement for beam reporting

##### 7.6.3.0.1 Minimum conformance requirements for SSB-based L1-RSRP measurement for beam reporting

Same as clause 5.6.3.0.1

The normative reference for this requirement is TS 38.133 [6] clause 9.5.3.1, 9.5.4.1 and 9.5.5.1.

##### 7.6.3.0.2 Minimum conformance requirements for CSI-RS-based L1-RSRP measurement for beam reporting

Same as clause 5.6.3.0.2

The normative reference for this requirement is TS 38.133 [6] clauses 9.5.3.1, 9.5.4.2 and 9.5.5.2.

#### 7.6.3.1 NR SA FR2 SSB-based L1-RSRP measurement in non-DRX

**Editor's Note: This test case has been completed for the following configurations:**

- Test frequency  $f \leq 40.8$  GHz
- UE PC3
- Normal conditions
- The test is incomplete for UE power classes other than PC3
- The test is incomplete for test frequencies  $> 40.8$  GHz
- The test case is incomplete for extreme conditions

##### 7.6.3.1.1 Test purpose

To verify that the UE makes correct reporting of L1-RSRP measurement in non-DRX within L1-RSRP measurement requirements in TS 38.133 [6] clause 9.5.4.1.



## 7.6.3.1.2 Test applicability

This test applies to all types of NR UE from Release 15 onwards.

## 7.6.3.1.3 Minimum conformance requirements

The minimum conformance requirements are specified in clause 7.6.3.0.1.

The normative reference for this requirement is TS 38.133 [6] clause A.7.6.3.1.

## 7.6.3.1.4 Test description

## 7.6.3.1.4.1 Initial conditions

This test shall be tested using any of the test configurations in Table 7.6.3.1.4.1-1.

**Table 7.6.3.1.4.1-1: NR SA FR2 SSB-based L1-RSRP measurement in non-DRX supported test configurations**

Test Case ID	Description
7.6.3.1-1	NR 120 kHz SSB SCS, 100 MHz bandwidth, TDD duplex mode
7.6.3.1-2	NR 240 kHz SSB SCS, 100 MHz bandwidth, TDD duplex mode
Note:	The UE is only required to be tested in one of the supported test configurations

**Table 7.6.3.1.4.1-2: General test parameters for NR SA FR2 SSB-based L1-RSRP measurement in non-DRX**

Parameter	Config	Unit	Value
SSB GSCN	1~2		freq1
Duplex mode	1~2		TDD
TDD Configuration	1~2		TDDConf.3.1
BW <sub>channel</sub>	1~2	MHz	100: N <sub>RB,c</sub> = 66
Data RBs allocated	1~2		66
PDSCH Reference measurement channel	1		SR.3.1 TDD
			SR.3.3 TDD
RMSI CORESET Reference Channel	1		CR.3.1 TDD
	2		CR.3.2 TDD
Dedicated CORESET Reference Channel	1		CCR.3.1 TDD
	2		CCR.3.7 TDD
SSB configuration	1		SSB.1 FR2
	2		SSB.2 FR2

OCNG Patterns	1~2		OP.1
Initial BWP Configuration	1~2		DLBWP.0.1 ULBWP.0.1
Dedicated BWP configuration	1~2		DLBWP.1.3 ULBWP.1.3
SMTC configuration	1~2		SMTC.1
TRS Configuration	1~2		TRS.2.1 TDD
PDCCH/PDSCH TCI Configuration	1~2		TCI.State.2
DRX configuration	1~2		Off
reportConfigType	1~2		periodic
reportQuantity	1~2		ssb-Index-RSRP
Number of reported RS	1~2		2
L1-RSRP reporting period	1~2	slot	320
T1	1~2	s	5
T2	1~2	s	2
EPRE ratio of PSS to SSS	1~2	dB	0
EPRE ratio of PBCH DMRS to SSS			
EPRE ratio of PBCH to PBCH DMRS			
EPRE ratio of PDCCH DMRS to SSS			
EPRE ratio of PDCCH to PDCCH DMRS			
EPRE ratio of PDSCH DMRS to SSS			
EPRE ratio of PDSCH to PDSCH DMRS			
EPRE ratio of OCNG DMRS to SSS <sup>Note 1</sup>			
EPRE ratio of OCNG to OCNG DMRS <sup>Note 1</sup>			
Propagation condition	1~2		AWGN
Note 1: OCNG shall be used such that both cells are fully allocated and a constant total transmitted power spectral density is achieved for all OFDM symbols.			

**Table 7.6.3.1.4-3: Test Environment parameters for NR SA FR2 SSB-based L1-RSRP measurement in non-DRX**

Parameter	Value		Comment
Test environment	NC		As specified in TS 38.508-1 [14] clause 4.1.
Test frequencies	As specified in Annex E, Table E.2-1 and TS 38.508-1 [14] clause 4.3.1 and 4.4.2.		
Channel bandwidth	As specified by the test configuration selected from Table 7.6.3.1.4.1-1.		
Propagation conditions	AWGN		As specified in Annex C.2.2.
Connection Diagram	TE Part	A.3.3.3.1-1	As specified in TS 38.508-1 [14] Annex A.
	DUT Part	A.3.4.1.1	
Exceptions to connection diagram			

1. Message contents are defined in clause 7.6.3.1.4.3.
2. The AoA setup for this test is Setup 1 as defined in clause A.9. The UE RX Beam Peak direction has been obtained previously using one of the search procedures as described in Annex I.

#### 7.6.3.1.4.2 Test procedure

Prior to the start of the time duration T1, the UE shall be configured for periodic CSI reporting in PUCCH [format 2] with a reporting periodicity as mentioned in the above table 7.6.3.1.4.1-2. Before the test, UE is configured to perform RLM, BFD and L1-RSRP measurement based on the SSBs.

1. Ensure the UE is in state RRC\_CONNECTED with generic procedure parameters Connectivity NR SA, Connected without release *On* and Test Mode *On*, according to TS 38.508-1 [14] clause 4.5 and general test parameters set according to Table 6.6.4.1.4.1-2.
2. Set the parameters according to T1 in Table 7.6.3.1.5-1. T1 starts.
3. The UE shall be transmitting CSI on PUCCH with a periodicity of 320 slots.
4. When T1 expires, the SS shall set the parameters according to T2 in 7.6.3.1.5-1. T2 starts.
5. The UE shall start sending valid L1-RSRP reports. The SS shall check the following requirements:
  - R1: the UE shall start to transmit valid L1-RSRP reports no later than 1760ms for UE supporting power class 1 in configuration 1, no later than 1720 ms for UE supporting power class 1 in configuration 2, no later than 1280 ms for UE supporting power class other than 1 in configuration 1 and no later than 1240 ms for UE supporting power class other than 1 in configuration 2 from the beginning of time period T2. A valid report shall meet the absolute L1-RSRP requirement for SSB#1 Table 5.6.3.1.5-2 for test configuration 1 and the corresponding absolute accuracy requirements in Table 5.6.3.1.5-3 for test configuration 2. If the first valid report is received before the specified time, the number of passed iterations for R1 is increased by one. Otherwise, the number of failed iterations for R1 is increased by one.
  - R2: the UE shall transmit L1-RSRP reports every 320 slots. If the reports are received accordingly, the number of passed iterations for R2 is increased by one. Otherwise, the number of failed iterations for R2 is increased by one.
  - R3: The L1-RSRP value of SSB#1 reported by the UE is compared to the expected L1-RSRP value for SSB#1. In all consecutive reports after the first valid value is received, if the resulting value is outside the corresponding absolute accuracy requirements in Table 7.6.3.1.5-2 for test configuration 1 and the corresponding absolute accuracy requirements in Table 7.6.3.1.5-3 for test configuration 2 the number of failed iterations for R3 is increased by one. Otherwise, the number of passed iterations for R3 is increased by one.
  - R4: The DIFF-RSRP value of SSB#0 reported by the UE is compared to the expected DIFF-RSRP value. In all consecutive reports after the first valid value is received, if the resulting value is outside the corresponding relative accuracy requirements in Table 7.6.3.1.5-4 for all test configurations, the number of failed iterations for R4 is increased by one. Otherwise, the number of passed iterations for R4 is increased by one.
6. The SS waits until T2 expires.
7. The SS shall transmit *RRCRelease* message to release the RRC connection which includes the release of the established radio bearers as well as all radio resources.
8. After the RRC connection release, the SS:
  - transmits in Cell 1 a *Paging* message (including *PagingRecord* with *ue-Identity*) for the UE and ensures the UE in state RRC\_CONNECTED with generic procedure parameters Connectivity NR SA, Connected without release *On* and Test Mode *On* according to TS 38.508-1 [14] clause 4.5. (if the paging fails, switches off and on the UE and ensures the UE is in state RRC\_CONNECTED with generic procedure parameters Connectivity NR SA, Connected without release *On* and Test Mode *On* according to TS 38.508-1 [14] clause 4.5.),
  - or:
  - switches off and on the UE and ensures the UE is in state RRC\_CONNECTED with generic procedure parameters Connectivity NR SA, Connected without release *On* and Test Mode *On* according to TS 38.508-1 [14] clause 4.5.
9. Repeat steps 2-8 until the confidence level according to Tables G.2.3-1 in Annex G clause G.2 is achieved.

#### 7.6.3.1.4.3 Message contents

Message contents are according to TS 38.508-1 [14] clause 4.6 with the following exceptions:

**Table 7.6.3.1.4.3-1: Common Exception messages NR SA FR2 SSB-based L1-RSRP measurement in non-DRX**

Default Message Contents	
Common contents of system information blocks exceptions	
Default RRC messages and information elements contents exceptions	Table H.3.1-1 Table H.3.1-2 Table H.3.6-2 with conditions PERIODIC and SS-RSRP Table H.3.6-3 with condition SSB

**Table 7.6.3.1.4.3-2: RadioLinkMonitoringConfig**

Derivation Path: TS 38.508-1 [14], Table 4.6.3-133			
Information Element	Value/remark	Comment	Condition
RadioLinkMonitoringConfig ::= SEQUENCE {			
failureDetectionResourcesToAddModList	1 entry		
SEQUENCE			
(SIZE(1..maxNrofFailureDetectionResources)) OF			
SEQUENCE {			
purpose	both	UE is configured to perform RLM and BFD based on the SSBs.	
detectionResource CHOICE {			
ssb-Index	0		
}			
}			
}			
}			

7.6.3.1.5 Test requirement

Table 7.6.3.1.5-1 defines the primary level settings including test tolerances for all tests.

**Table 7.6.3.1.5-1: Cell specific test parameters for NR SA FR2 SSB-based L1-RSRP measurement in non-DRX**

Parameter	Config	Unit	SSB#0		SSB#1	
			T1	T2	T1	T2
Angle of arrival configuration			Setup 1 according to A.9			
Assumption for UE beams Note 4	1~2		Rough			
$N_{oc}$ Note2	1~2	dBm/15kHz	-105			
$N_{oc}$ Note2	1	dBm/SSB SCS	-96			
	2		-93			
$\hat{E}_s / I_{ot}$	1~2	dB	0	0	-Infinity	9
SSB_RP Note3	1	dBm/SSB SCS	-96	-96	-Infinity	-87
	2		-93	-93	-Infinity	-84
Io Note3	1	dBm/95.04MHz	-63.97	-63.97	-66.98	-57.47
	2		-63.97	-63.97	-66.98	-57.47
$\hat{E}_s / N_{oc}$	1~2	dB	0	0	-Infinity	9
Note 1:	The resources for uplink transmission are assigned to the UE prior to the start of time period T2.					
Note 2:	Interference from other cells and noise sources not specified in the test is assumed to be constant over subcarriers and time and shall be modelled as AWGN of appropriate power for $N_{oc}$ to be fulfilled.					
Note 3:	SSB_RP and Io levels have been derived from other parameters for information purposes. They are not settable parameters themselves.					
Note 4:	Information about types of UE beam is given in TS 38.133 Annex B.2.1.3, and does not limit UE implementation or test system implementation					

The UE shall send L1-RSRP report every 320 slots. No later than X ms plus 640 slots from the beginning of time period T2, UE shall send L1-RSRP report including the results for both SSB#0 and SSB#1 while meeting the accuracy requirements defined in clause 10.1.20.1, where X is

- 1680 for UE supporting power class 1
- 1200 for UE supporting power class 2,3 or 4.

Each L1-RSRP measurement report shall meet the corresponding absolute accuracy requirements in Table 7.6.3.1.5-2 for for test configuration 1 and the corresponding absolute accuracy requirements in Table 7.6.3.1.5-3 for test configuration 2 and the corresponding relative accuracy requirements in Table 7.6.3.1.5-4 for all test configurations.

**Table 7.6.3.1.5-2: L1-RSRP absolute accuracy requirements for the reported values for test configuration 1**

Normal Conditions	T1	T2
Lowest reported value (SSB#1)	-	40
Highest reported value (SSB#1)	-	99

**Table 7.6.3.1.5-3: L1-RSRP absolute accuracy requirements for the reported values for test configuration 2**

Normal Conditions	T1	T2
Lowest reported value (SSB#1)	-	43
Highest reported value (SSB#1)	-	102

**Table 7.6.3.1.5-4: L1-RSRP relative accuracy requirements for the reported values for all test configurations**

	T1	T2
Lowest DIFF RSRP reported (SSB#0)	-	1
Highest DIFF RSRP reported (SSB#0)	-	7

For the test to pass, the ratio of successful reported valued for each requirement (R1 to R4) shall be at least 90% with a confidence level of 95%. Each requirement is evaluated independently of the others.

### 7.6.3.2 NR SA FR2 SSB-based L1-RSRP measurement in DRX

**Editor's Note:** This test case has been completed for the following configurations:

- Test frequency  $f \leq 40.8$  GHz
- UE PC3
- Normal conditions
- The test is incomplete for UE power classes other than PC3
- The test is incomplete for test frequencies  $> 40.8$  GHz
- The test case is incomplete for extreme conditions

#### 7.6.3.2.1 Test purpose

To verify that the UE makes correct reporting of L1-RSRP measurement in DRX within L1-RSRP measurement requirements in TS 38.133 [6] clause 9.5.4.1.

#### 7.6.3.2.2 Test applicability

This test applies to all types of NR UE Release 15 and forward supporting 5GS NR SA FR2 and long DRX cycle.

#### 7.6.3.2.3 Minimum conformance requirements

The minimum conformance requirements are specified in clause 7.6.3.0.1.

The normative reference for this requirement is TS 38.133 [6] clause A.7.6.3.2.

#### 7.6.3.2.4 Test description

##### 7.6.3.2.4.1 Initial conditions

This test shall be tested using any of the test configurations in Table 7.6.3.2.4.1-1.

**Table 7.6.3.2.4.1-1: NR SA FR2 SSB-based L1-RSRP measurement in DRX supported test configurations**

Test Case ID	Description
7.6.3.2-1	NR 120 kHz SSB SCS, 100 MHz bandwidth, TDD duplex mode
7.6.3.2-2	NR 240 kHz SSB SCS, 100 MHz bandwidth, TDD duplex mode
Note:	The UE is only required to be tested in one of the supported test configurations

**Table 7.6.3.2.4.1-2: General test parameters for NR SA FR2 SSB-based L1-RSRP measurement in DRX**

Parameter	Config	Unit	Value
SSB GSCN	1~2		freq1
Duplex mode	1~2		TDD
TDD Configuration	1~2		TDDConf.3.1
BW <sub>channel</sub>	1~2	MHz	100: N <sub>RB,c</sub> = 66
Data RBs allocated	1~2		66
PDSCH Reference measurement channel	1		SR.3.1 TDD
	2		SR.3.3 TDD
RMSI CORESET Reference Channel	1		CR.3.1 TDD
	2		CR.3.2 TDD
Dedicated CORESET Reference Channel	1		CCR.3.1 TDD
	2		CCR.3.7 TDD
SSB configuration	1		SSB.1 FR2
	2		SSB.2 FR2
OCNG Patterns	1~2		OP.1
Initial BWP Configuration	1~2		DLBWP.0.1 ULBWP.0.1
Dedicated BWP configuration	1~2		DLBWP.1.3 ULBWP.1.3
SMTc configuration	1~2		SMTc.1
TRS Configuration	1~2		TRS.2.1 TDD
PDCCH/PDSCH TCI Configuration	1~2		TCI.State.2
DRX configuration	1~2		DRX.3
reportConfigType	1~2		periodic
reportQuantity	1~2		ssb-Index-RSRP
Number of reported RS	1~2		2
L1-RSRP reporting period	1~2	slot	320
T1	1~2	s	5
T2	1~2	s	3
EPRE ratio of PSS to SSS	1~2	dB	0
EPRE ratio of PBCH DMRS to SSS			
EPRE ratio of PBCH to PBCH DMRS			
EPRE ratio of PDCCH DMRS to SSS			
EPRE ratio of PDCCH to PDCCH DMRS			
EPRE ratio of PDSCH DMRS to SSS			
EPRE ratio of PDSCH to PDSCH DMRS			
EPRE ratio of OCNG DMRS to SSS <sup>Note 1</sup>			
EPRE ratio of OCNG to OCNG DMRS <sup>Note 1</sup>			
Propagation condition			
Note 1: OCNG shall be used such that both cells are fully allocated and a constant total transmitted power spectral density is achieved for all OFDM symbols.			

**Table 7.6.3.2.4-3: Test Environment parameters for NR SA FR2 SSB-based L1-RSRP measurement in DRX**

Parameter	Value	Comment
Test environment	NC	As specified in TS 38.508-1 [14] clause 4.1.
Test frequencies	As specified in Annex E, Table E.2-1 and TS 38.508-1 [14] clause 4.3.1 and 4.4.2.	

Channel bandwidth	As specified by the test configuration selected from Table 7.6.3.2.4.1-1.	
Propagation conditions	AWGN	As specified in Annex C.2.2.
Connection Diagram	TE Part	A.3.3.3.1-1
	DUT Part	A.3.4.1.1
Exceptions to connection diagram		

1. Message contents are defined in clause 7.6.3.2.4.3.
2. The AoA setup for this test is Setup 1 as defined in clause A.9. The UE RX Beam Peak direction has been obtained previously using one of the search procedures as described in Annex I.

7.6.3.2.4.2 Test procedure

Same as in 7.6.3.1.4.2 with the following exception:

5. The UE shall start sending valid L1-RSRP reports. The SS shall check the following requirements:
  - R1: the UE shall start to transmit valid L1-RSRP reports no later than 2960ms for UE supporting power class 1 in configuration 1, no later than 2920ms for UE supporting power class 1 in configuration 2, no later than 2000ms for UE supporting power class other than 1 in configuration 1 and no later than 1960 ms for UE supporting power class other than 1 in configuration 2 from the beginning of time period T2. A valid report shall meet the absolute L1-RSRP requirement for SSB#1 Table 5.6.3.1.5-2 for test configuration 1 and the corresponding absolute accuracy requirements in Table 5.6.3.1.5-3 for test configuration 2. If the first valid report is received before the specified time, the number of passed iterations for R1 is increased by one. Otherwise, the number of failed iterations for R1 is increased by one.
  - R2: the UE shall transmit L1-RSRP reports every 320 slots. If the reports are received accordingly, the number of passed iterations for R2 is increased by one. Otherwise, the number of failed iterations for R2 is increased by one.
  - R3: The L1-RSRP value of SSB#1 reported by the UE is compared to the expected L1-RSRP value for SSB#1. In all consecutive reports after the first valid value is received, if the resulting value is outside the corresponding absolute accuracy requirements in Table 7.6.3.2.5-2 for test configurations 1 and 2 and the corresponding absolute accuracy requirements in Table 7.6.3.2.5-3 for test configurations 3 and 4 the number of failed iterations for R3 is increased by one. Otherwise, the number of passed iterations for R3 is increased by one.
  - R4: The DIFF-RSRP value of SSB#0 reported by the UE is compared to the expected DIFF-RSRP value. In all consecutive reports after the first valid value is received, if the resulting value is outside the corresponding relative accuracy requirements in Table 7.6.3.2.5-4 for all test configurations, the number of failed iterations for R4 is increased by one. Otherwise, the number of passed iterations for R4 is increased by one.

7.6.3.2.4.3 Message contents

Same message content as in subclause 7.6.3.1.4.3 with the following exception:

**Table 7.6.3.2.4.3-1: Common Exception messages NR SA FR2 SSB-based L1-RSRP measurement in DRX**

Default Message Contents	
Common contents of system information blocks exceptions	
Default RRC messages and information elements contents exceptions	Table H.3.1-1 Table H.3.1-2 Table H.3.7-1 with condition DRX.3



7.6.3.2.5 Test requirement

Table 7.6.3.2.5-1 defines the primary level settings including test tolerances for all tests.

**Table 7.6.3.2.5-1: Cell specific test parameters for NR SA FR2 SSB-based L1-RSRP measurement in DRX**

Parameter	Config	Unit	SSB#0		SSB#1	
			T1	T2	T1	T2
Angle of arrival configuration			Setup 1 according to A.9			
Assumption for UE beams Note 4	1~2		Rough			
$N_{oc}$ Note2	1~2	dBm/15kHz	-105			
$N_{oc}$ Note2	1	dBm/SSB SCS	-96			
	2		-93			
$\hat{E}_s / I_{ot}$	1~2	dB	0	0	-Infinity	9
SSB_RP Note3	1	dBm/SSB SCS	-96	-96	-Infinity	-87
	2		-93	-93	-Infinity	-84
Io Note3	1	dBm/95.04MHz	-63.97	-63.97	-66.98	-57.47
	2		-63.97	-63.97	-66.98	-57.47
$\hat{E}_s / N_{oc}$	1~2	dB	0	0	-Infinity	9
Note 1: The resources for uplink transmission are assigned to the UE prior to the start of time period T2. Note 2: Interference from other cells and noise sources not specified in the test is assumed to be constant over subcarriers and time and shall be modelled as AWGN of appropriate power for $N_{oc}$ to be fulfilled. Note 3: SSB_RP and Io levels have been derived from other parameters for information purposes. They are not settable parameters themselves. Note 4: Information about types of UE beam is given in TS 38.133 Annex B.2.1.3, and does not limit UE implementation or test system implementation						

The UE shall send L1-RSRP report every 320 slots. No later than X ms plus 640 slots from the beginning of time period T2, UE shall send L1-RSRP report including the results for both SSB#0 and SSB#1 while meeting the accuracy requirements defined in clause 10.1.20.1, where X is

- 2880 for UE supporting power class 1
- 1920 for UE supporting power class 2,3 or 4.

Each L1-RSRP measurement report shall meet the corresponding absolute accuracy requirements in Table 7.6.3.2.5-2 for test configuration 1 and the corresponding absolute accuracy requirements in Table 7.6.3.2.5-3 for test configuration 2 and the corresponding relative accuracy requirements in Table 7.6.3.2.5-4 for all test configurations.

**Table 7.6.3.2.5-2: L1-RSRP absolute accuracy requirements for the reported values for test configuration 1**

Normal Conditions	T1	T2
Lowest reported value (SSB#1)	-	40
Highest reported value (SSB#1)	-	99

**Table 7.6.3.2.5-3: L1-RSRP absolute accuracy requirements for the reported values for test configuration 2**

Normal Conditions	T1	T2
Lowest reported value (SSB#1)	-	43
Highest reported value (SSB#1)	-	102

**Table 7.6.3.2.5-4: L1-RSRP relative accuracy requirements for the reported values for all test configurations**

	T1	T2
Lowest DIFF RSRP reported (SSB#0)	-	1
Highest DIFF RSRP reported (SSB#0)	-	7

For the test to pass, the ratio of successful reported values for each requirement (R1 to R4) shall be at least 90% with a confidence level of 95%. Each requirement is evaluated independently of the others.

### 7.6.3.3 NR SA FR2 CSI-RS-based L1-RSRP measurement in non-DRX

**Editor's Note:** This test case has been completed for the following configurations:

- Test frequency  $f \leq 40.8$  GHz
- UE PC3
- Normal conditions
- The test is incomplete for UE power classes other than PC3
- The test is incomplete for test frequencies  $> 40.8$  GHz
- The test case is incomplete for extreme conditions

#### 7.6.3.3.1 Test purpose

To verify that the UE makes correct reporting of L1-RSRP measurement in non-DRX within L1-RSRP measurement requirements in TS 38.133 [6] clause 9.5.4.2.

#### 7.6.3.3.2 Test applicability

This test applies to all types of NR UE from Release 15 onwards.

#### 7.6.3.3.3 Minimum conformance requirements

The minimum conformance requirements are specified in clause 7.6.3.0.2.

The normative reference for this requirement is TS 38.133 [6] clause A.7.6.3.3.

#### 7.6.3.3.4 Test description

##### 7.6.3.3.4.1 Initial conditions

This test shall be tested using any of the test configurations in Table 7.6.3.3.4.1-1.

**Table 7.6.3.3.4.1-1: NR SA FR2 CSI-RS-based L1-RSRP measurement in non-DRX supported test configurations**

Test Case ID	Description
7.6.3.4-1	NR 120 kHz CSI-RS SCS, 100 MHz bandwidth, TDD duplex mode

**Table 7.6.3.3.4.1-2: General test parameters for NR SA FR2 CSI-RS-based L1-RSRP measurement in non-DRX**

Parameter	Config	Unit	Value
SSB GSCN	1		freq1
Duplex mode	1		TDD
TDD Configuration	1		TDDConf.3.1
BW <sub>channel</sub>	1	MHz	100: N <sub>RB,c</sub> = 66
Data <sub>RBs</sub> allocated	1		66
PDSCH Reference measurement channel	1		SR.3.1 TDD
RMSI CORESET Reference Channel	1		CR.3.1 TDD
Dedicated CORESET Reference Channel	1		CCR.3.1 TDD
SSB configuration	1		SSB.1 FR2
CSI-RS configuration	1		CSI-RS.3.3 TDD
OCNG Patterns	1		OP.1
Initial BWP Configuration	1		DLBWP.0.1 ULBWP.0.1
Dedicated BWP configuration	1		DLBWP.1.3 ULBWP.1.3
SMTTC configuration	1		SMTTC.1
TRS Configuration	1		TRS.2.1 TDD
PDCCH/PDSCH TCI Configuration	1		TCI.State.2
DRX configuration	1		Off
reportConfigType	1		aperiodic
reportQuantity	1		cri-RSRP
Number of reported RS	1		2
qcl-Info	1		SSB#0 for resource#0 SSB#1 for resource#1
reportSlotOffsetList	1		8
Propagation condition	1		AWGN
T1	1	s	5
EPRE ratio of PSS to SSS	1	dB	0
EPRE ratio of PBCH DMRS to SSS			
EPRE ratio of PBCH to PBCH DMRS			
EPRE ratio of PDCCH DMRS to SSS			
EPRE ratio of PDCCH to PDCCH DMRS			
EPRE ratio of PDSCH DMRS to SSS			
EPRE ratio of PDSCH to PDSCH DMRS			
EPRE ratio of OCNG DMRS to SSS <sup>Note 1</sup>			
EPRE ratio of OCNG to OCNG DMRS <sup>Note 1</sup>			
Note 1: OCNG shall be used such that both cells are fully allocated and a constant total transmitted power spectral density is achieved for all OFDM symbols.			

**Table 7.6.3.3.4-3: Test Environment parameters for NR SA FR2 CSI-RS-based L1-RSRP measurement in non-DRX**

Parameter	Value		Comment
Test environment	NC		As specified in TS 38.508-1 [14] clause 4.1.
Test frequencies	As specified in Annex E, Table E.2-1 and TS 38.508-1 [14] clause 4.3.1 and 4.4.2.		
Channel bandwidth	As specified by the test configuration selected from Table 7.6.3.3.4.1-1.		
Propagation conditions	AWGN		As specified in Annex C.2.2.
Connection Diagram	TE Part	A.3.3.3.1-1	As specified in TS 38.508-1 [14] Annex A.
	DUT Part	A.3.4.1.1	
Exceptions to connection diagram			

1. Message contents are defined in clause 7.6.3.3.4.3.
2. The AoA setup for this test is Setup 1 as defined in clause A.9. The UE RX Beam Peak direction has been obtained previously using one of the search procedures as described in Annex I.

#### 7.6.3.3.4.2 Test procedure

The test consists of a single time period T1, during which the UE is triggered via DCI to report L1-RSRP on aperiodic CSI-RS resources. Prior to the start of the time duration T1, the UE shall be fully synchronized to PCell. UE is also configured to measure L1-RSRP based on SSB. Upon receiving the DCI trigger, UE provides the report back based on the reporting configuration as defined in table 7.6.3.3.4.1-2.

1. Ensure the UE is in state RRC\_CONNECTED with generic procedure parameters Connectivity NR SA, Connected without release *On* and Test Mode *On*, according to TS 38.508-1 [14] clause 4.5.
2. Set the parameters according to T1 in Table 7.6.3.3.5-1. T1 starts.
3. After 480ms from the start of the test the SS transmits the DCI trigger in slot 1.
4. The SS shall check following requirements:
  - R1: the UE shall send L1-RSRP report at slot 8 from the reception of DCI trigger. If the report is received at slot 8 from the reception of DCI trigger, the number of passed iterations for R1 is increased by one. Otherwise, the number of failed iterations for R1 is increased by one.
  - R2: the L1-RSRP value of CSI-RS#1 reported by the UE is compared to the expected L1-RSRP value for CSI-RS #1. If the resulting value is outside the limits in Table 7.6.3.3.5-2 or the UE fails to report the measurement value for CSI-RS #1, the number of failed iterations for R2 is increased by one. Otherwise, the number of passed iterations for R2 is increased by one.
  - R3: The DIFF RSRP value of CSI-RS #0 reported by the UE is compared to the expected DIFF RSRP value. If the resulting value is outside the limits in Table 7.6.3.3.5-4 or the UE fails to report the measurement value for CSI-RS #0, the number of failed iterations for R3 is increased by one. Otherwise, the number of passed iterations for R3 is increased by one.
6. The SS shall transmit *RRCRelease* message to release the RRC connection which includes the release of the established radio bearers as well as all radio resources.
7. After the RRC connection release, the SS:
  - transmits in Cell 1 a *Paging* message (including *PagingRecord* with *ue-Identity*) for the UE and ensures the UE in state RRC\_CONNECTED with generic procedure parameters Connectivity NR SA, Connected without release *On* and Test Mode *On* according to TS 38.508-1 [14] clause 4.5. (if the paging fails, switches off and on the UE and ensures the UE is in state RRC\_CONNECTED with generic procedure parameters Connectivity NR SA, Connected without release *On* and Test Mode *On* according to TS 38.508-1 [14] clause 4.5.),
  - or:
  - switches off and on the UE and ensures the UE is in state RRC\_CONNECTED with generic procedure

parameters Connectivity NR SA, Connected without release *On* and Test Mode *On* according to TS 38.508-1 [14] clause 4.5.

8. Repeat steps 2-7 until the confidence level according to Tables G.2.3-1 in Annex G clause G.2 is achieved.

7.6.3.3.4.3 Message contents

Message contents are according to TS 38.508-1 [14] clause 7.3 with the following exceptions:

**Table 7.6.3.3.4.3-1: Common Exception messages NR SA FR2 CSI-RS-based L1-RSRP measurement in non-DRX**

Default Message Contents	
Common contents of system information blocks exceptions	
Default RRC messages and information elements contents exceptions	Table H.3.1-1 Table H.3.1-2 Table H.3.6-2 with conditions APERIODIC and CSI-RSRP Table H.3.6-3 with conditions CSI-RS and APERIODIC

**Table 7.6.3.3.4.3-2: RadioLinkMonitoringConfig**

Derivation Path: TS 38.508-1 [14], Table 4.6.3-133			
Information Element	Value/remark	Comment	Condition
RadioLinkMonitoringConfig ::= SEQUENCE {			
failureDetectionResourcesToAddModList SEQUENCE (SIZE(1..maxNrofFailureDetectionResources)) OF SEQUENCE {	1 entry		
purpose	both	UE is configured to perform RLM and BFD based on the SSBs.	
}			
}			

7.6.3.3.5 Test requirement

Table 7.6.3.3.5-1 defines the primary level settings including test tolerances for all tests.

**Table 7.6.3.3.5-1: Cell specific test parameters for NR SA FR2 CSI-RS-based L1-RSRP measurement in non-DRX**

Parameter	Config	Unit	CSI-RS#0	CSI-RS#1
Angle of arrival configuration	1		Setup 1 according to A.9	
$N_{oc}$ <sup>Note1</sup>	1	dBm/15kHz	-105	
$N_{oc}$ <sup>Note1</sup>	1	dBm/SSB SCS	-95.97	
$\hat{E}_s / I_{ot}$	1	dB	0	9
CSI-RS RSRP <sup>Note2</sup>	1	dBm/SSB SCS	-95.97	-86.97
$I_o$ <sup>Note2</sup>	1	dBm/95.04MHz	-63.97	-57.47
$\hat{E}_s / N_{oc}$	1	dB	0	9
Note 1: Void Note 2: Interference from other cells and noise sources not specified in the test is assumed to be constant over subcarriers and time and shall be modelled as AWGN of appropriate power for $N_{oc}$ to be fulfilled. Note 3: CSI-RS RSRP and $I_o$ levels have been derived from other parameters for information purposes. They are not settable parameters themselves.				

After 480ms from the beginning of the test, the UE shall send L1-RSRP report at slot 8 from the reception of DCI triggering the L1-RSRP measurement. The L1-RSRP report shall include the results for both CSI-RS#0 and CSI-RS#1. Each L1-RSRP measurement report shall meet the corresponding absolute accuracy requirements in Table 7.6.3.3.5-2 the corresponding relative accuracy requirements in Table 7.6.3.3.5-3.

**Table 7.6.3.3.5-2: L1-RSRP absolute accuracy requirements for the reported values**

Normal Conditions	T1
Lowest reported value (CSI-RS#1)	40
Highest reported value (CSI-RS#1)	99

**Table 7.6.3.3.5-3: L1-RSRP relative accuracy requirements for the reported values**

	T1
Lowest DIFF RSRP reported (CSI-RS#0)	1
Highest DIFF RSRP reported (CSI-RS#0)	7

The rate of correct events observed during repeated tests shall be at least 90% with a confidence level of 95%.

NOTE: The actual overall delays measured in the test may be up to  $2 \times TTI_{DCCH}$  higher than the measurement reporting delays above because of TTI insertion uncertainty of the measurement report in DCCH.

#### 7.6.3.4 NR SA FR2 CSI-RS-based L1-RSRP measurement in DRX

**Editor's Note:** This test case has been completed for the following configurations:

- Test frequency  $f \leq 40.8$  GHz
- UE PC3
- Normal conditions
- The test is incomplete for UE power classes other than PC3
- The test is incomplete for test frequencies  $> 40.8$  GHz
- The test case is incomplete for extreme conditions

##### 7.6.3.4.1 Test purpose

To verify that the UE makes correct reporting of L1-RSRP measurement in DRX within L1-RSRP measurement requirements in TS 38.133 [6] clause 9.5.4.2.

##### 7.6.3.4.2 Test applicability

This test applies to all types of NR UE Release 15 and forward supporting 5GS NR SA FR2 and long DRX cycle.

##### 7.6.3.4.3 Minimum conformance requirements

The minimum conformance requirements are specified in clause 7.6.3.0.2.

The normative reference for this requirement is TS 38.133 [6] clause A.7.6.3.4.

##### 7.6.3.4.4 Test description

###### 7.6.3.4.4.1 Initial conditions

This test shall be tested using any of the test configurations in Table 7.6.3.4.4.1-1.

**Table 7.6.3.4.4.1-1: NR SA FR2 CSI-RS-based L1-RSRP measurement in DRX supported test configurations**

Test Case ID	Description
7.6.3.4-1	NR 120 kHz CSI-RS SCS, 100 MHz bandwidth, TDD duplex mode

**Table 7.6.3.4.4.1-2: General test parameters for NR SA FR2 CSI-RS-based L1-RSRP measurement in DRX**

Parameter	Config	Unit	Value
SSB GSCN	1		freq1
Duplex mode	1		TDD
TDD Configuration	1		TDDConf.3.1
BW <sub>channel</sub>	1	MHz	100: N <sub>RB,c</sub> = 66
Data <sub>RBs</sub> allocated	1		66
PDSCH Reference measurement channel	1		SR.3.1 TDD
RMSI CORESET Reference Channel	1		CR.3.1 TDD
Dedicated CORESET Reference Channel	1		CCR.3.1 TDD
SSB configuration	1		SSB.1 FR2
CSI-RS configuration	1		CSI-RS.3.3 TDD
OCNG Patterns	1		OP.1
Initial BWP Configuration	1		DLBWP.0.1 ULBWP.0.1
Dedicated BWP configuration	1		DLBWP.1.3 ULBWP.1.3
SMTc configuration	1		SMTc.1
TRS Configuration	1		TRS.2.1 TDD
PDCCH/PDSCH TCI Configuration	1		TCI.State.2
DRX configuration	1		DRX.3
reportConfigType	1		aperiodic
reportQuantity	1		cri-RSRP
Number of reported RS	1		2
qcl-Info	1		SSB#0 for resource#0 SSB#1 for resource#1
reportSlotOffsetList	1		8
Propagation condition	1		AWGN
T1	1	s	5
EPRE ratio of PSS to SSS	1	dB	0
EPRE ratio of PBCH DMRS to SSS			
EPRE ratio of PBCH to PBCH DMRS			
EPRE ratio of PDCCH DMRS to SSS			
EPRE ratio of PDCCH to PDCCH DMRS			
EPRE ratio of PDSCH DMRS to SSS			
EPRE ratio of PDSCH to PDSCH DMRS			
EPRE ratio of OCNG DMRS to SSS <sup>Note 1</sup>			
EPRE ratio of OCNG to OCNG DMRS <sup>Note 1</sup>			
Note 1: OCNG shall be used such that both cells are fully allocated and a constant total transmitted power spectral density is achieved for all OFDM symbols.			

**Table 7.6.3.4.4-3: Test Environment parameters for NR SA FR2 CSI-RS-based L1-RSRP measurement in DRX**

Parameter	Value		Comment
Test environment	NC		As specified in TS 38.508-1 [14] clause 4.1.
Test frequencies	As specified in Annex E, Table E.2-1 and TS 38.508-1 [14] clause 4.3.1 and 4.4.2.		
Channel bandwidth	As specified by the test configuration selected from Table 7.6.3.4.4.1-1.		
Propagation conditions	AWGN		As specified in Annex C.2.2.
Connection Diagram	TE Part	A.3.3.3.1-1	As specified in TS 38.508-1 [14] Annex A.
	DUT Part	A.3.4.1.1	
Exceptions to connection diagram			

1. Message contents are defined in clause 7.6.3.4.4.3.
2. The AoA setup for this test is Setup 1 as defined in clause A.9. The UE RX Beam Peak direction has been obtained previously using one of the search procedures as described in Annex I.

**7.6.3.4.4.2 Test procedure**

Same test procedure as in subclause 7.6.3.3.4.2 with tables 7.6.3.3.4.1-2 and 7.6.3.3.5-1 replaced by tables 7.6.3.4.4.1-2 and 7.6.3.4.5-1 and following change in step 3.

3. After 1440ms from the start of the test the SS transmits the DCI trigger in slot 1.

**7.6.3.4.4.3 Message contents**

Same message content as in subclause 7.6.3.3.4.3 with the following exception:

**Table 7.6.3.4.4.3-1: Common Exception messages NR SA FR2 CSI-RS-based L1-RSRP measurement in DRX**

Default Message Contents	
Common contents of system information blocks exceptions	
Default RRC messages and information elements contents exceptions	Table H.3.1-1 Table H.3.1-2 Table H.3.7-1 with condition DRX.3

**7.6.3.4.5 Test requirement**

Table 7.6.3.4.5-1 defines the primary level settings including test tolerances for all tests.



**Table 7.6.3.4.5-1: Cell specific test parameters for NR SA FR2 CSI-RS-based L1-RSRP measurement in DRX**

Parameter	Config	Unit	CSI-RS#0	CSI-RS#1
Angle of arrival configuration	1		Setup 1 according to A.9	
Assumption for UE beams <sup>Note 3</sup>	1~2		Rough	
$N_{oc}$ <sup>Note1</sup>	1	dBm/15kHz	-105	
$N_{oc}$ <sup>Note1</sup>	1	dBm/SSB SCS	-95.97	
$\hat{E}_s / I_{ot}$	1	dB	0	9
CSI-RS RSRP <sup>Note2</sup>	1	dBm/SSB SCS	-95.97	-86.97
$I_o$ <sup>Note2</sup>	1	dBm/95.04MHz	-63.97	-57.47
$\hat{E}_s / N_{oc}$	1	dB	0	9
Note 1: Void Note 2: Interference from other cells and noise sources not specified in the test is assumed to be constant over subcarriers and time and shall be modelled as AWGN of appropriate power for $N_{oc}$ to be fulfilled. Note 3: CSI-RS RSRP and $I_o$ levels have been derived from other parameters for information purposes. They are not settable parameters themselves. Note 4: Information about types of UE beam is given in TS 38.133 Annex B.2.1.3, and does not limit UE implementation or test system implementation				

After 1440ms from the beginning of the test, the UE shall send L1-RSRP report at slot 8 from the reception of DCI triggering the L1-RSRP measurement. The L1-RSRP report shall include the results for both CSI-RS#0 and CSI-RS#1. Each L1-RSRP measurement report shall meet the corresponding absolute accuracy requirements in Table 7.6.3.4.5-2 the corresponding relative accuracy requirements in Table 7.6.3.4.5-3.

**Table 7.6.3.4.5-2: L1-RSRP absolute accuracy requirements for the reported values**

Normal Conditions	T1
Lowest reported value (CSI-RS#1)	40
Highest reported value (CSI-RS#1)	99

**Table 7.6.3.4.5-3: L1-RSRP relative accuracy requirements for the reported values**

	T1
Lowest DIFF RSRP reported (CSI-RS#0)	1
Highest DIFF RSRP reported (CSI-RS#0)	7

The rate of correct events observed during repeated tests shall be at least 90% with a confidence level of 95%.

NOTE: The actual overall delays measured in the test may be up to  $2 \times TTI_{DCC}$  higher than the measurement reporting delays above because of TTI insertion uncertainty of the measurement report in DCC.

## 7.6.4 CLI measurements

### 7.6.4.0 Minimum conformance requirements

#### 7.6.4.0.1 Minimum conformance requirements for SRS-RSRP measurement period

The UE shall be capable of performing SRS-RSRP measurement based on the configured SRS resource, and the UE shall be capable of reporting SRS-RSRP measured over measurement period of  $T_{SRS\_RSRP\_measurement\_period}$  for FR1 and FR2.

**Table 7.6.4.0.1-1 Measurement period  $T_{\text{SRS\_RSRP\_measurement\_period}}$** 

Configuration	$T_{\text{SRS\_measurement\_period}}$ (ms)
No DRX	$\text{Max}(60, 3 \times T_{\text{SRS}})$
DRX cycle $\leq 320\text{ms}$	$\text{Max}(60, \text{Ceil}(1.5 \times 3) \times \text{max}(T_{\text{SRS}}, T_{\text{DRX}}))$
DRX cycle $> 320\text{ms}$	$3 \times T_{\text{DRX}}$
Note:	$T_{\text{SRS}}$ is SRS measurement periodicity configured <i>SRS-PeriodicityAndOffset</i> , and $T_{\text{DRX}}$ is the DRX cycle length.

If the SRS resources configured for measurement are partially or fully overlapping with SMTC window, SSB or CSI-RS configured for RLM, BFD, CBD or L1-RSRP measurement or measurement gaps, requirements are not specified for  $T_{\text{SRS\_RSRP\_measurement\_period}}$ .

When configured by the network, the UE shall be able to perform SRS-RSRP measurements of configured *srs-ResourceConfigCLI*. The requirements apply when the subcarrier spacing for SRS-RSRP measurement resource configuration is the same as the subcarrier spacing of the active DL BWP of serving cell. The UE is not required to measure SRS using different SCS compared to the downlink active BWP SCS of the same carrier.

The requirements as provided:

- SRS resources configured for SRS-RSRP measurements are measurable.

An SRS resource configured for SRS-RSRP shall be considered measurable when for each relevant SRS the following conditions are met:

- SRS-RSRP related side conditions given in clauses 10.1.22.1 for FR1 and FR2 for a corresponding band,
- $\text{SRS\_RP}$  and  $\text{SRS } \hat{E}_s/I_{ot}$  according to Annex B.2.7 for a corresponding band.

The UE shall send SRS-RSRP reports only for report configurations according to *reportType* which is *cliPeriodical* or *cliEventTriggered* when SRS-RSRP report is configured.

The UE shall report the SRS-RSRP value as a 7-bit value in the range [-140, -44] dBm with 1dB step size according to clause 10.1.22.1 for FR1 and FR2.

Reported SRS-RSRP measurements contained in periodically triggered measurement reports shall meet the requirements in clause 10.1.22.1.

Reported SRS-RSRP measurements contained in periodically triggered measurement reports shall meet the requirements in clauses 10.1.22.1.

The first report in event triggered periodic measurement reporting shall meet the requirements specified in clause 9.7.2.3.3.

Reported SRS-RSRP measurements contained in periodically triggered measurement reports shall meet the requirements in clause 10.1.22.1.

The UE shall not send any event triggered measurement reports as long as no reporting criteria is fulfilled.

The measurement reporting delay is defined as the time between an event that will trigger a measurement report and the point when the UE starts to transmit the measurement report over the air interface. This requirement assumes that the measurement report is not delayed by other RRC signalling on the DCCH. This measurement reporting delay excludes a delay uncertainty resulted when inserting the measurement report to the TTI of the uplink DCCH. The delay uncertainty is:  $2 \times \text{TTI}_{\text{DCCH}}$ . This measurement reporting delay excludes a delay which caused by no UL resources for UE to send the measurement report on.

The normative reference for this requirement is TS 38.133 [6] clause 9.7.2.5 and 9.7.2.1, 9.7.2.2 and 9.7.2.3

#### 7.6.4.1 NR SA FR2 SRS-RSRP measurement in non-DRX

**Editor's Note:** This test case is incomplete. Following aspects are either missing or TBD

- The test applicability is FFS
- The test procedure is incomplete

- The message content is FFS

- MU/TT analysis is FFS

#### 7.6.4.1.1 Test purpose

The purpose of this test case is to verify that the UE makes correct reporting of SRS-RSRP measurement in non-DRX within SRS-RSRP measurement requirements in TS 38.133 [6] clause 9.7.2.5

#### 7.6.4.1.2 Test applicability

FFS

#### 7.6.4.1.3 Minimum conformance requirements

The minimum conformance requirements are specified in clause 7.6.4.0.1

The normative reference for this requirement is TS 38.133 [6] clause 9.7.2.5 and A.7.6.4.1.

#### 7.6.4.1.4 Test description

One cell is deployed in the test, which is FR2 PCell (Cell 1).

##### 7.6.4.1.4.1 Initial conditions

This test shall be tested using any of the test configurations in Table 7.6.4.1.4.1-1.

**Table 7.6.4.1.4.1-1: Supported test configurations**

Test Case ID	Description
7.6.4.1 - 1	NR 120 kHz SRS SCS, 100 MHz bandwidth, TDD duplex mode

Configure the test equipment and the DUT according to the parameters in Table 7.6.4.1.4.1-2.

**Table 7.6.4.1.4.1-2: Initial conditions SA FR2 SRS-RSRP measurement in non-DRX**

Parameter	Value		Comment
Test environment	NC		As specified in TS 38.508-1 [14] clause 4.1.
Test frequencies	As specified in Annex E, Table E.5-1 and TS 38.508-1 [14] clause 4.3.1.		
Channel bandwidth	As specified by the test configuration selected from Table 6.6.1.1.4.1-1.		
Propagation conditions	AWGN		As specified in Annex C.2.2
Connection Diagram	TE Part	A.3.3.1.1	As specified in TS 38.508-1 [14] Annex A.
	DUT Part	A.3.4.1.1	
Exceptions to connection diagram	N/A		

1. The test parameters are given in Table 7.6.4.1.4.1-3 below.
2. Message contents are defined in clause 7.6.4.1.4.3.
3. One cell is deployed in the test, which is FR2 PCell (Cell 1).. The test parameters for PSCell is given in Table A.7.6.4.1.4.1-3
4. The UE Rx beam peak direction has been obtained previously using one of the Rx Beam Peak Search procedures as described in Annex I.

**Table 7.6.4.1.4.1-3: General test parameters for SRS-RSRP event triggered reporting for PCell in FR2**

Parameter	Unit	Test configuration	Value	Comment
Active cell		1	Cell 1	
RF Channel Number		1	1: Cell 1	
SSB configuration		1	SSB.1 FR2	
SMTC configuration		1	SMTC.1	
SRS configuration		1	SRSCnf.1	Table A.7.6.4.1.2-4
CP length		1	Normal	
i1-Threshold	dBm	1	-103	
Hysteresis	dB	1	0	
Time To Trigger	s	1	0	
Filter coefficient		1	0	L3 filtering is not used
DRX	ms	1	OFF	Non-DRX
Time offset between DL from serving cell and SRS from test system	µs	1	10.67	
T1	s	1	5	
T2	s	1	1	

#### 7.6.4.1.4.2 Test procedure

There is one cell is deployed in the test, which is FR2 PSCell (Cell 1)

In the measurement control information, a measurement object is configured for the frequency of the PSCell, and it is indicated to the UE that event-triggered reporting with Event I1 is used. The test consists of two successive time periods, with time duration of T1 and T2, respectively.

During the test, the test system transmits SRS resource for measurement in the DL slot according to the SRS configuration in Table 7.6.4.1.5-3 and the test parameters for the (virtual) neighbour cell UE in Table 7.6.4.1.5-23. During the test, the test system does not transmit PDCCH/PDSCH/OCNG on SRS symbol to be transmitted and on 2 data symbols before SRS to be transmitted.

1. Ensure the UE is in state RRC\_CONNECTED with generic procedure parameters Connectivity *NR*, Connected without release *On* and Test Mode *On* according to TS 38.508-1 [14] clause 4.5.
2. Set the parameters according to Table 7.6.4.1.5-1 as appropriate.
3. The SS shall transmit an RRCReconfiguration message on Cell 1 with event I1 configured..
4. The UE shall transmit an RRCReconfigurationComplete message.
5. The UE shall transmit periodically MeasurementReport messages.

<rest of the steps are FFS >

#### 7.6.4.1.4.3 Message contents

Message contents are according to TS 38.508-1 [14] clause 7.3 with the following exceptions:

FFS

#### 7.6.4.1.5 Test requirement

Table 7.6.4.1.5-1 defines the cell specific settings for all tests. Table 7.6.4.1.5-2 defines the OTA primary level settings including test tolerances for all tests.

**Table 7.6.4.1.5-1: NR Cell specific test parameters for SA SRS-RSRP event triggered reporting for PCell in FR2**

Parameter	Unit	Test configuration	Cell 1	
			T1	T2
TDD configuration		1	TDDConf.3.1	
PDSCH RMC configuration		1	SR.3.1 TDD	
RMSI CORESET RMC configuration		1	CR.3.1 TDD	
Dedicated CORESET RMC configuration		1	CCR.3.1 TDD	
OCNG Patterns		1	OP.1	
TRS configuration			TRS.2.1. TDD	
PDSCH/PDCCH TCI state		1	TCI.State.2	
Initial BWP configuration		1	DLBWP.0.1 ULBWP.0.1	
Active DL BWP configuration		1	DLBWP.1.1	
Active UL BWP configuration		1	ULBWP.1.1	
Propagation Condition		1	AWGN	

**Table 7.6.4.1.5-2: NR OTA Cell specific test parameters for SA SRS-RSRP event triggered reporting for PCell and neighbour cell UE in FR2**

Parameter	Unit	Test configuration	Cell 1		Neighbour cell UE	
			T1	T2	T1	T2
AoA setup		1	Setup 1 defined in A.3.15.1			
Beam assumption Note 4		1	Fine			
$N_{oc}$ Note 2	dBm/15 kHz	1	-98		-98	
$N_{oc}$ Note 2	dBm/SCS	1	-89		-89	
$\hat{E}_s/I_{ot}$	dB	1	-	-	-infinity	4
$\hat{E}_s/N_{oc}$	dB	1	-	-	-infinity	4
SRS-RSRP Note 3	dBm/SCS kHz	1	-	-	-infinity	-94
$l_o$	dBm/95.04 MHz	1	-70.01	-68.82	-70.01	-68.82
<p>Note 1: The resources for uplink transmission are assigned to the UE prior to the start of time period T2.</p> <p>Note 2: Interference from other cells and noise sources not specified in the test is assumed to be constant over subcarriers and time and shall be modelled as AWGN of appropriate power for <math>N_{oc}</math> to be fulfilled.</p> <p>Note 3: SRS-RSRP levels have been derived from other parameters for information purposes. They are not settable parameters themselves.</p> <p>Note 4: Information about types of UE beam is given in B.2.1.3, and does not limit UE implementation or test system implementation.</p>						

**Table 7.6.4.1.5-3: SRS configuration for measurement reporting**

	Field	SRSCnf.1	Comments
SRS-ResourceSet	srs-ResourceSetId	0	
	srs-ResourceIdList	0	
	resourceType	Periodic	
	Usage	Codebook	
SRS-Resource	SRS-ResourceId	0	
	nrofSRS-Ports	Port1	
	transmissionComb	n2	
	combOffset-n2	0	
	cyclicShift-n2	0	
	resourceMapping startPosition	0	
	resourceMapping nrofSymbols	n1	
	resourceMapping repetitionFactor	n1	
	freqDomainPosition	0	
	freqDomainShift	0	
	freqHopping c-SRS	12	
	freqHopping b-SRS	0	
	freqHopping b-hop	0	
	groupOrSequenceHopping	Neither	
	resourceType	Periodic	
	periodicityAndOffset	sl40, 25	
	sequenceId	0	Any 10 bit number

The UE shall send one Event I1 triggered measurement report, with a measurement reporting delay less than 60 ms from the beginning of time period T2.

The UE shall not send event triggered measurement reports, as long as the reporting criteria are not fulfilled.

The rate of correct events observed during repeated tests shall be at least 90%.

NOTE: The actual overall delays measured in the test may be up to  $2 \times TTI_{DCCH}$  higher than the measurement reporting delays above because of TTI insertion uncertainty of the measurement report in DCCH.

## 7.6.5

### 7.6.6 L1-SINR measurement for beam reporting

#### 7.6.6.0 Minimum conformance requirements

##### 7.6.6.0.1 L1-SINR reporting with CSI-RS based CMR and no dedicated IMR configured

Same as clause 5.6.5.0.1

The normative reference for this requirement is TS 38.133 [6] clause 9.8.3, 9.8.4.1 and 9.8.5.

##### 7.6.6.0.2 L1-SINR reporting with SSB based CMR and dedicated IMR configured

Same as clause 5.6.5.0.2

The normative reference for this requirement is TS 38.133 [6] clauses 9.8.3, 9.8.4.2 and 9.8.5.

##### 7.6.6.0.3 L1-SINR reporting with CSI-RS based CMR and dedicated IMR configured

Same as clause 5.6.5.0.3

The normative reference for this requirement is TS 38.133 [6] clauses 9.8.3, 9.8.4.3 and 9.8.5.

### 7.6.6.1 NR SA FR2 CSI-RS based CMR and no dedicated IMR L1-SINR measurement in non-DRX

**Editor's Note:** This test case has been completed for the following configurations:

- Test frequency  $f \leq 40.8$  GHz
- UE PC3
- Normal conditions
- The test is incomplete for UE power classes other than PC3
- The test is incomplete for test frequencies  $> 40.8$  GHz
- The test case is incomplete for extreme conditions

#### 7.6.6.1.1 Test purpose

To verify that the UE makes correct reporting of L1-SINR measurement in non-DRX within L1-SINR measurement requirements in TS 38.133 [6] clause 9.8.4.1.

#### 7.6.6.1.2 Test applicability

This test applies to all types of NR UE from Release 16 onwards and supporting L1-SINR measurement.

#### 7.6.6.1.3 Minimum conformance requirements

The minimum conformance requirements are specified in clause 7.6.6.0.1.

The normative reference for this requirement is TS 38.133 [6] clause A.7.6.6.1.

#### 7.6.6.1.4 Test description

##### 7.6.6.1.4.1 Initial conditions

This test shall be tested using any of the test configurations in Table 7.6.6.1.4.1-1.

**Table 7.6.6.1.4.1-1: Applicable NR configurations for FR2 CSI-RS based CMR and no dedicated IMR L1-SINR measurement**

Config	Description
1	NR 120 kHz CSI-RS SCS, 100 MHz bandwidth, TDD duplex mode
Note:	The UE is only required to be tested in one of the supported test configurations

**Table 7.6.6.1.4.1-2: General test parameters for FR2 CSI-RS based CMR and no dedicated IMR L1-SINR measurement**

Parameter	Config	Unit	Value
SSB GSCN	1		freq1
Duplex mode	1		TDD
TDD Configuration	1		TDDConf.3.1
$BW_{\text{channel}}$	1	MHz	100: $N_{RB,c} = 66$
PDSCH Reference measurement channel	1		SR.3.1 TDD
RMSI CORESET Reference Channel	1		CR.3.1 TDD
Dedicated CORESET Reference Channel	1		CCR.3.1 TDD
SSB configuration	1		SSB.1 FR2
CSI-RS configuration	1		CSI-RS.3.3 TDD
OCNG Patterns	1		OP.1
Initial BWP Configuration	1		DLBWP.0.1 ULBWP.0.1
Dedicated BWP configuration	1		DLBWP.1.3 ULBWP.1.3
SMTc configuration	1		SMTc.1
TRS Configuration	1		TRS.2.1 TDD
PDCCH/PDSCH TCI Configuration	1		TCI.State.2
DRX configuration	1		Off
reportConfigType	1		aperiodic
reportQuantity	1		cri-SINR
reportQuantity-r16	1		cri-SINR-r16
Number of reported RS	1		2
qcl-Info	1		SSB#0 for resource#0 SSB#1 for resource#1
reportSlotOffsetList	1		26
Propagation condition	1		AWGN
T1	1	s	5
EPRE ratio of PSS to SSS	1	dB	0
EPRE ratio of PBCH DMRS to SSS			
EPRE ratio of PBCH to PBCH DMRS			
EPRE ratio of PDCCH DMRS to SSS			
EPRE ratio of PDCCH to PDCCH DMRS			
EPRE ratio of PDSCH DMRS to SSS			
EPRE ratio of PDSCH to PDSCH DMRS			
EPRE ratio of OCNG DMRS to SSS <sup>Note 1</sup>			
EPRE ratio of OCNG to OCNG DMRS <sup>Note 1</sup>			
Note 1:			



**Table 7.6.6.1.4.1-3: Test Environment parameters for FR2 CSI-RS based CMR and no dedicated IMR L1-SINR measurement**

Parameter	Value		Comment
Test environment	NC		As specified in TS 38.508-1 [14] clause 4.1.
Test frequencies	As specified in Annex E, Table E.2-1 and TS 38.508-1 [14] clause 4.3.1 and 4.4.2.		
Channel bandwidth	As specified by the test configuration selected from Table 7.6.6.1.4.1-1.		
Propagation conditions	AWGN		As specified in Annex C.2.2.
Connection Diagram	TE Part	A.3.3.3.1-1	As specified in TS 38.508-1 [14] Annex A.
	DUT Part	A.3.4.1.1	
Exceptions to connection diagram			

1. Message contents are defined in clause 7.6.6.1.4.3.
2. The AoA setup for this test is Setup 1 as defined in clause A.9. The UE RX Beam Peak direction has been obtained previously using one of the search procedures as described in Annex I.

#### 7.6.6.1.4.2 Test procedure

The test consists of a single time period T1, during which the UE is triggered via DCI to report L1-SINR on aperiodic CSI-RS resources. Prior to the start of the time duration T1, the UE shall be fully synchronized to PCell. UE is also configured to measure L1-SINR based on SSB. Upon receiving the DCI trigger, UE provides the report back based on the reporting configuration as defined in table 7.6.6.1.4.1-2.

1. Ensure the UE is in state RRC\_CONNECTED with generic procedure parameters Connectivity NR SA, Connected without release *On* and Test Mode *On*, according to TS 38.508-1 [14] clause 4.5.
2. Set the parameters according to T1 in Table 7.6.6.1.5-1. T1 starts.
3. After 160ms from the start of the test the SS transmits the DCI trigger in slot 8.
4. The SS shall check following requirements:
  - R1: the UE shall send L1-SINR report at slot 26 from the reception of DCI trigger. If the report is received at slot 26 from the reception of DCI trigger, the number of passed iterations for R1 is increased by one. Otherwise, the number of failed iterations for R1 is increased by one.
  - R2: the L1-SINR value of CSI-RS#1 reported by the UE is compared to the expected L1-SINR value for CSI-RS #1. If the resulting value is outside the limits in Table 7.6.6.1.5-2 or the UE fails to report the measurement value for CSI-RS #1, the number of failed iterations for R2 is increased by one. Otherwise, the number of passed iterations for R2 is increased by one.
  - R3: The DIFF SINR value of CSI-RS #0 reported by the UE is compared to the expected DIFF SINR value. If the resulting value is outside the limits in Table 7.6.6.1.5-3 or the UE fails to report the measurement value for CSI-RS #0, the number of failed iterations for R3 is increased by one. Otherwise, the number of passed iterations for R3 is increased by one.
6. The SS shall transmit *RRCRelease* message to release the RRC connection which includes the release of the established radio bearers as well as all radio resources.
7. After the RRC connection release, the SS:
  - transmits in Cell 1 a *Paging* message (including *PagingRecord* with *ue-Identity*) for the UE and ensures the UE in state RRC\_CONNECTED with generic procedure parameters Connectivity NR SA, Connected without release *On* and Test Mode *On* according to TS 38.508-1 [14] clause 4.5. (if the paging fails, switches off and on the UE and ensures the UE is in state RRC\_CONNECTED with generic procedure parameters Connectivity NR SA, Connected without release *On* and Test Mode *On* according to TS 38.508-1 [14] clause 4.5.),
  - or:
  - switches off and on the UE and ensures the UE is in state RRC\_CONNECTED with generic procedure

parameters Connectivity NR SA, Connected without release *On* and Test Mode *On* according to TS 38.508-1 [14] clause 4.5.

8. Repeat steps 2-7 until the confidence level according to Tables G.2.3-1 in Annex G clause G.2 is achieved.

7.6.6.1.4.3 Message contents

Message contents are according to TS 38.508-1 [14] clause 7.3 with the following exceptions:

**Table 7.6.6.1.4.3-1: Common Exception messages for FR2 CSI-RS based CMR and no dedicated IMR L1-SINR measurement in non-DRX**

Default Message Contents	
Common contents of system information blocks exceptions	
Default RRC messages and information elements contents exceptions	Table H.3.6A-1 with conditions APERIODIC and CSI-SINR Table H.3.6A-2 with conditions CSI-RS and APERIODIC

**Table 7.6.6.1.4.3-2: RadioLinkMonitoringConfig**

Derivation Path: TS 38.508-1 [14], Table 4.6.3-133			
Information Element	Value/remark	Comment	Condition
RadioLinkMonitoringConfig ::= SEQUENCE {			
failureDetectionResourcesToAddModList SEQUENCE (SIZE(1..maxNrofFailureDetectionResources)) OF SEQUENCE {	1 entry		
purpose	both	UE is configured to perform RLM and BFD based on the SSBs.	
}			
}			

7.6.6.1.5 Test requirement

Table 7.6.6.1.5-1 defines the primary level settings including test tolerances for all tests.

**Table 7.6.6.1.5-1: CSI-RS specific test parameters for NR SA FR2 CSI-RS-based L1-SINR measurement in non-DRX**

Parameter	Config	Unit	CSI-RS#0	CSI-RS#1
Angle of arrival configuration	1		Setup 1 according to A.3.15.1	
Beam assumption <sup>Note 3</sup>	1		Rough	
$N_{oc}$ <sup>Note1</sup>	1	dBm/15kHz	-105	
$N_{oc}$ <sup>Note1</sup>	1	dBm/SSB SCS	-95.97	
$\hat{E}_s / I_{ot}$	1	dB	0	9
CSI-RS RSRP <sup>Note3</sup>	1	dBm/SSB SCS	-95.97	-86.97
$I_o$ <sup>Note2</sup>	1	dBm/95.04MHz	-63.97	-57.47
$\hat{E}_s / N_{oc}$	1	dB	0	9
<p>Note 1: Interference from other cells and noise sources not specified in the test is assumed to be constant over subcarriers and time and shall be modelled as AWGN of appropriate power for <math>N_{oc}</math> to be fulfilled.</p> <p>Note 2: CSI-RS RSRP and <math>I_o</math> levels have been derived from other parameters for information purposes. They are not settable parameters themselves.</p> <p>Note 3: Information about types of UE beam is given in B.2.1.3, and does not limit UE implementation or test system implementation</p>				

After 160ms from the beginning of the test, the UE shall send L1-SINR report at slot 26 from the reception of DCI triggering the L1-SINR measurement. The L1-SINR report shall include the results for both CSI-RS#0 and CSI-RS#1. Each L1-SINR measurement report shall meet the corresponding absolute accuracy requirements in Table 7.6.6.1.5-2 the corresponding relative accuracy requirements in Table 7.6.6.1.5-3.

**Table 7.6.6.1.5-2: L1-SINR absolute accuracy requirements for the reported values**

Normal Conditions	T1
Lowest reported value (CSI-RS#1)	51
Highest reported value (CSI-RS#1)	74

**Table 7.6.6.1.5-3: L1-SINR relative accuracy requirements for the reported values**

	T1
Lowest DIFF SINR reported (CSI-RS#0)	4
Highest DIFF SINR reported (CSI-RS#0)	13

The rate of correct events observed during repeated tests shall be at least 90% with a confidence level of 95%.

NOTE: The actual overall delays measured in the test may be up to  $2xTTI_{DCCH}$  higher than the measurement reporting delays above because of TTI insertion uncertainty of the measurement report in DCCH.

## 7.6.6.2 NR SA FR2 SSB based CMR and dedicated IMR L1-SINR measurement in DRX

**Editor's Note:** This test case has been completed for the following configurations:

- Test frequency  $f \leq 40.8$  GHz
- UE PC3

- Normal conditions
- The test is incomplete for UE power classes other than PC3
- The test is incomplete for test frequencies > 40.8 GHz
- The test case is incomplete for extreme conditions

#### 7.6.6.2.1 Test purpose

To verify that the UE makes correct reporting of L1-SINR measurement in DRX within L1-SINR measurement requirements in TS 38.133 [6] clause 9.8.4.2.

#### 7.6.6.2.2 Test applicability

This test applies to all types of NR UE from Release 16 onwards, supporting long DRX cycle and L1-SINR measurement.

#### 7.6.6.2.3 Minimum conformance requirements

The minimum conformance requirements are specified in clause 7.6.6.0.2.

The normative reference for this requirement is TS 38.133 [6] clause A.7.6.6.2.

#### 7.6.6.2.4 Test description

##### 7.6.6.2.4.1 Initial conditions

This test shall be tested using any of the test configurations in Table 7.6.6.2.4.1-1.

**Table 7.6.6.2.4.1-1: Applicable NR configurations for FR2 SSB based CMR and CSI-IM based IMR L1-SINR measurement**

Config	Description
1	NR 120 kHz SSB SCS, 100 MHz bandwidth, TDD duplex mode
2	NR 240 kHz SSB SCS, 100 MHz bandwidth, TDD duplex mode
Note: The UE is only required to be tested in one of the supported test configurations	

**Table 7.6.6.2.4.1-2: General test parameters for FR2 SSB based CMR and CSI-IM based IMR L1-SINR measurement**

Parameter	Config	Unit	Value
SSB GSCN	1~2		freq1
Duplex mode	1~2		TDD
TDD Configuration	1~2		TDDConf.3.1
$BW_{channel}$	1~2	MHz	100: $N_{RB,c} = 66$
PDSCH Reference measurement channel	1~2		SR.3.1 TDD
RMSI CORESET Reference Channel	1~2		CR.3.1 TDD
Dedicated CORESET Reference Channel	1~2		CCR.3.1 TDD
SSB configuration	1		SSB.1 FR2
	2		SSB.2 FR2

CSI-IM configuration	1~2		CSI-IM.3.1 TDD
OCNG Patterns	1~2		OP.1
Initial BWP Configuration	1~2		DLBWP.0.1 ULBWP.0.1
Dedicated BWP configuration	1~2		DLBWP.1.3 ULBWP.1.3
SMTC configuration	1~2		SMTC.1
TRS Configuration	1~2		TRS.2.1 TDD
PDCCH/PDSCH TCI Configuration	1~2		TCI.State.2
DRX configuration	1~2		DRX.3
reportConfigType	1~2		periodic
reportQuantity-r16	1~2		ssb-Index-SINR-r16
Number of reported RS	1~2		2
L1-SINR reporting period	1~2	slot	640
T1	1~2	s	5
T2	1~2	s	2
Propagation condition	1~2		AWGN
EPRE ratio of PSS to SSS	1~2	dB	0
EPRE ratio of PBCH DMRS to SSS			
EPRE ratio of PBCH to PBCH DMRS			
EPRE ratio of PDCCH DMRS to SSS			
EPRE ratio of PDCCH to PDCCH DMRS			
EPRE ratio of PDSCH DMRS to SSS			
EPRE ratio of PDSCH to PDSCH DMRS			
EPRE ratio of OCNG DMRS to SSS <sup>Note 1</sup>			
EPRE ratio of OCNG to OCNG DMRS <sup>Note 1</sup>			
Propagation condition			
Note 1: OCNG shall be used such that both cells are fully allocated and a constant total transmitted power spectral density is achieved for all OFDM symbols.			

**Table 7.6.6.2.4-3: Test Environment parameters for FR2 SSB based CMR and CSI-IM based IMR L1-SINR measurement**

Parameter	Value		Comment
Test environment	NC		As specified in TS 38.508-1 [14] clause 4.1.
Test frequencies	As specified in Annex E, Table E.2-1 and TS 38.508-1 [14] clause 4.3.1 and 4.4.2.		
Channel bandwidth	As specified by the test configuration selected from Table 7.6.6.2.4.1-1.		
Propagation conditions	AWGN		As specified in Annex C.2.2.
Connection Diagram	TE Part	A.3.3.3.1-1	As specified in TS 38.508-1 [14] Annex A.
	DUT Part	A.3.4.1.1	
Exceptions to connection diagram			

1. Message contents are defined in clause 7.6.6.2.4.3.
2. The AoA setup for this test is Setup 1 as defined in clause A.9. The UE RX Beam Peak direction has been obtained previously using one of the search procedures as described in Annex I.

#### 7.6.6.2.4.2 Test procedure

Prior to the start of the time duration T1, the UE shall be configured for periodic CSI reporting in PUCCH [format 2] with a reporting periodicity as mentioned in the above table 7.6.6.2.4.1-2. Before the test, UE is configured to perform RLM, BFD and L1-SINR measurement based on the SSBs.

1. Ensure the UE is in state `RRC_CONNECTED` with generic procedure parameters Connectivity NR SA, Connected without release *On* and Test Mode *On*, according to TS 38.508-1 [14] clause 4.5 and general test parameters set according to Table 6.6.4.1.4.1-2.
2. Set the parameters according to T1 in Table 7.6.6.2.5-1. T1 starts.
3. The UE shall be transmitting CSI on PUCCH with a periodicity of 640 slots.
4. When T1 expires, the SS shall set the parameters according to T2 in 7.6.6.2.5-1. T2 starts.
5. The UE shall start sending valid L1-SINR reports. The SS shall check the following requirements:
  - R1: the UE shall start to transmit valid L1-SINR reports no later than 2960ms for UE supporting power class 1 in configuration 1, no later than 2920ms for UE supporting power class 1 in configuration 2, no later than 2000ms for UE supporting power class other than 1 in configuration 1 and no later than 1960 ms for UE supporting power class other than 1 in configuration 2 from the beginning of time period T2. A valid report shall meet the absolute L1-SINR requirements for SSB#1 Table 7.6.6.2.5-2 for all test configurations. If the first valid report is received before the specified time, the number of passed iterations for R1 is increased by one. Otherwise, the number of failed iterations for R1 is increased by one.
  - R2: the UE shall transmit L1-SINR reports every 640 slots. If the reports are received accordingly, the number of passed iterations for R2 is increased by one. Otherwise, the number of failed iterations for R2 is increased by one.
  - R3: The L1-SINR value of SSB#1 reported by the UE is compared to the expected L1-SINR value for SSB#1. In all consecutive reports after the first valid value is received, if the resulting value is outside the corresponding absolute accuracy requirements in Table 7.6.6.2.5-2 for all test configurations, the number of failed iterations for R3 is increased by one. Otherwise, the number of passed iterations for R3 is increased by one.
  - R4: The DIFF-SINR value of SSB#0 reported by the UE is compared to the expected DIFF-SINR value. In all consecutive reports after the first valid value is received, if the resulting value is outside the corresponding relative accuracy requirements in Table 7.6.6.2.5-3 for all test configurations, the number of failed iterations for R4 is increased by one. Otherwise, the number of passed iterations for R4 is increased by one.
6. The SS waits until T2 expires.
7. The SS shall transmit *RRCRelease* message to release the RRC connection which includes the release of the established radio bearers as well as all radio resources.
8. After the RRC connection release, the SS:
  - transmits in Cell 1 a *Paging* message (including *PagingRecord* with *ue-Identity*) for the UE and ensures the UE in state `RRC_CONNECTED` with generic procedure parameters Connectivity NR SA, Connected without release *On* and Test Mode *On* according to TS 38.508-1 [14] clause 4.5. (if the paging fails, switches off and on the UE and ensures the UE is in state `RRC_CONNECTED` with generic procedure parameters Connectivity NR SA, Connected without release *On* and Test Mode *On* according to TS 38.508-1 [14] clause 4.5.),
  - or:
  - switches off and on the UE and ensures the UE is in state `RRC_CONNECTED` with generic procedure parameters Connectivity NR SA, Connected without release *On* and Test Mode *On* according to TS 38.508-1 [14] clause 4.5.
9. Repeat steps 2-8 until the confidence level according to Tables G.2.3-1 in Annex G clause G.2 is achieved.

#### 7.6.6.2.4.3 Message contents

Message contents are according to TS 38.508-1 [14] clause 4.6 with the following exceptions:

**Table 7.6.6.2.4.3-1: Common Exception messages for FR2 SSB based CMR and CSI-IM based IMR L1-SINR measurement**

Default Message Contents	
Common contents of system information blocks exceptions	
Default RRC messages and information elements contents exceptions	Table H.3.6A-1 with conditions PERIODIC and SS-SINR and CSI-IM_IMR Table H.3.6A-2 with conditions SSB and PERIODIC Table H.3.6A-4 with condition PERIODIC Table H.3.7-1 with condition DRX.3 Table H.3.4-1

**Table 7.6.6.2.4.3-2: RadioLinkMonitoringConfig**

Derivation Path: TS 38.508-1 [14], Table 4.6.3-133			
Information Element	Value/remark	Comment	Condition
RadioLinkMonitoringConfig ::= SEQUENCE {			
failureDetectionResourcesToAddModList SEQUENCE (SIZE(1..maxNrofFailureDetectionResources)) OF SEQUENCE {	1 entry		
purpose	both	UE is configured to perform RLM and BFD based on the SSBs.	
detectionResource CHOICE {			
ssb-Index	0		
}			
}			
}			

7.6.6.2.5 Test requirement

Table 7.6.6.2.5-1 defines the primary level settings including test tolerances for all tests.

**Table 7.6.6.2.5-1: SSB specific test parameters for FR2 SSB based CMR and CSI-IM based IMR L1-SINR measurement**

Parameter	Config	Unit	SSB#0		SSB#1	
			T1	T2	T1	T2
Angle of arrival configuration	1~2		Setup 1 according to A.3.15.1			
Beam assumption <sup>Note 4</sup>	1~2		Rough			
$N_{oc}$ <sup>Note2</sup>	1~2	dBm/15kHz	-105			
$N_{oc}$ <sup>Note2</sup>	1	dBm/SSB SCS	-96			
	2		-93			
$\hat{E}_s/I_{ot}$	1~2	dB	0	0	-Infinity	9
SSB RSRP <sup>Note3</sup>	1	dBm/SSB SCS	-96	-96	-Infinity	-87
	2		-93	-93	-Infinity	-84
$I_o$ <sup>Note3</sup>	1	dBm/95.04MHz	-64	-64	-67	-57.5
	2		-64	-64	-67	-57.5

$\hat{E}_s / N_{oc}$	1~2	dB	0	0	-Infinity	9
Note 1:	The resources for uplink transmission are assigned to the UE prior to the start of time period T2.					
Note 2:	Interference from other cells and noise sources not specified in the test is assumed to be constant over subcarriers and time and shall be modelled as AWGN of appropriate power for $N_{oc}$ to be fulfilled.					
Note 3:	SSB RSRP and $I_o$ levels have been derived from other parameters for information purposes. They are not settable parameters themselves.					
Note 4:	Information about types of UE beam is given in B.2.1.3, and does not limit UE implementation or test system implementation					

The UE shall send L1-SINR report every 640 slots. No later than X ms plus 640 slots from the beginning of time period T2, UE shall send L1-SINR report including the results for both SSB#0+CSI-IM#0 and SSB#1+CSI-IM#1 while meeting the accuracy requirements defined in clause 10.1.28.2, where X is

- 2880 for UE supporting power class 1
- 1920 for UE supporting power class 2,3 or 4.

Each L1-SINR measurement report shall meet the corresponding absolute accuracy requirements in Table 7.6.6.2.5-2 for all test configurations and the corresponding relative accuracy requirements in Table 7.6.6.2.5-3 for all test configurations.

**Table 7.6.6.2.5-2: L1-SINR absolute accuracy requirements for the reported values for all test configurations**

Normal Conditions	T1	T2
Lowest reported value (SSB#1)	-	53
Highest reported value (SSB#1)	-	72

**Table 7.6.6.2.5-4: L1-SINR relative accuracy requirements for the reported values for all test configurations**

	T1	T2
Lowest DIFF SINR reported (SSB#0)	-	5
Highest DIFF SINR reported (SSB#0)	-	12

For the test to pass, the ratio of successful reported values for each requirement (R1 to R4) shall be at least 90% with a confidence level of 95%. Each requirement is evaluated independently of the others.

The rate of correct events observed during repeated tests shall be at least 90%.

NOTE: The actual overall delays measured in the test may be up to  $2 \times TTI_{DCCH}$  higher than the measurement reporting delays above because of TTI insertion uncertainty of the measurement report in DCCH.

### 7.6.6.3 NR SA FR2 CSI-RS based CMR and dedicated IMR L1-SINR measurement in DRX

**Editor's Note:** This test case has been completed for the following configurations:

- Test frequency  $f \leq 40.8$  GHz
- UE PC3
- Normal conditions
- The test is incomplete for UE power classes other than PC3
- The test is incomplete for test frequencies  $> 40.8$  GHz



**- The test case is incomplete for extreme conditions****7.6.6.3.1 Test purpose**

To verify that the UE makes correct reporting of L1-SINR measurement in DRX within L1-SINR measurement requirements in TS 38.133 [6] clause 9.8.4.3.

**7.6.6.3.2 Test applicability**

This test applies to all types of NR UE from Release 16 onwards and supporting long DRX cycle and L1-SINR measurement.

**7.6.6.3.3 Minimum conformance requirements**

The minimum conformance requirements are specified in clause 7.6.6.0.3.

The normative reference for this requirement is TS 38.133 [6] clause A.7.6.6.3.

**7.6.6.3.4 Test description****7.6.6.3.4.1 Initial conditions**

This test shall be tested using any of the test configurations in Table 7.6.6.3.4.1-1.

**Table 7.6.6.3.4.1-1: Applicable NR configurations for FR2 CSI-RS based CMR and CSI-RS based IMR L1-SINR measurement**

<b>Config</b>	<b>Description</b>
1	LTE FDD, NR 120 kHz CSI-RS SCS, 100 MHz bandwidth, TDD duplex mode
Note:	The UE is only required to be tested in one of the supported test configurations

**Table 7.6.6.3.4.1-2: General test parameters for FR2 CSI-RS based CMR and CSI-RS based IMR L1-SINR measurement**

Parameter	Config	Unit	Value
SSB GSCN	1		freq1
Duplex mode	1		TDD
TDD Configuration	1		TDDConf.3.1
$BW_{\text{channel}}$	1	MHz	100: $N_{RB,c} = 66$
PDSCH Reference measurement channel	1		SR.3.1 TDD
RMSI CORESET Reference Channel	1		CR.3.1 TDD
Dedicated CORESET Reference Channel	1		CCR.3.1 TDD
SSB configuration	1		SSB.1 FR2
CSI-RS as CMR configuration	1		CSI-RS.3.3 TDD
CSI-RS as IMR configuration	1		CSI-RS.3.2A TDD
OCNG Patterns	1		OP.1
Initial BWP Configuration	1		DLBWP.0.1 ULBWP.0.1
Dedicated BWP configuration	1		DLBWP.1.3 ULBWP.1.3
SMTc configuration	1		SMTc.1
TRS Configuration	1		TRS.2.1 TDD
PDCCH/PDSCH TCI Configuration	1		TCI.State.2
DRX configuration	1		DRX.3
reportConfigType	1		aperiodic
reportQuantity-r16	1		cri-SINR-r16
Number of reported RS	1		2
qcl-Info	1		SSB#0 for resource#0 SSB#1 for resource#1
reportSlotOffsetList	1		26
T1	1	s	5
EPRE ratio of PSS to SSS	1	dB	0
EPRE ratio of PBCH DMRS to SSS			
EPRE ratio of PBCH to PBCH DMRS			
EPRE ratio of PDCCH DMRS to SSS			
EPRE ratio of PDCCH to PDCCH DMRS			
EPRE ratio of PDSCH DMRS to SSS			
EPRE ratio of PDSCH to PDSCH DMRS			
EPRE ratio of OCNG DMRS to SSS <sup>Note 1</sup>			
EPRE ratio of OCNG to OCNG DMRS <sup>Note 1</sup>			
Propagation condition			
Note 1: OCNG shall be used such that both cells are fully allocated and a constant total transmitted power spectral density is achieved for all OFDM symbols.			

**Table 7.6.6.3.4.1-3: Test Environment parameters for FR2 CSI-RS based CMR and CSI-RS based IMR L1-SINR measurement**

Parameter	Value		Comment
Test environment	NC		As specified in TS 38.508-1 [14] clause 4.1.
Test frequencies	As specified in Annex E, Table E.2-1 and TS 38.508-1 [14] clause 4.3.1 and 4.4.2.		
Channel bandwidth	As specified by the test configuration selected from Table 7.6.6.3.4.1-1.		
Propagation conditions	AWGN		As specified in Annex C.2.2.
Connection Diagram	TE Part	A.3.3.3.1-1	As specified in TS 38.508-1 [14] Annex A.
	DUT Part	A.3.4.1.1	
Exceptions to connection diagram			

1. Message contents are defined in clause 7.6.6.3.4.3.
2. The AoA setup for this test is Setup 1 as defined in clause A.9. The UE RX Beam Peak direction has been obtained previously using one of the search procedures as described in Annex I.

#### 7.6.6.3.4.2 Test procedure

The test consists of a single time period T1, during which the UE is triggered via DCI to report L1-SINR on aperiodic CSI-RS resources. Prior to the start of the time duration T1, the UE shall be fully synchronized to PCell. UE is also configured to measure L1-SINR based on SSB. Upon receiving the DCI trigger, UE provides the report back based on the reporting configuration as defined in table 7.6.6.3.4.1-2.

1. Ensure the UE is in state RRC\_CONNECTED with generic procedure parameters Connectivity NR SA, Connected without release *On* and Test Mode *On*, according to TS 38.508-1 [14] clause 4.5.
2. Set the parameters according to T1 in Table 7.6.6.3.5-1. T1 starts.
3. After 1440ms from the start of the test the SS transmits the DCI trigger in slot 8.
4. The SS shall check following requirements:
  - R1: the UE shall send L1-SINR report at slot 26 from the reception of DCI trigger. If the report is received at slot 26 from the reception of DCI trigger, the number of passed iterations for R1 is increased by one. Otherwise, the number of failed iterations for R1 is increased by one.
  - R2: the L1-SINR value of CSI-RS#1 reported by the UE is compared to the expected L1-SINR value for CSI-RS #1. If the resulting value is outside the limits in Table 7.6.6.3.5-2 or the UE fails to report the measurement value for CSI-RS #1, the number of failed iterations for R2 is increased by one. Otherwise, the number of passed iterations for R2 is increased by one.
  - R3: The DIFF SINR value of CSI-RS #0 reported by the UE is compared to the expected DIFF SINR value. If the resulting value is outside the limits in Table 7.6.6.3.5-3 or the UE fails to report the measurement value for CSI-RS #0, the number of failed iterations for R3 is increased by one. Otherwise, the number of passed iterations for R3 is increased by one.
6. The SS shall transmit *RRCRelease* message to release the RRC connection which includes the release of the established radio bearers as well as all radio resources.
7. After the RRC connection release, the SS:
  - transmits in Cell 1 a *Paging* message (including *PagingRecord* with *ue-Identity*) for the UE and ensures the UE in state RRC\_CONNECTED with generic procedure parameters Connectivity NR SA, Connected without release *On* and Test Mode *On* according to TS 38.508-1 [14] clause 4.5. (if the paging fails, switches off and on the UE and ensures the UE is in state RRC\_CONNECTED with generic procedure parameters Connectivity NR SA, Connected without release *On* and Test Mode *On* according to TS 38.508-1 [14] clause 4.5.),
  - or:
  - switches off and on the UE and ensures the UE is in state RRC\_CONNECTED with generic procedure

parameters Connectivity NR SA, Connected without release *On* and Test Mode *On* according to TS 38.508-1 [14] clause 4.5.

8. Repeat steps 2-7 until the confidence level according to Tables G.2.3-1 in Annex G clause G.2 is achieved.

7.6.6.3.4.3 Message contents

Message contents are according to TS 38.508-1 [14] clause 7.3 with the following exceptions:

**Table 7.6.6.3.4.3-1: Common Exception messages for FR2 CSI-RS based CMR and CSI-RS based IMR L1-SINR measurement**

Default Message Contents	
Common contents of system information blocks exceptions	
Default RRC messages and information elements contents exceptions	Table H.3.6A-1 with conditions APERIODIC and CSI-SINR and CSI-RS_IMR Table H.3.6A-2 with conditions CSI-RS and APERIODIC Table H.3.6A-3 with conditions APERIODIC Table H.3.7-1 with condition DRX.3 Table H.3.4-1

**Table 7.6.6.3.4.3-2: RadioLinkMonitoringConfig**

Derivation Path: TS 38.508-1 [14], Table 4.6.3-133			
Information Element	Value/remark	Comment	Condition
RadioLinkMonitoringConfig ::= SEQUENCE {			
failureDetectionResourcesToAddModList	1 entry		
SEQUENCE			
(SIZE(1..maxNrofFailureDetectionResources)) OF			
SEQUENCE {			
purpose	both	UE is configured to perform RLM and BFD based on the SSBs.	
}			
}			

7.6.6.3.5 Test requirement

Table 7.6.6.3.5-1 defines the primary level settings including test tolerances for all tests.

**Table 7.6.6.3.5-1: CSI-RS specific test parameters for NR SA FR2 CSI-RS-based CMR and CSI-RS based IMR L1-SINR measurement**

Parameter	Config	Unit	CSI-RS#0	CSI-RS#1
Angle of arrival configuration	1~2		Setup 1 according to A.3.15.1	
Assumption for UE beams <sup>Note 3</sup>	1~2		Rough	
$N_{oc}$ <sup>Note1</sup>	1~2	dBm/15kHz	-105	
$N_{oc}$ <sup>Note1</sup>	1~2	dBm/SSB SCS	-95.97	
$\hat{E}_s / I_{ot}$	1~2	dB	1.5	9
CSI-RS RSRP <sup>Note2</sup>	1~2	dBm/SSB SCS	-94.5	-87.0
$I_o$ <sup>Note2</sup>	1~2	dBm/95.04MHz	-63.2	-57.5
$\hat{E}_s / N_{oc}$	1~2	dB	1.5	9
<p>Note 1: Interference from other cells and noise sources not specified in the test is assumed to be constant over subcarriers and time and shall be modelled as AWGN of appropriate power for <math>N_{oc}</math> to be fulfilled.</p> <p>Note 2: CSI-RS RSRP and <math>I_o</math> levels have been derived from other parameters for information purposes. They are not settable parameters themselves.</p> <p>Note 3: Information about types of UE beam is given in B.2.1.3, and does not limit UE implementation or test system implementation</p>				

After 1440ms from the beginning of the test, the UE shall send L1-SINR report at slot 26 from the reception of DCI triggering the L1-SINR measurement. The L1-SINR report shall include the results for both CSI-RS#0 as CMR + CSI-RS#0 as IMR and CSI-RS#1 as CMR + CSI-RS#1 as IMR. Each L1-SINR measurement report shall meet the corresponding absolute accuracy requirements in Table 7.6.6.3.5-2 the corresponding relative accuracy requirements in Table 7.6.6.3.5-3.

**Table 7.6.6.3.5-2: L1-SINR absolute accuracy requirements for the reported values**

Normal Conditions	T1
Lowest reported value (CSI-RS#1)	54
Highest reported value (CSI-RS#1)	71

**Table 7.6.6.3.5-3: L1-SINR relative accuracy requirements for the reported values**

	T1
Lowest DIFF SINR reported (CSI-RS#0)	4
Highest DIFF SINR reported (CSI-RS#0)	10

The rate of correct events observed during repeated tests shall be at least 90% with a confidence level of 95%.

NOTE: The actual overall delays measured in the test may be up to  $2 \times TTI_{DCC}$  higher than the measurement reporting delays above because of TTI insertion uncertainty of the measurement report in DCC.

## 7.7 Measurement performance requirements

### 7.7.1 SS-RSRP

#### 7.7.1.0 Minimum conformance requirements

##### 7.7.1.0.1 Intra-frequency SS-RSRP measurement accuracy requirements

Same as in clause 5.7.1.0.1.

##### 7.7.1.0.2 Inter-frequency SS-RSRP measurement accuracy requirements

Same as in clause 5.7.1.0.2.

#### 7.7.1.1 NR SA FR2 SS-RSRP measurement accuracy

**Editor's Note:** This test case has been completed for the following configurations:

- Test frequency  $f \leq 40.8$  GHz
- UE PC3
- Normal conditions
- The test is incomplete for UE power classes other than PC3
- The test is incomplete for test frequencies  $> 40.8$  GHz
- The test is incomplete for extreme conditions

##### 7.7.1.1.1 Test purpose

The purpose of this test is to verify that the intra-frequency SS-RSRP measurement accuracy is within the specified limits for all bands.

##### 7.7.1.1.2 Test applicability

This test applies to all types of NR UE from Release 15 onwards.

##### 7.7.1.1.3 Minimum conformance requirements

The minimum conformance requirements are specified in clause 7.7.1.0.1.

The normative reference for this requirement is TS 38.133 [6] clause A.7.7.1.1.

##### 7.7.1.1.4 Test description

Two cells are configured in this test: Cell 1 is the NR FR2 serving cell and Cell 2 is the NR FR2 neighbour cell.

##### 7.7.1.1.4.1 Initial conditions

This test shall be tested using any of the test configurations in Table 7.7.1.1.4.1-1.

**Table 7.7.1.1.4.1-1: Supported test configurations**

Configuration	Description
7.7.1.1-1	NR 120 kHz SSB SCS, 100 MHz bandwidth, FDD duplex mode
Note:	The UE is only required to be tested in one of the supported test configurations

Configure the test equipment and the DUT according to the parameters in Table 7.7.1.1.4.1-2.

Table 7.7.1.1.4.1-2: Initial conditions

Parameter	Value	Comment
Test environment	NC	As specified in TS 36.508 [25] clause 4.1.
Test frequencies	As specified in Annex E, Table E.5-1 and TS 38.508-1 [14] clause 4.3.1.	
Channel bandwidth	As specified by the selected test configuration.	
Propagation conditions	AWGN	As specified in Annex C.2.1
Connection Diagram	TE Part: A.3.3.1.1 DUT Part: A.3.4.1.1	As specified in TS 38.508-1 [14] Annex A.
Exceptions to connection diagram	N/A	

1. The general test parameter settings are set up according to Table 7.7.1.1.4.1-3.
2. Message contents are defined in clause 7.7.1.1.4.3.
3. There are two intra-frequency cells specified in the test, where Cell 1 is the NR FR2 serving cell and Cell 2 is the neighbour cell on the same NR FR2 carrier and the target cell for the SS-RSRP measurements.
4. The UE Rx beam peak direction has been obtained previously using one of the Rx Beam Peak Search procedures as described in Annex I.

#### 7.7.1.1.4.2 Test procedure

1. Ensure the UE is in state RRC\_CONNECTED with generic procedure parameters Connectivity *NR*, Connected without release *On* and Test Mode *On* according to TS 38.508-1 [14] clause 4.5.
2. Set the parameters according to Table 7.7.1.1.5-1 as appropriate.
3. The SS shall transmit an RRCReconfiguration message on Cell 1.
4. The UE shall transmit an RRCReconfigurationComplete message.
5. The UE shall transmit periodically MeasurementReport messages.
6. After 10s wait from Step 3, the SS shall check the SS-RSRP reported values in the periodic MeasurementReport for the following requirements:
  - R1: The SS-RSRP value of Cell 1 reported by the UE is compared to the expected SS-RSRP for Cell 1. If the value is outside the limits in Table 7.7.1.1.5-3 or the UE fails to report the measurement value for Cell 1, the number of failed iterations for R1 is increased by one. Otherwise, the number of passed iterations for R1 is increased by one.
  - R2: The SS-RSRP value of Cell 2 reported by the UE is compared to the expected SS-RSRP for Cell 2. If the value is outside the limits in Table 7.7.1.1.5-3 or the UE fails to report the measurement value for Cell 2, the number of failed iterations for R2 is increased by one. Otherwise, the number of passed iterations for R2 is increased by one.
  - R3: The SS-RSRP value of Cell 2 reported by the UE is compared to the reported SS-RSRP of Cell 1. If the resulting value is outside the limits in Table 7.7.1.1.5-4 or the UE fails to report the measurement value for Cell 1 or Cell 2, the number of failed iterations for R3 is increased by one. Otherwise, the number of passed iterations for R3 is increased by one.
7. The SS shall continue checking the MeasurementReport messages transmitted by the UE until the confidence level according to Table G.2.3-1 in Annex G for each of the requirements is achieved. The evaluation of a specific requirement is concluded when the confidence level for that requirement is reached, even if more measurement reports are required for the remaining requirements.

8. Set the parameters according to Test 2 in Table 7.7.1.1.5-2 as appropriate and repeat steps 5-7. In Step 6, the SS shall check the following requirements:
  - R4: The SS-RSRP value of Cell 1 reported by the UE is compared to the expected SS-RSRP for Cell 1. If the value is outside the limits in Table 7.7.1.1.5-3 or the UE fails to report the measurement value for Cell 1, the number of failed iterations for R4 is increased by one. Otherwise, the number of passed iterations for R4 is increased by one.
  - R5: The SS-RSRP value of Cell 2 reported by the UE is compared to the expected SS-RSRP for Cell 2. If the value is outside the limits in Table 7.7.1.1.5-3 or the UE fails to report the measurement value for Cell 2, the number of failed iterations for R5 is increased by one. Otherwise, the number of passed iterations for R5 is increased by one.
  - R6: The SS-RSRP value of Cell 2 reported by the UE is compared to the reported SS-RSRP of Cell 1. If the resulting value is outside the limits in Table 7.7.1.1.5-4 or the UE fails to report the measurement value for Cell 1 or Cell 2, the number of failed iterations for R6 is increased by one. Otherwise, the number of passed iterations for R6 is increased by one.
  - R7: The SS-RSRP value of Cell 1 reported by the UE during Test 2 is compared to the reported SS-RSRP of Cell 1 during Test 1 for the same iteration. If the resulting value is outside the limits in Table 7.7.1.1.5-5 or the UE fails to report the measurement value for Cell 1, the number of failed iterations for R7 is increased by one. Otherwise, the number of passed iterations for R7 is increased by one.
  - R8: The SS-RSRP value of Cell 2 reported by the UE during Test 2 is compared to the reported SS-RSRP of Cell 2 during Test 1 for the same iteration. If the resulting value is outside the limits in Table 7.7.1.1.5-5 or the UE fails to report the measurement value for Cell 2, the number of failed iterations for R8 is increased by one. Otherwise, the number of passed iterations for R8 is increased by one.
9. If more measurement reports with Test 1 configuration are needed in order to complete the evaluation R7 or R8, the SS shall set the parameters according to Table 7.7.1.1.5-2 as appropriate and repeat steps 5 to 8, evaluating R7 and / or R8 as appropriate.

7.7.1.1.4.3 Message contents

Message contents are according to TS 38.508-1 [14] clause 7.3 with the following exceptions:

**Table 7.7.1.1.4.3-1: Common Exception messages**

Default Message Contents	
Common contents of system information blocks exceptions	
Default RRC messages and information elements contents exceptions	Table H.3.1-1 Table H.3.1-2 Table H.3.1-3 with Condition Synchronous cells Table H.3.1-5 Table H.3.1-7 Table 7.3.1-3 in TS 38.508-1 [14] with condition SMTC.1

**Table 7.7.1.1.4.3-2: ReportConfigNR-DEFAULT(Periodical)**

Derivation Path: 38.508-1 [14] Table 4.6.3-142 with condition PERIODICAL			
Information Element	Value/remark	Comment	Condition
ReportConfigNR ::= SEQUENCE {			
reportType CHOICE {			
periodical SEQUENCE {			PERIODICAL
reportQuantityCell SEQUENCE {			
rsrq	false		
sinr	false		
}			
maxReportCells	2		
}			
}			
}			



## 7.7.1.1.5 Test requirement

Table 7.7.1.1.5-1 defines the cell specific settings for all tests. Table 7.7.1.1.5-2 defines the OTA primary level settings including test tolerances for all tests.

The SS-RSRP measurement accuracy shall fulfil the absolute accuracy requirements in clause 7.7.1.0.1.1 and relative accuracy requirements in clause 7.7.1.0.1.2. The following eight requirements are to be verified:

During T1:

R1: Absolute accuracy of Cell 1. The UE is deemed to meet the requirement if the reported SS-RSRP is in the range shown in Table 7.7.1.1.5-3 and Table 7.7.1.1.5-3a.

R2: Absolute accuracy of Cell 2. The UE is deemed to meet the requirement if the reported SS-RSRP is in the range shown in Table 7.7.1.1.5-3 and Table 7.7.1.1.5-3a.

R3: Relative accuracy of Cell 2 compared with Cell 1. The UE is deemed to meet the requirement if the difference in reported SS-RSRP meets the requirements in Table 7.7.1.1.5-4.

During T2:

R4: Absolute accuracy of Cell 1. The UE is deemed to meet the requirement if the reported SS-RSRP is in the range shown in table 7.7.1.1.5-3 and Table 7.7.1.1.5-3a.

R5: Absolute accuracy of Cell 2. The UE is deemed to meet the requirement if the reported SS-RSRP is in the range shown in table 7.7.1.1.5-3 and Table 7.7.1.1.5-3a..

R6: Relative accuracy of Cell 2 compared with Cell 1. The UE is deemed to meet the requirement if the difference in reported SS-RSRP meets the requirements in Table 7.7.1.1.5-4.

During T1 and T2:

R7: Relative accuracy of Cell 1 during T2 compared with Cell 1 during T1. The UE is deemed to meet the requirement if the difference in reported SS-RSRP meets the requirements in Table 7.7.1.1.5-5.

R8: Relative accuracy of Cell 2 during T2 compared with Cell 2 during T1. The UE is deemed to meet the requirement if the difference in reported SS-RSRP meets the requirements in Table 7.7.1.1.5-5.

**Table 7.7.1.1.5-1: SS-RSRP Intra frequency general test parameters**

Parameter <sup>Note 5</sup>	Unit	T1		T2	
		Cell 1	Cell 2	Cell 1	Cell 2
Physical cell ID		489	0	489	0

SSB ARFCN		freq1		freq1	
Duplex mode		TDD		TDD	
TDD configuration		TDDConf.3.1		TDDConf.3.1	
BW <sub>channel</sub>	MHz	100: N <sub>RB,C</sub> = 66		100: N <sub>RB,C</sub> = 66	
Data RBs allocated		24		24	
Downlink initial BWP configuration		DLBW P.0.1	-	DLBW P.0.1	-
Downlink dedicated BWP configuration		DLBW P.1.1	-	DLBW P.1.1	-
Uplink initial BWP configuration		ULBW P.0.1	-	ULBW P.0.1	-
Uplink dedicated BWP configuration		ULBW P.1.1	-	ULBW P.1.1	-
DRX cycle configuration		Not applicable	-	Not applicable	-
TRS configuration		TRS.2.1 TDD	-	TRS.2.1 TDD	-
TCI state		TCI.State.0	-	TCI.State.0	-
PDSCH Reference measurement channel		SR.3.2 TDD	-	SR.3.2 TDD	-
RMSI CORESET Reference Channel		CR.3.1 TDD	-	CR.3.1 TDD	-
Dedicated CORESET Reference Channel		CCR.3.1 TDD	-	CCR.3.1 TDD	-
OCNG Patterns		OP.3	OP.3	OP.3	OP.3
SSB configuration		SSB.3 FR2	SSB.3 FR2	SSB.3 FR2	SSB.3 FR2
SMTc configuration		SMTc.1	SMTc.1	SMTc.1	SMTc.1
Time offset with Cell 1	µs	-	3	-	3
PDSCH/PDCCH subcarrier spacing	kHz	120	120	120	120
EPRE ratio of PSS to SSS	dB	0	0	0	0
EPRE ratio of PBCH_DMRS to SSS					
EPRE ratio of PBCH to PBCH_DMRS					
EPRE ratio of PDCCH_DMRS to SSS					
EPRE ratio of PDCCH to PDCCH_DMRS					
EPRE ratio of PDSCH_DMRS to SSS					
EPRE ratio of PDSCH to PDSCH_DMRS					
EPRE ratio of OCNG DMRS to SSS <sup>Note 1</sup>					
EPRE ratio of OCNG to OCNG DMRS <sup>Note 1</sup>					
Propagation conditions		AWGN	AWGN	AWGN	AWGN
Antenna configuration		1x2	1x2	1x2	1x2
<p>Note 1: OCNG shall be used such that both cells are fully allocated and a constant total transmitted power spectral density is achieved for all OFDM symbols.</p> <p>Note 2: Void</p> <p>Note 3: Void</p> <p>Note 4: Void</p> <p>Note 5: All parameters apply for configuration 1 and 2</p> <p>Note 6: Void</p>					

Table 7.7.1.1.5-2: SS-RSRP Intra frequency OTA related test parameters

Parameter	Unit	T1		T2	
		Cell 1	Cell 2	Cell 1	Cell 2
Angle of arrival configuration		Setup 1			
Assumption for UE beams <sup>Note 8</sup>		Rough			
$N_{oc}$ <sup>Note1</sup>	dBm/15kHz $z$ <sup>Note4</sup>	-97.4		N/A	
$N_{oc}$ <sup>Note1</sup>	dBm/SCS <sup>Note4</sup>	-88.37		N/A	
$\hat{E}_s / N_{oc}$	dB	6.0	1.4	N/A	N/A
$E_s$	dBm/SCS <sup>Note4</sup>			(Table B.2.2-2 Rx Beam Peak +9.8dB)	(Table B.2.2-2 Rx Beam Peak +9.8dB)
SSB_RP <sup>Note2</sup>	dBm/SCS	-82.37	-86.97	(Table B.2.2-2 Rx Beam Peak +9.8dB)	(Table B.2.2-2 Rx Beam Peak +9.8dB)
$\hat{E}_s / I_{ot\ BB}$ <sup>Note6</sup>	dB	2.20	-5.59	-1.77	-1.77
$I_o$ <sup>Note2</sup>	dBm/95.04 MHz <sup>Note4</sup>	-55.74		(Table B.2.2-2 Rx Beam Peak +37.40dB)	
Note 1:	Where used, interference from other cells and noise sources not specified in the test is assumed to be constant over subcarriers and time and shall be modelled as AWGN of appropriate power for $N_{oc}$ to be fulfilled.				
Note 2:	SSB_RP, $E_s/I_{ot}$ and $I_o$ levels have been derived from other parameters for information purposes. They are not settable parameters themselves.				
Note 3:	Void				
Note 4:	Equivalent power received by an antenna with 0 dBi gain at the centre of the quiet zone				
Note 5:	Void				
Note 6:	Calculation of $E_s/I_{ot\ BB}$ includes the effect of UE internal noise up to the value assumed for the associated Refsens requirement in clause 7.3.2 of TS 38.101-2 [3], and an allowance of 1dB for UE multi-band relaxation factor $\Delta MB_P$ from TS 38.101-2 [3] Table 6.2.1.3-4.				
Note 7:	All parameters apply for configurations 1 and 2				
Note 8:	Information about types of UE beam is given in B.2.1.3 of TS 38.133 [6], and does not limit UE implementation or test system implementation				

**Table 7.7.1.1.5-3: evaluation limits for the reported values for T1 and T2 absolute accuracy rules R1, R2, R4, R5**

UE power class 3			
Normal Conditions	Test 1 All bands	Test 2	
Lowest reported value (Cell 1)	50	n257, n258, n261	31
		n260	33
		n259	FFS
Highest reported value (Cell 1)	108	n257, n258, n261	88
		n260	90
		n259	FFS
Lowest reported value (Cell 2)	46	n257, n258, n261	31
		n260	33
		n259	FFS
Highest reported value (Cell 2)	103	n257, n258, n261	88
		n260	90
		n259	FFS
Extreme Conditions	Test 1 All bands	Test 2	
Lowest reported value (Cell 1)	47+ FFS	n257, n258, n261	28 + FFS
		n260	30 + FFS
		n259	FFS
Highest reported value (Cell 1)	111+ FFS	n257, n258, n261	91 + FFS
		n260	93 + FFS
		n259	FFS
Lowest reported value (Cell 2)	46+ FFS	n257, n258, n261	28+ FFS
		n260	30+ FFS
		n259	FFS
Highest reported value (Cell 2)	106+ FFS	n257, n258, n261	91+ FFS
		n260	93+ FFS
		n259	FFS

**Table 7.7.1.1.5-3a: evaluation limits for the  $\Delta(\text{Max-Min})$  reported values for each cell during each time period**

UE power class 3		
Normal Conditions	Test 1 All bands	Test 2 All bands
$\Delta(\text{Max-Min})$ reported value Cell 1	16	16
$\Delta(\text{Max-Min})$ reported value Cell 2	16	16
Extreme Conditions	Test 1 All bands	Test 2 All bands
$\Delta(\text{Max-Min})$ reported value Cell 1	16 + FFS	16+ FFS
$\Delta(\text{Max-Min})$ reported value Cell 2	16 + FFS	16 + FFS

**Table 7.7.1.1.5-4: evaluation limits for the reported values for T1 and T2 relative accuracy rules R3, R6**

UE power class 3		
Normal Conditions	Test 1 All bands	Test 2 All bands
Lowest reported value (Cell 2 – Cell 1)	- 12	- 6
Highest reported value (Cell 2 – Cell 1)	+ 2	+ 6
Extreme Conditions	Test 1 All bands	Test 2 All bands
Lowest reported value (Cell 2 – Cell 1)	- 15+ FFS	- 9+ FFS
Highest reported value (Cell 2 – Cell 1)	+ 5+ FFS	+ 9+ FFS

**Table 7.7.1.1.5-5: evaluation limits for the reported values for T2 with respect to T1 relative accuracy rules R7, R8**

UE power class 3			
Test 2	Bands	Normal Conditions	Extreme Conditions
Lowest reported value (Cell 1 T2 – Cell 1 T1)	n257, n258, n261	- 28	- 31+ FFS
	n260	- 26	- 29+ FFS
	n259	FFS	FFS
Highest reported value (Cell 1 T2 – Cell 2 T1)	n257, n258, n261	- 12	- 9+ FFS
	n260	- 10	- 7+ FFS
	n259	FFS	FFS
Lowest reported value (Cell 2 T2 – Cell 2 T1)	n257, n258, n261	- 24	- 27+ FFS
	n260	- 21	- 24+ FFS
	n259	FFS	FFS
Highest reported value (Cell 2 T2 – Cell 2 T1)	n257, n258, n261	- 8	- 5+ FFS
	n260	- 5	- 2+ FFS
	n259	FFS	FFS

For the test to pass, the ratio of successful reported values for each requirement (R1 to R8) shall be more than 90% with a confidence level of 95%. Each requirement is evaluated independently of the others.

### 7.7.1.2 NR SA FR2-FR2 SS-RSRP measurement accuracy

**Editor's Note:** This test case has been completed for the following configurations:

- Test frequency  $f \leq 40.8$  GHz
- UE PC3
- Normal conditions
- The test is incomplete for UE power classes other than PC3
- The test is incomplete for test frequencies  $> 40.8$  GHz
- The test is incomplete for extreme conditions

#### 7.7.1.2.1 Test purpose

The purpose of this test is to verify that the inter-frequency SS-RSRP measurement accuracy is within the specified limits for all bands.

### 7.7.1.2.2 Test applicability

This test applies to all types of NR UE from Release 15 onwards.

### 7.7.1.2.3 Minimum conformance requirements

The minimum conformance requirements are specified in clause 7.7.1.0.2.

The normative reference for this requirement is TS 38.133 [6] clause A.7.7.1.2.

### 7.7.1.2.4 Test description

Two cells are configured in this test: Cell 1 is the NR FR2 serving cell and Cell 2 is the inter-frequency NR FR2 neighbour cell.

#### 7.7.1.2.4.1 Initial conditions

This test shall be tested using any of the test configurations in Table 7.7.1.2.4.1-1.

**Table 7.7.1.2.4.1-1: Supported test configurations**

Configuration	Description
7.7.1.2-1	NR 120 kHz SSB SCS, 100 MHz bandwidth, FDD duplex mode
7.7.1.2-2	NR 240 kHz SSB SCS, 100 MHz bandwidth, TDD duplex mode
Note: The UE is only required to be tested in one of the supported test configurations	

Configure the test equipment and the DUT according to the parameters in Table 7.7.1.2.4.1-2.

**Table 7.7.1.2.4.1-2: Initial conditions**

Parameter	Value	Comment
Test environment	NC	As specified in TS 36.508 [25] clause 4.1.
Test frequencies	As specified in Annex E, Table E.5-1 and TS 38.508-1 [14] clause 4.3.1.	
Channel bandwidth	As specified by the selected test configuration.	
Propagation conditions	AWGN	As specified in Annex C.2.1
Connection Diagram	TE Part: A.3.3.1.1 DUT Part: A.3.4.1.1	As specified in TS 38.508-1 [14] Annex A.
Exceptions to connection diagram	N/A	

1. The general test parameter settings are set up according to Table 7.7.1.2.4.1-3.
2. Message contents are defined in clause 7.7.1.2.4.3.
3. There are two inter-frequency cells specified in the test, where Cell 1 is the serving cell on an NR FR2 carrier and Cell 2 is the neighbour cell on a different NR FR2 carrier and the target cell for the SS-RSRP measurements.
4. The rx beam peak and directions in which the UE meets the EIS spherical coverage criteria have been found with one of the procedures from Annex I.

#### 7.7.1.2.4.2 Test procedure

1. Configure the positioning system for a valid test point as defined in A.9.4. Ensure the UE is in state RRC\_CONNECTED with generic procedure parameters Connectivity NR, Connected without release On and Test Mode On according to TS 38.508-1 [14] clause 4.5.
2. Set the parameters according to Table 7.7.1.2.5-1 as appropriate.
3. The SS shall transmit an RRCReconfiguration message on Cell 1.

4. The UE shall transmit an RRCReconfigurationComplete message.
5. The UE shall transmit periodically MeasurementReport messages.
6. After 10s wait from Step 3, the SS shall check the SS-RSRP reported values in the periodic MeasurementReport for the following requirements:
  - R1: The SS-RSRP value of Cell 1 reported by the UE is compared to the expected SS-RSRP for Cell 1. If the value is outside the limits in Table 7.7.1.2.5-3 or the UE fails to report the measurement value for Cell 1, the number of failed iterations for R1 is increased by one. Otherwise, the number of passed iterations for R1 is increased by one.
  - R2: The SS-RSRP value of Cell 2 reported by the UE is compared to the expected SS-RSRP for Cell 2. If the value is outside the limits in Table 7.7.1.2.5-3 or the UE fails to report the measurement value for Cell 2, the number of failed iterations for R2 is increased by one. Otherwise, the number of passed iterations for R2 is increased by one.
  - R3: The SS-RSRP value of Cell 2 reported by the UE is compared to the reported SS-RSRP of Cell 1. If the resulting value is outside the limits in Table 7.7.1.2.5-4 or the UE fails to report the measurement value for Cell 1 or Cell 2, the number of failed iterations for R3 is increased by one. Otherwise, the number of passed iterations for R3 is increased by one.
7. The SS shall continue checking the MeasurementReport messages transmitted by the UE until the confidence level according to Table G.2.3-1 in Annex G for each of the requirements is achieved. The evaluation of a specific requirement is concluded when the confidence level for that requirement is reached, even if more measurement reports are required for the remaining requirements.
8. The SS shall select a new test point as defined in A.9.4 and rotate the positioning system for the selected test point.
9. Set the parameters according to Test 2 in Table 7.7.2.1.5-2 as appropriate and repeat steps 5-7. In Step 6, the SS shall check the following requirements:
  - R4: The SS-RSRP value of Cell 1 reported by the UE is compared to the expected SS-RSRP for Cell 1. If the value is outside the limits in Table 7.7.2.1.5-3 or the UE fails to report the measurement value for Cell 1, the number of failed iterations for R4 is increased by one. Otherwise, the number of passed iterations for R4 is increased by one.
  - R5: The SS-RSRP value of Cell 2 reported by the UE is compared to the expected SS-RSRP for Cell 2. If the value is outside the limits in Table 7.7.2.1.5-3 or the UE fails to report the measurement value for Cell 2, the number of failed iterations for R5 is increased by one. Otherwise, the number of passed iterations for R5 is increased by one.
  - R6: The SS-RSRP value of Cell 2 reported by the UE is compared to the reported SS-RSRP of Cell 1. If the resulting value is outside the limits in Table 7.7.2.1.5-4 or the UE fails to report the measurement value for Cell 1 or Cell 2, the number of failed iterations for R6 is increased by one. Otherwise, the number of passed iterations for R6 is increased by one.

7.7.1.2.4.3 Message contents

Message contents are according to TS 38.508-1 [14] clause 7.3 with the following exceptions:

**Table 7.7.1.2.4.3-1: Common Exception messages**

Default Message Contents	
Common contents of system information blocks exceptions	
Default RRC messages and information elements contents exceptions	Table H.3.1-1 Table H.3.1-2 with condition INTER-FREQ and GAP NEEDED Table H.3.1-3 with Conditions INTER-FREQ MO and Synchronous cells Table H.3.1-5 Table H.3.1-6 with condition Pattern #0 Table H.3.1-7 with condition INTER-FREQ Table 7.3.1-3 in TS 38.508-1 [14] with condition SMTC.1

**Table 7.7.1.2.4.3-2: ReportConfigNR-DEFAULT(Periodical)**

Derivation Path: 38.508-1 [14] Table 4.6.3-142 with condition PERIODICAL			
Information Element	Value/remark	Comment	Condition
ReportConfigNR ::= SEQUENCE {			
reportType CHOICE {			
periodical SEQUENCE {			PERIODICAL
reportQuantityCell SEQUENCE {			
rsrq	false		
sinr	false		
}			
maxReportCells	2		
}			
}			
}			

### 7.7.1.2.5 Test requirement

Table 7.7.1.2.5-1 defines the cell specific settings for all tests. Table 7.7.1.2.5-2 defines the OTA primary level settings including test tolerances for all tests.

The SS-RSRP measurement accuracy shall fulfil the absolute accuracy requirements in clause 7.7.1.0.2.1 and relative accuracy requirements in clause 7.7.1.0.2.2. The following eight requirements are to be verified:

During T1:

R1: Absolute accuracy of Cell 1. The UE is deemed to meet the requirement if the reported SS-RSRP is in the range shown in Table 7.7.1.2.5-3 for test configuration 1 and in Table 7.7.1.2.5-4 for test configuration 2.

R2: Absolute accuracy of Cell 2. The UE is deemed to meet the requirement if the reported SS-RSRP is in the range shown in Table 7.7.1.2.5-3 for test configuration 1 and in Table 7.7.1.2.5-4 for test configuration 2.

R3: Relative accuracy of Cell 2 compared with Cell 1. The UE is deemed to meet the requirement if the difference in reported SS-RSRP meets the requirements in Table 7.7.1.2.5-5.

During T2:

R4: Absolute accuracy of Cell 1. The UE is deemed to meet the requirement if the reported SS-RSRP is in the range shown in table 7.7.1.2.5-3 for test configuration 1 and in Table 7.7.1.2.5-4 for test configuration 2.

R5: Absolute accuracy of Cell 2. The UE is deemed to meet the requirement if the reported SS-RSRP is in the range shown in table 7.7.1.2.5-3 for test configuration 1 and in Table 7.7.1.2.5-4 for test configuration 2.

R6: Relative accuracy of Cell 2 compared with Cell 1. The UE is deemed to meet the requirement if the difference in reported SS-RSRP meets the requirements in Table 7.7.1.2.5-5.



**Table 7.7.1.2.5-1: SS-RSRP Inter frequency general test parameters**

Parameter	Config	Unit	Test 1		Test 2	
			Cell 1	Cell 2	Cell 1	Cell 2
SSB ARFCN	1~2		freq1	freq2	freq1	freq2
BW <sub>channel</sub>	1~2		100: N <sub>RB,c</sub> = 66		100: N <sub>RB,c</sub> = 66	
Data RBs allocated	1		24		24	
	2		48		48	
Gap pattern ID			0		0	
Duplex mode	1~2		TDD		TDD	
TDD configuration	1~2		TDDConf.3.1		TDDConf.3.1	
PDSCH Reference measurement channel	1		SR.3.2 TDD	-	SR.3.2 TDD	-
	2		SR.3.3 TDD		SR.3.3 TDD	
RMSI CORESET Reference Channel	1		CR.3.1 TDD	-	CR.3.1 TDD	-
	2		CR.3.2 TDD		CR.3.2 TDD	
Dedicated CORESET Reference Channel	1		CCR.3.1 TDD	-	CCR.3.1 TDD	-
	2		CCR.3.7 TDD		CCR.3.7 TDD	
SSB configuration	1		SSB.3 FR2		SSB.3 FR2	
	2		SSB.4 FR2		SSB.4 FR2	
PDSCH/PDCCH subcarrier spacing	1~2	kHz	120		120	
OCNG Patterns	1~2		OP.3		OP.3	
Initial BWP Configuration	1~2		DLBWP.0.1		DLBWP.0.1	
			ULBWP.0.1		ULBWP.0.1	
Dedicated BWP configuration	1~2		DLBWP.1.3		DLBWP.1.3	
			ULBWP.1.3		ULBWP.1.3	
TRS Configuration	1~2		TRS.2.1 TDD		TRS.2.1 TDD	
PDCCH/PDSCH TCI Configuration	1~2		TCI.State.2		TCI.State.2	
SMTc configuration	1~2		SMTc.1		SMTc.1	
Time offset between Cell 2 and Cell 1	1~2	µs	3		3	
EPRE ratio of PSS to SSS	1~2	dB	0	0	0	0
EPRE ratio of PBCH DMRS to SSS						
EPRE ratio of PBCH to PBCH DMRS						
EPRE ratio of PDCCH DMRS to SSS						
EPRE ratio of PDCCH to PDCCH DMRS						
EPRE ratio of PDSCH DMRS to SSS						
EPRE ratio of PDSCH to PDSCH DMRS						
EPRE ratio of OCNG DMRS to SSS <sup>Note 1</sup>						
EPRE ratio of OCNG to OCNG DMRS <sup>Note 1</sup>						
Propagation condition						
Antenna configuration	1~2	-	1x2	1x2	1x2	1x2
Note 1: OCNG shall be used such that a constant total transmitted power spectral density is achieved for all OFDM symbols. Note 2: Void.						

**Table 7.7.1.2.5-2: SS-RSRP Inter frequency OTA related test parameters**

Parameter	Config	Unit	Test 1		Test 2	
			Cell 1	Cell 2	Cell 1	Cell 2
Angle of arrival configuration	1~2		Setup 4b according to clause A.9.4		Setup 4b according to clause A.9.4	
			AoA1 Spherical coverage	AoA2 Rx Beam Peak	AoA1 Spherical coverage	AoA2 Rx Beam Peak
Assumption for UE beams <sup>Note 7</sup>	1~2		Rough		Rough	
$N_{oc}$ <sup>Note1</sup>	1,	dBm/15kHz <sup>Note4</sup>	-96.3	-96.3	(Table B.2.3-2 Rx Beam Peak <sup>Note 8</sup> -4.63dB)	(Table B.2.3-2 Rx Beam Peak <sup>Note 8</sup> -3.03dB)
	2		-99.3	-99.3		
$N_{oc}$ <sup>Note1</sup>	1	dBm/SCS <sup>Note4</sup>	-87.3	-87.3	(Table B.2.3-2 Rx Beam Peak <sup>Note 8</sup> +4.4dB)	(Table B.2.3-2 Rx Beam Peak <sup>Note 8</sup> +6.0dB)
	2		-87.3	-87.3	(Table B.2.3-2 Rx Beam Peak <sup>Note 8</sup> +7.4dB)	(Table B.2.3-2 Rx Beam Peak <sup>Note 8</sup> +9.0dB)
$\hat{E}_s / N_{oc}$	1~2	dB	6.0	6.0	17.0	1.0
SSB_RP <sup>Note2</sup>	1	dBm/SCS	-81.3	-81.3	(Table B.2.3-2 Rx Beam Peak <sup>Note 8</sup> +21.4dB)	(Table B.2.3-2 Rx Beam Peak <sup>Note 8</sup> +7.0dB)
	2		-81.3	-81.3	(Table B.2.3-2 Rx Beam Peak <sup>Note 8</sup> +24.4dB)	(Table B.2.3-2 Rx Beam Peak <sup>Note 8</sup> +10.0dB)
(SSB_RP <sub>Cell 1</sub> – SSB_RP <sub>Cell 2</sub> )	1~2	dB	0		14.40	
$\hat{E}_s / I_{ot\ BB}$ <sup>Note6</sup>	1	dB	5.23	5.93	5.38	-1.46
	2		4.58	5.87		
$I_o$ <sup>Note2</sup>	1	dBm/95.04 MHz <sup>Note4</sup>	-55.70	-55.70	(Table B.2.3-2 Rx Beam Peak <sup>Note 8</sup> +46.08dB)	(Table B.2.3-2 Rx Beam Peak <sup>Note 8</sup> +35.13dB)
	2		-55.7	-55.7	(Table B.2.3-2 Rx Beam Peak <sup>Note 8</sup> +49.09dB)	(Table B.2.3-2 Rx Beam Peak <sup>Note 8</sup> +38.14dB)
( $I_{o\ freq\ 1} - I_{o\ freq\ 2}$ )	1~2	dB	0		11.95	

Note 1:	Where used, interference from other cells and noise sources not specified in the test is assumed to be constant over subcarriers and time and shall be modelled as AWGN of appropriate power for $N_{oc}$ to be fulfilled.
Note 2:	SSB <sub>RP</sub> , Es/lot, I <sub>o</sub> , (SSB <sub>RP</sub> <sub>Cell 2</sub> – SSB <sub>RP</sub> <sub>Cell 1</sub> ) and (I <sub>ofreq 2</sub> – I <sub>ofreq 1</sub> ) levels have been derived from other parameters for information purposes. They are not settable parameters themselves.
Note 3:	Void
Note 4:	Equivalent power received by an antenna with 0 dBi gain at the centre of the quiet zone
Note 5:	Void
Note 6:	Calculation of Es/lot <sub>BB</sub> includes the effect of UE internal noise up to the value assumed for the associated Refsens requirement in clause 7.3.2 of TS 38.101-2 [3], and an allowance of 1dB for UE multi-band relaxation factor ΔMB <sub>P</sub> or ΔMB <sub>S</sub> from TS 38.101-2 [3] Table 6.2.1.3-4.
Note 7:	Information about types of UE beam is given in B.2.1.3 of TS 38.133 [6], and does not limit UE implementation or test system implementation
Note 8:	The value in Table B.2.3-2 of TS 38.133 [6] is the Minimum SSB <sub>RP</sub> for SCS <sub>SSB</sub> = 120 kHz, selected according to the operating band of Cell 2 and UE power class, without ΔMB <sub>P,n</sub> adjustment.

**Table 7.7.1.2.5-3: evaluation limits for the reported values for T1 and T2 absolute accuracy rules R1, R2, R4, R5 for test configuration 1**

UE power class 3				
Normal Conditions	Test 1		Test 2	
Lowest reported value (Cell 1)	n257, n258, n261	41	n257, n258, n261	33
	n260	39	n260	34
	n259	FFS	n259	FFS
Highest reported value (Cell 1)	All bands: 109		n257, n258, n261	101
			n260	104
			n259	FFS
Lowest reported value (Cell 2)	All bands: 52		n257, n258, n261	32
			n260	34
			n259	FFS
Highest reported value (Cell 2)	All bands: 109		n257, n258, n261	87
			n260	90
			n259	FFS
Extreme Conditions	Test 1		Test 2	
Lowest reported value (Cell 1)	n257, n258, n261	41 + FFS	n257, n258, n261	33 + FFS
	n260	39 + FFS	n260	34 + FFS
	n259	FFS	n259	FFS
Highest reported value (Cell 1)	All bands: 109 + FFS		n257, n258, n261	101 + FFS
			n260	104 + FFS
			n259	FFS
Lowest reported value (Cell 2)	All bands: 52 + FFS		n257, n258, n261	32+ FFS
			n260	34+ FFS
			n259	FFS
Highest reported value (Cell 2)	All bands: 109 + FFS		n257, n258, n261	87+ FFS
			n260	90+ FFS
			n259	FFS

**Table 7.7.1.2.5-4: evaluation limits for the reported values for T1 and T2 absolute accuracy rules R1, R2, R4, R5 for test configuration 2**

UE power class 3				
Normal Conditions	Test 1		Test 2	
Lowest reported value (Cell 1)	n257, n258, n261	41	n257, n258, n261	36
	n260	39	n260	37
	n259	FFS	n259	FFS
Highest reported value (Cell 1)	All bands: 109		n257, n258, n261	104
			n260	107
			n259	FFS
Lowest reported value (Cell 2)	All bands: 52		n257, n258, n261	35
			n260	37
			n259	FFS
Highest reported value (Cell 2)	All bands: 109		n257, n258, n261	90
			n260	93
			n259	FFS
Extreme Conditions	Test 1		Test 2	
Lowest reported value (Cell 1)	n257, n258, n261	41 + FFS	n257, n258, n261	36 + FFS
	n260	39 + FFS	n260	37 + FFS
	n259	FFS	n259	FFS
Highest reported value (Cell 1)	All bands: 109 + FFS		n257, n258, n261	104 + FFS
			n260	107 + FFS
			n259	FFS
Lowest reported value (Cell 2)	All bands: 52 + FFS		n257, n258, n261	35+ FFS
			n260	37+ FFS
			n259	FFS
Highest reported value (Cell 2)	All bands: 109 + FFS		n257, n258, n261	90+ FFS
			n260	93+ FFS
			n259	FFS

**Table 7.7.1.2.5-5: evaluation limits for the reported values for T1 and T2 relative accuracy rules R3, R6**

UE power class 3				
Normal Conditions	Test 1		Test 2 All bands	
Lowest value (RSRP report Cell 2 – RSRP report Cell 1)	All bands: -15		-29	
Highest value (RSRP report Cell 2 – RSRP report Cell 1)	n257, n258, n261	+25	n257, n258, n261	+11
	n260	+27	n260	+13
	n259	FFS	n259	FFS
Extreme Conditions	Test 1		Test 2 All bands	
Lowest value (RSRP report Cell 2 – RSRP report Cell 1)	-15 + FFS		-29+ FFS	
Highest value (RSRP report Cell 2 – RSRP report Cell 1)	n257, n258, n261	+25 + FFS	n257, n258, n261	+11 + FFS
	n260	+27+ FFS	n260	+13 + FFS
	n259	FFS	n259	FFS

For the test to pass, the ratio of successful reported values for each requirement (R1 to R6) shall be more than 90% with a confidence level of 95%. Each requirement is evaluated independently of the others.

### 7.7.1.3 Inter-frequency measurements between FR1 and FR2

#### 7.7.1.3.1 NR SA FR1-FR2 SS-RSRP measurement accuracy

##### Editor's Note:

- Test tolerance analysis is missing.
- Connection diagram is TBD.

- Table 7.7.1.3.1.5-3 of reported value is FFS

- RAN4 dependency: Some test parameters are still TBD.

#### 7.7.1.3.1.1 Test Purpose

The purpose of this test is to verify that the inter-frequency SS-RSRP absolute measurement accuracy with FR1 serving cell and FR2 target cell.

#### 7.7.1.3.1.2 Test applicability

This test applies to all types of NR UE release 15 onwards.

#### 7.7.1.3.1.3 Minimum conformance requirements

The minimum conformance requirements are specified in clause 7.7.1.0.2.

The normative reference for this requirement is TS 38.133 [6] clause A.7.7.1.3.

#### 7.7.1.3.1.4 Test description

##### 7.7.1.3.1.4.1 Initial conditions

This test shall be tested using any of the test configurations in Table 7.7.1.3.1.4.1-1.

**Table 7.7.1.3.1.4.1-1: Applicable NR configurations for FR1 inter-frequency SS-RSRP accuracy test**

Config	Description of serving cell	Description of target cell
7.7.1.3.1-1	NR 15 kHz SSB SCS, 10MHz bandwidth, FDD duplex mode	120 kHz SSB SCS, 100MHz bandwidth, TDD duplex mode
7.7.1.3.1-2	NR 15 kHz SSB SCS, 10MHz bandwidth, TDD duplex mode	
7.7.1.3.1-3	NR 30kHz SSB SCS, 40MHz bandwidth, TDD duplex mode	

Configure the test equipment and the DUT according to the parameters in Table 7.7.1.3.1.4.1-2.

**Table 7.7.1.3.1.4.1-2: Initial conditions for NR SA FR1-FR2 SS-RSRP absolute measurement accuracy**

Parameter	Value		Comment
Test environment	NC, TL/VL, TL/VH, TH/VL, TH/VH		As specified in TS 38.508-1 [14] clause 4.1.
Test frequencies	As specified in Annex E, table E.4-1 and TS 38.508-1 [14] clause 4.3.1.		
Channel bandwidth	As specified by the test configuration selected from Table 7.7.1.3.1.4.1-1.		
Propagation conditions	AWGN		As specified in Annex C.2.2.
Connection Diagram	TE Part	A.3.TBD	As specified in TS 38.508-1 [14] Annex A.
	DUT Part	A.3.TBD	
Exceptions to connection diagram	N/A		

1. Message contents are defined in clause 7.7.1.3.1.4.3.

2. Cell 1 is the NR FR1 serving cell (PCell) and Cell 2 is the NR FR2 neighbour cell (the target cell for SS-RSRP measurements) on a different frequency than the PCell. The connection setup is done according to the settings in Annex C.1.1 and C.1.2.

#### 7.7.1.3.1.4.2 Test procedure

Same as test procedure in clause 6.7.1.1.4.2 with the following changes:

- Table 6.7.1.1.5-1 is replaced by Table 7.7.1.3.1.5-1 and 7.7.1.3.1.5-2;
- Table 6.7.1.2.1.5-2 is replaced by Table 7.7.1.3.1.5-3 for test 1 and Table 7.7.1.3.1.5-4 for test 2.

## 7.7.1.3.1.4.3 Message contents

Message contents are according to TS 38.508-1 [14] clause 7.3 with the following exceptions:

**Table 7.7.1.3.1.4.3-1: Common Exception messages for NR SA FR1-FR2 SS-RSRP absolute measurement accuracy**

Default Message Contents	
Common contents of system information blocks exceptions	
Default RRC messages and information elements contents exceptions	Table H.3.1-1 Table H.3.1-2 with Condition INTER-FREQ and GAP NEEDED Table H.3.1-3 with Condition SSB.1 FR1 and Synchronous cells Table H.3.1-7 with Condition INTER-FREQ

**Table 7.7.1.3.1.4.3-2: ReportConfigNR-DEFAULT**

Derivation Path: TS 38.508-1 [14] Table 4.6.3-142 with Condition PERIODICAL
---

## 7.7.1.3.1.5 Test requirement

Table 7.7.1.3.1.5-1 and Table 7.7.1.3.1.5-2 define the primary level settings including test tolerances for all tests.

Each SS-RSRP measurement report for each of the tests in Table 7.7.1.3.1.5-1 and 7.7.1.3.1.5-2 shall meet the corresponding absolute accuracy requirements in Table 7.7.1.3.1.5-3.

**Table 7.7.1.3.1.5-1: SS-RSRP inter-frequency test parameters**



Parameter	Config	Unit	Test 1		Test 2	
			Cell 1	Cell 2	Cell 1	Cell 2
SSB ARFCN	1~3		freq1	freq2	freq1	freq2
BW <sub>channel</sub>	1	MHz	10: N <sub>RB,c</sub> = 52	100: N <sub>RB,c</sub> = 66	10: N <sub>RB,c</sub> = 52	100: N <sub>RB,c</sub> = 66
	2		10: N <sub>RB,c</sub> = 52		10: N <sub>RB,c</sub> = 52	
	3		40: N <sub>RB,c</sub> = 106		40: N <sub>RB,c</sub> = 106	
Duplex mode	1		FDD	TDD	FDD	TDD
	2		TDD		TDD	
	3		TDD		TDD	
TDD configuration	1		N/A	TDDConf. 3.1	N/A	TDDConf. 3.1
	2		TDDConf. 1.1		TDDConf. 1.1	
	3		TDDConf. 2.1		TDDConf. 2.1	
PDSCH Reference measurement channel	1		SR.1.1 FDD	-	SR.1.1 FDD	-
	2		SR.1.1 TDD		SR.1.1 TDD	
	3		SR.2.1 FDD		SR.2.1 FDD	
RMSI CORESET Reference Channel	1		CR.1.1 FDD	-	CR.1.1 FDD	-
	2		CR.1.1 TDD		CR.1.1 TDD	
	3		CR.2.1 FDD		CR.2.1 FDD	
Dedicated CORESET Reference Channel	1		CCR.1.1 FDD	-	CCR.1.1 FDD	-
	2		CCR.1.1 TDD		CCR.1.1 TDD	
	3		CCR.2.1 TDD		CCR.2.1 TDD	
SSB configuration	1		SSB.1 FR1	SSB.1 FR2	SSB.1 FR1	SSB.1 FR2
	2		SSB.1 FR1		SSB.1 FR1	
	3		SSB.2 FR1		SSB.2 FR1	
OCNG Patterns	1~3		OP.1		OP.1	
Initial BWP Configuration	1~3		DLBWP.0.1 ULBWP.0.1		DLBWP.0.1 ULBWP.0.1	
Dedicated BWP configuration	1~3		DLBWP.1.3 ULBWP.1.3		DLBWP.1.3 ULBWP.1.3	
TRS Configuration	1~3		TRS.2.1 TDD		TRS.2.1 TDD	
PDCCH/PDSCH TCI Configuration	1~3		TCI.State.2		TCI.State.2	
SMTTC configuration	1~3		SMTTC.1		SMTTC.1	
Time offset between Cell 1 and Cell 2	1~3	µs	3		3	
EPRE ratio of PSS to SSS	1~3	dB	0	0	0	0
EPRE ratio of PBCH DMRS to SSS						
EPRE ratio of PBCH to PBCH DMRS						
EPRE ratio of PDCCH DMRS to SSS						
EPRE ratio of PDCCH to PDCCH DMRS						
EPRE ratio of PDSCH DMRS to SSS						
EPRE ratio of PDSCH to PDSCH DMRS						
EPRE ratio of OCNG DMRS to SSS <sup>Note 1</sup>						
EPRE ratio of OCNG to OCNG DMRS <sup>Note 1</sup>						
Propagation condition	1~3	-	NA	AWGN	NA	AWGN
Antenna configuration	1~3	-	Link only, see TS 38.133 [6] clause A.3.7A	1x2	Link only, see TS 38.133 [6] clause A.3.7A	1x2

Note 1: OCNG shall be used such that both cells are fully allocated and a constant total transmitted power spectral density is achieved for all OFDM symbols.  
 Note 2: Interference from other cells and noise sources not specified in the test is assumed to be constant over subcarriers and time and shall be modelled as AWGN of appropriate power for  $N_{oc}$  to be fulfilled.

**Table 7.7.1.3.1.5-2: SS-RSRP inter-frequency OTA related test parameters**

Parameter	Config	Unit	Test 1		Test 2 <sup>NOTE 3</sup>	
			Cell 1	Cell 2	Cell 1	Cell 2
$N_{oc}$	1~3	dBm/15kHz	NA Link only, see 38.133 [6] clause A.3.7A	TBD	NA Link only, see 38.133 [6] clause A.3.7A	NA
$N_{oc}$	1,2	dBm/SSB SCS		TBD		NA
	3			TBD		NA
$\hat{E}_s / I_{ot}$	1~3	dB		TBD		NA
SS-RSRP <sup>Note1</sup>	1,2	dBm/SCS		TBD		As in 38.133 [6] Table B.2.3-2
	3			TBD		As in 38.133 [6] Table B.2.3-2
$I_o$ <sup>Note1</sup>	1~3	dBm/95.04MHz		TBD		SS-RSRP+ 28.98
$\hat{E}_s / N_{oc}$	1~3	dB	TBD	NA		
Note 1: RSRP and $I_o$ levels have been derived from other parameters for information purposes. They are not settable parameters themselves. Note 2: RSRP minimum requirements are specified assuming independent interference and noise at each receiver antenna port. Note 3: No additional noise is added by the test system in Test 2.						

**Table 7.7.1.3.1.5-3: SS-RSRP inter-frequency absolute accuracy requirements for the reported values for Test 1**

FFS

**Table 7.7.1.3.1.5-4: SS-RSRP inter-frequency absolute accuracy requirements for the reported values for Test 2**

FFS

For the test to pass, the ratio of successful reported values in each test shall be more than 90% with a confidence level of 95%.

7.7.1.3.2 Void

**7.7.2 SS-RSRQ**

**7.7.2.0 Minimum conformance requirements**

**7.7.2.0.1 Intra-frequency SS-RSRQ measurement accuracy requirements**

Same as in clause 5.7.2.0.1.

**7.7.2.0.2 Inter-frequency SS-RSRQ measurement accuracy requirements**

Same as in clause 5.7.2.0.2.

### 7.7.2.1 NR SA FR2 SS-RSRQ measurement accuracy

Editor's Note: This test case has been completed for the following configurations:

- Test frequency  $f \leq 40.8$  GHz
- UE PC3
- Normal conditions
- The test is incomplete for UE power classes other than PC3
- The test is incomplete for test frequencies  $> 40.8$  GHz
- The test is incomplete for extreme conditions

#### 7.7.2.1.1 Test purpose

The purpose of this test is to verify that the intra-frequency SS-RSRQ measurement accuracy is within the specified limits for all bands.

#### 7.7.2.1.2 Test applicability

This test applies to all types of NR UE from Release 15 onwards.

#### 7.7.2.1.3 Minimum conformance requirements

The minimum conformance requirements are specified in clause 7.7.2.0.1.

The normative reference for this requirement is TS 38.133 [6] clause A.7.7.2.1.

#### 7.7.2.1.4 Test description

Two cells are configured in this test: Cell 1 is the NR FR2 serving cell and Cell 2 is the intra-frequency NR FR2 neighbour cell.

##### 7.7.2.1.4.1 Initial conditions

This test shall be tested using any of the test configurations in Table 7.7.2.1.4.1-1.

**Table 7.7.2.1.4.1-1: Supported test configurations**

Configuration	Description
7.7.2.1-1	NR 120 kHz SSB SCS, 100 MHz bandwidth, FDD duplex mode
Note:	The UE is only required to be tested in one of the supported test configurations

Configure the test equipment and the DUT according to the parameters in Table 7.7.2.1.4.1-2.

**Table 7.7.2.1.4.1-2: Initial conditions**

Parameter	Value	Comment
Test environment	NC	As specified in TS 36.508 [25] clause 4.1.
Test frequencies	As specified in Annex E, Table E.5-1 and TS 38.508-1 [14] clause 4.3.1.	
Channel bandwidth	As specified by the selected test configuration.	
Propagation conditions	AWGN	As specified in Annex C.2.1
Connection Diagram	TE Part: A.3.3.1.1 DUT Part: A.3.4.1.1	As specified in TS 38.508-1 [14] Annex A.
Exceptions to connection diagram	N/A	

1. The general test parameter settings are set up according to Table 7.7.2.1.4.1-3.
2. Message contents are defined in clause 7.7.2.1.4.3.
3. There are two intra-frequency cells specified in the test, where Cell 1 is the NR FR2 serving cell and Cell 2 is the neighbour cell on the same NR FR2 carrier and the target cell for the SS-RSRQ measurements.
4. The UE Rx beam peak direction has been obtained previously using one of the Rx Beam Peak Search procedures as described in Annex I.

#### 7.7.2.1.4.2 Test procedure

1. Ensure the UE is in state RRC\_CONNECTED with generic procedure parameters Connectivity *NR*, Connected without release *On* and Test Mode *On* according to TS 38.508-1 [14] clause 4.5.
2. Set the parameters according to Table 7.7.2.1.5-1 as appropriate.
3. The SS shall transmit an RRCReconfiguration message on Cell 1.
4. The UE shall transmit an RRCReconfigurationComplete message.
5. The UE shall transmit periodically MeasurementReport messages.
6. After 10s wait from Step 3, the SS shall check the SS-RSRQ reported values in the periodic MeasurementReport. The SS-RSRQ value of Cell 2 reported by the UE is compared to the expected SS-RSRQ. If the value is outside the limits in Table 7.7.2.1.5-3 or the UE fails to report the measurement value for Cell 2, the number of failed iterations is increased by one. Otherwise, the number of passed iterations is increased by one.
7. The SS shall continue checking the MeasurementReport messages transmitted by the UE until the confidence level according to Table G.2.3-1 in Annex G is achieved.
8. Set the parameters according to each sub-test in Table 7.7.2.1.5-2 as appropriate and repeat steps 5-7.

#### 7.7.2.1.4.3 Message contents

Message contents are according to TS 38.508-1 [14] clause 7.3 with the following exceptions:

**Table 7.7.2.1.4.3-1: Common Exception messages**

Default Message Contents	
Common contents of system information blocks exceptions	
Default RRC messages and information elements contents exceptions	Table H.3.1-1 Table H.3.1-2 Table H.3.1-3 with Condition Synchronous cells Table H.3.1-5 Table H.3.1-7 Table 7.3.1-3 in TS 38.508-1 [14] with condition SMTC.1

**Table 7.7.2.1.4.3-2: ReportConfigNR-DEFAULT(Periodical)**

Derivation Path: 38.508-1 [14] Table 4.6.3-142 with condition PERIODICAL			
Information Element	Value/remark	Comment	Condition
ReportConfigNR ::= SEQUENCE {			
reportType CHOICE {			
periodical SEQUENCE {			PERIODICAL
reportQuantityCell SEQUENCE {			
rsrp	false		
sinr	false		
}			
maxReportCells	2		
}			
}			

7.7.2.1.5 Test requirement

Table 7.7.2.1.5-1 defines the cell specific settings for all tests. Table 7.7.2.1.5-2 defines the OTA primary level settings including test tolerances for all tests.

Each SS-RSRQ measurement report for each of the tests in Table 7.7.2.1.5-2 shall meet the corresponding absolute accuracy requirements in Table 7.7.2.1.5-3.

Table 7.7.2.1.5-1: SS-RSRQ Intra frequency test parameters

Parameter		Unit	Test 1		Test 2	
			Cell 1	Cell 2	Cell 1	Cell 2
SSB ARFCN			Freq1		Freq1	
Duplex mode			TDD		TDD	
TDD configuration			TDDConf.3.1		TDDConf.3.1	
BW <sub>channel</sub>		MHz	100: N <sub>RB,c</sub> = 66		100: N <sub>RB,c</sub> = 66	
BWP configuration	Initial DL BWP		DLBWP.0.1			
	Dedicated DL BWP		DLBWP.1.1			
	Initial UL BWP		ULBWP.0.1			
	Dedicated UL BWP		ULBWP.1.1			
TRS configuration			TRS.2.1 TDD		TRS.2.1 TDD	
TCI state			TCI.State .0		TCI.State .0	
PDSCH Reference measurement channel			SR.3.1 TDD		SR.3.1 TDD	
RMSI CORESET Reference Channel			CR.3.1 TDD	-	CR.3.1 TDD	
Control channel RMC			CCR.3.1 TDD	-	CCR.3.1 TDD	-
OCNG Patterns			OP.1	OP.1	OP.1	OP.1
SMTC configuration			SMTC.1			
SSB configuration			SSB.3 FR2	SSB.3 FR2	SSB.3 FR2	SSB.3 FR2
PDSCH/PDCCH subcarrier spacing		kHz	120	120	120	120
SS-RSSI-Measurement			Not Applicable			
EPRE ratio of PSS to SSS		dB	0	0	0	0
EPRE ratio of PBCH_DMRS to SSS						
EPRE ratio of PBCH to PBCH_DMRS						
EPRE ratio of PDCCH_DMRS to SSS						
EPRE ratio of PDCCH to PDCCH_DMRS						
EPRE ratio of PDSCH_DMRS to SSS						
EPRE ratio of PDSCH to PDSCH_DMRS						
EPRE ratio of OCNG DMRS to SSS <sup>Note 1</sup>						
EPRE ratio of OCNG to OCNG DMRS <sup>Note 1</sup>						
Propagation condition			AWGN		AWGN	
Antenna Configuration			1x2		1x2	
Note 1: OCNG shall be used such that both cells are fully allocated and a constant total transmitted power spectral density is achieved for all OFDM symbols. Note 2: Void Note 3: Void Note 4: Void Note 5: Void.						

**Table 7.7.2.1.5-2: SS-RSRQ Intra frequency OTA related test parameters**

Parameter	Unit	Test 1		Test 2	
		Cell 1	Cell 2	Cell 1	Cell 2
Angle of arrival configuration		Setup 1		Setup 1	
Assumption for UE beams <sup>Note 9</sup>		Rough			
$N_{oc}$ <sup>Note1</sup>	dBm/15kHz <sup>Note4</sup>	-100.7		-96.7	
$N_{oc}$ <sup>Note1</sup>	dBm/SCS <sup>Note3</sup>	-91.67		-87.67	
SSB_RP <sup>Note2</sup>	dBm/SCS <sup>Note4</sup>	-88.67	-88.67	-90.67	-90.67
SS-RSRQ <sup>Note2</sup>	dB	-14.81	-14.81	-16.84	-16.84
$\hat{E}_s / I_{ot}$	dB	-1.76	-1.76	-4.76	-4.76
$\hat{E}_s / N_{oc}$	dB	3	3	-3	-3
$I_o$ <sup>Note2</sup>	dBm/95.04 MHz <sup>Note4</sup>	-55.7		-55.67	-55.67
<p>Note 1: Interference from other cells and noise sources not specified in the test is assumed to be constant over subcarriers and time and shall be modelled as AWGN of appropriate power for <math>N_{oc}</math> to be fulfilled.</p> <p>Note 2: SS-RSRQ, SSB_RP, and <math>I_o</math> levels have been derived from other parameters for information purposes. They are not settable parameters themselves.</p> <p>Note 3: SS-RSRQ and SSB_RP minimum requirements are specified assuming independent interference and noise at each receiver antenna port.</p> <p>Note 4: Equivalent power received by an antenna with 0dBi gain at the centre of the quiet zone</p> <p>Note 5: As observed with 0dBi gain antenna at the centre of the quiet zone</p> <p>Note 6: Void.</p> <p>Note 7: Void</p> <p>Note 8: Void</p> <p>Note 9: Information about types of UE beam is given in B.2.1.3 of TS 38.133 [6], and does not limit UE implementation or test system implementation</p>					

**Table 7.7.2.1.5-3: SS-RSRQ Intra frequency absolute accuracy requirements for the reported values**

UE Power Class 3	Test 1 (All bands)	Test 2	
Normal Conditions			
Lowest reported value (Cell 2)	SS-RSRQ_41	n257, n258, n261	SS-RSRQ_35
		n260	SS-RSRQ_34
		n259	FFS
Highest reported value (Cell 2)	SS-RSRQ_73	All bands	SS-RSRQ_71
Extreme Conditions			
Lowest reported value (Cell 2)	SS-RSRQ_38+ FFS	n257, n258, n261	SS-RSRQ_34+ FFS
		n260	SS-RSRQ_33+ FFS
		n259	FFS
Highest reported value (Cell 2)	SS-RSRQ_76+ FFS	All bands	SS-RSRQ_72+ FFS

For the test to pass, the ratio of successful reported values in each test shall be more than 90% with a confidence level of 95%.

**7.7.2.2 NR SA FR2-FR2 SS-RSRQ measurement accuracy**

**Editor’s Note:** This test case has been completed for the following configurations:

- Test frequency  $f \leq 40.8$  GHz

- UE PC3
- Normal conditions
- The test is incomplete for UE power classes other than PC3
- The test is incomplete for test frequencies > 40.8 GHz
- The test is incomplete for extreme conditions

#### 7.7.2.2.1 Test purpose

The purpose of this test is to verify that the inter-frequency SS-RSRP measurement accuracy is within the specified limits for all bands.

#### 7.7.2.2.2 Test applicability

This test applies to all types of NR UE from Release 15 onwards.

#### 7.7.2.2.3 Minimum conformance requirements

The minimum conformance requirements are specified in clause 7.7.2.0.2.

The normative reference for this requirement is TS 38.133 [6] clause A.7.7.2.2.

#### 7.7.2.2.4 Test description

Two cells are configured in this test: Cell 1 is the NR FR2 serving cell and Cell 2 is the inter-frequency NR FR2 neighbour cell.

##### 7.7.2.2.4.1 Initial conditions

This test shall be tested using any of the test configurations in Table 7.7.2.2.4.1-1.

**Table 7.7.2.2.4.1-1: Supported test configurations**

Configuration	Description
7.7.2.2-1	NR 120 kHz SSB SCS, 100 MHz bandwidth, FDD duplex mode
Note: The UE is only required to be tested in one of the supported test configurations	

Configure the test equipment and the DUT according to the parameters in Table 7.7.2.2.4.1-2.

**Table 7.7.2.2.4.1-2: Initial conditions**

Parameter	Value	Comment
Test environment	NC	As specified in TS 36.508 [25] clause 4.1.
Test frequencies	As specified in Annex E, Table E.5-1 and TS 38.508-1 [14] clause 4.3.1.	
Channel bandwidth	As specified by the selected test configuration.	
Propagation conditions	AWGN	As specified in Annex C.2.1
Connection Diagram	TE Part: A.3.3.1.1 DUT Part: A.3.4.1.1	As specified in TS 38.508-1 [14] Annex A.
Exceptions to connection diagram	N/A	

1. The general test parameter settings are set up according to Table 7.7.2.2.4.1-3.
2. Message contents are defined in clause 7.7.2.2.4.3.



3. There are two inter-frequency cells specified in the test, where Cell 1 is the serving cell on an NR FR2 carrier and Cell 2 is the neighbour cell on a different NR FR2 carrier and the target cell for the SS-RSRQ measurements.
4. The UE Rx beam peak direction has been obtained previously using one of the Rx Beam Peak Search procedures as described in Annex I.

#### 7.7.2.2.4.2 Test procedure

1. Ensure the UE is in state RRC\_CONNECTED with generic procedure parameters Connectivity *NR*, Connected without release *On* and Test Mode *On* according to TS 38.508-1 [14] clause 4.5.
2. Set the parameters according to Table 7.7.2.2.5-1 as appropriate.
3. The SS shall transmit an RRCReconfiguration message on Cell 1.
4. The UE shall transmit an RRCReconfigurationComplete message.
5. The UE shall transmit periodically MeasurementReport messages.
6. After 10s wait from Step 3, the SS shall check the SS-RSRQ reported values in the periodic MeasurementReport for the following requirements:
  - R1: The SS-RSRQ value of Cell 1 reported by the UE is compared to the expected SS-RSRQ for Cell 1. If the value is outside the limits in Table 7.7.2.2.5-3 or the UE fails to report the measurement value for Cell 1, the number of failed iterations for R1 is increased by one. Otherwise, the number of passed iterations for R1 is increased by one.
  - R2: The SS-RSRQ value of Cell 2 reported by the UE is compared to the expected SS-RSRQ for Cell 2. If the value is outside the limits in Table 7.7.2.2.5-3 or the UE fails to report the measurement value for Cell 2, the number of failed iterations for R2 is increased by one. Otherwise, the number of passed iterations for R2 is increased by one.
  - R3: The SS-RSRQ value of Cell 2 reported by the UE is compared to the reported SS-RSRQ of Cell 1. If the resulting value is outside the limits in Table 7.7.2.2.5-4 or the UE fails to report the measurement value for Cell 1 or Cell 2, the number of failed iterations for R3 is increased by one. Otherwise, the number of passed iterations for R3 is increased by one.
7. The SS shall continue checking the MeasurementReport messages transmitted by the UE until the confidence level according to Table G.2.3-1 in Annex G is achieved.
8. Set the parameters according to each sub-test in Table 7.7.2.2.5-2 as appropriate and repeat steps 5-7. In Step 6, the SS shall check the following requirements:
  - R4: The SS-RSRQ value of Cell 1 reported by the UE is compared to the expected SS-RSRQ for Cell 1. If the value is outside the limits in Table 7.7.2.2.5-3 or the UE fails to report the measurement value for Cell 1, the number of failed iterations for R4 is increased by one. Otherwise, the number of passed iterations for R4 is increased by one.
  - R5: The SS-RSRQ value of Cell 2 reported by the UE is compared to the expected SS-RSRQ for Cell 2. If the value is outside the limits in Table 7.7.2.2.5-3 or the UE fails to report the measurement value for Cell 2, the number of failed iterations for R5 is increased by one. Otherwise, the number of passed iterations for R5 is increased by one.
  - R6: The SS-RSRQ value of Cell 2 reported by the UE is compared to the reported SS-RSRQ of Cell 1. If the resulting value is outside the limits in Table 7.7.2.2.5-4 or the UE fails to report the measurement value for Cell 1 or Cell 2, the number of failed iterations for R6 is increased by one. Otherwise, the number of passed iterations for R6 is increased by one.

#### 7.7.2.2.4.3 Message contents

Message contents are according to TS 38.508-1 [14] clause 7.3 with the following exceptions:

**Table 7.7.2.2.4.3-1: Common Exception messages**

Default Message Contents	
Common contents of system information blocks exceptions	
Default RRC messages and information elements contents exceptions	Table H.3.1-1 Table H.3.1-2 with condition INTER-FREQ and GAP NEEDED Table H.3.1-3 with Conditions INTER-FREQ MO and Synchronous cells Table H.3.1-5 Table H.3.1-6 with condition Pattern #0 Table H.3.1-7 with condition INTER-FREQ Table 7.3.1-3 in TS 38.508-1 [14] with condition SMTC.1

**Table 7.7.2.2.4.3-2: ReportConfigNR-DEFAULT(Periodical)**

Derivation Path: 38.508-1 [14] Table 4.6.3-142 with condition PERIODICAL			
Information Element	Value/remark	Comment	Condition
ReportConfigNR ::= SEQUENCE {			
reportType CHOICE {			
periodical SEQUENCE {			PERIODICAL
reportQuantityCell SEQUENCE {			
rsrp	false		
sinr	false		
}			
maxReportCells	2		
}			
}			
}			

**7.7.2.2.5 Test requirement**

Table 7.7.2.2.5-1 defines the cell specific settings for all tests. Table 7.7.2.2.5-2 defines the OTA primary level settings including test tolerances for all tests.

The SS-RSRQ measurement accuracy shall fulfil the absolute accuracy requirements in clause 7.7.2.0.2.1 and relative accuracy requirements in clause 7.7.2.0.2.2. The following eight requirements are to be verified:

During T1:

R1: Absolute accuracy of Cell 1. The UE is deemed to meet the requirement if the reported SS-RSRQ is in the range shown in Table 7.7.2.2.5-3.

R2: Absolute accuracy of Cell 2. The UE is deemed to meet the requirement if the reported SS-RSRQ is in the range shown in Table 7.7.2.2.5-3.

R3: Relative accuracy of Cell 2 compared with Cell 1. The UE is deemed to meet the requirement if the difference in reported SS-RSRQ meets the requirements in Table 7.7.2.2.5-4.

During T2:

R4: Absolute accuracy of Cell 1. The UE is deemed to meet the requirement if the reported SS-RSRQ is in the range shown in table 7.7.2.2.5-3.

R5: Absolute accuracy of Cell 2. The UE is deemed to meet the requirement if the reported SS-RSRQ is in the range shown in table 7.7.2.2.5-3.

R6: Relative accuracy of Cell 2 compared with Cell 1. The UE is deemed to meet the requirement if the difference in reported SS-RSRQ meets the requirements in Table 7.7.2.2.5-4.

**Table 7.7.2.2.5-1: SS-RSRQ Inter frequency general test parameters**

Parameter	Unit	Test 1		Test 2	
		Cell 1	Cell 2	Cell 1	Cell 2
SSB ARFCN		Freq1	freq2	freq1	Freq2
SSB Configuration		SSB.1 FR2	SSB.1 FR2	SSB.1 FR2	SSB.1 FR2
Duplex mode		TDD		TDD	
TDD configuration		TDDConf.3.1		TDDConf.3.1	
BW <sub>channel</sub>	MHz	100: N <sub>RB,c</sub> = 66		100: N <sub>RB,c</sub> = 66	
Data RBs allocated		66		66	
Downlink initial BWP configuration		DLBW P.0.1	-	DLBW P.0.1	-
Downlink dedicated BWP configuration		DLBW P.1.1	-	DLBW P.1.1	-
Uplink initial BWP configuration		ULBW P.0.1	-	ULBW P.0.1	-
Uplink dedicated BWP configuration		ULBW P.1.1	-	ULBW P.1.1	-
DRX cycle configuration		Not applicable	-	Not applicable	-
TRS configuration		TRS.2. 1 TDD	-	TRS.2. 1 TDD	-
TCI state		TCI.State.0	-	TCI.State.0	-
PDSCH Reference measurement channel		SR.3.1 TDD	-	SR.3.1 TDD	-
RMSI CORESET Reference Channel		CR.3.1 TDD	-	CR.3.1 TDD	-
OCNG Patterns		OP.1	OP.1	OP.1	OP.1
SMTC configuration		SMTC. 1 FR2	SMTC. 1 FR2	SMTC. 1 FR2	SMTC. 1 FR2
PDSCH/PDCCH subcarrier spacing	kHz	120	120	120	120
EPRE ratio of PSS to SSS	dB	0	0	0	0
EPRE ratio of PBCH_DMRS to SSS					
EPRE ratio of PBCH to PBCH_DMRS					
EPRE ratio of PDCCH_DMRS to SSS					
EPRE ratio of PDCCH to PDCCH_DMRS					
EPRE ratio of PDSCH_DMRS to SSS					
EPRE ratio of PDSCH to PDSCH_DMRS					
EPRE ratio of OCNG DMRS to SSS <sup>Note 1</sup>					
EPRE ratio of OCNG to OCNG DMRS <sup>Note 1</sup>					
Propagation conditions					
Antenna configuration		1x2	1x2	1x2	1x2
Note 1: OCNG shall be used such that both cells are fully allocated and a constant total transmitted power spectral density is achieved for all OFDM symbols. Note 2: Void Note 3: Void Note 4: Void					

**Table 7.7.2.2.5-2: SS-RSRQ Inter frequency OTA related test parameters**

Parameter	Unit	Test 1		Test 2	
		Cell 1	Cell 2	Cell 1	Cell 2

AoA setup		Setup 1		Setup 1	
Assumption for UE beams <sup>Note 8</sup>		Rough		Rough	
$N_{oc}$ <sup>Note1</sup>	dBm/15kHz <sup>Note4</sup>	-95.93	-95.93	-95.44	-95.44
$N_{oc}$ <sup>Note1</sup>	dBm/SCS <sup>Note3</sup>	-86.9	-86.9	-86.41	-86.41
$\hat{E}_s / N_{oc}$	dB	-1.75	-1.75	-3	-3
SSB_RP <sup>Note2</sup>	dBm/SCS <sup>Note4</sup>	-88.65	-88.65	-89.41	-89.41
SS-RSRQ <sup>Note2</sup>	dB	-14.75	-14.75	-15.56	-15.56
$\hat{E}_s / I_{ot}$	dB	-1.75	-1.75	-3	-3
$I_o$ <sup>Note2</sup>	dBm/95.04 MHz <sup>Note4</sup>	-55.7	-55.7	-55.7	-55.7
<p>Note 1: Interference from other cells and noise sources not specified in the test is assumed to be constant over subcarriers and time and shall be modelled as AWGN of appropriate power for <math>N_{oc}</math> to be fulfilled.</p> <p>Note 2: SS-RSRQ, SSB_RP, and <math>I_o</math> levels have been derived from other parameters for information purposes. They are not settable parameters themselves.</p> <p>Note 3: SS-RSRQ and SS-RSRP minimum requirements are specified assuming independent interference and noise at each receiver antenna port.</p> <p>Note 4: Equivalent power received by an antenna with 0dBi gain at the centre of the quiet zone</p> <p>Note 5: As observed with 0dBi gain antenna at the centre of the quiet zone</p> <p>Note 6: Void</p> <p>Note 7: Void</p> <p>Note 8: Information about types of UE beam is given in B.2.1.3 of TS 38.133 [6], and does not limit UE implementation or test system implementation</p>					

**Table 7.7.2.2.5-3: evaluation limits for the reported values for T1 and T2 absolute accuracy rules R1, R2, R4, R5**

UE power class 3		
Normal Conditions	Test 1 All bands	Test 2 All bands
Lowest reported value (Cell 1)	RSRQ_41	RSRQ_37
Highest reported value (Cell 1)	RSRQ_73	RSRQ_74
Lowest reported value (Cell 2)	RSRQ_41	RSRQ_37
Highest reported value (Cell 2)	RSRQ_73	RSRQ_74
Extreme Conditions	Test 1 All bands	Test 2 All bands
Lowest reported value (Cell 1)	RSRQ_41 + FFS	RSRQ_37 + FFS
Highest reported value (Cell 1)	RSRQ_73 + FFS	RSRQ_74 + FFS
Lowest reported value (Cell 2)	RSRQ_41 + FFS	RSRQ_37 + FFS
Highest reported value (Cell 2)	RSRQ_73 + FFS	RSRQ_74 + FFS

**Table 7.7.2.2.5-4: evaluation limits for the reported values for T1 and T2 relative accuracy rules R3, R6**

UE power class 3		
Normal Conditions	Test 1 All bands	Test 2 All bands
Lowest value (RSRQ report Cell 2 – RSRQ report Cell 1)	- 7	- 9
Highest value (RSRQ report Cell 2 – RSRQ report Cell 1)	+ 7	+ 9
Extreme Conditions	Test 1 All bands	Test 2 All bands
Lowest value (RSRQ report Cell 2 – RSRQ report Cell 1)	- 7 + FFS	- 9 + FFS
Highest value (RSRQ report Cell 2 – RSRQ report Cell 1)	+ 7 + FFS	+ 9 + FFS

For the test to pass, the ratio of successful reported values for each requirement (R1 to R6) shall be more than 90% with a confidence level of 95%. Each requirement is evaluated independently of the others.

### 7.7.3 SS-SINR

#### 7.7.3.0 Minimum conformance requirements

##### 7.7.3.0.1 Intra-frequency SS-SINR measurement accuracy requirements

Same as in clause 5.7.3.0.1.

##### 7.7.3.0.2 Inter-frequency SS-SINR measurement accuracy requirements

Same as in clause 5.7.3.0.2.

#### 7.7.3.1 NR SA FR2 SS-SINR measurement accuracy

**Editor's Note:** This test case has been completed for the following configurations:

- Test frequency  $f \leq 40.8$  GHz

- UE PC3
- Normal conditions
- The test is incomplete for UE power classes other than PC3
- The test is incomplete for test frequencies > 40.8 GHz
- The test is incomplete for extreme conditions

7.7.3.1.1 Test purpose

The purpose of this test is to verify that the intra-frequency SS-SINR measurement accuracy is within the specified limits for all bands.

7.7.3.1.2 Test applicability

This test applies to all types of NR UE from Release 15 onwards supporting ss-SINR-Meas.

7.7.3.1.3 Minimum conformance requirements

The minimum conformance requirements are specified in clause 7.7.3.0.1.

The normative reference for this requirement is TS 38.133 [6] clause A.7.7.3.1.

7.7.3.1.4 Test description

Two cells are configured in this test: Cell 1 is the NR FR2 serving cell and Cell 2 is the intra-frequency NR FR2 neighbour cell.

7.7.3.1.4.1 Initial conditions

This test shall be tested using any of the test configurations in Table 7.7.3.1.4.1-1.

**Table 7.7.3.1.4.1-1: Supported test configurations**

Configuration	Description
7.7.3.1-1	NR 120 kHz SSB SCS, 100 MHz bandwidth, FDD duplex mode
Note: The UE is only required to be tested in one of the supported test configurations	

Configure the test equipment and the DUT according to the parameters in Table 7.7.3.1.4.1-2.

**Table 7.7.3.1.4.1-2: Initial conditions**

Parameter	Value	Comment
Test environment	NC	As specified in TS 36.508 [25] clause 4.1.
Test frequencies	As specified in Annex E, Table E.5-1 and TS 38.508-1 [14] clause 4.3.1.	
Channel bandwidth	As specified by the selected test configuration.	
Propagation conditions	AWGN	As specified in Annex C.2.1
Connection Diagram	TE Part: A.3.3.1.1 DUT Part: A.3.4.1.1	As specified in TS 38.508-1 [14] Annex A.
Exceptions to connection diagram	N/A	

1. The general test parameter settings are set up according to Table 7.7.3.1.4.1-3.
2. Message contents are defined in clause 7.7.3.1.4.3.

3. There are two intra-frequency cells specified in the test, where Cell 1 is the NR FR2 serving cell and Cell 2 is the neighbour cell on the same NR FR2 carrier and the target cell for the SS-SINR measurements.
4. The UE Rx beam peak direction has been obtained previously using one of the Rx Beam Peak Search procedures as described in Annex I.

7.7.3.1.4.2 Test procedure

1. Ensure the UE is in state RRC\_CONNECTED with generic procedure parameters Connectivity NR, Connected without release On and Test Mode On according to TS 38.508-1 [14] clause 4.5.
2. Set the parameters according to Table 7.7.3.1.5-1 as appropriate.
3. The SS shall transmit an RRCReconfiguration message on Cell 1.
4. The UE shall transmit an RRCReconfigurationComplete message.
5. The UE shall transmit periodically MeasurementReport messages.
6. After 10s wait from Step 3, the SS shall check the SS-SINR reported values in the periodic MeasurementReport. The SS-SINR value of Cell 2 reported by the UE is compared to the expected SS-SINR. If the value is outside the limits in Table 7.7.3.1.5-2 or the UE fails to report the measurement value for Cell 2, the number of failed iterations is increased by one. Otherwise, the number of passed iterations is increased by one.
7. The SS shall continue checking the MeasurementReport messages transmitted by the UE until the confidence level according to Table G.2.3-1 in Annex G is achieved.
8. Set the parameters according to each sub-test in Table 7.7.3.1.5-1 as appropriate and repeat steps 5-7.

7.7.3.1.4.3 Message contents

Message contents are according to TS 38.508-1 [14] clause 7.3 with the following exceptions:

**Table 7.7.3.1.4.3-1: Common Exception messages**

Default Message Contents	
Common contents of system information blocks exceptions	
Default RRC messages and information elements contents exceptions	Table H.3.1-1 Table H.3.1-2 Table H.3.1-3 with Condition Synchronous cells Table H.3.1-5 Table H.3.1-7 Table 7.3.1-3 in TS 38.508-1 [14] with condition SMTC.1

**Table 7.7.3.1.4.3-2: ReportConfigNR-DEFAULT(Periodical)**

Derivation Path: 38.508-1 [14] Table 4.6.3-142 with condition PERIODICAL			
Information Element	Value/remark	Comment	Condition
ReportConfigNR ::= SEQUENCE {			
reportType CHOICE {			
periodical SEQUENCE {			PERIODICAL
reportQuantityCell SEQUENCE {			
rsrp	false		
rsrq	false		
}			
maxReportCells	2		
}			
}			
}			

7.7.3.1.5 Test requirement

Table 7.7.3.1.5-1 defines the cell specific settings for all tests. Table 7.7.3.1.5-2 defines the OTA primary level settings including test tolerances for all tests.

Each SS-SINR measurement report for each of the tests in Table 7.7.3.1.5-2 shall meet the corresponding absolute accuracy requirements in Table 7.7.3.1.5-3.

**Table 7.7.3.1.5-1: SS-SINR Intra frequency test parameters**

Parameter	Unit	Test 1		Test 2	
		Cell 1	Cell 2	Cell 1	Cell 2
SSB ARFCN		Freq2		Freq2	
Duplex mode		TDD		TDD	
TDD configuration		TDDConf.3.1		TDDConf.3.1	
BW <sub>channel</sub>	MHz	100: N <sub>RB,c</sub> = 66		100: N <sub>RB,c</sub> = 66	
Downlink initial BWP configuration		DLBWP.0.1			
Downlink dedicated BWP configuration		DLBWP.1.1			
Uplink initial BWP configuration		ULBWP.0.1			
Uplink dedicated BWP configuration		ULBWP.1.1			
DRX cycle configuration	ms	Not applicable			
TRS configuration		TRS.2.1 TDD			
TCI state		TCI.State.0			
PDSCH Reference measurement channel		SR.3.1 TDD		SR.3.1 TDD	
RMSI CORESET Reference Channel		CR.3.1 TDD	-	CR.3.1 TDD	-
Dedicated RMSI CORESET Reference Channel		CCR.3 .1 TDD	-	CCR.3. 1 TDD	-
OCNG Patterns		OP.1	OP.1	OP.1	OP.1
SMTC configuration		SMTC.1			
SSB configuration		SSB.3 FR2	SSB.3 FR2	SSB.3 FR2	SSB.3 FR2
PDSCH/PDCCH subcarrier spacing	kHz	120	120	120	120
SS-RSSI-Measurement		Not Applicable			
EPRE ratio of PSS to SSS	dB	0	0	0	0
EPRE ratio of PBCH_DMRS to SSS					
EPRE ratio of PBCH to PBCH_DMRS					
EPRE ratio of PDCCH_DMRS to SSS					
EPRE ratio of PDCCH to PDCCH_DMRS					
EPRE ratio of PDSCH_DMRS to SSS					
EPRE ratio of PDSCH to PDSCH_DMRS					
EPRE ratio of OCNG DMRS to SSS <sup>Note 1</sup>					
EPRE ratio of OCNG to OCNG DMRS <sup>Note 1</sup>					
Propagation condition		AWGN		AWGN	
Antenna Configuration		1x2		1x2	
Note 1: OCNG shall be used such that both cells are fully allocated and a constant total transmitted power spectral density is achieved for all OFDM symbols. Note 2: Void. Note 3: Void Note 4: Void					



**Table 7.7.3.1.5-2: SS-SINR Intra frequency OTA related test parameters**

Parameter		Unit	Test 1		Test 2	
			Cell 1	Cell 2	Cell 1	Cell 2
Angle of arrival configuration			Setup 1		Setup 1	
Assumption for UE beams <sup>Note 9</sup>			Rough		Rough	
$N_{oc}$ <sup>Note1</sup>		dBm/15kHz <sup>Note4</sup>	-105		-105	
$N_{oc}$ <sup>Note1</sup>		dBm/SCS <sup>Note3</sup>	-96		-96	
SSB_RP <sup>Note2</sup>		dBm/SCS <sup>Note4</sup>	-91.46	-93.34	-98.8	-98.8
SS-SINR <sup>Note2</sup>	n257, 258, n261	dB	-0.18	-3.32	-4.95	-4.95
	n260		-0.31	-3.42	-5.20	-5.20
	n259		-0.39	-3.48	-5.48	-5.48
$\hat{E}_s / I_{ot}$	n257, 258, n261	dB	-0.18	-3.32	-4.95	-4.95
	n260		-0.31	-3.42	-5.20	-5.20
	n259		-0.39	-3.48	-5.48	-5.48
$\hat{E}_s / N_{oc}$		dB	4.54	2.66	-3	-3
$I_o$ <sup>Note2</sup>		dBm/95.04 MHz <sup>Note4</sup>	-59.43		-63.87	
<p>Note 1: Interference from other cells and noise sources not specified in the test is assumed to be constant over subcarriers and time and shall be modelled as AWGN of appropriate power for <math>N_{oc}</math> to be fulfilled.</p> <p>Note 2: SS-SINR, SSB_RP, and <math>I_o</math> levels have been derived from other parameters for information purposes. They are not settable parameters themselves.</p> <p>Note 3: SS-SINR and SSB_RP minimum requirements are specified assuming independent interference and noise at each receiver antenna port.</p> <p>Note 4: Equivalent power received by an antenna with 0dBi gain at the centre of the quiet zone</p> <p>Note 5: As observed with 0dBi gain antenna at the centre of the quiet zone</p> <p>Note 6: Void.</p> <p>Note 7: Void</p> <p>Note 8: Void</p> <p>Note 9: Information about types of UE beam is given in B.2.1.3 of TS 38.133 [6], and does not limit UE implementation or test system implementation</p>						

**Table 7.7.3.1.5-3: SS-SINR Intra frequency absolute accuracy requirements for the reported values**

UE Power Class 3	Test 1		Test 2	
Normal Conditions				
Lowest reported value (Cell 2)	n257, n258, n261	SS-SINR_22	All bands	SS-SINR_18
	n260	SS-SINR_21		
	n259	FFS		
Highest reported value (Cell 2)	All bands	SS-SINR_58	n257, n258, n261	SS-SINR_55
			n260	SS-SINR_54
			n259	FFS
Extreme Conditions				
Lowest reported value (Cell 2)	n257, n258, n261	SS-SINR_21+ FFS	All bands	SS-SINR_17+ FFS
	n260	SS-SINR_20+ FFS		
	n259	FFS		
Highest reported value (Cell 2)	All bands	SS-SINR_59+ FFS	n257, n258, n261	SS-SINR_56+ FFS
			n260	SS-SINR_55+ FFS
			n259	FFS

For the test to pass, the ratio of successful reported values in each test shall be more than 90% with a confidence level of 95%.

### 7.7.3.2 NR SA FR2-FR2 SS-SINR measurement accuracy

Editor's Note: This test case has been completed for the following configurations:

- Test frequency  $f \leq 40.8$  GHz
- UE PC3
- Normal conditions
- The test is incomplete for UE power classes other than PC3
- The test is incomplete for test frequencies  $> 40.8$  GHz
- The test is incomplete for extreme conditions

#### 7.7.3.2.1 Test purpose

The purpose of this test is to verify that the inter-frequency SS-SINR measurement accuracy is within the specified limits for all bands.

#### 7.7.3.2.2 Test applicability

This test applies to all types of NR UE from Release 15 onwards supporting ss-SINR-Meas.

#### 7.7.3.2.3 Minimum conformance requirements

The minimum conformance requirements are specified in clause 7.7.3.0.2.

The normative reference for this requirement is TS 38.133 [6] clause A.7.7.3.2.

#### 7.7.3.2.4 Test description

Two cells are configured in this test: Cell 1 is the NR FR2 serving cell and Cell 2 is the inter-frequency NR FR2 neighbour cell.

##### 7.7.3.2.4.1 Initial conditions

This test shall be tested using any of the test configurations in Table 7.7.3.2.4.1-1.

**Table 7.7.3.2.4.1-1: Supported test configurations**

Configuration	Description
7.7.3.2-1	NR 120 kHz SSB SCS, 100 MHz bandwidth, FDD duplex mode
Note:	The UE is only required to be tested in one of the supported test configurations

Configure the test equipment and the DUT according to the parameters in Table 7.7.3.2.4.1-2.

Table 7.7.3.2.4.1-2: Initial conditions

Parameter	Value	Comment
Test environment	NC	As specified in TS 36.508 [25] clause 4.1.
Test frequencies	As specified in Annex E, Table E.5-1 and TS 38.508-1 [14] clause 4.3.1.	
Channel bandwidth	As specified by the selected test configuration.	
Propagation conditions	AWGN	As specified in Annex C.2.1
Connection Diagram	TE Part: A.3.3.1.1 DUT Part: A.3.4.1.1	As specified in TS 38.508-1 [14] Annex A.
Exceptions to connection diagram	N/A	

1. The general test parameter settings are set up according to Table 7.7.3.2.4.1-3.
2. Message contents are defined in clause 7.7.3.2.4.3.
3. There are two inter-frequency cells specified in the test, where Cell 1 is the serving cell on an NR FR2 carrier and Cell 2 is the neighbour cell on a different NR FR2 carrier and the target cell for the SS-SINR measurements.
4. The UE Rx beam peak direction has been obtained previously using one of the Rx Beam Peak Search procedures as described in Annex I.

#### 7.7.3.2.4.2 Test procedure

1. Ensure the UE is in state RRC\_CONNECTED with generic procedure parameters Connectivity *NR*, Connected without release *On* and Test Mode *On* according to TS 38.508-1 [14] clause 4.5.
2. Set the parameters according to Table 7.7.3.2.5-1 as appropriate.
3. The SS shall transmit an RRCReconfiguration message on Cell 1.
4. The UE shall transmit an RRCReconfigurationComplete message.
5. The UE shall transmit periodically MeasurementReport messages.
6. After 10s wait from Step 3, the SS shall check the SS-SINR reported values in the periodic MeasurementReport for the following requirements:
  - R1: The SS-SINR value of Cell 1 reported by the UE is compared to the expected SS-SINR for Cell 1. If the value is outside the limits in Table 7.7.3.2.5-3 or the UE fails to report the measurement value for Cell 1, the number of failed iterations for R1 is increased by one. Otherwise, the number of passed iterations for R1 is increased by one.
  - R2: The SS-SINR value of Cell 2 reported by the UE is compared to the expected SS-SINR for Cell 2. If the value is outside the limits in Table 7.7.3.2.5-3 or the UE fails to report the measurement value for Cell 2, the number of failed iterations for R2 is increased by one. Otherwise, the number of passed iterations for R2 is increased by one.
  - R3: The SS-SINR value of Cell 2 reported by the UE is compared to the reported SS-SINR of Cell 1. If the resulting value is outside the limits in Table 7.7.3.2.5-4 or the UE fails to report the measurement value for Cell 1 or Cell 2, the number of failed iterations for R3 is increased by one. Otherwise, the number of passed iterations for R3 is increased by one.
7. The SS shall continue checking the MeasurementReport messages transmitted by the UE until the confidence level according to Table G.2.3-1 in Annex G is achieved.
8. Set the parameters according to each sub-test in Table 7.7.3.2.5-2 as appropriate and repeat steps 5-7. In Step 6, the SS shall check the following requirements for Test 2:

- R4: The SS-SINR value of Cell 1 reported by the UE is compared to the expected SS-SINR for Cell 1. If the value is outside the limits in Table 7.7.3.2.5-3 or the UE fails to report the measurement value for Cell 1, the number of failed iterations for R4 is increased by one. Otherwise, the number of passed iterations for R4 is increased by one.
- R5: The SS-SINR value of Cell 2 reported by the UE is compared to the expected SS-SINR for Cell 2. If the value is outside the limits in Table 7.7.3.2.5-3 or the UE fails to report the measurement value for Cell 2, the number of failed iterations for R5 is increased by one. Otherwise, the number of passed iterations for R5 is increased by one.
- R6: The SS-SINR value of Cell 2 reported by the UE is compared to the reported SS-SINR of Cell 1. If the resulting value is outside the limits in Table 7.7.3.2.5-4 or the UE fails to report the measurement value for Cell 1 or Cell 2, the number of failed iterations for R6 is increased by one. Otherwise, the number of passed iterations for R6 is increased by one.

And the following requirements for Test 3:

- R7: The SS-SINR value of Cell 1 reported by the UE is compared to the expected SS-SINR for Cell 1. If the value is outside the limits in Table 7.7.3.2.5-3 or the UE fails to report the measurement value for Cell 1, the number of failed iterations for R7 is increased by one. Otherwise, the number of passed iterations for R7 is increased by one.
- R8: The SS-SINR value of Cell 2 reported by the UE is compared to the expected SS-SINR for Cell 2. If the value is outside the limits in Table 7.7.3.2.5-3 or the UE fails to report the measurement value for Cell 2, the number of failed iterations for R8 is increased by one. Otherwise, the number of passed iterations for R8 is increased by one.
- R9: The SS-SINR value of Cell 2 reported by the UE is compared to the reported SS-SINR of Cell 1. If the resulting value is outside the limits in Table 7.7.3.2.5-4 or the UE fails to report the measurement value for Cell 1 or Cell 2, the number of failed iterations for R9 is increased by one. Otherwise, the number of passed iterations for R9 is increased by one.

7.7.3.2.4.3 Message contents

Message contents are according to TS 38.508-1 [14] clause 7.3 with the following exceptions:

**Table 7.7.3.2.4.3-1: Common Exception messages**

Default Message Contents	
Common contents of system information blocks exceptions	
Default RRC messages and information elements contents exceptions	Table H.3.1-1 Table H.3.1-2 with condition INTER-FREQ and GAP NEEDED Table H.3.1-3 with Conditions INTER-FREQ MO and Synchronous cells Table H.3.1-5 Table H.3.1-6 with condition Pattern #0 Table H.3.1-7 with condition INTER-FREQ Table 7.3.1-3 in TS 38.508-1 [14] with condition SMTC.1

**Table 7.7.3.1.4.3-2: ReportConfigNR-DEFAULT(Periodical)**

Derivation Path: 38.508-1 [14] Table 4.6.3-142 with condition PERIODICAL			
Information Element	Value/remark	Comment	Condition
ReportConfigNR ::= SEQUENCE {			
reportType CHOICE {			
periodical SEQUENCE {			PERIODICAL
reportQuantityCell SEQUENCE {			
rsrp	false		
rsrq	false		
}			
maxReportCells	2		
}			
}			
}			

### 7.7.3.2.5 Test requirement

Table 7.7.3.2.5-1 defines the cell specific settings for all tests. Table 7.7.3.2.5-2 defines the OTA primary level settings including test tolerances for all tests.

The SS-SINR measurement accuracy shall fulfil the absolute accuracy requirements in clause 7.7.3.0.2.1 and relative accuracy requirements in clause 7.7.3.0.2.2. The following eight requirements are to be verified:

During Test 1:

R1: Absolute accuracy of Cell 1. The UE is deemed to meet the requirement if the reported SS-SINR is in the range shown in Table 7.7.3.2.5-3.

R2: Absolute accuracy of Cell 2. The UE is deemed to meet the requirement if the reported SS-SINR is in the range shown in Table 7.7.3.2.5-3.

R3: Relative accuracy of Cell 2 compared with Cell 1. The UE is deemed to meet the requirement if the difference in reported SS-SINR meets the requirements in Table 7.7.3.2.5-4.

During Test 2:

R4: Absolute accuracy of Cell 1. The UE is deemed to meet the requirement if the reported SS-SINR is in the range shown in table 7.7.3.2.5-3.

R5: Absolute accuracy of Cell 2. The UE is deemed to meet the requirement if the reported SS-SINR is in the range shown in table 7.7.3.2.5-3.

R6: Relative accuracy of Cell 2 compared with Cell 1. The UE is deemed to meet the requirement if the difference in reported SS-SINR meets the requirements in Table 7.7.3.2.5-4.

During Test 3:

R7: Absolute accuracy of Cell 1. The UE is deemed to meet the requirement if the reported SS-SINR is in the range shown in table 7.7.3.2.5-3.

R8: Absolute accuracy of Cell 2. The UE is deemed to meet the requirement if the reported SS-SINR is in the range shown in table 7.7.3.2.5-3.

R9: Relative accuracy of Cell 2 compared with Cell 1. The UE is deemed to meet the requirement if the difference in reported SS-SINR meets the requirements in Table 7.7.3.2.5-4.

**Table 7.7.3.2.5-1: SS-SINR Inter frequency general test parameters**

Parameter	Unit	Test 1		Test 2		Test 3	
		Cell 1	Cell 2	Cell 1	Cell 2	Cell 1	Cell 2
SSB ARFCN		freq1	freq2	freq1	freq2	freq1	freq2
Duplex mode		TDD		TDD		TDD	
TDD configuration		TDDConf.3.1		TDDConf.3.1		TDDConf.3.1	
BW <sub>channel</sub>	MHz	100: N <sub>RB,c</sub> = 66		100: N <sub>RB,c</sub> = 66		100: N <sub>RB,c</sub> = 66	
Data RBs allocated		66		66		66	
Downlink initial BWP configuration		DLBWP.0.1					
Downlink dedicated BWP configuration		DLBWP.1.1					
Uplink initial BWP configuration		ULBWP.0.1					
Uplink dedicated BWP configuration		ULBWP.1.1					
DRX cycle configuration	ms	Not applicable					
TRS configuration		TRS.2.1 TDD					
TCI state		TCI.State.0					
PDSCH Reference measurement channel		SR.3.1 TDD	-	SR.3.1 TDD	-	SR.3.1 TDD	-
RMSI CORESET Reference Channel		CR.3.1 TDD	-	CR.3.1 TDD	-	CR.3.1 TDD	-
OCNG Patterns		OP.1	OP.1	OP.1	OP.1	OP.1	OP.1
SMTC configuration		SMTC. 1 FR2	SMTC. 1 FR2	SMTC. 1 FR2	SMTC. 1 FR2	SMTC. 1 FR2	SMTC. 1 FR2
SSB configuration		SSB.3 FR2	SSB.3 FR2	SSB.3 FR2	SSB.3 FR2	SSB.3 FR2	SSB.3 FR2
PDSCH/PDCCH subcarrier spacing	kHz	120	120	120	120	120	120
EPRE ratio of PSS to SSS	dB	0	0	0	0	0	0
EPRE ratio of PBCH_DMRS to SSS							
EPRE ratio of PBCH to PBCH_DMRS							
EPRE ratio of PDCCH_DMRS to SSS							
EPRE ratio of PDCCH to PDCCH_DMRS							
EPRE ratio of PDSCH_DMRS to SSS							
EPRE ratio of PDSCH to PDSCH_DMRS							
EPRE ratio of OCNG DMRS to SSS <sup>Note 1</sup>							
EPRE ratio of OCNG to OCNG DMRS <sup>Note 1</sup>							
Propagation conditions		AWGN	AWGN	AWGN	AWGN	AWGN	AWGN
Antenna Configuration		1x2	1x2	1x2	1x2	1x2	1x2
Note 1: OCNG shall be used such that both cells are fully allocated and a constant total transmitted power spectral density is achieved for all OFDM symbols. Note 2: Void Note 3: Void Note 4: Void							

**Table 7.7.3.2.5-2: SS-SINR Inter frequency OTA related test parameters**

Parameter	Unit	Test 1		Test 2		Test 3	
		Cell 1	Cell 2	Cell 1	Cell 2	Cell 1	Cell 2

Angle of arrival configuration	degrees	Setup 1		Setup 1		Setup 1	
Assumption for UE beams <sup>Note 10</sup>		Rough		Rough		Rough	
$N_{oc}$ <sup>Note1</sup>	dBm/15kHz <sup>Note4</sup>	-105	-105	-105.1	-105.1	-105	-105
$N_{oc}$ <sup>Note1</sup>	dBm/SCS <sup>Note3</sup>	-96	-96	-96.1	-96.1	-96	-96
$\hat{E}_s / N_{oc}$	dB	-0.5	-0.5	11	11	-2.1	-2.1
SS-RSRP <sup>Note2</sup>	dBm/SCS <sup>Note4</sup>	-96.5	-96.5	-85.1	-85.1	-98.1	-98.1
SS-SINR <sup>Note2</sup>	dB	-0.5	-0.5	11	11	-2.1	-2.1
$\hat{E}_s / I_{ot}$	dB	-0.5	-0.5	11	11	-2.1	-2.1
$I_o$ <sup>Note2</sup>	dBm/95.04 MHz <sup>Note4</sup>	-69.3	-69.3	-55.75	-55.75	-64.9	-64.9

- Note 1: Interference from other cells and noise sources not specified in the test is assumed to be constant over subcarriers and time and shall be modelled as AWGN of appropriate power for  $N_{oc}$  to be fulfilled.
- Note 2: SS-SINR, SSB\_RP, and  $I_o$  levels have been derived from other parameters for information purposes. They are not settable parameters themselves.
- Note 3: SS-SINR and SS-RSRP minimum requirements are specified assuming independent interference and noise at each receiver antenna port.
- Note 4: Equivalent power received by an antenna with 0dBi gain at the centre of the quiet zone
- Note 5: As observed with 0dBi gain antenna at the centre of the quiet zone
- Note 6: Void
- Note 7: Void
- Note 8: Void
- Note 9: Void
- Note 10: Information about types of UE beam is given in B.2.1.3 of TS 38.133 [6], and does not limit UE implementation or test system implementation

**Table 7.7.3.2.5-3: evaluation limits for the reported values for T1 and T2 absolute accuracy rules R1, R2, R4, R5**

UE power class 3						
Normal Conditions	Test 1 All bands		Test 2 All bands		Test 3 All bands	
Lowest reported value (Cell 1)	SINR <sub>27</sub>		SINR <sub>48</sub>		n257, n258, n261	SINR <sub>23</sub>
					n260	SINR <sub>22</sub>
					n259	FFS
Highest reported value (Cell 1)	n257, n258, n261	SINR <sub>62</sub>	n257, n258, n261	SINR <sub>87</sub>	n257, n258, n261	SINR <sub>60</sub>
	n260	SINR <sub>61</sub>	n260	SINR <sub>86</sub>	n260	SINR <sub>59</sub>
	n259	FFS	n259	FFS	n259	FFS
Lowest reported value (Cell 2)	SINR <sub>27</sub>		SINR <sub>48</sub>		n257, n258, n261	SINR <sub>23</sub>
					n260	SINR <sub>22</sub>
					n259	FFS
Highest reported value (Cell 2)	n257, n258, n261	SINR <sub>62</sub>	n257, n258, n261	SINR <sub>87</sub>	n257, n258, n261	SINR <sub>60</sub>
	n260	SINR <sub>61</sub>	n260	SINR <sub>86</sub>	n260	SINR <sub>59</sub>
	n259	FFS	n259	FFS	n259	FFS
Extreme Conditions	Test 1 All bands		Test 2 All bands		Test 3 All bands	
Lowest reported value (Cell 1)	SINR <sub>27</sub> + FFS		SINR <sub>48</sub> + FFS		n257, n258, n261	SINR <sub>23</sub> + FFS
					n260	SINR <sub>22</sub> + FFS
					n259	FFS
Highest reported value (Cell 1)	n257, n258, n261	SINR <sub>62</sub> + FFS	n257, n258, n261	SINR <sub>87</sub> + FFS	n257, n258, n261	SINR <sub>60</sub> + FFS
	n260	SINR <sub>61</sub> + FFS	n260	SINR <sub>86</sub> + FFS	n260	SINR <sub>59</sub> + FFS
	n259	FFS	n259	FFS	n259	FFS
Lowest reported value (Cell 2)	SINR <sub>27</sub> + FFS		SINR <sub>48</sub> + FFS		n257, n258, n261	SINR <sub>23</sub> + FFS
					n260	SINR <sub>22</sub> + FFS
					n259	FFS
Highest reported value (Cell 2)	n257, n258, n261	SINR <sub>62</sub> + FFS	n257, n258, n261	SINR <sub>87</sub> + FFS	n257, n258, n261	SINR <sub>60</sub> + FFS
	n260	SINR <sub>61</sub> + FFS	n260	SINR <sub>86</sub> + FFS	n260	SINR <sub>59</sub> + FFS
	n259	FFS	n259	FFS	n259	FFS

**Table 7.7.3.2.5-4: evaluation limits for the reported values for T1 and T2 relative accuracy rules R3, R6**

UE power class 3			
Normal Conditions	Test 1 All bands	Test 2 All bands	Test 3 All bands
Lowest value (SINR report Cell 2 – SINR report Cell 1)	- 8	- 17	- 9
Highest value (SINR report Cell 2 – SINR report Cell 1)	+ 8	+ 17	+ 9
Extreme Conditions	Test 1 All bands	Test 2 All bands	Test 3 All bands
Lowest value (SINR report Cell 2 – SINR report Cell 1)	- 8 + FFS	- 17 + FFS	- 9 + FFS
Highest value (SINR report Cell 2 – SINR report Cell 1)	+ 8 + FFS	+ 17 + FFS	+ 9 + FFS

For the test to pass, the ratio of successful reported values for each requirement (R1 to R6) shall be more than 90% with a confidence level of 95%. Each requirement is evaluated independently of the others.



## 7.7.4 L1-RSRP

### 7.7.4.0 Minimum conformance requirements

#### 7.7.4.0.1 SSB-based L1-RSRP absolute measurement accuracy requirements

Same as in clause 5.7.4.0.1.

#### 7.7.4.0.2 SSB-based L1-RSRP relative measurement accuracy requirements

Same as in clause 5.7.4.0.2.

#### 7.7.4.0.3 CSI-RS-based L1-RSRP absolute measurement accuracy requirements

Same as in clause 5.7.4.0.3.

#### 7.7.4.0.4 CSI-RS-based L1-RSRP relative measurement accuracy requirements

Same as in clause 5.7.4.0.4.

### 7.7.4.1 NR SA FR2 SSB based L1-RSRP measurement accuracy

**Editor's Note: This test case has been completed for the following configurations:**

- Test frequency  $f \leq 40.8$  GHz
- UE PC3
- Normal conditions
- The test is incomplete for UE power classes other than PC3
- The test is incomplete for test frequencies  $> 40.8$  GHz
- The test is incomplete for extreme conditions

#### 7.7.4.1.1 Test purpose

The purpose of this test is to verify that the SSB based L1-RSRP absolute measurement accuracy is within the specified limits for all bands.

#### 7.7.4.1.2 Test applicability

This test applies to all types of NR UE from Release 15 onwards.

#### 7.7.4.1.3 Minimum conformance requirements

The minimum conformance requirements are specified in clause 7.7.4.0.1 and 7.7.4.0.2.

The normative reference for this requirement is TS 38.133 [6] clause A.7.7.4.1.

#### 7.7.4.1.4 Test description

##### 7.7.4.1.4.1 Initial conditions

This test shall be tested using any of the test configurations in Table 7.7.4.1.4.1-1.

**Table 7.7.4.1.4.1-1: Supported test configurations**

Test Case ID	Description
7.7.4.1-1	NR 120 kHz SSB SCS, 100 MHz bandwidth, TDD duplex mode
7.7.4.1-2	NR 240 kHz SSB SCS, 100 MHz bandwidth, TDD duplex mode
Note: The UE is only required to be tested in one of the supported test configurations	

Configure the test equipment and the DUT according to the parameters in Table 7.7.4.1.4.1-2.

**Table 7.7.4.1.4.1-2: Initial conditions**

Parameter	Value		Comment
Test environment	NC, TL/VL, TL/VH, TH/VL, TH/VH		As specified in TS 38.508-1 [14] clause 4.1.
Test frequencies	As specified in Annex E, Table E.5-1 and TS 38.508-1 [14] clause 4.3.1.		
Channel bandwidth	As specified by the test configuration selected from Table 7.7.4.1.4.1-1.		
Propagation conditions	AWGN		As specified in Annex C.2.2.
Connection Diagram	TE Part	A.3.3.3.1-1	As specified in TS 38.508-1 [14] Annex A.
	DUT Part	A.3.4.1.1	
Exceptions to connection diagram	N/A		

1. Message contents are defined in clause 7.7.4.1.4.3.
2. Cell 1 is the NR FR2 cell and the target for SSB-based L1-RSRP measurements. The UE is configured to perform RLM, BFD and L1-RSRP measurement based on the SSBs. The connection setup is done according to the settings in Annex C.1.1.
3. The UE Rx beam peak direction has been obtained previously using one of the Rx Beam Peak Search procedures as described in Annex I.

#### 7.7.4.1.4.2 Test procedure

Prior to the start of the time duration T1, the UE shall be fully synchronized to Cell 1. The UE shall be configured for periodic CSI reporting in PUCCH [format 2] with a reporting periodicity as mentioned in the above table 7.7.4.1.4.1-2.

1. Ensure the UE is in state RRC\_CONNECTED with generic procedure parameters Connectivity *NR*, Connected without release *On* and Test Mode *On* according to TS 38.508-1 [14] clause 4.5.
2. Set the parameters according to T1 in Table 7.7.4.1.5-1.
3. After 320 ms from the beginning of T1, the UE shall start sending L1-RSRP report including results of both SSB#0 and SSB#1 every 80 slots.
4. The SS shall check the L1-RSRP reported values of SSB#0 and SSB#1 in the periodic L1-RSRP reports for the following requirements:
  - R1: The L1-RSRP value of SSB#0 reported by the UE is compared to the expected L1-RSRP value for SSB#0. If the value is outside the limits in Table 7.7.4.1.5-3 or Table 7.7.4.1.5-4 (depending on the test configuration) or the UE fails to report the measurement value for SSB#0, the number of failed iterations for R1 is increased by one. Otherwise, the number of passed iterations for R1 is increased by one.
  - R2: The L1-RSRP value of SSB#1 reported by the UE is compared to the expected L1-RSRP value for SSB#1. If the value is outside the limits in Table 7.7.4.1.5-3 or Table 7.7.4.1.5-4 (depending on the test configuration) or the UE fails to report the measurement value for SSB#1, the number of failed iterations for R2 is increased by one. Otherwise, the number of passed iterations for R2 is increased by one.
  - R3: The L1-RSRP value of SSB#1 reported by the UE is compared to the reported L1-RSRP value of SSB#0. If the resulting value is outside the limits in Table 5.7.1.1.5-5 or the UE fails to report the measurement value for SSB#0 or SSB#1, the number of failed iterations for R3 is increased by one. Otherwise, the number of passed iterations for R3 is increased by one.
5. The SS shall continue checking the L1-RSRP report messages transmitted by the UE until the confidence level according to Table G.2.3-1 in Annex G is achieved.
6. Set the parameters according to each sub-test in Table 7.7.4.1.5-1 as appropriate and repeat steps 3-5. In Step 4, the SS shall check for the following requirements.
  - R4: The L1-RSRP value of SSB#0 reported by the UE is compared to the expected L1-RSRP value for SSB#0. If the value is outside the limits in Table 7.7.4.1.5-3 or Table 7.7.4.1.5-4 (depending on the test configuration) or the UE fails to report the measurement value for SSB#0, the number of failed iterations for R1 is increased by one. Otherwise, the number of passed iterations for R4 is increased by one.

- R5: The L1-RSRP value of SSB#1 reported by the UE is compared to the expected L1-RSRP value for SSB#1. If the value is outside the limits in Table 7.7.4.1.5-3 or Table 7.7.4.1.5-4 (depending on the test configuration) or the UE fails to report the measurement value for SSB#1, the number of failed iterations for R2 is increased by one. Otherwise, the number of passed iterations for R5 is increased by one.
- R6: The L1-RSRP value of SSB#1 reported by the UE is compared to the reported L1-RSRP value of SSB#0. If the resulting value is outside the limits in Table 5.7.1.1.5-5 or the UE fails to report the measurement value for SSB#0 or SSB#1, the number of failed iterations for R3 is increased by one. Otherwise, the number of passed iterations for R6 is increased by one.

7.7.4.1.4.3 Message contents

Message contents are according to TS 38.508-1 [14] clause 7.3 with the following exceptions:

**Table 7.7.4.1.4.3-1: Common Exception messages**

Default Message Contents	
Common contents of system information blocks exceptions	
Default RRC messages and information elements contents exceptions	Table H.3.1-1 Table H.3.1-2 Table H.3.6-2 with conditions PERIODIC and SS-RSRP Table H.3.6-3 with conditions SSB and PERIODIC Table 7.3.1-3 in TS 38.508-1 [14] with condition SMTC.1

**Table 7.7.4.1.4.3-2: RadioLinkMonitoringConfig**

Derivation Path: TS 38.508-1 [14], Table 4.6.3-133			
Information Element	Value/remark	Comment	Condition
RadioLinkMonitoringConfig ::= SEQUENCE {			
failureDetectionResourcesToAddModList	1 entry		
SEQUENCE			
(SIZE(1..maxNrofFailureDetectionResources)) OF			
SEQUENCE {			
purpose	both	UE is configured to perform RLM and BFD based on the SSBs.	
detectionResource CHOICE {			
ssb-Index	0		
}			
}			
}			

7.7.4.1.5 Test requirement

Table 7.7.4.1.5-1 defines the primary level settings including test tolerances for all tests.

Each L1-RSRP measurement report for each of the tests in Table 7.7.4.1.5-1 shall meet the corresponding absolute accuracy requirements in Table 7.7.4.1.5-2 for test configurations 1, 2, 4 and 5, and the corresponding absolute accuracy requirements in Table 7.7.4.1.5-3 for test configurations 3 and 6.

Table 7.7.4.1.5-1: L1-RSRP test parameters

Parameter	Config	Unit	Test 1	Test 2
SSB GSCN	1,2		freq1	freq1
Duplex mode	1,2		TDD	TDD
TDD Configuration	1,2		TDDConf.3.1	TDDConf.3.1
BW <sub>channel</sub>	1,2	MHz	100: N <sub>RB,c</sub> = 66	100: N <sub>RB,c</sub> = 66
Data RBs allocated	1,2		66	66
PDSCH Reference measurement channel	1		SR.3.2 TDD	SR.3.2 TDD
	2		SR.3.3 TDD	SR.3.3 TDD
RMSI CORESET Reference Channel	1		CR.3.1 TDD	CR.3.1 TDD
	2		CR.3.2 TDD	CR.3.2 TDD
Dedicated CORESET Reference Channel	1		CCR.3.1 TDD	CCR.3.1 TDD
	2		CCR.3.7 TDD	CCR.3.7 TDD
SSB configuration	1		SSB.1 FR2	SSB.1 FR2
	2		SSB.2 FR2	SSB.2 FR2
OCNG Patterns	1,2		OP.1	OP.1
Initial BWP Configuration	1,2		DLBWP.0.1 ULBWP.0.1	DLBWP.0.1 ULBWP.0.1
Dedicated BWP configuration	1,2		DLBWP.1.3 ULBWP.1.3	DLBWP.1.3 ULBWP.1.3
TRS Configuration	1,2		TRS.2.1 TDD	TRS.2.1 TDD
PDCCH/PDSCH TCI Configuration	1,2		TCI.State.2	TCI.State.2
SMTc configuration	1,2		SMTc.1	SMTc.1
reportConfigType	1,2		periodic	periodic
reportQuantity	1,2		ssb-Index-RSRP	ssb-Index-RSRP
Number of reported RS	1,2		2	2
L1-RSRP reporting period	1,2		slot320	slot320
Propagation condition	1,2		AWGN	AWGN
Antenna configuration			1x2	1x2
EPRE ratio of PSS to SSS	1,2	dB	0	0
EPRE ratio of PBCH DMRS to SSS				
EPRE ratio of PBCH to PBCH DMRS				
EPRE ratio of PDCCH DMRS to SSS				
EPRE ratio of PDCCH to PDCCH DMRS				
EPRE ratio of PDSCH DMRS to SSS				
EPRE ratio of PDSCH to PDSCH DMRS				
EPRE ratio of OCNG DMRS to SSS <sup>Note 1</sup>				
EPRE ratio of OCNG to OCNG DMRS <sup>Note 1</sup>				
Note 1:	OCNG shall be used such that both cells are fully allocated and a constant total transmitted power spectral density is achieved for all OFDM symbols.			
Note 2:	Interference from other cells and noise sources not specified in the test is assumed to be constant over subcarriers and time and shall be modelled as AWGN of appropriate power for $N_{oc}$ to be fulfilled.			

**Table 7.7.4.1.5-2: L1-RSRP OTA related test parameters**

Parameter	Config	Unit	Test 1		Test 2 <sup>NOTE 3</sup>	
			SSB0	SSB1	SSB0	SSB1
Angle of arrival configuration			Setup 1 according to A.3.15.1		Setup 1 according to A.3.15.1	
Assumption for UE beams <sup>Note 4</sup>			Rough		Rough	
$N_{oc}$	1,2	dBm/15 kHz	-104.1		n.a.	
$N_{oc}$	1	dBm/SS B SCS	-95.1		n.a.	
	2		-92.1		n.a.	
$\hat{E}_s / I_{ot}$	1,2	dB	10	-1.6	n.a.	
SSB_RP <sup>Note1</sup>	1	dBm/SC S	-85.1	-96.9	As in Table B.2.4-2 + 5.7	
	2		-78	-90	As in Table B.2.4-2 + 5.7	
$I_o$ <sup>Note1</sup>	1,2	dBm/95.04M Hz	-55.67		SSB_RP+34.68	
$\hat{E}_s / N_{oc}$	1,2	dB	10	-1.6	n.a.	
Note 1: SSB_RP and $I_o$ levels have been derived from other parameters for information purposes. They are not settable parameters themselves. Note 2: Void Note 3: No additional noise is added by the test system in Test 2. Note 4: Information about types of UE beam is given in B.2.1.3, and does not limit UE implementation or test system implementation						

**Table 7.7.4.1.5-3: L1-RSRP absolute accuracy requirements for the reported values for test configurations 1 and 2 for the absolute accuracy rules R1, R2, R4, R5**

UE power class 3			
Normal Conditions	Test 1 All bands	Test 2	
Lowest reported value (SSB#0)	42	n257, n258, n261	27
		n260	30
		n259	FFS
Highest reported value (SSB#0)	101	n257, n258, n261	83
		n260	86
		n259	FFS
Lowest reported value (SSB#1)	31	n257, n258, n261	27
		n260	30
		n259	FFS
Highest reported value (SSB#1)	89	n257, n258, n261	83
		n260	86
		n259	FFS
Extreme Conditions	Test 1 All bands	Test 2	
Lowest reported value (SSB#0)	39 + FFS	n257, n258, n261	24 + FFS
		n260	27 + FFS
		n259	FFS
Highest reported value (SSB#0)	104 + FFS	n257, n258, n261	86 + FFS
		n260	89 + FFS
		n259	FFS
Lowest reported value (SSB#1)	28+ FFS	n257, n258, n261	25 + FFS
		n260	27 + FFS
		n259	FFS
Highest reported value (SSB#1)	92+ FFS	n257, n258, n261	86 + FFS
		n260	89 + FFS
		n259	FFS

**Table 7.7.4.1.5-4: L1-RSRP absolute accuracy requirements for the reported values for test configurations 3 and 4 for the absolute accuracy rules R1, R2, R4, R5**

UE power class 3			
Normal Conditions	Test 1 All bands	Test 2	
Lowest reported value (SSB#0)	45	n257, n258, n261	30
		n260	33
		n259	FFS
Highest reported value (SSB#0)	104	n257, n258, n261	86
		n260	89
		n259	FFS
Lowest reported value (SSB#1)	34	n257, n258, n261	30
		n260	33
		n259	FFS
Highest reported value (SSB#1)	92	n257, n258, n261	86
		n260	89
		n259	FFS
Extreme Conditions	Test 1 All bands	Test 2	
Lowest reported value (SSB#0)	42+ FFS	n257, n258, n261	27 + FFS
		n260	30 + FFS
		n259	FFS
Highest reported value (SSB#0)	107+ FFS	n257, n258, n261	89 + FFS
		n260	92 + FFS
		n259	FFS
Lowest reported value (SSB#1)	31+ FFS	n257, n258, n261	27+ FFS
		n260	30+ FFS
		n259	FFS
Highest reported value (SSB#1)	95+ FFS	n257, n258, n261	89+ FFS
		n260	92+ FFS
		n259	FFS

**Table 7.7.4.1.5-5: evaluation limits for the reported values for T1 and T2 relative accuracy rules R3, R6**

UE power class 3		
Normal Conditions	Test 1 All bands	Test 2 All bands
Lowest reported value (L1-RSRP SSB#1 – L1-RSRP SSB#0)	- 9	- 4
Highest reported value ((L1-RSRP SSB#1 – L1-RSRP SSB#0))	- 2	+ 4
Extreme Conditions	Test 1 All bands	Test 2 All bands
Lowest reported value ((L1-RSRP SSB#1 – L1-RSRP SSB#0))	- 12+ FFS	- 7+ FFS
Highest reported value ((L1-RSRP SSB#1 – L1-RSRP SSB#0))	+ 1+ FFS	+ 7+ FFS

For the test to pass, the ratio of successful reported values for each requirement (R1 to R6) shall be more than 90% with a confidence level of 95%. Each requirement is evaluated independently of the others.

#### 7.7.4.2 NR SA FR2 CSI-RS based L1-RSRP measurement accuracy

Editor's Note: This test case has been completed for the following configurations:

- Test frequency  $f \leq 40.8$  GHz
- UE PC3
- Normal conditions

- The test is incomplete for UE power classes other than PC3
- The test is incomplete for test frequencies > 40.8 GHz
- The test is incomplete for extreme conditions

7.7.4.2.1 Test purpose

The purpose of this test is to verify that the CSI-RS based L1-RSRP absolute measurement accuracy is within the specified limits for all bands.

7.7.4.2.2 Test applicability

This test applies to all types of NR UE from Release 15 onwards.

7.7.4.2.3 Minimum conformance requirements

The minimum conformance requirements are specified in clause 7.7.4.0.3 and 7.7.4.0.4.

The normative reference for this requirement is TS 38.133 [6] clause A.7.7.4.1.

7.7.4.2.4 Test description

7.7.4.2.4.1 Initial conditions

This test shall be tested using any of the test configurations in Table 7.7.4.2.4.1-1.

**Table 7.7.4.2.4.1-1: Supported test configurations**

Test Case ID	Description
7.7.4.2-1	NR 120 kHz SSB SCS, 100 MHz bandwidth, TDD duplex mode
Note: The UE is only required to be tested in one of the supported test configurations	

Configure the test equipment and the DUT according to the parameters in Table 7.7.4.2.4.1-2.

**Table 7.7.4.2.4.1-2: Initial conditions**

Parameter	Value	Comment
Test environment	NC, TL/VL, TL/VH, TH/VL, TH/VH	As specified in TS 38.508-1 [14] clause 4.1.
Test frequencies	As specified in Annex E, Table E.5-1 and TS 38.508-1 [14] clause 4.3.1.	
Channel bandwidth	As specified by the test configuration selected from Table 7.7.4.2.4.1-1.	
Propagation conditions	AWGN	As specified in Annex C.2.2.
Connection Diagram	TE Part	A.3.3.1.1
	DUT Part	A.3.4.1.1
Exceptions to connection diagram	N/A	

1. Message contents are defined in clause 7.7.4.2.4.3.
2. Cell 1 is the NR FR2 cell and the target for CSI-RS-based L1-RSRP measurements. The UE is configured to perform RLM, BFD and L1-RSRP measurement based on the SSBs. The connection setup is done according to the settings in Annex C.1.1.
3. The UE Rx beam peak direction has been obtained previously using one of the Rx Beam Peak Search procedures as described in Annex I.

7.7.4.2.4.2 Test procedure

Prior to the start of the time duration T1, the UE shall be fully synchronized to Cell 1. The UE shall be configured for periodic CSI reporting in PUCCH [format 2] with a reporting periodicity as mentioned in the above table 7.7.4.2.4.1-2.

1. Ensure the UE is in state RRC\_CONNECTED with generic procedure parameters Connectivity NR, Connected without release On and Test Mode On according to TS 38.508-1 [14] clause 4.5.
2. Set the parameters according to T1 in Table 7.7.4.2.5-1.
3. After 320 ms from the beginning of T1, the UE shall start sending L1-RSRP report including results of both CSI-RS0 and CSI-RS1.
4. The SS shall check the L1-RSRP reported values of CSI-RS0 and CSI-RS1 in the periodic L1-RSRP reports for the following requirements:
  - R1: The L1-RSRP value of CSI-RS0 reported by the UE is compared to the expected L1-RSRP value for CSI-RS0. If the value is outside the limits in Table 7.7.4.2.5-3 or Table 7.7.4.2.5-4 (depending on the test configuration) or the UE fails to report the measurement value for CSI-RS0, the number of failed iterations for R1 is increased by one. Otherwise, the number of passed iterations for R1 is increased by one.
  - R2: The L1-RSRP value of CSI-RS1 reported by the UE is compared to the expected L1-RSRP value for CSI-RS1. If the value is outside the limits in Table 7.7.4.2.5-3 or Table 7.7.4.2.5-4 (depending on the test configuration) or the UE fails to report the measurement value for CSI-RS1, the number of failed iterations for R2 is increased by one. Otherwise, the number of passed iterations for R2 is increased by one.
  - R3: The L1-RSRP value of CSI-RS1 reported by the UE is compared to the reported L1-RSRP value of CSI-RS0. If the resulting value is outside the limits in Table 5.7.1.1.5-5 or the UE fails to report the measurement value for CSI-RS0 or CSI-RS1, the number of failed iterations for R3 is increased by one. Otherwise, the number of passed iterations for R3 is increased by one.
5. The SS shall continue checking the L1-RSRP report messages transmitted by the UE until the confidence level according to Table G.2.3-1 in Annex G is achieved.
6. Set the parameters according to each sub-test in Table 7.7.4.2.5-1 as appropriate and repeat steps 3-5. In Step 4, the SS shall check for the following requirements.
  - R4: The L1-RSRP value of CSI-RS0 reported by the UE is compared to the expected L1-RSRP value for CSI-RS0. If the value is outside the limits in Table 7.7.4.2.5-3 or Table 7.7.4.2.5-4 (depending on the test configuration) or the UE fails to report the measurement value for CSI-RS0, the number of failed iterations for R1 is increased by one. Otherwise, the number of passed iterations for R4 is increased by one.
  - R5: The L1-RSRP value of CSI-RS1 reported by the UE is compared to the expected L1-RSRP value for CSI-RS1. If the value is outside the limits in Table 7.7.4.2.5-3 or Table 7.7.4.2.5-4 (depending on the test configuration) or the UE fails to report the measurement value for CSI-RS1, the number of failed iterations for R2 is increased by one. Otherwise, the number of passed iterations for R5 is increased by one.
  - R6: The L1-RSRP value of CSI-RS1 reported by the UE is compared to the reported L1-RSRP value of CSI-RS0. If the resulting value is outside the limits in Table 5.7.1.1.5-5 or the UE fails to report the measurement value for CSI-RS0 or CSI-RS1, the number of failed iterations for R3 is increased by one. Otherwise, the number of passed iterations for R6 is increased by one.

7.7.4.2.4.3 Message contents

Message contents are according to TS 38.508-1 [14] clause 7.3 with the following exceptions:

**Table 7.7.4.2.4.3-1: Common Exception messages**

Default Message Contents	
Common contents of system information blocks exceptions	
Default RRC messages and information elements contents exceptions	Table H.3.1-1 Table H.3.1-2 Table H.3.6-2 with conditions PERIODIC and CSI-RSRP Table H.3.6-3 with conditions CSI-RS and PERIODIC Table 7.3.1-3 in TS 38.508-1 [14] with condition SMTC.1



**Table 7.7.4.2.4.3-2: RadioLinkMonitoringConfig**

Derivation Path: TS 38.508-1 [14], Table 4.6.3-133			
Information Element	Value/remark	Comment	Condition
RadioLinkMonitoringConfig ::= SEQUENCE {			
failureDetectionResourcesToAddModList	1 entry		
SEQUENCE			
(SIZE(1..maxNrofFailureDetectionResources)) OF			
SEQUENCE {			
purpose	both	UE is configured to perform RLM and BFD based on the SSBs.	
detectionResource CHOICE {			
csi-RS-Index	0		
}			
}			
}			

#### 7.7.4.2.5 Test requirement

Table 7.7.4.2.5-1 defines the primary level settings including test tolerances for all tests.

Each L1-RSRP measurement report for each of the tests in Table 7.7.4.2.5-1 shall meet the corresponding absolute accuracy requirements in Table 7.7.4.2.5-2 for test configurations 1, 2, 4 and 5, and the corresponding absolute accuracy requirements in Table 7.7.4.2.5-3 for test configurations 3 and 6.

Table 7.7.4.2.5-1: L1-RSRP test parameters

Parameter	Config	Unit	Test 1	Test 2
SSB GSCN	1		freq1	freq1
Duplex mode	1		TDD	TDD
TDD Configuration	1		TDDConf.3.1	TDDConf.3.1
BW <sub>channel</sub>	1	MHz	100: N <sub>RB,c</sub> = 66	100: N <sub>RB,c</sub> = 66
PDSCH Reference measurement channel	1		SR.3.1 TDD	SR.3.1 TDD
RMSI CORESET Reference Channel	1		CR.3.1 TDD	CR.3.1 TDD
Dedicated CORESET Reference Channel	1		CCR.3.1 TDD	CCR.3.1 TDD
SSB configuration	1		SSB.1 FR2	SSB.1 FR2
OCNG Patterns	1		OP.1	OP.1
Initial BWP Configuration	1		DLBWP.0.1 ULBWP.0.1	DLBWP.0.1 ULBWP.0.1
Dedicated BWP configuration	1		DLBWP.1.1 ULBWP.1.1	DLBWP.1.1 ULBWP.1.1
TRS Configuration	1		TRS.2.1 TDD	TRS.2.1 TDD
PDCCH/PDSCH TCI Configuration	1		TCI.State.2	TCI.State.2
SMTc configuration	1		SMTc.1	SMTc.1
CSI-RS	1		CSI-RS.3.2 TDD	CSI-RS.3.2 TDD
reportConfigType	1		periodic	periodic
reportQuantity	1		cri-RSRP	cri-RSRP
Number of reported RS	1		2	2
L1-RSRP reporting period	1		slot320	slot320
Propagation condition	1		AWGN	AWGN
Antenna configuration	1		1x2	1x2
EPRE ratio of PSS to SSS	1	dB	0	0
EPRE ratio of PBCH DMRS to SSS				
EPRE ratio of PBCH to PBCH DMRS				
EPRE ratio of PDCCH DMRS to SSS				
EPRE ratio of PDCCH to PDCCH DMRS				
EPRE ratio of PDSCH DMRS to SSS				
EPRE ratio of PDSCH to PDSCH DMRS				
EPRE ratio of OCNG DMRS to SSS <sup>Note 1</sup>				
EPRE ratio of OCNG to OCNG DMRS <sup>Note 1</sup>				
<p>Note 1: OCNG shall be used such that both cells are fully allocated and a constant total transmitted power spectral density is achieved for all OFDM symbols.</p> <p>Note 2: Interference from other cells and noise sources not specified in the test is assumed to be constant over subcarriers and time and shall be modelled as AWGN of appropriate power for <math>N_{oc}</math> to be fulfilled.</p>				

**Table 7.7.4.2.5-2: L1-RSRP OTA related test parameters**

Parameter	Config	Unit	Test 1		Test 2 <sup>NOTE 3</sup>	
			CSI-RS0	CSI-RS1	CSI-RS0	CSI-RS1
Angle of arrival configuration			Setup 1 according to A.3.15.1		Setup 1 according to A.3.15.1	
Assumption for UE beams <sup>Note 4</sup>			Rough		Rough	
$N_{oc}$	1	dBm/15 kHz	-104.10		n.a.	
$N_{oc}$	1	dBm/SS B SCS	-95.11		n.a. n.a.	
$\hat{E}_s / I_{ot}$	1	dB	10	-1.8	n.a.	
CSI-RS_RP <sup>Note1</sup>	1	dBm/SC S	-85.11	-96.93	As in Table B.2.4.2-2 + 5.7	
$I_o$ <sup>Note1</sup>	1	dBm/95.04M Hz	-55.67		CSI-RS_RP+34.68	
$\hat{E}_s / N_{oc}$	1	dB	10	-1.82	n.a.	
<p>Note 1: RSRP and <math>I_o</math> levels have been derived from other parameters for information purposes. They are not settable parameters themselves.</p> <p>Note 2: RSRP minimum requirements are specified assuming independent interference and noise at each receiver antenna port.</p> <p>Note 3: No additional noise is added by the test system in Test 2.</p> <p>Note 4: Information about types of UE beam is given in B.2.1.3, and does not limit UE implementation or test system implementation</p>						

**Table 7.7.4.2.5-3: L1-RSRP absolute accuracy requirements for the reported values for the absolute accuracy rules R1, R2, R4, R5**

UE power class 3			
Normal Conditions	Test 1 All bands	Test 2	
		Lowest reported value (CSI-RS0)	48
		n260	30
		n259	FFS
Highest reported value (CSI-RS0)	95	n257, n258, n261	83
		n260	86
		n259	FFS
Lowest reported value (CSI-RS1)	30	n257, n258, n261	27
		n260	30
		n259	FFS
Highest reported value (CSI-RS1)	89	n257, n258, n261	83
		n260	86
		n259	FFS
Extreme Conditions	Test 1 All bands	Test 2	
Lowest reported value (CSI-RS0)	45+ FFS	n257, n258, n261	25 + FFS
		n260	27 + FFS
		n259	FFS
Highest reported value (CSI-RS0)	98+ FFS	n257, n258, n261	86 + FFS
		n260	89 + FFS
		n259	FFS
Lowest reported value (CSI-RS1)	27+ FFS	n257, n258, n261	25 + FFS
		n260	27 + FFS
		n259	FFS
Highest reported value (CSI-RS1)	92+ FFS	n257, n258, n261	86 + FFS
		n260	89 + FFS
		n259	FFS

**Table 7.7.4.2.5-4: evaluation limits for the reported values for T1 and T2 relative accuracy rules R3, R6**

UE power class 3		
Normal Conditions	Test 1 All bands	Test 2 All bands
Lowest reported value (L1-RSRP CSI-RS1 – L1-RSRP CSI-RS0)	- 9	- 4
Highest reported value ((L1-RSRP CSI-RS1 – L1-RSRP CSI-RS0))	- 2	+ 4
Extreme Conditions	Test 1 All bands	Test 2 All bands
Lowest reported value ((L1-RSRP CSI-RS1 – L1-RSRP CSI-RS0))	- 12+ FFS	- 7+ FFS
Highest reported value ((L1-RSRP CSI-RS1 – L1-RSRP CSI-RS0))	+ 1+ FFS	+ 7+ FFS

For the test to pass, the ratio of successful reported values for each requirement (R1 to R6) shall be more than 90% with a confidence level of 95%. Each requirement is evaluated independently of the others.

## 7.7.5 SRS-RSRP

### 7.7.5.0 Minimum conformance requirements

#### 7.7.5.0.1 Minimum conformance requirements for SRS-RSRP measurement accuracy

The SRS-RSRP measurement reported by the UE shall fulfil the accuracy requirements defined in Table 7.7.5.0.1-1 for FR1 and Table 5.7.7.0.1-2 for FR2, provided that the following conditions are met. The accuracy requirements in this clause are derived based on AWGN radio propagation conditions.

- Conditions defined in clause 7.3 of TS 38.101-1 [18] for reference sensitivity are fulfilled.
- Conditions for SRS-RSRP measurements are fulfilled according to Annex B.2.z for a corresponding Band for each relevant SRS resource configured for measurement.
- The time difference between UE's DL reference timing in the serving cell and SRS arrival time is no larger than  $T_{\text{error\_SRS\_RSRP}}$ , where
  - $T_{\text{error\_SRS\_RSRP}} = T_C \times N_{\text{TA\_offset}} + 4.67\text{us}$  for FR1
  - $T_{\text{error\_SRS\_RSRP}} = T_C \times N_{\text{TA\_offset}} + 3.67\text{us}$  for FR2
  - $N_{\text{TA\_offset}}$  is defined in Table 7.1.2-2
  - $T_C$  is 0.509ns
- The number of SRS ports in the SRS resource configured for measurement is 1,
- The number of symbols in the SRS resource configured for measurement is 1,
- The number of repetitions in the SRS resource configured for measurement is 1,
- Frequency hopping, sequence group hopping or sequence hopping is disabled in the SRS resource configured for measurement,
- The bandwidth of the SRS resource is 48 PRBs.
- One of the following conditions is met
  - There is no other SRS resource with the same root sequence and on the same symbol and with same comb as the relevant SRS resource.
  - If multiple SRS resources are on the same symbol and with same comb, the distance between cyclic shifts of any two resources is no less than 6 if  $\text{transmissionComb} = n_4$ , and no less than 4 if  $\text{transmissionComb} = n_2$ .

Table 7.7.5.0.1-1: SRS-RSRP absolute accuracy in FR1

Accuracy						Conditions						
Normal condition			Extreme condition			SRS Es/lot	Io <sup>Note 1</sup> range					
							NR operating band groups <sup>Note 2</sup>	Minimum Io			Maximum Io	
dB						dB	dBm / SCS <sub>SRS</sub>			dBm/BW Channel	dBm/BW Channel	
SCS <sub>SRS</sub> (kHz)		SCS <sub>SRS</sub> (kHz)					SCS <sub>SRS</sub> s = 15 kHz	SCS <sub>SRS</sub> s = 30 kHz	SCS <sub>SRS</sub> s = 60 kHz			
15	30	60	15	30	60							
±3	±3.5	±5	±7.5	±8	±9.5	≥1	NR_TDD_FR1_A , NR_TDD_FR1_C , NR_TDD_FR1_D , NR_TDD_FR1_E	-120	-117	-114	N/A	-70
±6.5	±7	±8.5	±9.5	±10	±11.5	≥1	NR_TDD_FR1_A , NR_TDD_FR1_C , NR_TDD_FR1_D , NR_TDD_FR1_E	N/A	N/A	N/A	-70	-50

NOTE 1: Io is assumed to have constant EPRE across the bandwidth.

NOTE 2: NR operating band groups in FR1 are as defined in clause 3.5.2.

Table 7.7.5.0.1-2: SRS-RSRP absolute accuracy in FR2

Accuracy				Conditions				
Normal condition		Extreme condition		SRS Es/lot	Io <sup>Note 1</sup> range			
					Minimum Io		Maximum Io	
dB				dB	dBm / SCS <sub>SRS</sub> <sup>Note 2</sup>		dBm/BW <sub>Channel</sub>	dBm/BW <sub>Channel</sub>
SCS <sub>SRS</sub> (kHz)		SCS <sub>SRS</sub> (kHz)			SCS <sub>SRS</sub> = 60kHz	SCS <sub>SRS</sub> = 120kHz		
60	120	60	120					
±6	±8.5	±9	±11.5	≥1	Same value as SRS_RP in Table B.2.7-2, according to UE Power class, operating band and angle of arrival		N/A	-70
±9	±11.5	±11	±13.5	≥1	N/A		-70	-50

NOTE 1: Io specified at the Reference point, and assumed to have constant EPRE across the bandwidth.

NOTE 2: Values based on Refsens and EIS spherical coverage as defined in clauses 7.3.2 and 7.3.4 of TS 38.101-2 [19]. Applicable side condition selected depending on angle of arrival.

NOTE 3: In the test cases, the SSB Es/lot and related parameters may need to be adjusted to ensure Es/lot at UE baseband is above the value defined in this table.

7.7.5.0.1.1 SRS-RSRP report mapping

The reporting range of SRS-RSRP is defined from -140 dBm to -44 dBm with 1 dB resolution. The mapping of measured quantity is defined in Table 5.7.7.0.1.2-1. The range in the signalling may be larger than the guaranteed accuracy range.

**Table 5.7.7.0.1.2-1: SRS-RSRP measurement report mapping**

Reported value	Measured quantity value	Unit
SRS-RSRP_0	SRS-RSRP<-140	dBm
SRS-RSRP_1	-140≤ SRS-RSRP<-139	dBm
SRS-RSRP_2	-139≤ SRS-RSRP<-138	dBm
SRS-RSRP_3	-138≤ SRS-RSRP<-137	dBm
SRS-RSRP_4	-137≤ SRS-RSRP<-136	dBm
..	..	...
SRS-RSRP_95	-46≤ SRS-RSRP<-45	dBm
SRS-RSRP_96	-45≤ SRS-RSRP<-44	dBm
SRS-RSRP_97	-44≤ SRS-RSRP	dBm
SRS-RSRP_98	Infinity	
Note:	'Infinity' means that UE cannot detect SRS due to too strong signal to measure.	

The normative reference for this requirement is TS 38.133 [6] clause 10.1.22.1.

### 7.7.5.1 NR SA FR2 SRS-RSRP measurement accuracy

**Editor's Note: This test case is incomplete. Following aspects are either missing or TBD**

- The test procedure is incomplete

- The message content is FFS

- MU/TT analysis is FFS

#### 7.7.5.1.1 Test purpose

The purpose of this test is to verify that the SRS-RSRP measurement accuracy is within the specified limits with SRS-RSRP measurement requirements in TS 38.133 [6] clause 10.1.22.1.1.

#### 7.7.5.1.2 Test applicability

This test applies to all types of NR UE release 16 onwards and supporting CLI-SRS-RSRP.

#### 7.7.5.1.3 Minimum conformance requirements

The minimum conformance requirements are specified in clause 7.7.5.0.1.

The normative reference for this requirement is TS 38.133 [6] clause A.7.7.5.1.

#### 7.7.5.1.4 Test description

##### 7.7.5.1.4.1 Initial conditions

This test shall be tested using any of the test configurations in Table 7.7.5.1.4.1-1.

**Table 7.7.5.1.4.1-1: Applicable NR configurations for FR2 SRS-RSRP accuracy test**

Config	Description
1	120 kHz SRS SCS, 100 MHz bandwidth, TDD duplex mode
Note:	The UE is only required to be tested in one of the supported test configurations in each supported band

Configure the test equipment and the DUT according to the parameters in Table 7.7.5.1.4.1-2.

**Table 7.7.5.1.4.1-2: Initial conditions SA FR2 SRS-RSRP measurement accuracy**

Parameter	Value		Comment
Test environment	NC		As specified in TS 38.508-1 [14] clause 4.1.
Test frequencies	As specified in Annex E, Table E.5-1 and TS 38.508-1 [14] clause 4.3.1.		
Channel bandwidth	As specified by the test configuration selected from Table 6.6.1.1.4.1-1.		
Propagation conditions	AWGN		As specified in Annex C.2.2
Connection Diagram	TE Part	A.3.3.1.1	As specified in TS 38.508-1 [14] Annex A.
	DUT Part	A.3.4.1.1	
Exceptions to connection diagram	N/A		

1. Message contents are defined in clause 7.7.5.1.4.3.
2. In this set of test cases there is one cell in the test, FR2 PCell (Cell 1). The test parameters for the Cell 1 are given in Table 7.7.5.1.5-1 and Table 7.7.5.1.5-2 below. The test parameter for the (virtual) neighbour cell UE transmitting SRS are given in Table 7.7.5.1.5-2.
3. The UE Rx beam peak direction has been obtained previously using one of the Rx Beam Peak Search procedures as described in Annex I.

#### 7.7.5.1.4 Test description

##### 7.7.5.1.4.1 Initial conditions

##### 7.7.5.1.4.2 Test procedure

1. Ensure the UE is in state RRC\_CONNECTED with generic procedure parameters Connectivity *NR*, Connected without release *On* and Test Mode *On* according to TS 38.508-1 [14] clause 4.5.
2. Set the parameters according to Table 7.7.5.1.5-1 as appropriate.
3. The SS shall transmit an RRCReconfiguration message on Cell 1.
4. The UE shall transmit an RRCReconfigurationComplete message.
5. The UE shall transmit periodically MeasurementReport messages.

<rest of the steps are FFS >

##### 7.7.5.1.4.3 Message contents

Message contents are according to TS 38.508-1 [14] clause 7.3 with the following exceptions:

FFS

##### 7.7.5.1.5 Test requirement

Table 7.7.5.1.5-1 defines the cell specific settings for all tests. Table 7.7.5.1.5-2 defines the OTA primary level settings including test tolerances for all tests.

Table 7.7.5.1.5-1: FR2 test parameters for SRS-RSRP accuracy

Parameter	Config	Unit	Test 1	Test 2
SSB GSCN	1		freq1	freq1
Duplex mode	1		TDD	TDD
TDD configuration	1		TDDConf.3.1	TDDConf.3.1
BW <sub>channel</sub>	1	MHz	100: N <sub>RB,c</sub> = 66	100: N <sub>RB,c</sub> = 66
PDSCH Reference measurement channel	1		SR.3.1 TDD	SR.3.1 TDD
RMSI CORESET Reference Channel	1		CR.3.1 TDD	CR.3.1 TDD
Dedicated CORESET Reference Channel	1		CCR.3.1 TDD	CCR.3.1 TDD
SSB configuration	1		SSB.3 FR2	SSB.3 FR2
OCNG Patterns	1		OP.1	OP.1
TRS configuration	1		TRS.2.1 TDD	TRS.2.1 TDD
Initial BWP Configuration	1		DLBWP.0.1 ULBWP.0.1	DLBWP.0.1 ULBWP.0.1
Dedicated BWP configuration	1		DLBWP.1.3 ULBWP.1.3	DLBWP.1.3 ULBWP.1.3
SMTc configuration	1		SMTc.1	SMTc.1
Time offset between DL from serving cell and SRS from test system	1	μs	10.76	10.67
EPRE ratio of PSS to SSS	1	dB	0	0
EPRE ratio of PBCH DMRS to SSS				
EPRE ratio of PBCH to PBCH DMRS				
EPRE ratio of PDCCH DMRS to SSS				
EPRE ratio of PDCCH to PDCCH DMRS				
EPRE ratio of PDSCH DMRS to SSS				
EPRE ratio of PDSCH to PDSCH DMRS				
EPRE ratio of OCNG DMRS to SSS <sup>Note 1</sup>				
EPRE ratio of OCNG to OCNG DMRS <sup>Note 1</sup>				
Propagation condition	1		AWGN	AWGN
Antenna configuration	1		1x2	1x2
Note 1: OCNG shall be used such that a constant total transmitted power spectral density is achieved for all OFDM symbols.				



**Table 7.7.5.1.5-2: SRS-RSRP accuracy OTA related test parameters for PCell and Neighbour cell UE in FR2**

Parameter	Unit	T1	T2
Angle of arrival configuration		Setup 1 defined A.3.15.1	Setup 1 defined A.3.15.1
Beam assumption Note 5		Fine	Fine
$N_{oc}$ Note1	dBm/15kHz $z$ Note3	-100	N/A
$N_{oc}$ Note1	dBm/SCS <sup>N</sup> <sub>ote3</sub>	-91	N/A
$\hat{E}_s / N_{oc}$	dB	2	N/A
$E_s$	dBm/SCS <sup>N</sup> <sub>ote3</sub>		(Table B.2.7-2 Rx Beam Peak)
SRS_RP <sup>Note2</sup>	dBm/SCS	-89	(Table B.2.7-2 Rx Beam Peak)
$\hat{E}_s / I_{ot\ BB}$ Note4	dB	>1	1
$I_o$ Note2	dBm/95.04 MHz <sup>Note3</sup>	-57.89	(Table B.2.7-2 Rx Beam Peak +50.79dB)
Note 1:	Where used, interference from other cells and noise sources not specified in the test is assumed to be constant over subcarriers and time and shall be modelled as AWGN of appropriate power for $N_{oc}$ to be fulfilled.		
Note 2:	SRS_RP, $E_s/I_{ot}$ and $I_o$ levels have been derived from other parameters for information purposes. They are not settable parameters themselves.		
Note 3:	Equivalent power received by an antenna with 0 dBi gain at the centre of the quiet zone		
Note 4:	Calculation of $E_s/I_{ot\ BB}$ includes the effect of UE internal noise up to the value assumed for the associated Refsens requirement in clause 7.3.2 of TS 36.101-2 [19], and an allowance of 2dB for UE multi-band relaxation factor $\sum MB_P$ from TS 38.101-2 [19] Table 6.2.1.3-4.		
Note 5:	Information about types of UE beam is given in B.2.1.3, and does not limit UE implementation or test system implementation.		

**Table 7.7.5.1.5-3: SRS configuration parameters for FR2 SRS-RSRP accuracy**

	Field	SRSCnf.1
SRS-ResourceSet	srs-ResourceSetId	0
	srs-ResourceIdList	0
	resourceType	Periodic
	Usage	Codebook
SRS-Resource	SRS-ResourceId	0
	nrofSRS-Ports	Port1
	transmissionComb	n2
	combOffset-n2	0
	cyclicShift-n2	0
	resourceMapping startPosition	0
	resourceMapping nrofSymbols	n1
	resourceMapping repetitionFactor	n1
	freqDomainPosition	0
	freqDomainShift	0
	freqHopping c-SRS	12
	freqHopping b-SRS	0
	freqHopping b-hop	0
	groupOrSequenceHopping	Neither
	resourceType	Periodic
	periodicityAndOffset-p	s160,25
	sequenceId	0

**Table 7.7.5.1.5-4: SRS-RSRP absolute accuracy test requirement**

SRS	Test requirement <sup>Notes1,2,3</sup>
	$SRS\_RP - \delta + G_{min} \leq \text{Reported SRS-RSRP(dBm)} \leq SRS\_RP + \delta + G_{max}$
Note 1:	SRS_RP is the equivalent power received by an antenna with 0dBi gain at the centre of the quiet zone configured in the test
Note 2:	$\delta$ is the RSRP absolute accuracy requirement from Table 10.1.22.1.1-2, selected according to the $I_o$ used in the test
Note 3:	$G_{min}$ and $G_{max}$ are the minimum and maximum UE gain values from Table B.2.1.5.1-1, selected according to the UE power class

The SRS-RSRP measurement accuracy shall fulfil the absolute accuracy requirements in clauses 7.7.5.0. The following requirements are to be verified:

During T1:

The UE is deemed to meet the requirement if the reported SRS-RSRP is in the range shown in table 7.7.5.1.5-4.

During T2:

The UE is deemed to meet the requirement if the reported SRS-RSRP is in the range shown in table 7.7.5.1.5-4.

For the test to pass, the ratio of successful reported values for each requirement shall be more than 90% with a confidence level of 95%. Each requirement is evaluated independently of the others.

## 7.7.6 L1-SINR

### 7.7.6.0 Minimum conformance requirements

#### 7.7.6.0.1 Minimum conformance requirements for CSI-RS based CMR and no dedicated IMR configured and CSI-RS resource set with repetition off

Dedicated resource configured as IMR for L1-SINR computation, and the UE physical layer shall be capable of reporting L1-SINR measured over the measurement period of  $T_{L1-SINR\_Measurement\_Period\_CSI-RS\_CMR\_Only}$ .

The value of  $T_{L1-SINR\_Measurement\_Period\_CSI-RS\_CMR\_Only}$  is defined in Table 7.7.6.0.1-1 for FR2, where

For the value of M,

- For periodic and semi-persistent CSI-RS resources as CMR, M=1 if higher layer parameter *timeRestrictionForChannelMeasurement* is configured, and M=3 otherwise;
- For aperiodic CSI-RS resources as CMR, M=1.

For the value of N in FR2

- For periodic CSI-RS resources as CMR in a resource set configured with higher layer parameter *repetition* set to OFF, N=1. The requirements apply if *qcl-InfoPeriodicCSI-RS* is configured for all the resources in the resource set and for each resource one RS has QCL-TypeD with
  - SSB for L1-RSRP or L1-SINR measurement, or
  - another CSI-RS in resource set configured with repetition ON.
- For periodic CSI-RS resources as CMR in a resource set configured with higher layer parameter *repetition* set to ON,  $N = \text{ceil}(\text{maxNumberRxBeam} / N_{\text{res\_per\_set}})$ , where  $N_{\text{res\_per\_set}}$  is number of resources in the resource set. The requirements apply provided *qcl-InfoPeriodicCSI-RS* is configured for all resources in the resource set.
- For semi-persistent CSI-RS resources as CMR in a resource set configured with higher layer parameter *repetition* set to OFF, N=1. The requirements apply provided TCI state is provided for all resources in the resource set in the MAC CE activating the resource set and for each resource has QCL-TypeD with
  - SSB for L1-RSRP or L1-SINR measurement, or
  - another CSI-RS in resource set configured with repetition ON.
- For semi-persistent CSI-RS resources as CMR in a resource set configured with higher layer parameter *repetition* set to ON,  $N = \text{ceil}(\text{maxNumberRxBeam} / N_{\text{res\_per\_set}})$ , where  $N_{\text{res\_per\_set}}$  is number of resources in the resource set. The requirements apply provided TCI state is provided for all resources in the resource set in the MAC CE activating the resource set.
- For aperiodic CSI-RS resources as CMR in a resource set configured with higher layer parameter *repetition* set to OFF, N=1. The requirements apply provided *qcl-info* is configured for all resources in the resource set and for each resource has QCL-TypeD with
  - SSB for L1-RSRP or L1-SINR measurement, or
  - another CSI-RS in resource set configured with repetition ON.
- For aperiodic CSI-RS resources as CMR in a resource set configured with higher layer parameter *repetition* set to ON, N=1. UE is not required to meet the accuracy requirements in clause 10.1.28.1 and 10.1.28.3 if number of resources in the resource set is smaller than *maxNumberRxBeam*. The requirements apply provided *qcl-info* is configured for all resources in the resource set.

For the value of P in FR2,

- P=1, when CSI-RS is not overlapped with measurement gap and also not overlapped with SMTC occasion.
- $P = \frac{1}{1 - \frac{T_{\text{CSI-RS}}}{\text{MRGP}}}$ , when CSI-RS is partially overlapped with measurement gap and CSI-RS is not overlapped with SMTC occasion ( $T_{\text{CSI-RS}} < \text{MRGP}$ )

- $P = \frac{1}{1 - \frac{T_{\text{CSI-RS}}}{T_{\text{SMTCperiod}}}}$ , when CSI-RS is not overlapped with measurement gap and CSI-RS is partially overlapped with SMTC occasion ( $T_{\text{CSI-RS}} < T_{\text{SMTCperiod}}$ ).
- $P=3$ , when CSI-RS is not overlapped with measurement gap and CSI-RS is fully overlapped with SMTC occasion ( $T_{\text{CSI-RS}} = T_{\text{SMTCperiod}}$ ).
- $P = \frac{1}{1 - \frac{T_{\text{CSI-RS}}}{\text{MGRP}} - \frac{T_{\text{CSI-RS}}}{T_{\text{SMTCperiod}}}}$ , when CSI-RS is partially overlapped with measurement gap and CSI-RS is partially overlapped with SMTC occasion ( $T_{\text{CSI-RS}} < T_{\text{SMTCperiod}}$ ) and SMTC occasion is not overlapped with measurement gap and
  - $T_{\text{SMTCperiod}} \neq \text{MGRP}$  or
  - $T_{\text{SMTCperiod}} = \text{MGRP}$  and  $T_{\text{CSI-RS}} < 0.5 * T_{\text{SMTCperiod}}$
- $P = \frac{3}{1 - \frac{T_{\text{CSI-RS}}}{\text{MGRP}}}$ , when CSI-RS is partially overlapped with measurement gap and CSI-RS is partially overlapped with SMTC occasion ( $T_{\text{CSI-RS}} < T_{\text{SMTCperiod}}$ ) and SMTC occasion is not overlapped with measurement gap and  $T_{\text{SMTCperiod}} = \text{MGRP}$  and  $T_{\text{CSI-RS}} = 0.5 * T_{\text{SMTCperiod}}$
- $P = \frac{1}{1 - \frac{T_{\text{CSI-RS}}}{\min(T_{\text{SMTCperiod}}, \text{MGRP})}}$ , when CSI-RS is partially overlapped with measurement gap ( $T_{\text{CSI-RS}} < \text{MGRP}$ ) and CSI-RS is partially overlapped with SMTC occasion ( $T_{\text{CSI-RS}} < T_{\text{SMTCperiod}}$ ) and SMTC occasion is partially or fully overlapped with measurement gap.
- $P = \frac{3}{1 - \frac{T_{\text{CSI-RS}}}{\text{MGRP}}}$ , when CSI-RS is partially overlapped with measurement gap and CSI-RS is fully overlapped with SMTC occasion ( $T_{\text{CSI-RS}} = T_{\text{SMTCperiod}}$ ) and SMTC occasion is partially overlapped with measurement gap ( $T_{\text{SMTCperiod}} < \text{MGRP}$ )

Where:

$T_{\text{SMTCperiod}}$  = the configured SMTC1 period or SMTC2 period if configured.

$T_{\text{CSI-RS}}$  = the periodicity of CSI-RS configured for L1-SINR measurement

If the high layer in TS 38.331 [2] signalling of *smtc2* is configured,  $T_{\text{SMTCperiod}}$  corresponds to the value of higher layer parameter *smtc2*; Otherwise  $T_{\text{SMTCperiod}}$  corresponds to the value of higher layer parameter *smtc1*.

Note: The overlap between CSI-RS for L1-SINR measurement and SMTC means that CSI-RS for L1-SINR measurement is within the SMTC window duration.

Longer evaluation period would be expected if the combination of CSI-RS, SMTC occasion and measurement gap configurations does not meet previous conditions.

**Table 7.7.6.0.1-1: Measurement period  $T_{\text{L1-SINR\_Measurement\_Period\_CSI-RS\_CMR\_Only}}$  for FR2**

Configuration	$T_{\text{L1-SINR\_Measurement\_Period\_CSI-RS\_CMR\_Only}}$ (ms)
non-DRX	$\max(T_{\text{Report}}, \text{ceil}(M * P * N) * T_{\text{CSI-RS}})$
DRX cycle $\leq$ 320ms	$\max(T_{\text{Report}}, \text{ceil}(1.5 * M * P * N) * \max(T_{\text{DRX}}, T_{\text{CSI-RS}}))$
DRX cycle $>$ 320ms	$\text{ceil}(M * P * N) * T_{\text{DRX}}$
Note 1:	$T_{\text{CSI-RS}}$ is the periodicity of CSI-RS configured for L1-SINR measurement. $T_{\text{DRX}}$ is the DRX cycle length. $T_{\text{Report}}$ is configured periodicity for reporting.
Note 2:	the requirements are applicable provided that the CSI-RS resource configured for L1-SINR measurement is transmitted with Density = 3.

The accuracy requirements in Table 7.7.6.0.1-3 are valid under the following conditions:

- Conditions defined in clause 7.3 of TS 38.101-2 [19] for reference sensitivity are fulfilled.
- Conditions for L1-SINR measurements are fulfilled according to Annex B.2.8.1 for a corresponding Band for each relevant CSI-RS based CMR.

- The bandwidth of CSI-RS as CMR is 48 PRBs and the density is 3.
- The measured signals are in the directions covered by the percentile EIS spherical coverage of the UE, defined in clause 7.3.4 of TS 38.101-2 [19].
- AWGN radio propagation conditions.

The performance with larger bandwidth of CSI-RS as CMR is equal to or better than the accuracy requirements in Table 7.7.6.0.1-3.

**Table 7.7.6.0.1-3: L1-SINR absolute accuracy for CSI-RS based CMR only in FR2**

Accuracy		Conditions			
Normal condition	Extreme condition	CSI-RS CMR $\hat{E}s/lot$ <sup>Note 3</sup>	$I_o$ <sup>Note 1</sup> range		
			Minimum $I_o$		Maximum $I_o$
dB	dB	dB	dBm / $SCS_{CSI-RS}$ <sup>Note 2</sup>		dBm/BW <sub>Channel</sub>
			$SCS_{CSI-RS} = 60kHz$	$SCS_{CSI-RS} = 120kHz$	
±5.5	±6.5	≥-3	Same value as CSI-RS_RP in Table in B.2.8.1, according to UE Power class, operating band and angle of arrival		-50
<p>NOTE 1: <math>I_o</math> specified at the Reference point, and assumed to have constant EPRE across the bandwidth.</p> <p>NOTE 2: Values based on Refsens and EIS spherical coverage as defined in clauses 7.3.2 and 7.3.4 of TS 38.101-2 [19]. Applicable side condition selected depending on angle of arrival.</p> <p>NOTE 3: In the test cases, the CSI-RS CMR <math>\hat{E}s/lot</math> and related parameters may need to be adjusted to ensure <math>\hat{E}s/lot</math> at UE baseband is above the value defined in this table.</p>					

The normative reference for this requirement is TS 38.133 [6] clauses 9.8.4.1 and 10.1.28.1.

### 7.7.6.0.2 Minimum conformance requirements for SSB based CMR and dedicated IMR L1-SINR measurement accuracy

The UE shall be capable of performing L1-SINR measurements with the SSB configured as CMR and dedicated resource configured as IMR for L1-SINR computation, in which the NZP-CSI-RS or CSI-IM resource configured as dedicated IMR shall be 1-to-1 mapped to SSB configured as CMR, with the same periodicity. The UE physical layer shall be capable of reporting L1-SINR measured over the measurement period of  $T_{L1-SINR\_Measurement\_Period\_SSB\_CMR\_IMR}$ .

The requirements in this clause are not applicable if NZP-CSI-RS or CSI-IM resource configured as dedicated IMR is scheduled with different periodicity as SSB configured as CMR.

The value of  $T_{L1-SINR\_Measurement\_Period\_SSB\_CMR\_IMR}$  is defined in Table 7.7.6.0.2-1 for FR2, where

For the value of M

- For periodic or semi-persistent NZP CSI-RS or CSI-IM resource as dedicated IMR, M=1 if the higher layer parameters *timeRestrictionForChannelMeasurements* and/or *timeRestrictionForInterferenceMeasurements* are configured, and M=3 otherwise;

For the value of N in FR2

- N = 8.

P is defined as the maximum value between  $P_{CMR}$  and  $P_{IMR}$ , i.e.,  $P = \max(P_{CMR}, P_{IMR})$ , where

- the value of  $P_{CMR}$  shall be derived in the same way as the value of P used for SSB based L1-RSRP measurement in clause 9.5.4.1, in which the occasions and period of the SSB for CMR shall be used instead.
- the value of  $P_{IMR}$  shall be derived in the same way as the value of P used for CSI-RS based L1-RSRP measurement in clause 9.5.4.2, in which the occasions and period of the NZP CSI-RS for NZP-IMR or CSI-IM for ZP-IMR shall be used instead.

Longer evaluation period would be expected if the combination of SSB, SMTC occasion and measurement gap configurations does not meet previous conditions.

For L1-SINR measurement with SSB as CMR and CSI-RS or CSI-IM as IMR, the requirement shall apply if the CSI-RS is configured as IMR with repetition field as “repetition = OFF” or CSI-IM is configured as IMR.

For L1-SINR measurement with SSB as CMR and CSI-RS/CSI-IM as IMR, no requirement shall apply if SSB occasions for CMR or CSI-RS/CSI-IM occasions for IMR are fully overlapped with the configured measurement gap

**Table 7.7.6.0.2-1: Measurement period  $T_{L1-SINR\_Measurement\_Period\_SSB\_CMR\_IMR}$  for FR2**

Configuration	$T_{L1-SINR\_Measurement\_Period\_SSB\_CMR\_IMR}$ (ms)
non-DRX	$\max(T_{Report}, \text{ceil}(M \cdot P \cdot N) \cdot T_{SSB})$
DRX cycle $\leq 320\text{ms}$	$\max(T_{Report}, \text{ceil}(1.5 \cdot M \cdot P \cdot N) \cdot \max(T_{DRX}, T_{SSB}))$
DRX cycle $> 320\text{ms}$	$\text{ceil}(1.5 \cdot M \cdot P \cdot N) \cdot T_{DRX}$
Note 1:	$T_{SSB}$ = ssb-periodicityServingCell is the periodicity of the SSB-Index configured for L1-SINR measurement. $T_{DRX}$ is the DRX cycle length. $T_{Report}$ is configured periodicity for reporting.
Note 2:	The requirements are applicable provided that the CSI-RS resource configured for interference measurement shall be 1-to-1 mapped to SSB configured for channel measurement, with the same periodicity.

The accuracy requirements in Tables 7.7.6.0.2-2 and 7.7.6.0.2-3 are valid under the following conditions:

- Conditions defined in clause 7.3 of TS 38.101-2 [19] for reference sensitivity are fulfilled.
- Conditions for L1-SINR measurements are fulfilled according to Annex B.2.8.2 for a corresponding Band for each relevant SSB based CMR and IMR.
- The bandwidth of NZP-IMR and ZP-IMR is 48 PRBs and the density is 3.
- The measured signals are in the directions covered by the percentile EIS spherical coverage of the UE, defined in clause 7.3.4 of TS 38.101-2 [19].
- AWGN radio propagation conditions.
- SSB based CMR and IMR in the test come from the same direction.

The performance with larger bandwidth of NZP-IMR and ZP-IMR is equal to or better than the accuracy requirements in Tables 7.7.6.0.2-2 and 7.7.6.0.2-3.

**Table 7.7.6.0.2-2: L1-SINR absolute accuracy for SSB based CMR and NZP-IMR in FR2**

Accuracy		Conditions				
Normal condition	Extreme condition	SSB CMR $\hat{E}_s/\text{lot}$ Note 3	NZP-IMR $\hat{E}_s/\text{lot}$ Note 3	$I_o$ Note 1 range		
				Minimum $I_o$		Maximum $I_o$
dB	dB	dB	dB	dBm / $SCS_{SSB}$ Note 2		dBm/ $BW_{Channel}$
				$SCS_{SSB} = 120\text{kHz}$	$SCS_{SSB} = 240\text{kHz}$	
$\pm 4.0$	$\pm 5.0$	$\geq 0$	$\geq 0$	Same value as SSB_RP in Table in B.2.8.2, according to UE Power class, operating band and angle of arrival		N/A
						-50

NOTE 1:  $I_o$  specified at the Reference point, and assumed to have constant EPRE across the bandwidth.  
 NOTE 2: Values based on Refsens and EIS spherical coverage as defined in clauses 7.3.2 and 7.3.4 of TS 38.101-2 [19]. Applicable side condition selected depending on angle of arrival.  
 NOTE 3: In the test cases, the SSB  $\hat{E}_s/\text{lot}$ , NZP-IMR  $\hat{E}_s/\text{lot}$  and related parameters may need to be adjusted to ensure  $\hat{E}_s/\text{lot}$  at UE baseband is above the value defined in this table.

Table 7.7.6.0.2-3: L1-SINR absolute accuracy for SSB based CMR and ZP-IMR in FR2

Accuracy		Conditions			
Normal condition	Extreme condition	SSB CMR $\hat{E}_s/I_{ot}$ <sup>Note 3</sup>	$I_o$ <sup>Note 1</sup> range		
			Minimum $I_o$		Maximum $I_o$
dB	dB	dB	dBm / $SCS_{SSB}$ <sup>Note 2</sup>		dBm/BW <sub>Channel</sub>
			$SCS_{SSB} = 120\text{kHz}$	$SCS_{SSB} = 240\text{kHz}$	
$\pm 4.5$	$\pm 5.5$	$\geq -3$	Same value as SSB_RP in Table in B.2.8.2, according to UE Power class, operating band and angle of arrival		N/A
NOTE 1: $I_o$ specified at the Reference point, and assumed to have constant EPRE across the bandwidth. NOTE 2: Values based on Refsens and EIS spherical coverage as defined in clauses 7.3.2 and 7.3.4 of TS 38.101-2 [19]. Applicable side condition selected depending on angle of arrival. NOTE 3: In the test cases, the SSB CMR $\hat{E}_s/I_{ot}$ and related parameters may need to be adjusted to ensure $\hat{E}_s/I_{ot}$ at UE baseband is above the value defined in this table.					

The normative reference for this requirement is TS 38.133 [6] clauses 9.8.4.2 and 10.1.28.2.

### 7.7.6.0.3 Minimum conformance requirements for CSI-RS based CMR and dedicated IMR L1-SINR measurement accuracy

The UE shall be capable of performing L1-SINR measurements with the CSI-RS resource configured as CMR and dedicated resource configured as IMR for L1-SINR computation, in which the NZP-CSI-RS or CSI-IM resource configured as dedicated IMR shall be 1-to-1 mapped to CSI-RS resource configured as CMR, with the same periodicity. The UE physical layer shall be capable of reporting L1-SINR measured over the measurement period of  $T_{L1-SINR\_Measurement\_Period\_CSI-RS\_CMR\_IMR}$ .

$T_{L1-SINR\_Measurement\_Period\_CSI-RS\_CMR\_IMR}$

The requirements in this clause are not applicable if NZP-CSI-RS or CSI-IM resource configured as dedicated IMR is scheduled with different periodicity as CSI-RS resource configured as CMR.

The value of  $T_{L1-SINR\_Measurement\_Period\_CSI-RS\_CMR\_IMR}$  is defined in Table 7.7.6.0.3-2 for FR2, where

For the value of M,

- M=1 shall be applied if
  - aperiodic NZP-CSI-RS as CMR or dedicated IMR, or
  - aperiodic CSI-IMR as dedicated IMR, or
  - periodic and semi-persistent NZP-CSI-RS as CMR or dedicated IMR and the higher layer parameters *timeRestrictionForChannelMeasurement* and/or *timeRestrictionForInterferenceMeasurements* are configured, or
  - periodic and semi-persistent CSI-IM as dedicated IMR and the higher layer parameters *timeRestrictionForChannelMeasurement* and/or *timeRestrictionForInterferenceMeasurements* are configured;
- M=3 otherwise.

For the value of N in FR2

- For periodic CSI-RS resources as CMR in a resource set configured with higher layer parameter *repetition* set to OFF, N=1. The requirements apply if *qcl-InfoPeriodicCSI-RS* is configured for all the resources in the resource set and for each resource one RS has QCL-TypeD with
  - SSB for L1-RSRP or L1-SINR measurement, or
  - another CSI-RS in resource set configured with repetition ON.

- For periodic CSI-RS resources as CMR in a resource set configured with higher layer parameter *repetition* set to ON,  $N = \text{ceil}(\text{maxNumberRxBeam} / N_{\text{res\_per\_set}})$ , where  $N_{\text{res\_per\_set}}$  is number of resources in the resource set. The requirements apply provided *qcl-InfoPeriodicCSI-RS* is configured for all resources in the resource set.
- For semi-persistent CSI-RS resources as CMR in a resource set configured with higher layer parameter *repetition* set to OFF,  $N=1$ . The requirements apply provided TCI state is provided for all resources in the resource set in the MAC CE activating the resource set and for each resource has QCL-TypeD with
  - SSB for L1-RSRP or L1-SINR measurement, or
  - another CSI-RS in resource set configured with repetition ON.
- For semi-persistent CSI-RS resources as CMR in a resource set configured with higher layer parameter *repetition* set to ON,  $N = \text{ceil}(\text{maxNumberRxBeam} / N_{\text{res\_per\_set}})$ , where  $N_{\text{res\_per\_set}}$  is number of resources in the resource set. The requirements apply provided TCI state is provided for all resources in the resource set in the MAC CE activating the resource set.
- For aperiodic CSI-RS resources as CMR in a resource set configured with higher layer parameter *repetition* set to OFF,  $N=1$ . The requirements apply provided *qcl-info* is configured for all resources in the resource set and for each resource has QCL-TypeD with
  - SSB for L1-RSRP or L1-SINR measurement, or
  - another CSI-RS in resource set configured with repetition ON.
- For aperiodic CSI-RS resources as CMR in a resource set configured with higher layer parameter *repetition* set to ON,  $N=1$ . UE is not required to meet the accuracy requirements in clause 10.1.28.1 and 10.1.28.3 if number of resources in the resource set is smaller than *maxNumberRxBeam*. The requirements apply provided *qcl-info* is configured for all resources in the resource set.

P is defined as the maximum value between  $P_{\text{CMR}}$  and  $P_{\text{IMR}}$ , i.e.,  $P = \max(P_{\text{CMR}}, P_{\text{IMR}})$ , where

- The value of  $P_{\text{CMR}}$  and  $P_{\text{IMR}}$  shall be derived in the same way as the value of P used for CSI-RS based L1-RSRP measurement in clause 9.5.4.2, in which the occasions and period of the CSI-RS for CMR and NZP CSI-RS for NZP-IMR or CSI-IM for ZP-IMR shall be used instead respectively.

Longer evaluation period would be expected if the combination of CSI-RS, SMTC occasion and measurement gap configurations does not meet pervious conditions.

For L1-SINR measurement with CSI-RS as CMR and CSI-RS as IMR, the requirement shall apply only if CSI-RS resources as CMR and IMR are configured with the same repetition field and the number of CSI-RS resources in the resource sets for CMR and IMR are same.

For L1-SINR measurement with CSI-RS as CMR and CSI-IM as IMR, the requirement shall apply only if the number of CSI-RS resources in the resource set for CMR and the number of CSI-IM resources in the resource set for IMR are same.

For L1-SINR measurement with CSI-RS as CMR and CSI-RS/CSI-IM as IMR, no requirement shall apply if CSI-RS occasions for CMR or CSI-RS/CSI-IM occasions for IMR are fully overlapped with the configured measurement gap.

**Table 7.7.6.0.3-1: Measurement period  $T_{\text{L1-SINR\_Measurement\_Period\_CSI-RS\_CMR\_IMR}}$  for FR2**

Configuration	$T_{\text{L1-SINR\_Measurement\_Period\_CSI-RS\_CMR\_IMR}}$ (ms)
non-DRX	$\max(T_{\text{Report}}, \text{ceil}(M \cdot P \cdot N) \cdot T_{\text{CSI-RS}})$
DRX cycle $\leq 320\text{ms}$	$\max(T_{\text{Report}}, \text{ceil}(1.5 \cdot M \cdot P \cdot N) \cdot \max(T_{\text{DRX}}, T_{\text{CSI-RS}}))$
DRX cycle $> 320\text{ms}$	$\text{ceil}(M \cdot P \cdot N) \cdot T_{\text{DRX}}$
Note 1:	$T_{\text{CSI-RS}}$ is the periodicity of CSI-RS configured for L1-SINR measurement. $T_{\text{DRX}}$ is the DRX cycle length. $T_{\text{Report}}$ is configured periodicity for reporting.
Note 2:	the requirements are applicable provided that the CSI-RS resource configured for L1-SINR measurement is transmitted with Density = 3.
Note 3:	The requirements are applicable provided that the CSI-RS resource configured for interference measurement shall be 1-to-1 mapped to CSI-RS configured for channel measurement, with the same periodicity.



The accuracy requirements in Tables 7.7.6.0.3-2 and 7.7.6.0.3-3 are valid under the following conditions:

- Conditions defined in clause 7.3 of TS 38.101-2 [19] for reference sensitivity are fulfilled.
- Conditions for L1-SINR measurements are fulfilled according to Annex B.2.8.3 for a corresponding Band for each relevant CSI-RS based CMR and IMR.
- The bandwidth of CSI-RS as CMR, NZP-IMR and ZP-IMR is 48 PRBs and the density is 3.
- The measured signals are in the directions covered by the percentile EIS spherical coverage of the UE, defined in clause 7.3.4 of TS 38.101-2 [19].
- AWGN radio propagation conditions.
- CSI-RS based CMR and IMR in the test come from the same direction.

The performance with larger bandwidth of CSI-RS as CMR, NZP-IMR and ZP-IMR is equal to or better than the accuracy requirements in Tables 7.7.6.0.3-2 and 7.7.6.0.3-3.

**Table 7.7.6.0.3-2: L1-SINR absolute accuracy for CSI-RS based CMR and NZP-IMR in FR2**

Accuracy		Conditions				
Normal condition	Extreme condition	CSI-RS CMR $\hat{E}_s/\text{lot}$ Note 3	NZP-IMR $\hat{E}_s/\text{lot}$ Note 3	$I_o$ Note 1 range		
				Minimum $I_o$		Maximum $I_o$
dB	dB	dB	dB	dBm / $SCS_{\text{CSI-RS}}$ Note 2		dBm/ $BW_{\text{Channel}}$
				$SCS_{\text{CSI-RS}}$ = 60kHz	$SCS_{\text{CSI-RS}}$ = 120kHz	
$\pm 4.0$	$\pm 5.0$	$\geq 0$	$\geq 0$	Same value as CSI-RS_RP in Table in B.2.8.3, according to UE Power class, operating band and angle of arrival		-50

NOTE 1:  $I_o$  specified at the Reference point, and assumed to have constant EPRE across the bandwidth.  
 NOTE 2: Values based on Refsens and EIS spherical coverage as defined in clauses 7.3.2 and 7.3.4 of TS 38.101-2 [19]. Applicable side condition selected depending on angle of arrival.  
 NOTE 3: In the test cases, the CSI-RS  $\hat{E}_s/\text{lot}$ , NZP-IMR  $\hat{E}_s/\text{lot}$  and related parameters may need to be adjusted to ensure  $\hat{E}_s/\text{lot}$  at UE baseband is above the value defined in this table.

**Table 7.7.6.0.3-3: L1-SINR absolute accuracy for CSI-RS based CMR and ZP-IMR in FR2**

Accuracy		Conditions				
Normal condition	Extreme condition	CSI-RS CMR $\hat{E}_s/\text{lot}$ Note 3	$I_o$ Note 1 range			
			Minimum $I_o$		Maximum $I_o$	
dB	dB	dB	dBm / $SCS_{\text{CSI-RS}}$ Note 2		dBm/ $BW_{\text{Channel}}$	
			$SCS_{\text{CSI-RS}}$ = 60kHz	$SCS_{\text{CSI-RS}}$ = 120kHz		
$\pm 4.5$	$\pm 5.5$	$\geq -3$	Same value as CSI-RS_RP in Table in B.2.8.3, according to UE Power class, operating band and angle of arrival		-50	

NOTE 1:  $I_o$  specified at the Reference point, and assumed to have constant EPRE across the bandwidth.  
 NOTE 2: Values based on Refsens and EIS spherical coverage as defined in clauses 7.3.2 and 7.3.4 of TS 38.101-2 [19]. Applicable side condition selected depending on angle of arrival.  
 NOTE 3: In the test cases, the CSI-RS  $\hat{E}_s/\text{lot}$  and related parameters may need to be adjusted to ensure  $\hat{E}_s/\text{lot}$  at UE baseband is above the value defined in this table.

The normative reference for this requirement is TS 38.133 [6] clauses 9.8.4.3 and 10.1.28.3.

### 7.7.6.1 NR SA FR2 CSI-RS based CMR and no dedicated IMR configured and CSI-RS resource set with repetition off L1-SINR measurement accuracy

Editor's note: This test case is incomplete. The following aspects are either missing or not yet determined:

- Test applicability is incomplete in TS38.522.
- Test Tolerance is FFS
- Test frequency  $f \leq 40.8$  GHz
- The test is incomplete for UE power classes other than PC3
- The test is incomplete for test frequencies  $> 40.8$  GHz
- The test is incomplete for extreme conditions

#### 7.7.6.1.1 Test purpose

The purpose of this test is to verify that the L1-SINR measurement accuracy is within the specified limits.

#### 7.7.6.1.2 Test applicability

This test applies to all types of NR UE from Release 16 onwards. Applicability requires support of L1-SINR measurements.

#### 7.7.6.1.3 Minimum conformance requirements

The minimum conformance requirements are specified in clause 7.7.6.0.1.

The normative reference for this requirement is TS 38.133 [6] clause A.7.7.6.1.

#### 7.7.6.1.4 Test description

##### 7.7.6.1.4.1 Initial conditions

This test shall be tested using any of the test configurations in Table 7.7.6.1.4.1-1.

**Table 7.7.6.1.4.1-1: Applicable NR configurations for FR2 L1-SINR test with CSI-RS based CMR and no dedicated IMR configured**

Config	Description
1	NR 120 kHz CSI-RS SCS, 100 MHz bandwidth, TDD duplex mode

Configure the test equipment and the DUT according to the parameters in Table 7.7.6.1.4.1-2.

**Table 7.7.6.1.4.1-2: Initial conditions for CSI-RS based L1-SINR absolute accuracy in FR2**

Parameter	Value	Comment
Test environment	NC	As specified in TS 36.508 [25] clause 4.1.
Test frequencies	As specified in Annex E, Table E.5-1 and TS 38.508-1 [14] clause 4.3.1.	
Channel bandwidth	As specified by the selected test configuration.	
Propagation conditions	AWGN	As specified in Annex C.2.1
Connection Diagram	TE Part: A.3.3.1.1 DUT Part: A.3.4.1.1	As specified in TS 38.508-1 [14] Annex A.
Exceptions to connection diagram	N/A	

1. Message contents are defined in clause 7.7.6.1.4.3.
2. Cell 1 is the NR FR2 cell. Cell 1 is the target cell for the CSI-RS based L1-SINR measurements. The UE is configured to perform RLM and BFD measurement based on the CSI-RS.
3. The UE Rx beam peak direction has been obtained previously using one of the Rx Beam Peak Search procedures as described in Annex I.

7.7.6.1.4.2 Test procedure

Prior to the start of the time duration T1, the UE shall be fully synchronized to PSCell. The UE shall be configured for periodic CSI reporting in PUCCH [format 2] with a reporting periodicity as mentioned in the above table 7.7.6.1.4.1-2.

1. Ensure the UE is in state RRC\_CONNECTED with generic procedure parameters Connectivity NR, Connected without release On and Test Mode On according to TS 38.508-1 [14] clause 4.5.
2. Set the parameters according to T1 in Table 7.7.6.1.5-1.
3. The UE shall start sending L1-SINR report including results of both CSI-RS#0 and CSI-RS#1 every 80 slots.
4. The SS shall check the L1-SINR reported values of CSI-RS#0 and CSI-RS#1 in the periodic L1-RSRP reports. If the value for both CSI-RSs is within the limits in Table 7.7.6.1.5-2 or Table 7.7.6.1.5-3 (depending on the test configuration), the number of passed iterations is increased by one, otherwise the number of failed iterations is increased by one.
5. The SS shall continue checking the L1-SINR report messages transmitted by the UE until the confidence level according to Table G.2.3-1 in Annex G is achieved.
6. Set the parameters according to each sub-test in Table 7.7.6.1.5-1 as appropriate and repeat steps 3-5.

7.7.6.1.4.3 Message contents

Message contents are according to TS 38.508-1 [14] clause 7.3 with the following exceptions:

**Table 7.7.6.1.4.3-1: Common Exception messages NR SA CSI-RS-based L1-RSRP measurement**

Default Message Contents	
Common contents of system information blocks exceptions	
Default RRC messages and information elements contents exceptions	Table H.3.6A-1 with conditions PERIODIC and CSI-SINR Table H.3.6A-2 with conditions CSI-RS and PERIODIC Table H.3.6A-3 with condition PERIODIC Table 7.3.1-3 in TS 38.508-1 [14] with condition SMTC.1

**Table 7.7.6.1.4.3-2: RadioLinkMonitoringConfig**

Derivation Path: TS 38.508-1 [14], Table 4.6.3-133			
Information Element	Value/remark	Comment	Condition
RadioLinkMonitoringConfig ::= SEQUENCE {			
failureDetectionResourcesToAddModList SEQUENCE (SIZE(1..maxNrofFailureDetectionResources)) OF SEQUENCE {	1 entry		
purpose	both	UE is configured to perform RLM and BFD based on the SSB.	
}			
}			

7.7.6.1.5 Test requirement

Table 7.7.6.1.5-1 defines the primary level settings excluding test tolerances for all tests. (Refer to Sec. 7.7.3.1.5)

Each L1-SINR measurement report for each of the tests in Table 7.7.6.1.5-1 shall meet the corresponding absolute accuracy requirements in Table 7.7.6.1.5-2 for test configurations 1 and 2, and the corresponding absolute accuracy requirements in Table 7.7.6.1.5-3 for test configuration 3.

**Table 7.7.6.1.5-1: FR2 CSI-RS based L1-SINR general test parameters**

Parameter	Config	Unit	Test 1
SSB GSCN	1		freq1
Duplex mode	1		TDD
TDD Configuration	1		TDDConf.3.1
BW <sub>channel</sub>	1	MHz	100: N <sub>RB,c</sub> = 66
PDSCH Reference measurement channel	1		SR.3.1 TDD
RMSI CORESET Reference Channel	1		CR.3.1 TDD
Dedicated CORESET Reference Channel	1		CCR.3.1 TDD
SSB configuration	1		SSB.1 FR2
OCNG Patterns	1		OP.1
Initial BWP Configuration	1		DLBWP.0.1 ULBWP.0.1
Dedicated BWP configuration	1		DLBWP.1.3 ULBWP.1.3
TRS Configuration	1		TRS.2.1 TDD
PDCCH/PDSCH TCI Configuration	1		TCI.State.2
SMTC configuration	1		SMTC.1
CSI-RS	1		CSI-RS.3.2 TDD
reportConfigType	1		periodic
reportQuantity	1		cri-SINR-r16
nrofReportedRS	1		2
L1-SINR reporting period	1		slot80
Propagation condition	1		AWGN
Antenna configuration	1		1x2
EPRE ratio of PSS to SSS	1	dB	0
EPRE ratio of PBCH DMRS to SSS			
EPRE ratio of PBCH to PBCH DMRS			
EPRE ratio of PDCCH DMRS to SSS			
EPRE ratio of PDCCH to PDCCH DMRS			
EPRE ratio of PDSCH DMRS to SSS			
EPRE ratio of PDSCH to PDSCH DMRS			
EPRE ratio of OCNG DMRS to SSS <sup>Note 1</sup>			
EPRE ratio of OCNG to OCNG DMRS <sup>Note 1</sup>			
<p>Note 1: OCNG shall be used such that both cells are fully allocated and a constant total transmitted power spectral density is achieved for all OFDM symbols.</p> <p>Note 2: Interference from other cells and noise sources not specified in the test is assumed to be constant over subcarriers and time and shall be modelled as AWGN of appropriate power for <math>N_{oc}</math> to be fulfilled.</p>			

**Table 7.7.6.1.5-2: FR2 CSI-RS based L1-SINR OTA related test parameters**

Parameter	Config	Unit	Test 1	
			CSI-RS0	CSI-RS1
Angle of arrival configuration			Setup 1 according to A.3.15.1	
Assumption for UE beams <sup>Note 4</sup>			Rough	
$N_{oc}$	1~2	dBm/15 kHz	-100	
$N_{oc}$	1~2	dBm/SS B SCS	-91	
$\hat{E}_s / I_{ot}$	1~2	dB	10	-2
CSI-RS-RSRP <sup>Note1</sup>	1~2	dBm/SC S	-81	-93
$I_o$ <sup>Note1</sup>	1~2	dBm/95.04M Hz	-59.86	
$\hat{E}_s / N_{oc}$	1~2	dB	10	-2
Note 1: RSRP and $I_o$ levels have been derived from other parameters for information purposes. They are not settable parameters themselves. Note 2: RSRP minimum requirements are specified assuming independent interference and noise at each receiver antenna port. Note 3: Void. Note 4: Information about types of UE beam is given in TS 38.133 Annex B.2.1.3, and does not limit UE implementation or test system implementation				

After 640ms from the beginning of the test, the L1-SINR measurement accuracy for CSI-RS#0 and CSI-RS#1 of Cell 1 shall fulfil the requirements in TS38.133 clauses 10.1.28.1. The following requirements are to be verified:

For Test 1:

Absolute accuracy of CSI-RS0 and absolute accuracy of CSI-RS1. The UE is deemed to meet the requirement if the reported L1-SINR is in the range shown in Table 7.7.6.1.5-3.

**Table 7.7.6.1.5-3: L1-SINR absolute accuracy test requirement**

	Test requirement <sup>Notes1,2</sup>
CSI-RS0	$L1-SINR0 - \delta \leq \text{Reported SINR (dB)} \leq L1-SINR0 + \delta$
Note 1:	L1-SINRn is the equivalent SINR received by an antenna with 0dBi gain at the centre of the quiet zone configured in the test for the CSI-RS n under consideration
Note 2:	$\delta$ is the SINR absolute accuracy requirement from TS 38.133 Table 10.1.28.2.1-1, selected according to the $I_o$ used in the test

### 7.7.6.2 NR SA FR2 SSB based CMR and dedicated IMR L1-SINR measurement accuracy

**Editor's note:** This test case is incomplete. The following aspects are either missing or not yet determined:

- Test applicability is incomplete in TS38.522.
- Test Tolerance is FFS
- Test frequency  $f \leq 40.8$  GHz
- The test is incomplete for UE power classes other than PC3
- The test is incomplete for test frequencies  $> 40.8$  GHz
- The test is incomplete for extreme conditions

### 7.7.6.2.1 Test purpose

The purpose of this test is to verify that the L1-SINR measurement accuracy is within the specified limits.

### 7.7.6.2.2 Test applicability

This test applies to all types of NR UE from Release 16 onwards. Applicability requires support of L1-SINR measurements.

### 7.7.6.2.3 Minimum conformance requirements

The minimum conformance requirements are specified in clause 7.7.6.0.2.

The normative reference for this requirement is TS 38.133 [6] clause A.7.7.6.2.

### 7.7.6.2.4 Test description

#### 7.7.6.2.4.1 Initial conditions

This test shall be tested using any of the test configurations in Table 7.7.6.2.4.1-1.

**Table 7.7.6.2.4.1-1: Applicable NR configurations for FR2 L1-SINR measurement test with SSB based CMR and CSI-IM based IMR**

Config	Description
1	LTE FDD, NR 120 kHz SSB SCS, 100 MHz bandwidth, TDD duplex mode
2	LTE FDD, NR 240 kHz SSB SCS, 100 MHz bandwidth, TDD duplex mode
Note:	The UE is only required to be tested in one of the supported test configurations in each supported band

Configure the test equipment and the DUT according to the parameters in Table 7.7.6.2.4.1-2.

**Table 7.7.6.2.4.1-2: Initial conditions for SSB based L1-SINR absolute accuracy in FR2**

Parameter	Value	Comment
Test environment	NC	As specified in TS 36.508 [25] clause 4.1.
Test frequencies	As specified in Annex E, Table E.5-1 and TS 38.508-1 [14] clause 4.3.1.	
Channel bandwidth	As specified by the selected test configuration.	
Propagation conditions	AWGN	As specified in Annex C.2.1
Connection Diagram	TE Part: A.3.3.1.1 DUT Part: A.3.4.1.1	As specified in TS 38.508-1 [14] Annex A.
Exceptions to connection diagram	N/A	

1. Message contents are defined in clause 7.7.6.2.4.3.
2. Cell 1 is the NR FR2 cell. Cell 1 is the target cell for the SSB-based L1-RSRP measurements. The UE is configured to perform RLM, BFD and L1-RSRP measurement based on the SSBs and CSI-RSs.
3. The UE Rx beam peak direction has been obtained previously using one of the Rx Beam Peak Search procedures as described in Annex I.

#### 7.7.6.2.4.2 Test procedure

Prior to the start of the time duration T1, the UE shall be fully synchronized to PSCell. The UE shall be configured for periodic CSI reporting in PUCCH [format 2] with a reporting periodicity as mentioned in the above table 7.7.6.2.4.1-2.

1. Ensure the UE is in state RRC\_CONNECTED with generic procedure parameters Connectivity NR SA, Connected without release  $O_n$  and Test Mode  $O_n$ , according to TS 38.508-1 [14] clause 4.5 and general test parameters set according to Table 7.7.6.2.4.1-2.

2. Set the parameters according to T1 in Table 7.7.6.2.5-1. SS transmits CSI-RS as IMR with a periodicity of 20 slots.
3. The UE shall start sending L1-SINR report including results of both SSB#0 and SSB#1 every 80 slots.
4. The SS shall check the L1-SINR reported values of CSI-RS#0 and CSI-RS#1 in the periodic L1-RSRP reports. If the value for both CSI-RSs is within the limits in Table 7.7.6.2.5-2 and Table 7.7.6.2.5-3 (depending on the test configuration), the number of passed iterations is increased by one, otherwise the number of failed iterations is increased by one.
5. The SS shall continue checking the L1-SINR report messages transmitted by the UE until the confidence level according to Table G.2.3-1 in Annex G is achieved.
6. Set the parameters according to each sub-test in Table 7.7.6.2.5-1 as appropriate and repeat steps 3-5.

7.7.6.2.4.3 Message contents

Message contents are according to TS 38.508-1 [14] clause 7.3 with the following exceptions:

**Table 7.7.6.2.4.3-1: Common Exception messages NR SA SSB based L1-RSRP measurement**

Default Message Contents	
Common contents of system information blocks exceptions	
Default RRC messages and information elements contents exceptions	Table H.3.6A-1 with conditions PERIODIC and SS-SINR and CSI-RS_IMR Table H.3.6A-2 with conditions SSB and PERIODIC Table H.3.6A-3 with condition PERIODIC Table 7.3.1-3 in TS 38.508-1 [14] with condition SMTC.1

**Table 7.7.6.2.4.3-2: RadioLinkMonitoringConfig**

Derivation Path: TS 38.508-1 [14], Table 4.6.3-133			
Information Element	Value/remark	Comment	Condition
RadioLinkMonitoringConfig ::= SEQUENCE {			
failureDetectionResourcesToAddModList	1 entry		
SEQUENCE (SIZE(1..maxNrofFailureDetectionResources)) OF			
SEQUENCE {			
purpose	both	UE is configured to perform RLM and BFD based on the SSBs.	
detectionResource CHOICE {			
ssb-Index	0		
}			
}			
}			
}			

7.7.6.2.5 Test requirement

Table 7.7.6.2.5-1 defines the primary level settings including test tolerances for all tests.

Each L1-RSRP measurement report for each of the tests in Table 7.7.6.2.5-1 shall meet the corresponding absolute accuracy requirements in Table 7.7.6.2.5-2 for test configurations 1 and 2, and the corresponding absolute accuracy requirements in Table 7.7.6.2.5-3 for test configuration 3.

**Table 7.7.6.2.5-1: FR2 L1-SINR general test parameters with SSB based CMR and CSI-IM based IMR**

Parameter	Config	Unit	Test 1
SSB GSCN	1~2		freq1
Duplex mode	1~2		TDD
TDD Configuration	1~2		TDDConf.3.1
BW <sub>channel</sub>	1~2	MHz	100: N <sub>RB,c</sub> = 66
PDSCH Reference measurement channel	1~2		SR.3.1 TDD
RMSI CORESET Reference Channel	1~2		CR.3.1 TDD
Dedicated CORESET Reference Channel	1~2		CCR.3.1 TDD
SSB configuration	1		SSB.1 FR2
	2		SSB.2 FR2
CSI-IM configuration	1~2		CSI-IM 3.1 TDD
OCNG Patterns	1~2		OP.1
Initial BWP Configuration	1~2		DLBWP.0.1
			ULBWP.0.1
Dedicated BWP configuration	1~2		DLBWP.1.3
			ULBWP.1.3
TRS Configuration	1~2		TRS.2.1 TDD
PDCCH/PDSCH TCI Configuration	1~2		TCI.State.2
SMTc configuration	1~2		SMTc.1
reportConfigType	1~2		periodic
reportQuantity-r16	1~2		ssb-Index-SINR-r16
Number of reported RS	1~2		2
L1-SINR reporting period	1~2		slot640
Propagation condition	1~2		AWGN
Antenna configuration	1~2		1x2
EPRE ratio of PSS to SSS	1~2	dB	0
EPRE ratio of PBCH DMRS to SSS			
EPRE ratio of PBCH to PBCH DMRS			
EPRE ratio of PDCCH DMRS to SSS			
EPRE ratio of PDCCH to PDCCH DMRS			
EPRE ratio of PDSCH DMRS to SSS			
EPRE ratio of PDSCH to PDSCH DMRS			
EPRE ratio of OCNG DMRS to SSS <sup>Note 1</sup>			
EPRE ratio of OCNG to OCNG DMRS <sup>Note 1</sup>			
<p>Note 1: OCNG shall be used such that both cells are fully allocated and a constant total transmitted power spectral density is achieved for all OFDM symbols.</p> <p>Note 2: Interference from other cells and noise sources not specified in the test is assumed to be constant over subcarriers and time and shall be modelled as AWGN of appropriate power for <math>N_{oc}</math> to be fulfilled.</p>			



Table 7.7.6.2.5-2: FR2 L1-SINR SSB specific test parameters

Parameter	Config	Unit	Test 1	
			SSB0	SSB1
Angle of arrival configuration			Setup 1 according to A.3.15.1	
Assumption for UE beams <sup>Note 4</sup>			Rough	
$N_{oc}$	1~2	dBm/15kHz	-100	
$N_{oc}$	1	dBm/SSB	-91	
	2	SCS	-88	
$\hat{E}_s / I_{ot}$	1~2	dB	10	-2
SS-RSRP <sup>Note1</sup>	1	dBm/SCS	-81	-93
	2		-78	-90
$I_o$ <sup>Note1</sup>	1~2	dBm/95.04 MHz	-51.57	
$\hat{E}_s / N_{oc}$	1~2	dB	10	-2
<p>Note 1: RSRP and <math>I_o</math> levels have been derived from other parameters for information purposes. They are not settable parameters themselves.</p> <p>Note 2: RSRP minimum requirements are specified assuming independent interference and noise at each receiver antenna port.</p> <p>Note 3: Information about types of UE beam is given in TS 38.133 Annex B.2.1.3, and does not limit UE implementation or test system implementation</p>				

After 640ms from the beginning of the test, the L1-SINR measurement accuracy for SSB#0+CSI-IM#0 and SSB#1+CSI-IM#1 of Cell 1 shall fulfil the requirements in TS 38.133 clauses 10.1.28.2. The following requirements are to be verified:

For Test 1:

Absolute accuracy of SSB#0+CSI-IM#0 and absolute accuracy of SSB#1+CSI-IM#1. The UE is deemed to meet the requirement if the reported L1-SINR is in the range shown in Table 7.7.6.2.5-3.

Table 7.7.6.2.5-3: L1-SINR absolute accuracy test requirement

	Test requirement <sup>Notes1,2</sup>
SSB#0+CSI-IM#0	$L1\_SINR0 - \delta \leq \text{Reported SINR(dB)} \leq L1\_SINR0 + \delta$
SSB#1+CSI-IM#1	$L1\_SINR1 - \delta \leq \text{Reported SINR(dB)} \leq L1\_SINR1 + \delta$
<p>Note 1: <math>L1\_SINRn</math> is the equivalent SINR received by an antenna with 0dBi gain at the centre of the quiet zone configured in the test for the SSB#n+CSI-IM#n under consideration</p> <p>Note 2: <math>\delta</math> is the SINR absolute accuracy requirement from TS 38.133 Table 10.1.28.2.1-2, selected according to the <math>I_o</math> used in the test</p>	

### 7.7.6.3 NR SA FR2 CSI-RS based CMR and dedicated IMR L1-SINR measurement accuracy

**Editor's note: This test case is incomplete. The following aspects are either missing or not yet determined:**

- Test Tolerance is FFS
- Test frequency  $f \leq 40.8$  GHz
- The test is incomplete for UE power classes other than PC3
- The test is incomplete for test frequencies  $> 40.8$  GHz
- The test is incomplete for extreme conditions

#### 7.7.6.3.1 Test purpose

The purpose of this test is to verify that the L1-SINR measurement accuracy is within the specified limits.

### 7.7.6.3.2 Test applicability

This test applies to all types of NR UE from Release 16 onwards. Applicability requires support of L1-SINR measurements.

### 7.7.6.3.3 Minimum conformance requirements

The minimum conformance requirements are specified in clause 7.7.6.0.3.

The normative reference for this requirement is TS 38.133 [6] clause A.7.7.6.3.

### 7.7.6.3.4 Test description

#### 7.7.6.3.4.1 Initial conditions

This test shall be tested using any of the test configurations in Table 7.7.6.3.4.1-1.

**Table 7.7.6.3.4.1-1: Applicable NR configurations for FR2 L1-SINR measurement test with CSI-RS based both CMR based IMR**

Config	Description
1	NR 120 kHz CSI-RS SCS, 100 MHz bandwidth, TDD duplex mode

Configure the test equipment and the DUT according to the parameters in Table 7.7.6.3.4.1-2.

**Table 7.7.6.3.4.1-2: Initial conditions for CSI-RS based L1-SINR absolute accuracy in FR2**

Parameter	Value	Comment
Test environment	NC	As specified in TS 36.508 [25] clause 4.1.
Test frequencies	As specified in Annex E, Table E.5-1 and TS 38.508-1 [14] clause 4.3.1.	
Channel bandwidth	As specified by the selected test configuration.	
Propagation conditions	AWGN	As specified in Annex C.2.1
Connection Diagram	TE Part: A.3.3.1.1 DUT Part: A.3.4.1.1	As specified in TS 38.508-1 [14] Annex A.
Exceptions to connection diagram	N/A	

1. Message contents are defined in clause 7.7.6.3.4.3.
2. Cell 1 is the NR FR2 cell. Cell 1 is the target cell for the SSB-based L1-RSRP measurements. The UE is configured to perform RLM, BFD and L1-RSRP measurement based on the SSBs and CSI-RSs.
3. The UE Rx beam peak direction has been obtained previously using one of the Rx Beam Peak Search procedures as described in Annex I.

#### 7.7.6.3.4.2 Test procedure

Prior to the start of the time duration T1, the UE shall be fully synchronized to PSCell. The UE shall be configured for periodic CSI reporting in PUCCH [format 2] with a reporting periodicity as mentioned in the above table 7.7.6.3.4.1-2.

1. Ensure the UE is in state RRC\_CONNECTED with generic procedure parameters Connectivity NR SA, Connected without release *On* and Test Mode *On*, according to TS 38.508-1 [14] clause 4.5 and general test parameters set according to Table 7.7.6.3.4.1-2.
2. Set the parameters according to T1 in Table 7.7.6.3.5-1. SS transmits CSI-RS as IMR with a periodicity of 20 slots.
3. The UE shall start sending L1-SINR report including results of both CSI-RS#0 and CSI-RS#1 every 80 slots.

4. The SS shall check the L1-SINR reported values of CSI-RS#0 and CSI-RS#1 in the periodic L1-RSRP reports. If the value for both CSI-RSs is within the limits in Table 7.7.6.3.5-2 and Table 7.7.6.3.5-3 (depending on the test configuration), the number of passed iterations is increased by one, otherwise the number of failed iterations is increased by one.
5. The SS shall continue checking the L1-SINR report messages transmitted by the UE until the confidence level according to Table G.2.3-1 in Annex G is achieved.
6. Set the parameters according to each sub-test in Table 7.7.6.3.5-1 as appropriate and repeat steps 3-5.

7.7.6.3.4.3 Message contents

Message contents are according to TS 38.508-1 [14] clause 7.3 with the following exceptions:

**Table 7.7.6.3.4.3-1: Common Exception messages NR SA CSI-RS-based L1-RSRP measurement**

Default Message Contents	
Common contents of system information blocks exceptions	
Default RRC messages and information elements contents exceptions	Table H.3.6A-1 with conditions PERIODIC and CSI-SINR Table H.3.6A-2 with conditions CSI-RS and PERIODIC Table H.3.6A-3 with condition PERIODIC Table 7.3.1-3 in TS 38.508-1 [14] with condition SMTC.1

**Table 7.7.6.3.4.3-2: RadioLinkMonitoringConfig**

Derivation Path: TS 38.508-1 [14], Table 4.6.3-133			
Information Element	Value/remark	Comment	Condition
RadioLinkMonitoringConfig ::= SEQUENCE {			
failureDetectionResourcesToAddModList	1 entry		
SEQUENCE			
(SIZE(1..maxNrofFailureDetectionResources)) OF			
SEQUENCE {			
purpose	both	UE is configured to perform RLM and BFD based on the SSB.	
}			
}			
}			

7.7.6.3.5 Test requirement

Table 7.7.6.3.5-1 defines the primary level settings excluding test tolerances for all tests.

Each L1-SINR measurement report for each of the tests in Table 7.7.6.3.5-1 shall meet the corresponding absolute accuracy requirements in Table 7.7.6.3.5-2 for test configurations 1 and 2, and the corresponding absolute accuracy requirements in Table 7.7.6.3.5-3 for test configuration 3.

Table 7.7.6.3.5-1: FR2 L1-SINR measurement test with CSI-RS based both CMR and IMR

Parameter	Config	Unit	Test 1
SSB GSCN	1		freq1
Duplex mode	1		TDD
TDD Configuration	1		TDDConf.3.1
$BW_{\text{channel}}$	1	MHz	100: $N_{RB,c} = 66$
PDSCH Reference measurement channel	1		SR.3.1 TDD
RMSI CORESET Reference Channel	1		CR.3.1 TDD
Dedicated CORESET Reference Channel	1		CCR.3.1 TDD
SSB configuration	1		SSB.1 FR2
OCNG Patterns	1		OP.1
Initial BWP Configuration	1		DLBWP.0.1 ULBWP.0.1
Dedicated BWP configuration	1		DLBWP.1.1 ULBWP.1.1
TRS Configuration	1		TRS.2.1 TDD
PDCCH/PDSCH TCI Configuration	1		TCI.State.2
SMTc configuration	1		SMTc.1
CSI-RS configuration as CMR	1		CSI-RS.3.2 TDD
CSI-RS configuration as IMR	1		CSI-RS.3.3A TDD
reportConfigType	1		periodic
reportQuantity-r16	1		cri-SINR-r16
nrofReportedRS	1		2
L1-RSRP reporting period	1		slot80
Propagation condition	1		AWGN
Antenna configuration	1		1x2
EPRE ratio of PSS to SSS	1	dB	0
EPRE ratio of PBCH DMRS to SSS			
EPRE ratio of PBCH to PBCH DMRS			
EPRE ratio of PDCCH DMRS to SSS			
EPRE ratio of PDCCH to PDCCH DMRS			
EPRE ratio of PDSCH DMRS to SSS			
EPRE ratio of PDSCH to PDSCH DMRS			
EPRE ratio of OCNG DMRS to SSS <sup>Note 1</sup>			
EPRE ratio of OCNG to OCNG DMRS <sup>Note 1</sup>			
<p>Note 1: OCNG shall be used such that both cells are fully allocated and a constant total transmitted power spectral density is achieved for all OFDM symbols.</p> <p>Note 2: Interference from other cells and noise sources not specified in the test is assumed to be constant over subcarriers and time and shall be modelled as AWGN of appropriate power for <math>N_{oc}</math> to be fulfilled.</p>			

**Table 7.7.6.3.5-2: FR2 CSI-RS based L1-SINR measurement OTA related test parameters**

Parameter	Config	Unit	Test 1	
			CSI-RS0	CSI-RS1
Angle of arrival configuration			Setup 1 according to A.3.15.1	
Assumption for UE beams <sup>Note 4</sup>			Rough	
$N_{oc}$	1~2	dBm/15 kHz	-100	
$N_{oc}$	1~2	dBm/SS B SCS	-91	
$\hat{E}_s / I_{ot}$	1~2	dB	10	0
CSI-RS-RSRP <sup>Note1</sup>	1~2	dBm/SC S	-81	-91
$I_o$ <sup>Note1</sup>	1~2	dBm/95.04M Hz	-59.86	
$\hat{E}_s / N_{oc}$	1~2	dB	10	0
Note 1: RSRP and $I_o$ levels have been derived from other parameters for information purposes. They are not settable parameters themselves. Note 2: RSRP minimum requirements are specified assuming independent interference and noise at each receiver antenna port. Note 3: No additional noise is added by the test system in Test 2. Note 4: Information about types of UE beam is given in TS 38.133 Annex B.2.1.3, and does not limit UE implementation or test system implementation				

After 640ms from the beginning of the test, the L1-SINR measurement accuracy for CSI-RS#0+CSI-RS#2 and CSI-RS#1+CSI-RS#3 of Cell 1 shall fulfil the requirements in TS38.133 clause 10.1.28.3. The following requirements are to be verified:

Absolute accuracy of CSI-RS#0 and absolute accuracy of CSI-RS#1. The UE is deemed to meet the requirement if the reported L1-SINR is in the range shown in Table 7.7.6.3.5-3.

Relative accuracy of CSI-RS#0 compared with CSI-RS#1. The UE is deemed to meet the requirement if the difference in reported L1-SINR meets the requirements in TS 38.133 Table 10.1.28.3.2-1.

**Table 7.7.6.3.5-3: L1-SINR absolute accuracy test requirement**

	Test requirement <sup>Notes1,2</sup>
CSI-RS#0	$L1-SINR_0 - \delta \leq \text{Reported SINR(dBm)} \leq L1-SINR_0 + \delta$
CSI-RS#1	$L1-SINR_1 - \delta \leq \text{Reported SINR(dBm)} \leq L1-SINR_1 + \delta$
Note 1:	L1-SINR <sub>n</sub> is the equivalent SINR received by an antenna with 0dBi gain at the centre of the quiet zone configured in the test for the CSI-RS#n under consideration
Note 2:	$\delta$ is the SINR absolute accuracy requirement from TS 38.133 Table 10.1.28.3.1-1.

## 8 E-UTRA - NR inter-RAT with E-UTRA serving cell

### 8.0 General

This clause contains test scenarios for E-UTRA - NR inter-RAT with the serving cell in E-UTRA. The NR cells can be in FR1, FR2 or both.

For conformance testing involving FR2 test cases in this specification, the UE under test shall be pre-configured with UL Tx diversity schemes disabled to account for single polarization System Simulator (SS) in the test environment. The UE under test may transmit with dual polarization.

### 8.1 Void

### 8.2 RRC\_IDLE state mobility

#### 8.2.1 Inter-RAT cell re-selection

##### 8.2.1.0 Minimum conformance requirements

##### 8.2.1.0.1 Minimum conformance requirements for E-UTRA-NR FR1 inter-RAT cell reselection

[TS 36.133, clause 4.2.1]

When the UE is in either *Camped Normally* state or *Camped on Any Cell* state on a cell, the UE shall attempt to detect, synchronise, and monitor intra-frequency, inter-frequency and inter-RAT cells indicated by the serving cell. UE measurement activity is also controlled by measurement rules defined in TS36.304, allowing the UE to limit its measurement activity.

[TS 36.133, clause 4.2.2]

The UE shall search every layer of higher priority at least every  $T_{\text{higher\_priority\_search}} = (60 * N_{\text{layers}})$  seconds when the UE is not configured with eDRX\_IDLE cycle, and at least every  $T_{\text{higher\_priority\_search}} = \text{MAX}(60 * N_{\text{layers}}, \text{one eDRX\_IDLE cycle})$  when UE is configured with eDRX\_IDLE cycle, where  $N_{\text{layers}}$  is the total number of configured higher priority E-UTRA, UTRA FDD, UTRA TDD, CDMA2000 1x, HRPD and NR carrier frequencies and is additionally increased by one if one or more groups of GSM frequencies is configured as a higher priority.

[TS 36.133, clause 4.2.2.5.6]

If  $S_{\text{rxlev}} > S_{\text{nonIntraSearchP}}$  and  $S_{\text{qual}} > S_{\text{nonIntraSearchQ}}$  then the UE shall search for inter-RAT NR layers of higher priority at least every  $T_{\text{higher\_priority\_search}}$  where  $T_{\text{higher\_priority\_search}}$  is described in TS 36.133 clause 4.2.2.

If  $S_{\text{rxlev}} \leq S_{\text{nonIntraSearchP}}$  or  $S_{\text{qual}} \leq S_{\text{nonIntraSearchQ}}$  then the UE shall search for and measure inter-RAT NR layers of higher, lower priority in preparation for possible reselection. In this scenario, the minimum rate at which the UE is required to search for and measure higher priority inter-RAT NR layers shall be the same as that defined below for lower priority RATs.

The requirements in this clause apply for inter-RAT NR measurements. When the measurement rules indicate that inter-RAT NR cells are to be measured, the UE shall measure SS-RSRP and SS-RSRQ of detected NR cells in the neighbour frequency list at the minimum measurement rate specified in this clause.

If  $S_{\text{rxlev}} \leq S_{\text{nonIntraSearchP}}$  or  $S_{\text{qual}} \leq S_{\text{nonIntraSearchQ}}$ , a carrier is indicated to meet high speed requirement if *highSpeedInterRAT-NR-r16* is configured and the carrier to be measured is configured with *highSpeedCarrierNR-r16*. If  $S_{\text{rxlev}} > S_{\text{nonIntraSearchP}}$  and  $S_{\text{qual}} > S_{\text{nonIntraSearchQ}}$ , the UE is required to meet non high speed requirements no matter whether *highSpeedInterRAT-NR-r16* or *highSpeedCarrierNR-r16* is configured or not. The parameter  $N_{\text{NR\_carrier}}$  is the number of configured NR carriers indicated to meet non high speed requirement in the neighbour frequency list.  $N_{\text{NR\_carrier\_HST}}$  is the number of configured carriers for reselection indicated to meet high speed requirements. The

parameter  $N_{NR\_carrier}$  for a UE configured with idle mode DC measurements (while T331 is running) is the combined number of configured NR carriers indicated to meet non high speed requirement in the neighbour frequency list, and NR carriers configured for idle mode DC measurements.

NOTE: Combined total number means that if a carrier is indicated in the neighbour frequency list and additionally a carrier configured for idle mode DC measurements, it only counts as one carrier.

The UE shall filter SS-RSRP and SS-RSRQ measurements of each measured NR cell using at least 2 measurements. Within the set of measurements used for the filtering, at least two measurements shall be spaced by at least half the minimum specified measurement period.

The UE shall be able to evaluate whether a newly detectable inter-RAT NR cell meets the reselection criteria defined in TS 36.304 [1] within  $N_{NR\_carrier\_HST} * T_{detect, NR\_HST} + N_{NR\_carrier} * T_{detect, NR}$

when  $S_{rxlev} \leq S_{nonIntraSearchP}$  or  $S_{qual} \leq S_{nonIntraSearchQ}$  when  $T_{reselection} = 0$  provided that the reselection criteria is met by a margin of at least 5 dB in FR1 or 6.5 dB in FR2 for reselections based on ranking or 6 dB in FR1 or 7.5 dB in FR2 for SS-RSRP reselections based on absolute priorities or 4 dB in FR1 and 4 dB in FR2 for SS-RSRQ reselections based on absolute priorities.

When higher priority cells are found by the higher priority search, they shall be measured at least every  $T_{measure, NR}$ . If, after detecting a cell in a higher priority search, it is determined that reselection has not occurred then the UE is not required to continuously measure the detected cell to evaluate the ongoing possibility of reselection. However, the minimum measurement filtering requirements specified later in this clause shall still be met by the UE before it makes any determination that it may stop measuring the cell.

If the UE detects on an inter-RAT NR carrier a cell whose physical identity is indicated as not allowed for that carrier in the measurement control system information of the serving cell, the UE is not required to perform measurements on that cell.

The UE shall not consider an inter-RAT NR cell in cell reselection, if it is indicated as not allowed in the measurement control system information of the serving cell.

Cells which have been detected shall be measured at least every  $N_{NR\_carrier\_HST} * T_{measure, NR\_HST} + N_{NR\_carrier} * T_{measure, NR}$  when  $S_{rxlev} \leq S_{nonIntraSearchP}$  or  $S_{qual} \leq S_{nonIntraSearchQ}$ .

For a cell that has been already detected, but that has not been reselected to, the filtering shall be such that the UE shall be capable of evaluating that an already identified inter-RAT NR cell has met reselection criterion defined in TS 36.304 [1] within  $N_{NR\_carrier\_HST} * T_{evaluate, NR\_HST} + N_{NR\_carrier} * T_{evaluate, NR}$  when  $T_{reselection} = 0$  as specified in Table 8.2.1.0.1-1 and table 8.2.1.0.1-2 provided that the reselection criteria is met by a margin of at least 5dB in FR1 or 6.5 dB in FR2 for reselections based on ranking or 6 dB in FR1 or 7.5 dB in FR2 for SS-RSRP reselections based on absolute priorities or 4 dB in FR1 and 4 dB in FR2 for SS-RSRQ reselections based on absolute priorities.

If  $T_{reselection}$  timer has a non-zero value and the inter-RAT NR cell is satisfied with the reselection criteria which are defined in TS 36.304 [1], the UE shall evaluate this NR cell for the  $T_{reselection}$  time. If this cell remains satisfied with the reselection criteria within this duration, then the UE shall reselect that cell.

**Table 8.2.1.0.1-1:  $T_{detect, NR}$ ,  $T_{measure, NR}$ , and  $T_{evaluate, NR}$**

DRX cycle length [s]	Scaling Factor (N1)		$T_{detect, NR}$ [s] (number of DRX cycles)	$T_{measure, NR}$ [s] (number of DRX cycles)	$T_{evaluate, NR}$ [s] (number of DRX cycles)
	FR1	FR2 <sup>Note1</sup>			
0.32	1	8	$11.52 \times 1.5 \times N1$ ( $36 \times 1.5 \times N1$ )	$1.28 \times 1.5 \times N1$ ( $4 \times 1.5 \times N1$ )	$5.12 \times 1.5 \times N1$ ( $16 \times 1.5 \times N1$ )
0.64		5	$17.92 \times N1$ ( $28 \times N1$ )	$1.28 \times N1$ ( $2 \times N1$ )	$5.12 \times N1$ ( $8 \times N1$ )
1.28		4	$32 \times N1$ ( $25 \times N1$ )	$1.28 \times N1$ ( $1 \times N1$ )	$6.4 \times N1$ ( $5 \times N1$ )
2.56		3	$58.88 \times N1$ ( $23 \times N1$ )	$2.56 \times N1$ ( $1 \times N1$ )	$7.68 \times N1$ ( $3 \times N1$ )

NOTE: Applies for UE supporting power class 2&3&4. For UE supporting power class 1,  $N1 = 8$  for all DRX cycle length.

**Table 8.2.1.0.1-2:  $T_{\text{detect,NR\_HST}}$ ,  $T_{\text{measure,NR\_HST}}$ , and  $T_{\text{evaluate,NR\_HST}}$  for UE configured with highSpeedInterRAT-NR-r16**

DRX cycle length [s]	$T_{\text{detect,NR\_HST}}$ [s] (number of DRX cycles)	$T_{\text{measure,NR\_HST}}$ [s] (number of DRX cycles)	$T_{\text{evaluate,NR\_HST}}$ [s] (number of DRX cycles)
0.32	$4.16 \times M2$ (13 x $M2$ ) <sup>Note 2</sup>	$0.64 \times M3$ (2 x $M3$ ) <sup>Note 2</sup>	$0.96 \times M4$ (3 x $M4$ ) <sup>Note 2</sup>
0.64	7.68 (12)	1.28 (2)	1.92 (3)
1.28	12.8(10)	1.28 (1)	3.84 (3)
2.56	58.88 (23)	2.56 (1)	7.68 (3)
NOTE 1: FR2 high speed requirements are not specified. NOTE 2: $M2=1.5$ , $M3=2$ and $M4=2$ if SMTC periodicity of measured intra-frequency cell > 40 ms; otherwise $M2=1$ .			

The normative reference for this requirement is TS 36.133 clause 4.2.1, 4.2.2, 4.2.2.5.6.

## 8.2.1.1 E-UTRA - NR FR1 cell re-selection to higher priority NR target cell

### 8.2.1.1.1 Test purpose

The purpose of this test is to verify the requirement for the E-UTRAN to NR inter-RAT cell reselection requirements specified in TS 36.133 [23] clause 4.2.2.5.6.

### 8.2.1.1.2 Test applicability

This test applies to all types of NR UE from Release 15 onwards.

### 8.2.1.1.3 Minimum conformance requirements

The minimum conformance requirements are specified in clause 8.2.1.0.

The normative reference for this requirement is TS 38.133 [6] clause A.8.2.1.1.

### 8.2.1.1.4 Test description

There are two cells configured in this test, the E-UTRA Cell 1 and NR Cell 2. E-UTRA Cell 1 is the PCell and NR Cell 2 is the neighbour cell. This test consists of three successive time periods, with time duration of T1, T2, and T3 respectively. E-UTRA Cell 1 is already identified by the UE prior to the start of the test. Cell 2 is of higher priority than cell 1.

#### 8.2.1.1.4.1 Initial conditions

This test shall be tested under any of the test configuration in Table 8.2.1.1.4.1-1.

**Table 8.2.1.1.4.1-1: Supported test configurations**

Configuration	Description
8.2.1.1-1	LTE FDD, NR 15 kHz SSB SCS, 10 MHz bandwidth, FDD duplex mode
8.2.1.1-2	LTE FDD, NR 15 kHz SSB SCS, 10 MHz bandwidth, TDD duplex mode
8.2.1.1-3	LTE FDD, NR 30 kHz SSB SCS, 40 MHz bandwidth, TDD duplex mode
8.2.1.1-4	LTE TDD, NR 15 kHz SSB SCS, 10 MHz bandwidth, FDD duplex mode
8.2.1.1-5	LTE TDD, NR 15 kHz SSB SCS, 10 MHz bandwidth, TDD duplex mode
8.2.1.1-6	LTE TDD, NR 30 kHz SSB SCS, 40 MHz bandwidth, TDD duplex mode
NOTE: The UE is only required to be tested in one of the supported test configurations.	

Configure the test requirement and the DUT according to the parameters in Table 8.2.1.1.4.1-2.



**Table 8.2.1.1.4.1-2: Initial conditions for E-UTRA - NR FR1 cell re-selection to higher priority NR target cell**

Parameter	Value		Comment
Test environment	NC		As specified in TS 36.508 [25] clause 4.1.
Test frequencies	As specified in Annex E, Table E.6-1 and TS 38.508-1 [14] clause 4.3.1.		
Channel bandwidth	As specified by the test configuration selected from Table 8.2.1.1.4.1-1.		
Propagation conditions	AWGN		As specified in clause C.2.1
Connection Diagram	TE Part	A.3.1. 6.1	As specified in TS 38.508-1 [14] Annex A.
	DUT Part	A.3.2.3.4	
Exceptions to connection diagram	N/A		

1. The general test parameter settings are set up according to Table 8.2.1.1.4.1-3.
2. Message contents are defined in clause 8.2.1.1.4.3.
3. The test scenario comprises of one NR cell and one E-UTRAN cell. E-UTRA Cell 1 is the PCell and Cell 2 is the neighbour cell. E-UTRA Cell 1 is configured according to TS 36.521-3 [26] clauses C.1.0 and C.1.1 and Cell 2 is configured according to clauses C.1.1 and C.1.2.

**Table 8.2.1.1.4.1-3: General test parameters for E-UTRA - NR FR1 cell re-selection to higher priority NR target cell**

Parameter		Unit	Test configuration	Value	Comment
Initial condition	Active cell		1, 2, 3, 4, 5, 6	Cell2	The UE camps on cell 2 in the initial phase
	Neighbour cells		1, 2, 3, 4, 5, 6	Cell1	
T1 end condition	Active cell			Cell1	During T1 period the UE reselects to cell 1
	Neighbour cell			Cell2	
T3 end condition	Active cell		1, 2, 3, 4, 5, 6	Cell2	The UE shall perform reselection to cell 2 during T3
	Neighbour cell		1, 2, 3, 4, 5, 6	Cell1	
RF Channel Number			1, 2, 3, 4, 5, 6	1, 2	E-UTRAN radio channel (1) and NR radio channel (2) are used for this test
Time offset between cells			1, 4	3 ms	Asynchronous cells
			2, 5	3 $\mu$ s	Synchronous cells
			3, 6	3 $\mu$ s	Synchronous cells
Access Barring Information		-	1, 2, 3, 4, 5, 6	Not Sent	No additional delays in random access procedure.
DRX cycle length		s	1, 2, 3, 4, 5, 6	1.28	The value shall be used for all cells in the test.
NR PRACH configuration index			1, 2, 3, 4, 5, 6	102	The detailed configuration is specified in TS 38.211 clause 6.3.3.2
T1		s	1, 2, 3, 4, 5, 6	15	T1 needs to be defined so that cell re-selection reaction time is taken into account.
T2		s	1, 2, 3, 4, 5, 6	>7	During T2, cell 2 shall be powered off, and during the off time the physical cell identity shall be changed. The intention is to ensure that cell 2 has not been detected by the UE prior to the start of period T3.
T3		s	1, 2, 3, 4, 5, 6	75	T3 needs to be defined so that cell re-selection reaction time is taken into account.

#### 8.2.1.1.4.2 Test procedure

Two cells are deployed in the test, which are one NR PCell (NR Cell 1) and a E-UTRA neighbour cell (E-UTRA Cell 1). The test consists of three successive time periods, with time duration of T1, T2, and T3 respectively. E-UTRA Cell 1 is already identified by the UE prior to the start of the test. NR Cell 2 is of higher priority than E-UTRA Cell 1.

In the following test procedure "UE responds" means "UE starts transmitting preamble on PRACH for sending the *RRCSetupRequest* message to perform a Registration procedure.

1. The SS shall send a *RRCConnectionRelease* message on NR Cell 2 to ensure the UE is in State RRC\_IDLE with generic procedure parameters connectivity = NR with Test Mode On according to TS 38.508-1 [14] clause 4.5 on Cell 2.
2. The SS shall set the parameters according to T1 in Table 8.2.1.1.5-1 and 8.2.1.1.5-2 at the same time instance *RRCConnectionRelease* message is sent on NR Cell 2, T1 starts.
3. The SS waits for random access requests information from the UE to perform cell re-selection on the lower priority cell, E-UTRA Cell 1.
4. If the UE responds on lower priority cell, E-UTRA Cell 1 during time duration T1 within 8 seconds from the beginning of time period T1, then count a success for the event "Re-select lower priority Cell 1". Otherwise count a fail for the event "Re-select lower priority Cell 1".
5. If the UE has re-selected E-UTRA Cell 1 within T1, after the re-selection or when T1 expires, continue with step 5a. Otherwise, if T1 expires and the UE has not yet re-selected Cell 1, the TE shall switch off and on the UE and skip to step 11.
- 5a. The SS shall send an *RRCConnectionRelease* message to ensure that the UE is in state RRC\_IDLE on Cell 1.
6. The SS shall switch the power setting from T1 to T2 as specified in Table 8.2.1.1.5-1. During time duration T2, Cell 2 shall be powered OFF and the physical cell identity = ((current Cell 2 physical cell identity + 1) mod 1008) shall be changed to ensure Cell 2 is not detected by the UE, T2 starts.
7. When T2 expires, the SS shall switch the power setting from T2 to T3 as specified in Table 8.2.1.1.5-1, T3 starts.
8. The SS waits for random access requests information from the UE to perform cell re-selection on the higher priority cell, NR Cell 2.
9. If the UE responds on higher priority cell, NR Cell 2 during time duration T3 within 68 seconds from the beginning of time period T3, then count a success for the event "Re-select higher priority Cell 2". Otherwise count a fail for the event "Re-select higher priority Cell 2".
10. If the UE has re-selected Cell 2 within T3, after the re-selection or when T3 expires, continues with step 10a. Otherwise, if T3 expires and the UE has not yet re-selected Cell 2, the TE shall switch off and on the UE and continue with step 11.
- 10a. The SS shall send an *RRCRelease* message on NR Cell 2 to ensure that the UE is in state RRC\_IDLE with generic procedure parameters connectivity = NR with Test Mode On according to TS 38.508-1 [14] clause 4.5 on Cell 2.
11. The SS shall set the parameters according to T1 in Table 8.2.1.1.5-1 and 8.2.1.1.5-2 at the same time instance *RRCConnectionRelease* message is sent on NR Cell 2.
12. Repeat step 2-11 until a test verdict has been achieved.  
Each of the events "Re-select lower priority Cell 1" and "Re-select higher priority Cell 2" is evaluated independently for the statistic, resulting in an event verdict: pass or fail. Each event is evaluated only until the confidence level according to Table G.2.3-1 in Annex G clause G.2 is achieved. Different events may require different times for a verdict.  
If both events pass, the test passes. If one event fails, the test fails.

#### 8.2.1.1.4.3 Message contents

Message contents are according to TS 36.508 [25] clause 7.3 with the following exceptions:

**Table 8.2.1.1.4.3-1: Common Exception messages**

Default Message Contents	
Common contents of system information blocks exceptions	Table H.2.3-1 Table H.2.3-2 with condition lower priority Table H.2.3-3 with condition lower priority
Default RRC messages and information elements contents exceptions	

**Table 8.2.1.1.4.3-2: SystemInformationBlockType3**

Derivation Path: TS 36.508 Table 4.4.3.3-2			
Information Element	Value/remark	Comment	Condition
SystemInformationBlockType3 ::= SEQUENCE {			
cellReselectionServingFreqInfo SEQUENCE {			
s-NonIntraSearch	25	Actual value = 50 dB	
threshServingLow	22	Actual value = 44 dB	
}			
}			

**Table 8.2.1.1.4.3-3: SystemInformationBlockType24**

Derivation Path: TS 36.508, Table 4.4.3.3-20 with Condition FR1			
Information Element	Value/remark	Comment	Condition
SystemInformationBlockType24-r15 ::= SEQUENCE {			
carrierFreqListNR-r15 SEQUENCE (SIZE (1..maxFreq)) OF SEQUENCE {	1 entry		
measTimingConfig-r15[n] SEQUENCE {			
periodicityAndOffset-r15 CHOICE {			
sf20	0		
}			
ssb-Duration-r15	sf5	Asynchronous cells	Configuration 1,4
	sf2	Synchronous cells	Configuration 2,3,5,6
}			
subcarrierSpacingSSB-r15[1]	kHz15		Configuration 1,2,4,5
	kHz30		Configuration 3,6
threshX-High-r15[1]	24	Actual value = 48 dB	
threshX-Low-r15[1]	25	Actual value = 50 dB	
}			
q-RxLevMin-r15[1]	-70	Actual value = -140 dBm	Configuration 1,2,4,5
	-69	Actual value = -137 dBm, Round down	Configuration 3,6
}			

**Table 8.2.1.1.4.3-4: Void**

**Table 8.2.1.1.4.3-5: Void**

#### 8.2.1.1.5 Test requirement

Tables 8.2.1.1.4.1-3, 8.2.1.1.5-1 and 8.2.1.1.5-2 define the primary level settings including test tolerances for higher priority NR cell re-selection test case.

**Table 8.2.1.1.5-1: NR Cell specific test parameters for E-UTRA -  
NR FR1 cell re-selection to higher priority NR target cell**

Parameter	Unit	Test configuration	Cell 2		
			T1	T2	T3
TDD configuration		1, 4	N/A		
		2, 5	TDDConf.1.1		
		3, 6	TDDConf.2.1		
PDSCH Reference measurement channel		1, 4	SR.1.1 FDD		
		2, 5	SR.1.1 TDD		
		3, 6	SR.2.1 TDD		
RMSI CORESET Reference Channel		1, 4	CR.1.1 FDD		
		2, 5	CR.1.1 TDD		
		3, 6	CR.2.1 TDD		
RMC CORESET Reference Channel		1, 4	CCR.1.1 FDD		
		2, 5	CCR.1.1 TDD		
		3, 6	CCR.2.1 TDD		
OCNG Patterns		1, 2, 3, 4, 5, 6	OP.1		
SMTc configuration		1, 2, 3, 4, 5, 6	SMTc.1		
SSB configuration		1, 4	SSB.1 FR1		
		2, 5	SSB.1 FR1		
		3, 6	SSB.2 FR1		
Initial DL BWP configuration		1, 2, 3, 4, 5, 6	DLBWP.0.1		
Initial UL BWP configuration		1, 2, 3, 4, 5, 6	ULBWP.0.1		
RLM-RS		1, 2, 3, 4, 5, 6	SSB		
Qrxlevmin	dBm/SCS	1, 2, 4, 5	-140		
		3, 6	-137		
Pcompensation	dB	1, 2, 3, 4, 5, 6	0		
Qhysts	dB	1, 2, 3, 4, 5, 6	0		
Qoffsets,n	dB	1, 2, 3, 4, 5, 6	0		
Cell_selection_and_reselection_quality_measurement		1, 2, 3, 4, 5, 6	SS-RSRP		
$\hat{E}_s / I_{ot}$	dB	1, 4	-3.65	-infinity	13.55
		2, 5			
		3, 6			
$N_{oc}$ Note2	dBm/SCS	1, 4	-99.90	-98	-98
		2, 5	-99.90	-98	-98
		3, 6	-96.90	-95	-95
$N_{oc}$ Note2	dBm/15 kHz	1, 4	-99.90	-98	-98
		2, 5			
		3, 6			
$\hat{E}_s / N_{oc}$	dB	1, 4	-3.65	-infinity	13.55
		2, 5			
		3, 6			
SS-RSRP Note3	dBm/SCS	1, 4	-103.55	-infinity	-84.45
		2, 5	-103.55	-infinity	-84.45
		3, 6	-100.54	-infinity	-81.44
Io	dBm/9.36 MHz	1, 4	-70.39	-70.05	-56.31
	dBm/9.36 MHz	2, 5	-70.39	-70.05	-56.31
	dBm/38.16 MHz	3, 6	-64.29	-63.94	-50.21
Treselection	s	1, 2, 3, 4, 5, 6	0	0	0
SnonintrasearchP	dB	1, 2, 3, 4, 5, 6	50		
Threshx,highP	dB	1, 2, 3, 4, 5, 6	48		
Threshserving,lowP	dB	1, 2, 3, 4, 5, 6	44		
Threshx,lowP	dB	1, 2, 3, 4, 5, 6	50		
Propagation Condition		1, 2, 3, 4, 5, 6	AWGN		
NOTE 1: OCNG shall be used such that both cells are fully allocated and a constant total transmitted power spectral density is achieved for all OFDM symbols.					
NOTE 2: Interference from other cells and noise sources not specified in the test is assumed to be constant over subcarriers and time and shall be modelled as AWGN of appropriate power for $N_{oc}$ to be fulfilled.					
NOTE 3: SS-RSRP levels have been derived from other parameters for information purposes. They are not settable parameters themselves.					

**Table 8.2.1.1.5-2: E-UTRA Cell specific test parameters for for E-UTRA - NR FR1 cell re-selection to higher priority NR target cell**

Parameter	Unit	Cell 1		
		T1	T2	T3
E-UTRA RF Channel number		1		
$BW_{\text{channel}}$	MHz	10		
OCNG Patterns defined in TS 36.133 [15] clause A.3.2		OP.2 TDD for test configuration 1, 2, 3; OP.2 FDD for test configuration 4, 5, 6		
PBCH_RA	dB	0		
PBCH_RB	dB			
PSS_RA	dB			
SSS_RA	dB			
PCFICH_RB	dB			
PHICH_RA	dB			
PHICH_RB	dB			
PDCCH_RA	dB			
PDCCH_RB	dB			
PDSCH_RA	dB			
PDSCH_RB	dB			
OCNG_RA <sup>Note 1</sup>	dB			
OCNG_RB <sup>Note 1</sup>	dB			
Qrxlevmin	dBm	-140		
$N_{oc}$ <sup>Note 2</sup>	dBm/15 kHz	-98		
RSRP <sup>Note 3</sup>	dBm/15 KHz	-84	-84	-82.45
$\hat{E}_s/I_{ot}$	dB	14	14	15.55
$\hat{E}_s/N_{oc}$	dB	14	14	15.55
Treselection <sub>EUTRAN</sub>	S	0		
SnonintrasearchP	dB	50		
Thresh <sub>x, highP</sub>	dB	48		
Thresh <sub>serv, lowP</sub>	dB	44		
Thresh <sub>x, lowP</sub>	dB	50		
Propagation Condition		AWGN		
NOTE 1: OCNG shall be used such that both cells are fully allocated and a constant total transmitted power spectral density is achieved for all OFDM symbols.				
NOTE 2: Interference from other cells and noise sources not specified in the test is assumed to be constant over subcarriers and time and shall be modelled as AWGN of appropriate power for $N_{oc}$ to be fulfilled.				
NOTE 3: RSRP levels have been derived from other parameters for information purposes. They are not settable parameters themselves.				

The cell reselection delay to a higher priority NR cell is defined as the time from the beginning of time period T3, to the moment when the UE camps on cell 2, and starts to send preambles on the PRACH for sending the *RRCSetupRequest* message to perform a Registration procedure for mobility on cell 2.

The cell re-selection delay to a higher priority cell shall be less than 68 s.

The rate of correct cell reselections observed during repeated tests shall be at least 90%.

NOTE: The cell re-selection delay to a higher priority cell can be expressed as:  $T_{\text{higher\_priority\_search}} + T_{\text{evaluate, NR}} + T_{\text{SI-NR}}$ , and to a lower priority cell can be expressed as:  $T_{\text{evaluate, NR}} + T_{\text{SI-NR}}$ ,

Where:

$T_{\text{higher\_priority\_search}}$  is the higher priority search period,  $T_{\text{higher\_priority\_search}} = 60$  ms according to TS 36.133 [23], clause 4.2.2;

$T_{\text{evaluate, NR}}$  is the evaluation time for NR Cell,  $T_{\text{evaluate, NR}} = 6400$  ms according TS 36.133 [23], Table 4.2.2.5.6-1;

$T_{SI-NR}$  is the maximum repetition period of relevant system info blocks that needs to be received by the UE to camp on a cell;  $T_{SI-NR} = 1280$  ms is assumed in this test case.

This gives a total of 67.68 s, allow 68 s for the cell re-selection delay to a higher priority NR cell and 7.68 s for the cell re-selection delay to a lower priority cell in the test case, which we allow 8 s.

## 8.2.1.2 E-UTRA - NR FR1 Cell reselection to lower priority NR target Cell in FR1 for UE configured with highSpeedInterRAT-NR-r16

### 8.2.1.2.1 Test purpose

The purpose of this test is to verify the requirement for the E-UTRAN to NR inter-RAT cell reselection requirements specified in TS 36.133 [23] clause 4.2.2.5.6.

### 8.2.1.2.2 Test applicability

This test applies to all types of NR UE configured with highSpeedInterRAT-NR-r16 from Release 16 onwards.

### 8.2.1.2.3 Minimum conformance requirements

The minimum conformance requirements are specified in clause 8.2.1.0.

The normative reference for this requirement is TS 38.133 [6] clause A.8.2.1.2.

### 8.2.1.2.4 Test description

#### 8.2.1.2.4.1 Initial conditions

This test shall be tested under any of the test configuration in Table 8.2.1.2.4.1-1.

**Table 8.2.1.2.4.1-1: Supported test configurations**

Configuration	Description
8.2.1.2-1	LTE FDD, NR 15 kHz SSB SCS, 10 MHz bandwidth, FDD duplex mode
8.2.1.2-2	LTE FDD, NR 15 kHz SSB SCS, 10 MHz bandwidth, TDD duplex mode
8.2.1.2-3	LTE FDD, NR 30 kHz SSB SCS, 40 MHz bandwidth, TDD duplex mode
8.2.1.2-4	LTE TDD, NR 15 kHz SSB SCS, 10 MHz bandwidth, FDD duplex mode
8.2.1.2-5	LTE TDD, NR 15 kHz SSB SCS, 10 MHz bandwidth, TDD duplex mode
8.2.1.2-6	LTE TDD, NR 30 kHz SSB SCS, 40 MHz bandwidth, TDD duplex mode
NOTE: The UE is only required to be tested in one of the supported test configurations.	

Configure the test requirement and the DUT according to the parameters in Table 8.2.1.2.4.1-2.

**Table 8.2.1.2.4.1-2: Initial conditions for E-UTRA - NR FR1 cell re-selection to lower priority NR target cell in FR1 for UE configured with highSpeedInterRAT-NR-r16**

Parameter	Value		Comment
Test environment	NC		As specified in TS 36.508 [25] clause 4.1.
Test frequencies	As specified in Annex E, Table E.6-1 and TS 38.508-1 [14] clause 4.3.1.		
Channel bandwidth	As specified by the test configuration selected from Table 8.2.1.2.4.1-1.		
Propagation conditions	AWGN		As specified in clause C.2.1
Connection Diagram	TE Part	A.3.1.8.2	As specified in TS 38.508-1 [14] Annex A.
	DUT Part	A.3.2.3.4	
Exceptions to connection diagram	N/A		

1. The general test parameter settings are set up according to Table 8.2.1.2.4.1-3.
2. Message contents are defined in clause 8.2.1.2.4.3.

3. The test scenario comprises of one NR cell and one E-UTRAN cell. E-UTRA Cell 1 is configured according to TS 36.521-3 [26] clause C.1.0 and C.1.1 and Cell 2 is configured according to clauses C.1.1 and C.1.2.
4. In SIB of the E-UTRA cell, highSpeedInterRAT-NR-r16 is configured and the carrier of NR cell is configured with highSpeedCarrierNR-r16.

**Table 8.2.1.2.4.1-3: General test parameters for E-UTRA - NR FR1 cell re-selection to lower priority NR target cell in FR1 for UE configured with highSpeedInterRAT-NR-r16**

Parameter		Unit	Test configuration	Value	Comment
Initial condition	Active cell		1, 2, 3, 4, 5, 6	Cell1	The UE camps on cell 1 in the initial phase
T1 end condition	Active cell		1, 2, 3, 4, 5, 6	Cell2	The UE shall perform reselection to cell 2 during T1
	Neighbour cells		1, 2, 3, 4, 5, 6	Cell1	
T2 end condition	Active cell		1, 2, 3, 4, 5, 6	Cell1	The UE shall perform reselection to cell 1 during T2 for iteration of the tests.
	Neighbour cells		1, 2, 3, 4, 5, 6	Cell2	
RF Channel Number			1, 2, 3, 4, 5, 6	1, 2	E-UTRAN radio channel (1) and NR radio channel (2) are used for this test
Time offset between cells			1, 4	3 ms	Asynchronous cells
			2, 5	3 $\mu$ s	Synchronous cells
			3, 6	3 $\mu$ s	Synchronous cells
Access Barring Information		-	1, 2, 3, 4, 5, 6	Not Sent	No additional delays in random access procedure.
DRX cycle length		s	1, 2, 3, 4, 5, 6	0.32	The value shall be used for all cells in the test.
NR PRACH configuration index			1, 2, 3, 4, 5, 6	102	The detailed configuration is specified in TS 38.211 clause 6.3.3.2
T1		s	1, 2, 3, 4, 5, 6	15	T1 needs to be defined so that cell re-selection reaction time is taken into account.
T2		s	1, 2, 3, 4, 5, 6	75	T2 needs to be defined so that cell re-selection reaction time is taken into account.

#### 8.2.1.2.4.2 Test procedure

Two cells are deployed in the test, which are one E-UTRA Cell 1 and NR Cell 2. The test consists of two successive time periods, with time duration of T1 and T2 respectively. Both cells are already identified by the UE prior to the start of the test. NR Cell 2 is of lower priority than E-UTRA Cell 1. UE is camped on E-UTRA Cell 1 during the initial phase of the test.

In the following test procedure "UE responds" means "UE starts transmitting preamble on PRACH for sending the *RRCSetupRequest* message to perform a Registration procedure.

1. Ensure the UE is in State RRC\_IDLE with generic procedure parameters Connectivity EUTRA/EPC with Test Mode *On* according to TS 38.508-1 [14] clause 4.5.
2. Set the parameters according to T2 in Table 8.2.1.2.5-1 and 8.2.1.2.5-2. Then wait 5s to ensure that Cell 2 has been detected by the UE.
3. Set the parameters according to T1 in Table 8.2.1.2.5-1 and 8.2.1.2.5-2, T1 starts.
4. The SS waits for random access requests information from the UE to perform cell re-selection on the lower priority NR Cell 2.
5. If the UE responds on lower priority cell, NR Cell 2 during time duration T1 within 3 seconds from the beginning of time period T1, then count a success for the event "Re-select lowe priority Cell 2". Otherwise count a fail for the event "Re-select lower priority Cell 2".
6. If the UE has re-selected Cell 2 within T1, after the re-selection or when T1 expires, skip to step 9. Otherwise, if T1 expires and the UE has not yet re-selected Cell 2, skip to step 8.



7. The SS shall switch the power setting from T1 to T2 as specified in Table Table 8.2.1.2.5-1 and 8.2.1.2.5-2. T2 starts.
8. The SS waits for random access requests information from the UE to perform cell re-selection on the higher priority E-UTRA Cell 1.
9. If the UE has re-selected Cell 1 within T2, after the re-selection or when T2 expires, skip to step 11. Otherwise, if T2 expires and the UE has not yet re-selected Cell 1, the TE shall switch off and on the UE and continue with step 10.
10. Ensure the UE is in state RRC\_IDLE with generic procedure parameters Connectivity EUTRA/EPC with Test Mode *On* according to TS 38.508-1 [14] clause 4.5 in Cell 1.
11. Repeat step 3-9 the confidence level according to Table G.2.3-1 in Annex G is achieved.

#### 8.2.1.2.4.3 Message contents

Message contents are same as in 8.2.1.1.4.3 with the following exceptions.

**Table 8.2.1.2.4.3-1: highSpeedCarrierNR-r16 in SystemInformationBlockType24**

Derivation Path: TS 36.508, Table 4.4.3.3-20 with Condition FR1			
Information Element	Value/remark	Comment	Condition
SystemInformationBlockType24-r15 ::= SEQUENCE {			
CarrierFreqNR-v1610 ::= SEQUENCE {(SIZE (1..maxFreq)) OF SEQUENCE {	1 entry		
highSpeedCarrierNR-r16	TRUE		
}			

**Table 8.2.1.2.4.3-2: highSpeedInterRAT-NR-r16 configuration**

Derivation Path: 36.508 Table 4.6.3-14			
Information Element	Value/remark	Comment	Condition
RadioResourceConfigCommonSIB ::= SEQUENCE {			
highSpeedInterRAT-NR-r16	TRUE		
}			

**Table 8.2.1.2.4.3-3: SIB2**

Derivation Path: TS 38.508-1, Table 4.6.2-1			
Information Element	Value/remark	Comment	Condition
SIB2 ::= SEQUENCE {			
cellReselectionServingFreqInfo SEQUENCE {			
s-NonIntraSearchP	Not sent		
}			
}			

#### 8.2.1.2.5 Test requirement

Tables 8.2.1.2.4.1-3, 8.2.1.2.5-1 and 8.2.1.2.5-2 define the primary level settings including test tolerances for higher priority E-UTRA cell re-selection test case.

**Table 8.2.1.2.5-1: NR Cell specific test parameters for E-UTRA - NR FR1 cell re-selection to lower priority NR target cell for UE configured with highSpeedInterRAT-NR-r16**

Parameter	Unit	Test configuration	Cell 2	
			T1	T2
TDD configuration		1, 4	N/A	
		2, 5	TDDConf.1.1	
		3, 6	TDDConf.2.1	

Parameter	Unit	Test configuration	Cell 2	
			T1	T2
PDSCH Reference measurement channel		1, 4	SR.1.1 FDD	
		2, 5	SR.1.1 TDD	
		3, 6	SR.2.1 TDD	
RMSI CORESET Reference Channel		1, 4	CR.1.1 FDD	
		2, 5	CR.1.1 TDD	
		3, 6	CR.2.1 TDD	
RMC CORESET Reference Channel		1, 4	CCR.1.1 FDD	
		2, 5	CCR.1.1 TDD	
		3, 6	CCR.2.1 TDD	
OCNG Patterns		1, 2, 3, 4, 5, 6	OP.1	
SMTC configuration		1, 2, 3, 4, 5, 6	SMTC.1	
SSB configuration		1, 4	SSB.1 FR1	
		2, 5	SSB.1 FR1	
		3, 6	SSB.2 FR1	
Initial DL BWP configuration		1, 2, 3, 4, 5, 6	DLBWP.0.1	
Initial UL BWP configuration		1, 2, 3, 4, 5, 6	ULBWP.0.1	
RLM-RS		1, 2, 3, 4, 5, 6	SSB	
Qrxlevmin	dBm/SCS	1, 2, 4, 5	-140	
		3, 6	-137	
Pcompensation	dB	1, 2, 3, 4, 5, 6	0	
Qhysts	dB	1, 2, 3, 4, 5, 6	0	
Qoffsets <sub>s,n</sub>	dB	1, 2, 3, 4, 5, 6	0	
Cell_selection_and_reselection_quality_measurement		1, 2, 3, 4, 5, 6	SS-RSRP	
$\hat{E}_s / I_{ot}$	dB	1, 4	17.45	14
		2, 5		
		3, 6		
$N_{oc}$ <sup>Note2</sup>	dBm/SCS	1, 4	-99.9	
		2, 5	-99.9	
		3, 6	-96.9	
$N_{oc}$ <sup>Note2</sup>	dBm/15 kHz	1, 4	-99.9	
		2, 5		
		3, 6		
$\hat{E}_s / N_{oc}$	dB	1, 4	17.45	14
		2, 5		
		3, 6		
SS-RSRP <sup>Note3</sup>	dBm/SCS	1, 4	-82.45	-85.90
		2, 5	-82.45	-85.90
		3, 6	-79.45	-82.90
I <sub>o</sub>	dBm/9.36 MHz	1, 4	-54.42	-57.78
	dBm/9.36 MHz	2, 5	-54.42	-57.78
	dBm/38.16 MHz	3, 6	-48.32	-51.68
Treselection	s	1, 2, 3, 4, 5, 6	0	
Snonintrasearch	dB	1, 2, 3, 4, 5, 6	Not sent	
Thresh <sub>x,high</sub>	dB	1, 2, 3, 4, 5, 6	48	
Thresh <sub>-serving,low</sub>	dB	1, 2, 3, 4, 5, 6	44	
Thresh <sub>x,low</sub>	dB	1, 2, 3, 4, 5, 6	50	

Parameter	Unit	Test configuration	Cell 2	
			T1	T2
Propagation Condition		1, 2, 3, 4, 5, 6	AWGN 3334 <sup>Note 4</sup>	
NOTE 1: OCNG shall be used such that both cells are fully allocated and a constant total transmitted power spectral density is achieved for all OFDM symbols.				
NOTE 2: Interference from other cells and noise sources not specified in the test is assumed to be constant over subcarriers and time and shall be modelled as AWGN of appropriate power for $N_{oc}$ to be fulfilled.				
NOTE 3: SS-RSRP levels have been derived from other parameters for information purposes. They are not settable parameters themselves.				
NOTE 4: The AWGN 3334 Hz condition is a non fading propagation channel with one tap. Doppler shift is a constant 3334 Hz.				

**Table 8.2.1.2.5-2: E-UTRA Cell specific test parameters for for E-UTRA - NR FR1 cell re-selection to lower priority NR target cell for UE configured with highSpeedInterRAT-NR-r16**

Parameter	Unit	Cell 1	
		T1	T2
E-UTRA RF Channel number		1	
$BW_{channel}$	MHz	10	
OCNG Patterns defined in TS 36.133 clause A.3.2		OP.2 TDD for test configuration 1, 2, 3; OP.2 FDD for test configuration 4, 5, 6	
PBCH_RA	dB	0	
PBCH_RB	dB		
PSS_RA	dB		
SSS_RA	dB		
PCFICH_RB	dB		
PHICH_RA	dB		
PHICH_RB	dB		
PDCCH_RA	dB		
PDCCH_RB	dB		
PDSCH_RA	dB		
PDSCH_RB	dB		
OCNG_RA <sup>Note 1</sup>	dB		
OCNG_RB <sup>Note 1</sup>	dB		
Qrxlevmin	dBm	-140	
$N_{oc}$ <sup>Note 2</sup>	dBm/15 kHz	-99.9	
RSRP <sup>Note 3</sup>	dBm/15 KHz	-103.55	-103.55
$\hat{E}_s / I_{ot}$	dB	-3.65	-3.65
$\hat{E}_s / N_{oc}$	dB	-3.65	-3.65
Treselection <sub>EUTRAN</sub>	S	0	
Snonintrasearch	dB	50	
Thresh <sub>x, high</sub>	dB	48	
Thresh <sub>serv, low</sub>	dB	44	
Thresh <sub>x, low</sub>	dB	50	
Propagation Condition		AWGN 1944 Hz <sup>Note4</sup>	
NOTE 1: OCNG shall be used such that both cells are fully allocated and a constant total transmitted power spectral density is achieved for all OFDM symbols.			
NOTE 2: Interference from other cells and noise sources not specified in the test is assumed to be constant over subcarriers and time and shall be modelled as AWGN of appropriate power for $N_{oc}$ to be fulfilled.			
NOTE 3: RSRP levels have been derived from other parameters for information purposes. They are not settable parameters themselves.			
NOTE 4: The AWGN 1944 Hz condition is a non fading propagation channel with one tap. Doppler shift is a constant 1944 Hz.			

The cell reselection delay to a lower priority NR cell is defined as the time from the beginning of time period T1, to the moment when the UE camps on cell 2, and starts to send preambles on the PRACH for sending the RRC CONNECTION REQUEST message to perform a Tracking Area Update procedure on cell 2.

The cell re-selection delay to a lower priority cell shall be less than 3 s.

The rate of correct cell reselections observed during repeated tests shall be at least 90% with a confidence level of 95%.

NOTE: The cell re-selection delay to a lower priority cell can be expressed as:  $T_{\text{evaluate, NR}} + T_{\text{SI-NR}}$ .

Where:

$T_{\text{evaluate, NR}}$  See Table 4.2.2.5.6-2 in clause 4.2.2.5.6 in TS 36.133 [23]

$T_{\text{SI-NR}}$  Maximum repetition period of relevant system info blocks that needs to be received by the UE to camp on a cell; 1280 ms is assumed in this test case.

This gives a total of 2.24 s, allow 3 s for the cell re-selection delay to a lower priority NR cell.

## 8.3 RRC\_CONNECTED state mobility

### 8.3.1 Inter-RAT cell handover

#### 8.3.1.0 Minimum conformance requirements

##### 8.3.1.0.1 Minimum conformance requirements for E-UTRA - NR FR1 handover

[TS 36.133, clause 5.3.4.2]

When the UE receives a RRC message implying inter-RAT handover to the UE shall be ready to start the transmission of the uplink PRACH channel in NR within  $D_{\text{handover}}$  seconds from the end of the last TTI containing the RRC command.  $D_{\text{handover}}$  is defined as:

$$D_{\text{handover}} = T_{\text{RRC\_procedure\_delay}} + T_{\text{interruption}}$$

Where:

$T_{\text{RRC\_procedure\_delay}}$ : it is the RRC procedure delay which is [50] ms.

$T_{\text{interruption}}$ : it is the time between end of the last TTI containing the RRC command on the PDSCH in E-UTRAN and the time the UE starts transmission of the PRACH in NR, excluding  $T_{\text{RRC\_procedure\_delay}}$ .  $T_{\text{interruption}}$  is defined in TS 36.133 clause 5.3.4.3.

[TS 36.133, clause 5.3.4.3]

When inter-RAT handover to NR is commanded, the interruption time shall be less than  $T_{\text{interruption}}$

$$T_{\text{interruption}} = T_{\text{search}} + T_{\text{IU}} + T_{\text{rs}} + 20 \text{ ms}$$

Where:

$T_{\text{search}}$  is the time required to search the target cell when the target cell is not already known when the handover command is received by the UE. If the target cell is known, then  $T_{\text{search}} = 0$  ms. If the target cell is an unknown cell and target cell  $E_s/I_{\text{ot}} \geq [-2]$  dB, then  $T_{\text{search}} = 3 \cdot T_{\text{rs}} + 2$  ms. Regardless of whether DRX is in use by the UE,  $T_{\text{search}}$  shall still be based on non-DRX target cell search times.

$T_{\text{IU}}$  is the interruption uncertainty in acquiring the first available PRACH occasion in the new cell.  $T_{\text{IU}}$  can be up to the summation of SSB to PRACH occasion association period and 10 ms. SSB to PRACH occasion associated period is defined in the table 8.1-1 of TS 38.213.

NOTE: The actual value of  $T_{\text{IU}}$  shall depend upon the PRACH configuration used in the target cell.

$T_{rs}$  is the SMTC period of the target NR cell if the UE has been provided with an SMTC configuration for the target cell prior to, or in the handover command, otherwise  $T_{rs}$  is the target cell SSB transmission period, if such is provided. If the UE is not provided with an SMTC configuration or SSB transmission period, the requirement in this clause is applied with  $T_{rs} = 5$  ms assuming the SSB transmission periodicity is 5ms. There is no requirement if the SSB transmission periodicity is not 5ms. If UE is provided with both SMTC configuration and SSB transmission period the requirement shall be based on SMTC periodicity.

In the interruption requirement a cell is known if it has been meeting the relevant cell identification requirement during the last 5 seconds otherwise it is unknown. Relevant cell identification requirements are described in clauses 8.1.2.4.21 and 8.1.2.4.22.

The normative reference for this requirement is TS 38.133 [6] clause 5.3.4.2 and 5.3.4.3.

### 8.3.1.1 E-UTRA - NR FR1 handover with known target cell

#### 8.3.1.1.1 Test purpose

The purpose of this test is to verify the E-UTRAN to NR FR1 handover requirements as specified in TS 36.133 [23] clause 5.3.4.

#### 8.3.1.1.2 Test applicability

This test applies to all E-UTRA UE release 15 onwards and capable of NR measurements.

#### 8.3.1.1.3 Minimum conformance requirements

The minimum conformance requirements are specified in clause 8.3.1.0.

The normative reference for this requirement is TS 38.133 [6] clause A.8.3.1.1.

#### 8.3.1.1.4 Test description

The test comprises of one E-UTRA carrier and one NR carrier. There are two cells and one cell on each carrier. Cell 1 is the E-UTRAN PCell and Cell 2 is an inter-RAT NR neighbour cell. The test consists of three successive time periods, with time durations of T1, T2 and T3 respectively. At the start of time duration T1, the UE does not have any timing information of Cell 2. Starting T2, Cell 2 becomes detectable and the UE is expected to detect and send a measurement report. Gap pattern configuration with id #0 as specified in Table 8.1.2.1-1 of TS 36.133 [23] is configured before T2 begins to enable inter-RAT frequency monitoring.

##### 8.3.1.1.4.1 Initial conditions

This test shall be tested using any of the test configurations in Table 8.3.1.1.4.1-1.

**Table 8.3.1.1.4.1-1: Supported test configurations for E-UTRA - NR FR1 handover with known target cell**

Configuration	Description
8.3.1.1-1	LTE FDD, NR 15 kHz SSB SCS, 10 MHz bandwidth, FDD duplex mode
8.3.1.1-2	LTE FDD, NR 15 kHz SSB SCS, 10 MHz bandwidth, TDD duplex mode
8.3.1.1-3	LTE FDD, NR 30 kHz SSB SCS, 40 MHz bandwidth, TDD duplex mode
8.3.1.1-4	LTE TDD, NR 15 kHz SSB SCS, 10 MHz bandwidth, FDD duplex mode
8.3.1.1-5	LTE TDD, NR 15 kHz SSB SCS, 10 MHz bandwidth, TDD duplex mode
8.3.1.1-6	LTE TDD, NR 30 kHz SSB SCS, 40 MHz bandwidth, TDD duplex mode
NOTE: The UE is only required to be tested in one of the supported test configurations.	

Configure the test requirement and the DUT according to the parameters in Table 8.3.1.1.4.1-2.

**Table 8.3.1.1.4.1-2: Initial conditions for E-UTRA - NR FR1 handover with known target cell**

Parameter	Value		Comment
Test environment	NC		As specified in TS 36.508 [25] clause 4.1.
Test frequencies	As specified in Annex E, Table E.6-1 and TS 38.508-1 [14] clause 4.3.1.		
Channel bandwidth	As specified by the test configuration selected from Table 8.3.1.1.4.1-1.		
Propagation conditions	AWGN		As specified in clause C.2.1
Connection Diagram	TE Part	A.3.1.8.2	As specified in TS 38.508-1 [14] Annex A.
	DUT Part	A.3.2.3.4	
Exceptions to connection diagram	N/A		

1. The general test parameter settings are set up according to Table 8.3.1.1.4.1-3.
2. Message contents are defined in clause 8.3.1.1.4.3.
3. There are two carriers and two cells specified in the test, where E-UTRA Cell 1 is the E-UTRA PCell on the E-UTRA carrier and Cell 2 is the NR neighbour cell on the NR carrier. E-UTRA Cell 1 is configured according to TS 36.521-3 [26] clause C.1.0 and C.1.1.

**Table 8.3.1.1.4.1-3: General test parameters for E-UTRA - NR FR1 handover with known target cell**

Parameter	Unit	Value	Comment
NR RF Channel Number		1	1 NR carrier frequency is used in the test
LTE RF Channel Number		2	1 E-UTRAN carrier frequency is used in the test
Initial conditions	Active cell	Cell 1	E-UTRAN cell
	Neighbouring cell	Cell 2	NR cell
Final condition	Active cell	Cell 2	
NR measurement quantity		SS-RSRP	
E-UTRAN measurement quantity		RSRP	
b2-Threshold1	dBm	-83	Absolute E-UTRAN RSRP threshold for event B2
b2-Threshold2NR	dBm	As specified in Table 8.3.1.1.5-2	Absolute NR SS-RSRP threshold for event B2
Hysteresis	dB	0	
TimeToTrigger	s	0	
Filter coefficient		0	L3 filtering is not used
DRX		OFF	Non-DRX test
Access Barring Information	-	Not sent	No additional delays in random access procedure
Time offset between cells		3 ms	Asynchronous cells
Gap pattern configuration Id		0	As specified in Table 8.1.2.1-1 started before T2 starts [23]
T1	s	5	
T2	s	≤5	
T3	s	1	

#### 8.3.1.1.4.2 Test procedure

The test comprises of one E-UTRA carrier and one NR carrier. There are two cells and one cell on each carrier. Cell 1 is the E-UTRAN and Cell 2 is an inter-RAT NR neighbour cell. The general and cell specific test parameters for PCell and neighbour cell are given in Table 8.3.1.1.4.1-3, 8.3.1.1.5-1 and 8.3.1.1.5-2, respectively.

The test consists of three successive time periods, with time durations of T1, T2 and T3 respectively. At the start of time duration T1, the UE does not have any timing information of Cell 2. Starting T2, Cell 2 becomes detectable and the UE is expected to detect and send a measurement report. Gap pattern configuration with id #0 as specified in Table 8.1.2.1-1 of TS 36.133 [23] is configured before T2 begins to enable inter-RAT frequency monitoring.

A RRC message implying handover shall be sent to the UE during period T2 after the UE has reported Event B2. The start of T3 is the instant when the last TTI containing the RRC message implying handover is sent to the UE. The handover message shall contain Cell 2 as the target cell.

1. Ensure the UE is in State 3A-RF according to TS 36.508 [25] clause 7.2A.3.
2. Set the parameters of Cell 1 and Cell 2 according to T1 in Table 8.3.1.1.5-1 and Table 8.3.1.1.5-2 respectively, T1 starts.
3. The SS shall transmit an *RRCConnectionReconfiguration* message.
4. The UE shall transmit an *RRCConnectionReconfigurationComplete* message.
5. When T1 expires, the SS shall switch the parameters setting from T1 to T2 as specified in Table 8.3.1.1.5-1 and Table 8.3.1.1.5-2 respectively. T2 Starts.
6. UE shall transmit a *MeasurementReport* message triggered by Event B2.
7. SS shall transmit a *MobilityFromEUTRACommand* message implying handover to Cell 2.
8. The start of T3 is the instant when the last TTI containing the *MobilityFromEUTRACommand* message implying handover is sent to the UE, at that instant the SS shall switch the power setting from T2 to T3 as specified in Table 8.3.1.1.5-1 and Table 8.3.1.1.5-2.
9. The UE shall transmit an *RRCReconfigurationComplete* message on Cell 2.
10. If the UE transmits the uplink PRACH channel to Cell 2 less than 112 ms from the beginning of time period T3 then the number of successful tests is increased by one. Otherwise, the number of failure tests is increased by one.
11. After T3 expires,
  - The SS could switch the parameters setting from T3 to T1 as specified in Table 8.3.1.1.5-1 and Table 8.3.1.1.5-2 respectively.
  - If the UE handover back to E-UTRA Cell 1, then T1 starts, skip to step 3. Otherwise, switch off and on the UE. Then ensure the UE is in State 3A-RF according to TS 36.508 [25] clause 7.2A.3. E-UTRA Cell 1 is the active cell.
  - Or, switch off and on the UE Then ensure the UE is in State 3A-RF according to TS 36.508 [25] clause 7.2A.3. E-UTRA Cell 1 is the active cell.
12. Set Cell 2 physical cell identity = ((current Cell 2 physical cell identity + 1) mod 1008) for next iteration of the test procedure loop.
13. Repeat step 2-12 until the confidence level according to Tables G.2.3-1 in Annex G clause G.2 is achieved

#### 8.3.1.1.4.3 Message contents

Message contents are according to TS 36.508 [25] clause 7.3 with the following exceptions:

**Table 8.3.1.1.4.3-1: Common Exception messages for E-UTRA - NR FR1 handover with known target cell**

Default Message Contents	
Common contents of system information blocks exceptions	
Default RRC messages and information elements contents exceptions	Table H.3.3-2; Table H.3.4-1a Table H.3.4-4 with Condition INTER-RAT NR, EVENT B2 and gapUE Table H.3.4-5 with Condition Pattern #0
Specific message contents exceptions for Test Configuration 8.3.1.1-1, 8.3.1.1-2, 8.3.1.1-4 and 8.3.1.1-5	Table H.3.4-6 with Condition SSB.1 FR1, SMTC.1 and Asynchronous cells
Specific message contents exceptions for Test Configuration 8.3.1.1-3 and 8.3.1.1-6	Table H.3.4-6 with Condition SSB.2 FR1, SMTC.1 and Asynchronous cells

8.3.1.1.5 Test requirement

Table 8.3.1.1.4.1-3, 8.3.1.1.5-1 and 8.3.1.1.5-2 define the primary level settings including test tolerances for E-UTRA - NR FR1 handover with known target cell.

**Table 8.3.1.1.5-1: E-UTRAN PCell specific test parameters for E-UTRA - NR FR1 handover with known target cell**

Parameter	Unit	Configuration	Cell 1		
			T1	T2	T3
RF channel number		1, 2, 3, 4, 5, 6	2		
Duplex mode		1, 2, 3	FDD		
		4, 5, 6	TDD		
TDD special subframe configuration <sup>Note1</sup>		4, 5, 6	6		
TDD uplink-downlink configuration <sup>Note1</sup>		4, 5, 6	1		
BW <sub>channel</sub>	MHz	1, 2, 3, 4, 5, 6	5 MHz: N <sub>RB,c</sub> = 25 10 MHz: N <sub>RB,c</sub> = 50 20 MHz: N <sub>RB,c</sub> = 100		
PRACH Configuration <sup>Note2</sup>		1, 2, 3	4		
		4, 5, 6	53		
PDSCH parameters: DL Reference Measurement Channel <sup>Note3</sup>		1, 2, 3	5 MHz: R.7 FDD 10 MHz: R.3 FDD 20 MHz: R.6 FDD		
		4, 5, 6	5 MHz: R.4 TDD 10 MHz: R.0 TDD 20 MHz: R.3 TDD		
PCFICH/PDCCH/PHICH parameters: DL Reference Measurement Channel <sup>Note3</sup>		1, 2, 3	5 MHz: R.11 FDD 10 MHz: R.6 FDD 20 MHz: R.10 FDD		
		4, 5, 6	5 MHz: R.11 TDD 10 MHz: R.6 TDD 20 MHz: R.10 TDD		
OCNG Patterns <sup>Note3</sup>		1, 2, 3	5 MHz: OP.20 FDD 10 MHz: OP.10 FDD 20 MHz: OP.17 FDD		
		4, 5, 6	5 MHz: OP.9 TDD 10 MHz: OP.1 TDD 20 MHz: OP.7 TDD		



Parameter	Unit	Configuration	Cell 1		
			T1	T2	T3
PBCH_RA	dB	1, 2, 3, 4, 5, 6	0		
PBCH_RB					
PSS_RA					
SSS_RA					
PCFICH_RB					
PHICH_RA					
PHICH_RB					
PDCCH_RA					
PDCCH_RB					
PDSCH_RA					
PDSCH_RB					
OCNG_RA <sup>Note4</sup>					
OCNG_RB <sup>Note4</sup>					
$N_{oc}$ <sup>Note5</sup>					
$\hat{E}_s/N_{oc}$	dB	1, 2, 3, 4, 5, 6	7	5.45	5.45
$\hat{E}_s/I_{ot}$ <sup>Note6</sup>	dB	1, 2, 3, 4, 5, 6	7	5.45	5.45
RSRP <sup>Note6</sup>	dBm/15kHz	1, 2, 3, 4, 5, 6	-91	-92.55	-92.55
SCH_RP <sup>Note6</sup>	dBm/15kHz	1, 2, 3, 4, 5, 6	-91	-92.55	-92.55
$I_o$ <sup>Note6</sup>	dBm/9MHz	1, 2, 3, 4, 5, 6	-62.43	-63.68	-63.68
Propagation Condition		1, 2, 3, 4, 5, 6	AWGN		
Antenna Configuration and Correlation Matrix <sup>Note7</sup>		1, 2, 3, 4, 5, 6	1x2 Low		

NOTE 1: Special subframe and uplink-downlink configurations are specified in table 4.2-1 in TS 36.211 [23].  
 NOTE 2: PRACH configurations are specified in table 5.7.1-2 and table 5.7.1-3 in TS 36.211 [23].  
 NOTE 3: DL RMCs and OCNG patterns are specified in clauses A.3.1 and A.3.2 of TS 36.133 [15] respectively.  
 NOTE 4: OCNG shall be used such that all cells are fully allocated and a constant total transmitted power spectral density is achieved for all OFDM symbols.  
 NOTE 5: Interference from other cells and noise sources not specified in the test is assumed to be constant over subcarriers and time and shall be modelled as AWGN of appropriate power for  $N_{oc}$  to be fulfilled.  
 NOTE 6:  $\hat{E}_s/I_{ot}$ , RSRP, SCH\_RP and  $I_o$  levels have been derived from other parameters for information purposes. They are not settable parameters themselves.  
 NOTE 7: Propagation condition and correlation matrix are defined in clause B.2 in TS 36.101 [27].

**Table 8.3.1.1.5-2: NR neighbour cell specific test parameters for E-UTRA - NR FR1 handover with known target cell**

Parameter	Unit	Configuration	Cell 2		
			T1	T2	T3
RF channel number		1, 2, 3, 4, 5, 6	1		
Duplex mode		1, 4	FDD		
		2, 3, 5, 6	TDD		
TDD Configuration		2, 5	TDDConf.1.1		
		3, 6	TDDConf.2.1		
BW <sub>channel</sub>	MHz	1, 4	10: $N_{RB,c} = 52$ (FDD)		
		2, 5	10: $N_{RB,c} = 52$ (TDD)		
		3, 6	40: $N_{RB,c} = 106$ (TDD)		
PDSCH reference measurement channel		1, 4	SR.1.1 FDD		
		2, 5	SR.1.1 TDD		
		3, 6	SR.2.1 TDD		
CORSET reference channel		1, 4	CR.1.1 FDD		
		2, 5	CR.1.1 TDD		
		3, 6	CR.2.1 TDD		
OCNG pattern <sup>Note1</sup>		1, 2, 3, 4, 5, 6	OP.1		
BWP	Initial DL BWP	1, 2, 3, 4, 5, 6	DLBWP.0.1		
	Dedicated DL BWP		DLBWP.1.1		
	Initial UL BWP		ULBWP.0.1		
	Dedicated UL BWP		ULBWP.1.1		
SMTc configuration		1, 2, 3, 4, 5, 6	SMTc.1		
SSB configuration		1, 2, 4, 5	SSB.1 FR1		
		3, 6	SSB.2 FR1		
b2-Threshold2NR	dBm	1, 2, 4, 5	-106		

		3, 6	-103		
EPRE ratio of PSS to SSS	dB	1, 2, 3, 4, 5, 6	0		
EPRE ratio of PBCH_DMRS to SSS					
EPRE ratio of PBCH to PBCH_DMRS					
EPRE ratio of PDCCH_DMRS to SSS					
EPRE ratio of PDCCH to PDCCH_DMRS					
EPRE ratio of PDSCH_DMRS to SSS					
EPRE ratio of PDSCH to PDSCH_DMRS					
EPRE ratio of OCNG DMRS to SSS					
EPRE ratio of OCNG to OCNG DMRS					
$N_{oc}^{Note2}$	dBm/15 KHz	1, 2, 3, 4, 5, 6	-98		
$N_{oc}^{Note2}$	dBm/SCS	1, 2, 4, 5	-98		
		3, 6	-95		
$\hat{E}_s/N_{oc}$	dB	1, 2, 3, 4, 5, 6	-infinity	1.55	1.55
$\hat{E}_s/I_{ot}^{Note3}$	dB	1, 2, 3, 4, 5, 6	-infinity	1.55	1.55
SS-RSRP <sup>Note3</sup>	dBm/SCS	1, 2, 4, 5	-infinity	-96.45	-96.45
		3, 6	-infinity	-93.44	-93.44
$I_o^{Note3}$	dBm/9.36 MHz	1, 2, 4, 5	-70.05	-66.19	-66.19
	dBm/38.16 MHz	3, 6	-63.94	-60.09	-60.09
Propagation condition		1, 2, 3, 4, 5, 6	AWGN		
Antenna Configuration and Correlation Matrix		1, 2, 3, 4, 5, 6	1x2 Low		
NOTE 1: OCNG shall be used such that both cells are fully allocated and a constant total transmitted power spectral density is achieved for all OFDM symbols.					
NOTE 2: Interference from other cells and noise sources not specified in the test is assumed to be constant over subcarriers and time and shall be modelled as AWGN of appropriate power for $N_{oc}$ to be fulfilled.					
NOTE 3: $\hat{E}_s/I_{ot}$ , SS-RSRP, and $I_o$ levels have been derived from other parameters for information purposes. They are not settable parameters themselves.					

The UE shall start to transmit the PRACH to Cell 2 less than 112 ms from the beginning of time period T3.

The handover delay can be expressed as: RRC procedure delay +  $T_{interrupt}$ , where:

- RRC procedure delay = 50 ms and is specified in TS 36.133 [23].
- $T_{interrupt}$  = 62 ms in the test;  $T_{interrupt}$  is defined in TS 36.133 [23] clause 5.3.4.3.

This gives a total of 112 ms.

The rate of correct handovers observed during repeated tests shall be at least 90%.

## 8.4 Measurement procedures

### 8.4.1 SFTD measurement delay

#### 8.4.1.0 Minimum conformance requirements

##### 8.4.1.0.1 Minimum conformance requirements for E-UTRA - NR FR1 SFTD measurement delay

[TS 36.133, clause 8.1.2.4.25.1]

The UE shall perform inter-RAT SFTD measurement and report SFTD result with/without SS-RSRP after the network requests with *reportSFTD-Meas* set to *neighborCells*. The overall delay includes RRC procedure delay to be defined in clause 11.2 in TS 36.331 and SFTD measurement reporting delay in TS 36.133 clause 8.1.2.4.25.3.

[TS 36.133, clause 8.1.2.4.25.2]

The requirements on SFTD measurement delay defined in this clause are applicable under the side condition SCH  $\hat{E}_s/I_{ot} \geq -3$  dB for the NR cell. Depending on configuration, the SFTD measurement may be carried out with or without

the support of configured measurement gaps. In the current release, indication on whether to carry out the SFTD measurement with or without measurement gaps is implicit and depending on whether measurement gaps are configured.

The UE shall be able to detect, identify and measure SFTD of up to 3 of the strongest NR cells on the carrier frequency provided in the SFTD measurement configuration. Further depending on the SFTD measurement configuration, the UE shall additionally report SS-RSRP for the one or more NR cells. The UE may or may not be configured with *cellsForWhichToReportSFTD*. The UE does not expect *cellsForWhichToReportSFTD* to change during an ongoing SFTD measurement.

When no measurement gaps are provided, the UE shall be capable of finding the NR cell regardless of its SSB position in the SMTC period. The SFTD measurement shall be conducted with sustained connection to the E-UTRA PCell and activated SCell(s), however, the UE may be allowed to cause a certain amount of interruptions for reconfiguration of the radio receiver, as specified in TS 36.133 clause 7.35.

When measurement gaps are provided, the UE shall be capable of finding the NR cell under the additional condition that the SSB at least occasionally falls within the measurement gap.

When no MCG DRX is used, the UE shall be capable of determining SFTD within a physical layer measurement period of  $T_{\text{measure\_SFTD1}}$  as follows:

- For SFTD measurements without measurement gaps, and without additional SS-RSRP reporting:
  - For NR carrier in FR1:  $T_{\text{measure\_SFTD1}} = [14] \text{ SMTC periods}$
- For SFTD measurements in measurement gaps, and without additional SS-RSRP reporting:
  - For NR carrier in FR1:  $T_{\text{measure\_SFTD1}} = [N_{\text{freq}} \times 8 \times \max(\text{MGRP}, \text{SMTC period})]$
- For SFTD measurements without measurement gaps, and with additional SS-RSRP reporting:
  - For NR carrier in FR1:  $T_{\text{measure\_SFTD1}} = [19] \text{ SMTC periods}$
- For SFTD measurements in measurement gaps, and with additional SS-RSRP reporting:
  - For NR carrier in FR1:  $T_{\text{measure\_SFTD1}} = [N_{\text{freq}} \times 13 \times \max(\text{MGRP}, \text{SMTC period})]$

Where  $N_{\text{freq}}$  is the number of carriers monitored in measurement gaps.

When MCG DRX is used, the same  $T_{\text{measure\_SFTD1}}$  as for non-DRX applies, but the reporting delay depends on the DRX cycle length in use.

In case an NR PSCell is added, the UE shall terminate the inter-RAT SFTD measurement.

In case PCell is changed due to handover, the UE shall terminate the inter-RAT SFTD measurement.

[TS 36.133, clause 8.1.2.4.25.3]

The SFTD measurement reporting delay is defined as the time between a command that will trigger an SFTD measurement report and the point when the UE starts to transmit the measurement report over the air interface. This requirement assumes that the measurement report is not delayed by other RRC signalling on the DCCH. This measurement reporting delay excludes a delay uncertainty resulted when inserting the measurement report to the TTI of the uplink DCCH. The delay uncertainty is:  $2 \times TTI_{\text{DCCH}}$ . This measurement reporting delay excludes any delay caused by no UL resources for UE to send the measurement report. When the UE is configured to perform SRS carrier-based switching, an additional delay can be expected.

The SFTD measurement reporting delay shall be less than  $T_{\text{measure\_SFTD1}}$  defined in TS 36.133, clause 8.1.2.4.25.2.

## 8.4.1.1 E-UTRA - NR FR1 SFTD measurement delay in non-DRX

### 8.4.1.1.1 Test purpose

The purpose of this test is to partly verify that measurement reporting delay for SFTD between E-UTRA PCell and inter-RAT NR neighbour cell in FR1 is within the requirements stated in clauses 8.1.2.4.25 and 8.1.2.4.26 of TS 36.133 [23] for E-UTRA FDD and TDD, respectively, when no measurement gaps are provided and no DRX is configured.

#### 8.4.1.1.2 Test applicability

This test applies to all E-UTRA UE release 15 onwards and capable of inter-RAT SFTD measurements.

#### 8.4.1.1.3 Minimum conformance requirements

The minimum conformance requirements are specified in clause 8.4.1.0.

The normative reference for this requirement is TS 38.133 [6] clause A.8.4.1.1.

#### 8.4.1.1.4 Test description

Two carriers are used in this test: one E-UTRA carrier with the PCell (Cell 1), and one NR carrier with the NR neighbour cell (Cell 2).

This test consists of a single time period of duration T1. Prior to the start of time duration T1, the UE is connected to Cell 1 and configured to carry out intra-frequency measurements only. The point in time at which the UE receives, at the UE antenna connector(s), a RRC message containing a measurement configuration for SFTD measurements on RF channel 1 defines the start of time duration T1. Following the start of T1 the UE shall detect Cell 2, determine the SFN and frame time difference of Cell 2 relative to Cell 1, and send a measurement report. No measurement gaps are provided and no DRX is configured in this test.

##### 8.4.1.1.4.1 Initial conditions

This test shall be tested using any of the test configurations in Table 8.4.1.1.4.1-1.

**Table 8.4.1.1.4.1-1: Supported test configurations for E-UTRA - NR FR1 SFTD measurement delay in non-DRX**

Config	Description
8.4.1.1-1	LTE FDD, NR 15 kHz SSB SCS, 10 MHz bandwidth, FDD duplex mode
8.4.1.1-2	LTE FDD, NR 15 kHz SSB SCS, 10 MHz bandwidth, TDD duplex mode
8.4.1.1-3	LTE FDD, NR 30 kHz SSB SCS, 40 MHz bandwidth, TDD duplex mode
8.4.1.1-4	LTE TDD, NR 15 kHz SSB SCS, 10 MHz bandwidth, FDD duplex mode
8.4.1.1-5	LTE TDD, NR 15 kHz SSB SCS, 10 MHz bandwidth, TDD duplex mode
8.4.1.1-6	LTE TDD, NR 30 kHz SSB SCS, 40 MHz bandwidth, TDD duplex mode

NOTE: The UE is only required to be tested in one of the supported test configurations.

Configure the test requirement and the DUT according to the parameters in Table 8.4.1.1.4.1-2.

**Table 8.4.1.1.4.1-2: Initial conditions for E-UTRA - NR FR1 SFTD measurement delay in non-DRX**

Parameter	Value	Comment
Test environment	NC	As specified in TS 36.508 [25] clause 4.1.
Test frequencies	As specified in Annex E, Table E.6-1 and TS 38.508-1 [14] clause 4.3.1.	
Channel bandwidth	As specified by the test configuration selected from Table 8.4.1.1.4.1-1.	
Propagation conditions	AWGN	As specified in clause C.2.1
Connection Diagram	TE Part DUT Part	A.3.1.8.2 A.3.2.3.4
Exceptions to connection diagram	N/A	

1. The general test parameter settings are set up according to Table 8.4.1.1.4.1-3.
2. Message contents are defined in clause 8.4.1.1.4.3.
3. There are two carriers and two cells specified in the test, where Cell 1 is the E-UTRA PCell on the E-UTRA carrier and Cell 2 is the NR neighbour cell on the NR carrier. Cell 1 is the cell used for connection setup for this test. E-UTRA Cell 1 is configured according to TS 36.521-3 [26] clauses C.1.0 and C.1.1.

**Table 8.4.1.1.4.1-3: General test parameters for E-UTRA - NR FR1 SFTD measurement delay in non-DRX**

Parameter	Unit	Test configuration	Value		Comment
			Test 1	Test 2	
E-UTRA RF Channel Number		Config 1,2,3,4,5,6	1		One E-UTRAN carrier frequencies is used.
NR RF Channel Number		Config 1,2,3,4,5,6	1		One NR FR1 carrier frequencies is used.
Active cell		Config 1,2,3,4,5,6	Cell 1		Cell 1 is on E-UTRA RF channel number 1.
Neighbour cell		Config 1,2,3,4,5,6	Cell 2		Cell 2 is on NR RF channel number 1.
SSB configuration		Config 1,4	SSB.1 FR1		As specified in TS 38.133 [6] clause A.3.10.1
		Config 2,5	SSB.1 FR1		As specified in TS 38.133 [6] clause A.3.10.1
		Config 3,6	SSB.2 FR1		As specified in TS 38.133 [6] clause A.3.10.1
CP length		Config 1,2,3,4,5,6	Normal		Applicable to both cells.
DRX		Config 1,2,3,4,5,6	OFF		DRX is not used
Frame time offset between serving and neighbour cells	ms	Config 1,2,4,5	3	7	Asynchronous cells. The timing of Cell 2 relative to the timing of Cell 1.
	µs	Config 3,6	3		Synchronous cells.
SFN offset between serving and neighbour cells		Config 1,2,3,4,5,6	0	1	SFN of Cell 2 relative to SFN of Cell 1.
T1	s	Config 1,2,3,4,5,6	1		

#### 8.4.1.1.4.2 Test procedure

Two cells are deployed in the test, which are E-UTRA PCell (Cell 1) on the E-UTRA carrier and a FR1 NR neighbour cell (Cell 2) on NR carrier. The general test parameters are given in Table 8.4.1.1.4.1-3. The test has two subtests with different frame time offset and SFN offset. Cell specific test parameters for the E-UTRA PCell and neighbour cell are given in Table 8.4.1.1.5-1 and 8.4.1.1.5-2, respectively.

In the measurement control information, it is indicated to the UE that inter-RAT SFTD measurement on Cell 2 is used. This test consists of single time period with time duration of T1. Prior to the start of time duration T1, the UE is connected to Cell 1 and configured to carry out intra-frequency measurements only.

Configure the frame time offset and SFN offset according to Test 1 in Table 8.4.1.1.4.1-3.

1. Ensure the UE is in State 3A-RF according to TS 36.508 [25] clause 7.2A.3.
2. Set the parameters of Cell 2 according to T1 in Table 8.4.1.1.5-2, T1 starts.
3. The SS shall transmit an *RRCCONNECTIONRECONFIGURATION* message.
4. The UE shall transmit an *RRCCONNECTIONRECONFIGURATIONCOMPLETE* message.
5. UE shall transmit a *MEASUREMENTREPORT* message triggered by SFTD measurement reporting. If the overall delays measured from the beginning of time period T1 is less than 297 ms then the number of successful tests is increased by one. If the UE fails to report within the overall delays measured requirement then the number of failure tests is increased by one.
6. After the SS receive the *MEASUREMENTREPORT* message in step 6) or when T1 expires, the SS shall transmit an *RRCCONNECTIONRELEASE* message to release the RRC connection which includes the release of the established radio bearers as well as all radio resources.
7. Set Cell 2 physical cell identity = ((current Cell 2 physical cell identity + 1) mod 1008) for next iteration of the test procedure loop.

8. After the RRC connection release, the SS:
  - transmits in Cell 1 a Paging message (including PagingRecord with UE-Identity) for the UE and ensures the UE is in State 3A according to TS 36.508 [25] clause 4.5.3A (if the paging fails, switches off and on the UE and ensures the UE is in State 3A-RF according to TS 36.508 [25] clause 7.2A.3); or
  - switches off and on the UE and ensures the UE is in State 3A-RF according to TS 36.508 [25] clause 7.2A.3.
9. Repeat step 2-8 until the confidence level according to Tables G.2.3-1 in Annex G clause G.2 is achieved.
10. Set the frame time offset and SFN offset for Test 2 according to Table 8.4.1.1.4.1-3 and repeat steps 1 to 9.

#### 8.4.1.1.4.3 Message contents

Message contents are according to TS 36.508 [25] clause 7.3 with the following exceptions:

**Table 8.4.1.1.4.3-1: Common Exception messages for E-UTRA - NR FR1 SFTD measurement delay in non-DRX**

Default Message Contents	
Common contents of system information blocks exceptions	
Default RRC messages and information elements contents exceptions	Table H.3.4-7 with Condition Inter-RAT and SFTD; Table H.3.4-4 with Condition INTER-RAT NR, SFTD and GAPLESS
Specific message contents exceptions for Test Configuration 8.4.1.1-1 8.4.1.1-2, 8.4.1.1-4 and 8.4.1.1-5	Table H.3.4-6 with Condition SSB.1 FR1 andSMTC.1
Specific message contents exceptions for Test Configuration 8.4.1.1-3 and 8.4.1.1-6	Table H.3.4-6 with Condition SSB.2 FR1 andSMTC.1

#### 8.4.1.1.5 Test requirement

Table 8.4.1.1.4.1-3, 8.4.1.1.5-1 and 8.4.1.1.5-2 define the primary level settings including test tolerances for E-UTRA - NR FR1 SFTD measurement delay in non-DRX.

**Table 8.4.1.1.5-1: E-UTRA Cell specific test parameters for E-UTRA - NR FR1 SFTD measurement delay in non-DRX**

Parameter	Unit	E-UTRAN Cell1
E-UTRA RF Channel Number		1
Duplex mode		FDD or TDD
TDD special subframe configuration <sup>Note1</sup>		6
TDD uplink-downlink configuration <sup>Note1</sup>		1
BW <sub>channel</sub>		5 MHz: N <sub>RB,c</sub> = 25 10 MHz: N <sub>RB,c</sub> = 50 20 MHz: N <sub>RB,c</sub> = 100
PDSCH parameters: DL Reference Measurement Channel <sup>Note2</sup>		5 MHz: R.7 FDD 10 MHz: R.3 FDD 20 MHz: R.6 FDD 5 MHz: R.4 TDD 10 MHz: R.0 TDD 20 MHz: R.3 TDD
PCFICH/PDCCH/PHICH parameters: DL Reference Measurement Channel <sup>Note2</sup>		5 MHz: R.11 FDD 10 MHz: R.6 FDD 20 MHz: R.10 FDD 5 MHz: R.11 TDD 10 MHz: R.6 TDD 20 MHz: R.10 TDD
OCNG Patterns <sup>Note2</sup>		5 MHz: OP.20 FDD 10 MHz: OP.10 FDD 20 MHz: OP.17 FDD 5 MHz: OP.9 TDD 10 MHz: OP.1 TDD 20 MHz: OP.7 TDD
PBCH_RA	dB	0

PBCH_RB	dB	
PSS_RA	dB	
SSS_RA	dB	
PCFICH_RB	dB	
PHICH_RA	dB	
PHICH_RB	dB	
PDCCH_RA	dB	
PDCCH_RB	dB	
PDSCH_RA	dB	
PDSCH_RB	dB	
OCNG_RA <sup>Note3</sup>	dB	
OCNG_RB <sup>Note3</sup>	dB	
$N_{oc}$ <sup>Note4</sup>	dBm/15 kHz	-104
$\bar{E}_s/N_{oc}$	dB	17
$\bar{E}_s/I_{ot}$	dB	17
RSRP <sup>Note5</sup>	dBm/15 kHz	-87
SCH_RP <sup>Note5</sup>	dBm/15 kHz	-87
$I_o$ <sup>Note5</sup>	dBm/Ch BW	$-59.13+10\log(N_{RB,c}/50)$
Propagation Condition		AWGN
Antenna Configuration		1x2
NOTE 1: Special subframe and uplink-downlink configurations are specified in table 4.2-1 in TS 36.211 [24].		
NOTE 2: DL RMCs and OCNG patterns are specified in clauses A 3.1 and A 3.2 of TS 36.133 [23] respectively.		
NOTE 3: OCNG shall be used such that all cells are fully allocated and a constant total transmitted power spectral density is achieved for all OFDM symbols.		
NOTE 4: Interference from other cells and noise sources not specified in the test is assumed to be constant over subcarriers and time and shall be modelled as AWGN of appropriate power for $N_{oc}$ to be fulfilled.		
NOTE 5: $\bar{E}_s/I_{ot}$ , RSRP, SCH_RP and $I_o$ levels have been derived from other parameters for information purposes. They are not settable parameters themselves.		

**Table 8.4.1.1.5-2: NR Cell specific test parameters for E-UTRA - NR FR1 SFTD measurement delay in non-DRX**

Parameter	Unit	Test configuration	Cell 2
NR RF Channel Number		Config 1,2,3,4,5,6	1
Duplex mode		Config 1,4	FDD
		Config 2,3,5,6	TDD
$BW_{\text{channel}}$	MHz	Config 1,4	10: $N_{RB,c} = 52$
		Config 2,5	10: $N_{RB,c} = 52$
		Config 3,6	40: $N_{RB,c} = 106$
TDD configuration		Config 2,5	TDDConf.1.1
		Config 3,6	TDDConf.2.1
OCNG Pattern defined in A.3.2.1.1		Config 1,2,3,4,5,6	OP.1
SMTC configuration		Config 1,2,3,4,5,6	SMTC.1
PDSCH/PDCCH subcarrier spacing	kHz	Config 1,2,4,5	15
		Config 3,6	30
EPRE ratio of PSS to SSS	dB	Config 1,2,3,4,5,6	0
EPRE ratio of PBCH DMRS to SSS	dB		
EPRE ratio of PBCH to PBCH DMRS	dB		
EPRE ratio of OCNG DMRS to SSS <small>Note 1</small>	dB		
EPRE ratio of OCNG to OCNG DMRS <small>Note 1</small>	dB		
$N_{oc}$ <small>Note2</small>	dBm/15kHz		-98
$N_{oc}$ <small>Note2</small>	dBm/SCS	Config 1,2,4,5	-98
		Config 3,6	-95
SS-RSRP <small>Note 3, 4</small>	dBm/SCS	Config 1,2,4,5	-94
		Config 3,6	-91
$\bar{E}_s/I_{ot}$	dB	Config 1,2,3,4,5,6	4
$\bar{E}_s/N_{oc}$	dB	Config 1,2,3,4,5,6	4
$I_o$ <small>Note 3</small>	dBm/9.36MHz	Config 1,2,4,5	-64.59
	dBm/38.16MHz	Config 3,6	-58.49
Propagation Condition		Config 1,2,3,4,5,6	AWGN
<p>NOTE 1: OCNG shall be used such that the cell is fully allocated and a constant total transmitted power spectral density is achieved for all OFDM symbols.</p> <p>NOTE 2: Interference from other cells and noise sources not specified in the test is assumed to be constant over subcarriers and time and shall be modelled as AWGN of appropriate power for <math>N_{oc}</math> to be fulfilled.</p> <p>NOTE 3: SS-RSRP and <math>I_o</math> levels have been derived from other parameters for information purposes. They are not settable parameters themselves.</p> <p>NOTE 4: SS-RSRP minimum requirements are specified assuming independent interference and noise at each receiver antenna port.</p>			

The overall delays measured is defined as the time from the beginning of time period T1, to the moment the UE send one SFTD measurement triggered measurement report.

The overall delays measured in the test may be up to  $2xTTI_{DCCH}$  higher than the measurement reporting delays because of TTI insertion uncertainty of the measurement report in DCCH.

The overall delays measured test requirement is expressed as:

- Overall delays measured = measurement reporting delay + TTI insertion uncertainty
- Measurement reporting delay =  $T_{RRC\_procedure\_delay} + T_{measure\_SFTD1}$

$T_{RRC\_procedure\_delay} = 15$  ms, is the RRC procedure delay for RRC reconfiguration, which is defined in TS 36.331 [2] Clause 11.2

$T_{measure\_SFTD1} = 280$  ms, is the SFTD measurement report delay defined in TS 36.133 [23] clause 8.1.2.4.25 and 8.1.2.4.26 for FDD and TDD E-UTRA Cell 1, respectively.

- TTI insertion uncertainty = 2 ms



The overall delays measured shall be less than a total of 297 ms.

For the test to pass, the total number of successful tests shall be more than 90% of the cases with a confidence level of 95%.

## 8.4.1.2 E-UTRA - NR FR1 SFTD measurement delay in DRX

### 8.4.1.2.1 Test purpose

The purpose of this test is:

- To partly verify that measurement reporting delay for SFTD between E-UTRA PCell and inter-RAT NR neighbour cell in FR1 is within the requirements stated in clauses 8.1.2.4.25 and 8.1.2.4.26 of TS 36.133 [23] for E-UTRA FDD and TDD, respectively, when no measurement gaps are provided and DRX is configured.

### 8.4.1.2.2 Test applicability

This test applies to all types of E-UTRA UE Release 15 and forward supporting inter-RAT SFTD measurements and long DRX cycle.

### 8.4.1.2.3 Minimum conformance requirements

The minimum conformance requirements are specified in clause 8.4.1.0.

The normative reference for this requirement is TS 38.133 [6] clause A.8.4.1.2.

### 8.4.1.2.4 Test description

Two carriers are used in this test: one E-UTRA carrier with the PCell (Cell 1), and one NR carrier with the NR neighbour cell (Cell 2).

This test consists of a single time period of duration T1. Prior to the start of time duration T1, the UE is connected to Cell 1 and configured to carry out intra-frequency measurements only. The point in time at which the UE receives, at the UE antenna connector(s), a RRC message containing a measurement configuration for SFTD measurements on RF channel 1 defines the start of time duration T1. Following the start of T1 the UE shall detect Cell 2, determine the SFN and frame time difference of Cell 2 relative to Cell 1, and send a measurement report. No measurement gaps are provided and DRX is configured in this test.

#### 8.4.1.2.4.1 Initial conditions

This test shall be tested using any of the test configurations in Table 8.4.1.2.4.1-1.

**Table 8.4.1.2.4.1-1: Supported test configurations for E-UTRA - NR FR1 SFTD measurement delay in DRX**

Config	Description
8.4.1.2-1	LTE FDD, NR 15 kHz SSB SCS, 10 MHz bandwidth, FDD duplex mode
8.4.1.2-2	LTE FDD, NR 15 kHz SSB SCS, 10 MHz bandwidth, TDD duplex mode
8.4.1.2-3	LTE FDD, NR 30 kHz SSB SCS, 40 MHz bandwidth, TDD duplex mode
8.4.1.2-4	LTE TDD, NR 15 kHz SSB SCS, 10 MHz bandwidth, FDD duplex mode
8.4.1.2-5	LTE TDD, NR 15 kHz SSB SCS, 10 MHz bandwidth, TDD duplex mode
8.4.1.2-6	LTE TDD, NR 30 kHz SSB SCS, 40 MHz bandwidth, TDD duplex mode
NOTE: The UE is only required to be tested in one of the supported test configurations.	

Configure the test requirement and the DUT according to the parameters in Table 8.4.1.2.4.1-2.

**Table 8.4.1.2.4.1-2: Initial conditions for E-UTRA - NR FR1 SFTD measurement delay in DRX**

Parameter	Value		Comment
Test environment	NC		As specified in TS 36.508 [25] clause 4.1.
Test frequencies	As specified in Annex E, Table E.6-1 and TS 38.508-1 [14] clause 4.3.1.		
Channel bandwidth	As specified by the test configuration selected from Table 8.4.1.2.4.1-1.		
Propagation conditions	AWGN		As specified in clause C.2.1
Connection Diagram	TE Part	A.3.1.8.2	As specified in TS 38.508-1 [14] Annex A.
	DUT Part	A.3.2.3.4	
Exceptions to connection diagram	N/A		

1. The general test parameter settings are set up according to Table 8.4.1.2.4.1-3.
2. Message contents are defined in clause 8.4.1.2.4.3.
3. There are two carriers and two cells specified in the test, where Cell 1 is the E-UTRA PCell on the E-UTRA carrier and Cell 2 is the NR neighbour cell on the NR carrier. Cell 1 is the cell used for connection setup for this test. E-UTRA Cell 1 is configured according to TS 36.521-3 [26] clauses C.1.0 and C.1.1.

**Table 8.4.1.2.4.1-3: General test parameters for E-UTRA - NR FR1 SFTD measurement delay in DRX**

Parameter	Unit	Test configuration	Value		Comment
			Test 1	Test 2	
E-UTRA RF Channel Number		Config 1,2,3,4,5,6	1		One E-UTRAN carrier frequencies is used.
NR RF Channel Number		Config 1,2,3,4,5,6	1		One NR FR1 carrier frequencies is used.
Active cell		Config 1,2,3,4,5,6	Cell 1		Cell 1 is on E-UTRA RF channel number 1.
Neighbour cell		Config 1,2,3,4,5,6	Cell 2		Cell 2 is on NR RF channel number 1.
SSB Configuration		Config 1,4	SSB.1 FR1		As specified in TS 38.133 [6] clause A.3.10.1
		Config 2,5	SSB.1 FR1		As specified in TS 38.133 [6] clause A.3.10.1
		Config 3,6	SSB.2 FR1		As specified in TS 38.133 [6] clause A.3.10.1
CP length		Config 1,2,3,4,5,6	Normal		Applicable to both cells.
DRX		Config 1,2,3,4,5,6	DRX.4		DRX configuration as specified in TS 38.133 [6] clause A.3.3.4
Frame time offset between serving and neighbour cells	ms	Config 1,2,4,5	3	7	Asynchronous cells. The timing of Cell 2 relative to the timing of Cell 1.
	µs	Config 3,6	3		Synchronous cells.
SFN offset between serving and neighbour cells		Config 1,2,3,4,5,6	0	1	SFN of Cell 2 relative to SFN of Cell 1.
T1	s	Config 1,2,3,4,5,6	1		

#### 8.4.1.2.4.2 Test procedure

Two cells are deployed in the test, which are E-UTRA PCell (Cell 1) on the E-UTRA carrier and a FR1 NR neighbour cell (Cell 2) on NR carrier. The general test parameters are given in Table 8.4.1.2.4.1-3. The test has two subtests with different frame time offset and SFN offset. Cell specific test parameters for the E-UTRA PCell and neighbour cell are given in Table 8.4.1.2.5-1 and 8.4.1.2.5-2, respectively.

In the measurement control information, it is indicated to the UE that inter-RAT SFTD measurement on Cell 2 is used. This test consists of single time period with time duration of T1. Prior to the start of time duration T1, the UE is connected to Cell 1 and configured to carry out intra-frequency measurements only.

Configure the frame time offset and SFN offset according to Test 1 in Table 8.4.1.2.4.1-3.

1. Ensure the UE is in State 3A-RF according to TS 36.508 [25] clause 7.2A.3.
2. Set the parameters of Cell 2 according to T1 in Table 8.4.1.2.5-2, T1 starts.
3. The SS shall transmit an *RRCConnectionReconfiguration* message.
4. The UE shall transmit an *RRCConnectionReconfigurationComplete* message.
5. UE shall transmit a *MeasurementReport* message triggered by SFTD measurement reporting. . If the overall delays measured from the beginning of time period T1 is less than 455 ms then the number of successful tests is increased by one, otherwise the number of failure tests is increased by one.
6. After the SS receive the *MeasurementReport* message in step 6) or when T1 expires, the SS shall transmit an *RRCConnectionRelease* message to release the RRC connection which includes the release of the established radio bearers as well as all radio resources.
7. Set Cell 2 physical cell identity = ((current Cell 2 physical cell identity + 1) mod1008) for next iteration of the test procedure loop.
8. After the RRC connection release, the SS:
  - transmits in Cell 1 a Paging message (including PagingRecord with UE-Identity) for the UE and ensures the UE is in State 3A according to TS 36.508 [25] clause 4.5.3A (if the paging fails, switches off and on the UE and ensures the UE is in State 3A-RF according to TS 36.508 [25] clause 7.2A.3); or
  - switches off and on the UE and ensures the UE is in State 3A-RF according to TS 36.508 [25] clause 7.2A.3.
9. Repeat step 2-8 until the confidence level according to Tables G.2.3-1 in Annex G clause G.2 is achieved.
10. Set the frame time offset and SFN offset for Test 2 according to Table 8.4.1.2.4.1-3 and repeat steps 1 to 9.

#### 8.4.1.2.4.3 Message contents

Message contents are according to TS 36.508 [25] clause 7.3 with the following exceptions.

**Table 8.4.1.2.4.3-1: Common Exception messages for E-UTRA - NR FR1 SFTD measurement delay in DRX**

Default Message Contents	
Common contents of system information blocks exceptions	
Default RRC messages and information elements contents exceptions	Table H.3.4-7 with Condition Inter-RAT and SFTD; Table H.3.4-4 with Condition INTER-RAT NR, SFTD and GAPLESS Table H.3.7-2 with Condition DRX.4
Specific message contents exceptions for Test Configuration 8.4.1.1-1, 8.4.1.1-2, 8.4.1.1-4 and 8.4.1.1-5	Table H.3.4-6 with Condition SSB.1 FR1 and SMTC.1 and
Specific message contents exceptions for Test Configuration 8.4.1.1-3 and 8.4.1.1-6	Table H.3.4-6 with Condition SSB.2 FR1 and SMTC.1

#### 8.4.1.2.5 Test requirement

Table 8.4.1.2.4.1-3, 8.4.1.2.5-1 and 8.4.1.2.5-2 define the primary level settings including test tolerances for E-UTRA - NR FR1 SFTD measurement delay in DRX.

**Table 8.4.1.2.5-1: E-UTRA Cell specific test parameters for E-UTRA - NR FR1 SFTD measurement delay in DRX**

Parameter	Unit	E-UTRAN Cell1
E-UTRA RF Channel Number		1
Duplex mode		FDD or TDD
TDD special subframe configuration <sup>Note1</sup>		6

TDD uplink-downlink configuration <sup>Note1</sup>		1
BW <sub>channel</sub>		5 MHz: N <sub>RB,c</sub> = 25 10 MHz: N <sub>RB,c</sub> = 50 20 MHz: N <sub>RB,c</sub> = 100
PDSCH parameters: DL Reference Measurement Channel <sup>Note2</sup>		5 MHz: R.7 FDD 10 MHz: R.3 FDD 20 MHz: R.6 FDD 5 MHz: R.4 TDD 10 MHz: R.0 TDD 20 MHz: R.3 TDD
PCFICH/PDCCH/PHICH parameters: DL Reference Measurement Channel <sup>Note2</sup>		5 MHz: R.11 FDD 10 MHz: R.6 FDD 20 MHz: R.10 FDD 5 MHz: R.11 TDD 10 MHz: R.6 TDD 20 MHz: R.10 TDD
OCNG Patterns <sup>Note2</sup>		5 MHz: OP.20 FDD 10 MHz: OP.10 FDD 20 MHz: OP.17 FDD 5 MHz: OP.9 TDD 10 MHz: OP.1 TDD 20 MHz: OP.7 TDD
PBCH_RA	dB	0
PBCH_RB	dB	
PSS_RA	dB	
SSS_RA	dB	
PCFICH_RB	dB	
PHICH_RA	dB	
PHICH_RB	dB	
PDCCH_RA	dB	
PDCCH_RB	dB	
PDSCH_RA	dB	
PDSCH_RB	dB	
OCNG_RA <sup>Note3</sup>	dB	
OCNG_RB <sup>Note3</sup>	dB	
N <sub>oc</sub> <sup>Note4</sup>	dBm/15 kHz	
$\bar{E}_s/N_{oc}$	dB	17
$\bar{E}_s/I_{ot}$	dB	17
RSRP <sup>Note5</sup>	dBm/15 kHz	-87
SCH_RP <sup>Note5</sup>	dBm/15 kHz	-87
I <sub>o</sub> <sup>Note5</sup>	dBm/Ch BW	-59.13+10log(N <sub>RB,c</sub> /50)
Propagation Condition		AWGN
Antenna Configuration		1x2
<p>NOTE 1: Special subframe and uplink-downlink configurations are specified in table 4.2-1 in TS 36.211 [24].</p> <p>NOTE 2: DL RMCs and OCNG patterns are specified in clauses A 3.1 and A 3.2 of TS 36.133 [23] respectively.</p> <p>NOTE 3: OCNG shall be used such that all cells are fully allocated and a constant total transmitted power spectral density is achieved for all OFDM symbols.</p> <p>NOTE 4: Interference from other cells and noise sources not specified in the test is assumed to be constant over subcarriers and time and shall be modelled as AWGN of appropriate power for N<sub>oc</sub> to be fulfilled.</p> <p>NOTE 5: E<sub>s</sub>/I<sub>ot</sub>, RSRP, SCH_RP and I<sub>o</sub> levels have been derived from other parameters for information purposes. They are not settable parameters themselves.</p>		

**Table 8.4.1.2.5-2: NR Cell specific test parameters for E-UTRA - NR FR1 SFTD measurement delay in DRX**

Parameter	Unit	Test configuration	Cell 2
NR RF Channel Number		Config 1,2,3,4,5,6	1
Duplex mode		Config 1,4	FDD
		Config 2,3,5,6	TDD
BW <sub>channel</sub>	MHz	Config 1,4	10: N <sub>RB,c</sub> = 52
		Config 2,5	10: N <sub>RB,c</sub> = 52
		Config 3,6	40: N <sub>RB,c</sub> = 106
TDD configuration		Config 2,5	TDDConf.1.1
		Config 3,6	TDDConf.2.1
OCNG Pattern defined in A.3.2.1.1		Config 1,2,3,4,5,6	OP.1
SMTC configuration		Config 1,2,3,4,5,6	SMTC.1
PDSCH/PDCCH subcarrier spacing	kHz	Config 1,2,4,5	15
		Config 3,6	30
EPRE ratio of PSS to SSS	dB	Config 1,2,3,4,5,6	0
EPRE ratio of PBCH DMRS to SSS	dB		
EPRE ratio of PBCH to PBCH DMRS	dB		
EPRE ratio of OCNG DMRS to SSS <small>Note 1</small>	dB		
EPRE ratio of OCNG to OCNG DMRS <small>Note 1</small>	dB		
N <sub>oc</sub> <small>Note2</small>	dBm/15kHz		-98
N <sub>oc</sub> <small>Note2</small>	dBm/SCS	Config 1,2,4,5	-98
		Config 3,6	-95
SS-RSRP <small>Note 3, 4</small>	dBm/SCS	Config 1,2,4,5	-94
		Config 3,6	-91
$\bar{E}_s/I_{ot}$	dB	Config 1,2,3,4,5,6	4
$\bar{E}_s/N_{oc}$	dB	Config 1,2,3,4,5,6	4
I <sub>o</sub> <small>Note 3</small>	dBm/9.36MHz	Config 1,2,4,5	-64.59
	dBm/38.16MHz	Config 3,6	-58.49
Propagation Condition		Config 1,2,3,4,5,6	AWGN
<p>NOTE 1: OCNG shall be used such that the cell is fully allocated and a constant total transmitted power spectral density is achieved for all OFDM symbols.</p> <p>NOTE 2: Interference from other cells and noise sources not specified in the test is assumed to be constant over subcarriers and time and shall be modelled as AWGN of appropriate power for N<sub>oc</sub> to be fulfilled.</p> <p>NOTE 3: SS-RSRP and I<sub>o</sub> levels have been derived from other parameters for information purposes. They are not settable parameters themselves.</p> <p>NOTE 4: SS-RSRP minimum requirements are specified assuming independent interference and noise at each receiver antenna port.</p>			

The overall delays measured is defined as the time from the beginning of time period T1, to the moment the UE send one SFTD measurement triggered measurement report.

The overall delays measured in the test may be up to 2xTTI<sub>DCCH</sub> higher than the measurement reporting delays because of TTI insertion uncertainty of the measurement report in DCCH.

The overall delays measured test requirement is expressed as:

- Overall delays measured = measurement reporting delay + TTI insertion uncertainty
- Measurement reporting delay = T<sub>RRC\_procedure\_delay</sub> + T<sub>measure\_SFTD1</sub> + T<sub>DRX\_transmission</sub>

T<sub>RRC\_procedure\_delay</sub> = 15 ms, is the RRC procedure delay for RRC reconfiguration, which is defined in TS 36.331 [2] Clause 11.2

T<sub>measure\_SFTD1</sub> = 280 ms, is the SFTD measurement report delay defined in TS 36.133 [23] clause 8.1.2.4.25 and 8.1.2.4.26 for FDD and TDD E-UTRA Cell 1, respectively. When DRX is used, the same T<sub>measure\_SFTD1</sub> as for non-DRX applies.

$T_{\text{DRX\_transmission}} = 158$  ms, it is the time until the next transmission in the worst case that the last PDDCH is missed at 280ms from the beginning of T1.

- TTI insertion uncertainty = 2 ms

The overall delays measured shall be less than a total of 455 ms.

For the test to pass, the total number of successful tests shall be more than 90% of the cases with a confidence level of 95%.

## 8.4.2 Inter-RAT measurements

### 8.4.2.0 Minimum conformance requirements

#### 8.4.2.0.1 Minimum conformance requirements for E-UTRA - NR event-triggered measurement

The UE shall be able to identify new inter-RAT E-UTRAN – NR cells and perform SS-RSRP, SS-RSRQ, and SS-SINR measurements of identified inter-RAT cells if carrier frequency information is provided by the PCell, even if no explicit neighbour list with physical layer cell identities is provided.

When measurement gaps are scheduled, the UE shall be able to identify a new detectable cell within  $T_{\text{identify\_irat\_without\_index}}$  if UE is not indicated to report SSB based RRM measurement result with the associated SSB index (*reportQuantityRsIndexes* or *maxNrofRSIndexesToReport* is not configured). Otherwise, UE shall be able to identify a new detectable inter-RAT frequency cell within  $T_{\text{identify\_irat\_with\_index}}$ . The UE shall be able to identify a new detectable inter-RAT SS block of an already detected cell within  $T_{\text{identify\_irat\_without\_index}}$ .

$$T_{\text{identify\_irat\_without\_index}} = (T_{\text{PSS/SSS\_sync\_irat}} + T_{\text{SSB\_measurement\_period\_irat}}) \text{ ms}$$

$$T_{\text{identify\_irat\_with\_index}} = (T_{\text{PSS/SSS\_sync\_irat}} + T_{\text{SSB\_measurement\_period\_irat}} + T_{\text{SSB\_time\_index\_irat}}) \text{ ms}$$

Where:

$T_{\text{PSS/SSS\_sync\_irat}}$ : it is the time period used in PSS/SSS detection: given in table 8.4.2.0.1-1 and table 8.4.2.0.1-2.

$T_{\text{SSB\_time\_index\_irat}}$ : it is the time period used to acquire the index of the SSB being measured given in table 8.4.2.0.1-3 and table 8.4.2.0.1-4.

$T_{\text{SSB\_measurement\_period\_irat}}$ : equal to a measurement period of SSB based measurement given in table 8.4.2.0.1-5 and table 8.4.2.0.1-6.

$M_{\text{pss/sss\_sync\_irat}}$ : For a UE supporting FR2 power class 1,  $M_{\text{pss/sss\_sync\_irat}}=64$  samples. For a UE supporting FR2 power class 2 (vehicle mounted),  $M_{\text{pss/sss\_sync\_irat}}=40$  samples. For a UE supporting FR2 power class 3 (handheld),  $M_{\text{pss/sss\_sync\_irat}}=40$  samples. For a UE supporting FR2 power class 4,  $M_{\text{pss/sss\_sync\_irat}}=40$  samples.

$M_{\text{SSB\_index\_irat}}$ : For a UE supporting power class 1,  $M_{\text{SSB\_index\_irat}}=40$  samples. For a vehicle mounted UE supporting power class 2 (vehicle mounted),  $M_{\text{pss/sss\_sync\_irat}}=24$  samples. For a UE supporting power class 3 (handheld),  $M_{\text{SSB\_index\_irat}}=24$  samples. For a UE supporting power class 4,  $M_{\text{meas\_period\_irat}}=24$  samples.

$M_{\text{meas\_period\_irat}}$ : For a UE supporting FR2 power class 1,  $M_{\text{meas\_period\_irat}}=64$  samples. For a vehicle mounted UE supporting FR2 power class 2 (vehicle mounted),  $M_{\text{pss/sss\_sync\_irat}}=40$  samples. For a UE supporting FR2 power class 3 (handheld),  $M_{\text{meas\_period\_irat}}=40$  samples. For a UE supporting FR2 power class 4,  $M_{\text{meas\_period\_irat}}=40$  samples.

$N_{\text{freq}}$  is defined in TS 36.133 [23] clause 8.1.2.1.1.

For per-FR measurement gap capable UE, when serving cells are in E-UTRA and measurement objects are only in FR2:

- UE can perform such measurements without gap; and
- UE fulfils the requirements for FR2 measurement objects based on effective MGRP = 20 ms.

**Table 8.4.2.0.1-1: Time period for PSS/SSS detection, (Frequency range FR1)**

Condition <sup>NOTE1,2</sup>	$T_{PSS/SSS\_sync\_irat}$
No DRX	$\max[600\text{ms}, 8 \times \max(\text{MGRP}, \text{SMTC period})] \times N_{\text{freq}}$
DRX cycle $\leq 320\text{ms}$	$\max[600\text{ms}, \text{ceil}(8 \times 1.5) \times \max(\text{MGRP}, \text{SMTC period}, \text{DRX cycle})] \times N_{\text{freq}}$
DRX cycle $> 320\text{ms}$	$8 \times \text{DRX cycle} \times N_{\text{freq}}$
NOTE 1: DRX or non DRX requirements apply according to the conditions described in TS 36.133 [23] clause 3.6.1	
NOTE 2: In EN-DC operation, the parameters, timers and scheduling requests referred to in TS 36.133 [23] clause 3.6.1 are for the secondary cell group. The DRX cycle is the DRX cycle of the secondary cell group.	

**Table 8.4.2.0.1-1A: Time period for PSS/SSS detection for UE configured with *highSpeedInterRAT-r16* (Frequency range FR1)**

Condition <sup>NOTE1,2</sup>	$T_{PSS/SSS\_sync\_irat}$
No DRX	$\text{Max}(600\text{ms}, 8 \times \text{Max}(\text{MGRP}, \text{SMTC period})) \times N_{\text{freq}}$
DRX cycle $< 320\text{ms}$	$\text{Max}(600\text{ms}, \text{ceil}(8 \times M) \times \max(\text{MGRP}, \text{SMTC period}, \text{DRX cycle})) \times N_{\text{freq}}$
DRX cycle $\geq 320\text{ms}$	$8 \times \text{DRX cycle} \times N_{\text{freq}}$
NOTE 1: DRX or non DRX requirements apply according to the conditions described in clause 3.6.1 of TS 38.133 [3].	
NOTE 2: In EN-DC operation, the parameters, timers and scheduling requests referred to in clause 3.6.1 of TS 38.133 [3] are for the secondary cell group. The DRX cycle is the DRX cycle of the secondary cell group.	
NOTE 3: $M = 1$ when $\text{SMTC} \leq 40\text{ms}$ , and $M = 1.5$ when $\text{SMTC} > 40\text{ms}$ .	

**Table 8.4.2.0.1-2: Time period for PSS/SSS detection, (Frequency range FR2)**

Condition <sup>NOTE1,2</sup>	$T_{PSS/SSS\_sync\_irat}$
No DRX	$\text{Max}(600\text{ms}, M_{\text{pss/sss\_sync\_irat}} \times \max(\text{MGRP}, \text{SMTC period})) \times N_{\text{freq}}$
DRX cycle $\leq 320\text{ms}$	$\text{Max}(600\text{ms}, (1.5 \times M_{\text{pss/sss\_sync\_irat}}) \times \max(\text{MGRP}, \text{SMTC period}, \text{DRX cycle})) \times N_{\text{freq}}$
DRX cycle $> 320\text{ms}$	$M_{\text{pss/sss\_sync\_irat}} \times \text{DRX cycle} \times N_{\text{freq}}$
NOTE 1: DRX or non DRX requirements apply according to the conditions described in TS 36.133 [23] clause 3.6.1	
NOTE 2: In EN-DC operation, the parameters, timers and scheduling requests referred to in TS 36.133 [23] clause 3.6.1 are for the secondary cell group. The DRX cycle is the DRX cycle of the secondary cell group.	

**Table 8.4.2.0.1-3: Time period for time index detection (Frequency range FR1)**

Condition <sup>NOTE1,2</sup>	$T_{SSB\_time\_index\_irat}$
No DRX	$\text{Max}(120\text{ms}, 3 \times \max(\text{MGRP}, \text{SMTC period})) \times N_{\text{freq}}$
DRX cycle $\leq 320\text{ms}$	$\text{Max}(120\text{ms}, \text{ceil}(3 \times 1.5) \times \max(\text{MGRP}, \text{SMTC period}, \text{DRX cycle})) \times N_{\text{freq}}$
DRX cycle $> 320\text{ms}$	$3 \times \text{DRX cycle} \times N_{\text{freq}}$
NOTE 1: DRX or non DRX requirements apply according to the conditions described in TS 36.133 [23] clause 3.6.1	
NOTE 2: In EN-DC operation, the parameters, timers and scheduling requests referred to in TS 36.133 [23] clause 3.6.1 are for the secondary cell group. The DRX cycle is the DRX cycle of the secondary cell group.	

**Table 8.4.2.0.1-3A: Time period for time index detection for UE configured with *highSpeedInterRAT-r16* (Frequency range FR1)**

Condition <sup>NOTE1,2</sup>	$T_{SSB\_time\_index\_irat}$
No DRX	$\text{Max}(120\text{ms}, 3 \times \text{Max}(\text{MGRP}, \text{SMTC period})) \times N_{\text{freq}}$
DRX cycle < 320ms	$\text{Max}(120\text{ms}, \text{Ceil}(3 \times M) \times \text{Max}(\text{MGRP}, \text{SMTC period}, \text{DRX cycle})) \times N_{\text{freq}}$
DRX cycle $\geq$ 320ms	$3 \times \text{DRX cycle} \times N_{\text{freq}}$
NOTE 1: DRX or non DRX requirements apply according to the conditions described in clause 3.6.1 of TS 38.133 [3].	
NOTE 2: In EN-DC operation, the parameters, timers and scheduling requests referred to in clause 3.6.1 of TS 38.133 [3] are for the secondary cell group. The DRX cycle is the DRX cycle of the secondary cell group.	
NOTE 3: $M = 1$ when $\text{SMTC} \leq 40\text{ms}$ , and $M = 1.5$ when $\text{SMTC} > 40\text{ms}$ .	

**Table 8.4.2.0.1-4: Time period for time index detection (Frequency range FR2)**

Condition <sup>NOTE1,2</sup>	$T_{SSB\_time\_index\_irat}$
No DRX	$\text{Max}(200\text{ms}, M_{SSB\_index\_irat} \times \text{max}(\text{MGRP}, \text{SMTC period})) \times N_{\text{freq}}$
DRX cycle $\leq$ 320ms	$\text{Max}(200\text{ms}, (1.5 \times M_{SSB\_index\_irat}) \times \text{max}(\text{MGRP}, \text{SMTC period}, \text{DRX cycle})) \times N_{\text{freq}}$
DRX cycle > 320ms	$M_{SSB\_index\_irat} \times \text{DRX cycle} \times N_{\text{freq}}$
NOTE 1: DRX or non DRX requirements apply according to the conditions described in TS 36.133 [23] clause 3.6.1	
NOTE 2: In EN-DC operation, the parameters, timers and scheduling requests referred to in TS 36.133 [23] clause 3.6.1 are for the secondary cell group. The DRX cycle is the DRX cycle of the secondary cell group.	

In the requirements, an NR cell is considered to be detectable when:

- NR SS-RSRP related conditions in the accuracy requirements in clause 9.11.1 are fulfilled for a corresponding Band, together with the corresponding side conditions in clause B.2.3 of TS 38.133 [6],
- NR SS-RSRQ related conditions in the accuracy requirements in clause 9.11.2 are fulfilled for a corresponding Band, together with the corresponding side conditions in clause B.2.3 of TS 38.133 [6],
- NR SS-SINR related conditions in the accuracy requirements in clause 9.11.3 are fulfilled for a corresponding Band, together with the corresponding side conditions in clause B.2.3 of TS 38.133 [6].

When measurement gaps are scheduled for NR measurements the UE physical layer shall be capable of reporting NR SS-RSRP, SS-RSRQ, and SS-SINR measurements to higher layers with measurement accuracy as specified in TS 36.133 [23] clause 9.11, with measurement period as shown in table 8.4.2.0.1-5 and table 8.4.2.0.1-6:

**Table 8.4.2.0.1-5: Measurement period for inter-RAT frequency measurements (Frequency FR1)**

Condition <sup>NOTE1,2</sup>	$T_{SSB\_measurement\_period\_irat}$
No DRX	$\text{Max}(200\text{ms}, 8 \times \text{max}(\text{MGRP}, \text{SMTC period})) \times N_{\text{freq}}$
DRX cycle $\leq$ 320ms	$\text{Max}(200\text{ms}, \text{ceil}(8 \times 1.5) \times \text{max}(\text{MGRP}, \text{SMTC period}, \text{DRX cycle})) \times N_{\text{freq}}$
DRX cycle > 320ms	$8 \times \text{DRX cycle} \times N_{\text{freq}}$
NOTE 1: DRX or non DRX requirements apply according to the conditions described in TS 36.133 [23] clause 3.6.1	
NOTE 2: In EN-DC operation, the parameters, timers and scheduling requests referred to in TS 36.133 [23] clause 3.6.1 are for the secondary cell group. The DRX cycle is the DRX cycle of the secondary cell group.	



**Table 8.4.2.0.1-5A: Measurement period for inter-RAT measurements for UE configured with *highSpeedInterRAT-r16* (Frequency range FR1)**

Condition <sup>NOTE1,2</sup>	$T_{SSB\_measurement\_period\_irat}$
No DRX	$\text{Max}(200\text{ms}, 8 \times \text{Max}(\text{MGRP}, \text{SMTC period})) \times N_{\text{freq}}$
DRX cycle < 320ms	$\text{Max}(200\text{ms}, \text{ceil}(8 \times M) \times \text{max}(\text{MGRP}, \text{SMTC period}, \text{DRX cycle})) \times N_{\text{freq}}$
DRX cycle $\geq$ 320ms	$4 \times M \times \text{DRX cycle} \times N_{\text{freq}}$
NOTE 1: DRX or non DRX requirements apply according to the conditions described in clause 3.6.1 of TS 38.133 [50].	
NOTE 2: In EN-DC operation, the parameters, timers and scheduling requests referred to in clause 3.6.1 of TS 38.133 [50] are for the secondary cell group. The DRX cycle is the DRX cycle of the secondary cell group.	
NOTE 3: $M = 1$ when $\text{SMTC} \leq 40\text{ms}$ , and $M = 1.5$ when $\text{SMTC} > 40\text{ms}$ .	

**Table 8.4.2.0.1-6: Measurement period for inter-RAT frequency measurements (Frequency FR2)**

Condition <sup>NOTE1,2</sup>	$T_{SSB\_measurement\_period\_irat}$
No DRX	$\text{Max}(400\text{ms}, M_{\text{meas\_period\_irat}} \times \text{max}(\text{MGRP}, \text{SMTC period})) \times N_{\text{freq}}$
DRX cycle $\leq$ 320ms	$\text{Max}(400\text{ms}, (1.5 \times M_{\text{meas\_period\_irat}}) \times \text{max}(\text{MGRP}, \text{SMTC period}, \text{DRX cycle})) \times N_{\text{freq}}$
DRX cycle > 320ms	$M_{\text{meas\_period\_irat}} \times \text{DRX cycle} \times N_{\text{freq}}$
NOTE 1: DRX or non DRX requirements apply according to the conditions described in TS 36.133 [23] clause 3.6.1.	
NOTE 2: In EN-DC operation, the parameters, timers and scheduling requests referred to in TS 36.133 [23] clause 3.6.1 are for the secondary cell group. The DRX cycle is the DRX cycle of the secondary cell group.	

The UE shall be capable of performing NR SS-RSRP, SS-RSRQ, and SS-SINR for up to 7 NR carrier frequencies.

For each RAT E-UTRAN - NR layer on FR1 or FR2, the UE shall be capable of monitoring at least 4 cells.

For each RAT E-UTRAN - NR layer on FR1, during each layer 1 measurement period, the UE shall be capable of monitoring at least 7 SSBs with different SSB index and/or PCI on the RAT E-UTRA -NR.

For each RAT E-UTRA - NR layer on FR2, during each layer 1 measurement period, the UE shall be capable of monitoring at least 10 SSBs with different SSB index and/or PCI on the RAT E-UTRAN - NR layer. The UE shall be capable of monitoring at least one SSB per cell.

The NR SS-RSRP measurement accuracy for all measured cells shall be as specified in TS 36.133 [23] clause 9.11.1. The NR SS-RSRQ measurement accuracy for all measured cells shall be as specified in TS 36.133 [23] clause 9.11.2. The NR SS-SINR measurement accuracy for all measured cells shall be as specified in TS 36.133 [23] clause 9.11.3.

Reported measurements in event triggered measurement reports shall meet the requirements in TS 36.133 [23] clause 9.

The UE shall not send any event triggered measurement reports, as long as the reporting criteria is not fulfilled.

The measurement reporting delay is defined as the time between any events that will trigger a measurement report until the UE starts to transmit the measurement report over the Uu interface. This requirement assumes that the measurement report is not delayed by other RRC signalling on the DCCH. This measurement reporting delay excludes a delay uncertainty resulted when inserting the measurement report to the TTI of the uplink DCCH. The delay uncertainty is twice the TTI of the uplink DCCH. This measurement reporting delay excludes a delay which caused by no UL resources for UE to send the measurement report.

The event triggered measurement reporting delay, measured without L3 filtering shall be less than  $T_{\text{identify\_irat\_without\_index}}$  or  $T_{\text{identify\_irat\_with\_index}}$  for the minimum requirements. When L3 filtering is used or IDC autonomous denial or the UE is performing reception and/or transmission for ProSe Direct Discovery and/or ProSe Direct Communication, or the UE is configured to perform SRS carrier based switching, an additional delay can be expected.

If a cell which has been detectable at least for the time period  $T_{\text{identify\_irat\_without\_index}}$  or  $T_{\text{identify\_irat\_with\_index}}$  for the minimum requirements and then triggers the measurement report as per TS 36.331 [2], the event triggered measurement reporting delay shall be less than  $T_{\text{measurement\_NR\_FDD}}$  provided the timing to that cell has not changed more than  $\pm 3200 T_c$  while

measurement gap has not been available and the L3 filter has not been used. When L3 filtering is used or IDC autonomous denial is configured or the UE is performing reception and/or transmission for ProSe Direct Discovery and/or ProSe Direct Communication, or the UE is configured to perform SRS carrier based switching, an additional delay can be expected.

The normative reference for this requirement is TS 36.133 [23] clause 8.1.2.4.21 and 8.1.2.4.22.

#### 8.4.2.0.2 Void

### 8.4.2.1 E-UTRA event-triggered reporting of a NR FR1 neighbour cell without SSB time index detection in non-DRX

#### 8.4.2.1.1 Test purpose

The purpose of this test is to verify that the UE makes correct reporting of an event and to verify partly the NR inter-RAT cell search requirements for E-UTRA FDD - NR FR1 measurements given in TS 36.133 [23] clause 8.1.2.4.21 and for E-UTRAN TDD - NR FR1 measurements given in TS 36.133 [23] clause 8.1.2.4.22.

#### 8.4.2.1.2 Test applicability

This test applies to all E-UTRA UE release 15 onwards and capable of NR measurements. Test 1 is applicable to UEs not supporting per-FR gap (IndependentGapConfig, as defined in TS 38.306 [11]) and Test 2 is applicable only to UEs supporting per-FR gap and Gap Pattern Id 4.

#### 8.4.2.1.3 Minimum conformance requirements

The minimum conformance requirements are specified in clause 8.4.2.0.1.

The normative reference for this requirement is TS 38.133 [6] clause A.8.4.2.1.

#### 8.4.2.1.4 Test description

The test consists of two sub-tests with two cells configured, the E-UTRA PCell and NR neighbour cell; the difference between the two sub-tests is whether per-FR measurement gap is configured or not. Each sub-test consists of two successive time periods, with time duration of T1 and T2 respectively. During time duration T1, the UE shall not have any timing information of NR neighbour cell. In all sub-tests the UE is not required to report SSB time index.

#### 8.4.2.1.4.1 Initial conditions

This test shall be tested using any of the test configurations in Table 8.4.2.1.4.1-1.

**Table 8.4.2.1.4.1-1: Supported test configurations for E-UTRA - NR FR1 event-triggered reporting without SSB time index detection in non-DRX**

Configuration	Description
8.4.2.1-1	LTE FDD, NR 15 kHz SSB SCS, 10 MHz bandwidth, FDD duplex mode
8.4.2.1-2	LTE FDD, NR 15 kHz SSB SCS, 10 MHz bandwidth, TDD duplex mode
8.4.2.1-3	LTE FDD, NR 30 kHz SSB SCS, 40 MHz bandwidth, TDD duplex mode
8.4.2.1-4	LTE TDD, NR 15 kHz SSB SCS, 10 MHz bandwidth, FDD duplex mode
8.4.2.1-5	LTE TDD, NR 15 kHz SSB SCS, 10 MHz bandwidth, TDD duplex mode
8.4.2.1-6	LTE TDD, NR 30 kHz SSB SCS, 40 MHz bandwidth, TDD duplex mode
NOTE: The UE is only required to be tested in one of the supported test configurations.	

Configure the test requirement and the DUT according to the parameters in Table 8.4.2.1.4.1-2.

**Table 8.4.2.1.4.1-2: Initial conditions for E-UTRA - NR FR1 event-triggered reporting without SSB time index detection in non-DRX**

Parameter	Value		Comment
Test environment	NC		As specified in TS 36.508 [25] clause 4.1.
Test frequencies	As specified in Annex E, Table E.6-1 and TS 38.508-1 [14] clause 4.3.1.		
Channel bandwidth	As specified by the test configuration selected from Table 8.4.2.1.4.1-1.		
Propagation conditions	AWGN		As specified in clause C.2.1
Connection Diagram	TE Part	A.3.1.8.2	As specified in TS 38.508-1 [14] Annex A.
	DUT Part	A.3.2.3.4	
Exceptions to connection diagram	N/A		

1. The general test parameter settings are set up according to Table 8.4.2.1.4.1-3.
2. Message contents are defined in clause 8.4.2.1.4.3.
3. There are two carriers and two cells specified in the test, where Cell 1 is the E-UTRA PCell on the E-UTRA carrier and Cell 2 is the NR neighbour cell on the NR carrier. Cell 1 is the cell used for connection setup with the power level set according to Table 8.4.2.1.5-1 for this test. Cell 1 is configured according to clauses C.1.1 and C.1.2.

**Table 8.4.2.1.4.1-3: General test parameters for E-UTRA - NR FR1 event-triggered reporting without SSB time index detection in non-DRX**

Parameter	Unit	Test configuration	Value		Comment
			Test 1	Test 2	
E-UTRA RF Channel Numbers		1, 2, 3, 4, 5, 6	1		One E-UTRA carrier frequency is used.
NR RF Channel Number		1, 2, 3, 4, 5, 6	1		One FR1 NR carrier frequency is used.
Active cell		1, 2, 3, 4, 5, 6	E-UTRA cell 1 (PCell)		E-UTRA cell 1 is on E-UTRA RF channel number 1.
Neighbour cell		1, 2, 3, 4, 5, 6	NR cell 2		NR cell 2 is on NR RF channel number 1.
Gap Pattern Id		1, 2, 3, 4, 5, 6	0	4	As specified in clause Table 8.1.2.1-1 of TS 36.133 [23].
Measurement gap offset		1, 2, 3, 4, 5, 6	39	19	As specified in TS 36.331 [29].
b2-Threshold1	dBm	1, 2, 3, 4, 5, 6	Note 1		E-UTRA RSRP threshold for E-UTRA RSRP measurement on cell 1 for event B2 [29]
b2-Threshold2NR	dBm	1, 2, 3, 4, 5, 6	Note 2		SS-RSRP threshold for SS-RSRP measurement on cell 2 for event B2 [29]
Hysteresis	dB	1, 2, 3, 4, 5, 6	0		
CP length		1, 2, 3, 4, 5, 6	Normal		
TimeToTrigger	s	1, 2, 3, 4, 5, 6	0		
Filter coefficient		1, 2, 3, 4, 5, 6	0		L3 filtering is not used
DRX		1, 2, 3, 4, 5, 6	OFF		DRX is not used
Time offset between serving and neighbour cells		1, 4	3ms		Asynchronous cells. The timing of Cell 2 is 3ms later than the timing of Cell 1.
		2, 3, 5, 6	3μs		Synchronous cells.
T1	s	1, 2, 3, 4, 5, 6	5		
T2	s	1, 2, 3, 4, 5, 6	1	1	

NOTE 1: The value of b2-Threshold1 is defined in Table 8.4.2.1.5-1.  
NOTE 2: The value of b2-Threshold2NR is defined in Table 8.4.2.1.5-2.

#### 8.4.2.1.4.2 Test procedure

Two cells are deployed in the test, which are E-UTRA PCell (Cell 1) on the E-UTRA carrier and a FR1 NR neighbour cell (Cell 2) on NR carrier. The general and cell specific test parameters for PCell and neighbour cell are given in Table 8.4.2.1.4.1-3, 8.4.2.1.5-1 and 8.4.2.1.5-2, respectively.

In sub-test 1 measurement gap pattern configuration #0 as defined in Table 8.4.2.1.4.1-3 is provided for UE that does not support per-FR gap and in sub-test 2 measurement gap pattern configuration #4 as defined in Table 8.4.2.1.4.1-3 is provided for UE that supports per-FR gap.

In the measurement control information, it is indicated to the UE that event-triggered reporting with Event B2 is used. The test consists of two successive time periods, with time duration of T1 and T2 respectively. During time duration T1, the UE shall not have any timing information of NR cell 2.

1. Ensure the UE is in State 3A-RF according to TS 36.508 [25] clause 7.2A.3.
2. Set the parameters of Cell 1 and Cell 2 according to T1 in Table 8.4.2.1.5-1 and Table 8.4.2.1.5-2 respectively, T1 starts.
3. The SS shall transmit an *RRCConnectionReconfiguration* message.
4. The UE shall transmit an *RRCConnectionReconfigurationComplete* message.
5. When T1 expires, the SS shall switch the parameters setting from T1 to T2 as specified in Table 8.4.2.1.5-1 and Table 8.4.2.1.5-2 respectively. T2 Starts.
6. UE shall transmit a *MeasurementReport* message triggered by Event B2. If the overall delays measured from the beginning of time period T2 is less than X ms then the number of successful tests is increased by one. If the UE fails to report the event within the overall delays measured requirement then the number of failure tests is increased by one. Where X is,
  - 922 for sub-test 1,
  - 802 for sub-test 2.
7. After the SS receive the *MeasurementReport* message in step 6) or when T2 expires, the SS shall transmit an *RRCConnectionRelease* message to release the RRC connection which includes the release of the established radio bearers as well as all radio resources, or
  - switch off the UE.
8. Set Cell 2 physical cell identity = ((current Cell 2 physical cell identity + 1) mod 14 + 2) for next iteration of the test procedure loop.
9. The SS:
  - transmits in Cell 1 a Paging message (including PagingRecord with UE-Identity) for the UE and ensures the UE is in State 3A according to TS 36.508 clause 4.5.3A (if the paging fails, switches off and on the UE and ensures the UE is in State 3A-RF according to TS 36.508 [25] clause 7.2A.3); or
  - switches on the UE and ensures the UE is in State 3A-RF according to TS 36.508 [25] clause 7.2A.3.
10. Repeat step 2-9 until the confidence level according to Tables G.2.3-1 in Annex G clause G.2 is achieved.

#### 8.4.2.1.4.3 Message contents

Message contents are according to TS 36.508 [25] clause 7.3 with the following exceptions.

**Table 8.4.2.1.4.3-1: Common Exception messages for E-UTRA - NR FR1 event-triggered reporting without SSB time index detection in non-DRX**

Default Message Contents	
Common contents of system information blocks exceptions	
Default RRC messages and information elements contents exceptions	Table H.3.4-7 with Condition Inter-RAT and EVENT B2; Table H.3.4-4 with Condition INTER-RAT NR, EVENT B2 for Test 1; Table H.3.4-4 with Condition INTER-RAT NR, EVENT B2 for Test 2; Table H.3.4-5 with Condition Pattern #0 for Test 1; Table H.3.4-5 with Condition Pattern #4 for Test 2;
Specific message contents exceptions for Test Configuration 8.4.2.1-1 and 8.4.2.1-4	Table H.3.4-6 with Conditions SMTC.2, SSB.1 FR1 and Asynchronous cells
Specific message contents exceptions for Test Configuration 8.4.2.1-2 and 8.4.2.1-5	Table H.3.4-6 with Conditions SMTC.1, SSB.1 FR1 and Synchronous cells
Specific message contents exceptions for Test Configuration 8.4.2.1-3 and 8.4.2.1-6	Table H.3.4-6 with Conditions SMTC.1, SSB.2 FR1 and Synchronous cells

**Table 8.4.2.1.4.3-2: SchedulingRequest-Config-DEFAULT**

Derivation Path: TS 36.508 [25] Table 4.6.3-20			
Information Element	Value/remark	Comment	Condition
SchedulingRequest-Config-DEFAULT ::= CHOICE { setup SEQUENCE { sr-ConfigIndex	25		Config 8.4.2.1-1/2/3
	22		Config 8.4.2.1-4/5/6
}			
}			

8.4.2.1.5 Test requirement

Table 8.4.2.1.4.1-3, 8.4.2.1.5-1 and 8.4.2.1.5-2 define the primary level settings including test tolerances for E-UTRA - NR FR1 event-triggered reporting without SSB time index detection in non-DRX.

**Table 8.4.2.1.5-1: E-UTRAN PCell specific test parameters for E-UTRA - NR FR1 event-triggered reporting without SSB time index detection in non-DRX**

Parameter	Unit	Configuration	Cell 1	
			T1	T2
RF channel number		1, 2, 3, 4, 5, 6	1	
Duplex mode		1, 2, 3	FDD	
		4, 5, 6	TDD	
TDD special subframe configuration <sup>Note1</sup>		4, 5, 6	6	
TDD uplink-downlink configuration <sup>Note1</sup>		4, 5, 6	1	
BW <sub>channel</sub>	MHz	1, 2, 3, 4, 5, 6	5 MHz: N <sub>RB,c</sub> = 25 10 MHz: N <sub>RB,c</sub> = 50 20 MHz: N <sub>RB,c</sub> = 100	
PDSCH parameters: DL Reference Measurement Channel <sup>Note2</sup>		1, 2, 3	5 MHz: R.7 FDD 10 MHz: R.3 FDD 20 MHz: R.6 FDD	
		4, 5, 6	5 MHz: R.4 TDD 10 MHz: R.0 TDD 20 MHz: R.3 TDD	
PCFICH/PDCCH/PHICH parameters: DL Reference Measurement Channel <sup>Note2</sup>		1, 2, 3	5 MHz: R.11 FDD 10 MHz: R.6 FDD 20 MHz: R.10 FDD	
		4, 5, 6	5 MHz: R.11 TDD 10 MHz: R.6 TDD 20 MHz: R.10 TDD	

OCNG Patterns <sup>Note2</sup>		1, 2, 3	5 MHz: OP.20 FDD 10 MHz: OP.10 FDD 20 MHz: OP.17 FDD	
		4, 5, 6	5 MHz: OP.9 TDD 10 MHz: OP.1 TDD 20 MHz: OP.7 TDD	
b2-Threshold1	dBm	1, 2, 3, 4, 5, 6	-77	
PBCH_RA	dB	1, 2, 3, 4, 5, 6	0	
PBCH_RB				
PSS_RA				
SSS_RA				
PCFICH_RB				
PHICH_RA				
PHICH_RB				
PDCCH_RA				
PDCCH_RB				
PDSCH_RA				
PDSCH_RB				
OCNG_RA <sup>Note3</sup>				
OCNG_RB <sup>Note3</sup>				
N <sub>oc</sub> <sup>Note4</sup>				
$\hat{E}_s/N_{oc}$	dB	1, 2, 3, 4, 5, 6	17	15.35
$\hat{E}_s/I_{ot}$ <sup>Note5</sup>	dB	1, 2, 3, 4, 5, 6	17	15.35
RSRP <sup>Note5</sup>	dBm/15kHz	1, 2, 3, 4, 5, 6	-87	-88.65
SCH_RP <sup>Note5</sup>	dBm/15kHz	1, 2, 3, 4, 5, 6	-87	-88.65
I <sub>o</sub> <sup>Note5</sup>	dBm/9MHz	1, 2, 3, 4, 5, 6	$-59.13+10\log(N_{RB,c}/50)$	$60.74+10\log(N_{RB,c}/50)$
Propagation Condition <sup>Note6</sup>		1, 2, 3, 4, 5, 6	ETU70	
Antenna Configuration and Correlation Matrix <sup>Note6</sup>		1, 2, 3, 4, 5, 6	1x2 Low	
<p>NOTE 1: Special subframe and uplink-downlink configurations are specified in table 4.2-1 in TS 36.211 [24].</p> <p>NOTE 2: DL RMCs and OCNG patterns are specified in clauses A 3.1 and A 3.2 of TS 36.133 [23] respectively.</p> <p>NOTE 3: OCNG shall be used such that all cells are fully allocated and a constant total transmitted power spectral density is achieved for all OFDM symbols.</p> <p>NOTE 4: Interference from other cells and noise sources not specified in the test is assumed to be constant over subcarriers and time and shall be modelled as AWGN of appropriate power for N<sub>oc</sub> to be fulfilled.</p> <p>NOTE 5: <math>\hat{E}_s/I_{ot}</math>, RSRP, SCH_RP and I<sub>o</sub> levels have been derived from other parameters for information purposes. They are not settable parameters themselves.</p> <p>NOTE 6: Propagation condition and correlation matrix are defined in clause B.2 in TS 36.101 [27].</p>				

**Table 8.4.2.1.5-2: NR neighbour cell specific test parameters for E-UTRA - NR FR1 event-triggered reporting without SSB time index detection in non-DRX**

Parameter	Unit	Test configuration	Cell 2	
			T1	T2
NR RF Channel Number		1, 2, 3, 4, 5, 6	1	
Duplex mode		1, 4	FDD	
		2, 3, 5, 6	TDD	
TDD configuration		2, 5	TDDConf.1.1	
		3, 6	TDDConf.2.1	
BW <sub>channel</sub>	MHz	1, 2, 4, 5	10: N <sub>RB,c</sub> = 52	
		3, 6	40: N <sub>RB,c</sub> = 106	
OCNG Patterns		1, 2, 3, 4, 5, 6	OP.1	
SMTC configuration		1, 4	SMTC.2	
		2, 3, 5, 6	SMTC.1	
PDSCH/PDCCH subcarrier spacing	kHz	1, 2, 4, 5	15	
		3, 6	30	
b2-Threshold2NR	dBm/SCS	1, 2, 4, 5	-101	
		3, 6	-98	
EPRE ratio of PSS to SSS		1, 2, 3, 4, 5, 6	0	
EPRE ratio of PBCH DMRS to SSS				
EPRE ratio of PBCH to PBCH DMRS				
EPRE ratio of PDCCH DMRS to SSS				
EPRE ratio of PDCCH to PDCCH DMRS				
EPRE ratio of PDSCH DMRS to SSS				
EPRE ratio of PDSCH to PDSCH				
EPRE ratio of OCNG DMRS to SSS (Note 1)				
EPRE ratio of OCNG to OCNG DMRS (Note 1)				
$N_{oc}$ <sup>Note2</sup>	dBm/15kHz	1, 2, 3, 4, 5, 6	-98	
$N_{oc}$ <sup>Note2</sup>	dBm/SCS	1, 2, 4, 5	-98	
		3, 6	-95	
SS-RSRP <sup>Note 3</sup>	dBm/SCS	1, 2, 4, 5	-Infinity	-89.35
		3, 6	-Infinity	-86.34
$\hat{E}_s/I_{ot}$	dB	1, 2, 3, 4, 5, 6	-Infinity	8.65
$\hat{E}_s/N_{oc}$	dB	1, 2, 3, 4, 5, 6	-Infinity	8.65
I <sub>o</sub> <sup>Note3</sup>	dBm/9.36MHz	1, 2, 4, 5	-70.05	-60.84
	dBm/38.16MHz	3, 6	-63.94	-54.74
Propagation Condition		1, 2, 3, 4, 5, 6	TDL-C 300ns 100Hz	
Antenna Configuration and Correlation Matrix		1, 2, 3, 4, 5, 6	1x2 Low	
NOTE 1: OCNG shall be used such that the cell is fully allocated and a constant total transmitted power spectral density is achieved for all OFDM symbols.				
NOTE 2: Interference from other cells and noise sources not specified in the test is assumed to be constant over subcarriers and time and shall be modelled as AWGN of appropriate power for $N_{oc}$ to be fulfilled.				
NOTE 3: SS-RSRP and I <sub>o</sub> levels have been derived from other parameters for information purposes. They are not settable parameters themselves.				
NOTE 4: SS-RSRP minimum requirements are specified assuming independent interference and noise at each receiver antenna port.				

In test 1 with per-UE gap, the UE shall send one Event B2 triggered measurement report, with a measurement reporting delay less than 922 ms from the beginning of time period T2. The UE shall not send event triggered measurement reports, as long as the reporting criteria are not fulfilled. The rate of correct events observed during repeated tests shall be at least 90%.

In test 2 with per-FR gap, the UE shall send one Event B2 triggered measurement report, with a measurement reporting delay less than 802 ms from the beginning of time period T2. The UE shall not send event triggered measurement reports, as long as the reporting criteria are not fulfilled. The rate of correct events observed during repeated tests shall be at least 90%.

In test 1 and test 2, the UE is not required to report SSB time index.

NOTE: The overall delay requirement is defined as the delay requirement in TS 38.133 plus 2 ms corresponding to the TTI insertion uncertainty of the measurement report in DCCH.

## 8.4.2.2 E-UTRA event-triggered reporting of a NR FR1 neighbour cell without SSB time index detection in DRX

### 8.4.2.2.1 Test purpose

The purpose of this test is to verify that the UE makes correct reporting of an event and to verify partly the NR inter-RAT cell search requirements given in clause 8.1.2.4.21 of TS 36.133 for E-UTRAN FDD-NR measurements and clause 8.1.2.4.22 of TS 36.133 for E-UTRAN TDD-NR measurements.

### 8.4.2.2.2 Test applicability

This test applies to all E-UTRA UE release 15 onwards supporting long DRX cycle and capable of NR measurements. Test 1 and Test 2 are applicable to UEs not supporting per-FR gap (IndependentGapConfig, as defined in TS 38.306 [11]) and Test 3 and Test 4 are applicable only to UEs supporting per-FR gap and Gap Pattern Id 4.

### 8.4.2.2.3 Minimum conformance requirements

The minimum conformance requirements are specified in clause 8.4.2.0.1.

The normative reference for this requirement is TS 38.133 [6] clause A.8.4.2.2.

### 8.4.2.2.4 Test description

The test consists of four sub-tests with two cells configured, the E-UTRA PCell and NR neighbour cell; the difference between the four sub-tests is whether per-FR measurement gap is configured or not and the DRX configuration parameters. Each sub-test consists of two successive time periods, with time duration of T1 and T2 respectively. During time duration T1, the UE shall not have any timing information of NR neighbour cell. In all sub-tests the UE is not required to report SSB time index.

#### 8.4.2.2.4.1 Initial conditions

This test shall be tested using any of the test configurations in Table 8.4.2.2.4.1-1.

**Table 8.4.2.2.4.1-1: Supported test configurations for E-UTRA - NR FR1 event-triggered reporting without SSB time index detection in DRX**

Configuration	Description
8.4.2.2-1	LTE FDD, NR 15 kHz SSB SCS, 10 MHz bandwidth, FDD duplex mode
8.4.2.2-2	LTE FDD, NR 15 kHz SSB SCS, 10 MHz bandwidth, TDD duplex mode
8.4.2.2-3	LTE FDD, NR 30 kHz SSB SCS, 40 MHz bandwidth, TDD duplex mode
8.4.2.2-4	LTE TDD, NR 15 kHz SSB SCS, 10 MHz bandwidth, FDD duplex mode
8.4.2.2-5	LTE TDD, NR 15 kHz SSB SCS, 10 MHz bandwidth, TDD duplex mode
8.4.2.2-6	LTE TDD, NR 30 kHz SSB SCS, 40 MHz bandwidth, TDD duplex mode
NOTE: The UE is only required to be tested in one of the supported test configurations.	

Configure the test requirement and the DUT according to the parameters in Table 8.4.2.2.4.1-2.



**Table 8.4.2.2.4.1-2: Initial conditions for E-UTRA - NR FR1 event-triggered reporting without SSB time index detection in DRX**

Parameter	Value		Comment
Test environment	NC		As specified in TS 36.508 [25] clause 4.1.
Test frequencies	As specified in Annex E, Table E.6-1 and TS 38.508-1 [14] clause 4.3.1.		
Channel bandwidth	As specified by the test configuration selected from Table 8.4.2.2.4.1-1.		
Propagation conditions	AWGN		As specified in clause C.2.1
Connection Diagram	TE Part	A.3.1.8.2	As specified in TS 38.508-1 [14] Annex A.
	DUT Part	A.3.2.3.4	
Exceptions to connection diagram	N/A		

1. The general test parameter settings are set up according to Table 8.4.2.2.4.1-3.
2. Message contents are defined in clause 8.4.2.2.4.3.
3. There are two carriers and two cells specified in the test, where Cell 1 is the E-UTRA PCell on the E-UTRA carrier and Cell 2 is the NR neighbour cell on the NR carrier. Cell 1 is the cell used for connection setup with the power level set according to Table 8.4.2.2.5-1 for this test. Cell 1 is configured according to clauses C.1.1 and C.1.2.

**Table 8.4.2.2.4.1-3: General test parameters for E-UTRA - NR FR1 event-triggered reporting without SSB time index detection in DRX**

Parameter	Unit	Test configuration	Value				Comment
			Test 1	Test 2	Test 3	Test 4	
E-UTRA RF Channel Number		1, 2, 3, 4, 5, 6	1				One E-UTRA carrier frequency is used.
NR RF Channel Number		1, 2, 3, 4, 5, 6	1				One FR1 NR carrier frequency is used.
Active cell		1, 2, 3, 4, 5, 6	E-UTRA cell 1 (PCell)				E-UTRA cell 1 is on E-UTRA RF channel number 1.
Neighbour cell		1, 2, 3, 4, 5, 6	NR cell 2				NR cell 2 is on NR RF channel number 1.
Gap Pattern Id		1, 2, 3, 4, 5, 6	0		4		As specified in clause Table 8.1.2.1-1 of TS 36.133 [23].
Measurement gap offset		1, 2, 3, 4, 5, 6	39		19		As specified in TS 36.331 [29].
b2-Threshold1	dBm	1, 2, 3, 4, 5, 6	Note 1				E-UTRA RSRP threshold for E-UTRA RSRP measurement on cell 1 for event B2 [29]
b2-Threshold2NR	dBm	1, 2, 3, 4, 5, 6	Note 2				SS-RSRP threshold for SS-RSRP measurement on cell 2 for event B2 [29]
Hysteresis	dB	1, 2, 3, 4, 5, 6	0				
CP length		1, 2, 3, 4, 5, 6	Normal				
TimeToTrigger	s	1, 2, 3, 4, 5, 6	0				
Filter coefficient		1, 2, 3, 4, 5, 6	0				L3 filtering is not used
DRX		1, 2, 3, 4, 5, 6	DRX.9	DRX.12	DRX.9	DRX.12	As specified in clause A.5
Time offset between serving and neighbour cells		1, 4	3ms				Asynchronous cells. The timing of Cell 2 is 3ms later than the timing of Cell 1.
		2, 3, 5, 6	3μs				Synchronous cells.
T1	s	1, 2, 3, 4, 5, 6	5				
T2	s	1, 2, 3, 4, 5, 6	2	11	2	11	
NOTE 1: The value of b2-Threshold1 is defined in Table 8.4.2.2.5-1.							
NOTE 2: The value of b2-Threshold2NR is defined in Table 8.4.2.2.5-2.							

#### 8.4.2.2.4.2 Test procedure

Two cells are deployed in the test, which are E-UTRA PCell (Cell 1) on the E-UTRA carrier and a FR1 NR neighbour cell (Cell 2) on NR carrier. The general and cell specific test parameters for PCell and neighbour cell are given in Table 8.4.2.2.4.1-3, 8.4.2.2.5-1 and 8.4.2.2.5-2, respectively.

In sub-test 1 and sub-test 2 measurement gap pattern configuration #0 as defined in Table 8.4.2.2.4.1-3 is provided for UE that does not support per-FR gap and in sub-test 3 and sub-test 4 measurement gap pattern configuration #4 as defined in Table 8.4.2.2.4.1-3 is provided for UE that supports per-FR gap.

DRX cycle = 40 ms is used in sub-test 1 and sub-test 3, DRX cycle = 640 ms is used in sub-test 2 and sub-test 4. The UE is allocated with PUSCH resource at every DRX cycle.

In the measurement control information, it is indicated to the UE that event-triggered reporting with Event B2 is used. The test consists of two successive time periods, with time duration of T1 and T2 respectively. During time duration T1, the UE shall not have any timing information of NR cell 2.

1. Ensure the UE is in State 3A-RF according to TS 36.508 [25] clause 7.2A.3.
2. Set the parameters of Cell 1 and Cell 2 according to T1 in Table 8.4.2.2.5-1 and Table 8.4.2.2.5-2 respectively, T1 starts.
3. The SS shall transmit an *RRCConnectionReconfiguration* message.
4. The UE shall transmit an *RRCConnectionReconfigurationComplete* message.
5. When T1 expires, the SS shall switch the parameters setting from T1 to T2 as specified in Table 8.4.2.2.5-1 and Table 8.4.2.2.5-2 respectively. T2 Starts.
6. UE shall transmit a *MeasurementReport* message triggered by Event B2. If the overall delays measured from the beginning of time period T2 is less than X ms then the number of successful tests is increased by one. If the UE fails to report the event within the overall delays measured requirement then the number of failure tests is increased by one. Where X is,
  - 1082 for sub-test 1 and sub-test 3,
  - 10242 for sub-test 2 and sub-test 4.
7. After the SS receive the *MeasurementReport* message in step 6) or when T2 expires, the SS shall:
  - transmit an *RRCConnectionRelease* message to release the RRC connection which includes the release of the established radio bearers as well as all radio resources, or
  - switch off the UE.
8. Set Cell 2 physical cell identity = ((current Cell 2 physical cell identity + 1) mod 14 + 2) for next iteration of the test procedure loop.
9. The SS:
  - transmits in Cell 1 a Paging message (including PagingRecord with UE-Identity) for the UE and ensures the UE is in State 3A according to TS 36.508 [25] clause 4.5.3A (if the paging fails, switches off and on the UE and ensures the UE is in State 3A-RF according to TS 36.508 [25] clause 7.2A.3); or
  - switches on the UE and ensures the UE is in State 3A-RF according to TS 36.508 [25] clause 7.2A.3.
10. Repeat step 2-9 until the confidence level according to Tables G.2.3-1 in Annex G clause G.2 is achieved.

#### 8.4.2.2.4.3 Message contents

Message contents are according to TS 36.508 [25] clause 7.3 with the following exceptions:

**Table 8.4.2.2.4.3-1: Common Exception messages for E-UTRA - NR FR1 event-triggered reporting without SSB time index detection in DRX**

Default Message Contents	
Common contents of system information blocks exceptions	
Default RRC messages and information elements contents exceptions	Table H.3.4-7 with Condition Inter-RAT and EVENT B2; Table H.3.4-4 with Condition INTER-RAT NR, EVENT B2 for Test 1 and Test 2; Table H.3.4-4 with Condition INTER-RAT NR, EVENT B2 for Test 3 and Test 4; Table H.3.4-5 with Condition Pattern #0 for Test 1 and Test 2; Table H.3.4-5 with Condition Pattern #4 for Test 3 and Test 4; Table H.3.7-2 with Condition DRX.9 and Gap for Test 1 and Test 3 Table H.3.7-2 with Condition DRX.12 and Gap for Test 2 and Test 4
Specific message contents exceptions for Test Configuration 8.4.2.2-1 and 8.4.2.2-4	Table H.3.4-6 with Conditions SMTC.2, SSB.1 FR1 and Asynchronous cells
Specific message contents exceptions for Test Configuration 8.4.2.2-2 and 8.4.2.2-5	Table H.3.4-6 with Conditions SMTC.1, SSB.1 FR1 and Synchronous cells
Specific message contents exceptions for Test Configuration 8.4.2.2-3 and 8.4.2.2-6	Table H.3.4-6 with Conditions SMTC.1, SSB.2 FR1 and Synchronous cells

**Table 8.4.2.2.4.3-2: SchedulingRequest-Config-DEFAULT**

Derivation Path: TS 36.508 [25] Table 4.6.3-20			
Information Element	Value/remark	Comment	Condition
SchedulingRequest-Config-DEFAULT ::= CHOICE { setup SEQUENCE { sr-ConfigIndex	25		Config 8.4.2.2-1/2/3
	22		Config 8.4.2.2-4/5/6
}			
}			

8.4.2.2.5 Test requirement

Table 8.4.2.2.4.1-3, 8.4.2.2.5-1 and 8.4.2.2.5-2 define the primary level settings including test tolerances for E-UTRA - NR FR1 event-triggered reporting without SSB time index detection in DRX.

**Table 8.4.2.2.5-1: E-UTRAN PCell specific test parameters for E-UTRA - NR FR1 event-triggered reporting without SSB time index detection in DRX**

Parameter	Unit	Configuration	Cell 1	
			T1	T2
RF channel number		1, 2, 3, 4, 5, 6	1	
Duplex mode		1, 2, 3	FDD	
		4, 5, 6	TDD	
TDD special subframe configuration <sup>Note1</sup>		4, 5, 6	6	
TDD uplink-downlink configuration <sup>Note1</sup>		4, 5, 6	1	
BW <sub>channel</sub>	MHz	1, 2, 3, 4, 5, 6	5 MHz: N <sub>RB,c</sub> = 25 10 MHz: N <sub>RB,c</sub> = 50 20 MHz: N <sub>RB,c</sub> = 100	
PDSCH parameters: DL Reference Measurement Channel <sup>Note2</sup>		1, 2, 3	5 MHz: R.7 FDD 10 MHz: R.3 FDD 20 MHz: R.6 FDD	
		4, 5, 6	5 MHz: R.4 TDD 10 MHz: R.0 TDD 20 MHz: R.3 TDD	
PCFICH/PDCCH/PHICH parameters:		1, 2, 3	5 MHz: R.11 FDD 10 MHz: R.6 FDD 20 MHz: R.10 FDD	

DL Reference Measurement Channel <sup>Note2</sup>		4, 5, 6	5 MHz: R.11 TDD 10 MHz: R.6 TDD 20 MHz: R.10 TDD	
OCNG Patterns <sup>Note2</sup>		1, 2, 3	5 MHz: OP.20 FDD 10 MHz: OP.10 FDD 20 MHz: OP.17 FDD	
		4, 5, 6	5 MHz: OP.9 TDD 10 MHz: OP.1 TDD 20 MHz: OP.7 TDD	
b2-Threshold1	dBm	1, 2, 3, 4, 5, 6	-77	
PBCH_RA	dB	1, 2, 3, 4, 5, 6	0	
PBCH_RB				
PSS_RA				
SSS_RA				
PCFICH_RB				
PHICH_RA				
PHICH_RB				
PDCCH_RA				
PDCCH_RB				
PDSCH_RA				
PDSCH_RB				
OCNG_RA <sup>Note3</sup>				
OCNG_RB <sup>Note3</sup>				
N <sub>oc</sub> <sup>Note4</sup>	dBm/15kHz	1, 2, 3, 4, 5, 6	-104	
$\hat{E}_s/N_{oc}$	dB	1, 2, 3, 4, 5, 6	17	15.35
$\hat{E}_s/I_{ot}$ <sup>Note5</sup>	dB	1, 2, 3, 4, 5, 6	17	15.35
RSRP <sup>Note5</sup>	dBm/15kHz	1, 2, 3, 4, 5, 6	-87	-88.65
SCH_RP <sup>Note5</sup>	dBm/15kHz	1, 2, 3, 4, 5, 6	-87	-88.65
I <sub>o</sub> <sup>Note5</sup>	dBm/9MHz	1, 2, 3, 4, 5, 6	$-59.13+10\log(N_{RB,c}/50)$	$-60.74+10\log(N_{RB,c}/50)$
Propagation Condition <sup>Note6</sup>		1, 2, 3, 4, 5, 6	ETU70	
Antenna Configuration and Correlation Matrix <sup>Note6</sup>		1, 2, 3, 4, 5, 6	1x2 Low	
<p>NOTE 1: Special subframe and uplink-downlink configurations are specified in table 4.2-1 in TS 36.211 [24].</p> <p>NOTE 2: DL RMCs and OCNG patterns are specified in clauses A 3.1 and A 3.2 of TS 36.133 [23] respectively.</p> <p>NOTE 3: OCNG shall be used such that all cells are fully allocated and a constant total transmitted power spectral density is achieved for all OFDM symbols.</p> <p>NOTE 4: Interference from other cells and noise sources not specified in the test is assumed to be constant over subcarriers and time and shall be modelled as AWGN of appropriate power for N<sub>oc</sub> to be fulfilled.</p> <p>NOTE 5: <math>\hat{E}_s/I_{ot}</math>, RSRP, SCH_RP and I<sub>o</sub> levels have been derived from other parameters for information purposes. They are not settable parameters themselves.</p> <p>NOTE 6: Propagation condition and correlation matrix are defined in clause B.2 in TS 36.101 [27].</p>				

**Table 8.4.2.2.5-2: NR neighbour cell specific test parameters for E-UTRA - NR FR1 event-triggered reporting without SSB time index detection in DRX**

Parameter	Unit	Test configuration	Cell 2	
			T1	T2
NR RF Channel Number		1, 2, 3, 4, 5, 6	1	
Duplex mode		1, 4	FDD	
		2, 3, 5, 6	TDD	
TDD configuration		2, 5	TDDConf.1.1	
		3, 6	TDDConf.2.1	
BW <sub>channel</sub>	MHz	1, 2, 4, 5	10: N <sub>RB,c</sub> = 52	
		3, 6	40: N <sub>RB,c</sub> = 106	
OCNG Patterns		1, 2, 3, 4, 5, 6	OP.1	
SMTC configuration		1, 4	SMTC.2	
		2, 3, 5, 6	SMTC.1	
PDSCH/PDCCH subcarrier spacing	kHz	1, 2, 4, 5	15	
		3, 6	30	
b2-Threshold2NR	dBm/SCS	1, 2, 4, 5	-101	
		3, 6	-98	
EPRE ratio of PSS to SSS		1, 2, 3, 4, 5, 6	0	
EPRE ratio of PBCH DMRS to SSS				
EPRE ratio of PBCH to PBCH DMRS				
EPRE ratio of PDCCH DMRS to SSS				
EPRE ratio of PDCCH to PDCCH DMRS				
EPRE ratio of PDSCH DMRS to SSS				
EPRE ratio of PDSCH to PDSCH				
EPRE ratio of OCNG DMRS to SSS (Note 1)				
EPRE ratio of OCNG to OCNG DMRS (Note 1)				
$N_{oc}$ <sup>Note2</sup>	dBm/15kHz	1, 2, 3, 4, 5, 6	-98	
$N_{oc}$ <sup>Note2</sup>	dBm/SCS	1, 2, 4, 5	-98	
		3, 6	-95	
SS-RSRP <sup>Note 3</sup>	dBm/SCS	1, 2, 4, 5	-Infinity	-89.35
		3, 6	-Infinity	-86.34
$\hat{E}_s/I_{ot}$	dB	1, 2, 3, 4, 5, 6	-Infinity	8.65
$\hat{E}_s/N_{oc}$	dB	1, 2, 3, 4, 5, 6	-Infinity	8.65
I <sub>o</sub> <sup>Note3</sup>	dBm/9.36MHz	1, 2, 4, 5	-70.05	-60.84
	dBm/38.16MHz	3, 6	-63.95	-54.74
Propagation Condition		1, 2, 3, 4, 5, 6	TDL-C 300ns 100Hz	
Antenna Configuration and Correlation Matrix		1, 2, 3, 4, 5, 6	1x2 Low	
NOTE 1: OCNG shall be used such that the cell is fully allocated and a constant total transmitted power spectral density is achieved for all OFDM symbols.				
NOTE 2: Interference from other cells and noise sources not specified in the test is assumed to be constant over subcarriers and time and shall be modelled as AWGN of appropriate power for $N_{oc}$ to be fulfilled.				
NOTE 3: SS-RSRP and I <sub>o</sub> levels have been derived from other parameters for information purposes. They are not settable parameters themselves.				
NOTE 4: SS-RSRP minimum requirements are specified assuming independent interference and noise at each receiver antenna port.				

In test 1 with per-UE gap, the UE shall send one Event B2 triggered measurement report, with a measurement reporting delay less than 1082 ms from the beginning of time period T2. The UE shall not send event triggered measurement reports, as long as the reporting criteria are not fulfilled. The rate of correct events observed during repeated tests shall be at least 90%.

In test 2 with per-UE gap, the UE shall send one Event B2 triggered measurement report, with a measurement reporting delay less than 10242 ms from the beginning of time period T2. The UE shall not send event triggered measurement reports, as long as the reporting criteria are not fulfilled. The rate of correct events observed during repeated tests shall be at least 90%.

In test 3 with per-FR gap, the UE shall send one Event B2 triggered measurement report, with a measurement reporting delay less than 1082 ms from the beginning of time period T2. The UE shall not send event triggered measurement reports, as long as the reporting criteria are not fulfilled. The rate of correct events observed during repeated tests shall be at least 90%.

In test 4 with per-FR gap, the UE shall send one Event B2 triggered measurement report, with a measurement reporting delay less than 10242 ms from the beginning of time period T2. The UE shall not send event triggered measurement reports, as long as the reporting criteria are not fulfilled. The rate of correct events observed during repeated tests shall be at least 90%.

In tests 1, 2, 3 and 4, the UE is not required to report SSB time index.

NOTE: The overall delay requirement is defined as the delay requirement in TS 38.133 plus 2 ms corresponding to the TTI insertion uncertainty of the measurement report in DCCH.

### 8.4.2.3 E-UTRA event-triggered reporting of a NR FR1 neighbour cell with SSB time index detection in non-DRX

#### 8.4.2.3.1 Test purpose

The purpose of this test is to verify that the UE makes correct reporting of an event and to verify partly the NR inter-RAT cell search requirements for E-UTRA FDD - NR FR1 measurements given in TS 36.133 [23] clause 8.1.2.4.21 and for E-UTRAN TDD - NR FR1 measurements given in TS 36.133 [23] clause 8.1.2.4.22.

#### 8.4.2.3.2 Test applicability

This test applies to all E-UTRA UE release 15 onwards and capable of NR measurements. Test 1 is applicable to UEs not supporting per-FR gap (IndependentGapConfig, as defined in TS 38.306 [11]) and Test 2 is applicable only to UEs supporting per-FR gap and Gap Pattern Id 4.

#### 8.4.2.3.3 Minimum conformance requirements

The minimum conformance requirements are specified in clause 8.4.2.0.2.

The normative reference for this requirement is TS 38.133 [6] clause A.8.4.2.3.

#### 8.4.2.3.4 Test description

The test consists of two sub-tests with two cells configured, the E-UTRA PCell and NR neighbour cell; the difference between the two sub-tests is whether per-FR measurement gap is configured or not. Each sub-test consists of two successive time periods, with time duration of T1 and T2 respectively. During time duration T1, the UE shall not have any timing information of NR neighbour cell. In the measurement configuration the UE shall be indicated to report the SSB index of the identified NR cell.

#### 8.4.2.3.4.1 Initial conditions

This test shall be tested using any of the test configurations in Table 8.4.2.3.4.1-1.

**Table 8.4.2.3.4.1-1: Supported test configurations for E-UTRA - NR FR1 event-triggered reporting with SSB time index detection in non-DRX**

Configuration	Description
8.4.2.3-1	LTE FDD, NR 15 kHz SSB SCS, 10 MHz bandwidth, FDD duplex mode
8.4.2.3-2	LTE FDD, NR 15 kHz SSB SCS, 10 MHz bandwidth, TDD duplex mode
8.4.2.3-3	LTE FDD, NR 30 kHz SSB SCS, 40 MHz bandwidth, TDD duplex mode
8.4.2.3-4	LTE TDD, NR 15 kHz SSB SCS, 10 MHz bandwidth, FDD duplex mode
8.4.2.3-5	LTE TDD, NR 15 kHz SSB SCS, 10 MHz bandwidth, TDD duplex mode
8.4.2.3-6	LTE TDD, NR 30 kHz SSB SCS, 40 MHz bandwidth, TDD duplex mode
NOTE: The UE is only required to be tested in one of the supported test configurations.	

Configure the test requirement and the DUT according to the parameters in Table 8.4.2.3.4.1-2.

**Table 8.4.2.3.4.1-2: Initial conditions for E-UTRA - NR FR1 event-triggered reporting with SSB time index detection in non-DRX**

Parameter	Value		Comment
Test environment	NC		As specified in TS 36.508 [25] clause 4.1.
Test frequencies	As specified in Annex E, Table E.6-1 and TS 38.508-1 [14] clause 4.3.1.		
Channel bandwidth	As specified by the test configuration selected from Table 8.4.2.3.4.1-1.		
Propagation conditions	AWGN		As specified in clause C.2.1
Connection Diagram	TE Part	A.3.1.8.2	As specified in TS 38.508-1 [14] Annex A.
	DUT Part	A.3.2.3.4	
Exceptions to connection diagram	N/A		

1. The general test parameter settings are set up according to Table 8.4.2.3.4.1-3.
2. Message contents are defined in clause 8.4.2.3.4.3.
3. There are two carriers and two cells specified in the test, where Cell 1 is the E-UTRA PCell on the E-UTRA carrier and Cell 2 is the NR neighbour cell on the NR carrier. Cell 1 is the cell used for connection setup with the power level set according to Table 8.4.2.3.5-1 for this test. Cell 1 is configured according to clauses C.1.1 and C.1.2.

**Table 8.4.2.3.4.1-3: General test parameters for E-UTRA - NR FR1 event-triggered reporting with SSB time index detection in non-DRX**

Parameter	Unit	Test configuration	Value		Comment
			Test 1	Test 2	
E-UTRA RF Channel Numbers		1, 2, 3, 4, 5, 6	1		One E-UTRA carrier frequency is used.
NR RF Channel Number		1, 2, 3, 4, 5, 6	1		One FR1 NR carrier frequency is used.
Active cell		1, 2, 3, 4, 5, 6	E-UTRA cell 1 (PCell)		E-UTRA cell 1 is on E-UTRA RF channel number 1.
Neighbour cell		1, 2, 3, 4, 5, 6	NR cell 2		NR cell 2 is on NR RF channel number 1.
Gap Pattern Id		1, 2, 3, 4, 5, 6	0	4	As specified in clause Table 8.1.2.1-1 of TS 36.133 [23].
Measurement gap offset		1, 2, 3, 4, 5, 6	39	19	As specified in TS 36.331 [29].
b2-Threshold1	dBm	1, 2, 3, 4, 5, 6	Note 1		E-UTRA RSRP threshold for E-UTRA RSRP measurement on cell 1 for event B2 [29]
b2-Threshold2NR	dBm	1, 2, 3, 4, 5, 6	Note 2		SS-RSRP threshold for SS-RSRP measurement on cell 2 for event B2 [29]
Hysteresis	dB	1, 2, 3, 4, 5, 6	0		
CP length		1, 2, 3, 4, 5, 6	Normal		
TimeToTrigger	s	1, 2, 3, 4, 5, 6	0		
Filter coefficient		1, 2, 3, 4, 5, 6	0		L3 filtering is not used
DRX		1, 2, 3, 4, 5, 6	OFF		DRX is not used
Time offset between serving and neighbour cells		1, 4	3ms		Asynchronous cells. The timing of Cell 2 is 3 ms later than the timing of Cell 1.
		2, 3, 5, 6	3μs		Synchronous cells.
T1	s	1, 2, 3, 4, 5, 6	5		
T2	s	1, 2, 3, 4, 5, 6	2	1	

NOTE 1: The value of b2-Threshold1 is defined in Table 8.4.2.3.5-1.  
NOTE 2: The value of b2-Threshold2NR is defined in Table 8.4.2.3.5-2.

#### 8.4.2.3.4.2 Test procedure

Two cells are deployed in the test, which are E-UTRA PCell (Cell 1) on the E-UTRA carrier and a FR1 NR neighbour cell (Cell 2) on NR carrier. The general and cell specific test parameters for PCell and neighbour cell are given in Table 8.4.2.3.4.1-3, 8.4.2.3.5-1 and 8.4.2.3.5-2, respectively.

In sub-test 1 measurement gap pattern configuration #0 as defined in Table 8.4.2.3.4.1-3 is provided for UE that does not support per-FR gap and in sub-test 2 measurement gap pattern configuration #4 as defined in Table 8.4.2.3.4.1-3 is provided for UE that supports per-FR gap.

In the measurement control information, it is indicated to the UE that event-triggered reporting with Event B2 is used. The test consists of two successive time periods, with time duration of T1 and T2 respectively. During time duration T1, the UE shall not have any timing information of NR cell 2.

1. Ensure the UE is in State 3A-RF according to TS 36.508 [25] clause 7.2A.3.
2. Set the parameters of Cell 1 and Cell 2 according to T1 in Table 8.4.2.3.5-1 and Table 8.4.2.3.5-2 respectively, T1 starts.
3. The SS shall transmit an *RRCConnectionReconfiguration* message.
4. The UE shall transmit an *RRCConnectionReconfigurationComplete* message.
5. When T1 expires, the SS shall switch the parameters setting from T1 to T2 as specified in Table 8.4.2.3.5-1 and Table 8.4.2.3.5-2 respectively. T2 Starts.
6. UE shall transmit a *MeasurementReport* message triggered by Event B2. If the overall delays measured from the beginning of time period T2 is less than X ms then the number of successful tests is increased by one. If the UE fails to report the event within the overall delays measured requirement then the number of failure tests is increased by one. Where X is,
  - 1042 for sub-test 1,
  - 922 for sub-test 2.
7. . After the SS receive the *MeasurementReport* message in step 6) or when T2 expires, the SS shall:
  - transmit an *RRCConnectionRelease* message to release the RRC connection which includes the release of the established radio bearers as well as all radio resources, or
  - switch off the UE.
8. Set Cell 2 physical cell identity = ((current Cell 2 physical cell identity + 1) mod 14 + 2) for next iteration of the test procedure loop.
9. The SS:
  - transmits in Cell 1 a Paging message (including PagingRecord with UE-Identity) for the UE and ensures the UE is in State 3A according to TS 36.508 [25] clause 4.5.3A (if the paging fails, switches off and on the UE and ensures the UE is in State 3A-RF according to TS 36.508 [25] clause 7.2A.3); or
  - switches on the UE and ensures the UE is in State 3A-RF according to TS 36.508 [25] clause 7.2A.3.
10. Repeat step 2-9 until the confidence level according to Tables G.2.3-1 in Annex G clause G.2 is achieved.

#### 8.4.2.3.4.3 Message contents

Message contents are according to TS 36.508 [25] clause 7.3 with the following exceptions.



**Table 8.4.2.3.4.3-1: Common Exception messages for E-UTRA - NR FR1 event-triggered reporting with SSB time index detection in non-DRX**

Default Message Contents	
Common contents of system information blocks exceptions	
Default RRC messages and information elements contents exceptions	Table H.3.4-7 with Condition Inter-RAT and EVENT B2; Table H.3.4-4 with Condition INTER-RAT NR, EVENT B2 for Test 1; Table H.3.4-4 with Condition INTER-RAT NR, EVENT B2 for Test 2; Table H.3.4-5 with Condition Pattern #0 for Test 1; Table H.3.4-5 with Condition Pattern #4 for Test 2; Table H.3.4-8 with Condition SSB-Index
Specific message contents exceptions for Test Configuration 8.4.2.3-1 and 8.4.2.3-4	Table H.3.4-6 with Conditions SMTC.2, SSB.1 FR1 and Asynchronous cells
Specific message contents exceptions for Test Configuration 8.4.2.3-2 and 8.4.2.3-5	Table H.3.4-6 with Conditions SMTC.1, SSB.1 FR1 and Synchronous cells
Specific message contents exceptions for Test Configuration 8.4.2.3-3 and 8.4.2.3-6	Table H.3.4-6 with Conditions SMTC.1, SSB.2 FR1 and Synchronous cells

**Table 8.4.2.3.4.3-2: SchedulingRequest-Config-DEFAULT**

Derivation Path: 36.508 [25] Table 4.6.3-20			
Information Element	Value/remark	Comment	Condition
SchedulingRequest-Config-DEFAULT ::= CHOICE {			
setup SEQUENCE {			
sr-ConfigIndex	25		Config 8.4.2.3-1/2/3
	22		Config 8.4.2.3-4/5/6
}			
}			

8.4.2.3.5 Test requirement

Table 8.4.2.3.4.1-3, 8.4.2.3.5-1 and 8.4.2.3.5-2 define the primary level settings including test tolerances for E-UTRA - NR FR1 event-triggered reporting with SSB time index detection in non-DRX.

**Table 8.4.2.3.5-1: E-UTRAN PCell specific test parameters for E-UTRA - NR FR1 event-triggered reporting with SSB time index detection in non-DRX**

Parameter	Unit	Configuration	Cell 1	
			T1	T2
RF channel number		1, 2, 3, 4, 5, 6	1	
Duplex mode		1, 2, 3	FDD	
		4, 5, 6	TDD	
TDD special subframe configuration <sup>Note1</sup>		4, 5, 6	6	
TDD uplink-downlink configuration <sup>Note1</sup>		4, 5, 6	1	
BW <sub>channel</sub>	MHz	1, 2, 3, 4, 5, 6	5 MHz: N <sub>RB,c</sub> = 25 10 MHz: N <sub>RB,c</sub> = 50 20 MHz: N <sub>RB,c</sub> = 100	
PDSCH parameters: DL Reference Measurement Channel <sup>Note2</sup>		1, 2, 3	5 MHz: R.7 FDD 10 MHz: R.3 FDD 20 MHz: R.6 FDD	
		4, 5, 6	5 MHz: R.4 TDD 10 MHz: R.0 TDD 20 MHz: R.3 TDD	
PCFICH/PDCCH/PHICH parameters: DL Reference Measurement Channel <sup>Note2</sup>		1, 2, 3	5 MHz: R.11 FDD 10 MHz: R.6 FDD 20 MHz: R.10 FDD	
		4, 5, 6	5 MHz: R.11 TDD 10 MHz: R.6 TDD	

Parameter	Unit	Configuration	Cell 1	
			T1	T2
OCNG Patterns <sup>Note2</sup>		1, 2, 3	20 MHz: R.10 TDD 5 MHz: OP.20 FDD 10 MHz: OP.10 FDD 20 MHz: OP.17 FDD	
		4, 5, 6	5 MHz: OP.9 TDD 10 MHz: OP.1 TDD 20 MHz: OP.7 TDD	
b2-Threshold1	dBm	1, 2, 3, 4, 5, 6	-77	
PBCH_RA	dB	1, 2, 3, 4, 5, 6	0	
PBCH_RB				
PSS_RA				
SSS_RA				
PCFICH_RB				
PHICH_RA				
PHICH_RB				
PDCCH_RA				
PDCCH_RB				
PDSCH_RA				
PDSCH_RB				
OCNG_RA <sup>Note3</sup>				
OCNG_RB <sup>Note3</sup>				
N <sub>oc</sub> <sup>Note4</sup>				
$\hat{E}_s/N_{oc}$	dB	1, 2, 3, 4, 5, 6	17	15.35
$\hat{E}_s/I_{ot}$ <sup>Note5</sup>	dB	1, 2, 3, 4, 5, 6	17	15.35
RSRP <sup>Note5</sup>	dBm/15kHz	1, 2, 3, 4, 5, 6	-87	-88.65
SCH_RP <sup>Note5</sup>	dBm/15kHz	1, 2, 3, 4, 5, 6	-87	-88.65
I <sub>o</sub> <sup>Note5</sup>	dBm/9MHz	1, 2, 3, 4, 5, 6	$-59.13+10\log(N_{RB,c}/50)$	$-60.74+10\log(N_{RB,c}/50)$
Propagation Condition <sup>Note6</sup>		1, 2, 3, 4, 5, 6	ETU70	
Antenna Configuration and Correlation Matrix <sup>Note6</sup>		1, 2, 3, 4, 5, 6	1x2 Low	

NOTE 1: Special subframe and uplink-downlink configurations are specified in table 4.2-1 in TS 36.211 [24].

NOTE 2: DL RMCs and OCNG patterns are specified in clauses A 3.1 and A 3.2 of TS 36.133 [23] respectively.

NOTE 3: OCNG shall be used such that all cells are fully allocated and a constant total transmitted power spectral density is achieved for all OFDM symbols.

NOTE 4: Interference from other cells and noise sources not specified in the test is assumed to be constant over subcarriers and time and shall be modelled as AWGN of appropriate power for N<sub>oc</sub> to be fulfilled.

NOTE 5:  $\hat{E}_s/I_{ot}$ , RSRP, SCH\_RP and I<sub>o</sub> levels have been derived from other parameters for information purposes. They are not settable parameters themselves.

NOTE 6: Propagation condition and correlation matrix are defined in clause B.2 in TS 36.101 [27].

**Table 8.4.2.3.5-2: NR neighbour cell specific test parameters for E-UTRA - NR FR1 event-triggered reporting with SSB time index detection in non-DRX**

Parameter	Unit	Test configuration	Cell 2	
			T1	T2
NR RF Channel Number		1, 2, 3, 4, 5, 6	1	
Duplex mode		1, 4	FDD	
		2, 3, 5, 6	TDD	
TDD configuration		2, 5	TDDConf.1.1	
		3, 6	TDDConf.2.1	
BW <sub>channel</sub>	MHz	1, 2, 4, 5	10: N <sub>RB,c</sub> = 52	
		3, 6	40: N <sub>RB,c</sub> = 106	
OCNG Patterns		1, 2, 3, 4, 5, 6	OP.1	
SMTC configuration		1, 4	SMTC.2	
		2, 3, 5, 6	SMTC.1	
PDSCH/PDCCH subcarrier spacing	kHz	1, 2, 4, 5	15	
		3, 6	30	
b2-Threshold2NR	dBm/SCS	1, 2, 4, 5	-101	
		3, 6	-98	
EPRE ratio of PSS to SSS		1, 2, 3, 4, 5, 6	0	
EPRE ratio of PBCH DMRS to SSS				
EPRE ratio of PBCH to PBCH DMRS				
EPRE ratio of PDCCH DMRS to SSS				
EPRE ratio of PDCCH to PDCCH DMRS				
EPRE ratio of PDSCH DMRS to SSS				
EPRE ratio of PDSCH to PDSCH				
EPRE ratio of OCNG DMRS to SSS (Note 1)				
EPRE ratio of OCNG to OCNG DMRS (Note 1)				
$N_{oc}$ <sup>Note2</sup>	dBm/15kHz	1, 2, 3, 4, 5, 6	-98	
$N_{oc}$ <sup>Note2</sup>	dBm/SCS	1, 2, 4, 5	-98	
		3, 6	-95	
SS-RSRP <sup>Note 3</sup>	dBm/SCS	1, 2, 4, 5	-Infinity	-89.35
		3, 6	-Infinity	-86.34
$\hat{E}_s/I_{ot}$	dB	1, 2, 3, 4, 5, 6	-Infinity	8.65
$\hat{E}_s/N_{oc}$	dB	1, 2, 3, 4, 5, 6	-Infinity	8.65
I <sub>o</sub> <sup>Note3</sup>	dBm/9.36MHz	1, 2, 4, 5	-70.05	-60.84
	dBm/38.16MHz	3, 6	-63.95	-54.74
Propagation Condition		1, 2, 3, 4, 5, 6	TDL-C 300ns 100Hz	
Antenna Configuration and Correlation Matrix		1, 2, 3, 4, 5, 6	1x2 Low	
<p>NOTE 1: OCNG shall be used such that the cell is fully allocated and a constant total transmitted power spectral density is achieved for all OFDM symbols.</p> <p>NOTE 2: Interference from other cells and noise sources not specified in the test is assumed to be constant over subcarriers and time and shall be modelled as AWGN of appropriate power for <math>N_{oc}</math> to be fulfilled.</p> <p>NOTE 3: SS-RSRP and I<sub>o</sub> levels have been derived from other parameters for information purposes. They are not settable parameters themselves.</p> <p>NOTE 4: SS-RSRP minimum requirements are specified assuming independent interference and noise at each receiver antenna port.</p>				

In test 1 with per-UE gap, the UE shall send one Event B2 triggered measurement report, with a measurement reporting delay less than 1042 ms from the beginning of time period T2. The UE shall not send event triggered measurement reports, as long as the reporting criteria are not fulfilled. The rate of correct events observed during repeated tests shall be at least 90%.

In test 2 with per-FR gap, the UE shall send one Event B2 triggered measurement report, with a measurement reporting delay less than 922 ms from the beginning of time period T2. The UE shall not send event triggered measurement reports, as long as the reporting criteria are not fulfilled. The rate of correct events observed during repeated tests shall be at least 90%.

In test 1 and test 2, the UE is required to report SSB time index.

NOTE: The overall delay requirement is defined as the delay requirement in TS 38.133 plus 2 ms corresponding to the TTI insertion uncertainty of the measurement report in DCCH.

#### 8.4.2.4 E-UTRA event-triggered reporting of a NR FR1 neighbour cell with SSB time index detection in DRX

##### 8.4.2.4.1 Test purpose

The purpose of this test is to verify that the UE makes correct reporting of an event and to verify partly the NR inter-RAT cell search requirements for E-UTRA FDD - NR FR1 measurements given in TS 36.133 [23] clause 8.1.2.4.21 and for E-UTRAN TDD - NR FR1 measurements given in TS 36.133 [23] clause 8.1.2.4.22.

##### 8.4.2.4.2 Test applicability

This test applies to all E-UTRA UE release 15 onwards supporting long DRX cycle and capable of NR measurements. Test 1 and Test 2 are applicable to UEs not supporting per-FR gap (IndependentGapConfig, as defined in TS 38.306 [11]) and Test 3 and Test 4 are applicable only to UEs supporting per-FR gap and Gap Pattern Id 4.

##### 8.4.2.4.3 Minimum conformance requirements

The minimum conformance requirements are specified in clause 8.4.2.0.2.

The normative reference for this requirement is TS 38.133 [6] clause A.8.4.2.4.

##### 8.4.2.4.4 Test description

The test consists of four sub-tests with two cells configured, the E-UTRA PCell and NR neighbour cell; the difference between the four sub-tests is whether per-FR measurement gap is configured or not and the DRX configuration. Each subtest consists of two successive time periods, with time duration of T1 and T2 respectively. During time duration T1, the UE shall not have any timing information of NR neighbour cell. In measurements configuration UE shall be indicated to report the SSB index of the identified NR cell.

##### 8.4.2.4.4.1 Initial conditions

This test shall be tested using any of the test configurations in Table 8.4.2.4.4.1-1.

**Table 8.4.2.4.4.1-1: Supported test configurations for E-UTRA - NR FR1 event-triggered reporting with SSB time index detection in DRX**

Configuration	Description
8.4.2.4-1	LTE FDD, NR 15 kHz SSB SCS, 10 MHz bandwidth, FDD duplex mode
8.4.2.4-2	LTE FDD, NR 15 kHz SSB SCS, 10 MHz bandwidth, TDD duplex mode
8.4.2.4-3	LTE FDD, NR 30 kHz SSB SCS, 40 MHz bandwidth, TDD duplex mode
8.4.2.4-4	LTE TDD, NR 15 kHz SSB SCS, 10 MHz bandwidth, FDD duplex mode
8.4.2.4-5	LTE TDD, NR 15 kHz SSB SCS, 10 MHz bandwidth, TDD duplex mode
8.4.2.4-6	LTE TDD, NR 30 kHz SSB SCS, 40 MHz bandwidth, TDD duplex mode
NOTE: The UE is only required to be tested in one of the supported test configurations.	

Configure the test requirement and the DUT according to the parameters in Table 8.4.2.4.4.1-2.

**Table 8.4.2.4.4.1-2: Initial conditions for E-UTRA - NR FR1 event-triggered reporting with SSB time index detection in DRX**

Parameter	Value		Comment
Test environment	NC		As specified in TS 36.508 [25] clause 4.1.
Test frequencies	As specified in Annex E, Table E.6-1 and TS 38.508-1 [14] clause 4.3.1.		
Channel bandwidth	As specified by the test configuration selected from Table 8.4.2.4.4.1-1.		
Propagation conditions	AWGN		As specified in clause C.2.1
Connection Diagram	TE Part	A.3.1.8.2	As specified in TS 38.508-1 [14] Annex A.
	DUT Part	A.3.2.3.4	
Exceptions to connection diagram	N/A		

1. The general test parameter settings are set up according to Table 8.4.2.4.4.1-3.
2. Message contents are defined in clause 8.4.2.4.4.3.
3. There are two carriers and two cells specified in the test, where Cell 1 is the E-UTRA PCell on the E-UTRA carrier and Cell 2 is the NR neighbour cell on the NR carrier. Cell 1 is the cell used for connection setup with the power level set according to Table 8.4.2.4.5-1 for this test. Cell 1 is configured according to clauses C.1.1 and C.1.2.

**Table 8.4.2.4.4.1-3: General test parameters for E-UTRA - NR FR1 event-triggered reporting with SSB time index detection in DRX**

Parameter	Unit	Test configuration	Value				Comment
			Test 1	Test 2	Test 3	Test 4	
E-UTRA RF Channel Number		1, 2, 3, 4, 5, 6	1				One E-UTRA carrier frequency is used.
NR RF Channel Number		1, 2, 3, 4, 5, 6	1				One FR1 NR carrier frequency is used.
Active cell		1, 2, 3, 4, 5, 6	E-UTRA cell 1 (PCell)				E-UTRA cell 1 is on E-UTRA RF channel number 1.
Neighbour cell		1, 2, 3, 4, 5, 6	NR cell 2				NR cell 2 is on NR RF channel number 1.
Gap Pattern Id		1, 2, 3, 4, 5, 6	0		4		As specified in clause Table 8.1.2.1-1 of TS 36.133 [23].
Measurement gap offset		1, 2, 3, 4, 5, 6	39		19		As specified in TS 36.331 [29].
b2-Threshold1	dBm	1, 2, 3, 4, 5, 6	Note 1				E-UTRA RSRP threshold for E-UTRA RSRP measurement on cell 1 for event B2 [29]
b2-Threshold2NR	dBm	1, 2, 3, 4, 5, 6	Note 2				SS-RSRP threshold for SS-RSRP measurement on cell 2 for event B2 [29]
Hysteresis	dB	1, 2, 3, 4, 5, 6	0				
CP length		1, 2, 3, 4, 5, 6	Normal				
TimeToTrigger	s	1, 2, 3, 4, 5, 6	0				
Filter coefficient		1, 2, 3, 4, 5, 6	0				L3 filtering is not used
DRX		1, 2, 3, 4, 5, 6	DRX.9	DRX.12	DRX.9	DRX.12	As specified in clause A.5
Time offset between serving and neighbour cells		1, 4	3ms				Asynchronous cells. The timing of Cell 2 is 3ms later than the timing of Cell 1.
		2, 3, 5, 6	3µs				Synchronous cells.
T1	s	1, 2, 3, 4, 5, 6	5				
T2	s	1, 2, 3, 4, 5, 6	2	13	2	13	

NOTE 1: The value of b2-Threshold1 is defined in Table 8.4.2.4.5-1.  
NOTE 2: The value of b2-Threshold2NR is defined in Table 8.4.2.4.5-2.

#### 8.4.2.4.4.2 Test procedure

Two cells are deployed in the test, which are E-UTRA PCell (Cell 1) on the E-UTRA carrier and a FR1 NR neighbour cell (Cell 2) on NR carrier. The general and cell specific test parameters for PCell and neighbour cell are given in Table 8.4.2.4.4.1-3, 8.4.2.4.5-1 and 8.4.2.4.5-2, respectively.

In sub-test 1 and sub-test 2 measurement gap pattern configuration #0 as defined in Table 8.4.2.4.4.1-3 is provided for UE that does not support per-FR gap and in sub-test 3 and sub-test 4 measurement gap pattern configuration #4 as defined in Table 8.4.2.4.4.1-3 is provided for UE that supports per-FR gap.

DRX cycle = 40 ms is used in sub-test 1 and sub-test 3, DRX cycle = 640 ms is used in sub-test 2 and sub-test 4. The UE is allocated with PUSCH resource at every DRX cycle.

In the measurement control information, it is indicated to the UE that event-triggered reporting with Event B2 is used. The test consists of two successive time periods, with time duration of T1 and T2 respectively. During time duration T1, the UE shall not have any timing information of NR cell 2.

1. Ensure the UE is in State 3A-RF according to TS 36.508 clause 7.2A.3.
2. Set the parameters of Cell 1 and Cell 2 according to T1 in Table 8.4.2.4.5-1 and Table 8.4.2.4.5-2 respectively, T1 starts.
3. The SS shall transmit an *RRCConnectionReconfiguration* message.
4. The UE shall transmit *RRCConnectionReconfigurationComplete* message.
5. When T1 expires, the SS shall switch the parameters setting from T1 to T2 as specified in Table 8.4.2.4.5-1 and Table 8.4.2.4.5-2 respectively. T2 Starts.
6. UE shall transmit a *MeasurementReport* message triggered by Event B2. If the overall delays measured from the beginning of time period T2 is less than X ms then the number of successful tests is increased by one. If the UE fails to report the event within the overall delays measured requirement then the number of failure tests is increased by one. Where X is,
  - 1282 for sub-test 1 and sub-test 3,
  - 12162 for sub-test 2 and sub-test 4.
7. . After the SS receive the *MeasurementReport* message in step 6) or when T2 expires, the SS shall:
  - transmit an *RRCConnectionRelease* message to release the RRC connection which includes the release of the established radio bearers as well as all radio resources, or
  - switch off the UE.
8. Set Cell 2 physical cell identity = ((current Cell 2 physical cell identity + 1) mod 14 + 2) for next iteration of the test procedure loop.
9. The SS:
  - transmits in Cell 1 a Paging message (including PagingRecord with UE-Identity) for the UE and ensures the UE is in State 3A according to TS 36.508 [25] clause 4.5.3A (if the paging fails, switches off and on the UE and ensures the UE is in State 3A-RF according to TS 36.508 [25] clause 7.2A.3); or
  - switches on the UE and ensures the UE is in State 3A-RF according to TS 36.508 [25] clause 7.2A.3.
10. Repeat step 2-9 until the confidence level according to Tables G.2.3-1 in Annex G clause G.2 is achieved.

#### 8.4.2.4.4.3 Message contents

Message contents are according to TS 36.508 [25] clause 7.3 with the following exceptions:

**Table 8.4.2.4.3-1: Common Exception messages for E-UTRA - NR FR1 event-triggered reporting with SSB time index detection in DRX**

Default Message Contents	
Common contents of system information blocks exceptions	
Default RRC messages and information elements contents exceptions	Table H.3.4-7 with Condition Inter-RAT and EVENT B2; Table H.3.4-4 with Condition INTER-RAT NR, EVENT B2 for Test 1 and Test 2; Table H.3.4-4 with Condition INTER-RAT NR, EVENT B2 for Test 3 and Test 4; Table H.3.4-5 with Condition Pattern #0 for Test 1 and Test 2; Table H.3.4-5 with Condition Pattern #4 for Test 3 and Test 4; Table H.3.4-8 with Condition SSB-Index Table H.3.7-2 with Condition DRX.9 and Gap for Test 1 and Test 3 Table H.3.7-2 with Condition DRX.12 and Gap for Test 2 and Test 4
Specific message contents exceptions for Test Configuration 8.4.2.4-1 and 8.4.2.4-4	Table H.3.4-6 with Conditions SMTC.2, SSB.1 FR1 and Asynchronous cells
Specific message contents exceptions for Test Configuration 8.4.2.4-2 and 8.4.2.4-5	Table H.3.4-6 with Conditions SMTC.1, SSB.1 FR1 and Synchronous cells
Specific message contents exceptions for Test Configuration 8.4.2.4-3 and 8.4.2.4-6	Table H.3.4-6 with Conditions SMTC.1, SSB.2 FR1 and Synchronous cells

**Table 8.4.2.4.3-2: SchedulingRequest-Config-DEFAULT**

Derivation Path: 36.508 [25] Table 4.6.3-20			
Information Element	Value/remark	Comment	Condition
SchedulingRequest-Config-DEFAULT ::= CHOICE {			
setup SEQUENCE {			
sr-ConfigIndex	25		Config 8.4.2.4-1/2/3
	22		Config 8.4.2.4-4/5/6
}			
}			

8.4.2.4.5 Test requirement

Table 8.4.2.4.4.1-3, 8.4.2.4.5-1 and 8.4.2.4.5-2 define the primary level settings including test tolerances for E-UTRA - NR FR1 event-triggered reporting with SSB time index detection in DRX.

**Table 8.4.2.4.5-1: E-UTRAN PCell specific test parameters for E-UTRA - NR FR1 event-triggered reporting with SSB time index detection in DRX**

Parameter	Unit	Configuration	Cell 1	
			T1	T2
RF channel number		1, 2, 3, 4, 5, 6	1	
Duplex mode		1, 2, 3	FDD	
		4, 5, 6	TDD	
TDD special subframe configuration <sup>Note1</sup>		4, 5, 6	6	
TDD uplink-downlink configuration <sup>Note1</sup>		4, 5, 6	1	
BW <sub>channel</sub>	MHz	1, 2, 3, 4, 5, 6	5 MHz: N <sub>RB,c</sub> = 25 10 MHz: N <sub>RB,c</sub> = 50 20 MHz: N <sub>RB,c</sub> = 100	
PDSCH parameters: DL Reference Measurement Channel <sup>Note2</sup>		1, 2, 3	5 MHz: R.7 FDD 10 MHz: R.3 FDD 20 MHz: R.6 FDD	

Parameter	Unit	Configuration	Cell 1	
			T1	T2
		4, 5, 6	5 MHz: R.4 TDD 10 MHz: R.0 TDD 20 MHz: R.3 TDD	
PCFICH/PDCCH/PHICH parameters: DL Reference Measurement Channel <sup>Note2</sup>		1, 2, 3	5 MHz: R.11 FDD 10 MHz: R.6 FDD 20 MHz: R.10 FDD	
		4, 5, 6	5 MHz: R.11 TDD 10 MHz: R.6 TDD 20 MHz: R.10 TDD	
OCNG Patterns <sup>Note2</sup>		1, 2, 3	5 MHz: OP.20 FDD 10 MHz: OP.10 FDD 20 MHz: OP.17 FDD	
		4, 5, 6	5 MHz: OP.9 TDD 10 MHz: OP.1 TDD 20 MHz: OP.7 TDD	
b2-Threshold1	dBm	1, 2, 3, 4, 5, 6	-77	
PBCH_RA	dB	1, 2, 3, 4, 5, 6	0	
PBCH_RB				
PSS_RA				
SSS_RA				
PCFICH_RB				
PHICH_RA				
PHICH_RB				
PDCCH_RA				
PDCCH_RB				
PDSCH_RA				
PDSCH_RB				
OCNG_RA <sup>Note3</sup>				
OCNG_RB <sup>Note3</sup>				
N <sub>oc</sub> <sup>Note4</sup>	dBm/15kHz	1, 2, 3, 4, 5, 6	-104	
$\hat{E}_s/N_{oc}$	dB	1, 2, 3, 4, 5, 6	17	15.35
$\hat{E}_s/I_{ot}$ <sup>Note5</sup>	dB	1, 2, 3, 4, 5, 6	17	15.35
RSRP <sup>Note5</sup>	dBm/15kHz	1, 2, 3, 4, 5, 6	-87	-88.65
SCH_RP <sup>Note5</sup>	dBm/15kHz	1, 2, 3, 4, 5, 6	-87	-88.65
I <sub>o</sub> <sup>Note5</sup>	dBm/9MHz	1, 2, 3, 4, 5, 6	$-59.13+10\log(N_{RB,c}/50)$	$-60.74+10\log(N_{RB,c}/50)$
Propagation Condition <sup>Note6</sup>		1, 2, 3, 4, 5, 6	ETU70	
Antenna Configuration and Correlation Matrix <sup>Note6</sup>		1, 2, 3, 4, 5, 6	1x2 Low	
<p>NOTE 1: Special subframe and uplink-downlink configurations are specified in table 4.2-1 in TS 36.211 [24].</p> <p>NOTE 2: DL RMCs and OCNG patterns are specified in clauses A 3.1 and A 3.2 of TS 36.133 [23] respectively.</p> <p>NOTE 3: OCNG shall be used such that all cells are fully allocated and a constant total transmitted power spectral density is achieved for all OFDM symbols.</p> <p>NOTE 4: Interference from other cells and noise sources not specified in the test is assumed to be constant over subcarriers and time and shall be modelled as AWGN of appropriate power for N<sub>oc</sub> to be fulfilled.</p> <p>NOTE 5: <math>\hat{E}_s/I_{ot}</math>, RSRP, SCH_RP and I<sub>o</sub> levels have been derived from other parameters for information purposes. They are not settable parameters themselves.</p> <p>NOTE 6: Propagation condition and correlation matrix are defined in clause B.2 in TS 36.101 [27].</p>				



**Table 8.4.2.4.5-2: NR neighbour cell specific test parameters for E-UTRA - NR FR1 event-triggered reporting with SSB time index detection in DRX**

Parameter	Unit	Test configuration	Cell 2	
			T1	T2
NR RF Channel Number		1, 2, 3, 4, 5, 6	1	
Duplex mode		1, 4	FDD	
		2, 3, 5, 6	TDD	
TDD configuration		2, 5	TDDConf.1.1	
		3, 6	TDDConf.2.1	
BW <sub>channel</sub>	MHz	1, 2, 4, 5	10: N <sub>RB,c</sub> = 52	
		3, 6	40: N <sub>RB,c</sub> = 106	
OCNG Patterns		1, 2, 3, 4, 5, 6	OP.1	
SMTC configuration		1, 4	SMTC.2	
		2, 3, 5, 6	SMTC.1	
PDSCH/PDCCH subcarrier spacing	kHz	1, 2, 4, 5	15	
		3, 6	30	
b2-Threshold2NR	dBm/SCS	1, 2, 4, 5	-101	
		3, 6	-98	
EPRE ratio of PSS to SSS		1, 2, 3, 4, 5, 6	0	
EPRE ratio of PBCH DMRS to SSS				
EPRE ratio of PBCH to PBCH DMRS				
EPRE ratio of PDCCH DMRS to SSS				
EPRE ratio of PDCCH to PDCCH DMRS				
EPRE ratio of PDSCH DMRS to SSS				
EPRE ratio of PDSCH to PDSCH				
EPRE ratio of OCNG DMRS to SSS (Note 1)				
EPRE ratio of OCNG to OCNG DMRS (Note 1)				
$N_{oc}$ <sup>Note2</sup>	dBm/15kHz	1, 2, 3, 4, 5, 6	-98	
$N_{oc}$ <sup>Note2</sup>	dBm/SCS	1, 2, 4, 5	-98	
		3, 6	-95	
SS-RSRP <sup>Note 3</sup>	dBm/SCS	1, 2, 4, 5	-Infinity	-89.35
		3, 6	-Infinity	-86.34
$\hat{E}_s/I_{ot}$	dB	1, 2, 3, 4, 5, 6	-Infinity	8.65
$\hat{E}_s/N_{oc}$	dB	1, 2, 3, 4, 5, 6	-Infinity	8.65
I <sub>o</sub> <sup>Note3</sup>	dBm/9.36MHz	1, 2, 4, 5	-70.05	-60.84
	dBm/38.16MHz	3, 6	-63.95	-54.74
Propagation Condition		1, 2, 3, 4, 5, 6	TDL-C 300ns 100Hz	
Antenna Configuration and Correlation Matrix		1, 2, 3, 4, 5, 6	1x2 Low	
<p>NOTE 1: OCNG shall be used such that the cell is fully allocated and a constant total transmitted power spectral density is achieved for all OFDM symbols.</p> <p>NOTE 2: Interference from other cells and noise sources not specified in the test is assumed to be constant over subcarriers and time and shall be modelled as AWGN of appropriate power for <math>N_{oc}</math> to be fulfilled.</p> <p>NOTE 3: SS-RSRP and I<sub>o</sub> levels have been derived from other parameters for information purposes. They are not settable parameters themselves.</p> <p>NOTE 4: SS-RSRP minimum requirements are specified assuming independent interference and noise at each receiver antenna port.</p>				

In test 1 with per-UE gap, the UE shall send one Event B2 triggered measurement report, with a measurement reporting delay less than 1282 ms from the beginning of time period T2. The UE shall not send event triggered measurement reports, as long as the reporting criteria are not fulfilled. The rate of correct events observed during repeated tests shall be at least 90%.

In test 2 with per-UE gap, the UE shall send one Event B2 triggered measurement report, with a measurement reporting delay less than 12162 ms from the beginning of time period T2. The UE shall not send event triggered measurement reports, as long as the reporting criteria are not fulfilled. The rate of correct events observed during repeated tests shall be at least 90%.

In test 3 with per-FR gap, the UE shall send one Event B2 triggered measurement report, with a measurement reporting delay less than 1282 ms from the beginning of time period T2. The UE shall not send event triggered measurement reports, as long as the reporting criteria are not fulfilled. The rate of correct events observed during repeated tests shall be at least 90%.

In test 4 with per-FR gap, the UE shall send one Event B2 triggered measurement report, with a measurement reporting delay less than 12162 ms from the beginning of time period T2. The UE shall not send event triggered measurement reports, as long as the reporting criteria are not fulfilled. The rate of correct events observed during repeated tests shall be at least 90%.

In tests 1, 2, 3 and 4, the UE is required to report SSB time index.

NOTE: The overall delay requirement is defined as the delay requirement in TS 38.133 plus 2 ms corresponding to the TTI insertion uncertainty of the measurement report in DCCH.

#### 8.4.2.5 E-UTRA event-triggered reporting of a NR FR2 neighbour cell without SSB time index detection in non-DRX

*Editor's notes: This test case is incomplete. The following aspects are either missing or TBD.*

- *Connection Diagram is TBD;*
- *Test tolerance analysis is missing;*
- *Test applicability Table in TS38.522 need to be updated.*

##### 8.4.2.5.1 Test purpose

To verify the UE's ability to make a correct reporting of an event without SSB time index detection in non-DRX within E-UTRA - NR FR2 cell search requirements.

##### 8.4.2.5.2 Test applicability

This test applies to all E-UTRA UE release 15 onwards and capable of NR FR2 measurements. Test 1 is applicable to UEs not supporting per-FR gap (IndependentGapConfig, as defined in TS 38.306 [11]) and Test 2 is applicable only to UEs supporting Gap Pattern Id 4.8.4.2.5.3 Minimum conformance requirements

The minimum conformance requirements are specified in clause 8.4.2.0.1.

The normative reference for this requirement is TS 38.133 [6] clause A.8.4.2.5.

##### 8.4.2.5.4 Test description

###### 8.4.2.5.4.1 Initial conditions

This test shall be tested using any of the test configurations in Table 8.4.2.5.4.1-1.

**Table 8.4.2.5.4.1-1: NR inter-RAT event triggered reporting tests without SSB index reading for FR2 in non-DRX**

Configuration	Description
8.4.2.5-1	LTE FDD, NR 120 kHz SSB SCS, 100 MHz bandwidth, TDD duplex mode
8.4.2.5-2	LTE TDD, NR 120 kHz SSB SCS, 100 MHz bandwidth, TDD duplex mode
NOTE: The UE is only required to be tested in one of the supported test configurations.	

Configure the test requirement and the DUT according to the parameters in Table 8.4.2.5.4.1-2.

**Table 8.4.2.5.4.1-2: Initial conditions for E-UTRA -  
NR FR2 event-triggered reporting without SSB time index detection in non-DRX**

Parameter	Value		Comment
Test environment	NC		As specified in TS 36.508 [25] clause 4.1.
Test frequencies	As specified in Annex E, Table E.6-1 and TS 38.508-1 [14] clause 4.3.1.		
Channel bandwidth	As specified by the test configuration selected from Table 8.4.2.5.4.1-1.		
Propagation conditions	AWGN		As specified in clause C.2.1
Connection Diagram	TE Part	TBD	As specified in TS 38.508-1 [14] Annex A.
	DUT Part	TBD	
Exceptions to connection diagram	N/A		

1. The general test parameter settings are set up according to Table 8.4.2.5.4.1-3.
2. Message contents are defined in clause 8.4.2.5.4.3.
3. There are two carriers and two cells specified in the test, where Cell 1 is the E-UTRA PCell on the E-UTRA carrier and Cell 2 is the NR FR2 neighbour cell on the NR carrier. Cell 1 is the cell used for connection setup with the power level set according to clause A.6.1.2 for this test.

**Table 8.4.2.5.4.1-3: General test parameters for NR inter-RAT event triggered reporting for FR2 without SSB time index detection in non-DRX**

Parameter	Unit	Test configuration	Value		Comment
			Test 1	Test 2	
E-UTRA RF Channel Number		1, 2	1		One E-UTRA carrier frequency is used.
NR RF Channel Number		1, 2	1		One FR2 NR carrier frequency is used.
Active cell		1, 2	E-UTRA cell 1 (PCell)		E-UTRA cell 1 is on E-UTRA RF channel number 1 as defined in clause A.6.1.2.
Neighbour cell		1, 2	NR cell 2		NR cell 2 is on NR RF channel number 1.
Gap Pattern Id		1, 2	0	4	As specified in clause Table 8.1.2.1-1 of TS 36.133 [23].
Measurement gap offset		1, 2	39	19	As specified in TS 36.331 [29].
b1-ThresholdNR	dBm	1, 2	Note 1		SS-RSRP threshold for SS-RSRP measurement on cell 2 for event B1 [29].
Hysteresis	dB	1, 2	0		
CP length		1, 2	Normal		
TimeToTrigger	s	1, 2	0		
Filter coefficient		1, 2	0		L3 filtering is not used.
DRX		1, 2	OFF		DRX is not used.
Time offset between serving and neighbour cells		1	3ms		Asynchronous cells. The timing of Cell 2 is 3ms later than the timing of Cell 1.
		2	3μs		Synchronous cells.
T1	s	1, 2	10		
T2	s	1, 2	6	3	

NOTE: The value of b1-ThresholdNR is defined in Table 8.4.2.5.5-1.

#### 8.4.2.5.4.2 Test procedure

In test 1 measurement gap pattern configuration # 0 as defined in Table 8.4.2.5.4.1-3 is provided for UE that does not support per-FR gap and in test 2 measurement gap pattern configuration #4 as defined in Table 8.4.2.5.4.1-3 is provided for UE that supports per-FR gap.

In the measurement control information, it is indicated to the UE that event-triggered reporting with Event B1 (Inter RAT neighbour becomes better than threshold) [29] is used. The test consists of two successive time periods, with time duration of T1, and T2 respectively. During time duration T1, the UE shall not have timing information of NR cell 2.

1. Ensure the UE is in State 3A-RF according to TS 36.508 [25] clause 7.2A.3.
2. Set the parameters of Cell 1 and Cell 2 according to Table A.6.1.2-1 and T1 in Table 8.4.2.5.5-1 respectively, T1 starts.
3. The SS shall transmit an *RRCConnectionReconfiguration* message.
4. The UE shall transmit an *RRCConnectionReconfigurationComplete* message.
5. When T1 expires, the SS shall switch the parameters setting from T1 to T2 as specified in Table 8.4.2.5.5-1. T2 Starts.
6. UE shall transmit a *MeasurementReport* message triggered by Event B1. If the overall delays measured from the beginning of time period T2 is less than X ms then the number of successful tests is increased by one. If the UE fails to report the event within the overall delays measured requirement then the number of failure tests is increased by one. Where X is,
  - 3200 for sub-test 1,
  - 1600 for sub-test 2.
7. . After the SS receive the *MeasurementReport* message in step 6) or when T2 expires, the SS shall:
  - transmit an *RRCConnectionRelease* message to release the RRC connection which includes the release of the established radio bearers as well as all radio resources, or
  - switch off the UE.
8. Set Cell 2 physical cell identity = ((current Cell 2 physical cell identity + 1) mod 1008) for next iteration of the test procedure loop.
9. The SS:
  - transmits in Cell 1 a Paging message (including PagingRecord with UE-Identity) for the UE and ensures the UE is in State 3A according to TS 36.508 clause 4.5.3A (if the paging fails, switches off and on the UE and ensures the UE is in State 3A-RF according to TS 36.508 [25] clause 7.2A.3); or
  - switches on the UE and ensures the UE is in State 3A-RF according to TS 36.508 [25] clause 7.2A.3.
10. Repeat step 2-9 until the confidence level according to Tables G.2.3-1 in Annex G clause G.2 is achieved.

#### 8.4.2.5.4.3 Message contents

Message contents are according to TS 36.508 [25] clause 7.3 with the following exceptions:

**Table 8.4.2.5.4.3-1: Common Exception messages for E-UTRA - NR FR2 event-triggered reporting without SSB time index detection in non-DRX**

Default Message Contents	
Common contents of system information blocks exceptions	
Default RRC messages and information elements contents exceptions	Table H.3.4-1a; Table H.3.4-4 with Condition INTER-RAT NR, EVENT B1 for Test 1; Table H.3.4-4 with Condition INTER-RAT NR, EVENT B1 and GAPLESS for Test 2; Table H.3.4-5 with Condition Pattern #0 for Test 1; Table H.3.4-5 with Condition Pattern #4 for Test 2;
Specific message contents exceptions for Test Configuration 8.4.2.5-1	Table H.3.4-6 with Conditions SMTC.2, SSB.3 FR2 and Asynchronous cells
Specific message contents exceptions for Test Configuration 8.4.2.5-2	Table H.3.4-6 with Conditions SMTC.1, SSB.3 FR2 and Synchronous cells

**Table 8.4.2.5.4.3-2: SchedulingRequest-Config-DEFAULT**

Derivation Path: 36.508 [25] Table 4.6.3-20			
Information Element	Value/remark	Comment	Condition
SchedulingRequest-Config-DEFAULT ::= CHOICE { setup SEQUENCE {			
sr-ConfigIndex	25		Config 8.4.2.5-1/2/3
	22		Config 8.4.2.5-4/5/6
}			
}			

8.4.2.5.5 Test requirement

Tables 8.4.2.5.4.1-3 and 8.4.2.5.5-1 define the primary level settings including test tolerances for E-UTRA - NR FR2 event-triggered reporting without SSB time index detection in non-DRX.

**Table 8.4.2.5.5-1: NR neighbour cell specific test parameters for NR inter-RAT event triggered reporting for FR2 without SSB time index detection in non-DRX**

Parameter	Unit	Test configuration	Cell 2	
			T1	T2
NR RF Channel Number		1, 2	1	
Duplex mode		1, 2	TDD	
TDD configuration		1, 2	TDDConf.3.1	
BW <sub>channel</sub>	MHz	1, 2	100: N <sub>RB,c</sub> = 66	
OCNG patterns		1, 2	OP.1	
SMTC configuration		1	SMTC.2	
		2	SMTC.1	
PDSCH/PDCCH subcarrier spacing	kHz	1, 2	120	
b1-ThresholdNR   UE power class 3	dBm/SCS	1, 2	-108	
EPRE ratio of PSS to SSS		1, 2	0	
EPRE ratio of PBCH DMRS to SSS				
EPRE ratio of PBCH to PBCH DMRS				
EPRE ratio of PDCCH DMRS to SSS				
EPRE ratio of PDCCH to PDCCH DMRS				
EPRE ratio of PDSCH DMRS to SSS				
EPRE ratio of PDSCH to PDSCH				
EPRE ratio of OCNG DMRS to SSS (Note 1)				
EPRE ratio of OCNG to OCNG DMRS (Note 1)				
AoA setup defined in A.9		1, 2	Setup 2a	
$N_{oc}$ <sup>Note2</sup>	dBm/15kHz	1, 2	-111+TT	
$N_{oc}$ <sup>Note2</sup>	dBm/SCS	1, 2	-102+TT	
SS-RSRP <sup>Note 3</sup>	dBm/SCS	1, 2	-Infinity	-88+TT
$\hat{E}_s/I_{ot}$	dB	1, 2	-Infinity	14+TT
$\hat{E}_s/N_{oc}$	dB	1, 2	-Infinity	14+TT
$I_o$ <sup>Note3</sup>	dBm/95.04MHz	1, 2	-Infinity	-58.84+TT
Propagation Condition		1, 2	AWGN	
NOTE 1: OCNG shall be used such that the cell is fully allocated and a constant total transmitted power spectral density is achieved for all OFDM symbols.				
NOTE 2: Interference from other cells and noise sources not specified in the test is assumed to be constant over subcarriers and time and shall be modelled as AWGN of appropriate power for $N_{oc}$ to be fulfilled.				
NOTE 3: SS-RSRP and $I_o$ levels have been derived from other parameters for information purposes. They are not settable parameters themselves.				
NOTE 4: SS-RSRP minimum requirements are specified assuming independent interference and noise at each receiver antenna port.				

**Table 8.4.2.5.5-2: Test requirements for NR inter-RAT event triggered reporting for FR2 without SSB time index detection in non-DRX**

Test case	Measurement reporting delay (ms)	
	Test 1: D1 ms	Test 2: D2 ms
UE power class 3	3200	1600

NOTE: The actual overall delays measured in the test may be up to  $2 \times TTI_{DCCH}$  higher than the measurement reporting delays above because of TTI insertion uncertainty of the measurement report in DCCH.

In test 1 with per-UE gap, the UE shall send one Event B1 triggered measurement report, with a measurement reporting delay less than D1 ms from the beginning of time period T2. The UE shall not send event triggered measurement reports, as long as the reporting criteria are not fulfilled. The rate of correct events observed during repeated tests shall be at least 90%.

In test 2 with per-FR gap, the UE shall send one Event B1 triggered measurement report, with a measurement reporting delay less than D2 ms from the beginning of time period T2. The UE shall not send event triggered measurement reports, as long as the reporting criteria are not fulfilled. The rate of correct events observed during repeated tests shall be at least 90%.

In test 1 and test 2, the UE is not required to report SSB time index.

#### 8.4.2.6 E-UTRA event-triggered reporting of a NR FR2 neighbour cell without SSB time index detection in DRX

*Editor's notes: This test case is incomplete. The following aspects are either missing or TBD.*

- *Connection Diagram is TBD;*
- *Test tolerance analysis is missing;*
- *Test applicability Table in TS38.522 need to be updated.*

##### 8.4.2.6.1 Test purpose

To verify the UE's ability to make a correct reporting of an event without SSB time index detection in DRX within E-UTRA - NR FR2 cell search requirements.

##### 8.4.2.6.2 Test applicability

This test applies to all E-UTRA UE release 15 onwards supporting long DRX cycle and capable of NR FR2 measurements. Test 1 and Test 2 is applicable to UEs not supporting per-FR gap (IndependentGapConfig, as defined in TS 38.306 [11]) and Test 3 and Test 4 are applicable only to UEs supporting Gap Pattern Id 4.

##### 8.4.2.6.3 Minimum conformance requirements

The minimum conformance requirements are specified in clause 8.4.2.0.1.

The normative reference for this requirement is TS 38.133 [6] clause A.8.4.2.6.

##### 8.4.2.6.4 Test description

###### 8.4.2.6.4.1 Initial conditions

This test shall be tested using any of the test configurations in Table 8.4.2.6.4.1-1.

**Table 8.4.2.6.4.1-1: NR inter-RAT event triggered reporting tests without SSB index reading for FR2 in DRX**

Configuration	Description
8.4.2.6-1	LTE FDD, NR 120 kHz SSB SCS, 100 MHz bandwidth, TDD duplex mode
8.4.2.6-2	LTE TDD, NR 120 kHz SSB SCS, 100 MHz bandwidth, TDD duplex mode
NOTE: The UE is only required to be tested in one of the supported test configurations.	

Configure the test requirement and the DUT according to the parameters in Table 8.4.2.6.4.1-2.

**Table 8.4.2.6.4.1-2: Initial conditions for E-UTRA - NR FR2 event-triggered reporting without SSB time index detection in DRX**

Parameter	Value	Comment				
Test environment	NC	As specified in TS 36.508 [25] clause 4.1.				
Test frequencies	As specified in Annex E, Table E.6-1 and TS 38.508-1 [14] clause 4.3.1.					
Channel bandwidth	As specified by the test configuration selected from Table 8.4.2.6.4.1-1.					
Propagation conditions	AWGN	As specified in clause C.2.1				
Connection Diagram	<table border="1"> <tr> <td>TE Part</td> <td>TBD</td> </tr> <tr> <td>DUT Part</td> <td>TBD</td> </tr> </table>	TE Part	TBD	DUT Part	TBD	As specified in TS 38.508-1 [14] Annex A.
TE Part	TBD					
DUT Part	TBD					
Exceptions to connection diagram	N/A					

1. The general test parameter settings are set up according to Table 8.4.2.6.4.1-3.
2. Message contents are defined in clause 8.4.2.6.4.3.
3. There are two carriers and two cells specified in the test, where Cell 1 is the E-UTRA PCell on the E-UTRA carrier and Cell 2 is the NR FR2 neighbour cell on the NR carrier. Cell 1 is the cell used for connection setup with the power level set according to clause A.6.1.2 for this test.

**Table 8.4.2.6.4.1-3: General test parameters for NR inter-RAT event triggered reporting for FR2 without SSB time index detection in DRX**

Parameter	Unit	Test configuration	Value				Comment
			Test 1	Test 2	Test 3	Test 4	
E-UTRA RF Channel Number		1, 2	1				One E-UTRA carrier frequency is used.
NR RF Channel Number		1, 2	1				One FR2 NR carrier frequency is used.
Active cell		1, 2, 3, 4, 5, 6	E-UTRA cell 1 (PCell)				E-UTRA cell 1 is on E-UTRA RF channel number 1 as defined in clause A.6.1.2.
Neighbour cell		1, 2, 3, 4, 5, 6	NR cell 2				NR cell 2 is on NR RF channel number 1.
Gap Pattern Id		1, 2, 3, 4, 5, 6	0		4		As specified in clause Table 8.1.2.1-1 of TS 36.133 [23].
Measurement gap offset		1, 2, 3, 4, 5, 6	39		19		As specified in TS 36.331 [29].
b1-ThresholdNR	dBm	1, 2	Note 1				SS-RSRP threshold for SS-RSRP measurement on cell 2 for event B1 [29].
Hysteresis	dB	1, 2, 3, 4, 5, 6	0				
CP length		1, 2, 3, 4, 5, 6	Normal				
TimeToTrigger	s	1, 2, 3, 4, 5, 6	0				
Filter coefficient		1, 2, 3, 4, 5, 6	0				L3 filtering is not used.
DRX		1, 2, 3, 4, 5, 6	DRX.9	DRX.12	DRX.9	DRX.12	As specified in clause A.3.3.
Time offset between serving and neighbour cells		1	3ms				Asynchronous cells. The timing of Cell 2 is 3ms later than the timing of Cell 1.
		2	3μs				Synchronous cells.
T1	s	1, 2, 3, 4, 5, 6	5				
T2	s	1, 2, 3, 4, 5, 6	6	83	6	83	

NOTE: The value of b1-ThresholdNR is defined in Table 8.4.2.6.5-1.

#### 8.4.2.6.4.2 Test procedure

In tests 1 and 2, measurement gap pattern configuration # 0 as defined in Table 8.4.2.6.4.1-3 is provided for UE that does not support per-FR gap and in tests 3 and 4, measurement gap pattern configuration #4 as defined in Table 8.4.2.6.4.1-3 is provided for UE that supports per-FR gap.

In the measurement control information, it is indicated to the UE that event-triggered reporting with Event B1 (Inter RAT neighbour becomes better than threshold) [29] is used. In the measurement configuration the UE shall be indicated to report the SSB index of the identified NR cell. The test consists of two successive time periods, with time duration of T1, and T2 respectively. During time duration T1, the UE shall not have timing information of NR cell 2.

1. Ensure the UE is in State 3A-RF according to TS 36.508 [25] clause 7.2A.3.
2. Set the parameters of Cell 1 and Cell 2 according to Table A.6.1.2-1 and T1 in Table 8.4.2.6.5-1 respectively, T1 starts.
3. The SS shall transmit an *RRCConnectionReconfiguration* message.
4. The UE shall transmit an *RRCConnectionReconfigurationComplete* message.
5. When T1 expires, the SS shall switch the parameters setting from T1 to T2 as specified in Table 8.4.2.6.5-1. T2 Starts.
6. UE shall transmit a *MeasurementReport* message triggered by Event B1. If the overall delays measured from the beginning of time period T2 is less than X ms then the number of successful tests is increased by one. If the UE fails to report the event within the overall delays measured requirement then the number of failure tests is increased by one. Where X is,
  - 4800 for sub-test 1 and sub-test 3,
  - 51200 for sub-test 2 and sub-test 4.



7. After the SS receive the *MeasurementReport* message in step 6) or when T2 expires, the SS shall:
  - transmit an *RRCCConnectionRelease* message to release the RRC connection which includes the release of the established radio bearers as well as all radio resources, or
  - switch off the UE
8. Set Cell 2 physical cell identity = ((current Cell 2 physical cell identity + 1) mod 1008) for next iteration of the test procedure loop.
9. The SS:
  - transmits in Cell 1 a Paging message (including PagingRecord with UE-Identity) for the UE and ensures the UE is in State 3A according to TS 36.508 [25] clause 4.5.3A (if the paging fails, switches off and on the UE and ensures the UE is in State 3A-RF according to TS 36.508 [25] clause 7.2A.3); or
  - switches on the UE and ensures the UE is in State 3A-RF according to TS 36.508 [25] clause 7.2A.3.
10. Repeat step 2-9 until the confidence level according to Tables G.2.3-1 in Annex G clause G.2 is achieved.

8.4.2.6.4.3 Message contents

Message contents are according to TS 36.508 [25] clause 7.3 with the following exceptions:

**Table 8.4.2.6.4.3-1: Common Exception messages for E-UTRA - NR FR2 event-triggered reporting without SSB time index detection in DRX**

Default Message Contents	
Common contents of system information blocks exceptions	
Default RRC messages and information elements contents exceptions	Table H.3.4-1a; Table H.3.4-4 with Condition INTER-RAT NR, EVENT B1 for Test 1 and Test 2; Table H.3.4-4 with Condition INTER-RAT NR, EVENT B1 and GAPLESS for Test 3 and Test 4; Table H.3.4-5 with Condition Pattern #0 for Test 1 and Test 2; Table H.3.4-5 with Condition Pattern #4 for Test 3 and Test 4; Table H.3.7-2 with Condition DRX.9 for Test 1 and Test 3 Table H.3.7-2 with Condition DRX.12 for Test 2 and Test 4
Specific message contents exceptions for Test Configuration 8.4.2.6-1	Table H.3.4-6 with Conditions SMTC.2, SSB.3 FR2 and Asynchronous cells
Specific message contents exceptions for Test Configuration 8.4.2.6-2	Table H.3.4-6 with Conditions SMTC.1, SSB.3 FR2 and Synchronous cells

**Table 8.4.2.6.4.3-2: SchedulingRequest-Config-DEFAULT**

Derivation Path: 36.508 [25] Table 4.6.3-20			
Information Element	Value/remark	Comment	Condition
SchedulingRequest-Config-DEFAULT ::= CHOICE {			
setup SEQUENCE {			
sr-ConfigIndex	25		Config 8.4.2.6-1/2/3
	22		Config 8.4.2.6-4/5/6
}			
}			

8.4.2.6.5 Test requirement

Tables 8.4.2.6.4.1-3 and 8.4.2.6.5-1 define the primary level settings including test tolerances for E-UTRA - NR FR2 event-triggered reporting without SSB time index detection in DRX.

**Table 8.4.2.6.5-1: NR neighbour cell specific test parameters for NR inter-RAT event triggered reporting for FR2 without SSB time index detection in DRX**

Parameter	Unit	Test configuration	Cell 2	
			T1	T2
NR RF Channel Number		1, 2	1	
Duplex mode		1, 2	TDD	
TDD configuration		1, 2	TDDConf.3.1	
BW <sub>channel</sub>	MHz	1, 2	100: N <sub>RB,c</sub> = 66	
OCNG patterns		1, 2	OP.1	
SMTC configuration		1	SMTC.2	
		2	SMTC.1	
PDSCH/PDCCH subcarrier spacing	kHz	1, 2	120	
b1-ThresholdNR   UE power class 3	dBm/SCS	1, 2	-96	
EPRE ratio of PSS to SSS		1, 2	0	
EPRE ratio of PBCH DMRS to SSS				
EPRE ratio of PBCH to PBCH DMRS				
EPRE ratio of PDCCH DMRS to SSS				
EPRE ratio of PDCCH to PDCCH DMRS				
EPRE ratio of PDSCH DMRS to SSS				
EPRE ratio of PDSCH to PDSCH				
EPRE ratio of OCNG DMRS to SSS (Note 1)				
EPRE ratio of OCNG to OCNG DMRS (Note 1)				
AoA setup defined in A.9		1, 2	Setup 1	
$N_{oc}$ <sup>Note2</sup>	dBm/15kHz	1, 2	-111+TT	
$N_{oc}$ <sup>Note2</sup>	dBm/SCS	1, 2	-102+TT	
SS-RSRP <sup>Note 3</sup>	dBm/SCS	1, 2	-Infinity	-88+TT
$\hat{E}_{sl}/I_{ot}$	dB	1, 2	-Infinity	14+TT
$\hat{E}_{sl}/N_{oc}$	dB	1, 2	-Infinity	14+TT
$I_o$ <sup>Note3</sup>	dBm/95.04MHz	1, 2	-Infinity	-58.84+TT
Propagation Condition		1, 2	AWGN	
NOTE 1: OCNG shall be used such that the cell is fully allocated and a constant total transmitted power spectral density is achieved for all OFDM symbols.				
NOTE 2: Interference from other cells and noise sources not specified in the test is assumed to be constant over subcarriers and time and shall be modelled as AWGN of appropriate power for $N_{oc}$ to be fulfilled.				
NOTE 3: SS-RSRP and $I_o$ levels have been derived from other parameters for information purposes. They are not settable parameters themselves.				
NOTE 4: SS-RSRP minimum requirements are specified assuming independent interference and noise at each receiver antenna port.				

**Table 8.4.2.6.5-2: Test requirements for NR inter-RAT event triggered reporting for FR2 without SSB time index detection in DRX**

Test case	Measurement reporting delay (ms)			
	Test 1: D1 ms	Test 2: D2 ms	Test 3: D3 ms	Test 4: D4 ms
UE power class 3	4800	51200	4800	51200

NOTE: The actual overall delays measured in the test may be up to  $2 \times TTI_{DCCH}$  higher than the measurement reporting delays above because of TTI insertion uncertainty of the measurement report in DCCH.

In test 1 with per-UE gap, the UE shall send one Event B1 triggered measurement report, with a measurement reporting delay less than D1 ms from the beginning of time period T2. The UE shall not send event triggered measurement reports, as long as the reporting criteria are not fulfilled. The rate of correct events observed during repeated tests shall be at least 90%.

In test 2 with per-UE gap, the UE shall send one Event B1 triggered measurement report, with a measurement reporting delay less than D2 ms from the beginning of time period T2. The UE shall not send event triggered measurement reports, as long as the reporting criteria are not fulfilled. The rate of correct events observed during repeated tests shall be at least 90%.

In test 3 with per-FR gap, the UE shall send one Event B1 triggered measurement report, with a measurement reporting delay less than D3 ms from the beginning of time period T2. The UE shall not send event triggered measurement reports, as long as the reporting criteria are not fulfilled. The rate of correct events observed during repeated tests shall be at least 90%.

In test 4 with per-FR gap, the UE shall send one Event B1 triggered measurement report, with a measurement reporting delay less than D4 ms from the beginning of time period T2. The UE shall not send event triggered measurement reports, as long as the reporting criteria are not fulfilled. The rate of correct events observed during repeated tests shall be at least 90%.

In tests 1, 2, 3 and 4, the UE is not required to report SSB time index.

#### 8.4.2.7 E-UTRA event-triggered reporting of a NR FR2 neighbour cell with SSB time index detection in non-DRX

*Editor's notes: This test case is incomplete. The following aspects are either missing or TBD.*

- *Connection Diagram is TBD;*
- *Test tolerance analysis is missing;*
- *Test applicability Table in TS38.522 need to be updated.*

##### 8.4.2.7.1 Test purpose

To verify the UE's ability to make a correct reporting of an event with SSB time index detection in non-DRX within E-UTRA - NR FR2 cell search requirements.

##### 8.4.2.7.2 Test applicability

This test applies to all E-UTRA UE release 15 onwards and capable of NR FR2 measurements. Test 1 is applicable to UEs not supporting per-FR gap (IndependentGapConfig, as defined in TS 38.306 [11]) and Test 2 is applicable only to UEs supporting Gap Pattern Id 4.

##### 8.4.2.7.3 Minimum conformance requirements

The minimum conformance requirements are specified in clause 8.4.2.0.1.

The normative reference for this requirement is TS 38.133 [6] clause A.8.4.2.7.

##### 8.4.2.7.4 Test description

###### 8.4.2.7.4.1 Initial conditions

This test shall be tested using any of the test configurations in Table 8.4.2.7.4.1-1.

**Table 8.4.2.7.4.1-1: NR inter-RAT event triggered reporting tests with SSB index reading for FR2 in non-DRX**

Configuration	Description
8.4.2.7-1	LTE FDD, NR 120 kHz SSB SCS, 100 MHz bandwidth, TDD duplex mode
8.4.2.7-2	LTE TDD, NR 120 kHz SSB SCS, 100 MHz bandwidth, TDD duplex mode
NOTE: The UE is only required to be tested in one of the supported test configurations.	

Configure the test requirement and the DUT according to the parameters in Table 8.4.2.7.4.1-2.

**Table 8.4.2.7.4.1-2: Initial conditions for E-UTRA - NR FR2 event-triggered reporting with SSB time index detection in non-DRX**

Parameter	Value		Comment
Test environment	NC		As specified in TS 36.508 [25] clause 4.1.
Test frequencies	As specified in Annex E, Table E.6-1 and TS 38.508-1 [14] clause 4.3.1.		
Channel bandwidth	As specified by the test configuration selected from Table 8.4.2.7.4.1-1.		
Propagation conditions	AWGN		As specified in clause C.2.1
Connection Diagram	TE Part	TBD	As specified in TS 38.508-1 [14] Annex A.
	DUT Part	TBD	
Exceptions to connection diagram	N/A		

1. The general test parameter settings are set up according to Table 8.4.2.7.4.1-3.
2. Message contents are defined in clause 8.4.2.7.4.3.
3. There are two carriers and two cells specified in the test, where Cell 1 is the E-UTRA PCell on the E-UTRA carrier and Cell 2 is the NR FR2 neighbour cell on the NR carrier. Cell 1 is the cell used for connection setup with the power level set according to clause A.6.1.2 for this test.

**Table 8.4.2.7.4.1-3: General test parameters for NR inter-RAT event triggered reporting for FR2 with SSB time index detection in non-DRX**

Parameter	Unit	Test configuration	Value		Comment
			Test 1	Test 2	
E-UTRA RF Channel Numbers		1, 2	1		One E-UTRA carrier frequency is used.
NR RF Channel Numbers		1, 2	1		One FR2 NR carrier frequency is used.
Active cell		1, 2	E-UTRA cell 1 (PCell)		E-UTRA cell 1 is on E-UTRA RF channel number 1 as defined in clause A.6.1.2.
Neighbour cell		1, 2	NR cell 2		NR cell 2 is on NR RF channel number 1.
Gap Pattern Id		1, 2	0	4	As specified in clause Table 8.1.2.1-1 of TS 36.133 [23].
Measurement gap offset		1, 2	39	19	As specified in TS 36.331 [29].
b1-ThresholdNR	dBm	1, 2	Note 1		SS-RSRP threshold for SS-RSRP measurement on cell 2 for event B1 [29]
Hysteresis	dB	1, 2	0		
CP length		1, 2	Normal		
TimeToTrigger	s	1, 2	0		
Filter coefficient		1, 2	0		L3 filtering is not used.
DRX		1, 2	OFF		DRX is not used.
Time offset between serving and neighbour cells		1	3ms		Asynchronous cells. The timing of Cell 2 is 3ms later than the timing of Cell 1.
		2	3µs		Synchronous cells.
T1	s	1, 2	5		
T2	s	1, 2	5	3	

NOTE: The value of b1-ThresholdNR is defined in Table A.8.4.2.7.5-1.

#### 8.4.2.7.4.2 Test procedure

In test 1 measurement gap pattern configuration # 0 as defined in Table 8.4.2.7.4.1-3 is provided for UE that does not support per-FR gap and in test 2 measurement gap pattern configuration #4 as defined in Table 8.4.2.7.4.1-3 is provided for UE that supports per-FR gap.

In the measurement control information, it is indicated to the UE that event-triggered reporting with Event B1 (Inter RAT neighbour becomes better than threshold) [29] is used. In the measurement configuration the UE shall be indicated

to report the SSB index of the identified NR cell. The test consists of two successive time periods, with time duration of T1, and T2 respectively. During time duration T1, the UE shall not have any timing information of NR cell 2.

1. Ensure the UE is in State 3A-RF according to TS 36.508 [25] clause 7.2A.3.
2. Set the parameters of Cell 1 and Cell 2 according to Table A.6.1.2-1 and T1 in Table 8.4.2.7.5-1 respectively, T1 starts.
3. The SS shall transmit an *RRCConnectionReconfiguration* message.
4. The UE shall transmit an *RRCConnectionReconfigurationComplete* message.
5. When T1 expires, the SS shall switch the parameters setting from T1 to T2 as specified in Table 8.4.2.7.5-1. T2 Starts.
6. UE shall transmit a *MeasurementReport* message triggered by Event B1. If the overall delays measured from the beginning of time period T2 is less than X ms then the number of successful tests is increased by one. If the UE fails to report the event within the overall delays measured requirement then the number of failure tests is increased by one. Where X is,
  - 4160 for sub-test 1,
  - 2080 for sub-test 2.
7. After the SS receive the *MeasurementReport* message in step 6) or when T2 expires, the SS shall:
  - transmit an *RRCConnectionRelease* message to release the RRC connection which includes the release of the established radio bearers as well as all radio resources, or
  - switch off the UE.
8. Set Cell 2 physical cell identity = ((current Cell 2 physical cell identity + 1) mod 1008) for next iteration of the test procedure loop.
9. The SS:
  - transmits in Cell 1 a Paging message (including PagingRecord with UE-Identity) for the UE and ensures the UE is in State 3A according to TS 36.508 clause 4.5.3A (if the paging fails, switches off and on the UE and ensures the UE is in State 3A-RF according to TS 36.508 [25] clause 7.2A.3); or
  - switches on the UE and ensures the UE is in State 3A-RF according to TS 36.508 [25] clause 7.2A.3.
10. Repeat step 2-9 until the confidence level according to Tables G.2.3-1 in Annex G clause G.2 is achieved.

#### 8.4.2.7.4.3 Message contents

Message contents are according to TS 36.508 [25] clause 7.3 with the following exceptions:

**Table 8.4.2.7.4.3-1: Common Exception messages for E-UTRA - NR FR2 event-triggered reporting with SSB time index detection in non-DRX**

Default Message Contents	
Common contents of system information blocks exceptions	
Default RRC messages and information elements contents exceptions	Table H.3.4-1a; Table H.3.4-4 with Condition INTER-RAT NR, EVENT B1 for Test 1; Table H.3.4-4 with Condition INTER-RAT NR, EVENT B1 and GAPLESS for Test 2; Table H.3.4-5 with Condition Pattern #0 for Test 1; Table H.3.4-5 with Condition Pattern #4 for Test 2;
Specific message contents exceptions for Test Configuration 8.4.2.7-1	Table H.3.4-6 with Conditions SMTC.2, SSB.3 FR2 and Asynchronous cells
Specific message contents exceptions for Test Configuration 8.4.2.7-2	Table H.3.4-6 with Conditions SMTC.1, SSB.3 FR2 and Synchronous cells

**Table 8.4.2.7.4.3-2: SchedulingRequest-Config-DEFAULT**

Derivation Path: 36.508 [25] Table 4.6.3-20			
Information Element	Value/remark	Comment	Condition
SchedulingRequest-Config-DEFAULT ::= CHOICE { setup SEQUENCE {			
sr-ConfigIndex	25		Config 8.4.2.7-1/2/3
	22		Config 8.4.2.7-4/5/6
}			
}			

8.4.2.7.5 Test requirement

Tables 8.4.2.7.4.1-3 and 8.4.2.7.5-1 define the primary level settings including test tolerances for E-UTRA - NR FR2 event-triggered reporting with SSB time index detection in non-DRX.

**Table 8.4.2.7.5-1: NR neighbour cell specific test parameters for NR inter-RAT event triggered reporting for FR2 with SSB time index detection in non-DRX**

Parameter	Unit	Test configuration	Cell 2	
			T1	T2
NR RF Channel Number		1, 2	1	
Duplex mode		1, 2	TDD	
TDD configuration		1, 2	TDDConf.3.1	
BW <sub>channel</sub>	MHz	1, 2	100: N <sub>RB,c</sub> = 66	
OCNG patterns		1, 2	OP.1	
SMTC configuration		1	SMTC.2	
		2	SMTC.1	
PDSCH/PDCCH subcarrier spacing	kHz	1, 2	120	
b1-ThresholdNR   UE power class 3	dBm/SCS	1, 2	-96	
EPRE ratio of PSS to SSS		1, 2	0	
EPRE ratio of PBCH DMRS to SSS				
EPRE ratio of PBCH to PBCH DMRS				
EPRE ratio of PDCCH DMRS to SSS				
EPRE ratio of PDCCH to PDCCH DMRS				
EPRE ratio of PDSCH DMRS to SSS				
EPRE ratio of PDSCH to PDSCH				
EPRE ratio of OCNG DMRS to SSS (Note 1)				
EPRE ratio of OCNG to OCNG DMRS (Note 1)				
AoA setup defined in A.9		1, 2	Setup 1	
$N_{oc}$ <sup>Note2</sup>	dBm/15kHz	1, 2	-111+TT	
$N_{oc}$ <sup>Note2</sup>	dBm/SCS	1, 2	-102+TT	
SS-RSRP <sup>Note 3</sup>	dBm/SCS	1, 2	-Infinity	-88+TT
$\hat{E}_s/I_{ot}$	dB	1, 2	-Infinity	14+TT
$\hat{E}_s/N_{oc}$	dB	1, 2	-Infinity	14+TT
$I_o$ <sup>Note3</sup>	dBm/95.04MHz	1, 2	-Infinity	-58.84+TT
Propagation Condition		1, 2	AWGN	
NOTE 1: OCNG shall be used such that the cell is fully allocated and a constant total transmitted power spectral density is achieved for all OFDM symbols.				
NOTE 2: Interference from other cells and noise sources not specified in the test is assumed to be constant over subcarriers and time and shall be modelled as AWGN of appropriate power for $N_{oc}$ to be fulfilled.				
NOTE 3: SS-RSRP and $I_o$ levels have been derived from other parameters for information purposes. They are not settable parameters themselves.				
NOTE 4: SS-RSRP minimum requirements are specified assuming independent interference and noise at each receiver antenna port.				

**Table 8.4.2.7.5-2: Test requirements for NR inter-RAT event triggered reporting for FR2 with SSB time index detection in non-DRX**

Test case	Measurement reporting delay (ms)	
	Test 1: D1 ms	Test 2: D2 ms
UE power class 3	4160	2080

NOTE: The actual overall delays measured in the test may be up to  $2 \times TTI_{DCCH}$  higher than the measurement reporting delays above because of TTI insertion uncertainty of the measurement report in DCCH.

In test 1 with per-UE gap, the UE shall send one Event B2 triggered measurement report, with a measurement reporting delay less than D1 ms from the beginning of time period T2. The UE shall not send event triggered measurement reports, as long as the reporting criteria are not fulfilled. The rate of correct events observed during repeated tests shall be at least 90%.

In test 2 with per-FR gap, the UE shall send one Event B2 triggered measurement report, with a measurement reporting delay less than D2 ms from the beginning of time period T2. The UE shall not send event triggered measurement reports, as long as the reporting criteria are not fulfilled. The rate of correct events observed during repeated tests shall be at least 90%.

In test 1 and test 2, the UE is required to report SSB time index.

NOTE: The actual overall delays measured in the test may be up to  $2 \times TTI_{DCCH}$  higher than the measurement reporting delays above because of TTI insertion uncertainty of the measurement report in DCCH.

#### 8.4.2.8 E-UTRA event-triggered reporting of a NR FR2 neighbour cell with SSB time index detection in DRX

*Editor's notes: This test case is incomplete. The following aspects are either missing or TBD.*

- *Connection Diagram is TBD;*
- *Test tolerance analysis is missing;*
- *Test applicability Table in TS38.522 need to be updated.*

##### 8.4.2.8.1 Test purpose

To verify the UE's ability to make a correct reporting of an event with SSB time index detection in DRX within E-UTRA - NR FR2 cell search requirements.

##### 8.4.2.8.2 Test applicability

This test applies to all E-UTRA UE release 15 onwards supporting long DRX cycle and capable of NR FR2 measurements. Test 1 and Test 2 is applicable to UEs not supporting per-FR gap (IndependentGapConfig, as defined in TS 38.306 [11]) and Test 3 and Test 4 are applicable only to UEs supporting Gap Pattern Id 4.

##### 8.4.2.8.3 Minimum conformance requirements

The minimum conformance requirements are specified in clause 8.4.2.0.1.

The normative reference for this requirement is TS 38.133 [6] clause A.8.4.2.8.

##### 8.4.2.8.4 Test description

###### 8.4.2.8.4.1 Initial conditions

This test shall be tested using any of the test configurations in Table 8.4.2.8.4.1-1.

**Table 8.4.2.8.4.1-1: NR inter-RAT event triggered reporting tests without SSB index reading for FR2 in DRX**

Configuration	Description
8.4.2.8-1	LTE FDD, NR 120 kHz SSB SCS, 100 MHz bandwidth, TDD duplex mode
8.4.2.8-2	LTE TDD, NR 120 kHz SSB SCS, 100 MHz bandwidth, TDD duplex mode
NOTE: The UE is only required to be tested in one of the supported test configurations.	

Configure the test requirement and the DUT according to the parameters in Table 8.4.2.8.4.1-2.

**Table 8.4.2.8.4.1-2: Initial conditions for E-UTRA - NR FR2 event-triggered reporting with SSB time index detection in DRX**

Parameter	Value	Comment
Test environment	NC	As specified in TS 36.508 [25] clause 4.1.
Test frequencies	As specified in Annex E, Table E.6-1 and TS 38.508-1 [14] clause 4.3.1.	
Channel bandwidth	As specified by the test configuration selected from Table 8.4.2.8.4.1-1.	
Propagation conditions	AWGN	As specified in clause C.2.1
Connection Diagram	TE Part DUT Part	TBD TBD
Exceptions to connection diagram	N/A	

1. The general test parameter settings are set up according to Table 8.4.2.8.4.1-3.
2. Message contents are defined in clause 8.4.2.8.4.3.
3. There are two carriers and two cells specified in the test, where Cell 1 is the E-UTRA PCell on the E-UTRA carrier and Cell 2 is the NR FR2 neighbour cell on the NR carrier. Cell 1 is the cell used for connection setup with the power level set according to clause A.6.1.2 for this test.



**Table 8.4.2.8.4.1-3: General test parameters for NR inter-RAT event triggered reporting for FR2 with SSB time index detection in DRX**

Parameter	Unit	Test configuration	Value				Comment
			Test 1	Test 2	Test 3	Test 4	
E-UTRA RF Channel Numbers		1, 2	1				One E-UTRA carrier frequency is used.
NR RF Channel Numbers		1, 2	1				One FR2 NR carrier frequency is used.
Active cell		1, 2	E-UTRA cell 1 (PCell)				E-UTRA cell 1 is on E-UTRA RF channel number 1 as defined in clause A.6.1.2.
Neighbour cell		1, 2	NR cell 2				NR cell 2 is on NR RF channel number 1.
Gap Pattern Id		1, 2	0		4		As specified in clause Table 8.1.2.1-1 of TS 36.133 [23].
Measurement gap offset		1, 2	39		19		As specified in TS 36.331 [29].
b1-ThresholdNR	dBm	1, 2	Note 1				SS-RSRP threshold for SS-RSRP measurement on cell 2 for event B1 [29].
Hysteresis	dB	1, 2	0				
CP length		1, 2	Normal				
TimeToTrigger	s	1, 2	0				
Filter coefficient		1, 2	0				L3 filtering is not used.
DRX			DRX.9	DRX.12	DRX.9	DRX.12	As specified in clause A.3.3.
Time offset between serving and neighbour cells		1	3ms				Asynchronous cells. The timing of Cell 2 is 3ms later than the timing of Cell 1.
		2	3μs				Synchronous cells.
T1	s	1, 2	5				
T2	s	1, 2	7	70	7	70	

NOTE: The value of b1-ThresholdNR is defined in Table A.8.4.2.8.5-1

#### 8.4.2.8.4.2 Test procedure

In tests 1 and 2, measurement gap pattern configuration # 0 as defined in Table 8.4.2.8.4.1-3 is provided for UE that does not support per-FR gap and in tests 3 and 4, measurement gap pattern configuration #4 as defined in Table 8.4.2.8.4.1-3 is provided for UE that supports per-FR gap.

In the measurement control information, it is indicated to the UE that event-triggered reporting with Event B1 (Inter RAT neighbour becomes better than threshold) [29] is used. In the measurement configuration the UE shall be indicated to report the SSB index of the identified NR cell. The test consists of two successive time periods, with time duration of T1, and T2 respectively. During time duration T1, the UE shall not have any timing information of NR cell 2.

1. Ensure the UE is in State 3A-RF according to TS 36.508 [25] clause 7.2A.3.
2. Set the parameters of Cell 1 and Cell 2 according to Table A.6.1.2-1 and T1 in Table 8.4.2.8.5-1 respectively, T1 starts.
3. The SS shall transmit an *RRCConnectionReconfiguration* message.
4. The UE shall transmit an *RRCConnectionReconfigurationComplete* message.
5. When T1 expires, the SS shall switch the parameters setting from T1 to T2 as specified in Table 8.4.2.8.5-1. T2 Starts.
6. UE shall transmit a *MeasurementReport* message triggered by Event B1. If the overall delays measured from the beginning of time period T2 is less than X ms then the number of successful tests is increased by one. If the UE fails to report the event within the overall delays measured requirement then the number of failure tests is increased by one. Where X is,
  - 4800 for sub-test 1 and sub-test 3,
  - 51200 for sub-test 2 and sub-test 4.

7. . After the SS receive the *MeasurementReport* message in step 6) or when T2 expires, the SS shall:
  - transmit an *RRCConnectionRelease* message to release the RRC connection which includes the release of the established radio bearers as well as all radio resources, or
  - switch off the UE.
8. Set Cell 2 physical cell identity = ((current Cell 2 physical cell identity + 1) mod 1008) for next iteration of the test procedure loop.
9. The SS:
  - transmits in Cell 1 a Paging message (including PagingRecord with UE-Identity) for the UE and ensures the UE is in State 3A according to TS 36.508 clause 4.5.3A (if the paging fails, switches off and on the UE and ensures the UE is in State 3A-RF according to TS 36.508 [25] clause 7.2A.3); or
  - switches on the UE and ensures the UE is in State 3A-RF according to TS 36.508 [25] clause 7.2A.3.
10. Repeat step 2-9 until the confidence level according to Tables G.2.3-1 in Annex G clause G.2 is achieved.

8.4.2.8.4.3 Message contents

Message contents are according to TS 36.508 [25] clause 7.3 with the following exceptions:

**Table 8.4.2.8.4.3-1: Common Exception messages for E-UTRA - NR FR2 event-triggered reporting with SSB time index detection in DRX**

Default Message Contents	
Common contents of system information blocks exceptions	
Default RRC messages and information elements contents exceptions	Table H.3.4-1a; Table H.3.4-4 with Condition INTER-RAT NR, EVENT B1 for Test 1 and Test 2; Table H.3.4-4 with Condition INTER-RAT NR, EVENT B1 and GAPLESS for Test 3 and Test 4; Table H.3.4-5 with Condition Pattern #0 for Test 1 and Test 2; Table H.3.4-5 with Condition Pattern #4 for Test 3 and Test 4; Table H.3.7-2 with Condition DRX.9 for Test 1 and Test 3 Table H.3.7-2 with Condition DRX.12 for Test 2 and Test 4
Specific message contents exceptions for Test Configuration 8.4.2.8-1	Table H.3.4-6 with Conditions SMTC.2, SSB.3 FR2 and Asynchronous cells
Specific message contents exceptions for Test Configuration 8.4.2.8-2	Table H.3.4-6 with Conditions SMTC.1, SSB.3 FR2 and Synchronous cells

**Table 8.4.2.8.4.3-2: SchedulingRequest-Config-DEFAULT**

Derivation Path: 36.508 [25] Table 4.6.3-20			
Information Element	Value/remark	Comment	Condition
SchedulingRequest-Config-DEFAULT ::= CHOICE {			
setup SEQUENCE {			
sr-ConfigIndex	25		Config 8.4.2.8-1/2/3
	22		Config 8.4.2.8-4/5/6
}			
}			

8.4.2.8.5 Test requirement

Tables 8.4.2.8.4.1-3 and 8.4.2.8.5-1 define the primary level settings including test tolerances for E-UTRA - NR FR2 event-triggered reporting with SSB time index detection in DRX.

**Table 8.4.2.8.5-1: NR neighbour cell specific test parameters for NR inter-RAT event triggered reporting for FR2 with SSB time index detection**

Parameter	Unit	Test configuration	Cell 2	
			T1	T2
NR RF Channel Number		1, 2	1	
Duplex mode		1, 2	TDD	
TDD configuration		1, 2	TDDConf.3.1	
BW <sub>channel</sub>	MHz	1, 2	100: N <sub>RB,c</sub> = 66	
OCNG patterns		1, 2	OP.1	
SMTC configuration		1	SMTC.2	
		2	SMTC.1	
PDSCH/PDCCH subcarrier spacing	kHz	1, 2	120	
b1-ThresholdNR   UE power class 3	dBm/SCS	1, 2	-96	
EPRE ratio of PSS to SSS		1, 2	0	
EPRE ratio of PBCH DMRS to SSS				
EPRE ratio of PBCH to PBCH DMRS				
EPRE ratio of PDCCH DMRS to SSS				
EPRE ratio of PDCCH to PDCCH DMRS				
EPRE ratio of PDSCH DMRS to SSS				
EPRE ratio of PDSCH to PDSCH				
EPRE ratio of OCNG DMRS to SSS (Note 1)				
EPRE ratio of OCNG to OCNG DMRS (Note 1)				
AoA setup defined in A.9		1, 2	Setup 1	
$N_{oc}^{Note2}$	dBm/15kHz	1, 2	-111+TT	
$N_{oc}^{Note2}$	dBm/SCS	1, 2	-102+TT	
SS-RSRP <sup>Note 3</sup>	dBm/SCS	1, 2	-Infinity	-88+TT
$\hat{E}_s/I_{ot}$	dB	1, 2	-Infinity	14+TT
$\hat{E}_s/N_{oc}$	dB	1, 2	-Infinity	14+TT
$I_o^{Note3}$	dBm/95.04MHz	1, 2	-Infinity	-58.84+TT
Propagation Condition		1, 2	AWGN	
NOTE 1: OCNG shall be used such that the cell is fully allocated and a constant total transmitted power spectral density is achieved for all OFDM symbols.				
NOTE 2: Interference from other cells and noise sources not specified in the test is assumed to be constant over subcarriers and time and shall be modelled as AWGN of appropriate power for $N_{oc}$ to be fulfilled.				
NOTE 3: SS-RSRP and $I_o$ levels have been derived from other parameters for information purposes. They are not settable parameters themselves.				
NOTE 4: SS-RSRP minimum requirements are specified assuming independent interference and noise at each receiver antenna port.				

**Table 8.4.2.8.5-2: Test requirements for NR inter-RAT event triggered reporting for FR2 with SSB time index detection in DRX**

Test case	Measurement reporting delay (ms)			
	Test 1: D1 ms	Test 2: D2 ms	Test 3: D3 ms	Test 4: D4 ms
UE power class 3	4800	51200	4800	51200

In test 1 with per-UE gap, the UE shall send one Event B2 triggered measurement report, with a measurement reporting delay less than D1 ms from the beginning of time period T2. The UE shall not send event triggered measurement reports, as long as the reporting criteria are not fulfilled. The rate of correct events observed during repeated tests shall be at least 90%.

In test 2 with per-UE gap, the UE shall send one Event B2 triggered measurement report, with a measurement reporting delay less than D2 ms from the beginning of time period T2. The UE shall not send event triggered measurement reports, as long as the reporting criteria are not fulfilled. The rate of correct events observed during repeated tests shall be at least 90%.

In test 3 with per-FR gap, the UE shall send one Event B2 triggered measurement report, with a measurement reporting delay less than D3 ms from the beginning of time period T2. The UE shall not send event triggered measurement

reports, as long as the reporting criteria are not fulfilled. The rate of correct events observed during repeated tests shall be at least 90%.

In test 4 with per-FR gap, the UE shall send one Event B2 triggered measurement report, with a measurement reporting delay less than  $D4$  ms from the beginning of time period T2. The UE shall not send event triggered measurement reports, as long as the reporting criteria are not fulfilled. The rate of correct events observed during repeated tests shall be at least 90%.

In tests 1, 2, 3 and 4, the UE is required to report SSB time index.

NOTE: The actual overall delays measured in the test may be up to  $2xTTI_{DCCH}$  higher than the measurement reporting delays above because of TTI insertion uncertainty of the measurement report in DCCH.

#### 8.4.2.9 E-UTRA event triggered reporting of a NR FR1 neighbour cell with SSB time index detection in DRX for UE configured with highSpeedInterRAT-NR-r16

##### 8.4.2.9.1 Test purpose

The purpose of this test is to verify that the UE makes correct reporting of an event and to verify partly the NR inter-RAT cell search requirements for E-UTRA FDD - NR FR1 measurements given in TS 36.133 [23] clause 8.1.2.4.21 and for E-UTRAN TDD - NR FR1 measurements given in TS 36.133 [23] clause 8.1.2.4.22 when UE is configured with *highSpeedInterRAT-NR-r16*.

##### 8.4.2.9.2 Test applicability

This test applies to all E-UTRA UEs capable of NR measurements and configured with highSpeedInterRAT-NR-r16 from release 16 onwards.

##### 8.4.2.9.3 Minimum conformance requirements

The minimum conformance requirements are specified in clause 8.4.2.0.1.

The normative reference for this requirement is TS 38.133 [6] clause A.8.4.2.9.

##### 8.4.2.9.4 Test description

###### 8.4.2.9.4.1 Initial conditions

This test shall be tested using any of the test configurations in Table 8.4.2.9.4.1-1.

**Table 8.4.2.9.4.1-1: Supported test configurations for NR inter-RAT event triggered reporting for FR1 with SSB time index detection for UE configured with highSpeedInterRAT-NR-r16**

Configuration	Description
8.4.2.1-1	LTE FDD, NR 15 kHz SSB SCS, 10 MHz bandwidth, FDD duplex mode
8.4.2.1-2	LTE FDD, NR 15 kHz SSB SCS, 10 MHz bandwidth, TDD duplex mode
8.4.2.1-3	LTE FDD, NR 30 kHz SSB SCS, 40 MHz bandwidth, TDD duplex mode
8.4.2.1-4	LTE TDD, NR 15 kHz SSB SCS, 10 MHz bandwidth, FDD duplex mode
8.4.2.1-5	LTE TDD, NR 15 kHz SSB SCS, 10 MHz bandwidth, TDD duplex mode
8.4.2.1-6	LTE TDD, NR 30 kHz SSB SCS, 40 MHz bandwidth, TDD duplex mode

NOTE: The UE is only required to be tested in one of the supported test configurations.

Configure the test requirement and the DUT according to the parameters in Table 8.4.2.9.4.1-2.

**Table 8.4.2.9.4.1-2: Initial conditions for NR inter-RAT event triggered reporting for FR1 with SSB time index detection for UE configured with highSpeedInterRAT-NR-r16**

Parameter	Value		Comment
Test environment	NC		As specified in TS 36.508 [25] clause 4.1.
Test frequencies	As specified in Annex E, Table E.6-1 and TS 38.508-1 [14] clause 4.3.1.		
Channel bandwidth	As specified by the test configuration selected from Table 8.4.2.1.4.1-1.		
Propagation conditions	AWGN		As specified in clause C.2.1
Connection Diagram	TE Part	A.3.1.8.2	As specified in TS 38.508-1 [14] Annex A.
	DUT Part	A.3.2.3.4	
Exceptions to connection diagram	N/A		

**Table 8.4.2.9.4.1-3: General test parameters for NR inter-RAT event triggered reporting for FR1 with SSB time index detection for UE configured with highSpeedInterRAT-NR-r16**

Parameter	Unit	Test configuration	Value	Comment
E-UTRA RF Channel Number		1, 2, 3, 4, 5, 6	1	One E-UTRA carrier frequency is used.
NR RF Channel Number		1, 2, 3, 4, 5, 6	1	One FR1 NR carrier frequency is used.
Active cell		1, 2, 3, 4, 5, 6	E-UTRA cell 1 (PCell)	E-UTRA cell 1 is on E-UTRA RF channel number 1.
Neighbour cell		1, 2, 3, 4, 5, 6	NR cell 2	NR cell 2 is on NR RF channel number 1.
Gap Pattern Id		1, 2, 3, 4, 5, 6	0	As specified in clause Table 8.1.2.1-1 of TS 36.133 [15].
Measurement gap offset		1, 2, 3, 4, 5, 6	39	As specified in TS 36.331 [16].
b2-Threshold1	dBm	1, 2, 3, 4, 5, 6	Note 1	E-UTRA RSRP threshold for E-UTRA RSRP measurement on cell 1 for event B2 [16]
b2-Threshold2NR	dBm	1, 2, 3, 4, 5, 6	Note 2	SS-RSRP threshold for SS-RSRP measurement on cell 2 for event B2 [16]
Hysteresis	dB	1, 2, 3, 4, 5, 6	0	
CP length		1, 2, 3, 4, 5, 6	Normal	
TimeToTrigger	s	1, 2, 3, 4, 5, 6	0	
Filter coefficient		1, 2, 3, 4, 5, 6	0	L3 filtering is not used
DRX		1, 2, 3, 4, 5, 6	DRX.5	As specified in clause A.3.3
Time offset between serving and neighbour cells		1, 4	3ms	Asynchronous cells. The timing of Cell 2 is 3ms later than the timing of Cell 1.
		2, 3, 5, 6	3μs	Synchronous cells.
T1	s	1, 2, 3, 4, 5, 6	5	
T2	s	1, 2, 3, 4, 5, 6	5	
NOTE 1: The value of b2-Threshold1 is defined in Table A.8.4.2.9.1-3.				
NOTE 2: The value of b2-Threshold2NR is defined in Table A.8.4.2.9.1-4.				

#### 8.4.2.9.4.2 Test procedure

Two cells are deployed in the test, which are E-UTRA PCell (Cell 1) on the E-UTRA carrier and a FR1 NR neighbour cell (Cell 2) on NR carrier. The general and cell specific test parameters for PCell and neighbour cell are given in Table 8.4.2.9.4.1-3, 8.4.2.9.5-1 and 8.4.2.9.5-2, respectively.

In the measurement control information, it is indicated to the UE that event-triggered reporting with Event B2 is used. The test consists of two successive time periods, with time duration of T1 and T2 respectively. During time duration T1, the UE shall not have any timing information of NR cell 2. UE is configured with *highSpeedInterRAT-NR-r16*.

1. Ensure the UE is in State 3A-RF according to TS 36.508 clause 7.2A.3.

2. Set the parameters of Cell 1 and Cell 2 according to T1 in Table 8.4.2.9.5-1 and Table 8.4.2.9.5-2 respectively, T1 starts.
3. The SS shall transmit an *RRCConnectionReconfiguration* message.
4. The UE shall transmit *RRCConnectionReconfigurationComplete* message.
5. When T1 expires, the SS shall switch the parameters setting from T1 to T2 as specified in Table 8.4.2.9.5-1 and Table 8.4.2.9.5-2 respectively. T2 Starts.
6. UE shall transmit a *MeasurementReport* message triggered by Event B2. If the overall delays measured from the beginning of time period T2 is less than 4.8s ms then the number of successful tests is increased by one. If the UE fails to report the event within the overall delays measured requirement then the number of failure tests is increased by one.
7. After the SS receive the *MeasurementReport* message in step 6) or when T2 expires, the SS shall transmit an *RRCConnectionRelease* message to release the RRC connection which includes the release of the established radio bearers as well as all radio resources.
8. Set Cell 2 physical cell identity = ((current Cell 2 physical cell identity + 1) mod 1008) for next iteration of the test procedure loop.
9. After the RRC connection release, the SS:
  - transmits in Cell 1 a Paging message (including PagingRecord with UE-Identity) for the UE and ensures the UE is in State 3A according to TS 36.508 [25] clause 4.5.3A (if the paging fails, switches off and on the UE and ensures the UE is in State 3A-RF according to TS 36.508 [25] clause 7.2A.3),
 or
  - switches off and on the UE and ensures the UE is in State 3A-RF according to TS 36.508 [25] clause 7.2A.3.
10. Repeat step 2-9 until the confidence level according to Tables G.2.3-1 in Annex G clause G.2 is achieved.

8.4.2.9.4.3 Message contents

Message contents are according to TS 38.508-1 [14] clause 7.3 with the following exceptions:

**Table 8.4.2.9.4.3-1: Common Exception messages**

Default Message Contents	
Common contents of system information blocks on condition of HighSpeedMeas with exceptions	Table H.2.1-3 with Condition HighSpeedMeas
Default RRC messages and information elements contents exceptions	Table H.3.4-7 with Condition Inter-RAT and EVENT B2; Table H.3.4-4 with Condition INTER-RAT NR and EVENT B2 Table H.3.4-5 with Condition Pattern #0 Table H.3.4-8 with Condition SSB-Index Table H.3.7-2 with Condition DRX.5 and Gap

**Table 8.4.2.9.4.3-2: highSpeedCarrierNR-r16 in SystemInformationBlockType24**

Derivation Path: TS 36.508, Table 4.4.3.3-20 with Condition FR1			
Information Element	Value/remark	Comment	Condition
SystemInformationBlockType24-r15 ::= SEQUENCE {			
CarrierFreqNR-v1610 ::= SEQUENCE	1 entry		
{{(SIZE (1..maxFreq)) OF SEQUENCE {			
highSpeedCarrierNR-r16	TRUE		
}			

**Table 8.4.2.9.4.3-3: highSpeedInterRAT-NR-r16 configuration**

Derivation Path: 36.508 Table 4.6.3-14			
Information Element	Value/remark	Comment	Condition
RadioResourceConfigCommonSIB:= SEQUENCE {			
highSpeedInterRAT-NR-r16	TRUE		
}			

8.4.2.9.5 Test requirement

Tables 8.4.2.9.4.1-3, 8.4.2.9.5-1 and 8.4.2.9.5-2 define the primary level settings including test tolerances for E-UTRA - NR FR2 event-triggered reporting with SSB time index detection in DRX for UE configured with highSpeedInterRAT-NR-r16.

**Table 8.4.2.9.5-1: E-UTRAN PCell specific test parameters for NR inter-RAT event triggered reporting with NR neighbour cell in FR1 with SSB time index detection for UE configured with highSpeedInterRAT-NR-r16**

Parameter	Unit	Configuration	Cell 1	
			T1	T2
RF channel number		1, 2, 3, 4, 5, 6	1	
Duplex mode		1, 2, 3	FDD	
		4, 5, 6	TDD	
TDD special subframe configuration <sup>Note1</sup>		4, 5, 6	6	
TDD uplink-downlink configuration <sup>Note1</sup>		4, 5, 6	1	
BW <sub>channel</sub>	MHz	1, 2, 3, 4, 5, 6	5 MHz: N <sub>RB,c</sub> = 25 10 MHz: N <sub>RB,c</sub> = 50 20 MHz: N <sub>RB,c</sub> = 100	
PDSCH parameters: DL Reference Measurement Channel <sup>Note2</sup>		1, 2, 3	5 MHz: R.7 FDD 10 MHz: R.3 FDD 20 MHz: R.6 FDD	
		4, 5, 6	5 MHz: R.4 TDD 10 MHz: R.0 TDD 20 MHz: R.3 TDD	
PCFICH/PDCCH/PHICH parameters: DL Reference Measurement Channel <sup>Note2</sup>		1, 2, 3	5 MHz: R.11 FDD 10 MHz: R.6 FDD 20 MHz: R.10 FDD	
		4, 5, 6	5 MHz: R.11 TDD 10 MHz: R.6 TDD 20 MHz: R.10 TDD	
OCNG Patterns <sup>Note2</sup>		1, 2, 3	5 MHz: OP.20 FDD 10 MHz: OP.10 FDD 20 MHz: OP.17 FDD	
		4, 5, 6	5 MHz: OP.9 TDD 10 MHz: OP.1 TDD 20 MHz: OP.7 TDD	
b2-Threshold1	dBm	1, 2, 3, 4, 5, 6	-77	
PBCH_RA	dB	1, 2, 3, 4, 5, 6	0	
PBCH_RB				
PSS_RA				
SSS_RA				
PCFICH_RB				
PHICH_RA				
PHICH_RB				
PDCCH_RA				
PDCCH_RB				
PDSCH_RA				
PDSCH_RB				
OCNG_RA <sup>Note3</sup>				
OCNG_RB <sup>Note3</sup>				

Parameter	Unit	Configuration	Cell 1	
			T1	T2
$N_{oc}$ <sup>Note4</sup>	dBm/15kHz	1, 2, 3, 4, 5, 6	-104	
$\hat{E}_s/N_{oc}$	dB	1, 2, 3, 4, 5, 6	17	17
$\hat{E}_s/I_{ot}$ <sup>Note5</sup>	dB	1, 2, 3, 4, 5, 6	17	17
RSRP <sup>Note5</sup>	dBm/15kHz	1, 2, 3, 4, 5, 6	-87	-87
SCH_RP <sup>Note5</sup>	dBm/15kHz	1, 2, 3, 4, 5, 6	-87	-87
$I_o$ <sup>Note5</sup>	dBm/9MHz	1, 2, 3, 4, 5, 6	$-59.13+10\log(N_{RB,c}/50)$	$-59.13+10\log(N_{RB,c}/50)$
Propagation Condition <sup>Note6</sup>		1, 2, 3, 4, 5, 6	AWGN	
Antenna Configuration and Correlation Matrix <sup>Note6</sup>		1, 2, 3, 4, 5, 6	1x2 Low	
<p>NOTE 1: Special subframe and uplink-downlink configurations are specified in table 4.2-1 in TS 36.211 [23].</p> <p>NOTE 2: DL RMCs and OCNG patterns are specified in clauses A 3.1 and A 3.2 of TS 36.133 [15] respectively.</p> <p>NOTE 3: OCNG shall be used such that all cells are fully allocated and a constant total transmitted power spectral density is achieved for all OFDM symbols.</p> <p>NOTE 4: Interference from other cells and noise sources not specified in the test is assumed to be constant over subcarriers and time and shall be modelled as AWGN of appropriate power for <math>N_{oc}</math> to be fulfilled.</p> <p>NOTE 5: <math>\hat{E}_s/I_{ot}</math>, RSRP, SCH_RP and <math>I_o</math> levels have been derived from other parameters for information purposes. They are not settable parameters themselves.</p> <p>NOTE 6: Propagation condition and correlation matrix are defined in clause B.2 in TS 36.101 [25].</p>				



**Table 8.4.2.9.5-2: NR neighbour cell specific test parameters for NR inter-RAT event triggered reporting for FR1 with SSB time index detection for UE configured with highSpeedInterRAT-NR-r16**

Parameter	Unit	Test configuration	Cell 2	
			T1	T2
NR RF Channel Number		1, 2, 3, 4, 5, 6	1	
Duplex mode		1, 4	FDD	
		2, 3, 5, 6	TDD	
TDD configuration		2, 5	TDDConf.1.1	
		3, 6	TDDConf.2.1	
BW <sub>channel</sub>	MHz	1, 2, 4, 5	10: N <sub>RB,c</sub> = 52	
		3, 6	40: N <sub>RB,c</sub> = 106	
OCNG Patterns		1, 2, 3, 4, 5, 6	OP.1	
SMTC configuration		1, 4	SMTC.2	
		2, 3, 5, 6	SMTC.1	
PDSCH/PDCCH subcarrier spacing	kHz	1, 2, 4, 5	15	
		3, 6	30	
b2-Threshold2NR	dBm/SCS	1, 2, 4, 5	-101	
		3, 6	-98	
EPRE ratio of PSS to SSS		1, 2, 3, 4, 5, 6	0	
EPRE ratio of PBCH DMRS to SSS				
EPRE ratio of PBCH to PBCH DMRS				
EPRE ratio of PDCCH DMRS to SSS				
EPRE ratio of PDCCH to PDCCH DMRS				
EPRE ratio of PDSCH DMRS to SSS				
EPRE ratio of PDSCH to PDSCH				
EPRE ratio of OCNG DMRS to SSS (Note 1)				
EPRE ratio of OCNG to OCNG DMRS (Note 1)				
<sup>Note2</sup> $N_{sc}$	dBm/15kHz			
<sup>Note2</sup> $N_{sc}$	dBm/SCS	1, 2, 4, 5	-98	
		3, 6	-95	
SS-RSRP <sup>Note 3</sup>	dBm/SCS	1, 2, 4, 5	-Infinity	-91
		3, 6	-Infinity	-88
$\hat{E}_s/I_{ot}$	dB	1, 2, 3, 4, 5, 6	-Infinity	7
$\hat{E}_s/N_{oc}$	dB	1, 2, 3, 4, 5, 6	-Infinity	7
I <sub>o</sub> <sup>Note3</sup>	dBm/9.36MHz	1, 2, 4, 5	-70.05	-62.26
	dBm/38.16MHz	3, 6	-63.95	-56.16
Propagation Condition		1, 2, 4, 5	AWGN1944	
		3,6	AWGN3334	
Antenna Configuration and Correlation Matrix		1, 2, 3, 4, 5, 6	1x2 Low	
<p>NOTE 1: OCNG shall be used such that the cell is fully allocated and a constant total transmitted power spectral density is achieved for all OFDM symbols.</p> <p>NOTE 2: Interference from other cells and noise sources not specified in the test is assumed to be constant over subcarriers and time and shall be modelled as AWGN of appropriate power for <math>N_{sc}</math> to be fulfilled.</p> <p>NOTE 3: SS-RSRP and I<sub>o</sub> levels have been derived from other parameters for information purposes. They are not settable parameters themselves.</p> <p>NOTE 4: SS-RSRP minimum requirements are specified assuming independent interference and noise at each receiver antenna port.</p>				

The UE shall send one Event B2 triggered measurement report, with a measurement reporting delay less than 4.8s from the beginning of time period T2. The UE is required to read the neighbour cell SSB index and report the acquired SSB index in this test. The rate of correct events observed during repeated tests shall be at least 90% with a confidence level of 95%.

NOTE: The actual overall delays measured in the test may be up to 2xTTI<sub>DCCCH</sub> higher than the measurement reporting delays above because of TTI insertion uncertainty of the measurement report in DCCCH.

## 8.5 Measurement performance requirements

### 8.5.1 SFTD measurement accuracy

#### 8.5.1.0 Minimum conformance requirements

##### 8.5.1.0.1 Intra-frequency absolute SS-RSRP measurement accuracy requirements

The SFN and frame timing difference (SFTD) is measured between PCell and NR cell for inter-RAT SFTD. The inter-RAT SFTD measurement can only be configured for E-UTRA - NR band combinations that are supported by the UE.

The accuracy requirements in Table 8.5.1.0.1-3 are applicable under the following conditions:

For PCell SFN and frame timing measurement:

- Cell specific reference signals are transmitted either from one, two or four antenna ports.
- Conditions defined in TS 36.101 clause 7.3 for reference sensitivity are fulfilled.
- No changes to the uplink transmission timing are applied during the measurement period.
- $RSRP_{dBm}$  according to TS 36.133 Annex B.3.5 for a corresponding Band.
- $I_o$  range defined in Table 8.5.1.0.1-1.

**Table 8.5.1.0.1-1: PCell  $I_o$  range conditions for SFTD measurement accuracy**

Parameter	$I_o$ <sup>Note 1</sup> range		
	E-UTRA operating band groups <sup>Note 4, 5</sup>	Minimum $I_o$ dBm/15kHz <sup>Note 2, 3</sup>	Maximum $I_o$ dBm/BW <sub>Channel</sub>
Conditions	FDD_A, TDD_A	-121	-50
	FDD_C, TDD_C	-120	-50
	FDD_D	-119.5	-50
	FDD_E, TDD_E	-119	-50
	FDD_F	-118.5	-50
	FDD_G	-118	-50
	FDD_H	-117.5	-50
	FDD_N	-114.5	-50

NOTE 1: When in dBm/15kHz, the minimum  $I_o$  condition is expressed as the average  $I_o$  per RE over all REs in that symbol.  $I_o$  may be different in different symbols within a subframe.

NOTE 2: The condition level is increased by  $\Delta > 0$ , when applicable, as described in clause B.4.2 and B.4.3.

NOTE 3: The condition level is increased by MSD as defined in clause 7.3B in TS 38.101-3 [54], if applicable depending on E-UTRA - NR band combination.

NOTE 4: E-UTRA operating band groups are as defined in clause 3.5.

NOTE 5: Only E-UTRA bands within EN-DC band combinations as specified in clause 5.5B in TS 38.101-3 [54] are applicable.

For NR PSCell, or NR cell SFN and frame timing measurement in FR1:

- Conditions defined in TS 38.101-1 clause 7.3 for reference sensitivity are fulfilled.
- $I_o$  range defined in Table 8.5.1.0.1-2.

Table 8.5.1.0.1-2: NR PSCell, or NR cell lo range conditions for SFTD measurement accuracy in FR1

Parameter	I <sub>o</sub> <sup>Note 1</sup> range			
	NR operating band groups <sup>Note 4, 5</sup>	Minimum I <sub>o</sub> <sup>Note 2, 3</sup>		Maximum I <sub>o</sub>
		dBm/ SCS <sub>SSB</sub>		
		SCS <sub>SSB</sub> = 15 kHz	SCS <sub>SSB</sub> = 30 kHz	dBm/BW <sub>Channel</sub>
Conditions	NR_FDD_FR1_A, NR_TDD_FR1_A	-121	-118	-50
	NR_FDD_FR1_B	-120.5	-117.5	-50
	NR_TDD_FR1_C	-120	-117	-50
	NR_FDD_FR1_D, NR_TDD_FR1_D	-119.5	-116.5	-50
	NR_FDD_FR1_E, NR_TDD_FR1_E	-119	-116	-50
	NR_FDD_FR1_G	-118	-115	-50
	NR_FDD_FR1_H	-117.5	-114.5	-50

NOTE 1: I<sub>o</sub> is assumed to have constant EPRE across the bandwidth.

NOTE 2: The condition level is increased by  $\Delta R_{B,c}$  as defined in clause 7.3B in TS 38.101-3 [54], depending on E-UTRA - NR band combination.

NOTE 3: The condition level is increased by MSD as defined in clause 7.3B in TS 38.101-3 [54], if applicable depending on E-UTRA - NR band combination.

NOTE 4: NR operating band groups are as defined in clause 3.5.

NOTE 5: Only NR bands within EN-DC band combinations as specified in clause 5.5B in TS 38.101-3 [54] are applicable.

Table 8.5.1.0.1-3: SFTD measurement accuracy

Accuracy	Conditions	
	$\dot{E}s/lot$	Frequency range
T <sub>s</sub> <sup>Note 1</sup>	dB	
40	≥ -3 dB	FR1

NOTE 1: T<sub>s</sub> is the basic timing unit defined in TS 36.211 [16].  
NOTE 2: The parameter  $\dot{E}s/lot$  is the minimum  $\dot{E}s/lot$  of the pair of cells to which the requirement applies.

## 8.5.1.1 E-UTRA - NR FR1 SFTD measurement accuracy

### 8.5.1.1.1 Test purpose

The purpose of this test is to verify that the SFTD measurement accuracy is within the specified limits and to verify the requirements as specified in clause 9.1.27 in TS 36.133 [23] for inter-RAT FR1 SFTD measurements.

### 8.5.1.1.2 Test applicability

This test applies to all types of NR UE from Release 15 onwards and support inter-RAT NR SFTD measurements.

### 8.5.1.1.3 Minimum conformance requirements

The minimum conformance requirements are specified in clause 8.5.1.0.

The normative reference for this requirement is TS 38.133 [6] clause A.8.5.1.1.

### 8.5.1.1.4 Test description

Two cells are configured in this test: E-UTRA Cell 1 is the E-UTRAN PCell and Cell 2 is the inter-RAT NR FR1 neighbour cell.

#### 8.5.1.1.4.1 Initial conditions

This test shall be tested using any of the test configurations in Table 8.5.1.1.4.1-1.

**Table 8.5.1.1.4.1-1: Supported test configurations for E-UTRA - NR FR1 SFTD measurement accuracy**

Configuration	Description
8.5.1.1-1	NR 15 kHz SSB SCS, 10 MHz bandwidth, FDD duplex mode, LTE FDD
8.5.1.1-2	NR 15 kHz SSB SCS, 10 MHz bandwidth, TDD duplex mode, LTE FDD
8.5.1.1-3	NR 30 kHz SSB SCS, 40 MHz bandwidth, TDD duplex mode, LTE FDD
8.5.1.1-4	NR 15 kHz SSB SCS, 10 MHz bandwidth, FDD duplex mode, LTE TDD
8.5.1.1-5	NR 15 kHz SSB SCS, 10 MHz bandwidth, TDD duplex mode, LTE TDD
8.5.1.1-6	NR 30 kHz SSB SCS, 40 MHz bandwidth, TDD duplex mode, LTE TDD

NOTE: The UE is only required to be tested in one of the supported test configurations.

Configure the test equipment and the DUT according to the parameters in Table 8.5.1.1.4.1-2.

**Table 8.5.1.1.4.1-2: Initial conditions for E-UTRA - NR FR1 SFTD measurement accuracy**

Parameter	Value	Comment
Test environment	NC	As specified in TS 36.508 [25] clause 4.1.
Test frequencies	As specified in Annex E, Table E.6-1 and TS 38.508-1 [14] clause 4.3.1.	
Channel bandwidth	As specified by the test configuration selected from Table 8.4.2.1.4.1-1.	
Propagation conditions	AWGN	As specified in clause C.2.1
Connection Diagram	TE Part	A.3.1.8.2
	DUT Part	A.3.2.3.4
Exceptions to connection diagram	N/A	

- The general test parameter settings are set up according to Table 8.5.1.1.4.1-3.
- Message contents are defined in clause 8.5.1.1.4.3.
- There are two carriers and two cells specified in the test, where E-UTRA Cell 1 is the E-UTRA PCell on the E-UTRA carrier and Cell 2 is the NR neighbour cell on the NR carrier. E-UTRA Cell 1 is configured according to TS 36.521-3 [26] clause C.1.0 and C.1.1.

#### 8.5.1.1.4.2 Test procedure

- Ensure the UE is in State 3A-RF according to TS 36.508 [25] clause 7.2A.3.
- Set the parameters according to Table 8.5.1.1.5-1 and Table 8.5.1.1.5-3 as appropriate. (Condition = 3)
- The SS shall transmit an *RRCCONNECTIONRECONFIGURATION* message on Cell 1.
- The UE shall transmit an *RRCCONNECTIONRECONFIGURATIONCOMPLETE* message.
- The UE shall transmit a *MEASUREMENTREPORT* message triggered by SFTD measurement.
- The SS shall check the reported values of SFN offset and frame boundary offset in the *MeasurementReport*. The SFN offset value and frame boundary offset value between E-UTRA Cell 1 and Cell 2 reported by the UE is compared to the expected SFN offset value and frame boundary offset, respectively. The number of failed iterations is increased by one, if
  - The value of *sfn-OffsetResult* is different with the expected SFN offset value, or
  - The value of *frameBoundaryOffsetResult* is outside the range given in Table 8.5.1.1.5-5, or
  - The UE fails to report the measurement value for Cell 2.
 Otherwise the number of successful iterations is increased by one.
- After the RRC connection release, the SS:

- transmits in Cell 1 a Paging message (including PagingRecord with UE-Identity) for the UE and ensures the UE is in State 3A according to TS 36.508 [25] clause 4.5.3A (if the paging fails, switches off and on the UE and ensures the UE is in State 3A-RF according to TS 36.508 [25] clause 7.2A.3); or
- switches off and on the UE and ensures the UE is in State 3A-RF according to TS 36.508 [25] clause 7.2A.3.

8. Repeat steps 1-7 until the confidence level according to Table G.2.3-1 in Annex G is achieved.

#### 8.5.1.1.4.3 Message contents

Message contents are according to TS 36.508 [25] clause 7.3 with the following exceptions:

**Table 8.5.1.1.4.3-1: Common Exception messages for E-UTRA - NR FR1 SFTD measurement accuracy**

Default Message Contents	
Common contents of system information blocks exceptions	
Default RRC messages and information elements contents exceptions	Table H.3.4-7 with Condition Inter-RAT and SFTD Table H.3.4-4 with Condition INTER-RAT NR, SFTD and GAPLESS
Specific message contents exceptions for Test Configuration 8.5.1.1-1 and 8.5.1.1-4	Table H.3.4-6 with Condition SSB.1 FR1 and SMTC.1
Specific message contents exceptions for Test Configuration 8.5.1.1-2 and 8.5.1.1-5	Table H.3.4-6 with Condition SSB.1 FR1 and SMTC.1
Specific message contents exceptions for Test Configuration 8.5.1.1-3 and 8.5.1.1-6	Table H.3.4-6 with Condition SSB.2 FR1 and SMTC.1

#### 8.5.1.1.5 Test requirement

Table 8.5.1.1.5-1 and 8.5.1.1.5-2 defines the primary level settings including test tolerances for E-UTRA - NR FR1 SFTD measurement accuracy.

The SFN offset and frame boundary offset between E-UTRA PCell and the inter-RAT neighbour cell shall be set to one of the configurations in Table 8.5.1.1.5-3. The reported SFTD accuracy shall fulfil the accuracy requirements in Table 8.5.1.1.5-4. The SFN offset in reported SFTD shall match the values in Table 8.5.1.1.5-3 and the frame boundary offset in reported SFTD shall be within the range given in Table 8.5.1.1.5-5.

**Table 8.5.1.1.5-1: E-UTRA cell specific test parameters for E-UTRA - NR FR1 SFTD measurement accuracy**

Parameter	Unit	Test 1
E-UTRA RF Channel Number		1
Duplex mode		FDD or TDD
TDD special subframe configuration <sup>Note1</sup>		6
TDD uplink-downlink configuration <sup>Note1</sup>		1
BW <sub>channel</sub>		5 MHz: N <sub>RB,c</sub> = 25 10 MHz: N <sub>RB,c</sub> = 50 20 MHz: N <sub>RB,c</sub> = 100
PDSCH parameters: DL Reference Measurement Channel <sup>Note2</sup>		5 MHz: R.7 FDD 10 MHz: R.3 FDD 20 MHz: R.6 FDD 5 MHz: R.4 TDD 10 MHz: R.0 TDD 20 MHz: R.3 TDD
PCFICH/PDCCH/PHICH parameters: DL Reference Measurement Channel <sup>Note2</sup>		5 MHz: R.11 FDD 10 MHz: R.6 FDD 20 MHz: R.10 FDD 5 MHz: R.11 TDD 10 MHz: R.6 TDD 20 MHz: R.10 TDD

OCNG Patterns <sup>Note2</sup>		5 MHz: OP.20 FDD 10 MHz: OP.10 FDD 20 MHz: OP.17 FDD 5 MHz: OP.9 TDD 10 MHz: OP.1 TDD 20 MHz: OP.7 TDD
PBCH_RA	dB	0
PBCH_RB	dB	
PSS_RA	dB	
SSS_RA	dB	
PCFICH_RB	dB	
PHICH_RA	dB	
PHICH_RB	dB	
PDCCH_RA	dB	
PDCCH_RB	dB	
PDSCH_RA	dB	
PDSCH_RB	dB	
OCNG_RA <sup>Note3</sup>	dB	
OCNG_RB <sup>Note3</sup>	dB	
$N_{oc}$ <sup>Note4</sup>	dBm/15 kHz	-104
$\bar{E}_s/N_{oc}$	dB	-2.2
$\bar{E}_s/I_{ot}$	dB	-2.2
RSRP <sup>Note5</sup>	dBm/15 kHz	-106.2
SCH_RP <sup>Note5</sup>	dBm/15 kHz	-106.2
$I_o$ <sup>Note5</sup>	dBm/Ch BW	-74.17 +10log ( $N_{RB,c}/50$ )
Propagation Condition		AWGN
Antenna Configuration		1x2
NOTE 1: Special subframe and uplink-downlink configurations are specified in table 4.2-1 in TS 36.211 [24].		
NOTE 2: DL RMCs and OCNG patterns are specified in clauses A 3.1 and A 3.2 of TS 36.133 [23] respectively.		
NOTE 3: OCNG shall be used such that all cells are fully allocated and a constant total transmitted power spectral density is achieved for all OFDM symbols.		
NOTE 4: Interference from other cells and noise sources not specified in the test is assumed to be constant over subcarriers and time and shall be modelled as AWGN of appropriate power for $N_{oc}$ to be fulfilled.		
NOTE 5: $\bar{E}_s/I_{ot}$ , RSRP, SCH_RP and $I_o$ levels have been derived from other parameters for information purposes. They are not settable parameters themselves.		

Table 8.5.1.1.5-2: NR cell specific test parameters for E-UTRA - NR FR1 SFTD measurement accuracy

Parameter		Config	Unit	Test 1				
SSB GSCN		1~6		freq1				
Duplex mode		1,4		FDD				
		2,5		TDD				
		3,6		TDD				
TDD Configuration		1,4		N/A				
		2,5		TDDConf.1.1				
		3,6		TDDConf.2.1				
BW <sub>channel</sub>		1,4	MHz	10: N <sub>RB,c</sub> = 52				
		2,5		10: N <sub>RB,c</sub> = 52				
		3,6		40: N <sub>RB,c</sub> = 106				
PDSCH Reference measurement channel		1,4		SR.1.1 FDD				
		2,5		SR.1.1 TDD				
		3,6		SR.2.1 TDD				
RMSI CORESET Reference Channel		1,4		CR.1.1 FDD				
		2,5		CR.1.1 TDD				
		3,6		CR.2.1 TDD				
RMC CORESET Reference Channel		1,4		CCR.1.1 FDD				
		2,5		CCR.1.1 TDD				
		3,6		CCR.2.1 TDD				
SSB configuration		1,4		SSB.1 FR1				
		2,5		SSB.1 FR1				
		3,6		SSB.2 FR1				
SMTC configuration		1~6		SMTC.1				
DL BWP configuration		1~6		DLBWP.1.1				
UL BWP configuration		1~6		ULBWP.1.1				
OCNG Patterns		1~6		OP.1				
EPRE ratio of PSS to SSS		1~6	dB	0				
EPRE ratio of PBCH DMRS to SSS								
EPRE ratio of PBCH to PBCH DMRS								
EPRE ratio of PDCCH DMRS to SSS								
EPRE ratio of PDCCH to PDCCH DMRS								
EPRE ratio of PDSCH DMRS to SSS								
EPRE ratio of PDSCH to PDSCH DMRS								
EPRE ratio of OCNG DMRS to SSS <sup>Note 1</sup>								
EPRE ratio of OCNG to OCNG DMRS <sup>Note 1</sup>								
N <sub>oc</sub> <sup>Note2</sup>	NR_FDD_FR1_A, NR_TDD_FR1_A				1~6	dBm/15kHz	-104	
	NR_FDD_FR1_B, NR_TDD_FR1_C							
	NR_FDD_FR1_D, NR_TDD_FR1_D							
	NR_FDD_FR1_E, NR_TDD_FR1_E							
	NR_FDD_FR1_G, NR_FDD_FR1_H							
	N <sub>oc</sub> <sup>Note2</sup>	NR_FDD_FR1_A, NR_TDD_FR1_A	1,2,4,5	dBm/SSB SCS				-104
		NR_FDD_FR1_B, NR_TDD_FR1_C						
		NR_FDD_FR1_D, NR_TDD_FR1_D						
NR_FDD_FR1_E, NR_TDD_FR1_E								
NR_FDD_FR1_G, NR_FDD_FR1_H								
NR_FDD_FR1_A, NR_TDD_FR1_A		3,6			dBm/SSB SCS	-101		
NR_FDD_FR1_B, NR_TDD_FR1_C								
NR_FDD_FR1_B, NR_TDD_FR1_C								

Parameter		Config	Unit	Test 1	
	NR_FDD_FR1_D, NR_TDD_FR1_D				
	NR_FDD_FR1_E, NR_TDD_FR1_E				
	NR_FDD_FR1_G				
	NR_FDD_FR1_H				
$\hat{E}_s / I_{ot}$		1~6	dB	-2.7	
$\hat{E}_s / N_{oc}$		1~6	dB	-2.7	
SS-RSRP Note3	NR_FDD_FR1_A, NR_TDD_FR1_A	1,2,4,5	dBm/SCS	-106.7	
	NR_FDD_FR1_B				
	NR_TDD_FR1_C				
	NR_FDD_FR1_D, NR_TDD_FR1_D				
	NR_FDD_FR1_E, NR_TDD_FR1_E				
	NR_FDD_FR1_G				
	NR_FDD_FR1_H				
	NR_FDD_FR1_A, NR_TDD_FR1_A	3,6			-103.7
	NR_FDD_FR1_B				
	NR_TDD_FR1_C				
	NR_FDD_FR1_D, NR_TDD_FR1_D				
	NR_FDD_FR1_E, NR_TDD_FR1_E				
	NR_FDD_FR1_G				
	NR_FDD_FR1_H				
Io Note3	NR_FDD_FR1_A, NR_TDD_FR1_A	1,2,4,5	dBm/9.36 MHz	-74.18	
	NR_FDD_FR1_B				
	NR_TDD_FR1_C				
	NR_FDD_FR1_D, NR_TDD_FR1_D				
	NR_FDD_FR1_E, NR_TDD_FR1_E				
	NR_FDD_FR1_G				
	NR_FDD_FR1_H				
	NR_FDD_FR1_A, NR_TDD_FR1_A	3,6		dBm/38.16 MHz	-68.08
	NR_FDD_FR1_B				
	NR_TDD_FR1_C				
	NR_FDD_FR1_D, NR_TDD_FR1_D				
	NR_FDD_FR1_E, NR_TDD_FR1_E				
	NR_FDD_FR1_G				
	NR_FDD_FR1_H				
Propagation condition		1~6		AWGN	
Antenna configuration		1~6		1x2	
NOTE 1: OCNB shall be used such that both cells are fully allocated and a constant total transmitted power spectral density is achieved for all OFDM symbols.					
NOTE 2: Interference from other cells and noise sources not specified in the test is assumed to be constant over subcarriers and time and shall be modelled as AWGN of appropriate power for $N_{oc}$ to be fulfilled.					
NOTE 3: SS-RSRP and Io levels have been derived from other parameters for information purposes. They are not settable parameters themselves.					
NOTE 4: SS-RSRP minimum requirements are specified assuming independent interference and noise at each receiver antenna port.					



**Table 8.5.1.1.5-3: Timing offsets for E-UTRA - NR FR1 SFTD measurement accuracy**

Condition	SFN offset between PCell and PSCell	Frame boundary offset between PCell and PSCell (Ts)
1	100	-122000
2	300	-60540
3	500	1000
4	700	62540
5	900	124000

**Table 8.5.1.1.5-4: SFTD measurement accuracy**

Accuracy	Conditions	
	$\hat{E}s/lot$	Frequency range
$T_s$ <sup>Note 1</sup>	dB	
40	$\geq -3$ dB	FR1

NOTE 1:  $T_s$  is the basic timing unit defined in TS 36.211 [24].  
NOTE 2: The parameter  $\hat{E}s/lot$  is the minimum  $\hat{E}s/lot$  of the pair of cells to which the requirement applies.

**Table 8.5.1.1.5-5: E-UTRA - NR FR1 SFTD measurement accuracy requirements for the value of frameBoundaryOffsetResult in reported SFTD**

Normal and Extreme Conditions	frameBoundaryOffsetResult				
	Condition 1	Condition 2	Condition 3	Condition 4	Condition 5
Lowest reported value	-24408	-12116	192	12100	24392
Highest reported value	-24392	-12100	208	12116	24408

For the test to pass, the ratio of successful reported values in each test shall be more than 90% with a confidence level of 95%.

## 8.5.2 Inter-RAT measurement accuracy

### 8.5.2.1 SS-RSRP

#### 8.5.2.1.0 Minimum conformance requirements

The measurement period of NR SS-RSRP measurements in RRC\_CONNECTED state is specified in TS 36.133 [23] Clause 8.1.2.4.21 for UE with FDD PCell not configured with E-UTRA-NR Dual Connectivity operation. The measurement period of NR SS-RSRP measurements in RRC\_CONNECTED state is specified in TS 36.133 [23] Clause 8.1.2.4.22 for UE with TDD PCell not configured with E-UTRA-NR Dual Connectivity operation.

The reporting range for SS-RSRP is defined from -156dBm to -31dBm with 1dB resolution. The mapping of the measured quantity to the reported value is defined by Table 4.7.1.0.1-2.

The normative reference for this requirement is TS 36.133 [23] clause 9.11.1.

#### 8.5.2.1.0.1 Inter-RAT E-UTRA - NR FR1 SS-RSRP measurement accuracy requirements

The accuracy requirements of NR SS-RSRP measurements in FR1 and the corresponding side conditions shall be the same as the inter-frequency SS-RSRP absolute accuracy requirements in clause 4.7.1.0.3.

#### 8.5.2.1.0.2 Inter-RAT E-UTRA - NR FR2 SS-RSRP minimum conformance requirements

The accuracy requirements of NR SS-RSRP measurements in FR2 and the corresponding side conditions shall be the same as the inter-frequency SS-RSRP absolute accuracy requirements in clause 5.7.1.0.2.

## 8.5.2.1.1 SS-RSRP with NR FR1 target cell

## 8.5.2.1.1.1 E-UTRA SS-RSRP absolute measurement accuracy of a NR FR1 neighbour cell

## 8.5.2.1.1.1.1 Test purpose

The purpose of this test is to verify that the inter-RAT SS-RSRP absolute measurement accuracy is within the specified limits for all bands, when the serving cell is E-UTRA and the target cell is NR FR1.

## 8.5.2.1.1.1.2 Test applicability

This test applies to all E-UTRA UE release 15 onwards and capable of NR measurements.

## 8.5.2.1.1.1.3 Minimum conformance requirements

The minimum conformance requirements are specified in clause 8.5.2.1.0.

The normative reference for this requirement is TS 38.133 [6] clause A.8.5.2.1.1.1.

## 8.5.2.1.1.1.4 Test description

Two cells are configured in this test: E-UTRA Cell 1 is the E-UTRAN PCell and Cell 2 is the inter-RAT NR FR1 neighbour cell.

## 8.5.2.1.1.1.4.1 Initial conditions

This test shall be tested using any of the test configurations in Table 8.5.2.1.1.4.1-1.

**Table 8.5.2.1.1.4.1-1: Supported test configurations**

Configuration	Description
8.5.2.1.1.1-1	NR 15 kHz SSB SCS, 10 MHz bandwidth, FDD duplex mode, LTE FDD
8.5.2.1.1.1-2	NR 15 kHz SSB SCS, 10 MHz bandwidth, TDD duplex mode, LTE FDD
8.5.2.1.1.1-3	NR 30 kHz SSB SCS, 40 MHz bandwidth, TDD duplex mode, LTE FDD
8.5.2.1.1.1-4	NR 15 kHz SSB SCS, 10 MHz bandwidth, FDD duplex mode, LTE TDD
8.5.2.1.1.1-5	NR 15 kHz SSB SCS, 10 MHz bandwidth, TDD duplex mode, LTE TDD
8.5.2.1.1.1-6	NR 30 kHz SSB SCS, 40 MHz bandwidth, TDD duplex mode, LTE TDD

NOTE: The UE is only required to be tested in one of the supported test configurations.

Configure the test equipment and the DUT according to the parameters in Table 8.5.2.1.1.4.1-2.

**Table 8.5.2.1.1.4.1-2: Initial conditions**

Parameter	Value	Comment
Test environment	NC, TL/VL, TL/VH, TH/VL, TH/VH	As specified in TS 36.508 [25] clause 4.1.
Test frequencies	As specified in Annex E, Table E.6-1 and TS 38.508-1 [14] clause 4.3.1.	
Channel bandwidth	As specified by the selected test configuration.	
Propagation conditions	AWGN	As specified in clause C.2.1
Connection Diagram	TE Part 2Rx	A.3.1.7.2
	TE Part 4Rx	A.3.1.7.3
	DUT Part 2Rx	A.3.2.3.4
	DUT Part 4Rx	A.3.2.5.2
Exceptions to connection diagram	Without faders	

1. The general test parameter settings are set up according to Table 8.5.2.1.1.4.1-3.
2. Message contents are defined in clause 8.5.2.1.1.4.3.

3. There are two carriers and two cells specified in the test, where E-UTRA Cell 1 is the E-UTRA PCell on the E-UTRA carrier and Cell 2 is the NR neighbour cell on the NR carrier. E-UTRA Cell 1 is configured according to TS 36.521-3 [26] clause C.1.0 and C.1.1.

8.5.2.1.1.1.4.2 Test procedure

1. Ensure the UE is in State 3A-RF according to TS 36.508 [25] clause 7.2A.3.
2. Set the parameters according to Table 8.5.2.1.1.1.5-1 as appropriate.
3. The SS shall transmit an *RRCConnectionReconfiguration* message on Cell 1.
4. The UE shall transmit an *RRCConnectionReconfigurationComplete* message.
5. The UE shall transmit periodically MeasurementReport messages.
6. After 10s wait from Step 3, the SS shall check the SS-RSRP reported values in the periodic MeasurementReport. The SS-RSRP value of Cell 2 reported by the UE is compared to the expected SS-RSRP. If the value is outside the limits in clause 8.5.2.1.1.1.5 or the UE fails to report the measurement value for Cell 2, the number of failed iterations is increased by one. Otherwise, the number of passed iterations is increased by one.
7. The SS shall continue checking the MeasurementReport messages transmitted by the UE until the confidence level according to Table G.2.3-1 in Annex G is achieved.
8. Set the parameters according to each sub-test in Table 8.5.2.1.1.1.5-1 as appropriate and repeat steps 5-7.

8.5.2.1.1.1.4.3 Message contents

Message contents are according to TS 36.508 [25] clause 7.3 with the following exceptions:

**Table 8.5.2.1.1.1.4.3-1: Common Exception messages**

Default Message Contents	
Common contents of system information blocks exceptions	
Default RRC messages and information elements contents exceptions	Table H.3.4-7 Table 4.6.6-2B in TS 36.508 [25]

**Table 8.5.2.1.1.1.4.3-2: ReportConfigInterRAT-DEFAULT(Periodical)**

Derivation Path: 36.508 [25] Table 4.6.6-9			
Information Element	Value/remark	Comment	Condition
ReportConfigNR ::= SEQUENCE {			
reportType CHOICE {			
periodical SEQUENCE {			
ReportQuantityNR-r15 SEQUENCE {	PRESENT		
ss-rsrp	true		
}			
}			
}			

8.5.2.1.1.1.5 Test requirement

Table 8.5.2.1.1.1.5-1 defines the primary level settings including test tolerances for all tests.

Each SS-RSRP measurement report for each of the tests in Table 8.5.2.1.1.1.5-1 shall meet the corresponding absolute accuracy requirements in Table 8.5.2.1.1.1.5-2 for test configurations 1, 2, 4 and 5, and the corresponding absolute accuracy requirements in Table 8.5.2.1.1.1.5-3 for test configurations 3 and 6.

Table 8.5.2.1.1.1.5-1: SS-RSRP inter-RAT test parameters

Parameter			Unit	Test 1		Test 2	
				Cell 2		Cell 2	
SSB ARFCN				freq1		freq1	
Duplex mode	Config 1,4		FDD				
	Config 2,3,5,6		TDD				
TDD configuration	Config 1,4		Not Applicable				
	Config 2,5		TDDConf.1.1				
	Config 3,6		TDDConf.2.1				
Downlink initial BWP configuration				DLBWP.0.1			
Uplink initial BWP configuration				ULBWP.0.1			
DRX Cycle configuration			ms	Not Applicable			
PDSCH Reference measurement channel	Config 1,4		-			-	
	Config 2,5		-			-	
	Config 3,6		-			-	
RMSI CORESET Reference Channel	Config 1,4		-			-	
	Config 2,5		-			-	
	Config 3,6		-			-	
Dedicated CORESET Reference Channel	Config 1,4		-			-	
	Config 2,5		-			-	
	Config 3,6		-			-	
OCNG Patterns				OP.1			
SS-RSSI-Measurement				Not Applicable			
SMTC configuration				SMTC.1			
SSB configuration	Config 1,2,4,5		SSB.1 FR1				
	Config 3,6		SSB.2 FR1				
PDSCH/PDCCH subcarrier spacing	Config 1,2,4,5		15				
	Config 3,6	kHz	30				
EPRE ratio of PSS to SSS			dB	0	0	0	0
EPRE ratio of PBCH DMRS to SSS							
EPRE ratio of PBCH to PBCH DMRS							
EPRE ratio of PDCCH DMRS to SSS							
EPRE ratio of PDCCH to PDCCH DMRS							
EPRE ratio of PDSCH DMRS to SSS							
EPRE ratio of PDSCH to PDSCH							
EPRE ratio of OCNG DMRS to SSS(Note 1)							
EPRE ratio of OCNG to OCNG DMRS (Note 1)							
$N_{oc}$ <sup>Note2</sup>	Config 1,2,4,5	Depending on band group	dBm/15k Hz	-94.65		-117 + $\Delta_{BG\_offset}$	
	Config 3,6	Depending on band group	dBm/15k Hz	-96.00		-117 + $\Delta_{BG\_offset}$	
$N_{oc}$ <sup>Note2</sup>	Config 1,2,4,5		dBm/SCS	-94.65		Same as $N_{oc}$ for 15kHz	
	Config 3,6	Depending on band group	dBm/SCS	-93.00		-114 + $\Delta_{BG\_offset}$	
$\hat{E}_s / I_{ot}$			dB	10		-3.2	
$\hat{E}_s / N_{oc}$			dB	10		-3.2	
SS-RSRP <sup>Note3</sup>	Config 1,2,4,5	Depending on band group	dBm/SCS	-84.65		-120.2 + $\Delta_{BG\_offset}$	
	Config 3,6	Depending on band group	dBm/SCS	-83.00		-117.2 + $\Delta_{BG\_offset}$	
$I_{o}$ <sup>Note3</sup>	Config 1,2,4,5	Depending on band group	dBm/9.36MHz	-56.28		-87.35 + $\Delta_{BG\_offset}$	
	Config 3,6	Depending on band group	dBm/38.16MHz	-51.53		-81.25 + $\Delta_{BG\_offset}$	
Propagation condition			-	AWGN			
Antenna configuration			-	1x2			

Parameter	Unit	Test 1	Test 2
		Cell 2	Cell 2
NOTE 1: OCNG shall be used such that both cells are fully allocated and a constant total transmitted power spectral density is achieved for all OFDM symbols.			
NOTE 2: Interference from other cells and noise sources not specified in the test is assumed to be constant over subcarriers and time and shall be modelled as AWGN of appropriate power for $N_{oc}$ to be fulfilled.			
NOTE 3: SS-RSRP, and $I_0$ levels have been derived from other parameters for information purposes. They are not settable parameters themselves.			
NOTE 4: SS-RSRP minimum requirements are specified assuming independent interference and noise at each receiver antenna port.			
NOTE 5: NR operating band groups are as defined in clause 3.5.2.			
NOTE 6: The test configuration excludes support for band n51 and it is not required to run this test on band n51 in this release of the specification.			

**Table 8.5.2.1.1.1.5-2: SS-RSRP Inter RAT absolute accuracy requirements for the reported values for test configurations 1, 2, 4 and 5**

Normal Conditions	Test 1 All bands	Test 2	
Lowest reported value (Cell 2)	62	Bands NR_FDD_FR1_A, NR_TDD_FR1_A	30
		Bands NR_FDD_FR1_B	31
		Bands NR_TDD_FR1_C	31
		Bands NR_FDD_FR1_D, NR_TDD_FR1_D	32
		Bands NR_FDD_FR1_E, NR_TDD_FR1_E	32
		Bands NR_FDD_FR1_F	33
		Bands NR_FDD_FR1_G	33
		Bands NR_FDD_FR1_H	34
Highest reported value (Cell 2)	82	Bands NR_FDD_FR1_A, NR_TDD_FR1_A	43
		Bands NR_FDD_FR1_B	43
		Bands NR_TDD_FR1_C	44
		Bands NR_FDD_FR1_D, NR_TDD_FR1_D	44
		Bands NR_FDD_FR1_E, NR_TDD_FR1_E	45
		Bands NR_FDD_FR1_F	45
		Bands NR_FDD_FR1_G	46
		Bands NR_FDD_FR1_H	46
Extreme Conditions	Test 1 All bands	Test 2	
Lowest reported value (Cell 2)	59	Bands NR_FDD_FR1_A, NR_TDD_FR1_A	26
		Bands NR_FDD_FR1_B	26
		Bands NR_TDD_FR1_C	27
		Bands NR_FDD_FR1_D, NR_TDD_FR1_D	27
		Bands NR_FDD_FR1_E, NR_TDD_FR1_E	28
		Bands NR_FDD_FR1_F	28
		Bands NR_FDD_FR1_G	29
		Bands NR_FDD_FR1_H	29
Highest reported value (Cell 2)	85	Bands NR_FDD_FR1_A, NR_TDD_FR1_A	47
		Bands NR_FDD_FR1_B	48
		Bands NR_TDD_FR1_C	48
		Bands NR_FDD_FR1_D, NR_TDD_FR1_D	49
		Bands NR_FDD_FR1_E, NR_TDD_FR1_E	49
		Bands NR_FDD_FR1_F	50
		Bands NR_FDD_FR1_G	50
		Bands NR_FDD_FR1_H	51
NOTE: NR operating band groups are defined in clause 3A.4, Table 3A.4.1-2.			

**Table 8.5.2.1.1.5-3: SS-RSRP Inter RAT absolute accuracy requirements for the reported values for test configurations 3 and 6**

Normal Conditions	Test 1 All bands	Test 2	
Lowest reported value (Cell 2)	64	Bands NR_FDD_FR1_A, NR_TDD_FR1_A	33
		Bands NR_FDD_FR1_B	34
		Bands NR_TDD_FR1_C	34
		Bands NR_FDD_FR1_D, NR_TDD_FR1_D	35
		Bands NR_FDD_FR1_E, NR_TDD_FR1_E	35
		Bands NR_FDD_FR1_F	36
		Bands NR_FDD_FR1_G	36
		Bands NR_FDD_FR1_H	37
Highest reported value (Cell 2)	83	Bands NR_FDD_FR1_A, NR_TDD_FR1_A	46
		Bands NR_FDD_FR1_B	46
		Bands NR_TDD_FR1_C	47
		Bands NR_FDD_FR1_D, NR_TDD_FR1_D	47
		Bands NR_FDD_FR1_E, NR_TDD_FR1_E	48
		Bands NR_FDD_FR1_F	48
		Bands NR_FDD_FR1_G	49
		Bands NR_FDD_FR1_H	49
Extreme Conditions	Test 1 All bands	Test 2	
Lowest reported value (Cell 2)	61	Bands NR_FDD_FR1_A, NR_TDD_FR1_A	29
		Bands NR_FDD_FR1_B	29
		Bands NR_TDD_FR1_C	30
		Bands NR_FDD_FR1_D, NR_TDD_FR1_D	30
		Bands NR_FDD_FR1_E, NR_TDD_FR1_E	31
		Bands NR_FDD_FR1_F	31
		Bands NR_FDD_FR1_G	32
		Bands NR_FDD_FR1_H	32
Highest reported value (Cell 2)	86	Bands NR_FDD_FR1_A, NR_TDD_FR1_A	50
		Bands NR_FDD_FR1_B	51
		Bands NR_TDD_FR1_C	51
		Bands NR_FDD_FR1_D, NR_TDD_FR1_D	52
		Bands NR_FDD_FR1_E, NR_TDD_FR1_E	52
		Bands NR_FDD_FR1_F	53
		Bands NR_FDD_FR1_G	53
		Bands NR_FDD_FR1_H	54
NOTE: NR operating band groups are defined in clause 3A.4, Table 3A.4.1-2.			

For the test to pass, the ratio of successful reported values in each test shall be more than 90% with a confidence level of 95%.

8.5.2.1.1.2 Void

8.5.2.1.2 E-UTRA SS-RSRP absolute measurement accuracy of a NR FR2 neighbour cell

**Editor's Note: This test case has been completed for the following configurations:**

- Test frequency  $f \leq 40.8$  GHz

- UE PC3
- Normal conditions
- The test is incomplete for UE power classes other than PC3
- The test is incomplete for test frequencies > 40.8 GHz
- The test is incomplete for extreme conditions

#### 8.5.2.1.2.1 Test purpose

The purpose of this test is to verify that the inter-RAT SS-RSRP measurement accuracy is within the specified limits for all bands, when the serving cell is E-UTRA and the target cell is NR FR2.

#### 8.5.2.1.2.2 Test applicability

This test applies to all E-UTRA UE release 15 onwards and capable of NR FR2 measurements.

#### 8.5.2.1.2.3 Minimum conformance requirements

The minimum conformance requirements are specified in clause 8.5.2.1.0.2.

The normative reference for this requirement is TS 38.133 [6] clause A.8.5.2.1.2.

#### 8.5.2.1.2.4 Test description

Two cells are configured in this test: E-UTRA Cell 1 is the E-UTRAN PCell and Cell 2 is the inter-RAT NR FR2 neighbour cell.

##### 8.5.2.1.2.4.1 Initial conditions

This test shall be tested using any of the test configurations in Table 8.5.2.1.2.4.1-1.

**Table 8.5.2.1.2.4.1-1: Supported test configurations**

Configuration	Description
8.5.2.1.2-1	NR 120 kHz SSB SCS, 100 MHz bandwidth, TDD duplex mode, LTE FDD
8.5.2.1.2-2	NR 120 kHz SSB SCS, 100 MHz bandwidth, TDD duplex mode, LTE TDD
NOTE: The UE is only required to be tested in one of the supported test configurations	

Configure the test equipment and the DUT according to the parameters in Table 8.5.2.1.2.4.1-2.

**Table 8.5.2.1.2.4.1-2: Initial conditions**

Parameter	Value	Comment
Test environment	NC, TL/VL, TL/VH, TH/VL, TH/VH	As specified in TS 36.508 [25] clause 4.1.
Test frequencies	As specified in Annex E, Table E.6-2 and TS 38.508-1 [14] clause 4.3.1.	
Channel bandwidth	As specified by the selected test configuration.	
Propagation conditions	AWGN	As specified in clause C.2.1
Connection Diagram	TE Part: A.3.3.3.1 UE Part: A.3.4.1.1	As specified in TS 38.508-1 [14] Annex A.
Exceptions to connection diagram	N/A	

1. The general test parameter settings are set up according to Table 8.5.2.1.2.4.1-3.
2. Message contents are defined in clause 8.5.2.1.2.4.3.



3. There are two carriers and two cells specified in the test, where E-UTRA Cell 1 is the E-UTRA PCell on the E-UTRA carrier and Cell 2 is the NR neighbour cell on the NR carrier. E-UTRA Cell 1 is configured according to TS 36.521-3 [26] clause C.1.0 and C.1.1.
4. The UE Rx beam peak direction has been obtained previously using one of the Rx beam peak search procedures as described in Annex I.

8.5.2.1.2.4.2 Test procedure

1. Ensure the UE is in State 3A-RF according to TS 36.508 [25] clause 7.2A.3.
2. Set the parameters according to Table 8.5.2.1.2.5-1 and Table 8.5.2.1.2.5-2 as appropriate. The TE shall ensure that the NR FR2 cell will be received by the UE from the Rx beam peak direction.
3. The SS shall transmit an *RRCConnectionReconfiguration* message on Cell 1 to configure inter-RAT NR neighbour cell periodical measurements.
4. The UE shall transmit an *RRCConnectionReconfigurationComplete* message.
5. The UE shall transmit periodically MeasurementReport messages.
6. After 10s wait from Step 3, the SS shall check the SS-RSRP reported values in the periodic MeasurementReport. The SS-RSRP value of Cell 2 reported by the UE is compared to the expected SS-RSRP. If the value is outside the limits in clause 8.5.2.1.2.5 or the UE fails to report the measurement value for Cell 2, the number of failed iterations is increased by one. Otherwise, the number of passed iterations is increased by one.
7. The SS shall continue checking the MeasurementReport messages transmitted by the UE until the confidence level according to Table G.2.3-1 in Annex G is achieved.
8. Set the parameters according to each sub-test in Tables 8.5.2.1.2.5-1 and 8.5.2.1.2.5-2 as appropriate and repeat steps 5-7.

8.5.2.1.2.4.3 Message contents

Message contents are according to TS 36.508 [25] clause 7.3 with the following exceptions:

**Table 8.5.2.1.2.4.3-1: Common Exception messages**

Default Message Contents	
Common contents of system information blocks exceptions	
Default RRC messages and information elements contents exceptions	Table H.3.4-7 Table 4.6.6-2B in TS 36.508 [25]

**Table 8.5.2.1.2.4.3-2: ReportConfigInterRAT-DEFAULT(Periodical)**

Derivation Path: 36.508 [25] Table 4.6.6-9			
Information Element	Value/remark	Comment	Condition
ReportConfigNR ::= SEQUENCE {			
reportType CHOICE {			
periodical SEQUENCE {			
ReportQuantityNR-r15 SEQUENCE {	PRESENT		
rsrp	true		
}			
}			
}			
}			

8.5.2.1.2.5 Test requirement

Table 8.5.2.1.2.5-1 defines the general test parameters and Table 8.5.2.1.2.5-2 defines the primary level OTA settings including test tolerances for all tests.

Each SS-RSRP measurement report for each of the tests in Table 8.5.2.1.2.5-2 shall meet the corresponding absolute accuracy requirements in Table 8.5.2.1.2.5-3

**Table 8.5.2.1.2.5-1: SS-RSRP Inter-RAT general test parameters**

Parameter	Unit	Test 1	Test 2
		Cell 2	Cell 2
SSB ARFCN		Freq1	freq1
Duplex mode		TDD	TDD
TDD configuration		TDDConf.3.1	TDDConf.3.1
$BW_{\text{channel}}$	MHz	100: $N_{\text{RB,c}} = 66$	100: $N_{\text{RB,c}} = 66$
Downlink initial BWP configuration		DLBWP.0.1	
Uplink initial BWP configuration		ULBWP.0.1	
DRX cycle configuration	ms	Not applicable	
PDSCH Reference measurement channel		-	-
RMSI CORESET Reference Channel		-	-
OCNG Patterns		OP.1	OP.1
SMTc configuration		SMTc.1	SMTc.1
SSB configuration		SSB.3 FR2	SSB.3 FR2
PDSCH/PDCCH subcarrier spacing	kHz	120	120
EPRE ratio of PSS to SSS	dB	0	0
EPRE ratio of PBCH_DMRS to SSS			
EPRE ratio of PBCH to PBCH_DMRS			
EPRE ratio of PDCCH_DMRS to SSS			
EPRE ratio of PDCCH to PDCCH_DMRS			
EPRE ratio of PDSCH_DMRS to SSS			
EPRE ratio of PDSCH to PDSCH_DMRS			
EPRE ratio of OCNG DMRS to SSS <sup>Note 1</sup>			
NOTE 1: OCNG shall be used such that both cells are fully allocated and a constant total transmitted power spectral density is achieved for all OFDM symbols.			
NOTE 2: Void.			
NOTE 3: Void.			
NOTE 4: Void.			

**Table 8.5.2.1.2.5-2: SS-RSRP Inter-RAT OTA related test parameters**

Parameter	Unit	Test 1	Test 2
		Cell 2	Cell 2
Angle of arrival configuration		Setup 1 according to A.3.15.1	Setup 1 according to A.3.15.1
Assumption for UE beams <sup>Note 9</sup>		Rough	Rough
$N_{oc}$ <sup>Note 1</sup>	dBm/15kHz <sup>Note 4</sup>	-105.1	N/A
$N_{oc}$ <sup>Note 1</sup>	dBm/SCS <sup>Note 4</sup>	-96.07	N/A
$\hat{E}_s / N_{oc}$	dB	11	N/A
$E_s$	dBm/SCS <sup>Note 4</sup>		(Table B.2.3-2 of TS 38.133 [6] Rx Beam Peak +6.65dB)
SSB_RP <sup>Note 2</sup>	dBm/SCS <sup>Note 4</sup>	-85.07	(Table B.2.3-2 of TS 38.133 [6] Rx Beam Peak +6.65dB)
$\hat{E}_s / I_{ot\ BB}$ <sup>Note 7</sup>	dB	9.95	1.84
$I_o$ <sup>Note 2</sup>	dBm/95.04 MHz <sup>Note 4</sup>	-55.75	(Table B.2.3-2 of TS 38.133 [6] Rx Beam Peak +35.65dB)
<p>NOTE 1: Where used, interference from other cells and noise sources not specified in the test is assumed to be constant over subcarriers and time and shall be modelled as AWGN of appropriate power for <math>N_{oc}</math> to be fulfilled.</p> <p>NOTE 2: SSB_RP, <math>E_s/I_{ot}</math> and <math>I_o</math> levels have been derived from other parameters for information purposes. They are not settable parameters themselves.</p> <p>NOTE 3: Void</p> <p>NOTE 4: Equivalent power received by an antenna with 0 dBi gain at the centre of the quiet zone</p> <p>NOTE 5: Void</p> <p>NOTE 6: Void</p> <p>NOTE 7: Calculation of <math>E_s/I_{ot\ BB}</math> includes the effect of UE internal noise up to the value assumed for the associated Refsens requirement in clause 7.3.2 of TS 36.101-2 [3], and an allowance of 1dB for UE multi-band relaxation factor <math>\Delta MB_P</math> from TS 38.101-2 [3] Table 6.2.1.3-4.</p> <p>NOTE 8: Information about types of UE beam is given in B.2.1.3, and does not limit UE implementation or test system implementation</p>			

**Table 8.5.2.1.2.5-3: evaluation limits for the reported values**

UE power class 3			
Normal Conditions	Test 1	Test 2	
	All bands		
Lowest reported value (Cell 2)	48	n257, n258, n261	29
		n260	32
		n259	33
Highest reported value (Cell 2)	105	n257, n258, n261	87
		n260	89
		n259	90
Extreme Conditions	Test 1	Test 2	
	All bands		
Lowest reported value (Cell 2)	45	n257, n258, n261	26
		n260	29
		n259	30
Highest reported value (Cell 2)	108	n257, n258, n261	90
		n260	92
		n259	93

For the test to pass, the ratio of successful reported values in each test shall be more than 90% with a confidence level of 95%.

## 8.5.2.2 SS-RSRQ

### 8.5.2.2.0 Minimum conformance requirements

The measurement period of NR SS-RSRQ measurements is the same as the measurement period of NR SS-RSRP measurements defined in clause 8.5.2.1.0.

The reporting range of SS-RSRQ is defined from -43 dB to 20 dB with 0.5 dB resolution. The mapping of measured quantity is defined in Table 4.7.2.0.1-2. The range in the signalling may be larger than the guaranteed accuracy range.

The normative reference for this requirement is TS 36.133 [23] clause 9.11.2.

#### 8.5.2.2.0.1 Inter-RAT E-UTRA - NR FR1 SS-RSRQ minimum conformance requirements

The accuracy requirements of NR SS-RSRQ measurements in FR1 and the corresponding side conditions shall be the same as the inter-frequency SS-RSRQ absolute accuracy requirements in clause 4.7.2.0.2.

#### 8.5.2.2.0.2 Inter-RAT E-UTRA - NR FR2 SS-RSRQ minimum conformance requirements

The accuracy requirements of NR SS-RSRP measurements in FR2 and the corresponding side conditions shall be the same as the inter-frequency SS-RSRP absolute accuracy requirements in clause 5.7.2.0.2.

### 8.5.2.2.1 E-UTRA SS-RSRQ absolute measurement accuracy of a NR FR1 neighbour cell

#### 8.5.2.2.1.1 Test purpose

The purpose of this test is to verify that the inter-RAT SS-RSRQ measurement accuracy is within the specified limits for all bands, when the serving cell is E-UTRA and the target cell is NR FR1.

#### 8.5.2.2.1.2 Test applicability

This test applies to all E-UTRA UE release 15 onwards and capable of NR measurements.

#### 8.5.2.2.1.3 Minimum conformance requirements

The minimum conformance requirements are specified in clause 8.5.2.2.0.1.

The normative reference for this requirement is TS 38.133 [6] clause A.8.5.2.2.1.

#### 8.5.2.2.1.4 Test description

Two cells are configured in this test: E-UTRA Cell 1 is the E-UTRAN PCell and Cell 2 is the inter-RAT NR FR1 neighbour cell.

##### 8.5.2.2.1.4.1 Initial conditions

This test shall be tested using any of the test configurations in Table 8.5.2.2.1.4.1-1.

**Table 8.5.2.2.1.4.1-1: Supported test configurations**

Configuration	Description
8.5.2.2.1-1	NR 15 kHz SSB SCS, 10 MHz bandwidth, FDD duplex mode, LTE FDD
8.5.2.2.1-2	NR 15 kHz SSB SCS, 10 MHz bandwidth, TDD duplex mode, LTE FDD
8.5.2.2.1-3	NR 30 kHz SSB SCS, 40 MHz bandwidth, TDD duplex mode, LTE FDD
8.5.2.2.1-4	NR 15 kHz SSB SCS, 10 MHz bandwidth, FDD duplex mode, LTE TDD
8.5.2.2.1-5	NR 15 kHz SSB SCS, 10 MHz bandwidth, TDD duplex mode, LTE TDD
8.5.2.2.1-6	NR 30 kHz SSB SCS, 40 MHz bandwidth, TDD duplex mode, LTE TDD

NOTE: The UE is only required to be tested in one of the supported test configurations.

Configure the test equipment and the DUT according to the parameters in Table 8.5.2.2.1.4.1-2.

**Table 8.5.2.2.1.4.1-2: Initial conditions**

Parameter	Value		Comment
Test environment	NC, TL/VL, TL/VH, TH/VL, TH/VH		As specified in TS 36.508 [25] clause 4.1.
Test frequencies	As specified in Annex E, Table E.6-1 and TS 38.508-1 [14] clause 4.3.1.		
Channel bandwidth	As specified by the selected test configuration.		
Propagation conditions	AWGN		As specified in clause C.2.1
Connection Diagram	TE Part 2Rx	A.3.1.7.2	As specified in TS 38.508-1 [14] Annex A.
	TE Part 4Rx	A.3.1.7.3	
	DUT Part 2Rx	A.3.2.3.4	
	DUT Part 4Rx	A.3.2.5.2	
Exceptions to connection diagram	N/A		

1. The general test parameter settings are set up according to Table 8.5.2.2.1.4.1-3.
2. Message contents are defined in clause 8.5.2.2.1.4.3.
3. There are two carriers and two cells specified in the test, where E-UTRA Cell 1 is the E-UTRA PCell on the E-UTRA carrier and Cell 2 is the NR neighbour cell on the NR carrier. E-UTRA Cell 1 is configured according to TS 36.521-3 [26] clause C.1.0 and C.1.1.

**8.5.2.2.1.4.2 Test procedure**

1. Ensure the UE is in State 3A-RF according to TS 36.508 [25] clause 7.2A.3.
2. Set the parameters according to Table 8.5.2.2.1.5-1 as appropriate.
3. The SS shall transmit an *RRCConnectionReconfiguration* message on Cell 1.
4. The UE shall transmit an *RRCConnectionReconfigurationComplete* message.
5. The UE shall transmit periodically MeasurementReport messages.
6. After 10s wait from Step 3, the SS shall check the SS-RSRQ reported values in the periodic MeasurementReport. The SS-RSRQ value of Cell 2 reported by the UE is compared to the expected SS-RSRQ. If the value is outside the limits in clause 8.5.2.2.1.5 or the UE fails to report the measurement value for Cell 2, the number of failed iterations is increased by one. Otherwise, the number of passed iterations is increased by one.
7. The SS shall continue checking the MeasurementReport messages transmitted by the UE until the confidence level according to Table G.2.3-1 in Annex G is achieved.
8. Set the parameters according to each sub-test in Table 8.5.2.2.1.5-1 as appropriate and repeat steps 5-7.

**8.5.2.2.1.4.3 Message contents**

Message contents are according to TS 36.508 [25] clause 7.3 with the following exceptions:

**Table 8.5.2.2.1.4.3-1: Common Exception messages**

Default Message Contents	
Common contents of system information blocks exceptions	
Default RRC messages and information elements contents exceptions	Table H.3.4-7 Table 4.6.6-2B in TS 36.508 [25]

**Table 8.5.2.2.1.4.3-2: ReportConfigInterRAT-DEFAULT(Periodical)**

Derivation Path: 36.508 [25] Table 4.6.6-9			
Information Element	Value/remark	Comment	Condition
ReportConfigNR::= SEQUENCE {			
reportType CHOICE {			
periodical SEQUENCE {			
ReportQuantityNR-r15 SEQUENCE {	PRESENT		
ss-rsrq	true		
}			
}			
}			
}			

8.5.2.2.1.5 Test requirement

Table 8.5.2.2.1.5-1 defines the primary level settings including test tolerances for all tests.

Each SS-RSRQ measurement report for each of the tests in Table 8.5.2.2.1.5-1 shall meet the corresponding absolute accuracy requirements in Table 8.5.2.2.1.5-2.

**Table 8.5.2.2.1.5-1: SS-RSRQ inter-RAT test parameters**

Parameter		Unit	Test 1		Test 2		Test 3	
			Cell 2		Cell 2		Cell 2	
SSB ARFCN			freq1		freq1		freq1	
Duplex mode	Config 1,4		FDD					
	Config 2,3,5,6		TDD					
TDD configuration	Config 1,4		Not Applicable					
	Config 2,5		TDDConf.1.1					
	Config 3,6		TDDConf.2.1					
Downlink initial BWP configuration			DLBWP.0.1					
Uplink initial BWP configuration			ULBWP.0.1					
DRX Cycle configuration		ms	Not Applicable					
PDSCH Reference measurement channel	Config 1,4		-		-		-	
	Config 2,5		-		-		-	
	Config 3,6		-		-		-	
RMSI CORESET Reference Channel	Config 1,4		-		-		-	
	Config 2,5		-		-		-	
	Config 3,6		-		-		-	
Dedicated CORESET Reference Channel	Config 1,4		-		-		-	
	Config 2,5		-		-		-	
	Config 3,6		-		-		-	
OCNG Patterns			OP.1					
SS-RSSI-Measurement			Not Applicable					
SMTC configuration			SMTC.1					
SSB configuration	Config 1,2,4,5		SSB.1 FR1					
	Config 3,6		SSB.2 FR1					
PDSCH/PDCCH subcarrier spacing	Config 1,2,4,5	kHz	15					
	Config 3,6		30					
EPRE ratio of PSS to SSS		dB	0		0		0	
EPRE ratio of PBCH DMRS to SSS			0		0		0	
EPRE ratio of PBCH to PBCH DMRS			0		0		0	
EPRE ratio of PDCCH DMRS to SSS			0		0		0	
EPRE ratio of PDCCH to PDCCH DMRS			0		0		0	
EPRE ratio of PDSCH DMRS to SSS			0		0		0	
EPRE ratio of PDSCH to PDSCH			0		0		0	
EPRE ratio of OCNG DMRS to SSS(Note 1)			0		0		0	
EPRE ratio of OCNG to OCNG DMRS (Note 1)			0		0		0	
$N_{oc}$ <sup>Note2</sup>	Config 1,2,4,5	Depending on band group	-81.68		-106		-116 + $\Delta_{BG\_offset}$	
	Config 3,6		-87.80		-113		Same as $N_{oc}$ for 15kHz for Config 1,2,4,5	

Parameter			Unit	Test 1	Test 2	Test 3
				Cell 2	Cell 2	Cell 2
$N_{oc}$ <sup>Note2</sup>	Config 1,2,4,5		dBm/SCS	-81.68	-106	Same as $N_{oc}$ for 15kHz
	Config 3,6	Depending on band group		-84.80	-110	$-113 + \Delta_{BG\_offset}$
$\hat{E}_s / I_{ot}$			dB	-1.75	-1.75	-1.75
$\hat{E}_s / N_{oc}$			dB	-1.75	-1.75	-1.75
SS-RSRP <sup>Note3</sup>	Config 1,2,4,5	Depending on band group	dBm/SCS	-83.43	-107.75	$-117.75 + \Delta_{BG\_offset}$
	Config 3,6	Depending on band group		-86.55	-111.75	$-114.75 + \Delta_{BG\_offset}$
SS-RSRQ <sup>Note3</sup>			dB	-14.77	-14.76	-14.76
$I_o$ <sup>Note3</sup>	Config 1,2,4,5	Depending on band group	dBm/9.36MHz	-50	-75.83	$-85.83 + \Delta_{BG\_offset}$
	Config 3,6	Depending on band group	dBm/38.16MHz	-50	-76.73	$-79.73 + \Delta_{BG\_offset}$
Propagation condition			-	AWGN		
Antenna configuration			-	1x2		
NOTE 1: OCNG shall be used such that both cells are fully allocated and a constant total transmitted power spectral density is achieved for all OFDM symbols.						
NOTE 2: Interference from other cells and noise sources not specified in the test is assumed to be constant over subcarriers and time and shall be modelled as AWGN of appropriate power for $N_{oc}$ to be fulfilled.						
NOTE 3: SS-RSRQ, SS-RSRP, and $I_o$ levels have been derived from other parameters for information purposes. They are not settable parameters themselves.						
NOTE 4: SS-RSRQ minimum requirements are specified assuming independent interference and noise at each receiver antenna port.						
NOTE 5: NR operating band groups are as defined in clause 3.5.2.						
NOTE 6: The test configuration excludes support for band n51 and it is not required to run this test on band n51 in this release of the specification.						

**Table 8.5.2.2.1.5-2: SS-RSRQ accuracy requirements for the reported values**

	Test 1	Test 2	Test 3
	All bands	All bands	All bands
Normal Conditions			
Lowest reported value (Cell 2)	SS-RSRQ_51	SS-RSRQ_51	SS-RSRQ_51
Highest reported value (Cell 2)	SS-RSRQ_63	SS-RSRQ_63	SS-RSRQ_63
Extreme Conditions			
Lowest reported value (Cell 2)	SS-RSRQ_48	SS-RSRQ_48	SS-RSRQ_48
Highest reported value (Cell 2)	SS-RSRQ_66	SS-RSRQ_66	SS-RSRQ_66

For the test to pass, the ratio of successful reported values in each test shall be more than 90% with a confidence level of 95%.

**8.5.2.2.2 E-UTRA SS-RSRQ absolute measurement accuracy of a NR FR2 neighbour cell**

**Editor's Note: This test case has been completed for the following configurations:**

- Test frequency  $f \leq 40.8$  GHz
- UE PC3
- Normal conditions
- The test is incomplete for UE power classes other than PC3
- The test is incomplete for test frequencies  $> 40.8$  GHz
- The test is incomplete for extreme conditions

#### 8.5.2.2.2.1 Test purpose

The purpose of this test is to verify that the inter-RAT SS-RSRQ measurement accuracy is within the specified limits for all bands, when the serving cell is E-UTRA and the target cell is NR FR2.

#### 8.5.2.2.2.2 Test applicability

This test applies to all E-UTRA UE release 15 onwards and capable of NR FR2 measurements.

#### 8.5.2.2.2.3 Minimum conformance requirements

The minimum conformance requirements are specified in clause 8.5.2.1.0.2.

The normative reference for this requirement is TS 38.133 [6] clause A.8.5.2.2.2.

#### 8.5.2.2.2.4 Test description

Two cells are configured in this test: E-UTRA Cell 1 is the E-UTRAN PCell and Cell 2 is the inter-RAT NR FR2 neighbour cell.

##### 8.5.2.2.2.4.1 Initial conditions

This test shall be tested using any of the test configurations in Table 8.5.2.2.2.4.1-1.

**Table 8.5.2.2.2.4.1-1: Supported test configurations**

Configuration	Description
8.5.2.2.2-1	NR 120 kHz SSB SCS, 100 MHz bandwidth, TDD duplex mode, LTE FDD
8.5.2.2.2-2	NR 120 kHz SSB SCS, 100 MHz bandwidth, TDD duplex mode, LTE TDD
NOTE: The UE is only required to be tested in one of the supported test configurations	

Configure the test equipment and the DUT according to the parameters in Table 8.5.2.2.2.4.1-2.

**Table 8.5.2.2.2.4.1-2: Initial conditions**

Parameter	Value	Comment
Test environment	NC, TL/VL, TL/VH, TH/VL, TH/VH	As specified in TS 36.508 [25] clause 4.1.
Test frequencies	As specified in Annex E, Table E.6-2 and TS 38.508-1 [14] clause 4.3.1.	
Channel bandwidth	As specified by the selected test configuration.	
Propagation conditions	AWGN	As specified in clause C.2.1
Connection Diagram	TE Part: A.3.3.3.1 UE Part: A.3.4.1.1	As specified in TS 38.508-1 [14] Annex A.
Exceptions to connection diagram	N/A	

1. The general test parameter settings are set up according to Table 8.5.2.2.2.4.1-3.
2. Message contents are defined in clause 8.5.2.2.2.4.3.
3. There are two carriers and two cells specified in the test, where E-UTRA Cell 1 is the E-UTRA PCell on the E-UTRA carrier and Cell 2 is the NR neighbour cell on the NR carrier. E-UTRA Cell 1 is configured according to TS 36.521-3 [26] clause C.1.0 and C.1.1.
4. The UE Rx beam peak direction has been obtained previously using one of the Rx beam peak search procedures as described in Annex I.

##### 8.5.2.2.2.4.2 Test procedure

1. Ensure the UE is in State 3A-RF according to TS 36.508 [25] clause 7.2A.3.



2. Set the parameters according to Table 8.5.2.2.2.5-1 and Table 8.5.2.2.2.5-2 as appropriate. The TE shall ensure that the NR FR2 cell will be received by the UE from the Rx beam peak direction.
3. The SS shall transmit an *RRCConnectionReconfiguration* message on Cell 1 to configure inter-RAT NR neighbour cell periodical measurements.
4. The UE shall transmit an *RRCConnectionReconfigurationComplete* message.
5. The UE shall transmit periodically MeasurementReport messages.
6. After 10s wait from Step 3, the SS shall check the SS-RSRQ reported values in the periodic MeasurementReport. The SS-RSRQ value of Cell 2 reported by the UE is compared to the expected SS-RSRQ. If the value is outside the limits in clause 8.5.2.2.2.5 or the UE fails to report the measurement value for Cell 2, the number of failed iterations is increased by one. Otherwise, the number of passed iterations is increased by one.
7. The SS shall continue checking the MeasurementReport messages transmitted by the UE until the confidence level according to Table G.2.3-1 in Annex G is achieved.
8. Set the parameters according to each sub-test in Tables 8.5.2.2.2.5-1 and 8.5.2.2.2.5-2 as appropriate and repeat steps 5-7.

8.5.2.2.2.4.3 Message contents

Message contents are according to TS 36.508 [25] clause 7.3 with the following exceptions:

**Table 8.5.2.2.2.4.3-1: Common Exception messages**

Default Message Contents	
Common contents of system information blocks exceptions	
Default RRC messages and information elements contents exceptions	Table H.3.4-7 Table 4.6.6-2B in TS 36.508 [25]

**Table 8.5.2.2.2.4.3-2: ReportConfigInterRAT-DEFAULT(Periodical)**

Derivation Path: 36.508 [25] Table 4.6.6-9			
Information Element	Value/remark	Comment	Condition
ReportConfigNR ::= SEQUENCE {			
reportType CHOICE {			
periodical SEQUENCE {			
ReportQuantityNR-r15 SEQUENCE {	PRESENT		
rsrq	true		
}			
}			
}			

8.5.2.2.2.5 Test requirement

Table 8.5.2.2.2.5-1 defines the general test parameters and Table 8.5.2.2.2.5-2 defines the primary level OTA settings including test tolerances for all tests.

Each SS-RSRQ measurement report for each of the tests in Table 8.5.2.2.2.5-2 shall meet the corresponding absolute accuracy requirements in Table 8.5.2.2.2.5-3

Table 8.5.2.2.5-1: SS-RSRQ Inter-RAT general test parameters

Parameter	Unit	Test 1	Test 2
		Cell 2	Cell 2
SSB ARFCN		Freq1	freq1
Duplex mode		TDD	TDD
TDD configuration		TDDConf.3.1	TDDConf.3.1
$BW_{\text{channel}}$	MHz	100: $N_{RB,c} = 66$	100: $N_{RB,c} = 66$
Downlink initial BWP configuration		DLBWP.0.1	
Uplink initial BWP configuration		ULBWP.0.1	
DRX cycle configuration	ms	Not applicable	
PDSCH Reference measurement channel		-	-
RMSI CORESET Reference Channel		-	-
OCNG Patterns		OP.1	OP.1
SMTc configuration		SMTc.1	SMTc.1
SSB configuration		SSB.3 FR2	SSB.3 FR2
PDSCH/PDCCH subcarrier spacing	kHz	120	120
EPRE ratio of PSS to SSS	dB	0	0
EPRE ratio of PBCH_DMRS to SSS			
EPRE ratio of PBCH to PBCH_DMRS			
EPRE ratio of PDCCH_DMRS to SSS			
EPRE ratio of PDCCH to PDCCH_DMRS			
EPRE ratio of PDSCH_DMRS to SSS			
EPRE ratio of PDSCH to PDSCH_DMRS			
EPRE ratio of OCNG DMRS to SSS <sup>Note 1</sup>			
NOTE 1: OCNG shall be used such that both cells are fully allocated and a constant total transmitted power spectral density is achieved for all OFDM symbols.			
NOTE 2: Interference from other cells and noise sources not specified in the test is assumed to be constant over subcarriers and time and shall be modelled as AWGN of appropriate power for $N_{oc}$ to be fulfilled.			
NOTE 3: SS-SINR, SS-RSRP and $I_o$ levels have been derived from other parameters for information purposes. They are not settable parameters themselves.			
NOTE 4: SS-SINR and SS-RSRP minimum requirements are specified assuming independent interference and noise at each receiver antenna port.			

Table 8.5.2.2.5-2: SS-RSRQ Inter-RAT OTA related test parameters

Parameter	Unit	Test 1	Test 2
		Cell 2	Cell 2
Angle of arrival configuration		Setup 1	Setup 1
Assumption for UE beams <sup>Note 10</sup>		Rough	Rough
$N_{oc}$ <sup>Note1</sup>	dBm/15kHz <sup>Note4</sup>	-105	(Table B.2.3-2 of TS 38.133 [6] Rx Beam Peak -5dB)  (Note 7)
$N_{oc}$ <sup>Note1</sup>	dBm/SCS <sup>Note4</sup>	-95.97	(Table B.2.3-2 of TS 38.133 [6] Rx Beam Peak +4dB)  (Note 7)
$\hat{E}_s / N_{oc}$	dB	-0.5	3.55
SSB_RP <sup>Note2</sup>	dBm/SCS <sup>Note4</sup>	-96.47	(Table B.2.3-2 of TS 38.133 [6] Rx Beam Peak +7.55dB)  (Note 8)
SS-RSRQ <sup>Note2</sup>	dB	-14.06	-12.38
$\hat{E}_s / I_{ot}$ <sup>Note2</sup>	dB	-0.5	3.55
$I_o$ <sup>Note2</sup>	dBm/95.04 MHz <sup>Note4</sup>	-64.21	(Table B.2.3-2 of TS 38.133 [6] Rx Beam Peak +43.16dB)  (Note 9)

NOTE 1: Interference from other cells and noise sources not specified in the test is assumed to be constant over subcarriers and time and shall be modelled as AWGN of appropriate power for  $N_{oc}$  to be fulfilled.

NOTE 2: SSB\_RP, SS-RSRQ,  $E_s/I_{ot}$  and  $I_o$  levels have been derived from other parameters for information purposes. They are not settable parameters themselves.

NOTE 3: Void

NOTE 4: Equivalent power received by an antenna with 0dBi gain at the centre of the quiet zone.

NOTE 5: Void

NOTE 6: Void

NOTE 7:  $N_{oc}$  for SCS 15kHz is applied at  $-10\log_{10}(8)+4$ dB above the minimum level specified in Table B.2.3-2 of TS 38.133 [6] for beam peak.  $N_{oc}$  for SCS 120kHz is applied at 4dB above the minimum level specified in Table B.2.3-2 for beam peak.

NOTE 8: SSB\_RP is applied at 2.25dB above the minimum level specified in Table B.2.3-2 of TS 38.133 [6] for beam peak.

NOTE 9:  $I_o$  is applied at  $10\log_{10}(792)+6.22$ dB above the minimum level specified in Table B.2.3-2 of TS 38.133 [6] for beam peak.

NOTE 10: Information about types of UE beam is given in B.2.1.3 of TS 38.133 [6], and does not limit UE implementation or test system implementation.

Table 8.5.2.2.5-3: evaluation limits for the reported values

Normal Conditions	Test 1	Test 2
Lowest reported value (Cell 2)	23	26
Highest reported value (Cell 2)	95	98
Extreme Conditions	Test 1	Test 2
Lowest reported value (Cell 2)	20	23
Highest reported value (Cell 2)	98	101

## 8.5.2.3 SS-SINR

### 8.5.2.3.0 Minimum conformance requirements

The measurement period of NR SS-SINR measurements is the same as the measurement period of NR SS-RSRP measurements defined in clause 8.5.2.1.0.

The reporting range of SS-SINR and CSI-SINR is defined from -23 dB to 40 dB with 0.5 dB resolution. The mapping of measured quantity is defined in Table 4.7.3.0.1-2. The range in the signalling may be larger than the guaranteed accuracy range.

The normative reference for this requirement is TS 36.133 [23] clause 9.11.3.

#### 8.5.2.3.0.1 Inter-RAT E-UTRA - NR FR1 SS-SINR minimum conformance requirements

The accuracy requirements of NR SS-SINR measurements in FR1 and the corresponding side conditions shall be the same as the inter-frequency SS-SINR absolute accuracy requirements in clause 4.7.3.0.2.

#### 8.5.2.3.0.2 Inter-RAT E-UTRA - NR FR2 SS-SINR minimum conformance requirements

The accuracy requirements of NR SS-SINR measurements in FR2 and the corresponding side conditions shall be the same as the inter-frequency SS-SINR absolute accuracy requirements in clause 5.7.3.0.2.

### 8.5.2.3.1 E-UTRA SS-SINR absolute measurement accuracy of a NR FR1 neighbour cell

#### 8.5.2.3.1.1 Test purpose

The purpose of this test is to verify that the inter-RAT SS-SINR measurement accuracy is within the specified limits for all bands, when the serving cell is E-UTRA and the target cell is NR FR1.

#### 8.5.2.3.1.2 Test applicability

This test applies to all E-UTRA UE release 15 onwards supporting ss-SINR-Meas and capable of NR measurements.

#### 8.5.2.3.1.3 Minimum conformance requirements

The minimum conformance requirements are specified in clause 8.5.2.3.0.1.

The normative reference for this requirement is TS 38.133 [6] clause A.8.5.2.3.1.

#### 8.5.2.3.1.4 Test description

Two cells are configured in this test: E-UTRA Cell 1 is the E-UTRAN PCell and Cell 2 is the inter-RAT NR FR1 neighbour cell.

##### 8.5.2.3.1.4.1 Initial conditions

This test shall be tested using any of the test configurations in Table 8.5.2.3.1.4.1-1.

**Table 8.5.2.3.1.4.1-1: Supported test configurations**

Configuration	Description
8.5.2.3.1-1	NR 15 kHz SSB SCS, 10 MHz bandwidth, FDD duplex mode, LTE FDD
8.5.2.3.1-2	NR 15 kHz SSB SCS, 10 MHz bandwidth, TDD duplex mode, LTE FDD
8.5.2.3.1-3	NR 30 kHz SSB SCS, 40 MHz bandwidth, TDD duplex mode, LTE FDD
8.5.2.3.1-4	NR 15 kHz SSB SCS, 10 MHz bandwidth, FDD duplex mode, LTE TDD
8.5.2.3.1-5	NR 15 kHz SSB SCS, 10 MHz bandwidth, TDD duplex mode, LTE TDD
8.5.2.3.1-6	NR 30 kHz SSB SCS, 40 MHz bandwidth, TDD duplex mode, LTE TDD

NOTE: The UE is only required to be tested in one of the supported test configurations.

Configure the test equipment and the DUT according to the parameters in Table 8.5.2.3.1.4.1-2.

**Table 8.5.2.3.1.4.1-2: Initial conditions**

Parameter	Value		Comment
Test environment	NC, TL/VL, TL/VH, TH/VL, TH/VH		As specified in TS 36.508 [25] clause 4.1.
Test frequencies	As specified in Annex E, Table E.6-1 and TS 38.508-1 [14] clause 4.3.1.		
Channel bandwidth	As specified by the selected test configuration.		
Propagation conditions	AWGN		As specified in clause C.2.1
Connection Diagram	TE Part 2Rx	A.3.1.7.2	As specified in TS 38.508-1 [14] Annex A.
	TE Part 4Rx	A.3.1.7.3	
	DUT Part 2Rx	A.3.2.3.4	
	DUT Part 4Rx	A.3.2.5.2	
Exceptions to connection diagram	N/A		

1. The general test parameter settings are set up according to Table 8.5.2.3.1.4.1-3.
2. Message contents are defined in clause 8.5.2.3.1.4.3.
3. There are two carriers and two cells specified in the test, where E-UTRA Cell 1 is the E-UTRA PCell on the E-UTRA carrier and Cell 2 is the NR neighbour cell on the NR carrier. E-UTRA Cell 1 is configured according to TS 36.521-3 [26] clause C.1.0 and C.1.1.

#### 8.5.2.3.1.4.2 Test procedure

1. Ensure the UE is in State 3A-RF according to TS 36.508 [25] clause 7.2A.3.
2. Set the parameters according to Table 8.5.2.3.1.5-1 as appropriate.
3. The SS shall transmit an *RRCConnectionReconfiguration* message on Cell 1.
4. The UE shall transmit an *RRCConnectionReconfigurationComplete* message.
5. The UE shall transmit periodically MeasurementReport messages.
6. After 10s wait from Step 3, the SS shall check the SS-SINR reported values in the periodic MeasurementReport. The SS- SINR value of Cell 2 reported by the UE is compared to the expected SS- SINR. If the value is outside the limits in clause 8.5.2.3.1.5 or the UE fails to report the measurement value for Cell 2, the number of failed iterations is increased by one. Otherwise, the number of passed iterations is increased by one.
7. The SS shall continue checking the MeasurementReport messages transmitted by the UE until the confidence level according to Table G.2.3-1 in Annex G is achieved.
8. Set the parameters according to each sub-test in Table 8.5.2.3.1.5-1 as appropriate and repeat steps 5-7.

#### 8.5.2.3.1.4.3 Message contents

Message contents are according to TS 36.508 [25] clause 7.3 with the following exceptions:

**Table 8.5.2.3.1.4.3-1: Common Exception messages**

Default Message Contents	
Common contents of system information blocks exceptions	
Default RRC messages and information elements contents exceptions	Table H.3.4-7 Table 4.6.6-2B in TS 36.508 [25]

**Table 8.5.2.3.1.4.3-2: ReportConfigInterRAT-DEFAULT(Periodical)**

Derivation Path: 36.508 [25] Table 4.6.6-9			
Information Element	Value/remark	Comment	Condition
ReportConfigNR::= SEQUENCE {			
reportType CHOICE {			
periodical SEQUENCE {			
ReportQuantityNR-r15 SEQUENCE {	PRESENT		
ss-sinr	true		
}			
}			
}			
}			

8.5.2.3.1.5 Test requirement

Table 8.5.2.3.1.5-1 defines the primary level settings including test tolerances for all tests.

Each SS-RSRQ measurement report for each of the tests in Table 8.5.2.3.1.5-1 shall meet the corresponding absolute accuracy requirements in Table 8.5.2.3.1.5-2.

**Table 8.5.2.3.1.5-1: SS-SINR inter-RAT test parameters**

Parameter		Unit	Test 1		Test 2		Test 3	
			Cell 2		Cell 2		Cell 2	
SSB ARFCN			freq1		freq1		freq1	
Duplex mode	Config 1,4		FDD					
	Config 2,3,5,6		TDD					
TDD configuration	Config 1,4		Not Applicable					
	Config 2,5		TDDConf.1.1					
	Config 3,6		TDDConf.2.1					
Downlink initial BWP configuration			DLBWP.0.1					
Uplink initial BWP configuration			ULBWP.0.1					
DRX Cycle configuration		ms	Not Applicable					
PDSCH Reference measurement channel	Config 1,4		-		-		-	
	Config 2,5		-		-		-	
	Config 3,6		-		-		-	
RMSI CORESET Reference Channel	Config 1,4		-		-		-	
	Config 2,5		-		-		-	
	Config 3,6		-		-		-	
Dedicated CORESET Reference Channel	Config 1,4		-		-		-	
	Config 2,5		-		-		-	
	Config 3,6		-		-		-	
OCNG Patterns			OP.1					
SS-RSSI-Measurement			Not Applicable					
SMTC configuration			SMTC.1					
SSB configuration	Config 1,2,4,5		SSB.1 FR1					
	Config 3,6		SSB.2 FR1					
PDSCH/PDCCH subcarrier spacing	Config 1,2,4,5	kHz	15					
	Config 3,6		30					
EPRE ratio of PSS to SSS		dB	0		0		0	
EPRE ratio of PBCH DMRS to SSS			0		0		0	
EPRE ratio of PBCH to PBCH DMRS			0		0		0	
EPRE ratio of PDCCH DMRS to SSS			0		0		0	
EPRE ratio of PDCCH to PDCCH DMRS			0		0		0	
EPRE ratio of PDSCH DMRS to SSS			0		0		0	
EPRE ratio of PDSCH to PDSCH			0		0		0	
EPRE ratio of OCNG DMRS to SSS <sup>(Note 1)</sup>			0		0		0	
EPRE ratio of OCNG to OCNG DMRS <sup>(Note 1)</sup>			0		0		0	
$N_{oc}$ <sup>Note2</sup>	Config 1,2,4,5	Depending on band group	dBm/15k Hz		-88		-108.5	
$N_{oc}$ <sup>Note2</sup>	Config 1,2,4,5		dBm/SCS		-88		-108.5	
							-119.5 + $\Delta_{BG\_offset}$	
							Same as $N_{oc}$ for 15kHz	

Parameter			Unit	Test 1	Test 2	Test 3
				Cell 2	Cell 2	Cell 2
	Config 3,6	Depending on band group		-85	-105.5	-116.5 + $\Delta_{BG\_offset}$
$\hat{E}_s / I_{ot}$			dB	-1.75	20	-3.2
$\hat{E}_s / N_{oc}$			dB	-1.75	20	-3.2
SS-RSRP <sup>Note3</sup>	Config 1,2,4,5	Depending on band group	dBm/SCS	-89.75	-88.5	-122.7 + $\Delta_{BG\_offset}$
	Config 3,6	Depending on band group		-86.75	-85.5	-119.7 + $\Delta_{BG\_offset}$
SS-SINR <sup>Note3</sup>			dB	-1.75	20	-4.0
I <sub>o</sub> <sup>Note3</sup>	Config 1,2,4,5	Depending on band group	dBm/9.36MHz	-57.83	-60.5	-89.85 + $\Delta_{BG\_offset}$
	Config 3,6	Depending on band group	dBm/38.16MHz	-51.73	-54.41	-83.75 + $\Delta_{BG\_offset}$
Propagation condition			-	AWGN		
Antenna configuration			-	1x2		
NOTE 1: OCNB shall be used such that both cells are fully allocated and a constant total transmitted power spectral density is achieved for all OFDM symbols.						
NOTE 2: Interference from other cells and noise sources not specified in the test is assumed to be constant over subcarriers and time and shall be modelled as AWGN of appropriate power for $N_{oc}$ to be fulfilled.						
NOTE 3: SS-SINR, SS-RSRP, and I <sub>o</sub> levels have been derived from other parameters for information purposes. They are not settable parameters themselves.						
NOTE 4: SS-SINR, SS-RSRP minimum requirements are specified assuming independent interference and noise at each receiver antenna port.						
NOTE 5: NR operating band groups are as defined in clause 3.5.2.						
NOTE 6: The test configuration excludes support for band n51 and it is not required to run this test on band n51 in this release of the specification.						

Table 8.5.2.3.1.5-2: SS-SINR accuracy requirements for the reported values

	Test 1	Test 2	Test 3
	All bands	All bands	All bands
Normal Conditions			
Lowest reported value (Cell 2)	SS-SINR_35	SS-SINR_79	SS-SINR_32
Highest reported value (Cell 2)	SS-SINR_51	SS-SINR_94	SS-SINR_49
Extreme Conditions			
Lowest reported value (Cell 2)	SS-SINR_33	SS-SINR_77	SS-SINR_31
Highest reported value (Cell 2)	SS-SINR_53	SS-SINR_96	SS-SINR_50

For the test to pass, the ratio of successful reported values in each test shall be more than 90% with a confidence level of 95%.

### 8.5.2.3.2 E-UTRA SS-SINR absolute measurement accuracy of a NR FR2 neighbour cell

**Editor's Note:** This test case has been completed for the following configurations:

- Test frequency  $f \leq 40.8$  GHz
- UE PC3
- Normal conditions
- The test is incomplete for UE power classes other than PC3
- The test is incomplete for test frequencies  $> 40.8$  GHz
- The test is incomplete for extreme conditions

#### 8.5.2.3.2.1 Test purpose

The purpose of this test is to verify that the inter-RAT SS-SINR measurement accuracy is within the specified limits for all bands, when the serving cell is E-UTRA and the target cell is NR FR2.

#### 8.5.2.3.2.2 Test applicability

This test applies to all E-UTRA UE release 15 onwards supporting ss-SINR-Meas and capable of NR FR2 measurements.

#### 8.5.2.3.2.3 Minimum conformance requirements

The minimum conformance requirements are specified in clause 8.5.2.3.0.2.

The normative reference for this requirement is TS 38.133 [6] clause A.8.5.2.3.2.

#### 8.5.2.3.2.4 Test description

Two cells are configured in this test: E-UTRA Cell 1 is the E-UTRAN PCell and Cell 2 is the inter-RAT NR FR2 neighbour cell.

##### 8.5.2.3.2.4.1 Initial conditions

This test shall be tested using any of the test configurations in Table 8.5.2.3.2.4.1-1.

**Table 8.5.2.3.2.4.1-1: Supported test configurations**

Configuration	Description
8.5.2.3.2-1	NR 120 kHz SSB SCS, 100 MHz bandwidth, TDD duplex mode, LTE FDD
8.5.2.3.2-2	NR 120 kHz SSB SCS, 100 MHz bandwidth, TDD duplex mode, LTE TDD

NOTE: The UE is only required to be tested in one of the supported test configurations

Configure the test equipment and the DUT according to the parameters in Table 8.5.2.3.2.4.1-2.

**Table 8.5.2.3.2.4.1-2: Initial conditions**

Parameter	Value	Comment
Test environment	NC, TL/VL, TL/VH, TH/VL, TH/VH	As specified in TS 36.508 [25] clause 4.1.
Test frequencies	As specified in Annex E, Table E.6-2 and TS 38.508-1 [14] clause 4.3.1.	
Channel bandwidth	As specified by the selected test configuration.	
Propagation conditions	AWGN	As specified in clause C.2.1
Connection Diagram	TE Part: A.3.3.3.1 UE Part: A.3.4.1.1	As specified in TS 38.508-1 [14] Annex A.
Exceptions to connection diagram	N/A	

1. The general test parameter settings are set up according to Table 8.5.2.3.2.4.1-3.
2. Message contents are defined in clause 8.5.2.3.2.4.3.
3. There are two carriers and two cells specified in the test, where E-UTRA Cell 1 is the E-UTRA PCell on the E-UTRA carrier and Cell 2 is the NR neighbour cell on the NR carrier. E-UTRA Cell 1 is configured according to TS 36.521-3 [26] clause C.1.0 and C.1.1.
4. The UE Rx beam peak direction has been obtained previously using one of the Rx beam peak search procedures as described in Annex I.

##### 8.5.2.3.2.4.2 Test procedure

1. Ensure the UE is in State 3A-RF according to TS 36.508 [25] clause 7.2A.3.
2. Set the parameters according to Table 8.5.2.3.2.5-1 and Table 8.5.2.3.2.5-2 as appropriate. The TE shall ensure that the NR FR2 cell will be received by the UE from the Rx beam peak direction.



3. The SS shall transmit an *RRCConnectionReconfiguration* message on Cell 1 to configure inter-RAT NR neighbour cell periodical measurements.
4. The UE shall transmit an *RRCConnectionReconfigurationComplete* message.
5. The UE shall transmit periodically MeasurementReport messages.
6. After 10s wait from Step 3, the SS shall check the SS-SINR reported values in the periodic MeasurementReport. The SS- SINR value of Cell 2 reported by the UE is compared to the expected SS- SINR. If the value is outside the limits in clause 8.5.2.3.2.5 or the UE fails to report the measurement value for Cell 2, the number of failed iterations is increased by one. Otherwise, the number of passed iterations is increased by one.
7. The SS shall continue checking the MeasurementReport messages transmitted by the UE until the confidence level according to Table G.2.3-1 in Annex G is achieved.
8. Set the parameters according to each sub-test in Tables 8.5.2.3.2.5-1 and 8.5.2.3.2.5-2 as appropriate and repeat steps 5-7.

8.5.2.3.2.4.3 Message contents

Message contents are according to TS 36.508 [25] clause 7.3 with the following exceptions:

**Table 8.5.2.3.2.4.3-1: Common Exception messages**

Default Message Contents	
Common contents of system information blocks exceptions	
Default RRC messages and information elements contents exceptions	Table H.3.4-7 Table 4.6.6-2B in TS 36.508 [25]

**Table 8.5.2.3.2.4.3-2: ReportConfigInterRAT-DEFAULT(Periodical)**

Derivation Path: 36.508 [25] Table 4.6.6-9			
Information Element	Value/remark	Comment	Condition
ReportConfigNR ::= SEQUENCE {			
reportType CHOICE {			
periodical SEQUENCE {			
ReportQuantityNR-r15 SEQUENCE {	PRESENT		
sinr	true		
}			
}			
}			

8.5.2.3.2.5 Test requirement

Table 8.5.2.3.2.5-1 defines the general test parameters and Table 8.5.2.3.2.5-2 defines the primary level OTA settings including test tolerances for all tests.

Each SS-RSRQ measurement report for each of the tests in Table 8.5.2.3.2.5-2 shall meet the corresponding absolute accuracy requirements in Table 8.5.2.3.2.5-3.

**Table 8.5.2.3.2.5-1: SS-SINR Inter-RAT general test parameters**

Parameter	Unit	Test 1	Test 2	Test 3
		Cell 2	Cell 2	Cell 2
SSB ARFCN		Freq1	freq1	freq1
Duplex mode		TDD	TDD	TDD
TDD configuration		TDDConf.3.1	TDDConf.3.1	TDDConf.3.1
BW <sub>channel</sub>	MHz	100: N <sub>RB,c</sub> = 66	100: N <sub>RB,c</sub> = 66	100: N <sub>RB,c</sub> = 66
Downlink initial BWP configuration		DLBWP.0.1		
Uplink initial BWP configuration		ULBWP.0.1		
DRX cycle configuration	ms	Not applicable		
PDSCH Reference measurement channel		-	-	-
RMSI CORESET Reference Channel		-	-	-
OCNG Patterns		OP.1	OP.1	OP.1
SMTc configuration		SMTc.1	SMTc.1	SMTc.1
SSB configuration		SSB.3 FR2	SSB.3 FR2	SSB.3 FR2
PDSCH/PDCCH subcarrier spacing	kHz	120	120	120
EPRE ratio of PSS to SSS	dB	0	0	0
EPRE ratio of PBCH_DMRS to SSS				
EPRE ratio of PBCH to PBCH_DMRS				
EPRE ratio of PDCCH_DMRS to SSS				
EPRE ratio of PDCCH to PDCCH_DMRS				
EPRE ratio of PDSCH_DMRS to SSS				
EPRE ratio of PDSCH to PDSCH_DMRS				
EPRE ratio of OCNG DMRS to SSS <sup>Note 1</sup>				
<p>NOTE 1: OCNG shall be used such that both cells are fully allocated and a constant total transmitted power spectral density is achieved for all OFDM symbols.</p> <p>NOTE 2: Interference from other cells and noise sources not specified in the test is assumed to be constant over subcarriers and time and shall be modelled as AWGN of appropriate power for <math>N_{oc}</math> to be fulfilled.</p> <p>NOTE 3: SS-SINR, SS-RSRP and I<sub>o</sub> levels have been derived from other parameters for information purposes. They are not settable parameters themselves.</p> <p>NOTE 4: SS-SINR and SS-RSRP minimum requirements are specified assuming independent interference and noise at each receiver antenna port.</p>				

**Table 8.5.2.3.2.5-2: SS-SINR Inter-RAT OTA related test parameters**

Parameter	Unit	Test 1	Test 2	Test 3
		Cell 2	Cell 2	Cell 2
Angle of arrival configuration		Setup 1	Setup 1	Setup 1
Assumption for UE beams <sup>Note 10</sup>		Rough	Rough	Rough
$N_{oc}$ <sup>Note1</sup>	dBm/15kHz <sup>Note4</sup>	-105	-105.1	(Table B.2.3-2 of TS 38.133 [6] Rx Beam Peak -5dB)  (Note 7)
$N_{oc}$ <sup>Note1</sup>	dBm/SCS <sup>Note4</sup>	-95.97	-96.07	(Table B.2.3-2 of TS 38.133 [6] Rx Beam Peak +4dB)  (Note 7)
$\hat{E}_s / N_{oc}$	dB	-0.5	11	3.7
SSB_RP <sup>Note2</sup>	dBm/SCS <sup>Note4</sup>	-96.47	-85.07	(Table B.2.3-2 of TS 38.133 [6] Rx Beam Peak +7.6dB)  (Note 8)
SS-SINR <sup>Note2</sup>	dB	-0.5	11	3.6
$\hat{E}_s / I_{ot}$ <sup>Note2</sup>	dB	-0.5	11	3.6
$I_o$ <sup>Note2</sup>	dBm/95.04 MHz <sup>Note4</sup>	-64.21	-55.75	(Table B.2.3-2 of TS 38.133 [6] Rx Beam Peak +43.19dB)  (Note 9)

NOTE 1: Interference from other cells and noise sources not specified in the test is assumed to be constant over subcarriers and time and shall be modelled as AWGN of appropriate power for  $N_{oc}$  to be fulfilled.

NOTE 2: SSB\_RP, SS-SINR,  $E_s/I_{ot}$  and  $I_o$  levels have been derived from other parameters for information purposes. They are not settable parameters themselves.

NOTE 3: Void

NOTE 4: Equivalent power received by an antenna with 0 dBi gain at the centre of the quiet zone.

NOTE 5: Void

NOTE 6: Void

NOTE 7:  $N_{oc}$  for SCS 15kHz is applied at  $-10\log_{10}(8)+4$ dB above the minimum level specified in Table B.2.3-2 of TS 38.133 [6] for beam peak.  $N_{oc}$  for SCS 120kHz is applied at 4dB above the minimum level specified in Table B.2.3-2 of TS 38.133 [6] for beam peak.

Note 8: SSB\_RP is applied at 3dB above the minimum level specified in Table B.2.3-2 of TS 38.133 [6] for beam peak.

Note 9:  $I_o$  is applied at level  $10\log_{10}(792)+6.54$ dB above the minimum level specified in Table B.2.3-2 of TS 38.133 [6] for beam peak.

Note 10: Information about types of UE beam is given in B.2.1.3 of TS 38.133 [6], and does not limit UE implementation or test system implementation.

**Table 8.5.2.3.2.5-3: evaluation limits for the reported values**

Normal Conditions	Test 1	Test 2	Test 3
Lowest reported value (Cell 2)	9	32	17
Highest reported value (Cell 2)	82	105	90
Extreme Conditions	Test 1	Test 2	Test 3
Lowest reported value (Cell 2)	7	30	15
Highest reported value (Cell 2)	84	107	92

## 9 NR sidelink

### 9.1 NR sidelink in FR1

#### 9.1.1 UE transmit timing

##### 9.1.1.0 Minimum conformance requirements

##### 9.1.1.0.1 Minimum conformance requirements for GNSS as synchronization reference source

The requirements in this subclause are applicable when the reference timing used by the UE for NR sidelink communication is derived from GNSS.

The sidelink transmissions takes place  $(N_{TA,SL} + N_{TA\ offset}) \times T_c$  before the subframe starting boundary as defined in TS 38.331 [13], where  $N_{TA\ offset} = 0$  and  $N_{TA,SL} = 0$ .

The transmission timing error for sidelink transmissions shall be less than or equal to  $\pm T_e$  where the timing error limit value  $T_e$  is defined in Table 9.1.1.0.1-1.

**Table 9.1.1.0.1-1:  $T_e$  Timing Error Limit**

Frequency Range of sidelink	$T_e$
FR1	$12 \cdot 64 \cdot T_c$
Note 1: $T_c$ is the basic timing unit defined in TS 38.211 [7].	

The normative reference for this requirement is TS 38.133 [6] clause 12.2.2.

##### 9.1.1.0.2 Minimum conformance requirements for SyncRef UE as synchronization reference source

The requirements in this subclause are applicable when the reference timing used for deriving sidelink transmission is from SyncRef UE transmitting sidelink synchronization signals.

The sidelink transmissions takes place  $(N_{TA,SL} + N_{TA\ offset}) \times T_c$  before the reception of the first detected path (in time) of the corresponding timing reference frame from the SyncRef UE, where  $N_{TA\ offset} = 0$  and  $N_{TA,SL} = 0$ .

The transmission timing error for sidelink transmissions shall be less than or equal to  $\pm T_e$  where the timing error limit value  $T_e$  is defined in Table 9.1.1.0.2-1.

**Table 9.1.1.0.2-1:  $T_e$  Timing Error Limit**

Frequency Range of sidelink	SCS of sidelink signals (kHz)	$T_e$
FR1	15	$12 \cdot 64 \cdot T_c$
	30	$8 \cdot 64 \cdot T_c$
	60	$5 \cdot 64 \cdot T_c$
Note 1: $T_c$ is the basic timing unit defined in TS 38.211 [7].		

The normative reference for this requirement is TS 38.133 [6] clause 12.2.5.

##### 9.1.1.0.3 Minimum conformance requirements for FR1 NR Cell as synchronization reference source

The requirements in this subclause are applicable when the reference timing used for sidelink transmissions is a NR serving cell on a non-NR sidelink carrier.

The sidelink transmissions takes place  $(N_{TA,SL} + N_{TA,offset}) \times T_c$  before the reception of the first detected path (in time) of the corresponding downlink frame from the reference cell, where  $N_{TA,offset} = 0$  and  $N_{TA,SL} = 0$ .

The transmission timing error for sidelink transmissions shall be less than or equal to  $\pm T_e$  where the timing error limit value  $T_e$  is defined in Table 9.1.1.0.3-1.

**Table 9.1.1.0.3-1:  $T_e$  Timing Error Limit**

Frequency Range of sidelink	SCS of SSB signals ( kHz)	SCS of sidelink signals (kHz)	$T_e$
FR1	15	15	$14 \cdot 64 \cdot T_c$
		30	$12 \cdot 64 \cdot T_c$
		60	$12 \cdot 64 \cdot T_c$
	30	15	$10 \cdot 64 \cdot T_c$
		30	$12 \cdot 64 \cdot T_c$
		60	$9 \cdot 64 \cdot T_c$
Note 1: $T_c$ is the basic timing unit defined in TS 38.211 [7].			

The normative reference for this requirement is TS 38.133 [6] clause 12.2.3.

### 9.1.1.1 NR SA FR1 UE transmit timing accuracy for GNSS as synchronization reference source

**Editor's notes: Following aspects of this test case are still incomplete:**

- Connect diagram is FFS;
- Message contents are still missing
- TT analysis is still missing

#### 9.1.1.1.1 Test purpose

The purpose of this test is to verify the UE timing requirements as specified in TS 38.133 [6] clause 12.2.2, when the GNSS is used as timing reference.

#### 9.1.1.1.2 Test applicability

This test applies to all types of NR UEs from release 16 onwards and supporting NR sidelink communication.

#### 9.1.1.1.3 Minimum conformance requirements

The minimum conformance requirements are defined in clause 9.1.1.0.1

The normative reference for this requirement is TS 38.133 [6] clause A.9.1.1.1.

#### 9.1.1.1.4 Test description

##### 9.1.1.1.4.1 Initial conditions

Configure the test equipment and the DUT according to the parameters in Table 9.1.1.1.4.1-1.

**Table 9.1.1.4.1-1: Initial conditions for NR SA FR1 UE transmit timing accuracy for GNSS as synchronization reference source**

Parameter	Value		Comment
Test environment	NC		As specified in TS 38.508-1 [14] clause 4.1.
Test frequencies	PC5: As specified in TS 38.508-1 [14] clause 4.3.1.8.		
Channel bandwidth	PC5: As specified by the test configuration selected from Table 9.1.1.4.1-2.		
Propagation conditions	AWGN		As specified in Annex C.2.2.
Connection Diagram	TE Part	FFS	As specified in TS 38.508-1 [14] Annex A.
	DUT Part	FFS	
Exceptions to connection diagram	N/A		

1. The parameter settings for the NR sidelink communication are pre-configured according to TS 38.508-1 [14] clause 4.10.1.
2. Message content exceptions are given in clause 9.1.1.4.3
3. The GNSS simulator is configured for Scenario #1: static in Geographical area #1, as defined in TS 38.508-1 [14] Table 4.11.2-2.

**Table 9.1.1.4.1-2: NR sidelink test parameters for NR SA FR1 UE transmit timing accuracy for GNSS as synchronization reference source**

Parameter	Unit	Value	Comment
RF Channel Number		1	HD carrier in Band n47 or n38
Channel Bandwidth ( $BW_{\text{channel}}$ ) <sup>Note 1</sup>	MHz	20 ( $N_{RB,c} = 50$ ) or 40 ( $N_{RB,c} = 100$ )	
SCS	kHz	30	
Active cell		None	
Active SyncRef UE		None	
NR sidelink communication pre-configuration		As specified in section A.11.2	IE values unless specified otherwise in this test.
PSCCH Reference Measurement Channel		CC.1A HD	As specified in Table A.11.3-1
PSSCH Reference Measurement Channel		CD.1A HD	As specified in Table A.11.3-2
Propagation condition		AWGN	
Note 1: The UE is only required to be tested in one of the supported test configurations.			

#### 9.1.1.4.2 Test procedure

For this test, the UE is triggered by the test loop function to transmit for NR sidelink communication. There is one GNSS based synchronization source during the test. The test system can emulate and send the GNSS signal to the test UE.

1. Ensure the UE is in state 4-A with generic procedure parameters Test Mode = *On* and GNSS Sync = *On* according to TS 38.508-1 [14] clause 4.4A.2.
2. The GNSS simulator is triggered to start step 1 of Scenario #1 to simulate a location in the centre of Geographical area #1.
3. Wait at least 20 seconds for the UE to acquire the GNSS signal.
4. The SS sends AT command +CCUTLE to close test loop function and trigger UE to transmit.
5. The UE starts to transmit NR sidelink communication data over the PC5 interface in accordance of pre-configuration and to schedule PSSCH.

6. After the UE is synchronized to the GNSS synchronization source, the SS shall monitor all PSSCH transmissions and verify that, for each received PSSCH, the timing is within  $(N_{TA,SL} + N_{TA\ offset}) \times T_c \pm T_e$  before the subframe starting boundary determined by the GNSS reference time in the GNSS simulator, where  $N_{TA\ offset} = 0$  and  $N_{TA,SL} = 0$ , and  $T_e$  is given in Table 9.1.1.1.5-1.
7. The SS sends AT command +CCUTLE to open test loop function.

#### 9.1.1.1.4.3 Message contents

FFS

#### 9.1.1.1.5 Test requirement

The sidelink transmissions takes place  $(N_{TA,SL} + N_{TA\ offset}) \times T_c$  before the subframe starting boundary as defined in TS 38.331 [13] clause 5.8.12, where  $N_{TA\ offset} = 0$  and  $N_{TA,SL} = 0$ .

The transmission timing error for sidelink transmissions shall be less than or equal to  $\pm T_e$  where the timing error limit value  $T_e$  is defined in Table 9.1.1.1.5-1.

**Table 9.1.1.1.5-1:  $T_e$  Timing Error Limit**

Frequency Range of sidelink	$T_e$
FR1	$12 \cdot 64 \cdot T_c$
Note 1: $T_c$ is the basic timing unit defined in TS 38.211 [7].	

#### 9.1.1.2 NR SA FR1 UE transmit timing accuracy for SyncRef UE as synchronization reference source

**Editor's notes: Following aspects of this test case are still incomplete:**

- **Connect diagram is FFS;**
- **Message contents are still missing**
- **TT analysis is still missing**

##### 9.1.1.2.1 Test purpose

The purpose of this test is to verify the UE timing requirements as specified in TS 38.133 [6] clause 12.2.5, when SyncRef UE is used as timing reference.

##### 9.1.1.2.2 Test applicability

This test applies to all types of NR UEs from release 16 onwards and supporting NR sidelink communication.

##### 9.1.1.2.3 Minimum conformance requirements

The minimum conformance requirements are defined in clause 9.1.1.0.2

The normative reference for this requirement is TS 38.133 [6] clause A.9.1.1.2.

##### 9.1.1.2.4 Test description

###### 9.1.1.2.4.1 Initial conditions

Configure the test equipment and the DUT according to the parameters in Table 9.1.1.2.4.1-1.

**Table 9.1.1.2.4.1-1: Initial conditions for NR SA FR1 UE transmit timing accuracy for SyncRef UE as synchronization reference source**

Parameter	Value		Comment
Test environment	NC		As specified in TS 38.508-1 [14] clause 4.1.
Test frequencies	PC5: As specified in TS 38.508-1 [14] clause 4.3.1.8.		
Channel bandwidth	PC5: As specified by the test configuration selected from Table 9.1.1.2.4.1-2.		
Propagation conditions	AWGN		As specified in Annex C.2.2.
Connection Diagram	TE Part	FFS	As specified in TS 38.508-1 [14] Annex A.
	DUT Part	FFS	
Exceptions to connection diagram	N/A		

1. The parameter settings for the NR sidelink communication are pre-configured according to TS 38.508-1 [14] clause 4.10.1.
2. Message content exceptions are given in clause 9.1.1.2.4.3
3. There is one NR-SS-UE (SyncRef UE 1) specified in this test. SyncRef UE 1 is configured according to the parameters in Table 9.1.1.2.4.1-1.

**Table 9.1.1.2.4.1-2: NR sidelink test parameters for NR SA FR1 UE transmit timing accuracy for SyncRef UE as synchronization reference source**

Parameter		Unit	Value	Comment
RF Channel Number			1	HD carrier in Band n47 or n38
Channel Bandwidth ( $BW_{channel}$ ) <sup>Note 3</sup>		MHz	20 ( $N_{RB,c} = 50$ ) or 40 ( $N_{RB,c} = 100$ )	
Active cell			None	
Active SyncRef UE			SyncRef UE 1	Transmitting S-SSB on RF channel number 1
NR sidelink communication preconfiguration			As specified in section A.11.2	IE values unless specified otherwise in this test.
PSCCH Reference Measurement Channel			CC.1A HD	As specified in Table A.11.3-1
PSSCH Reference Measurement Channel			CD.1A HD	As specified in Table A.11.3-2
$N_{oc}$ <sup>Note1,2</sup>		dBm/30kHz	-95	
SyncRef UE 1	sl-SSB-TimeAllocation		sl-SSB-TimeAllocation1	
	slssid		30	
	inCoverage		TRUE	In MIB-SL
	networkControlledSyncTx		ON	
	NR sidelink communication configuration		As specified in section A.11.2	IE values unless specified otherwise in this test.
	$\hat{E}_s/N_{oc}$		3	
PSBCH-RSRP <sup>Note1, Note 2</sup>		dBm/30kHz	-92	
Propagation condition			AWGN	
Note 1: PSBCH-RSRP levels have been derived from other parameters for information purposes. They are not settable parameters themselves.				
Note 2: S-PSS $\hat{E}_s/N_{oc}$ and S-PSS $\hat{E}_s/N_{oc}$ are set the same as PSBCH $\hat{E}_s/N_{oc}$ .				
Note 3: The UE is only required to be tested in one of the supported test configurations.				

#### 9.1.1.2.4.2 Test procedure

In this test there is one active NR-SS-UE (SyncRef UE 1) and no serving cell nor GNSS signals. The UE is triggered by the test loop function to transmit for NR sidelink communication.



1. Ensure the UE is in state 4-A with generic procedure parameters Test Mode = *On* according to TS 38.508-1 [14] clause 4.4A.2.
2. The SS sends AT command +CCUTLE to close test loop function and trigger UE to transmit.
3. The UE starts to transmit NR sidelink communication data over the PC5 interface in accordance of pre-configuration and to schedule PSSCH.
4. Power on SyncRef UE 1 and wait at least 8 seconds for the UE to be synchronized to SyncRef UE 1.
5. After the UE is synchronized to SyncRef UE 1, the SS shall monitor all PSSCH transmissions and verify that, for each received PSSCH, the timing is within  $(N_{TA,SL} + N_{TA,offset}) \times T_c \pm T_e$  before the subframe starting boundary determined by the reception of the first detected path (in time) of corresponding timing reference frame from SyncRef UE 1, where  $N_{TA,offset} = 0$  and  $N_{TA,SL} = 0$ , and  $T_e$  is given in Table 9.1.1.2.5-1.
6. The SS sends AT command +CCUTLE to open test loop function.

#### 9.1.1.2.4.3 Message contents

FFS

#### 9.1.1.2.5 Test requirement

The sidelink transmissions takes place  $(N_{TA,SL} + N_{TA,offset}) \times T_c$  before the reception of the first detected path (in time) of the corresponding timing reference frame from SyncRef UE 1, where  $N_{TA,offset} = 0$  and  $N_{TA,SL} = 0$ .

The transmission timing error for sidelink transmissions shall be less than or equal to  $\pm T_e$  where the timing error limit value  $T_e$  is defined in Table 9.1.1.2.5-1.

**Table 9.1.1.2.5-1:  $T_e$  Timing Error Limit**

Frequency Range of sidelink	SCS of sidelink signals (kHz)	$T_e$
FR1	30	$8 \cdot 64 \cdot T_c$
Note 1: $T_c$ is the basic timing unit defined in TS 38.211 [7].		

#### 9.1.1.3 NR SA FR1 UE transmit timing accuracy for FR1 NR cell as synchronization reference source

**Editor's notes: Following aspects of this test case are still incomplete:**

- Connect diagram is FFS;
- Message contents are still missing
- TT analysis is still missing

##### 9.1.1.3.1 Test purpose

The purpose of this test is to verify the UE timing requirements as specified in TS 38.133 [6] clause 12.2.5, when the downlink timing of the serving cell (RRC\_IDLE) or PCell (RRC\_CONNECTED) on a non-sidelink NR carrier is used as timing reference.

##### 9.1.1.3.2 Test applicability

This test applies to all types of NR UEs from release 16 onwards and supporting NR Uu and sidelink communication.

##### 9.1.1.3.3 Minimum conformance requirements

The minimum conformance requirements are defined in clause 9.1.1.0.3

The normative reference for this requirement is TS 38.133 [6] clause A.9.1.1.3.

## 9.1.1.3.4 Test description

## 9.1.1.3.4.1 Initial conditions

This test shall be tested using any of the test configurations in Table 9.1.1.3.4.1-1.

**Table 9.1.1.3.4.1-1: Supported test configurations for FR1 NR Cell**

Configuration	Description
9.1.1.3-1	NR Uu: FDD, SSB SCS 15 kHz, data SCS 15 kHz, BW 10 MHz
9.1.1.3-2	NR Uu: TDD, SSB SCS 15 kHz, data SCS 15 kHz, BW 10 MHz
9.1.1.3-3	NR Uu: TDD, SSB SCS 30 kHz, data SCS 30 kHz, BW 40 MHz
Note:	The UE is only required to pass in one of the supported test configurations in FR1

Configure the test equipment and the DUT according to the parameters in Table 9.1.1.3.4.1-2.

**Table 9.1.1.3.4.1-2: Initial conditions for NR SA FR1 UE transmit timing accuracy for FR1 NR cell as synchronization reference source**

Parameter	Value	Comment
Test environment	NC	As specified in TS 38.508-1 [14] clause 4.1.
Test frequencies	Uu: As specified in Table FFS and TS 38.508-1 [14] clause 4.3.1. PC5: As specified in TS 38.508-1 [14] clause 4.3.1.8.	
Channel bandwidth	Uu: As specified by the test configuration selected from Table 9.1.1.3.4.1-1 PC5: As specified by the test configuration selected from Table 9.1.1.3.4.1-2.	
Propagation conditions	AWGN	As specified in Annex C.2.2.
Connection Diagram	TE Part	FFS
	DUT Part	FFS
Exceptions to connection diagram	N/A	

1. The parameter settings for the NR sidelink communication are pre-configured according to TS 38.508-1 [14] clause 4.10.1.
2. Message content exceptions are defined in clause 9.1.1.3.4.3
3. There is one NR Uu carrier and one NR Cell (Cell 1) specified in this test. Cell 1 is configured according to Annex C.1.1 and C.1.2.
4. Test parameters for Cell 1 are given in Table 9.1.1.3.4.1-3.

**Table 9.1.1.3.4.1-2: NR sidelink test parameters for NR SA FR1 UE transmit timing accuracy for FR1 NR cell as synchronization reference source**

Parameter	Unit	Value	Comment
RF Channel Number		1	HD carrier in Band n47 or n38
Channel Bandwidth ( $BW_{\text{channel}}$ ) <sup>Note 1</sup>	MHz	20 ( $N_{\text{RB},c} = 50$ ) or 40 ( $N_{\text{RB},c} = 100$ )	
SCS	kHz	30	
Active cell		Cell 1	
Active SyncRef UE		None	
V2X sidelink communication configuration		As specified in section A.11.2	IE values unless specified otherwise in this test.
PSCCH Reference Measurement Channel		CC.1A HD	As specified in Table A.11.3-1
PSSCH Reference Measurement Channel		CD.1A HD	As specified in Table A.11.3-2
Note 1: The UE is only required to be tested in one of the supported test configurations.			

**Table 9.1.1.3.4.1-3: Cell Test Parameters for NR SA FR1 UE transmit timing accuracy for FR1 NR cell as synchronization reference source**

Parameter	Unit	Cell 1
RF Channel Number		2
Duplex Mode	Config 1	FDD
	Config 2,3	TDD
TDD configuration	Config 1	Not Applicable
	Config 2	TDDConf.1.1
	Config 3	TDDConf.2.1
Channel Bandwidth ( $BW_{\text{channel}}$ )	Config 1,2	10: $N_{\text{RB},c} = 52$
	Config 3	40: $N_{\text{RB},c} = 106$
Initial BWP Configuration		DLBWP.0.1 ULBWP.0.1
Dedicated BWP Configuration		DLBWP.1.1 ULBWP.1.1
DRX Cycle		N/A
PDSCH Reference measurement channel	Config 1	SR.1.1 FDD
	Config 2	SR.1.1 TDD
	Config 3	SR.2.1 TDD
CORESET Reference Channel	Config 1	CR.1.1 FDD
	Config 2	CR.1.1 TDD
	Config 3	CR.2.1 TDD
Dedicated CORESET Reference Channel	Config 1	CCR.1.1 FDD
	Config 2	CCR.1.1 TDD
	Config 3	CCR.2.1 TDD
SSB configuration	Config 1,2	SSB.1 FR1
	Config 3	SSB.2 FR1

SMTC Configuration			SMTC.2
OCNG Patterns			OP.1
EPRE ratio of PSS to SSS		dB	0
EPRE ratio of PBCH DMRS to SSS			
EPRE ratio of PBCH to PBCH DMRS			
EPRE ratio of PDCCH DMRS to SSS			
EPRE ratio of PDCCH to PDCCH DMRS			
EPRE ratio of PDSCH DMRS to SSS			
EPRE ratio of PDSCH to PDSCH			
EPRE ratio of OCNG DMRS to SSS(Note 1)			
EPRE ratio of OCNG to OCNG DMRS (Note 1)			
Noc <sup>Note2</sup>	Config 1,2,3		
Noc <sup>Note2</sup>	Config 1,2	dBm/SCS	-98
	Config 3		-95
Es/Noc		dB	3
SS-RSRP <sup>Note3</sup>	Config 1,2	dBm/SCS	-95
	Config 3		-92
Io <sup>Note 3</sup>	Config 1,2	dBm/9.36 MHz	-65.2
	Config 3	dBm/38.1 MHz	-59.2
Propagation Condition			AWGN
<p>Note 1: OCNG shall be used such that cell is fully allocated and a constant total transmitted power spectral density is achieved for all OFDM symbols.</p> <p>Note 2: Interference from other cells and noise sources not specified in the test is assumed to be constant over subcarriers and time and shall be modelled as AWGN of appropriate power for Noc to be fulfilled.</p> <p>Note 3: SS-RSRP levels have been derived from other parameters for information purposes. They are not settable parameters themselves.</p>			

#### 9.1.1.3.4.2 Test procedure

In this test there is one active cell (Cell 1). For this test, the UE is triggered by the test loop function or the upper layers to transmit for NR sidelink communication.

1. Ensure the UE is in state 1N-B with generic procedure parameters Test Mode = *On* according to TS 38.508-1 [14] clause 4.4A.2.
2. The SS sends AT command +CCUTLE to close test loop function and trigger UE to transmit.
3. The UE starts to transmit NR sidelink communication data over the PC5 interface in according to Pre-configuration and to schedule PSSCH.
4. After the UE is synchronized to the SyncRef UE, the SS shall monitor all PSSCH transmissions and verify that, for each received PSSCH, the timing is within  $(N_{TA,SL} + N_{TA,offset}) \times T_c \pm T_e$  before the subframe starting boundary determined by the reception of the first detected path (in time) of the corresponding downlink frame from the Cell 1, where  $N_{TA,offset} = 0$  and  $N_{TA,SL} = 0$ , and  $T_e$  is given in Table 9.1.1.3.5-1.
5. The SS sends AT command +CCUTLE to open test loop function.

#### 9.1.1.3.4.3 Message contents

FFS

#### 9.1.1.3.5 Test requirement

The sidelink transmissions takes place  $(N_{TA,SL} + N_{TA,offset}) \times T_c$  before the subframe starting boundary determined by the reception of the first detected path (in time) of the corresponding downlink frame from the Cell 1, where  $N_{TA,offset} = 0$  and  $N_{TA,SL} = 0$ .

The transmission timing error for sidelink transmissions shall be less than or equal to  $\pm T_e$  where the timing error limit value  $T_e$  is defined in Table 9.1.1.3.5-1.

Table 9.1.1.3.5-1:  $T_e$  Timing Error Limit

Frequency Range of sidelink	SCS of SSB signals ( kHz)	SCS of sidelink signals (kHz)	$T_e$
FR1	15	30	$12 \cdot 64 \cdot T_c$
	30		

Note 1:  $T_c$  is the basic timing unit defined in TS 38.211 [7].

## 9.1.2 Initiation/Cease of S-SSB transmission

### 9.1.2.0 Minimum conformance requirements

#### 9.1.2.0.1 Minimum conformance requirements for FR1 NR cell as synchronization reference source

The requirements apply when the NR Cell is used as synchronization reference source and when the UE is

- out of coverage on the NR sidelink carrier and in-coverage with a serving cell on a NR non-sidelink carrier,

and when the conditions for SLSS transmissions specified in TS 38.331[13] are met; *networkControlledSyncTx* is not configured; and *syncTxThreshIC* is included in *SIB12*. The UE shall be capable of measuring the RSRP of the cell used as synchronization reference source to evaluate to initiate/cease SLSS transmissions within  $T_{\text{evaluate,SLSS}}$

where,

- $T_{\text{evaluate,SLSS}}$  is as specified in Table 9.1.2.0.1-1 when UE performs SSB based measurements without measurement gaps.
- $T_{\text{evaluate,SLSS}}$  is as specified in Table 9.1.2.0.1-2 when UE performs SSB based measurements with measurement gaps.

**Table 9.1.2.0.1-1:  $T_{\text{evaluate,SLSS}}$  for measurements without measurement gaps when NR cell is used as synchronization reference source (FR1)**

DRX cycle in NR cell	$T_{\text{evaluate,SLSS}}$
No DRX	$\max(400\text{ms}, \text{ceil}(2 \times 5 \times K_p) \times \text{SMTC period})^{\text{Note 1}}$
DRX cycle $\leq 320\text{ms}$	$\max(400\text{ms}, \text{ceil}(1.5 \times 2 \times 5 \times K_p) \times \max(\text{SMTC period}, \text{DRX cycle}))$
DRX cycle $> 320\text{ms}$	$\text{ceil}(7 \times K_p) \times \text{DRX cycle}$

NOTE 1: If different SMTC periodicities are configured for different cells, the SMTC period in the requirement is the one used by the cell being identified

**Table 9.1.2.0.1-2:  $T_{\text{evaluate,SLSS}}$  for measurements with measurement gaps when NR cell is used as synchronization reference source (FR1)**

DRX cycle in NR cell	$T_{\text{evaluate,SLSS}}$
No DRX	$\max(400\text{ms}, 2 \times 5 \times \max(\text{MGRP}, \text{SMTC period})) \times \text{CSSF}_{\text{intra}}$
DRX cycle $\leq 320\text{ms}$	$\max(400\text{ms}, \text{ceil}(2 \times 1.5 \times 5) \times \max(\text{MGRP}, \text{SMTC period}, \text{DRX cycle})) \times \text{CSSF}_{\text{intra}}$
DRX cycle $> 320\text{ms}$	$7 \times \max(\text{MGRP}, \text{DRX cycle}) \times \text{CSSF}_{\text{intra}}$

If higher layer filtering is configured, an additional delay in evaluation to initiate/cease SLSS transmissions can be expected.

For the NR cell as synchronization reference source:

- SS-RSRP related side conditions given in 38.133[6] clauses 10.1.2 for FR1, respectively, for a corresponding Band,

- SS-RSRQ related side conditions given in 38.133[6] clauses 10.1.7 for FR1, respectively, for a corresponding Band,
- SS-SINR related side conditions given in 38.133[6] clauses 10.1.12 for FR1, respectively, for a corresponding Band,
- SSB<sub>RP</sub> and SSB  $\hat{E}_s/I_{ot}$  according to Annex B.2.2 for a corresponding Band.

The normative reference for this requirement is TS 38.133 [6] clause 12.3.1.1.

**9.1.1.0.2 Minimum conformance requirements for SyncRef UE as synchronization reference source**

The requirements apply when SyncRef UE is used as synchronization reference source and when the UE is

- in any cell selection state, or
- out of coverage on the NR sidelink carrier and is associated with a serving cell on a non-sidelink carrier,

and when the conditions for SLSS transmissions specified in TS 38.331[13] are met and when SyncRef UE is used as synchronization reference source and if *syncTxThreshOoC* is included in the pre-configuration parameters.

The UE shall be capable of measuring the PSBCH-RSRP of the selected SyncRef UE used as synchronization reference source and evaluate it to initiate/cease SLSS transmissions within  $T_{evaluate,SLSS} = 4 S$ -SSB periods.

If higher layer filtering for PSBCH-RSRP measurements is pre-configured, an additional delay in evaluation to initiate/cease SLSS transmissions can be expected.

For the selected SyncRef UE as defined in TS 38.331 [2] used to derive transmission timing for NR sidelink communication:

- PSBCH-RSRP related side conditions given in 38.133[6] clause 10.4 for a corresponding Band are fulfilled,
- NR S-SSB<sub>RP</sub> and S-SSB  $\hat{E}_s/I_{ot}$  according to Annex B.4 for a corresponding Band are fulfilled.

The requirements for absolute accuracy of PSBCH-RSRP apply to a NR sidelink synchronization source on the same frequency as that of the own NR sidelink UE performing the measurement in FR1.

The accuracy requirements in Table 9.1.1.0.2-1 are valid under the following conditions:

- Demodulation reference signals are transmitted from one port.
- Conditions defined in Clause 7.3E of TS 38.101-1 [2] for reference sensitivity are fulfilled.
- Conditions for PSBCH-RSRP measurements are fulfilled according to Annex B.4.2 for a corresponding Band for each relevant PSBCH-DMRS.

**Table 9.1.1.0.2-1: Intra-frequency PSBCH-RSRP absolute accuracy in FR1**

Accuracy		Conditions						
Normal condition	Extreme condition	$\hat{E}_s/I_{ot}$ Note 3	NR sidelink operating band groups Note 2	$I_o$ Note 1 range				
				Minimum $I_o$			Maximum $I_o$	
dB	dB	dB		dBm / $SCS_{SL}$			dBm/ $BW_{Channel}$	dBm/ $BW_{Channel}$
				$SCS_{SL} = 15$ kHz	$SCS_{SL} = 30$ kHz	$SCS_{SL} = 60$ kHz		
±4.5	±9	≥-6	NR_TDD_FR1_B	-120.5	-117.5	-114.5	N/A	-70
			NR_TDD_FR1_J	-116.5	-113.5	-110.5	N/A	-70
±8	±11	≥-6	NR_TDD_FR1_B, NR_TDD_FR1_J	N/A	N/A	N/A	-70	-50

NOTE 1:  $I_o$  is assumed to have constant EPRE across the bandwidth.  
 NOTE 2: NR sidelink operating band groups in FR1 are as defined in clause 3.5.2.  
 NOTE 3:  $\hat{E}_s/I_{ot}$  for a SyncRef UE is the  $\hat{E}_s/I_{ot}$  of PSBCH-DMRS.

The relative accuracy of PSBCH-RSRP is defined as the PSBCH-RSRP measured from one NR sidelink synchronization source compared to the PSBCH-RSRP measured from another NR sidelink synchronization source on the same frequency in FR1.

The accuracy requirements in Table 9.1.1.0.2-2 are valid under the following conditions:

- Demodulation reference signals are transmitted from one port.
- Conditions defined in Clause 7.3E of TS 38.101-1 [2] for reference sensitivity are fulfilled.
- Conditions for PSBCH-RSRP accuracy measurements are fulfilled according to Annex B.4.2 for a corresponding Band for each relevant PSBCH-DMRS.

**Table 9.1.1.0.2-2: Intra-frequency PSBCH-RSRP relative accuracy in FR1**

Accuracy		Conditions						
Normal condition	Extreme condition	Ês/lot Note 3	NR sidelink operating band groups Note 2	I <sub>o</sub> Note 1 range				
				Minimum I <sub>o</sub>			Maximum I <sub>o</sub>	
dB	dB	dB		dBm / SCS <sub>SL</sub>			dBm/BW <sub>Channel</sub>	dBm/BW <sub>Channel</sub>
				SCS <sub>SL</sub> = 15 kHz	SCS <sub>SL</sub> = 30 kHz	SCS <sub>SL</sub> = 60 kHz		
±2	±3	≥-3	NR_TDD_FR1_B	-120.5	-117.5	-114.5	N/A	-50
			NR_TDD_FR1_J	-116.5	-113.5	-110.5	N/A	-50
±3	±3	≥-6	Note 4	Note 4	Note 4	Note 4	N/A	Note 4

NOTE 1: I<sub>o</sub> is assumed to have constant EPRE across the bandwidth.  
 NOTE 2: NR sidelink operating band groups in FR1 are as defined in clause 3A.4.1.  
 NOTE 3: Ês/lot for a SyncRef UE is the Ês/lot of PSBCH-DMRS.  
 NOTE 4: The same bands and the same I<sub>o</sub> conditions for each band apply for this requirement as for the corresponding highest accuracy requirement.

The normative references for this requirement are TS 38.133 [6] clause 10.4.2 and 12.3.1.4.

**9.1.2.1 NR SA FR1 initiation/cease of S-SSB transmission for FR1 NR cell as synchronization reference source**

Editor's notes: Following aspects of this test case are still incomplete:

- Connect diagram is FFS;
- Message contents are still missing
- TT analysis is still missing

**9.1.2.1.1 Test purpose**

The purpose of this test is to verify that the NR sidelink UE meets the requirements related to the maximum evaluation time allowed to initiate and cease S-SSB transmissions defined in TS 38.133 [6] clause 12.3.1.1, when the reference timing used for sidelink transmissions is a NR serving cell in FR1 on a non-sidelink carrier.

**9.1.2.1.2 Test applicability**

This test applies to all types of NR UEs from release 16 onwards and supporting NR Uu and sidelink communication.

**9.1.2.1.3 Minimum conformance requirements**

The minimum conformance requirements are defined in clause 9.1.2.0.1

The normative reference for this requirement is TS 38.133 [6] clause A.9.1.2.1.

9.1.2.1.4 Test description

9.1.2.1.4.1 Initial conditions

This test shall be tested using any of the test configurations in Table 9.1.2.1.4.1-1.

**Table 9.1.2.1.4.1-1: Supported test configurations for FR1 NR Cell**

Configuration	Description
9.1.2.1-1	NR Uu: FDD, SSB SCS 15 kHz, data SCS 15 kHz, BW 10 MHz
9.1.2.1-2	NR Uu: TDD, SSB SCS 15 kHz, data SCS 15 kHz, BW 10 MHz
9.1.2.1-3	NR Uu: TDD, SSB SCS 30 kHz, data SCS 30 kHz, BW 40 MHz
Note:	The UE is only required to pass in one of the supported test configurations in FR1

Configure the test equipment and the DUT according to the parameters in Table 9.1.2.1.4.1-2.

**Table 9.1.2.1.4.1-2: Initial conditions for Initiation/Cease of S-SSB Transmission Test for FR1 NR cell as synchronization reference source**

Parameter	Value	Comment
Test environment	NC	As specified in TS 38.508-1 [14] clause 4.1.
Test frequencies	Uu: As specified in Table FFS and TS 38.508-1 [14] clause 4.3.1. PC5: As specified in TS 38.508-1 [14] clause 4.3.1.8.	
Channel bandwidth	Uu: As specified by the test configuration selected from Table 9.1.1.3.4.1-1 PC5: As specified by the test configuration selected from Table 9.1.1.3.4.1-2.	
Propagation conditions	AWGN	As specified in Annex C.2.2.
Connection Diagram	TE Part	FFS
	DUT Part	FFS
Exceptions to connection diagram	N/A	

1. The parameter settings for the NR sidelink communication are configured according to Table 9.1.2.1.4.1-3.
2. Message content exceptions are given in clause 9.1.2.1.4.3
3. There is one NR Uu carrier and one NR Cell (Cell 1) specified in this test. Cell 1 is configured according to Annex C.1.1 and C.1.2.
4. General test parameters for Cell 1 are given in Table 9.1.2.1.4.1-3.



**Table 9.1.2.1.4.1-3: NR sidelink test parameters and NR Cell general test parameters for Initiation/Cease of S-SSB Transmission Test for FR1 NR cell as synchronization reference source**

Parameter	Unit	Value	Comment
SCS	kHz	30	
Active cell		Cell 1	Serving cell on RF channel number 1
Active SyncRef UE		None	
Active NR sidelink UE		NR sidelink UE	Transmitting S-SSB on RF channel number 2(HD carrier in Band n47 or n38)
NR sidelink communication configuration		As specified in A.11.2	IE values unless specified otherwise in this test
networkControlledSyncTx		Not configured	
syncTxThreshIC	dBm/SCS	-110	In SIB12
DRX		OFF	
T1	s	3	
T2	s	5.24	
T3	s	5.24	

#### 9.1.2.1.4.2 Test procedure

In this test there is one active cell (Cell 1). The test consists of three successive time periods, with time duration of T1, T2 and T3 respectively.

1. Ensure the UE is in state 1N-B with generic procedure parameters Test Mode = *On* according to TS 38.508-1 [14] clause 4.4A.2.
2. The SS shall set parameters according to T1 in Table 9.1.2.1.5-1. T1 starts.
3. If the SS observes that no SL SSB is transmitted by the UE until T1 expires then count a success for the event "No S-SSB transmission", otherwise count a fail for the event "No S-SSB transmission".
4. When T1 expires, the SS shall switch the power setting from T1 to T2 in Table 9.1.2.1.5-1. T2 starts.
5. If the UE starts to send S-SSB within 560 ms from the start of T2 then count a success for the event "S-SSB transmission initiation", otherwise count a fail for the event "S-SSB transmission initiation".
6. When T2 expires, the SS shall switch the power setting from T2 to T3 in Table 9.1.2.1.5-1. T3 starts.
7. If the UE stops to send S-SSB within 560 ms from the start of T3 then count a success for the event "S-SSB transmission cease", otherwise count a fail for the event "S-SSB transmission cease".
8. Repeat step 2-7 until the confidence level according to Tables G.2.3-1 in Annex G clause G.2 is achieved.

Each of the events "No S-SSB transmission", "S-SSB transmission initiation" and "S-SSB transmission cease" is evaluated independently for the statistic, resulting in an event verdict pass or fail. Different events may require different times for a verdict.

If all events pass, the test passes. If one event fails, the test fails.

#### 9.1.2.1.4.3 Message contents

FFS

#### 9.1.2.1.5 Test requirement

Cell specific test parameters for NR Cell 1 is given in Table 9.1.2.1.5-1.

**Table 9.1.2.1.5-1: FR1 NR Cell-specific test parameters for Initiation/Cease of S-SSB Transmission Test for FR1 NR cell as synchronization reference source**

Parameter	Unit	Cell1		
		T1	T2	T3

NR RF Channel Number			1		
Duplex Mode	Config 1		FDD		
	Config 2,3		TDD		
TDD configuration	Config 1		Not applicable		
	Config 2		TDDConf.1.1		
	Config 3		TDDConf.2.1		
Channel Bandwidth (BW <sub>channel</sub> )	Config 1,2	MHz	10:N <sub>RB,c</sub> = 52		
	Config 3		40:N <sub>RB,c</sub> = 106		
Initial BWP Configuration			DLBWP.0.1 ULBWP.0.1		
Dedicated BWP Configuration			DLBWP.1.1 ULBWP.1.1		
DRX Cycle		ms	N/A		
PDSCH Reference measurement channel	Config 1		SR.1.1 FDD		
	Config 2		SR.1.1 TDD		
	Config 3		SR.2.1 TDD		
CORESET Reference Channel	Config 1		CR.1.1 FDD		
	Config 2		CR.1.1 TDD		
	Config 3		CR.2.1 TDD		
Dedicated CORESET Reference Channel	Config 1		CCR.1.1 FDD		
	Config 2		CCR.1.1 TDD		
	Config 3		CCR.2.1 TDD		
SSB configuration	Config 1,2		SSB.1 FR1		
	Config 3		SSB.2 FR1		
SMTTC Configuration	Config 1		SMTTC.2		
	Config 2,3		SMTTC.1		
TRS configuration	Config 1		TRS.1.1 FDD		
	Config 2		TRS.1.1 TDD		
	Config 3		TRS.1.2 TDD		
OCNG Patterns			OP.1		
EPRE ratio of PSS to SSS		dB	0		
EPRE ratio of PBCH DMRS to SSS					
EPRE ratio of PBCH to PBCH DMRS					
EPRE ratio of PDCCH DMRS to SSS					
EPRE ratio of PDCCH to PDCCH DMRS					
EPRE ratio of PDSCH DMRS to SSS					
EPRE ratio of PDSCH to PDSCH					
EPRE ratio of OCNG DMRS to SSS <sup>Note 1</sup>					
EPRE ratio of OCNG to OCNG DMRS <sup>Note 1</sup>					
Noc <sup>Note2</sup>	Config 1,2,3				
	Config 1,2	dBm/SCS	-110		
	Config 3		-107		
Ēs/Noc		dB	4.5	-4.5	4.5
Ēs/lot		dB	4.5	-4.5	4.5
SS-RSRP <sup>Note3</sup>	Config 1,2	dBm/SCS	-105.5	-114.5	-105.5
	Config 3		-102.5	-111.5	-102.5
I <sub>o</sub> <sup>Note3</sup>	Config 1,2	dBm/9.36MHz	-76.2	-80.7	-76.2
	Config 3	dBm/38.16MHz	-70.1	-74.6	-70.1
Propagation condition			AWGN		
<p>Note 1: OCNG shall be used such that both cells are fully allocated and a constant total transmitted power spectral density is achieved for all OFDM symbols.</p> <p>Note 2: Interference from other cells and noise sources not specified in the test is assumed to be constant over subcarriers and time and shall be modelled as AWGN of appropriate power for Noc to be fulfilled.</p> <p>Note 3: SS-RSRP and I<sub>o</sub> levels have been derived from other parameters for information purposes. They are not settable parameters themselves.</p> <p>Note 4: SS-RSRP minimum requirements are specified assuming independent interference and noise at each receiver antenna port.</p>					

During T1, the SS-RSRP of the PCell is above *syncTxThreshIC* and the UE is not expected to be transmitting S-SSB.

During T2, the SS-RSRP of the PCell is lowered below *syncTxThreshIC* and the UE is expected to initiate S-SSB transmissions.

During T3, the SS-RSRP of the PCell is increased back to be above *syncTxThreshIC* and the UE is expected to cease S-SSB transmissions.

The S-SSB transmission initiation delay is defined as the time from the beginning of time period T2 up to the moment when the UE initiates the S-SSB transmission.

The S-SSB transmission initiation delay shall be less than  $T_{\text{evaluate,SLSS}} + \text{S-SSB period} = 560\text{ms}$ , where,

$T_{\text{evaluate,SLSS}} = \max(400 \text{ ms}, \text{ceil}(10 \cdot K_p) \cdot \text{SMTC period}) = 400 \text{ ms}$ , is the evaluation time specified in 38.133 [6] Table 12.3.1.1-1, where

SMTC period = 20ms according to Table 9.1.2.1.5-1.

$K_p = 1$  according to Table 9.1.2.1.5-1.

S-SSB period = 160 ms.

The S-SSB transmission cease delay is defined as the time from the beginning of time period T3 up to the moment when the UE ceases the S-SSB transmission.

The S-SSB transmission cease delay shall be less than  $T_{\text{evaluate,SLSS}} + \text{S-SSB period} = 560\text{ms}$ .

The rate of correct initiation/cease delay of S-SSB transmissions observed during repeated tests shall be at least 90%.

### 9.1.2.2 NR SA FR1 initiation/cease of S-SSB transmission for SyncRef UE as synchronization reference source

**Editor's notes: Following aspects of this test case are still incomplete:**

- Connect diagram is FFS;
- Message contents are still missing
- TT analysis is still missing

#### 9.1.2.2.1 Test purpose

The purpose of this test is to verify that the NR sidelink UE meets the requirements related to the maximum evaluation time allowed to initiate and cease S-SSB transmissions defined in TS 38.133 [6] clause 12.3.1.4, when the reference timing used for sidelink transmissions is a SyncRef UE.

#### 9.1.2.2.2 Test applicability

This test applies to all types of NR UEs from release 16 onwards and supporting NR sidelink communication.

#### 9.1.2.2.3 Minimum conformance requirements

The minimum conformance requirements are defined in clause 9.1.2.0.2

The normative reference for this requirement is TS 38.133 [6] clause A.9.1.2.2.

#### 9.1.2.2.4 Test description

##### 9.1.2.2.4.1 Initial conditions

Configure the test equipment and the DUT according to the parameters in Table 9.1.2.2.4.1-1.

**Table 9.1.2.2.4.1-1: Initial conditions for NR SA FR1 initiation/cease of S-SSB transmission for SyncRef UE as synchronization reference source**

Parameter	Value		Comment
Test environment	NC		As specified in TS 38.508-1 [14] clause 4.1.
Test frequencies	PC5: As specified in TS 38.508-1 [14] clause 4.3.1.8.		
Channel bandwidth	PC5: As specified by the test configuration selected from Table 9.1.1.3.4.1-2.		
Propagation conditions	AWGN		As specified in Annex C.2.2.
Connection Diagram	TE Part	FFS	As specified in TS 38.508-1 [14] Annex A.
	DUT Part	FFS	
Exceptions to connection diagram	N/A		

1. The parameter settings for the NR sidelink communication are configured according to Table 9.1.2.2.4.1-2.
2. Message content exceptions are given in clause 9.1.2.2.4.3
3. There is one NR-SS-UE (SyncRef UE 1) specified in this test. SyncRef UE 1 is configured according to the parameters in Table 9.1.1.2.4.1-2.

**Table 9.1.2.2.4.1-2: NR sidelink test parameters for NR SA FR1 initiation/cease of S-SSB transmission for SyncRef UE as synchronization reference source**

Parameter	Unit	Value	Comment
SCS	kHz	30	
Active cell		None	
Active SyncRef UE		SyncRef UE 1	Transmitting S-SSB on RF channel number 1(HD carrier in Band n47 or n38)
Active NR sidelink UE		NR sidelink UE	Transmitting S-SSB on RF channel number 1(HD carrier in Band n47 or n38)
NR sidelink communication preconfiguration		As specified in section A.11.2	IE values unless specified otherwise in this test
networkControlledSyncTx		Not configured	
syncTxThreshOoC	dBm/30kHz	-97	
T1	s	3	
T2	s	5.24	
T3	s	5.24	

#### 9.1.2.2.4.2 Test procedure

In this test there is one active NR-SS-UE (SyncRef UE 1) and no serving cell nor GNSS signals. The test system shall emulate SyncRef UE 1 to transmit S-SSB every synchronization period with the SLSSID and inCoverage indicator as specified in Table 9.1.2.2.5-1.

The test consists of three successive time periods, with time duration of T1, T2 and T3 respectively.

1. Ensure the UE is in state 4-A with generic procedure parameters Test Mode = *On* according to TS 38.508-1 [14] clause 4.4A.2.
2. The SS powers on SyncRef UE 1, sets parameters according to T3 in Table 9.1.2.2.5-1. Then the SS waits at least 8 seconds for the UE to be synchronized to SyncRef UE 1.
3. The SS sets parameters according to T1 in Table 9.1.2.2.5-1, T1 starts.

4. During T1, if the SS observes that no SL SSB is transmitted by the UE until T1 expires, then count a success for the event "No S-SSB transmission", otherwise count a fail for the event "No S-SSB transmission".
5. When T1 expires, the SS shall switch the power setting from T1 to T2 in Table 9.1.2.2.5-1. T2 starts.
6. If the UE
  - a) starts to send S-SSB within 800 ms from the start of T2, and
  - b) uses SLSSID = 30, and
  - c) *inCoverage* = FALSE in *MasterInformationBlockSidelink*
 then count a success for the event "S-SSB transmission initiation", otherwise count a fail for the event "S-SSB transmission initiation".
7. When T2 expires, the SS shall switch the power setting from T2 to T3 in Table 9.1.2.2.5-1. T3 starts.
8. If the UE transmits no SL SSB from 800 ms after the start of T3 then count a success for the event "S-SSB transmission cease", otherwise count a fail for the event "S-SSB transmission cease".
9. Repeat step 3-8 until the confidence level according to Tables G.2.3-1 in Annex G clause G.2 is achieved.

Each of the events "No S-SSB transmission", "S-SSB transmission initiation" and "S-SSB transmission cease" is evaluated independently for the statistic, resulting in an event verdict pass or fail. Different events may require different times for a verdict.

If all events pass, the test passes. If one event fails, the test fails.

9.1.2.2.4.3 Message contents

FFS

9.1.2.2.5 Test requirement

SyncRef UE Specific test parameters for SyncRef UE 1 is given in Table 9.1.2.2.5-1.

**Table 9.1.2.2.5-1: SyncRef UE Specific test parameters for NR SA FR1 initiation/cease of S-SSB transmission for SyncRef UE as synchronization reference source**

Parameter	Unit	SyncRef UE 1		
		T1	T2	T3
NR RF Channel Number		1		
V2X SL communication resource pool configuration		As specified in section A.11.2		
Channel Bandwidth ( $BW_{channel}$ ) <sup>Note3</sup>	MHz	20( $N_{RB,c} = 50$ ) or 40( $N_{RB,c} = 100$ )		
SLSSID		30		
<i>inCoverage</i>		TRUE		
<i>networkControlledSyncTx</i>		ON		
$Noc$ <sup>Note1</sup>	dBm/30 kHz	-98		
$\bar{E}s/Noc$	dB	5.5	-3.5	5.5
PSBCH $\bar{E}s/Noc$	dB	5.5	-3.5	5.5
PSBCH-RSRP <sup>Note2</sup>	dBm/30 kHz	-92.5	-101.5	-92.5
$I_o$ <sup>Note2</sup>	dBm /3.96MHz	-70.2	-75.2	-70.2
Propagation condition		AWGN		
Note 1:	Interference from other UEs and noise sources not specified in the test is assumed to be constant over subcarriers and time and shall be modelled as AWGN of appropriate power for $Noc$ to be fulfilled.			
Note 2:	PSBCH-RSRP and $I_o$ levels have been derived from other parameters for information purposes. They are not settable parameters themselves. $I_o$ level is based on the allocated RBs for S-PSS/S-SSS/PSBCH symbols.			
Note 3:	The UE is only required to be tested in one of the supported test configurations.			
Note 4:	S-PSS $\bar{E}s/Noc$ and S-SSS $\bar{E}s/Noc$ are set the same as PSBCH $\bar{E}s/Noc$ .			

During T1, the PSBCH-RSRP of SyncRef UE 1 is above *syncTxThreshOOC* and the UE is not expected to be transmitting S-SSB.

During T2, the PSBCH-RSRP of SyncRef UE 1 is lowered below *syncTxThreshOOC* and the UE is expected to initiate S-SSB transmissions.

During T3, the PSBCH-RSRP of SyncRef UE 1 is increased back to be above *syncTxThreshOOC* and the UE is expected to cease S-SSB transmissions.

The S-SSB transmission initiation delay is defined as the time from the beginning of time period T2 up to the moment when the UE initiates the S-SSB transmission.

The S-SSB transmission initiation delay shall be less than  $T_{\text{evaluate,SLSS}} + \text{S-SSB period} = 800$  ms, where,

$T_{\text{evaluate,SLSS}} = 4 \cdot \text{S-SSB period}$ , is the evaluation time specified in 38.133 [6] clause 12.3.1.4,

S-SSB period = 160 ms.

The S-SSB transmission cease delay is defined as the time from the beginning of time period T3 up to the moment when the UE ceases the S-SSB transmission.

The S-SSB transmission cease delay shall be less than  $T_{\text{evaluate,SLSS}} + \text{S-SSB period} = 800$  ms.

The rate of correct initiation/cease delay of S-SSB transmissions observed during repeated tests shall be at least 90%.

### 9.1.3 Synchronization reference selection/reselection

#### 9.1.3.0 Minimum conformance requirements

##### 9.1.3.0.1 Minimum conformance requirements for GNSS configured as the highest priority synchronization reference source

The requirements defined in this clause do not apply to the UEs that do not support transmission and reception of SLSS.

A SyncRef UE is considered to be detectable when

- PSBCH-RSRP related side conditions given in 38.133 [6] clause 10.4 are fulfilled for a corresponding Band,
- NR sidelink SCH<sub>RP</sub> and SCH<sub>Es/Iot</sub> according to Annex B.4 for a corresponding Band are fulfilled.

When GNSS synchronization reference source is configured as the highest priority and

- UE is synchronized to GNSS directly,
- UE shall not drop any NR SLSS and data transmission for the purpose of selection/reselection to the SyncRef UE.
- UE is synchronized to a SyncRef UE that is synchronized to GNSS directly or in-directly,
  - UE shall not drop any NR sidelink data transmission for the purpose of selection/reselection to the SyncRef UE. The UE shall be able to identify newly detectable intra-frequency SyncRef UE within  $T_{\text{detect,SyncRef UE}_V2X}$  seconds if the SyncRef UE meets the selection / reselection criterion defined in TS 38.331[13].  $T_{\text{detect,SyncRef UE}_V2X}$  is defined as 1.6 seconds at SCH<sub>Es/Iot</sub>  $\geq 0$  dB, provided that the UE is allowed to drop a maximum of 30% of its SLSS transmissions during  $T_{\text{detect,SyncRef UE}_V2X}$  for the purpose of selection / reselection to the SyncRef UE.
- in other case
  - The UE shall be able to identify newly detectable intra-frequency SyncRef UE within  $T_{\text{detect,SyncRef UE}_V2X}$  seconds if the SyncRef UE meets the selection / reselection criterion defined in TS 38.331[13].  $T_{\text{detect,SyncRef UE}_V2X}$  is defined as 8 seconds at SCH<sub>Es/Iot</sub>  $\geq 0$  dB, provided that the UE is allowed to drop a maximum of 6 % of its NR sidelink data and SLSS transmissions during  $T_{\text{detect,SyncRef UE}_V2X}$  for the purpose of selection / reselection to the SyncRef UE.

- UE is allowed to drop up to 2 slots of its NR sidelink data reception per PSBCH monitoring occasion and overall drop rate shall not exceed 0.3% of its NR sidelink data reception during  $T_{\text{detect,SyncRef UE\_V2X}}$  for the purpose of selection / reselection to the SyncRef UE.

UE shall be capable of performing PSBCH-RSRP measurements for 3 identified intra-frequency SyncRef UEs with the measurement period of 320 ms. It is assumed that the SyncRef UE do not drop or delay any SLSS transmission within the measurement period. Otherwise, the measurement period may be extended.

When UE is synchronized to GNSS directly, before selection / reselection of the new synchronization reference source UE shall evaluate the GNSS synchronization source reliability for at least 20 seconds before changing the synchronization reference from GNSS to another synchronization reference source. UE shall be always synchronized to GNSS directly during the evaluation of GNSS synchronization source reliability.

The requirements for absolute accuracy of PSBCH-RSRP apply to a NR sidelink synchronization source on the same frequency as that of the own NR sidelink UE performing the measurement in FR1.

The accuracy requirements in Table 9.1.3.0.1-1 are valid under the following conditions:

- Demodulation reference signals are transmitted from one port.
- Conditions defined in Clause 7.3E of TS 38.101-1 [2] for reference sensitivity are fulfilled.
- Conditions for PSBCH-RSRP measurements are fulfilled according to Annex B.4.2 for a corresponding Band for each relevant PSBCH-DMRS.

**Table 9.1.3.0.1-1: Intra-frequency PSBCH-RSRP absolute accuracy in FR1**

Accuracy		Conditions						
Normal condition	Extreme condition	$\hat{E}s/lot$ Note 3	$Io$ Note 1 range					
			NR Sidelink operating band groups Note 2	Minimum $Io$			Maximum $Io$	
dB	dB	dB		dBm / $SCS_{SL}$			dBm/ $BW_{Channel}$	dBm/ $BW_{Channel}$
				$SCS_{SL}$ = 15 kHz	$SCS_{SL}$ = 30 kHz	$SCS_{SL}$ = 60 kHz		
±4.5	±9	≥-6	NR_TDD_FR1_B	-120.5	-117.5	-114.5	N/A	-70
			NR_TDD_FR1_J	-116.5	-113.5	-110.5	N/A	-70
±8	±11	≥-6	NR_TDD_FR1_B, NR_TDD_FR1_J	N/A	N/A	N/A	-70	-50

NOTE 1:  $Io$  is assumed to have constant EPRE across the bandwidth.  
 NOTE 2: NR sidelink operating band groups in FR1 are as defined in clause 3.5.2.  
 NOTE 3:  $\hat{E}s/lot$  for a SyncRef UE is the  $\hat{E}s/lot$  of PSBCH-DMRS.

The relative accuracy of PSBCH-RSRP is defined as the PSBCH-RSRP measured from one NR sidelink synchronization source compared to the PSBCH-RSRP measured from another NR sidelink synchronization source on the same frequency in FR1.

The accuracy requirements in Table 9.1.3.0.1-2 are valid under the following conditions:

- Demodulation reference signals are transmitted from one port.
- Conditions defined in Clause 7.3E of TS 38.101-1 [2] for reference sensitivity are fulfilled.
- Conditions for PSBCH-RSRP accuracy measurements are fulfilled according to Annex B.4.2 for a corresponding Band for each relevant PSBCH-DMRS.

**Table 9.1.3.0.1-2: Intra-frequency PSBCH-RSRP relative accuracy in FR1**

Accuracy		Conditions				
Normal condition	Extreme condition	$\hat{E}s/lot$ Note 3	$Io$ Note 1 range			
			NR sidelink operating band groups Note 2	Minimum $Io$		

dB	dB	dB		dBm / SCS <sub>SL</sub>			dBm/BW <sub>Channel</sub>	dBm/BW <sub>Channel</sub>
				SCS <sub>SL</sub> = 15 kHz	SCS <sub>SL</sub> = 30 kHz	SCS <sub>SL</sub> = 60 kHz		
±2	±3	≥-3	NR_TDD_FR1_B	-120.5	-117.5	-114.5	N/A	-50
			NR_TDD_FR1_J	-116.5	-113.5	-110.5	N/A	-50
±3	±3	≥-6	Note 4	Note 4	Note 4	Note 4	N/A	Note 4

NOTE 1: I<sub>o</sub> is assumed to have constant EPRE across the bandwidth.  
 NOTE 2: NR sidelink operating band groups in FR1 are as defined in clause 3A.4.1.  
 NOTE 3: Ês/Iot for a SyncRef UE is the Ês/Iot of PSBCH-DMRS.  
 NOTE 4: The same bands and the same I<sub>o</sub> conditions for each band apply for this requirement as for the corresponding highest accuracy requirement.

The normative references for this requirement are TS 38.133 [6] clause 10.4.2 and 12.4.

### 9.1.3.0.2 Minimum conformance requirements for eNB/gNB configured as the highest priority synchronization reference source

The requirements defined in this clause do not apply to the UEs that do not support transmission and reception of SLSS.

A SyncRef UE is considered to be detectable when

- PSBCH-RSRP related side conditions given in 38.133 [6] clause 10.4 are fulfilled for a corresponding Band,
- NR sidelink SCH<sub>RP</sub> and SCH Ês/Iot according to Annex B for a corresponding Band are fulfilled.

When serving cell/PCell synchronization reference source is configured as the highest priority,

- UE shall be able to identify newly detectable intra-frequency SyncRef UE within T<sub>detect,SyncRef UE\_V2X</sub> seconds if the SyncRef UE meets the selection / reselection criterion defined in TS 38.331 [13]. T<sub>detect,SyncRef UE\_V2X</sub> is defined as 8 seconds at SCH Ês/Iot ≥ 0 dB, provided that the NR sidelink UE is allowed to drop a maximum of 6 % of its NR sidelink data and SLSS transmissions for the purpose of selection / reselection to the SyncRef UE.
- UE is allowed to drop up to 2 slots of its NR sidelink data reception per PSBCH monitoring occasion and overall drop rate shall not exceed 0.3% of its NR sidelink data reception during T<sub>detect,SyncRef UE\_V2X</sub> for the purpose of selection / reselection to the SyncRef UE.

UE shall be capable of performing PSBCH-RSRP measurements for 3 identified intra-frequency SyncRef UEs with the measurement period of 320 ms. It is assumed that the SyncRef UE do not drop or delay any SLSS transmission within the measurement period. Otherwise, the measurement period may be extended.

The requirements for absolute accuracy of PSBCH-RSRP apply to a NR sidelink synchronization source on the same frequency as that of the own NR sidelink UE performing the measurement in FR1.

The accuracy requirements in Table 9.1.3.0.2-1 are valid under the following conditions:

- Demodulation reference signals are transmitted from one port.
- Conditions defined in Clause 7.3E of TS 38.101-1 [2] for reference sensitivity are fulfilled.
- Conditions for PSBCH-RSRP measurements are fulfilled according to Annex B.4.2 for a corresponding Band for each relevant PSBCH-DMRS.

**Table 9.1.3.0.2-1: Intra-frequency PSBCH-RSRP absolute accuracy in FR1**

Accuracy		Conditions						
Normal condition	Extreme condition	Ês/Iot Note 3	I <sub>o</sub> Note 1 range				dBm/BW <sub>Channel</sub>	dBm/BW <sub>Channel</sub>
			NR Sidelink operating band groups Note 2	Minimum I <sub>o</sub>				
dB	dB	dB		dBm / SCS <sub>SL</sub>			dBm/BW <sub>Channel</sub>	dBm/BW <sub>Channel</sub>
				SCS <sub>SL</sub> = 15 kHz	SCS <sub>SL</sub> = 30 kHz	SCS <sub>SL</sub> = 60 kHz		



±4.5	±9	≥-6	NR_TDD_FR1_B	-120.5	-117.5	-114.5	N/A	-70
			NR_TDD_FR1_J	-116.5	-113.5	-110.5	N/A	-70
±8	±11	≥-6	NR_TDD_FR1_B, NR_TDD_FR1_J	N/A	N/A	N/A	-70	-50

NOTE 1:  $I_0$  is assumed to have constant EPRE across the bandwidth.  
NOTE 2: NR sidelink operating band groups in FR1 are as defined in clause 3.5.2.  
NOTE 3:  $\hat{E}_s/\text{lot}$  for a SyncRef UE is the  $\hat{E}_s/\text{lot}$  of PSBCH-DMRS.

The relative accuracy of PSBCH-RSRP is defined as the PSBCH-RSRP measured from one NR sidelink synchronization source compared to the PSBCH-RSRP measured from another NR sidelink synchronization source on the same frequency in FR1.

The accuracy requirements in Table 9.1.3.0.2-2 are valid under the following conditions:

- Demodulation reference signals are transmitted from one port.
- Conditions defined in Clause 7.3E of TS 38.101-1 [2] for reference sensitivity are fulfilled.
- Conditions for PSBCH-RSRP accuracy measurements are fulfilled according to Annex B.4.2 for a corresponding Band for each relevant PSBCH-DMRS.

**Table 9.1.3.0.2-2: Intra-frequency PSBCH-RSRP relative accuracy in FR1**

Accuracy		Conditions						
Normal condition	Extreme condition	$\hat{E}_s/\text{lot}$ Note 3	$I_0$ Note 1 range					
			NR sidelink operating band groups Note 2	Minimum $I_0$			Maximum $I_0$	
dB	dB	dB		dBm / $SCS_{SL}$			dBm/ $BW_{Channel}$	dBm/ $BW_{Channel}$
				$SCS_{SL}$ = 15 kHz	$SCS_{SL}$ = 30 kHz	$SCS_{SL}$ = 60 kHz		
±2	±3	≥-3	NR_TDD_FR1_B	-120.5	-117.5	-114.5	N/A	-50
			NR_TDD_FR1_J	-116.5	-113.5	-110.5	N/A	-50
±3	±3	≥-6	Note 4	Note 4	Note 4	Note 4	N/A	Note 4

NOTE 1:  $I_0$  is assumed to have constant EPRE across the bandwidth.  
NOTE 2: NR sidelink operating band groups in FR1 are as defined in clause 3A.4.1.  
NOTE 3:  $\hat{E}_s/\text{lot}$  for a SyncRef UE is the  $\hat{E}_s/\text{lot}$  of PSBCH-DMRS.  
NOTE 4: The same bands and the same  $I_0$  conditions for each band apply for this requirement as for the corresponding highest accuracy requirement.

### 9.1.3.1 NR SA FR1 synchronization reference selection/reselection for GNSS configured as the highest priority synchronization reference source

**Editor's notes: Following aspects of this test case are still incomplete:**

- **Connect diagram is FFS;**
- **Message contents are still missing**
- **TT analysis is still missing**

#### 9.1.3.1.1 Test purpose

The purpose of this test is to verify the requirements related to SyncRef UE (re)selection as specified in TS 38.133 [6] clause 12.4, when GNSS is configured as the highest priority.

#### 9.1.3.1.2 Test applicability

This test applies to all types of NR UEs from release 16 onwards and supporting NR sidelink communication.

### 9.1.3.1.3 Minimum conformance requirements

The minimum conformance requirements are defined in clause 9.1.3.0.1

The normative reference for this requirement is TS 38.133 [6] clause A.9.1.3.1.

### 9.1.3.1.4 Test description

#### 9.1.3.1.4.1 Initial conditions

Configure the test equipment and the DUT according to the parameters in Table 9.1.3.1.4.1-1.

**Table 9.1.3.1.4.1-1: Initial conditions for NR SA FR1 synchronization reference selection/reselection for GNSS configured as the highest priority synchronization reference source**

Parameter	Value		Comment
Test environment	NC		As specified in TS 38.508-1 [14] clause 4.1.
Test frequencies	PC5: As specified in TS 38.508-1 [14] clause 4.3.1.8.		
Channel bandwidth	PC5: As specified by the test configuration selected from Table 9.1.3.1.4.1-2.		
Propagation conditions	AWGN		As specified in Annex C.2.2.
Connection Diagram	TE Part	FFS	As specified in TS 38.508-1 [14] Annex A.
	DUT Part	FFS	
Exceptions to connection diagram	N/A		

1. The parameter settings for the NR sidelink communication are pre-configured according to TS 38.508-1 [14] clause 4.10.1.
2. Message content exceptions are given in clause 9.1.3.1.4.3
3. There are three NR-SS-UEs (SyncRef UE 1, SyncRef UE 2 and SyncRef UE 3) specified in this test. SyncRef UE 1, SyncRef UE 2 and SyncRef UE 3 are configured according to the generic parameters in Table 9.1.3.1.4.1-2.

**Table 9.1.3.1.4.1-2: NR sidelink test parameters for NR SA FR1 synchronization reference selection/reselection for GNSS configured as the highest priority synchronization reference source**

Parameter		Unit	Value	Comment
Initial condition	Active synchronization source		Sync Ref UE 1	DUT transmits for NR Sidelink Communication and S-SSB with SLSS ID = 30 and in-coverage set as FALSE in MIB-SL.
T2 end condition	Active synchronization source		Sync Ref UE 2	DUT transmits for NR Sidelink Communication and S-SSB with SLSS ID = 336 and in-coverage set as FALSE in MIB-SL.
Final condition	Active synchronization source		Sync Ref UE 3	UE transmits for NR Sidelink Communication and S-SSB with SLSS ID = 0 and in-coverage set as FALSE in MIB-SL.
Active SyncRef UEs			SyncRef UE 1 SyncRef UE 2 SyncRef UE 3	Transmitting S-SSB on RF channel number 1 (HD carrier in Band n47 or n38)
Timing offset among SyncRef UEs		μs	CP/2	Synchronous
Frequency offset of SyncRef UE 1,2 and 3		ppm	0	
NR sidelink Communication configuration			As specified in clause A.11.2	IE values unless specified otherwise in this test.
sl-SyncPriority			gnss	
syncTxThreshOoC			+infinity	
T1		s	24	
T2		s	16	
T3		s	3.2	

#### 9.1.3.1.4.2 Test procedure

In this test there are three active SyncRef UEs (SyncRef UE 1, SyncRef UE 2 and SyncRef UE 3) and no GNSS signals nor Cells. The test system shall emulate SyncRef UE 1, SyncRef UE 2 and SyncRef UE 3 to transmit S-SSB every S-SSB period with the SLSSIDs and inCoverage indicators specified in Table 9.1.3.1.5-1.

The test consists of three successive time periods, with time duration of T1, T2 and T3 respectively. SyncRef UE 1, SyncRef UE 2 and SyncRef UE 3 are all switched off before starting the test. For this test, the UE is triggered by the test loop function or the upper layers to transmit for V2X Sidelink Communication.

1. Ensure the UE is in state 4-A with generic procedure parameters Test Mode = *On* according to TS 38.508-1 [14] clause 4.4A.2.
2. The UE transmits S-SSB with SLSSID belonging to *id\_oon* set and *inCoverage* = false in SL MIB.
3. The SS sends AT command +CCUTLE to close test loop function and trigger UE to transmit.
4. The SS sets parameters according to T1 in Table 9.1.3.1.5-1. T1 starts.
5. If the UE
  - a) starts to transmit S-SSB within 8800 ms from the start of T1 with SLSSID = 30 and *inCoverage* = false in *MasterInformationBlockSidelink*, and
  - b) drops no more than 6 % of its PSSCH and S-SSB transmissions within 8000 ms from the start of T1.
 then count a success for the event "select SyncRef UE 1", otherwise count a fail for the event "select SyncRef UE 1".
6. When T1 expires, the SS shall switch the power setting from T1 to T2 in Table 9.1.3.1.5-1. T2 starts.
7. If the UE
  - a) starts to transmit S-SSB within 8800 ms from the start of T2 with SLSSID = 336 and *inCoverage* = false in *MasterInformationBlockSidelink*, and

- b) drops no more than 6 % of its PSSCH and S-SSB transmissions within 8000 ms from the start of T2.  
then count a success for the event "reselect SyncRef UE 2", otherwise count a fail for the event "reselect SyncRef UE 2".
- 8. When T2 expires, the SS shall switch the power setting from T2 to T3 in Table 9.1.3.1.5-1. T3 starts.
- 9. If the UE
  - a) starts to transmit S-SSB within 2400 ms from the start of T3 with SLSSID = 0 and *inCoverage* = false in *MasterInformationBlockSidelink*, and
  - b) drops no more than 30 % of its S-SSB transmissions within 1600 ms from the start of T3.  
then count a success for the event "reselect SyncRef UE 3", otherwise count a fail for the event" reselect SyncRef UE 3".
- 10. When T3 expires, the SS shall switch off all three SyncRef UEs and wait at least 8 seconds.
- 11. The SS sends AT command +CCUTLE to open test loop function and trigger UE to stop transmitting.
- 12. Repeat step 2-11 until the confidence level according to Tables G.2.3-1 in Annex G clause G.2 is achieved.

Each of the events " select SyncRef UE 1", " reselect SyncRef UE 2" and " reselect SyncRef UE 3" is evaluated independently for the statistic, resulting in an event verdict pass or fail. Different events may require different times for a verdict.

If all events pass, the test passes. If one event fails, the test fails.

9.1.3.1.4.3 Message contents

FFS

9.1.3.1.5 Test requirement

SyncRef UE Specific test parameters for SyncRef UEs are given in Table 9.1.3.1.5-1.

**Table 9.1.3.1.5-1: SyncRef UE Specific Test Parameters for NR SA FR1 synchronization reference selection/reselection for GNSS configured as the highest priority synchronization reference source**

Parameter	Unit	SyncRef UE 1			SyncRef UE 2			SyncRef UE 3		
		T1	T2	T3	T1	T2	T3	T1	T2	T3
NR RF Channel Number		1(HD carrier in Band n47 or n38)								
Channel Bandwidth ( $BW_{channel}$ ) <sup>Note 4</sup>	MHz	20 ( $N_{RB,c} = 50$ ) or 40 ( $N_{RB,c} = 100$ )								
V2X Sidelink Communication resource pool configuration		As specified in Table A.11.2-2								
networkControlledSyncTx		ON			N/A			ON		
syncTxThreshOoC	dBm/SCS	N/A			+∞			N/A		
SLSSID		30			0			0		
inCoverage (in MIB-SL)		TRUE			FALSE			TRUE		
$N_{oc}$ <sup>Note1</sup>	dBm/SCS	-95								
$\bar{E}_s/N_{oc}$	dB	0	0	0	-∞	0	0	-∞	-∞	3
$\bar{E}_s/I_{ot}$	dB	0	0	-4.76	-∞	0	0	-∞	-∞	0
PSBCH-RSRP <sup>Note2, Note 3</sup>	dBm/SCS	-95	-95	-95	-∞	-95	-95	-∞	-∞	-92
Propagation Condition		AWGN								
Note 1: Interference from other cells and noise sources not specified in the test is assumed to be constant over subcarriers and time and shall be modelled as AWGN of appropriate power for $N_{oc}$ to be fulfilled. Note 2: PSBCH-RSRP levels have been derived from other parameters for information purposes. They are not settable parameters themselves. Note 3: S-PSS/S-SSS $\bar{E}_s/I_{ot}$ is set the same as PSBCH $\bar{E}_s/I_{ot}$ . Note 4: The UE is only required to be tested in one of the supported test configurations.										

During T1, the UE shall detect, evaluate and select SyncRef UE 1 as synchronization source. Then it shall change its S-SSB transmission timing with SLSSID = 30 and *inCoverage* = FALSE in *MasterInformationBlockSidelink* after SyncRef UE selection delay from start of T1.

During T2, the UE shall detect, evaluate and reselect SyncRef UE 2 as synchronization source. Then it shall change its S-SSB transmission timing with SLSSID = 336 and *inCoverage* = FALSE in *MasterInformationBlockSidelink* after SyncRef UE reselection delay from start of T2.

During T3, the UE will detect, evaluate and reselect SyncRef UE 3 as synchronization source. Then it shall change its S-SSB transmission timing with SLSSID = 0 and *inCoverage* = FALSE in *MasterInformationBlockSidelink* after SyncRef UE reselection delay from start of T2.

SyncRef UE (re)selection delay is defined as the time from the beginning of corresponding time instant to the time UE is synchronized to SyncRef UE and changes its S-SSB transmissions timing and SLSSID to follow SyncRef UE as the synchronization source. The SyncRef UE (re)selection delay can be expressed as:

SyncRef UE selection delay =  $T_{\text{detect,SyncRef UE}} + T_{\text{evaluate,SLSS}} + \text{S-SSB period}$

- $T_{\text{detect,SyncRef UE}} = 1.6$  seconds, is the time to identify newly detectable intra-frequency SyncRef UE as specified in 38.133 [6] clause 12.4 when UE is synchronized to a SyncRef UE that is synchronized to GNSS directly or indirectly, otherwise  $T_{\text{detect,SyncRef UE}} = 8$  seconds if UE is not directly synchronized to GNSS.
- $T_{\text{evaluate,SLSS}} = 4$  S-SSB periods, is the time to measure the PSBCH-RSRP of the selected SyncRef UE used as synchronization reference source and evaluate it to initiate/cease S-SSB transmissions.
- S-SSB period = 160 ms.

Which gives SyncRef UE (re)selection delay = 8800 ms for T1 and T2, and 2400 ms for T3.

The test system will also verify that the UE does not drop or delay more than 6% of its sidelink data and S-SSB transmissions during the duration of T1 and T2, and does not drop or delay more than 30% of its S-SSB transmissions during the duration of T3.

The rate of correct SyncRef UE (re)selection observed during repeated tests shall be at least 90%.

### 9.1.3.2 NR SA FR1 synchronization reference selection/reselection for FR1 NR Cell configured as the highest priority synchronization reference source

**Editor's notes: Following aspects of this test case are still incomplete:**

- **Connect diagram is FFS;**
- **Message contents are still missing**
- **TT analysis is still missing**

#### 9.1.3.2.1 Test purpose

The purpose of this test is to verify the requirements related to SyncRef UE (re)selection as specified in TS 38.133 [6] clause 12.4, when gNB is configured as the highest priority.

#### 9.1.3.2.2 Test applicability

This test applies to all types of NR UEs from release 16 onwards and supporting gNB as synchronization source and NR sidelink communication.

#### 9.1.3.2.3 Minimum conformance requirements

The minimum conformance requirements are defined in clause 9.1.3.0.2

The normative reference for this requirement is TS 38.133 [6] clause A.9.1.3.2.

9.1.3.2.4 Test description

9.1.3.2.4.1 Initial conditions

Configure the test equipment and the DUT according to the parameters in Table 9.1.3.2.4.1-1.

**Table 9.1.3.2.4.1-1: Initial conditions for NR SA FR1 synchronization reference selection/reselection for FR1 NR Cell configured as the highest priority synchronization reference source**

Parameter	Value		Comment
Test environment	NC		As specified in TS 38.508-1 [14] clause 4.1.
Test frequencies	PC5: As specified in TS 38.508-1 [14] clause 4.3.1.8.		
Channel bandwidth	PC5: As specified by the test configuration selected from Table 9.1.3.2.4.1-2.		
Propagation conditions	AWGN		As specified in Annex C.2.2.
Connection Diagram	TE Part	FFS	As specified in TS 38.508-1 [14] Annex A.
	DUT Part	FFS	
Exceptions to connection diagram	N/A		

1. The parameter settings for the NR sidelink communication are pre-configured according to TS 38.508-1 [14] clause 4.10.1.
2. Message content exceptions are given in clause 9.1.3.2.4.3
3. There are two NR-SS-UEs (SyncRef UE 1 and SyncRef UE 2) specified in this test. SyncRef UE 1 and SyncRef UE 2 are configured according to the generic parameters in Table 9.1.3.2.4.1-2.
4. The GNSS simulator is configured for Scenario #1: static in Geographical area #1, as defined in TS 38.508-1 [14] Table 4.11.2-2.

**Table 9.1.3.2.4.1-2: NR sidelink test parameters for NR SA FR1 synchronization reference selection/reselection for FR1 NR Cell configured as the highest priority synchronization reference source**

Parameter		Unit	Value	Comment
SCS		kHz	30	
Initial condition	Active synchronization source		GNSS	DUT transmits for NR Sidelink Communication and S-SSB with SLSSID = 0 and inCoverage set as TRUE in MIB-SL.
T2 end condition	Active synchronization source		Sync Ref UE 1	DUT transmits for NR Sidelink Communication and S-SSB with SLSSID = 395 and inCoverage set as FALSE in MIB-SL.
Final condition	Active synchronization source		Sync Ref UE 2	DUT transmits for V2X Sidelink Communication and S-SSB with SLSSID = 30 and inCoverage set as FALSE in MIB-SL.
Active cell			None	
Active SyncRef UEs			SyncRef UE 1 SyncRef UE 2	Transmitting S-SSB on RF channel number 1
Timing offset between SyncRef UE 1 and SyncRef UE 2		ms	3	Asynchronous
Frequency offset of SyncRef UE 1 and 2		ppm	0	
NR sidelink Communication preconfiguration			As specified in Clause A.11.2	IE values unless specified otherwise in this test.
syncPriority			gnb	
syncTxThreshOoC			13 (+infinity)	
T1		s	24	
T2		s	16	
T3		s	16	

#### 9.1.3.2.4.2 Test procedure

In this test there are two active SyncRef UEs (SyncRef UE 1 and SyncRef UE 2). There are no active cells and GNSS is reliable during the whole test. The test system can emulate and send the GNSS signal to the test UE. The test system shall emulate SyncRef UE 1 and SyncRef UE 2 to transmit S-SSB every S-SSB period with the SLSSIDs and inCoverage indicators specified in Table 9.1.3.2.5-1.

The test consists of three successive time periods with time duration of T1, T2 and T3 respectively. SyncRef UE 1 and SyncRef UE 2 are all switched off before starting the test. For this test, the UE is triggered by the test loop function or the upper layers to transmit for V2X Sidelink Communication.

1. Ensure the UE is in state 4-A with generic procedure parameters Test Mode = *On* according to TS 38.508-1 [14] clause 4.4A.2.
2. The GNSS simulator is triggered to start step 1 of Scenario #1 to simulate a location in the centre of Geographical area #1.
3. Wait at least 20 seconds for the UE to acquire the GNSS signal.
4. The SS sends AT command +CCUTLE to close test loop function and trigger UE to transmit.
5. The SS sets parameters according to T1 in Table 9.1.3.2.5-1. T1 starts.
6. The UE transmits S-SSB with SLSSID = 0 and *inCoverage* = true in *MasterInformationBlockSidelink*.
7. When T1 expires, the SS shall switch the power setting from T1 to T2 in Table 9.1.3.2.5-1. T2 starts.
8. If the UE
  - a) starts to transmit S-SSB within 8800 ms from the start of T2 with SLSSID = 395 and *inCoverage* = false in *MasterInformationBlockSidelink*, and
  - b) drops no more than 6 % of its PSSCH and S-SSB transmissions within 8000 ms from the start of T2

then count a success for the event "reselect SyncRef UE 1", otherwise count a fail for the event "reselect SyncRef UE 1".

9 When T2 expires, the SS shall switch the power setting from T2 to T3 in Table 9.1.3.2.5-1. T3 starts.

10. If the UE

- a) starts to transmit S-SSB within 8800 ms from the start of T3 with SLSSID = 30 and *inCoverage* = false in *MasterInformationBlockSidelink*, and
  - b) drops no more than 6 % of its PSSCH and S-SSB transmissions within 8000 ms from the start of T2
- then count a success for the event "reselect SyncRef UE 2", otherwise count a fail for the event" reselect SyncRef UE 2".

11. When T3 expires, the SS shall switch off all SyncRef UEs.

12. The SS sends AT command +CCUTLE to open test loop function and trigger UE to stop transmitting.

13. Repeat step 3-12 until the confidence level according to Tables G.2.3-1 in Annex G clause G.2 is achieved.

Each of the events " reselect SyncRef UE 1" and " reselect SyncRef UE 2" is evaluated independently for the statistic, resulting in an event verdict pass or fail. Different events may require different times for a verdict.

If all events pass, the test passes. If one event fails, the test fails.

9.1.3.2.4.3 Message contents

FFS

9.1.3.2.5 Test requirement

SyncRef UE Specific test parameters for SyncRef UEs are given in Table 9.1.3.2.5-1.

**Table 9.1.3.2.5-1: SyncRef UE Specific Test Parameters for NR SA FR1 synchronization reference selection/reselection for FR1 NR Cell configured as the highest priority synchronization reference source**

Parameter	Unit	SyncRef UE 1			SyncRef UE 2		
		T1	T2	T3	T1	T2	T3
NR RF Channel Number		1(HD carrier in Band n47 or n38)					
Channel Bandwidth ( $BW_{channel}$ ) <sup>Note 4</sup>	MHz	20( $N_{RB,c} = 50$ ) or 40( $N_{RB,c} = 100$ )					
NR Sidelink Communication resource pool configuration		As specified in Table A.11.2-2			As specified in Table A.11.2-2		
networkControlledSyncTx		N/A			ON		
syncTxThreshOoC	dBm/15 kHz	+infinity			N/A		
SLSSID		59			30		
inCoverage (in MIB-SL)		FALSE			TRUE		
$N_{oc}$ <sup>Note1</sup>	dBm/30 kHz	-95					
$\hat{E}_s/N_{oc}$	dB	$-\infty$	0	0	$-\infty$	$-\infty$	0
$\hat{E}_s/I_{ot}$	dB	$-\infty$	0	0	$-\infty$	$-\infty$	0
PSBCH-RSRP <sup>Note2, Note 3</sup>	dBm/30 kHz	$-\infty$	-95	-95	$-\infty$	$-\infty$	-95
Propagation Condition		AWGN					
Note 1:	Interference from other cells and noise sources not specified in the test is assumed to be constant over subcarriers and time and shall be modelled as AWGN of appropriate power for $N_{oc}$ to be fulfilled.						
Note 2:	PSBCH-RSRP levels have been derived from other parameters for information purposes. They are not settable parameters themselves.						
Note 3:	S-PSS $E_s/I_{ot}$ and S-SSS $E_s/I_{ot}$ are set the same as PSBCH $E_s/I_{ot}$ .						
Note 4:	The UE is only required to be tested in one of the supported test configurations.						

During T1, both SyncRef UE 1 and SyncRef UE 2 are powered off. The UE will select GNSS as synchronization source.



During T2, the UE shall detect, evaluate and reselect SyncRef UE 1 as synchronization source. Then it shall change its S-SSB transmission timing with SLSSID = 395 and *inCoverage* = false in *MasterInformationBlockSidelink* after SyncRef UE reselection delay from start of T2.

During T3, the UE will detect, evaluate and reselect SyncRef UE 2 as synchronization source. Then it shall change its S-SSB transmission timing with SLSSID = 30 and *inCoverage* = false in *MasterInformationBlockSidelink* after SyncRef UE reselection delay from start of T2.

SyncRef UE reselection delay is defined as the time from the beginning of corresponding time instant to the time UE is synchronized to SyncRef UE and changes its S-SSB transmissions timing and SLSSID to follow SyncRef UE as the synchronization source. The SyncRef UE (re)selection delay can be expressed as:

$$\text{SyncRef UE reselection delay} = T_{\text{detect,SyncRef UE}} + T_{\text{evaluate,SLSS}} + \text{S-SSB period}$$

- $T_{\text{detect,SyncRef UE}} = 8$  seconds, is the time to identify newly detectable intra-frequency SyncRef UE as specified in 38.133 [6] clause 12.4 when UE is not directly synchronized to GNSS.
- $T_{\text{evaluate,SLSS}} = 4$  S-SSB periods, is the time to measure the PSBCH-RSRP of the selected SyncRef UE used as synchronization reference source and evaluate it to initiate/cease S-SSB transmissions.
- S-SSB period = 160 ms.

Which gives SyncRef UE reselection delay = 8800 ms.

The test system will also verify that the UE does not drop or delay more than 6% of its sidelink data and S-SSB transmissions during the duration of T1 and T2.

The rate of correct SyncRef UE reselection observed during repeated tests shall be at least 90%.

## 9.1.4 L1 SL-RSRP measurements

### 9.1.4.0 Minimum conformance requirements

#### 9.1.4.0.1 Minimum conformance requirements for resource selection/reselection, re-evaluation and pre-emption

The UE physical layer shall be capable of performing the L1 SL-RSRP measurements on the carrier operating NR sidelink communication for determining the subset of resources to be excluded in PSSCH resource selection in sidelink transmission mode 2. The L1 SL-RSRP measurement period corresponds to one slot and the measurement shall meet the L1 SL-RSRP measurement accuracy requirement in 38.133 [6] clause 10.4.4. After resource (re-)selection procedure, re-evaluation is performed on the reserved resources by L1 SL-RSRP measurements before transmission of SCI with reservation when the conditions specified in TS 38.214 [9] are satisfied.

When the pre-emption mechanism is enabled for the resource pool that UE is monitoring and selecting resource from, after UE selects from the resource not excluded based on L1 SL-RSRP measurement procedure, the UE shall be capable of triggering reselection of already signalled resource(s) as a resource reservation when the conditions specified in TS 38.214 [9] are satisfied.

The requirements for absolute accuracy of L1 SL-RSRP in this clause apply to a UE performing PSCCH-RSRP and/or PSSCH-RSRP measurements on the same frequency as used by operating NR sidelink communication.

The accuracy requirements in Table 9.1.4.0.1-1 are valid under the following conditions:

- Demodulation reference signals for PSCCH and/or PSSCH are transmitted from one port.
- Conditions defined in clause 7.3E of TS 38.101-1 [2] for reference sensitivity are fulfilled.
- PSCCH-RSRP[dBm] and/or PSSCH-RSRP[dBm] according to Annex B.4.4 for a corresponding Band are fulfilled.

**Table 9.1.4.0.1-1: Intra-frequency L1 SL-RSRP absolute accuracy for UE capable of NR sidelink communication**

Accuracy		Conditions						
Normal condition	Extreme condition	$\hat{E}s/lot$ Note 3	NR Sidelink operating band groups Note 2	$I_o$ Note 1 range				
				Minimum $I_o$			Maximum $I_o$	
dB	dB	dB		dBm/SCS			dBm/BW <sub>Channel</sub>	dBm/BW <sub>Channel</sub>
				SCS = 15kHz	SCS = 30kHz	SCS = 60kHz		
± 4.5	± 9	≥ 0 dB	NR_TDD_FR1_B	-120.5	-117.5	-114.5	N/A	-70
			NR_TDD_FR1_J	-116.5	-113.5	-110.5	N/A	-70
± 8	± 11	≥ 0 dB	NR_TDD_FR1_B NR_TDD_FR1_J	N/A	N/A	N/A	-70	-50

NOTE 1:  $I_o$  is assumed to have constant EPRE across the bandwidth.

NOTE 2: NR sidelink operating band groups are as defined in Section 3.5 for the corresponding NR operating bands.

NOTE 3: The parameter  $\hat{E}s/lot$  is the  $\hat{E}s/lot$  of PSCCH-DMRS and/or PSSCH-DMRS.

The normative references for this requirement are TS 38.133 [6] clause 10.4.4 and 12.5.

#### 9.1.4.1 NR SA FR1 L1 SL-RSRP measurement for autonomous resource selection/reselection

**Editor's notes: Following aspects of this test case are still incomplete:**

- Connect diagram is FFS;
- Message contents are still missing
- TT analysis is still missing

##### 9.1.4.1.1 Test purpose

The purpose of this test is to verify the requirements related to autonomous resource selection / reselection for NR sidelink UE in mode 2 defined in TS 38.133 [6] clause 12.5.

##### 9.1.4.1.2 Test applicability

This test applies to all types of NR UEs from release 16 onwards and supporting and NR sidelink communication.

##### 9.1.4.1.3 Minimum conformance requirements

The minimum conformance requirements are defined in clause 9.1.4.0.1

The normative reference for this requirement is TS 38.133 [6] clause A.9.1.4.1.

##### 9.1.4.1.4 Test description

###### 9.1.4.1.4.1 Initial conditions

Configure the test equipment and the DUT according to the parameters in Table 9.1.4.1.4.1-1.

**Table 9.1.4.1.4.1-1: Initial conditions for NR SA FR1 L1 SL-RSRP measurement for autonomous resource selection/reselection**

Parameter	Value		Comment
Test environment	NC		As specified in TS 38.508-1 [14] clause 4.1.
Test frequencies	PC5: As specified in TS 38.508-1 [14] clause 4.3.1.8.		
Channel bandwidth	PC5: As specified by the test configuration selected from Table 9.1.4.1.4.1-2.		
Propagation conditions	AWGN		As specified in Annex C.2.2.
Connection Diagram	TE Part	FFS	As specified in TS 38.508-1 [14] Annex A.
	DUT Part	FFS	
Exceptions to connection diagram	N/A		

1. The parameter settings for the NR sidelink communication are pre-configured according to TS 38.508-1 [14] clause 4.10.1.
2. Message content exceptions are given in clause 9.1.4.1.4.3
3. There are 50 NR-SS-UEs (active sidelink UE  $i$ ,  $i=0,1,\dots,49$ ) specified in this test. active sidelink UE  $i$ ,  $i=0,1,\dots,49$ , is configured according to the generic parameters in Table 9.1.4.1.4.1-2.
4. The GNSS simulator is configured for Scenario #1: static in Geographical area #1, as defined in TS 38.508-1 [14] Table 4.11.2-2.

**Table 9.1.4.1.4.1-2: NR sidelink test parameters for NR SA FR1 L1 SL-RSRP measurement for autonomous resource selection/reselection**

Parameter		Unit	Value	Comment
NR RF Channel Number			1	HD carrier in Band n47 or n38
Channel Bandwidth ( $BW_{\text{channel}}$ ) <sup>Note 2</sup>		MHz	20 ( $N_{\text{RB,c}} = 50$ ) or 40 ( $N_{\text{RB,c}} = 100$ )	
SCS		kHz	30	
NR sidelink communication pre-configuration			As specified in clause A.11.2	IE values unless specified otherwise in this test.
sl-TimeResource-r16 included in SL-ResourcePool			1111111111	Indicates the bitmap of the TX and Rx resource pool, which is defined by repeating the bitmap within a SFN cycle (see TS 38.213 [8])
sl-NumSubchannel-r16 included in SL-ResourcePool			5	Indicates the number of sub-channels for TX resource pool
sl-SubchannelSize-r16 included in SL-ResourcePool			10	Indicates the minimum granularity in frequency domain for the sensing for PSSCH resource selection in the unit of PRB
Number of Active Sidelink UEs			50	Active Sidelink UE $i = 0, \dots, 49$
SL-Thres-RSRP			12	Corresponding -106 dBm as defined in Section 6.3.5 in TS 38.331[13] Same for all priority level pairs.
Active Sidelink UEs (UE $i = 0, \dots, 49$ )	NR sidelink Communication preconfiguration		As specified in clause A.11.2	IE values unless specified otherwise in this test.
	sl-TimeResource-r16 included in SL-ResourcePool		$\{1_i\}$ <sup>Note1</sup>	Indicates the bitmap of the TX and Rx resource pool, which is defined by repeating the bitmap within a SFN cycle (see TS 38.213 [8])
	sl-NumSubchannel-r16 included in SL-ResourcePool		1	Indicates the number of sub-channels for TX resource pool
	sl-StartRB-Subchannel-r16 included in SL-ResourcePool		$\text{floor}(i/10) \times 10$	Indicates the lowest RB index of the subchannel with the lowest index. UE 0~9 start RB=0; UE 10~19 start RB=10; UE 20~29 start RB=20; UE 30~39 start RB=30; UE 40~49 start RB=40;
	sl-SubchannelSize-r16 included in SL-ResourcePool		10	Indicates the minimum granularity in frequency domain for the sensing for PSSCH resource selection in the unit of PRB
Timing offset among Active Sidelink UEs		$\mu\text{s}$	CP/2	Synchronous
Note 1: $\{1_i\}$ is a sequence of nine 0's with one 1 in $(\text{mod}(i,10)+1)$ 'th position.				
Note 2: The UE is only required to be tested in one of the supported test configurations.				

#### 9.1.4.1.4.2 Test procedure

In this test there are 50 active sidelink UEs (UE  $i, i=0,1,\dots,49$ ). There are no active cells and GNSS is reliable during the whole test. The test system can emulate and send the GNSS signal to the test UE. DUT and all active sidelink UEs

select GNSS as synchronization reference source. The test system shall emulate the active sidelink UEs to transmit PSCCH/PSSCH every 5ms as specified in Table 9.1.4.1.4.1-2.

The test consists of two successive time periods with time duration of T1, T2 respectively. T1 and T2 should be long enough. For this test, the UE is triggered by the test loop function or the upper layers to transmit for V2X Sidelink Communication.

1. Ensure the UE is in state 4-A with generic procedure parameters Test Mode = *On* according to TS 38.508-1 [14] clause 4.4A.2.
2. The GNSS simulator is triggered to start step 1 of Scenario #1 to simulate a location in the centre of Geographical area #1.
3. Wait at least 20 seconds for the UE to acquire the GNSS signal.
4. The SS sends AT command +CCUTLE to close test loop function and trigger UE to transmit.
5. The SS switches on all sidelink UEs and sets parameters according to T1 in Table 9.1.4.1.5-1. T1 starts.
6. During T1, the SS records:
  - $N_{\text{resource, total}}$ : the number of resources occupied by the PSSCH transmissions of the DUT on all subchannels.
  - $N_{\text{resource, subch 2}}$  the number of resources occupied by the PSSCH transmissions of the DUT on subchannel #2.

If  $N_{\text{resource, subch 2}}$  (corresponds to the "ne" in Annex G.2.3) and  $N_{\text{resource, total}}$  (corresponds to the "ns" in Annex G.2.3) achieve the confidence level according to Tables G.2.3-1, T1 expires.
7. If the ratio  $N_{\text{resource, subch 2}} / N_{\text{resource, total}}$  is less than 10%, count a success for the event "subchannel #2 resource not available", otherwise count a fail for the event "subchannel #2 resource not available".
8. When T1 expires, the SS shall switch the power setting from T1 to T2 in Table 9.1.4.1.5-1. T2 starts.
9. During T2, the SS records:
  - $N_{\text{resource, total}}$ : the number of resources occupied by PSSCH transmission of the DUT on all subchannels.
  - $N_{\text{resource, non-subch 2}}$  the number of resources occupied by PSSCH transmission of the DUT on subchannels other than subchannel #2.

If  $N_{\text{resource, non-subch 2}}$  (corresponds to the "ne" in Annex G.2.3) and  $N_{\text{resource, total}}$  (corresponds to the "ns" in Annex G.2.3) achieve the confidence level according to Tables G.2.3-1, T2 expires.
10. If the ratio  $N_{\text{resource, non-subch 2}} / N_{\text{resource, total}}$  is less than 10%, count a success for the event "subchannel #2 resource available", otherwise count a fail for the event "subchannel #2 resource available".
12. When T2 expires, the SS sends AT command +CCUTLE to open test loop function and trigger UE to stop transmitting.

Each of the events "subchannel #2 resource not available" and "subchannel #2 resource available" is evaluated independently, resulting in an event verdict pass or fail. If all events pass, the test passes. If one event fails, the test fails.

#### 9.1.4.1.4.3 Message contents

FFS

#### 9.1.4.1.5 Test requirement

Active sidelink UE specific test parameters are given in Table 9.1.4.1.5-1.

**Table 9.1.4.1.5-1: SyncRef UE Specific Test Parameters for NR SA FR1 L1 SL-RSRP measurement for autonomous resource selection/reselection**

Parameter	Unit	Active Sidelink UE <i>i</i> ( <i>i</i> = 0, ..., 49)	
		T1	T2
NR RF Channel Number	-	1	
Channel Bandwidth ( $BW_{channel}$ ) <sup>Note 5</sup>	MHz	20 ( $N_{RB,c} = 50$ ) or 40 ( $N_{RB,c} = 100$ )	
PSCCH RMC	-	CC.1A HD	
PSSCH RMC	-	CD.1A HD	
$N_{oc}$ <sup>Note1</sup>	dBm/30 kHz	-111	-121
$\bar{E}_s/N_{oc}$ <sup>Note3</sup>	dB	10	
$\bar{E}_s/I_{ot}$ <sup>Note2,3</sup>	dB	10	
$\bar{E}_s/N_{oc}$ <sup>Note4</sup>	dB	0	20
$\bar{E}_s/I_{ot}$ <sup>Note2,4</sup>	dB	0	20
PSSCH-RSRP <sub>1</sub> <sup>Note 2,3</sup>	dBm/SC S	-101	-111
PSSCH-RSRP <sub>2</sub> <sup>Note 2,4</sup>	dBm/SC S	-111	-101
SL-RSSI <sub>1</sub> <sup>Note 2,3</sup>	dBm/3.6 MHz	-79.79	-89.79
SL-RSSI <sub>2</sub> <sup>Note 2,4</sup>	dBm/3.6 MHz	-87.20	-80.17
Antenna Configuration	-	1x2	
Propagation Condition	-	AWGN	
Note 1:	Interference from other UEs and noise sources not specified in the test is assumed to be constant over subcarriers and time and shall be modelled as AWGN of appropriate power for $N_{oc}$ to be fulfilled.		
Note 2:	$\bar{E}_s/I_{ot}$ , PSSCH-RSRP and SL-RSSI levels have been derived from other parameters for information purposes. They are not settable parameters themselves.		
Note 3:	For UE 20 to 29, occupying subchannel #2		
Note 4:	For UE 0 to 19 and 30 to 49, occupying subchannel #0/1/3/4		
Note 5:	The UE is only required to be tested in one of the supported test configurations.		

During T1, the signal from test equipment are configured such that

- The measured PSSCH-RSRP for 10 active NR sidelink UEs(UE 20~UE 29) is above  $SL-Thres-RSRP$ . Then the resources occupied by these 10 active NR sidelink UEs (resources on subchannel #2) are expected to be excluded in the resource selection procedure and,
- The measured PSSCH-RSRP for other 40 active NR sidelink UEs(UE 0~UE 19, UE 30~UE 49) is below the  $SL-Thres-RSRP$ , and the resources occupied by these 40 active NR sidelink UEs (resources on subchannels other than subchannel #2) are expected to be included in the resource selection procedure.

The rate of PSSCH transmissions on the resources on subchannel #2 shall be less than 10% during T1.

During T2, the signal from test equipment are configured such that

- the measured PSSCH-RSRP for the 10 active NR sidelink UEs (UE 20~UE 29) is below  $SL-Thres-RSRP$ . Then the resources occupied by these 10 active NR sidelink UEs (resources on subchannel #2) are expected to be included in the resource selection procedure and,
- the measured PSSCH-RSRP for other 40 active NR sidelink UEs (UE 0~UE 19, UE 30~UE 49) is above  $SL-Thres-RSRP$ , and the resources occupied by these 40 active NR sidelink UEs (subchannels other than subchannel #2) are expected to be excluded in the resource selection procedure.

The rate of PSSCH transmissions on the resources on subchannel #2 shall be larger than 90% during T2.

Figure 9.1.4.1.5-2 shows the two different time durations and the corresponding variation of the power level in the active sidelink UEs to emulate change of candidate resource set.

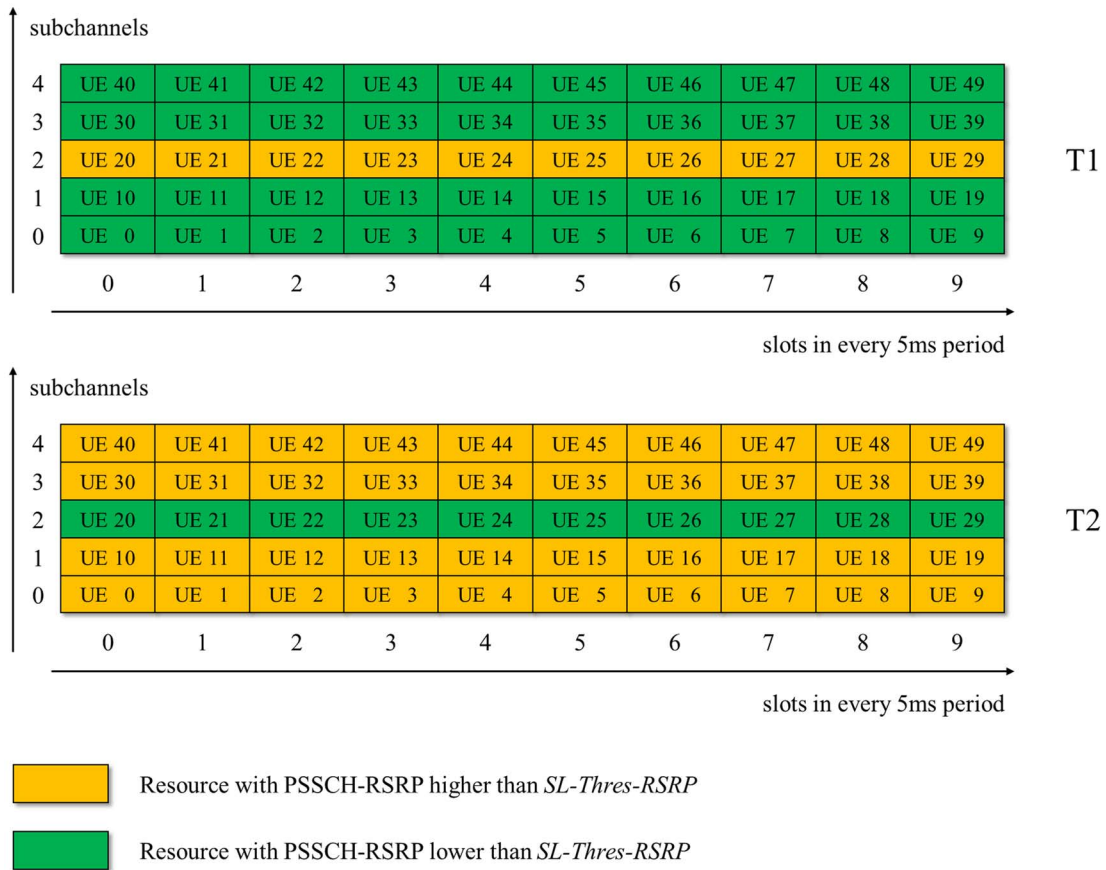

**Figure 9.1.4.1.5-2: Power level variation of active sidelink UEs for NR SA FR1 L1 SL-RSRP measurement for autonomous resource selection/reselection**

9.1.4.2 NR SA FR1 L1 SL-RSRP measurement for resource pre-emption

Editor's notes: Following aspects of this test case are still incomplete:

- Connect diagram is FFS;
- Message contents are still missing
- TT analysis is still missing

9.1.4.2.1 Test purpose

The purpose of this test is to verify the requirements related to autonomous resource pre-emption for NR sidelink UE in mode 2 defined in TS 38.133 [6] clause 12.5.

9.1.4.2.2 Test applicability

This test applies to all types of NR UEs from release 16 onwards and supporting and NR sidelink communication.

9.1.4.2.3 Minimum conformance requirements

The minimum conformance requirements are defined in clause 9.1.4.0.1

The normative reference for this requirement is TS 38.133 [6] clause A.9.1.4.2.

9.1.4.2.4 Test description

9.1.4.2.4.1 Initial conditions

Configure the test equipment and the DUT according to the parameters in Table 9.1.4.2.4.1-1.

**Table 9.1.4.2.4.1-1: Initial conditions for NR SA FR1 L1 SL-RSRP measurement for resource pre-emption**

Parameter	Value		Comment
Test environment	NC		As specified in TS 38.508-1 [14] clause 4.1.
Test frequencies	PC5: As specified in TS 38.508-1 [14] clause 4.3.1.8.		
Channel bandwidth	PC5: As specified by the test configuration selected from Table 9.1.4.2.4.1-2.		
Propagation conditions	AWGN		As specified in Annex C.2.2.
Connection Diagram	TE Part	FFS	As specified in TS 38.508-1 [14] Annex A.
	DUT Part	FFS	
Exceptions to connection diagram	N/A		

1. The parameter settings for the NR sidelink communication are pre-configured according to TS 38.508-1 [14] clause 4.10.1.
2. Message content exceptions are given in clause 9.1.4.2.4.3
3. There are 1 NR-SS-UEs (active NR sidelink UE) specified in this test. active NR sidelink UE is configured according to the generic parameters in Table 9.1.4.2.4.1-2.
4. The GNSS simulator is configured for Scenario #1: static in Geographical area #1, as defined in TS 38.508-1 [14] Table 4.11.2-2.



**Table 9.1.4.2.4.1-2: NR sidelink test parameters for NR SA FR1 L1 SL-RSRP measurement for resource pre-emption**

Parameter		Unit	Value	Comment
NR RF Channel Number			1	HD carrier in Band n47 and n38
Channel Bandwidth (BW <sub>channel</sub> ) <sup>Note 1</sup>		MHz	20 (N <sub>RB,c</sub> = 50) or 40 (N <sub>RB,c</sub> = 100)	
SCS		kHz	30	
V2X sidelink communication pre-configuration			As specified in Annex A.11.2	IE values unless specified otherwise in this test.
sl-TimeResource-r16 included in SL-ResourcePool in SL-ResourcePool in sl-TxPoolSelectedNormal-r16			10000000000000000000	Indicates the time resource of resource pool within <i>sl-Period</i> . (see TS 38.213 [8]) Note that this is for Tx pool.
sl-TimeResource-r16 included in SL-ResourcePool in sl-RxPool-r16			11111111111111111111	Indicates the time resource of resource pool within <i>sl-Period</i> . (see TS 38.213 [8]) Note that this is for Rx pool.
sl-NumSubchannel-r16 included in SL-ResourcePool			1	Indicates the number of subchannels in the corresponding resource pool, which consists of contiguous PRBs only
sl-SubchannelSize-r16 included in SL-ResourcePool			10	Indicates the minimum granularity in frequency domain for the sensing for PSSCH resource selection in the unit of PRB
sl-StartRB-Subchannel-r16 included in SL-ResourcePool			10	Indicates the lowest RB index of the subchannel with the lowest index.
Number of Active Sidelink UEs			1	
SL-Thres-RSRP			12	Corresponding -106 dBm as defined in Section 6.3.8 in TS38.331[13]
Active Sidelink UEs	V2X sidelink Communication preconfiguration		As specified in Annex A.11.2	IE values unless specified otherwise in this test.
	sl-TimeResource-r16 included in SL-ResourcePool		11111111111111111111	Indicates the bitmap of the TX and Rx resource pool, which is defined by repeating the bitmap within a SFN cycle (see TS 38.213[8])
	sl-NumSubchannel-r16 included in SL-ResourcePool		1	Indicates the number of sub-channels for TX resource pool
	sl-StartRB-Subchannel-r16 included in SL-ResourcePool		0	Indicates the lowest RB index of the subchannel with the lowest index.
	sl-SubchannelSize-r16 included in SL-ResourcePool		10	Indicates the minimum granularity in frequency domain for the sensing for PSSCH resource selection in the unit of PRB
Timing offset among Active Sidelink Ues		µs	CP/2	Synchronous
Note 1: The UE is only required to be tested in one of the supported test configurations.				

9.1.4.2.4.2 Test procedure

In this test there is one active sidelink UE. There are no active cells and GNSS is reliable during the whole test. The test system can emulate and send the GNSS signal to the test UE. Both DUT and active sidelink UE select GNSS as synchronization reference source.

The test consists of two successive time periods with time duration of T1, T2 respectively. T1 and T2 should be long enough. For this test, the UE is triggered by the test loop function or the upper layers to transmit for V2X Sidelink Communication.

1. Ensure the UE is in state 4-A with generic procedure parameters Test Mode = *On* according to TS 38.508-1 [14] clause 4.4A.2.
2. The GNSS simulator is triggered to start step 1 of Scenario #1 to simulate a location in the centre of Geographical area #1.
3. Wait at least 20 seconds for the UE to acquire the GNSS signal.
4. The SS sends AT command +CCUTLE to close test loop function and trigger UE to transmit.
5. The SS switches on active sidelink UE and sets parameters according to T1 in Table 9.1.4.2.5-1. T1 starts.
6. The SS keeps monitoring PSCCH sent by the UE. If the SS detecting a PSCCH sent by the UE which reserves multiple PSSCH resources, T1 expires.
7. When T1 expires, the SS shall switch the power setting from T1 to T2 in Table 9.1.4.2.5-1. T2 starts.
8. Denoting the slot occupied by the second PSCCH scheduled by the PSSCH in step 6 as "slot n". The active sidelink UE shall send PSCCH no later than slot n-5 which:
  - indicates higher priority than the PSCCH in step 6, and
  - schedules the same resource in slot n as the PSCCH in step 6.
9. If the UE sends no PSSCH on the resource in slot n, count a success for the test, otherwise count a fail for the test. T2 expires.
10. When T2 expires, the SS sends AT command +CCUTLE to open test loop function and trigger UE to stop transmitting
11. Repeat step 4-10 until the confidence level according to Tables G.2.3-1 in Annex G clause G.2 is achieved

#### 9.1.4.2.4.3 Message contents

FFS

#### 9.1.4.2.5 Test requirement

Active sidelink UE specific test parameters are given in Table 9.1.4.2.5-1.

**Table 9.1.4.2.5-1: SyncRef UE Specific Test Parameters for NR SA FR1 L1 SL-RSRP measurement for resource pre-emption**

Parameter	Unit	Active Sidelink UE	
		T1	T2

NR RF Channel Number	-	1
Channel Bandwidth ( $BW_{channel}$ ) <sup>Note 3</sup>	MHz	20 ( $N_{RB,c} = 50$ ) or 40 ( $N_{RB,c} = 100$ )
PSCCH RMC	-	CC.1A HD
PSSCH RMC	-	CD.1A HD
$Noc$ <sup>Note1</sup>	dBm/30 kHz	-100
PSCCH $\hat{E}_s/Noc$	dB	N/A
PSSCH $\hat{E}_s/Noc$	dB	
PSCCH $\hat{E}_s/lot$ <sup>Note2</sup>	dB	
PSSCH $\hat{E}_s/lot$ <sup>Note2</sup>	dB	
PSSCH-RSRP <sup>Note 2</sup>	dBm/30kHz	
Antenna Configuration	-	1x2
Propagation Condition	-	AWGN
<p>Note 1: Interference from other Ues and noise sources not specified in the test is assumed to be constant over subcarriers and time and shall be modelled as AWGN of appropriate power for <math>Noc</math> to be fulfilled.</p> <p>Note 2: <math>\hat{E}_s/lot</math>, PSSCH-RSRP have been derived from other parameters for information purposes. They are not settable parameters themselves.</p> <p>Note 3: The UE is only required to be tested in one of the supported test configurations.</p>		

During T1, The UE under test keep transmitting PSCCH/PSSCH and reserve resources in slot n for future transmission.

During T2, The UE under test is required to trigger resource reselection and not to transmit on the reserved resource at slot n when the high priority reservation is transmitted by the active sidelink UE before  $n-T_{pre-empt}$ , where,

$$T_{pre-empt} = T_3 + T_{proc,0}$$

- $T_3 = 5$  slots, is given in 38.214 Table 8.1.4-2.
- $T_{proc,0} = 1$  slot, is given in 38.214 Table 8.1.4-1.

Which gives a total of  $T_{pre-empt} = 6$  slots.

The rate of PSSCH transmissions on the resources at slot n shall be less than 10% during repeated tests.

Figure 9.1.4.2.5-2 shows the two different time durations and the corresponding variation of the power level in the active sidelink UE to emulate resource pre-emption.

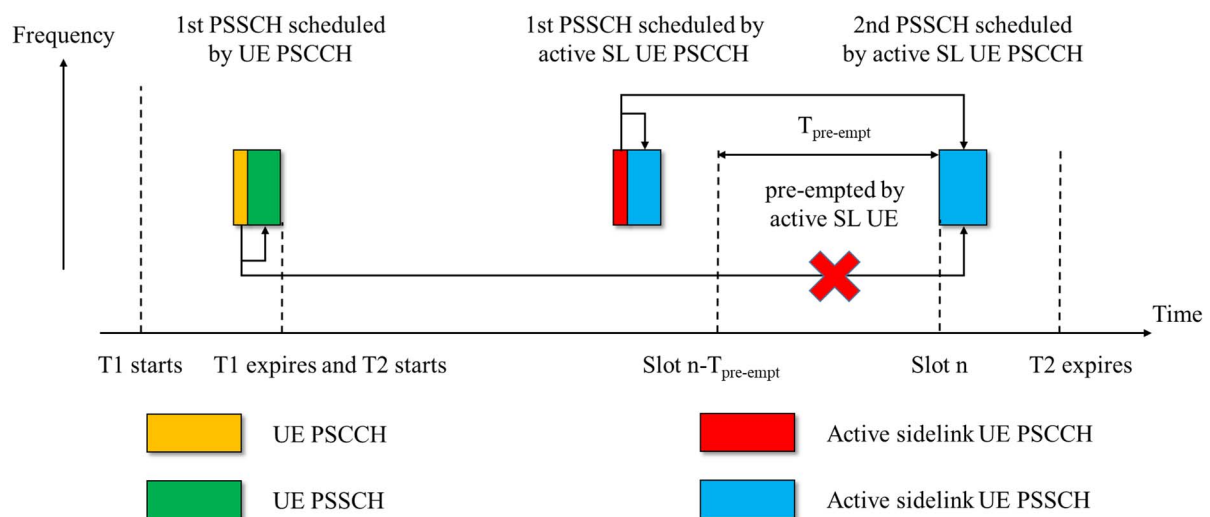

**Figure 9.1.4.2.5-2: Power level variation of active sidelink UE for NR SA FR1 L1 SL-RSRP measurement for resource pre-emption**

### 9.1.4.3 NR SA FR1 L1 SL-RSRP measurement for resource re-evaluation

Editor's notes: Following aspects of this test case are still incomplete:

- Connect diagram is FFS;
- Message contents are still missing
- TT analysis is still missing

#### 9.1.4.3.1 Test purpose

The purpose of this test is to verify the requirements related to autonomous resource re-evaluation for NR sidelink UE in mode 2 defined in TS 38.133 [6] clause 12.5.

#### 9.1.4.3.2 Test applicability

This test applies to all types of NR UEs from release 16 onwards and supporting and NR sidelink communication.

#### 9.1.4.3.3 Minimum conformance requirements

The minimum conformance requirements are defined in clause 9.1.4.0.1

The normative reference for this requirement is TS 38.133 [6] clause A.9.1.4.3.

#### 9.1.4.3.4 Test description

##### 9.1.4.3.4.1 Initial conditions

Configure the test equipment and the DUT according to the parameters in Table 9.1.4.3.4.1-1.

**Table 9.1.4.3.4.1-1: Initial conditions for NR SA FR1 L1 SL-RSRP measurement for resource re-evaluation**

Parameter	Value		Comment
Test environment	NC		As specified in TS 38.508-1 [14] clause 4.1.
Test frequencies	PC5: As specified in TS 38.508-1 [14] clause 4.3.1.8.		
Channel bandwidth	PC5: As specified by the test configuration selected from Table 9.1.4.3.4.1-2.		
Propagation conditions	AWGN		As specified in Annex C.2.2.
Connection Diagram	TE Part	FFS	As specified in TS 38.508-1 [14] Annex A.
	DUT Part	FFS	
Exceptions to connection diagram	N/A		

1. The parameter settings for the NR sidelink communication are pre-configured according to TS 38.508-1 [14] clause 4.10.1.
2. Message content exceptions are given in clause 9.1.4.3.4.3
3. There are 130 NR-SS-UEs (active NR sidelink UE  $i$ ,  $i = 0, 1, \dots, 129$ ) specified in this test. Active NR sidelink UEs are configured according to the generic parameters in Table 9.1.4.3.4.1-2.
4. The GNSS simulator is configured for Scenario #1: static in Geographical area #1, as defined in TS 38.508-1 [14] Table 4.11.2-2.

**Table 9.1.4.3.4.1-2: NR sidelink test parameters for NR SA FR1 L1 SL-RSRP measurement for resource re-evaluation**

Parameter		Unit	Value	Comment
NR RF Channel Number			1	HD carrier in Band n47 and n38
Channel Bandwidth (BW <sub>channel</sub> ) <sup>Note 2</sup>		MHz	20 (N <sub>RB,c</sub> = 50) or 40 (N <sub>RB,c</sub> = 100)	
SCS		kHz	30	
V2X sidelink communication pre-configuration			As specified in Annex A.11.2	IE values unless specified otherwise in this test.
sl-TimeResource-r16 included in SL-ResourcePool			11111111111111111111 11111111111111111111 11111111111111111111 11111111111111111111	Indicates the bitmap of the TX and Rx resource pool, which is defined by repeating the bitmap within a SFN cycle (see TS 38.213[3])
sl-NumSubchannel-r16 included in SL-ResourcePool			1	Indicates the number of sub-channels for TX resource pool
sl-SubchannelSize-r16 included in SL-ResourcePool			10	
sl-StartRB-Subchannel-r16			0	
Number of Active Sidelink UEs			130	Active Sidelink UE i = 0, ..., 129
SL-Thres-RSRP-r16			17	Corresponding -96 dBm as defined in Section 6.3.5 in TS38.331[2]
Active Sidelink UEs(UE i=0-99)	V2X sidelink Communication preconfiguration		As specified in Annex A.11.2	IE values unless specified otherwise in this test.
	sl-TimeResource-r16 included in SL-ResourcePool		{1} <sup>Note1</sup>	Indicates the bitmap of the TX resource pool, which is defined by repeating the bitmap within a SFN cycle (see TS 38.213 [3])
	sl-NumSubchannel-r16 included in SL-ResourcePool		1	Indicates the number of sub-channels for TX resource pool
	sl-SubchannelSize-r16 included in SL-ResourcePool		10	Indicates the size of sub-channels for TX resource pool
	sl-ResourceReservePeriod 2-r16	ms	50	
Active Sidelink UEs(UE i= 100-129)	V2X sidelink Communication preconfiguration		As specified in Annex A.11.2	IE values unless specified otherwise in this test.
	sl-TimeResource-r16 included in SL-ResourcePool		{1} <sup>Note1</sup>	Indicates the bitmap of the TX resource pool, which is defined by repeating the bitmap within a SFN cycle (see TS 38.213 [3])
	sl-NumSubchannel-r16 included in SL-ResourcePool		1	Indicates the number of sub-channels for TX resource pool
	sl-SubchannelSize included in SL-ResourcePool		10	Indicates the size of sub-channels for TX resource pool
	sl-MultiReserveResource-r16		enabled	
	sl-MaxNumPerReserve-r16		n2	
	sl-ResourceReservePeriod 2-r16		0	Unit:ms

Timing offset among Active Sidelink UEs	$\mu$ s	CP/2	Synchronous
T0	s	1	
T1	ms	50	
T2	ms	50	
Note 1: $\{1_i\}$ is a sequence of ninety-nine 0's with one 1 in $(\text{mod}(i,100)+1)$ 'th position.			
Note 2: The UE is only required to be tested in one of the supported test configurations.			

#### 9.1.4.3.4.2 Test procedure

In this test there is 130 active sidelink UEs (denoted as UE  $i$ ,  $i = 0,1,\dots,129$ ). There are no active cells and GNSS is reliable during the whole test. The test system can emulate and send the GNSS signal to the test UE. DUT and all active sidelink UEs select GNSS as synchronization reference source. The first 100 active sidelink UEs are scheduled to send with 50ms periodicity. The last 30 active sidelink UEs are aperiodic service UE with reservation period of 15ms.

The test consists of three successive time periods with time duration of T0, T1 and T2 respectively. For this test, the UE is triggered by the test loop function or the upper layers to transmit for V2X Sidelink Communication.

1. Ensure the UE is in state 4-A with generic procedure parameters Test Mode = *On* according to TS 38.508-1 [14] clause 4.4A.2.
2. The GNSS simulator is triggered to start step 1 of Scenario #1 to simulate a location in the centre of Geographical area #1.
3. Wait at least 20 seconds for the UE to acquire the GNSS signal.
4. The SS switches on UE 0~UE 99, triggers UE 0 ~UE 99 to transmit PSCCH/PSSCH with 50ms periodicity, and set power level of UE 0~UE 99 to ensure their measured PSSCH-RSRP is higher than  $SL-Thres-RSRP$ . T0 starts.
5. When T0 expires, the SS sets parameters according to T1 in Table 9.1.4.3.5-1. T1 starts.
6. The SS sends AT command +CCUTLE to close test loop function and trigger UE to transmit at the end of T1.
7. When T1 expires, the SS shall switch the power setting from T1 to T2 in Table 9.1.4.3.5-1. T2 starts.
8. The SS switches off UE 0~UE 29, switches on UE 101~UE 129, and triggers UE 101~UE 129 to transmit PSCCH/PSSCH aperiodically with a time resource assignment interval of 15ms.
9. During T2, the SS accumulates:
  - $N_{\text{resource, total}}$ : the number of resources occupied by the PSSCH transmissions of the DUT during T2 since the beginning of the test.
  - $N_{\text{resource, 65-84}}$  the number of resources in slot  $(i \bmod 100 = 65,66,\dots,84)$  occupied by the PSSCH transmissions of the DUT during T2 since the beginning of the test.
10. When T2 expires, the SS sends AT command +CCUTLE to open test loop function and trigger UE to stop transmitting
11. The SS switches off all active sidelink UEs.
12. Repeat step 4-11 until  $N_{\text{resource, total}} - N_{\text{resource, 65-84}}$  (corresponds to the "ne" in Annex G.2.3) and  $N_{\text{resource, total}}$  (corresponds to the "ns" in Annex G.2.3) achieve the confidence level according to Tables G.2.3-1.

If the ratio  $N_{\text{resource, 65-84}}/N_{\text{resource, total}}$  is larger than 90%, count a success for the test, otherwise count a fail for the test.

#### 9.1.4.3.4.3 Message contents

FFS

#### 9.1.4.3.5 Test requirement

Active sidelink UE specific test parameters for UE 0~UE 99 and UE 100~UE 129 are given in Table 9.1.4.3.5-1 and Table 9.1.4.3.5-2 respectively.

**Table 9.1.4.3.5-1: SyncRef UE Specific Test Parameters for NR SA FR1 L1 SL-RSRP measurement for resource re-evaluation (UE #0...99)**

Parameter	Unit	Active Sidelink UE i (i = 0, ..., 99)	
		T1	T2
NR RF Channel Number	-	1	
Channel Bandwidth ( $BW_{channel}$ ) <sup>Note 7</sup>	MHz	20 ( $N_{RB,c} = 50$ ) or 40 ( $N_{RB,c} = 100$ )	
PSCCH RMC	-	CC.1A HD	
PSSCH RMC	-	CD.1A HD	
$N_{oc}$ <sup>Note1</sup>	dBm/SCS	-103	
PSSCH1 $\hat{E}_s/N_{oc}$ <sup>Note 3</sup>	dB	22	22
PSSCH2 $\hat{E}_s/N_{oc}$ <sup>Note 4</sup>	dB	2	2
PSSCH3 $\hat{E}_s/N_{oc}$ <sup>Note 5</sup>	dB	12	-infinity
PSSCH4 $\hat{E}_s/N_{oc}$ <sup>Note 6</sup>	dB	12	12
PSSCH1 $\hat{E}_s/lot$ <sup>Note2,3</sup>	dB	22	22
PSSCH2 $\hat{E}_s/lot$ <sup>Note2,4</sup>	dB	2	2
PSSCH3 $\hat{E}_s/lot$ <sup>Note2,5</sup>	dB	12	-infinity
PSSCH4 $\hat{E}_s/lot$ <sup>Note2,6</sup>	dB	12	12
PSSCH -RSRP1 <sup>Note 2, 3</sup>	dBm/SCS	-81	-81
PSSCH -RSRP2 <sup>Note 2, 4</sup>	dBm/SCS	-101	-101
PSSCH -RSRP3 <sup>Note 2, 5</sup>	dBm/SCS	-91	-infinity
PSSCH -RSRP4 <sup>Note 2, 6</sup>	dBm/SCS	-91	-91
Antenna Configuration	-	1x2	
Propagation Condition	-	AWGN	
<p>Note 1: Interference from other UEs and noise sources not specified in the test is assumed to be constant over subcarriers and time and shall be modelled as AWGN of appropriate power for <math>N_{oc}</math> to be fulfilled.</p> <p>Note 2: <math>\hat{E}_s/lot</math>, PSSCH-RSRP levels have been derived from other parameters for information purposes. They are not settable parameters themselves.</p> <p>Note 3: UE #50~64 and UE #85~99 will periodically occupy the subchannels on the slot with “#slot index mod 100” = #50-64 and #85-99.</p> <p>Note 4: UE #30~49 will periodically occupy the subchannels on the slot with “#slot index mod 100” = #30-49.</p> <p>Note 5: UE #0~29 will periodically occupy the subchannels on the slot with “#slot index mod 100” = #0-29.</p> <p>Note 6: UE #65~84 will periodically occupy the subchannels on the slot with “#slot index mod 100” = #65-84.</p> <p>Note 7: The UE is only required to be tested in one of the supported configurations.</p>			

**Table 9.1.4.3.5-2: SyncRef UE Specific Test Parameters for NR SA FR1 L1 SL-RSRP measurement for resource re-evaluation (UE #100...129)**

Parameter	Unit	Active Sidelink UE i (i = 100, ..., 129)	
		T1	T2

NR RF Channel Number	-	1	
Channel Bandwidth ( $BW_{\text{channel}}$ ) <sup>Note 4</sup>	MHz	20 ( $N_{RB,C} = 50$ ) or 40 ( $N_{RB,C} = 100$ )	
PSSCH RMC	-	CC.1A HD	
PSSCH RMC	-	CD.1 A HD	
Noc <sup>Note1</sup>	dBm/SCS	-103	
PSSCH $\hat{E}_s/\text{Noc}$	dB	-infinity	22
PSSCH $\hat{E}_s/\text{lot}$ <sup>Note2</sup>	dB	-infinity	22
PSSCH-RSRP <sup>Note 2, Note 3</sup>	dBm/SCS	-infinity	-81
Antenna Configuration	-	1x2	
Propagation Condition	-	AWGN	
<p>Note 1: Interference from other UEs and noise sources not specified in the test is assumed to be constant over subcarriers and time and shall be modelled as AWGN of appropriate power for Noc to be fulfilled.</p> <p>Note 2: <math>\hat{E}_s/\text{lot}</math>, PSSCH-RSRP levels have been derived from other parameters for information purposes. They are not settable parameters themselves.</p> <p>Note 3: UE #100~129 will occupy the subchannels on the slots with “#slot index mod 100”= #0-29 during T2.</p> <p>Note 4: The UE is only required to be tested in one of the supported configurations.</p>			

During T0, the SS shall configure UE 0~UE 99 to transmit PSSCH/PSSCH every 50ms. The measured PSSCH-RSRP of UE 0 ~UE 99 is above  $SL\text{-Thres-RSRP}$ . Hence the resources occupied by UE 0 ~UE 99 are expected to be excluded in the resource selection procedure.

During T1, the SS shall configure UE 0~UE 99 to transmit PSSCH/PSSCH every 50ms. The measured PSSCH-RSRP of UE 0~UE 29, UE 50 ~ UE 99 is above  $SL\text{-Thres-RSRP}$ , and the measured PSSCH-RSRP of UE 30~UE 49 is below  $SL\text{-Thres-RSRP}$ . Hence the resource occupied by UE 30 ~UE 49 are expected to be included in the resource selection procedure and other resources are expected to be excluded in the resource selection procedure.

At the end of T1, the UE under test shall be triggered to periodically transmit PSSCH/PSSCH.

During T2, the SS switches off UE 0~UE 29. and switches on UE 100~UE 129. UE 100~UE 129 transmit PSSCH/PSSCH with the maximum number of reserved PSSCH/PSSCH resources equalling  $n_2$  and time resource assignment interval as 15ms in the beginning 30 slots. The measured PSSCH-RSRP of UE 100~UE 129 is above  $SL\text{-Thres-RSRP}$ . Hence the resource occupied by UE 100 ~UE 129 are expected to be excluded in the resource re-evaluation procedure. The UE under test is expected to reselect the resources and transmit the PSSCH/PSSCH in the newly re-evaluated resources.

The rate of PSSCH transmissions on the resources which are occupied by UE #65-84 shall be more than 90% during T2.

Figure 9.1.4.3.5-3 shows the two different time durations and the corresponding variation of the power level in the active sidelink UEs to emulate change of candidate resource set.



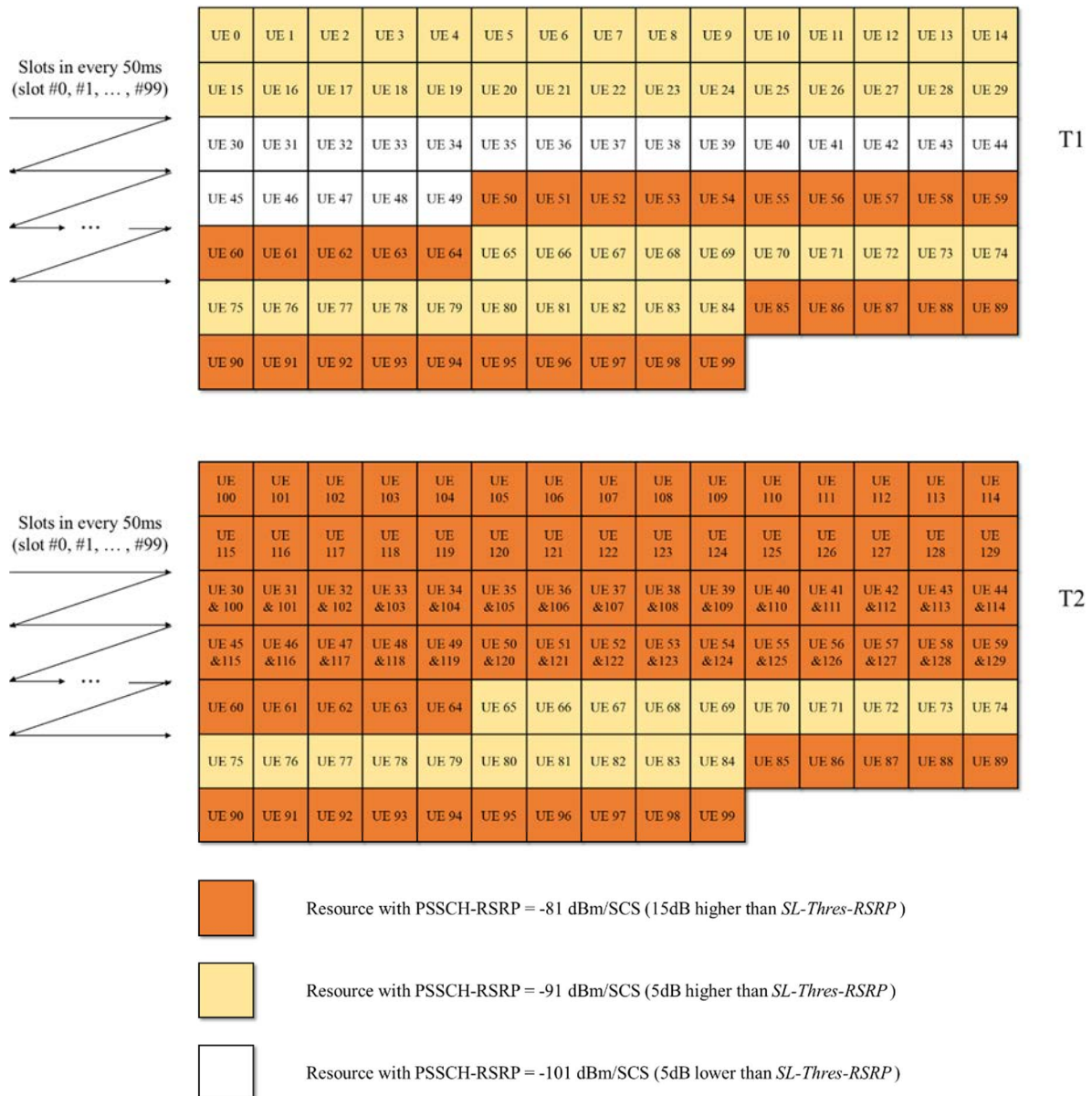

Figure 9.1.4.3.5-3: Power level variation of active sidelink UEs for NR SA FR1 L1 SL-RSRP measurement for resource re-evaluation

## 9.1.5 Congestion control measurement

### 9.1.5.0 Minimum conformance requirements

#### 9.1.5.0.1 Minimum conformance requirements for congestion control measurements

The UE shall be capable of estimating the channel busy ratio for one or more transmission pools indicated by higher layers in TS 38.331[13], based on SL-RSSI measurements provided by the physical layer.

When no sidelink transmissions occur, the UE physical layer shall perform a single-shot SL-RSSI measurement for each sub-channel included in all the slots configured as transmission pools.

The SL-RSSI measurement performed according to this clause shall meet the SL-RSSI measurement accuracy requirements defined in 38.133 [6] clause 10.4.

The UE shall perform channel busy ratio (CBR) measurement based on SL-RSSI measurements as described in TS 38.215 [10].

The intra-frequency SL-RSSI requirements are specified in Table 9.1.5.0.1-1. The requirements apply for measurement period of 1 slot and for any configured measurement bandwidth larger than 10 RBs, provided that:

- All symbols during each RSSI measurement duration are available for RSSI sampling within the same measurement interval.

**Table 9.1.5.0.1-1: Intra-frequency SL-RSSI absolute accuracy**

Accuracy		Conditions				
Normal condition	Extreme condition	NR sidelink operating band groups <sup>Note 2</sup>	Io <sup>Note 1</sup> range			Maximum Io
			Minimum Io			
dB	dB		dBm/SCS <sub>SL</sub>			dBm/BW <sub>Channel</sub>
			SCS <sub>SL</sub> = 15kHz	SCS <sub>SL</sub> = 30kHz	SCS <sub>SL</sub> = 60kHz	
±2.5	±5.5	NR_TDD_FR1_B	-120.5	-117.5	-114.5	-50
		NR_TDD_FR1_J	-116.5	-113.5	-110.5	-50
±4.5	±7.5	Note 3	Note 3	Note 3	Note 3	Note 3

NOTE 1: Io is assumed to have constant EPRE across the bandwidth.  
NOTE 2: NR sidelink operating band groups are as defined in Section 3A.4 for the corresponding NR operating bands.  
NOTE 3: The same bands and the same Io conditions for each band apply for this requirement as for the corresponding highest accuracy requirement.

The normative references for this requirement are TS 38.133 [6] clause 10.4.3 and 12.6.

### 9.1.5.1 NR SA FR1 congestion control measurement for concurrent operation

**Editor's notes: Following aspects of this test case are still incomplete:**

- Connect diagram is FFS;
- Message contents are still missing
- TT analysis is still missing

#### 9.1.5.1.1 Test purpose

The purpose of this test is to verify the congestion control measurement requirements in TS 38.133 [6] clause 12.6. This test will also verify that UE makes correct reporting of an event for CBR measurement.

#### 9.1.5.1.2 Test applicability

This test applies to all types of NR UEs from release 16 onwards and supporting both Uu and sidelink communication.

#### 9.1.5.1.3 Minimum conformance requirements

The minimum conformance requirements are defined in clause 9.1.5.0.1

The normative reference for this requirement is TS 38.133 [6] clause A.9.1.5.

## 9.1.5.1.4 Test description

## 9.1.5.1.4.1 Initial conditions

This test shall be tested using any of the test configurations in Table 9.1.5.1.4.1-1.

**Table 9.1.5.1.4.1-1: Supported test configurations for FR1 NR Cell**

Configuration	Description
9.1.5.1-1	NR Uu: FDD, SSB SCS 15 kHz, data SCS 15 kHz, BW 10 MHz
9.1.5.1-2	NR Uu: TDD, SSB SCS 15 kHz, data SCS 15 kHz, BW 10 MHz
9.1.5.1-3	NR Uu: TDD, SSB SCS 30 kHz, data SCS 30 kHz, BW 40 MHz
Note:	The UE is only required to pass in one of the supported test configurations in FR1

Configure the test equipment and the DUT according to the parameters in Table 9.1.5.1.4.1-2.

**Table 9.1.5.1.4.1-2: Initial conditions for NR SA FR1 congestion control measurement for concurrent operation**

Parameter	Value	Comment
Test environment	NC	As specified in TS 38.508-1 [14] clause 4.1.
Test frequencies	Uu: As specified in Table FFS and TS 38.508-1 [14] clause 4.3.1. PC5: As specified in TS 38.508-1 [14] clause 4.3.1.8.	
Channel bandwidth	Uu: As specified by the test configuration selected from Table 9.1.1.3.4.1-1 PC5: As specified by the test configuration selected from Table 9.1.5.1.4.1-2.	
Propagation conditions	AWGN	As specified in Annex C.2.2.
Connection Diagram	TE Part      FFS DUT Part      FFS	As specified in TS 38.508-1 [14] Annex A.
Exceptions to connection diagram	N/A	

1. The parameter settings for the NR sidelink communication are pre-configured according to TS 38.508-1 [14] clause 4.10.1.
2. Message content exceptions are given in clause 9.1.5.1.4.3
3. There is one NR Uu carrier and one NR Cell (Cell 1) specified in this test. Cell 1 is configured according to Annex C.1.1 and C.1.2.
4. Test parameters for Cell 1 are given in Table 9.1.5.1.5-2.
5. There are 4 NR-SS-UEs (active NR sidelink UE  $i$ ,  $i = 0,1,2,3$ ) specified in this test. Active NR sidelink UEs are configured according to the generic parameters in Table 9.1.5.1.4.1-3.

**Table 9.1.5.1.4.1-3: NR sidelink test parameters for NR SA FR1 congestion control measurement for concurrent operation**

Parameter		Unit	Value	Comment
NR RF Channel Number			1	HD carrier in Band n47 or n38
Channel Bandwidth ( $BW_{\text{channel}}$ ) <sup>Note 2</sup>		MHz	20 ( $N_{RB,c} = 50$ ) or 40 ( $N_{RB,c} = 100$ )	
SCS		kHz	30	
V2X sidelink communication configuration			As specified in Annex A.11.2	IE values unless specified otherwise in this test.
sl-TimeResource-r16 included in SL-ResourcePool			11111111111111111111 11111111111111111111 11111111111111111111 11111111111111111111 11111111111111111111	Indicates the bitmap of the TX and Rx resource pool, which is defined by repeating the bitmap within a SFN cycle (see TS 38.213[8])
sl-NumSubchannel-r16 included in SL-ResourcePool			1	ENUMERATED {n1}
sl-SubchannelSize included in SL-ResourcePool			10	ENUMERATED {n10}
sl-StartRB-Subchannel-r16			0	
<i>threshS-RSSI-CBR</i>			19	Corresponding -74dBm as defined in Section 6.3.8 in TS38.331[13]
Number of Active Sidelink UEs every 50ms			4	Active Sidelink UE $i$ , where $i = 0, 1, 2, 3$
Active Sidelink UEs ( $i = 0, 1, 2, 3$ )	V2X sidelink Communication configuration		As specified in Table A.3.21.2-1 and A.3.21.2-3	IE values unless specified otherwise in this test.
	sl-TimeResource-r16 included in SL-ResourcePool		{1 <sub><math>i</math></sub> } <sup>Note1</sup>	Indicates the bitmap of the TX and Rx resource pool, which is defined by repeating the bitmap within a SFN cycle (see TS 38.213[8])
	sl-NumSubchannel-r16 included in SL-ResourcePool		1	
	sl-SubchannelSize included in SL-ResourcePool		10	
Timing offset between V2X UE and Active Sidelink UEs		$\mu\text{s}$	CP/2	Synchronous
c1-Threshold-r16			2	Corresponding 0.02 as defined in Section 6.3.2 in TS38.331[13]
Hysteresis			0	
Time To Trigger		s	0	
Filter coefficient			0	L3 filtering is not used
T1		s	5	
T2		s	5	
Note 1: {1 <sub><math>i</math></sub> } is a sequence of ninety nine 0's with one 1 in $i+1$ 'th position.				
Note 2: The UE is only required to be tested in one of the channel bandwidths.				

#### 9.1.5.1.4.2 Test procedure

In this test there is 4 active sidelink UEs (denoted as UE  $i$ ,  $i = 0, 1, 2, 3$ ). There are 1 active cells (Cell 1) and no GNSS during the whole test. DUT and all active sidelink UEs select Cell 1 as synchronization reference source. All active sidelink UEs are scheduled to transmit PSCCH/PSSCH with 50ms periodicity.

The test consists of two successive time periods with time duration of T1 and T2 respectively.

1. Ensure the UE is in state 3N-B with generic procedure parameters Test Mode = *On* according to TS 38.508-1 [14] clause 4.4A.2.
2. The SS switches on all active sidelink UEs, triggers all active sidelink UEs to transmit PSCCH/PSSCH with 50ms periodicity.

3. The SS sets parameters according to T1 in Table 9.1.5.1.5-1. T1 starts.
4. The SS sends a *RRCReconfiguration* message with *sl-ConfigDedicatedNR* and *measConfig* to configure event C1 triggered CBR measurement and reporting.
5. The UE sends a *RRCReconfigurationComplete* message.
6. If the UE send no *measurementReport* message before T1 expires, then count a success for the event "entry condition is not satisfied", otherwise count a fail for the event "entry condition is not satisfied".
7. When T1 expires, the SS shall switch the power setting from T1 to T2 in Table 9.1.5.1.5-1. T2 starts.
8. If the UE sends a *measurementReport* message before T2 expires, then count a success for the event "entry condition is satisfied", otherwise count a fail for the event "entry condition is satisfied".
9. The SS sends a *RRCReconfiguration* message with *measConfig* to release configure event C1 triggered CBR measurement and reporting.
10. The UE sends a *RRCReconfigurationComplete* message.
11. Repeat step 3-10 until the confidence level according to Tables FFS is achieved.

#### 9.1.5.1.4.3 Message contents

FFS

#### 9.1.5.1.5 Test requirement

Active sidelink UE specific test parameters for UE 0~UE 4 are given in Table 9.1.5.1.5-1. Cell specific test parameters for Cell 1 are given in Table 9.1.5.1.5-2.

**Table 9.1.5.1.5-1: SyncRef UE Specific Test Parameters for NR SA FR1 congestion control measurement for concurrent operation**

Parameter	Unit	Active Sidelink UE $i$ ( $i = 0, 1, 2, 3$ )	
		T1	T2
NR RF Channel Number		1	
Channel Bandwidth ( $BW_{\text{channel}}$ ) <sup>Note 7</sup>	MHz	20 ( $N_{\text{RB,c}} = 50$ ) or 40 ( $N_{\text{RB,c}} = 100$ )	
PSCCH RMC (defined in A.3.21.3)		CC.1A HD	
PSSCH RMC (defined in A.3.21.3)		CD.1A HD	
$N_{\text{oc}}$ <sup>Note1</sup>	dBm/30 kHz	-103	
$\hat{E}_s/N_{\text{oc}}$	dB	4.35	10.32
PSSCH-RSRP <sup>Note 2</sup>	dBm/30 kHz	-98.65	-92.68
SL-RSSI1 <sup>Note 2,3</sup>	dBm/3.6 MHz	-76.5	-71.5
SL-RSSI2 <sup>Note 2,4</sup>	dBm/3.6 MHz	-82.21	-82.21
$l_{\text{o1}}$ <sup>Note 2,5</sup>	dBm/3.6 MHz	-76.5	-71.5
$l_{\text{o2}}$ <sup>Note 2,6</sup>	dBm/3.6 MHz	-82.21	-82.21
Propagation Condition	-	AWGN	
Note 1:	Interference from other UEs and noise sources not specified in the test is assumed to be constant over subcarriers and time and shall be modelled as AWGN of appropriate power for $N_{\text{oc}}$ to be fulfilled.		
Note 2:	PSSCH $\hat{E}_s/N_{\text{oc}}$ , PSSCH-RSRP, SL-RSSI1, SL-RSSI2, $l_{\text{o1}}$ and $l_{\text{o2}}$ levels have been derived from other parameters for information purposes. They are not settable parameters themselves.		
Note 3:	SL-RSSI1 is the SL-RSSI level measured on the slot# 0 - 3 with "SFN mod 5 = 0".		
Note 4:	SL-RSSI2 is the SL-RSSI level measured on the slot# 4-9 with "SFN mod 5 = 0" and the slot# 0-9 with "SFN mod 5 = 1, ..., 4".		
Note 5:	$l_{\text{o1}}$ is the $l_{\text{o}}$ level measured on the slot# 0 - 3 with "SFN mod 5 = 0".		
Note 6:	$l_{\text{o2}}$ is the $l_{\text{o}}$ level measured on the slot# 4-9 with "SFN mod 5 = 0" and the slot# 0-9 with "SFN mod 5 = 1, ..., 4".		
Note 7:	The UE is only required to be tested in one of the supported test configurations.		

**Table 9.1.5.1.5-2: Cell specific Test Parameters for NR SA FR1 congestion control measurement for concurrent operation**

Parameter		Unit	Cell 1
RF Channel Number			2
Duplex Mode	Config 1		FDD
	Config 2,3		TDD
TDD configuration	Config 1		Not Applicable
	Config 2		TDDConf.1.1
	Config 3		TDDConf.2.1
Channel Bandwidth ( $BW_{channel}$ )	Config 1,2	MHz	10: $N_{RB,c} = 52$
	Config 3		40: $N_{RB,c} = 106$
Initial BWP Configuration			DLBWP.0.1 ULBWP.0.1
Dedicated BWP Configuration			DLBWP.1.1 ULBWP.1.1
DRX Cycle			N/A
PDSCH Reference measurement channel	Config 1		SR.1.1 FDD
	Config 2		SR.1.1 TDD
	Config 3		SR.2.1 TDD
CORESET Reference Channel	Config 1		CR.1.1 FDD
	Config 2		CR.1.1 TDD
	Config 3		CR.2.1 TDD
Dedicated CORESET Reference Channel	Config 1		CCR.1.1 FDD
	Config 2		CCR.1.1 TDD
	Config 3		CCR.2.1 TDD
SSB configuration	Config 1,2		SSB.1 FR1
	Config 3		SSB.2 FR1
SMTTC Configuration			SMTTC.2
OCNG Patterns			OP.1
EPRE ratio of PSS to SSS		dB	0
EPRE ratio of PBCH DMRS to SSS			
EPRE ratio of PBCH to PBCH DMRS			
EPRE ratio of PDCCH DMRS to SSS			
EPRE ratio of PDCCH to PDCCH DMRS			
EPRE ratio of PDSCH DMRS to SSS			
EPRE ratio of PDSCH to PDSCH			
EPRE ratio of OCNG DMRS to SSS(Note 1)			
EPRE ratio of OCNG to OCNG DMRS (Note 1)			
$N_{oc}$ <sup>Note2</sup>	Config 1,2,3		
	Config 1,2		
$N_{oc}$ <sup>Note2</sup>	Config 3	dBm/SCS	-98
			-95
$\hat{E}_s/N_{oc}$		dB	3
SS-RSRP <sup>Note3</sup>	Config 1,2	dBm/SCS	-95
	Config 3		-92
$I_o$ <sup>Note 3</sup>	Config 1,2	dBm/9.36 MHz	-65.2
	Config 3	dBm/38.1 MHz	-59.2
Propagation Condition			AWGN
<p>Note 1: OCNG shall be used such that cell is fully allocated and a constant total transmitted power spectral density is achieved for all OFDM symbols.</p> <p>Note 2: Interference from other cells and noise sources not specified in the test is assumed to be constant over subcarriers and time and shall be modelled as AWGN of appropriate power for <math>N_{oc}</math> to be fulfilled.</p> <p>Note 3: SS-RSRP levels have been derived from other parameters for information purposes. They are not settable parameters themselves.</p>			

During T1, all of active sidelink UEs are configured to transmit PSCCH/PSSCH every 50ms such that the SL-RSSI on the resources occupied by active sidelink UEs is lower than  $threshS-RSSI-CBR$ . Then the measured CBR is lower than  $c1-Threshold$ . No CBR measurement reporting shall be triggered.

During T2, all of active sidelink UEs are configured to transmit PSCCH/PSSCH every 50ms such that the SL-RSSI on the resources occupied by active sidelink UEs is higher than  $threshS-RSSI-CBR$ . Then the measured CBR is higher than  $c1-Threshold$ . CBR measurement reporting shall be triggered.

The rate of correct events observed during repeated tests shall be at least 98%.

### 9.1.5.2 NR SA FR1 congestion control measurement for PC5-only operation

Editor's notes: Following aspects of this test case are still incomplete:

- Connect diagram is FFS;
- Message contents are still missing
- TT analysis is still missing

#### 9.1.5.2.1 Test purpose

The purpose of this test is to verify the congestion control measurement requirements in TS 38.133 [6] clause 12.6.

#### 9.1.5.2.2 Test applicability

This test applies to all types of NR UEs from release 16 onwards and supporting only sidelink communication.

#### 9.1.5.2.3 Minimum conformance requirements

The minimum conformance requirements are defined in clause 9.1.5.0.1

The normative reference for this requirement is TS 38.133 [6] clause A.9.1.5.

#### 9.1.5.2.4 Test description

##### 9.1.5.2.4.1 Initial conditions

Configure the test equipment and the DUT according to the parameters in Table 9.1.5.2.4.1-1.

**Table 9.1.5.2.4.1-1: Initial conditions for NR SA FR1 congestion control measurement for PC5-only operation**

Parameter	Value		Comment
Test environment	NC		As specified in TS 38.508-1 [14] clause 4.1.
Test frequencies	PC5: As specified in TS 38.508-1 [14] clause 4.3.1.8.		
Channel bandwidth	PC5: As specified by the test configuration selected from Table 9.1.5.2.4.1-2.		
Propagation conditions	AWGN		As specified in Annex C.2.2.
Connection Diagram	TE Part	FFS	As specified in TS 38.508-1 [14] Annex A.
	DUT Part	FFS	
Exceptions to connection diagram	N/A		

1. The parameter settings for the NR sidelink communication are pre-configured according to TS 38.508-1 [14] clause 4.10.1.
2. Message content exceptions are given in clause 9.1.5.2.4.3
3. There are 4 NR-SS-UEs (active NR sidelink UE  $i$ ,  $i = 0,1,2,3$ ) specified in this test. Active NR sidelink UEs are configured according to the generic parameters in Table 9.1.5.2.4.1-2.

**Table 9.1.5.2.4.1-2: NR sidelink test parameters for NR SA FR1 congestion control measurement for PC5-only operation**

Parameter		Unit	Value	Comment
NR RF Channel Number			1	HD carrier in Band n47 or n38
Channel Bandwidth ( $BW_{\text{channel}}$ ) <sup>Note 2</sup>		MHz	20 ( $N_{RB,c} = 50$ ) or 40 ( $N_{RB,c} = 100$ )	
SCS		kHz	30	
V2X sidelink communication configuration			As specified in Annex A.11.2	IE values unless specified otherwise in this test.
sl-TimeResource-r16 included in SL-ResourcePool			11111111111111111111 11111111111111111111 11111111111111111111 11111111111111111111 11111111111111111111	Indicates the bitmap of the TX and Rx resource pool, which is defined by repeating the bitmap within a SFN cycle (see TS 38.213[8])
sl-NumSubchannel-r16 included in SL-ResourcePool			1	ENUMERATED {n1}
sl-SubchannelSize included in SL-ResourcePool			10	ENUMERATED {n10}
sl-StartRB-Subchannel-r16			0	
<i>threshS-RSSI-CBR</i>			19	Corresponding -74dBm as defined in Section 6.3.8 in TS38.331[13]
Number of Active Sidelink UEs every 50ms			4	Active Sidelink UE $i$ , where $i = 0, 1, 2, 3$
Active Sidelink UEs ( $i = 0, 1, 2, 3$ )	V2X sidelink Communication configuration		As specified in Table A.3.21.2-1 and A.3.21.2-3	IE values unless specified otherwise in this test.
	sl-TimeResource-r16 included in SL-ResourcePool		{1 <sub><math>i</math></sub> } <sup>Note1</sup>	Indicates the bitmap of the TX and Rx resource pool, which is defined by repeating the bitmap within a SFN cycle (see TS 38.213[8])
	sl-NumSubchannel-r16 included in SL-ResourcePool		1	
	sl-SubchannelSize included in SL-ResourcePool		10	
Timing offset between V2X UE and Active Sidelink UEs		$\mu\text{s}$	CP/2	Synchronous
sl-CBR-RangeConfigList-r16			[2 100]	Two ranges are defined by this list: 0 to 0.02 and 0.02 to 1
sl-CR-Limit-r16			10000 and 10	Corresponding to the two CBR ranges: if $\text{CBR} > 0.02$ , $\text{CR} \leq 0.001$ , otherwise $\text{CR} > 0.001$
sl-Thres-RSRP-r16			12	Configure threshold $< -98.64\text{dBm}/30\text{kHz}$ to ensure not blocking transmission
Hysteresis			0	
Time To Trigger		s	0	
Filter coefficient			0	L3 filtering is not used
T1		s	5	
T2		s	5	
Note 1: {1 <sub><math>i</math></sub> } is a sequence of ninety nine 0's with one 1 in $i+1$ 'th position.				
Note 2: The UE is only required to be tested in one of the channel bandwidths.				

#### 9.1.5.2.4.2 Test procedure

In this test there is 4 active sidelink UEs (denoted as UE  $i$ ,  $i = 0, 1, 2, 3$ ). There are 1 active cells (Cell 1) and no GNSS during the whole test. DUT and all active sidelink UEs select Cell 1 as synchronization reference source. All active sidelink UEs are scheduled to transmit PSCCH/PSSCH with 50ms periodicity.

The test consists of two successive time periods with time duration of T1 and T2 respectively.



1. Ensure the UE is in state 4-A with generic procedure parameters Test Mode = *On* according to TS 38.508-1 [14] clause 4.4A.2.
2. The SS switches on all active sidelink UEs, triggers all active sidelink UEs to transmit PSCCH/PSSCH with 50ms periodicity.
3. The SS sends AT command +CCUTLE to close test loop function and trigger UE to transmit.
3. The SS sets parameters according to T1 in Table 9.1.5.2.5-1. T1 starts.
4. During T1, the SS recodes the number of resources occupied by the PSSCH transmission of the UE under test (denoted as  $N_{\text{resource, low CBR}}$ ) until T1 expires. If  $N_{\text{resource, low CBR}} > 10$ , then count as success for the event "high CR limit", otherwise count a fail for the event "high CR limit".
5. When T1 expires, the SS shall switch the power setting from T1 to T2 in Table 9.1.5.2.5-1. T2 starts.
6. During T2, the SS recodes the number of resources occupied by the PSSCH transmission of the UE under test (denoted as  $N_{\text{resource, high CBR}}$ ) until T2 expires. If  $N_{\text{resource, low CBR}} \leq 10$ , then count as success for the event "low CR limit", otherwise count a fail for the event "low CR limit".
7. When T2 expires, the SS sends AT command +CCUTLE to open test loop function and trigger UE to stop transmitting.
8. Repeat step 3-7 until the confidence level according to Tables FFS is achieved.

9.1.5.2.4.3 Message contents

FFS

9.1.5.2.5 Test requirement

Active sidelink UE specific test parameters for UE 0~UE 4 are given in Table 9.1.5.2.5-1.

**Table 9.1.5.2.5-1: SyncRef UE Specific Test Parameters for NR SA FR1 congestion control measurement for PC5-only operation**

Parameter	Unit	Active Sidelink UE $i$ ( $i = 0, 1, 2, 3$ )	
		T1	T2
NR RF Channel Number		1	
Channel Bandwidth ( $BW_{\text{channel}}$ ) <sup>Note 7</sup>	MHz	20 ( $N_{\text{RB,c}} = 50$ ) or 40 ( $N_{\text{RB,c}} = 100$ )	
PSCCH RMC (defined in A.3.21.3)		CC.1A HD	
PSSCH RMC (defined in A.3.21.3)		CD.1A HD	
$N_{\text{oc}}$ <sup>Note 1</sup>	dBm/30 kHz	-103	
$\hat{E}_s/N_{\text{oc}}$	dB	4.35	10.32
PSSCH-RSRP <sup>Note 2</sup>	dBm/30 kHz	-98.65	-92.68
SL-RSSI1 <sup>Note 2,3</sup>	dBm/3.6 MHz	-76.5	-71.5
SL-RSSI2 <sup>Note 2,4</sup>	dBm/3.6 MHz	-82.21	-82.21
$Io_1$ <sup>Note 2,5</sup>	dBm/3.6 MHz	-76.5	-71.5
$Io_2$ <sup>Note 2,6</sup>	dBm/3.6 MHz	-82.21	-82.21
Propagation Condition	-	AWGN	
Note 1: Interference from other UEs and noise sources not specified in the test is assumed to be constant over subcarriers and time and shall be modelled as AWGN of appropriate power for $N_{\text{oc}}$ to be fulfilled. Note 2: PSSCH $E_s/N_{\text{oc}}$ , PSSCH-RSRP, SL-RSSI1, SL-RSSI2, $Io_1$ and $Io_2$ levels have been derived from other parameters for information purposes. They are not settable parameters themselves. Note 3: SL-RSSI1 is the SL-RSSI level measured on the slot# 0 - 3 with "SFN mod 5 = 0". Note 4: SL-RSSI2 is the SL-RSSI level measured on the slot# 4-9 with "SFN mod 5 = 0" and the slot# 0-9 with "SFN mod 5 = 1, ..., 4". Note 5: $Io_1$ is the $Io$ level measured on the slot# 0 - 3 with "SFN mod 5 = 0". Note 6: $Io_2$ is the $Io$ level measured on the slot# 4-9 with "SFN mod 5 = 0" and the slot# 0-9 with "SFN mod 5 = 1, ..., 4". Note 7: The UE is only required to be tested in one of the supported test configurations.			

During T1, all of active sidelink UEs are configured to transmit PSCCH/PSSCH every 50ms such that the SL-RSSI on the resources occupied by active sidelink UEs is lower than *threshS-RSSI-CBR*. Then the measured CBR is lower than 2%. The UE needs to ensure its channel occupancy ratio higher than 1% in T1.

During T2, all of active sidelink UEs are configured to transmit PSCCH/PSSCH every 50ms such that the SL-RSSI on the resources occupied by active sidelink UEs is higher than *threshS-RSSI-CBR*. Then the measured CBR is higher than 2%. The UE needs to ensure its channel occupancy ratio lower than 1% in T2.

The rate of correct events observed during repeated tests shall be at least 98%.

## 9.1.6 Congestion control measurement

### 9.1.6.0 Minimum conformance requirements

#### 9.1.6.0.1 Minimum conformance requirements for interruption to WAN due to NR sidelink communication

This clause contains the requirements related to the interruptions on the PCell/serving cell due to NR sidelink communication.

A UE capable of NR sidelink communication may indicate its interest (initiation or termination) in NR sidelink communication to the connected gNB using IE *SidelinkUEInformationNR* in TS 38.331 [13].

The UE is allowed an interruption of up to the duration shown in Table 9.1.6.0.1-1 on the PCell/serving cell during the RRC reconfiguration procedure that includes the V2X sidelink communication configuration message *SL-ConfigDedicatedNR* in TS 38.331 [13] (setup and release). This interruption is for both uplink and downlink of the PCell/serving cell.

**Table 9.1.6.0.1-1: Interruption length at V2X RRC reconfiguration**

$\mu$	NR Slot length (ms)	Interruption length (number of slots)
0	1	2
1	0.5	3
2	0.25	5
3	0.125	9

The normative references for this requirement are TS 38.133 [6] clause 12.7.

#### 9.1.6.1 NR SA FR1 interruption to WAN due to NR sidelink communication

**Editor's notes: Following aspects of this test case are still incomplete:**

- **Connect diagram is FFS;**
- **Message contents are still missing**
- **TT analysis is still missing**

##### 9.1.6.1.1 Test purpose

The purpose of this test is to verify the requirements related to interruptions due to NR sidelink communication as specified in TS 38.133 [6] clause 12.7.1, when UE is out of coverage on the NR sidelink carrier and is associated with a serving cell on a non-sidelink carrier.

##### 9.1.6.1.2 Test applicability

This test applies to all types of NR UEs from release 16 onwards and supporting NR Uu and sidelink communication.

### 9.1.6.1.3 Minimum conformance requirements

The minimum conformance requirements are defined in clause 9.1.6.0.1

The normative reference for this requirement is TS 38.133 [6] clause A.9.1.6.1.

### 9.1.6.1.4 Test description

#### 9.1.6.1.4.1 Initial conditions

This test shall be tested using any of the test configurations in Table 9.1.6.1.4.1-1.

**Table 9.1.6.1.4.1-1: Supported test configurations for FR1 NR Cell**

Configuration	Description
9.1.6.1-1	NR Uu: FDD, SSB SCS 15 kHz, data SCS 15 kHz, BW 10 MHz
9.1.6.1-2	NR Uu: TDD, SSB SCS 15 kHz, data SCS 15 kHz, BW 10 MHz
9.1.6.1-3	NR Uu: TDD, SSB SCS 30 kHz, data SCS 30 kHz, BW 40 MHz
Note:	The UE is only required to pass in one of the supported test configurations in FR1

Configure the test equipment and the DUT according to the parameters in Table 9.1.6.1.4.1-2.

**Table 9.1.6.1.4.1-2: Initial conditions for NR SA FR1 interruption to WAN due to NR sidelink communication**

Parameter	Value	Comment
Test environment	NC	As specified in TS 38.508-1 [14] clause 4.1.
Test frequencies	Uu: As specified in Table FFS and TS 38.508-1 [14] clause 4.3.1. PC5: As specified in TS 38.508-1 [14] clause 4.3.1.8.	
Channel bandwidth	Uu: As specified by the test configuration selected from Table 9.1.6.1.4.1-1 PC5: As specified by the test configuration selected from Table 9.1.6.1.4.1-2.	
Propagation conditions	AWGN	As specified in Annex C.2.2.
Connection Diagram	TE Part	FFS
	DUT Part	FFS
Exceptions to connection diagram	N/A	

1. The parameter settings for the NR sidelink communication are pre-configured according to TS 38.508-1 [14] clause 4.10.1.
2. Message content exceptions are defined in clause 9.1.6.1.4.3
3. There is one NR Uu carrier and one NR Cell (Cell 1) specified in this test. Cell 1 is configured according to Annex C.1.1 and C.1.2.
4. Test parameters for Cell 1 are given in Table 9.1.6.1.4.1-3.
5. There are 8 active sidelink UEs (UE  $i$ ,  $i=0,1,\dots,7$ ) in this test. Test parameters for active sidelink UEs are given in Table 9.1.6.1.4.1-3 and Table 9.1.6.1.4.1-4.

**Table 9.1.6.1.4.1-3: General test parameters for NR SA FR1 interruption to WAN due to NR sidelink communication**

Parameter	Unit	Value	Comment
RF Channel Number	-	1, 2	RF channel 1 is non-sidelink carrier RF channel 2 is sidelink carrier
SCS	kHz	30	
Active cell	-	Cell 1	PCell on RF channel number 1
CP length of Cell 1	-	Normal	
T1	s	5.12	
T2	s	Up to receiving RRC reconfiguration setup complete from the UE, or up to 2 second if UE does not transmit <i>SidelinkUEInformationNR</i> during this period.	
T3	s	10	

**Table 9.1.6.1.4.1-4: Sidelink test parameters for NR SA FR1 interruption to WAN due to NR sidelink communication**

Parameter	Unit	Value	Comment	
RF Channel Number	-	2	HD carrier in Band n47 or n38	
Channel Bandwidth (BW <sub>channel</sub> ) <sup>Note 1</sup>	MHz	20 (N <sub>RB,c</sub> = 50) or 40 (N <sub>RB,c</sub> = 100)		
Sidelink Communication configuration	-	As specified in Annex A.11.2	IE values unless specified otherwise in this test.	
Number of Active Sidelink UEs	-	8	Active Sidelink UE i = 0, ..., 7	
Active Sidelink UEs (UE i = 0, ..., 7)	Sidelink Communication configuration	-	As specified in Annex A.11.2	IE values unless specified otherwise in this test.
	PSCCH Reference Measurement Channel	-	CC.1A HD	As specified in Table A.11.2.2-1
	PSSCH Reference Measurement Channel	-	CD.1A HD	As specified in Table A.11.2.2-2
	sl-NumSubchannel-r16 included in SL-ResourcePool	-	1	Indicates the number of sub-channels for TX resource pool
	sl-StartRB-Subchannel-r16 included in SL-ResourcePool	-	i	Indicates the lowest RB index of the subchannel with the lowest index for active Sidelink UE i = 0, ..., 7.
PSBCH-RSRP	dBm/30kHz	-95		

Note 1: The UE is only required to be tested in one of the supported test configurations.

#### 9.1.6.1.4.2 Test procedure

In this test there is one active cell (Cell 1) and 8 active sidelink UEs transmitting sidelink communication. The UE under test and all active sidelink UEs select the active cell as synchronization source.

The test consists of three successive time periods, with time duration of T1, T2 and T3 respectively.

For this test, the UE is triggered by the test loop function or the upper layers to monitor NR sidelink communication.

1. Ensure the UE is in state 1N-B with generic procedure parameters Test Mode = *On* according to TS 38.508-1 [14] clause 4.4A.2.
2. The SS switches on all active sidelink UEs. Active sidelink UEs are configured to transmit PSCCH/PSSCH according to the parameters specified in Table 9.1.6.1.4.1-4.

3. The SS sends AT command +CCUTLE to close test loop function and trigger UE to receive.
4. The SS sets parameters according to T1 in Table 9.1.6.1.5-1. T1 starts.
5. When T1 expires, the SS sends a paging message including matched *ng-5G-S-TMSI*.
6. The UE sends an *RRCSetupRequest* message.
7. The SS sends an *RRCSetup* message.
8. The UE sends an *RRCSetupComplete* message.
9. The SS shall switch the power setting from T1 to T2 in Table 9.1.6.1.5-1 upon receiving the *RRCSetupComplete* message sent by the UE, T2 starts.
10. If the UE sends a *SidelinkUEInformationNR* message within 2 seconds from the beginning of T2. continues with step 11, otherwise skips to step XX.
11. The SS sends an *RRCReconfiguration* message with *SL-ConfigDedicatedNR* to provide sidelink communication configuration to the UE.
12. The UE sends a *RRCReconfigurationComplete* message.
13. T2 expires. The SS shall switch the power setting from T2 to T3 in Table 9.1.6.1.5-1. T3 starts.
14. During T3, The SS continuously schedules the UE to perform DL reception in every DL slots and monitoring corresponding ACK/NACK feedback in UL slots.
15. If the SS observes on missing ACK/NACKs until T3 expiring, then count a success for the test, otherwise count a fail for the test.
16. When T3 expires, the SS sends AT command +CCUTLE to open test loop function.

9.1.6.1.4.3 Message contents

FFS

9.1.6.1.5 Test requirement

Cell-specific test parameters for Cell 1 are given in Table 9.1.6.1.5-1.

**Table 9.1.6.1.5-1: Cell specific test parameters for NR SA FR1 interruption to WAN due to NR sidelink communication**

Parameter		Unit	Cell 1		
			T1	T2	T3
RF Channel Number			1		
UE RRC state			IDLE	CONNECTED	
Duplex Mode	Config 1		FDD		
	Config 2,3		TDD		
TDD configuration	Config 1		Not Applicable		
	Config 2		TDDConf.1.1		
	Config 3		TDDConf.2.1		
Channel Bandwidth ( $BW_{channel}$ )	Config 1,2	MHz	10: $N_{RB,c} = 52$		
	Config 3		40: $N_{RB,c} = 106$		
Initial BWP Configuration			DLBWP.0.1 ULBWP.0.1		
Dedicated BWP Configuration			DLBWP.1.1 ULBWP.1.1		
DRX Cycle			N/A		
PDSCH Reference measurement channel	Config 1		N/A	None	SR.1.1 FDD
	Config 2		N/A	None	SR.1.1 TDD
	Config 3		N/A	None	SR.2.1 TDD
CORESET Reference Channel	Config 1		CR.1.1 FDD		
	Config 2		CR.1.1 TDD		
	Config 3		CR.2.1 TDD		

Dedicated CORESET Reference Channel	Config 1		CCR.1.1 FDD
	Config 2		CCR.1.1 TDD
	Config 3		CCR.2.1 TDD
SSB configuration	Config 1,2		SSB.1 FR1
	Config 3		SSB.2 FR1
SMTc Configuration			SMTc.2
OCNG Patterns			OP.1
EPRE ratio of PSS to SSS		dB	0
EPRE ratio of PBCH DMRS to SSS			
EPRE ratio of PBCH to PBCH DMRS			
EPRE ratio of PDCCH DMRS to SSS			
EPRE ratio of PDCCH to PDCCH DMRS			
EPRE ratio of PDSCH DMRS to SSS			
EPRE ratio of PDSCH to PDSCH			
EPRE ratio of OCNG DMRS to SSS(Note 1)			
EPRE ratio of OCNG to OCNG DMRS (Note 1)			
Noc <sup>Note2</sup>	Config 1,2,3	dBm/15 kHz	-98
Noc <sup>Note2</sup>	Config 1,2	dBm/SCS	-98
	Config 3		-95
Es/Noc		dB	3
SS-RSRP <sup>Note3</sup>	Config 1,2	dBm/SCS	-95
	Config 3		-92
Io <sup>Note 3</sup>	Config 1,2	dBm/9.36 MHz	-65.3
	Config 3	dBm/38.1 MHz	-59.2
Antenna Configuration			1x2
Propagation Condition			AWGN
<p>Note 1: OCNG shall be used such that cell is fully allocated and a constant total transmitted power spectral density is achieved for all OFDM symbols.</p> <p>Note 2: Interference from other cells and noise sources not specified in the test is assumed to be constant over subcarriers and time and shall be modelled as AWGN of appropriate power for Noc to be fulfilled.</p> <p>Note 3: SS-RSRP levels have been derived from other parameters for information purposes. They are not settable parameters themselves.</p>			

During T1, the UE is in RRC\_IDLE and monitoring the sidelink communication transmission from other active Sidelink UEs on the sidelink communication resources.

During T2, the test system establishes a RRC connection with the UE. No PDSCH is scheduled for UE, and the UE is expected to transmit *SidelinkUEInformationNR* indicating *sl-RxInterestedFreqList*. On reception of *SidelinkUEInformationNR*, the test system shall send *RRCReconfiguration* message to the UE and wait for the UE to respond with *RRCReconfigurationComplete* message before transitioning to T3. If the UE does not transmit *SidelinkUEInformationNR* for up to 2 second, the test system shall transition to T3.

During T3, the UE is continuously scheduled with PDSCH on PCell downlink. The test system will count the missed ACK/NACKs during T3 to verify the allowed interruptions during NR sidelink communication. 100% of all expected ACK/NACKs shall be transmitted by the UE.

## Annex A (normative): RRM test configurations

### A.1 Reference measurement channels

#### A.1.0 General

This clause contains the Reference Measurement Channels (RMC) to be used for the RRM test scenarios in Clauses 4 to 7 of this document.

#### A.1.1 PDSCH

##### A.1.1.1 FDD

**Table A.1.1.1-1: PDSCH Reference Measurement Channels for SCS = 15 kHz for FDD**

Parameter	Unit	Value
Reference channel		SR.1.1 FDD
Channel bandwidth	MHz	Defined in test case
Number of transmitter antennas		1
Allocated resource blocks for PDSCH <sup>Note 1</sup>		24
Allocated slots per Radio Frame		10
Radio frame containing SSB	slots	Note 5
Radio frame not containing SSB	slots	10
MCS index		4
Modulation		QPSK
Target Coding Rate		1/3
Number of control symbols		2
PDSCH mapping type		Type A
Information Bit Payload		
For slots with RMSI <sup>Note 2</sup>	Bits	1608
For slots without RMSI	Bits	1864
Number of Code Blocks per slot		1
Binary Channel Bits Per slot		
For slots with RMSI <sup>Note 2, 4</sup>	Bits	5184
For slots without RMSI <sup>Note 6</sup>	Bits	6048
NOTE 1: Allocated outside the SMTC duration in time and in resource blocks which do not overlap with the resource blocks allocated for SS/PBCH block.		
NOTE 2: PDSCH is scheduled on the slots with RMSI.		
NOTE 3: If necessary, the information bit payload size can be adjusted to facilitate the test implementation. The payload sizes are defined in 3GPP TS 38.213 [8].		
NOTE 4: Derived based on the PDSCH DMRS assumption: dmrs-TypeA-Position=2, dmrs-Type=1, dmrs-AdditionalPositions=2, maxLength=1, Antenna port index: 1000, and Number of PDSCH DMRS CDM group(s) without data: 2.		
NOTE 5: PDSCH is not scheduled in slots containing SSB according to the SSB configuration used in the test. SSB configurations are defined in clause A.3.		
NOTE 6: Derived based on the PDSCH DMRS assumption: dmrs-TypeA-Position=2, dmrs-Type=1, dmrs-AdditionalPositions=2, maxLength=1, Antenna port index: 1000, and Number of PDSCH DMRS CDM group(s) without data: 1.		
NOTE 7: When DRX is configured, PDCCH can be scheduled both for downlink assignment and/or UL grant only during ([10ms] – drx-InactivityTimer) from timingwhen <i>drx-onDurationTimer</i> starts, unless otherwise specified in the test case.		

## A.1.1.2 TDD

Table A.1.1.2-1: PDSCH Reference Measurement Channels for SCS = 15 kHz for TDD

Parameter	Unit	Value	Value
Reference channel		SR.1.1 TDD	SR.1.2 TDD
Channel bandwidth	MHz	Defined in test case	Defined in test case
Number of transmitter antennas		1	1
Allocated resource blocks for PDSCH <sup>Note 1</sup>		24	24
Allocated slots per Radio Frame			
Radio frame containing SSB	slots	Note 5	Note 5
Radio frame not containing SSB	slots	4	6
MCS table		64QAM	64QAM
MCS index		4	4
Modulation		QPSK	QPSK
Target Coding Rate		1/3	1/3
Number of control symbols		2	2
PDSCH mapping type		Type A	Type A
Information Bit Payload			
For slots with RMSI <sup>Note 2</sup>	Bits	1608	1608
For slots without RMSI	Bits	1864	1864
For special slots	Bits	N/A	1128
Number of Code Blocks per slot		1	
Binary Channel Bits Per slot			
For slots with RMSI <sup>Note 2, 4</sup>	Bits	5184	5184
For slots without RMSI <sup>Note 6</sup>	Bits	6048	6048
For special slots <sup>Note 6</sup>	Bits	-	3744
NOTE 1: Allocated outside the SMTC duration in time and in resource blocks which do not overlap with the resource blocks allocated for SS/PBCH block.			
NOTE 2: PDSCH is scheduled on the slots with RMSI.			
NOTE 3: If necessary, the information bit payload size can be adjusted to facilitate the test implementation. The payload sizes are defined in 3GPP TS 38.213 [8].			
NOTE 4: Derived based on the PDSCH DMRS assumption: dmrs-TypeA-Position=2, dmrs-Type=1, dmrs-AdditionalPositions=2, maxLength=1, Antenna port index: 1000, and Number of PDSCH DMRS CDM group(s) without data: 2.			
NOTE 5: PDSCH is not scheduled in slots containing SSB according to the SSB configuration used in the test. SSB configurations are defined in clause A.3.10.			
NOTE 6: Derived based on the PDSCH DMRS assumption: dmrs-TypeA-Position=2, dmrs-Type=1, dmrs-AdditionalPositions=2, maxLength=1, Antenna port index: 1000, and Number of PDSCH DMRS CDM group(s) without data: 1.			
NOTE 7: When DRX is configured, PDCCH can be scheduled both for downlink assignment and/or UL grant only during ([10]ms – drx-InactivityTimer) from timing when <i>drx-onDurationTimer</i> starts, unless otherwise specified in the test case.			



Table A.1.1.2-2: PDSCH Reference Measurement Channels for SCS = 30 kHz for TDD

Parameter	Unit	Value
Reference channel		SR.2.1 TDD
Channel bandwidth	MHz	Defined in test case
Number of transmitter antennas		1
Allocated resource blocks for PDSCH <sup>Note 1</sup>		24
Allocated slots per Radio Frame		
Radio frame containing SSB	slots	Note 5
Radio frame not containing SSB	slots	10
MCS table		64QAM
MCS index		4
Modulation		QPSK
Target Coding Rate		1/3
Number of control symbols		2
PDSCH mapping type		Type A
Information Bit Payload		
For slots with RMSI <sup>Note 2</sup>	Bits	1608
For slots without RMSI	Bits	1864
Number of Code Blocks per slot		1
Binary Channel Bits Per slot		
For slots with RMSI <sup>Note 2, 4</sup>	Bits	5184
For slots without RMSI <sup>Note 6</sup>	Bits	6048
NOTE 1: Allocated outside the SMTC duration in time and in resource blocks which do not overlap with the resource blocks allocated for SS/PBCH block.		
NOTE 2: PDSCH is scheduled on the slots with RMSI.		
NOTE 3: If necessary, the information bit payload size can be adjusted to facilitate the test implementation. The payload sizes are defined in 3GPP TS 38.213 [8].		
NOTE 4: Derived based on the PDSCH DMRS assumption: dmrs-TypeA-Position=2, dmrs-Type=1, dmrs-AdditionalPositions=2, maxLength=1, Antenna port index: 1000, and Number of PDSCH DMRS CDM group(s) without data: 2.		
NOTE 5: PDSCH is not scheduled in slots containing SSB according to the SSB configuration used in the test. SSB configurations are defined in clause A.3.10.		
NOTE 6: Derived based on the PDSCH DMRS assumption: dmrs-TypeA-Position=2, dmrs-Type=1, dmrs-AdditionalPositions=2, maxLength=1, Antenna port index: 1000, and Number of PDSCH DMRS CDM group(s) without data: 1.		
NOTE 7: When DRX is configured, PDCCH can be scheduled both for downlink assignment and/or UL grant only during ([10]ms – drxInactivityTimer) from timing when <i>drx-onDurationTimer</i> starts, unless otherwise specified in the test case.		

Table A.1.1.2-3: PDSCH Reference Measurement Channels for SCS = 120 kHz for TDD

Parameter	Unit	Value		
		SR.3.1 TDD	SR.3.2 TDD	SR.3.3 TDD
Reference channel		SR.3.1 TDD	SR.3.2 TDD	SR.3.3 TDD
Channel bandwidth	MHz	100	100	100
Number of transmitter antennas		1	1	1
Allocated resource blocks for PDSCH		24 <sup>Note 1</sup>	24 <sup>Note 7</sup>	48 <sup>Note 7</sup>
Allocated slots per Radio Frame				
Radio frame containing SSB	slots	Note 5	Note 8	Note 5
Radio frame not containing SSB	slots	48	48	48
MCS table		64QAM	64QAM	64QAM
MCS index		4	4	4
Modulation		QPSK	QPSK	QPSK
Target Coding Rate		1/3	1/3	1/3
Number of control symbols		2	2	2
PDSCH mapping type		Type A	Type A	Type A
Information Bit Payload				
For slots with RMSI	Bits	1608	1608	3104
For slots without RMSI	Bits	1864	1864	3624
Number of Code Blocks per slot		1	1	1
Binary Channel Bits Per slot				
For slots with RMSI <sup>Note 4</sup>	Bits	5184	5184	10368
For slots without RMSI <sup>Note 6</sup>	Bits	6048	6048	12096
NOTE 1: Allocated in resource blocks which do not overlap with the resource blocks allocated for SS/PBCH block.				
NOTE 2: Void				
NOTE 3: If necessary, the information bit payload size can be adjusted to facilitate the test implementation. The payload sizes are defined in 3GPP TS 38.213 [8].				
NOTE 4: Derived based on the PDSCH DMRS assumption: dmrs-TypeA-Position=2, dmrs-Type=1, dmrs-AdditionalPositions=2, maxLength=1, Antenna port index: 1000, and Number of PDSCH DMRS CDM group(s) without data: 2.				
NOTE 5: PDSCH is not scheduled in slots containing SSB according to the SSB configuration used in the test. SSB configurations are defined in clause A.3.10.				
NOTE 6: Derived based on the PDSCH DMRS assumption: dmrs-TypeA-Position=2, dmrs-Type=1, dmrs-AdditionalPositions=2, maxLength=1, Antenna port index: 1000, and Number of PDSCH DMRS CDM group(s) without data: 1.				
NOTE 7: Allocated in the same resource blocks as the CORESET.				
NOTE 8: When DRX is configured, PDSCH is scheduled only while <i>drx-onDurationTimer</i> is running, unless otherwise specified in the test case.				

## A.1.2 CORESET for RMSI scheduling

### A.1.2.1 FDD

**Table A.1.2.1-1: RMSI CORESET Reference Measurement Channels for SCS = 15 kHz for FDD**

Parameter	Unit	Value
Reference channel		CR.1.1 FDD
Channel bandwidth	MHz	Defined in test case
Subcarrier spacing for RMSI CORESET	kHz	15
Allocated resource blocks for RMSI CORESET <sup>Note 7</sup>		24
Subcarrier spacing for SSB	kHz	15
SSB and RMSI CORESET multiplexing configuration		Pattern 1
Offset between SSB and RMSI CORESET <sup>Note 3, 7</sup>	RB	0 (Note 8)
Configuration of PDCCH monitoring occasions for RMSI CORESET <sup>Note 4</sup>		Index 4
Number of transmitter antennas		1
Duration of RMSI CORESET <sup>Note 7</sup>	symbols	2
DCI Format <sup>Note 1</sup>		Note 2
Aggregation level	CCE	8
DMRS precoder granularity		6
REG bundle size		6
Mapping from REG to CCE		Distributed
Cell ID		Note 5
Payload (without CRC)	Bits	Note 6
<p>NOTE 1: DCI formats are defined in TS 38.212 [31].</p> <p>NOTE 2: DCI format shall depend upon the test configuration.</p> <p>NOTE 3: The offset is defined with respect to the subcarrier spacing of the CORESET from the smallest RB index of RMSI CORESET to the smallest RB index of the common RB overlapping with the first RB of the SS/PBCH block.</p> <p>NOTE 4: The configuration of PDCCH monitoring occasions for RMSI CORESET is defined in Table 13-11 in TS 38.213 [8].</p> <p>NOTE 5: Cell ID shall depend upon the test configuration.</p> <p>NOTE 6: Payload size shall depend upon the test configuration.</p> <p>NOTE 7: The configuration of set of resource blocks and slot symbols of control resource set for Type0-PDCCH search space corresponds to index 0 in Table 13-1 in TS 38.213 [8].</p> <p>NOTE 8: Other values can be used to align with GSCN as long as SSB does not overlap the RMC</p>		

## A.1.2.2 TDD

Table A.1.2.2-1: RMSI CORESET Reference Measurement Channels for SCS = 15 kHz for TDD

Parameter	Unit	Value
Reference channel		CR.1.1 TDD
Channel bandwidth	MHz	Defined in test case
Subcarrier spacing for RMSI CORESET	kHz	15
Allocated resource blocks for RMSI CORESET <sup>Note 7</sup>		24
Index of transmitted SSB within an SS-Burst		#0
SSB and RMSI CORESET multiplexing configuration		Pattern 1
Offset between SSB and RMSI CORESET <sup>Note 3, 7</sup>	RB	0 (Note 8)
Configuration of PDCCH monitoring occasions for RMSI CORESET <sup>Note 4</sup>		Index 4
Number of transmitter antennas		1
Duration of RMSI CORESET <sup>Note 7</sup>	symbols	2
DCI Format <sup>Note 1</sup>		Note 2
Aggregation level	CCE	8
DMRS precoder granularity		6
REG bundle size		6
Mapping from REG to CCE		Distributed
Cell ID		Note 5
Payload (without CRC)	Bits	Note 6
<p>NOTE 1: DCI formats are defined in TS 38.212 [31].</p> <p>NOTE 2: DCI format shall depend upon the test configuration.</p> <p>NOTE 3: The offset is defined with respect to the subcarrier spacing of the CORESET from the smallest RB index of RMSI CORESET to the smallest RB index of the common RB overlapping with the first RB of the SS/PBCH block.</p> <p>NOTE 4: The configuration of PDCCH monitoring occasions for RMSI CORESET is defined in Table 13-11 in TS 38.213 [8].</p> <p>NOTE 5: Cell ID shall depend upon the test configuration.</p> <p>NOTE 6: Payload size shall depend upon the test configuration.</p> <p>NOTE 7: The configuration of set of resource blocks and slot symbols of control resource set for Type0-PDCCH search space corresponds to index 0 in Table 13-1 in TS 38.213 [8].</p> <p>NOTE 8: Other values can be used to align with GSCN as long as SSB does not overlap the RMC</p>		

**Table A.1.2.2-2: RMSI CORESET Reference Measurement Channels for SCS = 30 kHz for TDD**

Parameter	Unit	Value
Reference channel		CR.2.1 TDD
Channel bandwidth	MHz	Defined in test case
Subcarrier spacing for RMSI CORESET	kHz	30
Allocated resource blocks for RMSI CORESET <sup>Note 7</sup>		24
Index of transmitted SSB within an SS-Burst		#0
SSB and RMSI CORESET multiplexing configuration		Pattern 1
Offset between SSB and RMSI CORESET <sup>Note 3, 7</sup>	RB	0 (Note 8)
Configuration of PDCCH monitoring occasions for RMSI CORESET <sup>Note 4</sup>		Index 4
Number of transmitter antennas		1
Duration of RMSI CORESET <sup>Note 7</sup>	symbols	2
DCI Format <sup>Note 1</sup>		Note 2
Aggregation level	CCE	8
DMRS precoder granularity		6
REG bundle size		6
Mapping from REG to CCE		Distributed
Cell ID		Note 5
Payload (without CRC)	Bits	Note 6
<p>NOTE 1: DCI formats are defined in TS 38.212 [31].</p> <p>NOTE 2: DCI format shall depend upon the test configuration.</p> <p>NOTE 3: The offset is defined with respect to the subcarrier spacing of the CORESET from the smallest RB index of RMSI CORESET to the smallest RB index of the common RB overlapping with the first RB of the SS/PBCH block.</p> <p>NOTE 4: The configuration of PDCCH monitoring occasions for RMSI CORESET is defined in Table 13-11 in TS 38.213 [8].</p> <p>NOTE 5: Cell ID shall depend upon the test configuration.</p> <p>NOTE 6: Payload size shall depend upon the test configuration.</p> <p>NOTE 7: The configuration of set of resource blocks and slot symbols of control resource set for Type0-PDCCH search space corresponds to index 0 in Table 13-6 in TS 38.213 [8].</p> <p>NOTE 8: Other values can be used to align with GSCN as long as SSB does not overlap the RMC</p>		

**Table A.1.2.2-3: RMSI CORESET Reference Measurement Channels for SCS = 120 kHz for TDD**

Parameter	Unit	Value	
		CR.3.1 TDD	CR.3.2 TDD
Reference channel			
Channel bandwidth	MHz	100	100
Subcarrier spacing for RMSI CORESET	kHz	120	120
Allocated resource blocks for RMSI CORESET		24 <sup>Note 7</sup>	48 <sup>Note 9</sup>
Subcarrier spacing for SSB	kHz	120	120
Index of transmitted SSB within an SS-Burst		#0	#0
SSB and RMSI CORESET multiplexing configuration		Pattern 1 <sup>Note 7</sup>	Pattern 1 <sup>Note 9</sup>
Offset between SSB and RMSI CORESET <sup>Note 3</sup>	RB	0 (Note 8) <sup>Note 7</sup>	0 (Note 8) <sup>Note 9</sup>
Configuration of PDCCH monitoring occasions for RMSI CORESET <sup>Note 4</sup>		Index 4	Index 4
Number of transmitter antennas		1	1
Duration of RMSI CORESET	symbols	2 <sup>Note 7</sup>	2 <sup>Note 9</sup>
DCI Format <sup>Note 1</sup>		Note 2	Note 2
Aggregation level	CCE	8	8
DMRS precoder granularity		6	6
REG bundle size		6	6
Mapping from REG to CCE		Distributed	Distributed
Cell ID		Note 5	Note 5
Payload (without CRC)	Bits	Note 6	Note 6
<p>NOTE 1: DCI formats are defined in TS 38.212 [31].</p> <p>NOTE 2: DCI format shall depend upon the test configuration.</p> <p>NOTE 3: The offset is defined with respect to the subcarrier spacing of the CORESET from the smallest RB index of RMSI CORESET to the smallest RB index of the common RB overlapping with the first RB of the SS/PBCH block.</p> <p>NOTE 4: The configuration of PDCCH monitoring occasions for RMSI CORESET is defined in Table 13-11 in TS 38.213 [8].</p> <p>NOTE 5: Cell ID shall depend upon the test configuration.</p> <p>NOTE 6: Payload size shall depend upon the test configuration.</p> <p>NOTE 7: The configuration of set of resource blocks and slot symbols of control resource set for Type0-PDCCH search space corresponds to index 0 in Table 13-8 in TS 38.213 [8].</p> <p>NOTE 8: Other values can be used to align with GSCN as long as SSB does not overlap the RMC</p> <p>NOTE 9: The configuration of set of resource blocks and slot symbols of control resource set for Type0-PDCCH search space corresponds to index 2 in Table 13-10 in TS 38.213 [8].</p>			

## A.1.3 CORESET for RMC scheduling

### A.1.3.1 FDD

**Table A.1.3.1-1: Control Channel RMC for SCS = 15 kHz for FDD**

Parameter	Unit	Value			
		CCR.1.1 FDD	CCR.1.2 FDD	CCR.1.3 FDD	CCR.1.4 FDD
Reference channel		Defined in test case	Defined in test case	Defined in test case	Defined in test case
Channel bandwidth	MHz	15	15	15	15
Subcarrier spacing for RMSI CORESET	kHz	24	18	24	18
Allocated resource blocks for CORESET		1	1	1	1
Number of transmitter antenna		2	2	2	2
Duration of CORESET	symbols	6	6	6	6
REG bundle size		Same as REG bundle size	Same as REG bundle size	Same as REG bundle size	Same as REG bundle size
DMRS precoder granularity		Interleaved	Interleaved	Interleaved	Interleaved
CCE to REG mapping		0	0	0	0
Interleave n_shift		2	2	2	2
Interleave size		N/A	N/A	N/A	N/A
Beamforming Pre-Coder		4	2	8	4
Aggregation level	CCE	Note 1	Note 1	Note 1	Note 1
DCI formats		Note 2	Note 2	Note 2	Note 2
Payload size (without CRC)	bits	Note 2	Note 2	Note 2	Note 2

NOTE 1: DCI format shall depend upon the test configuration.  
NOTE 2: Payload size shall depend upon the test configuration  
NOTE 3: Allocated in the resource blocks where the associated RMC is scheduled.

### A.1.3.2 TDD

**Table A.1.3.2-1: Control Channel RMC for SCS = 15 kHz for TDD**

Parameter	Unit	Value			
		CCR.1.1 TDD	CCR.1.2 TDD	CCR.1.3 TDD	CCR.1.4 TDD
Reference channel		Defined in test case	Defined in test case	Defined in test case	Defined in test case
Channel bandwidth	MHz	15	15	15	15
Subcarrier spacing	kHz	24	18	24	18
Allocated resource blocks for CORESET <sup>Note3</sup>		1	1	1	1
Number of transmitter antennas		2	2	2	2
Duration of CORESET	symbols	6	6	6	6
REG bundle size		Same as REG bundle size	Same as REG bundle size	Same as REG bundle size	Same as REG bundle size
DMRS precoder granularity		Interleaved	Interleaved	Interleaved	Interleaved
CCE to REG mapping		0	0	0	0
Interleave n_shift		2	2	2	2
Interleave size		N/A	N/A	N/A	N/A
Beamforming Pre-Coder		4	2	8	4
Aggregation level	CCE	Note 1	Note 1	Note 1	Note 1
DCI formats		Note 2	Note 2	Note 2	Note 2
Payload size (without CRC)	bits	Note 2	Note 2	Note 2	Note 2

NOTE 1: DCI format shall depend upon the test configuration.  
NOTE 2: Payload size shall depend upon the test configuration  
NOTE 3: Allocated in the resource blocks where the associated RMC is scheduled.

Table A.1.3.2-2: Control Channel RMC for SCS = 30 kHz for TDD

Parameter	Unit	Value			
		CCR.2.1 TDD	CCR.2.2 TDD	CCR.2.3 TDD	CCR.2.4 TDD
Reference channel					
Channel bandwidth	MHz	40	40	40	40
Subcarrier spacing for RMSI CORESET	kHz	30	30	30	30
Allocated resource blocks for CORESET <sup>3</sup>		24	24	18	18
Number of transmitter antenna		1	1	1	1
Duration of CORESET	symbols	2	2	2	2
REG bundle size		6	6	6	6
DMRS precoder granularity		Same as REG bundle size	Same as REG bundle size	Same as REG bundle size	Same as REG bundle size
CCE to REG mapping		Interleaved	Interleaved	Interleaved	Interleaved
Interleave n_shift		0	0	0	0
Interleave size		2	2	2	2
Beamforming Pre-Coder		N/A	N/A	N/A	N/A
Aggregation level	CCE	4	8	4	2
DCI formats		Note 1	Note 1	Note 1	Note 1
Payload size (without CRC)	bits	Note 2	Note 2	Note 2	Note 2
Note 1: DCI format shall depend upon the test configuration.					
Note 2: Payload size shall depend upon the test configuration.					
Note 3: Allocated in the same resource blocks where the associated RMC is scheduled.					

Table A.1.3.2-3: Control Channel RMC for SCS = 120 kHz for TDD

Parameter	Unit	Value						
		CCR.3.1 TDD	CCR.3.2 TDD	CCR.3.3 TDD	CCR.3.4 TDD	CCR.3.5 TDD	CCR.3.6 TDD	CCR.3.7 TDD
Reference channel								
Channel bandwidth	MHz	100	100	100	100	100	100	100
Subcarrier spacing for RMSI CORESET	kHz	120	120	120	120	120	120	120
Allocated resource blocks for CORESET <sup>Note 3</sup>		24	24	24	24	24	24	48
Number of transmitter antenna		1	1	1	1	1	1	1
monitoringSlotPeriodicityAnd Offset <sup>Note 4</sup>		sl160 0	sl160 0	sl160 80	sl160 0	sl160 0	sl160 80	sl160 0
monitoringSymbolsWithinSlot		1100000 0000000	0011000 0000000	1100000 0000000	1100000 0000000	0011000 0000000	1100000 0000000	1100000 0000000
Duration of CORESET	symbols	1	1	1	1	1	1	1
REG bundle size		6	6	6	6	6	6	6
DMRS precoder granularity		Same as REG bundle size	Same as REG bundle size	Same as REG bundle size	Same as REG bundle size	Same as REG bundle size	Same as REG bundle size	Same as REG bundle size
CCE to REG mapping		Interleave d	Interleave d	Interleave d	Interleaved	Interleave d	Interleave d	Interleave d
Interleave n_shift		0	0	0	0	0	0	0
Interleave size		2	2	2	2	2	2	2
Beamforming Pre-Coder		N/A	N/A	N/A	N/A	N/A	N/A	N/A
Aggregation level	CCE	4	4	4	8	8	8	4
DCI formats		Note 1	Note 1	Note 1	Note 1	Note 1	Note 1	Note 1
Payload size (without CRC)	bits	Note 2	Note 2	Note 2	Note 2	Note 2	Note 2	Note 2
NOTE 1: DCI format shall depend upon the test configuration.								
NOTE 2: Payload size shall depend upon the test configuration								
NOTE 3: Allocated in the same resource blocks where the associated PDSCH RMC is scheduled.								
NOTE 4: <i>monitoringSlotPeriodicityAndOffset</i> can be set to other values depending on test purpose of respective test cases, as needed, e.g. <i>monitoringSlotPeriodicityAndOffset</i> is set to "sl1 0" if it is specifically stated that cell(s) configured with one of the control channel RMCs above shall transmit PDCCHs continuously.								



## A.1.4 CSI-RS

### A.1.4.1 FDD

Table A.1.4.1-1: CSI-RS Reference Measurement Channels for SCS = 15 kHz for FDD

	CSI-RS.1.1 FDD	CSI-RS.1.2 FDD	CSI-RS.1.3 FDD	CSI-RS.1.4 FDD
Resource Type	periodic	periodic	aperiodic	aperiodic
<b>Resource Set Config</b>				
nzp-CSI-ResourceSetId	0	0	0	0
repetition	N/A	off	off	on
aperiodicTriggeringOffset	N/A	N/A	4	4
trs-Info	N/A	N/A	N/A	N/A
<b>Resource Config</b>				
nzp-CSI-RS-ResourceId	0 for resource #0	0 for resource #0	0 for resource #0	0 for resource #0
				1 for resource #1
				2 for resource #2
		1 for resource #1	1 for resource #1	3 for resource #3
				4 for resource #4
				5 for resource #5
				6 for resource #6
7 for resource #7				
powerControlOffset	0	0	0	0
powerControlOffsetSS	db0	db0	db0	db0
scramblingID	0	0	0	0
Period (slots)	slot5	slot10	N/A	N/A
Offset	1	1	N/A	N/A
qcl-InfoPeriodicCSI-RS	TCI.State.0	TCI.State.0	N/A	N/A
		TCI.State.1		
frequencyDomainAllocation	000001	0001	0001	0001
nrofPorts	2	1	1	1
firstOFDMsymbolInTimeDomain	4 for resource #0	6 for resource #0	6 for resource #0	0 for resource #0
				1 for resource #1
				2 for resource #2
		10 for resource #1	10 for resource #1	3 for resource #3
				4 for resource #4
				5 for resource #5
				6 for resource #6
7 for resource #7				
cdm-Type	FD-CDM2	noCDM	noCDM	noCDM
density	1	3	3	3
startingRB	0	0	0	0
nrofRBs	276	276	276	276

**Table A.1.4.1-1A: CSI-RS Reference Measurement Channels for SCS=15 kHz for FDD**

Resource Type	CSI-RS.1.1A FDD periodic	CSI-RS.1.2A FDD aperiodic	CSI-RS.1.3A FDD periodic
<b>Resource Set Config</b>			
nzp-CSI-ResourceSetId	1	1	1
repetition	off	off	off
aperiodicTriggeringOffset	n.a.	6	n.a.
trs-Info	n.a.	n.a.	n.a.
<b>Resource Config</b>			
nzp-CSI-RS-ResourceId	12 for resource #0	22 for resource #0	14 for resource #0
	13 for resource #1	23 for resource #1	15 for resource #1
powerControlOffset	0	0	0
powerControlOffsetSS	db0	db0	db0
scramblingID	0	0	0
Period (slots)	slot20	n.a.	slot10
Offset	1	n.a.	2
qcl-InfoPeriodicCSI-RS	n.a.	n.a.	n.a.
frequencyDomainAllocation	0001	0001	0001
nrofPorts	1	1	1
firstOFDMsymbolInTimeDomain	6 for resource #0	7 for resource #0	6 for resource #0
	10 for resource #1	11 for resource #1	10 for resource #1
cdm-Type	noCDM	noCDM	noCDM
density	3	3	3
startingRB	0	0	0
nrofRBs	276 (Note 1)	276 (Note 1)	276 (Note 1)
Note 1: If the configured value of PRBs is larger than the width of the corresponding BWP relevant for the test case, the Test Equipment shall implement CSI-RS only in the width of that BWP.			

**A.1.4.2 TDD**

**Table A.1.4.2-1: CSI-RS Reference Measurement Channels for SCS = 15 kHz for TDD**

Resource Type	CSI-RS.1.1 TDD periodic	CSI-RS.1.2 TDD periodic	CSI-RS.1.3 TDD aperiodic	CSI-RS.1.4 TDD aperiodic
<b>Resource Set Config</b>				
nzp-CSI-ResourceSetId	0	0	0	0
repetition	N/A	off	off	on
aperiodicTriggeringOffset	N/A	N/A	4	4
trs-Info	N/A	N/A	N/A	N/A
<b>Resource Config</b>				
nzp-CSI-RS-ResourceId	0 for resource #0	0 for resource #0	0 for resource #0	0 for resource #0
				1 for resource #1
				2 for resource #2
		1 for resource #1	1 for resource #1	3 for resource #3
				4 for resource #4
				5 for resource #5
				6 for resource #6
7 for resource #7				
powerControlOffset	0	0	0	0
powerControlOffsetSS	db0	db0	db0	db0
scramblingID	0	0	0	0
Period (slots)	slot5	slot10	N/A	N/A
Offset	1	1	N/A	N/A
qcl-InfoPeriodicCSI-RS	TCI.State.0	TCI.State.0 TCI.State.1	N/A	N/A
frequencyDomainAllocation	000001	0001	0001	0001
nrofPorts	2	1	1	1
firstOFDMsymbolInTimeDomain	4 for resource #0	6 for resource #0	6 for resource #0	0 for resource #0
				1 for resource #1

				2 for resource #2
				3 for resource #3
		10 for resource #1	10 for resource #1	4 for resource #4
				5 for resource #5
				6 for resource #6
				7 for resource #7
cdm-Type	FD-CDM2	noCDM	noCDM	noCDM
density	1	3	3	3
startingRB	0	0	0	0
nrofRBs	276	276	276	276

**Table A.1.4.2-1A: CSI-RS Reference Measurement Channels for SCS=15 kHz for TDD**

	CSI-RS.1.1A TDD	CSI-RS.1.2A TDD	CSI-RS.1.3A TDD
Resource Type	periodic	aperiodic	periodic
<b>Resource Set Config</b>			
nzp-CSI-ResourceSetId	1	1	1
repetition	off	off	off
aperiodicTriggeringOffset	n.a.	6	n.a.
trs-Info	n.a.	n.a.	n.a.
<b>Resource Config</b>			
nzp-CSI-RS-ResourceId	12 for resource #0	22 for resource #0	14 for resource #0
	13 for resource #1	23 for resource #1	15 for resource #1
powerControlOffset	0	0	0
powerControlOffsetSS	db0	db0	db0
scramblingID	0	0	0
Period (slots)	slot20	n.a.	slot10
Offset	1	n.a.	2
qcl-InfoPeriodicCSI-RS	n.a.	n.a.	n.a.
frequencyDomainAllocation	0001	0001	0001
nrofPorts	1	1	1
firstOFDMSymbolInTimeDomain	6 for resource #0	7 for resource #0	6 for resource #0
	10 for resource #1	11 for resource #1	10 for resource #1
cdm-Type	noCDM	noCDM	noCDM
density	3	3	3
startingRB	0	0	0
nrofRBs	276 (Note 1)	276 (Note 1)	276 (Note 1)
Note 1: If the configured value of PRBs is larger than the width of the corresponding BWP relevant for the test case, the Test Equipment shall implement CSI-RS only in the width of that BWP.			

**Table A.1.4.2-2: CSI-RS Reference Measurement Channels for SCS = 30 kHz for TDD**

	CSI-RS.2.1 TDD	CSI-RS.2.2 TDD	CSI-RS.2.3 TDD	CSI-RS.2.4 TDD
Resource Type	periodic	periodic	aperiodic	aperiodic
<b>Resource Set Config</b>				
nzp-CSI-ResourceSetId	0	0	0	0
repetition	N/A	off	off	on
aperiodicTriggeringOffset	N/A	N/A	4	4
trs-Info	N/A	N/A	N/A	N/A
<b>Resource Config</b>				
nzp-CSI-RS-ResourceId	0 for resource #0	0 for resource #0	0 for resource #0	0 for resource #0
				1 for resource #1
				2 for resource #2
		1 for resource #1	1 for resource #1	3 for resource #3
				4 for resource #4
				5 for resource #5
				6 for resource #6
7 for resource #7				

powerControlOffset	0	0	0	0
powerControlOffsetSS	db0	db0	db0	db0
scramblingID	0	0	0	0
Period (slots)	slot10	slot20	N/A	N/A
Offset	2	2	N/A	N/A
qcl-InfoPeriodicCSI-RS	TCI.State.0	TCI.State.0 TCI.State.1	N/A	N/A
frequencyDomainAllocation	000001	0001	0001	0001
nrofPorts	2	1	1	1
firstOFDMSymbolInTimeDomain	5 for resource #0	6 for resource #0	6 for resource #0	0 for resource #0
				1 for resource #1
				2 for resource #2
		10 for resource #1	10 for resource #1	3 for resource #3
				4 for resource #4
				5 for resource #5
				6 for resource #6
7 for resource #7				
cdm-Type	FD-CDM2	noCDM	noCDM	noCDM
density	1	3	3	3
startingRB	0	0	0	0
nrofRBs	276	276	276	276

**Table A.1.4.2-2A: CSI-RS Reference Measurement Channels for SCS=30 kHz for TDD**

Resource Type	CSI-RS.2.1A TDD periodic	CSI-RS.2.2A TDD aperiodic	CSI-RS.2.3A TDD periodic
<b>Resource Set Config</b>			
nzp-CSI-ResourceSetId	1	1	1
repetition	off	off	off
aperiodicTriggeringOffset	n.a.	6	n.a.
trs-Info	n.a.	n.a.	n.a.
<b>Resource Config</b>			
nzp-CSI-RS-ResourceId	12 for resource #0	22 for resource #0	14 for resource #0
	13 for resource #1	23 for resource #1	15 for resource #1
powerControlOffset	0	0	0
powerControlOffsetSS	db0	db0	db0
scramblingID	0	0	0
Period (slots)	slot40	n.a.	slot20
Offset	2	n.a.	4
qcl-InfoPeriodicCSI-RS	n.a.	n.a.	n.a.
frequencyDomainAllocation	0001	0001	0001
nrofPorts	1	1	1
firstOFDMSymbolInTimeDomain	6 for resource #0	7 for resource #0	6 for resource #0
	10 for resource #1	11 for resource #1	10 for resource #1
cdm-Type	noCDM	noCDM	noCDM
density	3	3	3
startingRB	0	0	0
nrofRBs	276 (Note 1)	276 (Note 1)	276 (Note 1)

Note 1: If the configured value of PRBs is larger than the width of the corresponding BWP relevant for the test case, the Test Equipment shall implement CSI-RS only in the width of that BWP.

**Table A.1.4.2-3: CSI-RS Reference Measurement Channels for SCS = 120 kHz for TDD**

Resource Type	CSI-RS.3.1 TDD	CSI-RS.3.2 TDD	CSI-RS.3.3 TDD	CSI-RS.3.4 TDD
Resource Set Config	periodic	periodic	aperiodic	aperiodic
nzp-CSI-ResourceSetId	0	0	0	0
repetition	N/A	off	off	on
aperiodicTriggeringOffset	N/A	N/A	4	4
trs-Info	N/A	N/A	N/A	N/A
Resource Config				
nzp-CSI-RS-ResourceId	0 for resource #0	0 for resource #0	0 for resource #0	0 for resource #0
				1 for resource #1
				2 for resource #2
				3 for resource #3
		1 for resource #1	1 for resource #1	4 for resource #4
				5 for resource #5
				6 for resource #6
				7 for resource #7
powerControlOffset	0	0	0	0
powerControlOffsetSS	db0	db0	db0	db0
scramblingID	0	0	0	0
Period (slots)	slot40	slot80	N/A	N/A
Offset	8	8	N/A	N/A
qcl-InfoPeriodicCSI-RS	TCI.State.0	TCI.State.0 TCI.State.1	N/A	N/A
frequencyDomainAllocation	000001	0001	0001	0001
nrofPorts	2	1	1	1
firstOFDMsymbolInTimeDomain	5 for resource #0	6 for resource #0	6 for resource #0	0 for resource #0
				1 for resource #1
				2 for resource #2
				3 for resource #3
		10 for resource #1	10 for resource #1	4 for resource #4
				5 for resource #5
				6 for resource #6
				7 for resource #7
cdm-Type	FD-CDM2	noCDM	noCDM	noCDM
density	1	3	3	3
startingRB	0	0	0	0
nrofRBs	276	276	276	276

Table A.1.4.2-3A: CSI-RS Reference Measurement Channels for SCS=120 kHz for TDD

Resource Type	CSI-RS.3.1A TDD periodic	CSI-RS.3.2A TDD aperiodic	CSI-RS.3.3A TDD periodic
<b>Resource Set Config</b>			
nzp-CSI-ResourceSetId	1	1	1
repetition	off	off	off
aperiodicTriggeringOffset	n.a.	6	n.a.
trs-Info	n.a.	n.a.	n.a.
<b>Resource Config</b>			
nzp-CSI-RS-ResourceId	12 for resource #0	22 for resource #0	14 for resource #0
	13 for resource #1	23 for resource #1	15 for resource #1
powerControlOffset	0	0	0
powerControlOffsetSS	db0	db0	db0
scramblingID	0	0	0
Period (slots)	slot160	n.a.	slot80
Offset	8	n.a.	16
qcl-InfoPeriodicCSI-RS	n.a.	n.a.	n.a.
frequencyDomainAllocation	0001	0001	0001
nrofPorts	1	1	1
firstOFDMsymbolInTimeDomain	6 for resource #0	7 for resource #0	6 for resource #0
	10 for resource #1	11 for resource #1	10 for resource #1
cdm-Type	noCDM	noCDM	noCDM
density	3	3	3
startingRB	0	0	0
nrofRBs	276 (Note 1)	276 (Note 1)	276 (Note 1)
Note 1:	If the configured value of PRBs is larger than the width of the corresponding BWP relevant for the test case, the Test Equipment shall implement CSI-RS only in the width of that BWP.		

## A.1.4A CSI-RS for tracking

### A.1.4A.1 FR1

#### A.1.4A.1.1 FDD

Table A.1.4A.1.1-1: CSI-RS for tracking FDD

Parameter	Unit	Value	
<b>Reference channel</b>		TRS.1.1 FDD	TRS.1.2 FDD
Bandwidth		BW of Active BWP <sup>1</sup>	BW of Active BWP <sup>1</sup>
SCS	kHz	15	30
First subcarrier index in the PRB used for CSI-RS		$k_0=0$ for CSI-RS resource 1,2,3,4	$k_0=0$ for CSI-RS resource 1,2,3,4
First OFDM symbol in the slot used for CSI-RS		$l_0 = 5$ for CSI-RS resource 1 and 3 $l_0 = 9$ for CSI-RS resource 2 and 4	$l_0 = 5$ for CSI-RS resource 1 and 3 $l_0 = 9$ for CSI-RS resource 2 and 4
Number of CSI-RS ports (X)		1 for CSI-RS resource 1,2,3,4	1 for CSI-RS resource 1,2,3,4
CDM Type		'No CDM' for CSI-RS resource 1,2,3,4	'No CDM' for CSI-RS resource 1,2,3,4
Density ( $\rho$ )		3 for CSI-RS resource 1,2,3,4	3 for CSI-RS resource 1,2,3,4
CSI-RS periodicity	slots	20 for CSI-RS resource 1,2,3,4	40 for CSI-RS resource 1,2,3,4
CSI-RS offset	slots	10 for CSI-RS resource 1 and 2 11 for CSI-RS resource 3 and 4	20 for CSI-RS resource 1 and 2 21 for CSI-RS resource 3 and 4
EPRE ratio to SSS	dB	0	0
TCI state		TCI.State.0	TCI.State.0
NOTE 1: BW of TRS is configured same as the BW size of UE active BWP in the RRM test cases			

A.1.4A.1.2 TDD

Table A.1.4A.1.2-1: CSI-RS for TDD

Parameter	Unit	Value	
Reference channel		TRS.1.1 TDD	TRS.1.2 TDD
Bandwidth		BW of Active BWP <sup>1</sup>	BW of Active BWP <sup>1</sup>
SCS	kHz	15	30
First subcarrier index in the PRB used for CSI-RS		$k_0=0$ for CSI-RS resource 1,2,3,4	$k_0=0$ for CSI-RS resource 1,2,3,4
First OFDM symbol in the slot used for CSI-RS		$l_0 = 5$ for CSI-RS resource 1 and 3 $l_0 = 9$ for CSI-RS resource 2 and 4	$l_0 = 5$ for CSI-RS resource 1 and 3 $l_0 = 9$ for CSI-RS resource 2 and 4
Number of CSI-RS ports (X)		1 for CSI-RS resource 1,2,3,4	1 for CSI-RS resource 1,2,3,4
CDM Type		'No CDM' for CSI-RS resource 1,2,3,4	'No CDM' for CSI-RS resource 1,2,3,4
Density ( $\rho$ )		3 for CSI-RS resource 1,2,3,4	3 for CSI-RS resource 1,2,3,4
CSI-RS periodicity	slots	20 for CSI-RS resource 1,2,3,4	40 for CSI-RS resource 1,2,3,4
CSI-RS offset	slots	10 for CSI-RS resource 1 and 2 11 for CSI-RS resource 3 and 4	20 for CSI-RS resource 1 and 2 21 for CSI-RS resource 3 and 4
EPRE ratio to SSS	dB	0	0
TCI state		TCI.State.0	TCI.State.0

NOTE 1: BW of TRS is configured same as the BW size of UE active BWP in the RRM test cases

A.1.4A.2 FR2

A.1.4A.2.1 TDD

Table A.1.4A.2.1-1: CSI-RS for tracking for TDD FR2

Parameter	Unit	Value	
Reference channel		TRS.2.1 TDD	TRS.2.2 TDD
Bandwidth		BW of Active BWP <sup>Note 1, 2</sup>	BW of Active BWP <sup>Note 1,2</sup>
SCS	kHz	120	120
First subcarrier index in the PRB used for CSI-RS		$k_0=0$ for CSI-RS resource 1,2,3,4	$k_0=0$ for CSI-RS resource 1,2,3,4
First OFDM symbol in the slot used for CSI-RS		$l_0 = 1$ for CSI-RS resource 1 and 3 $l_0 = 5$ for CSI-RS resource 2 and 4	$l_0 = 2$ for CSI-RS resource 1 and 3 $l_0 = 6$ for CSI-RS resource 2 and 4
Number of CSI-RS ports (X)		1 for CSI-RS resource 1,2,3,4	1 for CSI-RS resource 1,2,3,4
CDM Type		'No CDM' for CSI-RS resource 1,2,3,4	'No CDM' for CSI-RS resource 1,2,3,4
Density ( $\rho$ )		3 for CSI-RS resource 1,2,3,4	3 for CSI-RS resource 1,2,3,4
CSI-RS periodicity	slots	80 for CSI-RS resource 1,2,3,4	80 for CSI-RS resource 1,2,3,4
CSI-RS offset	slots	40 for CSI-RS resource 1 and 2 41 for CSI-RS resource 3 and 4	40 for CSI-RS resource 1 and 2 41 for CSI-RS resource 3 and 4
EPRE ratio to SSS	dB	0	0
TCI state		TCI.State.0	TCI.State.1

NOTE 1: BW of TRS is configured same as the BW size of UE active BWP in the RRM test cases

NOTE 2: If active BWP is larger than 52RBs, BW of TRS is configured as 52RBs. Otherwise, same as active BWP size.

A.1.4B CSI-IM configurations

A.1.4B.1 FDD

Table A.1.4B.1-1: CSI-IM Reference Measurement Channels for SCS=15kHz

	CSI-IM.1.1 FDD	CSI-IM.1.2 FDD	CSI-IM.1.3 FDD
--	----------------	----------------	----------------

Resource Type	periodic	aperiodic	periodic
<b>Resource Set Config</b>			
csi-IM-ResourceSetId	0	0	0
<b>Resource Config</b>			
csi-IM-ResourceId	0 for resource #0	10 for resource #0	2 for resource #0
	1 for resource #1	11 for resource #1	3 for resource #1
csi-IM-ResourceElementPattern	pattern1	pattern1	pattern1
subcarrierLocation-p1	s0	s0	s0
symbolLocation-p1	6 for resource #0	7 for resource #0	6 for resource #0
	10 for resource #1	11 for resource #1	10 for resource #1
Period (slots)	slot20	n.a.	slot10
Offset	1	n.a.	2
startingRB	0	0	0
nrofRBs	276 (Note 1)	276 (Note 1)	276 (Note 1)
Note 1: If the configured value of PRBs is larger than the width of the corresponding BWP relevant for the test case, the test Equipment shall implement CSI-RS only in the width of that BWP.			

A.1.4B.2 TDD

Table A.1.4B.2-1: CSI-IM Reference Measurement Channels for SCS=15kHz

Resource Type	CSI-IM.1.1 TDD	CSI-IM.1.2 TDD	CSI-IM.1.3 TDD
	periodic	aperiodic	periodic
<b>Resource Set Config</b>			
csi-IM-ResourceSetId	0	0	0
<b>Resource Config</b>			
csi-IM-ResourceId	0 for resource #0	10 for resource #0	2 for resource #0
	1 for resource #1	11 for resource #1	3 for resource #1
csi-IM-ResourceElementPattern	pattern1	pattern1	pattern1
subcarrierLocation-p1	s0	s0	s0
symbolLocation-p1	6 for resource #0	7 for resource #0	6 for resource #0
	10 for resource #1	11 for resource #1	10 for resource #1
Period (slots)	slot20	n.a.	slot10
Offset	1	n.a.	2
startingRB	0	0	0
nrofRBs	276 (Note 1)	276 (Note 1)	276 (Note 1)
Note 1: If the configured value of PRBs is larger than the width of the corresponding BWP relevant for the test case, the test Equipment shall implement CSI-RS only in the width of that BWP.			

Table A.1.4B.2-2: CSI-IM Reference Measurement Channels for SCS=30kHz

Resource Type	CSI-IM.2.1 TDD	CSI-IM.2.2 TDD	CSI-IM.2.3 TDD
	periodic	aperiodic	periodic
<b>Resource Set Config</b>			
csi-IM-ResourceSetId	0	0	0
<b>Resource Config</b>			



csi-IM-ResourceId	0 for resource #0	10 for resource #0	2 for resource #0
	1 for resource #1	11 for resource #1	3 for resource #1
csi-IM-ResourceElementPattern	pattern1	pattern1	pattern1
subcarrierLocation-p1	s0	s0	s0
symbolLocation-p1	6 for resource #0	7 for resource #0	6 for resource #0
	10 for resource #1	11 for resource #1	10 for resource #1
Period (slots)	slot40	n.a.	slot40
Offset	2	n.a.	4
startingRB	0	0	0
nrofRBs	276 (Note 1)	276 (Note 1)	276 (Note 1)
Note 1: If the configured value of PRBs is larger than the width of the corresponding BWP relevant for the test case, the test Equipment shall implement CSI-RS only in the width of that BWP.			

Table A.1.4B.2-3: CSI-RS Reference Measurement Channels for SCS=120kHz

	CSI-IM.3.1 TDD periodic	CSI-IM.3.2 TDD aperiodic	CSI-IM.3.3 TDD periodic
<b>Resource Type</b>			
<b>Resource Set Config</b>			
csi-IM-ResourceSetId	0	0	0
<b>Resource Config</b>			
csi-IM-ResourceId	0 for resource #0	10 for resource #0	2 for resource #0
	1 for resource #1	11 for resource #1	3 for resource #1
csi-IM-ResourceElementPattern	pattern1	pattern1	pattern1
subcarrierLocation-p1	s0	s0	s0
symbolLocation-p1	6 for resource #0	7 for resource #0	6 for resource #0
	10 for resource #1	11 for resource #1	10 for resource #1
Period (slots)	slot160	n.a.	slot80
Offset	8	n.a.	16
startingRB	0	0	0
nrofRBs	276 (Note 1)	276 (Note 1)	276 (Note 1)
Note 1: If the configured value of PRBs is larger than the width of the corresponding BWP relevant for the test case, the test Equipment shall implement CSI-RS only in the width of that BWP.			

## A.1.5 TDD UL/DL configuration

Table A.1.5-1: TDD UL/DL configuration for SCS=15kHz

Parameter	Unit	Value	
Reference channel		TDDConf.1.1	
<i>referenceSubcarrierSpacing</i>	kHz	15	
TDD UL/DL pattern 1 <sup>Note 2</sup>		'DSUU' S='10DL:2GP:2UL'	
<i>dl-UL-TransmissionPeriodicity</i>	ms	4	
<i>nrofDownlinkSlots</i>		1	
<i>nrofDownlinkSymbols</i>		10	
<i>nrofUplinkSlot</i>		2	
<i>nrofUplinkSymbols</i>		2	
TDD UL/DL pattern 2 <sup>Note 2</sup>		'D'	
<i>dl-UL-TransmissionPeriodicity</i>	ms	1	
<i>nrofDownlinkSlots</i>		1	
<i>nrofDownlinkSymbols</i>		0	
<i>nrofUplinkSlot</i>		0	
<i>nrofUplinkSymbols</i>		0	
NOTE 1: As specified in TS 38.213 [8] and TS 38.331 [13].			
NOTE 2: For information			

Table A.1.5-2: TDD UL/DL configuration for SCS=30kHz

Parameter	Unit	Value	
Reference channel		TDDConf.2.1	
<i>referenceSubcarrierSpacing</i>	kHz	30	
TDD UL/DL pattern 1 <sup>Note 2</sup>		'3D1S4U' S='6DL:4GP:4UL'	
<i>dl-UL-TransmissionPeriodicity</i>	ms	4	
<i>nrofDownlinkSlots</i>		3	
<i>nrofDownlinkSymbols</i>		6	
<i>nrofUplinkSlot</i>		4	
<i>nrofUplinkSymbols</i>		4	
TDD UL/DL pattern 2 <sup>Note 2</sup>		'DD'	
<i>dl-UL-TransmissionPeriodicity</i>	ms	1	
<i>nrofDownlinkSlots</i>		2	
<i>nrofDownlinkSymbols</i>		0	
<i>nrofUplinkSlot</i>		0	
<i>nrofUplinkSymbols</i>		0	
NOTE 1: As specified in TS 38.213 [8] and TS 38.331 [13].			
NOTE 2: For information			

Table A.1.5-3: TDD UL/DL configuration for SCS=120kHz

Parameter	Unit	Value	
Reference channel		TDDConf.3.1	
referenceSubcarrierSpacing	kHz	120	
TDD UL/DL pattern 1 <sup>Note 2</sup>		'DDDSU' S='10DL:2GP:2UL'	
dl-UL-TransmissionPeriodicity	ms	0.625	
nrofDownlinkSlots		3	
nrofDownlinkSymbols		10	
nrofUplinkSlot		1	
nrofUplinkSymbols		2	
TDD UL/DL pattern 2 <sup>Note 2</sup>		Not configured	
dl-UL-TransmissionPeriodicity	ms	Not configured	
nrofDownlinkSlots		Not configured	
nrofDownlinkSymbols		Not configured	
nrofUplinkSlot		Not configured	
nrofUplinkSymbols		Not configured	

NOTE 1: As specified in TS 38.213 [8] and TS 38.331 [13].  
NOTE 2: For information

## A.1.6 PUSCH

This rule applies to NR cell(s), which the UE is connected to. The UE is in RRC\_CONNECTED mode.

When signalling or data payloads are expected to be sent on the PUSCH, the UE may be provided in advance with PUSCH resources by the SS. For sake of simplicity, the PUSCH scheduling may also occur continuously over many consecutive subframes. These options shall not be used if:

- 1) stated otherwise in the test description, or
- 2) the transmission of PUSCH and UL scheduling information affects the test purpose (e.g. DRX, PUCCH reception etc.)

## A.2 Reference OCGN configuration

### A.2.1 Generic OFDMA channel noise generator (OCNG)

The OCGN pattern is used in a test for modelling the allocation of unused resourced in the channel bandwidth to virtual UEs (UEs that are not under test). The OCGN pattern simulates both PDCCH and PDSCH transmissions to the virtual UEs.

Table A.2.1-1: OP.1: Generic OCGN pattern for all unused REs

OCNG Parameters	Control Region	Data Region
Resource allocation	Unused REs (Note 1)	Unused REs (Note 2)
Channel	PDCCH	PDSCH
Contents	Virtual UE IDs	Uncorrelated pseudo random QPSK modulated data
Antenna transmission scheme	Same as used in PDCCH RMC	Same as used in PDSCH RMC
Subcarrier spacing	Same as used in PDCCH RMC	Same as used in PDSCH RMC
Aggregation level	Same as used in PDCCH RMC	N/A
Code rate	Same as used in PDCCH RMC	Same as used in PDSCH RMC
Transmit Power	Same as used in PDCCH RMC	Same as used in PDSCH RMC
CP length	Same as used in PDCCH RMC	Same as used in PDSCH RMC

NOTE 1: REs not used in the active CORESETs where PDCCH is scheduled for the UE under test.  
NOTE 2: REs not allocated to any physical channels, CORESET, SSB or any other reference signal within the channel bandwidth of the cell, confined to  $BW_{occupied}$  where specified in the test case.

**Table A.2.1-2: OP.2: Generic OCNB pattern for all unused REs for 2AoA setup**

OCNB Parameters	Control Region	Data Region
Probe	Transmitting the serving beam	
Resource allocation	Unused REs (Note 1) in the symbols where SSB/CSI-RS are not transmitted from both the serving beam probe and non-serving beam probe.	Unused REs (Note 2) in the symbols where SSB/CSI-RS are not transmitted from both the serving beam probe and non-serving beam probe.
Channel	PDCCH	PDSCH
Contents	Virtual UE IDs	Uncorrelated pseudo random QPSK modulated data
Antenna transmission scheme	Same as used in PDCCH RMC	Same as used in PDSCH RMC
Subcarrier spacing	Same as used in PDCCH RMC	Same as used in PDSCH RMC
Aggregation level	Same as used in PDCCH RMC	N/A
Code rate	Same as used in PDCCH RMC	Same as used in PDSCH RMC
Transmit Power	Same as used in PDCCH RMC	Same as used in PDSCH RMC
CP length	Same as used in PDCCH RMC	Same as used in PDSCH RMC
NOTE 1: REs not used in the active CORESETs where PDCCH is scheduled for the UE under test.		
NOTE 2: REs not allocated to any physical channels, CORESET, SSB or any other reference signal within the channel bandwidth of the cell, confined to $BW_{occupied}$ where specified in the test case.		
NOTE 3: No OCNB is transmitted from the probe transmitting non-serving beam.		

**Table A.2.1-3: OP.3: Generic OCNB pattern for unused REs in the same BW as CORESET**

OCNB Parameters	Control Region	Data Region
Resource allocation	Unused REs (Note 1)	Unused REs (Note 2)
Channel	PDCCH	PDSCH
Contents	Virtual UE IDs	Uncorrelated pseudo random QPSK modulated data
Antenna transmission scheme	Same as used in PDCCH RMC	Same as used in PDSCH RMC
Subcarrier spacing	Same as used in PDCCH RMC	Same as used in PDSCH RMC
Aggregation level	Same as used in PDCCH RMC	N/A
Code rate	Same as used in PDCCH RMC	Same as used in PDSCH RMC
Transmit Power	Same as used in PDCCH RMC	Same as used in PDSCH RMC
CP length	Same as used in PDCCH RMC	Same as used in PDSCH RMC
NOTE 1: REs not used in the active CORESETs where PDCCH is scheduled for the UE under test. REs for OCNB shall not be allocated outside the allocated bandwidth of the CORESET of the serving cell.		
NOTE 2: REs not allocated to any physical channels, CORESET, SSB or any other reference signal within the allocated bandwidth of the CORESET of the serving cell. REs for OCNB shall not be allocated outside the allocated bandwidth of the CORESET of the serving cell.		

**Table A.2.1-4: OP.4: Generic OCNG pattern for all unused REs outside SSB slot(s)**

OCNG Parameters	Control Region	Data Region
Resource allocation	Unused REs (Note 1)	Unused REs (Note 2)
Channel	PDCCH	PDSCH
Contents	Virtual UE IDs	Uncorrelated pseudo random QPSK modulated data
Antenna transmission scheme	Same as used in PDCCH RMC	Same as used in PDSCH RMC
Subcarrier spacing	Same as used in PDCCH RMC	Same as used in PDSCH RMC
Aggregation level	Same as used in PDCCH RMC	N/A
Code rate	Same as used in PDCCH RMC	Same as used in PDSCH RMC
Transmit Power	Same as used in PDCCH RMC	Same as used in PDSCH RMC
CP length	Same as used in PDCCH RMC	Same as used in PDSCH RMC
NOTE 1: REs not used in the active CORESETs where PDCCH is scheduled for the UE under test. REs for OCNG shall not be allocated in the slot(s) containing SSB of the respective cell.		
NOTE 2: REs not allocated to any physical channels, CORESET, SSB or any other reference signal within the channel bandwidth of the cell. REs for OCNG shall not be allocated in the slot(s) containing SSB of the respective cell.		

**Table A.2.1-5: OP.5: Generic OCNG pattern for unused REs in the same BW as CORESET for 2AoA setup**

OCNG Parameters	Control Region	Data Region
Probe	Transmitting the serving beam	
Resource allocation	Unused REs (Note 1) in the symbols where SSB/CSI-RS are not transmitted from both the serving beam probe and non-serving beam probe.	Unused REs (Note 2) in the symbols where SSB/CSI-RS are not transmitted from both the serving beam probe and non-serving beam probe.
Channel	PDCCH	PDSCH
Contents	Virtual UE IDs	Uncorrelated pseudo random QPSK modulated data
Antenna transmission scheme	Same as used in PDCCH RMC	Same as used in PDSCH RMC
Subcarrier spacing	Same as used in PDCCH RMC	Same as used in PDSCH RMC
Aggregation level	Same as used in PDCCH RMC	N/A
Code rate	Same as used in PDCCH RMC	Same as used in PDSCH RMC
Transmit Power	Same as used in PDCCH RMC	Same as used in PDSCH RMC
CP length	Same as used in PDCCH RMC	Same as used in PDSCH RMC
NOTE 1: REs not used in the active CORESETs where PDCCH is scheduled for the UE under test. REs for OCNG shall not be allocated outside the allocated bandwidth of the CORESET of the serving cell.		
NOTE 2: REs not allocated to any physical channels, CORESET, SSB or any other reference signal within the allocated bandwidth of the CORESET of the serving cell. REs for OCNG shall not be allocated outside the allocated bandwidth of the CORESET of the serving cell.		
NOTE 3: No OCNG is transmitted from the probe transmitting non-serving beam.		

## A.3 Reference SSB configuration

### A.3.1 SSB configuration for FR1

Table A.3.1-1: SSB allocation for FR1

SSB Parameters	Unit	Value								
		SSB.1 FR1	SSB.2 FR1	SSB.3 FR1		SSB.4 FR1		SSB.5 FR1	SSB.6 FR1	
Channel bandwidth	MHz	10	40	10		40		10	40	
SSB SCS	kHz	15	30	15		30		15	30	
SSB periodicity ( $T_{SSB}$ )	ms	20								
Number of SSBs per SS-burst		1	1	2		2		1	1	
SS/PBCH block index		0	0	0	1	0	1	0	0	
Indices of symbols containing SSB		2-5	4-7 or 2-5 Note 2	2-5	8-11	4-7 or 2-5 Note 2	8-11	2-5	4-7 or 2-5 Note 2	
Indices of slots containing SSB		0								
Indices of SFN containing SSB		SFN mod ( $\max(T_{SSB}, 10\text{ms})/10\text{ms}$ ) = 0						SFN mod ( $\max(T_{SSB}, 10\text{ms})/10\text{ms}$ ) = 1		
RB numbers containing SSB within channel BW		(RB <sub>J</sub> , RB <sub>J+1</sub> , ..., RB <sub>J+19</sub> ) <sup>Note 1</sup>								
NOTE 1: RBs containing SSB can be configured in any frequency location within the cell bandwidth according to the allowed synchronization raster defined in TS 38.104 [28].										
NOTE 2: Symbols 4-7 are chosen if the SSB pattern Case B should be used for the current band as indicated by Table 5.4.3.3-1 of TS 38.104 [28]; Otherwise, symbols 2-5 are chosen.										

### A.3.2 SSB configuration for FR2

Table A.3.2-1: SSB allocation for FR2

SSB Parameters	Unit	Value												
		SSB.1 FR2		SSB.2 FR2		SSB.3 FR2	SSB.4 FR2		SSB.5 FR2		SSB.6 FR2		SSB.7 FR2	SSB.8 FR2
Channel bandwidth	MHz	100												
SSB SCS	kHz	120	240	120	240	120	240	120	240	120	240	120	240	
SSB periodicity ( $T_{SSB}$ )	ms	20												
Number of SSBs per SS-burst		2		2		1	1		2		2		1	1
SS/PBCH block index		0	1	0	1	0	0	2	3	2	3	1	1	
Indices of symbols containing SSB		4-7	8-11	8-11	12-13, 0-1	4-7	8-11	2-5	6-9	2-5	6-9	8-11	12-13, 0-1	
Indices of slots containing SSB		0	0	0-1	0	0	1	1	1	1	1	0	0-1	
Indices of SFN containing SSB		SFN mod ( $\max(T_{SSB}, 10\text{ms})/10\text{ms}$ ) = 0												
RB numbers containing SSB within channel BW		(RB <sub>J</sub> , RB <sub>J+1</sub> , ..., RB <sub>J+19</sub> ) <sup>Note 1</sup>												
NOTE 1: RBs containing SSB can be configured in any frequency location within the cell bandwidth according to the allowed synchronization raster defined in TS 38.104 [28].														

## A.4 Reference SMTC configuration

Table A.4-1: SMTC configurations

SMTC Parameters	Unit	Value					
		SMTC.1	SMTC.2	SMTC.3	SMTC.4	SMTC.5	SMTC.6
SMTC Pattern							
SMTC periodicity	ms	20	20	160	20	20	20
SMTC offset	ms	0	0	0	10	10	17
SMTC duration	ms	1	5	1	1	5	5

## A.5 Reference DRX configurations

The reference DRX configurations for the NR serving cell are captured in Table A.5-1. The reference DRX configurations for the E-UTRA serving cell for EN-DC and inter-RAT test cases are captured in Table A.5-2.

Table A.5-1: DRX configurations for NR serving cell

Parameter	Unit	Value						
		DRX.1	DRX.2	DRX.3	DRX.6	DRX.7	DRX.8	DRX.11
DRX Configuration								
drx-onDurationTimer	ms	1	1	6	1	6	6	6
drx-InactivityTimer	ms	1	1	1	1	1	1	1
drx-RetransmissionTimerDL	slot	1	1	1	1	1	1	1
drx-RetransmissionTimerUL	slot	1	1	1	1	1	1	1
drx-LongCycleStartOffset	ms	40	640	40	320	640	320	20
shortDRX	-	disabled	disabled	disabled	disabled	disabled	disabled	disabled
TimeAlignmentTimer	ms	500	500	Infinity	500	Infinity	Infinity	Infinity

NOTE 1: The DRX cycle and time alignment timer parameters are specified in clause 6.3.2 in TS 38.331 [13].

Table A.5-2: DRX configurations for E-UTRA serving cell

Parameter	Unit	Value				
		DRX.4	DRX.5	DRX.9	DRX.10	DRX.12
DRX Configuration						
drx-onDurationTimer	ms	psf2	psf6	psf2	psf6	psf6
drx-InactivityTimer	ms	psf2	psf1920	psf100	psf1920	psf2
drx-RetransmissionTimerDL	slot	psf16	psf16	psf16	psf16	psf16
drx-LongCycleStartOffset	ms	sf160, 0	sf320, 0	sf40, 0	sf640, 0	sf640, 0
shortDRX	-	disabled	disabled	disabled	disabled	disabled
TimeAlignmentTimer	ms	Infinity	Infinity	500	500	Infinity

NOTE 1: The DRX cycle and time alignment timer parameters are specified in clause 6.3.2 in TS 36.331 [29]

## A.6 EN-DC test setup

The purpose of this Annex is to specify the EN-DC configuration for the test cases in Chapters 4 and 5 of this test specification.

### A.6.1 E-UTRA serving cell parameters

This clause defines the cell power levels and other specific cell parameters of the E-UTRA serving cell for EN-DC.

#### A.6.1.1 E-UTRA serving cell parameters for EN-DC tests with NR FR1

Table A.6.1.1-1 defines the E-UTRA serving cell parameters for EN-DC tests with NR FR1 cell(s), defined in Chapter 4 of this test specification and for iRAT tests with E-UTRA serving cell and NR FR1 cell(s) defined in Chapter 8 of this test specification. Unless otherwise stated within the test, all measurements in Clauses 4 and 5 are performed only on the NR carrier. The E-UTRA PCell shall be configured to not interfere with NR operation and the E-UTRA PCell signal power shall not be critical to the test purpose.

Table A.6.1.1-1: E-UTRAN cell specific test parameters for EN-DC tests with NR FR1

Parameter	Unit	E-UTRAN Cell1	
E-UTRA RF Channel Number		1	
Duplex mode		FDD or TDD	
TDD special subframe configuration <sup>Note1</sup>		6	
TDD uplink-downlink configuration <sup>Note1</sup>		1	
BW <sub>channel</sub> <sup>Note 6</sup>		5MHz: N <sub>RB,c</sub> = 25 10MHz: N <sub>RB,c</sub> = 50 20MHz: N <sub>RB,c</sub> = 100	
PDSCH parameters: DL Reference Measurement Channel <sup>Note2,</sup> Note 6		5MHz: R.7 FDD 10MHz: R.3 FDD 20MHz: R.6 FDD 5MHz: R.4 TDD 10MHz: R.0 TDD 20MHz: R.3 TDD	
PCFICH/PDCCH/PHICH parameters: DL Reference Measurement Channel <sup>Note2,</sup> Note 6		5MHz: R.11 FDD 10MHz: R.6 FDD 20MHz: R.10 FDD 5MHz: R.11 TDD 10MHz: R.6 TDD 20MHz: R.10 TDD	
OCNG Patterns <sup>Note 2</sup>		5MHz: OP.20 FDD 10MHz: OP.10 FDD 20MHz: OP.17 FDD 5MHz: OP.9 TDD 10MHz: OP.1 TDD 20MHz: OP.7 TDD	
PBCH_RA	dB	0	
PBCH_RB	dB		
PSS_RA	dB		
SSS_RA	dB		
PCFICH_RB	dB		
PHICH_RA	dB		
PHICH_RB	dB		
PDCCH_RA	dB		
PDCCH_RB	dB		
PDSCH_RA	dB		
PDSCH_RB	dB		
OCNG_RA <sup>Note 3</sup>	dB		
OCNG_RB <sup>Note 3</sup>	dB		
N <sub>oc</sub> <sup>Note 4</sup>	dBm/15 kHz		-104
$\bar{E}_s/N_{oc}$	dB		17
$\bar{E}_s/I_{ot}$	dB	17	
RSRP <sup>Note 5</sup>	dBm/15 kHz	-87	
SCH_RP <sup>Note 5</sup>	dBm/15 kHz	-87	
I <sub>o</sub> <sup>Note 5</sup>	dBm/Ch BW	-59.13 + 10log(N <sub>RB,c</sub> /50)	
Propagation Condition		AWGN	
Antenna Configuration		1x2	
NOTE 1: Special subframe and uplink-downlink configurations are specified in table 4.2-1 in TS 36.211 [24].			
NOTE 2: DL RMCs and OCNG patterns are specified in clauses A.1, A.2 and D.1 of TS 36.521-3 [26].			
NOTE 3: OCNG shall be used such that all cells are fully allocated and a constant total transmitted power spectral density is achieved for all OFDM symbols.			
NOTE 4: Interference from other cells and noise sources not specified in the test is assumed to be constant over subcarriers and time and shall be modelled as AWGN of appropriate power for N <sub>oc</sub> to be fulfilled.			
NOTE 5: E <sub>s</sub> /I <sub>ot</sub> , RSRP, SCH_RP and I <sub>o</sub> levels have been derived from other parameters for information purposes. They are not settable parameters themselves.			
NOTE 6: For E-UTRA anchor configuration, pick 5 MHz as default channel bandwidth setting in the tests as it is supported by all E-UTRA bands. If none of the UE supported EN-DC band combos support 5MHz E-UTRA carrier, pick 20 MHz channel BW or 10 MHz channel BW, in that order,			



**Table A.6.1.1-2: CQI-ReportConfig-DEFAULT: Additional E-UTRA Anchor Configuration**

Derivation Path: TS 36.508 [7] clause 4.6.3, Table 4.6.3-2 CQI-ReportConfig-DEFAULT			
Information Element	Value/remark	Comment	Condition
CQI-ReportConfig-DEFAULT ::= SEQUENCE {			
cqi-ReportModeAperiodic	NOT PRESENT		
cqi-ReportPeriodic	NOT PRESENT		
}			

**Table A.6.1.1-3: PhysicalConfigDedicated-DEFAULT: Additional E-UTRA Anchor Configuration**

Derivation Path: TS 36.508 [7] clause 4.8.2, Table 4.8.2.1.6-1 PhysicalConfigDedicated-DEFAULT			
Information Element	Value/remark	Comment	Condition
PhysicalConfigDedicated-DEFAULT ::= SEQUENCE {			
soundingRS-UL-ConfigDedicated	Not present		RBC
}			

**Table A.6.1.1-4: MAC-MainConfig-RBC: Additional E-UTRA Anchor Configuration**

Derivation Path: TS 36.508 [7] clause 4.8.2.1.5, Table 4.8.2.1.5-1 MAC-MainConfig-RBC			
Information Element	Value/remark	Comment	Condition
timeAlignmentTimerDedicated	Infinity		

## A.6.1.2 E-UTRA serving cell parameters for EN-DC tests with NR FR2

Table A.6.1.2-1 defines the E-UTRA serving cell parameters for EN-DC tests with NR FR2 cell(s), defined in Chapter 5 of this test specification and for iRAT tests with E-UTRA serving cell and NR FR1 cell(s) defined in Chapter 8 of this test specification. Unless otherwise stated within the test, all measurements in Clauses 5 and 7 are performed only on the NR carrier. The E-UTRA PCell shall be configured to not interfere with NR operation and the E-UTRA PCell signal power shall not be critical to the test purpose.

**Table A.6.1.2-1: E-UTRAN cell specific test parameters for EN-DC tests with NR FR2**

Parameter	Unit	E-UTRAN Cell1
E-UTRA RF Channel Number		1
Duplex mode		FDD or TDD
TDD special subframe configuration <sup>Note1</sup>		6
TDD uplink-downlink configuration <sup>Note1</sup>		1
BW <sub>channel</sub> <sup>Note 5</sup>	MHz	5MHz: N <sub>RB,c</sub> = 25 10MHz: N <sub>RB,c</sub> = 50 20MHz: N <sub>RB,c</sub> = 100
PDSCH parameters: DL Reference Measurement Channel <sup>Note2, Note 5</sup>		5MHz: R.7 FDD 10MHz: R.3 FDD 20MHz: R.6 FDD 5MHz: R.4 TDD 10MHz: R.0 TDD 20MHz: R.3 TDD
PCFICH/PDCCH/PHICH parameters: DL Reference Measurement Channel <sup>Note2, Note 5</sup>		5MHz: R.11 FDD 10MHz: R.6 FDD 20MHz: R.10 FDD 5MHz: R.11 TDD 10MHz: R.6 TDD 20MHz: R.10 TDD
OCNG Patterns <sup>Note2, Note 5</sup>		5MHz: OP.20 FDD 10MHz: OP.10 FDD 20MHz: OP.17 FDD 5MHz: OP.9 TDD 10MHz: OP.1 TDD 20MHz: OP.7 TDD
PBCH_RA	dB	0
PBCH_RB	dB	
PSS_RA	dB	
SSS_RA	dB	
PCFICH_RB	dB	
PHICH_RA	dB	
PHICH_RB	dB	
PDCCH_RA	dB	
PDCCH_RB	dB	
PDSCH_RA	dB	
PDSCH_RB	dB	
OCNG_RA <sup>Note3</sup>	dB	
OCNG_RB <sup>Note3</sup>	dB	
<p>NOTE 1: Special subframe and uplink-downlink configurations are specified in table 4.2-1 in TS 36.211 [24].</p> <p>NOTE 2: DL RMCs and OCNG patterns are specified in clauses A 1, A.2 and D.1 of TS 36.521-3 [26].</p> <p>NOTE 3: OCNG shall be used such that all cells are fully allocated and a constant total transmitted power spectral density is achieved for all OFDM symbols.</p> <p>NOTE 4: The E-UTRA signal is required only to ensure the E-UTRA link to the DUT in the EN-DC operation. The Test System shall provide a stable and noise-free E-UTRA signal without need of precise propagation modelling, path loss and polarization control. Further details of the E-UTRA signal configuration are not defined as part of the cell specific test parameters, since the E-UTRA link is not under performance verification and is not expected to influence the NR FR2 requirement.</p> <p>NOTE 5: The For E-UTRA anchor configuration, pick 5 MHz as default channel bandwidth setting in the tests as it is supported by all E-UTRA bands. If none of the UE supported EN-DC band combos support 5MHz E-UTRA carrier, pick 20 MHz channel BW or 10 MHz channel BW, in that order,</p>		

**Table A.6.1.2-2: CQI-ReportConfig-DEFAULT: Additional E-UTRA Anchor Configuration**

Derivation Path: TS 36.508 [7] clause 4.6.3, Table 4.6.3-2 CQI-ReportConfig-DEFAULT			
Information Element	Value/remark	Comment	Condition
CQI-ReportConfig-DEFAULT ::= SEQUENCE {			
cqi-ReportModeAperiodic	NOT PRESENT		
cqi-ReportPeriodic	NOT PRESENT		
}			

**Table A.6.1.2-3: PhysicalConfigDedicated-DEFAULT: Additional E-UTRA Anchor Configuration**

Derivation Path: TS 36.508 [7] clause 4.8.2, Table 4.8.2.1.6-1 PhysicalConfigDedicated-DEFAULT			
Information Element	Value/remark	Comment	Condition
PhysicalConfigDedicated-DEFAULT ::= SEQUENCE {			
soundingRS-UL-ConfigDedicated	Not present		RBC
}			

**Table A.6.1.2-4: MAC-MainConfig-RBC: Additional E-UTRA Anchor Configuration**

Derivation Path: TS 36.508 [7] clause 4.8.2.1.5, Table 4.8.2.1.5-1 MAC-MainConfig-RBC			
Information Element	Value/remark	Comment	Condition
timeAlignmentTimerDedicated	Infinity		

## A.6A NR FR1-FR2 test setup

Some test cases in clause 7 have NR cells in both FR1 and FR2. Unless otherwise stated within the test, the NR FR1 Cell signal is required only to provide a link to the UE under test. The Test Equipment shall provide a stable and noise-free NR FR1 signal without need of precise propagation modelling, path loss and polarization control. Further details of the NR FR1 signal configuration are not defined as part of the cell specific test parameters, since the NR FR1 link is not under performance verification and is not expected to influence the test purpose.

## A.7 Reference PRACH configurations

This clause provides the typical PRACH configurations used for all RRM test cases defined in this test specification. Parameters not listed in this clause can be derived from the configuration of each test.

### A.7.1 PRACH configurations for FR1

Table A.7.1-1 defines the PRACH configurations for FR1. Each of the PRACH configurations defined in Table A.7.1-1 have different applicabilities:

- PRACH.1 FR1 for SSB-based contention based random access in FR1.
- PRACH.2 FR1 for SSB-based non-contention based random access in FR1.
- PRACH.3 FR1 for CSI-RS based non-contention based random access in FR1.
- PRACH.4 FR1 for CSI-RS based non-contention based random access in FR1 to convey BFR.

Table A.7.1-1 Parameters for PRACH Configurations for FR1

Field	Value				Comment
	PRACH.1 FR1	PRACH.2 FR1	PRACH.3 FR1	PRACH.4 FR1	
<i>prach-ConfigurationIndex</i>	102	102	102	102	10ms PRACH periodicity and other detailed configuration defined in table 6.3.3.2-2 in TS 38.211 [7].
<i>msg1-SubcarrierSpacing</i>	Same as UL carrier SCS	Same as UL carrier SCS	Same as UL carrier SCS	Same as UL carrier SCS	
<i>totalNumberOfRA-Preambles</i>	48	48	48	48	Total number of preambles used for contention based and contention free random access
<i>numberOfRA-PreamblesGroupA</i>	48	48	48	48	No group B.
<i>prach-RootSequenceIndex</i>	0	0	0	0	Logic sequence index = 0, resulting in root sequence = 1.
<i>ssb-perRACH-OccasionAndCB-PreamblesPerSSB</i>	oneFourth, n48	-	-	-	OneFourth: 1 SSB associated with 4 RACH occasions n48: 48 contention based preambles per SSB
<i>ssb-perRACH-Occasion</i>	-	oneFourth	oneFourth	oneFourth	OneFourth: 1 SSB associated with 4 RACH occasions
<i>msg1-FDM</i>	One	One	One	One	One PRACH transmission occasions FDMed in one time instance.
<i>rsrp-ThresholdSSB</i>	RSRP_51	RSRP_51	N/A	RSRP_51	The actual value of the threshold is -105dBm, as defined in TS 38.331 [13].
<i>rsrp-ThresholdCSI-RS</i>	N/A	N/A	RSRP_51	N/A	
<i>ra-ContentionResolutionTimer</i>	sf48	-	-	-	48 sub-frames
<i>powerRampingStep</i>	dB2	dB2	dB2	dB2	
<i>preambleReceivedTargetPower</i>	dBm-120	dBm-120	dBm-120	dBm-120	
<i>preambleTransMax</i>	n6	n6	n6	n200	Max number of RA preamble transmission performed before declaring a failure is 6
<i>ra-ResponseWindow</i>	sl10	sl10	sl10	sl1	10 slots
<i>zeroCorrelationZoneConfig</i>	11	11	11	11	N-CS configuration, N <sub>CS</sub> = 23
Backoff Parameter Index	2	2	2	2	20ms, as defined in table 7.2-1 in TS 38.321 [12].
<i>ssb-ResourceList</i>	-	present	N/A	N/A	Associated with SSB index 0
<i>ra-PreambleIndex</i>	-	50	N/A	N/A	Associated with SSB index 0. UE doesn't use <i>ssb-ResourceList</i> and <i>BFR-SSB-Resource</i> IEs at the same time. UE doesn't use this field if is transmitting CFRA to convey BFR.
<i>BFR-SSB-Resource</i>	-	present	N/A	N/A	Associated with SSB index 0
<i>ra-PreambleIndex</i>	-	50	N/A	N/A	Associated with SSB index 0. UE doesn't use <i>ssb-ResourceList</i> and <i>BFR-SSB-Resource</i> IEs at the same time. UE uses this field only if is transmitting CFRA to convey BFR
<i>csirs-ResourceList</i>	N/A	N/A	present	presnt	Associated with CSI-RS configured
<i>ra-PreambleIndex</i>	N/A	N/A	50	50	Associated with CSI-RS configured
<i>ra-OccasionList</i>	-	-	1	1	RA occasions allowed corresponding to CSI-RS
<i>ra-ssb-OccasionMaskIndex</i>	-	1	N/A	N/A	PRACH occasion index 1 is allowed

NOTE: For further information see Clause 6.3.2 in TS 38.331 [13].

## A.7.2 PRACH configurations for FR2

Table A.7.2-1 defines the PRACH configurations for FR2. Each of the PRACH configurations defined in Table A.7.2-1 have different applicabilities:

- PRACH.1 FR2 for SSB-based contention based random access in FR2.
- PRACH.2 FR2 for SSB-based non-contention based random access in FR2.
- PRACH.3 FR2 for CSI-RS based non-contention based random access in FR2.
- PRACH.4 FR2 for CSI-RS based non-contention based random access in FR2 to convey BFR.

**Table A.7.2-1 Parameters for PRACH Configurations for FR2**

Field	Value				Comment
	PRACH.1 FR2	PRACH.2 FR2	PRACH.3 FR2	PRACH.4 FR2	
<i>prach-ConfigurationIndex</i>	190	190	190	190	Preamble format C2, 10ms PRACH periodicity and other detailed configuration defined in table 6.3.3.2-4 in TS 38.211 [7].
<i>msg1-SubcarrierSpacing</i>	Same as UL carrier SCS	Same as UL carrier SCS	Same as UL carrier SCS	Same as UL carrier SCS	
<i>totalNumberOfRA-Preambles</i>	48	48	48	48	Total number of preambles used for contention based and contention free random access
<i>numberOfRA-PreamblesGroupA</i>	48	48	48	48	No group B.
<i>prach-RootSequenceIndex</i>	0	0	0	0	Logic sequence index = 0, resulting in root sequence = 1.
<i>ssb-perRACH-OccasionAndCB-PreamblesPerSSB</i>	oneFourth, n48	N/A	N/A	N/A	OneFourth: 1 SSB associated with 4 RACH occasions n48: 48 contention based preambles per SSB
<i>ssb-perRACH-Occasion</i>	N/A	oneFourth	oneFourth	oneFourth	OneFourth: 1 SSB associated with 4 RACH occasions
<i>msg1-FDM</i>	One	One	One	One	One PRACH transmission occasions FDMed in one time instance.
<i>rsrp-ThresholdSSB</i>	RSRP_51	RSRP_51	N/A	RSRP_51	The actual value of the threshold is -105dBm, as defined in TS 38.331 [13].
<i>rsrp-ThresholdCSI-RS</i>	N/A	N/A	RSRP_51	N/A	
<i>ra-ContentionResolutionTimer</i>	sf48	N/A	N/A	N/A	48 sub-frames
<i>powerRampingStep</i>	dB2	dB2	dB2	dB2	
<i>preambleReceivedTargetPower</i>	dBm-120	dBm-120	dBm-120	dBm-120	
<i>preambleTransMax</i>	n6	n6	n6	n200	Max number of RA preamble transmission performed before declaring a failure
<i>ra-ResponseWindow</i>	sl10	sl10	sl10	sl40	
<i>zeroCorrelationZoneConfig</i>	11	11	11	11	N-CS configuration, $N_{cs} = 23$
Backoff Parameter Index	2	2	2	2	20ms, as defined in table 7.2-1 in TS 38.321 [12].
<i>ssb-ResourceList</i>	-	present	N/A	N/A	Associated with SSB index 0
<i>ra-PreambleIndex</i>	-	50	N/A	N/A	Associated with SSB index 0
<i>csirs-ResourceList</i>	N/A	present	present	present	Associated with CSI-RS configured
<i>ra-PreambleIndex</i>	N/A	50	50	50	Associated with CSI-RS configured
<i>ra-OccasionList</i>	-	-	1	1	RA occasions allowed corresponding to CSI-RS
<i>ra-ssb-OccasionMaskIndex</i>	-	1	N/A	N/A	PRACH occasion index 1 is allowed

NOTE: For further information see Clause 6.3.2 in TS 38.331 [13].

## A.7A Reference MsgA configurations

This clause provides the typical PRACH and PUSCH configurations for MsgA used for all RRM test cases defined in this test specification. Parameters not listed in this clause can be derived from the configuration of each test.

### A.7A.1 MsgA configurations for FR1

Table A.7A.1-1 defines the MsgA configurations for FR1. Each of the MsgA configurations defined in Table A.7A.1-1 have different applicabilities:

- MsgA.1 FR1 for SSB-based 2-step contention based random access in FR1.
- MsgA.2 FR1 for SSB-based 2-step non-contention based random access in FR1.

Table A.7A.1-1 Parameters for MsgA Configurations for FR1

Field	Value		Comment
	MsgA.1 FR1	MsgA.2 FR1	
MsgA Configuration	MsgA.1 FR1	MsgA.2 FR1	
msgA-prach-ConfigurationIndex	102	102	10ms PRACH periodicity and other detailed configuration defined in table 6.3.3.2-2 in TS 38.211 [7].
msgA-SubcarrierSpacing	Same as UL carrier SCS	Same as UL carrier SCS	
msgA-totalNumberOfRA-Preambles	48	48	Total number of preambles used for contention based and contention free random access
numberOfRA-PreamblesGroupA	48	48	No group B.
msgA-PRACH-RootSequenceIndex	0	0	Logic sequence index = 0, resulting in root sequence = 1.
msgA-SSB-perRACH-OccasionAndCB-PreamblesPerSSB	oneFourth, n48	oneFourth	OneFourth: 1 SSB associated with 4 RACH occasions
msgA-RO-FDM	One	One	One PRACH transmission occasions FDMed in one time instance.
ra-ContentionResolutionTimer	sf48	-	48 sub-frames
msgA-PreamblePowerRampingStep	dB2	dB2	
msgA-PreambleReceivedTargetPower	dBm-120	dBm-120	
preambleTransMax	n6	n6	Max number of RA preamble transmission performed before declaring a failure is 6
msgB-ResponseWindow	sl10	sl10	10 slots
msgA-ZeroCorrelationZoneConfig	11	11	N-CS configuration, N <sub>CS</sub> = 23
Backoff Parameter Index	2	2	20ms, as defined in table 7.2-1 in TS 38.321 [7].
ssb-ResourceList	-	ra-PreambleIndex = 50	Associated with SSB index 0. UE doesn't use ssb-ResourceList and BFR-SSB-Resource IEs at the same time. UE doesn't use this field if is transmitting CFRA to convey BFR.
BFR-SSB-Resource	-	ra-PreambleIndex = 50	Associated with SSB index 0. UE doesn't use ssb-ResourceList and BFR-SSB-Resource IEs at the same time. UE uses this field only if is transmitting CFRA to convey BFR
ra-ssb-OccasionMaskIndex	-	1	PRACH occasion index 1 is allowed
msgA-MCS	1	1	MCS index for MsgA PUSCH
nrofSlotsMsgA-PUSCH	1	1	Number of slots containing one or multiple PUSCH occasions
nrofMsgA-PO-PerSlot	1	1	Number of time domain PUSCH occasions in each slot
msgA-PUSCH-TimeDomainOffset	1	1	A single time offset with respect to the start of each PRACH slot, counted as the number of slots
PUSCH start symbol	0	0	
PUSCH allocation length	14	14	
mappingTypeMsgA-PUSCH	typeA	typeA	
nrofPRBs-PerMsgA-PO	2	2	Number of RBs per PUSCH occasion
nrofMsgA-PO-FDM	One	One	The number of MsgA PUSCH occasions FDMed in one time instance
msgA-DMRS-AdditionalPosition	pos1	pos1	Position for additional DM-RS
msgA-PUSCH-NrofPorts	1	1	Configure 1 port per CDM group
msgA-DeltaPreamble	3	3	Power offset of msgA PUSCH relative to the preamble received target power
msgA-Alpha	alpha1	alpha1	Alpha value for MsgA PUSCH. Set 1
deltaMCS	Disabled	Disabled	Whether to apply delta MCS

NOTE: For further information see clause 6.3.2 in TS 38.331 [13].

## A.7A.2 MsgA configurations for FR2

Table A.7A.2-1 defines the MsgA configurations for FR2. Each of the MsgA configurations defined in Table A.7A.2-1 have different applicabilities:

- MsgA.1 FR2 for SSB-based contention based random access in FR2.
- MsgA.2 FR2 for SSB-based non-contention based random access in FR2.



Table A.7A.2-1 Parameters for MsgA Configurations for FR2

Field	Value		Comment
MsgA Configuration	MsgA.1 FR2	MsgA.2 FR2	
msgA-prach-ConfigurationIndex	190	190	Preamble Format C2, 10ms PRACH periodicity and other detailed configuration defined in table 6.3.3.2-2 in TS 38.211 [7].
msgA-SubcarrierSpacing	Same as UL carrier SCS	Same as UL carrier SCS	
msgA-totalNumberOfRA-Preambles	48	48	Total number of preambles used for contention based and contention free random access
numberOfRA-PreamblesGroupA	48	48	No group B.
msgA-PRACH-RootSequenceIndex	0	0	Logic sequence index = 0, resulting in root sequence = 1.
msgA-SSB-perRACH-OccasionAndCB-PreamblesPerSSB	oneFourth, n48	oneFourth	OneFourth: 1 SSB associated with 4 RACH occasions
msgA-RO-FDM	One	One	One PRACH transmission occasions FDMed in one time instance.
ra-ContentionResolutionTimer	sf48	-	48 sub-frames
msgA-PreamblePowerRampingStep	dB2	dB2	
msgA-PreambleReceivedTargetPower	dBm-120	dBm-120	
preambleTransMax	n6	n6	Max number of RA preamble transmission performed before declaring a failure is 6
msgB-ResponseWindow	sl10	sl10	10 slots
msgA-ZeroCorrelationZoneConfig	11	11	N-CS configuration, $N_{CS} = 23$
Backoff Parameter Index	2	2	20ms, as defined in table 7.2-1 in TS 38.321 [7].
ssb-ResourceList	-	ra-PreambleIndex = 50	Associated with SSB index 0. UE doesn't use ssb-ResourceList and BFR-SSB-Resource IEs at the same time. UE doesn't use this field if is transmitting CFRA to convey BFR.
BFR-SSB-Resource	-	ra-PreambleIndex = 50	Associated with SSB index 0. UE doesn't use ssb-ResourceList and BFR-SSB-Resource IEs at the same time. UE uses this field only if is transmitting CFRA to convey BFR
ra-ssb-OccasionMaskIndex	-	1	PRACH occasion index 1 is allowed
msgA-MCS	1	1	MCS index for MsgA PUSCH
nrofSlotsMsgA-PUSCH	1	1	Number of slots containing one or multiple PUSCH occasions
nrofMsgA-PO-PerSlot	1	1	Number of time domain PUSCH occasions in each slot
msgA-PUSCH-TimeDomainOffset	1	1	A single time offset with respect to the start of each PRACH slot, counted as the number of slots
PUSCH start symbol	0	0	
PUSCH allocation length	10	10	
mappingTypeMsgA-PUSCH	typeA	typeA	
nrofPRBs-PerMsgA-PO	2	2	Number of RBs per PUSCH occasion
nrofMsgA-PO-FDM	One	One	The number of MsgA PUSCH occasions FDMed in one time instance
msgA-DMRS-AdditionalPosition	pos1	pos1	Position for additional DM-RS
msgA-PUSCH-NrofPorts	1	1	Configure 1 port per CDM group
msgA-DeltaPreamble	3	3	Power offset of msgA PUSCH relative to the preamble received target power
msgA-Alpha	alpha1	alpha1	Alpha value for MsgA PUSCH. Set 1
deltaMCS	Disabled	Disabled	Whether to apply delta MCS

NOTE: For further information see clause 6.3.2 in TS 38.331 [13].

## A.8 Reference BWP configurations

This clause provides the typical BWP configurations used for RRM test cases defined in this test specification. For downlink BWP, both initial BWP and dedicated BWP configurations are specified in clause A.8.1 and for uplink BWP, dedicated BWP configurations are specified in clause A.8.2. Parameters not listed in this clause can be derived from the configuration of each test.

### A.8.1 Downlink BWP configurations

Table A.8.1-1 defines the different downlink initial BWP configurations. Table A.8.1-2 defines the different downlink dedicated BWP configurations.

**Table A.8.1-1: Downlink BWP patterns for initial BWP configuration**

BWP Parameters	Unit	Values	
DL BWP		DLBWP.0.1	DLBWP.0.2
Starting PRB index		0	RB <sub>c</sub> <sup>Note 1</sup>
Bandwidth		Same as RF channel defined in each test	same as RMSI CORESET(CORE SET #0) defined in each test
NOTE 1: RB <sub>c</sub> is the lowest PRB index to guarantee the BWP including CORESET #0 which is defined in Clause A.1.2.			

**Table A.8.1-2: Downlink BWP patterns for dedicated BWP configuration**

BWP Parameters	Unit	Values										
DL BWP		DLBWP.1.1	DLBWP.1.2				DLBWP.1.3		DLBWP.1.4			
Starting PRB index		0	RB <sub>b</sub> <sup>Note 1</sup>				RB <sub>a</sub> <sup>Note 2</sup>		0			
SSB SCS	kHz		15	30	120	240	15	30	120	240	120	240
Bandwidth	RB	Same as RF channel defined for the serving cell in each test	25	51	32	48	25	51	32	48	24	24
NOTE 1: RB <sub>b</sub> is the lowest PRB index to guarantee the BWP not fully overlapped with SSB PRB index (RBJ, RBJ+1, ..., RBJ+19) which is defined in Clause A.3.												
NOTE 2: RB <sub>a</sub> is the lowest PRB index to guarantee the BWP including SSB PRB index (RBJ, RBJ+1, ..., RBJ+19) which is defined in Clause A.3.												

### A.8.2 Uplink BWP configurations

Table A.8.2-1 defines the uplink initial BWP configurations. Table A.8.2-2 defines the uplink dedicated BWP configurations.

**Table A.8.2-1: Uplink BWP patterns for initial BWP configurations**

BWP Parameters	Values	
UL BWP	ULBWP.0.1	ULBWP.0.2
Starting PRB index	0	RB <sub>c</sub> <sup>Note 1</sup>
Bandwidth	Same as RF channel defined in each test	same as RMSI CORESET(CORESET #0) defined in each test
NOTE 1: RB <sub>c</sub> is the lowest PRB index to guarantee the BWP including CORESET #0 which is defined in Clause A.1.2.		

Table A.8.2-2: Uplink BWP patterns for dedicated BWP configurations

BWP Parameters	Unit	Values										
		ULBWP.1.1	ULBWP.1.2				ULBWP.1.3				ULBWP.1.4	
Starting PRB index		0	RB <sub>b</sub> <sup>Note 1</sup>				RB <sub>a</sub> <sup>Note 1</sup>				0	
SSB SCS	kHz		15	30	120	240	15	30	120	240	120	240
Bandwidth	RB	Same as RF channel defined for the serving cell in each test	25	51	32	48	25	51	32	48	24	24
NOTE 1: RB <sub>b</sub> is the lowest PRB index to guarantee the BWP not fully overlapped with SSB PRB index (RBJ, RBJ+1,....., RBJ+19) which is defined in Clause A.3.												
NOTE 2: RB <sub>a</sub> is the lowest PRB index to guarantee the BWP including SSB PRB index (RBJ, RBJ+1,....., RBJ+19) which is defined in Clause A.3.												

## A.9 Angle of Arrival (AoA) for FR2 RRM test cases

This clause specifies the AoA setups for FR2 RRM test cases in clause 5 and 7. The applicable AoA setup is defined in each test case in clause 5 and 7.

### A.9.1 Setup 1: Single AoA in Rx beam peak direction

There is only one active probe in the test. The DL signals, and noise if applicable, transmitted from the probe, are aligned to the UE Rx beam peak direction (as defined in TS 38.101-2 [3]).

### A.9.2 Setup 2: Single AoA in non Rx beam peak direction

#### A.9.2.1 Setup 2a: Single AoA in non Rx beam peak direction without change in direction

There is only one active probe in the test. The DL signals, and noise if applicable, transmitted from the probe, align to a direction (AoA) which is from the set of directions corresponding to the EIS spherical coverage percentile of the DUT as defined in clause 7.3.4 of TS 38.101-2 [3] for each UE power class. The direction (AoA) of the signals shall not be changed between test iterations.

#### A.9.2.2 Setup 2b: Single AoA in non Rx beam peak direction with change in direction

There is only one active probe in the test. The DL signals, and noise if applicable, transmitted from the probe, align to a direction (AoA) which is from the set of directions corresponding to the EIS spherical coverage percentile of the DUT as defined in clause 7.3.4 of TS 38.101-2 [3] for each UE power class. For UE power class 3, the direction (AoA) of the signals shall be changed for each test iteration (for UE power classes other than 3, this is FFS). Unless otherwise specified by the test case, the TE shall alternate between a minimum of 33 different AoAs. The minimum separation between AoAs used in consecutive iterations shall be 30° in great-circle distance.

NOTE: if it is not possible to find at least 33 different test points meeting the required criteria (FFS), the test shall alternate between all the available test points.

### A.9.3 Setup 3: 2 AoAs

There are 2 active probes in the test. The DL signals, and noise if applicable, transmitted from the two active probes, align to directions (AoAs) which are from the set of directions corresponding to the EIS spherical coverage percentile of the DUT as defined in clause 7.3.4 of TS 38.101-2 [3] for each UE power class. The relative angular offset between the directions (AoAs) of the 2 active probes, shall be changed for each test iteration. Unless otherwise specified by the test case, the TE shall alternate between a minimum of 33 different test points. A test point comprehends the relative angular offset between the active probes, and the AoA of each of the signals from the UE point of view. The relative angular offset between the active probes shall change for consecutive test points.

The applicable set of relative angular offsets between the 2 active probes is given in Table A.9.3-1 for each UE power class.

**Table A.9.3-1: Set of relative angular offsets between active probes for each power class**

UE Power class	Relative angular offset between active probes
1	FFS
2	FFS
3	30°, 60°, 90°, 120° and 150°
4	FFS

NOTE: if it is not possible to find at least 33 different test points meeting the required criteria (that is, the two AoAs are from the set of directions corresponding to the EIS spherical coverage percentile of the DUT as defined in clause 7.3.4 of TS 38.101-2 [3] and the angular offset between them corresponds to one of the offsets in Table A.9.3-1 for the corresponding UE power class), the test shall alternate between all the available test points.

## A.9.4 Setup 4: 2 AoAs, 1 AoA in Rx beam peak direction, 1 in non Rx beam peak

### A.9.4.1 Setup 4a: 2 AoAs, 1 AoA in Rx beam peak direction, 1 in non Rx beam peak without change in direction

There are 2 active probes in the test. The DL signals, and noise if applicable, are transmitted from the two active probes. One probe is aligned to the UE Rx beam peak direction as defined in TS 38.101-2 [3]. The second is aligned to a direction (AoA) which is from the set of directions corresponding to the EIS spherical coverage percentile of the DUT as defined in clause 7.3.4 of TS 38.101-2 [3] for each UE power class. The direction (AoA) of the non Rx beam peak signal shall not be changed between test iterations.

### A.9.4.2 Setup 4b: 2 AoAs, 1 AoA in Rx beam peak direction, 1 in non Rx beam peak with change in direction

There are 2 active probes in the test. The DL signals, and noise if applicable, are transmitted from the two active probes. One probe is aligned to the UE Rx beam peak direction as defined in TS 38.101-2 [3]. The second is aligned to a direction (AoA) which is from the set of directions corresponding to the EIS spherical coverage percentile of the DUT as defined in clause 7.3.4 of TS 38.101-2 [3] for each UE power class.

For UE power class 3, the relative angular offset between the directions (AoAs) of the 2 active probes shall be changed for each test iteration, within the probe alignment described above. The applicable set of relative angular offsets between the 2 active probes is given in Table A.9.3-1 for each UE power class. Unless otherwise specified by the test case, the TE shall alternate between a minimum of 5 different test points. A test point comprehends the relative angular offset between the active probes, and the AoA of each of the signals from the UE point of view, one of them being the Rx beam peak direction. The relative angular offset between the active probes shall change for consecutive test points.

NOTE: if it is not possible to find at least 5 different test points meeting the required criteria (that is, the two AoAs are from the set of directions corresponding to the EIS spherical coverage percentile of the DUT as defined in clause 7.3.4 of TS 38.101-2 [3] and the angular offset between them corresponds to one of the offsets in Table A.9.3-1 for the corresponding UE power class), the test shall alternate between all the available test points.

---

## A.10 TCI State Configuration

### A.10.1 Introduction

This clause provides the configurations for TCI states towards either SSB or CSI-RS. The TCI states defined in this clause are configured in each test when applicable to indicate that certain DL signals are quasi-collocated with the referenceSignal configured in the TCI states.

## A.10.2 TCI states

Table A.10.2-1: TCI States

Parameter	TCI.State.0	TCI.State.1	TCI.State.2	TCI.State.3
tc-StateId	Id0	Id1	Id2	Id3
qcl-Type1	typeC	typeC	typeA	typeA
qcl-Type2 <sup>Note1</sup>	typeD	typeD	typeD	typeD
referenceSignal	SSB0	SSB1	Resource #4 in TRS resource set 1 <sup>Note3</sup>	Resource #4 in TRS resource set 2 <sup>Note3</sup>
NOTE 1: qcl-Type2 of typeD only where applicable. For RRM test cases, this will be only in FR2				
NOTE 2: referenceSignal configurations towards which the TCI states are configured are defined in a test-specific manner.				
NOTE 3: Reference TRS resource sets are defined in A.3.17, and the applicable TRS resource set(s) are specified in each test case. When a single TRS resource set is configured in a test case, it is considered as resource set 1.				

## A.11 NR sidelink communication

### A.11.1 Introduction

This clause also defines the principle and the reference configurations that are applicable to test cases verifying RRM core requirements for V2X sidelink communication.

### A.11.2 Reference resource pool configurations for NR Sidelink Communication

Table A.11.2-1: NR sidelink SL-BWP configuration

Field	Value	Comment
SL-BWP-ConfigCommon-r16		
sl-BWP-ConfigCommon-r16		
sl-LengthSymbols-r16	sym14	All 14 symbols in a slot without S-SSB are used for sidelink
sl-StartSymbol-r16	sym0	Symbol #0 is the starting symbol used for sidelink in a slot without S-SSB
sl-BWP-PoolConfigCommon-r16		
sl-RxPool-r16		Indicates the resource pool for reception on the configured BWP. 1 entry
SL-ResourcePool-r16[1]	Set according to Table A.11.2-2	Entry 1
sl-TxPoolSelectedNormal-r16		Indicates the resources pool for mode 2 sidelink communication on the configured BWP. 1 entry
SL-ResourcePoolConfig-r16[1]		Entry 1
sl-ResourcePool-r16	Set according to Table A.11.2-3	
sl-TxPoolExceptional-r16	Not present	

Table A.11.2-2:NR sidelink resource pool configuration

Field	Value	Comment
SL-ResourcePool-r16		
sl-PSCCH-Config-r16	Set according to Table A.11.3-1	
sl-PSSCH-Config-r16	Set according to Table A.11.3-2	
sl-PSFCH-Config-r16	Not present	
sl-SyncAllowed-r16		Indicates the allowed synchronization reference(s) which is (are) allowed to use the configured resource pool.
gnss-Sync-r16	true	
gnbEnb-Sync-r16	true	
ue-Sync-r16	true	
sl-SubchannelSize-r16	n10	Subchannel bandwidth is 10 RB
sl-StartRB-Subchannel-r16	0	The offset of lowest RB index of the subchannel with the lowest index in the resource pool with respect to the lowest RB index of a SL BWP
sl-NumSubchannel-r16	1	Number of subchannels for SL transmission
sl-UE-SelectedConfigRP-r16		
sl-Thres-RSRP-List-r16	Set according to the specific test configuration	Indicates a list of 64 thresholds, and the threshold should be selected based on the priority in the decoded SCI and the priority in the SCI to be transmitted. A resource is excluded if it is indicated or reserved by a decoded SCI and PSSCH RSRP in the associated data resource is above a threshold.
sl-MultiReserveResource-r16	Not present	
sl-MaxNumPerReserve-r16	n2	At most 2 PSCCH/PSSCH resources can be reserved by a single SCI.
sl-SensingWindow-r16	ms100	Length of resource sensing window specified in TS 38.214 [9] subclause 8.1.4. which is 100ms.
sl-SelectionWindowList-r16		Parameter that determines the end of the selection window for each priority level 8 entries
SL-SelectionWindowConfig-r16[k,k=1..8]		entry k
sl-Priority-r16	k	priority k
sl-SelectionWindow-r16	n20	Length of resource selection window specified in TS 38.214 [9] subclause 8.1.4. which is $20 \cdot 2^{\mu}$ slots, where $\mu=0,1,2,3$ refers to SCS 15,30,60,120 kHz respectively
sl-ResourceReservePeriodList-r16	Not present	
sl-RS-ForSensing-r16	pssch	PSSCH-RSRP measurement is used in the sensing operation.
sl-RxParametersNcell	Not present	
sl-ZoneConfigMCR-List-r16	Not present	
sl-PreemptionEnable-r16	enabled	
sl-MinMaxMCS-List-r16		1 entry
SL-MinMaxMCS-Config-r16[1]		Entry 1
sl-MCS-Table-r16	qam64	TS 38.214 [9] Table 5.1.3.1-1 is the MCS table used in the resource pool.
sl-TimeResource-r16	11111111111111 111111	Every slot in a period of 20 slots during a SFN or DFN cycle can be used for sidelink

Table A.11.3-3: NR sidelink UE autonomous resource selection configuration

Field	Value	Comment
SL-UE-SelectedConfig-r16		
sl-PSSCH-TxConfigList-r16		1 entry
SL-PSSCH-TxConfig-r16[1]		Entry 1
sl-TypeTxSync-r16	Not present	When this field is absent, the configuration is applicable for all synchronization reference types.
sl-ThresUE-Speed-r16	kmph200	UE shall apply the parameters in sl-ParametersAboveThres-r16 if UE absolute speed is higher than 200 km/h, otherwise UE shall apply the parameters in sl-ParametersBelowThres-r16
sl-ParametersAboveThres-r16		
sl-MinMCS-PSSCH-r16	0	The minimum MCS index value can be used for PSSCH transmission.
sl-MaxMCS-PSSCH-r16	15	The maximum MCS index value can be used for PSSCH transmission.
sl-MinSubChannelNumPSSCH-r16	1	The minimum number of subchannels can be used for PSSCH transmission.
sl-MaxSubchannelNumPSSCH-r16	1	The maximum number of subchannels can be used for PSSCH transmission.
sl-MaxTxTransNumPSSCH-r16	1	The maximum transmission number for PSSCH (including new transmission and retransmission).
sl-MaxTxPower-r16	Not present	Not applicable
sl-ParametersBelowThres-r16		
sl-MinMCS-PSSCH-r16	4	Same as above
sl-MaxMCS-PSSCH-r16	25	Same as above
sl-MinSubChannelNumPSSCH-r16	1	Same as above
sl-MaxSubchannelNumPSSCH-r16	1	Same as above
sl-MaxTxTransNumPSSCH-r16	1	Same as above
sl-MaxTxPower-r16	Not present	Same as above
sl-ProbResourceKeep-r16	v0dot8	The probability of UE keeping current resource is 80% when the resource reselection counter reaches 0 (see TS 38.321 [12]).
sl-ReselectAfter-r16	n1	Resource reselection is triggered after 1 sidelink transmission is skipped (see TS 38.321 [12]).

### A.11.3 Reference measurement channels for NR Sidelink Communication

**Table A.11.3-1: PSCCH Reference Measurement Channels**

Parameter		Unit	Value
Reference channel			CC.1A HD
Channel bandwidth		MHz	Note2
Number of PSCCH symbols per slot			2
Number of PSCCH RB			10
Modulation			QPSK
Information Bit Payload (without CRC)		Bits	26
Information Bit	Number of DMRS ports		0 (1 port)
	Priority		As set by higher layers
	Resource reservation period		N/A
	Modulation and coding scheme		Set as the PSSCH MCS specified in the test
	DMRS pattern		0 (2 DMRS)
	2 <sup>nd</sup> stage SCI format		00 (SCI format 2-A)
	Beta offset indicator		Set as specified in the test
	Frequency resource assignment		Set as per PSSCH RB allocation specific in the test
	Time resource assignment		Set as per PSSCH slot allocation specific in the test
	Reserved bits		Set all these bits to 0
Transport block CRC		Bits	24
Binary Channel Bits (Note 1)		Bits	360
Note 1: Binary channel bits calculated under assumption of 2 CP-OFDM symbols per subframe.			
Note 2: Channel bandwidth depends on test configuration.			

**Table A.11.3-2: PSSCH Reference Measurement Channels**

Parameter		Unit	Value
Reference channel			CD.1A HD
Sidelink transmission mode			2
Channel bandwidth		MHz	Note1
Allocated PSSCH resource blocks			10
Number of PSSCH symbols per slot			10
Modulation			QPSK
Target Code Rate			1/3
Information Bit Payload (Transport block size)		Bits	672
Transport block CRC		Bits	24
Number of PSSCH HARQ retransmissions			0
Binary Channel Bits		Bits	2160
Note 1: Channel bandwidth depends on test configuration.			
Note 2: 2nd state SCI and PSFCH are not allocated per slot.			



## Annex B (normative): Conditions for RRM requirements applicability for operating bands

### B.1 Conditions for NR RRC\_IDLE state mobility

#### B.1.1 Introduction

In Annex B.1, the following conditions are specified:

- UE conditions which shall apply for UE intra-frequency idle state mobility test cases in clauses 6.1 and 7.1,
- UE conditions which shall apply for UE inter-frequency idle state mobility test cases in clauses 6.1 and 7.1.

#### B.1.2 Conditions for measurements on NR intra-frequency cells for cell re-selection

Editor's notes for Table B.1.2-2 (RAN4 dependant):

- The value of Y for Power classes 1 and 4 is FFS, where  $Y_1$  and  $Y_4$  are the rough/fine beam gain differences in Rx beam peak direction for Power classes 1 and 4 respectively
- The value of Z for Power classes 1 and 4 is FFS, where  $Z_1$  and  $Z_4$  are the rough/fine beam gain differences in spherical coverage directions for Power classes 1 and 4 respectively

This clause defines the following conditions for NR intra-frequency measurements performed based on SSBs for cell re-selection: SSB<sub>RP</sub> and SSB  $\hat{E}_s/I_{ot}$ , applicable for a corresponding operating band.

The conditions are defined in Table B.1.2-1 for FR1 NR cells.

The conditions are defined in Table B.1.2-2 for FR2 NR cells.

**Table B.1.2-1: Conditions for intra-frequency cell re-selection in FR1**

Parameter	NR operating band groups <sup>Note1</sup>	Minimum SSB <sub>RP</sub>		SSB $\hat{E}_s/I_{ot}$
		dBm / SCS <sub>SSB</sub>		
		SCS <sub>SSB</sub> = 15 kHz	SCS <sub>SSB</sub> = 30 kHz	dB
Conditions	NR_FDD_FR1_A, NR_TDD_FR1_A	-124	-121	≥ -4
	NR_FDD_FR1_B	-123.5	-120.5	
	NR_TDD_FR1_C	-123	-120	
	NR_FDD_FR1_D, NR_TDD_FR1_D	-122.5	-119.5	
	NR_FDD_FR1_E, NR_TDD_FR1_E	-122	-119	
	NR_FDD_FR1_G	-121	-118	
	NR_FDD_FR1_H	-120.5	-117.5	

NOTE 1: NR operating band groups are defined in Clause 3A.4.

**Table B.1.2-2: Conditions for intra-frequency cell re-selection in FR2**

Parameter	Angle of arrival	NR operating bands	Minimum SSB <sub>RP</sub> <small>Note 2, Note 3</small>				SSB $\bar{E}$ s/lot	
			dBm / SCS <sub>SSB</sub>					
			SCS <sub>SSB</sub> = 120 kHz		SCS <sub>SSB</sub> = 240 kHz			
			UE Power class		UE Power class			
		1	2	3	4	1, 2, 3, 4	dB	
Conditions	Rx Beam Peak	n257	- 125.3+Y 1	-110.8	-109.1	- 124.8+Y 4		(Value for SCS <sub>SSB</sub> = 120 kHz) +3dB
		n258	- 125.3+Y 1	-110.8	-109.1	- 124.8+Y 4		
		n259			-105.5			
		n260	- 122.3+Y 1		-106.5	- 122.8+Y 4		
		n261	- 125.3+Y 1	-110.8	-109.1	- 124.8+Y 4		
	Spherical coverage <small>Note 1</small>	n257	- 117.3+Z 1	-99.8	-98.2	- 115.8+Z 4	(Value for SCS <sub>SSB</sub> = 120 kHz) +3dB	
		n258	- 117.3+Z 1	-99.8	-98.2	- 115.8+Z 4		
		n259			-92.7			
		n260	- 114.3+Z 1		-93.9	- 110.8+Z 4		
		n261	- 117.3+Z 1	-99.8	-98.2	- 115.8+Z 4		

NOTE 1: Values based on EIS spherical coverage as defined in clause 7.3.4 of TS 38.101-2 [19]. Side condition applies for directions in which EIS spherical coverage requirement is met.  
 NOTE 2: Values specified at the Reference point to give minimum SSB  $\bar{E}$ s/lot, with no applied noise.  
 NOTE 3: For UEs that support multiple FR2 bands, Rx Beam Peak values are increased by  $\Delta MB_{P,n}$  and Spherical coverage values are increased by  $\Delta MB_{S,n}$ , the UE multi-band relaxation factor in dB specified in clause 6.2.1 of TS 38.101-2 [19].

### B.1.3 Conditions for measurements on NR inter-frequency cells for cell re-selection

This clause defines the following conditions for NR inter-frequency measurements performed based on SSBs for cell re-selection: SSB<sub>RP</sub> and SSB  $\bar{E}$ s/lot, applicable for a corresponding operating band.

The conditions defined in Table B.1.2-1 for FR1 NR intra-frequency cell re-selection shall also apply for FR1 NR inter-frequency cells in this clause.

The conditions defined in Table B.1.2-2 for FR2 NR intra-frequency cell re-selection shall also apply for FR2 NR inter-frequency cells in this clause.

## B.2 Conditions for NR RRC\_CONNECTED state

### B.2.1 Introduction

In Annex B.2, the following conditions are specified:

- UE conditions which shall apply for UE intra-frequency measurement procedures and measurement performance tests in clauses 4.6, 4.7, 5.6, 5.7, 6.6, 6.7, 7.6 and 7.7,

- UE conditions which shall apply for UE inter-frequency measurements procedures and requirements in Clause 9,
- UE conditions which shall apply for UE intra-frequency measurements performance requirements in Clause 10,
- UE conditions which shall apply for UE inter-frequency measurements performance requirements in Clause 10.

## B.2.2 Conditions for NR intra-frequency measurements

Editor’s notes for Table B.2.2-2 (RAN4 dependant):

- The value of Y for power classes 1 and 4 is FFS, where  $Y_1$  and  $Y_4$  are the rough/fine beam gain differences in Rx beam peak direction for power classes 1 and 4 respectively
- The value of Z for power classes 1 and 4 is FFS, where  $Z_1$  and  $Z_4$  are the rough/fine beam gain differences in spherical coverage directions for power classes 1 and 4 respectively

This clause defines the following conditions for NR intra-frequency measurements and corresponding procedures performed based on SSBs: SSB\_RP and SSB  $\hat{E}_s/\text{lot}$ , applicable for a corresponding operating band.

The conditions are defined in Table B.2.2-1 for FR1 NR cells.

The conditions are defined in Table B.2.2-2 for FR2 NR cells.

**Table B.2.2-1: Conditions for intra-frequency measurements in FR1**

Parameter	NR operating band groups <sup>Note1</sup>	Minimum SSB_RP		SSB $\hat{E}_s/\text{lot}$
		dBm / SCS <sub>SSB</sub>		
		SCS <sub>SSB</sub> = 15 kHz	SCS <sub>SSB</sub> = 30 kHz	dB
Conditions	NR_FDD_FR1_A, NR_TDD_FR1_A	-127	-124	≥ -6
	NR_FDD_FR1_B	-126.5	-123.5	
	NR_TDD_FR1_C	-126	-123	
	NR_FDD_FR1_D, NR_TDD_FR1_D	-125.5	-122.5	
	NR_FDD_FR1_E, NR_TDD_FR1_E	-125	-122	
	NR_FDD_FR1_G	-124	-121	
	NR_FDD_FR1_H	-123.5	-120.5	

NOTE 1: NR operating band groups are defined in Clause 3A.4.

**Table B.2.2-2: Conditions for intra-frequency measurements in FR2**

Parameter	Angle of arrival	NR operating bands	Minimum SSB_RP <sup>Note 2, Note 3</sup>				SSB $\hat{E}_s/\text{lot}$	
			dBm / SCS <sub>SSB</sub>					
			SCS <sub>SSB</sub> = 120 kHz				SCS <sub>SSB</sub> = 240 kHz	dB
			UE power class				UE power class	
1	2	3	4	1, 2, 3, 4				
Conditions	Rx Beam Peak	n257	-128.3+ $Y_1$	-113.8	-112.1	-127.8+ $Y_4$	(Value for SCS <sub>SSB</sub> = 120 kHz) +3dB	≥ -6
		n258	-128.3+ $Y_1$	-113.8	-112.1	-127.8+ $Y_4$		
		n259			-108.5			
		n260	-125.3+ $Y_1$		-109.5	-125.8+ $Y_4$		
		n261	-128.3+ $Y_1$	-113.8	-112.1	-127.8+ $Y_4$		
	Spherical coverage <sup>Note 1</sup>	n257	-120.3+ $Z_1$	-102.8	-101.2	-118.8+ $Z_4$	(Value for SCS <sub>SSB</sub> = 120 kHz) +3dB	
		n258	-120.3+ $Z_1$	-102.8	-101.2	-118.8+ $Z_4$		
		n259			-95.7			
		n260	-117.3+ $Z_1$		-96.9	-113.8+ $Z_4$		
		n261	-120.3+ $Z_1$	-102.8	-101.2	-118.8+ $Z_4$		

NOTE 1: Values based on EIS spherical coverage as defined in clause 7.3.4 of TS 38.101-2 [19]. Side condition applies for directions in which EIS spherical coverage requirement is met.

NOTE 2: Values specified at the Reference point to give minimum SSB  $\hat{E}_s/\text{lot}$ , with no applied noise.

NOTE 3: For UEs that support multiple FR2 bands, Rx Beam Peak values are increased by  $\Delta\text{MB}_{P,n}$  and spherical coverage values are increased by  $\Delta\text{MB}_{S,n}$  the UE multi-band relaxation factor in dB specified in clause 6.2.1 of TS 38.101-2 [19].

## B.2.3 Conditions for NR inter-frequency measurements

Editor’s notes for Table B.2.3-2 (RAN4 dependant):

- The value of Y for power classes 1 and 4 is FFS, where  $Y_1$  and  $Y_4$  are the rough/fine beam gain differences in Rx beam peak direction for power classes 1 and 4 respectively

- The value of Z for power classes 1 and 4 is FFS, where  $Z_1$ , and  $Z_4$  are the rough/fine beam gain differences in spherical coverage directions for power classes 1 and 4 respectively

This clause defines the following conditions for NR inter-frequency measurements and corresponding procedures performed based on SSBs: SSB\_RP and SSB  $\hat{E}_s/I_{ot}$ , applicable for a corresponding operating band.

The conditions are defined in Table B.2.3-1 for FR1 NR cells.

The conditions are defined in Table B.2.3-2 for FR2 NR cells.

**Table B.2.3-1: Conditions for inter-frequency measurements in FR1**

Parameter	NR operating band groups <sup>Note1</sup>	Minimum SSB_RP		SSB $\hat{E}_s/I_{ot}$
		dBm / SCS <sub>SSB</sub>		
		SCS <sub>SSB</sub> = 15 kHz	SCS <sub>SSB</sub> = 30 kHz	dB
Conditions	NR_FDD_FR1_A, NR_TDD_FR1_A	-125	-122	≥ -4
	NR_FDD_FR1_B	-124.5	-121.5	
	NR_TDD_FR1_C	-124	-121	
	NR_FDD_FR1_D, NR_TDD_FR1_D	-124.5	-120.5	
	NR_FDD_FR1_E, NR_TDD_FR1_E	-123	-120	
	NR_FDD_FR1_G	-122	-119	
	NR_FDD_FR1_H	-121.5	-118.5	

NOTE 1: NR operating band groups are defined in Clause 3A.4.

**Table B.2.3-2: Conditions for inter-frequency measurements in FR2**

Parameter	Angle of arrival	NR operating bands	Minimum SSB_RP <sup>Note 2, Note 3</sup>				SSB $\hat{E}_s/I_{ot}$	
			dBm / SCS <sub>SSB</sub>					
			SCS <sub>SSB</sub> = 120 kHz			SCS <sub>SSB</sub> = 240 kHz	dB	
			UE power class			UE power class		
1	2	3	4	1, 2, 3, 4				
Conditions	Rx Beam Peak	n257	-126.3+ $Y_1$	-111.8	-110.1	-125.8+ $Y_4$	≥ -4	
		n258	-126.3+ $Y_1$	-111.8	-110.1	-125.8+ $Y_4$		
		n259				-106.5		
		n260	-123.3+ $Y_1$			-107.5		-123.8+ $Y_4$
		n261	-126.3+ $Y_1$	-111.8	-110.1	-125.8+ $Y_4$		
	Spherical coverage <sup>Note 1</sup>	n257	-118.3+ $Z_1$	-100.8	-99.2	-116.8+ $Z_4$	≥ -4	
		n258	-118.3+ $Z_1$	-100.8	-99.2	-116.8+ $Z_4$		
		n259				-93.7		
		n260	-115.3+ $Z_1$			-94.9		-111.8+ $Z_4$
		n261	-118.3+ $Z_1$	-100.8	-99.2	-116.8+ $Z_4$		

NOTE 1: Values based on EIS spherical coverage as defined in clause 7.3.4 of TS 38.101-2 [19]. Side condition applies for directions in which EIS spherical coverage requirement is met.

NOTE 2: Values specified at the Reference point to give minimum SSB  $\hat{E}_s/I_{ot}$ , with no applied noise.

NOTE 3: For UEs that support multiple FR2 bands, Rx Beam Peak values are increased by  $\Delta MB_{P,n}$  and Spherical coverage values are increased by  $\Delta MB_{S,n}$ , the UE multi-band relaxation factor in dB specified in clause 6.2.1 of TS 38.101-2 [19].

## B.2.4 Conditions for NR L1-RSRP reporting

### B.2.4.1 Conditions for SSB based L1-RSRP reporting

Editor’s notes for Table B.2.4.1-2 (RAN4 dependant):

- The value of Y for power classes 1 and 4 is FFS, where  $Y_1$  and  $Y_4$  are the rough/fine beam gain differences in Rx beam peak direction for power classes 1 and 4 respectively

- The value of Z for power classes 1 and 4 is FFS, where  $Z_1$  and  $Z_4$  are the rough/fine beam gain differences in spherical coverage directions for power classes 1 and 4 respectively

This clause defines the following conditions for NR L1-RSRP measurement reporting and corresponding procedures performed based on SSBs: SSB\_RP and SSB  $\hat{E}_s/\text{lot}$ , applicable for a corresponding operating band.

The conditions are defined in Table B.2.4.1-1 for FR1 NR cells.

The conditions are defined in Table B.2.4.1-2 for FR2 NR cells.

**Table B.2.4.1-1: Conditions for SSB based L1-RSRP measurements in FR1**

Parameter	NR operating band groups <sup>Note 1</sup>	Minimum SSB_RP		SSB $\hat{E}_s/\text{lot}$
		dBm / SCS <sub>SSB</sub>		
		SCS <sub>SSB</sub> = 15 kHz	SCS <sub>SSB</sub> = 30 kHz	dB
Conditions	NR_FDD_FR1_A, NR_TDD_FR1_A, NR_SDL_FR1_A	-124	-121	≥ -3
	NR_FDD_FR1_B	-123.5	-120.5	
	NR_TDD_FR1_C	-123	-120	
	NR_FDD_FR1_D, NR_TDD_FR1_D	-122.5	-119.5	
	NR_FDD_FR1_E, NR_TDD_FR1_E	-122	-119	
	NR_FDD_FR1_G	-121	-118	
	NR_FDD_FR1_H	-120.5	-117.5	

NOTE 1: NR operating band groups are defined in clause 3A.4

**Table B.2.4.1-2: Conditions for SSB based L1-RSRP measurements in FR2**

Parameter	Angle of arrival	NR operating bands	Minimum SSB_RP <sup>Note 2, Note 3</sup>				SSB $\hat{E}_s/\text{lot}$
			dBm / SCS <sub>SSB</sub>				
			SCS <sub>SSB</sub> = 120 kHz			SCS <sub>SSB</sub> = 240 kHz	dB
			UE power class			UE power class	
1	2	3	4	1, 2, 3, 4			
Conditions	Rx Beam Peak	n257	-125.3+ $Y_1$	-110.8	-109.1	-124.8+ $Y_4$	≥ -3
		n258	-125.3+ $Y_1$	-110.8	-109.1	-124.8+ $Y_4$	
		n259			-105		
		n260	-122.3+ $Y_1$		-106.5	-122.8+ $Y_4$	
		n261	-125.3+ $Y_1$	-110.8	-109.1	-124.8+ $Y_4$	
	Spherical coverage <sup>Note 1</sup>	n257	-117.3+ $Z_1$	-99.8	-98.2	-115.8+ $Z_4$	≥ -3
		n258	-117.3+ $Z_1$	-99.8	-98.2	-115.8+ $Z_4$	
		n259			-92.3		
		n260	-114.3+ $Z_1$		-93.9	-110.8+ $Z_4$	
		n261	-117.3+ $Z_1$	-99.8	-98.2	-115.8+ $Z_4$	

NOTE 1: Values based on EIS spherical coverage as defined in clause 7.3.4 of TS 38.101-2 [19]. Side condition applies for directions in which EIS spherical coverage requirement is met.

NOTE 2: Values specified at the Reference point to give minimum SSB  $\hat{E}_s/\text{lot}$ , with no applied noise.

NOTE 3: For UEs that support multiple FR2 bands, Rx Beam Peak values are increased by  $\Delta MB_{P,n}$  and Spherical coverage values are increased by  $\Delta MB_{S,n}$ , the UE multi-band relaxation factor in dB specified in clause 6.2.1 of TS 38.101-2 [19].

### B.2.4.2 Conditions for CSI-RS based L1-RSRP reporting

Editor’s notes for Table B.2.4.2-2 (RAN4 dependant):

- The value of Y for power classes 1 and 4 is FFS, where  $Y_1$  and  $Y_4$  are the rough/fine beam gain differences in Rx beam peak direction for power classes 1 and 4 respectively

- The value of Z for power classes 1 and 4 is FFS, where  $Z_1$  and  $Z_4$  are the rough/fine beam gain differences in spherical coverage directions for power classes 1 and 4 respectively

This clause defines the following conditions for NR L1-RSRP measurement reporting and corresponding procedures performed based on CSI-RS: CSI-RS<sub>RP</sub> and CSI-RS  $\hat{E}$ s/lot, applicable for a corresponding operating band.

The conditions are defined in Table B.2.4.2-1 for FR1 NR cells.

The conditions are defined in Table B.2.4.2-2 for FR2 NR cells.

**Table B.2.4.2-1: Conditions for CSI-RS based L1-RSRP measurements in FR1**

Parameter	NR operating band groups <sup>Note1</sup>	Minimum CSI-RS <sub>RP</sub>			CSI-RS $\hat{E}$ s/lot
		dBm / SCS <sub>CSI-RS</sub>			
		SCS <sub>CSI-RS</sub> = 15 kHz	SCS <sub>CSI-RS</sub> = 30 kHz	SCS <sub>CSI-RS</sub> = 60 kHz	
Conditions	NR_FDD_FR1_A, NR_TDD_FR1_A, NR_SDL_FR1_A	-124	-121	-118	≥ -3
	NR_FDD_FR1_B	-123.5	-120.5	-117.5	
	NR_TDD_FR1_C	-123	-120	-117	
	NR_FDD_FR1_D, NR_TDD_FR1_D	-122.5	-119.5	-116.5	
	NR_FDD_FR1_E, NR_TDD_FR1_E	-122	-119	-116	
	NR_FDD_FR1_G	-121	-118	-115	
	NR_FDD_FR1_H	-120.5	-117.5	-114.5	

NOTE 1: NR operating band groups are defined in clause 3.5.2.

**Table B.2.4.2-2: Conditions for CSI-RS based L1-RSRP measurements in FR2**

Parameter	Angle of arrival	NR operating bands	Minimum CSI-RS <sub>RP</sub> <sup>Note 2, Note 3</sup>				CSI-RS $\hat{E}$ s/lot
			dBm / SCS <sub>CSI-RS</sub>				
			SCS <sub>CSI-RS</sub> = 60 kHz			SCS <sub>CSI-RS</sub> = 120 kHz	
			UE power class			UE power class	
			1	2	3	4	
Conditions	Rx Beam Peak	n257	-128.3+ $Y_1$	-113.8	-112.1	-127.8+ $Y_4$	≥ -3
		n258	-128.3+ $Y_1$	-113.8	-112.1	-127.8+ $Y_4$	
		n259			-108.5		
		n260	-125.3+ $Y_1$		-109.5	-125.8+ $Y_4$	
		n261	-128.3+ $Y_1$	-113.8	-112.1	-127.8+ $Y_4$	
	Spherical coverage <sup>Note 1</sup>	n257	-120.3+ $Z_1$	-102.8	-101.2	-118.8+ $Z_4$	≥ -3
		n258	-120.3+ $Z_1$	-102.8	-101.2	-118.8+ $Z_4$	
		n259			-95.7		
		n260	-117.3+ $Z_1$		-96.9	-113.8+ $Z_4$	
		n261	-120.3+ $Z_1$	-102.8	-101.2	-118.8+ $Z_4$	

NOTE 1: Values based on EIS spherical coverage as defined in clause 7.3.4 of TS 38.101-2 [19]. Side condition applies for directions in which EIS spherical coverage requirement is met.

NOTE 2: Values specified at the Reference point to give minimum CSI-RS  $\hat{E}$ s/lot, with no applied noise.

NOTE 3: For UEs that support multiple FR2 bands, Rx Beam Peak values are increased by  $\Delta MB_{P,n}$  and Spherical coverage values are increased by  $\Delta MB_{S,n}$ , the UE multi-band relaxation factor in dB specified in clause 6.2.1 of TS 38.101-2 [19].

## B.2.5 Conditions for RRC connection release with redirection to NR

Editor’s notes for Table B.2.5.2-2:

- The value of Y for power classes 1 and 4 is FFS, where  $Y_1$  and  $Y_4$  are the rough/fine beam gain differences in Rx beam peak direction for power classes 1 and 4 respectively

- The value of Z for power classes 1 and 4 is FFS, where  $Z_1$  and  $Z_4$  are the rough/fine

This clause defines the following conditions for RRC connection release with redirection to NR: SSB\_RP and SSB  $\hat{E}_s/\text{lot}$ , applicable for a corresponding operating band.

The conditions are defined in Table B.2.5-1 for FR1 NR cells.

The conditions are defined in Table B.2.5-2 for FR2 NR cells.

**Table B.2.5-1: Conditions for RRC connection release with redirection to NR in FR1**

Parameter	NR operating band groups <sup>Note1</sup>	Minimum SSB_RP		SSB $\hat{E}_s/\text{lot}$
		dBm / SCS <sub>SSB</sub>		
		SCS <sub>SSB</sub> = 15 kHz	SCS <sub>SSB</sub> = 30 kHz	dB
Conditions	NR_FDD_FR1_A, NR_TDD_FR1_A	-125	-122	≥ -4
	NR_FDD_FR1_B	-124.5	-121.5	
	NR_TDD_FR1_C	-124	-121	
	NR_FDD_FR1_D, NR_TDD_FR1_D	-124.5	-120.5	
	NR_FDD_FR1_E, NR_TDD_FR1_E	-123	-120	
	NR_FDD_FR1_G	-122	-119	
	NR_FDD_FR1_H	-121.5	-118.5	

NOTE 1: NR operating band groups are defined in clause 3.5.2.

**Table B.2.5-2: Conditions for RRC connection release with redirection to NR in FR2**

Parameter	Angle of arrival	NR operating bands	Minimum SSB_RP <sup>Note 2, Note 3</sup>				SSB $\hat{E}_s/\text{lot}$
			dBm / SCS <sub>SSB</sub>				
			SCS <sub>SSB</sub> = 120 kHz			SCS <sub>SSB</sub> = 240 kHz	dB
			UE power class			UE power class	
			1	2	3	4	
Conditions	Rx Beam Peak	n257	-126.3+Y <sub>1</sub>	-111.8	-110.1	-125.8+Y <sub>4</sub>	≥ -4
		n258	-126.3+Y <sub>1</sub>	-111.8	-110.1	-125.8+Y <sub>4</sub>	
		n259			-106.5		
		n260	-123.3+Y <sub>1</sub>		-107.5	-123.8+Y <sub>4</sub>	
		n261	-126.3+Y <sub>1</sub>	-111.8	-110.1	-125.8+Y <sub>4</sub>	
	Spherical coverage <sup>Note 1</sup>	n257	-118.3+Z <sub>1</sub>	-100.8	-99.2	-116.8+Z <sub>4</sub>	≥ -4
		n258	-118.3+Z <sub>1</sub>	-100.8	-99.2	-116.8+Z <sub>4</sub>	
		n259			-93.7		
		n260	-115.3+Z <sub>1</sub>		-94.9	-111.8+Z <sub>4</sub>	
		n261	-114.3	-100.8	-99.2	-116.8+Z <sub>4</sub>	

NOTE 1: Values based on EIS spherical coverage as defined in clause 7.3.4 of TS 38.101-2 [19]. Side condition applies for directions in which EIS spherical coverage requirement is met.

NOTE 2: Values specified at the Reference point to give minimum SSB  $\hat{E}_s/\text{lot}$ , with no applied noise.

NOTE 3: For UEs that support multiple FR2 bands, Rx Beam Peak values are increased by  $\Delta MB_{P,n}$  and spherical coverage values are increased by  $\Delta MB_{S,n}$ , the UE multi-band relaxation factor in dB specified in clause 6.2.1 of TS 38.101-2 [19].

## B.2.6 Conditions for UE transmit timing

### B.2.6.1 Conditions for SSB based UE transmit timing

Editor’s notes for Table B.2.6.1-2:

- The value of Y for power classes 1 and 4 is FFS, where  $Y_1$  and  $Y_4$  are the rough/fine beam gain differences in Rx beam peak direction for power classes 1 and 4 respectively

- The value of Z for power classes 1 and 4 is FFS, where  $Z_1$  and  $Z_4$  are the rough/fine beam gain differences in spherical coverage directions for power classes 1 and 4 respectively

This clause defines the following conditions for UE transmit timing adjustment performed based on SSBs: SSB<sub>RP</sub> and SSB  $\hat{E}_s/\text{lot}$  and applicable for a corresponding operating band.

The conditions are defined in Table B.2.6.1-1 for FR1 SSB.

**Table B.2.6.1-1: Conditions for SSB based UE transmit timing in FR1**

Parameter	NR operating band groups <sup>Note1</sup>	Minimum SSB <sub>RP</sub>		SSB $\hat{E}_s/\text{lot}$
		dBm / SCS <sub>SSB</sub>		dB
		SCS <sub>SSB</sub> =15 kHz	SCS <sub>SSB</sub> =30 kHz	
Conditions	NR_FDD_FR1_A, NR_TDD_FR1_A, NR_SDL_FR1_A	-124	-121	≥ -3
	NR_FDD_FR1_B	-123.5	-120.5	
	NR_TDD_FR1_C	-123	-120	
	NR_FDD_FR1_D, NR_TDD_FR1_D	-122.5	-119.5	
	NR_FDD_FR1_E, NR_TDD_FR1_E	-122	-119	
	NR_FDD_FR1_G	-121	-118	
	NR_FDD_FR1_H	-120.5	-117.5	

NOTE 1: NR operating band groups are defined in clause 3.5.2.

The conditions are defined in Table B.2.6.1-2 for FR2 SSB.

**Table B.2.6.1-2: Conditions for SSB based UE transmit timing in FR2**

Parameter	Angle of arrival	NR operating bands	Minimum SSB <sub>RP</sub> <sup>Note 2, Note 3</sup>				SSB $\hat{E}_s/\text{lot}$
			dBm / SCS <sub>SSB</sub>				dB
			SCS <sub>SSB</sub> = 120 kHz		SCS <sub>SSB</sub> = 240 kHz		
			UE power class				UE power class
			1	2	3	4	1, 2, 3, 4
Conditions	Rx Beam Peak	n257	-125.3+Y <sub>1</sub>	-110.8	-109.1	-124.8+Y <sub>4</sub>	≥ -3
		n258	-125.3+Y <sub>1</sub>	-110.8	-109.1	-124.8+Y <sub>4</sub>	
		n259			-105.5		
		n260	-122.3+Y <sub>1</sub>		-106.5	-122.8+Y <sub>4</sub>	
		n261	-125.3+Y <sub>1</sub>	-110.8	-109.1	-124.8+Y <sub>4</sub>	
	Spherical coverage <sup>Note 1</sup>	n257	-117.3+Z <sub>1</sub>	-99.8	-98.2	-115.8+Z <sub>4</sub>	≥ -3
		n258	-117.3+Z <sub>1</sub>	-99.8	-98.2	-115.8+Z <sub>4</sub>	
		n259			-92.7		
		n260	-114.3+Z <sub>1</sub>		-93.9	-110.8+Z <sub>4</sub>	
		n261	-117.3+Z <sub>1</sub>	-99.8	-98.2	-115.8+Z <sub>4</sub>	

NOTE 1: Values based on EIS spherical coverage as defined in clause 7.3.4 of TS 38.101-2 [19]. Side condition applies for directions in which EIS spherical coverage requirement is met.

NOTE 2: Values specified at the Reference point to give minimum SSB  $\hat{E}_s/\text{lot}$ , with no applied noise.

NOTE 3: For UEs that support multiple FR2 bands, Rx Beam Peak values are increased by  $\Delta\text{MB}_{P,n}$  and Spherical coverage values are increased by  $\Delta\text{MB}_{S,n}$ , the UE multi-band relaxation factor in dB specified in clause 6.2.1 of TS 38.101-2 [19].

## B.3 RRM requirement exceptions

### B.3.1 Introduction

Annex B.3 covers exceptions for the side conditions based on receiver sensitivity for CA, DC, and SUL.

### B.3.2 Receiver sensitivity relaxation for CA

#### B.3.2.1 Receiver sensitivity relaxation for UE supporting CA in FR1

For a UE supporting inter-band carrier aggregation configuration with uplink in NR band, if there is a relaxation of receiver sensitivity  $\Delta R_{IB,c} > 0$  dB as defined in TS 38.101-1 [18, Clause 7.3A.3], the relevant side conditions specifying



received power levels (SSB<sub>RP</sub> and I<sub>o</sub>) shall be increased by the amount  $\Delta=\Delta R_{IB,c}$  defined for the corresponding downlink NR bands.

For a UE supporting CA configuration in FR1, the requirement in this clause applies for both SC and CA operation.

## B.3.2.2 Receiver sensitivity relaxation for UE configured with CA in FR1

### B.3.2.2.1 Inter-band carrier aggregation

For a UE configured with inter-band carrier aggregation with active uplink in NR band, if there is a relaxation of receiver sensitivity  $\Delta R_{IB,c}>0$  dB as defined in TS 38.101-1, Clause 7.3A.3 [2], the relevant side conditions specifying received power levels (SSB<sub>RP</sub> and I<sub>o</sub>) shall be increased by the amount  $\Delta=\Delta R_{IB,c}$  defined for the corresponding downlink NR bands.

If the relaxation  $\Delta$  specified in this clause applies, then the relaxation specified in Clause B.3.2.1 should not be applied.

#### B.3.2.2.2 Reference sensitivity exceptions due to UL harmonic interference for CA

In this clause, requirements exceptions are described for the UE configured with a band in FR1 when it is impacted by UL harmonic interference from another band in FR1 of the same CA configuration.

A relevant side condition (SSB<sub>RP</sub> and I<sub>o</sub>) in a requirement shall be increased by the amount  $\Delta=L2-L1$ , where L1 is the reference sensitivity level specified in TS 38.101-1 [2], Clause 7.3.2, and L2 is the reference sensitivity level based on the requirements in TS 38.101-1 [2], Clause 7.3A.4, when the following conditions are fulfilled,

- corresponding downlink component carriers on different NR bands are configured with CA and active,
- the uplink is configured in the NR low operating band and is active,
- the uplink configuration is as specified in TS 38.101-1 [2], Clause 7.3A.4, and
- the exception requirements specified in TS 38.101-1 [2], Clause 7.3A.4 apply.

If the relaxation  $\Delta$  specified in this clause applies, then the relaxation specified in Clause B.3.2.1 should not be applied.

#### B.3.2.2.3 Reference sensitivity exceptions due to intermodulation interference due to 2UL CA

In this clause, requirements exceptions are described for the UE with an inter-band carrier aggregation with uplink assigned to two NR bands.

A relevant side condition (SSB<sub>RP</sub> and I<sub>o</sub>) in a requirement shall be increased by the amount  $\Delta=L2-L1$ , where L1 is the reference sensitivity level specified in TS 38.101-1 [2], Clause 7.3.2, and L2 is the reference sensitivity level based on the requirements in TS 38.101-1 [2], Clause 7.3A.5, when the following conditions are fulfilled,

- corresponding downlink component carriers on different bands are configured with CA and active,
- uplinks are assigned to two NR bands,
- the exception requirements specified in TS 38.101-1 [2], Clause 7.3A.5 apply.

If the relaxation  $\Delta$  specified in this clause applies, then the relaxation specified in Clause B.3.2.1 should not be applied.

## B.3.2.3 Receiver sensitivity relaxation for UE supporting CA in FR2

**Editor's note: TBD**

## B.3.2.4 Receiver sensitivity relaxation for UE configured with CA in FR2

### B.3.2.4.1 Intra-band contiguous carrier aggregation

For a UE configured with intra-band contiguous carrier aggregation in NR band in FR2, if there is a relaxation of receiver sensitivity  $\Delta R_{IB}>0$  dB as defined in TS 38.101-2 [3], Clause 7.3A.2.1 depending on the aggregated channel bandwidth, the relevant side conditions specifying received power levels (SSB<sub>RP</sub> and I<sub>o</sub>) shall be increased by the amount  $\Delta=\Delta R_{IB}$  defined for the corresponding downlink NR bands.

### B.3.2.4.2 Intra-band non-contiguous carrier aggregation

For a UE configured with intra-band non-contiguous carrier aggregation in NR band in FR2, if there is a relaxation of receiver sensitivity  $\Delta R_{IB} > 0$  dB as defined in TS 38.101-2 [3], Clause 7.3A.2.1 depending on the aggregated channel bandwidth, the relevant side conditions specifying received power levels (SSB\_RP and  $I_o$ ) shall be increased by the amount  $\Delta = \Delta R_{IB}$  defined for the corresponding downlink NR bands.

## B.3.3 Receiver sensitivity relaxation for DC

Editor's note: TBD

## B.3.4 Receiver sensitivity relaxation for SUL

### B.3.4.1 Receiver sensitivity relaxation for UE supporting SUL in FR1

For a UE supporting a SUL configuration in FR1, if there is a relaxation of receiver sensitivity  $\Delta R_{IB,c} > 0$  dB as defined in TS 38.101-1 [2], Clause 7.3C.3, the relevant side conditions specifying received power levels (SSB\_RP and  $I_o$ ) shall be increased by the amount  $\Delta = \Delta R_{IB,c}$  defined for the corresponding downlink NR bands.

For a UE supporting a SUL configuration in FR1, the requirement in this clause applies for both SC and SUL operation.

### B.3.4.2 Receiver sensitivity relaxation for UE configured with SUL in FR1

#### B.3.4.2.1 Reference sensitivity exceptions due to UL harmonic interference for SUL

In this clause, requirements exceptions are described for the UE with a band in FR1 when it is impacted by UL harmonic interference from another band in FR1 of the same SUL configuration.

A relevant side condition (SSB\_RP and  $I_o$ ) in a requirement shall be increased by the amount  $\Delta = L2 - L1$ , where  $L1$  is the reference sensitivity level specified in TS 38.101-1 [2], Clause 7.3.2, and  $L2$  is the reference sensitivity level based on the requirements in TS 38.101-1 [2], Clause 7.3C.2, when the following conditions are fulfilled,

- a downlink component carrier is configured in NR band and is active,
- the uplink is configured in the NR low operating band and is active,
- the uplink configuration is as specified in TS 38.101-1 [2], Clause 7.3C.2, and
- the exception requirements specified in TS 38.101-1 [2], Clause 7.3C.2 apply.

If the relaxation  $\Delta$  specified in this clause applies, then the relaxation specified in Clause B.3.4.1 should not be applied.

## B.4 Conditions for NR sidelink

### B.4.1 Test parameters for GNSS signals

This clause defines the reference signal power levels of generated satellites for a corresponding GNSS, which will be used in NR sidelink test cases.

**Table B.4.1-1: GNSS Reference Signal Power Parameters**

System	Parameters	Unit	Value
	Number of generated satellites per system	-	6
GPS <sup>Note 1</sup>	Reference signal power level for all satellites	dBm	-128.5
Galileo	Reference signal power level for all satellites	dBm	-127
GLONASS	Reference signal power level for all satellites	dBm	-131
BDS	Reference signal power level for all satellites	dBm	-133
NOTE 1: "GPS" here means GPS L1 C/A, Modernized GPS, or both, dependent on UE capabilities.			
NOTE 2: The DUT UE does not need to support all systems. The DUT UE shall support at least one system and will be test for the supported systems.			

## B.4.2 Conditions for PSBCH-RSRP Accuracy Requirements

This clause defines the following conditions for PSBCH-RSRP measurement accuracy requirements applicable for a corresponding operating band.

The conditions are defined in Table B.4.2-1 for FR1.

**Table B.4.2-1: Conditions for PSBCH-RSRP measurements in FR1**

Parameter	NR sidelink operating band groups <sup>Note1</sup>	Minimum S-SSB <sub>RP</sub>			S-SSB $\hat{E}_s/\text{lot}$
		dBm/SCS <sub>S-SSB</sub>			dB
		SCS <sub>S-SSB</sub> = 15kHz	SCS <sub>S-SSB</sub> = 30kHz	SCS <sub>S-SSB</sub> = 60kHz	
	NR_TDD_FR1_B	-126.5	-123.5	-120.5	≥ -6
	NR_TDD_FR1_J	-122.5	-119.5	-116.5	

NOTE 1: NR sidelink operating band groups are as defined in Section 3A.4 for the corresponding NR operating bands.

## B.4.3 Conditions for Selection/Reselection to Intra-frequency SyncRef UE

This clause defines the S-SSB<sub>RP</sub> and S-SSB  $\hat{E}_s/\text{lot}$  applicable for a corresponding operating band.

The conditions for selection/reselection to intra-frequency SyncRef UE are defined in Table B.4.3-1 for FR1.

**Table B.4.3-1: NR sidelink synchronization measurements in FR1**

Parameter	NR sidelink operating band groups <sup>Note1</sup>	Minimum S-SSB <sub>RP</sub>			S-SSB $\hat{E}_s/\text{lot}$
		dBm/SCS <sub>S-SSB</sub>			dB
		SCS <sub>S-SSB</sub> = 15kHz	SCS <sub>S-SSB</sub> = 30kHz	SCS <sub>S-SSB</sub> = 60kHz	
	NR_TDD_FR1_B	-120.5	-117.5	-114.5	≥ 0
	NR_TDD_FR1_J	-116.5	-113.5	-110.5	≥ 0

NOTE 1: NR sidelink operating band groups are as defined in Section 3A.4 for the corresponding NR operating bands.

## B.4.4 Conditions for L1 SL-RSRP Accuracy Requirements

This clause defines the following conditions for L1 SL-RSRP measurement accuracy requirements applicable for a corresponding operating band.

The conditions are defined in Table B.4.4-1 for FR1.

**Table B.4.4-1: Conditions for L1 SL-RSRP measurements in FR1**

Parameter	NR sidelink operating band groups <sup>Note1</sup>	Minimum L1 SL-RSRP			$\hat{E}_s/\text{lot}$
		dBm/SCS			dB
		SCS = 15kHz	SCS = 30kHz	SCS = 60kHz	
	NR_TDD_FR1_B	-120.5	-117.5	-114.5	≥ 0
	NR_TDD_FR1_J	-116.5	-113.5	-110.5	

NOTE 1: NR sidelink operating band groups are as defined in Section 3A.4 for the corresponding NR operating bands.  
 NOTE 2: The parameter  $\hat{E}_s/\text{lot}$  is the  $\hat{E}_s/\text{lot}$  of PSCCH-DMRS and/or PSSCH-DMRS.  
 NOTE 3: The SCS is for PSCCH and/or PSSCH.

# Annex C (normative): Downlink physical channels and propagation conditions

## C.1 Downlink physical channels

### C.1.1 General

The following clauses describe the downlink physical channels that are needed for setting a connection and channels that are needed during a connection.

### C.1.2 Default downlink signal levels

The downlink power settings in Table C.1.2-1 and Table C.1.2-2 are used unless otherwise specified in a test case for FR1 cell and FR2 cell, respectively. The downlink power settings in Table C.1.2-1 and Table C.1.2-2 are also used for the initial registration for NR /5GC test cases in clauses 6 and 7. For EN-DC test cases in clauses 4 and 5, the E-UTRA power settings used for initial registration are defined in Annex A.6.

For FR1, if the UE has more than one Rx antenna, the downlink signal is applied to each one. All UE Rx antennas shall be connected.

**Table C.1.2-1: Default Downlink power levels for NR (FR1)**

SCS (kHz)	Parameter	Unit	Value											
	Channel bandwidth	MHz	5	10	15	20	25	30	40	50	60	80	90	100
15	Number of RBs		25	50	75	100	128	160	215	270	N/A	N/A	N/A	N/A
	Channel BW power	dBm	-60	-57	-55	-54	-53	-52	-51	-50	N/A	N/A	N/A	N/A
30	Number of RBs		10	24	36	50	64	75	100	128	162	216	243	270
	Channel BW power	dBm	-61	-57	-55	-54	-53	-52	-51	-50	-49	-48	-47	-47
60	Number of RBs		N/A	10	18	24	30	36	50	64	75	100	120	135
	Channel BW power	dBm	N/A	-58	-56	-54	-53	-52	-51	-50	-49	-48	-47	-47
	RS EPRE	dBm/15kHz	-85	-85	-85	-85	-85	-85	-85	-85	-85	-85	-85	-85
NOTE 1: The channel bandwidth powers are informative, based on -85dBm/15kHz SS/PBCH SSS EPRE, then scaled according to the number of RBs and rounded to the nearest integer dBm value. Full RE allocation with no boost or deboost is assumed.														
NOTE 2: The power level is specified at each UE Rx antenna.														
NOTE 3: DL level is applied for any of the Subcarrier Spacing configuration ( ) with the same power spectrum density of -85dBm/15kHz.														

**Table C.1.2-2: Default Downlink power levels for NR (FR2)**

SCS (kHz)		Unit	Channel Bandwidth			
			50 MHz	100 MHz	200 MHz	400 MHz
60	Number of RBs		66	132	264	N/A
	Channel BW power	dBm	-70	-67	-64	N/A
120	Number of RBs		32	66	132	264
	Channel BW power	dBm	-70	-67	-64	-61
	SS/PBCH SSS EPRE	dBm/60kHz	-99	-99	-99	-99

NOTE 1: The channel bandwidth powers are informative, based on -99dBm/60kHz SS/PBCH SSS EPRE, then scaled according to the number of RBs and rounded to the nearest integer dBm value. Full RE allocation with no boost or deboost is assumed.

NOTE 2: The power level is specified at the centre of quiet zone.

NOTE 3: DL level is applied for any of the Subcarrier Spacing configuration ( $\mu$ ) with the same power spectrum density of -99dBm/60kHz.

The default signal level uncertainty for FR1 is +/-3dB at each test port, for any level specified. The default signal level uncertainty for FR2 is +/-6dB at centre of quiet zone, for any level specified. If the uncertainty value is critical for the Test purpose, a tighter uncertainty is specified for the related test case in Annex F

### C.1.3 Default connection setup

Table C.1.3-1 describes the downlink physical channels that are required for NR connection setup. For EN-DC test cases in clauses 4 and 5, the required E-UTRA downlink physical channels are defined in TS 36.521-3 [26] Annex C.2.

**Table C.1.3-1: Downlink physical channels required for NR connection set-up**

Physical Channel	EPRE Ratio	Note
PBCH	PBCH_RA = 0 dB	
	PBCH_RB = 0 dB	
PSS	PSS_RA = 0 dB	
SSS	SSS_RA = 0 dB	
PDCCH	PDCCH_RA = 0 dB	
	PDCCH_RB = 0 dB	
	MPDCCH_RB = 0 dB	
PDSCH	PDSCH_RA = 0 dB	
	PDSCH_RB = 0 dB	
DMRS	TBD	
CSI-RS	TBD	

NOTE 1: No boosting is applied

As common PDSCH and PDCCH configuration parameters the parameters in Table A.1 and C.1.3-2 shall be used to bring up the connection setup for FR1 and FR2 NR cell.

**Table C.1.3-2: PDSCH and PDCCH configuration**

Parameter	Unit	Value
Number of HARQ processes		8
Maximum number of HARQ transmission		5

## C.2 Propagation conditions

### C.2.0 General

The propagation conditions and channel models for various environments are specified. For each environment a propagation model is used to evaluate the propagation pathloss due to the distance. Channel models are formed by combining delay profiles with a Doppler spectrum, with the addition of correlation properties in the case of a multi-antenna scenario.

## C.2.1 No interference

The downlink connection between the SS and the UE is without AWGN, and has no fading or multipath effects.

## C.2.2 Static propagation conditions

### C.2.2.0 General

The downlink connection between the SS and the UE is an AWGN environment (unless otherwise stated) with no fading or multipath effects.

#### C.2.2.1 UE receiver with 2Rx antenna connectors

For 1 port transmission to UE receiver with 2Rx the channel matrix is defined in the frequency domain by

$$\mathbf{H} = \begin{pmatrix} 1 \\ 1 \end{pmatrix}.$$

For 2 port transmission to UE Receiver with 2Rx the channel matrix is defined in the frequency domain by

$$\mathbf{H} = \begin{pmatrix} 1 & j \\ 1 & -j \end{pmatrix}$$

For 4 port transmission to UE Receiver with 2Rx the channel matrix is defined in the frequency domain by

$$\mathbf{H} = \begin{bmatrix} 1 & 1 & j & j \\ 1 & 1 & -j & -j \end{bmatrix}$$

#### C.2.2.2 UE receiver with 4Rx antenna connectors

For 1 port transmission to UE receiver with 4Rx the channel matrix is defined in the frequency domain by

$$\mathbf{H} = \begin{bmatrix} 1 \\ 1 \\ 1 \\ 1 \end{bmatrix}.$$

For 2 port transmission to UE Receiver with 4Rx the channel matrix is defined in the frequency domain by

$$\mathbf{H} = \begin{bmatrix} 1 & j \\ 1 & -j \\ 1 & j \\ 1 & -j \end{bmatrix}.$$

For 4 port transmission to UE Receiver with 4Rx the channel matrix is defined in the frequency domain by

$$\mathbf{H} = \begin{bmatrix} 1 & 1 & j & j \\ 1 & 1 & -j & -j \\ 1 & -1 & j & -j \\ 1 & -1 & -j & j \end{bmatrix}.$$

## C.2.3 Multi-path fading propagation conditions

Same as defined in TS 38.521-4 [20] clause B.2.

---

## Annex D (normative): Deviations from standard test configuration

### D.1 Test cases with different numerologies

TBD

---

### D.2 EN-DC test cases with different EN-DC configurations

#### D.2.0 General

In clauses 4 and 5, EN-DC test cases may be defined for two component carriers (CCs) as well as for more than two CCs to verify the same RRM requirement.

#### D.2.1 Principle of testing

If multiple EN-DC test cases are defined for two CCs as well as for more than two CCs to verify the same type of RRM requirement, and this requirement is dependent on the number of CCs, then from the UE performance point of view the test coverage can be considered fulfilled by executing only the EN-DC test cases with the maximum number of CCs in EN-DC supported by the UE. Otherwise if the same type of RRM requirement is independent of the number of CCs then from the UE performance point of view the test coverage can be considered fulfilled by executing only the EN-DC test cases with two CCs in EN-DC supported by the UE.

*Editor's Note: The maximum number of CCs that can be used in FR2 tests in EN-DC would depend on the test equipment capability.*

---

### D.3 Carrier aggregation test cases with different CA configurations

#### D.3.0 General

In clauses 6 and 7, carrier aggregation test cases may be defined for two CCs as well as for more than two CCs to verify the same RRM requirement.

#### D.3.1 Principle of testing

If multiple carrier aggregation test cases are defined for two CCs as well as for more than two CCs to verify the same RRM requirement, and the test requirement is dependent on the number of CCs, then from the UE performance point of view the test coverage can be considered fulfilled by executing only the CA test cases with the maximum number of CCs in CA supported by the UE. Otherwise if the same type of RRM requirement is independent of the number of CCs then from the UE performance point of view the test coverage can be considered fulfilled by executing only the CA test cases with at least two CCs in CA supported by the UE.

*Editor's Note: The maximum number of CCs that can be used in FR2 tests in CA would depend on the test equipment capability.*

---

### D.4 Antenna connection for 4Rx capable UEs

#### D.4.0 General

All the tests in this test specification are defined for UEs supporting 2Rx. This clause explains how to apply the 2Rx tests in clauses 4 and 6 to UEs supporting 4Rx antenna ports. No tests are currently specified in clauses 4 or 6 which are



applicable only to 4Rx antenna ports, so 4Rx capable UEs are always tested by reusing tests which were originally specified for 2Rx UEs. Please notice that 4Rx is in general not supported for the test cases in clauses 5 and 7.

## D.4.1 Principle of testing

### D.4.1.1 Single carrier tests

For 4Rx capable UEs supporting at least one band where 2Rx is supported and 4Rx is not supported, all single carrier tests specified in clauses 4 and 6, except 4.7 and 6.7 shall be tested with 2Rx on any band where 2Rx is supported and 4Rx is not supported, with the antenna connection defined in D.4.2.1. Single carrier tests specified clauses 4.7 and 6.7 are band dependent and shall be tested in all bands supported by the UE, using 2Rx and the antenna connection defined in D.4.2.1 for the bands where 2Rx is supported and 4Rx is not supported, and the antenna connection defined in D.4.2.2 for the bands where 2Rx is not supported.

For 4Rx capable UEs that do not support any band where 2Rx is supported and 4Rx is not supported, all single carrier tests in clauses 4 and 6 shall be tested with 4Rx using the antenna configuration defined in D.4.2.2. For radio link monitoring tests, the SNR levels are modified according to table D.4.1.1-1 and table D.4.1.1-2

**Table D.4.1.1-1: Modified parameters for RLM out of sync testing with 4 RX antenna connection**

Test case	SNR during T3 (dB)			
	Test 1	Test 2	Test 3	Test 4
4.5.1.1	-18	N/A	N/A	N/A
4.5.1.3	-18	N/A	N/A	N/A
4.5.1.5	-18	N/A	N/A	N/A
4.5.1.7	-18	N/A	N/A	N/A
5.5.1.1	-18	N/A	N/A	N/A
5.5.1.3	-18	N/A	N/A	N/A
5.5.1.5	-18	N/A	N/A	N/A
5.5.1.7	-18	N/A	N/A	N/A
6.5.1.1	-18	N/A	N/A	N/A
6.5.1.3	-18	N/A	N/A	N/A
6.5.1.5	-18	N/A	N/A	N/A
6.5.1.7	-18	N/A	N/A	N/A
7.5.1.1	-18	N/A	N/A	N/A
7.5.1.3	-18	N/A	N/A	N/A
7.5.1.5	-18	N/A	N/A	N/A
7.5.1.7	-18	N/A	N/A	N/A

**Table D.4.1.1-2: Modified parameters for RLM in sync single carrier testing with 4 RX antenna connection**

Test case	SNR during T3 (dB)		SNR during T4 (dB)	
	Test 1	Test 2	Test 1	Test 2
4.5.1.2	-18	N/A	-8	N/A
4.5.1.4	-18	N/A	-8	N/A
4.5.1.6	-18	N/A	-8	N/A
4.5.1.8	-18	N/A	-8	N/A
5.5.1.2	-18	N/A	-8	N/A
5.5.1.4	-18	N/A	-8	N/A
5.5.1.6	-18	N/A	-8	N/A
5.5.1.8	-18	N/A	-8	N/A
6.5.1.2	-18	N/A	-8	N/A
6.5.1.4	-18	N/A	-8	N/A
6.5.1.6	-18	N/A	-8	N/A
6.5.1.8	-18	N/A	-8	N/A
7.5.1.2	-18	N/A	-8	N/A
7.5.1.4	-18	N/A	-8	N/A
7.5.1.6	-18	N/A	-8	N/A
7.5.1.8	-18	N/A	-8	N/A

**Table D.4.1.1-3: Modified parameters for Beam Failure Detection and Link Recovery testing with 4 RX antenna connection**

Test case	SNR for RS in set $q_0$ during T3, T4 and T5.(dB)
	Test 1
4.5.5.1	-15
4.5.5.2	-15
4.5.5.3	-15
4.5.5.4	-15
5.5.5.1	-15
5.5.5.2	-15
5.5.5.3	-15
5.5.5.4	-15
6.5.5.1	-15
6.5.5.2	-15
6.5.5.3	-15
6.5.5.4	-15
7.5.5.1	-15
7.5.5.2	-15
7.5.5.3	-15
7.5.5.4	-15

### D.4.1.2 Carrier aggregation tests

For carrier aggregation tests, the antenna connection is selected independently for each cell, the PCell and the SCell(s). If a cell (either PCell or any of the SCell(s)) is on a band where 2Rx is supported and 4Rx is not supported, antenna connection in Clause D.4.2.1 shall be used for this cell. If the cell is on a band where 2Rx is not supported, antenna connection in clause D.4.2.2 shall be used for this cell.

### D.4.1.3 EN-DC tests

For all EN-DC tests, the antenna connection is selected independently for each cell. For the E-UTRA PCell, the antenna connection specified in D.4.2.3 shall be used if the PCell is on an E-UTRA band where 2Rx is supported and 4Rx is not supported, and the antenna connection specified in D.4.2.4 shall be used if the PCell is on an E-UTRA band not supporting 2Rx.

For the NR PSCell and SCell(s), the principle of testing is the same as in D.4.1.2.

## D.4.2 Antenna connection

### D.4.2.1 Antenna connection for NR bands where 2Rx is supported

For NR bands where 2Rx is supported and 4Rx is not supported, the UE shall decide via manufacturer declaration and antenna port configuration which 2 of the 4 antenna ports shall be connected with the downlink signal from the SS. The remaining 2 antenna ports shall be connected to zero input. The parameters and test requirements remain unmodified.

### D.4.2.2 Antenna connection for NR bands where only 4Rx is supported

For NR bands where only 4Rx is supported, all 4Rx antenna ports shall be connected to the downlink signal from the SS. The system simulator shall provide independent noise and fading (low correlation) for each antenna port. Except for the modifications to radio link monitoring tests specified in D.4.1.1 and D.4.1.2, the parameters and test requirements remain unmodified.

### D.4.2.3 Antenna connection for E-UTRA bands where 2Rx is supported

For E-UTRAN bands where 2Rx is supported and 4Rx is not supported, the UE shall decide via manufacturer declaration and antenna port configuration which 2 of the 4 antenna ports shall be connected with the downlink signal from the SS. The remaining 2Rx antenna ports shall be connected to zero input. The parameters and test requirements remain unmodified.

## D.4.2.4 Antenna connection for E-UTRA bands where only 4Rx is supported

For E-UTRAN bands where only 4Rx is supported, all 4Rx antenna ports shall be connected to the downlink signal from the SS. The system simulator shall provide independent noise and fading (low correlation) for each antenna port. Except for the modifications to radio link monitoring tests specified in TS36.521-1 [26] clause 3A.4.1.2.1 and 3A.4.1.2.2, the parameters and test requirements remain unmodified.

---

# D.5 Test Cases with Different Channel Bandwidths

## D.5.1 Test Cases with Different E-UTRA Channel Bandwidths

### D.5.1.1 Introduction

Test cases involving E-UTRA cell(s) may be defined with different E-UTRA channel bandwidths to verify the same type of RRM requirement.

### D.5.1.2 Principle of testing

If multiple test cases involving E-UTRA cell(s) are defined with different E-UTRA channel bandwidths to verify the same type of RRM requirement that is E-UTRA channel bandwidth independent, then the UE needs to be tested with only one channel bandwidth in each E-UTRA cell and with the same bandwidth in all the E-UTRA cells used in the test case.

---

# D.6 Test Cases for Synchronous and Asynchronous DC Operations

## D.6.1 EN-DC Test Cases for Synchronous and Asynchronous EN-DC Operations

### D.6.1.1 Introduction

This clause defines a principle, which is applicable to test cases verifying RRM requirements for EN-DC operation in synchronous and asynchronous scenarios.

Test cases may be defined in both synchronous EN-DC and asynchronous EN-DC scenarios to verify the same type of RRM requirement.

### D.6.1.2 Principle of Testing

If EN-DC test cases are defined in both synchronous and asynchronous EN-DC scenarios to verify the same type of RRM requirement then the UE capable of both synchronous and asynchronous EN-DC operations needs to be tested with one of the tests in either synchronous or asynchronous EN-DC scenarios.

---

# Annex E (normative): Cell configuration mapping

## E.0 General

The cells used in TS 38.533 do not correspond to the cells defined in TS 38.508-1 [14] clause 4.4.2. This annex describes the mapping between the test cases in TS 38.533 and the cells defined in TS 38.508-1 [14]. The test case shall apply the RF parameters as defined in TS 38.533 according to the column heading.

NOTE: For example if the second cell in a test case is an inter-frequency cell then Cell3 from TS 38.508-1 [14] clause 4.4.2 is used with the radio parameters as defined for Cell2 in TS 38.533.

---

## E.1 Test frequency selection

### E.1.0 General

The requirements defined in this test specification comprise EN-DC and NR/5GC test cases. The test cases are defined with a single NR cell or with multiple NR cells. The multi-cell test cases can be either intra-frequency, i.e. the NR cells defined by the test are overlapping in the frequency domain, or inter-frequency, i.e. the NR cells defined by the test have different centre frequencies, separated from each other by a frequency value bigger than the respective cell bandwidths. This clause describes the general rule on how to select the test frequencies for the NR RRM test cases in this test specification.

#### E.1.1 E-UTRA PCell for EN-DC test cases

Unless otherwise stated, the E-UTRA PCell for EN-DC test cases shall be configured using the test frequency “Mid” as defined in TS 36.508 [25] for the corresponding E-UTRA band.

In case that the “Mid” test frequency overlaps with any of the NR test frequencies required by the test case, the E-UTRA PCell shall be shifted to an additional frequency within the E-UTRA same band. If the E-UTRA band channel bandwidth is not sufficient to allocate a non-overlapping E-UTRA PCell, the auxiliary band as defined in TS 36.521-3 [26] clause 3 shall be used.

#### E.1.2 Test cases with one NR cell

Unless otherwise stated, for NR test cases with one NR cell, this cell shall be configured using the test frequency “Mid” as defined in TS 38.508-1 [14] for the corresponding band under test.

#### E.1.3 Test cases with more than one NR cell

##### E.1.3.1 Intra-frequency test cases

Unless otherwise stated, multi-cell intra-frequency test cases shall be tested using the test frequency “Mid” as defined in TS 38.508-1 [14] for the corresponding NR band under test.

##### E.1.3.2 Inter-frequency test cases

For NR/5GC and EN-DC multi-cell inter-frequency test cases in FR1, unless otherwise stated, the serving cell shall be configured using the test frequency “Low” as defined in TS 38.508-1 [14] for the corresponding band under test. Any inter-frequency neighbour cell shall be configured using the test frequency “High” as defined in TS 38.508-1 [14] for the corresponding band under test.

For NR/5GC multi-cell inter-frequency test cases in FR2, unless otherwise stated, the serving cell (and any other neighbour cell in the same frequency carrier) shall be configured using the test frequency “Mid” as defined in TS 38.508-1 [14], clause 7.2.3.2 for the corresponding band under test. Any inter-frequency neighbour cell shall be configured using a non-overlapping test frequency adjacent to the serving cell frequency, as defined in TS 38.508-1 [14], clause 7.2.3.2.

For EN-DC multi-cell inter-frequency test cases in FR2, unless otherwise stated, the PSCell (and any other neighbour cell in the same frequency carrier) shall be configured using the test frequency “Mid” as defined in TS 38.508-1 [14], clause 7.2.3.2 for the corresponding band under test. Any inter-frequency neighbour cell shall be configured using a non-overlapping test frequency adjacent to the PSCell frequency, as defined in TS 38.508-1 [14], clause 7.2.3.2.

## E.1.4 Carrier aggregation test cases

### E.1.4.1 Inter-band carrier aggregation

For inter-band carrier aggregation test cases, each of the component carriers and their respective neighbour cells shall be configured following the same principles defined in E.1.2 and E.1.3.

### E.1.4.2 Intra-band contiguous carrier aggregation

For intra-band contiguous carrier aggregation with 2 CCs in FR1, unless otherwise specified, the serving cells (and any other neighbour cell(s) in the same frequency carriers) shall be configured using the test frequency “Low” as defined in TS 38.508-1 [14], subclause 4.3.1.1.3 for the corresponding band under test (SpCC = CC1 and SCC = CC2).

For intra-band contiguous carrier aggregation with 2 CCs in FR2, unless otherwise specified, the serving cells (and any other neighbour cell(s) in the same frequency carriers) shall be configured using the test frequency “Mid” as defined in TS 38.508-1 [14], subclause 4.3.1.2.3 for the corresponding band under test (SpCC = CC1 and SCC = CC2).

### E.1.4.3 Intra-band non-contiguous carrier aggregation

For intra-band non-contiguous carrier aggregation in FR1, unless otherwise specified, the test frequency selection shall be done following the maximum W<sub>gap</sub> principle, i.e. selecting the test frequencies (of the test frequencies defined in TS 38.508-1 [14]) with the widest frequency separation within the band under test.

For intra-band non-contiguous carrier aggregation in FR2, the test frequency selection is TBD.

## E.1.5 E-UTRA – NR inter RAT test cases

Unless otherwise stated, the E-UTRA serving/neighbour cell for E-UTRA – NR inter-RAT test cases shall be configured using the test frequency “Mid” as defined in TS 36.508 [25] for the corresponding E-UTRA band.

In case that the “Mid” test frequency overlaps with any of the NR test frequencies required by the test case, the E-UTRA cell shall be shifted to an additional frequency within the E-UTRA same band. If the E-UTRA band channel bandwidth is not sufficient to allocate a non-overlapping E-UTRA cell, the auxiliary band as defined in TS 36.521-3 [26] clause 3 shall be used.

## E.1.6 Intra-band EN-DC test cases

### E.1.6.1 Intra-band non-contiguous EN-DC

For intra-band non-contiguous EN-DC in FR1, unless otherwise specified, the test frequency selection shall be done following the maximum W<sub>gap</sub> principle, i.e. selecting the test frequencies (of the test frequencies defined in TS 38.508-1 [14]) with the widest frequency separation within the band under test.

#### E.1.6.1.1 Inter frequency neighbour cell

Unless otherwise stated, any inter-frequency neighbour cell shall be configured using the test frequency “Mid” as defined in TS 38.508-1 [14] for the corresponding NR band under test. If the NR band channel bandwidth is not sufficient to allocate a non-overlapping the neighbour cell, the auxiliary band as defined in TBD shall be used.

### E.1.6.2 Intra-band contiguous EN-DC

#### E.1.6.1.1 E-UTRA PCell

Unless otherwise stated, the E-UTRA PCell for intra-band contiguous EN-DC test cases shall be configured using same test frequency, e.g., “Mid” as for NR PSCell as defined in TS 38.508-1 [14].

## E.1.7 NR sidelink test cases

Unless otherwise stated, for NR sidelink test cases the NR sidelink carrier shall be configured using the test frequency “Mid” as defined in TS 38.508-1 [14] for the corresponding band under test.

For con-current operation, unless otherwise stated, each of the NR Uu carriers and their respective cells shall be configured following the sample principles defined in E.1.2 and E.1.3.

## E.2 Cell configuration mapping for EN-DC FR1 test cases in Chapter 4

Table E.2-1 defines the cell configuration mapping for EN-DC FR1 test cases in chapter 4 of this test specification.

**Table E.2-1: Cell configuration mapping for EN-DC FR1 RRM testing**

TC	Description	38.533 LTE Cell1	38.533 NR Cell2	38.533 NR Cell3	38.533 NR Cell4	CA Type
4.3.2.2.1	EN-DC FR1 contention based random access	LTE Cell 1	NR Cell 1			
4.3.2.2.2	EN-DC FR1 non-contention based random access	LTE Cell 1	NR Cell 1			
4.3.2.2.3	EN-DC FR1 2-step contention based random access	LTE Cell 1	NR Cell 1			
4.3.2.2.4	EN-DC FR1 2-step non-contention based random access	LTE Cell 1	NR Cell 1			
4.4.1.1	EN-DC FR1 UE transmit timing accuracy	LTE Cell 1	NR Cell 1			
4.4.3.1	EN-DC FR1 timing advance adjustment accuracy	LTE Cell 1	NR Cell 1			
4.5.1.1	EN-DC FR1 radio link monitoring out-of-sync test for PSCell configured with SSB-based RLM RS in non-DRX mode	LTE Cell 1	NR Cell 1			
4.5.1.2	EN-DC FR1 radio link monitoring in-sync test for PSCell configured with SSB-based RLM RS in non-DRX mode	LTE Cell 1	NR Cell 1			
4.5.1.3	EN-DC FR1 radio link monitoring out-of-sync test for PSCell configured with SSB-based RLM RS in DRX mode	LTE Cell 1	NR Cell 1			
4.5.1.4	EN-DC FR1 radio link monitoring in-sync test for PSCell configured with SSB-based RLM RS in DRX mode	LTE Cell 1	NR Cell 1			
4.5.1.5	EN-DC FR1 radio link monitoring out-of-sync test for PSCell configured with CSI-RS-based RLM RS in non-DRX mode	LTE Cell 1	NR Cell 1			
4.5.1.6	EN-DC FR1 radio link monitoring in-sync test for PSCell configured with CSI-RS-based RLM RS in non-DRX mode	LTE Cell 1	NR Cell 1			
4.5.1.7	EN-DC FR1 radio link monitoring out-of-sync test for PSCell configured with CSI-RS-based RLM RS in DRX mode	LTE Cell 1	NR Cell 1			
4.5.1.8	EN-DC FR1 radio link monitoring in-sync test for PSCell configured with CSI-RS-based RLM RS in DRX mode	LTE Cell 1	NR Cell 1			
4.5.2.1	EN-DC FR1 interruptions at transitions between active and non-active during DRX in synchronous EN-DC	LTE Cell 1	NR Cell 1			
4.5.2.2	EN-DC FR1 interruptions at transitions between active and non-active during DRX in asynchronous EN-DC	LTE Cell 1	NR Cell 1			
4.5.2.3	EN-DC FR1 interruptions during measurements on deactivated NR SCC in synchronous EN-DC	LTE Cell 1	NR Cell 1	NR Cell 6		intra-band
				NR Cell 10		inter-band
4.5.2.4	EN-DC FR1 interruptions during measurements on deactivated NR SCC in asynchronous EN-DC	LTE Cell 1	NR Cell 1	NR Cell 6		intra-band
				NR Cell 10		inter-band

TC	Description	38.533 LTE Cell1	38.533 NR Cell2	38.533 NR Cell3	38.533 NR Cell4	CA Type
4.5.2.5	EN-DC FR1 interruptions during measurements on deactivated E-UTRAN SCC in synchronous EN-DC	LTE Cell 6	NR Cell 1	LTE Cell 3		
4.5.2.6	EN-DC FR1 interruptions during measurements on deactivated E-UTRAN SCC in asynchronous EN-DC	LTE Cell 6	NR Cell 1	LTE Cell 3		
4.5.3.1	EN-DC FR1 SCell activation and deactivation of known SCell in non-DRX for 160ms SCell measurement cycle	LTE Cell 1	NR Cell 1	NR Cell 6		intra-band
				NR Cell 10		inter-band
4.5.3.2	EN-DC FR1 SCell activation and deactivation of known SCell in non-DRX for 640ms SCell measurement cycle	LTE Cell 1	NR Cell 1	NR Cell 6		intra-band
				NR Cell 10		inter-band
4.5.3.3	EN-DC FR1 SCell activation and deactivation of unknown SCell in non-DRX	LTE Cell 1	NR Cell 1	NR Cell 6		intra-band
				NR Cell 10		inter-band
4.5.4.1	EN-DC FR1 UE UL carrier RRC reconfiguration delay	LTE Cell 1	NR Cell 6	NR Cell 3		
4.5.5.1	EN-DC FR1 SSB-based beam failure detection and link recovery in non-DRX	LTE Cell 1	NR Cell 1			
4.5.5.2	EN-DC FR1 SSB-based beam failure detection and link recovery in DRX	LTE Cell 1	NR Cell 1			
4.5.5.3	EN-DC FR1 CSI-RS-based beam failure detection and link recovery in non-DRX	LTE Cell 1	NR Cell 1			
4.5.5.4	EN-DC FR1 CSI-RS-based beam failure detection and link recovery in DRX	LTE Cell 1	NR Cell 1			
4.5.5.5	EN-DC FR1 SCell CSI-RS-based beam failure detection and SSB-based link recovery in non-DRX	LTE Cell 1	NR Cell 1			
4.5.5.6	EN-DC FR1 SCell CSI-RS-based beam failure detection and SSB-based link recovery in DRX	LTE Cell 1	NR Cell 1			
4.5.6.1.1	EN-DC FR1 DCI-based DL active BWP switch in non-DRX in synchronous EN-DC	LTE Cell 1	NR Cell 1			
4.5.6.1.2	EN-DC FR1 DCI-based DL active BWP switch with SCell in non-DRX in synchronous EN-DC	LTE Cell 1	NR Cell 6	NR Cell 3		
4.5.6.2.1	EN-DC FR1 RRC-based DL active BWP switch in non-DRX in synchronous EN-DC	LTE Cell 1	NR Cell 1			
4.5.7.1	EN-DC FR1 addition and release delay of known PSCell	LTE Cell 1	NR Cell 1			
4.5.8.1	EN-DC FR1 interruptions at switching between two uplink carriers	LTE Cell 1	NR Cell 1			
4.6.1.1	EN-DC FR1 event-triggered reporting without gap in non-DRX	LTE Cell 1	NR Cell 1	NR Cell 2		
4.6.1.2	EN-DC FR1 event-triggered reporting without gap in DRX	LTE Cell 1	NR Cell 1	NR Cell 2		
4.6.1.3	EN-DC FR1 event-triggered reporting with gap in non-DRX	LTE Cell 1	NR Cell 1	NR Cell 2		
4.6.1.4	EN-DC FR1 event-triggered reporting with gap in DRX	LTE Cell 1	NR Cell 1	NR Cell 2		
4.6.1.5	EN-DC FR1 event-triggered reporting without gap in non-DRX with SSB time index detection	LTE Cell 1	NR Cell 1	NR Cell 2		
4.6.1.6	EN-DC FR1 event-triggered reporting with gap in non-DRX with SSB time index detection	LTE Cell 1	NR Cell 1	NR Cell 2		
4.6.1.7	EN-DC FR1 event-triggered reporting without gap in DRX for UE configured with highSpeedMeasFlag-r16	LTE Cell 1	NR Cell 1	NR Cell 2		
4.6.2.1	EN-DC FR1-FR1 event-triggered reporting in non-DRX	LTE Cell 1	NR Cell 6	NR Cell 3		
4.6.2.2	EN-DC FR1-FR1 event-triggered reporting in DRX	LTE Cell 1	NR Cell 6	NR Cell 3		
4.6.2.5	EN-DC FR1-FR1 event-triggered reporting in non-DRX with SSB time index detection	LTE Cell 1	NR Cell 6	NR Cell 3		

TC	Description	38.533 LTE Cell1	38.533 NR Cell2	38.533 NR Cell3	38.533 NR Cell4	CA Type
4.6.2.6	EN-DC FR1-FR1 event-triggered reporting in DRX with SSB time index detection	LTE Cell 1	NR Cell 6	NR Cell 3		
4.6.4.1	EN-DC FR1 SSB-based L1-RSRP measurement in non-DRX	LTE Cell 1	NR Cell 1			
4.6.4.2	EN-DC FR1 SSB-based L1-RSRP measurement in DRX	LTE Cell 1	NR Cell 1			
4.6.4.3	EN-DC FR1 CSI-RS-based L1-RSRP measurement in non-DRX	LTE Cell 1	NR Cell 1			
4.6.4.4	EN-DC FR1 CSI-RS-based L1-RSRP measurement in DRX	LTE Cell 1	NR Cell 1			
4.6.7.1	EN-DC FR1 CSI-RS based CMR and no dedicated IMR L1-SINR measurement in non-DRX	LTE Cell 1	NR Cell 1			
4.6.7.2	EN-DC FR1 SSB based CMR and dedicated IMR L1-SINR measurement in DRX	LTE Cell 1	NR Cell 1			
4.6.7.3	EN-DC FR1 CSI-RS based CMR and dedicated IMR L1-SINR measurement in DRX	LTE Cell 1	NR Cell 1			
4.7.1.1.1	EN-DC FR1 SS-RSRP absolute measurement accuracy	LTE Cell 1	NR Cell 489	NR Cell 1		
4.7.1.1.2	EN-DC FR1 SS-RSRP relative measurement accuracy	LTE Cell 1	NR Cell 489	NR Cell 1		
4.7.1.2.1	EN-DC FR1-FR1 SS-RSRP absolute measurement accuracy	LTE Cell 1	NR Cell 6	NR Cell 3		
4.7.1.2.2	EN-DC FR1-FR1 SS-RSRP relative measurement accuracy	LTE Cell 1	NR Cell 6	NR Cell 3		
4.7.2.1	EN-DC FR1 SS-RSRQ measurement accuracy	LTE Cell 1	NR Cell 1	NR Cell 2		
4.7.2.2.1	EN-DC FR1-FR1 SS-RSRQ absolute measurement accuracy	LTE Cell 1	NR Cell 6	NR Cell 3		
4.7.2.2.2	EN-DC FR1-FR1 SS-RSRQ relative measurement accuracy	LTE Cell 1	NR Cell 6	NR Cell 3		
4.7.3.1	EN-DC FR1 SS-SINR measurement accuracy	LTE Cell 1	NR Cell 1	NR Cell 2		
4.7.3.2.1	EN-DC FR1-FR1 SS-SINR absolute measurement accuracy	LTE Cell 1	NR Cell 6	NR Cell 3		
4.7.3.2.2	EN-DC FR1-FR1 SS-SINR relative measurement accuracy	LTE Cell 1	NR Cell 6	NR Cell 3		
4.7.4.1.1	EN-DC FR1 SSB based L1-RSRP absolute measurement accuracy	LTE Cell 1	NR Cell 1			
4.7.4.1.2	EN-DC FR1 SSB based L1-RSRP relative measurement accuracy	LTE Cell 1	NR Cell 1			
4.7.4.2.1	EN-DC FR1 CSI-RS based L1-RSRP absolute measurement accuracy	LTE Cell 1	NR Cell 1			
4.7.4.2.2	EN-DC FR1 CSI-RS based L1-RSRP relative measurement accuracy	LTE Cell 1	NR Cell 1			
4.7.5.1	EN-DC FR1 SFTD measurement accuracy	LTE Cell 1	NR Cell 1			
4.7.7.1	EN-DC FR1 CSI-RS based CMR and no dedicated IMR configured and CSI-RS resource set with repetition off L1-SINR measurement accuracy	LTE Cell 1	NR Cell 1			
4.7.7.2	EN-DC FR1 SSB based CMR and dedicated IMR L1-SINR absolute measurement accuracy	LTE Cell 1	NR Cell 1			
4.7.7.3	EN-DC FR1 CSI-RS based CMR and dedicated IMR L1-SINR measurement accuracy	LTE Cell 1	NR Cell 1			



---

## E.3 Cell configuration mapping for EN-DC FR2 test cases in Chapter 5

Table E.3-1 defines the cell configuration mapping for EN-DC FR2 test cases in chapter 5 of this test specification.

**Table E.3-1: Cell configuration mapping for EN-DC FR2 RRM testing**

TC	Description	38.533 LTE Cell1	38.533 NR Cell2	38.533 NR Cell3	38.533 NR Cell4	CA Type
5.3.2.2.1	EN-DC FR2 contention based random access	LTE Cell 1	NR Cell 1			
5.3.2.2.2	EN-DC FR2 non-contention based random access	LTE Cell 1	NR Cell 1			
5.3.2.2.3	EN-DC FR2 2-step contention based random access	LTE Cell 1	NR Cell 1			
5.3.2.2.4	EN-DC FR2 2-step non-contention based random access	LTE Cell 1	NR Cell 1			
5.4.1.1	EN-DC FR2 UE transmit timing accuracy	LTE Cell 1	NR Cell 1			
5.4.3.1	EN-DC FR2 timing advance adjustment accuracy	LTE Cell 1	NR Cell 1			
5.5.1.1	EN-DC FR2 radio link monitoring out-of-sync test for PSCell configured with SSB-based RLM RS in non-DRX mode	LTE Cell 1	NR Cell 6			
5.5.1.3	EN-DC FR2 radio link monitoring out-of-sync test for PSCell configured with SSB-based RLM RS in DRX mode	LTE Cell 1	NR Cell 6			
5.5.1.5	EN-DC FR2 radio link monitoring out-of-sync test for PSCell configured with CSI-RS-based RLM RS in non-DRX mode	LTE Cell 1	NR Cell 1			
5.5.1.6	EN-DC FR2 radio link monitoring in-sync test for PSCell configured with CSI-RS-based RLM RS in non-DRX mode	LTE Cell 1	NR Cell 1			
5.5.1.7	EN-DC FR2 radio link monitoring out-of-sync test for PSCell configured with CSI-RS-based RLM RS in DRX mode	LTE Cell 1	NR Cell 1			
5.5.1.8	EN-DC FR2 radio link monitoring in-sync test for PSCell configured with CSI-RS-based RLM RS in DRX mode	LTE Cell 1	NR Cell 1			
5.5.1.9	EN-DC FR2 radio link monitoring UE scheduling restrictions	LTE Cell 1	NR Cell 1			
5.5.2.1	EN-DC FR2 interruptions at transitions between active and non-active during DRX in synchronous EN-DC	LTE Cell 1	NR Cell 1			
5.5.2.2	EN-DC FR2 interruptions at transitions between active and non-active during DRX in asynchronous EN-DC	LTE Cell 1	NR Cell 1			
5.5.2.3	EN-DC FR2 interruptions during measurements on deactivated NR SCC in synchronous EN-DC	LTE Cell 1	NR Cell 1	NR Cell 6		intra-band
				NR Cell 10		inter-band
5.5.2.4	EN-DC FR2 interruptions during measurements on deactivated NR SCC in asynchronous EN-DC	LTE Cell 1	NR Cell 1	NR Cell 6		intra-band
				NR Cell 10		inter-band
5.5.2.5	EN-DC FR2 interruptions during measurements on deactivated E-UTRAN SCC in synchronous EN-DC	LTE Cell 6	NR Cell 1	LTE Cell 3		
5.5.2.6	EN-DC FR2 interruptions during measurements on deactivated E-UTRAN SCC in asynchronous EN-DC	LTE Cell 6	NR Cell 1	LTE Cell 3		
5.5.3.1	EN-DC FR2 SCell activation and deactivation intra-band in non-DRX	LTE Cell 1	NR Cell 1	NR Cell 6		intra-band
5.5.5.1	EN-DC FR2 SSB-based beam failure detection and link recovery in non-DRX	LTE Cell 1	NR Cell 1			
5.5.5.2	EN-DC FR2 SSB-based beam failure detection and link recovery in DRX	LTE Cell 1	NR Cell 1			
5.5.5.3	EN-DC FR2 CSI-RS-based beam failure detection and link recovery in non-DRX	LTE Cell 1	NR Cell 1			
5.5.5.4	EN-DC FR2 CSI-RS-based beam failure detection and link recovery in DRX	LTE Cell 1	NR Cell 1			
5.5.5.5	EN-DC FR2 scheduling available restriction during SSB-based beam failure detection and link recovery in non-DRX	LTE Cell 1	NR Cell 1			
5.5.5.6	EN-DC FR2 SCell CSI-RS-based beam failure detection and link recovery in non-DRX	LTE Cell 1	NR Cell 1	NR Cell 6		

TC	Description	38.533 LTE Cell1	38.533 NR Cell2	38.533 NR Cell3	38.533 NR Cell4	CA Type
5.3.2.2.1	EN-DC FR2 contention based random access	LTE Cell 1	NR Cell 1			
5.3.2.2.2	EN-DC FR2 non-contention based random access	LTE Cell 1	NR Cell 1			
5.3.2.2.3	EN-DC FR2 2-step contention based random access	LTE Cell 1	NR Cell 1			
5.3.2.2.4	EN-DC FR2 2-step non-contention based random access	LTE Cell 1	NR Cell 1			
5.4.1.1	EN-DC FR2 UE transmit timing accuracy	LTE Cell 1	NR Cell 1			
5.4.3.1	EN-DC FR2 timing advance adjustment accuracy	LTE Cell 1	NR Cell 1			
5.5.1.1	EN-DC FR2 radio link monitoring out-of-sync test for PSCell configured with SSB-based RLM RS in non-DRX mode	LTE Cell 1	NR Cell 6			
5.5.1.3	EN-DC FR2 radio link monitoring out-of-sync test for PSCell configured with SSB-based RLM RS in DRX mode	LTE Cell 1	NR Cell 6			
5.5.5.7	EN-DC FR2 SCell CSI-RS-based beam failure detection and link recovery in DRX	LTE Cell 1	NR Cell 1	NR Cell 6		
5.5.8.1	EN-DC FR2 MAC-CE based active TCI state switch	LTE Cell 1	NR Cell 1			
5.5.8.2	EN-DC FR2 RRC based active TCI state switch	LTE Cell 1	NR Cell 1			
5.6.1.1	EN-DC FR2 event-triggered reporting without gap in non-DRX	LTE Cell 1	NR Cell 1	NR Cell 2		
5.6.1.2	EN-DC FR2 event-triggered reporting without gap in DRX	LTE Cell 1	NR Cell 1	NR Cell 2		
5.6.1.3	EN-DC FR2 event-triggered reporting with gap in non-DRX	LTE Cell 1	NR Cell 1	NR Cell 2		
5.6.1.4	EN-DC FR2 event-triggered reporting with gap in DRX	LTE Cell 1	NR Cell 1	NR Cell 2		
5.6.2.1	EN-DC FR2-FR2 event-triggered reporting in non-DRX	LTE Cell 1	NR Cell 6	NR Cell 3		
5.6.2.2	EN-DC FR2-FR2 event-triggered reporting in DRX	LTE Cell 1	NR Cell 6	NR Cell 3		
5.6.2.3	EN-DC FR2-FR2 event-triggered reporting in non-DRX with SSB time index detection	LTE Cell 1	NR Cell 6	NR Cell 3		
5.6.2.4	EN-DC FR2-FR2 event-triggered reporting in DRX with SSB time index detection	LTE Cell 1	NR Cell 6	NR Cell 3		
5.6.2.5	EN-DC FR1-FR2 event-triggered reporting in non-DRX	LTE Cell 1	NR Cell 6	NR Cell 3		
5.6.2.6	EN-DC FR1-FR2 event-triggered reporting in DRX	LTE Cell 1	NR Cell 6	NR Cell 3		
5.6.2.7	EN-DC FR1-FR2 event-triggered reporting in non-DRX with SSB time index detection	LTE Cell 1	NR Cell 6	NR Cell 3		
5.6.2.8	EN-DC FR1-FR2 event-triggered reporting in DRX with SSB time index detection	LTE Cell 1	NR Cell 6	NR Cell 3		
5.6.3.1	EN-DC FR2 SSB-based L1-RSRP measurement in non-DRX	LTE Cell 1	NR Cell 1			
5.6.3.2	EN-DC FR2 SSB-based L1-RSRP measurement in DRX	LTE Cell 1	NR Cell 1			
5.6.3.3	EN-DC FR2 CSI-RS-based L1-RSRP measurement in non-DRX	LTE Cell 1	NR Cell 1			
5.6.3.4	EN-DC FR2 CSI-RS-based L1-RSRP measurement in DRX	LTE Cell 1	NR Cell 1			
5.6.6.1	EN-DC FR2 CSI-RS based CMR and no dedicated IMR L1-SINR measurement in DRX	LTE Cell 1	NR Cell 1			
5.6.6.2	EN-DC FR2 SSB based CMR and dedicated IMR L1-SINR measurement in non-DRX	LTE Cell 1	NR Cell 1			
5.6.6.3	EN-DC FR2 CSI-RS based CMR and dedicated IMR L1-SINR measurement in non-DRX	LTE Cell 1	NR Cell 1			
5.7.1.1	EN-DC FR2 SS-RSRP measurement accuracy	LTE Cell 1	NR Cell 489	NR Cell 1		

TC	Description	38.533 LTE Cell1	38.533 NR Cell2	38.533 NR Cell3	38.533 NR Cell4	CA Type
5.3.2.2.1	EN-DC FR2 contention based random access	LTE Cell 1	NR Cell 1			
5.3.2.2.2	EN-DC FR2 non-contention based random access	LTE Cell 1	NR Cell 1			
5.3.2.2.3	EN-DC FR2 2-step contention based random access	LTE Cell 1	NR Cell 1			
5.3.2.2.4	EN-DC FR2 2-step non-contention based random access	LTE Cell 1	NR Cell 1			
5.4.1.1	EN-DC FR2 UE transmit timing accuracy	LTE Cell 1	NR Cell 1			
5.4.3.1	EN-DC FR2 timing advance adjustment accuracy	LTE Cell 1	NR Cell 1			
5.5.1.1	EN-DC FR2 radio link monitoring out-of-sync test for PSCell configured with SSB-based RLM RS in non-DRX mode	LTE Cell 1	NR Cell 6			
5.5.1.3	EN-DC FR2 radio link monitoring out-of-sync test for PSCell configured with SSB-based RLM RS in DRX mode	LTE Cell 1	NR Cell 6			
5.7.1.2	EN-DC FR2-FR2 SS-RSRP measurement accuracy	LTE Cell 1	NR Cell 6	NR Cell 3		
5.7.2.1	EN-DC FR2 SS-RSRQ measurement accuracy	LTE Cell 1	NR Cell 1	NR Cell 2		
5.7.2.2	EN-DC FR2-FR2 SS-RSRQ measurement accuracy	LTE Cell 1	NR Cell 6	NR Cell 3		
5.7.3.1	EN-DC FR2 SS-SINR measurement accuracy	LTE Cell 1	NR Cell 1	NR Cell 2		
5.7.3.2	EN-DC FR2-FR2 SS-SINR measurement accuracy	LTE Cell 1	NR Cell 6	NR Cell 3		

## E.4 Cell configuration mapping for SA FR1 test cases in Chapter 6

Table E.4-1 defines the cell configuration mapping for NR/5GC FR1 test cases in chapter 6 of this test specification.

**Table E.4-1: Cell configuration mapping for SA FR1 RRM testing**

TC	Description	38.533 NR Cell1	38.533 NR Cell2	38.533 NR Cell3	38.533 NR Cell4	CA Type
6.1.1.1	NR SA FR1 cell re-selection	NR Cell 1	NR Cell 11			
6.1.1.2	NR SA FR1-FR1 cell re-selection	NR Cell 6	NR Cell 23			
6.1.1.3	NR SA FR1 cell re-selection for UE fulfilling low mobility relaxed measurement criterion	NR Cell 1	NR Cell 11			
6.1.1.4	NR SA FR1 cell re-selection for UE fulfilling not-at-cell edge relaxed measurement criterion	NR Cell 1	NR Cell 11			
6.1.1.5	NR SA FR1-FR1 cell re-selection for UE fulfilling low mobility relaxed measurement criterion	NR Cell 1	NR Cell 23			
6.1.1.6	NR SA FR1-FR1 cell re-selection for UE fulfilling not-at-cell edge relaxed measurement criterion	NR Cell 1	NR Cell 23			
6.1.1.7	NR SA FR1 cell re-selection for UE configured with highSpeedMeasFlag-r16	NR Cell 1	NR Cell 11			
6.3.1.1	NR SA FR1 handover with known target cell	NR Cell 1	NR Cell 2			
6.3.1.2	NR SA FR1 handover with unknown target cell	NR Cell 1	NR Cell 2			
6.3.1.3	NR SA FR1-FR1 Handover with unknown Target Cell	NR Cell 6	NR Cell 3			
6.3.1.7	NR SA FR1 synchronous DAPS handover	NR Cell 1	NR Cell 2			
6.3.1.8	NR SA FR1 asynchronous DAPS handover	NR Cell 1	NR Cell 2			
6.3.1.9	NR SA FR1 Intra-band inter-frequency synchronous DAPS handover	NR Cell 6	NR Cell 3			

TC	Description	38.533 NR Cell1	38.533 NR Cell2	38.533 NR Cell3	38.533 NR Cell4	CA Type
6.3.1.10	NR SA FR1 Intra-band inter-frequency asynchronous DAPS handover	NR Cell 6	NR Cell 3			
6.3.1.11	NR SA FR1 Inter-band inter-frequency synchronous DAPS handover	NR Cell 1	NR Cell 10			
6.3.1.12	NR SA FR1 Inter-band inter-frequency asynchronous DAPS handover	NR Cell 1	NR Cell 10			
6.3.2.1.1	NR SA FR1 RRC re-establishment	NR Cell 1	NR Cell 2			
6.3.2.1.2	NR SA FR1 - FR1 RRC re-establishment	NR Cell 6	NR Cell 3			
6.3.2.1.3	NR SA FR1 RRC re-establishment without serving cell timing	NR Cell 1	NR Cell 2			
6.3.2.2.1	NR SA FR1 contention based random access	NR Cell 1				
6.3.2.2.2	NR SA FR1 non-contention based random access	NR Cell 1				
6.3.2.2.3	NR SA FR1 2-step contention based random access	NR Cell 1				
6.3.2.2.4	NR SA FR1 2-step non-contention based random access	NR Cell 1				
6.3.2.3.1	NR SA FR1 RRC connection release with redirection	NR Cell 6	NR Cell 2			
6.3.3.1	NR SA FR1 conditional handover	NR Cell 1	NR Cell 2			
6.3.3.2	NR SA FR1-FR1 conditional handover	NR Cell 1	NR Cell 6			
6.4.3.1	NR SA FR1 timing advance adjustment accuracy	NR Cell 1				
6.5.1.1	NR SA FR1 radio link monitoring out-of-sync test for PCell configured with SSB-based RLM RS in non-DRX mode	NR Cell 1				
6.5.1.2	NR SA FR1 radio link monitoring in-sync test for PCell configured with SSB-based RLM RS in non-DRX mode	NR Cell 1				
6.5.1.3	NR SA FR1 radio link monitoring out-of-sync test for PCell configured with SSB-based RLM RS in DRX mode	NR Cell 1				
6.5.1.4	NR SA FR1 radio link monitoring in-sync test for PCell configured with SSB-based RLM RS in DRX mode	NR Cell 1				
6.5.1.5	NR SA FR1 radio link monitoring out-of-sync test for PCell configured with CSI-RS-based RLM RS in non-DRX mode	NR Cell 1				
6.5.1.6	NR SA FR1 radio link monitoring in-sync test for PCell configured with CSI-RS-based RLM RS in non-DRX mode	NR Cell 1				
6.5.1.7	NR SA FR1 radio link monitoring out-of-sync test for PCell configured with CSI-RS-based RLM RS in DRX mode	NR Cell 1				
6.5.1.8	NR SA FR1 radio link monitoring in-sync test for PCell configured with CSI-RS-based RLM RS in DRX mode	NR Cell 1				
6.5.2.1	NR SA FR1 interruptions during measurements on deactivated NR SCC	NR Cell 1	NR Cell 6 NR Cell 10			intra-band inter-band
6.5.3.1	NR SA FR1 SCell activation and deactivation of known SCell in non-DRX for 160ms SCell measurement cycle	NR Cell 1	NR Cell 6 NR Cell 10			intra-band inter-band
6.5.3.2	NR SA FR1 SCell activation and deactivation of known SCell in non-DRX for 640ms SCell measurement cycle	NR Cell 1	NR Cell 6 NR Cell 10			intra-band inter-band
6.5.3.3	NR SA FR1 SCell activation and deactivation of unknown SCell in non-DRX	NR Cell 1	NR Cell 6 NR Cell 10			intra-band inter-band
6.5.4.1	NR SA FR1 UE UL carrier RRC reconfiguration delay	NR Cell 1	NR Cell 33			
6.5.5.1	NR SA FR1 SSB-based beam failure detection and link recovery in non-DRX	NR Cell 1				
6.5.5.2	NR SA FR1 SSB-based beam failure detection and link recovery in DRX	NR Cell 1				

TC	Description	38.533 NR Cell1	38.533 NR Cell2	38.533 NR Cell3	38.533 NR Cell4	CA Type
6.5.5.3	NR SA FR1 CSI-RS-based beam failure detection and link recovery in non-DRX	NR Cell 1				
6.5.5.4	NR SA FR1 CSI-RS-based beam failure detection and link recovery in DRX	NR Cell 1				
6.5.6.1.1	NR SA FR1-FR1 DCI-based DL active BWP switch in non-DRX	NR Cell 6	NR Cell 3			
6.5.6.1.2	NR SA FR1 DCI-based DL active BWP switch in non-DRX	NR Cell 1				
6.5.6.2.1	NR SA FR1 RRC-based DL active BWP switch in non-DRX	NR Cell 1				
6.5.7.1	NR SA FR1 DL Interruptions at switching between two uplink carriers in FDD-TDD CA	NR Cell 1	NR Cell 10			inter-band
6.5.7.2	NR SA FR1 DL Interruptions at switching between two uplink carriers in TDD-TDD CA	NR Cell 1	NR Cell 10			inter-band
6.6.1.1	SA event triggered reporting tests without gap under non-DRX	NR Cell 1	NR Cell 2			
6.6.1.2	SA event triggered reporting tests without gap under DRX	NR Cell 1	NR Cell 2			
6.6.1.3	SA event triggered reporting tests with per-UE gaps under non-DRX	NR Cell 1	NR Cell 2			
6.6.1.4	SA event triggered reporting tests with per-UE gaps under DRX	NR Cell 1	NR Cell 2			
6.6.1.5	SA event triggered reporting tests without gap under non-DRX with SSB index reading	NR Cell 1	NR Cell 2			
6.6.1.6	SA event triggered reporting tests with per-UE gaps under non-DRX with SSB index reading	NR Cell 1	NR Cell 2			
6.6.1.7	NR SA FR1 event-triggered reporting without gap in DRX for UE configured with highSpeedMeasFlag-r16	NR Cell 1	NR Cell 2			
6.6.2.1	NR SA FR1-FR1 event-triggered reporting in non-DRX	NR Cell 6	NR Cell 3			
6.6.2.2	NR SA FR1-FR1 event-triggered reporting in DRX	NR Cell 6	NR Cell 3			
6.6.2.5	NR SA FR1-FR1 event-triggered reporting in non-DRX with SSB time index detection	NR Cell 6	NR Cell 3			
6.6.2.6	NR SA FR1-FR1 event-triggered reporting in DRX with SSB time index detection	NR Cell 6	NR Cell 3			
6.6.4.1	NR SA FR1 SSB-based L1-RSRP measurement in non-DRX	NR Cell 1				
6.6.4.2	NR SA FR1 SSB-based L1-RSRP measurement in DRX	NR Cell 1				
6.6.4.3	NR SA FR1 CSI-RS-based L1-RSRP measurement in non-DRX	NR Cell 1				
6.6.4.4	NR SA FR1 CSI-RS-based L1-RSRP measurement in DRX	NR Cell 1				
6.6.4.5	NR SA FR1 SSB-based L1-RSRP measurement in DRX for UE configured with highSpeedMeasFlag-r16	NR Cell 1				
6.6.8.1	NR SA FR1 CSI-RS based CMR and no dedicated IMR L1-SINR measurement in DRX	NR Cell 1				
6.6.8.2	NR SA FR1 SSB based CMR and dedicated IMR L1-SINR measurement in non-DRX	NR Cell 1				
6.6.8.3	NR SA FR1 CSI-RS based CMR and dedicated IMR L1-SINR measurement in non-DRX	NR Cell 1				
6.7.1.3.1	NR SA FR1-FR2 SS-RSRP absolute measurement accuracy	NR Cell 1	NR Cell 2			
6.7.1.3.2	NR SA FR1-FR2 SS-RSRP relative measurement accuracy	NR Cell 1	NR Cell 2			
6.7.1.1.1	NR SA FR1 SS-RSRP absolute measurement accuracy	NR Cell 489	NR Cell 1			
6.7.1.1.2	NR SA FR1 SS-RSRP relative measurement accuracy	NR Cell 489	NR Cell 1			

TC	Description	38.533 NR Cell1	38.533 NR Cell2	38.533 NR Cell3	38.533 NR Cell4	CA Type
6.7.1.2.1	NR SA FR1-FR1 SS-RSRP absolute measurement accuracy	NR Cell 6	NR Cell 3			
6.7.1.2.2	NR SA FR1-FR1 SS-RSRP relative measurement accuracy	NR Cell 6	NR Cell 3			
6.7.2.1	NR SA FR1 SS-RSRQ measurement accuracy	NR Cell 1	NR Cell 2			
6.7.2.2.1	NR SA FR1-FR1 SS-RSRQ absolute measurement accuracy	NR Cell 6	NR Cell 3			
6.7.2.2.2	NR SA FR1-FR1 SS-RSRQ relative measurement accuracy	NR Cell 6	NR Cell 3			
6.7.3.1	NR SA FR1 SS-SINR measurement accuracy	NR Cell 1	NR Cell 2			
6.7.3.2.1	NR SA FR1-FR1 SS-SINR absolute measurement accuracy	NR Cell 6	NR Cell 3			
6.7.3.2.2	NR SA FR1-FR1 SS-SINR relative measurement accuracy	NR Cell 6	NR Cell 3			
6.7.4.1.1	NR SA FR1 SSB based L1-RSRP absolute measurement accuracy	NR Cell 1				
6.7.4.1.2	NR SA FR1 SSB based L1-RSRP relative measurement accuracy	NR Cell 1				
6.7.4.2.1	NR SA FR1 CSI-RS based L1-RSRP absolute measurement accuracy	NR Cell 1				
6.7.4.2.2	NR SA FR1 CSI-RS based L1-RSRP relative measurement accuracy	NR Cell 1				
6.7.9.1	NR SA FR1 CSI-RS based CMR and no dedicated IMR configured and CSI-RS resource set with repetition off L1-SINR measurement accuracy	NR Cell 1				
6.7.9.2	NR SA FR1 SSB based CMR and dedicated IMR L1-SINR absolute measurement accuracy	NR Cell 1				
6.7.9.3	NR SA FR1 CSI-RS based CMR and dedicated IMR L1-SINR measurement accuracy	NR Cell 1				

Table E.4-2 defines the cell configuration mapping for NR/5GC FR1 – E-UTRA Inter-RAT test cases (serving cell in NR) in chapter 6 of this test specification.

**Table E.4-2: Cell configuration mapping for SA FR1 – E-UTRA Inter-RAT RRM testing**

TC	Description	38.533 NR Cell1	38.533 LTE Cell2	38.533 LTE Cell3	38.533 LTE Cell4	CA Type
6.1.2.1	NR SA FR1 – E-UTRA cell re-selection to higher priority E-UTRA	NR Cell 1	LTE Cell 1			
6.1.2.2	NR SA FR1 – E-UTRA cell re-selection to lower priority E-UTRA	NR Cell 1	LTE Cell 1			
6.1.2.3	NR SA FR1 – E-UTRA cell re-selection to lower priority E-UTRAN for UE fulfilling low mobility relaxed measurement criterion	NR Cell 1	LTE Cell 1			
6.1.2.4	NR SA FR1 – E-UTRA cell re-selection to lower priority E-UTRAN for UE fulfilling not-at-cell edge relaxed measurement criterion	NR Cell 1	LTE Cell 1			
6.1.2.5	NR SA FR1 – E-UTRA cell re-selection to lower priority E-UTRA for UE configured with highSpeedMeasFlag-r16	NR Cell 1	LTE Cell 11			
6.3.1.4	NR SA FR1 – E-UTRA handover with known target cell	NR Cell 1	LTE Cell 1			
6.3.1.5	NR SA FR1 – E-UTRA handover with unknown target cell	NR Cell 1	LTE Cell 1			
6.3.2.3.2	NR SA FR1 – E-UTRA RRC connection release with redirection	NR Cell 1	LTE Cell 1			
6.6.3.1	NR SA FR1 – E-UTRAN event-triggered reporting in non-DRX	NR Cell 1	LTE Cell 1			

TC	Description	38.533 NR Cell1	38.533 LTE Cell2	38.533 LTE Cell3	38.533 LTE Cell4	CA Type
6.6.3.2	NR SA FR1 – E-UTRAN event-triggered reporting in DRX	NR Cell 1	LTE Cell 1			
6.6.3.3	NR SA FR1 – E-UTRAN event-triggered reporting in DRX for UE configured with highSpeedMeasFlag-r16	NR Cell 1	LTE Cell 1			
6.7.5.1	NR SA FR1 – E-UTRAN RSRP absolute measurement accuracy	NR Cell 1	LTE Cell 1			
6.7.6.1	NR SA FR1 – E-UTRAN RSRQ absolute measurement accuracy	NR Cell 1	LTE Cell 1			
6.7.7.1	NR SA FR1 – E-UTRAN RS-SINR absolute measurement accuracy	NR Cell 1	LTE Cell 1			

**Table E.4-3: Cell configuration mapping for SA FR1 – UTRA FDD Inter-RAT RRM testing**

TC	Description	38.533 NR Cell1	38.533 UTRA Cell2	38.533 UTRA Cell3	38.533 UTRA Cell4	CA Type
6.3.1.6	NR SA FR1 – UTRA cell re-selection to higher priority UTRA	NR Cell 1	UTRA Cell 1			
6.6.5.1	NR SA FR1 – UTRAN event-triggered reporting in non-DRX	NR Cell 1	UTRA Cell 1			

## E.5 Cell configuration mapping for SA FR2 test cases in Chapter 7

Table E.5-1 defines the cell configuration mapping for NR/5GC FR2 test cases in chapter 7 of this test specification.

**Table E.5-1: Cell configuration mapping for SA FR2 RRM testing**

TC	Description	38.533 NR Cell1	38.533 NR Cell2	38.533 NR Cell3	38.533 NR Cell4	CA Type
7.1.1.1	NR SA FR2 cell re-selection	NR Cell 1	NR Cell 11			
7.1.1.2	NR SA FR2-FR2 cell re-selection	NR Cell 1	NR Cell 23			
7.1.1.3	NR SA FR2 cell re-selection for UE fulfilling low mobility relaxed measurement criterion	NR Cell 1	NR Cell 2			
7.1.1.4	NR SA FR2 cell re-selection for UE fulfilling not-at-cell edge relaxed measurement criterion	NR Cell 1	NR Cell 2			
7.1.1.5	NR SA FR2-FR2 cell re-selection for UE fulfilling low mobility relaxed measurement criterion	NR Cell 1	NR Cell 2			
7.1.1.6	NR SA FR2-FR2 cell re-selection for UE fulfilling not-at-cell edge relaxed measurement criterion	NR Cell 1	NR Cell 2			
7.3.1.4	NR SA FR1-FR2 synchronous DAPS handover	NR Cell 1	NR Cell 10			
7.3.1.5	NR SA FR1-FR2 asynchronous DAPS handover	NR Cell 1	NR Cell 10			
7.3.2.1.1	NR SA FR2 RRC re-establishment	NR Cell 1				
7.3.2.1.2	NR SA FR2-FR2 re-establishment	NR Cell 1				
7.3.2.1.3	NR SA FR2 RRC re-establishment without serving cell timing	NR Cell 1	NR Cell 2			
7.3.2.2.1	NR SA FR2 contention based random access	NR Cell 1				
7.3.2.2.2	NR SA FR2 non-contention based random access	NR Cell 1				
7.3.2.2.4	NR SA FR2 2-step non-contention based random access	NR Cell 1				
7.3.3.1	NR SA FR2 conditional handover	NR Cell 1	NR Cell 2			
7.3.3.2	NR SA FR2-FR2 conditional handover	NR Cell 1	NR Cell 6			
7.5.1.9	NR SA FR2 radio link monitoring UE scheduling restrictions	NR Cell 1				



TC	Description	38.533 NR Cell1	38.533 NR Cell2	38.533 NR Cell3	38.533 NR Cell4	CA Type
7.5.5.1	NR SA FR2 SSB-based beam failure detection and link recovery in non-DRX	NR Cell 1				
7.5.5.2	NR SA FR2 SSB-based beam failure detection and link recovery in DRX	NR Cell 1				
7.5.5.3	NR SA FR2 CSI-RS-based beam failure detection and link recovery in non-DRX	NR Cell 1				
7.5.5.4	NR SA FR2 CSI-RS-based beam failure detection and link recovery in DRX	NR Cell 1				
7.5.5.6	NR SA FR2 Scell CSI-RS-based beam failure detection and link recovery in non-DRX	NR Cell 1	NR Cell 6			
7.5.5.7	NR SA FR2 Scell CSI-RS-based beam failure detection and link recovery in DRX	NR Cell 1	NR Cell 6			
7.5.6.1	NR SA FR2 DCI-based DL active BWP switch in non-DRX	NR Cell 1				
7.6.1.1	NR SA FR2 event-triggered reporting without gap in non-DRX	NR Cell 1	NR Cell 2			
7.6.1.2	NR SA FR2 event-triggered reporting without gap in DRX	NR Cell 1	NR Cell 2			
7.6.1.3	NR SA FR2 event-triggered reporting with gap in non-DRX	NR Cell 1	NR Cell 2			
7.6.1.4	NR SA FR2 event-triggered reporting with gap in DRX	NR Cell 1	NR Cell 2			
7.6.2.1	NR SA FR2-FR2 event-triggered reporting in non-DRX	NR Cell 6	NR Cell 3			
7.6.2.2	NR SA FR2-FR2 event-triggered reporting in DRX	NR Cell 6	NR Cell 3			
7.6.2.3	NR SA FR2-FR2 event-triggered reporting in non-DRX with SSB time index detection	NR Cell 6	NR Cell 3			
7.6.2.4	NR SA FR2-FR2 event-triggered reporting in DRX with SSB time index detection	NR Cell 6	NR Cell 3			
7.6.2.5	NR SA FR1-FR2 event-triggered reporting in non-DRX	NR Cell 6	NR Cell 3			
7.6.2.6	NR SA FR1-FR2 event-triggered reporting in DRX	NR Cell 6	NR Cell 3			
7.6.2.7	NR SA FR1-FR2 event-triggered reporting in non-DRX with SSB time index detection	NR Cell 6	NR Cell 3			
7.6.2.8	NR SA FR1-FR2 event-triggered reporting in DRX with SSB time index detection	NR Cell 6	NR Cell 3			
7.6.3.1	NR SA FR2 SSB-based L1-RSRP measurement in non-DRX	NR Cell 1				
7.6.3.2	NR SA FR2 SSB-based L1-RSRP measurement in DRX	NR Cell 1				
7.6.3.3	NR SA FR2 CSI-RS-based L1-RSRP measurement in non-DRX	NR Cell 1				
7.6.3.4	NR SA FR2 CSI-RS-based L1-RSRP measurement in DRX	NR Cell 1				
7.6.6.1	NR SA FR2 CSI-RS based CMR and no dedicated IMR configured and CSI-RS resource set with repetition off L1-SINR measurement accuracy	NR Cell 1				
7.6.6.2	NR SA FR2 SSB based CMR and dedicated IMR L1-SINR measurement accuracy	NR Cell 1				
7.6.6.3	NR SA FR2 CSI-RS based CMR and dedicated IMR L1-SINR measurement accuracy	NR Cell 1				
7.7.1.1	NR SA FR2 SS-RSRP measurement accuracy	NR Cell 489	NR Cell 1			
7.7.1.2	NR SA FR2-FR2 SS-RSRP measurement accuracy	NR Cell 6	NR Cell 3			
7.7.1.3.1	NR SA FR1-FR2 SS-RSRP absolute measurement accuracy	NR Cell 1	NR Cell 10			
7.7.1.3.2	Void					
7.7.2.1	NR SA FR2 SS-RSRQ measurement accuracy	NR Cell 1	NR Cell 2			

TC	Description	38.533 NR Cell1	38.533 NR Cell2	38.533 NR Cell3	38.533 NR Cell4	CA Type
7.7.2.2	NR SA FR2-FR2 SS-RSRQ measurement accuracy	NR Cell 6	NR Cell 3			
7.7.3.1	NR SA FR2 SS-SINR measurement accuracy	NR Cell 1	NR Cell 2			
7.7.3.2	NR SA FR2-FR2 SS-SINR measurement accuracy	NR Cell 6	NR Cell 3			

## E.6 Cell configuration mapping for E-UTRAN – SA test cases in Chapter 8

Table E.6-1 defines the cell configuration mapping for E-UTRAN - NR/5GC FR1 Inter-RAT test cases (serving cell in LTE) in chapter 8 of this test specification.

**Table E.6-1: Cell configuration mapping for E-UTRA – SA FR1 Inter-RAT RRM testing**

TC	Description	38.533 LTE Cell1	38.533 NR Cell2	38.533 NR Cell3	38.533 NR Cell4	CA Type
8.2.1.1	E-UTRA – NR FR1 cell re-selection to higher priority NR target cell	LTE Cell 1	NR Cell 1			
8.2.1.2	E-UTRA – NR FR1 Cell reselection to lower priority NR target Cell in FR1 for UE configured with highSpeedInterRAT-NR-r16	LTE Cell 1	NR Cell 1			
8.3.1.1	E-UTRA – NR FR1 handover with unknown target cell	LTE Cell 1	NR Cell 1			
8.4.1.1	E-UTRA – NR FR1 SFTD measurement delay in non-DRX	LTE Cell 1	NR Cell 1			
8.4.1.2	E-UTRA – NR FR1 SFTD measurement delay in DRX	LTE Cell 1	NR Cell 1			
8.4.2.1	E-UTRA event-triggered reporting of a NR FR1 neighbour cell without SSB time index detection in non-DRX	LTE Cell 1	NR Cell 1			
8.4.2.2	E-UTRA event-triggered reporting of a NR FR1 neighbour cell without SSB time index detection in DRX	LTE Cell 1	NR Cell 1			
8.4.2.3	E-UTRA event-triggered reporting of a NR FR1 neighbour cell with SSB time index detection in non-DRX	LTE Cell 1	NR Cell 1			
8.4.2.4	E-UTRA event-triggered reporting of a NR FR1 neighbour cell with SSB time index detection in DRX	LTE Cell 1	NR Cell 1			
8.4.2.9	E-UTRA – NR Inter-RAT event triggered reporting tests for FR1 with SSB time index detection in DRX for UE configured with highSpeedInterRAT-NR-r16	LTE Cell 1	NR Cell 1			
8.5.1.1	E-UTRA – NR FR1 SFTD measurement accuracy	LTE Cell 1	NR Cell 1			
8.5.2.1.1.1	E-UTRA SS-RSRP absolute measurement accuracy of a NR FR1 neighbour cell	LTE Cell 1	NR Cell 1			
8.5.2.2.1	Void	LTE Cell 1	NR Cell 1			
8.5.2.3.1	E-UTRA SS-RSRP absolute measurement accuracy of a NR FR2 neighbour cell	LTE Cell 1	NR Cell 1			

Table E.6-2 defines the cell configuration mapping for E-UTRAN - NR/5GC FR2 Inter-RAT test cases (serving cell in LTE) in chapter 8 of this test specification.

**Table E.6-2: Cell configuration mapping for E-UTRA – SA FR2 Inter-RAT RRM testing**

TC	Description	38.533 LTE Cell1	38.533 NR Cell2	38.533 NR Cell3	38.533 NR Cell4	CA Type
8.4.2.5	E-UTRA event-triggered reporting of a NR FR2 neighbour cell without SSB time index detection in non-DRX	LTE Cell 1	NR Cell 1			
8.4.2.6	E-UTRA event-triggered reporting of a NR FR2 neighbour cell without SSB time index detection in DRX	LTE Cell 1	NR Cell 1			
8.4.2.7	E-UTRA event-triggered reporting of a NR FR2 neighbour cell with SSB time index detection in non-DRX	LTE Cell 1	NR Cell 1			
8.4.2.8	E-UTRA event-triggered reporting of a NR FR2 neighbour cell with SSB time index detection in DRX	LTE Cell 1	NR Cell 1			
8.5.2.1.2	E-UTRA SS-RSRP absolute measurement accuracy of a NR FR2 neighbour cell	LTE Cell 1	NR Cell 1			
8.5.2.2.2	SS-RSRQ	LTE Cell 1	NR Cell 1			
8.5.2.3.2	E-UTRA SS-RSRQ absolute measurement accuracy of a NR FR1 neighbour cell	LTE Cell 1	NR Cell 1			

## E.7 Cell configuration mapping for NR sidelink test cases in Chapter 9

Table E.7-1 defines the cell configuration mapping for NR PC5 – NR SA FR1 Uu con-current test cases (serving cell in FR1) in chapter 9 of this test specification.

**Table E.7-1: Cell configuration mapping for NR PC5 – NR SA FR1 Uu con-current RRM testing**

TC	Description	38.533 NR Cell1	38.533 NR Cell2	38.533 NR Cell3	38.533 NR Cell4	CA Type
9.1.1.3	NR SA FR1 UE transmit timing accuracy for FR1 NR cell as synchronization reference source	NR Cell 1				
9.1.2.1	NR SA FR1 initiation/cease of S-SSB transmission for FR1 NR cell as synchronization reference source	NR Cell 1				
9.1.5.1	NR SA FR1 congestion control measurement for concurrent operation	NR Cell 1				
9.1.6.1	NR SA FR1 interruption to WAN due to NR sidelink communication	NR Cell 1				

Table E.7-2 defines the cell configuration mapping for NR PC5 – NR SA FR2 Uu con-current test cases (serving cell in FR2) in chapter 9 of this test specification.

**Table E.7-2: Cell configuration mapping for NR PC5 – SA FR2 con-current RRM testing**

FFS

## Annex F (normative): Measurement uncertainties and test tolerances

The requirements of this clause apply to all tests in the present document.

### F.1 Measurement uncertainties and test tolerances for FR1 and FR2

#### F.1.1 Acceptable uncertainty of test system (normative)

See TS 38.521-1 [17] annex F.1.

##### F.1.1.1 Measurement of test environments

See TS 38.521-1 [17] Annex F1.1.

##### F.1.1.2 Measurement of RRM requirements

This clause defines the maximum test system uncertainty for the RRM requirements. The maximum uncertainty values allowed for the typical RRM measurement uncertainty contributors is defined in Table F.1.1.2-1 and Table F.1.1.2-2. Unless explicitly stated for a particular test case, these maximum uncertainty values should be used as starting point to perform the test tolerance analysis in TR 38.903 [22] for each of the test cases. Specific test cases might require a tighter measurement uncertainty value for some of the contributors. Exceptions to the general values in Table F.1.1.2-1 and Table F.1.1.2-2 shall be handled case by case.

**Table F.1.1.2-1: Maximum allowed measurement uncertainty values for the test system for FR1 (up to 6 GHz) and Cell BW ≤ 40 MHz**

MU contributor	Unit	Value	Comment
AWGN absolute power, $N_{oc}$ averaged over $BW_{Config}$	dB	±1.5	
AWGN absolute power, $N_{oc}$ for Measurement PRB	dB	±1.5	Measurement PRB may be for example #RB <sub>J</sub> to RB <sub>J+19</sub> for SSB-based, or selected RBs in the range #RB <sub>0</sub> to RB <sub>105</sub> for CSI-RS-based
Ratio of cell X signal / AWGN, $\hat{E}_{s_x} / N_{oc}$ averaged over $BW_{Config}$	dB	±0.3	Same as in LTE
Ratio of cell X signal / AWGN, $\hat{E}_{s_x} / N_{oc}$ for Measurement PRB	dB	±0.3	Measurement PRB may be for example #RB <sub>J</sub> to RB <sub>J+19</sub> for SSB-based, or selected RBs in the range #RB <sub>0</sub> to RB <sub>105</sub> for CSI-RS-based
Fading profile uncertainty	dB	±0.5 for 1 Tx ±0.7 for 2 Tx	Depends on fading profile, can be referenced from TS 38.101-4 [20]
AWGN and signal flatness*	dB	±2.0	Same as in LTE, can be referenced from TS 38.101-4 [20]
Uplink absolute power measurement	dB	±1.5	Same as in TS 38.521-1 [17]
Uplink relative power measurement	dB	±0.7	Same as in TS 38.521-1 [17]
Uplink signal transmit timing relative to downlink	Tc	±112	
Relative transmit timing accuracy during UE timing adjustment	Tc	±88	
Timing Advance Adjustment accuracy	Tc	±88	

MU contributor	Unit	Value	Comment
Note 1: The values in this table are specified per cell. Multi-cell test cases need to combined these values in the TT analysis in TR 38.903			
Note 2: These values apply for cell BW ≤ 40 MHz. The maximum allowed measurement uncertainty for higher cell BW is FFS.			
Note 3: Void			

**Table F.1.1.2-2: Maximum allowed measurement uncertainty values for the test system for FR2 (up to 40GHz) and Cell BW ≤ 400 MHz**

MU contributor	Unit	Value	Comment
AWGN absolute power, $N_{oc}$ averaged over $BW_{Config}$	dB	PC3: $\pm 5.65^{4,5}$ PC1: FFS	
AWGN absolute power, $N_{oc}$ for Measurement PRB	dB	PC3: $\pm 5.65^{4,5}$ PC1: FFS	Measurement PRB may be for example #RB <sub>J</sub> to RB <sub>J+19</sub> for SSB-based, or selected RBs in the range #RB <sub>0</sub> to RB <sub>274</sub> for CSI-RS-based
Ratio of cell X signal / AWGN, $\hat{E}_{s_x} / N_{oc}$ averaged over $BW_{Config}$	dB	$\pm 0.3$	
Ratio of cell X signal / AWGN, $\hat{E}_{s_x} / N_{oc}$ for Measurement PRB	dB	$\pm 0.3$	Measurement PRB may be for example #RB <sub>J</sub> to RB <sub>J+19</sub> for SSB-based, or selected RBs in the range #RB <sub>0</sub> to RB <sub>274</sub> for CSI-RS-based
$\hat{E}_{s_x}^{Note 3}$ absolute power, $N_{oc}$ averaged over $BW_{Config}$	dB	PC3: $\pm 5.65^{4,5}$ PC1: FFS	
$\hat{E}_{s_x}^{Note 3}$ absolute power, $N_{oc}$ for Measurement PRB	dB	PC3: $\pm 5.65^{4,5}$ PC1: FFS	Measurement PRB may be for example #RB <sub>J</sub> to RB <sub>J+19</sub> for SSB-based, or selected RBs in the range #RB <sub>0</sub> to RB <sub>274</sub> for CSI-RS-based
Relative power between any two $\hat{E}_s$ levels at the same frequency	dB	$\pm 2.0$	
Fading profile uncertainty	dB	$\pm 0.5$ for 1 Tx $\pm 0.7$ for 2 Tx	
Uplink absolute power measurement	dB	TBD	
Uplink relative power measurement	dB	TBD	
Uplink signal transmit timing relative to downlink	Tc	$\pm 48$	
Relative transmit timing during UE timing adjustment	Tc	$\pm 40$	
Timing Advance Adjustment	Tc	$\pm 40$	
NOTE 1: The values in this table are specified per cell. Multi-cell test cases need to combine these values in the TT analysis in TR 38.903			
NOTE 2: These values apply for cell BW ≤ 400 MHz. The maximum allowed measurement uncertainty for higher cell BW is FFS.			
NOTE 3: Applies for test cases that use $\hat{E}_s$ without AWGN			
NOTE 4: Total Expanded MU for IFF for Max device size ≤ 30cm in TR 38.903 [22] Table E.3.1.1-2 for PC3 UEs and in Table FFS for PC1 UEs.			
NOTE 5: If the TT analysis for a specific test case based on this MU value results in an unsolvable conflict, making the test case untestable, even after the alternative solutions listed in TR 38.903 [22] clause A.4 have been considered for the test case in TS 38.133 [6] Annex A, the TT analysis shall be repeated using a lower MU value, taking into account the values defined in clause E.3.1 TR 38.903 [22]. The test case will be applicable for the subset of the test systems meeting this reduced MU Threshold.			

The maximum test system uncertainty for the EN-DC FR1 test cases in chapter 4 is defined in Table F.1.1.2-3.

The maximum test system uncertainty for the NR/5GC FR1 test cases in chapter 6 is defined in Table F.1.1.2-4.

The maximum test system uncertainty for the EN-DC FR2 test cases in chapter 5 is defined in Table F.1.1.2-5.

The maximum test system uncertainty for the NR/5GC FR2 test cases in chapter 7 is defined in Table F.1.1.2-6.

**Table F.1.1.2-3: Maximum test system uncertainty for RRM requirements for EN-DC FR1 test cases**

Subclause	Maximum Test System Uncertainty <sup>1</sup>	Derivation of Test System Uncertainty
4.3.2.2.1 Contention based random access test in FR1 for PSCell in EN-DC	$N_{oc} \pm 1.5$ dB $\hat{E}_{S_2} / N_{oc} \pm 0.3$ dB  Uplink absolute power measurement $\pm 1.5$ dB  Uplink relative power measurement $\pm 0.7$ dB  $\pm 112T_c$ Uplink signal transmit timing relative to downlink	$\hat{E}_{S_2} / N_{oc}$ is the ratio of cell 2 signal / AWGN  $T_c = 1/(480000 \times 4096)$ seconds, the basic timing unit defined in TS 38.211 [7]
4.3.2.2.2 Non-contention based random access test in FR1 for PSCell in EN-DC	Same as 4.3.2.2.1	Same as 4.3.2.2.1
4.4.1.1 EN-DC FR1 UE transmit timing accuracy	$N_{oc} \pm 1.5$ dB  $\hat{E}_{S_2} / N_{oc} \pm 0.3$ dB  $\pm 112T_c$ Uplink signal transmit timing relative to downlink	$\hat{E}_{S_2} / N_{oc}$ is the ratio of cell 2 signal / AWGN  $T_c = 1/(480000 \times 4096)$ seconds, the basic timing unit defined in TS 38.211 [7]
4.4.3.1 EN-DC FR1 timing advance adjustment accuracy	$N_{oc} \pm 1.5$ dB  $\hat{E}_{S_2} / N_{oc} \pm 0.3$ dB  $\pm 88T_c$ Timing Advance Adjustment accuracy	$\hat{E}_{S_2} / N_{oc}$ is the ratio of cell 2 signal / AWGN  $T_c = 1/(480000 \times 4096)$ seconds, the basic timing unit defined in TS 38.211 [7]
4.5.1.1 EN-DC FR1 radio link monitoring out-of-sync test for PSCell configured with SSB-based RLM RS in non-DRX mode	Average $N_{oc_2} \pm 1.5$ dB Average $\hat{E}_{S_2} / N_{oc_2} \pm 0.3$ dB Meas PRB $N_{oc_2} \pm 1.5$ dB Meas PRB $\hat{E}_{S_2} / N_{oc_2} \pm 0.3$ dB Fading profile $\pm 0.7$ dB	Note: $N_{oc_2}$ is the AWGN on cell 2 frequency $\hat{E}_{S_2} / N_{oc_2}$ is the SNR  Meas PRB are the measurement PRB for SSB-based RLM #RB <sub>J</sub> to RB <sub>J+19</sub>
4.5.1.2 EN-DC FR1 radio link monitoring in-sync test for PSCell configured with SSB-based RLM RS in non-DRX mode	Same as 4.5.1.1	Same as 4.5.1.1
4.5.1.3 EN-DC FR1 radio link monitoring out-of-sync test for PSCell configured with SSB-based RLM RS in DRX mode	Same as 4.5.1.1	Same as 4.5.1.1
4.5.1.4 EN-DC FR1 radio link monitoring in-sync test for PSCell configured with SSB-based RLM RS in DRX mode	Same as 4.5.1.1	Same as 4.5.1.1
4.5.1.5 EN-DC FR1 radio link monitoring out-of-sync test for PSCell configured with CSI-RS-based RLM RS in non-DRX mode	Same as 4.5.1.1	Same as 4.5.1.1
4.5.1.6 EN-DC FR1 radio link monitoring in-sync test for PSCell configured with CSI-RS-based RLM RS in non-DRX mode	Same as 4.5.1.1	Same as 4.5.1.1
4.5.1.7 EN-DC FR1 radio link monitoring out-of-sync test for PSCell configured with CSI-RS-based RLM RS in DRX mode	Same as 4.5.1.1	Same as 4.5.1.1
4.5.1.8 EN-DC FR1 radio link monitoring in-sync test for PSCell configured with CSI-RS-based RLM RS in DRX mode	Same as 4.5.1.1	Same as 4.5.1.1

4.5.2.1 EN-DC FR1 interruptions at transitions between active and non-active during DRX in synchronous EN-DC	$\pm 0.6$ dB (AWGN conditions)	Overall system uncertainty for AWGN condition comprises two quantities: 1. Signal-to-noise ratio uncertainty 2. Effect of AWGN flatness and signal flatness  Items 1 and 2 are assumed to be uncorrelated so can be root sum squared: AWGN flatness and signal flatness has x 0.25 effect on the required SNR, so use sensitivity factor of x 0.25 for the uncertainty contribution. Test System uncertainty = SQRT (Signal-to-noise ratio uncertainty $^2$ + (0.25 x AWGN flatness and signal flatness) $^2$ ) Signal-to-noise ratio uncertainty $\pm 0.3$ dB AWGN flatness and signal flatness $\pm 2.0$ dB
4.5.2.2 EN-DC FR1 interruptions at transitions between active and non-active during DRX in asynchronous EN-DC	Same as 4.5.2.1	Same as 4.5.2.1
4.5.2.3 EN-DC FR1 interruptions during measurements on deactivated NR SCC in synchronous EN-DC	$Noc_2 \pm 1.5$ dB $Noc_3 \pm 1.5$ dB $\hat{E}_{S_2} / Noc_2 \pm 0.3$ dB $\hat{E}_{S_3} / Noc_3 \pm 0.3$ dB	Note: $\hat{E}_{S_2} / Noc_2$ is the ratio of cell 2 signal / AWGN $\hat{E}_{S_3} / Noc_3$ is the ratio of cell 3 signal / AWGN
4.5.2.4 EN-DC FR1 interruptions during measurements on deactivated NR SCC in asynchronous EN-DC	Same as 4.5.2.3	Same as 4.5.2.3
4.5.2.5 EN-DC FR1 interruptions during measurements on deactivated E-UTRAN SCC in synchronous EN-DC	$Noc_1 \pm 1.5$ dB $Noc_2 \pm 1.5$ dB $Noc_3 \pm 1.5$ dB $\hat{E}_{S_1} / Noc \pm 0.3$ dB $\hat{E}_{S_2} / Noc \pm 0.3$ dB $\hat{E}_{S_3} / Noc \pm 0.3$ dB	Note: $Noc_1$ is the AWGN on E-UTRAN cell 1 frequency $\hat{E}_{S_1} / Noc_1$ is the ratio of E-UTRAN cell 1 signal / AWGN $Noc_2$ is the AWGN on NR cell 2 frequency $\hat{E}_{S_2} / Noc_2$ is the ratio of NR cell 2 signal / AWGN $Noc_3$ is the AWGN on E-UTRAN cell 3 frequency $\hat{E}_{S_3} / Noc_3$ is the ratio of E-UTRAN cell 3 signal / AWGN
4.5.2.6 EN-DC FR1 interruptions during measurements on deactivated E-UTRAN SCC in asynchronous EN-DC	Same as 4.5.2.5	Same as 4.5.2.5
4.5.3.1 EN-DC FR1 SCell activation and deactivation of known SCell in non-DRX for 160ms SCell measurement cycle	Average $Noc_2 \pm 1.5$ dB Average $Noc_3 \pm 1.5$ dB Average $\hat{E}_{S_2} / Noc_2 \pm 0.3$ dB Average $\hat{E}_{S_3} / Noc_3 \pm 0.3$ dB Meas PRB $Noc_2 \pm 1.5$ dB Meas PRB $Noc_3 \pm 1.5$ dB Meas PRB $\hat{E}_{S_2} / Noc_2 \pm 0.3$ dB Meas PRB $\hat{E}_{S_3} / Noc_3 \pm 0.3$ dB	Note: $Noc_2$ is the AWGN on cell 2 frequency $\hat{E}_{S_2} / Noc_2$ is the ratio of cell 2 signal / AWGN $Noc_3$ is the AWGN on cell 3 frequency $\hat{E}_{S_3} / Noc_3$ is the ratio of cell 3 signal / AWGN  Meas PRB are the measurement PRB for SS-RSRP #RB <sub>J</sub> to RB <sub>J+19</sub>
4.5.3.2 EN-DC FR1 SCell activation and deactivation of known SCell in non-DRX for 640ms SCell measurement cycle	Same as 4.5.3.1	Same as 4.5.3.1
4.5.3.3 EN-DC FR1 SCell activation and deactivation of unknown SCell in non-DRX	Same as 4.5.3.1	Same as 4.5.3.1
4.5.4.1 EN-DC FR1 UE UL carrier RRC reconfiguration delay	$Noc_2 \pm 1.5$ dB $\hat{E}_{S_2} / Noc_2 \pm 0.3$ dB $Noc_3 \pm 1.5$ dB $\hat{E}_{S_3} / Noc_3 \pm 0.3$ dB	Note: $Noc_2$ is the AWGN on cell 2 frequency $\hat{E}_{S_2} / Noc_2$ is the ratio of cell 2 signal / AWGN $Noc_3$ is the AWGN on cell 3 frequency $\hat{E}_{S_3} / Noc_3$ is the ratio of cell 3 signal / AWGN
4.5.5.1 EN-DC FR1 SSB-based beam failure detection and link recovery in non-DRX	Average $Noc_2 \pm 1.5$ dB Average $\hat{E}_{S_2} / Noc_2 \pm 0.3$ dB Meas PRB $Noc_2 \pm 1.5$ dB Meas PRB $\hat{E}_{S_2} / Noc_2 \pm 0.3$ dB Fading profile $\pm 0.7$ dB	Note: $Noc_2$ is the AWGN on cell 2 frequency $\hat{E}_{S_2} / Noc_2$ is the SNR for the SSB  Meas PRB is the measurement PRB for SS-RSRP #RB <sub>J</sub> to RB <sub>J+19</sub>



4.5.5.2 EN-DC FR1 SSB-based beam failure detection and link recovery in DRX	Same as 4.5.5.1	Same as 4.5.5.1
4.5.5.3 EN-DC FR1 CSI-RS-based beam failure detection and link recovery in non-DRX	Average $Noc_2 \pm 1.5$ dB Average $\hat{E}_{S_2} / Noc_2 \pm 0.3$ dB Meas PRB $Noc_2 \pm 1.5$ dB Meas PRB $\hat{E}_{S_2} / Noc_2 \pm 0.3$ dB Fading profile $\pm 0.7$ dB	Note: $Noc_2$ is the AWGN on cell 2 frequency $\hat{E}_{S_2} / Noc_2$ is the SNR for the CSI-RS  Meas PRB is the measurement PRB for CSI-RSRP #RB <sub>0</sub> to RB <sub>274</sub>
4.5.5.4 EN-DC FR1 CSI-RS-based beam failure detection and link recovery in DRX	Same as 4.5.5.3	Same as 4.5.5.3
4.5.5.5 EN-DC FR1 SCell CSI-RS-based beam failure detection and SSB-based link recovery in non-DRX	Average $Noc_2 \pm 1.5$ dB Average $\hat{E}_{S_2} / Noc_2 \pm 0.3$ dB Meas PRB $Noc_2 \pm 1.5$ dB Meas PRB $\hat{E}_{S_2} / Noc_2 \pm 0.3$ dB Fading profile $\pm 0.7$ dB	Note: $Noc_2$ is the AWGN on cell 2 frequency $\hat{E}_{S_2} / Noc_2$ is the SNR for the SSB  Meas PRB is the measurement PRB for SS-RSRP #RB <sub>J</sub> to RB <sub>J+19</sub>  $Noc_2$ is the AWGN on cell 2 frequency $\hat{E}_{S_2} / Noc_2$ is the SNR for the CSI-RS  Meas PRB is the measurement PRB for CSI-RSRP #RB <sub>0</sub> to RB <sub>274</sub>
4.5.5.6 EN-DC FR1 SCell CSI-RS-based beam failure detection and SSB-based link recovery in DRX	Same as 4.5.5.5	Same as 4.5.5.5
4.5.6.1.1 EN-DC FR1 DCI-based DL active BWP switch in non-DRX in synchronous EN-DC	$\pm 0.6$ dB	Overall system uncertainty for fading conditions comprises two quantities: 1. Signal-to-noise ratio uncertainty 2. Effect of AWGN flatness and signal flatness  Items 1 and 2 are assumed to be uncorrelated so can be root sum squared: AWGN flatness and signal flatness has x 0.25 effect on the required SNR, so use sensitivity factor of x 0.25 for the uncertainty contribution. Test System uncertainty = SQRT (Signal-to-noise ratio uncertainty <sup>2</sup> + (0.25 x AWGN flatness and signal flatness) <sup>2</sup> ) Signal-to-noise ratio uncertainty $\pm 0.3$ dB AWGN flatness and signal flatness $\pm 2.0$ dB
4.5.6.1.2 EN-DC FR1 DCI-based DL active BWP switch with SCell in non-DRX in synchronous EN-DC	Same as 4.5.6.1.1	Same as 4.5.6.1.1
4.5.6.2.1 EN-DC FR1 RRC-based DL active BWP switch in non-DRX in synchronous EN-DC	$\pm 0.6$ dB	Overall system uncertainty for fading conditions comprises two quantities: 1. Signal-to-noise ratio uncertainty 2. Effect of AWGN flatness and signal flatness  Items 1 and 2 are assumed to be uncorrelated so can be root sum squared: AWGN flatness and signal flatness has x 0.25 effect on the required SNR, so use sensitivity factor of x 0.25 for the uncertainty contribution. Test System uncertainty = SQRT (Signal-to-noise ratio uncertainty <sup>2</sup> + (0.25 x AWGN flatness and signal flatness) <sup>2</sup> ) Signal-to-noise ratio uncertainty $\pm 0.3$ dB AWGN flatness and signal flatness $\pm 2.0$ dB

4.5.7.1 EN-DC FR1 addition and release delay of known PSCell	Average $Noc_1 \pm 1.5$ dB Average $\hat{E}_{S1} / Noc_1 \pm 0.3$ dB  Meas PRB $Noc_1 \pm 1.5$ dB Meas PRB $\hat{E}_{S1} / Noc_1 \pm 0.3$ dB	$Noc_1$ is the AWGN on NR freq1 $\hat{E}_{S1} / Noc_1$ is the ratio of cell 1 signal / AWGN  Meas PRB are the measurement PRB for SS-RSRP #RB <sub>J</sub> to RB <sub>J+19</sub>
4.5.8.1 EN-DC FR1 interruptions at switching between two uplink carriers	Average $Noc \pm 1.5$ dB Average $\hat{E}_s / Noc \pm 0.3$ dB	$Noc$ is the AWGN on cell 2 frequency $\hat{E}_s / Noc$ is the ratio of cell 2 signal / AWGN
4.6.1.1 EN-DC FR1 event-triggered reporting without gap in non-DRX	$Noc \pm 1.5$ dB $\hat{E}_{S2} / Noc \pm 0.3$ dB $\hat{E}_{S3} / Noc \pm 0.3$ dB	Note: $\hat{E}_{S2} / Noc$ is the ratio of cell 2 signal / AWGN $\hat{E}_{S3} / Noc$ is the ratio of cell 3 signal / AWGN
4.6.1.2 EN-DC FR1 event-triggered reporting without gap in DRX	Same as 4.6.1.1	Same as 4.6.1.1
4.6.1.3 EN-DC FR1 event-triggered reporting with gap in non-DRX	Same as 4.6.1.1	Same as 4.6.1.1
4.6.1.4 EN-DC FR1 event-triggered reporting with gap in DRX	Same as 4.6.1.1	Same as 4.6.1.1
4.6.1.5 EN-DC FR1 event-triggered reporting without gap in non-DRX with SSB time index detection	Same as 4.6.1.1	Same as 4.6.1.1
4.6.1.6 EN-DC FR1 event-triggered reporting with gap in non-DRX with SSB time index detection	Same as 4.6.1.1	Same as 4.6.1.1
4.6.1.7 EN-DC FR1 event-triggered reporting without gap in DRX for UE configured with highSpeedMeasFlag-r16	Same as 4.6.1.1	Same as 4.6.1.1
4.6.2.1 EN-DC FR1-FR1 event-triggered reporting in non-DRX	Average $Noc_2 \pm 1.5$ dB Average $Noc_3 \pm 1.5$ dB Average $\hat{E}_{S2} / Noc_2 \pm 0.3$ dB Average $\hat{E}_{S3} / Noc_3 \pm 0.3$ dB Meas PRB $Noc_2 \pm 1.5$ dB Meas PRB $Noc_3 \pm 1.5$ dB Meas PRB $\hat{E}_{S2} / Noc_2 \pm 0.3$ dB Meas PRB $\hat{E}_{S3} / Noc_3 \pm 0.3$ dB	$Noc_2$ is the AWGN on NR freq2 $Noc_3$ is the AWGN on NR freq3 $\hat{E}_{S2} / Noc_2$ is the ratio of cell 2 signal / AWGN $\hat{E}_{S3} / Noc_3$ is the ratio of cell 3 signal / AWGN  Meas PRB are the measurement PRB for SS-RSRP #RB <sub>J</sub> to RB <sub>J+19</sub>
4.6.2.2 EN-DC FR1-FR1 event-triggered reporting in DRX	Same as 4.6.2.1	Same as 4.6.2.1
4.6.2.5 EN-DC FR1-FR1 event-triggered reporting in non-DRX with SSB time index detection	Same as 4.6.2.1	Same as 4.6.2.1
4.6.2.6 EN-DC FR1-FR1 event-triggered reporting in DRX with SSB time index detection	Same as 4.6.2.1	Same as 4.6.2.1
4.6.4.1 EN-DC FR1 SSB-based L1-RSRP measurement in non-DRX	Average $Noc \pm 1.5$ dB Average $\hat{E}_{S0} / Noc \pm 0.3$ dB Average $\hat{E}_{S1} / Noc \pm 0.3$ dB Meas PRB $Noc \pm 1.5$ dB Meas PRB $\hat{E}_{S0} / Noc \pm 0.3$ dB Meas PRB $\hat{E}_{S1} / Noc \pm 0.3$ dB	$Noc$ is the AWGN on NR freq1 $\hat{E}_{S0} / Noc$ is the SNR for the SSB#0 $\hat{E}_{S1} / Noc$ is the SNR for the SSB#1  Meas PRB is the measurement PRB for SS-RSRP #RB <sub>J</sub> to RB <sub>J+19</sub>
4.6.4.2 EN-DC FR1 SSB-based L1-RSRP measurement in DRX	Same as 4.6.4.1	Same as 4.6.4.1
4.6.4.3 EN-DC FR1 CSI-RS-based L1-RSRP measurement in non-DRX	Average $Noc \pm 1.5$ dB Average $\hat{E}_{S0} / Noc \pm 0.3$ dB Average $\hat{E}_{S1} / Noc \pm 0.3$ dB Meas PRB $Noc \pm 1.5$ dB Meas PRB $\hat{E}_{S0} / Noc \pm 0.3$ dB Meas PRB $\hat{E}_{S1} / Noc \pm 0.3$ dB	$Noc$ is the AWGN on NR freq1 $\hat{E}_{S0} / Noc$ is the SNR for the CSI-RS#0 $\hat{E}_{S1} / Noc$ is the SNR for the CSI-RS#1  Meas PRB is the measurement PRB for CSI-RSRP #RB <sub>0</sub> to RB <sub>274</sub>
4.6.4.4 EN-DC FR1 CSI-RS-based L1-RSRP measurement in DRX	Same as 4.6.4.3	Same as 4.6.4.3
4.6.4.5 EN-DC FR1 SSB-based L1-RSRP measurement in DRX for UE configured with highSpeedMeasFlag-r16	Same as 4.6.4.1	Same as 4.6.4.1
4.6.5.2 EN-DC FR1 CLI-RSSI measurement with non-DRX	$Noc_2 \pm 1.5$ dB $\hat{E}_{S2} / Noc_2 \pm 0.3$ dB	Note: $Noc_2$ is the AWGN on cell 2 (NR) frequency $\hat{E}_{S2} / Noc_2$ is the ratio of cell 2 signal / AWGN

4.6.7.1 EN-DC FR1 CSI-RS based CMR and no dedicated IMR L1-SINR measurement in non-DRX	Average $N_{oc} \pm 1.5$ dB Average $\hat{E}_{s_0} / N_{oc} \pm 0.3$ dB Average $\hat{E}_{s_1} / N_{oc} \pm 0.3$ dB Meas PRB $N_{oc} \pm 1.5$ dB Meas PRB $\hat{E}_{s_0} / N_{oc} \pm 0.3$ dB Meas PRB $\hat{E}_{s_1} / N_{oc} \pm 0.3$ dB	$N_{oc}$ is the AWGN on Cell 2 frequency $\hat{E}_{s_0} / N_{oc}$ is the SNR for the CSI-RS#0 $\hat{E}_{s_1} / N_{oc}$ is the SNR for the CSI-RS#1  Meas PRB is the measurement PRB for CSI-SINR #RB <sub>0</sub> to RB <sub>275</sub>
4.6.7.2 EN-DC FR1 SSB based CMR and dedicated IMR L1-SINR measurement in DRX	Average $N_{oc} \pm 1.5$ dB Average $\hat{E}_{s_0} / N_{oc} \pm 0.3$ dB Average $\hat{E}_{s_1} / N_{oc} \pm 0.3$ dB Meas PRB $N_{oc} \pm 1.5$ dB Meas PRB $\hat{E}_{s_0} / N_{oc} \pm 0.3$ dB Meas PRB $\hat{E}_{s_1} / N_{oc} \pm 0.3$ dB	$N_{oc}$ is the AWGN on Cell 2 frequency $\hat{E}_{s_0} / N_{oc}$ is the SNR for the SSB#0 $\hat{E}_{s_1} / N_{oc}$ is the SNR for the SSB#1  Meas PRB is the measurement PRB for SS-SINR #RB <sub>J</sub> to RB <sub>J+19</sub>
4.6.7.3 EN-DC FR1 CSI-RS based CMR and dedicated IMR L1-SINR measurement in DRX	Average $N_{oc} \pm 1.5$ dB Average $\hat{E}_{s_0} / N_{oc} \pm 0.3$ dB Average $\hat{E}_{s_1} / N_{oc} \pm 0.3$ dB Meas PRB $N_{oc} \pm 1.5$ dB Meas PRB $\hat{E}_{s_0} / N_{oc} \pm 0.3$ dB Meas PRB $\hat{E}_{s_1} / N_{oc} \pm 0.3$ dB	$N_{oc}$ is the AWGN on Cell 2 frequency $\hat{E}_{s_0} / N_{oc}$ is the SNR for the CSI-RS#0 $\hat{E}_{s_1} / N_{oc}$ is the SNR for the CSI-RS#1  Meas PRB is the measurement PRB for CSI-SINR #RB <sub>0</sub> to RB <sub>275</sub>
4.7.1.1.1 EN-DC FR1 SS-RSRP absolute measurement accuracy	Average $N_{oc} \pm 1.5$ dB Average $\hat{E}_{s_2} / N_{oc} \pm 0.3$ dB Average $\hat{E}_{s_3} / N_{oc} \pm 0.3$ dB Meas PRB $N_{oc} \pm 1.5$ dB Meas PRB $\hat{E}_{s_2} / N_{oc} \pm 0.3$ dB Meas PRB $\hat{E}_{s_3} / N_{oc} \pm 0.3$ dB	$N_{oc}$ is the AWGN on NR freq1 $\hat{E}_{s_2} / N_{oc}$ is the cell 2 SNR $\hat{E}_{s_3} / N_{oc}$ is the cell 3 SNR  Meas PRB is the measurement PRB for SS-RSRP #RB <sub>J</sub> to RB <sub>J+19</sub>
4.7.1.1.2 EN-DC FR1 SS-RSRP relative measurement accuracy	Same as 4.7.1.1.1	Same as 4.7.1.1.1
4.7.1.2.1 EN-DC FR1-FR1 SS-RSRP absolute measurement accuracy	Average $N_{oc_1} \pm 1.5$ dB Average $N_{oc_2} \pm 1.5$ dB Average $\hat{E}_{s_2} / N_{oc_1} \pm 0.3$ dB Average $\hat{E}_{s_3} / N_{oc_2} \pm 0.3$ dB Meas PRB $N_{oc_1} \pm 1.5$ dB Meas PRB $N_{oc_2} \pm 1.5$ dB Meas PRB $\hat{E}_{s_2} / N_{oc_1} \pm 0.3$ dB Meas PRB $\hat{E}_{s_3} / N_{oc_2} \pm 0.3$ dB	$N_{oc_1}$ is the AWGN on NR freq1 $N_{oc_2}$ is the AWGN on NR freq2 $\hat{E}_{s_2} / N_{oc_1}$ is the cell 2 SNR $\hat{E}_{s_3} / N_{oc_2}$ is the cell 3 SNR  Meas PRB is the measurement PRB for SS-RSRP #RB <sub>J</sub> to RB <sub>J+19</sub>
4.7.1.2.2 EN-DC FR1-FR1 SS-RSRP relative measurement accuracy	Same as 4.7.1.2.1	Same as 4.7.1.2.1
4.7.2.1 EN-DC FR1 SS-RSRQ measurement accuracy	Same as 4.7.1.1.1	Same as 4.7.1.1.1
4.7.2.2.1 EN-DC FR1-FR1 SS-RSRQ absolute measurement accuracy	Same as 4.7.1.2.1	Same as 4.7.1.2.1
4.7.2.2.2 EN-DC FR1-FR1 SS-RSRQ relative measurement accuracy	Same as 4.7.1.2.1	Same as 4.7.1.2.1
4.7.3.1 EN-DC FR1 SS-SINR measurement accuracy	Same as 4.7.1.1.1	Same as 4.7.1.1.1
4.7.3.2.1 EN-DC FR1-FR1 SS-SINR absolute measurement accuracy	Same as 4.7.1.2.1	Same as 4.7.1.2.1
4.7.3.2.2 EN-DC FR1-FR1 SS-SINR relative measurement accuracy	Same as 4.7.1.2.1	Same as 4.7.1.2.1
4.7.4.1.1 EN-DC FR1 SSB based L1-RSRP absolute measurement accuracy	Average $N_{oc} \pm 1.5$ dB Average $\hat{E}_{s_2} / N_{oc} \pm 0.3$ dB Meas PRB $\hat{E}_{s_2} / N_{oc} \pm 0.8$ dB	$N_{oc}$ is the AWGN on NR freq1 $\hat{E}_{s_2} / N_{oc}$ is the cell 2 SNR Meas PRB is the measurement PRB for SS-RSRP #RB <sub>J</sub> to RB <sub>J+19</sub>
4.7.4.1.2 EN-DC FR1 SSB based L1-RSRP relative measurement accuracy	Same as 4.7.4.1.1	Same as 4.7.4.1.1
4.7.4.2.1 EN-DC FR1 CSI-RS based L1-RSRP absolute measurement accuracy	Same as 4.7.4.1.1	Same as 4.7.4.1.1
4.7.4.2.2 EN-DC FR1 CSI-RS based L1-RSRP relative measurement accuracy	Same as 4.7.4.1.1	Same as 4.7.4.1.1

4.7.5.1 EN-DC FR1 SFTD measurement accuracy	<p>Average <math>N_{oc1} \pm 1.5</math> dB  Average <math>\hat{E}_{s1} / N_{oc1} \pm 0.3</math> dB</p> <p>Meas PRB <math>N_{oc1} \pm 1.5</math> dB  Meas PRB <math>\hat{E}_{s1} / N_{oc1} \pm 0.3</math> dB</p> <p>Average <math>N_{oc2} \pm 1.5</math> dB  Average <math>\hat{E}_{s2} / N_{oc2} \pm 0.3</math> dB</p> <p>Meas PRB <math>N_{oc2} \pm 1.5</math> dB  Meas PRB <math>\hat{E}_{s2} / N_{oc2} \pm 0.8</math> dB</p>	<p><math>N_{oc1}</math> is the AWGN on NR freq1  <math>\hat{E}_{s1} / N_{oc1}</math> is the ratio of cell 1 signal / AWGN</p> <p>Meas PRB are the measurement PRB for SS-RSRP #RB<sub>J</sub> to RB<sub>J+19</sub></p> <p><math>N_{oc2}</math> is the AWGN on E-UTRA freq2  <math>\hat{E}_{s2} / N_{oc2}</math> is the ratio of cell 2 signal / AWGN</p> <p>Meas PRB are the measurement PRB for SS-RSRP #RB<sub>22</sub> to RB<sub>27</sub></p>
---	---	--

**Table F.1.1.2-4 Maximum test system uncertainty for RRM requirements for SA FR1 test cases**

Subclause	Maximum Test System Uncertainty <sup>1</sup>	Derivation of Test System Uncertainty
6.1.1.1 NR SA FR1 cell re-selection	Noc $\pm 1.5$ dB $\hat{E}s_1 / \text{Noc} \pm 0.3$ dB $\hat{E}s_2 / \text{Noc} \pm 0.3$ dB	Note: $\hat{E}s_1 / \text{Noc}$ is the ratio of cell 1 signal / AWGN $\hat{E}s_2 / \text{Noc}$ is the ratio of cell 2 signal / AWGN
6.1.1.2 NR SA FR1-FR1 cell re-selection	Noc1 $\pm 1.5$ dB $\hat{E}s_1 / \text{Noc1} \pm 0.3$ dB Noc2 $\pm 1.5$ dB $\hat{E}s_2 / \text{Noc2} \pm 0.3$ dB	Note: Noc1 is the AWGN on cell 1 frequency $\hat{E}s_1 / \text{Noc1}$ is the ratio of cell 1 signal / AWGN Noc2 is the AWGN on cell 2 frequency $\hat{E}s_2 / \text{Noc2}$ is the ratio of cell 2 signal / AWGN
6.1.1.3 NR SA FR1 cell re-selection for UE fulfilling low mobility relaxed measurement criterion	Same as 6.1.1.1	Same as 6.1.1.1
6.1.1.4 NR SA FR1 cell re-selection for UE fulfilling not-at-cell edge relaxed measurement criterion	Same as 6.1.1.1	Same as 6.1.1.1
6.1.1.5 NR SA FR1-FR1 cell re-selection for UE fulfilling low mobility relaxed measurement criterion	Same as 6.1.1.2	Same as 6.1.1.2
6.1.1.6 NR SA FR1-FR1 cell re-selection for UE fulfilling not-at-cell edge relaxed measurement criterion	Same as 6.1.1.2	Same as 6.1.1.2
6.1.1.7 NR SA FR1 cell re-selection for UE configured with highSpeedMeasFlag-r16	Same as 6.1.1.1	Same as 6.1.1.1
6.1.2.1 NR SA FR1 – E-UTRA cell re-selection to higher priority E-UTRA	Noc1 $\pm 1.5$ dB $\hat{E}s_1 / \text{Noc1} \pm 0.3$ dB Noc2 $\pm 1.5$ dB $\hat{E}s_2 / \text{Noc2} \pm 0.3$ dB	Note: Noc1 is the AWGN on cell 1 (NR) frequency $\hat{E}s_1 / \text{Noc1}$ is the ratio of cell 1 signal / AWGN Noc2 is the AWGN on cell 2 (E-UTRAN) frequency $\hat{E}s_2 / \text{Noc2}$ is the ratio of cell 2 signal / AWGN
6.1.2.2 NR SA FR1 – E-UTRA cell re-selection to lower priority E-UTRA	Same as 6.1.2.1	Same as 6.1.2.1
6.1.2.3 NR SA FR1 – E-UTRA cell re-selection to lower priority E-UTRAN for UE fulfilling low mobility relaxed measurement criterion	Same as 6.1.2.1	Same as 6.1.2.1
6.1.2.4 NR SA FR1 – E-UTRA cell re-selection to lower priority E-UTRAN for UE fulfilling not-at-cell edge relaxed measurement criterion	Same as 6.1.2.1	Same as 6.1.2.1
6.1.2.5 NR SA FR1 – E-UTRA cell re-selection to lower priority E-UTRA for UE configured with highSpeedMeasFlag-r16	Same as 6.1.2.1	Same as 6.1.2.1
6.3.1.1 NR SA FR1 handover with known target cell	Average Noc $\pm 1.5$ dB Average $\hat{E}s_1 / \text{Noc} \pm 0.3$ dB Average $\hat{E}s_2 / \text{Noc} \pm 0.3$ dB Meas PRB Noc $\pm 1.5$ dB Meas PRB $\hat{E}s_1 / \text{Noc} \pm 0.3$ dB Meas PRB $\hat{E}s_2 / \text{Noc} \pm 0.3$ dB	Note: $\hat{E}s_1 / \text{Noc}$ is the ratio of cell 1 signal / AWGN $\hat{E}s_2 / \text{Noc}$ is the ratio of cell 2 signal / AWGN Meas PRB are the measurement PRB for SS-RSRP #RB <sub>J</sub> to RB <sub>J+19</sub>
6.3.1.2 NR SA FR1 handover with unknown target cell	Same as 6.3.1.1	Same as 6.3.1.1
6.3.1.3 NR SA FR1-FR1 Handover with unknown Target Cell	Noc1 $\pm 1.5$ dB $\hat{E}s_1 / \text{Noc1} \pm 0.3$ dB Noc2 $\pm 1.5$ dB $\hat{E}s_2 / \text{Noc2} \pm 0.3$ dB	Note: Noc1 is the AWGN on cell 1 frequency $\hat{E}s_1 / \text{Noc1}$ is the ratio of cell 1 signal / AWGN Noc2 is the AWGN on cell 2 frequency $\hat{E}s_2 / \text{Noc2}$ is the ratio of cell 2 signal / AWGN
6.3.1.4 NR SA FR1 – E-UTRA handover with known target cell	Same as 6.1.2.1	Same as 6.1.2.1
6.3.1.5 NR SA FR1 – E-UTRA handover with unknown target cell	Same as 6.1.2.1	Same as 6.1.2.1

6.3.1.6 NR SA FR1 – UTRAN FDD handover with known target cell	$N_{oc} \pm 1.5$ dB $\hat{E}_s / N_{oc} \pm 0.3$ dB $l_{oc} \pm 0.7$ dB $\hat{l}_{or} / l_{oc} \pm 0.3$ dB $CPICH E_c / l_{or} \pm 0.1$ dB $SCH E_c / l_{or} \pm 0.1$ dB	Note: $N_{oc}$ is the AWGN on cell 1 frequency $\hat{E}_s / N_{oc}$ is the ratio of cell 1 signal / AWGN $l_{oc}$ is the AWGN on cell 2 frequency $\hat{l}_{or} / l_{oc}$ is the ratio of cell 2 signal / AWGN $CPICH E_c / l_{or}$ is the ratio of cell 2 CPICH code level / $l_{or}$ $SCH E_c / l_{or}$ is the ratio of cell 2 SCH code level / $l_{or}$
6.3.1.7 NR SA FR1 synchronous DAPS handover	Same as 6.3.1.1	Same as 6.3.1.1
6.3.1.8 NR SA FR1 asynchronous DAPS handover	Same as 6.3.1.1	Same as 6.3.1.1
6.3.1.9 NR SA FR1 Intra-band inter-frequency synchronous DAPS handover	Same as 6.3.1.3	Same as 6.3.1.3
6.3.1.10 NR SA FR1 Intra-band inter-frequency asynchronous DAPS handover	Same as 6.3.1.3	Same as 6.3.1.3
6.3.1.11 NR SA FR1 Inter-band inter-frequency synchronous DAPS handover	Same as 6.3.1.3	Same as 6.3.1.3
6.3.1.12 NR SA FR1 Inter-band inter-frequency asynchronous DAPS handover	Same as 6.3.1.3	Same as 6.3.1.3
6.3.2.1.1 NR SA FR1 RRC re-establishment	Same as 6.1.1.1	Same as 6.1.1.1
6.3.2.1.2 NR SA FR1 – FR1 RRC re-establishment	Same as 6.1.1.2	Same as 6.1.1.2
6.3.2.1.3 NR SA FR1 RRC re-establishment without serving cell timing	Average $N_{oc} \pm 1.5$ dB Average $\hat{E}_{s1} / N_{oc} \pm 0.3$ dB Average $\hat{E}_{s2} / N_{oc} \pm 0.3$ dB  Meas PRB $N_{oc} \pm 1.5$ dB Meas PRB $\hat{E}_{s1} / N_{oc} \pm 0.3$ dB Meas PRB $\hat{E}_{s2} / N_{oc} \pm 0.3$ dB	Note: $\hat{E}_{s1} / N_{oc}$ is the ratio of cell 1 signal / AWGN $\hat{E}_{s2} / N_{oc}$ is the ratio of cell 2 signal / AWGN  Meas PRB is the measurement PRB for SS-RSRP #RB <sub>J</sub> to RB <sub>J+19</sub>
6.3.2.2.1	$N_{oc} \pm 1.5$ dB $\hat{E}_s / N_{oc} \pm 0.3$ dB  Uplink absolute power measurement $\pm 1.5$ dB  Uplink relative power measurement $\pm 0.7$ dB  $\pm 112T_c$ Uplink signal transmit timing relative to downlink	$\hat{E}_{s1} / N_{oc}$ is the ratio of cell 1 signal / AWGN  $T_c = 1/(480000 \times 4096)$ seconds, the basic timing unit defined in TS 38.211 [7]
6.3.2.2.2	Same as 6.3.2.2.1	Same as 6.3.2.2.1
6.3.2.3.1 NR SA FR1 RRC connection release with redirection	Same as 6.1.1.2	Same as 6.1.1.2
6.3.2.3.2 NR SA FR1 – E-UTRA RRC connection release with redirection	Same as 6.1.2.1	Same as 6.1.2.1
6.3.3.1 NR SA FR1 conditional handover	Same as 6.3.1.1	Same as 6.3.1.1
6.3.3.2 NR SA FR1-FR1 conditional handover	Same as 6.3.1.3	Same as 6.3.1.3
6.4.1.1 EN-DC FR1 UE transmit timing accuracy	$N_{oc} \pm 1.5$ dB $\hat{E}_{s1} / N_{oc} \pm 0.3$ dB  $\pm 112T_c$ Uplink signal transmit timing relative to downlink	$\hat{E}_{s1} / N_{oc}$ is the ratio of cell 1 signal / AWGN  $T_c = 1/(480000 \times 4096)$ seconds, the basic timing unit defined in TS 38.211 [7]

6.4.3.1 NR SA FR1 timing advance adjustment accuracy	Noc $\pm 1.5$ dB $\hat{E}_{s1} / N_{oc} \pm 0.3$ dB $\pm 88T_c$ Timing Advance Adjustment accuracy	$\hat{E}_{s1} / N_{oc}$ is the ratio of cell 1 signal / AWGN $T_c = 1/(480000 \times 4096)$ seconds, the basic timing unit defined in TS 38.211 [7]
6.5.1.1 NR SA FR1 radio link monitoring out-of-sync test for PCell configured with SSB-based RLM RS in non-DRX mode	Average Noc $\pm 1.5$ dB Average $\hat{E}_s / N_{oc} \pm 0.3$ dB Meas PRB Noc $\pm 1.5$ dB Meas PRB $\hat{E}_s / N_{oc} \pm 0.3$ dB Fading profile $\pm 0.7$ dB	Noc is the AWGN on cell 1 frequency $\hat{E}_s / N_{oc}$ is the SNR Meas PRB are the measurement PRB for SSB-based RLM #RB <sub>J</sub> to RB <sub>J+19</sub>
6.5.1.2 NR SA FR1 radio link monitoring in-sync test for PCell configured with SSB-based RLM RS in non-DRX mode	Same as 6.5.1.1	Same as 6.5.1.1
6.5.1.3 NR SA FR1 radio link monitoring out-of-sync test for PCell configured with SSB-based RLM RS in DRX mode	Same as 6.5.1.1	Same as 6.5.1.1
6.5.1.4 NR SA FR1 radio link monitoring in-sync test for PCell configured with SSB-based RLM RS in DRX mode	Same as 6.5.1.1	Same as 6.5.1.1
6.5.1.5 NR SA FR1 radio link monitoring out-of-sync test for PCell configured with CSI-RS-based RLM RS in non-DRX mode	Same as 6.5.1.1	Same as 6.5.1.1
6.5.1.6 NR SA FR1 radio link monitoring in-sync test for PCell configured with CSI-RS-based RLM RS in non-DRX mode	Same as 6.5.1.1	Same as 6.5.1.1
6.5.1.7 NR SA FR1 radio link monitoring out-of-sync test for PCell configured with CSI-RS-based RLM RS in DRX mode	Same as 6.5.1.1	Same as 6.5.1.1
6.5.1.8 NR SA FR1 radio link monitoring in-sync test for PCell configured with CSI-RS-based RLM RS in DRX mode	Same as 6.5.1.1	Same as 6.5.1.1
6.5.2.1 NR SA FR1 interruptions during measurements on deactivated NR SCC	Noc <sub>1</sub> $\pm 1.5$ dB Noc <sub>2</sub> $\pm 1.5$ dB $\hat{E}_{s1} / N_{oc1} \pm 0.3$ dB $\hat{E}_{s2} / N_{oc2} \pm 0.3$ dB	Note: $\hat{E}_{s1} / N_{oc1}$ is the ratio of cell 1 signal / AWGN $\hat{E}_{s2} / N_{oc2}$ is the ratio of cell 2 signal / AWGN
6.5.3.1 NR SA FR1 SCell activation and deactivation of known SCell in non-DRX for 160ms SCell measurement cycle	Average Noc <sub>1</sub> $\pm 1.5$ dB Average Noc <sub>2</sub> $\pm 1.5$ dB Average $\hat{E}_{s1} / N_{oc1} \pm 0.3$ dB Average $\hat{E}_{s2} / N_{oc2} \pm 0.3$ dB Meas PRB Noc <sub>1</sub> $\pm 1.5$ dB Meas PRB Noc <sub>2</sub> $\pm 1.5$ dB Meas PRB $\hat{E}_{s1} / N_{oc1} \pm 0.3$ dB Meas PRB $\hat{E}_{s2} / N_{oc2} \pm 0.3$ dB	Note: Noc <sub>1</sub> is the AWGN on cell 1 frequency Noc <sub>2</sub> is the AWGN on cell 2 frequency $\hat{E}_{s1} / N_{oc1}$ is the ratio of cell 1 signal / AWGN $\hat{E}_{s2} / N_{oc2}$ is the ratio of cell 2 signal / AWGN Meas PRB are the measurement PRB for SS-RSRP #RB <sub>J</sub> to RB <sub>J+19</sub>
6.5.3.2 NR SA FR1 SCell activation and deactivation of known SCell in non-DRX for 640ms SCell measurement cycle	Same as 6.5.3.1	Same as 6.5.3.1
6.5.3.3 NR SA FR1 SCell activation and deactivation of unknown SCell in non-DRX	Same as 6.5.3.1	Same as 6.5.3.1
6.5.5.1 NR SA FR1 SSB-based beam failure detection and link recovery in non-DRX	Average Noc <sub>1</sub> $\pm 1.5$ dB Average $\hat{E}_{s1} / N_{oc1} \pm 0.3$ dB Meas PRB Noc <sub>1</sub> $\pm 1.5$ dB Meas PRB $\hat{E}_{s1} / N_{oc1} \pm 0.3$ dB Fading profile $\pm 0.7$ dB	Note: Noc <sub>1</sub> is the AWGN on cell 1 frequency $\hat{E}_{s1} / N_{oc1}$ is the SNR for the SSB Meas PRB is the measurement PRB for SS-RSRP #RB <sub>J</sub> to RB <sub>J+19</sub>
6.5.5.2 NR SA FR1 SSB-based beam failure detection and link recovery in DRX	Same as 6.5.5.1	Same as 6.5.5.1



6.5.5.3 NR SA FR1 CSI-RS-based beam failure detection and link recovery in non-DRX	Average $N_{oc1} \pm 1.5$ dB Average $\hat{E}_{s1} / N_{oc1} \pm 0.3$ dB Meas PRB $N_{oc1} \pm 1.5$ dB Meas PRB $\hat{E}_{s1} / N_{oc1} \pm 0.3$ dB Fading profile $\pm 0.7$ dB	Note: $N_{oc1}$ is the AWGN on cell 1 frequency $\hat{E}_{s1} / N_{oc1}$ is the SNR for the CSI-RS  Meas PRB is the measurement PRB for CSI-RSRP #RB <sub>0</sub> to RB <sub>274</sub>
6.5.5.4 NR SA FR1 CSI-RS-based beam failure detection and link recovery in DRX	Same as 6.5.5.3	Same as 6.5.5.3
6.5.6.1.1 NR SA FR1-FR1 DCI-based DL active BWP switch in non-DRX	$\pm 0.6$ dB	Overall system uncertainty for fading conditions comprises two quantities: 1. Signal-to-noise ratio uncertainty 2. Effect of AWGN flatness and signal flatness  Items 1 and 2 are assumed to be uncorrelated so can be root sum squared: AWGN flatness and signal flatness has x 0.25 effect on the required SNR, so use sensitivity factor of x 0.25 for the uncertainty contribution. Test System uncertainty = SQRT (Signal-to-noise ratio uncertainty <sup>2</sup> + (0.25 x AWGN flatness and signal flatness) <sup>2</sup> ) Signal-to-noise ratio uncertainty $\pm 0.3$ dB AWGN flatness and signal flatness $\pm 2.0$ dB
6.5.6.1.2 NR SA FR1 DCI-based DL active BWP switch in non-DRX	Same as 6.5.6.1.1	Same as 6.5.6.1.1
6.5.6.2.1 NR SA FR1 RRC-based DL active BWP switch in non-DRX	$\pm 0.6$ dB	Overall system uncertainty for fading conditions comprises two quantities: 1. Signal-to-noise ratio uncertainty 2. Effect of AWGN flatness and signal flatness  Items 1 and 2 are assumed to be uncorrelated so can be root sum squared: AWGN flatness and signal flatness has x 0.25 effect on the required SNR, so use sensitivity factor of x 0.25 for the uncertainty contribution. Test System uncertainty = SQRT (Signal-to-noise ratio uncertainty <sup>2</sup> + (0.25 x AWGN flatness and signal flatness) <sup>2</sup> ) Signal-to-noise ratio uncertainty $\pm 0.3$ dB AWGN flatness and signal flatness $\pm 2.0$ dB
6.6.1.1 SA event triggered reporting tests without gap under non-DRX	$N_{oc} \pm 1.5$ dB $\hat{E}_{s1} / N_{oc} \pm 0.3$ dB $\hat{E}_{s2} / N_{oc} \pm 0.3$ dB	Note: $\hat{E}_{s1} / N_{oc}$ is the ratio of cell 1 signal / AWGN $\hat{E}_{s2} / N_{oc}$ is the ratio of cell 2 signal / AWGN
6.6.1.2 SA event triggered reporting tests without gap under DRX	Same as 6.6.1.1	Same as 6.6.1.1
6.6.1.3 SA event triggered reporting tests with per-UE gaps under non-DRX	Same as 6.6.1.1	Same as 6.6.1.1
6.6.1.4 SA event triggered reporting tests with per-UE gaps under DRX	Same as 6.6.1.1	Same as 6.6.1.1
6.6.1.5 SA event triggered reporting tests without gap under non-DRX with SSB index reading	Same as 6.6.1.1	Same as 6.6.1.1
6.6.1.6 SA event triggered reporting tests with per-UE gaps under non-DRX with SSB index reading	Same as 6.6.1.1	Same as 6.6.1.1
6.6.1.7 NR SA FR1 event-triggered reporting without gap in DRX for UE configured with highSpeedMeasFlag-r16	Same as 6.6.1.1	Same as 6.6.1.1

6.6.2.1 NR SA FR1-FR1 event-triggered reporting in non-DRX	Average $N_{oc1} \pm 1.5$ dB Average $N_{oc2} \pm 1.5$ dB Average $\hat{E}_{s1} / N_{oc1} \pm 0.3$ dB Average $\hat{E}_{s2} / N_{oc2} \pm 0.3$ dB Meas PRB $N_{oc1} \pm 1.5$ dB Meas PRB $N_{oc2} \pm 1.5$ dB Meas PRB $\hat{E}_{s1} / N_{oc1} \pm 0.3$ dB Meas PRB $\hat{E}_{s2} / N_{oc2} \pm 0.3$ dB	$N_{oc1}$ is the AWGN on NR freq1 $N_{oc2}$ is the AWGN on NR freq2 $\hat{E}_{s1} / N_{oc1}$ is the ratio of cell 1 signal / AWGN $\hat{E}_{s2} / N_{oc2}$ is the ratio of cell 2 signal / AWGN  Meas PRB are the measurement PRB for SS-RSRP #RB <sub>J</sub> to RB <sub>J+19</sub>
6.6.2.2 NR SA FR1-FR1 event-triggered reporting in DRX	Same as 6.6.2.1	Same as 6.6.2.1
6.6.2.5 NR SA FR1-FR1 event-triggered reporting in non-DRX with SSB time index detection	Same as 6.6.2.1	Same as 6.6.2.1
6.6.2.6 NR SA FR1-FR1 event-triggered reporting in DRX with SSB time index detection	Same as 6.6.2.1	Same as 6.6.2.1
6.6.3.1 NR SA FR1 – E-UTRAN event-triggered reporting in non-DRX	Freq 1 $N_{oc} \pm 1.5$ dB Freq 2 $N_{oc} \pm 1.5$ dB $\hat{E}_{s1} / N_{oc} \pm 0.3$ dB $\hat{E}_{s2} / N_{oc} \pm 0.3$ dB Fading $\pm 0.5$ dB	Note: $\hat{E}_{s1} / N_{oc}$ is the ratio of cell 1 signal / AWGN $\hat{E}_{s2} / N_{oc}$ is the ratio of cell 2 signal / AWGN
6.6.3.2 NR SA FR1 – E-UTRAN event-triggered reporting in DRX	Same as 6.6.3.1	Same as 6.6.3.1
6.6.3.3 NR SA FR1 – E-UTRAN event-triggered reporting in DRX for UE configured with highSpeedMeasFlag-r16	Freq 1 $N_{oc} \pm 1.5$ dB Freq 2 $N_{oc} \pm 1.5$ dB $\hat{E}_{s1} / N_{oc} \pm 0.3$ dB $\hat{E}_{s2} / N_{oc} \pm 0.3$ dB	Note: $\hat{E}_{s1} / N_{oc}$ is the ratio of cell 1 signal / AWGN $\hat{E}_{s2} / N_{oc}$ is the ratio of cell 2 signal / AWGN
6.6.4.1 NR SA FR1 SSB-based L1-RSRP measurement in non-DRX	Average $N_{oc} \pm 1.5$ dB Average $\hat{E}_{s0} / N_{oc} \pm 0.3$ dB Average $\hat{E}_{s1} / N_{oc} \pm 0.3$ dB Meas PRB $N_{oc} \pm 1.5$ dB Meas PRB $\hat{E}_{s0} / N_{oc} \pm 0.3$ dB Meas PRB $\hat{E}_{s1} / N_{oc} \pm 0.3$ dB	$N_{oc}$ is the AWGN on NR freq1 $\hat{E}_{s0} / N_{oc}$ is the SNR for the SSB#0 $\hat{E}_{s1} / N_{oc}$ is the SNR for the SSB#1  Meas PRB is the measurement PRB for SS-RSRP #RB <sub>J</sub> to RB <sub>J+19</sub>
6.6.4.2 NR SA FR1 SSB-based L1-RSRP measurement in DRX	Same as 6.6.4.1	Same as 6.6.4.1
6.6.4.3 NR SA FR1 CSI-RS-based L1-RSRP measurement in non-DRX	Average $N_{oc} \pm 1.5$ dB Average $\hat{E}_{s0} / N_{oc} \pm 0.3$ dB Average $\hat{E}_{s1} / N_{oc} \pm 0.3$ dB Meas PRB $N_{oc} \pm 1.5$ dB Meas PRB $\hat{E}_{s0} / N_{oc} \pm 0.3$ dB Meas PRB $\hat{E}_{s1} / N_{oc} \pm 0.3$ dB	$N_{oc}$ is the AWGN on NR freq1 $\hat{E}_{s0} / N_{oc}$ is the SNR for the CSI-RS#0 $\hat{E}_{s1} / N_{oc}$ is the SNR for the CSI-RS#1  Meas PRB is the measurement PRB for CSI-RSRP #RB <sub>0</sub> to RB <sub>274</sub>
6.6.4.4 NR SA FR1 CSI-RS-based L1-RSRP measurement in DRX	Same as 6.6.4.3	Same as 6.6.4.3
6.6.4.5 NR SA FR1 SSB-based L1-RSRP measurement in DRX for UE configured with highSpeedMeasFlag-r16	Same as 6.6.4.1	Same as 6.6.4.1
6.6.5.1 NR SA FR1 – UTRAN event-triggered reporting in non-DRX	$N_{oc} \pm 1.5$ dB $\hat{E}_s / N_{oc} \pm 0.3$ dB $l_{oc} \pm 0.7$ dB $\hat{l}_{or} / l_{oc} \pm 0.3$ dB CPICH $E_c / l_{or} \pm 0.1$ dB SCH $E_c / l_{or} \pm 0.1$ dB	Note: $N_{oc}$ is the AWGN on cell 1 frequency $\hat{E}_s / N_{oc}$ is the ratio of cell 1 signal / AWGN $l_{oc}$ is the AWGN on cell 2 frequency $\hat{l}_{or} / l_{oc}$ is the ratio of cell 2 signal / AWGN CPICH $E_c / l_{or}$ is the ratio of cell 2 CPICH code level / $l_{or}$ SCH $E_c / l_{or}$ is the ratio of cell 2 SCH code level / $l_{or}$
6.6.8.1 NR SA FR1 CSI-RS based CMR and no dedicated IMR L1-SINR measurement in DRX	Average $N_{oc} \pm 1.5$ dB Average $\hat{E}_{s0} / N_{oc} \pm 0.3$ dB Average $\hat{E}_{s1} / N_{oc} \pm 0.3$ dB Meas PRB $N_{oc} \pm 1.5$ dB Meas PRB $\hat{E}_{s0} / N_{oc} \pm 0.3$ dB Meas PRB $\hat{E}_{s1} / N_{oc} \pm 0.3$ dB	$N_{oc}$ is the AWGN on Cell 1 frequency $\hat{E}_{s0} / N_{oc}$ is the SNR for the CSI-RS#0 $\hat{E}_{s1} / N_{oc}$ is the SNR for the CSI-RS#1  Meas PRB is the measurement PRB for CSI-SINR #RB <sub>0</sub> to RB <sub>275</sub>

6.6.8.2 NR SA FR1 SSB based CMR and dedicated IMR L1-SINR measurement in non-DRX	Average $N_{oc} \pm 1.5$ dB Average $\hat{E}_{s0} / N_{oc} \pm 0.3$ dB Average $\hat{E}_{s1} / N_{oc} \pm 0.3$ dB Meas PRB $N_{oc} \pm 1.5$ dB Meas PRB $\hat{E}_{s0} / N_{oc} \pm 0.3$ dB Meas PRB $\hat{E}_{s1} / N_{oc} \pm 0.3$ dB	$N_{oc}$ is the AWGN on Cell 1 frequency $\hat{E}_{s0} / N_{oc}$ is the SNR for the SSB#0 $\hat{E}_{s1} / N_{oc}$ is the SNR for the SSB#1  Meas PRB is the measurement PRB for SS-SINR #RB <sub>J</sub> to RB <sub>J+19</sub>
6.6.8.3 NR SA FR1 CSI-RS based CMR and dedicated IMR L1-SINR measurement in non-DRX	Average $N_{oc} \pm 1.5$ dB Average $\hat{E}_{s0} / N_{oc} \pm 0.3$ dB Average $\hat{E}_{s1} / N_{oc} \pm 0.3$ dB Meas PRB $N_{oc} \pm 1.5$ dB Meas PRB $\hat{E}_{s0} / N_{oc} \pm 0.3$ dB Meas PRB $\hat{E}_{s1} / N_{oc} \pm 0.3$ dB	$N_{oc}$ is the AWGN on Cell 1 frequency $\hat{E}_{s0} / N_{oc}$ is the SNR for the CSI-RS#0 $\hat{E}_{s1} / N_{oc}$ is the SNR for the CSI-RS#1  Meas PRB is the measurement PRB for CSI-SINR #RB <sub>0</sub> to RB <sub>275</sub>
6.7.1.1.1 NR SA FR1 SS-RSRP absolute measurement accuracy	Average $N_{oc} \pm 1.5$ dB Average $\hat{E}_{s1} / N_{oc} \pm 0.3$ dB Average $\hat{E}_{s2} / N_{oc} \pm 0.3$ dB  meas PRB $\hat{E}_{s1} / N_{oc} \pm 0.3$ dB meas PRB $\hat{E}_{s2} / N_{oc} \pm 0.3$ dB	$N_{oc}$ is the AWGN on NR freq1 $\hat{E}_{s1} / N_{oc}$ is the cell 1 SNR $\hat{E}_{s2} / N_{oc}$ is the cell 2 SNR  meas PRB is the measurement PRB for SS-RSRP #RB <sub>J</sub> to RB <sub>J+19</sub>
6.7.1.1.2 NR SA FR1 SS-RSRP relative measurement accuracy	Same as 6.7.1.1.1	Same as 6.7.1.1.1
6.7.1.2.1 NR SA FR1-FR1 SS-RSRP absolute measurement accuracy	Average $N_{oc1} \pm 1.5$ dB Average $N_{oc2} \pm 1.5$ dB Average $\hat{E}_{s1} / N_{oc1} \pm 0.3$ dB Average $\hat{E}_{s2} / N_{oc2} \pm 0.3$ dB  meas PRB $\hat{E}_{s1} / N_{oc1} \pm 0.3$ dB meas PRB $\hat{E}_{s2} / N_{oc2} \pm 0.3$ dB	$N_{oc1}$ is the AWGN on NR freq1 $N_{oc2}$ is the AWGN on NR freq2 $\hat{E}_{s1} / N_{oc1}$ is the cell 2 SNR $\hat{E}_{s2} / N_{oc2}$ is the cell 3 SNR  meas PRB is the measurement PRB for SS-RSRP #RB <sub>J</sub> to RB <sub>J+19</sub>
6.7.1.2.2 NR SA FR1-FR1 SS-RSRP relative measurement accuracy	Same as 6.7.1.2.1	Same as 6.7.1.2.1
6.7.2.1 NR SA FR1 SS-RSRQ measurement accuracy	Same as 6.7.1.1.1	Same as 6.7.1.1.1
6.7.2.2.1 NR SA FR1-FR1 SS-RSRQ absolute measurement accuracy	Same as 6.7.1.2.1	Same as 6.7.1.2.1
6.7.2.2.2 NR SA FR1-FR1 SS-RSRQ relative measurement accuracy	Same as 6.7.1.2.1	Same as 6.7.1.2.1
6.7.3.1 NR SA FR1 SS-SINR measurement accuracy	Same as 6.7.1.1.1	Same as 6.7.1.1.1
6.7.3.2.1 NR SA FR1-FR1 SS-SINR absolute measurement accuracy	Same as 6.7.1.2.1	Same as 6.7.1.2.1
6.7.3.2.2 NR SA FR1-FR1 SS-SINR relative measurement accuracy	Same as 6.7.1.2.1	Same as 6.7.1.2.1
6.7.4.1.1 NR SA FR1 SSB based L1-RSRP absolute measurement accuracy	Average $N_{oc} \pm 1.5$ dB Average $\hat{E}_{s1} / N_{oc} \pm 0.3$ dB Meas PRB $\hat{E}_{s1} / N_{oc} \pm 0.8$ dB	$N_{oc}$ is the AWGN on NR freq1 $\hat{E}_{s2} / N_{oc}$ is the cell 1 SNR Meas PRB is the measurement PRB for SS-RSRP #RB <sub>J</sub> to RB <sub>J+19</sub>
6.7.4.1.2 NR SA FR1 SSB based L1-RSRP relative measurement accuracy	Same as 6.7.4.1.1	Same as 6.7.4.1.1
6.7.4.2.1 NR SA FR1 CSI-RS based L1-RSRP absolute measurement accuracy	Same as 6.7.4.1.1	Same as 6.7.4.1.1
6.7.4.2.2 NR SA FR1 CSI-RS based L1-RSRP relative measurement accuracy	Same as 6.7.4.1.1	Same as 6.7.4.1.1
6.7.5.1 NR SA FR1 – E-UTRAN RSRP absolute measurement accuracy	Average $N_{oc} \pm 1.5$ dB Average $\hat{E}_s / N_{oc} \pm 0.3$ dB  Meas PRB $N_{oc} \pm 1.5$ dB Meas PRB $\hat{E}_s / N_{oc} \pm 0.8$ dB	$N_{oc}$ is the AWGN on E-UTRA freq1 $\hat{E}_s / N_{oc}$ is the ratio of cell 1 signal / AWGN  Meas PRB are the measurement PRB for RSRP #RB <sub>22</sub> to RB <sub>27</sub>
6.7.6.1 NR SA FR1 – E-UTRAN RSRQ absolute measurement accuracy	Same as 6.7.5.1	Same as 6.7.5.1
6.7.7.1 NR SA FR1 – E-UTRAN RS-SINR absolute measurement accuracy	Same as 6.7.5.1	Same as 6.7.5.1

**Table F.1.1.2-5: Maximum test system uncertainty for RRM requirements for EN-DC FR2 test cases**

Subclause	Maximum Test System Uncertainty <sup>1</sup>	Derivation of Test System Uncertainty
5.3.2.2.1 EN-DC FR2 contention based random access	Average $\hat{E}_s \pm 6.0$ dB Meas PRB $\hat{E}_s \pm 6.0$ dB  Uplink absolute power measurement $\pm 6.0$ dB  Uplink relative power measurement $\pm FFS$ dB  $\pm [48]T_c$ Uplink signal transmit timing relative to downlink	Meas PRB is the measurement PRB for SS-RSRP #RB <sub>J</sub> to RB <sub>J+19</sub>  $T_c = 1/(480000 \times 4096)$ seconds, the basic timing unit defined in TS 38.211 [7]
5.3.2.2.2 EN-DC FR2 non-contention based random access	Same as 5.3.2.2.1	Same as 5.3.2.2.1
5.4.1.1 EN-DC FR2 UE transmit timing accuracy	$N_{oc} \pm 5.65$ dB, $f \leq 40.8$ GHz  $\hat{E}_{s2} / N_{oc} \pm 0.3$ dB  $\pm 48T_c$ Uplink signal transmit timing relative to downlink $\pm 40T_c$ Relative during UE timing adjustment	$\hat{E}_{s2} / N_{oc}$ is the ratio of cell 2 signal / AWGN  $T_c = 1/(480000 \times 4096)$ seconds, the basic timing unit defined in TS 38.211 [7]
5.4.3.1 EN-DC FR2 UE timing advance adjustment accuracy	$N_{oc} \pm 5.65$ dB, $f \leq 40.8$ GHz  $\hat{E}_{s1} / N_{oc} \pm 0.3$ dB  $\pm 40T_c$ timing advance adjustment	$\hat{E}_{s1} / N_{oc}$ is the ratio of cell 1 signal / AWGN  $T_c = 1/(480000 \times 4096)$ seconds, the basic timing unit defined in TS 38.211 [7]
5.5.1.5 EN-DC FR2 radio link monitoring out-of-sync test for PSCell configured with CSI-RS-based RLM RS in non-DRX mode	Average $N_{oc} \pm 5.65$ dB, $f \leq 40.8$ GHz  Average $\hat{E}_{s1} / N_{oc} \pm 0.3$ dB Average $\hat{E}_{s2} / N_{oc} \pm 0.3$ dB  Fading profile $\pm 0.5$ dB for 1Tx	$\hat{E}_{s1} / N_{oc}$ is the SNR of RLM-RS1 $\hat{E}_{s2} / N_{oc}$ is the SNR of RLM-RS2
5.5.1.6 EN-DC FR2 radio link monitoring in-sync test for PSCell configured with CSI-RS-based RLM RS in non-DRX mode	Same as 5.5.1.5	Same as 5.5.1.5
5.5.2.1 EN-DC FR2 interruptions at transitions between active and non-active during DRX in synchronous EN-DC	$N_{oc} \pm 5.65$ dB, $f \leq 40.8$ GHz  $\hat{E}_{s2} / N_{oc} \pm 0.3$ dB	$\hat{E}_{s2} / N_{oc}$ is the ratio of cell 2 signal / AWGN
5.5.2.2 EN-DC FR2 interruptions at transitions between active and non-active during DRX in asynchronous EN-DC	Same as 5.5.2.1	Same as 5.5.2.1
5.5.5.1 EN-DC FR2 SSB-based beam failure detection and link recovery in non-DRX	$N_{oc}$ averaged over $BW_{Config}$ , $\pm 5.65$ dB, $f \leq 40.8$ GHz $N_{oc}$ averaged over measured PRBs, $\pm 5.65$ dB, $f \leq 40.8$ GHz  $\hat{E}_s / N_{oc}$ averaged over $BW_{Config}$ : $\pm 0.3$ dB $\hat{E}_s / N_{oc}$ averaged over measured PRBs: $\pm 0.3$ dB  Fading profile $\pm 0.7$ dB, 2Tx	$N_{oc}$ averaged over $BW_{Config}$ is the AWGN absolute power averaged over $BW_{Config}$ $N_{oc}$ averaged over measured PRBs is the AWGN absolute power averaged over measured PRBs  $\hat{E}_s / N_{oc}$ averaged over $BW_{Config}$ is the Ratio of cell signal / AWGN averaged over $BW_{Config}$ $\hat{E}_s / N_{oc}$ averaged over measured PRBs is the Ratio of cell signal / AWGN averaged over measured PRBs
5.5.5.2 EN-DC FR2 SSB-based beam failure detection and link recovery in DRX	Same as 5.5.5.1	Same as 5.5.5.1
5.5.5.3 EN-DC FR2 CSI-RS-based beam failure detection and link recovery in non-DRX	$N_{oc} \pm 5.65$ dB, $f \leq 40.8$ GHz  $\hat{E}_{s2} / N_{oc} \pm 0.3$ dB  Fading profile $\pm 0.7$ dB for 2Tx	Note: $N_{oc}$ is the AWGN on cell 2 frequency $\hat{E}_{s2} / N_{oc}$ is the SNR for the CSI-RS

5.5.5.4 EN-DC FR2 CSI-RS-based beam failure detection and link recovery in DRX	Same as 5.5.5.3	Same as 5.5.5.3
5.5.5.5 EN-DC FR2 scheduling available restriction during SSB-based beam failure detection and link recovery in non-DRX	Same as 5.5.5.1	Same as 5.5.5.1
5.5.5.6 EN-DC FR2 SCell CSI-RS-based beam failure detection and link recovery in non-DRX	$N_{oc} \pm 5.65$ dB, $f \leq 40.8$ GHz $\hat{E}_{s3} / N_{oc} \pm 0.3$ dB Fading profile $\pm 0.7$ dB for 2Tx	Note: $N_{oc}$ is the AWGN on cell 3 frequency $\hat{E}_{s3} / N_{oc}$ is the SNR for the CSI-RS
5.5.5.7 EN-DC FR2 SCell CSI-RS-based beam failure detection and link recovery in DRX	Same as 5.5.5.6	Same as 5.5.5.6
5.6.1.1 EN-DC FR2 event-triggered reporting without gap in non-DRX	$\hat{E}_{s2}$ averaged over BW $\pm 5.65$ dB, $f \leq 40.8$ GHz $\hat{E}_{s2}$ averaged over measured PRB $\pm 5.65$ dB, $f \leq 40.8$ GHz $\hat{E}_{s3}$ averaged over BW $\pm 5.65$ dB, $f \leq 40.8$ GHz $\hat{E}_{s3}$ averaged over measured PRB $\pm 5.65$ dB, $f \leq 40.8$ GHz	$\hat{E}_{s2}$ averaged over BW is the absolute power of cell 2 signal averaged over BW $\hat{E}_{s2}$ averaged over measured PRB is the absolute power of cell 2 signal averaged over measured PRB $\hat{E}_{s3}$ averaged over BW is the absolute power of cell 3 signal averaged over BW $\hat{E}_{s3}$ averaged over measured PRB is the absolute power of cell 3 signal averaged over measured PRB
5.6.1.2 EN-DC FR2 event-triggered reporting without gap in DRX	$N_{oc} \pm 5.65$ dB $\hat{E}_{s2} / N_{oc} \pm 0.3$ dB $\hat{E}_{s3} / N_{oc} \pm 0.3$ dB	$\hat{E}_{s2} / N_{oc}$ is the ratio of cell 2 signal / AWGN $\hat{E}_{s3} / N_{oc}$ is the ratio of cell 3 signal / AWGN
5.6.1.3 EN-DC FR2 event-triggered reporting without gap in non-DRX	Same as 5.6.1.1	Same as 5.6.1.1
5.6.1.4 EN-DC FR2 event-triggered reporting with gap in DRX	Same as 5.6.1.2	Same as 5.6.1.2
5.6.2.1 EN-DC FR2-FR2 event-triggered reporting in non-DRX	Average $\hat{E}_{s1} \pm 5.65$ dB, $f \leq 40.8$ GHz Meas PRB $\hat{E}_{s1} \pm 5.65$ dB, $f \leq 40.8$ GHz Average $\hat{E}_{s2} \pm 5.65$ dB Meas PRB $\hat{E}_{s2} \pm 5.65$ dB	$\hat{E}_{s1}$ is NR cell 2 signal $\hat{E}_{s2}$ is NR cell 3 signal Meas PRB is the measurement PRB for SS-RSRP #RBJ to RBJ+19
5.6.2.2 EN-DC FR2-FR2 event-triggered reporting in DRX	Average $N_{oc} \pm 5.65$ dB, $f \leq 40.8$ GHz $N_{oc}$ over meas PRBs $\pm 5.65$ dB $f \leq 40.8$ GHz Average $\hat{E}_{s1} / N_{oc} \pm 0.3$ dB $\hat{E}_{s1} / N_{oc}$ over meas PRBs $\pm 0.3$ dB Average $\hat{E}_{s2} / N_{oc} \pm 0.3$ dB $\hat{E}_{s2} / N_{oc}$ over meas PRBs $\pm 0.3$ dB	$\hat{E}_{s1}$ is NR cell 2 signal $\hat{E}_{s2}$ is NR cell 3 signal Meas PRB is the measurement PRB for SS-RSRP #RBJ to RBJ+19
5.6.2.3 EN-DC FR2-FR2 event-triggered reporting in non-DRX with SSB time index detection	Same as 5.6.2.1	Same as 5.6.2.1
5.6.2.4 EN-DC FR2-FR2 event-triggered reporting in DRX with SSB time index detection	Same as 5.6.2.2	Same as 5.6.2.2
5.6.2.5 EN-DC FR1-FR2 event-triggered reporting in non-DRX	Average $\hat{E}_{s2} \pm 5.65$ , $f \leq 40.8$ GHz	$\hat{E}_{s2}$ is NR cell 2 signal Meas PRB is the measurement PRB for SS-RSRP #RBJ to RBJ+19

5.6.2.6 EN-DC FR1-FR2 event-triggered reporting in DRX	Noc $\pm 5.65$ dB, $f \leq 40.8$ GHz $\hat{E}s_2 / \text{Noc} \pm 0.3$ dB	$\hat{E}s_2 / \text{Noc}$ is the ratio of cell 2 signal / AWGN
5.6.2.7 EN-DC FR1-FR2 event-triggered reporting in non-DRX with SSB time index detection	Same as 5.6.2.5	Same as 5.6.2.5
5.6.2.8 EN-DC FR1-FR2 event-triggered reporting in DRX with SSB time index detection	Same as 5.6.2.6	Same as 5.6.2.6
5.6.3.1 EN-DC FR2 SSB-based L1-RSRP measurement in non-DRX	Average Noc $\pm 5.65$ dB, $f \leq 40.8$ GHz Noc over meas PRBs $\pm 5.65$ dB $f \leq 40.8$ GHz  Average $\hat{E}s_0 / \text{Noc} \pm 0.3$ dB $\hat{E}s_0 / \text{Noc}$ over meas PRBs $\pm 0.3$ dB Average $\hat{E}s_1 / \text{Noc} \pm 0.3$ dB $\hat{E}s_1 / \text{Noc}$ over meas PRBs $\pm 0.3$ dB	$\hat{E}s_0 / \text{Noc}$ is the SNR for the SSB#0 $\hat{E}s_1 / \text{Noc}$ is the SNR for the SSB#1  Meas PRB is the measurement PRB for SS-RSRP #RBJ to RBJ+19
5.6.3.2 EN-DC FR2 SSB-based L1-RSRP measurement in DRX	Same as 5.6.3.1	Same as 5.6.3.1
5.6.3.3 EN-DC FR2 CSI-RS-based L1-RSRP measurement in non-DRX	Average Noc $\pm 5.65$ dB, $f \leq 40.8$ GHz Noc over meas PRBs $\pm 5.65$ dB $f \leq 40.8$ GHz  Average $\hat{E}s_0 / \text{Noc} \pm 0.3$ dB $\hat{E}s_0 / \text{Noc}$ over meas PRBs $\pm 0.3$ dB Average $\hat{E}s_1 / \text{Noc} \pm 0.3$ dB $\hat{E}s_1 / \text{Noc}$ over meas PRBs $\pm 0.3$ dB	$\hat{E}s_0 / \text{Noc}$ is the SNR for the CSI-RS#0 $\hat{E}s_1 / \text{Noc}$ is the SNR for the CSI-RS#1  Meas PRB is the measurement PRB for CSI-RS-RSRP
5.6.3.4 EN-DC FR2 CSI-RS-based L1-RSRP measurement in DRX	Same as 5.6.3.3	Same as 5.6.3.3
5.6.6.1 EN-DC FR2 CSI-RS based CMR and no dedicated IMR L1-SINR measurement in DRX	Average Noc $\pm 5.65$ dB, $f \leq 40.8$ GHz Noc over meas PRBs $\pm 5.65$ dB $f \leq 40.8$ GHz  Average $\hat{E}s_0 / \text{Noc} \pm 0.3$ dB $\hat{E}s_0 / \text{Noc}$ over meas PRBs $\pm 0.3$ dB Average $\hat{E}s_1 / \text{Noc} \pm 0.3$ dB $\hat{E}s_1 / \text{Noc}$ over meas PRBs $\pm 0.3$ dB	$\hat{E}s_0 / \text{Noc}$ is the SNR for the CSI-RS#0 $\hat{E}s_1 / \text{Noc}$ is the SNR for the CSI-RS#1  Meas PRB is the measurement PRB for CSI-RS-SINR #RBJ to RBJ+275
5.6.6.2 EN-DC FR2 SSB based CMR and dedicated IMR L1-SINR measurement in non-DRX	Average Noc $\pm 5.65$ dB, $f \leq 40.8$ GHz Noc over meas PRBs $\pm 5.65$ dB $f \leq 40.8$ GHz  Average $\hat{E}s_0 / \text{Noc} \pm 0.3$ dB $\hat{E}s_0 / \text{Noc}$ over meas PRBs $\pm 0.3$ dB Average $\hat{E}s_1 / \text{Noc} \pm 0.3$ dB $\hat{E}s_1 / \text{Noc}$ over meas PRBs $\pm 0.3$ dB	$\hat{E}s_0 / \text{Noc}$ is the SNR for the SSB#0 $\hat{E}s_1 / \text{Noc}$ is the SNR for the SSB#1  Meas PRB is the measurement PRB for SS-SINR#RBJ to RBJ+19
5.6.6.3 EN-DC FR2 CSI-RS based CMR and dedicated IMR L1-SINR measurement in non-DRX	Same as 5.6.6.1	Same as 5.6.6.1

5.7.1.1 EN-DC FR2 SS-RSRP measurement accuracy	<p>Test 1 Noc <math>\pm 5.65</math> dB, <math>f \leq 40.8</math> GHz Noc over meas PRBs <math>\pm 5.65</math> dB <math>f \leq 40.8</math> GHz</p> <p><math>\hat{E}s1 / \text{Noc} \pm 0.3</math> dB <math>\hat{E}s2 / \text{Noc} \pm 0.3</math> dB Meas PRB <math>\hat{E}s1 / \text{Noc} \pm 0.3</math> dB Meas PRB <math>\hat{E}s2 / \text{Noc} \pm 0.3</math> dB</p> <p>Test 2 Average <math>\hat{E}s1 \pm 5.65</math> dB, <math>f \leq 40.8</math> GHz Meas PRB <math>\hat{E}s1 \pm 5.65</math> dB, <math>f \leq 40.8</math> GHz</p> <p>Average <math>\hat{E}s2 \pm 5.65</math> dB, <math>f \leq 40.8</math> GHz Meas PRB <math>\hat{E}s2 \pm 5.65</math> dB, <math>f \leq 40.8</math> GHz</p>	<p>Test 1 Noc is the AWGN on the NR freq</p> <p><math>\hat{E}s1 / \text{Noc}</math> is the ratio of cell 2 signal / AWGN <math>\hat{E}s2 / \text{Noc}</math> is the ratio of cell 3 signal / AWGN Meas PRB is the measurement PRB for SS-RSRP #RBJ to RBJ+19</p> <p>Test 2 <math>\hat{E}s1</math> is NR cell 2 signal <math>\hat{E}s2</math> is NR cell 3 signal</p> <p>Meas PRB is the measurement PRB for SS-RSRP #RBJ to RBJ+19</p>
5.7.1.2 EN-DC FR2-FR2 SS-RSRP measurement accuracy	<p>Noc1 <math>\pm 5.65</math> dB, <math>f \leq 40.8</math> GHz Noc1 over measPRBs <math>\pm 5.65</math> dB, <math>f \leq 40.8</math> GHz Noc2 <math>\pm 5.65</math> dB, <math>f \leq 40.8</math> GHz Noc2 over measPRBs <math>\pm 5.65</math> dB, <math>f \leq 40.8</math> GHz</p> <p><math>\hat{E}s1 / \text{Noc1} \pm 0.3</math> dB <math>\hat{E}s2 / \text{Noc2} \pm 0.3</math> dB Meas PRB <math>\hat{E}s1 / \text{Noc1} \pm 0.3</math> dB Meas PRB <math>\hat{E}s2 / \text{Noc2} \pm 0.3</math> dB</p>	<p>Noc1 is the AWGN on the NR freq 1 Noc2 is the AWGN on the NR freq 2</p> <p><math>\hat{E}s1 / \text{Noc1}</math> is the ratio of cell 2 signal / AWGN <math>\hat{E}s2 / \text{Noc2}</math> is the ratio of cell 3 signal / AWGN Meas PRB is the measurement PRB for SS-RSRP #RBJ to RBJ+19</p>
5.7.2.1 EN-DC FR2 SS-RSRQ measurement accuracy	<p>Noc <math>\pm 5.65</math> dB, <math>f \leq 40.8</math> GHz Noc over meas PRBs <math>\pm 5.65</math> dB, <math>f \leq 40.8</math> GHz</p> <p><math>\hat{E}s1 / \text{Noc} \pm 0.3</math> dB <math>\hat{E}s2 / \text{Noc} \pm 0.3</math> dB Meas PRB <math>\hat{E}s1 / \text{Noc} \pm 0.3</math> dB Meas PRB <math>\hat{E}s2 / \text{Noc} \pm 0.3</math> dB</p>	<p>Noc is the AWGN on the NR freq</p> <p><math>\hat{E}s1 / \text{Noc}</math> is the ratio of cell 2 signal / AWGN <math>\hat{E}s2 / \text{Noc}</math> is the ratio of cell 3 signal / AWGN Meas PRB is the measurement PRB for SS-RSRP #RBJ to RBJ+19</p>
5.7.2.2 EN-DC FR2-FR2 SS-RSRQ measurement accuracy	Same as 5.7.1.2	Same as 5.7.1.2
5.7.3.1 EN-DC FR2 SS-SINR measurement accuracy	Same as 5.7.2.1	Same as 5.7.2.1
5.7.3.2 EN-DC FR2-FR2 SS-SINR measurement accuracy	Same as 5.7.1.2	Same as 5.7.1.2
5.7.4.1 EN-DC FR2 SSB based L1-RSRP measurement accuracy	<p>Test 1 Noc <math>\pm 5.65</math> dB, <math>f \leq 40.8</math> GHz Noc over meas PRBs <math>\pm 5.65</math> dB <math>f \leq 40.8</math> GHz</p> <p><math>\hat{E}s1 / \text{Noc} \pm 0.3</math> dB Meas PRB <math>\hat{E}s1 / \text{Noc} \pm 0.3</math> dB</p> <p>Test 2 Average <math>\hat{E}s1 \pm 5.65</math> dB, <math>f \leq 40.8</math> GHz Meas PRB <math>\hat{E}s1 \pm 5.65</math> dB, <math>f \leq 40.8</math> GHz</p>	<p>Test 1 Noc is the AWGN on the NR freq</p> <p><math>\hat{E}s1 / \text{Noc}</math> is the ratio of cell 2 signal / AWGN Meas PRB is the measurement PRB for SS-RSRP #RBJ to RBJ+19</p> <p>Test 2 <math>\hat{E}s1</math> is NR cell 2 signal Meas PRB is the measurement PRB for SS-RSRP #RBJ to RBJ+19</p>



5.7.4.2 EN-DC FR2 CSI-RS based L1-RSRP measurement accuracy	<p>Test 1  <math>N_{oc} \pm 5.65 \text{ dB}</math>, <math>f \leq 40.8 \text{ GHz}</math>  <math>N_{oc}</math> over meas PRBs <math>\pm 5.65 \text{ dB}</math>  <math>f \leq 40.8 \text{ GHz}</math></p> <p><math>\hat{E}_{s1} / N_{oc} \pm 0.3 \text{ dB}</math>  Meas PRB <math>\hat{E}_{s1} / N_{oc} \pm 0.3 \text{ dB}</math></p> <p>Test 2  Average <math>\hat{E}_{s1} \pm 5.65 \text{ dB}</math>, <math>f \leq 40.8 \text{ GHz}</math>  Meas PRB <math>\hat{E}_{s1} \pm 5.65 \text{ dB}</math>, <math>f \leq 40.8 \text{ GHz}</math></p>	<p>Test 1  <math>N_{oc}</math> is the AWGN on the NR freq</p> <p><math>\hat{E}_{s1} / N_{oc}</math> is the ratio of cell 2 signal / AWGN  Meas PRB is the measurement PRB for CSI-RS-RSRP</p> <p>Test 2  <math>\hat{E}_{s1}</math> is NR cell 2 signal</p> <p>Meas PRB is the measurement PRB for CSI-RS-RSRP</p>
---	---	---

**Table F.1.1.2-6: Maximum test system uncertainty for RRM requirements for SA FR2 test cases**

Subclause	Maximum Test System Uncertainty <sup>1</sup>	Derivation of Test System Uncertainty
7.3.1.4 NR SA FR1-FR2 synchronous DAPS handover	<p>Noc, averaged over <math>BW_{\text{Config}}</math>, <math>\pm 5.65</math> dB</p> <p>Noc, averaged over Measurement PRB, <math>\pm 5.65</math> dB</p> <p><math>E_{s2}/\text{Noc}</math> averaged over <math>BW_{\text{Config}} \pm 0.3</math> dB</p> <p><math>E_{s2}/\text{Noc}</math> averaged over Measurement PRB <math>\pm 0.3</math> dB</p>	<p>Noc averaged over <math>BW_{\text{Config}}</math> is the AWGN absolute power of RF channel 2 averaged over <math>BW_{\text{Config}}</math></p> <p>Noc averaged over Measurement PRB is the AWGN absolute power of RF channel 2 averaged over Measurement PRB</p> <p><math>E_{s2}/\text{Noc}</math> averaged over <math>BW_{\text{Config}}</math> is Ratio of cell 2 signal / AWGN averaged over <math>BW_{\text{Config}}</math></p> <p><math>E_{s2}/\text{Noc}</math> averaged over Measurement PRB is Ratio of cell 2 signal / AWGN averaged over Measurement PRB</p>
7.3.1.5 NR SA FR1-FR2 asynchronous DAPS handover	Same as 7.3.1.4	Same as 7.3.1.4
7.3.2.1.1 NR SA FR2 RRC re-establishment	<p>Average Noc <math>\pm 5.65</math> dB, <math>f \leq 40.8</math> GHz</p> <p>Noc over meas PRBs <math>\pm 5.65</math> dB <math>f \leq 40.8</math> GHz</p> <p>Average <math>\hat{E}_{s1} / \text{Noc} \pm 0.3</math> dB</p> <p><math>\hat{E}_{s1} / \text{Noc}</math> over meas PRBs <math>\pm 0.3</math> dB</p> <p>Average <math>\hat{E}_{s2} / \text{Noc} \pm 0.3</math> dB</p> <p><math>\hat{E}_{s2} / \text{Noc}</math> over meas PRBs <math>\pm 0.3</math> dB</p>	<p><math>\hat{E}_{s1}</math> is NR cell 1 signal</p> <p><math>\hat{E}_{s2}</math> is NR cell 2 signal</p> <p>Meas PRB is the measurement PRB for SS-RSRP #RBJ to RBJ+19</p>
7.3.2.1.2 NR SA FR2 - FR2 RRC re-establishment	<p>Average Noc<sub>1</sub> <math>\pm 5.65</math> dB, <math>f \leq 40.8</math> GHz</p> <p>Noc<sub>1</sub> over meas PRBs <math>\pm 5.65</math> dB <math>f \leq 40.8</math> GHz</p> <p>Average Noc<sub>2</sub> <math>\pm 5.65</math> dB, <math>f \leq 40.8</math> GHz</p> <p>Noc<sub>2</sub> over meas PRBs <math>\pm 5.65</math> dB <math>f \leq 40.8</math> GHz</p> <p>Average <math>\hat{E}_{s1} / \text{Noc}_1 \pm 0.3</math> dB</p> <p><math>\hat{E}_{s1} / \text{Noc}</math> over meas PRBs <math>\pm 0.3</math> dB</p> <p>Average <math>\hat{E}_{s2} / \text{Noc}_2 \pm 0.3</math> dB</p> <p><math>\hat{E}_{s2} / \text{Noc}</math> over meas PRBs <math>\pm 0.3</math> dB</p>	<p><math>\hat{E}_{s1}</math> is NR cell 1 signal</p> <p><math>\hat{E}_{s2}</math> is NR cell 2 signal</p> <p>Meas PRB is the measurement PRB for SS-RSRP #RBJ to RBJ+19</p>
7.3.2.2.1 NR SA FR2 contention based random access	<p>Average <math>\hat{E}_s \pm 6.0</math> dB</p> <p>Meas PRB <math>\hat{E}_s \pm 6.0</math> dB</p> <p>Uplink absolute power measurement <math>\pm 6.0</math> dB</p> <p>Uplink relative power measurement <math>\pm \text{FFS}</math> dB</p> <p><math>\pm [48]T_c</math> Uplink signal transmit timing relative to downlink</p>	<p>Meas PRB is the measurement PRB for SS-RSRP #RBJ to RBJ+19</p> <p><math>T_c = 1/(480000 \times 4096)</math> seconds, the basic timing unit defined in TS 38.211 [7]</p>
7.3.2.2.2 NR SA FR2 non-contention based random access	Same as 7.3.2.2.1	Same as 7.3.2.2.1

7.3.3.1 NR SA FR2 conditional handover	<p><math>N_{oc}</math> averaged over <math>BW_{Config}</math>, <math>\pm 5.65</math> dB</p> <p><math>N_{oc}</math>, averaged over Measurement PRB, <math>\pm 5.65</math> dB</p> <p><math>E_{s1}/N_{oc}</math> averaged over <math>BW_{Config} \pm 0.3</math> dB</p> <p><math>E_{s1}/N_{oc}</math> averaged over Measurement PRB <math>\pm 0.3</math> dB</p> <p><math>E_{s2}/N_{oc} \pm 0.3</math> dB</p> <p><math>N_{oc}</math>, averaged over <math>BW_{Config}</math>, <math>\pm 5.65</math> dB</p> <p><math>E_{s2}/N_{oc}</math> averaged over Measurement PRB <math>\pm 0.3</math> dB</p>	<p><math>N_{oc}</math> averaged over <math>BW_{Config}</math>, is the AWGN absolute power of RF channel 1 averaged over <math>BW_{Config}</math>,</p> <p><math>N_{oc}</math> averaged over Measurement PRB, is the AWGN absolute power of RF channel 1 averaged over Measurement PRB,</p> <p><math>E_{s1}/N_{oc}</math> averaged over <math>BW_{Config}</math> is Ratio of cell 1 signal / AWGN averaged over <math>BW_{Config}</math></p> <p><math>E_{s1}/N_{oc}</math> averaged over Measurement PRB is Ratio of cell 1 signal / AWGN averaged over Measurement PRB</p> <p><math>E_{s2}/N_{oc}</math> averaged over <math>BW_{Config}</math> is Ratio of cell 2 signal / AWGN averaged over <math>BW_{Config}</math></p> <p><math>E_{s2}/N_{oc}</math> averaged over Measurement PRB is Ratio of cell 2 signal / AWGN averaged over Measurement PRB</p>
7.4.1.1 SA FR2 UE transmit timing accuracy	<p><math>N_{oc} \pm 5.65</math> dB</p> <p><math>\hat{E}_{s1} / N_{oc} \pm 0.3</math> dB</p> <p><math>\pm 48T_c</math> Uplink signal transmit timing relative to downlink</p> <p><math>\pm 40T_c</math> Relative during UE timing adjustment</p>	<p><math>\hat{E}_{s1} / N_{oc}</math> is the ratio of cell 1 signal / AWGN</p> <p><math>T_c = 1/(480000 \times 4096)</math> seconds, the basic timing unit defined in TS 38.211 [7]</p>
7.4.3.1 NR SA FR2 UE timing advance adjustment accuracy	<p><math>N_{oc} \pm 5.65</math> dB</p> <p><math>\hat{E}_{s1} / N_{oc} \pm 0.3</math> dB</p> <p><math>\pm 40T_c</math> timing advance adjustment</p>	<p><math>\hat{E}_{s1} / N_{oc}</math> is the ratio of cell 1 signal / AWGN</p> <p><math>T_c = 1/(480000 \times 4096)</math> seconds, the basic timing unit defined in TS 38.211 [7]</p>
7.5.5.1 NR SA FR2 SSB-based beam failure detection and link recovery in non-DRX	Same as 5.5.5.1	Same as 5.5.5.1
7.5.5.2 NR SA FR2 SSB-based beam failure detection and link recovery in DRX	Same as 5.5.5.1	Same as 5.5.5.1
7.5.5.3 NR SA FR2 CSI-RS-based beam failure detection and link recovery in non-DRX	<p><math>N_{oc} \pm 5.65</math> dB, <math>f \leq 40.8</math> GHz</p> <p><math>\hat{E}_{s1} / N_{oc} \pm 0.3</math> dB</p> <p>Fading profile <math>\pm 0.7</math> dB for 2Tx</p>	<p>Note:</p> <p><math>N_{oc}</math> is the AWGN on cell 1 frequency</p> <p><math>\hat{E}_{s1} / N_{oc}</math> is the SNR for the CSI-RS</p>
7.5.5.4 NR SA FR2 CSI-RS-based beam failure detection and link recovery in DRX	Same as 7.5.5.3	Same as 7.5.5.3
7.5.5.5 NR SA FR2 scheduling available restriction during SSB-based beam failure detection and link recovery in non-DRX	Same as 5.5.5.1	Same as 5.5.5.1
7.5.5.6 NR SA FR2 SCell CSI-RS-based beam failure detection and link recovery in non-DRX	<p><math>N_{oc} \pm 5.65</math> dB, <math>f \leq 40.8</math> GHz</p> <p><math>\hat{E}_{s2} / N_{oc} \pm 0.3</math> dB</p> <p>Fading profile <math>\pm 0.7</math> dB for 2Tx</p>	<p>Note:</p> <p><math>N_{oc}</math> is the AWGN on cell 2 frequency</p> <p><math>\hat{E}_{s2} / N_{oc}</math> is the SNR for the CSI-RS</p>
7.5.5.7 NR SA FR2 SCell CSI-RS-based beam failure detection and link recovery in DRX	Same as 7.5.5.6	Same as 7.5.5.6

7.6.1.1 NR SA FR2 event-triggered reporting without gap in non-DRX	$\hat{E}s_1$ averaged over BW $\pm 5.65$ dB, $f \leq 40.8$ GHz $\hat{E}s_1$ averaged over measured PRB $\pm 5.65$ dB, $f \leq 40.8$ GHz  $\hat{E}s_2$ averaged over BW $\pm 5.65$ dB, $f \leq 40.8$ GHz $\hat{E}s_2$ averaged over measured PRB $\pm 5.65$ dB, $f \leq 40.8$ GHz	$\hat{E}s_1$ averaged over BW is the absolute power of cell 1 signal averaged over BW $\hat{E}s_1$ averaged over measured PRB is the absolute power of cell 1 signal averaged over measured PRB  $\hat{E}s_2$ averaged over BW is the absolute power of cell 2 signal averaged over BW $\hat{E}s_2$ averaged over measured PRB is the absolute power of cell 2 signal averaged over measured PRB
7.6.1.2 NR SA FR2 event-triggered reporting without gap in DRX	Noc averaged over BW, $\pm 5.65$ dB, $f \leq 40.8$ GHz Noc averaged over measured PRB, $\pm 5.65$ dB, $f \leq 40.8$ GHz  $\hat{E}s_1 / \text{Noc}$ averaged over BW, $\pm 0.3$ dB, $f \leq 40.8$ GHz $\hat{E}s_1 / \text{Noc}$ averaged over measured PRB, $\pm 0.3$ dB, $f \leq 40.8$ GHz  $\hat{E}s_2 / \text{Noc}$ averaged over BW, $\pm 0.3$ dB, $f \leq 40.8$ GHz $\hat{E}s_2 / \text{Noc}$ averaged over measured PRB, $\pm 0.3$ dB, $f \leq 40.8$ GHz	Noc averaged over BW is AWGN absolute power averaged over BW. Noc averaged over measured PRB is AWGN absolute power averaged over measured PRB.  $\hat{E}s_1 / \text{Noc}$ averaged over BW is the ratio of cell 1 signal / AWGN averaged over BW $\hat{E}s_1 / \text{Noc}$ averaged over measured PRB is the ratio of cell 1 signal / AWGN averaged over measured PRB  $\hat{E}s_2 / \text{Noc}$ averaged over BW is the ratio of cell 2 signal / AWGN averaged over BW. $\hat{E}s_2 / \text{Noc}$ averaged over measured PRB is the ratio of cell 2 signal / AWGN averaged over measured PRB.
7.6.1.3 NR SA FR2 event-triggered reporting without gap in non-DRX	Same as 7.6.1.1	Same as 7.6.1.1
7.6.1.4 NR SA FR2 event-triggered reporting with gap in DRX	Same as 7.6.1.2	Same as 7.6.1.2
7.6.2.1 NR SA FR2-FR2 event-triggered reporting in non-DRX	Average $\hat{E}s_1 \pm 5.65$ dB, $f \leq 40.8$ GHz Meas PRB $\hat{E}s_1 \pm 5.65$ dB, $f \leq 40.8$ GHz  Average $\hat{E}s_2 \pm 5.65$ dB Meas PRB $\hat{E}s_2 \pm 5.65$ dB	$\hat{E}s_1$ is NR cell 1 signal $\hat{E}s_2$ is NR cell 2 signal  Meas PRB is the measurement PRB for SS-RSRP #RBJ to RBJ+19
7.6.2.2 NR SA FR2-FR2 event-triggered reporting in DRX	Average $\text{Noc}_1 \pm 5.65$ dB, $f \leq 40.8$ GHz $\text{Noc}_1$ over meas PRBs $\pm 5.65$ dB $f \leq 40.8$ GHz Average $\text{Noc}_2 \pm 5.65$ dB, $f \leq 40.8$ GHz $\text{Noc}_2$ over meas PRBs $\pm 5.65$ dB $f \leq 40.8$ GHz  Average $\hat{E}s_1 / \text{Noc}_1 \pm 0.3$ dB $\hat{E}s_1 / \text{Noc}$ over meas PRBs $\pm 0.3$ dB Average $\hat{E}s_2 / \text{Noc}_2 \pm 0.3$ dB $\hat{E}s_2 / \text{Noc}_2$ over meas PRBs $\pm 0.3$ dB	$\hat{E}s_1$ is NR cell 1 signal $\hat{E}s_2$ is NR cell 2 signal  Meas PRB is the measurement PRB for SS-RSRP #RBJ to RBJ+19
7.6.2.3 NR SA FR2-FR2 event-triggered reporting in non-DRX with SSB time index detection	Same as 7.6.2.1	Same as 7.6.2.1
7.6.2.4 NR SA FR2-FR2 event-triggered reporting in DRX with SSB time index detection	Same as 7.6.2.2	Same as 7.6.2.2
7.6.2.5 NR SA FR1-FR2 event-triggered reporting in non-DRX	Average $\hat{E}s_2 \pm 5.65$ dB, $f \leq 40.8$ GHz	$\hat{E}s_2$ is NR cell 2 signal  Meas PRB is the measurement PRB for SS-RSRP #RBJ to RBJ+19

7.6.2.6 NR SA FR1-FR2 event-triggered reporting in DRX	Noc $\pm 5.65$ dB, $f \leq 40.8$ GHz $\hat{E}s_2 / \text{Noc} \pm 0.3$ dB	$\hat{E}s_2 / \text{Noc}$ is the ratio of cell 2 signal / AWGN
7.6.2.7 NR SA FR1-FR2 event-triggered reporting in non-DRX with SSB time index detection	Same as 7.6.2.5	Same as 7.6.2.5
7.6.2.8 NR SA FR1-FR2 event-triggered reporting in DRX with SSB time index detection	Same as 7.6.2.6	Same as 7.6.2.6
7.6.3.1 NR SA FR2 SSB-based L1-RSRP measurement in non-DRX	Average Noc $\pm 5.65$ dB, $f \leq 40.8$ GHz Noc over meas PRBs $\pm 5.65$ dB $f \leq 40.8$ GHz  Average $\hat{E}s_0 / \text{Noc} \pm 0.3$ dB $\hat{E}s_0 / \text{Noc}$ over meas PRBs $\pm 0.3$ dB Average $\hat{E}s_1 / \text{Noc} \pm 0.3$ dB $\hat{E}s_1 / \text{Noc}$ over meas PRBs $\pm 0.3$ dB	$\hat{E}s_0 / \text{Noc}$ is the SNR for the SSB#0 $\hat{E}s_1 / \text{Noc}$ is the SNR for the SSB#1  Meas PRB is the measurement PRB for SS-RSRP #RBJ to RBJ+19
7.6.3.2 NR SA FR2 SSB-based L1-RSRP measurement in DRX	Same as 7.6.3.1	Same as 7.6.3.1
7.6.3.3 NR SA FR2 CSI-RS-based L1-RSRP measurement in non-DRX	Average Noc $\pm 5.65$ dB, $f \leq 40.8$ GHz Noc over meas PRBs $\pm 5.65$ dB $f \leq 40.8$ GHz  Average $\hat{E}s_0 / \text{Noc} \pm 0.3$ dB $\hat{E}s_0 / \text{Noc}$ over meas PRBs $\pm 0.3$ dB Average $\hat{E}s_1 / \text{Noc} \pm 0.3$ dB $\hat{E}s_1 / \text{Noc}$ over meas PRBs $\pm 0.3$ dB	$\hat{E}s_0 / \text{Noc}$ is the SNR for the CSI-RS#0 $\hat{E}s_1 / \text{Noc}$ is the SNR for the CSI-RS#1  Meas PRB is the measurement PRB for CSI-RS-RSRP
7.6.3.4 NR SA FR2 CSI-RS-based L1-RSRP measurement in DRX	Same as 7.6.3.3	Same as 7.6.3.3
7.6.6.1 NR SA FR2 CSI-RS based CMR and no dedicated IMR configured and CSI-RS resource set with repetition off L1-SINR measurement accuracy	Average Noc $\pm 5.65$ dB, $f \leq 40.8$ GHz Noc over meas PRBs $\pm 5.65$ dB $f \leq 40.8$ GHz  Average $\hat{E}s_0 / \text{Noc} \pm 0.3$ dB $\hat{E}s_0 / \text{Noc}$ over meas PRBs $\pm 0.3$ dB Average $\hat{E}s_1 / \text{Noc} \pm 0.3$ dB $\hat{E}s_1 / \text{Noc}$ over meas PRBs $\pm 0.3$ dB	$\hat{E}s_0 / \text{Noc}$ is the SNR for the CSI-RS#0 $\hat{E}s_1 / \text{Noc}$ is the SNR for the CSI-RS#1  Meas PRB is the measurement PRB for CSI-RS-SINR #RBJ to RBJ+275
7.6.6.2 NR SA FR2 SSB based CMR and dedicated IMR L1-SINR measurement accuracy	Average Noc $\pm 5.65$ dB, $f \leq 40.8$ GHz Noc over meas PRBs $\pm 5.65$ dB $f \leq 40.8$ GHz  Average $\hat{E}s_0 / \text{Noc} \pm 0.3$ dB $\hat{E}s_0 / \text{Noc}$ over meas PRBs $\pm 0.3$ dB Average $\hat{E}s_1 / \text{Noc} \pm 0.3$ dB $\hat{E}s_1 / \text{Noc}$ over meas PRBs $\pm 0.3$ dB	$\hat{E}s_0 / \text{Noc}$ is the SNR for the SSB#0 $\hat{E}s_1 / \text{Noc}$ is the SNR for the SSB#1  Meas PRB is the measurement PRB for SS-SINR #RBJ to RBJ+19
7.6.6.3 NR SA FR2 CSI-RS based CMR and dedicated IMR L1-SINR measurement accuracy	Same as 7.6.6.1	Same as 7.6.6.1

7.7.1.1 NR SA FR2 SS-RSRP measurement accuracy	<p>Test 1 Noc <math>\pm 5.65</math> dB, <math>f \leq 40.8</math> GHz Noc over meas PRBs <math>\pm 5.65</math> dB <math>f \leq 40.8</math> GHz</p> <p><math>\hat{E}s1 / \text{Noc} \pm 0.3</math> dB <math>\hat{E}s2 / \text{Noc} \pm 0.3</math> dB Meas PRB <math>\hat{E}s1 / \text{Noc} \pm 0.3</math> dB Meas PRB <math>\hat{E}s2 / \text{Noc} \pm 0.3</math> dB</p> <p>Test 2 Average <math>\hat{E}s1 \pm 5.65</math> dB, <math>f \leq 40.8</math> GHz Meas PRB <math>\hat{E}s1 \pm 5.65</math> dB, <math>f \leq 40.8</math> GHz</p> <p>Average <math>\hat{E}s2 \pm 5.65</math> dB, <math>f \leq 40.8</math> GHz Meas PRB <math>\hat{E}s2 \pm 5.65</math> dB, <math>f \leq 40.8</math> GHz</p>	<p>Test 1 Noc is the AWGN on the NR freq</p> <p><math>\hat{E}s1 / \text{Noc}</math> is the ratio of cell 1 signal / AWGN <math>\hat{E}s2 / \text{Noc}</math> is the ratio of cell 1 signal / AWGN Meas PRB is the measurement PRB for SS-RSRP #RBJ to RBJ+19</p> <p>Test 2 <math>\hat{E}s1</math> is NR cell 1 signal <math>\hat{E}s2</math> is NR cell 2 signal</p> <p>Meas PRB is the measurement PRB for SS-RSRP #RBJ to RBJ+19</p>
7.7.1.2 NR SA FR2-FR2 SS-RSRP measurement accuracy	<p>Noc1 <math>\pm 5.65</math> dB, <math>f \leq 40.8</math> GHz Noc1 over measPRBs <math>\pm 5.65</math> dB, <math>f \leq 40.8</math> GHz Noc2 <math>\pm 5.65</math> dB, <math>f \leq 40.8</math> GHz Noc2 over measPRBs <math>\pm 5.65</math> dB, <math>f \leq 40.8</math> GHz</p> <p><math>\hat{E}s1 / \text{Noc1} \pm 0.3</math> dB <math>\hat{E}s2 / \text{Noc2} \pm 0.3</math> dB Meas PRB <math>\hat{E}s1 / \text{Noc1} \pm 0.3</math> dB Meas PRB <math>\hat{E}s2 / \text{Noc2} \pm 0.3</math> dB</p>	<p>Noc1 is the AWGN on the NR freq 1 Noc2 is the AWGN on the NR freq 2</p> <p><math>\hat{E}s1 / \text{Noc1}</math> is the ratio of cell 1 signal / AWGN <math>\hat{E}s2 / \text{Noc2}</math> is the ratio of cell 2 signal / AWGN Meas PRB is the measurement PRB for SS-RSRP #RBJ to RBJ+19</p>
7.7.2.1 NR SA FR2 SS-RSRQ measurement accuracy	<p>Noc <math>\pm 5.65</math> dB, <math>f \leq 40.8</math> GHz Noc over meas PRBs <math>\pm 5.65</math> dB, <math>f \leq 40.8</math> GHz</p> <p><math>\hat{E}s1 / \text{Noc} \pm 0.3</math> dB <math>\hat{E}s2 / \text{Noc} \pm 0.3</math> dB Meas PRB <math>\hat{E}s1 / \text{Noc} \pm 0.3</math> dB Meas PRB <math>\hat{E}s2 / \text{Noc} \pm 0.3</math> dB</p>	<p>Noc is the AWGN on the NR freq</p> <p><math>\hat{E}s1 / \text{Noc}</math> is the ratio of cell 1 signal / AWGN <math>\hat{E}s2 / \text{Noc}</math> is the ratio of cell 2 signal / AWGN Meas PRB is the measurement PRB for SS-RSRP #RBJ to RBJ+19</p>
7.7.2.2 NR SA FR2-FR2 SS-RSRQ measurement accuracy	Same as 7.7.1.2	Same as 7.7.1.2
7.7.3.1 NR SA FR2 SS-SINR measurement accuracy	Same as 7.7.2.1	Same as 7.7.2.1
7.7.3.3 NR SA FR2-FR2 SS-SINR measurement accuracy	Same as 7.7.1.2	Same as 7.7.1.2
7.7.4.1 NR SA FR2 SSB based L1-RSRP measurement accuracy	<p>Test 1 Noc <math>\pm 5.65</math> dB, <math>f \leq 40.8</math> GHz Noc over meas PRBs <math>\pm 5.65</math> dB <math>f \leq 40.8</math> GHz</p> <p><math>\hat{E}s1 / \text{Noc} \pm 0.3</math> dB Meas PRB <math>\hat{E}s1 / \text{Noc} \pm 0.3</math> dB</p> <p>Test 2 Average <math>\hat{E}s1 \pm 5.65</math> dB, <math>f \leq 40.8</math> GHz Meas PRB <math>\hat{E}s1 \pm 5.65</math> dB, <math>f \leq 40.8</math> GHz</p>	<p>Test 1 Noc is the AWGN on the NR freq</p> <p><math>\hat{E}s1 / \text{Noc}</math> is the ratio of cell 1 signal / AWGN Meas PRB is the measurement PRB for SS-RSRP #RBJ to RBJ+19</p> <p>Test 2 <math>\hat{E}s1</math> is NR cell 1 signal Meas PRB is the measurement PRB for SS-RSRP #RBJ to RBJ+19</p>

7.7.4.2 NR SA FR2 CSI-RS based L1-RSRP measurement accuracy	<p>Test 1  <math>N_{oc} \pm 5.65</math> dB, <math>f \leq 40.8</math> GHz  <math>N_{oc}</math> over meas PRBs <math>\pm 5.65</math> dB  <math>f \leq 40.8</math> GHz</p> <p><math>\hat{E}_{s1} / N_{oc} \pm 0.3</math> dB  Meas PRB <math>\hat{E}_{s1} / N_{oc} \pm 0.3</math> dB</p> <p>Test 2  Average <math>\hat{E}_{s1} \pm 5.65</math> dB, <math>f \leq 40.8</math> GHz  Meas PRB <math>\hat{E}_{s1} \pm 5.65</math> dB, <math>f \leq 40.8</math> GHz</p>	<p>Test 1  <math>N_{oc}</math> is the AWGN on the NR freq</p> <p><math>\hat{E}_{s1} / N_{oc}</math> is the ratio of cell 1 signal / AWGN  Meas PRB is the measurement PRB for CSI-RS-RSRP</p> <p>Test 2  <math>\hat{E}_{s1}</math> is NR cell 1 signal</p> <p>Meas PRB is the measurement PRB for CSI-RS-RSRP</p>
---	---	---



**Table F.1.1.2-7: Maximum test system uncertainty for RRM requirements for E-UTRA – NR inter-RAT test cases with E-UTRA serving cell**

Subclause	Maximum Test System Uncertainty <sup>1</sup>	Derivation of Test System Uncertainty
8.2.1.1 E-UTRA – NR FR1 cell re-selection to higher priority NR target cell	Average $Noc_1 \pm 1.5$ dB Average $Noc_2 \pm 1.5$ dB Average $\hat{E}_{S1} / Noc_1 \pm 0.3$ dB Average $\hat{E}_{S2} / Noc_2 \pm 0.3$ dB Meas PRB $Noc_2 \pm 1.5$ dB Meas PRB $\hat{E}_{S2} / Noc_2 \pm 0.3$ dB	Note: $Noc_1$ is the AWGN on cell 1 frequency $Noc_2$ is the AWGN on cell 2 frequency $\hat{E}_{S1} / Noc_1$ is the ratio of cell 1 signal / AWGN $\hat{E}_{S2} / Noc_2$ is the ratio of cell 2 signal / AWGN Meas PRB on cell 2 are the measurement PRB for SS-RSRP #RB <sub>J</sub> to RB <sub>J+19</sub>
8.2.1.2 E-UTRA – NR FR1 Cell reselection to lower priority NR target Cell in FR1 for UE configured with highSpeedInterRAT-NR-r16	Average $Noc_1 \pm 1.5$ dB Average $Noc_2 \pm 1.5$ dB Average $\hat{E}_{S1} / Noc_1 \pm 0.3$ dB Average $\hat{E}_{S2} / Noc_2 \pm 0.3$ dB Meas PRB $Noc_2 \pm 1.5$ dB Meas PRB $\hat{E}_{S2} / Noc_2 \pm 0.3$ dB	Note: $Noc_1$ is the AWGN on cell 1 frequency $Noc_2$ is the AWGN on cell 2 frequency $\hat{E}_{S1} / Noc_1$ is the ratio of cell 1 signal / AWGN $\hat{E}_{S2} / Noc_2$ is the ratio of cell 2 signal / AWGN Meas PRB on cell 2 are the measurement PRB for SS-RSRP #RB <sub>J</sub> to RB <sub>J+19</sub>
8.3.1.1 E-UTRA – NR FR1 handover with known target cell	Average $Noc_1 \pm 1.5$ dB Average $Noc_2 \pm 1.5$ dB Average $\hat{E}_{S1} / Noc_1 \pm 0.3$ dB Average $\hat{E}_{S2} / Noc_2 \pm 0.3$ dB Meas PRB $Noc_2 \pm 1.5$ dB Meas PRB $\hat{E}_{S2} / Noc_2 \pm 0.3$ dB	Note: $Noc_1$ is the AWGN on cell 1 frequency $Noc_2$ is the AWGN on cell 2 frequency $\hat{E}_{S1} / Noc_1$ is the ratio of cell 1 signal / AWGN $\hat{E}_{S2} / Noc_2$ is the ratio of cell 2 signal / AWGN Meas PRB on cell 2 are the measurement PRB for SS-RSRP #RB <sub>J</sub> to RB <sub>J+19</sub>
8.4.1.1 E-UTRA – NR FR1 SFTD measurement delay in non-DRX	Average $Noc_1 \pm 1.5$ dB Average $Noc_2 \pm 1.5$ dB Average $\hat{E}_{S1} / Noc_1 \pm 0.3$ dB Average $\hat{E}_{S2} / Noc_2 \pm 0.3$ dB Meas PRB $Noc_2 \pm 1.5$ dB Meas PRB $\hat{E}_{S2} / Noc_2 \pm 0.3$ dB	Note: $Noc_1$ is the AWGN on cell 1 frequency $Noc_2$ is the AWGN on cell 2 frequency $\hat{E}_{S1} / Noc_1$ is the ratio of cell 1 signal / AWGN $\hat{E}_{S2} / Noc_2$ is the ratio of cell 2 signal / AWGN Meas PRB on cell 2 are the measurement PRB for SS-RSRP #RB <sub>J</sub> to RB <sub>J+19</sub>
8.4.1.2 E-UTRA – NR FR1 SFTD measurement delay in DRX	Same as 8.4.1.1	Same as 8.4.1.1
8.4.2.1 E-UTRA event-triggered reporting of a NR FR1 neighbour cell without SSB time index detection in non-DRX	Average $Noc_1 \pm 1.5$ dB Average $Noc_2 \pm 1.5$ dB Average $\hat{E}_{S1} / Noc_1 \pm 0.3$ dB Average $\hat{E}_{S2} / Noc_2 \pm 0.3$ dB Meas PRB $Noc_2 \pm 1.5$ dB Meas PRB $\hat{E}_{S2} / Noc_2 \pm 0.3$ dB Fading profile $\pm 0.5$ dB	Note: $Noc_1$ is the AWGN on cell 1 frequency $Noc_2$ is the AWGN on cell 2 frequency $\hat{E}_{S1} / Noc_1$ is the ratio of cell 1 signal / AWGN $\hat{E}_{S2} / Noc_2$ is the ratio of cell 2 signal / AWGN Meas PRB on cell 2 are the measurement PRB for SS-RSRP #RB <sub>J</sub> to RB <sub>J+19</sub>
8.4.2.2 E-UTRA event-triggered reporting of a NR FR1 neighbour cell without SSB time index detection in DRX	Same as 8.4.2.1	Same as 8.4.2.1
8.4.2.3 E-UTRA event-triggered reporting of a NR FR1 neighbour cell with SSB time index detection in non-DRX	Same as 8.4.2.1	Same as 8.4.2.1
8.4.2.4 E-UTRA event-triggered reporting of a NR FR1 neighbour cell with SSB time index detection in DRX	Same as 8.4.2.1	Same as 8.4.2.1
8.4.2.9 E-UTRA – NR Inter-RAT event triggered reporting tests for FR1 with SSB time index detection in DRX for UE configured with highSpeedInterRAT-NR-r16	Average $Noc_1 \pm 1.5$ dB Average $Noc_2 \pm 1.5$ dB Average $\hat{E}_{S1} / Noc_1 \pm 0.3$ dB Average $\hat{E}_{S2} / Noc_2 \pm 0.3$ dB Meas PRB $Noc_2 \pm 1.5$ dB Meas PRB $\hat{E}_{S2} / Noc_2 \pm 0.3$ dB	Average $Noc_1 \pm 1.5$ dB Average $Noc_2 \pm 1.5$ dB Average $\hat{E}_{S1} / Noc_1 \pm 0.3$ dB Average $\hat{E}_{S2} / Noc_2 \pm 0.3$ dB Meas PRB $Noc_2 \pm 1.5$ dB Meas PRB $\hat{E}_{S2} / Noc_2 \pm 0.3$ dB
8.5.1.1 E-UTRA – NR FR1 SFTD measurement accuracy	Average $\hat{E}_{S1} / Noc_1 \pm 0.8$ dB Average $\hat{E}_{S2} / Noc_2 \pm 0.3$ dB Meas PRB $\hat{E}_{S1} / Noc_1 \pm 0.8$ dB Meas PRB $\hat{E}_{S2} / Noc_2 \pm 0.3$ dB	$\hat{E}_{S1} / Noc_1$ is the ratio of cell 1 signal / AWGN $\hat{E}_{S2} / Noc_2$ is the ratio of cell 2 signal / AWGN Meas PRB on cell 2 are the measurement PRB for SS-RSRP #RB <sub>J</sub> to RB <sub>J+19</sub>
8.5.2.1.1.1 E-UTRA SS-RSRP absolute measurement accuracy of a NR FR1 neighbour cell	Average $Noc \pm 1.5$ dB $Noc$ over meas PRBs #RB <sub>J+19</sub> $\pm 1.5$ dB Average $\hat{E}_s / Noc \pm 0.3$ dB  meas PRB $\hat{E}_{S1} / Noc_1 \pm 0.8$ dB	$Noc$ is the AWGN on the NR freq  $\hat{E}_s / Noc$ is the cell SNR  meas PRB is the measurement PRB for SS-RSRP #RB <sub>J</sub> to RB <sub>J+19</sub>

8.5.2.1.2 E-UTRA SS-RSRP absolute measurement accuracy of a NR FR2 neighbour cell	<u>Test 1</u> Average Noc $\pm 5.65$ dB Noc over meas PRBs $\pm 5.65$ dB Average $\hat{E}_s / \text{Noc}$ $\pm 0.3$ dB  $\hat{E}_s / \text{Noc}$ over meas PRBs $\pm 0.3$ dB  <u>Test 2</u> Average $E_s$ $\pm 5.65$ dB $E_s$ over meas PRBs $\pm 5.65$ dB	<u>Test 1</u> Noc is the AWGN on the NR freq  $\hat{E}_s / \text{Noc}$ is the cell SNR  meas PRB is the measurement PRB for SS-RSRP #RB <sub>J</sub> to RB <sub>J+19</sub>
8.5.2.2.1 E-UTRA SS-RSRQ absolute measurement accuracy of a NR FR1 neighbour cell	Same as 8.5.2.1.1.1	Same as 8.5.2.1.1.1
8.5.2.2.2 E-UTRA SS-RSRQ absolute measurement accuracy of a NR FR2 neighbour cellA	Same as 8.5.2.1.2	Same as 8.5.2.1.2
8.5.2.3.1 E-UTRA SS-SINR absolute measurement accuracy of a NR FR1 neighbour cell	Same as 8.5.2.1.1.1	Same as 8.5.2.1.1.1
8.5.2.3.2 E-UTRA SS-SINR absolute measurement accuracy of a NR FR2 neighbour cell	Same as 8.5.2.1.2	Same as 8.5.2.1.2

## F.1.2 Interpretation of measurement results (normative)

See TS 38.521-1 [17] Annex F.2.

## F.1.3 Test Tolerance and Derivation of Test Requirements (informative)

See TS 38.521-1 [17] Annex F.3.

### F.1.3.1 Measurement of test environments

See TS 38.521-1 [17] Annex F.3.1.

### F.1.3.2 Measurement of RRM requirements

Because the relationships between the test system uncertainties and the test tolerances are often complex, it is not always possible to give a simple derivation of the test requirement in this document. The analysis is recorded in 3GPP TR 38 903 [22].

The derivation of the test requirements for the EN-DC FR1 test cases in chapter 4 is defined in Table F.1.3.2-1.

The derivation of the test requirements for the NR/5GC FR1 test cases in chapter 6 is defined in Table F.1.3.2-2.

The derivation of the test requirements for the EN-DC FR2 test cases in chapter 5 is defined in Table F.1.3.2-3.

The derivation of the test requirements for the NR/5GC FR2 test cases in chapter 7 is defined in Table F.1.3.2-4.

**Table F.1.3.2-1: Derivation of test requirements for EN-DC FR1 RRM tests**

Test	Minimum requirement in TS 38.133 [6]	Test tolerance (TT)	Test requirement in TS 38.533
4.3.2.2.1	Absolute uplink power: Normal conditions $\pm 9$ dB  Relative uplink power step: Normal conditions $\pm 2.5$ dB  Uplink timing: 15kHz SCS $T_e \pm 12 \cdot 64 \cdot T_c$ 30kHz SCS $T_e \pm 8 \cdot 64 \cdot T_c$	2.1dB  0.7dB  112T <sub>c</sub> 112T <sub>c</sub>	Absolute uplink power: Normal conditions $\pm 11.1$ dB  Relative uplink power step: Normal conditions $\pm 3.2$ dB  Uplink timing: 15kHz SCS $T_e \pm 880 \cdot T_c$ 30kHz SCS $T_e \pm 624 \cdot T_c$
4.3.2.2.2	Same as 4.3.2.2.1	Same as 4.3.2.2.1	Same as 4.3.2.2.1
4.4.1.1 EN-DC FR1 UE transmit timing accuracy	<u>Test 1 (no DRX):</u> Uplink timing: $\pm 12 \cdot 64 T_c$ for 15 KHz SSB SCS, 15 kHz UL SCS $\pm 10 \cdot 64 T_c$ for 15 KHz SSB SCS, 30 kHz UL SCS $\pm 10 \cdot 64 T_c$ for 15 KHz SSB SCS, 60 kHz UL SCS $\pm 8 \cdot 64 T_c$ for 30 KHz SSB SCS, 15 kHz UL SCS $\pm 8 \cdot 64 T_c$ for 30 KHz SSB SCS, 30 kHz UL SCS $\pm 7 \cdot 64 T_c$ for 30 KHz SSB SCS, 60 kHz UL SCS  Max step size T <sub>q</sub> : $5.5 \cdot 64 \cdot T_c$ Min adjust rate T <sub>p</sub> : $5.5 \cdot 64 \cdot T_c$ Max adjust rate: $5.5 \cdot 64 \cdot T_c$ $\hat{E}S_2 / N_{oc}$ : +3.00dB N <sub>oc</sub> = -98 dBm/15 kHz (Config 1,2,3)  <u>Test 2 (with DRX):</u> $\pm 12 \cdot 64 T_c$ for 15 KHz SSB SCS, 15 kHz UL SCS $\pm 10 \cdot 64 T_c$ for 15 KHz SSB SCS, 30 kHz UL SCS $\pm 10 \cdot 64 T_c$ for 15 KHz SSB SCS, 60 kHz UL SCS $\pm 8 \cdot 64 T_c$ for 30 KHz SSB SCS, 15 kHz UL SCS $\pm 8 \cdot 64 T_c$ for 30 KHz SSB SCS, 30 kHz UL SCS $\pm 7 \cdot 64 T_c$ for 30 KHz SSB SCS, 60 kHz UL SCS  $\hat{E}S_2 / N_{oc}$ : +3.00dB	$\pm 1.75 \cdot 64 \cdot T_c$ $\pm 1.75 \cdot 64 \cdot T_c$ $\pm 1.75 \cdot 64 \cdot T_c$ $\pm 1.75 \cdot 64 \cdot T_c$ $\pm 1.75 \cdot 64 \cdot T_c$ $\pm 1.75 \cdot 64 \cdot T_c$  +0.5 $\cdot 64 T_c$ -3.6 $\cdot 64 T_c$ +1.1 $\cdot 64 T_c$ +0.3 dB +1.5 dB  $\pm 1.75 \cdot 64 \cdot T_c$ $\pm 1.75 \cdot 64 \cdot T_c$ $\pm 1.75 \cdot 64 \cdot T_c$ $\pm 1.75 \cdot 64 \cdot T_c$ $\pm 1.75 \cdot 64 \cdot T_c$ $\pm 1.75 \cdot 64 \cdot T_c$  +0.3dB	<u>Test 1 (10MHz Ch BW):</u> Uplink timing: $\pm 13.75 \cdot 64 \cdot T_c$ Uplink timing: $\pm 11.75 \cdot 64 \cdot T_c$ Uplink timing: $\pm 11.75 \cdot 64 \cdot T_c$ Uplink timing: $\pm 9.75 \cdot 64 \cdot T_c$ Uplink timing: $\pm 9.75 \cdot 64 \cdot T_c$ Uplink timing: $\pm 8.75 \cdot 64 \cdot T_c$  Max step size T <sub>q</sub> : $6.0 \cdot 64 \cdot T_c$ Min adjust rate: $1.9 \cdot 64 \cdot T_c$ Max adjust rate: $6.6 \cdot 64 \cdot T_c$ $\hat{E}S_2 / N_{oc}$ : +3.30dB N <sub>oc</sub> = -98 dBm/15 kHz (Config 1,2,3) +1.5 dB  <u>Test 2 (with DRX):</u> Uplink timing: $\pm 13.75 \cdot 64 \cdot T_c$ Uplink timing: $\pm 11.75 \cdot 64 \cdot T_c$ Uplink timing: $\pm 11.75 \cdot 64 \cdot T_c$ Uplink timing: $\pm 9.75 \cdot 64 \cdot T_c$ Uplink timing: $\pm 9.75 \cdot 64 \cdot T_c$ Uplink timing: $\pm 8.75 \cdot 64 \cdot T_c$  $\hat{E}S_2 / N_{oc}$ : +3.30dB
4.4.3.1 EN-DC FR1 timing advance adjustment accuracy	N <sub>oc</sub> = -98 dBm/15 kHz (Config 1, 2, 4, 5) N <sub>oc</sub> = -95 dBm/15 kHz (Config 3, 6)  $\hat{E}S_x / N_{oc}$ = 3 dB  UE Timing Advance Adjustment Accuracy for 15kHz SCS = $\pm 256 T_c$ + TT  UE Timing Advance Adjustment Accuracy for 30kHz SCS = $\pm 256 T_c$ + TT	0 0 0 +/- 88 T <sub>c</sub> +/- 88 T <sub>c</sub>	N <sub>oc</sub> = -98 dBm/15 kHz (Config 1, 2, 4, 5) N <sub>oc</sub> = -95 dBm/15 kHz (Config 3, 6)  $\hat{E}S_x / N_{oc}$ = 3 dB  UE TAAA for 15kHz SCS = $\pm 344 T_c$  UE TAAA for 30kHz SCS = $\pm 344 T_c$
4.5.1.1 EN-DC FR1 radio link monitoring out-of-sync test for PSCell configured with SSB-based RLM RS in non-DRX mode	SNR during T1: 1dB T2: -7dB T3: -15dB	Offset during T1: +0.8dB T2: +0.8dB T3: -0.8dB	SNR during T1: 1.8dB T2: -6.2dB T3: -15.8dB
4.5.1.2 EN-DC FR1 radio link monitoring in-sync test for PSCell configured with SSB-based RLM RS in non-DRX mode	SNR during T1: 1dB T2: -7dB T3: -15dB T4: -4.5dB T5: 1dB	Offset during T1: +0.8dB T2: +0.8dB T3: -0.8dB T4: -0.8dB T5: +0.8dB	SNR during T1: 1.8dB T2: -6.2dB T3: -15.8dB T4: -5.3dB T5: 1.8dB  For testing of a UE which supports 4RX on all bands, the SNR during T3 and T4 is modified as specified in clause D.4.1.1

4.5.1.3 EN-DC FR1 radio link monitoring out-of-sync test for PSCell configured with SSB-based RLM RS in DRX mode	Same as 4.5.1.1	Same as 4.5.1.1	Same as 4.5.1.1
4.5.1.4 EN-DC FR1 radio link monitoring in-sync test for PSCell configured with SSB-based RLM RS in DRX mode	Same as 4.5.1.2	Same as 4.5.1.2	Same as 4.5.1.2
4.5.1.5 EN-DC FR1 radio link monitoring out-of-sync test for PSCell configured with CSI-RS-based RLM RS in non-DRX mode	Same as 4.5.1.1	Same as 4.5.1.1	Same as 4.5.1.1
4.5.1.6 EN-DC FR1 radio link monitoring in-sync test for PSCell configured with CSI-RS-based RLM RS in non-DRX mode	Same as 4.5.1.2	Same as 4.5.1.2	Same as 4.5.1.2
4.5.1.7 EN-DC FR1 radio link monitoring out-of-sync test for PSCell configured with CSI-RS-based RLM RS in DRX mode	Same as 4.5.1.1	Same as 4.5.1.1	Same as 4.5.1.1
4.5.1.8 EN-DC FR1 radio link monitoring in-sync test for PSCell configured with CSI-RS-based RLM RS in DRX mode	Same as 4.5.1.2	Same as 4.5.1.2	Same as 4.5.1.2
4.5.2.1 EN-DC FR1 interruptions at transitions between active and non-active during DRX in synchronous EN-DC	SNRs as specified	0.6dB	Formula: SNR + TT
4.5.2.2 EN-DC FR1 interruptions at transitions between active and non-active during DRX in asynchronous EN-DC	Same as 4.5.2.1	Same as 4.5.2.1	Same as 4.5.2.1
4.5.2.3 EN-DC FR1 interruptions during measurements on deactivated NR SCC in synchronous EN-DC	During T1: Noc2: -104dBm/15kHz Noc3: -104dBm/15kHz Es2 / Noc2: +17dB Es3 / Noc3: +17dB	During T1: 0dB 0dB 0dB 0dB	During T1: Noc2: -104dBm/15kHz Noc3: -104dBm/15kHz Es2 / Noc2: +17dB Es3 / Noc3: +17dB
4.5.2.4 EN-DC FR1 interruptions during measurements on deactivated NR SCC in asynchronous EN-DC	Same as 4.5.2.3	Same as 4.5.2.3	Same as 4.5.2.3
4.5.2.5 EN-DC FR1 interruptions during measurements on deactivated E-UTRAN SCC in synchronous EN-DC	During T1: Noc1: -104dBm/15kHz Noc2: -104dBm/15kHz Noc3: -104dBm/15kHz Es1 / Noc1: +17dB Es2 / Noc2: +17dB Es3 / Noc3: +17dB	During T1: 0dB 0dB 0dB 0dB	During T1: Noc1: -104dBm/15kHz Noc2: -104dBm/15kHz Noc3: -104dBm/15kHz Es1 / Noc1: +17dB Es2 / Noc2: +17dB Es3 / Noc3: +17dB
4.5.2.6 EN-DC FR1 interruptions during measurements on deactivated E-UTRAN SCC in asynchronous EN-DC	Same as 4.5.2.5	Same as 4.5.2.5	Same as 4.5.2.5

4.5.3.1 EN-DC FR1 SCell activation and deactivation of known SCell in non-DRX for 160ms SCell measurement cycle	<p>During T1: Noc<sub>2</sub>: -104dBm/15kHz Noc<sub>3</sub>: -104dBm/15kHz <math>\hat{E}_{S2} / \text{Noc}_2</math>: +17dB <math>\hat{E}_{S3} / \text{Noc}_3</math>: +17dB</p> <p>During T2: Noc<sub>2</sub>: -104dBm/15kHz Noc<sub>3</sub>: -104dBm/15kHz <math>\hat{E}_{S2} / \text{Noc}_2</math>: +17dB <math>\hat{E}_{S3} / \text{Noc}_3</math>: +17dB</p> <p>During T3: Noc<sub>2</sub>: -104dBm/15kHz Noc<sub>3</sub>: -104dBm/15kHz <math>\hat{E}_{S2} / \text{Noc}_2</math>: +17dB <math>\hat{E}_{S3} / \text{Noc}_3</math>: +17dB</p>	<p>During T1: 0dB 0dB 0dB 0dB</p> <p>During T2: 0dB 0dB 0dB 0dB</p> <p>During T3: 0dB 0dB 0dB 0dB</p>	<p>During T1: Noc<sub>2</sub>: -104dBm/15kHz Noc<sub>3</sub>: -104dBm/15kHz <math>\hat{E}_{S2} / \text{Noc}_2</math>: +17dB <math>\hat{E}_{S3} / \text{Noc}_3</math>: +17dB</p> <p>During T2: Noc<sub>2</sub>: -104dBm/15kHz Noc<sub>3</sub>: -104dBm/15kHz <math>\hat{E}_{S2} / \text{Noc}_2</math>: +17dB <math>\hat{E}_{S3} / \text{Noc}_3</math>: +17dB</p> <p>During T3: Noc<sub>2</sub>: -104dBm/15kHz Noc<sub>3</sub>: -104dBm/15kHz <math>\hat{E}_{S2} / \text{Noc}_2</math>: +17dB <math>\hat{E}_{S3} / \text{Noc}_3</math>: +17dB</p>
4.5.3.2 EN-DC FR1 SCell activation and deactivation of known SCell in non-DRX for 640ms SCell measurement cycle	Same as 4.5.3.1	Same as 4.5.3.1	Same as 4.5.3.1
4.5.3.3 EN-DC FR1 SCell activation and deactivation of unknown SCell in non-DRX	Same as 4.5.3.1	Same as 4.5.3.1	Same as 4.5.3.1
4.5.4.1 EN-DC FR1 UE UL carrier RRC reconfiguration delay	<p>During T1: Noc<sub>2</sub>: -102dBm/15kHz Noc<sub>3</sub>: -102dBm/15kHz <math>\hat{E}_{S2} / \text{Noc}_2</math>: +16dB <math>\hat{E}_{S3} / \text{Noc}_3</math>: +16dB</p> <p>During T2: Noc<sub>2</sub>: -102dBm/15kHz Noc<sub>3</sub>: -102dBm/15kHz <math>\hat{E}_{S2} / \text{Noc}_2</math>: +16dB <math>\hat{E}_{S3} / \text{Noc}_3</math>: +16dB</p> <p>During T3: Noc<sub>2</sub>: -102dBm/15kHz Noc<sub>3</sub>: -102dBm/15kHz <math>\hat{E}_{S2} / \text{Noc}_2</math>: +16dB <math>\hat{E}_{S3} / \text{Noc}_3</math>: +16dB</p>	<p>During T1: 0dB 0dB 0dB 0dB</p> <p>During T2: 0dB 0dB 0dB 0dB</p> <p>During T3: 0dB 0dB 0dB 0dB</p>	<p>During T1: Noc<sub>2</sub>: -102dBm/15kHz Noc<sub>3</sub>: -102dBm/15kHz <math>\hat{E}_{S2} / \text{Noc}_2</math>: +16dB <math>\hat{E}_{S3} / \text{Noc}_3</math>: +16dB</p> <p>During T2: Noc<sub>2</sub>: -102dBm/15kHz Noc<sub>3</sub>: -102dBm/15kHz <math>\hat{E}_{S2} / \text{Noc}_2</math>: +16dB <math>\hat{E}_{S3} / \text{Noc}_3</math>: +16dB</p> <p>During T3: Noc<sub>2</sub>: -102dBm/15kHz Noc<sub>3</sub>: -102dBm/15kHz <math>\hat{E}_{S2} / \text{Noc}_2</math>: +16dB <math>\hat{E}_{S3} / \text{Noc}_3</math>: +16dB</p>
4.5.5.1 EN-DC FR1 SSB-based beam failure detection and link recovery in non-DRX	<p>q0 SSB SNR during: T1: 5dB T2: -3dB T3: -12dB T4: -12dB T5: -12dB</p> <p>q1 SSB during T1: Noc<sub>2</sub>: -98dBm/15kHz <math>\hat{E}_{S2} / \text{Noc}_2</math>: -10dB</p> <p>q1 SSB during T2: Noc<sub>2</sub>: -98dBm/15kHz <math>\hat{E}_{S2} / \text{Noc}_2</math>: -10dB</p> <p>q1 SSB during T3, T4 and T5: Noc<sub>2</sub>: -98dBm/15kHz <math>\hat{E}_{S2} / \text{Noc}_2</math>: +10dB</p>	<p>Offset during: T1: +0.8dB T2: +0.8dB T3: -0.8dB T4: -0.8dB T5: -0.8dB</p> <p>q1 SSB during T1: 0dB -0.2dB</p> <p>q1 SSB during T2: 0dB -0.2dB</p> <p>q1 SSB during T3, T4 and T5: 0dB +0.2dB</p>	<p>SNR during: T1: +5.8dB T2: -2.2dB T3: -12.8dB T4: -12.8dB T5: -12.8dB</p> <p>For testing of a UE which supports 4RX on all bands, the SNR during T3, T4 and T5 is modified as specified in clause D.4.1.1</p> <p>q1 SSB during T1: Noc<sub>2</sub>: -98dBm/15kHz <math>\hat{E}_{S2} / \text{Noc}_2</math>: -10.2dB</p> <p>q1 SSB during T2: Noc<sub>2</sub>: -98dBm/15kHz <math>\hat{E}_{S2} / \text{Noc}_2</math>: -10.2dB</p> <p>q1 SSB during T3, T4 and T5: Noc<sub>2</sub>: -98dBm/15kHz <math>\hat{E}_{S2} / \text{Noc}_2</math>: +10.2dB</p>

4.5.5.2 EN-DC FR1 SSB-based beam failure detection and link recovery in DRX	Same as 4.5.5.1	Same as 4.5.5.1	Same as 4.5.5.1
4.5.5.3 EN-DC FR1 CSI-RS-based beam failure detection and link recovery in non-DRX	<p>q0 CSI-RS SNR during:  T1: 5dB  T2: -3dB  T3: -12dB  T4: -12dB  T5: -12dB</p> <p>q1 CSI-RS during T1:  <math>N_{oc2}</math>: -98dBm/15kHz  <math>\hat{E}_{s2} / N_{oc2}</math>: -10dB</p> <p>q1 CSI-RS during T2:  <math>N_{oc2}</math>: -98dBm/15kHz  <math>\hat{E}_{s2} / N_{oc2}</math>: -10dB</p> <p>q1 CSI-RS during T3, T4 and T5:  <math>N_{oc2}</math>: -98dBm/15kHz  <math>\hat{E}_{s2} / N_{oc2}</math>: +10dB</p>	<p>Offset during:  T1: +0.8dB  T2: +0.8dB  T3: -0.8dB  T4: -0.8dB  T5: -0.8dB</p> <p>q1 CSI-RS during T1:  0dB  -0.2dB</p> <p>q1 CSI-RS during T2:  0dB  -0.2dB</p> <p>q1 CSI-RS during T3, T4 and T5:  0dB  +0.2dB</p>	<p>SNR during:  T1: +5.8dB  T2: -2.2dB  T3: -12.8dB  T4: -12.8dB  T5: -12.8dB</p> <p>For testing of a UE which supports 4RX on all bands, the SNR during T3, T4 and T5 is modified as specified in clause D.4.1.1</p> <p>q1 CSI-RS during T1:  <math>N_{oc2}</math>: -98dBm/15kHz  <math>\hat{E}_{s2} / N_{oc2}</math>: -10.2dB</p> <p>q1 CSI-RS during T2:  <math>N_{oc2}</math>: -98dBm/15kHz  <math>\hat{E}_{s2} / N_{oc2}</math>: -10.2dB</p> <p>q1 CSI-RS during T3, T4 and T5:  <math>N_{oc2}</math>: -98dBm/15kHz  <math>\hat{E}_{s2} / N_{oc2}</math>: +10.2dB</p>
4.5.5.4 EN-DC FR1 CSI-RS-based beam failure detection and link recovery in DRX	Same as 4.5.5.3	Same as 4.5.5.3	Same as 4.5.5.3



<p>4.5.5.5 EN-DC FR1 Scell CSI-RS-based beam failure detection and SSB-based link recovery in non-DRX</p>	<p>q0 SSB SNR during: T1: 5dB T2: -3dB T3: -12dB T4: -12dB T5: -12dB</p> <p>q1 SSB during T1: Noc<sub>2</sub>: -98dBm/15kHz Ê<sub>s2</sub> / Noc<sub>2</sub>: -10dB</p> <p>q1 SSB during T2: Noc<sub>2</sub>: -98dBm/15kHz Ê<sub>s2</sub> / Noc<sub>2</sub>: -10dB</p> <p>q1 SSB during T3, T4 and T5: Noc<sub>2</sub>: -98dBm/15kHz Ê<sub>s2</sub> / Noc<sub>2</sub>: +10dB</p> <p>q1 CSI-RS during T1: Noc<sub>2</sub>: -98dBm/15kHz Ê<sub>s2</sub> / Noc<sub>2</sub>: -10dB</p> <p>q1 CSI-RS during T2: Noc<sub>2</sub>: -98dBm/15kHz Ê<sub>s2</sub> / Noc<sub>2</sub>: -10dB</p> <p>q1 CSI-RS during T3, T4 and T5: Noc<sub>2</sub>: -98dBm/15kHz Ê<sub>s2</sub> / Noc<sub>2</sub>: +10dB</p>	<p>Offset during: T1: +0.8dB T2: +0.8dB T3: -0.8dB T4: -0.8dB T5: -0.8dB</p> <p>q1 SSB during T1: 0dB -0.2dB</p> <p>q1 SSB during T2: 0dB -0.2dB</p> <p>q1 SSB during T3, T4 and T5: 0dB +0.2dB</p> <p>q1 CSI-RS during T1: 0dB -0.2dB</p> <p>q1 CSI-RS during T2: 0dB -0.2dB</p> <p>q1 CSI-RS during T3, T4 and T5: 0dB +0.2dB</p>	<p>SNR during: T1: +5.8dB T2: -2.2dB T3: -12.8dB T4: -12.8dB T5: -12.8dB</p> <p>For testing of a UE which supports 4RX on all bands, the SNR during T3, T4 and T5 is modified as specified in section D.4.1.1</p> <p>q1 SSB during T1: Noc<sub>2</sub>: -98dBm/15kHz Ê<sub>s2</sub> / Noc<sub>2</sub>: -10.2dB</p> <p>q1 SSB during T2: Noc<sub>2</sub>: -98dBm/15kHz Ê<sub>s2</sub> / Noc<sub>2</sub>: -10.2dB</p> <p>q1 SSB during T3, T4 and T5: Noc<sub>2</sub>: -98dBm/15kHz Ê<sub>s2</sub> / Noc<sub>2</sub>: +10.2dB</p> <p>q1 CSI-RS during T1: Noc<sub>2</sub>: -98dBm/15kHz Ê<sub>s2</sub> / Noc<sub>2</sub>: -10.2dB</p> <p>q1 CSI-RS during T2: Noc<sub>2</sub>: -98dBm/15kHz Ê<sub>s2</sub> / Noc<sub>2</sub>: -10.2dB</p> <p>q1 CSI-RS during T3, T4 and T5: Noc<sub>2</sub>: -98dBm/15kHz Ê<sub>s2</sub> / Noc<sub>2</sub>: +10.2dB</p>
<p>4.5.5.6 EN-DC FR1 Scell CSI-RS-based beam failure detection and SSB-based link recovery in DRX</p>	<p>Same as 4.5.5.5</p>	<p>Same as 4.5.5.5</p>	<p>Same as 4.5.5.5</p>
<p>4.5.6.1.1 EN-DC FR1 DCI-based DL active BWP switch in non-DRX in synchronous EN-DC</p>	<p>During T1: Noc<sub>2</sub>: -104dBm/15kHz Ê<sub>s2</sub> / Noc<sub>2</sub>: +17dB</p> <p>During T2: Noc<sub>2</sub>: -104dBm/15kHz Ê<sub>s2</sub> / Noc<sub>2</sub>: +17dB</p> <p>During T3: Noc<sub>2</sub>: -104dBm/15kHz Ê<sub>s2</sub> / Noc<sub>2</sub>: +17dB</p>	<p>During T1: 0dB 0dB</p> <p>During T2: 0dB 0dB</p> <p>During T3: 0dB 0dB</p>	<p>During T1: Noc<sub>2</sub>: -104dBm/15kHz Ê<sub>s2</sub> / Noc<sub>2</sub>: +17dB</p> <p>During T2: Noc<sub>2</sub>: -104dBm/15kHz Ê<sub>s2</sub> / Noc<sub>2</sub>: +17dB</p> <p>During T3: Noc<sub>2</sub>: -104dBm/15kHz Ê<sub>s2</sub> / Noc<sub>2</sub>: +17dB</p>

4.5.6.1.2 EN-DC FR1 DCI-based DL active BWP switch with SCell in non-DRX in synchronous EN-DC	<p>During T1: Noc<sub>2</sub>: -104dBm/15kHz Ê<sub>S2</sub> / Noc<sub>2</sub>: +17dB Noc<sub>3</sub>: -104dBm/15kHz Ê<sub>S3</sub> / Noc<sub>3</sub>: +17dB</p> <p>During T2: Noc<sub>2</sub>: -104dBm/15kHz Ê<sub>S2</sub> / Noc<sub>2</sub>: +17dB Noc<sub>3</sub>: -104dBm/15kHz Ê<sub>S3</sub> / Noc<sub>3</sub>: +17dB</p> <p>During T3: Noc<sub>2</sub>: -104dBm/15kHz Ê<sub>S2</sub> / Noc<sub>2</sub>: +17dB Noc<sub>3</sub>: -104dBm/15kHz Ê<sub>S3</sub> / Noc<sub>3</sub>: +17dB</p>	<p>During T1: 0dB 0dB 0dB 0dB</p> <p>During T2: 0dB 0dB 0dB 0dB</p> <p>During T3: 0dB 0dB 0dB 0dB</p>	<p>During T1: Noc<sub>2</sub>: -104dBm/15kHz Ê<sub>S2</sub> / Noc<sub>2</sub>: +17dB Noc<sub>3</sub>: -104dBm/15kHz Ê<sub>S3</sub> / Noc<sub>3</sub>: +17dB</p> <p>During T2: Noc<sub>2</sub>: -104dBm/15kHz Ê<sub>S2</sub> / Noc<sub>2</sub>: +17dB Noc<sub>3</sub>: -104dBm/15kHz Ê<sub>S3</sub> / Noc<sub>3</sub>: +17dB</p> <p>During T3: Noc<sub>2</sub>: -104dBm/15kHz Ê<sub>S2</sub> / Noc<sub>2</sub>: +17dB Noc<sub>3</sub>: -104dBm/15kHz Ê<sub>S3</sub> / Noc<sub>3</sub>: +17dB</p>
4.5.6.2.1 EN-DC FR1 RRC-based DL active BWP switch in non-DRX in synchronous EN-DC	<p>During T1: Noc<sub>2</sub>: -104dBm/15kHz Ê<sub>S2</sub> / Noc<sub>2</sub>: +17dB</p>	<p>During T1: 0dB 0dB</p>	<p>During T1: Noc<sub>2</sub>: -104dBm/15kHz Ê<sub>S2</sub> / Noc<sub>2</sub>: +17dB</p>
4.5.7.1 EN-DC FR1 addition and release delay of known PSCell	<p>For Test Configurations 1,2,4,5 Noc: -88dBm/15kHz Ê<sub>S</sub> / Noc: 0.0dB B1-Threshold: -96 dBm/SCS</p> <p>For Test Configurations 3,6 Noc: -88dBm/15kHz Ê<sub>S</sub> / Noc: 0.0dB B1-Threshold: -93 dBm/SCS</p>	<p>-0.6dB 0dB -3dB</p> <p>-0.6dB 0dB -3dB</p>	<p>Noc: -88.6dBm/15kHz Ê<sub>S</sub> / Noc: 0.0dB B1-Threshold: -99 dBm/SCS</p> <p>Noc: -88.6dBm/15kHz Ê<sub>S</sub> / Noc: 0.0dB B1-Threshold: -96 dBm/SCS</p>
4.5.8.1 EN-DC FR1 interruptions at switching between two uplink carriers	<p>Noc: -104dBm/15kHz Ê<sub>S</sub> / Noc: 17dB</p>	<p>0dB 0dB</p>	<p>Noc: -104dBm/15kHz Ê<sub>S</sub> / Noc: 17dB</p>
4.6.1.1 EN-DC FR1 event-triggered reporting without gap in non-DRX	<p>During T1: Noc: -98dBm/15kHz Ê<sub>S1</sub> / Noc: +4.00dB Ê<sub>S2</sub> / Noc: -infinity</p> <p>During T2: Noc: -98dBm/15kHz Ê<sub>S1</sub> / Noc: +4.00dB Ê<sub>S2</sub> / Noc: +4.00dB</p>	<p>During T1: 0dB 0dB 0dB</p> <p>During T2: 0dB 0dB 0dB</p>	<p>During T1: Noc: -98dBm/15kHz Ê<sub>S1</sub> / Noc: +4.00dB Ê<sub>S2</sub> / Noc: -infinity</p> <p>During T2: Noc: -98dBm/15kHz Ê<sub>S1</sub> / Noc: +4.00dB Ê<sub>S2</sub> / Noc: +4.00dB</p>
4.6.1.2 EN-DC FR1 event-triggered reporting without gap in DRX	Same as 4.6.1.1	Same as 4.6.1.1	Same as 4.6.1.1
4.6.1.3 EN-DC FR1 event-triggered reporting with gap in non-DRX	Same as 4.6.1.1	Same as 4.6.1.1	Same as 4.6.1.1
4.6.1.4 EN-DC FR1 event-triggered reporting with gap in DRX	Same as 4.6.1.1	Same as 4.6.1.1	Same as 4.6.1.1
4.6.1.5 EN-DC FR1 event-triggered reporting without gap in non-DRX with SSB time index detection	Same as 4.6.1.1	Same as 4.6.1.1	Same as 4.6.1.1
4.6.1.6 EN-DC FR1 event-triggered reporting with gap in non-DRX with SSB time index detection	Same as 4.6.1.1	Same as 4.6.1.1	Same as 4.6.1.1
4.6.1.7 EN-DC FR1 event-triggered reporting without gap in DRX for UE configured with highSpeedMeasFlag-r16	Same as 4.6.1.1	Same as 4.6.1.1	Same as 4.6.1.1

4.6.2.1 EN-DC FR1-FR1 event-triggered reporting in non-DRX	<p>During T1: Freq 2 Noc: -98dBm/15kHz Freq 3 Noc: -98dBm/15kHz <math>\hat{E}s_2</math> / Noc: +4.00dB <math>\hat{E}s_3</math> / Noc: -infinity</p> <p>During T2: Freq 2 Noc: -98dBm/15kHz Freq 3 Noc: -98dBm/15kHz <math>\hat{E}s_2</math> / Noc: +4.00dB <math>\hat{E}s_3</math> / Noc: +7.00dB</p>	<p>During T1: 0dB 0dB 0dB 0dB</p> <p>During T2: 0dB 0dB 0dB 0dB</p>	<p>During T1: Freq 2 Noc: -98dBm/15kHz Freq 3 Noc: -98dBm/15kHz <math>\hat{E}s_2</math> / Noc: +4.00dB <math>\hat{E}s_3</math> / Noc: -infinity</p> <p>During T2: Freq 2 Noc: -98dBm/15kHz Freq 3 Noc: -98dBm/15kHz <math>\hat{E}s_2</math> / Noc: +4.00dB <math>\hat{E}s_3</math> / Noc: +7.00dB</p>
4.6.2.2 EN-DC FR1-FR1 event-triggered reporting in DRX	Same as 4.6.2.1	Same as 4.6.2.1	Same as 4.6.2.1
4.6.2.5 EN-DC FR1-FR1 event-triggered reporting in non-DRX with SSB time index detection	Same as 4.6.2.1	Same as 4.6.2.1	Same as 4.6.2.1
4.6.2.6 EN-DC FR1-FR1 event-triggered reporting in DRX with SSB time index detection	Same as 4.6.2.1	Same as 4.6.2.1	Same as 4.6.2.1
4.6.4.1 EN-DC FR1 SSB-based L1-RSRP measurement in non-DRX	<p>During T1: Noc: -94.65dBm/15kHz <math>\hat{E}s_0</math> / Noc: +0.00dB <math>\hat{E}s_1</math> / Noc: -infinity</p> <p>During T2: Noc: -94.65dBm/15kHz <math>\hat{E}s_0</math> / Noc: 0.00dB <math>\hat{E}s_1</math> / Noc: +3.00dB</p> <p>Reported SSB#0 SS-RSRP values <math>\pm</math> 10dB Reported SSB#1 SS-RSRP values <math>\pm</math> 10dB Reported Differential SS-RSRP values <math>\pm</math> 3dB</p>	<p>During T1: 0dB 0dB 0dB</p> <p>During T2: 0dB 0dB 0.5dB</p> <p>Via mapping</p>	<p>During T1: Noc: -94.65dBm/15kHz <math>\hat{E}s_0</math> / Noc: +0.00dB <math>\hat{E}s_1</math> / Noc: -infinity</p> <p>During T2: Noc: -94.65dBm/15kHz <math>\hat{E}s_0</math> / Noc: 0.00dB <math>\hat{E}s_1</math> / Noc: +3.50dB</p> <p><b>For configuration 1,2,4,5</b> SSB#1: RSRP_55 to RSRP_75 SSB#0: DIFFRSRP_0 to DIFFRSRP_3</p> <p><b>For configuration 3,6</b> SSB#1: RSRP_58 to RSRP_78 SSB#0: DIFFRSRP_0 to DIFFRSRP_3</p>
4.6.4.2 EN-DC FR1 SSB-based L1-RSRP measurement in DRX	Same as 4.6.4.1	Same as 4.6.4.1	Same as 4.6.4.1
4.6.4.3 EN-DC FR1 CSI-RS-based L1-RSRP measurement in non-DRX	<p>Noc: -94.65dBm/15kHz <math>\hat{E}s_0</math> / Noc: 0.00dB <math>\hat{E}s_1</math> / Noc: +3.00dB</p> <p>Reported CSI-RSRP values <math>\pm</math> 10dB Reported Differential CSI-RSRP values <math>\pm</math> 3dB</p>	<p>0dB 0dB 0.5dB</p> <p>Via mapping</p>	<p>Noc: -94.65dBm/15kHz <math>\hat{E}s_0</math> / Noc: 0.00dB <math>\hat{E}s_1</math> / Noc: +3.50dB</p> <p><b>For configuration 1,2,4,5</b> CSI-RS#1: RSRP_55 to RSRP_75 CSI-RS#0: DIFFRSRP_0 to DIFFRSRP_3</p> <p><b>For configuration 3,6</b> CSI-RS#1: RSRP_58 to RSRP_78 CSI-RS#0: DIFFRSRP_0 to DIFFRSRP_3</p>
4.6.4.4 EN-DC FR1 CSI-RS-based L1-RSRP measurement in DRX	Same as 4.6.4.3	Same as 4.6.4.3	Same as 4.6.4.3
4.6.4.5 EN-DC FR1 SSB-based L1-RSRP measurement in DRX for UE configured with highSpeedMeasFlag-r16	Same as 4.6.4.1	Same as 4.6.4.1	Same as 4.6.4.1

<p>4.6.5.2 EN-DC FR1 CLI-RSSI measurement with non-DRX</p>	<p>During T1: Noc on CLI RSSI: -116 dBm/15kHz Io on CLI RSSI : -97.43 dBm/ 1.08 MHz</p> <p>During T2: Noc on CLI RSSI: -108dBm/15kHz Io on CLI RSSI : -89.43 dBm/ 1.08 Mhz</p>	<p>During T1: 0dB 0dB</p> <p>During T2: 0dB 0.5dB</p>	<p>During T1: Noc: -116 dBm/15kHz Io on CLI RSSI : -97.43 dBm/ 1.08 MHz</p> <p>During T2: Noc: -116 dBm/15kHz Io on CLI RSSI : -88.93 dBm/ 1.08 MHz</p>
<p>4.6.7.1 EN-DC FR1 CSI-RS based CMR and no dedicated IMR L1-SINR measurement in non-DRX</p>	<p>Noc: -94.65dBm/15kHz <math>\hat{E}_{S0}</math> / Noc: 0.00dB <math>\hat{E}_{S1}</math> / Noc: +3.00dB</p> <p>Reported CSI-SINR values <math>\pm</math> 5.5dB Reported Differential CSI-SINR values <math>\pm</math> 4.5dB</p>	<p>0dB 0dB 0dB</p> <p>Via mapping</p>	<p>Noc: -94.65dBm/15kHz <math>\hat{E}_{S0}</math> / Noc: 0.00dB <math>\hat{E}_{S1}</math> / Noc: +3.00dB</p> <p><b>For configuration 1,2,3,4,5,6</b> CSI-RS#1: SINR_41 to SINR_64 CSI-RS#0: DIFFSINR_0 to DIFFSINR_7</p>
<p>4.6.7.2 EN-DC FR1 SSB based CMR and dedicated IMR L1-SINR measurement in DRX</p>	<p>Noc: -94.65dBm/15kHz <math>\hat{E}_{S0}</math> / Noc: 0.00dB <math>\hat{E}_{S1}</math> / Noc: +3.00dB</p> <p>Reported SS-SINR values <math>\pm</math>4.5dB Reported Differential SS-SINR values <math>\pm</math>3.5dB</p>	<p>0dB 0dB 0dB</p> <p>Via mapping</p>	<p>Noc: -94.65dBm/15kHz <math>\hat{E}_{S0}</math> / Noc: 0.00dB <math>\hat{E}_{S1}</math> / Noc: +3.00dB</p> <p><b>For configuration 1,2,3,4,5,6</b> SSB#1: SINR_43 to SINR_62 SSB#0: DIFFSINR_0 to DIFFSINR_6</p>
<p>4.6.7.3 EN-DC FR1 CSI-RS based CMR and dedicated IMR L1-SINR measurement in DRX</p>	<p>Noc: -94.65dBm/15kHz <math>\hat{E}_{S0}</math> / Noc: 0.00dB <math>\hat{E}_{S1}</math> / Noc: +3.00dB</p> <p>Reported CSI-SINR values <math>\pm</math>4dB Reported Differential CSI-SINR values <math>\pm</math>3dB</p>	<p>0dB 0.5dB 0dB</p> <p>Via mapping</p>	<p>Noc: -94.65dBm/15kHz <math>\hat{E}_{S0}</math> / Noc: 0.50dB <math>\hat{E}_{S1}</math> / Noc: +3.00dB</p> <p><b>For configuration 1,2,3,4,5,6</b> CSI-RS#1: SINR_44 to SINR_61 CSI-RS#0: DIFFSINR_0 to DIFFSINR_5</p>
<p>4.7.1.1.1 EN-DC FR1 SS-RSRP absolute measurement accuracy</p>	<p><b>TEST CONFIGURATION 1, 2, 4, 5</b></p>		
	<p><u>Test 1:</u> Noc: -106dBm/15kHz <math>\hat{E}_{S2}</math> / Noc: +6.0dB <math>\hat{E}_{S3}</math> / Noc: +1.0dB Reported RSRP values: <math>\pm</math>4.5dB</p> <p><u>Test 2:</u> Noc: -88dBm/15kHz <math>\hat{E}_{S2}</math> / Noc: +6.0dB <math>\hat{E}_{S3}</math> / Noc: +1.0dB Reported RSRP values: <math>\pm</math>8dB</p> <p><u>Test 3:</u> Noc: -116dBm/15kHz + <math>\Delta_{BG\_offset}</math> <math>\hat{E}_{S2}</math> / Noc: +3.0dB <math>\hat{E}_{S3}</math> / Noc: -1.0dB</p> <p>Reported RSRP values: <math>\pm</math>6dB</p>	<p><u>Test 1:</u> -1.5dB 0dB +0.4dB Via mapping</p> <p><u>Test 2:</u> 0dB 0dB +0.4dB Via mapping</p> <p><u>Test 3:</u> 0dB 0dB +0.2dB</p> <p>Via mapping</p>	<p><u>Test 1:</u> Noc: -107.5dBm/15kHz <math>\hat{E}_{S2}</math> / Noc: +6.0dB <math>\hat{E}_{S3}</math> / Noc: +1.4dB RSRP_44 to RSRP_56</p> <p><u>Test 2:</u> Noc: -88dBm/15kHz <math>\hat{E}_{S2}</math> / Noc: +6.0dB <math>\hat{E}_{S3}</math> / Noc: +1.4dB RSRP_60 to RSRP_79</p> <p><u>Test 3:</u> Noc: -116dBm/15kHz + <math>\Delta_{BG\_offset}</math> <math>\hat{E}_{S2}</math> / Noc: +3.0dB <math>\hat{E}_{S3}</math> / Noc: -0.8dB</p> <p>RSRP_34 to RSRP_46 RSRP_34 to RSRP_46 RSRP_35 to RSRP_47 RSRP_35 to RSRP_47 RSRP_36 to RSRP_48 RSRP_37 to RSRP_49 RSRP_37 to RSRP_49 depending on operating band</p>
<p><b>TEST CONFIGURATION 3, 6</b></p>			

	<p><u>Test 1:</u>  <math>N_{oc}</math>: -110dBm/30kHz  <math>\hat{E}_{S2} / N_{oc}</math>: +6.0dB  <math>\hat{E}_{S3} / N_{oc}</math>: +1.0dB                  Reported RSRP values: <math>\pm 4.5</math>dB</p> <p><u>Test 2:</u>  <math>N_{oc}</math>: -91dBm/30kHz  <math>\hat{E}_{S2} / N_{oc}</math>: +6.0dB  <math>\hat{E}_{S3} / N_{oc}</math>: +1.0dB                  Reported RSRP values: <math>\pm 8</math>dB</p> <p><u>Test 3:</u>  <math>N_{oc}</math>: -113dBm/30kHz + <math>\Delta_{BG\_offset}</math>  <math>\hat{E}_{S2} / N_{oc}</math>: +3.0dB  <math>\hat{E}_{S3} / N_{oc}</math>: -1.0dB                  Reported RSRP values: <math>\pm 6</math>dB</p>	<p><u>Test 1:</u>                  -0.8dB                  0dB                  +0.4dB                  Via mapping</p> <p><u>Test 2:</u>                  0dB                  0dB                  +0.4dB                  Via mapping</p> <p><u>Test 3:</u>                  0dB                  0dB                  +0.2dB                  Via mapping</p>	<p><u>Test 1:</u>  <math>N_{oc}</math>: -110.8dBm/30kHz  <math>\hat{E}_{S2} / N_{oc}</math>: +6.0dB  <math>\hat{E}_{S3} / N_{oc}</math>: +1.4dB                  RSRP_41 to RSRP_53</p> <p><u>Test 2:</u>  <math>N_{oc}</math>: -91dBm/30kHz  <math>\hat{E}_{S2} / N_{oc}</math>: +6.0dB  <math>\hat{E}_{S3} / N_{oc}</math>: +1.4dB                  RSRP_57 to RSRP_76</p> <p><u>Test 3:</u>  <math>N_{oc}</math>: -113dBm/30kHz + <math>\Delta_{BG\_offset}</math>  <math>\hat{E}_{S2} / N_{oc}</math>: +3.0dB  <math>\hat{E}_{S3} / N_{oc}</math>: -0.8dB                  RSRP_37 to RSRP_49                  RSRP_37 to RSRP_49                  RSRP_38 to RSRP_50                  RSRP_38 to RSRP_50                  RSRP_39 to RSRP_51                  RSRP_40 to RSRP_52                  RSRP_40 to RSRP_52                  depending on operating band</p>
--	---	---	--

The derivation of the RSRP values takes into account the uncertainty in Cell 3 SS-RSRP from  $N_{oc}$  and  $\hat{E}_{S3} / N_{oc}$ , the allowed UE reporting accuracy, and the UE mapping function.  
 The SS-RSRP values given above are for normal conditions. In all cases the RSRP values are 4.5dB wider at each end for extreme conditions.

4.7.1.1.2 EN-DC FR1 SS-RSRP relative measurement accuracy	<p><u>Test 1:</u>  <math>N_{oc}</math>:                  Test configuration 1, 2, 4, 5: -106dBm/15kHz                  Test configuration 3, 6: -110dBm/30kHz  <math>\hat{E}_{S2} / N_{oc}</math>: +6.0dB  <math>\hat{E}_{S3} / N_{oc}</math>: +1.0dB                  Reported relative SS-RSRP values: <math>\pm 3</math>dB</p> <p><u>Test 2:</u>  <math>N_{oc}</math>: -88dBm/15kHz  <math>\hat{E}_{S2} / N_{oc}</math>: +6.0dB  <math>\hat{E}_{S3} / N_{oc}</math>: +1.0dB                  Reported relative SS-RSRP values: <math>\pm 3</math>dB</p> <p><u>Test 3:</u>  <math>N_{oc}</math>: -116dBm/15kHz + <math>\Delta_{BG\_offset}</math>  <math>\hat{E}_{S2} / N_{oc}</math>: +3.0dB  <math>\hat{E}_{S3} / N_{oc}</math>: -1.0dB                  Reported relative SS-RSRP values: <math>\pm 3</math>dB</p>	<p><u>Test 1:</u>                  0 dB                  0 dB                  0 dB                  +1.0dB                  Via mapping</p> <p><u>Test 2:</u>                  0dB                  0dB                  +1.0dB                  Via mapping</p> <p><u>Test 3:</u>                  0dB                  0dB                  +1.0dB                  Via mapping</p>	<p><u>Test 1:</u>  <math>N_{oc}</math>: -106 dBm/15kHz  <math>N_{oc}</math>: -110 dBm/30kHz  <math>\hat{E}_{S2} / N_{oc}</math>: +6.0dB  <math>\hat{E}_{S3} / N_{oc}</math>: +2.0dB                  RSRP_x-8 to RSRP_x-1</p> <p><u>Test 2:</u>  <math>N_{oc}</math>: -88dBm/15kHz  <math>\hat{E}_{S2} / N_{oc}</math>: +6.0dB  <math>\hat{E}_{S3} / N_{oc}</math>: +2.0dB                  RSRP_x-8 to RSRP_x-1</p> <p><u>Test 3:</u>  <math>N_{oc}</math>: -116dBm/15kHz + <math>\Delta_{BG\_offset}</math>  <math>\hat{E}_{S2} / N_{oc}</math>: +3.0dB  <math>\hat{E}_{S3} / N_{oc}</math>: 0dB                  RSRP_x-7 to RSRP_x+1</p>
---	---	--	--

The derivation of the SS-RSRP values takes into account the uncertainty in Cell 2 and Cell 3 RSRP from  $N_{oc}$ ,  $\hat{E}_{S2} / N_{oc}$  and  $\hat{E}_{S3} / N_{oc}$ , the allowed UE reporting accuracy, and the UE mapping function.  
 The RSRP values given above are for both normal and extreme conditions.

4.7.1.2.1 EN-DC FR1-FR1 SS-RSRP absolute measurement accuracy	<b>TEST CONFIGURATION 1, 2, 4, 5</b>		
---	--------------------------------------	--	--

	<p><b>Test 1:</b>  <math>N_{oc1}</math>: -94.65 dBm/15kHz  <math>N_{oc2}</math>: -94.65 dBm/15kHz  <math>\hat{E}_{S2} / N_{oc1}</math>: +10.0dB  <math>\hat{E}_{S3} / N_{oc2}</math>: +10.0dB                      Reported RSRP values: <math>\pm 8</math>dB</p> <p><b>Test 2:</b>  <math>N_{oc1}</math>: -107dBm/15kHz + <math>\Delta_{BG\_offset}</math>  <math>N_{oc2}</math>: -118dBm/15kHz + <math>\Delta_{BG\_offset}</math>  <math>\hat{E}_{S2} / N_{oc1}</math>: +13.0dB  <math>\hat{E}_{S3} / N_{oc2}</math>: -3.0dB                      Reported RSRP values: <math>\pm 4.5</math>dB</p>	<p><b>Test 1:</b>                      0dB                      0dB                      0dB                      0dB                      Via mapping</p> <p><b>Test 2:</b>                      0dB                      0dB                      0dB                      0dB                      Via mapping</p>	<p><b>Test 1:</b>  <math>N_{oc1}</math>: -94.65dBm/15kHz  <math>N_{oc2}</math>: -94.65dBm/15kHz  <math>\hat{E}_{S2} / N_{oc1}</math>: +10.0dB  <math>\hat{E}_{S3} / N_{oc2}</math>: +10.0dB                      RSRP_62 to RSRP_81</p> <p><b>Test 2:</b>  <math>N_{oc1}</math>: -107dBm/15kHz + <math>\Delta_{BG\_offset}</math>  <math>N_{oc2}</math>: -118dBm/15kHz + <math>\Delta_{BG\_offset}</math>  <math>\hat{E}_{S2} / N_{oc1}</math>: +13.0dB  <math>\hat{E}_{S3} / N_{oc2}</math>: -3.0dB                      RSRP_32 to RSRP_45                      RSRP_33 to RSRP_45                      RSRP_33 to RSRP_46                      RSRP_34 to RSRP_46                      RSRP_34 to RSRP_47                      RSRP_35 to RSRP_48                      RSRP_36 to RSRP_48                      depending on operating band</p>
<b>TEST CONFIGURATION 3, 6</b>			
	<p><b>Test 1:</b>  <math>N_{oc1}</math>: -94.65 dBm/15kHz  <math>N_{oc2}</math>: -94.65 dBm/15kHz  <math>\hat{E}_{S2} / N_{oc1}</math>: +10.0dB  <math>\hat{E}_{S3} / N_{oc2}</math>: +10.0dB                      Reported RSRP values: <math>\pm 8</math>dB</p> <p><b>Test 2:</b>  <math>N_{oc1}</math>: -107dBm/15kHz + <math>\Delta_{BG\_offset}</math>  <math>N_{oc1}</math>: -118dBm/15kHz + <math>\Delta_{BG\_offset}</math>  <math>\hat{E}_{S2} / N_{oc1}</math>: +13.0dB  <math>\hat{E}_{S3} / N_{oc2}</math>: -3.0dB                      Reported RSRP values: <math>\pm 4.5</math>dB</p>	<p><b>Test 1:</b>                      -1.35dB                      -1.35dB                      0dB                      0dB                      Via mapping</p> <p><b>Test 2:</b>                      0dB                      0dB                      0dB                      0dB                      Via mapping</p>	<p><b>Test 1:</b>  <math>N_{oc1}</math>: -96dBm/15kHz  <math>N_{oc2}</math>: -96dBm/15kHz  <math>\hat{E}_{S2} / N_{oc1}</math>: +10.0dB  <math>\hat{E}_{S3} / N_{oc2}</math>: +10.0dB                      RSRP_64 to RSRP_83</p> <p><b>Test 2:</b>  <math>N_{oc}</math>: -107dBm/15kHz + <math>\Delta_{BG\_offset}</math>  <math>N_{oc1}</math>: -118dBm/15kHz + <math>\Delta_{BG\_offset}</math>  <math>\hat{E}_{S2} / N_{oc1}</math>: +13.0dB  <math>\hat{E}_{S3} / N_{oc2}</math>: -3.0dB                      RSRP_35 to RSRP_48                      RSRP_36 to RSRP_48                      RSRP_36 to RSRP_49                      RSRP_37 to RSRP_49                      RSRP_37 to RSRP_50                      RSRP_38 to RSRP_51                      RSRP_39 to RSRP_51                      depending on operating band</p>
<p>The derivation of the RSRP values takes into account the uncertainty in Cell 3 SS-RSRP from <math>N_{oc2}</math> and <math>\hat{E}_{S3} / N_{oc2}</math>, the allowed UE reporting accuracy, and the UE mapping function.                      The SS-RSRP values given above are for normal conditions. For extreme conditions, the RSRP values are 3.0dB wider at each end for Test 1, and 4.5 dB wider at each for Test 2.</p>			
4.7.1.2.2 EN-DC FR1-FR1 SS-RSRP relative measurement accuracy	<p><b>Test 1:</b>  <math>N_{oc1}</math>: -94.65 dBm/15kHz  <math>N_{oc2}</math>: -94.65 dBm/15kHz  <math>\hat{E}_{S2} / N_{oc1}</math>: +10.0dB  <math>\hat{E}_{S3} / N_{oc2}</math>: +10.0dB                      Reported relative RSRP values: <math>\pm 4.5</math>dB</p> <p><b>Test 2:</b>  <math>N_{oc1}</math>: -107dBm/15kHz + <math>\Delta_{BG\_offset}</math>  <math>N_{oc1}</math>: -118dBm/15kHz + <math>\Delta_{BG\_offset}</math>  <math>\hat{E}_{S2} / N_{oc1}</math>: +13.0dB  <math>\hat{E}_{S3} / N_{oc2}</math>: -3.0dB                      Reported relative RSRP values: <math>\pm 4.5</math>dB</p>	<p><b>Test 1:</b>                      0dB                      0dB                      0dB                      0dB                      Via mapping</p> <p><b>Test 2:</b>                      0dB                      0dB                      0dB                      0dB                      Via mapping</p>	<p><b>Test 1:</b>  <math>N_{oc1}</math>: -94.65dBm/15kHz  <math>N_{oc2}</math>: -94.65dBm/15kHz  <math>\hat{E}_{S2} / N_{oc1}</math>: +10.0dB  <math>\hat{E}_{S3} / N_{oc2}</math>: +10.0dB                      RSRP_x-7 to RSRP_x+7</p> <p><b>Test 2:</b>  <math>N_{oc}</math>: -107dBm/15kHz + <math>\Delta_{BG\_offset}</math>  <math>N_{oc1}</math>: -118dBm/15kHz + <math>\Delta_{BG\_offset}</math>  <math>\hat{E}_{S2} / N_{oc1}</math>: +13.0dB  <math>\hat{E}_{S3} / N_{oc2}</math>: -3.0dB                      RSRP_x-31 to RSRP_x-18</p>
<p>The derivation of the SS-RSRP values takes into account the uncertainty in Cell 2 and Cell 3 RSRP from <math>N_{oc}</math>, <math>\hat{E}_{S2} / N_{oc}</math> and <math>\hat{E}_{S3} / N_{oc}</math>, the allowed UE reporting accuracy, and the UE mapping function.                      The SS-RSRP values given above are for normal conditions. For extreme conditions, the RSRP values are 1.5dB wider at each end.</p>			
4.7.2.1 EN-DC FR1 SS-RSRQ measurement accuracy	<b>TEST CONFIGURATION 1, 2, 4, 5</b>		

	<p><u>Test 1:</u>  <math>N_{oc}</math>: -85dBm/15kHz  <math>\hat{E}_{S2} / N_{oc}</math>: +3.0dB  <math>\hat{E}_{S3} / N_{oc}</math>: +3.0dB                      Reported RSRQ values: <math>\pm 2.5</math>dB</p> <p><u>Test 2:</u>  <math>N_{oc}</math>: -101dBm/15kHz  <math>\hat{E}_{S2} / N_{oc}</math>: -2.9dB  <math>\hat{E}_{S3} / N_{oc}</math>: -2.9dB                      Reported RSRQ values: <math>\pm 3.5</math>dB</p> <p><u>Test 3:</u>  <math>N_{oc}</math>: -114dBm/15kHz + <math>\Delta_{BG\_offset}</math>  <math>\hat{E}_{S2} / N_{oc}</math>: -4.0dB  <math>\hat{E}_{S3} / N_{oc}</math>: -4.0dB                      Reported RSRQ values: <math>\pm 3.5</math>dB</p>	<p><u>Test 1:</u>                      -1.5dB                      0dB                      0dB                      Via mapping</p> <p><u>Test 2:</u>                      0dB                      0dB                      0dB                      Via mapping</p> <p><u>Test 3:</u>                      0dB                      0dB                      0dB                      Via mapping</p>	<p><u>Test 1:</u>  <math>N_{oc}</math>: -86.5dBm/15kHz  <math>\hat{E}_{S2} / N_{oc}</math>: +3.0dB  <math>\hat{E}_{S3} / N_{oc}</math>: +3.0dB                      RSRQ_52 to RSRQ_62</p> <p><u>Test 2:</u>  <math>N_{oc}</math>: -101dBm/15kHz  <math>\hat{E}_{S2} / N_{oc}</math>: -2.9dB  <math>\hat{E}_{S3} / N_{oc}</math>: -2.9dB                      RSRQ_46 to RSRQ_60</p> <p><u>Test 3:</u>  <math>N_{oc}</math>: -114dBm/15kHz + <math>\Delta_{BG\_offset}</math>  <math>\hat{E}_{S2} / N_{oc}</math>: -4.0dB  <math>\hat{E}_{S3} / N_{oc}</math>: -4.0dB                      RSRQ_44 to RSRQ_59</p>
<b>TEST CONFIGURATION 3, 6</b>			
	<p><u>Test 1:</u>  <math>N_{oc}</math>: -91dBm/15kHz  <math>\hat{E}_{S2} / N_{oc}</math>: +3.0dB  <math>\hat{E}_{S3} / N_{oc}</math>: +3.0dB                      Reported RSRQ values: <math>\pm 2.5</math>dB</p> <p><u>Test 2:</u>                      N/A</p> <p><u>Test 3:</u>  <math>N_{oc}</math>: -114dBm/15kHz + <math>\Delta_{BG\_offset}</math>  <math>\hat{E}_{S2} / N_{oc}</math>: -4.0dB  <math>\hat{E}_{S3} / N_{oc}</math>: -4.0dB                      Reported RSRQ values: <math>\pm 3.5</math>dB</p>	<p><u>Test 1:</u>                      -1.6dB                      0dB                      0dB                      Via mapping</p> <p><u>Test 2:</u>                      N/A</p> <p><u>Test 3:</u>                      0dB                      0dB                      0dB                      Via mapping</p>	<p><u>Test 1:</u>  <math>N_{oc}</math>: -92.6dBm/15kHz  <math>\hat{E}_{S2} / N_{oc}</math>: +3.0dB  <math>\hat{E}_{S3} / N_{oc}</math>: +3.0dB                      RSRQ_52 to RSRQ_62</p> <p><u>Test 2:</u>                      N/A</p> <p><u>Test 3:</u>  <math>N_{oc}</math>: -114dBm/15kHz + <math>\Delta_{BG\_offset}</math>  <math>\hat{E}_{S2} / N_{oc}</math>: -4.0dB  <math>\hat{E}_{S3} / N_{oc}</math>: -4.0dB                      RSRQ_44 to RSRQ_59</p>
<p>The derivation of the RSRQ values takes into account the uncertainty in Cell 3 SS-RSRQ from <math>N_{oc}</math> and <math>\hat{E}_{S3} / N_{oc}</math>, the allowed UE reporting accuracy, and the UE mapping function.                      The SS-RSRQ values given above are for normal conditions. For extreme conditions, the SS-RSRQ values are 1.5dB wider at each end for Test 1, and 0.5 dB wider at each for Tests 2 and 3.</p>			
4.7.2.2.1 EN-DC FR1-FR1 SS-RSRQ absolute measurement accuracy	<b>TEST CONFIGURATION 1, 2, 4, 5</b>		
	<p><u>Test 1:</u>  <math>N_{oc1}</math>: -80.18 dBm/15kHz  <math>N_{oc2}</math>: -80.18 dBm/15kHz  <math>\hat{E}_{S2} / N_{oc1}</math>: -1.75dB  <math>\hat{E}_{S3} / N_{oc2}</math>: -1.75dB                      Reported RSRQ values: <math>\pm 2.5</math>dB</p> <p><u>Test 2:</u>  <math>N_{oc1}</math>: -106dBm/15kHz  <math>N_{oc2}</math>: -106dBm/15kHz  <math>\hat{E}_{S2} / N_{oc1}</math>: -1.75dB  <math>\hat{E}_{S3} / N_{oc2}</math>: -1.75dB                      Reported RSRQ values: <math>\pm 2.5</math>dB</p> <p><u>Test 3:</u>  <math>N_{oc1}</math>: -116dBm/15kHz + <math>\Delta_{BG\_offset}</math>  <math>N_{oc2}</math>: -116dBm/15kHz + <math>\Delta_{BG\_offset}</math>  <math>\hat{E}_{S2} / N_{oc1}</math>: 3dB  <math>\hat{E}_{S3} / N_{oc2}</math>: -1.75dB                      Reported RSRQ values: <math>\pm 2.5</math>dB</p>	<p><u>Test 1:</u>                      -1.5dB                      -1.5dB                      0dB                      0dB                      Via mapping</p> <p><u>Test 2:</u>                      0dB                      0dB                      0dB                      0dB                      Via mapping</p> <p><u>Test 3:</u>                      0dB                      0dB                      0dB                      Via mapping</p>	<p><u>Test 1:</u>  <math>N_{oc1}</math>: -81.68dBm/15kHz  <math>N_{oc2}</math>: -81.68dBm/15kHz  <math>\hat{E}_{S2} / N_{oc1}</math>: -1.75dB  <math>\hat{E}_{S3} / N_{oc2}</math>: -1.75dB                      RSRQ_52 to RSRQ_62</p> <p><u>Test 2:</u>  <math>N_{oc1}</math>: -106dBm/15kHz  <math>N_{oc2}</math>: -106dBm/15kHz  <math>\hat{E}_{S2} / N_{oc1}</math>: -1.75dB  <math>\hat{E}_{S3} / N_{oc2}</math>: -1.75dB                      RSRQ_52 to RSRQ_62</p> <p><u>Test 3:</u>  <math>N_{oc1}</math>: -116dBm/15kHz + <math>\Delta_{BG\_offset}</math>  <math>N_{oc2}</math>: -116dBm/15kHz + <math>\Delta_{BG\_offset}</math>  <math>\hat{E}_{S2} / N_{oc1}</math>: 3dB  <math>\hat{E}_{S3} / N_{oc2}</math>: -1.75dB                      RSRQ_52 to RSRQ_62</p>
<b>TEST CONFIGURATION 3, 6</b>			

	<p><u>Test 1:</u>  <math>N_{oc1}</math>: -86.27 dBm/15kHz  <math>N_{oc2}</math>: -86.27 dBm/15kHz  <math>\hat{E}_{S2} / N_{oc1}</math>: -1.75dB  <math>\hat{E}_{S3} / N_{oc2}</math>: -1.75dB  <u>Reported RSRQ values: ±2.5dB</u></p> <p><u>Test 2:</u>  <math>N_{oc1}</math>: -106dBm/15kHz  <math>N_{oc2}</math>: -106dBm/15kHz  <math>\hat{E}_{S2} / N_{oc1}</math>: -1.75dB  <math>\hat{E}_{S3} / N_{oc2}</math>: -1.75dB  <u>Reported RSRQ values: ±2.5dB</u></p> <p><u>Test 3:</u>  <math>N_{oc1}</math>: -116dBm/15kHz + <math>\Delta_{BG\_offset}</math>  <math>N_{oc2}</math>: -116dBm/15kHz + <math>\Delta_{BG\_offset}</math>  <math>\hat{E}_{S2} / N_{oc1}</math>: 3dB  <math>\hat{E}_{S3} / N_{oc2}</math>: -1.75dB  <u>Reported RSRQ values: ±2.5dB</u></p>	<p><u>Test 1:</u>  -1.53dB  -1.53dB  0dB  0dB  Via mapping</p> <p><u>Test 2:</u>  0dB  0dB  0dB  0dB  Via mapping</p> <p><u>Test 3:</u>  0dB  0dB  0dB  0dB  Via mapping</p>	<p><u>Test 1:</u>  <math>N_{oc1}</math>: -87.8dBm/15kHz  <math>N_{oc2}</math>: -87.8dBm/15kHz  <math>\hat{E}_{S2} / N_{oc1}</math>: -1.75dB  <math>\hat{E}_{S3} / N_{oc2}</math>: -1.75dB  RSRQ_52 to RSRQ_62</p> <p><u>Test 2:</u>  <math>N_{oc1}</math>: -106dBm/15kHz  <math>N_{oc2}</math>: -106dBm/15kHz  <math>\hat{E}_{S2} / N_{oc1}</math>: -1.75dB  <math>\hat{E}_{S3} / N_{oc2}</math>: -1.75dB  RSRQ_52 to RSRQ_62</p> <p><u>Test 3:</u>  <math>N_{oc1}</math>: -116dBm/15kHz + <math>\Delta_{BG\_offset}</math>  <math>N_{oc2}</math>: -116dBm/15kHz + <math>\Delta_{BG\_offset}</math>  <math>\hat{E}_{S2} / N_{oc1}</math>: 3dB  <math>\hat{E}_{S3} / N_{oc2}</math>: -1.75dB  RSRQ_52 to RSRQ_62</p>
--	--	--	---

The derivation of the RSRQ values takes into account the uncertainty in Cell 3 SS-RSRQ from  $N_{oc2}$  and  $\hat{E}_{S3} / N_{oc2}$ , the allowed UE reporting accuracy, and the UE mapping function.  
The SS-RSRQ values given above are for normal conditions. For extreme conditions, the RSRQ values are 1.5dB wider at each end.

4.7.2.2.2 EN-DC FR1-FR1 SS-RSRQ relative measurement accuracy

**TEST CONFIGURATION 1, 2, 4, 5**

	<p><u>Test 1:</u>  <math>N_{oc1}</math>: -80.18 dBm/15kHz  <math>N_{oc2}</math>: -80.18 dBm/15kHz  <math>\hat{E}_{S2} / N_{oc1}</math>: -1.75dB  <math>\hat{E}_{S3} / N_{oc2}</math>: -1.75dB  <u>Reported RSRQ values: ±3dB</u></p> <p><u>Test 2:</u>  <math>N_{oc1}</math>: -106dBm/15kHz  <math>N_{oc2}</math>: -106dBm/15kHz  <math>\hat{E}_{S2} / N_{oc1}</math>: -1.75dB  <math>\hat{E}_{S3} / N_{oc2}</math>: -1.75dB  <u>Reported RSRQ values: ±3dB</u></p> <p><u>Test 3:</u>  <math>N_{oc1}</math>: -116dBm/15kHz + <math>\Delta_{BG\_offset}</math>  <math>N_{oc2}</math>: -116dBm/15kHz + <math>\Delta_{BG\_offset}</math>  <math>\hat{E}_{S2} / N_{oc1}</math>: 3dB  <math>\hat{E}_{S3} / N_{oc2}</math>: -1.75dB  <u>Reported RSRQ values: ±3dB</u></p>	<p><u>Test 1:</u>  -1.5dB  -1.5dB  0dB  0dB  Via mapping</p> <p><u>Test 2:</u>  0dB  0dB  0dB  0dB  Via mapping</p> <p><u>Test 3:</u>  0dB  0dB  0dB  0dB  Via mapping</p>	<p><u>Test 1:</u>  <math>N_{oc1}</math>: -81.68dBm/15kHz  <math>N_{oc2}</math>: -81.68dBm/15kHz  <math>\hat{E}_{S2} / N_{oc1}</math>: -1.75dB  <math>\hat{E}_{S3} / N_{oc2}</math>: -1.75dB  RSRQ_x-7 to RSRQ_x+7</p> <p><u>Test 2:</u>  <math>N_{oc1}</math>: -106dBm/15kHz  <math>N_{oc2}</math>: -106dBm/15kHz  <math>\hat{E}_{S2} / N_{oc1}</math>: -1.75dB  <math>\hat{E}_{S3} / N_{oc2}</math>: -1.75dB  RSRQ_x-7 to RSRQ_x+7</p> <p><u>Test 3:</u>  <math>N_{oc1}</math>: -116dBm/15kHz + <math>\Delta_{BG\_offset}</math>  <math>N_{oc2}</math>: -116dBm/15kHz + <math>\Delta_{BG\_offset}</math>  <math>\hat{E}_{S2} / N_{oc1}</math>: 3dB  <math>\hat{E}_{S3} / N_{oc2}</math>: -1.75dB  RSRQ_x-11 to RSRQ_x+2</p>
--	--	--	--

**TEST CONFIGURATION 3, 6**



	<p><b>Test 1:</b>  <math>N_{oc1}</math>: -86.27 dBm/15kHz  <math>N_{oc2}</math>: -86.27 dBm/15kHz  <math>\hat{E}_{S2} / N_{oc1}</math>: -1.75dB  <math>\hat{E}_{S3} / N_{oc2}</math>: -1.75dB                  Reported RSRQ values: <math>\pm 2.5</math>dB</p> <p><b>Test 2:</b>  <math>N_{oc1}</math>: -106dBm/15kHz  <math>N_{oc2}</math>: -106dBm/15kHz  <math>\hat{E}_{S2} / N_{oc1}</math>: -1.75dB  <math>\hat{E}_{S3} / N_{oc2}</math>: -1.75dB                  Reported RSRQ values: <math>\pm 3</math>dB</p> <p><b>Test 3:</b>  <math>N_{oc1}</math>: -116dBm/15kHz + <math>\Delta_{BG\_offset}</math>  <math>N_{oc2}</math>: -116dBm/15kHz + <math>\Delta_{BG\_offset}</math>  <math>\hat{E}_{S2} / N_{oc1}</math>: 3dB  <math>\hat{E}_{S3} / N_{oc2}</math>: -1.75dB                  Reported RSRQ values: <math>\pm 3</math>dB</p>	<p><b>Test 1:</b>                  -1.53dB                  -1.53dB                  0dB                  0dB                  Via mapping</p> <p><b>Test 2:</b>                  0dB                  0dB                  0dB                  0dB                  Via mapping</p> <p><b>Test 3:</b>                  0dB                  0dB                  0dB                  0dB                  Via mapping</p>	<p><b>Test 1:</b>  <math>N_{oc1}</math>: -87.8dBm/15kHz  <math>N_{oc2}</math>: -87.8dBm/15kHz  <math>\hat{E}_{S2} / N_{oc1}</math>: -1.75dB  <math>\hat{E}_{S3} / N_{oc2}</math>: -1.75dB                  RSRQ_x-7 to RSRQ_x+7</p> <p><b>Test 2:</b>  <math>N_{oc1}</math>: -106dBm/15kHz  <math>N_{oc2}</math>: -106dBm/15kHz  <math>\hat{E}_{S2} / N_{oc1}</math>: -1.75dB  <math>\hat{E}_{S3} / N_{oc2}</math>: -1.75dB                  RSRQ_x-7 to RSRQ_x+7</p> <p><b>Test 3:</b>  <math>N_{oc1}</math>: -116dBm/15kHz + <math>\Delta_{BG\_offset}</math>  <math>N_{oc2}</math>: -116dBm/15kHz + <math>\Delta_{BG\_offset}</math>  <math>\hat{E}_{S2} / N_{oc1}</math>: 3dB  <math>\hat{E}_{S3} / N_{oc2}</math>: -1.75dB                  RSRQ_x-11 to RSRQ_x+2</p>
--	---	--	--

The derivation of the RSRQ values takes into account the uncertainty in Cell 2 and Cell 3 SS-RSRQ from  $N_{oc2}$  and  $\hat{E}_{S3} / N_{oc2}$ , the allowed UE reporting accuracy, and the UE mapping function.  
 The SS-RSRQ values given above are for normal conditions. For extreme conditions, the RSRQ values are 1dB wider at each end.

4.7.3.1 EN-DC FR1 SS-SINR measurement accuracy

**TEST CONFIGURATION 1, 2, 4, 5**

	<p><b>Test 1:</b>  <math>N_{oc}</math>: -93dBm/15kHz  <math>\hat{E}_{S2} / N_{oc}</math>: +4.54dB  <math>\hat{E}_{S3} / N_{oc}</math>: +4.54dB                  Reported SINR values: <math>\pm 3.5</math>dB</p> <p><b>Test 2:</b>  <math>N_{oc}</math>: -116dBm/15kHz+ <math>\Delta_{BG\_offset}</math>  <math>\hat{E}_{S2} / N_{oc}</math>: -4dB  <math>\hat{E}_{S3} / N_{oc}</math>: -4dB                  Reported SINR values: <math>\pm 3.5</math>dB</p>	<p><b>Test 1:</b>                  0dB                  0dB                  0dB                  Via mapping</p> <p><b>Test 2:</b>                  0dB                  0.5dB                  0.5dB                  Via mapping</p>	<p><b>Test 1:</b>  <math>N_{oc}</math>: -93dBm/15kHz  <math>\hat{E}_{S2} / N_{oc}</math>: +4.54dB  <math>\hat{E}_{S3} / N_{oc}</math>: +4.54dB                  SINR_31 to SINR_49</p> <p><b>Test 2:</b>  <math>N_{oc}</math>: -116dBm/15kHz+ <math>\Delta_{BG\_offset}</math>  <math>\hat{E}_{S2} / N_{oc}</math>: -3.5dB  <math>\hat{E}_{S3} / N_{oc}</math>: -3.5dB                  SINR_28 to SINR_45</p>
--	--	---	--

**TEST CONFIGURATION 3, 6**

	<p><b>Test 1:</b>  <math>N_{oc}</math>: -93dBm/15kHz  <math>\hat{E}_{S2} / N_{oc}</math>: +4.54dB  <math>\hat{E}_{S3} / N_{oc}</math>: +4.54dB                  Reported SINR values: <math>\pm 3.5</math>dB</p> <p><b>Test 2:</b>  <math>N_{oc}</math>: -116dBm/15kHz+ <math>\Delta_{BG\_offset}</math>  <math>\hat{E}_{S2} / N_{oc}</math>: -4dB  <math>\hat{E}_{S3} / N_{oc}</math>: -4dB                  Reported SINR values: <math>\pm 3.5</math>dB</p>	<p><b>Test 1:</b>                  -0.2dB                  0dB                  0dB                  Via mapping</p> <p><b>Test 2:</b>                  0dB                  0.5dB                  0.5dB                  Via mapping</p>	<p><b>Test 1:</b>  <math>N_{oc}</math>: -93.2dBm/15kHz  <math>\hat{E}_{S2} / N_{oc}</math>: +4.54dB  <math>\hat{E}_{S3} / N_{oc}</math>: +4.54dB                  SINR_31 to SINR_49</p> <p><b>Test 2:</b>  <math>N_{oc}</math>: -116dBm/15kHz+ <math>\Delta_{BG\_offset}</math>  <math>\hat{E}_{S2} / N_{oc}</math>: -3.5dB  <math>\hat{E}_{S3} / N_{oc}</math>: -3.5dB                  SINR_28 to SINR_45</p>
--	--	--	--

The derivation of the SINR values takes into account the uncertainty in Cell 3 SS- SINR from  $N_{oc}$  and  $\hat{E}_{S3} / N_{oc}$ , the allowed UE reporting accuracy, and the UE mapping function.  
 The SS- SINR values given above are for normal conditions. For extreme conditions, the SS- SINR values are 0.5dB wider at each end.

4.7.3.2.1 EN-DC FR1-FR1 SS-SINR absolute measurement accuracy

**TEST CONFIGURATION 1, 2, 3, 4, 5, 6**

	<p><b>Test 1:</b>  <math>N_{oc1}</math>: -88 dBm/15kHz  <math>N_{oc2}</math>: -88 dBm/15kHz  <math>\hat{E}_{S2} / N_{oc1}</math>: -1.75dB  <math>\hat{E}_{S3} / N_{oc2}</math>: -1.75dB  <u>Reported SINR values: ±3dB</u></p> <p><b>Test 2:</b>  <math>N_{oc1}</math>: -108.5dBm/15kHz  <math>N_{oc2}</math>: -108.5dBm/15kHz  <math>\hat{E}_{S2} / N_{oc1}</math>: 20dB  <math>\hat{E}_{S3} / N_{oc2}</math>: 20dB  <u>Reported SINR values: ±3dB</u></p> <p><b>Test 3:</b>  <math>N_{oc1}</math>: -119.5dBm/15kHz + <math>\Delta_{BG\_offset}</math>  <math>N_{oc2}</math>: -119.5dBm/15kHz + <math>\Delta_{BG\_offset}</math>  <math>\hat{E}_{S2} / N_{oc1}</math>: -4dB  <math>\hat{E}_{S3} / N_{oc2}</math>: -4dB  <u>Reported SINR values: ±3.5dB</u></p>	<p><b>Test 1:</b>  0dB  0dB  0dB  0dB  Via mapping</p> <p><b>Test 2:</b>  0dB  0dB  0dB  0dB  Via mapping</p> <p><b>Test 3:</b>  0dB  0dB  0.8dB  0.8dB  Via mapping</p>	<p><b>Test 1:</b>  <math>N_{oc1}</math>: -88 dBm/15kHz  <math>N_{oc2}</math>: -88 dBm/15kHz  <math>\hat{E}_{S2} / N_{oc1}</math>: -1.75dB  <math>\hat{E}_{S3} / N_{oc2}</math>: -1.75dB  SINR_35 to SINR_51</p> <p><b>Test 2:</b>  <math>N_{oc1}</math>: -108.5dBm/15kHz  <math>N_{oc2}</math>: -108.5dBm/15kHz  <math>\hat{E}_{S2} / N_{oc1}</math>: 20dB  <math>\hat{E}_{S3} / N_{oc2}</math>: 20dB  SINR_79 to SINR_94</p> <p><b>Test 3:</b>  <math>N_{oc1}</math>: -119.5dBm/15kHz + <math>\Delta_{BG\_offset}</math>  <math>N_{oc2}</math>: -119.5dBm/15kHz + <math>\Delta_{BG\_offset}</math>  <math>\hat{E}_{S2} / N_{oc1}</math>: -3.2dB  <math>\hat{E}_{S3} / N_{oc2}</math>: -3.2dB  SINR_32 to SINR_49</p>
--	--	--	---

The derivation of the SINR values takes into account the uncertainty in Cell 3 SS- SINR from  $N_{oc}$  and  $\hat{E}_{S3} / N_{oc}$ , the allowed UE reporting accuracy, and the UE mapping function.  
The SS- SINR values given above are for normal conditions. For extreme conditions, the SS- SINR values are 1dB wider at each for Tests 1 and 2 and 0.5dB wider at each end for Test 3.

**4.7.3.2.2 EN-DC FR1-FR1 SS-SINR relative measurement accuracy** **TEST CONFIGURATION 1, 2, 3, 4, 5, 6**

	<p><b>Test 1:</b>  <math>N_{oc1}</math>: -88 dBm/15kHz  <math>N_{oc2}</math>: -88 dBm/15kHz  <math>\hat{E}_{S2} / N_{oc1}</math>: -1.75dB  <math>\hat{E}_{S3} / N_{oc2}</math>: -1.75dB  <u>Reported SINR values: ±3.5dB</u></p> <p><b>Test 2:</b>  <math>N_{oc1}</math>: -108.5dBm/15kHz  <math>N_{oc2}</math>: -108.5dBm/15kHz  <math>\hat{E}_{S2} / N_{oc1}</math>: 20dB  <math>\hat{E}_{S3} / N_{oc2}</math>: 20dB  <u>Reported SINR values: ±3.5dB</u></p> <p><b>Test 3:</b>  <math>N_{oc1}</math>: -119.5dBm/15kHz + <math>\Delta_{BG\_offset}</math>  <math>N_{oc2}</math>: -119.5dBm/15kHz + <math>\Delta_{BG\_offset}</math>  <math>\hat{E}_{S2} / N_{oc1}</math>: -4dB  <math>\hat{E}_{S3} / N_{oc2}</math>: -4dB  <u>Reported SINR values: ±4dB</u></p>	<p><b>Test 1:</b>  0dB  0dB  0dB  0dB  Via mapping</p> <p><b>Test 2:</b>  0dB  0dB  0dB  0dB  Via mapping</p> <p><b>Test 3:</b>  0dB  0dB  0.8dB  0.8dB  Via mapping</p>	<p><b>Test 1:</b>  <math>N_{oc1}</math>: -88 dBm/15kHz  <math>N_{oc2}</math>: -88 dBm/15kHz  <math>\hat{E}_{S2} / N_{oc1}</math>: -1.75dB  <math>\hat{E}_{S3} / N_{oc2}</math>: -1.75dB  SINR_x-10 to SINR_x+10</p> <p><b>Test 2:</b>  <math>N_{oc1}</math>: -108.5dBm/15kHz  <math>N_{oc2}</math>: -108.5dBm/15kHz  <math>\hat{E}_{S2} / N_{oc1}</math>: 20dB  <math>\hat{E}_{S3} / N_{oc2}</math>: 20dB  SINR_x-10 to SINR_x+10</p> <p><b>Test 3:</b>  <math>N_{oc1}</math>: -119.5dBm/15kHz + <math>\Delta_{BG\_offset}</math>  <math>N_{oc2}</math>: -119.5dBm/15kHz + <math>\Delta_{BG\_offset}</math>  <math>\hat{E}_{S2} / N_{oc1}</math>: -3.2dB  <math>\hat{E}_{S3} / N_{oc2}</math>: -3.2dB  SINR_x-11 to SINR_x+11</p>
--	--	--	---

The derivation of the SINR values takes into account the uncertainty in Cell 3 SS- SINR from  $N_{oc}$  and  $\hat{E}_{S3} / N_{oc}$ , the allowed UE reporting accuracy, and the UE mapping function.  
The SS- SINR values given above are for normal conditions. For extreme conditions, the SS- SINR values are 0.5dB wider at each for Tests 1 and 2 and 0dB wider at each end for Test 3.

**4.7.4.1.1 EN-DC FR1 SSB based L1-RSRP absolute measurement accuracy**

<p>Test Configuration 1,2,4,5</p>	<p><u>Test 1:</u> N<sub>oc1</sub>: -94.65 dBm/15kHz Ê<sub>S2</sub> / N<sub>oc1</sub>: 10dB <u>Reported L1-RSRP values: ±8.5dB</u> (±4.5dB additionally for extreme conditions)</p> <p><u>Test 2:</u> N<sub>oc1</sub>: -119.5dBm/15kHz + Δ<sub>BG_offset</sub> Ê<sub>S2</sub> / N<sub>oc1</sub>: -3dB <u>Reported L1-RSRP values: ±5dB</u> (±3dB additionally for extreme conditions)</p>	<p><u>Test 1:</u> 0dB 0dB Via mapping</p> <p><u>Test 2:</u> 0dB 0.8dB Via mapping</p>	<p><u>Test 1:</u> N<sub>oc1</sub>: -94.65dBm/15kHz Ê<sub>S2</sub> / N<sub>oc1</sub>: 10dB RSRP_62 to RSRP_82</p> <p><u>Test 2:</u> N<sub>oc1</sub>: -119.2dBm/15kHz + Δ<sub>BG_offset</sub> Ê<sub>S2</sub> / N<sub>oc1</sub>: -2.2dB RSRP_31 to RSRP_44 RSRP_31 to RSRP_45 RSRP_32 to RSRP_45 RSRP_32 to RSRP_46 RSRP_33 to RSRP_46 RSRP_34 to RSRP_47 RSRP_34 to RSRP_48 depending on operating band</p>
<p>Test Configuration 3,6</p>	<p><u>Test 1:</u> N<sub>oc1</sub>: -94.65 dBm/15kHz Ê<sub>S2</sub> / N<sub>oc1</sub>: 10dB <u>Reported L1-RSRP values: ±8.5dB</u> (±4.5dB additionally for extreme conditions)</p> <p><u>Test 2:</u> N<sub>oc1</sub>: -119.5dBm/15kHz + Δ<sub>BG_offset</sub> Ê<sub>S2</sub> / N<sub>oc1</sub>: -3dB <u>Reported L1-RSRP values: ±5dB</u> (±3dB additionally for extreme conditions)</p>	<p><u>Test 1:</u> -1.35dB 0dB Via mapping</p> <p><u>Test 2:</u> 0dB 0.8dB Via mapping</p>	<p><u>Test 1:</u> N<sub>oc1</sub>: -96dBm/15kHz Ê<sub>S2</sub> / N<sub>oc1</sub>: 10dB RSRP_63 to RSRP_84</p> <p><u>Test 2:</u> N<sub>oc1</sub>: -116.2dBm/15kHz + Δ<sub>BG_offset</sub> Ê<sub>S2</sub> / N<sub>oc1</sub>: -2.2dB RSRP_34 to RSRP_47 RSRP_34 to RSRP_48 RSRP_35 to RSRP_48 RSRP_35 to RSRP_49 RSRP_36 to RSRP_49 RSRP_37 to RSRP_50 RSRP_37 to RSRP_51 depending on operating band</p>
<p>4.7.4.1.2 EN-DC FR1 SSB based L1-RSRP relative measurement accuracy</p>			
<p>Test Configuration 1,2,4,5</p>	<p><u>Test 1:</u> N<sub>oc1</sub>: -94.65 dBm/15kHz Ê<sub>S2</sub> / N<sub>oc1</sub>: 10dB <u>Reported L1-RSRP values: ±8.5dB</u> (±1dB additionally for extreme conditions)</p> <p><u>Test 2:</u> N<sub>oc1</sub>: -119.5dBm/15kHz + Δ<sub>BG_offset</sub> Ê<sub>S2</sub> / N<sub>oc1</sub>: -3dB <u>Reported L1-RSRP values: ±5dB</u> (±1dB additionally for extreme conditions)</p>	<p><u>Test 1:</u> 0dB 0dB Via mapping</p> <p><u>Test 2:</u> 0dB 0.8dB Via mapping</p>	<p><u>Test 1:</u> N<sub>oc1</sub>: -94.65dBm/15kHz Ê<sub>S2</sub> / N<sub>oc1</sub>: 10dB RSRP_x-3 to RSRP_x+3</p> <p><u>Test 2:</u> N<sub>oc1</sub>: -119.2dBm/15kHz + Δ<sub>BG_offset</sub> Ê<sub>S2</sub> / N<sub>oc1</sub>: -2.2dB RSRP_x-3 to RSRP_x+3</p>
<p>Test Configuration 3,6</p>	<p><u>Test 1:</u> N<sub>oc1</sub>: -94.65 dBm/15kHz Ê<sub>S2</sub> / N<sub>oc1</sub>: 10dB <u>Reported L1-RSRP values: ±8.5dB</u> (±1dB additionally for extreme conditions)</p> <p><u>Test 2:</u> N<sub>oc1</sub>: -119.5dBm/15kHz + Δ<sub>BG_offset</sub> Ê<sub>S2</sub> / N<sub>oc1</sub>: -3dB <u>Reported L1-RSRP values: ±5dB</u> (±1dB additionally for extreme conditions)</p>	<p><u>Test 1:</u> -1.35dB 0dB Via mapping</p> <p><u>Test 2:</u> 0dB 0.8dB Via mapping</p>	<p><u>Test 1:</u> N<sub>oc1</sub>: -96dBm/15kHz Ê<sub>S2</sub> / N<sub>oc1</sub>: 10dB RSRP_x-3 to RSRP_x+3</p> <p><u>Test 2:</u> N<sub>oc1</sub>: -116.2dBm/15kHz + Δ<sub>BG_offset</sub> Ê<sub>S2</sub> / N<sub>oc1</sub>: -2.2dB RSRP_x-3 to RSRP_x+3</p>

4.7.4.2.1 EN-DC FR1 CSI-RS based L1-RSRP absolute measurement accuracy	Same as 4.7.4.1.1	Same as 4.7.4.1.1	Same as 4.7.4.1.1
4.7.4.2.2 EN-DC FR1 CSI-RS based L1-RSRP relative measurement accuracy	Same as 4.7.4.1.2	Same as 4.7.4.1.2	Same as 4.7.4.1.2
4.7.5.1 EN-DC FR1 SFTD measurement accuracy	$N_{oc1}$ : -104dBm/15kHz $\hat{E}_{s1} / N_{oc1}$ : -3.0dB  $N_{oc2}$ : -104dBm/15kHz $\hat{E}_{s2} / N_{oc2}$ : 17.0dB	0dB 0.3dB  0dB 0dB	$N_{oc1}$ : -104dBm/15kHz $\hat{E}_{s1} / N_{oc1}$ : -2.7dB  $N_{oc2}$ : -104dBm/15kHz $\hat{E}_{s2} / N_{oc2}$ : 17.0dB

**Table F.1.3.2-2: Derivation of test requirements for NR SA FR1 RRM tests**

Test	Minimum requirement in TS 38.133 [6]	Test tolerance (TT)	Test requirement in TS 38.533
6.1.1.1 NR SA FR1 cell re-selection	<p>During T1: Noc: -98dBm/15kHz <math>\hat{E}s1</math> / Noc: +16dB <math>\hat{E}s2</math> / Noc: -infinity</p> <p>During T2: Noc: -98dBm/15kHz <math>\hat{E}s1</math> / Noc: +13dB <math>\hat{E}s2</math> / Noc: +16dB</p> <p>During T3: Noc: -98dBm/15kHz <math>\hat{E}s1</math> / Noc: +16dB <math>\hat{E}s2</math> / Noc: +13dB</p>	<p>During T1: 0dB 0dB 0dB</p> <p>During T2: 0dB 0dB 0.45dB</p> <p>During T3: 0dB 0.45dB 0dB</p>	<p>During T1: Noc: -98dBm/15kHz <math>\hat{E}s1</math> / Noc: +16dB <math>\hat{E}s2</math> / Noc: -infinity</p> <p>During T2: Noc: -98dBm/15kHz <math>\hat{E}s1</math> / Noc: +13dB <math>\hat{E}s2</math> / Noc: +16.45dB</p> <p>During T3: Noc: -98dBm/15kHz <math>\hat{E}s1</math> / Noc: +16.45dB <math>\hat{E}s2</math> / Noc: +13dB</p>
6.1.1.2 NR SA FR1-FR1 cell re-selection	<p>During T1: Noc1: -98dBm/15kHz Noc2: -98dBm/15kHz <math>\hat{E}s1</math> / Noc1: +14dB <math>\hat{E}s2</math> / Noc2: -4dB</p> <p>During T2: Noc1: -98dBm/15kHz Noc2: -98dBm/15kHz <math>\hat{E}s1</math> / Noc1: +14dB <math>\hat{E}s2</math> / Noc2: -infinity</p> <p>During T3: Noc1: -98dBm/15kHz Noc2: -98dBm/15kHz <math>\hat{E}s1</math> / Noc1: +14dB <math>\hat{E}s2</math> / Noc2: +12dB</p>	<p>During T1: 0dB -2dB 1.6dB 0.4dB</p> <p>During T2: 0dB 0dB 1.6dB 0dB</p> <p>During T3: 0dB 0dB 1.6dB 1.6dB</p>	<p>During T1: Noc1: -98dBm/15kHz Noc2: -100dBm/15kHz <math>\hat{E}s1</math> / Noc1: +15.6dB <math>\hat{E}s2</math> / Noc2: -3.6dB</p> <p>During T2: Noc1: -98dBm/15kHz Noc2: -98dBm/15kHz <math>\hat{E}s1</math> / Noc1: +15.6dB <math>\hat{E}s2</math> / Noc2: -infinity</p> <p>During T3: Noc1: -98dBm/15kHz Noc2: -98dBm/15kHz <math>\hat{E}s1</math> / Noc1: +15.6dB <math>\hat{E}s2</math> / Noc2: 13.6dB</p>
6.1.1.3 NR SA FR1 cell re-selection for UE fulfilling low mobility relaxed measurement criterion	<p>During T1: Noc: -98dBm/15kHz <math>\hat{E}s1</math> / Noc: +13dB <math>\hat{E}s2</math> / Noc: +16dB</p> <p>During T2: Noc: -98dBm/15kHz <math>\hat{E}s1</math> / Noc: +16dB <math>\hat{E}s2</math> / Noc: +13dB</p> <p>In Signalling SSearchDeltaP = 3dB</p>	<p>During T1: 0dB -0.45dB 0dB</p> <p>During T2: 0dB 0dB -0.45dB</p> <p>In Signalling 3dB</p>	<p>During T1: Noc: -98dBm/15kHz <math>\hat{E}s1</math> / Noc: +12.55dB <math>\hat{E}s2</math> / Noc: +16dB</p> <p>During T2: Noc: -98dBm/15kHz <math>\hat{E}s1</math> / Noc: +16dB <math>\hat{E}s2</math> / Noc: +12.55dB</p> <p>In Signalling SSearchDeltaP = 6dB</p>
6.1.1.4 NR SA FR1 cell re-selection for UE fulfilling not-at-cell edge relaxed measurement criterion	<p>During T1: Noc: -98dBm/15kHz <math>\hat{E}s1</math> / Noc: +13dB <math>\hat{E}s2</math> / Noc: +16dB</p> <p>During T2: Noc: -98dBm/15kHz <math>\hat{E}s1</math> / Noc: +16dB <math>\hat{E}s2</math> / Noc: +13dB</p>	<p>During T1: 0dB -0.45dB 0dB</p> <p>During T2: 0dB 0dB -0.45dB</p>	<p>During T1: Noc: -98dBm/15kHz <math>\hat{E}s1</math> / Noc: +12.55dB <math>\hat{E}s2</math> / Noc: +16dB</p> <p>During T2: Noc: -98dBm/15kHz <math>\hat{E}s1</math> / Noc: +16dB <math>\hat{E}s2</math> / Noc: +12.55dB</p>

<p>6.1.1.5 NR SA FR1-FR1 cell re-selection for UE fulfilling low mobility relaxed measurement criterion</p>	<p>During T1: Noc1: -98dBm/15kHz Es1 / Noc1: +14dB Noc2: -98dBm/15kHz Es2 / Noc2: -4dB</p> <p>During T2: Noc1: -98dBm/15kHz Es1 / Noc1: +14dB Noc2: -98dBm/15kHz Es2 / Noc2: +12dB</p> <p>In signalling: Thresh_X_HighP of Cell 1 = 48dB Thresh_X_HighP of Cell 2 = 48dB Thresh_X_LowP of Cell 1 = 50dB Thresh_X_LowP of Cell 2 = 50dB Thresh_Serving_LowP of Cell 1 = 44dB Thresh_Serving_LowP of Cell 2 = 44dB SSearchDeltaP of Cell 1 = 3dB SSearchDeltaP of Cell 2 = 3dB</p>	<p>During T1: 0dB 0dB 0dB 0.3dB</p> <p>During T2: 0dB 0dB 0dB -2.25dB</p> <p>In signalling: 0dB -4dB -2dB 0dB 0dB 2dB 0dB 12dB</p>	<p>During T1: Noc1: -98dBm/15kHz Es1 / Noc1: +14dB Noc2: -98dBm/15kHz Es2 / Noc2: -3.7dB</p> <p>During T2: Noc1: -98dBm/15kHz Es1 / Noc1: +14dB Noc1: -98dBm/15kHz Es2 / Noc2: +9.75dB</p> <p>In signalling: Thresh_X_HighP of Cell 1 = 48dB Thresh_X_HighP of Cell 2 = 44dB Thresh_X_LowP of Cell 1 = 48dB Thresh_X_LowP of Cell 2 = 50dB Thresh_Serving_LowP of Cell 1 = 44dB Thresh_Serving_LowP of Cell 2 = 46dB SSearchDeltaP of Cell 1 = 3dB SSearchDeltaP of Cell 2 = 15dB</p>
<p>6.1.1.6 NR SA FR1-FR1 cell re-selection for UE fulfilling not-at-cell edge relaxed measurement criterion</p>	<p>During T1: Noc1: -98dBm/15kHz Es1 / Noc1: +14dB Noc2: -98dBm/15kHz Es2 / Noc2: -4dB</p> <p>During T2: Noc1: -98dBm/15kHz Es1 / Noc1: +14dB Noc2: -98dBm/15kHz Es2 / Noc2: +12dB</p> <p>In signalling: SSearchThresholdP of Cell 1 = 50dB SSearchThresholdP of Cell 2 = 50dB</p>	<p>During T1: 0dB 2dB -2dB 0.35dB</p> <p>During T2: 0dB 0dB -2dB 4dB</p> <p>In signalling: 0dB -16dB</p>	<p>During T1: Noc1: -98dBm/15kHz Es1 / Noc1: +16dB Noc2: -100dBm/15kHz Es2 / Noc2: -3.65dB</p> <p>During T2: Noc1: -98dBm/15kHz Es1 / Noc1: +14dB Noc1: -100dBm/15kHz Es2 / Noc2: +16dB</p> <p>In signalling: SSearchThresholdP of Cell 1 = 50dB SSearchThresholdP of Cell 2 = 34dB</p>
<p>6.1.1.7 NR SA FR1 cell re-selection for UE configured with highSpeedMeasFlag-r16</p>	<p>During T1: Noc: -98dBm/15kHz Es1 / Noc: +16dB Es2 / Noc: -infinity</p> <p>During T2: Noc: -98dBm/15kHz Es1 / Noc: +13dB Es2 / Noc: +16dB</p> <p>During T3: Noc: -98dBm/15kHz Es1 / Noc: +16dB Es2 / Noc: +13dB</p>	<p>During T1: 0dB 0dB 0dB</p> <p>During T2: 0dB 0dB 0.45dB</p> <p>During T3: 0dB 0.45dB 0dB</p>	<p>During T1: Noc: -98dBm/15kHz Es1 / Noc: +16dB Es2 / Noc: -infinity</p> <p>During T2: Noc: -98dBm/15kHz Es1 / Noc: +13dB Es2 / Noc: +16.45dB</p> <p>During T3: Noc: -98dBm/15kHz Es1 / Noc: +16.45dB Es2 / Noc: +13dB</p>

6.1.2.1 NR SA FR1 – E-UTRA cell re-selection to higher priority E-UTRA	<p>During T1: Noc1: -98dBm/15kHz Noc2: -98dBm/15kHz <math>\hat{E}s1</math> / Noc1: +14dB <math>\hat{E}s2</math> / Noc2: -infinity</p> <p>During T2: Noc1: -98dBm/15kHz Noc2: -98dBm/15kHz <math>\hat{E}s1</math> / Noc1: +14dB <math>\hat{E}s2</math> / Noc2: +12dB</p> <p>During T3: Noc1: -98dBm/15kHz Noc2: -98dBm/15kHz <math>\hat{E}s1</math> / Noc1: +14dB <math>\hat{E}s2</math> / Noc2: -4dB</p>	<p>During T1: 0dB 0dB 0dB 0dB</p> <p>During T2: 0dB 0dB 1.6dB 1.6dB</p> <p>During T3: 0dB -2dB 1.6dB 0.4dB</p>	<p>During T1: Noc1: -98dBm/15kHz Noc2: -98dBm/15kHz <math>\hat{E}s1</math> / Noc1: +14dB <math>\hat{E}s2</math> / Noc2: -infinity</p> <p>During T2: Noc1: -98dBm/15kHz Noc2: -98dBm/15kHz <math>\hat{E}s1</math> / Noc1: +15.6dB <math>\hat{E}s2</math> / Noc2: 13.6dB</p> <p>During T3: Noc1: -98dBm/15kHz Noc2: -100dBm/15kHz <math>\hat{E}s1</math> / Noc1: +15.6dB <math>\hat{E}s2</math> / Noc2: -3.6dB</p>
6.1.2.2 NR SA FR1 – E-UTRA cell re-selection to lower priority E-UTRA	<p>During T1: Noc1: -98dBm/15kHz Noc2: -98dBm/15kHz <math>\hat{E}s1</math> / Noc1: -4dB <math>\hat{E}s2</math> / Noc2: +14dB</p> <p>During T2: Noc1: -98dBm/15kHz Noc2: -98dBm/15kHz <math>\hat{E}s1</math> / Noc1: +12dB <math>\hat{E}s2</math> / Noc2: +14dB</p>	<p>During T1: -2dB 0dB 0.4dB 1.6dB</p> <p>During T2: 0dB 0dB 1.6dB 0dB</p>	<p>During T1: Noc1: -100dBm/15kHz Noc2: -98dBm/15kHz <math>\hat{E}s1</math> / Noc1: -3.6dB <math>\hat{E}s2</math> / Noc2: +15.6dB</p> <p>During T2: Noc1: -98dBm/15kHz Noc2: -98dBm/15kHz <math>\hat{E}s1</math> / Noc1: +13.6dB <math>\hat{E}s2</math> / Noc2: +14dB</p>
6.1.2.3 NR SA FR1 – E-UTRA cell re-selection to lower priority E-UTRAN for UE fulfilling low mobility relaxed measurement criterion	<p>During T1: Noc1: -98dBm/15kHz Noc2: -98dBm/15kHz <math>\hat{E}s1</math> / Noc1: -4dB <math>\hat{E}s2</math> / Noc2: +14dB</p> <p>During T2: Noc1: -98dBm/15kHz Noc2: -98dBm/15kHz <math>\hat{E}s1</math> / Noc1: +12dB <math>\hat{E}s2</math> / Noc2: +14dB</p>	<p>During T1: -2dB 0dB 0.4dB 1.6dB</p> <p>During T2: 0dB 0dB 1.6dB 0dB</p>	<p>During T1: Noc1: -100dBm/15kHz Noc2: -98dBm/15kHz <math>\hat{E}s1</math> / Noc1: -3.6dB <math>\hat{E}s2</math> / Noc2: +15.6dB</p> <p>During T2: Noc1: -98dBm/15kHz Noc2: -98dBm/15kHz <math>\hat{E}s1</math> / Noc1: +13.6dB <math>\hat{E}s2</math> / Noc2: +14dB</p>
6.1.2.4 NR SA FR1 – E-UTRA cell re-selection to lower priority E-UTRAN for UE fulfilling not-at-cell edge relaxed measurement criterion	<p>During T1: Noc1: -98dBm/15kHz Noc2: -98dBm/15kHz <math>\hat{E}s1</math> / Noc1: -4dB <math>\hat{E}s2</math> / Noc2: +14dB</p> <p>During T2: Noc1: -98dBm/15kHz Noc2: -98dBm/15kHz <math>\hat{E}s1</math> / Noc1: +12dB <math>\hat{E}s2</math> / Noc2: +14dB</p>	<p>During T1: -2dB 0dB 0.4dB 1.6dB</p> <p>During T2: 0dB 0dB 1.6dB 0dB</p>	<p>During T1: Noc1: -100dBm/15kHz Noc2: -98dBm/15kHz <math>\hat{E}s1</math> / Noc1: -3.6dB <math>\hat{E}s2</math> / Noc2: +15.6dB</p> <p>During T2: Noc1: -98dBm/15kHz Noc2: -98dBm/15kHz <math>\hat{E}s1</math> / Noc1: +13.6dB <math>\hat{E}s2</math> / Noc2: +14dB</p>
6.1.2.5 NR SA FR1 – E-UTRA cell re-selection to lower priority E-UTRA for UE configured with highSpeedMeasFlag-r16	Same as 6.1.2.2	Same as 6.1.2.2	Same as 6.1.2.2
6.3.1.1 NR SA FR1 handover with known target cell	TEST CONFIGURATION 1, 2 A3-Offset: 0dB	-1dB	A3-Offset: -1dB



	<p>During T1: Noc1: -98dBm/15kHz Noc2: -98dBm/15kHz Ês1 / Noc1: 8dB Ês2 / Noc2: -infinity</p> <p>During T2: Noc1: -98dBm/15kHz Noc2: -98dBm/15kHz Ês1 / Noc1: +8dB Ês2 / Noc2: +11dB</p> <p>During T3: Noc1: -98dBm/15kHz Noc2: -98dBm/15kHz Ês1 / Noc1: +8dB Ês2 / Noc2: +11dB</p>	<p>During T1: 0dB 0dB 0dB 0dB</p> <p>During T2: 0dB 0dB 0dB -1dB</p> <p>During T3: 0dB 0dB 0dB -1dB</p>	<p>During T1: Noc1: -98dBm/15kHz Noc2: -98dBm/15kHz Ês1 / Noc1: 8dB Ês2 / Noc2: -infinity</p> <p>During T2: Noc1: -98dBm/15kHz Noc2: -98dBm/15kHz Ês1 / Noc1: +8dB Ês2 / Noc2: +10dB</p> <p>During T3: Noc1: -98dBm/15kHz Noc2: -98dBm/15kHz Ês1 / Noc1: +8dB Ês2 / Noc2: +10dB</p>
	<p>TEST CONFIGURATION 3 A3-Offset: 0dB</p>	-1dB	A3-Offset: -1dB
	<p>During T1: Noc1: -98dBm/15kHz Noc2: -98dBm/15kHz Ês1 / Noc1: 8dB Ês2 / Noc2: -infinity</p> <p>During T2: Noc1: -98dBm/15kHz Noc2: -98dBm/15kHz Ês1 / Noc1: +8dB Ês2 / Noc2: +11dB</p> <p>During T3: Noc1: -98dBm/15kHz Noc2: -98dBm/15kHz Ês1 / Noc1: +8dB Ês2 / Noc2: +11dB</p>	<p>During T1: 0dB 0dB 0dB 0dB</p> <p>During T2: 0dB 0dB 0dB -1dB</p> <p>During T3: 0dB 0dB 0dB -1dB</p>	<p>During T1: Noc1: -98dBm/15kHz Noc2: -98dBm/15kHz Ês1 / Noc1: 8dB Ês2 / Noc2: -infinity</p> <p>During T2: Noc1: -98dBm/15kHz Noc2: -98dBm/15kHz Ês1 / Noc1: +8dB Ês2 / Noc2: +10dB</p> <p>During T3: Noc1: -98dBm/15kHz Noc2: -98dBm/15kHz Ês1 / Noc1: +8dB Ês2 / Noc2: +10dB</p>
6.3.1.2 NR SA FR1 handover with unknown target cell	<p>A3-Offset: 0dB</p> <p>During T1: Noc1: -98dBm/15kHz Noc2: -98dBm/15kHz Ês1 / Noc1: 8dB Ês2 / Noc2: -infinity</p> <p>During T2: Noc1: -98dBm/15kHz Noc2: -98dBm/15kHz Ês1 / Noc1: +8dB Ês2 / Noc2: +8dB</p>	-1dB	A3-Offset: -1dB
6.3.1.3 NR SA FR1-FR1 Handover with unknown Target Cell	<p>During T1: Noc1: -98dBm/15kHz Noc2: -98dBm/15kHz Ês1 / Noc1: 4dB Ês2 / Noc2: -infinity</p> <p>During T2: Noc1: -98dBm/15kHz Noc2: -98dBm/15kHz Ês1 / Noc1: +4dB Ês2 / Noc2: +5dB</p>	<p>During T1: 0dB 0dB 0dB 0dB</p> <p>During T2: 0dB 0dB 0dB 1.7dB</p>	<p>During T1: Noc1: -98dBm/15kHz Noc2: -98dBm/15kHz Ês1 / Noc1: 4dB Ês2 / Noc2: -infinity</p> <p>During T2: Noc1: -98dBm/15kHz Noc2: -98dBm/15kHz Ês1 / Noc1: +4dB Ês2 / Noc2: +6.7dB</p>

6.3.1.4 NR SA FR1 – E-UTRA handover with known target cell	<p>During T1: Noc1: -100dBm/15kHz Noc2: -98dBm/15kHz <math>\hat{E}s_1</math> / Noc1: +12dB <math>\hat{E}s_2</math> / Noc2: -infinity</p> <p>During T2: Noc1: -100dBm/15kHz Noc2: -98dBm/15kHz <math>\hat{E}s_1</math> / Noc1: -4dB <math>\hat{E}s_2</math> / Noc2: +8dB</p> <p>During T3: Noc1: -100dBm/15kHz Noc2: -98dBm/15kHz <math>\hat{E}s_1</math> / Noc1: -4dB <math>\hat{E}s_2</math> / Noc2: +8dB</p>	<p>During T1: 0dB 0dB 1.55dB 0dB</p> <p>During T2: 0dB 0dB -1.55dB 1.55dB</p> <p>During T3: 0dB 0dB -1.55dB 1.55dB</p>	<p>During T1: Noc1: -100dBm/15kHz Noc2: -98dBm/15kHz <math>\hat{E}s_1</math> / Noc1: +13.55dB <math>\hat{E}s_2</math> / Noc2: -infinity</p> <p>During T2: Noc1: -100dBm/15kHz Noc2: -98dBm/15kHz <math>\hat{E}s_1</math> / Noc1: -5.55dB <math>\hat{E}s_2</math> / Noc2: +9.55dB</p> <p>During T3: Noc1: -100dBm/15kHz Noc2: -98dBm/15kHz <math>\hat{E}s_1</math> / Noc1: -5.55dB <math>\hat{E}s_2</math> / Noc2: +9.55dB</p>
6.3.1.5 NR SA FR1 – E-UTRA handover with unknown target cell	<p>During T1: Noc1: -98dBm/15kHz Noc2: -98dBm/15kHz <math>\hat{E}s_1</math> / Noc1: 0dB <math>\hat{E}s_2</math> / Noc2: -infinity</p> <p>During T2: Noc1: -98dBm/15kHz Noc2: -98dBm/15kHz <math>\hat{E}s_1</math> / Noc1: 0dB <math>\hat{E}s_2</math> / Noc2: +7dB</p>	<p>During T1: 0dB 0dB 0dB 0dB</p> <p>During T2: 0dB 0dB 0dB 0dB</p>	<p>During T1: Noc1: -98dBm/15kHz Noc2: -98dBm/15kHz <math>\hat{E}s_1</math> / Noc1: 0dB <math>\hat{E}s_2</math> / Noc2: -infinity</p> <p>During T2: Noc1: -98dBm/15kHz Noc2: -98dBm/15kHz <math>\hat{E}s_1</math> / Noc1: 0dB <math>\hat{E}s_2</math> / Noc2: +7dB</p>
6.3.1.6 NR SA FR1 – UTRAN FDD handover with known target cell	<p>During T1: Noc: -100dBm/15kHz <math>\hat{E}s</math> / Noc: 12dB Ioc: -70dBm/3.84MHz <math>\hat{I}or</math> / Ioc: -infinity CPICH Ec / Ior: -10dB SCH Ec / Ior: -12dB</p> <p>During T2: Noc: -100dBm/15kHz <math>\hat{E}s</math> / Noc: -4dB Ioc: -70dBm/3.84MHz <math>\hat{I}or</math> / Ioc: -infinity CPICH Ec / Ior: -10dB SCH Ec / Ior: -12dB</p> <p>During T3: Noc: -100dBm/15kHz <math>\hat{E}s</math> / Noc: -4dB Ioc: -70dBm/3.84MHz <math>\hat{I}or</math> / Ioc: -infinity CPICH Ec / Ior: -10dB SCH Ec / Ior: -12dB</p>	<p>During T1: -1.54dB 0dB 0dB 0dB 0dB 0dB</p> <p>During T2: -1.54dB 0dB 0dB 0dB 0dB 0dB</p> <p>During T3: -1.54dB 0dB 0dB 0dB 0dB 0dB</p>	<p>During T1: Noc: -101.54dBm/15kHz <math>\hat{E}s</math> / Noc: 12dB Ioc: -70dBm/3.84MHz <math>\hat{I}or</math> / Ioc: -infinity CPICH Ec / Ior: -10dB SCH Ec / Ior: -12dB</p> <p>During T2: Noc: -101.54dBm/15kHz <math>\hat{E}s</math> / Noc: -4dB Ioc: -70dBm/3.84MHz <math>\hat{I}or</math> / Ioc: -infinity CPICH Ec / Ior: -10dB SCH Ec / Ior: -12dB</p> <p>During T3: Noc: -101.54dBm/15kHz <math>\hat{E}s</math> / Noc: -4dB Ioc: -70dBm/3.84MHz <math>\hat{I}or</math> / Ioc: -infinity CPICH Ec / Ior: -10dB SCH Ec / Ior: -12dB</p>

<p>6.3.1.7 NR SA FR1 synchronous DAPS handover</p>	<p>During T1: Noc: -98dBm/15kHz Ês1 / Noc: +8dB Ês2 / Noc: -infinity</p> <p>During T2: Noc: -98dBm/15kHz Ês1 / Noc: +8dB Ês2 / Noc: +9dB</p> <p>During T3: Noc: -98dBm/15kHz Ês1 / Noc: +8dB Ês2 / Noc: +9dB</p> <p>During T4: Noc: -98dBm/15kHz Ês1 / Noc: +8dB Ês2 / Noc: +9dB</p> <p>During T5: Noc: -98dBm/15kHz Ês1 / Noc: +8dB Ês2 / Noc: +9dB</p> <p>In signaling: A3-offset: 0dB</p>	<p>During T1: 0dB 0dB 0dB</p> <p>During T2: 0dB 0dB 1dB</p> <p>During T3: 0dB 0dB 1dB</p> <p>During T4: 0dB 0dB 1dB</p> <p>During T5: 0dB 0dB 1dB</p> <p>In signaling: -1dB</p>	<p>During T1: Noc: -98dBm/15kHz Ês1 / Noc: +8dB Ês2 / Noc: -infinity</p> <p>During T2: Noc: -98dBm/15kHz Ês1 / Noc: +8dB Ês2 / Noc: +10dB</p> <p>During T3: Noc: -98dBm/15kHz Ês1 / Noc: +8dB Ês2 / Noc: +10dB</p> <p>During T4: Noc: -98dBm/15kHz Ês1 / Noc: +8dB Ês2 / Noc: +10dB</p> <p>During T5: Noc: -98dBm/15kHz Ês1 / Noc: +8dB Ês2 / Noc: +10dB</p> <p>In signaling: A3-offset: -1dB</p>
<p>6.3.1.8 NR SA FR1 asynchronous DAPS handover</p>	<p>During T1: Noc: -98dBm/15kHz Ês1 / Noc: +8dB Ês2 / Noc: -infinity</p> <p>During T2: Noc: -98dBm/15kHz Ês1 / Noc: +8dB Ês2 / Noc: +9dB</p> <p>During T3: Noc: -98dBm/15kHz Ês1 / Noc: +8dB Ês2 / Noc: +9dB</p> <p>During T4: Noc: -98dBm/15kHz Ês1 / Noc: +8dB Ês2 / Noc: +9dB</p> <p>During T5: Noc: -98dBm/15kHz Ês1 / Noc: +8dB Ês2 / Noc: +9dB</p> <p>In signaling: A3-offset: 0dB</p>	<p>During T1: 0dB 0dB 0dB</p> <p>During T2: 0dB 0dB 1dB</p> <p>During T3: 0dB 0dB 1dB</p> <p>During T4: 0dB 0dB 1dB</p> <p>During T5: 0dB 0dB 1dB</p> <p>In signaling: -1dB</p>	<p>During T1: Noc: -98dBm/15kHz Ês1 / Noc: +8dB Ês2 / Noc: -infinity</p> <p>During T2: Noc: -98dBm/15kHz Ês1 / Noc: +8dB Ês2 / Noc: +10dB</p> <p>During T3: Noc: -98dBm/15kHz Ês1 / Noc: +8dB Ês2 / Noc: +10dB</p> <p>During T4: Noc: -98dBm/15kHz Ês1 / Noc: +8dB Ês2 / Noc: +10dB</p> <p>During T5: Noc: -98dBm/15kHz Ês1 / Noc: +8dB Ês2 / Noc: +10dB</p> <p>In signaling: A3-offset: -1dB</p>

6.3.1.9 NR SA FR1 Intra-band inter-frequency synchronous DAPS handover	<p>During T1: Noc: -98dBm/15kHz <math>\hat{E}s1</math> / Noc: +8dB <math>\hat{E}s2</math> / Noc: -infinity</p> <p>During T2: Noc: -98dBm/15kHz <math>\hat{E}s1</math> / Noc: +8dB <math>\hat{E}s2</math> / Noc: +8dB</p> <p>During T3: Noc: -98dBm/15kHz <math>\hat{E}s1</math> / Noc: +8dB <math>\hat{E}s2</math> / Noc: +8dB</p> <p>During T4: Noc: -98dBm/15kHz <math>\hat{E}s1</math> / Noc: +8dB <math>\hat{E}s2</math> / Noc: +8dB</p> <p>During T5: Noc: -98dBm/15kHz <math>\hat{E}s1</math> / Noc: +8dB <math>\hat{E}s2</math> / Noc: +8dB</p> <p>In signaling: A3-offset: 0dB</p>	<p>During T1: 0dB 0dB 0dB</p> <p>During T2: 0dB 0dB 3.7dB</p> <p>During T3: 0dB 0dB 3.7dB</p> <p>During T4: 0dB 0dB 3.7dB</p> <p>During T5: 0dB 0dB 3.7dB</p> <p>In signaling: -3dB</p>	<p>During T1: Noc: -98dBm/15kHz <math>\hat{E}s1</math> / Noc: +8dB <math>\hat{E}s2</math> / Noc: -infinity</p> <p>During T2: Noc: -98dBm/15kHz <math>\hat{E}s1</math> / Noc: +8dB <math>\hat{E}s2</math> / Noc: +11.7dB</p> <p>During T3: Noc: -98dBm/15kHz <math>\hat{E}s1</math> / Noc: +8dB <math>\hat{E}s2</math> / Noc: +11.7dB</p> <p>During T4: Noc: -98dBm/15kHz <math>\hat{E}s1</math> / Noc: +8dB <math>\hat{E}s2</math> / Noc: +11.7dB</p> <p>During T5: Noc: -98dBm/15kHz <math>\hat{E}s1</math> / Noc: +8dB <math>\hat{E}s2</math> / Noc: +11.7dB</p> <p>In signaling: A3-offset: -3dB</p>
6.3.1.10 NR SA FR1 Intra-band inter-frequency asynchronous DAPS handover	<p>During T1: Noc: -98dBm/15kHz <math>\hat{E}s1</math> / Noc: +8dB <math>\hat{E}s2</math> / Noc: -infinity</p> <p>During T2: Noc: -98dBm/15kHz <math>\hat{E}s1</math> / Noc: +8dB <math>\hat{E}s2</math> / Noc: +8dB</p> <p>During T3: Noc: -98dBm/15kHz <math>\hat{E}s1</math> / Noc: +8dB <math>\hat{E}s2</math> / Noc: +8dB</p> <p>During T4: Noc: -98dBm/15kHz <math>\hat{E}s1</math> / Noc: +8dB <math>\hat{E}s2</math> / Noc: +8dB</p> <p>During T5: Noc: -98dBm/15kHz <math>\hat{E}s1</math> / Noc: +8dB <math>\hat{E}s2</math> / Noc: +8dB</p> <p>In signaling: A3-offset: 0dB</p>	<p>During T1: 0dB 0dB 0dB</p> <p>During T2: 0dB 0dB 3.7dB</p> <p>During T3: 0dB 0dB 3.7dB</p> <p>During T4: 0dB 0dB 3.7dB</p> <p>During T5: 0dB 0dB 3.7dB</p> <p>In signaling: -3dB</p>	<p>During T1: Noc: -98dBm/15kHz <math>\hat{E}s1</math> / Noc: +8dB <math>\hat{E}s2</math> / Noc: -infinity</p> <p>During T2: Noc: -98dBm/15kHz <math>\hat{E}s1</math> / Noc: +8dB <math>\hat{E}s2</math> / Noc: +11.7dB</p> <p>During T3: Noc: -98dBm/15kHz <math>\hat{E}s1</math> / Noc: +8dB <math>\hat{E}s2</math> / Noc: +11.7dB</p> <p>During T4: Noc: -98dBm/15kHz <math>\hat{E}s1</math> / Noc: +8dB <math>\hat{E}s2</math> / Noc: +11.7dB</p> <p>During T5: Noc: -98dBm/15kHz <math>\hat{E}s1</math> / Noc: +8dB <math>\hat{E}s2</math> / Noc: +11.7dB</p> <p>In signaling: A3-offset: -3dB</p>

<p>6.3.1.11 NR SA FR1 Inter-band inter-frequency synchronous DAPS handover</p>	<p>During T1: Noc: -98dBm/15kHz Ēs1 / Noc: +4dB Ēs2 / Noc: -infinity</p> <p>During T2: Noc: -98dBm/15kHz Ēs1 / Noc: +4dB Ēs2 / Noc: +4dB</p> <p>During T3: Noc: -98dBm/15kHz Ēs1 / Noc: +4dB Ēs2 / Noc: +4dB</p> <p>During T4: Noc: -98dBm/15kHz Ēs1 / Noc: +4dB Ēs2 / Noc: +4dB</p> <p>During T5: Noc: -98dBm/15kHz Ēs1 / Noc: +4dB Ēs2 / Noc: +4dB</p> <p>In signaling: A3-offset: -6dB</p>	<p>During T1: 0dB 0dB 0dB</p> <p>During T2: 0dB 0dB 0dB</p> <p>During T3: 0dB 0dB 0dB</p> <p>During T4: 0dB 0dB 0dB</p> <p>During T5: 0dB 0dB 0dB</p> <p>In signaling: -1dB for config 1,2,4,5,9</p> <p>In signaling: -4dB for config 3,6</p> <p>In signaling: 2dB for config 7,8</p>	<p>During T1: Noc: -98dBm/15kHz Ēs1 / Noc: +4dB Ēs2 / Noc: -infinity</p> <p>During T2: Noc: -98dBm/15kHz Ēs1 / Noc: +4dB Ēs2 / Noc: +4dB</p> <p>During T3: Noc: -98dBm/15kHz Ēs1 / Noc: +4dB Ēs2 / Noc: +4dB</p> <p>During T4: Noc: -98dBm/15kHz Ēs1 / Noc: +4dB Ēs2 / Noc: +4dB</p> <p>During T5: Noc: -98dBm/15kHz Ēs1 / Noc: +4dB Ēs2 / Noc: +4dB</p> <p>In signaling: -7dB for config 1,2,4,5,9</p> <p>In signaling: -10dB for config 3,6</p> <p>In signaling: -4dB for config 7,8</p>
<p>6.3.1.12 NR SA FR1 Inter-band inter-frequency asynchronous DAPS handover</p>	<p>During T1: Noc: -98dBm/15kHz Ēs1 / Noc: +4dB Ēs2 / Noc: -infinity</p> <p>During T2: Noc: -98dBm/15kHz Ēs1 / Noc: +4dB Ēs2 / Noc: +4dB</p> <p>During T3: Noc: -98dBm/15kHz Ēs1 / Noc: +4dB Ēs2 / Noc: +4dB</p> <p>During T4: Noc: -98dBm/15kHz Ēs1 / Noc: +4dB Ēs2 / Noc: +4dB</p> <p>During T5: Noc: -98dBm/15kHz Ēs1 / Noc: +4dB Ēs2 / Noc: +4dB</p> <p>In signaling: A3-offset: -4dB</p>	<p>During T1: 0dB 0dB 0dB</p> <p>During T2: 0dB 0dB 0dB</p> <p>During T3: 0dB 0dB 0dB</p> <p>During T4: 0dB 0dB 0dB</p> <p>During T5: 0dB 0dB 0dB</p> <p>In signaling: -3dB for config 1,2,4,5,9</p> <p>In signaling: -6dB for config 3,6</p> <p>In signaling: 0dB for config 7,8</p>	<p>During T1: Noc: -98dBm/15kHz Ēs1 / Noc: +4dB Ēs2 / Noc: -infinity</p> <p>During T2: Noc: -98dBm/15kHz Ēs1 / Noc: +4dB Ēs2 / Noc: +4dB</p> <p>During T3: Noc: -98dBm/15kHz Ēs1 / Noc: +4dB Ēs2 / Noc: +4dB</p> <p>During T4: Noc: -98dBm/15kHz Ēs1 / Noc: +4dB Ēs2 / Noc: +4dB</p> <p>During T5: Noc: -98dBm/15kHz Ēs1 / Noc: +4dB Ēs2 / Noc: +4dB</p> <p>In signaling: -7dB for config 1,2,4,5,9</p> <p>In signaling: -10dB for config 3,6</p> <p>In signaling: -4dB for config 7,8</p>

6.3.2.1.1 NR SA FR1 RRC re-establishment	<p>During T1: Noc: -98dBm/15kHz <math>\hat{E}s_1</math> / Noc: +7dB <math>\hat{E}s_2</math> / Noc: +4dB</p> <p>During T2: Noc: -98dBm/15kHz <math>\hat{E}s_1</math> / Noc: -infinity <math>\hat{E}s_2</math> / Noc: +4dB</p> <p>During T3: Noc: -98dBm/15kHz <math>\hat{E}s_1</math> / Noc: -infinity <math>\hat{E}s_2</math> / Noc: +4dB</p>	<p>During T1: 0dB 0dB 0dB</p> <p>During T2: 0dB 0dB 0dB</p> <p>During T3: 0dB 0dB 0dB</p>	<p>During T1: Noc: -98dBm/15kHz <math>\hat{E}s_1</math> / Noc: +7dB <math>\hat{E}s_2</math> / Noc: +4dB</p> <p>During T2: Noc: -98dBm/15kHz <math>\hat{E}s_1</math> / Noc: -infinity <math>\hat{E}s_2</math> / Noc: +4dB</p> <p>During T3: Noc: -98dBm/15kHz <math>\hat{E}s_1</math> / Noc: -infinity <math>\hat{E}s_2</math> / Noc: +4dB</p>
6.3.2.1.2 NR SA FR1 - FR1 RRC re-establishment	<p>During T1: Noc1: -98dBm/15kHz Noc2: -98dBm/15kHz <math>\hat{E}s_1</math> / Noc1: +4dB <math>\hat{E}s_2</math> / Noc2: -infinity</p> <p>During T2: Noc1: -98dBm/15kHz Noc2: -98dBm/15kHz <math>\hat{E}s_1</math> / Noc1: -infinity <math>\hat{E}s_2</math> / Noc2: -infinity</p> <p>During T3: Noc1: -98dBm/15kHz Noc2: -98dBm/15kHz <math>\hat{E}s_1</math> / Noc1: -infinity <math>\hat{E}s_2</math> / Noc2: +7dB</p>	<p>During T1: 0dB 0dB 0dB 0dB</p> <p>During T2: 0dB 0dB 0dB 0dB</p> <p>During T3: 0dB 0dB 0dB 0dB</p>	<p>During T1: Noc1: -98dBm/15kHz Noc2: -98dBm/15kHz <math>\hat{E}s_1</math> / Noc1: +4dB <math>\hat{E}s_2</math> / Noc2: -infinity</p> <p>During T2: Noc1: -98dBm/15kHz Noc2: -98dBm/15kHz <math>\hat{E}s_1</math> / Noc1: -infinity <math>\hat{E}s_2</math> / Noc2: -infinity</p> <p>During T3: Noc1: -98dBm/15kHz Noc2: -98dBm/15kHz <math>\hat{E}s_1</math> / Noc1: -infinity <math>\hat{E}s_2</math> / Noc2: +7dB</p>
6.3.2.1.3 NR SA FR1 RRC re-establishment without serving cell timing	<p>During T1: Noc: -98dBm/15kHz <math>\hat{E}s_1</math> / Noc: +4dB <math>\hat{E}s_2</math> / Noc: -infinity</p> <p>During T2: Noc: -98dBm/15kHz <math>\hat{E}s_1</math> / Noc: -infinity <math>\hat{E}s_2</math> / Noc: -infinity</p> <p>During T3: Noc: -98dBm/15kHz <math>\hat{E}s_1</math> / Noc: -infinity <math>\hat{E}s_2</math> / Noc: +4dB</p>	<p>During T1: 0dB 0dB 0dB</p> <p>During T2: 0dB 0dB 0dB</p> <p>During T3: 0dB 0dB 0dB</p>	<p>During T1: Noc: -98dBm/15kHz <math>\hat{E}s_1</math> / Noc: +4dB <math>\hat{E}s_2</math> / Noc: -infinity</p> <p>During T2: Noc: -98dBm/15kHz <math>\hat{E}s_1</math> / Noc: -infinity <math>\hat{E}s_2</math> / Noc: -infinity</p> <p>During T3: Noc: -98dBm/15kHz <math>\hat{E}s_1</math> / Noc: -infinity <math>\hat{E}s_2</math> / Noc: +4dB</p>
6.3.2.2.1	<p>Absolute uplink power: Normal conditions <math>\pm 9</math>dB</p> <p>Relative uplink power step: Normal conditions <math>\pm 2.5</math>dB</p> <p>Uplink timing: 15kHz SCS <math>T_e \pm 12 \cdot 64 \cdot T_c</math> 30kHz SCS <math>T_e \pm 8 \cdot 64 \cdot T_c</math></p>	<p>2.1dB</p> <p>0.7dB</p> <p>112<math>T_c</math> 112<math>T_c</math></p>	<p>Absolute uplink power: Normal conditions <math>\pm 11.1</math>dB</p> <p>Relative uplink power step: Normal conditions <math>\pm 3.2</math>dB</p> <p>Uplink timing: 15kHz SCS <math>T_e \pm 880 \cdot T_c</math> 30kHz SCS <math>T_e \pm 624 \cdot T_c</math></p>
6.3.2.2.2	Same as 6.3.2.2.1	Same as 6.3.2.2.1	Same as 6.3.2.2.1
6.3.2.3.1 NR SA FR1 RRC connection release with redirection	<p>During T1: Noc1: -98dBm/15kHz Noc2: -98dBm/15kHz <math>\hat{E}s_1</math> / Noc1: +4dB <math>\hat{E}s_2</math> / Noc2: -infinity</p> <p>During T2: Noc1: -98dBm/15kHz Noc2: -98dBm/15kHz <math>\hat{E}s_1</math> / Noc1: +4dB <math>\hat{E}s_2</math> / Noc2: +4dB</p>	<p>During T1: 0dB 0dB 0dB 0dB</p> <p>During T2: 0dB 0dB 0dB 0dB</p>	<p>During T1: Noc1: -98dBm/15kHz Noc2: -98dBm/15kHz <math>\hat{E}s_1</math> / Noc1: +4dB <math>\hat{E}s_2</math> / Noc2: -infinity</p> <p>During T2: Noc1: -98dBm/15kHz Noc2: -98dBm/15kHz <math>\hat{E}s_1</math> / Noc1: +4dB <math>\hat{E}s_2</math> / Noc2: +4dB</p>

6.3.2.3.2 NR SA FR1 – E-UTRA RRC connection release with redirection	<p>During T1: Noc1: -98dBm/15kHz Noc2: -98dBm/15kHz Ēs1 / Noc1: +4dB Ēs2 / Noc2: -infinity</p> <p>During T2: Noc1: -98dBm/15kHz Noc2: -98dBm/15kHz Ēs1 / Noc1: +4dB Ēs2 / Noc2: +4dB</p>	<p>During T1: 0dB 0dB 0dB 0dB</p> <p>During T2: 0dB 0dB 0dB 0dB</p>	<p>During T1: Noc1: -98dBm/15kHz Noc2: -98dBm/15kHz Ēs1 / Noc1: +4dB Ēs2 / Noc2: -infinity</p> <p>During T2: Noc1: -98dBm/15kHz Noc2: -98dBm/15kHz Ēs1 / Noc1: +4dB Ēs2 / Noc2: +4dB</p>
6.3.3.1 NR SA FR1 conditional handover	<p>During T1: Noc: -98dBm/15kHz Ēs1 / Noc: +8dB Ēs2 / Noc: -infinity</p> <p>During T2: Noc: -98dBm/15kHz Ēs1 / Noc: +8dB Ēs2 / Noc: +11dB</p> <p>In signaling: A3-offset: 0dB</p>	<p>During T1: 0dB 0dB 0dB</p> <p>During T2: 0dB 0dB -1dB</p> <p>In signaling: -1dB</p>	<p>During T1: Noc: -98dBm/15kHz Ēs1 / Noc: +8dB Ēs2 / Noc: -infinity</p> <p>During T2: Noc: -98dBm/15kHz Ēs1 / Noc: +8dB Ēs2 / Noc: +10dB</p> <p>In signaling: A3-offset: -1dB</p>
6.3.3.2 NR SA FR1-FR1 conditional handover	<p>During T1: Noc1: -98dBm/15kHz Noc2: -98dBm/15kHz Ēs1 / Noc1: +4dB Ēs2 / Noc2: -infinity</p> <p>During T2: Noc1: -98dBm/15kHz Noc2: -98dBm/15kHz Ēs1 / Noc1: +4dB Ēs2 / Noc2: +5dB</p>	<p>During T1: 0dB 0dB 0dB 0dB</p> <p>During T2: 0dB 0dB 0dB 1.7dB</p>	<p>During T1: Noc1: -98dBm/15kHz Noc2: -98dBm/15kHz Ēs1 / Noc1: +4dB Ēs2 / Noc2: -infinity</p> <p>During T2: Noc1: -98dBm/15kHz Noc2: -98dBm/15kHz Ēs1 / Noc1: +4dB Ēs2 / Noc2: +6.7dB</p>





6.5.1.4 NR SA FR1 radio link monitoring in-sync test for PCell configured with SSB-based RLM RS in DRX mode	Same as 6.5.1.2	Same as 6.5.1.2	Same as 6.5.1.2
6.5.1.5 NR SA FR1 radio link monitoring out-of-sync test for PCell configured with CSI-RS-based RLM RS in non-DRX mode	Same as 6.5.1.1	Same as 6.5.1.1	Same as 6.5.1.1
6.5.1.6 NR SA FR1 radio link monitoring in-sync test for PCell configured with CSI-RS-based RLM RS in non-DRX mode	Same as 6.5.1.2	Same as 6.5.1.2	Same as 6.5.1.2
6.5.1.7 NR SA FR1 radio link monitoring out-of-sync test for PCell configured with CSI-RS-based RLM RS in DRX mode	Same as 6.5.1.1	Same as 6.5.1.1	Same as 6.5.1.1
6.5.1.8 NR SA FR1 radio link monitoring in-sync test for PCell configured with CSI-RS-based RLM RS in DRX mode	Same as 6.5.1.2	Same as 6.5.1.2	Same as 6.5.1.2
6.5.2.1 NR SA FR1 interruptions during measurements on deactivated NR SCC	During T1: Noc <sub>1</sub> : -104dBm/15kHz Noc <sub>2</sub> : -104dBm/15kHz $\hat{E}_{S1} / \text{Noc}_1$ : +17dB $\hat{E}_{S2} / \text{Noc}_2$ : +17dB	During T1: 0dB 0dB 0dB 0dB	During T1: Noc <sub>1</sub> : -104dBm/15kHz Noc <sub>2</sub> : -104dBm/15kHz $\hat{E}_{S1} / \text{Noc}_1$ : +17dB $\hat{E}_{S2} / \text{Noc}_2$ : +17dB
6.5.3.1 NR SA FR1 SCell activation and deactivation of known SCell in non-DRX for 160ms SCell measurement cycle	During T1: Noc <sub>1</sub> : -104dBm/15kHz Noc <sub>2</sub> : -104dBm/15kHz $\hat{E}_{S1} / \text{Noc}_1$ : +17dB $\hat{E}_{S2} / \text{Noc}_2$ : +17dB  During T2: Noc <sub>1</sub> : -104dBm/15kHz Noc <sub>2</sub> : -104dBm/15kHz $\hat{E}_{S1} / \text{Noc}_1$ : +17dB $\hat{E}_{S2} / \text{Noc}_2$ : +17dB  During T3: Noc <sub>1</sub> : -104dBm/15kHz Noc <sub>2</sub> : -104dBm/15kHz $\hat{E}_{S1} / \text{Noc}_1$ : +17dB $\hat{E}_{S2} / \text{Noc}_2$ : +17dB	During T1: 0dB 0dB 0dB 0dB  During T2: 0dB 0dB 0dB 0dB  During T3: 0dB 0dB 0dB 0dB	During T1: Noc <sub>1</sub> : -104dBm/15kHz Noc <sub>2</sub> : -104dBm/15kHz $\hat{E}_{S1} / \text{Noc}_1$ : +17dB $\hat{E}_{S2} / \text{Noc}_2$ : +17dB  During T2: Noc <sub>1</sub> : -104dBm/15kHz Noc <sub>2</sub> : -104dBm/15kHz $\hat{E}_{S1} / \text{Noc}_1$ : +17dB $\hat{E}_{S2} / \text{Noc}_2$ : +17dB  During T3: Noc <sub>1</sub> : -104dBm/15kHz Noc <sub>2</sub> : -104dBm/15kHz $\hat{E}_{S1} / \text{Noc}_1$ : +17dB $\hat{E}_{S2} / \text{Noc}_2$ : +17dB
6.5.3.2 NR SA FR1 SCell activation and deactivation of known SCell in non-DRX for 640ms SCell measurement cycle	Same as 6.5.3.1	Same as 6.5.3.1	Same as 6.5.3.1
6.5.3.3 NR SA FR1 SCell activation and deactivation of unknown SCell in non-DRX	Same as 6.5.3.1	Same as 6.5.3.1	Same as 6.5.3.1

<p>6.5.5.1 NR SA FR1 SSB-based beam failure detection and link recovery in non-DRX</p>	<p>q0 SSB SNR during: T1: 5dB T2: -3dB T3: -12dB T4: -12dB T5: -12dB</p> <p>q1 SSB during T1: Noc<sub>1</sub>: -98dBm/15kHz Ê<sub>S1</sub> / Noc<sub>1</sub>: -10dB</p> <p>q1 SSB during T2: Noc<sub>1</sub>: -98dBm/15kHz Ê<sub>S1</sub> / Noc<sub>1</sub>: -10dB</p> <p>q1 SSB during T3, T4 and T5: Noc<sub>1</sub>: -98dBm/15kHz Ê<sub>S1</sub> / Noc<sub>1</sub>: +10dB</p>	<p>Offset during: T1: +0.8dB T2: +0.8dB T3: -0.8dB T4: -0.8dB T5: -0.8dB</p> <p>q1 SSB during T1: 0dB -0.2dB</p> <p>q1 SSB during T2: 0dB -0.2dB</p> <p>q1 SSB during T3, T4 and T5: 0dB +0.2dB</p>	<p>SNR during: T1: +5.8dB T2: -2.2dB T3: -12.8dB T4: -12.8dB T5: -12.8dB</p> <p>For testing of a UE which supports 4RX on all bands, the SNR during T3, T4 and T5 is modified as specified in clause D.4.1.1</p> <p>q1 SSB during T1: Noc<sub>1</sub>: -98dBm/15kHz Ê<sub>S1</sub> / Noc<sub>1</sub>: -10.2dB</p> <p>q1 SSB during T2: Noc<sub>1</sub>: -98dBm/15kHz Ê<sub>S1</sub> / Noc<sub>1</sub>: -10.2dB</p> <p>q1 SSB during T3, T4 and T5: Noc<sub>1</sub>: -98dBm/15kHz Ê<sub>S1</sub> / Noc<sub>1</sub>: +10.2dB</p>
<p>6.5.5.2 NR SA FR1 SSB-based beam failure detection and link recovery in DRX</p>	<p>Same as 6.5.5.1</p>	<p>Same as 6.5.5.1</p>	<p>Same as 6.5.5.1</p>
<p>6.5.5.3 NR SA FR1 CSI-RS-based beam failure detection and link recovery in non-DRX</p>	<p>q0 CSI-RS SNR during: T1: 5dB T2: -3dB T3: -12dB T4: -12dB T5: -12dB</p> <p>q1 CSI-RS during T1: Noc<sub>1</sub>: -98dBm/15kHz Ê<sub>S1</sub> / Noc<sub>1</sub>: -10dB</p> <p>q1 CSI-RS during T2: Noc<sub>2</sub>: -98dBm/15kHz Ê<sub>S1</sub> / Noc<sub>1</sub>: -10dB</p> <p>q1 CSI-RS during T3, T4 and T5: Noc<sub>2</sub>: -98dBm/15kHz Ê<sub>S1</sub> / Noc<sub>1</sub>: +10dB</p>	<p>Offset during: T1: +0.8dB T2: +0.8dB T3: -0.8dB T4: -0.8dB T5: -0.8dB</p> <p>q1 CSI-RS during T1: 0dB -0.2dB</p> <p>q1 CSI-RS during T2: 0dB -0.2dB</p> <p>q1 CSI-RS during T3, T4 and T5: 0dB +0.2dB</p>	<p>SNR during: T1: +5.8dB T2: -2.2dB T3: -12.8dB T4: -12.8dB T5: -12.8dB</p> <p>For testing of a UE which supports 4RX on all bands, the SNR during T3, T4 and T5 is modified as specified in clause D.4.1.1</p> <p>q1 CSI-RS during T1: Noc<sub>1</sub>: -98dBm/15kHz Ê<sub>S1</sub> / Noc<sub>1</sub>: -10.2dB</p> <p>q1 CSI-RS during T2: Noc<sub>1</sub>: -98dBm/15kHz Ê<sub>S1</sub> / Noc<sub>1</sub>: -10.2dB</p> <p>q1 CSI-RS during T3, T4 and T5: Noc<sub>1</sub>: -98dBm/15kHz Ê<sub>S1</sub> / Noc<sub>1</sub>: +10.2dB</p>
<p>6.5.5.4 NR SA FR1 CSI-RS-based beam failure detection and link recovery in DRX</p>	<p>Same as 6.5.5.3</p>	<p>Same as 6.5.5.3</p>	<p>Same as 6.5.5.3</p>

6.5.6.1.1 NR SA FR1-FR1 DCI-based DL active BWP switch in non-DRX	<p>During T1: Noc<sub>1</sub>: -104dBm/15kHz Noc<sub>2</sub>: -104dBm/15kHz <math>\hat{E}_{S1} / \text{Noc}_1</math>: +17dB <math>\hat{E}_{S2} / \text{Noc}_2</math>: +17dB</p> <p>During T2: Noc<sub>1</sub>: -104dBm/15kHz Noc<sub>2</sub>: -104dBm/15kHz <math>\hat{E}_{S1} / \text{Noc}_1</math>: +17dB <math>\hat{E}_{S2} / \text{Noc}_2</math>: +17dB</p> <p>During T3: Noc<sub>1</sub>: -104dBm/15kHz Noc<sub>2</sub>: -104dBm/15kHz <math>\hat{E}_{S1} / \text{Noc}_1</math>: +17dB <math>\hat{E}_{S2} / \text{Noc}_2</math>: +17dB</p>	<p>During T1: 0dB 0dB 0dB 0dB</p> <p>During T2: 0dB 0dB 0dB 0dB</p> <p>During T3: 0dB 0dB 0dB 0dB</p>	<p>During T1: Noc<sub>1</sub>: -104dBm/15kHz Noc<sub>2</sub>: -104dBm/15kHz <math>\hat{E}_{S1} / \text{Noc}_1</math>: +17dB <math>\hat{E}_{S2} / \text{Noc}_2</math>: +17dB</p> <p>During T2: Noc<sub>1</sub>: -104dBm/15kHz Noc<sub>2</sub>: -104dBm/15kHz <math>\hat{E}_{S1} / \text{Noc}_1</math>: +17dB <math>\hat{E}_{S2} / \text{Noc}_2</math>: +17dB</p> <p>During T3: Noc<sub>1</sub>: -104dBm/15kHz Noc<sub>2</sub>: -104dBm/15kHz <math>\hat{E}_{S1} / \text{Noc}_1</math>: +17dB <math>\hat{E}_{S2} / \text{Noc}_2</math>: +17dB</p>
6.5.6.1.2 NR SA FR1 DCI-based DL active BWP switch in non-DRX	<p>During T1: Noc<sub>1</sub>: -104dBm/15kHz <math>\hat{E}_{S1} / \text{Noc}_1</math>: +17dB</p> <p>During T2: Noc<sub>1</sub>: -104dBm/15kHz <math>\hat{E}_{S1} / \text{Noc}_1</math>: +17dB</p> <p>During T3: Noc<sub>1</sub>: -104dBm/15kHz <math>\hat{E}_{S1} / \text{Noc}_1</math>: +17dB</p>	<p>During T1: 0dB 0dB</p> <p>During T2: 0dB 0dB</p> <p>During T3: 0dB 0dB</p>	<p>During T1: Noc<sub>1</sub>: -104dBm/15kHz <math>\hat{E}_{S1} / \text{Noc}_1</math>: +17dB</p> <p>During T2: Noc<sub>1</sub>: -104dBm/15kHz <math>\hat{E}_{S1} / \text{Noc}_1</math>: +17dB</p> <p>During T3: Noc<sub>1</sub>: -104dBm/15kHz <math>\hat{E}_{S1} / \text{Noc}_1</math>: +17dB</p>
6.5.6.2.1 NR SA FR1 RRC-based DL active BWP switch in non-DRX	<p>During T1: Noc<sub>1</sub>: -104dBm/15kHz <math>\hat{E}_{S1} / \text{Noc}_1</math>: +17dB</p>	<p>During T1: 0dB 0dB</p>	<p>During T1: Noc<sub>1</sub>: -104dBm/15kHz <math>\hat{E}_{S1} / \text{Noc}_1</math>: +17dB</p>
6.6.1.1 SA event triggered reporting tests without gap under non-DRX	<p>During T1: Noc: -98dBm/15kHz <math>\hat{E}_{S1} / \text{Noc}</math>: +4.00dB <math>\hat{E}_{S2} / \text{Noc}</math>: -infinity</p> <p>During T2: Noc: -98dBm/15kHz <math>\hat{E}_{S1} / \text{Noc}</math>: +4.00dB <math>\hat{E}_{S2} / \text{Noc}</math>: +4.00dB</p>	<p>During T1: 0dB 0dB 0dB</p> <p>During T2: 0dB 0dB 0dB</p>	<p>During T1: Noc: -98dBm/15kHz <math>\hat{E}_{S1} / \text{Noc}</math>: +4.00dB <math>\hat{E}_{S2} / \text{Noc}</math>: -infinity</p> <p>During T2: Noc: -98dBm/15kHz <math>\hat{E}_{S1} / \text{Noc}</math>: +4.00dB <math>\hat{E}_{S2} / \text{Noc}</math>: +4.00dB</p>
6.6.1.2 SA event triggered reporting tests without gap under DRX	Same as 6.6.1.1	Same as 6.6.1.1	Same as 6.6.1.1
6.6.1.3 SA event triggered reporting tests with per-UE gaps under non-DRX	Same as 6.6.1.1	Same as 6.6.1.1	Same as 6.6.1.1
6.6.1.4 SA event triggered reporting tests with per-UE gaps under DRX	Same as 6.6.1.1	Same as 6.6.1.1	Same as 6.6.1.1
6.6.1.5 SA event triggered reporting tests without gap under non-DRX with SSB index reading	Same as 6.6.1.1	Same as 6.6.1.1	Same as 6.6.1.1
6.6.1.6 SA event triggered reporting tests with per-UE gaps under non-DRX with SSB index reading	Same as 6.6.1.1	Same as 6.6.1.1	Same as 6.6.1.1
6.6.1.7 NR SA FR1 event-triggered reporting without gap in DRX for UE configured with highSpeedMeasFlag-r16	Same as 6.6.1.1	Same as 6.6.1.1	Same as 6.6.1.1

6.5.3.1	<p>During T1: Noc<sub>1</sub>: -104dBm/15kHz Noc<sub>2</sub>: -104dBm/15kHz <math>\hat{E}_{S1} / \text{Noc}_1</math>: +17dB <math>\hat{E}_{S2} / \text{Noc}_2</math>: +17dB</p> <p>During T2: Noc<sub>1</sub>: -104dBm/15kHz Noc<sub>2</sub>: -104dBm/15kHz <math>\hat{E}_{S1} / \text{Noc}_1</math>: +17dB <math>\hat{E}_{S2} / \text{Noc}_2</math>: +17dB</p> <p>During T3: Noc<sub>1</sub>: -104dBm/15kHz Noc<sub>2</sub>: -104dBm/15kHz <math>\hat{E}_{S1} / \text{Noc}_1</math>: +17dB <math>\hat{E}_{S2} / \text{Noc}_2</math>: +17dB</p>	<p>During T1: 0dB 0dB 0dB 0dB</p> <p>During T2: 0dB 0dB 0dB 0dB</p> <p>During T3: 0dB 0dB 0dB 0dB</p>	<p>During T1: Noc<sub>1</sub>: -104dBm/15kHz Noc<sub>2</sub>: -104dBm/15kHz <math>\hat{E}_{S1} / \text{Noc}_1</math>: +17dB <math>\hat{E}_{S2} / \text{Noc}_2</math>: +17dB</p> <p>During T2: Noc<sub>1</sub>: -104dBm/15kHz Noc<sub>2</sub>: -104dBm/15kHz <math>\hat{E}_{S1} / \text{Noc}_1</math>: +17dB <math>\hat{E}_{S2} / \text{Noc}_2</math>: +17dB</p> <p>During T3: Noc<sub>1</sub>: -104dBm/15kHz Noc<sub>2</sub>: -104dBm/15kHz <math>\hat{E}_{S1} / \text{Noc}_1</math>: +17dB <math>\hat{E}_{S2} / \text{Noc}_2</math>: +17dB</p>
6.5.3.2	Same as 6.5.3.1	Same as 6.5.3.1	Same as 6.5.3.1
6.5.3.3	Same as 6.5.3.1	Same as 6.5.3.1	Same as 6.5.3.1
6.6.2.1 NR SA FR1-FR1 event-triggered reporting in non-DRX	<p>During T1: Freq 1 Noc: -98dBm/15kHz Freq 2 Noc: -98dBm/15kHz <math>\hat{E}_{S1} / \text{Noc}</math>: +4.00dB <math>\hat{E}_{S2} / \text{Noc}</math>: -infinity</p> <p>During T2: Freq 1 Noc: -98dBm/15kHz Freq 2 Noc: -98dBm/15kHz <math>\hat{E}_{S1} / \text{Noc}</math>: +4.00dB <math>\hat{E}_{S2} / \text{Noc}</math>: +7.00dB</p>	<p>During T1: 0dB 0dB 0dB 0dB</p> <p>During T2: 0dB 0dB 0dB 0dB</p>	<p>During T1: Freq 1 Noc: -98dBm/15kHz Freq 2 Noc: -98dBm/15kHz <math>\hat{E}_{S1} / \text{Noc}</math>: +4.00dB <math>\hat{E}_{S2} / \text{Noc}</math>: -infinity</p> <p>During T2: Freq 1 Noc: -98dBm/15kHz Freq 2 Noc: -98dBm/15kHz <math>\hat{E}_{S1} / \text{Noc}</math>: +4.00dB <math>\hat{E}_{S2} / \text{Noc}</math>: +7.00dB</p>
6.6.2.2 NR SA FR1-FR1 event-triggered reporting in DRX	Same as 6.6.2.1	Same as 6.6.2.1	Same as 6.6.2.1
6.6.2.5 NR SA FR1-FR1 event-triggered reporting in non-DRX with SSB time index detection	Same as 6.6.2.1	Same as 6.6.2.1	Same as 6.6.2.1
6.6.2.6 NR SA FR1-FR1 event-triggered reporting in DRX with SSB time index detection	Same as 6.6.2.1	Same as 6.6.2.1	Same as 6.6.2.1
6.6.3.1 NR SA FR1 – E-UTRAN event-triggered reporting in non-DRX	<p>During T1: Freq 1 Noc: -106dBm/15kHz Freq 2 Noc: -106dBm/15kHz <math>\hat{E}_{S1} / \text{Noc}</math>: +18.00dB <math>\hat{E}_{S2} / \text{Noc}</math>: -infinity</p> <p>During T2: Freq 1 Noc: -106dBm/15kHz Freq 2 Noc: -106dBm/15kHz <math>\hat{E}_{S1} / \text{Noc}</math>: -2dB <math>\hat{E}_{S2} / \text{Noc}</math>: +19.00dB</p>	<p>During T1: 0dB 0dB +1.65dB 0dB</p> <p>During T2: 0dB 0dB -1.65dB 1.65dB</p>	<p>During T1: Freq 1 Noc: -106dBm/15kHz Freq 2 Noc: -106dBm/15kHz <math>\hat{E}_{S1} / \text{Noc}</math>: +19.65dB <math>\hat{E}_{S2} / \text{Noc}</math>: -infinity</p> <p>During T2: Freq 1 Noc: -106dBm/15kHz Freq 2 Noc: -106dBm/15kHz <math>\hat{E}_{S1} / \text{Noc}</math>: -3.65dB <math>\hat{E}_{S2} / \text{Noc}</math>: +20.65dB</p>
6.6.3.2 NR SA FR1 – E-UTRAN event-triggered reporting in DRX	Same as 6.6.3.1	Same as 6.6.3.1	Same as 6.6.3.1
6.6.3.3 NR SA FR1 – E-UTRAN event-triggered reporting in DRX for UE configured with highSpeedMeasFlag-r16	<p>During T1: Freq 1 Noc: -106dBm/15kHz Freq 2 Noc: -106dBm/15kHz <math>\hat{E}_{S1} / \text{Noc}</math>: +18.00dB <math>\hat{E}_{S2} / \text{Noc}</math>: -infinity</p> <p>During T2: Freq 1 Noc: -106dBm/15kHz Freq 2 Noc: -106dBm/15kHz <math>\hat{E}_{S1} / \text{Noc}</math>: -2dB <math>\hat{E}_{S2} / \text{Noc}</math>: +19.00dB</p>	<p>During T1: 0dB 0dB 0dB 0dB</p> <p>During T2: 0dB 0dB 0dB 0dB</p>	<p>During T1: Freq 1 Noc: -106dBm/15kHz Freq 2 Noc: -106dBm/15kHz <math>\hat{E}_{S1} / \text{Noc}</math>: +18.00dB <math>\hat{E}_{S2} / \text{Noc}</math>: -infinity</p> <p>During T2: Freq 1 Noc: -106dBm/15kHz Freq 2 Noc: -106dBm/15kHz <math>\hat{E}_{S1} / \text{Noc}</math>: -2dB <math>\hat{E}_{S2} / \text{Noc}</math>: +19.00dB</p>

6.6.4.1 NR SA FR1 SSB-based L1-RSRP measurement in non-DRX	<p>During T1: Noc: -98dBm/15kHz <math>\hat{E}_{S0}</math> / Noc: +0.00dB <math>\hat{E}_{S1}</math> / Noc: -infinity</p> <p>During T2: Noc: -98dBm/15kHz <math>\hat{E}_{S0}</math> / Noc: 0.00dB <math>\hat{E}_{S1}</math> / Noc: +3.00dB</p> <p>Reported SSB#0 SS-RSRP values <math>\pm</math> 10dB Reported SSB#1 SS-RSRP values <math>\pm</math> 10dB Reported Differential SS-RSRP values <math>\pm</math> 3dB</p>	<p>During T1: 0dB 0dB 0dB</p> <p>During T2: 0dB 0dB 0.5dB</p> <p>Via mapping</p>	<p>During T1: Noc: -94.65dBm/15kHz <math>\hat{E}_{S0}</math> / Noc: +0.00dB <math>\hat{E}_{S1}</math> / Noc: -infinity</p> <p>During T2: Noc: -94.65dBm/15kHz <math>\hat{E}_{S0}</math> / Noc: 0.00dB <math>\hat{E}_{S1}</math> / Noc: +3.50dB</p> <p><b>For configuration 1,2,4,5</b> SSB#1: RSRP_55 to RSRP_75 SSB#0: DIFFRSRP_0 to DIFFRSRP_3</p> <p><b>For configuration 3,6</b> SSB#1: RSRP_58 to RSRP_78 SSB#0: DIFFRSRP_0 to DIFFRSRP_3</p>
6.6.4.2 NR SA FR1 SSB-based L1-RSRP measurement in DRX	Same as 6.6.4.1	Same as 6.6.4.1	Same as 6.6.4.1
6.6.4.3 NR SA FR1 CSI-RS-based L1-RSRP measurement in non-DRX	<p>Noc: -98dBm/15kHz <math>\hat{E}_{S0}</math> / Noc: 0.00dB <math>\hat{E}_{S1}</math> / Noc: +3.00dB</p> <p>Reported CSI-RSRP values <math>\pm</math> 10dB Reported Differential CSI-RSRP values <math>\pm</math> 3dB</p>	<p>0dB 0dB 0.5dB</p> <p>Via mapping</p>	<p>Noc: -94.65dBm/15kHz <math>\hat{E}_{S0}</math> / Noc: 0.00dB <math>\hat{E}_{S1}</math> / Noc: +3.50dB</p> <p><b>For configuration 1,2,4,5</b> CSI-RS#1: RSRP_55 to RSRP_75 CSI-RS#0: DIFFRSRP_0 to DIFFRSRP_3</p> <p><b>For configuration 3,6</b> CSI-RS#1: RSRP_58 to RSRP_78 CSI-RS#0: DIFFRSRP_0 to DIFFRSRP_3</p>
6.6.4.4 NR SA FR1 CSI-RS-based L1-RSRP measurement in DRX	Same as 6.6.4.3	Same as 6.6.4.3	Same as 6.6.4.3
6.6.4.5 NR SA FR1 SSB-based L1-RSRP measurement in DRX for UE configured with highSpeedMeasFlag-r16	Same as 6.6.4.1	Same as 6.6.4.1	Same as 6.6.4.1
6.6.5.1 NR SA FR1 – UTRAN event-triggered reporting in non-DRX	<p>During T1: Noc: -106dBm/15kHz <math>\hat{E}_s</math> / Noc: 18dB Ioc: -70dBm/3.84MHz <math>\hat{I}_{or}</math> / Ioc: -infinity CPICH Ec / Ior: -10dB SCH Ec / Ior: -12dB</p> <p>During T2: Noc: -106dBm/15kHz <math>\hat{E}_s</math> / Noc: -2dB Ioc: -70dBm/3.84MHz <math>\hat{I}_{or}</math> / Ioc: -1.8dB CPICH Ec / Ior: -10dB SCH Ec / Ior: -12dB</p>	<p>During T1: 0dB 0dB 0dB 0dB 0dB 0dB</p> <p>During T2: 0dB 0dB 0dB 0dB 0dB 0dB</p>	<p>During T1: Noc: -106dBm/15kHz <math>\hat{E}_s</math> / Noc: 18dB Ioc: -70dBm/3.84MHz <math>\hat{I}_{or}</math> / Ioc: -infinity CPICH Ec / Ior: -10dB SCH Ec / Ior: -12dB</p> <p>During T2: Noc: -106dBm/15kHz <math>\hat{E}_s</math> / Noc: -2dB Ioc: -70dBm/3.84MHz <math>\hat{I}_{or}</math> / Ioc: -1.8dB CPICH Ec / Ior: -10dB SCH Ec / Ior: -12dB</p>
6.6.8.1 NR SA FR1 CSI-RS based CMR and no dedicated IMR L1-SINR measurement in DRX	<p>Noc: -94.65dBm/15kHz <math>\hat{E}_{S0}</math> / Noc: 0.00dB <math>\hat{E}_{S1}</math> / Noc: +3.00dB</p> <p>Reported CSI-SINR values <math>\pm</math>5.5dB Reported Differential CSI-SINR values <math>\pm</math>4.5dB</p>	<p>0dB 0dB 0dB</p> <p>Via mapping</p>	<p>Noc: -94.65dBm/15kHz <math>\hat{E}_{S0}</math> / Noc: 0.00dB <math>\hat{E}_{S1}</math> / Noc: +3.00dB</p> <p><b>For configuration 1,2,3,4,5,6</b> CSI-RS#1: SINR_41 to SINR_64 CSI-RS#0: DIFFSINR_0 to DIFFSINR_7</p>

<p>6.6.8.2 NR SA FR1 SSB based CMR and dedicated IMR L1-SINR measurement in non-DRX</p>	<p>Noc: -94.65dBm/15kHz  <math>\hat{E}_{S0}</math> / Noc: 0.00dB  <math>\hat{E}_{S1}</math> / Noc: +3.00dB</p> <p>Reported SS-SINR values <math>\pm 4</math>dB                  Reported Differential SS-SINR values <math>\pm 3</math>dB</p>	<p>0dB                  0.5dB                  0dB</p> <p>Via mapping</p>	<p>Noc: -94.65dBm/15kHz  <math>\hat{E}_{S0}</math> / Noc: 0.50dB  <math>\hat{E}_{S1}</math> / Noc: +3.00dB</p> <p><b>For configuration 1,2,3,4,5,6</b>                  SSB#1: SINR_44 to SINR_61                  SSB#0: DIFFSINR_0 to DIFFSINR_5</p>
<p>6.6.8.3 NR SA FR1 CSI-RS based CMR and dedicated IMR L1-SINR measurement in non-DRX</p>	<p>Noc: -94.65dBm/15kHz  <math>\hat{E}_{S0}</math> / Noc: 0.00dB  <math>\hat{E}_{S1}</math> / Noc: +3.00dB</p> <p>Reported CSI-SINR values <math>\pm 4.5</math>dB                  Reported Differential CSI-SINR values <math>\pm 3.5</math>dB</p>	<p>0dB                  0dB                  0dB</p> <p>Via mapping</p>	<p>Noc: -94.65dBm/15kHz  <math>\hat{E}_{S0}</math> / Noc: 0.00dB  <math>\hat{E}_{S1}</math> / Noc: +3.00dB</p> <p><b>For configuration 1,2,3,4,5,6</b>                  CSI-RS#1: SINR_43 to SINR_62                  CSI-RS#0: DIFFSINR_0 to DIFFSINR_6</p>
<p>6.7.1.1.1 NR SA FR1 SS-RSRP absolute measurement accuracy</p>	<p>TEST CONFIGURATION 1, 2,</p>		
	<p>Test 1:                  Noc: -106dBm/15kHz  <math>\hat{E}_{s1}</math> / Noc: +6.0dB  <math>\hat{E}_{s2}</math> / Noc: +1.0dB                  Reported RSRP values: <math>\pm 4.5</math>dB</p> <p>Test 2:                  Noc: -88dBm/15kHz  <math>\hat{E}_{s1}</math> / Noc: +6.0dB  <math>\hat{E}_{s2}</math> / Noc: +1.0dB                  Reported RSRP values: <math>\pm 8</math>dB</p> <p>Test 3:                  Noc: -116dBm/15kHz + <math>\Delta BG_{offset}</math>  <math>\hat{E}_{s1}</math> / Noc: +3.0dB  <math>\hat{E}_{s2}</math> / Noc: -1.0dB</p> <p>Reported RSRP values: <math>\pm 6</math>dB</p>	<p>Test 1:                  -1.5dB                  0dB                  +0.4dB                  Via mapping</p> <p>Test 2:                  0dB                  0dB                  +0.4dB                  Via mapping</p> <p>Test 3:                  0dB                  0dB                  +0.2dB                  Via mapping</p>	<p>Test 1:                  Noc: -107.5dBm/15kHz  <math>\hat{E}_{s1}</math> / Noc: +6.0dB  <math>\hat{E}_{s2}</math> / Noc: +1.4dB                  RSRP_44 to RSRP_56</p> <p>Test 2:                  Noc: -88dBm/15kHz  <math>\hat{E}_{s1}</math> / Noc: +6.0dB  <math>\hat{E}_{s2}</math> / Noc: +1.4dB                  RSRP_60 to RSRP_79</p> <p>Test 3:                  Noc: -116dBm/15kHz + <math>\Delta BG_{offset}</math>  <math>\hat{E}_{s1}</math> / Noc: +3.0dB  <math>\hat{E}_{s2}</math> / Noc: -0.8dB</p> <p>RSRP_34 to RSRP_46                  RSRP_34 to RSRP_46                  RSRP_35 to RSRP_47                  RSRP_35 to RSRP_47                  RSRP_36 to RSRP_48                  RSRP_37 to RSRP_49                  RSRP_37 to RSRP_49                  depending on operating band</p>
	<p>TEST CONFIGURATION 3</p>		

	<p>Test 1: Noc: -110dBm/30kHz <math>\hat{E}_{s1}</math> / Noc: +6.0dB <math>\hat{E}_{s2}</math> / Noc: +1.0dB Reported RSRP values: <math>\pm 4.5</math>dB</p> <p>Test 2: Noc: -91dBm/30kHz <math>\hat{E}_{s1}</math> / Noc: +6.0dB <math>\hat{E}_{s2}</math> / Noc: +1.0dB Reported RSRP values: <math>\pm 8</math>dB</p> <p>Test 3: Noc: -113dBm/30kHz + <math>\Delta BG_{offset}</math> <math>\hat{E}_{s1}</math> / Noc: +3.0dB <math>\hat{E}_{s2}</math> / Noc: -1.0dB</p> <p>Reported RSRP values: <math>\pm 6</math>dB</p>	<p>Test 1: -0.8dB 0dB +0.4dB Via mapping</p> <p>Test 2: 0dB 0dB +0.4dB Via mapping</p> <p>Test 3: 0dB 0dB +0.2dB</p> <p>Via mapping</p>	<p>Test 1: Noc: -110.8dBm/30kHz <math>\hat{E}_{s1}</math> / Noc: +6.0dB <math>\hat{E}_{s2}</math> / Noc: +1.4dB RSRP_41 to RSRP_53</p> <p>Test 2: Noc: -91dBm/30kHz <math>\hat{E}_{s1}</math> / Noc: +6.0dB <math>\hat{E}_{s2}</math> / Noc: +1.4dB RSRP_57 to RSRP_76</p> <p>Test 3: Noc: -113dBm/30kHz + <math>\Delta BG_{offset}</math> <math>\hat{E}_{s1}</math> / Noc: +3.0dB <math>\hat{E}_{s2}</math> / Noc: -0.8dB</p> <p>RSRP_37 to RSRP_49 RSRP_37 to RSRP_49 RSRP_38 to RSRP_50 RSRP_38 to RSRP_50 RSRP_39 to RSRP_51 RSRP_40 to RSRP_52 RSRP_40 to RSRP_52 depending on operating band</p>
--	--	---	--

The derivation of the RSRP values takes into account the uncertainty in Cell 2 SS-RSRP from  $N_{oc}$  and  $\hat{E}_{s2} / N_{oc}$ , the allowed UE reporting accuracy, and the UE mapping function.  
The SS-RSRP values given above are for normal conditions. In all cases the RSRP values are 4.5dB wider at each end for extreme conditions.

6.7.1.1.2 NR SA FR1 SS-RSRP relative measurement accuracy	<p>Test 1: Noc: <u>Test configuration 1, 2:-106dBm/15kHz</u> <u>Test configuration 3:-110dBm/30kHz</u></p> <p><math>\hat{E}_{s1}</math> / Noc: +6.0dB <math>\hat{E}_{s2}</math> / Noc: +1.0dB Reported rel. SS-RSRP values: <math>\pm 3</math>dB</p> <p>Test 2: Noc: -88dBm/15kHz <math>\hat{E}_{s1}</math> / Noc: +6.0dB <math>\hat{E}_{s2}</math> / Noc: +1.0dB Reported rel. SS-RSRP values: <math>\pm 3</math>dB</p> <p>Test 3: Noc: -116dBm/15kHz + <math>\Delta BG_{offset}</math></p> <p><math>\hat{E}_{s1}</math> / Noc: +3.0dB <math>\hat{E}_{s2}</math> / Noc: -1.0dB Reported re. SS-RSRP values: <math>\pm 3</math>dB</p>	<p>Test 1: 0 dB 0 dB</p> <p>0 dB +1.0dB Via mapping</p> <p>Test 2: 0dB 0dB +1.0dB Via mapping</p> <p>Test 3: 0dB +1.0dB Via mapping</p>	<p>Test 1: Noc: -106 dBm/15kHz Noc: -110 dBm/30kHz</p> <p><math>\hat{E}_{s1}</math> / Noc: +6.0dB <math>\hat{E}_{s2}</math> / Noc: +2.0dB RSRP_x-8 to RSRP_x-1</p> <p>Test 2: Noc: -88dBm/15kHz <math>\hat{E}_{s1}</math> / Noc: +6.0dB <math>\hat{E}_{s2}</math> / Noc: +2.0dB RSRP_x-8 to RSRP_x-1</p> <p>Test 3: Noc: -116dBm/15kHz + <math>\Delta BG_{offset}</math> <math>\hat{E}_{s1}</math> / Noc: +3.0dB <math>\hat{E}_{s2}</math> / Noc: 0dB RSRP_x-7 to RSRP_x+1</p>
---	---	---	--

The derivation of the SS-RSRP values takes into account the uncertainty in Cell 1 and Cell 2 RSRP from  $N_{oc}$ ,  $\hat{E}_{s1} / N_{oc}$  and  $\hat{E}_{s2} / N_{oc}$ , the allowed UE reporting accuracy, and the UE mapping function.  
The RSRP values given above are for both normal and extreme conditions.

6.7.1.2.1 NR SA FR1-FR1 SS-RSRP absolute measurement accuracy	<b>TEST CONFIGURATION 1, 2, 4, 5</b>
---	--------------------------------------

	<p><b>Test 1:</b>  <math>N_{oc1}</math>: -94.65 dBm/15kHz  <math>N_{oc2}</math>: -94.65 dBm/15kHz  <math>\hat{E}s1 / N_{oc1}</math>: +10.0dB  <math>\hat{E}s2 / N_{oc2}</math>: +10.0dB  <u>Reported RSRP values: ±8dB</u></p> <p><b>Test 2:</b>  <math>N_{oc1}</math>: -107dBm/15kHz + <math>\Delta_{BG\_offset}</math>  <math>N_{oc2}</math>: -118dBm/15kHz + <math>\Delta_{BG\_offset}</math>  <math>\hat{E}s1 / N_{oc1}</math>: +13.0dB  <math>\hat{E}s2 / N_{oc2}</math>: -3.0dB  <u>Reported RSRP values: ±4.5dB</u></p>	<p><b>Test 1:</b>  0dB  0dB  0dB  0dB  Via mapping</p> <p><b>Test 2:</b>  0dB  0dB  0dB  0dB  Via mapping</p>	<p><b>Test 1:</b>  <math>N_{oc1}</math>: -94.65dBm/15kHz  <math>N_{oc2}</math>: -94.65dBm/15kHz  <math>\hat{E}s1 / N_{oc1}</math>: +10.0dB  <math>\hat{E}s2 / N_{oc2}</math>: +10.0dB  RSRP_62 to RSRP_81</p> <p><b>Test 2:</b>  <math>N_{oc1}</math>: -107dBm/15kHz + <math>\Delta_{BG\_offset}</math>  <math>N_{oc2}</math>: -118dBm/15kHz + <math>\Delta_{BG\_offset}</math>  <math>\hat{E}s1 / N_{oc1}</math>: +13.0dB  <math>\hat{E}s2 / N_{oc2}</math>: -3.0dB  RSRP_32 to RSRP_45  RSRP_33 to RSRP_45  RSRP_33 to RSRP_46  RSRP_34 to RSRP_46  RSRP_34 to RSRP_47  RSRP_35 to RSRP_48  RSRP_36 to RSRP_48  depending on operating band</p>
<b>TEST CONFIGURATION 3, 6</b>			
	<p><b>Test 1:</b>  <math>N_{oc1}</math>: -94.65 dBm/15kHz  <math>N_{oc2}</math>: -94.65 dBm/15kHz  <math>\hat{E}s1 / N_{oc1}</math>: +10.0dB  <math>\hat{E}s2 / N_{oc2}</math>: +10.0dB  <u>Reported RSRP values: ±8dB</u></p> <p><b>Test 2:</b>  <math>N_{oc1}</math>: -107dBm/15kHz + <math>\Delta_{BG\_offset}</math>  <math>N_{oc2}</math>: -118dBm/15kHz + <math>\Delta_{BG\_offset}</math>  <math>\hat{E}s1 / N_{oc1}</math>: +13.0dB  <math>\hat{E}s2 / N_{oc2}</math>: -3.0dB  <u>Reported RSRP values: ±4.5dB</u></p>	<p><b>Test 1:</b>  -1.35dB  -1.35dB  0dB  0dB  Via mapping</p> <p><b>Test 2:</b>  0dB  0dB  0dB  0dB  Via mapping</p>	<p><b>Test 1:</b>  <math>N_{oc1}</math>: -96dBm/15kHz  <math>N_{oc2}</math>: -96dBm/15kHz  <math>\hat{E}s1 / N_{oc1}</math>: +10.0dB  <math>\hat{E}s2 / N_{oc2}</math>: +10.0dB  RSRP_64 to RSRP_83</p> <p><b>Test 2:</b>  <math>N_{oc}</math>: -107dBm/15kHz + <math>\Delta_{BG\_offset}</math>  <math>N_{oc1}</math>: -118dBm/15kHz + <math>\Delta_{BG\_offset}</math>  <math>\hat{E}s1 / N_{oc1}</math>: +13.0dB  <math>\hat{E}s2 / N_{oc2}</math>: -3.0dB  RSRP_35 to RSRP_48  RSRP_36 to RSRP_48  RSRP_36 to RSRP_49  RSRP_37 to RSRP_49  RSRP_37 to RSRP_50  RSRP_38 to RSRP_51  RSRP_39 to RSRP_51  depending on operating band</p>
<p>The derivation of the RSRP values takes into account the uncertainty in Cell 2 SS-RSRP from <math>N_{oc2}</math> and <math>\hat{E}s2 / N_{oc2}</math>, the allowed UE reporting accuracy, and the UE mapping function.  The SS-RSRP values given above are for normal conditions. For extreme conditions, the RSRP values are 3.0 dB wider at each end for Test 1, and 4.5 dB wider at each for Test 2.</p>			
<p>6.7.1.2.2 NR SA FR1-FR1 SS-RSRP relative measurement accuracy</p>	<p><b>Test 1:</b>  <math>N_{oc1}</math>: -94.65 dBm/15kHz  <math>N_{oc2}</math>: -94.65 dBm/15kHz  <math>\hat{E}s1 / N_{oc1}</math>: +10.0dB  <math>\hat{E}s2 / N_{oc2}</math>: +10.0dB  <u>Reported relative RSRP values: ±4.5dB</u></p> <p><b>Test 2:</b>  <math>N_{oc1}</math>: -107dBm/15kHz + <math>\Delta_{BG\_offset}</math>  <math>N_{oc1}</math>: -118dBm/15kHz + <math>\Delta_{BG\_offset}</math>  <math>\hat{E}s1 / N_{oc1}</math>: +13.0dB  <math>\hat{E}s2 / N_{oc2}</math>: -3.0dB  <u>Reported relative RSRP values: ±4.5dB</u></p>	<p><b>Test 1:</b>  0dB  0dB  0dB  0dB  Via mapping</p> <p><b>Test 2:</b>  0dB  0dB  0dB  0dB  Via mapping</p>	<p><b>Test 1:</b>  <math>N_{oc1}</math>: -94.65dBm/15kHz  <math>N_{oc2}</math>: -94.65dBm/15kHz  <math>\hat{E}s1 / N_{oc1}</math>: +10.0dB  <math>\hat{E}s2 / N_{oc2}</math>: +10.0dB  RSRP_x-7 to RSRP_x+7</p> <p><b>Test 2:</b>  <math>N_{oc}</math>: -107dBm/15kHz + <math>\Delta_{BG\_offset}</math>  <math>N_{oc1}</math>: -118dBm/15kHz + <math>\Delta_{BG\_offset}</math>  <math>\hat{E}s1 / N_{oc1}</math>: +13.0dB  <math>\hat{E}s2 / N_{oc2}</math>: -3.0dB  RSRP_x-31 to RSRP_x-18</p>
<p>The derivation of the SS-RSRP values takes into account the uncertainty in Cell 1 and Cell 2 RSRP from <math>N_{oc}</math>, <math>\hat{E}s1 / N_{oc}</math> and <math>\hat{E}s2 / N_{oc}</math>, the allowed UE reporting accuracy, and the UE mapping function.  The SS-RSRP values given above are for normal conditions. For extreme conditions, the RSRP values are 1.5dB wider at each end.</p>			
<p>6.7.2.1 NR SA FR1 SS-RSRQ measurement accuracy</p>	<b>TEST CONFIGURATION 1, 2, 4, 5</b>		



	<p><b>Test 1:</b>  <math>N_{oc}</math>: -85dBm/15kHz  <math>\hat{E}s1 / N_{oc}</math>: +3.0dB  <math>\hat{E}s2 / N_{oc}</math>: +3.0dB                      Reported RSRQ values: <math>\pm 2.5</math>dB</p> <p><b>Test 2:</b>  <math>N_{oc}</math>: -101dBm/15kHz  <math>\hat{E}s1 / N_{oc}</math>: -2.9dB  <math>\hat{E}s2 / N_{oc}</math>: -2.9dB                      Reported RSRQ values: <math>\pm 3.5</math>dB</p> <p><b>Test 3:</b>  <math>N_{oc}</math>: -114dBm/15kHz + <math>\Delta_{BG\_offset}</math>  <math>\hat{E}s1 / N_{oc}</math>: -4.0dB  <math>\hat{E}s2 / N_{oc}</math>: -4.0dB                      Reported RSRQ values: <math>\pm 3.5</math>dB</p>	<p><b>Test 1:</b>                      -1.5dB                      0dB                      0dB                      Via mapping</p> <p><b>Test 2:</b>                      0dB                      0dB                      0dB                      Via mapping</p> <p><b>Test 3:</b>                      0dB                      0dB                      0dB                      Via mapping</p>	<p><b>Test 1:</b>  <math>N_{oc}</math>: -86.5dBm/15kHz  <math>\hat{E}s1 / N_{oc}</math>: +3.0dB  <math>\hat{E}s2 / N_{oc}</math>: +3.0dB                      RSRQ_52 to RSRQ_62</p> <p><b>Test 2:</b>  <math>N_{oc}</math>: -101dBm/15kHz  <math>\hat{E}s1 / N_{oc}</math>: -2.9dB  <math>\hat{E}s2 / N_{oc}</math>: -2.9dB                      RSRQ_46 to RSRQ_60</p> <p><b>Test 3:</b>  <math>N_{oc}</math>: -114dBm/15kHz + <math>\Delta_{BG\_offset}</math>  <math>\hat{E}s1 / N_{oc}</math>: -3.5dB  <math>\hat{E}s2 / N_{oc}</math>: -3.5dB                      RSRQ_44 to RSRQ_59</p>
<b>TEST CONFIGURATION 3, 6</b>			
	<p><b>Test 1:</b>  <math>N_{oc}</math>: -91dBm/15kHz  <math>\hat{E}s1 / N_{oc}</math>: +3.0dB  <math>\hat{E}s2 / N_{oc}</math>: +3.0dB                      Reported RSRQ values: <math>\pm 2.5</math>dB</p> <p><b>Test 2:</b>                      N/A</p> <p><b>Test 3:</b>  <math>N_{oc}</math>: -114dBm/15kHz + <math>\Delta_{BG\_offset}</math>  <math>\hat{E}s1 / N_{oc}</math>: -4.0dB  <math>\hat{E}s2 / N_{oc}</math>: -4.0dB                      Reported RSRQ values: <math>\pm 3.5</math>dB</p>	<p><b>Test 1:</b>                      -1.6dB                      0dB                      0dB                      Via mapping</p> <p><b>Test 2:</b>                      N/A</p> <p><b>Test 3:</b>                      0dB                      0dB                      0dB                      Via mapping</p>	<p><b>Test 1:</b>  <math>N_{oc}</math>: -92.6dBm/15kHz  <math>\hat{E}s1 / N_{oc}</math>: +3.0dB  <math>\hat{E}s2 / N_{oc}</math>: +3.0dB                      RSRQ_52 to RSRQ_62</p> <p><b>Test 2:</b>                      N/A</p> <p><b>Test 3:</b>  <math>N_{oc}</math>: -114dBm/15kHz + <math>\Delta_{BG\_offset}</math>  <math>\hat{E}s1 / N_{oc}</math>: -3.5dB  <math>\hat{E}s2 / N_{oc}</math>: -3.5dB                      RSRQ_44 to RSRQ_59</p>
<p>The derivation of the RSRQ values takes into account the uncertainty in Cell 2 SS-RSRQ from <math>N_{oc}</math> and <math>\hat{E}s2 / N_{oc}</math>, the allowed UE reporting accuracy, and the UE mapping function.                      The SS-RSRQ values given above are for normal conditions. For extreme conditions, the SS-RSRQ values are 1.5dB wider at each end for Test 1, and 0.5 dB wider at each for Tests 2 and 3.</p>			
6.7.2.2.1 NR SA FR1-FR1 SS-RSRQ absolute measurement accuracy	<b>TEST CONFIGURATION 1, 2, 4, 5</b>		
	<p><b>Test 1:</b>  <math>N_{oc1}</math>: -80.18 dBm/15kHz  <math>N_{oc2}</math>: -80.18 dBm/15kHz  <math>\hat{E}s1 / N_{oc1}</math>: -1.75dB  <math>\hat{E}s2 / N_{oc2}</math>: -1.75dB                      Reported RSRQ values: <math>\pm 2.5</math>dB</p> <p><b>Test 2:</b>  <math>N_{oc1}</math>: -106dBm/15kHz  <math>N_{oc2}</math>: -106dBm/15kHz  <math>\hat{E}s1 / N_{oc1}</math>: -1.75dB  <math>\hat{E}s2 / N_{oc2}</math>: -1.75dB                      Reported RSRQ values: <math>\pm 2.5</math>dB</p> <p><b>Test 3:</b>  <math>N_{oc1}</math>: -116dBm/15kHz + <math>\Delta_{BG\_offset}</math>  <math>N_{oc2}</math>: -116dBm/15kHz + <math>\Delta_{BG\_offset}</math>  <math>\hat{E}s1 / N_{oc1}</math>: 3dB  <math>\hat{E}s2 / N_{oc2}</math>: -1.75dB                      Reported RSRQ values: <math>\pm 2.5</math>dB</p>	<p><b>Test 1:</b>                      -1.5dB                      -1.5dB                      0dB                      0dB                      Via mapping</p> <p><b>Test 2:</b>                      0dB                      0dB                      0dB                      0dB                      Via mapping</p> <p><b>Test 3:</b>                      0dB                      0dB                      0dB                      Via mapping</p>	<p><b>Test 1:</b>  <math>N_{oc1}</math>: -81.68dBm/15kHz  <math>N_{oc2}</math>: -81.68dBm/15kHz  <math>\hat{E}s1 / N_{oc1}</math>: -1.75dB  <math>\hat{E}s2 / N_{oc2}</math>: -1.75dB                      RSRQ_52 to RSRQ_62</p> <p><b>Test 2:</b>  <math>N_{oc1}</math>: -106dBm/15kHz  <math>N_{oc2}</math>: -106dBm/15kHz  <math>\hat{E}s1 / N_{oc1}</math>: -1.75dB  <math>\hat{E}s2 / N_{oc2}</math>: -1.75dB                      RSRQ_52 to RSRQ_62</p> <p><b>Test 3:</b>  <math>N_{oc1}</math>: -116dBm/15kHz + <math>\Delta_{BG\_offset}</math>  <math>N_{oc2}</math>: -116dBm/15kHz + <math>\Delta_{BG\_offset}</math>  <math>\hat{E}s1 / N_{oc1}</math>: 3dB  <math>\hat{E}s2 / N_{oc2}</math>: -1.75dB                      RSRQ_52 to RSRQ_62</p>
<b>TEST CONFIGURATION 3, 6</b>			

	<p><b>Test 1:</b>  <math>N_{oc1}</math>: -86.27 dBm/15kHz  <math>N_{oc2}</math>: -86.27 dBm/15kHz  <math>\hat{E}s1 / N_{oc1}</math>: -1.75dB  <math>\hat{E}s2 / N_{oc2}</math>: -1.75dB  <u>Reported RSRQ values: ±2.5dB</u></p> <p><b>Test 2:</b>  <math>N_{oc1}</math>: -106dBm/15kHz  <math>N_{oc2}</math>: -106dBm/15kHz  <math>\hat{E}s1 / N_{oc1}</math>: -1.75dB  <math>\hat{E}s2 / N_{oc2}</math>: -1.75dB  <u>Reported RSRQ values: ±2.5dB</u></p> <p><b>Test 3:</b>  <math>N_{oc1}</math>: -116dBm/15kHz + <math>\Delta_{BG\_offset}</math>  <math>N_{oc2}</math>: -116dBm/15kHz + <math>\Delta_{BG\_offset}</math>  <math>\hat{E}s1 / N_{oc1}</math>: 3dB  <math>\hat{E}s2 / N_{oc2}</math>: -1.75dB  <u>Reported RSRQ values: ±2.5dB</u></p>	<p><b>Test 1:</b>  -1.53dB  -1.53dB  0dB  0dB  Via mapping</p> <p><b>Test 2:</b>  0dB  0dB  0dB  0dB  Via mapping</p> <p><b>Test 3:</b>  0dB  0dB  0dB  0dB  Via mapping</p>	<p><b>Test 1:</b>  <math>N_{oc1}</math>: -87.8dBm/15kHz  <math>N_{oc2}</math>: -87.8dBm/15kHz  <math>\hat{E}s1 / N_{oc1}</math>: -1.75dB  <math>\hat{E}s2 / N_{oc2}</math>: -1.75dB  RSRQ_52 to RSRQ_62</p> <p><b>Test 2:</b>  <math>N_{oc1}</math>: -106dBm/15kHz  <math>N_{oc2}</math>: -106dBm/15kHz  <math>\hat{E}s1 / N_{oc1}</math>: -1.75dB  <math>\hat{E}s2 / N_{oc2}</math>: -1.75dB  RSRQ_52 to RSRQ_62</p> <p><b>Test 3:</b>  <math>N_{oc1}</math>: -116dBm/15kHz + <math>\Delta_{BG\_offset}</math>  <math>N_{oc2}</math>: -116dBm/15kHz + <math>\Delta_{BG\_offset}</math>  <math>\hat{E}s1 / N_{oc1}</math>: 3dB  <math>\hat{E}s2 / N_{oc2}</math>: -1.75dB  RSRQ_52 to RSRQ_62</p>
<p>The derivation of the RSRQ values takes into account the uncertainty in Cell 2 SS-RSRQ from <math>N_{oc2}</math> and <math>\hat{E}s2 / N_{oc2}</math>, the allowed UE reporting accuracy, and the UE mapping function.  The SS-RSRQ values given above are for normal conditions. For extreme conditions, the RSRQ values are 1.5dB wider at each end.</p>			
<p>6.7.2.2.2 NR SA FR1-FR1 SS-RSRQ relative measurement accuracy</p>	<p><b>TEST CONFIGURATION 1, 2, 4, 5</b></p>		
	<p><b>Test 1:</b>  <math>N_{oc1}</math>: -80.18 dBm/15kHz  <math>N_{oc2}</math>: -80.18 dBm/15kHz  <math>\hat{E}s1 / N_{oc1}</math>: -1.75dB  <math>\hat{E}s2 / N_{oc2}</math>: -1.75dB  <u>Reported RSRQ values: ±3dB</u></p> <p><b>Test 2:</b>  <math>N_{oc1}</math>: -106dBm/15kHz  <math>N_{oc2}</math>: -106dBm/15kHz  <math>\hat{E}s1 / N_{oc1}</math>: -1.75dB  <math>\hat{E}s2 / N_{oc2}</math>: -1.75dB  <u>Reported RSRQ values: ±3dB</u></p> <p><b>Test 3:</b>  <math>N_{oc1}</math>: -116dBm/15kHz + <math>\Delta_{BG\_offset}</math>  <math>N_{oc2}</math>: -116dBm/15kHz + <math>\Delta_{BG\_offset}</math>  <math>\hat{E}s1 / N_{oc1}</math>: 3dB  <math>\hat{E}s2 / N_{oc2}</math>: -1.75dB  <u>Reported RSRQ values: ±3dB</u></p>	<p><b>Test 1:</b>  -1.5dB  -1.5dB  0dB  0dB  Via mapping</p> <p><b>Test 2:</b>  0dB  0dB  0dB  0dB  Via mapping</p> <p><b>Test 3:</b>  0dB  0dB  0dB  0dB  Via mapping</p>	<p><b>Test 1:</b>  <math>N_{oc1}</math>: -81.68dBm/15kHz  <math>N_{oc2}</math>: -81.68dBm/15kHz  <math>\hat{E}s1 / N_{oc1}</math>: -1.75dB  <math>\hat{E}s2 / N_{oc2}</math>: -1.75dB  RSRQ_x-7 to RSRQ_x+7</p> <p><b>Test 2:</b>  <math>N_{oc1}</math>: -106dBm/15kHz  <math>N_{oc2}</math>: -106dBm/15kHz  <math>\hat{E}s1 / N_{oc1}</math>: -1.75dB  <math>\hat{E}s2 / N_{oc2}</math>: -1.75dB  RSRQ_x-7 to RSRQ_x+7</p> <p><b>Test 3:</b>  <math>N_{oc1}</math>: -116dBm/15kHz + <math>\Delta_{BG\_offset}</math>  <math>N_{oc2}</math>: -116dBm/15kHz + <math>\Delta_{BG\_offset}</math>  <math>\hat{E}s1 / N_{oc1}</math>: 3dB  <math>\hat{E}s2 / N_{oc2}</math>: -1.75dB  RSRQ_x-11 to RSRQ_x+2</p>
<p><b>TEST CONFIGURATION 3, 6</b></p>			

	<p><b>Test 1:</b>  <math>N_{oc1}</math>: -86.27 dBm/15kHz  <math>N_{oc2}</math>: -86.27 dBm/15kHz  <math>\hat{E}s1 / N_{oc1}</math>: -1.75dB  <math>\hat{E}s2 / N_{oc2}</math>: -1.75dB                  Reported RSRQ values: <math>\pm 2.5</math>dB</p> <p><b>Test 2:</b>  <math>N_{oc1}</math>: -106dBm/15kHz  <math>N_{oc2}</math>: -106dBm/15kHz  <math>\hat{E}s1 / N_{oc1}</math>: -1.75dB  <math>\hat{E}s2 / N_{oc2}</math>: -1.75dB</p> <p>Reported RSRQ values: <math>\pm 3</math>dB</p> <p><b>Test 3:</b>  <math>N_{oc1}</math>: -116dBm/15kHz + <math>\Delta_{BG\_offset}</math>  <math>N_{oc2}</math>: -116dBm/15kHz + <math>\Delta_{BG\_offset}</math>  <math>\hat{E}s1 / N_{oc1}</math>: 3dB  <math>\hat{E}s2 / N_{oc2}</math>: -1.75dB</p> <p>Reported RSRQ values: <math>\pm 3</math>dB</p>	<p><b>Test 1:</b>                  -1.53dB                  -1.53dB                  0dB                  0dB                  Via mapping</p> <p><b>Test 2:</b>                  0dB                  0dB                  0dB                  0dB                  Via mapping</p> <p><b>Test 3:</b>                  0dB                  0dB                  0dB                  0dB                  Via mapping</p>	<p><b>Test 1:</b>  <math>N_{oc1}</math>: -87.8dBm/15kHz  <math>N_{oc2}</math>: -87.8dBm/15kHz  <math>\hat{E}s1 / N_{oc1}</math>: -1.75dB  <math>\hat{E}s2 / N_{oc2}</math>: -1.75dB                  RSRQ_x-7 to RSRQ_x+7</p> <p><b>Test 2:</b>  <math>N_{oc1}</math>: -106dBm/15kHz  <math>N_{oc2}</math>: -106dBm/15kHz  <math>\hat{E}s1 / N_{oc1}</math>: -1.75dB  <math>\hat{E}s2 / N_{oc2}</math>: -1.75dB</p> <p>RSRQ_x-7 to RSRQ_x+7</p> <p><b>Test 3:</b>  <math>N_{oc1}</math>: -116dBm/15kHz + <math>\Delta_{BG\_offset}</math>  <math>N_{oc2}</math>: -116dBm/15kHz + <math>\Delta_{BG\_offset}</math>  <math>\hat{E}s1 / N_{oc1}</math>: 3dB  <math>\hat{E}s2 / N_{oc2}</math>: -1.75dB</p> <p>RSRQ_x-11 to RSRQ_x+2</p>
--	---	--	--

The derivation of the RSRQ values takes into account the uncertainty in Cell 1 and Cell 2 SS-RSRQ from  $N_{oc2}$  and  $\hat{E}s2 / N_{oc2}$ , the allowed UE reporting accuracy, and the UE mapping function.  
 The SS-RSRQ values given above are for normal conditions. For extreme conditions, the RSRQ values are 1dB wider at each end.

**6.7.3.1 NR SA FR1 SS-SINR measurement accuracy** **TEST CONFIGURATION 1, 2, 4, 5**

	<p><b>Test 1:</b>  <math>N_{oc}</math>: -93dBm/15kHz  <math>\hat{E}s1 / N_{oc}</math>: +4.54dB  <math>\hat{E}s2 / N_{oc}</math>: +4.54dB                  Reported SINR values: <math>\pm 3.5</math>dB</p> <p><b>Test 2:</b>  <math>N_{oc}</math>: -116dBm/15kHz+ <math>\Delta_{BG\_offset}</math>  <math>\hat{E}s1 / N_{oc}</math>: -4dB  <math>\hat{E}s2 / N_{oc}</math>: -4dB                  Reported SINR values: <math>\pm 3.5</math>dB</p>	<p><b>Test 1:</b>                  0dB                  0dB                  0dB                  Via mapping</p> <p><b>Test 2:</b>                  0dB                  0.5dB                  0.5dB                  Via mapping</p>	<p><b>Test 1:</b>  <math>N_{oc}</math>: -93dBm/15kHz  <math>\hat{E}s1 / N_{oc}</math>: +4.54dB  <math>\hat{E}s2 / N_{oc}</math>: +4.54dB                  SINR_31 to SINR_49</p> <p><b>Test 2:</b>  <math>N_{oc}</math>: -116dBm/15kHz+ <math>\Delta_{BG\_offset}</math>  <math>\hat{E}s1 / N_{oc}</math>: -3.5dB  <math>\hat{E}s2 / N_{oc}</math>: -3.5dB                  SINR_28 to SINR_45</p>
--	--	---	--

**TEST CONFIGURATION 3, 6**

	<p><b>Test 1:</b>  <math>N_{oc}</math>: -93dBm/15kHz  <math>\hat{E}s1 / N_{oc}</math>: +4.54dB  <math>\hat{E}s2 / N_{oc}</math>: +4.54dB                  Reported SINR values: <math>\pm 3.5</math>dB</p> <p><b>Test 2:</b>  <math>N_{oc}</math>: -116dBm/15kHz+ <math>\Delta_{BG\_offset}</math>  <math>\hat{E}s1 / N_{oc}</math>: -4dB  <math>\hat{E}s2 / N_{oc}</math>: -4dB                  Reported SINR values: <math>\pm 3.5</math>dB</p>	<p><b>Test 1:</b>                  -0.2dB                  0dB                  0dB                  Via mapping</p> <p><b>Test 2:</b>                  0dB                  0.5dB                  0.5dB                  Via mapping</p>	<p><b>Test 1:</b>  <math>N_{oc}</math>: -93.2dBm/15kHz  <math>\hat{E}s1 / N_{oc}</math>: +4.54dB  <math>\hat{E}s2 / N_{oc}</math>: +4.54dB                  SINR_31 to SINR_49</p> <p><b>Test 2:</b>  <math>N_{oc}</math>: -116dBm/15kHz+ <math>\Delta_{BG\_offset}</math>  <math>\hat{E}s1 / N_{oc}</math>: -3.5dB  <math>\hat{E}s2 / N_{oc}</math>: -3.5dB                  SINR_28 to SINR_45</p>
--	--	--	--

The derivation of the SINR values takes into account the uncertainty in Cell 2 SS- SINR from  $N_{oc}$  and  $\hat{E}s2 / N_{oc}$ , the allowed UE reporting accuracy, and the UE mapping function.  
 The SS- SINR values given above are for normal conditions. For extreme conditions, the SS- SINR values are 0.5dB wider at each end.

**6.7.3.2.1 NR SA FR1-FR1 SS-SINR absolute measurement accuracy** **TEST CONFIGURATION 1, 2, 3, 4, 5, 6**

	<p><b>Test 1:</b>  <math>N_{oc1}</math>: -88 dBm/15kHz  <math>N_{oc2}</math>: -88 dBm/15kHz  <math>\hat{E}s1 / N_{oc1}</math>: -1.75dB  <math>\hat{E}s2 / N_{oc2}</math>: -1.75dB  <u>Reported SINR values: <math>\pm 3</math>dB</u></p> <p><b>Test 2:</b>  <math>N_{oc1}</math>: -108.5dBm/15kHz  <math>N_{oc2}</math>: -108.5dBm/15kHz  <math>\hat{E}s1 / N_{oc1}</math>: 20dB  <math>\hat{E}s2 / N_{oc2}</math>: 20dB  <u>Reported SINR values: <math>\pm 3</math>dB</u></p> <p><b>Test 3:</b>  <math>N_{oc1}</math>: -119.5dBm/15kHz + <math>\Delta_{BG\_offset}</math>  <math>N_{oc2}</math>: -119.5dBm/15kHz + <math>\Delta_{BG\_offset}</math>  <math>\hat{E}s1 / N_{oc1}</math>: -4dB  <math>\hat{E}s2 / N_{oc2}</math>: -4dB  <u>Reported SINR values: <math>\pm 3.5</math>dB</u></p>	<p><b>Test 1:</b>  0dB  0dB  0dB  0dB  Via mapping</p> <p><b>Test 2:</b>  0dB  0dB  0dB  0dB  Via mapping</p> <p><b>Test 3:</b>  0dB  0dB  0.8dB  0.8dB  Via mapping</p>	<p><b>Test 1:</b>  <math>N_{oc1}</math>: -88 dBm/15kHz  <math>N_{oc2}</math>: -88 dBm/15kHz  <math>\hat{E}s1 / N_{oc1}</math>: -1.75dB  <math>\hat{E}s2 / N_{oc2}</math>: -1.75dB  SINR_35 to SINR_51</p> <p><b>Test 2:</b>  <math>N_{oc1}</math>: -108.5dBm/15kHz  <math>N_{oc2}</math>: -108.5dBm/15kHz  <math>\hat{E}s1 / N_{oc1}</math>: 20dB  <math>\hat{E}s2 / N_{oc2}</math>: 20dB  SINR_79 to SINR_94</p> <p><b>Test 3:</b>  <math>N_{oc1}</math>: -119.5dBm/15kHz + <math>\Delta_{BG\_offset}</math>  <math>N_{oc2}</math>: -119.5dBm/15kHz + <math>\Delta_{BG\_offset}</math>  <math>\hat{E}s1 / N_{oc1}</math>: -3.2dB  <math>\hat{E}s2 / N_{oc2}</math>: -3.2dB  SINR_32 to SINR_49</p>
--	--	--	---

The derivation of the SINR values takes into account the uncertainty in Cell 2 SS- SINR from  $N_{oc}$  and  $\hat{E}s2 / N_{oc}$ , the allowed UE reporting accuracy, and the UE mapping function.  
The SS- SINR values given above are for normal conditions. For extreme conditions, the SS- SINR values are 1dB wider at each for Tests 1 and 2 and 0.5dB wider at each end for Test 3.

**6.7.3.2.2 NR SA FR1-FR1 SS-SINR relative measurement accuracy**

**TEST CONFIGURATION 1, 2, 3, 4, 5, 6**

	<p><b>Test 1:</b>  <math>N_{oc1}</math>: -88 dBm/15kHz  <math>N_{oc2}</math>: -88 dBm/15kHz  <math>\hat{E}s1 / N_{oc1}</math>: -1.75dB  <math>\hat{E}s2 / N_{oc2}</math>: -1.75dB  <u>Reported SINR values: <math>\pm 3.5</math>dB</u></p> <p><b>Test 2:</b>  <math>N_{oc1}</math>: -108.5dBm/15kHz  <math>N_{oc2}</math>: -108.5dBm/15kHz  <math>\hat{E}s1 / N_{oc1}</math>: 20dB  <math>\hat{E}s2 / N_{oc2}</math>: 20dB  <u>Reported SINR values: <math>\pm 3.5</math>dB</u></p> <p><b>Test 3:</b>  <math>N_{oc1}</math>: -119.5dBm/15kHz + <math>\Delta_{BG\_offset}</math>  <math>N_{oc2}</math>: -119.5dBm/15kHz + <math>\Delta_{BG\_offset}</math>  <math>\hat{E}s1 / N_{oc1}</math>: -4dB  <math>\hat{E}s2 / N_{oc2}</math>: -4dB  <u>Reported SINR values: <math>\pm 4</math>dB</u></p>	<p><b>Test 1:</b>  0dB  0dB  0dB  0dB  Via mapping</p> <p><b>Test 2:</b>  0dB  0dB  0dB  0dB  Via mapping</p> <p><b>Test 3:</b>  0dB  0dB  0.8dB  0.8dB  Via mapping</p>	<p><b>Test 1:</b>  <math>N_{oc1}</math>: -88 dBm/15kHz  <math>N_{oc2}</math>: -88 dBm/15kHz  <math>\hat{E}s1 / N_{oc1}</math>: -1.75dB  <math>\hat{E}s2 / N_{oc2}</math>: -1.75dB  SINR_x-10 to SINR_x+10</p> <p><b>Test 2:</b>  <math>N_{oc1}</math>: -108.5dBm/15kHz  <math>N_{oc2}</math>: -108.5dBm/15kHz  <math>\hat{E}s1 / N_{oc1}</math>: 20dB  <math>\hat{E}s2 / N_{oc2}</math>: 20dB  SINR_x-10 to SINR_x+10</p> <p><b>Test 3:</b>  <math>N_{oc1}</math>: -119.5dBm/15kHz + <math>\Delta_{BG\_offset}</math>  <math>N_{oc2}</math>: -119.5dBm/15kHz + <math>\Delta_{BG\_offset}</math>  <math>\hat{E}s1 / N_{oc1}</math>: -3.2dB  <math>\hat{E}s2 / N_{oc2}</math>: -3.2dB  SINR_x-11 to SINR_x+11</p>
--	--	--	---

The derivation of the SINR values takes into account the uncertainty in Cell 1 and Cell 2 SS- SINR from  $N_{oc}$  and  $\hat{E}s2 / N_{oc}$ , the allowed UE reporting accuracy, and the UE mapping function.  
The SS- SINR values given above are for normal conditions. For extreme conditions, the SS- SINR values are 0.5dB wider at each for Tests 1 and 2 and 0dB wider at each end for Test 3.

**6.7.4.1.1 NR SA FR1 SSB based L1-RSRP absolute measurement accuracy**

<p>Test Configuration 1,2,4,5</p>	<p><u>Test 1:</u> N<sub>oc1</sub>: -94.65 dBm/15kHz Ê<sub>S1</sub> / N<sub>oc1</sub>: 10dB <u>Reported L1-RSRP values: ±8.5dB</u> (±4.5dB additionally for extreme conditions)</p> <p><u>Test 2:</u> N<sub>oc1</sub>: -119.5dBm/15kHz + Δ<sub>BG_offset</sub> Ê<sub>S1</sub> / N<sub>oc1</sub>: -3dB <u>Reported L1-RSRP values: ±5dB</u> (±3dB additionally for extreme conditions)</p>	<p><u>Test 1:</u> 0dB 0dB Via mapping</p> <p><u>Test 2:</u> 0dB 0.8dB Via mapping</p>	<p><u>Test 1:</u> N<sub>oc1</sub>: -94.65dBm/15kHz Ê<sub>S1</sub> / N<sub>oc1</sub>: 10dB RSRP_62 to RSRP_82</p> <p><u>Test 2:</u> N<sub>oc1</sub>: -119.2dBm/15kHz + Δ<sub>BG_offset</sub> Ê<sub>S1</sub> / N<sub>oc1</sub>: -2.2dB RSRP_31 to RSRP_44 RSRP_31 to RSRP_45 RSRP_32 to RSRP_45 RSRP_32 to RSRP_46 RSRP_33 to RSRP_46 RSRP_34 to RSRP_47 RSRP_34 to RSRP_48 depending on operating band</p>
<p>Test Configuration 3,6</p>	<p><u>Test 1:</u> N<sub>oc1</sub>: -94.65 dBm/15kHz Ê<sub>S1</sub> / N<sub>oc1</sub>: 10dB <u>Reported L1-RSRP values: ±8.5dB</u> (±4.5dB additionally for extreme conditions)</p> <p><u>Test 2:</u> N<sub>oc1</sub>: -119.5dBm/15kHz + Δ<sub>BG_offset</sub> Ê<sub>S1</sub> / N<sub>oc1</sub>: -3dB <u>Reported L1-RSRP values: ±5dB</u> (±3dB additionally for extreme conditions)</p>	<p><u>Test 1:</u> -1.35dB 0dB Via mapping</p> <p><u>Test 2:</u> 0dB 0.8dB Via mapping</p>	<p><u>Test 1:</u> N<sub>oc1</sub>: -96dBm/15kHz Ê<sub>S1</sub> / N<sub>oc1</sub>: 10dB RSRP_63 to RSRP_84</p> <p><u>Test 2:</u> N<sub>oc1</sub>: -116.2dBm/15kHz + Δ<sub>BG_offset</sub> Ê<sub>S1</sub> / N<sub>oc1</sub>: -2.2dB RSRP_34 to RSRP_47 RSRP_34 to RSRP_48 RSRP_35 to RSRP_48 RSRP_35 to RSRP_49 RSRP_36 to RSRP_49 RSRP_37 to RSRP_50 RSRP_37 to RSRP_51 depending on operating band</p>
<p>6.7.4.1.2 NR SA FR1 SSB based L1-RSRP relative measurement accuracy</p>			
<p>Test Configuration 1,2,4,5</p>	<p><u>Test 1:</u> N<sub>oc1</sub>: -94.65 dBm/15kHz Ê<sub>S1</sub> / N<sub>oc1</sub>: 10dB <u>Reported L1-RSRP values: ±8.5dB</u> (±1dB additionally for extreme conditions)</p> <p><u>Test 2:</u> N<sub>oc1</sub>: -119.5dBm/15kHz + Δ<sub>BG_offset</sub> Ê<sub>S1</sub> / N<sub>oc1</sub>: -3dB <u>Reported L1-RSRP values: ±5dB</u> (±1dB additionally for extreme conditions)</p>	<p><u>Test 1:</u> 0dB 0dB Via mapping</p> <p><u>Test 2:</u> 0dB 0.8dB Via mapping</p>	<p><u>Test 1:</u> N<sub>oc1</sub>: -94.65dBm/15kHz Ê<sub>S1</sub> / N<sub>oc1</sub>: 10dB RSRP_x-3 to RSRP_x+3</p> <p><u>Test 2:</u> N<sub>oc1</sub>: -119.2dBm/15kHz + Δ<sub>BG_offset</sub> Ê<sub>S1</sub> / N<sub>oc1</sub>: -2.2dB RSRP_x-3 to RSRP_x+3</p>
<p>Test Configuration 3,6</p>	<p><u>Test 1:</u> N<sub>oc1</sub>: -94.65 dBm/15kHz Ê<sub>S1</sub> / N<sub>oc1</sub>: 10dB <u>Reported L1-RSRP values: ±8.5dB</u> (±1dB additionally for extreme conditions)</p> <p><u>Test 2:</u> N<sub>oc1</sub>: -119.5dBm/15kHz + Δ<sub>BG_offset</sub> Ê<sub>S1</sub> / N<sub>oc1</sub>: -3dB <u>Reported L1-RSRP values: ±5dB</u> (±1dB additionally for extreme conditions)</p>	<p><u>Test 1:</u> -1.35dB 0dB Via mapping</p> <p><u>Test 2:</u> 0dB 0.8dB Via mapping</p>	<p><u>Test 1:</u> N<sub>oc1</sub>: -96dBm/15kHz Ê<sub>S1</sub> / N<sub>oc1</sub>: 10dB RSRP_x-3 to RSRP_x+3</p> <p><u>Test 2:</u> N<sub>oc1</sub>: -116.2dBm/15kHz + Δ<sub>BG_offset</sub> Ê<sub>S1</sub> / N<sub>oc1</sub>: -2.2dB RSRP_x-3 to RSRP_x+3</p>

6.7.4.2.1 NR SA FR1 CSI-RS based L1-RSRP absolute measurement accuracy	Same as 6.7.4.1.1	Same as 6.7.4.1.1	Same as 6.7.4.1.1
6.7.4.2.2 NR SA FR1 CSI-RS based L1-RSRP relative measurement accuracy	Same as 6.7.4.1.2	Same as 6.7.4.1.2	Same as 6.7.4.1.2
6.7.5.1 NR SA FR1 – E- UTRAN RSRP absolute measurement accuracy	<p>Test 1: N<sub>oc</sub>: -91.65dBm/15kHz Ê<sub>s</sub> / N<sub>oc</sub>: +10.0dB Reported RSRP values: ±9dB (±2dB additionally for extreme conditions)</p> <p>Test 2: N<sub>oc</sub>: -117dBm/15kHz+ Δ<sub>BG_offset</sub> Ê<sub>s</sub> / N<sub>oc</sub>: -4.0dB Reported RSRP values: ±4.5dB (±3.5dB additionally for extreme conditions)</p>	<p>Test 1: 0dB 0dB Via mapping</p> <p>Test 2: 0dB 0.8dB Via mapping</p>	<p>Test 1: N<sub>oc</sub>: -91.65dBm/15kHz Ê<sub>s</sub> / N<sub>oc</sub>: 10dB RSRP_48 to RSRP_70</p> <p>Test 2: N<sub>oc</sub>: -117dBm/15kHz+ Δ<sub>BG_offset</sub> Ê<sub>s</sub> / N<sub>oc</sub>: -3.2dB RSRP_14 to RSRP_27 RSRP_15 to RSRP_27 RSRP_15 to RSRP_28 RSRP_16 to RSRP_28 RSRP_16 to RSRP_29 RSRP_17 to RSRP_30 RSRP_18 to RSRP_30 Depending on operating band</p>
6.7.6.1 NR SA FR1 – E- UTRAN RSRQ absolute measurement accuracy	<p>Test 1: N<sub>oc</sub>: -83dBm/15kHz Ê<sub>s</sub> / N<sub>oc</sub>: -1.75dB Reported RSRQ values: ±2.5dB (±1.5dB additionally for extreme conditions)</p> <p>Test 2: N<sub>oc</sub>: -104.7dBm/15kHz Ê<sub>s</sub> / N<sub>oc</sub>: -4.0dB Reported RSRQ values: ±3.5dB (±0.5dB additionally for extreme conditions)</p> <p>Test 3: N<sub>oc</sub>: -119.5dBm/15kHz+ Δ<sub>BG_offset</sub> Ê<sub>s</sub> / N<sub>oc</sub>: -4.0dB Reported RSRQ values: ±3.5dB (±0.5dB additionally for extreme conditions)</p>	<p>Test 1: 0dB 0dB Via mapping</p> <p>Test 2: 0dB 0.8dB Via mapping</p> <p>Test 3: 0dB 0.8dB Via mapping</p>	<p>Test 1: N<sub>oc</sub>: -83dBm/15kHz Ê<sub>s</sub> / N<sub>oc</sub>: -1.75dB RSRQ_4 to RSRQ_16</p> <p>Test 2: N<sub>oc</sub>: -104.7dBm/15kHz Ê<sub>s</sub> / N<sub>oc</sub>: -3.2dB RSRQ_0 to RSRQ_16</p> <p>Test 3: N<sub>oc</sub>: -119.5dBm/15kHz+ Δ<sub>BG_offset</sub> Ê<sub>s</sub> / N<sub>oc</sub>: -3.2dB RSRQ_0 to RSRQ_16</p>
6.7.7.1 NR SA FR1 – E- UTRAN RS-SINR absolute measurement accuracy	<p>Test 1: N<sub>oc</sub>: -88dBm/15kHz Ê<sub>s</sub> / N<sub>oc</sub>: -1.75dB Reported RS-SINR values: ±3.0dB (±1.0dB additionally for extreme conditions)</p> <p>Test 2: N<sub>oc</sub>: -108.5dBm/15kHz Ê<sub>s</sub> / N<sub>oc</sub>: 20.0dB Reported RS-SINR values: ±3.0dB (±1.0dB additionally for extreme conditions)</p> <p>Test 3: N<sub>oc</sub>: -119.5dBm/15kHz+ Δ<sub>BG_offset</sub> Ê<sub>s</sub> / N<sub>oc</sub>: -4.0dB Reported RS-SINR values: ±3.5dB (±0.5dB additionally for extreme conditions)</p>	<p>Test 1: 0dB 0dB Via mapping</p> <p>Test 2: 0dB 0dB Via mapping</p> <p>Test 3: 0dB 0.8dB Via mapping</p>	<p>Test 1: N<sub>oc</sub>: -88dBm/15kHz Ê<sub>s</sub> / N<sub>oc</sub>: -1.75dB SINR_35 to SINR_51</p> <p>Test 2: N<sub>oc</sub>: -108.5dBm/15kHz Ê<sub>s</sub> / N<sub>oc</sub>: 20.0dB SINR_79 to SINR_94</p> <p>Test 3: N<sub>oc</sub>: -119.5dBm/15kHz+ Δ<sub>BG_offset</sub> Ê<sub>s</sub> / N<sub>oc</sub>: -3.2dB SINR_32 to SINR_49</p>

**Table F.1.3.2-3: Derivation of test requirements for EN-DC FR2 RRM tests**

Test	Minimum requirement in TS 38.133 [6]	Test tolerance (TT)	Test requirement in TS 38.533
5.3.2.2.1 EN-DC FR2 contention based random access	<p>Absolute uplink power:  <math>P_{int} \geq P \geq P_{min} \pm 14.0\text{dB}</math>  <math>P_{UMAX} \geq P &gt; P_{int} \pm 12.0\text{dB}</math></p> <p>Relative uplink power step:  <math>P_{int} \geq P \geq P_{min} \pm 6.0\text{dB}</math></p> <p><math>P_{UMAX} \geq P &gt; P_{int} \pm 4.0\text{dB}</math></p> <p>Uplink timing:  <math>120\text{kHz SCS } T_e \pm 3.5 \cdot 64 \cdot T_c</math></p>	<p>Not applicable due to UL calibration</p> <p>FFS dB</p> <p>FFS dB</p> <p>[48]<math>T_c</math></p>	<p>Absolute uplink power:  <math>\pm \text{FFS dB}</math></p> <p>Relative uplink power step:  <math>\pm(6+\text{FFS})\text{dB}</math>, either PRACH being compared <math>\leq (P_{max} - 6\text{dB})</math>  <math>\pm(4+\text{FFS})\text{dB}</math>, both PRACHs being compared <math>&gt; (P_{max} - 6\text{dB})</math></p> <p>Uplink timing:  <math>120\text{kHz SCS } T_e \pm 224 \pm [48] \cdot T_c</math></p>
5.3.2.2.2 EN-DC FR2 non-contention based random access	Same as 5.3.2.2.1	Same as 5.3.2.2.1	Same as 5.3.2.2.1
5.4.1.1 EN-DC FR2 UE transmit timing accuracy	<p><u>Test 1 (no DRX):</u>  Uplink timing: <math>\pm 3 \cdot 64 \cdot T_c</math> for 240 kHz SSB SCS  Max step size <math>T_q</math>: <math>2.5 \cdot 64 \cdot T_c</math>  Min adjust rate <math>T_p</math>: <math>2.5 \cdot 64 \cdot T_c</math>  Max adjust rate: <math>2.5 \cdot 64 \cdot T_c</math>  <math>N_{oc} = -112 \text{ dBm}/15 \text{ kHz}</math>  <math>\hat{E}s_2 / N_{oc}</math>: <math>+4.0\text{dB}</math></p> <p><u>Test 2 (with DRX):</u>  Uplink timing: <math>\pm 3 \cdot 64 \cdot T_c</math> for 240 kHz SSB SCS  <math>N_{oc} = -112 \text{ dBm}/15 \text{ kHz}</math>  <math>\hat{E}s_2 / N_{oc}</math>: <math>+4.0\text{dB}</math></p>	<p><math>\pm 0.75 \cdot 64 \cdot T_c</math>  <math>+0.625 \cdot 64 \cdot T_c</math>  <math>-3.725 \cdot 64 \cdot T_c</math>  <math>+1.225 \cdot 64 \cdot T_c</math>  <math>0\text{dB}</math>  <math>0\text{dB}</math></p> <p><math>\pm 0.75 \cdot 64 \cdot T_c</math>  <math>0\text{dB}</math>  <math>0\text{dB}</math></p>	<p><u>Test 1 (no DRX):</u>  Uplink timing: <math>\pm 3.75 \cdot 64 \cdot T_c</math>  Max step size <math>T_q</math>: <math>3.125 \cdot 64 \cdot T_c</math>  Min adjust rate: <math>-1.225 \cdot 64 \cdot T_c</math>  Max adjust rate: <math>3.725 \cdot 64 \cdot T_c</math>  <math>N_{oc} = -112 \text{ dBm}/15 \text{ kHz}</math>  <math>\hat{E}s_2 / N_{oc}</math>: <math>+4.0\text{dB}</math></p> <p><u>Test 2 (with DRX):</u>  Uplink timing: <math>\pm 3.75 \cdot 64 \cdot T_c</math>  <math>N_{oc} = -112 \text{ dBm}/15 \text{ kHz}</math>  <math>\hat{E}s_2 / N_{oc}</math>: <math>+4.0\text{dB}</math></p>
5.4.3.1 EN-DC FR2 UE timing advance adjustment accuracy	<p><math>N_{oc} = -112 \text{ dBm}/15 \text{ kHz}</math></p> <p><math>\hat{E}s_1 / N_{oc} = 4 \text{ dB}</math></p> <p><u>UE Timing Advance Adjustment Accuracy for 120kHz SCS = <math>\pm 32 T_c</math></u></p>	<p><math>0\text{dB}</math></p> <p><math>0\text{dB}</math></p> <p><math>\pm 40 T_c</math></p>	<p><math>N_{oc} = -112 \text{ dBm}/15 \text{ kHz}</math></p> <p><math>\hat{E}s_1 / N_{oc} = 4 \text{ dB}</math></p> <p><u>UE TAAA for 120kHz SCS = <math>\pm 72 T_c</math></u></p>
5.5.1.5 EN-DC FR2 radio link monitoring out-of-sync test for PSCell configured with CSI-RS-based RLM RS in non-DRX mode	<p><u>During T1:</u>  <math>N_{oc}</math>: <math>-92.1 \text{ dBm}/15\text{kHz}</math>  <math>\hat{E}s_1 / N_{oc}</math>: <math>+2 \text{ dB}</math>  <math>\hat{E}s_2 / N_{oc}</math>: <math>+2 \text{ dB}</math></p> <p><u>During T2:</u>  <math>N_{oc}</math>: <math>-92.1 \text{ dBm}/15\text{kHz}</math>  <math>\hat{E}s_1 / N_{oc}</math>: <math>-6 \text{ dB}</math>  <math>\hat{E}s_2 / N_{oc}</math>: <math>-14 \text{ dB}</math></p> <p><u>During T3:</u>  <math>N_{oc}</math>: <math>-92.1 \text{ dBm}/15\text{kHz}</math>  <math>\hat{E}s_1 / N_{oc}</math>: <math>-15 \text{ dB}</math>  <math>\hat{E}s_2 / N_{oc}</math>: <math>-15 \text{ dB}</math></p>	<p>During T1:  <math>-2.7 \text{ dB}</math>  <math>2.1 \text{ dB}</math>  <math>2.1 \text{ dB}</math></p> <p>During T2:  <math>-2.7 \text{ dB}</math>  <math>2.1 \text{ dB}</math>  <math>0 \text{ dB}</math></p> <p>During T3:  <math>-2.7 \text{ dB}</math>  <math>0 \text{ dB}</math>  <math>0 \text{ dB}</math></p>	<p><u>During T1:</u>  <math>N_{oc}</math>: <math>-94.8 \text{ dBm}/15\text{kHz}</math>  <math>\hat{E}s_1 / N_{oc}</math>: <math>+4.1 \text{ dB}</math>  <math>\hat{E}s_2 / N_{oc}</math>: <math>+4.1 \text{ dB}</math></p> <p><u>During T2:</u>  <math>N_{oc}</math>: <math>-94.8 \text{ dBm}/15\text{kHz}</math>  <math>\hat{E}s_1 / N_{oc}</math>: <math>-3.9 \text{ dB}</math>  <math>\hat{E}s_2 / N_{oc}</math>: <math>-14 \text{ dB}</math></p> <p><u>During T3:</u>  <math>N_{oc}</math>: <math>-94.8 \text{ dBm}/15\text{kHz}</math>  <math>\hat{E}s_1 / N_{oc}</math>: <math>-15 \text{ dB}</math>  <math>\hat{E}s_2 / N_{oc}</math>: <math>-15 \text{ dB}</math></p>



<p>5.5.1.6 EN-DC FR2 radio link monitoring in-sync test for PSCell configured with CSI-RS-based RLM RS in non-DRX mode</p>	<p><u>During T1:</u> Noc: -92.1 dBm/15kHz <math>\hat{E}s_1</math> / Noc: +2 dB <math>\hat{E}s_2</math> / Noc: +2 dB</p> <p><u>During T2:</u> Noc: -92.1dBm/15kHz <math>\hat{E}s_1</math> / Noc: -6 dB <math>\hat{E}s_2</math> / Noc: -14 dB</p> <p><u>During T3:</u> Noc: -92.1dBm/15kHz <math>\hat{E}s_1</math> / Noc: -15 dB <math>\hat{E}s_2</math> / Noc: -15 dB</p> <p><u>During T4:</u> Noc: -92.1dBm/15kHz <math>\hat{E}s_1</math> / Noc: -4.5 dB <math>\hat{E}s_2</math> / Noc: -15 dB</p> <p><u>During T5:</u> Noc: -92.1dBm/15kHz <math>\hat{E}s_1</math> / Noc: +2 dB <math>\hat{E}s_2</math> / Noc: -14 dB</p>	<p><u>During T1:</u> -2.7 dB 2.1 dB 2.1 dB</p> <p><u>During T2:</u> -2.7 dB 2.1 dB 0 dB</p> <p><u>During T3:</u> -2.7 dB 0 dB 0 dB</p> <p><u>During T4:</u> -2.7 dB 0 dB 0 dB</p> <p><u>During T5:</u> -2.7 dB 2.1 dB 0 dB</p>	<p><u>During T1:</u> Noc: -94.8 dBm/15kHz <math>\hat{E}s_1</math> / Noc: +4.1 dB <math>\hat{E}s_2</math> / Noc: +4.1 dB</p> <p><u>During T2:</u> Noc: -94.8 dBm/15kHz <math>\hat{E}s_1</math> / Noc: -3.9 dB <math>\hat{E}s_2</math> / Noc: -14 dB</p> <p><u>During T3:</u> Noc: -94.8 dBm/15kHz <math>\hat{E}s_1</math> / Noc: -15 dB <math>\hat{E}s_2</math> / Noc: -15 dB</p> <p><u>During T4:</u> Noc: -94.8 dBm/15kHz <math>\hat{E}s_1</math> / Noc: -4.5 dB <math>\hat{E}s_2</math> / Noc: -15 dB</p> <p><u>During T5:</u> Noc: -94.8 dBm/15kHz <math>\hat{E}s_1</math> / Noc: 4.1 dB <math>\hat{E}s_2</math> / Noc: -14 dB</p>
<p>5.5.5.1 EN-DC FR2 SSB-based beam failure detection and link recovery in non-DRX</p>	<p><u>During T1:</u> SNR_SSB q<sub>0</sub>: 5 dB SNR_SSB q<sub>1</sub>: 0.2 dB</p> <p><u>During T2:</u> SNR_SSB q<sub>0</sub>: -3 dB SNR_SSB q<sub>1</sub>: 0.2 dB</p> <p><u>During T3-T5:</u> SNR_SSB q<sub>0</sub>: -12 dB SNR_SSB q<sub>1</sub>: 20.2 dB</p> <p><u>In signaling:</u> rsrp-ThresholdSSB: -95 dBm/120kHz for Config 1,2 rsrp-ThresholdSSB: -92 dBm/240kHz for Config 3,4</p>	<p><u>+8.70 dB</u> <u>0 dB</u></p> <p><u>+8.70 dB</u> <u>0 dB</u></p> <p><u>0 dB</u> <u>-0.2 dB</u></p> <p><u>-14 dB</u></p> <p><u>-14 dB</u></p>	<p><u>During T1:</u> SNR_SSB q<sub>0</sub>: 13.7 dB SNR_SSB q<sub>1</sub>: 0.2 dB</p> <p><u>During T2:</u> SNR_SSB q<sub>0</sub>: 5.7 dB SNR_SSB q<sub>1</sub>: 0.2 dB</p> <p><u>During T3-T5:</u> SNR_SSB q<sub>0</sub>: -12 dB SNR_SSB q<sub>1</sub>: 20 dB</p> <p><u>In signaling:</u> rsrp-ThresholdSSB: -109 dBm/120kHz for Config 1,2 srp-ThresholdSSB: -106 dBm/240kHz for Config 3,4</p>
<p>5.5.5.2 EN-DC FR2 SSB-based beam failure detection and link recovery in DRX</p>	<p>Same as 5.5.5.1</p>	<p>Same as 5.5.5.1</p>	<p>Same as 5.5.5.1</p>
<p>5.5.5.3 EN-DC FR2 CSI-RS-based beam failure detection and link recovery in non-DRX</p>	<p><u>Noc = -104.7 dBm/120 kHz</u></p> <p><u><math>\hat{E}s_2</math> / Noc for CSI-RS set q<sub>0</sub></u> T1: 5 dB T2: -3 dB T3: -12 dB T4: -12 dB T5: -12 dB</p> <p><u><math>\hat{E}s_2</math> / Noc for CSI-RS set q<sub>1</sub></u> T1: 0.2 dB T2: 0.2 dB T3: 20.2 dB T4: 20.2 dB T5: 20.2 dB</p> <p><u>rsrp-ThresholdSSB: -95 dBm/SCS kHz</u></p>	<p><u>0 dB</u></p> <p><u>8.7 dB</u> <u>8.7 dB</u> <u>0 dB</u> <u>0 dB</u> <u>0 dB</u></p> <p><u>0 dB</u> <u>0 dB</u> <u>-0.2 dB</u> <u>-0.2 dB</u> <u>-0.2 dB</u></p> <p><u>-14 dB</u></p>	<p><u>Noc = -104.7 dBm/120 kHz</u></p> <p><u><math>\hat{E}s_2</math> / Noc for CSI-RS set q<sub>0</sub></u> T1: 13.7 dB T2: 5.7 dB T3: -12 dB T4: -12 dB T5: -12 dB</p> <p><u><math>\hat{E}s_2</math> / Noc for CSI-RS set q<sub>1</sub></u> T1: 0.2 dB T2: 0.2 dB T3: 20 dB T4: 20 dB T5: 20 dB</p> <p><u>rsrp-ThresholdSSB: -109.0 dBm/SCS kHz</u></p>

5.5.5.4 EN-DC FR2 CSI-RS-based beam failure detection and link recovery in DRX	Same as 5.5.5.3	Same as 5.5.5.3	Same as 5.5.5.3
5.5.5.5 EN-DC FR2 scheduling available restriction during SSB-based beam failure detection and link recovery in non-DRX	Same as 5.5.5.1	Same as 5.5.5.1	Same as 5.5.5.1
5.5.5.6 EN-DC FR2 SCell CSI-RS-based beam failure detection and link recovery in non-DRX	<p><u>Noc = -104.7 dBm/120 kHz</u></p> <p><u><math>\hat{E}_{s3} / N_{oc}</math> for CSI-RS set q0</u>  T1: 5 dB  T2: -3 dB  T3: -12 dB  T4: -12 dB  T5: -12 dB</p> <p><u><math>\hat{E}_{s3} / N_{oc}</math> for CSI-RS set q1</u>  T1: 0.2 dB  T2: 0.2 dB  T3: 20.2 dB  T4: 20.2 dB  T5: 20.2 dB</p> <p>rsrp-ThresholdBFR: -95 dBm/SCS kHz</p>	<p><u>0 dB</u></p> <p><u>8.7 dB</u>  <u>8.7 dB</u>  <u>0 dB</u>  <u>0 dB</u>  <u>0 dB</u></p> <p><u>0 dB</u>  <u>0 dB</u>  <u>-0.2 dB</u>  <u>-0.2 dB</u>  <u>-0.2 dB</u></p> <p><u>-14 dB</u></p>	<p><u>Noc = -104.7 dBm/120 kHz</u></p> <p><u><math>\hat{E}_{s3} / N_{oc}</math> for CSI-RS set q0</u>  T1: 13.7 dB  T2: 5.7 dB  T3: -12 dB  T4: -12 dB  T5: -12 dB</p> <p><u><math>\hat{E}_{s3} / N_{oc}</math> for CSI-RS set q1</u>  T1: 0.2 dB  T2: 0.2 dB  T3: 20 dB  T4: 20 dB  T5: 20 dB</p> <p>rsrp-ThresholdBFR: -109.0 dBm/SCS kHz</p>
5.5.5.7 EN-DC FR2 SCell CSI-RS-based beam failure detection and link recovery in DRX	Same as 5.5.5.6	Same as 5.5.5.6	Same as 5.5.5.6
5.6.1.1 EN-DC FR2 event-triggered reporting without gap in non-DRX	<p>During T1:  <math>\hat{E}_{s2}</math>: -86dBm/120kHz  <math>\hat{E}_{s3}</math>: -infinity</p> <p>During T2:  <math>\hat{E}_{s2}</math>: -86dBm/120kHz  <math>\hat{E}_{s3}</math>: -86dBm/120kHz</p>	<p>During T1:  <u>0dB</u>  <u>0dB</u></p> <p>During T2:  <u>0dB</u>  <u>0dB</u></p>	<p>During T1:  <math>\hat{E}_{s2}</math>: -86dBm/120kHz  <math>\hat{E}_{s3}</math>: -infinity</p> <p>During T2:  <math>\hat{E}_{s2}</math>: -86dBm/120kHz  <math>\hat{E}_{s3}</math>: -86dBm/120kHz</p>
5.6.1.2 EN-DC FR2 event-triggered reporting without gap in DRX	<p>During T1:  Noc: -98dBm/15kHz  <math>\hat{E}_{s2} / N_{oc}</math>: +4.00dB  <math>\hat{E}_{s3} / N_{oc}</math>: -infinity</p> <p>During T2:  Noc: -98dBm/15kHz  <math>\hat{E}_{s2} / N_{oc}</math>: +4.00dB  <math>\hat{E}_{s3} / N_{oc}</math>: +4.00dB</p> <p>Signalled A3-offset:  -6.0</p>	<p>During T1:  -3.5dB  0dB  0dB</p> <p>During T2:  -3.5dB  0dB  0dB</p> <p>Signalled A3-offset:  -1.0</p>	<p>During T1:  Noc: -101.5dBm/15kHz  <math>\hat{E}_{s2} / N_{oc}</math>: +4.00dB  <math>\hat{E}_{s3} / N_{oc}</math>: -infinity</p> <p>During T2:  Noc: -101.5dBm/15kHz  <math>\hat{E}_{s2} / N_{oc}</math>: +4.00dB  <math>\hat{E}_{s3} / N_{oc}</math>: +4.00dB</p> <p>Signalled A3-offset:  -7.0</p>
5.6.1.3 EN-DC FR2 event-triggered reporting with gap in non-DRX	Same as 5.6.1.1	Same as 5.6.1.1	Same as 5.6.1.1
5.6.1.4 EN-DC FR2 event-triggered reporting with gap in DRX	Same as 5.6.1.2	Same as 5.6.1.2	Same as 5.6.1.2
5.6.2.1 EN-DC FR2-FR2 event-triggered reporting in non-DRX	<p>During T1:  <math>\hat{E}_{s1}</math>: -87 dBm/120kHz  <math>\hat{E}_{s2}</math>: - infinity</p> <p>During T2:  <math>\hat{E}_{s1}</math>: -87 dBm/120kHz  <math>\hat{E}_{s2}</math>: -87 dBm/120kHz</p>	<p>During T1:  <u>0dB</u>  <u>0dB</u></p> <p>During T2:  <u>0dB</u>  <u>0dB</u></p>	<p>During T1:  <math>\hat{E}_{s1}</math>: -87 dBm/120kHz  <math>\hat{E}_{s2}</math>: - infinity</p> <p>During T2:  <math>\hat{E}_{s1}</math>: -87 dBm/120kHz  <math>\hat{E}_{s2}</math>: -87 dBm/120kHz</p>

5.6.2.2 EN-DC FR2-FR2 event-triggered reporting in DRX	<p>During T1: Noc: -104.70dBm/15kHz <math>\hat{E}s_1</math> / Noc: +6.00dB <math>\hat{E}s_2</math> / Noc: -infinity</p> <p>During T2: Noc: -104.70dBm/15kHz <math>\hat{E}s_1</math> / Noc: +6.00dB <math>\hat{E}s_2</math> / Noc: +9.00dB</p> <p>Signalled A3-offset: -6.0</p>	<p>During T1: 0dB 0dB 0dB</p> <p>During T2: 0dB 0dB 0dB</p> <p>Signalled A3-offset: -6.0</p>	<p>During T1: Noc: -104.70dBm/15kHz <math>\hat{E}s_1</math> / Noc: +6.00dB <math>\hat{E}s_2</math> / Noc: -infinity</p> <p>During T2: Noc: -104.70dBm/15kHz <math>\hat{E}s_1</math> / Noc: +6.00dB <math>\hat{E}s_2</math> / Noc: +9.00dB</p> <p>Signalled A3-offset: -12.0</p>
5.6.2.3 EN-DC FR2-FR2 event-triggered reporting in non-DRX with SSB time index detection	Same as 5.6.2.1	Same as 5.6.2.1	Same as 5.6.2.1
5.6.2.4 EN-DC FR2-FR2 event-triggered reporting in DRX with SSB time index detection	Same as 5.6.2.2	Same as 5.6.2.2	Same as 5.6.2.2
5.6.2.5 EN-DC FR1-FR2 event-triggered reporting in non-DRX	<p>During T1: <math>\hat{E}s_2</math>: - Infinity</p> <p>During T2: <math>\hat{E}s_2</math>: -87 dBm/120kHz</p>	<p>During T1: 0dB</p> <p>During T2: 0dB</p>	<p>During T1: <math>\hat{E}s_2</math>: - Infinity</p> <p>During T2: <math>\hat{E}s_2</math>: -87 dBm/120kHz</p>
5.6.2.6 EN-DC FR1-FR2 event-triggered reporting in DRX	<p>During T1: Noc = -104.7 dBm/15 kHz <math>\hat{E}s_2</math> / Noc = - Infinity</p> <p>During T2: Noc = -104.7 dBm/15 kHz <math>\hat{E}s_2</math> / Noc = 9 dB</p>	<p>During T1: 0dB 0dB</p> <p>During T2: 0dB 0dB</p>	<p>During T1: Noc = -104.7 dBm/15 kHz <math>\hat{E}s_2</math> / Noc = - Infinity</p> <p>During T2: Noc = -104.7 dBm/15 kHz <math>\hat{E}s_2</math> / Noc = 9 dB</p>
5.6.2.7 EN-DC FR1-FR2 event-triggered reporting in non-DRX with SSB time index detection	Same as 5.6.2.5	Same as 5.6.2.5	Same as 5.6.2.5
5.6.2.8 EN-DC FR1-FR2 event-triggered reporting in DRX with SSB time index detection	Same as 5.6.2.6	Same as 5.6.2.6	Same as 5.6.2.6
5.6.3.1 EN-DC FR2 SSB-based L1-RSRP measurement in non-DRX	<p>During T1: Noc: -105dBm/15kHz <math>\hat{E}s_0</math> / Noc: 0.00dB <math>\hat{E}s_1</math> / Noc: -infinity</p> <p>During T2: Noc: -105dBm/15kHz <math>\hat{E}s_0</math> / Noc: 0.00dB <math>\hat{E}s_1</math> / Noc: +9.00dB</p>	<p>During T1: 0dB 0dB 0dB</p> <p>During T2: 0dB 0dB 0dB</p>	<p>During T1: Noc: -105dBm/15kHz <math>\hat{E}s_0</math> / Noc: 0.00dB <math>\hat{E}s_1</math> / Noc: -infinity</p> <p>During T2: Noc: -105dBm/15kHz <math>\hat{E}s_0</math> / Noc: 0.00dB <math>\hat{E}s_1</math> / Noc: +9.00dB</p>
5.6.3.2 EN-DC FR2 SSB-based L1-RSRP measurement in DRX	Same as 5.6.3.1	Same as 5.6.3.1	Same as 5.6.3.1
5.6.3.3 EN-DC FR2 CSI-RS-based L1-RSRP measurement in non-DRX	<p>Noc: -105dBm/15kHz <math>\hat{E}s_0</math> / Noc: 0.00dB <math>\hat{E}s_1</math> / Noc: +9.00dB</p> <p>Reported CSI-RSRP values <math>\pm</math> 29dB Reported Differential CSI-RSRP values <math>\pm</math> 7dB</p>	<p>0dB 0dB 0dB</p> <p>Via mapping</p>	<p>Noc: -105dBm/15kHz <math>\hat{E}s_0</math> / Noc: 0.00dB <math>\hat{E}s_1</math> / Noc: +9.00dB</p> <p>CSI-RS#1: RSRP_40 to RSRP_99 CSI-RS#0: DIFFRSRP_1 to DIFFRSRP_7</p>
5.6.3.4 EN-DC FR2 CSI-RS-based L1-RSRP measurement in DRX	Same as 5.6.3.3	Same as 5.6.3.3	Same as 5.6.3.3

<p>5.6.6.1 EN-DC FR2 CSI-RS based CMR and no dedicated IMR L1-SINR measurement in DRX</p>	<p>Noc: -105dBm/15kHz  <math>\hat{E}_{s0}</math> / Noc: 0.00dB  <math>\hat{E}_{s1}</math> / Noc: +9.00dB</p> <p>Reported CSI-SINR values <math>\pm</math> 5.5dB                  Reported Differential CSI-SINR values <math>\pm</math> 4.5dB</p>	<p><u>0dB</u>  <u>0dB</u>  <u>0dB</u></p> <p>Via mapping</p>	<p>Noc: -105dBm/15kHz  <math>\hat{E}_{s0}</math> / Noc: 0.00dB  <math>\hat{E}_{s1}</math> / Noc: +9.00dB</p> <p>CSI-RS#1: SINR_51 to SINR_74                  CSI-RS#0: DIFFSINR_4 to DIFFSINR_13</p>
<p>5.6.6.2 EN-DC FR2 SSB based CMR and dedicated IMR L1-SINR measurement in non-DRX</p>	<p>During T1:                  Noc: -105dBm/15kHz  <math>\hat{E}_{s0}</math> / Noc: 0.00dB  <math>\hat{E}_{s1}</math> / Noc: -infinity</p> <p>During T2:                  Noc: -105dBm/15kHz  <math>\hat{E}_{s0}</math> / Noc: 0.00dB  <math>\hat{E}_{s1}</math> / Noc: +9.00dB</p> <p>Reported SS-SINR values <math>\pm</math> 4.0dB                  Reported Differential SS-SINR values <math>\pm</math> 3.0dB</p>	<p>During T1:                  0dB                  1.5dB                  0dB</p> <p>During T2:                  0dB                  1.5dB                  0dB</p> <p>Via mapping</p>	<p>During T1:                  Noc: -105dBm/15kHz  <math>\hat{E}_{s0}</math> / Noc: +1.50dB  <math>\hat{E}_{s1}</math> / Noc: -infinity</p> <p>During T2:                  Noc: -105dBm/15kHz  <math>\hat{E}_{s0}</math> / Noc: +1.50dB  <math>\hat{E}_{s1}</math> / Noc: +9.00dB</p> <p>SSB#1: SINR_54 to SINR_71                  SSB#0: DIFFSINR_4 to DIFFSINR_10</p>
<p>5.6.6.3 EN-DC FR2 CSI-RS based CMR and dedicated IMR L1-SINR measurement in non-DRX</p>	<p>Noc: -105dBm/15kHz  <math>\hat{E}_{s0}</math> / Noc: 0.00dB  <math>\hat{E}_{s1}</math> / Noc: +9.00dB</p> <p>Reported CSI-SINR values <math>\pm</math> 4.5dB                  Reported Differential CSI-SINR values <math>\pm</math> 3.5dB</p>	<p><u>0dB</u>  <u>0dB</u>  <u>0dB</u></p> <p>Via mapping</p>	<p>Noc: -105dBm/15kHz  <math>\hat{E}_{s0}</math> / Noc: 0.00dB  <math>\hat{E}_{s1}</math> / Noc: +9.00dB</p> <p>CSI-RS#1: SINR_53 to SINR_72                  CSI-RS#0: DIFFSINR_5 to DIFFSINR_12</p>
<p>5.7.1.1 EN-DC FR2 SS-RSRP measurement accuracy</p>	<p><u>Test 1:</u>                  Noc: -91.60dBm/15kHz  <math>\hat{E}_{s2}</math> / Noc: +6.0dB  <math>\hat{E}_{s3}</math> / Noc: +1.0dB                  Reported absolute RSRP values: <math>\pm</math>8dB                  Reported relative RSRP values: <math>\pm</math>6dB                  For extreme conditions allow <math>\pm</math>3dB + FFS MU additionally</p> <p><u>Test 2:</u>                  n257 <math>\hat{E}_{s2}</math>: -110.0dBm/120kHz                  n257 <math>\hat{E}_{s3}</math>: -110.0dBm/120kHz                  n260 <math>\hat{E}_{s2}</math>: -107.4dBm/120kHz                  n260 <math>\hat{E}_{s3}</math>: -107.4dBm/120kHz</p> <p>Reported absolute RSRP values: <math>\pm</math>8dB                  Reported relative RSRP values: <math>\pm</math>6dB                  For extreme conditions allow <math>\pm</math>3dB+ FFS MU additionally</p>	<p><u>Test 1:</u>                  -5.80dB                  0dB                  0.4dB                  Via Mapping</p> <p><u>Test 2:</u>                  7.70dB                  7.70dB                  7.70dB                  7.70dB                  Via Mapping</p>	<p><u>Test 1:</u>                  Noc: -97.40dBm/15kHz  <math>\hat{E}_{s2}</math> / Noc: +6.0dB  <math>\hat{E}_{s3}</math> / Noc: +1.4dB                  Cell 2: RSRP_50 to RSRP_108                  Cell 3: RSRP_46 to RSRP_103                  Cell 3: RSRP_x-12 to RSRP_X+2</p> <p><u>Test 2:</u>                  n257 <math>\hat{E}_{s2}</math>: -102.3dBm/120kHz                  n257 <math>\hat{E}_{s3}</math>: -102.3dBm/120kHz                  n260 <math>\hat{E}_{s2}</math>: -99.7dBm/120kHz                  n260 <math>\hat{E}_{s3}</math>: -99.7dBm/120kHz</p> <p>Band dependent. See test case tables in clause 5.7.1.1.5</p>

<p>5.7.1.2 EN-DC FR2-FR2 SS-RSRP measurement accuracy</p>	<p>Test 1 Config 1: Noc1: -90.60dBm/15kHz Noc2: -90.60dBm/15kHz <math>\hat{E}s1</math> / Noc1: +6.0dB <math>\hat{E}s2</math> / Noc2: +6.0dB Reported absolute RSRP values: <math>\pm 8.0</math>dB For extreme conditions allow <math>\pm 3</math>dB+ FFS MU additionally</p> <p>Reported relative RSRP values: <math>\pm 6.0</math>dB For extreme conditions allow <math>\pm 3</math>dB+ FFS MU additionally</p> <p>Test 2 Config 1: n257 Noc1: -108.13dBm/15kHz n257 Noc2: -113.13dBm/15kHz n260 Noc1: -105.53dBm/15kHz n260 Noc2: -110.53dBm/15kHz <math>\hat{E}s1</math> / Noc1: 17.0dB <math>\hat{E}s2</math> / Noc2: -1.0dB Reported absolute RSRP values: <math>\pm 8.0</math>dB For extreme conditions allow <math>\pm 3</math>dB+ FFS MU additionally</p> <p>Reported relative RSRP values: <math>\pm 6.0</math>dB For extreme conditions allow <math>\pm 3</math>dB+ FFS MU additionally</p> <p>Test 1 Config 2: Noc1: -93.70dBm/15kHz Noc2: -93.70dBm/15kHz <math>\hat{E}s1</math> / Noc1: +6.0dB <math>\hat{E}s2</math> / Noc2: +6.0dB Reported absolute RSRP values: <math>\pm 8.0</math>dB For extreme conditions allow <math>\pm 3</math>dB+ FFS MU additionally</p> <p>Reported relative RSRP values: <math>\pm 6.0</math>dB For extreme conditions allow <math>\pm 3</math>dB+ FFS MU additionally</p> <p>Test 2 Config 2: n257 Noc1: -108.13dBm/15kHz n257 Noc2: -113.13dBm/15kHz n260 Noc1: -105.53dBm/15kHz n260 Noc2: -110.53dBm/15kHz <math>\hat{E}s1</math> / Noc1: 17.0dB <math>\hat{E}s2</math> / Noc2: -1.0dB Reported absolute RSRP values: <math>\pm 8.0</math>dB For extreme conditions allow <math>\pm 3</math>dB+ FFS MU additionally</p>	<p>Test 1 Config 1: -5.70dB -5.70dB 0dB 0dB Via Mapping</p> <p>Via Mapping</p> <p>Test 2 Config 1: -6.60dB 0dB -6.60dB 0dB 0dB 2dB Via Mapping</p> <p>Via Mapping</p> <p>Test 1 Config 2: -5.60dB -5.60dB 0dB 0dB Via Mapping</p> <p>Via Mapping</p> <p>Test 2 Config 2: -6.60dB 0dB -6.60dB 0dB 0dB 2dB Via Mapping</p>	<p>Test 1 Config 1: Noc1: -96.30dBm/15kHz Noc2: -96.30dBm /15kHz <math>\hat{E}s1</math> / Noc1: +6.0dB <math>\hat{E}s2</math> / Noc2: +6.0dB Cell 2 n257: RSRP 41 to RSRP 109 n260: RSRP 39 to RSRP 109 Cell 3: RSRP 52 to RSRP 109</p> <p>Cell 3: n257: RSRP x-15 to RSRP x+25 n260: RSRP x-15 to RSRP x+27</p> <p>Test 2 Config 1: -114.73dBm/15kHz -113.13dBm/15kHz -112.13dBm/15kHz -110.53dBm/15kHz <math>\hat{E}s1</math> / Noc1: 17.0dB <math>\hat{E}s2</math> / Noc2: 1.0dB Cell 2 n257: RSRP 33 to RSRP 101 n260: RSRP 34 to RSRP 104 Cell 3: n257: RSRP 32 to RSRP 87 n260: RSRP 34 to RSRP 90</p> <p>Cell 3: n257: RSRP x-29 to RSRP x+11 n260: RSRP x-29 to RSRP x+13</p> <p>Test 1 Config 2: Noc1: -99.30dBm/15kHz Noc2: -99.30dBm /15kHz <math>\hat{E}s1</math> / Noc1: +6.0dB <math>\hat{E}s2</math> / Noc2: +6.0dB Cell 12 n257: RSRP 41 to RSRP 109 n260: RSRP 39 to RSRP 109 Cell 3: RSRP 52 to RSRP 109</p> <p>Cell 3: n257: RSRP x-15 to RSRP x+25 n260: RSRP x-15 to RSRP x+27</p> <p>Test 2 Config 2: -114.73dBm/15kHz -113.13dBm/15kHz -112.13dBm/15kHz -110.53dBm/15kHz <math>\hat{E}s1</math> / Noc1: 17.0dB <math>\hat{E}s2</math> / Noc2: 1.0dB Cell 2 n257: RSRP 36 to RSRP 104 n260: RSRP 37 to RSRP 107 Cell 3: n257: RSRP 35 to RSRP 90 n260: RSRP 37 to RSRP 93</p>
---	---	--	---

	Reported relative RSRP values: $\pm 6.0\text{dB}$ For extreme conditions allow $\pm 3\text{dB}+$ FFS MU additionally	Via Mapping	Cell 3: n257: RSRP $x-29$ to RSRP $x+11$ n260: RSRP $x-29$ to RSRP $x+13$
5.7.2.1 EN-DC FR2 SS-RSRQ measurement accuracy	Test 1: Noc: $-95.0\text{dBm}/15\text{kHz}$ $\hat{E}s2 / \text{Noc}$ : $+3.0\text{dB}$ $\hat{E}s3 / \text{Noc}$ : $+3.0\text{dB}$ Reported absolute RSRQ values: $\pm 2.5\text{dB}$ For extreme conditions allow $\pm 1.5\text{dB}+$ FFS MU additionally  Test 2: Noc: $-95.0\text{dBm}/15\text{kHz}$ $\hat{E}s2 / \text{Noc}$ : $-3.0\text{dB}$ $\hat{E}s3 / \text{Noc}$ : $-3.0\text{dB}$ Reported absolute RSRQ values: $\pm 3.5\text{dB}$ For extreme conditions allow $\pm 0.5\text{dB}+$ FFS MU additionally	Test 1: $-5.70\text{dB}$ $0\text{dB}$ $0\text{dB}$ Via Mapping  Test 2: $-1.70\text{dB}$ $0\text{dB}$ $0\text{dB}$ Via Mapping	Test 1: Noc: $-100.70\text{dBm}/15\text{kHz}$ $\hat{E}s2 / \text{Noc}$ : $+3.0\text{dB}$ $\hat{E}s3 / \text{Noc}$ : $+3.0\text{dB}$ Cell 3: All bands: RSRQ $41$ to RSRQ $73$  Test 2: Noc: $-96.70\text{dBm}/15\text{kHz}$ $\hat{E}s2 / \text{Noc}$ : $-3.0\text{dB}$ $\hat{E}s3 / \text{Noc}$ : $-3.0\text{dB}$ Cell 3: n257, n258, n261: RSRQ $35$ to RSRQ $71$ n260: RSRQ $34$ to RSRQ $71$
5.7.2.2 EN-DC FR2-FR2 SS-RSRQ measurement accuracy	Test 1: Noc1: $-94.03\text{dBm}/15\text{kHz}$ Noc2: $-94.03\text{dBm}/15\text{kHz}$ $\hat{E}s1 / \text{Noc1}$ : $-1.75\text{dB}$ $\hat{E}s2 / \text{Noc2}$ : $-1.75\text{dB}$ Reported absolute RSRQ values: $\pm 2.5\text{dB}$ For extreme conditions allow $\pm 1.5\text{dB}+$ FFS MU additionally Reported relative RSRQ values: $\pm 3.0\text{dB}$ For extreme conditions allow $\pm 1.0\text{dB}+$ FFS MU additionally  Test 2: Noc1: $-94.03\text{dBm}/15\text{kHz}$ Noc2: $-94.03\text{dBm}/15\text{kHz}$ $\hat{E}s1 / \text{Noc1}$ : $-3.0\text{dB}$ $\hat{E}s2 / \text{Noc2}$ : $-3.0\text{dB}$ Reported absolute RSRQ values: $\pm 3.5\text{dB}$ For extreme conditions allow $\pm 0.5\text{dB}+$ FFS MU additionally Reported relative RSRQ values: $\pm 4.0\text{dB}$ For extreme conditions allow $\pm 0.0\text{dB}+$ FFS MU additionally	Test 1: $-1.90\text{dB}$ $-1.90\text{dB}$ $0\text{dB}$ $0\text{dB}$ Via Mapping  Via Mapping  Test 2: $-1.41\text{dB}$ $-1.41\text{dB}$ $0\text{dB}$ $0\text{dB}$ Via Mapping  Via Mapping	Test 1: Noc1: $-95.93\text{dBm}/15\text{kHz}$ Noc2: $-95.93\text{dBm}/15\text{kHz}$ $\hat{E}s1 / \text{Noc1}$ : $-1.75\text{dB}$ $\hat{E}s2 / \text{Noc2}$ : $-1.75\text{dB}$ Cell 2 and Cell 3: RSRQ $41$ to RSRQ $73$  Cell 3: RSRQ $x-7$ to RSRQ $x+7$  Test 2: Noc1: $-95.44\text{dBm}/15\text{kHz}$ Noc2: $-95.44\text{dBm}/15\text{kHz}$ $\hat{E}s1 / \text{Noc1}$ : $-3.0\text{dB}$ $\hat{E}s2 / \text{Noc2}$ : $-3.0\text{dB}$ Cell 2 and Cell 3: RSRQ $37$ to RSRQ $74$  Cell 3: RSRQ $x-9$ to RSRQ $x+9$
5.7.3.1 EN-DC FR2 SS-SINR measurement accuracy	Test 1: Noc: $-105.0\text{dBm}/15\text{kHz}$ $\hat{E}s2 / \text{Noc}$ : $+4.54\text{dB}$ $\hat{E}s3 / \text{Noc}$ : $+2.66\text{dB}$ Reported absolute SINR values: $\pm 3.5\text{dB}$ For extreme conditions allow $\pm 0.5\text{dB}+$ FFS MU additionally  Test 2: Noc: $-105.0\text{dBm}/15\text{kHz}$ $\hat{E}s2 / \text{Noc}$ : $-3.0\text{dB}$ $\hat{E}s3 / \text{Noc}$ : $-3.0\text{dB}$ Reported absolute SINR values: $\pm 3.5\text{dB}$ For extreme conditions allow $\pm 0.5\text{dB}+$ FFS MU additionally	Test 1: $0\text{dB}$ $0\text{dB}$ $0\text{dB}$ Via Mapping  Test 2: $0\text{dB}$ $0.2\text{dB}$ $0.2\text{dB}$ Via Mapping	Test 1: Noc: $-105.0\text{dBm}/15\text{kHz}$ $\hat{E}s2 / \text{Noc}$ : $+4.54\text{dB}$ $\hat{E}s3 / \text{Noc}$ : $+2.66\text{dB}$ Cell 3: n257, n258, n261: SINR $22$ to RSRQ $58$ n260: SINR $21$ to RSRQ $58$  Test 2: Noc: $-105.0\text{dBm}/15\text{kHz}$ $\hat{E}s2 / \text{Noc}$ : $-2.8\text{dB}$ $\hat{E}s3 / \text{Noc}$ : $-2.8\text{dB}$ Cell 3: n257, n258, n261: SINR $18$ to RSRQ $55$ n260: SINR $18$ to RSRQ $54$

<p>5.7.3.2 EN-DC FR2-FR2 SS-SINR measurement accuracy</p>	<p>Test 1:  <u>Noc1: -105.0dBm/15kHz</u>  <u>Noc2: -105.0dBm/15kHz</u>  <u>Es1 / Noc1: -0.5dB</u>  <u>Es2 / Noc2: -0.5dB</u>                      Reported absolute SINR values: <math>\pm 3.0</math>dB                      For extreme conditions allow <math>\pm 1.0</math>dB+ FFS MU additionally</p> <p>Reported absolute SINR values: <math>\pm 3.5</math>dB                      For extreme conditions allow <math>\pm 0.5</math>dB+ FFS MU additionally</p> <p>Test 2:  <u>Noc1: -105.0dBm/15kHz</u>  <u>Noc2: -105.0dBm/15kHz</u>  <u>Es1 / Noc1: +11.0dB</u>  <u>Es2 / Noc2: +11.0dB</u>                      Reported absolute SINR values: <math>\pm 3.0</math>dB                      For extreme conditions allow <math>\pm 1.0</math>dB+ FFS MU additionally</p> <p>Reported absolute SINR values: <math>\pm 3.5</math>dB                      For extreme conditions allow <math>\pm 0.5</math>dB+ FFS MU additionally</p> <p>Test 3:  <u>Noc1: -105.0dBm/15kHz</u>  <u>Noc2: -105.0dBm/15kHz</u>  <u>Es1 / Noc1: -3.0dB</u>  <u>Es2 / Noc2: -3.0dB</u>                      Reported absolute SINR values: <math>\pm 3.5</math>dB                      For extreme conditions allow <math>\pm 0.5</math>dB+ FFS MU additionally</p> <p>Reported absolute SINR values: <math>\pm 4.0</math>dB                      For extreme conditions allow <math>\pm 0.0</math>dB+ FFS MU additionally</p>	<p>Test 1:                      0dB                      0dB                      0dB                      0dB                      Via Mapping</p> <p>Via Mapping</p> <p>Test 2:                      -0.1dB                      -0.1dB                      0dB                      0dB                      Via Mapping</p> <p>Via Mapping</p> <p>Test 3:                      0dB                      0dB                      0.9dB                      0.9dB                      Via Mapping</p> <p>Via Mapping</p>	<p>Test 1:  <u>Noc1: -105.0dBm/15kHz</u>  <u>Noc2: -105.0dBm/15kHz</u>  <u>Es1 / Noc1: -0.5dB</u>  <u>Es2 / Noc2: -0.5dB</u>                      Cell 2 and Cell 3:  <u>n257, n258, n261:</u>  <u>SINR 27 to SINR 62</u>  <u>n260: SINR 27 to SINR 61</u></p> <p>Cell 3: SINR <math>x-8</math> to SINR <math>x+8</math></p> <p>Test 2:  <u>Noc1: -105.1dBm/15kHz</u>  <u>Noc2: -105.1dBm/15kHz</u>  <u>Es1 / Noc1: +11.0dB</u>  <u>Es2 / Noc2: +11.0dB</u>                      Cell 2 and Cell 3:  <u>n257, n258, n261:</u>  <u>SINR 48 to SINR 87</u>  <u>n260: SINR 48 to SINR 86</u></p> <p>Cell 3: SINR <math>x-17</math> to SINR <math>x+17</math></p> <p>Test 3:  <u>Noc1: -105.0dBm/15kHz</u>  <u>Noc2: -105.0dBm/15kHz</u>  <u>Es1 / Noc1: -2.1dB</u>  <u>Es2 / Noc2: -2.1dB</u>                      Cell 2 and Cell 3:  <u>n257, n258, n261:</u>  <u>SINR 23 to SINR 60</u>  <u>n260: SINR 22 to SINR 59</u></p> <p>Cell 3: SINR <math>x-9</math> to SINR <math>x+9</math></p>
<p>5.7.4.1 EN-DC FR2 SSB based L1-RSRP measurement accuracy</p>	<p>Test 1:  <u>Noc: -100dBm/15kHz</u>  <u>SSB#0 Es / Noc: +10.0dB</u>  <u>SSB#1 Es / Noc: -2.0dB</u>                      Reported absolute RSRP values: <math>\pm 8.5</math>dB                      Reported relative RSRP values: <math>\pm 6.5</math>dB                      For extreme conditions allow <math>\pm 3</math>dB + FFS MU additionally</p> <p>Test 2:  <u>n257 SSB#0 Es: -108.1dBm/120kHz</u>  <u>n257 SSB#1 Es: -105.5dBm/120kHz</u>  <u>n260 SSB#0 Es: -108.1dBm/120kHz</u>  <u>n260 SSB#1 Es: -105.5dBm/120kHz</u></p> <p>Reported absolute RSRP values: <math>-6.5 + 8.5</math>dB                      Reported relative RSRP values: <math>\pm 6.5</math>dB                      For extreme conditions allow <math>\pm 3</math>dB+ FFS MU additionally</p>	<p>Test 1:                      -4.1dB                      0dB                      0.4dB</p> <p>Test 2:                      5.7dB</p>	<p>Test 1:  <u>Noc: -104.1dBm/15kHz</u>  <u>SSB#0 Es / Noc: +10.0dB</u>  <u>SSB#1 Es / Noc: -1.6dB</u>                      SSB#0: RSRP 42 to RSRP 101                      SSB#1: RSRP 31 to RSRP 89                      SSB#1-SSB#0: <math>-9</math> to <math>-2</math></p> <p>Test 2:  <u>n257 SSB#0 Es: -102.4dBm/120kHz</u>  <u>n257 SSB#1 Es: -99.8dBm/120kHz</u>  <u>n260 SSB#0 Es: -102.4dBm/120kHz</u>  <u>n260 SSB#1 Es: -99.8dBm/120kHz</u></p> <p>SSB#0 and SSB#1                      n257: RSRP 27 to RSRP 83                      n260: RSRP 30 to RSRP 86                      SSB#1-SSB#0: <math>-4</math> to <math>+4</math></p>

<p>5.7.4.2 EN-DC FR2 CSI-RS based L1-RSRP measurement accuracy</p>	<p><u>Test 1:</u>  <u>Noc: -100dBm/15kHz</u>  <u>CSI-RS#0 <math>\hat{E}_s</math> / Noc: +10.0dB</u>  <u>CSI-RS#1 <math>\hat{E}_s</math> / Noc: -2.0dB</u>  <u>Reported absolute RSRP values: <math>\pm 8.5</math>dB</u>  <u>Reported relative RSRP values: <math>\pm 6.5</math>dB</u>  <u>For extreme conditions allow <math>\pm 3</math>dB + FFS MU additionally</u></p> <p><u>Test 2:</u>  <u>n257 CSI-RS#0 <math>\hat{E}_s</math>: -108.1dBm/120kHz</u>  <u>n257 CSI-RS#1 <math>\hat{E}_s</math>: -105.5dBm/120kHz</u>  <u>n260 CSI-RS#0 <math>\hat{E}_s</math>: -108.1dBm/120kHz</u>  <u>n260 CSI-RS#1 <math>\hat{E}_s</math>: -105.5dBm/120kHz</u></p> <p><u>Reported absolute RSRP values: -6.5 +8.5dB</u>  <u>Reported relative RSRP values: <math>\pm 6.5</math>dB</u>  <u>For extreme conditions allow <math>\pm 3</math>dB+ FFS MU additionally</u></p>	<p><u>Test 1:</u>  <u>-4.1dB</u>  <u>0dB</u>  <u>0.2dB</u></p> <p><u>Test 2:</u>  <u>5.7dB</u></p>	<p><u>Test 1:</u>  <u>Noc: -104.1dBm/15kHz</u>  <u>CSI-RS#0 <math>\hat{E}_s</math> / Noc: +10.0dB</u>  <u>CSI-RS#1 <math>\hat{E}_s</math> / Noc: -1.8dB</u>  <u>CSI-RS#0: RSRP 48 to RSRP 95</u>  <u>CSI-RS#1: RSRP 30 to RSRP 89</u>  <u>CSI-RS#1-CSI-RS#0: -9 to -2</u></p> <p><u>Test 2:</u>  <u>n257 CSI-RS#0 <math>\hat{E}_s</math>: -102.4dBm/120kHz</u>  <u>n257 CSI-RS#1 <math>\hat{E}_s</math>: -99.8dBm/120kHz</u>  <u>n260 CSI-RS#0 <math>\hat{E}_s</math>: -102.4dBm/120kHz</u>  <u>n260 CSI-RS#1 <math>\hat{E}_s</math>: -99.8dBm/120kHz</u></p> <p><u>CSI-RS#0 and CSI-RS#1</u>  <u>n257: RSRP 27 to RSRP 83</u>  <u>n260: RSRP 30 to RSRP 86</u>  <u>CSI-RS#1-CSI-RS#0: -4 to +4</u></p>
--	---	--	---



**Table F.1.3.2-4: Derivation of test requirements for NR SA FR2 RRM tests**

Test	Minimum requirement in TS 38.133 [6]	Test tolerance (TT)	Test requirement in TS 38.533
7.3.1.4 NR SA FR1-FR2 synchronous DAPS handover	<p>During T1: Noc -104.7dBm/15kHz Es<sub>2</sub>/Noc -infinity</p> <p>During T2-T5: Noc -104.7 dBm/15kHz Es<sub>2</sub>/Noc 10 dB</p>	<p>During T1: 0 dB 0 dB</p> <p>During T2-T5: 0 dB 0 dB</p>	<p>During T1: Noc -104.7dBm/15kHz Es<sub>2</sub>/Noc -infinity</p> <p>During T2-T5: Noc -104.7 dBm/15kHz Es<sub>2</sub>/Noc 10 dB</p>
7.3.1.5 NR SA FR1-FR2 asynchronous DAPS handover	Same as 7.3.1.4	Same as 7.3.1.4	Same as 7.3.1.4
7.3.2.1.1 NR SA FR2 RRC re-establishment	<p>During T1: Noc = -104.7 dBm/15 kHz <math>\hat{E}s_1 / Noc = 4 \text{ dB}</math> <math>\hat{E}s_2 / Noc = 2 \text{ dB}</math></p> <p>During T2: Noc = -104.7 dBm/15 kHz <math>\hat{E}s_1 / Noc = - \text{Infinity}</math> <math>\hat{E}s_2 / Noc = 2 \text{ dB}</math></p> <p>During T3: Noc = -104.7 dBm/15 kHz <math>\hat{E}s_1 / Noc = - \text{Infinity}</math> <math>\hat{E}s_2 / Noc = 2 \text{ dB}</math></p>	<p>During T1: 0dB 0dB 0dB</p> <p>During T2: 0dB 0dB 0dB</p> <p>During T3: 0dB 0dB 0dB</p>	<p>During T1: Noc = -104.7 dBm/15 kHz <math>\hat{E}s_1 / Noc = 4 \text{ dB}</math> <math>\hat{E}s_2 / Noc = 2 \text{ dB}</math></p> <p>During T2: Noc = -104.7 dBm/15 kHz <math>\hat{E}s_1 / Noc = - \text{Infinity}</math> <math>\hat{E}s_2 / Noc = 2 \text{ dB}</math></p> <p>During T3: Noc = -104.7 dBm/15 kHz <math>\hat{E}s_1 / Noc = - \text{Infinity}</math> <math>\hat{E}s_2 / Noc = 2 \text{ dB}</math></p>
7.3.2.1.2 NR SA FR2 - FR2 RRC re-establishment	<p>During T1: Noc1 = -92.1 dBm/15 kHz Noc2 = -92.1 dBm/15 kHz <math>\hat{E}s_1 / Noc1 = 0 \text{ dB}</math> <math>\hat{E}s_2 / Noc 2 = - \text{Infinity}</math></p> <p>During T2: Noc1 = -92.1 dBm/15 kHz Noc2 = -92.1 dBm/15 kHz <math>\hat{E}s_1 / Noc1 = - \text{Infinity}</math> <math>\hat{E}s_2 / Noc2 = - \text{Infinity}</math></p> <p>During T3: Noc1 = -92.1 dBm/15 kHz Noc2 = -92.1 dBm/15 kHz <math>\hat{E}s_1 / Noc1 = - \text{Infinity}</math> <math>\hat{E}s_2 / Noc2 = 0 \text{ dB}</math></p>	<p>During T1: -0.2dB -0.2dB 0dB 0dB</p> <p>During T2: -0.2dB -0.2dB 0dB 0dB</p> <p>During T3: -0.2dB -0.2dB 0dB 0dB</p>	<p>During T1: Noc1 = -92.3 dBm/15 kHz Noc2 = -92.3 dBm/15 kHz <math>\hat{E}s_1 / Noc1 = 0 \text{ dB}</math> <math>\hat{E}s_2 / Noc 2 = - \text{Infinity}</math></p> <p>During T2: Noc1 = -92.3 dBm/15 kHz Noc2 = -92.3 dBm/15 kHz <math>\hat{E}s_1 / Noc1 = - \text{Infinity}</math> <math>\hat{E}s_2 / Noc2 = - \text{Infinity}</math></p> <p>During T3: Noc1 = -92.3 dBm/15 kHz Noc2 = -92.3 dBm/15 kHz <math>\hat{E}s_1 / Noc1 = - \text{Infinity}</math> <math>\hat{E}s_2 / Noc2 = 0 \text{ dB}</math></p>
7.3.2.2.1 NR SA FR2 contention based random access	<p>Absolute uplink power: <math>P_{\text{int}} \geq P \geq P_{\text{min}} \pm 14.0 \text{ dB}</math> <math>P_{\text{UMAX}} \geq P &gt; P_{\text{int}} \pm 12.0 \text{ dB}</math></p> <p>Relative uplink power step: <math>P_{\text{int}} \geq P \geq P_{\text{min}} \pm 6.0 \text{ dB}</math></p> <p><math>P_{\text{UMAX}} \geq P &gt; P_{\text{int}} \pm 4.0 \text{ dB}</math></p> <p>Uplink timing: 120kHz SCS <math>T_e \pm 3.5 \cdot 64 \cdot T_c</math></p>	<p>Not applicable due to UL calibration</p> <p>FFS dB</p> <p>FFS dB</p> <p>[48]<math>T_c</math></p>	<p>Absolute uplink power: <math>\pm \text{FFS dB}</math></p> <p>Relative uplink power step: <math>\pm(6+\text{FFS})\text{dB}</math>, either PRACH being compared <math>\leq (P_{\text{max}} - 6\text{dB})</math> <math>\pm(4+\text{FFS})\text{dB}</math>, both PRACHs being compared <math>&gt; (P_{\text{max}} - 6\text{dB})</math></p> <p>Uplink timing: 120kHz SCS <math>T_e \pm 224 \pm [48] \cdot T_c</math></p>
7.3.2.2.2 NR SA FR2 non-contention based random access	Same as 7.3.2.2.1	Same as 7.3.2.2.1	Same as 7.3.2.2.1

<p>7.3.3.1 NR SA FR2 conditional handover</p>	<p>During T1: Noc -104.7dBm/15kHz Es<sub>1</sub>/Noc 6 dB Es<sub>2</sub>/Noc -infinity</p> <p>During T2: Noc -104.7dBm/15kHz Es<sub>1</sub>/Noc 6 dB Es<sub>2</sub>/Noc 11dB</p> <p>In signaling: A3-offset = -1dB</p>	<p>During T1 -1.5dB 0dB 0dB</p> <p>During T2 -1.5dB 0dB 0dB</p> <p>In signaling: -1dB</p>	<p>During T1: Noc -106.2 dBm/15kHz Es<sub>1</sub>/Noc 6 dB Es<sub>2</sub>/Noc -infinity</p> <p>During T2: Noc -106.2 dBm/15kHz Es<sub>1</sub>/Noc 6 dB Es<sub>2</sub>/Noc 11dB</p> <p>In signaling: A3-offset = -2dB</p>
<p>7.4.1.1 SA FR2 UE transmit timing accuracy</p>	<p>Test 1 (no DRX): Uplink timing: <math>\pm 3 \cdot 64 \cdot T_c</math> for 240 kHz SSB SCS Max step size <math>T_q</math>: <math>2.5 \cdot 64 \cdot T_c</math> Min adjust rate <math>T_p</math>: <math>2.5 \cdot 64 \cdot T_c</math> Max adjust rate: <math>2.5 \cdot 64 \cdot T_c</math> Noc = -112 dBm/15 kHz <math>\hat{E}s_1 / N_{oc}</math>: +4.0dB</p> <p>Test 2 (with DRX): Uplink timing: <math>\pm 3 \cdot 64 \cdot T_c</math> for 240 kHz SSB SCS Noc = -112 dBm/15 kHz <math>\hat{E}s_1 / N_{oc}</math>: +4.0dB</p>	<p><math>\pm 0.75 \cdot 64 \cdot T_c</math> <math>+0.625 \cdot 64 T_c</math> <math>-3.725 \cdot 64 \cdot T_c</math> <math>+1.225 \cdot 64 \cdot T_c</math> 0dB 0dB</p> <p><math>\pm 0.75 \cdot 64 \cdot T_c</math> 0dB 0dB</p>	<p>Test 1 (no DRX): Uplink timing: <math>\pm 3.75 \cdot 64 \cdot T_c</math> Max step size <math>T_q</math>: <math>3.125 \cdot 64 \cdot T_c</math> Min adjust rate: <math>-1.225 \cdot 64 \cdot T_c</math> Max adjust rate: <math>3.725 \cdot 64 \cdot T_c</math> Noc = -112 dBm/15 kHz <math>\hat{E}s_1 / N_{oc}</math>: +4.0dB</p> <p>Test 2 (with DRX): Uplink timing: <math>\pm 3.75 \cdot 64 \cdot T_c</math> Noc = -112 dBm/15 kHz <math>\hat{E}s_1 / N_{oc}</math>: +4.0dB</p>
<p>7.4.3.1 NR SA FR2 UE timing advance adjustment accuracy</p>	<p><u>Noc = -112 dBm/15 kHz</u></p> <p><u><math>\hat{E}s_1 / N_{oc} = 4</math> dB</u></p> <p><u>UE Timing Advance Adjustment Accuracy for 120kHz SCS = <math>\pm 32 T_c</math></u></p>	<p><u>0dB</u></p> <p><u>0dB</u></p> <p><u>+/- 40 Tc</u></p>	<p><u>Noc = -112 dBm/15 kHz</u></p> <p><u><math>\hat{E}s_1 / N_{oc} = 4</math> dB</u></p> <p><u>UE TAA for 120kHz SCS = <math>\pm 72 T_c</math></u></p>
<p>7.5.5.1 NR SA FR2 SSB-based beam failure detection and link recovery in non-DRX</p>	<p>During T1: <u>SNR<sub>SSB</sub> q<sub>0</sub>: 5 dB</u> <u>SNR<sub>SSB</sub> q<sub>1</sub>: 0.2 dB</u></p> <p>During T2: <u>SNR<sub>SSB</sub> q<sub>0</sub>: -3 dB</u> <u>SNR<sub>SSB</sub> q<sub>1</sub>: 0.2 dB</u></p> <p>During T3-T5: <u>SNR<sub>SSB</sub> q<sub>0</sub>: -12 dB</u> <u>SNR<sub>SSB</sub> q<sub>1</sub>: 20.2 dB</u></p> <p>In signaling: <u>rsrp-ThresholdSSB: -95 dBm/120kHz for Config 1</u> <u>rsrp-ThresholdSSB: -92 dBm/240kHz for Config 2</u></p>	<p><u>+8.70 dB</u> <u>0 dB</u></p> <p><u>+8.70 dB</u> <u>0 dB</u></p> <p><u>0 dB</u> <u>-0.2 dB</u></p> <p><u>-14 dB</u></p> <p><u>-14 dB</u></p>	<p>During T1: <u>SNR<sub>SSB</sub> q<sub>0</sub>: 13.7 dB</u> <u>SNR<sub>SSB</sub> q<sub>1</sub>: 0.2 dB</u></p> <p>During T2: <u>SNR<sub>SSB</sub> q<sub>0</sub>: 5.7 dB</u> <u>SNR<sub>SSB</sub> q<sub>1</sub>: 0.2 dB</u></p> <p>During T3-T5: <u>SNR<sub>SSB</sub> q<sub>0</sub>: -12 dB</u> <u>SNR<sub>SSB</sub> q<sub>1</sub>: 20 dB</u></p> <p>In signaling: <u>rsrp-ThresholdSSB: -109 dBm/120kHz for Config 1</u> <u>srp-ThresholdSSB: -106 dBm/240kHz for Config 2</u></p>
<p>7.5.5.2 NR SA FR2 SSB-based beam failure detection and link recovery in DRX</p>	<p>Same as 7.5.5.1</p>	<p>Same as 7.5.5.1</p>	<p>Same as 7.5.5.1</p>

<p>7.5.5.3 NR SA FR2 CSI-RS-based beam failure detection and link recovery in non-DRX</p>	<p><u>Noc = -104.7 dBm/120 kHz</u></p> <p><u><math>\hat{E}_{s1} / N_{oc}</math> for CSI-RS set q0</u>  T1: 5 dB  T2: -3 dB  T3: -12 dB  T4: -12 dB  T5: -12 dB</p> <p><u><math>\hat{E}_{s1} / N_{oc}</math> for CSI-RS set q1</u>  T1: 0.2 dB  T2: 0.2 dB  T3: 20.2 dB  T4: 20.2 dB  T5: 20.2 dB</p> <p>rsrp-ThresholdSSB: -95 dBm/SCS kHz</p>	<p>0 dB</p> <p>8.7 dB  8.7 dB  0 dB  0 dB  0 dB</p> <p>0 dB  0 dB  -0.2 dB  -0.2 dB  -0.2 dB</p> <p>-14 dB</p>	<p><u>Noc = -104.7 dBm/120 kHz</u></p> <p><u><math>\hat{E}_{s1} / N_{oc}</math> for CSI-RS set q0</u>  T1: 13.7 dB  T2: 5.7 dB  T3: -12 dB  T4: -12 dB  T5: -12 dB</p> <p><u><math>\hat{E}_{s1} / N_{oc}</math> for CSI-RS set q1</u>  T1: 0.2 dB  T2: 0.2 dB  T3: 20 dB  T4: 20 dB  T5: 20 dB</p> <p>rsrp-ThresholdSSB: -109.0 dBm/SCS kHz</p>
<p>7.5.5.4 NR SA FR2 CSI-RS-based beam failure detection and link recovery in DRX</p>	<p>Same as 7.5.5.3</p>	<p>Same as 7.5.5.3</p>	<p>Same as 7.5.5.3</p>
<p>7.5.5.5 NR SA FR2 scheduling available restriction during SSB-based beam failure detection and link recovery in non-DRX</p>	<p>Same as 7.5.5.1</p>	<p>Same as 7.5.5.1</p>	<p>Same as 7.5.5.1</p>
<p>7.5.5.6 NR SA FR2 SCell CSI-RS-based beam failure detection and link recovery in non-DRX</p>	<p><u>Noc = -104.7 dBm/120 kHz</u></p> <p><u><math>\hat{E}_{s2} / N_{oc}</math> for CSI-RS set q0</u>  T1: 5 dB  T2: -3 dB  T3: -12 dB  T4: -12 dB  T5: -12 dB</p> <p><u><math>\hat{E}_{s2} / N_{oc}</math> for CSI-RS set q1</u>  T1: 0.2 dB  T2: 0.2 dB  T3: 20.2 dB  T4: 20.2 dB  T5: 20.2 dB</p> <p>rsrp-ThresholdBFR: -95 dBm/SCS kHz</p>	<p>0 dB</p> <p>8.7 dB  8.7 dB  0 dB  0 dB  0 dB</p> <p>0 dB  0 dB  -0.2 dB  -0.2 dB  -0.2 dB</p> <p>-14 dB</p>	<p><u>Noc = -104.7 dBm/120 kHz</u></p> <p><u><math>\hat{E}_{s2} / N_{oc}</math> for CSI-RS set q0</u>  T1: 13.7 dB  T2: 5.7 dB  T3: -12 dB  T4: -12 dB  T5: -12 dB</p> <p><u><math>\hat{E}_{s2} / N_{oc}</math> for CSI-RS set q1</u>  T1: 0.2 dB  T2: 0.2 dB  T3: 20 dB  T4: 20 dB  T5: 20 dB</p> <p>rsrp-ThresholdBFR: -109.0 dBm/SCS kHz</p>
<p>7.5.5.7 NR SA FR2 SCell CSI-RS-based beam failure detection and link recovery in DRX</p>	<p>Same as 7.5.5.6</p>	<p>Same as 7.5.5.6</p>	<p>Same as 7.5.5.6</p>
<p>7.6.1.1 NR SA FR2 event-triggered reporting without gap in non-DRX</p>	<p>During T1:  <math>\hat{E}_{s1}</math>: -86dBm/120kHz  <math>\hat{E}_{s2}</math>: -infinity</p> <p>During T2:  <math>\hat{E}_{s1}</math>: -86dBm/120kHz  <math>\hat{E}_{s2}</math>: -86dBm/120kHz</p>	<p>During T1:  0dB  0dB</p> <p>During T2:  0dB  0dB</p>	<p>During T1:  <math>\hat{E}_{s1}</math>: -86dBm/120kHz  <math>\hat{E}_{s2}</math>: -infinity</p> <p>During T2:  <math>\hat{E}_{s1}</math>: -86dBm/120kHz  <math>\hat{E}_{s2}</math>: -86dBm/120kHz</p>

7.6.1.2 NR SA FR2 event-triggered reporting without gap in DRX	<p>During T1: Noc: -98dBm/15kHz <math>\hat{E}s1</math> / Noc: +4.00dB <math>\hat{E}s2</math> / Noc: -infinity</p> <p>During T2: Noc: -98dBm/15kHz <math>\hat{E}s1</math> / Noc: +4.00dB <math>\hat{E}s2</math> / Noc: +4.00dB</p> <p>Signalled A3-offset: -6.0</p>	<p>During T1: -3.5dB 0dB 0dB</p> <p>During T2: -3.5dB 0dB 0dB</p> <p>Signalled A3-offset: -1.0</p>	<p>During T1: Noc: -101.5dBm/15kHz <math>\hat{E}s1</math> / Noc: +4.00dB <math>\hat{E}s2</math> / Noc: -infinity</p> <p>During T2: Noc: -101.5dBm/15kHz <math>\hat{E}s1</math> / Noc: +4.00dB <math>\hat{E}s2</math> / Noc: +4.00dB</p> <p>Signalled A3-offset: -7.0</p>
7.6.1.3 NR SA FR2 event-triggered reporting with gap in non-DRX	Same as 7.6.1.1	Same as 7.6.1.1	Same as 7.6.1.1
7.6.1.4 NR SA FR2 event-triggered reporting with gap in DRX	Same as 7.6.1.2	Same as 7.6.1.2	Same as 7.6.1.2
7.6.2.1 NR SA FR2-FR2 event-triggered reporting in non-DRX	<p>During T1: <math>\hat{E}s1</math>: -87 dBm/120kHz <math>\hat{E}s2</math>: - infinity</p> <p>During T2: <math>\hat{E}s1</math>: -87 dBm/120kHz <math>\hat{E}s2</math>: -87 dBm/120kHz</p>	<p>During T1: 0dB 0dB</p> <p>During T2: 0dB 0dB</p>	<p>During T1: <math>\hat{E}s1</math>: -87 dBm/120kHz <math>\hat{E}s2</math>: - infinity</p> <p>During T2: <math>\hat{E}s1</math>: -87 dBm/120kHz <math>\hat{E}s2</math>: -87 dBm/120kHz</p>
7.6.2.3 NR SA FR2-FR2 event-triggered reporting in non-DRX with SSB time index detection	Same as 7.6.2.1	Same as 7.6.2.1	Same as 7.6.2.1
7.6.2.5 SA event triggered reporting tests for FR2 without SSB time index detection when DRX is not used (PCell in FR1)	<p>During T1: <math>\hat{E}s2</math>: - Infinity</p> <p>During T2: <math>\hat{E}s2</math>: -87 dBm/120kHz</p>	<p>During T1: 0dB</p> <p>During T2: 0dB</p>	<p>During T1: <math>\hat{E}s2</math>: - Infinity</p> <p>During T2: <math>\hat{E}s2</math>: -87 dBm/120kHz</p>

7.6.2.6 SA event triggered reporting tests for FR2 without SSB time index detection when DRX is used (PCell in FR1)	<p>During T1: Noc = -104.7 dBm/15 kHz <math>\hat{E}_{s2} / \text{Noc} = -\text{Infinity}</math></p> <p>During T2: Noc = -104.7 dBm/15 kHz <math>\hat{E}_{s2} / \text{Noc} = 9 \text{ dB}</math></p>	<p>During T1: 0dB 0dB</p> <p>During T2: 0dB 0dB</p>	<p>During T1: Noc = -104.7 dBm/15 kHz <math>\hat{E}_{s2} / \text{Noc} = -\text{Infinity}</math></p> <p>During T2: Noc = -104.7 dBm/15 kHz <math>\hat{E}_{s2} / \text{Noc} = 9 \text{ dB}</math></p>
7.6.2.7 SA event triggered reporting tests for FR2 with SSB time index detection when DRX is not used (PCell in FR1)	Same as 5.6.2.5	Same as 5.6.2.5	Same as 5.6.2.5
7.6.2.8 SA event triggered reporting tests for FR2 with SSB time index detection when DRX is used (PCell in FR1)	Same as 5.6.2.6	Same as 5.6.2.6	Same as 5.6.2.6
7.6.3.1 NR SA FR2 SSB-based L1-RSRP measurement in non-DRX	Same as 5.6.3.1	Same as 5.6.3.1	Same as 5.6.3.1
7.6.3.2 NR SA FR2 SSB-based L1-RSRP measurement in DRX	Same as 5.6.3.1	Same as 5.6.3.1	Same as 5.6.3.1
7.6.3.3 NR SA FR2 CSI-RS-based L1-RSRP measurement in non-DRX	<p>Noc: -105dBm/15kHz <math>\hat{E}_{s0} / \text{Noc}</math>: 0.00dB <math>\hat{E}_{s1} / \text{Noc}</math>: +9.00dB</p> <p>Reported CSI-RSRP values <math>\pm 29\text{dB}</math> Reported Differential CSI-RSRP values <math>\pm 7\text{dB}</math></p>	<p>0dB 0dB 0dB</p> <p>Via mapping</p>	<p>Noc: -105dBm/15kHz <math>\hat{E}_{s0} / \text{Noc}</math>: 0.00dB <math>\hat{E}_{s1} / \text{Noc}</math>: +9.00dB</p> <p>CSI-RS#1: RSRP_40 to RSRP_99 CSI-RS#0: DIFFRSRP_1 to DIFFRSRP_7</p>
7.6.3.4 NR SA FR2 CSI-RS-based L1-RSRP measurement in DRX	Same as 7.6.3.3	Same as 7.6.3.3	Same as 7.6.3.3
7.6.6.1 NR SA FR2 CSI-RS based CMR and no dedicated IMR configured and CSI-RS resource set with repetition off L1-SINR measurement accuracy	Same as 5.6.6.1	Same as 5.6.6.1	Same as 5.6.6.1
7.6.6.2 NR SA FR2 SSB based CMR and dedicated IMR L1-SINR measurement accuracy	<p>During T1: Noc: -105dBm/15kHz <math>\hat{E}_{s0} / \text{Noc}</math>: 0.00dB <math>\hat{E}_{s1} / \text{Noc}</math>: -infinity</p> <p>During T2: Noc: -105dBm/15kHz <math>\hat{E}_{s0} / \text{Noc}</math>: 0.00dB <math>\hat{E}_{s1} / \text{Noc}</math>: +9.00dB</p> <p>Reported SS-SINR values <math>\pm 4.5\text{dB}</math> Reported Differential SS-SINR values <math>\pm 3.5\text{dB}</math></p>	<p>During T1: 0dB 0dB 0dB</p> <p>During T2: 0dB 0dB 0dB</p> <p>Via mapping</p>	<p>During T1: Noc: -105dBm/15kHz <math>\hat{E}_{s0} / \text{Noc}</math>: 0.00dB <math>\hat{E}_{s1} / \text{Noc}</math>: -infinity</p> <p>During T2: Noc: -105dBm/15kHz <math>\hat{E}_{s0} / \text{Noc}</math>: 0.00dB <math>\hat{E}_{s1} / \text{Noc}</math>: +9.00dB</p> <p>SSB#1: SINR_53 to SINR_72 SSB#0: DIFFSINR_5 to DIFFSINR_12</p>
7.6.6.3 NR SA FR2 CSI-RS based CMR and dedicated IMR L1-SINR measurement accuracy	<p>Noc: -105dBm/15kHz <math>\hat{E}_{s0} / \text{Noc}</math>: 0.00dB <math>\hat{E}_{s1} / \text{Noc}</math>: +9.00dB</p> <p>Reported CSI-SINR values <math>\pm 4.0\text{dB}</math> Reported Differential CSI-SINR values <math>\pm 3.0\text{dB}</math></p>	<p>0dB 1.5dB 0dB</p> <p>Via mapping</p>	<p>Noc: -105dBm/15kHz <math>\hat{E}_{s0} / \text{Noc}</math>: +1.50dB <math>\hat{E}_{s1} / \text{Noc}</math>: +9.00dB</p> <p>CSI-RS#1: SINR_54 to SINR_71 CSI-RS#0: DIFFSINR_4 to DIFFSINR_10</p>

<p>7.7.1.1 NR SA FR2 SS- RSRP measurement accuracy</p>	<p><u>Test 1:</u>  <u>Noc: -91.60dBm/15kHz</u>  <u>Es1 / Noc: +6.0dB</u>  <u>Es2 / Noc: +1.0dB</u>  <u>Reported absolute RSRP values: ±8dB</u>  <u>Reported relative RSRP values: ±6dB</u>  <u>For extreme conditions allow ±3dB + FFS MU</u>  <u>additionally</u></p> <p><u>Test 2:</u>  <u>n257 Es1: -110.0dBm/120kHz</u>  <u>n257 Es2: -110.0dBm/120kHz</u>  <u>n260 Es1: -107.4dBm/120kHz</u>  <u>n260 Es2: -107.4dBm/120kHz</u></p> <p><u>Reported absolute RSRP values: ±8dB</u>  <u>Reported relative RSRP values: ±6dB</u>  <u>For extreme conditions allow ±3dB+ FFS MU</u>  <u>additionally</u></p>	<p><u>Test 1:</u>  <u>-5.80dB</u>  <u>0dB</u>  <u>0.4dB</u>  <u>Via Mapping</u></p> <p><u>Test 2:</u>  <u>7.70dB</u>  <u>7.70dB</u>  <u>7.70dB</u>  <u>Via Mapping</u></p>	<p><u>Test 1:</u>  <u>Noc: -97.40dBm/15kHz</u>  <u>Es1 / Noc: +6.0dB</u>  <u>Es2 / Noc: +1.4dB</u>  <u>Cell 1: RSRP 50 to</u>  <u>RSRP 108</u>  <u>Cell 2: RSRP 46 to</u>  <u>RSRP 103</u>  <u>Cell 2: RSRP x-12 to</u>  <u>RSRP X+2</u></p> <p><u>Test 2:</u>  <u>n257 Es1: -102.3dBm/120kHz</u>  <u>n257 Es2: -102.3dBm/120kHz</u>  <u>n260 Es1: -99.7dBm/120kHz</u>  <u>n260 Es2: -99.7dBm/120kHz</u></p> <p><u>Band dependent. See test</u>  <u>case tables in clause 5.7.1.1.5</u></p>
--	---	--	---

<p>7.7.1.2 NR SA FR2-FR2 SS-RSRP measurement accuracy</p>	<p>Test 1 Config 1: Noc1: -90.60dBm/15kHz Noc2: -90.60dBm/15kHz <math>\hat{E}_{s1}</math> / Noc1: +6.0dB <math>\hat{E}_{s2}</math> / Noc2: +6.0dB Reported absolute RSRP values: <math>\pm 8.0</math>dB For extreme conditions allow <math>\pm 3</math>dB+ FFS MU additionally</p>	<p>Test 1 Config 1: -5.70dB -5.70dB 0dB 0dB Via Mapping</p>	<p>Test 1 Config 1: Noc1: -96.30dBm/15kHz Noc2: -96.30dBm /15kHz <math>\hat{E}_{s1}</math> / Noc1: +6.0dB <math>\hat{E}_{s2}</math> / Noc2: +6.0dB Cell 1 n257: RSRP 41 to RSRP 109 n260: RSRP 39 to RSRP 109 Cell 2: RSRP 52 to RSRP 109</p>
	<p>Reported relative RSRP values: <math>\pm 6.0</math>dB For extreme conditions allow <math>\pm 3</math>dB+ FFS MU additionally</p>	<p>Via Mapping</p>	<p>Cell 2: n257: RSRP x-15 to RSRP x+25 n260: RSRP x-15 to RSRP x+27</p>
	<p>Test 2 Config 1: n257 Noc1: -108.13dBm/15kHz n257 Noc2: -113.13dBm/15kHz n260 Noc1: -105.53dBm/15kHz n260 Noc2: -110.53dBm/15kHz <math>\hat{E}_{s1}</math> / Noc1: 17.0dB <math>\hat{E}_{s2}</math> / Noc2: -1.0dB Reported absolute RSRP values: <math>\pm 8.0</math>dB For extreme conditions allow <math>\pm 3</math>dB+ FFS MU additionally</p>	<p>Test 2 Config 1: -6.60dB 0dB -6.60dB 0dB 0dB 2dB Via Mapping</p>	<p>Test 2 Config 1: -114.73dBm/15kHz -113.13dBm/15kHz -112.13dBm/15kHz -110.53dBm/15kHz <math>\hat{E}_{s1}</math> / Noc1: 17.0dB <math>\hat{E}_{s2}</math> / Noc2: 1.0dB Cell 1 n257: RSRP 33 to RSRP 101 n260: RSRP 34 to RSRP 104 Cell 2: n257: RSRP 32 to RSRP 87 n260: RSRP 34 to RSRP 90</p>
	<p>Reported relative RSRP values: <math>\pm 6.0</math>dB For extreme conditions allow <math>\pm 3</math>dB+ FFS MU additionally</p>	<p>Via Mapping</p>	<p>Cell 2: n257: RSRP x-29 to RSRP x+11 n260: RSRP x-29 to RSRP x+13</p>
	<p>Test 1 Config 2: Noc1: -93.70dBm/15kHz Noc2: -93.70dBm/15kHz <math>\hat{E}_{s1}</math> / Noc1: +6.0dB <math>\hat{E}_{s2}</math> / Noc2: +6.0dB Reported absolute RSRP values: <math>\pm 8.0</math>dB For extreme conditions allow <math>\pm 3</math>dB+ FFS MU additionally</p>	<p>Test 1 Config 2: -5.60dB -5.60dB 0dB 0dB Via Mapping</p>	<p>Test 1 Config 2: Noc1: -99.30dBm/15kHz Noc2: -99.30dBm /15kHz <math>\hat{E}_{s1}</math> / Noc1: +6.0dB <math>\hat{E}_{s2}</math> / Noc2: +6.0dB Cell 1 n257: RSRP 41 to RSRP 109 n260: RSRP 39 to RSRP 109 Cell 2: RSRP 52 to RSRP 109</p>
	<p>Reported relative RSRP values: <math>\pm 6.0</math>dB For extreme conditions allow <math>\pm 3</math>dB+ FFS MU additionally</p>	<p>Via Mapping</p>	<p>Cell 2: n257: RSRP x-15 to RSRP x+25 n260: RSRP x-15 to RSRP x+27</p>
	<p>Test 2 Config 2: n257 Noc1: -108.13dBm/15kHz n257 Noc2: -113.13dBm/15kHz n260 Noc1: -105.53dBm/15kHz n260 Noc2: -110.53dBm/15kHz <math>\hat{E}_{s1}</math> / Noc1: 17.0dB <math>\hat{E}_{s2}</math> / Noc2: -1.0dB Reported absolute RSRP values: <math>\pm 8.0</math>dB For extreme conditions allow <math>\pm 3</math>dB+ FFS MU additionally</p>	<p>Test 2 Config 2: -6.60dB 0dB -6.60dB 0dB 0dB 2dB Via Mapping</p>	<p>Test 2 Config 2: -114.73dBm/15kHz -113.13dBm/15kHz -112.13dBm/15kHz -110.53dBm/15kHz <math>\hat{E}_{s1}</math> / Noc1: 17.0dB <math>\hat{E}_{s2}</math> / Noc2: 1.0dB Cell 1 n257: RSRP 36 to RSRP 104 n260: RSRP 37 to RSRP 107 Cell 2: n257: RSRP 35 to RSRP 90 n260: RSRP 37 to RSRP 93</p>



	Reported relative RSRP values: $\pm 6.0$ dB For extreme conditions allow $\pm 3$ dB+ FFS MU additionally	Via Mapping	Cell 2: n257: RSRP_x-29 to RSRP_x+11 n260: RSRP_x-29 to RSRP_x+13
7.7.2.1 NR SA FR2 SS-RSRQ measurement accuracy	Test 1: Noc: -95.0dBm/15kHz $\hat{E}_{s1}$ / Noc: +3.0dB $\hat{E}_{s2}$ / Noc: +3.0dB Reported absolute RSRQ values: $\pm 2.5$ dB For extreme conditions allow $\pm 1.5$ dB+ FFS MU additionally  Test 2: Noc: -95.0dBm/15kHz $\hat{E}_{s1}$ / Noc: -3.0dB $\hat{E}_{s2}$ / Noc: -3.0dB Reported absolute RSRQ values: $\pm 3.5$ dB For extreme conditions allow $\pm 0.5$ dB+ FFS MU additionally	Test 1: -5.70dB 0dB 0dB Via Mapping  Test 2: -1.70dB 0dB 0dB Via Mapping	Test 1: Noc: -100.70dBm/15kHz $\hat{E}_{s1}$ / Noc: +3.0dB $\hat{E}_{s2}$ / Noc: +3.0dB Cell 2: All bands: RSRQ_41 to RSRQ_73  Test 2: Noc: -96.70dBm/15kHz $\hat{E}_{s1}$ / Noc: -3.0dB $\hat{E}_{s2}$ / Noc: -3.0dB Cell 2: n257, n258, n261: RSRQ_35 to RSRQ_71 n260: RSRQ_34 to RSRQ_71
7.7.2.2 NR SA FR2-FR2 SS-RSRQ measurement accuracy	Test 1: Noc1: -94.03dBm/15kHz Noc2: -94.03dBm/15kHz $\hat{E}_{s1}$ / Noc1: -1.75dB $\hat{E}_{s2}$ / Noc2: -1.75dB Reported absolute RSRQ values: $\pm 2.5$ dB For extreme conditions allow $\pm 1.5$ dB+ FFS MU additionally Reported relative RSRQ values: $\pm 3.0$ dB For extreme conditions allow $\pm 1.0$ dB+ FFS MU additionally  Test 2: Noc1: -94.03dBm/15kHz Noc2: -94.03dBm/15kHz $\hat{E}_{s1}$ / Noc1: -3.0dB $\hat{E}_{s2}$ / Noc2: -3.0dB Reported absolute RSRQ values: $\pm 3.5$ dB For extreme conditions allow $\pm 0.5$ dB+ FFS MU additionally Reported relative RSRQ values: $\pm 4.0$ dB For extreme conditions allow $\pm 0.0$ dB+ FFS MU additionally	Test 1: -1.90dB -1.90dB 0dB 0dB Via Mapping  Via Mapping  Test 2: -1.41dB -1.41dB 0dB 0dB Via Mapping  Via Mapping	Test 1: Noc1: -95.93dBm/15kHz Noc2: -95.93dBm/15kHz $\hat{E}_{s1}$ / Noc1: -1.75dB $\hat{E}_{s2}$ / Noc2: -1.75dB Cell 1 and Cell 2: RSRQ_41 to RSRQ_73  Cell 2: RSRQ_x-7 to RSRQ_x+7  Test 2: Noc1: -95.44dBm/15kHz Noc2: -95.44dBm/15kHz $\hat{E}_{s1}$ / Noc1: -3.0dB $\hat{E}_{s2}$ / Noc2: -3.0dB Cell 1 and Cell 2: RSRQ_37 to RSRQ_74  Cell 2: RSRQ_x-9 to RSRQ_x+9
7.7.3.1 NR SA FR2 SS-SINR measurement accuracy	Test 1: Noc: -105.0dBm/15kHz $\hat{E}_{s1}$ / Noc: +4.54dB $\hat{E}_{s2}$ / Noc: +2.66dB Reported absolute SINR values: $\pm 3.5$ dB For extreme conditions allow $\pm 0.5$ dB+ FFS MU additionally  Test 2: Noc: -105.0dBm/15kHz $\hat{E}_{s1}$ / Noc: -3.0dB $\hat{E}_{s2}$ / Noc: -3.0dB Reported absolute SINR values: $\pm 3.5$ dB For extreme conditions allow $\pm 0.5$ dB+ FFS MU additionally	Test 1: 0dB 0dB 0dB Via Mapping  Test 2: 0dB 0.2dB 0.2dB Via Mapping	Test 1: Noc: -105.0dBm/15kHz $\hat{E}_{s1}$ / Noc: +4.54dB $\hat{E}_{s2}$ / Noc: +2.66dB Cell 2: n257, n258, n261: SINR_22 to RSRQ_58 n260: SINR_21 to RSRQ_58  Test 2: Noc: -105.0dBm/15kHz $\hat{E}_{s1}$ / Noc: -2.8dB $\hat{E}_{s2}$ / Noc: -2.8dB Cell 2: n257, n258, n261: SINR_18 to RSRQ_55 n260: SINR_18 to RSRQ_54

<p>7.7.3.2 NR SA FR2-FR2 SS-SINR measurement accuracy</p>	<p><u>Test 1:</u>  <u>Noc1: -105.0dBm/15kHz</u>  <u>Noc2: -105.0dBm/15kHz</u>  <u>Es1 / Noc1: -0.5dB</u>  <u>Es2 / Noc2: -0.5dB</u>  <u>Reported absolute SINR values: ±3.0dB</u>  <u>For extreme conditions allow ±1.0dB+ FFS MU additionally</u></p> <p><u>Reported absolute SINR values: ±3.5dB</u>  <u>For extreme conditions allow ±0.5dB+ FFS MU additionally</u></p> <p><u>Test 2:</u>  <u>Noc1: -105.0dBm/15kHz</u>  <u>Noc2: -105.0dBm/15kHz</u>  <u>Es1 / Noc1: +11.0dB</u>  <u>Es2 / Noc2: +11.0dB</u>  <u>Reported absolute SINR values: ±3.0dB</u>  <u>For extreme conditions allow ±1.0dB+ FFS MU additionally</u></p> <p><u>Reported absolute SINR values: ±3.5dB</u>  <u>For extreme conditions allow ±0.5dB+ FFS MU additionally</u></p> <p><u>Test 3:</u>  <u>Noc1: -105.0dBm/15kHz</u>  <u>Noc2: -105.0dBm/15kHz</u>  <u>Es1 / Noc1: -3.0dB</u>  <u>Es2 / Noc2: -3.0dB</u>  <u>Reported absolute SINR values: ±3.5dB</u>  <u>For extreme conditions allow ±0.5dB+ FFS MU additionally</u></p> <p><u>Reported absolute SINR values: ±4.0dB</u>  <u>For extreme conditions allow ±0.0dB+ FFS MU additionally</u></p>	<p><u>Test 1:</u>  <u>0dB</u>  <u>0dB</u>  <u>0dB</u>  <u>0dB</u>  <u>Via Mapping</u></p> <p><u>Via Mapping</u></p> <p><u>Test 2:</u>  <u>-0.1dB</u>  <u>-0.1dB</u>  <u>0dB</u>  <u>0dB</u>  <u>Via Mapping</u></p> <p><u>Via Mapping</u></p> <p><u>Test 3:</u>  <u>0dB</u>  <u>0dB</u>  <u>0.9dB</u>  <u>0.9dB</u>  <u>Via Mapping</u></p> <p><u>Via Mapping</u></p>	<p><u>Test 1:</u>  <u>Noc1: -105.0dBm/15kHz</u>  <u>Noc2: -105.0dBm/15kHz</u>  <u>Es1 / Noc1: -0.5dB</u>  <u>Es2 / Noc2: -0.5dB</u>  <u>Cell 1 and Cell 2:</u>  <u>n257, n258, n261:</u>  <u>SINR 27 to SINR 62</u>  <u>n260: SINR 27 to SINR 61</u></p> <p><u>Cell 2: SINR x-8 to SINR x+8</u></p> <p><u>Test 2:</u>  <u>Noc1: -105.1dBm/15kHz</u>  <u>Noc2: -105.1dBm/15kHz</u>  <u>Es1 / Noc1: +11.0dB</u>  <u>Es2 / Noc2: +11.0dB</u>  <u>Cell 1 and Cell 2:</u>  <u>n257, n258, n261:</u>  <u>SINR 48 to SINR 87</u>  <u>n260: SINR 48 to SINR 86</u></p> <p><u>Cell 2: SINR x-17 to SINR x+17</u></p> <p><u>Test 3:</u>  <u>Noc1: -105.0dBm/15kHz</u>  <u>Noc2: -105.0dBm/15kHz</u>  <u>Es1 / Noc1: -2.1dB</u>  <u>Es2 / Noc2: -2.1dB</u>  <u>Cell 1 and Cell 2:</u>  <u>n257, n258, n261:</u>  <u>SINR 23 to SINR 60</u>  <u>n260: SINR 22 to SINR 59</u></p> <p><u>Cell 2: SINR x-9 to SINR x+9</u></p>
<p>7.7.4.1 NR SA FR2 SSB based L1-RSRP measurement accuracy</p>	<p><u>Test 1:</u>  <u>Noc: -100dBm/15kHz</u>  <u>SSB#0 Es / Noc: +10.0dB</u>  <u>SSB#1 Es / Noc: -2.0dB</u>  <u>Reported absolute RSRP values: ±8.5dB</u>  <u>Reported relative RSRP values: ±6.5dB</u>  <u>For extreme conditions allow ±3dB + FFS MU additionally</u></p> <p><u>Test 2:</u>  <u>n257 SSB#0 Es: -108.1dBm/120kHz</u>  <u>n257 SSB#1 Es: -105.5dBm/120kHz</u>  <u>n260 SSB#0 Es: -108.1dBm/120kHz</u>  <u>n260 SSB#1 Es: -105.5dBm/120kHz</u></p> <p><u>Reported absolute RSRP values: -6.5 +8.5dB</u>  <u>Reported relative RSRP values: ±6.5dB</u>  <u>For extreme conditions allow ±3dB+ FFS MU additionally</u></p>	<p><u>Test 1:</u>  <u>-4.1dB</u>  <u>0dB</u>  <u>0.4dB</u></p> <p><u>Test 2:</u>  <u>5.7dB</u></p>	<p><u>Test 1:</u>  <u>Noc: -104.1dBm/15kHz</u>  <u>SSB#0 Es / Noc: +10.0dB</u>  <u>SSB#1 Es / Noc: -1.6dB</u>  <u>SSB#0: RSRP 42 to RSRP 101</u>  <u>SSB#1: RSRP 31 to RSRP 89</u>  <u>SSB#1-SSB#0: -9 to -2</u></p> <p><u>Test 2:</u>  <u>n257 SSB#0 Es: -102.4dBm/120kHz</u>  <u>n257 SSB#1 Es: -99.8dBm/120kHz</u>  <u>n260 SSB#0 Es: -102.4dBm/120kHz</u>  <u>n260 SSB#1 Es: -99.8dBm/120kHz</u></p> <p><u>SSB#0 and SSB#1</u>  <u>n257: RSRP 27 to RSRP 83</u>  <u>n260: RSRP 30 to RSRP 86</u>  <u>SSB#1-SSB#0: -4 to +4</u></p>

<p>7.7.4.2 NR SA FR2 CSI-RS based L1-RSRP measurement accuracy</p>	<p><u>Test 1:</u>  <u>Noc: -100dBm/15kHz</u>  <u>CSI-RS#0 <math>\hat{E}_s</math> / Noc: +10.0dB</u>  <u>CSI-RS#1 <math>\hat{E}_s</math> / Noc: -2.0dB</u>  <u>Reported absolute RSRP values: <math>\pm 8.5</math>dB</u>  <u>Reported relative RSRP values: <math>\pm 6.5</math>dB</u>  <u>For extreme conditions allow <math>\pm 3</math>dB + FFS MU additionally</u></p> <p><u>Test 2:</u>  <u>n257 CSI-RS#0 <math>\hat{E}_s</math>: -108.1dBm/120kHz</u>  <u>n257 CSI-RS#1 <math>\hat{E}_s</math>: -105.5dBm/120kHz</u>  <u>n260 CSI-RS#0 <math>\hat{E}_s</math>: -108.1dBm/120kHz</u>  <u>n260 CSI-RS#1 <math>\hat{E}_s</math>: -105.5dBm/120kHz</u></p> <p><u>Reported absolute RSRP values: -6.5 +8.5dB</u>  <u>Reported relative RSRP values: <math>\pm 6.5</math>dB</u>  <u>For extreme conditions allow <math>\pm 3</math>dB+ FFS MU additionally</u></p>	<p><u>Test 1:</u>  <u>-4.1dB</u>  <u>0dB</u>  <u>0.2dB</u></p> <p><u>Test 2:</u>  <u>5.7dB</u></p>	<p><u>Test 1:</u>  <u>Noc: -104.1dBm/15kHz</u>  <u>CSI-RS#0 <math>\hat{E}_s</math> / Noc: +10.0dB</u>  <u>CSI-RS#1 <math>\hat{E}_s</math> / Noc: -1.8dB</u>  <u>CSI-RS#0: RSRP 45 to RSRP 104</u>  <u>CSI-RS#1: RSRP 30 to RSRP 89</u>  <u>CSI-RS#1-CSI-RS#0: -9 to -2</u></p> <p><u>Test 2:</u>  <u>n257 CSI-RS#0 <math>\hat{E}_s</math>: -102.4dBm/120kHz</u>  <u>n257 CSI-RS#1 <math>\hat{E}_s</math>: -99.8dBm/120kHz</u>  <u>n260 CSI-RS#0 <math>\hat{E}_s</math>: -102.4dBm/120kHz</u>  <u>n260 CSI-RS#1 <math>\hat{E}_s</math>: -99.8dBm/120kHz</u></p> <p><u>CSI-RS#0 and CSI-RS#1</u>  <u>n257: RSRP 27 to RSRP 83</u>  <u>n260: RSRP 30 to RSRP 86</u>  <u>CSI-RS#1-CSI-RS#0: -4 to +4</u></p>
--	---	--	--

**Table F.1.3.2-6: Derivation of test requirements for E-UTRA – NR inter-RAT test cases with E-UTRA serving cell RRM tests**

Test	Minimum requirement in TS 38.133 [6]	Test tolerance (TT)	Test requirement in TS 38.533
8.2.1.1 E-UTRA – NR FR1 cell re-selection to higher priority NR target cell	<p>During T1: Noc1: -98dBm/15kHz Noc2: -98dBm/15kHz Ês1 / Noc1: +14dB Ês2 / Noc2: -4dB</p> <p>During T2: Noc1: -98dBm/15kHz Noc2: -98dBm/15kHz Ês1 / Noc1: +14dB Ês2 / Noc2: -infinity</p> <p>During T3: Noc1: -98dBm/15kHz Noc2: -98dBm/15kHz Ês1 / Noc1: +14dB Ês2 / Noc2: +12dB</p>	<p>During T1: 0dB -1.90dB 0dB 0.35dB</p> <p>During T2: 0dB 0dB 0dB 0dB</p> <p>During T3: 0dB 0dB 1.55dB 1.55dB</p>	<p>During T1: Noc1: -98dBm/15kHz Noc2: -99.90dBm/15kHz Ês1 / Noc1: +14dB Ês2 / Noc2: -3.65dB</p> <p>During T2: Noc1: -98dBm/15kHz Noc2: -98dBm/15kHz Ês1 / Noc1: +14dB Ês2 / Noc2: -infinity</p> <p>During T3: Noc1: -98dBm/15kHz Noc2: -98dBm/15kHz Ês1 / Noc1: +15.55dB Ês2 / Noc2: +13.55dB</p>
8.2.1.2 E-UTRA – NR FR1 Cell reselection to lower priority NR target Cell in FR1 for UE configured with highSpeedInterRAT-NR-r16	<p>During T1: Noc1: -98dBm/15kHz Noc2: -98dBm/15kHz Ês1 / Noc1: -4dB Ês2 / Noc2: 14dB</p> <p>During T2: Noc1: -98dBm/15kHz Noc2: -98dBm/15kHz Ês1 / Noc1: +12dB Ês2 / Noc2: +14dB</p>	<p>During T1: -1.90dB -1.90dB 0.35dB 3.45dB</p> <p>During T2: -1.90dB -1.90dB 3.45dB 0dB</p>	<p>During T1: Noc1: -99.9dBm/15kHz Noc2: -99.9dBm/15kHz Ês1 / Noc1: -3.65dB Ês2 / Noc2: 17.45dB</p> <p>During T2: Noc1: -99.9dBm/15kHz Noc2: -99.9dBm/15kHz Ês1 / Noc1: +15.45dB Ês2 / Noc2: +14dB</p>
8.3.1.1 E-UTRA – NR FR1 handover with known target cell	<p>During T1: Noc1: -98dBm/15kHz Noc2: -98dBm/15kHz Ês1 / Noc1: +7dB Ês2 / Noc2: -infinity</p> <p>During T2: Noc1: -98dBm/15kHz Noc2: -98dBm/15kHz Ês1 / Noc1: +7dB Ês2 / Noc2: 0dB</p> <p>During T3: Noc1: -98dBm/15kHz Noc2: -98dBm/15kHz Ês1 / Noc1: +7dB Ês2 / Noc2: 0dB</p>	<p>During T1: 0dB 0dB 0dB 0dB</p> <p>During T2: 0dB 0dB -1.55dB +1.55dB</p> <p>During T3: 0dB 0dB -1.55dB +1.55dB</p>	<p>During T1: Noc1: -98dBm/15kHz Noc2: -98dBm/15kHz Ês1 / Noc1: +7dB Ês2 / Noc2: -infinity</p> <p>During T2: Noc1: -98dBm/15kHz Noc2: -98dBm/15kHz Ês1 / Noc1: +5.45dB Ês2 / Noc2: +1.55dB</p> <p>During T3: Noc1: -98dBm/15kHz Noc2: -98dBm/15kHz Ês1 / Noc1: +5.45dB Ês2 / Noc2: +1.55dB</p>
8.4.1.1 E-UTRA – NR FR1 SFTD measurement delay in non-DRX	<p>During T1: Noc1: -104dBm/15kHz Noc2: -98dBm/15kHz Ês1 / Noc1: +17dB Ês2 / Noc2: +4dB</p>	<p>During T1: 0dB 0dB 0dB 0dB</p>	<p>During T1: Noc1: -104dBm/15kHz Noc2: -98dBm/15kHz Ês1 / Noc1: +17dB Ês2 / Noc2: +4dB</p>
8.4.1.2 E-UTRA – NR FR1 SFTD measurement delay in DRX	Same as 8.4.1.1	Same as 8.4.1.1	Same as 8.4.1.1
8.4.2.1 E-UTRA event-triggered reporting of a NR FR1 neighbour cell without SSB time index detection in non-DRX	<p>During T1: Noc1: -104dBm/15kHz Noc2: -98dBm/15kHz Ês1 / Noc1: +17dB Ês2 / Noc2: -infinity</p> <p>During T2: Noc1: -104dBm/15kHz Noc2: -98dBm/15kHz Ês1 / Noc1: +17dB Ês2 / Noc2: +7dB</p>	<p>During T1: 0dB 0dB 0dB 0dB</p> <p>During T2: 0dB 0dB -1.65dB +1.65dB</p>	<p>During T1: Noc1: -104dBm/15kHz Noc2: -98dBm/15kHz Ês1 / Noc1: +17dB Ês2 / Noc2: -infinity</p> <p>During T2: Noc1: -98dBm/15kHz Noc2: -98dBm/15kHz Ês1 / Noc1: +15.35dB Ês2 / Noc2: +8.65dB</p>

8.4.2.2 E-UTRA event-triggered reporting of a NR FR1 neighbour cell without SSB time index detection in DRX	Same as 8.4.2.1	Same as 8.4.2.1	Same as 8.4.2.1
8.4.2.3 E-UTRA event-triggered reporting of a NR FR1 neighbour cell with SSB time index detection in non-DRX	Same as 8.4.2.1	Same as 8.4.2.1	Same as 8.4.2.1
8.4.2.4 E-UTRA event-triggered reporting of a NR FR1 neighbour cell with SSB time index detection in DRX	Same as 8.4.2.1	Same as 8.4.2.1	Same as 8.4.2.1
8.4.2.9 E-UTRA – NR Inter-RAT event triggered reporting tests for FR1 with SSB time index detection in DRX for UE configured with highSpeedInterRAT-NR-r16	During T1: Noc1: -104dBm/15kHz Noc2: -98dBm/15kHz Ês1 / Noc1: +17dB Ês2 / Noc2: -infinity  During T2: Noc1: -104dBm/15kHz Noc2: -98dBm/15kHz Ês1 / Noc1: +17dB Ês2 / Noc2: +7dB	During T1: 0dB 0dB 0dB 0dB  During T2: 0dB 0dB 0dB 0dB	During T1: Noc1: -104dBm/15kHz Noc2: -98dBm/15kHz Ês1 / Noc1: +17dB Ês2 / Noc2: -infinity  During T2: Noc1: -104dBm/15kHz Noc2: -98dBm/15kHz Ês1 / Noc1: +17dB Ês2 / Noc2: +7dB
8.5.1.1 E-UTRA – NR FR1 SFTD measurement accuracy	<u>Test 1</u> Ês1 / Noc1: -3dB Ês2 / Noc2: -3dB	<u>Test 1:</u> +0.8dB +0.3dB	<u>Test 1:</u> Ês1 / Noc1: -2.2dB Ês2 / Noc2: -2.7dB
8.5.2.1.1.1 E-UTRA SS-RSRP absolute measurement accuracy of a NR FR1 neighbour cell			
Test Configuration 1,2,4,5	<u>Test 1:</u> Noc1: -94.65 dBm/15kHz Ês1 / Noc1: +10.0dB <u>Reported RSRP values: ±8dB</u> (±3.0dB additionally for extreme conditions)  <u>Test 2:</u> Noc1: -117dBm/15kHz + ΔBG_offset  Ês1 / Noc1: -4.0dB <u>Reported RSRP values: ±4.5dB</u> (±4.5dB additionally for extreme conditions)	<u>Test 1:</u> 0dB 0dB Via mapping  <u>Test 2:</u> 0dB  0.8dB Via mapping	<u>Test 1:</u> Noc1: -94.65dBm/15kHz Ês1 / Noc1: +10.0dB RSRP_62 to RSRP_82  <u>Test 2:</u> Noc1: -117dBm/15kHz + ΔBG_offset Ês1 / Noc1: -3.2dB RSRP_30 to RSRP_43 RSRP_31 to RSRP_43 RSRP_31 to RSRP_44 RSRP_32 to RSRP_44 RSRP_32 to RSRP_45 RSRP_33 to RSRP_45 RSRP_33 to RSRP_46 RSRP_34 to RSRP_46 depending on operating band

Test Configuration 3,6	<p><u>Test 1:</u>  <math>N_{oc1}</math>: -94.65 dBm/15kHz  <math>\hat{E}s1 / N_{oc1}</math>: +10.0dB  <u>Reported RSRP values: ±8dB</u>  (±3.0dB additionally for extreme conditions)</p> <p><u>Test 2:</u>  <math>N_{oc1}</math>: -117dBm/15kHz + <math>\Delta_{BG\_offset}</math></p> <p><math>\hat{E}s1 / N_{oc1}</math>: -4.0dB  <u>Reported RSRP values: ±4.5dB</u>  (±4.5dB additionally for extreme conditions)</p>	<p><u>Test 1:</u>  -1.35dB  0dB  Via mapping</p> <p><u>Test 2:</u>  0dB  0.8dB  Via mapping</p>	<p><u>Test 1:</u>  <math>N_{oc1}</math>: -96.00dBm/15kHz  <math>\hat{E}s1 / N_{oc1}</math>: +10.0dB  RSRP_64 to RSRP_83</p> <p><u>Test 2:</u>  <math>N_{oc1}</math>: -117dBm/15kHz + <math>\Delta_{BG\_offset}</math>  <math>\hat{E}s1 / N_{oc1}</math>: -3.2dB  RSRP_33 to RSRP_46  RSRP_34 to RSRP_46  RSRP_34 to RSRP_47  RSRP_35 to RSRP_47  RSRP_35 to RSRP_48  RSRP_36 to RSRP_48  RSRP_36 to RSRP_49  RSRP_37 to RSRP_49  depending on operating band</p>
8.5.2.1.2 E-UTRA SS-RSRP absolute measurement accuracy of a NR FR2 neighbour cell	<p><u>Test 1:</u>  <math>N_{oc}</math>: -105dBm/15kHz  <math>\hat{E}s / N_{oc}</math> 11dB  Reported RSRP values: ±8dB  (±3dB additionally for extreme conditions)</p> <p><u>Test 2:</u>  <math>\hat{E}s</math> FR2a PC3: -109.1dBm/SCS  Reported RSRP values: ±8dB</p> <p><math>\hat{E}s</math> FR2b PC3: -106.5dBm/SCS  Reported RSRP values: ±8dB</p> <p><math>\hat{E}s</math> FR2c PC3: -105.5dBm/SCS  Reported RSRP values: ±8dB</p> <p>(±3dB additionally for extreme conditions in all frequency ranges)</p>	<p><u>Test 1:</u>  -0.1dB  0dB  Via mapping</p> <p><u>Test 2:</u>  +5.65dB  Via mapping</p> <p>+5.65dB  Via mapping</p> <p>+5.65dB  Via mapping</p>	<p><u>Test 1:</u>  <math>N_{oc}</math>: -105.1dBm/15kHz  <math>\hat{E}s / N_{oc}</math>: +11.0dB  RSRP_48 to RSRP_105</p> <p><u>Test 2:</u>  <math>\hat{E}s</math>: -103.45dBm/SCS  RSRP_29 to RSRP_87</p> <p><math>\hat{E}s</math>: -100.85dBm/SCS  RSRP_32 to RSRP_89</p> <p><math>\hat{E}s</math>: -99.85dBm/SCS  RSRP_33 to RSRP_90</p>
8.5.2.2.1 E-UTRA SS-RSRQ absolute measurement accuracy of a NR FR1 neighbour cell			
Test Configuration 1,2,4,5	<p><u>Test 1:</u>  <math>N_{oc1}</math>: -80.18 dBm/15kHz  <math>\hat{E}s1 / N_{oc1}</math>: -1.75dB  <u>Reported RSRQ values: ±2.5dB</u>  (±1.5dB additionally for extreme conditions)</p> <p><u>Test 2:</u>  <math>N_{oc1}</math>: -106dBm/15kHz  <math>\hat{E}s1 / N_{oc1}</math>: -1.75dB  <u>Reported RSRQ values: ±2.5dB</u>  (±1.5dB additionally for extreme conditions)</p> <p><u>Test 3:</u>  <math>N_{oc1}</math>: -116dBm/15kHz + <math>\Delta_{BG\_offset}</math></p> <p><math>\hat{E}s1 / N_{oc1}</math>: -1.75dB  <u>Reported RSRQ values: ±2.5dB</u>  (±1.5dB additionally for extreme conditions)</p>	<p><u>Test 1:</u>  -1.5dB  0dB  Via mapping</p> <p><u>Test 2:</u>  0dB  0dB  Via mapping</p> <p><u>Test 3:</u>  0dB  Via mapping</p>	<p><u>Test 1:</u>  <math>N_{oc1}</math>: -81.68dBm/15kHz  <math>\hat{E}s1 / N_{oc1}</math>: -1.75dB  RSRQ_51 to RSRQ_63</p> <p><u>Test 2:</u>  <math>N_{oc1}</math>: -106dBm/15kHz  <math>\hat{E}s1 / N_{oc1}</math>: -1.75dB  RSRQ_51 to RSRQ_63</p> <p><u>Test 3:</u>  <math>N_{oc1}</math>: -116dBm/15kHz + <math>\Delta_{BG\_offset}</math>  <math>\hat{E}s1 / N_{oc1}</math>: -1.75dB  RSRQ_51 to RSRQ_63</p>

<p>Test Configuration 3,6</p>	<p><u>Test 1:</u>  <math>N_{oc1}</math>: -86.27 dBm/15kHz  <math>\hat{E}s1 / N_{oc1}</math>: -1.75dB  <u>Reported RSRQ values: ±2.5dB</u>                  (±1.5dB additionally for extreme conditions)</p> <p><u>Test 2:</u>  <math>N_{oc1}</math>: -113dBm/15kHz  <math>\hat{E}s1 / N_{oc1}</math>: -1.75dB  <u>Reported RSRQ values: ±2.5dB</u>                  (±1.5dB additionally for extreme conditions)</p> <p><u>Test 3:</u>  <math>N_{oc1}</math>: -116dBm/15kHz + <math>\Delta_{BG\_offset}</math></p> <p><math>\hat{E}s1 / N_{oc1}</math>: -1.75dB  <u>Reported RSRQ values: ±2.5dB</u>                  (±1.5dB additionally for extreme conditions)</p>	<p><u>Test 1:</u>                  -1.53dB                  0dB                  Via mapping</p> <p><u>Test 2:</u>                  0dB                  0dB                  Via mapping</p> <p><u>Test 3:</u>                  0dB                  0dB                  Via mapping</p>	<p><u>Test 1:</u>  <math>N_{oc1}</math>: -87.80dBm/15kHz  <math>\hat{E}s1 / N_{oc1}</math>: -1.75dB                  RSRQ_51 to RSRQ_63</p> <p><u>Test 2:</u>  <math>N_{oc1}</math>: -113dBm/15kHz  <math>\hat{E}s1 / N_{oc1}</math>: -1.75dB                  RSRQ_51 to RSRQ_63</p> <p><u>Test 3:</u>  <math>N_{oc1}</math>: -116dBm/15kHz + <math>\Delta_{BG\_offset}</math>  <math>\hat{E}s1 / N_{oc1}</math>: -1.75dB                  RSRQ_51 to RSRQ_63</p>
<p>8.5.2.2.2 E-UTRA SS-RSRQ absolute measurement accuracy of a NR FR2 neighbour cell</p>	<p><u>Test 1:</u>  <math>N_{oc1}</math>: -105dBm/15kHz  <math>\hat{E}s1 / N_{oc1}</math>: -0.5dB  <u>Reported RSRQ values: ±2.5dB</u>                  (±1.5dB additionally for extreme conditions)</p> <p><u>Test 2:</u>  <math>N_{oc1}</math> FR2a PC3: -115.1dBm/15kHz  <math>N_{oc1}</math> FR2b PC3: -112.5dBm/15kHz  <math>N_{oc1}</math> FR2c PC3: -111.5dBm/15kHz</p> <p><math>\hat{E}s1 / N_{oc1}</math>: -1.75dB</p> <p><u>Reported RSRQ values: ±2.5dB</u>                  (±1.5dB additionally for extreme conditions in all frequency ranges)</p>	<p><u>Test 1:</u>                  0dB                  0dB                  Via mapping</p> <p><u>Test 2:</u>                  0dB                  0dB                  0dB                  5.3dB                  Via mapping</p>	<p><u>Test 1:</u>  <math>N_{oc1}</math>: -105dBm/15kHz  <math>\hat{E}s1 / N_{oc1}</math>: -0.5dB                  RSRQ_23 to RSRQ_95</p> <p><u>Test 2:</u>  <math>N_{oc1}</math>: -115.1dBm/15kHz  <math>N_{oc1}</math>: -112.5dBm/15kHz  <math>N_{oc1}</math>: -111.5dBm/SCS  <math>\hat{E}s1 / N_{oc1}</math>: 3.55dB                  RSRQ_26 to RSRQ_98</p>
<p>8.5.2.3.1 E-UTRA SS-SINR absolute measurement accuracy of a NR FR1 neighbour cell</p>	<p><u>Test 1:</u>  <math>N_{oc1}</math>: -88 dBm/15kHz  <math>\hat{E}s1 / N_{oc1}</math>: -1.75dB  <u>Reported SINR values: ±3dB</u></p> <p><u>Test 2:</u>  <math>N_{oc1}</math>: -108.5dBm/15kHz  <math>\hat{E}s1 / N_{oc1}</math>: 20dB</p> <p><u>Reported SINR values: ±3dB</u></p> <p><u>Test 3:</u>  <math>N_{oc1}</math>: -119.5dBm/15kHz + <math>\Delta_{BG\_offset}</math></p> <p><math>\hat{E}s1 / N_{oc1}</math>: -4dB  <u>Reported SINR values: ±3.5dB</u></p>	<p><u>Test 1:</u>                  0dB                  0dB                  Via mapping</p> <p><u>Test 2:</u>                  0dB                  0dB                  Via mapping</p> <p><u>Test 3:</u>                  0dB                  0.8dB                  Via mapping</p>	<p><u>Test 1:</u>  <math>N_{oc1}</math>: -88 dBm/15kHz  <math>\hat{E}s1 / N_{oc1}</math>: -1.75dB                  SINR_35 to SINR_51</p> <p><u>Test 2:</u>  <math>N_{oc1}</math>: -108.5dBm/15kHz  <math>\hat{E}s1 / N_{oc1}</math>: 20dB                  SINR_79 to SINR_94</p> <p><u>Test 3:</u>  <math>N_{oc1}</math>: -119.5dBm/15kHz + <math>\Delta_{BG\_offset}</math>  <math>\hat{E}s1 / N_{oc1}</math>: -3.2dB                  SINR_32 to SINR_49</p>



<p>8.5.2.3.2 E-UTRA SS-SINR absolute measurement accuracy of a NR FR2 neighbour cell</p>	<p><u>Test 1:</u>  <math>N_{oc1}</math>: -105dBm/15kHz  <math>\hat{E}s1 / N_{oc1}</math>: -0.5dB  <u>Reported SINR values:</u> <math>\pm 3</math>dB  (<math>\pm 1</math>dB additionally for extreme conditions)</p> <p><u>Test 2:</u>  <math>N_{oc1}</math>: -105dBm/15kHz  <math>\hat{E}s1 / N_{oc1}</math>: 11dB  <u>Reported SINR values:</u> <math>\pm 3</math>dB  (<math>\pm 1</math>dB additionally for extreme conditions)</p> <p><u>Test 3:</u>  <math>N_{oc1}</math> FR2a PC3: -115.1dBm/15kHz  <math>N_{oc1}</math> FR2b PC3: -112.5dBm/15kHz  <math>N_{oc1}</math> FR2c PC3: -111.5dBm/15kHz</p> <p><math>\hat{E}s1 / N_{oc1}</math>: -1dB</p> <p><u>Reported SINR values:</u> <math>\pm 3</math>dB</p> <p>(<math>\pm 1</math>dB additionally for extreme conditions in all frequency ranges)</p>	<p><u>Test 1:</u>  0dB  0dB  Via mapping</p> <p><u>Test 2:</u>  -0.1dB  0dB  Via mapping</p> <p><u>Test 3:</u>  0dB  0dB  0dB</p> <p>4.6dB</p> <p>Via mapping</p>	<p><u>Test 1:</u>  <math>N_{oc1}</math>: -105dBm/15kHz  <math>\hat{E}s1 / N_{oc1}</math>: -0.5dB  SINR_9 to SINR_82</p> <p><u>Test 2:</u>  <math>N_{oc1}</math>: -105.1dBm/15kHz  <math>\hat{E}s1 / N_{oc1}</math>: 11dB  SINR_32 to SINR_105</p> <p><u>Test 3:</u>  <math>N_{oc1}</math>: -115.1dBm/15kHz  <math>N_{oc1}</math>: -112.5dBm/15kHz  <math>N_{oc1}</math>: -111.5dBm/SCS</p> <p><math>\hat{E}s1 / N_{oc1}</math>: 3.6dB</p> <p>SINR_17 to SINR_90</p>
--	--	---	---

---

## Annex G (normative): Statistical testing

### G.1 General

The test requirements are expressed as absolute requirements with a single value stating the requirement or expressed as a success rate. The statistical nature depends on the type of test requirement. Some have large statistical variations, while others are not statistical in nature at all. When testing a parameter with a statistical nature, a confidence level is set. This establishes the probability that a Device Under Test (DUT) passing the test actually meets the test requirement and determines how many times a test have to be repeated and what the pass and fail criteria is. This Annex describes how to set the statistical significance.

---

### G.2 Statistical testing of delay and UE measurement performance in RRM tests

#### G.2.1 General

The RRM tests are either of deterministic or of statistical nature. The pass fail limits in tests of statistical nature are expressed as a limit (e.g. delay limit) and a success ratio applicable for the limit. The success ratio is 90% uniform (the complement is the error ratio  $ER = 10\%$ ).

#### G.2.2 Design of the test

The test is defined by the following design principles (see TS 36.521-1 clause G.X, Theory):

- 1) The early decision concept is applied.
- 2) A second limit is introduced: bad DUT factor  $M > 1$

To decide the test pass:

Supplier risk is applied based on the bad DUT quality

To decide the test fails

Customer risk is applied based on the specified DUT quality

The test is defined by the following parameters:

- 1) Limit  $ER = 0.1$  (success ratio = 90%)
- 2) Bad DUT factor  $M = 1.5$  (selectivity)
- 3) Confidence level  $CL = 95\%$  (for specified DUT and bad DUT-quality)

#### G.2.3 Numerical definition of the pass fail limits

**Editor's Note:**

- Further investigate the technical details behind this statistical method to ensure that this is applicable for FR2 radiated test cases.

Table G.2.3-1: pass fail limits

ne	ns <sub>p</sub>	ns <sub>r</sub>	ne	ns <sub>p</sub>	ns <sub>r</sub>	ne	ns <sub>p</sub>	ns <sub>r</sub>	ne	ns <sub>p</sub>	ns <sub>r</sub>
0	33	NA	43	408	283	86	737	644	129	1056	1021
1	46	NA	44	416	291	87	745	653	130	1064	1030
2	58	NA	45	424	299	88	752	661	131	1071	1039
3	69	NA	46	432	307	89	760	670	132	1078	1048
4	79	NA	47	440	315	90	767	679	133	1086	1057
5	89	NA	48	447	324	91	775	687	134	1093	1066
6	99	NA	49	455	332	92	782	696	135	1100	1074
7	109	NA	50	463	340	93	790	705	136	1108	1083
8	118	NA	51	471	348	94	797	713	137	1115	1092
9	127	NA	52	478	356	95	804	722	138	1122	1101
10	136	39	53	486	365	96	812	731	139	1130	1110
11	145	45	54	494	373	97	819	739	140	1137	1119
12	154	51	55	502	381	98	827	748	141	1144	1128
13	163	58	56	509	389	99	834	757	142	1152	1137
14	172	64	57	517	398	100	842	766	143	1159	1147
15	180	71	58	525	406	101	849	774	144	1166	1155
16	189	78	59	532	414	102	857	783	145	1174	1164
17	197	85	60	540	423	103	864	792	146	1181	1173
18	206	92	61	548	431	104	871	801	147	NA	1182
19	214	99	62	555	440	105	879	809	148		
20	223	106	63	563	448	106	886	818	149		
21	231	113	64	571	456	107	894	827	150		
22	239	120	65	578	465	108	901	836	151		
23	248	128	66	586	473	109	909	844	152		
24	256	135	67	594	482	110	916	853	153		
25	264	142	68	601	490	111	923	862	154		
26	272	150	69	609	499	112	931	871	155		
27	281	157	70	616	507	113	938	880	156		
28	289	165	71	624	516	114	946	888	157		
29	297	173	72	632	524	115	953	897	158		
30	305	180	73	639	533	116	960	906	159		
31	313	188	74	647	541	117	968	915	160		
32	321	196	75	654	550	118	975	924	161		
33	329	204	76	662	558	119	983	933	162		
34	337	211	77	669	567	120	990	941	163		
35	345	219	78	677	575	121	997	950	164		
36	353	227	79	684	584	122	1005	959	165		
37	361	235	80	692	592	123	1012	968	166		
38	369	243	81	700	601	124	1019	977	167		
39	377	251	82	707	610	125	1027	986	168		
40	385	259	83	715	618	126	1034	994	169		
41	393	267	84	722	627	127	1042	1003			
42	400	275	85	730	635	128	1049	1012			

The first column is the number of errors (ne = number of exceeded delays or number of wrong reports)

The second column is the number of samples for the pass limit (ns<sub>p</sub>, ns=Number of samples= number of successes + number of exceedings or number of reports)

The third column is the number of samples for the fail limit (ns<sub>r</sub>)

## G.2.4 Pass fail decision rules

The pass fail decision rules apply for a single test, comprising one component in the test vector. The over all Pass /Fail conditions are defined in clause G.2.6

Having observed 0 errors, pass the test at 33+ samples, otherwise continue

Having observed 1 error, pass the test at 46+ samples, otherwise continue

Having observed 2 errors, pass the test at 58+ samples, otherwise continue

Having observed 10 errors, pass the test at 136+ samples, fail the test at 39 samples, otherwise continue

Having observed 146 errors, pass the test at 1181+ samples, fail the test at 1173- samples, otherwise continue

Having observed 147 errors, fail the test at 1182- samples,

Where x+ means: x or more, x- means x or less

NOTE 1: an ideal DUT passes after 33 samples. The maximum test time is 1181 samples.

## G.2.5 Void

## G.2.6 Test conditions for delay tests and UE measurement performance

Table G.2.6-1: test conditions

Test	Statistical independence	Number of components in the test vector, as specified in the test requirements and initial conditions of the applicable test	Over all Pass/Fail condition
All tests in clauses 4.4.3, 4.5, 4.6, 5.4.3, 5.5, 5.6, 6.1, 6.2, 6.3.1, 6.3.2.1, 6.3.2.3, 6.4.3, 6.5, 6.6, 7.1, 7.2, 7.3.1, 7.3.2.1, 7.3.2.3, 7.4.3, 7.5, 7.6 are delay tests of statistical nature while 4.3.2.2, 4.4.1, 5.3.2.2, 5.4.1, 6.3.2.2, 6.4.1, 7.3.2.2, 7.4.1 are not applicable, since they are deterministic.	Test procedure in all statistical tests ensures independency	1 per operating band (if tested, see 3A.3)	Full set of environmental conditions (5) per operating band
All tests in clauses 4.7, 5.7, 6.7 and 7.7 are UE level reports of statistical nature	Independency is assumed, although Layer 1 filtering is applied to the reported results	Full set of environmental conditions (5) per operating band	Full set of environmental conditions (5) per operating band

## G.3 Statistical testing of NR sidelink CBR measurement tests

### G.3.1 General

The CBR measurement tests are of statistical nature. The pass fail limits in tests of statistical nature are expressed as a limit (e.g. delay limit) and a success ratio applicable for the limit. The success ratio is 98% (the complement is the error ratio ER = 2%).

### G.3.2 Design of the test

The test is defined by the following design principles (see TS 36.521-1 clause G.X, Theory):

- 1) The early decision concept is applied.
- 2) A second limit is introduced: bad DUT factor  $M > 1$

To decide the test pass:

- Supplier risk is applied based on the bad DUT quality

To decide the test fails

- Customer risk is applied based on the specified DUT quality

The test is defined by the following parameters:

- 1) Limit ER = 0.02 (success ratio = 98%)
- 2) Bad DUT factor M=1.5 (selectivity)
- 3) Confidence level CL = 95% (for specified DUT and bad DUT-quality)

### G.3.3 Numerical definition of the pass fail limits

**Table G.3.3-1: pass fail limits for ER = 0.02**

FFS

The first column is the number of errors ( $n_e$  = number of exceeded delays or number of wrong reports)

The second column is the number of samples for the pass limit ( $n_{s_p}$ ,  $n_s$ =Number of samples= number of successes + number of wrong reports)

The third column is the number of samples for the fail limit ( $n_{s_f}$ )

### G.3.4 Pass fail decision rules

FFS

---

## G.X Theory to derive the numbers in Table G.2.3-1 (informative)

TS 36.521-1 Annex G.X applies.

## Annex H (normative): Default message contents for RRM

### H.1 Void

### H.2 System information blocks message content exceptions

#### H.2.1 System information blocks message contents exceptions for NR intra frequency cell re-selection

SIB2: for NR intra-frequency cell re-selection

**Table H.2.1-1: SIB2: NR intra frequency cell re-selection**

Derivation Path: TS 38.508-1 [14], Table 4.6.2-1			
Information Element	Value/remark	Comment	Condition
SIB2 ::= SEQUENCE {			
cellReselectionInfoCommon SEQUENCE {			
rangeToBestCell	Not present		
}			
intraFreqCellReselectionInfo SEQUENCE {			
q-RxLevMin	-70	-140 is actual value in dBm (-70 * 2 dBm)	SCS15
	-69	-138 is actual value in dBm (-69 * 2 dBm)	SCS30
	-69	-138 is actual value in dBm (-69 * 2 dBm)	SCS120
	-68	-136 is actual value in dBm (-68 * 2 dBm)	SCS240
s-IntraSearchP	30	60 is actual value in dB (30 * 2 dB)	
smtc	SSB-MTC specified in TS 38.508-1 [14] Table 7.3.1-3 with condition SMTC.n		SMTC.n
deriveSSB-IndexFromCell	false		Asynchronous cells
	true		Synchronous cells
}			
}			

Condition	Explanation
SMTC.n	SMTC pattern n according to TS 38.133 [6] A.3.11
Synchronous cells	SSB indices of neighbour cells can be derived from timing of serving cell
Asynchronous cells	SSB indices of neighbour cells cannot be derived from timing of serving cell

SIB3: for NR intra-frequency cell re-selection

**Table H.2.1-2: SIB3: NR intra frequency cell re-selection**

Derivation Path: TS 38.508-1 [14], Table 4.6.2-2			
Information Element	Value/remark	Comment	Condition
SIB3 ::= SEQUENCE {			
intraFreqNeighCellList SEQUENCE (SIZE (1..maxCellIntra)) OF SEQUENCE {			
IntraFreqNeighCellInfo ::= SEQUENCE{			
physCellId	Set according to the neighbour cell PCI		
q-OffsetCell	dB0	0 is actual value in dB (0 * 2 dB)	
}			
}			
}			

SIB1: for NR intra frequency cell re-selection

**Table H.2.1-3: SIB1: NR intra frequency cell re-selection**

Derivation Path: TS 38.508-1 [14], Table 4.6.1-28			
Information Element	Value/remark	Comment	Condition
SIB1 ::= SEQUENCE {			
cellSelectionInfo SEQUENCE {			
q-RxLevMin	-70	-140 is actual value in dBm (-70 * 2 dBm)	SCS15
	-69	-138 is actual value in dBm (-69 * 2 + 1 dBm)	SCS30
	-69	-138 is actual value in dBm (-69 * 2 dBm)	SCS120
	-68	-136 is actual value in dBm (-68 * 2 dBm)	SCS240
}			
servingCellConfigCommon SEQUENCE {			
highSpeedConfig-r16 SEQUENCE {			
highSpeedMeasFlag-r16	true		HighSpeedMeas
}			
}			
}			

Condition	Explanation
HighSpeedMeas	highSpeedMeasFlag-r16 is configured. UE shall apply the enhanced measurement requirements to support high speed up to 500 km/h as specified in TS 38.133 [14]

## H.2.2 System information blocks message contents exceptions for NR inter frequency cell re-selection

SIB2: for NR inter-frequency cell re-selection

**Table H.2.2-1: SIB2: NR inter frequency cell re-selection**

Derivation Path: TS 38.508-1 [14], Table 4.6.2-1			
Information Element	Value/remark	Comment	Condition
SIB2 ::= SEQUENCE {			
cellReselectionInfoCommon SEQUENCE {			
rangeToBestCell	Not present		
}			
cellReselectionServingFreqInfo SEQUENCE {			
s-NonIntraSearchP	25	50 is actual value in dB (25 * 2 dB)	
threshServingLowP	22	44 is actual value in dB (22 * 2 dB)	
cellReselectionPriority	4		NR Cell 1
	5		NR Cell 2
}			
}			

SIB4: for NR inter-frequency cell re-selection

**Table H.2.2-2: SIB4: NR inter frequency cell re-selection**

Derivation Path: TS 38.508-1 [14], Table 4.6.2-3			
Information Element	Value/remark	Comment	Condition
SIB4 ::= SEQUENCE {			
interFreqCarrierFreqList SEQUENCE (SIZE (1..maxFreq)) OF SEQUENCE {	1 Entry		
dl-CarrierFreq[1]	Downlink NR SSB ARFCN of NR Cell 2		NR Cell 1
	Downlink NR SSB ARFCN of NR Cell 1		NR Cell 2
smtc	SSB-MTC specified in TS 38.508-1 [14] Table 7.3.1-3 with condition SMTC.n		SMTC.n
deriveSSB-IndexFromCell[1]	false		Asynchronous cells
	true		Synchronous cells
q-RxLevMin[1]	-70	-140 is actual value in dBm (-70 * 2 dBm)	dBm/15kHz
	-69	-137 is actual value in dBm (-69 * 2 + 1 dBm)	dBm/30kHz
threshX-HighP[1]	24	48 is actual value in dB (24 * 2 dB)	
threshX-LowP[1]	25	50 is actual value in dB (25 * 2 dB)	
cellReselectionPriority[1]	5		NR Cell 1
	4		NR Cell 2
q-OffsetFreq[1]	dB0	0 is actual value in dB (0 * 2 dB).	
}			
}			

Condition	Explanation
-----------	-------------



SSB.n FRm	SSB pattern n in FRm according to TS 38.133 [6] A.3.10
Synchronous cells	SSB indices of neighbour cells can be derived from timing of serving cell
Asynchronous cells	SSB indices of neighbour cells cannot be derived from timing of serving cell

SIB1: for NR inter frequency cell re-selection

**Table H.2.2-3: SIB1: NR inter frequency cell re-selection**

Derivation Path: TS 38.508-1 [14], Table 4.6.1-28			
Information Element	Value/remark	Comment	Condition
SIB1 ::= SEQUENCE {			
cellSelectionInfo SEQUENCE {			
q-RxLevMin	-70	-140 is actual value in dBm (-70 * 2 dBm)	dBm/15kHz
	-69	-137 is actual value in dBm (-69 * 2 + 1 dBm)	dBm/30kHz
}			
}			

## H.2.3 System information blocks message contents exceptions for NR inter-RAT cell re-selection

SIB1: for inter-RAT NR – E-UTRA cell re-selection

**Table H.2.3-1: SIB1: Inter-RAT NR – E-UTRA cell re-selection**

Derivation Path: TS 38.508-1 [14], Table 4.6.1-28			
Information Element	Value/remark	Comment	Condition
SIB1 ::= SEQUENCE {			
cellSelectionInfo SEQUENCE {			
q-RxLevMin	-70	-140 is actual value in dBm (-70 * 2 dBm)	SCS15
	-69	-137 is actual value in dBm (-69 * 2 + 1 dBm)	SCS30
}			
}			

SIB2: for inter-RAT NR – E-UTRA cell re-selection

**Table H.2.3-2: SIB2: Inter-RAT NR – E-UTRA cell re-selection**

Derivation Path: TS 38.508-1 [14], Table 4.6.2-1			
Information Element	Value/remark	Comment	Condition
SIB2 ::= SEQUENCE {			
cellReselectionServingFreqInfo SEQUENCE {			
s-NonIntraSearchP	25	50 is actual value in dB (25 * 2 dB)	
threshServingLowP	22	44 is actual value in dB (22 * 2 dB)	
cellReselectionPriority	4		higher priority
	5		lower priority
}			
intraFreqCellReselectionInfo SEQUENCE {			
smtc	SSB-MTC specified in TS 38.508-1 [14] Table 7.3.1-3 with condition SMTC.n		SMTC.n
}			
}			

Condition	Explanation
SMTc.n	SMTc pattern n according to TS 38.133 [6] A.3.11
higher priority	NR cell re-selection to higher priority E-UTRA
lower priority	NR cell re-selection to lower priority E-UTRA

SIB5: for inter-RAT NR – E-UTRA cell re-selection

**Table H.2.3-3: SIB5: Inter-RAT NR – E-UTRA cell re-selection**

Derivation Path: TS 38.508-1 [14], Table 4.6.2-4			
Information Element	Value/remark	Comment	Condition
SIB5 ::= SEQUENCE {			
carrierFreqListEUTRA SEQUENCE (SIZE (1..maxEUTRA-Carrier)) OF SEQUENCE {	1 Entry		
carrierFreq[1]	Downlink EUTRA ARFCN of E-UTRA Cell 1		
eutra-FreqNeighCellList[1] SEQUENCE (SIZE (1..maxCellEUTRA)) OF SEQUENCE {			
physCellId	E-UTRA physical cell identity		
dummy	dB0		
}			
presenceAntennaPort1[1]	FALSE		
cellReselectionPriority[1]	5		higher priority
	4		lower priority
threshX-High	24	48 is actual value in dB (24 * 2 dB)	
threshX-Low	25	50 is actual value in dB (25 * 2 dB)	
q-RxLevMin	-70	-140 is actual value in dBm (-70 * 2 dBm)	
}			
}			

Condition	Explanation
higher priority	NR cell re-selection to higher priority E-UTRA
lower priority	NR cell re-selection to lower priority E-UTRA

## H.3 RRC message content exceptions

### H.3.1 RRC messages and information elements contents exceptions for NR measurement configuration

RRCReconfiguration

To setup NR Measurement Configuration.

**Table H.3.1-1: RRCReconfiguration: NR measurement Configuration**

Derivation Path: TS 38.508-1 [14], Table 4.6.1-13 with condition NR_MEAS			
Information Element	Value/remark	Comment	Condition
RRCReconfiguration ::= SEQUENCE {			
criticalExtensions CHOICE {			
rrcReconfiguration ::= SEQUENCE {			
measConfig	MeasConfig-DEFAULT	Measurements configuration	
}			
}			
}			

MeasConfig-DEFAULT

Configuration for NR measurement.

**Table H.3.1-2: MeasConfig-DEFAULT: Configuration of NR measurement**

Derivation path: 38.508-1 [14] table 4.6.3-69			
Information Element	Value/Remark	Comment	Condition
measConfig ::= SEQUENCE {			
measObjectToAddModList SEQUENCE (SIZE (1..maxNrofMeasId)) OF SEQUENCE {	n entries	n=1 without condition n=2 for INTER-FREQ OR INTER-RAT OR Deactivated SCell	
measObjectId[1]	1		
measObject[1] CHOICE {			
measObjectNR	MeasObjectNR-DEFAULT with Condition INTRA-FREQ MO		
}			
measObjectId[2]	2		INTER-FREQ OR INTER-RAT OR Deactivated SCell
measObject[2] CHOICE {			
measObjectNR	MeasObjectNR-DEFAULT with Condition INTER-FREQ MO		INTER-FREQ
measObjectNR	MeasObjectNR-DEFAULT with Condition Deactivated SCell		Deactivated SCell
measObjectEUTRA	MeasObjectEUTRA-DEFAULT		INTER-RAT
}			
}			
reportConfigToAddModList SEQUENCE(SIZE (1..maxReportConfigId)) OF SEQUENCE {	1 entry		
reportConfigId[1]	ReportConfigId		
reportConfig[1] CHOICE {			
reportConfigNR	ReportConfigNR-DEFAULT		
reportConfigNR	ReportConfigNR-DEFAULT		INTER-FREQ OR Deactivated SCell
reportConfigInterRAT	ReportConfigInterRAT-DEFAULT		INTER-RAT
}			
}			
measIdToAddModList SEQUENCE (SIZE (1..maxNrofMeasId)) OF SEQUENCE {	1 entry		
measId[1]	MeasId		
measObjectId[1]	1 2		INTER-FREQ OR INTER-RAT OR Deactivated SCell
reportConfigId[1]	ReportConfigId		
}			
quantityConfig	QuantityConfig-DEFAULT QuantityConfig	TS 38.508-1 Table 4.6.3-127	L3 FILTERING NEEDED

measGapConfig	MeasGapConfig-DEFAULT		GAP NEEDED
}			

Condition	Explanation
GAP NEEDED	Measurement gap on the NR Cell is needed for measurement
INTER-FREQ	Configuration for inter-frequency NR measurement tests
INTER-RAT	Configuration for inter-RAT EUTRA measurement tests
Deactivated SCell	Configuration for measurement on deactivated SCell tests
L3 FILTERING NEEDED	L3 filtering is needed for measurement

## MeasObjectNR-DEFAULT

NR measurement object configuration.

**Table H.3.1-3: MeasObjectNR-DEFAULT: NR intra-frequency measurement object configuration**

Derivation Path: TS 38.508-1 [14], Table 4.6.3-76			
Information Element	Value/remark	Comment	Condition
MeasObjectNR ::= SEQUENCE {			
ssbFrequency	ARFCN-ValueNR of the SSB associated to serving cell	frequency of the serving cell	INTRA-FREQ MO
	ARFCN-ValueNR of the SSB associated to SCell		Deactivated SCell
	ARFCN-ValueNR of the SSB associated to inter-frequency neighbour cell		INTER-FREQ MO
referenceSignalConfig SEQUENCE {			
ssb-ConfigMobility SEQUENCE {			
ssb-ToMeasure	Not present		
deriveSSB-IndexFromCell	false		
	true		Synchronous cells OR RLM
}			
}			
absThreshSS-BlocksConsolidation SEQUENCE {			
thresholdRSRP	0	SS-RSRP < -156dB	NOT SS-SINR
thresholdSINR	0	SS-SINR < -23	SS-SINR
}			
measCycleSCell-v1530	sf640		Deactivated SCell
}			

Condition	Explanation
INTRA-FREQ MO	Configuration for NR MO associated to intra-frequency carrier
INTER-FREQ MO	Configuration for NR MO associated to inter-frequency carrier
Synchronous cells	SSB indices of neighbour cells can be derived from timing of serving cell
RLM	Configuration for RLM tests
Deactivated SCell	Configuration for SCell activation and deactivation tests
SS-SINR	Configuration for SS-SINR tests

## MeasObjectEUTRA-DEFAULT

EUTRA measurement object configuration for NR FR1 to E-UTRAN handover.

**Table H.3.1-3A: MeasObjectEUTRA-DEFAULT: InterRAT EUTRA measurement object configuration for FR1 to E-UTRAN handover**

Derivation Path: TS 38.508-1 [14], Table 4.6.3-74			
Information Element	Value/remark	Comment	Condition
MeasObjectEUTRA ::= SEQUENCE {			
cellsToAddModListEUTRAN SEQUENCE (SIZE (1..maxCellMeasEUTRA)) OF SEQUENCE{			
cellIndexEUTRA	1		
physCellId	Physical Cell ID of the E-UTRA cell	Annex E	
cellIndividualOffset	dB0		
}			
eutra-PresenceAntennaPort1	false		
}			

ReportConfigNR-DEFAULT

NR Report Configuration

**Table H.3.1-4: ReportConfigNR-DEFAULT(a3-offset): NR report configuration for event A3**

Derivation Path: 38.508-1 [14] Table 4.6.3-142 with condition EVENT_A3			
Information Element	Value/remark	Comment	Condition
ReportConfigNR ::= SEQUENCE {			
reportType CHOICE {			
eventTriggered SEQUENCE {			
eventId CHOICE {			
eventA3 SEQUENCE {			
a3-Offset CHOICE {			
rsrp	A3-offset*2	The actual value is field value * 0.5 dB	
}			
hysteresis	0	0 dB	
timeToTrigger	ms0		
}			
}			
reportQuantity-RsIndexes SEQUENCE {			SSB Index
rsrp	true		
rsrq	false		
sinr	false		
}			
maxReportCells	2		
maxNrofRS-IndexesToReport	2		SSB Index
}			
}			

Condition	Explanation
SSB Index	To include SSB Index





**Table H.3.1-4A: ReportConfigInterRAT- DEFAULT (b2-Thres1, b2-Thres2): InterRAT NR report configuration for FR1 to E-UTRAN handover with b2-Threshold1 = b2-Thres1 and b2-Threshold2EUTRA = b2-Thres2 dBm**

Derivation Path: 38.508-1 [4] Table 4.6.3-141			
Information Element	Value/remark	Comment	Condition
ReportConfigInterRAT ::= SEQUENCE {			
reportType CHOICE {			
eventTriggered SEQUENCE {			
eventId CHOICE {			
eventB2 SEQUENCE {			
b2-Threshold1 CHOICE {			
rsrp	b2-Thres1	b2-Thres1 – 156 dBm	
}			
b2-Threshold2EUTRA CHOICE {			
rsrp	b2-Thres2	b2-Thres2 – 140 dBm	
}			
hysteresis	0	0 dB	
timeToTrigger	ms0		
}			
}			
reportQuantityCell SEQUENCE {			
rsrp	true		
rsrq	false		
sinr	false		
}			
}			

#### QuantityConfig-DEFAULT

NR quantity configuration when L3 filtering is not used.

**Table H.3.1-5: QuantityConfig-DEFAULT: NR quantity configuration when L3 filtering is not used**

Derivation Path: TS 38.508-1 [14], Table 4.6.3-127			
Information Element	Value/remark	Comment	Condition
QuantityConfig ::= SEQUENCE {			
quantityConfigNR-List SEQUENCE (SIZE (1..maxNrofQuantityConfig)) OF SEQUENCE {	1 entry		
quantityConfigCell[1] SEQUENCE {			
ssb-FilterConfig SEQUENCE {			
filterCoefficientRSRP	fc0	No L3 filtering	
filterCoefficientRSRQ	fc0	No L3 filtering	
filterCoefficientRS-SINR	fc0	No L3 filtering	
}			
csi-RS-FilterConfig SEQUENCE {			
filterCoefficientRSRP	fc0	No L3 filtering	
filterCoefficientRSRQ	fc0	No L3 filtering	
filterCoefficientRS-SINR	fc0	No L3 filtering	
}			
}			
}			
quantityConfigEUTRA	Not present		
quantityConfigEUTRA SEQUENCE {			INTER-RAT
filterCoefficientRSRP	fc0		
filterCoefficientRSRQ	fc0		
filterCoefficientRS-SINR	fc0		

Condition	Explanation
INTER-RAT	Configuration for inter-RAT EUTRA measurement tests

MeasGapConfig-DEFAULT

Measurement gap configuration.

Table H.3.1-6: MeasGapConfig: measurement gap configuration

Derivation Path: TS 38.508-1 [14], Table 4.6.3-70			
Information Element	Value/remark	Comment	Condition
MeasGapConfig ::= SEQUENCE {			
gapFR2 CHOICE {			gapFR2
setup SEQUENCE {			
gapOffset	39		Pattern #13
mgl	ms5dot5		Pattern #13
mgrp	ms40		Pattern #13
mgta	ms0		
}			
}			
gapFR1 CHOICE {			gapFR1
setup SEQUENCE {			
gapOffset	39		Pattern #2
	19		Pattern #4
mgl	ms3		Pattern #2
	ms6		Pattern #4
mgrp	ms40		Pattern #2
	ms20		Pattern #4
mgta	ms0		
}			
}			
gapUE CHOICE {			gapUE
setup SEQUENCE {			
gapOffset	39		Pattern #0 OR Pattern #2 OR Pattern #13
	0		RLM OR BFD
mgl	ms6		Pattern #0 OR RLM OR BFD
	ms3		Pattern #2
	ms5dot5		Pattern #13
mgrp	ms40		Pattern #0 OR Pattern #2 OR Pattern #13 OR RLM OR BFD
mgta	ms0		
}			
}			
}			

Condition	Explanation
Pattern #0	Measurement gap pattern #0 defined in TS 38.133 [6] Table 9.1.2-1 is used for measurement tests
Pattern #2	Measurement gap pattern #2 defined in TS 38.133 [6] Table 9.1.2-1 is used for measurement tests
Pattern #4	Measurement gap pattern #4 defined in TS 38.133 [6] Table 9.1.2-1 is used for measurement tests
Pattern #13	Measurement gap pattern #13 defined in TS 38.133 [6] Table 9.1.2-1 is used for measurement tests
RLM	Measurement gap pattern for RLM tests
BFD	Measurement gap pattern for Beam Failure Detection tests
gapFR2	Indicates measurement gap configuration that applies to FR2 only. gapFR2 cannot be configured together with gapUE. In (NG)EN-DC or NE-DC, gapFR2 can only be set up by NR RRC
gapFR1	Indicates measurement gap configuration that applies to FR1 only. gapFR1 cannot be configured together with gapUE. In (NG)EN-DC, gapFR1 cannot be set up by NR RRC
gapUE	Indicates measurement gap configuration that applies to all frequencies (FR1 and FR2). If gapUE is configured, then neither gapFR1 nor gapFR2 can be configured. In (NG)EN-DC, gapUE cannot be set up by NR RRC.

MeasResults-DEFAULT

measurement result for NR measurements.

**Table H.3.1-7: MeasResults: measurement result for NR measurements**

Derivation Path: TS 38.508-1 [14], Table 4.6.3-79 with condition A3			
Information Element	Value/remark	Comment	Condition
measResults SEQUENCE {			
measId	MeasId		
measResultServingMOList SEQUENCE (SIZE (1..maxNrofServingCells)) OF SEQUENCE {	2 entries		
servCellId[1]	ServCellIndex of NR SpCell		
measResultServingCell[1] SEQUENCE {			
physCellId	PhysCellId of NR SpCell		
measResult SEQUENCE {			
cellResults SEQUENCE {			
resultsSSB-Cell SEQUENCE {			
rsrp	(0..127)		
rsrq	(0..127)		
}			
}			
}			
}			
servCellId[2]	ServCellIndex of NR SCell		Deactivated SCell
measResultServingCell[2] SEQUENCE {			Deactivated SCell
physCellId	PhysCellId of NR SCell		
measResult SEQUENCE {			
cellResults SEQUENCE {			
resultsSSB-Cell SEQUENCE {			
rsrp	(0..127)		
rsrq	(0..127)		
}			
}			
}			
measResultNeighCells CHOICE {			
measResultListNR SEQUENCE (SIZE(1..maxCellReport)) OF SEQUENCE {	1 entry		INTRA-FREQ OR INTER-FREQ
physCellId[1]	PhysCellId of NR neighbour Cell		
measResult[1] SEQUENCE {			
cellResults SEQUENCE {			
resultsSSB-Cell SEQUENCE {			
rsrp	(0..127)		
}			
}			
rsIndexResults SEQUENCE {	<i>n</i> entires of ResultsPerSSB-Index	<i>ResultsPerSSB-IndexList</i>	SSB Index
resultsPerSSB-Index SEQUENCE {	entry [1]		
ssb-Index	SSB-Index	an SS-Block within an SS-Burst	
}			
}			
}			
measResultListEUTRA SEQUENCE (SIZE (1..maxCellReport)) OF SEQUENCE {	1 entry		INTER-RAT
eutra-PhysCellId [1]	PhysCellId of E-UTRA neighbour Cell		
measResult[1] SEQUENCE {			
rsrp	(0..97)		
rsrq	(0..34)		
}			

cgi-Info	Not present		
}			
}			
}			

Condition	Explanation
SSB Index	To include SSB Index
INTRA-FREQ	Configuration for intra-frequency NR measurement tests
INTER-FREQ	Configuration for inter-frequency NR measurement tests
INTER-RAT	Configuration for inter-RAT EUTRA measurement tests
Deactivated SCell	Configuration for measurement on Deactivated SCell tests

#### RadioLinkMonitoringConfig -DEFAULT

Default configuration for RLM resources.

**Table H.3.1-8: RadioLinkMonitoringConfig-DEFAULT: Default configuration for RLM and BFD resources**

Derivation Path: TS 38.508-1 [14], Table 4.6.3-133			
Information Element	Value/remark	Comment	Condition
RadioLinkMonitoringConfig ::= SEQUENCE {			
failureDetectionResourcesToAddModList	n entries	n = 1 for FR1, n = 2 for FR2	SSB RLM OR CSI-RS RLM
SEQUENCE (SIZE(1..maxNrofFailureDetectionResources)) OF {			
RadioLinkMonitoringRS[1] SEQUENCE {			
radioLinkMonitoringRS-Id	0		
purpose	rlf		
detectionResource CHOICE {			
ssb-Index	0	Index of SSB #0	SSB RLM
csi-RS-Index	NZP-CSI-RS-ResourceId for TRS(4)	TS 38.508-1[14], table 7.3.1-7C	CSI-RS RLM
}			
}			
RadioLinkMonitoringRS[2] SEQUENCE {			FR2
radioLinkMonitoringRS-Id	1		
purpose	rlf		
detectionResource CHOICE {			
ssb-Index	1	Index of SSB #1	SSB RLM
csi-RS-Index	NZP-CSI-RS-ResourceId for TRS(4) with condition SECOND_SET	TS 38.508-1[14], table 7.3.1-7C	CSI-RS RLM
}			
}			
failureDetectionResourcesToAddModList	2 entries		SSB BFD OR CSI-RS BFD
SEQUENCE (SIZE(1..maxNrofFailureDetectionResources)) OF {			
RadioLinkMonitoringRS[1] SEQUENCE {			
radioLinkMonitoringRS-Id	0		
purpose	both		
detectionResource CHOICE {			
ssb-Index	0	Index of SSB #0	SSB BFD
csi-RS-Index	NZP-CSI-RS-ResourceId for BM(0)	TS 38.508-1[14], Table 7.3.1-7E	CSI-RS BFD
}			
}			
RadioLinkMonitoringRS[2] SEQUENCE {			
radioLinkMonitoringRS-Id	1		
purpose	rlf		
detectionResource CHOICE {			
ssb-Index	1	Index of SSB #1	SSB BFD
csi-RS-Index	NZP-CSI-RS-ResourceId for BM(1)	TS 38.508-1[14], Table 7.3.1-7E	CSI-RS BFD
}			
}			
beamFailureInstanceMaxCount	n1		SSB BFD OR CSI-RS BFD
beamFailureDetectionTimer	pbfd4		SSB BFD OR CSI-RS BFD
}			

Condition	Explanation
SSB RLM	Used when SSB based RLM is configured in test case
CSI-RS RLM	Used when CSI-RS based RLM is configured in test case
SSB BFD	Used when SSB based BFD is configured in test case
CSI-RS BFD	Used when CSI-RS based BFD is configured in test case

## RLF-TimersAndConstants-DEFAULT

Default parameters for RLM related timers and counters.

**Table H.3.1-9: RLF-TimersAndConstants-DEFAULT**

Derivation Path: TS 38.508-1 [14], Table 4.6.3-150			
Information Element	Value/remark	Comment	Condition
RLF-TimersAndConstants ::= SEQUENCE {			
t310	ms0		
}			

## BeamFailureRecoveryConfig-DEFAULT

Default configuration for CBD and contention-free RACH in link recovery.



**Table H.3.1-10: BeamFailureRecoveryConfig-DEFAULT**

Derivation Path: TS 38.508-1 [14], Table 4.6.3-6			
Information Element	Value/remark	Comment	Condition
BeamFailureRecoveryConfig ::= SEQUENCE {			
rootSequenceIndex-BFR	0		
rach-ConfigBFR	RACH-ConfigGeneric specified in 38.508-1 [14] Table 7.3.1-14		SSB
	RACH-ConfigGeneric specified in 38.508-1 [14] Table 7.3.1-14 with condition PRACH.4 FR1		CSI-RS and FR1
	RACH-ConfigGeneric specified in 38.508-1 [14] Table 7.3.1-14 with condition PRACH.4 FR2		CSI-RS and FR1
rsrp-ThresholdSSB	58	Actual value is 58 - 156 = -98 dBm	SCS15
	61	Actual value is 61 - 156 = -95 dBm	SCS30
	47	Actual value is 47 - 156 = -109 dBm	SCS120
	50	Actual value is 50 - 156 = -106 dBm	SCS240
candidateBeamRSList SEQUENCE (SIZE(1..maxNrofCandidateBeams)) OF CHOICE {	1 entry		
ssb[1] SEQUENCE {			SSB
ssb	1		
ra-PreambleIndex	50		
}			
csi-RS[1] SEQUENCE {			CSI-RS
csi-RS	NZP-CSI-RS-ResourceId of the CSI-RS resource used for CBD		
ra-OccasionList	1		
ra-PreambleIndex	50		
}			
}			
ssb-perRACH-Occasion	oneFourth		
ra-ssb-OccasionMaskIndex	Not present		
	1		PRACH.2 FR1 OR PRACH.2 FR2
recoverySearchSpaceId	SearchSpaceId of the search space used for BFD RAR in DL active BWP		
ra-Prioritization	Not present		
beamFailureRecoveryTimer	Not present		
}			

Condition	Explanation
SSB	Configuration for SSB based CBD
CSI-RS	Configuration for CSI-RS based CBD

BWP-UplinkDedicated

Default BWP configuration for Beam Failure Recovery

**Table H.3.1-10A: BWP-UplinkDedicated**

Derivation Path: TS 38.508-1 [14], Table 4.6.3-15			
Information Element	Value/remark	Comment	Condition
BWP-UplinkDedicated ::= SEQUENCE {			
beamFailureRecoveryConfig	BeamFailureRecoveryConfig-DEFAULT		
}			

**Table H.3.1-11: Void**

BeamFailureRecoverySCellConfig-DEFAULT

Default configuration for CBD and contention-free RACH in link recovery.

**Table H.3.1-12: BeamFailureRecoverySCellConfig-DEFAULT**

Derivation Path: TS 38.508-1 [14], Table 4.6.3-6AA			
Information Element	Value/remark	Comment	Condition
BeamFailureRecoverySCellConfig ::= SEQUENCE {			
rsrp-ThresholdBFR-r16	58	-98dBm	SCS15
	61	-95dBm	SCS30
	47	-109dBm	SCS120
candidateBeamRSCellList-r16 SEQUENCE (SIZE(1..maxNrofCandidateBeams-r16)) OF SEQUENCE {			
CandidateBeamRS-r16[1] SEQUENCE {			
candidateBeamConfig-r16 CHOICE {			
ssb-r16	1		SSB
csi-RS-r16	NZP-CSI-RS-ResourceId of the CSI-RS resource used for CBD		CSI-RS
}			
servingCellId	ServCellIndex of the SCell		
}			

BWP-DownlinkDedicated

**Table H.3.1-13: BWP-DownlinkDedicated**

Derivation Path: TS 38.331 [6], clause 6.3.2			
Information Element	Value/remark	Comment	Condition
BWP-DownlinkDedicated ::= SEQUENCE {			
beamFailureRecoverySCellConfig-r16 CHOICE {			
setup	BeamFailureRecoverySCellConfig-DEFAULT		SCell
}			
}			

## H.3.2 RRC messages and information elements contents exceptions for and handover

**Table H.3.2-1: Void**

**Table H.3.2-2: RRCReconfiguration-HO**

Derivation Path: TS 38.508-1, table 4.6.1-13			
Information Element	Value/remark	Comment	Condition
RRCReconfiguration ::= SEQUENCE {			
criticalExtensions CHOICE {			
rrcReconfiguration SEQUENCE {			
radioBearerConfig	RadioBearerConfig with conditions SRB1 and SRB2 and DRBn and Re-establish_PDCP		RBConfig_KeyChange
	RadioBearerConfig with conditions DRBn and Recover_PDCP		RBConfig_NoKeyChange
secondaryCellGroup	Not present		
nonCriticalExtension SEQUENCE {			
masterCellGroup	CellGroupConfig	Table H.3.2-3	
}			
}			
}			
}			

Condition	Explanation
RBConfig_KeyChange	RadioBearerConfig to perform Intra-NR handover with security key change
RBConfig_NoKeyChange	RadioBearerConfig to perform Intra-NR handover without security key change

**Table H.3.2-3: CellGroupConfig**

Derivation Path: TS 38.508-1 [14] Table 4.6.3-19 with condition PCell_change			
Information Element	Value/remark	Comment	Condition
CellGroupConfig ::= SEQUENCE {			
spCellConfig SEQUENCE {			
reconfigurationWithSync SEQUENCE {			
smtc	SMTC specified in 38.508-1 [14] Table 7.3.1-3 with condition SMTC.n	SMTC.n is the SMTC reference configuration used in test case	
}			
}			

### H.3.3 RRC messages and information elements contents exceptions for NR inter-RAT handover

MobilityFromNRCommand

For Inter-RAT NR handover.

**Table H.3.3-1: *MobilityFromNRCommand*: InterRAT NR handover**

Derivation Path: TS 38.508-1 [14], Table 4.6.1-8			
Information Element	Value/remark	Comment	Condition
MobilityFromNRCommand ::= SEQUENCE {			
rrc-TransactionIdentifier	RRC-TransactionIdentifier		
criticalExtensions CHOICE {			
mobilityFromNRCommand SEQUENCE {			
targetRAT-Type	eutra		
targetRAT-MessageContainer	OCTET STRING including the RRCConnectionReconfiguration message according to TS 36.508 [2], table 4.6.1-8 with condition HO-TO-EUTRA		
nas-SecurityParamFromNR	The 4 LSB of the downlink NAS COUNT		
lateNonCriticalExtension	Not present		
nonCriticalExtension SEQUENCE {}	Not present		
}			
}			
}			

MobilityFromEUTRACommand

**Table H.3.3-2: *MobilityFromEUTRACommand*: inter-RAT handover to NR Cell**

Derivation Path: TS 36.508 [25] Table 4.6.1-6			
Information Element	Value/remark	Comment	Condition
MobilityFromEUTRACommand ::= SEQUENCE {			
criticalExtensions CHOICE {			
c1 CHOICE {			
mobilityFromEUTRACommand-r9 SEQUENCE {			
purpose CHOICE {			
handover SEQUENCE {			
targetRAT-Type	nr		
targetRAT-MessageContainer	OCTET STRING containing RRCReconfiguration according to TS 38.508-1 [14] with Condition NR		
nas-SecurityParamFromEUTRA	Not present		
systemInformation	Not present		
}			
}			
}			
}			
}			
}			

### H.3.4 E-UTRA RRC messages and information elements contents exceptions for NR measurement configuration

#### *RRCConnectionReconfiguration*

Includes the nr-SecondaryCellGroupConfig-r15 to convey NR *RRCReconfiguration* message as specified in TS 38.331 [13].

**Table H.3.4-1: RRCConnectionReconfiguration: NR RRC Reconfiguration in EN-DC**

Derivation Path: 36.508 [25], Table 4.6.1-8 with condition MCG_and_SCG			
Information Element	Value/remark	Comment	Condition
RRCConnectionReconfiguration ::= SEQUENCE {			
criticalExtensions CHOICE {			
c1 CHOICE{			
rrcConnectionReconfiguration-r8 ::= SEQUENCE {			
nonCriticalExtensions ::= SEQUENCE {			
nonCriticalExtensions ::= SEQUENCE {			
nonCriticalExtensions ::= SEQUENCE {			
nonCriticalExtensions ::= SEQUENCE {			
nonCriticalExtensions ::= SEQUENCE {			
nonCriticalExtensions ::= SEQUENCE {			
nonCriticalExtensions ::= SEQUENCE {			
setup SEQUENCE {			
nr-SecondaryCellGroupConfig-r15	<i>RRCReconfiguration</i>		
}			
}			
}			
}			
}			
}			
}			
}			
}			
}			

**Table H.3.4-1a: RRCConnectionReconfiguration for measurement configuration**

For measurement configuration provided by NR PSCell under EN-DC.



**Table H.3.4-3: RRCConnectionReconfigurationComplete: NR RRC Reconfiguration Complete in EN-DC**

Derivation Path: 36.508 [25], Table 4.6.1-9: with condition MCG_and_SCG			
Information Element	Value/remark	Comment	Condition
RRCConnectionReconfigurationComplete ::= SEQUENCE {			
rrc-TransactionIdentifier	RRC-TransactionIdentifier-UL		
criticalExtensions CHOICE {			
rrcConnectionReconfigurationComplete-r8			
SEQUENCE {			
nonCriticalExtension SEQUENCE {			
scg-ConfigResponseNR-r15	OCTET STRING including the RRCReconfigurationComplete message according TS 38.508-1, table 4.6.1-14.		
}			
}			
}			

**MeasConfig-DEFAULT**

Configures measurement gap that applies to FR1 only in EN-DC as specified in TS 38.331 [13].

**Table H.3.4-4: MeasConfig-DEFAULT**

Derivation Path: 36.508 [25], Table 4.6.6-1			
Information Element	Value/remark	Comment	Condition
MeasConfig-DEFAULT ::= SEQUENCE {			
measObjectToAddModList SEQUENCE (SIZE (1..maxObjectld)) OF SEQUENCE {	1 entry		
measObjectld[1]	1		
measObject[1] CHOICE {			
measObjectEUTRA	MeasObjectEUTRA-GENERIC(Freq)	Freq is the frequency of E-UTRA PCell	
}			
}			
measObjectToAddModList SEQUENCE (SIZE (1..maxObjectld)) OF SEQUENCE {	2 entries		INTER-RAT NR
measObjectld[1]	1		
measObject[1] CHOICE {			
measObjectEUTRA	MeasObjectEUTRA-GENERIC(Freq)	Freq is the frequency of E-UTRA PCell	
}			
measObjectld[2]	2		
measObject[2] CHOICE {			
measObjectNR-r15	MeasObjectNR	Table H.3.4-6	
}			
}			
reportConfigToAddModList SEQUENCE (SIZE (1..maxReportConfigld)) OF SEQUENCE {	1 entry		INTER-RAT NR
reportConfigld[1]	1		
reportConfig[1] CHOICE {			
reportConfigEUTRA	ReportConfigEUTRA-A4(Thres)	Set Thres according to test parameters specified in test cases	EVENT A4
reportConfigInterRAT	ReportConfigInterRAT-B2-NR(EUTRA-Thres, NR-Thres)	Set EUTRA-Thres and NR-Thres according to test parameters specified in test cases	EVENT B2
	ReportConfigInterRAT-B1-NR(EUTRA-Thres, NR-Thres)	Set EUTRA-Thres and NR-Thres according to test parameters specified in test cases	EVENT B1
	ReportConfigInterRAT-SFTD with Condition INTER-RAT	TS 36.508 [25] Table 4.6.6-8B	SFTD
	ReportConfigInterRAT-PERIODICAL	Table 4.6.6-9 in TS 36.508 [25]	PERIODICAL
}			
}			
measIdToAddModList SEQUENCE (SIZE (1..maxMeasld)) OF SEQUENCE {	1 entry		INTER-RAT NR
measId[1]	1		
measObjectld[1]	2		
reportConfigld[1]	1		
}			
measGapConfig	MeasGapConfig-FR1	Table H.3.4-5	
	Not present		GAPLESS
fr1-Gap-r15	false		gapUE
	true		gapFR1
}			



Condition	Explanation
gapUE	fr1-Gap-r15 set to false indicates the gap is applicable for measurements on FR1 and FR2. E-UTRAN includes this field only when the UE is configured with (NG)EN-DC.
gapFR1	fr1-Gap-r15 set to true indicates the gap is only applicable for measurements on FR1. E-UTRAN includes this field only when the UE is configured with (NG)EN-DC.
INTER-RAT NR	Measurement configuration for inter-RAT NR measurements
EVENT B2	For event B2 triggered measurement reporting test cases
EVENT B1	For event B1 triggered measurement reporting test cases
EVENT A4	For event A4 triggered measurement reporting
SFTD	For inter-RAT SFTD measurement test cases
GAPLESS	MG is not needed in test
PERIODICAL	For periodic measurement reporting test cases

### MeasGapConfig

Configures measurement gap by LTE RRC in EN-DC as specified in TS 38.331 [13].

**Table H.3.4-5: MeasGapConfig**

Derivation Path: 36.508 [25], Table 4.6.6-1A			
Information Element	Value/remark	Comment	Condition
MeasGapConfig ::= CHOICE {			
setup SEQUENCE {			
gapOffset CHOICE {			
gp0	39	TGRP = 40 ms	Pattern #0
	0		BFD
gp4-r15	19	TGRP = 20 ms	Pattern #4
}			
}			
}			

Condition	Explanation
Pattern #0	gp0 corresponds to gap offset of Gap Pattern Id "0" with MGRP = 40ms
Pattern #4	gp4-r15 corresponds to gap offset of Gap Pattern Id "4" with MGRP = 40ms (see TS 38.133, Table 9.1.2-1). It can be applied for (NG)EN-DC, see TS 38.133, Table 9.1.2-2.
BFD	Measurement gap pattern for Beam Failure Detection tests

**Table H.3.4-6: MeasObjectNR**

Derivation Path: TS 36.508 [25] Table 4.6.6-2B			
Information Element	Value/remark	Comment	Condition
MeasObjectNR-GENERIC(Freq) ::= SEQUENCE {			
rs-ConfigSSB-r15 ::= SEQUENCE {			
measTimingConfig-r15 ::= SEQUENCE {			
periodicityAndOffset-r15 CHOICE {			
sf20-r15	0		SMTC.1 or SMTC.2
	10		SMTC.4 or SMTC.5
	17		SMTC.6
sf160-r15	0		SMTC.3
}			
ssb-Duration-r15	sf1		SMTC.1, SMTC.3 or SMTC.4
	sf5		SMTC.2, SMTC.5 or SMTC.6
}			
subcarrierSpacingSSB-r15	kHz15		SSB.1 FR1, SSB.3 FR1 or SSB.5 FR1
	kHz30		SSB.2 FR1, SSB.4 FR1 or SSB.6 FR1
	kHz120		SSB.1 FR2, SSB.3 FR2, SSB.5 FR2 or SSB.7 FR2
	KHz240		SSB.2 FR2, SSB.4 FR2, SSB.6 FR2 or SSB.8 FR2
}			
deriveSSB-IndexFromCell-r15	Not present		
	true		Synchronous cells
	false		Asynchronous cells
}			

**Table H.3.4-7: RRCConnectionReconfiguration for iRAT measurement configuration**

Derivation Path: 36.508 [25], Table 4.6.1-8 with condition MEAS			
Information Element	Value/remark	Comment	Condition
RRCConnectionReconfiguration ::= SEQUENCE {			
criticalExtensions CHOICE {			
c1 CHOICE{			
rrcConnectionReconfiguration-r8 ::= SEQUENCE {			
measConfig	MeasConfig-DEFAULT with Conditions INTER RAT NR and PERIODICAL	Table H.3.4-4	
	MeasConfig-DEFAULT with Conditions INTER RAT NR and SFTD	Table H.3.4-4	INTER-RAT and SFTD
	MeasConfig-DEFAULT with Conditions INTER RAT NR and EVENT B2	Table H.3.4-4	INTER-RAT and EVENT B2
	MeasConfig-DEFAULT with Conditions INTER RAT NR and EVENT B1	Table H.3.4-4	INTER-RAT and EVENT B1
}			
}			
}			
}			

**Table H.3.4-8: ReportConfigInterRAT-B2-NR(EUTRA-Thres, NR-Thres)**

Derivation Path: 36.508 [25], Table 4.6.6-8A			
Information Element	Value/remark	Comment	Condition
ReportConfigInterRAT-B2-NR ::= SEQUENCE {			
maxReportRS-Index-r15	2		SSB-Index
reportQuantityRS-IndexNR-r15 SEQUENCE {			SSB-Index
ss-rsrp	TRUE		
ss-rsrq	FALSE		
ss-sinr	FALSE		
}			
reportRS-IndexResultsNR	TRUE		SSB-Index
}			

Condition	Explanation
SSB-Index	To include SSB Index

### H.3.5 RRC messages and information elements contents exceptions for NR radio link monitoring (RLM)

CSI-RS information elements contents exception for NR RLM SSB-Based test cases

**Table H.3.5-1 to H.3.5-3: Void**

**Table H.3.5-4: CSI-ReportConfig**

Derivation Path: TS 38.508[14] Table 7.3.1-12F			
Information Element	Value/remark	Comment	Condition
CSI-ReportConfig ::= SEQUENCE {			
reportConfigType CHOICE {			
periodic SEQUENCE {			
reportSlotConfig ::= CHOICE {			
slots5	0		SCS15kHz_FDD
slots5	2		SCS15kHz_TDD
slots10	4		SCS30kHz
slots40	16		SCS120kHz
}			
pucch-CSI-ResourceList SEQUENCE (SIZE (1..maxNrofBWPs)) OF{			
PUCCH_CSI_Resource[0] SEQUENCE {			
uplinkBandwidthPartId	BWP-Id		
pucch_Resource	9		
}			
}			
}			
}			

**Table H.3.5-5 to H.3.5-7: Void**

BWP-DownlinkDedicated: to setup radioLinkMonitoringConfig Configuration

Table H.3.5-8: Void

RadioLinkMonitoringConfig: Configuration for RLM RS

**Table H.3.5-9: RadioLinkMonitoringConfig**

Derivation Path: TS 38.508-1 [4], Table 4.6.3-133			
Information Element	Value/remark	Comment	Condition
RadioLinkMonitoringConfig ::= SEQUENCE {			
failureDetectionResourcesToAddModList	1 entry		
SEQUENCE			
(SIZE(1..maxNrofFailureDetectionResources)) OF			
SEQUENCE {			
radioLinkMonitoringRS-Id[1]	0		
purpose[1]	rlf		
detectionResource[1] CHOICE {			
ssb-Index	0		SSB RLM
csi-RS-Index	NZP-CSI-RS-ResourceId for TRS(4)		CSI-RS RLM
}			
}			
failureDetectionResourcesToReleaseList	Not present		
beamFailureInstanceMaxCount	Not present		
beamFailureDetectionTimer	Not present		
}			

Condition	Explanation
SSB RLM	Configuration for SSB based RLM test cases
CSI-RS RLM	Configuration for CSI-RS based RLM test cases

**Table H.3.5-10: Void**

## H.3.6 RRC messages and IE content exceptions for L1-RSRP measurement for beam reporting

ServingCellConfig: Default generic configuration for enabling CSI measurements and reporting

**Table H.3.6-1: Void**

CSI-ReportConfig: Default generic configuration for L1-RSRP measurements

**Table H.3.6-2: CSI-ReportConfig**

Derivation Path: TS 38.508-1 [14], Table 7.3.1-12G			
Information Element	Value/remark	Comment	Condition
CSI-ReportConfig ::= SEQUENCE {			
csi-IM-ResourcesForInterference	Not present		
nzp-CSI-RS-ResourcesForInterference	Not present		
reportConfigType CHOICE {			
periodic SEQUENCE {			PERIODIC
reportSlotConfig CHOICE {			
slot80	7	Periodicity 80 slots and offset 7	SCS30
	2	Periodicity 80 slots and offset 2	SCS15
slot320	4	Periodicity 320 slots and offset 4	FR2
pucch-CSI-ResourceList SEQUENCE {	1 entry		
(SIZE (1..maxNrofBWPs)) OF SEQUENCE {			
uplinkBandwidthPartId	BWP-Id of active BWP		
pucch-Resource	8	PUCCH-format2 as configured in TS 38.508-1 [14], Table 4.6.3-112	
}			
}			
}			
}			
reportQuantity CHOICE {			
ssb-Index-RSRP	NULL		SS-RSRP
cri-RSRP	NULL		CSI-RSRP
}			
timeRestrictionForChannelMeasurements	configured		
groupBasedBeamReporting CHOICE {			
disabled SEQUENCE {			
nrofReportedRS	n2		
}			
}			
}			

Condition	Explanation
PERIODIC	Configuration for periodic reporting
SS-RSRP	L1-RSRP measurement based on SSB
CSI-RSRP	L1-RSRP measurement based on CSI-RS

CSI-ResourceConfig: Default generic resource configuration for L1-RSRP measurements

**Table H.3.6-3: CSI-ResourceConfig**

Derivation Path: TS 38.508-1 [14], Table 7.3.1-12B			
Information Element	Value/remark	Comment	Condition
CSI-ResourceConfig ::= SEQUENCE {			
csi-RS-ResourceSetList CHOICE {			
nzp-CSI-RS-SSB SEQUENCE {			
nzp-CSI-RS-ResourceSetList SEQUENCE (SIZE (1..maxNrofNzp-CSI-RS-ResourceSetsPerConfig)) OF {	1 entry		CSI-RS
Nzp-CSI-RS-ResourceSetId[0]	0		
}			
csi-SSB-ResourceSetList SEQUENCE (SIZE (1..maxNrofCSI-SSB-ResourceSetsPerConfig)) OF {	1 entry		SSB
CSI-SSB-ResourceSetId[0]	0		
}			
}			
}			
}			

Condition	Explanation
SSB	Configuration for SSB based CSI
CSI-RS	Configuration for CSI-RS based CSI

**Table H.3.6-4 to H.3.6-9: Void**

## H.3.6A RRC messages and IE content exceptions for L1-SINR measurement for beam reporting

ServingCellConfig: Default generic configuration for enabling CSI measurements and reporting.

CSI-ReportConfig: Default generic configuration for L1-SINR measurements.

**Table H.3.6A-1: CSI-ReportConfig**

Derivation Path: TS 38.508-1 [14], Table 7.3.1-12G			
Information Element	Value/remark	Comment	Condition
CSI-ReportConfig ::= SEQUENCE {			
csi-IM-ResourcesForInterference	CSI-IM-ResourceConfigId-IMR		CSI-IM_IMR
	CSI-IM-ResourceConfigId-IMR with condition APERIODIC		CSI-IM_IMR AND APERIODIC
nzp-CSI-RS-ResourcesForInterference	CSI-ResourceConfigId-IMR		CSI-RS_IMR
	CSI-ResourceConfigId-IMR with condition APERIODIC		CSI-RS_IMR AND APERIODIC
reportConfigType CHOICE {			
periodic SEQUENCE {			PERIODIC
reportSlotConfig CHOICE {			
slot80	7	Periodicity 80 slots and offset 7	SCS30
	2	Periodicity 80 slots and offset 2	SCS15
	4	Periodicity 80 slots and offset 4	FR2
pucch-CSI-ResourceList SEQUENCE {	1 entry		
(SIZE (1..maxNrofBWPs)) OF SEQUENCE {			
uplinkBandwidthPartId	BWP-Id of active BWP		
pucch-Resource	8	PUCCH-format2 as configured in TS 38.508-1 [14], Table 4.6.3-112	
}			
}			
aperiodic SEQUENCE {			APERIODIC
reportSlotOffsetList SEQUENCE (SIZE (1..maxNrofUL-Allocations)) OF {	1 entry		
INTEGER[1]	26		
}			
}			
timeRestrictionForChannelMeasurements	configured		
groupBasedBeamReporting CHOICE {			
disabled SEQUENCE {			
nrofReportedRS	n2		
}			
}			
reportQuantity-r16 CHOICE {			
cri-SINR-r16	NULL		CSI-SINR
ssb-Index- SINR-r16	NULL		SS-SINR
}			
}			



Condition	Explanation
PERIODIC	Configuration for periodic reporting
APERIODIC	Configuration for aperiodic reporting
SS-SINR	L1-SINR measurement based on SSB
CSI-SINR	L1-SINR measurement based on CSI-RS
CSI-RS_IMR	Configuration for NZP-CSI-RS based IMR
CSI-IM_IMR	Configuration for CSI-IM based IMR

CSI-ResourceConfig for CMR: Default generic resource configuration for L1-SINR measurements.

**Table H.3A.6-2: CSI-ResourceConfig for CMR**

Derivation Path: TS 38.508-1 [14], Table 7.3.1-12B			
Information Element	Value/remark	Comment	Condition
CSI-ResourceConfig ::= SEQUENCE {			
csi-RS-ResourceSetList CHOICE {			
nzp-CSI-RS-SSB SEQUENCE {			
nzp-CSI-RS-ResourceSetList SEQUENCE (SIZE (1..maxNrofNZP-CSI-RS-ResourceSetsPerConfig)) OF {	1 entry		CSI-RS
Nzp-CSI-RS-ResourceSetId[1]	0		
}			
csi-SSB-ResourceSetList SEQUENCE (SIZE (1..maxNrofCSI-SSB-ResourceSetsPerConfig)) OF {	1 entry		SSB
CSI-SSB-ResourceSetId[1]	0		
}			
}			
bwp-Id	BWP-Id of active BWP		
resourceType	aperiodic		APERIODIC
	periodic		PERIODIC
}			

Condition	Explanation
SSB	Configuration for SSB based CMR
CSI-RS	Configuration for CSI-RS based CMR

CSI-ResourceConfig for IMR: For NZP-CSI-RS resource configured as dedicated IMR, refer to Table H.3A.6-3; For CSI-IM resource configured as dedicated IMR, refer to Table H.3A.6-4.

**Table H.3A.6-3: CSI-ResourceConfig for NZP-CSI-RS as IMR**

Derivation Path: TS 38.508-1 [14], Table 7.3.1-12B			
Information Element	Value/remark	Comment	Condition
CSI-ResourceConfig ::= SEQUENCE {			
csi-ResourceConfigId	CSI-ResourceConfigId-IMR		
	CSI-ResourceConfigId-IMR with condition APERIODIC		APERIODIC
csi-RS-ResourceSetList CHOICE {			
nzp-CSI-RS-SSB SEQUENCE {			
nzp-CSI-RS-ResourceSetList SEQUENCE (SIZE (1..maxNrofNZP-CSI-RS-ResourceSetsPerConfig)) OF {	1 entry		
NZP-CSI-RS-ResourceSetId[1]	NZP-CSI-RS-ResourceSetId-IMR		
	NZP-CSI-RS-ResourceSetId-IMR with condition APERIODIC		APERIODIC
}			
}			
}			
bwp-Id	BWP-Id of active BWP		
resourceType	aperiodic		APERIODIC
	periodic		PERIODIC
}			

**Table H.3A.6-3a: NZP-CSI-RS-ResourceSet for IMR**

Derivation Path: TS 38.508-1 [14], Table 7.3.1-11B			
Information Element	Value/remark	Comment	Condition
NZP-CSI-RS-ResourceSet ::= SEQUENCE {			
nzp-CSI-ResourceSetId	NZP-CSI-RS-ResourceSetId-IMR		
	NZP-CSI-RS-ResourceSetId-IMR with condition APERIODIC		APERIODIC
nzp-CSI-RS-Resources SEQUENCE (SIZE (1..maxNrofNZP-CSI-RS-ResourcesPerSet)) OF NZP-CSI-RS-ResourcecId {	2 entries		
NZP-CSI-RS-ResourcecId[1]	NZP-CSI-RS-ResourcecId for IMR(0)	INTEGER 12	
	NZP-CSI-RS-ResourcecId for IMR(0) with condition APERIODIC	INTEGER 22	APERIODIC
NZP-CSI-RS-ResourcecId[2]	NZP-CSI-RS-ResourcecId for IMR(1)	INTEGER 13	
	NZP-CSI-RS-ResourcecId for IMR(1) with condition APERIODIC	INTEGER 23	APERIODIC
}			
aperiodicTriggeringOffset	6		APERIODIC
}			

Table H.3A.6-3b: NZP-CSI-RS-Resource for IMR(lid)

Derivation Path: TS 38.508-1 [14], Table 7.3.1-7B			
Information Element	Value/remark	Comment	Condition
NZP-CSI-RS-Resource ::= SEQUENCE {			
nzp-CSI-RS-ResourceId	NZP-CSI-RS-ResourceId for IMR(lid)		
	NZP-CSI-RS-ResourceId for IMR(lid) with condition APERIODIC		APERIODIC
resourceMapping SEQUENCE {			
frequencyDomainAllocation CHOICE {			
row1	0001		
}			
nrofPorts	p1		
firstOFDMSymbolInTimeDomain	6		ld = 0
	10		ld = 1
	7		ld = 0 AND APERIODIC
	11		ld = 1 AND APERIODIC
cdm-Type	noCDM		
density CHOICE {			
three	NULL		
}			
freqBand	CSI-FrequencyOccupation-RRM		See TS 38.508-1 [14], Table 7.3.1-10
}			
powerControlOffset	0		
powerControlOffsetSS	db0		
scramblingID	0		
periodicityAndOffset {			
slots20	1		SCS15
slots40	2		SCS30
}			
periodicityAndOffset	Not present		APERIODIC
qcl-InfoPeriodicCSI-RS	Not present		
}			

Table H.3A.6-3c: NZP-CSI-RS-ResourceSetId-IMR

Derivation Path: TS 38.331 [6], clause 6.3.2			
Information Element	Value/remark	Comment	Condition
NZP-CSI-RS-ResourceSetId	1		

Table H.3A.6-4: CSI-ResourceConfig for CSI-IM as IMR

Derivation Path: TS 38.508-1 [14], Table 7.3.1-12B			
Information Element	Value/remark	Comment	Condition
CSI-ResourceConfig ::= SEQUENCE {			
csi-ResourceConfigId	CSI-IM-ResourceConfigId-IMR		
	CSI-IM-ResourceConfigId-IMR with condition APERIODIC		APERIODIC
csi-RS-ResourceSetList CHOICE {			
csi-IM-ResourceSetList SEQUENCE (SIZE (1..maxNrofCSI-IM-ResourceSetsPerConfig) OF {	1 entry		
CSI-IM-ResourceSetId[1]	CSI-IM-ResourceSetId-IMR		
	CSI-IM-ResourceSetId-IMR with condition APERIODIC		APERIODIC
}			
}			
bwp-Id	BWP-Id of active BWP		
resourceType	aperiodic		APERIODIC
	periodic		PERIODIC
}			

Table H.3A.6-4a: CSI-IM-ResourceSet for IMR

Derivation Path: TS 38.508-1 [14], Table 7.3.1-26			
Information Element	Value/remark	Comment	Condition
CSI-IM-ResourceSet ::= SEQUENCE {			
csi-IM-ResourceSetId	CSI-IM-ResourceSetId-IMR		
	CSI-IM-ResourceSetId-IMR with condition APERIODIC		APERIODIC
csi-IM-Resources SEQUENCE (SIZE (1..maxNrofCSI-IM-ResourcesPerSet)) OF CSI-IM-ResourceCid {	2 entries		
CSI-IM-ResourceCid[1]	CSI-IM-ResourceCid for IMR(0)	INTEGER 0	
	CSI-IM-ResourceCid for IMR(0) with condition APERIODIC	INTEGER 10	APERIODIC
CSI-IM-ResourceCid[2]	CSI-IM-ResourceCid for IMR(1)	INTEGER 1	
	CSI-IM-ResourceCid for IMR(1) with condition APERIODIC	INTEGER 11	APERIODIC
}			
}			

**Table H.3A.6-4b: CSI-IM-Resource for IMR(Id)**

Derivation Path: TS 38.508-1 [14], Table 7.3.1-24			
Information Element	Value/remark	Comment	Condition
CSI-IM-Resource ::= SEQUENCE {			
csi-IM-ResourceId	CSI-IM-ResourceId for IMR(Id)		
	CSI-IM-ResourceId for IMR(Id) with condition APERIODIC		APERIODIC
csi-IM-ResourceElementPattern CHOICE {			
pattern1 SEQUENCE {			
subcarrierLocation-p1	s0		
symbolLocation-p1	6		Id = 0
	10		Id = 1
	7		Id = 0 AND APERIODIC
	11		Id = 1 AND APERIODIC
}			
}			
freqBand	CSI-FrequencyOccupation-RRM		See TS 38.508-1 [14], Table 7.3.1-10
periodicityAndOffset	CSI-ResourcePeriodicityAndOffset for CSI		
slots20	1		SCS15
slots40	2		SCS30
}			
periodicityAndOffset	Not present		APERIODIC
}			

**Table H.3A.6-4c: CSI-IM-ResourceSetId-IMR**

Derivation Path: TS 38.331 [6], clause 6.3.2			
Information Element	Value/remark	Comment	Condition
CSI-IM-ResourceSetId	0		

## H.3.7 RRC messages and information elements contents exceptions for NR cell search when DRX is used

MAC-CellGroupConfig: DRX configuration for NR serving cell

**Table H.3.7-1: *MAC-CellGroupConfig*: NR intra-frequency cell search when DRX is used**

Derivation Path: TS 38.508-1, Table 4.6.3-68			
Information Element	Value/remark	Comment	Condition
MAC-CellGroupConfig ::= SEQUENCE {			
drx-Config CHOICE {			
setup SEQUENCE {			
drx-onDurationTimer CHOICE {			
milliSeconds	ms1		DRX.1 OR DRX.2 OR DRX.6
	ms6		DRX.3 OR DRX.7 OR DRX.8 OR DRX.11
}			
drx-InactivityTimer	ms1		
drx-RetransmissionTimerDL	sl1		
drx-RetransmissionTimerUL	sl1		
drx-LongCycleStartOffset CHOICE {			
ms20	0		DRX.11
ms40	0		DRX.1 or DRX.3
	10		(DRX.1 and Gap) OR (DRX.1 and Offset)
	15		DRX.1 and Gap and INTER-FREQ
	20		DRX.3 and Gap
ms320	0		DRX.6 OR DRX.8
	10		DRX.6 and Gap
ms640	0		DRX.2 OR DRX.7
	10		(DRX.2 and Gap) OR (DRX.7 and Offset)
	15		DRX.2 and Gap and INTER-FREQ
}			
shortDRX	not present		
drx-SlotOffset	0		
}			
tag-Config SEQUENCE {			
tag-ToReleaseList	Not present		
tag-ToAddModList SEQUENCE (SIZE (1..maxNrofTAGs)) OF SEQUENCE {	1 entry		
tag-Id[1]	0		
timeAlignmentTimer[1]	ms500		DRX.1 OR DRX.2 OR DRX.6
	infinity		DRX.3 OR DRX.7 OR DRX.8 OR DRX.11
}			
}			

Condition	Explanation
-----------	-------------

DRX.1	DRX Configuration 1 according to TS 38.133 [6] A.3.3.1
DRX.2	DRX Configuration 2 according to TS 38.133 [6] A.3.3.2
DRX.3	DRX Configuration 3 according to TS 38.133 [6] A.3.3.3
DRX.6	DRX Configuration 6 according to TS 38.133 [6] A.3.3.6
DRX.7	DRX Configuration 7 according to TS 38.133 [6] A.3.3.7
DRX.8	DRX Configuration 8 according to TS 38.133 [6] A.3.3.8
INTER-FREQ	Configuration for inter-frequency NR measurement tests
Gap	Configuration for tests with measurement gap
Offset	Tests that requires offset for DRX to eliminate overlap of DRX and SMTC

MAC-MainConfig: DRX configuration for E-UTRAN serving cell

**Table H.3.7-2: MAC-MainConfig**

Derivation Path: 36.508, Table 4.8.2.1.5-1			
Information Element	Value/remark	Comment	Condition
MAC-MainConfig ::= SEQUENCE {			
drx-Config CHOICE {			
setup SEQUENCE {			
onDurationTimer	psf2		DRX.4 OR DRX.9
	psf6		DRX.5 OR DRX.10 OR DRX.12
drx-InactivityTimer	psf2		DRX.4 OR DRX.12
	psf1920		DRX.5 OR DRX.10
	psf100		DRX.9
longDRX-CycleStartOffset CHOICE {			
sf160	0		DRX.4
sf320	0		DRX.5
	10		DRX.5 and Gap
sf40	0		DRX.9
	10		DRX.9 and Gap
sf640	0		DRX.10 OR DRX.12
	10		DRX.12 and Gap
}			
}			
timeAlignmentTimerDedicated	infinity		DRX.4 OR DRX.5 OR DRX.12
	sf500		DRX.9 OR DRX.10
}			

Condition	Explanation
DRX.4	DRX Configuration 4 according to TS 38.133 [6] A.3.3.4
DRX.5	DRX Configuration 5 according to TS 38.133 [6] A.3.3.5
DRX.9	DRX Configuration 9 according to TS 38.133 [6] A.3.3.9
DRX.10	DRX Configuration 10 according to TS 38.133 [6] A.3.3.10
DRX.12	DRX Configuration 12 according to TS 38.133 [6] A.3.3.12



## H.3.8 RRC messages and information elements contents exceptions for NR RRC reconfiguration delay

ServingCellConfigCommonSIB: information elements content exception for RRC reconfiguration delay test cases to specific both NR uplink and supplementary uplink for SCell.

**Table H.3.8-1: ServingCellConfigCommonSIB-Procedure Delay**

Derivation Path: TS 38.508-1, table 4.6.3-169			
Information Element	Value/remark	Comment	Condition
ServingCellConfigCommonSIB ::= SEQUENCE {			
downlinkConfigCommon	DownlinkConfigCommonSIB		
uplinkConfigCommon	UplinkConfigCommonSIB	NR uplink	
supplementaryUplink	UplinkConfigCommonSIB with condition SUL_NUL		SUL
n-TimingAdvanceOffset	Not present		SUL
ssb-PositionsInBurst SEQUENCE {			
inOneGroup	'0100 0000'B	When carrier frequency is smaller than or equal to 3 GHz, only the 4 leftmost bits are valid;	
groupPresence	Not present		
}			
ssb-PeriodicityServingCell	ms20		
tdd-UL-DL-ConfigurationCommon	TDD-UL-DL-ConfigCommon		FR1_TDD
ss-PBCH-BlockPower	0		
}			

RRCReconfiguration: information elements contents exception for RRC reconfiguration delay test cases to specific radio bearers and cell groups.

**Table H.3.8-2: RRCReconfiguration-Procedure Delay**

Derivation Path: TS 38.508-1, table 4.6.1-13			
Information Element	Value/remark	Comment	Condition
RRCReconfiguration ::= SEQUENCE {			
criticalExtensions CHOICE {			
c1 CHOICE {			
rrcReconfiguration ::= SEQUENCE {			
radioBearerConfig	RadioBearerConfig with conditions SRB2 and DRB1		
}			
secondaryCellGroup	CellGroupConfig with condition EN-DC_SCell_add	OCTET STRING (CONTAINING CellGroupConfig)	
nonCriticalExtension SEQUENCE {			
masterCellGroup	CellGroupConfig with conditions EN-DC	OCTET STRING (CONTAINING CellGroupConfig)	
}			
}			
}			

## H.3.9 RRC messages and information elements contents exceptions for UL timing

**Table H.3.9-1: PUSCH-TimeDomainResourceAllocationList**

Derivation Path: TS 38.508-1, Table 4.6.3-122			
Information Element	Value/remark	Comment	Condition
PUSCH-TimeDomainResourceAllocationList ::= SEQUENCE (SIZE(1..maxNrofUL-Allocations)) OF {	2 entries		
PUSCH-TimeDomainResourceAllocation[1]			
SEQUENCE {			
startSymbolAndLength	41	Start symbol(S)=0, Length(L)=13	
}			
PUSCH-TimeDomainResourceAllocation[2]		addressed by Msg3 PUSCH time resource allocation field of the Random Access Response acc. to TS 38.213 [22] Table 8.2-1.	
SEQUENCE {			
startSymbolAndLength	41	Start symbol(S)=0, Length(L)=13	
}			
}			

# Annex I (normative): RRM OTA procedures

Annex I defines the RRM OTA procedures for the permitted testing methodologies defined in [32].

## I.0 Test applicability per permitted test method

The applicability of each permitted test method for the different RRM Angle of Arrival (AoA) setups as defined in Clause A.9 is defined in Table I.0-1.

**Table I.0-1 AoA Test Setup applicability per permitted test method**

AoA Test Setup	D > 5cm or No declaration	D ≤ 5cm
Setup 1	IFF, Enhanced IFF	DFF, IFF, Enhanced IFF, IFF+DFF
Setup 2a	IFF, Enhanced IFF	DFF, IFF, Enhanced IFF, IFF+DFF
Setup 2b	IFF, Enhanced IFF	DFF, IFF, Enhanced IFF, IFF+DFF
Setup 3	Enhanced IFF	DFF, Enhanced IFF, IFF+DFF
Setup 4a	Enhanced IFF	DFF, Enhanced IFF, IFF+DFF
Setup 4b	Enhanced IFF	DFF, Enhanced IFF, IFF+DFF
NOTE1: D =The diameter of the smallest sphere that encloses the radiating parts of the phase coherent array antenna(s) active at any one time during the test., declared by UE vendor as per Table 4.3.9-9 in TS 38.508-2		
NOTE2: DFF indicates both DFF and DFF simplification in TR 38.810.		
NOTE3: For DFF and DFF part of IFF+DFF, minimum range length needs to meet the requirement as specified in 38.508-1 Annex B.2.2-4 with the declared D		

## I.1 Direct far field (DFF)

### I.1.1 RX beam peak direction search

The Rx beam peak direction search can be found using any of the following options:

- Same measurement procedure as in clause Annex K.1.2 of TS 38.521-2 [18].
- Any of the procedures described in Annex I.4.

### I.1.2 Search for directions corresponding to the EIS spherical coverage percentile

The test directions corresponding to the EIS spherical coverage percentile can be found using any of the following options:

- EIS spherical coverage scan procedure as described in Annex K.1.6 of TS 38.521-2 [18].
- Any of the procedures described in Annex I.4.

## I.2 Direct far field (DFF) simplification

### I.2.1 RX beam peak direction search

The Rx beam peak direction search can be found using any of the following options:

- Same measurement procedure as in clause Annex K.2.2 of TS 38.521-2 [18].

- Any of the procedures described in Annex I.4.

## 1.2.2 Search for directions corresponding to the EIS spherical coverage percentile

The test directions corresponding to the EIS spherical coverage percentile can be found using any of the following options:

- EIS spherical coverage scan procedure as described in Annex K.1.6 of TS 38.521-2 [18].
- Any of the procedures described in Annex I.4.

---

## 1.3 Indirect far field (IFF)

### 1.3.1 RX beam peak direction search

The Rx beam peak direction search can be found using any of the following options:

- Same measurement procedure as in clause Annex K.3.2 of TS 38.521-2 [18].
- Any of the procedures described in Annex I.4.

### 1.3.2 Search for directions corresponding to the EIS spherical coverage percentile

The test directions corresponding to the EIS spherical coverage percentile can be found using any of the following options:

- EIS spherical coverage scan procedure as described in Annex K.1.6 of TS 38.521-2 [18].
- Any of the procedures described in Annex I.4.

---

## 1.3A Enhanced indirect far field (Enhanced IFF)

### 1.3A.1 RX beam peak direction search

Same as in clause I.3.1 for IFF.

### 1.3A.2 Search for directions corresponding to the EIS spherical coverage percentile

Same as in clause I.3.2 for IFF.

---

## 1.4 Procedures to search test directions for RRM FR2

### 1.4.1 RSRPB-based scan with fallback option to Rx beam peak direction search

This clause provides RSRPB-based scan to find the Rx beam peak of the UE for Setup 1, single AoA cases and one of the test directions for Setup 4. It also provides a method to find test directions fulfilling the EIS Spherical Coverage (TS 38.521-2 [18] clause 7.3.4.3) for Setup 2, 3 and 4. Other approaches are not precluded. RSRPB-based peak beam scan greatly reduces the time to find the peak beam position compared to traditional EIS scan using either constant step size or constant density. The procedure can be used with DFF as well as IFF methodology. The procedure is achieved implementing the following steps:

1. Enable periodic RSRPB reporting from the UE

2. Set of grid points for the UE scan can be user defined set or entire sphere.
3. Set the DL SSB\_RP (at the centre of the QZ) to -95 dBm / SCS. For each grid point, record RSRPB first by connecting SS to the DUT through the measurement antenna with  $\text{Pol}_{\text{Link}} = \theta$  polarization to form the Rx beam towards the measurement antenna.
4. Wait for BEAM\_SELECT\_WAIT\_TIME before recording the RSRPB reports.
- 4a For each of the grid points, calculate the RSRPB result for  $\text{Pol}_{\text{Link}} = \theta$  as the linear sum of the 2 RSRPB reports (one per receiver branch).
- 4b Repeat Steps 3, 4 and 4a with  $\text{Pol}_{\text{Link}} = \phi$ .
5. Once the grid points scan is completed, sort the grid points based on the linear sum of the RSRPB results for  $\text{Pol}_{\text{Link}} = \theta$  and  $\text{Pol}_{\text{Link}} = \phi$ .
6. For the top 10 grid points, run the REFSENS throughput test as per the test condition defined in TS 38.521-2 [18] clause 7.3.2
7. Select the grid point with the best REFSENS result among the 10 points from Step 6 as the Rx beam peak for RRM test cases using AoA Setup 1 or 4.
- .
8. Use the EIS result for the RRM beam peak to offset the RSRPB results to obtain an estimate of the EIS Spherical coverage (SC) map.
9. From the EIS map in Step 8, select all the points meeting the EIS SC criteria (as defined in TS 38.521-2 [18] Clause 7.3.4.3) as potential test directions for AoA Setup 2a, 2b, 3 and 4. In order to confirm that the grid point is suitable, run the REFSENS throughput test as per the test condition defined in TS 38.521-2 [18] clause 7.3.2 and verify that the EIS SC criteria is met. .

If not enough grid points are found using this method, fallback to using the method in Annex I.1, I.2, I.3 or I.3A as applicable.

## Annex J (informative): Change history

Change history							
Date	Meeting	TDoc	CR	Rev	Cat	Subject/Comment	New version
2017-08	RAN5#7 6	R5-175205	-	-	-	Introduction of TS 38.533	0.0.1
2018-08	RAN5#8 0	R5-184115	-	-	-	Added specification structure including headers up to third level	0.0.2
2018-11	RAN5#8 1	R5-186706	-	-	-	Added references and common sections	0.1.0
2018-11	RAN5#8 1	R5-187847	-	-	-	Added RMCs, OCGN, SMTC and SSB configurations to Annex A	0.1.0
2018-11	RAN5#8 1	R5-187996	-	-	-	Added test cases 6.7.1.1.1 to 6.7.1.2.2	0.1.0
2018-11	RAN5#8 1	R5-187997	-	-	-	Added test cases 4.6.2.1 to 4.6.2.8	0.1.0
2018-11	RAN5#8 1	R5-187998	-	-	-	Added test cases 5.6.2.1 to 5.6.2.4	0.1.0
2018-11	RAN5#8 1	R5-187999	-	-	-	Added test cases 6.6.2.1 to 6.6.2.8	0.1.0
2018-11	RAN5#8 1	R5-188000	-	-	-	Added test cases 7.6.2.1 to 7.6.2.4	0.1.0
2018-11	RAN5#8 1	R5-188001	-	-	-	Added test case 4.4.1.1	0.1.0
2018-11	RAN5#8 1	R5-188002	-	-	-	Added test cases 4.7.1.1.1 to 4.7.1.2.2	0.1.0
2018-11	RAN5#8 1	R5-188005	-	-	-	Added Annexes B to H	0.1.0
2018-11	RAN5#8 1	R5-188011	-	-	-	Added test case 4.4.3.1	0.1.0
2019-01	RAN5#4 5G-NR AH	R5-190448	-	-	-	Updating FR1 MU for timing measurements	0.2.0
2019-01	RAN5#4 5G-NR AH	R5-190476	-	-	-	Addition of band group power offsets	0.2.0
2019-01	RAN5#4 5G-NR AH	R5-190477	-	-	-	Update of the annexes	0.2.0
2019-01	RAN5#4 5G-NR AH	R5-190478	-	-	-	Changes to 4.7.1.x tests	0.2.0
2019-01	RAN5#4 5G-NR AH	R5-190479	-	-	-	Addition of 4.7.2.x tests	0.2.0
2019-01	RAN5#4 5G-NR AH	R5-190480	-	-	-	Addition of 4.7.4.x tests	0.2.0
2019-01	RAN5#4 5G-NR AH	R5-190481	-	-	-	Changes to 6.7.1.x tests	0.2.0
2019-01	RAN5#4 5G-NR AH	R5-190482	-	-	-	Addition of 6.7.2.x tests	0.2.0
2019-01	RAN5#4 5G-NR AH	R5-190483	-	-	-	Addition of 6.7.4.x tests	0.2.0
2019-01	RAN5#4 5G-NR AH	R5-190512	-	-	-	Addition of EN-DC FR1 radio link monitoring out-of-sync test for PSCell configured with CSI-RS-based RLM RS in non-DRX mode test case 4.5.1.5	0.2.0
2019-01	RAN5#4 5G-NR AH	R5-190513	-	-	-	Addition of EN-DC FR1 radio link monitoring in-sync test for PSCell configured with CSI-RS-based RLM RS in non-DRX mode test case 4.5.1.6	0.2.0
2019-01	RAN5#4 5G-NR AH	R5-190514	-	-	-	Addition of EN-DC FR1 radio link monitoring out-of-sync test for PSCell configured with CSI-RS-based RLM RS in DRX mode test case 4.5.1.7	0.2.0
2019-01	RAN5#4 5G-NR AH	R5-190515	-	-	-	Addition of EN-DC FR1 radio link monitoring in-sync test for PSCell configured with CSI-RS-based RLM RS in DRX mode test case 4.5.1.8	0.2.0

Change history							
Date	Meeting	TDoc	CR	Rev	Cat	Subject/Comment	New version
2019-01	RAN5#4 5G-NR AH	R5-190516	-	-	-	Addition of EN-DC FR1 interruptions at transitions between active and non-active during DRX in synchronous EN-DC test case 4.5.2.1	0.2.0
2019-01	RAN5#4 5G-NR AH	R5-190517	-	-	-	Addition of EN-DC FR1 interruptions at transitions between active and non-active during DRX in asynchronous EN-DC test case 4.5.2.2	0.2.0
2019-01	RAN5#4 5G-NR AH	R5-190518	-	-	-	Addition of EN-DC FR1 interruptions during measurements on deactivated NR SCC in synchronous EN-DC test case 4.5.2.3	0.2.0
2019-01	RAN5#4 5G-NR AH	R5-190519	-	-	-	Addition of EN-DC FR1 interruptions during measurements on deactivated NR SCC in asynchronous EN-DC test case 4.5.2.4	0.2.0
2019-01	RAN5#4 5G-NR AH	R5-190520	-	-	-	Addition of EN-DC FR1 interruptions during measurements on deactivated E-UTRAN SCC in synchronous EN-DC test case 4.5.2.5	0.2.0
2019-01	RAN5#4 5G-NR AH	R5-190582	-	-	-	Annex F correction	0.2.0
2019-01	RAN5#4 5G-NR AH	R5-190803	-	-	-	Update Annex G in TS 38.533	0.2.0
2019-01	RAN5#4 5G-NR AH	R5-190874	-	-	-	Addition of NR test case 6.6.1.1-reporting without gap non-DRX	0.2.0
2019-01	RAN5#4 5G-NR AH	R5-190875	-	-	-	Addition of NR test case 6.6.1.2-reporting without gap DRX	0.2.0
2019-01	RAN5#4 5G-NR AH	R5-190876	-	-	-	Addition of NR test case 6.6.1.3-with gap non DRX	0.2.0
2019-01	RAN5#4 5G-NR AH	R5-190877	-	-	-	Addition of NR test case 6.6.1.4-with gap DRX	0.2.0
2019-01	RAN5#4 5G-NR AH	R5-190878	-	-	-	Addition of NR test case 6.6.1.5-without gap non DRX SBI reading	0.2.0
2019-01	RAN5#4 5G-NR AH	R5-190879	-	-	-	Addition of NR test case 6.6.1.6-with gap non DRX SBI reading	0.2.0
2019-01	RAN5#4 5G-NR AH	R5-190880	-	-	-	CR to 38.533 annex for event triggered reporting test cases	0.2.0
2019-01	RAN5#4 5G-NR AH	R5-190881	-	-	-	Addition of EN-DC FR1 event triggered reporting test case 4.6.1.5	0.2.0
2019-01	RAN5#4 5G-NR AH	R5-190882	-	-	-	Addition of EN-DC FR1 event triggered reporting test case 4.6.1.6	0.2.0
2019-01	RAN5#4 5G-NR AH	R5-190883	-	-	-	Addition of EN-DC FR1 event triggered reporting test case 4.6.1.3	0.2.0
2019-01	RAN5#4 5G-NR AH	R5-190884	-	-	-	Addition of EN-DC FR1 event triggered reporting test case 4.6.1.4	0.2.0
2019-01	RAN5#4 5G-NR AH	R5-190885	-	-	-	Addition of default config for event triggered test cases	0.2.0
2019-01	RAN5#4 5G-NR AH	R5-190886	-	-	-	Introduction of 5G RRM TC 4.5.3.1	0.2.0
2019-01	RAN5#4 5G-NR AH	R5-190887	-	-	-	Introduction of 5G RRM TC 4.5.3.2	0.2.0
2019-01	RAN5#4 5G-NR AH	R5-190888	-	-	-	Introduction of 5G RRM TC 4.5.3.3	0.2.0
2019-01	RAN5#4 5G-NR AH	R5-190889	-	-	-	Introduction of 5G RRM TC 4.6.1.1	0.2.0
2019-01	RAN5#4 5G-NR AH	R5-190890	-	-	-	Introduction of 5G RRM TC 4.6.1.2	0.2.0

Change history							
Date	Meeting	TDoc	CR	Rev	Cat	Subject/Comment	New version
2019-01	RAN5#4 5G-NR AH	R5-190891	-	-	-	Introduction of 5G RRM TC 5.5.3.1	0.2.0
2019-01	RAN5#4 5G-NR AH	R5-190892	-	-	-	Introduction of 5G RRM TC 6.6.3.1	0.2.0
2019-01	RAN5#4 5G-NR AH	R5-190893	-	-	-	pCR for Addition of TC 6.5.1.3 NR SA FR1 RLM OOS in DRX	0.2.0
2019-01	RAN5#4 5G-NR AH	R5-190894	-	-	-	pCR for Addition of TC 6.4.3.1 NR SA FR1 TAA Accuracy	0.2.0
2019-01	RAN5#4 5G-NR AH	R5-190895	-	-	-	pCR for Modification of TC 4.4.3.1 EN-DC FR1 TAA accuracy	0.2.0
2019-01	RAN5#4 5G-NR AH	R5-190896	-	-	-	pCR for Addition of TC 6.5.1.1 NR SA FR1 RLM OOS	0.2.0
2019-01	RAN5#4 5G-NR AH	R5-190897	-	-	-	pCR for Addition of TC 4.5.1.1 EN-DC FR1 RLM OOS	0.2.0
2019-01	RAN5#4 5G-NR AH	R5-190898	-	-	-	pCR for Addition of TC 4.5.1.3 EN-DC FR1 RLM OOS in DRX	0.2.0
2019-01	RAN5#4 5G-NR AH	R5-190899	-	-	-	Update to EN-DC FR1 transmit timing accuracy test	0.2.0
2019-01	RAN5#4 5G-NR AH	R5-190900	-	-	-	Addition of EN-DC FR1 RLM IS non-DRX test with SSB-based RLM RS	0.2.0
2019-01	RAN5#4 5G-NR AH	R5-190901	-	-	-	Addition of EN-DC FR1 RLM IS DRX test with SSB-based RLM RS	0.2.0
2019-01	RAN5#4 5G-NR AH	R5-190902	-	-	-	Addition of NR SA FR1 RLM IS non-DRX test with SSB-based RLM RS	0.2.0
2019-01	RAN5#4 5G-NR AH	R5-190903	-	-	-	Addition of NR SA FR1 RLM IS DRX test with SSB-based RLM RS	0.2.0
2019-01	RAN5#4 5G-NR AH	R5-190904	-	-	-	Correction of RRM 5G Test Cases 4.6.2 - EN-DC FR1-FR1 Inter-frequency measurements	0.2.0
2019-01	RAN5#4 5G-NR AH	R5-190905	-	-	-	Correction of RRM 5G Test Cases 6.6.2 - NR SA FR1-FR1 Inter-frequency measurements	0.2.0
2019-01	RAN5#4 5G-NR AH	R5-190906	-	-	-	Correction of RRM 5G Test Cases 7.6.2 - NR SA FR2-FR2 Inter-frequency measurements	0.2.0
2019-01	RAN5#4 5G-NR AH	R5-190907	-	-	-	Addition of RRM Test Cases 4.5.2.6: EN-DC FR1 interruptions during measurements on deactivated E-UTRAN SCC in asynchronous EN-DC	0.2.0
2019-01	RAN5#4 5G-NR AH	R5-190908	-	-	-	Addition of RRM Test Cases 5.5.2.1: EN-DC FR2 interruptions at transitions between active and non-active during DRX in synchronous EN-DC	0.2.0
2019-01	RAN5#4 5G-NR AH	R5-190909	-	-	-	Addition of RRM Test Cases 5.5.2.2: EN-DC FR2 interruptions at transitions between active and non-active during DRX in asynchronous EN-DC	0.2.0
2019-01	RAN5#4 5G-NR AH	R5-190910	-	-	-	Addition of RRM Test Cases 5.5.2.3: EN-DC FR2 interruptions during measurements on deactivated NR SCC in synchronous EN-DC	0.2.0
2019-01	RAN5#4 5G-NR AH	R5-190911	-	-	-	Addition of RRM Test Cases 5.5.2.4: EN-DC FR2 interruptions during measurements on deactivated NR SCC in asynchronous EN-DC	0.2.0
2019-01	RAN5#4 5G-NR AH	R5-190912	-	-	-	Addition of RRM Test Cases 5.5.2.5: EN-DC FR2 interruptions during measurements on deactivated E-UTRAN SCC in synchronous EN-DC	0.2.0
2019-01	RAN5#4 5G-NR AH	R5-190913	-	-	-	Addition of RRM Test Cases 5.5.2.6: EN-DC FR2 interruptions during measurements on deactivated E-UTRAN SCC in asynchronous EN-DC	0.2.0
2019-01	RAN5#4 5G-NR AH	R5-190914	-	-	-	Addition of RRM Test Cases 6.1.1.1: NR SA FR1 cell re-selection	0.2.0



Change history							
Date	Meeting	TDoc	CR	Rev	Cat	Subject/Comment	New version
2019-01	RAN5#4 5G-NR AH	R5-190915	-	-	-	Addition of RRM Test Cases 6.1.1.2: NR SA FR1-FR1 cell re-selection	0.2.0
2019-01	RAN5#4 5G-NR AH	R5-190916	-	-	-	Addition of cell re-selection to higher priority E-UTRAN test case 6.1.2.1	0.2.0
2019-01	RAN5#4 5G-NR AH	R5-190917	-	-	-	Addition of cell re-selection to lower priority E-UTRAN test case 6.1.2.2	0.2.0
2019-01	RAN5#4 5G-NR AH	R5-190918	-	-	-	Addition of SA NR to E-UTRAN handover test case 6.3.1.4	0.2.0
2019-01	RAN5#4 5G-NR AH	R5-190919	-	-	-	Addition of SA NR to E-UTRAN handover test case 6.3.1.5	0.2.0
2019-01	RAN5#4 5G-NR AH	R5-190920	-	-	-	Addition of NR SA FR1 UE UL carrier RRC reconfiguration delay test case 6.5.4.1	0.2.0
2019-01	RAN5#4 5G-NR AH	R5-190921	-	-	-	Addition of NR SA FR1 CSI-RS based RLM out-of-sync non-DRX test case 6.5.1.5	0.2.0
2019-01	RAN5#4 5G-NR AH	R5-190922	-	-	-	Addition of NR SA FR1 CSI-RS based RLM in-sync non-DRX test case 6.5.1.6	0.2.0
2019-01	RAN5#4 5G-NR AH	R5-190923	-	-	-	Addition of NR SA FR1 CSI-RS based RLM out-of-sync in DRX test case 6.5.1.7	0.2.0
2019-01	RAN5#4 5G-NR AH	R5-190924	-	-	-	Addition of NR SA FR1 CSI-RS based RLM in-sync in DRX test case 6.5.1.8	0.2.0
2019-01	RAN5#4 5G-NR AH	R5-190987	-	-	-	38.533 Common Section updates to clarify leverage across architecture options	0.2.0
2019-03	RAN5#8 2	R5-191484	-	-	-	Correction Annex G	0.3.0
2019-03	RAN5#8 2	R5-191485	-	-	-	Correction NSA Options	0.3.0
2019-03	RAN5#8 2	R5-191486	-	-	-	Modifications NSA FR1 SS-RSRP tests	0.3.0
2019-03	RAN5#8 2	R5-191487	-	-	-	Modifications NSA FR1 SS-RSRQ tests	0.3.0
2019-03	RAN5#8 2	R5-191488	-	-	-	Modifications NSA FR1 L1-RSRP tests	0.3.0
2019-03	RAN5#8 2	R5-191489	-	-	-	Modifications SA FR1 SS-RSRP tests	0.3.0
2019-03	RAN5#8 2	R5-191490	-	-	-	Modifications SA FR1 SS-RSRQ tests	0.3.0
2019-03	RAN5#8 2	R5-191491	-	-	-	Modifications SA FR1 L1-RSRP tests	0.3.0
2019-03	RAN5#8 2	R5-191492	-	-	-	Addition NSA FR1 BWP switch tests	0.3.0
2019-03	RAN5#8 2	R5-191493	-	-	-	Addition SA FR1 BWP switch tests	0.3.0
2019-03	RAN5#8 2	R5-191494	-	-	-	Addition NSA FR2 BWP switch tests	0.3.0
2019-03	RAN5#8 2	R5-191495	-	-	-	Addition SA FR2 BWP switch tests	0.3.0
2019-03	RAN5#8 2	R5-191720	-	-	-	addition of cell mapping for BFD and measurement	0.3.0
2019-03	RAN5#8 2	R5-191924	-	-	-	Correction of default message contents for RRM	0.3.0
2019-03	RAN5#8 2	R5-191926	-	-	-	Addition of event-triggered reporting Test Cases to Cell configuration mapping in Annex E	0.3.0
2019-03	RAN5#8 2	R5-191930	-	-	-	Correction of 5G RRM Test Case 4.6.2.3	0.3.0
2019-03	RAN5#8 2	R5-191931	-	-	-	Correction of 5G RRM Test Case 4.6.2.4	0.3.0
2019-03	RAN5#8 2	R5-191934	-	-	-	Correction of 5G RRM Test Case 4.6.2.7	0.3.0
2019-03	RAN5#8 2	R5-191935	-	-	-	Correction of 5G RRM Test Case 4.6.2.8	0.3.0

Change history							
Date	Meeting	TDoc	CR	Rev	Cat	Subject/Comment	New version
2019-03	RAN5#8 2	R5-191936	-	-	-	Addition of Minimum conformance requirements 5.6.2.0	0.3.0
2019-03	RAN5#8 2	R5-191937	-	-	-	Correction of 5G RRM Test Case 5.6.2.1	0.3.0
2019-03	RAN5#8 2	R5-191938	-	-	-	Correction of 5G RRM Test Case 5.6.2.2	0.3.0
2019-03	RAN5#8 2	R5-191939	-	-	-	Correction of 5G RRM Test Case 5.6.2.3	0.3.0
2019-03	RAN5#8 2	R5-191940	-	-	-	Correction of 5G RRM Test Case 5.6.2.4	0.3.0
2019-03	RAN5#8 2	R5-191945	-	-	-	Addition of Minimum conformance requirements 7.6.2.0	0.3.0
2019-03	RAN5#8 2	R5-191946	-	-	-	Correction of 5G RRM Test Case 7.6.2.1	0.3.0
2019-03	RAN5#8 2	R5-191947	-	-	-	Correction of 5G RRM Test Case 7.6.2.2	0.3.0
2019-03	RAN5#8 2	R5-191948	-	-	-	Correction of 5G RRM Test Case 7.6.2.3	0.3.0
2019-03	RAN5#8 2	R5-191949	-	-	-	Correction of 5G RRM Test Case 7.6.2.4	0.3.0
2019-03	RAN5#8 2	R5-191950	-	-	-	Correction of 5G RRM Test Case 7.6.2.5	0.3.0
2019-03	RAN5#8 2	R5-191951	-	-	-	Correction of 5G RRM Test Case 7.6.2.6	0.3.0
2019-03	RAN5#8 2	R5-191952	-	-	-	Correction of 5G RRM Test Case 7.6.2.7	0.3.0
2019-03	RAN5#8 2	R5-191953	-	-	-	Correction of 5G RRM Test Case 7.6.2.8	0.3.0
2019-03	RAN5#8 2	R5-192062	-	-	-	Update of EN-DC FR1 event triggered reporting test case 4.6.1.6	0.3.0
2019-03	RAN5#8 2	R5-192063	-	-	-	Update of EN-DC FR1 event triggered reporting test case 4.6.1.3	0.3.0
2019-03	RAN5#8 2	R5-192064	-	-	-	Update of EN-DC FR1 event triggered reporting test case 4.6.1.4	0.3.0
2019-03	RAN5#8 2	R5-192221	-	-	-	Update on RRC_Connected generic procedure within RRM tests	0.3.0
2019-03	RAN5#8 2	R5-192477	-	-	-	Introduction of FR1 EN-DC Contention based random access Test case	0.3.0
2019-03	RAN5#8 2	R5-192478	-	-	-	Introduction of FR1 EN-DC non-Contention based random access Test case	0.3.0
2019-03	RAN5#8 2	R5-192479	-	-	-	Introduction of FR1 standalone Contention based random access Test case	0.3.0
2019-03	RAN5#8 2	R5-192480	-	-	-	Introduction of FR1 standalone Non-contention based random access Test case	0.3.0
2019-03	RAN5#8 2	R5-192481	-	-	-	Updated to 5G RRM TC 4.6.1.1	0.3.0
2019-03	RAN5#8 2	R5-192482	-	-	-	Updated to 5G RRM TC 4.6.1.2	0.3.0
2019-03	RAN5#8 2	R5-192483	-	-	-	Addition of NR test case 6.7.1.3.1-absolute RSRP	0.3.0
2019-03	RAN5#8 2	R5-192484	-	-	-	Addition of NR test case 6.7.1.3.2-relative RSRP	0.3.0
2019-03	RAN5#8 2	R5-192485	-	-	-	Addition of NR test case 6.5.5.3 FR1 CSI-RS BFD nonDRX	0.3.0
2019-03	RAN5#8 2	R5-192486	-	-	-	Addition of NR test case 6.5.5.4 FR1 CSI-RS BFD DRX	0.3.0
2019-03	RAN5#8 2	R5-192487	-	-	-	Addition of NR test case 7.5.5.1 FR2 SSB BFD nonDRX	0.3.0
2019-03	RAN5#8 2	R5-192488	-	-	-	Addition of NR test case 7.5.5.2 FR2 SSB BFD DRX	0.3.0
2019-03	RAN5#8 2	R5-192489	-	-	-	Addition of NR test case 7.5.5.3 FR2 CSI-RS BFD nonDRX	0.3.0
2019-03	RAN5#8 2	R5-192490	-	-	-	Addition of NR test case 7.5.5.4 FR2 CSI-RS BFD DRX	0.3.0
2019-03	RAN5#8 2	R5-192492	-	-	-	Correction of 5G RRM Test Case 4.6.2.1	0.3.0
2019-03	RAN5#8 2	R5-192493	-	-	-	Correction of 5G RRM Test Case 4.6.2.2	0.3.0
2019-03	RAN5#8 2	R5-192494	-	-	-	Correction of 5G RRM Test Case 4.6.2.5	0.3.0

Change history							
Date	Meeting	TDoc	CR	Rev	Cat	Subject/Comment	New version
2019-03	RAN5#8 2	R5-192495	-	-	-	Correction of 5G RRM Test Case 4.6.2.6	0.3.0
2019-03	RAN5#8 2	R5-192496	-	-	-	Correction of 5G RRM Test Case 6.6.2.1	0.3.0
2019-03	RAN5#8 2	R5-192497	-	-	-	Correction of 5G RRM Test Case 6.6.2.2	0.3.0
2019-03	RAN5#8 2	R5-192498	-	-	-	Correction of 5G RRM Test Case 6.6.2.3	0.3.0
2019-03	RAN5#8 2	R5-192499	-	-	-	Correction of 5G RRM Test Case 6.6.2.4	0.3.0
2019-03	RAN5#8 2	R5-192500	-	-	-	Update of EN-DC FR1 event triggered reporting test case 4.6.1.5	0.3.0
2019-03	RAN5#8 2	R5-192503	-	-	-	Update to EN-DC FR1 transmit timing accuracy test	0.3.0
2019-03	RAN5#8 2	R5-192674	-	-	-	Update to EN-DC FR1 RLM IS non-DRX test with SSB-based RLM RS	0.3.0
2019-03	RAN5#8 2	R5-192675	-	-	-	Update to EN-DC FR1 RLM IS DRX test with SSB-based RLM RS	0.3.0
2019-03	RAN5#8 2	R5-192676	-	-	-	Update to NR SA FR1 RLM IS non-DRX test with SSB-based RLM RS	0.3.0
2019-03	RAN5#8 2	R5-192677	-	-	-	Update to NR SA FR1 RLM IS DRX test with SSB-based RLM RS	0.3.0
2019-03	RAN5#8 2	R5-192678	-	-	-	pCR for modification of TAAA TC for EN-DC FR1	0.3.0
2019-03	RAN#83	RP-190161	-	-	-	Presented to the RAN#83 plenary for 1-step approval	1.0.0
2019-03	RAN#83	-	-	-	-	Upgraded to Rel-15 with small editorial changes	15.0.0
2019-06	RAN#84	R5-193578	0100	-	F	Update the test case number of TC 4.3.2.2.2	15.1.0
2019-06	RAN#84	R5-193755	0102	-	F	Update of Minimum conformance requirements 6.6.1.0	15.1.0
2019-06	RAN#84	R5-193758	0104	-	F	Update of EN-DC RLM in-sync in non-DRX test case 4.5.1.6	15.1.0
2019-06	RAN#84	R5-193759	0105	-	F	Update of EN-DC RLM out-of-sync in DRX test case 4.5.1.7	15.1.0
2019-06	RAN#84	R5-193760	0106	-	F	Update of EN-DC RLM in-sync in DRX test case 4.5.1.8	15.1.0
2019-06	RAN#84	R5-193761	0107	-	F	Addition of Minimum conformance requirements 6.3.2	15.1.0
2019-06	RAN#84	R5-193762	0108	-	F	Addition of NR RRM TC 6.3.2.1.1-Intra Freq RRC Re-establishment	15.1.0
2019-06	RAN#84	R5-193763	0109	-	F	Addition of FR1-FR1 re-establishment test case 6.3.2.1.2	15.1.0
2019-06	RAN#84	R5-193764	0110	-	F	Addition of FR1 RRC connection release with redirection test case 6.3.2.3.1	15.1.0
2019-06	RAN#84	R5-193765	0111	-	F	Addition of FR1-E-UTRA RRC connection release with redirection test case 6.3.2.3.2	15.1.0
2019-06	RAN#84	R5-193766	0112	-	F	Update of TC 6.5.1.5 SA FR1 CSI-RS RLM OOS non-DRX	15.1.0
2019-06	RAN#84	R5-193767	0113	-	F	Update of TC 6.5.1.6 SA FR1 CSI-RS RLM IS non-DRX	15.1.0
2019-06	RAN#84	R5-193768	0114	-	F	Update of TC 6.5.1.7 SA FR1 CSI-RS RLM OOS DRX	15.1.0
2019-06	RAN#84	R5-193769	0115	-	F	Update of TC 6.5.1.8 SA FR1 CSI-RS RLM IS DRX	15.1.0
2019-06	RAN#84	R5-193770	0116	-	F	Addition of Minimum conformance requirements 6.5.5.0	15.1.0
2019-06	RAN#84	R5-193771	0117	-	F	Update of TC 6.5.5.3 SA FR1 CSI-RS BFD non-DRX	15.1.0
2019-06	RAN#84	R5-193772	0118	-	F	Update of TC 6.5.5.4 SA FR1 CSI-RS BFD DRX	15.1.0
2019-06	RAN#84	R5-193773	0119	-	F	Addition of Minimum conformance requirements 7.5.5.0	15.1.0
2019-06	RAN#84	R5-193774	0120	-	F	Update of TC 7.5.5.1 SA FR2 SSB BFD non-DRX	15.1.0
2019-06	RAN#84	R5-193775	0121	-	F	Update of TC 7.5.5.2 SA FR2 SSB BFD DRX	15.1.0
2019-06	RAN#84	R5-193776	0122	-	F	Update of TC 7.5.5.3 SA FR2 CSI-RS BFD non-DRX	15.1.0
2019-06	RAN#84	R5-193777	0123	-	F	Update of TC 7.5.5.4 SA FR2 CSI-RS BFD DRX	15.1.0
2019-06	RAN#84	R5-193778	0124	-	F	Addition of Minimum conformance requirements 7.6.1.0	15.1.0
2019-06	RAN#84	R5-193779	0125	-	F	Addition of 7.6.1.1 SA FR2 RRM measurement no-gap non-DRX	15.1.0
2019-06	RAN#84	R5-193780	0126	-	F	Addition of 7.6.1.2 SA FR2 RRM measurement no-gap DRX	15.1.0
2019-06	RAN#84	R5-193781	0127	-	F	Addition of 7.6.1.3 SA FR2 RRM measurement gap non-DRX	15.1.0
2019-06	RAN#84	R5-193782	0128	-	F	Addition of 7.6.1.4 SA FR2 RRM measurement gap DRX	15.1.0
2019-06	RAN#84	R5-193784	0130	-	F	Update of FR1 cell re-selection test case 6.1.1.1	15.1.0
2019-06	RAN#84	R5-193785	0131	-	F	Update of FR1-FR1 cell re-selection test case 6.1.1.2	15.1.0
2019-06	RAN#84	R5-193786	0132	-	F	Update of FR1-EUTRA higher priority cell re-selection test case 6.1.2.1	15.1.0
2019-06	RAN#84	R5-193787	0133	-	F	Update of FR1-EUTRA lower priority cell re-selection test case 6.1.2.2	15.1.0
2019-06	RAN#84	R5-193788	0134	-	F	Update of FR1-EUTRA handover known cell test case 6.3.1.4	15.1.0
2019-06	RAN#84	R5-193790	0136	-	F	Update of 6.6.1.1 SA FR1 RRM measurement no-gap non-DRX	15.1.0
2019-06	RAN#84	R5-193791	0137	-	F	Update of 6.6.1.2 SA FR1 RRM measurement no-gap DRX	15.1.0
2019-06	RAN#84	R5-193792	0138	-	F	Update of 6.6.1.3 SA FR1 RRM measurement gap non-DRX	15.1.0
2019-06	RAN#84	R5-193793	0139	-	F	Update of 6.6.1.4 SA FR1 RRM measurement gap DRX	15.1.0
2019-06	RAN#84	R5-193794	0140	-	F	Update of FR1 event-triggered without gap with SSB index test case 6.6.1.5	15.1.0
2019-06	RAN#84	R5-193795	0141	-	F	Update of FR1 event-triggered with gap with SSB index test case 6.6.1.6	15.1.0

Change history							
Date	Meeting	TDoc	CR	Rev	Cat	Subject/Comment	New version
2019-06	RAN#84	R5-193812	0145	-	F	Addition of 6.3.2.2 minimum conformance requirements	15.1.0
2019-06	RAN#84	R5-193872	0146	-	F	Introduction of TC 4.5.5.4 EN-DC FR1 CSI-RS-based beam failure detection and link recovery in DRX	15.1.0
2019-06	RAN#84	R5-193949	0148	-	F	Correction of PRACH Configurations	15.1.0
2019-06	RAN#84	R5-194328	0153	-	F	Additional of new reference used in RRM test spec	15.1.0
2019-06	RAN#84	R5-194329	0154	-	F	Correction of reference spec number in RRM spec	15.1.0
2019-06	RAN#84	R5-194494	0165	-	F	Addition missing Editor's note 4.5.2.5	15.1.0
2019-06	RAN#84	R5-194549	0173	-	F	Correction of 5G RRM Test Case 5.6.2.1	15.1.0
2019-06	RAN#84	R5-194550	0174	-	F	Correction of 5G RRM Test Case 5.6.2.2	15.1.0
2019-06	RAN#84	R5-194551	0175	-	F	Correction of 5G RRM Test Case 5.6.2.3	15.1.0
2019-06	RAN#84	R5-194552	0176	-	F	Correction of 5G RRM Test Case 5.6.2.4	15.1.0
2019-06	RAN#84	R5-194553	0177	-	F	Correction of 5G RRM Test Case 5.6.2.5	15.1.0
2019-06	RAN#84	R5-194555	0179	-	F	Correction of 5G RRM Test Case 5.6.2.7	15.1.0
2019-06	RAN#84	R5-194556	0180	-	F	Correction of 5G RRM Test Case 5.6.2.8	15.1.0
2019-06	RAN#84	R5-194557	0181	-	F	Correction of Minimum conformance requirements 6.6.2.0	15.1.0
2019-06	RAN#84	R5-194562	0186	-	F	Correction of Minimum conformance requirements 7.6.2.0	15.1.0
2019-06	RAN#84	R5-194564	0188	-	F	Correction of 5G RRM Test Case 7.6.2.2	15.1.0
2019-06	RAN#84	R5-194565	0189	-	F	Correction of 5G RRM Test Case 7.6.2.3	15.1.0
2019-06	RAN#84	R5-194566	0190	-	F	Correction of 5G RRM Test Case 7.6.2.4	15.1.0
2019-06	RAN#84	R5-194567	0191	-	F	Correction of 5G RRM Test Case 7.6.2.5	15.1.0
2019-06	RAN#84	R5-194568	0192	-	F	Correction of 5G RRM Test Case 7.6.2.6	15.1.0
2019-06	RAN#84	R5-194569	0193	-	F	Correction of 5G RRM Test Case 7.6.2.7	15.1.0
2019-06	RAN#84	R5-194570	0194	-	F	Correction of 5G RRM Test Case 7.6.2.8	15.1.0
2019-06	RAN#84	R5-194571	0195	-	F	Correction of Minimum conformance requirements 7.3.2.1.0	15.1.0
2019-06	RAN#84	R5-194572	0196	-	F	Correction of 5G RRM Test Case 7.3.2.1.1	15.1.0
2019-06	RAN#84	R5-194573	0197	-	F	Correction of 5G RRM Test Case 7.3.2.1.2	15.1.0
2019-06	RAN#84	R5-194700	0208	-	F	Clean-up in EN-DC FR1 transmit timing accuracy test	15.1.0
2019-06	RAN#84	R5-194702	0210	-	F	Update to EN-DC FR1 RLM IS DRX test with SSB-based RLM RS	15.1.0
2019-06	RAN#84	R5-194703	0211	-	F	Update to NR SA FR1 RLM IS non-DRX test with SSB-based RLM RS	15.1.0
2019-06	RAN#84	R5-194704	0212	-	F	Update to NR SA FR1 RLM IS DRX test with SSB-based RLM RS	15.1.0
2019-06	RAN#84	R5-194710	0214	-	F	Update to E-UTRA configuration for RRM EN-DC tests to align with core spec update	15.1.0
2019-06	RAN#84	R5-194713	0216	-	F	Update to EN-DC FR1 RLM IS DRX test with SSB-based RLM RS	15.1.0
2019-06	RAN#84	R5-195013	0156	1	F	Updated to EN-DC FR1 RRM tests in clause 4.5.3	15.1.0
2019-06	RAN#84	R5-195016	0198	1	F	Test tolerance and measurement uncertainty in Annex F for Inter-Freq measurement test cases	15.1.0
2019-06	RAN#84	R5-195017	0129	1	F	Addition of default configuration in Annex H	15.1.0
2019-06	RAN#84	R5-195018	0143	1	F	Update of 6.3.2.2.1 random access	15.1.0
2019-06	RAN#84	R5-195019	0144	1	F	Update of 6.3.2.2.2 non-contention random access	15.1.0
2019-06	RAN#84	R5-195020	0151	1	F	Updated to EN-DC FR1 RRM tests in clause 4.6.1	15.1.0
2019-06	RAN#84	R5-195021	0207	1	F	Modification of EN-DC FR1 TAAA	15.1.0
2019-06	RAN#84	R5-195024	0199	1	F	Modification of EN-DC FR1 SSB RLM OOS in non-DRX	15.1.0
2019-06	RAN#84	R5-195025	0200	1	F	Modification of EN-DC FR1 SSB RLM OOS in DRX	15.1.0
2019-06	RAN#84	R5-195026	0201	1	F	Modification of NR SA FR1 TAAA	15.1.0
2019-06	RAN#84	R5-195027	0202	1	F	Modification of SA FR1 SSB RLM OOS in non-DRX	15.1.0
2019-06	RAN#84	R5-195028	0203	1	F	Modification of SA FR1 SSB RLM OOS in DRX	15.1.0
2019-06	RAN#84	R5-195029	0204	1	F	Modification of EN-DC FR2 TAAA	15.1.0
2019-06	RAN#84	R5-195030	0205	1	F	Modification of EN-DC FR2 SSB RLM OOS in non-DRX	15.1.0
2019-06	RAN#84	R5-195031	0206	1	F	Modification of EN-DC FR2 SSB RLM OOS in DRX	15.1.0
2019-06	RAN#84	R5-195032	0219	1	F	Update to EN-DC FR2 RLM IS non-DRX test with SSB-based RLM RS	15.1.0
2019-06	RAN#84	R5-195033	0220	1	F	Update to EN-DC FR2 RLM IS DRX test with SSB-based RLM RS	15.1.0
2019-06	RAN#84	R5-195034	0221	1	F	Addition of EN-DC FR2 Transmit Timing Accuracy tests	15.1.0
2019-06	RAN#84	R5-195035	0209	1	F	Update to EN-DC FR1 RLM IS non-DRX test with SSB-based RLM RS	15.1.0
2019-06	RAN#84	R5-195036	0150	1	F	Correction to EN-DC FR1 UE transmit timing accuracy TC 4.4.1.1	15.1.0
2019-06	RAN#84	R5-195037	0155	1	F	Updated to cell configuration mapping table for RRM tests	15.1.0
2019-06	RAN#84	R5-195038	0147	1	F	Introduction of TC 6.5.2.1 NR SA FR1 interruptions during measurements on deactivated NR SCC	15.1.0
2019-06	RAN#84	R5-195039	0178	1	F	Correction of 5G RRM Test Case 5.6.2.6	15.1.0
2019-06	RAN#84	R5-195040	0166	1	F	Correction of default message content for RRM in Annex H	15.1.0
2019-06	RAN#84	R5-195041	0217	1	F	Update to NR SA FR1 RLM IS non-DRX test with SSB-based RLM RS	15.1.0
2019-06	RAN#84	R5-195042	0218	1	F	Update to NR SA FR1 RLM IS DRX test with SSB-based RLM RS	15.1.0
2019-06	RAN#84	R5-195043	0215	1	F	Update to EN-DC FR1 RLM IS non-DRX test with SSB-based RLM RS	15.1.0
2019-06	RAN#84	R5-195044	0187	1	F	Correction of 5G RRM Test Case 7.6.2.1	15.1.0
2019-06	RAN#84	R5-195045	0103	1	F	Update of EN-DC RLM out-of-sync in non-DRX test case 4.5.1.5	15.1.0

Change history							
Date	Meeting	TDoc	CR	Rev	Cat	Subject/Comment	New version
2019-06	RAN#84	R5-195099	0223	-	F	RRM implementation of FR2 UL demod OTA tests using single pol Rx TE	15.1.0
2019-06	RAN#84	R5-195173	0167	1	F	Correction of Minimum conformance requirements 4.6.2.0	15.1.0
2019-06	RAN#84	R5-195174	0168	1	F	Correction of 5G RRM Test Case 4.6.2.1 with FR1 Test tolerance	15.1.0
2019-06	RAN#84	R5-195175	0169	1	F	Correction of 5G RRM Test Case 4.6.2.2 with FR1 Test tolerance	15.1.0
2019-06	RAN#84	R5-195176	0170	1	F	Correction of 5G RRM Test Case 4.6.2.3 with FR1 Test tolerance	15.1.0
2019-06	RAN#84	R5-195177	0171	1	F	Correction of 5G RRM Test Case 4.6.2.4 with FR1 Test tolerance	15.1.0
2019-06	RAN#84	R5-195179	0172	1	F	Correction of Minimum conformance requirements 5.6.2.0	15.1.0
2019-06	RAN#84	R5-195182	0142	1	F	Addition of FR1-E-UTRAN event-triggered reporting in DRX test case 6.6.3.2	15.1.0
2019-06	RAN#84	R5-195185	0158	1	F	Update of FR1 Test tolerance and uncertainties in AnnexF	15.1.0
2019-06	RAN#84	R5-195186	0182	1	F	Correction of 5G RRM Test Case 6.6.2.1 with FR1 Test tolerance	15.1.0
2019-06	RAN#84	R5-195187	0183	1	F	Correction of 5G RRM Test Case 6.6.2.2 with FR1 Test tolerance	15.1.0
2019-06	RAN#84	R5-195188	0184	1	F	Correction of 5G RRM Test Case 6.6.2.3 with FR1 Test tolerance	15.1.0
2019-06	RAN#84	R5-195189	0185	1	F	Correction of 5G RRM Test Case 6.6.2.4 with FR1 Test tolerance	15.1.0
2019-06	RAN#84	R5-195445	0152	2	F	Updated to SA FR1 RRM tests in clause 6.6.3	15.1.0
2019-06	RAN#84	-	-	-	-	Administrative release upgrade to match the release of 3GPP TS 38.508-1 and TS 38.521-1 which were upgraded at RAN#84 to Rel-16 due to Rel-16 relevant CR(s)	16.0.0
2019-09	RAN#85	R5-195563	0228	-	F	Addition of 5.6.1.0 minimum requirements	16.1.0
2019-09	RAN#85	R5-195568	0233	-	F	Update of 6.1.1.2 inter-freq cell re-selection	16.1.0
2019-09	RAN#85	R5-195569	0234	-	F	Update of 6.1.2.1 inter-RAT cell re-selection to higher priority	16.1.0
2019-09	RAN#85	R5-195571	0236	-	F	Update of 6.3.1.4 inter-RAT handover to known cell	16.1.0
2019-09	RAN#85	R5-195573	0238	-	F	Update Test Tolerance of 6.3.2.1.1 intra-freq RRC re-establishment	16.1.0
2019-09	RAN#85	R5-195574	0239	-	F	Update Test Tolerance of 6.3.2.1.2 inter-freq RRC re-establishment	16.1.0
2019-09	RAN#85	R5-195575	0240	-	F	Update Test Tolerance of 6.3.2.3.1 NR RRC redirection	16.1.0
2019-09	RAN#85	R5-195576	0241	-	F	Update Test Tolerance of 6.3.2.3.2 inter-RAT RRC redirection	16.1.0
2019-09	RAN#85	R5-195577	0242	-	F	Update of 6.5.1.5 RLM out-of-sync non-DRX	16.1.0
2019-09	RAN#85	R5-195578	0243	-	F	Update of 6.5.1.6 RLM in-sync non-DRX	16.1.0
2019-09	RAN#85	R5-195579	0244	-	F	Update of 6.5.1.7 RLM out-of-sync in DRX	16.1.0
2019-09	RAN#85	R5-195580	0245	-	F	Update of 6.5.1.8 RLM in-sync in DRX	16.1.0
2019-09	RAN#85	R5-195581	0246	-	F	Update of 6.5.5.3 CSI-RS-based BFD non-DRX	16.1.0
2019-09	RAN#85	R5-195582	0247	-	F	Update of 6.5.5.4 CSI-RS-based BFD in DRX	16.1.0
2019-09	RAN#85	R5-195596	0248	-	F	Addition of minimum conformance requirements for FR2 EN-DC CSI-RS based RLM	16.1.0
2019-09	RAN#85	R5-195601	0253	-	F	Addition of minimum conformance requirements for FR2 EN-DC CSI-RS based BFD	16.1.0
2019-09	RAN#85	R5-195604	0256	-	F	Addition of minimum conformance requirements for SA FR2 reselection	16.1.0
2019-09	RAN#85	R5-195605	0257	-	F	Addition of NR test case 7.1.1.1-intra freq reselection	16.1.0
2019-09	RAN#85	R5-195606	0258	-	F	Addition of NR test case 7.1.1.2-inter freq reselection	16.1.0
2019-09	RAN#85	R5-195608	0260	-	F	Addition of NR test case 8.4.2.1-without SBI non-DRX	16.1.0
2019-09	RAN#85	R5-195609	0261	-	F	Addition of NR test case 8.4.2.2-without SBI DRX	16.1.0
2019-09	RAN#85	R5-195610	0262	-	F	Addition of NR test case 8.4.2.3-with SBI non-DRX	16.1.0
2019-09	RAN#85	R5-195611	0263	-	F	Addition of NR test case 8.4.2.4-with SBI DRX	16.1.0
2019-09	RAN#85	R5-195612	0264	-	F	Addition of minimum conformance requirements for FR1 EN-DC CSI-RS based RLM	16.1.0

Change history							
Date	Meeting	TDoc	CR	Rev	Cat	Subject/Comment	New version
2019-09	RAN#85	R5-195623	0275	-	F	Correction of NR test case 5.5.2.1-interruption transition DRX sync	16.1.0
2019-09	RAN#85	R5-195624	0276	-	F	Correction of NR test case 5.5.2.2-interruption transition DRX async	16.1.0
2019-09	RAN#85	R5-195625	0277	-	F	Correction of NR test case 5.5.2.3-interruption NR deactivated SCell sync	16.1.0
2019-09	RAN#85	R5-195626	0278	-	F	Correction of NR test case 5.5.2.4-interruption NR deactivated SCell async	16.1.0
2019-09	RAN#85	R5-195627	0279	-	F	Correction of NR test case 5.5.2.5-interruption LTE deactivated SCell sync	16.1.0
2019-09	RAN#85	R5-195628	0280	-	F	Correction of NR test case 5.5.2.6-interruption LTE deactivated SCell async	16.1.0
2019-09	RAN#85	R5-195629	0281	-	F	Correction of NR test case 7.5.5.1-SSB BFD non-DRX	16.1.0
2019-09	RAN#85	R5-195630	0282	-	F	Correction of NR test case 7.5.5.2-SSB BFD DRX	16.1.0
2019-09	RAN#85	R5-195631	0283	-	F	Correction of NR test case 7.5.5.3-CSI-RS BFD non-DRX	16.1.0
2019-09	RAN#85	R5-195632	0284	-	F	Correction of NR test case 7.5.5.4-CSI-RS BFD DRX	16.1.0
2019-09	RAN#85	R5-195633	0285	-	F	Correction of NR test case 7.6.1.1-without gap non-DRX	16.1.0
2019-09	RAN#85	R5-195634	0286	-	F	Correction of NR test case 7.6.1.2-without gap DRX	16.1.0
2019-09	RAN#85	R5-195636	0288	-	F	Correction of NR test case 7.6.1.4-with gap DRX	16.1.0
2019-09	RAN#85	R5-196140	0295	-	F	Update NR operating band groups	16.1.0
2019-09	RAN#85	R5-196250	0296	-	F	Correction to EN-DC FR1 event-triggered reporting without gap TC 4.6.1.1 and 4.6.1.2	16.1.0
2019-09	RAN#85	R5-196503	0301	-	F	Updated to EN-DC FR1 RRM tests in clause 4.5.3	16.1.0
2019-09	RAN#85	R5-196504	0302	-	F	Updated to EN-DC FR2 RRM tests in clause 5.5.3	16.1.0
2019-09	RAN#85	R5-196547	0304	-	F	Update of FR1 Test tolerance and uncertainties in AnnexF	16.1.0
2019-09	RAN#85	R5-196601	0306	-	F	Correction of the reference for test frequencies and test mode - Chapter 4	16.1.0
2019-09	RAN#85	R5-196602	0307	-	F	Correction of the reference for test frequencies and test mode - Chapter 6	16.1.0
2019-09	RAN#85	R5-196603	0308	-	F	Editorial Corrections to section 5.5	16.1.0
2019-09	RAN#85	R5-196659	0309	-	F	Editorial corrections of Annex A	16.1.0
2019-09	RAN#85	R5-196660	0310	-	F	Correction of RRM Test Case 7.3.2.1.1	16.1.0
2019-09	RAN#85	R5-196661	0311	-	F	Correction of RRM Test Case 7.3.2.1.2	16.1.0
2019-09	RAN#85	R5-196662	0312	-	F	Correction of cell configuration mapping for RRM Test Cases in Annex E.3	16.1.0
2019-09	RAN#85	R5-196666	0316	-	F	Correction of RRM Test Case 5.6.2.1	16.1.0
2019-09	RAN#85	R5-196667	0317	-	F	Correction of RRM Test Case 5.6.2.2	16.1.0
2019-09	RAN#85	R5-196668	0318	-	F	Correction of RRM Test Case 5.6.2.3	16.1.0
2019-09	RAN#85	R5-196669	0319	-	F	Correction of RRM Test Case 5.6.2.4	16.1.0
2019-09	RAN#85	R5-196670	0320	-	F	Correction of RRM Test Case 5.6.2.5	16.1.0
2019-09	RAN#85	R5-196671	0321	-	F	Correction of RRM Test Case 5.6.2.6	16.1.0
2019-09	RAN#85	R5-196672	0322	-	F	Correction of RRM Test Case 5.6.2.7	16.1.0

Change history							
Date	Meeting	TDoc	CR	Rev	Cat	Subject/Comment	New version
2019-09	RAN#85	R5-196673	0323	-	F	Correction of RRM Test Case 5.6.2.8	16.1.0
2019-09	RAN#85	R5-196674	0324	-	F	Addition of minimum conformance requirements for L1-RSRP measurement RRM FR1 test cases	16.1.0
2019-09	RAN#85	R5-196675	0325	-	F	Addition of SSB based L1-RSRP measurement RRM test case 4.6.3.1	16.1.0
2019-09	RAN#85	R5-196676	0326	-	F	Addition of SSB based L1-RSRP measurement RRM test case 4.6.3.2	16.1.0
2019-09	RAN#85	R5-196677	0327	-	F	Addition of CSI-RS based L1-RSRP measurement RRM test case 4.6.3.3	16.1.0
2019-09	RAN#85	R5-196679	0329	-	F	Addition of minimum conformance requirements for L1-RSRP measurement RRM FR2 test cases	16.1.0
2019-09	RAN#85	R5-196680	0330	-	F	Addition of SSB based L1-RSRP measurement RRM test case 5.6.3.1	16.1.0
2019-09	RAN#85	R5-196681	0331	-	F	Addition of SSB based L1-RSRP measurement RRM test case 5.6.3.2	16.1.0
2019-09	RAN#85	R5-196682	0332	-	F	Addition of CSI-RS based L1-RSRP measurement RRM test case 5.6.3.3	16.1.0
2019-09	RAN#85	R5-196735	0334	-	F	Editorial to fix conversion issues with two equations	16.1.0
2019-09	RAN#85	R5-196736	0335	-	F	Adding Chapter 8	16.1.0
2019-09	RAN#85	R5-196737	0336	-	F	New test 4.5.7.1	16.1.0
2019-09	RAN#85	R5-196738	0337	-	F	New test 4.5.5.1	16.1.0
2019-09	RAN#85	R5-196739	0338	-	F	New test 4.5.5.2	16.1.0
2019-09	RAN#85	R5-196740	0339	-	F	New test 4.7.3.1	16.1.0
2019-09	RAN#85	R5-196741	0340	-	F	New test 4.7.3.2	16.1.0
2019-09	RAN#85	R5-196742	0341	-	F	New test 6.7.3.1	16.1.0
2019-09	RAN#85	R5-196743	0342	-	F	New test 6.7.3.2	16.1.0
2019-09	RAN#85	R5-196925	0351	-	F	Modification of EN-DC FR2 TAAA Section 5.4.3.1	16.1.0
2019-09	RAN#85	R5-196943	0360	-	F	Addition of CSI-RS based L1-RSRP measurement RRM test case 5.6.3.4	16.1.0
2019-09	RAN#85	R5-197361	0357	1	F	Modification of SA FR1 TAAA Section 6.4.3.1	16.1.0
2019-09	RAN#85	R5-197364	0290	1	F	Update of NR UE Tx Timing Accuracy Test	16.1.0
2019-09	RAN#85	R5-197366	0235	1	F	Update Test Tolerance of 6.1.2.2 inter-RAT cell re-selection to lower priority	16.1.0
2019-09	RAN#85	R5-197396	0346	1	F	Update NSA Event trigger reporting test case	16.1.0
2019-09	RAN#85	R5-197397	0352	1	F	Modification of EN-DC FR2 SSB-RLM OOS Section 5.5.1.1	16.1.0
2019-09	RAN#85	R5-197398	0353	1	F	Modification of EN-DC FR2 SSB-RLM OOS in DRX Section 5.5.1.3	16.1.0
2019-09	RAN#85	R5-197399	0354	1	F	Modification of Synchronous EN-DC FR2 RRC DL BWP Switch in non-DRX Section 5.5.6.2.1	16.1.0
2019-09	RAN#85	R5-197400	0355	1	F	Modification of SA FR1 Handover with unknown Target Cell Section 6.3.1.2	16.1.0
2019-09	RAN#85	R5-197401	0356	1	F	Modification of SA FR1-FR1 Handover with unknown Target Cell Section 6.3.1.3	16.1.0

Change history							
Date	Meeting	TDoc	CR	Rev	Cat	Subject/Comment	New version
2019-09	RAN#85	R5-197402	0224	1	F	Update of 4.6.1.3 event with gap non-DRX	16.1.0
2019-09	RAN#85	R5-197403	0225	1	F	Update of 4.6.1.4 event with gap in DRX	16.1.0
2019-09	RAN#85	R5-197404	0226	1	F	Update of 4.6.1.5 event without gap with ssb index	16.1.0
2019-09	RAN#85	R5-197405	0227	1	F	Update of 4.6.1.6 event with gap with ssb index	16.1.0
2019-09	RAN#85	R5-197406	0314	1	F	Correction of 5G RRM Inter Frequency measurements EN-DC test cases	16.1.0
2019-09	RAN#85	R5-197407	0229	1	F	Addition of 5.6.1.1 event without gap non-DRX	16.1.0
2019-09	RAN#85	R5-197408	0230	1	F	Addition of 5.6.1.2 event without gap in DRX	16.1.0
2019-09	RAN#85	R5-197409	0231	1	F	Addition of 5.6.1.3 event with gap non-DRX	16.1.0
2019-09	RAN#85	R5-197410	0232	1	F	Addition of 5.6.1.4 event with gap in DRX	16.1.0
2019-09	RAN#85	R5-197411	0249	1	F	Addition of NR test case 5.5.1.5-CSI-RS RLM OOS non-DRX	16.1.0
2019-09	RAN#85	R5-197412	0250	1	F	Addition of NR test case 5.5.1.6-CSI-RS RLM IS non-DRX	16.1.0
2019-09	RAN#85	R5-197413	0251	1	F	Addition of NR test case 5.5.1.7-CSI-RS RLM OOS DRX	16.1.0
2019-09	RAN#85	R5-197414	0252	1	F	Addition of NR test case 5.5.1.8-CSI-RS RLM IS DRX	16.1.0
2019-09	RAN#85	R5-197415	0254	1	F	Addition of NR test case 5.5.5.3-CSI-RS BFD non-DRX	16.1.0
2019-09	RAN#85	R5-197416	0255	1	F	Addition of NR test case 5.5.5.4-CSI-RS BFD DRX	16.1.0
2019-09	RAN#85	R5-197417	0259	1	F	Addition of minimum conformance requirements for inter-RAT NR measurements	16.1.0
2019-09	RAN#85	R5-197418	0289	1	F	Correction of default configuration in annex H	16.1.0
2019-09	RAN#85	R5-197419	0303	1	F	Updated to cell configuration mapping table for RRM tests	16.1.0
2019-09	RAN#85	R5-197420	0313	1	F	Correction of default message content for RRM in Annex H	16.1.0
2019-09	RAN#85	R5-197422	0305	1	F	Clarification on NE-DC tests for RRM	16.1.0
2019-09	RAN#85	R5-197423	0343	1	F	Addition RRM FR2 test setups into TS 38.533	16.1.0
2019-09	RAN#85	R5-197424	0345	1	F	Update TDD UL-DL Config based on TS 38.133	16.1.0
2019-09	RAN#85	R5-197425	0347	1	F	Modification of EN-DC FR1 UE Transmit Timing Section 4.4.1.1	16.1.0
2019-09	RAN#85	R5-197426	0265	1	F	Correction of NR test case 4.5.1.5-CSI-RS RLM OOS non-DRX	16.1.0
2019-09	RAN#85	R5-197427	0266	1	F	Correction of NR test case 4.5.1.6-CSI-RS RLM IS non-DRX	16.1.0
2019-09	RAN#85	R5-197428	0267	1	F	Correction of NR test case 4.5.1.7-CSI-RS RLM OOS DRX	16.1.0
2019-09	RAN#85	R5-197429	0268	1	F	Correction of NR test case 4.5.1.8-CSI-RS RLM IS DRX	16.1.0
2019-09	RAN#85	R5-197430	0269	1	F	Correction of NR test case 4.5.2.1-interruption transition DRX sync	16.1.0
2019-09	RAN#85	R5-197431	0270	1	F	Correction of NR test case 4.5.2.2-interruption transition DRX async	16.1.0
2019-09	RAN#85	R5-197432	0271	1	F	Correction of NR test case 4.5.2.3-interruption NR deactivated SCell sync	16.1.0
2019-09	RAN#85	R5-197433	0272	1	F	Correction of NR test case 4.5.2.4-interruption NR deactivated SCell async	16.1.0
2019-09	RAN#85	R5-197434	0273	1	F	Correction of NR test case 4.5.2.5-interruption LTE deactivated SCell sync	16.1.0
2019-09	RAN#85	R5-197435	0274	1	F	Correction of NR test case 4.5.2.6-interruption LTE deactivated SCell async	16.1.0



Change history							
Date	Meeting	TDoc	CR	Rev	Cat	Subject/Comment	New version
2019-09	RAN#85	R5-197436	0328	1	F	Addition of CSI-RS based L1-RSRP measurement RRM test case 4.6.3.4	16.1.0
2019-09	RAN#85	R5-197437	0315	1	F	Correction of 5G RRM Inter Frequency measurements SA test cases	16.1.0
2019-09	RAN#85	R5-197570	0294	1	F	Annex E and F FR1 Test tolerance update for SS-RSRP	16.1.0
2019-09	RAN#85	R5-197584	0344	1	F	Addition Annex for RRM OTA procedures in TS 38.533	16.1.0
2019-09	RAN#85	R5-197607	0287	1	F	Correction of NR test case 7.6.1.3-with gap non-DRX.	16.1.0
2019-09	RAN#85	R5-197611	0237	1	F	Update of 6.3.1.5 inter-RAT handover to unknown cell	16.1.0
2019-09	RAN#85	R5-197612	0291	1	F	Update of SSB-based RLM in-sync test cases	16.1.0
2019-09	RAN#85	R5-197624	0297	1	F	Correction to PRACH configurations for FR1	16.1.0
2019-09	RAN#85	R5-197651	0348	2	F	Modification of EN-DC FR1 TAAA Section 4.4.3.1	16.1.0
2019-09	RAN#85	R5-197652	0349	2	F	Modification of EN-DC FR1 SSB-RLM OOS Section 4.5.1.1	16.1.0
2019-09	RAN#85	R5-197653	0350	2	F	Modification of EN-DC FR1 SSB-RLM OOS DRX Section 4.5.1.3	16.1.0
2019-09	RAN#85	R5-197654	0358	2	F	Modification of SA FR1 SSB RLM OOS in non-DRX Section 6.5.1.1	16.1.0
2019-09	RAN#85	R5-197655	0359	2	F	Modification of SA FR1 SSB RLM OOS in DRX Section 6.5.1.3	16.1.0
2019-09	RAN#85	R5-197656	0292	2	F	FR1 Test tolerance update for SS-RSRP NSA FR1 test cases	16.1.0
2019-09	RAN#85	R5-197657	0300	2	F	Correction to EN-DC FR1 radio link monitoring TC 4.5.1.1 and 4.5.1.2	16.1.0
2019-09	RAN#85	R5-197658	0293	2	F	FR1 Test tolerance update for SS-RSRP SA FR1 test cases	16.1.0
2019-12	RAN#86	R5-197794	0369	-	F	Update Test Tolerance of 4.5.2.1 interruptions active and non-active in sync	16.2.0
2019-12	RAN#86	R5-197795	0370	-	F	Update Test Tolerance of 4.5.2.2 interruptions active and non-active in async	16.2.0
2019-12	RAN#86	R5-197804	0379	-	F	Update Test Tolerance of 6.6.3.1 inter-RAT measurement non-DRX	16.2.0
2019-12	RAN#86	R5-197805	0380	-	F	Update Test Tolerance of 6.6.3.2 inter-RAT measurement DRX	16.2.0
2019-12	RAN#86	R5-197813	0382	-	F	Addition of minimum conformance requirements 5.5.5.0.1-SSB based BFD	16.2.0
2019-12	RAN#86	R5-197814	0383	-	F	Addition of minimum conformance requirements 8.2.1.0-inter-RAT reselection	16.2.0
2019-12	RAN#86	R5-197815	0384	-	F	Addition of minimum conformance requirements 8.3.1.0-inter-RAT handover	16.2.0
2019-12	RAN#86	R5-197816	0385	-	F	Addition of minimum conformance requirements 8.4.1.0-inter-RAT SFTD delay	16.2.0
2019-12	RAN#86	R5-197817	0386	-	F	Addition of minimum conformance requirements 8.5.1.0-inter-RAT SFTD accuracy	16.2.0
2019-12	RAN#86	R5-197820	0389	-	F	Addition of NR test case 8.2.1.1-high priority NR reselection	16.2.0
2019-12	RAN#86	R5-198029	0394	-	F	Update NSA SS-RSRP tests for 4Rx connection diagram	16.2.0
2019-12	RAN#86	R5-198032	0397	-	F	Align Annex D to TS 38.133	16.2.0
2019-12	RAN#86	R5-198289	0400	-	F	Correction of PRACH index in 6.1.1.1, 6.3.2.2.1 and 6.3.2.2.2	16.2.0
2019-12	RAN#86	R5-198415	0404	-	F	Correction to NR SA FR1 timing advance adjustment accuracy TC 6.4.3.1	16.2.0

Change history							
Date	Meeting	TDoc	CR	Rev	Cat	Subject/Comment	New version
2019-12	RAN#86	R5-198416	0405	-	F	Correction to intra-frequency event-triggered reporting TC 6.6.1.1, 6.6.1.2, 6.6.1.3	16.2.0
2019-12	RAN#86	R5-198421	0410	-	F	Correction to FR1 SA random access test cases	16.2.0
2019-12	RAN#86	R5-198472	0412	-	F	Correct message contents for 5.6.2.x tests	16.2.0
2019-12	RAN#86	R5-198477	0416	-	F	Correction to Annex E	16.2.0
2019-12	RAN#86	R5-198518	0418	-	F	Update PUSCH symbol length as message exception in 6.4.1.1 in TS 38.533	16.2.0
2019-12	RAN#86	R5-198519	0419	-	F	Update 4.4.3.1 test requirements	16.2.0
2019-12	RAN#86	R5-198545	0420	-	F	Update 4.7.1.1.1 test requirements in TS 38.533	16.2.0
2019-12	RAN#86	R5-198549	0421	-	F	Updated to cell configuration mapping table for RRM tests	16.2.0
2019-12	RAN#86	R5-198550	0422	-	F	Minimum conformance requirements updated for 5G RRM Inter-RAT measurements tests	16.2.0
2019-12	RAN#86	R5-198551	0423	-	F	Minimum conformance requirements updated for 5G RRM SCell activation and deactivation delay tests	16.2.0
2019-12	RAN#86	R5-198558	0428	-	F	5G RRM Spec 3GPP style correction in clause 4 and 5	16.2.0
2019-12	RAN#86	R5-198572	0429	-	F	Correction of minimum conformance requirements 4.6.2.0	16.2.0
2019-12	RAN#86	R5-198575	0432	-	F	Correction of minimum conformance requirements 5.6.3.0	16.2.0
2019-12	RAN#86	R5-198577	0434	-	F	Correction of clause 3 definitions, symbols and abbreviations	16.2.0
2019-12	RAN#86	R5-198578	0435	-	F	Correction of RRM Test Case 4.6.3.1	16.2.0
2019-12	RAN#86	R5-198581	0438	-	F	Correction of RRM Test Case 4.6.3.4	16.2.0
2019-12	RAN#86	R5-198582	0439	-	F	Correction of RRM Test Case 5.6.2.1	16.2.0
2019-12	RAN#86	R5-198583	0440	-	F	Correction of RRM Test Case 5.6.2.2	16.2.0
2019-12	RAN#86	R5-198584	0441	-	F	Correction of RRM Test Case 5.6.2.3	16.2.0
2019-12	RAN#86	R5-198585	0442	-	F	Correction of RRM Test Case 5.6.2.4	16.2.0
2019-12	RAN#86	R5-198586	0443	-	F	Correction of RRM Test Case 5.6.2.5	16.2.0
2019-12	RAN#86	R5-198587	0444	-	F	Correction of RRM Test Case 5.6.2.6	16.2.0
2019-12	RAN#86	R5-198588	0445	-	F	Correction of RRM Test Case 5.6.2.7	16.2.0
2019-12	RAN#86	R5-198589	0446	-	F	Correction of RRM Test Case 5.6.2.8	16.2.0
2019-12	RAN#86	R5-198594	0451	-	F	Correction of RRM Test Case 7.6.2.1	16.2.0
2019-12	RAN#86	R5-198595	0452	-	F	Correction of RRM Test Case 7.6.2.2	16.2.0
2019-12	RAN#86	R5-198596	0453	-	F	Correction of RRM Test Case 7.6.2.3	16.2.0
2019-12	RAN#86	R5-198597	0454	-	F	Correction of RRM Test Case 7.6.2.4	16.2.0
2019-12	RAN#86	R5-198598	0455	-	F	Correction of RRM Test Case 7.6.2.5	16.2.0
2019-12	RAN#86	R5-198599	0456	-	F	Correction of RRM Test Case 7.6.2.6	16.2.0
2019-12	RAN#86	R5-198601	0458	-	F	Correction of RRM Test Case 7.6.2.8	16.2.0
2019-12	RAN#86	R5-198692	0471	-	F	Addition of RRM Test Case 6.6.4.1	16.2.0
2019-12	RAN#86	R5-198693	0472	-	F	Addition of RRM Test Case 6.6.4.2	16.2.0
2019-12	RAN#86	R5-198694	0473	-	F	Addition of RRM Test Case 6.6.4.3	16.2.0

Change history							
Date	Meeting	TDoc	CR	Rev	Cat	Subject/Comment	New version
2019-12	RAN#86	R5-198695	0474	-	F	Addition of RRM Test Case 6.6.4.4	16.2.0
2019-12	RAN#86	R5-198696	0475	-	F	Addition of RRM Test Case 7.6.3.1	16.2.0
2019-12	RAN#86	R5-198697	0476	-	F	Addition of RRM Test Case 7.6.3.2	16.2.0
2019-12	RAN#86	R5-198698	0477	-	F	Addition of RRM Test Case 7.6.3.3	16.2.0
2019-12	RAN#86	R5-198699	0478	-	F	Addition of RRM Test Case 7.6.3.4	16.2.0
2019-12	RAN#86	R5-199364	0365	1	F	Update Test Tolerance of 4.5.1.5 RLM OOS non-DRX	16.2.0
2019-12	RAN#86	R5-199365	0367	1	F	Update Test Tolerance of 4.5.1.7 RLM OOS DRX	16.2.0
2019-12	RAN#86	R5-199366	0375	1	F	Update Test Tolerance of 6.5.1.5 SA RLM OOS non-DRX	16.2.0
2019-12	RAN#86	R5-199367	0377	1	F	Update Test Tolerance of 6.5.1.7 SA RLM OOS DRX	16.2.0
2019-12	RAN#86	R5-199368	0366	1	F	Update Test Tolerance of 4.5.1.6 RLM in-sync non-DRX	16.2.0
2019-12	RAN#86	R5-199369	0368	1	F	Update Test Tolerance of 4.5.1.8 RLM in-sync DRX	16.2.0
2019-12	RAN#86	R5-199370	0376	1	F	Update Test Tolerance of 6.5.1.6 SA RLM in-sync non-DRX	16.2.0
2019-12	RAN#86	R5-199371	0378	1	F	Update Test Tolerance of 6.5.1.8 SA RLM in-sync DRX	16.2.0
2019-12	RAN#86	R5-199379	0417	1	F	Update 4.4.1.1 test procedure in TS 38.533	16.2.0
2019-12	RAN#86	R5-199380	0479	1	F	Update 4.5.1.1 and 4.5.1.2 in TS 38.533	16.2.0
2019-12	RAN#86	R5-199381	0406	1	F	Correction to NR SA FR1 SS-RSRP absolute and relative measurement accuracy Intra-frequency measurements	16.2.0
2019-12	RAN#86	R5-199389	0402	1	F	Correction to NR SA Cell re-selection tests	16.2.0
2019-12	RAN#86	R5-199390	0436	1	F	Correction of RRM Test Case 4.6.3.2	16.2.0
2019-12	RAN#86	R5-199391	0437	1	F	Correction of RRM Test Case 4.6.3.3	16.2.0
2019-12	RAN#86	R5-199392	0387	1	F	Addition of NR test case 5.5.5.1-ENDC FR2 SSB BFD no-DRX	16.2.0
2019-12	RAN#86	R5-199393	0388	1	F	Addition of NR test case 5.5.5.2-ENDC FR2 SSB BFD DRX	16.2.0
2019-12	RAN#86	R5-199394	0431	1	F	Correction of minimum conformance requirements 5.6.2.0	16.2.0
2019-12	RAN#86	R5-199395	0395	1	F	Update SA SS-RSRP tests for 4Rx connection diagram	16.2.0
2019-12	RAN#86	R5-199396	0403	1	F	Correction to NR SA FR1 UE transmit timing accuracy TC 6.4.1.1	16.2.0
2019-12	RAN#86	R5-199397	0457	1	F	Correction of RRM Test Case 7.6.2.7	16.2.0
2019-12	RAN#86	R5-199398	0361	1	F	Add AoA Setup 4 for FR2 RRM Test cases	16.2.0
2019-12	RAN#86	R5-199399	0390	1	F	Addition of NR test case 8.3.1.1-known handover	16.2.0
2019-12	RAN#86	R5-199400	0391	1	F	Addition of NR test case 8.4.1.1-SFTD delay non-DRX	16.2.0
2019-12	RAN#86	R5-199401	0392	1	F	Addition of NR test case 8.4.1.2-SFTD delay DRX	16.2.0
2019-12	RAN#86	R5-199402	0393	1	F	Addition of NR test case 8.5.1.1-SFTD accuracy	16.2.0
2019-12	RAN#86	R5-199403	0396	1	F	Align Annex A to TS 38.133	16.2.0
2019-12	RAN#86	R5-199404	0413	1	F	Clean up RRM message contents in Annex H	16.2.0
2019-12	RAN#86	R5-199405	0424	1	F	New 5G RRM Inter-RAT measurement TC 8.4.2.5	16.2.0
2019-12	RAN#86	R5-199406	0425	1	F	New 5G RRM Inter-RAT measurement TC 8.4.2.6	16.2.0
2019-12	RAN#86	R5-199407	0426	1	F	New 5G RRM Inter-RAT measurement TC 8.4.2.7	16.2.0

Change history							
Date	Meeting	TDoc	CR	Rev	Cat	Subject/Comment	New version
2019-12	RAN#86	R5-199408	0427	1	F	New 5G RRM Inter-RAT measurement TC 8.4.2.8	16.2.0
2019-12	RAN#86	R5-199409	0433	1	F	Correction of message content in Annex H	16.2.0
2019-12	RAN#86	R5-199436	0470	1	F	Introduction of n29 and n65 to 38.533	16.2.0
2019-12	RAN#86	R5-199499	0401	1	F	Correction to EN-DC FR1 UE transmit timing accuracy TC 4.4.1.1	16.2.0
2019-12	RAN#86	R5-199515	0381	1	F	Update Test Tolerance in Annex F	16.2.0
2019-12	RAN#86	R5-199517	0481	1	F	Update General parameters in test case 4.5.1.2	16.2.0
2019-12	RAN#86	R5-199533	0482	1	F	Update NSA FR2 RLM IS non-DRX test	16.2.0
2019-12	RAN#86	R5-199534	0483	1	F	Update NSA FR2 RLM IS test with DRX	16.2.0
2019-12	RAN#86	R5-199535	0484	1	F	Update NSA FR2 Timing Accuracy Test	16.2.0
2019-12	RAN#86	R5-199544	0399	1	F	Add applicable test methods for RRM FR2	16.2.0
2019-12	RAN#86	R5-199550	0463	1	F	Addition of NR SA FR1 Handover with known Target Cell Section 6.3.1.1	16.2.0
2019-12	RAN#86	R5-199551	0464	1	F	Modification of NR SA FR1 Handover with unknown Target Cell Section 6.3.1.2	16.2.0
2019-12	RAN#86	R5-199552	0465	1	F	Modification of NR SA FR1-FR1 Handover with unknown Target Cell Section 6.3.1.3	16.2.0
2019-12	RAN#86	R5-199583	0409	1	F	Correction to FR1 NSA random access test cases	16.2.0
2020-03	RAN#87	R5-200822	0544	-	F	Correction to Test Applicability for 4.3.2.2.2 Non-contention based random access test in FR1 for PSCell in EN-DC	16.3.0
2020-03	RAN#87	R5-200823	0545	-	F	Correction to SRS Configuration for 4.4.3.1 EN-DC FR1 timing advance adjustment accuracy	16.3.0
2020-03	RAN#87	R5-200829	0551	-	F	Correction to Message Exception for 4.6.1.5 EN-DC FR1 event-triggered reporting without gap in non-DRX with SSB time index detection	16.3.0
2020-03	RAN#87	R5-200833	0555	-	F	Correction to Test Applicability for 6.3.2.2.2 Non-Contention based random access test in FR1 for NR standalone	16.3.0
2020-03	RAN#87	R5-200834	0556	-	F	Correction to SRS Configuration for 6.4.3.1 NR SA FR1 timing advance adjustment accuracy	16.3.0
2020-03	RAN#87	R5-200839	0561	-	F	Correction to Message Exception for 6.6.1.5 NR SA FR1 event-triggered reporting without gap in non-DRX with SSB time index detection	16.3.0
2020-03	RAN#87	R5-200277	0488	-	F	Test tolerance update intra-frequency SS-SINR NSA	16.3.0
2020-03	RAN#87	R5-200278	0489	-	F	Test tolerance update inter-frequency SS-SINR NSA	16.3.0
2020-03	RAN#87	R5-200279	0490	-	F	Test tolerance update inter-frequency SS-RSRP SA	16.3.0
2020-03	RAN#87	R5-200281	0492	-	F	Test tolerance update inter-frequency SS-RSRQ SA	16.3.0
2020-03	RAN#87	R5-200282	0493	-	F	Test tolerance update intra-frequency SS-SINR SA	16.3.0
2020-03	RAN#87	R5-200283	0494	-	F	Test tolerance update inter-frequency SS-SINR SA	16.3.0
2020-03	RAN#87	R5-200306	0497	-	F	Reference SSB configuration correction	16.3.0
2020-03	RAN#87	R5-200421	0508	-	F	Correction to Active UL BWP for intra-frequency event triggered reporting with gap	16.3.0
2020-03	RAN#87	R5-200422	0509	-	F	Correction to EN-DC FR1 event-triggered reporting test cases	16.3.0
2020-03	RAN#87	R5-200423	0510	-	F	Correction to FR1 NR SA E-UTRA cell re-selection test cases	16.3.0

Change history							
Date	Meeting	TDoc	CR	Rev	Cat	Subject/Comment	New version
2020-03	RAN#87	R5-200425	0512	-	F	Correction to NR SA FR1 SS-RSRP measurement accuracy tests	16.3.0
2020-03	RAN#87	R5-200427	0514	-	F	Correction to the simulated cell for cell-reselection test cases	16.3.0
2020-03	RAN#87	R5-200428	0515	-	F	Correction to UE transmit timing accuracy test case	16.3.0
2020-03	RAN#87	R5-200564	0524	-	F	Correction to Statistical testing of delay and UE measurement performance in RRM tests	16.3.0
2020-03	RAN#87	R5-200606	0526	-	F	Cell mapping update measurement tests Annex E	16.3.0
2020-03	RAN#87	R5-200607	0527	-	F	Re-submission R5-197804 not implemented	16.3.0
2020-03	RAN#87	R5-200608	0528	-	F	Corrections to SS-RSRP meas accuracy NSA tests	16.3.0
2020-03	RAN#87	R5-200610	0530	-	F	Correct message contents measurement tests	16.3.0
2020-03	RAN#87	R5-200705	0533	-	F	Correction to TC 6.1.1.2 FR1 inter-freq re-selection	16.3.0
2020-03	RAN#87	R5-200708	0536	-	F	Update of TC 6.3.2.3.1 FR1 RRC redirection	16.3.0
2020-03	RAN#87	R5-200709	0537	-	F	Update of TC 6.3.2.3.2 inter-freq RRC redirection	16.3.0
2020-03	RAN#87	R5-200785	0539	-	F	Update of EN-DC SSB-based RLM TC 4.5.1.1, 4.5.1.2, 4.5.1.3 and 4.5.1.4	16.3.0
2020-03	RAN#87	R5-200786	0540	-	F	Update of EN-DC CSI-RS-based RLM TC 4.5.1.5, 4.5.1.6, 4.5.1.7 and 4.5.1.8	16.3.0
2020-03	RAN#87	R5-200787	0541	-	F	Update of NR CSI-RS-based RLM TC 6.5.1.5, 6.5.1.6, 6.5.1.7 and 6.5.1.8	16.3.0
2020-03	RAN#87	R5-200818	0543	-	F	Correction to cell mapping Annex E	16.3.0
2020-03	RAN#87	R5-200858	0569	-	F	Corrections to Table H.3.1-8	16.3.0
2020-03	RAN#87	R5-200916	0538	1	F	Update to test applicability per permitted test method	16.3.0
2020-03	RAN#87	R5-200986	0507	1	F	Core alignment for event-triggered reporting test cases	16.3.0
2020-03	RAN#87	R5-200987	0534	1	F	Update of TC 6.3.2.1.1 FR1 RRC re-establishment	16.3.0
2020-03	RAN#87	R5-200988	0535	1	F	Update of TC 6.3.2.1.2 inter-freq RRC re-establishment	16.3.0
2020-03	RAN#87	R5-201030	0529	1	F	Corrections to SS-RSRP meas accuracy SA tests	16.3.0
2020-03	RAN#87	R5-201039	0485	1	F	Test tolerance update inter-frequency SS-RSRP NSA	16.3.0
2020-03	RAN#87	R5-201040	0486	1	F	Test tolerance update intra-frequency SS-RSRQ NSA	16.3.0
2020-03	RAN#87	R5-201041	0491	1	F	Test tolerance update intra-frequency SS-RSRQ SA	16.3.0
2020-03	RAN#87	R5-201056	0511	1	F	Correction to message contents in 6.6.1.5 and 6.6.1.6	16.3.0
2020-03	RAN#87	R5-201057	0513	1	F	Correction to test description of RRM TC 4.6.1.3 and 4.6.1.6	16.3.0
2020-03	RAN#87	R5-201058	0516	1	F	Update of maximum test system uncertainty for FR1 RRM Test	16.3.0
2020-03	RAN#87	R5-201063	0517	1	F	Update FR1 Test Tolerance of 4.5.2.3 interruptions on NR SCC in sync	16.3.0
2020-03	RAN#87	R5-201064	0518	1	F	Update FR1 Test Tolerance of 4.5.2.4 interruptions on NR SCC in async	16.3.0
2020-03	RAN#87	R5-201071	0552	1	F	Correction to Test Applicability for 4.6.2.2 EN-DC FR1-FR1 event-triggered reporting in DRX	16.3.0
2020-03	RAN#87	R5-201072	0553	1	F	Correction to Test Applicability for 4.6.2.5 EN-DC FR1-FR1 event-triggered reporting in non-DRX with SSB time index detection	16.3.0

Change history							
Date	Meeting	TDoc	CR	Rev	Cat	Subject/Comment	New version
2020-03	RAN#87	R5-201073	0554	1	F	Correction to Test Applicability for 4.6.2.6 EN-DC FR1-FR1 event-triggered reporting in DRX with SSB time index detection	16.3.0
2020-03	RAN#87	R5-201078	0562	1	F	Correction to Test Applicability for 6.6.2.1 NR SA FR1-FR1 event-triggered reporting in non-DRX	16.3.0
2020-03	RAN#87	R5-201080	0564	1	F	Correction to Test Applicability for 6.6.2.5 NR SA FR1-FR1 event-triggered reporting in non-DRX with SSB time index detection	16.3.0
2020-03	RAN#87	R5-201081	0565	1	F	Correction to Test Applicability for 6.6.2.6 NR SA FR1-FR1 event-triggered reporting in DRX with SSB time index detection	16.3.0
2020-03	RAN#87	R5-201082	0571	1	F	Correction to Test Parameters for 4.6.1.1	16.3.0
2020-03	RAN#87	R5-201083	0572	1	F	Correction to Test Parameters for 4.6.1.2	16.3.0
2020-03	RAN#87	R5-201160	0531	1	F	Correct message contents event triggered measurement tests	16.3.0
2020-03	RAN#87	R5-201166	0567	1	F	Update RLM non DRX test cases	16.3.0
2020-03	RAN#87	R5-201167	0568	1	F	Update 4.5.1.4 test case	16.3.0
2020-03	RAN#87	R5-201168	0570	1	F	Clarification 4.4.1.1 test procedure	16.3.0
2020-03	RAN#87	R5-201169	0521	1	F	Update of FR1 Test Tolerance in Annex F	16.3.0
2020-03	RAN#87	R5-201190	0542	1	F	Update of NR SSB-based RLM TC 6.5.1.1, 6.5.1.2, 6.5.1.3 and 6.5.1.4	16.3.0
2020-03	RAN#87	R5-201240	0563	2	F	Correction to Test Applicability for 6.6.2.2 NA SA FR1-FR1 event-triggered reporting in DRX	16.3.0
2020-03	RAN#87	R5-201242	0532	2	F	Correction to Test Applicability for 4.6.2.1 EN-DC FR1-FR1 event-triggered reporting in non-DRX	16.3.0
2020-03	RAN#87	R5-200276	0487	-	F	Test tolerance update inter-frequency SS-RSRQ NSA	16.3.0
2020-03	RAN#87	R5-200284	0495	-	F	Test tolerance update measurement tests Annex F	16.3.0
2020-03	RAN#87	R5-201044	0496	-	F	Test Tolerance and Measurement Uncertainty in Annex F for L1-RSRP measurement test cases	16.3.0
2020-03	RAN#87	R5-201045	0499	1	F	Correction of RRM Test Case 4.6.3.1 including FR1 Test Tolerance	16.3.0
2020-03	RAN#87	R5-201046	0500	1	F	Correction of RRM Test Case 4.6.3.2 including FR1 Test Tolerance	16.3.0
2020-03	RAN#87	R5-201047	0501	1	F	Correction of RRM Test Case 4.6.3.3 including FR1 Test Tolerance	16.3.0
2020-03	RAN#87	R5-201048	0502	1	F	Correction of RRM Test Case 4.6.3.4 including FR1 Test Tolerance	16.3.0
2020-03	RAN#87	R5-201049	0503	1	F	Correction of RRM Test Case 6.6.4.1 including FR1 Test Tolerance	16.3.0
2020-03	RAN#87	R5-201050	0504	1	F	Correction of RRM Test Case 6.6.4.2 including FR1 Test Tolerance	16.3.0
2020-03	RAN#87	R5-201051	0505	1	F	Correction of RRM Test Case 6.6.4.3 including FR1 Test Tolerance	16.3.0
2020-03	RAN#87	R5-201052	0506	1	F	Correction of RRM Test Case 6.6.4.4 including FR1 Test Tolerance	16.3.0
2020-03	RAN#87	R5-201070	0548	1	F	Correction to Message Exception for 4.5.1.3 EN-DC FR1 radio link monitoring Out-of-sync test for PSCell configured with SSB-based RLM RS in DRX mode	16.3.0
2020-03	RAN#87	R5-201074	0557	1	F	Correction to Test Parameter for 6.5.1.1 NR SA FR1 radio link monitoring Out-of-sync test for PSCell configured with SSB-based RLM RS in non-DRX mode	16.3.0
2020-03	RAN#87	R5-201075	0558	1	F	Correction to Test Procedure for 6.5.1.2 NR SA FR1 radio link monitoring in-sync test for PCell configured with SSB-based RLM RS in non-DRX mode	16.3.0

Change history							
Date	Meeting	TDoc	CR	Rev	Cat	Subject/Comment	New version
2020-03	RAN#87	R5-201076	0559	1	F	Correction to Message Exception for 6.5.1.3 NR SA FR1 radio link monitoring Out-of-sync test for PSCell configured with SSB-based RLM RS in DRX mode	16.3.0
2020-03	RAN#87	R5-201077	0560	1	F	Correction to Message Exception for 6.5.1.4 NR SA FR1 radio link monitoring In-sync test for PSCell configured with SSB-based RLM RS in DRX mode	16.3.0
2020-03	RAN#87	R5-201105	0546	1	F	Correction to Test Parameters for 4.5.1.1 EN-DC FR1 radio link monitoring Out-of-sync test for PSCell configured with SSB-based RLM RS in non-DRX mode	16.3.0
2020-03	RAN#87	R5-201106	0547	1	F	Correction to Test Procedure for 4.5.1.2 EN-DC FR1 radio link monitoring in-sync test for PSCell configured with SSB-based RLM RS in non-DRX mode	16.3.0
2020-06	RAN#88	R5-201395	0576	-	F	Correction to NR test case 7.7.1.3.2 SS-RSRP relative accuracy	16.4.0
2020-06	RAN#88	R5-201396	0577	-	F	Correction to NR test case 8.2.1.1 higher priority NR cell reselection	16.4.0
2020-06	RAN#88	R5-201398	0579	-	F	Correction to NR test case 8.4.1.1 SFTD non-DRX	16.4.0
2020-06	RAN#88	R5-201399	0580	-	F	Correction to NR test case 8.4.1.2 SFTD DRX	16.4.0
2020-06	RAN#88	R5-201400	0581	-	F	Correction to NR test case 8.4.2.1 event-triggered without SSB index non-DRX	16.4.0
2020-06	RAN#88	R5-201401	0582	-	F	Correction to NR test case 8.4.2.2 event-triggered without SSB index DRX	16.4.0
2020-06	RAN#88	R5-201402	0583	-	F	Correction to NR test case 8.4.2.3 event-triggered with SSB index non-DRX	16.4.0
2020-06	RAN#88	R5-201403	0584	-	F	Correction to NR test case 8.4.2.4 event-triggered with SSB index DRX	16.4.0
2020-06	RAN#88	R5-201404	0585	-	F	Correction to NR test case 8.5.1.1 SFTD accuracy	16.4.0
2020-06	RAN#88	R5-201405	0586	-	F	Addition to minimum conformance requirement 5.5.5.0.3 - scheduling restriction for BFD and CBD	16.4.0
2020-06	RAN#88	R5-201407	0588	-	F	Addition to minimum conformance requirement 5.5.8.0 - TCI-state switch	16.4.0
2020-06	RAN#88	R5-201408	0589	-	F	Addition to NR test case 5.5.8.1 MAC-CE based TCI switch	16.4.0
2020-06	RAN#88	R5-201409	0590	-	F	Addition to NR test case 5.5.8.2 RRC based TCI switch	16.4.0
2020-06	RAN#88	R5-201412	0593	-	F	Addition to minimum conformance requirements 7.5.1.0.5 - Scheduling restriction for RLM	16.4.0
2020-06	RAN#88	R5-201414	0595	-	F	Addition to minimum Conformance Requirements 7.5.6.1.0 - DCI-based DL active BWP switch	16.4.0
2020-06	RAN#88	R5-201415	0596	-	F	Addition to NR test case 7.5.6.1.3 FR2 DCI-based DL active BWP switch non-DRX	16.4.0
2020-06	RAN#88	R5-201619	0603	-	F	Corrections to 6.7.1.1	16.4.0
2020-06	RAN#88	R5-201676	0614	-	F	Correction to inter-freq measurement TCs for SSB configuration	16.4.0
2020-06	RAN#88	R5-201677	0615	-	F	Correction to TC 6.3.2.3.1 for the test procedure	16.4.0
2020-06	RAN#88	R5-201679	0617	-	F	Update of TC 5.6.1.1 event-triggered without gap non-DRX	16.4.0
2020-06	RAN#88	R5-201680	0618	-	F	Update of TC 5.6.1.2 event-triggered without gap DRX	16.4.0
2020-06	RAN#88	R5-201681	0619	-	F	Update of TC 5.6.1.3 event-triggered with gap non-DRX	16.4.0
2020-06	RAN#88	R5-201682	0620	-	F	Update of TC 5.6.1.4 event-triggered with gap DRX	16.4.0

Change history							
Date	Meeting	TDoc	CR	Rev	Cat	Subject/Comment	New version
2020-06	RAN#88	R5-201686	0624	-	F	Update of TC 8.4.2.5 FR2 event-triggered without SSB index non-DRX	16.4.0
2020-06	RAN#88	R5-201687	0625	-	F	Update of TC 8.4.2.6 FR2 event-triggered without SSB index DRX	16.4.0
2020-06	RAN#88	R5-201688	0626	-	F	Update of TC 8.4.2.7 FR2 event-triggered with SSB index non-DRX	16.4.0
2020-06	RAN#88	R5-201689	0627	-	F	Update of TC 8.4.2.8 FR2 event-triggered with SSB index DRX	16.4.0
2020-06	RAN#88	R5-201821	0634	-	F	Correction of SS-SINR applicability -NSA	16.4.0
2020-06	RAN#88	R5-201822	0635	-	F	Correction of SS-SINR applicability -SA	16.4.0
2020-06	RAN#88	R5-201824	0637	-	F	Corrections to 4.7.1.1	16.4.0
2020-06	RAN#88	R5-202054	0644	-	F	Minimum Requirements SS-RSRP iRAT	16.4.0
2020-06	RAN#88	R5-202055	0645	-	F	Addition 8.5.2.1.1	16.4.0
2020-06	RAN#88	R5-202056	0646	-	F	Addition 8.5.2.1.2	16.4.0
2020-06	RAN#88	R5-202057	0647	-	F	Minimum Requirements SS-RSRQ iRAT	16.4.0
2020-06	RAN#88	R5-202058	0648	-	F	Addition 8.5.2.2.1	16.4.0
2020-06	RAN#88	R5-202059	0649	-	F	Addition 8.5.2.2.2	16.4.0
2020-06	RAN#88	R5-202060	0650	-	F	Minimum Requirements SS-SINR iRAT	16.4.0
2020-06	RAN#88	R5-202061	0651	-	F	Addition 8.5.2.3.1	16.4.0
2020-06	RAN#88	R5-202062	0652	-	F	Addition 8.5.2.3.2	16.4.0
2020-06	RAN#88	R5-202063	0653	-	F	Minimum requirements SS-RSRP NSA FR2	16.4.0
2020-06	RAN#88	R5-202064	0654	-	F	Addition 5.7.1.1	16.4.0
2020-06	RAN#88	R5-202065	0655	-	F	Addition 5.7.1.2	16.4.0
2020-06	RAN#88	R5-202066	0656	-	F	Addition 5.7.1.3	16.4.0
2020-06	RAN#88	R5-202067	0657	-	F	Minimum requirements SS-RSRQ NSA FR2	16.4.0
2020-06	RAN#88	R5-202068	0658	-	F	Addition 5.7.2.1	16.4.0
2020-06	RAN#88	R5-202069	0659	-	F	Addition 5.7.2.2	16.4.0
2020-06	RAN#88	R5-202070	0660	-	F	Minimum requirements SS-SINR NSA FR2	16.4.0
2020-06	RAN#88	R5-202071	0661	-	F	Addition 5.7.3.1	16.4.0
2020-06	RAN#88	R5-202072	0662	-	F	Addition 5.7.3.2	16.4.0
2020-06	RAN#88	R5-202073	0663	-	F	Minimum requirements SS-RSRP SA FR2	16.4.0
2020-06	RAN#88	R5-202074	0664	-	F	Addition 7.7.1.1	16.4.0
2020-06	RAN#88	R5-202075	0665	-	F	Addition 7.7.1.2	16.4.0
2020-06	RAN#88	R5-202076	0666	-	F	Minimum requirements SS-RSRQ SA FR2	16.4.0
2020-06	RAN#88	R5-202077	0667	-	F	Addition 7.7.2.1	16.4.0
2020-06	RAN#88	R5-202078	0668	-	F	Addition 7.7.2.2	16.4.0
2020-06	RAN#88	R5-202079	0669	-	F	Minimum requirements SS-SINR SA FR2	16.4.0
2020-06	RAN#88	R5-202080	0670	-	F	Addition 7.7.3.1	16.4.0
2020-06	RAN#88	R5-202081	0671	-	F	Addition 7.7.3.2	16.4.0



Change history							
Date	Meeting	TDoc	CR	Rev	Cat	Subject/Comment	New version
2020-06	RAN#88	R5-202091	0672	-	F	Correction of OCN configurations and CSI-RS for tracking in Annex A	16.4.0
2020-06	RAN#88	R5-202092	0673	-	F	Cell configuration for SA FR2 event-triggered reporting test cases	16.4.0
2020-06	RAN#88	R5-202093	0674	-	F	Correction of MeasGapConfig in Annex H	16.4.0
2020-06	RAN#88	R5-202095	0676	-	F	Correction of AoA configuration for FR2 SA Inter-freq measurement test cases in clause 5.6.2	16.4.0
2020-06	RAN#88	R5-202096	0677	-	F	Correction of RRM Test Case 7.6.2.1	16.4.0
2020-06	RAN#88	R5-202097	0678	-	F	Correction of RRM Test Case 7.6.2.2	16.4.0
2020-06	RAN#88	R5-202098	0679	-	F	Correction of RRM Test Case 7.6.2.3	16.4.0
2020-06	RAN#88	R5-202099	0680	-	F	Correction of RRM Test Case 7.6.2.4	16.4.0
2020-06	RAN#88	R5-202100	0681	-	F	Correction of RRM Test Case 7.6.2.5	16.4.0
2020-06	RAN#88	R5-202101	0682	-	F	Correction of RRM Test Case 7.6.2.6	16.4.0
2020-06	RAN#88	R5-202102	0683	-	F	Correction of RRM Test Case 7.6.2.7	16.4.0
2020-06	RAN#88	R5-202103	0684	-	F	Correction of RRM Test Case 7.6.2.8	16.4.0
2020-06	RAN#88	R5-202263	0704	-	F	Core alignment in 4.6.1.5 and 4.6.1.6 Event Triggered Reporting with SSB time index detection	16.4.0
2020-06	RAN#88	R5-202265	0706	-	F	Correction on EN-DC FR1 radio link monitoring out-of-sync test	16.4.0
2020-06	RAN#88	R5-202273	0714	-	F	Correction to NR SA FR1 - E-UTRA RRC Connection release with redirection	16.4.0
2020-06	RAN#88	R5-202277	0718	-	F	Editorial Correction to FR2 Interruption test cases	16.4.0
2020-06	RAN#88	R5-202385	0720	-	F	Addition of RRM Cell configuration mapping table for EN-DC FR1 Test Case 4.5.4.1	16.4.0
2020-06	RAN#88	R5-202387	0721	-	F	Addition of RRC message content exceptions for UE UL Carrier Reconfiguration Delay	16.4.0
2020-06	RAN#88	R5-202389	0722	-	F	Addition of RRM Test Case 4.5.4.1 in Annex F	16.4.0
2020-06	RAN#88	R5-202415	0728	-	F	Alignment 5.4.1.1 test procedure with 4.4.1.1	16.4.0
2020-06	RAN#88	R5-202418	0730	-	F	Update 6.5.1.1 and CSI-ReportConfig in Annex H	16.4.0
2020-06	RAN#88	R5-202488	0736	-	F	Correction to the simulated cell for cell-reselection test cases	16.4.0
2020-06	RAN#88	R5-202496	0744	-	F	Correction of RRM Test Case 6.4.1.1	16.4.0
2020-06	RAN#88	R5-202497	0745	-	F	Title Correction of Annex D.4.2.4	16.4.0
2020-06	RAN#88	R5-202700	0723	1	F	Addition of new RRM Test Case 4.5.4.1	16.4.0
2020-06	RAN#88	R5-202701	0675	1	F	Editorial correction of RRM TT in Annex F	16.4.0
2020-06	RAN#88	R5-202744	0708	1	F	Correction to EN-DC FR1 radio link monitoring tests	16.4.0
2020-06	RAN#88	R5-202745	0727	1	F	Clarification cell2 SS-RSRP in 4.7.1.2.1	16.4.0
2020-06	RAN#88	R5-202746	0587	1	F	Addition to NR test case 5.5.5.5 scheduling available restriction	16.4.0
2020-06	RAN#88	R5-202747	0707	1	F	Correction on NR SA FR1 - E-UTRAN event-triggered reporting tests	16.4.0
2020-06	RAN#88	R5-202748	0731	1	F	Update 6.5.1.2 message content exception and test procedure	16.4.0
2020-06	RAN#88	R5-202749	0737	1	F	Correction of RRM Test Case 6.1.1.1	16.4.0

Change history							
Date	Meeting	TDoc	CR	Rev	Cat	Subject/Comment	New version
2020-06	RAN#88	R5-202750	0738	1	F	Correction of RRM Test Case 6.1.1.2	16.4.0
2020-06	RAN#88	R5-202751	0621	1	F	Update of TC 7.1.1.1 intra-freq cell re-selection	16.4.0
2020-06	RAN#88	R5-202752	0622	1	F	Update of TC 7.1.1.2 inter-freq cell re-selection	16.4.0
2020-06	RAN#88	R5-202753	0724	1	F	Addition of new RRM Test Cases in clause 7.5.3	16.4.0
2020-06	RAN#88	R5-202754	0725	1	F	Addition of new RRM Test Cases in clause 7.5.7	16.4.0
2020-06	RAN#88	R5-202812	0685	1	F	Correction to Test Applicability for 4.6.1.3 EN-DC FR1 event-triggered reporting with gap in non-DRX	16.4.0
2020-06	RAN#88	R5-202813	0686	1	F	Correction to Test Applicability for 4.6.1.4 EN-DC FR1 event-triggered reporting with gap in DRX	16.4.0
2020-06	RAN#88	R5-202814	0687	1	F	Correction to Test Applicability & Message Exception for 4.6.1.6 EN-DC FR1 event-triggered reporting with gap in non-DRX with SSB time index detection	16.4.0
2020-06	RAN#88	R5-202815	0688	1	F	Correction to Test Applicability for 6.6.1.3 NR SA FR1 event-triggered reporting with gap in non-DRX	16.4.0
2020-06	RAN#88	R5-202816	0689	1	F	Correction to Test Applicability for 6.6.1.4 NR SA FR1 event-triggered reporting with gap in DRX	16.4.0
2020-06	RAN#88	R5-202817	0732	1	F	Correction to Test Requirement for 4.4.3.1 by updating TT values from Annex F	16.4.0
2020-06	RAN#88	R5-202833	0591	1	F	Addition to NR test case 6.3.2.1.3 FR1-FR1 RRC re-establishment without serving cell timing	16.4.0
2020-06	RAN#88	R5-202834	0575	1	F	Correction to NR test case 7.7.1.3.1 SA FR2 SS-RSRP absolute accuracy	16.4.0
2020-06	RAN#88	R5-202835	0592	1	F	Addition to NR test case 7.3.2.1.3 FR2-FR2 RRC re-establishment without serving cell timing	16.4.0
2020-06	RAN#88	R5-202836	0594	1	F	Addition to NR test case 7.5.1.9 FR2 RLM scheduling restrictions	16.4.0
2020-06	RAN#88	R5-202837	0578	1	F	Correction to NR test case 8.3.1.1 handover to known cell	16.4.0
2020-06	RAN#88	R5-202838	0597	1	F	Addition of Default Configuration in Annex H	16.4.0
2020-06	RAN#88	R5-202839	0628	1	F	Update of Annex D.4.1.1 for parameters of BFD with 4RX	16.4.0
2020-06	RAN#88	R5-202840	0630	1	F	Update of Cell mapping in Annex E	16.4.0
2020-06	RAN#88	R5-202841	0633	1	F	Add auxiliary bands for RRM inter-frequency SA tests	16.4.0
2020-06	RAN#88	R5-202909	0697	1	F	Correction to Test Requirements in 4.4.1.1, Table 4.4.1.1.5-5 to include TT values from Annex F	16.4.0
2020-06	RAN#88	R5-202910	0698	1	F	Correction to Test Requirements in 6.4.1.1, Table 6.4.1.1.5-5 to include TT values from Annex F	16.4.0
2020-06	RAN#88	R5-202911	0734	1	F	Correction to Test Requirement for 6.4.3.1 by updating TT values from Annex F	16.4.0
2020-06	RAN#88	R5-202912	0735	1	F	Annex I RRM OTA procedures update to add RSRPB based UE Positioning Method for FR2	16.4.0
2020-06	RAN#88	R5-202913	0703	1	F	Clarification of disabling Tx diversity for FR2 UE for FR2 RRM testing	16.4.0
2020-06	RAN#88	R5-202914	0719	1	F	Updates of FR2 MU and TT in TS 38.533	16.4.0
2020-06	RAN#88	R5-202950	0693	1	F	Correction to Message Exception for 4.6.2.5 EN-DC FR1-FR1 event-triggered reporting in non-DRX with SSB time index detection	16.4.0

Change history							
Date	Meeting	TDoc	CR	Rev	Cat	Subject/Comment	New version
2020-06	RAN#88	R5-202951	0694	1	F	Correction to Message Exception for 4.6.2.6 EN-DC FR1-FR1 event-triggered reporting in DRX with SSB time index detection	16.4.0
2020-06	RAN#88	R5-202961	0690	1	F	Correction to Test Applicability and Message Exception for 6.6.1.6 NR SA FR1 event-triggered reporting with gap in non-DRX with SSB index reading	16.4.0
2020-06	RAN#88	R5-202969	0639	1	F	Corrections to 4.7.2.1	16.4.0
2020-06	RAN#88	R5-202970	0641	1	F	Corrections to 4.7.3.1	16.4.0
2020-06	RAN#88	R5-202971	0642	1	F	Corrections to 4.7.3.2	16.4.0
2020-06	RAN#88	R5-202972	0598	1	F	Corrections to 6.7.1.2 and core spec alignment	16.4.0
2020-06	RAN#88	R5-202973	0599	1	F	Corrections to 6.7.2.1 and core spec alignment	16.4.0
2020-06	RAN#88	R5-202974	0600	1	F	Corrections to 6.7.2.2 and core spec alignment	16.4.0
2020-06	RAN#88	R5-202975	0601	1	F	Corrections to 6.7.3.1 and core spec alignment	16.4.0
2020-06	RAN#88	R5-202976	0602	1	F	Corrections to 6.7.3.2 and core spec alignment	16.4.0
2020-06	RAN#88	R5-202977	0638	1	F	Corrections to 4.7.1.2	16.4.0
2020-06	RAN#88	R5-202978	0640	1	F	Corrections to 4.7.2.2	16.4.0
2020-06	RAN#88	R5-202982	0710	1	F	Correction to FR1 UE transmit timing accuracy	16.4.0
2020-06	RAN#88	R5-202983	0709	1	F	Correction to EN-DC FR2 RRC-based DL active BWP switch in non-DRX in synchronous ENDC	16.4.0
2020-06	RAN#88	R5-202984	0711	1	F	Correction to FR2 UE transmit timing accuracy	16.4.0
2020-06	RAN#88	R5-202985	0705	1	F	Core alignment in 6.6.1.2 NR SA FR1 event-triggered reporting without gap in DRX	16.4.0
2020-06	RAN#88	R5-202986	0713	1	F	Correction to NR E-UTRA reselection tests	16.4.0
2020-06	RAN#88	R5-202987	0715	1	F	Correction to NR SA FR1 handover test cases	16.4.0
2020-06	RAN#88	R5-202996	0604	1	F	Update FR1 Test Tolerance of 4.5.2.5 E-UTRAN SCC in sync	16.4.0
2020-06	RAN#88	R5-202997	0605	1	F	Update FR1 Test Tolerance of 4.5.2.6 E-UTRAN SCC in async	16.4.0
2020-06	RAN#88	R5-202998	0606	1	F	Update FR1 Test Tolerance of 4.5.3.1 SCell activation 160ms	16.4.0
2020-06	RAN#88	R5-202999	0607	1	F	Update FR1 Test Tolerance of 4.5.3.2 SCell activation 320ms	16.4.0
2020-06	RAN#88	R5-203000	0608	1	F	Update FR1 Test Tolerance of 4.5.3.3 unknown SCell activation	16.4.0
2020-06	RAN#88	R5-203091	0623	1	F	Update of 4.5.3.0 minimum requirements for Scell activation	16.4.0
2020-06	RAN#88	R5-203092	0613	1	F	Update FR1 Test Tolerance of 6.5.4.1 UL carrier RRC reconfiguration delay	16.4.0
2020-06	RAN#88	R5-203093	0629	1	F	Update of FR1 Test Tolerance in Annex F	16.4.0
2020-06	RAN#88	R5-203095	0609	1	F	Addition FR1 Test Tolerance of 6.5.5.1 SSB BFD non-DRX	16.4.0
2020-06	RAN#88	R5-203096	0610	1	F	Addition FR1 Test Tolerance of 6.5.5.2 SSB BFD DRX	16.4.0
2020-06	RAN#88	R5-203097	0611	1	F	Update FR1 Test Tolerance of 6.5.5.3 CSI-RS BFD non-DRX	16.4.0
2020-06	RAN#88	R5-203098	0612	1	F	Update FR1 Test Tolerance of 6.5.5.4 CSI-RS BFD DRX	16.4.0
2020-09	RAN#89	R5-203234	0747	-	F	Update TC 8.5.2.1.1.1 with TT results and message contents	16.5.0
2020-09	RAN#89	R5-203235	0748	-	F	Update TC 8.5.2.2.1 with TT results and message contents	16.5.0

Change history							
Date	Meeting	TDoc	CR	Rev	Cat	Subject/Comment	New version
2020-09	RAN#89	R5-203249	0758	-	F	Annex E and F update with TT results for 8.5.2.x.x iRAT periodic reporting test cases	16.5.0
2020-09	RAN#89	R5-203250	0759	-	F	Annex E and F update with TT results for 4.7.4.x.x EN-DC L1-RSRP periodic reporting test cases	16.5.0
2020-09	RAN#89	R5-203252	0761	-	F	Void unnecessary TC 8.5.2.1.1.2	16.5.0
2020-09	RAN#89	R5-203267	0765	-	F	[EDITORIAL] Fix formatting issues throwing DOCX conversion errors in TS 38.533	16.5.0
2020-09	RAN#89	R5-203268	0766	-	F	Correction of test applicability for EN-DC event-triggered tests	16.5.0
2020-09	RAN#89	R5-203269	0767	-	F	Correction of test applicability for NR SA event-triggered tests	16.5.0
2020-09	RAN#89	R5-203270	0768	-	F	Adding annex table for iRAT measurement configuration	16.5.0
2020-09	RAN#89	R5-203271	0769	-	F	Clarification on the usage of auxiliary bands	16.5.0
2020-09	RAN#89	R5-203272	0770	-	F	Remove IE includeBeamMeasurements from 6.6.1.5 and 6.6.1.6	16.5.0
2020-09	RAN#89	R5-203280	0772	-	F	n26 addition to group of bands in 38.533	16.5.0
2020-09	RAN#89	R5-203299	0773	-	F	Corrected test description in non-DRX test case 6.5.1.2	16.5.0
2020-09	RAN#89	R5-203300	0774	-	F	Correction of comment for monitoringSymbolsWithinSlot	16.5.0
2020-09	RAN#89	R5-203301	0775	-	F	Correction of delta offset application for Cell 2 in test case 4.7.1.2.1	16.5.0
2020-09	RAN#89	R5-203303	0777	-	F	PUSCH allocation correction in test case 6.4.3.1	16.5.0
2020-09	RAN#89	R5-203304	0778	-	F	Correction to the RRC Reconfiguration message for measurements	16.5.0
2020-09	RAN#89	R5-203306	0779	-	F	Update extreme conditions limits in TC 4.7.1.2.1	16.5.0
2020-09	RAN#89	R5-203307	0780	-	F	Update extreme conditions limits in TC 6.7.1.2.1	16.5.0
2020-09	RAN#89	R5-203308	0781	-	F	Update extreme conditions limits in TC 4.7.1.2.1 and TC 6.7.1.2.1 - Annex F	16.5.0
2020-09	RAN#89	R5-203309	0782	-	F	Correction power offset for Band Group F	16.5.0
2020-09	RAN#89	R5-203317	0786	-	F	Removing SearchSpaceId and ControlResourceSetId modification	16.5.0
2020-09	RAN#89	R5-203319	0788	-	F	Unification of cell frequency for FR1-FR1 test cases	16.5.0
2020-09	RAN#89	R5-203732	0790	-	F	Set ss-sinr request to false for EN-DC RRM measurement accuracy tests	16.5.0
2020-09	RAN#89	R5-203733	0791	-	F	Set ss-sinr request to false for NR SA RRM measurement accuracy tests	16.5.0
2020-09	RAN#89	R5-203832	0798	-	F	Update of 4.5.6.1.0 minimum requirement for DCI-based BWP switch	16.5.0
2020-09	RAN#89	R5-203835	0801	-	F	Update of 4.5.6.2.0 minimum requirement for RRC-based BWP switch	16.5.0
2020-09	RAN#89	R5-203837	0803	-	F	Update of FR1 Test Tolerance in 6.3.2.1.3 RRC re-establishment without serving cell timing	16.5.0
2020-09	RAN#89	R5-203838	0804	-	F	Addition of 6.5.2.0 minimum requirement for interruptions during measurements on NR SCC	16.5.0
2020-09	RAN#89	R5-203839	0805	-	F	Update of 6.5.2.1 interruptions during measurements on deactivated NR SCC	16.5.0
2020-09	RAN#89	R5-203840	0806	-	F	Addition of new Test Case 6.5.3.1 SCell activation and deactivation for 160ms cycle	16.5.0

Change history							
Date	Meeting	TDoc	CR	Rev	Cat	Subject/Comment	New version
2020-09	RAN#89	R5-203841	0807	-	F	Addition of new Test Case 6.5.3.2 SCell activation and deactivation for 320ms cycle	16.5.0
2020-09	RAN#89	R5-203842	0808	-	F	Addition of new Test Case 6.5.3.3 SCell activation and deactivation of unknown SCell	16.5.0
2020-09	RAN#89	R5-203847	0813	-	F	Update of 6.5.6.1.0 minimum requirement for DCI-based BWP switch	16.5.0
2020-09	RAN#89	R5-203850	0816	-	F	Update of 6.5.6.2.0 minimum requirement for RRC-based BWP switch	16.5.0
2020-09	RAN#89	R5-203853	0819	-	F	Correction to FR1 intra-frequency measurement with gap test cases	16.5.0
2020-09	RAN#89	R5-203855	0821	-	F	Update of Cell mapping in Annex E	16.5.0
2020-09	RAN#89	R5-204034	0827	-	F	CR to 38.533 on RRM Test Cases in clause 7.5.3	16.5.0
2020-09	RAN#89	R5-204036	0828	-	F	CR to 38.533 on RRM Test Cases in clause 7.5.7	16.5.0
2020-09	RAN#89	R5-204068	0829	-	F	Correction to FR2 timing advance adjustment accuracy	16.5.0
2020-09	RAN#89	R5-204069	0830	-	F	Correction to EN-DC FR2 interruptions at transitions between active and non-active during DRX	16.5.0
2020-09	RAN#89	R5-204070	0831	-	F	Addition of E-UTRA Test frequency selection rule for IRAT test cases	16.5.0
2020-09	RAN#89	R5-204071	0832	-	F	Correction on event-triggered reporting with gap in DRX and DRX configuration settings for NR serving cell	16.5.0
2020-09	RAN#89	R5-204072	0833	-	F	Correction to EN-DC and SA FR1-FR1 SS-RSRP and SS-RSRQ periodical measurement accuracy	16.5.0
2020-09	RAN#89	R5-204073	0834	-	F	Correction to SS-RSRQ periodical measurement accuracy	16.5.0
2020-09	RAN#89	R5-204075	0836	-	F	Correction to message configuration for radio link monitoring tests	16.5.0
2020-09	RAN#89	R5-204076	0837	-	F	Correction to NR SA FR1 E-UTRA RRC connection release with redirection	16.5.0
2020-09	RAN#89	R5-204077	0838	-	F	Correction to SRS PeriodicityAndOffset for Timing Advance tests	16.5.0
2020-09	RAN#89	R5-204079	0840	-	F	Correction to CSI-RS for tracking for TDD FR2	16.5.0
2020-09	RAN#89	R5-204116	0841	-	F	Correction of EN-DC FR2 SSB-based L1-RSRP measurement test case 5.6.3.1	16.5.0
2020-09	RAN#89	R5-204118	0843	-	F	Correction of EN-DC FR2 CSI-RS-based L1-RSRP measurement test case 5.6.3.3	16.5.0
2020-09	RAN#89	R5-204119	0844	-	F	Correction of EN-DC FR2 CSI-RS-based L1-RSRP measurement test case 5.6.3.4	16.5.0
2020-09	RAN#89	R5-204122	0847	-	F	Correction of NR SA FR2 SSB-based L1-RSRP measurement test case 7.6.3.1	16.5.0
2020-09	RAN#89	R5-204123	0848	-	F	Correction of NR SA FR2 SSB-based L1-RSRP measurement test case 7.6.3.2	16.5.0
2020-09	RAN#89	R5-204124	0849	-	F	Correction of NR SA FR2 CSI-RS-based L1-RSRP measurement test case 7.6.3.3	16.5.0
2020-09	RAN#89	R5-204125	0850	-	F	Correction of NR SA FR2 CSI-RS-based L1-RSRP measurement test case 7.6.3.4	16.5.0
2020-09	RAN#89	R5-204126	0851	-	F	Correction of minimum conformance requirements 4.6.4.0 for EN-DC FR1 L1-RSRP measurement test cases	16.5.0
2020-09	RAN#89	R5-204127	0852	-	F	Correction of minimum conformance requirements 5.6.3.0 for EN-DC FR2 L1-RSRP measurement test cases	16.5.0

Change history							
Date	Meeting	TDoc	CR	Rev	Cat	Subject/Comment	New version
2020-09	RAN#89	R5-204128	0853	-	F	Correction of minimum conformance requirements 7.6.3.0 for SA FR2 L1-RSRP measurement test cases	16.5.0
2020-09	RAN#89	R5-204220	0854	-	F	Update missing SMTC and SSB configurations in H.2	16.5.0
2020-09	RAN#89	R5-204221	0855	-	F	Update missing SMTC and SSB configurations in H.3	16.5.0
2020-09	RAN#89	R5-204222	0856	-	F	Editorial: correct table placement in H.2	16.5.0
2020-09	RAN#89	R5-204285	0859	-	F	Correction to Message Exceptions for 4.6.2.5 EN-DC FR1-FR1 event-triggered reporting in non-DRX with SSB time index detection	16.5.0
2020-09	RAN#89	R5-204337	0874	-	F	Addition of 4.5.5.0 minimum requirement for BFR	16.5.0
2020-09	RAN#89	R5-204730	0792	1	F	Update of PDSCH RMC in Annex A.1.1	16.5.0
2020-09	RAN#89	R5-204733	0793	1	F	Correction of RRM Test Case 6.1.1.1	16.5.0
2020-09	RAN#89	R5-204734	0824	1	F	Correction of RRM Test Case 6.1.1.2	16.5.0
2020-09	RAN#89	R5-204735	0825	1	F	Correction of RRM Test Case 7.1.1.1	16.5.0
2020-09	RAN#89	R5-204736	0826	1	F	Correction of RRM Test Case 7.1.1.2	16.5.0
2020-09	RAN#89	R5-204775	0751	1	F	Update TC 4.7.4.1.2 with TT results and message contents	16.5.0
2020-09	RAN#89	R5-204776	0753	1	F	Update TC 4.7.4.2.2 with TT results and message contents	16.5.0
2020-09	RAN#89	R5-204777	0771	1	F	Correction of measurement gap configuration for intra-frequency even-triggered tests needing gap	16.5.0
2020-09	RAN#89	R5-204778	0755	1	F	Update TC 6.7.4.1.2 with TT results and message contents	16.5.0
2020-09	RAN#89	R5-204779	0757	1	F	Update TC 6.7.4.2.2 with TT results and message contents	16.5.0
2020-09	RAN#89	R5-204780	0762	1	F	Correction to the test procedure of NR SA event triggered tests	16.5.0
2020-09	RAN#89	R5-204781	0763	1	F	Correction to the test procedure of NR SA event triggered tests inter-freq	16.5.0
2020-09	RAN#89	R5-204782	0764	1	F	Correction to the test procedure of NR SA event triggered tests inter-RAT	16.5.0
2020-09	RAN#89	R5-204783	0749	1	F	Update TC 8.5.2.3.1 with TT results and message contents	16.5.0
2020-09	RAN#89	R5-204784	0760	1	F	Annex E and F update with TT results for 6.7.4.x.x NR SA L1-RSRP periodic reporting test cases	16.5.0
2020-09	RAN#89	R5-204785	0785	1	F	Correction in A.1.4 CSI-RS for nzp-CSI-RS-ResourceId values	16.5.0
2020-09	RAN#89	R5-204786	0820	1	F	Update of FR1 Test Tolerance in Annex F	16.5.0
2020-09	RAN#89	R5-204787	0823	1	F	Correction to default configurations in Annex H	16.5.0
2020-09	RAN#89	R5-204872	0857	1	F	Correction to Test Procedure and sync to latest RAN4 in 4.4.1.1 EN-DC FR1 UE transmit timing accuracy	16.5.0
2020-09	RAN#89	R5-204873	0858	1	F	Correction to Test Procedure and sync to latest RAN4 in 6.4.1.1 NR SA FR1 UE transmit timing accuracy	16.5.0
2020-09	RAN#89	R5-204874	0866	1	F	Correction to 6.5.1.1 NR SA FR1 RLM OOS test with SSB-based RLM RS in non-DRX mode, sync to latest RAN4 Core Spec	16.5.0
2020-09	RAN#89	R5-204875	0867	1	F	Correction to 6.5.1.2 NR SA FR1 RLM IS test with SSB-based RLM RS in non-DRX mode, sync to latest RAN4 Core Spec	16.5.0
2020-09	RAN#89	R5-204876	0868	1	F	Correction to 6.5.1.3 NR SA FR1 RLM OOS test with SSB-based RLM RS in DRX mode, sync to latest RAN4 Core Spec	16.5.0
2020-09	RAN#89	R5-204877	0869	1	F	Correction to 6.5.1.4 NR SA FR1 RLM IS test with SSB-based RLM RS in DRX mode, sync to latest RAN4 Core Spec	16.5.0

Change history							
Date	Meeting	TDoc	CR	Rev	Cat	Subject/Comment	New version
2020-09	RAN#89	R5-204878	0750	1	F	Update TC 4.7.4.1.1 with TT results and message contents	16.5.0
2020-09	RAN#89	R5-204879	0752	1	F	Update TC 4.7.4.2.1 with TT results and message contents	16.5.0
2020-09	RAN#89	R5-204880	0754	1	F	Update TC 6.7.4.1.1 with TT results and message contents	16.5.0
2020-09	RAN#89	R5-204881	0756	1	F	Update TC 6.7.4.2.1 with TT results and message contents	16.5.0
2020-09	RAN#89	R5-204882	0776	1	F	Gap Pattern Id correction in section 6.6.2 to align to core spec 38.133	16.5.0
2020-09	RAN#89	R5-204883	0787	1	F	Test Procedure correction in test case 6.5.1.3 for definition of Point C	16.5.0
2020-09	RAN#89	R5-204884	0789	1	F	Addition of new RRM Test Cases in clause 7.5.5	16.5.0
2020-09	RAN#89	R5-204885	0783	1	F	CR to update the RRM FR2 MUs in Annex F	16.5.0
2020-09	RAN#89	R5-204886	0784	1	F	Add information on the AoA change during test for RRM FR2 tests	16.5.0
2020-09	RAN#89	R5-204941	0835	1	F	Correction to connection diagram for radio link monitoring tests	16.5.0
2020-09	RAN#89	R5-204942	0842	1	F	Correction of EN-DC FR2 SSB-based L1-RSRP measurement test case 5.6.3.2	16.5.0
2020-09	RAN#89	R5-204943	0845	1	F	Correction of FR2 condition tables in Annex B	16.5.0
2020-09	RAN#89	R5-204944	0846	1	F	Introduction of band n259 in clause 3	16.5.0
2020-09	RAN#89	R5-204985	0794	1	F	Update of FR1 Test Tolerance in 4.5.5.1 SSB based BFR in non-DRX	16.5.0
2020-09	RAN#89	R5-204986	0795	1	F	Update of FR1 Test Tolerance in 4.5.5.2 SSB based BFR in DRX	16.5.0
2020-09	RAN#89	R5-204987	0796	1	F	Addition of new Test Case 4.5.5.3 CSI-RS based BFR non-DRX with FR1 Test Tolerance	16.5.0
2020-09	RAN#89	R5-204988	0797	1	F	Update of FR1 Test Tolerance in 4.5.5.4 CSI-RS based BFR in DRX	16.5.0
2020-09	RAN#89	R5-204989	0799	1	F	Update of FR1 Test Tolerance in 4.5.6.1.1 DCI-based BWP switch	16.5.0
2020-09	RAN#89	R5-204990	0800	1	F	Update of FR1 Test Tolerance in 4.5.6.1.2 DCI-based BWP switch with SCell	16.5.0
2020-09	RAN#89	R5-204991	0802	1	F	Update of FR1 Test Tolerance in 4.5.6.2.1 RRC-based BWP switch	16.5.0
2020-09	RAN#89	R5-204992	0809	1	F	Update of FR1 Test Tolerance in 6.5.5.1 SSB based BFR in non-DRX	16.5.0
2020-09	RAN#89	R5-204993	0810	1	F	Update of FR1 Test Tolerance in 6.5.5.2 SSB based BFR in DRX	16.5.0
2020-09	RAN#89	R5-204994	0811	1	F	Update of FR1 Test Tolerance in 6.5.5.3 CSI-RS based BFR in non-DRX	16.5.0
2020-09	RAN#89	R5-204995	0812	1	F	Update of FR1 Test Tolerance in 6.5.5.4 CSI-RS based BFR in DRX	16.5.0
2020-09	RAN#89	R5-204996	0814	1	F	Update of FR1 Test Tolerance in 6.5.6.1.1 DCI-based BWP switch with SCell	16.5.0
2020-09	RAN#89	R5-204997	0815	1	F	Addition of new Test Case 6.5.6.1.2 DCI-based BWP switch with FR1 Test Tolerance	16.5.0
2020-09	RAN#89	R5-204998	0817	1	F	Update of FR1 Test Tolerance in 6.5.6.2.1 RRC-based BWP switch	16.5.0
2020-09	RAN#89	R5-204999	0818	1	F	Update of test parameters in 6.3.1.4 inter-RAT handover	16.5.0
2020-09	RAN#89	R5-205000	0822	1	F	Update of default configurations for RMC scheduling in Annex A	16.5.0
2020-12	RAN#90	R5-205051	0879	-	F	Message contents for RRM iRAT	16.6.0

Change history							
Date	Meeting	TDoc	CR	Rev	Cat	Subject/Comment	New version
2020-12	RAN#90	R5-205059	0884	-	F	Message contents for RRM PSCell addition	16.6.0
2020-12	RAN#90	R5-205063	0885	-	F	Update RRM 8.5.2.1.2 including TT analysis results	16.6.0
2020-12	RAN#90	R5-205068	0890	-	F	Correction of the measObjectID, measID and reportConfigID in Annex H	16.6.0
2020-12	RAN#90	R5-205070	0892	-	F	Remove includeBeamMeasurements requirement for TC4.6.1.5	16.6.0
2020-12	RAN#90	R5-205257	0907	-	F	NR Band n53 addition to RRM group of bands	16.6.0
2020-12	RAN#90	R5-205296	0914	-	F	Add FR2 Fading MU values	16.6.0
2020-12	RAN#90	R5-205813	0920	-	F	Correction of EN-DC FR2 Inter-frequency measurements test case 5.6.2.1	16.6.0
2020-12	RAN#90	R5-205814	0921	-	F	Correction of EN-DC FR2 Inter-frequency measurements test case 5.6.2.2	16.6.0
2020-12	RAN#90	R5-205815	0922	-	F	Correction of EN-DC FR2 Inter-frequency measurements test case 5.6.2.3	16.6.0
2020-12	RAN#90	R5-205816	0923	-	F	Correction of EN-DC FR2 Inter-frequency measurements test case 5.6.2.4	16.6.0
2020-12	RAN#90	R5-205817	0924	-	F	Correction of EN-DC FR2 Inter-frequency measurements test case 5.6.2.5	16.6.0
2020-12	RAN#90	R5-205818	0925	-	F	Correction of EN-DC FR2 Inter-frequency measurements test case 5.6.2.6	16.6.0
2020-12	RAN#90	R5-205819	0926	-	F	Correction of EN-DC FR2 Inter-frequency measurements test case 5.6.2.7	16.6.0
2020-12	RAN#90	R5-205820	0927	-	F	Correction of EN-DC FR2 Inter-frequency measurements test case 5.6.2.8	16.6.0
2020-12	RAN#90	R5-205821	0928	-	F	Correction of NR SA FR2 Inter-frequency measurements test case 7.6.2.1	16.6.0
2020-12	RAN#90	R5-205822	0929	-	F	Correction of NR SA FR2 Inter-frequency measurements test case 7.6.2.2	16.6.0
2020-12	RAN#90	R5-205823	0930	-	F	Correction of NR SA FR2 Inter-frequency measurements test case 7.6.2.3	16.6.0
2020-12	RAN#90	R5-205824	0931	-	F	Correction of NR SA FR2 Inter-frequency measurements test case 7.6.2.4	16.6.0
2020-12	RAN#90	R5-205826	0933	-	F	Correction of NR SA FR2 Inter-frequency measurements test case 7.6.2.6	16.6.0
2020-12	RAN#90	R5-205827	0934	-	F	Correction of NR SA FR2 Inter-frequency measurements test case 7.6.2.7	16.6.0
2020-12	RAN#90	R5-205828	0935	-	F	Correction of NR SA FR2 Inter-frequency measurements test case 7.6.2.8	16.6.0
2020-12	RAN#90	R5-205834	0939	-	F	Correction of message content exceptions in Annex H	16.6.0
2020-12	RAN#90	R5-205953	0946	-	F	Update of FR1 TT in 8.4.1.1 inter-RAT SFTD in non-DRX	16.6.0
2020-12	RAN#90	R5-205954	0947	-	F	Update of FR1 TT in 8.4.1.2 inter-RAT SFTD in DRX	16.6.0
2020-12	RAN#90	R5-205960	0953	-	F	Addition of test case 5.5.1.9 EN-DC FR2 radio link monitoring UE scheduling restrictions	16.6.0
2020-12	RAN#90	R5-205961	0954	-	F	Update of test case 5.5.3.1 EN-DC FR2 SCell activation and deactivation	16.6.0



Change history							
Date	Meeting	TDoc	CR	Rev	Cat	Subject/Comment	New version
2020-12	RAN#90	R5-205963	0956	-	F	Update of 7.3.2.1.3 SA FR2 RRC re-establishment without serving cell timing	16.6.0
2020-12	RAN#90	R5-205967	0960	-	F	Update of Annex E for cell mapping	16.6.0
2020-12	RAN#90	R5-205975	0964	-	F	Correction to default configuration in Annex H	16.6.0
2020-12	RAN#90	R5-205976	0965	-	F	Correction to SSB reference configuration	16.6.0
2020-12	RAN#90	R5-206100	0968	-	F	Correction to EN-DC FR1 interruptions at transitions between active and non-active during DRX	16.6.0
2020-12	RAN#90	R5-206102	0970	-	F	Correction to FR1 NSA SS-SINR measurement TCs	16.6.0
2020-12	RAN#90	R5-206105	0973	-	F	Correction to message exception for inter-RAT reselection TCs	16.6.0
2020-12	RAN#90	R5-206106	0974	-	F	Editorial correction of RSRP tests	16.6.0
2020-12	RAN#90	R5-206111	0976	-	F	Update of Annex C.1.3 of default connection setup	16.6.0
2020-12	RAN#90	R5-206156	0977	-	F	Addition of missing PRACH configuration 4 for FR1 and FR2 applicability	16.6.0
2020-12	RAN#90	R5-206214	0979	-	F	Alignment test parameter table with TS 38.133 in SA cell reselection test case	16.6.0
2020-12	RAN#90	R5-206215	0980	-	F	Alignment test parameter table with TS 38.133 in SA handover test case	16.6.0
2020-12	RAN#90	R5-206216	0981	-	F	Addition RLM IE into event trigger reporting CSI-RS based RLM	16.6.0
2020-12	RAN#90	R5-206217	0982	-	F	Addition RLM IE into event trigger reporting SSB based	16.6.0
2020-12	RAN#90	R5-206219	0984	-	F	Update message content section in SS-SINR test cases	16.6.0
2020-12	RAN#90	R5-206221	0985	-	F	Update to Section 5.4.1.1 NSA FR2 Transmit Timing Accuracy	16.6.0
2020-12	RAN#90	R5-206222	0986	-	F	Update to Section 5.4.3.1 NSA FR2 Timing Advance Accuracy	16.6.0
2020-12	RAN#90	R5-206606	0998	-	F	Update of CSI-RS RMC configuration in Annex A	16.6.0
2020-12	RAN#90	R5-206672	0918	1	F	Editorial CR to clarify SS-RSRP dBm / 15 kHz for PRACH tests	16.6.0
2020-12	RAN#90	R5-206673	0941	1	F	Correction of RRM TC 4.7.2.1	16.6.0
2020-12	RAN#90	R5-206674	0943	1	F	Update of message contents for EN-DC RLM test case	16.6.0
2020-12	RAN#90	R5-206675	0969	1	F	Correction to FR1 Inter frequency Event triggered Reporting test cases	16.6.0
2020-12	RAN#90	R5-206677	0987	1	F	Update to Message Exceptions for 4.3.2.2.2 EN-DC Non Contention Based Random Access	16.6.0
2020-12	RAN#90	R5-206678	0989	1	F	Update to 4.5.1.1 NSA FR1 OOS RLM to reword the Note for proper application of SNR for 4Rx Vs 2Rx	16.6.0
2020-12	RAN#90	R5-206679	0990	1	F	Update to 4.5.1.2 NSA FR1 IS RLM to reword the Note for proper application of SNR for 4Rx Vs 2Rx	16.6.0
2020-12	RAN#90	R5-206680	0991	1	F	Update to 4.5.1.3 NSA FR1 OOS RLM in DRX to reword the Note for proper application of SNR for 4Rx Vs 2Rx	16.6.0
2020-12	RAN#90	R5-206681	0992	1	F	Update to 4.5.1.4 NSA FR1 IS RLM in DRX to reword the Note for proper application of SNR for 4Rx Vs 2Rx	16.6.0
2020-12	RAN#90	R5-206682	0993	1	F	Update to 6.5.1.1 SA FR1 OOS RLM to reword the Note for proper application of SNR for 4Rx Vs 2Rx	16.6.0
2020-12	RAN#90	R5-206683	0994	1	F	Update to 6.5.1.2 SA FR1 IS RLM to reword the Note for proper application of SNR for 4Rx Vs 2Rx	16.6.0

Change history							
Date	Meeting	TDoc	CR	Rev	Cat	Subject/Comment	New version
2020-12	RAN#90	R5-206684	0995	1	F	Update to 6.5.1.3 SA FR1 OOS RLM in DRX to reword the Note for proper application of SNR for 4Rx Vs 2Rx	16.6.0
2020-12	RAN#90	R5-206685	0996	1	F	Update to 6.5.1.4 SA FR1 IS RLM in DRX to reword the Note for proper application of SNR for 4Rx Vs 2Rx	16.6.0
2020-12	RAN#90	R5-206686	0952	1	F	Update of 5.5.1 EN-DC FR2 radio link monitoring	16.6.0
2020-12	RAN#90	R5-206687	0955	1	F	Update of 5.5.5 EN-DC FR2 Beam failure detection	16.6.0
2020-12	RAN#90	R5-206688	0891	1	F	Corrections to re-selection test procedure	16.6.0
2020-12	RAN#90	R5-206689	0896	1	F	Correction of RRM TC 6.1.1.2	16.6.0
2020-12	RAN#90	R5-206690	0897	1	F	Correction of RRM TC 6.1.2.1	16.6.0
2020-12	RAN#90	R5-206691	0899	1	F	Correction of RRM TC 6.3.2.2.2	16.6.0
2020-12	RAN#90	R5-206692	0910	1	F	Correction of RRM TC 6.5.5.3	16.6.0
2020-12	RAN#90	R5-206693	0911	1	F	Correction of RRM TC 6.5.5.4	16.6.0
2020-12	RAN#90	R5-206694	0919	1	F	Editorial CR to clarify SS-RSRP dBm / 15 kHz for SA PRACH tests	16.6.0
2020-12	RAN#90	R5-206695	0942	1	F	Correction of RRM TC 6.7.2.1	16.6.0
2020-12	RAN#90	R5-206696	0961	1	F	Update of FR1 TT in 6.1.1.1 intra-freq re-selection	16.6.0
2020-12	RAN#90	R5-206697	0962	1	F	Correction of clause 6.1 cell re-selection	16.6.0
2020-12	RAN#90	R5-206698	0967	1	F	Correction to NR SA RLM out-of-sync test cases	16.6.0
2020-12	RAN#90	R5-206699	0983	1	F	Clarification in message exception for SA RLM out of synch test cases in non DRX	16.6.0
2020-12	RAN#90	R5-206700	0900	1	F	Correction of RRM TC 7.1.1.2	16.6.0
2020-12	RAN#90	R5-206701	0932	1	F	Correction of NR SA FR2 Inter-frequency measurements test case 7.6.2.5	16.6.0
2020-12	RAN#90	R5-206702	0936	1	F	Correction of NR SA FR2 RRC re-establishment test case 7.3.2.1.1	16.6.0
2020-12	RAN#90	R5-206703	0937	1	F	Correction of NR SA FR2-FR2 RRC re-establishment test case 7.3.2.1.2	16.6.0
2020-12	RAN#90	R5-206704	0957	1	F	Update of clause 7.5.5 SA FR2 Beam failure detection	16.6.0
2020-12	RAN#90	R5-206705	0958	1	F	Update of clause 7.6.1 SA FR2 Intra-frequency measurements	16.6.0
2020-12	RAN#90	R5-206706	0889	1	F	Correction of the message contents for RRM re-selection test cases	16.6.0
2020-12	RAN#90	R5-206707	0917	1	F	Correction to the aggregation level in the CORESET for RMC scheduling	16.6.0
2020-12	RAN#90	R5-206708	0938	1	F	Correction of clause 3.3 Abbreviations	16.6.0
2020-12	RAN#90	R5-206709	0963	1	F	Update of Annex H for cell re-selection	16.6.0
2020-12	RAN#90	R5-206797	0882	1	F	Complete RRM 4.5.7.1 including TT analysis results	16.6.0
2020-12	RAN#90	R5-206798	0875	1	F	Complete RRM 6.7.5.1 including TT analysis results	16.6.0
2020-12	RAN#90	R5-206799	0916	1	F	Add FR2 PRACH Test cases 7.3.2.2.1 and 7.3.2.2.2	16.6.0
2020-12	RAN#90	R5-206800	0944	1	F	Update of FR1 TT in 8.2.1.1 inter-RAT cell re-selection	16.6.0
2020-12	RAN#90	R5-206801	0945	1	F	Update of FR1 TT in 8.3.1.1 inter-RAT handover	16.6.0
2020-12	RAN#90	R5-206802	0948	1	F	Update of FR1 TT in 8.4.2.1 inter-RAT event-triggered reporting without SSB time index in non-DRX	16.6.0

Change history							
Date	Meeting	TDoc	CR	Rev	Cat	Subject/Comment	New version
2020-12	RAN#90	R5-206803	0949	1	F	Update of FR1 TT in 8.4.2.2 inter-RAT event-triggered reporting without SSB time index in DRX	16.6.0
2020-12	RAN#90	R5-206804	0950	1	F	Update of FR1 TT in 8.4.2.3 inter-RAT event-triggered reporting with SSB time index in non-DRX	16.6.0
2020-12	RAN#90	R5-206805	0951	1	F	Update of FR1 TT in 8.4.2.4 inter-RAT event-triggered reporting with SSB time index in DRX	16.6.0
2020-12	RAN#90	R5-206806	0878	1	F	Annex E and F iRAT measurement accuracy tests	16.6.0
2020-12	RAN#90	R5-206807	0888	1	F	Annex E and F iRAT FR2 measurement accuracy tests	16.6.0
2020-12	RAN#90	R5-206808	0959	1	F	Update of Annex F for Test Tolerance	16.6.0
2020-12	RAN#90	R5-206834	0915	1	F	Update FR2 Downlink and Es/Noc MU values	16.6.0
2020-12	RAN#90	R5-206843	0876	1	F	Complete RRM 6.7.6.1 including TT analysis results	16.6.0
2020-12	RAN#90	R5-206844	0886	1	F	Update RRM 8.5.2.2.2 including TT analysis results	16.6.0
2020-12	RAN#90	R5-206871	0894	1	F	Correction of RRM TC 4.3.2.2.2	16.6.0
2020-12	RAN#90	R5-206872	0905	1	F	New DRX configuration for RLM TC	16.6.0
2020-12	RAN#90	R5-206895	0971	1	F	Correction to message configuration for NSA radio link monitoring CSI-RS Based in DRX mode tests	16.6.0
2020-12	RAN#90	R5-206906	0880	1	F	Complete RRM 4.7.5.1 including TT analysis results	16.6.0
2020-12	RAN#90	R5-206907	0877	1	F	Complete RRM 6.7.7.1 including TT analysis results	16.6.0
2020-12	RAN#90	R5-206908	0972	1	F	Correction to message configuration for SA radio link monitoring CSI RS Based RLM RS	16.6.0
2020-12	RAN#90	R5-206909	0887	1	F	Update RRM 8.5.2.3.2 including TT analysis results	16.6.0
2020-12	RAN#90	R5-206910	0881	1	F	Annex E and F 4.7.5.1 SFTD measurement accuracy test	16.6.0
2021-03	RAN#91	R5-210134	0999	-	F	Update of first preamble power for EN-DC TC 4.3.2.2.1 and 4.3.2.2.2	16.7.0
2021-03	RAN#91	R5-210135	1000	-	F	Update of first preamble power for SA TC 6.3.2.2.1 and 6.3.2.2.2	16.7.0
2021-03	RAN#91	R5-210136	1001	-	F	Update of UE initial state for SA RLM TC 6.5.1.x	16.7.0
2021-03	RAN#91	R5-210137	1002	-	F	Update of process delay for SFTD measurement TC 8.4.1.x	16.7.0
2021-03	RAN#91	R5-210138	1003	-	F	Update of cell frequency for TC 6.7.2.2.2	16.7.0
2021-03	RAN#91	R5-210171	1004	-	F	Editorial update of SS-RSRP for TC 6.7.1.2.1	16.7.0
2021-03	RAN#91	R5-210173	1006	-	F	Update of RRC message for TC 6.4.3.1 and 6.5.2.1	16.7.0
2021-03	RAN#91	R5-210176	1009	-	F	Update of Scell activation and CSI reporting time for EN-DC TC 5.5.3.1	16.7.0
2021-03	RAN#91	R5-210177	1010	-	F	Update of CSI reporting time for SA TC 7.5.3.1 and 7.5.3.2	16.7.0
2021-03	RAN#91	R5-210178	1011	-	F	Update of PRACH configuration for SA TC 7.3.2.2.2	16.7.0
2021-03	RAN#91	R5-210179	1012	-	F	Update of PRACH configuration for EN-DC TC 4.5.5.3 and 4.5.5.4	16.7.0
2021-03	RAN#91	R5-210180	1013	-	F	Update of PRACH configuration for EN-DC TC 5.5.5.x	16.7.0
2021-03	RAN#91	R5-210181	1014	-	F	Update of PRACH configuration for SA TC 6.5.5.3 and 6.5.5.4	16.7.0
2021-03	RAN#91	R5-210182	1015	-	F	Update of PRACH configuration for SA TC 7.5.5.x	16.7.0
2021-03	RAN#91	R5-210183	1016	-	F	Update of prach-ConfigurationIndex for FR1 PRACH configuration 4 in A.7	16.7.0

Change history							
Date	Meeting	TDoc	CR	Rev	Cat	Subject/Comment	New version
2021-03	RAN#91	R5-210279	1017	-	F	Addition of minimum conformance requirements for R16 NR HST cell re-selection in 6.1.1.0	16.7.0
2021-03	RAN#91	R5-210281	1019	-	F	Addition of minimum conformance requirements for R16 NR HST measurement in 6.6.1.0	16.7.0
2021-03	RAN#91	R5-210283	1021	-	F	Update of Annex H.2.1-3 for R16 NR HST	16.7.0
2021-03	RAN#91	R5-210434	1025	-	F	Correct cell mapping for 5.4.3.1	16.7.0
2021-03	RAN#91	R5-210437	1027	-	F	Annex E and F 4.5.7.1 PSCell addition test	16.7.0
2021-03	RAN#91	R5-210440	1029	-	F	Update of TT analysis results in Annex F for FR2 iRAT test cases	16.7.0
2021-03	RAN#91	R5-210442	1030	-	F	Update TT results for SS-RSRP measurement accuracy test cases chapter 4	16.7.0
2021-03	RAN#91	R5-210443	1031	-	F	Update TT results for SS-RSRP measurement accuracy test cases chapter 6	16.7.0
2021-03	RAN#91	R5-210444	1032	-	F	Update TT results for SS-RSRP measurement accuracy test cases Annex F	16.7.0
2021-03	RAN#91	R5-210446	1033	-	F	Update TT results for SS-RSRQ measurement accuracy test cases chapter 4	16.7.0
2021-03	RAN#91	R5-210447	1034	-	F	Update TT results for SS-RSRQ measurement accuracy test cases chapter 6	16.7.0
2021-03	RAN#91	R5-210448	1035	-	F	Update TT results for SS-RSRQ measurement accuracy test cases Annex F	16.7.0
2021-03	RAN#91	R5-210456	1039	-	F	Update Annex I to TS 38.533	16.7.0
2021-03	RAN#91	R5-210457	1040	-	F	Update NR frequency band groups for FR1	16.7.0
2021-03	RAN#91	R5-210458	1041	-	F	Correction RLM config for event triggered test cases	16.7.0
2021-03	RAN#91	R5-210465	1046	-	F	Editorial correction of title of clause 6	16.7.0
2021-03	RAN#91	R5-210466	1047	-	F	Corrections to 6.3.2.2.1 and 6.3.2.2.2	16.7.0
2021-03	RAN#91	R5-210467	1048	-	F	Corrections to 4.3.2.2.2	16.7.0
2021-03	RAN#91	R5-210470	1049	-	F	Clarification on SSB Index to use in the PUCCH-PowerControl for RRM tests with more than one SSB	16.7.0
2021-03	RAN#91	R5-210471	1050	-	F	Clarification on SSB Index to use in the PUCCH-PowerControl for RRM tests with more than one SSB - EN-DC	16.7.0
2021-03	RAN#91	R5-210472	1051	-	F	Editorial: correct title of PRACH test cases to match RRM work plan - EN-DC FR1	16.7.0
2021-03	RAN#91	R5-210473	1052	-	F	Editorial: correct title of PRACH test cases to match RRM work plan - SA FR1	16.7.0
2021-03	RAN#91	R5-210474	1053	-	F	Editorial: correct title of PRACH test cases to match RRM work plan - SA FR2	16.7.0
2021-03	RAN#91	R5-210475	1054	-	F	Editorial: correct title of PRACH test cases to match RRM work plan - Annexes	16.7.0
2021-03	RAN#91	R5-210507	1056	-	F	Correction of test applicability for long DRX cycle related test cases in section 4	16.7.0
2021-03	RAN#91	R5-210508	1057	-	F	Correction of test applicability for long DRX cycle related test cases in section 5	16.7.0
2021-03	RAN#91	R5-210509	1058	-	F	Correction of test applicability for long DRX cycle related test cases in section 6	16.7.0

Change history							
Date	Meeting	TDoc	CR	Rev	Cat	Subject/Comment	New version
2021-03	RAN#91	R5-210510	1059	-	F	Correction of test applicability for long DRX cycle related test cases in section 7	16.7.0
2021-03	RAN#91	R5-210511	1060	-	F	Correction of test applicability for long DRX cycle related test cases in section 8	16.7.0
2021-03	RAN#91	R5-210528	1062	-	F	Correction to test procedure in test case 6.5.1.4	16.7.0
2021-03	RAN#91	R5-210529	1063	-	F	Correction to Interruptions during measurements on deactivated NR SCC test cases	16.7.0
2021-03	RAN#91	R5-210530	1064	-	F	Correction to message configuration for NSA CSI-RS-based RLM RS test cases	16.7.0
2021-03	RAN#91	R5-210531	1065	-	F	Correction to NR SA RLM out-of-sync test cases	16.7.0
2021-03	RAN#91	R5-210532	1066	-	F	Correction to NR SA FR1 RRC Re-establishment test cases	16.7.0
2021-03	RAN#91	R5-210533	1067	-	F	Correction to 4.5.1.2 and 6.5.1.2 PDCCH Aggregation Level	16.7.0
2021-03	RAN#91	R5-210535	1069	-	F	Correction to FR1 NSA SS-SINR measurement test cases	16.7.0
2021-03	RAN#91	R5-210536	1070	-	F	Correction to L1-RSRP test cases	16.7.0
2021-03	RAN#91	R5-210537	1071	-	F	Correction to the procedure to add a step for establishing SRB2 and DRB	16.7.0
2021-03	RAN#91	R5-210538	1072	-	F	Update of DRX configuration in FR1 Event-triggered Test cases	16.7.0
2021-03	RAN#91	R5-210601	1073	-	F	Clarification of BWP1 and BWP2 in 6.6.1.3, 6.6.1.4, 6.6.1.6	16.7.0
2021-03	RAN#91	R5-210608	1077	-	F	Correction in 4.5.2.1 and 4.5.2.2 test procedure	16.7.0
2021-03	RAN#91	R5-210613	1079	-	F	Correction in SIB5 for iRAT cell reselection	16.7.0
2021-03	RAN#91	R5-210614	1080	-	F	Correction in 6.1.2.2 test procedure	16.7.0
2021-03	RAN#91	R5-210814	1085	-	F	Finalise FR2 Timing MU values	16.7.0
2021-03	RAN#91	R5-210816	1086	-	F	Update of FR2 Tx Timing Test case 5.4.1.1 Test Tolerances	16.7.0
2021-03	RAN#91	R5-210851	1089	-	F	Update of FR1 TT for 4.5.5.1 and 4.5.5.2 SSB based LR	16.7.0
2021-03	RAN#91	R5-210852	1090	-	F	Update of FR1 TT for 4.5.5.3 and 4.5.5.4 CSI-RS based LR	16.7.0
2021-03	RAN#91	R5-210853	1091	-	F	Correction to 4.6.4.3 and 4.6.4.4 L1-RSRP reporting delay	16.7.0
2021-03	RAN#91	R5-210857	1095	-	F	Update of FR1 TT for 6.5.5.1 and 6.5.5.2 SSB based LR	16.7.0
2021-03	RAN#91	R5-210858	1096	-	F	Update of FR1 TT for 6.5.5.3 and 6.5.5.4 CSI-RS based LR	16.7.0
2021-03	RAN#91	R5-210860	1098	-	F	Correction to 6.6.4.3 and 6.6.4.4 L1-RSRP reporting delay	16.7.0
2021-03	RAN#91	R5-210863	1101	-	F	Update of 6.5.3.1 SCell activation and deactivation	16.7.0
2021-03	RAN#91	R5-210864	1102	-	F	Update of D.4 antenna configuration	16.7.0
2021-03	RAN#91	R5-210866	1104	-	F	Correction to CSI-RS RMC	16.7.0
2021-03	RAN#91	R5-210867	1105	-	F	Correction to default configuration on L1-RSRP reporting in Annex H	16.7.0
2021-03	RAN#91	R5-210959	1113	-	F	Update to 6.5.4.1 NR SA FR1 UE UL carrier RRC reconfiguration delay	16.7.0
2021-03	RAN#91	R5-211049	1116	-	F	Additional of default downlink level for FR2	16.7.0
2021-03	RAN#91	R5-211219	1124	-	F	Correction of the minimum conformance requirements for Inter-RAT measurements 6.6.3.0	16.7.0

Change history							
Date	Meeting	TDoc	CR	Rev	Cat	Subject/Comment	New version
2021-03	RAN#91	R5-211220	1125	-	F	Addition of new RRM iRAT measurement Inter-RAT measurements test case 6.6.3.3	16.7.0
2021-03	RAN#91	R5-211255	1131	-	F	Clarification of BWP1 and BWP2 in 4.6.1.3, 4.6.1.4, 4.6.1.6	16.7.0
2021-03	RAN#91	R5-211614	1007	1	F	Update of Scell activation and CSI reporting time for EN-DC TC 4.5.3.1	16.7.0
2021-03	RAN#91	R5-211615	1026	1	F	Complete RRM 4.5.7.1 including TT analysis results	16.7.0
2021-03	RAN#91	R5-211616	1087	1	F	Update Test Tolerance for FR1 RLM Test Cases	16.7.0
2021-03	RAN#91	R5-211617	1092	1	F	Correction to EN-DC radio link monitoring	16.7.0
2021-03	RAN#91	R5-211618	1093	1	F	Update of 4.5.3.1 SCell activation and deactivation	16.7.0
2021-03	RAN#91	R5-211619	1108	1	F	Update to 4.5.4.1 EN-DC FR1 UE UL carrier RRC reconfiguration delay	16.7.0
2021-03	RAN#91	R5-211620	1109	1	F	Update to 4.7.5.1 EN-DC FR1 SFTD measurement accuracy	16.7.0
2021-03	RAN#91	R5-211621	1117	1	F	Correction of applied TT for EN-DC FR1 L1-RSRP measurement test cases	16.7.0
2021-03	RAN#91	R5-211622	1023	1	F	Update 5.4.3.1 with TT analysis results	16.7.0
2021-03	RAN#91	R5-211623	1119	1	F	Correction of EN-DC FR2 inter-freq measurement test case 5.6.2.1 including TT	16.7.0
2021-03	RAN#91	R5-211624	1120	1	F	Correction of EN-DC FR2 inter-freq measurement test case 5.6.2.3 including TT	16.7.0
2021-03	RAN#91	R5-211625	1008	1	F	Update of CSI reporting time for SA TC 6.5.3.1	16.7.0
2021-03	RAN#91	R5-211626	1094	1	F	Correction to SA radio link monitoring	16.7.0
2021-03	RAN#91	R5-211627	1110	1	F	Update to 6.3.2.2.1 Contention based random access test in FR1 for NR standalone	16.7.0
2021-03	RAN#91	R5-211628	1111	1	F	Update to 6.3.2.2.2 Non-Contention based random access test in FR1 for NR standalone	16.7.0
2021-03	RAN#91	R5-211629	1112	1	F	Update to 6.5.2.1 NR SA FR1 interruptions during measurements on deactivated NR SCC	16.7.0
2021-03	RAN#91	R5-211630	1114	1	F	Update to 6.6.3.1 NR SA FR1 - E-UTRAN event-triggered reporting in non-DRX	16.7.0
2021-03	RAN#91	R5-211631	1115	1	F	Update to 6.6.3.2 NR SA FR1 - E-UTRAN event-triggered reporting in DRX	16.7.0
2021-03	RAN#91	R5-211632	1118	1	F	Correction of applied TT for SA FR1 L1-RSRP measurement test cases	16.7.0
2021-03	RAN#91	R5-211633	1121	1	F	Correction of SA FR2 inter-freq measurement test case 7.6.2.1 including TT	16.7.0
2021-03	RAN#91	R5-211634	1122	1	F	Correction of SA FR2 inter-freq measurement test case 7.6.2.3 including TT	16.7.0
2021-03	RAN#91	R5-211635	1028	1	F	Complete FR2 iRAT measurement accuracy test cases	16.7.0
2021-03	RAN#91	R5-211636	1024	1	F	Update Annex F for 5.4.3.1 and 7.4.3.1 with TT analysis results	16.7.0
2021-03	RAN#91	R5-211637	1038	1	F	Update DL AWGN MU for RRM FR2	16.7.0
2021-03	RAN#91	R5-211638	1084	1	F	Update FR2 Downlink and Uplink MU values	16.7.0
2021-03	RAN#91	R5-211639	1103	1	F	Update of Annex F for Test Tolerance	16.7.0
2021-03	RAN#91	R5-211640	1123	1	F	Correction of MTSU and applied TT in Annex F	16.7.0

Change history							
Date	Meeting	TDoc	CR	Rev	Cat	Subject/Comment	New version
2021-03	RAN#91	R5-211641	1130	1	F	Addition of new RMCs and OCNs into Annex A	16.7.0
2021-03	RAN#91	R5-211722	1042	1	F	Correction EN-DC FR1 timing tests	16.7.0
2021-03	RAN#91	R5-211723	1043	1	F	Corrections to 5.4.1.1	16.7.0
2021-03	RAN#91	R5-211724	1061	1	F	Clarification of SNR for 4RX UE in RLM Test Cases	16.7.0
2021-03	RAN#91	R5-211725	1076	1	F	Correction in 4.7.3.2.1 test parameters	16.7.0
2021-03	RAN#91	R5-211726	1005	1	F	Update of RRC message for TC 6.3.1.4, 6.3.1.5 and 6.3.2.3.2	16.7.0
2021-03	RAN#91	R5-211727	1045	1	F	Corrections NR SA FR1 timing test cases	16.7.0
2021-03	RAN#91	R5-211728	1097	1	F	Correction to NR TC 6.6.3.2-Inter-RAT DRX	16.7.0
2021-03	RAN#91	R5-211729	1099	1	F	Update of 6.5.1.2 and 6.5.1.4 SSB based RLM	16.7.0
2021-03	RAN#91	R5-211730	1083	1	F	Clarification of BWP1 and BWP2 in 7.6.1.3 and 7.6.1.4	16.7.0
2021-03	RAN#91	R5-211731	1044	1	F	Addition of Serving Cell Config for RRM timing test cases	16.7.0
2021-03	RAN#91	R5-211827	1018	1	F	Addition of new test case 6.1.1.7 for R16 NR HST	16.7.0
2021-03	RAN#91	R5-211828	1020	1	F	Addition of new test case 6.6.1.7 for R16 NR HST	16.7.0
2021-03	RAN#91	R5-211829	1022	1	F	Addition of cell configuration mapping in Annex E for R16 NR HST	16.7.0
2021-03	RAN#91	R5-211830	1126	1	F	Correction of the minimum conformance requirements for E-UTRA - NR FR1 Cell reselection 8.2.1.0	16.7.0
2021-03	RAN#91	R5-211831	1127	1	F	Addition of new RRM E-UTRA - NR FR1 Cell reselection test case 8.2.1.2	16.7.0
2021-03	RAN#91	R5-211832	1128	1	F	Correction of the minimum conformance requirements for E-UTRA - NR Inter-RAT event triggered reporting tests 8.4.2.0	16.7.0
2021-03	RAN#91	R5-211833	1129	1	F	Addition of new RRM E-UTRA - NR Inter-RAT event triggered reporting test case 8.4.2.9	16.7.0
2021-03	RAN#91	R5-211889	1036	1	F	Update TT results for 6.3.1.1	16.7.0
2021-03	RAN#91	R5-211890	1037	1	F	Update TT results for 6.3.1.1 Annex F	16.7.0
2021-06	RAN#92	R5-212024	1132	-	F	Complete 5.7.1.1 with TT analysis results	16.8.0
2021-06	RAN#92	R5-212025	1133	-	F	Complete 5.7.2.1 with TT analysis results	16.8.0
2021-06	RAN#92	R5-212026	1134	-	F	Complete 5.7.3.1 with TT analysis results	16.8.0
2021-06	RAN#92	R5-212256	1138	-	F	Core alignment of TCI state of CSI-RS for TRS	16.8.0
2021-06	RAN#92	R5-212257	1139	-	F	Introducing additional band for n38	16.8.0
2021-06	RAN#92	R5-212265	1147	-	F	Updates to DRX configuration in FR1 Event-triggered Test cases	16.8.0
2021-06	RAN#92	R5-212266	1148	-	F	Core alignment of BWP configuration parameter in 6.5.2.1	16.8.0
2021-06	RAN#92	R5-212267	1149	-	F	Correction to CSI-RS based L1-RSRP measurement tests	16.8.0
2021-06	RAN#92	R5-212612	1153	-	F	Addition of new test case 6.6.4.5 for R16 NR HST	16.8.0
2021-06	RAN#92	R5-212613	1154	-	F	Addition of cell configuration mapping in Annex E for TC 6.6.4.5	16.8.0
2021-06	RAN#92	R5-212712	1158	-	F	Remove obsolete message contents tables after Chapter 7 alignment	16.8.0
2021-06	RAN#92	R5-212715	1161	-	F	Correcting measurement accuracy iRAT test cases	16.8.0
2021-06	RAN#92	R5-212716	1162	-	F	Corrections to 5.4.1.1	16.8.0

Change history							
Date	Meeting	TDoc	CR	Rev	Cat	Subject/Comment	New version
2021-06	RAN#92	R5-212717	1163	-	F	Corrections to 5.4.3.1	16.8.0
2021-06	RAN#92	R5-212718	1164	-	F	Corrections to 4.4.1.1	16.8.0
2021-06	RAN#92	R5-212719	1165	-	F	Corrections to 4.4.3.1	16.8.0
2021-06	RAN#92	R5-212720	1166	-	F	Corrections to 6.4.1.1	16.8.0
2021-06	RAN#92	R5-212721	1167	-	F	Corrections to 6.4.3.1	16.8.0
2021-06	RAN#92	R5-212726	1171	-	F	Correct applicability of Interruption EN-DC test cases with CA	16.8.0
2021-06	RAN#92	R5-212727	1172	-	F	Correct applicability of Scell activation EN-DC test cases with CA	16.8.0
2021-06	RAN#92	R5-212728	1173	-	F	Correct applicability of Interruption SA test cases with CA	16.8.0
2021-06	RAN#92	R5-212729	1174	-	F	Correct applicability of Scell activation SA test cases with CA	16.8.0
2021-06	RAN#92	R5-212731	1175	-	F	Addition of RRM FR2 EN-DC PRACH test case 5.3.2.2.1	16.8.0
2021-06	RAN#92	R5-212732	1176	-	F	Addition of RRM FR2 EN-DC PRACH test case 5.3.2.2.2	16.8.0
2021-06	RAN#92	R5-212737	1177	-	F	Update to test applicability of RRM TC6.5.4.1	16.8.0
2021-06	RAN#92	R5-212745	1178	-	F	Update to RRM Antenna connection for 4Rx capable Ues	16.8.0
2021-06	RAN#92	R5-212895	1180	-	F	Correction to FR1 EN-DC interruption during SCell measurement test cases	16.8.0
2021-06	RAN#92	R5-212896	1181	-	F	Correction to FR1 EN-DC beam failure recovery test cases	16.8.0
2021-06	RAN#92	R5-212900	1185	-	F	Correction to FR1 NR SA TC 6.5.3.1-SCell activation	16.8.0
2021-06	RAN#92	R5-212901	1186	-	F	Correction to FR1 NR SA beam failure recovery test cases	16.8.0
2021-06	RAN#92	R5-212904	1189	-	F	Correction to RMSI CORESET reference configuration in Annex A	16.8.0
2021-06	RAN#92	R5-212905	1190	-	F	Correction to CSI-RS reference configuration in annex A	16.8.0
2021-06	RAN#92	R5-212906	1191	-	F	Correction to TRS reference configuration in annex A	16.8.0
2021-06	RAN#92	R5-212909	1194	-	F	Correction to BWP reference configuration in Annex A	16.8.0
2021-06	RAN#92	R5-212910	1195	-	F	Correction of minimum requirements for L1-RSRP reporting test cases	16.8.0
2021-06	RAN#92	R5-212911	1196	-	F	Addition of FR1 EN-DC TC 4.6.4.5-HST L1-RSRP	16.8.0
2021-06	RAN#92	R5-213183	1205	-	F	Extension of Annex I for EIS spherical coverage points	16.8.0
2021-06	RAN#92	R5-213227	1212	-	F	Correction of SA FR2 inter-freq measurement test case 7.6.2.5 including TT	16.8.0
2021-06	RAN#92	R5-213228	1213	-	F	Correction of SA FR2 inter-freq measurement test case 7.6.2.6 including TT	16.8.0
2021-06	RAN#92	R5-213229	1214	-	F	Correction of SA FR2 inter-freq measurement test case 7.6.2.7 including TT	16.8.0
2021-06	RAN#92	R5-213230	1215	-	F	Correction of SA FR2 inter-freq measurement test case 7.6.2.8 including TT	16.8.0
2021-06	RAN#92	R5-213240	1219	-	F	Test frequency selection for Inter-frequency RRM test cases in Annex E	16.8.0
2021-06	RAN#92	R5-213345	1222	-	F	Update on iRAT measurement 6.6.3.2 test case	16.8.0
2021-06	RAN#92	R5-213346	1223	-	F	Update on Annex H.3.1 for iRAT measurement	16.8.0
2021-06	RAN#92	R5-213351	1224	-	F	Correction to Coreset and Search Space RMC for FR2 RRM	16.8.0



Change history							
Date	Meeting	TDoc	CR	Rev	Cat	Subject/Comment	New version
2021-06	RAN#92	R5-213352	1225	-	F	Correction to Message Exceptions for 6.3.2.2.2 Non-contention based random access test in FR1	16.8.0
2021-06	RAN#92	R5-213353	1226	-	F	Correction to PDSCH RMC when DRX is configured	16.8.0
2021-06	RAN#92	R5-213354	1227	-	F	Correction to intra and inter frequency reselection test cases with asynchronous cells	16.8.0
2021-06	RAN#92	R5-213847	1179	1	F	Addition of inter-frequency measurements configuration for FR1 EN-DC BFD and RLM test cases	16.8.0
2021-06	RAN#92	R5-213848	1183	1	F	Addition of inter-frequency measurements configuration for FR1 NR SA BFD and RLM test cases	16.8.0
2021-06	RAN#92	R5-213849	1184	1	F	Correction to FR1 NR SA interruption during SCell measurement test cases	16.8.0
2021-06	RAN#92	R5-213850	1193	1	F	Correction to PRACH reference configuration in Annex H	16.8.0
2021-06	RAN#92	R5-213921	1145	1	F	Correction to test procedure for SSB-based L1-RSRP measurement reporting	16.8.0
2021-06	RAN#92	R5-213922	1159	1	F	Remove obsolete message contents tables after Chapter 7 alignment - EN-DC	16.8.0
2021-06	RAN#92	R5-213923	1168	1	F	Corrections to RLM test cases EN-DC	16.8.0
2021-06	RAN#92	R5-213924	1141	1	F	Correction to FR2 RRM test channel reference for Event triggered reporting test	16.8.0
2021-06	RAN#92	R5-213925	1142	1	F	Correction to FR2 RRM test channel reference for RLM and BFD tests	16.8.0
2021-06	RAN#92	R5-213926	1143	1	F	Correction to FR2 RRM test channel reference for UL timing test	16.8.0
2021-06	RAN#92	R5-213927	1208	1	F	Correction of EN-DC FR2 inter-freq measurement test case 5.6.2.5 including TT	16.8.0
2021-06	RAN#92	R5-213928	1209	1	F	Correction of EN-DC FR2 inter-freq measurement test case 5.6.2.6 including TT	16.8.0
2021-06	RAN#92	R5-213929	1210	1	F	Correction of EN-DC FR2 inter-freq measurement test case 5.6.2.7 including TT	16.8.0
2021-06	RAN#92	R5-213930	1211	1	F	Correction of EN-DC FR2 inter-freq measurement test case 5.6.2.8 including TT	16.8.0
2021-06	RAN#92	R5-213931	1156	1	F	Correct reference to cell mapping for SA test cases	16.8.0
2021-06	RAN#92	R5-213932	1160	1	F	Correcting typos in PRACH test case	16.8.0
2021-06	RAN#92	R5-213933	1169	1	F	Corrections to RLM test cases SA	16.8.0
2021-06	RAN#92	R5-213934	1135	1	F	Annex F for EN-DC and SA FR2 Measurement Accuracy	16.8.0
2021-06	RAN#92	R5-213935	1157	1	F	Align Annex H of TS 38.533 to Clause 7 of TS 38.508-1	16.8.0
2021-06	RAN#92	R5-213936	1202	1	F	Correction to AoA Test Setup applicability per permitted test method	16.8.0
2021-06	RAN#92	R5-213937	1204	1	F	Adapt Annex F to indicate applicability of the RRM FR2 TT analysis results	16.8.0
2021-06	RAN#92	R5-213938	1207	1	F	Correction of MTSU and applied TT in Annex F for FR2 inter-freq measurement test cases	16.8.0
2021-06	RAN#92	R5-214009	1151	1	F	Addition of 5G-SRVCC RRM TC 6.3.1.6-handover	16.8.0
2021-06	RAN#92	R5-214010	1152	1	F	Addition of 5G-SRVCC RRM TC 6.6.5.1-event triggered reporting non-DRX	16.8.0
2021-06	RAN#92	R5-214060	1182	1	F	Correction to FR1 EN-DC BWP switching test cases	16.8.0

Change history							
Date	Meeting	TDoc	CR	Rev	Cat	Subject/Comment	New version
2021-06	RAN#92	R5-214061	1198	1	F	Update of CSI reporting time for EN-DC FR1 TC 4.5.3.1	16.8.0
2021-06	RAN#92	R5-214062	1199	1	F	Update of CSI reporting time for EN-DC FR2 TC 5.5.3.1	16.8.0
2021-06	RAN#92	R5-214063	1203	1	F	Adapt RRM FR2 test cases to indicate applicability of the TT analysis results	16.8.0
2021-06	RAN#92	R5-214064	1146	1	F	Corrections to NR SA FR1 RRC Re-establishment tests	16.8.0
2021-06	RAN#92	R5-214065	1187	1	F	Correction to FR1 NR SA BWP switch test cases	16.8.0
2021-06	RAN#92	R5-214066	1200	1	F	Update of CSI reporting time for SA FR1 TC 6.5.3.1	16.8.0
2021-06	RAN#92	R5-214067	1201	1	F	Update of CSI reporting time for SA FR2 TC 7.5.3.1 and 7.5.3.2	16.8.0
2021-06	RAN#92	R5-214068	1188	1	F	Correction to NR inter-RAT measurement test cases	16.8.0
2021-06	RAN#92	R5-214090	1197	1	F	Correction to Annex A.9 on the selection of test direction	16.8.0
2021-06	RAN#92	R5-214091	1206	1	F	Extension of the RSRPB Rx Beak Peak Search method	16.8.0
2021-06	RAN#92	R5-214092	1221	1	F	Update on test frequencies selection for inter-frequency test cases	16.8.0
2021-06	RAN#92	R5-214108	1216	1	F	Correction of EN-DC FR2 inter-freq measurement test case 5.6.2.1 and 5.6.2.3	16.8.0
2021-06	RAN#92	R5-214109	1217	1	F	Correction of SA FR2 inter-freq measurement test case 7.6.2.1 and 7.6.2.3	16.8.0
2021-06	RAN#92	R5-214111	1144	1	F	Correction to Interruptions during measurements on deactivated NR SCC	16.8.0
2021-06	RAN#92	R5-214113	1140	1	F	Correction to FR2 event-triggered reporting of intra frequency cell	16.8.0
2021-09	RAN#93	R5-214195	1232	-	F	Completion 7.7.2.2 including TT analysis results	16.9.0
2021-09	RAN#93	R5-214197	1234	-	F	Annex E and F update for FR2 inter-frequency periodic measurements tests	16.9.0
2021-09	RAN#93	R5-214198	1235	-	F	Completion 7.7.1.1	16.9.0
2021-09	RAN#93	R5-214199	1236	-	F	Completion 7.7.2.1	16.9.0
2021-09	RAN#93	R5-214200	1237	-	F	Completion 7.7.3.1	16.9.0
2021-09	RAN#93	R5-214339	1239	-	F	Correction to 4.5.1.1 message contents and core spec alignment	16.9.0
2021-09	RAN#93	R5-214342	1242	-	F	Correction to 4.5.1.4 core spec alignment	16.9.0
2021-09	RAN#93	R5-214343	1243	-	F	Correction to 4.5.1.5 message contents and core spec alignment	16.9.0
2021-09	RAN#93	R5-214345	1245	-	F	Correction to 4.4.1.1 and core spec alignment	16.9.0
2021-09	RAN#93	R5-214347	1247	-	F	Editorial corrections and core spec alignment for 5.7.1.1	16.9.0
2021-09	RAN#93	R5-214348	1248	-	F	Editorial corrections and core spec alignment for 5.7.2.1	16.9.0
2021-09	RAN#93	R5-214349	1249	-	F	Editorial corrections and core spec alignment for 5.7.3.1	16.9.0
2021-09	RAN#93	R5-214350	1250	-	F	Core spec alignment for 5.6.1.1	16.9.0
2021-09	RAN#93	R5-214351	1251	-	F	Core spec alignment for 5.6.1.2	16.9.0
2021-09	RAN#93	R5-214352	1252	-	F	Core spec alignment for 5.6.1.3	16.9.0
2021-09	RAN#93	R5-214353	1253	-	F	Core spec alignment for 5.6.1.4	16.9.0
2021-09	RAN#93	R5-214354	1254	-	F	Correction to 5.6.2.1 message contents	16.9.0
2021-09	RAN#93	R5-214355	1255	-	F	Correction to 5.6.2.2 message contents	16.9.0

Change history							
Date	Meeting	TDoc	CR	Rev	Cat	Subject/Comment	New version
2021-09	RAN#93	R5-214356	1256	-	F	Correction to 5.6.2.3 message contents	16.9.0
2021-09	RAN#93	R5-214357	1257	-	F	Correction to 5.6.2.4 message contents	16.9.0
2021-09	RAN#93	R5-214358	1258	-	F	Correction to 5.6.2.5 message contents	16.9.0
2021-09	RAN#93	R5-214359	1259	-	F	Correction to 5.6.2.6 message contents	16.9.0
2021-09	RAN#93	R5-214360	1260	-	F	Correction to 5.6.2.7 message contents	16.9.0
2021-09	RAN#93	R5-214361	1261	-	F	Correction to 5.6.2.8 message contents	16.9.0
2021-09	RAN#93	R5-214363	1263	-	F	Correction to 6.5.1.1 message contents and core spec alignment	16.9.0
2021-09	RAN#93	R5-214365	1265	-	F	Correction to 6.5.1.5 message contents and core spec alignment	16.9.0
2021-09	RAN#93	R5-214367	1267	-	F	Correction to 6.3.1.6 and core spec alignment	16.9.0
2021-09	RAN#93	R5-214368	1268	-	F	Correction to 6.5.2.1 and core spec alignment	16.9.0
2021-09	RAN#93	R5-214370	1270	-	F	Correction to 6.7.5.1 and core spec alignment	16.9.0
2021-09	RAN#93	R5-214371	1271	-	F	Correction to 6.7.6.1 and core spec alignment	16.9.0
2021-09	RAN#93	R5-214372	1272	-	F	Correction to 6.7.7.1 and core spec alignment	16.9.0
2021-09	RAN#93	R5-214373	1273	-	F	Core spec alignment for 7.6.1.1	16.9.0
2021-09	RAN#93	R5-214374	1274	-	F	Core spec alignment for 7.6.1.2	16.9.0
2021-09	RAN#93	R5-214375	1275	-	F	Core spec alignment for 7.6.1.3	16.9.0
2021-09	RAN#93	R5-214376	1276	-	F	Core spec alignment for 7.6.1.4	16.9.0
2021-09	RAN#93	R5-214378	1278	-	F	Correction to 8.3.1.1 and core spec alignment	16.9.0
2021-09	RAN#93	R5-214395	1280	-	F	Addition of FR1 mobility enhancement TC 6.3.1.9-Intra-band inter-frequency sync DAPS HO in SA for FR1	16.9.0
2021-09	RAN#93	R5-214407	1281	-	F	Clarification of test procedure for 4.3.2.2.1	16.9.0
2021-09	RAN#93	R5-214408	1282	-	F	Corrections to 4.7.1.x.y SS-RSRP test cases	16.9.0
2021-09	RAN#93	R5-214409	1283	-	F	Corrections to 4.7.2.x SS-RSRQ test cases	16.9.0
2021-09	RAN#93	R5-214410	1284	-	F	Corrections to 4.7.3.x SS-SINR test cases	16.9.0
2021-09	RAN#93	R5-214411	1285	-	F	Corrections to 4.5.1.6	16.9.0
2021-09	RAN#93	R5-214412	1286	-	F	Corrections to 4.5.1.8	16.9.0
2021-09	RAN#93	R5-214413	1287	-	F	Core spec alignment of EN-DC FR2 PRACH	16.9.0
2021-09	RAN#93	R5-214414	1288	-	F	Corrections to 6.5.1.2	16.9.0
2021-09	RAN#93	R5-214415	1289	-	F	Corrections to 6.5.1.4	16.9.0
2021-09	RAN#93	R5-214416	1290	-	F	Corrections to 6.7.1.x.y SS-RSRP test cases	16.9.0
2021-09	RAN#93	R5-214417	1291	-	F	Corrections to 6.7.2.x SS-RSRQ test cases	16.9.0
2021-09	RAN#93	R5-214418	1292	-	F	Corrections to 6.7.3.x SS-SINR test cases	16.9.0
2021-09	RAN#93	R5-214419	1293	-	F	Corrections to 6.5.1.6	16.9.0
2021-09	RAN#93	R5-214420	1294	-	F	Corrections to 6.5.1.8	16.9.0
2021-09	RAN#93	R5-214421	1295	-	F	Align 6.3.2.2.x to core spec	16.9.0
2021-09	RAN#93	R5-214422	1296	-	F	Align 6.4.3.1 to core spec	16.9.0

Change history							
Date	Meeting	TDoc	CR	Rev	Cat	Subject/Comment	New version
2021-09	RAN#93	R5-214423	1297	-	F	Align 6.6.2.x to core spec	16.9.0
2021-09	RAN#93	R5-214424	1298	-	F	Align 6.6.3.x to core spec	16.9.0
2021-09	RAN#93	R5-214426	1300	-	F	Correction to Table H.3.5-9	16.9.0
2021-09	RAN#93	R5-214427	1301	-	F	Clarification CSI-ReportConfig from Annex H	16.9.0
2021-09	RAN#93	R5-214519	1302	-	F	Addition of FR1 mobility enhancement TC 6.3.1.10-Intra-band inter-frequency asynchronous DAPS HO in SA for FR1	16.9.0
2021-09	RAN#93	R5-214520	1303	-	F	Addition of FR1 mobility enhancement TC 6.3.1.11-Inter-band inter-frequency sync DAPS HO in SA for FR1	16.9.0
2021-09	RAN#93	R5-214521	1304	-	F	Addition of FR1 mobility enhancement TC 6.3.1.12-Inter-band inter-frequency asynchronous DAPS HO in SA for FR1	16.9.0
2021-09	RAN#93	R5-214522	1305	-	F	Update of applicability for RLM TC 4.6.1.3 and 4.6.1.6	16.9.0
2021-09	RAN#93	R5-214525	1308	-	F	Update of applicability for RLM TC 6.6.1.3 and 6.6.1.6	16.9.0
2021-09	RAN#93	R5-214526	1309	-	F	Correction of cell configuration for SA FR1 TC 6.3.2.1.2 and 6.3.2.1.3	16.9.0
2021-09	RAN#93	R5-214527	1310	-	F	Correction of specific message content for SA FR2 TC 7.6.1.4	16.9.0
2021-09	RAN#93	R5-214528	1311	-	F	Correction of cell configuration for SA FR2 TC 7.3.2.1.1, 7.3.2.1.2 and 7.3.2.1.3	16.9.0
2021-09	RAN#93	R5-214529	1312	-	F	Update of TCI configuration for SA FR2 TC 7.6.2.1 and 7.6.2.3	16.9.0
2021-09	RAN#93	R5-214530	1313	-	F	Correction of non-existent config for SA FR2 TC 7.7.1.3.1	16.9.0
2021-09	RAN#93	R5-214681	1319	-	F	Core alignment for DRX configuration	16.9.0
2021-09	RAN#93	R5-214682	1320	-	F	Correction to FR2 event-triggered reporting in DRX test cases	16.9.0
2021-09	RAN#93	R5-214685	1323	-	F	Correction to Inter-RAT SFTD measurement delay and event triggered reporting tests	16.9.0
2021-09	RAN#93	R5-214687	1325	-	F	Correction to 4.5.7.1EN-DC FR1 addition and release delay of known PSCell	16.9.0
2021-09	RAN#93	R5-214688	1326	-	F	Correction to NR SA FR1 - E-UTRAN event-triggered reporting tests	16.9.0
2021-09	RAN#93	R5-214689	1327	-	F	Correction to the number of entries in the measObjectToAddModList	16.9.0
2021-09	RAN#93	R5-214693	1331	-	F	Clean up on editor notes for FR2 test cases	16.9.0
2021-09	RAN#93	R5-214711	1335	-	F	Add minimum conformance requirements for DAPS handover	16.9.0
2021-09	RAN#93	R5-214832	1337	-	F	Correction to 5G-SRVCC RRM TC 6.3.1.6-handover	16.9.0
2021-09	RAN#93	R5-214833	1338	-	F	Correction to 5G-SRVCC RRM TC 6.6.5.1-event triggered reporting non-DRX	16.9.0
2021-09	RAN#93	R5-214921	1340	-	F	Alignment HO test case 6.3.1.2 with core requirements	16.9.0
2021-09	RAN#93	R5-214922	1341	-	F	Correction re-establishment test cases 6.3.2.1.x	16.9.0
2021-09	RAN#93	R5-214923	1342	-	F	Remove gapUE and gapFR1 from iRAT test cases	16.9.0
2021-09	RAN#93	R5-214924	1343	-	F	Annex A.6.1 for iRAT test cases	16.9.0
2021-09	RAN#93	R5-214948	1344	-	F	Addition of FR-1 NSA CLI Measurement test cases	16.9.0
2021-09	RAN#93	R5-214983	1349	-	F	Correction to FR1 EN-DC TCs-RLM	16.9.0
2021-09	RAN#93	R5-214985	1351	-	F	Correction to FR2 EN-DC TCs-RLM	16.9.0

Change history							
Date	Meeting	TDoc	CR	Rev	Cat	Subject/Comment	New version
2021-09	RAN#93	R5-214986	1352	-	F	Correction to FR2 EN-DC TCs-SCell activation	16.9.0
2021-09	RAN#93	R5-214987	1353	-	F	Correction to FR1 NR SA TC 6.5.2.1-SCell interruption	16.9.0
2021-09	RAN#93	R5-214989	1355	-	F	Correction to FR1 NR SA TCs-cell reselection	16.9.0
2021-09	RAN#93	R5-214991	1357	-	F	Correction to FR1 NR SA TCs-RLM	16.9.0
2021-09	RAN#93	R5-214993	1359	-	F	Correction to FR2 NR SA TCs-cell reselection	16.9.0
2021-09	RAN#93	R5-214994	1360	-	F	Correction to FR2 NR SA TCs-SCell activation	16.9.0
2021-09	RAN#93	R5-214996	1362	-	F	Correction to LTE SA TCs-cell reselection	16.9.0
2021-09	RAN#93	R5-214997	1363	-	F	Correction to LTE SA TCs-inter-RAT delay	16.9.0
2021-09	RAN#93	R5-214999	1365	-	F	Correction to cell mapping for CA TCs	16.9.0
2021-09	RAN#93	R5-215005	1367	-	F	Addition of minimum requirements for FR1 CHO	16.9.0
2021-09	RAN#93	R5-215006	1368	-	F	Addition of minimum requirements for FR2 CHO	16.9.0
2021-09	RAN#93	R5-215007	1369	-	F	Addition of NR Mob_Enh RRM TC 6.3.1.7-intra freq sync DAPS HO	16.9.0
2021-09	RAN#93	R5-215008	1370	-	F	Addition of NR Mob_Enh RRM TC 6.3.1.8-intra freq async DAPS HO	16.9.0
2021-09	RAN#93	R5-215009	1371	-	F	Addition of NR Mob_Enh RRM TC 6.3.3.1-intra freq CHO	16.9.0
2021-09	RAN#93	R5-215010	1372	-	F	Addition of NR Mob_Enh RRM TC 6.3.3.2-inter freq CHO	16.9.0
2021-09	RAN#93	R5-215011	1373	-	F	Addition of NR Mob_Enh RRM TC 7.3.1.4-inter band sync DAPS HO	16.9.0
2021-09	RAN#93	R5-215012	1374	-	F	Addition of NR Mob_Enh RRM TC 7.3.1.5-inter band async DAPS HO	16.9.0
2021-09	RAN#93	R5-215013	1375	-	F	Addition of NR Mob_Enh RRM TC 7.3.3.1-intra freq CHO	16.9.0
2021-09	RAN#93	R5-215014	1376	-	F	Addition of NR Mob_Enh RRM TC 7.3.3.2-inter freq CHO	16.9.0
2021-09	RAN#93	R5-215020	1378	-	F	Addition of minimum requirements for inter-freq relaxed measurement	16.9.0
2021-09	RAN#93	R5-215022	1380	-	F	Addition of minimum requirements for intra-freq relaxed measurement	16.9.0
2021-09	RAN#93	R5-215023	1381	-	F	Addition of NR PS RRM TC 6.1.1.3 - intra-freq cell reselection low mobility	16.9.0
2021-09	RAN#93	R5-215024	1382	-	F	Addition of NR PS RRM TC 6.1.1.4 - intra-freq cell reselection non-cell-edge	16.9.0
2021-09	RAN#93	R5-215025	1383	-	F	Addition of NR PS RRM TC 6.1.1.5 - inter-freq cell reselection low mobility	16.9.0
2021-09	RAN#93	R5-215026	1384	-	F	Addition of NR PS RRM TC 6.1.1.6 - inter-freq cell reselection non-cell-edge	16.9.0
2021-09	RAN#93	R5-215036	1388	-	F	Correction to minimum requirements for inter-RAT cell reselection with highSpeedMeasFlag	16.9.0
2021-09	RAN#93	R5-215037	1389	-	F	Correction to minimum requirements for intra-frequency measurement with highSpeedMeasFlag	16.9.0
2021-09	RAN#93	R5-215038	1390	-	F	Correction to NR HST RRM TC 6.1.1.7-HST intra-freq cell reselection	16.9.0
2021-09	RAN#93	R5-215039	1391	-	F	Addition of cell mapping for NR HST RRM TCs	16.9.0
2021-09	RAN#93	R5-215243	1398	-	F	Update of test case 6.6.4.5 for R16 NR HST	16.9.0

Change history							
Date	Meeting	TDoc	CR	Rev	Cat	Subject/Comment	New version
2021-09	RAN#93	R5-215244	1399	-	F	Editorial change of RRM test case 6.6.1.7	16.9.0
2021-09	RAN#93	R5-215352	1401	-	F	Correction to test frequency selection for intra-band EN-DC	16.9.0
2021-09	RAN#93	R5-215354	1403	-	F	Correction to test requirement for 8.4.2.4 and error in writing for 8.4.2.x	16.9.0
2021-09	RAN#93	R5-215355	1404	-	F	Correction to DRX configuration for eliminating overlap between DRX and SMTC	16.9.0
2021-09	RAN#93	R5-215360	1405	-	F	Correction to test case 6.3.1.1 and 6.3.1.3	16.9.0
2021-09	RAN#93	R5-215365	1406	-	F	Core spec alignment to add CCR configuration for EN-DC PRACH	16.9.0
2021-09	RAN#93	R5-215366	1407	-	F	Core spec alignment to add CCR configuration for EN-DC Timing	16.9.0
2021-09	RAN#93	R5-215367	1408	-	F	Core spec alignment to add CCR configuration for EN-DC event triggered	16.9.0
2021-09	RAN#93	R5-215368	1409	-	F	Addition of minimum conformance requirements of cell re-selection with relaxed measurement criterion in FR2	16.9.0
2021-09	RAN#93	R5-215392	1410	-	F	Add test case 4.3.2.2.3 for EN-DC FR1 2-step PRACH	16.9.0
2021-09	RAN#93	R5-215393	1411	-	F	Add test case 4.3.2.2.4 for EN-DC FR1 2-step PRACH	16.9.0
2021-09	RAN#93	R5-215394	1412	-	F	Add test case 5.3.2.2.3 for EN-DC FR2 2-step PRACH	16.9.0
2021-09	RAN#93	R5-215395	1413	-	F	Add test case 5.3.2.2.4 for EN-DC FR2 2-step PRACH	16.9.0
2021-09	RAN#93	R5-215396	1414	-	F	Add test case 6.3.2.2.3 for SA FR1 2-step PRACH	16.9.0
2021-09	RAN#93	R5-215397	1415	-	F	Add test case 6.3.2.2.4 for SA FR1 2-step PRACH	16.9.0
2021-09	RAN#93	R5-215398	1416	-	F	Add 2-Step PRACH test cases to Annex E	16.9.0
2021-09	RAN#93	R5-215412	1417	-	F	Addition of cell configuration for RRM HST test cases in Annex E	16.9.0
2021-09	RAN#93	R5-215413	1418	-	F	Correction of RRM HST Inter-RAT measurements test case 6.6.3.3	16.9.0
2021-09	RAN#93	R5-215414	1419	-	F	Correction of RRM HST E-UTRA NR FR1 Cell reselection test case 8.2.1.2	16.9.0
2021-09	RAN#93	R5-215415	1420	-	F	Correction of RRM HST E-UTRA NR Inter-RAT event triggered reporting test case 8.4.2.9	16.9.0
2021-09	RAN#93	R5-215420	1425	-	F	Correction of RRM EN-DC FR2 CSI-RS-based L1-RSRP measurement in DRX test case 5.6.3.4	16.9.0
2021-09	RAN#93	R5-215425	1430	-	F	Correction of RRM EN-DC FR2-FR2 event-triggered reporting in DRX test case 5.6.2.2 including Test Tolerance	16.9.0
2021-09	RAN#93	R5-215426	1431	-	F	Correction of RRM EN-DC FR2-FR2 event-triggered reporting in DRX with SSB time index detection test case 5.6.2.4 including Test Tolerance	16.9.0
2021-09	RAN#93	R5-215427	1432	-	F	Correction of RRM SA FR2-FR2 event-triggered reporting in DRX test case 7.6.2.2 including Test Tolerance	16.9.0
2021-09	RAN#93	R5-215428	1433	-	F	Correction of RRM SA FR2-FR2 event-triggered reporting in DRX with SSB time index detection test case 7.6.2.4 including Test Tolerance	16.9.0
2021-09	RAN#93	R5-215429	1434	-	F	Editorial correction of RRM FR2 EN-DC event triggered measurement test cases	16.9.0
2021-09	RAN#93	R5-215430	1435	-	F	Editorial correction of RRM FR2 SA event triggered measurement test cases	16.9.0
2021-09	RAN#93	R5-215431	1436	-	F	Correction of Measurement Uncertainty and Test Tolerance in Annex F for RRM test cases	16.9.0

Change history							
Date	Meeting	TDoc	CR	Rev	Cat	Subject/Comment	New version
2021-09	RAN#93	R5-215436	1437	-	F	Add MsgA configuration to the TS 38.533 annexes	16.9.0
2021-09	RAN#93	R5-215614	1438	-	F	Update on 6.3.1.1 to be aligned with TS 38.133	16.9.0
2021-09	RAN#93	R5-215620	1439	-	F	MTSU and TT mapping related to Max Device Size in TS 38.533	16.9.0
2021-09	RAN#93	R5-215622	1441	-	F	Updates on 5.6.1.3 and 5.6.1.4 CSI-RS RLM test cases test applicability	16.9.0
2021-09	RAN#93	R5-215624	1443	-	F	Correction in 5.6.1.1, 5.6.1.3 test procedure to configure iterations	16.9.0
2021-09	RAN#93	R5-215625	1444	-	F	Correction in 5.6.2.1, 5.6.2.2, 5.6.2.3, 5.6.2.4 test procedure to configure iterations	16.9.0
2021-09	RAN#93	R5-215655	1451	-	F	Update to applicability statement to include gap pattern id 13 for applicable NSA event triggered test cases	16.9.0
2021-09	RAN#93	R5-215656	1452	-	F	TRS configuration update to NSA FR1 TC 6.5.4.1.1	16.9.0
2021-09	RAN#93	R5-215903	1238	1	F	Change to EN-DC L1-RSRP test cases to add evaluation rules	16.9.0
2021-09	RAN#93	R5-215904	1240	1	F	Correction to 4.5.1.2 core spec alignment	16.9.0
2021-09	RAN#93	R5-215905	1241	1	F	Correction to 4.5.1.3 message contents and core spec alignment	16.9.0
2021-09	RAN#93	R5-215906	1244	1	F	Correction to 4.5.1.7 message contents and core spec alignment	16.9.0
2021-09	RAN#93	R5-215907	1329	1	F	Correction to FR1 and FR2 event-triggered reporting with gap tests	16.9.0
2021-09	RAN#93	R5-215908	1262	1	F	Change to SA L1-RSRP test cases to add evaluation rules	16.9.0
2021-09	RAN#93	R5-215909	1264	1	F	Correction to 6.5.1.3 message contents and core spec alignment	16.9.0
2021-09	RAN#93	R5-215910	1266	1	F	Correction to 6.5.1.7 message contents and core spec alignment	16.9.0
2021-09	RAN#93	R5-215911	1356	1	F	Correction to FR1 NR SA TCs-inter-RAT accuracy	16.9.0
2021-09	RAN#93	R5-215912	1402	1	F	Correction to test procedure for 6.1.2.2 IRAT ReSelection	16.9.0
2021-09	RAN#93	R5-215913	1277	1	F	Change title of iRAT test cases for clarity	16.9.0
2021-09	RAN#93	R5-215914	1361	1	F	Correction to LTE SA TC 8.5.1.1-SFTD accuracy	16.9.0
2021-09	RAN#93	R5-215915	1279	1	F	Change title of iRAT test cases for clarity - Annexes	16.9.0
2021-09	RAN#93	R5-215916	1333	1	F	Update to Annex H.3.4	16.9.0
2021-09	RAN#93	R5-215917	1366	1	F	Correction to default configuration-Annex H	16.9.0
2021-09	RAN#93	R5-215918	1421	1	F	Correction of CSI-ReportConfig in Annex H	16.9.0
2021-09	RAN#93	R5-215932	1377	1	F	Addition of cell mapping for Mob_Enh RRM TCs	16.9.0
2021-09	RAN#93	R5-215938	1316	1	F	Addition of NR SA FR2-FR2 cell re-selection for UE fulfilling low mobility relaxed measurement criterion	16.9.0
2021-09	RAN#93	R5-215939	1385	1	F	Addition of cell mapping for NR PS RRM TCs	16.9.0
2021-09	RAN#93	R5-215940	1392	1	F	Addition of minimum conformance requirements of inter-RAT cell re-selection with relaxed measurement criterion	16.9.0
2021-09	RAN#93	R5-215941	1395	1	F	Update of Annex E and Annex F for test cases with relaxed measurement criterion	16.9.0
2021-09	RAN#93	R5-215948	1386	1	F	Addition of NR HST RRM TC 4.6.1.7-intra-freq DRX highSpeedMeasFlag	16.9.0
2021-09	RAN#93	R5-215949	1387	1	F	Addition of NR HST RRM TC 6.1.2.5-intra-freq cell reselection highSpeedMeasFlag	16.9.0
2021-09	RAN#93	R5-216042	1328	1	F	Correction to FR1 Beam Failure Detection and Link Recovery tests	16.9.0

Change history							
Date	Meeting	TDoc	CR	Rev	Cat	Subject/Comment	New version
2021-09	RAN#93	R5-216043	1339	1	F	Correction message contents 4.3.2.2.2	16.9.0
2021-09	RAN#93	R5-216044	1345	1	F	Update to applicability of test cases on CSI-RS based RLM	16.9.0
2021-09	RAN#93	R5-216045	1445	1	F	Updates to DCI based BWP switch NSA FR1 TC 4.5.6.1.1	16.9.0
2021-09	RAN#93	R5-216046	1446	1	F	Updates to DCI based BWP switch NSA FR1 2DLCA TC 4.5.6.1.2	16.9.0
2021-09	RAN#93	R5-216047	1447	1	F	Updates to RRC based BWP switch NSA FR1 TC 4.5.6.2.1	16.9.0
2021-09	RAN#93	R5-216048	1228	1	F	Completion 5.7.1.2 including TT analysis results	16.9.0
2021-09	RAN#93	R5-216049	1229	1	F	Completion 5.7.2.2 including TT analysis results	16.9.0
2021-09	RAN#93	R5-216050	1230	1	F	Completion 5.7.3.2 including TT analysis results	16.9.0
2021-09	RAN#93	R5-216051	1322	1	F	Correction to 6.5.3.1 NR SA FR1 SCell activation and deactivation of known SCell	16.9.0
2021-09	RAN#93	R5-216052	1231	1	F	Completion 7.7.1.2 including TT analysis results	16.9.0
2021-09	RAN#93	R5-216053	1233	1	F	Completion 7.7.3.2 including TT analysis results	16.9.0
2021-09	RAN#93	R5-216054	1346	1	F	Update to applicability of test cases requiring gap pattern ID 4	16.9.0
2021-09	RAN#93	R5-216055	1299	1	F	Completion Annex C.2.3	16.9.0
2021-09	RAN#93	R5-216098	1336	1	F	Correction to EN-DC FR2 interruptions at transitions between active and non-active during DRX	16.9.0
2021-09	RAN#93	R5-216099	1324	1	F	Correction to 6.5.2.1 NR SA FR1 interruptions during measurements on deactivated NR SCC	16.9.0
2021-09	RAN#93	R5-216100	1330	1	F	Correction to the propagation condition of NR cell for Inter RAT test cases	16.9.0
2021-09	RAN#93	R5-216101	1318	1	F	Addition of BWP definition for FR2 SSB SCS240kHz	16.9.0
2021-09	RAN#93	R5-216123	1448	1	F	Updates to DCI based BWP switch SA FR1 2DLCA TC 6.5.6.1.1	16.9.0
2021-09	RAN#93	R5-216124	1449	1	F	Updates to DCI based BWP switch SA FR1 TC 6.5.6.1.2	16.9.0
2021-09	RAN#93	R5-216125	1450	1	F	Updates to RRC based BWP switch SA FR1 TC 6.5.6.2.1	16.9.0
2021-09	RAN#93	R5-216132	1347	1	F	Correction to FR1 EN-DC TC 4.5.7.1-PSCell addition	16.9.0
2021-09	RAN#93	R5-216133	1348	1	F	Correction to FR1 EN-DC TCs-BWP switching	16.9.0
2021-09	RAN#93	R5-216134	1350	1	F	Correction to FR1 EN-DC TCs-SCell activation	16.9.0
2021-09	RAN#93	R5-216135	1354	1	F	Correction to FR1 NR SA TCs-BWP switching	16.9.0
2021-09	RAN#93	R5-216136	1358	1	F	Correction to FR1 NR SA TCs-SCell activation	16.9.0
2021-09	RAN#93	R5-216137	1454	1	F	Correction to UL BWP configuration for SA FR1 TC 6.5.2.1	16.9.0
2021-09	RAN#93	R5-216138	1364	1	F	Correction to LTE SA TCs-SFTD delay	16.9.0
2021-09	RAN#93	R5-216143	1393	1	F	Addition of 6.1.2.3 inter-RAT cell re-selection with relaxed measurement with low mobility	16.9.0
2021-09	RAN#93	R5-216144	1394	1	F	Addition of 6.1.2.4 inter-RAT cell re-selection with relaxed measurement with not at cell edge	16.9.0
2021-09	RAN#93	R5-216145	1422	1	F	Correction of RRM EN-DC FR2 SSB-based L1-RSRP measurement in non-DRX test case 5.6.3.1 including Test Tolerance	16.9.0
2021-09	RAN#93	R5-216146	1423	1	F	Correction of RRM EN-DC FR2 SSB-based L1-RSRP measurement in DRX test case 5.6.3.2 including Test Tolerance	16.9.0



Change history							
Date	Meeting	TDoc	CR	Rev	Cat	Subject/Comment	New version
2021-09	RAN#93	R5-216147	1424	1	F	Correction of RRM EN-DC FR2 CSI-RS-based L1-RSRP measurement in non-DRX test case 5.6.3.3	16.9.0
2021-09	RAN#93	R5-216148	1426	1	F	Correction of RRM NR SA FR2 SSB-based L1-RSRP measurement in non-DRX test case 7.6.3.1 including Test Tolerance	16.9.0
2021-09	RAN#93	R5-216149	1427	1	F	Correction of RRM NR SA FR2 SSB-based L1-RSRP measurement in DRX test case 7.6.3.2 including Test Tolerance	16.9.0
2021-09	RAN#93	R5-216360	1428	1	F	Correction of RRM NR SA FR2 CSI-RS-based L1-RSRP measurement in non-DRX test case 7.6.3.3	16.9.0
2021-09	RAN#93	R5-216361	1429	1	F	Correction of RRM NR SA FR2 CSI-RS-based L1-RSRP measurement in DRX test case 7.6.3.4	16.9.0
2021-09	RAN#93	R5-216364	1314	1	F	Addition of NR SA FR2 cell re-selection for UE fulfilling low mobility relaxed measurement criterion	16.9.0
2021-09	RAN#93	R5-216365	1315	1	F	Addition of NR SA FR2 cell re-selection for UE fulfilling not-at-cell edge relaxed measurement criterion	16.9.0
2021-09	RAN#93	R5-216366	1317	1	F	Addition of NR SA FR2-FR2 cell re-selection for UE fulfilling not-at-cell edge relaxed measurement criterion	16.9.0
2021-09	RAN#93	R5-215968	1397	1	B	Introduction of n24	17.0.0
2021-12	RAN#94	R5-216602	1455	-	F	Update of TC 6.7.1.1.2	17.1.0
2021-12	RAN#94	R5-216839	1458	-	F	Correction to CSI-RS based beam failure detection test cases	17.1.0
2021-12	RAN#94	R5-216840	1459	-	F	Correction to Initial DL and UL BWP for test case 6.3.2.1.2	17.1.0
2021-12	RAN#94	R5-216841	1460	-	F	Correction to SRS configuration for FR1 timing test cases	17.1.0
2021-12	RAN#94	R5-216842	1461	-	F	Correction to SRS configuration for FR2 timing test cases	17.1.0
2021-12	RAN#94	R5-216843	1462	-	F	Correction to FR1 CA RRM tests for generic channel BW configurations	17.1.0
2021-12	RAN#94	R5-216844	1463	-	F	Correction to FR1 Active BWP Switch Delay TCs	17.1.0
2021-12	RAN#94	R5-216845	1464	-	F	Correction to FR1 Redirection test cases	17.1.0
2021-12	RAN#94	R5-216846	1465	-	F	Correction to message exceptions for CSI-RS based BFR tests	17.1.0
2021-12	RAN#94	R5-216857	1470	-	F	Correction to FR2 EN-DC RRM TCs - RLM	17.1.0
2021-12	RAN#94	R5-216860	1473	-	F	Correction to FR2 EN-DC RRM TCs using Table H.3.1-4 for event A4	17.1.0
2021-12	RAN#94	R5-216861	1474	-	F	Correction to FR1 NR SA RRM TC 6.1.1.1 - intra-freq reselection	17.1.0
2021-12	RAN#94	R5-216862	1475	-	F	Correction to FR1 NR SA RRM TC 6.7.6.1 - inter-RAT meas	17.1.0
2021-12	RAN#94	R5-216864	1477	-	F	Correction to FR1 NR SA RRM TCs 6.5.2.1 - interruption	17.1.0
2021-12	RAN#94	R5-216866	1479	-	F	Correction to FR2 NR SA RRM TCs using Table H.3.1-4 for event A4	17.1.0
2021-12	RAN#94	R5-216868	1481	-	F	Correction to SSB reference configurations	17.1.0
2021-12	RAN#94	R5-216869	1482	-	F	Correction to Annex H for RRM TCs	17.1.0
2021-12	RAN#94	R5-216873	1485	-	F	Correction to Mob_enh RRM TC 6.3.3.1 - FR1 intra CHO	17.1.0
2021-12	RAN#94	R5-216874	1486	-	F	Correction to Mob_enh RRM TC 6.3.3.2 - FR1 inter CHO	17.1.0
2021-12	RAN#94	R5-216876	1488	-	F	Correction to Mob_enh RRM TC 7.3.1.5 - inter-FR DAPS async	17.1.0
2021-12	RAN#94	R5-216886	1492	-	F	Correction to PS RRM TC 6.1.1.3 - intra low mobility	17.1.0

Change history							
Date	Meeting	TDoc	CR	Rev	Cat	Subject/Comment	New version
2021-12	RAN#94	R5-216887	1493	-	F	Correction to PS RRM TC 6.1.1.4 - intra not cell edge	17.1.0
2021-12	RAN#94	R5-216888	1494	-	F	Correction to PS RRM TC 6.1.1.5 - inter low mobility	17.1.0
2021-12	RAN#94	R5-216889	1495	-	F	Correction to PS RRM TC 6.1.1.6 - inter not cell edge	17.1.0
2021-12	RAN#94	R5-216890	1496	-	F	Correction to Annex F for PS RRM TCs	17.1.0
2021-12	RAN#94	R5-216900	1497	-	F	Correction to SRVCC RRM TC 6.3.1.6 - UTRA handover	17.1.0
2021-12	RAN#94	R5-216902	1499	-	F	Correction to Annex F for SRVCC RRM TCs	17.1.0
2021-12	RAN#94	R5-216912	1500	-	F	Correction to HST RRM TC 4.6.1.7 - intra-freq meas	17.1.0
2021-12	RAN#94	R5-216913	1501	-	F	Correction to HST RRM TC 4.6.4.5 - L1-RSRP	17.1.0
2021-12	RAN#94	R5-216914	1502	-	F	Correction to HST RRM TC 6.1.2.5 - inter-RAT reselection	17.1.0
2021-12	RAN#94	R5-216915	1503	-	F	Correction to Annex F for HST RRM TCs	17.1.0
2021-12	RAN#94	R5-217070	1505	-	F	Correction of message configuration for EN-DC FR1 SFTD TC 4.7.5.1	17.1.0
2021-12	RAN#94	R5-217122	1510	-	F	Reinstate wrongly deleted Table H.3.5-4	17.1.0
2021-12	RAN#94	R5-217123	1511	-	F	Correct B2 Threshold in H.3.1-4A	17.1.0
2021-12	RAN#94	R5-217124	1512	-	F	Corrections to 4.3.2.2.1	17.1.0
2021-12	RAN#94	R5-217131	1515	-	F	Corrections to L1-RSRP EN-DC test cases	17.1.0
2021-12	RAN#94	R5-217132	1516	-	F	Corrections to L1-RSRP NR SA test cases	17.1.0
2021-12	RAN#94	R5-217145	1517	-	F	Correct reference to test frequencies	17.1.0
2021-12	RAN#94	R5-217203	1519	-	F	Addition of minimum requirements for EN-DC L1-SINR measurement for beam reporting	17.1.0
2021-12	RAN#94	R5-217207	1523	-	F	Addition of minimum requirements for NR SA FR1 L1-SINR measurement for beam reporting	17.1.0
2021-12	RAN#94	R5-217211	1527	-	F	Addition of the abbreviations for Rel-16 NR MIMO	17.1.0
2021-12	RAN#94	R5-217213	1529	-	F	Addition of Annex A.1.4B CSI-IM Reference Measurement Channels	17.1.0
2021-12	RAN#94	R5-217214	1530	-	F	Addition of Annex H.3.6A RRC messages and IE exceptions for L1-SINR measurement for beam reporting	17.1.0
2021-12	RAN#94	R5-217228	1539	-	F	Correct of RRM Test Cases for test applicability	17.1.0
2021-12	RAN#94	R5-217229	1540	-	F	Correct of RRM Test Cases	17.1.0
2021-12	RAN#94	R5-217255	1541	-	F	Addition of FR-1 NSA CLI accuracy test cases	17.1.0
2021-12	RAN#94	R5-217258	1542	-	F	Corrections to event-triggered iRAT	17.1.0
2021-12	RAN#94	R5-217395	1545	-	F	Update of 6.1.2.3 and 6.1.2.4 for MU and TT	17.1.0
2021-12	RAN#94	R5-217396	1546	-	F	Update of Annex F for test cases with relaxed measurement criterion	17.1.0
2021-12	RAN#94	R5-217436	1550	-	F	Correction to E-UTRA - NR FR1 cell re-selection to higher priority NR target cell	17.1.0
2021-12	RAN#94	R5-217438	1551	-	F	Correction to SIB4 exceptions in Annex H	17.1.0
2021-12	RAN#94	R5-217439	1552	-	F	Correction to FR2 event-triggered reporting with gap test	17.1.0
2021-12	RAN#94	R5-217441	1553	-	F	Correction to test procedure in 8.2.1.1	17.1.0

Change history							
Date	Meeting	TDoc	CR	Rev	Cat	Subject/Comment	New version
2021-12	RAN#94	R5-217443	1555	-	F	Correction to test requirement in 8.3.1.1	17.1.0
2021-12	RAN#94	R5-217520	1559	-	F	Addition of RMC CORESET to FR2 random access tests	17.1.0
2021-12	RAN#94	R5-217570	1561	-	F	Correction of RRM HST Inter-RAT measurements test case 6.6.3.3 including Test Tolerance	17.1.0
2021-12	RAN#94	R5-217572	1563	-	F	Correction of RRM HST E-UTRA NR Inter-RAT event triggered reporting test case 8.4.2.9 including Test Tolerance	17.1.0
2021-12	RAN#94	R5-217573	1564	-	F	Correction of RRM EN-DC FR2 CSI-RS-based L1-RSRP measurement in non-DRX test case 5.6.3.3 including Test Tolerance	17.1.0
2021-12	RAN#94	R5-217574	1565	-	F	Correction of RRM EN-DC FR2 CSI-RS-based L1-RSRP measurement in DRX test case 5.6.3.4 including Test Tolerance	17.1.0
2021-12	RAN#94	R5-217575	1566	-	F	Correction of RRM NR SA FR2 CSI-RS-based L1-RSRP measurement in non-DRX test case 7.6.3.3 including Test Tolerance	17.1.0
2021-12	RAN#94	R5-217576	1567	-	F	Correction of RRM NR SA FR2 CSI-RS-based L1-RSRP measurement in DRX test case 7.6.3.4 including Test Tolerance	17.1.0
2021-12	RAN#94	R5-217577	1568	-	F	Correction of SA FR2 RRC re-establishment test case 7.3.2.1.1	17.1.0
2021-12	RAN#94	R5-217580	1571	-	F	Correction of Measurement Uncertainty and Test Tolerance in Annex F for RRM test cases	17.1.0
2021-12	RAN#94	R5-217585	1572	-	F	Correction of Minimum conformance requirements for FR1 re-establishment test cases	17.1.0
2021-12	RAN#94	R5-217586	1573	-	F	Correction of Minimum conformance requirements for FR2 re-establishment test cases	17.1.0
2021-12	RAN#94	R5-217661	1574	-	F	Update on FR2 Radio Link monitoring SSB based RLM test cases	17.1.0
2021-12	RAN#94	R5-217663	1575	-	F	Update on FR2 radio link monitoring CSI-RS based RLM test cases	17.1.0
2021-12	RAN#94	R5-217736	1576	-	F	Update to SA Handover delay requirements	17.1.0
2021-12	RAN#94	R5-218207	1577	-	F	Correct 5.7.3.2 / 7.7.3.2 test case limits based on TT analysis results	17.1.0
2021-12	RAN#94	R5-218215	1457	1	F	Correction to Mob_enh RRM TC 6.3.1.9 - inter-freq sync DAPS HO	17.1.0
2021-12	RAN#94	R5-218216	1491	1	F	Correction to Annex F for Mob_enh RRM TCs	17.1.0
2021-12	RAN#94	R5-218217	1504	1	F	Correction to Mob_enh RRM TC 6.3.1.10 - inter-freq async DAPS HO	17.1.0
2021-12	RAN#94	R5-218250	1469	1	F	Correction to FR1 EN-DC RRM TCs 4.5.2.X - interruption	17.1.0
2021-12	RAN#94	R5-218251	1513	1	F	Corrections to RLM EN-DC test cases	17.1.0
2021-12	RAN#94	R5-218252	1548	1	F	Correction to EN-DC FR1 addition and release delay of known PSCell	17.1.0
2021-12	RAN#94	R5-218253	1471	1	F	Correction to FR2 EN-DC RRM TCs - RRC based	17.1.0
2021-12	RAN#94	R5-218254	1506	1	F	Correction of T2 timer value for SA FR1 TC 6.3.2.1.3	17.1.0
2021-12	RAN#94	R5-218255	1514	1	F	Corrections to RLM NR SA test cases	17.1.0
2021-12	RAN#94	R5-218256	1478	1	F	Correction to FR2 NR SA RRM TCs - RLM	17.1.0
2021-12	RAN#94	R5-218257	1507	1	F	Correction of RRC re-establishment delay for SA FR2 TC 7.3.2.1.1	17.1.0
2021-12	RAN#94	R5-218258	1508	1	F	Correction of T2 timer value for SA FR2 TC 7.3.2.1.2	17.1.0
2021-12	RAN#94	R5-218259	1509	1	F	Correction of T2 timer value for SA FR2 TC 7.3.2.1.3	17.1.0

Change history							
Date	Meeting	TDoc	CR	Rev	Cat	Subject/Comment	New version
2021-12	RAN#94	R5-218260	1569	1	F	Correction of SA FR2 - FR2 RRC re-establishment test case 7.3.2.1.2	17.1.0
2021-12	RAN#94	R5-218261	1480	1	F	Correction to LTE SA RRM TCs - NR inter-RAT accuracy	17.1.0
2021-12	RAN#94	R5-218294	1544	1	F	Update of Annex for 4.5.8.1 EN-DC FR1 DL interruptions at switching between two uplink carriers	17.1.0
2021-12	RAN#94	R5-218296	1483	1	F	Correction to Mob_enh RRM TC 6.3.1.7 - intra DAPS sync	17.1.0
2021-12	RAN#94	R5-218297	1484	1	F	Correction to Mob_enh RRM TC 6.3.1.8 - intra DAPS async	17.1.0
2021-12	RAN#94	R5-218298	1487	1	F	Correction to Mob_enh RRM TC 7.3.1.4 - inter-FR DAPS sync	17.1.0
2021-12	RAN#94	R5-218299	1490	1	F	Correction to Mob_enh RRM TC 7.3.3.2 - FR2 inter CHO	17.1.0
2021-12	RAN#94	R5-218313	1520	1	F	Addition of 4.6.7.1 EN-DC FR1 CSI-RS based CMR and no dedicated IMR L1-SINR measurement in non-DRX	17.1.0
2021-12	RAN#94	R5-218314	1521	1	F	Addition of 4.6.7.2 EN-DC FR1 SSB based CMR and dedicated IMR L1-SINR measurement in DRX	17.1.0
2021-12	RAN#94	R5-218315	1522	1	F	Addition of 4.6.7.3 EN-DC FR1 CSI-RS based CMR and dedicated IMR L1-SINR measurement in DRX	17.1.0
2021-12	RAN#94	R5-218316	1524	1	F	Addition of 6.6.8.1 NR SA FR1 CSI-RS based CMR and no dedicated IMR L1-SINR measurement in DRX	17.1.0
2021-12	RAN#94	R5-218317	1525	1	F	Addition of 6.6.8.2 NR SA FR1 SSB based CMR and dedicated IMR L1-SINR measurement in non-DRX	17.1.0
2021-12	RAN#94	R5-218318	1526	1	F	Addition of 6.6.8.3 NR SA FR1 CSI-RS based CMR and dedicated IMR L1-SINR measurement in non-DRX	17.1.0
2021-12	RAN#94	R5-218319	1528	1	F	Addition of CSI-RS Reference Measurement Channels based on IMR	17.1.0
2021-12	RAN#94	R5-218320	1531	1	F	Addition of 4.5.5.5 EN-DC FR1 Scell CSI-RS-based beam failure detection and SSB-based link recovery in non-DRX	17.1.0
2021-12	RAN#94	R5-218321	1532	1	F	Addition of 4.5.5.6 EN-DC FR1 Scell CSI-RS-based beam failure detection and SSB-based link recovery in DRX	17.1.0
2021-12	RAN#94	R5-218322	1533	1	F	Addition of 4.7.7.1 EN-DC FR1 CSI-RS based CMR and no dedicated IMR configured and CSI-RS resource set with repetition off L1-SINR measurement accuracy	17.1.0
2021-12	RAN#94	R5-218323	1535	1	F	Addition of 4.7.7.3 EN-DC FR1 CSI-RS based CMR and dedicated IMR L1-SINR measurement accuracy	17.1.0
2021-12	RAN#94	R5-218324	1536	1	F	Addition of 6.7.9.1 NR SA FR1 CSI-RS based CMR and no dedicated IMR configured and CSI-RS resource set with repetition off L1-SINR measurement accuracy	17.1.0
2021-12	RAN#94	R5-218325	1537	1	F	Addition of 6.7.9.2 NR SA FR1 SSB based CMR and dedicated IMR L1-SINR absolute measurement accuracy	17.1.0
2021-12	RAN#94	R5-218326	1538	1	F	Addition of 6.7.9.3 NR SA FR1 CSI-RS based CMR and dedicated IMR L1-SINR measurement accuracy	17.1.0
2021-12	RAN#94	R5-218327	1547	1	F	Addition of cell configuration MU and TT for Enhancement on MIMO	17.1.0
2021-12	RAN#94	R5-218336	1498	1	F	Correction to SRVCC RRM TC 6.6.5.1 - UTRA meas	17.1.0
2021-12	RAN#94	R5-218351	1562	1	F	Correction of RRM HST E-UTRA NR FR1 Cell reselection test case 8.2.1.2 including Test Tolerance	17.1.0
2021-12	RAN#94	R5-218352	1570	1	F	Correction of Measurement Uncertainty and Test Tolerance in Annex F for RRM HST test cases	17.1.0

Change history							
Date	Meeting	TDoc	CR	Rev	Cat	Subject/Comment	New version
2021-12	RAN#94	R5-218372	1543	1	F	Addition of 4.5.8.1 EN-DC FR1 DL interruptions at switching between two uplink carriers	17.1.0
2021-12	RAN#94	R5-218439	1468	1	F	Correction to FR1 EN-DC RRM TCs - RRC based	17.1.0
2021-12	RAN#94	R5-218440	1560	1	F	Test Procedure update for FR1 Event Triggered test cases with CDRX	17.1.0
2021-12	RAN#94	R5-218441	1472	1	F	Correction to FR2 EN-DC RRM TCs 5.5.2.X - interruption	17.1.0
2021-12	RAN#94	R5-218442	1558	1	F	Update to FR2 interruption tests 5.5.2.1 and 5.5.2.2	17.1.0
2021-12	RAN#94	R5-218443	1456	1	F	Addition of clause 3A.6 for UE with Multiband Capability	17.1.0
2021-12	RAN#94	R5-218444	1556	1	F	Clarification on cl 3A.1.1 test coverage across 5G NR architecture options for RRM	17.1.0
2021-12	RAN#94	R5-218461	1489	1	F	Correction to Mob_enh RRM TC 7.3.3.1 - FR2 intra CHO	17.1.0
2021-12	RAN#94	R5-218464	1534	1	F	Addition of 4.7.7.2 EN-DC FR1 SSB based CMR and dedicated IMR L1-SINR absolute measurement accuracy	17.1.0
2022-03	RAN#95	R5-220096	1578	-	F	Correction to Mob_enh RRM TC 6.3.1.11 - inter-band sync DAPS HO including test tolerance	17.2.0
2022-03	RAN#95	R5-220097	1579	-	F	Correction to Mob_enh RRM TC 6.3.1.12 - inter-band async DAPS HO including test tolerance	17.2.0
2022-03	RAN#95	R5-220109	1580	-	F	Update of SA FR1 TC 4.5.3.1 and 4.5.3.3	17.2.0
2022-03	RAN#95	R5-220110	1581	-	F	Update of SA FR1 TC 6.5.3.1 and 6.5.3.3	17.2.0
2022-03	RAN#95	R5-220136	1582	-	F	Correction to Annex F for Mob_enh RRM TCs	17.2.0
2022-03	RAN#95	R5-220160	1583	-	F	Add test case 7.3.2.2.4 for SA FR2 2-step PRACH	17.2.0
2022-03	RAN#95	R5-220167	1584	-	F	Updates to RRM HST Test Case 6.6.1.7	17.2.0
2022-03	RAN#95	R5-220168	1585	-	F	Updates to RRM HST Test Case 6.6.4.5	17.2.0
2022-03	RAN#95	R5-220196	1586	-	F	Update to table E.5-1 to add the cell configurations for one 2-step RACH test case	17.2.0
2022-03	RAN#95	R5-220278	1587	-	F	Clarifications on 5G NR connectivity options for RRM	17.2.0
2022-03	RAN#95	R5-220282	1588	-	F	Test case update for FR1 CLI-RSSI measurement with non-DRX	17.2.0
2022-03	RAN#95	R5-220283	1589	-	F	Annexure update for test tolerance for FR1 CLI-RSSI measurement with non-DRX	17.2.0
2022-03	RAN#95	R5-220689	1592	-	F	Correction to FR1 EN-DC RRM TCs - SCell activation	17.2.0
2022-03	RAN#95	R5-220697	1600	-	F	Correction to FR2 EN-DC RRM TC 5.6.1.2	17.2.0
2022-03	RAN#95	R5-220699	1602	-	F	Correction to FR2 EN-DC RRM TC 5.6.1.4	17.2.0
2022-03	RAN#95	R5-220701	1604	-	F	Correction to FR1 NR SA RRM TC 6.5.2.1 - interruption SCC	17.2.0
2022-03	RAN#95	R5-220702	1605	-	F	Correction to FR1 NR SA RRM TCs - SCell activation	17.2.0
2022-03	RAN#95	R5-220726	1623	-	F	Addition of band group for NR SL RRM test	17.2.0
2022-03	RAN#95	R5-220727	1624	-	F	Addition of minimum requirements for NR SL UE Tx timing TCs	17.2.0
2022-03	RAN#95	R5-220728	1625	-	F	Addition of NR SL RRM TC 9.1.1.1 - Tx Timing GNSS	17.2.0
2022-03	RAN#95	R5-220729	1626	-	F	Addition of NR SL RRM TC 9.1.1.2 - Tx Timing SyncRef UE	17.2.0
2022-03	RAN#95	R5-220730	1627	-	F	Addition of NR SL RRM TC 9.1.1.3 - Tx Timing NR Cell	17.2.0
2022-03	RAN#95	R5-220731	1628	-	F	Addition of minimum requirements for NR SL S-SSB Tx TCs	17.2.0

Change history							
Date	Meeting	TDoc	CR	Rev	Cat	Subject/Comment	New version
2022-03	RAN#95	R5-220734	1631	-	F	Addition of minimum requirements for NR SL SyncRef reselection TCs	17.2.0
2022-03	RAN#95	R5-220737	1634	-	F	Addition of minimum requirements for NR SL L1 SL-RSRP TCs	17.2.0
2022-03	RAN#95	R5-220738	1635	-	F	Addition of NR SL RRM TC 9.1.4.1 - Resource sensing	17.2.0
2022-03	RAN#95	R5-220741	1638	-	F	Addition of minimum requirements for NR SL Congestion control TCs	17.2.0
2022-03	RAN#95	R5-220742	1639	-	F	Addition of NR SL RRM TC 9.1.5.1 - SL-RSSI con-current	17.2.0
2022-03	RAN#95	R5-220744	1641	-	F	Addition of minimum requirements for NR SL interruption TCs	17.2.0
2022-03	RAN#95	R5-220745	1642	-	F	Addition of NR SL RRM TC 9.1.6.1 - WAN interruption	17.2.0
2022-03	RAN#95	R5-220747	1644	-	F	Addition of side conditions for NR SL RRM test in Annex B	17.2.0
2022-03	RAN#95	R5-220748	1645	-	F	Correction to Annex E for NR SL RRM TCs	17.2.0
2022-03	RAN#95	R5-220749	1646	-	F	Correction to Annex G for NR SL RRM TCs	17.2.0
2022-03	RAN#95	R5-220798	1647	-	F	Update to 5.5.5.0 FR2 BFD minimum requirements	17.2.0
2022-03	RAN#95	R5-220801	1650	-	F	Update to 7.5.5.0 FR2 BFD minimum requirements	17.2.0
2022-03	RAN#95	R5-220804	1653	-	F	Update to Annex E for eMIMO test cases	17.2.0
2022-03	RAN#95	R5-220910	1657	-	F	Correction to TRS Configuration of 6.3.2.1.3	17.2.0
2022-03	RAN#95	R5-220911	1658	-	F	Correction to test procedure of 6.1.1.2	17.2.0
2022-03	RAN#95	R5-220912	1659	-	F	Correction to reference of test frequency in 6.3.1.x NR only test cases	17.2.0
2022-03	RAN#95	R5-220918	1661	-	F	Correction to SRS configuration condition for FR1 timing test cases	17.2.0
2022-03	RAN#95	R5-220920	1662	-	F	Correction to DRX setting of 8.4.2.9	17.2.0
2022-03	RAN#95	R5-220921	1663	-	F	Correction to message exception for handover test cases	17.2.0
2022-03	RAN#95	R5-220923	1665	-	F	Correction to BWP switch delay test cases	17.2.0
2022-03	RAN#95	R5-220924	1666	-	F	Correction to message exception for 4.7.5.1	17.2.0
2022-03	RAN#95	R5-220927	1668	-	F	Correction to 6.3.2.3.1 NR SA FR1 RRC connection release with redirection	17.2.0
2022-03	RAN#95	R5-220928	1669	-	F	Correction to NR-EUTRA and EUTRA-NR reselection with high speed	17.2.0
2022-03	RAN#95	R5-220929	1670	-	F	Correction to message exception for 8.5.1.1	17.2.0
2022-03	RAN#95	R5-220930	1671	-	F	Correction to ssb-ResourceList for 5.3.2.2.2	17.2.0
2022-03	RAN#95	R5-220931	1672	-	F	Correction to SMTC configuration in 6.1.1.7	17.2.0
2022-03	RAN#95	R5-220933	1674	-	F	Correction to T HARQ setting for 6.5.3.1	17.2.0
2022-03	RAN#95	R5-220938	1678	-	F	Correction to DRX setting of 6.6.1.7	17.2.0
2022-03	RAN#95	R5-220939	1679	-	F	Correction to message exception of 4.6.1.7	17.2.0
2022-03	RAN#95	R5-220940	1680	-	F	Correction to test procedure for 8.2.1.2	17.2.0
2022-03	RAN#95	R5-220941	1681	-	F	Correction to SIB1 message exceptions of 4.6.1.7 and 4.6.4.5	17.2.0
2022-03	RAN#95	R5-220942	1682	-	F	Addition of new test case 7.7.6.1 NR SA FR2 CSI-RS based CMR and no dedicated IMR configured and CSI-RS resource set with repetition off L1-SINR measurement accuracy	17.2.0

Change history							
Date	Meeting	TDoc	CR	Rev	Cat	Subject/Comment	New version
2022-03	RAN#95	R5-220943	1683	-	F	Addition of new test case 7.7.6.2 NR SA FR2 SSB based CMR and dedicated IMR L1-SINR measurement accuracy	17.2.0
2022-03	RAN#95	R5-220944	1684	-	F	Addition of new test case 7.7.6.3 NR SA FR2 CSI-RS based CMR and dedicated IMR L1-SINR measurement accuracy	17.2.0
2022-03	RAN#95	R5-220986	1688	-	F	Update of 4.6.7.1 EN-DC FR1 CSI-RS based CMR and no dedicated IMR L1-SINR measurement in non-DRX	17.2.0
2022-03	RAN#95	R5-220988	1690	-	F	Update of 4.6.7.3 EN-DC FR1 CSI-RS based CMR and dedicated IMR L1-SINR measurement in DRX	17.2.0
2022-03	RAN#95	R5-220989	1691	-	F	Update of 6.6.8.1 NR SA FR1 CSI-RS based CMR and no dedicated IMR L1-SINR measurement in DRX	17.2.0
2022-03	RAN#95	R5-220991	1693	-	F	Update of 6.6.8.3 NR SA FR1 CSI-RS based CMR and dedicated IMR L1-SINR measurement in non-DRX	17.2.0
2022-03	RAN#95	R5-220992	1694	-	F	Update of Annex for EN-DC FR1 L1-SINR measurement test cases	17.2.0
2022-03	RAN#95	R5-220993	1695	-	F	Update of Annex for NR SA FR1 L1-SINR measurement test cases	17.2.0
2022-03	RAN#95	R5-221001	1696	-	F	Correction to Annex H.3.6A RRC messages for L1-SINR measurement	17.2.0
2022-03	RAN#95	R5-221008	1698	-	F	Editorial corrections for EditHelp comments s1 to s3	17.2.0
2022-03	RAN#95	R5-221009	1699	-	F	Editorial corrections for EditHelp comments s4	17.2.0
2022-03	RAN#95	R5-221010	1700	-	F	Editorial corrections to revert headers to h6 for s4	17.2.0
2022-03	RAN#95	R5-221011	1701	-	F	Editorial corrections for EditHelp comments s5	17.2.0
2022-03	RAN#95	R5-221012	1702	-	F	Editorial corrections to revert headers to h6 for s5	17.2.0
2022-03	RAN#95	R5-221013	1703	-	F	Editorial corrections for EditHelp comments s6.1 to s6.3	17.2.0
2022-03	RAN#95	R5-221014	1704	-	F	Editorial corrections for EditHelp comments s6.4 to s6.5	17.2.0
2022-03	RAN#95	R5-221015	1705	-	F	Editorial corrections for EditHelp comments s7	17.2.0
2022-03	RAN#95	R5-221016	1706	-	F	Editorial corrections for EditHelp comments s8	17.2.0
2022-03	RAN#95	R5-221017	1707	-	F	Editorial corrections to revert headers to h6 for s8	17.2.0
2022-03	RAN#95	R5-221018	1708	-	F	Editorial corrections for EditHelp comments Annexes	17.2.0
2022-03	RAN#95	R5-221019	1709	-	F	New section for NE-DC RRM test cases	17.2.0
2022-03	RAN#95	R5-221020	1710	-	F	Minimum requirements for EN-DC FR1 L1-RSRP test cases	17.2.0
2022-03	RAN#95	R5-221021	1711	-	F	Minimum requirements for EN-DC FR2 L1-RSRP test cases	17.2.0
2022-03	RAN#95	R5-221024	1714	-	F	Correct message contents reference iRAT	17.2.0
2022-03	RAN#95	R5-221025	1715	-	F	Add auxiliary band for n39	17.2.0
2022-03	RAN#95	R5-221026	1716	-	F	Corrections to 5.7.x.x	17.2.0
2022-03	RAN#95	R5-221027	1717	-	F	Corrections to 8.4.2.4	17.2.0
2022-03	RAN#95	R5-221028	1718	-	F	Corrections to 8.2.1.1	17.2.0
2022-03	RAN#95	R5-221029	1719	-	F	Corrections to 8.5.2.2.1	17.2.0
2022-03	RAN#95	R5-221031	1721	-	F	Correction reportAmount for B2 report	17.2.0
2022-03	RAN#95	R5-221033	1723	-	F	Corrections to message contents for 8.4.2.3 and 8.4.2.4	17.2.0
2022-03	RAN#95	R5-221187	1728	-	F	Correct message content for RLM-SSB Based FR2 5.5.1.1	17.2.0

Change history							
Date	Meeting	TDoc	CR	Rev	Cat	Subject/Comment	New version
2022-03	RAN#95	R5-221188	1729	-	F	Correct message content for RLM-SSB Based FR2 5.5.1.2	17.2.0
2022-03	RAN#95	R5-221189	1730	-	F	Correct message content for RLM-SSB Based FR2 5.5.1.3	17.2.0
2022-03	RAN#95	R5-221190	1731	-	F	Correct message content for RLM-SSB Based FR2 5.5.1.4	17.2.0
2022-03	RAN#95	R5-221191	1732	-	F	Correct message content for FR2 interruption	17.2.0
2022-03	RAN#95	R5-221254	1733	-	F	Update 4.5.7.1 test procedure	17.2.0
2022-03	RAN#95	R5-221256	1734	-	F	Update number of HARQ processes for FDD	17.2.0
2022-03	RAN#95	R5-221289	1736	-	F	Correction of RRM re-establishment test case 7.3.2.1.1 including Test Tolerance	17.2.0
2022-03	RAN#95	R5-221290	1737	-	F	Correction of RRM re-establishment test case 7.3.2.1.2 including Test Tolerance	17.2.0
2022-03	RAN#95	R5-221291	1738	-	F	Test Tolerance addition in Annex F for RRM FR2 re-establishment test cases	17.2.0
2022-03	RAN#95	R5-221297	1739	-	F	Addition of Minimum conformance requirements for DL interruptions at switching between two uplink carriers	17.2.0
2022-03	RAN#95	R5-221298	1740	-	F	Addition of UL switching test case 6.5.7.1	17.2.0
2022-03	RAN#95	R5-221300	1742	-	F	Cell configuration mapping for UL switching test cases	17.2.0
2022-03	RAN#95	R5-221301	1743	-	F	Addition of Idle mode CA/DC measurement test case 6.6.9.1	17.2.0
2022-03	RAN#95	R5-221302	1744	-	F	Addition of Idle Mode measurements of inter-RAT CA candidate cells for early reporting test case 6.6.15.1	17.2.0
2022-03	RAN#95	R5-221370	1748	-	F	Update to PDSCH reference measurement channels for RRM test cases with DRX config	17.2.0
2022-03	RAN#95	R5-221637	1613	1	F	Correction to FR2 NR SA RRM TC 7.6.1.2 with TT	17.2.0
2022-03	RAN#95	R5-221638	1615	1	F	Correction to FR2 NR SA RRM TC 7.6.1.4 with TT	17.2.0
2022-03	RAN#95	R5-221645	1619	1	F	Correction to Mob_enh RRM TC 7.3.1.4 with TT	17.2.0
2022-03	RAN#95	R5-221646	1620	1	F	Correction to Mob_enh RRM TC 7.3.1.5 with TT	17.2.0
2022-03	RAN#95	R5-221650	1685	1	F	Completion 4.5.5.5 including TT analysis results	17.2.0
2022-03	RAN#95	R5-221651	1686	1	F	Completion 4.5.5.6 including TT analysis results	17.2.0
2022-03	RAN#95	R5-221652	1687	1	F	Addition of cell configuration MU and TT for Enhancement on MIMO	17.2.0
2022-03	RAN#95	R5-221653	1689	1	F	Update of 4.6.7.2 EN-DC FR1 SSB based CMR and dedicated IMR L1-SINR measurement in DRX	17.2.0
2022-03	RAN#95	R5-221654	1692	1	F	Update of 6.6.8.2 NR SA FR1 SSB based CMR and dedicated IMR L1-SINR measurement in non-DRX	17.2.0
2022-03	RAN#95	R5-221655	1656	1	F	Correction to NR SA FR1 cell re-selection for UE configured with highSpeedMeasFlag-r16	17.2.0
2022-03	RAN#95	R5-221713	1591	1	F	Correction to FR1 EN-DC RRM TCs - interruption SCC	17.2.0
2022-03	RAN#95	R5-221714	1746	1	F	Introduce Test case for LTE PSCell addition and release in NE-DC	17.2.0
2022-03	RAN#95	R5-221715	1593	1	F	Correction to FR2 EN-DC RRM TCs - RLM	17.2.0
2022-03	RAN#95	R5-221716	1594	1	F	Correction to FR2 EN-DC RRM TC 5.5.5.1 with TT	17.2.0
2022-03	RAN#95	R5-221717	1595	1	F	Correction to FR2 EN-DC RRM TC 5.5.5.2 with TT	17.2.0
2022-03	RAN#95	R5-221718	1596	1	F	Correction to FR2 EN-DC RRM TC 5.5.5.3 with TT	17.2.0



Change history							
Date	Meeting	TDoc	CR	Rev	Cat	Subject/Comment	New version
2022-03	RAN#95	R5-221719	1597	1	F	Correction to FR2 EN-DC RRM TC 5.5.5.4 with TT	17.2.0
2022-03	RAN#95	R5-221720	1598	1	F	Correction to FR2 EN-DC RRM TC 5.5.5.5 with TT	17.2.0
2022-03	RAN#95	R5-221721	1599	1	F	Correction to FR2 EN-DC RRM TC 5.6.1.1 with TT	17.2.0
2022-03	RAN#95	R5-221722	1601	1	F	Correction to FR2 EN-DC RRM TC 5.6.1.3 with TT	17.2.0
2022-03	RAN#95	R5-221723	1712	1	F	New test case 5.7.4.1	17.2.0
2022-03	RAN#95	R5-221724	1713	1	F	New test case 5.7.4.2	17.2.0
2022-03	RAN#95	R5-221725	1725	1	F	Update to RRM test case with CDRX	17.2.0
2022-03	RAN#95	R5-221726	1720	1	F	Corrections to 6.7.x.x	17.2.0
2022-03	RAN#95	R5-221727	1607	1	F	Correction to FR2 NR SA RRM TC 7.5.5.1 with TT	17.2.0
2022-03	RAN#95	R5-221728	1608	1	F	Correction to FR2 NR SA RRM TC 7.5.5.2 with TT	17.2.0
2022-03	RAN#95	R5-221729	1609	1	F	Correction to FR2 NR SA RRM TC 7.5.5.3 with TT	17.2.0
2022-03	RAN#95	R5-221730	1610	1	F	Correction to FR2 NR SA RRM TC 7.5.5.4 with TT	17.2.0
2022-03	RAN#95	R5-221731	1611	1	F	Correction to FR2 NR SA RRM TC 7.5.5.5 with TT	17.2.0
2022-03	RAN#95	R5-221732	1612	1	F	Correction to FR2 NR SA RRM TC 7.6.1.1 with TT	17.2.0
2022-03	RAN#95	R5-221733	1614	1	F	Correction to FR2 NR SA RRM TC 7.6.1.3 with TT	17.2.0
2022-03	RAN#95	R5-221734	1667	1	F	Correction to message exception for 8.4.2.x with SSB index detection	17.2.0
2022-03	RAN#95	R5-221735	1726	1	F	Test procedure update to L2NR Cell reselection test case	17.2.0
2022-03	RAN#95	R5-221736	1616	1	F	Correction to Annex F for FR2 SSB based BFD TCs	17.2.0
2022-03	RAN#95	R5-221737	1617	1	F	Correction to Annex F for FR2 SSB based intra-freq measurement TCs	17.2.0
2022-03	RAN#95	R5-221738	1618	1	F	Correction to default configuration in Annex H	17.2.0
2022-03	RAN#95	R5-221739	1722	1	F	Updates to CSI-ReportConfig for FR2	17.2.0
2022-03	RAN#95	R5-221740	1724	1	F	Update report config for iRAT test cases	17.2.0
2022-03	RAN#95	R5-221741	1745	1	F	Correction of clause 3	17.2.0
2022-03	RAN#95	R5-221742	1749	1	F	Correction to test frequencies for intra-band contiguous CA	17.2.0
2022-03	RAN#95	R5-221798	1741	1	F	Addition of UL switching test case 6.5.7.2	17.2.0
2022-03	RAN#95	R5-221812	1621	1	F	Correction to Mob_enh RRM TC 7.3.3.1 with TT	17.2.0
2022-03	RAN#95	R5-221813	1622	1	F	Correction to Annex F for Mob_enh RRM TCs	17.2.0
2022-03	RAN#95	R5-221821	1629	1	F	Addition of NR SL RRM TC 9.1.2.1 - SLSS Tx NR Cell	17.2.0
2022-03	RAN#95	R5-221822	1630	1	F	Addition of NR SL RRM TC 9.1.2.2 - SLSS Tx SyncRef UE	17.2.0
2022-03	RAN#95	R5-221823	1632	1	F	Addition of NR SL RRM TC 9.1.3.1 - SyncRef reselection GNSS	17.2.0
2022-03	RAN#95	R5-221824	1633	1	F	Addition of NR SL RRM TC 9.1.3.2 - SyncRef reselection Cell	17.2.0
2022-03	RAN#95	R5-221825	1636	1	F	Addition of NR SL RRM TC 9.1.4.2 - Resource pre-emption	17.2.0
2022-03	RAN#95	R5-221826	1637	1	F	Addition of NR SL RRM TC 9.1.4.3 - Resource re-evaluation	17.2.0
2022-03	RAN#95	R5-221827	1640	1	F	Addition of NR SL RRM TC 9.1.5.2 - SL-RSSI PC5 only	17.2.0
2022-03	RAN#95	R5-221828	1643	1	F	Addition of RMC for NR SL RRM test in Annex A	17.2.0

Change history							
Date	Meeting	TDoc	CR	Rev	Cat	Subject/Comment	New version
2022-03	RAN#95	R5-221833	1648	1	F	Addition of 5.5.5.6 FR2 SCell BFD in non-DRX for NSA	17.2.0
2022-03	RAN#95	R5-221834	1649	1	F	Addition of 5.5.5.7 FR2 SCell BFD in DRX for NSA	17.2.0
2022-03	RAN#95	R5-221835	1651	1	F	Addition of 7.5.5.6 FR2 SCell BFD in non-DRX for SA	17.2.0
2022-03	RAN#95	R5-221836	1652	1	F	Addition of 7.5.5.7 FR2 SCell BFD in DRX for SA	17.2.0
2022-03	RAN#95	R5-221837	1654	1	F	Update to Annex F for eMIMO test cases	17.2.0
2022-03	RAN#95	R5-221838	1655	1	F	Update to Annex H for eMIMO test cases	17.2.0
2022-03	RAN#95	R5-221839	1697	1	F	Update of RRM Test Cases for UE Enhancements on MIMO	17.2.0
2022-03	RAN#95	R5-221859	1664	1	F	Correction to DRX setting of 4.6.4.5 and 6.6.4.5	17.2.0
2022-03	RAN#95	R5-221893	1590	1	F	Add test case 7.3.2.2.3 for NR SA FR2 2-step RACH	17.2.0
2022-03	RAN#95	R5-221923	1660	1	F	Correction to test procedure of SFTD measurement accuracy	17.2.0
2022-03	RAN#95	R5-221924	1677	1	F	Correction to BWP configuration for 4.5.6.1.2	17.2.0
2022-03	RAN#95	R5-221925	1673	1	F	Correction to active BWP ID and TRS configuration in 6.5.6.1.1	17.2.0
2022-03	RAN#95	R5-221926	1675	1	F	Correction to CSI-RS offset for 6.5.3.1	17.2.0
2022-03	RAN#95	R5-221927	1676	1	F	Correction to CSI report offset for 6.5.3.1	17.2.0
2022-06	RAN#96	R5-222490	1752	-	F	Correction to test time in 6.1.1.7	17.3.0
2022-06	RAN#96	R5-222491	1753	-	F	Editorial correction in 6.1.2.5	17.3.0
2022-06	RAN#96	R5-222492	1754	-	F	Correction to physical cell identity in 6.6.3.2 and 6.6.3.3	17.3.0
2022-06	RAN#96	R5-222493	1755	-	F	Correction to test procedure in 8.2.1.2	17.3.0
2022-06	RAN#96	R5-222494	1756	-	F	Correction to test procedure in 8.5.1.1	17.3.0
2022-06	RAN#96	R5-222505	1758	-	F	Correction to test parameters in 5.6.1.x and 5.6.2.x	17.3.0
2022-06	RAN#96	R5-222507	1760	-	F	Correction to DRX offset setting in 6.6.1.7	17.3.0
2022-06	RAN#96	R5-222508	1761	-	F	Correction to DRX offset setting in 6.6.3.3	17.3.0
2022-06	RAN#96	R5-222509	1762	-	F	Correction to DRX offset setting in 8.4.2.x	17.3.0
2022-06	RAN#96	R5-222517	1765	-	F	Add minimum requirements for 7.7.4	17.3.0
2022-06	RAN#96	R5-222522	1769	-	F	Remove incorrect references - Chapter 4	17.3.0
2022-06	RAN#96	R5-222523	1770	-	F	Remove incorrect references - Chapter 5	17.3.0
2022-06	RAN#96	R5-222524	1771	-	F	Remove incorrect references - Chapter 6	17.3.0
2022-06	RAN#96	R5-222525	1772	-	F	Remove incorrect references - Chapter 7	17.3.0
2022-06	RAN#96	R5-222526	1773	-	F	Remove incorrect references - Chapter 8	17.3.0
2022-06	RAN#96	R5-222527	1774	-	F	Corrections to 6.6.3.1	17.3.0
2022-06	RAN#96	R5-222528	1775	-	F	Corrections to 8.4.1.2	17.3.0
2022-06	RAN#96	R5-222529	1776	-	F	Modification to the asynchronous / synchronous cells conditions	17.3.0
2022-06	RAN#96	R5-222531	1778	-	F	Clean-up asynchronous / synchronous cells conditions for IRAT	17.3.0
2022-06	RAN#96	R5-222532	1779	-	F	Editorial correction to H.3.4-5	17.3.0
2022-06	RAN#96	R5-222533	1780	-	F	Corrections to 5.6.1.3	17.3.0
2022-06	RAN#96	R5-222534	1781	-	F	Corrections to 5.6.1.4	17.3.0

Change history							
Date	Meeting	TDoc	CR	Rev	Cat	Subject/Comment	New version
2022-06	RAN#96	R5-222535	1782	-	F	Correction to H.3.4-7	17.3.0
2022-06	RAN#96	R5-222536	1783	-	F	Editorial correction 4.5.5.x	17.3.0
2022-06	RAN#96	R5-222633	1791	-	F	Correction to NR SL RRM TCs	17.3.0
2022-06	RAN#96	R5-222636	1792	-	F	Correction to FR1 EN-DC TC 4.7.5.1 - SFTD	17.3.0
2022-06	RAN#96	R5-222638	1794	-	F	Correction to FR1 NR SA TCs 6.1.2.2 - low priority reselection	17.3.0
2022-06	RAN#96	R5-222640	1796	-	F	Correction to inter-RAT TC 8.5.1.1 - SFTD	17.3.0
2022-06	RAN#96	R5-222882	1803	-	F	Editorial update to minimum requirement in 6.5.7.0	17.3.0
2022-06	RAN#96	R5-222887	1804	-	F	Update to minimum requirements for BFR	17.3.0
2022-06	RAN#96	R5-222890	1807	-	F	Update to FR2 SCell BFD test cases	17.3.0
2022-06	RAN#96	R5-222962	1810	-	F	Corrections AoA setup references	17.3.0
2022-06	RAN#96	R5-222964	1812	-	F	Corrections 7.6.3.1	17.3.0
2022-06	RAN#96	R5-222965	1813	-	F	Corrections 7.6.3.2	17.3.0
2022-06	RAN#96	R5-222966	1814	-	F	Corrections 7.6.3.3	17.3.0
2022-06	RAN#96	R5-222967	1815	-	F	Corrections 7.6.3.4	17.3.0
2022-06	RAN#96	R5-222968	1816	-	F	Update to 4.3.2.2.3	17.3.0
2022-06	RAN#96	R5-222969	1817	-	F	Update to 4.3.2.2.4	17.3.0
2022-06	RAN#96	R5-222970	1818	-	F	Update to 6.3.2.2.3	17.3.0
2022-06	RAN#96	R5-222971	1819	-	F	Update to 6.3.2.2.4	17.3.0
2022-06	RAN#96	R5-222998	1821	-	F	Update of 4.6.7 EN-DC FR1 L1-SINR measurement procedure	17.3.0
2022-06	RAN#96	R5-222999	1822	-	F	Update of 6.6.8 NR SA FR1 L1-SINR measurement procedure	17.3.0
2022-06	RAN#96	R5-223001	1824	-	F	Addition of 5.6.6.1 EN-DC FR2 L1-SINR measurement including Test Tolerance	17.3.0
2022-06	RAN#96	R5-223002	1825	-	F	Addition of 5.6.6.2 EN-DC FR2 L1-SINR measurement including Test Tolerance	17.3.0
2022-06	RAN#96	R5-223004	1827	-	F	Addition of 7.6.6.1 NR SA FR2 L1-SINR measurement including Test Tolerance	17.3.0
2022-06	RAN#96	R5-223007	1830	-	F	Addition of Annex E and Annex F for FR2 L1-SINR measurement	17.3.0
2022-06	RAN#96	R5-223214	1835	-	F	Editorial correction to 5G RRM TCs	17.3.0
2022-06	RAN#96	R5-223246	1836	-	F	Correction to Annexes for RRM SCell activation test cases	17.3.0
2022-06	RAN#96	R5-223305	1837	-	F	Update to eMIMO test cases 4.5.5.5 and 4.5.5.6	17.3.0
2022-06	RAN#96	R5-223605	1826	1	F	Addition of 5.6.6.3 EN-DC FR2 L1-SINR measurement including Test Tolerance	17.3.0
2022-06	RAN#96	R5-223606	1829	1	F	Addition of 7.6.6.3 NR SA FR2 L1-SINR measurement including Test Tolerance	17.3.0
2022-06	RAN#96	R5-223607	1750	1	F	Correction to EN-DC FR2 RLM tests for PSCell configured with CSI-RS-based RLM RS in non-DRX including TT	17.3.0
2022-06	RAN#96	R5-223615	1763	1	F	Completing 5.7.4.1 including TT analysis	17.3.0
2022-06	RAN#96	R5-223616	1766	1	F	Completing 7.7.4.1 including TT analysis	17.3.0

Change history							
Date	Meeting	TDoc	CR	Rev	Cat	Subject/Comment	New version
2022-06	RAN#96	R5-223707	1823	1	F	Addition of minimum requirements for EN-DC FR2 L1-SINR measurement for beam reporting	17.3.0
2022-06	RAN#96	R5-223710	1786	1	F	Introduction of EN-DC FR2 SRS-RSRP measurement in non-DRX test case 5.6.4.1	17.3.0
2022-06	RAN#96	R5-223711	1787	1	F	Introduction of EN-DC FR2 SRS-RSRP measurement accuracy test case 5.7.5.1	17.3.0
2022-06	RAN#96	R5-223712	1797	1	F	Introduction of NR SA FR2 SRS-RSRP measurement in non-DRX test case 7.6.4.1	17.3.0
2022-06	RAN#96	R5-223713	1798	1	F	Introduction of NR SA FR2 SRS-RSRP measurement accuracy test case 7.7.5.1	17.3.0
2022-06	RAN#96	R5-223850	1777	1	F	Corrections to 4.7.5.1	17.3.0
2022-06	RAN#96	R5-223851	1784	1	F	Corrections to 4.5.5.1	17.3.0
2022-06	RAN#96	R5-223853	1808	1	F	Remove condition asynchronous cells	17.3.0
2022-06	RAN#96	R5-223854	1757	1	F	Correction to CSI-RS for tracking in 5.6.1.2	17.3.0
2022-06	RAN#96	R5-223855	1764	1	F	Completing 5.7.4.2 including TT analysis	17.3.0
2022-06	RAN#96	R5-223856	1790	1	F	Update to FR2 interruption test case 5.5.2.1	17.3.0
2022-06	RAN#96	R5-223857	1793	1	F	Correction to FR2 EN-DC BFD TCs	17.3.0
2022-06	RAN#96	R5-223858	1809	1	F	Corrections to 6.6.3.2	17.3.0
2022-06	RAN#96	R5-223859	1751	1	F	Editorial reference correction to NR SA FR2 cell re-selection test requirements	17.3.0
2022-06	RAN#96	R5-223860	1767	1	F	Completing 7.7.4.2 including TT analysis	17.3.0
2022-06	RAN#96	R5-223861	1795	1	F	Correction to FR2 NR SA BFD TCs	17.3.0
2022-06	RAN#96	R5-223862	1831	1	F	Correction of RRM test case 7.7.1.1	17.3.0
2022-06	RAN#96	R5-223863	1768	1	F	Annex F for L1-RSRP meas accuracy test cases	17.3.0
2022-06	RAN#96	R5-223864	1788	1	F	Alignment of RMC note for DRX test cases	17.3.0
2022-06	RAN#96	R5-223870	1785	2	F	Corrections to 4.5.5.2	17.3.0
2022-06	RAN#96	R5-223874	1759	1	F	Correction to Active UL BWP-2 Configuration in 4.5.6.1.1 and 6.5.6.1.2	17.3.0
2022-06	RAN#96	R5-223878	1832	1	F	Correction of UL switching test case 6.5.7.1 including Test Tolerance	17.3.0
2022-06	RAN#96	R5-223879	1833	1	F	Correction of UL switching test case 6.5.7.2 including Test Tolerance	17.3.0
2022-06	RAN#96	R5-223880	1805	1	F	Addition of eMIMO test case 6.5.5.5	17.3.0
2022-06	RAN#96	R5-223881	1806	1	F	Addition of eMIMO test case 6.5.5.6	17.3.0
2022-06	RAN#96	R5-223882	1828	1	F	Addition of 7.6.6.2 NR SA FR2 L1-SINR measurement including Test Tolerance	17.3.0
2022-06	RAN#96	R5-223886	1789	1	F	Update to FR1 Scell activation and deactivation test cases	17.3.0
2022-07	RAN#96	R5-223615	1763	1	F	addition of missing changes from R5-223615 in Tables 5.7.4.1.5-2, /-3, /-4	17.3.1

---

# History

<b>Document history</b>		
V17.2.0	July 2022	Publication
V17.3.1	September 2022	Publication