

# ETSI TS 138 551 V17.0.0 (2024-01)



**5G;  
NR;  
User Equipment (UE) Multiple Input Multiple Output (MIMO)  
Over-the-Air (OTA) performance;  
Conformance testing  
(3GPP TS 38.551 version 17.0.0 Release 17)**



---

Reference

RTS/TSGR-0538551vh00

---

Keywords

5G

**ETSI**

650 Route des Lucioles  
F-06921 Sophia Antipolis Cedex - FRANCE

Tel.: +33 4 92 94 42 00 Fax: +33 4 93 65 47 16

Siret N° 348 623 562 00017 - APE 7112B  
Association à but non lucratif enregistrée à la  
Sous-Préfecture de Grasse (06) N° w061004871

---

**Important notice**

The present document can be downloaded from:

<https://www.etsi.org/standards-search>

The present document may be made available in electronic versions and/or in print. The content of any electronic and/or print versions of the present document shall not be modified without the prior written authorization of ETSI. In case of any existing or perceived difference in contents between such versions and/or in print, the prevailing version of an ETSI deliverable is the one made publicly available in PDF format at [www.etsi.org/deliver](http://www.etsi.org/deliver).

Users of the present document should be aware that the document may be subject to revision or change of status.

Information on the current status of this and other ETSI documents is available at

<https://portal.etsi.org/TB/ETSIDeliverableStatus.aspx>

If you find errors in the present document, please send your comment to one of the following services:

<https://portal.etsi.org/People/CommitteeSupportStaff.aspx>

If you find a security vulnerability in the present document, please report it through our  
Coordinated Vulnerability Disclosure Program:

<https://www.etsi.org/standards/coordinated-vulnerability-disclosure>

---

**Notice of disclaimer & limitation of liability**

The information provided in the present deliverable is directed solely to professionals who have the appropriate degree of experience to understand and interpret its content in accordance with generally accepted engineering or other professional standard and applicable regulations.

No recommendation as to products and services or vendors is made or should be implied.

No representation or warranty is made that this deliverable is technically accurate or sufficient or conforms to any law and/or governmental rule and/or regulation and further, no representation or warranty is made of merchantability or fitness for any particular purpose or against infringement of intellectual property rights.

In no event shall ETSI be held liable for loss of profits or any other incidental or consequential damages.

Any software contained in this deliverable is provided "AS IS" with no warranties, express or implied, including but not limited to, the warranties of merchantability, fitness for a particular purpose and non-infringement of intellectual property rights and ETSI shall not be held liable in any event for any damages whatsoever (including, without limitation, damages for loss of profits, business interruption, loss of information, or any other pecuniary loss) arising out of or related to the use of or inability to use the software.

---

**Copyright Notification**

No part may be reproduced or utilized in any form or by any means, electronic or mechanical, including photocopying and microfilm except as authorized by written permission of ETSI.

The content of the PDF version shall not be modified without the written authorization of ETSI.

The copyright and the foregoing restriction extend to reproduction in all media.

© ETSI 2024.  
All rights reserved.

---

# Intellectual Property Rights

## Essential patents

IPRs essential or potentially essential to normative deliverables may have been declared to ETSI. The declarations pertaining to these essential IPRs, if any, are publicly available for **ETSI members and non-members**, and can be found in ETSI SR 000 314: "*Intellectual Property Rights (IPRs); Essential, or potentially Essential, IPRs notified to ETSI in respect of ETSI standards*", which is available from the ETSI Secretariat. Latest updates are available on the ETSI Web server (<https://ipr.etsi.org/>).

Pursuant to the ETSI Directives including the ETSI IPR Policy, no investigation regarding the essentiality of IPRs, including IPR searches, has been carried out by ETSI. No guarantee can be given as to the existence of other IPRs not referenced in ETSI SR 000 314 (or the updates on the ETSI Web server) which are, or may be, or may become, essential to the present document.

## Trademarks

The present document may include trademarks and/or tradenames which are asserted and/or registered by their owners. ETSI claims no ownership of these except for any which are indicated as being the property of ETSI, and conveys no right to use or reproduce any trademark and/or tradename. Mention of those trademarks in the present document does not constitute an endorsement by ETSI of products, services or organizations associated with those trademarks.

**DECT™**, **PLUGTESTS™**, **UMTS™** and the ETSI logo are trademarks of ETSI registered for the benefit of its Members. **3GPP™** and **LTE™** are trademarks of ETSI registered for the benefit of its Members and of the 3GPP Organizational Partners. **oneM2M™** logo is a trademark of ETSI registered for the benefit of its Members and of the oneM2M Partners. **GSM®** and the GSM logo are trademarks registered and owned by the GSM Association.

---

# Legal Notice

This Technical Specification (TS) has been produced by ETSI 3rd Generation Partnership Project (3GPP).

The present document may refer to technical specifications or reports using their 3GPP identities. These shall be interpreted as being references to the corresponding ETSI deliverables.

The cross reference between 3GPP and ETSI identities can be found under <https://webapp.etsi.org/key/queryform.asp>.

---

# Modal verbs terminology

In the present document "**shall**", "**shall not**", "**should**", "**should not**", "**may**", "**need not**", "**will**", "**will not**", "**can**" and "**cannot**" are to be interpreted as described in clause 3.2 of the [ETSI Drafting Rules](#) (Verbal forms for the expression of provisions).

"**must**" and "**must not**" are **NOT** allowed in ETSI deliverables except when used in direct citation.

# Contents

Intellectual Property Rights .....	2
Legal Notice .....	2
Modal verbs terminology.....	2
Foreword.....	5
1 Scope .....	7
2 References .....	7
3 Definitions of terms, symbols, and abbreviations .....	7
3.1 Terms.....	7
3.2 Symbols.....	8
3.3 Abbreviations .....	8
4 General .....	8
4.1 Relationship between minimum requirements and test requirements .....	9
4.2 Applicability of minimum requirements .....	9
5 Frequency Bands .....	9
5.1 General .....	9
5.2 Operating bands.....	9
6 FR1 MIMO OTA Performance .....	9
6.1 General .....	9
6.1.1 Definition of MIMO throughput.....	9
6.1.2 Total Radiated Multi-Antenna Sensitivity (TRMS).....	10
6.2 Minimum requirement.....	11
<b>Annex A (normative): FR1 Test methodology.....</b>	<b>12</b>
A.1 General .....	12
A.2 Multi-Probe Anechoic Chamber (MPAC).....	12
A.2.1 System setup.....	12
A.2.2 Calibration procedure .....	12
A.2.3 Test procedure .....	13
A.2.4 Minimum Range Length .....	14
A.3 EUT positioning.....	14
<b>Annex B (normative): MU Budget .....</b>	<b>15</b>
B.1 MU budget of FR1 MPAC system.....	15
B.2 Measurement error contribution descriptions for MPAC.....	16
B.2.1 Mismatch for measurement process .....	16
B.2.2 Measurement distance uncertainty .....	16
B.2.3 Quality of quiet zone .....	16
B.2.4 Base Station simulator.....	16
B.2.5 Channel Emulator.....	16
B.2.6 Amplifier uncertainties.....	16
B.2.7 Random uncertainty .....	17
B.2.8 Throughput measurement: output level step resolution.....	17
B.2.9 Signal flatness .....	17
B.2.10 Mismatch for calibration process .....	17
B.2.11 Reference antenna positioning misalignment.....	18
B.2.12 Total Uncertainty of the Network Analyzer .....	18
B.2.13 Uncertainty of an absolute gain of the calibration antenna .....	18
B.2.14 Offset of the Phase Center of the Reference Antenna .....	18
<b>Annex C (normative): FR1 Channel models and Validation procedure.....</b>	<b>19</b>

C.1	FR1 Channel models .....	19
C.2	FR1 Base Station beam configuration.....	20
C.3	FR1 Channel model validation.....	21
C.3.1	General .....	21
C.3.2	Power Delay Profile (PDP) .....	22
C.3.3	Doppler/Temporal correlation .....	24
C.3.4	Spatial correlation.....	28
C.3.5	Cross-polarization .....	35
C.3.6	Power validation.....	37
C.4	Validation Pass/fail limit .....	39
C.4.1	General .....	39
C.4.2	Pass/Fail Criteria of PDP.....	39
C.4.3	Pass/Fail Criteria of Doppler/Temporal correlation .....	39
C.4.4	Pass/Fail Criteria of Spatial correlation.....	41
C.4.5	Pass/Fail Criteria of Cross-polarization.....	44
C.4.6	Pass/Fail Criteria of Power validation .....	45
<b>Annex D (normative):    gNB configurations .....</b>		<b>46</b>
D.1	FR1 gNB configurations .....	46
<b>Annex E (normative):    Environmental requirements.....</b>		<b>51</b>
E.1	Scope .....	51
E.2	Ambient temperature.....	51
E.3	Operating voltage .....	51
<b>Annex F (informative):    Change history .....</b>		<b>52</b>
History .....		53

---

# Foreword

This Technical Specification has been produced by the 3rd Generation Partnership Project (3GPP).

The contents of the present document are subject to continuing work within the TSG and may change following formal TSG approval. Should the TSG modify the contents of the present document, it will be re-released by the TSG with an identifying change of release date and an increase in version number as follows:

Version x.y.z

where:

- x the first digit:
  - 1 presented to TSG for information;
  - 2 presented to TSG for approval;
  - 3 or greater indicates TSG approved document under change control.
- y the second digit is incremented for all changes of substance, i.e. technical enhancements, corrections, updates, etc.
- z the third digit is incremented when editorial only changes have been incorporated in the document.

In the present document, modal verbs have the following meanings:

**shall** indicates a mandatory requirement to do something

**shall not** indicates an interdiction (prohibition) to do something

The constructions "shall" and "shall not" are confined to the context of normative provisions, and do not appear in Technical Reports.

The constructions "must" and "must not" are not used as substitutes for "shall" and "shall not". Their use is avoided insofar as possible, and they are not used in a normative context except in a direct citation from an external, referenced, non-3GPP document, or so as to maintain continuity of style when extending or modifying the provisions of such a referenced document.

**should** indicates a recommendation to do something

**should not** indicates a recommendation not to do something

**may** indicates permission to do something

**need not** indicates permission not to do something

The construction "may not" is ambiguous and is not used in normative elements. The unambiguous constructions "might not" or "shall not" are used instead, depending upon the meaning intended.

**can** indicates that something is possible

**cannot** indicates that something is impossible

The constructions "can" and "cannot" are not substitutes for "may" and "need not".

**will** indicates that something is certain or expected to happen as a result of action taken by an agency the behaviour of which is outside the scope of the present document

**will not** indicates that something is certain or expected not to happen as a result of action taken by an agency the behaviour of which is outside the scope of the present document

**might** indicates a likelihood that something will happen as a result of action taken by some agency the behaviour of which is outside the scope of the present document

**might not** indicates a likelihood that something will not happen as a result of action taken by some agency the behaviour of which is outside the scope of the present document

In addition:

**is** (or any other verb in the indicative mood) indicates a statement of fact

**is not** (or any other negative verb in the indicative mood) indicates a statement of fact

The constructions "is" and "is not" do not indicate requirements.

---

# 1 Scope

The present document specifies details of conformance testing of UE Multiple Input Multiple Output (MIMO) Over-the-Air (OTA) requirements and test methodologies for FR1 (NR SA and NSA). The correspondent testing methodologies are also presented in the Annex A of the present document.

---

# 2 References

The following documents contain provisions which, through reference in this text, constitute provisions of the present document.

- References are either specific (identified by date of publication, edition number, version number, etc.) or non-specific.
- For a specific reference, subsequent revisions do not apply.
- For a non-specific reference, the latest version applies. In the case of a reference to a 3GPP document (including a GSM document), a non-specific reference implicitly refers to the latest version of that document *in the same Release as the present document*.

- [1] 3GPP TR 21.905: "Vocabulary for 3GPP Specifications".
- [2] 3GPP TS 38.101-1: "NR; User Equipment (UE) radio transmission and reception; Part 1: Range 1 Standalone".
- [3] 3GPP TS 38.101-3: "NR; User Equipment (UE) radio transmission and reception; Part 3: Range 1 and Range 2 Interworking operation with other radios".
- [4] 3GPP TS 38.508-1: "5GS; User Equipment (UE) conformance specification; Part 1: Common test environment".
- [5] 3GPP TR 38.901: "Study on channel model for frequencies from 0.5 to 100 GHz".
- [6] 3GPP TS 38.101-4: "NR; User Equipment (UE) radio transmission and reception; Part 4: Performance requirements".
- [7] 3GPP TS 38.151: "NR; User Equipment (UE) Multiple Input Multiple Output (MIMO) Over-the-Air (OTA) performance requirements".
- [8] 3GPP TS 38.561: "UE TRP (Total Radiated Power) and TRS (Total Radiated Sensitivity) requirements and test methodologies for FR1 (NR SA and EN-DC); User Equipment (UE) conformance specification".

---

# 3 Definitions of terms, symbols, and abbreviations

## 3.1 Terms

For the purposes of the present document, the terms given in 3GPP TR 21.905 [1] and the following apply. A term defined in the present document takes precedence over the definition of the same term, if any, in 3GPP TR 21.905 [1].

**Free Space (FS):** UE used in a free space configuration

**Handheld UE:** UE intended to be used in hand held scenario

**MIMO Average Spherical Coverage:** averaged sensitivity of best 18 FR2 MIMO OTA sensitivity values within the 3D sphere with constant-density points for PC3 device

**primary mechanical mode:** mode that is most often used for a specific user scenario.



**PAS Similarity Percentage (PSP):** similarity of the PAS produced by the OTA system and the reference PAS. PSP is defined as  $(1-TVD) * 100 \%$ . PSP=100 % denotes full similarity and PSP = 0 % denotes full dissimilarity.

## 3.2 Symbols

For the purposes of the present document, the following symbols apply:

$P_{RS-EPRE-MAX}$  Maximum downlink RS-EPRE

## 3.3 Abbreviations

For the purposes of the present document, the abbreviations given in 3GPP TR 21.905 [1] and the following apply. An abbreviation defined in the present document takes precedence over the definition of the same abbreviation, if any, in 3GPP TR 21.905 [1].

AOA	Azimuth angle Of Arrival
AOD	Azimuth angle Of Departure
BS	Base Station
CDL	Clustered Delay Line
CW	Continuous Wave
DML	Data Mode Landscape
DMP	Data Mode Portrait
DMSU	Data Mode Screen Up
DUT	Device Under Test
EUT	Equipment Under Test
FR1	Frequency Range 1
FS	Free Space
MASC	MIMO Average Spherical Coverage
MIMO	Multiple Input Multiple Output
MPAC	Multi-Probe Anechoic Chamber
NR	New Radio
NSA	Non-Standalone

NOTE: A mode of operation where operation of an other radio is assisted with an other radio

OTA	Over The Air
PAS	Power Angular Spectrum
PDP	Power Delay Profile
PSP	PAS Similarity Percentage
RS-EPRE	Reference Signal-Energy Per Resource Element
SS	System Simulator
SSS	Secondary Synchronization Signal
TRMS	Total Radiated Multi-antenna Sensitivity
UE	User Equipment
UMa	Urban Macro
UMi	Urban Micro
XPR	Cross-Polarization Ratio
ZOA	Zenith angle Of Arrival
ZOD	Zenith angle Of Departure
ZSA	Zenith angle Spread of Arrival
ZSD	Zenith angle Spread of Departure

---

## 4 General

**Editor's Note:** Intended to capture additional general information to be used within this test specification, such as follows:

### 4.3 Specification suffix information

4.4 Test point analysis

4.5 Applicability and test coverage rules

4.6 Pass fail decisions rule of test case based on Test Tolerance definitions.

## 4.1 Relationship between minimum requirements and test requirements

The Minimum Requirements given in 3GPP TS 38.151 [7] make no allowance for Measurement Uncertainty (MU). The present document defines the MU and Test Tolerances in Annex B for FR1 MIMO OTA. The test tolerances are used to relax the Minimum Requirements in 3GPP TS 38.151 [7] to create the Test Requirements.

## 4.2 Applicability of minimum requirements

The MIMO OTA minimum requirements apply only to the primary mechanical mode of UE which is declared by the manufacturer if the UE can support multiple mechanical modes.

The minimum requirements apply only to the UE under normal environmental conditions specified in Annex E.

---

# 5 Frequency Bands

## 5.1 General

NR MIMO OTA Requirements are defined separately for different Frequency Ranges (FR). The frequency ranges in which NR can operate according to this version of the specification are identified as described in Table 5.1-1.

**Table 5.1-1: Definition of frequency ranges**

Frequency range designation	Corresponding frequency range
FR1	410 MHz - 7125 MHz
FR2	24250 MHz - 52600 MHz

The present specification covers FR1 operating bands.

## 5.2 Operating bands

NR is designed to operate in FR1 operating bands defined in 3GPP TS 38.101-1 [3]. NSA band combinations are defined in 3GPP TS 38.101-3 [3].

---

# 6 FR1 MIMO OTA Performance

## 6.1 General

### 6.1.1 Definition of MIMO throughput

The MIMO throughput is defined here as the time-averaged number of correctly received transport blocks in a communication system running an application, where a Transport Block is defined in the reference measurement channel. From OTA perspective, this is also called MIMO OTA throughput. It will be used as the baseline figure of merit for FR1 and FR2 MIMO OTA testing.

The MIMO OTA throughput is measured at the top of physical layer of NR system under the use of FRC, the SS transmit fixed-size payload bits to the DUT. The DUT signals back either ACK or NACK to the SS. The SS then records the following:

- number of ACKs;
- number of NACKs; and
- number of DTX slots.

Hence the MIMO (OTA) throughput can be calculated as:

$$MIMO\ (OTA)\ Throughput = \frac{Transmitted\ TBS \times Num\ of\ ACKs}{MeasurementTime}$$

Where Transmitted TBS is the Transport Block Size transmitted by the SS, which is fixed for an FRC during the measurement period. Measurement Time is the total composed of successful slots (ACK), unsuccessful slots (NACK) and DTX-symbols.

The time-averaging is to be taken over a time period sufficiently long to average out the variations due to the fading channel. Therefore, this is also called the average MIMO OTA throughput. The throughput should be measured at a time when eventual start-up transients in the system have evanesced.

## 6.1.2 Total Radiated Multi-Antenna Sensitivity (TRMS)

The average TRMS of free space data mode portrait (FS DMP), free space data mode landscape (FS DML), and free space data mode screen up (FS DMSU), is defined as the FR1 MIMO OTA requirement. The averaging shall be done in linear scale for the TRMS results at these DUT positions, according to the formula:

$$TRMS_{average,70} = 10 \log \left[ 3 / \left( \frac{1}{10^{S_{FS\_DMP,70}/10}} + \frac{1}{10^{S_{FS\_DML,70}/10}} + \frac{1}{10^{S_{FS\_DMSU,70}/10}} \right) \right]$$

where

$$S_{MODE,70} = 10 \log \left[ 12 / \left( \frac{1}{10^{P_{MODE,70,0}/10}} + \frac{1}{10^{P_{MODE,70,1}/10}} + \dots + \frac{1}{10^{P_{MODE,70,11}/10}} \right) \right]$$

Such that *MODE* is one of {*FS\_DMP*, *FS\_DML*, *FS\_DMSU*}, and { $P_{MODE,70,0}$ , ...,  $P_{MODE,70,11}$ } are the measured sensitivity values at each azimuth position at the 70% throughput outage.

The reported TRMS value shall be corrected by  $-0.5 \cdot output\ level\ step\ resolution$  of the final power step search and the correction shall be noted in the test report.

If 1 azimuth position does not result in a defined measured sensitivity at 70 % throughput,  $S_{MODE,70}$  is calculated using the 11 measured sensitivities and the maximum downlink RS-EPRE  $P_{RS-EPRE-MAX}$  (substitution approach) for the one missing result.  $P_{RS-EPRE-MAX}$  is the maximum downlink RS-EPRE supported by the test system, and is defined as -80 dBm/15 kHz (or equivalent -77 dBm/30 kHz) for FR1 MIMO OTA.

The TRMS shall be measured at the mid channel as specified in 3GPP TS 38.508-1 [4], subclause 4.3.1. The average TRMS shall be lower than the average TRMS requirements specified in Clause 6.2.

The additional criterion in azimuthal orientations shall be met:

- The EUT has to meet 70 % throughput in 11 of total 12 azimuthal orientations. If the EUT fails to meet this criterion even under maximum downlink power condition (i.e.  $P_{RS-EPRE-MAX}$ ), the EUT shall fail the FR1 MIMO OTA test.
- The EUT has to meet 90 % throughput in 10 of total 12 azimuthal orientations. If the EUT fails to meet this criterion even under maximum downlink power condition (i.e.  $P_{RS-EPRE-MAX}$ ), the EUT shall fail the FR1 MIMO OTA test.

## 6.2 Minimum requirement

Editor's Note: TRMS values for n28/n79 are pending in RAN4 spec TS38.151.

FR1 TRMS minimum performance requirements for NR handheld UEs operating on SA mode in free space and the primary mechanical mode for 70% DL throughput with the corresponding measurement configurations (i.e. channel model and gNB configuration) specified in clause C.1 and clause E.1 are defined in Table 6.2-1.

**Table 6.2-1: FR1 TRMS minimum performance requirements for NR handheld UEs operating on SA mode in free space and the primary mechanical mode**

NR bands	Bandwidth (MHz)	MIMO layer	Channel model	Reference channel	TRMS <sub>average,70</sub>
n28	10	2x2	FR1 UMi CDL-C	R.PDSCH.1-3.1 FDD	[...] dBm/15kHz
n41	40	4x4	FR1 UMa CDL-C	R.PDSCH.2-2.4 TDD	-93.3 dBm/30kHz
n78	40	4x4	FR1 UMa CDL-C	R.PDSCH.2-2.4 TDD	-94.8 dBm/30kHz
n79	40	4x4	FR1 UMa CDL-C	R.PDSCH.2-2.4 TDD	[...] dBm/30kHz

# Annex A (normative): FR1 Test methodology

## A.1 General

FR1 MIMO OTA requirement testing is based on UE-noise limited environmental condition, i.e. UE throughput characterized as a function of signal power incident to the DUT antennas.

The minimum test zone size for FR1 MIMO OTA test methods is 20cm. "Black-box" testing approach is adopted for NR MIMO OTA testing, the physical centre of the EUT shall be placed in the centre of the test zone, the EUT shall be completely contained within the minimum test zone size.

FR1 MIMO OTA requirement testing should be performed under primary mechanical mode. The primary mechanical mode for devices having multiple mechanical modes shall be declared by the manufacturers. Single primary mechanical mode for each device should be declared for MIMO OTA conformance testing.

## A.2 Multi-Probe Anechoic Chamber (MPAC)

### A.2.1 System setup

MPAC test method is the reference methodology for FR NR MIMO OTA testing. By arranging an array of antennas around the Equipment Under Test (EUT), a spatial distribution of angles of arrival in MPAC system may be simulated to expose the EUT to a near field environment that appears to have originated from a complex multipath far field environment.

As illustrated schematically in Figure A.2.1-1, signals propagate from the base station/communication tester to the EUT through a simulated multipath environment known as a spatial channel model, where appropriate channel impairments such as Doppler and fading are applied to each path prior to injecting all of the directional signals into the chamber simultaneously through the antenna array. The resulting field distribution in the test zone is then integrated by the EUT antenna(s) and processed by the receiver(s) just as it would do so in any non-simulated multipath environment. MPAC system with 16 uniformly spaced dual-polarized probes is permitted for NR FR1 MIMO OTA testing.

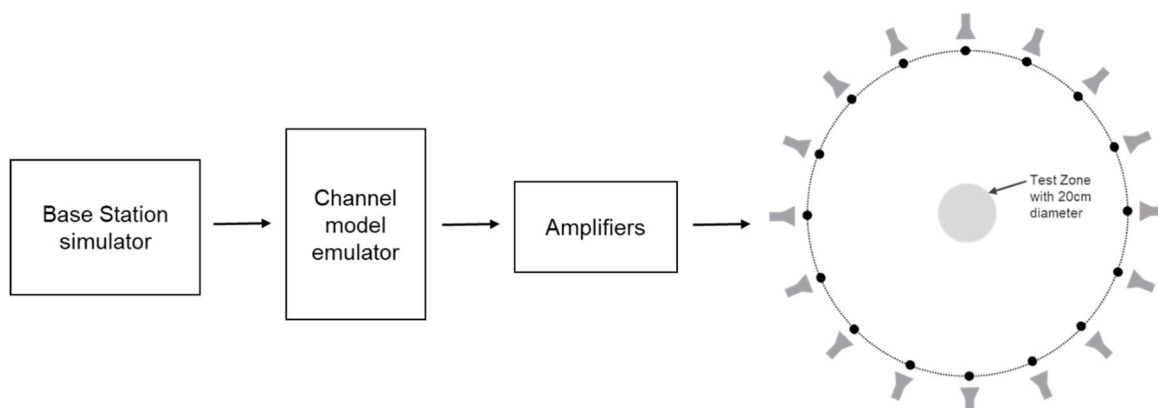

Figure A.2.1-1: MPAC system layout for NR FR1 MIMO OTA testing

### A.2.2 Calibration procedure

The system needs to be calibrated by using a reference calibration antenna with known gain values in order to ensure that the downlink signal power is correct. In Non-Standalone (NSA) mode, the LTE link antenna provides a stable LTE signal without precise path loss or polarization control.

Unlike traditional TRP/TRS testing where the path loss corrections can all be applied as a post processing step to the measured data, the path loss for each probe in the MPAC system has to be balanced at test time in order to generate the desired channel model environment within the test zone of the chamber. The imbalance of each path during testing would result in an alteration of the angular dependence of the channel model (i.e. varied characteristics of generated channel model) within the test zone of the chamber:

- 1) Place a vertical reference dipole in the centre of the test zone, connected to a VNA port, with the other VNA port connected to the input of the channel emulator unit.
- 2) Configure the channel emulator for bypass mode.
- 3) Measure the response of each path from each vertical polarization probe to the reference antenna in the centre of test zone.
- 4) Adjust the power on all vertical polarization branches of the channel emulator so that the powers received at the centre are equal.
- 5) Repeat the steps 1 to 4 with the magnetic loop or horizontally polarized reference dipole instead and adjust the horizontal polarization branches of the channel emulator.
- 6) The worst-case path loss becomes the reference path loss of the entire system; this loss is used to compute the power in the centre of the test zone relative to the output power of the Base Station simulator. Besides, based on the reference path loss, the relative offset of each path loss shall be corrected.

NOTE: Calibration based on other antennas, e.g. horn antennas is not precluded.

## A.2.3 Test procedure

Before throughput testing, the initial conditions shall be confirmed to reach the correct measurement state for each test case:

- 1) Ensure environmental requirements of Annex E are met.
- 2) Configure the test system according to Annexes C, D and E for the applicable test case.
- 3) Verify the implementation of the channel model as specified in clause C.3.
- 4) Position the UE in the chamber according to clause A.3.
- 5) Power on the UE.
- 6) Set up the connection.

NOTE: For step 3, the verification of the channel model implementation is usually performed once for each channel model as part of the laboratory accreditation process and will remain valid as long as the setup and instruments remain unchanged. Otherwise, the channel model validation may need to be performed prior to starting each throughput test.

For throughput testing, the following steps shall be followed in order to evaluate NR MIMO OTA performance of the DUT:

- 1) Measure MIMO OTA throughput from one measurement point, the maximum downlink power  $P_{RS-EPRE-MAX}$  is defined in clause 6.1.2. MIMO OTA throughput is the minimum downlink signal power resulting in a pre-defined throughput value, i.e. 70 % and 90 % of the maximum theoretical throughput. The downlink signal power step size shall be no more than 0.5 dB when RF power level is near the NR MIMO sensitivity level.
- 2) Rotate the UE around vertical axis of the test system by 30 degrees and repeat from step 1 until one complete rotation has been measured i.e. 12 different UE azimuth rotations.
- 3) Repeat the test from step 1 for each specified device orientation. A list of orientations is given in clause A.3.
- 4) The postprocessing method to calculate the average MIMO Throughput is defined in clause 6.

NOTE: For step 1 of throughput testing, the measurement is not needed to start from maximum downlink power each time. To save testing time, the starting downlink power can be set as a proper value (lower than maximum downlink power supported by test system) as long as all the throughput curve curves at 12 different UE azimuth rotations can reach at least 90% of the maximum theoretical throughput.

## A.2.4 Minimum Range Length

The minimum range length of FR1 MPAC system is defined as the distance from the centre of the test zone to the aperture of the measurement probes/antennas, as illustrated in Figure A.2.4-1.

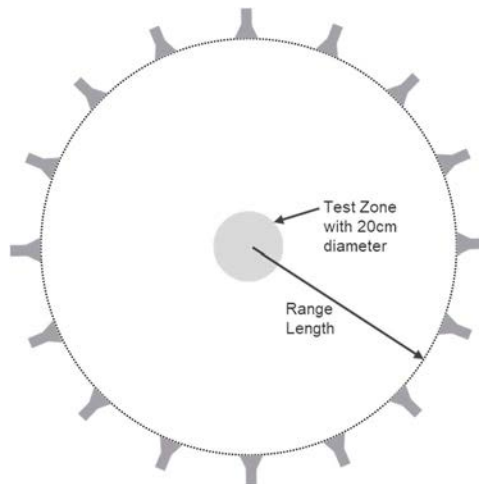

**Figure A.2.4-1: Illustration of range length definition of FR1 MPAC**

The minimum range length for NR FR1 MPAC OTA systems with 20cm test zone size is 1.2 m. While for MPAC systems, the far-field requirements do not have to apply, it was shown that the spatial correlation can be impacted significantly for distances below 1.2 m.

---

## A.3 EUT positioning

This Clause defines the measurement coordinate system for the NR MIMO OTA.

For FR1 MIMO OTA, the DUT shall be tested under Free Space Data Mode Portrait (FS DMP), Free Space Data Mode Landscape (FS DML), and Free Space Data Mode Screen Up (FS DMSU), the DUT azimuthal rotation shall be performed over 360 degrees per orientation in 30 degree steps (12 total positions).

## Annex B (normative): MU Budget

### B.1 MU budget of FR1 MPAC system

This clause defines the Preliminary measurement uncertainty (MU) budget for FR1 MPAC system, as shown in Table B.1-1.

**Table B.1-1: Preliminary measurement uncertainty budget for FR1 MPAC system**

UID	Description of uncertainty contribution	Example value (410 MHz < f ≤ 3 GHz) [dB]	Example value (3 GHz < f ≤ 7.125GHz) [dB]	Distribution of the probability	Std Uncertainty (410 MHz < f ≤ 3 GHz) [dB]	Std Uncertainty (3 GHz < f ≤ 7.125GHz) [dB]
<b>Stage 2: DUT measurement</b>						
1	Mismatch for measurement process	0	0	U-Shaped	0	0
2	Measure distance uncertainty	0	0	Normal	0	0
3	Quality of quiet zone	0.5	0.5	Actual	0.5	0.5
4	Base Station simulator	1.3	1.3	Normal	0.65	0.65
5	Channel Emulator - absolute output power - output signal stability - output stability with temperature	1.5 0.5 0.4	1.5 0.5 0.4	Actual (Normal - power; rect-stability)	0.84	0.84
6	Amplifier uncertainties	0.7	0.7	Rectangular	0.40	0.40
7	Random uncertainty	0.4	0.4	Normal	0.20	0.20
8	Throughput measurement: output level step resolution	0	0	Rectangular	0	0
9	Signal flatness	0	0	Normal	0	0
<b>Stage 1: Calibration measurement</b>						
10	Mismatch for calibration process - loopback cable path - system input path - reference antenna	0.2	0.2	U-Shaped	0.14	0.14
11	Reference antenna positioning misalignment	0	0	Normal	0	0
12	Quality of quiet zone	0.5	0.5	Rectangular	0.29	0.20
13	Total uncertainty of the Network Analyzer	0.2	0.5	Normal	0.10	0.25
14	Uncertainty of an absolute gain of the calibration antenna	0.58	0.58	Normal	0.29	0.29
15	Offset of the Phase Center of the Reference Antenna	0	0	Normal	0	0
<b>Total Expanded Uncertainty, U, with 95 % Confidence Interval</b>					<b>2.61</b>	<b>2.65</b>

The detailed descriptions of each measurement uncertainty contributor are defined in in clause B.2.



---

## B.2 Measurement error contribution descriptions for MPAC

### B.2.1 Mismatch for measurement process

This term comes from the mismatch between the system input cables connecting to the base station simulator output port. For more information, see clause A.4.2.1 of 3GPP TS 38.561 [8].

### B.2.2 Measurement distance uncertainty

The cause of this uncertainty contributor is due to the reduction of distance between the measurement antenna and the DUT. Given that 1.2 m is defined as the minimum range length for FR1 MPAC system and the device is not offset from the axis(es) of rotation, this term could be set as 0 dB.

### B.2.3 Quality of quiet zone

The quality of the quiet zone procedure characterizes the quiet zone performance of the anechoic chamber, specifically the effect of reflections within the anechoic chamber including any positioners and support structures. For FR1 quality of quiet zone measurements, reference antennas of sleeve dipole or magnetic loop are used. For more information, see clause A.4.2.8 of 3GPP TS 38.561 [8] with the exception that only the phi-axis ripple test is performed for MIMO OTA.

### B.2.4 Base Station simulator

gNB emulator is used to drive a signal to the channel emulator and then to the device under test. Generally there occurs uncertainty contribution from absolute level accuracy, non-linearity and frequency characteristic of the gNB emulator.

For practical reasons, in a case that a VNA is used as a calibration equipment, gNB emulator is connected to the system after the calibration measurement is performed by the VNA. Hence, the uncertainty on the absolute level of gNB emulator (transmitter device) cannot be assumed as systematic. This uncertainty will be determined from the manufacturer's datasheet and the distribution used shall match that provided in the datasheet which are commonly quoting MUs/accuracies with a "95 % confidence level" and/or a "coverage factor of 2". In the absence of a declared distribution in the datasheet, the rectangular distribution should be used. Furthermore, the uncertainty of the non-linearity is included in the absolute level uncertainty.

### B.2.5 Channel Emulator

The channel emulator is also working as a signal source in the NR MIMO OTA system, therefore there occurs uncertainty contribution from absolute level accuracy, non-linearity, frequency characteristic and stability of the channel emulator. These uncertainty contributions shall be taken from the manufacturer's data sheet.

### B.2.6 Amplifier uncertainties

Any components in the setup can potentially introduce measurement uncertainty. It is then needed to determine the uncertainty contributors associated with the use of such components. For the case of external amplifiers, the following uncertainties should be considered but the applicability is contingent to the measurement implementation and calibration procedure:

- Stability:
  - An uncertainty contribution comes from the output level stability of the amplifier. Even if the amplifier is part of the system for both measurement and calibration, the uncertainty due to the stability shall be considered. This uncertainty can be either measured or determined by the manufacturers' data sheet for the operating conditions in which the system will be required to operate.
- Linearity:

- An uncertainty contribution comes from the linearity of the amplifier since in most cases calibration and measurements are performed at two different input/output power levels. This uncertainty can be either measured or determined by the manufacturers' data sheet.
- Noise Figure:
  - When the signal goes into an amplifier, noise is added so that the SNR at the output is reduced with regard to the SNR of the signal at the input. This added noise introduces error on the signal which affects the Error Rate of the receiver thus the EVM (Error Vector Magnitude). An uncertainty can be calculated through the following formula:

$$\varepsilon_{EVM} = 20 \log_{10} \left( 1 + 10^{\frac{-SNR}{20}} \right)$$

- Where SNR is the signal to noise ratio in dB at the signal level used during the sensitivity measurement.
- Mismatch:
  - If the external amplifier is used for both stages, measurement and calibration the uncertainty contribution associated with it can be considered systematic and constant -> 0dB. If it is not the case, the mismatch uncertainty at its input and output shall be either measured or determined by the method described in 3GPP TR 38.901 [5].
- Gain:
  - If the external amplifier is used for both stages, measurement and calibration the uncertainty contribution associated with it can be considered systematic and constant -> 0 dB. If it is not the case, this uncertainty shall be considered.

## B.2.7 Random uncertainty

This contribution is used to account for all the unknown, unquantifiable, etc. uncertainties associated with the measurements.

Random uncertainty MU contributions are normally distributed. The random uncertainty term, by definition, cannot be measured, or even isolated completely. A fixed value of 0.4 dB is suggested for TRMS measurements to include a digital error rate uncertainty and is aligned with the random uncertainty for TRS for NR FR1 (3GPP TS 38.561 [8]).

## B.2.8 Throughput measurement: output level step resolution

When output power of the communication tester is swept to reach the throughput target that defines the sensitivity threshold, the final power step resolution represents an asymmetric uncertainty contribution that can be corrected since this uncertainty is device and test system independent. The lab shall correct the TRMS results by *-0,5 output level step resolution* of the final power step search and note the correction in the test report. If the alternate DL signal power search procedure with linearization, detailed in clause A.2.3 is applied to assess the DL signal power at each grid point, no correction of TRMS shall be applied and no additional MU shall be considered.

## B.2.9 Signal flatness

For wireless technologies with wide channel bandwidths, the test system might not have a flat frequency response across the entire channel. While the range calibration corrects for any variation of frequency response as a function of the centre frequency of the channel, the broadband delivered to the test zone will be a function of the entire channel bandwidth as opposed to just the centre frequency. For more information, see clause A.4.2.14 of 3GPP TS 38.561 [8].

## B.2.10 Mismatch for calibration process

During calibration stage, there will be impedance mismatch between the various RF cables and components used within the system. Standing waves are created by the reflections between any two components and uncertainty in the signal level will be generated. In general, three mismatch for calibration process should be considered:

- Loopback cable path: This item comes from the mismatch between the reference cable and the loopback cable during the loopback cable measurement step.
- System input path: This item comes from the mismatch between the loopback cable and the system input cable (generally the output cable after BS simulator). The reflectivity of the source output port is measured at the end of the loopback cable connecting to the system input cable.
- Reference antenna: This item comes from the mismatch between the VNA input port and the reference antenna. The reflectivity of the VNA input port is measured at the end of the reference cable connecting to the reference antenna.

For more information, see clause A.4.2.1 of 3GPP TS 38.561 [8].

## B.2.11 Reference antenna positioning misalignment

This contribution originates from reference antenna alignment and pointing error. In this measurement if the maximum gain directions of the reference antenna and the receiving antenna are aligned to each other, this contribution can be considered negligible and therefore set to zero.

## B.2.12 Total Uncertainty of the Network Analyzer

This contribution originates from all uncertainties involved transmission magnitude measurement (including drift and frequency flatness) with a network analyser. will be determined from the manufacturer's datasheet which is now commonly quoting MUs/accuracies with a "95 % confidence level" and/or a "coverage factor of 2" and the distribution used shall match that provided in the datasheet. In the absence of a declared distribution in the datasheet, the rectangular distribution should be used.

## B.2.13 Uncertainty of an absolute gain of the calibration antenna

The calibration antenna only appears in calibration phase (Stage 1). Therefore, the gain uncertainty has to be taken into account.

This uncertainty shall come from a calibration report (which is now commonly quoting MUs/accuracies with a "95 % confidence level" and/or a "coverage factor of 2") with traceability to a National Metrology Institute with measurement uncertainty budgets generated following the guidelines outlined in internationally accepted standards. In the absence of a declared distribution in the present document, the rectangular distribution should be used.

## B.2.14 Offset of the Phase Center of the Reference Antenna

During range reference measurement, if a directional antenna is used, the uncertainty in the accuracy of positioning its phase center on the axis of rotation will directly generate an uncertainty in this part of the measurement. In practical measurement, sleeve dipoles and loops are used for FR1 calibration, then the uncertainty of this element should be 0 dB, since the phase center offset is negligible.

# Annex C (normative): FR1 Channel models and Validation procedure

## C.1 FR1 Channel models

The following channel models are required for FR1 MIMO OTA measurement.

The generic models are Table C.1-1 FR1 UMi CDL-C and Table C.1-2 FR1 UMa CDL-C, which do not include base station antenna filtering. UMi CDL-C and UMa CDL-C are selected to define 2x2 and 4x4 MIMO OTA requirements, respectively.

Therefore, in addition, the BS beam filtering effect defined in clause C.2 also apply when emulating the channel models.

**Table C.1-1: Channel model parameters for UMi CDL-C at 3.5 GHz**

Cluster #	Absolute Delay [ns]	Power in [dB]	AOD in [°]	AOA in [°]	ZOD in [°]	ZOA in [°]
1	0	-4.4215	-36.1891	-122.2815	98.9242	90
2	20.99	-1.25	-21.5937	125.831	99.1915	90
3	22.19	-3.4684	-21.5937	125.831	99.1915	90
4	23.29	-5.2294	-21.5937	125.831	99.1915	90
5	21.76	-2.5215	-32.5709	-143.6126	99.5732	90
6	63.66	0	-7.4275	166.4003	99.306	90
7	64.48	-2.2185	-7.4275	166.4003	99.306	90
8	65.6	-3.9794	-7.4275	166.4003	99.306	90
9	65.84	-7.4215	37.2175	73.8315	100.4513	90
10	79.35	-7.1215	-47.1664	82.7664	98.5616	90
11	82.13	-10.7215	41.5716	-79.6999	100.6231	90
12	93.36	-11.1215	-67.1585	66.9895	98.218	90
13	122.85	-5.1215	-41.5244	84.0543	100.165	90
14	130.83	-6.8215	-47.0437	-96.2818	100.2604	90
15	217.04	-8.7215	-55.7519	94.8406	98.1225	90
16	271.05	-13.2215	55.3698	53.9494	100.2604	90
17	425.89	-13.9215	53.2234	16.0364	98.4852	90
18	460.03	-13.9215	46.8456	32.2963	98.1416	90
19	549.02	-15.8215	-70.1021	18.2098	97.9698	90
20	560.77	-17.1215	48.9306	37.0455	100.7376	90
21	630.65	-16.0215	49.6052	33.7452	98.1225	90
22	663.74	-15.7215	57.7615	29.801	98.1034	90
23	704.27	-21.6215	65.6725	11.6092	100.4513	90
24	865.23	-22.8215	-83.5324	56.2837	100.9476	90
Per-Cluster Parameters						
Parameter	CASD in [°]	CASA in [°]	CZSD in [°]	CZSA in [°]	XPR in [dB]	
Value	1.2265	12.0742	0.5726	0	7	

Table C.1-2: Channel model parameters for UMa CDL-C at 3.5 GHz

Cluster #	Absolute Delay [ns]	Power in [dB]	AOD in [°]	AOA in [°]	ZOD in [°]	ZOA in [°]
1	0	-4.4215	-37.4195	-96.4031	96.7645	90
2	76.6135	-1.25	-21.7362	118.7405	98.4506	90
3	80.9935	-3.4684	-21.7362	118.7405	98.4506	90
4	85.0085	-5.2294	-21.7362	118.7405	98.4506	90
5	79.424	-2.5215	-33.5316	-124.0196	100.8594	90
6	232.359	0	-6.5142	171.2639	99.1732	90
7	235.352	-2.2185	-6.5142	171.2639	99.1732	90
8	239.44	-3.9794	-6.5142	171.2639	99.1732	90
9	240.316	-7.4215	41.4581	51.4188	106.3995	90
10	289.6275	-7.1215	-49.2149	62.9864	94.4761	90
11	299.7745	-10.7215	46.1367	-41.2744	107.4834	90
12	340.764	-11.1215	-70.697	42.5606	92.3083	90
13	448.4025	-5.1215	-43.1524	64.6538	104.5929	90
14	477.5295	-6.8215	-49.0831	-62.7423	105.1951	90
15	792.196	-8.7215	-58.4403	78.6184	91.7061	90
16	989.3325	-13.2215	60.9633	25.6781	105.1951	90
17	1554.4985	-13.9215	58.6569	-23.4063	93.9944	90
18	1679.1095	-13.9215	51.8037	-2.3553	91.8265	90
19	2003.923	-15.8215	-73.86	-20.5926	90.7426	90
20	2046.8105	-17.1215	54.0442	3.7933	108.2061	90
21	2301.8725	-16.0215	54.7691	-0.4794	91.7061	90
22	2422.651	-15.7215	63.5332	-5.5859	91.5856	90
23	2570.5855	-21.6215	72.0338	-29.1381	106.3995	90
24	3158.0895	-22.8215	-88.2912	28.7003	109.5309	90
Per-Cluster Parameters						
Parameter	CASD in [°]	CASA in [°]	CZSD in [°]	CZSA in [°]	XPR in [dB]	
Value	1.3179	15.632	3.6131	0	7	

## C.2 FR1 Base Station beam configuration

The emulated BS beam configuration to be used for all emulation of channel models defined in Annex C.1 is specified in this clause.

The Base Station beam configuration includes basic antenna parameters and beamforming characteristic. The basic BS antenna parameters is defined in Table C.2-1.

Table C.2-1: BS Antenna Parameters

Parameter description	Symbol	Parameter value	
		FR1 ≤ 2.5GHz	FR1 > 2.5GHz
Antenna panels in vertical dimension	$M_g$	1	1
Antenna panels in horizontal dimension	$N_g$	1	1
Elements per panel in vertical dimension	$M_e$	4	8
Elements per panel in horizontal dimension	$N_e$	8	8
Number of polarizations per panel	$P$	2	2
Element spacing in horizontal dimension ( $\lambda$ )	$d_H$	0.5	0.5
Element spacing in vertical dimension ( $\lambda$ )	$d_V$	0.5	0.5

Antenna element radiation patterns, including orientation of the element main polarization components as well as orientation of the antenna array are as in the example pattern in Table 7.3-1 of 3GPP TR 38.901 [5]. The antenna element has  $\pm 45^\circ$  polarization components and the radiation pattern parameters are  $\theta_{3dB} = 65^\circ$ ,  $\phi_{3dB} = 65^\circ$ ,  $A_{max} = 30dB$ ,  $SLA_V = 30dB$ ,  $G_{E,max} = 8$  dBi.

The beamforming characteristic of the FR1 BS pattern is defined as follow:

- A code book of 60 fixed beams is constructed to a grid of five elevation angles from  $-20^\circ$  to  $+20^\circ$  with  $10^\circ$  steps and 12 azimuth angles from  $-80^\circ$  to  $+80^\circ$  with  $\sim 15^\circ$  steps.
- For 4x4 MIMO OTA, two strongest transmitting beams are selected from the pre-defined beam grid based on their proximity to the strong clusters of each FR1 channel model. These beams should have different azimuth directions and can provide the highest receive power for UE.
- For 2x2 MIMO OTA, 1 strongest transmitting beam is selected from the pre-defined beam grid which provides the highest received power for UE based on the FR1 channel model.
- Beam directions for channels model given in clause C.1 are:
  - For UMa CDL-C, the beam directions are:
    - Strongest beam: AoD:  $-7.27^\circ$ , ZoD:  $100^\circ$
    - 2<sup>nd</sup> strongest beam: AoD:  $-21.82^\circ$ , ZoD:  $100^\circ$
  - For UMi CDL-C, the strongest beam direction is: AoD:  $-7.27^\circ$ , ZoD:  $100^\circ$ .

## C.3 FR1 Channel model validation

### C.3.1 General

This clause describes the MIMO OTA validation measurements, in order to ensure that the channel models are correctly implemented and hence capable of generating the propagation environment, as described by the model, within the test zone.

The following measurements shall be done for FR1 channel model validation:

- Power Delay Profile (PDP).
- Doppler/Temporal correlation.
- Spatial correlation.
- Cross-polarization.
- Power validation.

Frequencies to be used to test for channel model validation.

**Table C.3.1-1: Frequencies for PDP, Doppler, Spatial correlation and Cross-polarization validation**

NR FR1 Bands	Range	Test frequency (MHz)
n71	Low	617 MHz
n12, n17, n29, n14, n28		722 MHz
n5, n8, n18, n20		836.5 MHz
n50, n51, n74	Mid	1575.42 MHz
n3, n2, n25, n39		1880 MHz
n1, n34, n65		2132.5 MHz
n7, n30, n41, n40, n38, [n90]		2450 MHz
n77, n78	High	3600 MHz
n79		[4700 MHz]

**Table C.3.1-2: Frequencies for Power validation**

NR FR1 Bands	Range	Test frequency (centre frequency of each band)
n71	Low	n71
n12, n17, n29, n14, n28		n28
n5, n8, n18, n20		n8
n50, n51, n74	Mid	n51
n3, n2, n25, n39		n3
n1, n34, n65		n1
n7, n30, n41, n40, n38, [n90]		n41
n77, n78	High	n78
n79		n79

### C.3.2 Power Delay Profile (PDP)

This measurement checks that the resulting power delay profile (PDP) is in-line with the PDP defined for the channel model. For PDP validation measurement, only Vertical validation is required.

The PDP measurement is performed with a Vector Network Analyser (VNA). An example setup for PDP measurement is shown in Figure C.3.2-1. VNA transmits frequency sweep signals through the NR MIMO OTA test system. A reference antenna (i.e. dipole antenna), within the centre of the test zone, receives the signal and VNA analyses the frequency response of the system. A number of traces (frequency responses) are measured and recorded by VNA and analysed by a post processing SW, e.g. Matlab. Special care has to be taken into account to keep the fading conditions unchanged, i.e. frozen, during the short period of time of a single trace measurement. The fading may proceed only in between traces.

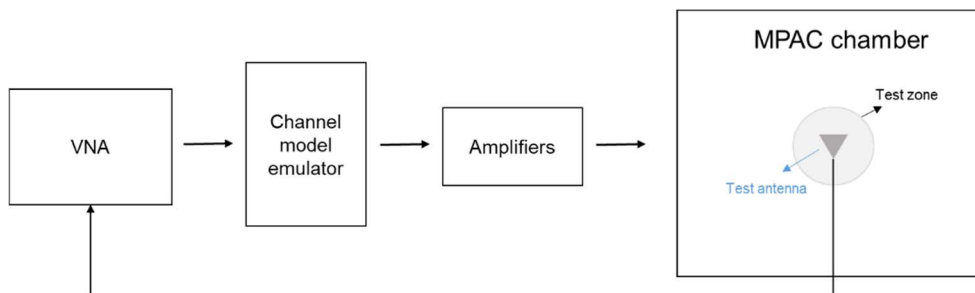

**Figure C.3.2-1: Setup for PDP measurements**

Step the emulation and store traces from VNA, i.e. run the emulation to CIR number 1, pause, measure VNA trace, run the emulation to CIR number 10, pause, measure VNA trace. Continue until 1000 VNA traces are measured.

VNA settings for PDP measurements are presented in Table C.3.2-1.

**Table C.3.2-1: VNA settings for PDP measurements**

Item	Unit	Value
Centre frequency	MHz	Downlink centre frequency in Table C.3.1-1
Span	MHz	200
Number of traces		1000
Number of points		1101
Averaging		1

Channel model specification for PDP measurements is presented in Table C.3.2-2.

**Table C.3.2-2: Channel model specification for PDP measurements**

Item	Unit	Value
Centre frequency	MHz	Downlink centre frequency in Table C.3.1-1
Distance between traces in channel model	wavelength (note)	> 2
Channel model		As specified in clause C.1
NOTE: Time [s] = distance [λ] / MS speed [λ/s]. MS speed [λ/s] = MS speed [m/s] / Speed of light [m/s] * Centre frequency [Hz].		

**Method of measurement result analysis:**

Measured VNA traces (frequency responses  $H(t,f)$ ) are saved into a hard drive. The data is read into, e.g. Matlab. The analysis is performed by taking the Fourier transform of each FR. The resulting impulse responses  $h(t,\tau)$  are averaged in power over time:

$$P(\tau) = \frac{1}{T} \sum_{t=1}^T |h(t, \tau)|^2$$

Finally the resulting PDP is shifted in delay, such that the first tap is on delay zero.

**Beam-Specific Block Diagram**

It is assumed that the beams are mapped to the inputs of the channel emulator as follows:

- Beam 1: Input 1 and Input 2.
- Beam 2: Input 3 and Input 4 (CDL-C UMa only).

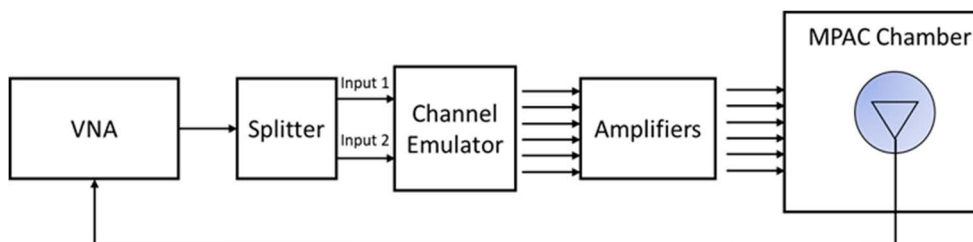

**Figure C.3.2-2: Setup for Beam-Specific PDP measurements (Beam 1)**

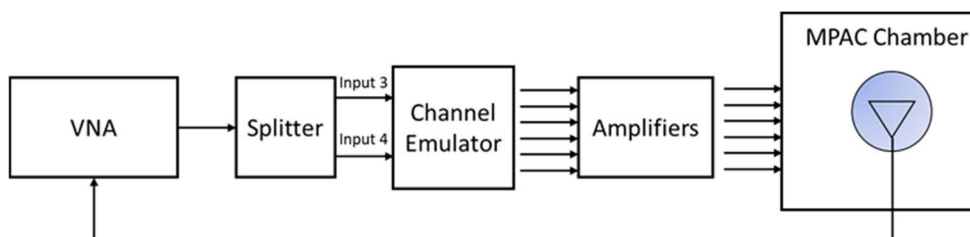

**Figure C.3.2-3: Setup for Beam-Specific PDP measurements (Beam 2 CDL-C UMa only)**

The detailed PDP reference value for CDL-C UMa and CDL-C UMi validation are defined in the following tables:

**Table C.3.2-3: PDP Targets for CDL-C UMa beam 1 at ≤ 2.5 GHz**

Combined Clusters index	Delay(ns)	Power(dB)
1	0	-34.3
2-5	80	-19.5
6-8	235	0
9-10	290	-33.0
11	450	-35.8
12	480	-34.0



**Table C.3.2-4: PDP Targets for CDL-C UMa beam 2 at  $\leq 2.5$  GHz**

Combined Clusters index	Delay(ns)	Power(dB)
1	0	-27.9
2-5	80	0
6-8	235	-18.4
9-10	290	-27.8
11	450	-27.9
12	480	-28.0

**Table C.3.2-5: PDP Targets for CDL-C UMa beam 1 at  $> 2.5$  GHz**

Combined Clusters index	Delay(ns)	Power(dB)
1	0	-34.2
2-5	80	-19.3
6-8	235	0
9	290	-34.7
10	450	-35.8
11	480	-34.7

**Table C.3.2-6: PDP Targets for CDL-C UMa beam 2 at  $> 2.5$  GHz**

Combined Clusters index	delay(ns)	power(dB)
1	0	-27.8
2-5	80	0
6-8	235	-18.3
9-10	290	-28.9
11	450	-28.1
12	480	-28.8

**Table C.3.2-7: PDP Targets for CDL-C UMi at  $\leq 2.5$  GHz and  $> 2.5$  GHz**

Combined Clusters index	Delay(ns)	Power(dB)
1	0	-30.7
2-5	20	-19.2
6-10	65	0
11-12	130	-31.4

### C.3.3 Doppler/Temporal correlation

This measurement checks the Doppler/temporal correlation. For Doppler/Temporal correlation validation measurement, only Vertical validation is required.

The Doppler spectrum is measured with a spectrum analyser as shown in Figure C.3.3-1. In this case a signal generator transmits CW signal through the NR MIMO OTA test system. The signal is received by a test antenna within the test area. Finally, the signal is analysed by a spectrum analyser and the measured spectrum is compared to the target spectrum. This setup can be used to measure Doppler Spectrum of the Channel models defined in clause C.1.

**Method of measurement:**

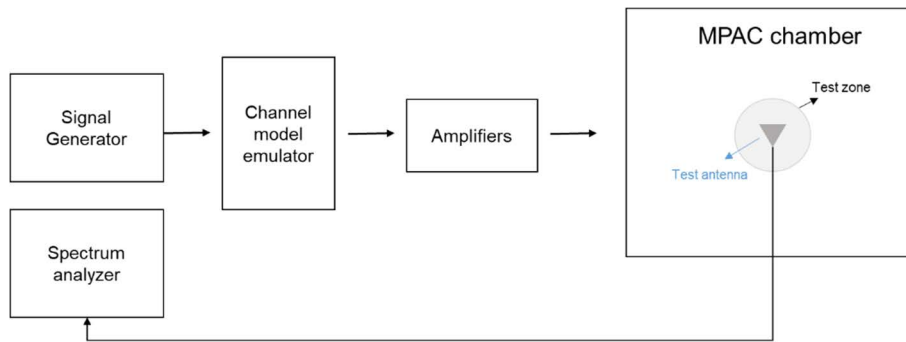

**Figure C.3.3-1: Setup for Doppler measurements**

Sine wave (CW, carrier wave) signal is transmitted from the signal generator. The signal is connected from the signal generator to fading emulator via cables. The fading emulator output signals are connected to power amplifier boxes via cables. The amplified signals are then transferred via cables to the probe antennas. The probe antennas radiate the signals over the air to the test antenna. The Doppler spectrum is measured by the spectrum analyser and the trace is saved.

Signal generator settings for Doppler/Temporal correlation measurements are presented in Table C.3.3-1.

**Table C.3.3-1: Signal generator settings for Doppler/Temporal correlation measurements**

Item	Unit	Value
Centre frequency	MHz	Downlink centre frequency in Table C.3.1-1
Modulation		OFF

Spectrum analyser settings for Doppler/Temporal correlation measurements are presented in Table C.3.3-2.

**Table C.3.3-2: Spectrum analyser settings for Doppler/Temporal correlation measurements**

Item	Unit	Value
Centre frequency	MHz	Downlink centre frequency in Table C.3.1-1
Minimum Span	Hz	4 kHz
RBW	Hz	1
VBW	Hz	1
Number of points		16002
Averaging		100

Channel model specification for Doppler/Temporal correlation measurements is presented in Table C.3.3-3.

**Table C.3.3-3: Channel model specification for Doppler/Temporal correlation measurements**

Item	Unit	Value
Centre frequency	MHz	Downlink centre frequency in Table C.3.1-1
Channel model		As specified in clause C.1
Mobile speed	km/h	100

Method of measurement result analysis: Measurement data file (Doppler power spectrum) is saved into hard drive. The data is read into, e.g. Matlab. The analysis is performed by taking the Fourier transformation of the Doppler spectrum. The resulting temporal correlation function  $R_t(\Delta t)$  is normalized such that  $\max(\text{abs}(R_t(\Delta t)))=1$ . Then the function values left from the maximum i.e. the negative lags are cut out. Further on the function values after five periods are cut out.

**Time Domain Alternate Method**

Time domain techniques can also be used to validate the temporal correlation. The temporal correlation validation measurement setup is illustrated in Figure C.3.3-2. In this case a Signal generator transmits a CW signal through the MIMO test system. The signal is received by a test antenna within the test area. Finally, the signal is collected by a signal analyser and the measured signal is stored as IQ data format for postprocessing.

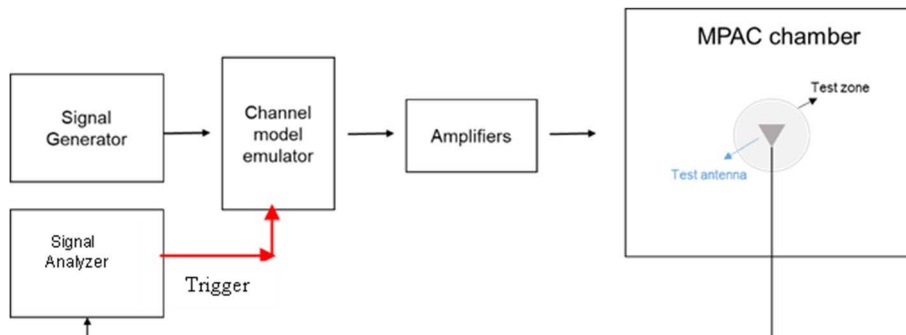

**Figure C.3.3-2: Setup for Doppler measurements based on time domain technique**

The time domain doppler spectrum is measured by the signal analyser and the trace in IQ format is saved. Follow the same procedure to post process the data and calculate the temporal correlation curve. Data recording is synchronized with the channel emulator trigger.

The settings for the signal analyser are in Table C.3.3-4.

**Table C.3.3-4: Signal Analyser Settings**

Item	Unit	Value
Centre frequency	MHz	Downlink centre frequency in Table C.3.1-1
Sampling	Hz	At least 15 times bigger than the max Doppler spread ( $f_d=v/\lambda$ )
Observation time	s	At least 16 s. Channel Model length should be the same or greater than the observation time

**Beam-Specific Block Diagram**

It is assumed that the beams are mapped to the inputs of the channel emulator as follows:

- Beam 1: Input 1 and Input 2.
- Beam 2: Input 3 and Input 4 (CDL-C UMa only).

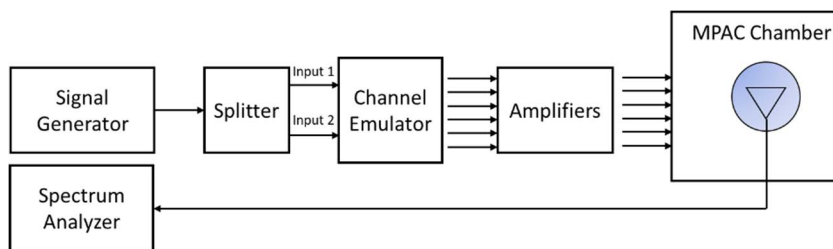

**Figure C.3.3-3: Setup for Beam-Specific Doppler measurements (Beam 1)**

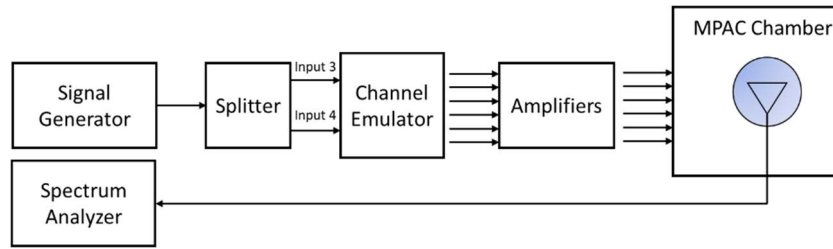

**Figure C.3.3-4: Setup for Beam-Specific Doppler measurements (Beam 2 CDL-C UMa only)**

The detailed Temporal correlation reference value for CDL-C UMa and CDL-C UMi channel model validation is defined in Table C.3.3-5.

**Table C.3.3-5: Autocorrelation Targets**

Lambda Separation	CDL-C UMa beam 1 at $\leq 2.5$ GHz	CDL-C UMa beam 2 at $\leq 2.5$ GHz	CDL-C UMa beam 1 at $> 2.5$ GHz	CDL-C UMa beam 2 at $> 2.5$ GHz	CDL-C UMi beam 1 at $\leq 2.5$ GHz	CDL-C UMi beam 1 at $> 2.5$ GHz
0.0	1.000	1.000	1.000	1.000	1.000	1.000
0.1	0.986	0.974	0.985	0.973	0.995	0.995
0.2	0.945	0.907	0.942	0.904	0.982	0.982
0.3	0.882	0.832	0.874	0.825	0.962	0.961
0.4	0.801	0.776	0.787	0.765	0.936	0.935
0.5	0.709	0.738	0.689	0.723	0.906	0.905
0.6	0.613	0.695	0.586	0.675	0.872	0.871
0.7	0.518	0.623	0.486	0.599	0.834	0.834
0.8	0.430	0.525	0.394	0.496	0.793	0.793
0.9	0.353	0.426	0.315	0.391	0.750	0.749
1.0	0.289	0.360	0.252	0.319	0.705	0.704
1.1	0.240	0.335	0.206	0.290	0.659	0.658
1.2	0.204	0.320	0.174	0.273	0.614	0.612
1.3	0.181	0.287	0.154	0.239	0.569	0.568
1.4	0.167	0.233	0.143	0.185	0.527	0.525
1.5	0.159	0.176	0.137	0.129	0.487	0.485
1.6	0.155	0.141	0.135	0.096	0.450	0.448
1.7	0.153	0.135	0.134	0.092	0.417	0.415
1.8	0.150	0.137	0.134	0.095	0.387	0.385
1.9	0.144	0.132	0.130	0.093	0.361	0.358
2.0	0.135	0.117	0.122	0.089	0.337	0.335
2.1	0.121	0.097	0.109	0.086	0.316	0.313
2.2	0.105	0.076	0.090	0.076	0.296	0.293
2.3	0.085	0.062	0.069	0.064	0.277	0.274
2.4	0.065	0.071	0.047	0.067	0.258	0.255
2.5	0.048	0.090	0.031	0.088	0.239	0.236
2.6	0.039	0.099	0.033	0.103	0.219	0.216
2.7	0.038	0.088	0.046	0.099	0.198	0.195
2.8	0.042	0.058	0.057	0.073	0.178	0.175
2.9	0.043	0.037	0.062	0.038	0.158	0.154
3.0	0.041	0.067	0.060	0.045	0.138	0.135
3.1	0.037	0.103	0.050	0.080	0.120	0.116
3.2	0.036	0.120	0.036	0.100	0.103	0.100
3.3	0.044	0.115	0.019	0.099	0.089	0.085
3.4	0.056	0.097	0.010	0.081	0.076	0.073
3.5	0.068	0.082	0.019	0.061	0.066	0.063
3.6	0.075	0.083	0.029	0.053	0.057	0.055
3.7	0.076	0.090	0.034	0.060	0.051	0.049
3.8	0.068	0.089	0.036	0.073	0.046	0.044
3.9	0.051	0.079	0.044	0.091	0.042	0.041
4.0	0.027	0.068	0.062	0.111	0.039	0.038
4.1	0.007	0.063	0.090	0.127	0.037	0.035
4.2	0.036	0.062	0.123	0.133	0.036	0.034
4.3	0.067	0.057	0.155	0.129	0.038	0.036
4.4	0.093	0.052	0.182	0.126	0.043	0.040
4.5	0.111	0.055	0.200	0.131	0.051	0.048

4.6	0.119	0.063	0.207	0.139	0.061	0.058
4.7	0.116	0.066	0.200	0.138	0.073	0.070
4.8	0.101	0.058	0.180	0.117	0.085	0.082
4.9	0.078	0.047	0.149	0.079	0.096	0.093
5.0	0.051	0.048	0.110	0.034	0.107	0.104

### C.3.4 Spatial correlation

This measurement checks whether the measured correlation curve follows the theoretical curve. For spatial correlation validation measurement, only Vertical validation measurement is required. Spatial correlation validation is only adopted for FR1 MIMO OTA.

The spatial correlation validation measurement setup is illustrated in Figure C.3.4-1. The network analyser transmits signals through the fading emulator and probes. The 16 probes radiate the signals within the anechoic chamber and a receiving test antenna is placed within the test zone. The test antenna is attached to a positioner that can move the antenna to pre-defined spatial locations on a fixed radius from the centre of the quiet zone. The received signal is measured with the network analyser.

The measurement and analysis procedure are as follows:

Set the target channel model to fading emulator:

- 1) For each position of the test antenna in the test zone, step & pause the emulator to different time instances. Measure the frequency responses  $H(f, t) = H(m\Delta f, n\Delta T)$ ,  $m = 0, \dots, M - 1$  for all stepped channel snapshots  $n = 0, \dots, N - 1$ , where the interval between frequency and time samples is  $\Delta f$  and  $\Delta T$ , respectively. The number of channel snapshots  $N$  and frequency samples  $M$  should be sufficiently high so that the matrix can be estimated reliably.
- 2) Move the measurement antenna with a positioner to another location  $k$  and repeat step 2 to record frequency responses  $H_k(m\Delta f, n\Delta T)$  of all stepped channel snapshots.
- 3) Repeat step 3 to record frequency responses at all  $k = 1, \dots, K$  spatial sample points.
- 4) Stack measured time and frequency samples to a vector and calculate correlation between the first spatial sample point (i.e.  $k = 1$ ) and other spatial points  $k = 1, \dots, K$ .
- 5)  $\rho_k = \text{corr}[\text{vec}(H_1(m\Delta f, n\Delta T)), \text{vec}(H_k(m\Delta f, n\Delta T))]$ .
- 6) Take the theoretical reference spatial correlation of the corresponding spatial sample points. Plot both the measured and theoretical curves.
- 7) Calculate the weighted RMS correlation error between the measured and the reference.

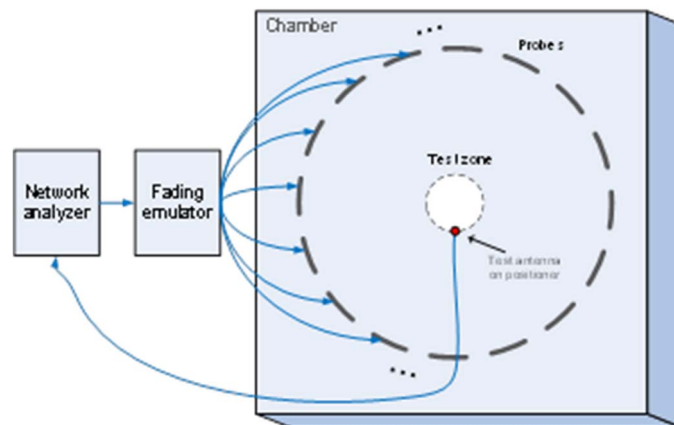

Figure C.3.4-1: Configuration for spatial correlation validation

Beam-Specific Block Diagram

It is assumed that the beams are mapped to the inputs of the channel emulator as follows:

- Beam 1: Input 1 and Input 2.
- Beam 2: Input 3 and Input 4 (CDL-C UMa only).

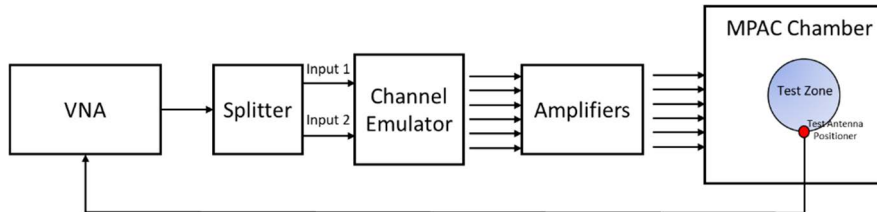

Figure C.3.4-2: Configuration for spatial correlation validation (CDL-C UMi)

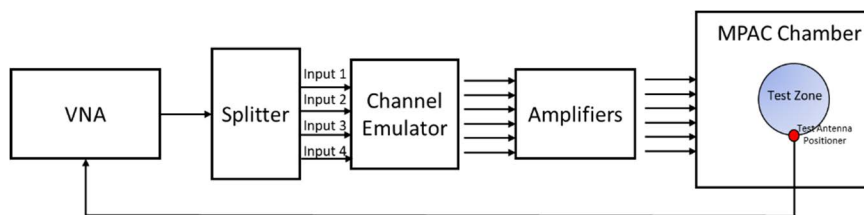

Figure C.3.4-3: Configuration for spatial correlation validation (CDL-C UMa)

Time and frequency samples

The number of temporal snapshots  $N$  and frequency samples  $M$  is shown in Table C.3.4-1. The channel model specification is presented in Table C.3.4-2.

Table C.3.4-1: VNA settings for spatial correlation

Item	Unit	Value
Center frequency	MHz	Downlink centre frequency in Table C.3.1-1
Span	MHz	0 (see note 2)
RF output level	dBm	-15
Number of traces		1000
Distance between traces in channel model	Wavelength (see note 1)	> 2
Number of points		1 (or the smallest possible) (see note 2)
Averaging		1

NOTE1: Time in seconds = distance [ $\lambda$ ] / MS speed [ $\lambda/s$ ].  
 MS speed [ $\lambda/s$ ] = MS speed [m /s] / Speed of light [m/s] \* Center frequency [Hz].  
 NOTE 2: Span and number of points may be increased to estimate reliably.

Table C.3.4-2: Channel model specification

Item	Unit	Value
Center frequency	MHz	Downlink centre frequency in Table C.3.1-1
Channel model samples	Wavelength	> 2000
Channel model		As specified in clause C.1
Mobile speed	km/h	30

Spatial samples

The spatial samples for the correlation validation measurement are on the circumference of the quiet zone, as illustrated in Figure C.3.4-4. The test zone is a circle with 20 cm diameter in the horizontal plane. The reference point (denoted by a red marker) is in AoA 270°. The mean AoAs of the CDL-C UMi and CDL-C UMa models are slightly different, but the underlying geometry for the CDL model indicates that the mean AoA (or assumed LoS direction) of the model is 180°. The reference point orientation of the validation measurement is proposed to be with 90° offset to the channel model reference AoA to enable accurate sampling of the main lobe of the spatial correlation curve. The reference point orientation has to be defined in the channel model coordinate system instead of the chamber/probe coordinate system to enable optimization of OTA model implementation to achieve better alignment with the cluster AoAs and probe directions. In order to have spatial samples that yield reasonable measurement times and adequately capture the main lobe of the correlation curve, a non-uniform sampling is used where the first quadrant i.e. 270°-180°, is sampled with dense sampling compared to the rest of the circle. The spacing of the spatial samples is summarized in Table C.3.4-3 for test frequencies less than 1800 MHz and equal to or greater than 1800 MHz.

Table C.3.4-3: Spacing of Spatial Samples

Test Frequencies [MHz]	First quadrant of test zone circumference (270°-180°)	Remaining quadrants
617, 722, 836.5 1575.42	$\lambda/15$	$\lambda/4$
1800, 2132.50, 2450, 3600, 4700	$\lambda/10$	$\lambda/2$

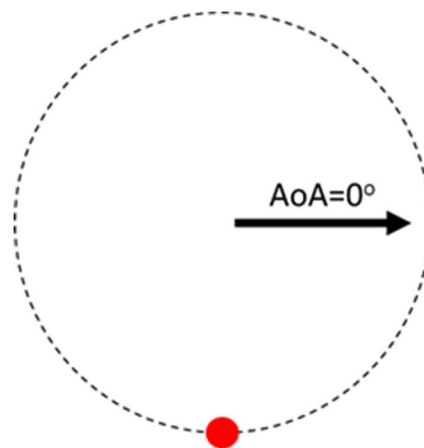

Figure C.3.4-4: Test zone interpretation with Angle of Arrival reference orientation

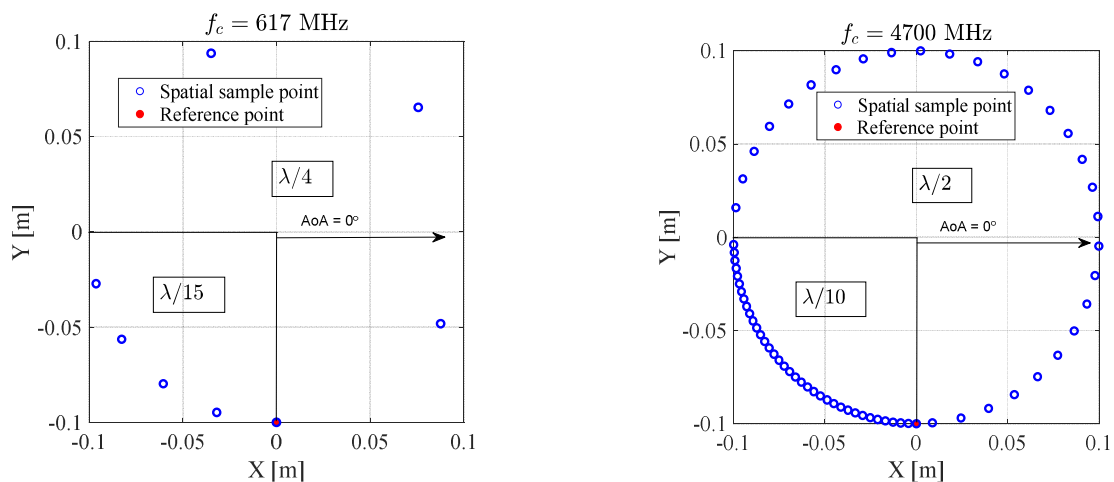

Figure C.3.4-5: Spatial sampling for spatial correlation validation measurement for test frequencies less than and equal to or greater than 1800 MHz: 617 MHz spatial sampling (left) and 4700 MHz spatial sampling (right)

Reference Spatial Correlation Curves

The spatial correlation validation reference curves are tabulated in Tables C.3.4-4 and C.3.4-5 for CDL-C UMi and CDL-C UMa, respectively, for a vertically polarized MPAC OTA setup with 16 uniformly spaced probes.

**Table C.3.4-4: Spatial correlation reference curves for CDL-C UMi model for a vertically polarized MPAC OTA setup with 16 uniformly spaced probes at FR1 test frequencies**

Azim [°]	$ \rho $ beam 1	Azim [°]	$ \rho $ beam 1	Azim [°]	$ \rho $ beam 1	Azim [°]	$ \rho $ beam 1	Azim [°]	$ \rho $ beam 1
<b>617 MHz</b>		<b>722 MHz</b>		<b>836.5 MHz</b>		<b>1575.42 MHz</b>		<b>1800 MHz</b>	
270.0	1.00	270.0	1.00	270.0	1.00	270.0	1.00	270.0	1.00
251.4	1.00	254.1	1.00	256.3	1.00	262.7	1.00	260.9	1.00
232.9	1.00	238.3	1.00	242.6	1.00	255.5	1.00	251.7	1.00
214.3	0.99	222.4	1.00	228.9	1.00	248.2	1.00	242.6	0.99
195.8	0.99	206.6	0.99	215.2	0.99	240.9	0.99	233.5	0.99
110.4	0.87	190.7	0.98	201.6	0.98	233.7	0.99	224.3	0.98
40.8	0.87	120.5	0.84	187.9	0.96	226.4	0.99	215.2	0.97
331.2	0.98	61.1	0.80	128.7	0.82	219.1	0.98	206.0	0.95
		1.6	0.91	77.3	0.73	211.9	0.97	196.9	0.92
		302.1	0.99	26.0	0.81	204.6	0.96	187.8	0.87
				334.7	0.95	197.3	0.94	134.3	0.39
				283.3	1.00	190.0	0.91	88.6	0.15
						182.8	0.87	43.0	0.24
						152.7	0.66	357.3	0.62
						125.5	0.44	311.6	0.94
						98.2	0.30		
						71.0	0.28		
						43.7	0.37		
						16.5	0.54		
						349.2	0.75		
						321.9	0.91		
						294.7	0.99		

Azim [°]	$ \rho $ beam 1	Azim [°]	$ \rho $ beam 1	Azim [°]	$ \rho $ beam 1	Azim [°]	$ \rho $ beam 1
<b>2132.5 MHz</b>		<b>2450 MHz</b>		<b>3600 MHz</b>		<b>4700 MHz</b>	
270.0	1.00	270.0	1.00	270.0	1.00	270.0	1.00
261.9	1.00	263.0	1.00	265.2	1.00	266.3	1.00
253.9	1.00	256.0	1.00	260.5	1.00	262.7	1.00
245.8	0.99	249.0	0.99	255.7	0.99	259.0	0.99
237.8	0.99	242.0	0.99	250.9	0.99	255.4	0.99
229.7	0.98	234.9	0.99	246.1	0.99	251.7	0.99
221.7	0.97	227.9	0.98	241.4	0.98	248.1	0.98
213.6	0.96	220.9	0.97	236.6	0.98	244.4	0.98
205.6	0.93	213.9	0.95	231.8	0.97	240.8	0.98
197.5	0.89	206.9	0.92	227.1	0.97	237.1	0.97
189.5	0.84	199.9	0.88	222.3	0.95	233.5	0.97
181.4	0.77	192.9	0.83	217.5	0.93	229.8	0.96
139.7	0.27	185.9	0.76	212.7	0.90	226.1	0.95
99.5	0.14	144.9	0.19	208.0	0.86	222.5	0.93
59.2	0.14	109.9	0.26	203.2	0.81	218.8	0.91
18.9	0.26	74.8	0.37	198.4	0.75	215.2	0.87
338.6	0.71	39.8	0.19	193.7	0.68	211.5	0.83
298.4	0.97	4.7	0.29	188.9	0.59	207.9	0.78
		329.7	0.74	184.1	0.49	204.2	0.72
		294.6	0.97	156.1	0.23	200.6	0.64
				132.3	0.62	196.9	0.56
				108.4	0.85	193.3	0.47
				84.6	0.93	189.6	0.37
				60.7	0.92	185.9	0.27
				36.9	0.79	182.3	0.18
				13.0	0.42	161.7	0.51
				349.1	0.15	143.5	0.83



Azim [°]	$ \rho $ beam 1	Azim [°]	$ \rho $ beam 1	Azim [°]	$ \rho $ beam 1	Azim [°]	$ \rho $ beam 1
2132.5 MHz		2450 MHz		3600 MHz		4700 MHz	
				325.3	0.60	125.2	0.95
				301.4	0.90	106.9	0.89
				277.6	1.00	88.6	0.80
						70.4	0.78
						52.1	0.88
						33.8	0.98
						15.5	0.91
						357.3	0.53
						339.0	0.09
						320.7	0.50
						302.4	0.82
						284.2	0.97

**Table C.3.4-5: Spatial correlation reference curves for CDL-C UMa model for a vertically polarized MPAC OTA setup with 16 uniformly spaced probes at FR1 test frequencies**

Azim [°]	$ \rho $ comb	Azim [°]	$ \rho $ comb	Azim [°]	$ \rho $ comb	Azim [°]	$ \rho $ comb	Azim [°]	$ \rho $ comb
617 MHz		722 MHz		836.5 MHz		1575.42 MHz		1800 MHz	
270.0	1.00	270.0	1.00	270.0	1.00	270.0	1.00	270.0	1.00
251.4	0.99	254.1	0.99	256.3	0.99	262.7	0.99	260.9	0.99
232.9	0.99	238.3	0.98	242.6	0.98	255.5	0.98	251.7	0.96
214.3	0.98	222.4	0.97	228.9	0.97	248.2	0.96	242.6	0.93
195.8	0.96	206.6	0.96	215.2	0.96	240.9	0.94	233.5	0.90
110.4	0.61	190.7	0.94	201.6	0.95	233.7	0.92	224.3	0.89
40.8	0.47	120.5	0.58	187.9	0.92	226.4	0.91	215.2	0.88
331.2	0.85	61.1	0.30	128.7	0.56	219.1	0.90	206.0	0.87
		1.6	0.56	77.3	0.19	211.9	0.89	196.9	0.84
		302.1	0.95	26.0	0.27	204.6	0.88	187.8	0.79
				334.7	0.70	197.3	0.87	134.3	0.16
				283.3	0.99	190.0	0.84	88.6	0.30
						182.8	0.79	43.0	0.22
						152.7	0.42	357.3	0.36
						125.5	0.13	311.6	0.57
						98.2	0.30		
						71.0	0.31		
						43.7	0.29		
						16.5	0.33		
						349.2	0.29		
						321.9	0.48		
						294.7	0.88		

Azim [°]	$ \rho $ comb	Azim [°]	$ \rho $ comb	Azim [°]	$ \rho $ comb	Azim [°]	$ \rho $ comb
2132.5 MHz		2450 MHz		3600 MHz		4700 MHz	
270.0	1.00	270.0	1.00	270.0	1.00	270.0	1.00
261.9	0.99	263.0	0.99	265.2	0.98	266.3	0.98
253.9	0.95	256.0	0.95	260.5	0.95	262.7	0.94
245.8	0.92	249.0	0.91	255.7	0.90	259.0	0.89
237.8	0.89	242.0	0.87	250.9	0.84	255.4	0.83
229.7	0.86	234.9	0.85	246.1	0.80	251.7	0.78
221.7	0.85	227.9	0.83	241.4	0.77	248.1	0.73
213.6	0.85	220.9	0.82	236.6	0.75	244.4	0.70
205.6	0.83	213.9	0.82	231.8	0.73	240.8	0.68
197.5	0.80	206.9	0.80	227.1	0.72	237.1	0.66
189.5	0.75	199.9	0.77	222.3	0.71	233.5	0.65
181.4	0.67	192.9	0.73	217.5	0.70	229.8	0.64
139.7	0.22	185.9	0.66	212.7	0.69	226.1	0.63
99.5	0.24	144.9	0.26	208.0	0.67	222.5	0.62
59.2	0.03	109.9	0.23	203.2	0.64	218.8	0.61
18.9	0.16	74.8	0.19	198.4	0.61	215.2	0.60
338.6	0.37	39.8	0.13	193.7	0.56	211.5	0.59

298.4	0.73	4.7	0.15	188.9	0.49	207.9	0.57
		329.7	0.38	184.1	0.41	204.2	0.55
		294.6	0.74	156.1	0.42	200.6	0.52
				132.3	0.19	196.9	0.48
				108.4	0.64	193.3	0.42
				84.6	0.47	189.6	0.35
				60.7	0.44	185.9	0.26
				36.9	0.28	182.3	0.18
				13.0	0.16	161.7	0.59
				349.1	0.16	143.5	0.26
				325.3	0.41	125.2	0.79
				301.4	0.40	106.9	0.43
				277.6	0.95	88.6	0.68
						70.4	0.63
						52.1	0.75
						33.8	0.87
						15.5	0.67
						357.3	0.09
						339.0	0.25
						320.7	0.32
						302.4	0.42
						284.2	0.73

Time Domain Alternative Method:

Time domain techniques can also be used to validate the spatial correlation. The spatial correlation validation measurement setup is illustrated in Figure C.3.4-3. In this case a Signal generator transmits a CW signal through the MIMO test system. The signal is received by a test antenna within the test area. Finally, the signal is collected by a signal analyser and the measured signal is stored for postprocessing.

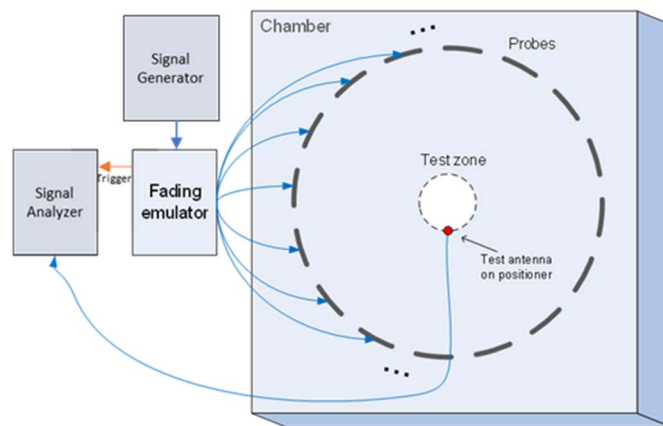

Figure C.3.4-6: Configuration for spatial correlation validation based on time domain techniques

For each spatial point, the channel emulator should issue a trigger signal each time fading is started. For each point collect a time domain trace with the signal analyser, when done, stop fading. Data recording is synchronized with the channel emulator trigger.

Follow the same procedure to postprocess the data and calculate the spatial correlation by setting  $m$  to 1. The settings for the Signal Generator and Signal Analyser are in Tables C.3.4-6 and C.3.4-7 respectively.

Table C.3.4-6: Signal Generator Settings

Item	Unit	Value
Centre frequency	MHz	Downlink centre frequency in Table C.3.1-1
Output power	dBm	Function of the CE. Sufficiently above Noise Floor

**Table C.3.4-7: Signal Analyser Settings**

Item	Unit	Value
Centre frequency	MHz	Downlink centre frequency in Table C.3.1-1
Sampling	Hz	At least 15 times bigger than the max Doppler spread ( $f_d=v/\lambda$ )
Observation time	s	At least 16 s. Channel Model length should be the same or greater than the observation time

**Beam-Simultaneous Block Diagram**

It is assumed that the beams are mapped to the inputs of the channel emulator as follows:

- Beam 1: Input 1 and Input 2.
- Beam 2: Input 3 and Input 4 (CDL-C UMa only).

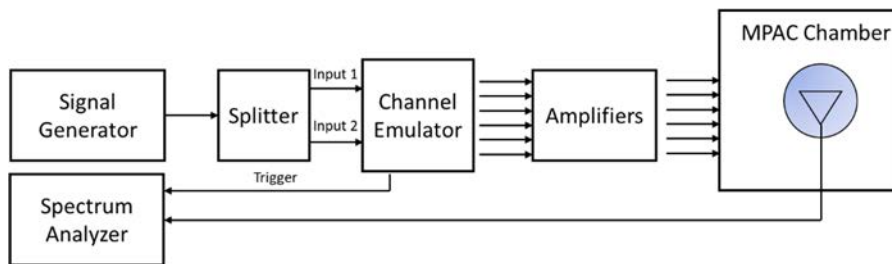

**Figure C.3.4-7: Configuration for spatial correlation validation based on time domain techniques (CDL-C UMi)**

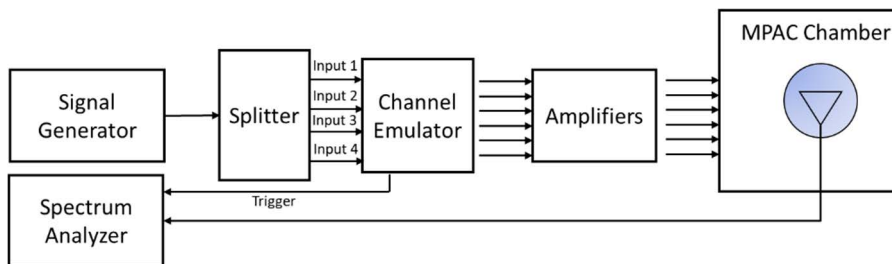

**Figure C.3.4-8: Configuration for spatial correlation validation based on time domain techniques (CDL-C UMa)**

**C.3.5 Cross-polarization**

This measurement checks how well the measured vertically or horizontally polarized power levels follow expected values. The test setup for cross-polarization is the same as PDP validation in Figure C.3.2-1.

**Method of measurement:** Step the emulation and store traces from VNA.

VNA settings for cross-polarization measurements are presented in Table C.3.5-1.

**Table C.3.5-1: VNA settings for cross-polarization**

Item	Unit	Value
Centre frequency	MHz	Downlink Centre Frequency in Table C.3.1-1
Span	MHz	40
Number of traces		1000
Number of points		802
Averaging		1

Channel model specification for cross-polarization measurements is presented in Table C.3.5-2.

**Table C.3.5-2: Channel model specification for cross-polarization**

Item	Unit	Value
Centre frequency	MHz	Downlink centre frequency in Table C.3.1-1
Distance between traces in channel model	wavelength (see note 1)	> 2
Channel model		As specified in clause C.1
Mobile speed (see note 2)	km/h	30

NOTE 1: Time [s] = distance [ $\lambda$ ] / MS speed [ $\lambda$ /s].  
 MS speed [ $\lambda$ /s] = MS speed [m /s] / Speed of light [m/s] \* Centre frequency [Hz].  
 NOTE 2: The mobile speed is valid for the Time Domain Alternative method only.

**Measurement Procedure:**

Step the emulation and store traces from VNA. i.e. run the emulation to CIR number 1, pause, measure VNA trace, run the emulation to CIR number 10, pause, measure VNA trace. Continue until 1000 VNA traces are measured:

- a. Use a vertically polarized sleeve dipole to measure the V component.
- b. Use a horizontally polarized (vertically oriented) magnetic loop dipole, or a horizontally polarized sleeve dipole measured in four orthogonal horizontal positions and summed to measure the H component.

**Method of measurement result analysis:**

Measured VNA traces (frequency responses  $H_V(t, f)$  and  $H_H(t, f)$ ) are saved into a hard drive. The data is read into, e.g. Matlab. The frequency responses are averaged in power over time and frequency and the V/H ratio calculated as follows:

$$P_V = \sum_t \sum_f |H_V(t, f)|^2$$

$$P_H = \sum_t \sum_f |H_H(t, f)|^2$$

$$P_{V/H} [dB] = 10 \log_{10} \left( \frac{P_V}{P_H} \right)$$

**Beam-Specific Block Diagram**

It is assumed that the beams are mapped to the inputs of the channel emulator as follows:

- Beam 1: Input 1 and Input 2
- Beam 2: Input 3 and Input 4 (CDL-C UMa only)

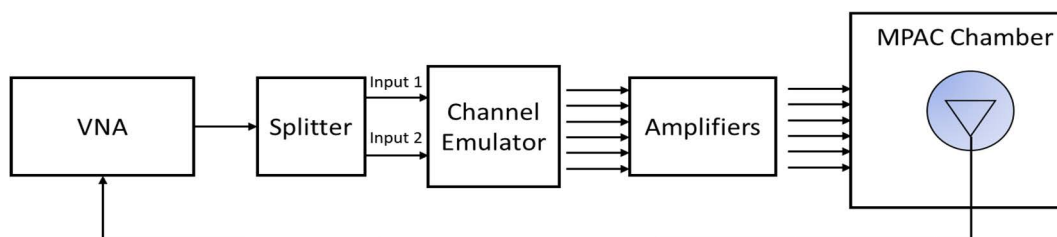

**Figure C.3.5-1: Setup for Beam-Specific V/H measurements (Beam 1)**

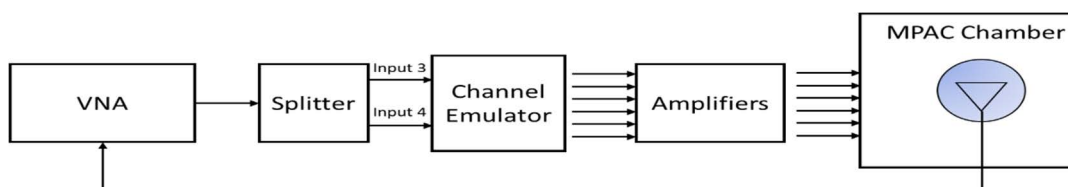

**Figure C.3.5-2: Setup for Beam-Specific V/H measurements (Beam 2 CDL-C UMa only)**

Time Domain Alternative Method:

The power in the Vertical and Horizontal polarizations can also be measured in time domain. The measurement setup for Beam-Specific are presented in Figures C.3.5-3, and C.3.5-4.

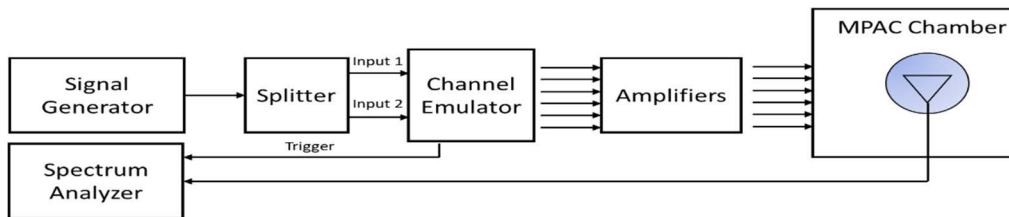

Figure C.3.5-3: Setup for Beam-Specific V/H measurements (Beam 1)

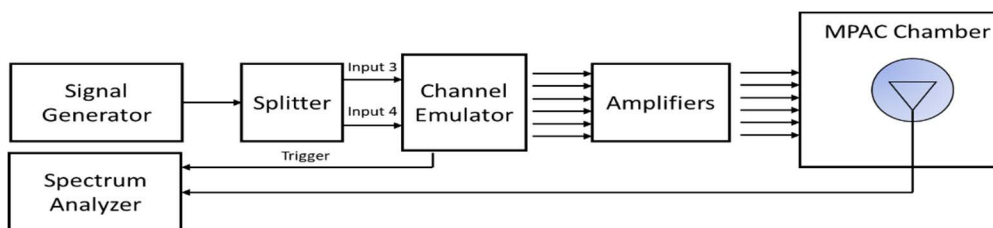

Figure C.3.5-4: Setup for Beam-Specific V/H measurements (Beam 2 CDL-C UMa only)

The instruments settings are the same as those in Tables C.3.4-6 and C.3.4-7. The measurement analysis is the same as that of the frequency domain method setting the summation over  $f$  to a single point.

The reference V/H-ratios for CDL-C UMa and CDL-C UMi channel model validation are defined in Tables C.3.5-3 and C.3.5-4, respectively.

Table C.3.5-3: Reference V/H-ratios for CDL-C UMa

UMa C, $f_c \leq 2.5$ GHz	Beam 1	Input 1+2: V/H = 0 dB
	Beam 2	Input 3+4: V/H = 0 dB
UMa C, $f_c > 2.5$ GHz	Beam 1	Input 1+2: V/H = 0 dB
	Beam 2	Input 3+4: V/H = 0 dB

Table C.3.5-4: Reference V/H-ratios for CDL-C UMi

UMi C, $f_c \leq 2.5$ GHz	Beam 1	Inputs 1+2: V/H = 0 dB
UMi C, $f_c > 2.5$ GHz	Beam 1	Inputs 1+2: V/H = 0 dB

### C.3.6 Power validation

This measurement checks the total power in the centre of the test zone. The power validation is measured with a spectrum analyser as shown in Figure C.3.6-1.

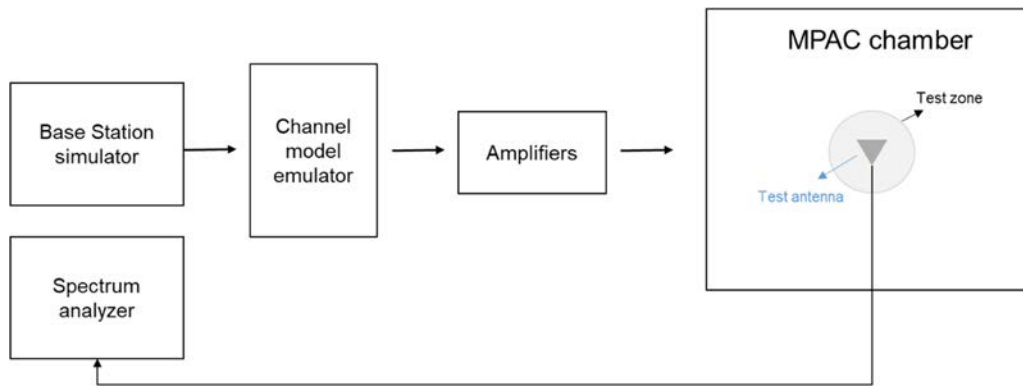

Figure C.3.6-1: Setup for power validation measurements

Table C.3.6-1: Spectrum analyser settings for power validation measurements

Item	Unit	Value
Centre frequency	MHz	Downlink centre frequency in Table C.3.1-2
Integrated Channel Span	Hz	40MHz
RBW	Hz	30 kHz
VBW	Hz	≥10MHz
Number of points		≥400
Averaging		≥100
Detector		RMS

**Measurement Procedure:**

- 1) Place a vertical reference dipole in the centre of the test zone connected to a spectrum analyser (or power meter) via a cable.
- 2) Record the cable and reference dipole gains.
- 3) Load the target channel model into the channel emulator and play the model.
- 4) Start the NR FR1 signalling in the base station emulator with the required parameter identical to the measurements conditions.
- 5) Average the power received by the spectrum analyser for a sufficient amount of time to account for the fading channel - one full channel simulation might be unnecessary.
- 6) Repeat steps 1 to 4 with a magnetic loop for the horizontal polarization, or a horizontally polarized sleeve dipole measured in at least four orthogonal horizontal positions and average the summed orientations to get the H component.
- 7) Calculate the total power received at the test area as the sum of the power in the two polarizations.

NOTE: In step 6, if horizontally polarized sleeve dipole is used, the reference gain correction should be the average of the theta gain pattern cut of the dipole. Besides, more horizontal positions for averaging will improve the measurement accuracy but increase the total measurement time.

The power validation result is considered as systematic offset, which needs to be corrected on the UE final sensitivity value to further reduce measurement uncertainty.

The detailed power validation setup for CDL-C UMi and CDL-C UMa channel models are illustrated in Figure C.3.6-2 and Figure C.3.6-3.

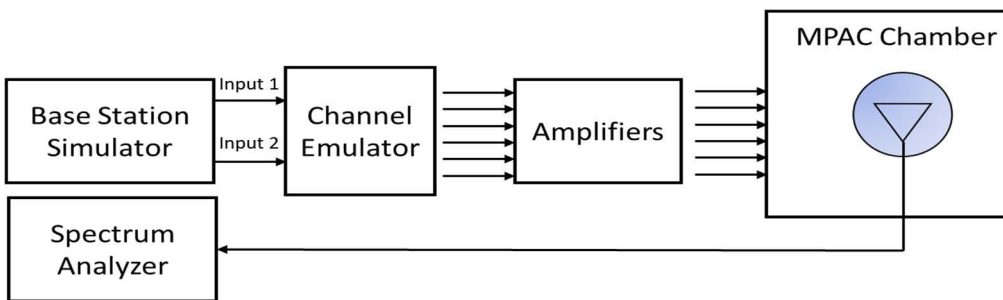

Figure C.3.6-2: Setup for power validation measurements for CDL-C UMi

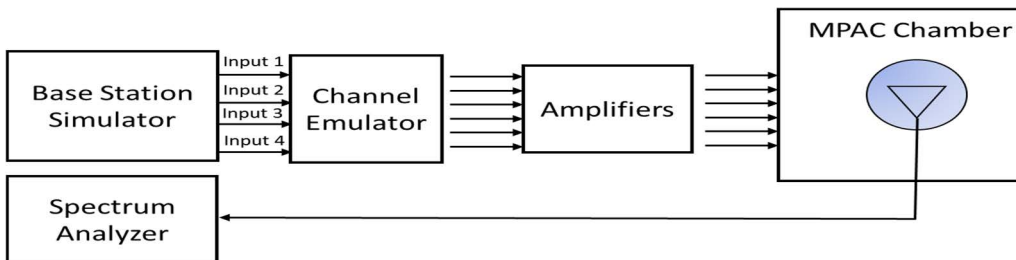

Figure C.3.6-3: Setup for power validation measurements for CDL-C Uma

## C.4 Validation Pass/fail limit

### C.4.1 General

This clause defines the pass/fail limit of FR1 MPAC system for FR1 channel model validation.

### C.4.2 Pass/Fail Criteria of PDP

This clause defines the pass/fail criteria of PDP, this pass/fail limits apply for all FR1 frequency bands, for both combined and individual beams.

The detailed pass/fail limits for each cluster of CDL-C UMa and CDL-C UMi are defined in Table C.4.2-1.

Table C.4.2-1: PDP pass/fail limits for CDL-C UMa and CDL-C UMi channel model validation

	Power Tolerance	Delay Tolerance
Paths from 0 dB to 10 dB	±1 dB	±6 ns
Paths from 10 dB to 20 dB	±2.5 dB	±6 ns
Paths from 20 dB to 30 dB	±5 dB	±6 ns
Paths from 30 dB to 40 dB	±10 dB	±6 ns

### C.4.3 Pass/Fail Criteria of Doppler/Temporal correlation

This clause defines the pass/fail criteria of doppler/temporal correlation, this pass/fail limits apply for all channel models in all FR1 frequency bands, for both combined and individual beams.

The pass/fail limits for theoretical temporal correlation defined in clause C.3.3 above 0.3 are formed as bands of ±0.1 of correlation capped at 1 at the high end. Additionally, when the theoretical temporal correlation drops below 0.3, the limits are formed at bands of ±0.3 of correlation capped at 0 at the low end.





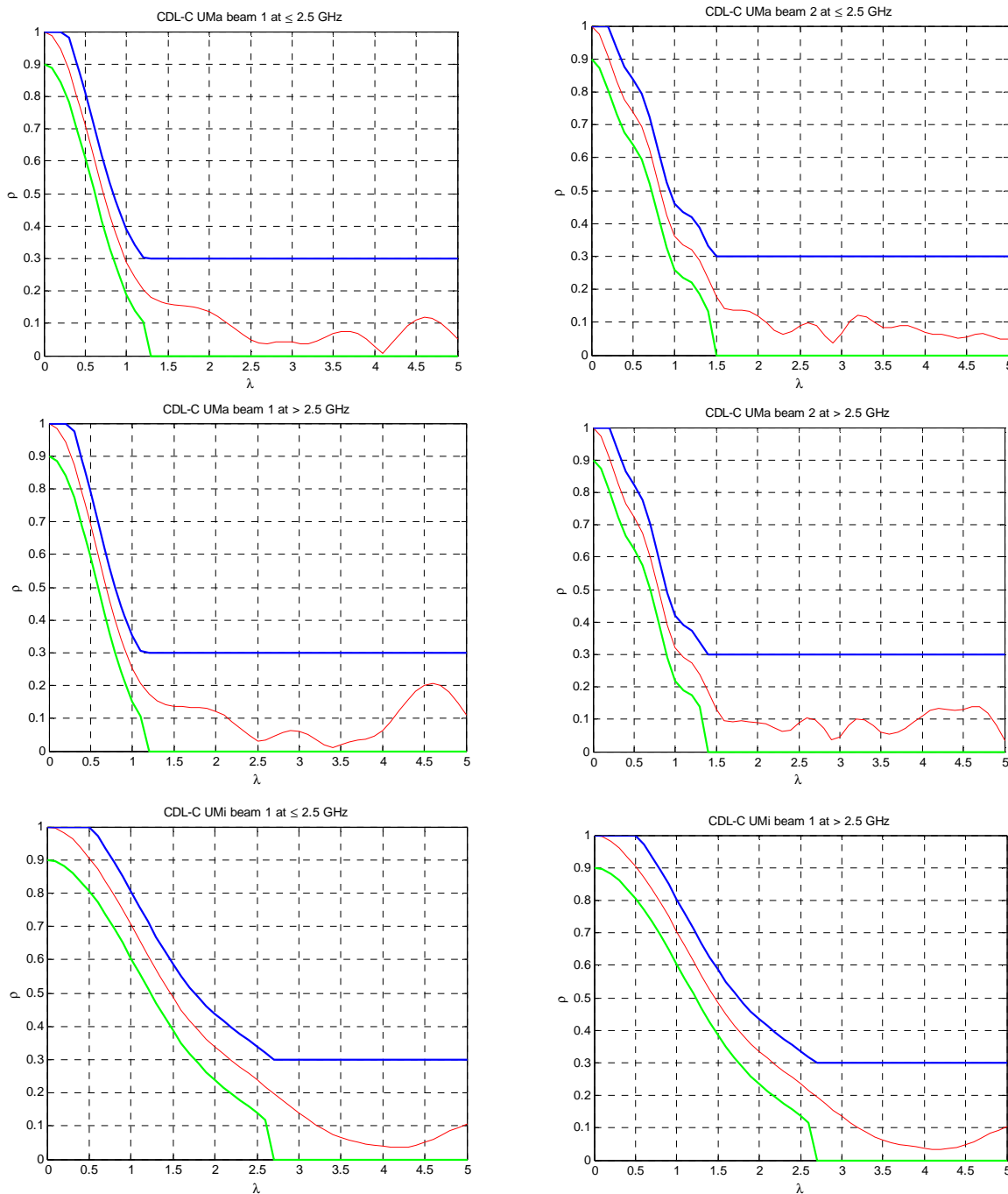

**Figure C.4.3-1: Pass/fail limits and targets of Temporal correlation for CDL-C UMa and CDL-C UMi channel model: red curve (reference), blue (upper limit) and green (lower limit)**

### C.4.4 Pass/Fail Criteria of Spatial correlation

This clause defines the pass/fail criteria of spatial correlation, this general pass/fail limits principle apply for all channel models in all FR1 frequency bands, for both combined and individual beams.

The pass/fail limits for spatial correlation are formed as bands of  $\pm 10\%$  of correlation capped at 100 % for the upper limit for target correlation defined in clause C.3.4 of 35 % (for CDL-C UMa @3600MHz, this value is 65 %) and above. For target correlations below 35 % (for CDL-C UMa @3600MHz, this value is 65 %), the band is widened to  $\pm 20\%$  capped at 0 %.

For the detailed pass/fail limit, the values are defined in the Table C.4.4-1 and Table C.4.4-2, for CDL-C UMi and CDL-C UMa channel model, respectively.

**Table C.4.4-1: Spatial correlation pass/fail limits for CDL-C UMi channel model**

Lower	Upper	Lower	Upper	Lower	Upper	Lower	Upper	Lower	Upper
617 MHz		722 MHz		836.5 MHz		1575.42 MHz		1880 MHz	
0.90	1.00	0.90	1.00	0.90	1.00	0.90	1.00	0.90	1.00
0.90	1.00	0.90	1.00	0.90	1.00	0.90	1.00	0.90	1.00
0.90	1.00	0.90	1.00	0.90	1.00	0.90	1.00	0.90	1.00
0.90	1.00	0.90	1.00	0.90	1.00	0.90	1.00	0.89	1.00
0.89	1.00	0.89	1.00	0.89	1.00	0.89	1.00	0.89	1.00
0.88	1.00	0.88	1.00	0.88	1.00	0.89	1.00	0.88	1.00
0.74	0.94	0.74	0.94	0.86	1.00	0.89	1.00	0.87	1.00
0.70	0.90	0.70	0.90	0.72	0.92	0.88	1.00	0.85	1.00
		0.81	1.00	0.63	0.83	0.87	1.00	0.82	1.00
		0.89	1.00	0.71	0.91	0.86	1.00	0.77	0.97
				0.85	1.00	0.84	1.00	0.29	0.49
				0.90	1.00	0.81	1.00	0.00	0.35
						0.77	0.97	0.04	0.44
						0.56	0.76	0.52	0.72
						0.34	0.54	0.84	1.00
						0.10	0.50		
						0.08	0.48		
						0.27	0.47		
						0.44	0.64		
						0.65	0.85		
						0.81	1.00		
						0.89	1.00		

Lower	Upper	Lower	Upper	Lower	Upper	Lower	Upper
2132.5 MHz		2450 MHz		3600 MHz		4700 MHz	
0.90	1.00	0.90	1.00	0.90	1.00	0.90	1.00
0.90	1.00	0.90	1.00	0.90	1.00	0.90	1.00
0.90	1.00	0.90	1.00	0.90	1.00	0.90	1.00
0.89	1.00	0.89	1.00	0.89	1.00	0.89	1.00
0.89	1.00	0.89	1.00	0.89	1.00	0.89	1.00
0.88	1.00	0.89	1.00	0.89	1.00	0.89	1.00
0.87	1.00	0.88	1.00	0.88	1.00	0.88	1.00
0.86	1.00	0.87	1.00	0.88	1.00	0.88	1.00
0.83	1.00	0.85	1.00	0.87	1.00	0.88	1.00
0.79	0.99	0.82	1.00	0.87	1.00	0.87	1.00
0.74	0.94	0.78	0.98	0.85	1.00	0.87	1.00
0.67	0.87	0.73	0.93	0.83	1.00	0.86	1.00
0.07	0.47	0.66	0.86	0.80	1.00	0.85	1.00
0	0.34	0.00	0.39	0.76	0.96	0.83	1.00
0	0.34	0.06	0.46	0.71	0.91	0.81	1.00
0.06	0.46	0.27	0.47	0.65	0.85	0.77	0.97
0.61	0.81	0.00	0.39	0.58	0.78	0.73	0.93
0.87	1.00	0.09	0.49	0.49	0.69	0.68	0.88
		0.64	0.84	0.39	0.59	0.62	0.82
		0.87	1.00	0.03	0.43	0.54	0.74
				0.52	0.72	0.46	0.66
				0.75	0.95	0.37	0.57
				0.83	1.00	0.27	0.47
				0.82	1.00	0.07	0.47
				0.69	0.89	0.00	0.38
				0.32	0.52	0.41	0.61
				0.00	0.35	0.73	0.93
				0.50	0.70	0.85	1.00
				0.80	1.00	0.79	0.99
				0.90	1.00	0.70	0.90
						0.68	0.88
						0.78	0.98
						0.88	1.00
						0.81	1.00
						0.43	0.63
						0.00	0.29
						0.40	0.60
						0.72	0.92
						0.87	1.00

Table C.4.4-2: Spatial correlation pass/fail limits for CDL-C UMa channel model

Lower	Upper	Lower	Upper	Lower	Upper	Lower	Upper	Lower	Upper
617 MHz		722 MHz		836.5 MHz		1575.42 MHz		1800 MHz	
0.90	1.00	0.90	1.00	0.90	1.00	0.90	1.00	0.90	1.00
0.89	1.00	0.89	1.00	0.89	1.00	0.89	1.00	0.89	1.00
0.89	1.00	0.88	1.00	0.88	1.00	0.88	1.00	0.86	1.00
0.88	1.00	0.87	1.00	0.87	1.00	0.86	1.00	0.83	1.00
0.86	1.00	0.86	1.00	0.86	1.00	0.84	1.00	0.80	1.00
0.51	0.71	0.84	1.00	0.85	1.00	0.82	1.00	0.79	0.99
0.37	0.57	0.48	0.68	0.82	1.00	0.81	1.00	0.78	0.98
0.75	0.95	0.20	0.40	0.46	0.66	0.80	1.00	0.77	0.97
		0.46	0.66	0.09	0.29	0.79	0.99	0.74	0.94
		0.85	1.00	0.17	0.37	0.78	0.98	0.69	0.89
				0.60	0.80	0.77	0.97	0.00	0.36
				0.89	1.00	0.74	0.94	0.10	0.50
						0.69	0.89	0.02	0.42
						0.32	0.52	0.26	0.46
						0.00	0.33	0.47	0.67
						0.10	0.50		
						0.11	0.51		
						0.09	0.49		

Lower	Upper	Lower	Upper	Lower	Upper	Lower	Upper	Lower	Upper
617 MHz		722 MHz		836.5 MHz		1575.42 MHz		1800 MHz	
						0.13	0.53		
						0.09	0.49		
						0.38	0.58		
						0.78	0.98		

Lower	Upper	Lower	Upper	Lower	Upper	Lower	Upper
2132.5 MHz		2450 MHz		3600 MHz		4700 MHz	
0.90	1.00	0.90	1.00	0.90	1.00	0.90	1.00
0.89	1.00	0.89	1.00	0.88	1.00	0.88	1.00
0.86	1.00	0.85	1.00	0.85	1.00	0.84	1.00
0.83	1.00	0.81	1.00	0.80	1.00	0.79	0.99
0.80	1.00	0.77	0.97	0.74	0.94	0.73	0.93
0.79	0.99	0.75	0.95	0.70	0.90	0.68	0.88
0.78	0.98	0.73	0.93	0.67	0.87	0.63	0.83
0.77	0.97	0.72	0.92	0.65	0.85	0.60	0.80
0.74	0.94	0.72	0.92	0.63	0.83	0.58	0.78
0.69	0.89	0.70	0.90	0.62	0.82	0.56	0.76
0.00	0.36	0.67	0.87	0.61	0.81	0.55	0.75
0.10	0.50	0.63	0.83	0.60	0.80	0.54	0.74
0.02	0.42	0.56	0.76	0.59	0.79	0.53	0.73
0.26	0.46	0.06	0.46	0.57	0.77	0.52	0.72
0.47	0.67	0.03	0.43	0.44	0.84	0.51	0.71
0.90	1.00	0.00	0.39	0.41	0.81	0.50	0.70
0.89	1.00	0.00	0.33	0.36	0.76	0.49	0.69
0.86	1.00	0.00	0.35	0.29	0.69	0.47	0.67
		0.28	0.48	0.21	0.61	0.45	0.65
		0.64	0.84	0.22	0.62	0.42	0.62
				0.00	0.49	0.38	0.58
				0.44	0.84	0.32	0.52
				0.27	0.67	0.15	0.55
				0.24	0.64	0.06	0.46
				0.08	0.58	0.00	0.38
				0.00	0.46	0.49	0.69
				0.00	0.46	0.06	0.46
				0.21	0.61	0.69	0.89
				0.20	0.60	0.33	0.53
				0.85	1.00	0.58	0.78
						0.53	0.73
						0.65	0.85
						0.77	0.97
						0.57	0.77
						0.00	0.29
						0.05	0.45
						0.12	0.52
						0.32	0.52
						0.63	0.83

The cross-polarization ratio pass/fail limit is specified as  $\pm 1$ dB.

### C.4.5 Pass/Fail Criteria of Cross-polarization

This clause defines the pass/fail criteria of cross-polarization, this pass/fail limits apply for all channel models in all FR1 frequency bands, for both combined and individual beams.

The cross-polarization ratio pass/fail limit is specified as  $\pm 1$ dB.

## C.4.6 Pass/Fail Criteria of Power validation

This clause defines the pass/fail criteria of power validation, this pass/fail limits apply for all channel models.

The power validation pass/fail limit is specified as  $\pm 1.5$  dB.

# Annex D (normative): gNB configurations

## D.1 FR1 gNB configurations

The gNodeB emulator parameters shall be set according to Table D.1-1 for FR1 common parameters, Table D.1-2 for FR1 FDD 2x2 test parameters, Table D.1-3 for FR1 TDD 2x2 test parameters, Table D.1-4 for FR1 FDD 4x4 test parameters, and Table D.1-5 for FR1 TDD 4x4 test parameters.

**Table D.1-1: FR1 Common test parameters**

Parameter		Unit	Value
PDSCH transmission scheme			Transmission scheme 1
Carrier configuration	Offset between Point A and the lowest usable subcarrier on this carrier (Note 2)	RBs	0
	Subcarrier spacing	kHz	15 or 30
DL BWP configuration #1	Cyclic prefix		Normal
	RB offset	RBs	0
	Number of contiguous PRB	PRBs	Maximum transmission bandwidth configuration as specified in clause 5.3.2 of 3GPP TS 38.101-1 [2] for tested channel bandwidth and subcarrier spacing
Common serving cell parameters	Physical Cell ID		0
	SSB position in burst		First SSB in Slot #0
	SSB periodicity	ms	20
	First DMRS position for Type A PDSCH mapping		2
PDCCH configuration	Slots for PDCCH monitoring		Each slot
	Symbols with PDCCH	Symbols	0, 1
	Number of PRBs in CORESET		Table 5.2-2 of 3GPP TS 38.101-4 [6] for tested channel bandwidth and subcarrier spacing
	Number of PDCCH candidates and aggregation levels		1/AL8
	CCE-to-REG mapping type		Non-interleaved
	DCI format		1_1
	TCI state		TCI state #1
Cross carrier scheduling			Not configured
CSI-RS for tracking	First subcarrier index in the PRB used for CSI-RS		$k_0=0$ for CSI-RS resource 1,2,3,4
	First OFDM symbol in the PRB used for CSI-RS		$l_0 = 6$ for CSI-RS resource 1 and 3 $l_0 = 10$ for CSI-RS resource 2 and 4
	Number of CSI-RS ports (X)		1 for CSI-RS resource 1,2,3,4
	CDM Type		'No CDM' for CSI-RS resource 1,2,3,4
	Density ( $\rho$ )		3 for CSI-RS resource 1,2,3,4
	CSI-RS periodicity	Slots	15 kHz SCS: 20 for CSI-RS resource 1,2,3,4 30 kHz SCS: 40 for CSI-RS resource 1,2,3,4
	CSI-RS offset	Slots	15 kHz SCS: 10 for CSI-RS resource 1 and 2 11 for CSI-RS resource 3 and 4  30 kHz SCS: 20 for CSI-RS resource 1 and 2 21 for CSI-RS resource 3 and 4
	Frequency Occupation		Start PRB 0 Number of PRB = BWP size
	QCL info		TCI state #0

Parameter		Unit	Value
NZP CSI-RS for CSI acquisition	First subcarrier index in the PRB used for CSI-RS		$k_0 = 0$
	First OFDM symbol in the PRB used for CSI-RS		$l_0 = 12$
	Number of CSI-RS ports (X)		Same as number of transmit antenna
	CDM Type		'FD-CDM2'
	Density ( $\rho$ )		1
	CSI-RS periodicity	Slots	15 kHz SCS: 20 30 kHz SCS: 40
	CSI-RS offset	Slots	0
	Frequency Occupation		Start PRB 0 Number of PRB = BWP size
	QCL info		TCI state #1
ZP CSI-RS for CSI acquisition	First subcarrier index in the PRB used for CSI-RS		$k_0 = 4$
	First OFDM symbol in the PRB used for CSI-RS		$l_0 = 12$
	Number of CSI-RS ports (X)		4
	CDM Type		'FD-CDM2'
	Density ( $\rho$ )		1
	CSI-RS periodicity	Slots	15 kHz SCS: 20 30 kHz SCS: 40
	CSI-RS offset	Slots	0
PDSCH DMRS configuration	Antenna ports indexes		{1000, 1001} for Rank 2 tests {1000-1003} for Rank 4 tests
	Number of PDSCH DMRS CDM group(s) without data		1 for Rank 2 tests 2 for Rank 4 tests
TCI state #0	Type 1 QCL information	SSB index QCL Type	SSB #0 Type C
	Type 2 QCL information	SSB index QCL Type	N/A N/A
TCI state #1	Type 1 QCL information	CSI-RS resource QCL Type	CSI-RS resource 1 from 'CSI-RS for tracking' configuration Type A
	Type 2 QCL information	CSI-RS resource QCL Type	N/A N/A
PT-RS configuration			PT-RS is not configured
Maximum number of code block groups for ACK/NACK feedback			1
Maximum number of HARQ transmission			1
HARQ ACK/NACK bundling			Multiplexed
Redundancy version coding sequence			N.A
Precoding configuration			SP Type I, Random per slot with PRB bundling granularity
Symbols for all unused REs			OCNG clause A.5 of 3GPP TS 38.101-4 [9]
Minimum Number of Slots per Stream			20000 for 15kHz SCS 40000 for 30kHz SCS (Note 3)
Transmit Power Control		dBm	13
DL power level (RS EPRE of SSS)		dBm / SCS	Set at gNodeB simulator with correction from calibration
EPRE ratio of PDSCH to SSS		dB	0
NOTE 1: UE assumes that the TCI state for the PDSCH is identical to the TCI state applied for the PDCCH transmission.			
NOTE 2: Point A coincides with minimum guard band as specified in Table 5.3.3-1 from 3GPP TS 38.101-1 [2] for tested channel bandwidth and subcarrier spacing.			
NOTE 3: For FR1 MIMO OTA test lab alignments and FR1 MIMO OTA UE performance requirements, the following values can be used: For FR1 bands >1GHz: 20k for 30kHz SCS, 10k for 15kHz SCS; For FR1 bands <1GHz: [20k] for 15kHz SCS;			

Table D.1-2: Test parameters for FR1 FDD 2x2

Parameter		Unit	Value
Duplex mode			FDD
Reference channel			R.PDSCH.1-3.1 FDD (Note)
Bandwidth		MHz	10
SCS		kHz	15
Modulation DL			64QAM
Modulation UL			QPSK
Active DL BWP index			1
PDSCH configuration	Mapping type		Type A
	k0		0
	Starting symbol (S)		2
	Length (L)		12
	PDSCH aggregation factor		1
	PRB bundling type		Static
	PRB bundling size		2
	Resource allocation type		Type 0
	RBG size		Config2
	VRB-to-PRB mapping type		Non-interleaved
VRB-to-PRB mapping interleave bundle size		N/A	
PDSCH DMRS configuration	DMRS Type		Type 1
	Number of additional DMRS		1
	Maximum number of OFDM symbols for DL front loaded DMRS		1
CSI-RS for tracking	CSI-RS periodicity	Slots	20
	CSI-RS offset	Slots	Table 5.2-1 [3]
Number of HARQ Processes			4
The number of slots between PDSCH and corresponding HARQ-ACK information			2
NOTE: "R.PDSCH.1-3.1 FDD" is defined in Table A.3.2.1.1-3 of 3GPP TS 38.101-4 [6].			

Table D.1-3: Test parameters for FR1 TDD 2x2

Parameter		Unit	Value
Duplex mode			TDD
Reference channel			R.PDSCH.2-3.1 TDD (Note 1)
Bandwidth		MHz	40
SCS		kHz	30
Modulation DL			64QAM
Modulation UL			QPSK
Active DL BWP index			1
PDSCH configuration	Mapping type		Type A
	k0		0
	Starting symbol (S)		2
	Length (L)		Specific to each Reference channel
	PDSCH aggregation factor		1
	PRB bundling type		Static
	PRB bundling size		2
	Resource allocation type		Type 0
	RBG size		Config2
	VRB-to-PRB mapping type		Non-interleaved
VRB-to-PRB mapping interleave bundle size		N/A	
PDSCH DMRS configuration	DMRS Type		Type 1
	Number of additional DMRS		1
	Maximum number of OFDM symbols for DL front loaded DMRS		1
CSI-RS for tracking	First OFDM symbol in the PRB used for CSI-RS		Table 5.2-1 [3]
	CSI-RS periodicity	Slots	40
	CSI-RS offset	Slots	Table 5.2-1 [3]
Number of HARQ Processes			8



Parameter	Unit	Value
TDD UL-DL pattern		FR1.30-1 (Note 2)
NOTE 1: "R.PDSCH.2-3.1 TDD" is defined in Table A.3.2.2.2-3 of 3GPP TS 38.101-4 [6].		
NOTE 2: "FR1.30-1" is defined in Annex A.1.2 of 3GPP TS 38.101-4 [6].		

Table D.1-4: Test parameters for FR1 FDD 4x4

Parameter	Unit	Value	
Duplex mode		FDD	
Reference channel		R.PDSCH.1-2.4 FDD (Note)	
Bandwidth	MHz	10	
SCS	kHz	15	
Modulation DL		16QAM	
Modulation UL		QPSK	
Active DL BWP index		1	
PDSCH configuration	Mapping type	Type A	
	k0	0	
	Starting symbol (S)	2	
	Length (L)	12	
	PDSCH aggregation factor	1	
	PRB bundling type	Static	
	PRB bundling size	2	
	Resource allocation type	Type 0	
	RBG size	Config2	
	VRB-to-PRB mapping type	Non-interleaved	
VRB-to-PRB mapping interleave bundle size	N/A		
PDSCH DMRS configuration	DMRS Type	Type 1	
	Number of additional DMRS	1	
	Maximum number of OFDM symbols for DL front loaded DMRS	1	
CSI-RS for tracking	CSI-RS periodicity	Slots	20
	CSI-RS offset	Slots	Table 5.2-1 [3]
Number of HARQ Processes		4	
The number of slots between PDSCH and corresponding HARQ-ACK information		2	
NOTE: "R.PDSCH.1-2.4 FDD" is defined in Table A.3.2.1.1-2 of 3GPP TS 38.101-4 [6].			

Table D.1-5: Test parameters for FR1 TDD 4x4

Parameter	Unit	Value
Duplex mode		TDD
Reference channel		R.PDSCH.2-2.4 TDD (Note 1)
Bandwidth	MHz	40
SCS	kHz	30
Modulation DL		16QAM
Modulation UL		QPSK
Active DL BWP index		1
PDSCH configuration	Mapping type	Type A
	k0	0
	Starting symbol (S)	2
	Length (L)	Specific to each Reference channel
	PDSCH aggregation factor	1
	PRB bundling type	Static
	PRB bundling size	2
	Resource allocation type	Type 0
	RBG size	Config2
	VRB-to-PRB mapping type	Non-interleaved
VRB-to-PRB mapping interleave bundle size	N/A	
PDSCH DMRS configuration	DMRS Type	Type 1
	Number of additional DMRS	1
	Maximum number of OFDM symbols for DL front loaded DMRS	1

Parameter		Unit	Value
CSI-RS for tracking	First OFDM symbol in the PRB used for CSI-RS		Table 5.2-1 [3]
	CSI-RS periodicity	Slots	40.
	CSI-RS offset	Slots	Table 5.2-1 [3]
Number of HARQ Processes			8
TDD UL-DL pattern			FR1.30-1 (Note 2)
NOTE 1: "R.PDSCH.2-2.4 TDD" is defined in Table A.3.2.2.2-2 of 3GPP TS 38.101-4 [6].			
NOTE 2: "FR1.30-1" is defined in clause A.1.2 of 3GPP TS 38.101-4 [6].			

---

## Annex E (normative): Environmental requirements

### E.1 Scope

The requirements in this clause apply to all types of UE(s) in FR1.

---

### E.2 Ambient temperature

All the MIMO OTA requirements are applicable in room temperature e.g. 25°C.

---

### E.3 Operating voltage

For FR1 MIMO OTA, all nominal voltage test cases shall be performed with the DUT operated in stand-alone battery powered mode.

For FR2 MIMO OTA, all nominal voltage test cases shall be performed with the DUT operated in stand-alone battery powered mode or external power source. It shall be demonstrated that the impact of external power source to device performance is negligible comparing to stand-alone battery powered mode.

## Annex F (informative): Change history

Change history							
Date	Meeting	TDoc	CR	Rev	Cat	Subject/Comment	New version
2022-11	RAN5#97	R5-227308	-	-	-	Initial Skeleton	0.0.1
2023-03	RAN5#98	R5-230842 R5-230843 R5-230844 R5-231803 R5-230847 R5-230848 R5-231804	-	-	-	Implementation of pCRs into TS 38.551 V0.1.0	0.1.0
2023-05	RAN5#99	R5-232699 R5-232701 R5-232702 R5-232703 R5-232704	-	-	-	Implementation of pCRs into TS 38.551 V0.2.0	0.2.0
2023-08	RAN5#100	R5-234597 R5-234598 R5-234599 R5-234600 R5-234601 R5-234602 R5-234603 R5-234604	-	-	-	Implementation of pCRs into TS 38.551 V0.3.0	0.3.0
2023-11	RAN5#101	R5-237844 R5-237846 R5-236788 R5-237845	-	-	-	Implementation of pCRs into TS 38.551 V0.4.0	0.4.0
2023-12	RAN#102	RP-233639	-	-	-	presented at RAN#102 for 1-step approval	1.0.0
2023-12	RAN#102	-	-	-	-	put under revision control as v17.0.0 with small editorial changes	17.0.0

---

# History

<b>Document history</b>		
V17.0.0	January 2024	Publication