

ETSI TS 143 010 V16.0.0 (2020-08)



**Digital cellular telecommunications system (Phase 2+) (GSM);
GSM Public Land Mobile Network (PLMN) connection types
(3GPP TS 43.010 version 16.0.0 Release 16)**



ReferenceRTS/TSGC-0343010vg00

KeywordsGSM

ETSI

650 Route des Lucioles
F-06921 Sophia Antipolis Cedex - FRANCE

Tel.: +33 4 92 94 42 00 Fax: +33 4 93 65 47 16

Siret N° 348 623 562 00017 - NAF 742 C
Association à but non lucratif enregistrée à la
Sous-Préfecture de Grasse (06) N° 7803/88

Important notice

The present document can be downloaded from:

<http://www.etsi.org/standards-search>

The present document may be made available in electronic versions and/or in print. The content of any electronic and/or print versions of the present document shall not be modified without the prior written authorization of ETSI. In case of any existing or perceived difference in contents between such versions and/or in print, the prevailing version of an ETSI deliverable is the one made publicly available in PDF format at www.etsi.org/deliver.

Users of the present document should be aware that the document may be subject to revision or change of status.

Information on the current status of this and other ETSI documents is available at

<https://portal.etsi.org/TB/ETSIDeliverableStatus.aspx>

If you find errors in the present document, please send your comment to one of the following services:

<https://portal.etsi.org/People/CommiteeSupportStaff.aspx>

Copyright Notification

No part may be reproduced or utilized in any form or by any means, electronic or mechanical, including photocopying and microfilm except as authorized by written permission of ETSI.

The content of the PDF version shall not be modified without the written authorization of ETSI.

The copyright and the foregoing restriction extend to reproduction in all media.

© ETSI 2020.

All rights reserved.

DECT™, **PLUGTESTS™**, **UMTS™** and the ETSI logo are trademarks of ETSI registered for the benefit of its Members.

3GPP™ and **LTE™** are trademarks of ETSI registered for the benefit of its Members and of the 3GPP Organizational Partners.

oneM2M™ logo is a trademark of ETSI registered for the benefit of its Members and of the oneM2M Partners.

GSM® and the GSM logo are trademarks registered and owned by the GSM Association.

Intellectual Property Rights

Essential patents

IPRs essential or potentially essential to normative deliverables may have been declared to ETSI. The information pertaining to these essential IPRs, if any, is publicly available for **ETSI members and non-members**, and can be found in ETSI SR 000 314: "*Intellectual Property Rights (IPRs); Essential, or potentially Essential, IPRs notified to ETSI in respect of ETSI standards*", which is available from the ETSI Secretariat. Latest updates are available on the ETSI Web server (<https://ipr.etsi.org/>).

Pursuant to the ETSI IPR Policy, no investigation, including IPR searches, has been carried out by ETSI. No guarantee can be given as to the existence of other IPRs not referenced in ETSI SR 000 314 (or the updates on the ETSI Web server) which are, or may be, or may become, essential to the present document.

Trademarks

The present document may include trademarks and/or tradenames which are asserted and/or registered by their owners. ETSI claims no ownership of these except for any which are indicated as being the property of ETSI, and conveys no right to use or reproduce any trademark and/or tradename. Mention of those trademarks in the present document does not constitute an endorsement by ETSI of products, services or organizations associated with those trademarks.

Legal Notice

This Technical Specification (TS) has been produced by ETSI 3rd Generation Partnership Project (3GPP).

The present document may refer to technical specifications or reports using their 3GPP identities. These shall be interpreted as being references to the corresponding ETSI deliverables.

The cross reference between 3GPP and ETSI identities can be found under <http://webapp.etsi.org/key/queryform.asp>.

Modal verbs terminology

In the present document "**shall**", "**shall not**", "**should**", "**should not**", "**may**", "**need not**", "**will**", "**will not**", "**can**" and "**cannot**" are to be interpreted as described in clause 3.2 of the [ETSI Drafting Rules](#) (Verbal forms for the expression of provisions).

"**must**" and "**must not**" are **NOT** allowed in ETSI deliverables except when used in direct citation.

Contents

Intellectual Property Rights	2
Legal Notice	2
Modal verbs terminology.....	2
Foreword.....	5
1 Scope	6
2 References	6
3 Definitions, symbols and abbreviations	9
3.1 Definitions	9
3.2 Abbreviations	9
4 General considerations	9
4.1 Relationship between lower layer capabilities and radio traffic channels	9
4.2 Transparent and non-transparent lower layer capabilities	10
4.3 The PLMN environment	10
4.3.1 The hand-over procedure	10
4.3.2 DTX procedure	10
5 Framework for the description of connection types	11
5.1 Introduction	11
5.2 Purpose of PLMN connection types	11
5.3 Functions associated with a PLMN connection.....	12
5.4 Applications of GSM PLMN connection types.....	13
5.5 PLMN connection involving several networks	14
6 PLMN connection types	15
6.1 Description of PLMN connection types	15
6.1.1 Rate adaptation	15
6.1.2 Radio Link Protocol.....	17
6.1.3 Layer 2 Relay function	17
6.1.4 Resources allocated by the PLMN network.....	17
6.2 PLMN connection elements	17
6.3 Rules of association for the attribute values of connection elements and connection types.....	18
6.3.1 Information transfer mode	18
6.3.2 Information transfer rate (kbit/s).....	18
6.3.3 Information transfer susceptance	18
6.3.4 Establishment of connection	19
6.3.5 Symmetry.....	19
6.3.6 Connection configuration Topology	19
6.3.7 Structure.....	19
6.3.8 Channels	20
6.3.8.1 Information channel (rate).....	20
6.3.8.2 Signalling channel (rate)	20
6.3.9 Connection control protocol	20
6.3.10 Information transfer coding/protocol.....	20
6.3.11 Further attributes and attribute values.....	21
6.4 PLMN connection types for GERAN A/Gb mode	22
6.4.1 Limited set of PLMN connection types (for TCH/F4.8 and TCH/F9.6 channel codings).....	22
6.4.2 Limited set of PLMN connection types (for TCH/F14.4 channel coding).....	27
6.4.3 Limited set of PLMN connection types (for EDGE channels)	29
6.5 PLMN connection types for GERAN Iu mode.....	31
6.5.1 Limited set of PLMN connection types (for TCH/F9.6 channel coding)	31
6.5.2 Limited set of PLMN connection types (for TCH/F14.4 channel coding).....	34
6.5.3 Limited set of PLMN connection types (for EDGE channels)	36
7 Relationship between Telecommunication services and connection types	38
7.1 General	38

7.2	Relationship between Bearer services and connection types.....	39
7.3	Relationship between Teleservices and connection types	39
7.4	Network capability to support in-call modification.....	39
7.5	Network capability to support channel mode modification.....	39
Annex A (informative):	List of definitions of PLMN connection type attributes and values	45
A.1	Attribute definition and their values.....	45
A.2	Definition of values	53
Annex B (informative):	Location of the transcoding, multiplexing and RA2 functions	54
Annex C (informative):	Change History	59
History		60

Foreword

This Technical Specification has been produced by the 3rd Generation Partnership Project (3GPP).

The contents of the present document are subject to continuing work within the TSG and may change following formal TSG approval. Should the TSG modify the contents of the present document, it will be re-released by the TSG with an identifying change of release date and an increase in version number as follows:

Version x.y.z

where:

- x the first digit:
 - 1 presented to TSG for information;
 - 2 presented to TSG for approval;
 - 3 or greater indicates TSG approved document under change control.
- y the second digit is incremented for all changes of substance, i.e. technical enhancements, corrections, updates, etc.
- z the third digit is incremented when editorial only changes have been incorporated in the document.

1 Scope

This specification is only applicable for a GERAN PLMN. In the 2nd generation is this a GSM PLMN. In the 3rd generation is this a PLMN that uses a GERAN as radio access network operating either in A/Gb mode or in Iu mode.

A PLMN may be described by a limited set of access interfaces (refer to 3GPP TS 24.002 and 22.001) and a limited set of PLMN connection types to support the telecommunication services described in the 3GPP 22-series of specifications. The present document identifies and defines these connection types in so far as they relate to the particular network capabilities for a PLMN.

The basic lower layer capabilities of a PLMN are represented by a set of PLMN connection types. The definition of a set of PLMN connection types provides the necessary input to identify network capabilities of a PLMN. In addition to describing network capabilities of a PLMN, the identification of connection types facilitates the specification of network-to-network interfaces. It may also assist in the allocation of network performance parameters.

The present document should be considered in conjunction with other 3GPP specifications with particular reference to 3GPP TS 22.001, 22.002, 22.003, 23.002, 24.002 and 44.004.

The present document provides a bridge between the service specification in the 3GPP TS 22-series of specifications and the more detailed specifications such as the 3GPP TS 43, 44, 23, 24, 27 and 29 series. As such, it establishes a framework for the specification and understanding of the more detailed specifications. It is therefore not a specification against which detailed conformance testing can be performed. However, it shall be considered mandatory for the understanding of the more detailed specifications and used to resolve issues of conflict in these specifications.

From R99 onwards the following services are no longer required by a PLMN:

- the dual Bearer Services “alternate speech/data” and “speech followed by data”
- the dedicated services for PAD and Packet access
- the single asynchronous and synchronous Bearer Services (BS 21..26, BS 31..34)

From Release 4 onwards the following services are no longer required by a PLMN:

- the synchronous Bearer Service non-transparent (BS 30 NT).
- the Basic Packet access
- the Teleservice Facsimile non-transparent (TS 61/62 NT).

If a PLMN network still provides these services it has to fulfil the specification of former releases.

2 References

The following documents contain provisions which, through reference in this text, constitute provisions of the present document.

- References are either specific (identified by date of publication, edition number, version number, etc.) or non-specific.
- For a specific reference, subsequent revisions do not apply.
- For a non-specific reference, the latest version applies. In the case of a reference to a 3GPP document (including a GSM document), a non-specific reference implicitly refers to the latest version of that document in the same Release as the present document.

[1] Void

[2] Void

[3] 3GPP TS 22.001: " Principles of telecommunications services supported by a Public Land Mobile Network (PLMN)".

[4] 3GPP TS 22.002: " Circuit Bearer Services (BS) supported by a Public Land Mobile Network (PLMN)".

- [5] 3GPP TS 22.003: " Circuit Teleservices supported by a Public Land Mobile Network (PLMN)".
- [6] Void.
- [7] 3GPP TS 23.002: "Network architecture".
- [8] 3GPP TS 23.009: "Handover procedures".
- [9] 3GPP TS 23.034: "High Speed Circuit Switched Data (HSCSD) - Stage 2 Service Description".
- [10] 3GPP TS 23.040: "Technical realization of the Short Message Service (SMS) Point-to-Point (PP)".
- [11] 3GPP TS 23.041: "Technical realization of Short Message Service Cell Broadcast (SMSCB)".
- [12] 3GPP TS 43.045: " Technical realization of facsimile group 3 transparent".
- [13] 3GPP TS 44.001: " Mobile Station - Base Station System (MS - BSS) interface General aspects and principles".
- [14] 3GPP TS 24.002: " GSM-UMTS Public Land Mobile Network (PLMN) access reference configuration".
- [15] 3GPP TS 44.004: " Layer 1 – General Requirements".
- [16] 3GPP TS 44.005: " Data Link (DL) layer; General aspects".
- [17] 3GPP TS 44.006: " Mobile Station - Base Station System (MS - BSS) interface Data Link (DL) layer specification".
- [18] 3GPP TS 24.007: " Mobile radio interface signalling layer 3; General aspects".
- [19] 3GPP TS 24.008: " Mobile radio interface layer 3 specification".
- [20] 3GPP TS 24.011: "Point-to-Point (PP) Short Message Service (SMS) support on mobile radio interface".
- [21] 3GPP TS 24.012: " Short Message Service Cell Broadcast (SMSCB) support on the mobile radio interface".
- [22] 3GPP TS 44.021: " Rate adaption on the Mobile Station - Base Station System (MS - BSS) interface".
- [23] 3GPP TS 24.022: " Radio Link Protocol (RLP) for circuit switched bearer and teleservices"
- [24] 3GPP TS 45.001: " Physical layer on the radio path (General description)".
- [25] 3GPP TS 45.003: " Channel coding".
- [26] 3GPP TS 45.008: " Radio subsystem link control".
- [27] 3GPP TS 46.031: " Discontinuous Transmission (DTX) for full rate speech traffic channels".
- [28] 3GPP TS 27.001: " General on Terminal Adaptation Functions (TAF) for Mobile Stations (MS)".
- [29] 3GPP TS 27.002: " Terminal Adaptation Functions (TAF) for services using asynchronous bearer capabilities".
- [30] 3GPP TS 27.003: " Terminal Adaptation Functions (TAF) for services using synchronous bearer capabilities".
- [31] 3GPP TS 48.004: " Base Station System - Mobile-services Switching Centre (BSS - MSC) interface Layer 1 specification".
- [32] 3GPP TS 48.006: " Signalling transport mechanism specification for the Base Station System - Mobile-services Switching Centre (BSS - MSC) interface".
- [33] 3GPP TS 48.008: " Mobile Switching Centre - Base Station System (MSC - BSS) interface Layer 3 specification".
- [34] 3GPP TS 48.020: " Rate adaption on the Base Station System - Mobile-services Switching Centre (BSS - MSC) interface".
- [35] Void.

- [36] 3GPP TS 29.007: "General requirements on interworking between the Public Land Mobile Network (PLMN) and the Integrated Services Digital Network (ISDN) or Public Switched Telephone Network (PSTN)".
- [37] ITU-T Recommendation I.460: "Multiplexing, rate adaption and support of existing interfaces".
- [38] ITU-T Recommendation V.110: "Support of Data Terminal Equipments (DTEs) with V-Series interfaces by an integrated services digital network".
- [39] ITU-T Recommendation V.21: "300 bits per second duplex modem standardised for use in the general switched telephone network".
- [40] ITU-T Recommendation V.22: "1 200 bits per second duplex modem standardised for use in the general switched telephone network and on point-to-point 2-wire leased telephone-type circuits".
- [41] ITU-T Recommendation V.22bis: "2 400 bits per second duplex modem using the frequency division technique standardised for use on the general switched telephone network and on point-to-point 2-wire leased telephone-type circuits".
- [42] ITU-T Recommendation V.24: "List of definitions for interchange circuits between Data Terminal Equipment (DTE) and Data Circuit-terminating Equipment (DCE)".
- [43] ITU-T Recommendation V.26ter: "2 400 bits per second duplex modem using the echo cancellation technique standardised for use on the general switched telephone network and on point-to-point 2-wire leased telephone-type circuits".
- [44] ITU-T Recommendation V.32: "A family of 2-wire, duplex modems operating at data signalling rates of up to 9 600 bit/s for use on the general switched telephone network and on leased telephone-type circuits".
- [45] ITU-T Recommendation V.42bis: "Data Compression for Data Circuit terminating Equipment (DCE) using Error Correction Procedures".
- [46] ITU-T Recommendation V.120: "Support by an ISDN of data terminal equipment with V-Series type interfaces with provision for statistical multiplexing".
- [47] ITU-T Recommendation X.21: "Interface between Data Terminal Equipment (DTE) and Data Circuit-terminating Equipment (DCE) for synchronous operation on public data networks".
- [48] ITU-T Recommendation X.21bis: "Use on public data networks of Data Terminal Equipment (DTE) which is designed for interfacing to synchronous V-series modems".
- [49] ITU-T Recommendation X.25: "Interface between Data Terminal Equipment (DTE) and Data Circuit-terminating Equipment (DCE) for terminals operating in the packet mode and connected to public data networks by dedicated circuit".
- [50] ITU-T Recommendation X.28: "DTE/DCE interface for a start-stop mode data terminal equipment accessing the Packet Assembly/Disassembly facility (PAD) in a public data network situated in the same country".
- [51] ITU-T Recommendation X.30: "Support of X.21, X.21bis and X.20bis based Data Terminal Equipments (DTEs) by an Integrated Services Digital Network (ISDN)".
- [52] ITU-T Recommendation X.31: "Support of packet mode terminal equipment by an ISDN".
- [53] ITU-T Recommendation X.32: "Interface between Data Terminal Equipment (DTE) and Data Circuit-terminating Equipment (DCE) for terminals operating in the packet mode and accessing a packet switched public data network through a public switched telephone network or an integrated services digital network or a circuit switched public data network".
- [54] ITU-T Recommendation V.34 (1994): "A modem operating at data signalling rates of up to 28 800 bits for use on the general switched telephone network and on leased point-to-point 2-wire telephone-type circuits".
- [55] ITU-T Recommendation I.440 (1989): "ISDN user-network interface data link layer - General aspects".
- [56] ITU-T Recommendation I.450 (1989): "ISDN user-network interface layer 3 General aspects".
- [57] ISO/IEC 6429 (1992): "Information technology - Control functions for coded character sets".
- [58] 3GPP TS 23.060: " General Packet Radio Service (GPRS) Service Description; Stage 2".

- [59] ITU-T Recommendation V.90 - A digital modem and analogue modem pair for use on the public switched telephone network (PSTN) at data signalling rates of up to 56 000 bit/s downstream and up to 33 600 bit/s upstream.
- [60] 3GPP TS 21.905: " Vocabulary for 3GPP Specifications "

3 Definitions, symbols and abbreviations

3.1 Definitions

For the purposes of the present document, the following definitions apply.

(DIGITAL) connection: A concatenation of (digital) transmission channels or (digital) telecommunication circuits, switching and other functional units set up to provide for the transfer of (digital) signals between two or more points in a telecommunication network to support a single communication.

PLMN connection: A connection that is established through PLMN between specified PLMN reference points.

PLMN connection type: A description of a set of PLMN connections which have the same characteristics.

EDGE channels: A general term referring to channels based on 8PSK modulation; i.e. TCH/F28.8, TCH/F32.0, and TCH/F43.2.

3.2 Abbreviations

Abbreviations used in this specification are listed in 3GPP TS 21.905.

4 General considerations

Low layer capabilities are defined in 3GPP TS 22.001 and characterized in 3GPP TS 22.002 for Bearer Services and 3GPP TS 22.003 for Teleservices. Apart from the short message service and GPRS, all Bearer Services and Teleservices are provided using low layer capabilities in the connection mode.

Network capabilities to support the short message services are defined in 3GPP TS 23.040 and 3GPP TS 24.011 for the point-to-point service, and in 3GPP TS 23.041 and 3GPP TS 24.012 for the cell broadcast service. Network capabilities to support GPRS are described in 3GPP TS 23.060.

4.1 Relationship between lower layer capabilities and radio traffic channels

The realization of low layer capabilities for the provision of telecommunication services will make use of a physical medium consisting of a traffic channel TCH (refer to 3GPP TS 44.004) or a combination of several full rate traffic channels (Multislot configuration for data) except for the short message point-to-point which uses a dedicated control channel DCCH (see 3GPP TS 24.011) or the cell broadcast service which uses the CBCH (see 3GPP TS 24.012). No multiplexing of data connections on one TCH is allowed.

Either a full rate or a half rate channel may be used depending on the requirements of the individual service. User data rates below or equal to 4 800 bit/s may be supported either on a full rate channel or on a half rate channel. Single slot

configurations of 9.6Kbit/s and above are always supported on a full rate channel. Multislot configurations for data use combinations of 4.8 kbit/s or 9.6 kbit/s or 14.4 kbit/s full rate traffic channels only.

Technically every MS, regardless of whether it uses a half or a full rate TCH for speech transmission, should be able to use both half and full rate TCHs for data transmission and telematic services. However, particular designs of MS may only provide access to a limited set of services and therefore only use limited options.

For the alternate speech and group 3 facsimile teleservice, when a full rate traffic channel is required for the speech or data portion of the service, a full rate traffic channel will be used for the duration of the call, see 3GPP TS 22.002.

Within a PLMN, the transport of user data and access interface status information (if present) will use a rate adaptation method based on ITU-T Recommendation V.110 except on TCH/F14.4 or EDGE channels for which PLMN specific rate adaptation is used between the mobile station and the interworking function. For the access interface, the rate adaptation schemes used are referenced in the 3GPP TS 27-series.

On the radio path, rate adaptation leads to rates of 43.5, 32.0, 29.0, 14.5, 12.0, 6.0 and 3.6 kbit/s per TCH (see 3GPP TS 44.021). However, in multislot configurations for data the 3.6 kbit/s per TCH/F rate is excluded. At the BSS to MSC interface, the rate adaptation scheme used is described in 3GPP TS 48.020.

Protection of information from errors on the radio path (i.e. between MS and BSS) will be implemented by use of FEC techniques (see 3GPP TS 45.003).

4.2 Transparent and non-transparent lower layer capabilities

Two classes of low layer capabilities have been identified (see 3GPP TS 22.002 and 3GPP TS 22.003):

- a transparent class which is characterized by constant throughput, constant transit delay and variable error rate;
- a non-transparent class for which an ARQ technique is used (see 3GPP TS 24.022) on the radio path and extended to an appropriate interworking function. This class is characterized by improved error rate with variable transit delay and throughput. Data compression can optionally be used in combination of non-transparent lower layer capability, to increase the data rate on the DTE/DCE interface (or the equivalent interface depending on the TE type).

The considerations described above provide the basis for the definition of a limited set of connection types to be implemented by a GERAN PLMN.

4.3 The PLMN environment

4.3.1 The hand-over procedure

The PLMN connection is heterogeneous and merges PCM links and radio path as a unit for the user.

One of the most specific characteristics of the mobile networks is the hand-over procedure (see 3GPP TS 23.009, 24.008, 45.008, 48.008) which result in a temporary break of the TCH, and consequently in a loss of information.

The PLMN makes it possible to use one TCH slot for signalling (frame stealing for FACCH) in one TDMA frame resulting in a loss of information.

For the transparent data calls, this will result in a period of highly errored stream. For the non-transparent services, the use of the ARQ procedure (3GPP TS 24.022) will overcome this problem.

After a hand-over, in case of loss of synchronization, the process to recover synchronization, as described in 3GPP TS 29.007 and 44.021 should apply. If data compression is used, V.42bis procedure should apply.

4.3.2 DTX procedure

For the full rate speech traffic channel, DTX function goes along with other procedures such as voice activity detection, generation of comfort noise, and is described in 3GPP TS 46.031.

For the non-transparent traffic channels, DTX apply according to 3GPP TS 48.020.

5 Framework for the description of connection types

5.1 Introduction

A PLMN provides a set of network capabilities, which enable telecommunication services to be offered to a user.

A PLMN connection is a connection established between PLMN reference points. A PLMN connection type is a way of referring to and describing PLMN connection. Thus a PLMN connection is a physical or a logical realization of a PLMN connection type. Each PLMN connection can be characterized as belonging to a PLMN connection type.

Figure 1 illustrates the concepts (see also figure 1 of 3GPP TS 22.001).

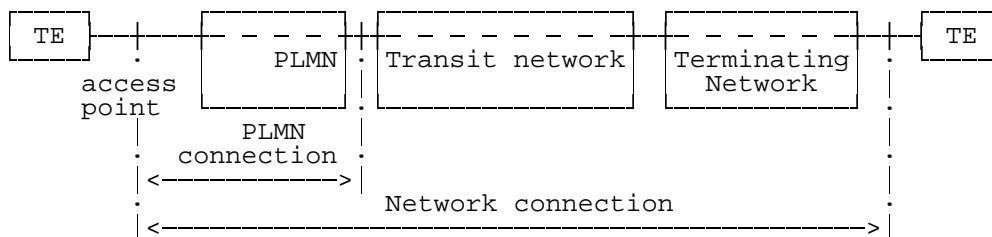

Figure 1: Framework for the description of GSM PLMN connections

5.2 Purpose of PLMN connection types

The definition of a set of PLMN connection types provides the necessary input to identify the network capabilities of a PLMN. Other key requirements of a PLMN are contained in other GSM specifications, in particular 3GPP TS 44.001 and 24.002. In addition to describing network capabilities of a PLMN, the identification of connection types facilitates

the specification of network-to-network interfaces. It may also assist in the allocation of network performance parameters.

NOTE 1: The user specifies only the telecommunication service required while the GSM PLMN allocates the resources to set up a connection of the specific type as necessary to support the requested service. It is further noted that, for certain service offerings, additional network functions, e.g. additional lower layer functions and/or higher layer functions, may be required (see figure 2).

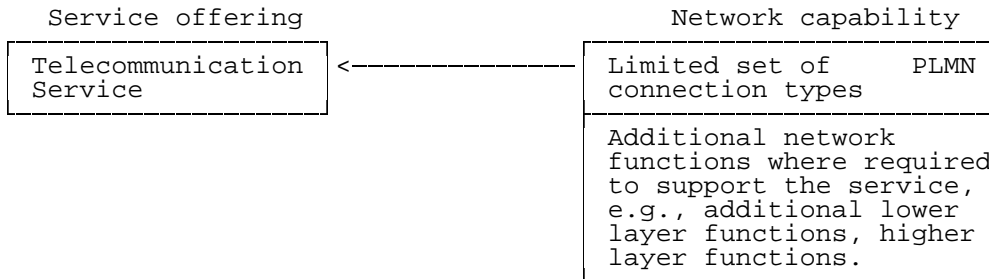

Figure 2: The role of network capabilities in supporting service offerings

5.3 Functions associated with a PLMN connection

Any GSM PLMN connection involves an association of functions to support telecommunication services as shown in figure 3. Three sets of functions are required.

- i) Connection means - including transmission and switching.
- ii) Control functions and protocols - including signalling, flow/congestion control and routing functions.
- iii) Operations and management functions - including network management and maintenance functions.

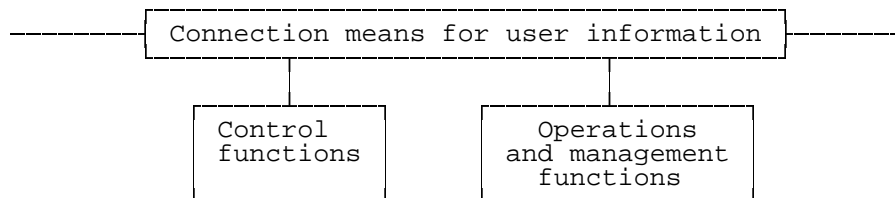

Figure 3: Functional description

5.4 Applications of GSM PLMN connection types

The following situations to which GSM PLMN connection types apply (see figure 4) may arise:

- Between two GSM PLMN user access points (refer to 3GPP TS 22.001 and 24.002): see figure 4a.
- Between a PLMN user access point and a network-to-network interface: see figure 4b.
- Between a PLMN user access point and an interface to a specialized resource within the GSM PLMN: see figure 4c.
- Between a PLMN user access point and an interface to a specialized resource outside the GSM PLMN: see figure 4d.

a)

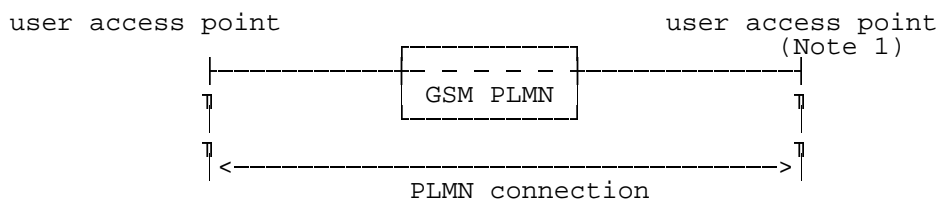

b)

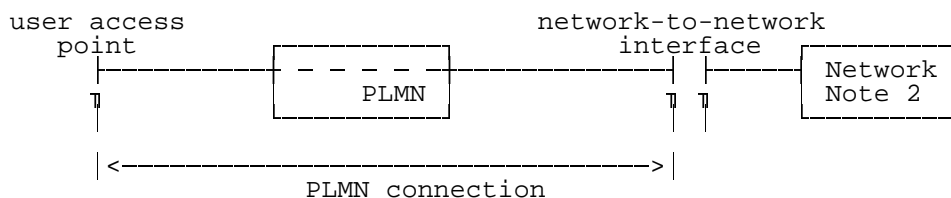

c)

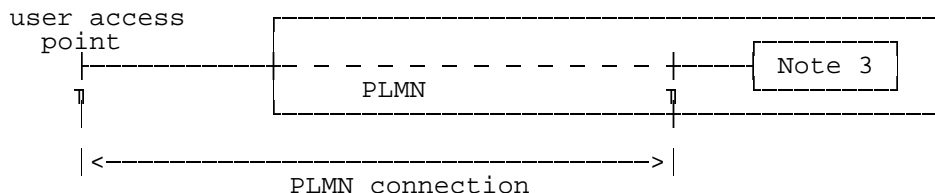

d)

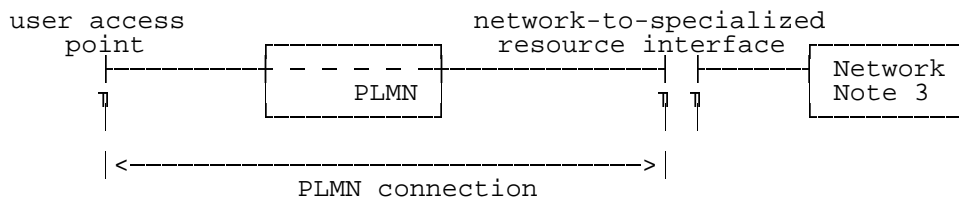

NOTE 1: See 3GPP TS 22.001.

NOTE 2: Network means here any fixed network as described in 3GPP TS 22.001.

NOTE 3: The box represents a specialized resource. Its use originates from a service request. Further study is required to give some examples.

Figure 4: Applications of PLMN connection types

5.5 PLMN connection involving several networks

A PLMN connection may comprise a number of tandem network connections. Figure 5 shows an example in which each end network is a PLMN. The intermediate network(s) must offer the appropriate network capabilities for the service provided by the (overall) PLMN connection. In (overall) PLMN connections involving several networks, each network provides a part of the connection and may be categorized by different attribute values.

The IWF/MSC can interwork with different type of networks, e.g.:

- analogue (A);
- digital circuit (D) with V.110/X.31 in band protocol;

Examples of such networks are:

- GSM (D);
- ISDN (A, D, P);
- PSTN (A).

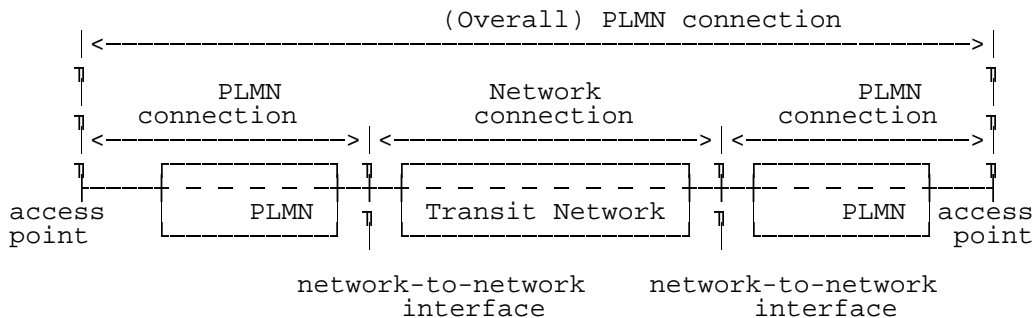

Figure 5: Example of a PLMN connection involving several networks

6 PLMN connection types

6.1 Description of PLMN connection types

The characterization of PLMN connection types is done by using a set of attributes. A PLMN connection type attribute is a specific characteristic of a PLMN connection type whose values distinguish it from another PLMN connection type. Particular values are assigned to each attribute when a given PLMN connection type is described and specified.

A list of definitions of attributes and values is contained in the annex A to this specification.

A PLMN connection type is partitioned into connection elements. This partitioning is based on the two most critical transitions of a connection, firstly, the change of signalling system, secondly, the type of transmission system. In a PLMN, the change in signalling and transmission between the radio interface and the A interface leads to two connection elements, the radio interface connection element and the A interface connection element. Subclause 6.3 describes the relationship between the attribute values of connection elements and connection types.

To complete the description of PLMN connection types, the definition of functions within the different entities of a PLMN which are involved in the realization of a PLMN Connection is needed. These functions will be used in subclauses 6.4 and 6.5 to describe the limited set of PLMN connection types.

The following functions have been identified:

- rate adaptation functions;
- the radio link protocol function;
- the forward error correction function;
- the Layer 2 relay function.

6.1.1 Rate adaptation

The RA0 rate adaptation is only used with asynchronous interfaces. Incoming asynchronous data is padded by the addition of stop elements to fit the same or nearest higher synchronous rate defined by 2 to the power n (where $n \leq 6$) times 600 bit/s, 14.4 kbit/s or 28.8 kbit/s. Thus 300 bit/s user data signalling rate shall be adapted to a synchronous 600 bit/s stream. This function is described in 3GPP TS 44.021. The RA0 used in the PLMN is not identical to that described in ITU-T Recommendation V.110 which converts the 14,4 and 28,8 kbit/s user rates to 19,2 and 38,4 kbit/s, respectively.

The intermediate rate adaptation function (RA1) is a rate adaptation function which turns either the output of the RA0 function or a synchronous user data stream into a data stream at 8, 16, or 32 kbit/s by bit repetition and frame addition. This function is described in 3GPP TS 48.020.

The adaptation of intermediate rates to 64 kbit/s (RA2) performs the final conversion from the intermediate rates generated by the RA1 function to 64 kbit/s.

The radio interface intermediate rate adaptation function (RA1') is in the case of transparent data transmission a variant of the RA1 function and it adapts synchronous user data stream or the output of the RA0 function to one of the following data rates: 3.6, 6.0 or 12.0 or 14.5 kbit/s over the radio path. In case of a TCH/F28.8 channel two 14.5 kbit/s substreams produced by the RA1' function are multiplexed into a 29.0 kbit/s air interface channel by an EDGE multiplexing function. For the non-transparent case, the RA1' function provides direct access to the 12.0 or 6.0 kbit/s data rates. This is achieved by allowing the V.110 frame status bits to be used as additional data bits. This function is described in 3GPP TS 44.021 and 3GPP TS 48.020. RA1' is not applied in TCH/F14.4 or EDGE non-transparent operation.

For TCH/F14.4 channel coding five PLMN-specific adaptation functions are used: namely, RA1'/RAA', RAA', RA1'/RAA'', RAE and RAA'' (3GPP TS 48.020). On the network side of the air interface, the 14.5 kbit/s substreams multiplexed into a 29.0 or 43.5 kbit/s air interface channel are transferred just as in a multislot connection of TCH/F14.4 substreams. RA1'/RAA' adapts between the 14.5 kbit/s air-interface rate and the 16 kbit/s rate used across the Abis-interface. RAA' adapts between the 16 kbit/s Abis Interface-rate and 16.0 kbit/s A-interface substream. (Up to four such A-interface substreams may be multiplexed into the 64kbit/s A-interface stream). RAA'' converts between the A-interface data substream(s) and the overall synchronous stream. In non-transparent operation the RAA'' converts

between the A-interface stream and the 290-bit blocks containing bits M1, M2, and 288 data bits as described in 3GPP TS 44.021. The RA1'/RAA'' function shall be used for channel codings TCH/F14.4 if the AIUR is equal to 64 kbit/s. It adapts between the 64 kbit/s data stream and the 14.5 kbit/s air-interface rate. For GERAN Iu mode exists another PLMN specific rate adaptation function, namely RAE. This function is the subsequent execution of RAA' and RAA'', i.e., it adapts between the 16 kbit/s Abis Interface rate and the overall synchronous stream.

In multislot data configurations the intermediate rates 16, 32, and 64 kbit/s are supported on those sections of the network where the overall data stream is not split into multiple channels (3GPP TS 44.021 and 48.020). RA1-adaptation is not applied to rates higher than 38.4 kbit/s. Instead, a PLMN-specific rate adaptation function RA1'' to user rates 48 and 56 kbit/s is applied; this function adapts between these rates and the 64 kbit/s "intermediate" rate. The RA2 function passes rate 64 kbit/s on as such.

In multislot data connections, the rate adaptation functions are performed per TCH/F between the Split/Combine-functions. On the A-interface up to four TCH/Fs are multiplexed into one 64 kbit/s channel according to the procedures defined in 3GPP TS 48.020. However, multiplexing is not applied to those user rates which make use of more than four TCH/Fs; for such rates the Split/Combine-function is located at the BSS.

The splitting and recombining of the data flow into/from TCH/Fs takes place at the RA1-function or RAA'' function (transparent service) at the MSC/IWF and at the MS's RA1'-function, or between the RLP and RA1' (RA1' not applied to TCH/F14.4) (non-transparent service) at the MS and between RA1 or RAA'' and RLP at MSC/IWF (figures 6 and 7). The TCH/Fs are treated as independent channels between the Split/Combine-functions.

For user rates requiring more than four TCH/Fs (transparent only) the Split/Combine-function is located at the RA1'-function at the MS and at the RA1'/RA1'' or RA1'/RAA''-function at the BSS (figures 6 and 7). The rate adaptation functions for the various user data rates are summarized in tables 1 to 3. It should be noted that in the case of synchronous data transmission, the RA0 is not present.

For 56 and 64 kbit/s connections using a 2xTCH/F32.0 channel configuration across the radio interface, no rate adaptation is applied as the PLMN offers a '64 kbit/s pipe' between TE and an external network.

For 32 kbit/s connections using a 1xTCH/F32.0 channel configuration across the radio interface, the ITU-T I.460 rate adaptation is applied as described in 3GPP TS 44.021.

Table 1: Rate adaptation functions for the support of TE2 in the transparent case

R I/F async	RA0 ←-----→	sync	RA1'	Radio I/F
≤ 2.4	←-----→	≤ 2.4	←-----→	3.6
4.8	←-----→	4.8	←-----→	6.0
9.6	←-----→	9.6	←-----→	12.0 or 2 x 6.0
14.4	←-----→	14.4	←-----→	14.5 or 2 x 12.0 or 3 x 6.0
19.2	←-----→	19.2	←-----→	2 x 12.0 or 4 x 6.0
28.8	←-----→	28.8	←-----→	1 x 29.0 or 2 x 14.5 or 3 x 12.0
		32	←-----→	1 x 32
38.4	←-----→	38.4	←-----→	3 x 14.5 or 4 x 12.0
		48.0	←-----→	4 x 14.5 or 5 x 12.0
		56.0	←-----→	2 x 32.0 or 4 x 14.5 or 5 x 12.0 note 1
		64.0	←-----→	2 x 32.0 or 5 x 14.5 or 6 x 12.0 note 1

NOTE 1: AIUR of 11.2 kbit/s per 12.0 kbit/s air interface channel (3GPP TS 44.021).

Table 2: Void.

Void

Table 3: RA1' function in the non-transparent case

	RA1'	
6.0	<----->	6.0
12.0	<----->	12.0

NOTE: RA1' not applicable to TCH/F14.4, TCH/F28.8, or TCH/F43.2

6.1.2 Radio Link Protocol

The Radio Link Protocol (RLP) is a layer 2 LAPB based protocol which performs grouping of user data for the purpose of implementing error control and retransmission mechanisms in the case of non-transparent low layer capabilities. The RLP layer is in charge of the transmission of the data compression parameters to the peer RLP entity and to the L2R layer, when those parameters have to be negotiated. The function that realizes the implementation of the protocol (described in 3GPP TS 24.022) takes place at both ends of the PLMN connection in the MT and the IWF/MSC.

6.1.3 Layer 2 Relay function

The Layer 2 Relay function (L2R) performs protocol conversion between the user data structure (e.g. characters or X.25 Layer 2 frames) and a structure more adapted to the radio link protocol. This function is described in the relevant 3GPP TS 27-series specifications.

The L2R function includes the data compression function.

6.1.4 Resources allocated by the PLMN network

Part of the PLMN connection concerns the resources allocated by the PLMN network on the basis of the attribute values of the connection elements.

For the speech calls, the PLMN codec is allocated.

For data calls, resources are provided at the IWF/MSC such as:

- V.110 based rate adaptation for such channel codings as TCH/F 4.8 and TCH/F9.6 and PLMN specific rate adaption for channel codings TCH/F14.4, TCH/F28.8, TCH/F43.2 (3GPP TS 44.021, 48.020);
- filtering of status bits (TS 27.001);
- RLP for non-transparent services (TS 24.022);
- Data compression (TS 24.022, 27.002).

These are sufficient for data services such as:

- asynchronous circuit (bearer service series 20), used with unrestricted digital information transfer capability;
- synchronous circuit (bearer service series 30), used with unrestricted digital information transfer capability when interworking with circuit switched digital networks.

In addition to the above listed resources, further resources are allocated in the other cases:

- modems for asynchronous circuit (bearer service series 20) or synchronous circuit (bearer service series 30) used with 3.1 kHz information transfer capability;
- fax adaptor for the fax group 3 (teleservice series 60);

6.2 PLMN connection elements

The radio interface connection element is the portion of the connection spanning from the Mobile Termination to an appropriate internal reference point within the Base Station System.

The A interface connection element is the portion of the connection from the above internal reference point within the base station to an appropriate internal reference point within the interworking function (IWF) of the MSC.

By using connection elements and attributes which have a layered nature the construction of a connection type is more easily viewed. The use of different values for the same attribute allows a greater degree of description and flexibility.

6.3 Rules of association for the attribute values of connection elements and connection types

This subclause describes the relationship between the attribute values of connection elements and connection types. For each attribute the various possible values recommended are listed. The definitions of the attributes and attribute values are contained in the annex A. In addition to the (possible) attribute values applicable to the connection elements, an association law is given (where appropriate) for each attribute to show how the value of the attribute for the overall connection type is obtained from the values of the attribute applicable to the connection elements.

6.3.1 Information transfer mode

Attribute values for connection elements:

Circuit.

Attribute values for overall connection type:

Circuit.

Association Law:

Circuit.

6.3.2 Information transfer rate (kbit/s)

Attribute values for connection elements:

3.6 or 6.0 or 12.0 or 13.0 or 14.5 or 29.0 or 32.0 or 43.5 or 64.0

or $n \times 6.0$ ($1 \leq n \leq 4$) or $n \times 12.0$ ($1 \leq n \leq 6$) or $n \times 14.5$ ($1 \leq n \leq 5$) or 2×29.0 or 2×32.0

Attribute values for overall connection type:

3.6 or 6.0 or 12.0 or 13.0 or 14.5 29.0 or 32.0 or 43.5 or 64.0;

or $n \times 6.0$ ($1 \leq n \leq 4$) or $n \times 12.0$ ($1 \leq n \leq 6$) or $n \times 14.5$ ($1 \leq n \leq 5$) or 2×29.0 or 2×32.0 .

Association Law:

The value for the overall connection type will be equal to the lowest value of any of its connection elements.

6.3.3 Information transfer susceptance

Attribute values for connection elements:

Speech processing functions (e.g. PLMN Speech Coding/A Law conversion, Discontinuous Transmission) and/or Echo suppression functions and/or Multiple satellite hops or null.

Attribute values for overall connection types:

Unrestricted Digital Information or Speech.

Association Law:

For an overall connection type to have the value Unrestricted digital no connection element may contain speech processing functions or echo suppression functions. Connection elements containing speech processing devices having the flexibility to change operation between speech and unrestricted digital would on the other hand be allowed to be part of a number of different connection types.

For an overall connection type to have the value speech it must contain PLMN Speech Coding/A Law conversion equipment and echo suppression functions when appropriate.

6.3.4 Establishment of connection

Attribute values for connection elements:

Demand.

Attribute values for overall connection type:

Demand.

Association Law:

If any of the connection elements are Demand, then the overall connection type is Demand.

6.3.5 Symmetry

Attribute values for connection elements:

Bidirectional Symmetric.

Bidirectional Asymmetric (Multislot connections for data).

Attribute values for overall connection type:

Bidirectional Symmetric.

Bidirectional Asymmetric (Multislot connections for data).

Association Law:

The overall symmetry can only be generated from the connection elements by analysis of the connection element values in the context of the architecture of the connection.

6.3.6 Connection configuration Topology

Attribute values for connection elements:

Point-to-point.

Attribute values for the overall connection type:

Not applicable.

Association Law:

Not applicable.

6.3.7 Structure

Attribute values for connection elements:

Unstructured or Service Data Unit Integrity.

Attribute values for the overall connection type:

As per values for connection elements.

Association Law:

Unspecified.

6.3.8 Channels

6.3.8.1 Information channel (rate)

Attribute values for connection elements:

Radio interface connection element: Full rate TCH or Full rate TCHs or Half rate TCH.

A interface connection element: 64.0 kbit/s.

Attribute values for the overall connection type:

Not applicable.

6.3.8.2 Signalling channel (rate)

Attribute values for connection elements:

Radio interface connection element: Dm.

A interface connection element: Common channel signalling system (64.0 kbit/s).

Attribute values for the overall connection type:

Not applicable.

6.3.9 Connection control protocol

Attribute values for connection elements:

Radio interface connection element:

Layer 1: 3GPP TS 44.004 and 3GPP TS 45-series.

Layer 2: 3GPP TS 44.005 and 44.006.

Layer 3: 3GPP TS 24.007 and 24.008, 24.011.

A interface connection element:

Layer 1: 3GPP TS 48.004.

Layer 2: 3GPP TS 48.006.

Layer 3: TS 24.007, 24.008 and 48.008.

Attribute values for the overall connection type:

Not applicable.

6.3.10 Information transfer coding/protocol

Attribute values for connection elements:

Radio interface connection elements:

Layer 1: 3GPP TS 44.021, 3GPP TS 45-series and 46-series.

Layer 2: 3GPP TS 44.006, 24.022 and 3GPP TS 27.002 or 3GPP TS 24.022 and 3GPP TS 27.003 or transparent.

Layer 3: Transparent, 3GPP TS 24.011.

A interface connection element:

Layer 1: 3GPP TS 48.004 and 3GPP TS 48.020.

Layer 2: 3GPP TS 24.022 and 3GPP TS 27.002 or 3GPP TS 24.022 and 3GPP TS 27.003 or transparent.

Layer 3: Transparent.

Attribute values for the overall connection type:

Not applicable.

6.3.11 Further attributes and attribute values

This subclause has outlined the relationships between those attributes values presently existing, the possibility for new values being added remains.

Table 4 summarizes the attributes values for PLMN connection elements.

Table 4: Values for attributes for PLMN connection elements

Attributes	Values for attributes	
	Radio interface connection element	A interface connection element
1 Information Transfer Mode	Circuit	Circuit
2 Information Transfer Rate Layer 1	3.6 or 6.0 or 12.0 or 13.0 or 14.5 or 29.0 or 32.0 or 43.5 or $n \times 6.0$ ($1 \leq n \leq 4$) or $n \times 12.0$ ($1 \leq n \leq 6$) or $n \times 14.5$ ($1 \leq n \leq 5$) or 2×29.0 or 2×32.0 kbit/s	64.0 kbit/s
3 Information Transfer Susceptance	Speech processing equipment, Echo suppression equipment, Null	Speech processing equipment, Echo suppression equipment, Null
4 Establishment of Connection	Demand	Demand
5 Symmetry	Bidirectional symmetric Bidirectional asymmetric	Bidirectional symmetric Bidirectional asymmetric
6 Connection Configuration Topology	Point-to-point	Point-to-point
7 Structure	Unstructured SDU integrity	Unstructured SDU integrity
8 Channel Rate Information Channel Signalling Channel	TCH/F(s) or TCH/H Dm	64.0 kbit/s Common channel signalling system
9 Connection Control Protocol Layer 1 Layer 2 Layer 3	3GPP TS 44.004 and 45 series 3GPP TS 44.005 and 44.006 3GPP TS 24.007, 24.008, 24.011	3GPP TS 48.004 3GPP TS 48.006 3GPP TS 24.007, 24.008, 48.008
10 Information Transfer Coding/Protocol Layer 1 Layer 2 Layer 3	3GPP TS 44.021 45 and 46 series 3GPP TS 24.022 and 27.002 or 24.022 and 27.003 44.006 or transparent Transparent, 24.011	3GPP TS 48.004 and 48.020 3GPP TS 24.022 and 27.002 or 24.022 and 27.003 or transparent Transparent

6.4 PLMN connection types for GERAN A/Gb mode

6.4.1 Limited set of PLMN connection types (for TCH/F4.8 and TCH/F9.6 channel codings)

From the two connection elements defined in subclause 6.2, the list of attributes and their possible values given in subclause 6.3, and from the service requirements defined in 3GPP TS 22.002 and 22.003, a limited set of PLMN connection types have been identified (see also table 5 and table 6 for the relationship between connection elements and telecommunication services).

Figure 6 gives the information transfer protocol models for the identified set of PLMN connection types. The S bits correspond to status bits and the D bits to data bits (3GPP TS 44.021); S* indicates that S bits are used only when 3.1 kHz audio ex PLMN. D' bits corresponds to user bits passed in the place of status bits in the non transparent case. Moreover, it should be noted that the RLP rate of 6 and 12 kbit/s correspond to the 8 and 16 kbit/s intermediate rate in the transparent case.

Protocol Models 1 b and e are the models for asynchronous data transmission in the transparent mode.

Protocol Models 2 b and e are the models for synchronous data transmission in the transparent mode.

Protocol Models 3 b and e are the models for character "asynchronous" mode data transmission in the non-transparent mode. In this case, L2RCOP represents the protocol used between the Layer 2 Relay functions (L2R) to convey characters between the MS and the IWF (see 3GPP TS 27.002). The data compression function is located in the L2R COP function.

In all of the above models, the b variants are for singleslot, the e variants are for multislot data configurations.

Protocol Model 5a is the model for the transparent support of group 3 facsimile transmission. Model 5b is for transparent support of group 3 facsimile transmission in multislot data configurations.

Protocol Model 6 is the model for speech transmission.

In the multislot-data models the data is split into parallel substreams between the Split/Combine-functions (S/C). These substreams are transmitted through parallel TCH/Fs which are treated as independent channels. Between the S/C-functions parallel RA- and FEC-functions are used.

For all the models, only the minimum functionality of the IWF is shown. Additional functions will be required for various interworking situations. These additional functions are described in specification 3GPP TS 29.007.

It should be noted that, in Figure 6, the representation of the transcoding and rate adaptation from the intermediate rate on the radio interface to the 64 kbit/s rate required by the MSC is not intended to indicate a particular implementation. The annex B to 3GPP TS 43.010 identifies alternative arrangements.

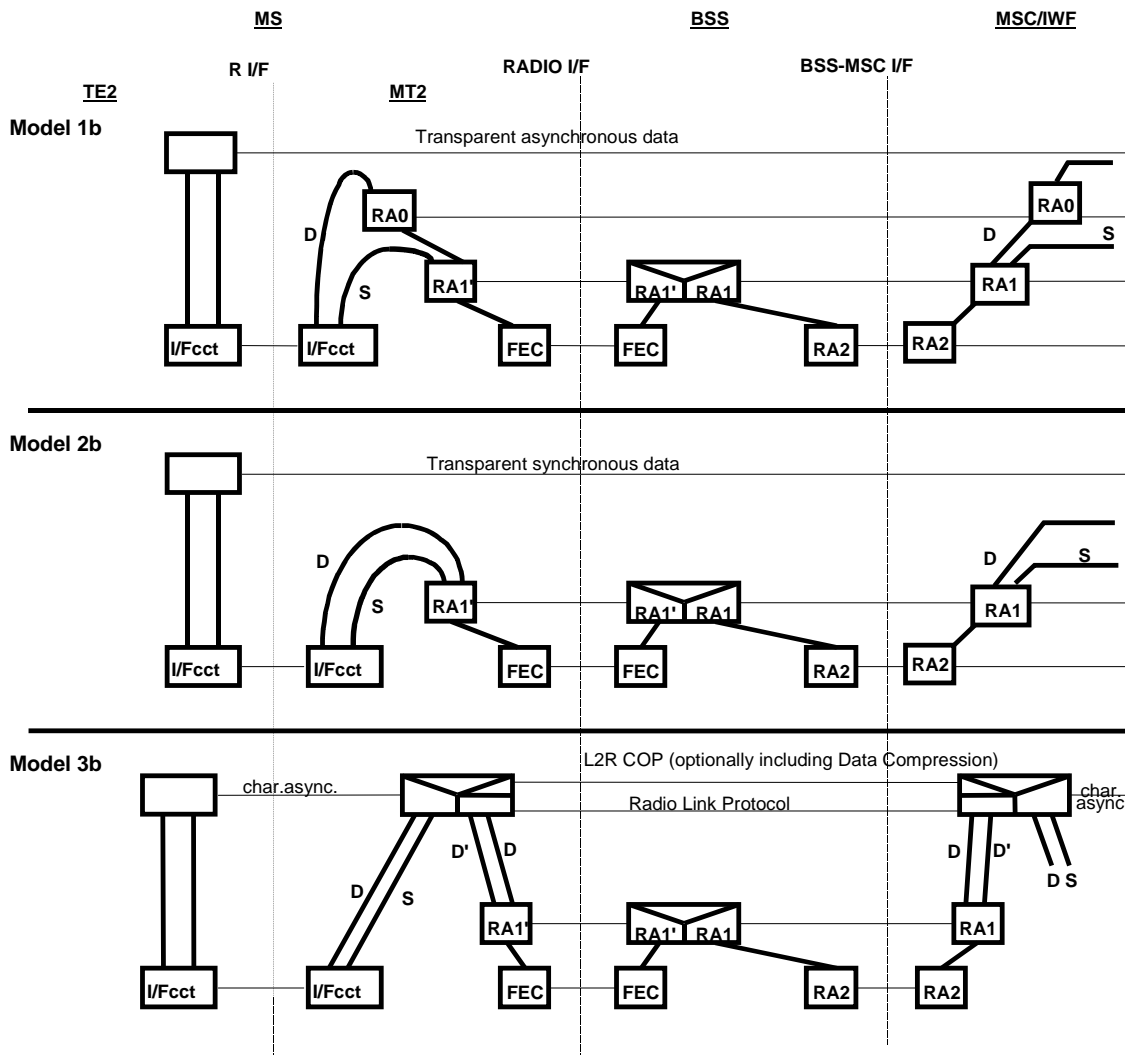

Figure 6: Information transfer protocol models for PLMN connections

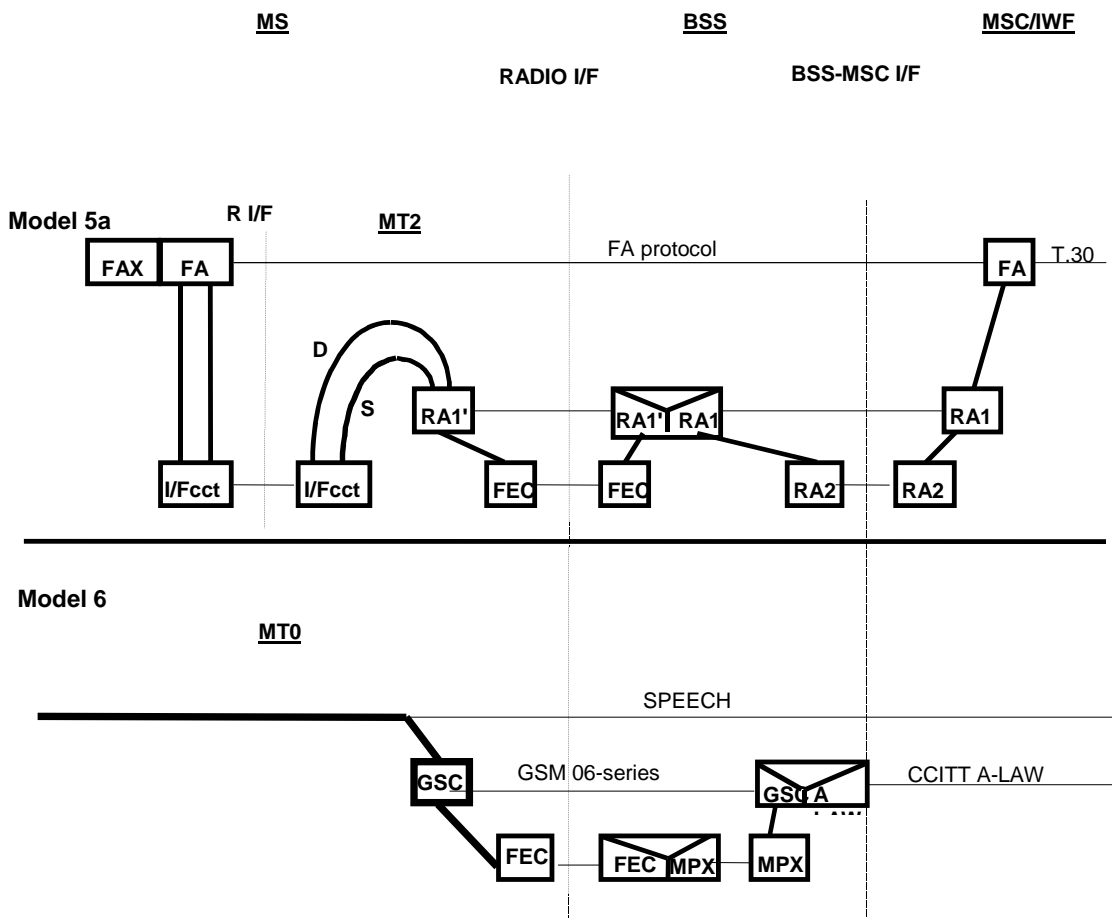

Figure 6 (continued): Information transfer protocol models for PLMN connections

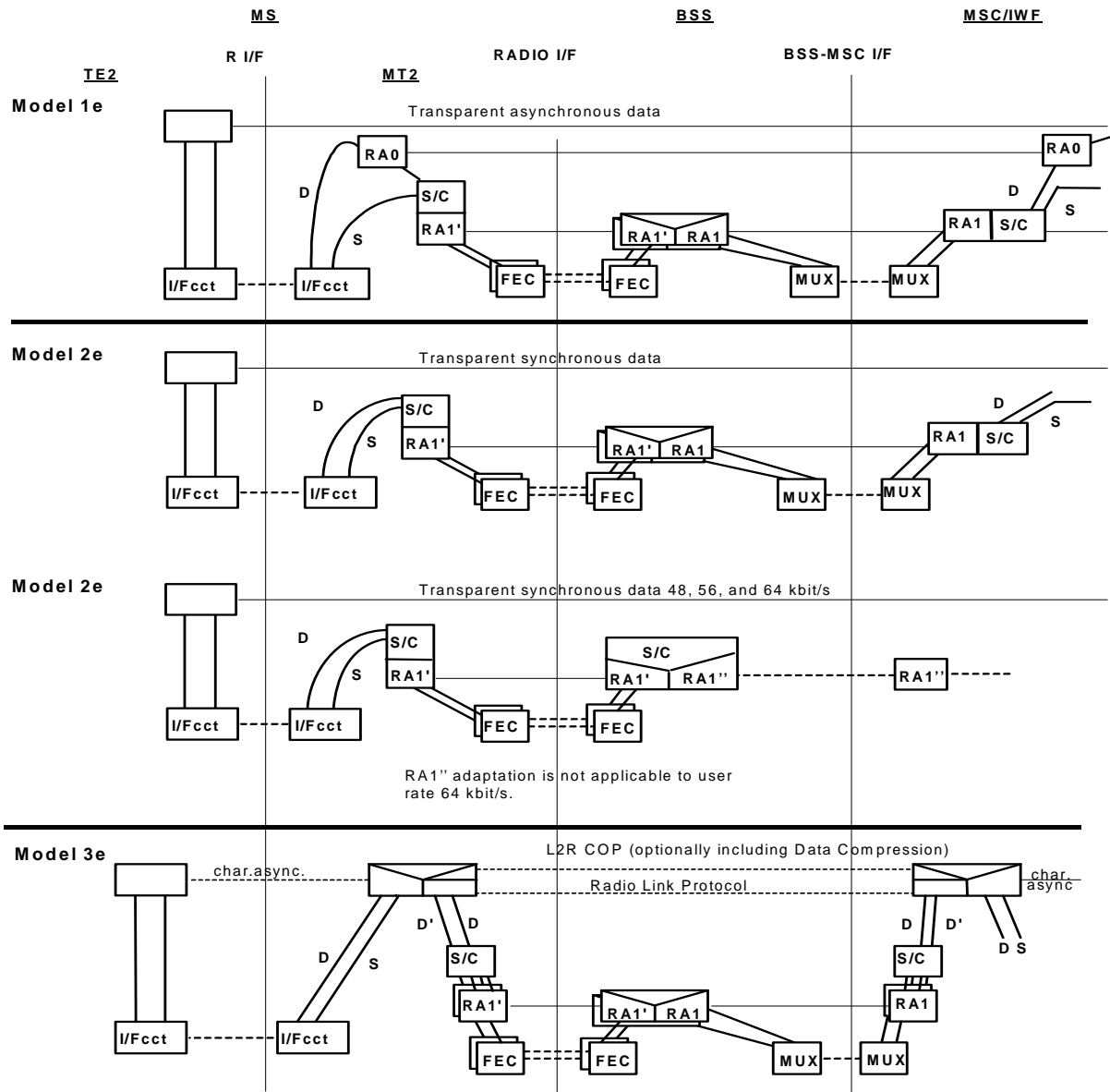

Figure 6 (continued): Information transfer protocol models for PLMN connections

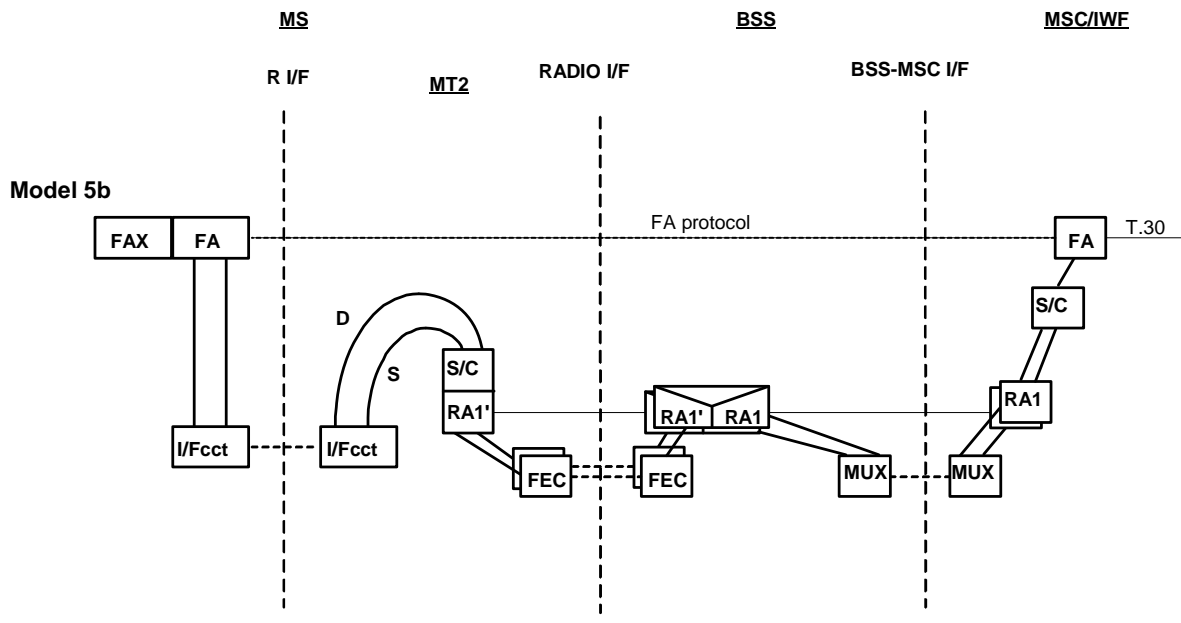

Figure 6 (concluded): Information transfer protocol models for PLMN connections

Legend to Figure 6:	
FA	= Fax Adaptor
GSC	= GSM Speech Codec
FEC	= Forward Error Correction
MPX	= Multiplex/Demultiplex
MUX	= Multiplex/Demultiplex
S/C	= Split/ Combine

6.4.2 Limited set of PLMN connection types (for TCH/F14.4 channel coding)

Figure 7 provides the information transfer protocol models for the identified set of PLMN connection types for support of TCH/F14.4. The description of models given in subclause 6.4.1 applies also to figure 7.

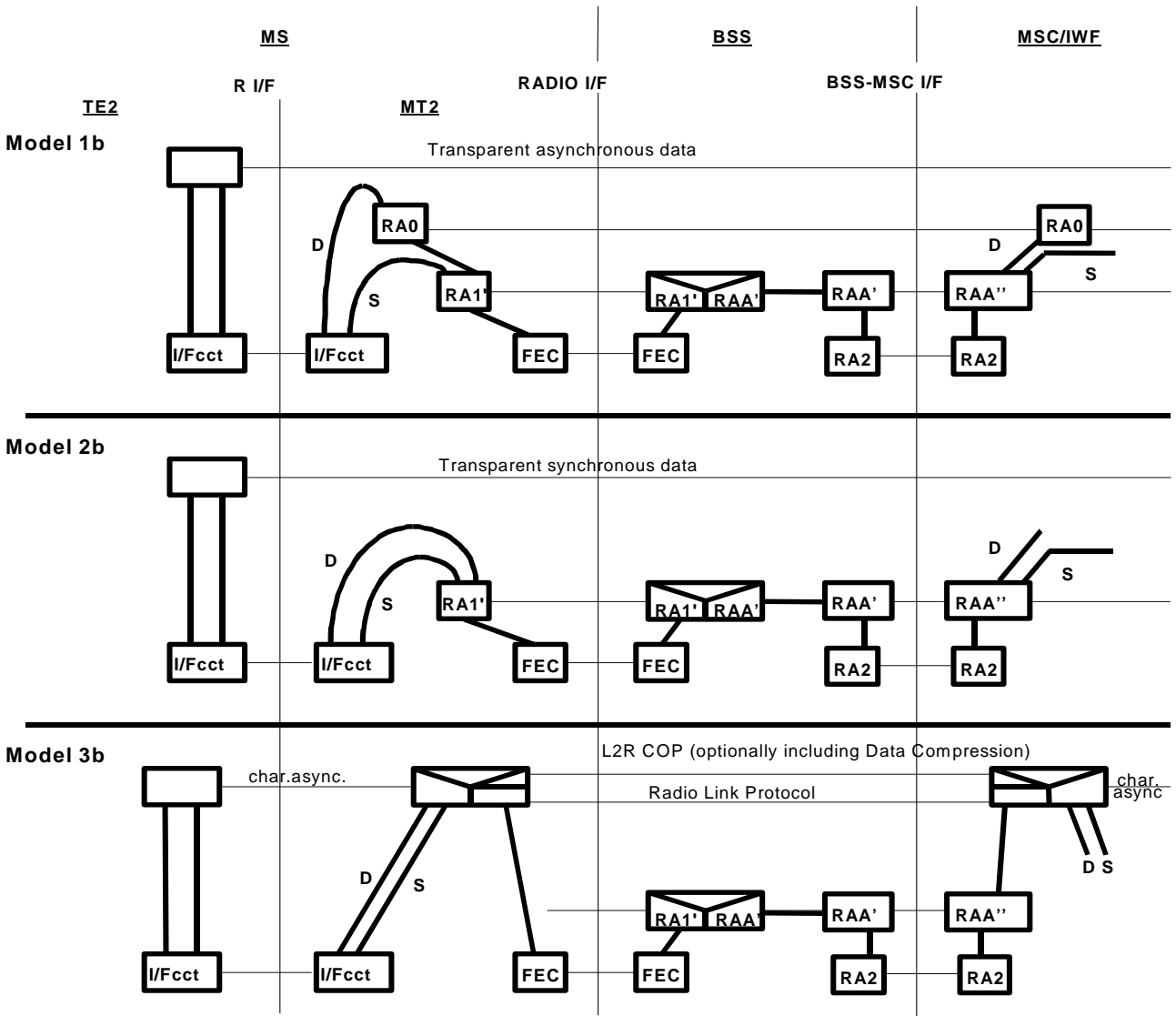

Figure 7 : Information transfer protocol models for PLMN connections using 14.4 channels

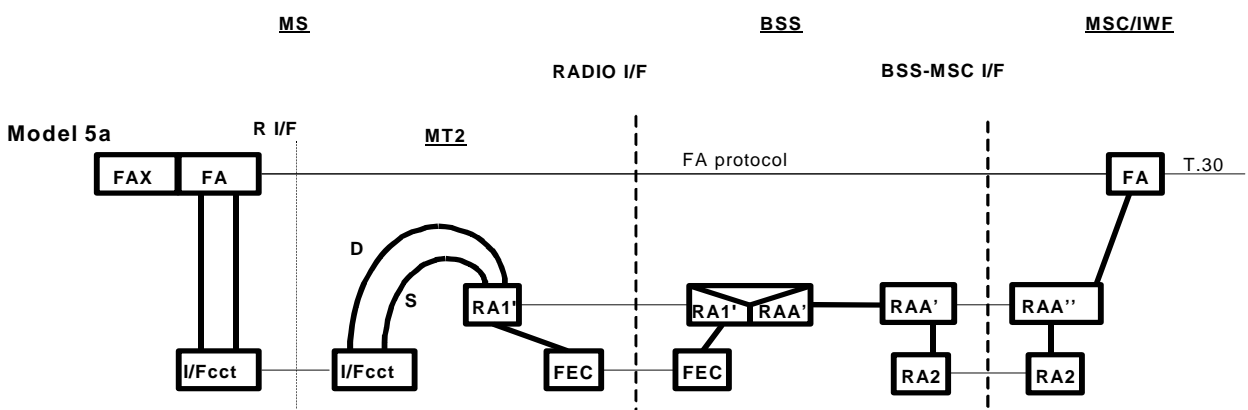

Figure 7 (continued) : Information transfer protocol models for PLMN connections using 14.4 channels

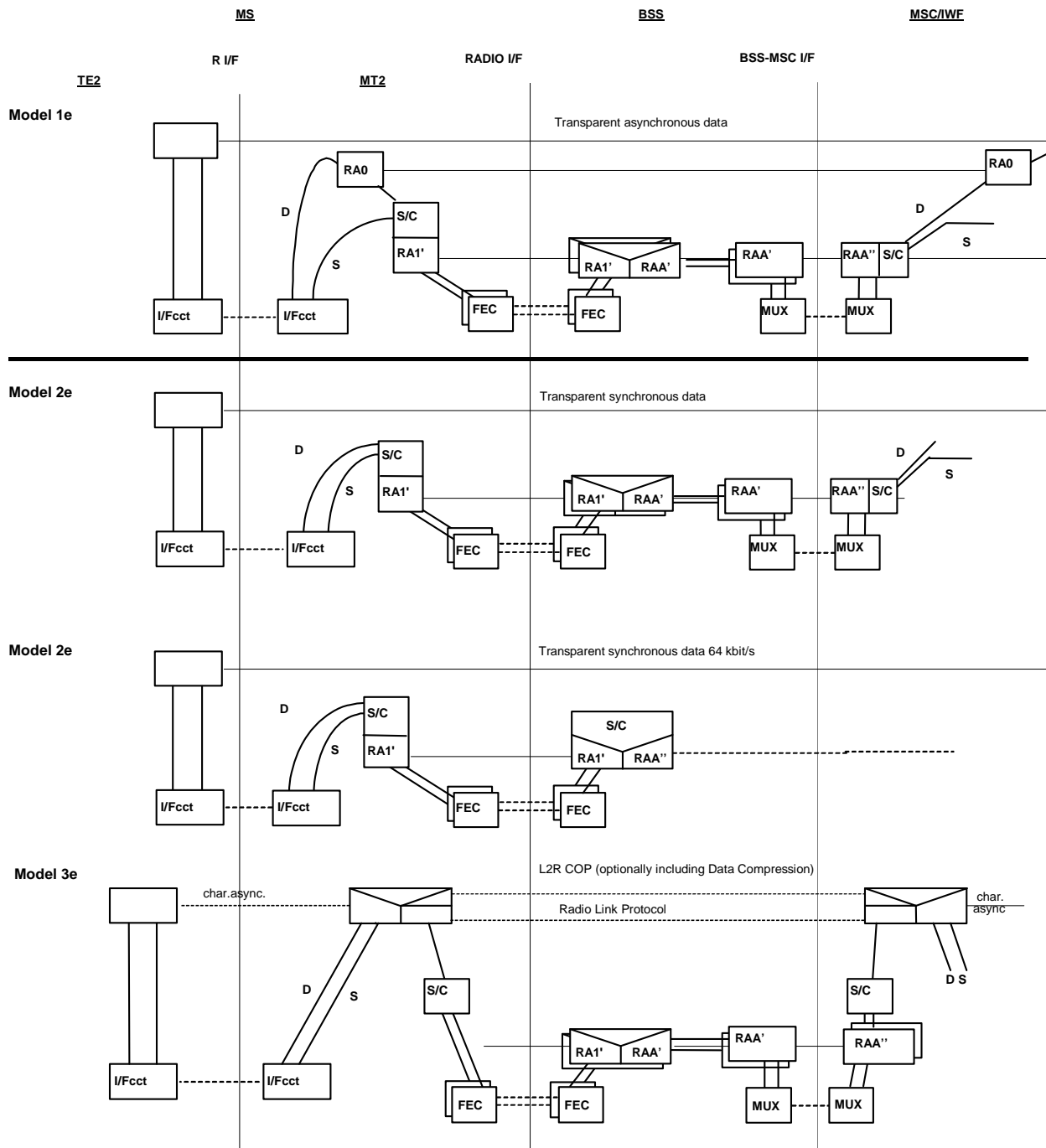

Figure 7 (continued) : Information transfer protocol models for PLMN connections using 14.4 channels

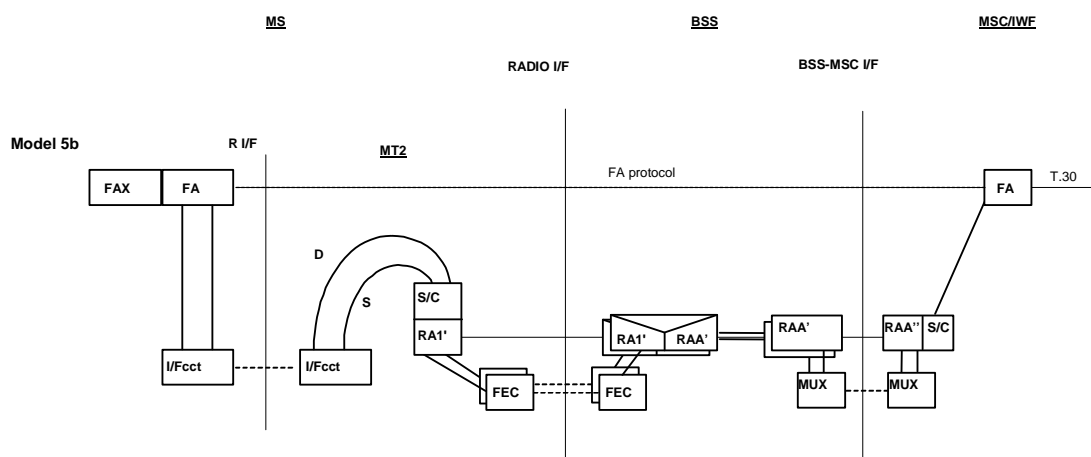

Figure 7 (concluded) : Information transfer protocol models for PLMN connections using 14.4 channels

Legend to Figure 7:

FA	= Fax Adaptor
GSC	= GSM Speech Codec
FEC	= Forward Error Correction
MPX	= Multiplex/Demultiplex
MUX	= Multiplex/Demultiplex
S/C	= Split/ Combine

6.4.3 Limited set of PLMN connection types (for EDGE channels)

Figure 8 provides the information transfer protocol models for the identified set of PLMN connection types for support of TCH/F28.8 or TCH/F43.2 and figure 9 the models for the support of TCH/F32.0. The description of models given in subclause 6.4.1 applies also to figures 8 and 9.

When a TCH/F28.8 channel is used in multislot configurations, multiple EDGE multiplexing functions are applied on both sides of the air-interface; i.e. one multiplexing function — on each side of the air interface — is associated with each air-interface channel.

When TCH/F32.0 channels are used in double slot configurations, no rate adaptation is applied as the PLMN offers a '64 kbit/s pipe' between TE and an external network. When TCH/F32.0 channels are used in single slot configurations, the ITU-T I.460 rate adaptation is applied. (For details refer to 3GPP TS 44.021).

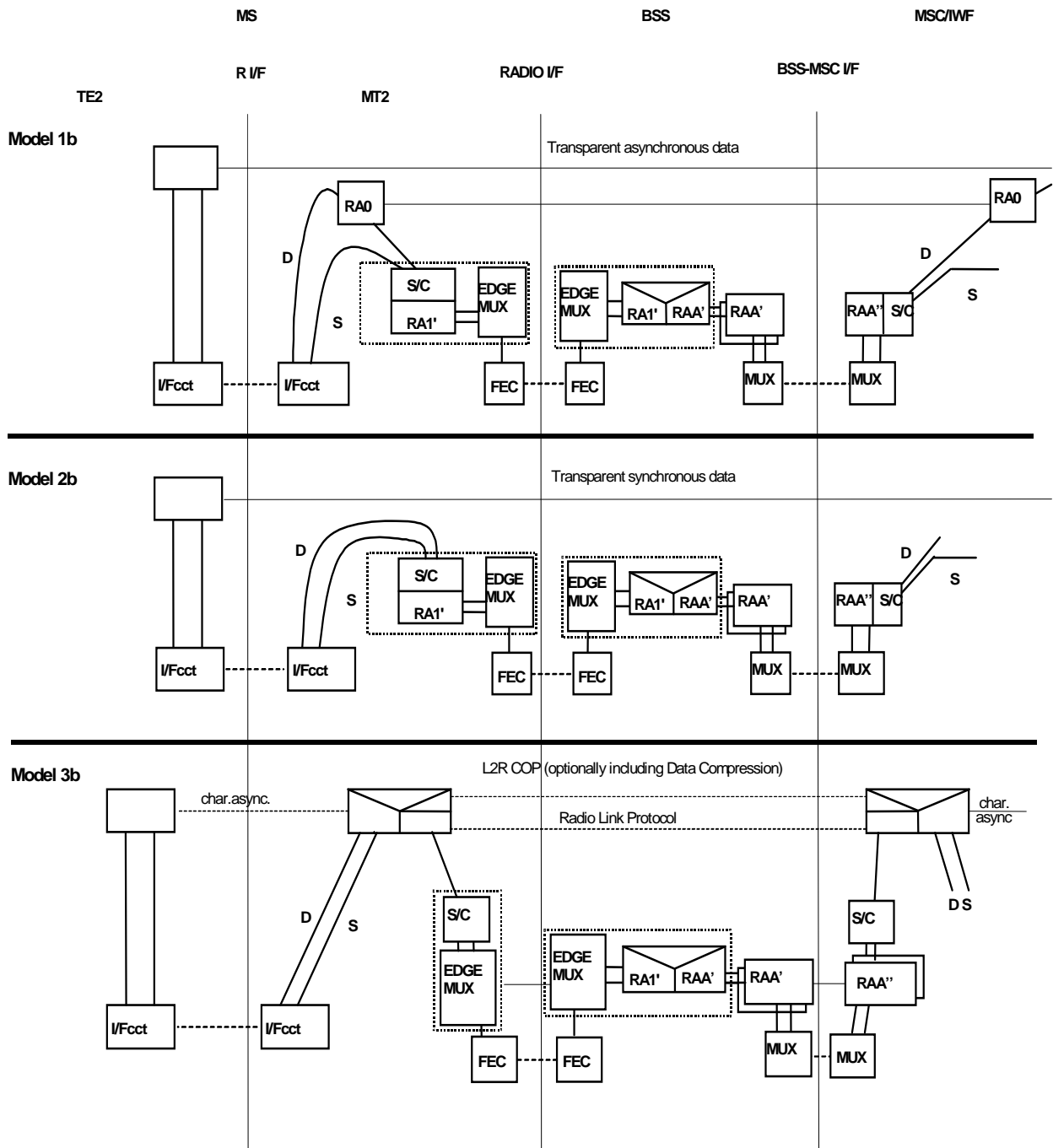

Figure 8: Information transfer protocol models for PLMN connections using EDGE channels

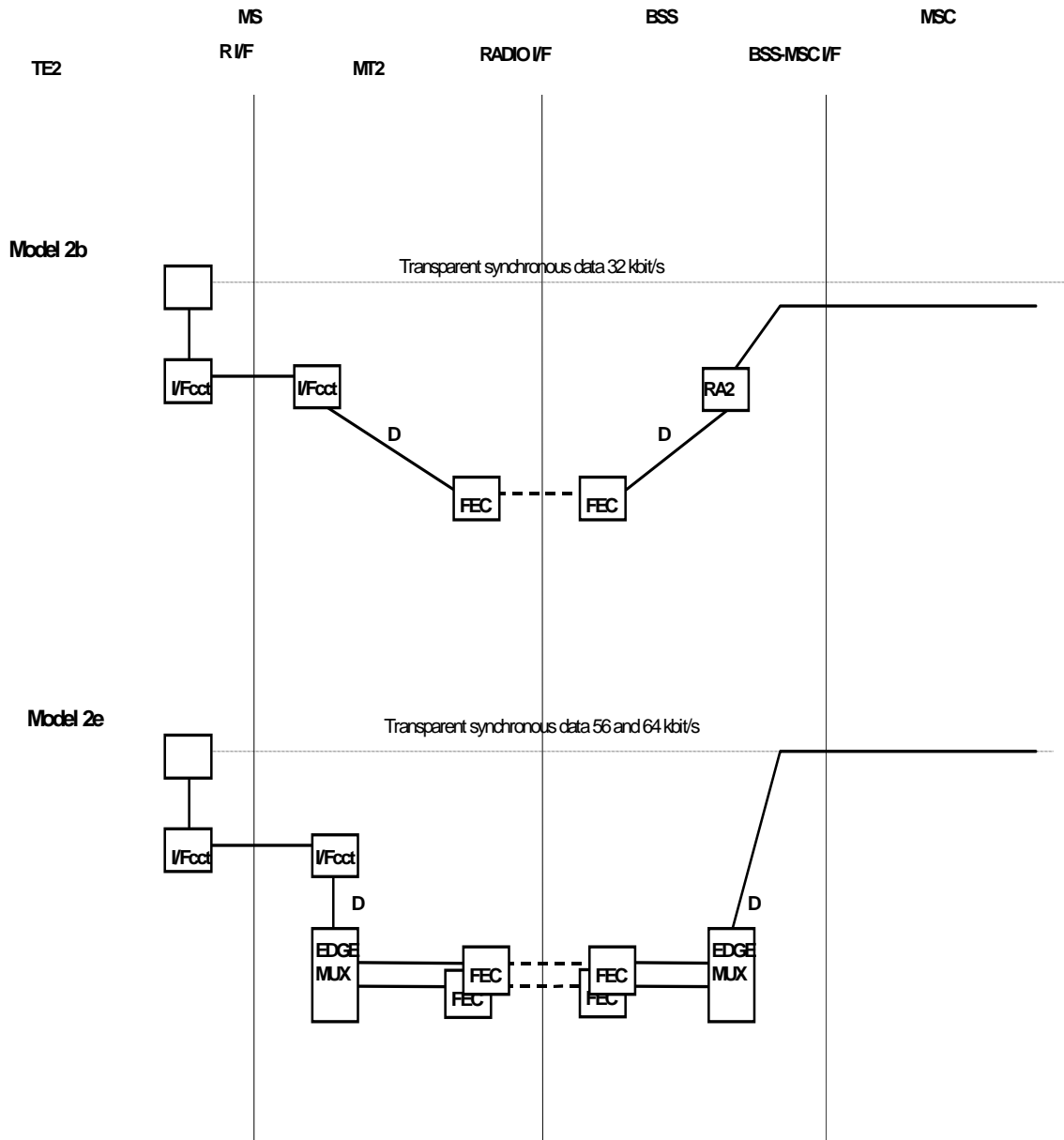

Figure 9: Information transfer protocol models for PLMN connections using TCH/F32.0 EDGE channels

6.5 PLMN connection types for GERAN lu mode

6.5.1 Limited set of PLMN connection types (for TCH/F9.6 channel coding)

Figure 10 provides the information transfer protocol models for the identified set of PLMN connection types for TCH/F9.6 channel coding. The description of models given in subclause 6.4.1 applies also to figure 10.

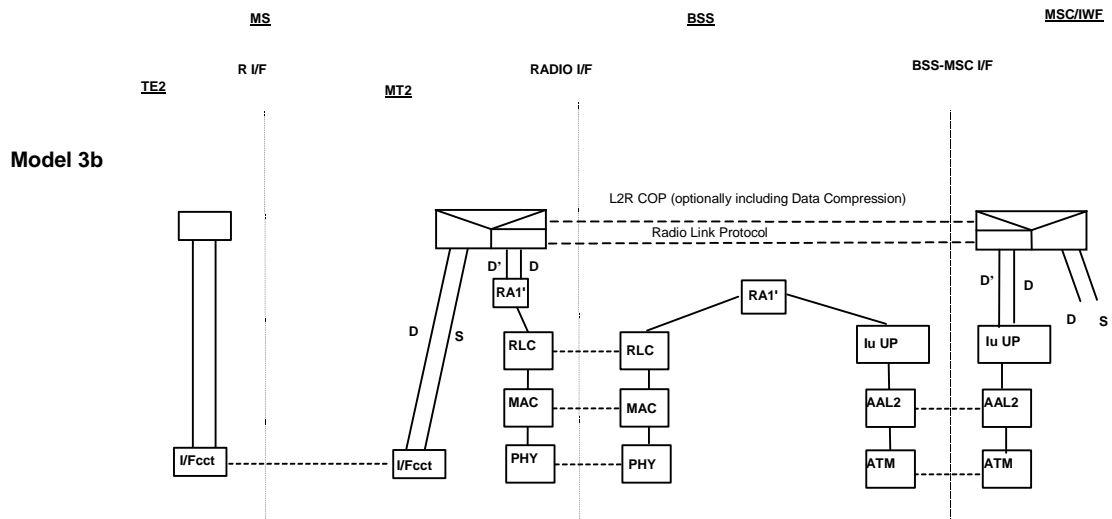
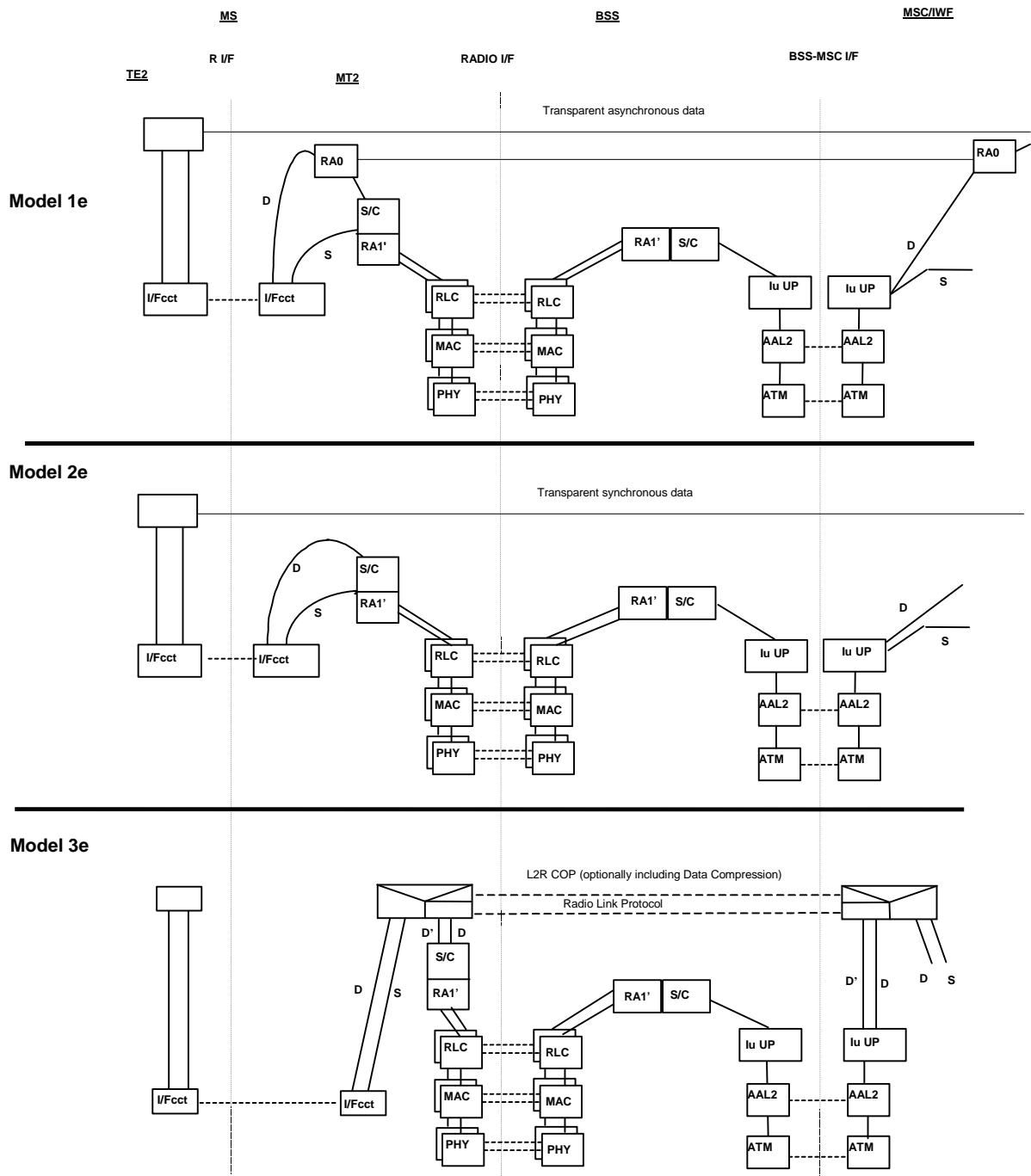

Figure 10: Information transfer protocol models for PLMN connections



Legend to Figure 10:

- RLC = Radio Link Control
- MAC = Medium Access Control
- PHY = Physical Layer
- S/C = Split/ Combine function
- Iu UP = Iu User Plane protocol
- ATM = Asynchronous Transfer Mode

Figure 10 (concluded): Information transfer protocol models for PLMN connections

6.5.2 Limited set of PLMN connection types (for TCH/F14.4 channel coding)

Figure 11 provides the information transfer protocol models for the identified set of PLMN connection types for support of TCH/F14.4. The description of models given in subclause 6.4.1 applies also to figure 11.

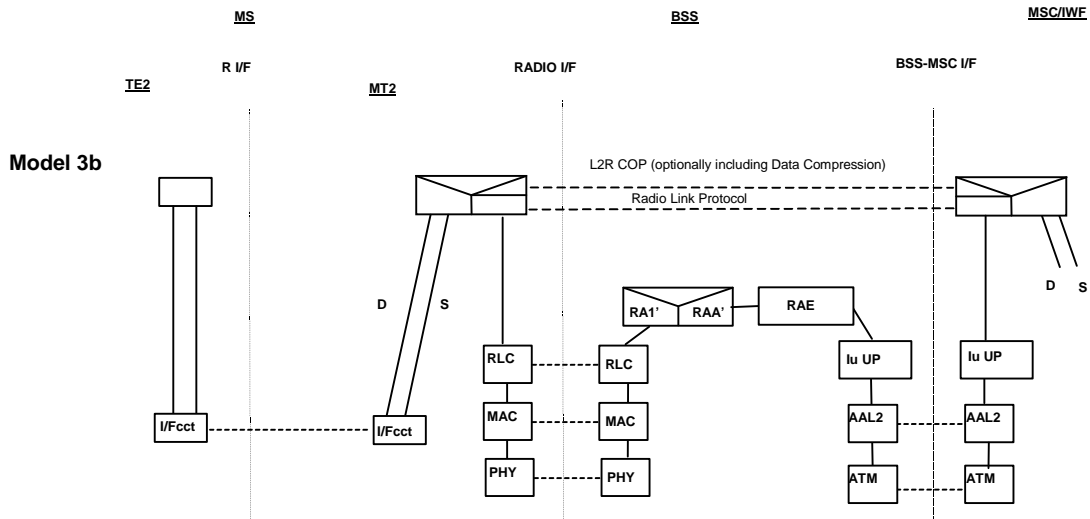

Figure 11: Information transfer protocol models for PLMN connections using 14.4 channels

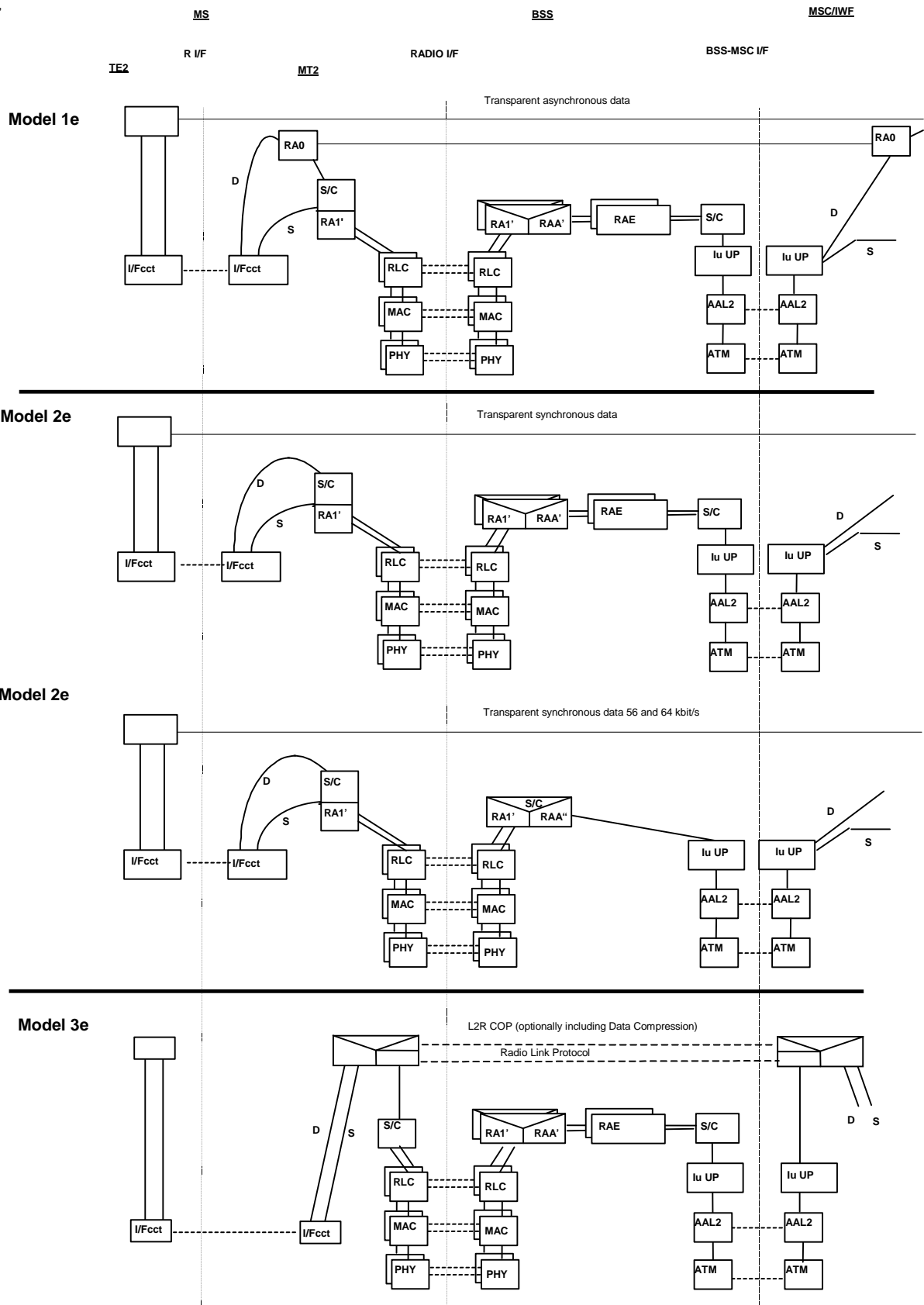

Figure 11 (concluded): Information transfer protocol models for PLMN connections using 14.4 channels

6.5.3 Limited set of PLMN connection types (for EDGE channels)

Figure 12 provides the information transfer protocol models for the identified set of PLMN connection types for support of TCH/F28.8 or TCH/F43.2 and figure 13 the models for the support of TCH/F32.0. The description of models given in subclause 6.4.1 applies also to figures 12 and 13.

When a TCH/F28.8 channel is used in multislot configurations, multiple EDGE multiplexing functions are applied on both sides of the air-interface; i.e. one multiplexing function — on each side of the air interface — is associated with each air-interface channel.

When TCH/F32.0 channels are used in double slot configurations, no rate adaptation is applied as the PLMN offers a '64 kbit/s pipe' between TE and an external network. When TCH/F32.0 channels are used in single slot configurations, the ITU-T I.460 rate adaptation is applied. (For details refer to 3GPP TS 44.021).

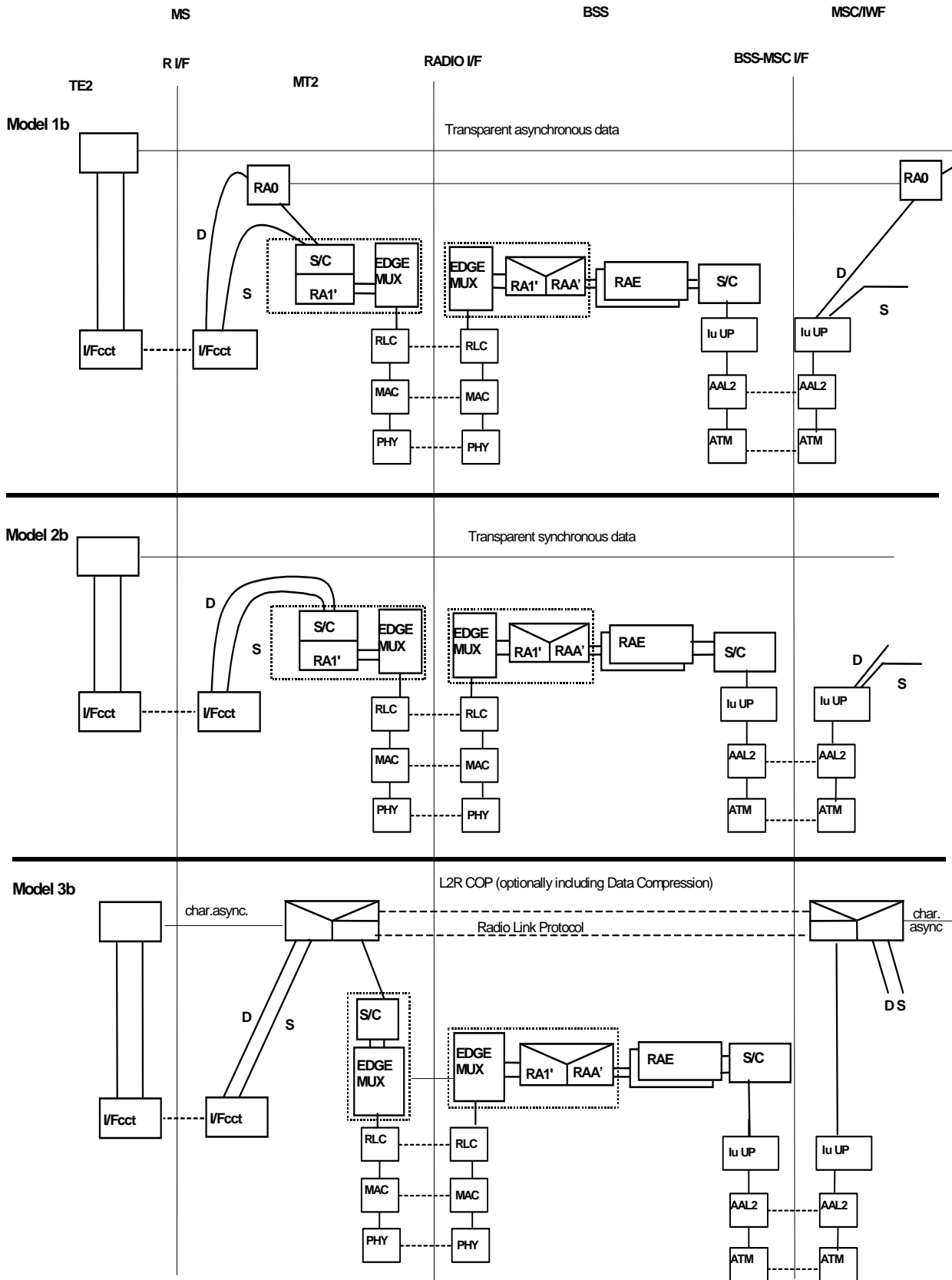

Figure 12: Information transfer protocol models for PLMN connections using EDGE channels

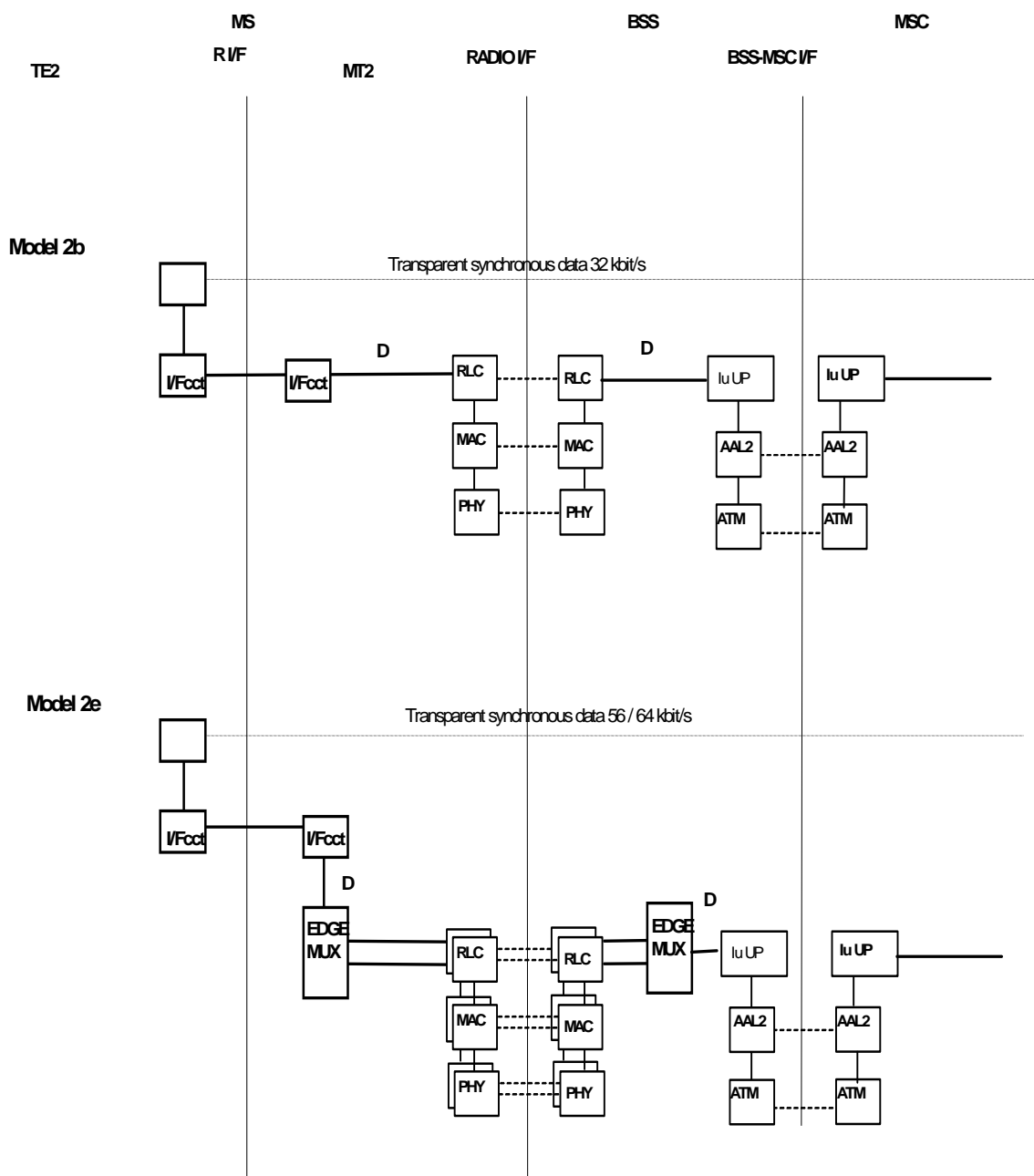

Figure 13: Information transfer protocol models for PLMN connections using TCH/F32.0 EDGE channels

7 Relationship between Telecommunication services and connection types

7.1 General

Given a request for a telecommunication service at the initiation of a call, the PLMN must establish a connection of a connection type that supports the attributes of the service requested. This establishment of a connection is effected at the time of call set up.

It should be noted that PLMN connection types represent the technical capabilities of a PLMN and provide a basis for the definition of performance and interworking with other networks. Telecommunication services supported by PLMN

are the packages offered to customers and the definition of their attributes is the means to standardize the service offerings in all PLMNs.

Quality of service and commercial attributes are relevant to telecommunication services whereas connection types are characterized by network performance, network operations and maintenance attributes.

7.2 Relationship between Bearer services and connection types

Table 5 shows the relationship between Bearer services and PLMN connection types. In table 5, the connection elements for each connection type related to a Bearer service are shown.

Dominant attributes of the connection elements, such as information transfer mode, information transfer rate, information transfer capability and structure are indicated. The type of radio traffic channel used is also shown (half rate and full rate). In the multislot cases the minimum number of timeslots per connection (n) is 1.

7.3 Relationship between Teleservices and connection types

Table 6 shows the relationship between teleservices and connection type elements, for those teleservices having PLMN connection type which does not correspond to the PLMN connection type of a bearer service. As in table 5/3GPP TS 43.010, dominant attributes of the connection elements and the type of radio traffic channel are shown. In the multislot cases the minimum number of timeslots per connection (n) is 1.

7.4 Network capability to support in-call modification

Specifications 3GPP TS 22.002 and 22.003 identify a particular need for a PLMN to support the Alternate speech and group 3 facsimile.

This service allows the use of in-call modification to change the mode of service. The network capability to support in-call modification is described in 3GPP TS 24.008. An in-call modification of the service mode is not possible for other services.

7.5 Network capability to support channel mode modification

Specification 3GPP TS 43.045 (Technical Realization of the Group 3 Facsimile Teleservice) identifies a need for a PLMN to support channel mode modification within the facsimile phase of the alternate speech and facsimile group 3 service. The network capability to support channel modification is described in 3GPP TS 24.008. Channel mode modification is not possible for other services. A channel mode modification results in a change of connection element over the radio interface with resultant change in access at the mobile station.

Table 5: Relationship between Bearer services and PLMN Connection elements

Connection description	Bearer service user data rate	Radio interface connection element	Intermediate rate at the BSS-MSC interface	BSS-MSC connection element	Protocol model in figure 6, 7, 8, 9, 10, 11, 12 or 13
Circuit mode unstructured with unrestricted digital capability transparent.	Data circuit duplex async $n \times 4\,800$ ($n \leq 4$) or $n \times 9\,600$ bit/s ($n \leq 4$). Data circuit duplex sync $n \times 4\,800$ ($n \leq 4$) or $n \times 9\,600$ bit/s ($n \leq 5$) or $n \times 1\,200$ bit/s ($n = 5$ or 6).	cct mode unstructured unrestricted $n \times 6$ kbit/s ($n \leq 4$) or $n \times 12$ kbit/s ($n \leq 6$) on n full rate channels.	8 or 16 kbit/s per TCH/F. For data connections using 5 or 6 TCH/Fs no intermediate rate(s) .	cct mode unstructured unrestricted 64 kbit/s.	Fig 6 : 1 e, 2 e Fig 10 : 1 e, 2 e
	Data circuit duplex async $n \times 14\,400$ bit/s ($n \leq 3$). Data circuit duplex sync $n \times 14\,400$ bit/s ($n \leq 5$)	cct mode unstructured unrestricted $n \times 14.5$ kbit/s ($n \leq 5$) on n full rate channels	16 kbit/s per TCH/F.	cct mode unstructured unrestricted 64 kbit/s.	Fig 7 : 1 e, 2 e Fig 11 : 1 e, 2 e
	Data circuit duplex async 28 800 bit/s. Data circuit duplex sync 28 800 bit/s	cct mode unstructured unrestricted 29.0 kbit/s on full rate channel	16 kbit/s per TCH/F.	cct mode unstructured unrestricted 64 kbit/s.	Fig 8 : 1 b, 2 b Fig 12 : 1 b, 2 b
	Data circuit duplex Sync 32 000 bit/s	cct mode unstructured unrestricted 32 kbit/s on full rate channel	32 kbit/s		Fig 9 : 2 b Fig 13 : 2 b
	Data circuit duplex sync 64 000 bit/s	cct mode unstructured unrestricted 2×32.0 kbit/s on full rate channels	No intermediate rate for the 64 000 bit/s rate		Fig 9 : 2 e Fig 13 : 2 e
	Data circuit duplex async 14 400 bit/s Data circuit duplex sync 14 400 bit/s	cct mode unstructured unrestricted 14.5 kbit/s on full rate Channel	16 kbit/s	cct mode unstructured unrestricted 64 kbit/s.	Fig 7 : 1 b, 2 b Fig 11 : 1 b, 2 b
	Data circuit duplex async 9 600 bit/s. Data circuit duplex sync 9 600 bit/s.	cct mode unstructured unrestricted 12 kbit/s on full rate channel.	16 kbit/s.	cct mode unstructured unrestricted 64 kbits/s.	Fig 6 : 1 b 2 b
	Data circuit duplex async 4 800 bit/s. Data circuit duplex sync 4 800 bit/s.	cct mode unstructured unrestricted 6 kbit/s on full rate channel and half rate channel.	8 kbit/s.	cct mode unstructured unrestricted 64 kbits/s.	Fig 6 1 b 2 b
	Data circuit duplex async 300. Data circuit duplex async 1 200. Data circuit duplex async 2 400. Data circuit duplex sync 1 200. Data circuit duplex sync 2 400.	cct mode unstructured unrestricted 3.6 kbit/s on full rate channel and half rate channel.	8 kbit/s.	cct mode unstructured unrestricted 64 kbits/s.	Fig 6 : 1 b

Connection description	Bearer service user data rate	Radio interface connection element	Intermediate rate at the BSS-MSC interface	BSS-MSC connection element	Protocol model in figure 6, 7, 8, 9, 10, 11, 12 or 13
Circuit mode unstructured with unrestricted digital capability non transparent.	Data circuit duplex async $n \times 4\,800$ ($n \leq 4$) or $n \times 9\,600$ bit/s ($n \leq 4$).	cct mode SDU unrestricted $n \times 6$ kbit/s ($n \leq 4$) or $n \times 12$ kbit/s ($n \leq 4$) on full rate channels.	8 or 16 kbit/s per TCH/F.	cct mode unstructured unrestricted 64 kbit/s.	Fig 6 : 3 e Fig 10 : 3 e
	Data circuit duplex async $n \times 14\,400$ bit/s ($n \leq 4$).	cct mode SDU unrestricted $n \times 14.5$ kbit/s ($n \leq 4$) on full rate channels.	16 kbit/s	cct mode unstructured unrestricted 64 kbit/s.	Fig 7 : 3 e Fig 11 : 3 e
	Data circuit duplex async $n \times 28\,800$ bit/s ($n \leq 2$). Data circuit duplex async 43 200 bit/s	cct mode SDU unrestricted $n \times 29.0$ kbit/s ($n \leq 2$) on full rate channels. cct mode SDU unrestricted 43.5 kbit/s on a full rate channel.	16 kbit/s per TCH/F. 16 kbit/s per TCH/F.	cct mode unstructured unrestricted 64 kbit/s.	Fig 8 : 3 b Fig 12 : 3 b
	Data circuit duplex async 14 400 bit/s	cct mode SDU unrestricted 14.5 kbit/s on full rate channel	16 kbit/s	cct mode unstructured unrestricted 64 kbit/s.	Fig 7 : 3 b Fig 11 : 3 e
	Data circuit duplex async 9 600 bit/s.	cct mode SDU unrestricted 12 kbit/s on full rate channel.	16 kbit/s.	cct mode unstructured unrestricted 64 kbit/s.	Fig 6 : 3 b Fig 10 : 3 b
	Data circuit duplex async 4 800 bit/s.	cct mode SDU unrestricted full rate channel, 12 kbit/s or half rate channel, 6 kbit/s.	16 kbit/s FR 8 kbit/s HR.	cct mode unstructured unrestricted 64 kbit/s.	Fig 6 : 3 b Fig 10 : 3 b
	Data circuit duplex async 300. Data circuit duplex async 1 200. Data circuit duplex async 2 400.	cct mode SDU unrestricted full rate channel, 12 kbit/s or half rate channel, 6 kbit/s.	16 kbit/s FR 8 kbit/s HR.	cct mode unstructured unrestricted 64 kbit/s.	Fig 6 : 3 b Fig 10 : 3 b

Connection description	Bearer service user data rate	Radio interface connection element	Intermediate rate at the BSS-MSC interface	BSS-MSC connection element	Protocol model in figure 6, 7, 8, 9, 10, 11, 12 or 13
Circuit mode unstructured with 3.1 kHz audio ex PLMN transparent.	Data circuit duplex async $n \times 4\,800$ bit/s ($n \leq 4$) or $n \times 9\,600$ bit/s ($n \leq 3$). Data circuit duplex sync $n \times 4\,800$ bit/s ($n \leq 4$) or $n \times 9\,600$ bit/s ($n \leq 3$).	cct mode unstructured unrestricted $n \times 6$ kbit/s ($n \leq 4$) or $n \times 12$ kbit/s ($n \leq 3$) on n full rate channels.	8 or 16 kbit/s TCH/F.	cct mode unstructured unrestricted 64 kbit/s.	Fig 6 : 1 e, 2 e Fig 10 : 1 e, 2 e
	Data circuit duplex async $n \times 14\,400$ bit/s ($n \leq 2$). Data circuit duplex sync $n \times 14\,400$ bit/s ($n \leq 2$)	cct mode unstructured unrestricted $x \times 14.5$ kbit/s ($n \leq 2$) on n full rate channels	16 kbit/s per TCH/F	cct mode unstructured unrestricted 64 kbit/s.	Fig 7 : 1 e, 2 e Fig 11 : 1 e, 2 e
	Data circuit duplex async 28 800 bit/s. Data circuit duplex sync 28 800 bit/s	cct mode unstructured unrestricted 29.0 kbit/s on a full rate channel	16 kbit/s per TCH/F.	cct mode unstructured unrestricted 64 kbit/s.	Fig 8 : 1 b, 2 b Fig 12 : 1 b, 2 b
	Data circuit duplex asynch 14 400 bit/s synch 14 400 bit/s	cct mode unstructured unrestricted 14.5 kbit/s on full rate channels	16 kbit/s	cct mode unstructured unrestricted 64 kbit/s.	Fig 7 : 1 b for asynch Fig 7 : 2 b for synch
	Data circuit duplex asynch 9.6 kbit/s synch 9.6 kbit/s.	cct mode unstructured unrestricted 12 kbit/s full rate channel.	16 kbit/s.	cct mode unstructured unrestricted 64 kbit/s.	Fig 6 : 1 b for asynch. Fig 6 : 2 b for synch.
	Data circuit duplex asynch 4.8 kbit/s synch 4.8 kbit/s.	cct mode unstructured unrestricted 6 kbit/s full and half rate channel.	8 kbit/s.		
	Data circuit duplex asynch $\leq 2\,400$ synch $\leq 2\,400$.	cct mode unstructured unrestricted 3.6 kbit/s full and half rate channel.	8 kbit/s.		

Connection description	Bearer service user data rate	Radio interface connection element	Intermediate rate at the BSS-MSC interface	BSS-MSC connection element	Protocol model in figure 6, 7, 8, 9, 10, 11, 12 or 13
Circuit mode unstructured with 3.1 kHz audio ex PLMN non transparent.	Data circuit duplex async $n \times 4\,800$ ($n \leq 4$) or $n \times 9\,600$ ($n \leq 4$) bit/s.	cct mode SDU unrestricted $n \times 6$ kbit/s ($n \leq 4$) or $n \times 12$ kbit/s ($n \leq 4$) on full rate channels.	8 or 16 kbit/s per TCH/F.	cct mode unstructured unrestricted 64 kbits/s.	Fig 6 : 3 e Fig 10 : 3 e
	Data circuit duplex async $n \times 14\,400$ bit/s ($n \leq 4$).	cct mode SDU unrestricted $n \times 14.5$ kbit/s ($n \leq 4$) on n full rate channels	16 kbit/s per TCH/F	cct mode unstructured unrestricted 64 kbits/s.	Fig 7 : 3 e Fig 11 : 3 e
	Data circuit duplex async 28 800 bit/s. Data circuit duplex async 43 200 bit/s	cct mode SDU unrestricted 29.0 kbit/s on a full rate channel. cct mode SDU unrestricted 43.5 kbit/s on a full rate channel.	16 kbit/s per TCH/F. 16 kbit/s per TCH/F.	cct mode unstructured unrestricted 64 kbits/s.	Fig 8 : 3 b Fig 12 : 3 e
	Data circuit duplex asynch 14 400 bit/s	cct mode SDU unrestricted 14.5 kbit/s full rate channel	16 kbit/s	cct mode unstructured unrestricted 64 kbits/s.	Fig 7 : 3 b Fig 11 : 3 b
	Data circuit duplex async 9.6 kbit/s	cct mode SDU unrestricted 12 kbit/s full rate channel.	16 kbit/s.	cct mode unstructured unrestricted 64 kbit/s.	Fig 6 : 3 b Fig 10 : 3 b
	Data circuit duplex async 4.8 kbit/s	cct mode SDU unrestricted half rate channel, 6 kbit/s or full rate channel, 12 kbit/s.	16 kbit/s FR 8 kbit/s HR.		
	Data circuit duplex async $\leq 2\,400$	cct mode SDU unrestricted half rate channel, 6 kbit/s or full rate channel, 12 kbit/s.			

Table 6: Relationship between Teleservices and PLMN connection types

Teleservice in a PLMN	Access at mobile station	Radio interface connection element	Intermediate rate at the BSS-MSC interface	BSS-MSC connection element	Protocol model in figure 6 or 7
Telephony.		cct mode speech.	NA.	cct mode structured 64 kbit/s speech.	Fig 6 : 6
Emergency calls.		cct mode speech.	NA.	cct mode structured 64 kbit/s speech.	Fig 6 : 6
Alternate Speech/ Facsimile Group 3.	Data cct duplex synchronous access alternate speech/ group 3 fax.	cct mode speech alternating with unstructured unrestricted 3.6 or 6 or 12 kbit/s or $n \times 6$ kbit/s ($n \leq 3$) or $n \times 12$ kbit/s ($n \leq 2$) on FR transparent.	Speech NA 8 or 16 kbit/s per TCH/F.	cct mode structured 64 kbit/s alternate speech/unrestricted.	Fig 6 : 5a or 5b and 6
		cct mode speech alternating with unstructured unrestricted 14.5 kbit/s or $n \times 14.5$ kbit/s ($n \leq 2$) on FR transparent	Speech NA 16 kbit/s per TCH/F.		Fig 7 : 5a or 5b and 6
Automatic Facsimile Group 3.	Data cct duplex synchronous access group 3 fax.	cct mode unstructured unrestricted 3.6 or 6 or 12 kbit/s or $n \times 6$ kbit/s ($n \leq 3$) or $n \times 12$ kbit/s ($n \leq 2$) on FR transparent.	8 or 16 kbit/s per TCH/F.	cct mode structured 64 kbit/s unrestricted.	Fig 6 : 5a, 5b
		cct mode unstructured unrestricted 14.5 kbit/s or $n \times 14.5$ kbit/s ($n \leq 2$) on FR transparent	16 kbit/s per TCH/F.		

NA: Not Applicable

NOTE: The multislot data connections and the connections using TCH/F14.4 coding belong to the General Bearer Services (Classes 20 and 30 in 3GPP TS 22.002).

Annex A (informative): List of definitions of PLMN connection type attributes and values

A.1 Attribute definition and their values

Information transfer mode:

This attribute describes the operational mode for transferring (transportation and switching) user information through a PLMN connection in the network.

Value: - Circuit

Information transfer capability:

This attribute describes the capability associated with the transfer of different types of information through a PLMN connection.

Values: - Unrestricted digital information

- Speech

- Group 3 facsimile

- 3.1 kHz audio ex PLMN

- Restricted digital information (Note: this value is signalled in the "Other ITC" element, due to a lack of further code points in the "ITC" element.)

Information transfer rate:

This attribute describes either the bit rate (circuit mode) or the throughput (packet mode, for further study). It refers to the transfer of digital information on a PLMN connection.

Values: - Appropriate bit rate

- Throughput rate

Establishment of connection:

This attribute describes the mode of establishment used to establish and release PLMN connections.

Value: - Demand

Symmetry:

This attribute describes the relationship of information flow between two (or more) access points or reference points involved in a PLMN connection.

Values: - Bidirectional symmetric

- Bidirectional asymmetric (Multislot configurations for data)

Connection configuration:

This attribute describes the spatial arrangement for transferring information on a given PLMN connection.

Value: - Point-to-point

Structure:

This attribute refers to the capability of a PLMN connection to deliver information to the destination access point or reference point in a structure that was presented in a corresponding signal structured at the origin (access point or reference point).

- Values: - Service data unit integrity (see note 1)
- Unstructured (see note 2)

NOTE 1: Applicable for connection element "non transparent".

NOTE 2: Applicable for connection element "transparent".

Channel rate:

This attribute describes the channels and their bit rate used to transfer the user information and/or signalling information.

- Value: - Name of channel (designation) and/or the corresponding bit rate

NOTE 3: This attribute can be used several times for connection characterization.

Connection control protocol, information transfer coding/protocol (layer 1 to 3):

These attributes characterize the protocols on the connection control and/or user information transfer channel.

- Value: - Appropriate protocol for each layer

NOTE 4: This attribute can be used several times for connection characterization.

Synchronous/Asynchronous:

This attribute describes the type of transmission between the reference access points.

- Values: - Synchronous
- Asynchronous

Negotiation:

This attribute describes the possibility of inband parameter exchange (according to V.110) between reference access points.

- Value: - In band negotiation not possible

User Rate:

This element is relevant between the IWF and the fixed network.

- Values: - 0.3 kbit/s
- 1.2 kbit/s
- 2.4 kbit/s
- 4.8 kbit/s
- 9.6 kbit/s

Intermediate rate:

This attribute defines the intermediate rate (according to 3GPP TS 48.020 and ITU-T V.110) at the A interface connection element part.

- Values: - 8 kbit/s
- 16 kbit/s

Fixed network user rate FNUR:

This element is relevant between the MSC and the fixed network.

Values: - 9.6 kbit/s
- 14.4 kbit/s
- 19.2 kbit/s
- 28.8 kbit/s
- 32.0 kbit/s
- 38.4 kbit/s
- 48.0 kbit/s
- 56.0 kbit/s
- 64.0 kbit/s

Acceptable channel coding(s) ACC:

This attribute indicates the channel codings acceptable to the MS. This parameter is given at call set-up and it is non negotiable.

Values: 4.8 kbit/s
and/or 9.6 kbit/s
and/or 14.4 kbit/s
and/or 28.8 kbit/s
and/or 32.0 kbit/s
and/or 43.2 kbit/s

Maximum number of TCH/Fs (Multislot configurations for data):

This attribute is given at call set-up and it enables the mobile user to limit the number of TCH/Fs used during the call.

Values: 1
2
3
4
5
6
7 (note 5)
8 (note 5)

NOTE 5: Not used by the currently specified services.

Wanted air interface user rate (AIUR):

This attribute is applicable to non-transparent services only, and it gives the AIUR that the mobile user wants and which the network tries to achieve but which it is not allowed to exceed.

Values: Not applicable

9.6 kbit/s
 14.4 kbit/s
 19.2 kbit/s
 28.8 kbit/s
 38.4 kbit/s
 43.2 kbit/s
 57.6 kbit/s

User initiated modification indication (Multislot configurations for data):

This element is relevant between the MT and the IWF.

- Values:
- User initiated modification not requested
 - User initiated modification up to 1 TCH/F requested
 - User initiated modification up to 2 TCH/F requested
 - User initiated modification up to 3 TCH/F requested
 - User initiated modification up to 4 TCH/F requested

The parameters where it is indicated that they are related to Multislot configurations for data are optional.

For multislot configuration, the following applies to the parameters contained in the BC-IE:

- Half rate channels are not supported. The MS shall code the radio channel requirement as "Full rate support only MS" or "Dual rate support MS, full rate preferred". In the second case, the network shall assign full rate channel(s) only.
- The "fixed network user rate" and "other modem type" take precedence over the "user rate" and "modem type", except for modem types "autobauding", "modem for undefined interface" or "none".
- The "intermediate rate" parameter is overridden. The intermediate rate used per each TCH/F is derived from the chosen channel type:

channel type	IR per TCH/F
TCH/F4.8	8 kbit/s
TCH/F9.6	16 kbit/s
TCH/F14.4	16 kbit/s (on the A interface but 32 kbit/s inside the MS)

- The user rate per TCH is derived from the chosen channel type:

channel type	user rate per TCH
TCH/F4.8	4.8 kbit/s
TCH/F9.6	9.6 kbit/s
TCH/F14.4	14.4 kbit/s

For CE: T, the padding procedure described in 3GPP TS 44.021 can be applied.

Network independent clocking on Tx:

This attribute defines the usage of NIC at the reference access point in the transmit direction.

- Values:
- Not required
 - Required

Network independent clocking on Rx:

This attribute defines the usage of NIC at the reference access point in the receive direction.

- Values:
- Not accepted
 - Accepted

Number of stop bits:

This attribute describes the number of stop bits for the asynchronous type of transmission between reference access points.

- Values:
- 1 bit
 - 2 bit

Number of data bits excluding parity if present:

This attribute describes the number of data bits for a character oriented mode of transmission between reference access points.

- Values:
- 7 bit
 - 8 bit

Parity information:

This attribute describes the type of parity information for a character oriented mode of transmission between the reference access points.

- Values:
- Odd
 - Even
 - None
 - Forced to 0
 - Forced to 1

Duplex mode:

This attribute describes the kind of transmission of the PLMN between reference access points.

- Value:
- Full duplex

Modem type:

This attribute describes the modem allocated by the IWF/MSC in the case of a 3.1 kHz audio used outside the PLMN information transfer capability.

- Values:
- V.21
 - V.22
 - V.22bis
 - V.26ter
 - V.32
 - Autobauding type 1
 - None
 -

Other Modem Type (OMT):

This element is relevant between the MS and IWF.

- Values:
- No other modem type
 - V.34

Compression

This attribute describes the possible usage of data compression between the reference access points. In the network to MS direction, it indicates the possibility of using data compression. In the MS to network direction, it indicates the allowance of data compression.

- Values:
- Data compression not possible/not allowed
 - Data compression possible/allowed (see note 6)

NOTE 6: Only applicable for the asynchronous transmission between the reference access points, if connection element is "non transparent".

Radio channel requirement:

This attribute describes the available channels for the transfer of the user information between the reference access points.

- Values:
- Full rate channel (Bm)
 - Half rate channel (Lm)
 - dual rate/full rate preferred
 - Dual rate/half rate preferred

Negotiation of Intermediate Rate Requested (NIRR)

This attribute indicates if 6 kbit/s radio interface rate is requested.

- Values:
- NIRR not requested/not accepted
 - NIRR requested/accepted

Connection element:

This attribute describes the possible usage of layer 2 protocol between the reference access points.

- Values:
- Transparent
 - Non-transparent (RLP)
 - Both, transparent preferred
 - Both, non transparent preferred

User information layer 2 protocol:

This attribute describes the layer 2 relay protocol used between the reference access points in non-transparent transmissions.

- Values:
- ISO 6429, code set 0
 - X.25 (note 7)
 - Character oriented protocol with no flow control

NOTE 7: This value was used by services defined for former 3GPP releases and does not need to be supported.

Signalling access protocol:

This attribute characterizes the protocol on the signalling or user information transfer channel at the mobile reference access point.

- Values: - I.440/450
- X.21 (note 7)
 - X.28, dedicated PAD, individual NUI (note 7)
 - X.28, dedicated PAD, universal NUI (note 7)
 - X.28, non dedicated PAD (note 7)
 - X.32 (note 7)

NOTE 7: This value was used by services defined for former 3GPP releases and does not need to be supported.

Rate adaptation:

This attribute describes the rate adaptation used at the fixed reference access point.

- Values: - V.110/X.30
- X.31 flag stuffing (note 7)
 - No rate adaptation
 - V.120 (Note: This value is signalled in the "Other Rate Adaption" element, due to a lack of further code points in the "Rate Adaptation" element.)

NOTE 7: This value was used by services defined for former 3GPP releases and does not need to be supported.

Coding standard:

This attribute refers to the structure of the BC-IE defined in the 3GPP TS 24.008.

- Value: - GSM

User information layer 1 protocol:

This attribute characterizes the layer 1 protocol to be used at the Um interface according to the 3GPP TS 45.001.

- Value: - Default

Rate adaption header/no header:

This attribute is relevant between IWF and the fixed network. It is only applicable for V.120 rate adaptation.

- Values: - Rate adaption header not included
- Rate adaption header included

Multiple frame establishment support in data link:

This attribute is relevant between IWF and the fixed network. It is only applicable for V.120 rate adaptation.

- Values: - Multiple frame establishment not supported. Only UI frames allowed
- Multiple frame establishment supported

Mode of operation:

This attribute is relevant between IWF and the fixed network. It is only applicable for V.120 rate adaptation.

- Values: - Bit transparent mode of operation

- Protocol sensitive mode of operation

Logical link identifier negotiation:

This attribute is relevant between IWF and the fixed network. It is only applicable for V.120 rate adaptation.

Values: - Default, LLI=256 only

- Full protocol negotiation (note 8)

NOTE 8: A connection over which protocol negotiation will be executed is indicated in the "In-band/out-band negotiation" parameter.

Assignor/assignee:

This attribute is relevant between IWF and the fixed network. It is only applicable for V.120 rate adaptation.

Values: - Message originator is "default assignee"

- Message originator is "assignor only"

In-band/out-band negotiation:

This attribute is relevant between IWF and the fixed network. It is only applicable for V.120 rate adaptation.

Values: - Negotiation is done with USER INFORMATION messages on a temporary signalling connection

- Negotiation is done in-band using logical link zero.

A.2 Definition of values

Unrestricted digital data information:

Transfer of information sequence of bits at its specified bit rate without alteration.

This implies: - bit sequence independence;

- digit sequence integrity;

- bit integrity.

Speech:

Digital representation of speech coded according to a specified encoding rule (e.g. A Law, 3GPP TS 06-series).

Demand connection:

A PLMN connection is set up at any time on demand via a digital channel in response to signalling information received from subscriber, other MSCs or other networks, i.e. on a per call basis.

Bidirectional symmetric:

This value applies when the information flow characteristics provided by the PLMN connection are the same between two (or more) access points or reference points in the forward and backward directions.

Bidirectional asymmetric (Multislot configurations for data):

This value applies when the information flow characteristics provided by the PLMN connection differ between two (or more) access points or reference points in the forward and backward directions on one or more TCH/Fs. In Multislot configurations for data the asymmetry is downlink biased, i.e. the MS may receive at a greater rate than it transmits.

Point-to-point connection:

This value applies when only two end points are provided by the connection.

Service data unit integrity:

This value applies when:

- i) at each user-network interface, protocols provide a mechanism for identifying the boundaries of service data units; and
- ii) all bits submitted within a single service data unit are delivered in a corresponding service data unit.

Unstructured:

This value is applicable when the PLMN connection neither provides structural boundaries nor preserves structural integrity.

Annex B (informative): Location of the transcoding, multiplexing and RA2 functions

The location of the transcoding and data rate adaptation functions used to convert from the data rate used on the radio interface to the 64 kbits/s required by the MSC, is considered in this annex B. There are four alternatives which are equally valid from a connection type point of view. The selection of which alternative to use is not considered in 3GPP TS 43.010. The alternatives are shown in figure 10.

Alternative 1 assumes that all the transcoding and data rate adaptation is located at the BSS end of the A interface.

Alternative 2 assumes that all the transcoding and data rate adaptation is located at the MSC end of the A interface and gives no indication how the information is carried on the link.

Alternative 3 assumes that the information is transferred on the A interface in 8 or 16 kbit/s channels using one of the sub-multiplexing schemes described in CCITT Recommendation I.460. The same sub-multiplexing scheme is used for both speech and data.

Alternative 4 illustrates a multislot connection in which the information is transferred on the A-interface in 64 kbit/s channel into which up to four channels of intermediate rate 16 kbit/s have been multiplexed (refer to 3GPP TS 48.020). Alternative 4 also shows a situation in which a multislot connection of 5 or 6 TCH/Fs is used; the rate between the RA1'/RA1- and RA1''-functions is 64 kbit/s.

The alternatives explained above correspond to all channels excluding TCH/F14.4 and EDGE.

Alternatives 1b, 2b, 3b, and 4b show similar approaches for channel codings TCH/F14.4, TCH/F28.8, and TCH/F43.2.

It should be noted that in all of the alternatives the transcoding and data rate adaptation are performed on the BSS side of the A-interface and is therefore considered to be a function of the BSS.

In the first three alternatives, the interface at the MSC is always based on 64 kbit/s without sub-multiplexing.

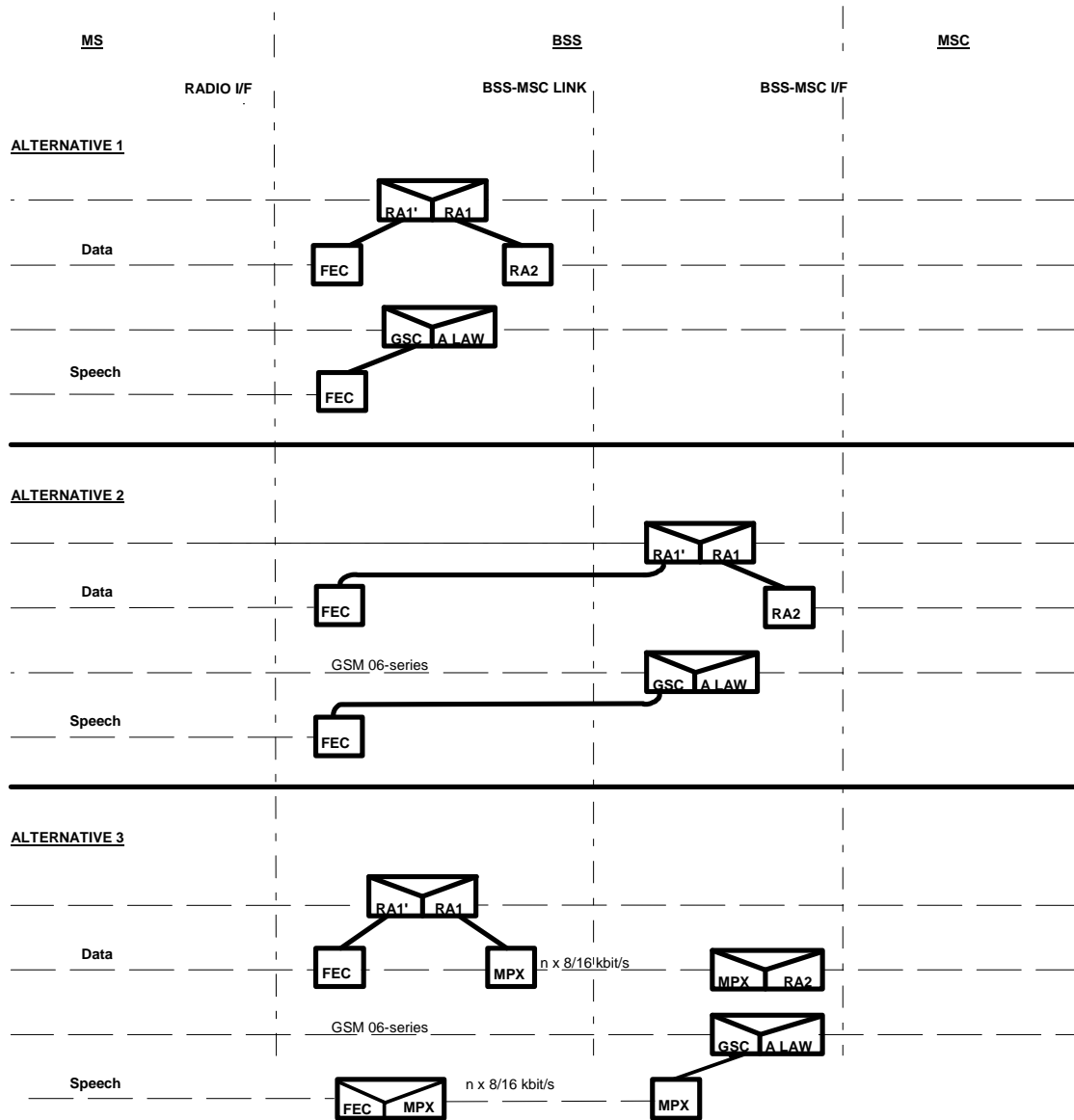

Figure 10: Location of transcoding and rate adaptation

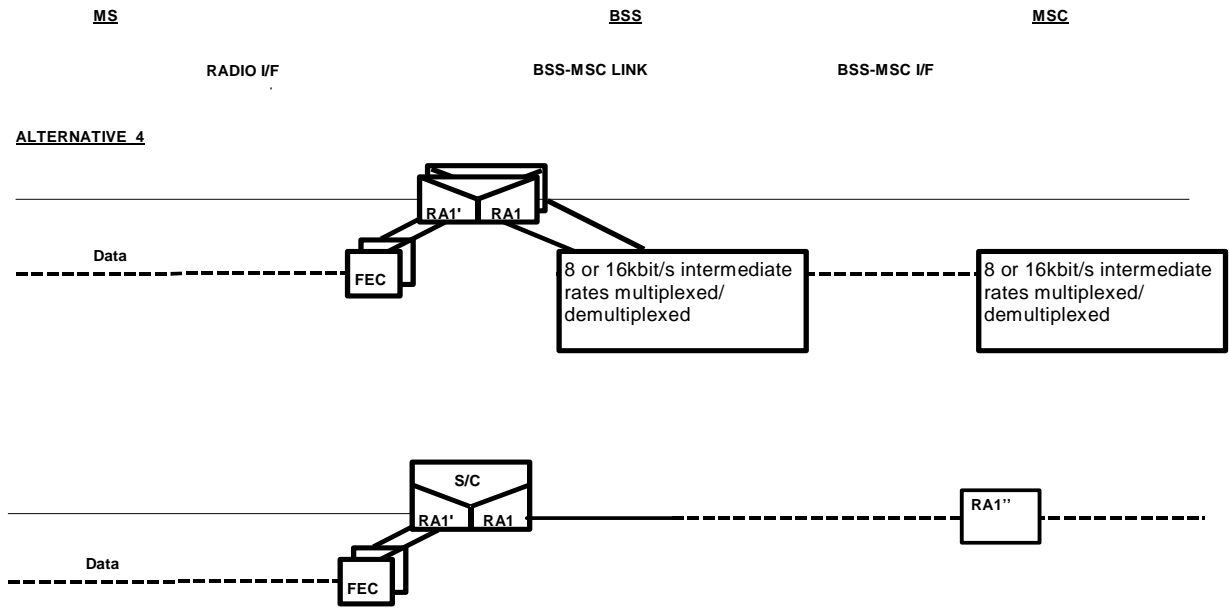

Figure 10 (continued): Location of transcoding and rate adaptation

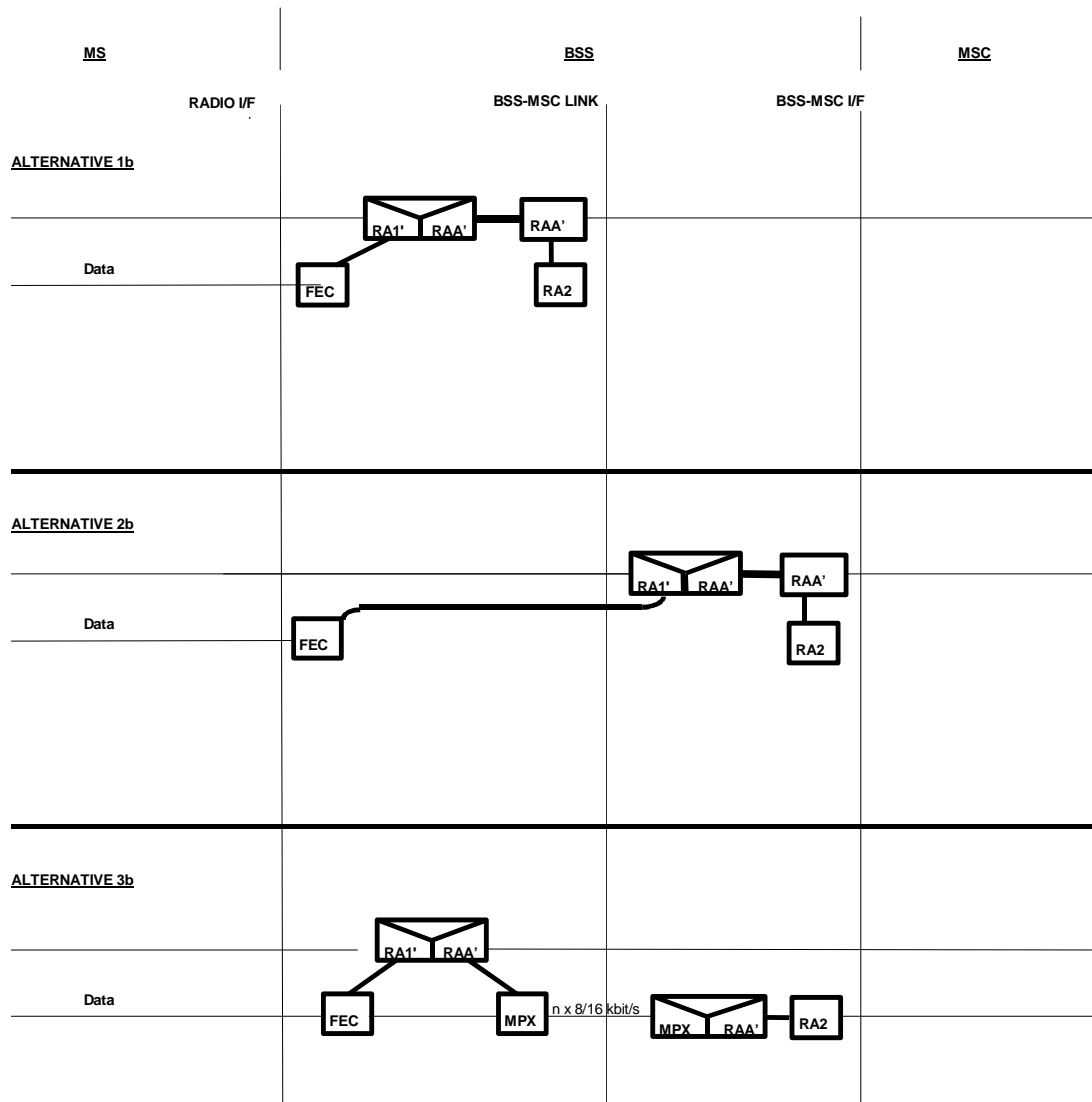

Figure 10 (concluded): Location of transcoding and rate adaptation

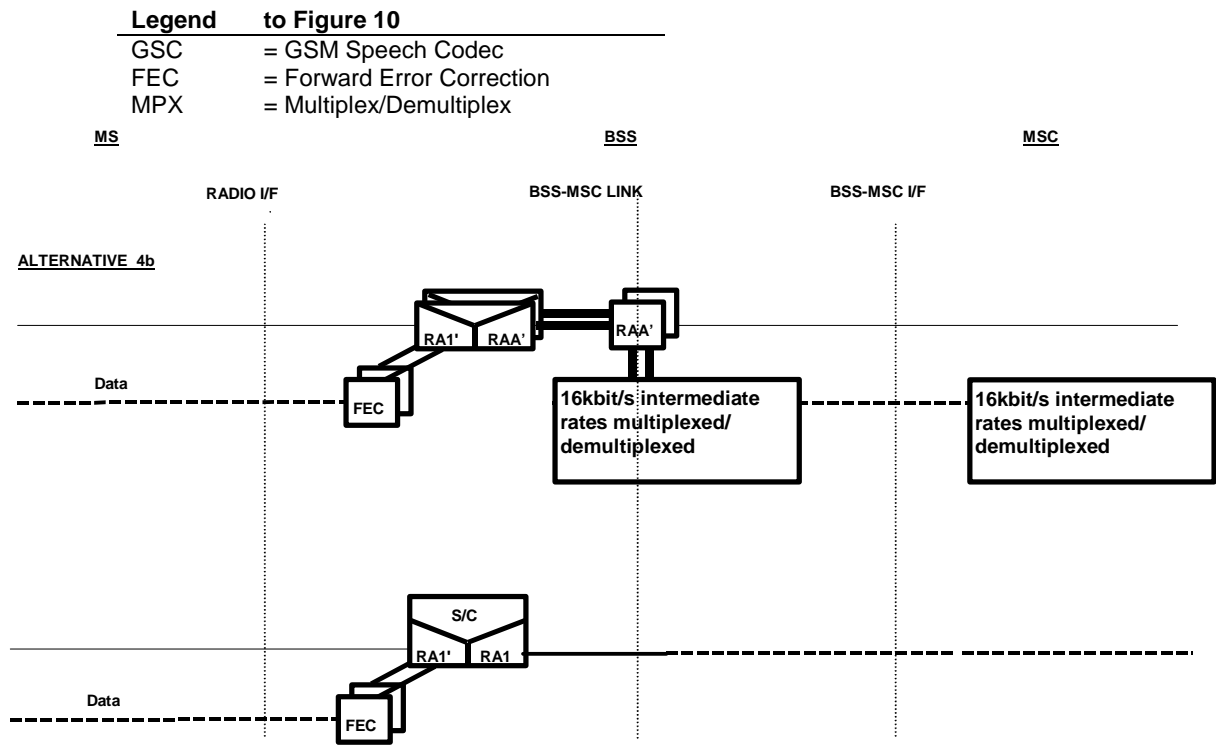

Figure 10 (concluded): Location of transcoding and rate adaptation

Annex C (informative): Change History

Change history							
Date	TSG #	TSG Doc.	CR	Rev	Subject/Comment	Old	New
-	S16		A001	2	Data Compression		5.0.0
-	S16		A002		Editorial correction to Channel Mode Modify		5.0.0
-	s21		A003		V.120 Interworking and RDI	5.0.0	5.1.0
-	s21		A004		HSCSD	5.0.0	5.1.0
-	s22		A005		Introduction of 14.4 kbit/s	5.1.0	5.2.0
-	s23		A006		Editorial modifications	5.2.0	5.3.0
-	s24		A007		Removal of 2*14.4=19.2 Transparent configuration	5.3.0	5.4.0
-	s27		A008		Clarification of RA0 adaptation function	5.4.0	7.0.0
-	s27		A009		Information transfer protocol model updates	5.4.0	7.0.0
-	s29		A010		Introduction of EDGE channel codings into the specifications	7.0.0	8.0.0
12-1999	TSG#06		A011		Service Clean up R99	8.0.0	8.1.0
09-2000	TSG#09	NP-000551	A012		32 kbit/s UDI/RDI multimedia in GSM	8.1.0	8.2.0
12-2000	TSG#10	NP-000604	A013		TCH/F32.0 reference models	8.2.0	8.3.0
12-2000	TSG#10	NP-000606	A014		Removal of BS 30 NT	8.3.0	4.0.0
03-2001	TSG#11	NP-010047	001		Removal of the S-reference point in MS	4.0.0	4.1.0
03-2001	TSG#11	NP-010047	002		Addition changes for removal BS30NT of BS30 NT and packet access	4.0.0	4.1.0
03-2001	TSG#11	NP-010046	003		Removal of FAX NT in GSM from Rel-4	4.0.0	4.1.0
03-2001	TSG#11	NP-010047	004		Removal of speech model	4.0.0	4.1.0
03-2002	TSG#15	NP-010085	005	1	Terminology Clarifications as requested by TSG GERAN	4.1.0	5.0.0
09-2002	TSG#17	NP-020405	006	1	Correction of Rate Adaptation Functions and removal of S Reference Point in MS	5.0.0	5.1.0
12-2002	TSG#18	NP-020617	007	1	CS Data Services (including HSCSD and EDGE) for GERAN lu mode	5.1.0	5.2.0
12-2004	CN#26				Upgraded to v6.0.0	5.2.0	6.0.0
06-2007	CT#36				Upgraded to v7.0.0	6.0.0	7.0.0
12-2008	CT#42				Upgraded to v8.0.0	7.0.0	8.0.0
12-2009	CT#46				Automatic upgrade from previous Release	8.0.0	9.0.0
03-2011	CT#51				Automatic upgrade from previous Release version 9.0.0	9.0.0	10.0.0
03-2011	CT#51				Correction of heading and numbering made by MCC	10.0.0	10.0.1
09-2012	CT#57				Automatic upgrade from previous Release version 10.0.1	10.0.1	11.0.0
09-2014	-	-	-		Format of figures 1 to 5 corrected	11.0.0	11.0.1
2014-10					Automatic upgrade from previous Release	11.0.1	12.0.0
2015-12					Automatic upgrade from previous Release	12.0.0	13.0.0
Change history							
Date	TSG #	TSG Doc.	CR	Rev	Cat	Subject/Comment	New
2017-03	CT#75						14.0.0
2018-06	SA#80	-	-	-		Automatic upgrade from previous Release	15.0.0
2020-07	SA#88e	-	-	-		Update to Rel-16 version (MCC)	16.0.0

History

Document history		
V16.0.0	August 2020	Publication