

ETSI TS 143 068 V5.4.0 (2004-09)

Technical Specification

**Digital cellular telecommunications system (Phase 2+);
Voice Group Call Service (VGCS);
Stage 2
(3GPP TS 43.068 version 5.4.0 Release 5)**



Reference

RTS/TSGN-0143068v540

Keywords

GSM

ETSI

650 Route des Lucioles
F-06921 Sophia Antipolis Cedex - FRANCE

Tel.: +33 4 92 94 42 00 Fax: +33 4 93 65 47 16

Siret N° 348 623 562 00017 - NAF 742 C
Association à but non lucratif enregistrée à la
Sous-Préfecture de Grasse (06) N° 7803/88

Important notice

Individual copies of the present document can be downloaded from:

<http://www.etsi.org>

The present document may be made available in more than one electronic version or in print. In any case of existing or perceived difference in contents between such versions, the reference version is the Portable Document Format (PDF). In case of dispute, the reference shall be the printing on ETSI printers of the PDF version kept on a specific network drive within ETSI Secretariat.

Users of the present document should be aware that the document may be subject to revision or change of status. Information on the current status of this and other ETSI documents is available at

<http://portal.etsi.org/tb/status/status.asp>

If you find errors in the present document, please send your comment to one of the following services:

http://portal.etsi.org/chaicor/ETSI_support.asp

Copyright Notification

No part may be reproduced except as authorized by written permission.
The copyright and the foregoing restriction extend to reproduction in all media.

© European Telecommunications Standards Institute 2004.
All rights reserved.

DECT™, PLUGTESTS™ and UMTS™ are Trade Marks of ETSI registered for the benefit of its Members.
TIPHON™ and the TIPHON logo are Trade Marks currently being registered by ETSI for the benefit of its Members.
3GPP™ is a Trade Mark of ETSI registered for the benefit of its Members and of the 3GPP Organizational Partners.

Intellectual Property Rights

IPRs essential or potentially essential to the present document may have been declared to ETSI. The information pertaining to these essential IPRs, if any, is publicly available for **ETSI members and non-members**, and can be found in ETSI SR 000 314: *"Intellectual Property Rights (IPRs); Essential, or potentially Essential, IPRs notified to ETSI in respect of ETSI standards"*, which is available from the ETSI Secretariat. Latest updates are available on the ETSI Web server (<http://webapp.etsi.org/IPR/home.asp>).

Pursuant to the ETSI IPR Policy, no investigation, including IPR searches, has been carried out by ETSI. No guarantee can be given as to the existence of other IPRs not referenced in ETSI SR 000 314 (or the updates on the ETSI Web server) which are, or may be, or may become, essential to the present document.

Foreword

This Technical Specification (TS) has been produced by ETSI 3rd Generation Partnership Project (3GPP).

The present document may refer to technical specifications or reports using their 3GPP identities, UMTS identities or GSM identities. These should be interpreted as being references to the corresponding ETSI deliverables.

The cross reference between GSM, UMTS, 3GPP and ETSI identities can be found under <http://webapp.etsi.org/key/queryform.asp>.

Contents

Intellectual Property Rights	2
Foreword.....	2
Foreword.....	5
1 Scope	6
2 References	6
3 Definitions and abbreviations.....	6
3.1 Definitions	6
3.2 Abbreviations	7
4 Main concepts	7
4.1 Group definition	7
4.2 Group conversations.....	8
4.2.1 Group call initiation.....	8
4.2.1.1 Normal operation with successful outcome	8
4.2.1.2 Exceptional procedures	9
4.2.2 On-going group calls	9
4.2.2.1 Normal operation with successful outcome	9
4.2.2.2 Exceptional procedures	10
4.2.3 Leaving of a group call without termination.....	10
4.2.4 Group call termination.....	10
4.2.5 Acknowledgements.....	10
4.2.6 Transactions between the mobile station and the network.....	11
4.2.7 Processing of originator-to-dispatcher information	11
5 General architecture	11
5.1 Group Call Register (GCR).....	11
5.2 Voice group call responsibility.....	12
6 Compatibility issues	13
7 Transmission	13
7.1 Transmission architecture.....	13
7.2 Radio channels	13
7.3 Data confidentiality	14
8 Information storage	14
8.1 Information stored in the GCR.....	14
8.1.1 Information used for routing of service subscriber originated voice group calls.....	14
8.1.2 Group call attributes.....	15
8.1.2.1 Group call area.....	15
8.1.2.2 Dispatcher identities.....	15
8.1.2.3 No activity time.....	16
8.1.2.4 Priorities.....	16
8.2 Information managed per subscriber	16
8.2.1 Stored in the HLR.....	16
8.2.2 Stored in the VLR.....	16
8.2.3 Stored in the SIM.....	16
8.3 Information used for routing of dispatcher originated voice group calls.....	16
9 Identities	17
9.1 Elementary identities for group calls.....	17
9.2 Use of identities in the network.....	18
10 Operation and maintenance aspects	19
11 Function and information flows	19
11.1 Group management	19

11.2	Group membership management.....	19
11.3	Call management.....	20
11.3.1	Call establishment.....	20
11.3.1.1	Service subscriber call establishment.....	20
11.3.1.1.1	Initial stage	20
11.3.1.1.2	Establishment of the transmission means	21
11.3.1.1.3	Release of the dedicated transmission means of the calling service subscriber.....	21
11.3.1.1.4	Release of the dedicated transmission means of mobile stations responding to a notification.....	21
11.3.1.1.5	Transfer of a talking service subscriber to a dedicated connection	21
11.3.1.2	Dispatcher call establishment.....	21
11.3.1.3	Notification procedures.....	22
11.3.1.4	Destination subscribers	24
11.3.1.5	Called dispatchers	24
11.3.2	Call release.....	24
11.3.2.1	Call termination by the calling subscriber.....	24
11.3.2.2	Call termination by dispatchers.....	24
11.3.3	Leaving of a dispatcher.....	25
11.3.4	Leaving and returning to a voice group call.....	25
11.3.5	Cell change	25
11.3.5.1	Listening subscriber	25
11.3.5.2	Talking subscriber.....	25
11.3.5.3	Dispatcher	25
11.3.6	New calls	26
11.3.7	Uplink transmission management.....	26
11.3.8	Overview of signalling.....	26
11.4	Functional requirement of Anchor MSC	48
11.5	Functional requirement of Relay MSC.....	56
11.6	Functional requirement of GCR	64
11.7	Functional requirement of VLR	67
12	Content of messages.....	69
12.1	Messages on the B-interface (MSC-VLR)	69
12.1.1	Allocate Group Call Number	69
12.1.2	Allocate Group Call Number ack	69
12.1.3	Allocate Group Call Number negative response.....	70
12.1.4	Release Group Call Number	70
12.2	Messages on the E-interface (MSC-MSC)	70
12.2.1	Prepare Group Call	70
12.2.2	Prepare Group Call ack.....	70
12.2.3	Prepare Group Call negative response	70
12.2.4	Send Group Call End Signal	70
12.2.5	Forward Group Call Signalling.....	71
12.2.6	Process Group Call Signalling.....	71
12.3	Messages on the I-interface (MSC-GCR)	72
12.3.1	GCR Interrogation	72
12.3.2	GCR Interrogation ack.....	73
12.3.3	GCR interrogation negative response	73
12.3.4	Call released.....	73
Annex A (informative):	Change History	74
History		76

Foreword

This Technical Specification has been produced by the 3rd Generation Partnership Project (3GPP).

The contents of the present document are subject to continuing work within the TSG and may change following formal TSG approval. Should the TSG modify the contents of the present document, it will be re-released by the TSG with an identifying change of release date and an increase in version number as follows:

Version x.y.z

where:

- x the first digit:
 - 1 presented to TSG for information;
 - 2 presented to TSG for approval;
 - 3 or greater indicates TSG approved document under change control.
- y the second digit is incremented for all changes of substance, i.e. technical enhancements, corrections, updates, etc.
- z the third digit is incremented when editorial only changes have been incorporated in the document.

1 Scope

The present document specifies the stage two description of the Voice Group Call Service (VGCS) which allows speech conversation of a predefined group of service subscribers in half duplex mode on the radio link taking into account multiple subscribers involved in the group call per cell.

2 References

The following documents contain provisions which, through reference in this text, constitute provisions of the present document.

- References are either specific (identified by date of publication, edition number, version number, etc.) or non-specific.
- For a specific reference, subsequent revisions do not apply.
- For a non-specific reference, the latest version applies. In the case of a reference to a 3GPP document (including a GSM document), a non-specific reference implicitly refers to the latest version of that document *in the same Release as the present document*.

- [1] Void.
- [1a] 3GPP TR 21.905: "Vocabulary for 3GPP Specifications".
- [2] 3GPP TS 42.068: "Voice Group Call Service (VGCS); Stage 1".
- [3] 3GPP TS 43.022: "Functions related to Mobile Station (MS) in idle mode".
- [4] 3GPP TS 23.067: "enhanced Multi-Level Precedence and Pre-emption service (eMLPP); Stage 2".
- [5] 3GPP TS 44.018: "Mobile radio interface layer 3 specification; Radio Resource Control Protocol".
- [6] 3GPP TS 45.008: "Radio subsystem link control".
- [7] 3GPP TS 24.008: "Mobile radio interface Layer 3 specification; Core network protocols; Stage 3".
- [8] ITU-T Recommendation E.164: "The international public telecommunication numbering plan".
- [9] 3GPP TS 42.009(Rel-4): "Security aspects".
- [10] 3GPP TS 43.020: "Security related network functions".
- [11] 3GPP TS 44.068: "Group Call Control (GCC) protocol".
- [12] 3GPP TS 22.083: "Call Waiting (CW) and Call Hold (HOLD) supplementary services; Stage 1".
- [13] 3GPP TS 29.002: "Mobile Application Part (MAP) specification".

3 Definitions and abbreviations

3.1 Definitions

For the purposes of the present document, the terms and definitions given in 3GPP TS 42.068 and the following apply:

group call anchor MSC: the MSC responsible for managing and maintaining a particular voice group call
The group call anchor MSC is determined as the one controlling the cells of the group call area (see also group call relay MSC). For voice group call services where the group call area exceeds one MSC area, the group call anchor MSC is predefined in the network.

Group Call Attributes (GCA): group call area, dispatcher identities, and the non-activity time which results in the release of the voice group call by the network

group call relay MSC: the MSC controlling cells of a group call area which are not under control of the group call anchor MSC for those voice group call services where the group call area exceeds one MSC area

Group Call Register (GCR): functionality in the network containing the group call attributes

group members: service subscribers entitled to belong to a particular group classified by a certain group identification (group ID)

notification: notifications are given on common control channels or dedicated channels in order to inform group members which are either in idle mode or in dedicated mode or participating in a voice group call or voice broadcast call on the existence of voice group calls

Notification Channel (NCH): common control channel on which the notifications are sent by the network (equivalent to a paging channel)

originator-to-dispatcher information: information sent by the service subscriber originating a voice group call to the network during call setup for distribution to the dispatchers to be attached to the group call during call setup

voice group call channel: combined uplink/downlink to be allocated in a cell of the group call area for a particular voice group call

The uplink can be used by the presently talking service subscriber only. All mobile stations of the listening service subscribers in one cell shall listen to the common downlink.

voice group call member: any group member or dispatcher participating in an on going voice group call

3.2 Abbreviations

For the purpose of the present document, the abbreviations given in 3GPP TR 21.905 [1a] and the following apply:

CC	Country Code
DRX	Discontinuous reception
eMLPP	enhanced Multi-Level Precedence and Pre-emption
GCA	Group Call Attributes
GCR	Group Call Register
NCH	Notification Channel
NDC	National Destination Code
SN	Subscriber Number
VBS	Voice Broadcast Service
VGCS	Voice Group Call Service

4 Main concepts

4.1 Group definition

Service subscribers can become group members on a PLMN wide basis to one or more groups pre-defined in the network by a corresponding group identification (group ID). The membership enables them to initiate or receive voice group calls associated with that group ID. Certain dispatchers connected to external networks also require the capability to initiate or receive voice group calls.

In addition to subscriber details in the HLR, it is necessary for the mobile station to be aware of its group membership by storing details on the SIM. This is required because it shall respond to notification messages which include only the group ID (i.e. no IMSI or TMSI details).

Having become a group member, each service subscriber can set to active state or deactive state the group ID or any one out of his several group IDs on the SIM. In active state the subscriber can initiate voice group calls to that group. When in deactive state the subscriber can not make voice group calls to the group and the mobile station ignores any notification for that group.

If no NCH is defined in the cell, mobiles shall assume VGCS service is not available on that cell.

4.2 Group conversations

4.2.1 Group call initiation

4.2.1.1 Normal operation with successful outcome

A group call area can be restricted to a single MSC area or can exceed one MSC area.

A voice group call shall be initiated by a calling subscriber by a related input function, e.g. via MMI, specifying the selected service and the group ID dialled. As an option, the request of the calling subscriber to set up a voice group call may specify information to be sent as originator-to-dispatcher information to the network; in this case the originator-to-dispatcher information is included in the signalling for call setup from the mobile station to the network. It is the responsibility of the input function to ensure that the originator-to-dispatcher information has a correct format (in particular, an allowed length).

The MSC in which a voice group call is initiated obtains (by requesting the Group Call Register (GCR, see clause 5) the group call attributes.

This GCR interrogation after call initiation also determines whether the MSC shall act as anchor or as relay MSC. If the MSC is not the MSC then the call will be "forwarded" from the relay to the respective MSC (information also delivered by GCR) and further "call-establishment" is done by the anchor MSC as described in the following.

When a calling subscriber initiates a voice group call, one voice group call channel shall be established in each cell of the group call area and notifications for that call shall be sent in each of these cells. As an alternative, voice group call channels may only be established in cells in reaction to responses received from mobile stations on the notifications using notification response procedure. At the same time standard connections to dispatchers in the mobile network or in an external network shall be established. If originator-to-dispatcher information has been received in the signalling for call setup from the mobile station to the network and if the originating MSC supports processing of originator-to-dispatcher information, this information is transformed into user-to-user information and sent to the dispatchers as UUS1 when setting up the standard connections.

A voice group call channel shall consist of a combined uplink/downlink. The uplink will be used exclusively by the presently talking service subscriber. All mobile stations of the listening service subscribers in one cell shall only listen to the same common downlink.

The calling subscriber shall have its dedicated standard connection during call establishment and for the first period when he will be the talking service subscriber up to the time when the network decides that he shall join the voice group call channel. The mobile station of the calling subscriber shall then go to the voice group call channel and the dedicated standard connection shall be released.

Only one voice group call channel shall be established in each cell for any given voice group call, although there may be a number of simultaneous voice group calls within the same cell.

Service subscribers shall be notified on the voice group call in each cell. These voice group call notification messages shall be broadcast on the Notification CHannel (NCH).

The notification messages use the group ID rather than individual TMSIs/IMSI. Additionally, a group call area identification shall be included in order to enable a resolution in the case of overlapping group call areas. A service subscriber's mobile station needs to be able to recognise notification messages for those group IDs subscribed to and presently activated.

The network may also send messages on appropriate voice group call channel FACCHs, in order to notify group call members who may participate in other voice group calls. In addition, also paging information messages for standard calls may be sent in order to inform group call members on actually paged point-to-point calls.

Further the network may provide notification on the voice group call to service subscribers who have subscribed to the paged group ID and which are in dedicated mode. The process of broadcasting messages on NCHs is to be carried out throughout the call in order to provide the "late entry" facility whereby group members entering the area can join the call.

On receiving notification of a voice group call a group call member's mobile station shall adjust to the nominated channel to receive the voice group call if this channel was described in the notification message and receive the information on the downlink. Whilst receiving, the mobile station shall not transmit on the uplink SACCH. This group receive mode is different to the normal idle mode or dedicated mode. If no channel description was provided in the notification message, the mobile station shall establish a dedicated connection by use of the notification response procedure in order to respond to the notification. The network may then provide the mobile station with a channel description for the voice group call.

As a further mobile station option, the mobile station may read its paging subchannel in the current cell while in group receive mode or in group transmit mode in order to receive paging messages for mobile terminated calls.

4.2.1.2 Exceptional procedures

Completion of links into congested cells where pre-emption did not occur is required.

On receiving details of a voice group call the user may choose to move to the notified call or the mobile station may automatically move to the notified call if the new call is of higher priority than the existing call and automatic acceptance applies for this priority level.

4.2.2 On-going group calls

4.2.2.1 Normal operation with successful outcome

Within each voice group call starting from the instant where the calling subscriber first becomes a listening service subscriber, one service subscriber has the access at any one time to the uplink of the voice group call channel and his speech is then broadcast on all voice group call channel downlinks accordingly. The mobile station of the talking service subscriber shall, while no dispatcher is talking, be commanded by the network to mute the downlink speech to avoid non intelligible echo's.

If more than one service subscriber apply to the uplink, contention resolution shall be performed in the network. Contention resolution shall be performed in the group call anchor MSC.

Additionally, in order to speed up the uplink access procedure, the BSS may grant the uplink prior to contention resolution being performed by the group call anchor MSC. This would mean that more than one service subscriber may access to the uplink and the respective speech may be combined in the group call bridge and broadcast onto all voice group call downlink channels during a transitional period. The anchor MSC shall then select one of the talking subscribers and pre-empt the uplink use of the other talking subscribers.

Dispatchers voice involved shall be broadcast on the voice group call channel downlink at any time. Mobile dispatchers are provided with a standard link and thus with an dedicated permanent uplink different from the voice group call channel.

All non-dispatcher group call members are provided with an indication on the voice group call channel of whether the uplink is in use. When the uplink is not in use, any non-dispatcher group call member can request access to the uplink. Any speech from dispatchers is combined with any speech from a talking service subscriber.

In case of one talking service subscriber plus a parallel talking dispatcher, the talking service subscriber's mobile station shall receive an indication by means of signalling from the network so that it can unmute the downlink. DTMF tones should be used between dispatcher and network to indicate that the dispatcher wants to talk or to indicate talking is concluded.

Editor's Note: The use of other means such as Voice Activity Detection (VAD) is for further study

The release of the uplink is triggered by the user and indicated by the mobile station to the network. The network shall then indicate to the listening mobile stations that the uplink is free.

Mobile stations in group receive mode use the group receive mode procedure (see 3GPP TS 43.022) to "camp-on" in a new cell to be able to listen to the group call channel. The mobile station may find the voice group call channel details of a new cell on the related NCH.

A network may decide not to establish voice group call channels in all cells. Instead, notifications containing no channel description may be provided. If a mobile station moves to such a cell, it must establish a dedicated connection and respond to the notification by use of the notification response procedure in order to receive the voice group call. The network may then establish a voice group call channel and inform the mobile station on the channel position.

A network may obtain knowledge on whether mobile stations are listening in a cell by sending an uplink access request in an uplink free message on the voice group call channel downlink when no talking service subscriber is present. Mobile stations receiving such a request shall use uplink reply procedure and send uplink access bursts on the voice group call channel uplink with the establishment cause "reply on uplink access request". If no uplink access bursts are received by the network, the network may decide to release the voice group call channel in that cell and then provide notifications containing no channel description.

NOTE: Concerning security aspects, whilst authentication and membership checking of mobile call originators and of mobile uplink users can be carried out, it is not possible to authenticate service subscribers in group receive mode if they have not before established a dedicated connection to responded to a notification. No equivalent of a group "TMSI" is provided to protect the "identity" of established voice group calls.

4.2.2.2 Exceptional procedures

When a talking subscriber's mobile station loses contact with the network, the network must detect this loss and set the uplink free so that other mobile stations may access the uplink. The talking subscriber's mobile station which has lost the contact with the network shall return immediately to the group receive mode.

If a mobile station in group receive mode indicates a failure due to radio link time-out, the mobile station shall behave as specified in 3GPP TS 45.008 and go back to idle mode, possibly in another cell, as determined by the cell re-selection algorithm. If a notification is received for the same call, the mobile station shall try to reconnect.

4.2.3 Leaving of a group call without termination

A service subscriber can leave the voice group call at any point by "deselecting" it via an MMI function. Having deselected the voice group call the mobile station returns to idle mode and "ignores" any further notification messages related to that voice group call.

NOTE: If a service subscriber does not wish to participate in calls to a particular group ID for long periods of time, the group ID shall be switched to deactivate state by the subscriber.

The service subscriber shall have the capability to reselect the voice group call. The mobile station shall not ignore notification messages to that call any more.

The dispatcher shall be able to leave a voice group call without terminating it.

4.2.4 Group call termination

A voice group call can only be terminated by the calling subscriber or by an entitled dispatcher or due to no activity timer expiry (see subclause 8.1.2.3).

The calling subscriber can terminate the call only if the calling subscriber has access to the uplink. He shall remain the calling subscriber during the length of the particular voice group call even if he leaves the call and then returns to it later.

The dispatcher can terminate the call by a network defined user operation (via DTMF).

4.2.5 Acknowledgements

The acknowledgement is an application option.

For voice group calls which are identified by an acknowledgement flag mobile stations which have acknowledgement facilities have to return an acknowledgement message with a predefined content in a predefined manner.

The acknowledgement shall be sent using an appropriate data service, to a predefined address or with a predefined short code stored on the SIM card. The network may apply geographical routing to a predefined acknowledgement service centre.

4.2.6 Transactions between the mobile station and the network

Mobile stations which are in group receive mode shall not perform any transactions with the network while adjusted to the voice group call channel. They shall leave the group receive mode and act in a standard way to perform any transaction if necessary and return to the voice group call afterwards.

Mobile stations which have access to the voice group call channel uplink shall not perform any transactions for supplementary services and SMS.

4.2.7 Processing of originator-to-dispatcher information

The originating service subscriber may include originator-to-dispatcher information during call setup. If the originating MSC supports processing of originator-to-dispatcher information, it transforms the received originator-to-dispatcher information into UUS1, and sends it:

- if the originating MSC is not the voice group call anchor MSC: to the voice group call anchor MSC;
- if the originating MSC is the voice group call anchor MSC: to the dispatchers to be attached to the group call during call setup of the connections to these dispatchers.

The anchor MSC receiving UUS1 in a voice group call setup from an originating relay MSC forwards this UUS1 to the dispatchers to be attached to the group call during call setup of the connections to these dispatchers.

Transformation of originator-to-dispatcher information: Originator-to-dispatcher information can be compressed or uncompressed.

- Decompression of compressed originator-to-dispatcher information is specified in 3GPP TS 44.068.
- The transformation of uncompressed originator-to-dispatcher information into UUS1 is the UUS1 containing the same user-user IE as the originator-to-dispatcher information.
- The transformation of compressed originator-to-dispatcher information into UUS1 is the UUS1 resulting from transforming the decompressed originator-to-dispatcher information into UUS1.

5 General architecture

5.1 Group Call Register (GCR)

The general architecture of GSM is maintained. In addition, a network function is required which is used for registration of the group call attributes, the Group Call Register (GCR).

The GCR function is mainly a database function, holding information about voice group calls.

NOTE 1: The GCR implementation is not specified. It may be realized e.g. as a new network node, in a PABX directly attached to an MSC, inside an MSC or as an HLR. The interface between the GCR function and other functions is not specified in the GSM technical specifications. As a consequence, the functional split between MSC and GCR as developed in the present document is only indicative, and other functional splits can be implemented.

The GCR data for a specific voice group call is set at the creation of the group call attributes, and can be subsequently modified. No support for these functions is specified in the GSM technical specifications.

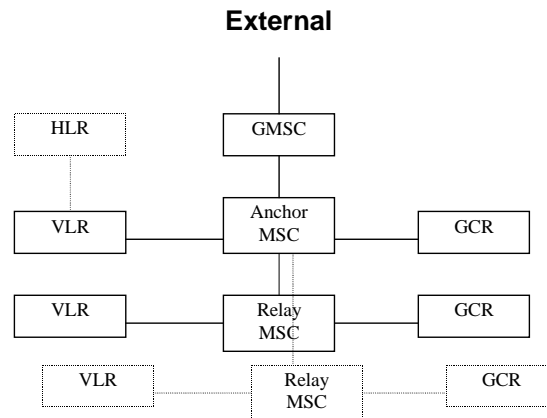

Figure 1: Functional architecture with a Group Call Register

The signalling between the entities shown in figure 1, for the two cases of service subscriber and dispatcher originated calls, shall be as defined in the following.

Service subscriber originated: The MSC containing the cell within which this voice group call is initiated shall perform subscription checking against VLR records. It shall then consult its GCR to determine the group call attributes related to its MSC area and whether it is the group call anchor MSC for that voice group call. If it is not, the GCR shall provide with the group call attributes the routing information identifying the group call anchor MSC to the originating MSC. The originating MSC shall then route the voice group call to the anchor MSC; if the initiation of the voice group call had specified originator-to-dispatcher information and processing of originator-to-dispatcher information is supported by the originating MSC, the originator-to-dispatcher information is transformed by the originating MSC into UUS1 and sent to the anchor MSC. If the originating MSC is the group call anchor MSC, along with the group call attributes, the GCR shall provide information on all group call relay MSCs to be involved.

The group call anchor MSC shall set up links to all group call relay MSCs. It shall also initiate setup of point-to-point connections to the dispatchers associated to the voice group call (see subclause 8.1.2.2); if UUS1 information has been received in the signalling for call setup from the originating MSC, this UUS1 information is included in the setup of point-to-point connections to the dispatchers. Each MSC involved in a voice group call obtains its proper group call attributes from the GCR related to the MSC.

The IMSI of the calling service subscriber must be provided to and stored in the anchor MSC and each relay MSC in order to allow the originator to clear the group call later on.

Dispatcher originated: In the case of dispatchers calling from an external network, the call request, in the form of an ISDN number, shall be received at a GMSC. The number shall be analysed and the call shall be directly routed to the group call anchor MSC by the GMSC based on the called identity without requesting an HLR. The group call anchor MSC shall interrogate the GCR and obtain the group call attributes. If an identical voice group call is currently in progress, the dispatcher shall be connected to this call and no new call shall be initiated. When interrogating the GCR, the identity of the dispatcher is compared with the list of dispatchers which are allowed to initiate the call. If the dispatcher is not in the list, or an identity is not provided, the network shall reject the call.

NOTE 2: Optionally dispatchers may also be user of the GSM network in which the VGCS service is provided or may directly be connected to a PABX containing the GCR. Dispatcher which are registered for a certain voice group call and which have also a subscription for VGCS with the same group ID as the voice group call for which they are dispatcher shall deactivate this group ID when they are located in the corresponding group call area in order to avoid conflicts between paging for the dispatcher and notifications for the group ID.

5.2 Voice group call responsibility

The MSC responsible for the voice group call is the one nominated within the GCR or the one to which the call is routed from the GMSC in the case of a dispatcher originated call. This MSC is termed the group call anchor MSC.

If the group call area extends beyond one MSC area then any MSCs controlling cells in the area outside of the group call anchor MSC are referred to as group call relay MSCs.

6 Compatibility issues

VGCS can not be used with standard Phase 1 or Phase 2 mobile stations. A dedicated mobile station with VGCS capability is required.

A mobile station with VGCS capability shall also provide the complete functionality in order to allow the use of Phase 2 services.

Standard Phase 1 and Phase 2 mobile stations in a network shall not be impacted by the presence of VGCS services in that network due to VGCS signalling, also if the mobile station is operated with a SIM of a VGCS service subscriber.

7 Transmission

7.1 Transmission architecture

A conference bridge is required to connect the transmission paths of the nominated cells. The bridge is to be located within the group call anchor MSC. The group call anchor MSC is responsible for setting up all connections, both to the nominated cells (voice group call channels) in the group call anchor MSC and in any related group call relay MSC, and to the dispatchers. Except when an originator, served by a relay MSC, is on the initial dedicated link, there shall be one link towards every relay MSC and a distribution function in the relay MSCs and from there one link per cell within the group call relay MSC which is involved in the voice group call, while the originator is on a dedicated link served by a relay MSC, there is an additional link from the anchor MSC to the relay MSC serving the originator and an additional link from the relay MSC serving the originator to the cell serving the originator. There shall be no secondary bridges in BSCs.

While a talker served by a relay MSC is on any other dedicated or group channel than the initial dedicated channel, the following applies: The distribution function shall be implemented using a secondary conference bridge at the relay MSC so that VGCS talker speech sent on the current channel uplink is transmitted to local relay cells as well as being transmitted over the link back to the anchor MSC, for distribution to the rest of the network, dispatchers and nominated cells at other relay MSCs.

NOTE 1: The conference bridge shall not mute the uplink speech.

A mechanism is required to indicate the downlink muting and uplink busy when the dispatcher is talking. DTMF should be used for this mechanism.

7.2 Radio channels

In each cell of the group call area one voice group call channel may be established consisting of a downlink received by all service subscriber's mobile stations and an uplink which shall be used by the talking subscriber's mobile station only.

The calling subscriber's mobile station shall use a dedicated standard uplink/downlink which is connected to the conference bridge up to the instant where the network decides that the mobile station shall join the voice group call channel and the dedicated connection is released.

The network may decide to switch a talking subscriber's mobile station from the voice group call channel to a dedicated standard uplink/downlink at any time. This dedicated connection shall then be maintained up to the instance where the network decides that the mobile station shall join the voice group call channel again and the dedicated connection is released.

A listening subscriber's mobile station which responds to a notification because no description of the voice group call channel was provided in the notification may be assigned a dedicated standard uplink/downlink which is connected to the conference bridge up to the instant where the network decides that the mobile station shall join the voice group call channel and the dedicated connection is released.

Voice group call channels shall be standard full rate or half rate speech channels. A specific voice group call can have cells in the group call area where the voice group call channels are either only half rate speech or only full rate speech or there are cells with half rate speech and cells with full rate speech. Those implementations are optional for the network operator.

Mobile station using the uplink are in group transmit mode. Signalling for this RR mode is specified in 3GPP TS 44.018. Mobile stations not using the uplink and not in dedicated mode shall ignore any signalling concerned only with uplink usage.

Full standard duplex channels shall be provided to all dispatchers listed in the GCR. These may be provided either via GSM, or via an external network. The links to the dispatchers are connected to the conference bridge.

The mobile station of the talking service subscriber will transmit on the uplink related to the downlink of the voice group call channel. The downlink of this channel which is also received by the mobile station using the uplink will typically echo the uplink unless one or more dispatchers are talking simultaneously. The mobile station of the talking service subscriber shall mute the downlink speech unless more than one speaker is talking. In this case, an indication shall be provided to the mobile station, and the mobile station shall no longer mute the downlink. When the downlink is not muted it is acceptable for the talking subscriber to hear an echo, and possibly other distortions which may occur, as the intention is to alert the talking subscriber to the fact that someone else is talking, rather than allow them to hear the message from the dispatcher. If no dispatcher is talking anymore and the talking service subscriber still has access to the uplink, an indication shall be provided to the mobile station, and the mobile station shall mute the downlink again.

7.3 Data confidentiality

Data confidentiality on the radio can be provided as a network option.

If data confidentiality is provided, both the uplink and the downlink of the voice group call channels in each cell of the group call area shall be ciphered using the same group key.

The group key is related to the group ID. For each group ID, there is a number of group keys stored on the SIM which are identified by a group key number. The group key number identifying the group key to be used for a particular voice group call is provided with the notification to the mobile stations. Mobile stations which have a dedicated connection shall be informed of the group key number before they join the voice group call channel.

The distribution of the group keys to the related SIMs shall be done off-line.

NOTE: The distribution of group keys shall be done by the service provider when editing the SIM. Distribution of group keys via the radio interface may be possible with future features as the SIM-toolkit. Those distribution schemes are for further study.

Details on data confidentiality for voice group calls are provided in 3GPP TS 42.009 and 3GPP TS 43.020.

8 Information storage

8.1 Information stored in the GCR

8.1.1 Information used for routing of service subscriber originated voice group calls

The GCR shall hold for a related MSC area for each group ID and cell from which voice group calls can be established by service subscribers the group call reference to be used for a voice group call to be established and an indication whether the originating MSC is the group call anchor MSC.

If the originating MSC is the group call anchor MSC, the GCR shall provide the group call attributes related to that group call reference as defined in subclause 8.1.2 to the originating MSC and the originating MSC shall establish the voice group call.

If the originating MSC is not the anchor MSC, the GCR shall provide the group call reference plus the routing information identifying the anchor MSC to the originating MSC and the originating MSC shall route the voice group call to the anchor MSC.

NOTE: In case the GCR function is distributed over different physical entities, each may hold only the information needed to treat requests coming from the MSCs connected to the physical GCR entity.

8.1.2 Group call attributes

Each MSC involved in a voice group call requests its proper group call attributes from its related GCR. For any group call reference the GCR shall provide the corresponding group call attributes to the requesting MSC. These lists shall be programmed by the service provider at registration of the network specific service configuration.

The contents of each list related to requests of the group call anchor MSC is as follows:

- a list of cells inside the MSC area of the group call anchor MSC into which the call is to be sent (part of the group call area), see subclause 8.1.2.1;
- a list of group call relay MSCs into which the call is to be sent;
- information on the cipher algorithm and the group key to be used for this voice group call;
- information on the codecs allowed for this voice group call;
- a list of identities of dispatchers to which a dedicated link is to be established, see subclause 8.1.2.2;
- a list of identities of dispatchers which are allowed to initiate the voice group call, see subclause 8.1.2.2;
- a list of identities of dispatchers which are allowed to terminate the voice group call, see subclause 8.1.2.2;
- the length of time over which no activity is detected before the voice group call is automatically terminated, see subclause 8.1.2.3;
- the default priority level related to the voice group call if eMLPP applies, see subclause 8.1.2.4;
- a status flag indicating if a voice group call with the related group call reference is on-going, see subclause 11.3.1.1.1.

The contents of each list related to requests of a group call relay MSC is as follows:

- a list of cells inside the MSC area of the requesting MSC into which the call is to be sent (part of the group call area), see subclause 8.1.2.1;
- identity of the group call anchor MSC;
- a status flag indicating if a voice group call with the related group call reference is on-going, see subclause 11.3.1.1.1.

8.1.2.1 Group call area

The group call area is defined as a list of cells inside the network. The cells shall be defined by their cell identification consisting of the Location Area Code and the Cell Identity as defined in 3GPP TS 24.008 and are therefore uniquely identified in the network.

In the case the group call area extends over several MSCs, only the cells belonging to the requesting MSC are included in the group call attributes.

8.1.2.2 Dispatcher identities

Dispatcher identities shall be ISDN numbers or MSISDN numbers with the structure according to ITU-T Recommendation E.164. They shall correspond both to the number to be used to establish a call toward the dispatcher and the number provided as calling line identification when the call is originated by a dispatcher.

The list of dispatcher identities is used by the anchor MSC to establish dedicated communication paths to each dispatcher and connect them to the conference bridge of the call.

The list of dispatcher identities which are allowed to initiate voice group calls is used by the anchor MSC for verification for a voice group call establishment by a dispatcher.

The list of dispatcher identities which are allowed to terminate voice group calls is used by the anchor MSC for verification for a voice group call release by a dispatcher.

8.1.2.3 No activity time

A timer in the anchor MSC used to release the voice group call because of no activity can be set to a fixed value or can be set to a value defined for each voice group call.

The timer in the anchor MSC shall be started each time an uplink release has been indicated to the MSC and no dispatcher is talking. It shall be reset each time an uplink access is indicated to the MSC or a dispatcher is talking.

When a variable timer is provided, there shall be sufficient timers such that one can be associated with each on-going group call. The corresponding time shall be stored in the GCR.

The length of the timer is not specified in the GSM technical specifications.

8.1.2.4 Priorities

If the eMLPP supplementary service is applied to a voice group call, the priority level shall be stored in the GCR. For further details see 3GPP TS 23.067.

8.2 Information managed per subscriber

8.2.1 Stored in the HLR

The following additional information shall be stored in the HLR:

- the subscription option for voice group calls which can be made in the HPLMN only or also in case of roaming;
- a list of all the group IDs a service subscriber is entitled to use.

The group IDs are defined in subclause 9.1.

A service subscriber shall not be provided with more than 50 group IDs.

8.2.2 Stored in the VLR

The list of all the group IDs a service subscriber is entitled to use shall be brought forward to a VLR at the same time as other subscriber information is copied, and VLR entries shall be modified when corresponding HLR records are changed.

8.2.3 Stored in the SIM

The information detailed in subclause 8.2.1 also needs to be stored on the SIM. The service subscriber shall be able to deactivate or reactivate a group ID by MMI interaction so that the mobile station does ignore notification messages to this group ID.

For each group ID where data confidentiality may be applied, the SIM needs to store the cipher algorithm to be used and the possible group keys.

8.3 Information used for routing of dispatcher originated voice group calls

Routing of dispatcher originated calls shall be performed on the MSISDN number received at a GMSC in the Initial_Address_Message.

- Because the group call reference is included in the called MSISDN number as defined in subclause 9.2d the routing information can be derived by the routing function of the GMSC. The GMSC afterwards directly routes the call request to the group call anchor MSC without requesting an HLR.

9 Identities

9.1 Elementary identities for group calls

a) Group ID

The group ID is a sequence of decimal digits with a maximum length depending on the composition of the group call reference defined under c). The length of Group ID shall be in a range of 1 to 6 digits.

The mobile station derives the group ID from the group call reference by identifying the longest group ID amongst those stored in the SIM and matching the least significant digits of the group call reference. If no group ID is stored in the SIM that matches the least significant digits of the group call reference, the mobile station is not able to derive the group ID from the group call reference.

NOTE 1: The network should use Group IDs matching an initial part of other group IDs with greatest care, if at all.

EXAMPLE: A mobile station storing the group IDs 678, 2 678 and 42 678 (and only those) in the SIM will derive group ID 2 678 from group call reference 13 452 678.

For definition of Group ID on the radio interface, A interface and Abis interface, see 3GPP TS 44.068 [11].

For definition of Group ID coding on MAP protocol interfaces, see 3GPP TS 29.002 [13].

b) Group call area ID

The group call area ID is a sequence of decimal digits uniquely assigned to a group call area in one network and with a maximum length depending on the composition of the group call reference defined under c).

c) Group call reference

Each voice group call in one network is uniquely identified by its Group call reference. The group call reference is a concatenated sequence of the group ID (as the least significant part) and the group call area ID (as the most significant part). The group call reference shall have a maximum length of 8 decimal digits. The composition of the group call area ID and the group ID can be specific for each network operator.

Group call area ID	Group ID
--------------------	----------

For definition of Group Call Reference (with leading zeros inserted as necessary) on the radio interface, A interface and Abis interface, see 3GPP TS 24.008 [7], 3GPP TS 44.018[5] and 3GPP TS 44.068 [11].

For definition of Group Call Reference coding (also known as ASCII Call Reference, Voice Group Call Reference or Voice Broadcast Call Reference) on MAP protocol interfaces, see 3GPP TS 29.002 [13].

9.2 Use of identities in the network

For each voice group call the identifications as defined in the following shall be used within the network for the related purpose mentioned.

For voice group call services which are to operate in more than one PLMN, group identities have to be co-ordinated between the network operators involved.

a) Identities used for GCR requests for service subscriber originated voice group calls

In case of a service subscriber originated call, the identity of the call used by the MSC in which the call is originated to interrogate the GCR shall consist of the originating serving cell identity as defined in 3GPP TS 24.008 and the group ID as defined in subclause 9.1.

Originating cell ID	Group ID
----------------------------	-----------------

A service subscriber initiating a voice group call has to call the wanted group ID. The MSC in which the call is originated shall accumulate from the BSS the called group ID and the originating cell ID.

If the group call area exceeds one MSC area, the identity used to interrogate the GCR by an MSC in which the call was not originated shall consist of the group call reference as defined in subclause 9.1.

b) Identities used for GCR requests for dispatcher originated voice group calls

In case of dispatcher originated call the identity used by the MSC to interrogate the GCR shall consist of the group call reference as defined in subclause 9.1.

c) Identities used for notifications

Identities used for notification messages shall consist of the group call reference as defined in subclause 9.1.

d) Identities used by dispatchers for voice group call establishment

For dispatcher originated calls an MSISDN is dialled. The Country Code (CC) and National Destination Code (NDC) are used as normal for routing purposes. The numbering scheme is according to ITU-T Recommendation E.164. The Subscriber Number (SN) is used to indicate:

- the request of a group call by use of a prefix. The length of the prefix shall be 1 to 2 digits;
- the wanted group call reference as defined in subclause 9.1.

CC	NDC	Prefix	Group call reference
-----------	------------	---------------	-----------------------------

e) Identities used for VLR requests for service subscriber originated group calls

The group ID shall be used on the B-Interface for VLR requests.

f) Anchor MSC address for routing of service subscriber originated calls from Relay MSC to anchor MSC

For service subscriber located in Relay MSCs originated calls an anchor MSC address is used as called party address to route the call to the anchor MSC. The anchor MSC address structure is the same as for dispatcher originated calls (see subclause d)) The Country Code (CC) and National Destination Code (NDC) are used as normal for routing purposes. The numbering scheme is according to ITU-T Recommendation E.164. The Subscriber Number (SN) is used to indicate:

- the request of a group call by use of a prefix. The length of the prefix shall be 1 to 2 digits; the actual value of the prefix may be different than the one dialled by dispatchers.
- the wanted group call reference as defined in subclause 9.1.

CC	NDC	Prefix	Group call reference
-----------	------------	---------------	-----------------------------

10 Operation and maintenance aspects

NOTE: A list and short description of the operation and maintenance aspects will be given. This includes the options and parameters which can be set by the operator:

- handling of timers;
- registration aspects; etc.

11 Function and information flows

11.1 Group management

The group call attributes, as given in subclause 8.1 shall be entered and modified by the service provider. A list providing information on necessary Operation and Maintenance actions is given in clause 10.

11.2 Group membership management

Once the membership is established, the individual membership of the group can be placed in an active or deactive state on the SIM by the user. If a subscriber has a group ID in an active state, the subscriber is able to establish voice group calls corresponding to that group ID.

In a deactive state the mobile station prevents the service subscriber from establishing calls using the group ID and the corresponding notifications need to be "ignored" by the mobile station.

The active state and deactive state entries may be password protected as an implementation option.

Group IDs are listed in the subscription data within the network and on the SIM. The SIM must be returned to the network operator or service provider for updating if the subscription is to be changed.

NOTE: Updating of subscription data over the radio interface is not considered. However, this shall not preclude future applications if corresponding mechanisms may be implemented.

Users can interrogate their mobile stations to determine to which groups they are members and which subscriptions are currently in an active state.

11.3 Call management

11.3.1 Call establishment

A voice group call can be established by either a service subscriber or by a dispatcher.

11.3.1.1 Service subscriber call establishment

11.3.1.1.1 Initial stage

The initial signalling from the originating service subscriber informs the network that a voice group call is required and details the group ID; it may specify originator-to-dispatcher information. No information relative to the group call area is given by the caller.

The network shall perform a number of checks in order to determine how to handle the call:

- check of the ability of the subscriber to establish the call;
- check whether the call can be initiated from the cell;
- check of the existence of an on-going call of the same group call reference.

The MSC shall check the VLR records for the ability of the subscriber to start the call. If the service subscriber has no subscription for the voice group call service with the indicated group ID, the call shall be released. In addition, the VLR shall return barring and identity presentation restriction checks to the MSC.

The MSC shall then request information from the GCR by giving the group ID and the originating cell ID as defined in subclause 9.2. The GCR first derives the group call area ID from the group ID and the originating cell ID. If no group call area ID is related to the group ID and originating cell ID, the call shall be released. If a group call area ID is related to the group ID and originating cell ID, the GCR shall transfer the corresponding group call attributes to the MSC. From that moment until the MSC indicates the contrary, the call shall be considered as on-going by the GCR.

If the MSC is not the group call anchor MSC for the voice group call as indicated in the GCR, then the voice group call request shall be passed to the group call anchor MSC; in that case, if the initiation of the voice group call had specified originator-to-dispatcher information and processing of originator-to-dispatcher information is supported by the MSC, the originator-to-dispatcher information is transformed by the originating MSC into UUS1 and sent to the anchor MSC.

It is possible that two service subscribers or a service subscriber and a dispatcher or two dispatchers may attempt to establish a call using the same group ID and corresponding to the same group call area ID. If the two voice group calls are established with the same group ID but for different group call areas then separate voice group calls shall be established. If the group call areas overlap, it is up to receiving mobile station to determine which call to participate in. If more than one call is made to identical group ID and group call area, the network shall reject all but one of the call attempts.

A service subscriber which is entitled by his subscription to establish voice group calls while roaming shall only be able to use supra-PLMN group IDs as defined in subclause 9.1 in case of roaming. In case of roaming, the mobile station shall only react on notifications for supra-PLMN group IDs.

If the GCR receives a new interrogation related to a group call reference where the call is indicated as on-going in the GCR, the GCR shall provide the on-going status together with the group call reference back to the MSC. The MSC shall then release the call with cause user busy in case of a service subscriber originated call request. The mobile station of the service subscriber shall then look for notifications of the respective group ID on the NCH and join the voice group call. In case of a dispatcher originated voice group call request, the MSC shall join the dispatcher to the conference bridge of the voice group call.

Because of the possibility of overlapping group call areas, each call requires a unique reference, assigned by the GCR related to the MSC in which the call was originated. The group call reference shall be composed of the group ID and a group call area ID (see clause 9).

Authentication of the calling subscriber can be performed by the network as for normal calls.

11.3.1.1.2 Establishment of the transmission means

A voice group call channel shall be established in all the cells throughout the identified group call area using physical channels selected by the BSCs as appropriate. The downlink channels shall be established without any return signalling from mobile stations. Whilst the downlink channel is being established, the MSC shall form a conference bridge containing the appropriate channels on all BTSs in the group call area. The MSC is responsible for adding dispatchers to the conference bridge.

Alternatively, the network may establish voice group call channels in a cell on demand, i.e. if mobile stations respond to the notifications as defined in subclause 4.2.2.1.

In parallel, a dedicated suitable channel is allocated to the caller if not already the case. Once this is done, and at least one downlink channel is established, the MSC shall signal to the calling subscriber that this has occurred so that he knows when to start speaking.

The mobile station shall indicate connection to the subscriber. If channels could not be established in particular cells because of congestion, channels are allocated to these cells as soon as possible.

11.3.1.1.3 Release of the dedicated transmission means of the calling service subscriber

The calling subscriber shall be given a dedicated connection up to the time where the network requests him to join the voice group call channel. If the calling subscriber is not talking, the network requests him to join the voice group call channel as a listener by use of a channel release procedure. Otherwise, the network shall request him to join the voice group call channel as a talker by either a channel assignment procedure or a handover procedure or a channel mode modify procedure.

For the time when the voice group call is established until the calling subscriber becomes a listening service subscriber for the first time, the "uplink busy" flag is set (see subclause 11.3.8). Mobile stations shall be programmed such that if they originate the call, they indicate to the user that it is required that an indication of the desire to speak should be made if he wants to speak. If this is not done within a certain time, the mobile station sends an UPLINK_REL message to the network and the uplink shall become free.

11.3.1.1.4 Release of the dedicated transmission means of mobile stations responding to a notification

Mobile stations which respond to a notification for which no description of the voice group call channel was given in the notification message may be given a dedicated connection up to the time where the network requests the mobile station to join the voice group call channel. If the service subscriber is not talking, the network requests him to join the voice group call channel as a listener by use of a channel release procedure. Otherwise, the network shall request him to join the voice group call channel as a talker by either a channel assignment procedure or a handover procedure or a channel mode modify procedure.

11.3.1.1.5 Transfer of a talking service subscriber to a dedicated connection

The network may decide to switch a talking subscriber's mobile station from the voice group call channel to a dedicated standard uplink/downlink at any time. This dedicated connection shall then be maintained up to the instance where the network decides that the mobile station shall join the voice group call channel again.

At this instance, if the service subscriber is not talking, the network requests him to join the voice group call channel as a listener by use of a channel release procedure. Otherwise, the network shall request him to join the voice group call channel as a talker by either a channel assignment procedure or a handover procedure or a channel mode modify procedure.

11.3.1.2 Dispatcher call establishment

In the case of dispatchers originated calls the call request, in the form of an MSISDN number, shall be received at a GMSC. Such a call can be treated by the GMSC as a normal mobile terminated call. In this case, the GMSC shall interrogate an HLR, determined on the basis of the MSISDN number. The HLR in turn may either interrogate the appropriate MSC/VLR to obtain an MSRN, or may supply an MSRN predefined in the HLR and related to the respective group call reference in the MSC/VLR. If the HLR interrogates the MSC/VLR for the MSRN, the HLR shall provide this MSC/VLR with the related IMSI including the group call reference as defined in clause 9.

Alternatively, the call request can be forwarded directly to the related group call anchor MSC on basis of the GMSC's internal routing table. In this case, the group call reference shall already be included in the requested MSISDN number as defined in clause 9.

When interrogated by the group call anchor MSC, the GCR shall check if the calling line identity is within the list of dispatcher identities allowed to establish the voice group call. If not the case, the call shall be rejected.

After reception of the call request, the group call anchor MSC checks whether an on-going call of the same group call reference exists, in which case the group call anchor MSC shall add the dispatcher to the call.

At the point at which notification messages are sent to mobile stations, a tone is relayed to the dispatcher to inform the dispatcher that the message can commence.

11.3.1.3 Notification procedures

Different notification procedures shall be applied in relation to the mode of the mobile station as presented in table 1 and defined in the following sections.

Table 1: Overview on different information messages for new or on-going calls

Incoming call type:	VBS or VGCS call	point-to-point call
MS states:		
Idle mode	(section a)	(standard paging)
Group mode, dedicated channel	(section b)	(section c)
group receive mode and group transmit mode	(section b)	(section c)
dedicated mode	(section b)	(standard Call Waiting) (note)
NOTE: only for point to point calls with certain restrictions as defined in 3GPP TS 22.083.		

a) Notification for mobile stations in idle mode

Once the voice group call channel has been established in a cell or the network is waiting to receive notification responses to establish a voice group call channel, notifications shall be broadcast on the NCH in that cell.

The position of the NCH is derived from the system information of the BCCH.

The notification messages shall include the group call reference and possibly the description of the voice group call channel, the call priority if eMLPP is applied, and the group cipher key number.

A notification message can contain no, one or more notifications.

The notification process needs to continue throughout the duration of the group call, in order to permit the "late entry" of other mobile stations. Mobile stations moving into the group call area which are in idle mode shall be directed to the voice group call channel by the notification messages, possibly by means of the notification response procedure.

The scheduling of the notification messages in a cell shall be managed by the BSS. Information can be added in the messages to limit the required reception of NCH messages. The following constraints shall be met:

- the three first initial notifications (i.e. the first for a given group call) shall have priority over subsequent notifications (i.e. the messages for an on-going group call) and must be sent as soon as possible;

NOTE 1: In addition initial notification messages for calls with or above an operator defined priority level can be sent on all possible paging or access grant channels to reduce the delay for those mobile stations which are not using Discontinuous reception (DRX).

- afterwards, an on-going group call in the cell shall be periodically notified on the NCH.

Since the information for the establishment of a voice group call is sent onto the NCH rather than on the PCH as for normal point-to-point calls, the mobile station must listen to the PCH as well as to the NCH. A "reduced NCH monitoring" mechanism can be used to save power in the mobile station when listening to the NCH.

A mobile station able to receive voice group calls either, depending on the implementation:

- can use the "reduced NCH monitoring" mechanism. When entering a cell, the mobile station shall listen to the NCH to get the notifications of the voice group calls on-going in the cell. Afterwards, the mobile station needs to listen to the NCH only if it is informed on the availability of a notification for a new voice group call. This shall be based on the NCH status information provided, as indicated in 3GPP TS 44.018;
- do not apply the "reduced NCH monitoring" mechanism and read all possible paging or access grant channels.

b) Notifications for mobile stations in group mode dedicated channel, group receive, group transmit or dedicated mode

In addition to sending initial notification messages on the NCH for the voice group call, the BSS can provide initial notification into on-going voice broadcast, group calls and point to point calls informing mobile stations partaking in these calls of new voice group calls that are being set-up in the cell.

NOTE 2: The additional notification into on-going voice broadcast and group calls and point to point calls should be provided by the BSS if the priority level of the new call is equal or higher than the O&M defined priority level.

In order to do this the BSS sends initial notification messages on FACCH to all on-going voice broadcast, group calls, and point to point calls in the cell. The initial notification message on FACCH shall contain the group call reference, the priority level if eMLPP applies and possibly the TCH description which allows the mobile station to connect directly to the new call without reading the NCH.

An indication of change of notifications in the current cell may be provided on SACCH by the BSS.

As a mobile station option, the mobile station may read the NCH of the current cell while in group mode dedicated channel, group receive, group transmit or dedicated mode in order to be notified on other voice group calls.

NOTE 3: Mobile stations may require an additional receiver to read the NCH in order to ensure a higher probability of receiving notifications for all present voice group calls without degradation of the received speech quality.

Late entry of mobile stations into ongoing high priority group calls is covered by the following mechanisms:

- Late entrance in dedicated mode

If a mobile station in dedicated mode is moving into an area where a group call (VGCS or VBS) with priority level equal or higher to an operator specific setting is ongoing, the BSS shall resend the notification message to the mobile station on FACCH, if the mobile station has ASCII capabilities. This notification shall be triggered by completion of the dedicated channel assignment.

Sending periodical notification on FACCH to mobile station in dedicated mode is optional, and is done as long as the group call (VGCS or VBS) with priority level equal or higher to an operator specific setting, is ongoing, with a repetition period given by an operator specific setting.

- Late entrance in group receive or group transmit mode

When a group call (VGCS or VBS) with priority level equal or higher to an operator specific setting, is established, the BSS shall send periodical notification on FACCH to all ongoing voice broadcast and group calls in the cell, except on the FACCH of the group call (VGCS or VBS) which has initiated this periodical notification. By this method the mobile station in group receive or group transmit mode moving into this cell is notified. Periodical notification on FACCH is done as long as the group call (VGCS or VBS) with priority level equal or higher to an operator specific setting, is ongoing, with a repetition period given by an operator specific setting.

NOTE 3a: The operator determined Periodical FACCH notification period shall be a BSS specific operator setting and be a minimum of 1s and maximum of 5s.

c) Paging into on-going voice group calls

Paging into on-going voice group calls shall be provided as an implementation option.

In addition to establishing the links for the voice group call, the network can provide paging information into on-going voice group calls informing mobile stations partaking in a voice group call of new incoming point-to-point calls.

The mobile station shall be ready to receive a paging message on the FACCH containing the mobile subscriber identity and the priority level if eMLPP applies.

The mechanism for the MSC to select the group calls to be paged as well as the mechanism for the MSC to inform the concerned BSS of paged group calls is still for further study.

In the event of a reorganisation of the PCH the BSS shall inform the mobile stations via the FACCH that paging reorganisation has occurred. A mobile station receiving this indication shall decode the BCCH in order to obtain the new paging configuration.

As a mobile station option, the mobile station may read its paging subchannel in the current cell in group receive mode or group transmit mode in order to receive paging messages.

NOTE 4: Mobile stations may require an additional receiver to read its PCH subchannel in order to ensure a higher probability of receiving all relevant paging messages without degradation of the received speech quality. The additional receiver may be the same as used for reception of the NCH described under b) above.

11.3.1.4 Destination subscribers

Mobile stations of destination subscribers which are in idle mode shall listen to notification messages on the NCH and move to the voice group call channel or respond to the notification.

Mobile stations which are busy shall either pre-empt the current call (if eMLPP is applied and the new call is of a sufficient priority), or shall provide the service subscriber with an indication similar to call waiting, when applicable.

11.3.1.5 Called dispatchers

Dispatchers are connected into the voice group call as a standard point-to-point call.

11.3.2 Call release

The voice group call can be terminated by the calling subscriber clearing it down, or by any dispatcher nominated in the GCR allowed to terminate the call.

11.3.2.1 Call termination by the calling subscriber

The calling subscriber will need to gain the uplink before he can issue a termination request. If this occurs a call release message shall be sent on the FACCH of all cells in the group call area and then all resources are freed.

The MSC has to store the identity of the calling subscriber and to check it against the identity of the service subscriber which sends the voice group call disconnect message.

A time-out mechanism is required, such that if the MSC does not detect any downlink activity (i.e. either uplink or dispatcher activity) for a pre-set time, the call is terminated by the network. For this a timer shall be provided with a length as defined in the group call attributes in the GCR or, as an implementation option, with a fixed length.

11.3.2.2 Call termination by dispatchers

A dispatcher entitled to terminate the call can be a mobile subscriber or a fixed line subscriber. The dispatcher may use out-of-band DTMF messages as a means for the control of the call termination, if it is a mobile dispatcher, or DTMF tones, if it is a fixed line dispatcher.

If the call is terminated by a mobile dispatcher using DTMF, the out-of-band messages START_DTMF(X) and STOP_DTMF are sent via the radio interface towards the network. If the out-of-band DTMF messages are sent by a mobile dispatcher who is not controlled by the anchor MSC, the DTMF messages will be converted by the controlling MSC (e.g. relay MSC or visited MSC) into DTMF tones and these DTMF tones will be sent through the network to the anchor MSC.

If a fixed dispatcher initiates DTMF tones, the DTMF tones will be sent through the network to the anchor MSC.

Both in case of a mobile and a fixed line dispatcher the anchor MSC is responsible for the detection and collection of the out-of-band or inband DTMF signals. After the evaluation of the DTMF signals, the anchor MSC shall trigger the appropriate function (see the figures 7b to 7d in 11.3.8).

In order to avoid the erroneous detection of the specific DTMF tone sequence for call termination by the MSC, this sequence shall consist of at least three DTMF digits.

11.3.3 Leaving of a dispatcher

A dispatcher can disconnect from the call at any time without terminating the call. In order to terminate the call a dispatcher who is entitled to do this must use the explicit signalling described in subclause 11.3.2.2.

11.3.4 Leaving and returning to a voice group call

A service subscriber shall automatically disconnect from the call when leaving the group call area.

A service subscriber shall be able to disconnect from the voice group call by a de-selection/re-selection process.

A mobile station shall leave the voice group call by no longer listening to the voice group call downlink and returning to idle mode. A voice group call is returned to by listening to the periodic notification messages for that call, and reacting on them appropriately.

11.3.5 Cell change

11.3.5.1 Listening subscriber

In all cases change of cell shall be initiated and performed by the service subscriber's mobile station. In order for the service subscribers changing from one cell to another within the group call area a cell list for the neighbouring cells belonging to this group call area is periodically broadcast on the downlink SACCH of the voice group call. In this case, mobile stations entering a new cell shall perform cell change according to the algorithm C2, see 3GPP TS 45.008 and 3GPP TS 43.022.

Mobile stations which want to enter a cell shall listen to the BCCH and to the NCH to determine which channel they shall retune to so that they can continue with the voice group call if available in that cell.

NOTE: Mobile stations may require an additional receiver to read the BCCH and NCH of the neighbour cells in order to ensure a higher probability of receiving the relevant messages without degradation of the received speech quality. The additional receiver may be the same as used in subclause 11.3.1.3.

Mobile stations entering a new location area shall perform location updating as normal.

11.3.5.2 Talking subscriber

Standard mobile station assisted handover shall be used for the cell change of the talking service subscriber as defined in 3GPP TS 45.008.

If the talking subscriber leaves the group call area or enters a BSC area not belonging to the service area, the uplink shall not be maintained by the network.

If the BSS does not know if one or more of the target cells are outside the group call area, the BSS shall use the MSC controlled handover procedure. The MSC shall reject the handover in the case that all target cells are outside the GCA and as an option release the uplink.

11.3.5.3 Dispatcher

Dispatchers which are mobile subscribers shall change the cell by standard handover procedures.

11.3.6 New calls

Any service subscriber originated new voice group calls which have identical group ID and group call area to on-going voice group calls shall be rejected by the network with cause busy. The mobile station shall then read the notifications for the corresponding group ID on the NCH.

For any dispatcher originated new voice group calls which are identical to on-going voice group calls as described above the network shall include the dispatcher in the on-going call.

Otherwise, new calls are treated as detailed in subclause 11.3.8. In the case of congestion, voice group calls are treated according to their priority with each BSC treating each downlink depending on the situation in each cell to which the call is sent. Therefore, it is possible that a voice group call might be established only in a subset of the required cells.

In the case where there are no conference bridges free, and pre-emption is not performed, then the call request shall be rejected.

In the case of group members involved in group or point-to-point calls who have been informed of a new voice group call, the mobile station shall make a decision as to which to monitor as if both the on-going call and new call were point-to-point calls, and follow the procedure defined in 3GPP TS 23.067.

11.3.7 Uplink transmission management

The downlink FACCH channel shall be used to indicate whether the uplink is in use.

If a request to talk is made by the user and the uplink has been free the mobile station shall start to transmit UPLINK_ACCESS messages as defined in the 3GPP TS 44.018.

If an VGCS_UPLINK_GRANT message is received by the mobile station with a different request reference than that of the access made by the mobile station, the mobile station shall not signal for a further 1 s. If in this time the uplink becomes busy, the mobile station shall indicate to the user that the access has been denied.

The user shall be provided with a short indication immediately after the reception of the VGCS_UPLINK_GRANT which indicates that he can speak. Contention caused by simultaneous access messages on the uplink of the voice group call channel shall be resolved as for standard random access procedures. If the uplink access is rejected a further indication shall be provided to the user to inform him that his access attempt was not successful.

The network then shall send an UPLINK_BUSY message on the FACCH of the voice group call channel downlink in all cells involved in the group call.

Signalling messages for call establishment and termination on the voice group call channel shall then only apply for the mobile station currently using the uplink. All other mobile stations shall not respond to this downlink signalling. Once the request to talk is over, this shall be indicated to the network by the mobile station, an UPLINK_FREE message is broadcast on all FACCHs in the group call area.

11.3.8 Overview of signalling

In this overview, the messages required to implement the specified concept are identified, and brief details are given of each message.

A diagrammatic representation of the voice group call message structure proposed and actions required is given in figures 2 to 7d.

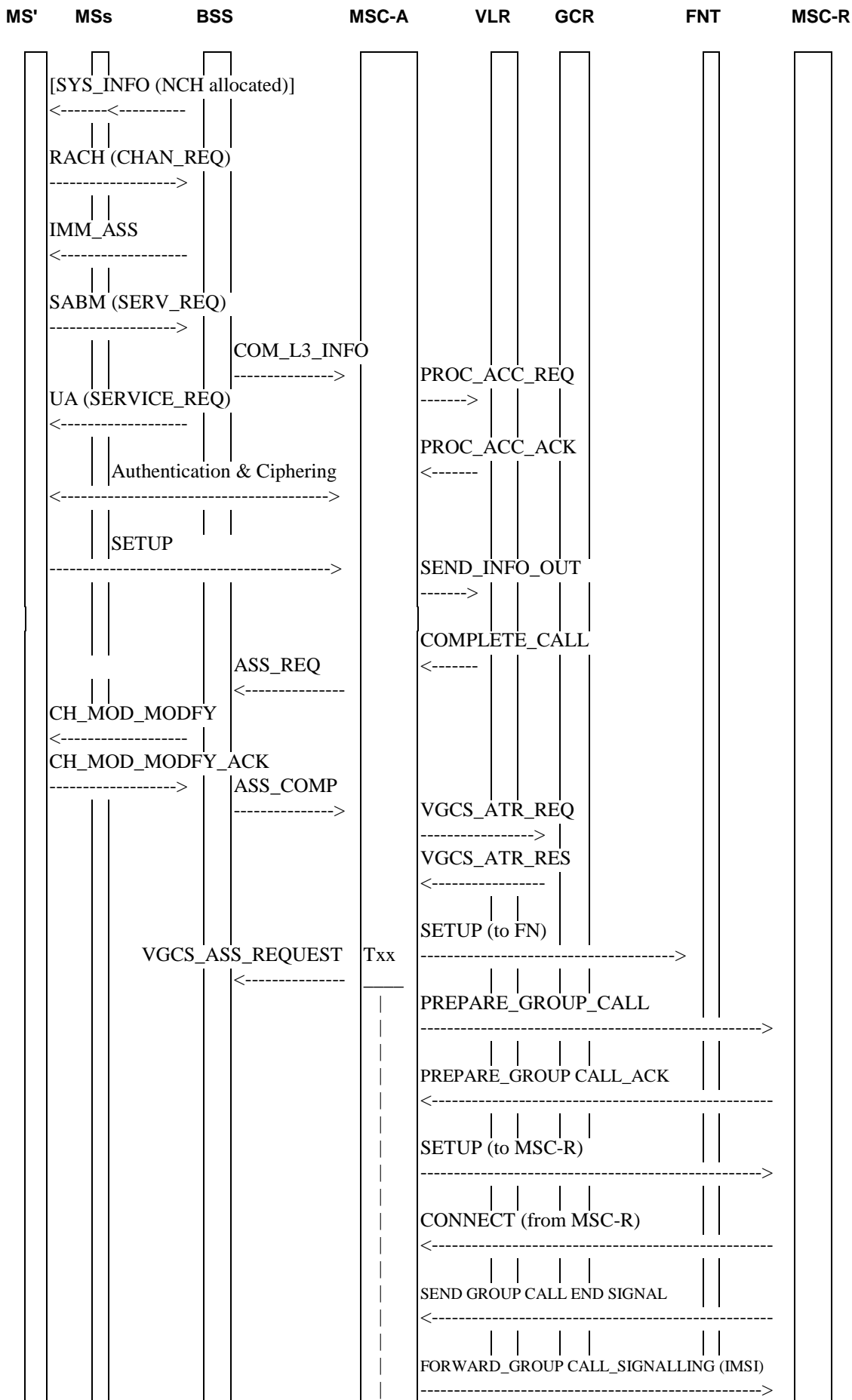

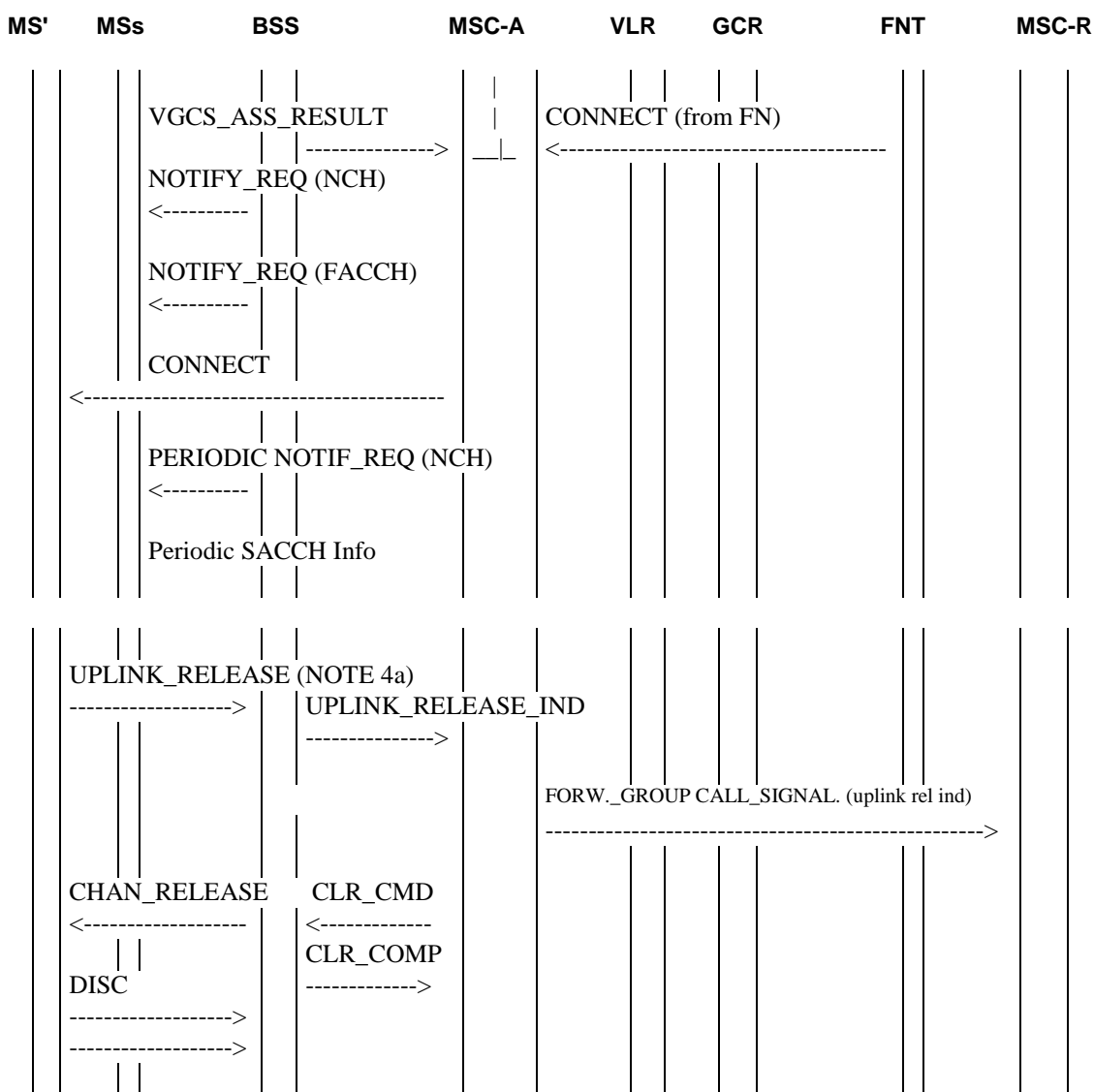

NOTE: MS' = calling subscriber mobile station;
 MSs = destination subscriber mobile stations;
 FNT = fixed network user terminal;
 MSC-A = anchor MSC;
 MSC-R = relay MSC.

Figure 2: Signaling information required for establishing voice group calls by a service subscriber roaming in the anchor MSC area

SYS_INFO (NCH allocated): Message used to indicate if the NCH is allocated on the CCCH in the cell.

Initial RACH CHAN_REQ: Standard message.

IMM_ASS: Standard message send on the PCH.

SERV_REQ (voice group call): Modified form of the current call request message L3-MM CM SERVICE REQUEST sent on the allocated channel. Teleservice Voice group call is indicated.

UA (SERV_REQ): This message is used to acknowledge the layer 2 link and provide contention resolution of the service request.

COM_L3_INFO: The MSC is provided with initial information about the voice group call.

NOTE 1: Messages flows for authentication and ciphering are not represented although performed as normal.

PROC_ACC_REQ: The MAP_PROCESS_ACC_REQ message is sent to the VLR to check the requested VGCS teleservice against the subscription data.

PROC_ACC_ACK: The MAP_PROCESS_ACC_ACK message acknowledges the requested service.

Authentication and Ciphering: Authentication and Ciphering may be performed. Acknowledgement of the service request can also be performed by sending the CM SERVICE ACCEPT.

SETUP: The MSC is provided with details about the voice group call.

NOTE 2: Alternatively, an IMMEDIATE_SETUP may have been send as the initial message including all details of the voice group call. In this case no SETUP message must be sent.

SEND_INFO_OUT: The requested group ID is transferred to the VLR in the MAP_SEND_INFO_FOR_OUTGOING_CALL message.

COMPLETE_CALL: The VLR returns the MAP_COMPLETE_CALL message confirming the use of the requested group ID.

ASSIGNMENT_REQUEST: Standard message.

CHAN_MOD_MODIFY: Standard message to modify the channel mode in case of very early assignment.

CHAN_MOD_MODIFY_ACK: Standard message to acknowledge the modification of the channel mode.

ASSIGNMENT_COMPLETE: Standard message.

NOTE 3: Alternatively, early assignment or OACSU procedures might be applied with the corresponding assignment messages not presented in figure 2.

VGCS_ATR_REQ: The group call attributes are requested from the GCR.

VGCS_ATR_RES: The requested information is returned from the GCR.

VGCS_ASSIGNMENT_REQ: This message is sent from the MSC to all affected BSCs, [including the group call reference, the channel type and possibly the call priority and details on the ciphering.

NOTE 4: As an operator option the voice group call channels, the links to them and optionally also the links to dispatchers can already be established and permanently reserved in order to speed up the call set-up for emergency voice group calls.

VGCS_ASSIGNMENT RESULT: Acknowledgement message from the affected BSC in answer to the assignment requests. If the assignment is not successful, a VGCS_ASSIGNMENT_FAILURE message shall be sent instead.

SETUP to fixed network users: Based on the information determined about the users of external networks to be involved in the call, the MSC shall initiate calls to these users in the normal manner, depending on their mode of connection into the MSC, and shall connect them into the conference bridge. Alternatively normal calls to GSM subscribers may be established for dispatchers being GSM subscribers which is not presented in the diagram.

PREPARE_GROUP CALL: The group call attributes are sent to every relay MSC and a Group Call number for call set-up to is requested.

PREPARE_GROUP CALL ACK: The Group Call number for call set-up is returned to the anchor MSC.

SETUP to MSC-R: The ISUP connection is set-up to the relay MSC.

CONNECT from MSC-R: Set-up of the ISUP connection to the relay MSC is confirmed.

SEND_GROUP CALL_END_SIGNAL: Indicates to the anchor MSC that conversation can start.

FORWARD_GROUP CALL_SIGNALLING (IMSI): The IMSI of the service subscriber who has established the voice group call and who is allowed to terminate the call is sent to every relay MSC.

Txx: Timer implemented in the MSC which is started with the incoming VGCS SETUP message and stops with the outgoing paging message. If the timer expires before the MSC receives all of the expected CHAN_REQ_ACK from the BSCs and the CONNECT messages from the external networks and SEND_GROUP CALL_END_SIGNALs from the relay MSCs, the VGCS shall be established by the MSC to all available parts of the group call area.

NOTIF_REQ (NCH): Messages for notification which contain the group call reference, the priority of the call if eMLPP is applied, and possibly the channel description of the voice group call channel to which the mobile stations shall listen and the number of the group key used for ciphering.

NOTIF_REQ (FACCH): Message for notification sent on the FACCH to the mobile stations currently involved in other calls. The notification on the FACCH shall include the group call reference, and the priority level and may also include the channel description and the group ciphering key numbers.

Periodic NOTIF_REQ (NCH): The notifications are sent periodically so that mobile stations moving into the area can join the voice group call.

Periodic SACCH Info: Periodic messages sent on SACCH. This message may include:

- information of changes of notifications;
- information used for cell re-selection.

CONNECT: Information to the mobile station of the calling subscriber that the VGCS is established with the related group call reference as the connected number.

UPLINK_RELEASE: When the calling service subscriber wants to become a listening service subscriber for the first time, a message indicating release of the uplink is required to be sent from the MS to the BSS in order to set the uplink free.

NOTE 4a: For different cases of uplink release and the related message flows refer to Figure 6.1 to 6.6.

UPLINK_RELEASE_INDICATION: The BSS informs the MSC on the uplink release.

FORWARD_GROUP_CALL_SIGNALLING (uplink release indication): This message is sent to every relay MSC to indicate that the uplink is free.

CLEAR COMMAND : The MSC requests the BSS to clear radio and terrestrial resources associated with originator dedicated link if not already done.

CHAN_RELEASE: The BSS sends a channel release message to the calling service subscriber's mobile station including the channel description of the voice group call channel to which the mobile station shall tune to.

NOTE 5: Alternatively, if no UPLINK_RELEASE has been sent to the network by the mobile station, the network may transfer the mobile station to the voice group call channel by the channel mode modify procedure or by an assignment procedure or by a handover procedure.

DISC: Two layer 2 disconnect messages shall be sent by the mobile station to the network.

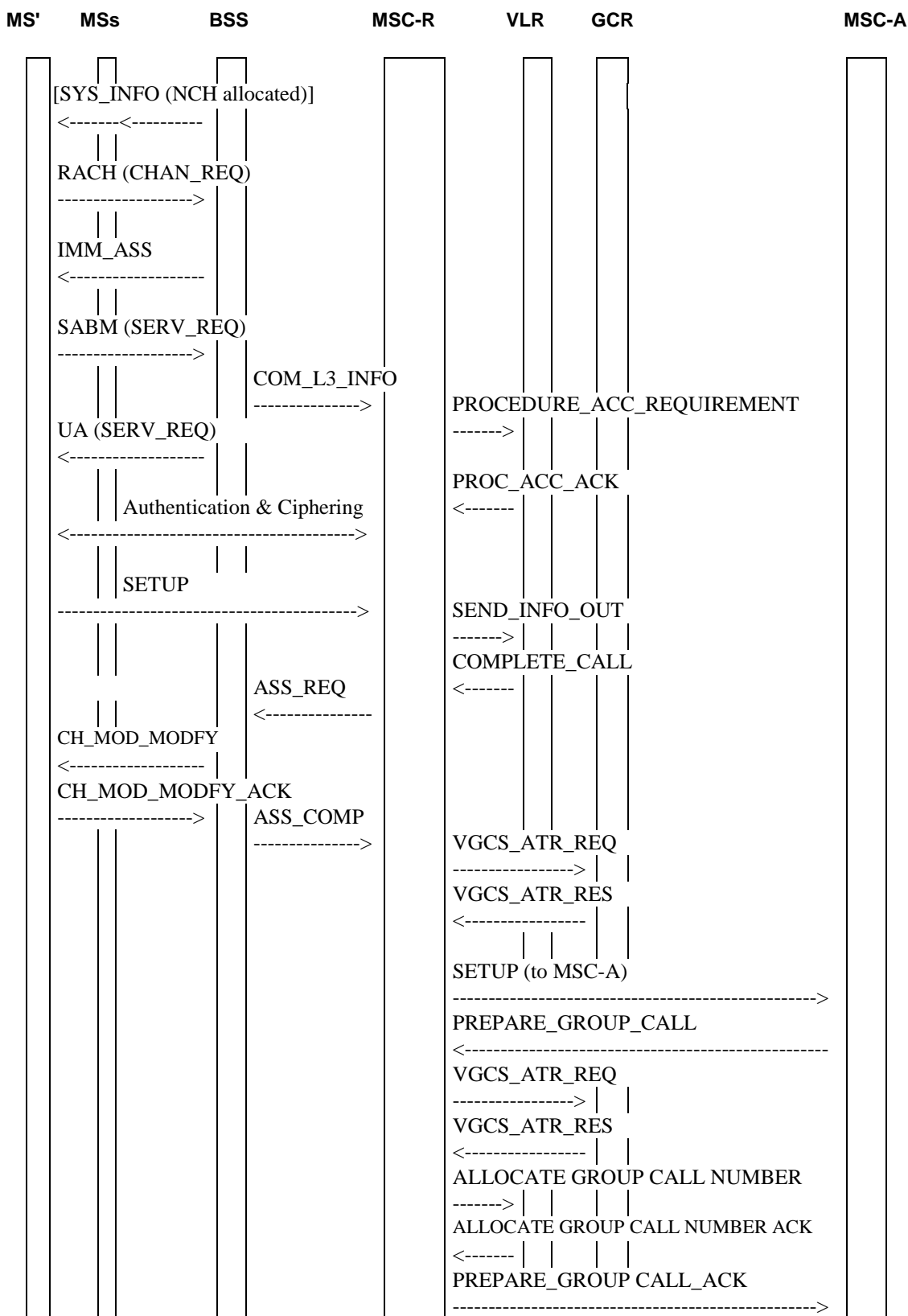

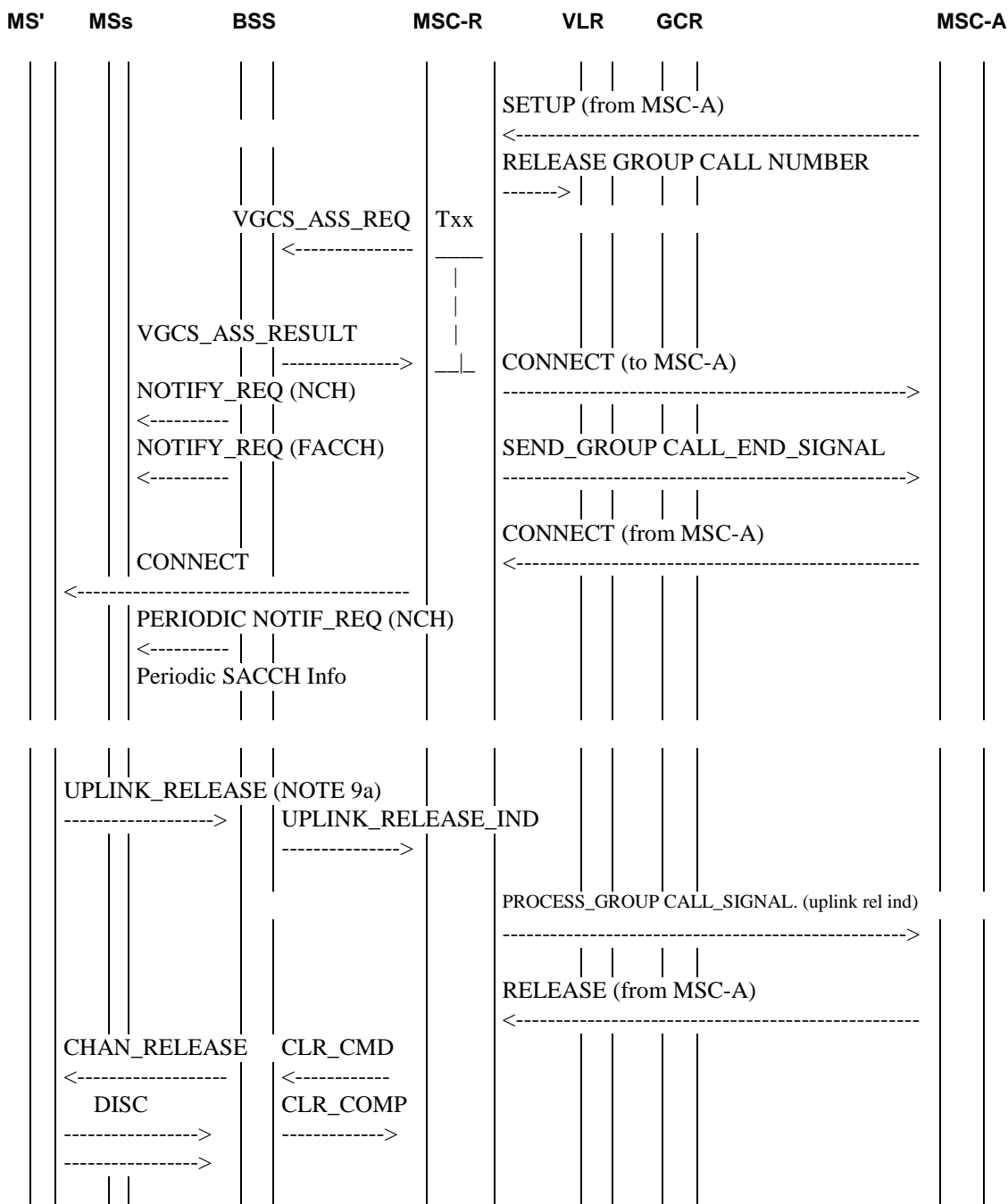

NOTE: MS' = calling subscriber mobile station;
 MSs = destination subscriber mobile stations;
 MSC-A = anchor MSC;
 MSC-R = relay MSC

Figure 3: Signalling information required for establishing voice group calls by a service subscriber roaming in the relay MSC area

SYS_INFO (NCH allocated): Message used to indicate if the NCH is allocated on the CCCH in the cell.

Initial RACH CHAN_REQ: Standard message.

IMM_ASS: Standard message send on the PCH.

SERV_REQ (voice group call): Modified form of the current call request message L3-MM CM SERVICE REQUEST sent on the allocated channel. Teleservice Voice group call is indicated.

UA (SERV_REQ): This message is used to acknowledge the layer 2 link and provide contention resolution of the service request.

COM_L3_INFO: The MSC is provided with initial information about the voice group call.

NOTE 6: Messages flows for authentication and ciphering are not represented although performed as normal.

PROC_ACC_REQ: The MAP_PROCESS_ACC_REQ message is sent to the VLR to check the requested VGCS teleservice against the subscription data.

PROC_ACC_ACK: The MAP_PROCESS_ACC_ACK message acknowledges the requested service.

Authentication & Ciphering: Authentication and Ciphering may be performed. Acknowledgement of the service request can also be performed by sending the CM SERVICE ACCEPT.

SETUP: The MSC is provided with details about the voice group call.

NOTE 7: Alternatively, an IMMEDIATE_SETUP may have been send as the initial message including all details of the voice group call. In this case no SETUP message must be sent.

SEND_INFO_OUT: The requested group ID is transferred to the VLR in the MAP_SEND_INFO_FOR_OUTGOING_CALL message.

COMPLETE_CALL: The VLR returns the MAP_COMPLETE_CALL message confirming the use of the requested group ID.

ASSIGNMENT_REQUEST: Standard message.

CHAN_MOD_MODIFY: Standard message to modify the channel mode in case of very early assignment.

CHAN_MOD_MODIFY_ACK: Standard message to acknowledge the modification of the channel mode.

ASSIGNMENT_COMPLETE: Standard message.

NOTE 8: Alternatively, early assignment or OACSU procedures might be applied with the corresponding assignment messages not presented in figure 3.

VGCS_ATR_REQ: The group call attributes are requested from the GCR.

VGCS_ATR_RES: The requested information (MSC-A address) is returned from the GCR.

SETUP to MSC-A: Based on information received from the GCR the relay MSC shall set-up a dedicated connection for the initiating service subscriber to the anchor MSC.

PREPARE_GROUP CALL: The group call attributes (parts) are received from the anchor MSC.

VGCS_ATR_REQ: The group call attributes are requested from the GCR.

VGCS_ATR_RES: The requested information (cell list) is returned from the GCR.

ALLOCATE GROUP CALL NUMBER: The Group Call number is requested from the VLR.

ALLOCATE GROUP CALL NUMBER ACK: The Group Call number is returned from the VLR.

PREPARE_GROUP_CALL_ACK: The Group Call number is sent to MSC-A.

SETUP from MSC-A: The ISUP connection is set-up between MSC-A and MSC-R.

RELEASE GROUP CALL NUMBER: The VLR is requested to release the Group Call number.

VGCS_ASSIGNMENT_REQ: This message is sent from the MSC to all affected BSCs, [one dedicated message for every requested channel in a cell,] including the group call reference, the channel type and possibly the call priority and details on the ciphering.

NOTE 9: As an operator option the voice group call channels, the links to them and optionally also the links to dispatchers can already be established and permanently reserved in order to speed up the call set-up for emergency voice group calls.

VGCS_ASSIGNMENT RESULT: Acknowledgement message from the affected BSC in answer to the assignment requests. If the assignment is not successful, a **VGCS_ASSIGNMENT_FAILURE** message shall be sent instead.

CONNECT to MSC-A: Set-up of the ISUP connection from the anchor MSC is confirmed.

SEND_GROUP_CALL_END_SIGNAL: Indicates to the anchor MSC that conversation can start. In addition the IMSI of service subscriber who has established the voice group call and who is allowed to terminate the call is included.

Txx: Timer implemented in the relay MSC which is started with the incoming **SETUP** message from the anchor MSC and stops with the outgoing paging message. If the timer expires before the MSC receives all of the expected **CHAN_REQ_ACK** from the BSCs, the VGCS shall be established by the relay MSC to all available parts of the group call area and the anchor MSC shall be informed that conversation can start.

NOTIF_REQ (NCH): Messages for notification which contain the group call reference, the priority of the call if eMLPP is applied, and possibly the channel description of the voice group call channel to which the mobile stations shall listen and the number of the group key used for ciphering.

NOTIF_REQ (FACCH): Message for notification sent on the FACCH to the mobile stations currently involved in other calls. The notification on the FACCH shall include the group call reference, and the priority level and may include also the channel description and the group ciphering key numbers.

Periodic NOTIF_REQ (NCH): The notifications are sent periodically so that mobile stations moving into the area can join the voice group call.

Periodic SACCH Info: Periodic messages sent on the downlink of the SACCH informing mobile stations of:

- information of changes of notifications;
- information used for cell re-selection.

CONNECT (from MSC-A): Call set-up of the dedicated connection for the calling service subscriber is confirmed.

CONNECT: Information to the mobile station of the calling subscriber that the VGCS is established with the related group call reference as the connected number.

UPLINK_RELEASE: When the calling service subscriber wants to become a listening service subscriber for the first time, a message indicating release of the uplink is required to be sent from the MS to the BSS in order to set the uplink free.

NOTE 9a: For different cases of uplink release and the related message flows refer to Figure 6.1 to 6.6.

UPLINK_RELEASE_INDICATION: The BSS informs the MSC on the uplink release.

PROCESS_GROUP_CALL_SIGNALLING (uplink release indication): To indicate to the anchor MSC that the uplink is free.

CLEAR COMMAND: The MSC requests the BSS to clear radio and terrestrial resources associated with originator dedicated link if not already done.

CHAN_RELEASE: The BSS sends a channel release message to the calling service subscriber's mobile station including the channel description of the voice group call channel to which the mobile station shall tune to.

NOTE 10: Alternatively, if no **UPLINK_RELEASE** has been sent to the network by the mobile station, the network may transfer the mobile station to the voice group call channel by the channel mode modify procedure or by an assignment procedure or by a handover procedure.

DISC: Two layer 2 disconnect messages shall be sent by the mobile station to the network.

RELEASE from MSC-A: The dedicated connection for the initiating service subscriber is released.

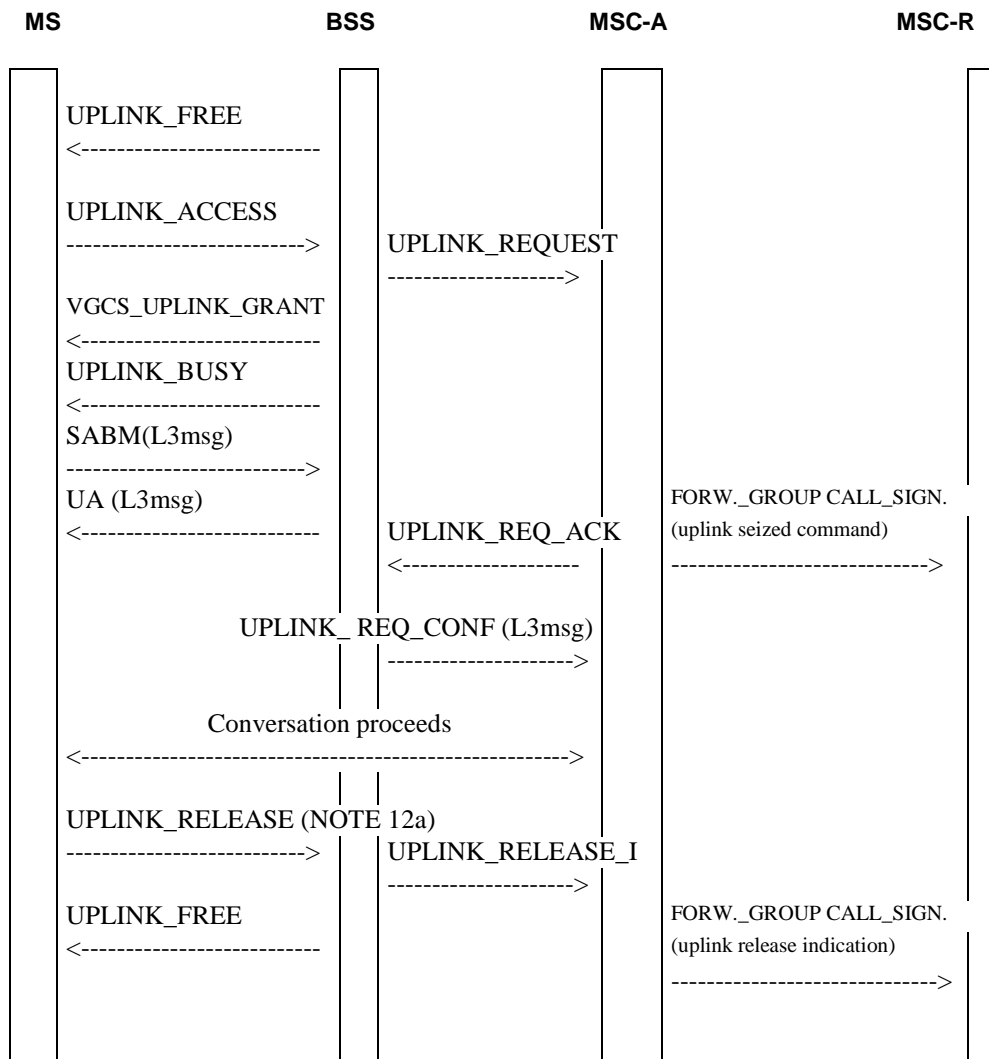

Figure 4: Signalling information required for the voice group call uplink access in the anchor MSC (normal case, without contention resolution)

UPLINK_FREE: This connectionless RR message is repeatedly sent by the BSS on the main signalling link (FACCH) to inform all mobile stations of the voice group call members that the uplink is free.

UPLINK_ACCESS: This is sent on the uplink of the voice group call channel using random access procedures. The UPLINK_ACCESS message is similar to a channel request but sent on the group call channel uplink. The establishment cause for subsequent talker uplink request as defined in 3GPP TS 44.018 shall be used for this purpose. The mobile station may send repeated UPLINK_ACCESS messages (see 3GPP TS 44.018).

UPLINK_REQUEST: The request for the uplink is indicated to the MSC. Only one request per BSC shall be forwarded.

VGCS_UPLINK_GRANT: The reply to the uplink request sent on the voice group channel downlink containing information for synchronisation of the mobile station to the network and uplink access contention resolution. The VGCS_UPLINK_GRANT message shall therefore include a request reference (reflecting the UPLINK_ACCESS) and the physical information required for transmission on the voice group call channel uplink. On receipt of a VGCS_UPLINK_GRANT, the related mobile station can start to send speech directly.

NOTE 11: UPLINK_FREE messages are stopped immediately.

UPLINK_BUSY: This connectionless RR message is sent on the downlink FACCH to inform all mobile stations that the uplink is now busy.

NOTE 12: The order of UPLINK_BUSY and SABM message is independent.

SABM(L3msg): The layer 2 link is set up and layer 3 information on classmark and mobile station identity included.

UA(L3msg): The layer 2 link is acknowledged and the layer 3 information reflected for contention resolution.

UPLINK_REQUEST_ACKNOWLEDGE: The anchor MSC acknowledges the uplink to one BSC. If uplink requests have been made by more than one BSC or MSC-R, all remaining uplink requests shall be rejected by an UPLINK_REJ which is not presented in figure 4. On reception of an UPLINK_REJ the BSS shall send an UPLINK_REL to the related mobile station, followed by an UPLINK_BUSY to indicate to the mobile stations that the uplink is in use. The MSC shall send to other BSCs which did not send an uplink request an UPLINK_SEIZED message which is not presented in figure 4. On reception of an UPLINK_SEIZED the BSS shall send an UPLINK_BUSY to indicate to the mobile stations that the uplink is in use.

FORWARD_GROUP_CALL_SIGNALLING (uplink seized command): This message is sent to all relay MSCs, to inform all mobile stations roaming in parts of the group call area which are controlled by relay MSCs, that the uplink is now busy.

UPLINK_REQUEST_CONFIRM: The BSS confirms the uplink use to the MSC together with the mobile station identity.

Conversation proceeds: Once the mobile station has control of the uplink, it shall be able to communicate directly. The two-way nature of the conference bridge will ensure that they are already connected to all appropriate downlink channels.

UPLINK_RELEASE: When the service subscriber who has access to the uplink wants to release the channel, then a message indicating release of the uplink is required to be sent from the MS to the BSS on the FACCH.

NOTE 12a: For different cases of uplink release and the related message flows refer to Figure 6.1 to 6.6.

UPLINK_RELEASE_INDICATION: The BSS informs the MSC on the uplink release.

FORWARD_GROUP_CALL_SIGNALLING (uplink release indication): The anchor MSC indicates to all relay MSCs that the uplink is free. On receipt of the uplink free indication the relay MSC shall send an UPLINK RELEASE message to every BSS of the group call area to indicate that the uplink free.

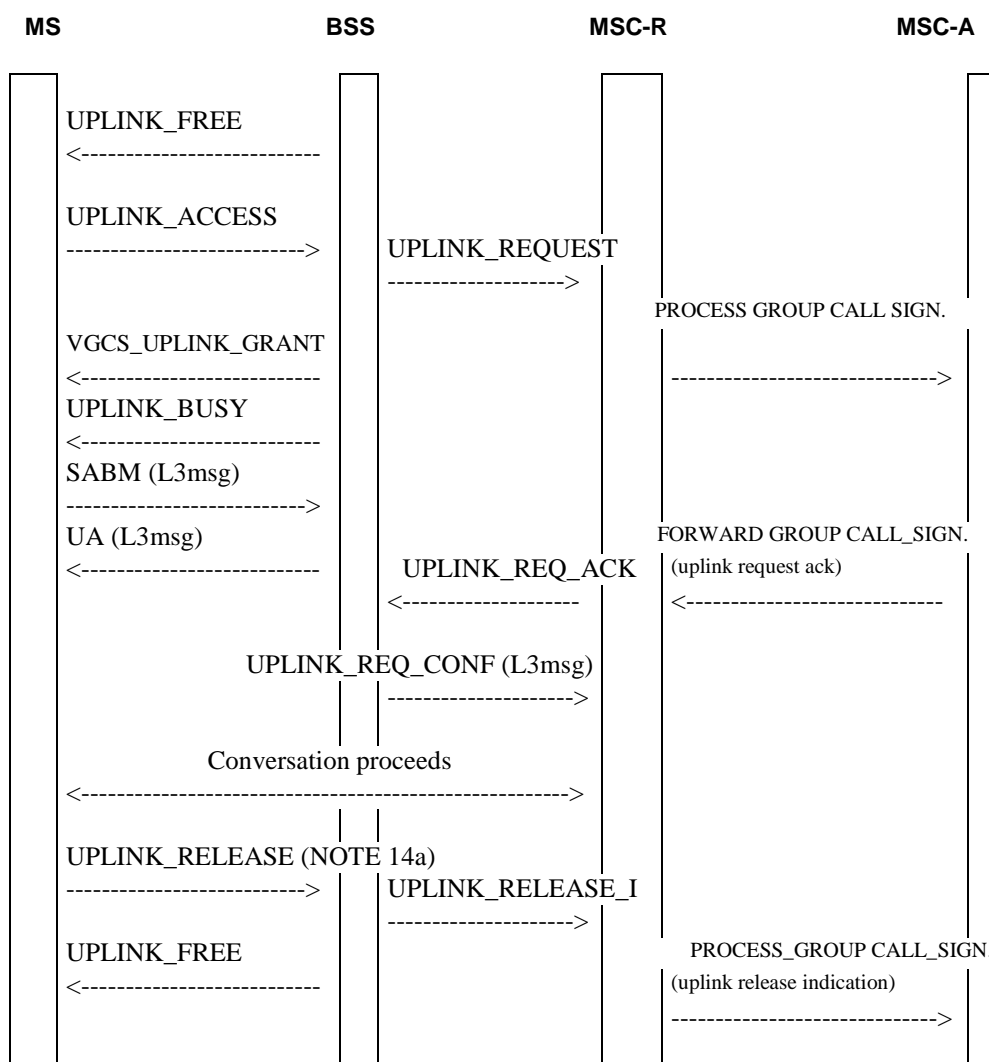

Figure 5: Signalling information required for the voice group call uplink access in the relay MSC (normal case, without contention resolution)

UPLINK_FREE: This connectionless RR message is repeatedly sent by the BSS on the main signalling link (FACCH) to inform all mobile stations of the voice group call members that the uplink is free.

UPLINK_ACCESS: This is sent on the uplink of the voice group call channel using random access procedures. The UPLINK_ACCESS message is similar to a channel request but sent on the group call channel uplink. The establishment cause for subsequent talker uplink request as defined in 3GPP TS 44.018 shall be used for this purpose. The mobile station may send repeated UPLINK_ACCESS messages (see 3GPP TS 44.018).

UPLINK_REQUEST: The request for the uplink is indicated to the MSC. Only one request per BSC shall be forwarded.

VGCS_UPLINK_GRANT: The reply to the uplink request sent on the voice group channel downlink containing information for synchronisation of the mobile station to the network and uplink access contention resolution. The VGCS_UPLINK_GRANT message shall therefore include a request reference (reflecting the UPLINK_ACCESS) and the physical information required for transmission on the voice group call channel uplink. On receipt of a VGCS_UPLINK_GRANT, the related mobile station can start to send speech directly.

NOTE 13: UPLINK_FREE messages are stopped immediately.

UPLINK_BUSY: This connectionless RR message is sent on the downlink FACCH to inform all mobile stations that the uplink is now busy.

NOTE 14: The order of UPLINK_BUSY and SABM message is independent.

SABM (L3msg): The layer 2 link is set up and layer 3 information on classmark and mobile station identity included.

UA (L3msg): The layer 2 link is acknowledged and the layer 3 information reflected for contention resolution.

PROCESS_GROUP CALL_SIGNALLING (uplink request): This message is sent to the anchor MSC, to indicate that the uplink is requested by a subscriber roaming in the relay MSC area.

FORWARD_GROUP CALL_SIGNALLING (uplink request ack): This message is sent to the relay MSC, to indicate that the uplink is granted to the mobile station roaming in parts of the group call area which are controlled by relay MSC.

UPLINK_REQUEST_ACKNOWLEDGE: The relay MSC acknowledges the uplink to one BSC. If uplink requests have been made by more than one BSC, all remaining uplink requests shall be rejected by an UPLINK_REJ which is not presented in figure 5. On reception of an UPLINK_REJ the BSS shall send an UPLINK_REL to the related mobile station, followed by an UPLINK_BUSY to indicate to the mobile stations that the uplink is in use. The MSC shall send to other BSCs which did not send an uplink request an UPLINK_SEIZED message which is not presented in figure 5. On reception of an UPLINK_SEIZED the BSS shall send an UPLINK_BUSY to indicate to the mobile stations that the uplink is in use.

UPLINK_REQUEST_CONFIRM : The BSS confirms the uplink use to the MSC together with the mobile station identity.

Conversation proceeds: Once the mobile station has control of the uplink, it shall be able to communicate directly. The two-way nature of the conference bridge will ensure that they are already connected to all appropriate downlink channels.

UPLINK_RELEASE: When the service subscriber who has access to the uplink wants to release the channel, then a message indicating release of the uplink is required to be sent from the MS to the BSS on the FACCH.

NOTE 14a: For different cases of uplink release and the related message flows refer to Figure 6.1 to 6.6.

UPLINK_RELEASE_INDICATION: The BSS informs the MSC on the uplink release.

PROCESS_GROUP CALL_SIGNALLING (uplink release indication): The relay MSC indicates to the anchor MSC that the uplink is free.

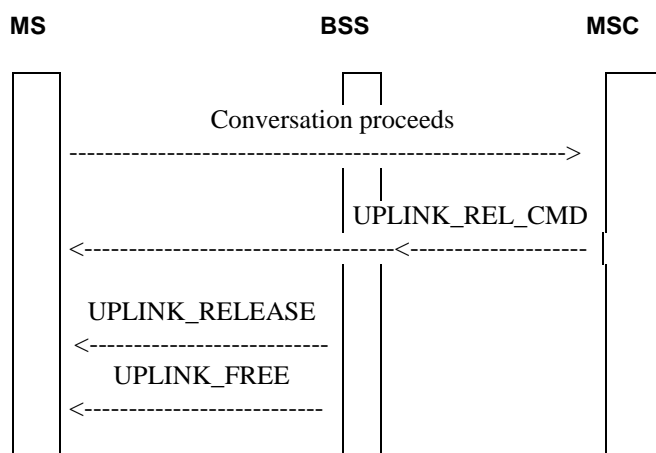

Figure 6: Signalling information required for the voice group call uplink release requested by the network

UPLINK_REL_CMD: When the network wants to release the uplink for any reason then a message requesting release of the uplink is required to be sent from the network to the mobile station on the FACCH.

The following figures 6.1 to 6.6 show the message flows applicable for the uplink release in normal and error cases, dependent on whether the talker is

- on a dedicated link (e.g. the talker is the originator); or

- on the group call channel (e.g. the talker is a subsequent talker).

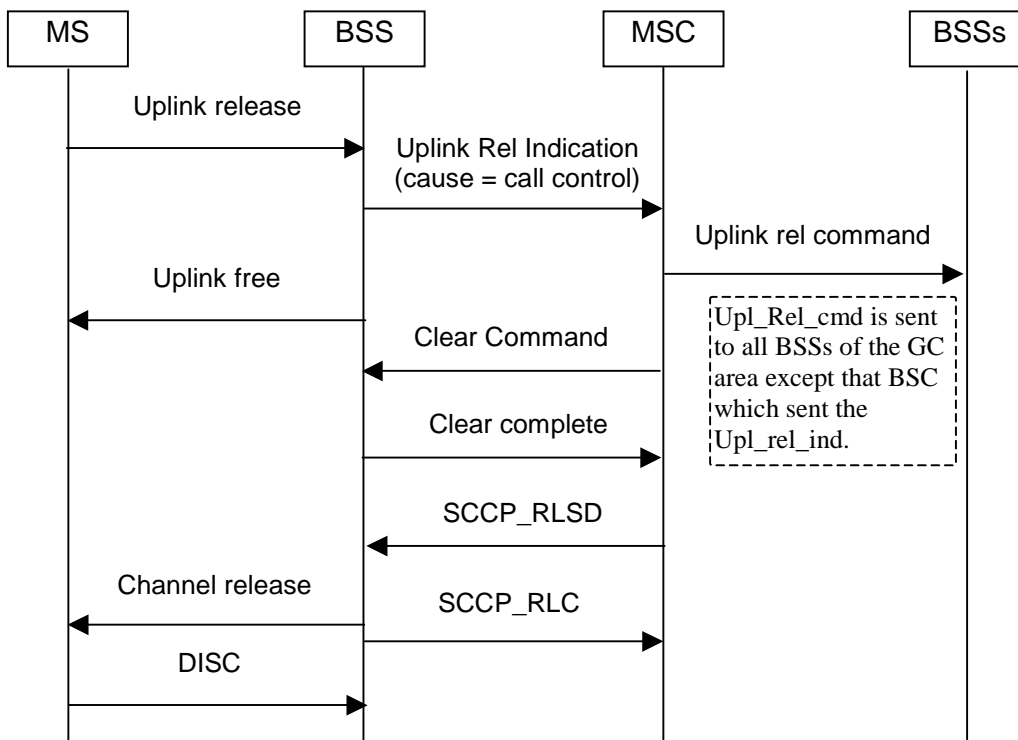

NOTE: The messages CLEAR CMD, CLEAR COM, etc., are used to release the dedicated connection of the talker.

Figure 6.1: Uplink release for the talker on a dedicated link: normal case

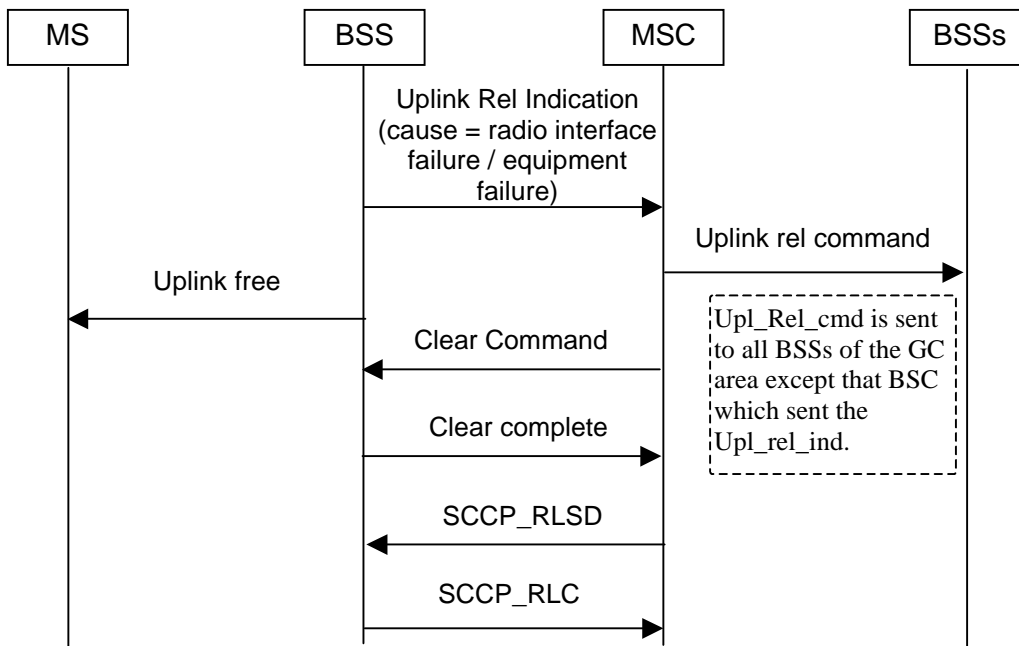

Note: The messages CLEAR CMD, CLEAR COM, etc., are used to release the dedicated connection of the talker. The same message flow applies for all cause values different from "call control".

Figure 6.2: Uplink release for the talker on a dedicated link: loss of radio contact or equipment failure (TRX, PCM ...)

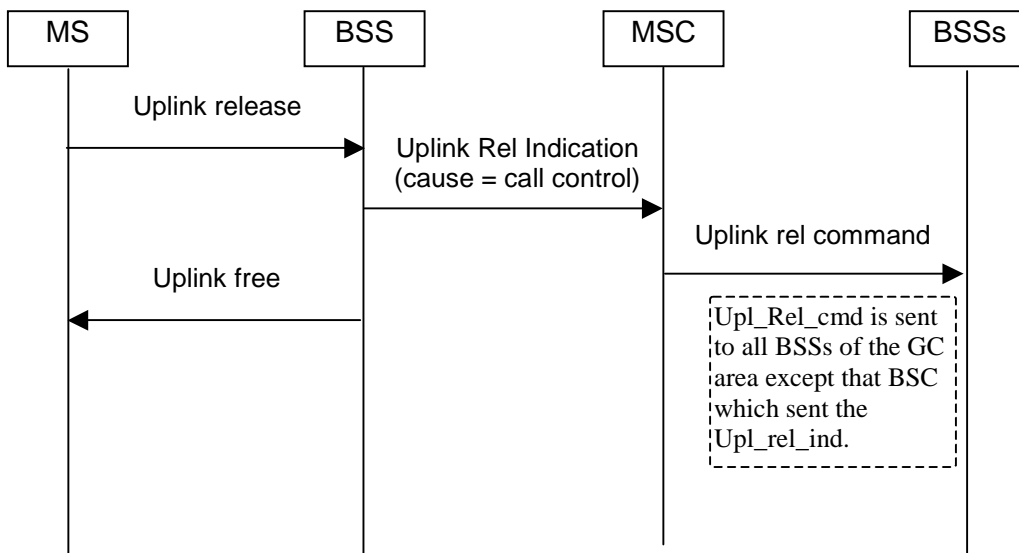

Figure 6.3: Uplink release for the talker on group call channel: normal case

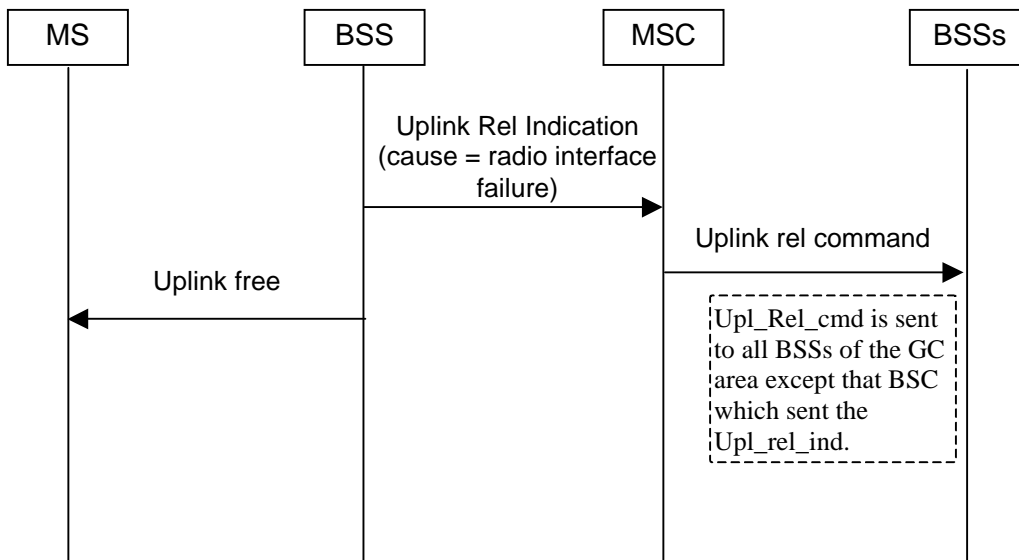
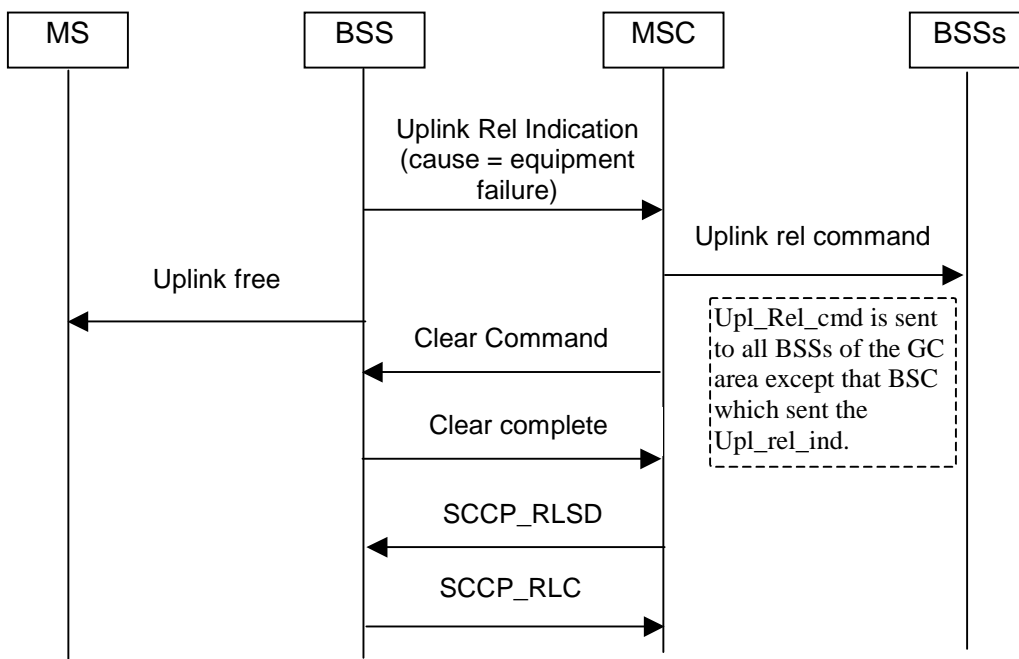

Figure 6.4: Uplink release for the talker on group call channel: loss of radio contact



NOTE: The messages CLEAR CMD, CLEAR COM, etc., are used to release the radio and terrestrial resources for the cell serving the talker. The same message flow applies for all cause values different from "call control", and "radio interface failure".

Figure 6.5: Uplink release for the talker on group call channel after equipment failure (TRX, PCM ...)

The BSC shall send the message UPLINK RELEASE INDICATION with cause value "equipment failure" or another appropriate cause value, if a failure concerning the cell that is serving the talker was detected and the radio and terrestrial resources related to this cell shall be released (see figure 6.5). After receipt of the UPLINK RELEASE INDICATION message the MSC shall send a CLEAR COMMAND message for the respective cell. The BSC does not send CLEAR REQUEST in addition to UPLINK RELEASE INDICATION in order to avoid conflicts.

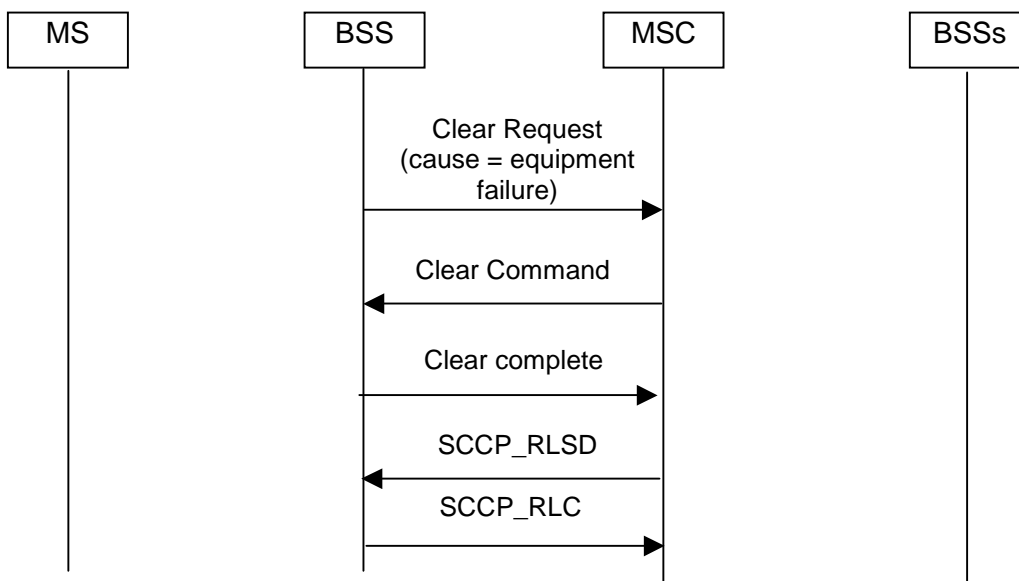

NOTE: The messages CLEAR CMD, CLEAR COM, etc., are used to release the radio and terrestrial resources for the cell not serving the talker. The same message flow applies also for all other cause values.

Figure 6.6: Release after equipment failure (TRX, PCM ...) concerning a cell that is not serving the talker

The BSC shall send the message CLEAR REQUEST with cause value "equipment failure" or another appropriate cause value, if a failure concerning a cell not serving the talker was detected and the resources related to this cell shall be released (see figure 6.6). After receipt of the CLEAR REQUEST message the MSC shall send a CLEAR COMMAND message for the respective cell.

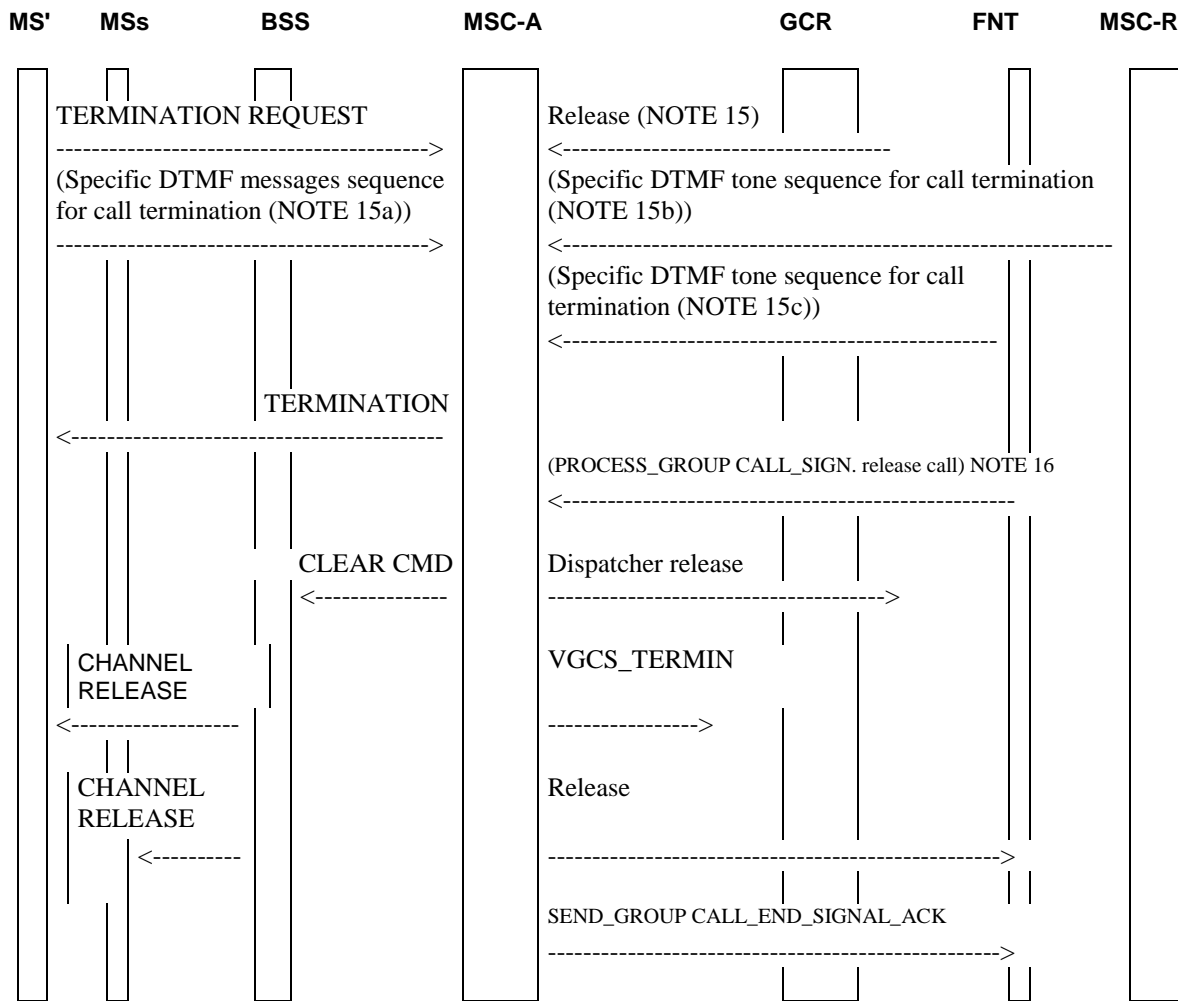

Figure 7: Signalling required to disconnect the group call

TERMINATION REQUEST: An authorized mobile station can send a TERMINATION REQUEST message to clear down the entire voice group call. To do this, the mobile station must have access to the uplink. The network has to check the IMSI to verify the calling subscriber. If the IMSI of the mobile station which has uplink access is presently not known to the network, the network shall send an identity request to the mobile station

NOTE 15: Alternatively an authorized dispatcher can terminate the voice group call in which case a release message is received from the external network.

NOTE 15a: Alternatively an authorized mobile dispatcher can terminate the voice group call by using a specific DTMF message sequence. If the mobile dispatcher is controlled by the anchor MSC, the specific DTMF message sequence is received by the anchor MSC (see figure 7b).

NOTE 15b: If the mobile dispatcher is controlled by a relay MSC, the specific DTMF message sequence is received by the relay MSC. The relay MSC converts the DTMF messages into DTMF tones and sends them towards the anchor MSC (see figure 7c).

NOTE 15c: Alternatively an authorized fixed line dispatcher can terminate the voice group call by using a specific DTMF tone sequence. In this case, the specific DTMF tone sequence is received by the anchor MSC (see figure 7d).

NOTE 16: Alternatively an authorized mobile station currently served by a relay MSC can clear down the entire group call in which case a PROCESS_GROUP CALL_SIGNALLING message indicating call release is received from the relay MSC.

CLEAR CMD: This message is sent from the MSC to all related cells to disconnect calls from the conference bridge and stop all periodic notifications for the voice group call to be released.

VGCS_TERMIN: The MSC informs the GCR that the voice group call with the related group call reference is terminated.

CHANNEL RELEASE: CHANNEL RELEASE messages are sent on all downlink FACCH to the service subscribers. The CHANNEL RELEASE messages shall be repeated for a predefined period in order to provide a high probability that the listening mobile stations receive the message.

- CHANNEL RELEASE message is sent using I frame for the talker.
- CHANNEL RELEASE messages are sent using UI frames for listeners.

In addition, release messages are sent to all related dispatchers and relay MSCs.

SEND_GROUP_CALL_END_SIGNAL_ACK: The dialogues to all relay MSCs are closed.

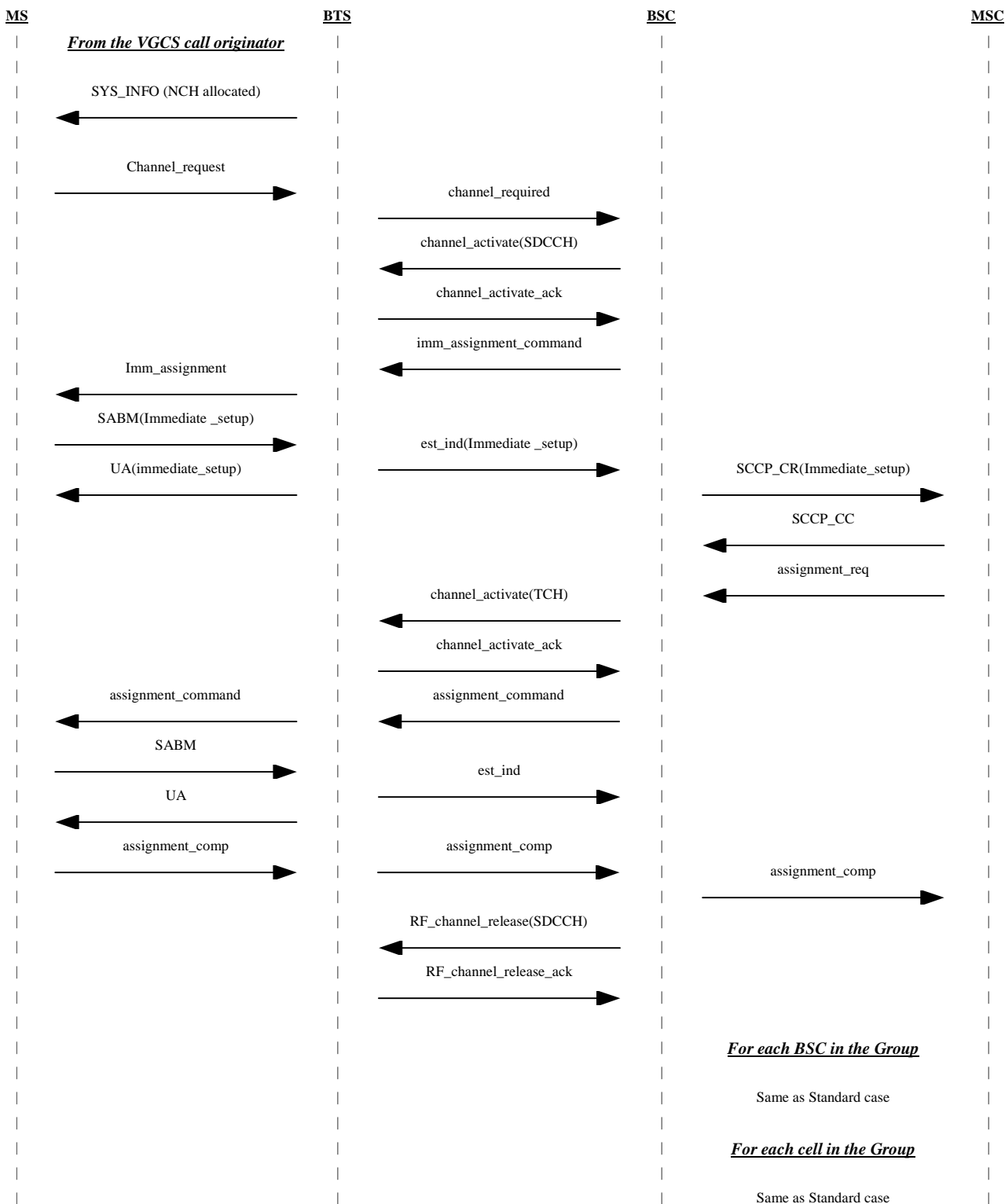

Figure 7a: Signalling information required for establishing voice group calls by a service subscriber using immediate setup

SYS_INFO (NCH allocated): Message used to indicate if the NCH is allocated on the CCCH in the cell.

Initial RACH CHAN_REQ: Standard message.

IMM_ASSIGNMENT: Standard message send on the PAGCH.

IMMEDIATE_SETUP: This message including all details of the voice group call is sent by the MS to the network in order to set-up a group call immediately, i.e. without previous establishment of an MM connection.

UA (IMMEDIATE_SETUP): This message is used to acknowledge the layer 2 link and provide contention resolution of the immediate setup.

NOTE 17: Authentication and/ or activation of Ciphering may be performed before or after sending a CONNECT message. If ciphering has not been activated before sending a CONNECT message, a CM_SERVICE ACCEPT may be sent before the CONNECT message by the MSC, however sending of the CM_SERVICE_ACCEPT is not mandatory.

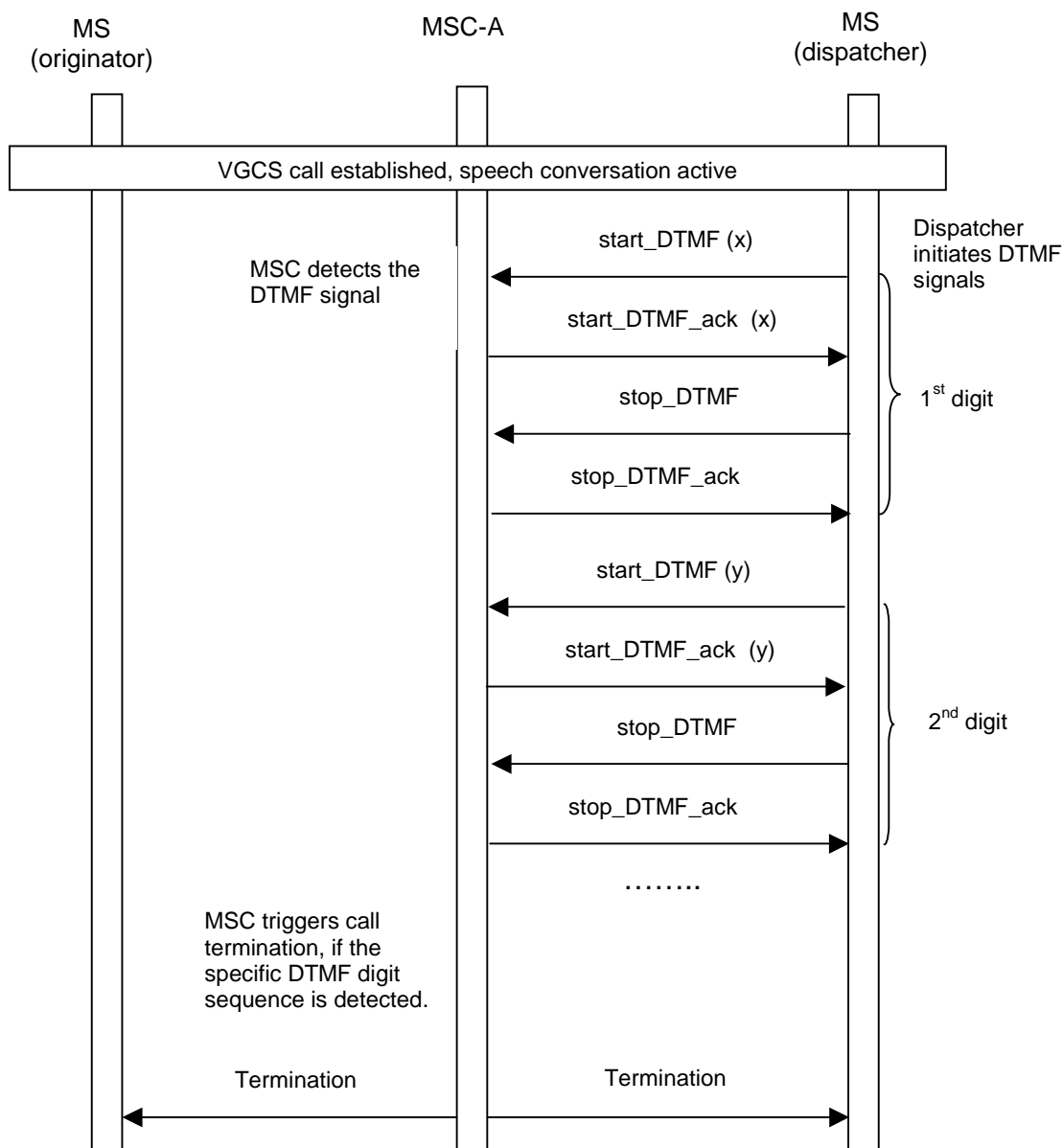

Figure 7b: Signalling required for group call termination by an entitled mobile dispatcher, if the mobile dispatcher is controlled by the anchor MSC of the group call.

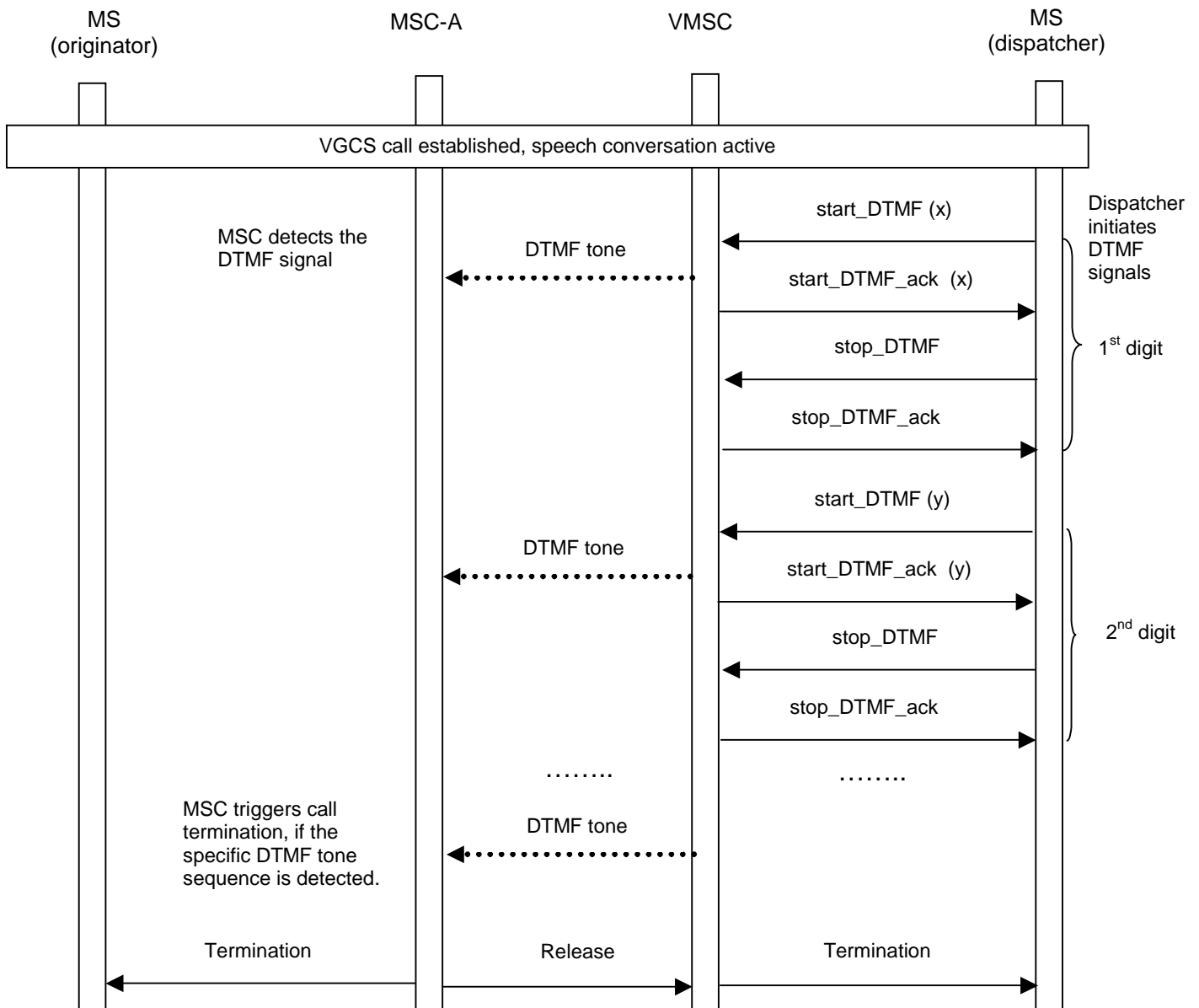

Figure 7c: Signalling required for group call termination by an entitled mobile dispatcher, if the mobile dispatcher is controlled by a visited MSC (could be a relay MSC) of the group call.

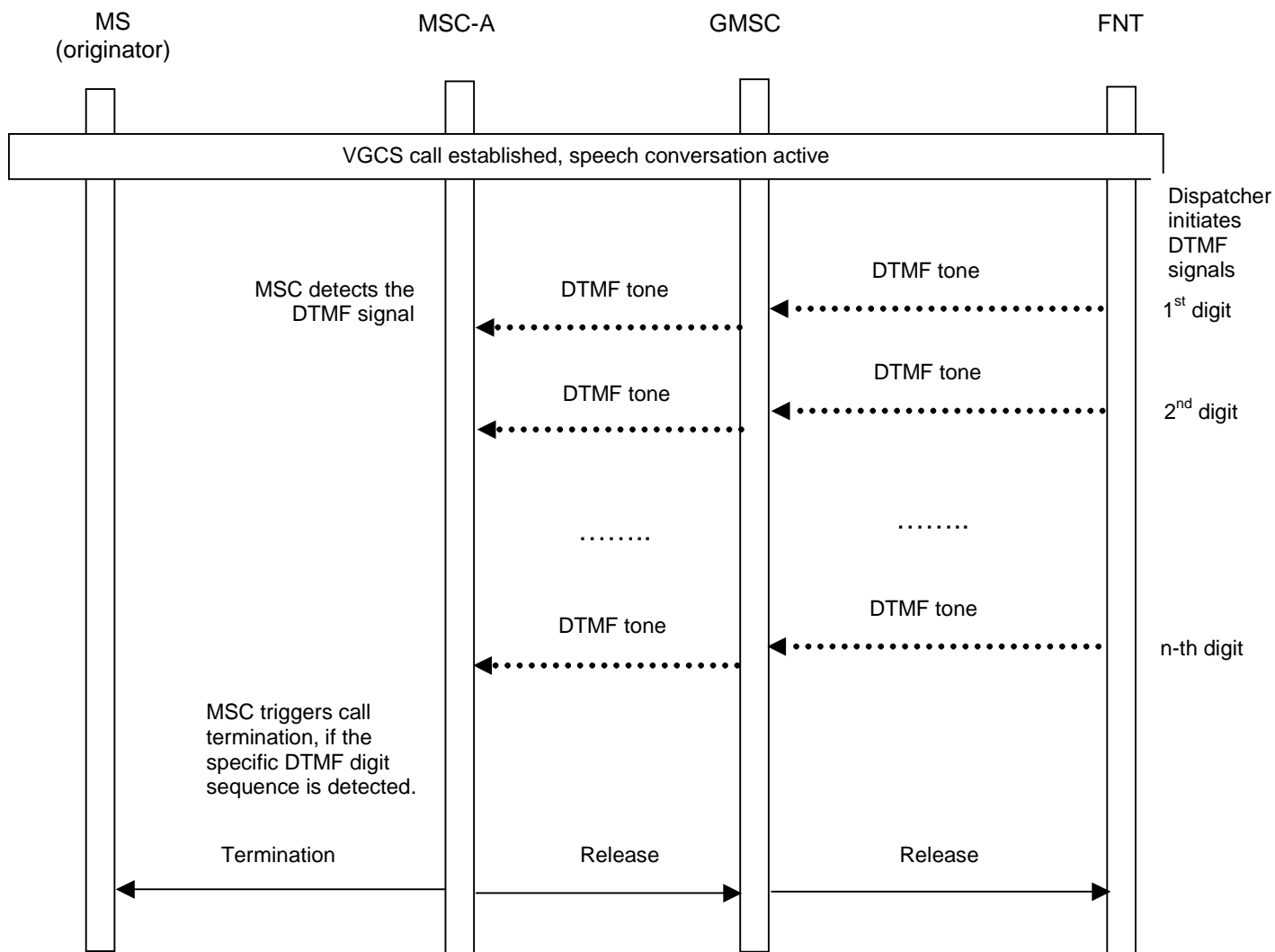

Figure 7d: Signalling required for group call termination by an entitled fixed line dispatcher.

11.4 Functional requirement of Anchor MSC

The VGCS handling process in the anchor MSC is shown in figure 8.

Successful call set-up

When the VGCS handling process in the anchor MSC receives a VGCS call set-up request from either a dispatcher or a service subscriber currently located in the anchor MSC's area or a service subscriber currently located in a relay MSC's area, it interrogates its associated GCR to retrieve the group call attributes, and waits for a response.

If the GCR returns a positive response containing the group call attributes, the anchor MSC sets up the downlinks to the cells inside the MSC area of the group call anchor MSC into which the call is to be sent, sets up the connections to the dispatchers to which a dedicated link is to be established, sets up the connections to the relay MSCs into which the call is to be sent, starts the No Activity Timer, sends Forward Group Call Signalling messages containing the IMSI of the service subscriber who has initiated the call -if the call was not initiated by a dispatcher- to all relay MSCs (however not to the relay MSC from which the IMSI was received within the Send Group Call End Signal message if the call was initiated by a service subscriber located in the relay MSC area), and waits for uplink management messages.

Procedure Set-up Connections to Relay MSCs

The procedure is shown in figure 9.

The procedure sends PREPARE_GROUP_CALL messages to all relay MSCs and waits for the responses.

If a positive response containing a Group Call number is received from a relay MSC, the anchor MSC constructs an IAM using the Group Call number as called party address, sends it to the relay MSC and waits for the SEND_GROUP_CALL_END_SIGNAL message.

If the SEND_GROUP_CALL_END_SIGNAL message is received, the procedure checks whether responses from other relay MSCs are outstanding. Relay MSCs that do not send positive responses on the PREPARE_GROUP_CALL message are no longer considered to belong to the list of relay MSCs for this VGCS call.

Negative response received from the GCR

If the GCR returns a negative response to the anchor MSC indicating that the call is already on-going, the anchor MSC checks whether the call was initiated by a dispatcher. If so, the dispatcher is connected to the on-going call and the process returns to the idle state. If the call was initiated by a service subscriber, a Release message indicating "user busy" is returned in order to force the mobile station of the service subscriber to look for notifications of the respective group ID on the NCH and join the group call.

If the negative response from the GCR indicates any other reason than "on-going call" the VGCS call set-up request is rejected by sending a release message back to the initiator and the process returns to the idle state.

Uplink management

If the anchor MSC receives an Uplink Release message from a BSC, it marks the uplink as free, sends Forward Group Call Signalling messages indicating "uplink release" indication to all relay MSCs, sends Uplink Release command messages to all other BSCs, restarts the No Activity Timer and waits for further uplink management messages.

If the anchor MSC receives an Uplink Request message from a BSC, it checks whether the uplink is marked as free. If so, an Uplink Request Confirm message is returned to the BSC, Forward Group Call Signalling messages indicating that the uplink is no longer free are sent to all relay MSCs, Uplink Seized Command messages are sent to all other BSCs, the uplink is marked busy and the process waits for further uplink management messages. If the uplink was not free when receiving the Uplink Request, the request is rejected.

If the anchor MSC receives an Uplink Cnf message from a BSC, it stores the received data and waits for further uplink management messages.

If the anchor MSC receives a Process Group Call Signalling message from a relay MSC indicating "uplink release indication", it marks the uplink as free, sends Forward Group Call Signalling messages indicating "uplink release indication" to all other relay MSCs, sends Uplink Release command messages to all BSCs, restarts the No Activity Timer and waits for further uplink management messages. If there is a dedicated connection for the talking service subscriber between the relay MSC and the anchor MSC, the anchor MSC shall release this connection.

If the anchor MSC receives a Process Group Call Signalling message from a relay MSC indicating "uplink request", it checks whether the uplink is marked as free. If so, a Forward Group Call Signalling message indicating "uplink request confirm" is returned to the relay MSC, Forward Group Call Signalling messages indicating that the uplink is no longer free are sent to all other relay MSCs, Uplink Seized Command messages are sent to all BSCs, the uplink is marked busy and the process waits for further uplink management messages. If the uplink was not free when receiving the Process Group Call Signalling message (Uplink Request), the request is rejected.

If the anchor MSC receives an ABORT message from a relay MSC, the connection to the relay MSC is released and the relay MSC is no longer considered to be part of the call.

Call release

If the anchor MSC receives the specific DTMF message sequence or the specific DTMF tone sequence for call termination from an entitled dispatcher (see figures 7b to 7d) or a Termination Request message from the initiating service subscriber who currently has access to the uplink, it sends Send Group Call End Signal ACK messages to all relay MSCs, sends Release messages to all relay MSCs, sends Release messages to all dispatchers and BSCs, informs the GCR that the call is no longer on-going and the process returns to the idle state.

If the anchor MSC receives a Process Group Call Signalling message from a relay MSC indicating "release group call" or an ISUP Release message from a relay MSC indicating "Normal call clearing" while the initiating subscriber is still on a dedicated connection, then the anchor MSC sends Send Group Call End Signal ACK messages to all relay MSCs, sends Release messages to all relay MSCs, sends Release messages to all dispatchers and BSCs, informs the GCR that the call is no longer on-going and the process returns to the idle state.

If the anchor MSC receives an ISUP Release message with cause value other than "Normal call clearing" from a relay MSC, while the initiating subscriber is still on a dedicated connection, then the anchor MSC shall send Uplink Release Command messages to all BSCs and Forward Group Call Signalling messages with Uplink Release Command parameter to all relay MSCs.

If the no activity time in the anchor MSC expires indicating that no voice activity has been detected for the time specified in the GCR, the anchor MSC sends Send Group Call End Signal ACK messages to all relay MSCs, sends Release messages to all relay MSCs, sends Release messages to all dispatchers and BSCs, informs the GCR that the call is no longer on-going and the process returns to the idle state.

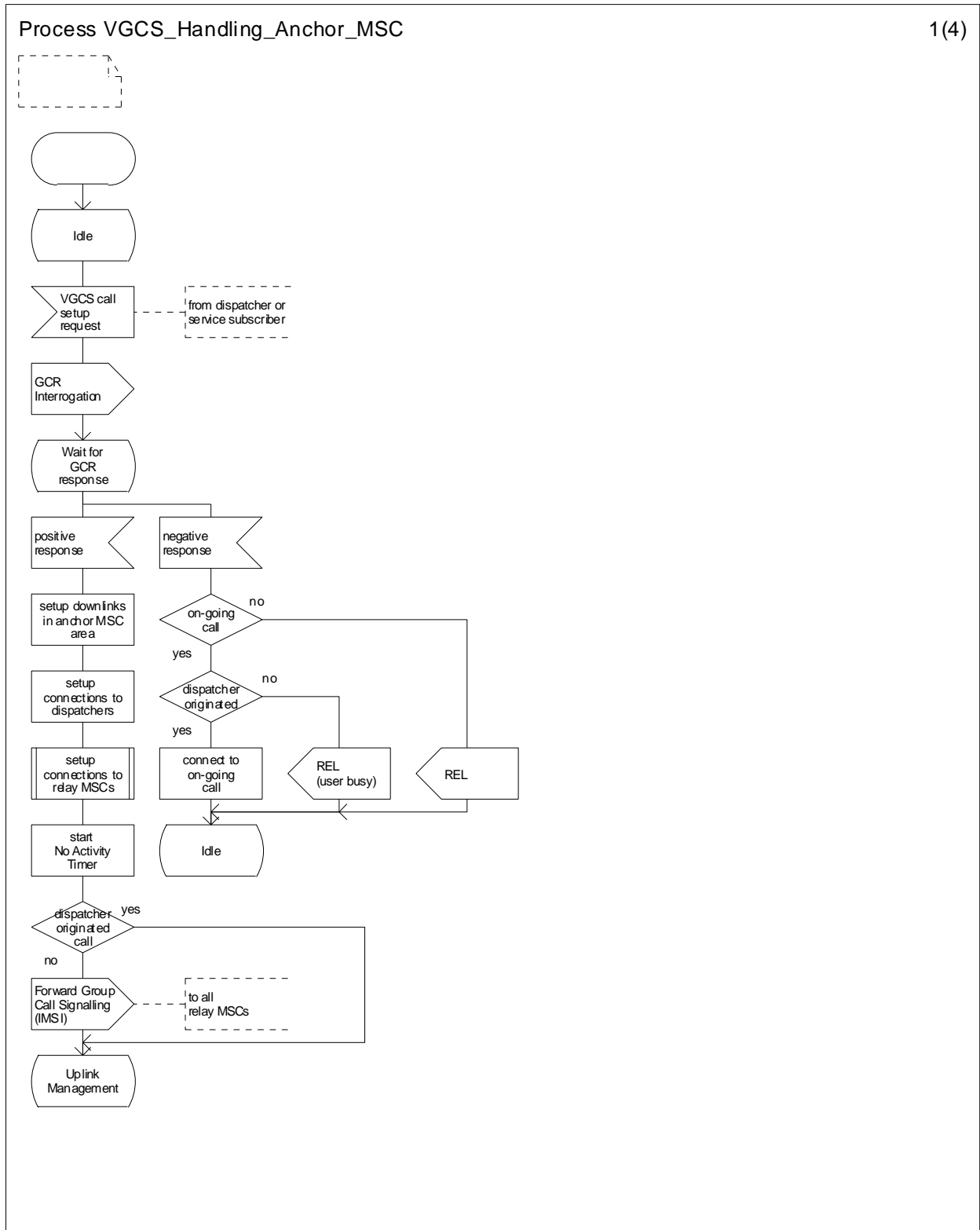

Figure 8: The VGCS handling process in the anchor MSC (sheet 1 of 4)

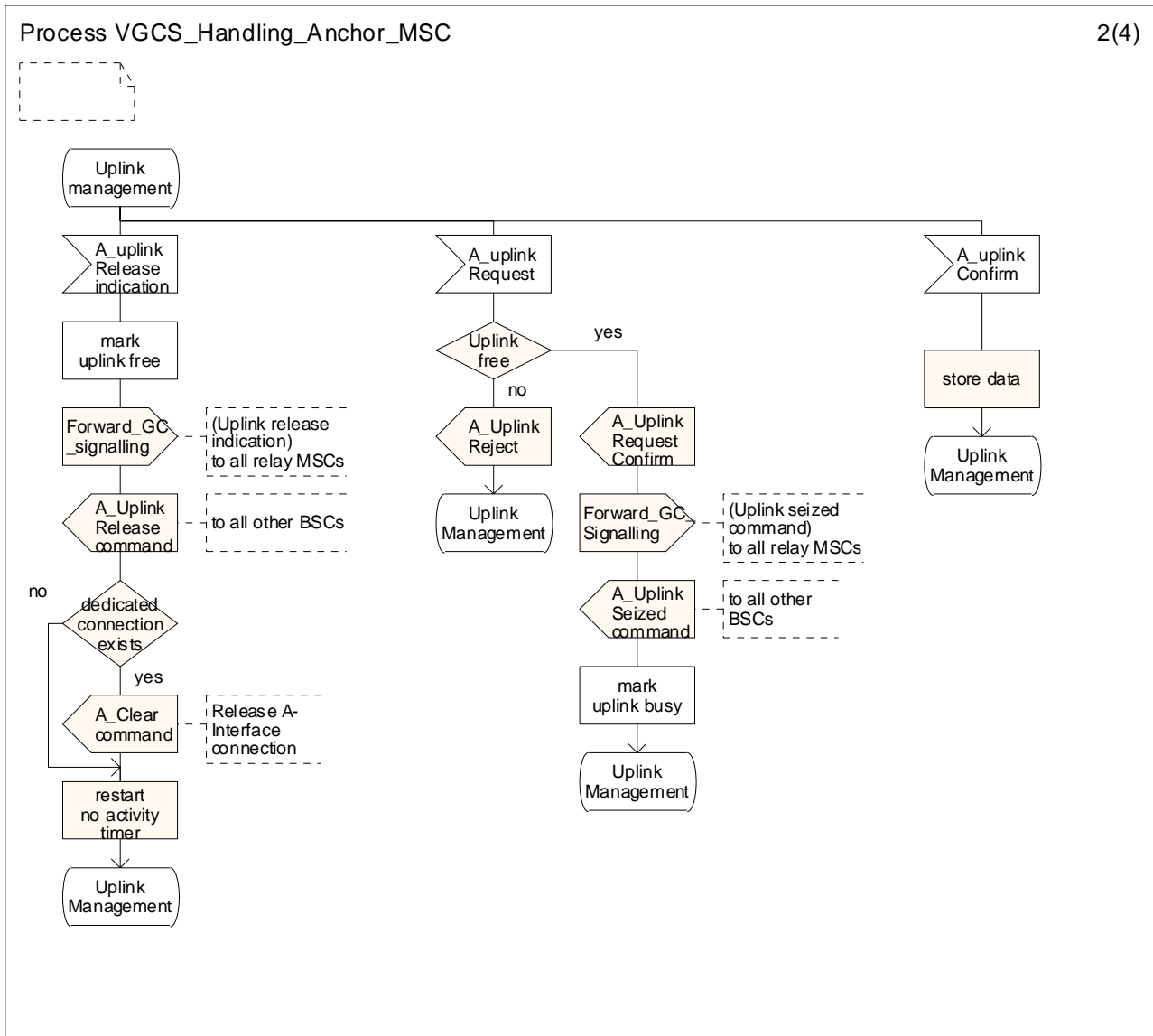

Figure 8: The VGCS handling process in the anchor MSC (sheet 2 of 4)

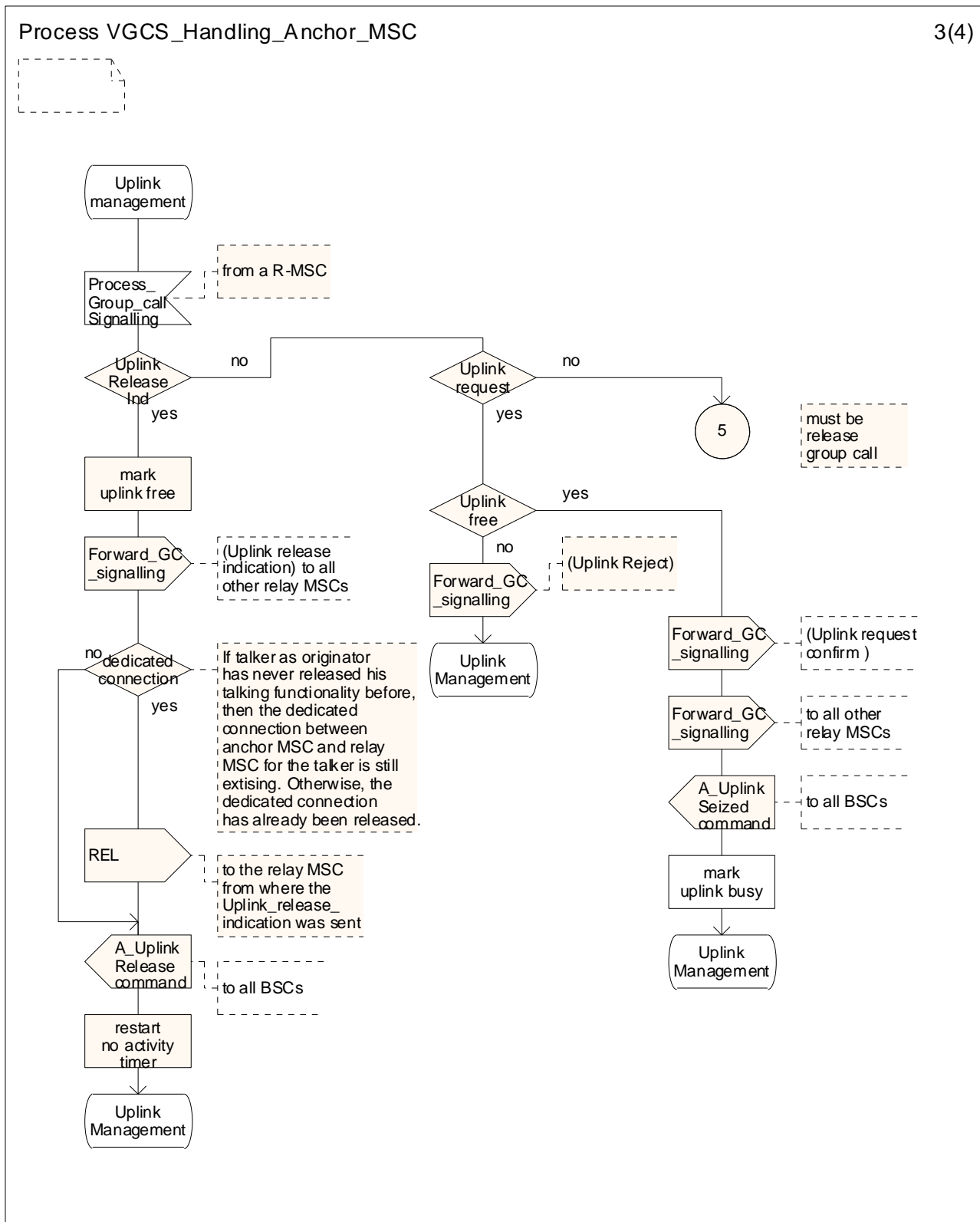

Figure 8: The VGCS handling process in the anchor MSC (sheet 3 of 4)

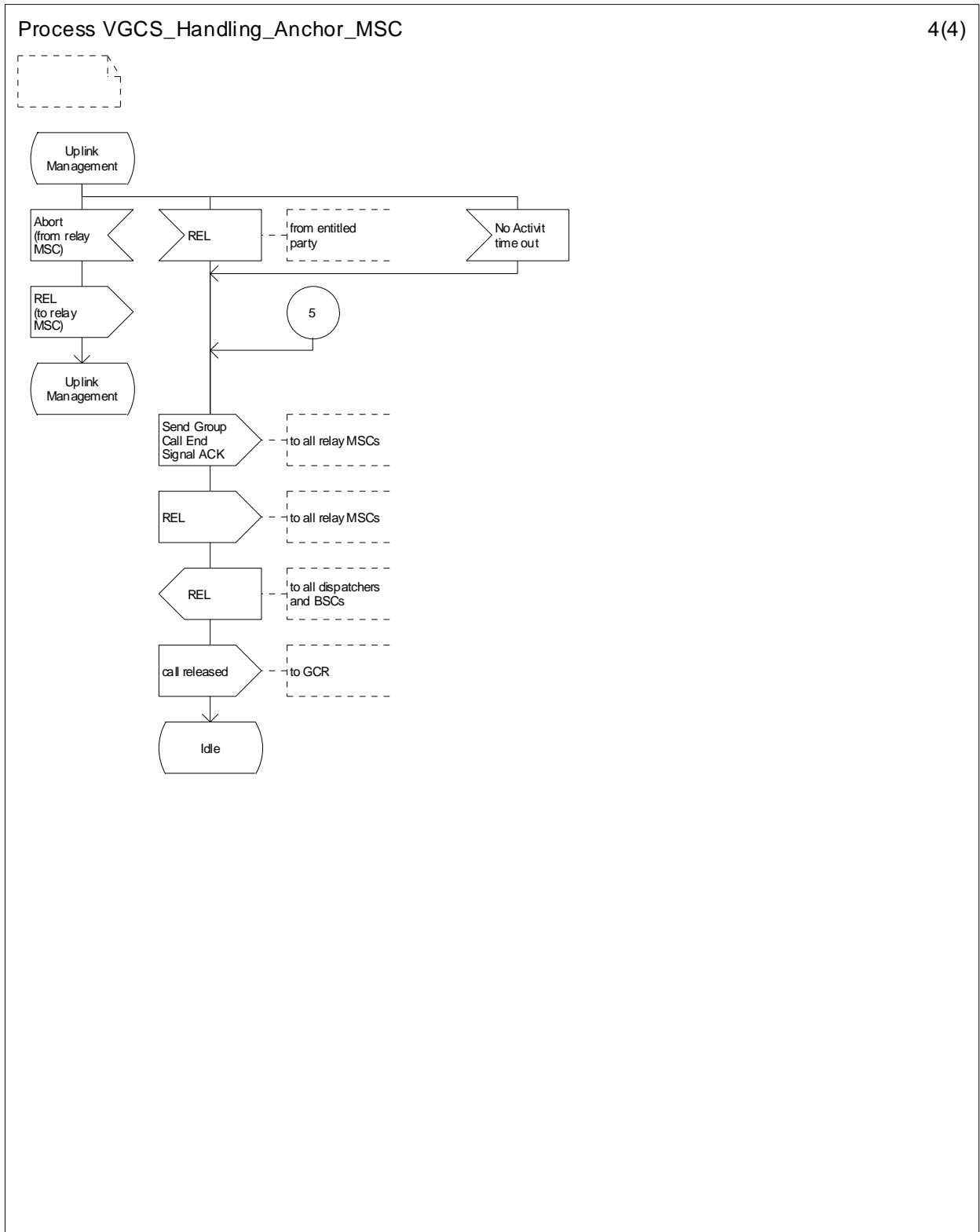

Figure 8: The VGCS handling process in the anchor MSC (sheet 4 of 4)

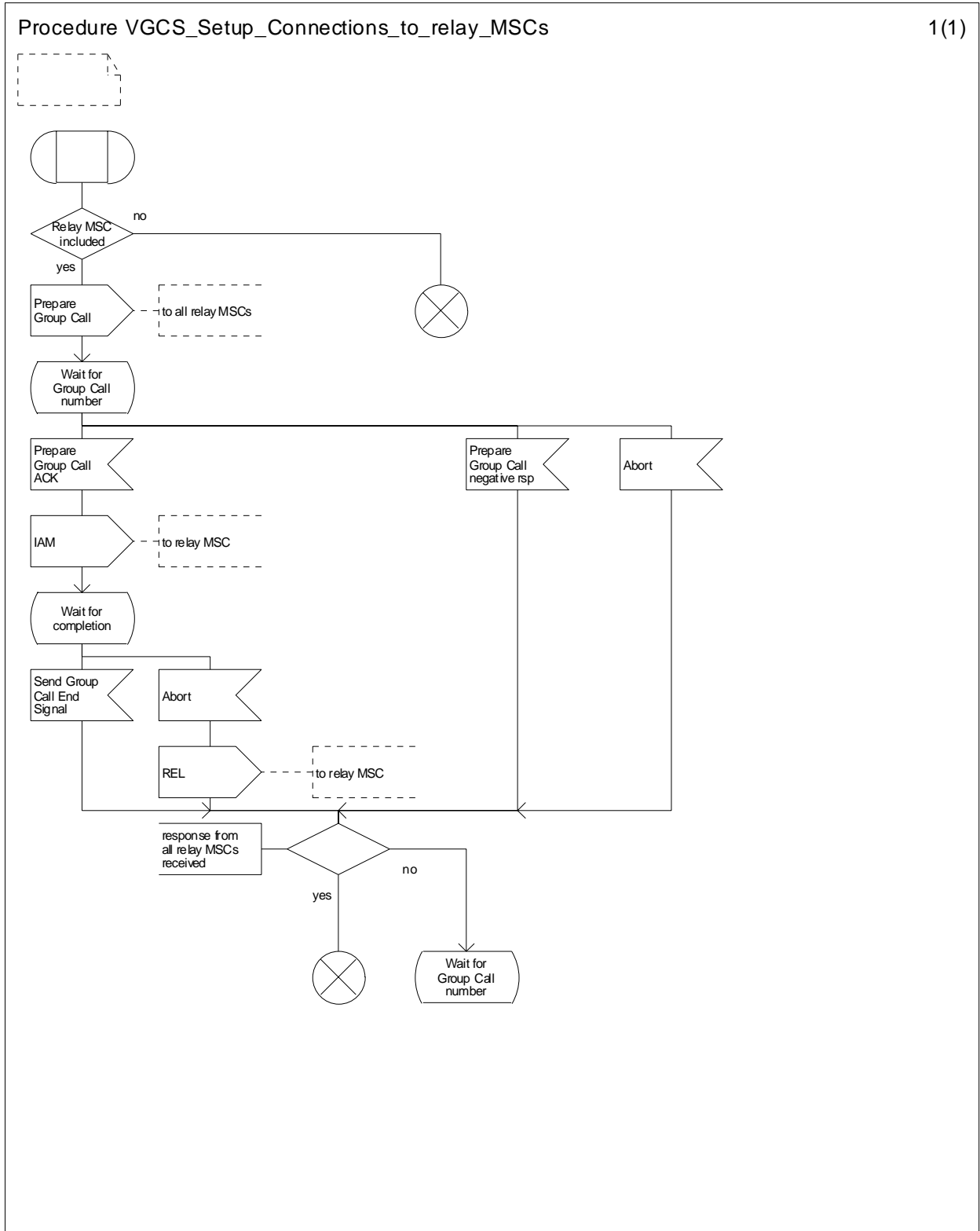

Figure 9: Procedure Set-up Connections to Relay MSCs

11.5 Functional requirement of Relay MSC

The VGCS handling process in the relay MSC is shown in figure 10.

Successful call set-up initiated by a service subscriber

When the VGCS handling process in the relay MSC receives a VGCS call set-up request from a service subscriber currently located in a relay MSC's area, it interrogates its associated GCR to retrieve the anchor MSC address and waits for a response.

If the GCR returns a positive response containing the anchor MSC address, the relay MSC sets up a dedicated connection for the initiating service subscriber to the anchor MSC by constructing an IAM with CLI set to the NDC plus prefix for VGCS plus group call reference, sending it to the anchor MSC, and waits for call release.

Negative response received from the GCR

If the GCR returns a negative response to the relay MSC indicating that the call is already on-going, the relay MSC sends a Release message indicating "user busy" to the service subscriber in order to force the mobile station of the service subscriber to look for notifications of the respective group ID on the NCH and join the group call.

If the negative response from the GCR indicates any other reason than "on-going call" the VGCS call set-up request is rejected by sending a release message back to the initiator and the process returns to the idle state.

Successful call set-up initiated by the anchor MSC

When the VGCS handling process in the relay MSC receives a PREPARE_GROUP_CALL message from the anchor MSC, it interrogates its associated GCR to retrieve the list of cells inside the relay MSC area into which the call is to be sent.

If the GCR returns a positive response, the relay MSC requests a Group Call number from its VLR.

If the VLR returns a Group Call number, a PREPARE_GROUP CALL acknowledgement containing the Group Call number is returned to the anchor MSC and the relay MSC waits for the incoming call.

If the incoming call identified by the Group Call number is received, the relay MSC releases the Group Call number, sets up the downlinks to the cells inside the relay MSC area into which the call is to be sent, sends a SEND_GROUP CALL END_SIGNAL message to the anchor MSC and waits for uplink management messages.

Negative response received from the GCR

If the GCR returns a negative response to the relay MSC, the relay MSC returns a PREPARE_GROUP_CALL negative response to the anchor MSC and returns to the idle state.

No Group Call number received from VLR

If the VLR could not allocate a Group Call number, the relay MSC returns a PREPARE_GROUP CALL_CALL negative response to the anchor MSC, informs the GCR that the call is no longer on-going and returns to the idle state.

Uplink management

If the relay MSC receives an Uplink Release message from a BSC, it marks the uplink as free, sends a Process Group Call Signalling message indicating "uplink release indication" to the anchor MSC, sends Uplink Release command messages to all other BSCs, and waits for further uplink management messages.

NOTE: If there is a dedicated connection for the talking service subscriber between the relay MSC and the anchor MSC, the anchor MSC will release this connection.

If the relay MSC receives an Uplink Request message from a BSC, it checks whether the uplink is marked as free. If so, a Process Group Call Signalling message indicating "uplink request" is sent to the anchor MSC, Uplink Seized Command messages are sent to all other BSCs, the uplink is marked busy and the process waits for further uplink management messages. If the uplink was not free when receiving the Uplink Request, the request is rejected.

If the relay MSC receives an Uplink Cnf message from a BSC, it stores the data and waits for further uplink management messages.

If the relay MSC receives a Forward Group Call Signalling message from an anchor MSC indicating "uplink release indication", it marks the uplink as free, sends Uplink Release command messages to all BSCs and waits for further uplink management messages.

If the relay MSC receives a Forward Group Call Signalling message from an anchor MSC indicating "uplink seized command", it marks the uplink as busy, sends Uplink Seized Command messages to all BSCs and waits for further uplink management messages.

If the relay MSC receives a Forward Group Call Signalling message from an anchor MSC indicating "uplink reject", it returns an Uplink Reject message to the BSC which has requested the uplink and waits for further uplink management messages.

If the relay MSC receives a Forward Group Call Signalling message from an anchor MSC indicating "uplink request confirm", it returns an Uplink Request Confirm message to the BSC which has requested the uplink, sets up a dedicated connection for the new talker to the anchor MSC (implementation option) and waits for further uplink management messages.

If the relay MSC receives a Forward Group Call Signalling message from an anchor MSC indicating "uplink release command", it sends an Uplink Release Command message to the BSC which currently has access to the uplink and waits for further uplink management messages.

If the relay MSC receives an ABORT message from an anchor MSC, it sends release messages to all BSCs, informs the GCR that the call is no longer on-going and the process returns to the idle state.

Call release

When receiving a release message from the anchor MSC for the dedicated connection which was set-up to for the initiating service subscriber located in the relay MSC area, the relay MSC releases the connection to the service subscriber and the process returns to the idle state.

When the initiating service subscriber releases the call while a dedicated connection to the anchor MSC is established, the relay MSC sends a release message for the dedicated connection to the anchor MSC and the process returns to the idle state.

When the initiating service subscriber releases the call, while on a group call channel, the relay MSC sends a Process Group Call Signalling message to the anchor MSC indicating "release group call" and waits for the Release message and the Send Group Call End Signal Acknowledgement from the anchor MSC.

When receiving a Send Group Call End Signal Acknowledgement from the anchor MSC, the relay MSC releases all downlinks to cells inside the relay MSC area, informs the GCR that the call is no longer on-going and the process returns to the idle state.

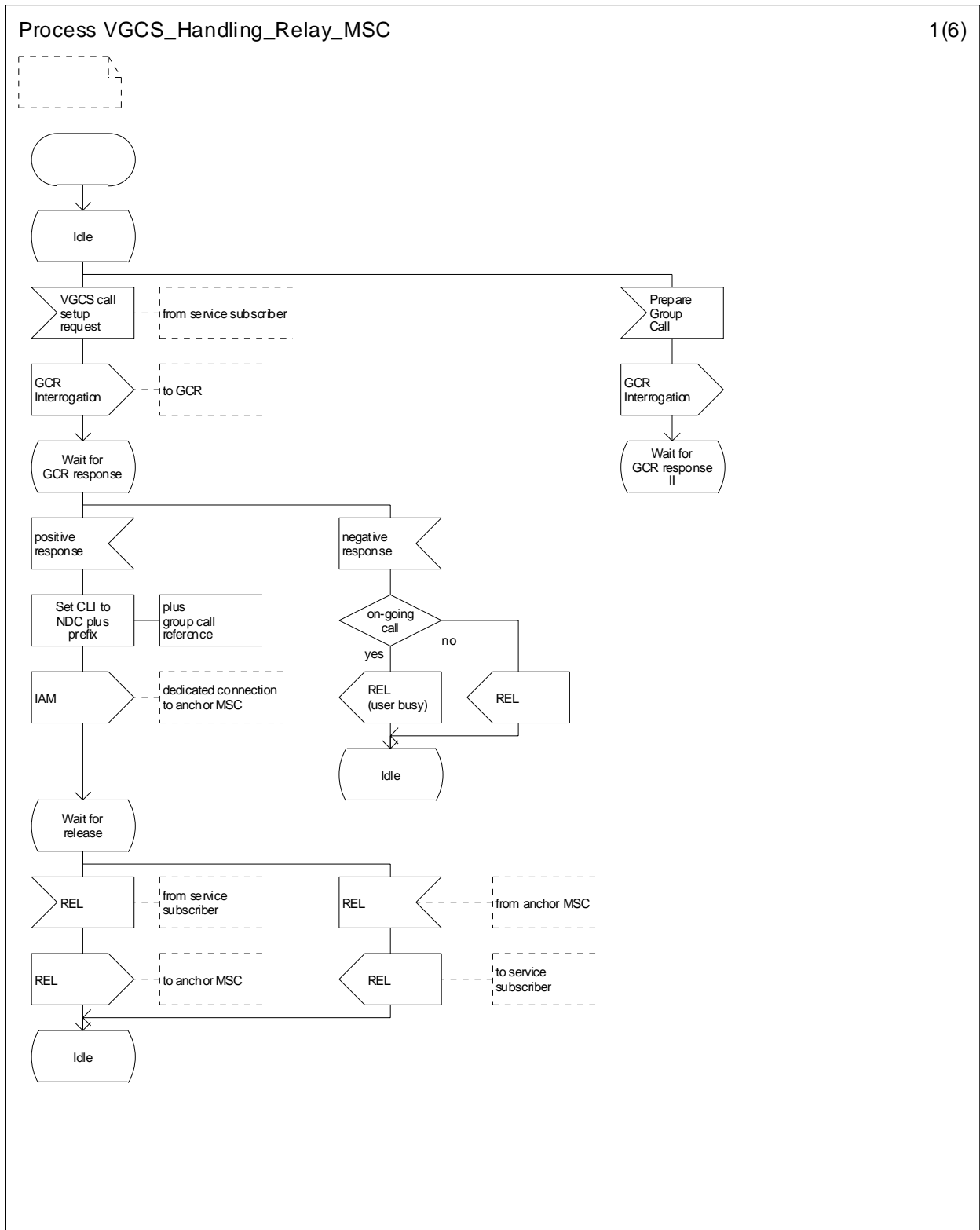

Figure 10: The VGCS handling process in the relay MSC (sheet 1 of 6)

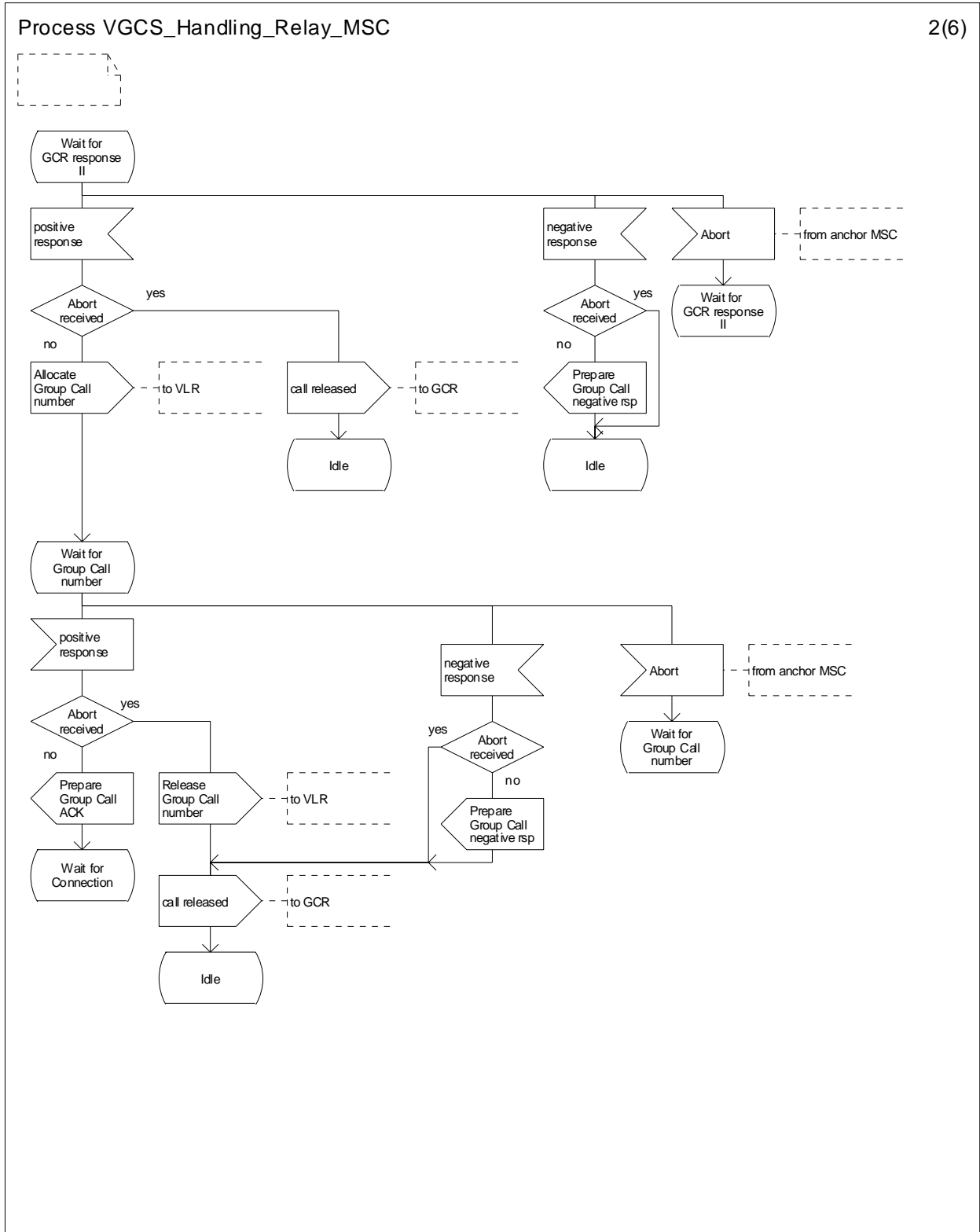

Figure 10: The VGCS handling process in the relay MSC (sheet 2 of 6)

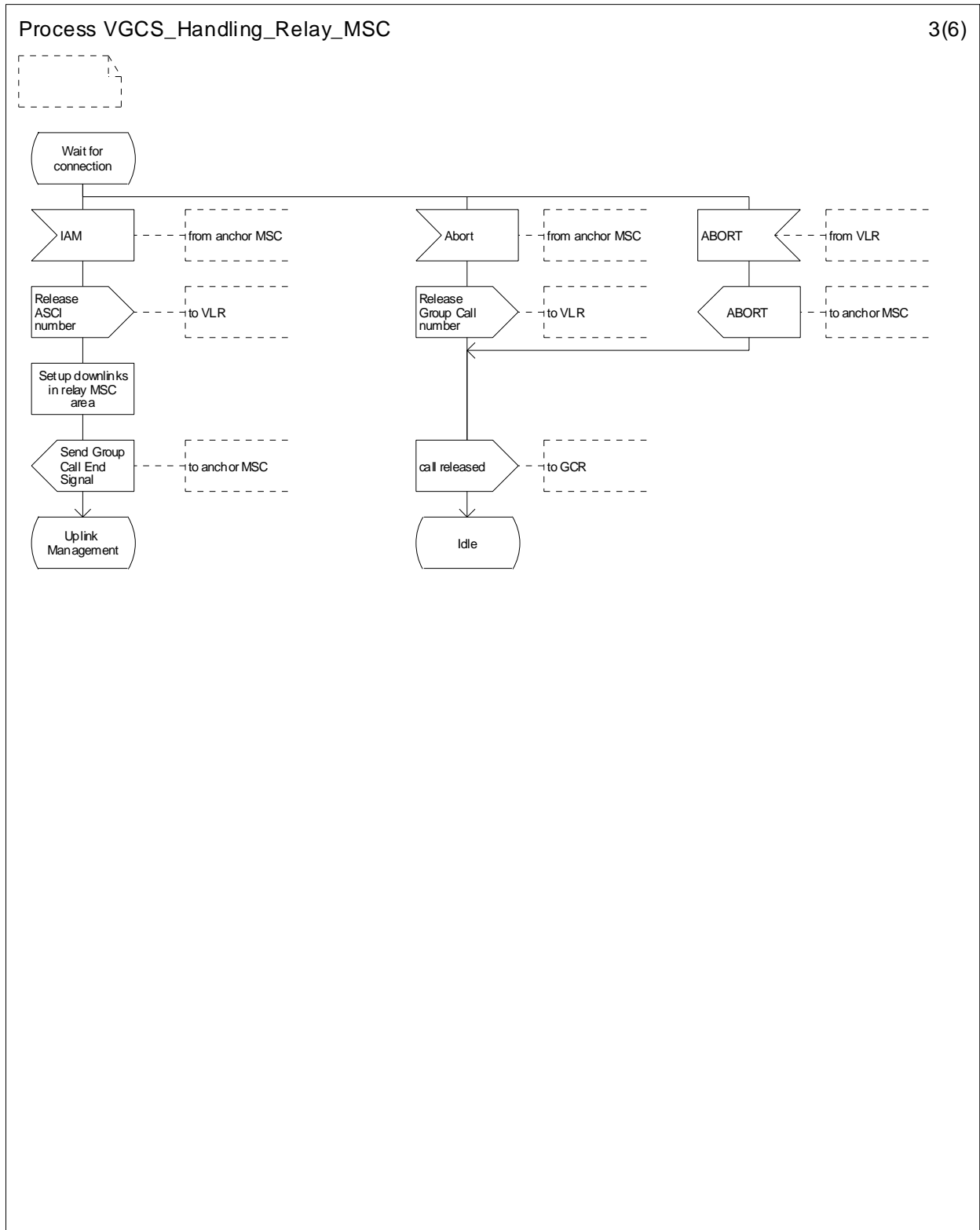

Figure 10: The VGCS handling process in the relay MSC (sheet 3 of 6)

Process VGCS_Handling_Relay_MSC

4(6)

Uplink management in Relay MSC. HO cases not covered.

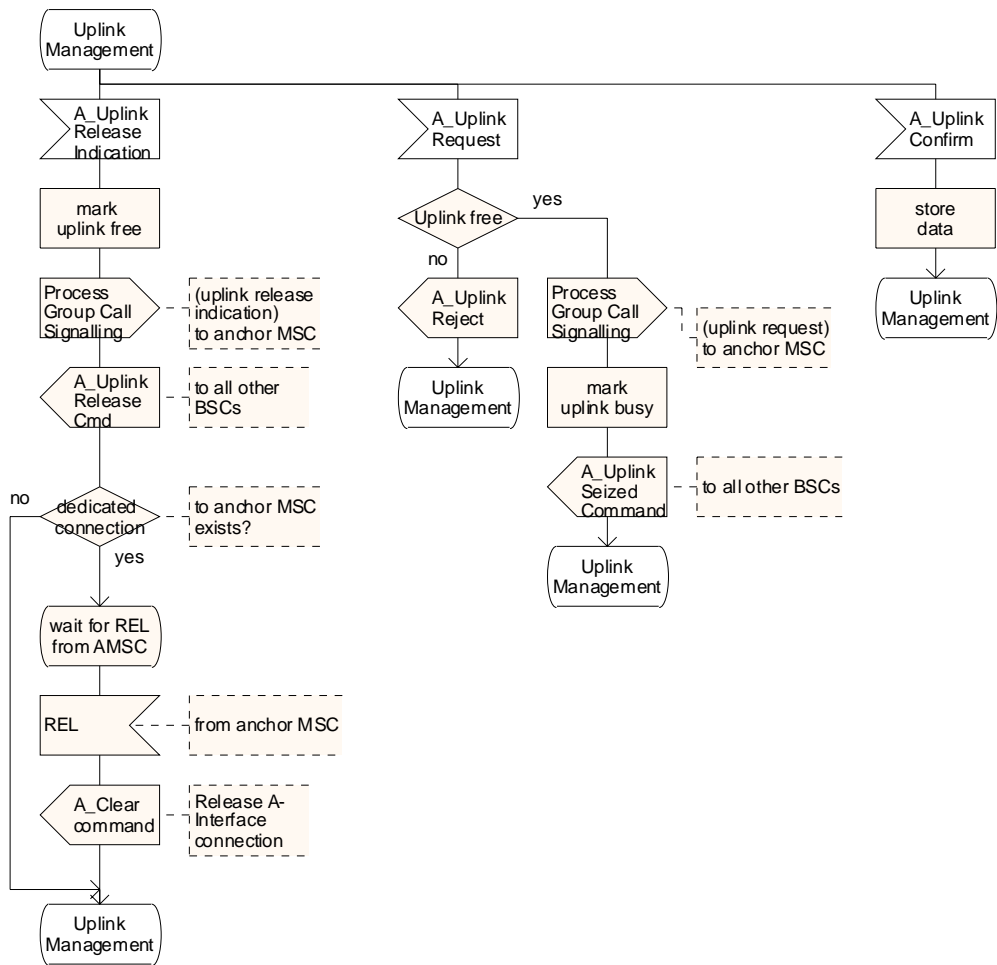

Figure 10: The VGCS handling process in the relay MSC (sheet 4 of 6)

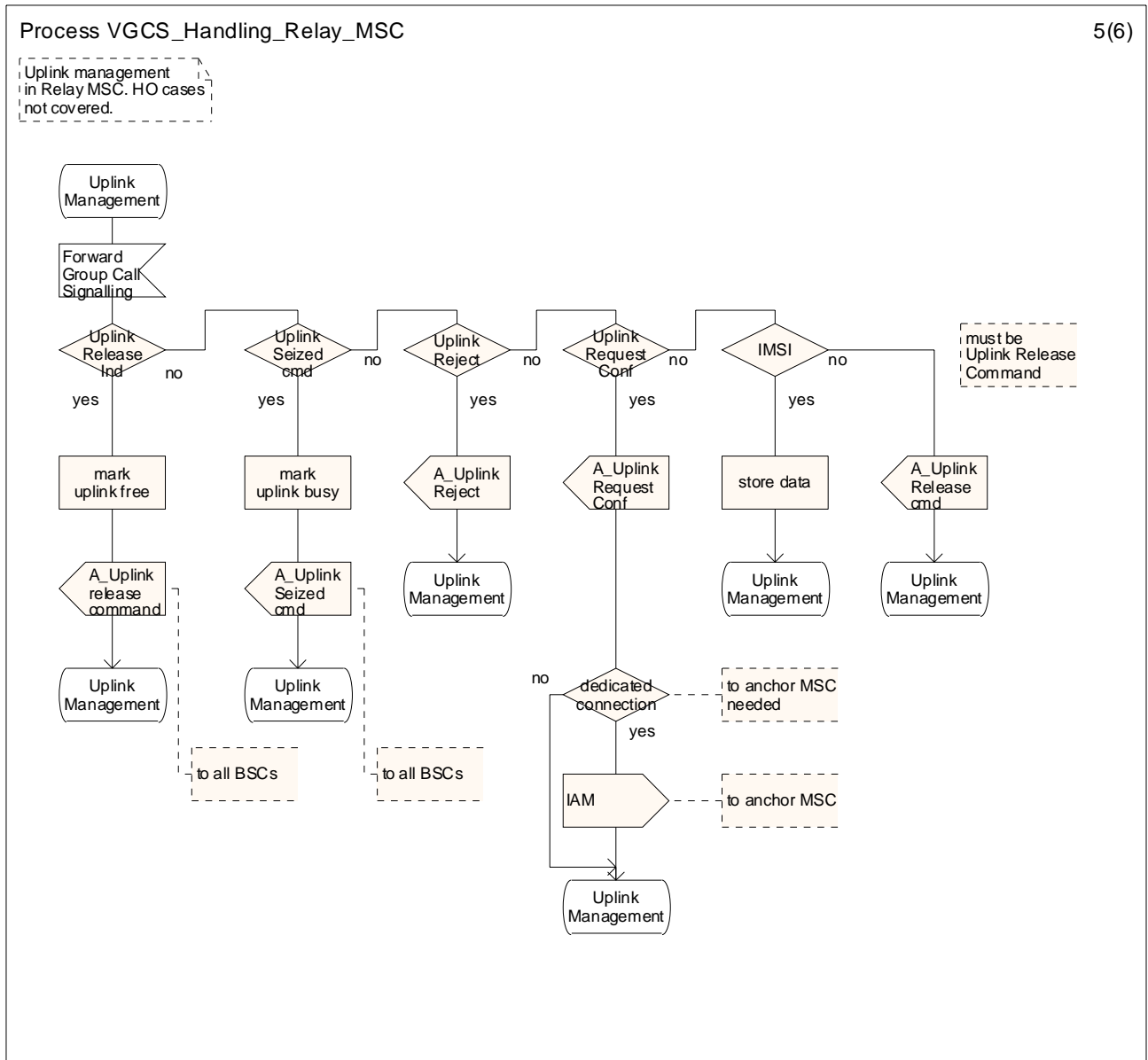

Figure 10: The VGCS handling process in the relay MSC (sheet 5 of 6)

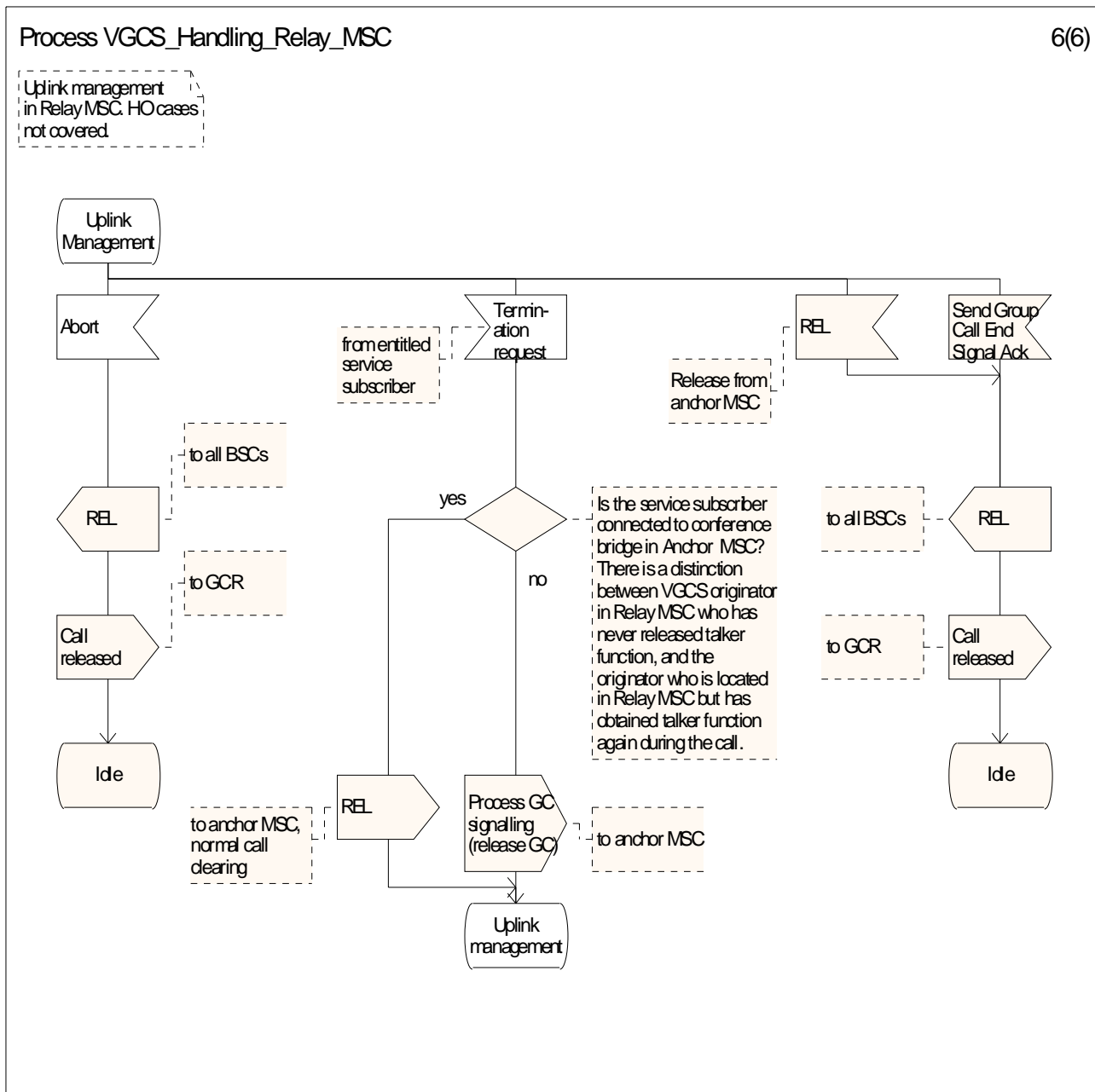

Figure 10: The VGCS handling process in the relay MSC (sheet 6 of 6)

11.6 Functional requirement of GCR

The process in the GCR is shown in figure 11.

Service subscriber initiated call

If the GCR receives an interrogation request for a call initiated by a service subscriber who is located in the MSC area of the associated MSC, the GCR calculates the group call reference from the Group ID and the originating cell ID.

If the group call reference was successfully calculated, the GCR checks whether a VGCS call with that group call reference is already on-going.

If the call is not marked as on-going, the GCR checks whether an anchor MSC address is stored in its group call reference record. If this is the case, a positive response including the anchor MSC address is returned to the MSC, the IMSI of the initiating service subscriber is stored in the GCR and the process returns to the idle state. If no anchor MSC address is stored (i.e. the associated MSC is anchor MSC with respect to this group call reference) the GCR marks its group call reference record with "on-going call" and returns a positive response including the group call attributes to the MSC and the process returns to the idle state.

If the group call reference could not be successfully calculated from the Group ID and the originating cell ID, the GCR returns a negative response indicating "failure" to the MSC and the process returns to the idle state.

If the call was marked as on-going, the GCR returns a negative response indicating "on-going call" to the MSC and the process returns to the idle state.

Dispatcher initiated call

If the GCR receives an interrogation request for a call initiated by a dispatcher or by a service subscriber who is not located in the MSC area of the associated MSC, the GCR checks the CLI of the initiator against the list of identities of dispatchers which are allowed to initiate the voice group call and against the VGCS prefix plus group call reference in order to determine whether the initiator is allowed to set-up the call. If the check is successful the GCR checks whether a VGCS call with the same group call reference is already on-going.

If the call is not marked as on-going, the GCR marks its group call reference record with "on-going call" and returns a positive response including the group call attributes to the MSC and the process returns to the idle state.

If the CLI check was not successful, the GCR returns a negative response indicating "failure" to the MSC and the process returns to the idle state.

If the call was marked as on-going, the GCR returns a negative response indicating "on-going call" to the MSC and the process returns to the idle state.

Anchor MSC triggered call

If the GCR (associated to a relay MSC) receives an interrogation request for a call triggered by the anchor MSC, the GCR deletes the IMSI of the initiating service subscriber which is possibly stored in its record, marks its group call reference record with "on-going call", returns a positive response including the list of cells inside the MSC area of the requesting MSC in which the call is to be sent to the MSC and the process returns to the idle state.

Call release

If the GCR receives a call released indication from the MSC, the "on-going call" indicator in the group call reference record is reset and the process returns to the idle state.

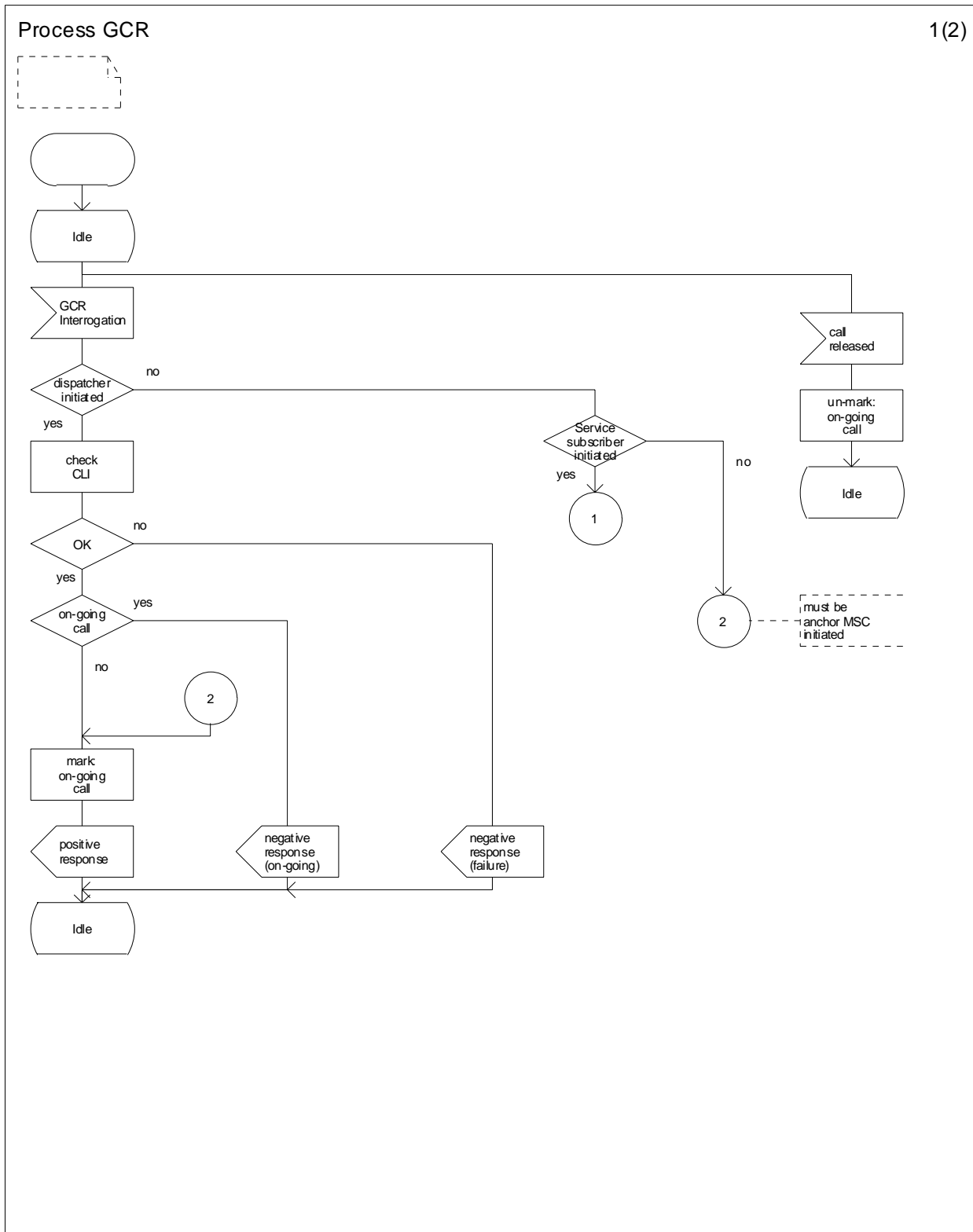

Figure 11: The process in the GCR (sheet 1 of 2)

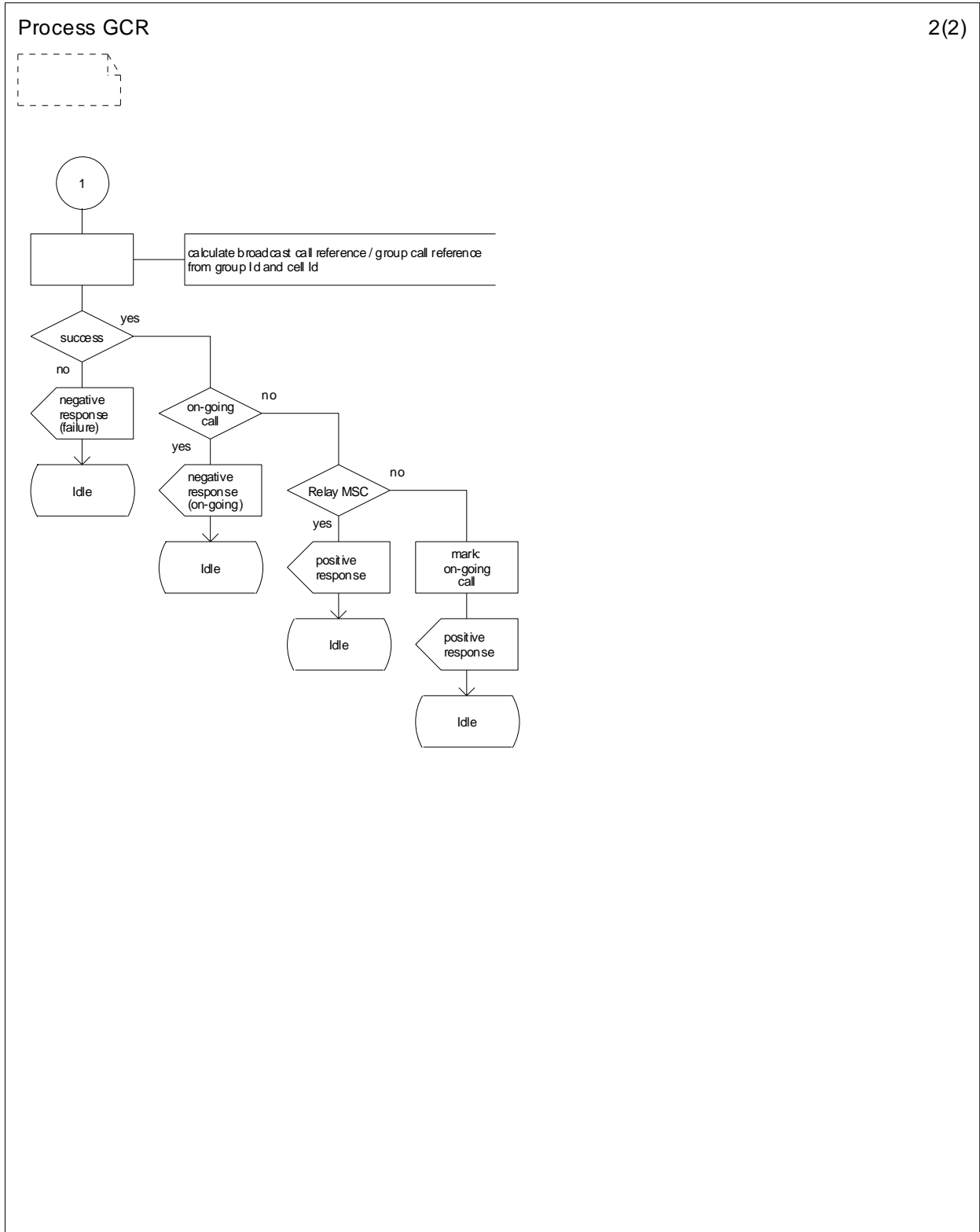

Figure 11: The process in the GCR (sheet 2 of 2)

11.7 Functional requirement of VLR

The Group Call number allocation process in the VLR is shown in figure 12.

Successful procedure

When receiving a request from the relay MSC to allocate a Group Call number, the VLR checks if a Group Call number is available. If so it selects a Group Call number, marks the number as allocated, returns a positive response including the Group Call number to the MSC, starts a supervision timer and waits for removal of the Group Call number. If the VLR receives a request to release the Group Call number, the VLR marks the Group Call number as free and the process returns to the idle state.

No Group Call number available

If no Group Call number is available, the VLR returns a negative response indicating "no Group Call number available" to the MSC and the process returns to the idle state.

Supervision timer expires

If the supervision timer expires, the VLR indicates to the relay MSC that the dialogue has to be aborted.

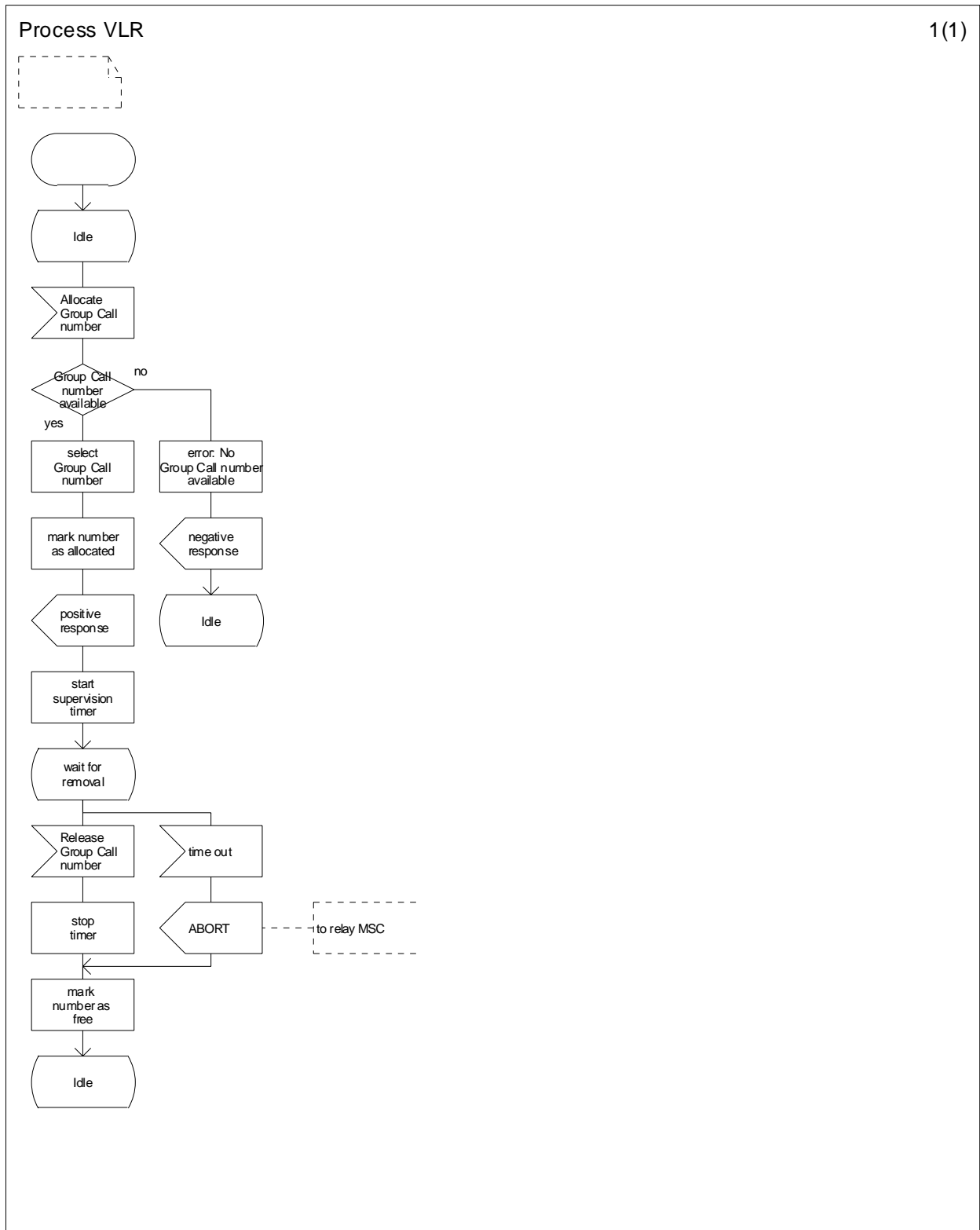

Figure 12: The Group Call number allocation process in the VLR

12 Content of messages

This clause specifies the content of the following messages:

On the B-interface (MSC-VLR):

- Allocate Group Call Number;
- Allocate Group Call Number ack;
- Allocate Group Call Number negative response;
- Release Group Call Number.

On the E-interface (MSC-MSC):

- Prepare Group Call;
- Prepare Group Call ack;
- Prepare Group Call negative response;
- Send Group Call End Signal;
- Forward Group Call Signalling;
- Process Group Call Signalling.

On the I-interface (MSC-GCR):

- GCR Interrogation;
- GCR Interrogation ack;
- GCR Interrogation negative response;
- Call Released.

In the tables which follow, information elements are shown as mandatory (M), conditional (C) or optional (O). A mandatory information element shall always be present. A conditional information element shall be present if certain conditions are fulfilled; if those conditions are not fulfilled it shall be absent. An optional element may be present or absent, at the discretion of the application at the sending entity.

12.1 Messages on the B-interface (MSC-VLR)

12.1.1 Allocate Group Call Number

No information element is required.

12.1.2 Allocate Group Call Number ack

The following information element is required.

Information element name	Required	Description
Group Call number	M	E.164 number required to route the call from the anchor MSC to the relay MSC

12.1.3 Allocate Group Call Number negative response

The negative response information element can take the following value:

- No Group Call number available.

12.1.4 Release Group Call Number

The following information element is required.

Information element name	Required	Description
Group Call number	M	E.164 number required to route the call from the anchor MSC to the relay MSC

12.2 Messages on the E-interface (MSC-MSC)

12.2.1 Prepare Group Call

The following information elements are required.

Information element name	Required	Description
Teleservice	M	The teleservice Voice Group Call indicates that a VGCS call has to be prepared
Group call reference	M	see clause 9
Cipher Algorithm, Group Key and Number	M	Information on the cipher algorithm and group key to be used
Priority	C	The default priority level must be present if eMLPP applies
Codec Info	M	Information on the codecs allowed for the VGCS call

12.2.2 Prepare Group Call ack

The following information element is required.

Information element name	Required	Description
Group Call number	M	E.164 number required to route the call from the anchor MSC to the relay MSC

12.2.3 Prepare Group Call negative response

The negative response information element can take the following value:

- No Group Call number available.

12.2.4 Send Group Call End Signal

The following information element is required.

Information element name	Required	Description
IMSI	C	The IMSI of the service subscriber who has initiated the call. Must be present if the call was initiated by a service subscriber in the relay MSC area

12.2.5 Forward Group Call Signalling

The following information elements are required.

Information element name	Required	Description
IMSI	C	IMSI of the service subscriber who has initiated the call. Must be present if the message is used to transfer the IMSI to the relay MSC
Uplink Request Acknowledgement flag	C	Must be present if the message is used as positive acknowledgement of an uplink request
Uplink Release Indication flag	C	Must be present if the message is used to indicate to the relay MSC that the uplink is no longer busy
Uplink Reject Command flag	C	Must be present if the message is used as negative acknowledgement of an uplink request
Uplink Seized Command flag	C	Must be present if the message is used to indicate to the relay MSC that the uplink has become busy
Uplink Release Command flag	C	Must be present if the message is used to indicate to the relay MSC that the uplink which is currently under control of the relay MSC has to be released

12.2.6 Process Group Call Signalling

The following information elements are required.

Information element name	Required	Description
Uplink Request flag	C	Must be present if the message is used to request uplink control from the anchor MSC
Uplink Release Indication flag	C	Must be present if the message is used to indicate to the anchor MSC that the uplink has become free
Release Group Call flag	C	Must be present if the message is used to indicate to the anchor MSC that the VGCS call shall be released

12.3 Messages on the I-interface (MSC-GCR)

12.3.1 GCR Interrogation

The following information elements are required.

Information element name	Required	Description
Group call reference	C	see clause 9. Must be present if the VGCS call was initiated by a dispatcher or by a service subscriber in the relay MSC area and the receiving GCR is associated to the anchor MSC
Group ID	C	see clause 9. Must be present if the VGCS call was initiated by a service subscriber in the own MSC area
Originating Cell ID	C	see clause 9. Must be present if the VGCS call was initiated by a service subscriber in the own MSC area
CLI	C	Calling Line Identity of the initiating dispatcher, or VGCS prefix plus group call reference in case of service subscriber originated VGCS call in the relay MSC. Must be present if the VGCS call was not initiated by a service subscriber located in the own MSC area
Relay MSC indicator	M	A flag indicating whether the GCR interrogation was triggered from a Prepare Group Call message received from the anchor MSC
IMSI	C	IMSI of the service subscriber who has initiated the VGCS call. Must be present if the VGCS call was initiated by a service subscriber in the own MSC area

12.3.2 GCR Interrogation ack

The following information elements are required.

Information element name	Required	Description
Cell List	C	A list of cells inside the MSC area into which the call is to be sent. Must be present if a) no anchor MSC address is present in the group call reference record, or b) the relay MSC indicator was set in the GCR Interrogation message
Anchor MSC Address	C	E.164 number required to route the call from the relay MSC to the anchor MSC. Must be present if the anchor MSC Address is present in the group call reference record
Relay MSC List	C	A list of relay MSCs into which the call is to be sent. Must be present if a relay MSC list is present in the group call reference record
Group Key and Number	C	Information on the cipher algorithm and the group key to be used. Must be present if Group Key and Number is present in the group call reference record
Codec Information	C	Information on the codecs allowed for the voice broadcast call. Must be present if Codec Info is present in the group call reference record
Establish to Dispatcher List	C	A list of identities of dispatchers to which a dedicated link is to be established. Must be present if included in the group call reference record. Note that the CLI possibly received with the GCR interrogation message must not be included
Release from Dispatcher List	C	A list of identities of dispatchers which are allowed to terminate the voice group call. Must be present if included in the group call reference record
Priority	C	The default priority level related to the voice group call if eMLPP applies. Must be present if included in the group call reference record
IMSI	C	IMSI of the service subscriber who has initiated the VGCS call. Must be present if the Relay MSC Indicator was set in the GCR interrogation message and the IMSI is present in the group call reference record
No Activity Time	C	The length of the time over which no activity is detected before the voice group call is automatically terminated

12.3.3 GCR interrogation negative response

The negative response information element can take the following value:

- on-going call;
- failure.

12.3.4 Call released

The following information element is required.

Information element name	Required	Description
Group call reference	M	see clause 9

Annex A (informative): Change History

TSG#	TSG doc	WG doc	Spec	CR	R ev	Ph	C at	Old vers	New vers	Title	WI
S#31		Feb 2000	03.68						8.0.0	Specification version upgrade to Release 1999 version 8.0.0	
CN#7	email before SMG#32	Apr 2000	03.68	A017		R99		8.0.0	8.1.0	VGCS Signalling Flows	ASCI
CN#7	email before SMG#32	Apr 2000	03.68	A019		R99		8.0.0	8.1.0	Data Flow for Fast Call setup	ASCI
CN#7	email before SMG#32	Apr 2000	03.68	A022		R99		8.0.0	8.1.0	Recommendation to use DTMF tones for VGCS talking subscriber downlink un-muting	ASCI
S#32 CN#8	NP-000275	N1-000738	03.68	A024		R99	F	8.1.0	8.2.0	Call Release clarification at the Relay MSC	ASCI
S#32 CN#8	NP-000275	N1-000739	03.68	A025		R99	F	8.1.0	8.2.0	Speech transmission architecture clarification	ASCI
S#32 CN#8	NP-000275	N1-000740	03.68	A026		R99	D	8.1.0	8.2.0	Clarification of anchor MSC address format	ASCI
S#32 CN#8	NP-000276	N1-000676	03.68	A023		R4	B	8.2.0	9.0.0	Introduction of Originator-to-dispatcher information into VGCS	ASCI
S#32 CN#8	NP-000276	N1-000767	03.68	A027		R4	F	8.2.0	9.0.0	VGCS service accessibility	ASCI
S#32 CN#8	NP-000276	N1-000769	03.68	A028		R4	C	8.2.0	9.0.0	talker outside Group Call Area	ASCI
S#32 CN#8	NP-000276	N1-000771	03.68	A029		R4	F	8.2.0	9.0.0	Notification response & uplink reply procedure definition	ASCI
S#32 CN#8	NP-000276	N1-000773	03.68	A030		R4	F	8.2.0	9.0.0	Release dataFlow correction	ASCI
			03.68 / 43.068					03.68 v9.0.0	43.068 v4.0.0	Conversion to 3GPP TS format	-
CN#9	NP-000449	N1-000873	43.068	001		R4	F	4.0.0	4.1.0	Uplink Release dataFlow correction	ASCI
CN#9	NP-000449	N1-000915	43.068	002		R4	F	4.0.0	4.1.0	Correction in the Notification procedure	ASCI
CN#9	NP-000449	N1-000918	43.068	003		R4	B	4.0.0	4.1.0	Identification of Group ID - The longest GID has to be matched	ASCI
Oct 2000								4.1.0	4.1.1	GSM references revert to pre-Release-4 spec number format.	
NP-10	NP-000667	N1-001171	43.068	004		Rel-4	F	4.1.1	4.2.0	Call Waiting is not applicable to an originator/talker in dedicated mode	ASCI
NP-10	NP-000667	N1-001181	43.068	005		REL-4	F	4.1.1	4.2.0	Wrong Field Name for OTDI	ASCI
NP-10	NP-000667	N1-001401	43.068	006	1	REL-4	F	4.1.1	4.2.0	DTMF precision	ASCI
			43.068			Rel-4		4.2.0	4.2.1	ETSI/MCC cleanup on references and editorials (version 4.2.1 was never issued in 2000-12, but 4.2.0 was the correct from the DBase).	05.05.2002
NP-16			43.068			Rel-5		4.2.1	5.0.0	CN plenary decision to make this TS also for Release 5.	June 2002
			43.068			Rel-5		5.0.0	5.0.1	Editorial correction, changing Note 1 to 15 and Note 2 to 16 in fig. 7, subclause 11.3.8.	27.06.2002

NP-17	NP-020383	N1-021687	43.068	007		Rel-5	F	5.0.1	5.1.0	ASCI VGCS call termination by dispatchers using DTMF	Sept 2002
NP-18	NP-020675		43.068	008	4	Rel-5	F	5.1.0	5.2.0	MS late entry notification	Dec 2002
NP-21	NP-030408	N1-031204	43.068	010	1	Rel-5	A	5.2.0	5.3.0	Correction of uplink release management	Sept 2003
NP-21	NP-030407	N1-031210	43.068	012	1	Rel-5	A	5.2.0	5.3.0	Correction to definition of Group-ID, Group call area ID and Group Call Reference	Sept 2003
NP-21	NP-030409	N1-031217	43.068	013	1	Rel-5	F	5.2.0	5.3.0	Correction to MS Late Entry description	Sept 2003
NP-25	NP-040373	N1-041526	43.068	018	1	Rel-5	A	5.3.0	5.4.0	Correction on notification for first talker of VGCS call	Sept 2004

History

Document history		
V5.0.0	June 2002	Publication
V5.0.1	June 2002	Publication
V5.1.0	September 2002	Publication
V5.2.0	December 2002	Publication
V5.3.0	September 2003	Publication
V5.4.0	September 2004	Publication