

ETSI TS 143 069 V16.0.0 (2020-08)



**Digital cellular telecommunications system (Phase 2+) (GSM);
Voice Broadcast Service (VBS);
Stage 2
(3GPP TS 43.069 version 16.0.0 Release 16)**



ReferenceRTS/TSGC-0143069vg00

KeywordsGSM

ETSI

650 Route des Lucioles
F-06921 Sophia Antipolis Cedex - FRANCE

Tel.: +33 4 92 94 42 00 Fax: +33 4 93 65 47 16

Siret N° 348 623 562 00017 - NAF 742 C
Association à but non lucratif enregistrée à la
Sous-Préfecture de Grasse (06) N° 7803/88

Important notice

The present document can be downloaded from:

<http://www.etsi.org/standards-search>

The present document may be made available in electronic versions and/or in print. The content of any electronic and/or print versions of the present document shall not be modified without the prior written authorization of ETSI. In case of any existing or perceived difference in contents between such versions and/or in print, the prevailing version of an ETSI deliverable is the one made publicly available in PDF format at www.etsi.org/deliver.

Users of the present document should be aware that the document may be subject to revision or change of status.

Information on the current status of this and other ETSI documents is available at

<https://portal.etsi.org/TB/ETSIDeliverableStatus.aspx>

If you find errors in the present document, please send your comment to one of the following services:

<https://portal.etsi.org/People/CommitteeSupportStaff.aspx>

Copyright Notification

No part may be reproduced or utilized in any form or by any means, electronic or mechanical, including photocopying and microfilm except as authorized by written permission of ETSI.

The content of the PDF version shall not be modified without the written authorization of ETSI.

The copyright and the foregoing restriction extend to reproduction in all media.

© ETSI 2020.

All rights reserved.

DECT™, **PLUGTESTS™**, **UMTS™** and the ETSI logo are trademarks of ETSI registered for the benefit of its Members.

3GPP™ and **LTE™** are trademarks of ETSI registered for the benefit of its Members and of the 3GPP Organizational Partners.

oneM2M™ logo is a trademark of ETSI registered for the benefit of its Members and of the oneM2M Partners.

GSM® and the GSM logo are trademarks registered and owned by the GSM Association.

Intellectual Property Rights

Essential patents

IPRs essential or potentially essential to normative deliverables may have been declared to ETSI. The information pertaining to these essential IPRs, if any, is publicly available for **ETSI members and non-members**, and can be found in ETSI SR 000 314: "*Intellectual Property Rights (IPRs); Essential, or potentially Essential, IPRs notified to ETSI in respect of ETSI standards*", which is available from the ETSI Secretariat. Latest updates are available on the ETSI Web server (<https://ipr.etsi.org/>).

Pursuant to the ETSI IPR Policy, no investigation, including IPR searches, has been carried out by ETSI. No guarantee can be given as to the existence of other IPRs not referenced in ETSI SR 000 314 (or the updates on the ETSI Web server) which are, or may be, or may become, essential to the present document.

Trademarks

The present document may include trademarks and/or tradenames which are asserted and/or registered by their owners. ETSI claims no ownership of these except for any which are indicated as being the property of ETSI, and conveys no right to use or reproduce any trademark and/or tradename. Mention of those trademarks in the present document does not constitute an endorsement by ETSI of products, services or organizations associated with those trademarks.

Legal Notice

This Technical Specification (TS) has been produced by ETSI 3rd Generation Partnership Project (3GPP).

The present document may refer to technical specifications or reports using their 3GPP identities. These shall be interpreted as being references to the corresponding ETSI deliverables.

The cross reference between 3GPP and ETSI identities can be found under <http://webapp.etsi.org/key/queryform.asp>.

Modal verbs terminology

In the present document "**shall**", "**shall not**", "**should**", "**should not**", "**may**", "**need not**", "**will**", "**will not**", "**can**" and "**cannot**" are to be interpreted as described in clause 3.2 of the [ETSI Drafting Rules](#) (Verbal forms for the expression of provisions).

"**must**" and "**must not**" are **NOT** allowed in ETSI deliverables except when used in direct citation.

Contents

Intellectual Property Rights	2
Legal Notice	2
Modal verbs terminology.....	2
Foreword.....	6
1 Scope	7
2 References	7
3 Definitions and abbreviations.....	8
3.1 Definitions	8
3.2 Abbreviations	9
4 Main concepts	9
4.1 Group definition	9
4.2 Broadcast process.....	10
4.2.1 Broadcast call initiation	10
4.2.1.1 Normal operation with successful outcome	10
4.2.1.2 Exceptional procedures	11
4.2.2 On-going broadcast calls	11
4.2.2.1 Normal operation with successful outcome	11
4.2.2.2 Exceptional procedures	12
4.2.3 Leaving of a broadcast call without termination.....	12
4.2.4 Broadcast call termination	12
4.2.5 Acknowledgements.....	12
4.2.6 Transactions between the mobile station and the network.....	12
4.2.7 Processing of originator-to-dispatcher information	12
5 General architecture	13
5.1 Group Call Register (GCR).....	13
5.2 Voice broadcast call responsibility.....	18
5.3 RANflex configuration with group call redundancy	18
5.3.1 MSC selection in a RANflex configuration with group call redundancy	18
5.3.2 GCR synchronization in a RANflex configuration with group call redundancy	19
5.3.3 GCR Restoration in a RANflex configuration with group call redundancy	19
6 Compatibility issues	19
7 Transmission	20
7.1 Transmission architecture.....	20
7.1a Transmission architecture – A interface circuit sharing	20
7.1a.1 Transmission architecture – general	20
7.1a.2 Transmission architecture – control plane	20
7.1a.3 Transmission architecture – user plane.....	20
7.1b Transmission architecture – A interface link sharing	21
7.1b.1 Transmission architecture – general	21
7.1b.2 Transmission architecture – control plane	21
7.1b.3 Transmission architecture – user plane.....	21
7.2 Radio channels	21
7.3 Data confidentiality	22
8 Information storage	23
8.1 Information stored in the GCR	23
8.1.1 Information used for routing of service subscriber originated voice broadcast calls.....	23
8.1.2 Static Broadcast call attributes.....	24
8.1.2.1 Group call area.....	25
8.1.2.2 Dispatcher identities.....	25
8.1.2.3 Priorities.....	25
8.1.3 Transient G roup Call Attributes.....	25

8.1.3.0	General	25
8.1.3.1	Group Call Status Information	25
8.1.3.2	Initial Talker Information.....	26
8.2	Information managed per subscriber	26
8.2.1	Stored in the HLR.....	26
8.2.2	Stored in the VLR.....	26
8.2.3	Stored in the SIM.....	26
8.2.3a	Stored in the USIM.....	26
8.3	Information used for routing of dispatcher originated broadcast calls	27
9	Identities	27
9.1	Elementary identities for broadcast calls.....	27
9.2	Use of identities in the network.....	28
10	Operation and maintenance aspects	30
11	Function and information flows	30
11.1	Broadcast function management	30
11.2	Group membership management.....	30
11.3	Call management.....	30
11.3.1	Call establishment.....	30
11.3.1.1	Service subscriber call establishment.....	30
11.3.1.1.1	Initial stage	30
11.3.1.1.2	Establishment of the transmission means	32
11.3.1.1.3	Release of the dedicated transmission means of mobile stations responding to a notification.....	33
11.3.1.2	Dispatcher call establishment.....	33
11.3.1.3	Notification procedures.....	34
11.3.1.4	Destination service subscribers	36
11.3.1.5	Destination dispatchers	36
11.3.2	Call release.....	36
11.3.2.1	Call termination by the calling subscriber.....	36
11.3.2.2	Call termination by dispatchers.....	36
11.3.3	Leaving of a dispatcher.....	36
11.3.4	Leaving and returning to a voice broadcast call of a service subscriber	37
11.3.5	Cell change	37
11.3.5.1	Listening subscriber	37
11.3.5.2	Calling service subscriber	37
11.3.5.3	Dispatcher	37
11.3.6	New calls	37
11.3.7	Uplink transmission management.....	38
11.3.7a	Signalling procedures for the user plane.....	38
11.3.7a.1	Broadcast call re-establishment by the BSS.....	38
11.3.8	Overview of signalling.....	38
11.4	Functional requirement of Anchor-MSC.....	62
11.5	Functional requirement of Relay-MSC	69
11.5A	Functional requirement of group call serving MSC (within a RANflex pool)	74
11.5B	Functional requirement of VMSC (within a RANflex pool).....	77
11.6	Functional requirement of GCR	80
11.7	Functional requirement of VLR	90
12	Content of messages.....	92
12.1	Messages on the B interface (MSC-VLR).....	92
12.1.1	Allocate Group Call Number	92
12.1.2	Allocate Group Call Number ack	92
12.1.3	Allocate Group Call Number negative response.....	93
12.1.4	Release Group Call Number	93
12.2	Messages on the E interface (MSC-MSC)	93
12.2.1	Prepare Group Call	93
12.2.2	Prepare Group Call ack.....	93
12.2.3	Prepare Group Call negative response	93
12.2.4	Send Group Call End Signal	94
12.2.5	Send Group Call Info.....	94
12.2.6	Send Group Call Info ack	94

12.2.7	Send Group Call Info negative response.....	94
12.3	Messages on the I interface (MSC-GCR).....	95
12.3.1	GCR Interrogation	95
12.3.2	GCR Interrogation ack.....	96
12.3.3	GCR interrogation negative response	97
12.3.4	Call released.....	97
12.4	Messages on the GCR - GCR interface	97
12.4.1	Sync GCR.....	97
12.4.2	Sync GCR ack.....	97
12.4.3	Sync GCR negative response.....	97
13	List of system parameters.....	98
13.1	Timers	98
13.1.1	Txx.....	98
13.1.2	Tast	98
13.1.3	T3.....	98
Annex A (informative):	Change History	99
History		103

Foreword

This Technical Specification has been produced by the 3rd Generation Partnership Project (3GPP).

The contents of the present document are subject to continuing work within the TSG and may change following formal TSG approval. Should the TSG modify the contents of the present document, it will be re-released by the TSG with an identifying change of release date and an increase in version number as follows:

Version x.y.z

where:

- x the first digit:
 - 1 presented to TSG for information;
 - 2 presented to TSG for approval;
 - 3 or greater indicates TSG approved document under change control.
- y the second digit is incremented for all changes of substance, i.e. technical enhancements, corrections, updates, etc.
- z the third digit is incremented when editorial only changes have been incorporated in the document.

1 Scope

The present document specifies the stage 2 description of the Voice Broadcast Service (VBS) which allows the distribution of speech (or other signals which can be transmitted via the speech codec), generated by a service subscriber, into a predefined geographical area to all or a group of service subscribers located in this area.

2 References

The following documents contain provisions which, through reference in this text, constitute provisions of the present document.

- References are either specific (identified by date of publication, edition number, version number, etc.) or non-specific.
- For a specific reference, subsequent revisions do not apply.
- For a non-specific reference, the latest version applies. In the case of a reference to a 3GPP document (including a GSM document), a non-specific reference implicitly refers to the latest version of that document *in the same Release as the present document*.

- [1] Void
- [1a] 3GPP TR 21.905: "Vocabulary for 3GPP Specifications".
- [2] 3GPP TS 42.009(Rel-4): "Security aspects".
- [3] 3GPP TS 42.069: "Voice Broadcast Service (VBS); Stage 1".
- [4] 3GPP TS 43.020: "Security related network functions".
- [5] 3GPP TS 43.022: "Functions related to Mobile Station (MS) in idle mode".
- [6] 3GPP TS 23.067: "enhanced Multi-Level Precedence and Pre-emption service (eMLPP); Stage 2".
- [7] 3GPP TS 44.018: "Mobile radio interface layer 3 specification; Radio Resource Control Protocol".
- [8] 3GPP TS 45.008: "Radio subsystem link control".
- [9] 3GPP TS 48.008: "Mobile-services Switching Centre - Base Station System (MSC - BSS) interface layer 3 specification".
- [10] ITU-T Recommendation E.164: "The international public telecommunication numbering plan".
- [11] 3GPP TS 44.069: "Broadcast Call Control (BCC) protocol".
- [12] 3GPP TS 22.083: "Call Waiting (CW) and Call Hold (HOLD) supplementary services; Stage 1".
- [13] 3GPP TS 29.002: "Mobile Application Part (MAP) specification".
- [14] 3GPP TS 24.008: "Mobile radio interface Layer 3 specification; Core network protocols; Stage 3".
- [15] 3GPP TS 23.236: "Intra-domain connection of Radio Access Network (RAN) nodes to multiple Core Network (CN) nodes".
- [16] 3GPP TS 28.062: "Inband Tandem Free Operation (TFO) of Speech Codecs; Service Description; Stage 3".

3 Definitions and abbreviations

3.1 Definitions

For the purposes of the present document, the terms and definitions given in 3GPP TS 42.069 and the following apply:

Broadcast call attributes: group call area, dispatcher identities

Group call anchor MSC: the MSC responsible for managing and maintaining a particular voice broadcast call. The group call anchor MSC is determined as the one controlling the cells of the group call area (see also group call relay MSC). For a voice broadcast call where the group call area exceeds an MSC area, the group call anchor MSC is predefined in the network. In a RANflex configuration with group call redundancy, the group call anchor MSC redundancy pool (instead of a group call anchor MSC) is predefined in a network for a given voice broadcast call.

Group members: service subscribers entitled to belong to a particular group classified by a certain group identification (group ID)

Group Call Register (GCR): functionality in the network containing the broadcast call attributes

group call serving MSC: In a RANflex configuration the group call serving MSC of a location area is a group call anchor MSC or a group call relay MSC that controls the group call signalling for this location area. A location area within the pool area has a unique group call serving MSC, or - in a RANflex configuration with group call redundancy - a unique group call serving MSC redundancy pool. For a given broadcast call at any location, the group call serving MSC is either the anchor MSC or one of the relay MSCs controlling the broadcast call. For a service subscriber located in this location area the visited MSC may be different from the location area's group call serving MSC.

In a RANflex configuration all location areas within a BSC service area are assigned to the same group call serving MSC.

In a RANflex configuration with group call redundancy all location areas within a BSC service area are assigned to the same group call serving MSC redundancy pool.

Group call relay MSC: the MSC controlling cells of a group call area which are not under control of the group call anchor MSC for those voice broadcast services where the group call area exceeds one MSC area. For a voice broadcast call where the group area exceeds one MSC area, the address of the group call relay MSC is pre-configured in the anchor MSC's GCR. In a RANflex configuration with group call redundancy this preconfigured address identifies a group call relay MSC redundancy pool (instead of a group call relay MSC).

group call serving MSC redundancy pool: A pool of group call serving MSCs each of which can take the same role for a given broadcast call (anchor /relay) and serve the same location areas within a RANflex pool area with broadcast call services. For a given voice broadcast call a location area's group call serving MSC redundancy pool is either the group call anchor MSC redundancy pool or one of the group call relay MSC redundancy pools.

group call anchor MSC redundancy pool: A group call serving MSC redundancy pool. Each MSC within the group call anchor MSC redundancy pool can take the role of the group call anchor MSC for a given broadcast call. For a given instance of a voice broadcast call one group call anchor MSC is selected from the group call anchor MSC redundancy pool.

group call relay MSC redundancy pool: A group call serving MSC redundancy pool. Each MSC within the group call relay MSC redundancy pool can take the role of the group call relay MSC for a given broadcast call. For a given instance of a voice broadcast call one group call relay MSC is selected from every relevant group call relay MSC redundancy pool.

Notification: notifications are given on common channels or dedicated channels in order to inform group members which are either in idle mode or in dedicated mode or participating in a voice group call or broadcast call on the existence of voice broadcast calls

Notification Channel (NCH): Common control channel on which the notifications are sent by the network (equivalent to a paging channel).

Originator-to-dispatcher information: information sent by the service subscriber originating a voice broadcast call to the network during call setup for distribution to the dispatchers to be attached to the voice broadcast call during call

RANflex configuration: A network configuration that allows a location area to be served by multiple MSCs in parallel. For details see 3GPP TS 23.236 [15]. In a RANflex configuration a given location area is associated with a single group call serving MSC. There is no support of group call redundancy.

RANflex configuration with group call redundancy: A RANflex configuration where a given location area is associated with a group call serving MSC redundancy pool (instead of with a single group call serving MSC). For a given voice broadcast call a location area's group call serving MSC redundancy pool may be a group call anchor MSC redundancy pool or a group call relay MSC redundancy pool.

Voice broadcast call member: any group member or dispatcher participating in an on going voice broadcast call

Voice broadcast channel: downlink to be allocated in each cell of the group call area for a particular voice broadcast call

All mobile stations of the destination subscriber being service subscribers in one cell shall listen to the common downlink.

3.2 Abbreviations

For the purposes of the present document, the abbreviations given in 3GPP TR 21.905 and the following apply:

AoIP	A over IP, using IP as the bearer of the user plane of A interface.
AMR	Adaptive Multi-Rate
CC	Country Code
EFR	Enhanced Full Rate
eMLPP	enhanced Multi-Level Precedence and Pre-emption
GCR	Group Call Register
NCH	Notification Channel
NDC	National Destination Code
SN	Subscriber Number
VBS	Voice Broadcast Service
VGCS	Voice Group Call Service

4 Main concepts

4.1 Group definition

Service subscribers can become group members on a PLMN wide basis to one or more groups pre-defined in the network by a corresponding group identification (group ID). The membership enables them to receive voice broadcast calls associated with that group ID. In addition, certain group members are entitled by their subscription to initiate voice broadcast calls. Certain dispatchers connected to external networks also require the capability to initiate or receive voice broadcast calls.

In addition to subscriber details in the HLR, it is necessary for the mobile station to be aware of its group membership by storing details on the SIM/USIM. This is required because it shall respond to notification messages which include only the group ID (i.e. no IMSI or TMSI details).

Having become a group member, each service subscriber can set to active state or deactivate state the group ID or any one out of his several group IDs on the SIM/USIM. In active state the subscriber can initiate voice broadcast calls to that group ID. When in deactivate state the subscriber can not make voice broadcast calls to the group and the mobile station ignores any notification for that group ID.

If no NCH is defined in the cell, mobiles shall assume VBS service is not available on that cell.

4.2 Broadcast process

4.2.1 Broadcast call initiation

4.2.1.1 Normal operation with successful outcome

A group call area can exceed one MSC area. In a RANflex configuration (with or without group call redundancy) a group call area can be restricted to a single pool area or can exceed one pool area.

A voice broadcast call shall be initiated by a calling service subscriber by a related input function, e.g. via MMI, specifying the selected service and the group ID dialled or by a calling dispatcher by the MSISDN address (see subclause 9.2). As an option, the request of the calling service subscriber to set up a voice broadcast call may specify information to be sent as originator-to-dispatcher information to the network; in this case the originator-to-dispatcher information is included in the signalling for call setup from the mobile station to the network. It is the responsibility of the input function to ensure that the originator-to-dispatcher information has a correct format (in particular, an allowed length).

The MSC in which the voice broadcast call is initiated obtains the group call attributes by requesting the Group Call Register (GCR, see clause 5). Without a RANflex configuration or in a RANflex configuration (with or without group call redundancy), if visited MSC and group call serving MSC are identical, the MSC performs a local GCR interrogation.

The local GCR interrogation after call initiation also determines whether the MSC shall act as anchor- or as relay MSC. If the MSC is not the anchor-MSC then the call will be "forwarded" from the relay to the respective anchor-MSC (information also delivered by GCR) and further "call-establishment" is done by the anchor-MSC as described in the following.

In a RANflex configuration the VMSC in which a voice broadcast call is initiated may be different from the group call serving MSC of the voice broadcast call initiating subscriber's location area. In this case the VMSC derives the identity of the group call serving MSC from the initiating subscriber's LAC and requests the group call anchor MSC address from the group call serving MSC by means of the SEND_GROUP_CALL_INFO MAP service. The call is then "forwarded" from the VMSC to the anchor MSC and further "call-establishment" is done by the anchor MSC as described in the following.

In a RANflex configuration with group call redundancy the VMSC in which a voice broadcast call is initiated may not belong to the group call serving MSC redundancy pool of the voice broadcast call initiating subscriber's location area. In this case the VMSC derives the identity of the group call serving MSC redundancy pool from the initiating subscriber's LAC and requests the group call anchor MSC redundancy pool address from the group call serving MSC by means of the SEND_GROUP_CALL_INFO MAP service. The call is then "forwarded" from the VMSC to the anchor MSC redundancy pool and further "call-establishment" is done by the selected anchor MSC as described in the following.

When a calling service subscriber or calling dispatcher initiates a voice broadcast call, one voice broadcast channel shall be established in each cell of the group call area and notifications for that call shall be sent in each of these cells. As an alternative, voice broadcast channels may only be established in cells in reaction to responses received from mobile stations on the notifications using notification response procedure. At the same time standard connections to dispatchers in the mobile network or in an external network shall be established. If originator-to-dispatcher information has been received in the signalling for call setup from the mobile station to the network and if the originating MSC supports processing of originator-to-dispatcher information, this information is transformed into user-to-user information and sent to the dispatchers as UUS1 when setting up the standard connections.

The calling service subscriber shall have a dedicated standard uplink/downlink. All mobile stations of the listening service subscribers in one cell shall only listen to the same common downlink (voice broadcast channel).

Only one voice broadcast channel shall be established in each cell for any given voice broadcast call, although there may be a number of simultaneous voice broadcast calls within the same cell.

Service subscribers shall be notified on the voice broadcast call in each cell. These voice broadcast call notification messages shall be broadcast on the Notification CHannel (NCH).

The notification messages use the group ID rather than individual TMSIs/IMSI. If the length of the group ID is less than 8 decimal digits, then the group call area ID is used in order to enable a resolution in the case of overlapping group

call areas. A service subscriber's mobile station needs to be able to recognize notification messages for those group IDs subscribed to and presently activated.

The network may also send messages on appropriate voice broadcast channel FACCHs, in order to notify voice broadcast call members who may participate in other voice broadcast calls. In addition, also paging information messages for standard calls may be sent in order to inform voice broadcast call members on actually paged point-to-point calls.

Further the network may provide notification on the voice broadcast call to service subscribers who have subscribed to the paged group ID and which are in dedicated mode.

The process of broadcasting messages on NCHs is to be carried out throughout the call in order to provide the "late entry" facility whereby group members entering the area can join the call.

On receiving notification of a voice broadcast call a voice broadcast call member's mobile station shall adjust to the nominated channel to receive the broadcast call if this channel was received in the notification message and receive the information on the downlink. Whilst receiving, the mobile station shall not transmit on the uplink SACCH. This group receive mode is different to the normal idle mode or dedicated mode. If no channel description was provided in the notification message, the mobile station shall establish a dedicated connection by use of notification response procedure in order to respond to the notification. The network may then provide the mobile station with a channel description for the voice broadcast call.

As a further mobile station option, the mobile station may read its paging subchannel in the current cell while in group receive mode or in group transmit mode in order to receive paging messages for mobile terminated calls.

4.2.1.2 Exceptional procedures

Completion of links into congested cells where pre-emption did not occur is required.

If the cell in which the calling service subscriber is located is reset, the voice broadcast call shall be released.

On receiving details of a voice broadcast call the user may choose to move to the notified call or the mobile station may automatically move to the notified call if the new call is of higher priority than the existing call and automatic acceptance applies for this priority level.

4.2.2 On-going broadcast calls

4.2.2.1 Normal operation with successful outcome

Within each voice broadcast call only the voice of the calling service subscriber or calling dispatcher shall be transmitted on the voice broadcast downlink channel.

Mobile stations in group receive mode use the group receive mode procedure (see 3GPP TS 43.022) to "camp-on" in a new cell to be able to listen to the voice broadcast channel. The mobile station may find the voice broadcast channel details of a new cell on the related NCH.

A network may decide not to establish voice broadcast channels in all cells. Instead, notifications containing no channel description may be provided. If a mobile station moves to such a cell, it must establish a dedicated connection and respond to the notification by use of the notification response procedure in order to receive the voice broadcast call. The network may then establish a voice broadcast channel and inform the mobile station on the channel position.

If the uplink reply procedure is applicable for the voice broadcast call, the network may obtain knowledge on whether mobile stations are listening in a cell by sending an uplink access request in an uplink free message on the broadcast call channel downlink. Mobile stations receiving such a request shall use uplink reply procedure and send uplink access bursts on the broadcast call channel uplink with the establishment cause "reply on uplink access request". If no uplink access bursts are received by the network, the network may decide to release the broadcast call channel in that cell and then provide notifications containing no channel description.

NOTE: Concerning security aspects, whilst authentication and membership checking of mobile call originators can be carried out, it is not possible to authenticate service subscribers in group receive mode if they have not before established a dedicated connection to responded to a notification. No equivalent of a group "TMSI" is provided to protect the "identity" of established voice broadcast calls.

The network may decide to reconfigure an existing voice broadcast call's physical channel configuration, frequencies and/or hopping sequences as well as the cell channel description. For the cell in which the broadcast call is being reconfigured, the network informs any listeners in group receive mode of the change in VBS channel description by using the VBS reconfiguration procedure (see 3GPP TS 44.018 [7]). Mobile stations on receipt of the VBS/VGCS reconfiguration messages shall remain on the existing broadcast channel until indicated starting time and then apply the new configuration to the VBS call that the mobile station is currently involved in.

4.2.2.2 Exceptional procedures

If a mobile station in group receive mode indicates a failure due to radio link time-out, the mobile station shall behave as specified in 3GPP TS 45.008 and go back to idle mode, possibly in another cell, as determined by the cell re-selection algorithm. If a notification is received for the same cell, the mobile station shall try to reconnect.

4.2.3 Leaving of a broadcast call without termination

A destination subscriber being service subscriber can leave the voice broadcast call at any point by "deselecting" it via an MMI function. Having deselected the call the mobile station returns to idle mode and "ignores" any further notification messages related to that call.

NOTE: If a service subscriber does not wish to participate in calls to a particular group ID for long periods of time, the group ID shall be switched to deactivate state by the subscriber.

The service subscriber shall have the capability to reselect the voice broadcast call. The mobile station shall not ignore notification messages to that call any more.

The destination dispatcher shall be able to leave a voice broadcast call without terminating it.

4.2.4 Broadcast call termination

A voice broadcast call can be terminated by the calling service subscriber or the calling dispatcher or an entitled dispatcher who is allowed to terminate a VBS call.

The call shall be terminated if the calling service subscriber leaves the group call area (e.g. if he moves into an MSC area where a group call area is no part of) or when calling dispatcher releases his call leg.

An entitled dispatcher can terminate the call at any time by using a network defined user operation (e.g. via DTMF).

4.2.5 Acknowledgements

The acknowledgement is an application option.

For voice broadcast calls which are identified by an acknowledgement flag mobile stations which have acknowledgement facilities have to return an acknowledgement message with a predefined content in a predefined manner.

The acknowledgement shall be sent using an appropriate data service, to a predefined address or with a predefined short code stored on the SIM/USIM card. The network may apply geographical routing to a predefined acknowledgement service centre.

4.2.6 Transactions between the mobile station and the network

Mobile stations which are in broadcast receive mode shall not perform any transactions with the network while adjusted to the voice broadcast channel. They shall leave the group receive mode and act in a standard way to perform any transaction if necessary and return to the voice broadcast call afterwards.

4.2.7 Processing of originator-to-dispatcher information

The originating service subscriber may include originator-to-dispatcher information during call setup. If the originating MSC supports processing of originator-to-dispatcher information, it transforms the received originator-to-dispatcher information into UUS1, and sends it:

- if the originating MSC is not the voice broadcast call anchor MSC: to the voice broadcast call anchor MSC;
- if the originating MSC is the voice broadcast call anchor MSC: to the dispatchers to be attached to the voice broadcast call during call setup of the connections to these dispatchers.

The anchor MSC receiving UUS1 in a voice broadcast call setup from an originating relay MSC forwards this UUS1 to the dispatchers to be attached to the voice broadcast call during call setup of the connections to these dispatchers.

Transformation of originator-to-dispatcher information: Originator-to-dispatcher information can be compressed or uncompressed.

- Decompression of compressed originator-to-dispatcher information is specified in 3GPP TS 44.069.
- The transformation of uncompressed originator-to-dispatcher information into UUS1 is the UUS1 containing the same user-user IE as the originator-to-dispatcher information.
- The transformation of compressed originator-to-dispatcher information into UUS1 is the UUS1 resulting from transforming the decompressed originator-to-dispatcher information into UUS1.

5 General architecture

5.1 Group Call Register (GCR)

The general architecture of GSM is maintained. In addition, a network function is required which is used for registration of the broadcast call attributes, the Group Call Register (GCR).

The GCR function is mainly a database function, holding information about voice broadcast calls.

NOTE 1: The GCR implementation is not specified. It may be realized e.g. as a new network node, in a PABX directly attached to an MSC, inside an MSC or as an HLR. The interface between the GCR function and other functions is not specified in the GSM technical specifications. As a consequence, the functional split between MSC and GCR as developed in the present document is only indicative, and other functional splits can be implemented.

The GCR data for a specific voice broadcast call is set at the creation of the broadcast call attributes, and can be subsequently modified. No support for these functions is specified in the GSM technical specifications.

In a RANflex configuration with group call redundancy GCRs associated to MSCs belonging to the same redundancy pool need to communicate with each other by means of SYNC_GCR messages.

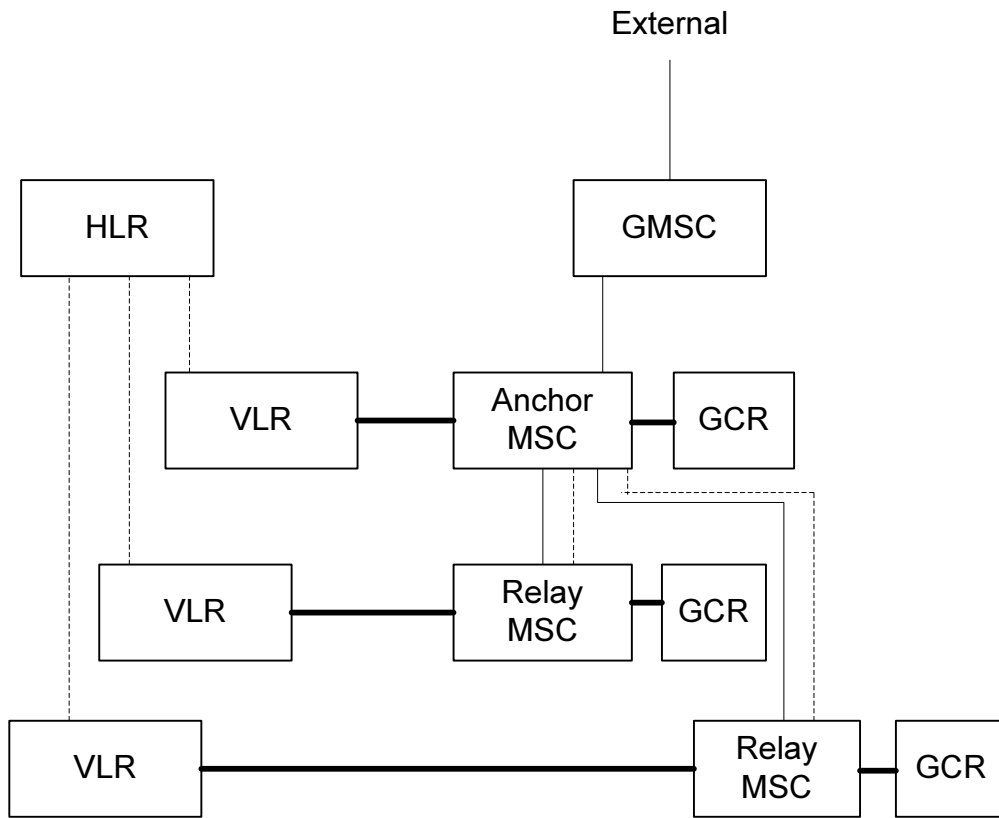
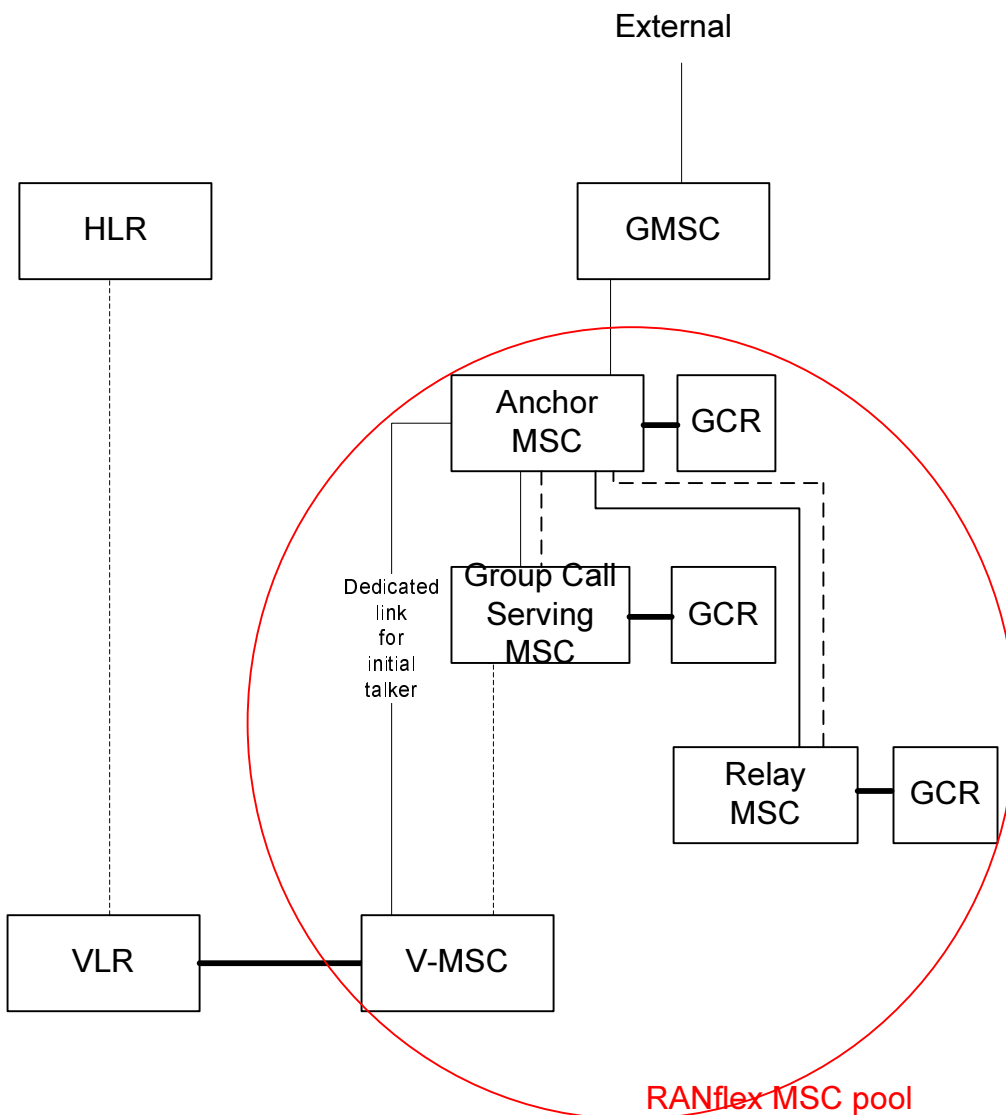
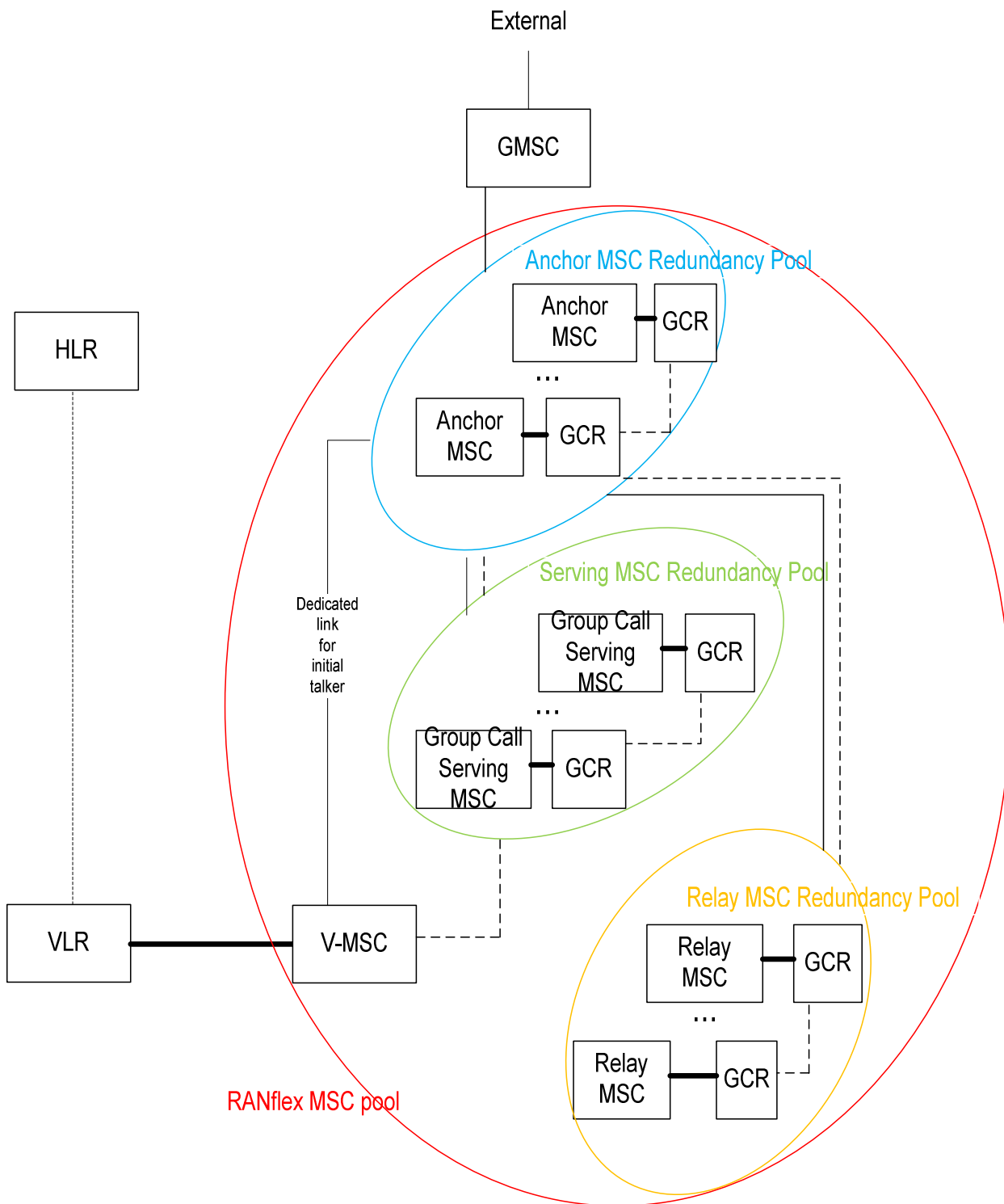

Figure 1: Functional architecture with a Group Call Register



NOTE: Figure 1a shows the configuration with only one RANflex MSC pool. Other configurations with more than one RANflex MSC pool are possible.

Figure 1a: Functional architecture with a Group Call Register in a RANflex configuration



NOTE: Figure 1b shows the configuration with only one RANflex MSC pool. Other configurations with more than one RANflex MSC pool are possible.

Figure 1b: Functional architecture with a Group Call Register in a RANflex configuration with group call redundancy

Dashed lines in figure 1, figure 1a and figure 1b indicate MAP interfaces, thin solid lines indicate ISUP interfaces, bold solid lines indicate interfaces without standardized protocol.

Lines in figure 1b ending at an MSC Redundancy Pool actually connect to the selected MSC within the redundancy pool. For MSC selection see subclause 5.3.1.

The signalling between the entities shown in figure 1, figure 1a and figure 1b, for the two cases of service subscriber and dispatcher originated calls, shall be as defined in the following.

Service subscriber originated: The service Subscriber's VMSC shall perform subscription checking against VLR records. In a RANflex configuration it shall then derive from the service subscriber's current location area the address of the group call serving MSC which may be different from the VMSC. In a RANflex configuration with group call redundancy this address identifies a group call serving MSC redundancy pool.

If one of the following configurations applies:

- a) no RANflex configuration;
- b) in a RANflex configuration, if the VMSC is the group call serving MSC; or
- c) in a RANflex configuration with group call redundancy, if the VMSC belongs to the group call serving MSC redundancy pool,

the VMSC shall consult its GCR to determine the broadcast call attributes related to its MSC area and whether it is the group call anchor MSC for that voice broadcast call. If it is not, the GCR shall provide with the broadcast call reference and the routing information identifying the group call anchor MSC (the group call anchor MSC redundancy pool in a RANflex configuration with group call redundancy) to the originating VMSC. The originating MSC shall then route the voice broadcast call to the anchor MSC.

If one of the following configurations applies:

- d) in a RANflex configuration, if the VMSC is not the group call serving MSC; or
- e) in a RANflex configuration with group call redundancy, if the VMSC does not belong to the group call serving MSC redundancy pool,

the VMSC shall consult the group call serving MSC by means of the MAP service SEND_GROUP_CALL_INFO and retrieve the group call anchor MSC address. The originating VMSC shall then route the voice broadcast call to the anchor MSC or the anchor MSC pool.

If the initiation of the voice broadcast call had specified originator-to-dispatcher information and processing of originator-to-dispatcher information is supported by the originating VMSC, the originator-to-dispatcher information is transformed by the originating VMSC into UUS1 and sent to the anchor MSC or the anchor MSC pool. If the originating VMSC is the group call anchor MSC (or belongs to the group call anchor MSC redundancy pool), along with the broadcast call attributes, the GCR shall provide information on all group call relay MSCs or group call relay MSC pools to be involved.

The group call anchor MSC shall set up links to all group call relay MSCs or relay MSC pools. It shall also initiate setup of point-to-point connections to the dispatchers associated to the voice broadcast call (see subclause 8.1.2.2); if UUS1 information has been received in the signalling for call setup from the originating VMSC, this UUS1 information is included in the setup of point-to-point connections to the dispatchers. Each MSC involved in a voice broadcast call obtains its own broadcast call attributes from the GCR related to the MSC.

Dispatcher originated: In the case of dispatchers calling from an external network, the call request, in the form of an ISDN number, shall be received at a GMSC. The number shall be analysed and the call shall be directly routed to the group call anchor MSC or anchor MSC pool by the GMSC based on the called identity without requesting an HLR. The group call anchor MSC shall interrogate the GCR and obtain the broadcast call attributes. If an identical voice broadcast call is currently in progress, the dispatcher shall be connected to this call and no new call shall be initiated. When interrogating the GCR, the identity of the calling dispatcher is compared with the list of dispatchers which are allowed to initiate the call. If the dispatcher is not in the list, or an identity is not provided, the network shall reject the call.

NOTE 2: A dispatcher may be a user of the GSM network in which the VBS service is provided or may be connected to a PABX which is connected to the MSC containing the GCR. A dispatcher which is registered in the GCR for a certain voice broadcast call and which also has a subscription for VBS with the same group ID as the voice broadcast call for which he is dispatcher shall deactivate this group ID when he is located in the corresponding group call area in order to avoid conflicts between paging for the dispatcher and notifications for the group ID.

5.2 Voice broadcast call responsibility

The MSC responsible for the voice broadcast call is the one nominated within the GCR or the one to which the call is routed from the GMSC in the case of a dispatcher originated call. This MSC is termed the group call anchor MSC.

If the group call area extends beyond one MSC area then any MSCs controlling cells in the area outside of the group call anchor MSC are referred to as group call relay MSCs.

In a RANflex configuration a given location area within the pool area is served (with group call services) by a single predefined group call serving MSC which for a specific group call is either anchor or relay MSC.

In a RANflex configuration with group call redundancy a given location area within the pool area is served (with broadcast call services) by predefined group call serving MSCs which form up the location area's group call serving MSC redundancy pool. One MSC shall not belong to more than one group call MSC redundancy pool. For a specific ongoing broadcast call the group call serving redundancy pool is either an anchor or a relay redundancy pool.

5.3 RANflex configuration with group call redundancy

5.3.1 MSC selection in a RANflex configuration with group call redundancy

In a RANflex configuration with group call redundancy, messages routed towards a group call MSC redundancy pool eventually need to be processed by a selected MSC out of the redundancy pool. MSC selection is done with appropriate routing mechanisms at call setup time.

Mixed configurations where e.g. the anchor MSC belongs to an anchor MSC redundancy pool but the relay MSC does not belong to a Relay MSC redundancy pool may be considered a RANflex configuration with group call redundancy where e.g. the relay MSC redundancy pool is formed up by just one relay MSC.

In a RANflex configuration with group call redundancy the following messages sent to an MSC do not address an individual MSC but an MSC redundancy pool:

- IAM (from dispatcher to Anchor MSC);
- IAM (from VMSC to Anchor MSC);
- SEND_GROUP_CALL_INFO (from VMSC to Group Call Serving MSC); and
- PREPARE_GROUP_CALL (from Anchor MSC to Relay MSC).

Network routing ensures that these messages are routed to one of the available (i.e. not out of service) MSCs within the redundancy pool. MSC selection by network routing can be based e.g. on a predefined prioritization mechanism or a load distribution mechanism but the exact mechanism is out of scope of this specification.

Once the message is received by one of the available MSCs, the receiving MSC shall check whether there is the need to forward the message to another specific MSC within the redundancy pool (for detailed behaviour of the MSC see subclauses 11.4, 11.5, and 11.5A). Network routing ensures that the forwarded message is routed to the specific MSC. Specific MSC routing may be done e.g. with address prefixes and is out of scope of this specification.

If the message forwarding MSC detects that the specific target MSC is out of service, it shall handle the request locally and repeat the GCR interrogation with an override indication.

In a RANflex configuration with group call redundancy the following messages sent to an MSC address an individual MSC and not an MSC redundancy pool:

- IAM (dispatcher originated) when forwarded within the group call anchor MSC redundancy pool from selected Anchor MSC to the Anchor MSC where the broadcast call is on-going;
- IAM (VMSC originated) when forwarded within the group call anchor MSC redundancy pool from selected Anchor MSC to the Anchor MSC where the broadcast call is on-going;
- IAM (from Anchor MSC to Relay MSC) routed with the temporary group call number allocated by the Relay MSC;

- SEND_GROUP_CALL_INFO (VMSC originated) when forwarded within the group call serving MSC redundancy pool from selected group call serving MSC to the group call serving MSC where the broadcast call is on-going; and
- Subsequent messages within a dialogue opened by a PREPARE_GROUP_CALL message (PREPARE_GROUP_CALL_ACK, SEND_GROUP_CALL_END_SIGNAL, FORWARD_GROUP_CALL_SIGNALLING; PROCESS_GROUP_CALL_SIGNALLING). MAP dialogue handling ensures that messages are exchanged between origin and selected destination of the dialogue.

Network routing ensures that these messages are routed to the individual MSC within the redundancy pool.

5.3.2 GCR synchronization in a RANflex configuration with group call redundancy

GCRs associated to MSCs which belong to the same redundancy pool need to synchronize their transient data. This is done by means of SYNC_GCR messages. As soon as transient data are modified in a GCR as a result of GCR interrogation from the associated MSC, the modification is propagated to the other GCRs.

This mechanism prevents the establishment of two simultaneous group calls with the same group call reference controlled by two different anchor MSCs.

5.3.3 GCR Restoration in a RANflex configuration with group call redundancy

When a GCR (and its associated MSC) restarts after planned or unplanned outage, its transient data may be lost or may be out of sync due to lost SYNC_GCR messages. To restore the transient data, the GCR shall after restart

- stop all T3 timers;
- delete all stored initial talker information; and
- mark all GCR records with "transient data not reliable".

When transient data are read while processing a GCR interrogation, the GCR shall check whether the record is marked "transient data not reliable". If so, the GCR shall retrieve transient data from the other GCR(s) within the redundancy pool by means of a SYNC_GCR message with request indication, store it and reset the mark "transient data not reliable" before processing the GCR interrogation. If the retrieval of transient data is unsuccessful, the GCR shall assume that the call is not on-going, reset the mark "transient data not reliable" and process the GCR interrogation.

When processing a received SYNC_GCR message without request indication while the record is marked "transient data not reliable", the GCR shall accept the request and reset the "transient data not reliable" mark.

When processing a received SYNC_GCR message with request indication while the record is marked "transient data not reliable", the GCR shall return a negative response (failure) and keep the "transient data not reliable" mark.

6 Compatibility issues

VBS can not be used with standard Phase 1 or Phase 2 mobile stations. A dedicated mobile station with VBS capability is required.

A mobile station with VBS capability shall also provide the complete functionality in order to allow the use of Phase 2 services.

Standard Phase 1 and Phase 2 mobile stations in a network shall not be impacted by the presence of VBS services in that network due to VBS signalling, also if the mobile station is operated with a SIM/USIM of a VBS service subscriber.

7 Transmission

7.1 Transmission architecture

A distribution function, is required to distribute the voice broadcast call to the nominated cells and dispatchers, respectively. The distribution function is to be located within the group call anchor MSC.

Without a RANflex configuration: The group call anchor MSC is responsible for setting up all connections, both to the nominated cells (voice broadcast channels) in the group call anchor MSC and to any related group call relay MSC, and to the dispatchers. There shall be one common link for all cells within the group call relay MSC which is involved in the voice broadcast call, i.e. there shall be a secondary distribution function in the group call relay MSCs.

In a RANflex configuration: The group call anchor MSC is responsible for setting up all connections, both to those cells of the group call area that belong to a location area for which the group call anchor MSC is the group call serving MSC and to any related group call relay MSC, and to the dispatchers. Except when a calling service subscriber, served by a relay MSC, is on the initial dedicated link, there shall be one link towards every relay MSC and a distribution function in the relay MSCs and from there one link per cell of the group call area that belongs to a location area for which the group call relay MSC is the group call serving MSC which is involved in the voice broadcast call.

In a RANflex configuration with group call redundancy: The group call anchor MSC selected from the anchor MSC redundancy pool is responsible for setting up all connections, both to those cells of the group call area that belong to a location area for which the group call anchor MSC is the group call serving MSC and to any related group call relay MSC pool, and to the dispatchers. Except when a calling service subscriber, served by a relay MSC, is on the initial dedicated link, there shall be one link towards every relay MSC redundancy pool and a distribution function in the selected relay MSCs and from there one link per cell of the group call area that belongs to a location area for which the group call relay MSC is the group call serving MSC which is involved in the voice broadcast call.

7.1a Transmission architecture – A interface circuit sharing

7.1a.1 Transmission architecture – general

The MSC and BSC shall negotiate during the setup of a voice broadcast call whether A-interface circuit sharing is supported by both entities. When this optional feature is supported by both entities, the same A-interface circuit can be shared for all cells belonging to a BSC for a given voice broadcast call. When AoIP is used, the same AoIP transport layer information can be shared for all cells belonging to a BSC for a given voice broadcast call.

7.1a.2 Transmission architecture – control plane

The control plane signalling shall be the same as in sub-clause 7.1.

7.1a.3 Transmission architecture – user plane

The following distribution functions are required to distribute the voice broadcast call to the nominated cells and dispatchers, respectively:

- a distribution function within the group call anchor MSC. There will be one link from the group call anchor MSC to each of the relay MSCs in the voice broadcast call. Also, there will be one link from each of these relay MSCs and the group call anchor MSC to each BSC controlled by the respective MSC and involved in the voice broadcast call;
- a distribution function within the BSC to distribute the speech to each of the nominated cells.

7.1b Transmission architecture – A interface link sharing

7.1b.1 Transmission architecture – general

The MSC and BSC shall negotiate during the setup of a voice broadcast call whether A-interface link sharing is supported by both entities. When this optional feature is supported by both entities, the same A-interface link (user and control plane) can be shared for all cells belonging to a BSC for a given voice broadcast call.

A conference bridge is required to connect the transmission paths of the nominated cells. The bridge is to be located within the group call anchor MSC. The group call anchor MSC is responsible for setting up a single A-interface link (i.e. either A-interface circuit or A interface IP address and UDP port value in case of AoIP and resource controlling SCCP connection) to each BSC containing nominated cells in the group call anchor MSC and links to any group call relay MSCs and to the dispatchers.

Each BSC is responsible for setting up a speech and signalling connection (voice broadcast call channel) to each nominated cell in the group call area served by this BSC. The BSC contains a distribution function that distributes speech and resource control related signalling from the MSC to each of the nominated cells.

7.1b.2 Transmission architecture – control plane

The MSC shall inform the BSC of the cells required to be setup for the broadcast call in the VBS ASSIGNMENT REQUEST. This message shall contain the list of group call area cells served by this BSC. If the entire list of cell identifiers does not fit into the message or if different methods of radio resource allocation (e.g. “immediate allocation” or “delay allowed”) are to be used for different cells controlled by the BSC, the MSC shall send one or more VBS AREA CELL INFO messages containing the remaining cell identifiers or the cell identifiers of cells using a different method of radio resource allocation. Once a channel could be established to the cell of origin or, if the cell of origin is not served by this BSC, to any other cell, the VBS ASSIGNMENT RESULT shall be sent to the MSC and timer T_{ast} shall be started. Timer T_{ast} is used to measure the duration between periodic reports from the BSC to the MSC of group call area cells for which channels have been assigned or released since the last periodic report. When timer T_{ast} expires, if new cells in the group call area have been established or existing ones have been released, pre-empted or failed, the MSC shall be informed of the changes. If no changes have taken place nothing shall be sent. Timer T_{ast} shall be started again to measure the period of time until the next report. The timer shall be stopped when the call is released.

Once all cells for a given group call area served by a BSC are established this BSC shall immediately send a VBS ASSIGNMENT STATUS message to the MSC indicating this and restart timer T_{ast}. This information shall be used by the MSC to determine the conditions for call set up as described in subclause 11.3.1.1.2.

The BSS is responsible to establish the channel to the different cells and manage the signalling accordingly (e.g. HO decisions, pre-emption, re-establishment of cells). The A-interface link (user and control plane) between MSC and BSC shall only be released when the call is released.

7.1b.3 Transmission architecture – user plane

The transmission architecture of the user plane as specified in subclause 7.1a.3 applies.

7.2 Radio channels

In each cell of the group call area one voice broadcast channel may be established consisting of a downlink received by all service subscribers' mobile stations and also an uplink which shall be used by the listening subscriber's mobile stations for the uplink reply procedure only.

The calling service subscriber's mobile station shall use a dedicated standard uplink/downlink which is connected as input to the distribution function.

A listening subscriber's mobile station which responds to a notification because no description of the voice broadcast channel was provided in the notification may be assigned a dedicated standard link up to the instant where the radio access network decides that the mobile station shall join the voice broadcast channel and the dedicated connection is released.

Voice broadcast channels shall be standard full rate or half rate speech channels, EFR speech channels, full rate AMR speech or half rate AMR speech channels. The support of voice broadcast channels other than full rate speech is a network option. A specific voice broadcast call can use either the same speech codec type in all cells of the group call area or different speech codec types in different cells of the group call area. Those implementations are optional for the network operator.

When establishing an AMR half rate or AMR full rate speech channel, the BSC shall select a suitable AMR codec configuration:

- for the dedicated channel used by the calling service subscriber, the BSC may select any configuration permitted for a point-to-point call;
- for a voice broadcast channel the BSC shall select one of the preferred configurations as defined in 3GPP TS 28.062 [16], Table 7.11.3.1.3-2. The BSC shall disable the rate adaptation mechanism and apply a single codec mode for the downlink until the channel is released.

Within a cell the BSC shall select the same codec configuration for all voice group and voice broadcast calls using the same AMR codec type, AMR FR or AMR HR, respectively. The selected configuration shall be broadcast on the NCH, as long as at least one voice group or voice broadcast call using the respective AMR codec type is active.

When A-interface circuit sharing or A-interface link sharing applies there is one A-interface circuit allocated for the broadcast call per BSC. In case of AoIP, there is one A-interface IP and port allocated for the broadcast call per BSC. Therefore the same speech codec is applied for all voice broadcast channels in the part of the group call area served by one BSC, if the TRAU is located between the MSC and the BSC-internal distribution function for speech (see subclause 7.1a.1 and 7.1b.1).

Full standard duplex channels shall be provided to all dispatchers listed in the GCR as for normal calls and connected to the distribution function although their speech shall not be added to the speech of the calling subscriber in the distribution function if they are destination subscribers. The links may be provided either via GSM, or via an external network.

Downlink and uplink radio channels are to be provided to all destination service subscribers, with one common downlink and one common uplink per cell. The uplink channel is used for the uplink reply procedure for VGCS and VBS (see subclause 4.2.2.1).

A separate standard duplex channel is to be provided to the calling service subscriber.

7.3 Data confidentiality

Data confidentiality on the radio link can be provided as a network option.

If data confidentiality is provided, the downlink of the voice broadcast channel within cell of the group call area shall be ciphered using broadcast group ciphering keys derived from the same group key, see 3GPP TS 43.020 [4].

The group key is related to the group ID. For each group ID, there is a number of group keys stored on the SIM which are identified by a group key number. The group key number identifying the group key to be used for a particular voice broadcast call is provided with the notification to the mobile stations. Mobile stations which have responded to a notification shall be informed of the group key number before they join the voice broadcast channel.

USIM based VBS ciphering uses a concept of short term keys where the short term key is derived by the GCR and the USIM from the group key and a RAND (random number) parameter. The actual broadcast group ciphering key is then derived by the BSS and the ME from the short term key, the cell global identifier, and a Cell Global Count parameter.

To include a subscriber into a voice group the required group data (including the 2 master group keys) shall be stored on the USIM, e.g. during the personalisation process or via OTA (over-the-air). To exclude a subscriber from a voice group the group data shall be deleted from the USIM. If a USIM is lost or stolen, all USIMs of the remaining members of the voice groups that this USIM is a member of need to be changed (e.g. via OTA or manual provisioning).

Details on data confidentiality for voice broadcast calls are provided in 3GPP TS 42.009 [2] and 3GPP TS 43.020 [4].

NOTE 1: USIM based VBS ciphering is not compatible with SIM based VBS ciphering which has not been completely specified. The SIM specifications contain no support for the storage of the group keys. A pre-Rel-6 VBS capable mobile station will be able to participate in an un-ciphered group call, if it is part of that group.

If data confidentiality is provided, then for a mobile station in originator in dedicated channel mode the uplink and the downlink of the dedicated channel shall be ciphered using the individual ciphering key of the service subscriber.

NOTE 2: The individual ciphering key is the key generated during a previous authentication procedure.

If data confidentiality is provided, then for a mobile dispatcher the uplink and the downlink of the dedicated channel shall be ciphered using the individual ciphering key of the dispatcher.

8 Information storage

8.1 Information stored in the GCR

8.1.1 Information used for routing of service subscriber originated voice broadcast calls

Without a RANflex configuration, the GCR shall hold for a related MSC area for each group ID and cell from which voice broadcast calls can be established by service subscribers the broadcast call reference to be used for a voice broadcast call to be established and an indication whether the originating MSC is the group call anchor MSC.

In a RANflex configuration, the GCR shall hold for a related MSC area (i.e. for those location areas for which the related MSC is the group call serving MSC) for each group ID and cell (within those location areas for which the related MSC is the group call serving MSC) from which voice broadcast calls can be established by service subscribers the broadcast call reference to be used for a voice broadcast call to be established and an indication whether the group call serving MSC is the group call anchor MSC.

In a RANflex configuration with group call redundancy, the GCR shall hold for a related MSC area (i.e. for those location areas for which the related MSC belongs to the group call serving MSC redundancy pool) for each group ID and cell (within those location areas for which the related MSC can act as the group call serving MSC) from which voice group calls can be established by service subscribers the group call reference to be used for a voice group call to be established and an indication whether the group call serving MSC belongs to the group call anchor MSC redundancy pool.

If one of the following configurations applies:

- a) without a RANflex configuration;
- b) in a RANflex configuration, if the VMSC is the group call serving MSC; or
- c) in a RANflex configuration with group call redundancy, if the VMSC belongs to the group call serving MSC redundancy pool:

If the VMSC is the group call anchor MSC or belongs to the group call anchor MSC redundancy pool, the GCR shall provide the broadcast call attributes related to that broadcast call reference as defined in subclause 8.1.2 and 8.1.3 to the VMSC and the VMSC shall establish the voice broadcast call.

If the VMSC is not the anchor MSC or does not belong to the group call anchor MSC redundancy pool, the GCR shall provide the broadcast call reference plus the routing information identifying the anchor MSC or anchor MSC redundancy pool to the VMSC and the VMSC shall route the voice broadcast call to the anchor MSC or anchor MSC redundancy pool.

If the following configuration applies:

- d) In a RANflex configuration, if the VMSC is different from the group call serving MSC:

If the group call serving MSC is a relay MSC for the broadcast call, the GCR shall provide the broadcast call reference plus the routing information identifying the anchor MSC to the group call serving MSC which passes this information to the VMSC.

If the group call serving MSC is the anchor MSC for the broadcast call, the GCR shall provide the broadcast call reference to the group call serving MSC which adds the routing information identifying the anchor MSC (i.e. its own MSC address) and passes the information to the VMSC.

Then the VMSC shall route the voice broadcast call to the anchor MSC.

If the following configuration applies:

- e) In a RANflex configuration with group call redundancy, if the VMSC does not belong to the group call serving MSC redundancy pool:

If the group call serving MSC redundancy pool is a group call relay MSC redundancy pool for the broadcast call, the GCR shall provide the group call reference plus the routing information identifying the anchor MSC redundancy pool to the requesting group call serving MSC which passes this information to the VMSC.

If the group call serving MSC redundancy pool is the group call anchor MSC redundancy pool for the broadcast call, the GCR shall provide the group call reference to the requesting group call serving MSC which adds the routing information identifying the anchor MSC redundancy pool and passes the information to the VMSC.

Then the VMSC shall route the voice broadcast call to the anchor MSC redundancy pool.

In a RANflex configuration with group call redundancy, the GCR shall provide the requesting MSC with "group call ongoing information". If the broadcast call is ongoing at another MSC within the redundancy pool, the requesting MSC shall forward the actual request to that MSC.

NOTE: In case the GCR function is distributed over different physical entities, each may hold only the information needed to treat requests coming from the MSCs connected to the physical GCR entity.

8.1.2 Static Broadcast call attributes

The GCR stores a list of static Broadcast Call Attributes for a given group call reference. These lists shall be programmed by the service provider at registration of the network specific service configuration. In RANflex configurations with group call redundancy these lists shall be identical in GCRs which are associated to MSCs belonging to the same redundancy pool.

The contents of each list related to requests of the group call anchor MSC is as follows:

- a list of cells inside the MSC area of the group call anchor MSC (in a RANflex configuration with or without group call redundancy, the cells belonging to a location area for which the group call anchor MSC is the group call serving MSC) into which the call is to be sent (part of the group call area), see subclause 8.1.2.1;
- a list of group call relay MSCs (or group call relay MSC redundancy pools) into which the call is to be sent;
- information on the cipher algorithm and the group key to be used for this voice broadcast call;
- information on the codecs allowed for this voice broadcast call. As an operator option, the EFR codec, standard half rate codec, AMR half rate codec, and AMR full rate codec can be supported;

NOTE: A pre-Rel-7 VBS capable mobile station will not be able to participate in a broadcast call using the EFR codec, AMR half rate codec or AMR full rate codec, if the mobile station is part of that group.

- a list of identities of dispatchers to which a dedicated link is to be established, see subclause 8.1.2.2;
- a list of identities of dispatchers which are allowed to initiate the voice broadcast call, see subclause 8.1.2.2;
- a list of identities of dispatchers which are allowed to terminate the voice broadcast call, see subclause 8.1.2.2;
- the default priority level related to that voice broadcast call if eMLPP applies, see subclause 8.1.2.3;
- an indication whether the uplink reply procedure is applicable for this voice broadcast call.

- in a RANflex configuration with group call redundancy: A list of GCR addresses identifying GCRs associated to MSCs within the redundancy pool.

The contents of each list related to requests of a group call relay MSC is as follows:

- a list of cells inside the MSC area of the group call relay MSC (in a RANflex configuration with or without group call redundancy, cells belonging to a location area for which the requesting MSC is the group call serving MSC) into which the call is to be sent (part of the group call area), see subclause 8.1.2.1;
- identity of the group call anchor MSC (or group call anchor MSC redundancy pool);
- in a RANflex configuration with group call redundancy: A list of GCR addresses identifying GCRs associated to MSCs within the redundancy pool.

8.1.2.1 Group call area

The group call area is defined as a list of cells. The cells shall be defined by their cell identification consisting of the Location Area Code and the Cell Identity as defined in 3GPP TS 48.008 and are therefore uniquely identified in the network.

In the case the group call area extends over several MSCs, only the cells belonging to the requesting MSC (in a RANflex configuration and in a RANflex configuration with group call redundancy, cells belonging to location areas for which the requesting MSC is the group call serving MSC) are included in the broadcast call attributes.

8.1.2.2 Dispatcher identities

Dispatcher identities shall be ISDN numbers or MSISDN numbers with the structure according to ITU-T Recommendation E.164. They shall correspond both to the number to be used to establish a call toward the dispatcher and the number provided as calling line identification when the call is originated by a dispatcher.

The list of dispatcher identities to which a dedicated link is to be established shall be passed to the MSC so that the distribution function can be set up.

The list of dispatcher identities which are allowed to initiate voice broadcast calls is used by the anchor MSC for verification for a voice broadcast call establishment by a dispatcher.

The list of dispatcher identities which are allowed to terminate voice broadcast calls is used by the anchor MSC for verification for a voice broadcast call release by a dispatcher.

8.1.2.3 Priorities

If the eMLPP supplementary service is applied to a voice broadcast call, the priority level shall be stored in the GCR.

For further details see 3GPP TS 23.067.

8.1.3 Transient Group Call Attributes

8.1.3.0 General

The GCR stores transient data for a given group call reference. These data are maintained by the GCR to reflect the current status of the corresponding voice broadcast call.

In a RANflex configuration with group call redundancy Transient GCR Data needs to be synchronized between all GCRs associated to MSCs belonging to the same redundancy pool.

8.1.3.1 Group Call Status Information

- a status flag indicating if a voice broadcast call with the related broadcast call reference is on-going, see subclause 11.3.1.1.1;
- in a RANflex configuration with group call redundancy: Address of the MSC within the redundancy pool, where the broadcast call is ongoing (if so).

8.1.3.2 Initial Talker Information

The relay MSC, and in a RANflex configuration (with or without group call redundancy) the group call serving MSC of the initiating service subscriber's current LAC, if this MSC is different from the VMSC, interrogate the GCR twice when setting up the broadcast call: The first GCR interrogation is triggered in the relay MSC by the service subscriber or in a RANflex configuration (with or without group call redundancy) in the group call serving MSC by the MAP service SEND_GROUP_CALL_INFO received from the VMSC. The second GCR interrogation is triggered in the relay MSC by the MAP service Prepare Group Call or in a RANflex configuration (with or without group call redundancy), if the anchor MSC is the group call serving MSC, by receiving the IAM from the VMSC.

At the first GCR interrogation the GCR shall store transient data in the GCR which are retrieved with the second GCR interrogation. These data are:

- the initiating service subscriber's IMSI;
- the originating cell id.

8.2 Information managed per subscriber

8.2.1 Stored in the HLR

The following additional information shall be stored in the HLR:

- the subscription option for voice broadcast calls which can be made in the HPLMN only or also in case of roaming;
- a list of all the group IDs for which a service subscriber has a subscription;
- an indication whether the subscriber is entitled to establish a voice broadcast call to one or more group IDs of his subscription.

The group IDs are defined in subclause 9.1.

A service subscriber shall not be provided with more than 50 group IDs.

8.2.2 Stored in the VLR

The list of all the group IDs a service subscriber is entitled to use and the entitlement to establish a voice broadcast call to a group ID shall be brought forward to a VLR at the same time as other subscriber information is copied, and VLR entries shall be modified when corresponding HLR records are changed.

8.2.3 Stored in the SIM

The information detailed in subclause 8.2.1 also needs to be stored on the SIM. The service subscriber shall be able to deactivate or reactivate a group ID by MMI interaction so that the mobile station ignores notification messages to this group ID, when the group ID is deactivated.

8.2.3a Stored in the USIM

The information detailed in subclause 8.2.1 also needs to be stored on the USIM. The service subscriber shall be able to deactivate or reactivate a group ID by MMI interaction so that the mobile station ignores notification messages to this group ID, when the group ID is deactivated.

For each group ID where data confidentiality may be applied, the USIM needs to store the cipher algorithm to be used and the possible group keys.

8.3 Information used for routing of dispatcher originated broadcast calls

Routing of dispatcher originated calls shall be performed on the MSISDN number received at a GMSC in the Initial_Address_Message.

- Because the group call reference is included in the called MSISDN number as defined in subclause 9.2d the routing information can be derived by the routing function of the GMSC. The GMSC afterwards directly routes the call request to the group call anchor MSC without requesting an HLR.

9 Identities

9.1 Elementary identities for broadcast calls

a) Group ID

The group ID is a sequence of decimal digits with a maximum length depending on the composition of the broadcast call reference defined under c). The length of Group ID shall be in a range of 1 to 8 digits.

The mobile station derives the group ID from the broadcast call reference by identifying the longest group ID amongst those stored in the SIM/USIM and matching the least significant digits of the broadcast call reference. If no group ID is stored in the SIM that matches the least significant digits of the broadcast call reference, the mobile station is not able to derive the group ID from the broadcast call reference.

NOTE 1: The network should use Group IDs matching an initial part of other group IDs with greatest care, if at all.

EXAMPLE: A mobile station storing the group IDs 678, 2 678 and 42 678 (and only those) in the SIM/USIM will derive group ID 2 678 from BROADCAST call reference 13 452 678.

For definition of Group ID on the radio interface, A interface and Abis interface, see 3GPP TS 44.069 [11].

For definition of Group ID coding on MAP protocol interfaces, see 3GPP TS 29.002 [13].

b) Group call area ID

The group call area ID is a sequence of decimal digits uniquely assigned to a group call area in one network and with a maximum length depending on the composition of the broadcast call reference defined under c).

c) Broadcast call reference

Each voice broadcast call in one network is uniquely identified by its broadcast call reference. The broadcast call reference is a concatenated sequence of the group ID (as the least significant part) and the group call area ID (as the most significant part). The broadcast call reference shall have a maximum length of 8 decimal digits. The composition of the group call area ID and the group ID can be specific for each network operator.

Group call area ID	Group ID
--------------------	----------

The group call reference is equal to the group ID when the group ID has a length of 8 decimal digits.

For definition of Broadcast Call reference (with leading zeros inserted as necessary) on the radio interface, A interface and Abis interface, see 3GPP TS 24.008 [14], 3GPP TS 44.018[7] and 3GPP TS 44.069 [11].

For definition of Broadcast Call reference coding (also known as ASCII Call Reference, Voice Group Call Reference or Voice Broadcast Call Reference) on MAP protocol interfaces, see 3GPP TS 29.002 [13].

9.2 Use of identities in the network

For each voice broadcast call the identifications as defined in the following shall be used within the network for the related purpose mentioned.

For voice broadcast services which are to operate in more than one PLMN, group identities have to be co-ordinated between the network operators involved.

a) Identities used for GCR requests for service subscriber originated voice broadcast calls

For a service subscriber originated call, the identity of the call used by the MSC in which the call is originated to interrogate the GCR shall consist of the originating serving cell identity as defined in 3GPP TS 48.008 and the group ID as defined in subclause 9.1. In a RANflex configuration (with or without group call redundancy) the same identity is used by the group call serving MSC to interrogate the GCR when it receives the MAP Send Group Call Info service.

Originating cell ID	Group ID
---------------------	----------

A service subscriber initiating a voice broadcast call has to call the wanted group ID. The MSC in which the call is originated shall accumulate from the BSS the called group ID and the originating cell ID.

If the group call area exceeds one MSC area, the identity used to interrogate the GCR by an MSC in which the call was not originated shall consist of the broadcast call reference as defined in subclause 9.1 except for the case in a RANflex configuration (with or without group call redundancy) where the GCR interrogation in the group call serving MSC is triggered by receipt of the MAP Send Group Call Info service.

Without a RANflex configuration: If the group call area exceeds one MSC area and the call was originated

in a relay MSC,

this relay MSC will perform a second GCR interrogation when the anchor MSC sets up the link to the relay MSC (see subclause 11.5).

In a RANflex configuration: If the group call area exceeds one MSC area and the call was originated

- in a relay MSC; or
- in a location area for which a relay MSC is the group call serving MSC,

this relay MSC will perform a second GCR interrogation when the anchor MSC sets up the link to the relay MSC (see subclause 11.5).

In a RANflex configuration with group call redundancy: If the group call area exceeds one MSC area and the call was originated

- in a relay MSC; or
- in a location area for which a relay MSC (belonging to a redundancy pool) is the group call serving MSC,

this relay MSC or another relay MSC belonging to the same redundancy pool will perform a second GCR interrogation when the anchor MSC sets up the link to the relay MSC (see subclause 11.5).

Independent of the configuration for the second GCR interrogation the relay MSC shall use the group call reference as defined in subclause 9.1 as the identity.

b) Identities used for GCR requests for dispatcher originated voice broadcast calls

In case of dispatcher originated call the identity used by the MSC to interrogate the GCR shall consist of the broadcast call references defined in subclause 9.1.

c) Identities used for notifications to service subscribers

Identities used for notification messages shall consist of the broadcast call reference as defined in subclause 9.

d) Identities used by dispatchers for voice broadcast call establishment

For dispatcher originated calls an MSISDN is dialled. The Country Code (CC) and National Destination Code (NDC) are used as normal for routing purposes. The CC and NDC may be omitted for internal calls. The numbering scheme is based on ITU-T Recommendation E.164. The Subscriber Number (SN) is used to indicate:

- the request of a broadcast call by use of a prefix. The length of the prefix shall be 1 to 2 digits [tbc];
- the wanted broadcast call reference as defined in subclause 9.1.

CC	NDC	Prefix	Broadcast call reference
----	-----	--------	--------------------------

e) Identities used for VLR requests for service subscriber originated broadcast calls

The group ID shall be used on the B-Interface for VLR requests.

f) Anchor MSC address for routing of service subscriber originated calls from originating MSC to anchor MSC

For service subscriber originated calls an anchor MSC address is used as called party address to route the call from the originating MSC to the anchor MSC. The anchor MSC address structure is the same as for dispatcher originated calls (see subclause d)) The Country Code (CC) and National Destination Code (NDC) are used as normal for routing purposes. The numbering scheme is based on ITU-T Recommendation E.164. The Subscriber Number (SN) is used to indicate:

- the request of a broadcast call by use of a prefix. The length of the prefix shall be 1 to 2 digits; the actual value of the prefix may be different than the one dialled by dispatchers;
- the wanted broadcast call reference as defined in subclause 9.1.

CC	NDC	Prefix	Broadcast call reference
----	-----	--------	--------------------------

g) Identities used for notifications to dispatchers

Identities used for notification messages to dispatchers shall be identical to those used by dispatchers to initiate calls as described in subclause d).

A notification identity is presented to a dispatcher terminal by making use of CLIP. Between the anchor MSC and MSC to which the dispatcher is attached, the information may be carried using the Calling Party Number parameter or Generic Number Parameter as agreed between the network operators. The Country Code (CC) and National Destination Code (NDC) are used as normal for routing purposes. The numbering scheme is based on ITU-T Recommendation E.164. The Subscriber Number (SN) is used to indicate:

- the indication of a broadcast call by use of a prefix. The length of the prefix shall be 1 to 2 digits; the actual value of the prefix shall be the same as the one dialled by dispatchers
- the broadcast call reference as defined in subclause 9.1.

CC	NDC	Prefix	Broadcast call reference
-----------	------------	---------------	---------------------------------

The Screening Indicator shall be set to "Network Provided"

The Type of Number shall be set to "International"

10 Operation and maintenance aspects

NOTE: A list and short description of the operation and maintenance aspects will be given. This includes the options and parameters which can be set by the operator.

- handling of timers;
- registration aspects etc.

11 Function and information flows

11.1 Broadcast function management

The broadcast call attributes, as given in subclause 8.1 shall be entered and modified by the service provider. A list providing information on necessary Operation and Maintenance actions is given in clause 10.

11.2 Group membership management

Once the membership is established, the individual membership of the group can be placed in an active or deactive state on the SIM/USIM by the user. If a subscriber has a group ID in an active state, the subscriber is able to establish voice broadcast calls corresponding to that group ID if he is entitled for it.

In a deactive state the mobile station prevents the service subscriber from establishing calls using the group ID and the corresponding notifications need to be "ignored" by the mobile station.

The active state and deactive state entries may be password protected as an implementation option.

Group IDs are listed in the subscription data within the network and on the SIM/USIM. The SIM/USIM must be returned to the network operator or service provider for updating if the subscription is to be changed.

NOTE: Updating of subscription data over the radio interface is not considered. However, this shall not preclude future applications if corresponding mechanisms may be implemented.

Users can interrogate their mobile stations to determine to which groups they are members and which subscriptions are currently in an active state.

11.3 Call management

11.3.1 Call establishment

A voice broadcast call can be established by either a service subscriber or by a dispatcher.

11.3.1.1 Service subscriber call establishment

11.3.1.1.1 Initial stage

The initial signalling from the calling service subscriber informs the network that a voice broadcast call is required and details the group ID; it may specify originator-to-dispatcher information. No information relative to the group call area is given by the calling service subscriber.

The network shall perform a number of checks in order to determine how to handle the call:

- check of the ability of the subscriber to establish the call;
- check whether the call can be initiated from the cell;
- check of the existence of an on-going call of the same broadcast call reference.

The originating MSC shall check the VLR records for the ability of the subscriber to start the call. If the service subscriber has no subscription for the voice broadcast service with the indicated group ID, the call shall be released. In addition, the VLR shall return barring and identity presentation restriction checks to the MSC.

In a RANflex configuration the originating MSC shall then derive the group call serving MSC address from the originating location area. If the group call serving MSC is different from the originating MSC (or in a RANflex configuration with group call redundancy if the originating MSC does not belong to the group call serving MSC redundancy pool) then the group call serving MSC is interrogated by means of the MAP service SEND_GROUP_CALL_INFO. The interrogation request contains the originating Cell Id and the Group Id. If the group call serving MSC is a relay MSC for the broadcast call, then its GCR shall derive the anchor MSC address and the broadcast call reference from the originating Cell Id and Group Id, and return it to the VMSC. If the group call serving MSC is the anchor MSC for the group call, then its GCR shall derive the broadcast call reference from the originating Cell Id and Group Id, and return it to the VMSC.

Without RANflex configuration or if in a RANflex configuration with or without group call redundancy the originating MSC is the group call serving MSC (derived from the originating location area) it shall then request information from the GCR by giving the group ID and the originating cell ID as defined in subclause 9.2.

If the length of the group ID is less than 8 decimal digits, the GCR first derives the group call area ID from the group ID and the originating cell ID. If no group call area ID is related to the group ID and originating cell ID, the call shall be released. If a group call area ID is related to the group ID and originating cell ID, the GCR shall transfer the corresponding broadcast call attributes to the MSC.

If the group ID has a length of 8 decimal digits, the group call reference is equal to the group ID. The GCR shall check whether the call was initiated within the group call area stored in the GCR. If not, the call shall be released; otherwise, the GCR shall transfer the corresponding group call attributes to the MSC.

When the GCR has transferred the broadcast call attributes to the MSC, the call shall be considered as on-going by the GCR, unless the GCR's associated MSC acts as group call relay MSC in a RANflex configuration with or without group call redundancy.

The GCR of the relay MSC and in a RANflex configuration with or without group call redundancy, if the group call serving MSC of the initiating service subscriber's current LAC is different from the VMSC, the GCR of this group call serving MSC shall store the initiating service subscriber's IMSI and originating cell id for later processing.

If the originating MSC is not the group call anchor MSC for the voice broadcast call as indicated in the GCR, then the voice broadcast call request shall be passed to the group call anchor MSC; in that case, if the initiation of the voice broadcast call had specified originator-to-dispatcher information and processing of originator-to-dispatcher information is supported by the MSC, the originator-to-dispatcher information is transformed by the originating MSC into UUS1 and sent to the anchor MSC.

When passing the call request to the anchor MSC the originating MSC shall include the VBS prefix plus broadcast call reference in the calling party number of the IAM. If in a RANflex configuration the originating MSC is not the group call serving MSC, it shall in addition include the address of the group call serving MSC in the generic number parameter of the IAM, with the number qualifier indicator set to "additional calling party number". Without RANflex configuration or if in a RANflex configuration with or without group call redundancy the originating MSC is the group call serving MSC, it shall additionally include the address of the originating relay MSC in the generic number parameter of the IAM, with the number qualifier indicator set to "additional calling party number", when passing the call request to the anchor MSC.

If the group call reference is composed of Group ID and group call area ID, it is possible that two service subscribers or a service subscriber and a dispatcher or two dispatchers may attempt to establish a call using the same group ID and corresponding to the same group call area ID. If the two voice broadcast calls are established with the same group ID but for different group call areas, then separate voice broadcast calls shall be established. If the group call areas overlap, it is up to receiving mobile station to determine which call to participate in. If more than one call is made to identical group ID and group call area, the network shall reject all but one of the call attempts.

If the group ID has a length of 8 decimal digits, if more than one call attempt is made to the same group ID, the network shall reject all but one of the call attempts.

If the GCR receives a new interrogation related to a broadcast call reference where the call is indicated as on-going in the GCR, the GCR shall provide the on-going status together with the broadcast call reference and - in a RANflex configuration with group call redundancy - together with the address of the MSC within the redundancy pool where the group call is ongoing back to the MSC. The MSC shall then

- a) in a configuration without RANflex;
- b) in a RANflex configuration; and
- c) in a RANflex configuration with group call redundancy, if the group call is ongoing at the requesting MSC:

release the call with a cause user busy in case of a service subscriber originated call request. The mobile station of the service subscriber shall then look for notifications of the respective group ID on the NCH and join the voice broadcast call. In case of a dispatcher originated voice broadcast call request, the MSC shall join the dispatcher to the distribution function of the voice broadcast call, or

- d) in a RANflex configuration with group call redundancy, if the broadcast call is ongoing at another MSC within the redundancy pool:

forward the original request to the MSC within the redundancy pool where the broadcast call is ongoing.

A service subscriber which is entitled by his subscription to establish voice broadcast calls while roaming shall only be able to use supra-PLMN group IDs as defined in subclause 9.1 in case of roaming. In case of roaming, the mobile station shall only react on notifications for supra-PLMN group IDs.

If the group ID has a length of 8 decimal digits, the operator can define for this group ID only one group call and one group call area within his network. If the length of the group ID is less than 8 decimal digits, the operator can define more than one group call using the same group ID, but different group call areas. Because of the possibility of overlapping group call areas, each call requires a unique reference, assigned by the GCR related to the originating MSC or the group call serving MSC (in a RANflex configuration). The broadcast call reference shall be composed of the group ID and a group call area ID (see clause 9).

Authentication of the calling service subscriber can be performed by the network as for normal calls.

11.3.1.1.2 Establishment of the transmission means

A voice broadcast call channel shall be established in all the cells throughout the identified group call area using physical channels selected by the BSCs as appropriate. The downlink channels shall be established without any return signalling from mobile stations. Whilst the downlink channel is being established, the MSC shall form a distribution function containing the appropriate channels to all BTSs in the group call area or in case of A-interface link sharing to all BSCs in the group call area. The MSC is responsible for adding dispatchers to the distribution function.

Alternatively, the network may establish voice broadcast channels in a cell on demand, i.e. if mobile stations respond to the notifications as defined in subclause 4.2.2.1 (see "uplink reply procedure"). As a network option the applicability of the uplink reply procedure for a voice broadcast call can be controlled by the GCR of the anchor MSC. If the anchor MSC supports this feature, it shall allow all affected BSCs to establish voice broadcast call channels on demand only if the GCR indicates that the uplink reply procedure is applicable. If the relay MSC supports this feature, it shall allow all affected BSCs to establish voice broadcast call channels on demand only if the anchor MSC indicates during the establishment of the voice broadcast call that the uplink reply procedure is applicable.

In parallel, a dedicated suitable channel is allocated to the calling service subscriber if not already the case. The call will be considered established provided that at least the downlink channel in the originating cell, in the case of a service subscriber originated voice broadcast call, or the downlink channel in any one cell within the group call area, in the case of a dispatcher originated voice broadcast call, is established. The MSC shall signal to the calling service subscriber that this has occurred so that he knows when to start speaking. If a voice broadcast call does not meet the above conditions in a configurable time (T_{xx}) then the call shall be released.

The mobile station shall indicate connection to the subscriber. If channels could not be established in particular cells because of congestion, channels are allocated to these cells as soon as possible.

The MSC may retry the VBS Assignment procedure to establish channels in cells where they are missing. If supported, the procedure may be initiated when:

- i) congestion (i.e. a lack of A-interface circuits) prevented the VBS ASSIGNMENT REQUEST message from being sent to the BSS;
- ii) a VBS ASSIGNMENT FAILURE message is received and the cause value indicates an acceptable reason for retry (e.g. no radio resource available);

- iii) the radio and terrestrial resources for the broadcast call channel are cleared (broadcast call on-going) and the cause value indicates an acceptable reason for retry (e.g. pre-emption);
- iv) no response to the VBS ASSIGNMENT REQUEST message is received (this is determined by the MSC in an implementation-dependent manner such as expiry of a timer); or
- v) no response is received following receipt of a VBS QUEUING INDICATION (this is determined by the MSC in an implementation-dependent manner such as expiry of a timer).

NOTE: If A-interface link sharing or broadcast call re-establishment by the BSS apply, the BSC is responsible for establishing/re-establishing channels in cells and scenario (ii) and (iii) do not apply, unless A-interface resources also need to be re-established (e.g. when the PCM system serving the A-interface circuit fails (equipment failure)). Scenario (v) does not apply to A-interface link sharing and broadcast call re-establishment by the BSS.

The MSC may repeat the VBS assignment procedure until a VBS ASSIGNMENT RESULT message is received, the call is released or an unacceptable reason for retry (e.g. protocol error between BSS and MSC) is received by the MSC. The time between subsequent retries is implementation-dependent. The MSC shall send each retry of the VBS ASSIGNMENT REQUEST over a new resource-controlling SCCP connection.

If a message is received with an unacceptable reason for retry then existing procedures apply. I.e. the MSC shall initiate the clearing of the radio and terrestrial resources, if necessary, and no further attempts to establish a broadcast call channel in the cell are made.

While using the retry procedure the MSC shall maintain the call controlling SCCP connection to a BSS until the call is released or until the MSC decides to stop any further attempts to establish broadcast call channels for the call on a BSS where no cells are established.

11.3.1.1.3 Release of the dedicated transmission means of mobile stations responding to a notification

Mobile stations which respond to a notification for which no description of the voice broadcast channel was given in the notification message may be given a dedicated connection up to the time where the network requests the mobile station to join the voice broadcast channel by use of a channel release procedure.

11.3.1.2 Dispatcher call establishment

In the case of dispatchers originated calls the call request, in the form of an MSISDN number, shall be received at a GMSC. Such a call can be treated by the GMSC as a normal mobile terminated call. In this case, the GMSC shall interrogate an HLR, determined on the basis of the MSISDN number. The HLR in turn may either interrogate the appropriate MSC/VLR to obtain an MSRN, or may supply an MSRN predefined in the HLR and related to the respective broadcast call reference in the MSC/VLR. If the HLR interrogates the MSC/VLR for the MSRN, the HLR shall provide this MSC/VLR with the related IMSI including the broadcast call reference as defined in clause 9.

Alternatively, the call request can be forwarded directly to the related group call anchor MSC on basis of the GMSC's internal routing table. In this case, the broadcast call reference shall already be included in the requested MSISDN number as defined in clause 9.

When interrogated by the group call anchor MSC, the GCR shall check if the calling line identity is within the list of dispatcher identities allowed to establish the voice broadcast call. If not the case, the call shall be rejected.

After reception of the call request, the group call anchor MSC checks whether an on-going call of the same broadcast call reference exists, in which case for the following configurations

- a) for configurations with or without RANflex;
- b) for RANflex configurations; and
- c) for RANflex configurations with group call redundancy where the broadcast call is ongoing at the call request receiving MSC:

the group call anchor MSC shall add the dispatcher to the call, and for the following configuration

- d) for RANflex configurations with group call redundancy where the broadcast call is ongoing at another MSC within the redundancy pool:

the call request receiving MSC shall forward the call request to the MSC where the broadcast call is ongoing.

At the point at which notification messages are sent to mobile stations, a tone is relayed to the calling dispatcher to inform him that he can commence his message.

11.3.1.3 Notification procedures

Different notification procedures shall be applied in relation to the mode of the mobile station as presented in table 1 and defined in the following clauses.

Table 1: Overview on different information messages for new or on-going calls

Incoming call type: MS states:	VBS or VGCS call	point-to-point call
Idle mode	(section a)	(standard paging)
Originator in dedicated channel mode	(section b)	(section c)
group receive mode	(section b)	(section c)
dedicated mode	(section b)	(standard Call Waiting) (note)
NOTE: Only for point to point calls with certain restrictions as defined in 3GPP TS 22.083.		

a) Notification for mobile stations in idle mode

Once the voice broadcast channel has been established in a cell or the network is waiting to receive notification responses to establish a voice broadcast channel, notifications shall be broadcast on the NCH in that cell.

The position of the NCH shall be derived from the system information of the BCCH.

The notification messages shall include the broadcast call reference and possibly the description of the voice broadcast channel, the call priority if eMLPP is applied, and the group cipher key number.

A notification message can contain no, one or more notifications.

The notification process needs to continue throughout the duration of the broadcast call, in order to permit the "late entry" of other mobile stations. Mobile stations moving into the group call area which are in idle mode shall be directed to the voice broadcast channel by the notification messages, possibly by means of the notification response procedure.

The scheduling of the notification messages in a cell shall be managed by the BSS. Information can be added in the messages to limit the required reception of NCH messages. The following constraints shall be met:

- the three first initial notifications (i.e. the first for a given broadcast call) shall have priority over subsequent notifications (i.e. the messages for an on-going broadcast call) and must be sent as soon as possible;

NOTE 1: In addition initial notification messages for calls with or above an operator defined priority level can be sent on all possible paging or access grant channels to reduce the delay for those mobile stations which are not using DRX.

- afterwards, an on-going broadcast call in the cell shall be periodically notified on the NCH.

Since the information for the establishment of a voice broadcast call is sent onto the NCH rather than on the PCH as for normal point-to-point calls, the mobile station must listen to the PCH as well as to the NCH. A "reduced NCH monitoring" mechanism can be used to save power in the mobile station when listening to the NCH.

A mobile station able to receive voice broadcast calls either, depending on the implementation:

- can use the "reduced NCH monitoring" mechanism. When entering a cell, the mobile station shall listen to the NCH to get the notifications of the voice broadcast calls on-going in the cell. Afterwards, the mobile station needs to listen to the NCH only if it is informed on the availability of a notification for a new voice broadcast call. This shall be based on the NCH status information provided, as indicated in 3GPP TS 44.018.

- do not apply the "reduced NCH monitoring" mechanism and read all possible paging or access grant channels.

b) Notification for mobile stations in group receive mode, dedicated mode or originator in dedicated channel mode

In addition to sending initial notification messages on the NCH for the voice broadcast call, the BSS can provide initial notification into on-going voice broadcast, group calls, and point to point calls informing mobile stations partaking in these calls of new voice broadcast calls that are being set-up in the cell.

NOTE 2: The additional notification into on-going voice broadcast, group calls and point to point calls should be provided by the BSS if the priority level of the new call is equal or higher than the O&M defined priority level.

In order to do this the BSS sends initial notification messages on FACCH to all other on-going voice broadcast, group calls, and point to point calls in the cell. The initial notification message on FACCH shall contain the broadcast call reference, the priority level if eMLPP applies and possibly the TCH description which allows the mobile station to connect directly to the new call without reading the NCH.

An indication of change of notifications in the current cell may be provided on SACCH by the BSS.

As a mobile station option, the mobile station may read the NCH of the current cell while in group receive mode, dedicated mode or originator in dedicated channel mode in order to be notified on other voice broadcast calls.

NOTE 3: Mobile stations may require an additional receiver to read the NCH in order to ensure a higher probability of receiving notifications for all present voice broadcast calls without degradation of the received speech quality.

Late entry of mobile stations into ongoing high priority group calls is covered by the following mechanisms:

- Late entrance in dedicated mode

If a mobile station in dedicated mode is moving into an area where a group call (VGCS or VBS) with priority level equal or higher to an operator specific setting is on-going, the BSS shall resend the notification message to the mobile station on FACCH, if the mobile station has ASCI capabilities. This notification shall be triggered by completion of the dedicated channel assignment.

Sending periodical notification on FACCH to mobile station in dedicated mode is optional, and is done as long as the group call (VGCS or VBS) with priority level equal or higher to an operator specific setting, is ongoing, with a repetition period given by an operator specific setting.

- Late entrance in group receive or group transmit mode

When a group call (VGCS or VBS) with priority level equal or higher to an operator specific setting, is established, the BSS shall send periodical notification on FACCH to all on-going voice broadcast and group calls in the cell, except on the FACCH of the group call (VGCS or VBS) which has initiated this periodical notification. By this method the mobile station in group receive or group transmit mode moving into this cell is notified. Periodical notification on FACCH is done as long as the group call (VGCS or VBS) with priority level equal or higher to an operator specific setting, is ongoing, with a repetition period given by an operator specific setting.

NOTE 3a: The operator determined Periodical FACCH notification period shall be a BSS specific operator setting and be a minimum of 1s and maximum of 5s.

c) Paging into on-going voice broadcast calls

Paging into on-going voice broadcast calls shall be provided as an implementation option.

In addition to establishing the links for the voice broadcast call, the network can provide paging information into on-going voice broadcast calls informing mobile stations partaking in a voice broadcast call of new incoming point-to-point calls.

The mobile station shall be ready to receive a paging message on the FACCH containing the mobile subscriber identity and the priority level if eMLPP applies.

In the event of a reorganisation of the PCH the BSS shall inform the mobile stations via the SACCH that paging reorganisation has occurred. A mobile station receiving this indication shall decode the BCCH in order to obtain the new paging configuration.

As a mobile station option, the mobile station may read its paging subchannel in the current cell in group receive mode or group transmit mode in order to receive paging messages.

NOTE 4: Mobile stations may require an additional receiver to read its PCH subchannel in order to ensure a higher probability of receiving all relevant paging messages without degradation of the received speech quality. The additional receiver may be the same as used for reception of the NCH described under b) above.

11.3.1.4 Destination service subscribers

Mobile stations of destination service subscribers which are in idle mode shall listen to notification messages on the NCH and move to the voice broadcast channel or respond to the notification.

Mobile stations which are busy shall either pre-empt the current call (if eMLPP is applied and the new call is of a sufficient priority, or shall provide the service subscriber with an indication similar to call waiting, when applicable.

11.3.1.5 Destination dispatchers

Destination dispatchers are connected into the voice broadcast call as a standard point-to-point call. The notification of the identity of the received broadcast call shall be supplied in the Calling Line Identity, formatted according to sub-clause 9.2.

11.3.2 Call release

The voice broadcast call can be terminated by the calling service subscriber or the calling dispatcher clearing it down, or by any dispatcher nominated in the GCR allowed to terminate the call.

11.3.2.1 Call termination by the calling subscriber

If the calling service subscriber issues a termination request a channel release message shall be sent on the FACCH of all cells in the group call area and then all resources are freed.

11.3.2.2 Call termination by dispatchers

A dispatcher entitled to terminate the call can be a mobile subscriber or a fixed line subscriber. The dispatcher may use out-of-band DTMF messages as a means for the control of the call termination, if it is a mobile dispatcher, or DTMF tones, if it is a fixed line dispatcher.

If the call is terminated by a mobile dispatcher using DTMF, the out-of-band messages START_DTMF(X) and STOP_DTMF are sent via the radio interface towards the network. If the out-of-band DTMF messages are sent by a mobile dispatcher who is not controlled by the anchor MSC, the DTMF messages will be converted by the controlling MSC (e.g. relay MSC or visited MSC) into DTMF tones and these DTMF tones will be sent through the network to the anchor MSC.

If a fixed dispatcher initiates DTMF tones, the DTMF tones will be sent through the network to the anchor MSC.

Both in case of a mobile and a fixed line dispatcher the anchor MSC is responsible for the detection and collection of the out-of-band or in-band DTMF signals. After the evaluation of the DTMF signals, the anchor MSC has to trigger the appropriate function (see the figures 4b to 4d in 11.3.8).

In order to avoid the erroneous detection of the specific DTMF tone sequence for call termination by the MSC, this sequence shall consist of at least three DTMF digits.

11.3.3 Leaving of a dispatcher

When the calling dispatcher releases his call leg, the entire VBS call shall be terminated. A dispatcher who is not the originator can disconnect from the call at any time without terminating the call. In order to terminate the call a dispatcher who is entitled to do this must use the explicit signalling described in subclause 11.3.2.1.

11.3.4 Leaving and returning to a voice broadcast call of a service subscriber

A destination service subscriber shall automatically disconnect from the call when leaving the group call area.

If the calling subscriber leaves the group call area or enters a BSC area not belonging to the service area, the call shall be terminated by the network, once the network has detected that the calling subscriber has left the Group Call Area.

A destination subscriber' mobile station shall leave the voice broadcast call by no longer listening to the voice broadcast channel downlink and returning to idle mode. A broadcast call is returned to by listening to the periodic notification messages for that call, and reacting on them appropriately.

11.3.5 Cell change

11.3.5.1 Listening subscriber

In all cases change of cell shall be initiated and performed by the service subscriber's mobile station. In order for the service subscribers changing from one cell to another within the group call area a cell list for the neighbouring cells belonging to this broadcast call area is periodically broadcast on the downlink SACCH of the voice broadcast call. In this case, mobile stations entering a new cell shall perform cell change according to the algorithm C2, see 3GPP TS 45.008 and 3GPP TS 43.022.

Mobile stations which want to enter a cell shall listen to the BCCH and to the NCH to determine which channel they shall retune to so that they can continue with the voice broadcast call if available in that cell.

NOTE: Mobile stations may require an additional receiver to read the BCCH and NCH of the neighbour cells in order to ensure a higher probability of receiving the relevant messages without degradation of the received speech quality. The additional receiver may be the same as used in subclause 11.3.1.3.

Mobile stations entering a new location area shall perform location updating as normal.

11.3.5.2 Calling service subscriber

Standard mobile station assisted handover shall be used for the cell change of the calling service subscriber as defined on 3GPP TS 45.008.

If the BSS does not know if one or more of the target cells are outside the group call area, the BSS shall use the MSC controlled handover procedure. The MSC shall reject the handover in the case that all target cells are outside the GCA and as an option release the call.

11.3.5.3 Dispatcher

Dispatchers which are mobile subscribers shall change the cell by standard handover procedures.

11.3.6 New calls

Any service subscriber originated new voice broadcast calls which have identical group ID and group call area to on-going voice broadcast calls shall be rejected by the network with cause busy. The mobile station shall then read the notifications for the corresponding group ID on the NCH.

For any dispatcher originated new voice broadcast calls which are identical to on-going voice broadcast calls as described above the network shall include the dispatcher in the on-going call.

Otherwise, new calls are treated as detailed in subclause 11.3.8. In the case of congestion, voice broadcast calls are treated according to their priority with each BSC treating each downlink depending on the situation in each cell to which the call is sent. Therefore, it is possible that a voice broadcast call might be established only in a subset of the required cells.

In the case where there are no distribution function free, and pre-emption is not performed, then the call request shall be rejected.

In the case of group members involved in voice broadcast or point-to-point calls who have been informed of a new voice broadcast call, the mobile station shall make a decision as to which to monitor as if both the on-going call and new call were point-to-point calls, and follow the procedure defined in 3GPP TS 23.067.

11.3.7 Uplink transmission management

The uplink related to the voice broadcast channel downlink is not used. No UPLINK_BUSY information is required.

11.3.7a Signalling procedures for the user plane

11.3.7a.1 Broadcast call re-establishment by the BSS

The MSC and BSS negotiate during the setup of a voice broadcast call whether broadcast call re-establishment by the BSS is supported by both entities.

If broadcast call re-establishment by the BSS is supported by both entities or the network uses a transmission architecture with A-interface link sharing, the following procedures apply:

- i) If the BSS needs to release the broadcast call channel in a cell due to an equipment failure or another BSS-generated reason (e.g. preemption), the BSS shall inform the MSC of the failure with a VBS Assignment Status message.

The terrestrial resource for the broadcast call channel is not released by the MSC.

- ii) When the condition that caused the failure is subsequently removed, the BSS shall re-allocate a radio resource for the broadcast call channel and inform the MSC of the recovery with a VBS Assignment Status message.
- iii) If A-interface link sharing is used, each of the VBS ASSIGNMENT STATUS messages in item (i) and (ii) shall be sent after expiry of timer T_{ast}.

Otherwise, if broadcast call re-establishment by the BSS is not supported by both entities and the network does not use a transmission architecture with A-interface link sharing, the following procedures apply:

- i) If the BSS needs to release the broadcast call channel in a cell due to an equipment failure or another BSS-generated reason (e.g. preemption), the BSS shall inform the MSC of the failure with a Clear Request message.
- ii) The MSC shall then initiate the clearing of the radio and terrestrial resources for the broadcast call channel. If supported, the MSC may retry the VBS Assignment procedure for the cell, depending on the reason for release.

Broadcast call re-establishment by the BSS does not apply to the dedicated link of the originating service subscriber, i.e. if the BSS needs to release the dedicated channel of the originating service subscriber due to an equipment failure or another BSS-generated reason (e.g. preemption), the BSS shall inform the MSC of the failure with a Clear Request message. The MSC shall then initiate release of the voice broadcast call.

11.3.8 Overview of signalling

In this overview, the messages required to implement the specified concept are identified, and brief details are given of each message.

A diagrammatic representation of the voice broadcast call message structure proposed and actions required are given in figures 2 to 4f.

In order to simplify the message flows for voice broadcast call establishment and call termination, the interaction between the MSC and the GCR is only shown for the MSC where the originator of the broadcast call is located or, for the case of a broadcast call originated by a dispatcher, only for the anchor MSC. In all cases, a similar interaction also takes place between the other MSC(s) and associated GCR(s) involved in the group call.

Summary of figures in this subclause:

Figure 2: voice broadcast call establishment by a service subscriber roaming in the anchor MSC area;

Figure 3: voice broadcast call establishment by a service subscriber roaming in the relay MSC area;

Figure 3a: voice broadcast call establishment by a service subscriber in a RANflex configuration;

Figure 3b: voice broadcast call establishment by a mobile dispatcher or fixed line dispatcher;

Figure 3c: Signalling information required for establishing voice broadcast calls by a service subscriber in a RANflex configuration with group call redundancy

Figure 4: termination of the broadcast call by the originating service subscriber;

Figure 4a: voice broadcast call establishment by a service subscriber using immediate setup;

Figure 4b: termination of the broadcast call by an entitled mobile dispatcher controlled by the anchor MSC;

Figure 4c: termination of the broadcast call by an entitled mobile dispatcher controlled by a visited MSC;

Figure 4d: termination of the broadcast call by an entitled fixed line dispatcher.

Figure 4e: A-interface link sharing used or broadcast call re-establishment by the BSS supported: Release after equipment failure (TRX, PCM, ...) concerning a cell not serving the originating service subscriber;

Figure 4f: A-interface link sharing used or broadcast call re-establishment by the BSS supported: Release after equipment failure concerning the link between MSC and BSS;

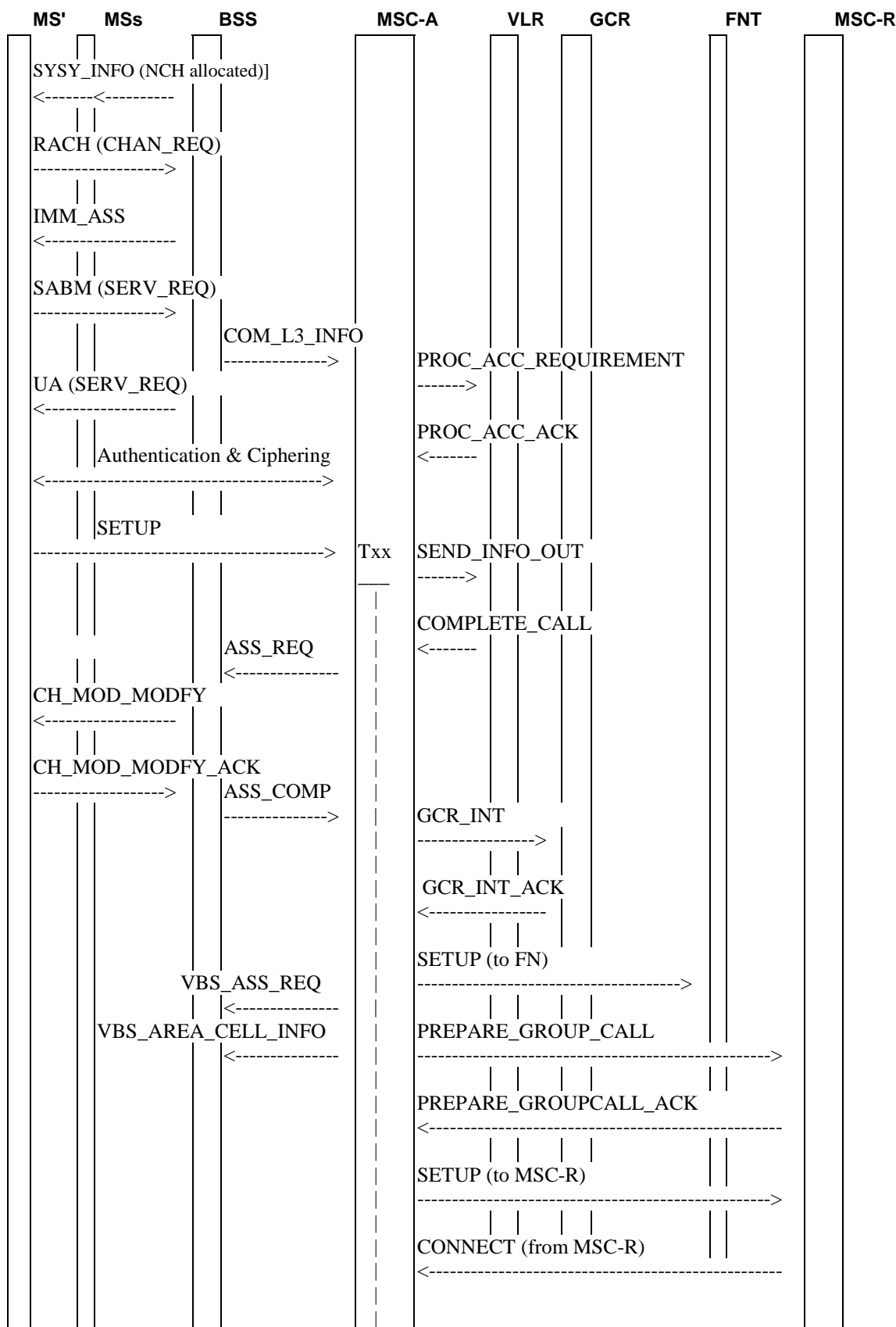

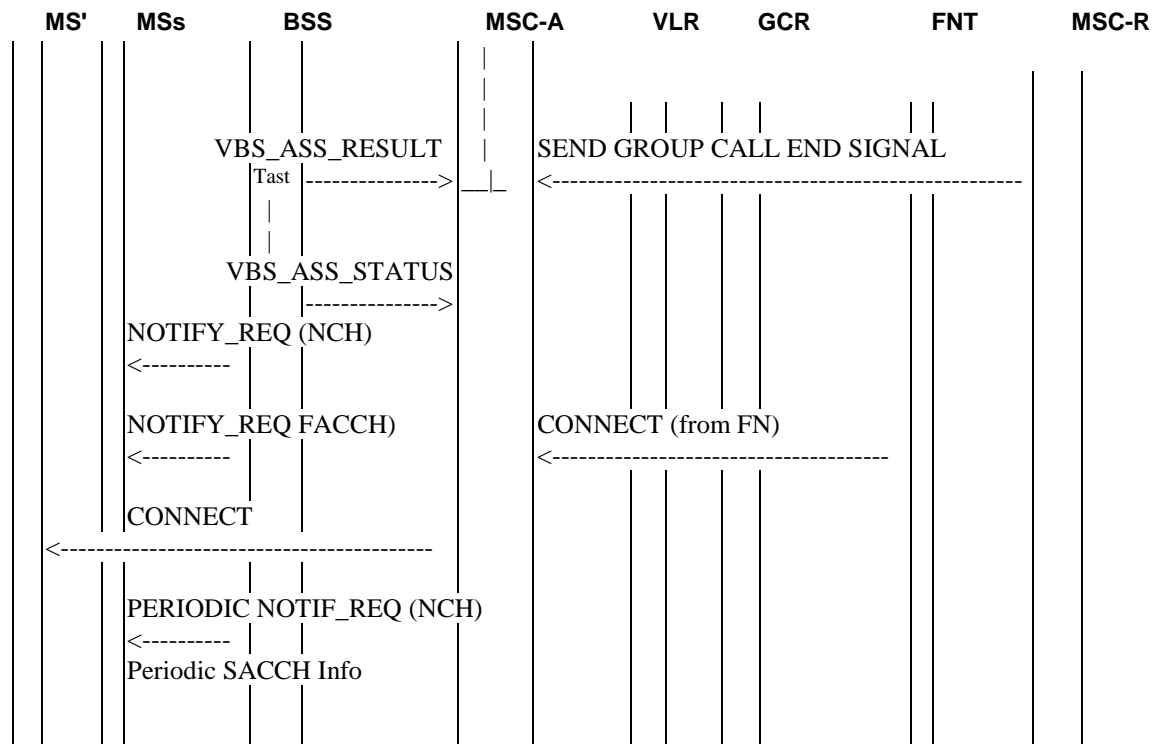

NOTE: MS' calling service subscriber mobile station;
 MSs destination service subscriber mobile stations
 FNT fixed network user terminal
 MSC-A anchor MSC;
 MSC-R relay MSC.

Figure 2: Signalling information required for establishing voice broadcast calls by a service subscriber roaming in the anchor MSC area

SYS_INFO (NCH allocated): Message used to indicate if the NCH is allocated on the CCCH in the cell.

Initial RACH_CHAN_REQ: Standard message.

IMM_ASS: Standard message sent on the AGCH.

SERV_REQ (voice broadcast call): Modified form of the current call request message L3-MM CM SERVICE REQUEST sent on the allocated channel. Teleservice voice broadcast call is indicated.

UA (SERV_REQ): This message is used to acknowledge the layer 2 link and provide contention resolution of the service request.

COM_L3_INFO: The MSC is provided with initial information about the voice broadcast call.

NOTE 1: Messages flows for authentication and ciphering are not represented although performed as normal.

PROC_ACC_REQ: The MAP_PROCESS_ACCESS_REQUEST message is sent to the VLR to check the requested VBS teleservice against the subscription data.

PROC_ACC_ACK: The MAP_PROCESS_ACCESS_REQUEST ack message acknowledges the requested service.

Authentication & Ciphering: Authentication and Ciphering may be performed. Acknowledgement of the service request can also be performed by sending the CM SERVICE ACCEPT.

SETUP: The MSC is provided with details about the voice broadcast call.

NOTE 2: Alternatively, an IMMEDIATE_SETUP may have been send as the initial message including all details of the voice broadcast call. In this case no SETUP message must be sent.

SEND_INFO_OUT: The requested group ID is transferred to the VLR in the MAP_SEND_INFO_FOR_OUTGOING_CALL message.

COMPLETE_CALL: The VLR returns the MAP_COMPLETE_CALL confirming the use of the requested group ID.

ASSIGNMENT_REQUEST: Standard message.

CHAN_MOD_MODIFY: Standard message to modify the channel mode in case of very early assignment.

CHAN_MOD_MODIFY_ACK: Standard message to acknowledge the modification of the channel mode.

ASSIGNMENT_COMPLETE: Standard message.

NOTE 3: Alternatively, early assignment or OACSU procedures might be applied with the corresponding assignment messages not presented in figure 2.

GCR_INT: The broadcast attributes are requested from the GCR.

GCR_INT_ACK: The requested information is returned from the GCR.

VBS_ASSIGNMENT_REQ: This message is sent from the MSC to all affected BSCs, [one dedicated message for every requested channel in a cell] including the broadcast call reference, the channel type and possibly the call priority and details on the ciphering.

In case of AoIP this message shall contain call identifier, codec list and AoIP Transport layer address information.

NOTE 4: As an operator option the voice broadcast channels, the links to them and optionally also the links to dispatchers can already be established and permanently reserved in order to speed up the call set-up for emergency voice broadcast calls.

In case of A-interface link sharing this message shall contain a list of all cells in the group call area served by this BSC. If the entire list of cell identifiers does not fit into the message, one or more VBS AREA CELL INFO messages with additional cell identifier lists shall be sent. If the cell of origin is served by this BSC, the cell shall be included in the VBS ASSIGNMENT REQUEST message.

VBS_AREA_CELL_INFO: This message shall contain the cell IDs that did not fit into the VBS ASSIGNMENT REQUEST message in case of A-interface link sharing.

PREPARE_GROUP_CALL: The broadcast attributes are sent to every relay MSC and a Group Call number for call set-up to is requested.

PREPARE_GROUP_CALL_ACK: The Group Call number for call set-up is returned to the anchor MSC.

SETUP to MSC-R: The ISUP connection is set-up to the relay MSC.

CONNECT from MSC-R: Set-up of the ISUP connection to the relay MSC is confirmed.

SEND_GROUP_CALL_END_SIGNAL: Indicates to the anchor MSC that at least one downlink channel has been established in the relay MSC area.

VBS_ASSIGNMENT_RESULT: Acknowledgement message from the affected BSC in answer to the assignment request. If the assignment is not successful, a VBS_ASSIGNMENT_FAILURE message shall be sent instead.

In case of A-interface link sharing this message shall be sent as soon as a channel could be established to the cell of origin or, if the cell of origin is not served by this BSC, to any other cell. Then timer T_{ast} shall be started.

In case of AoIP this message shall contain AoIP Transport layer address, call identifier and speech codec information.

T_{ast}: In a network supporting A-interface link sharing timer T_{ast} shall be used to measure the duration between periodic reports from the BSC to the MSC of Group Call Area cells for which channels have been assigned or released since the last periodic report. When timer T_{ast} expires, if new cells in the Group Call Area have been established or existing ones have been released, pre-empted or failed, the MSC shall be informed of the changes (see subclause 7.1b). Timer T_{ast} shall be started again to measure the period of time until the next report. The timer shall be stopped when the call is released.

VBS_ASSIGNMENT_STATUS: This message shall be sent in case of A-interface link sharing from the BSC to inform the MSC about the status of the channel establishment to the cells of a given VBS call. This message shall be

sent after timer *Tast* expires and new channels are established or existing channels were released, pre-empted or failed. This message shall also be immediately sent, and *Tast* restarted, when all cells for a given group call area served by the BSC are established, indicating this.

SETUP to fixed network users: Based on the information determined about the users of external networks to be involved in the call, the MSC shall initiate calls to these users in the normal manner, depending on their mode of connection into the MSC, and shall connect them to the distribution function. Alternatively normal calls to GSM subscribers may be established for dispatchers being GSM subscribers which are not presented in the diagram.

Txx: Timer implemented in the MSC which is started with receipt of the SETUP message from the calling service subscriber. If the timer expires before the conditions for establishment have been met, as per subclause 11.3.1.1.2, then the call shall be released.

NOTIF_REQ (NCH): Messages for notification which contain the broadcast call reference, the priority of the call if eMLPP is applied, and possibly the channel description of the voice broadcast channel to which the mobile stations shall listen and the number of the group key used for ciphering.

NOTIF_REQ (FACCH): Message for notification sent on the FACCH to the mobile stations currently involved in other calls. The notification on the FACCH can include the broadcast call reference, and the priority level and may also include the channel description and the group ciphering key numbers.

Periodic NOTIF_REQ (NCH): The notifications are sent periodically so that mobile stations moving into the area can join the voice broadcast call.

Periodic SACCH Info: Periodic messages sent on SACCH. This message may include:

- information of changes of notifications;
- information used for cell reselection.

CONNECT: Information to the mobile station of the calling service subscriber that the VBS is established with the related broadcast call reference as the connected number. The CONNECT message is sent as soon as conditions for establishment are met, as per subclause 11.3.1.1.2.

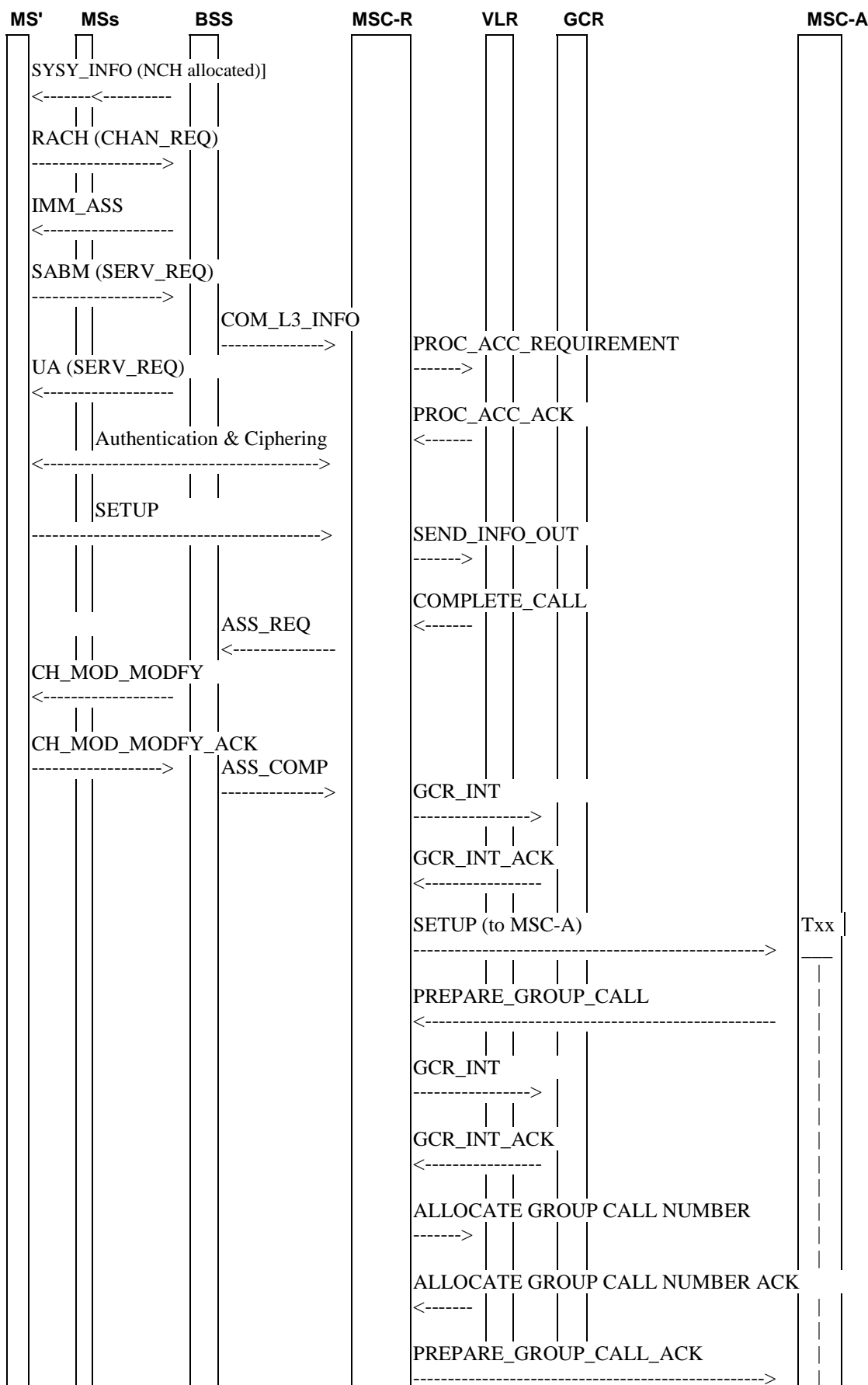

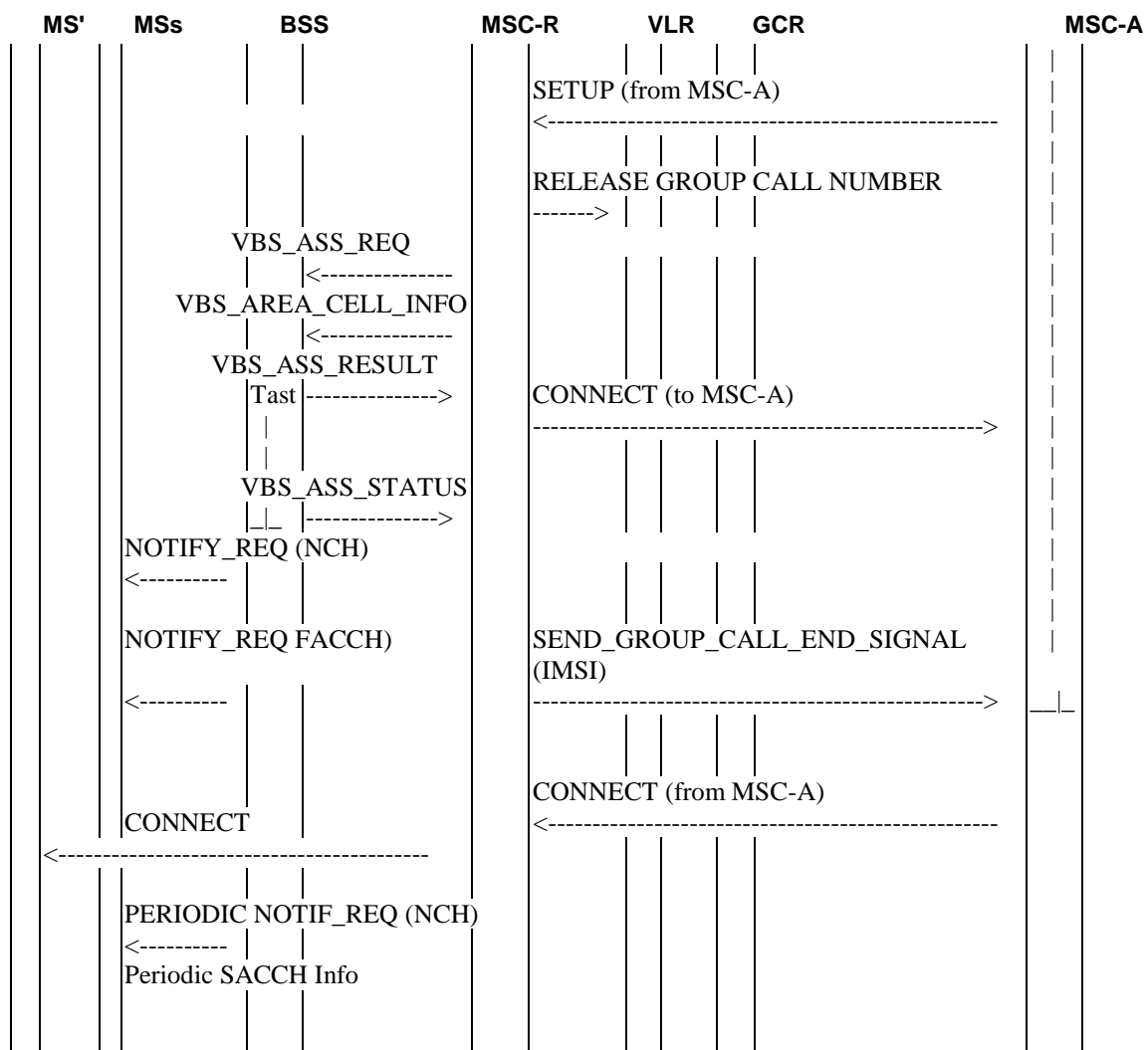

NOTE: MS' = calling service subscriber mobile station;
 MSs = destination service subscriber mobile stations;
 MSC-A = anchor MSC;
 MSC-R = relay MSC.

Figure 3: Signalling information required for establishing voice broadcast calls by a service subscriber roaming in the relay-MS area

SYS_INFO (NCH allocated): Message used to indicate if the NCH is allocated on the CCCH in the cell.

Initial RACH_CHAN_REQ: Standard message.

IMM_ASS: Standard message sent on the AGCH.

SERV_REQ (voice broadcast call): Modified form of the current call request message L3-MM CM SERVICE REQUEST sent on the allocated channel. Teleservice Voice broadcast call is indicated.

UA (SERV_REQ): This message is used to acknowledge the layer 2 link and provide contention resolution of the service request.

COM_L3_INFO: The MSC is provided with initial information about the voice broadcast call.

NOTE 5: Messages flows for authentication and ciphering are not represented although performed as normal.

PROC_ACC_REQ: The MAP_PROCESS_ACC_REQ message is sent to the VLR to check the requested VBS teleservice against the subscription data.

PROC_ACC_ACK: The MAP_PROCESS_ACC_ACK message acknowledges the requested service.

Authentication & Ciphering: Authentication and Ciphering may be performed. Acknowledgement of the service request can also be performed by sending the CM SERVICE ACCEPT.

SETUP: The MSC is provided with details about the voice broadcast call.

NOTE 6: Alternatively, an IMMEDIATE_SETUP may have been send as the initial message including all details of the voice broadcast call. In this case no SETUP message must be sent.

SEND_INFO_OUT: The requested group ID is transferred to the VLR in the MAP_SEND_INFO_FOR_OUTGOING_CALL message.

COMPLETE_CALL: The VLR returns the MAP_COMPLETE_CALL message confirming the use of the requested group ID.

ASSIGNMENT_REQUEST: Standard message.

CHAN_MOD_MODIFY: Standard message to modify the channel mode in case of very early assignment.

CHAN_MOD_MODIFY_ACK: Standard message to acknowledge the modification of the channel mode.

ASSIGNMENT_COMPLETE: Standard message.

NOTE 7: Alternatively, early assignment or OACSU procedures might be applied with the corresponding assignment messages not presented in this figure.

GCR_INT: The broadcast call attributes are requested from the GCR.

GCR_INT_ACK: The requested information (MSC-A address) is returned from the GCR.

SETUP to MSC-A: Based on information received from the GCR the relay MSC shall set-up a dedicated connection for the calling service subscriber to the anchor MSC. The VBS prefix plus broadcast call reference shall be sent as calling party number, and the address of the calling service subscriber's relay MSC shall be sent as generic number parameter, with the number qualifier indicator set to "additional calling party number".

PREPARE_GROUP_CALL: The broadcast call attributes (parts) are received from the anchor MSC.

GCR_INT: The broadcast call attributes are requested from the GCR.

GCR_INT_ACK: The requested information (cell list) is returned from the GCR.

ALLOCATE GROUP CALL NUMBER: The Group Call number is requested from the VLR.

ALLOCATE GROUP CALL NUMBER ACK: The Group Call number is returned from the VLR.

PREPARE_GROUP_CALL_ACK: The Group Call number is sent to MSC-A.

SETUP from MSC-A: The ISUP connection is set-up between MSC-A and MSC-R.

RELEASE GROUP CALL NUMBER: The VLR is requested to release the Group Call number.

VBS_ASSIGNMENT_REQ: This message is sent from the MSC to all affected BSCs, [one dedicated message for every requested channel in a cell,] including the broadcast call reference, the channel type and possibly the call priority and details on the ciphering.

NOTE 8: As an operator option the voice broadcast call channels, the links to them and optionally also the links to dispatchers can already be established and permanently reserved in order to speed up the call set-up for emergency voice broadcast calls.

In case of A-interface link sharing this message shall contain a list of all cells in the group call area served by this BSC. If the entire list of cell identifiers does not fit into the message, one or more VBS AREA CELL INFO messages with additional cell identifier lists shall be sent. If the cell of origin is served by this BSC, the cell shall be included in the VBS ASSIGNMENT REQUEST message.

In case of AoIP this message shall contain call identifier, codec list and AoIP Transport layer address information.

VBS_AREA_CELL_INFO: This message shall contain the cell IDs that did not fit into the VBS ASSIGNMENT REQUEST message in case of A-interface link sharing.

VBS_ASSIGNMENT RESULT: Acknowledgement message from the affected BSC in answer to the assignment requests. If the assignment is not successful, a VBS_ASSIGNMENT_FAILURE message shall be sent instead.

In case of A-interface link sharing this message shall be sent as soon as a channel could be established to the cell of origin or, if the cell of origin is not served by this BSC, to any other cell. Then timer T_{ast} shall be started.

In case of AoIP this message shall contain AoIP Transport layer address, call identifier and speech codec information.

T_{ast}: In a network supporting A-interface link sharing timer T_{ast} shall be used to measure the duration between periodic reports from the BSC to the MSC of Group Call Area cells for which channels have been assigned or released since the last periodic report. When timer T_{ast} expires, if new cells in the Group Call Area have been established or existing ones have been released, pre-empted or failed the MSC shall be informed of the changes (see subclause 7.1b). Timer T_{ast} shall be started again to measure the period of time until the next report. The timer shall be stopped when the call is released.

VBS_ASSIGNMENT_STATUS: This message shall be sent in case of A-interface link sharing from the BSC to inform the MSC about the status of the channel establishment to the cells of a given VBS call. This message shall be sent after timer T_{ast} expires and new channels are established or existing channels are released, pre-empted or failed. This message shall also be immediately sent, and T_{ast} restarted, when all cells for a given group call area served by the BSC are established, indicating this.

CONNECT to MSC-A: Set-up of the ISUP connection from the anchor MSC is confirmed.

SEND_GROUP_CALL_END_SIGNAL (IMSI): This message is sent by the relay MSC on receipt of the VBS ASSIGNMENT RESULT message for the cell in which the call was originated. The IMSI of the calling service subscriber who has established the voice broadcast call indicates to the anchor MSC that this message is sent by the relay MSC where the call was originated and that conversation can start.

If there is more than one relay MSC involved in the VBS call, all other relay MSCs send the SEND_GROUP_CALL_END_SIGNAL message to the anchor MSC when at least one downlink channel has been established in that relay MSC area. In these other SEND_GROUP_CALL_END_SIGNAL messages no IMSI is included.

NOTIF_REQ (NCH): Messages for notification which contain the broadcast call reference, the priority of the call if eMLPP is applied, and possibly the channel description of the voice broadcast call channel to which the mobile stations shall listen and the number of the group key used for ciphering.

NOTIF_REQ (FACCH): Message for notification sent on the FACCH to the mobile stations currently involved in other calls. The notification on the FACCH shall include the broadcast call reference, and the priority level and may include also the channel description and the group ciphering key numbers.

Periodic NOTIF_REQ (NCH): The notifications are sent periodically so that mobile stations moving into the area can join the voice broadcast call.

Periodic SACCH Info: Periodic messages sent on the downlink of the SACCH. This message may include:

- information of changes of notifications;
- information used for cell reselection.

CONNECT (from MSC-A): Call set-up of the dedicated connection for the calling service subscriber is confirmed.

CONNECT: Information to the mobile station of the calling service subscriber that the VBS is established with the related broadcast call reference as the connected number. The CONNECT message is sent as soon as conditions for establishment are met, as per subclause 11.3.1.1.2.

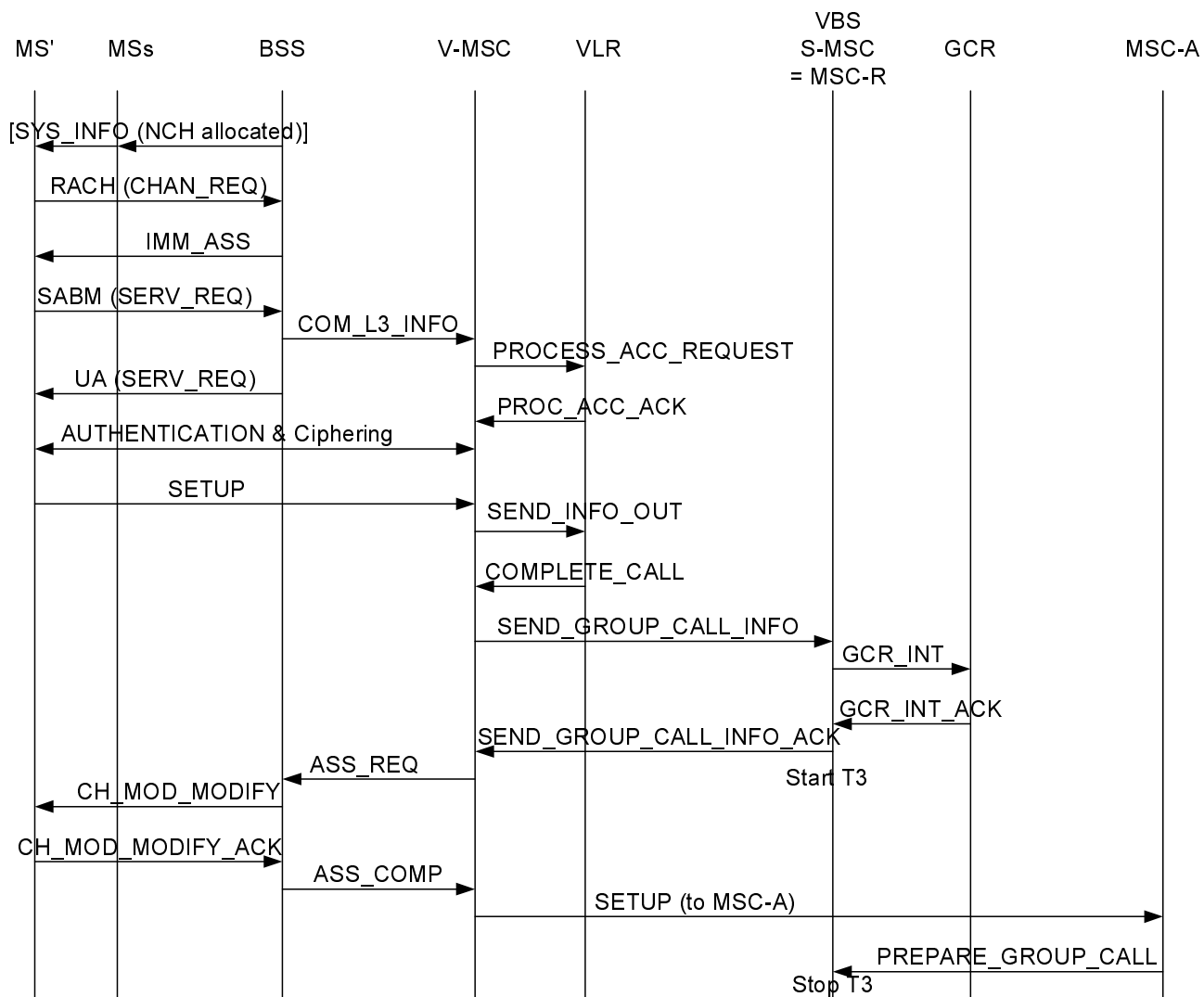

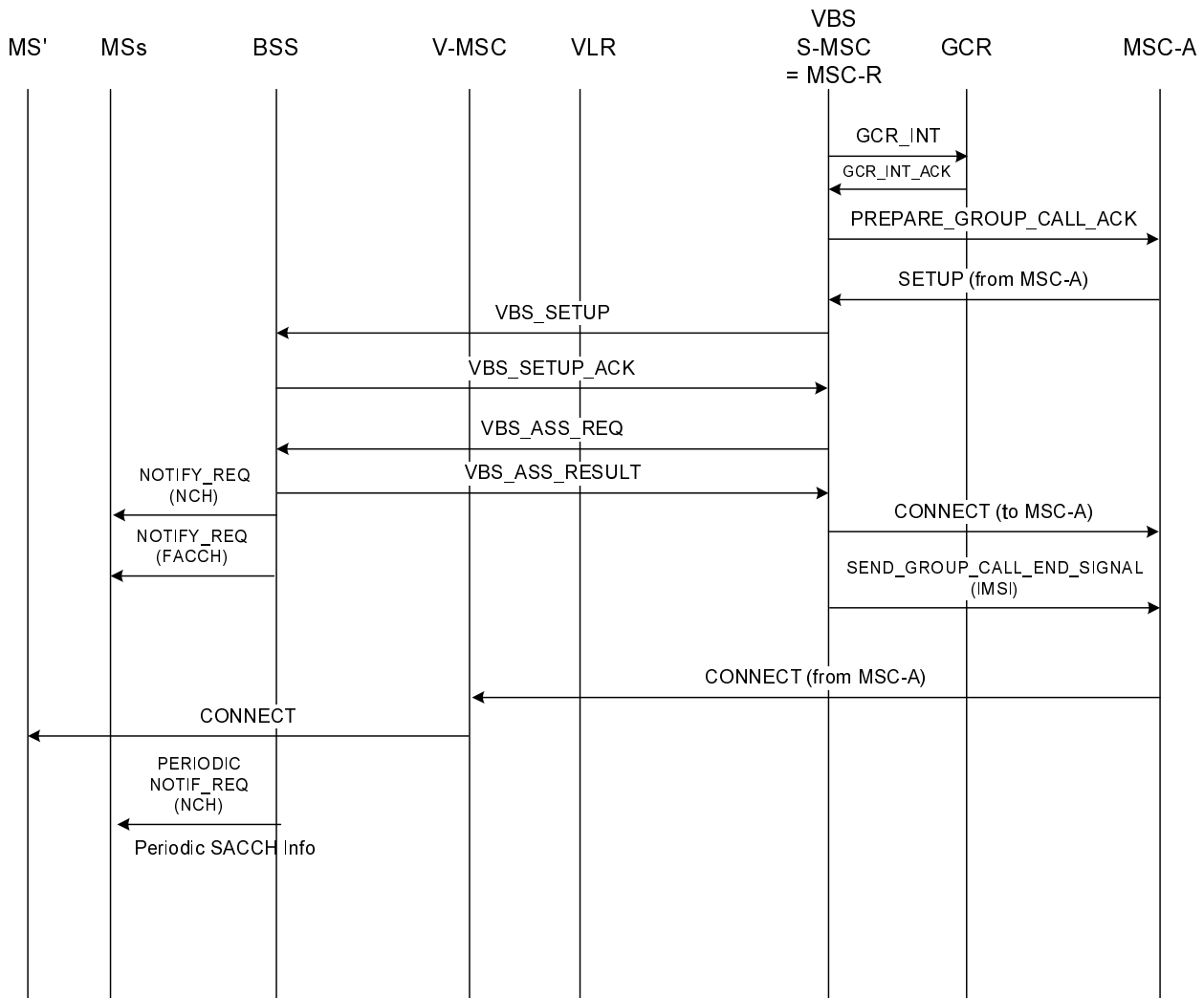

NOTE: MS' = calling service subscriber mobile station;
 MSs = destination service subscriber mobile stations;
 MSC-A = anchor MSC;
 MSC-R = relay MSC;
 V-MSC = visited MSC

Figure 3a: Signalling information required for establishing voice broadcast calls by a service subscriber in a RANflex configuration

SYS_INFO (NCH allocated): Message used to indicate if the NCH is allocated on the CCCH in the cell.

Initial RACH CHAN_REQ: Standard message.

IMM_ASS: Standard message sent on the AGCH.

SERV_REQ (voice broadcast call): Modified form of the current call request message L3-MM CM SERVICE REQUEST sent on the allocated channel. Teleservice Voice broadcast call is indicated.

UA (SERV_REQ): This message is used to acknowledge the layer 2 link and provide contention resolution of the service request.

COM_L3_INFO: The MSC is provided with initial information about the voice broadcast call.

NOTE 8a: Messages flows for authentication and ciphering are not represented although performed as normal.

PROC_ACC_REQ: The MAP_PROCESS_ACC_REQ message is sent to the VLR to check the requested VBS teleservice against the subscription data.

PROC_ACC_ACK: The MAP_PROCESS_ACC_ACK message acknowledges the requested service.

Authentication & Ciphering: Authentication and Ciphering may be performed. Acknowledgement of the service request can also be performed by sending the CM SERVICE ACCEPT.

SETUP: The MSC is provided with details about the voice broadcast call.

NOTE 8b: Alternatively, an IMMEDIATE_SETUP can be sent as the initial message including all details of the voice broadcast call. In this case no SETUP message is sent.

SEND_INFO_OUT: The requested group ID is transferred to the VLR in the MAP_SEND_INFO_FOR_OUTGOING_CALL message.

COMPLETE_CALL: The VLR returns the MAP_COMPLETE_CALL message confirming the use of the requested group ID.

SEND_GROUP_CALL_INFO: The MSC derives from the originating cell's LAC the address of the group call serving MSC and sends MAP_SEND_GROUP_CALL_INFO to it, to retrieve the MSC-A address.

GCR_INT: The broadcast call reference and MSC-A address are requested from the GCR through the GCR Interrogation message sent by the MSC.

GCR_INT_ACK: The requested information (MSC-A address) is returned from the GCR in the GCR Interrogation Ack message.

SEND_GROUP_CALL_INFO_ACK: The requested information is returned to the visited MSC.

ASSIGNMENT_REQUEST: Standard message.

CHAN_MOD_MODIFY: Standard message to modify the channel mode in case of very early assignment.

CHAN_MOD_MODIFY_ACK: Standard message to acknowledge the modification of the channel mode.

ASSIGNMENT_COMPLETE: Standard message.

NOTE 8c: Alternatively, early assignment or OACSU procedures might be applied with the corresponding assignment messages not presented in figure 3a.

SETUP to MSC-A: Based on information received from the group call serving MSC the VMSC shall set-up a dedicated connection for the calling service subscriber to the anchor MSC. The VBS prefix plus broadcast call reference shall be sent as calling party number, and the address of the calling service subscriber's group call serving MSC shall be sent as generic number parameter, with the number qualifier indicator set to "additional calling party number".

PREPARE_GROUP CALL: The broadcast call attributes (parts) are received from the anchor MSC.

GCR_INT: The broadcast call attributes are requested from the GCR through the GCR Interrogation message sent by the MSC.

GCR_INT_ACK: The requested information (cell list) is returned from the GCR in the GCR Interrogation Ack message.

ALLOCATE GROUP CALL NUMBER (not shown in figure 3a): MSC-R requests the group call number from its associated VLR

ALLOCATE GROUP CALL NUMBER ACK (not shown in figure 3a): The Group Call number is returned from the VLR.

PREPARE_GROUP_CALL_ACK: The Group Call number is sent to MSC-A.

SETUP from MSC-A: The ISUP connection is set-up between MSC-A and MSC-R.

RELEASE GROUP CALL NUMBER (not shown in figure 3a): The VLR is requested to release the Group Call number.

VBS_SETUP: This message is sent from the MSC to all affected BSCs, [one dedicated message for each BSC,] including the broadcast call reference with the eMLPP priority, and optionally the call priority.

VBS_SETUP_ACK: Acknowledgement message from the affected BSC in answer to the VBS_SETUP setup message. If the setup is not successful, a VBS_SETUP_REFUSE message shall be sent instead.

VBS_ASSIGNMENT_REQ: This message is sent from the MSC to all affected BSCs, [one dedicated message for every requested channel in a cell,] including the broadcast call reference, the channel type and possibly the call priority and details on the ciphering.

In case of AoIP this message shall contain call identifier, codec list and AoIP Transport layer address information.

NOTE 8d: As an operator option the voice broadcast call channels, the links to them and optionally also the links to dispatchers can already be established and permanently reserved in order to speed up the call set-up for emergency voice broadcast calls.

VBS_ASSIGNMENT_RESULT: Acknowledgement message from the affected BSC in answer to the assignment requests. If the assignment is not successful, a VBS_ASSIGNMENT_FAILURE message shall be sent instead.

In case of AoIP this message shall contain AoIP Transport layer address, call identifier and speech codec information.

CONNECT to MSC-A: Set-up of the ISUP connection from the anchor MSC is confirmed.

SEND_GROUP_CALL_END_SIGNAL (IMSI): This message is sent by the relay MSC on receipt of the VBS ASSIGNMENT RESULT message for the cell in which the call was originated. The IMSI of the calling service subscriber who has established the voice broadcast call indicates to the anchor MSC that this message is sent by the relay MSC where the call was originated and that conversation can start.

If there is more than one relay MSC involved in the VBS call, all other relay MSCs send the SEND_GROUP_CALL_END_SIGNAL message to the anchor MSC when at least one downlink channel has been established in that relay MSC area. In these other SEND_GROUP_CALL_END_SIGNAL messages no IMSI is included.

NOTIF_REQ (NCH): Messages for notification which contain the broadcast call reference, the priority of the call if eMLPP is applied, and possibly the channel description of the voice broadcast call channel to which the mobile stations shall listen and the number of the group key used for ciphering.

NOTIF_REQ (FACCH): Message for notification sent on the FACCH to the mobile stations currently involved in other calls. The notification on the FACCH shall include the broadcast call reference, and the priority level and may include also the channel description and the group ciphering key numbers.

CONNECT (from MSC-A): Call set-up of the dedicated connection for the calling service subscriber is confirmed.

CONNECT: Information to the mobile station of the calling service subscriber that the VBS is established with the related broadcast call reference as the connected number.

Periodic NOTIF_REQ (NCH): The notifications are sent periodically so that mobile stations moving into the area can join the voice broadcast call.

Periodic SACCH Info: Periodic messages sent on the downlink of the SACCH informing mobile stations of:

- information of changes of notifications;
- information used for cell re-selection.

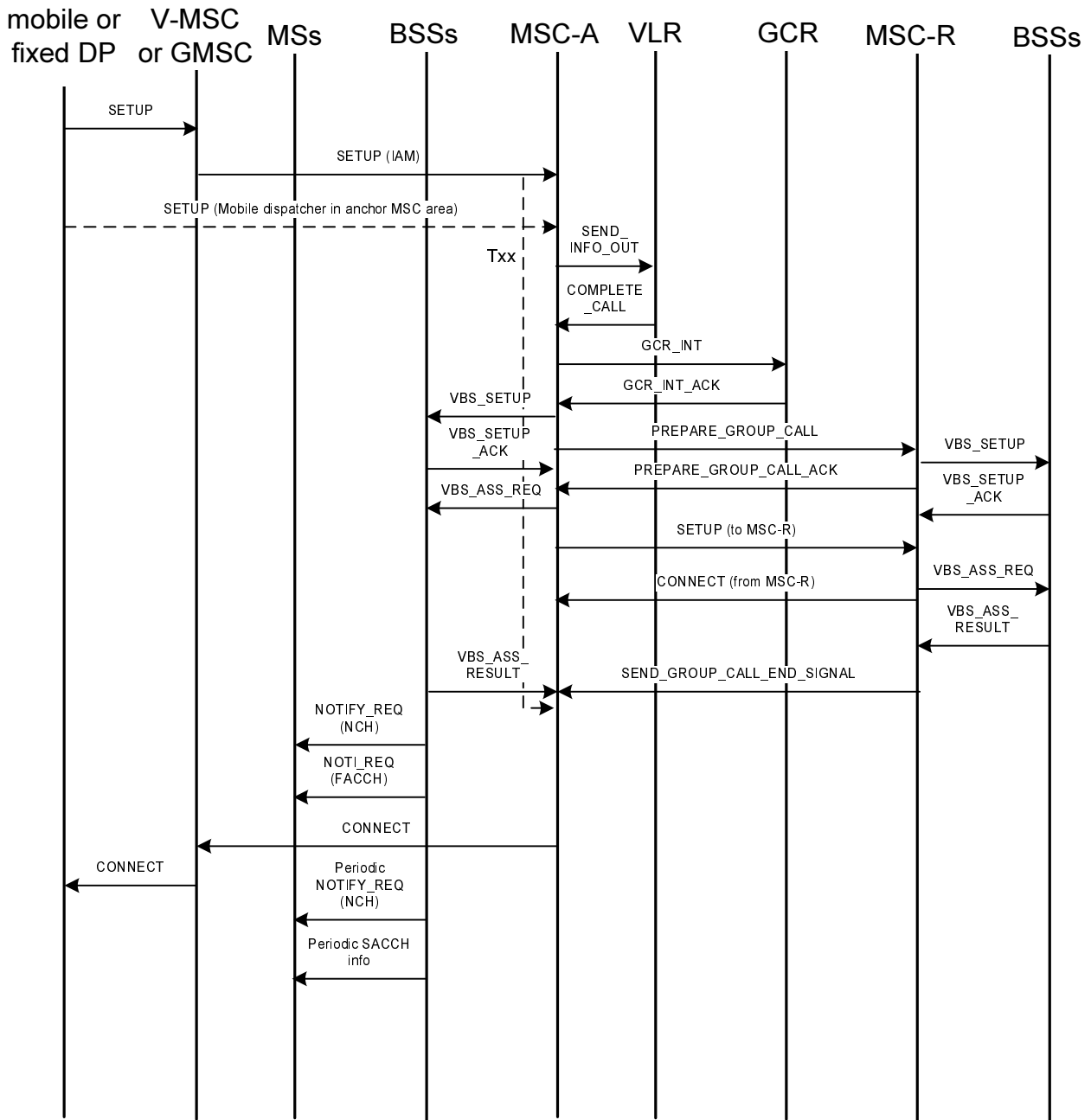

NOTE: DP = dispatcher;
 MSs = destination subscriber mobile stations;
 MSC-A = anchor MSC;
 MSC-R = relay MSC;
 V-MSC = visited MSC;
 GMSC = Gateway MSC

Figure 3b: Signalling information required for establishing voice broadcast calls by a mobile dispatcher or fixed line dispatcher

SETUP: Mobile dispatcher or fixed line dispatcher sets up a VGCS call. The visited MSC or the Gateway MSC receives the SETUP message with details about the voice broadcast call including the Group Call Reference within the MSISDN dialled by the originating dispatcher.

SETUP (IAM): The visited MSC or the Gateway MSC sends an IAM message to the anchor MSC of the group call based on the called party MSISDN number.

SETUP (Mobile dispatcher in anchor MSC area): If the originating mobile dispatcher is located in the anchor MSC area, the SETUP message with details about the voice broadcast call including the Group Call Reference within the

MSISDN dialled by the originating dispatcher is received directly by the anchor MSC (further messages regarding the standard SETUP procedure are not drawn in the Fig.)

SEND_INFO_OUT: The requested group ID is transferred to the VLR in the internal MAP_SEND_INFO_FOR_OUTGOING_CALL message.

COMPLETE_CALL: The VLR returns the MAP_COMPLETE_CALL message confirming the use of the requested group ID.

GCR_INT: The group call attributes are requested from the GCR through the GCR Interrogation message sent by the MSC.

GCR_INT_ACK: The requested information is returned from the GCR in the GCR Interrogation Ack message.

VBS_SETUP: Anchor MSC sends to BSS's a VBS SETUP message across VBS call controlling SCCP connection to initiate a VBS call set-up procedures.

VBS SETUP ACK: After receiving the VBS_SETUP message, BSS will allocate resources to the call and returns VBS SETUP ACK message to the MSC. This connection is established for the lifetime of the VBS call.

VBS_ASSIGNMENT_REQ: This message is sent from the MSC to all affected BSCs, [including the group call reference, the channel type and possibly the call priority and details on the ciphering. In case of AoIP this message shall contain call identifier, codec list and AoIP **Transport layer address** information.

PREPARE_GROUP CALL: The group call attributes are sent to every relay MSC and a Group Call number for call set-up to is requested.

PREPARE_GROUP CALL ACK: The Group Call number for call set-up is returned to the anchor MSC.

SETUP to MSC-R: The ISUP connection is set-up to the relay MSC.

VBS_SETUP: Relay MSC sends to BSSs a VBS SETUP message to initiate a VBS call set-up procedures.

VBS SETUP ACK: After receiving the VBS_SETUP message, BSS will allocate resources to the call and returns VBS SETUP ACK message to the MSC. This connection is established for the lifetime of the VBS call.

VBS_ASSIGNMENT_REQ: This message is sent from the relay MSC to all affected BSCs, [including the group call reference, the channel type and possibly the call priority and details on the ciphering. In case of AoIP this message shall contain call identifier, codec list and AoIP Transport layer address information.

CONNECT from MSC-R: Set-up of the ISUP connection to the relay MSC is confirmed.

VBS_ASSIGNMENT RESULT: Acknowledgement message from the affected BSC in answer to the assignment requests. If the assignment is not successful, a VBS_ASSIGNMENT_FAILURE message shall be sent instead.

In case of AoIP this message shall contain AoIP Transport layer address, call identifier and speech codec information.

SEND_GROUP CALL_END_SIGNAL: Indicates to the anchor MSC that at least one voice broadcast call channel has been established in the relay MSC area.

Txx: Timer implemented in the anchor MSC which is started with receipt of the SETUP message from the dispatcher. If the timer expires before the conditions for establishment have been met, as per subclause 11.3.1.1.2, then the call shall be released.

NOTIF_REQ (NCH): Messages for notification which contain the group call reference, the priority of the call if eMLPP is applied, and possibly the channel description of the voice broadcast call channel to which the mobile stations shall listen and the number of the group key used for ciphering.

NOTIF_REQ (FACCH): Message for notification sent on the FACCH to the mobile stations currently involved in other calls. The notification on the FACCH shall include the group call reference; and the priority level and may also include the channel description and the group ciphering key numbers.

CONNECT: Information to the originating that the VBS is established with the related group call reference as the connected number.

Periodic NOTIF_REQ (NCH): The notifications are sent periodically so that mobile stations moving into the area can join the voice broadcast call.

Periodic SACCH Info: Periodic messages sent on SACCH. This message may include:

- information of changes of notifications;
- information used for cell re-selection.

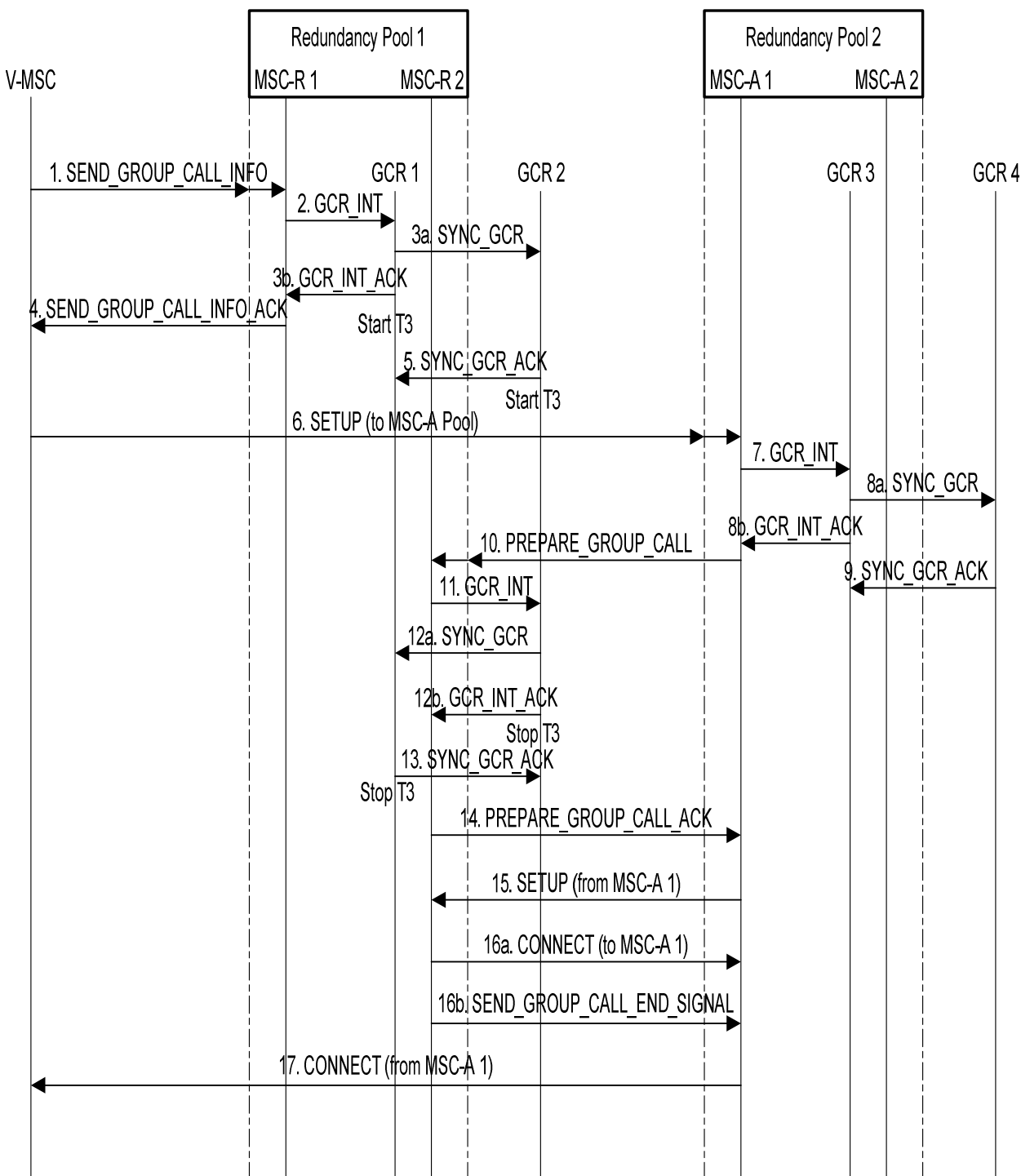

Figure 3c: Signalling information required for establishing voice broadcast calls by a service subscriber in a RANflex configuration with group call redundancy

See also figure 3a

- 1. SEND_GROUP_CALL_INFO:** The V-MSC derives from the originating cell's LAC the address of the group call serving MSC redundancy pool and sends MAP_SEND_GROUP_CALL_INFO to it, to retrieve the group call anchor MSC redundancy pool address. Network routing shall be configured so that the message is routed to one of the available MSCs within the redundancy pool. In this example MSC-R1 is selected. The message includes initial talker information.
 - 2. GCR_INT:** MSC-R 1 requests from its associated GCR the group call reference and group call anchor MSC redundancy pool address. The message may contain initial talker information.
 - 3a. SYNC_GCR:** Initial Talker Information is propagated to all GCRs associated to MSCs within the redundancy pool.
 - 3b. GCR_INT_ACK:** The requested information is returned from the GCR in the GCR Interrogation Ack message. To avoid glare cases GCR 1 may need to wait for message 5 before sending message 3b.
 - 4. SEND_GROUP_CALL_INFO_ACK:** The requested information is returned to the visited MSC.
 - 5. SYNC_GCR_ACK:** Successful GCR synchronization is acknowledged.
 - 6. SETUP to MSC-A:** Based on information received from the group call serving MSC the VMSC shall set-up a dedicated connection for the calling service subscriber to the group call anchor MSC redundancy pool. Network routing shall be configured so that the message is routed to one of the available MSCs within the redundancy pool. In this example MSC-A1 is selected. The VBS prefix plus broadcast call reference shall be sent as calling party number. The address of the calling service subscriber's group call serving MSC pool shall be sent as generic number parameter, with the number qualifier indicator set to "additional calling party number"; this shall be the same address as used to route message 1.
 - 7. GCR_INT:** MSC-A 1 requests from its associated GCR the broadcast call attributes and makes the broadcast call "on-going".
 - 8a. SYNC_GCR:** The "on-going" indication is propagated to all GCRs associated to MSCs within the redundancy pool.
 - 8b. GCR_INT_ACK:** The requested information is returned from the GCR in the GCR Interrogation Ack message. To avoid glare cases GCR 3 may need to wait for message 9 before sending message 8b.
 - 9. SYNC_GCR_ACK:** Successful GCR synchronization is acknowledged.
 - 10. PREPARE_GROUP_CALL:** MSC-A 1 sends PREPARE_GROUP_CALL to the group call relay MSC redundancy pool. Network routing shall be configured so that the message is routed to one of the available MSCs within the redundancy pool. In this example MSC-R2 is selected.
 - 11. GCR_INT:** MSC-R 2 interrogates its associated GCR to retrieve the group call attributes and initial talker information and to mark the broadcast call "on-going" and to delete the initial talker information.
 - 12a. SYNC_GCR:** The "on-going" indication is propagated to all GCRs associated to MSCs within the redundancy pool.
 - 12b. GCR_INT_ACK:** The requested information is returned from the GCR in the GCR Interrogation Ack message.
 - 13. SYNC_GCR_ACK:** Successful GCR synchronization is acknowledged.
- ALLOCATE GROUP CALL NUMBER (not shown in figure 8a):** MSC-R2 requests the Group Call number from its associated VLR
- ALLOCATE GROUP CALL NUMBER ACK (not shown in figure 8a):** The Group Call number is returned from the VLR.
- 14. PREPARE_GROUP_CALL_ACK:** The Group Call number is sent to MSC-A1.
 - 15. SETUP from MSC-A1:** The ISUP connection is set-up between MSC-A1 and MSC-R2 using the Group Call number received in step 14.
 - RELEASE GROUP CALL NUMBER (not shown in figure 8a):** The VLR is requested to release the Group Call number.
 - 16a. CONNECT to MSC-A:** Set-up of the ISUP connection from the anchor MSC is confirmed.

16b. SEND_GROUP_CALL_END_SIGNAL (IMSI): Indicates to the anchor MSC that conversation can start. In addition the IMSI of calling service subscriber who has established the voice group call and who is allowed to terminate the call is included. After sending message 16b MSC-R2 deletes initial talker information (if any) as it may be invalid due to a lost race condition. Valid initial talker information (if any) may be received with message 17b.

17. CONNECT (from MSC-A): Call set-up of the dedicated connection for the calling service subscriber is confirmed.

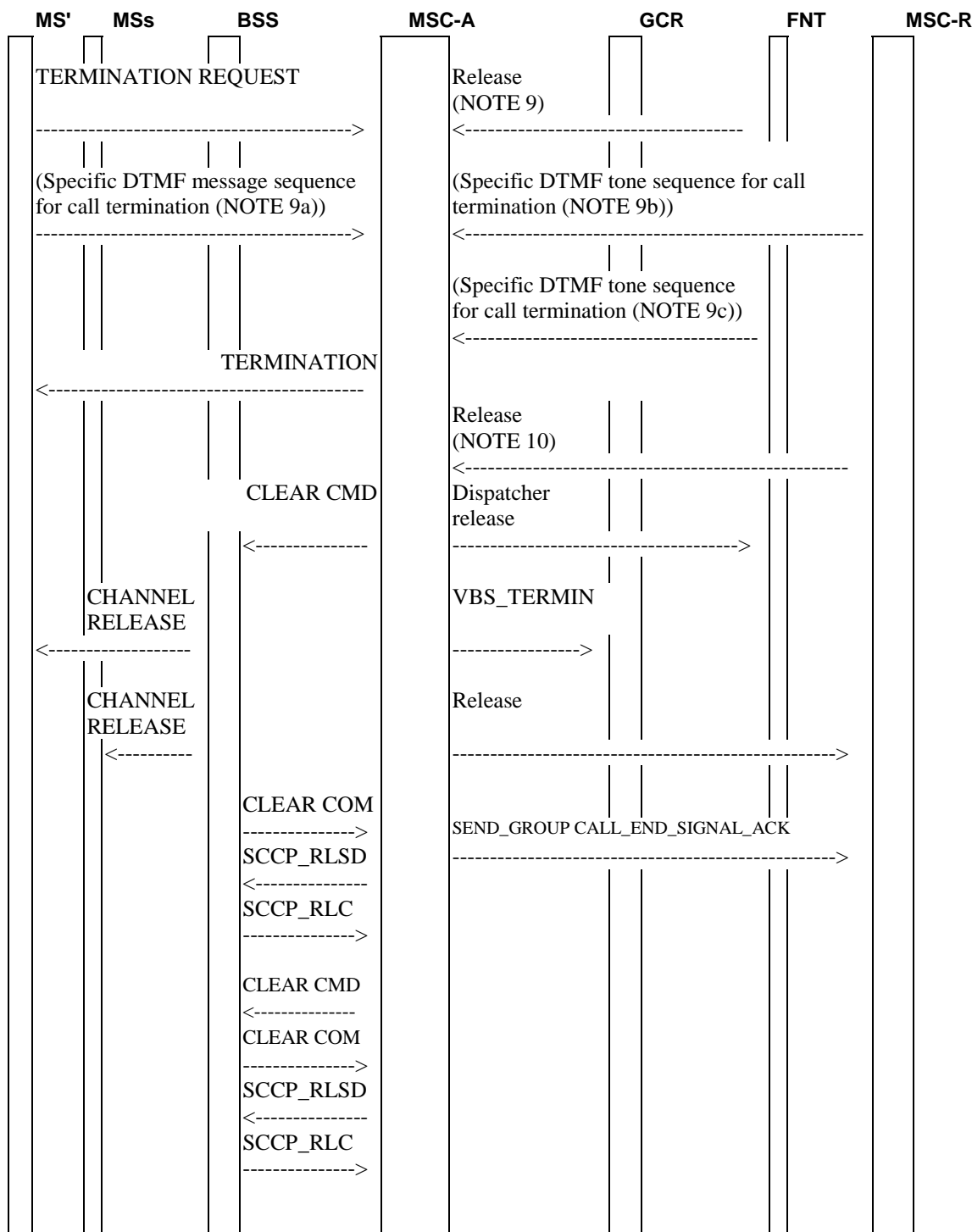

Figure 4: Signalling required to disconnect the voice broadcast call

TERMINATION REQUEST: The calling service subscriber's mobile station can send a TERMINATION REQUEST message to clear down the entire voice broadcast call.

NOTE 9: Alternatively an authorized dispatcher can terminate the voice broadcast call in which case a release message is received from the external network.

NOTE 9a: Alternatively an authorized mobile dispatcher can terminate the voice broadcast call by using a specific DTMF message sequence. If the mobile dispatcher is controlled by the anchor MSC, the specific DTMF message sequence is received by the anchor MSC (see figure 4b).

NOTE 9b: If the mobile dispatcher is controlled by a relay MSC, the specific DTMF message sequence is received by the relay MSC. The relay MSC converts the DTMF messages into DTMF tones and sends them towards the anchor MSC (see figure 4c).

NOTE 9c: Alternatively an authorized fixed line dispatcher can terminate the voice broadcast call by using a specific DTMF tone sequence. In this case, the specific DTMF tone sequence is received by the anchor MSC (see figure 4d).

NOTE 10: Alternatively the calling service subscriber currently served by the relay-MSC can terminate the call in which case a release message is received from the relay MSC on the dedicated connection.

CLEAR CMD: This message is sent from the MSC to the BSS via each Resource Controlling SCCP connection to clear radio and terrestrial resources.

VBS_TERMIN: The MSC informs the GCR that the voice broadcast call with the related broadcast call reference is terminated.

CHANNEL RELEASE: CHANNEL RELEASE messages are sent to the calling subscriber and on all downlink FACCH to the service subscribers. The CHANNEL RELEASE messages shall be repeated for a predefined period in order to provide a high probability that the listening mobile stations receive the message.

- CHANNEL RELEASE message is sent using I frame for the calling subscriber.
- CHANNEL RELEASE messages are sent using UI frames for listeners.

In addition, release messages are sent to all related dispatchers and relay MSCs.

SEND_GROUP_CALL_END_SIGNAL_ACK: The dialogues to all relay MSCs are closed.

CLEAR COMPLETE: standard message.

SCCP_RLSD: standard message sent via resource controlling SCCP connection.

SCCP_RLC: standard message.

CLEAR CMD: This message is sent from the MSC to the BSS via the Call Controlling SCCP connection, after all the terrestrial resources associated with the BSS for this broadcast call have been released.

CLEAR COMPLETE: standard message.

SCCP_RLSD: standard message sent via call controlling SCCP connection.

SCCP_RLC: standard message.

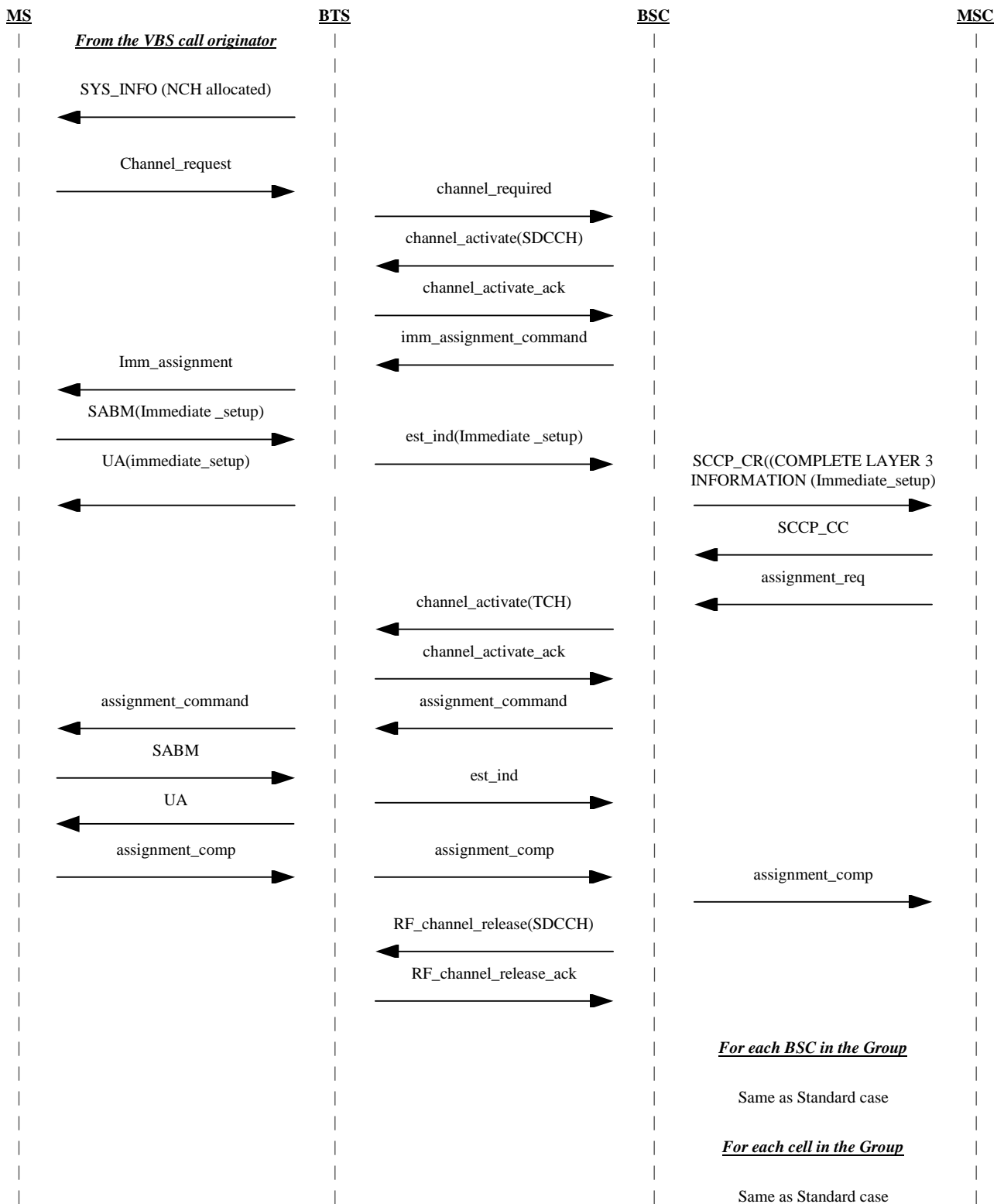

Figure 4a: Signalling information required for establishing voice broadcast calls by a service subscriber using immediate setup

SYS_INFO (NCH allocated): Message used to indicate if the NCH is allocated on the CCCH in the cell.

Initial RACH CHAN_REQ: Standard message.

IMM_ASSIGNMENT: Standard message sent on the AGCH.

IMMEDIATE_SETUP: This message including all details of the broadcast call is sent by the MS to the network in order to set-up a broadcast call immediately, i.e. without previous establishment of an MM connection.

UA (IMMEDIATE_SETUP): This message is used to acknowledge the layer 2 link and provide contention resolution of the immediate setup.

NOTE 11: Authentication and/ or activation of Ciphering may be performed before or after sending a CONNECT message. If ciphering has not been activated before sending a CONNECT message, a CM_SERVICE ACCEPT may be sent before the CONNECT message by the MSC, however sending of the CM_SERVICE_ACCEPT is not mandatory.

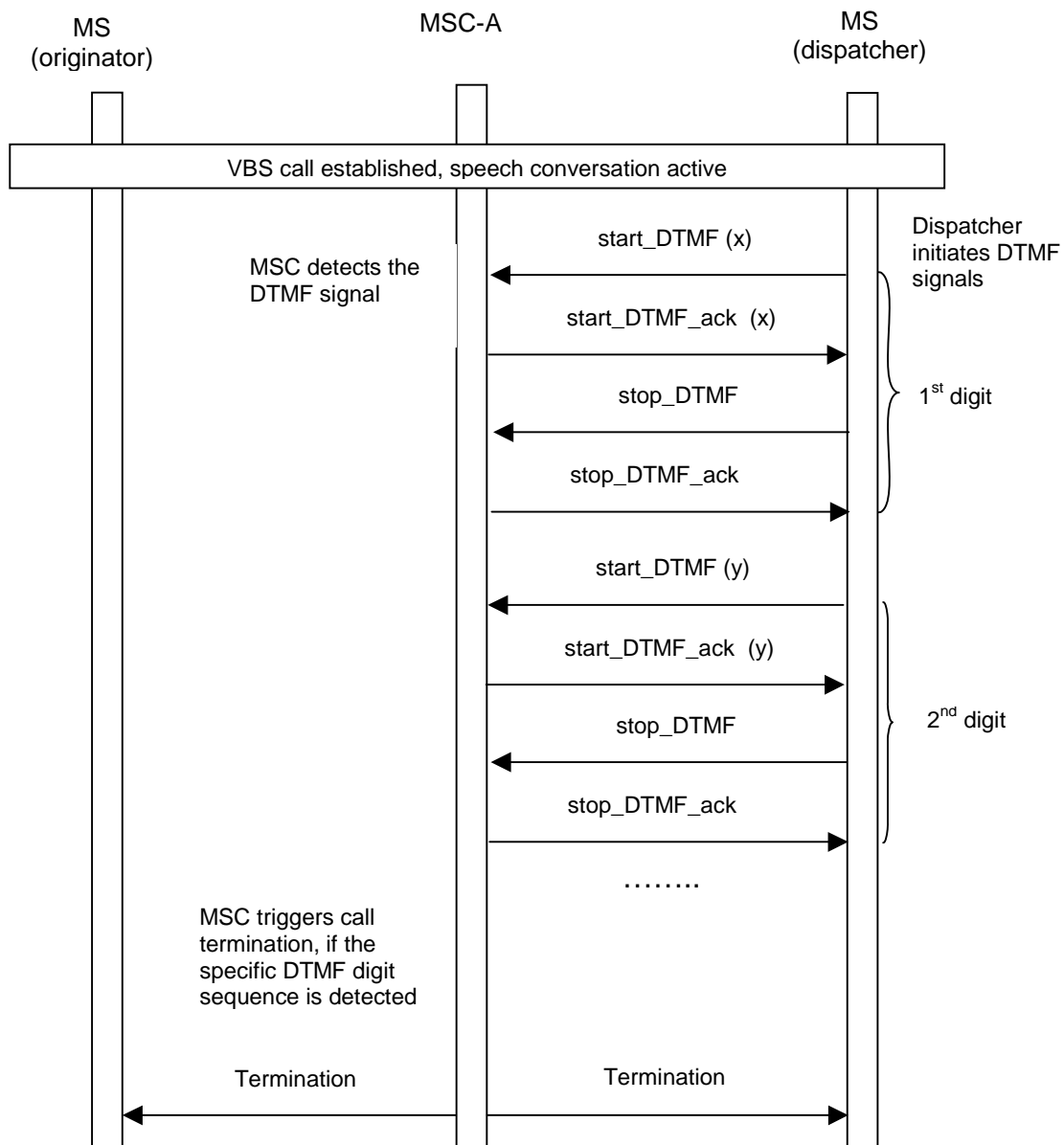

Figure 4b: Signalling required for broadcast call termination by an entitled mobile dispatcher, if the mobile dispatcher is controlled by the anchor MSC of the broadcast call.

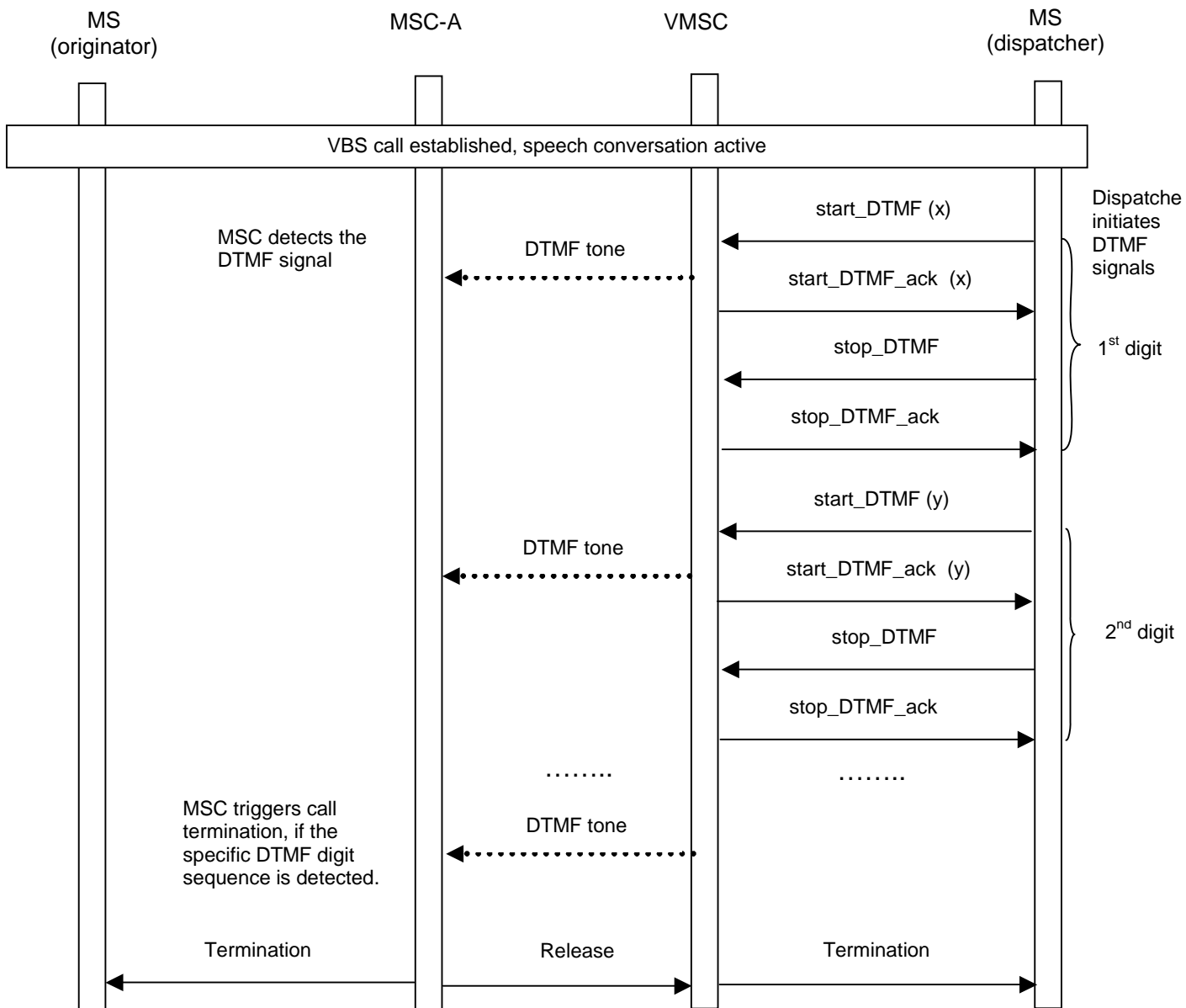

Figure 4c: Signalling required for broadcast call termination by an entitled mobile dispatcher, if the mobile dispatcher is controlled by a visited MSC (could be a relay MSC) of the broadcast call.

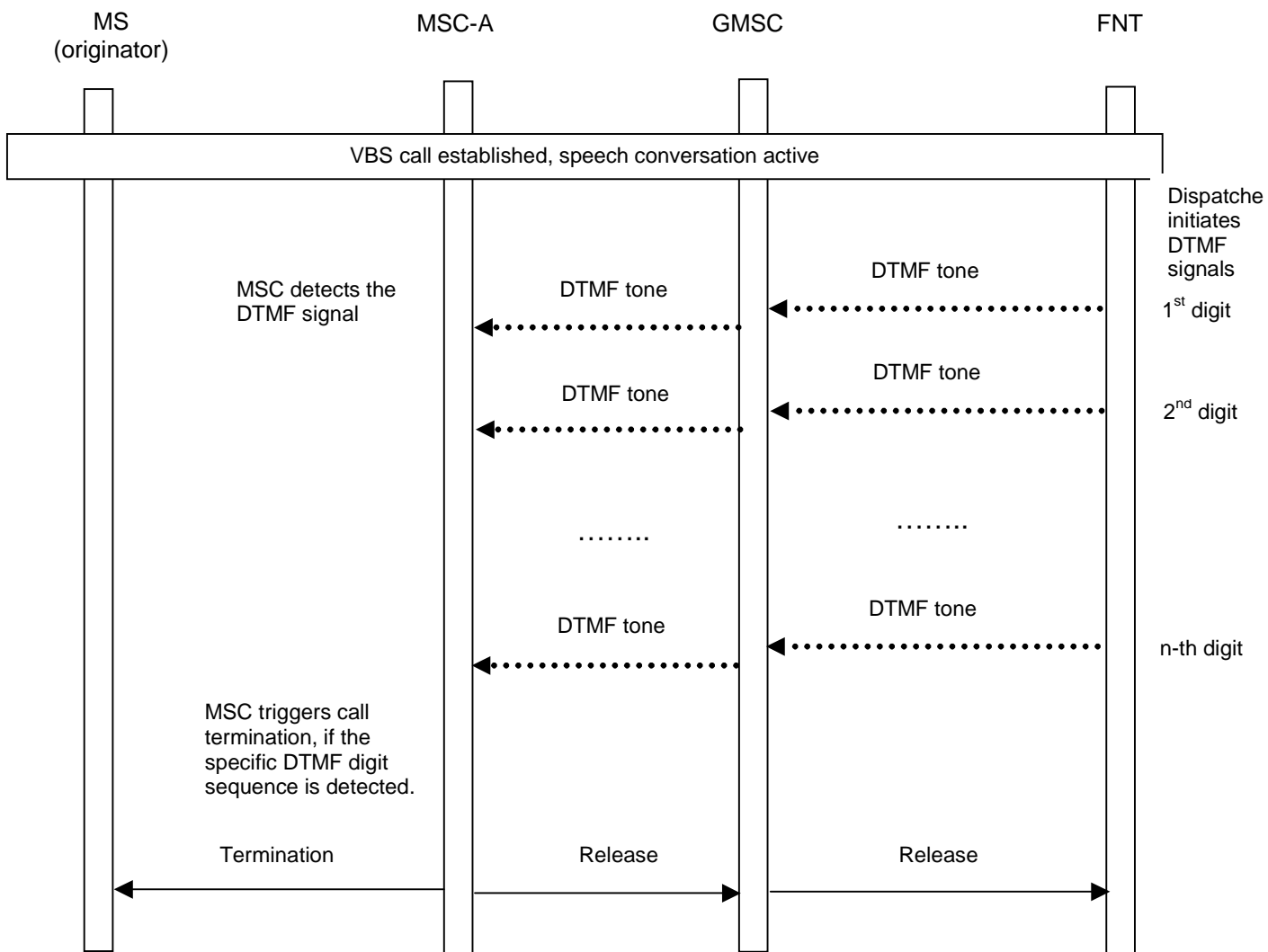
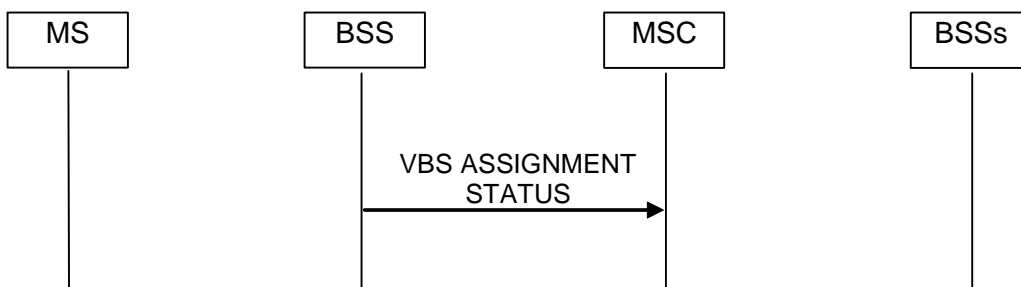

Figure 4d: Signalling required for broadcast call termination by an entitled fixed line dispatcher.



NOTE: The terrestrial resource for the broadcast call channel is not released.

Figure 4e: A-interface link sharing used or broadcast call re-establishment by the BSS supported: release after equipment failure (TRX, PCM ...) concerning a cell that is not serving the originating service subscriber

If A-interface link sharing is used or broadcast call re-establishment by the BSS is supported, and a failure concerning a cell that is not serving the originating service subscriber was detected, the BSS shall send the VBS ASSIGNMENT STATUS message indicating that the connection to this cell is no longer established (see figure 4e). If A-interface link sharing is used, the VBS ASSIGNMENT STATUS message shall be sent on expiry of timer T_{ast}.

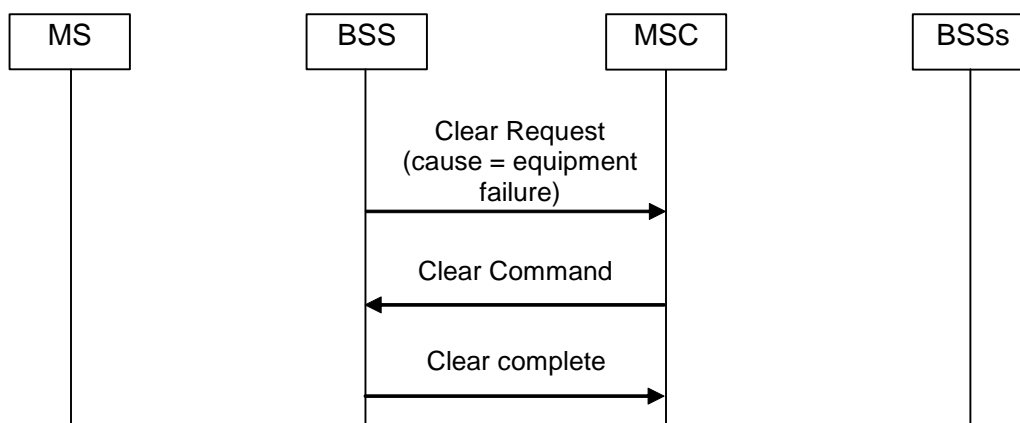

Figure 4f: A-interface link sharing used or broadcast call re-establishment by the BSS supported: release after equipment failure concerning the link between MSC and BSS

If A-interface link sharing is used or broadcast call re-establishment by the BSS is supported, the BSC shall send the message CLEAR REQUEST with cause value "equipment failure" or another appropriate cause value, if a failure concerning the link between MSC and BSS was detected and the resources related to this connection shall be released (see figure 4f). After receipt of the CLEAR REQUEST message the MSC shall send a CLEAR COMMAND message for the respective connection and try to establish a new connection.

11.4 Functional requirement of Anchor-MSC

The VBS handling process in the anchor MSC is shown in figure 5.

Successful call set-up

When the VBS handling process in the anchor MSC receives a VBS call set-up request from either a dispatcher or a service subscriber currently located in the anchor MSC's area or a service subscriber currently located in a relay MSC's area, or - in a RANflex configuration or in a RANflex configuration with group call redundancy - from a service subscriber currently registered in a VMSC, it interrogates its associated GCR to retrieve the broadcast call attributes, and waits for a response.

If the GCR returns a positive response containing the broadcast call attributes, the anchor MSC sets up the downlinks to the cells inside the MSC area of the group call anchor MSC into which the call is to be sent, sets up the connections to the dispatchers to which a dedicated link is to be established, sets up the connections to the relay MSCs or relay MSC redundancy pools into which the call is to be sent and waits for call release.

Procedure Setup Connections to Relay MSCs and BSCs

The procedure is shown in figure 6.

The procedure

- sets up the downlinks to the cells inside the MSC area of the group call anchor MSC into which the call is to be sent;
- sends PREPARE_GROUP_CALL messages to all relay MSCs (in a RANflex configuration with group call redundancy: to all group call relay MSC redundancy pools) and waits for the responses.

If a positive response containing a Group Call number is received from a relay MSC, the anchor MSC constructs an IAM using the Group Call number as called party address, sends it to the relay MSC and waits for the SEND_GROUP_CALL_END_SIGNAL message.

If a SEND_GROUP_CALL_END_SIGNAL message without IMSI is received from a relay MSC, this indicates to the anchor MSC that at least one downlink to a cell has been successfully connected in the relay MSC.

If the call was originated by a service subscriber in a relay MSC area and a SEND_GROUP_CALL_END_SIGNAL message with the IMSI of the originator is received from this relay MSC, this indicates to the anchor MSC that the downlink to the originating cell has been successfully connected.

Relay MSCs (in a RANflex configuration with group call redundancy: relay MSC redundancy pools) that do not send positive responses to the PREPARE_GROUP_CALL message are no longer considered to belong to the list of relay MSCs (or relay MSC redundancy pools) for this VBS call.

If, after receipt of a positive response containing a Group Call number from a relay MSC, the anchor MSC receives an ABORT from the relay MSC, the relay MSC or relay MSC redundancy pool will no longer be considered to belong to the list of relay MSCs or relay MSC redundancy pools for this VBS call.

Optionally in both cases the anchor MSC may retry to establish the connection to the relay MSC or relay MSC redundancy pool, instead of no longer considering the relay MSC or relay MSC redundancy pool to belong to the list of relay MSCs or relay MSC redundancy pools.

If an ABORT message is received from the relay MSC or relay MSC redundancy pool the anchor MSC releases the connection, established with the Group Call number, to the relay MSC or relay MSC redundancy pool and the relay MSC or relay MSC redundancy pool is no longer considered to belong to the list of relay MSCs or relay MSC redundancy pools for this VBS call.

If a Release message for the connection established with the Group Call number is received from a relay MSC or relay MSC redundancy pool, then the relay MSC or relay MSC redundancy pool is no longer considered to belong to the list of relay MSCs or relay MSC redundancy pools for this VBS call. If the negative response on the PREPARE_GROUP_CALL message is received from originating relay MSC, the call may be released.

Unsuccessful call set-up

If the call set-up is unsuccessful (i.e. conditions for call establishment have not been met as per subclause 11.3.1.1.2) the anchor MSC releases the connections to the relay MSCs, aborts any dialogues to relay MSCs, releases all connections to dispatchers, all downlinks to cells inside the anchor MSC area are released, the GCR is informed that the call is no longer on-going and the process returns to the idle state.

Negative response received from the GCR

If the GCR returns a negative response to the anchor MSC indicating that the call is already on-going locally i.e. at the associated MSC, the anchor MSC checks whether the new call was initiated by a dispatcher. If so, the dispatcher is connected to the on-going call and the process returns to the idle state. If the new call was initiated by a service subscriber, a Release message indicating 'user busy' is returned in order to force the mobile station of the service subscriber to look for notifications of the respective group ID on the NCH and join the broadcast call.

If (in a RANflex configuration with group call redundancy) the GCR returns a negative response to the selected anchor MSC indicating that the call is already on-going at another MSC within the group call anchor MSC redundancy pool, the selected anchor MSC checks whether the new call was initiated by a dispatcher or a service subscriber served by another VMSC. If so, the selected anchor MSC forwards the call setup request to the anchor MSC where the group call is ongoing (possibly using a special prefix for the called party number). The selected anchor MSC then acts as a transit node unless it recognizes that the anchor MSC where the broadcast call is ongoing is out of service. In the latter case the selected anchor MSC repeats the GCR interrogation including "ongoing call override indication". If the call was initiated by a service subscriber served by the selected anchor MSC, the selected anchor MSC interrogates the anchor MSC where the broadcast call is ongoing by means of the MAP service SEND_GROUP_CALL_INFO and waits for a response. If the selected anchor MSC recognizes that the anchor MSC where the broadcast call is ongoing is out of service or if that anchor MSC responds with a positive SEND_GROUP_CALL_INFO response (i.e. the GCRs are out of synch and the broadcast call at the other anchor MSC is not ongoing), then the selected anchor MSC repeats the GCR interrogation including "ongoing call override indication". If the anchor MSC where the broadcast call is ongoing responds with a negative SEND_GROUP_CALL_INFO response (ongoing call), then the selected anchor MSC returns a Release message indicating "user busy" in order to force the mobile station of the service subscriber to look for notifications of the respective group ID on the NCH and join the broadcast call.

If the negative response from the GCR indicates any other reason than 'on-going call' the VBS call set-up request is rejected by sending a release message back to the initiator and the process returns to the idle state.

Call release

If the anchor MSC receives the specific DTMF message sequence or the specific DTMF tone sequence for call termination from a dispatcher who is allowed to terminate the voice broadcast call (see figures 4b to 4d), or a Termination Request message from the service subscriber who has initiated the VBS call or a Release message from the relay MSC for the calling service subscriber's dedicated connection to the anchor MSC, the connections to the relay MSCs are released and any MAP dialogues to relay MSCs are closed by sending SEND_GROUP_CALL_END_SIGNAL_ACK, all connections to dispatchers are released, all downlinks to cells inside the anchor MSC area are released, the GCR is informed that the call is no longer on-going and the process returns to the idle state.

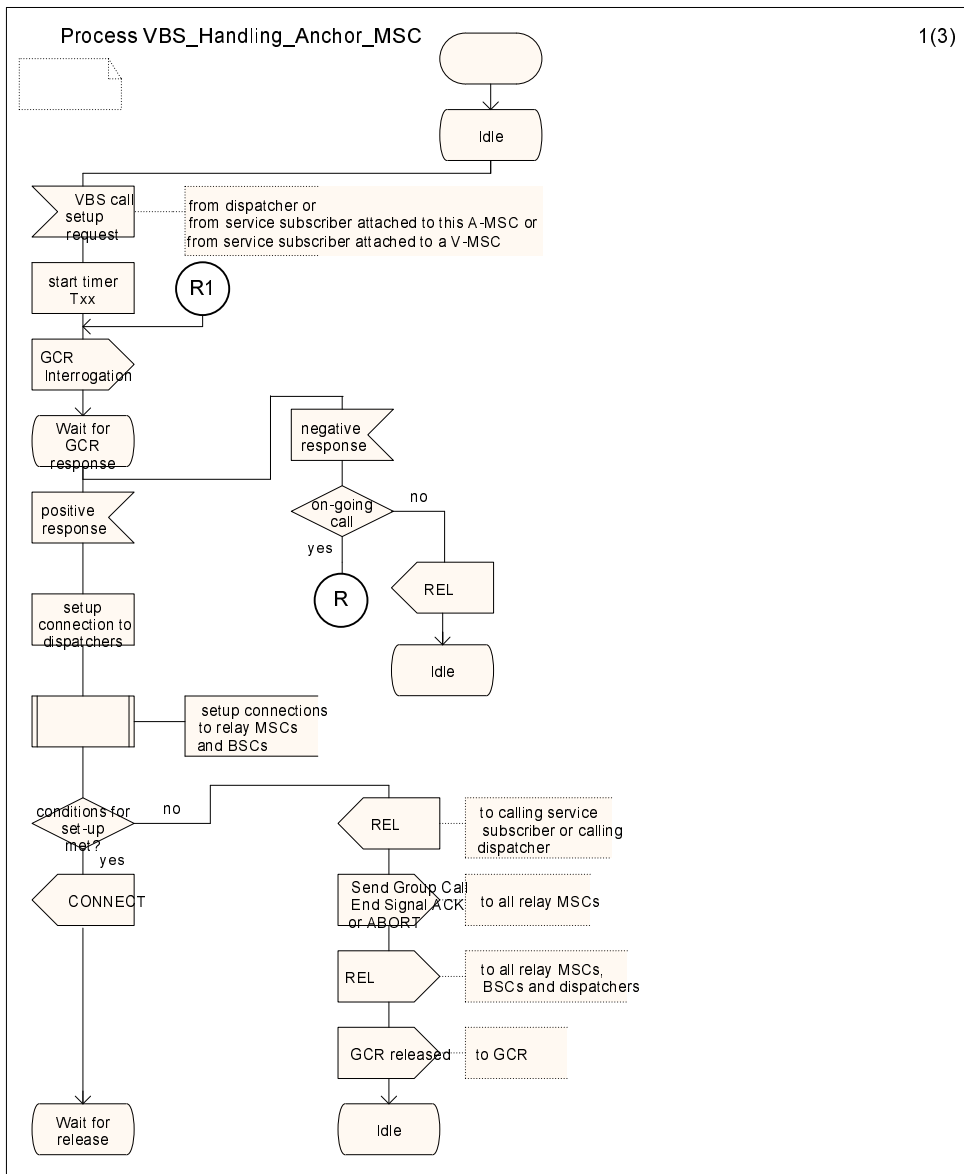

Figure 5: VBS handling process in the anchor MSC (sheet 1 of 3)

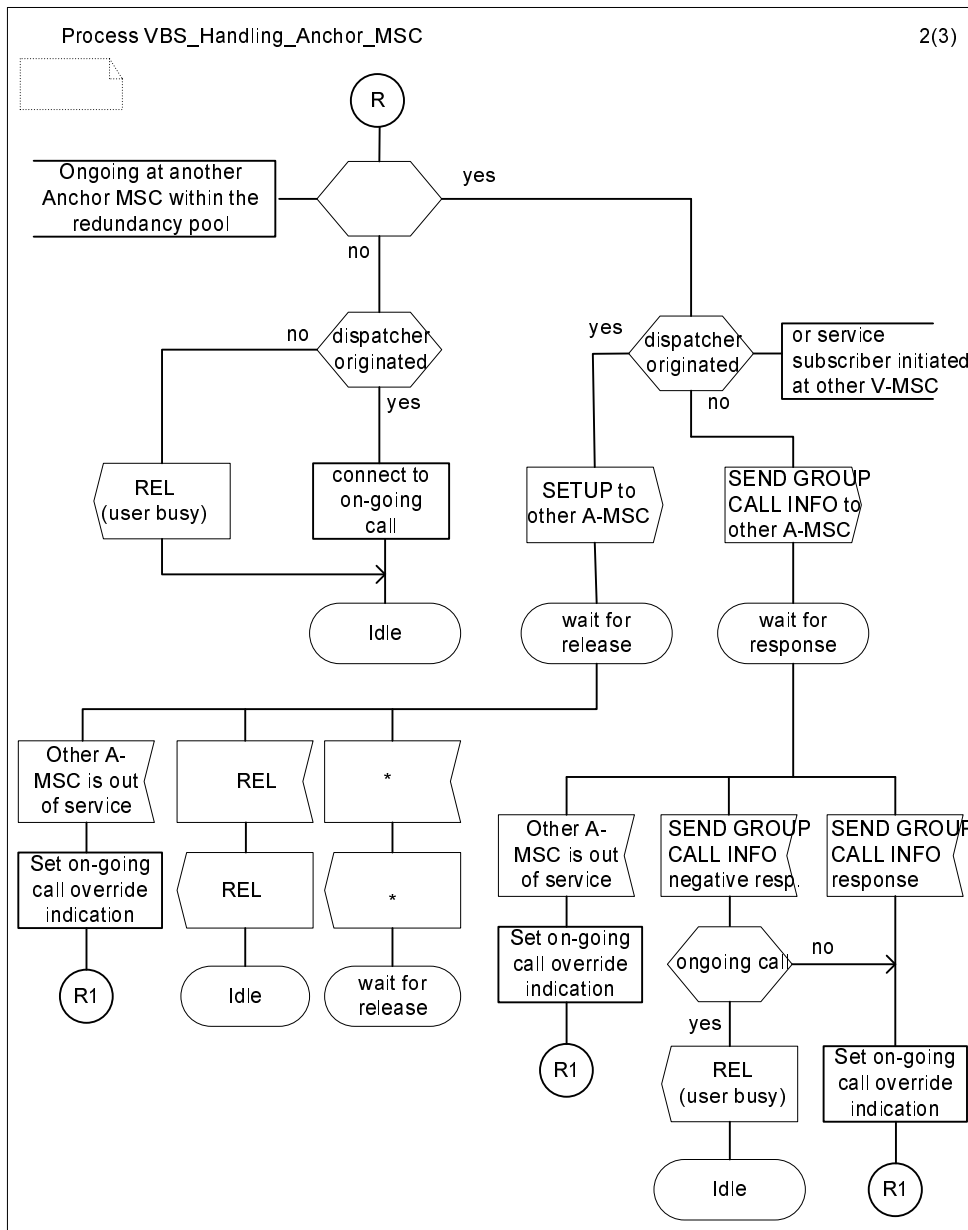

Figure 5: The VBS handling process in the anchor MSC (sheet 2 of 3)

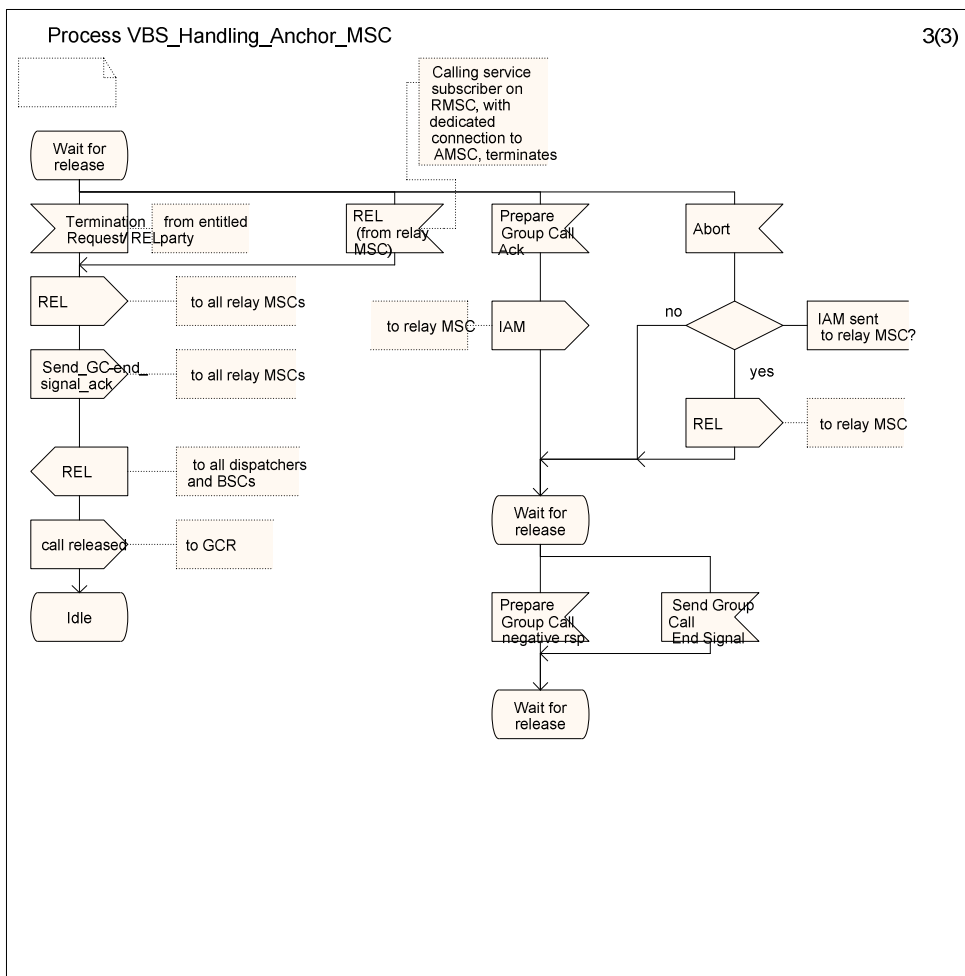

Figure 5: VBS handling process in the anchor MSC (sheet 3 of 3)

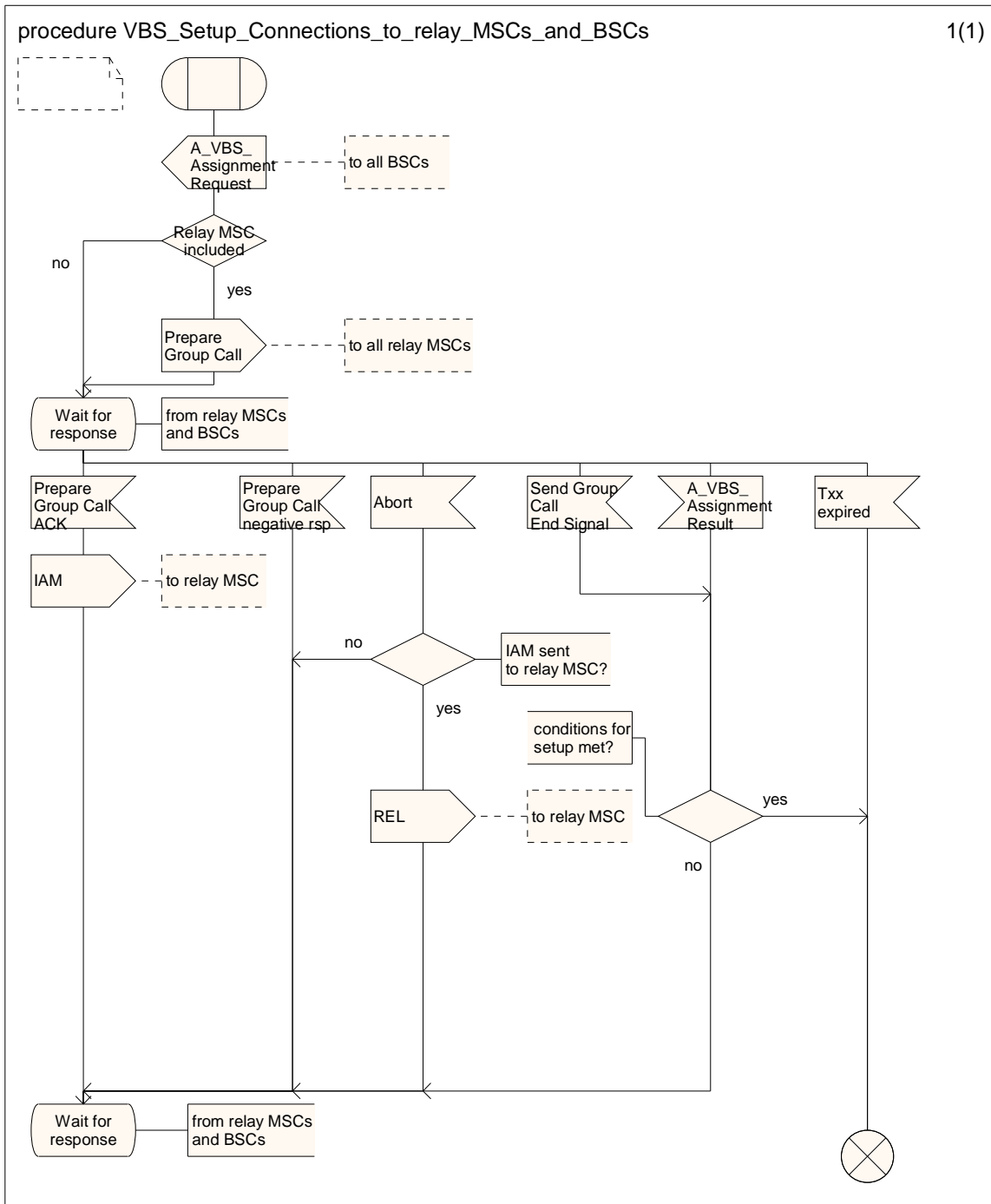

Figure 6: Set-up connection to relay MSCs and BSCs (sheet 1 of 1)

11.5 Functional requirement of Relay-MS-C

The VBS handling process in the relay MSC is shown in figure 7.

Successful call set-up initiated by a service subscriber

When the VBS handling process in the relay MSC receives a VBS call set-up request from a service subscriber currently located in a relay MSC's area, it interrogates its associated GCR to retrieve the anchor MSC address and waits for a response.

If the GCR returns a positive response containing the anchor MSC address, the relay MSC sets up a dedicated connection for the initiating service subscriber to the anchor MSC by constructing an IAM with calling party number set to the VBS prefix plus broadcast call reference, and with a generic number parameter with the number qualifier indicator set to "additional calling party number" and address signal set to the address of this relay MSC, sending it to the anchor MSC, and waits for call release.

Negative response received from the GCR

If the GCR returns a negative response to the relay MSC indicating that the call is already on-going locally, i.e. at the associated MSC, the relay MSC sends a Release message indicating 'user busy' to the service subscriber in order to force the mobile station of the service subscriber to look for notifications of the respective group ID on the NCH and join the broadcast call.

If (in a RANflex configuration with group call redundancy) the GCR returns a negative response to the relay MSC indicating that the call is already on-going at another MSC within the group call relay MSC redundancy pool, the selected relay MSC interrogates the relay MSC where the broadcast call is ongoing by means of the MAP service SEND_GROUP_CALL_INFO and waits for a response. If the selected relay MSC recognizes that the relay MSC where the broadcast call is ongoing is out of service or if that relay MSC responds with a positive SEND_GROUP_CALL_INFO response (i.e. the GCRs are out of synch and the broadcast call at the other relay MSC is not ongoing), then the selected relay MSC repeats the GCR interrogation including "ongoing call override indication". If the relay MSC where the broadcast call is ongoing responds with a negative SEND_GROUP_CALL_INFO response (ongoing call), then the selected relay MSC returns a Release message indicating "user busy" in order to force the mobile station of the service subscriber to look for notifications of the respective group ID on the NCH and join the broadcast call.

If the negative response from the GCR indicates any other reason than 'on-going call' the VBS call set-up request is rejected by sending a release message back to the initiator and the process returns to the idle state.

Successful call set-up initiated by the anchor MSC

When the VBS handling process in the relay MSC receives a PREPARE_GROUP_CALL message from the anchor MSC, it interrogates its associated GCR to retrieve the list of cells inside the relay MSC area into which the call is to be sent.

If the GCR returns a positive response, the relay MSC requests a Group Call number from its VLR.

If the VLR returns a Group Call number, a PREPARE_GROUP_CALL acknowledgement containing the Group Call number is returned to the anchor MSC and the relay MSC waits for the incoming call.

If the incoming call identified by the Group Call number is received, the relay MSC releases the Group Call number and sets up the downlinks to the cells inside the relay MSC area into which the call is to be sent.

If the call was originated by a service subscriber from the relay MSC area, the relay MSC shall send a SEND_GROUP_CALL_END_SIGNAL message including the IMSI of the originator to the anchor MSC when the downlink has been set up successfully to the originating cell.

If the call was not originated by a service subscriber from the relay MSC area, the relay MSC shall send a SEND_GROUP_CALL_END_SIGNAL message without IMSI information element to the anchor MSC as soon as the downlink has been set up successfully to any cell.

Then the relay MSC waits for the call to be released.

Negative response received from the GCR II

If the GCR returns a negative response to the relay MSC, the relay MSC returns a PREPARE_GROUP_CALL negative response to the anchor MSC and returns to the idle state.

No Group Call number received from VLR

If the VLR could not allocate a Group Call number, the relay MSC returns a PREPARE_GROUP_CALL negative response to the anchor MSC, informs the GCR that the call is no longer on-going and returns to the idle state.

Abort received from VLR

If the VLR indicates that the Group Call number supervision timer has expired, the relay MSC sends an ABORT message to the anchor MSC, informs the GCR that the call is no longer on-going and returns to the idle state.

Abort received from Anchor MSC

If, after returning a PREPARE_GROUP_CALL acknowledgement containing the Group Call number, an ABORT is received from the anchor MSC the relay MSC releases the Group Call number, informs the GCR that the call is no longer on-going and returns to the idle state.

Abort initiated by Relay MSC

The relay MSC may abort the dialogue by sending an ABORT message to the anchor MSC (e.g. if the relay MSC fails to establish any downlinks in its area). The relay MSC then also releases any resources, informs the GCR that the call is no longer on-going and returns to the idle state.

Unsuccessful call set-up

Unsuccessful call set-up is determined in the anchor MSC (as per subclause 11.3.1.1.2). The relay MSC follows the procedures specified for 'ABORT received from Anchor MSC' and 'Call release'.

Call release

When receiving a release message from the anchor MSC for the dedicated connection which was set-up to for the initiating service subscriber located in the relay MSC area, the relay MSC releases the connection to the service subscriber and the process returns to the idle state.

When the initiating service subscriber terminates the call, the relay MSC sends a release message for the dedicated connection to the anchor MSC and the process returns to the idle state.

When receiving a release message from the anchor MSC for the connection which was set up using the Group Call number or an ABORT message, the relay MSC releases all downlinks to cells inside the relay MSC area, informs the GCR that the call is no longer on-going and the process returns to the idle state.

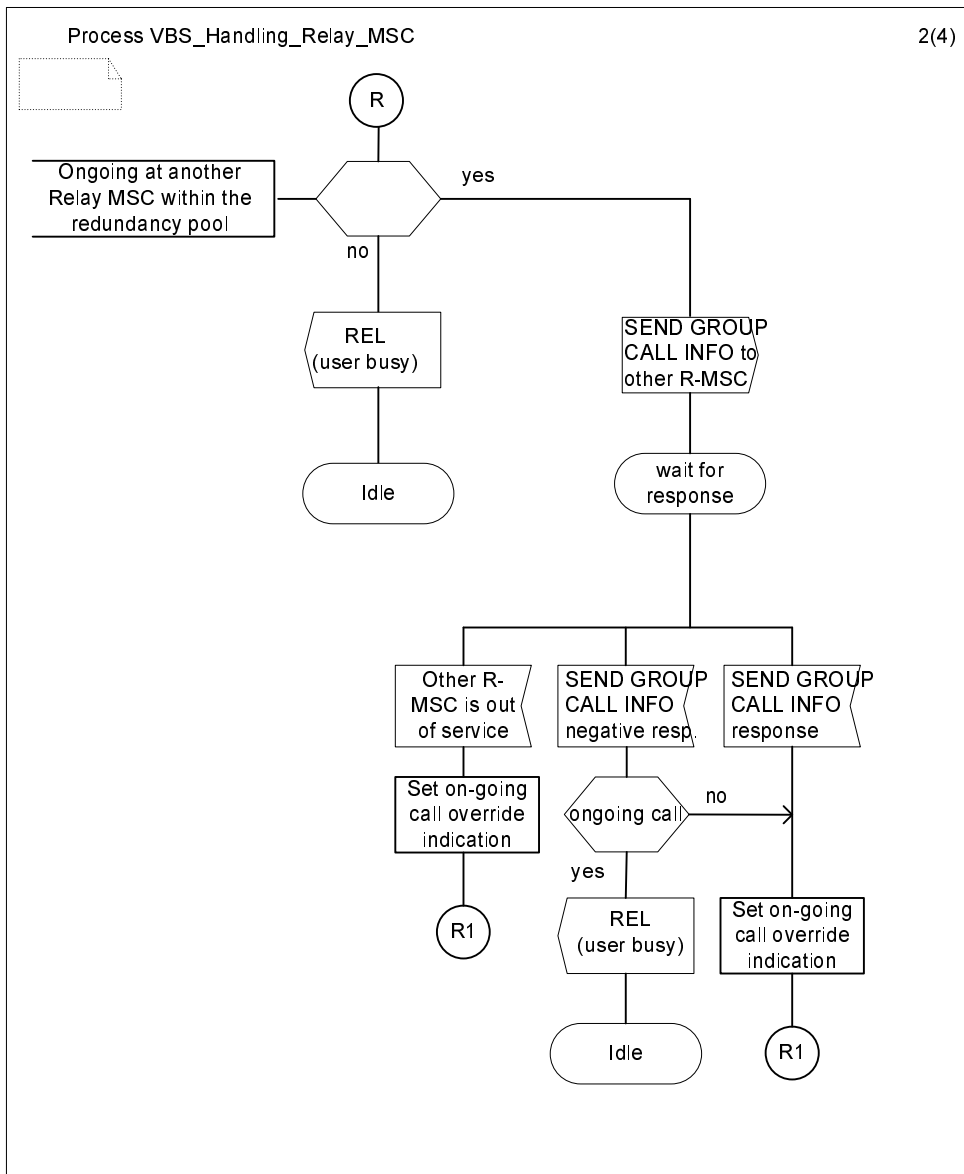

Figure 7: The VBS handling process in the relay MSC (sheet 2 of 4)

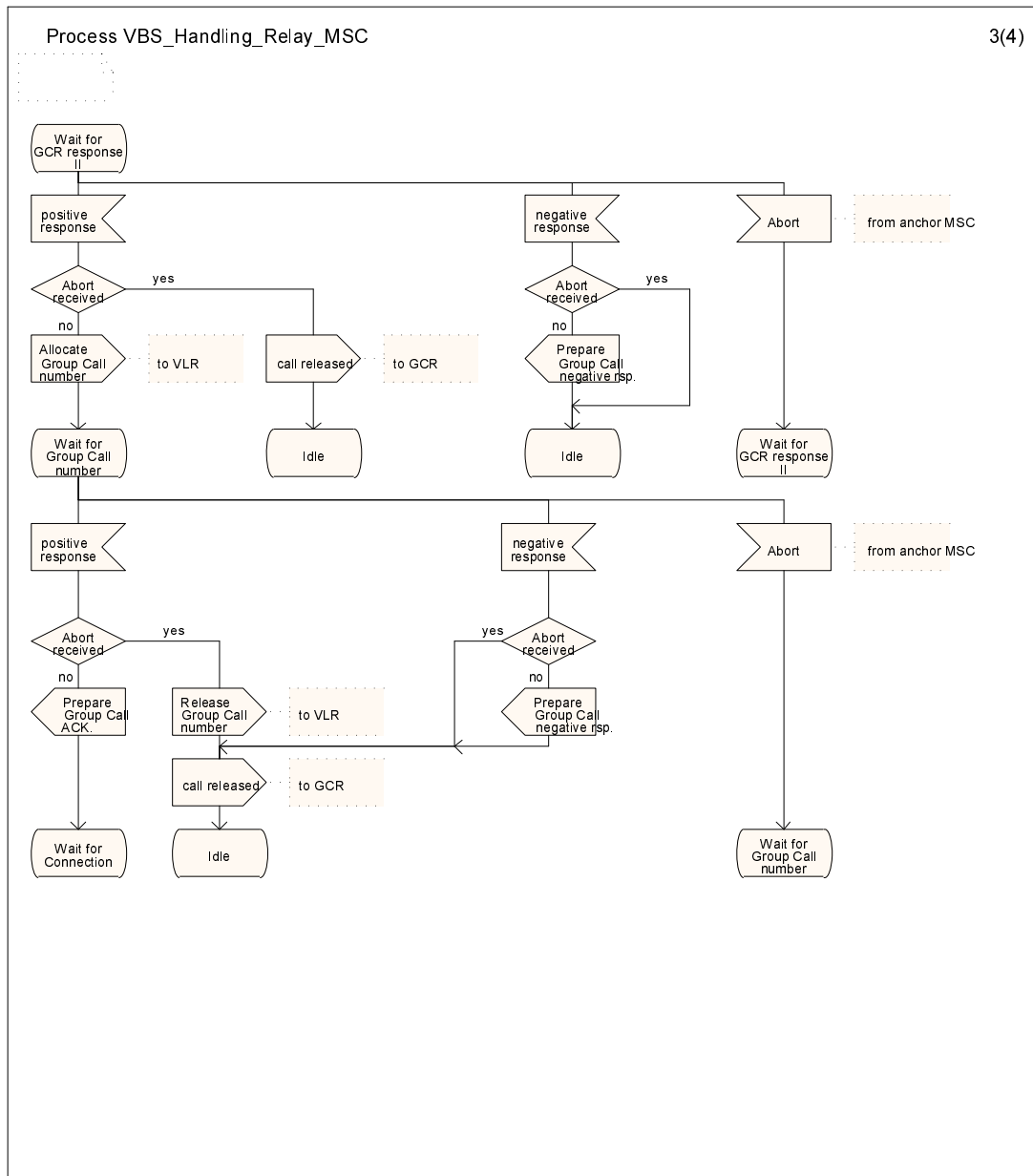

Figure 7: VBS handling process in the relay MSC (sheet 3 of 4)

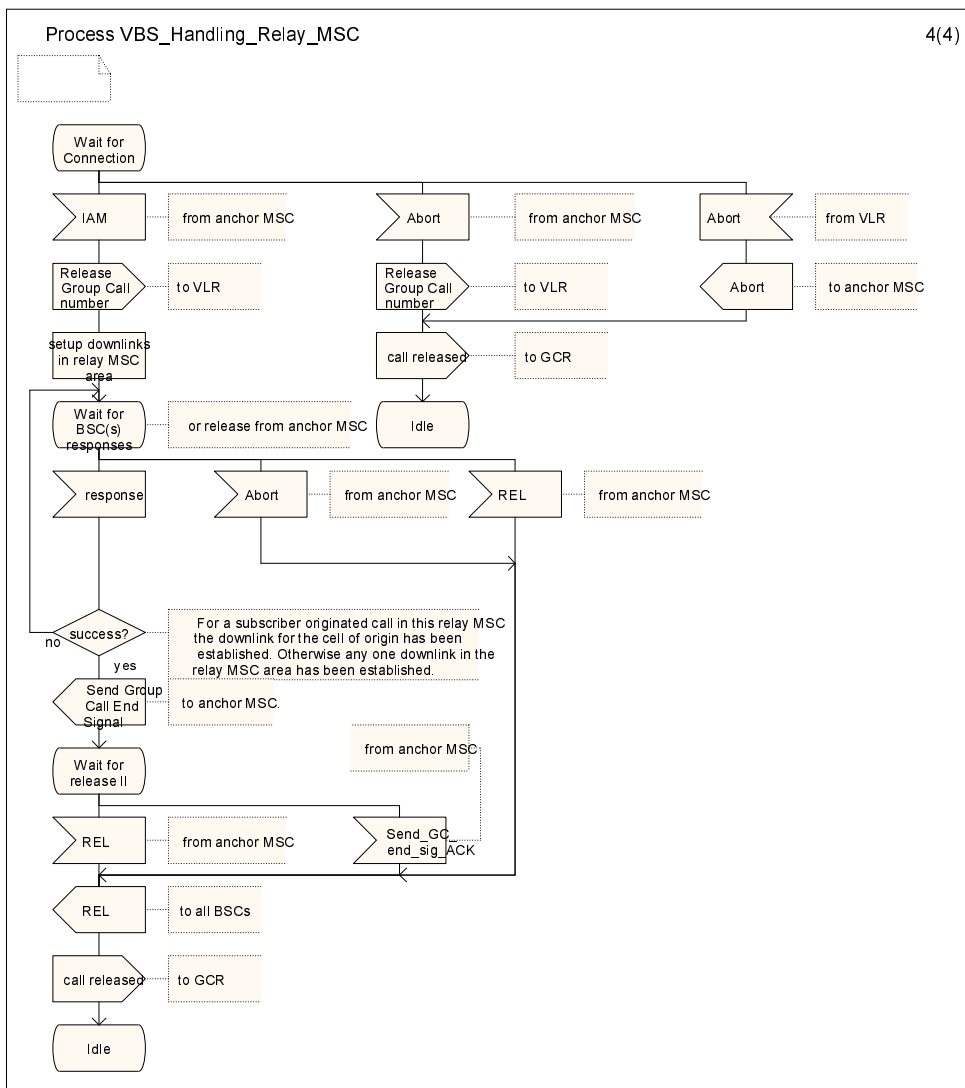

Figure 7: VBS handling process in the relay MSC (sheet 4 of 4)

11.5A Functional requirement of group call serving MSC (within a RANflex pool)

The process in the group call serving MSC is shown in figure 7A.

The group call serving MSC is either the anchor MSC or a relay MSC.

Successful call set-up initiated by a service subscriber

When receiving a SEND_GROUP_CALL_INFO interrogation request from a VMSC, the group call serving MSC (in a RANflex configuration with group call redundancy: the selected group call serving MSC) interrogates its associated GCR to retrieve the Broadcast Call Reference and the Anchor MSC address from the given cell Id / Group Id pair and return this information to the VMSC. The group call serving MSC shall temporarily store in its associated GCR the initiating subscriber's IMSI and originating cell Id as received in the interrogation request from the VMSC. The group call serving MSC shall then wait for the broadcast call being set up:

If the group call serving MSC is the anchor MSC, it waits for an IAM from the VMSC; if the group call serving MSC is a relay MSC, it waits for a PREPARE_GROUP_CALL from the anchor MSC.

Waiting for the broadcast call being set up shall be supervised by a timer T3.

When receiving IAM from the visited MSC, timer T3 is stopped and processing continues in the process VBS_Handling_Anchor_MSC after reception of the VBS call setup request in Idle state.

When receiving PREPARE_GROUP_CALL from the anchor MSC, timer T3 is stopped and processing continues in the process VBS_Handling_Relay_MSC after reception of PREPARE GROUP CALL in Idle state.

Unsuccessful call set-up

In a RANflex configuration: If the broadcast call reference could not be retrieved or the GCR returns a negative response indicating "on-going call" to the group call serving MSC, an error indication is returned to the VMSC and the process returns to the idle state.

In a RANflex configuration with group call redundancy: If the GCR returns a negative response indicating "on-going call" to the group call serving MSC, the group call serving MSC forwards the SEND_GROUP_CALL_INFO message within the same redundancy pool to the group call serving MSC where the broadcast call is ongoing.

If the selected group call serving MSC recognizes that the group call serving MSC where the broadcast call is ongoing is out of service or if that group call serving MSC responds with a positive SEND_GROUP_CALL_INFO response (i.e. the GCRs are out of synch and the broadcast call at the other group call serving MSC is not ongoing), then the selected group call serving MSC repeats the GCR interrogation including "ongoing call override indication". If the group call serving MSC where the broadcast call is ongoing responds with a negative SEND_GROUP_CALL_INFO response (ongoing call), then the selected group call serving MSC returns a negative SEND_GROUP_CALL_INFO response indicating "ongoingGroupCall" to the VMSC in order to force the mobile station of the service subscriber to look for notifications of the respective group ID on the NCH and join the broadcast call.

At timeout of timer T3 the temporarily stored initiating subscriber's IMSI and originating cell Id shall be deleted from the GCR.

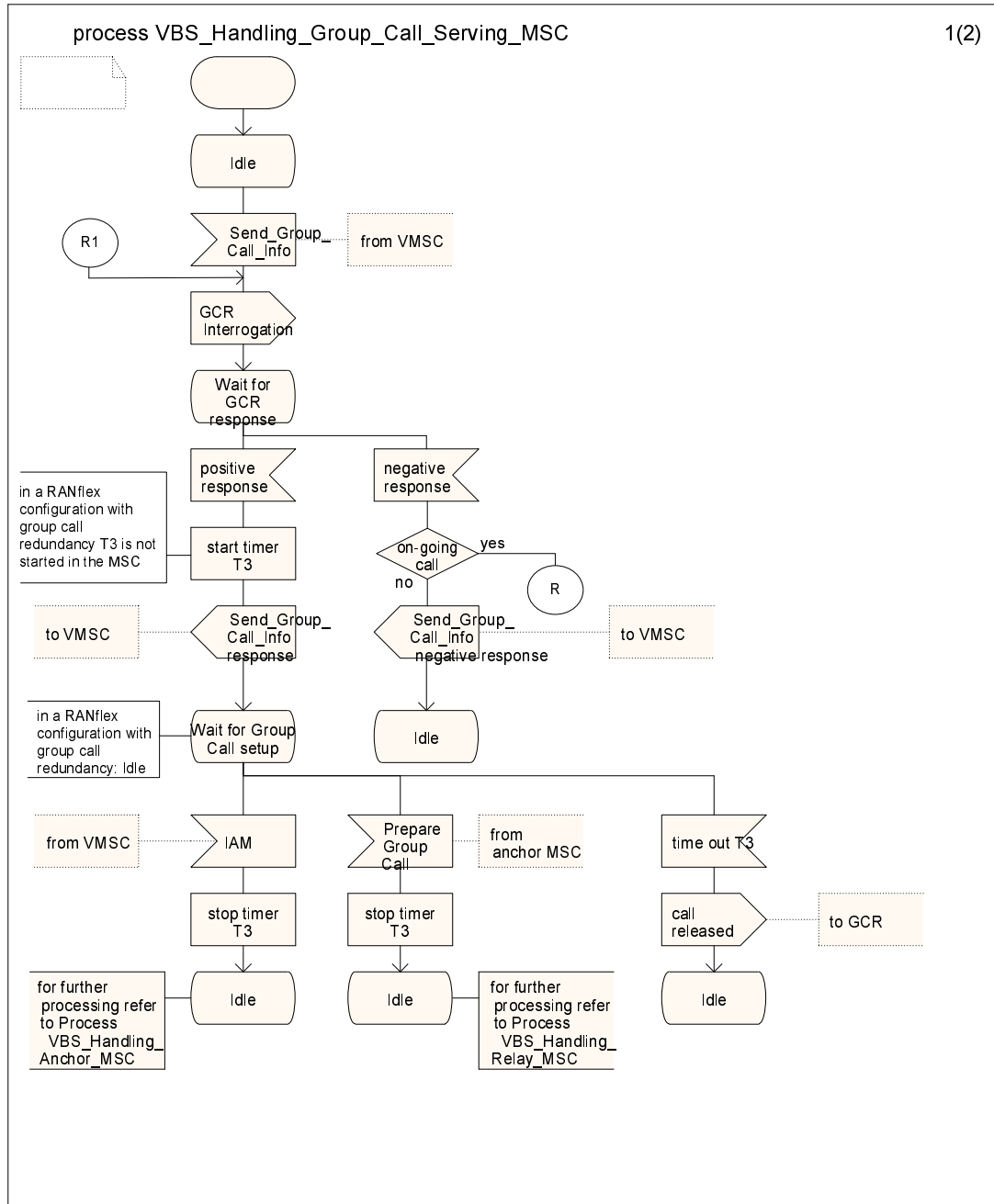

Figure 7A: The VBS handling process in the group call serving MSC (sheet 1 of 2)

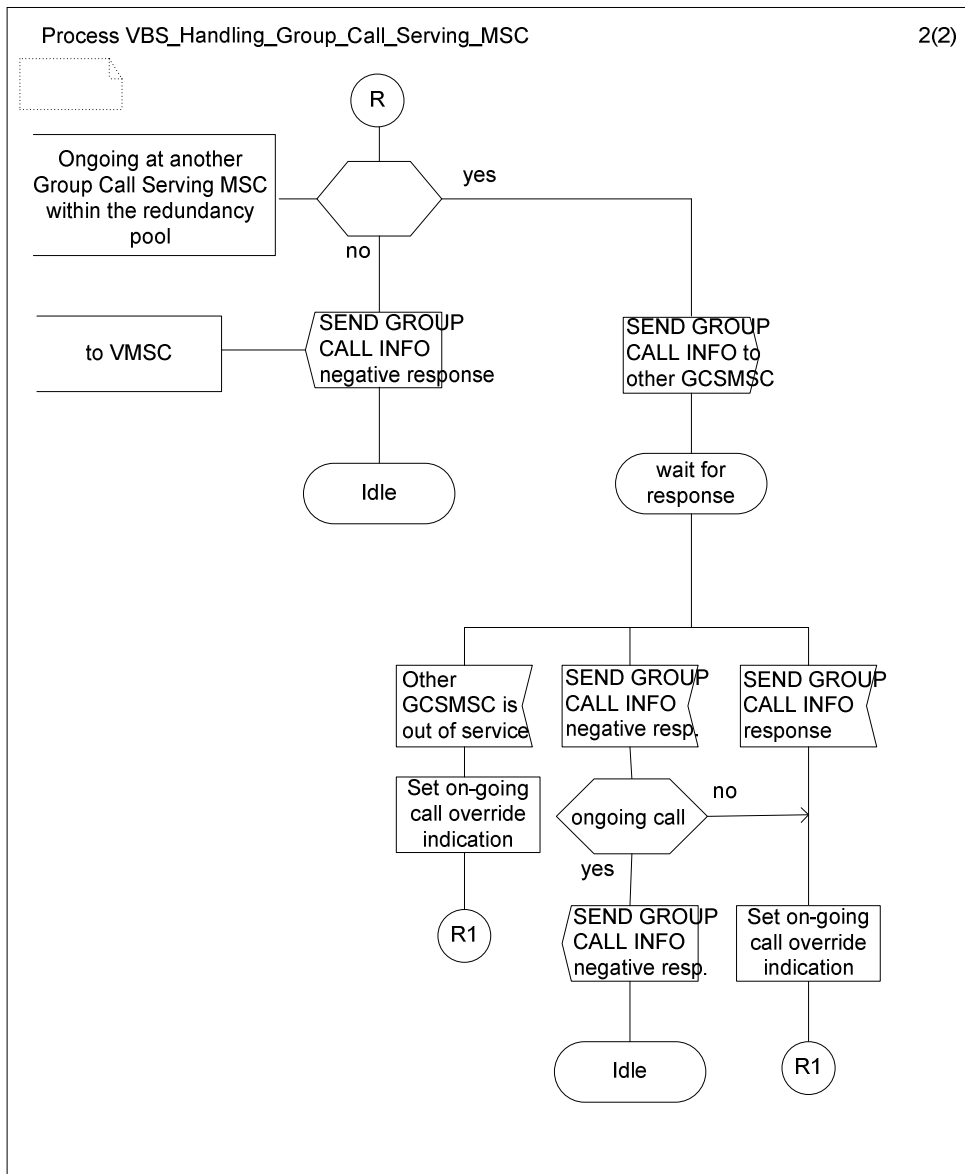

Figure 7A: The VBS handling process in the group call serving MSC (sheet 2 of 2)

11.5B Functional requirement of VMSC (within a RANflex pool)

The process in the visited MSC is shown in figure 7B.

Successful call set-up initiated by a service subscriber

When the VBS handling process in the originating MSC receives a VBS call set-up request from a service subscriber, the VMSC derives the address of the group call serving MSC or group call serving MSC redundancy pool from the requesting subscriber's current LAC. If the VMSC is the group call serving MSC or belongs to the group call serving MSC redundancy pool of the requesting subscriber's current LAC, processing continues in the process VBS_Handling_Anchor_MSC or VGCS_Handling_Relay_MSC after reception of the VGCS call setup request in Idle state. Otherwise, the visited MSC interrogates the group call serving MSC by means of the MAP service SEND_GROUP_CALL_INFO to retrieve the anchor MSC address and Broadcast Call Reference and waits for a response.

If the group call serving MSC returns a positive response containing the address of the anchor MSC or anchor MSC redundancy pool and the address is different from the visited MSC's address, the originating MSC sets up a dedicated connection for the initiating service subscriber to the anchor MSC by constructing an IAM with calling party number set to VBS prefix plus broadcast call reference, and with a generic number parameter with the number qualifier

indicator set to "additional calling party number" and address signal set to the address of the group call serving MSC (in a RANflex configuration with group call redundancy this shall be the same address as used to route the SEND_GROUP_CALL_INFO message, i.e. identifying the redundancy pool), sending it to the anchor MSC, and waits for call release. If the VMSC is the anchor MSC or belongs to the anchor MSC redundancy pool, processing continues in the process VBS_Handling_Anchor_MSC after reception of the VBS call setup request in Idle state.

Negative response received from the group call serving MSC

If the group call serving MSC returns a negative response to the originating MSC indicating that the call is already on-going, the originating MSC sends a Release message indicating "user busy" to the service subscriber in order to force the mobile station of the service subscriber to look for notifications of the respective group ID on the NCH and join the group call.

If the negative response from the group call serving MSC indicates any other reason than "on-going call" the VBSS call set-up request is rejected by sending a release message back to the initiator and the process returns to the idle state.

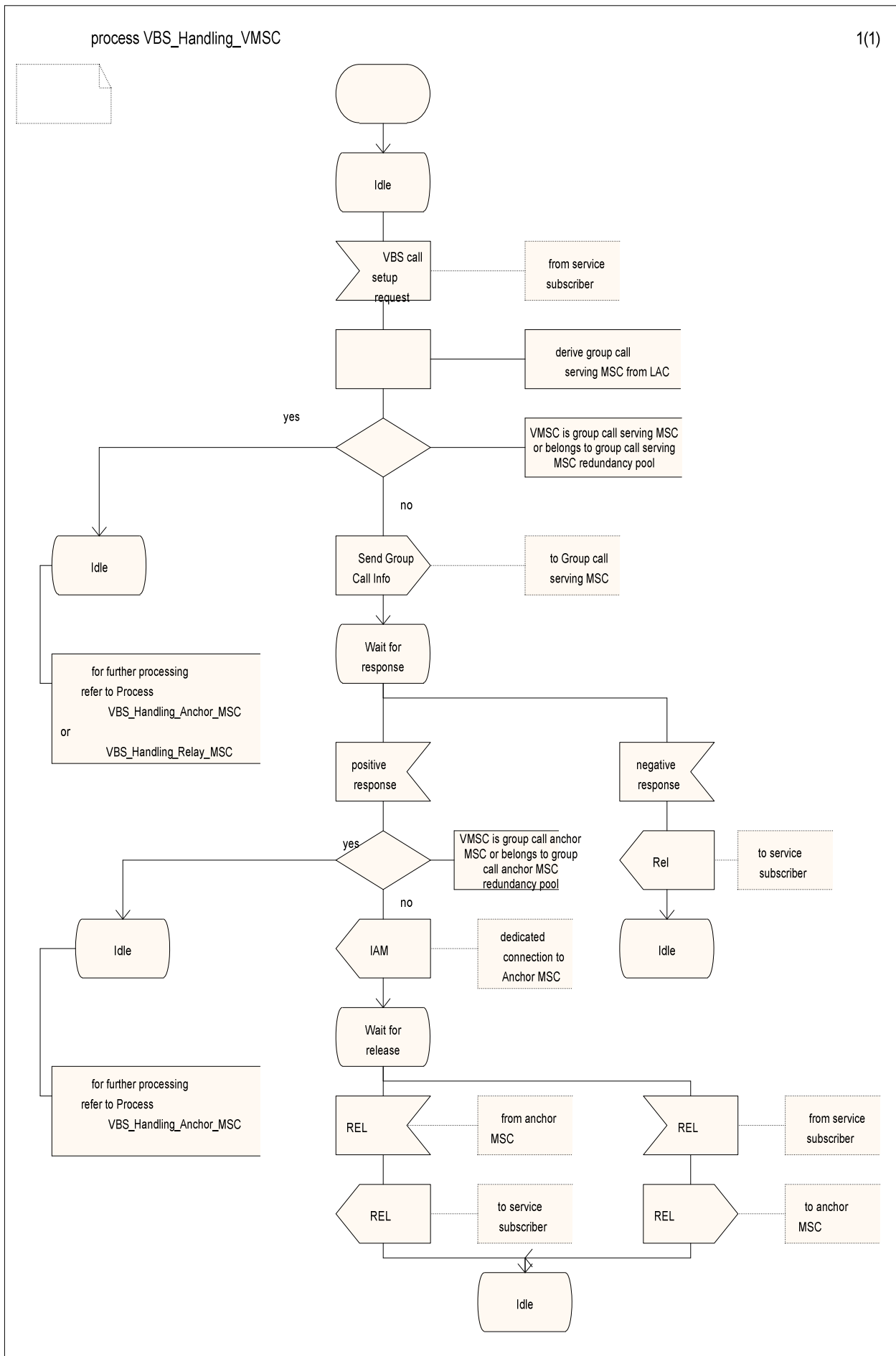

Figure 7B: The VBS handling process in the VMSC

11.6 Functional requirement of GCR

The process in the GCR for RANflex and without RANflex configurations is shown in figure 8.

The process in the GCR for RANflex configuration with group call redundancy is shown in figure 8A. Figure 8A does not show details on GCR restoration (see subclause 5.3.3).

Service subscriber initiated call

If the GCR receives an interrogation request for a call initiated by a service subscriber who is located in the MSC area of the associated MSC, the GCR calculates the broadcast call reference from the Group ID and the originating cell ID.

If the broadcast call reference was successfully calculated, the GCR checks whether a VBS call with that broadcast call reference is already on-going.

If the call is not marked as on-going, the GCR checks whether an anchor MSC address is stored in its broadcast call reference record. If this is the case and initial talker information is not yet stored, a positive response including the anchor MSC address is returned to the MSC, the initial talker information (IMSI, originating cell id) of the initiating service subscriber is stored in the GCR and the process returns to the idle state. If anchor MSC address and initial talker information are stored (this is the case where the associated MSC is relay MSC, and timer T3 is running, i.e. broadcast call setup is in progress but the call is not yet fully established), a negative response indicating "on-going call" is returned to the MSC and the process returns to the idle state. If no anchor MSC address is stored (i.e. the associated MSC is anchor MSC with respect to this broadcast call reference) the GCR marks its broadcast call reference record with 'on-going call' and returns a positive response including the broadcast call attributes to the MSC and the process returns to the idle state.

If the broadcast call reference could not be successfully calculated from the Group ID and the originating cell ID, the GCR returns a negative response indicating 'failure' to the MSC and the process returns to the idle state.

If the call was marked as on-going, the GCR returns a negative response indicating 'on-going call' to the MSC and the process returns to the idle state.

IAM initiated call

If the GCR receives an interrogation request for a call initiated by a dispatcher or by a service subscriber who is not located in the MSC area of the associated MSC, the GCR checks the calling party number of the initiator against the list of identities of dispatchers which are allowed to initiate the voice broadcast call and against the prefix for VBS plus broadcast call reference in order to determine whether the initiator is allowed to set-up the call. If the check is successful the GCR checks whether a VBS call with the same broadcast call reference is already on-going.

If the call is not marked as on-going, the GCR marks its broadcast call reference record with 'on-going call' and returns a positive response including the broadcast call attributes to the MSC and the process returns to the idle state. In addition the GCR shall delete stored initial talker information (if any).

If the calling party number check was not successful, the GCR returns a negative response indicating 'failure' to the MSC and the process returns to the idle state.

If the call was marked as on-going, the GCR returns a negative response indicating 'on-going call' to the MSC and the process returns to the idle state.

Anchor MSC triggered call

If the GCR (associated to a relay MSC) receives an interrogation request for a call triggered by the anchor MSC, the GCR returns a positive response to the MSC including:

- the list of cells inside the MSC area of the requesting MSC in which the call is to be sent; and
- the stored initial talker information (if any) to the MSC;

and:

- marks its broadcast call reference with "on-going call";
- deletes the stored initial talker information (if any)

and the process returns to the idle state.

VMSC triggered call (in a RANflex configuration)

If the GCR (associated to a group call serving MSC) receives an interrogation request for a call triggered by the VMSC, the GCR

- calculates the broadcast call reference from the Group ID and the originating cell ID;

If for the calculated broadcast call reference the record is marked with "on-going call" or initial talker information are already stored, a negative response indicating "on-going call" is returned to the GCSMSC and the process returns to the idle state. Otherwise the GCR:

- stores the initial talker information (IMSI and originating cell ID received with the request); and
- returns a positive response including broadcast call reference and, if the group call serving MSC is a relay MSC, the anchor MSC address.

Call release

If the GCR receives a call released indication from the MSC, the 'on-going call' indicator in the broadcast call reference record is reset, the initial talker information is deleted (if any) and the process returns to the idle state.

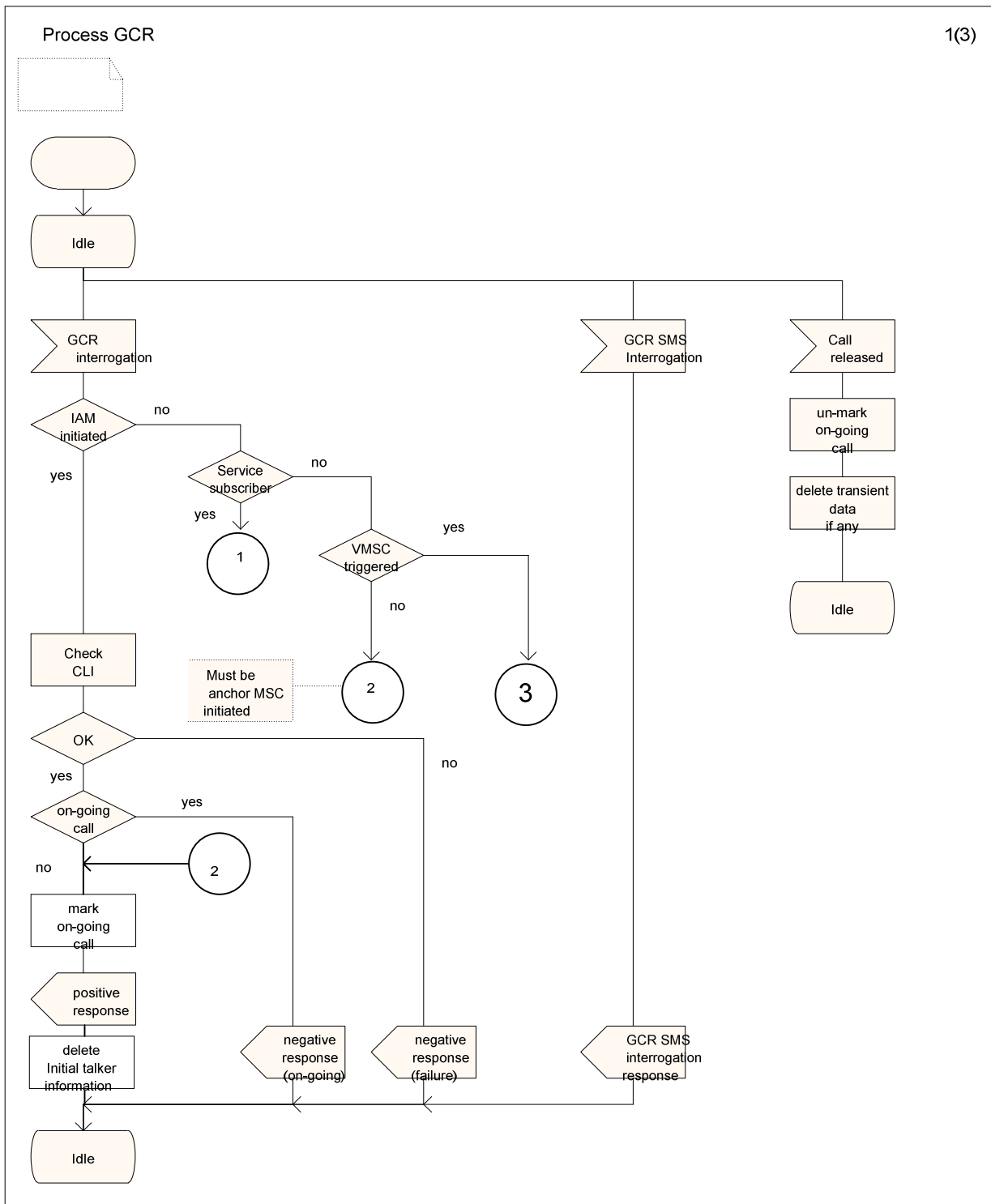

Figure 8: Process in the GCR (sheet 1 of 3)

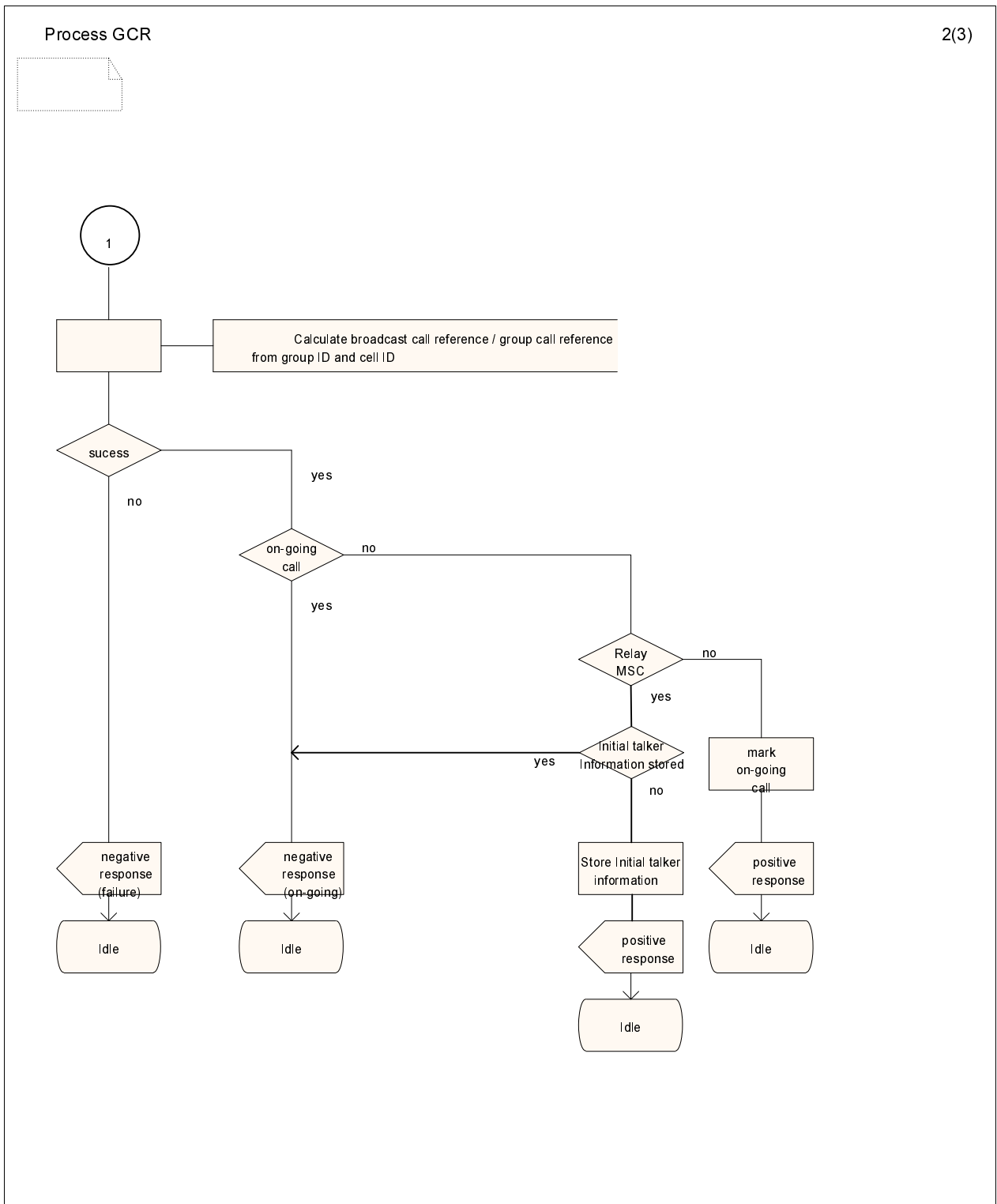

Figure 8: Process in the GCR (sheet 2 of 3)

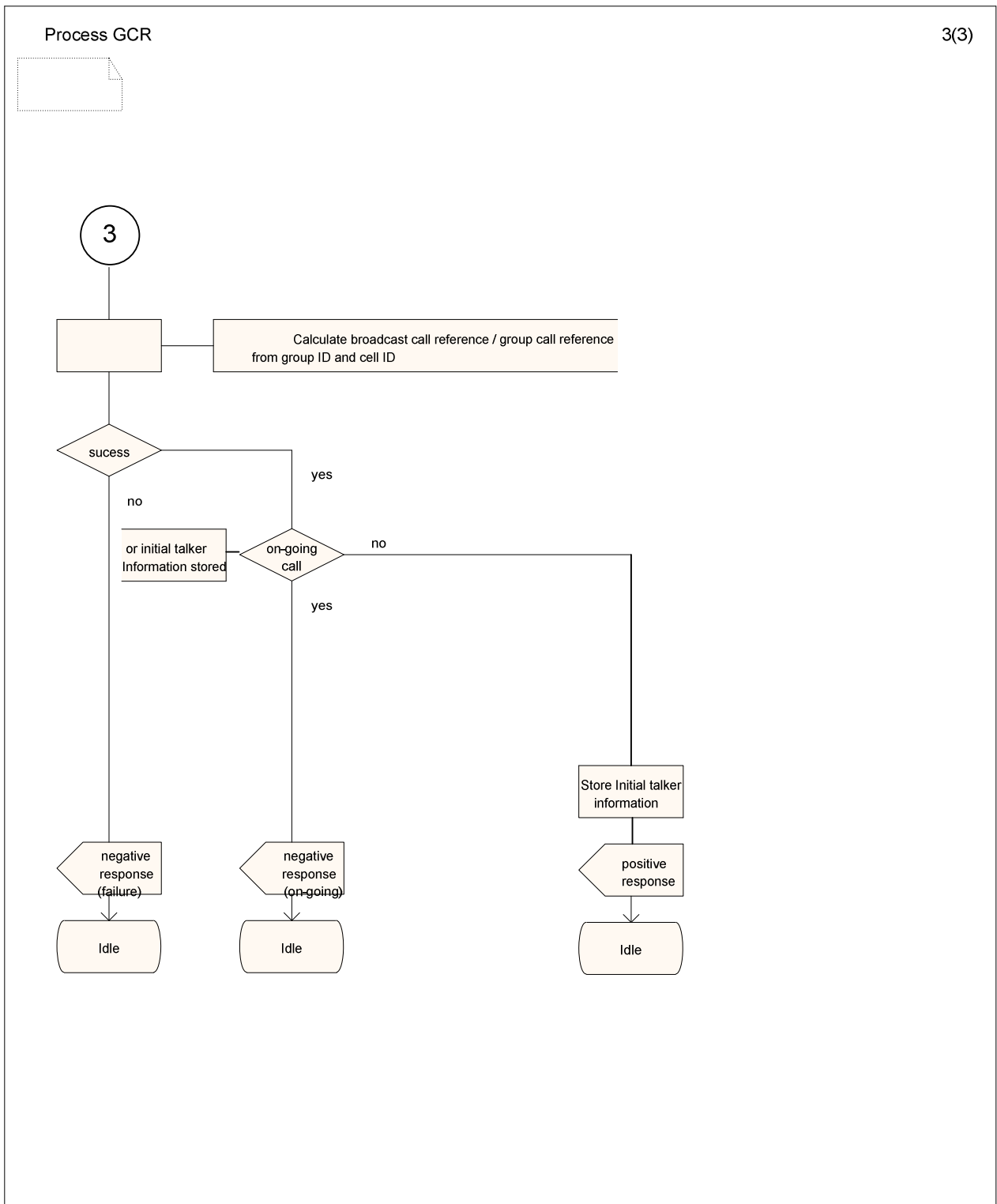

Figure 8: Process in the GCR (sheet 3 of 3)

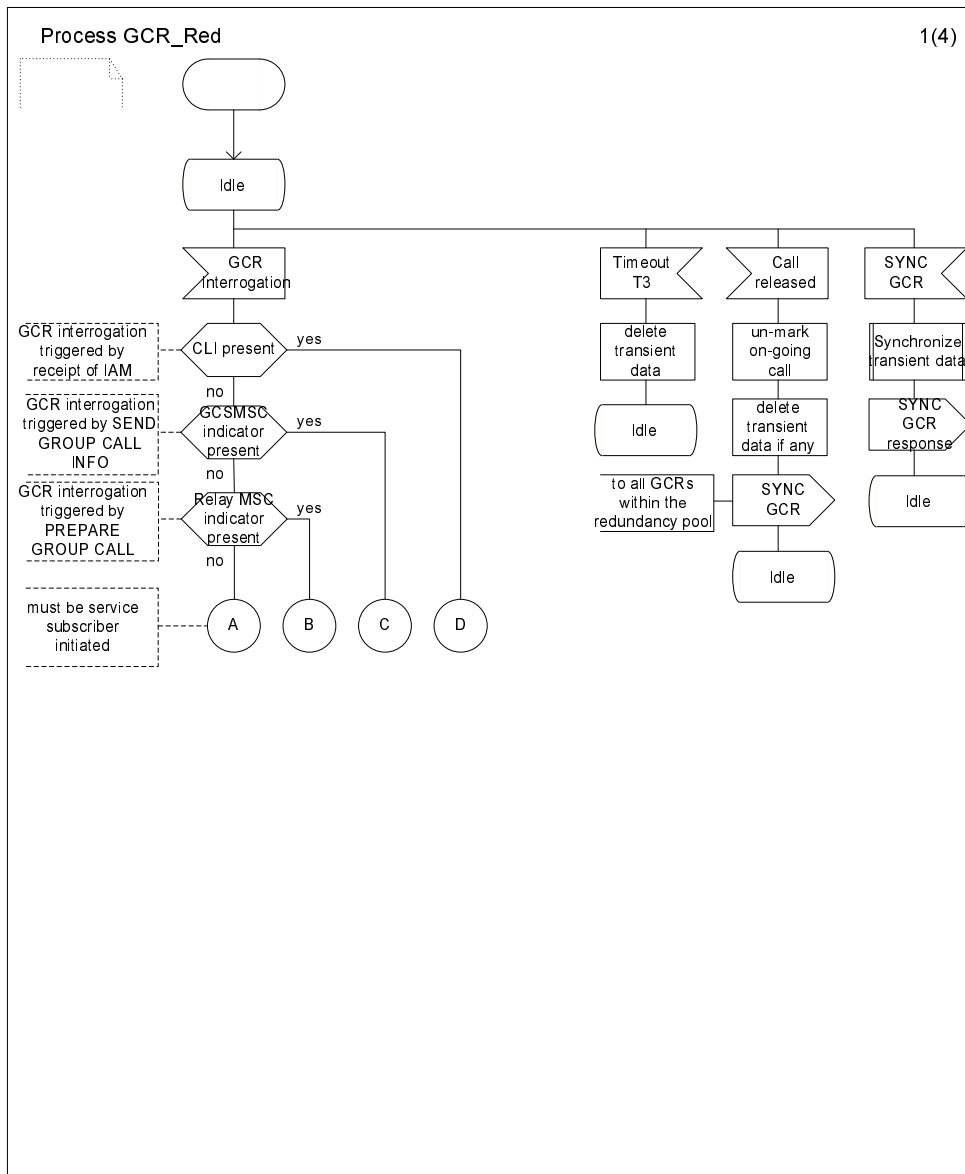

Figure 8A: The Process in the GCR for RANflex with group call redundancy (sheet 1 of 4)

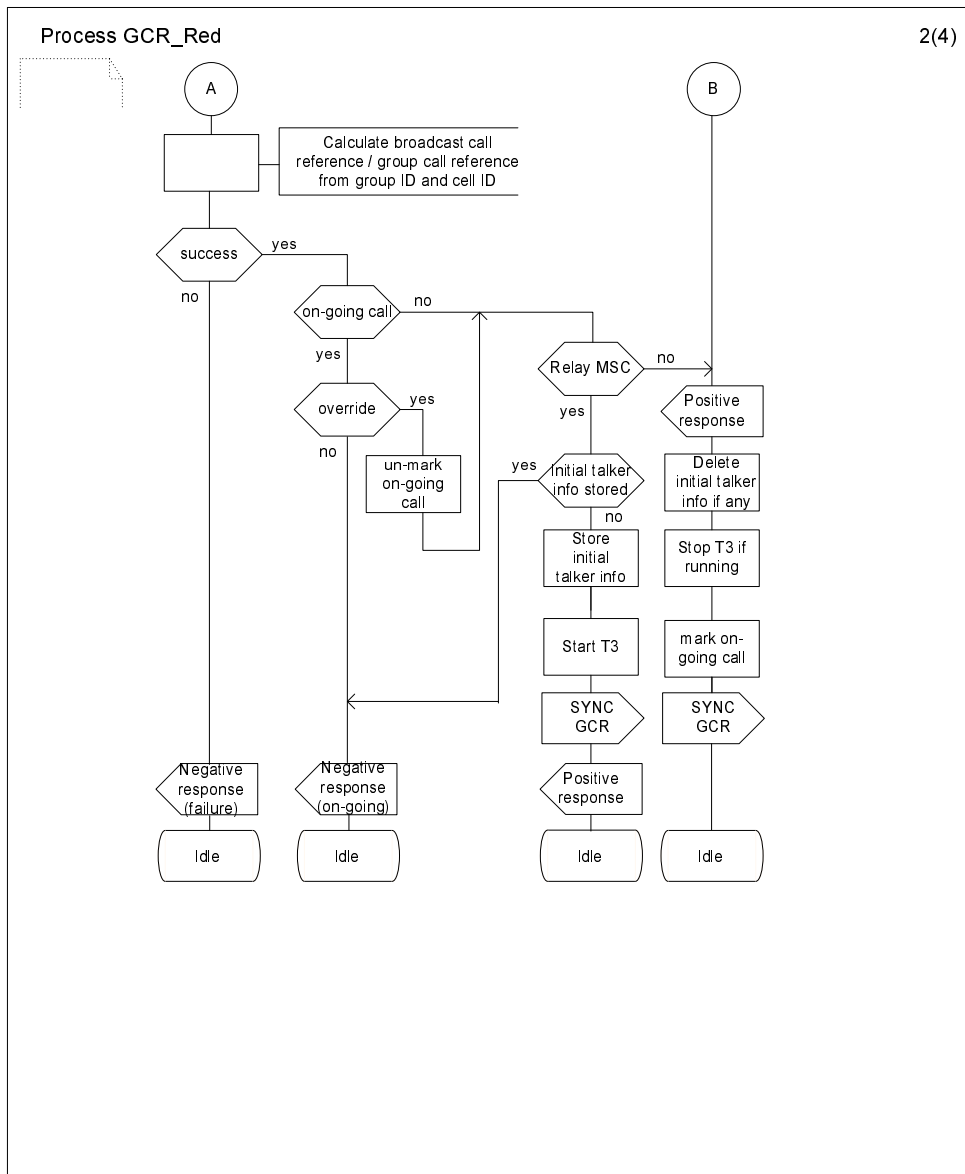

Figure 8A: The Process in the GCR for RANflex with group call redundancy (sheet 2 of 4)

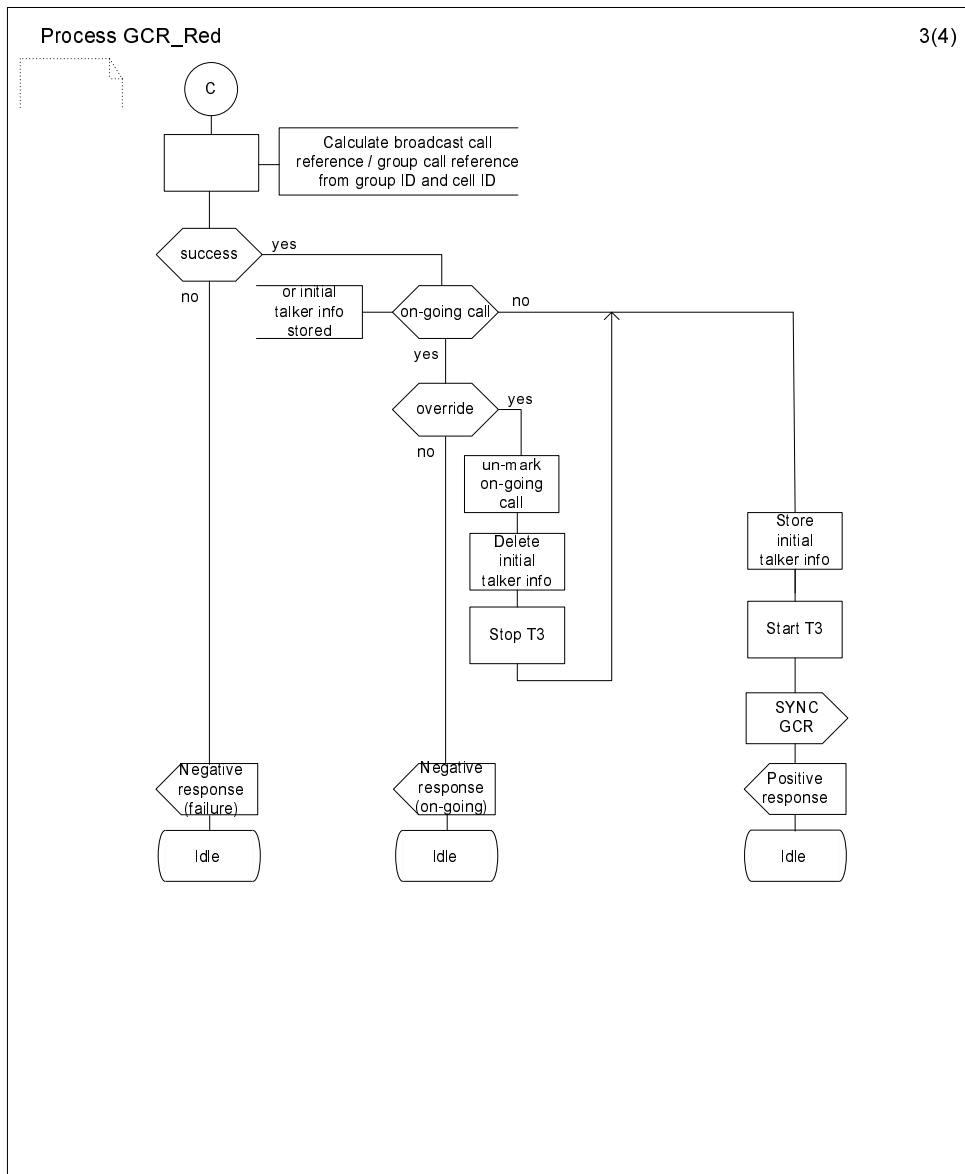

Figure 8A: The Process in the GCR for RANflex with group call redundancy (sheet 3 of 4)

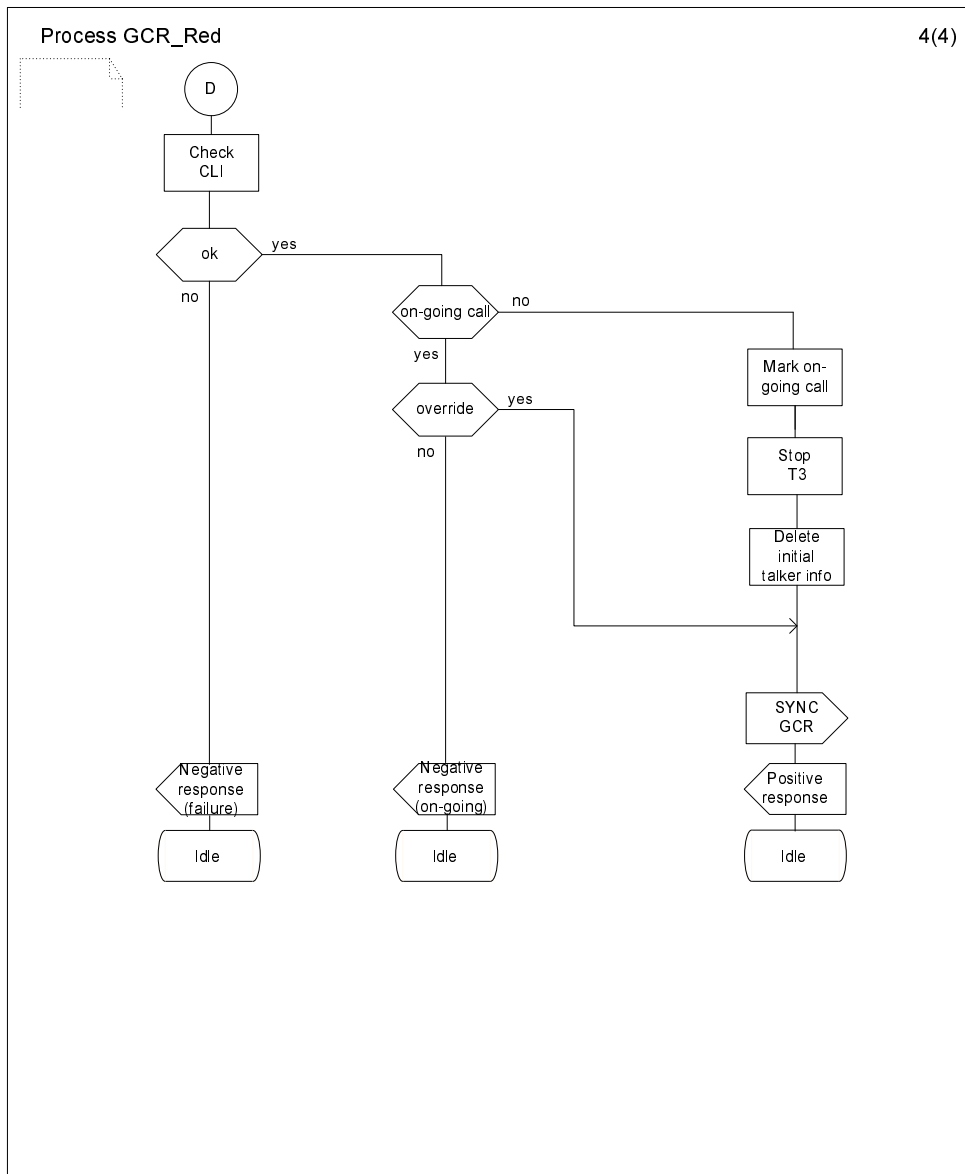

Figure 8A: The Process in the GCR for RANflex with group call redundancy (sheet 4 of 4)

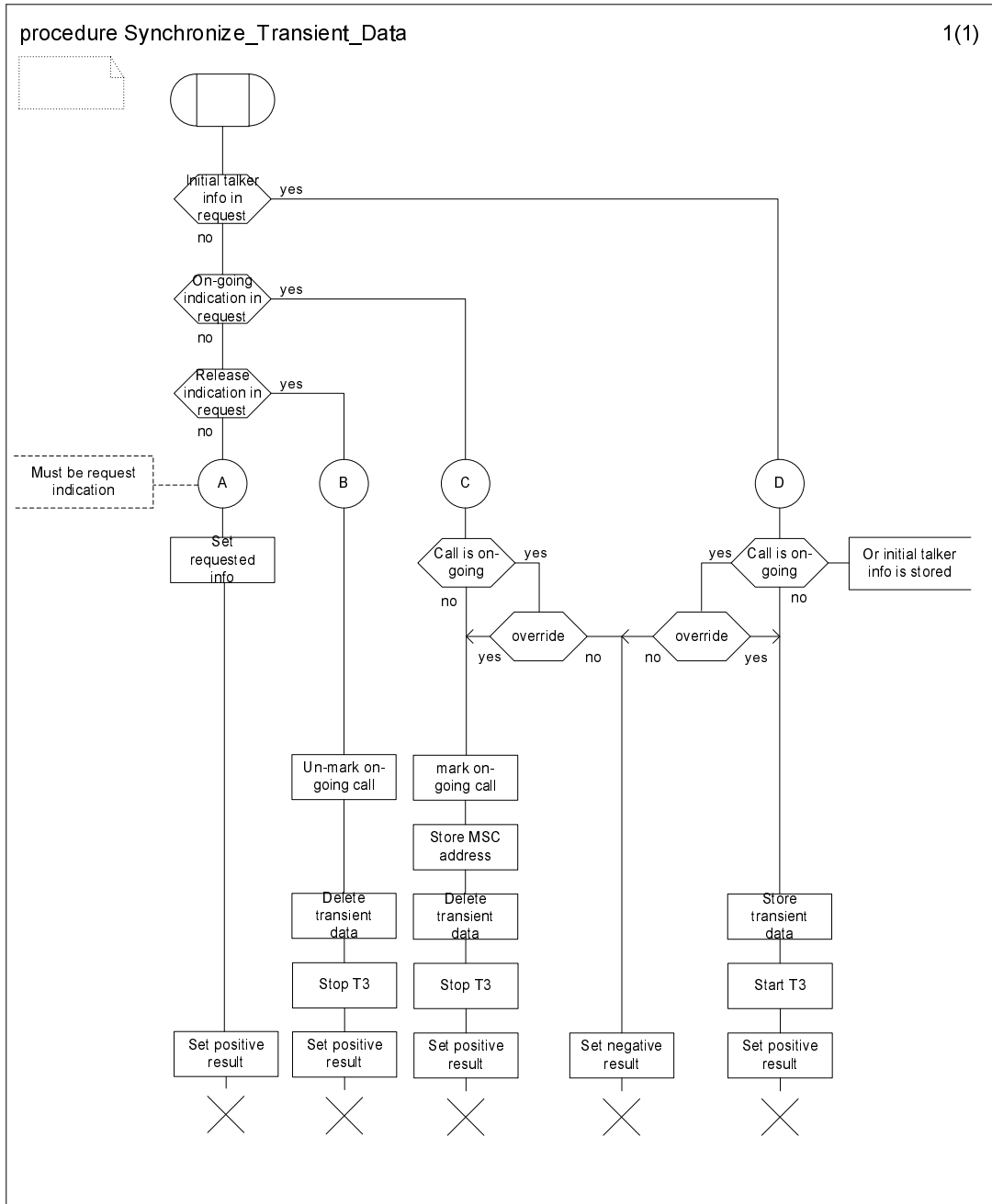

Figure 8B: Procedure Synchronize Transient Data

11.7 Functional requirement of VLR

The Group Call number allocation process in the VLR is shown in figure 9.

Successful procedure

When receiving a request from the relay MSC to allocate a Group Call number, the VLR checks if a Group Call number is available. If so it selects a Group Call number, marks the number as allocated, returns a positive response including the Group Call number to the MSC, starts a supervision timer and waits for removal of the Group Call number. If the VLR receives a request to release the Group Call number, the VLR marks the Group Call number as free and the process returns to the idle state.

No Group Call number available

If no Group Call number is available, the VLR returns a negative response indicating 'no Group Call number available' to the MSC and the process returns to the idle state.

Supervision timer expires

If the supervision timer expires, the VLR indicates to the relay MSC that the dialogue has to be aborted.

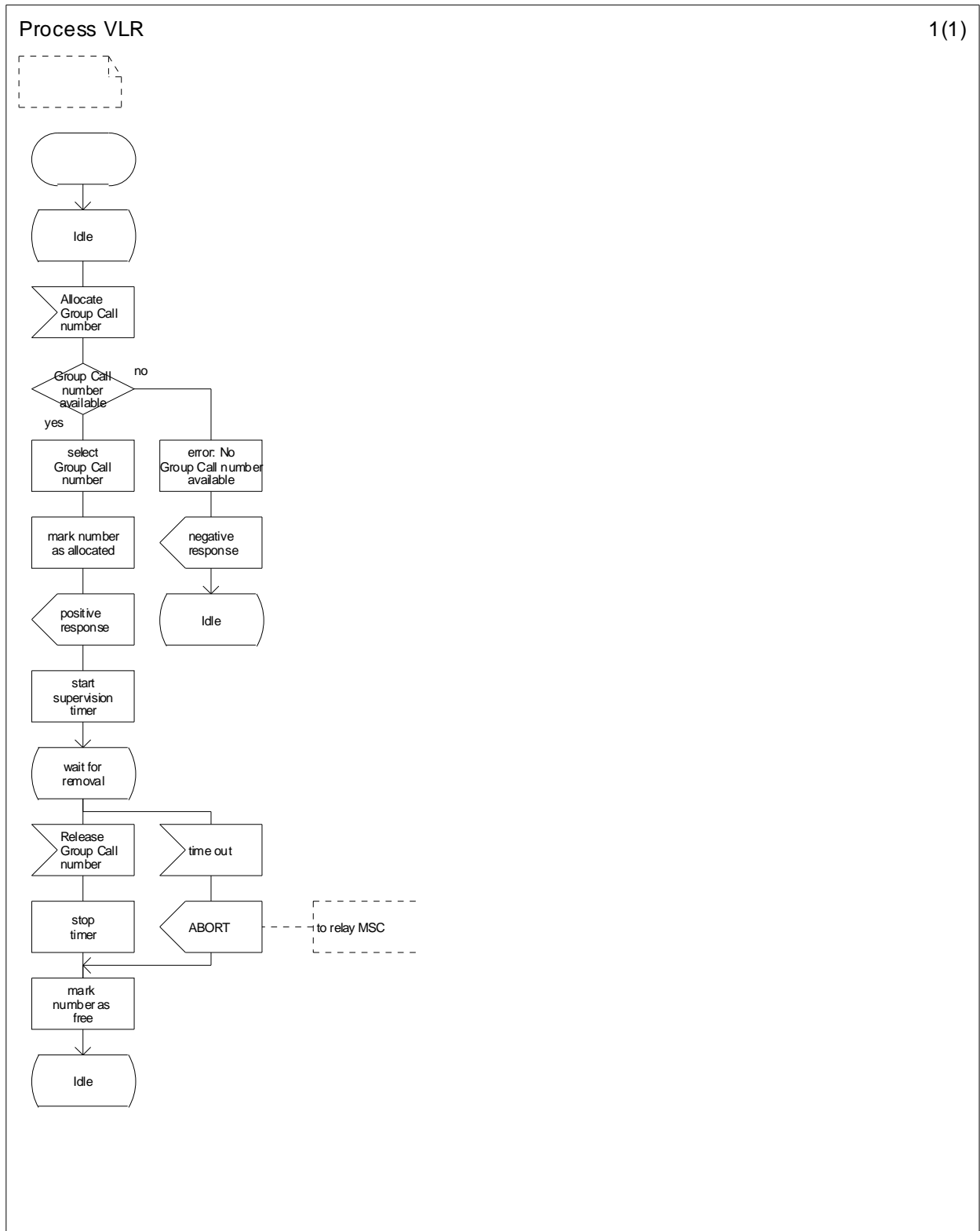

Figure 9: Group Call number allocation process in the VLR

12 Content of messages

This clause specifies the content of the following messages:

On the B interface (MSC-VLR):

- Allocate Group Call Number;
- Allocate Group Call Number ack;
- Allocate Group Call Number negative response;
- Release Group Call Number.

On the E interface (MSC-MSC):

- Prepare Group Call;
- Prepare Group Call ack;
- Prepare Group Call negative response;
- Send Group Call End Signal;
- Send Group Call Info;
- Send Group Call Info ack;
- Send Group Call Info negative response.

On the I interface (MSC-GCR):

- GCR Interrogation;
- GCR Interrogation ack;
- GCR Interrogation negative response;
- Call Released.

On the GCR-GCR-interface:

- Sync GCR ;
- Sync GCR ack;
- Sync GCR negative response.

In the tables which follow, information elements are shown as Mandatory (M), Conditional (C) or Optional (O). A mandatory information element shall always be present. A conditional information element shall be present if certain conditions are fulfilled; if those conditions are not fulfilled it shall be absent. An optional element may be present or absent, at the discretion of the application at the sending entity.

12.1 Messages on the B interface (MSC-VLR)

12.1.1 Allocate Group Call Number

No information element is required.

12.1.2 Allocate Group Call Number ack

The following information element is required.

Information element name	Required	Description
Group Call number	M	E.164 number required to route the call from the anchor MSC to the relay MSC

12.1.3 Allocate Group Call Number negative response

The negative response information element can take the following value:

- No Group Call number available.

12.1.4 Release Group Call Number

The following information element is required.

Information element name	Required	Description
Group Call number	M	E.164 number required to route the call from the anchor MSC to the relay MSC

12.2 Messages on the E interface (MSC-MSC)

12.2.1 Prepare Group Call

The following information elements are required.

Information element name	Required	Description
Teleservice	M	The teleservice Voice Broadcast Call indicates that a VBS call has to be prepared
Broadcast call reference	M	see clause 9
Ciphering Algorithm, Group Key and Number	M	information on the cipher algorithm and group key to be used
Priority	C	The default priority level must be present if eMLPP applies
Codec Info	M	Information on the codecs allowed for the VBS call
Uplink Reply Indicator	O	Indicates that the uplink reply procedure is applicable for the voice broadcast call. Must be present if the GCR provides the corresponding information.

12.2.2 Prepare Group Call ack

The following information element is required.

Information element name	Required	Description
Group Call number	M	E.164 number required to route the call from the anchor MSC to the relay MSC

12.2.3 Prepare Group Call negative response

The negative response information element can take the following value:

- No Group Call number available.

12.2.4 Send Group Call End Signal

The following information element is required.

Information element name	Required	Description
IMSI	C	The IMSI of the service subscriber who has initiated the call. Must be present if the call was initiated by a service subscriber in the relay MSC area.

12.2.5 Send Group Call Info

The following information elements are required.

Information element name	Required	Description
Teleservice	M	The teleservice Voice Broadcast Call indicates that the request is for VBS
Requested Info	M	Indicates that Anchor MSC Address and Broadcast Call Reference are requested
Group ID	M	see clause 9.
Cell Id	M	Identification of the cell where the group call initiating service subscriber is located.
IMSI	M	IMSI of the service subscriber for whom the request is sent.

12.2.6 Send Group Call Info ack

The following information elements are required.

Information element name	Required	Description
Anchor MSC Address	M	E.164 number required to route the call from the VMSC to the anchor MSC.
Broadcast call reference	M	see clause 9.

12.2.7 Send Group Call Info negative response

The negative response information element can take the following value:

- ongoing call;
- failure.

12.3 Messages on the I interface (MSC-GCR)

12.3.1 GCR Interrogation

The following information elements are required.

Information element name	Required	Description
Broadcast call reference	C	see clause 9. Must be present if the VBS call was initiated by a dispatcher or by a service subscriber in the relay MSC area and the receiving GCR is associated to the anchor MSC, or if the receiving GCR is associated to a relay MSC and the GCR interrogation was triggered by a Prepare Group Call message received from the anchor MSC.
Group ID	C	see clause 9. Must be present if one of the following conditions is fulfilled: 1) the MSC is the visited MSC of the service subscriber initiating the VBS call, except if the MSC is a relay MSC and the GCR interrogation was triggered by a Prepare Group Call message received from the anchor MSC; 2) the GCR interrogation was triggered by a Send Group Call Info message received from the VMSC.
Originating Cell ID	C	see clause 9. Must be present if one of the following conditions is fulfilled: 1) the MSC is the visited MSC of the service subscriber initiating the VBS call, except if the MSC is a relay MSC and the GCR interrogation was triggered by a Prepare Group Call message received from the anchor MSC; 2) the GCR interrogation was triggered by a Send Group Call Info message received from the VMSC.
CLI	C	Calling Line Identity of the initiating dispatcher, or VBS prefix plus broadcast call reference in case of service subscriber originated VBS call in the relay MSC. Must be present if the MSC is not the visited MSC of the service subscriber initiating the VBS call.
Relay MSC indicator	M	A flag indicating whether the GCR interrogation was triggered from a Prepare Group Call message received from the anchor MSC
Group Call Serving MSC indicator	C	A flag indicating whether the GCR interrogation was triggered from a Send Group Call Info message received from the VMSC. May be set to "yes" in a RANflex configuration (with or without group call redundancy) only.
IMSI	C	IMSI of the service subscriber who has initiated the VBS call. Must be present if the MSC is the visited MSC of the service subscriber initiating the VBS call, or the GCR interrogation was triggered by a Send Group Call Info message received from the VMSC
Uplink Reply Indicator	O	Indicates that the uplink reply procedure is applicable for the voice broadcast call. Must be present if the MSC is the anchor MSC and the related flag exists and is set in the GCR.
Ongoing Call Override Indication	C	Indicates that the GCR shall delete any ongoing call information before processing the request. May be set to "yes" in a RANflex configuration with group call redundancy only.

12.3.2 GCR Interrogation ack

The following information elements are required.

Information element name	Required	Description
Broadcast Call Reference	C	Must be present if the GCR receives an interrogation request containing a Group ID and an Originating Cell ID.
Cell List	C	A list of cells inside the MSC area into which the call is to be sent. Must be present if a) no anchor MSC address is present in the broadcast call reference record and the GCR interrogation was not triggered by a Send Group Call Info message, or b) the relay MSC indicator was set in the GCR Interrogation message
Anchor MSC Address	C	E.164 number required to route the call from the relay MSC and in a RANflex configuration (with or without group call redundancy) from the VMSC to the anchor MSC. Must be present if the anchor MSC Address is present in the broadcast call reference record
Relay MSC List	C	A list of relay MSCs into which the call is to be sent. Must be present if a relay MSC list is present in the broadcast call reference record and the GCR interrogation was not triggered by a Send Group Call Info message
Group Key and Number	C	Information on the cipher algorithm and the group key to be used. Must be present if Group Key and Number is present in the broadcast call reference record and the GCR interrogation was not triggered by a Send Group Call Info message
Codec Info	C	Information on the codecs allowed for the voice broadcast call. Must be present if Codec Info is present in the broadcast call reference record and the GCR interrogation was not triggered by a Send Group Call Info message
Establish to Dispatcher List	C	A list of identities of dispatchers to which a dedicated link is to be established. Must be present if included in the broadcast call reference record. Note that the CLI possibly received with the GCR interrogation message must not be included
Release from Dispatcher List	C	A list of identities of dispatchers which are allowed to terminate the voice broadcast call. Must be present if included in the broadcast call reference record and the GCR interrogation was not triggered by a Send Group Call Info message
Priority	C	The default priority level related to the voice broadcast call if eMLPP applies. Must be present if included in the broadcast call reference record and the GCR interrogation was not triggered by a Send Group Call Info message
IMSI	C	IMSI of the service subscriber who has initiated the VBS call. Must be present if the Relay MSC Indicator was set in the GCR interrogation message and the IMSI is present in the broadcast call reference record
Originating Cell ID	C	Must be present if originating cell id is present in the broadcast call reference record

12.3.3 GCR interrogation negative response

The negative response information element can take the following values:

- on-going call. In a RANflex configuration with group call redundancy the MSC address of the MSC within the redundancy pool at which the group call is ongoing shall be present in the negative response; and
- failure.

12.3.4 Call released

The following information element is required.

Information element name	Required	Description
Broadcast call reference	M	see clause 9

12.4 Messages on the GCR - GCR interface

12.4.1 Sync GCR

The following information elements are required.

Information element name	Required	Description
Teleservice	M	The teleservice Voice Broadcast Service indicates that a VBS call has to be prepared
Group call reference	M	see clause 9
Initial Talker Information	C	see subclause 8.1.3.2
on-going indication	C	indicates by its present that the broadcast call is ongoing
MSC Address	C	Address of the sending GCR's associated MSC, at which the broadcast call is ongoing.
call released indication	C	indicates by its presence that the broadcast call is no longer ongoing.
override indication	C	indicates by its presence that the receiving GCR shall replace the stored MSC-Address with the received value.
request indication	C	indicated by its presence that the sending GCR requests ongoing information and MSC Address from the receiving GCR

12.4.2 Sync GCR ack

The following information elements are required.

Information element name	Required	Description
Status of the voice group call	C	Indicating whether the voice broadcast call is established or not.
MSC Address	C	Address of the MSC, at which the broadcast call is ongoing.
Initial Talker Information	C	see subclause 8.1.3.2

12.4.3 Sync GCR negative response

The negative response information element can take the following values:

- on-going call. The MSC address of the MSC within the redundancy pool at which the broadcast call is ongoing shall be present in the negative response;

- initial talker information; and
- failure.

13 List of system parameters

13.1 Timers

13.1.1 Txx

This is a supervision timer on the anchor MSC for the setup of the voice broadcast call. It is started on receipt of a SETUP message from the calling subscriber when the calling subscriber is in the anchor MSC area and on receipt of an ISUP IAM from the relay MSC when the calling subscriber is in the relay MSC area. Refer to subclause 11.3.1.1.2 for procedures on expiry.

The value of timer Txx is operator specific.

13.1.2 Tast

In a network supporting A-interface link sharing timer Tast shall be used to measure the duration between periodic reports from the BSC to the MSC of Group Call Area cells for which channels have been assigned or released, pre-empted or failed since the last periodic report. When timer Tast expires, if new cells in the Group Call Area have been established or existing ones have been released, pre-empted or failed, the MSC shall be informed of the changes (see subclause 7.1b). If no changes have occurred nothing shall be sent. Timer Tast shall be restarted to measure the period of time until the next report. The timer shall be stopped when the call is released.

The value of timer Tast is operator specific. Its default value is 5 seconds.

13.1.3 T3

In a RANflex configuration the group call serving MSC when receiving Send Group Call Info from the VMSC shall supervise the setup of the broadcast call by timer T3. T3 is started when a positive Send Group Call Info result is returned to the VMSC and it is stopped when the broadcast call is set up. At timeout the temporarily stored transient data are deleted from the GCR.

In a RANflex configuration with group call redundancy T3 shall be implemented in the GCR instead of in the MSC. T3 is started when initial talker information is stored and stopped when initial talker information is deleted. At timeout initial talker information is deleted from the GCR.

The value of timer T3 is operator specific. Its default value is 5 seconds.

Annex A (informative): Change History

TSG#	TSG doc	WG doc	Spec	CR	Rev	Ph	C at	Old vers	New vers	Title	WI/date
S#31		Feb 2000	03.69						8.0.0	Specification version upgrade to Release 1999 version 8.0.0	
CN#7	email before SMG#32	Apr 2000	03.69	A015		R99		8.0.0	8.1.0	Data Flow for Fast Call setup	ASCI
S#32 CN#8			03.69	A017				8.1.0	8.2.0	Clarification of anchor MSC address format	ASCI
S#32 NP-08	NP-000276	N1-000678	03.69	A016		R00	B	8.2.0	9.0.0	Introduction of Originator-to-dispatcher information into VBS	ASCI
S#32 NP-08	NP-000276	N1-000768	03.69	A018		R00	F	8.2.0	9.0.0	VBS service accessibility	ASCI
S#32 NP-08	NP-000276	N1-000770	03.69	A019		R00	C	8.2.0	9.0.0	Originator outside Group Call Area	ASCI
S#32 NP-08	NP-000276	N1-000772	03.69	A020		R00	F	8.2.0	9.0.0	Notification response & uplink reply procedure definition	ASCI
S#32 NP-08	NP-000276	N1-000774	03.69	A021		R00	F	8.2.0	9.0.0	Release dataFlow correction	ASCI
			03.69 / 43.069					03.69 v9.0.0	43.069 v4.0.0	Conversion to 3GPP TS format	-

CN#9	NP-000449	N1-000916	43.069	001		R00	F	4.0.0	4.1.0	Correction in the Notification procedure	ASCI
CN#9	NP-000449	N1-000970	43.069	002	1	R00	B	4.0.0	4.1.0	Identification of Group ID - The longest GID has to be matched	ASCI
Oct 2000								4.1.0	4.1.1	Correction of references.	
NP-10	NP-000667	N1-001172	43.069	003		Rel-4	F	4.1.1	4.2.0	Call Waiting is not applicable to an originator in dedicated mode	ASCI
NP-10	NP-000667	N1-001182	43.069	004		Rel-4	F	4.1.1	4.2.0	Wrong Field Name for OTDI	ASCI
			43.069			Rel-4		4.2.0	4.2.1	ETSI/MCC cleanup on references and editorials.	05.05.2002
NP-16			43.069			Rel-5		4.2.1	5.0.0	CN plenary decision to make this TS also for Release 5.	June 2002
			43.069			Rel-5		5.0.0	5.0.1	Editorial correction, changing Note 1 to 9 and Note 2 to 10 in fig. 4, subclause 11.3.8.	27.06.2002
NP-17	NP-020383	N1-021688	43.069	006		Rel-5	F	5.0.1	5.1.0	ASCI VBS call termination by dispatchers using DTMF	Sept 2002
NP-18	NP-020676		43.069	007	4	Rel-5	F	5.1.0	5.2.0	MS late entry notification	Dec 2002
NP-21	NP-030407	N1-031216	43.069	009	1	Rel-5	A	5.2.0	5.3.0	Correction to definition of Group-ID, Group call area ID and Broadcast Call Reference	Sept 2003
NP-21	NP-030409	N1-031218	43.069	010	1	Rel-5	F	5.2.0	5.3.0	Correction to MS Late Entry description	Sept 2003
NP-25	NP-040373	N1-041530	43.069	013	1	Rel-5	A	5.3.0	5.4.0	Correction on notification procedures for Originator of VBS call	Sept 2004
NP-25	NP-040373	N1-041548	43.069	014	1	Rel-6	B	5.4.0	6.0.0	Introduction of USIM based ciphering for VBS	Sept 2004
NP-26	NP-040515	N1-042077	43.069	015	1	Rel-6	B	6.0.0	6.1.0	USIM based ciphering on dedicated channels	Dec 2004
NP-26	NP-040515	N1-042042	43.069	016	1	Rel-6	F	6.0.0	6.1.0	Broadcast call reference handling by the MSC during VBS call establishment	Dec 2004
NP-26	NP-040515	N1-041827	43.069	017		Rel-6	D	6.0.0	6.1.0	Notification Response procedure	Dec 2004
NP-26	NP-040515	N1-041828	43.069	018		Rel-6	D	6.0.0	6.1.0	Clarification on Immediate Setup procedure	Dec 2004
NP-27	NP-050076	N1-050282	43.069	023	1	Rel-6	F	6.1.0	6.2.0	EPRT Inter-PLMN Broadcast Call notification for dispatchers	March 2005
CP-28	CP-050057	C1-050473	43.069	026		Rel-6	A	6.2.0	6.3.0	Correction on the use of calling subscriber and destination subscriber	June 2005
CP-28	CP-050073	C1-050743	43.069	027	2	Rel-7	B	6.3.0	7.0.0	VBS Broadcast Point in the BSS	June 2005
CP-31	CP-060126	C1-060616	43.069	077	2	Rel-7	C	7.0.0	7.1.0	Modification of conditions for VBS call establishment	March 2006
CP-31	CP-060162	C1-060552	43.069	029	1	Rel-7	F	7.0.0	7.1.0	EPRT - Correction/clarification of voice broadcast call release procedures	March 2006
CP-32	CP-060276	C1-061102	43.069	0078	2	Rel-7	B	7.1.0	7.2.0	VBS-A interface link sharing	June 2006
CP-32	CP-060276	C1-060730	43.069	0079		Rel-7	F	7.1.0	7.2.0	EPRT: Add signalling flow for a dispatcher originated VBS	June 2006
CP-32	CP-060276	C1-061104	43.069	0080	1	Rel-7	B	7.1.0	7.2.0	Group Call Re-establishment by the BSS	June 2006
CP-32	CP-060276	C1-061105	43.069	0081	1	Rel-7	F	7.1.0	7.2.0	Including IMSI in Send_Group_Call_End_Signal message for VBS	June 2006
CP-32	CP-060276	C1-060787	43.069	0082		Rel-7	F	7.1.0	7.2.0	Correction to process VBS_Handling_Relay_MSC	June 2006

CP-33	CP-060457	C1-061476	43.069	0091		Rel-7	A	7.2.0	7.3.0	TCRT : Addition of VBS reconfiguration procedure	Sept 2006
CP-33	CP-060457	C1-061474	43.069	0089		Rel-7	A	7.2.0	7.3.0	TCRT : Correction of PCH re-organisation notification	Sept 2006
CP-33	CP-060470	C1-061817	43.069	0084	1	Rel-7	B	7.2.0	7.3.0	Addition of interoperability with RANflex	Sept 2006
CP-33	CP-060506	C1-061815	43.069	0086	1	Rel-7	C	7.2.0	7.3.0	Failure cases during VBS call establishment	Sept 2006
CP-33	CP-060506	C1-061436	43.069	0085		Rel-7	B	7.2.0	7.3.0	Support of EFR and AMR codecs for VBS	Sept 2006
CP-34	CP-060665	C1-062112	43.069	0094	-	Rel-7	B	7.3.0	7.4.0	Condition for the inclusion of parameters in the GCR interrogation message	Dec 2006
CP-34	CP-060665	C1-062114	43.069	0095	-	Rel-7	F	7.3.0	7.4.0	Addition of Teleservice Code to SendGroupCallInfo	Dec 2006
CP-35	CP-070131	C1-070609	43.069	0103	2	Rel-7	A	7.4.0	7.5.0	TCRT: Definition of BSSAP procedure for release of VBS call controlling connections	March 2007
CP-35	CP-070155	C1-070243	43.069	0100	-	Rel-7	F	7.4.0	7.5.0	Alignment of SDLs with condition for successful call setup	March 2007
CP-35	CP-070155	C1-070607	43.069	0098	3	Rel-7	F	7.4.0	7.5.0	Indication of the originating relay MSC address to anchor MSC	March 2007
CP-35	CP-070155	C1-070606	43.069	0099	2	Rel-7	F	7.4.0	7.5.0	Removal of the limitation of speech version in A interface sharing	March 2007
CP-35	CP-070155	C1-070526	43.069	0097	1	Rel-7	C	7.4.0	7.5.0	Extension of Group ID	March 2007
CP-36	CP-070387	C1-071159	43.069	0101	2	Rel-7	F	7.5.0	7.6.0	Alignment between VBS and VGCS call establishment	June 2007
CP-36	CP-070387	C1-070976	43.069	0105	2	Rel-7	B	7.5.0	7.6.0	Retry of the VBS Assignment procedure	June 2007
CP-37	CP-070604	C1-071619	43.069	0106		Rel-8	F	7.6.0	8.0.0	TCRT: Various corrections to the VBS specification	Sept 2007
CP-39	CP-080136	C1-080287	43.069	0107		Rel-8	F	8.0.0	8.1.0	TCRT: Paging for incoming p-t-p transaction to service subscriber in an ongoing broadcast call	March 2008
CP-46						Rel-9		8.1.0	9.0.0	Upgrade to Rel-9	Dec 2009
CP-47	CP-100135	C1-100477	43.069	0108		Rel-9	C	9.0.0	9.1.0	TCRT: Uplink reply procedure	March 2010
CP-51						Rel-10				Upgrade to Rel-10	March 2011
CP-54	CP-110882	C1-114667	43.069	0109		Rel-11		10.0.0	11.0.0	TC-RT: Initial Talker Information handling (solving race conditions)	Dec 2011
CP-54	CP-110882	C1-114669	43.069	0110		Rel-11		10.0.0	11.0.0	TC-RT: GCR Transient Data	Dec 2011
CP-55	CP-120121	C1-120522	43.069	0111	1	Rel-11	B	11.0.0	11.1.0	TC-RT: Broadcast Call Redundancy	March 2012
CP-55	CP-120099	C1-120631	43.069	0116	1	Rel-11	A	11.0.0	11.1.0	TC-RT: Additional Calling Party Number	March 2012
CP-55			43.069			Rel-11		11.0.0	11.1.1	Minor editorial fixes	March 2012
CP-56	CP-120319	C1-121129	43.069	0117		Rel-11	F	11.1.1	11.2.0	Cleanup corrections to broadcast call redundancy	June 2012
CP-57	CP-120596	C1-122635	43.069	0118		Rel-11	F	11.2.0	11.3.0	TC-RT: Corrections to broadcast call redundancy	Sept 2012
CP-57	CP-120584	C1-122637	43.069	0119		Rel-11	F	11.2.0	11.3.0	TC-RT: Cleanup of editorial or textual defects	Sept 2012
CP-58	CP-120808	C1-124673	43.069	0120	1	Rel-11	F	11.3.0	11.4.0	TC-RT: Additional Calling Party Number	Dec 2012
CP-58	CP-120808	C1-124674	43.069	0121	1	Rel-11	F	11.3.0	11.4.0	TC RT: Uplink reply procedure	Dec 2012
CP-65						Rel-12		11.4.0	12.0.0	Upgrade to Rel-12	Sept 2014
CP-69	CP-150511	C1-153187	43.069	0122	4	Rel-12	F	12.0.0	12.1.0	RT : Voice Broadcast Services with AoIP	Sept 2015
CP-70			43.069			Rel-13		12.1.0	13.0.0	Upgrade to Rel-13	Dec 2015

Change history							
Date	Meeting	TDoc	CR	Rev	Cat	Subject/Comment	New version
2017-03	SA#75					Upgrade to Rel-14	14.0.0
2018-06	SA#80	-	-	-	-	Update to Rel-15 version (MCC)	15.0.0
2020-07	SA#88e	-	-	-	-	Update to Rel-16 version (MCC)	16.0.0

History

Document history		
V16.0.0	August 2020	Publication